

# SERVICE

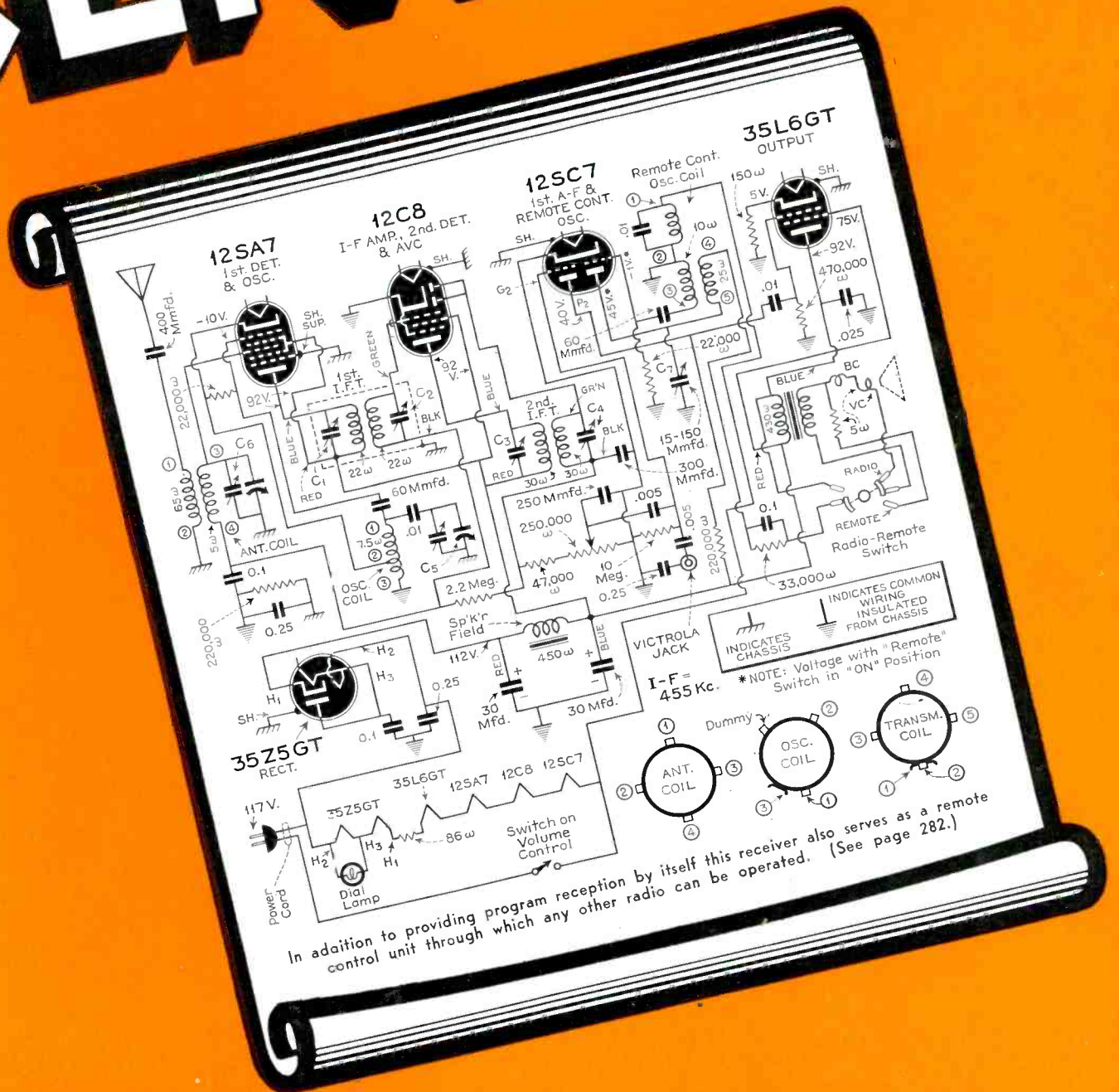

June  
1939



**BUILD**

*with*

**P.R. MALLORY & CO., Inc.**  
**MALLORY**

**T**he set manufacturers who use Mallory parts as original equipment are the "who's who" of the radio industry... and in the replacement field, Mallory parts enjoy the same leadership.

Mallory Replacement Vibrators, Condensers, Volume Controls and other replacement parts enjoy a long standing reputation for trouble-free operation and long life. The millions in use

testify that you can depend on them for the kind of customer satisfaction that translates itself into increased profits.

In the development of these replacement parts Mallory engineering has made possible many advances in standardiza-

tion and ease of application. These lead directly to lower inventory investment with faster turnover... and to faster, more profitable service work.

**CONDENSERS**

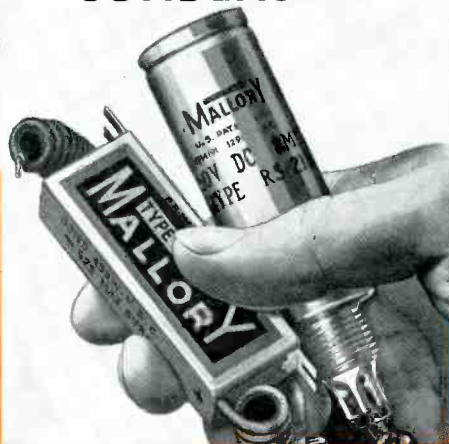

**VIBRATORS**



Get this complete and up-to-date Vibrator Guide from your distributor now. Covers all makes of auto and battery operated receivers. Nothing else like it. It's yours, absolutely FREE.

**VOLUME CONTROLS**



Use **P.R. MALLORY & CO. Inc.**  
**MALLORY**  
REPLACEMENT  
CONDENSERS...VIBRATORS

**P. R. MALLORY & CO., Inc.**  
INDIANAPOLIS INDIANA  
Cable Address—PELMALLO

Use **YAXLEY**  
REPLACEMENT  
VOLUME CONTROLS



# SERVICE

A Monthly Digest of Radio and Allied Maintenance

Reg. U. S. Patent Office

Edited by  
ROBERT G. HERZOG

Published Monthly  
by the

**Bryan Davis  
Publishing Co.**  
Inc.

19 East 47 Street  
New York City

Telephone PLaza 3-0483

BRYAN S. DAVIS  
*President*

JAS. A. WALKER  
*Secretary*

SANFORD R. COWAN  
*Manager*

PAUL S. WEIL  
*Advertising Manager*

A. GOEBEL  
*Circulation Manager*

Chicago Office:  
608 S. Dearborn Street  
C. O. Stimpson, Mgr.  
Telephone Wabash 1903

Wellington, New Zealand:  
Tearo Book Depot

Melbourne, Australia:  
McGill's Agency

Entered as second-class  
matter June 14, 1932, at  
the Post Office at New  
York, N. Y., under the  
Act of March 3, 1879.  
Subscription price: \$2.00  
per year in the United  
States of America and  
Canada; 25 cents per  
copy. \$3.00 per year in  
foreign countries; 35  
cents per copy.

## Contents

Cathode-Ray Oscilloscope Characteristics .....	296
Crystal Pickup Installation <i>By Ralph P. Glover</i> .....	276
Deflecting Circuits for Television Receivers <i>By Madison Carwein</i> .....	271
RCA 5X51, 5X5W Multiplex Receiver .....	282
Parts Show Map and Program .....	291
Technical Features of Zenith 1939 Receivers .....	280
Television I-Fs .....	281
Your Cathode-Ray Oscilloscope <i>By J. H. Reyner</i> .....	292
<b>Antenna</b> .....	268
<b>Associations</b> .....	318, 319
<b>Auto-Radio</b>	
Auto-Radio Data .....	312
Ford-Philco FI640 <i>By Eugene Triman</i> .....	284
RCA 8M3 Case History <i>By Allan Siepman</i> .....	311
<b>Book Review</b> .....	301
<b>Case Histories</b>	
A-C, D-C Sets <i>By J. N. Goltzen</i> .....	314
Crosley 534 <i>By D. C. Sprong</i> .....	314
Philco 60 <i>By D. C. Sprong</i> .....	316
RCA 1939 Motor Electric Tuning <i>By J. G. Cooney</i> .....	316
RCA 1939 Motor Electric Tuning <i>By Willard Moody</i> .....	316
RCA 8M3 <i>By Allan Siepman</i> .....	311
Stewart-Warner 07-511 to 07-519 (Chas. 07-51) <i>By J. N. Goltzen</i> .....	300
Stewart-Warner 97-571 to 97-579 (Chas. 97-57) <i>By J. N. Goltzen</i> .....	310
Westinghouse 1939 Motor Electric Tuning Westinghouse WR306 <i>By D. C. Sprong</i> .....	316
Zenith 805 <i>By D. C. Sprong</i> .....	316
<b>Circuits</b>	
A-C, D-C Rectifier Protection .....	314
Electronic Frequency Modulator .....	292
Ford-Philco FI640 .....	284
Frequency Modulator .....	292
Oscilloscope to Set Connections .....	293
Philco Impulse Motor .....	286
Phonograph Pickup Connections .....	276, 277
Phonograph Pickup Equalizer .....	278
RCA 5X51, 5X5W .....	Front Cover
Synchronizing Signal Separator .....	273
Television I-Fs .....	281
Television Sweep Oscillator .....	272
Westinghouse WR306 A-F and Bleeder Circuits .....	310
<b>Cover Diagram</b>	
RCA 5X51, 5X5W Multiplex Receiver .....	282
<b>Highlights</b> .....	317, 321
<b>Index to Advertisers</b> .....	322
<b>Manufacturers</b> .....	302, 305, 306
<b>Sound Facts</b>	
Crystal Pickup Installation <i>By Ralph P. Glover</i> .....	276
<b>Television</b>	
Deflecting Circuits <i>By Madison Carwein</i> .....	271
Television I-Fs .....	281
<b>Test Equipment</b>	
Cathode-Ray Oscilloscope Characteristics .....	296
Line and Heater Voltages <i>By F. E. Wenger</i> .....	311
Your Cathode-Ray Oscilloscope <i>By J. H. Reyner</i> .....	292

Copyright 1939 Bryan Davis Publishing Co., Inc.

Also publishers of COMMUNICATIONS



# A N T E N N A

## • • • joint rma-nab campaign

**T**HE joint all-radio campaign of the Radio Manufacturers Association and the National Association of Broadcasters is now in full swing. Broadcasters in Cleveland, Denver, Pittsburgh and other cities have called meetings of Service Men in their respective localities and have outlined plans for the campaign to urge upon the public a broader appreciation of the variety and character of the program service now being broadcast by the American radio stations. A foundation of mutual beneficial interest is being established which should lead to more receiver sales and a consequent larger market for service work.

We should all cooperate with this effort. There can be no doubt that everyone concerned can reap ample reward.

## • • • study television

**D**URING the last few months we have said, on these pages, that the radio industry needs television to bring it out of the bargain basement. It needs television to restore price levels and to increase employment. We have been conducting surveys, both in television service areas and elsewhere, and we find that if the public is told the truth about the status of television they will not hesitate to purchase radio receivers now. This is especially true of that class of buyers (by far the large majority) that purchases sets around and below the \$60 price range.

There is no need to hush up the fact that television is here. Spread the word around. Urge your clients to seek out demonstrations whenever and wherever they may be held. If they are planning to attend the New York World's Fair, 1939 or the Golden Gate International Exposition tell them about television there. Those of you who are fortunate enough to be in the present television service area can suggest that your customers visit the nearest dealer or department store, that is if you can't see your way clear to get a receiver and give demonstrations of your own.

Aside from all this the time to study television is right now . . . whether you are in a service area or at the most

remote point. It will reach you sooner or later and you will have to be ready.

## • • • remote control

**W**E HAVE in the past predicted that Service Men would soon be selling devices for tuning the receiver from a remote point. These for use with sets already in their customers homes. Several such devices are now on the market and more are promised in the very near future. A unique adaptation of such a tuner is shown on the front cover of this issue. This and others of its kind should prove real money makers for the wide awake Service Man.

## • • • battery portables

**T**HE interest shown in battery portables is growing by leaps and bounds. With only a few models available several months ago there are well over a hundred now. Suitable batteries are available, too, so that even with pee-wee portables one can expect reasonable battery life.

We have said before and we repeat, every radio listener is a potential customer for one of these receivers. Take a portable along with you on every call. Its appearance as well as its performance will act to make it sell itself.

## • • • phonograph pickups

**A**S AN added money maker, especially during slow periods, try selling your customers a record-player attachment for their radios. For many months the market has been literally flooded with such devices in every price range. Many of your clients do not know that these can be used with their own sets, largely because there are no visible posts or jacks for the purpose. It is in these cases, especially, where you can shine. Every set can be wired for phonograph reproduction without any difficulty. On pages 276, 277 and 278 Ralph P. Glover discusses crystal pickup installation. The time spent in reading this article should prove profitable.

# OVER A MILLION BENDS *Without Conductor Breakage!*

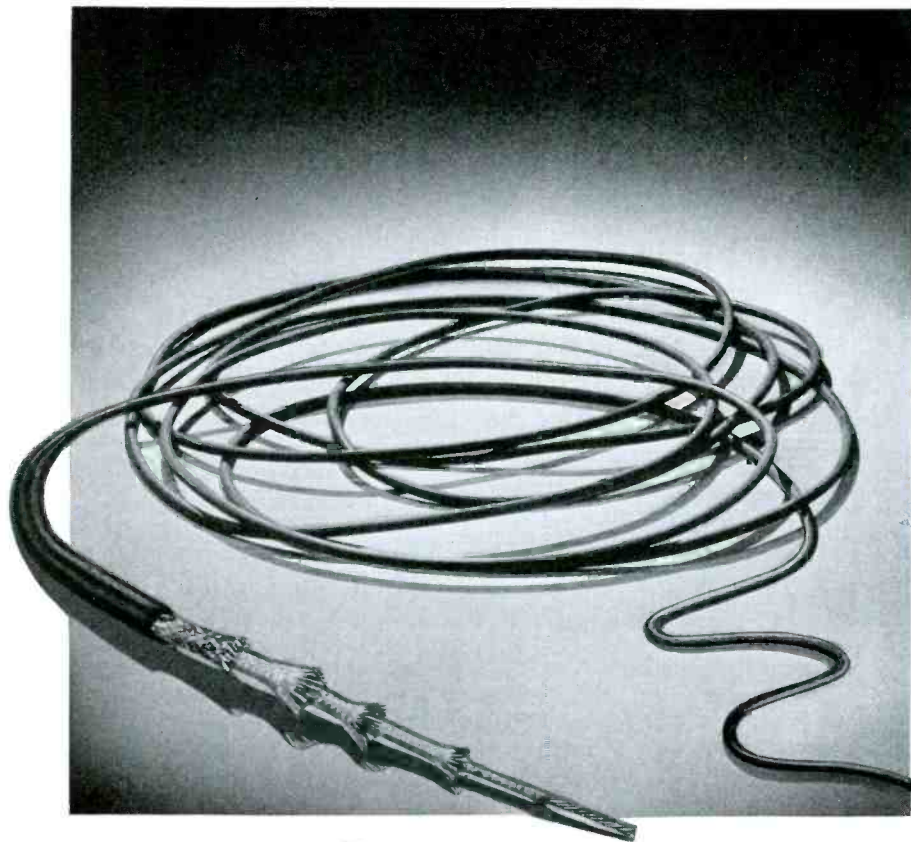

*New* **LENZ** *Super Flexible*  
**CRYSTAL MICROPHONE CABLE**

- Conductor of Super Flexible Construction and great mechanical strength.
- Non-Hygroscopic, high dielectric insulation.
- Close tinned copper electrostatic shield.
- Tough, wear-resisting, rubber jacket.

**LENZ ELECTRIC MANUFACTURING CO.**  
1751 NO. WESTERN AVE. CHICAGO, U. S. A.



"IN BUSINESS SINCE 1904"

SEE YOUR  
NEAREST  
DISTRIBUTOR  
FOR FURTHER  
DETAILS

**MORE THAN  
600 HOURS IN A SALT BATH  
- AND STILL GOING STRONG!**

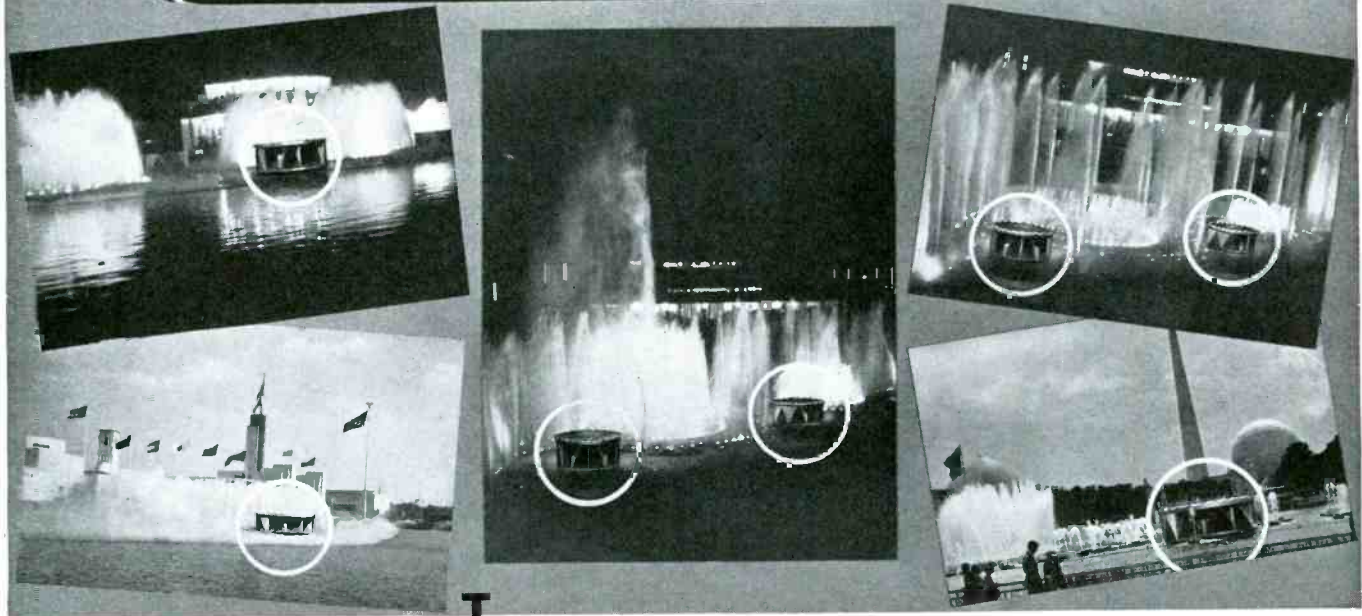

**I**F you're looking for evidence of speaker stamina, engineering genius and amazing dependability, take a trip to the World's Fair. See in the Lagoon of Nations, where nightly magic fountains are set to music, the world's largest speakers. Built to specifications by Cinaudagraph engineers, these units must withstand tons of salt spray night after night. For more than 600 hours they've "taken it". And still going strong!

In the Utilities and General Motors exhibits, you'll find other Cinaudagraph speakers just as faithfully on the job. World's Fair engineers chose these speakers for the mighty Public Address system networking the entire grounds. Seventy-six installations—1800 speaker units! That's Cinaudagraph's contribution to the World of Tomorrow. And proof enough, we think, that Cinaudagraph can build to any specifications—and build well.

*For performance, protection and bigger profits in your business, look to Cinaudagraph for speakers. You, too, will agree with enthusiastic Fair engineers, "it pays to insist on the finest". For the speaker line designed for the World of Tomorrow is more than capable of today's demands.*

*Description of the Cinaudagraph 27" electro-dynamic speaker installation at the New York World's Fair available on request. Also catalog describing the entire Cinaudagraph line of speakers. We cordially invite you to visit our display of Cinaudagraph Products at the National Radio Trade Show. Our booth number is 927 Faraday Avenue. Additional equipment will be exhibited in rooms 4A-5A-7A.*

**CINAUDAGRAPH CORPORATION**  
STAMFORD CONNECTICUT

# DEFLECTING CIRCUITS

## For Television Receivers

TELEVISION receiver circuits may be divided into six parts: r-f; i-f; video; audio; deflection and power supply circuits. It is the purpose of this article to discuss the deflection circuits in order to acquaint the Service Man with a rough working theory of television deflection systems. Such a knowledge is quite necessary if he is even to approach the service problems which he will encounter. Other portions of the receiver circuit will be discussed in subsequent articles.

The process of rectilinear scanning employed in commercial television in the United States consists of directing a beam of electricity known as the spot, to pass rapidly (at approximately 10,000 ft. per second for a 10-in. picture) across a picture from left to right, strip by strip (Fig. 1.) This beam of electricity is composed of high speed electrons (at velocities from 10,000 to 30,000 miles per second) and the width of each strip is roughly equal to the diameter of the region to which the electrons are confined. The strips over which the spot scans are located one beneath the other and spaced apart by a strip width. Two-hundred and twenty and a half strips are traced from top to bottom of the picture. The beam is then directed again to the top of the picture to trace the other set of strips which lie between those over which it passed on the first trip.

In television parlance the strips are called *lines*. Each sequence of  $220\frac{1}{2}$  lines from top to bottom of the picture is accomplished in  $1/60$  second and represents one-half *frame* because only one-half the information of the picture is scanned on each trip. On alternate trips the electrons are directed to fall exactly along lines which lie between the others (shaded in Fig. 1). This system is known as the *double interlace* system of scanning and two sets of lines from top to bottom of the picture are required for a complete frame which contains all

the detail or information of the picture. Thus each frame contains  $2 \times 220\frac{1}{2} = 441$  interlaced lines, and requires  $2 \times 1/60 = 1/30$  second for transmission.



Choice of these standards constitutes the 441 line, 30 frame, double interlace system of television scanning. This choice of standards is based on power-line frequency, 60-cycles and on flicker. The system is a practical one which minimizes the effect of hum on pictures. The interlace is a trick necessary to prevent flicker and at the same time to

force. No man knows exactly what an electron is, nor exactly what is the real nature of a field of force. Their practical interactions and laws of control are well understood, however. There are two kinds of electric fields of force: the electrostatic field, and the electromagnetic field. Most scientists believe these fields to be different aspects of one thing, but usually discuss them separately for simplicity.

*Electrostatic fields* exist between conductors of different potential, the latter expressed in volts. The fields force electrons to move toward the point of highest positive voltage, and the speed of the electrons depends upon the voltage. The electrostatic field acts in the space surrounding charged conductors to deflect a speeding beam of electrons toward the most positively charged conductor. High speed beams pass quickly through the electrostatic field of the conductors and receive less deflection than low speed beams on which the force acts for a longer time. The practical result of this is that the deflection voltage in an electrostatic system must be increased proportionally to the high voltage employed on a television picture tube anode.

*Electromagnetic fields* exist around an electric current, the latter expressed in amperes. These fields force a speeding beam of electrons to move in a path that curls circularly around the axis of the coils through which the current flows. The electromagnetic field acts in the space

surrounding coils with flowing currents to deflect a speeding beam of electrons in such direction that the space current of the beam tends to follow a parallel path to the current in the coils.

One peculiarity of the action of an electromagnetic field is that the deflecting force on the beam current increases with the speed of the electrons in the beam. There is no action on an electron which is not moving. The time that the force acts, however, is decreased with

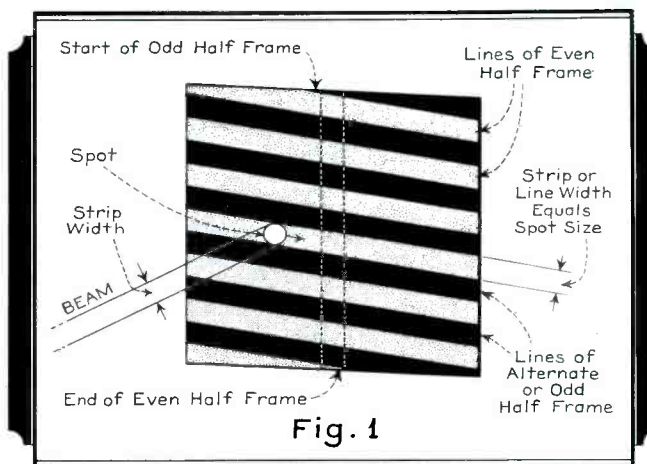

limit the rate of projection of television pictures to a reasonable value (30 per second). Motion pictures are projected at 24 per second, but are interrupted once in each projection to give an effective flicker frequency of 48 cycles which is the limit the average eye can stand. Interlace in television corresponds to shutter interruption in motion pictures.

The direction of the electron scanning beam is controlled by electric fields of

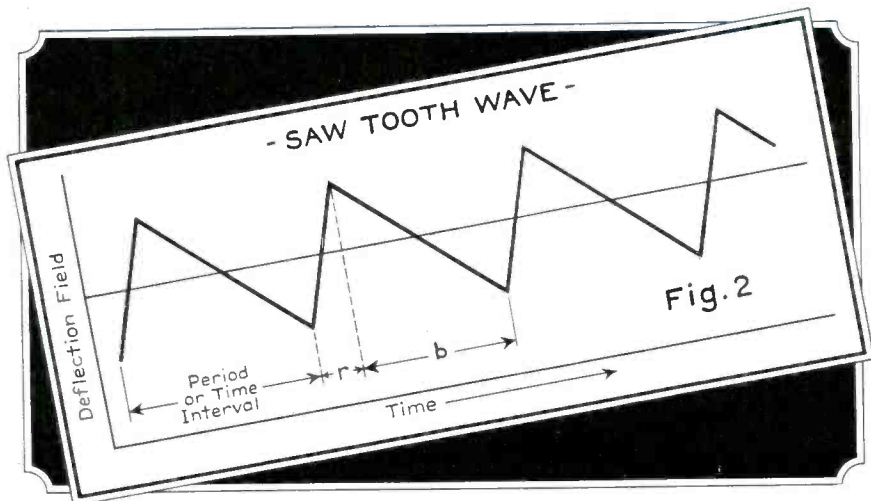

Fig. 2. The deflecting field may be proportional to either voltage or current depending upon which type (electrostatic or electromagnetic) of deflection system is used.

increased speed. The practical result of this is that the deflection current must be increased proportionally to the square-root of the high voltage employed on a television picture tube in order to maintain the proper size of picture.

• • • waveform

In rectilinear scanning, the spot must move across the picture in a linear manner: that is, the displacement from left to right must be proportional to the time. Other systems could be used but are not used because the linear system is more simple. When the spot has reached the extreme right-hand edge of the picture it must be returned to the left edge for the start of the succeeding line. During this return period the beam current is cut off during transmission; otherwise a ghost-picture would appear in the background. Actually, the beam current itself is not returned across the picture but the deflection field changes its direction during an interval of time while the beam is cut off. When the beam is turned on again the field is in such direction as to start the line at the left-hand side of the picture and slightly below the preceding line. It requires two deflecting fields to accomplish this result: namely, (1) a horizontal deflecting field which deflects the spot from side to side; and (2) a vertical deflecting field which deflects the spot from top to bottom. The speed of the vertical field is much slower than the speed of the horizontal field. The vertical field directs the spot at a slow steady rate, in time, from top to bottom of the picture while the horizontal field is deflecting the spot at a fast steady rate, in time, from left to right. The net effect of these two actions is that the lines have a slight slope in relation to the edges of the picture as shown in Fig. 1. When the spot has reached the bottom of the picture and at the completion of the

220½ line, the electron beam is cut off and the vertical field is suddenly changed so as to direct the spot again to the top of the picture. The horizontal field has a period of 1/13,230 second: that is, it takes this length of time for the direction of the horizontal field to change linearly from left to right edge

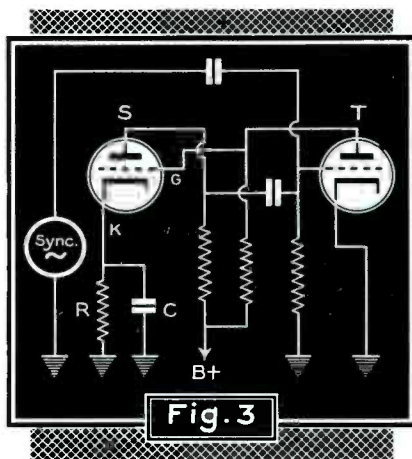

Fig. 3. The principal time controlling circuit of the saw-toothed oscillator is composed of the resistor R and capacitor C.

of the picture and back again to left edge. The vertical field has a period of 1/60 second: that is, it takes 1/60 second for the vertical field to change its direction from top to bottom of the picture and for it to come back to top

again. It is attempted in television circuits to make the return time of the field, during the period in which the beam is cut off, as rapid as possible because this time is useless insofar as picture reproduction is concerned. Actually, the return time is approximately ten per cent of the trace time. The two portions of the deflecting cycles have been referred to in the literature as trace and retrace: trace referring to the useful portion of the cycle during which the electron current flows across the picture, and retrace referring to the useless portion of the cycle during which the electron current is cut off. Other terms for these portions of the cycle will be encountered: that is, sweep for trace and fly-back time or return-time for retrace.

A graph of the displacement of the deflecting field in time is plotted in Fig. 2. The field, which may be proportional to either voltage or current depending upon the use of electrostatic or electromagnetic deflection, is plotted in the vertical direction on this graph and time is plotted in the horizontal direction. The resulting waveform of Fig. 2 is known as a saw-tooth waveform. It applies to either horizontal or vertical deflection systems, for which only the value of the time element must be changed. Thus, the time intervals represent 1/13,230-second in horizontal deflecting systems and 1/60-second in vertical deflecting systems. These time intervals are the time of the cycle of the deflecting wave. Each cycle is broken into two portions: trace portion denoted in Fig. 2 by letter b, and retrace portion denoted by the letter r. If the time of the entire cycle be treated as unity, b + r is always equal to one. Under RMA standards b is approximately equal to 93 percent of the cycle and r is approximately equal to 7 percent of the cycle for the vertical deflecting field, while b is approximately equal to 85 percent of the cycle and r is approximately equal to 15 percent of the cycle for the horizontal deflecting field.

When an oscilloscope is connected across the deflecting plates of the cathode ray tube on a television receiver employing electrostatic deflection, the waveform of Fig. 2 will appear on the

Fig. 5. The current in tube S (Fig. 3) has impulsive wave form such as flows through a condenser across which a saw-toothed voltage exists.

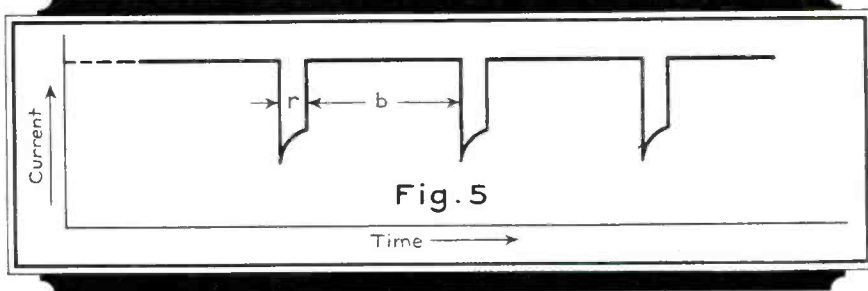



oscilloscope screen when proper synchronization of the oscilloscope with the deflecting wave is obtained; or if the oscilloscope be used to examine the current in a resistor in series with the deflecting coils of a television receiver employing electromagnetic scanning this waveform will be seen. Always the trace portion of the saw-tooth cycle must be a perfect straight line when the receiver is adjusted properly. The retrace or steep portion of the wave may have exponential curvature without detracting from picture reproduction. The only important feature of the retrace portion of the cycle is that it be accomplished rapidly, that is, during that small percentage of the cycle when the electron beam is cut off. It is important that any oscilloscope utilized to examine these waveforms have excellent fidelity over a band of frequencies to 250,000 cycles, and that the phase response of the oscilloscope be perfectly linear from frequencies below 30 cycles to frequencies above 250,000 cycles. Otherwise a true picture of the deflecting waveforms will not be obtained. Deflecting waves are made up of many frequency components, consisting of the fundamental frequency, which is the reciprocal of the time of a cycle, and all of its harmonics.

In practice, 100 harmonics of the 60-cycle fundamental of the frame deflecting field are required to reproduce the frame deflecting waveform, and at least 20 harmonics of the horizontal deflecting field fundamental frequency of 13,230 cycles are required. Loss of higher harmonics will result in rounding of the points of the saw-tooth wave, and phase shift of the low-frequency component and harmonics will cause curvature of the sweep portion of the cycle.

### • • • deflection generators

It is necessary to supply deflection fields of the form of Fig. 2 in television receivers by means of either saw-tooth voltage waves or saw-tooth current waves. Some means of generating such waves is necessary. Saw-tooth generators are usually of the relaxation oscillator type. In essence, the relaxation oscillator is a violently regenerative device which may have many arrange-

Fig. 6. The saw-toothed frequency is controlled by transmission of what is termed the RMA standard synchronizing wave.

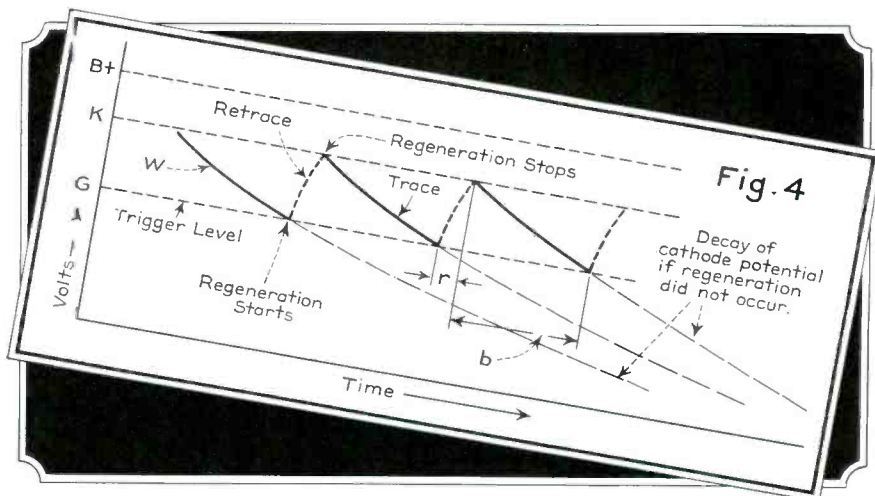
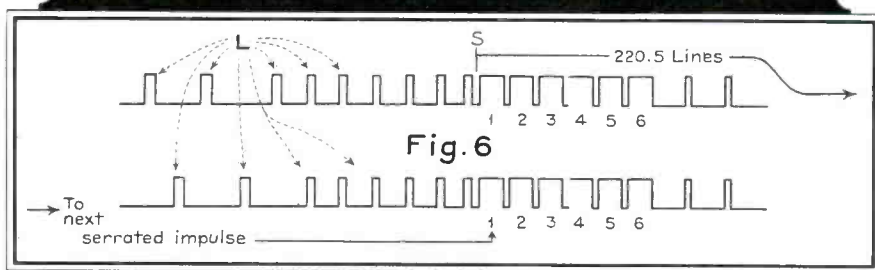

Fig. 4. The condenser C (Fig. 3) discharges in the manner indicated by the solid line. This curve is known as an exponential.

ments in practice. A simple two-tube circuit is shown in Fig. 3.

In this circuit the plate current varies between negative cutoff and positive overload alternately in the two tubes. The frequency of the current waves is dependent upon the time constants of

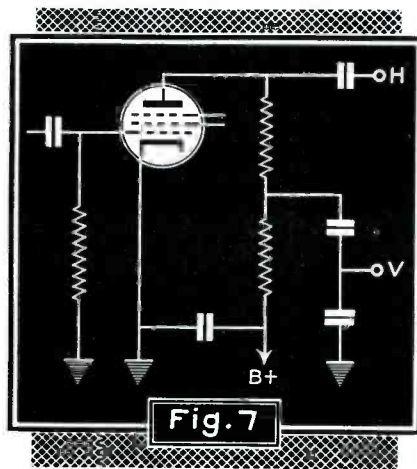

Fig. 7. A special tube is used to separate the synchronizing pulses for the H and V circuits.

the associated circuit elements, that is, upon the products of capacitors and resistors. The principal time controlling circuit in Fig. 3 is composed of resistor R and capacitor C. The product of R in ohms and C in farads has the dimensions of time. Thus, if R is one (1)

megohm and C is 0.1 microfarad the product is  $10^6 \text{ ohms} \times 10^{-7} \text{ farads} = 0.1 \text{ seconds}$ . This product is known as the time constant of the RC circuit and should in general be larger than the period of a cycle of the saw-tooth wave: in general 1/10 second is sufficient time constant to produce linear waves of frame frequency, that is at 60 cycles. Condenser C charges up from tube S until the cathode potential of S, is so great that the plate current is cut off. Since tube T has no bias, the plate of R which is connected to the grid of S will be much lower in potential than the cathode of S, and will thus keep the plate current of S at zero. C discharges through R in a manner indicated by the solid line in the graph of Fig. 4: This curve is known in mathematics as an exponential. When a sufficiently small portion of this curve is examined, it will be found to be approximately linear. When the voltage of C which is connected to the cathode of tube S approaches the grid voltage of tube S shown in dotted line G of Fig. 4, the current again begins to flow.

This flow of current reduces the bias of tube T allowing its plate voltage to rise, and regenerating the flow of current in tube S so that condenser C is very rapidly charged from the B+ source to the potential K of Fig. 4, where the tube S again cuts off. This process continues indefinitely and the cathode potential of tube S follows the solid line variation shown in Fig. 4 which is an exponential saw-tooth wave that is almost linear. The greater the amplitude of this wave the more curvature it will exhibit. In practice it is attempted to keep the amplitude of the generated saw-tooth wave low, in order to obtain good linearity. The wave form of the plate current in tube S is shown in Fig. 5.

This wave is known as the impulsive wave and represents the form of the current which flows through a con-

denser across which saw-tooth voltage exists. It also represents the form of the voltage which exists across electromagnetic coils through which saw-tooth current flows. The physical reason for this inverse relationship of voltage and current in coils and condensers arises from the fact that their reactances have opposite signs: that is, if the reactance of an inductor be considered as positive, the reactance of a capacitor must be considered as negative. The relationship between currents and voltages in capaci-

though frame synchronization will be. In order to insure that the horizontal and vertical relaxation oscillators trip exactly in time with the transmitted signal it is necessary to separate the horizontal synchronizing pulses from the vertical serrated synchronizing pulses. There are many ways in which to accomplish this. Fundamentally the difference in the duration between the horizontal pulses and the serrated pulses is the most important physical characteristic upon which to work to obtain

tubes, that is, from three to seven inches in diameter. Current amplifiers will be encountered in receivers employing large cathode-ray tubes, that is, from seven to fifteen inches in diameter. It is possible to use either system of deflection with any size of tube. The purpose of this article, however, is to describe for your benefit, the circuits which are usually encountered.

Electrostatic deflection systems are simple arrangements when the electron beam velocity is relatively low, as in the cathode-ray tubes employing less than 2,000 volts of plate potential. In such receivers the oscillator voltage waveform W of Fig. 4 is applied directly to the grid of a triode amplifier. Resistance coupled amplification is used in this case and a fraction of the plate voltage wave developed is applied to the grid of a second triode amplifier having a large plate resistance, the output of which will be in the inverse polarity to that of the first triode amplifier. These two outputs are then applied via high-voltage blocking condensers directly to either the vertical or horizontal deflecting plates of the cathode-ray picture tube. Approximately 250 volts, peak-to-peak, of saw-tooth voltage is required from each amplifier in order to scan a short-necked five-inch tube. Smaller voltages are required for long-necked five-inch tubes. Tubes of the double triode type, as the 6F8G, are usually sufficient in the electrostatic deflection systems. They impose relatively low power requirements on the receiver power supply.

The electromagnetic deflection amplifier problem is much more complex than the electrostatic. For one thing, the polarity of the wave shown in Fig. 4 is incorrect for application to the grid of a saw-tooth current amplifier. It is extremely important that the retrace or steep portion of the saw-tooth wave occur in a negative rather than a positive direction, otherwise the inertia effect of the electromagnetic scanning coils in the plate circuit of the scanning power tube will prevent the rapid collapse of scanning field so necessary in obtaining rapid retrace during the period in which the cathode-ray beam is cut off.

There are relaxation oscillators which will generate the wave of Fig. 4 in reverse polarity. The reverse polarity wave may be applied directly to the grid, preferably of a beam power tube of the type 6L6, or of higher rating. The plate circuit of this tube contains a reactive load composed of the reflected reactance of scanning coils through a scanning transformer. This reflected load must be of low impedance at all the harmonic frequencies which compose the saw-tooth wave in order that the

(Continued on page 300)

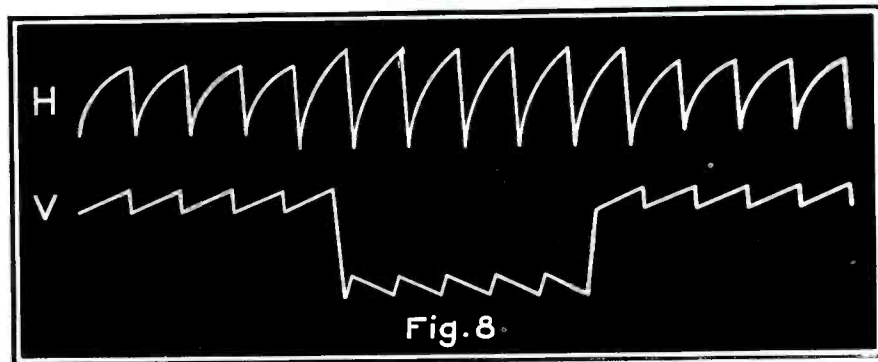

Fig. 8. The voltage pulses of Fig. 6 applied to the grid of the tube of Fig. 7 will produce the pulses indicated at H and V of Fig. 7.

tors and inductors will be found helpful in trouble-shooting television receivers.

#### • • • synchronization

Deflection generators in general will oscillate with good saw-tooth waveform at a frequency determined by the time constant of the associated circuits and the characteristics of the tube. This frequency must be controlled in a television receiver in order that the receiver picture keep exactly in step with the transmitted picture. The control is accomplished by transmission of what is known as the RMA standard synchronizing wave which is of impulsive form as shown in Fig. 6.

This synchronizing wave has an accurately timed wave generated at the transmitter and consisting of 441 equally spaced line impulses at each 1/30 second and two equally spaced series of serrated vertical synchronizing pulses spaced at 1/60 second. Because of the odd-number relationship between 441 and 60 there is always one half-line extra between each series of six vertical synchronizing serrated pulses. The horizontal relaxation oscillator must trigger exactly at the start of each of the pulses L in Fig. 6, and the vertical relaxation oscillator should trip exactly on the leading serrated pulse S in Fig. 6. If the vertical oscillator does not trigger on the leading pulses S it must trigger on identically related pulses, from one to six, on each occurrence of the serrations at intervals of 1/60 second. Otherwise interlace of the receiver will not be maintained, al-

though frame synchronization will be. In Fig. 7 there is shown the circuit of a synchronizing separator tube.

The separation accomplished by this tube is dependent only upon the time constant of the associated RC circuits. The voltage pulses of Fig. 6 applied to the grid of the tube of Fig. 7 will produce voltage pulses at H and V of Fig. 7 which have a form as shown in Fig. 8.

Voltage H is applied directly to the grid of tube T in a horizontal frequency relaxation oscillator similar to that shown in Fig. 3, and serves to accurately start each horizontal deflection cycle at the proper time. The voltage V is applied to the grid of tube T in a vertical frequency relaxation oscillator similar to that shown in Fig. 3 in order to accurately time the start of the vertical saw-tooth cycle.

The waves generated at the cathodes K (see Fig. 3) of the horizontal and vertical deflection oscillators are of saw-tooth form and may be utilized to excite either voltage or current amplifiers for the purpose of deflecting the electron beam of a cathode ray tube in a television receiver.

#### • • • deflection amplifiers

Deflection amplifiers are of two types: voltage amplifiers and current amplifiers. Voltage amplifiers are used in receivers employing electrostatic deflection. Current amplifiers are used in receivers employing electromagnetic deflection. Voltage amplifiers are in general much less complex than current amplifiers. They will be encountered in receivers employing small cathode-ray

# EVEN THE FEDERAL COMMUNICATIONS COMMISSION ITSELF USES RAYTHEON TUBES

In a recent purchase by the Federal Communications Commission of a quantity of receivers, RAYTHEON radio tubes met the rigid F. C. C. specifications and requirements—just as they have been found, by radio set engineers, to operate perfectly in more diversified circuits than any other tube!

Hundreds of thousands of dollars have been spent on RAYTHEON research and quality control—just to insure constructional superiority and to keep RAYTHEON ahead technically.

Servicemen, who are in business to stay, are rapidly turning to RAYTHEON replacement tubes as one of the best ways of protecting their profits, turnover and the good will they have built up in their communities.

RAYTHEONS cost no more than the second-best tube.

## RAYTHEON

NEWTON, MASS. • NEW YORK • CHICAGO • SAN FRANCISCO • ATLANTA



**"WORLD'S LARGEST EXCLUSIVE RADIO TUBE MANUFACTURERS"**

SERVICE, JUNE, 1939 • 275

# CRYSTAL PICKUP

By RALPH P.

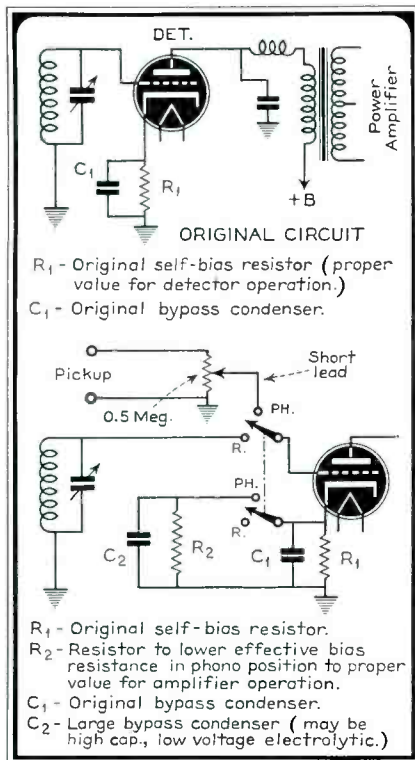

Fig. 4. A common receiver layout includes a power detector feeding the output stage. The best solution is indicated.

IF YOU ARE called upon to select and install a crystal pickup for record reproduction you have available a considerable choice of styles, types and prices. The final quality of reproduction, however, depends not only on the pickup itself but also on the method of installation. The response of the very finest crystal pickup can be ruined by failure to observe a few basic, simple installation precautions. Actually, proper installation is a simple matter, and by following the suggestions in this article, you should obtain the really fine reproduction for which quality crystal pickups are noted.

Electrically the crystal is the equivalent of a condenser with a capacity of about 1,500 mmfd. The impedance of the device, therefore, is quite high (100,000 ohms at 1,000 cycles and 1 meg at 100 cycles) and the *lower* the frequency, the *higher* the impedance. Instead of a power generator, the crystal pickup may be thought of as a voltage generator which requires a very high-impedance load so that the greater part of the generator voltage, at all frequencies of interest, will appear across the load.

## • • • terminal impedance

Since the impedance of the pickup is highest at low frequencies, it is evident that the choice of load resistance will directly govern the low frequency response. This effect of terminal impedance on low frequency response holds regardless of any other considerations.

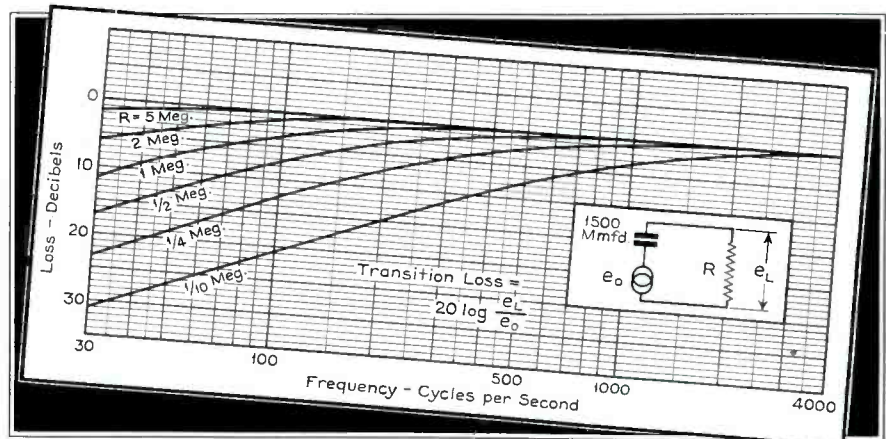

Fig. 1. Since the impedance of the crystal pickup is highest at the low frequencies, the choice of load resistance will directly govern the low frequency response.

It is inherent in the use of the crystal with its capacitive internal impedance. Crystal microphones, of course, display the same effect.

Fig. 1 shows how the terminal voltage is affected by load resistance alone for a crystal of 1,500-mmfd. capacity. A resistance of 5 meg introduces practically no frequency discrimination while lower

the point of connection to receiver or amplifier presents a sufficiently high resistance to the crystal pickup. On the other hand, if the speaker is very small, elevated bass response in the pickup is likely to result in bad distortion due to excessive speaker stiffness and poor radiating ability at low frequencies. In such cases, the practical solution is to reduce the bass response of the pickup until the overall performance is suitable. Try 0.5, 0.25 and 0.1 meg terminations until the best results are attained.

Since the crystal is a capacitive generator, the effect of shunt capacity is merely to reduce the voltage output of the pickup uniformly at all frequencies. No frequency discrimination is introduced by capacity only. Actually, however, the use of a resistance potentiometer volume control, in the presence of various circuit capacities, may introduce some high frequency loss. This, however, also occurs with sources other than crystal pickups. The effect can be minimized by methods which will be discussed below.

Many modern receivers have input terminals which will accommodate a crystal pickup. The arrangement is frequently as shown in Fig. 3 where the receiver volume control is a potentiometer in the first a-f grid circuit. The phono-radio switch simply shifts this potentiometer from the phono input terminals to the detector output and vice versa. The receiver volume control also controls the volume on phonograph. The potentiometer should have a resistance of 0.5 to 1.0 meg as explained previously for proper bass response. Sometimes tone compensating circuits are tapped into the potentiometer. They

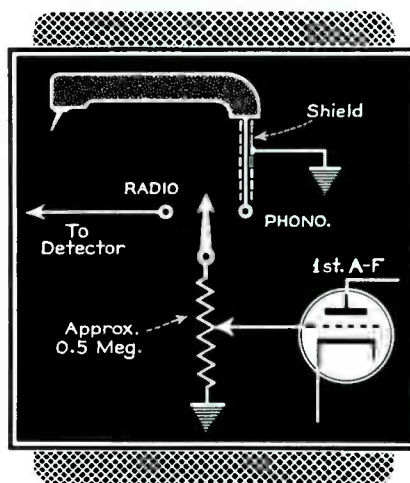

Fig. 3. If the receiver employs the volume control method shown, a single-pole double-throw switch can be wired for phono operation.

values reduce the low-frequency response as shown.

Fig. 2 illustrates the effect of load resistance on the response curve of a representative high-quality pickup. Experience has shown that for home reproduction on sets with good speakers, most listeners prefer the elevated bass response obtained with terminations of 0.5 meg or more, and therefore the Service Man should make certain that

# INSTALLATION

GLOVER\*

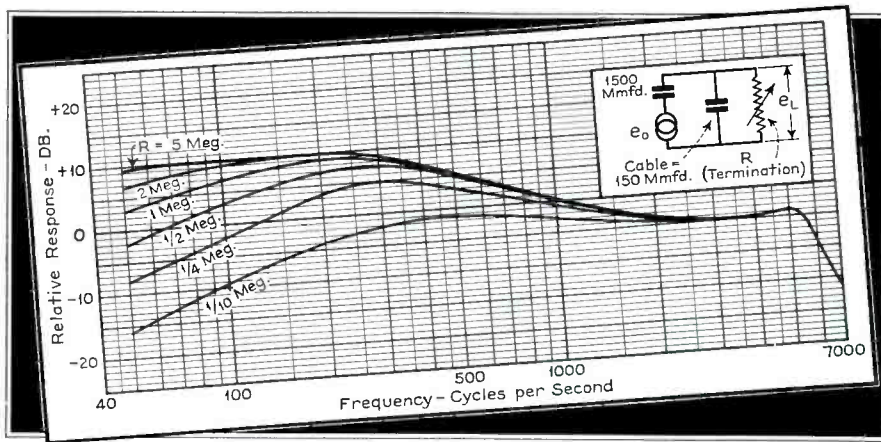

Fig. 2. Experience has shown that most listeners prefer the elevated bass response obtained with terminations of 0.5 meg or more across the pickup.

will not ordinarily affect the phono reproduction adversely, but if the quality of reproduction is poor, or if the frequency response appears to vary considerably as the volume control setting is varied, it is advisable to test the effect of disconnecting the tone compensating networks from the potentiometer. If they prove to be the cause of the trouble, they should be switched out during phonograph operation. If the receiver employs the volume control method shown in Fig. 3 but has no provision for phono input, a single-pole double throw switch can be mounted on the chassis and wired as shown. The switch should be located near the potentiometer so that leads will be short and hum pickup possibilities minimized. It is advisable to shield the lead from the phono post to the switch. The switch should make on the phono position before breaking the radio circuit to avoid a thump due to momentary removal of grid bias.

Occasionally the audio system will have such high gain that the pickup will overload the first stage at full volume and necessitate working at such a low setting of the potentiometer that volume adjustments are critical and quality of reproduction may be poor. The remedy is a shunt condenser of 0.001 mfd or larger across the pickup at the input terminals. Increase the condenser capacity until there is no overloading apparent on listening test with the receiver volume control wide open. Pay particular attention to the bass reproduction during the listening test, for the maximum peak levels occur at the lower frequencies. Increase the size

of the shunt condenser until the bass is clean.

It is always good practice to attain normal loudness with the audio volume control of the receiver almost wide open. At medium and low volume settings, the input capacity of the tube plus stray circuit capacities form an L network

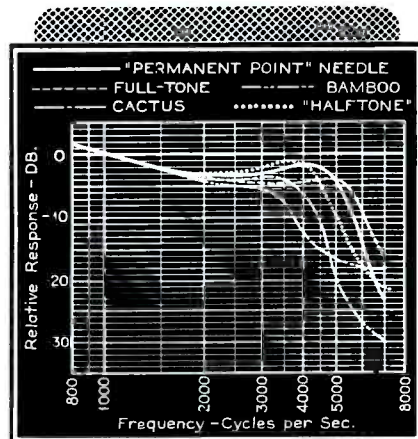

Fig. 6. Special needles provide some scratch reduction because they cut-off earlier at the high frequency end.

in conjunction with the resistance in the upper section of the potentiometer with a resulting loss of the higher frequencies. This effect is largely avoided by operating at near-maximum settings.

When a volume control is provided on a simple crystal record player which is located some distance from the receiver, there will almost always be a loss of highs due to the effect of the connecting lead capacity in conjunction with the potentiometer resistance whenever the

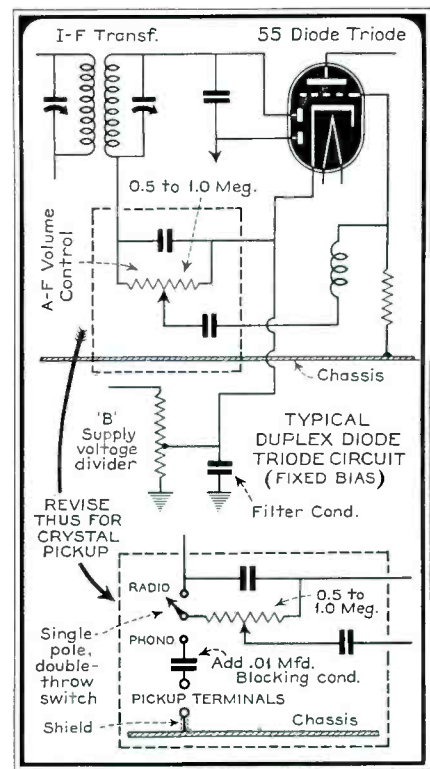

Fig. 5. In grid circuits employing fixed bias a blocking condenser should be used to prevent the application of the bias to the pickup.

volume control is turned down below maximum. There is less loss of highs with a relatively low-resistance potentiometer (of the order of 0.25 meg) but this may be offset by poor bass response, especially if the record player volume control and the receiver volume control are in parallel and combine to present a still lower terminal resistance to the pickup. When the feature of volume control at the record player is not absolutely essential, the reproduction will usually be improved considerably by disconnecting the record player control entirely, depending on the control at the receiver. Of course these remarks do not apply to record players of the wireless type or to those which incorporate an audio amplifier tube following the pickup; in these cases the tube associated with the pickup may effectively isolate the pickup volume control from the connecting line and subsequent equipment.

Many receivers of early vintage have no provision for phonograph pickup connections; others have phono connections which are only suitable for magnetic pickups. The alert Service Man can build up his profits by adding crystal record players to such receivers and by modernizing yesterday's phonograph combinations with crystal pickups. Circuit changes to accommodate the crystal pickup are not difficult if a few fundamentals are kept in mind. In the first place, transformers are *out!* They will

\*Shure Brothers.

not provide the proper terminal connections for high-quality crystal pickup performance. Connect the crystal pickup in the grid circuit of an audio stage across a resistance of 0.5 meg or more (which may be the radio volume control) and make certain that no low-impedance circuits are across the pickup.

A common receiver layout includes a power detector feeding the output stage. Radio volume control is probably effected in a preceding r-f circuit. The best solution is to switch the detector tube grid to a 0.5 meg pickup volume control mounted on the chassis (or

#### • • • diode-triodes

Frequently the detector and first audio element are combined in a single tube, the familiar duplex-diode triode. Circuit variations are numerous and a careful study of the individual circuit of the particular receiver is strongly indicated before the work is started. The problem is to get at the grid of the triode section, making use of the receiver volume control if possible. Particular attention must be paid to the method by which the cathode is biased.

A circuit in which fixed bias is employed, is shown in Fig. 5, together with

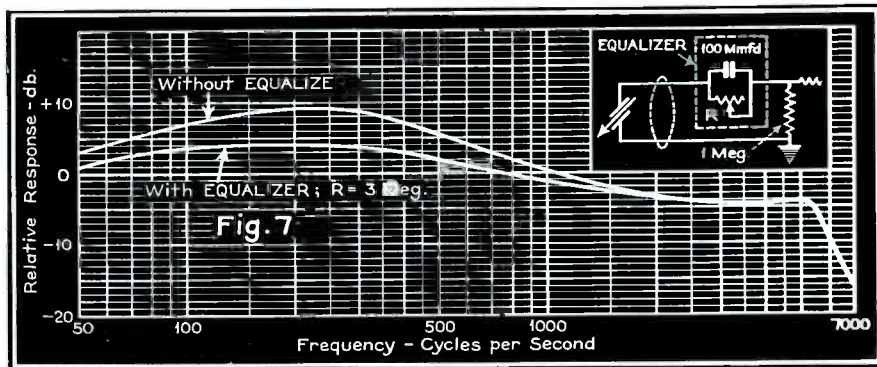

Fig. 7. Equalization for relatively flat response can be provided by means of a fixed condenser and a resistor.

motorboard if a combination) at the same time switching the bias to the proper value for Class A studio amplification instead of detection. Fig. 4 shows one possible arrangement.

As before, the switch blade connected to the grid should make in the phono position before breaking the radio circuit to avoid switching thump. The shunt resistor  $R_2$  must have the proper value to make the parallel combination of resistors afford correct amplifier bias. Measure the applied plate voltage and then consult your tube manual for the correct bias voltage and plate current for amplifier operation.

Divide the required bias voltage by plate current to find the resistance which the parallel combination of  $R_1$  and  $R_2$  must provide. After installing the correct resistor  $R_2$ , recheck bias voltage and plate voltage. Occasionally the applied plate voltage will drop and necessitate a slight change in the bias resistor.

The lowered bias resistance for amplifier operation will require an increase in cathode by-pass capacity. This can be provided by installing a low-voltage high capacity electrolytic or other suitable condenser at  $C_2$ . Both the switch and volume control should be located as close to the tube as possible. After these parts are mounted and the set operates properly on phonograph, it is wise to realign the tuned circuit feeding the detector which will probably be a little high in capacity due to that added to the circuit by the switch.

the proper switching circuit for crystal pickup. The only modification is the provision of a single-pole double-throw switch to shift the high-side of the volume control potentiometer from the radio circuit to the phono input with a blocking condenser in series to prevent the application of bias voltage to the pickup.

It is not possible to discuss here all of the diode-triode circuit variations which are used in radio receivers. It should be remembered, however, that even the most complicated circuit can be licked by switching grid and cathode to a separate phono volume control and self-bias resistor and by-pass condenser, respectively. Keep leads as short as possible and shield wires if hum is encountered.

#### • • • equalizing

It has been intimated, elsewhere in this article, that a large percentage of radio set buyers have been educated to prefer excessive bass response. This fact probably accounts for the elevated bass response which is characteristic of most present-day commercial crystal pickups.

Equalization for relatively flat response is easily provided, should an occasional customer prefer high-quality music. As shown in Fig. 7, all that is required is a fixed condenser and a fixed or preferably variable resistance, connected as indicated. If a variable re-

sistor is employed, any response curve between the fully equalized and the normal unequalized can be obtained at will. The curves shown have been matched at the high frequency end and therefore indicate only the relative frequency response.

#### • • • scratch noise

It has been a common notion that sharply-tuned rejector circuits would eliminate needle scratch or surface noise in phonograph reproduction. The reasoning seems to have been that the disturbing noise was localized in a narrow band around 2500 or 3000 cycles and that the removal of the audio components in substantially this band alone, would considerably lessen the reproduced surface noise with minimum effect on the general quality of reproduction.

Without going into detail regarding special cases that are of little practical interest, it appears that there are no appreciable benefits in narrow band-elimination from the noise reduction standpoint. Surface noise components are of random character and are distributed throughout the entire audio range. Effective noise reduction goes hand-in-hand with reduction in quality of reproduction. Special needles (such as halitone, cactus, bamboo, etc.), provide some scratch reduction because they cut-off earlier at the high frequency end, with of course a corresponding elimination of what may have been recorded in the lost frequency interval. Adjustment of the ordinary tone control of the receiver or amplifier, with its adjustable, tapering high frequency loss, will probably completely satisfy most listeners.

#### • • • additional hints

Crystal pickups will not withstand temperatures above 125° F. for long periods of time. Make sure that adequate cabinet ventilation is provided. Deflect heat from power and rectifier tubes if necessary with a sheet of asbestos board or other heat insulating material. Check-up with a thermometer placed at the pickup position. Long experience has proved that the temperature limitation is easily satisfied if it is recognized and given attention.

Should it be necessary to replace the crystal cartridge or cordage, apply minimum heat when unsoldering and resoldering connections at the cartridge terminals. Cool the lug with a cotton swab dipped in alcohol immediately after removing the soldering iron. Heavy-handed sweating-in of soldered joints at the cartridge terminals is practically certain to ruin the crystal. Quick soldering with minimum heat, immediately cooling the joint, is absolutely safe.

# NEW LOW PRICES **EFFECTIVE JUNE 7th!**



**NOW ONLY \$49<sup>50</sup>**  
Headphones not included

Model 669  
Vacuum Tube Voltmeter  
and Signal Detector



**NOW ONLY \$24<sup>00</sup>**

Model 697  
Pocket Volt-Ohmmeter



**NOW ONLY \$45<sup>00</sup>**

Model 773  
Portable Tube Checker



**NOW ONLY \$93<sup>00</sup>**

Model 775  
Combination Super-Sensitive  
Analyzer and Tube Checker



**NOW ONLY \$49<sup>50</sup>**  
Prices net to servicemen in U. S. A.

Model 772  
Super-Sensitive Analyzer

## WESTON *Fundamental* RADIO-TELEVISION TEST EQUIPMENT

Here's a *two-fold* opportunity for you . . . an opportunity to save on the initial cost of these *proved* radio-television test units—and an opportunity to save *substantially* through owning fundamental WESTON instruments. For WESTON instruments will serve you dependably for many years; eliminate rebuilding and replacement costs due to early instrument obsolescence. Remember, too, that these instruments are *not* discontinued models; nor has there been any change in quality. The *only* change has been in price! Return coupon for complete information.

While at the RADIO PARTS SHOW . . . be sure to visit the WESTON Booth Nos. 419-421 Marconi Boulevard, and see TELEVISION equipment demonstrated . . . see how to install and service television with WESTON instruments.

**NOW!**  
it costs no more  
to own  
**WESTON'S**  
*Return  
Coupon*

Weston Electrical Instrument Corporation  
604 Frelinghuysen Ave., Newark, N. J.  
Send complete information on WESTON radio and tele-  
vision test equipment.

Name \_\_\_\_\_  
Address \_\_\_\_\_ State \_\_\_\_\_  
City \_\_\_\_\_





# TELEVISION I-F S

By F. W. SICKLES CO.

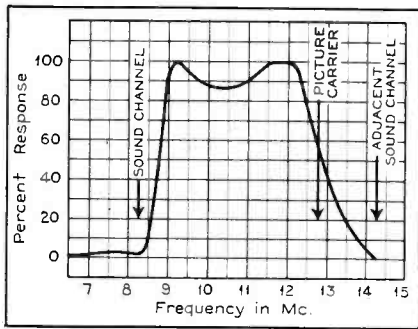

Four wave filters incorporated in the picture i-f channel attenuate the frequencies representing the sound channel and adjacent channel sound carrier.

IT IS apparent that the varying requirements made upon television i-f systems will not be met by one particular form of amplifier. The coupling units used in the accompanying circuits were, therefore, developed so that they may be used in various amplifier combinations. Though incorporating different circuits the units are, with one exception, all the same size and are designed for sub-chassis mounting, reducing lead length to a minimum. Shield dimensions are  $3\frac{1}{4}$  inches by  $1\frac{5}{32}$  inches.

Generally speaking the coupling units consist of plate and grid inductors, permeability tuned; which, together with the tube capacitances, form tuned circuits. Coupling elements, either simple inductive or capacitive elements or tuned circuits offering the necessary reactive component, are fixed; except in the case of unit No. 40. The resulting band-pass network will have a useful bandwidth of 3.65 to 4 megacycles, depending upon alignment procedure and loading. Wave filters to attenuate further the intermediate frequencies corresponding to the associated sound and adjacent channel sound carriers are incorporated in some of the units.

### • • • gain

The gain of the typical amplifier shown is approximately 3500 for a usable bandwidth of 3.85 megacycles. The sound channel gain is approximately 4000.

A simple method of increasing the gain without adding to the number of stages is the substitution of 1852 type tubes for the 1853's used in the first two stages of the i-f amplifier. Cathode resistor bias will have to be substituted for the fixed minimum bias (pavc) assumed for the operation of the 1853's in the amplifier described. Replace R-8 and R-14 each with the R-19, R-20, C-12 network. Gains of 7000 to 8000 with a useful bandwidth of 3.85 megacycles and 6000 to 6500 at a bandwidth of 4 megacycles are attainable in this way.

To neutralize the effects of input capacitance and loading change caused by changing plate currents (avc), degeneration is applied to the converter and i-f stages as may be seen in the circuit diagram.

Addition of another i-f stage, should it appear necessary, can be accomplished by using a wide band unit, No. 40 for example, in connection with the additional tube. If properly damped, the additional stage should alter the response of the amplifier only slightly, whereas the gain will be considerably increased. Other units, of course, can also be used, should it be necessary to change the sound carrier rejection characteristics at the same time.

### • • • wave filters

Four wave filters are incorporated to attenuate, in the picture i-f channel, the frequencies representing the sound channel and adjacent channel sound carrier. Rejection factors of 300 to 500 for the sound carrier i-f and 600 to 1000 for the adjacent channel sound carrier i-f (8.25 and 14.25 mc in the described amplifier) are attainable with a useful bandwidth of 3.85 megacycles.

### • • • alignment data

Sound i-f channel: Alignment corresponds to standard i-f alignment procedure, both adjusting screws on units

R1	1,000	R25	4,000
R2	3,000	R26	100,000
R3	35	R27	100,000
R4	225	R28	68
R5	60,000	R29	1,000
R6	5,000	R30	100,000
R7	100,000	R31	100,000
R8	68	R32	68
R9	30,000	R33	30,000
R10	1,000	R34	1,000
R11	7,500	R35	50,000
R12	2,500	R36	500,000
R13	100,000	R37	2,000
R14	68	R38	500,000
R15	30,000	R39	30,000
R16	1,000		
R17	7,500	C2	400 mmfd
R18	7,500	C3	0.006 mfd
R19	35	C16	400 mmfd
R20	125	C23	50 mfd
R21	60,000	C24	50 mfd
R22	1,000	C25	0.02 mfd
R23	5,000	C26	5.0 mfd
R24	6,000		All others 0.01 mid

44-R and 44-L set for maximum response at the sound channel intermediate frequency.

Picture i-f channel: Alignment of the picture i-f channel should be done by means of an i-f sweep generator, though point-to-point alignment using a signal generator is possible. A microammeter in the detector load circuit or a vacuum tube voltmeter across the load may be used for tuning indication.

General alignment procedure: Feed the generator output to the grid of the last i-f tube, make the necessary adjustments, and proceed to the grid of the preceding i-f tube. Alignment is simplified if the grid of the stage under alignment is disconnected from the preceding coupling unit. Provision must be made to maintain adequate bias.

Unit No. 40: Two slotted studs:—Inductor adjustments; center screw:—Coupling capacitor adjustment.

Preliminary adjustment can be made by tuning both inductors to a frequency slightly higher than the high frequency peak of the desired response curve, the coupling adjustment being set several turns from its maximum capacity position. Increase the coupling slowly until the two peaks formed take the desired positions in the frequency band.

Unit No. 48: Two slotted studs:—Inductor adjustments; Center screw:—Wave-trap setting.

Set the wave-trap for maximum attenuation at the adjacent channel sound i-f peak. Resetting may be necessary

(Continued on page 301)

The varying requirements made upon television i-f systems will not be met by one particular form of amplifier.

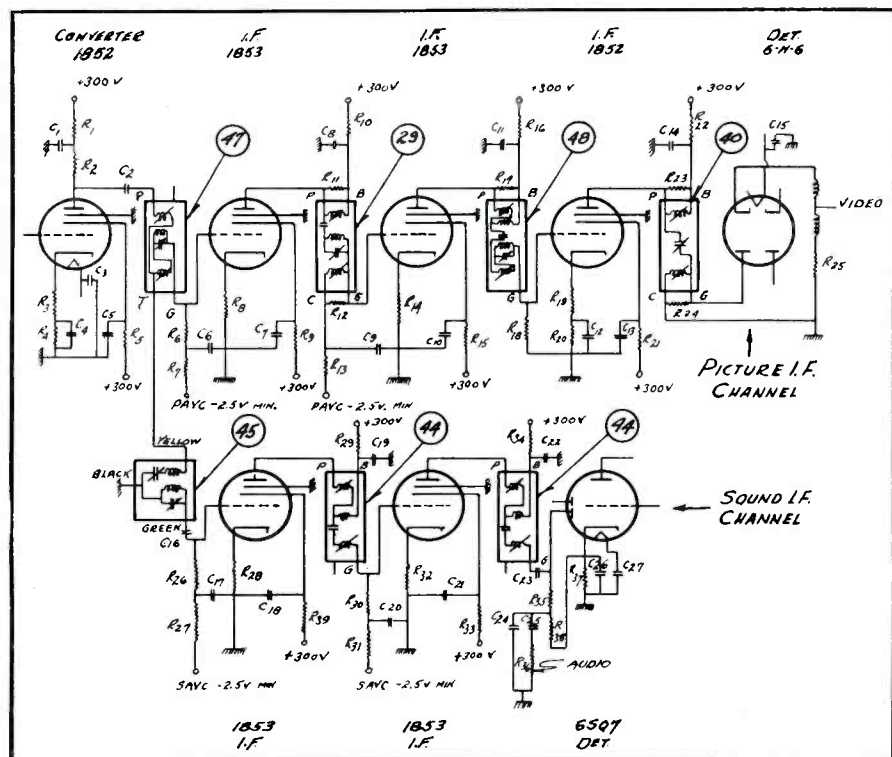

# RCA 5X5I, 5X5W

(See Front Cover)



RCA 5X5 controls the remote receiver without extra wiring and without making any changes in either receiver or the 5X5.

tuned will be heard. If the receiver is equipped with tuning indicator (Magic Eye) the correct point will most easily be obtained by observing the indicator. Any station tuned in on the 5X5 dial will be heard on the controlled receiver. The volume will also be controlled with the 5X5 volume control.

A TINY multi-purpose radio has been introduced by RCA Victor (see front cover), which in addition to providing program reception by itself serves as a remote control unit through which any other radio can be operated. Connected with a record-player, recorded music may also be reproduced through its own me-

Remote control oscillator adjustment range: 540 to 800 kc.  
I-F peak: 455 kc.  
Power supply: 100 to 125 volts, a-c or d-c.  
Power consumption: 30 watts.  
Power output: Maximum, 2.0 watts; Undistorted, 1.5 watts.  
Speaker 4-inch; Field: 450 ohms.  
Dial lamp: No. 47.  
Cabinet dimensions: 8 $\frac{3}{8}$  W, 5 $\frac{1}{8}$  H, 4 $\frac{1}{2}$  D.  
Weight: 5 $\frac{1}{4}$  lbs.

If it is desired to operate the controlled receiver on its own controls it is only necessary to set the switch on the filter coupling unit to its position marked radio.

In the event that, with the 5X5 as a remote control, other receivers in the home are in use, trouble may be experienced due to noise and hum. To avoid this, connect a power line filter coupling unit to each of these other receivers, as shown in accompanying drawing.

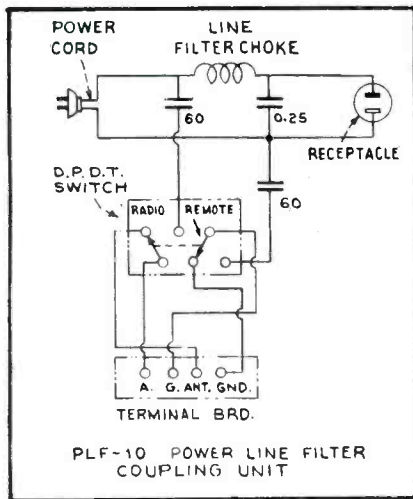

To avoid trouble from noise and hum in locations where other receivers are employed, a line filter coupling unit should be used.

chanism or remotely through another radio. A switch located at the back of the cabinet permits selection of either direct or remote control operation.

The new instruments are equipped with a plug-in attachment for a record-player, and the same plug-in arrangement is also designed to permit connection with an RCA Victor television attachment for complete sight-sound reception in areas serviced by a television transmitter.

Two models are available: the 5X5W in a moulded plastic cabinet in walnut finish and the 5X5I in ivory finish. The addition of a filter is recommended for best results in the remote control functions. This filter should be connected between the remotely controlled receiver and its power line plug, as indicated in the accompanying diagrams.

## • • • specifications

Cabinet: Moulded plastic.  
Tuning: Manual.  
Range: 540 to 1,720 kc.

## • • • remote control setup

Install the 5X5 and tune in any desired station. Turn the control switch on the back of the 5X5 to its clockwise position marked remote. The 5X5 becomes silent.

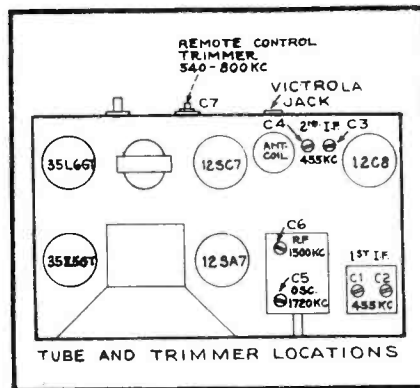

Six adjustments are provided for alignment of the r-f and i-f circuits of the lithe nipper. Five tubes are employed in a superheterodyne circuit

The 5X5 now becomes a small relay station for signaling to the controlled receiver via the power line wiring.

Tune the main receiver to the exact frequency of transmission of the 5X5, usually 540 kc. Tune carefully to this frequency, setting the volume control as high as permissible with regard to hum and noise conditions. The station to which the 5X5 was

## • • • lead dress

Dress first i-f plate and grid leads against chassis and away from each other. Dress plate lead from 12C8 close to chassis. Dress avc condenser 12C8 close to chassis. Dress tight to 0.25 mmfd condenser.

The set is equipped with length of antenna wire. Do not connect the antenna to ground. If an outdoor antenna is used, it should not be longer than 100 feet, including lead-in. If it is longer, connect a 100 to 200 mmfd capacitor in series with the lead-in.

A jack is provided on the rear of chassis for connecting a victrola attachment into the audio-amplifying circuit.

If the electric supply circuit is a three-

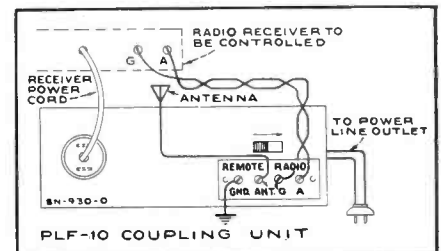

The line filter coupling unit should be connected to the controlled receiver as close to the power line connections as possible.

wire system, it may be necessary to connect a 0.25-mfd, 700-volt condenser between the two outside lines of the system.

## RCA 5X5I, 5X5W ALIGNMENT OPERATIONS

Connect Generator to	Dummy Antenna	Generator Frequency	Dial Setting	Peak Trimmer
Osc. stator gang cond.	0.01 mfd	455 kc	1,600 kc	C1, C2, C3, C4
Antenna	100 mmfd	1,720 kc	1,720 kc <sup>1</sup>	C5
Antenna	100 mmfd	1,500 kc	1,500 kc <sup>2</sup>	C6

<sup>1</sup>Plates should be completely out of mesh.  
<sup>2</sup>Tune receiver to signal.

# Now!

## WORLD'S OLDEST, LARGEST CAPACITOR MANUFACTURER

### Announces **NEW CAPACITOR Analyzer and Bridge**



#### CAPACITOR ANALYZER

Cornell-Dubilier's new Capacitor Analyzer. Measures quickly, accurately all important characteristics of paper, mica, oil and wet and dry electrolytics, including A.C. motor starting types. It is the only instrument which provides a complete and thorough capacitor test.

Some of the advanced features of the new C-D analyzer model BF-50 are:

- Capacity measurements, .00001 to 240 mfd.
- Power-factor measurements 0 to 50%.
- Insulation resistance measurements to 1,500 megohms.
- Push button switch control.
- High sensitivity control provides sharp or broad balances for quick and accurate readings.
- Checks leaky, shorted, open, high and low capacity.
- Requires no outside standards, headphones, meters or other accessories.
- It's complete in itself! It's portable. It's outstanding!

The Analyzer is supplied in attractive walnut cabinet with removable hinged cover. Model BF50 list, less tubes . . . \$41.50.

DEALER NET. . . . . **\$24<sup>90</sup>**

#### CAPACITOR BRIDGE

NEW C-D CAPACITOR BRIDGE for quick and accurate measurement of all type capacitors between .00001 and 50 mfd.

- Indicates power-factor of electrolytic capacitors.
- Checks, opens, shorts, high and low capacity.
- Dual type "visual eye" detector indicates bridge balance.

The most compact and useful instrument of its type ever offered to the radio service field!

The Capacitor Bridge is complete, requires no head-phones or other accessories, is supplied in attractive bakelite case 3 3/8" x 5" x 3", with detachable leads and instruction booklet. Model BN Capacitor Bridge, complete, less tubes . . . List \$16.50

DEALER NET. . . . . **\$9<sup>90</sup>**



#### C-D CAPACITOR DECADES



Ideally suited for test circuits, filter design, bridge measurements, and many other service and experimental applications. Capacity range between .0001 and 10 mfd. is available in three decade units. They can be used continuously in circuits where voltages do not exceed 220 V. A. C. or 600 V. D. C. Encased in compact, attractive bakelite cases, 3 3/8" x 5" x 3". Individual chart furnished with each Capacitor Decade.

#### TAKE ADVANTAGE OF THE LONGEST CAPACITOR EXPERIENCE IN THE INDUSTRY. . . . .

Equip now for greater profits with Cornell-Dubilier advanced, guaranteed test equipment. For limited time only! This offer expires Aug. 1, 1939. The Coupon below is worth \$1.00! Present it to your local C-D jobber and he will allow you \$1.00 toward the purchase price of any single instrument. See your C-D Jobber today! Bring the coupon with you.



**CORNELL-DUBILIER ELECTRIC CORPORATION,**  
SOUTH PLAINFIELD, NEW JERSEY

Please rush to me the following catalog material.

- Catalog No. 167A on Capacitor Instruments.
- Catalog No. 165A on industrial and transmitting capacitors.
- Catalog No. 166A on Quietone Interference Filters.
- Place me on your mailing list for Free C-D House Organ.

Name . . . . .

Address . . . . .

City . . . . .

State . . . . .

**CORNELL-DUBILIER**  
**ELECTRIC CORPORATION**

1026 Hamilton Boulevard, South Plainfield, New Jersey  
Cable Address: "CORDU"

# FORD-PHILCO F1640

By EUGENE TRIMAN

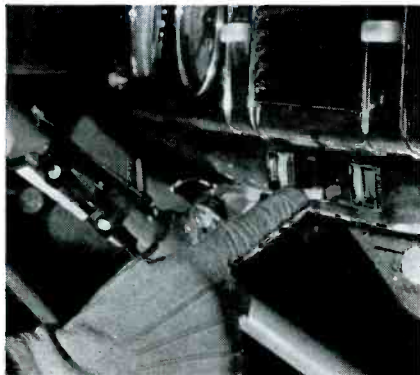

Fig. 1. The button is operated a successive number of times until the indicator shows the call letters of the station desired.

APPEARING this season, in several Philco custom auto radios, is a novel push-button tuning device. In the Lincoln-Zephyr L1660, Packard P1617, Studebaker S1616, Ford F1640 and Graham-Paige G1615 the set can be tuned to any one of five desired stations by pushing a single button (see Fig. 1). The button is pushed a successive number of times until the station indicator shows the call letters of the one required.

## • • • the solenoid

A simple solenoid arrangement is used to rotate a wafer switch. The switch connects the proper pretuned circuit for the station desired. The necessity of a line of several push buttons is eliminated. In addition, the time diverted from driving which would be necessitated with multiple buttons, is eliminated.

This solenoid assembly is termed an

impulse motor. The principal parts are indicated in Fig. 2. The dimensions are distorted somewhat to show the design principles more clearly.

In the figure, the solenoid is energized when the push-button is pressed as in Fig. 1. The magnetic flux of the solenoid pulls the pole piece in, to which is attached an L lever arrangement. At the end of this lever is a thin strip of tempered metal. The metal strip, engaged at the other end with the tooth-slot in the cogwheel, is pushed in the direction indicated, and consequently, rotates the cogwheel in a counterclockwise direction.

The thrust of the metal strip is such that the cogwheel turns exactly one tooth when the push-button is released and the deenergized solenoid allows the L to return to its original position. The second tooth takes the same position that the first one had and when the button is again pressed the action repeats. The gear can thus be made to turn by merely pushing the automatic tuning button as many times as desired.

## • • • the switch

The automatic tuning is effected by using a rotary wafer switch the rotor of which is on the same shaft as the cogwheel of the impulse motor. The location of the rotary switch is shown in the chassis pictured in Fig. 3. The impulse motor is shown on the underside of the same chassis in Fig. 4.

There are six teeth on the cogwheel. Each tooth has a switch position on the wafer switch. Five of the positions are for stations and the sixth is for a "dial" setting. This position on the switch changes the tuning arrangement from push-button to manual.

In the circuit diagram (which is for the Ford Model F-1640) the electrical location of the impulse motor and switching assembly is shown. The impulse motor is marked 57. The part labelled 60 is a duplicate of the impulse motor, but more compact in size. This unit is located in the control head itself. Its function is to rotate a six-sided drum dial. Station call letters are placed in five of the faces, and a tab marked "dial" is placed in its proper face. This drum turns in synchronism with the wafer station selector, each face jump-into consecutive view as the push button is operated.

Fig. 5. In the Ford-Philco F1640, and in several other Philco custom auto-radio models, a novel push-button tuning device is used.

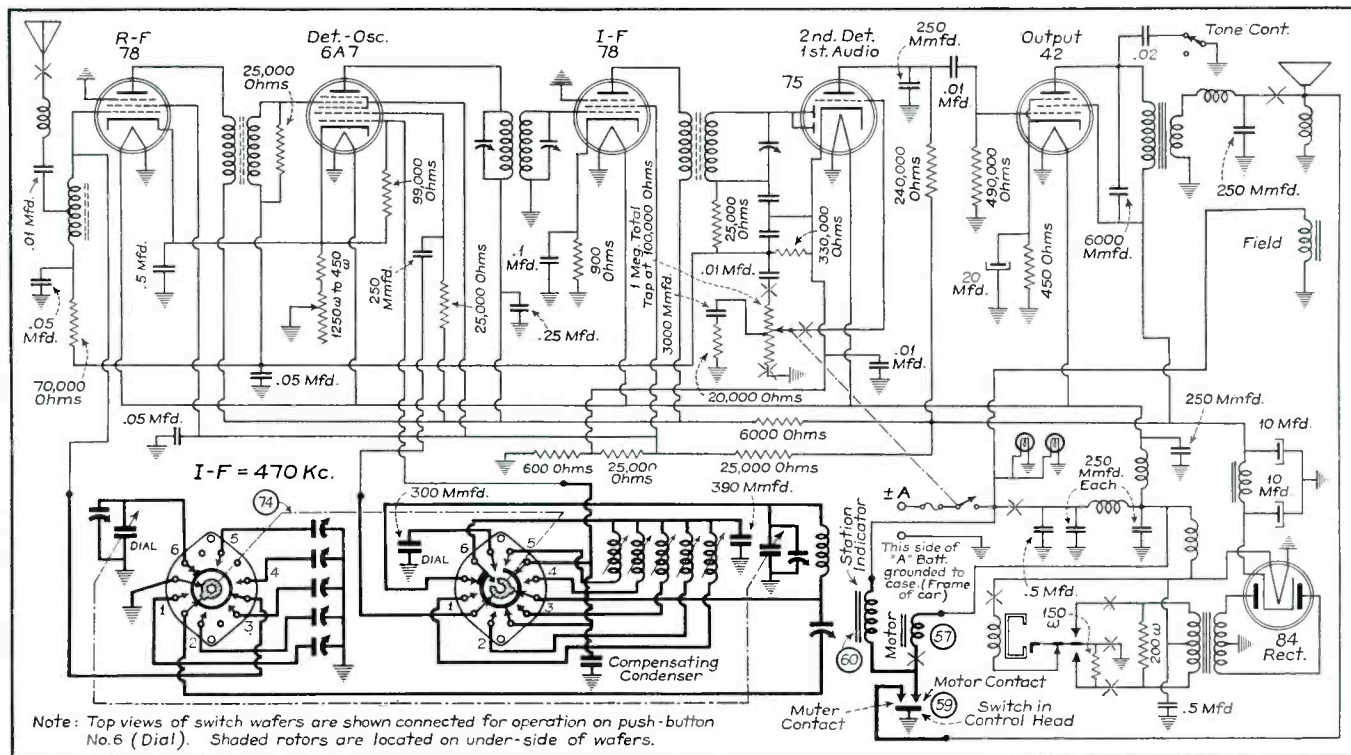

# Build your own Sight and Sound Receiver for



**F. A. D. ANDREA**  
Pioneer in Radio  
and Television

Andrea led the way with radio kits in 1923. Service men will remember his famous Neutrodyne kits. Behind the Andrea Television Kit are long years of experience that assure successful assembly and "Sharp-Focus" television reception from the finished receiver.

# TELEVISION

**SERVICE MEN, SET BUILDERS, STUDENTS and EXPERIMENTERS**

The Andrea Television Kit gives you factory-built performance at rock-bottom cost—plus the experience and profit of building your own. Already, service men are reporting enthusiastically about results from their assembled KT-E-5 kits:

In the N. Y. Sun, April 15th, E. L. Bragdon, Radio Editor, said: "In the writer's

opinion, gained through the actual assembly of the (Andrea) kit, the plan of instructions devised by the manufacturer sets a new high point in that field of radio.—The individual steps in the formation of this televisor have been so clearly outlined that the only excuse for failure is carelessness on the part of the builder."

## FROM TELEVISION HEADQUARTERS

ANDREA RADIO CORP. is the only television manufacturer whose factory and laboratories are located right in New York City. Thus ANDREA engineers have not been limited to laboratory receiving tests from miniature, experimental transmitters. No, indeed! Every step in the perfection of ANDREA "Sharp-Focus" sets and kits has been checked on actual reception from the New York transmitters which are setting the standards of television technique in the U. S. A.

## FINISHED, COMMERCIAL DESIGN: ANDREA

is the only manufacturer of television receivers who is making a standard, commercial set available in construction kit form for experimenters, students,

and service men. Because the ANDREA KT-E-5 kit is actually comprised of the parts of the factory-built model 1-F-5 receiver, the kit, when assembled in accordance with the instructions provided, will give you sight and sound reception equal to the factory-built set.

**SUCCESS ASSURED:** You need only a soldering iron, screwdriver, and pliers. No testing instruments are necessary, for the R.F. circuits are assembled, wired and precision pre-tuned to the 44-50 and 50-56 mc. channels. You'll be delighted to see how every last detail has been planned to assure your success.

**BE THE FIRST SERVICEMAN IN YOUR NEIGHBORHOOD TO BUILD AN ANDREA TELEVISION RECEIVER!**

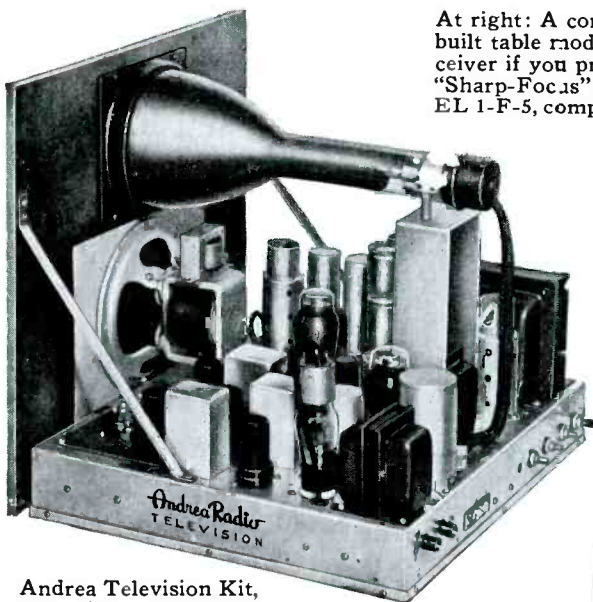

Andrea Television Kit,  
rear view, assembled.

**\$79.95**  
less tubes

At right: A complete, factory-built table model television receiver if you prefer it. Andrea "Sharp-Focus" receiver MODEL 1-F-5, complete with tubes.

**\$189.50**

Andrea Teleceptor Antenna specially designed for television reception.

**\$9.50**

- Complete Wiring Diagrams and Step-by-Step Instructions supplied free with every Andrea KT-E-5 Kit.

Or send \$1 for diagrams and instructions alone—authoritative, detailed, profusely illustrated.



## IMMEDIATE DELIVERY:

Leading dealers and service shops are now displaying and demonstrating Andrea sets and kits. Write for the Andrea Television literature.

# Andrea Radio

"SHARP-FOCUS" TELEVISION

ANDREA RADIO CORP. • 48-36 48th Ave., Woodside, L. I., N. Y. • Telephone: STillwell 4-4754

SERVICE, JUNE, 1939 • 285

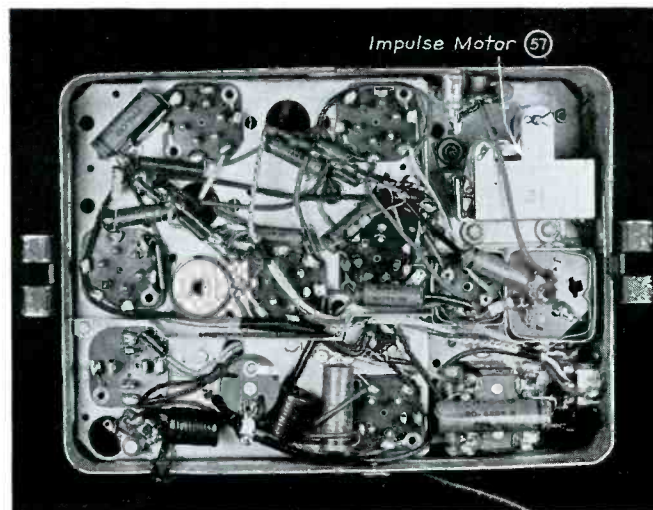
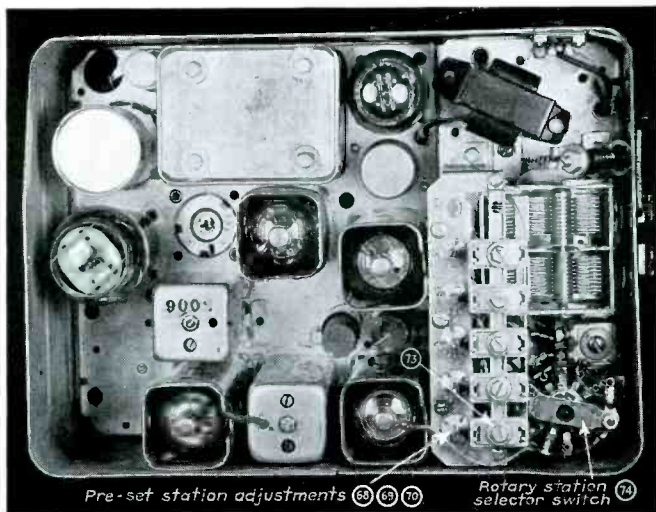

Figs. 3 and 4 (above). The automatic tuning is effected by using a rotary wafer switch the rotor of which is on the same shaft as the cog-wheel of the impulse motor. Fig. 2 (below). The magnetic flux of the solenoid pulls the pole piece and attached L lever arrangement into the coil.

A muter contact short circuits the voice coil on the speaker when the station selector switch is in action.

• • • installation

The installation of these units requires the usual care and accuracy required of Service Men. An additional precaution against possible trouble should be observed when the control box is mounted through the instrument panel. The close fit of the push button and the hole through which it projects on the instrument panel is cause for a certain amount of care. Unless the control unit is in the proper position after it is tightened to the panel, the push button will rub and remain in an unreleased position. The major trouble arising from this maladjustment is encountered when the drum indicator fails to jump into position and either indicates the adjacent station or partially shows two adjacent station tabs.

It is conceivable but not experienced as yet, that the push-button switch might remain in full or partial contact causing unnecessary drain on the car battery. To guard against any possibility of this trouble in one of its forms described, mount the control head in place and be sure that the button has free-play in its slot. If the button rubs on more than one side and appears too large, remove the control unit and pull the plastic button from mounting. The button can then be made smaller by scraping it with a straight edge. It is preferable to scrape it rather than sandpaper it, for the sandpaper usually dulls the finish and shows the treatment.

We have found that following up an installation or service job on these sets with the attention which requires time enough to determine whether the push-button operates freely or not will cause the car owner to be fully impressed by the fact that you have special consideration for his investment and return at a

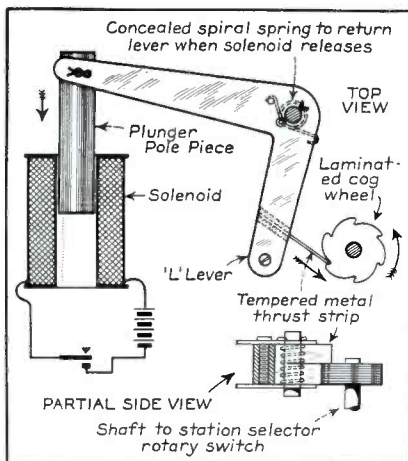

later time fully prepared to place the radio in your hands.

• • • call letters

The automatic dial is shipped without call letters so that the owner may select his favorite stations.

(1) To install call letters remove the automatic dial assembly in the right end of the control from the housing. It is installed like a drawer and can easily

be pulled out from the rear of the control.

(2) Turn on the receiver so that the current is supplied to operate the automatic dial, but do not advance the volume.

(3) Select and remove from the call letter sheets those of the desired stations.

(4) Push the station selector button until the No. 1 section of the dial will rotate in front of the window. (See Fig. 6.) Insert in this position the call letter tab of the station having the highest frequency. Insert in front of the tab one of the small celluloid tabs which are attached to the call letter sheets.

(5) Repeat in like manner the insertion of call letters in positions 2, 3, 4, 5, installing them in the order of their frequency. Replace the automatic dial assembly in the control unit.

• • • push-button alignment

Before setting up the receiver for automatic tuning, it is necessary to synchronize the automatic dial to the receiver. Turn on the receiver and try to tune in a station with the manual tuning control. If no station can be picked up, push the automatic station selector until a position is found where the receiver responds to the manual tuning control. This is the "dial" position.

(Continued on page 288)

FORD-PHILCO F1640 ALIGNMENT OPERATIONS

Connect Generator to	Dummy Antenna	Generator Frequency	Dial Setting	Peak Trimmer
6A7 Grid	0.5 mfd	470 kc	1580 kc <sup>1</sup>	25, 15, 17
Antenna	30 mmfd	1580 kc	1580 kc <sup>2</sup>	78
Antenna	30 mmfd	1400 kc	1400 kc <sup>3</sup>	77
Antenna	30 mmfd	580 kc	580 kc <sup>3</sup>	56 <sup>4</sup>
Antenna	30 mmfd	1580 kc	1580 kc <sup>5</sup>	78
Antenna	30 mmfd	1400 kc	1400 kc <sup>3</sup>	77 <sup>5</sup>

<sup>1</sup>Automatic station selector should be set for dial tuning throughout the alignment procedure.  
<sup>2</sup>Turn condenser rotor plates out of mesh as far as they will go.  
<sup>3</sup>Tune receiver to signal.  
<sup>4</sup>Rock dial for optimum setting.  
<sup>5</sup>Final adjustment of antenna stage should be made with receiver installed in the car and connected to the car antenna.

# VEDOLYZER

**SUPREME'S CONCEPTION OF A NEW, AMAZINGLY FAST AND COMPLETE METHOD OF RADIO SERVICE**

Can you . . . check R. F. filtering in detector and A. V. C. circuits visually . . . see and locate the noise created by faulty parts . . . attach test oscillator to dead receiver and go from stage to stage and locate dead portion without turning any knobs or tuning any circuits . . . check receiver oscillator performance without tuning any test instrument circuits . . . measure FREQUENCY AND AMPLITUDE of the signals in all stages of a receiver . . . measure 6,000 D. C. VOLTS with a 150 MEGOHM INPUT . . . measure from ONE BILLION OHMS down to ONE-HALF OHM . . . make NO-CURRENT VOLTAGE measurements without disturbing receiver's operation . . . SEE the actual Broadcast, I. F. and A. F. SIGNAL any place and every place in any receiver . . . measure radio signal throughout set in MICROVOLTS and VOLTS . . . SEE where DISTORTION occurs . . . SEE THE SIGNAL during broadcast and television receiver servicing?

Every up-to-date serviceman, radio and television engineer should have the complete story on the VEDOLYZER.



Don't buy any instrument until you have the complete and interesting story on this new SUPREME equipment. Write today for literature, soon available, and nearest place and date of demonstration, in your locality



EXPORT DEPT., Associated Exporters Co., 145 W. 45th Street, New York  
Cable Address: LOPREH. N. Y.

The Supreme 561 Combination Signal Generator includes (1) a sinusoidal A. F. wave output from 15 to 15,000 cycles, (2) an unmodulated R. F. wave output from 65 K. C. to 20.5 M. C. on fundamentals and above 60 M. C. on harmonics, (3) a variable audio modulated R. F. signal using the internal 15-15,000 cycle audio oscillator, (4) a metered variable percentage of modulation control on this R. F. signal from 0 to 75%, (5) a frequency modulated oscillator having a 30 K. C. wide band pass which may be used, (6) to frequency modulate the internal R. F. oscillator for visual alignment and also for A. F. C. adjustments, (7) availability of externally modulating the R. F. signal with suitable equipment.

A. F. oscillator has power output of 150 milliwatts and open circuit voltage of 35 volts. Continuously variable on 6" illuminated dial; 4 output impedances (center tapped) for correct matching.

R. F. oscillator uses iron core coils and air dielectric trimmer condensers. 1/2 of 1% accuracy assured. Ladder type attenuator. 2 speed tuning control. Shadow type, razor edge, tuning indicator and illuminated dial. Frequency modulator uses famous SUPREME LOCK-CENTER-SYNCHRONIZE circuit which completely eliminates image wandering.

**SUPREME**  
INSTRUMENTS CORP.  
GREENWOOD, MISS., U.S.A.



Model 432-A  
**\$17.85**

# YOUR PROFITS ASSURED with these NEW *Readrite* RANGER METERS TESTERS

When you buy Readrite testers you get the best at a price you can afford to pay. Your profit is assured with Readrite quality and low cost investment. Readrite has made tube testers since radio tubes first were used for broadcasting and receiving. Buy a lasting product from a reputable manufacturer and you buy right. Honest repair service is a Readrite feature that goes with every tester—our lasting reputation has stood the test of this service we feel we owe to every user. Made by a tester manufacturer with a modern plant, modern equipment and managed by thoroughly trained workmen. **BUY READRITE AND YOU BUY RIGHT.**

## TODAY'S TESTER...TESTS TOMORROW'S TUBES... MODEL 432-A

• Today's outstanding tube tester value—a guaranteed quality tester at a price you can afford to pay. The needs of tomorrow have been anticipated by the advanced design of Model 432-A, along with complete provision for today's testing.

Greater filament switching ranges . . . 20 steps from 1 to 110 volts . . . Anticipates future filament voltages. Broader Testing Facilities . . . Checks Loctals, Single Ends, Bantam Jr., Gaseous Rectifier, Ballast, the New High Voltage Series and all other present types. Direct-Reading GOOD-BAD scale . . . 3" Triplet precision indicating instrument (Grade "A" only). Approved RMA circuit. Neon shorts test—Separate plate tests on diodes and rectifiers.

Professional appearing black leatherette case has handle and removable cover. Modernistic etched panel—black and polished nickel . . . as good as it looks.

Model 432-A — U. S. A. Dealer Price . . . \$17.85

Model 432-A-742 is a combination Tube-Tester and Volt-Ohm-Milliammeter in a similar case, but slightly larger. Volt-Ohm-Milliammeter panel is a separate section. Ranges: AC-DC Volts 0-10-50-250-500-2500 (DC at 1000 ohms per volt); DC Milliamperes 0-1-10-100; Resistance .5 to 500 with 25 ohms center scale; 0-100,000 and 1½ Megohms. Model 432-A-742 U. S. A. Dealer Price . . . \$26.85

**Model 738**  
D.C. Pocket Volt-Ohm-Milliammeter with precision Triplet instrument having two genuine sapphire jewel bearings. Has selector switch, molded case. Ranges: D. C. Volts 0-15-150-750-1500 at 1000 ohms per volt; D. C. Milliamperes 0-1½-15-150; 0-500 low ohms, backup circuit; 0-500,000 ohms. Complete with accessories. U. S. A. Dealer Price . . . \$7.50

**Model 739**  
AC-DC Pocket Volt-Ohm-Milliammeter with precision Triplet instrument having two genuine sapphire jewel bearings. Has selector switch, molded case. Ranges: AC-DC Volts 0-15-150-750-1500 (D. C. 1000 ohms per volt); D. C. Milliamperes 0-1½-15-150; 0-500 low ohms; 0-500,000 ohms. Complete with accessories. U. S. A. Dealer Price \$9.90.

**READRITE METER WORKS**  
617 College Dr., Bluffton, Ohio

Please send me more information on  Model 432-A;  432-A-742;  Model 738;  Model 739.

Name .....

Address .....

City ..... State .....

## FORD-PHILCO F1640

(Continued from page 286)

tion. Push the automatic station selector once more and hold it down. Rotate the automatic dial up with your finger or the rubber on the end of a lead pencil until the word "dial" appears in the

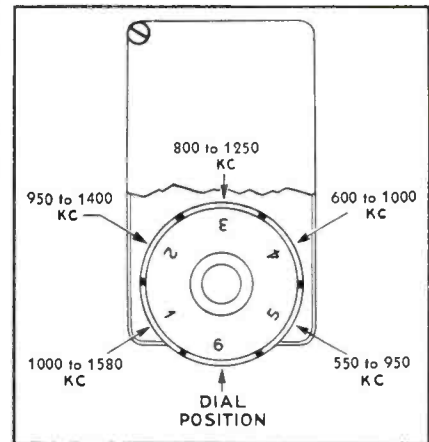

Fig. 6. The automatic dial is shipped without call letters so that the owner may select his favorite stations. The rotation of the dial is synchronized with that of the station selector switch.

dial window. Release the automatic station selector button and the automatic dial will be synchronized with the receiver.

The adjusting screws in the receiver can now be adjusted to the stations set

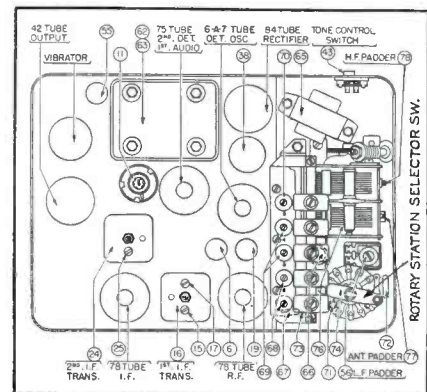

Fig. 8. There are six adjusting screws for alignment of the manual tuning and i-f circuits. In addition, five pairs of adjusting screws are provided for setting up the automatic tuning. The set employs six tubes.

up on the automatic dial. It is very important that these adjusting screws be set on a weak signal from the station so that the circuit will be sharply tuned to the particular station. Because of the strength of signals from strong local stations it is necessary that the antenna rod be removed from the antenna while these adjustments are made so that a minimum of signal will be received and thus assure sharp adjustments of the circuits.

# ASTATIC



Spring-Axial Cushioning, Bakelite Cartridge Assembly, latest Torque Crystal Element, Ebonite water-proof Crystal Coating, Massive Die-Cast Arm and other improved features.

**NEW CRYSTAL PICKUP**  
MODEL AB-8 offers more advanced design features than ever before combined in a single pickup unit at a similarly low price. Truest tone reproducing qualities. Ultra modern in design and finishes. **List Price \$10.00**

**ASTATIC MICROPHONE LABORATORY, INC.**  
Pioneer Manufacturers of Quality Crystal Devices **YOUNGSTOWN, OHIO** Licensed Under Brush Development Co. Patents



(1) Turn the receiver on and allow it to operate for about 20 minutes. Remove the cover plate over the automatic tuning adjusting screws. This plate is on the front of the receiver and can easily be pried off.

(2) Push the automatic station selector button until the word dial is at the window. Tune in the station whose call letters are in the No. 5 position on the dial (the lowest frequency station. See Fig. 7) and note the program so that it can be identified. Push the automatic station selector five times and this sta-

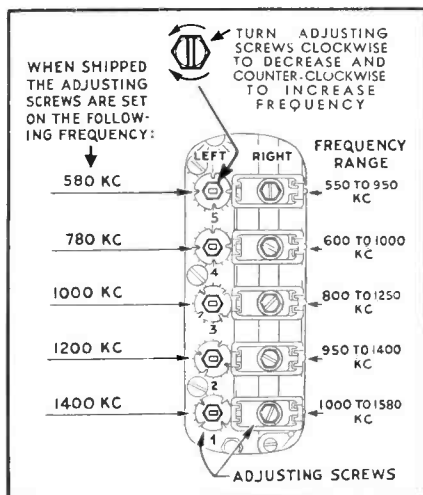

Fig. 7. The adjusting screws are set at the factory near the middle of the band which each covers. The frequency of the station desired should be determined and the screws turned clockwise to decrease their frequency setting and counterclockwise to increase it.

tion's call letters will appear at the window.

(3) With a small screwdriver, turn No. 5 adjusting screw (see Fig. 7) in the left column to the right or left until that station is tuned in. Adjust the corresponding screw in the right column until maximum volume is obtained.

Repeat this procedure until each of the five pairs of adjusting screws has been set to its respective station. It is necessary that the setting of the adjusting screws be repeated in the order given to be sure that they are properly set for maximum performance.

The call letters may be installed and the radio adjusted to the stations before the receiver is installed in the car, but final adjustments must be made with the radio operating with the car antenna.

• • • 1400-kc adjustment

Tune the receiver manually to a weak station at or near 1400 kc on the dial. If there is no station at that point then turn the volume control up until atmospheric background noise is heard. Remove the large snap button on the end of the receiver and adjust the trimmer for maximum output.

# The *SERVICEMAN'S* CHOICE



● It's so easy to replace broken-down condensers the AEROVOX exact-duplicate way. Handy listings in the form of wall chart at your jobber's, or in our catalog for your own shop use, indicate precisely which replacement goes into that set.

And that AEROVOX exact-duplicate replacement is matched electrically and mechanically to the original factory unit. Mount it in place—without a struggle. Connect it up—without messy patching. Turn on the set—and you've got a "good as new" job. That means a good price for your work, prompt payment, and a satisfied set owner.



★ Look us up at 208 Columbus St., Stevens Hotel.

## Ask for CATALOG...

Latest edition contains up-to-the-minute listing of exact duplicates, as well as other essential condensers. Ask your jobber for a copy—or write us direct. Meanwhile, try an exact duplicate on your very next job. Compare material and labor costs with old-fashioned way.

## AEROVOX CORPORATION

*New Bedford, Mass.*

Sales Offices in All Principal Cities



Have it  
your own way but  
have it the  
long way

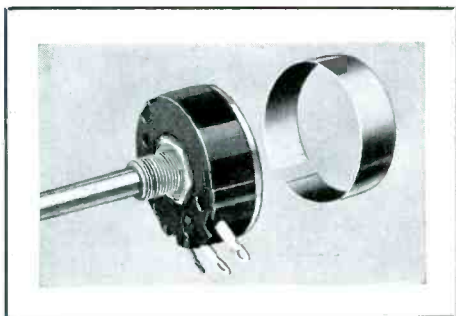

**STANDARD RADIOHM**  
The old reliable "Standard" that is 1 3/4" in diameter . . . used wherever sufficient space for this control is available.

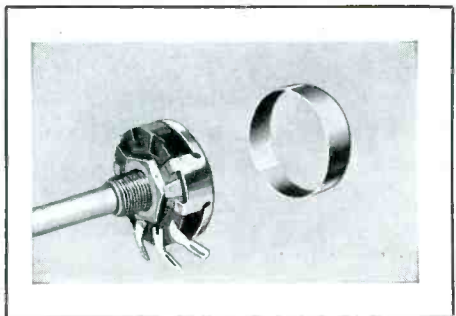

**MIDGET RADIOHM**  
1 1/4" in diameter . . . this small size necessary for re-placements in a great many modern sets.



**ADASHAFT KIT**  
Housed in metal box, hinged, contains ten Midget Radiohms, five types of attachable shafts, etc. . . . for more than 400 makes of receivers . . . actually thousands of different models.

Old Man Centralab is willing to be neutral as to your choice of Volume Control as long as you select one of his famous products . . . with the wall type resistor strip that hugs the inner circumference of the bakelite housing. Choose one of the Centralab family — STANDARD . . . MIDGET . . . or ADASHAFT . . . and be assured of

- Maximum resistor length for case diameter
- Lower specific resistance and attendant low noise level
- Close uniformity between resistors
- Better power dissipation
- Accurate tapers
- Longer life

# Centralab

**Div. of Globe-Union, Inc.  
Milwaukee, Wis.**

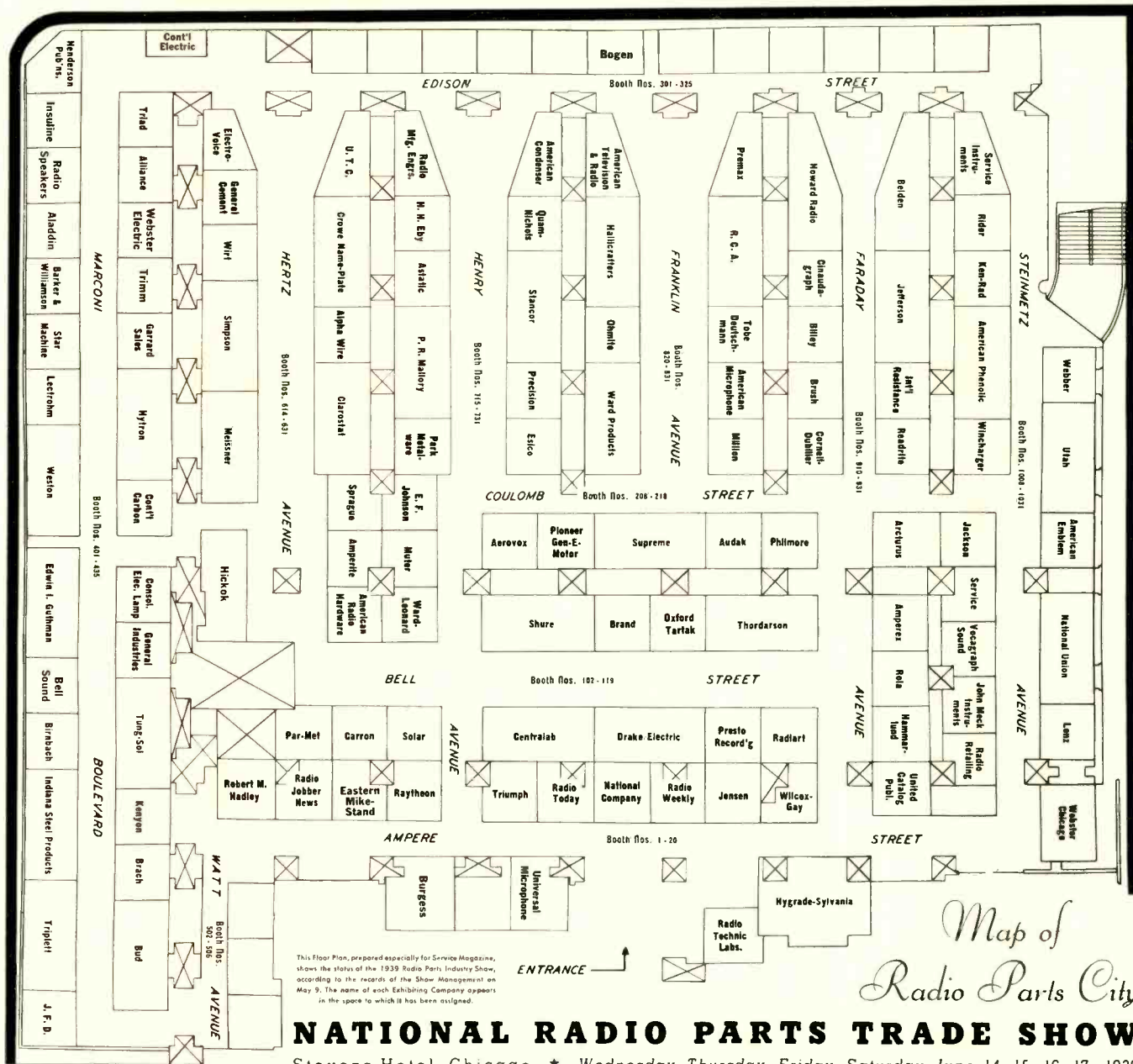

Map of  
Radio Parts City

**NATIONAL RADIO PARTS TRADE SHOW**  
Stevens Hotel, Chicago \* Wednesday, Thursday, Friday, Saturday, June 14, 15, 16, 17, 1939

**SHOW PROGRAM**

Second Annual Convention,  
Radio Servicemen of America  
Stevens Hotel, Chicago  
North Ball Room

**WEDNESDAY AND THURSDAY, JUNE 14-15**

10:00 A.M. Annual meeting of the Board of Directors of RSA, election of National Officers, reports of retiring officers, and other business of the board. Room 412.

**FRIDAY, JUNE 16**

3:00 P.M. "Facsimile," a lecture and demonstration of facsimile by engineers of Station WGN.  
4:00 P.M. "Television Service Problems and Suitable Test Devices," O. J. Morelock, Television Engineer, Weston Electrical Instrument Corp.  
7:00 P.M. Annual RSA Membership Meeting, T. P. Robinson, national president RSA, presiding. Presentation of reports of national officers, introduction to the convention of newly elected national officers and directors, and other business of the convention.

8:00 P.M. "Some Unusual Technical Features of Our Television System," a theoretical lecture with discussion of installation and service problems, Albert Preissman, RCA Institutes.  
9:00 P.M. "Radio Service Test Equipment," John F. Rider.

**SATURDAY, JUNE 17**

2:00 P.M. "Peak Limiting Amplifiers," Douglas Fortune, Thordarson Electric Manufacturing Co.  
3:00 P.M. "Radio Interference and Its Causes and Cures," Clarence W. Metcalf, Tobe Deutschmann Corp.  
4:00 P.M. "Complete Dynamic Testing with the New Supreme Vedolyzer," Bruce O. Burlingame, Supreme Instruments Corp.  
5:00 P.M. J. L. McLaughlin, Biley Electric Co., subject to be announced.  
5:30 P.M. G. L. Cole, Hallicrafters, Inc., subject to be announced.  
7:00 P.M. "What Television Will Mean to the Serviceman," Sanford R. Cowan, SERVICE Magazine.  
8:00 P.M. Awards of attendance prizes.  
8:05 P.M. "Tube Developments," George Connor, Hygrade-Sylvania, Corp.

**TOURS**

The Chicago chapter RSA and the Women's auxiliary of the Chicago chapter have arranged an interesting program of tours for the RSA Convention, June 16 and 17. Transportation and guides will be furnished RSA members on the tours.

**FRIDAY, JUNE 16:**

10:30 A.M. to 12:00 NOON. Stancor factory tour, with luncheon at the factory.  
1:00 P.M. to 2:30 P.M. Stockyards tour. Alternates: Chicago Historical Society. Lincoln Park buildings. Museum of Science and Industry.  
4:00 P.M. to 5:00 P.M. Tour of Marshall Field store.  
8:30 P.M. to . . . . . Visit a radio station.

**SATURDAY, JUNE 17**

9:30 A.M. to 12:00 NOON. Underwriters' Laboratory tour.  
1:00 P.M. to 5:00 P.M. Brookfield Zoo. Alternates: Shedd Aquarium. Field Museum. Adler Planetarium. Bus tour of city (Charge is \$1.50).  
7:30 P.M. WLS Barn Dance Show (reservations must be made in advance).

# YOUR CATHODE-RAY OSCILLOSCOPE

By J. H. REYNER

**T**HE examination of wave forms is only one of the many applications of the cathode-ray tube. In fact, any detailed discussion of its other possibilities is quite impracticable in the space allotted here. We can, however, consider some of the more important of these applications. The first of these is the alignment of receivers.

A cathode-ray tube can be made to operate at an instantaneous electronic voltmeter, the movement of the spot being made to correspond with the amplitude of the signal at any instant. This principle is used to plot resonance curves of the tuned circuits in a receiver.

An average signal generator applies a steady frequency to the input of the receiver and the voltage output may be noted at some convenient point by a v-t voltmeter or by an output meter. As the frequency of the signal generator is varied the voltage developed (i.e., the response of the receiver) changes, reaching a maximum at resonance and falling away on either side.

## • • • frequency modulator

For cathode-ray alignment, the frequency of the signal generator is caused to vary slightly over a small range of, say, 25 kc on each side of the mean

value. Thus, if the apparatus is set so that the mean value coincides with the resonance point of the receiver, the frequency actually varies from 25 kc below resonance to 25 kc above and back again. This excursion is usually enough to cover the whole of the normal response since a modern set gives only a negligible output 25 kc off resonance.

Let us assume that this variation in frequency is achieved by an additional trimmer condenser connected in parallel with the main condenser of the signal generator. Then as we rotate this condenser the output voltage will rise from practically zero to a maximum and back again. Suppose that instead of an output meter we connect a cathode-ray tube so arranged that the vertical movement of the spot is proportional to the voltage at any instant. Then as we rotate the trimmer on the signal generator, the cathode-ray spot will rise and fall.

Suppose now that we gang with the trimmer condenser a potentiometer connected to a battery, and take the slider of this potentiometer to the X plates of the tube as shown in Fig. 1. Then as the spindle is rotated an increasing voltage will be applied to the X plates, causing the spot to move in a horizontal direction. But we have already seen that the rotation of the spindle causes

the spot to rise to a maximum and fall to zero again, so that the combined effect of the two motions will be to produce a resonance curve as indicated.

If the operation is carried out slowly we shall not see the whole resonance curve at once (unless the tube is one which has a very long afterglow). If, however, we could arrange that the operation was carried out fairly rapidly, say 60 times per second, then a series of successive traces would be obtained all lying one on top of one another and we should obtain the impression of a stationary image in exactly the same way as we do with waveforms. One method of accomplishing this is to connect the spindle to an electric motor and set this in rotation. This is the basic principle of the frequency modulator.

## • • • mechanical systems

There are several precautions required in this simple arrangement. The shape of the trimmer condenser must be so arranged that the frequency is directly proportional to the rotation. Then if the potentiometer on the spindle is linear, the horizontal position of the spot will be proportional to the frequency at every point, and a true representation of the resonance curve will result.

Another difficulty is that with a normally constituted condenser a rotation of 180 degrees will provide the maximum change of capacitance, and any further rotation will cause the plates to come out of mesh again so that the capacity begins to decrease. The voltage developed by the potentiometer, however, is continually increasing, so that we obtain two resonance curves side by side, one being the mirror image of the other.

These difficulties can be overcome but this method has lost favor mainly because of the mechanical difficulties due to wear of the potentiometer and the like. In some instances the motor employed has been a synchronous type which makes one complete revolution in one period of the a-c supply. It becomes unnecessary to have a potentiometer, for it is possible to supply a-c directly

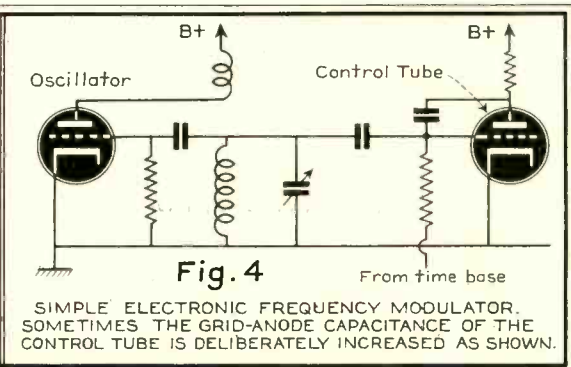
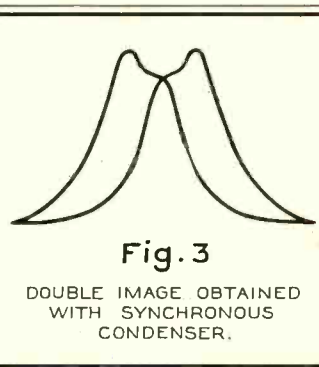
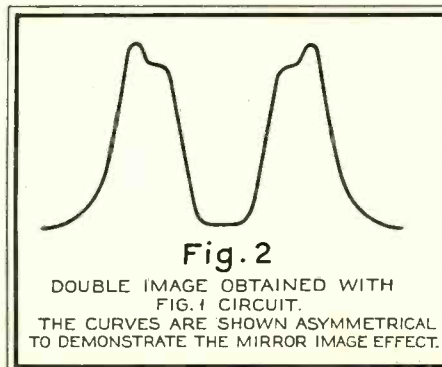
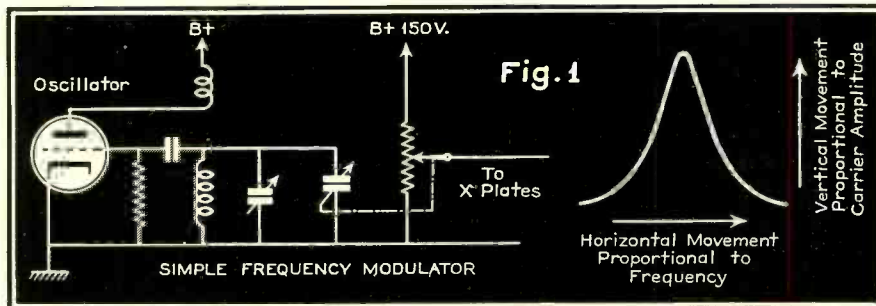

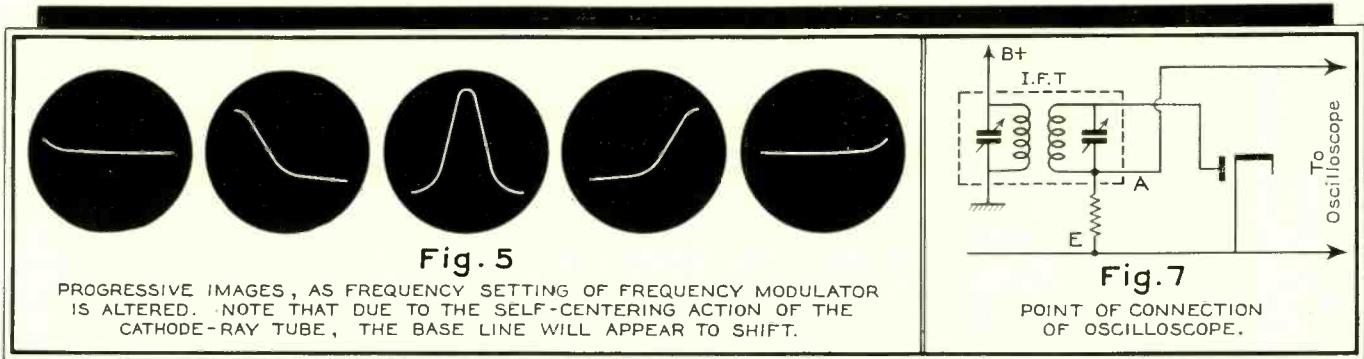

to the horizontal plates. The spot will then move over the screen and back again in one period, thus maintaining synchronism with the rotating condenser.

This method has the disadvantage that it shows the two response curves traced on the initial and return stroke of the condenser superposed, as indicated in Fig. 3. Once again, the images are mirror images and the presence of two patterns are apt to be confusing.

• • • **electronic methods**

Because of these difficulties modern frequency modulators usually adopt an electronic method of modulation. It is known that the grid-cathode or the plate-cathode reactance of a vacuum tube depends upon operating conditions. The simple circuit of Fig. 4, for instance, includes a tube with a resistive plate circuit. Under these conditions the input capacitance is

$$C_{eff} = C_{gc} + C_{gp} (1 + A)$$

where  $C_{gc}$  and  $C_{gp}$  are the grid-cathode and grid-plate capacitances respectively and  $A$  is the amplification of the stage.

Consequently, if the amplification  $A$  can be varied the effective input capacitance can be changed. The stage gain can be altered quite easily by varying the bias, and by suitable choice of tube and operating conditions it is possible to ensure that this change is linear with respect to the control voltage. If such a circuit is connected across an oscillator, the frequency generated can be varied by altering the bias on the tube.

This form of circuit can very conveniently be used with an oscilloscope by connecting the grid of the control tube to the oscilloscope sweep circuit. This is generating a gradually increasing voltage and if a suitable proportion of this voltage is applied to the grid of the control tube, the input capacitance and hence the frequency output from the oscillator can be varied in unison. The sweep voltage is already causing the spot on the cathode-ray screen to move horizontally and at the same time the frequency from the oscillator is changing, so that the output from the set is varying in similar fashion.

There are various other forms of

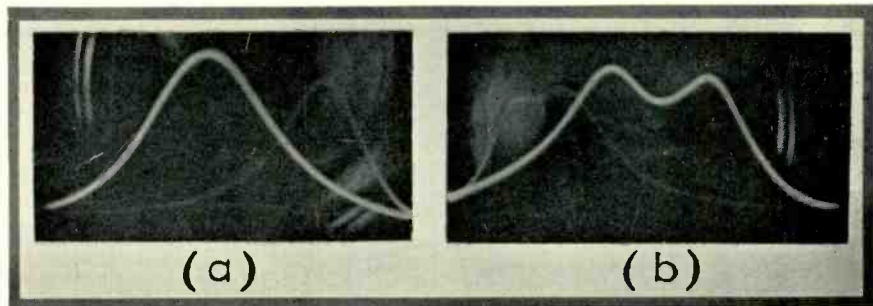

**Fig. 6.** The resonance curve for the primary of an i-f transformer is shown at (a). The curve for the entire transformer is shown at (b).

frequency control circuits with which the reader will doubtless be familiar since they are used in receivers embodying automatic frequency-control. Since we are concerned in this article with the cathode-ray tube it is not proposed to go into any further detail on this point. Any convenient method of frequency modulation can be used for the purpose.

• • • **image form**

It is interesting to consider the practical results of applying such a frequency modulated signal to a receiver or to any of the tuned circuits. Assuming again that the cathode-ray tube is so connected that the height of the spot indicates the voltage output from the receiver, let us see what happens for a frequency-modulated input. When the frequency is off resonance there will be no response and therefore the pattern on the screen of the cathode-ray tube will be a horizontal line (since it is being

deflected horizontally by the sweep voltage). As the signal generator dial is varied its frequency will ultimately come within the range of the receiver setting. When it does so a resonance curve will appear on the screen. It will start by a lifting of one side of the line and as the generator dial is steadily rotated, the whole of the pattern will gradually appear, as it were from the wings, and will pass slowly across the screen and off the other side.

The reason for this is clear on little consideration. Suppose the receiver is tuned to 1000 kc and its total tuning network provides a cut-off at anything outside the band 980—1020 kc. Let us assume further that the bandwidth of the frequency modulator is 50 kc total, i.e. 25 kc on each side of the mean frequency. When the mean frequency reaches 955 kc, the input frequency at one end of its excursion will just reach 980 kc, and since at this point the receiver begins to exhibit some response there will be a slight lifting of the line on the cathode-ray screen at one end.

When the signal generator reaches

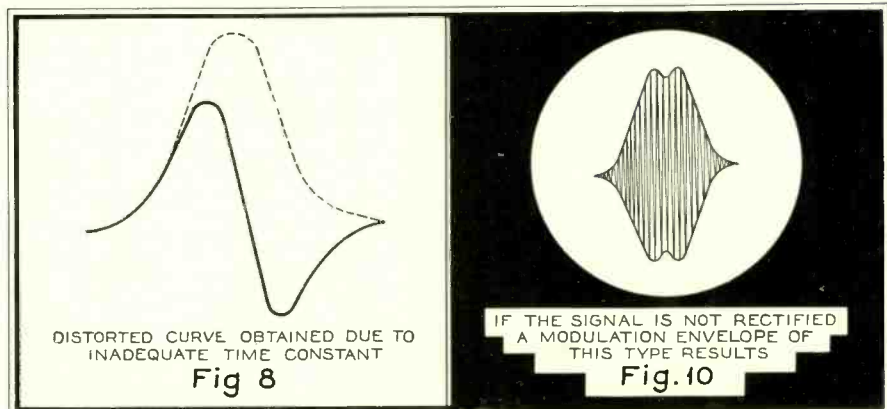

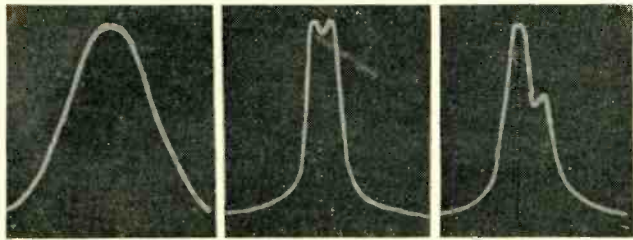

Fig. 9. Various types of resonance curves, showing a broadly tuned single stage; a band-pass i-f system; and the effect of detuning on an i-f transformer.

980 kc one half of the resonance curve will appear, for over that part of the excursion which runs from 980 to 1005 kc the receiver is responding, while on the other half no response is present. When the mean frequency reaches 1000 kc the image will be in the middle of the screen, and as the frequency is made still higher the image passes off the screen on the other side. The general effect is as illustrated in Fig. 5.

• • • self centering action

Fig. 5 also illustrates an effect common to many oscilloscopes—that of the self centering of the image. Since the plates are usually coupled to the work through isolating condensers a d-c potential cannot be sustained. Hence even if the impulses applied to the plates are all in the same direction the pattern on the screen will not lie entirely in the top (or bottom) half of the tube.

The isolating condenser will settle at a mean level such that the positive and negative charges acquired over the complete cycle are equal. This will cause the zero line to shift, and in fact as the process of tuning is carried out the base of the curve will shift downwards, often quite slowly if the time constant of the coupling circuit is long, as it should be.

The same thing will happen when examining an asymmetrical waveform, and in such cases a change of amplitude will be followed by a shifting of the pattern on the screen. This does not mean that something is wrong but it is apt to be confusing unless the reason for the shift is understood.

Many oscilloscopes, of course, are provided with shift controls, which are simple potentiometers applying d-c potentials to the plates so that the position of the image on the screen may be altered at will.

Fig. 6. (a) shows a resonance curve taken with an electronic frequency modulator of the type just discussed. This is a curve for the primary of an i-f transformer. Fig. 6 (b) shows the response of the complete transformer showing a nice double hump.

Inspection of the curves, however, shows that the width of the second curve is greater than that of the first. This should not be, for the purpose of the double circuit is usually to give better selectivity—i.e. a narrower band width. Fig. 6 (b) was actually taken with the circuits not correctly tuned. As the cir-

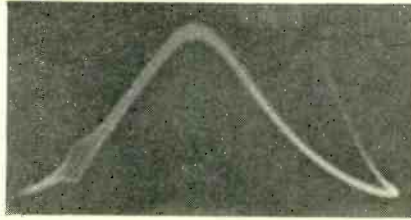

Fig. 11. Occasionally one finds a parasitic oscillation sitting on the resonance curve.

cuits are tuned correctly the humps come closer together and the optimum adjustment gives a band width definitely less than for a single circuit.

In practice therefore the trimmers should be adjusted for minimum bandwidth the top of the curve being either peaked or slightly double-humped depending on the type of set. The point is referred to further in Fig. 9.

• • • connection to receiver

Where should the oscilloscope be connected to obtain these response curves? Although an output meter is normally connected across the output stage of the

Fig. 12. One of the many uses of the oscilloscope is the checking of the modulation of a transmitter.

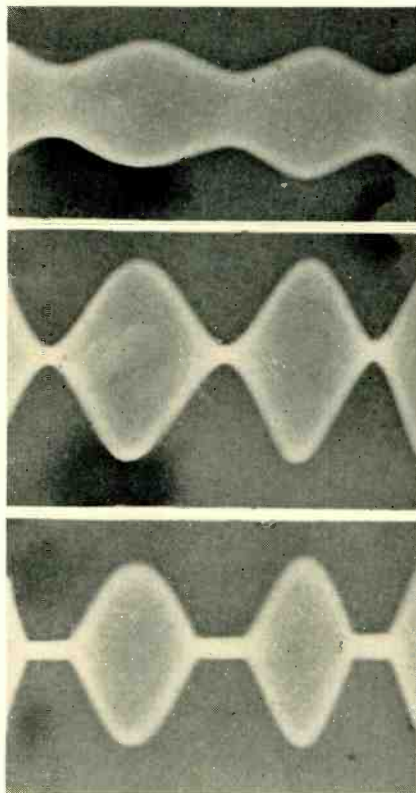

receiver, this is not practicable with a cathode-ray tube. The most usual position is to connect it across the detector, i.e. across the points shown in Fig. 7 which represents a typical diode detector. The voltage developed across this diode resistance is proportional to the instantaneous value of the carrier, so that when the circuit is in tune there is a large d-c voltage across the points A E and as the tuning falls off the d-c voltage decreases in proportion. If we connected the plates of the cathode-ray tube directly across these points, we should immediately fulfill the requirement that the height of the spot on the screen was proportional to the instantaneous signal strength.

As already explained, however, most oscilloscopes are not directly connected to the work but are isolated from d-c through a condenser and leak. It is essential therefore that the time constant of this condenser-leak combination shall be large enough to sustain any applied voltage for at least 1/50 second. If the voltage on the diode resistance rises, the coupling condenser is charged and this charge immediately begins to leak away. If this leak is too rapid, the effective voltage across the condenser will fall short of the true voltage and, worse still, when the voltage begins to fall again the condenser will charge up in the opposite direction and a curve of the form shown in Fig. 8 will be obtained instead of the true resonance curve (shown dotted).

• • • long time constant

The time constant required to avoid this happening is much longer than is necessary to transmit the ordinary low musical frequencies of 50 or 100 cycles, and a product CR of at least 1 megohm-microfarad is desirable.

It is possible to ensure that the condenser and leak in the oscilloscope do conform to this requirement, but the time constants of the couplings in the average radio receiver are by no means as good as this. Therefore, if the oscilloscope is connected at any stage later than the actual diode resistance it is almost certain that this distorted resonance curve will result.

Fig. 13. Applying the modulated wave to the Y plates and the modulation voltage to the X plates will produce a trapezoidal figure.

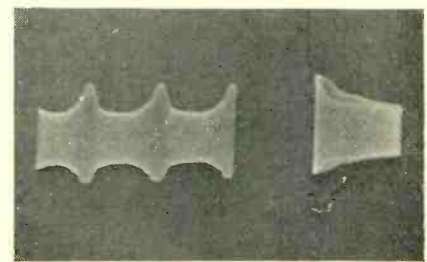

# A New TROUBLE SHOOTER

## THE MEISSNER ANALYST

*In Kit form  
at about  
half the  
price*

*Note Ease of Reading  
Channel by Channel*

**SERVICES  
ANY TYPE OF  
RECEIVER  
\$60 NET**

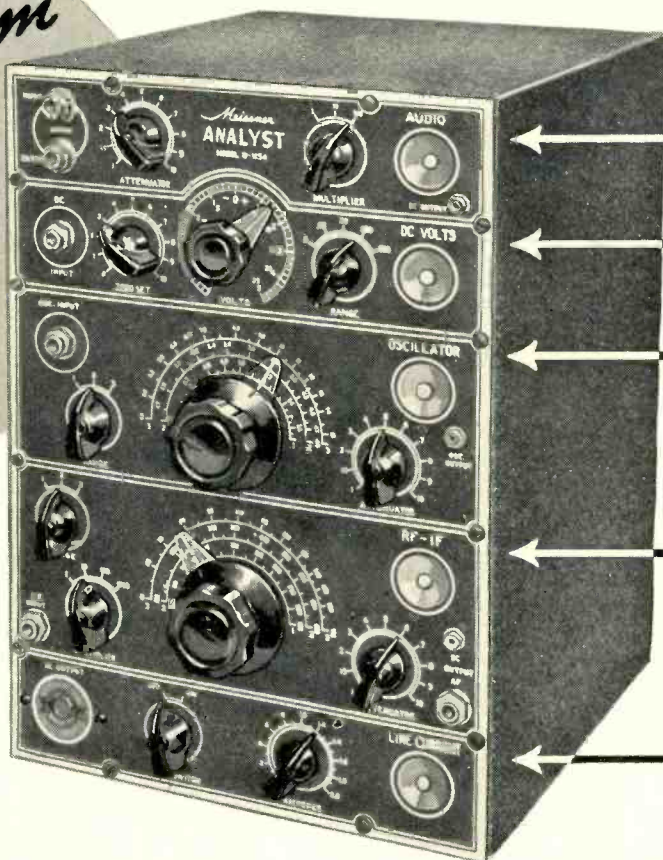

**AUDIO**  
50-50,000  
CYCLES

**VOLTMETER**  
5, 15, 50, 150,  
500 VOLTS

**OSCILLATOR**  
0.6 to 15.0 MC.

**RF-IF**  
95 to 1700 KC

**LINE CURRENT**  
0.3 to 3.0 AMP.

The Meissner ANALYST is not only highly efficient—covering every conceivable phase of signal testing—but is surprisingly easy to read and operate. This up-to-the-minute instrument will work wonders in raising the standard of service in your shop. It will take the kinks out of your toughest servicing problems... step up your efficiency... save valuable time... increase your profits.

It accurately measures both control and operating voltages without affecting the operation of the set. Channels can be tested individually or simultaneously. Reading is greatly simplified. There's an individual panel for each channel.

And best of all you buy the ANALYST in KIT FORM... Save nearly HALF the cost of a factory-wired set of comparable quality and efficiency. And at the same time acquire a fundamental knowledge of this instrument and what it will do for you that could not otherwise be obtained by weeks of study and experiment.

Get the facts on this revolutionary TIME and TROUBLE SAVER... See the Meissner ANALYST at your Parts Jobber's—or mail coupon below for FREE FOLDER... It tells the whole story!

This Folder gives you complete facts on the Meissner ANALYST. Explains in detail the scores of testing operations it performs faster and better.



MAIL IN ENVELOPE OR PASTE ON PENNY POSTCARD

MEISSNER MANUFACTURING COMPANY  
Mt. Carmel, Illinois, Dept. S-6

- I want that folder on the Meissner ANALYST  
 Also your 1939-40 Catalog on the complete Line

Name.....

Address.....

City..... State.....







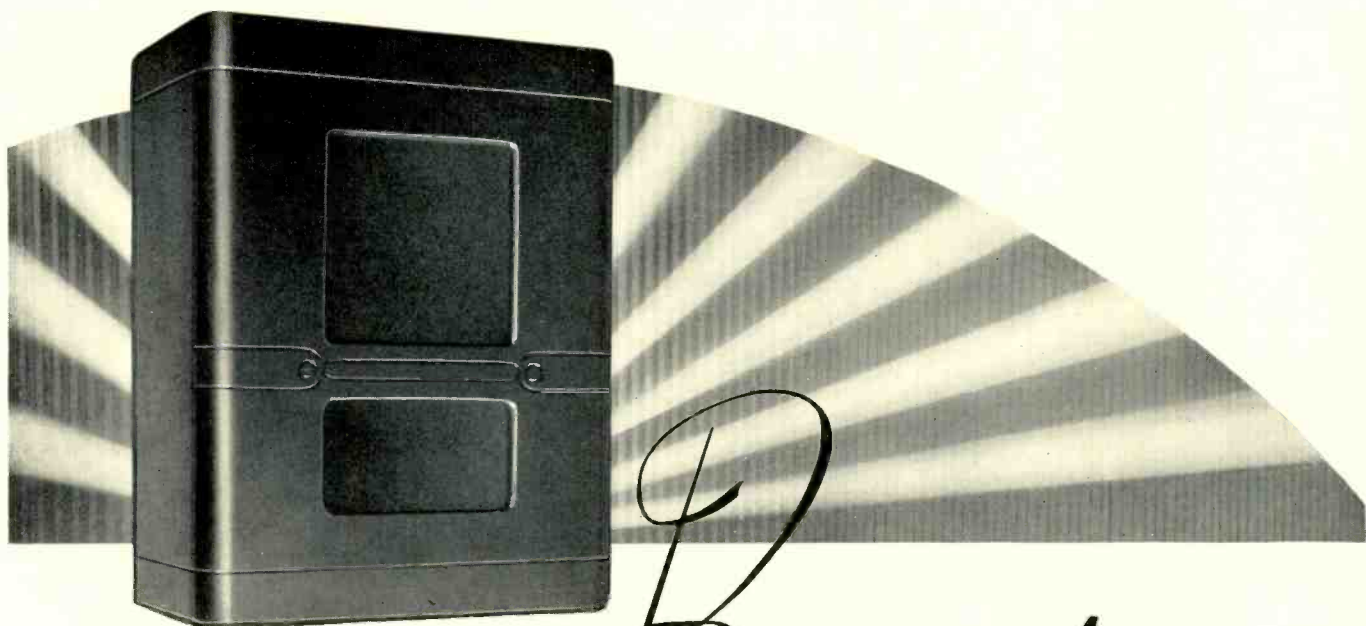

# **NEW** *Beauty* **IN JENSEN PERI-DYNAMIC** *Bass Reflex* **REPRODUCERS**

Jensen Scores Again! First—the introduction of those basic new principles in the acoustic art—*Peri-Dynamic* and *Bass Reflex*. In terms of actual performance this meant that new low frequency octaves could now be heard and over-all performance was raised to the highest level in the history of the cone type loud speaker. The skill and ability of Jensen engineers produced this scientific accomplishment which, when applied, delivered a complete product with compelling advantages. Cabinets were of acceptable dimensions, even though exceeding an infinite baffle in ability, and cost was surprisingly low. Now Jensen creates and adds to these exclusive values, cabinets as appropriate in beauty as the Reproducers are outstanding in performance.

These newly styled cabinets are finished in rich brown lacquer in subdued contrasting colors. Ideal for home, studio and public address use, these new cabinets further stress the Jensen policy of providing the utmost in practical values without price premium. Thus, Jensen provides Dealers, Service and Public Address Men with consistently greater opportunities for increase of volume and profit. Remember—*Peri-Dynamic* enclosures are shipped in convenient knock-down form; can be assembled in a few moments.

Write for illustrated literature.

## FIVE NEW MODELS

These new Reproducers are available with either 8, 10, 12, 15 or 18-inch Speakers; each speaker size with its own specially designed cabinet. Prices for complete reproducer (including speaker) from \$22.85 up. For Cabinet only, from \$16.00 up.

**Jensen**  
*"The Name  
Insures the Quality"*

**JENSEN RADIO MANUFACTURING COMPANY . . . 6601 SO. LARAMIE AVE., CHICAGO, ILL.**

It should be noted in passing that the voltage developed across the diode resistance is not enough in most cases to provide a satisfactory movement of the spot on the cathode ray screen, so that the voltage has to be passed through the amplifier of the oscilloscope, and it is essential to make sure that the time constants both of the input and output circuits of this amplifier conform to the stringent requirements just specified.

When testing a complete receiver it should be remembered that, due to a/c, the voltage developed across the diode load tends to remain constant. In aligning a receiver the procedure is to introduce frequency-modulated signals (through the i-f peak) to the grid of the last i-f tube and to note the output on the diode. This will give a broad resonance curve of the type shown in Fig. 9. The input is then transferred one stage farther back and the input suitably reduced. The resonance curve will then appear as before but narrower, and if there is any band-pass action in the tuning circuit it will probably show up better than on the first test.

The process is continued until the mixer is reached, after which the signal is introduced on to the antenna posts (at broadcast frequency), until the final response curve on the screen is that of the complete receiver.

At each stage the trimmers of the i-f transformers or r-f circuits may be adjusted until the maximum response is obtained and until the response is symmetrical and of minimum width. Fig. 9 (c) shows the effect of a detuned i-f transformer in which the hump has appreciably slipped. It is worth noting in passing that the reading given on a normal output meter would be very much the same for this resonance curve as for that shown in the previous figure, whereas there can be no question as to which adjustment gives the better quality.

• • • alternative connections

It is sometimes convenient to determine the response of a single circuit either on the bench or in course of examination of some part of a receiver prior to the normal detector. In such a case it is practicable to use the amplifier in the oscilloscope itself, converted to a detector by increasing the cathode resistance so that it operates as a plate-bend detector. Alternatively, an additional rectifier may be connected up ex-

ternal to the set and the output from this fed to the oscilloscope. The advantage of this method is that it is possible to examine any individual circuit in the receiver without necessarily coming off the end of the tuning chain.

Actually, it is not necessary to rectify the signals at all, for if the oscilloscope is connected across the tuned circuits themselves, the spot will move rapidly up and down at a radio frequency and the amplitude of this line will vary according to the tuning of the receiver. If this is done a filled-in resonance curve of the type shown in Fig. 10 (actually a modulation envelope in which the top of the pattern shows the resonance curve and the bottom shows the same curve upside down) will be obtained. In some cases it is convenient to adopt this technique. It is necessary, of course, either to have sufficient voltage to operate the tube directly or else

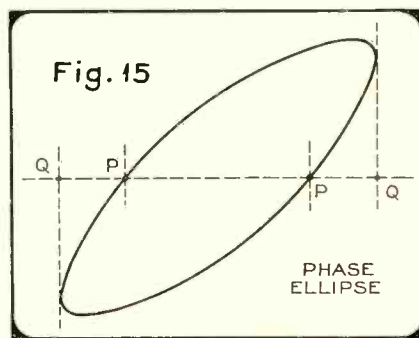

to use an amplifier which is capable of handling the radio frequency signal, at any rate, to some extent.

Attention should also be directed to the point mentioned in the last article, that the cathode ray tube is no respecter of sense—that the resonance curve may well appear upside down. It is not always easy to reverse it, for if the leads are changed over it is quite possible that some hum may be introduced with unpleasant effects, so that it is preferable to work the resonance curve upside down if it happens to appear this way.

If the amplifier in the oscilloscope overloads before full deflection is obtained the resonance curve will show a sharp flat top. Make sure therefore that the amplifier is linear over the full range of deflection.

Generally speaking the full gain of the amplifier should be used and the input to the set kept as low as possible to avoid overloading the earlier stages.

Hum, superposed on the image will cause puzzling effects, making the image

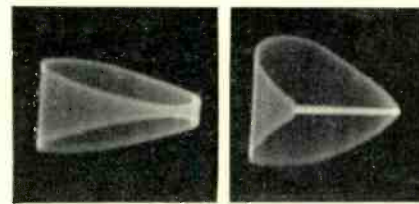

Fig. 14.

appear lopsided or producing a continual expansion and contraction of the band width. See that when no input is applied the trace on the screen is a horizontal straight line and does not exhibit any ripple. A slight reduction of the gain of the oscilloscope amplifier sometimes helps.

In any case it is best to operate the sweep at 60 cycles and to synchronize off the power line. (Most oscilloscopes have provision for this.) The image will then be quite steady.

A form of frequency modulator often used is the constant bandwidth type in which a mixing arrangement is used. A small oscillator is arranged to operate at some frequency outside the bandwidth to be examined. This oscillator is frequency modulated by one of the electronic methods already discussed. This wobbled oscillation is mixed with another oscillation from the signal generator such that the difference between the two gives the frequency required. For example, if the local frequency modulated oscillation is operating at 2000 kc and the signal generator is set at 2450 kc, then the beat output will be 450 kc and will be frequency modulated.

The advantage of this method is that the bandwidth of the frequency modulation is determined entirely by the fixed oscillator, and if this is adjusted to say 50 kc overall, then whatever the final beat frequency chosen whether it be i-f or r-f, it remains frequency modulated by this same 50 kc, so that the scale of the resonance curve appearing on the cathode ray screen is unchanged.

This method is quite popular. It has one disadvantage that a number of subsidiary resonance curves can appear on the screen which makes searching a little confusing. It is necessary therefore to know the frequency to which the receiver is tuned within a fair approximation and to see that the signal generator is correctly set to deliver somewhere around this frequency. Then as the generator dial is rotated the resonance curve will appear and may be easily recognized.

If there is any difficulty, a convenient test is to alter the dial setting of the receiver. If the arrangement is working correctly this will cause the resonance curve on the screen to move to one side or the other in exactly the

(Continued on page 308)

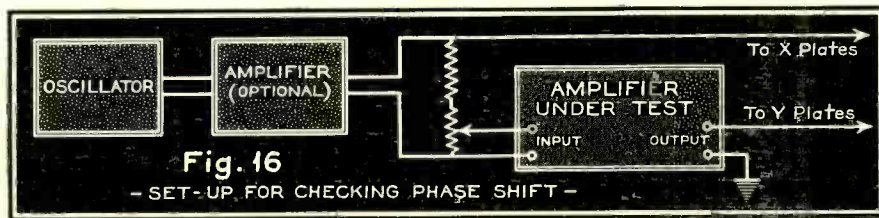

# Cunningham Radio Tubes Have the Advantage of RCA's TELEVISION Experience

Let the radio owners in your neighborhood know you use and recommend Cunningham Radio Tubes—the tubes built by RCA—the company that brought television to America... the tubes that are backed by the same careful research and built with the same skill that made the television dream an actual fact. The public will be impressed with this story—will come to you for Cunningham Radio Tubes!

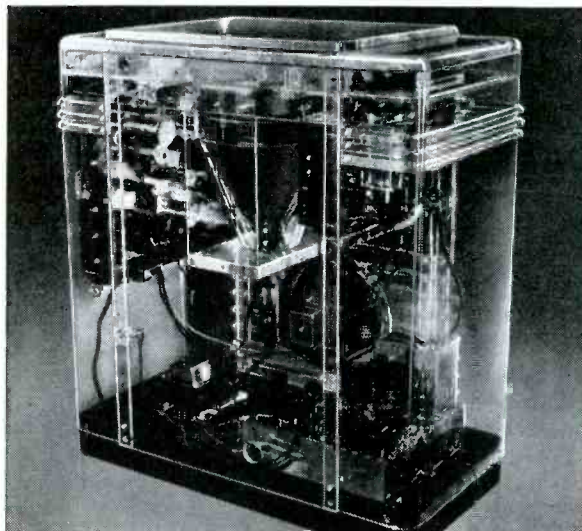

Above is shown a glass-enclosed interior of RCA Victor Television receiver on display at New York World's Fair. You can capitalize on the tremendous publicity that is being given RCA Victor Television if you feature Cunningham Radio Tubes.

Over 95 million Cunningham Radio Tubes have been sold for replacement service work.

Trademark "Cunningham" Reg. U. S. Pat. Off. by RCA Manufacturing Co., Inc.

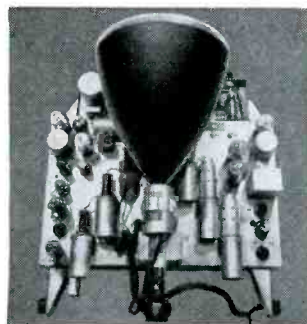

Typical RCA Victor Television chassis shows large number of tubes used. This is going to help you boost your Cunningham Radio Tube business because eventually all of these tubes will have to be replaced.

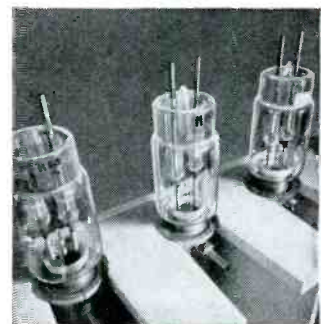

These are RCA High Frequency Television Tubes, built by the same men who build Cunningham Radio Tubes. The same research and skill that are responsible for these tubes are also incorporated in Cunningham Radio Tubes.

You are invited to witness a demonstration of  
RCA High Definition Electronic

## TELEVISION

at the RCA Victor Showrooms, 441 North Lake Shore Drive, Chicago, Ill., June 14-17. Tickets of admission may be obtained upon request from your distributor or at the RCA Mfg. Co. booth at the Parts Show.

# Cunningham Radio Tubes

STANDARD SINCE 1915

## DEFLECTING CIRCUITS

(Continued from page 274)

current amplifier deliver the maximum current to the deflection system. It requires in the neighborhood of 80 milliamperes peak-to-peak saw-tooth current in the plate circuit of a horizontal electromagnetic scanning amplifier to produce the 0.5 ampere current in the deflection coils which is necessary to scan a nine or twelve-inch cathode-ray tube at 6000 volts plate potential. Distributed capacitances in the plate circuit of the amplifier or across the scanning coils will short-circuit the high frequency components of the deflecting saw-tooth

wave and cause non-linearity of the picture and insufficiently rapid return time of the deflecting field. In such cases, the picture may be badly crowded from one side to the other and even a partial ghost-image may be produced in the background.

In servicing television receivers these points must be kept constantly in mind.

### • • • adjustments

Commercial television receivers employ various numbers of controls for adjusting the scanning pattern of the receiver. In general, the more expensive the receiver the more controls will be employed. In present day practice,

it is usual to provide at least six scanning controls. These are: the vertical hold control which controls the synchronization of the picture framing; picture height control which controls the amplitude of the vertical deflection; picture centering control which controls either the d-c potential on one deflecting plate or a d-c current through the deflecting coils to take care of misalignment of the cathode-ray beam at the center of the picture tube; horizontal hold control, which controls the horizontal synchronization; picture width control, which controls the amplitude of the horizontal deflection; and horizontal centering control.

Too great an amplitude of scanning and too great an amplitude of deflection may result in an overload of deflection amplifiers which will produce curvature and crowding in the picture and also may produce ghost-images. Improper adjustment of the hold controls may cause failure of interlace, or *tearing* from side to side of the lines of the picture. Overload of the contrast control can also cause these troubles. It must be emphasized that usually three or four different misadjustments may all contribute to the same effect of distortion in the received picture. For this reason a Service Man must become well versed in the theory of television scanning.

For this purpose it is suggested that he acquire and read all available current articles appearing on this subject. No general trouble-shooting information on all the troubles to be encountered can be given here.

**STEWART-WARNER 07-511 to 07-519 (CHAS. 07-51)**

*Hum or noise:* In some locations, due to peculiar power line conditions, background hum or noise may be excessive when the built-in antenna is used. In such cases try reversing the power line plug. If this doesn't correct the condition, remove the connector between A and A<sub>1</sub> on the back of the chassis. Connect an external antenna to A.

*Adjusting dial light:* The tuning knob and indicator should be spaced about 1/16 inch from the cabinet so that the dial light illuminates the dial scale and the pointer. For uniform illumination, the dial light bulb filament should be located directly over the tuning shaft. If it isn't, bend the dial light bracket slightly. In later production receivers, a round dial light bulb is used so that it is not necessary to bend the bracket.

*Production changes:* One change has been made in the later production of this receiver and is not indicated in the service manual. The resistor (No. 17, 33 ohms) connected in parallel with the pilot light has been changed to a 3-watt moulded wire wound resistor instead of the original 1/2 watt type. This is advisable so as to protect the resistor in case the pilot lamp fails. The 3-watt rating should be used for replacement in every case.

J. N. Goltzen

# HICKOK LEADS AGAIN!

## NEW ZERO CURRENT VOLTMETER HAS RANGES FOR RADIO AND TELEVISION SERVICING ---

### MODEL 210X

*Infinite Ohms per Volt at 250 Volts! . . . . . 10,000 Volts at 88,888 ohms per Volt!*

Other Features Include: NEW 9 1/4" RECTANGULAR METER with scale length of 8 3/4"—Two inches longer than same size round meter.

METERED POWER OUTLET in the panel by means of which the power consumption of the unit under test may be checked at any time or watched for intermittent troubles.

2.5 and 25 Ampere Ranges are incorporated in a specially designed circuit which eliminates all errors due to contact resistance.

In addition to these features also has wide ranges of A.C. and D.C. volts at 1000 ohms per volt to 2500 volts, D.C. milliamperes, resistance to 50 megohms, capacity to 200 microfarads and decibels.

Other new Hickok Instruments and improvements to present Hickok Testers include new panels, larger ranges for television as well as radio testing.

*See them at the Radio Show and mail the coupon for complete literature and information.*

**THE HICKOK ELECTRICAL INSTRUMENT CO.**  
CLEVELAND, OHIO

**MAIL THIS COUPON**



**THE HICKOK ELECTRICAL INSTRUMENT CO.,**  
10407 Dupont Ave., Cleveland, Ohio

GENTLEMEN:  Please send literature on Model 210X.  
 Please send literature on complete line of new Radio Test Equipment.

NAME .....  
ADDRESS .....  
CITY ..... STATE .....

## BOOK REVIEW

*A. C. MOTORS OF FRACTIONAL HORSE-POWER*, by H. H. Jones, published by the Chemical Publishing Company of N. Y. Inc., 148 Lafayette Street, New York City, 1938, 189 pages, price \$3.00.

Since the emphasis in this book is placed mainly upon the practical aspects of motor construction, the treatment is non-mathematical in character. The few formulas which appear require but the slightest knowledge of elementary algebra.

The author prefaces the exposition of each type of motor with an excellent, oversimplified description of the underlying theory. He then jumps to a design formula but does not explain the theoretical significance of this formula. In addition, the author uses terms pertaining to motors which he does not explain. It is regrettable that these defects should mar an otherwise excellent book, for, as it stands, this book can only be recommended either to the engineer already familiar with motor principles, or to the individual who is willing to supplement his reading in this book by some other text in the field. D. B.

## TELEVISION I-FS

(Continued from page 281)

after the inductors have been set for suitable pass-band response. This unit contains a fixed coupling element, the response being controlled by the inductor adjustments only.

**Unit No. 29.** Two slotted studs:—Inductor adjustments; Center screw:—Wave-trap setting.

Adjustment of unit No. 29 is similar to that of No. 48, except that its wave trap be set for maximum attenuation at the associated sound channel intermediate frequency. It is advisable to adjust units No. 48 and 29 simultaneously, the signal being fed into the first i-f grid.

**Unit No. 47.** Two slotted studs:—Inductor adjustments; Center screw:—Wave-trap setting.

Set wave-trap for maximum attenuation of the adjacent channel sound intermediate frequency. This unit combines with No. 45 to form a suitable network. The inductor adjustment should be made only after unit No. 45 has been adjusted. Re-setting of the wave-trap may be necessary after the inductors have been set for suitable pass-band response.

**Unit No. 45.** Two top trimmers—Adjustments for sound i-f wave trap and sound channel input circuit.

Using an associated sound channel i-f signal, set the wave-trap (side having yellow lug) for maximum attenuation in the picture i-f response. Set the sound channel input circuit trimmer (side having green lug) for maximum sound i-f channel output. Circuit interaction requires resetting of both settings after alignment of unit No. 47 is completed. When aligning the 47-45 combination the signal is fed into the converter grid.

• • • frequencies

Sound channel i-f: 8.25 mc; picture channel i-f: 12.75 mc; adjacent channel sound i-f: 14.25 mc.

# 4 SPRAGUE CONDENSER LEADERS

## SWING 'EM—BEND 'EM —OR ADJUST 'EM

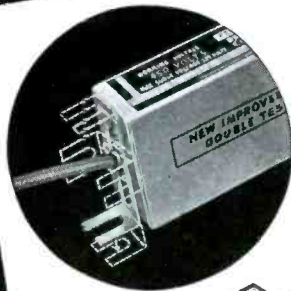

Your job made easier! Always a leader in quality, Sprague Type PTM 450 V. small cardboard drys are now equipped with a Universal Mounting Tab which makes them doubly useful—doubly easy to install. Mount 'em in any position. Put 'em any old place or in any old chassis holes. And don't forget! PTM'S are conservatively rated at 525 volts but will stand surges as high as 560 to 580 volts—and come back for more. They're tops for any radio need!

"The Quality Condensers for Those 'Careful' Jobs"

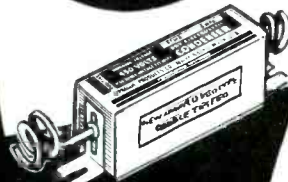

## MONEY-SAVERS FOR UNIVERSAL REPLACEMENT USE

Sprague ATOMS (midget drys) are the fastest selling condensers on the market today—and the more you use them, the better you like them. Atoms are smaller. They are made in both single and dual combinations in all voltages for every replacement need. They've got lower power factor, lower leakage. They're unconditionally guaranteed against "blow-ups." They're first choice of smart buyers for old replacement jobs where the call is for big league condenser performance at a rock-bottom price.

**TYPICAL ATOM VALUES**

TA-10, 10 mfd.	UT-8, 8 mfd.	UT-88, 8-8 mfd.
25 volts	450 volts	450 volts
5% x 1 1/2%	13/16" x 1 1/8"	1" x 2 3/8"
Net 24¢	Net 36¢	Net 60¢

Other values and sizes in proportion.



## HIGH VOLTAGE PROTECTION FOR AMATEURS

No chance to electrocute yourself here! Sprague Transmitting Condensers with the new Life-guard Terminal Protective Caps are designed to protect every amateur who recognizes the danger of the high voltages now used in most rigs. Caps fit snugly over condenser terminals — give absolute protection against danger of accidental contact. Lifeguards supplied free with all Sprague Xmitting units, or you can buy them for your old condensers at 25c list per pair. WRITE for complete Sprague Catalog of all types of Condensers, Interference Materials, Test Units, etc.



## HERE'S REAL BY-PASS RELIABILITY!



Servicemen who started using Sprague TC Tubulars more than ten years ago, still insist on them today. There is no better evidence of the dependability that has made TC's the most widely used condensers ever produced! Test voltage 1,200 volts; working voltage 600 volts. Made in all ranges from .001 mfd. to 1.0 mfd. Sold singly or in handy kits that save you time and money.

"Not a Failure in a Million!"

# SPRAGUE

THE NAME THAT HAS STOOD FOR BETTER CONDENSERS SINCE THE BEGINNING OF RADIO

SPRAGUE PRODUCTS COMPANY

NORTH ADAMS, MASS.

SERVICE, JUNE, 1939 • 301

# MANUFACTURERS

## C-D CAPACITOR TESTERS

Cornell-Dubilier have released their capacitor test equipment line. The first instruments to be built will be the capacitor analyzer, capacitor bridge and capacitor decade boxes. The Model BF 50 capacitor analyzer will measure the characteristics of paper, mica, oil, wet and dry electrolytic and motor starting capacitors. The Analyzer consists essentially of a Wien bridge connected to a single stage of amplification which operates a visual indicator

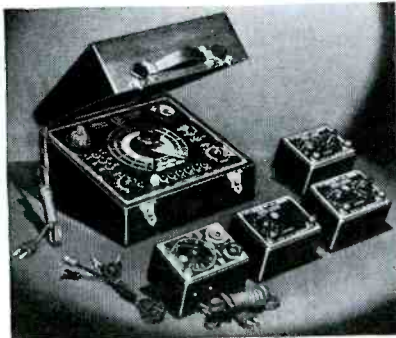

tube. A built-in power supply provides 450 v d-c for leakage and insulation resistance measurements.

These instruments are described in detail in Catalog 167A which may be obtained directly from *Cornell-Dubilier Electric Corp.*, South Plainfield, N. J.

## PHANTOM TUNETTE

Beverly Electric have announced their Phantom Tunette, a push-button and manual remote control device of the heterodyne oscillator type. No change is required in the receiver for its operation. It will control one or more radios from the remote point without wire interconnection.

For additional information write to *Beverly Electric Mfg. Co.*, Beverly Hills, Calif.

## BELL P-A SYSTEM

The Bell 15-watt high-gain amplifier, shown in the accompanying illustration, incorporates inverse feedback; tone compensation; three input channels, with separate controls; beam power tubes and a tap switch for matching the output impedance to its load. Two 10-in. pm. speakers are mounted in the halves of a grey Keratol carrying case. The system can also be wired for remote control.

For more complete information on this and other Bell p-a items write to *Bell Sound Systems, Inc.*, 1183 Essex Ave., Columbus, Ohio.

## CLARION MOBILE AMPLIFIER

The Clarion Model A30MR mobile amplifier contains a built-in 6-volt and 110-volt power supply. It features 3 input channels with mixing facilities and tone control. Output impedances are provided from 2 to 500 ohms. Gain: 122 db. Two 12-in. pm. speakers with parabolic reflectors are also included.

For additional information write to *Transformer Corp., of America*, 69 Wooster St., New York City.

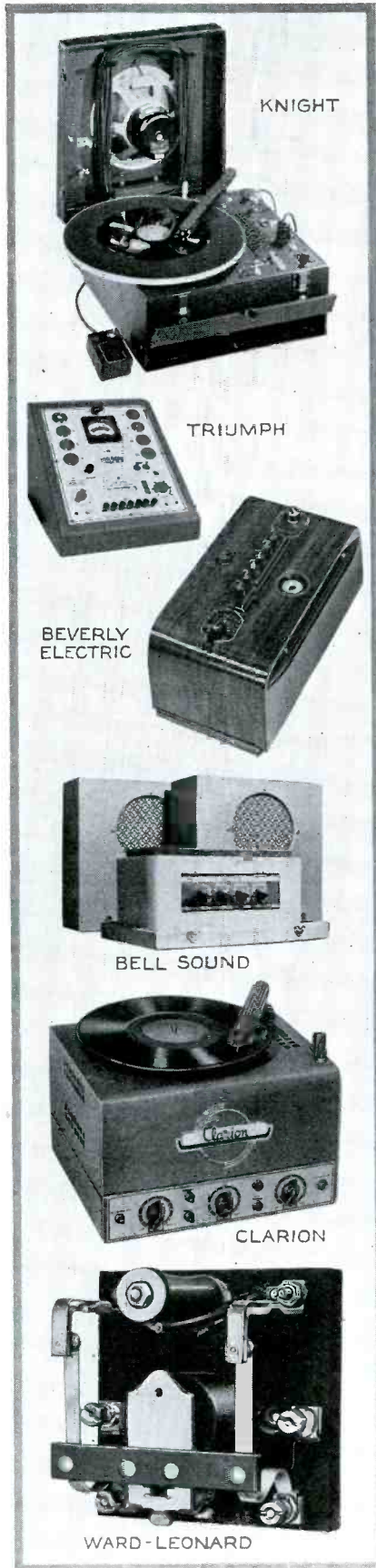

## KNIGHT RECORDER

The Knight transcription player has a provision for remote control whereby the turntable can be stopped or started and the volume controlled from any distance up to 50 ft. The 16-in. cast aluminum turntable will accommodate records up to 17½ in. A dual speed induction motor is used.

For additional information write to *Allied Radio Corp.*, 833 W. Jackson Blvd., Chicago.

## DUMONT PEEK-A-BOOTH

To facilitate the proper demonstration of television in day-lighted or brightly illuminated stores, a handy booth referred to as the Peek-A-Booth is now made available to dealers by DuMont.

Additional information may be obtained from *Allen B. DuMont Labs.*, 2 Main Ave., Passaic, N. J.

## TRIUMPH TUBE TESTER

The Triumph Model 430LX tube tester is of the push-button type and is designed to test all types of tubes including the new 1.4-volt, GT and loktal types. A spare loktal socket for roaming filament connection is also included. A neon short indicator serves to test ballast resistor tubes as well. Provision is also made for testing pilot lamps.

For additional information and prices write to *Triumph Mfg. Co.*, 4019 W. Lake St., Chicago.

## HICKOK VOLTMETER

The Hickok Model 210X is a bench tester with the zero-current voltmeter. Additional ranges are added (at 88,888-ohms-per-volt) to 1,000 and 10,000 volts. A 2.5- and 25-amp range; a-c and d-c voltage ranges (at 1,000-ohms-per-volt) to 2,500 volts; d-c ma; ohms to 50 meg; capacity to 200 mfd; db and power con-

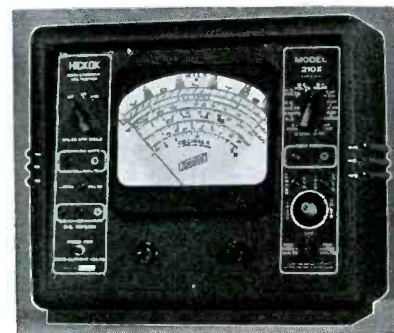

sumption tests are additional features of the instrument.

For more information and prices on this and other Hickok instruments write to *Hickok Electrical Instrument Co.*, 10507 Dupont Ave., Cleveland, Ohio.

## WARD LEONARD RELAYS

The Ward Leonard safety relay No. 507-546 has been developed for installation on high voltage devices to protect the operator against shock from static discharges. The relay automatically discharges the filter condensers. A complete description of the device is contained on data sheet No. 5070. Write to *Ward Leonard Electric Co.*, Mt. Vernon, N. Y.

(Continued on page 305)

Can you test . . .

**LOKTALS? BANTAMS? "S" TYPES?  
35, 45, 50, 70, 85 VOLT  
HEATER TYPES?**



**NATIONAL UNION  
QUALITY**

QUALITY is the National Union By-Word. Radio Service Engineers recognize and recommend the finer quality, research skill and time-proven experience that backs every N.U. tube. For absolute customer satisfaction, you should feature National Union Quality.

**Take advantage of NATIONAL UNION offers  
NOW before contract points GO UP JULY 1st.**

**Your Choice of these famous makes tube testers  
ALL GUARANTEED to TEST LATEST TUBES!**

Here's the chance of a lifetime to get the tube testing equipment you always want and need. National Union NOW makes it possible for you to choose from all the newest models of leading instrument manufacturers . . . every one guaranteed to test all the latest tubes! AND—right now is the time to get it! Before the Purchase Points Go Up July 1st.

See your National Union jobber at once. He will give you details of the simple N.U. plan which has already provided thousands of satisfactory deals. Arrange to have the tester you choose shipped immediately.

**NATIONAL UNION RADIO CORPORATION  
NEWARK, N. J.**

**GET A NEW TESTER  
Free!**

NATIONAL UNION RADIO CORPORATION  
57 State Street, Newark, N. J.

Please send me information on how I can  
get my choice of leading test equipment FREE.

Name .....

Address .....

City..... State.....

S-639

# RSA is YOUR Host

Second Annual RSA Convention  
JUNE 16 and 17, STEVENS HOTEL, CHICAGO

YOU CAN'T AFFORD TO MISS:

★ **TELEVISION** Lectures for servicemen by outstanding television authorities.

★ **FACSIMILE**                      ★ **TEST EQUIPMENT**  
★ **TUBES**                              ★ **NOISE ELIMINATION**

MAIL THIS COUPON FOR YOUR ADVANCE COPY OF RSA CONVENTION PROGRAM

**RADIO SERVICEMEN OF AMERICA, Inc.**  
304 S. Dearborn St., Chicago, Ill.  
Sure I'll be at the RSA Convention.

Name .....

Address .....

City..... State.....

Please send advance copy of Convention Program.....

I am interested in RSA Membership. Tell me about it....

I am enclosing \$4.00 for National dues and initiation.....

(Does not include Local Chapter dues where Local Chapters are organized.)

S-539

Because we are the only NATIONAL organization of servicemen, we are able to arrange an outstanding program for RSA members. RSA invites YOU, Mr. Serviceman, to attend our Convention and see what RSA is doing for you.

The RSA Convention is only one of the benefits RSA is providing. You can get ALL the benefits by joining your fellow servicemen in RSA.

*Let's Grow Together  
in 1939!*



**RADIO SERVICEMEN OF AMERICA, INC.**

304 S. DEARBORN STREET, CHICAGO

## SERVICE MEN

Here is a soldering iron designed especially for your use. Note the features listed below and remember that "High Heat" means high value for you.

### FEATURES

3/8 IN. COPPER TIP

125-WATT ELEMENT  
WOUND WITH NICHROME ON AMBER MICA WITH NICKEL PLATED SEAMLESS HOUSING

BAFFLE PLATES  
KEEP HANDLE COOL

LISTED BY  
UNDERWRITERS' LABORATORIES

6 FT. CORD  
UNBREAKABLE PLUG



No. 325 SPECIAL (Complete with Stand) \$4.50 List  
See Drake Soldering Irons at your parts jobber's or at the Radio Parts Trade Show.

**DRAKE ELECTRIC WORKS**  
INC.  
3656 LINCOLN AVE., CHICAGO, ILL.

### RCA TELEVISION AT PARTS SHOW

Visitors attending the Trade Show in Chicago will be given an opportunity to witness a television demonstration as the guests of RCA Victor. Each visitor attending the demonstration will be permitted to appear before the television cameras, while fellow visitors see and hear him by means of stock RCA Victor television receivers in an adjoining room.

Demonstrations will be held daily during the Parts Show (June 14 to 17 inclusive) in special television studios at the RCA Victor Distributing Corp., 441 North Lake Shore Drive. Tickets for the demonstration are being mailed to all RCA parts, tube, instrument, test equipment and power tube distributors for their own use and for distributing to their dealers who will attend the Parts Show. The demonstration will be conducted from 10:00 to 11:45 A.M., and from 2:00 to 4:30 P.M., each day.

### MAJESTIC TELEVISION

Majestic have entered into a license agreement with the Allen B. DuMont Labs. whereby the former will sell television receivers manufactured by DuMont. A full line of table and console models will be available. For additional information write to Majestic Radio & Television Corp., 2600 W. 50th St., Chicago.

### KENRAD TUBE CHART

KenRad Tube & Lamp Corp., Owensboro, Ky., have released their latest tube characteristics chart which gives essential data on all types of tubes released on or before May 15, 1939.

Copies may be obtained directly from KenRad.

## TELEVISION ADVANCED TRAINING

FOR MEN NOW EMPLOYED IN THE RADIO INDUSTRY

To those now employed in radio, we offer thorough, modern advanced training in television, endorsed by men in the radio industry, created by experienced engineers, backed by costly equipment conforming to RMA standards.

### FOUR PLANS

Four plans, carefully designed to fit the individual needs of the majority of men now engaged in radio, are available. The tuition rate is low, yet outstanding quality is apparent.

### TELEVISION HAS ARRIVED

Regardless of the position you hold or the kind of radio work you are doing, television will probably affect you. Then too, you should not overlook the new opportunities that television can place within your reach.

### Write For Details

We invite you to write for complete information at once. Your inquiry will receive the personal attention of Mr. C. L. Taylor, President.

### MIDLAND TELEVISION, INC.

Power and Light Bldg.,  
Kansas City, Mo.  
AFFILIATED WITH KMBC



#### ATR SHAVERPACKS

ATR announce a complete line of shaver-packs for operating a-c razors from 6, 12, 32, 110 and 220 volt d-c lines. The units may also be used for operating other small a-c motors from d-c sources. The shaver-



packs deliver a maximum of 15 watts at 60 cycles.

Additional information may be obtained from *American Television & Radio Co.*, 300 E. 4th St., St. Paul, Minn.

#### DRAKE IRON STAND

Drake Electric are featuring a soldering iron stand with a cup or depression in the bottom which is filled with steel wool. By twising the tip of the iron in this steel



wool the operator can remove the oxide conveniently, it is said.

For additional information write *Drake Electric Works, Inc.*, 3656 Lincoln Ave., Chicago.

#### IRC MIDGET CONTROLS

Midget controls with metallized type resistance element and construction features heretofore available only in the larger controls have been announced by the IRC. Known as IRC Type D Midgets, the new controls are designed to accommodate two types of plug-in shafts.

The new IRC Volume Control Replacement Guide is now available free of charge to bonafide Service Men. It includes com-

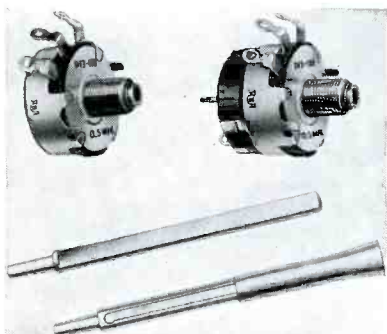

plete listings of the new midget controls as well as the recently announced IRC auto radio and type W wire wound controls, thus providing an accurate guide for practically any replacement. Write to *International Resistance Co.*, 401 N. Broad St., Philadelphia, Pa.

## Overcoming a Handicap

- For many years a great handicap has existed in the Radio Service Industry. This was the factor of obsolescence of test equipment introduced each time a tube engineer developed a new tube or a receiver manufacturer announced a variation in circuit design. Men who have been active in radio servicing during the past fifteen years have felt the financial pressure brought to bear by the continued need for new equipment—a definite hardship on an industry operating with limited funds.
- When we introduced the Rider Chanalyst in 1938 we made the statement that "here was a servicing instrument which was virtually independent of the obsolescence factor" . . . because it was founded upon the most fundamental element in communication—the Signal itself. Its application and usefulness would not be curtailed by developments in radio receiver circuits and tubes.
- That statement is true today. The Rider Chanalyst is just as fundamental in 1939 as it was last year, and we guarantee that it will be just as fundamental in 1940 and the years to come. The present day Chanalyst is a basic unit applicable to the servicing of forty million American receivers now in the hands of the public. When television, radio facsimile and frequency modulated form of transmission become widespread throughout the United States today's Chanalyst will still be the fundamental servicing instrument, because such transmission, like the present day broadcasts, is still the propagation of a signal.
- The statement we made to servicemen in 1938 to the effect that the Rider Chanalyst would not become obsolete is as true today as it was then. The 1939 Radio Parts Show in Chicago will see this instrument just as it was in 1938. The radio servicemen who bought this instrument in 1938 made a secure investment. The men who buy Rider Chanalysts during 1939 can do so with the full and complete confidence that their financial expenditure will be safe for years to come.

*John F. Rider*

#### RCA TUBES

Preliminary technical information has been released on four new RCA tubes, as follows: 6J7GT triple-grid detector amplifier, 6K6GT power amplifier pentode, 12J7GT triple-grid detector amplifier, 35Z5GT high-vacuum half-wave rectifier with heater tap for pilot lamp. These four types have octal bases and tubular (T-9) bulbs and supplement types in the GT-series already announced. Ratings and characteristics of these new tubes are available from *RCA Radiotron Division, RCA Manufacturing Co., Inc.*, Harrison, N. J.

#### TACO TELE ANTENNA

A television antenna with universal joint mounting, permitting adjustments in all directions, is now offered by TACO. The di-pole is constructed of duraluminum rods held together with a center insulator. Two extension rods screw into the center rods for attaining the correct length of the dipole. Mounting straps are provided for mounting to an iron pipe or wooden mast. A reflector is available wherever needed, and the same adjustments are provided for the full antenna-reflector assembly.

Additional information may be obtained directly from *Technical Appliance Corp.*, 17 E. 16 St., New York City.

#### OHIO INSULATED RESISTOR

Ohio Carbon announce their Ohiohm porcelain insulated carbon resistor, available in  $\frac{1}{4}$ ,  $\frac{1}{2}$  and 1 watt ratings. The resistor is enclosed in a ceramic tube of uniform wall-thickness and is sealed at both ends. The resistors are supplied in resistance ranges from 50 to 250,000 ohms.

Additional details may be obtained from *Ohio Carbon Co.*, 12508 Beren Rd., Cleveland, Ohio.

#### AMCON CAPACITORS

American Condenser Corp. have introduced their midget line of electrolytic capacitors which they call Little Americans. It is said that, in making these units, compactness has been accomplished without sacrificing efficiency or life.

A descriptive bulletin may be obtained directly from *American Condenser Corp.*, 2508 S. Michigan Ave., Chicago.

#### DUAL REMOTE CONTROLS

Dual Remote Control Co., Inc., are featuring a line of auto-radio remote controls for dash board and/or rear seat tuning of the receiver. They are said to consist of a single unit, preassembled (interchangeable) gear for universal mounting available for all sets and all cars. Special types are also available for flush, recessed or surface mounting of the control.

A descriptive bulletin No. 101, is available upon request. Write to *Dual Remote Control Co., Inc.*, 505 Guaranty Bldg., Detroit, Mich.

#### THORDARSON MOBILE UNIT

The new 6-volt d-c, 115-volt a-c mobile amplifier announced by Thordarson is said to handle practically any type of sound reinforcement requirement. 28 watts of power are delivered. The phono motor is mounted to withstand the jolts and strain of sound truck installations. Three input circuits with separate gain controls accommodate two high-impedance microphones and a phono pickup. A standby switch for turning off the vibrator plate supply conserves power when battery operated and eliminates the warming up period. For complete details write the *Thordarson Electric Co.*, 500 W. Huron St., Chicago.

#### BOGEN RECORDERS

A recent entry in the field of recorders is the David Bogen Co. A complete line of recorders has been put into production. The model 212 RP recorder shown comes complete in a carrying case finished in



BOGEN

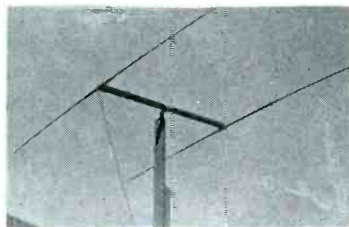

TACO

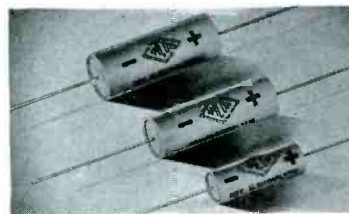

AMERICAN CONDENSER

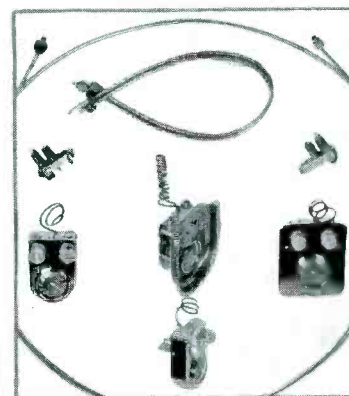

DUAL REMOTE CONTROL CO.



THORDARSON

brown leatherette with handle for easy portability. Literature and technical data may be obtained from *David Bogen Co., Inc.*, 663 Broadway, New York City.

#### CONSOLIDATED WIRE RESISTORS

Consolidated have announced a new line of adjustable wire-wound resistors in 10-, 25-, 50- and 75-watt ratings. Four ratings of wire-wound fixed resistors are also offered in 5, 10, 20 and 50 watts.

Additional information may be obtained from *Consolidated Wire & Associated Corps.*, 518 So. Peoria St., Chicago.

#### RADIOTECHNIC INSTRUMENTS

Radiotechnic Laboratory, having built tube testers exclusively for the past 6 years, is about to enter allied fields. The intention is to manufacture no types of instruments already available, but to bring out several auxiliary devices whose purpose is to extend the type of service which may be offered by Service Men and dealers. It is expected to have one or two of the instruments ready for distribution early in July.

For additional information write to *Radiotechnic Laboratory*, 1328 Sherman Avenue, Evanston, Ill.

#### CINAUDAGRAPH 27-IN. DYNAMIC

Dan P. O'Brien, sales director of the Cinaudagraph Corp., manufacturers of pm and electrodynamic speakers and magnetic alloys, advises that 27-in. electrodynamic speakers, of the type used at the Lagoon of Nations at the New York 1939 World's Fair, are available to the trade. At least one of these giant speakers will be on demonstration at Chicago during the Trade Show, June 14 to 17, at the Stevens Hotel.

For additional information on this and other Cinaudagraph products write to the *Cinaudagraph Corp.*, Stamford, Conn.

#### MUELLER ALLIGATORS

Mueller Electric are announcing a new line of alligator clips both insulated and uninsulated and also a solid copper alligator for r-f test work. The No. 85 clip will be called the crocodile.

A descriptive and illustrative bulletin covering these clips may be obtained directly from *Mueller Electric Co.* 1583 E. 31 St., Cleveland, Ohio.

#### ARCTURUS MIDGET TUBES

Four new GT midget tubes were recently announced by Arcturus. They include two pentagrid converters, a new diode-triode-pentode and a half-wave, high-vacuum rectifier with pilot-lamp tap. All are now in production and will be used in forthcoming small receiving set models. Complete technical data is now available and may be obtained from *Arcturus Radio Tube Co.*, 750 Frelinghuysen Ave., Newark, N. J.

#### AUDAX MICRODYNE

Audax have released their series D Audax compensated inductor microdyne phonograph pickup. The needle impedance of the new model is said to have been reduced almost to the vanishing point.

Additional details may be obtained from *Audax Co.*, 500 Fifth Ave., New York City.

#### SOLAR TUBULARS

The Solar Sealdtite condenser is a wax molded paper tubular which is said to have a life expectancy of from 2 to 5 that of other tubulars due to the molded wax seal.

Additional information on this and other Solar condenser products may be obtained from *Solar Mfg. Corp.*, Bayonne, N. J.

# THE SET TESTER WITH EVERYTHING

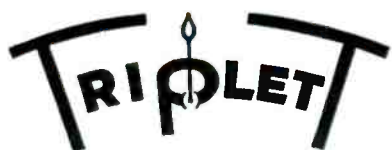

**MODEL 1604**

with **RED • DOT**  
**LIFETIME**  
**GUARANTEED METER**



**A** NEW Sensational Set Tester—Triplet quality-made, with the features that give the serviceman everything he will want. Twelve A.C. and D.C. Voltage ranges, D.C. at 25,000 ohms per volt; Nine Direct Current ranges; Low and High Ohms ranges; Complete Free Point Tester; Condenser Tester, and provisions for Decibel readings make the Model 1604 the outstanding Multi-Purpose Set Tester of them all.

D.C. VOLTS—0-10-50-250-500-1,000-2,500 at 25,000 ohms per volt.

A.C. VOLTS—0-10-50-250-500-1,000-2,500 at 1,000 ohms per volt.

DIRECT CURRENT—0-50 microamperes; 0-1-10-50-250-500 milliamperes; 0-1-2-20 amperes.

RESISTANCE—0-500 low ohms, shunt type circuit; 0-20,000 and 0-200,000 ohms, 2 and 20 megohms, series type circuit.

CONDENSER TESTER—Ranges for capacity checking, .001 to 30 mfd. Electrolytic leakage test.

**FREE POINT TESTER**—Makes all series and parallel meter connections through seven sockets, including Loctal and Bantam Jr. types. Standard RMA markings.

**DECIBEL METER**—Special chart provides Decibel readings against volts from minus 20 to plus 55.

**LARGE MODERNISTIC INDICATING INSTRUMENT** with Red • Dot Lifetime Guarantee against defects in materials and workmanship. Tester also has separate line voltage meter for line control.

**RESISTANCE MEASUREMENTS BY EXCLUSIVE CIRCUIT** (Patented)—The ohmmeter zero adjustment is unique in this tester. There is but one adjustment for all resistance ranges. It is more accurate and does not require re-setting of zero when reading different ohmmeter scales. The only tester which can employ this remarkable proven circuit.

**PLUG-IN RECTIFIER**—Simplifies replacement in case of accidental damage. Rectifier is pre-calibrated for the tester.

**NEW ATTRACTIVE QUALITY CASE**—Heavy steel with black suede baked enamel finish. Size 14 1/2" x 7 5/8" x 4 1/2". Leather strap handle. Black, silver and red etched panel. A new feature is the snap-on metal cover. Elastic band inside cover convenient for accessories and instructions. Rubber feet on two sides of case for convenience in using.

Model 1604 . . . Complete with all accessories. Shipping weight 26 pounds. U. S. A. **Dealer Net Price** . . . . . \$49.84

**\$49.84**  
**DEALER NET**

## TRIPLE SHIELDED SIGNAL GENERATOR

This new model is now made with full vision dial having six scales with total length of over 50 inches. Improved accuracy, shielding and attenuation equal to oscillators for which you would pay much more. Six bands 115 Kc to 30.5 Mc. — A.C. operated Write for full details of this oscillator and other Triplet test instruments you'll be proud to own.

**Net Price \$29.84**



**Model 1232-A**

**The TRIPLET ELECTRICAL INSTRUMENT CO.**  
176 Harmon Avenue, Bluffton, Ohio.

- Please send me more information on Model 1604;
- Model 1232-A; I am also interested in . . . . .

Name . . . . .

Address . . . . .

City . . . . . State . . . . .

# DEWALD

## QUALITY RADIOS

SINCE 1921

Since the beginning of commercial Radio, DeWALD has been a recognized style and merchandising factor . . . and never was a more powerful line than that which we are displaying at Chicago this year.

### NEW!



**CUB No. 414**  
\$19.95 list

This marvelous new Portable is astonishingly capable, for all its tiny size! Built in true DeWALD fashion, with good tone and plenty of volume. For picnics, beach parties and general Summer use. Built-in aerial; no wires to connect; just carry it naturally like a suit-case; airplane luggage cabinet and smart alligator finish; full reading, easy vision dial; high ratio Vernier dial.

See complete line at

**BLACKSTONE HOTEL**  
CHICAGO

June 14th to June 17th

De Wald Radio Mfg. Corp.  
440 Lafayette St., New York City  
Licensed by RCA and Hazeltine Companies

### YOUR C-R OSCILLOSCOPE

(Continued from page 298)

same way as the variation of the unmodulated signal generator setting does. If the oscillation is a subsidiary one, however, it will not be affected by this alteration. Alteration of the setting of the modulated signal generator setting will always cause the curves to move whether they are true or spurious.

• • • **parasitic oscillations**

Occasionally one finds a parasitic oscillation sitting on the resonance curve as illustrated in Fig. 11. This is due to a relatively low frequency beat between two of the various oscillators in the system, or possibly even due to interference from a signal actually received on the set at the time. It corresponds in fact with the birdies often experienced with superhet receivers. It may usually be ignored since it does not affect the lining up, but if it is troublesome it can be removed by altering the tune of the i-f slightly.

The presence of such a parasitic does not necessarily indicate that birdies will be noted in actual reception, because the beat may be arising from interaction with the oscillator in the frequency modulator which will not be present in actual reception.

• • • **modulation patterns**

We can conclude with a brief review of the other uses of the oscilloscope. One is the checking of the modulation of a transmitter (or signal generator). The simplest method is to apply the modulated signal to the Y plates, either directly or through the amplifier if this will handle r-f, and to set the sweep to some sub-multiple of the modulation frequency. A band pattern will then appear of the type shown in Fig. 12.

Until the sweep is synchronized the pattern will be confused being brighter in the middle. As the sweep frequency control is altered the pattern will resolve itself into the correct modulation pattern and the application of synchronism (or suitable adjustment of the frequency if the synchronism is automatic) will cause the pattern to lock.

The modulation pattern should be symmetrical and the depth of modulation is given by  $\frac{a-b}{a+b}$  where a is the maximum and b the minimum height of the pattern.

An alternative method is to apply the modulated wave to the Y plates and the modulation voltage to the X plates. This will produce a trapezoidal figure as shown in Fig. 13, which is the modulation pattern of a small service signal generator. On the left is the pattern

### PARALLEL PRECISION CONTACTS

#### INSURE QUALITY IN

## NAALD SOCKETS

### ADAPTERS and TEST EQUIPMENT



This patented contact is the only one that has withstood life test of 1,750,000 insertions.

Contacts of other design regardless of shape or material start to fail upward of 5,000 insertions.

Why? Because at some point there is considerable flexing movement that sets up crystallization.

In the parallel precision contact, the contact floats to meet any bent or irregularly placed prongs. The open end moves on an average of but .003 of an inch. Because this movement is reduced by leverage to the fulcrum points and by the proper balance of thickness of the clip, the movement or flexing of the metal molecules at these points is microscopic; thus no crystallization can set up to cause failure.

Insist on these quality sockets in instruments you buy or make. Their price is not prohibitive for either you or manufacturers.

Write for a bulletin!

**ALDEN PRODUCTS CO.**  
DEPT. S6 BROCKTON, MASS.

### NOISE REDUCING

## AUTO RADIO

### AERIALS

•

### INCREASED

### EFFICIENCY

with this

### NEW TYPE

### BOOSTER COIL

### ANTENNA

•



Here is the aerial every serviceman has been wanting. It combines increased efficiency and noise-reduction with the best in design. These tri-bar aerials fold down to very short lengths (as shown in the illustration) or open out to reach well above the car to pick up broadcast signals. An ingenious slide arrangement allows these aerials to be used at any length between the two extremes to give a variable capacity effect. They are furnished for either cowl mounting or hinge mounting. A trial will convince you of their performance.

GUARANTEED RATTLE FREE

See Them at Your Jobber's Today!

**CONSOLIDATED**  
WIRE AND  
ASSOCIATED  
**CORPORATIONS**

518 S. PEORIA ST., CHICAGO, ILL.

produced by the sweep circuit method, while on the right is the trapezoidal form. The same expression for modulation depth holds, so that for full modulation the trapezium becomes a triangle.

One advantage of the second method is that it shows modulation defects more easily. Thus in the example there is distortion in the modulating system, as evidenced by the fact that the sides of the trapezium are not straight, while there is also phase displacement as shown by the double pattern.

Phase shift in the modulating system causes the pattern to appear as if wrapped round a cylinder. Fig. 14 illustrates this more clearly.

• • • phase angle

Phase shift is very easily disclosed with a cathode-ray tube. The two voltages to be examined are applied to the X and Y plates respectively and their amplitudes adjusted to be approximately equal. If there is no phase shift, the pattern formed is a straight line, but with any difference of phase the figure degenerates into an ellipse.

The phase angle can be estimated by tracing the ellipse on a piece of transparent paper and estimating the distances PP and QQ as shown in Fig. 15. Then  $\sin \phi = PP/QQ$ ,  $\phi$  is the phase angle. This expression holds irrespective of the relative amplitudes of the two voltages but examination is simplified if the amplitudes are roughly equal. If a graduated cover scale is provided, PP and QQ may be estimated directly.

The input and output of an amplifier or any single stage, for example, can be checked by this means. Start with a source of input large enough to provide a reasonable deflection on the tube. If your oscillator does not give enough output use an amplifier first. Any phase shift in this preliminary stage will not matter.

Across the input connect a potentiometer as shown in Fig. 16 and feed the amplifier with a suitable proportion such that its output is of the same order as the original (full) input. If your amplifier is good the pattern will be a narrow ellipse or even a straight line. More likely it will be quite a wide ellipse while if there is any overloading at any stage the ellipse will be distorted.

In fact, by a simple modification of the technique the actual characteristics of the amplifier tubes can be shown, but it is impracticable to dwell on this point in detail.

The reader who wishes to examine the subject further can refer to

Cathode Ray Oscillographs by J. H. Reyner (Pitman)

The Cathode Ray Tube at work by John F. Rider (Rider)

The Low Voltage Cathode Ray Tube by G. Parr (Chapman & Hall)

**ON THEIR WAY!**

**Bringing You Servicing Data You Need RIGHT NOW**

**RIDER MANUAL VOL. X  
OUT AUGUST 19th**

**1650 PAGES \$10.00**

**T**HOUSANDS of copies of Rider Manual Volume X are on their way to the servicemen of America. The publication date this year has been advanced to August 19th in order to make available to you the tremendous amount of servicing material awaiting publication.

The great number of receiver models being produced by the manufacturers—the new television receivers—facsimile receivers—wireless record players—all have combined to create such a need—such a demand for servicing data that Volume X will be made available 4 months ahead of the usual date.

**NEW SERVICE DATA**

Complete servicing data you need on the receivers now in your shop . . . The data you would ordinarily get in November, ready for you four months ahead of time. The information you have asked us for—in the form you asked for it—all in Rider's Volume X.

**LATEST DEVELOPMENTS**

Television—Facsimile—Wireless Record Players—the servicing information on these important

new developments for the servicemen will be found complete in Volume X. You must have the manufacturer's instructions when you install or service any of these new sets.

**NEW "HOW IT WORKS"**

Easy-to-understand explanations on the theory of Television—Facsimile—Wireless Record Players, etc. are in the new, 64-page "HOW IT WORKS" section which is included at no extra cost. This is the type information you have always found so helpful.

Volume X index covers all 10 Rider Manuals.

*Place Your Order Now*

You can't go wrong with a RIDER Manual!

**YOU NEED ALL 10**

**JOHN F. RIDER, Publisher, 404 FOURTH AVE., NEW YORK CITY**

# FOUND!

## PAUL BUNYAN'S SCREW DRIVER

See it at the  
**XCELITE BOOTH #721**  
Chicago Trade Show



Xcelite tools are recognized  
as leaders in the industry

Quality tools, properly balanced, tempered and finished—plus merchandising ideas—displays—assortments—and new exclusive tools. Make our booth your headquarters. We'll be glad to see you. If you don't visit the show, be sure to write for literature on our entire line.

**PARK METALWARE CO., Inc.**  
ORCHARD PARK, N. Y., U. S. A.

# BRACH Television Antennae

Endorsed by  
Leading Manufacturers

Will Be Exhibited  
At the Radio Show  
Chicago, June 14th-17th  
Booth 406

**L. S. BRACH**  
Manufacturing Corporation  
World's Largest Makers  
of Antenna Systems  
55-67 Dickerson Street  
NEWARK, NEW JERSEY

STEWART-WARNER 97-571 TO 97-579  
(CHAS. 97-57)

*Oscillation or squealing:* If a squeal develops with the volume control fairly well advanced, separate the 6Q7G grid lead and the speaker wires as much as possible by pulling the grid lead to the side of the 6Q7G nearest the variable condenser.

If there is a loud heterodyne whistle when tuning in stations, the i-f stage may be oscillating. If this happens, move the lead from the 6A8G cathode to the 6Q7G cathode as close to the chassis and as far from other wires as possible. If necessary, connect a 0.05-mfd 200-volt condenser to one of the above cathode terminals which does not already have such a condenser connected directly to it.

*Production change:* A small percentage of these chassis were equipped with 6K7 metal i-f tubes but most of them are using the 6K7G glass tube. Because of shield requirements, these tubes cannot be used interchangeably. In other words, a metal tube must be used to replace a metal tube, while in a chassis originally equipped with a glass i-f tube, a glass tube must be used as a replacement.

J. N. Golden

### WESTINGHOUSE WR306

*Thin tone, set inoperative on all but treble position of tone control:* Cause open primary of first audio transformer No. 84. To repair proceed as follows: Shunt 350-ohm, 1-watt resistor across 100-ohm section of voltage divider resistor No. 103. Remove old a-f transformer and mount Thordarson T-57A40 p-p input transformer in its place with secondary side toward i-f transformer No. 75. Clip off primary leads close or tape up as they are unused. Remove short blue wire from plate of 6F5 tube to terminal strip and replace with 0.05-mfd, 600-volt tubular condenser. Connect one grid lead of new transformer to same terminal on terminal strip. Connect center tap to ground lug on chassis, other grid lead to first lug from rear of chassis on strip nearest coil shields. Connect 250,000-ohm, 1/2-watt resistor from fourth lug

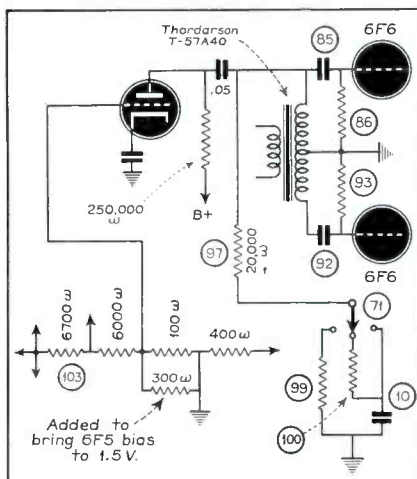

from rear on same strip and to plate of 6F5. Remove 5,000-ohm resistor No. 83 from same strip and 0.02-mfd condenser No. 90. Disconnect 75,000-ohm resistor No. 99 and 0.02-mfd condenser No. 101 from rear lug on short terminal strip near tone control switch and connect to ground lug on same strip, leaving or reconnecting red wires to rear lug. Customers claim performance for superior to original.

D. C. Sprong

# 110 Volt Tubes!



The new Jackson Model 634 Dynamic Tube Tester will test 110 v. tubes! This model is provided with full range filament selection for all tubes from 1.4 v. up to and including 110 v. In addition, there are two extra unused positions on the filament switch. Amazingly compact, light and sturdy. Priced at only \$28.95. See it at your jobber's now.

THE JACKSON  
ELECTRICAL  
INSTRUMENT CO.  
DAYTON, OHIO

WRITE  
TODAY  
for latest  
Jackson  
catalog.

# JACKSON

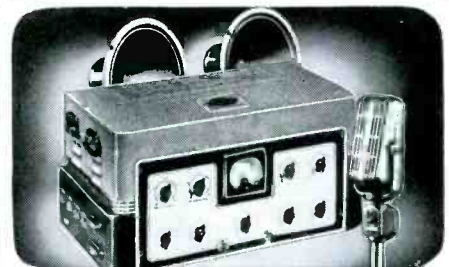

### NEW Knight AMPLIFIER SYSTEMS

Have you seen the great new line of KNIGHT Sound Systems in ALLIED's new Spring Catalog? You owe it to yourself to get your free copy now. See the greatest P. A. values ever offered. Systems for every need—8 to 65 watts—standard and de luxe models—permanent, portable, and mobile. The 35 Watt System Illustrated above is just a sample of what to expect. Check these features: Remote Control; Monitor Speaker; V. I. Meter; A.V.E.; A.V.S.; 5 Channel Mixer; Dual Phone Input; Speaker Matching Switch, etc. And wait until you see the price! Send coupon now!

**AN AMAZING P. A. GUARANTEE**  
Each KNIGHT sound system and amplifier is fully licensed and sold by E. R. P. I. and is sold with the strongest P. A. guarantee you could ask for. See Page 70 of the Spring & Summer ALLIED Catalog for full details.

**TIME PAYMENTS**  
You can buy KNIGHT Public Address Equipment on attractive Monthly Payment Terms. You'll like our plan. See our Catalog for complete details.

**ALLIED RADIO CORP.**  
ALLIED RADIO CORP., Dept. 19-F-9  
833 W. Jackson Blvd.  
Chicago, Ill.  
 Send me your FREE Spring & Summer Catalog with complete P. A. listing.

Name.....  
Address.....  
City..... State.....

## LINE AND HEATER VOLTAGES

A GREAT number of good Service Men give the receivers they are repairing a thorough check but forget the all important line voltage test. Plate, screen and other voltages can vary without a very noticeable difference in the output of the set . . . but what about the heater voltage?

The cathode was designed to emit so many electrons at a certain temperature; when the temperature is changed the emission changes. (However, when the saturation point is reached increase in temperature does not increase the emission.)

Temperature is a function of heater current, which is controlled by the voltage. With good regulation and correct voltage the current, and consequently the temperature, is normal. When the voltage is high the current and temperature are high; when the voltage is low the current and temperature are also low.

Theoretically for all cathodes a temperature higher than normal will materially shorten the life of the tube without adding to its efficiency during operation. In extreme cases higher temperatures can completely paralyze the tube. Some Service Men like to keep the heater voltages low in the belief that this lengthens the useful life of the tube. *This is a fallacy and is not borne out in theory or practice* as it is well known that *low voltages cause heater hardening* and after a certain period of time the heater will not emit sufficient electrons.

The heater voltages should be as near correct as possible. In the last two years great strides have been made improving the temperature characteristics of cathodes that allow them to be stable over a wider range of temperature. However, as Service Men we are also interested in the older model sets which have tubes that are rather critical to temperature of filament.

On thoriated type cathodes changing the temperature from 1900 to 2500 decreases the useful life of the heater approximately 99 per cent.

During a study of filament voltages of a representative number of tubes, the writer observed the following:

1) On tubes that had not been used previously, uniform results were received from the radio when the filament voltages were changed plus or minus 15 per cent.

2) After 100 hours of use the tubes gave normal results at rated, and at 15 per cent above normal voltages, but dropped off in efficiency with heater voltages below normal. This lowered efficiency showed up more and more as the tube characteristics were plotted against time, until at 1000 hours at 15 per cent lower heater voltage, the efficiency of the tube was off approximately 50 per cent. When proper heater voltage was applied the efficiency came up.

The effect of these studies together with the study of the line voltage conditions in various cities led the writer to believe there were a large number of radios in use today that were not delivering proper service due to low line voltage.

This affects the Service Men in many ways, but chiefly when it comes to testing tubes. If he uses a properly designed tube tester, the tube tester applies the correct filament voltage to the tube and will show the tube in its true condition. This tube may be used in a set where the line voltage is from 95 to 100 volts and due to low cathode temperature will not function properly causing much customer dissatisfaction.

When it is found that new tubes in the

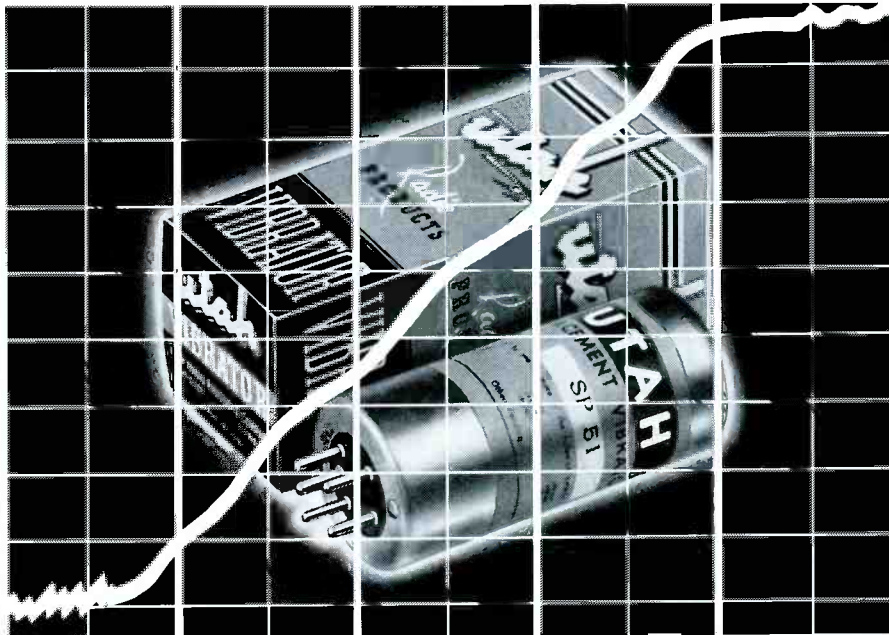

## HOW UTAH VIBRATORS CONTRIBUTED TO THE 900% Increase IN AUTO RADIO VOLUME

The immediate acceptance of the numerous vibrator developments which were originated in the Utah laboratory, contributed largely to the spectacular increase in auto radio volume of 900% in four short years. And those same improvements *plus* the performance and advanced engineering of Utah products have won a continued preference from all branches of the industry.

Because Utah designs and produces *both* vibrators and transformers, Utah engineers have a decided advantage in "matching" the characteristics of the two and in developing maximum performance features. The complete fabrication of vibrators and transformers in the *Utah factory* enables absolute control of correlated characteristics of

both—thus assuring dependability, uniformity and satisfactory performance.

Utah service, too, has been important in the development of the industry—Utah engineers have from the first co-operated with receiver manufacturers, by directing the use of vibrators best suited for each individual requirement.

For original equipment or replacement requirements there is a Utah Vibrator to meet every need.

### WRITE FOR FREE CATALOG

In addition to complete information about vibrators the new Utah catalog contains important facts about Speakers, Transformers and Utah-Carter Parts. Write for your free copy today—no obligation.



SPEAKERS

TRANSFORMERS

UTAH-CARTER PARTS

CANADIAN SALES OFFICE: 414 BAY ST., TORONTO, CANADA



radio set improve the performance considerably, although a reliable tube tester showed the tubes were perfect, check the line voltage—as low line voltage is in all probability causing the trouble.

The moral of this article is obvious—that is, if the Service Man wants to keep his customer a friend he should be sure exactly what the customer's line voltage conditions are. Do not condemn tubes until you know the conditions under which they are laboring. Above all—do not depend upon a tube tester that uses low voltages to reject tubes, as some smart Service Man may explain to your customer why his set is unsatisfactory and correct this trouble by either raising line voltage in cooperation with his local power company, or by use of a voltage regulator.

After all, a Service Man has a certain amount of equipment and the equipment can do a very effective job providing the Service Man uses good, common sense in applying this equipment to the job, studying all factors, analyzing the trouble and applying the corrective measures.

F. E. Wenger

TRIPLETT ELECTRICAL INSTRUMENT CO.

RCA 8M3

*Blows fuse in car, but not on bench:* Because the vibrator is mounted in a peculiar position on the end of the chassis, the center reed will short to the live reed if it loses tension. Although a new vibrator is indicated the trouble may be remedied by reversing the position of the vibrator.

Allan Siepmann

**DEALERS  
WHO HAVE  
"SOMETHING  
ON THE  
BALL!"**



 We're interested in dealers who have a reputable radio service business; dealers who can turn over their tube stock at least every three or four months; who have facilities to display sales-producing advertising materials; and who have a reputation for maintaining standard prices.

Dealers who qualify as Tung-Sol retail partners sell to a market free from interference with already established Tung-Sol retailers, and they make full profit on every sale.

*If you have this type of establishment  
— write us today.*

*Vibration  
Tested* **TUNG-SOL  
RADIO TUBES**

Booth 410, Radio Trade Show

TUNG-SOL LAMP WORKS INC. Dept. D Radio Tube Division  
SALES OFFICES: Atlanta - Chicago - Dallas - Denver  
Detroit - Kansas City - Los Angeles - New York  
General Offices: - - - Newark, New Jersey

## AUTO-RADIO DATA

(Continued from May)

### Lafayette Wholesale Radio Service

Model	Tubes	Year	Gear Ratio	Dial Direction <sup>1</sup>	I-F
A60	6	1933	6/1	CW	175
AM20	6	1933	6/1	CW	175
B8	5	1939	16/1	*	178
BB9	5	1939	2	—	456
B62	5	1935	2	—	175
B90	6	1936	12/1	CW	175
B92, B93	6	1937	12/1	CW	175
C60	6	1935	6/1	CCW	175
D6	5	1939	2	—	456
D15	7	1938	16/1	CW	262
D37	7	1938	16/1	CW	262
D39	8	1938	16/1	CW	262
D45	6	1935	8/1	CCW	262.5
D46	6	1935	8/1	CCW	262.5
D52	5	1935	8/1	CCW	456
EB17	6	1938	16/1	CCW	262
EMI6	5	1938	2	—	456
J37	5	1934	2	—	480
JA1, JA2	5	1937	2	—	480
JA1, late	5	1937	2	—	456
L22, L23	6	1932	8/1	CCW	175
L30, late	6	1935	8/1	CCW	175
L30	6	1934	8/1	CCW	262.5
LW10	6	1934	6/1	CCW	175
M94	6	1938	16/1	CCW	262
S9	6	1938	2	—	*
TC50	6	1933	6/1	CW	175

### Lyric Rudolph Wurlitzer Mfg. Co.

Model	Tubes	Year	Gear Ratio	Dial Direction	I-F
A60	6	*	*	*	485
460	5	*	*	*	175

### Majestic Grigsby-Grunow Co.

Model	Tubes	Year	Gear Ratio	Dial Direction	I-F
66, 6-66	6	*	6/1	CW	175
110	7	*	*	*	TRF
111	6	*	*	*	175
114	6	*	*	*	175
116	6	*	*	*	456
116A	6	*	*	*	456
118	6	*	*	*	175

### Mission Bell Mission Bell Radio Mfg. Co.

Model	Tubes	Year	Gear Ratio	Dial Direction <sup>1</sup>	I-F
5	5	*	*	*	252
10	6	*	*	*	252
10A	6	*	*	*	252
11	6	*	*	*	252
12	6	*	*	*	456
14	5	*	*	*	*
15	5	*	*	*	465
16, 3516	5	*	*	*	262
19A	5	*	*	*	262
19B	5	*	*	*	262
3517	*	*	*	*	262
3518	*	*	*	*	262
3716	*	*	12/1	CCW	*
3718	*	*	12/1	CCW	*

### Mobilette Calvert Motors Associates, Ltd.

Model	Tubes	Year	Gear Ratio	Dial Direction	I-F
A40B	4	*	*	*	TRF
A50E	5	*	*	*	TRF
M40B	4	*	*	*	TRF
M50E	5	*	*	*	TRF

<sup>1</sup>CW denotes clockwise rotation. CCW, counterclockwise. By clockwise rotation is meant that receiver is being tuned to a higher frequency when the dial scale or pointer rotates in a clockwise direction when viewed from the front of the control head.

<sup>2</sup>No remote control is used.

\*Information not readily available.



P43E	4	*	*	*	TRF
P44S	4	*	*	*	TRF

**Motorola**  
Galvin Mfg. Co.

Model	Tubes	Year	Gear Ratio	Dial Direction	I-F
5T71A	5	1929	10/1	CW	TRF
6T12	6	1930	10/1	CW	TRF
7T38	7	1931	10/1	CW	TRF
7T47A	7	1932	10/1	CW	175
8-30	6	1938	12/1	CW	262
8-40	6	1938	12/1	CW	262
8-50	6	1938	12/1	CW	262
8-60	6	1938	12/1	CW	262
8-70	6	1938	12/1	CW	262
8-80	8	1938	12/1	CW	262
34	5	1934	12/1	CW	262
35	6	1937	12/1	CCW	262
44	5	1933	16/1	CW	456
45	6	1937	12/1	CW	262
50	6	1936	12/1	CW	262
55	5	1933	16/1	CW	456
57, 62	5	1935	12/1	CCW	456
60	6	1936	12/1	CW	262
61	6	1932	10/1	CW	175
65	6	1937	12/1	CW	262
70	6	1937	12/1	CW	262
75, 79	6	1935	12/1	CW	262
77, 77A, 77AB	7	1933	12/1	CW	456
80	8	1936	12/1	CW	262
88	8	1932	10/1	CW	175
90	10	1936	12/1	CW	262
100, 110	8	1935	12/1	CW	262
9-24	6	1939	2	—	*
9-29	6	1939	*	CW	*
9-44	6	1939	*	CW	*
9-49	6	1939	*	CW	*
9-69	8	1939	*	CW	*
15-F	6	1939	2	—	*
16-C	6	1939	2	—	*
17-D	6	1939	2	—	*
18-0	6	1939	2	—	*
19-B	7	1939	2	—	*
D-6	6	1934	12/1	CW	262
G-V	*	1938	12/1	CW	*
T-8	8	1934	12/1	CW	262

**Nash Automobile & Studebaker Automobile**  
Philco Transitone Corp.

Model	Tubes	Year	Gear Ratio	Dial Direction	I-F
1416	6	1937	*	*	260
1431	6	1937	*	*	260
1433	6	1937	*	*	260
1434	6	1937	*	*	260
1437	6	1937	*	*	260
1514	6	1938	*	*	260
1516	6	1938	*	*	260
1524	7	1938	*	*	260
1526	7	1938	*	*	260
1614, -16	6	1939	*	*	470
1624, -26	6	1939	*	*	470
C	6	1934	*	*	260
D	6	1934	*	*	260
D-122	6	1934	*	*	260
J	6	1934	*	*	260
Q	6	1934	*	*	260
T7	6	1935	*	*	260
T12	6	1936	*	*	260
T15	6	1936	*	*	260

**Packard Bell**  
Packard Bell Co.

Model	Tubes	Year	Gear Ratio	Dial Direction	I-F
5	4	1934	6/1	CW	465
7	*	1934	6/1	CW	460
25	5	1935	6/1	CW	460
65	5	1936	12/1	CW	460
67	7	1936	12/1	CW	460
75	5	1937	16/1	CCW	460
76	6	1937	16/1	CCW	465
78	8	1937	16/1	CCW	460

(To be continued)

# STANCOR

## UNIVERSAL POWER TRANSFORMERS

TYPE "M"



HALF SHELL MOUNTING



VERTICAL MOUNTING



HORIZONTAL MOUNTING



UNDERWRITERS TYPE

### The Outstanding Value of the Industry

#### Note these Features

- Choice of four mounting positions.
- Compact design without sacrificing quality.
- Higher grade steel permits smaller laminations to accommodate more half-shell applications.
- More universal THAN ANY OTHER power transformer.
- Fits more than 80% of all power transformer replacement requirements.
- Majority of units electrostatically shielded.
- Four neat black enameled universal brackets.
- Heavy eight-inch flexible leads.
- All leads tinned for easy soldering.
- Transformers may be mounted in Underwriters approved method.
- Complete line of units to fill every power transformer replacement requirement.
- Each unit carefully insulated for abnormal voltages.
- First universal line to incorporate motor tuning windings.
- Individually and attractively boxed with full instructions.
- Fully guaranteed.
- Attractively priced.

80% OF POWER TRANSFORMER REQUIREMENTS ARE LISTED HERE

Stancor No.	Plate No.	Filament 1	Filament 2	Filament 3	Type	Mounting Area	Weight	List Price
Number	Volts	C.T.	M.A.	Volts	Amps	Volts	Amps	Volts
<b>Universal Type — 2.5 Volt</b>								
P-6001	4-5	650	40	50.C.T.	2.0	2.5.C.T.	4.0	M 2 1/2" x 3" 2" x 2 1/2" 3.3 22.35
P-6002	5-8	700	50	50.C.T.	3.0	2.5.C.T.	7.25	M 2 1/2" x 3" 2" x 2 1/2" 3.3 3.00
P-6003	6-7	700	70	50.C.T.	3.0	2.5.C.T.	9.0	M 3 1/4" x 3 1/4" 2 1/2" x 2 1/2" 5.4 4.00
P-6004	8-9	750	90	50.C.T.	3.0	2.5.C.T.	12.5	M 2 1/2" x 3 1/4" 2 1/2" x 2 1/2" 5.4 4.00
P-6005	6-7	550	70	50.C.T.	3.0	2.5.C.T.	10.5	M 2 1/2" x 3 1/4" 2 1/2" x 2 1/2" 5.9 5.00
P-6006	6-7	700	70	50.C.T.	3.0	2.5.C.T.	9.0	M 3 1/4" x 3 1/4" 2 1/2" x 2 1/2" 6.3 5.00
P-6007	11-13	700	120	50.C.T.	3.0	2.5.C.T.	12.5	M 3 1/4" x 3 1/4" 2 1/2" x 2 1/2" 6.3 5.00
P-6008	10-12	800	110	50.C.T.	3.0	2.5.C.T.	15.0	M 3 1/4" x 3 1/4" 2 1/2" x 2 1/2" 6.3 5.00
<b>Universal Type — 6.3 Volt</b>								
P-4297	4-8	400	40	50.C.T.	2.0	6.3.C.T.	2.0	M 2 1/2" x 3" 2" x 2 1/2" 3.2 2.25
P-4010	4-8	650	40	50.C.T.	3.0	6.3.C.T.	2.0	M 2 1/2" x 3" 2" x 2 1/2" 3.3 2.50
P-4011	6-7	700	70	50.C.T.	3.0	6.3.C.T.	2.5	M 2 1/2" x 3 1/4" 2 1/2" x 2 1/2" 5.2 3.75
P-4012	8-9	700	90	50.C.T.	3.0	6.3.C.T.	3.5	M 3 1/4" x 3 1/4" 2 1/2" x 2 1/2" 5.3 4.25
P-4013	11-13	700	120	50.C.T.	3.0	6.3.C.T.	4.7	M 3 1/4" x 3 1/4" 2 1/2" x 2 1/2" 5.8 5.75
P-4014	13-15	750	180	50.C.T.	3.0	6.3.C.T.	5.5	M 3 1/4" x 3 1/4" 2 1/2" x 2 1/2" 6.5 6.50
P-4165	14-16	800	200	50.C.T.	4.0	6.3.C.T.	5.5	M 3 1/4" x 3 1/4" 2 1/2" x 2 1/2" 6.5 6.50
<b>Universal Type — 6.3 and 2.5 Volt Combination</b>								
P-4293	6-7	600	60	50.C.T.	3.0	6.3.C.T.	2.5	M 2 1/2" x 3 1/4" 2 1/2" x 2 1/2" 4.0 4.00
P-4294	8-9	750	85	50.C.T.	3.0	2.5.C.T.	9.0	M 2 1/2" x 3 1/4" 2 1/2" x 2 1/2" 4.0 4.50
P-4295	8-9	700	90	50.C.T.	3.0	6.3 & 2.5.C.T.	12.0	M 3 1/4" x 3 1/4" 2 1/2" x 2 1/2" 5.7 4.60
P-4296	11-13	750	125	50.C.T.	3.0	2.5.C.T.	12.0	M 3 1/4" x 3 1/4" 2 1/2" x 2 1/2" 6.5 6.00
P-6008	14-16	750	180	50.C.T.	3.0	6.3.C.T.	3.3	M 2 1/2" x 3 1/4" 2 1/2" x 2 1/2" 6.0 5.00

... WITH MOTOR TUNING WINDINGS

P-6008 also has an additional 2.5 V. at 1.75 A.C.T. winding.

**UNIVERSAL POWER TRANSFORMERS** ... WITH MOTOR TUNING WINDINGS

Push button motor tuning and special dial arrangements require special transformers. A careful survey of sets and analysis of their requirements indicated that a group of transformers with the specifications given below would service the greatest majority of these radios. Conservative in design and construction for long service packed with wiring diagram.

P-4296 11-13 700 120 50.C.T. 3.0 6.3 5.0 4.0 M 3 1/4" x 3 1/4" 2 1/2" x 2 1/2" 5.9 6.25

P-4297 4-8 400 40 50.C.T. 2.0 6.3 5.0 4.0 M 2 1/2" x 3" 2" x 2 1/2" 3.2 2.25

P-4298 11-13 750 125 50.C.T. 3.0 2.5.C.T. 12.0 6.3 5.0 4.0 M 3 1/4" x 3 1/4" 2 1/2" x 2 1/2" 6.5 6.00

P-4299 13-15 750 180 50.C.T. 3.0 6.3 5.2 50-24-18 M 4 1/4" x 3 1/4" 3 1/4" x 2 1/2" 7.8 8.00

P-4291 13-15 750 180 50.C.T. 3.0 6.3 5.2 50-24-18 M 4 1/4" x 3 1/4" 3 1/4" x 2 1/2" 7.8 8.00

P-4292 800 200 50.C.T. 3.0 6.3 5.2 50-24-18 M 4 1/4" x 3 1/4" 3 1/4" x 2 1/2" 7.8 8.00

transformers are for operation on 110-115 volts 50-60 cycles. Any of them may be supplied for 220-230 volts 50-60 cycles or both. For 220-230 volts, increase list price 15% for 25 cycles, 60% for 220-230 volts 50 cycles and both. For 220-230 volts, increase list price 15% for 25 cycles, 60% for 220-230 volts 50 cycles and both.

ing studs tapped to fit the bolts on these transformers, and supplied with screws and lock washers are now available. Catalog No. 2053. List price \$0.25 (set of 4).

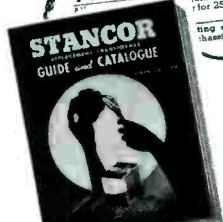

**THE ABOVE LISTING IS TAKEN FROM THE NEW STANCOR GUIDE AND CATALOG**

**Get Your Copy FREE!**

From Your STANCOR Jobber

## STANDARD TRANSFORMER CORPORATION

1500 NORTH HALSTED STREET, CHICAGO

Playing  
Safe...



• There are two good reasons why you're taking no chances when you standardize on CLAROSTAT volume controls:

First, you can feel *absolutely* sure of having selected the *correct* type for any standard set, because of the completeness and accuracy of CLAROSTAT up-to-the-minute listings. A CLAROSTAT replacement means *correct* resistance, taper, bias, switch, shaft.

And when you've installed that *correct* CLAROSTAT control, you are assured of a stay-put, profitable, good-will job. So don't delay that insurance. Ask your local CLAROSTAT jobber for our

**New MANUAL!**

Just off the press. All listings under respective sets. Handy. Accurate. Complete.

If your jobber can't give you a copy, write us direct.

And, when you get to the Parts Show, look us up at Booth 620-22 Hertz Ave.

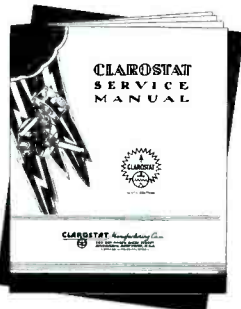

**CLAROSTAT**  
MANUFACTURING CO.  
Incorporated  
285 North Sixth St.  
Brooklyn, N. Y.

**A-C, D-C SETS**

Shorted filter condenser and/or defective rectifier tube: We have noted that there is a tendency for filter condensers and rectifiers in a-c, d-c re-

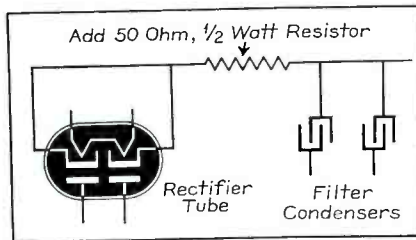

ceivers, to fail prematurely. As a result the engineering department of Stewart-Warner has investigated this condition in collaboration with the manufacturers of the tubes and the electrolytic condensers and have developed a simple remedy.

It has been found that all makes of a-c, d-c receivers are more or less subject to this trouble which is due to a peculiar power line condition. This difficulty is not due to high line voltages nor is it due to any fault in either the tube or the condenser. With certain line impedances it has been found that extremely high surge voltages are developed across the filter condenser. As a result the condenser will puncture and thus this causes the rectifier tube to fail. The instantaneous surge voltages which are developed may be as high as 300 volts. These occur, however, only if the set happens to be turned off on a particular part of the cycle. Since this difficulty is due to a power line condition, it is very likely to happen repeatedly in any one location. In other words, if it happens once in a certain customer's home, it is very likely to happen again.

The remedy for this trouble is to connect an inexpensive 50-ohm resistor in series with the connection from the rectifier tube cathodes to the electrolytic filter condensers. The proper connection of the resistor is shown in the accompanying diagram.

J. N. Golten

STEWART-WARNER CORPORATION

**CROSLY 534**

*Insufficient audio gain:* Cause too low plate supply voltage to 75 tube. Remove 300,000-ohm plate filter resistor and replace with 250,000-ohm, 1/2-watt unit, connecting plate supply end to high voltage end of voltage divider resistor (Candohm) No. 41/42 or to lug on electrolytic condenser which is connected to same point. Remove 10,000-ohm resistor No. 40 and replace with 13,000-ohm unit, 1/2-watt rating.

*Impossible to track dial and 600-ke Padder:* Some individual sets had too many turns on be antenna coil No. 1 secondary. Cure either by removing turns by cut and try method or by replacing coil ass'y. Necessary to remove from 10 to 30 turns. First track oscillator with dial then prune antenna coil until antenna stage  
(Continued on page 316)

**DAVID BOGEN CO. inc.**

Presents



A Complete Line of Recording Equipment

**EMBODYING NEW and EXCLUSIVE DEVELOPMENTS**

Don't fail to visit our display of these New Recorders at the Chicago Radio Trade Show, 313 Edison St., Exhibition Hall, or Rooms 512 and 513, Hotel Stevens. Features include dual-speed units, recessed turntables, quick change-over for 33 1/3 or 78 r.p.m., precision overhead lead screw assembly, dual action level control cutting head, positive automatic idler engagement and release, High Fidelity type symphonic induction play-back pick-up, exclusive depth of cut indicator, "Floating Power" internal rim drive. Portable, in leatherette case. Prices range from \$179.50 to \$415.00.

**Phonoflex BLANKS**

More durable than acetate, flexible and non-inflammable, the sensational new Phonoflex recording blanks are filling a long-felt need. They're uniform...unaffected by temperature...will not develop dry or hard spots. Priced, also, to stretch dollar bills!

Address: DAVID BOGEN COMPANY, INC.  
663 Broadway, New York, N. Y.

**PIONEERS IN SOUND EQUIPMENT ENGINEERING**

**ANTENNAS BY PREMAX**

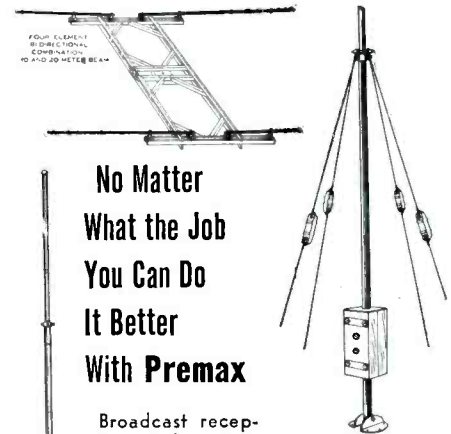

No Matter  
What the Job  
You Can Do  
It Better  
With Premax

Broadcast reception, television dipole mountings, vertical radiators, horizontal rotary beams, Hi-Q verticals, aluminum radiators, monel marine masts, frames, rotomounts—PREMAX HAS THEM ALL—and at prices everyone can afford. Attractive discounts for jobbers and dealers. Write today.

SEE PREMAX AT THE  
N. R. T. SHOW—BOOTH 830

SEND FOR  
BULLETIN  
53  
AND NET  
PRICES

**Premax Products**  
Division of Chisholm-Reader Co., Inc.

3953 HIGHLAND AVE.  
NIAGARA FALLS, N. Y.

**YOU SAVE \$1.00**

by using the

**Group  
Subscription Plan**

OUR GROUP SUBSCRIPTION PLAN enables you and three or more of your co-workers to subscribe to SERVICE at one-half the regular yearly rate. In other words it will cost you and your friends only \$1.00 each for twelve issues of SERVICE. The G-S-Plan low rate only applies when 4 or more subscriptions are ordered at one time. (Foreign \$2.00.)

Speak to three or more of your friends . . . let them sign up with you and then you can remit for the whole group. (Renewals or extended subscriptions are acceptable as part of a group.)

**TEAR OUT AND MAIL**

**SERVICE—19 E. 47th St., N. Y. C.**

Please enter annual subscriptions (12 issues) for each of the undersigned for which payment is enclosed at the rate of \$1.00 each; foreign \$2.00. (This rate applies only on 4 or more subscriptions when occupations are given.)

Name .....

Address .....

City-State .....

Occupation .....

Employed by .....

State whether Employer is a Service Organization, Dealer, Jobber or Manufacturer .....

Name .....

Address .....

City-State .....

Occupation .....

Employed by .....

State whether Employer is a Service Organization, Dealer, Jobber or Manufacturer .....

Name .....

Address .....

City-State .....

Occupation .....

Employed by .....

State whether Employer is a Service Organization, Dealer, Jobber or Manufacturer .....

Name .....

Address .....

City-State .....

Occupation .....

Employed by .....

State whether Employer is a Service Organization, Dealer, Jobber or Manufacturer .....

*Now! Modernize  
for more business!*  
**THIS LOW COST WAY**  
**RCP Test Equipment**

Servicemen awake to the times are going for these dependable, multi-purpose RCP test instruments. It's smart low-cost modernization. And it pays! With new improved RCP testers you're equipped to test all the latest type tubes. This service builds good will for you, opens the door to profitable sales you might never have made. Study the instruments shown here. Remember, space permits only partial listing of the many outstanding RCP features. Send for more complete information.

**NEW and IMPROVED Model 308 Dynoptimum Tube Tester.**

Model 308 offers servicemen an unusual instrument buy. Not only is the initial cost remarkably low—actually lower in price than other equipment far less advanced—but this instrument pays for itself more quickly. If you demand efficiency, wide working range, super dependability and economy, here's the tube tester for you. Will test all 35-45-50-70 volt tubes and provides for 40-75-80-115 volt tubes projected for the future. Checks all types including loctals, OZ-4, cold-cathode rectifiers, etc. Hot interelement short and leakage test. Direct reading "good/bad" scale. Model 308 net... **\$16.95**



Counter and portable model 308P net ..... **\$18.95**



**Model 660  
Electronic Multitester**

Here's RCP's new vacuum-tube Volt-Ohmmeter for the serviceman who realizes the importance of being properly equipped. Lowest voltage reading 0.6 V. (full division), highest voltage reading 6,000 V. Lowest ohmmeter reading 0.1 ohm, highest 1,000,000,000 ohms. Maximum voltage used in ohmmeter 7½ V. No exposure to high voltages when making high resistance measurements. Supplied complete in hand-rubbed sloping walnut case. Net.... **\$18.85**

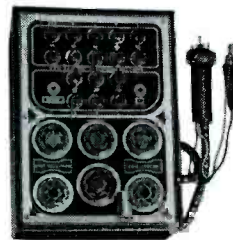

**Model 505, Analyzer**

For complete modernization, the serviceman needs the new Model 505 Analyzer. This is a multiple circuit selector unit for quick analysis of symptoms at socket terminals of radio sets, P. A. systems and television receivers. Loctal socket built into unit. Can be mounted in cover of most instruments. Both current and voltage in any circuit can be measured at same time. Model 505 less case net..... **\$9.95**

For more details on these and other economical RCP test equipment use convenient coupon below. Start your modernization.

*NOW—use coupon for the easiest way.*

**RADIO CITY** Products Co. INC  
**88 PARK PLACE NEW YORK CITY**

**RADIO CITY PRODUCTS CORPORATION, S639**  
88 Park Place, New York City.

Rush complete literature on all RCP instruments. . . .  
Send me the address of the nearest RCP distributor.

Name .....

Address .....

City .....

State .....

# See THE Hit OF THE Show

• "New-Matic" AUTOMATIC AUTO AERIAL. Fully automatic 2 section. Operates independent of ignition or vacuum system. Easy, quick installation.

• CONCEALED COWL MOUNTING AERIALS. 4 different models available. Mounts under hood; eliminates drilling of finished surfaces.

• "TOWER" Aerial. 4-section, telescopic side-cowl aerial. Extends 100' for long distance pick-up. Ceramic insulators. Rattle-proof. Rust-proof.

• "Tela-Vision" Rear-View Mirror. Adjustable to any make aerial. Adds to signal strength. Can be sold to cars already equipped with aerials or with new aerials.

See WARD'S Display  
At The Chicago Show  
P. S. If you don't get to the show,  
write for free catalog.

**The WARD PRODUCTS Corp.**  
Ward Bldg. - Cleveland, O.

## CROSLEY 534

(Continued from page 314)

tracks with oscillator. Tuning wand is of great help when making this correction. The improvement in sensitivity at the low frequency end of the tuning range makes the operation well worth while.

D. C. Sprong

## PHILCO 60

*Intermittent Oscillation:* Cause usually is open 78 i-f cathode by-pass condenser. (Some of the earlier models have separate bias resistors and by-pass condensers for 78 i-f and 6A7 det-osc tube). It is to these sets that the above applies. On sets that have common bias resistor and cathode by-pass condenser replace condenser No. 8 (double 0.09-mfd black bakelite near center of chassis).

D. C. Sprong

## RCA 1939 MOTOR ELECTRIC TUNING

*Dial pointer oscillates around stations:* The motor drive system makes use of a flywheel on the motor shaft which may come in for its share of attention where high line voltage causes the dial pointer on the receiver to oscillate too much. The adjustment that is required is not one involving a lateral movement of this flywheel, as might be expected, but rather a tightening or loosening of the screw set into the flywheel. Generally, it is necessary to first remove the cement or binder used by the manufacturer to hold the set screw firmly in position, before anything can be done about adjusting it. When this step has been taken, the screw is adjusted and resealed back into its position. If the adjustment has been unsuccessful, look to the contacts on the rear of the tuning condenser. The tension, or pressure, of these contacts

should be increased by inserting a screwdriver between successive turns of the individual springs used on each contact and thus stretching them, increasing tension.

If the buttons do not latch properly, which is a very common fault, see that the chassis is forward far enough in the cabinet to ensure easy action of the buttons on the separate blades of the button switches. In the Westinghouse models, the buttons have pieces of rubber in the form of vertically oriented tubes which should fit properly. If they do not, binding or other trouble will result.

Willard Moody

*If the usual tightening or loosening of the set screws in the flywheel does not help the following procedure may do the trick:* Place a small spring behind the flywheel between the motor and the washer, so that when the current is interrupted the motor will disengage. This can be made from the type taken from a carbon brush used with vacuum cleaner or other small motors. Two or three turns should suffice.

J. G. Cooney

## WESTINGHOUSE 1939 MOTOR ELECTRIC TUNING

*Dial pointer oscillates around stations:* These sets are very similar in design and construction to the 1939 RCA receivers discussed elsewhere on this page.

## ZENITH 805

*Oscillator inoperative over part or all of tuning range:* Check 0.01-mfd oscillator plate coupling condenser for leakage. It is connected between oscillator plate prong and oscillator coil. Replace with 600-volt unit. For quick check oscillator plate voltage will, in extreme cases, be much lower than 125-volt normal.

D. C. Sprong

# THORDARSON AMPLIFIERS for 1939

Let your **EYE** and **EAR** decide.

**NEW 20-WATT**  
A Jewel in Steel

- Quality at . . . \$
  - Beauty at . . . \$
  - Performance at . . .
  - Compactness at . . .
- # 75<sup>00</sup> LIST



### Model T-25W20

Controls: Two microphone, one phono, one treble and one bass.

See your parts distributor or write factory direct for free Catalog No. 600-D on the full line. Lists eight models including a new 28-watt mobile unit.

**THORDARSON**  
ELECTRIC MANUFACTURING COMPANY  
AMPLIFIER DIVISION  
500 W. HURON STREET CHICAGO, ILLINOIS



Jerry Kahn, president of Standard Transformer Corp.

**STANCOR SERVICE GUIDE**

Standard Transformer Corp., 1500 N. Halsted St., Chicago, have issued the fifth edition of their replacement transformer guide and catalog. The 38-page book includes 24 pages of receiver listings which show the power, a-f transformer and filter choke requirements as well as the tube compliments for a great number of receivers.

Copies may be obtained from Stancor.

**UNIVERSITY LABS CATALOG**

University Labs., 195 Chrystie St., New York City, have released their latest catalog featuring exponential horn units, horns and reflexed acoustic reproducers. Copies may be obtained directly from University Labs.

**JFD CATALOG**

JFD Manufacturing Co., 4111 Ft. Hamilton Pkwy., Brooklyn, N. Y., have issued their 1939 catalog of auto-radio antennas, auto-radio accessories and vertical roof antennas. Copies may be obtained directly from JFD.

**EPCO BULLETINS**

A number of bulletins have just been made available by Electronic Products Co., St. Charles, Illinois, describing their line of photoelectric control apparatus for various applications. Copies may be secured from the above organization.

**PARK METALWARE BULLETINS**

Park Metalware Co., Orchard Park, N. Y., manufacturers of Xcelite screwdrivers, for regular and Phillips screws; nut-drivers, tool holders, Xcel pliers and similar tools, have issued several bulletins illustrating and describing additions to their line. Copies may be obtained directly from Park Metalware Co.

**TUNG-SOL TUBE CHART**

The seventh edition of the Tung-Sol radio tubes characteristics chart is now available. Considerable information is contained in this booklet which may be obtained by writing to the Tung-Sol Lamp Works Inc., Newark, N. J.

**DEWALD 1940 LINE**

The new line of the De Wald Radio Mfg. Corp., 440 Lafayette St., New York City, to be shown at the Blackstone Hotel during the Chicago Show, includes a cub portable; the Phonoscope, that plays through its own speaker, and plenty of other features which are said to make this line appealing to live merchandisers.

**RECORDING BLANKS BULLETIN**

Duralite, a new type of instantaneous recording blank, is discussed in a bulletin available from Musicraft Records, Inc., 10 W. 47th St., New York City. Features, prices and specifications are given.

**SEE**  
the **NEWER**  
**GREATER**  
*line of*  
**"PRECISION"**  
**TEST**  
**EQUIPMENT**

*on display at the*  
**Radio Parts Show**

Ask your distributor for  
our 1940 catalog listing  
more than 40 new  
"PRECISION" models

**PRECISION**  
**APPARATUS CO.**  
647 KENT AVENUE  
BROOKLYN NEW YORK



**Which Do You Need?**

**IF** you haven't the regular Complement Book, send for No. 1. All the contents of Sylvania's standard Tube Complement Book—plus a big, complete 56-page Supplement giving the tube complements and i-f peaks of all the new, recently-announced sets—bound right into the center of the regular book! 221 pages, all told . . . and it's yours for only 25c.

**OR**—if you already own a Sylvania Tube Complement Book—just send for No. 2. The 1938-39 Supplement will bring it completely up-to-date—and thus improve your servicing on new sets. The Supplement is 10c.

**SYLVANIA**

SET-TESTED RADIO TUBES

*Also makers of famous Hygrade Lamp Bulbs.*

**1**

RUSH THIS COUPON TO DEPT. S-69, HYGRADE SYLVANIA CORP., EMPORIUM, PA.

**2**

DEPT. S-69, HYGRADE SYLVANIA CORP. Emporium, Pa.

Please send me the Complement Book (No. 1) complete with 1938-39 Supplement @ 25c.

Send me the 1938-39 Supplement (No. 2) @ 10c.

Name .....

Address .....

City ..... State .....

Name of Jobber .....

# ASSOCIATIONS

## RADIO SERVICEMEN OF AMERICA

### Binghamton

At our meeting of April 17, we started a card index system (each member having a card index and box) of bad accounts. Each card has the customer's name, type of set and model and serial numbers, amount of charge, and excuse or excuses for nonpayment. A time each meeting will be devoted to bringing each file up to date.

At our meeting of May 16, Leon Van Buskirk invited us to the Southern Tier Electric Supply Co. here and let us see some of the Beam-O-Scope ideas of G. E. A stock model was soon apart! Van gave us a nice talk on these Beam-O-Scopes. Liquid refreshments followed.

Here's to a big time at the convention!

*Earl L. Pittsley, publicity.*

### Boston

Meetings are being held weekly by our chapter. Lectures, demonstrations, discussions, and (sometimes) refreshments are served to the members. An especially interesting meeting was held May 17, when John P. Sheridan, of the Eastern Co. lectured and demonstrated adjusting phonograph and automatic devices.

*Ingvor Paulsen, secretary.*

### Bridgeport

A pinochle party was sponsored by our chapter on April 24. About fifty attended, with an enjoyable evening reported by all. Mrs. S. Sivy was in charge of arrangements. Many thanks is in order to her from all members.

Bob Herzog of SERVICE magazine gave us a lecture on Television on May 15. Sixty members and guest Service Men were present. Door prizes of two years subscription to SERVICE and two years to COMMUNICATIONS were won by Phil Stern and James Gompertz. Bob discussed the RMA scanning methods used in television, the cathode-ray tube, and the transmission of pictures. He stressed the fact that too much care in servicing television is still not enough, since the voltages are dangerous. He also showed us that there must be no free service if we want to stay in business, whether it's sound radio or television we are servicing.

*A. H. Stendahl, secretary.*

### Chicago

As is usual, the months of May and June are always busy ones for the Chicago chapter, preparatory to the Convention and Trade Show. It's our task to prepare the RSA booth and provide a well balanced program of entertainment for our fellow members from out of town. The plans as they stand now promise to make the RSA booth one of the highlights of the show.

Our special RCA Television Service Course at RCA Institutes is entering its third month, and is going strong. Judging from what has been covered so far, it's quite evident that the Television Servicemen need specialized training, if he is to succeed at all. Our chapter has secured exactly this sort of special advanced training, which at present is not available anywhere (in this locality at least) at any price. Well, it's one more ac-

complishment the Chicago chapter can be proud of.

Oh, yes—order your Brandex now, addressing Chicago chapter treasurer O. S. Dawson, 1031 E. 47 St., Chicago. Price 25 cents, with order.

*Al Kilian, publicity.*

### Cleveland

Our chapter is cooperating with RMA and NAB in their campaign to increase listener interest and to further the American system of broadcasting. Members of the Cleveland chapter submitted many questions (and answers) that the public are asking Service Men every day. The whole business was rewritten into script form, and WGAR aired the works under the heading of "Radio Tuneup."

*L. Vangunten, publicity.*

### Danville

Tonight (April 28) we had a fairly nice crowd at a meeting that was all business. We discussed many things in our unfinished business, including our approaching radio programs and our future activities.

The instruction part of the evening was conducted by our program chairman and yours truly (Owen McArdle and Cal Stapp). The subject was "Overhead Expenses," using the Round Table Discussion in the November Radio Serviceman, Arthur Rhine's articles in SERVICE and Radio Today, and Joe Marty's articles in Radio Retailing as our source of information. Using the charts published in the Serviceman, each member was asked to put down their own figures. The results were very surprising to all. We tried to put the idea across to each and every one present that they must charge sufficiently to cover overhead and make a profit before they could ever hope to get ahead in radio servicing.

*Cal Stapp, secretary.*

### Denver

Everything is going along fine out here in these old Rocky Mountains.

We have met with officials of station KFEL and discussed our part and the station's part in the NAB-RMA program. We are willing to give this campaign our cooperation in any way we may aid in making it successful.

Our credentials, charter and member certificates, were received and distributed to the membership. Thanks for the snappy action.

We hope to take some action on the servicing conditions in Denver in the near future, and I am sure our group can do some real good along these lines.

*Olin Hurley, secretary.*

### Detroit

Our committee on Minimum Service Charges has announced its plan. A great deal of work and investigation was done before prices for certain common service operations were determined and a service policy suggested. The principal points of the plan are these:

1) Work in the customer's home is limited to simple repairs to exposed parts of the chassis and speaker, antenna and ground and the testing of tubes.

2) A service call charge includes removal of the radio to the shop and return to the customer, as well as a general test and inspection of the installation.

3) An analysis charge includes a complete analysis to determine all the faults and an estimate of charges for complete reconditioning.

4) Minimum charges for each common part replacement or service operation, together with charges for work not commonly encountered, are added to the call charge and the analysis charge. The sum of these charges, plus the list price of parts and tubes used, constitutes the charge to the customer.

5) Any part of the work may be authorized by the customer, but the call charge and analysis charge are to be collected in any case.

6) "Free Services" are limited wherever possible to the testing of

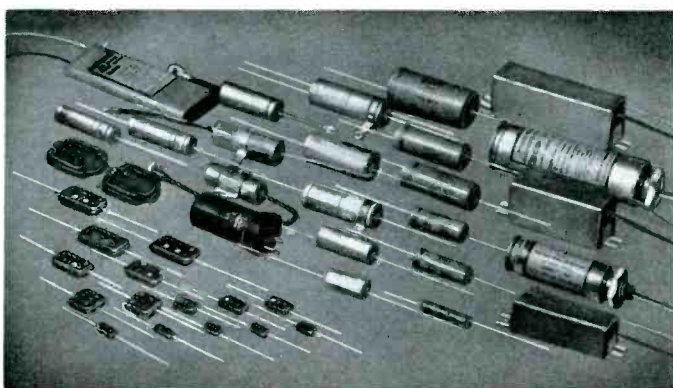

**Micamold** offers YOU the same high quality components that the company furnishes all the leading radio set manufacturers . . .

Ask your distributor for catalog listing the complete line of MICAMOLD products, including such popular types as the new Unicords, Ballastrons, Vibracons, Tublytics, etc.

**MICAMOLD RADIO CORP.**

Flushing and Porter Avenues • Brooklyn, New York

## SAVE \$1.00!!!!

- The Group Subscription Plan for *Service* enables a group of service men, dealers or jobbers to subscribe at one-half the usual yearly rate.
- The regular individual rate is \$2.00 a year. In groups of 4 or more the subscription rate is \$1.00 a year (in foreign countries, \$2.00).
- The service departments of thousands of dealers, independent service men, etc., have used this Group Plan for years, in renewing their subscription to *Service*.
- Each subscriber should print his name and address clearly and state his occupation—whether a dealer, jobber, independent service man, service organization, etc.

Remember this Group Plan when  
Your Subscription Expires

**SERVICE**

19 EAST 47TH STREET, NEW YORK, N. Y.

Visit our Booth at the Trade Show—Steinmetz Avenue

tubes when the tubes are brought into the shop.

Printed price cards were prepared and distributed to chapter members. There was a great deal of interest shown by non-members, so it was thought wise to make these cards available to all Service Men. The committee is now on a semi-permanent basis, and will review all criticisms of the plan and make constructive revisions as required. The response to this plan has been very gratifying, and comments have been entirely favorable. Districts where cut prices are the rule are being closely watched to see what effect the plan will have on their price schedules.

The Board of Directors plans to extend the chapter activities to study the major headaches of the Service Men of this area, and establish a plan of action intended to cure each of them.

The entire chapter sends sympathy to Lester Shelton, whose mother recently passed away.

We are expecting to have a big delegation at the Chicago Convention. See you then.

A. E. Lindner, secretary.

#### Duluth

On May 15 a resume of the Philco Television demonstration was given by members Elmgren, Springer, and Goodell. Al Zmeskal of Lucker Sales, Minneapolis, spoke on antenna systems, a.f.c., inverse feedback, and production methods of radio manufacture. Mr. Rietan elucidated on the intricacies of television, and Mr. Kane, of the same company, spoke on establishing a credit rating and financing problems.

E. N. Holmlund, secretary.

#### Long Island

"Servicing Television Receivers" was the subject of our May 18 meeting, when Milton B. Sleeper of Andrea Radio Corp., Messrs. Yocum and Higgins of Weston Instruments,

and Robert G. Herzog of SERVICE gave us very interesting talks on television circuits and servicing problems.

Beginning in June, we will hold two meetings a month. The first Wednesday of the month will be a technical meeting, the third Thursday will be our regular business meeting.

Arthur Cyr, secretary.

#### Nashville

A motion to penalize absent members a dime was adopted. Better attend now, boys, or it will cost you.

It was decided to accept men connected with local wholesale houses as associate members.

Mr. Thomas' resignation as chairman was accepted with regret, and an honorary membership in the chapter was voted him. K. Head was unanimously elected to succeed Mr. Thomas.

K. Head, chairman.

#### New Hampshire

April 18 meeting: There was some discussion of a local survey of operating expenses of the individual Service Man. It was decided that the secretary should compile and distribute the necessary data and question sheets.

A blacklist of non-paying customers was discussed, and a motion to adopt the blacklist system, the necessary information to be sent out with the monthly bulletin, was adopted.

Instruction in dynamic testing of receivers was conducted by Mr. Sawtelle.

On May 2, the blacklist committee reported progress in their plans. They cautioned that a blacklist could not be posted in public.

A discussion of the proposed questions of the operating cost survey was submitted to the members.

Ralph Goulet took the big jump some time last month. He is now on his way back from the San Francisco World's Fair.

Ray Rogers, secretary.

#### Newark

Mr. Clark, one of our members, gave us a swell demonstration and instruction on the use of the slide rule at our meeting of May 9. It sure was educational, and everyone present learned a lot about the old slip stick, even Garry Goracci! Splendid demonstration, Clarky.

We received a copy of the Chicago chapter publication, the RSA Nucleus. They suggest that it would be a grand idea if all the chapters would intercommunicate, bringing about a closer relationship.

Bruce Burlingame of Supreme gave the members and guests present a splendid talk on May 24. He said some swell things about the RSA, pointing out that the sooner the non-members got together and united in a powerful National organization, the sooner it can be recognized and correct the wrongs of the servicing industry. Mr. Burlingame then gave us an instructive talk on television. We always enjoy Bruce and hope to have him again in the near future.

A. Fasanello, secretary.

#### Pittsburgh

A special cooperative plan involving the entire radio industry in an effort to create and stimulate a keener interest in radio reception by the general public was outlined at our meeting of May 9. General business and election of officers was held.

Our Tenth Anniversary Dinner-Dance was held May 23 at Eddie Peyton's. It was a gala affair.

Bill Irlam, secretary.

#### Rockford

Rockford chapter enjoyed a friendly get-together May 9, which included a supper and an interesting discussion by our friend Mr. Mohaupt. Many prospective members of RSA were present as guests of the chapter. A number joined at the conclusion of the meeting. Don Stover, director of this RSA district, and Joe Marty,

executive secretary, explained RSA, its setup, aims, objectives and accomplishments. The ever welcome Freeport chapter was also represented at the meeting.

Ted Detweiler, secretary.

#### Washington, D. C.

Our local by-laws and regulations are very near completion. Upon adoption, an election of officers to govern the chapter next year will be held.

We were very fortunate to have Milt Shapiro talk on May 2. He kept the interest of the entire organization well in hand for two and a half hours, and very diplomatically kept sales out. However, we knew that the gentleman is a representative of Radiart!

Phil Partridge, secretary.

#### OTHER GROUPS

##### ART of British Columbia

On Friday, April 14, the task of allotting the various offices to the newly elected executives was the order of the day. The results: Tom Brown, president; Art Houghton, vice-president; Allan Johns, secretary; Fred Lewis, treasurer; and Wilf Munton, recording secretary.

##### PRISMA

Irwin T. Higgins, of the Weston Electrical Instrument Co., will point out the "Possibilities for Television Servicing," at the June 20 meeting. He will bring along some interesting demonstration equipment.

There is a rumor circulating to the effect that Bob Herzog, editor of SERVICE, will be present.

PUT THIS DATE ON YOUR CALENDAR!

AERIALS - STANDARD OF COMPARISON  
R.V.M.  
(RADIANT VIBRATOR MANUAL)  
at  
RADIANT JOBBERS  
25¢  
RADIART

VIBRATORS - GUARANTEED 1 YEAR  
R.V.M.  
(RADIANT VIBRATOR MANUAL)  
128 PAGES of  
AUTO RADIO SERVICE  
INFORMATION  
25¢  
RADIART

# SIMPLIFIED

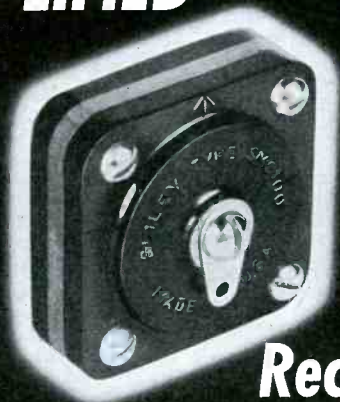

## Receiver ALIGNMENT

With a Bliley SMC100 Dual-Frequency Crystal Unit and a few standard parts, you can easily construct a Crystal Calibrator. This inexpensive instrument cannot be beat for rapid and accurate receiver alignment and is indispensable for performing quick overall checks of sensitivity and alignment.

Any Bliley Distributor can supply the SMC100 crystal unit for only \$7.75. Bulletin E-7, containing full information on a complete Crystal Calibrator, is yours for the asking. Bliley Electric Co., Erie, Pa.

## BLILEY DUAL FREQUENCY CRYSTAL

# ATR

THE CHOICE OF THE INDUSTRY

See the Complete ATR Line of Vibrators, Vibrator-Operated and Rectifier Power Supplies at the Radio Parts Show, BOOTH No. 831

### QUALITY PRODUCTS

- Auto Radio Vibrators
- Farm Radio Vibrators
- Inverter Vibrators
- Shaverpacks
- Low Power Inverters
- Radio Inverters
- Industrial Inverters
- Vibrator Packs
- Polarity Changers
- "A" Battery Eliminators
- Battery Chargers
- Rectifier Packs
- Special Supplies
- "A-B" Power Units

American Television & Radio Co. has consistently devoted its efforts and energies to the perfection and production of vibrators and associated equipment and today, after nine years of pains-taking, persistent, and diligent work resulting in steady development and progress, is considered the World's Leader in its field.

ATR Vibrators, the heart of vibrator-operated power supplies, are proven units of the highest quality, engineered to perfection. They are backed by more than nine years of vibrator design and research, development and manufacturing—ATR pioneered in the vibrator field.

All ATR products incorporate only the best materials and workmanship and are carefully manufactured under rigid engineering inspections and tests, making them the finest that can be built.

#### ATR Products Are FULLY GUARANTEED

Be Sure to Specify and Insist on ATR—There is No Substitute!

Your ATR Distributor Will Be Happy to Serve You

Write for Complete Literature

## AMERICAN TELEVISION & RADIO CO.

St. Paul, Minn., U. S. A. Cable Address: "Likex," New York

## THE SHURE LINE ANSWERS EVERY SOUND NEED!

### NEW "UNIDYNE" DYNAMIC

Gives true cardioid-type uni-directional pickup. Gets the sound you want, free from feedback and audience noise. Low and high impedance models, with 25-ft. cable, at \$42.50 and \$45.00 list.

### NEW "ROCKET" DYNAMIC

New moving conductor type with smooth, wide-range response that sets a new quality standard for economically priced Dynamic microphones. Low and high impedance models, with cable, at \$26.00 to \$27.50 list.

### NEW "UNIPLEX" CRYSTAL

Sensitive at Front, Dead at Rear! Solves feedback, reverberation and background noise. The only microphone with such performance at such low cost! Complete with 25-ft. cable, \$32.50 list.

and there are others, too, in the complete Shure Line—"Ultra Wide-Range" Crystal Microphones, Low-Cost Economy Mikes, High Quality "Communications" Microphones, "Stabilized" Floor Stands, Improved Low-Cost Pickups.

Write for Catalog 150S. See Them All at BOOTHS 109 and 111, National Radio Parts Trade Show.

Shure Patents Pending. Crystal Devices licensed under Brush Patents.

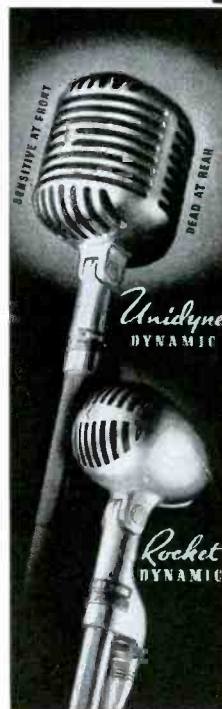

SHURE

M

SHURE BROTHERS  
225 W. HURON ST., CHICAGO, U.S.A.  
CABLE ADDRESS: SHUREMICRO

MICROPHONES & ACOUSTIC DEVICES

## MUELLER Presents— A Complete New Line of Alligator Clips

All Popular Types — Insulated and Uninsulated

**IMPROVEMENTS!**

Plus a Unique Solid Copper R. F. Alligator!

SEND FOR FREE SAMPLES AND SHEET 802

*Mueller Electric Co.* 1563 East 31st Street  
Cleveland, Ohio

## A GOOD NAME GOES A LONG WAY



High engineering standards, multiple inspection, close-limit testing, make Ken-Rad Radio Tubes the logical choice of careful buyers.

KEN-RAD TUBE & LAMP CORPORATION  
Owensboro, Kentucky

# KEN-RAD

DEPENDABLE RADIO TUBES





The Raytheon Production Corp., 445 Lake Shore Drive, Chicago, are announcing a new line of free displays and advertising material to help their dealers and Service Men increase tube profits and speed up turnover. The photograph illustrates one of the window effects that can be achieved with part of this material.

**CUSHWAY TO WEBSTER-CHICAGO**

This year's Radio Parts Show will find Charlie Cushway, veteran sales executive, greeting his friends from the booth of the



Webster Company, Chicago manufacturer of sound systems and record-playing equipment. Mr. Cushway was formerly with Thordarson.

**HENRY HUTCHINS TO NATIONAL UNION**

On leave of absence from four-year Vice-Presidency of Western Advertising Agency's Chicago Office, Henry Hutchins



has returned to National Union to direct its selling program. It was back in 1930 that Henry was first appointed Sales Manager of N. U.

★  
**HUNDREDS of  
THOUSANDS of**

*Wire-Wound  
Resistance  
Units in Stock  
for Quick  
Shipments*

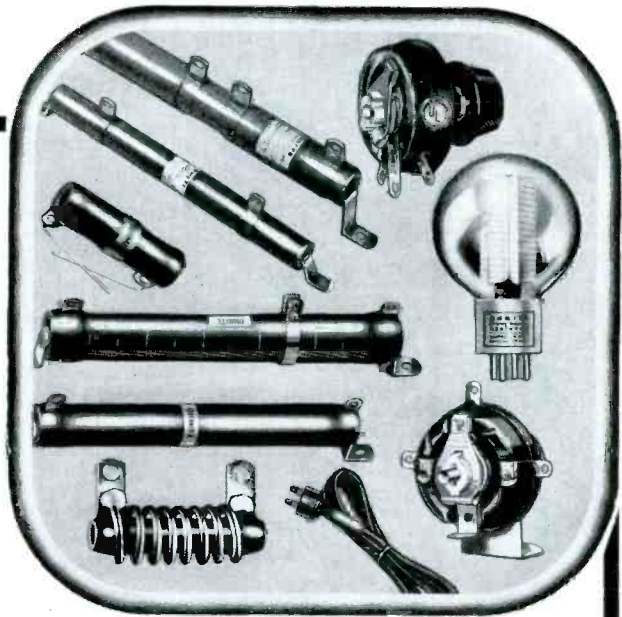

★  
**OHMITE Resistance Units**

Here, Mr. Serviceman, are some of the outstanding Ohmite parts so widely used by engineers and servicemen the world over. They're extra sturdy, dependable, time-proved under the toughest service conditions. They do the job *better*.

**BROWN DEVILS.** The popular 10 watt and 20 watt all-porcelain wire-wound resistors with the permanent protection of Ohmite vitreous enamel. Resistances from 1 to 100,000 ohms.

**DIVIDOHMS.** The handy wire-wound all-porcelain vitreous-enamelled *adjustable* resistors. 10 to 200 watts; resistances to 100,000 ohms.

Fixed Resistors ★ Close-Control Rheostats ★ Cordohm Line Cord Resistors ★ Power Line Chokes ★ Soldering Iron Control Rheostats ★ And of course, R. F. Plate Chokes, Parasitic Suppressors, Dummy Antenna, Tap Switches, etc.

**ASK YOUR JOBBER**

See us at **BOOTH 825,**  
**National Radio Parts Trade Show.**

★ This is a service only Ohmite can render so completely. For here at Ohmite you have on call through your Jobber the largest, most complete stock of wire-wound Resistors and Rheostats in the country—hundreds of thousands of units in a range of types and sizes unmatched anywhere—readily available at all times for immediate shipments the same day orders are received. So remember—if it's in the Ohmite Catalog 17, you can get it in a hurry.

--- SEND FOR FREE CATALOG ---

**OHMITE MANUFACTURING CO.**

4879 Flornoy Street, Chicago, U. S. A.

Send me FREE CATALOG 17.

Name .....  
Address .....  
City .....  
Occupation .....

*Be Right with* **OHMITE**  
RHEOSTATS ★ RESISTORS ★ TAP SWITCHES

**SAVE \$1.00 !!!**

- The Group Subscription Plan for *Service* enables a group of service men, dealers or jobbers to subscribe at one-half the usual yearly rate.
- The regular individual rate is \$2.00 a year. In groups of 4 or more, the subscription rate is \$1.00 a year. (In foreign countries, \$2.00.)
- Each subscriber should print his name and address clearly and state his occupation—whether a dealer, jobber, independent service man, service organization, etc.

**Remember this Group Plan when Your Subscription Expires**

**Now..**  
**5 VITAL FEATURES**  
 COMBINED IN  
**AMPERITE VELOCITY**  
 WITH ACOUSTIC COMPENSATOR



- it's a **VELOCITY**
- it's a **DYNAMIC**
- UNI-DIRECTIONAL**
- NON-DIRECTIONAL**
- HIGH OR LOW PITCH**

By moving up the Acoustic Compensator, you change the Amperite Velocity Microphone to dynamic operation — without peaks. At the same time you reduce the back pickup, making the microphone practically **UNI-DIRECTIONAL**.

UNI-DIRECTIONAL PICK-UP FIELD COMPENSATOR UP

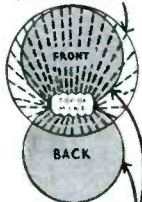

With the Acoustic Compensator down, the microphone is **BI-DIRECTIONAL** . . . 120 degrees front and back without frequency discrimination. Rotating the microphone until it parallels the ceiling makes

PICK-UP FIELD COMPENSATOR DOWN

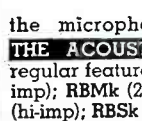

the microphone **NON-DIRECTIONAL**. **THE ACOUSTIC COMPENSATOR** is a regular feature of these models: RBHk (hi-imp); RBMk (200 ohms) LIST \$42.00. RSHk (hi-imp); RBSk (200 ohms) LIST \$32.00



**Sell "Contact Mikes" to Professional and Amateur Musicians**

New high output model can be used in the home. Professional musicians are buying Amperite "Contact Mikes" because "it makes an ordinary violin sound like a Strad". Now amateurs, too, can benefit by the "Contact Mikes". The new **HIGH OUTPUT MODEL SKH** can be used in the home. It operates on most radio sets made since 1935. It is connected to the phono-input, or to grid ground of detector tube, or across the volume control. Note new clamp, making the mike easy to attach to guitars, ukes, etc.

**MODEL SKH** (hi-imp); **SKL** (200 ohms) \$12.00 LIST. Any number up to 5 SKH's can be put in parallel and fed into one input. **NEW FOOT PEDAL** \$12.00 LIST. **CLAMP** for Contact Mike, \$1.00 LIST.



**FOR TOP-NOTCH QUALITY AND AMAZING RUGGEDNESS, AT LOW COST SPECIFY MODEL RAH (OR RAL)**

Here's why this popular Amperite Velocity Microphone leads the low-price field: (1) it is excellent for both speech and music; (2) has flat response without undesirable peaks; (3) reduces feedback; (4) stands up under rain, wind, heat, and rough handling . . . Frequency range 60 to 7500 CPS. Output, -68 db. **MODEL RAH** (hi-imp.), with 12' of cable; **MODEL RAL** (200 ohms) with 8' of cable. \$22.00 LIST

Write for Complete Illustrated Bulletins and Valuable Sales Helps

**AMPERITE Co.** 561 BROADWAY, N. Y. Cable Address: Alkem, New York

**AMPERITE** Velocity **MICROPHONES**

**Index to Advertisers**

A	
Aerovox Corp. . . . .	289
Alden Mfg. Co. . . . .	308
Allied Radio Corp. . . . .	310
American Television & Radio Corp. . . . .	320
Amperite Co. . . . .	322
Andrea Radio Corp. . . . .	285
Astatic Microphone Laboratory, Inc. . . . .	288
B	
Bliley Electric Co. . . . .	320
Bogen Co., Inc., David. . . . .	314
Brach Mfg. Corp., L. S. . . . .	310
C	
Centralab . . . . .	290
Cinaudagraph Corp. . . . .	270
Clarostat Mfg. Co., Inc. . . . .	314
Consolidated Wire & Associated Corps. . . . .	308
Cornell-Dubilier Electric Corp. . . . .	283
D	
DeWald Radio Mfg. Co. . . . .	308
Drake Electric Works. . . . .	304
H	
Hickok Electrical Instrument Corp., The. . . . .	300
Hygrade Sylvania Corp. . . . .	317
J	
Jackson Electrical Inst. Co. . . . .	310
Jensen Radio Mfg. Co. . . . .	297
K	
Ken-Rad Tube & Lamp Corp. . . . .	320
L	
Lenz Electric Mfg. Co. . . . .	269
M	
Mallory & Co., P. R. . . . .	Second Cover
Meissner Mfg. Co. . . . .	295
Micamold Radio Corp. . . . .	318
Midland Television, Inc. . . . .	304
Mueller Electric Co. . . . .	320
N	
National Union Radio Corp. . . . .	303
O	
Ohmite Mfg. Co. . . . .	321
P	
Park Metalware Co. . . . .	310
Post Merchandise Corp. . . . .	322
Precision Apparatus Corp. . . . .	317
Premax Products . . . . .	314
R	
RCA Mfg. Co., Inc. . . . .	299, Fourth Cover
Radiart Corp., The. . . . .	319
Radio City Products Co., Inc. . . . .	315
Radio Servicemen of America, Inc. . . . .	304
Raytheon Production Corp. . . . .	275
Readrite Meter Works. . . . .	288
Rider, John F., Publisher. . . . .	309
S	
Service Instruments, Inc. . . . .	305
Shure Brothers . . . . .	320
Solar Mfg. Corp. . . . .	Third Cover
Sprague Products Co. . . . .	301
Standard Transformer Corp. . . . .	313
Supreme Instruments Corp. . . . .	287
T	
Thordarson Elec. Mfg. Co. . . . .	316
Triplet Elec. Inst. Co., The. . . . .	307
Tung-Sol Lamp Works, Inc. . . . .	312
U	
Utah Radio Products Co. . . . .	311
W	
Ward Products Corp., The. . . . .	316
Weston Electrical Instrument Corp. . . . .	279
Y	
Yaxley Mfg. Division. . . . .	Second Cover

**Now!**  
**BALLAST REPLACEMENT**

made **AMAZINGLY SIMPLE**

• Servicemen, with only 4 standard types of Amperite AC-DC Regulators you can replace 90% (over 100 types) of AC-DC Ballast Tubes now in use! Consult your jobber.

• Amperite Regulators are equipped with a patented Automatic Starting Resistor to prevent untimely burnouts and save pilot lights.

• New Low Price on Amperite AC-DC Regulators: \$1.00 LIST

Amperite Replacements for 2V Battery Set ballasts \$1.25 list



**AMPERITE Company**  
 561 BROADWAY  
 NEW YORK

WRITE FOR CHART AR

**AMPERITE**  
 AUTOMATIC REGULATORS



**CONVERT ANY SET TO AUTOMATIC TUNING**

WITH THE NEW

**KALETTE Tune Master**

Containing 5 Tubes

**WIRELESS CONTROL**

A wireless remote control that provides push button tuning and automatic volume control for any type receiver. A complete modernizing unit for new and older radios. Increases sharpness of tuning and aids sensitivity. Operates from any A.C.-D.C. circuit. No changes or adjustments to radio required. Does not affect independent operation of set, or interfere with neighborhood radios.

An exceptional profit opportunity for dealers at

**\$7 50**  
 LIST PRICE **\$25**

as advertised in Saturday Eve. Post, November 5, 1938 issue.

Territories open for Jobbers and Distributors

WRITE FOR DESCRIPTIVE CIRCULAR  
 Sole Distributors in U. S. A.

**Post Merchandise Corp.**  
 277 BROADWAY NEW YORK CITY  
 Cable Address: POSTMERCH

**NEW**



# "SEALDTITE" TUBULAR PAPER CAPACITORS

*Wax-molded*

**the only major advance  
in the last decade**

**2 to 5 times  
average life expectancy**

Now has an engineer's dream come true! Here is a new paper tubular of standard size and price, but totally sealed so that immersion does not harm it. It speaks for itself in any laboratory, any climate.

The new Sealdtite has a standardized non-inductive winding with full-diameter hot-soldered leads. But this assembly is not stuck into a tube with the doubtful results shown in figures 1 and 2. It is held mechanically centered in molds; an exclusive newly developed Sealdtite wax compound is molded around it. The even walls totally exclude moisture. Hard; will not soften at any ordinary operating temperatures. For convenience, enclosed in a labeling tube.

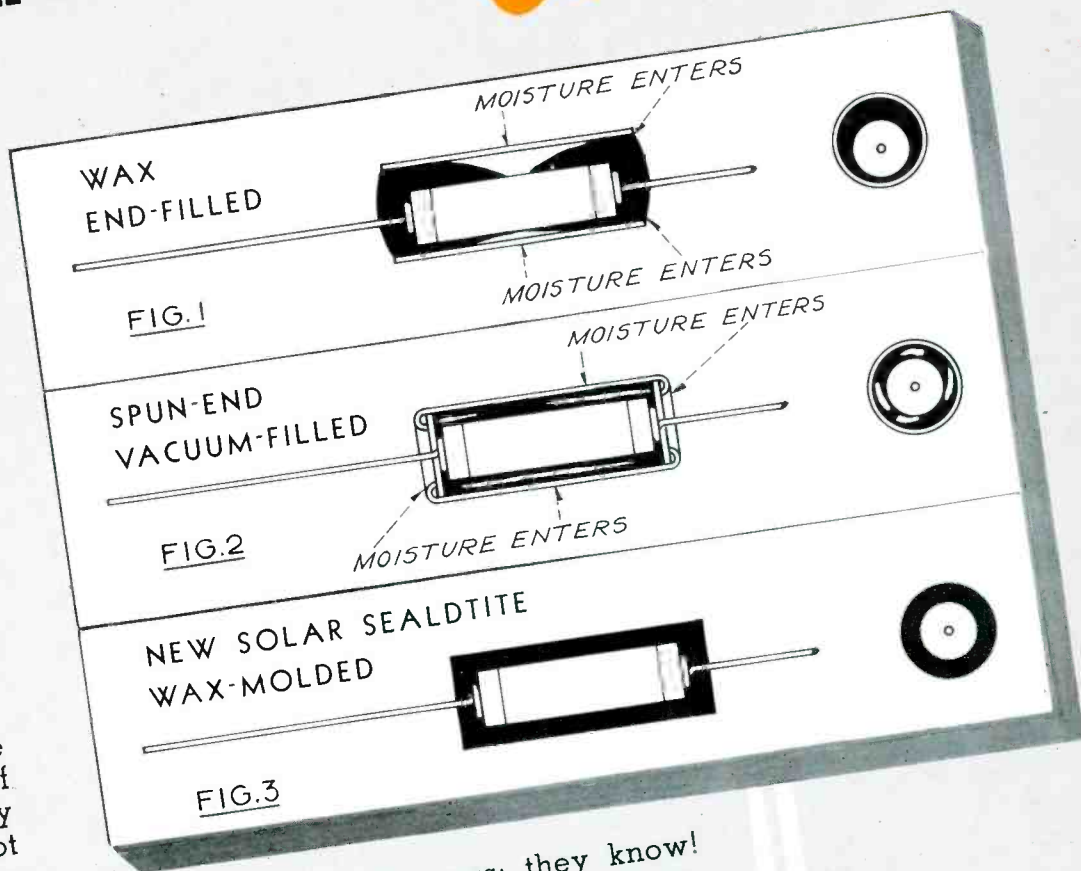

Engineers do not guess; they know! You too will be astounded at test results, for the new Sealdtite is a major advance in the capacitor art. Sealdtites for Safety!

Your jobber can supply this most modern Tubular in factory-sealed cartons-of-ten.

*Investigate!*

**SOLAR MFG. CORP.  
Bayonne, New Jersey**

# WAIT!

# UNTIL YOU SEE WHAT RCA HAS COMING!

You'll find out about the big, important surprises RCA has for you when you attend the Parts Show. They're surprises that will amaze and delight you . . . and help you make more money!

*Over 335 million RCA radio tubes have been purchased by radio users...in tubes, as in radio sets, it pays to go RCA All the Way*



## *Test Equipment*

A SERVICE OF THE  
RADIO CORPORATION  
OF AMERICA

RCA MANUFACTURING CO., INC., CAMDEN, N. J.