

# SERVICE

A Monthly Digest of

# RADIO

and Allied Maintenance

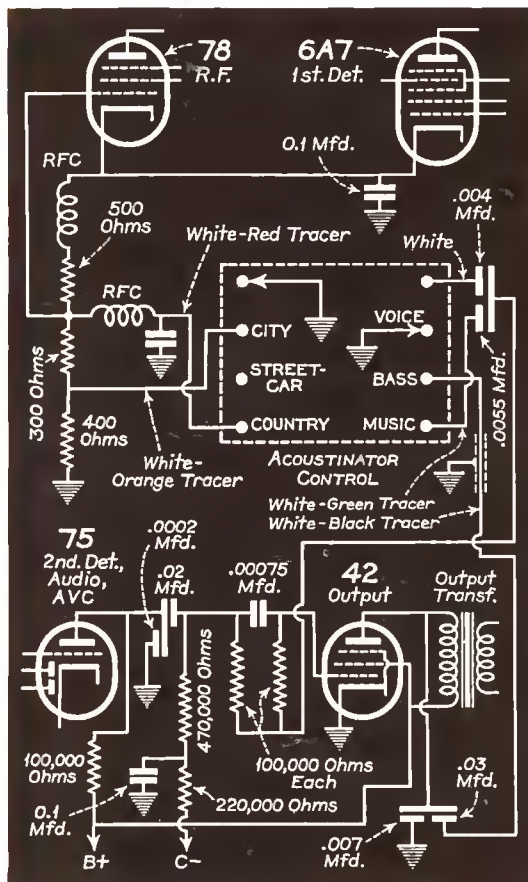

Sensitivity Tone Control

(See page 278)

PER COPY  
25 CENTS

MAY  
1937



I always thought...



I never knew...



I had an idea...

Well... here are facts!

**MALLORY-YAXLEY**  
*Precision Radio* REPLACEMENT  
PARTS COST NO MORE THAN  
ORDINARY PRODUCTS

**T**HREE service men check the prices of Mallory Condensers, Mallory Vibrators, and Yaxley Volume Controls against the prices of competitive products. All three are surprised to learn — and tickled to death to know — that Mallory-Yaxley products with all their well-deserved prestige and popularity *cost no more than ordinary products.*

Said one—"I always thought that because Mallory-Yaxley had done so much for the service man that I'd have to pay a premium to use their products." Said another—"I never knew that a company big enough to publish a book like the Mallory-Yaxley Radio Service Encyclopedia would charge no more for its products than I pay for those of companies that have done little or nothing to advance the service man's interests."

And the third remarked—"I had an idea that products with the reputation and prestige of the Mallory-Yaxley line just couldn't be priced on a really competitive basis."

So—if you "always thought"; if you "never knew"; if you've "had an idea"—check with your dealer or distributor—through counter or catalogue and get the proof that will make you say: "I'm going to buy Mallory-Yaxley from now on!" And—after you've used these precision replacement parts awhile you'll find that the goodwill and good business they build make Mallory-Yaxley products *actually cost less in the long run!*

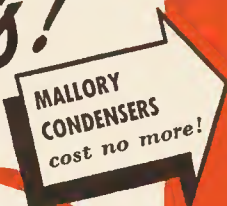

*No More Time Wasting*

when you get a copy of the **MALLORY-YAXLEY RADIO SERVICE ENCYCLOPEDIA** from your distributor.

All the information on Circuits—Schematics, I. F. Peak Frequencies, Transformer Circuits, Condensers, Volume Controls, Vibrators and Tubes—in one book, on one page, on one line for any receiving set.

Use  
**P. R. MALLORY & CO. Inc.**  
**MALLORY**  
REPLACEMENT  
CONDENSERS...VIBRATORS

**P. R. MALLORY & CO., Inc.**  
INDIANAPOLIS INDIANA  
CABLE ADDRESS—PELMALLO

Use  
**YAXLEY**  
REPLACEMENT  
VOLUME CONTROLS

# SERVICE

A Monthly Digest of Radio and Allied Maintenance  
 Reg. U. S. Patent Office. Member, Audit Bureau of Circulations

EDITOR

Robert G. Herzog

MAY, 1937

VOL. 6, NO. 5

## EDITORIAL CONTENTS

### FEATURES

Gain Measurements in R-F and I-F Stages By Jack Avins.....	273
Meter Accuracy By Samuel C. Milbourne.....	302
P-A Kinks By L. T. Chadbourne.....	296
Philcophone Intercommunicator .....	298
Power Supply Analysis with the Cathode-Ray Oscillograph By Howard J. Surbey.....	277
Selling Through Service.....	304
Sensitivity Tone Control (Motorola)....	278

ANTENNA .....	270
ASSOCIATION NEWS .....	310-311

### AUTO RADIO

Arvin Auto-Radio Service Notes.....	308
Cadillac-LaSalle 5X .....	292
Sensitivity Tone Control (Motorola)....	278

### CIRCUITS

Cadillac-LaSalle 5X .....	292
Calibrated Attenuator for use with Service oscillators .....	274
Cutaway View of "Acoustinator" showing color coding .....	278
Increasing Line Voltage.....	304
Philcophone Intercommunicator .....	300
RCA 5T6, 5T7, 5T8.....	284
RCA 220 Power Supply.....	278
Sensitivity Tone Control.....Front Cover	288
Sparton 517, 557, 567.....	288
Stromberg-Carlson 160, 160-L, 160-LB, 160-P, 160-PB .....	279
Stromberg-Carlson 160, 160-L, 160-LB, 160-P, 160-PB Wiring Layout.....	282
Typical R-F or I-F Stage.....	273

### GENERAL DATA

Gain Measurements in R-F and I-F Stages By Jack Avins.....	273
G.E. A-70, A-75 Service Note.....	294
Power Supply Analysis with the Cathode-Ray Oscillograph By Howard J. Surbey.....	277
RCA 5T6, 5T7, 5T8.....	284
RCA 6K2 (Second Production) Service Note .....	294
Sparton 517, 557, 567.....	288
Stromberg-Carlson Speaker Data.....	306
Stromberg-Carlson 160, 160-L, 160-LB, 160-P, 160-PB .....	279
Technical Features of 1937 Emerson Radio Receivers .....	287

HIGHLIGHTS .....	312
------------------	-----

MANUFACTURERS .....	316-318-319
---------------------	-------------

ON THE JOB.....	304-306
-----------------	---------

### PUBLIC ADDRESS

P-A Kinks By L. T. Chadbourne.....	296
Philcophone Intercommunicator .....	298

RECEIVER CASE HISTORIES.....	308
------------------------------	-----

### TEST EQUIPMENT

Gain Measurements in R-F and I-F Stages By Jack Avins.....	273
Meter Accuracy By Samuel C. Milbourne.....	302
Power Supply Analysis with the Cathode-Ray Oscillograph By Howard J. Surbey.....	277

Copyright 1937—Bryan Davis Publishing Co., Inc.

BRYAN S. DAVIS  
 President

JAS. A. WALKER  
 Secretary

Chicago Office—608 S. Dearborn St.—C. O. Stumpson, Mgr.  
 Telephone: Wabash 1903  
 Wellington, New Zealand—Tearo Book Depot.

Published Monthly by the

Bryan Davis Publishing Co., Inc.  
 19 East 47th Street  
 New York City

Telephone: Plaza 3-0483

SANFORD R. COWAN  
 Advertising Manager  
 PAUL S. WEIL  
 Eastern Advertising  
 Manager  
 A. B. CARLSEN  
 Circulation Manager

Cleveland Office—10515 Wilbur Ave.—J. C. Munn, Mgr.  
 Telephone: Republic 0905-J  
 Melbourne, Australia—McGill's Agency.



Entered as second-class matter June 14, 1932, at the Post Office at New York, N. Y., under the Act of March 3, 1879. Subscription price \$2.00 per year in the United States of America and Canada; 25 cents per copy. \$3.00 per year in foreign countries; 35 cents per copy.



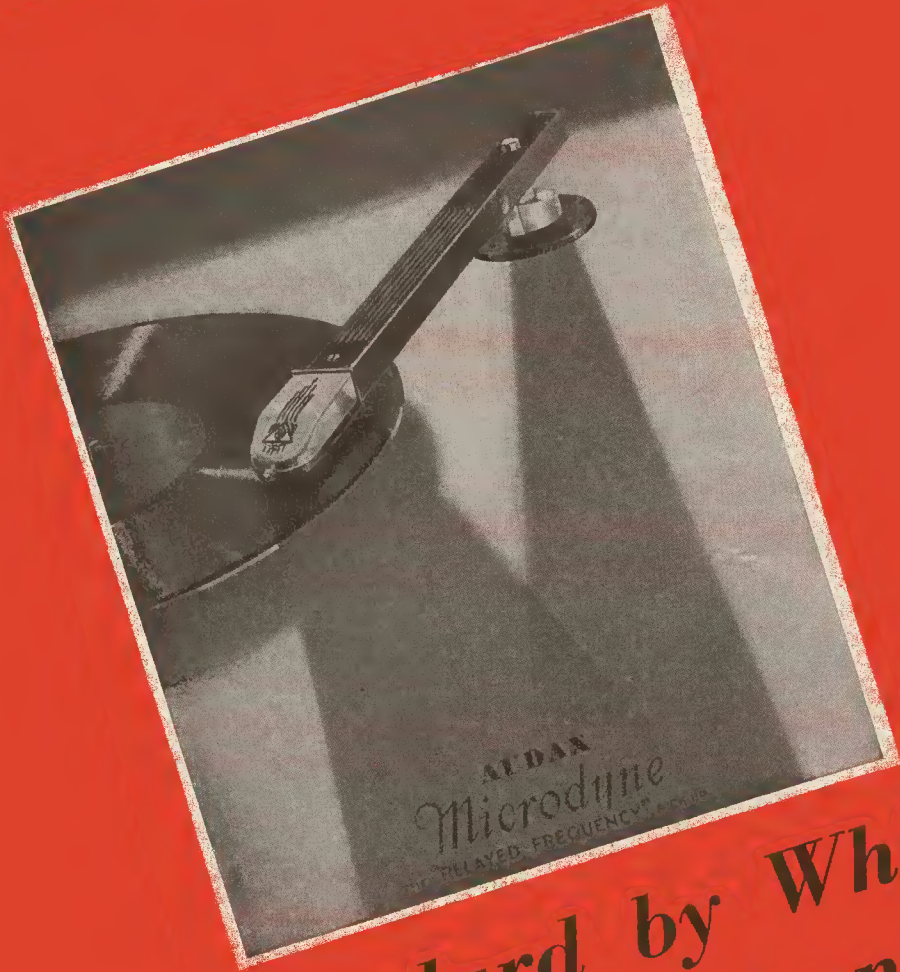

## “The Standard by Which Others Are Judged and Valued”

**H**ERE is recording-microphone fidelity, right down to the finest detail . . . an ideal toward which the industry has worked its way by slow and careful degrees. Not since the advent of the pick-up in 1926 has there been a development so important to recorded music. Now . . . listen to absolute *fac-simile* reproduction . . . delightful to engineers and laymen alike . . . a real wide-range pick-up performance that has made skeptical technicians exclaim, “That’s THE answer to the problem!”

In addition to the remarkable performance of MICRODYNE, it embodies features which, without doubt, will in time be adapted by others. For example, needle insertion is at last made convenient by MICRODYNE—feeding it from the top and automatically holding it. While but a minor matter, it is one of many features which puts MICRODYNE in a class by itself.

Also available with “offset” head.  
Ask your jobber or write direct for new low prices.

**AUDAK COMPANY**  
500 Fifth Avenue, New York

“Creators of High Grade Electrical and Acoustical Apparatus Since 1915”

## RADIO'S FOUNDATION—A GOOD ANTENNA

- A complete line of couplers available for existing doublet antennae. Also inexpensive straight wire kits.



- TACO No. 400 System. Economical All-Wave job. Includes aerial wire, insulators, transfer unit, download and set coupler. \$3.75 list.



- TACO No. 510 System. All-Wave. Full Noise-Reducing. Includes transformer in antenna circuit. \$4.50 list.



- TACO No. 210 DeLuxe System. Lic. A.A.K. Patent Re. 19854. Improved circuit. All-Wave. Full Noise-Reducing. Greater efficiency in entire short-wave spectrum and also in broadcast band. For superlative performance. \$6.75 list.
- TACO Wave-Traps. Three models covering the broadcast band. Adjustable. Tunes out annoying local station. Only \$0.95 list.

# Your Chance to Cash In!

**Y**OU can sell a TACO Antenna System for every set, new or old, in your territory. That means extra money from your calls. Also better satisfied customers, because TACO Antenna Systems positively improve the performance of ANY set.

## MASTER ANTENNA SYSTEM for Apartment or Private Dwelling

Just the thing for private dwellings. An Antenna-Ground Outlet for every room. Ideal results. Simple, practical, inexpensive. The TACO Master Antenna System is equally applicable to private dwelling or giant apartment house, hotel, hospital, etc.

System available in handy foundation unit kit for aerial and download, and as many outlet units as required. Exposed or concealed wiring. Foolproof installation.

Hundreds of installations now in use. Enthusiastic reports from property owners and radio listeners. Remember, there's a handsome profit in every job. So why not get your share?



Exposed wiring type outlet coupler (above) and concealed wiring type outlet shown below.

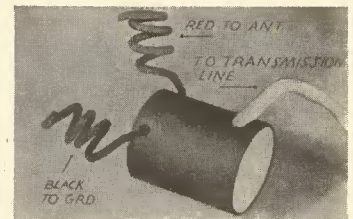

**Ask for DATA:** Literature covering Master and other TACO systems available through your local jobber or direct from us.

# TACO

**TECHNICAL APPLIANCE CORP.**

17 East 16th St.

New York City

IN CANADA: 414 BAY STREET, TORONTO

**A Fully-wired Building is Wired for Radio**



# THE ANTENNA . . .

---

## IN THIS ISSUE

IT CAN EASILY BE shown that service equipment represents your greatest investment. To receive a just dividend from that investment you must obtain an easy understanding of the applications and functions of your various test instruments.

Without equipment service work at best can be classed as mere tinkering. We need not elaborate concerning the many hours spent by some, who, in a vain effort to "doctor" an ailing receiver, change part after part with little success—until at last they talk themselves into believing that "anyway, it works better than it did before."

Those who have and know how to use modern test equipment, but on occasion have been forced to guess at the troubles in a given receiver, will readily concede that the Service Man is no more efficient than the equipment he possesses—in fact, no more so than his ability to use that equipment, for good instruments cannot help by just remaining idle on the test bench.

There are undoubtedly many times when the customer complains, "I'm sure the set played louder than it does now" . . . or "WXX doesn't come in as well as it did before" . . . What is your answer to troubles such as these? Is the customer's memory failing? Or is he exaggerating some negligible loss in sensitivity, literally making a mountain of a mole-hill?

Gain measurements, as discussed by Jack Avins in this issue, should help you in locating the causes of these ailments—or of determining if they really exist.

Now that lower priced cathode-ray oscillographs are available many more Service Men will be anxious to purchase such instruments. Howard J. Surbey demonstrates one of the many uses for this type of equipment. Any one of you in the course of your everyday service jobs can duplicate the tests that Mr. Surbey suggests.

Meter accuracy has undoubtedly troubled many . . . Samuel C. Milbourne explains the standard method used by practically all meter manufacturers in expressing the accuracy of their instruments.

With ever a thought for improvement we have expanded the technical features chart in this issue to include speaker field resistance, volume and tone control replacement data. The first chart, published in SERVICE about a year ago, brought forth so much favorable comment that it has been continued as a regular department.

It is our honest opinion that the introduction of the many types of intercommunicating systems is definitely

a boon for the Service Man. These systems open up a highly lucrative field for your exclusive exploitation. A little serious sales effort on your part, it does not need very much, and you start the ball rolling . . .

The service data and circuit diagrams of the intercommunicating system given in this issue is the first of a series of such material to be continued in the future.

• • •

## SERVICE MEN'S ASSOCIATIONS

THERE IS HARDLY A Service Man who hasn't some complaint about business or competition. Many of these problems can be solved through proper action taken by Service Men's Associations.

Aside from the educational and social value of your association—it can be used to voice the common complaints of its members when and where it will do the most good. By using the weight of numbers something will be accomplished toward remedying many grievances.

• • •

## NATIONAL PARTS SHOW

THE STEVENS HOTEL IN Chicago, from June 10 to the 13, inclusive, will be the scene of the Fifth Annual Convention of the Institute of Radio Service Men; the Annual Shindig of the American Radio Relay League; a meeting of the Institute of Radio Engineers, the Sales Managers Club, the Representatives, the Radio Manufacturers Association and the National Parts Show.

It seems, from the number of organizations interested and from the advance preparations, that this affair will truly be "bigger and better than ever." The readers of SERVICE are invited to the show and technical sessions without admission charge.

Here will gather manufacturers and their representatives from all parts of the land. Engineers, Service Men, salesmen, amateurs and experimenters from near and far will mix together at the technical sessions, in the exhibition halls, in the lobbies and rooms of the hotel to discuss their many mutual problems or to voice their varied complaints.

Come and meet the manufacturer; comment upon his product and his policies; listen in at the technical sessions where noted speakers will lecture on timely subjects; meet your fellow Service Men . . .

And see us at booth 111.

New

**VARI**

PATENT



**TRAN** UNITS

PENDING

# FOR CONTINUOUSLY VARIABLE VOLTAGE CONTROL

The UTC VARITRAN is an ideal voltage control unit of the type employing a sliding contact riding over the transformer turns. Using a newly developed method of construction the UTC VARITRAN has been made very compact, simple, rugged and inexpensive.

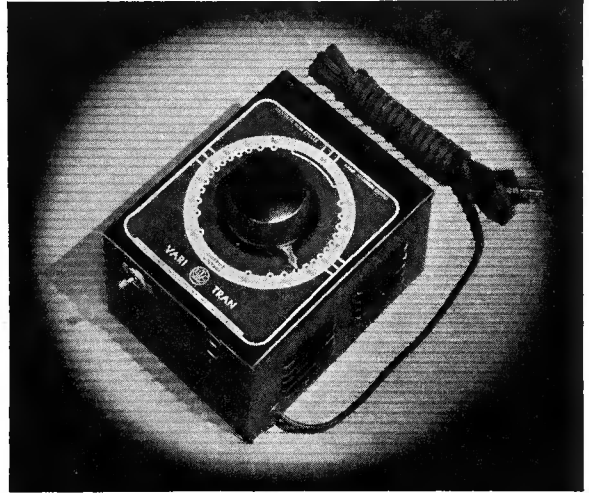

The V-1 unit illustrated has stepless voltage control from 0 to 130 volts and is designed to control the voltage to any load which draws a maximum of 5 amps. at 115 volts.

## VARIPOWER AUTOFORMERS

The UTC Varipower autoformer is a universal voltage control device suitable for every purpose where a step type voltage control is satisfactory. These autoformers are being put to new uses daily, some of the commercial uses being:

- Adjustment of voltages for testing refrigerators, radio sets, neon signs, insulation strength, etc.
- Measuring power consumption and other operating characteristics of electrical appliances where input voltage must be controlled.
- Control of soldering iron temperatures, temperature control of heating pots and electric furnaces.
- Dimmer control for theatre lighting.
- Stand-in and light adjusting control for photographic purposes.
- Motor speed control.
- Welding current control for spot welders.

They are designed to effect reduced power for transmitter operation, and they are so arranged that simultane-

ously with line voltage correction any output voltage from 0 to 130 volts can be obtained in five volt steps. The Varipower Autoformer thus permits control of filament voltage AT THE TUBE SOCKET to within 2 1/2% of any desired value simultaneously with the line voltage and plate voltage control. These Varipower units may also be used to reduce or increase voltages on filament transformers. Thus an 872 filament transformer can be used for 866 tubes. A 203A unit may be used to supply the filaments of 800's, 801's, 807's, etc. No power or filament equipment becomes obsolete with a Varipower Autoformer. The Varipower Autoformer has taps at 55, 75, 95, 100, 105, 110, 115, 120, 125 volts.

- VA-1—150 watt output rating, net — 3.60
- VA-2—250 watt output rating, net — 4.50
- VA-3—500 watt output rating, net — 6.00
- VA-4—1000 watt output rating, net — 9.00
- VA-5—2000 watt output rating, net — 12.00

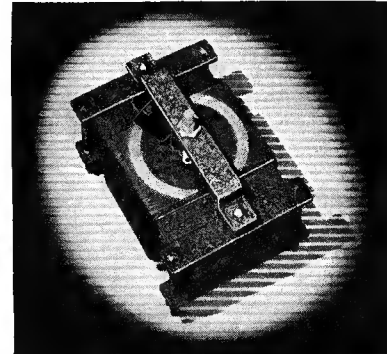
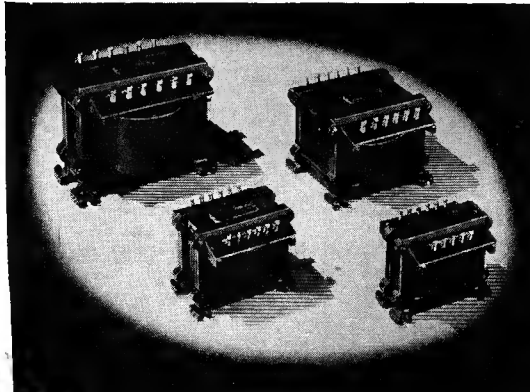

**MODEL V-1**—VARITRAN 570 watts, maximum rating, 115 volts 50/60 cycles input. Output 0 to 130 volts, complete with cord, plug and switch as illustrated .....\$10

**MODEL V-2**—Same rating as VA-1 but uncased with terminal strip for rack mounting, etc. ....\$9

### OTHER VARITRAN MODELS

The standard Varitran is available in ratings of 250, 500, 850, 1250, 2000 watts.

UTC also manufactures an Automatic type of VARITRAN control designed to correct automatically line voltage varying plus or minus 25% to plus or minus 2%. These units are ideal for broadcast and laboratory service. Designs are available in ratings of .5, 1, 2, 5, 7.5, 10, 15, 25 KVA. Other sizes on request.

# UNITED TRANSFORMER CORP.

72 SPRING STREET

NEW YORK, N. Y.

EXPORT DIVISION: 100 VARICK STREET NEW YORK, N. Y. CABLES: "ARLAB"

# AMPERITE VELOCITY MICROPHONES

Distinguished in Performance, Design, and Construction. Used in Leading P.A. Systems.

Considered by P.A. Men As the Greatest Values in Microphones Available Today.

## PERFORMANCE!

"A magnificent instrument. Despite the climate here, results are marvelous and could not be bettered, I am sure." — D. Hopkins, Raffles Hotel, Singapore.

## DESIGN!

"Your streamline mike is going over big with our trade. Congratulations on its fine design and performance." — R. Ruben Saugus, Mass.

## CONSTRUCTION!

"We believe no other mike could take the punishment it has and still give such excellent reproduction." — Johnston P.A. Service, Oneonta, N. Y.

## VALUE!

"The finest type microphone that I ever used. . . . Please duplicate my order." — Ridley's P.A. Systems, Inc., Tulsa, Okla.



## FEATURES

The Amperite Velocity is compact, streamline, modern. Embodies the latest technique in microphone design, featuring . . .

1. Output increased 6 DB.
2. Triple Shielded—against all RF or magnetic fields, entirely eliminating hum pickup.
3. Eliminates feedback troubles.
4. Excellent for close talking and distant pickup.
5. Acoustically designed to eliminate any possibility of cavity resonance.

## A POPULAR AMPERITE VELOCITY . . . \$22.00 LIST

A Velocity Microphone of very high excellence. Built to Amperite standards. Used for both speech and music with great success. No peaks. Flat response over audible range. Output, -68 db. Triple shielded. Fitted with shock absorber and swivel bracket. MODEL RAL (200 ohms) with 8 ft. of cable; MODEL RAH (2000 ohms) high impedance, with 12 ft. of cable.

\$22.00 LIST

CHROME OR EGG SHELL . . . . \$23.00 LIST



## PASTEL COLORS on Microphones and Stands.

Amperite now furnishes microphones and stands in EGG SHELL or other pastel finishes to suit decorative schemes. The stands feature the patented positive, non-sliding clutch. Complete line of desk, banquet, floor and studio stands. Available in Chrome or Egg Shell at \$1.00 LIST extra per stand.

Write for Bulletin ST-66

## LEADING MODELS

MODELS RBHn (High Impedance); RBMn (200 ohms); with cable connector and switch, \$42.00 LIST

Chrome, or Egg Shell . . . . . \$43.00 LIST

MODELS RBSn, RSHn, streamline design, slightly lower output than above, with switch only, \$32.00 LIST

With cable connector . . . . . \$34.00 LIST

FINISHES: All microphones have the new standard gunmetal finish.

Chrome or Egg Shell, extra \$1.00 LIST

OTHER PASTEL SHADES extra \$2.00 LIST

## FREE TRIAL OFFER TO STUDIOS

A Two Weeks' Trial Offer of the Amperite SR-80 Velocity is extended to broadcasting studios only. No deposit, obligation, or strings attached. Give the SR-80 an exhaustive two weeks' test. Then you may either return the microphone or keep it on our very attractive terms. Write, specifying either MODEL SR-80 (low impedance); or SR-80 H, high impedance. LIST \$80.00, with New Special Discount to Studios.

## FREE: WINDOW DECAL

A striking window decal advertising your SOUND SERVICE. Size, 5 1/4 x 9 1/4, finished in 4 colors.

Free to Jobbers, Dealers, and Service Men. Write for it today.

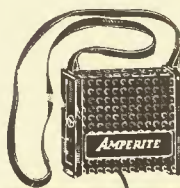

## AMPERITE JUNIOR

A "lapel" Velocity of surpassing quality. Size of a match box. Ideal for lectures and specialty acts. Can be hidden under coat. Output constant with any position of the head. Transformer included in microphone case. MODEL 7J (200 ohms); or MODEL 7J-H (2000 ohms) \$30.00 LIST

AMPERITE Company

561 BROADWAY, N. Y. U.S.A. ALKEM, NEW YORK

CABLE ADDRESS

VELOCITY

AMPERITE

MICROPHONES



# SERVICE

A Monthly Digest of Radio and Allied Maintenance

FOR MAY, 1937

## GAIN MEASUREMENTS IN R-F AND I-F STAGES

By JACK AVINS

THE determination of gain is one of the measurements that the Service Man can often use to advantage in his everyday service work. It is the purpose of this article to discuss the various methods for making measurements of this type. In connection with one very desirable method of gain measurement, which makes use of a signal generator with a calibrated output, a new type of attenuator is also described. This attenuator is especially adapted to the requirements of the Service Man.

### VACUUM-TUBE VOLTMETER METHOD

While the vacuum-tube voltmeter method of measuring the amplification of a stage is possibly the most suitable one for the Service Man, it is subject to certain limitations with which he may not be familiar. In this method a signal generator is connected to the grid of the stage being investigated and if the stage is functioning a voltage will appear across the output tuned circuit. The vacuum-tube voltmeter is connected across the input of the stage and then across the output. The signal voltage is measured in each case. Obviously the amplification of the stage is equal to the ratio of the two voltages.

In applying this method there are a number of precautions which must be observed. Since the vacuum-tube voltmeter places a certain amount of capacity across the output tuned circuit, the signal generator must be carefully tuned so that maximum voltage output is obtained. In addition, the grid of the stage preceding the one being measured should be by-passed to ground with a 0.1-mfd condenser to prevent possible feedback difficulties which would produce an error in the measurement. It is equally important to by-pass the grid of the tube in the stage following the one being investigated since the avc system will ordinarily

function to overbias the stage, so that the measured value of gain will be considerably less than the actual gain of the stage at the normal value of grid bias.

An important consideration in the measurement of gain with this method is that the output of the signal generator which is used must be sufficiently great so that a readable deflection is produced on the vacuum-tube voltmeter. As a general rule, this requirement necessitates an output voltage of at least 0.1 volt, and while most signal generators produce an output of this order at intermediate frequencies and frequencies up to the broadcast band, some may have insufficient output. This consideration often limits the application of the vacuum-tube voltmeter method of measuring gain, especially at the higher radio frequencies.

In some cases, the design of service signal generators is such that the r-f output signal contains not only a radio-frequency component, but an audio-frequency component as well, which cannot be removed. In using the vacuum-tube voltmeter method with such signal generators, it is essential that the grid clip remain connected to the tube so that the grid tuned circuit will short the audio-frequency voltage. If this precaution is not observed, the vacuum-tube voltmeter

will read the a-f voltage, as well as the r-f voltage when connected to the grid side. In general, the result of failure to observe this precaution is to indicate a measured value of gain which is considerably less than the actual gain of the stage.

It is not surprising that relatively few Service Men ever take the trouble to use the vacuum-tube voltmeter method of measuring gain. While it is a considerable improvement over purely qualitative methods under certain conditions, it is, as a general rule, a process far too time consuming.

### CONSTANT SIGNAL METHOD

A method which utilizes the amplification of all the stages following the one being investigated is more convenient than, but not so quantitative as the vacuum-tube voltmeter method. The procedure used with this method will be explained in connection with Fig. 1. If the stage included between the lines X and Y is being investigated, a signal is first applied to the grid of the tube following this stage, that is at Y, and the signal generator adjusted so that a low but readable value of output is obtained at the speaker. Without changing the setting of the signal generator attenuator, the output lead is shifted

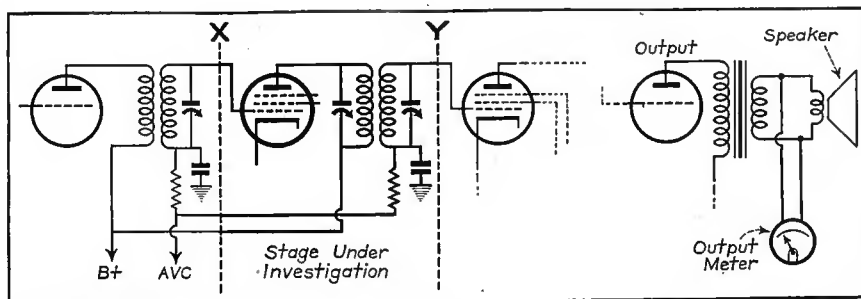

Fig. 1. Typical r-f or i-f stage under investigation.

to the input of the stage at X, and the audio output at the speaker noted. The gain of the stage is then equal to the ratio of the two audio outputs, since this is obviously a measure of the contribution of the stage to the sensitivity of the receiver.

As in the vacuum-tube voltmeter method, the stage directly preceding the one being measured should be by-passed to ground in order to avoid stray voltage pickup at points sensitive to low signal levels. Unlike the vacuum-tube voltmeter method, however, the stages following the one being investigated function in a normal manner.

It is essential that the avc feed line be grounded temporarily when this method of gain measurement is used. If the avc circuit is left operative, then the increased control voltage produced when the signal generator is connected to the input side of the stage will reduce the gain of all the controlled tubes; in many cases this will result in an apparent loss in the stage, although the stage is in reality functioning properly.

While this source of error is removed by rendering the avc circuit inoperative, the danger of overload arises when the gain of the stage is high. This can be minimized by using the lowest possible input signal from the signal generator and in any event, the presence of overload can always be detected by reducing the output of the signal generator; if this adjustment is accompanied by an increase in audio output, then it follows that overloading is taking place.

This method of gain measurement has the advantage that it does not require a calibrated value of signal generator output, since the same signal level is applied to the two test points. It is especially useful at the higher frequencies where the measurement of gain by means of the vacuum-tube voltmeter method is especially difficult. However, it is not so quantitative as might be desired because of the tendency toward overload with high values of stage gain.

#### STANDARD SIGNAL GENERATOR METHOD

In a very real sense, all of the methods of gain measurement discussed so far are substitute arrangements. Each method has sought to avoid the use of a signal generator which is capable of providing known signal voltages. As a result, the efficiency and usefulness of the methods have been impaired.

A more suitable method makes possible direct, simple and accurate measurement of the sensitivity of a receiver. Referring again to Fig. 1, the signal voltage required at Y to produce some standard voltage at the speaker is noted; the signal generator is then shifted to the input of the stage at X, and the signal generator output attenuated so that the output meter indicates the same value of audio output. The gain of the stage included between points X and Y is then equal to the ratio of the two signal generator voltages.

For example, if 50,000-microvolts input is required at point Y to produce 1 volt across the voice coil, and 2,000 microvolts is required at X to produce the same output, then the gain of the stage is equal to 50,000 divided by 2,000, or 25.

Here again, the stage preceding the one being measured should be by-passed to ground to avoid stray signal pickup. However, it is unnecessary to disturb the avc circuit since all the stages, including the avc rectifier, operate at the same value of signal input throughout the course of the measurements. It is possible in using this method to operate at a comparatively low level of output—below the level at which the avc circuit functions—and therefore to measure the maximum value of the stage gain; or it is possible to use a stronger signal level, in which case the value of gain measured is proportionately less than the maximum value.

It need hardly be emphasized that the method indicated above is a direct and ultimate test of receiver performance. The principal reason why it has

not found wide application among Service Men as a standard testing practice, is the scarcity of service signal generators which are provided with calibrated attenuators. Signal generators of the type which can be used satisfactorily for measuring sensitivity and gain-per-stage by this method are generally limited at the present time to laboratory instruments which are too expensive for use in service work.

#### CALIBRATED ATTENUATOR

The attenuator circuit shown in Fig. 2 was evolved after a careful study of the requirements called for in signal generators. The device is basically new and original and can produce signal voltages ranging from 1 microvolt to 1 volt when used in conjunction with any conventional test oscillator. Over the i-f band and the standard broadcast band the attenuator produces voltages as high as 10 volts. This high output is easily attainable and is useful for facilitating the calibration of the instrument as well as for other applications.

The attenuator circuit (Fig. 2) employs a vacuum tube, the gain of which is controlled by the cathode rheostat R4. A step-by-step control over the attenuation is obtained by switching in the appropriate value of resistance in the plate circuit of the tube.

In operation, the output of a signal generator is fed to the input terminals of the attenuator and the voltage at these input terminals is adjusted to a fixed reference value of either 0.1 volt or 1 volt. A vacuum-tube voltmeter can be conveniently used for making this adjustment.

Two attenuation controls are provided. One control, R4, permits a continuous variation of the output over a 100 to 1 range. In addition to this control, the switch S provides multiplying factors up to 100,000 in steps of 10 to 1, by cutting in the proper value of load resistance in the plate circuit.

The continuous range of attenuation is accomplished by varying the bias of the tube. For low values of attenuation R4 functions as an ordinary self-bias rheostat, while for higher values of attenuation the bleeder current flowing through R4 makes possible a more rapid attenuation. While it is possible to cover a range of attenuation as large as 1000 to 1, by means of a variation in bias voltage alone, it is more desirable to limit this since the mutual conductance of variable- $\mu$  pentode tubes varies rapidly in the cut-off region and is susceptible to small changes in electrode voltages, as well as to vibration and ionization effects. These undesirable effects are not experienced to any extent if the continuous attenuation range is held down to about 100 to 1; for this

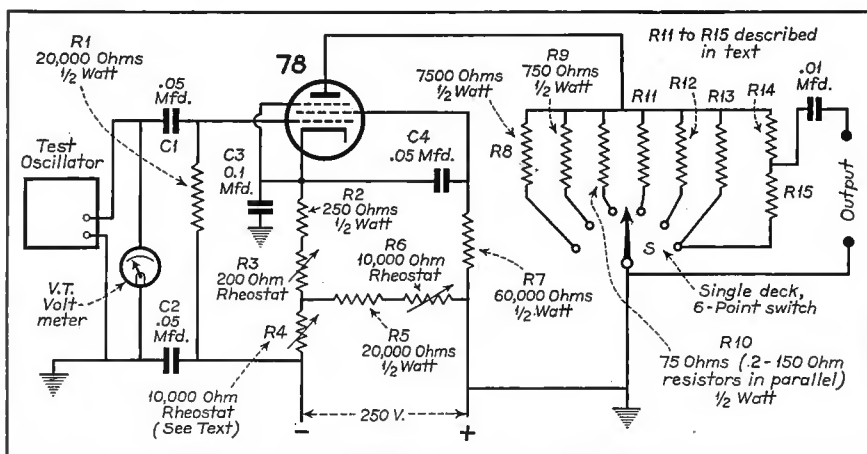

Fig. 2. Calibrated attenuator circuit for use with service oscillators.



range the lower limit of the mutual conductance is of the order of 10 micromhos.

#### LOAD RESISTANCES

The values of load resistance which are used for the several ranges are as follows: for the 100M range, 7500 ohms; for the 10M range, 750 ohms; for the 1M range, 75 ohms; for the 100 range, 7.5 ohms; for the 10 range, .75 ohms; and for the 1 range, a voltage divider arrangement described below.

The first three load resistors, R8, R9 and R10, are commercial  $\frac{1}{2}$ -watt resistors of the metallized type. These resistors have been entirely satisfactory at radio frequencies and are considerably more convenient than the non-inductive wire-wound type of resistor. The resistors R11, R12, R13, R14 and R15 are wound non-inductively with manganin wire on a  $\frac{3}{4}$ -in. slotted bakelite tube.

In winding these units, the direction of winding is reversed at every turn in order to reduce the self-inductance of the unit. This type of winding is known as the Curtis-Grover winding, and Service Men who have SERVICE for July, 1936, will find it described on page 301 of that issue.

Unless a bridge is available, it is suggested that these resistances be wound on the basis of a length rather than a resistance measurement. The number of inches of wire required for each of the units is as follows:

Resistor	Ohmage	Length inches	Manganin size
R11	7.5	7.8	No. 36
R12	0.75	4.9	No. 28
R13	0.9	5.8	No. 28
R14	4.5	4.7	No. 36
R15	0.5	2.8	No. 28

The resistors R14 and R15 form a voltage divider across R13 so as to permit a lower range of output voltages. This arrangement is necessitated because it is not practical to wind non-inductive resistors smaller than 0.1 ohm, and to avoid using values of load resistance which are comparable with the switch contact resistance. In the circuit shown, the three resistors form an effective load resistance of 0.075 ohms for the range in question, in that only  $\frac{1}{10}$  the voltage present across R13 is impressed across the output terminals of the attenuator.

As is evident in the illustration all the load resistors are mounted directly on the switch, and connect to the output terminals through very short leads.

#### CALIBRATION OF ATTENUATOR

The calibration of the attenuator is most conveniently carried out at audio frequencies, and requires an audio

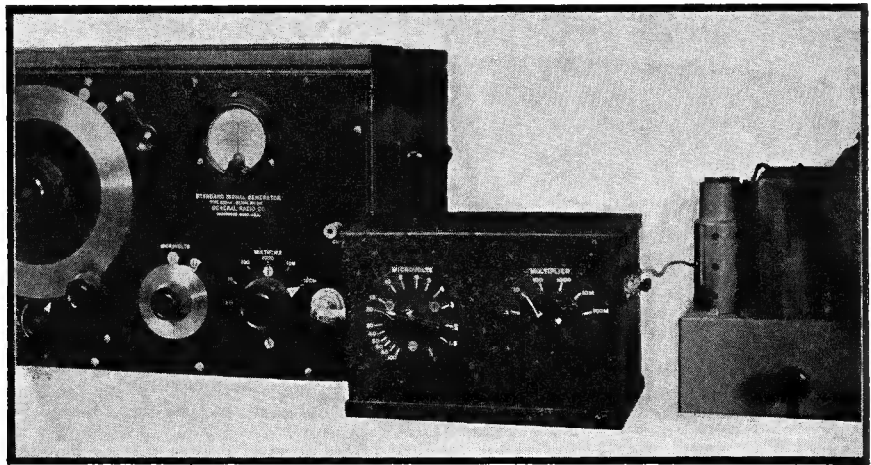

Fig. 3. Front view of the attenuator showing the calibration.

oscillator, and either a calibrated vacuum-tube voltmeter or a cathode-ray oscillograph. In describing the calibration, we shall assume that a cathode-ray oscillograph is being used, the procedure, however, is similar if a vacuum-tube voltmeter is used as the indicator.

Connect an audio oscillator to the input terminals, the oscillograph across the output terminals, and set the continuous attenuation control R4 to zero resistance. This corresponds to the maximum mutual conductance setting of the tube (approximately 1300 micromhos). To compensate for individual tube differences, the rheostat R3 should be adjusted until the audio voltage across the output terminals of the attenuator is 10 times as great as that across the input terminals. A signal input of approximately 1 volt should be used for all adjustments, and the multiplier set at the 100M position.

With the same value of input signal the attenuation control R4 should be set at maximum resistance, and with this latter setting, the rheostat R6 should be adjusted so as to reduce the output voltage indicated by the oscillograph from its previous value of 10 volts to 0.1 volt.

Since only the comparative or relative values of the input and output voltages are significant, all voltage measurements can be carried out by measuring the length of the beam deflection on the screen of the cathode-ray tube with a uniform scale or rule, with the gain of the oscillograph amplifier set at some convenient value.

These two rheostats R3 and R6 adjust the attenuator circuit so that the end points on the control R4 can be correctly identified with the factors 100 and 1, and insure that the range covered by the attenuator will be exactly 100 to 1.

The complete calibration of the dial is easily accomplished after R3 and R6 have been adjusted. It is convenient

to start at the high attenuation end of the dial (1) and to turn the rheostat from this position until the voltage output increases to 1.5 times its initial value. The position of the pointer on the rheostat will then identify the 1.5 mark on the scale. Similarly, advance the rheostat until the output is double its initial value, and this position will then identify the 2.0 mark on the scale. In the same way, all the intervening points up to 100 can be filled in readily.

Note that when the 10 position on the scale is passed, the beam will probably be deflected beyond the screen limits. The procedure is to set the rheostat at the 10 position which has just been calibrated and to reduce the gain of the oscillograph amplifier until a small deflection is again obtained. There will then be no difficulty in calibrating the points on the dial between 10 and 100.

Although the continuous attenuation control is calibrated in conjunction with the highest range only, this same calibration will of course obtain regardless of which multiplier range is used. This follows because the mutual conductance of the tube follows the same variation on all the ranges and because the load resistance is in all cases extremely small in comparison with the plate resistance of the tube. In this connection, the primary reason for the inclusion of the 10-volt range is to facilitate the calibration of the attenuator, so that only instruments which are usually available in the well-equipped service shop are required for the operation.

The calibration of an attenuator which employs a type 78 tube and the circuit of Fig. 2 can be seen in the photograph of Fig. 3 which shows a front view of the instrument. The calibration is approximately logarithmic over the two decades which are covered; the dial is somewhat more open for the higher values of attenuation.

It will be noted that the calibration

is dependent, among other factors, upon the taper of the rheostat which is used for R4. This rheostat may have either a right or left hand taper but in any event, it should be connected into the circuit so that the tapered end is used for small values of bias resistance—that is for small values of attenuation. If a left hand taper rheostat is used, then the scale will show increasing values of output, as the pointer is advanced counterclockwise, while if the rheostat is provided with a right hand taper, the scale will show increasing values of output for a clockwise rotation.

In the attenuator shown in the accompanying illustration, a General Radio type 371-T rheostat is used, and since this is available only in the left hand type, a clockwise rotation of the control decreases the output. Where economy and space are important considerations, a 10,000-ohm tapered volume control will serve very satisfactorily, although it will not be so permanent and stable as the larger wire wound unit shown in Fig. 3.

#### CIRCUIT CONSIDERATIONS

The properties of the variable- $\mu$  tube and the biasing circuit used in the attenuator are such that no distortion is introduced by the attenuator; this is true even when the tube is operated at maximum attenuation (minimum mutual conductance). This is an important consideration since one of the checks which is often made in conjunction with gain measurements involves an examination of the waveform of the output voltage.

Reference to the circuit in Fig. 2 will show that the capacity between the grid and plate provides a path for the

signal voltage to reach the output terminals which is independent of the setting of the continuous attenuation control R4. However, an evaluation of the importance of this error shows that it is negligible at even the highest frequencies because of the relatively small value of the grid to plate capacity (the order of 0.01 mmfd) and because of the small value of load resistance which is used on the higher attenuation ranges where this leakage effect must be considered.

In addition to minimizing the effect of grid-to-plate capacity, the comparatively small load resistance reduces the effects of capacitive and inductive couplings to other parts of the circuit and makes it possible to secure a high degree of attenuation.

An important advantage of the circuit which is here described is that it is possible to obtain an unusually small value of output impedance, which for almost all measurements is so small that it does not have to be considered. Referring to the values of load resistances which are shown in Fig. 2, it will be observed that the output impedance remains less than 7.5 ohms for values of signal voltage which are less than 0.1 volts, and furthermore remains constant over the 100 to 1 range covered by the continuous attenuation control. For values of signal voltage output less than 10,000 microvolts, the impedance of the signal generator remains less than 0.75 ohms.

Despite the low value of output impedance of the attenuator, a negligible amount of signal power is drawn from the oscillator which supplies the attenuator. Not only does this minimize the reaction of the attenuator on the signal

generator but it also simplifies the problem of coupling the oscillator to the attenuator. This is in marked contrast to the resistance type of attenuator which draws an appreciable amount of power from the oscillator.

#### ARRANGEMENT OF COMPONENTS

By far the most difficult problem involved in the application of the type of attenuator under discussion is that of adequately shielding all sections of the oscillator, attenuator, and vacuum-tube voltmeter which carry radio-frequency currents. In the model of the attenuator which is shown in the accompanying photograph, Fig. 4, the arrangement of the various components is clearly visible. The vacuum-tube used in the attenuator, as well as all parts which carry radio frequency currents—with the one exception of the attenuator load unit—are placed entirely within a shielded copper box which is completely enclosed. (The cover was removed in the illustration to show the tube and other parts inside the compartment.)

In addition to placing the various condensers and leads carrying r-f currents inside this copper shield the jacks which carry the signal voltage from the oscillator to the attenuator tube are mounted inside this box, and in this way the r-f field external to this shielded compartment is kept to a minimum value.

Only those parts which must carry r-f currents and cannot be filtered are placed inside the shielded box which contains the attenuator tube. The general procedure which governs the wiring of the unit is to by-pass all the units inside the shielded box to a common ground and to filter all leads which are brought out of the box to the several rheostats and to the power supply. It is advisable to use a shielded r-f choke to filter each lead coming out of this compartment because of the comparatively strong r-f field present inside the box. To avoid complicating the diagram, these r-f chokes and associated by-pass condensers are not indicated in Fig. 2.

Reference to Fig. 4 will show that the attenuator tube is mounted close to the right hand side of the shielded box so that the plate lead which runs into the right is completely shielded. The tube socket should be mounted so that the plate prong faces correctly; the plate lead can then be brought out through a shielded tube which extends through the baffle separating the two compartments. This careful shielding of the plate lead is required so as not to expose it to the high field intensity present inside the inner shield.

(Continued on page 290)

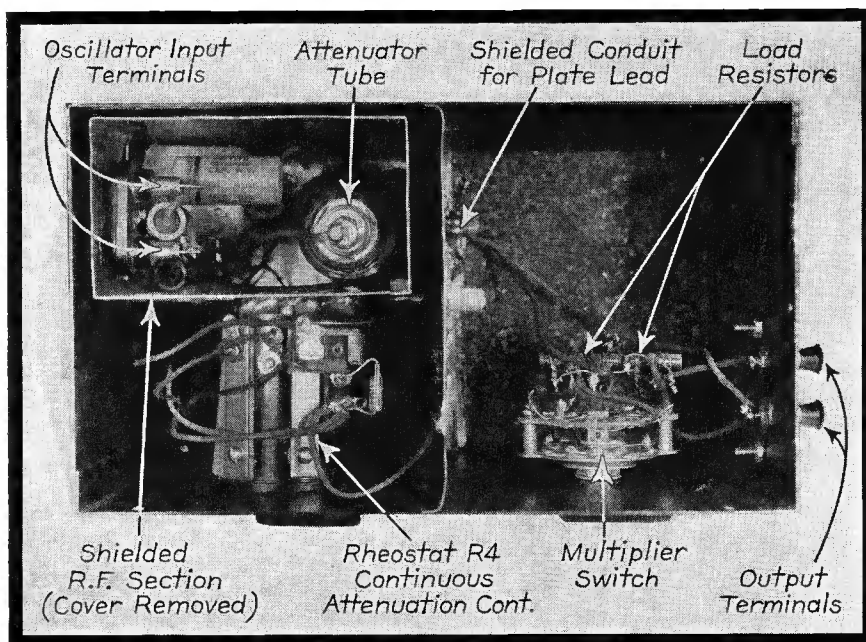

Fig. 4. Underchassis view of the attenuator showing layout.



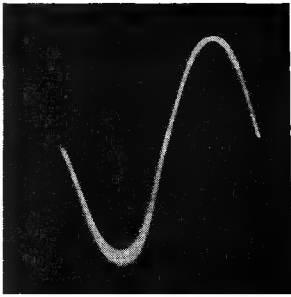

Fig. 1. Sixty-cycle wave trace.

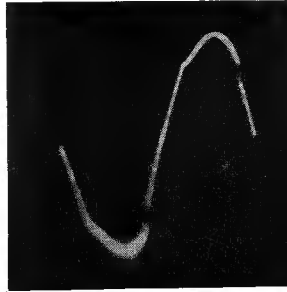

Fig. 2. Trace at point A, full load.

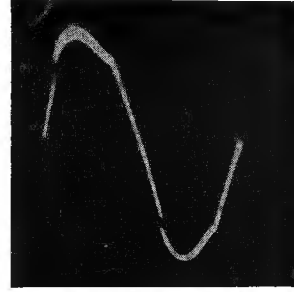

Fig. 3. Trace at point B, full load.

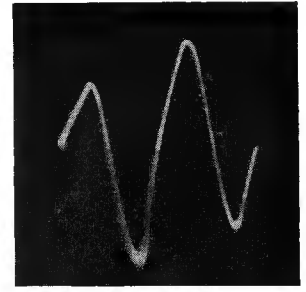

Fig. 4. Rectified wave at point C.

## POWER SUPPLY ANALYSIS

### with the cathode-ray oscillograph

By HOWARD J. SURBEY

THE cathode-ray oscillograph may be used with special advantage to find various types of defects—difficult and often impossible to locate with other test instruments. Facility in making tests comes naturally with greater experience with the oscillograph. It should prove helpful, however, if the Service Man knows the general shape of the trace to expect for certain connections and receiver conditions.

The oscillograms shown herewith were obtained by connecting the vertical plates of the oscillograph to various points in the power supply of an RCA Victor Model 220 receiver as indicated in Fig. 8. The receiver was in normal operating condition with the antenna shorted to the chassis and the volume control on full. This particular receiver was used for the tests largely because it was easily available — any similar receiver should produce similar tracings.

Before making the tests the oscillograph was placed in operation, focussed, and the vertical plates connected to a 60-cycle source. The internal linear sweep circuit was switched to the horizontal plates, adjusted to 60 cycles and synchronized with the voltage on the vertical plates. The single wave tracing shown in Fig. 1 was obtained.

The a-c supply voltage was removed from the vertical plates and the test leads substituted. The test lead from the vertical plate terminal marked "Ground" was attached to the receiver chassis and remained connected throughout the tests indicated. The other test lead was connected to each of the various positions as indicated in the circuit diagram shown in Fig. 8.

A pattern identical to Fig. 1 was ob-

tained by connecting the vertical plate test prod to point A in the power supply circuit (see Fig. 8) with the receiver turned on and the type 80 rectifier tube removed from its socket. The vertical plate amplifier gain control was reduced to keep the curve within the cathode-ray tube's screen area. The wave also has a frequency of 60 cycles as is evidenced by the single tracing for the 60-cycle setting of the sweep circuit.

By connecting the vertical plate test prod to point B (Fig. 8) a pattern identical in form but reversed in phase to the one shown in Fig. 1 was obtained.

These tests show that both halves of the high-voltage winding are delivering voltage, and if the amplitude of each curve is noted for a given setting of the vertical amplifier gain control the two readings obtained may be compared.

The type 80 rectifier tube was replaced in its socket and the receiver switch left in its on position.

The test prod was again connected to the points A and B (Fig. 8). The oscillograms shown in Figs. 2 and 3 were obtained as a result. The variation from Fig. 1 is due to the receiver loading on this winding of the power transformer.

This test should reveal any differ-

ences in the halves of the winding under full load conditions.

With the test prod attached to point C (Fig. 8) the double-wave tracing shown in Fig. 4 appeared. It was necessary to increase the gain control setting to obtain these curves. The oscillogram of Fig. 5 was obtained with the test prod connected to point D, the filament connection to which the receiver plate supply was connected. These two tracings would be identical if the plate load were taken from a center tap of the filament winding.

The double wave for these oscillograms, with a 60-cycle setting of the sweep circuit, shows that the frequency at these points is 120 cycles. This is to be expected from a fullwave rectifier. If only half of the rectifier were functioning the curve would only have one wave trace. This test is difficult to make with other test instruments.

By substituting other type 80 tubes in the rectifier socket and noting results the condition of the tubes under load may be determined. In this manner the oscillograph may be used as a tube tester.

With the test prod at the point E (Fig. 8) and the gain control increased, the pattern shown in Fig. 6 was obtained. Here the loops have been prac-

Fig. 5. Rectified wave at point D.

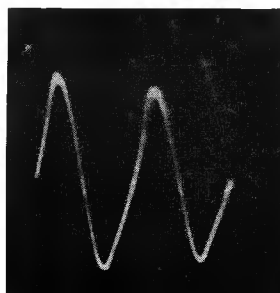
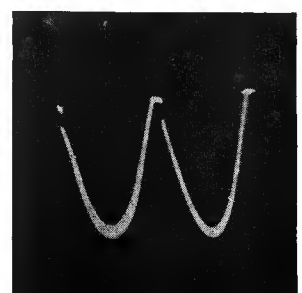

Fig. 6. Filtered plate supply.



Fig. 7. Open condenser condition.



tically eliminated. It is rather difficult to obtain a good photo of this pattern since higher settings of the gain control cause the tracing to flicker. But the curve obtained showed as practically a straight line until amplified greatly, which indicated that the filter condensers and choke were performing their job satisfactorily and producing a smooth plate supply voltage.

To obtain the effect of an open circuit in condenser C1, this condenser was disconnected and the test lead again attached to point D. The resulting oscillogram is given in Fig. 7. A pattern similar to Fig. 5 was obtained when the prod was connected to point E.

Condenser C1 was properly reconnected and condenser C2 disconnected. The patterns obtained at both points D and E were similar to the one shown in Fig. 5.

Resistors of low ohmage were shunted across condensers C1 and C2 to obtain the effect of leakage or variation in power factor. The pattern obtained with the prod connected to point E was similar to that shown in Fig. 6 but with higher loops. This showed a reduction in the filtering effect of the condensers.

Both halves of filament windings can

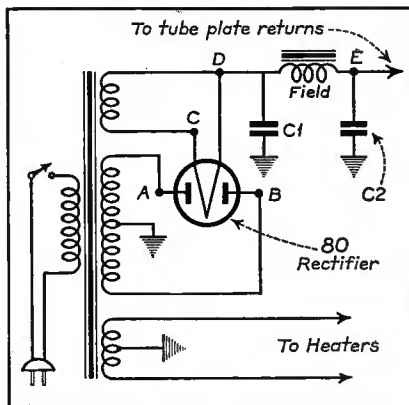

Fig. 8. RCA 220 power supply circuit.

be tested in the same manner as the high voltage winding. When the gain control is advanced curves identical with that given in Fig. 1 will be obtained.

The Service Man can make similar tests with his cathode-ray oscillograph on operating receivers in his spare moments. The results obtained should be clearly noted or remembered. They will prove useful in enabling him to make full use of the oscillograph quickly and

with increasing facility.

Once a Service Man has obtained a facility in using the instrument for his daily service tests, it will prove as indispensable as his volt-ohmmeter or tube tester.

Dynamic curves of vacuum tubes may be taken with the oscillograph with the tubes operating normally in the actual circuits of the radio receiver, similar to the method mentioned above for the type 80 rectifier tube. In this way tubes may be checked for performance and compared for quality under actual individual operating conditions.

Response curves of audio stages may be taken to determine the characteristics of the stage or the effect of making changes of load resistors, coupling condensers, etc.

Hum may be traced to its source. In full-wave circuits hum caused by insufficient filtering will be 120 cycles as mentioned above. Induced hum (from the power transformer to nearby chokes or audio components) will have a frequency of 60 cycles.

Innumerable tests on the operating receiver will suggest themselves to the Service Man the more he experiments with the equipment.

## SENSITIVITY TONE CONTROL

( See Front Cover )

THE 1937 Motorola auto-radio receivers are equipped with a sensitivity-tone control called the "Acoustinator." The diagram on the front cover shows the particular connections of this device as used on the Motorola Model 70.

The control performs the function of varying the sensitivity of the receiver in three predetermined steps from that necessary in isolated communities to the sensitivity desired in metropolitan areas and also changes the tone characteristics (independently of the sensitivity) in three different positions to correct for the acoustic differences in the various makes of automobiles and to give an

effect to any type of program that the listener might prefer.

The control unit is arranged so that it may be mounted at a point most convenient to the customer to allow for unhampered adjustment as required.

### SENSITIVITY

Referring to the diagram on the cover, the sensitivity section of the "Acoustinator" control is in reality a tap switch so arranged that various resistors in the cathode circuit of the r-f and first detector stages can be shorted to vary the sensitivity of these stages.

When the switch is in the country position both the 300- and 400-ohm re-

sistors in the cathode circuits are shorted. The 500-ohm resistor, alone, provides bias for the tubes. This gives an average sensitivity of 1.5 microvolts for 1-watt output, the highest for the receiver. This position can be used for distant reception and wherever atmospheric noise pickup and static is not a problem.

With the switch in the city position only the 400-ohm resistor is shorted, the 500- and 300-ohm resistors providing bias for the 78 and 6A7 tubes. This gives an average sensitivity of 5 microvolts for 1-watt output. The city position can be used for average reception

(Continued on page 315)

Right: Fig. 3. Relative effect to the ear of the three tone control positions in the average automobile expressed in percentage of 1-watt output.

Below: Fig. 2. Cutaway of the "Acoustinator" showing color coding.

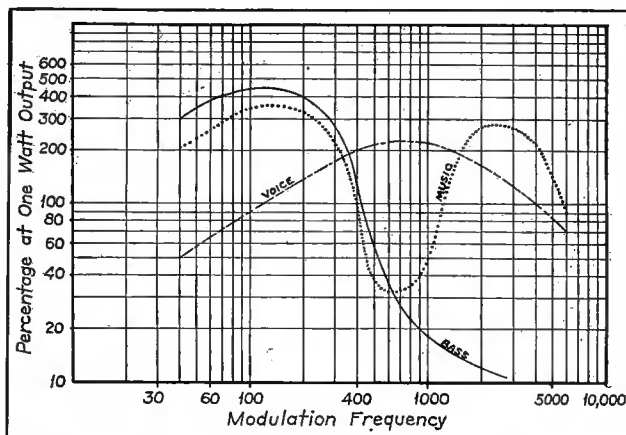
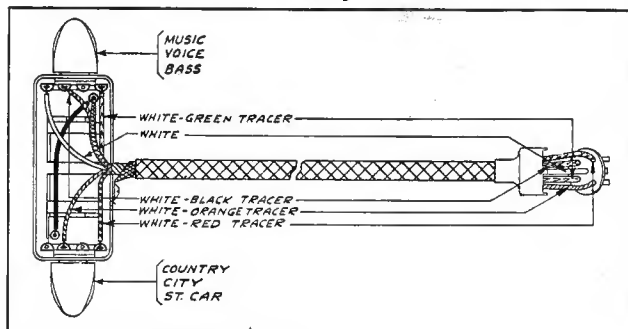



# General Data . . .

## Stromberg-Carlson 160, 160-L, 160-LB, 160-P, 160-PB

The Stromberg-Carlson Model 160 is a 14-tube, adjustable high fidelity receiver employing metal tubes and including beam-power output tubes. There are five tuning ranges which cover the frequencies from 145 kc to 370 kc and from 530 kc to 60 mc. This receiver uses a Carpinchoe high-fidelity dynamic speaker and has incorporated in it the Stromberg-Carlson "tri-focal" tuning system and the Stromberg-Carlson "acoustic labyrinth." This device is designed to extend the bass response, to provide reproduction only from the front of the cabinet, and to eliminate cabinet resonance. Sound diffusing vanes in front of the loudspeaker opening distribute the higher pitched tones providing reproduction in all parts of the room by spreading out these directional frequencies.

This receiver is also equipped with an automatic tone control circuit which operates automatically to reduce the high-frequency noise which is present when the receiver is tuned to a weak signal. The tube which operates in this automatic tone control circuit is indicated on the circuit diagram shown in Fig. 2.

In addition to the above features the Model 160-P receiver is furnished with an automatic record changer phonograph

unit which is equipped with a new type of pickup suspension device.

Maximum selectivity between adjacent stations located in the standard-broadcast band is obtained by the use of an additional tuned r-f "bi-resonator"

the socket prongs lettered on the diagram.

The various values of voltages are obtained by measuring between the tube socket contacts and the chassis base, with the tubes in their responsive sockets. The receiver is, therefore, in operation when the measurements are made. Fig. 1 shows the terminal layouts of the sockets with the proper terminal numbers.

Voltages are given for a line voltage

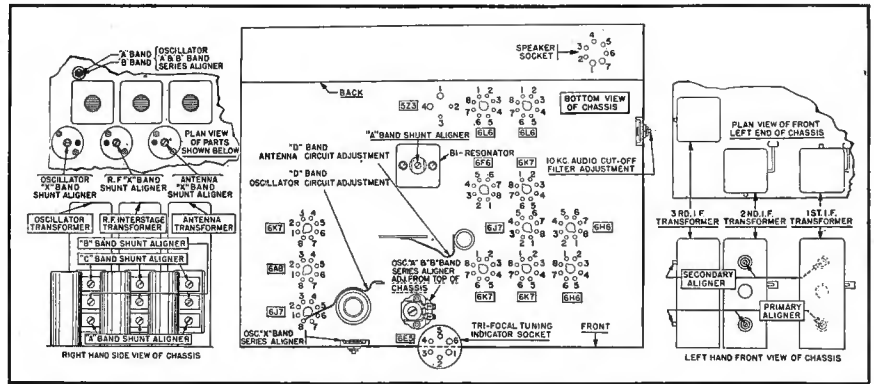

Fig. 1. Terminal layout of tube sockets and trimmer locations.

circuit. When either the X, B, C or D ranges are in operation this additional tuned r-f circuit is automatically out of the receiver circuit. Adjustable high fidelity is obtained from this receiver by means of variable bandwidth i-f transformers used in two of the i-f stages.

The circuit diagram of the Stromberg-Carlson Model 160 is given in Fig 2 with the tubes used, their functions and the voltages encountered on

of 120 volts, and allowance should be made for differences when the line voltage is higher or lower. A meter having a resistance of 1000-ohms-per-volt should be used for measuring the d-c voltages. Voltage values shown are those obtained on the lowest possible scale of a meter having the following ranges: 0-2.5, 0-10, 0-100, 0-250, 0-500, 0-1000 volts except when an asterisk appears after any given voltage value in

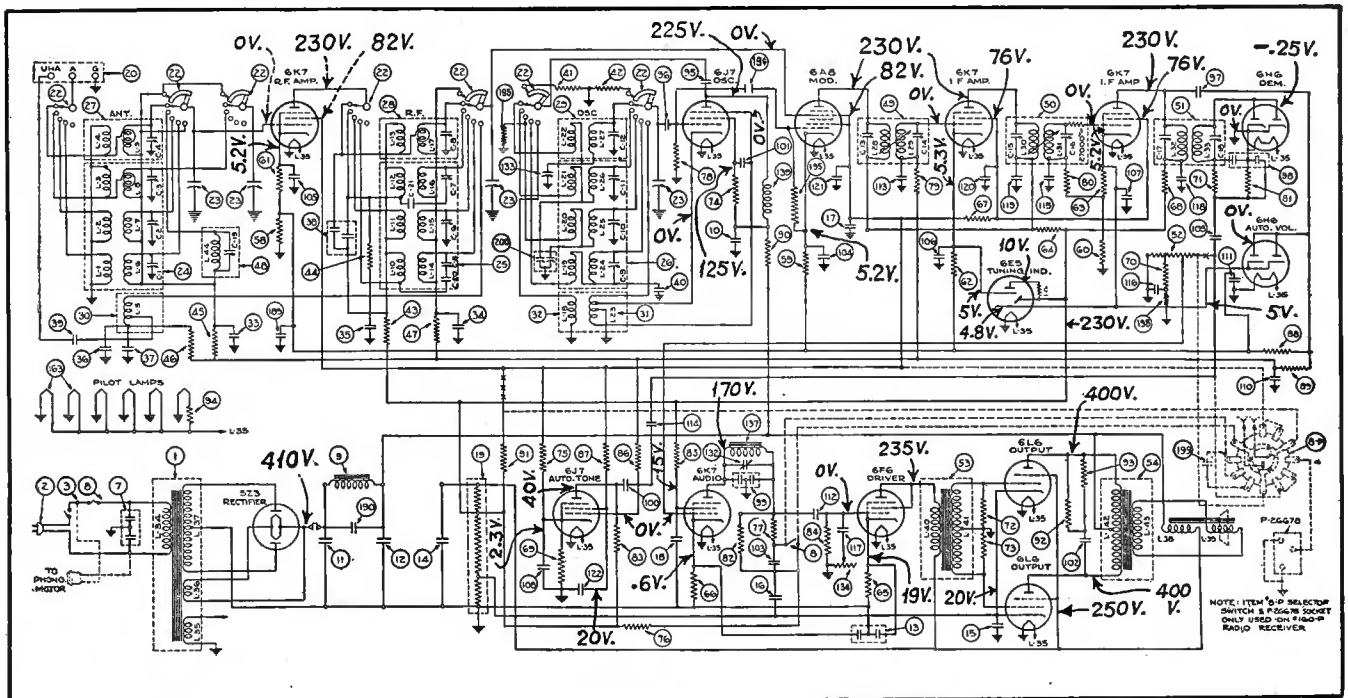

Fig. 2. Stromberg-Carlson 160 circuit diagram.

# GENERAL DATA—continued

Item	Condenser	Item	Condenser	Item	Resistor	Item	Resistor
7	Dual 0.01 mfd	101	0.008 mfd	19	Voltage divider	74	22,000 ohms
10	1 mfd	102	0.008 mfd	41	100 ohms	75	27,000 ohms
11	8 mfd	103	0.004 mfd	42	100 ohms	76	47,000 ohms
12	8 mfd	104	0.1 mfd	43	1000 ohms	77	82,000 ohms
13	Dual 10 mfd	105	0.1 mfd	44	47,000 ohms	78	47,000 ohms
14	16 mfd	106	0.1 mfd	45	100,000 ohms	79	100,000 ohms
15	12 mfd	107	0.1 mfd	46	100,000 ohms	80	100,000 ohms
16	4 mfd	108	0.1 mfd	47	100,000 ohms	81	100,000 ohms
17	4 mfd	109	0.04 mfd	58	180 ohms	82	270,000 ohms
18	4 mfd	110	0.04 mfd	59	270 ohms	83	470,000 ohms
33	0.04 mfd	111	0.04 mfd	60	390 ohms	84	470,000 ohms
34	0.04 mfd	112	0.04 mfd	61	390 ohms	85	1 meg
35	0.05 mfd	113	0.04 mfd	62	560 ohms	86	1 meg
36	0.0017 mfd	114	0.04 mfd	63	560 ohms	87	1 meg
37	0.0017 mfd	115	0.04 mfd	64	560 ohms	88	1 meg
38	Dual 200 mmfd	116	0.01 mfd	65	1000 ohms	89	1 meg
39	100 mmfd	117	0.01 mfd	66	2700 ohms	90	12,000 ohms
40	0.004 mfd	118	0.05 mfd	67	1000 ohms	91	15,000 ohms
95	0.001 mfd	119	0.05 mfd	67	1000 ohms	92	20,000 ohms
96	50 mmfd	120	0.05 mfd	68	1000 ohms	93	20,000 ohms
97	50 mmfd	121	0.05 mfd	69	680 ohms	94	3.5 ohms
98	Dual 100 mmfd	122	0.05 mfd	70	4700 ohms	195	100,000 ohms
99	Dual 100 mmfd	189	12 mfd	71	10,000 ohms	196	4700 ohms
100	100 mmfd	194	50 mmfd	72	10,000 ohms	198	10,000 ohms
		199	0.015 mfd	73	10,000 ohms		1 meg in 6E5 socket

Parts list (see Fig. 2).

which case the 1000 volt scale was used. The voltage across the vernier dial pilot lamp is 5.3 volts. The receiver was tuned to 100 kc on the broadcast band and the antenna shorted to the chassis during the measurements. The volume control was turned on full.

### ALIGNMENT PROCEDURE

Connect the output indicator across the primary of the output transformer or across the speaker voice coil.

Turn the volume control to maximum and keep it there throughout the

entire alignment procedure. The output meter reading should be maintained in a half-scale position by means of the attenuator on the signal generator.

The location of the trimmer condensers is shown in Fig. 1.

### I-F ALIGNMENT

Because of the necessity of obtaining the proper shape of resonance curve of these stages in a high fidelity receiver, it is recommended that unless it is absolutely essential, these i-f adjustments be untouched. In the factory these ad-

justments are made using a visual system which allows the operator to see the exact shape of the resonance curve. For this reason it is best to have these adjustments made at the factory. However, in the case where this cannot be done, the following procedure should be followed.

Set the signal generator for operation at 465 kc. Connect its output to the grid of the 6A8 modulator tube through a 0.002-mfd condenser (with the tube grid clip in place). Connect the signal generator ground lead to the receiver chassis. Turn on the receiver and signal generator and allow both to warm up for at least 15 minutes before attempting adjustments.

Operate the range switch of the receiver to the A range position. Set the tuning dial at its extreme low-frequency position, and operate the tone-fidelity control knob so that the receiver is adjusted for the standard fidelity position as indicated by the fidelity indicator located on the front panel of the receiver. Never attempt to align the i-f circuits of this receiver with the tone-fidelity control set at any position other than the standard fidelity. The i-f circuits may then be checked for alignment by adjusting the aligning capacitors in the exact order as follows: Secondary trimmer (C-18) on the third i-f transformer; primary trimmer (C-17); secondary trimmer (C-16) on the second i-f transformer; primary trimmer (C-15); secondary trimmer (C-14) on the first i-f transformer and the primary trimmer (C-13). For more accurate

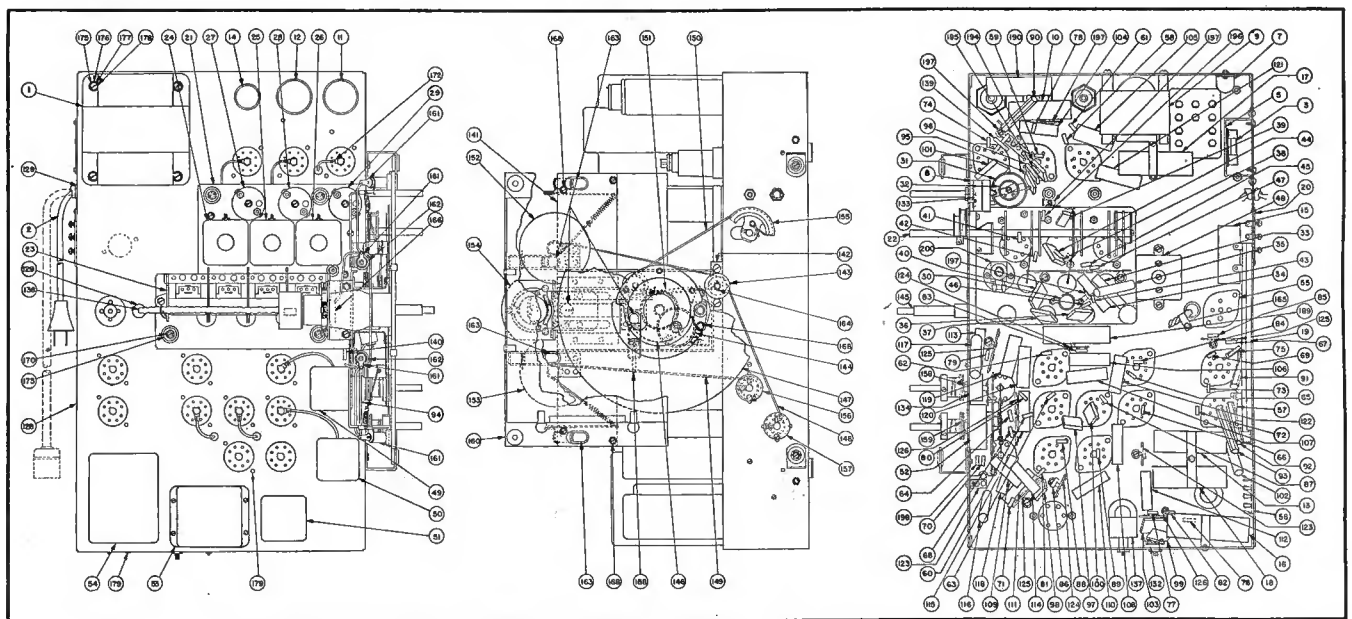

Fig. 4. Chassis assembly.



# SENSATIONAL NEW SUPREME



## 2" OSCILLOSCOPES SET NEW PERFORMANCE RECORDS!

ONLY \$4.00 Down **\$29.95**  
\$4.14 FOR 7 MONTHS

Actual tests prove **SUPREME 2" OSCILLOSCOPES** far superior, more accurate, have four times larger screen area than the 1" kind!

SUPREME'S new 2" Oscilloscopes have created a sensation! In performance! In price! In value! And no wonder! Imagine a 2" Oscilloscope, actually using a 2" cathode ray tube (not a magnifying arrangement), that gives four times more effective screen area than the 1" kind—and yet costs even less than the average 1" Oscilloscope! In addition, you get extra, exclusive features found in no other instruments of similar price. What's more—

for less than 13c per day you can own one of these new 2" Oscilloscopes. This small amount is not for the life of your instrument but only during the few months that you are paying for it on SUPREME'S S. I. C. time payment plan—the world's easiest installment terms! Remember—one of these new 2" Oscilloscopes will cost you *less* than your cigarettes! See your parts jobber today!

### VISUAL PROOF THAT CAN'T BE DENIED!

**JUDGE THESE COMPARATIVE PHOTOGRAPHS YOURSELF!**

This side-by-side comparison shows the same illustration reproduced both in 2" and 1" size. It portrays the demodulated output of the SUPREME Model 580 Signal Generator, obtained with a SUPREME 2" Oscilloscope which contains an *actual* 2" size tube (not a magnifying arrangement). Carrier frequency 600 kilocycles amplitude modulated at 400 cycles. Oscillogram made with vertical plates connected across demodulator stage load resistor of superheterodyne receiver. Judge for yourself which is clearer, more distinct, and which will give a more accurate reading. You'll place your vote for the 2" size!

### MODEL 530—2" OSCILLOSCOPE

**8 EXCLUSIVE features found in no other instrument of similar price!**

1. The *only* 2" Oscilloscope at this price!
2. Exclusive SELECTIVE RETURN SWEEP ELIMINATOR for inclusion or rejection of power supply frequency return sweep!
3. Exclusive UNI-CONTROL allows separate control of two potentiometers from one shaft protrusion on the panel!
4. Exclusive ANTIQUE BRONZE PANEL!
5. Exclusive LIGHT WEIGHT and SMALL SIZE!
6. Exclusive "POWER ON" INDICATOR lamp!
7. Exclusive MAXIMUM FUNCTIONS with MINIMUM number of PANEL KNOBS!
8. Exclusive FLEXIBILITY OF CONTROL FUNCTIONS!

SPECIAL LOW INSTALLMENT TERMS ON SIGNAL GENERATOR-OSCILLOSCOPE COMBINATION

### MODEL 535—2" OSCILLOSCOPE

**10 EXCLUSIVE features found in no other instrument of similar price!**

1. The *only* 2" Oscilloscope at this price!
2. Exclusive RETURN SWEEP ELIMINATOR for completely removing high frequency linear sweep return!
3. Exclusive SELECTIVE RETURN SWEEP ELIMINATOR for inclusion or rejection of power supply frequency return sweep!
4. Exclusive SNAP-LOCK SYNCHRONIZER for positive interlock between linear time base and incoming signal—Range 15 cycles to over 500 k.c.!
5. Exclusive UNI-CONTROL allows separate control of two potentiometers from one shaft protrusion—Grouping of controls eliminates groping for controls!
6. Exclusive ANTIQUE BRONZE PANEL!
7. Exclusive SMALL SIZE and LIGHT WEIGHT!
8. Exclusive MINIMUM number of PANEL KNOBS control MAXIMUM number of INSTRUMENT FUNCTIONS!
9. Exclusive "POWER ON" INDICATOR lamp!
10. Exclusive FLEXIBILITY OF CONTROL FUNCTIONS!

ONLY \$5.50 Down **\$49.95**  
\$4.95 for 10 Months



**SOLD ON SUPREME S. I. C. TERMS—THE WORLD'S EASIEST INSTALLMENT TERMS!**

## SUPREME INSTRUMENTS CORPORATION

GREENWOOD, MISSISSIPPI





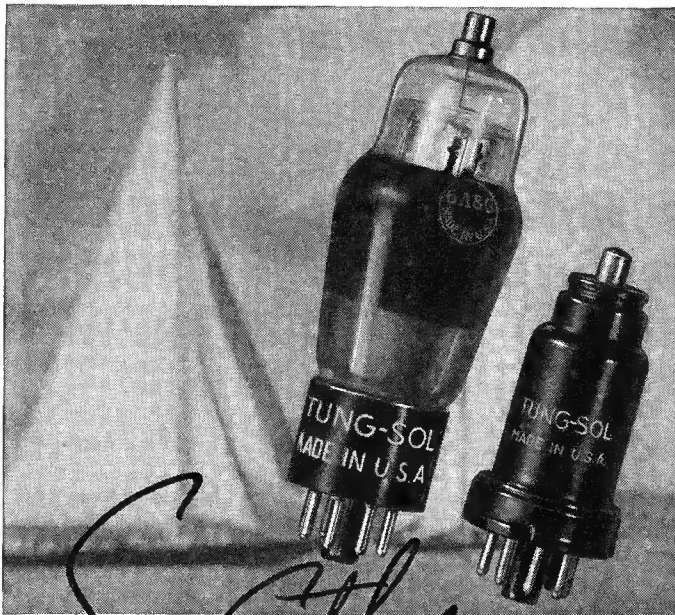

*Smooth Sailing*  
**WITH TUNG-SOL**

Every retail advantage which the radio dealer has ever hoped to find is included in the TUNG-SOL CONSIGNMENT PLAN: No cash investment at any time—an adequate, up-to-the-minute stock—full-profit protection—and remittance only after tubes are sold.

You may have the required qualifications to join the thousands of Tung-Sol Retail Agents who are making real money selling radio tubes. Write for name of your nearest Tung-Sol wholesaler.

**TUNG-SOL**  
*Tone-flow radio Tubes*

TUNG-SOL LAMP WORKS, INC.  
 Radio Tube Division

Sales Offices: Atlanta, Boston, Charlotte, Chicago, Dallas, Detroit, Kansas City, Los Angeles, New York. General Office: Newark, N.J.

**NONE HAVE DARED...**  
 -to Build Sound Amplifiers  
 with "HUSHED POWER"  
 Performance!



**New VOCAGRAPH Sound Systems**

**"HUSHED POWER"**

—one of many exclusive VOCAGRAPH features

"Hushed Power"—provides more usable watts from the same rated power output—thus giving you more sound per dollar invested.

"Hushed Power"—performance is secured by new circuit design and balancing stage gain to give greater output with fewer tubes. These tubes are operated at lower ratings, thus reducing noise and overload.

"Hushed Power"—results are not guesswork. Every VOCAGRAPH amplifier must pass tests for gain, output, and wave-form on the beat-note audio oscillator, power level indicator, cathode-ray oscillograph, and General Radio's finest wave-analyzer.

Series 40 Line—offers these additional features: Built-in monitor speaker; Dual tone controls; All plug-in connectors; Illuminated control panel; and modern streamlining. Write for full description.

**Distributors' Franchise**

A proposition offering 100% complete protection on a life of sales compelling merit is available in certain distributing centers. If interested, write at once.

Combine—  
**Startling Performance**  
**Lowest Cost**

Here at last is the answer to your sound problems! Quality performance at a new low cost.

You ask how it is done, for NONE HAVE DARED to take such a revolutionary step. Only VOCAGRAPH, with the advantages of "Hushed Power" design and modern production methods, can afford to offer so much performance per sound dollar.

The new VOCAGRAPH line has been designed today—for today's needs—eliminating time-worn engineering and production handicaps.

The complete line contains over twenty models in separate chassis, semi-portable and fully portable systems.

Write today for your copy of the new engineering bulletin, "NONE HAVE DARED," and the complete VOCAGRAPH catalog.

*Write or wire TODAY  
 for full information*

**ELECTRONIC DESIGN CORPORATION**



162-B N. May St., Chicago, U. S. A.

**VOCAGRAPH SOUND SYSTEMS**

Send at once new VOCAGRAPH engineering bulletins, complete catalog, and dealer net prices.

**Clip and Mail Today**

Name \_\_\_\_\_  
 Address \_\_\_\_\_  
 City \_\_\_\_\_ State \_\_\_\_\_

# GENERAL DATA—continued

alignment these trimmers should be re-adjusted.

## R.F. ALIGNMENT

The alignment of the radio-frequency circuits for the various ranges in this receiver should be very carefully made in the order and at the frequencies specified.

It will be noted that no instructions are given for aligning the receiver at other than two frequencies for any range. Each receiver is given an exacting check for tracking at various frequencies in each range before leaving the factory. It is felt by the manufacturers that should any receiver through accident require a check on the tracking, it should be returned to the factory, where this may be easily and accurately done.

Remove the signal generator output lead from the 6A8 grid cap and connect it to the receiver antenna input through a 0.0002-mfd condenser.

**Long-wave weather range (X band):** Adjust the X band oscillator shunt aligning condenser (C-12) at 350 kc; the interstage r-f shunt aligning condenser (C-8) at 350, and the antenna shunt aligning condenser (C-4) at 350

kc. The X band oscillator series aligning condenser (133) should be aligned at 150 kc.

The shunt alignments should then be repeated.

**Standard-broadcast range (A band):** Adjust the A band oscillator shunt aligning condenser (C-11) for maximum output at 1500 kc; the r-f interstage shunt aligning condenser (C-7), the antenna shunt aligning condenser (C-3) and the r-f "bi-resonator" shunt aligning condenser (C-19) at the same frequency. The A band oscillator series aligning condenser (200) should be aligned at 600 kc. The shunt alignment adjustments should then be repeated.

**B band alignment:** Adjust the oscillator shunt aligning condenser (C-10), the r-f shunt aligning capacitor (C-6) and the antenna shunt aligning condenser (C-2) for the B band at 5 megacycles. The oscillator series aligning condenser (200) should be aligned at 1.8 megacycles. The shunt alignment adjustments should be repeated.

**C band alignment:** The oscillator (C-9), the r-f (C-5) and antenna (C-1) shunt trimmers should be aligned for maximum output at 16 megacycles.

## Ultra-short-wave range (D band):

The only adjustment which it is necessary to make for bringing the D band oscillator's circuit into alignment is accomplished by bending the ground loop (shown in Fig. 1 as D band oscillator circuit adjustment) either closer to the coil or farther away from the coil. This adjustment should be made with the signal generator set to a frequency of 20 megacycles.

The only adjustment which it is necessary to make for bringing the D band antenna's circuit into alignment is accomplished by bending the grid lead loop (shown in Fig. 1 as D band antenna circuit adjustment) so as to form either a smaller or larger loop. This adjustment should also be made with the signal generator set to a frequency of 20 megacycles.

## RCA 5T6, 5T7, 5T8

These receivers are of the superheterodyne type and their design includes magnetite-core adjusted i-f transformers and wave trap; aural-compensated volume control; high-frequency tone control; resistance-coupled audio system; phonograph terminal board; illuminated, band-indicating dial pointers;

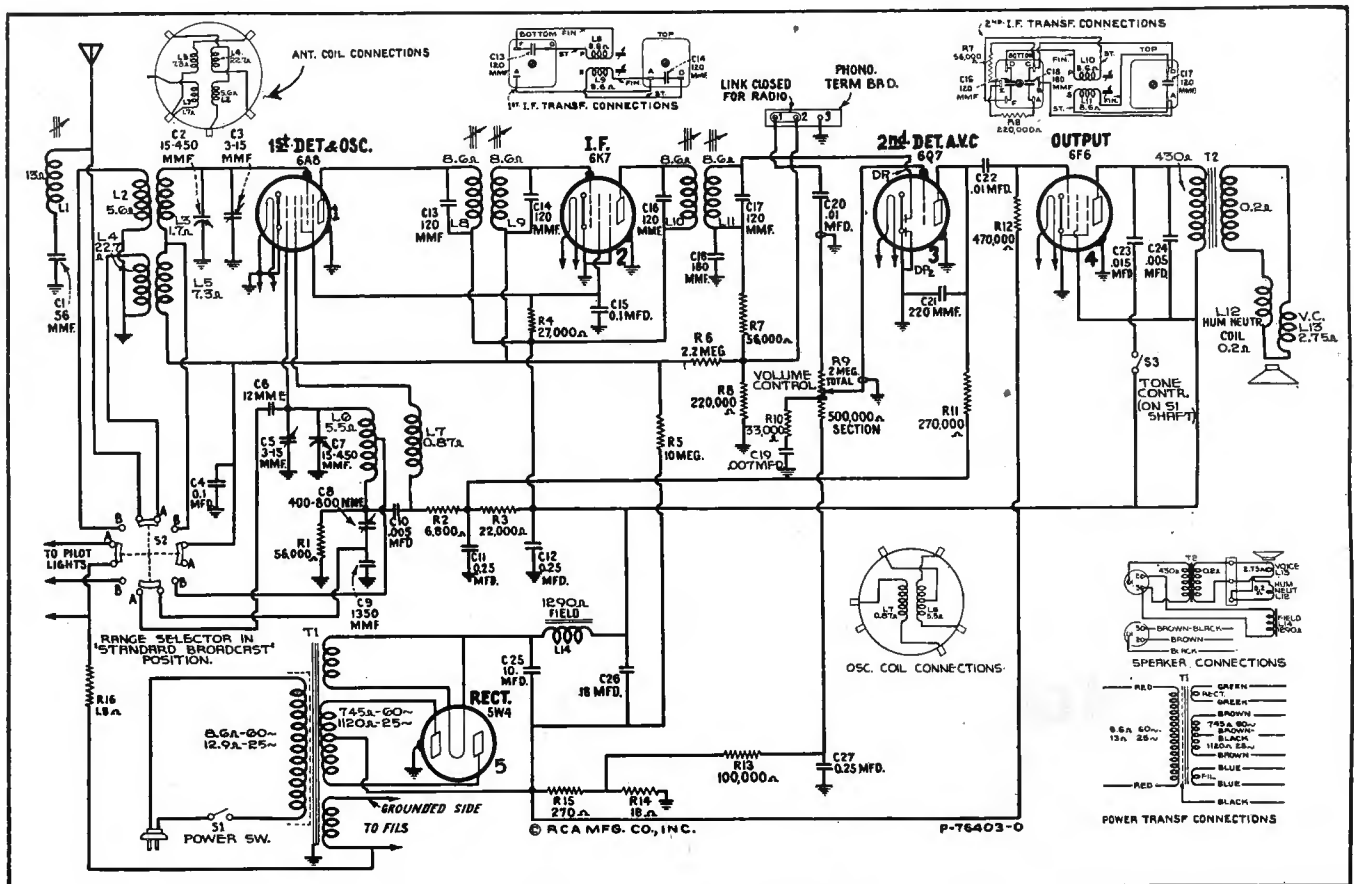

Fig. 1. RCA 5T6, 5T7, 5T8 circuit diagram.



*Sales  
Are Booming*  
**AND SERVICE DEALERS  
ARE CASHING IN!**



**Get in on Arvin's triple-profit car radio program.** You'll make money on the Arvin Phantom Filter Car Radios you sell and get a second profit on your own installation and service. Your third profit comes from the installation and service other Arvin dealers require.

When you sign up as an authorized Arvin service dealer, you get all this free: A comprehensive service manual, with circuit diagrams . . . complete service information on all Arvin models . . . regular service bulletins to keep you up to date . . . and the authorized Arvin service station emblem.

With the way Arvin sales are booming . . . and with the action-getting merchandise behind this line . . . nation-wide consumer advertising and other promotional material, it's just sound business for you to get in on Arvin's triple-profit car radio program. See your jobber . . . ask about the Arvin Floor Plan Deal and special service dealer plans.

**NOBLITT-SPARKS INDUSTRIES, INC.**  
Columbus, Indiana . . . Also makers of Arvin Home Radios and Arvin Hot Water Car Heaters

**Free**—This striking Roll-Around Display Demonstrator and a complete kit of effective sales helps including a big 10-foot cloth banner in three colors—all free with the Arvin Floor Plan Deal.



**PROFIT** by Arvin National Consumer Advertising! Two of a series of Arvin ads appearing in Post and Collier's, shown here in miniature.

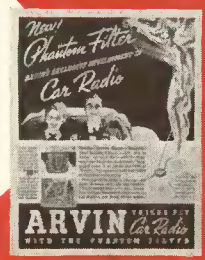

Three powerful Phantom Filter Models—6 and 7-tube sets—with overhead, in-the-set or separate case speakers and matching panel controls—as low as

**\$39<sup>95</sup>**



A 6-tube radio with in-the-set speaker and your choice of any one of the 47 Arvin matching panel or universal controls—complete for only

**\$29<sup>95</sup>**

and a six-inch, dust-proof, electrodynamic loudspeaker.

Tuning is continuous through the standard broadcast and short-wave bands from 540 to 6600 kc. An undistorted power output of 2.0 watts is available with a maximum of 4.5 watts.

THE CIRCUIT

The first detector and oscillator functions are accomplished in a single tube, a 6A8. The input of this tube is coupled to the antenna through a tuned transformer. A shunt (magnetite-core adjusted) wave trap is connected across the primary of this transformer to prevent signals of intermediate frequency (460 kc) from being introduced into the first stage as interference. The two-section gang condenser, which tunes the antenna transformer secondary and the heterodyne oscillator coil, has adjustable trimmers for obtaining exact alignment. Each of these coils is tapped so that the range switch increases the range of tuning by decreasing the amount of inductance.

The intermediate-frequency amplifier is coupled to the 6A8 and to the 6Q7 by means of tuned transformers. These transformers resonate with fixed capacitors and are adjusted by molded magnetite cores to tune to 460 kc.

The modulated signal as obtained from the output of the i-f system is detected by one of the diodes of the 6Q7. Audio frequency secured by this process is applied to the control grid of this same tube, for voltage amplification, through the acoustically tapered volume control. The d-c voltage, which results from detection of the signal, is used for automatic volume control. This voltage, which develops across resistor R8, is applied as avc bias to the first detector and i-f tubes through a suitable resistance-capacitance filter. Minimum operating bias for these tubes, under condi-

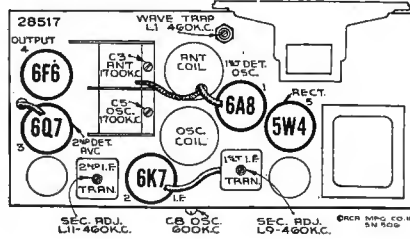

Fig. 2. Tube and trimmer locations.

tions of little or no signal, is developed across resistors R6 and R8 which form a portion of the bias divider circuit, R5, R6 and R8. These latter three resistors are connected in shunt with the main bias resistors R15 and R14.

The output of the 6Q7 is transmitted by resistance-capacitance coupling to the input of the 6F6 power-output stage, which, in turn, is transformer coupled to the electrodynamic loudspeaker. High-frequency tone control is provided by means of a shunt capacitor C23 across the plate circuit of the output tube. This capacitor may be cut in or out of the circuit with a control switch S3.

The power-supply system consists of a 5W4 full-wave rectifier tube, power transformer, and suitable filter network. The loudspeaker field coil is used as the filter reactor.

DIAL ADJUSTMENT

Calibrate the tuning dial by adjusting dial pointer to the horizontal center line (between the two dial scales) with the two-gang tuning condenser in full-mesh position. Two screws are provided on the dial hub for this adjustment.

ALIGNMENT PROCEDURE

For accurate calibration of the tuned circuits of the receiver the adjustments should be made in the order indicated.

Cathode-ray alignment is preferable; the vertical plates should be connected

to the terminal marked 2 on the phonograph board, and to the receiver chassis. If an output meter is used it should be connected across the voice coil or across the primary of the speaker transformer. The receiver volume control should be advanced to the full on position.

I-F ALIGNMENT

Connect the output of the test oscillator to the control grid of the 6K7 i-f tube through a 0.001-mfd condenser and to the receiver chassis. Turn on the receiver and the test oscillator; tune the test oscillator to 460 kc and adjust its output so that the signal is just readable on the output meter. The signal in the speaker should be audible but not loud. Throughout the alignment procedure the test oscillator output should be kept low, by means of its attenuator (and the receiver volume control on full), to prevent avc action. The receiver should be tuned to some quiet point between 550 and 750 kc. Allow both the receiver and test oscillator about 15 minutes to warm up before making adjustments.

Adjust the magnetite-core screws on the second i-f transformer (L11 and L10, Figs. 2 and 3) for maximum (peak) output. Adjust the magnetite-core screws on the first i-f transformer (L9 and L8, Figs. 2 and 3) for maximum output. Repeat the i-f adjustments for greater accuracy.

R-F ALIGNMENT

Connect the output of the test oscillator to the antenna post of the receiver through a 200-mfd condenser, and to the receiver chassis. With the test oscillator tuned to exactly 460 kc and the receiver set on a quiet point in the short-wave band, adjust the magnetite-core screw on the wave trap (L1, Fig. 2) for minimum output. It may be necessary to increase the test oscillator to make this adjustment.

Set the wave-change switch to the broadcast position and tune the receiver to 600 kc. Set the test oscillator to exactly 600 kc and adjust the low-frequency oscillator trimmer (C8, Fig. 2) for maximum indication on the output meter.

Tune the receiver to 1700 kc and set the test oscillator to the same frequency. Adjust the high-frequency oscillator trimmer (C5, Fig. 2) for maximum output. Adjust the antenna trimmer (C3, Fig. 2) for maximum output.

Repeat the r-f alignment for greater accuracy.

SOCKET VOLTAGES

The various voltages encountered on

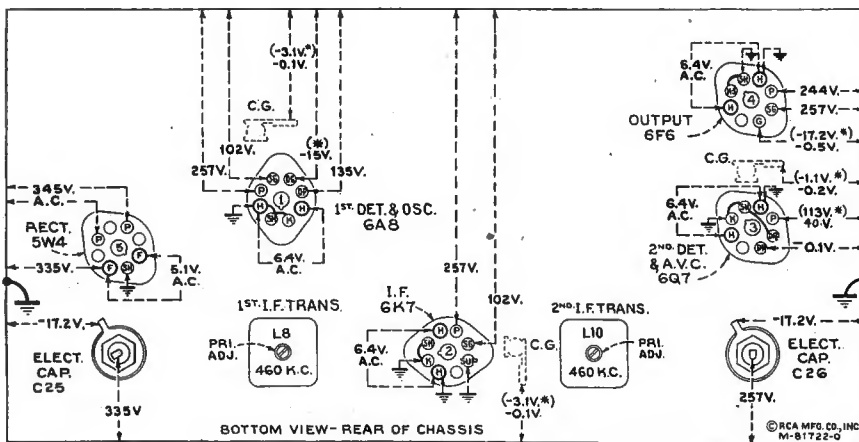

Fig. 1. Socket layout showing voltages.







# GENERAL DATA—continued

the tube socket prongs and the coil and trimmer locations are shown in Fig. 3. Two voltage values are given for some readings. The value shown in parentheses with an asterisk (\*) indicates operating conditions without voltmeter loading. The other value (generally lower) is the actual measured voltage and differs from the value shown in parentheses because of the additional loading of the voltmeter through the high series circuit resistance.

The voltage values indicated from the Radiotron socket contacts, grid caps, resistors, and terminals to receiver chassis ground on Fig. 3 will assist in locating cause of faulty operation. Each value as specified should hold within  $\pm 20\%$  when the receiver is normally operative at its rated line voltage. Variations in excess of this limit will usually be indicative of trouble in the basic circuits. To duplicate the conditions under which the voltages were measured requires a 1,000-ohm-per-volt d-c meter, having ranges of 10, 50, 250 and 500 volts. Use the nearest range above the specified measured voltage. A-c voltages were measured with a corresponding a-c meter.

### LOUDSPEAKER

Centering of the loudspeaker voice coil is made in the usual manner with three narrow paper feelers after first removing the front dust cover. This may be removed by softening its cement

with a light application of acetone, using care not to allow the acetone to flow into the air gap. The dust cover should be cemented back in place with ambroid upon completion of adjustment.

### PHONOGRAPH ATTACHMENT

A terminal board is provided for connecting a phonograph into the audio-amplifying circuit. Models R-93, R-93-2, R-93-S Record Players should be connected as follows: remove link between terminals 1 and 2 on receiver. Connect green wire in Radio-Record switch cable to terminal 1, yellow to terminal 2; and shield extension to terminal 3. Tape unused red and blue leads separately. Connect a 2-conductor twisted cable between the Record Player binding posts and the screw terminals on radio-record switch.

### Sparton 517, 557, 567

The Sparton Models 517 and 557 are table models. The 567 is a console model. The 517X table model uses the same circuit but is equipped with a universal power transformer. These models are 5-tube superheterodynes and employ glass tubes in the circuit shown in Fig. 1. The tubes used, their functions and the various voltages encountered on the socket prongs are lettered on the diagram. Additional chassis views are shown in Fig. 2.

### ALIGNMENT PROCEDURE

For the proper alignment of these receivers the procedure given below should be followed in the same order in which it is given. Unless otherwise specified the adjustment of any trimmer or padder consists of turning the adjusting screw or nut to the right or left until the output meter registers the greatest deflection. The meter reading should be kept as low as possible by means of the attenuator on the test oscillator.

### I-F ALIGNMENT

Turn on the receiver and the test oscillator and allow both to warm up for at least 15 minutes before attempting to adjust any condensers.

Turn the band selector switch to the broadcast position, and turn the station selector knob until the rotor plates are completely out of mesh with the stator plates.

Connect the antenna connection of the test oscillator to the grid cap of the 6A7 first detector-oscillator tube and ground the other terminal to the receiver chassis. Connect an output meter from the plate of the 42 output tube (through an 0.1-mfd condenser) to the receiver chassis or across the speaker voice coil.

Tune the test oscillator to exactly 456 kc. Turn the volume control of the receiver on full and adjust the test oscillator attenuator so that the reading

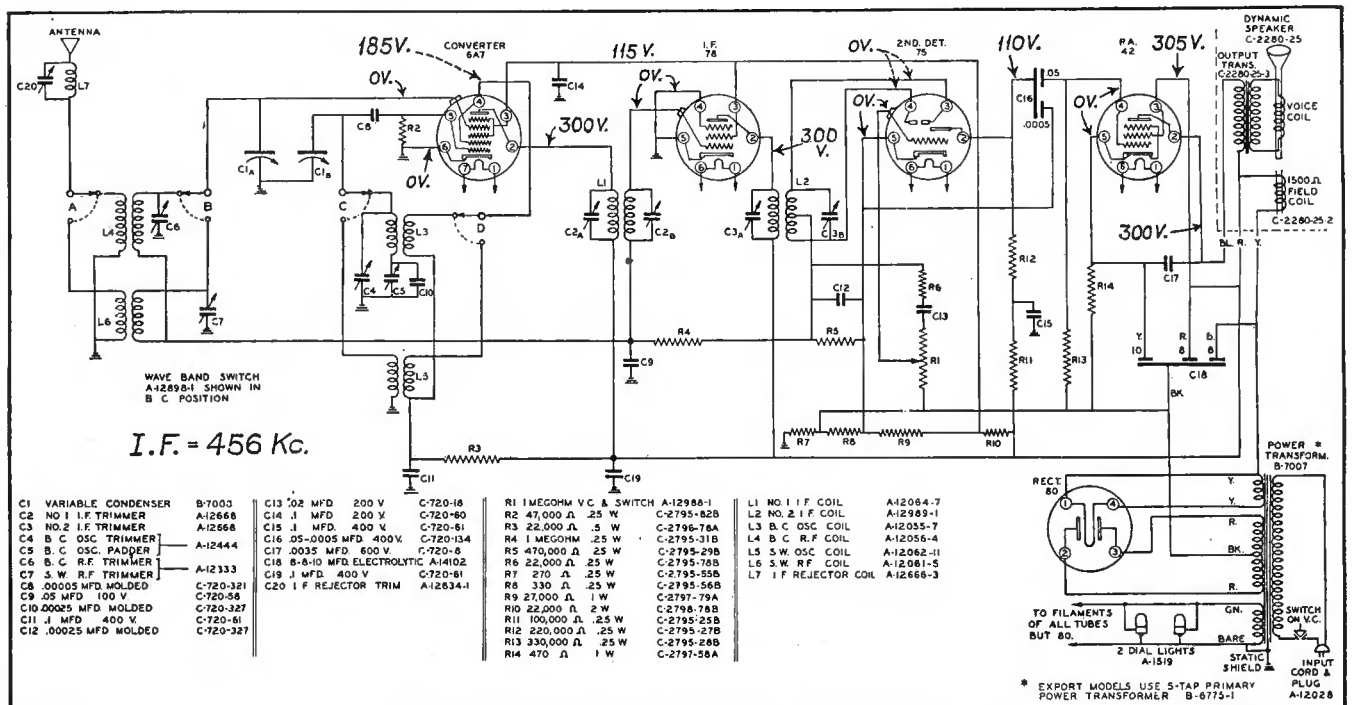

Fig. 1. Sparton 517, 557, 567 circuit diagram.



**"I've USED  
CENTRALAB  
SINCE THE  
PIONEER  
DAYS"**

Says Mr. F. D. Wardner  
Wardner Electric Co.  
St. Paul, Minn.

Thanks, Mr. Wardner, and because we understand that you are one of the outstanding service men in the Northwest, we are doubly proud of your faith and confidence in Centralab.

Yes — since the very beginning Centralab has been building a *Quality control*.

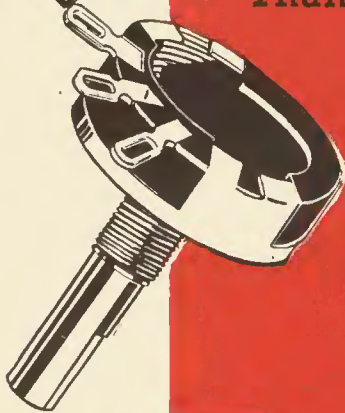

Servicemen everywhere are following Mr. Wardner's plan . . . by staying with Centralab for All replacements . . . You can do a better service job with Centralab controls . . . so consult your jobber and get new 1937 CENTRALAB Volume Control Guide from him . . . free!

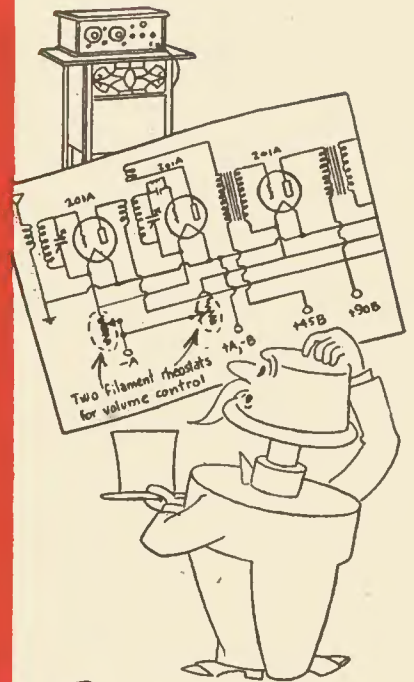

**Remember-**

when diagrams like these were all the vogue . . . and *Centralab Controls* were among the few "dependable" units?

**Centralab**  
R A D I O H M

Milwaukee, Wisconsin  
Division of Globe-Union Inc.  
BRITISH CENTRALAB, Ltd.  
Canterbury Road; Kilburn  
London, N. W. 6, England  
FRENCH CENTRALAB CO.  
118 Avenue Ledru-Rollin  
Paris XI, France

## GENERAL DATA—continued

on the output meter is just readable.

Adjust the i-f trimmers C3 and C2, starting with the secondary trimmer on the second i-f transformer and working toward the primary trimmer on the first i-f transformer. Repeat the adjustments for greater accuracy.

### WAVE-TRAP ALIGNMENT

Disconnect the antenna connection of the test oscillator from the grid cap of the 6A7 tube and connect it to the antenna terminal of the receiver in series with a 150-mmfd condenser.

With the test oscillator still tuned to 456 kc, adjust the wave-trap trimmer C20 (reached from the rear of the chassis) for minimum output.

### DIAL ADJUSTMENT

The dial pointer should be exactly parallel with the horizontal line of the dial scale when the condenser plates are fully meshed. If the pointer does not read correctly loosen the two small screws directly to the rear of the diffusion disc and dial drum, hold the rotor plates fully meshed with the stator plates and set the pointer so that it is parallel with the horizontal lines on the kilocycle scale, then tighten the screws.

### R-F ALIGNMENT

**Broadcast band:** Tune the receiver and the test oscillator to 1500 kc and adjust the broadcast band oscillator trimmer (C4) and also the broadcast band antenna trimmer (C6). These can be reached from the bottom of the chassis.

Tune the test oscillator and the receiver to 600 kc. Adjust the broadcast oscillator padder (C5). This can also be reached from the bottom of the chassis.

Retune the receiver and test oscillator to 1500 kc and check the adjustments of the condensers C4 and C6. Calibration of the broadcast band should also be checked at 900 and at 600 kc.

**Short-wave band:** Turn the band selector switch to the short-wave or foreign band.

Remove the 150-mmfd condenser from the test oscillator antenna and lead and replace with a 400-ohm non-inductive resistor dummy antenna.

Tune test oscillator and receiver to a frequency of 15,000 kilocycles (15 megacycles) and adjust condenser C7 (short-wave antenna trimmer) reached from the bottom of the chassis.

**Caution:** On this band care must be taken to adjust this condenser to the fundamental of the 15 megacycle signal and not to the image. The image signal is equal to the fundamental minus twice

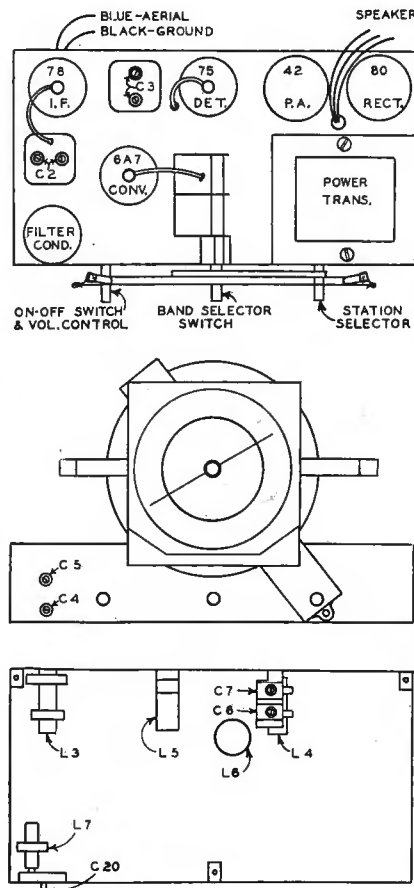

Fig. 2. Sparton 517, 557, 567 chassis assembly.

the intermediate frequency of the receiver.

A set that is adjusted to the image frequency instead of the fundamental may be detected by tuning over the band and checking the sensitivity at various points. If a dead spot appears near the center of the band, the adjustable condenser for that band has probably been adjusted to the image instead of to the fundamental.

This type of mis-alignment may also be detected by tuning the test oscillator to a frequency of 15 megacycles and the station selector of the receiver to approximately 15,900 kilocycles. If a strong signal is found approximately at this frequency, it indicates that the band has been adjusted to the image frequency. The normal image frequency for 15,000 kilocycles would be 15,000 kilocycles minus twice 456 kilocycles or approximately 14,100 kilocycles. Therefore, a signal of this frequency may be found with the test oscillator generating a 15,000 kilocycle note.

**Note:** There are no other trimmers for the short-wave or foreign band. However, it is advisable to check the receiver for sensitivity and calibration

at both 15,000 kilocycles and 7,500 kilocycles.

**Important:** All adjustments should be rechecked to assure accuracy and stability of adjustment and calibration.

### GAIN MEASUREMENTS

(Continued from page 276)

The experimental model of the vacuum-tube attenuator which is described and shown in the illustrations does not incorporate a vacuum-tube voltmeter; this was omitted from the unit as a matter of convenience because a standard signal generator was available for measuring the input voltage to the attenuator during the course of the development work. As far as the application to service work is concerned, the unit can be used without an internal vacuum-tube voltmeter, as described, by measuring the maximum open circuit voltage of the oscillator with which it is to be used at three or four points in each wave band. It is convenient to permanently record this voltage so that this value plus a knowledge of the attenuation factor will give the output voltage at the terminals of the attenuator.

For example, if the maximum output of the test oscillator is 0.25 volt at the approximate frequency being used and the reading of the attenuator is 10,000 microvolts, then it follows that the voltage delivered by the attenuator is 10,000 microvolts multiplied by 0.25, or 2,500 microvolts. This follows because the attenuator scales are predicated on the basis of a 1-volt input to the attenuator and therefore if the input is only one-quarter volt, the output will likewise be one-quarter of the indicated value.

It should be emphasized that under no condition can an *unshielded* vacuum-tube voltmeter be placed across the input to the attenuator while a measurement is being made on a receiver. This is especially true at the higher frequencies and where it is desired to obtain small values of voltage from the attenuator. Failure to observe this precaution will result in excessive values of leakage signal.

Where the vacuum-tube voltmeter is incorporated in the attenuator unit, it is suggested that the Service Man go one step further, and place the test oscillator and the attenuator unit inside one completely enclosed shield can; this will provide very effective shielding against stray signal voltages.



# The Delicate Balance of "High-Fi" Sets Easily Adjusted with . .

MODEL 1200-C  
VOLT - OHM -  
MILLIAMMETER

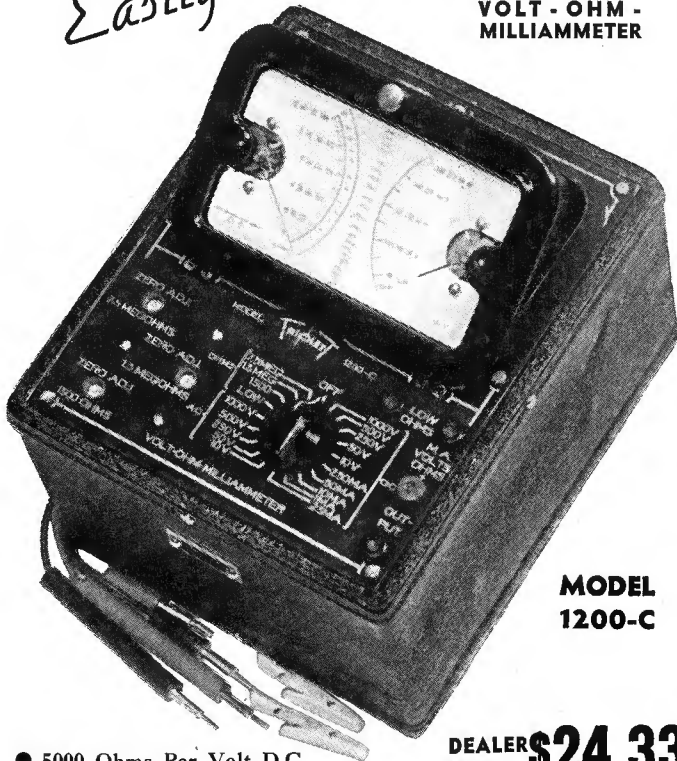

MODEL 1200-C

DEALER PRICE **\$24.33**

- 5000 Ohms Per Volt D.C.
- Resistance Readings to 7.5 Megohms
- For All Radio Measurements Not Requiring a No Current Draw Vacuum Tube Voltmeter

Has separate A.C. and D.C. instruments in twin case with tilting feature for accurate reading. Ohm Scales separately adjusted. Low loss switch. (Contact error on milliamperes less than 1/2%—no contact error on voltage measurements.) Low Ohms Scale requires but 6 2/3 milliamperes. Accuracy both A.C. and D.C. guaranteed within 2%. All Metal Case.

Scale reads: D.C. 10-50-250-500-1,000 volts at 5,000 ohms per volt; 250 microamperes; 1-10-50-250 milliamperes; 1/2 to 500 low ohms backup circuit; 1,500 ohms; 1.5 and 7.5 megohms; A.C. 10-50-250-500-1,000 volts.

The delicate balance of high fidelity sets requires servicing instruments capable of measuring high resistance and all voltages accurately.

Model 1200-C Volt-Ohm-Milliammeter has self-contained power for readings to 7.5 megohms. The D.C. voltage readings are at 5,000 ohms per volt, enabling you to read accurately the voltages of low power.

A TRIPLETT MASTER UNIT

See Your Jobber

Write for Catalog



## ELECTRICAL INSTRUMENTS

THE TRIPLETT ELECTRICAL INSTRUMENT CO.  
175 Harmon Ave., Bluffton, Ohio

Without obligation please send me more information on:  
 Model 1200-C  Complete Triplet Master Unit Line

Name .....  
Address .....  
City ..... State .....

IT HELPS ME  
ON ALMOST  
EVERY JOB!



Are you one of the thousands of service men getting help from the new Sylvania Technical Manual? Get on the "band-wagon" now!

If you knew how many thousands of service men are using the new Sylvania Technical Manual on almost every job—you'd realize what a whale of a value it is for 15 cents!

This handy pocket manual contains 184 pages listing 193 tube types with important circuit application information on each—all about glass, metal and "G" type tubes as well as those for Majestic receivers . . . and full information on Sylvania "Ballast Tubes." Don't be without it! It's one of the handiest tools you could carry! Send the coupon and 15 cents—we'll do the rest.

## SYLVANIA SET-TESTED RADIO TUBES

HYGRADE SYLVANIA CORPORATION, Emporium, Pa. S-57

I enclose 15 cents, for which please send me a copy of the new Sylvania

Technical Manual. I am (check below):

Experimenter..... Amateur..... Call..... Serviceman.....  
Employed by dealer.... Independent.....

Member Service Organization.....

Name .....

Address .....

City..... State.....

Name of Jobber.....

Address .....

# Auto-Radio . . .

## Cadillac-LaSalle 5X

The Cadillac-LaSalle Model 5X is a five-tube automobile radio using metal tubes in a superheterodyne circuit. It covers a frequency range from 528 to 1581 kc. A power output of 2.4 watts is available at the 6-in. dynamic speaker. The selectivity is rated at 42 kc broad at 1000 times the signal and the sensitivity, 2.0 microvolts at 1-watt output.

### THE CIRCUIT

The signal is fed through an antenna transformer with tuned secondary into a 6K7 tube which functions as an r-f amplifier. A tapped connection is provided in the primary of the antenna transformer for installations in cars in which a high capacity antenna is used.

The output of the r-f tube is fed through another r-f transformer with tuned secondary into a 6J7 tube which functions as the first detector and oscillator. The oscillating circuit is tuned by the oscillator section of the gang condenser and is always resonant at a frequency 175 kc above the frequency to which the r-f circuits are tuned.

One stage of i-f amplification is employed using a 6K7 tube. The primary and secondary of the first i-f transformer and the primary of the second

i-f transformer are tuned by small trimmer condensers.

A local-distance switch is used to reduce the sensitivity for city driving. When the switch is in the local position, resistor R13 is in series with r-f and i-f bias resistor R8, causing a reduction in sensitivity. When the switch is in the distant position, resistor R13 is short circuited and full sensitivity is obtained.

A 6B7 duo diode-pentode tube functions as a diode second detector, avc tube and a one stage audio amplifier. Avc voltage is applied to the control grid circuits of the 6K7 r-f and i-f tubes. The manual volume control varies the audio voltage applied to the grid of the 6B7 tube.

Resistance coupling is used between the first audio stage and the output stage which uses a 6B5 tube. A dynamic reproducer is employed.

A synchronous type vibrator is used in the power unit. This vibrator interrupts the current through the primary of the power transformer and also rectifies the current in the secondary circuit.

Polarity in inserting the vibrator must be observed. It can be inserted in two ways, and the correct method depends on which terminal of the car

storage battery is grounded.

A circuit diagram of the 5X is given in Fig. 1 with the various voltages encountered on the socket prongs lettered on the diagram. These voltages were read with a 1000-ohm-per-volt voltmeter with the antenna plug withdrawn the local-distance switch in the distance position and a battery voltage of 6.3 volts at the battery under full load.

### ALIGNMENT PROCEDURE

Misalignment of condensers generally manifests itself as broad tuning and lack of volume at portions or all of the standard-wave band. The radios are all properly aligned at the factory with precision instruments and realignment should not be attempted unless all other possible causes of the faulty operation have first been investigated and unless the service technician has the proper equipment.

A signal generator that will provide accurately calibrated signals over the standard-wave band and at the intermediate frequency, and an output meter are required for indicating the effect of adjustments.

Use a non-metallic screwdriver for the adjustments.

Connect the output of the signal generator through a 0.05-mfd condenser to the stator of the first-detector section of the tuning condenser. See Fig. 2 for the location of this section.

Connect the generator ground lead to the receiver chassis. The chassis

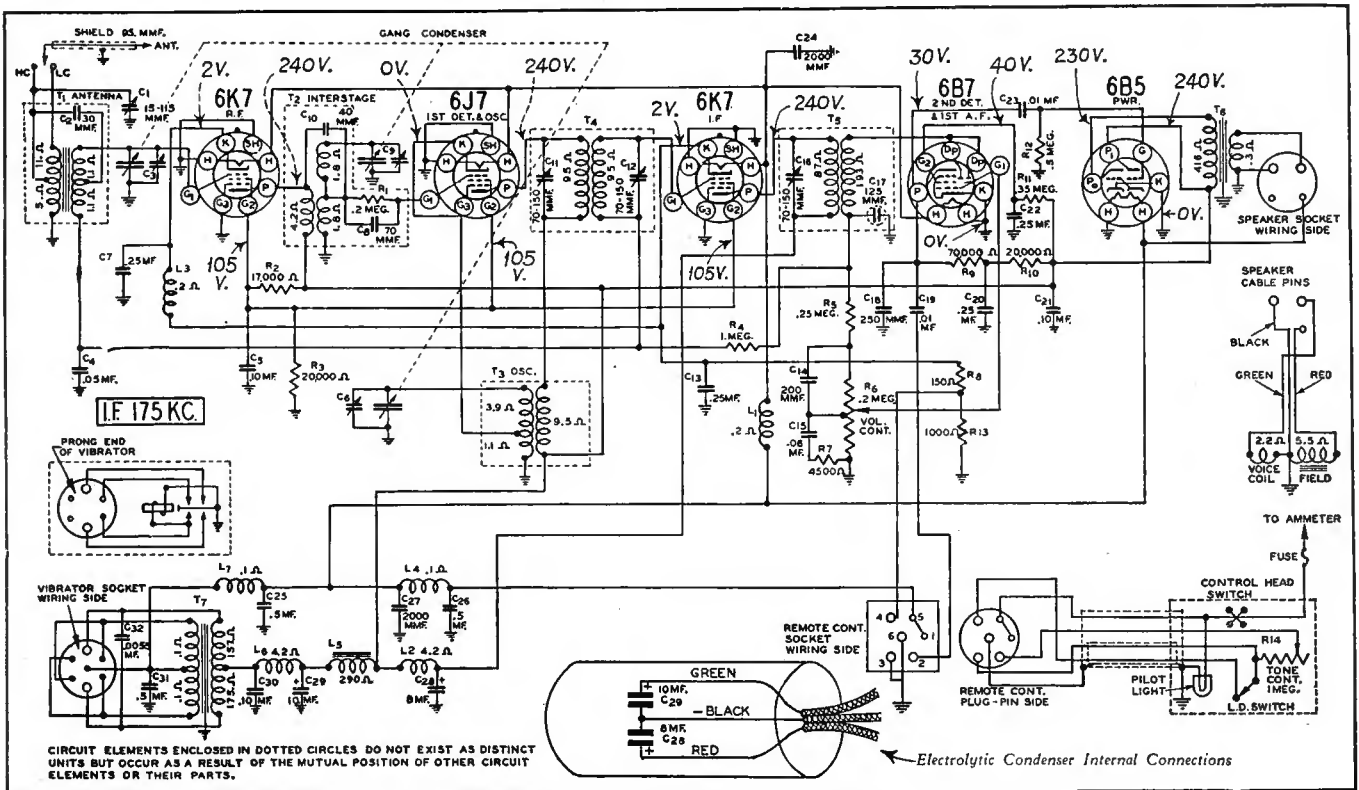

Fig. 1. Cadillac-LaSalle 5X circuit diagram.

# PREVIEW

# DOUBLE FEATURE

BOOTHS 40-41, RADIO PARTS SHOW, CHICAGO

THE *New*  
MODEL 775

## WESTON SERVISET

...Combining the Model 772  
ANALYZER and the new,  
matched Model 773  
TUBE CHECKER!



### Features:

1. Complete, modern servicing combination in a solid, polished-wood case of finest construction! Real luggage handles.
2. Contains the famed Model 772 and the new, matched Model 773 Tube Checker.
3. Model 773 perfected emission type tester . . . tests tubes under standardized load resistance . . . big, sensitive meter.
4. Improved noise test . . . all electrodes. Neon short check . . . while tubes are hot. Cathode leakage test.
5. Wired for rotating filaments . . . spare socket . . . obsolescence forestalled!
6. New, exclusive rapid-reference tube chart.
7. Model 772 has big WESTON Meter . . . sensitivity 20,000 ohms-per-volt . . . resistance ranges up to 30 megohms . . . current as low as 1/2 microampere. Wide range of usefulness . . . including all receivers, P. A. systems, television, sound movies, photo-cell circuits, etc.

*Model 775 combines the Model 772, 20,000 ohms-per-volt Analyzer . . . with the new, matched Model 773 Tube Checker . . . in a handsome, solid-wood case of finest construction. Model 773 also used as counter tube seller.*



### A *New* CONCEPTION IN COUNTER TUBE SELLERS!

Entirely different! Commands instant attention in this striking, polished solid-wood case. Conveys to customers the impression of true, scientific accuracy. Instrument also fits the single and combination carrying cases. Quickly interchangeable. *Note the new Weston rotator-type tube chart. You 'spot' your tube instantly. Charts easily replaceable.*

See this modern servicing unit at the show, or return the coupon for complete details.

Weston Electrical Instrument Corporation,  
604 Frelinghuysen Avenue, Newark, N. J.  
Send data on Model 775.

Name \_\_\_\_\_

Address \_\_\_\_\_

City \_\_\_\_\_

State \_\_\_\_\_

WESTON instruments can be purchased under the WESTON deferred INVESTMENT PLAN!



should be in its case. Turn the local-distance switch to the distance position and keep it in this position for all adjustments. Set the volume control at the maximum position. Turn on the receiver and signal generator and allow both at least 15 minutes to warm up before attempting adjustments.

**I-F ALIGNMENT**

Set the signal generator for a signal of 175 kc. Attenuate the signal from the generator to prevent the leveling-off action of the receiver's avc.

Adjust the three i-f trimmers until maximum output is obtained. The location of these trimmers is shown in Fig. 2. Repeat the i-f adjustments for greater accuracy.

**R-F ALIGNMENT**

**1581-kc alignment:** Set the signal generator for 1581 kc.

Turn the rotor of the tuning condenser to the full open position.

Insert the antenna plug for a high capacity antenna (mark on LC side). Connect the shielded antenna lead from the chassis through a 120-mmfd condenser to the antenna post of the signal generator.

For this and all subsequent adjustments keep the volume control at the maximum position and attenuate the signal from the signal generator to prevent avc action.

Adjust the trimmer of the oscillator section of the three gang condenser until maximum output is obtained. See Fig. 2 for location of this trimmer.

**1400-kc alignment:** Set the signal generator for 1400 kc.

Turn the rotor of the tuning condenser carefully until maximum output is obtained.

Adjust the first detector and antenna 1400 kc trimmers for maximum output.

Do not change the setting of the oscillator trimmer.

**600-kc alignment:** Set the signal generator for 600 kc.

Turn the tuning condenser rotor until maximum output is obtained.

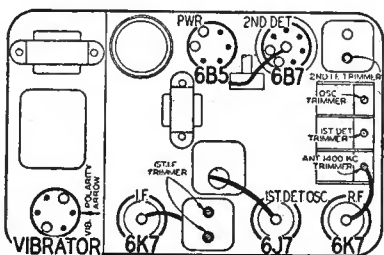

Fig. 2. Location of tubes and trimmers.

Adjust the antenna 600 kc trimmer to maximum. This trimmer is reached from the outside of the case. See Fig. 3.

After the alignment procedure is completed, the antenna plug may be withdrawn and re-inserted for a low capacity antenna (mark on HC side) if a low capacity car antenna is used.

**ANTENNA ADJUSTMENT**

After the radio is installed and the car antenna is connected, it will be necessary to readjust the antenna 600 kc trimmer.

Tune in a weak signal at approximately 600 kc with the volume control about three-fourths on. Turn the adjusting screw of the antenna 600 kc trimmer up or down until maximum output is obtained. See Fig. 3 for location of this trimmer.

**CALIBRATING THE DIAL**

Tune in a signal of known frequency at about the center of the dial. Choose a station with a frequency which corresponds to one of the numbers on the dial drum. For example, WLW, with a frequency of 700 kc, corresponds to 70 on the dial.

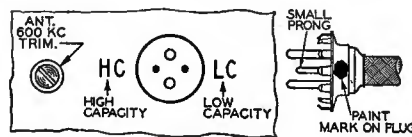

Fig. 3. Antenna plug insertion.

Hold the tuning knob. Using a clean eraser on the end of a lead pencil, turn the dial drum until the frequency of the station tuned in is at the center of the dial opening.

**ANTENNA PLUG**

The antenna plug can be inserted in two ways depending on whether the antenna is of high or low capacity.

Referring to Fig. 3, it will be noted that the letters HC and LC are stamped on the case. There is a spot of paint on the antenna plug. When the plug is inserted with the spot of paint on the LC side, it is properly inserted for a high capacity antenna and when it is inserted with the spot of paint on the HC side, it is properly inserted for a low capacity antenna.

If the total capacity of the antenna and shielded lead is approximately 200 mmfd which would be the case in a running board or ordinary roof antenna (not metal roof), insert the antenna plug for a high capacity antenna or with the mark on the LC side.

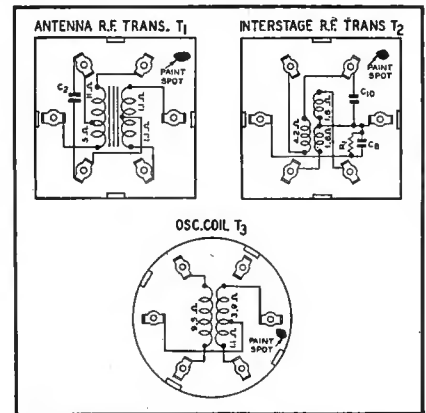

Fig. 4. R-f and oscillator coil base terminal arrangement and resistance of windings.

If the total capacity of the antenna and shielded lead is approximately 70 mmfd, such as may be the case if a "fish pole" antenna is used, insert the antenna plug for a low capacity antenna or with the mark on the HC side.

**G. E. A-70, A-75**

**Speaker rattle:** In a large majority of cases what seems to be a speaker rattle in this and other receivers will be found to be some loose part of the set, cabinet or dial. In this particular model the celluloid dial strip often vibrates loose and causes such trouble.

C. L. Smith

**RCA 6K2 (Second Production)**

**Service notes:** These receivers are similar to the model 6K2 (first production) except for the i-f transformers, loudspeaker and a few component parts. Visual inspection of the i-f transformers will readily identify these receivers. Service data for the model 6K2 is directly applicable to these receivers except the information concerning the parts mentioned. The primary adjustments for

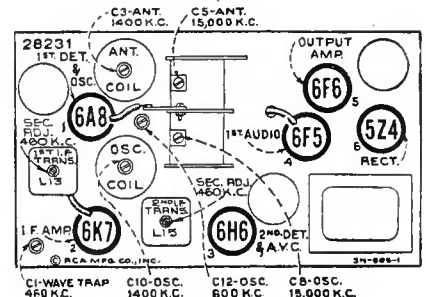

the i-f transformers are located on the bottom of the transformers while the secondary adjustments are located on the top.

# 30,000 SERVICEMEN Can't Be Wrong!

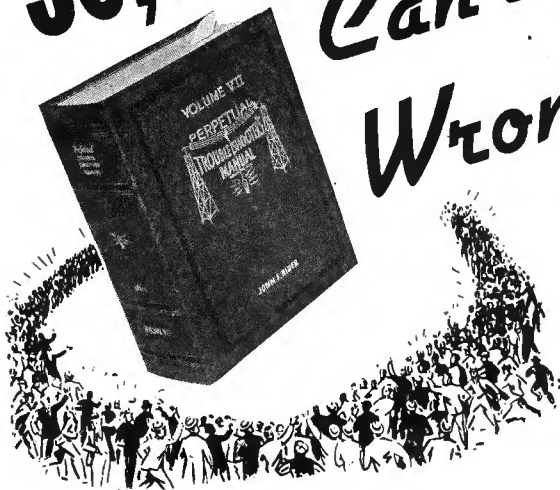

THE GREATEST ENDORSEMENT ever given any Manual is that given Rider's by the 31,000 servicemen who have year after year bought the latest volumes from their jobbers.

BUT, rather than your depending upon the findings of others we suggest you compare Rider Manuals with any other such service now available. Compare the number of set manufacturers, number of models of each make, alignment instructions, I. F. peaks, replacement parts list. Compare the good-sized and clearly printed diagrams, the ease with which facts can be found all in one place—in one book. Compare the number of pages—type of binding—and anything which bears on their usefulness to you.

—and be sure you have all seven volumes so you can display the

## RIDER 100% GROUP CERTIFICATE

This certificate, suitable for framing, is accompanied by a pocket identification card and counter display card. You can get yours by mailing us the seven title pages from your set of Rider Manuals. See the April-May issue of *Successful Servicing* for further details. Write us if you do not regularly receive *Successful Servicing*.

VOLUME VII—(Pictured above)

1600 Pages—

Covers 1936-37 ..... \$10.00

Other six volumes covering years from 1930 to 1936—

Each volume ..... \$7.50

**JOHN F. RIDER, PUBLISHER**  
1440 Broadway, New York City

### EVERY SERVICEMAN SHOULD HAVE THESE RIDER BOOKS

**Servicing Superheterodynes**  
Changes, changes, changes! That has been the history of the superheterodyne circuit. Make repairs quickly by analyzing the different parts of the circuit quickly. Rider shows you how. 288 pp. profusely ill. Price . . . \$100

**Servicing Receivers By Means of Resistance Measurement**  
Tells how to take guess-work out of servicing by using an ohmmeter. This method is in line with continuity data being furnished by set manufacturers. 203 pp. 93 ill. \$100 Price . . . . .

**Aligning Philco Receivers**  
This new book presents authentic and complete instructions for fast and accurate alignment operation on ANY Philco receiver. Every trimmer is located for you. 176 pp. Hard cover. Only \$100

**The Cathode-Ray Tube at Work**  
With introduction of new, cheaper Cathode-Ray Tubes, this book is even more indispensable for its complete practical information on Oscillographs, etc. 336 pp. \$250 450 ill. Price . . . . .

**"An Hour a Day with Rider" Books**  
Hard Covers 60c each  
ON  
Resonance and Alignment  
Automatic Volume Control  
D-C Voltage Distribution in Receivers  
A. C. Currents in Radio Receivers

# RIDER MANUALS NOW IN SEVEN VOLUMES

# TRY TO MATCH THIS 12-WATT SOUND SYSTEM



Model PA-712 LIST PRICE, \$111.00 Complete

- Portable . . . Entire System Housed in One Sturdy Carrying Case.
- Amplifier is 12-Watt, 4-Stage, 7-Tube, High Gain, Beam Type Design.
- Two 10" P. M. Speakers with Multiple Arrangement for Additional speakers.

Among new designs of moderate power, Model PA-712 "rings the bell." It will handle audiences up to 1500 people, is suitable for churches, lodges, theaters, convention dinners, etc.

Has the latest design features including beam tubes and multiple output arrangement for additional speakers. Ultra portability. . . . One case, 44 lbs., easily packed, easily carried. Easily set up too, and not critical on hum or microphonics.

At the price, Model PA-712 becomes a system that sound specialists can afford and can rent at a profit. It is modern in design too and professional looking throughout. Ask to see it at your local jobbers.

# WEBSTER-CHICAGO

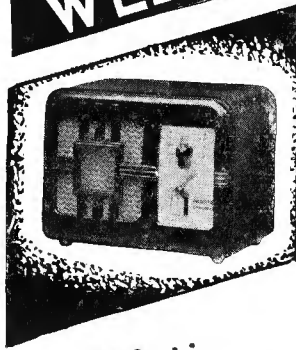

Plastic Cases . . . Choice of Colors  
Outstanding in appearance and performance. Two-way communication between all points up to ten. This is the system to sell for repeat business. Ask for jobber demonstration.

## THE OUTSTANDING MULTIPLE STATION INTER-COMMUNICATION SYSTEM

**NOTICE TO DEALERS**  
Webster-Chicago, Section MY-5, Chicago, Ill.  
5622 Bloomingdale Ave., Chicago, Ill.  
Without obligation please send me  New 1937 Catalog;  Information on Inter-Communication System;  Information on Model PA-712.

Name . . . . . State . . . . .  
Address . . . . .  
City . . . . .  
See us at the Trade Show, Hotel Stevens, Booths 114-115, Display Room 537-A.

# Public Address . . .

## P-A KINKS

By L. T. CHADBOURNE

SOME small refinements of detail in a public-address installation may often be as important as overall performance in impressing and pleasing the purchaser or renter. The refinements in question may cost little or nothing, or in some cases may work out to an actual reduction in the total cost of the system, but they convey to the user the idea that he is getting well-engineered equipment and that the seller is exceptionally competent in his business.

### SPEAKERS ON SOUND TRUCK

For example, one detail that has nothing at all to do with sound quality or performance relates to the method of mounting loudspeakers on a car or truck. Anyone can drill holes through the roof of the car and spoil the roof. But there are two ways to avoid drilling holes. One is to use the new suction grips now made for this purpose. With their help, speakers will remain firmly in place, yet can be removed at any time and will leave the roof unmarred. A business man who may at times want to use a p-a system in his car for advertising purposes, but doesn't want the car spoiled or want the speakers showing when they are not required, will be impressed with p-a apparatus that can be installed or taken out at pleasure, and that leaves no mark behind.

While the suction mountings just mentioned constitute the most convenient arrangement, there is another way of getting the same result with some cars, although not with all. Where there is a suitable overhang above the windshield and above the windows, projecting supports of wood or of metal may be anchored at those places. These supports then form the anchorage for a false roof on which the speakers are mounted. The method of fastening the supports to the overhang above the windshield and windows will of course vary according to the construction of the car. Sometimes there is a moulding outside the windows, and outside the windshield, which is held in place with wood-screws or bolts. The screws or bolts are removed, the moulding is removed, and a piece of stiff metal, drilled to match the same screw-holes or bolt-holes, is inserted. The mould-

ing is then put back over the metal, and the same screws or bolts, or longer ones if necessary, hold everything in place. The strip of metal projects out beyond the moulding to form a support for the false roof. The screws or bolts, and the material to which they anchor, must of course be strong enough to hold the additional pull.

Sometimes a short strip of stiff metal, hammered to proper shape, can be hooked in under the top of the window and windshield. Cables passing around the top of the car and drawn tight with turnbuckles hold the metal strips in position. A small board placed on the roof and fastened to the cables forms the foundation on which the speakers mount. The whole arrangement can be removed in a few moments by loosening the turnbuckles. A soft padding can be used at points of contact with the automobile to prevent scratches.

### DIVIDING POWER AMONG SPEAKERS

Another useful and interesting refinement relates to multiple-speaker systems, such as may be used in a tourist camp, hospital, school, city hall, or any place where a number of speakers of different sound power are required. In a school, for example, a few large speakers may be wanted for the auditorium or gymnasium, and a number of smaller ones for the classrooms. A calling system in a city hall or other set of offices, in a fire house, in an industrial plant, and so on, will probably have to supply rooms of several sizes, with several different degrees of noise background. There are many installations, particularly the larger ones, where this requirement is found.

The common practice, familiar to most sound men, is to match the amplifier output with a suitable number of speakers of different sizes but all of the same impedance, and all wired in parallel. Attenuators are then connected across the smaller speakers to cut down their volume to that required of them.

This method is crude, wasteful of power, and calls for an amplifier larger than would otherwise be necessary, in order to make good the attenuator losses. The multiplicity of loudspeakers (and of speaker matching transformers) now on the market makes possible a

more efficient method of securing the same result.

Take the case of an installation that requires two speakers to work at 3 watts each; four to work at 6 watts each, and two to work at 12 watts each. This totals 54 watts, and might call for a 60-watt amplifier, the output impedance of which probably will be 500 ohms.

With reference first to volume distribution, note that if speakers of different impedance are connected across a common output line the power will divide inversely as the impedance, and by choosing suitable values for the speaker transformers it will be entirely practical to put 12 watts into one and 3 watts into another, although both are connected to the same pair of wires. This amounts to no more than screwing a 10-watt bulb and a 100-watt bulb into the same lighting fixture.

In the case of the speakers, however, the sum total of all impedances must match the output impedance of the amplifier, and this requires a little work with pencil and paper to arrive at the proper lineup, using standard speaker transformers that are easily obtained at no extra cost. The formula for these simple calculations is known to everyone:

$$Z = \frac{1}{\frac{1}{Z_1} + \frac{1}{Z_2} + \frac{1}{Z_3} + \frac{1}{Z_4} + \frac{1}{Z_{etc}}}$$

Taking as example the installation mentioned above, and using 12-watt speakers having 2500 ohms input impedance each; these two in parallel will present a total impedance of 1250 ohms. The 6-watt speakers may have 4400 ohms impedance each, and since there are four of them, they will total 1100 ohms. The two 3-watt speakers may then be of 7000 ohms each, amounting to 3500 ohms when they are wired in parallel. If these values are checked according to the formula just given, the total impedance with all speakers in parallel will be found to be 501 ohms.

As to power distribution, there are three sets of speakers totalling 1250, 1100 and 3500 ohms, respectively, across a 500-ohm line and power will divide inversely between them. The power to each of these sets of speakers (they are all in parallel, and speakers of the same power and impedance ratings are treated as a set, only for-



# WHY DO INCREASING THOUSANDS OF DEALERS Pay Cash FOR RAYTHEON TUBES?

NOT BAD INTEREST  
ON YOUR MONEY!



# RAYTHEON

IT costs upwards of 5% to "sell" tubes to dealers on any of the "no investment" finance plans. Who pays the 5% or more? In most cases it is you—the dealer. Under other policies the dealer is asked to get it from the customer. But it comes out of the dealer's "hide" either way.

RAYTHEON protects your investment because thousands of dealers know that (1) RAYTHEON is the tube with great consumer acceptance and fair list prices that insure faster turnover... (2) RAYTHEON is the tube that is not sold at cut prices, insuring full profit... (3) RAYTHEON is the tube that needs no apologies or explanations, due to its long established quality.

These facts are the reasons why increasing thousands of dealers and service men are finding RAYTHEON the safest and most profitable tube investment.

## ASK YOUR JOBBER

See Raytheon display Booth No. 91, Radio Parts Manufacturers' National Trade Show, Stevens Hotel, June 10, 11, 12 and 13

RAYTHEON PRODUCTION CORPORATION

420 Lexington Ave., New York, N. Y. 445 Lake Shore Drive, Chicago, Illinois  
55 Chapel Street, Newton, Mass. 555 Howard Street, San Francisco, Cal.  
415 Peachtree Street, N. E., Atlanta, Ga.

RAYTHEON IS THE MOST COMPLETE LINE—ALL TYPES OF GLASS, OCTAL BASE, METAL, RESISTANCE AND AMATEUR TRANSMITTER TUBES

convenience in arithmetic) will be approximately:

$$\frac{500}{1250} \times 54 = 22 \text{ watts}$$

or 11 watts per speaker;

$$\frac{500}{1100} \times 54 = 24 \text{ watts}$$

or 6 watts per speaker;

$$\frac{500}{3500} \times 54 = 7 \text{ watts,}$$

or  $3\frac{1}{2}$  watts per speaker.

This is entirely close enough to the distribution originally decided upon, of two speakers at 12 watts each; four at 6 watts each, and two at 3 watts each. The figure 54, in the equations above, of course, represents the total power output at the level at which the amplifier will be operated.

These equations tell us how to start to find the proper speaker input impedances for a job of this kind. The number of speakers needed, and the power at which each must operate, are requirements fixed by the nature of the installation. The total power needed is also known. Then in place of the figures 1250, 1100 and 3500, above, x, y and z can be written in, and the equations solved for those unknowns. However, when the unknowns are found according to power requirements, their total effective impedance may not match the output impedance of the amplifier. At worst, this would mean a special output transformer, but that is seldom necessary. Amplifiers today usually offer a number of output impedances, and speakers a number of input impedances. The power distribution can always be altered by a watt or so for or against any one speaker, and therefore by several watts for a set of speakers which are all of one impedance and work at the same power. Consequently it is nearly always possible, by spending an hour with a pencil, paper, and catalog of available equipment, to work out a suitable arrangement.

This method represents a real saving to the user, and therefore a lower price that will result in a sale against competitors using attenuators. If all eight speakers in the system just described were supplied with maximum power—11 watts each—and the surplus to the smaller speakers shunted out with pots, an 88-watt amplifier would have to be used in place of a 60-watt amplifier. Moreover, the cost of the attenuator (to handle as much as  $7\frac{1}{2}$  watts each) would have to be added in, whereas all the speaker input impedances mentioned above are standard, and can be had at

no extra cost. Still further, with the arrangement just described impedances match throughout, while with attenuators they do not; and to secure the same accuracy of impedance match pads would have to be used instead of potentiometers, at even greater cost.

### DEAD SPOTS

There are two tricks that are worth knowing in connection with indoor work in which there is trouble in obtaining an even distribution of sound to all parts of the auditorium. Many auditoriums are so built that there are dead spots very difficult to reach with adequate volume, even when the speakers are equipped with strongly directional baffles. The seats close up front in the extreme corners are often missed, especially when there is a stage and the stage is narrower than the auditorium. Speakers are frequently pointed outward in an effort to reach such corners. The method is only partly successful, as a rule, and has the drawback of taking volume from the center of the house.

Instead of pointing the speakers outward to reach such corners, point them strongly inward, using the right-hand speaker to supply the left-hand front corner, and vice versa. The beams of sound will cross in the center of the house, maintaining full volume or more than full volume in that important location, and at the same time the corners will be reached more efficiently than by the other method.

Other dead spots in a difficult auditorium can sometimes be reached by reflected sound. That is, instead of pointing the speakers directly toward such a location (which may not work), point them at some wall, cove or dome that is easily reached by the beam of sound, and from which the beam may be reflected into the difficult area. In judging the possibilities of such reflection, remember that sound is reflected in the same way as light—at the equal but opposite angle.

There are three minor points that are also of value in dealing with acoustic difficulties. (1) If volume is at all inadequate, keep speakers pointed downward (unless there is a balcony). Don't waste sound on the ceiling. (2) If the house is reverberant, point speakers directly at the audience, and keep the volume as low as possible. The audience, and its clothing especially, absorb sound, and so prevent repeated reflections from hard walls which constitute the condition of reverberation. Keeping volume down to the lowest possible level is a further help. (3) If

the auditorium is acoustically dead point sound at the walls and ceiling, rather than at the audience, to obtain as much reverberation as possible. Naturally, this remedy can be used only if enough reserve volume is available.

### DOUBLE CHANNELS

Another small refinement, not always applicable but extremely valuable in some cases, is to wire a system with double plugs or switches to provide for use of an emergency amplifier. This provision must be explained diplomatically to avoid giving the user the impression that his amplifier is considered unreliable; and the word emergency should never be used, of course. The arrangements can be described as "standard dual channel wiring," or "regular procedure to allow for future expansion," or by some other phrase that indicates the installer is merely looking ahead, and doing his work in such a way as to save the buyer unnecessary expense at some future time. The idea of an emergency channel, suggested in this manner, may work out eventually in the sale of a second amplifier. But the procedure is useful only when the seller has previously obtained the full confidence of the buyer—otherwise it is best left alone.

### Philophone Intercommunicator

The Philophone is a system for voice communication between a central point and one or more remote points. The system consists of a master station (Model 901) and from one to four remote phones (Model 902).

The Model 901 contains the amplifier, talk-listen switch, remote phone-selector switch, terminal panel, dynamic speaker and volume control. The Model 902 remote phone unit consists of a dynamic speaker and a terminal panel to which the cable is connected at the remote point. The schematic diagram (Fig. 1) shows the connections for from one to four units to the master control circuit.

### CONNECTING REMOTE PHONES

There are five terminals at the rear of the master phone, numbered 1 to 5. A connecting link joins terminals 2 to 3 and 4 to 5 as the outfit is furnished. This connection is correct for the use of one remote phone.

When using only one remote phone, connect the wires from it to terminals 1 and 2 at back of master phone.

When using two remote phones, remove the connecting link between terminals 2 and 3, and connect the second phone to terminals 2 and 3. When using

# NOW!

# A

# Utah

## PERMO DYNAMIC SPEAKER

## FOR Every

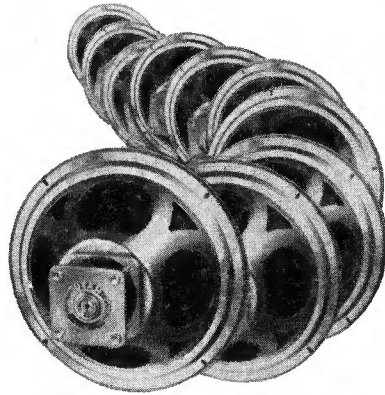

## SOUND REQUIREMENT

They're ready for you—at low prices, too! Thirty-four models—all with UTAH'S recent advancement in permanent magnet dynamic speaker efficiency. Cone diameters range from five to fourteen inches, with output capacities as high as thirty watts. The new UTAH "Perpetual Magnets" weigh from five to forty-six ounces.

Select your permanent magnet dynamic speakers from the UTAH line. It's complete! It's more efficient! It includes a speaker that *exactly* suits every sound requirement. Write Dept. S-5 for details.

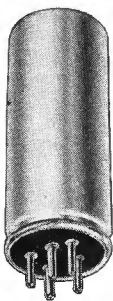

### REMEMBER!

### UTAH VIBRATORS LAST LONGER AND ARE MORE EFFICIENT!

Use the vibrator that can *really* take it! Recent tests prove UTAH vibrators are the finest and toughest ever made. Test them yourself. You'll find they work better, last longer, but cost no more. Write Dept. S-5 for details.

See the UTAH exhibit at the National Radio Parts Trade Show Booths 69-70

## UTAH RADIO PRODUCTS CO.

CHICAGO, U. S. A.

TORONTO ONTARIO, CANADA BUENOS AIRES (UCOA RADIO PRODUCTS CO.)

## "15 YEARS OF LEADERSHIP"

# CUT RATE OUTLETS

*...are places where  
National Union  
Radio Tubes  
AIN'T!*

A nice comfortable feeling! We mean that secure, clean cut feeling a National Union Service Specialist has when he installs N.U. tubes. He knows he's gotten a fair price for premium quality merchandise. He's rendered a genuine service to a set owner and he's not going to be embarrassed by having his customer see N.U. tubes advertised in some gyp joint down the street as a loss leader.

No, Sir! National Union has kept the market clean for you. National Union tubes are not listed in cut price mail order catalogs. You won't find them in price slashing chain stores or department stores.

Your profit margin is reasonable when you sell at established list prices and National Union has always felt that you are entitled to protection on it.

Remember these facts . . . the boys who are selling N.U. tubes are selling them with complete confidence . . . they're not running a chance of customer ill-will . . . because the set owner will never see N.U. tubes offered for sale with the heart cut out of the price!

This business of keeping the market clean for the Service Industry is only one of the reasons that N.U. is such an overwhelming favorite in the service field. . . . Have you ever heard the entire National Union sales story? It will pay you handsome dividends to be tied up with N.U.

Find out why . . . send the coupon below . . . NOW.

**MEET US**—AT THE NATIONAL RADIO PARTS TRADE SHOW—BOOTHS 104 - 105 Hotel Stevens—CHICAGO—June 10, 11, 12, 13

**CLIP! . . . . MAIL!**

S-537

NATIONAL UNION RADIO CORP. of N. Y.  
570 Lexington Avenue, New York, N. Y.

Who is the nearest N.U. distributor? I want to find out what N.U. can do for me.

Name .....

Street .....

City..... State.....





three remote phones, connect the third to terminals 3 and 4.

If four remote phones are used, remove both of the links and connect the leads from the fourth phone to terminals 4 and 5.

When more than one remote phone station is used, an eight-foot extension cable may be employed. This is a cable equipped with spade terminals at one end which connect on to the terminals at the back of the control unit. The other end of the cable is equipped with a terminal strip similar to the one on the back of the control unit. It can be securely fastened to the baseboard or the under side of a desk. In this way the various pairs of wires coming from the different remote phone stations are all brought to one terminal strip out of sight. Thus, instead of having several transmission lines running up to the back of the master unit, there is but one cable.

Since there is no high voltage in the wiring between stations, it is unnecessary to run this wiring in conduit.

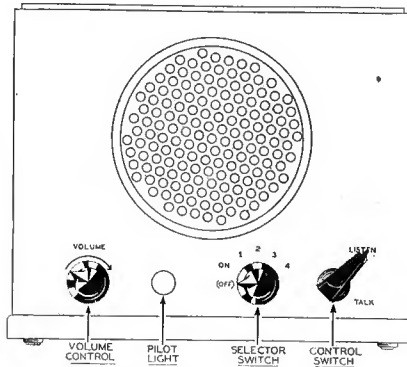

**Fig. 2. Front view of the Philcophone showing arrangement of the controls.**

**OPERATION**

Turn the selector switch to "on." Advance the volume control a portion of the total movement of rotation (the best position for normal operating use will vary slightly with each installation and can be determined best by trial).

Allow a few moments for the tubes (in the master phone) to reach operating temperature. The system is then

ready for use. It should remain turned on during the entire period of the day that there might be occasion to use it. This will enable a call to be made instantly either from the master phone to the remote phone or vice versa.

To call any one of the stations where a remote phone is located, turn the selector switch on the master phone to the correct number corresponding to that station, press the control switch to the talk position and speak in the general direction of the loudspeaker in the unit. When finished release the control switch to the listen position. An answer may then be received from the party at the remote phone. By following this procedure two-way conversation can be maintained as long as desired. For best results a normal tone of voice should be used—about two feet away from the unit. Advancing the volume control on the master phone increases the volume and sensitivity of the system so that conversation can be

*(Continued on page 314)*

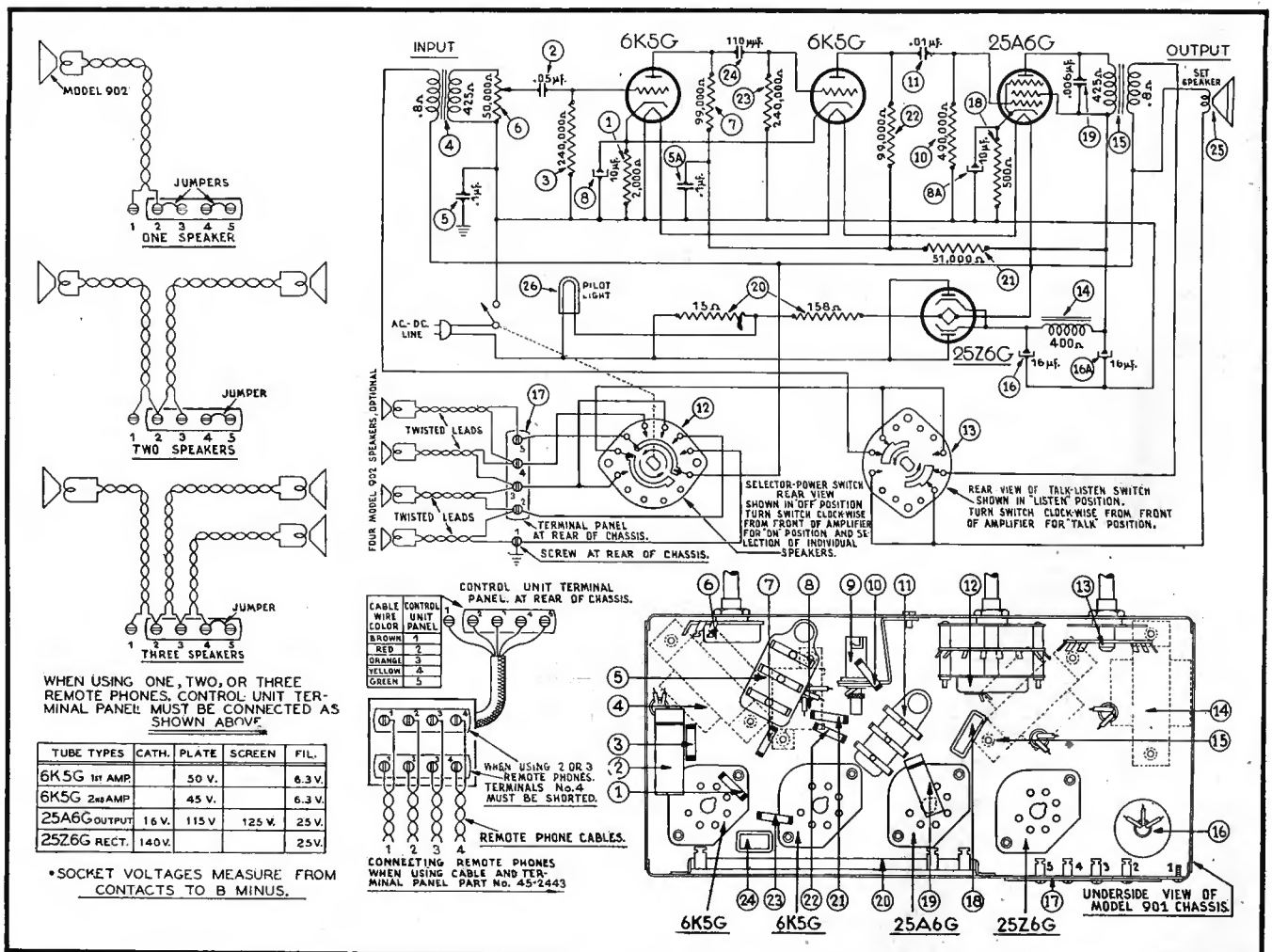

**Fig. 1. Philcophone 901, 902 circuit diagram. Underchassis view and connection for from 1 to 4 units.**

**INSTANT  
DEPENDABLE  
POWER**  
*for*  
**DEMONSTRATING  
AND TESTING  
Auto Radios**  
*and* **ELECTRICAL ACCESSORIES**

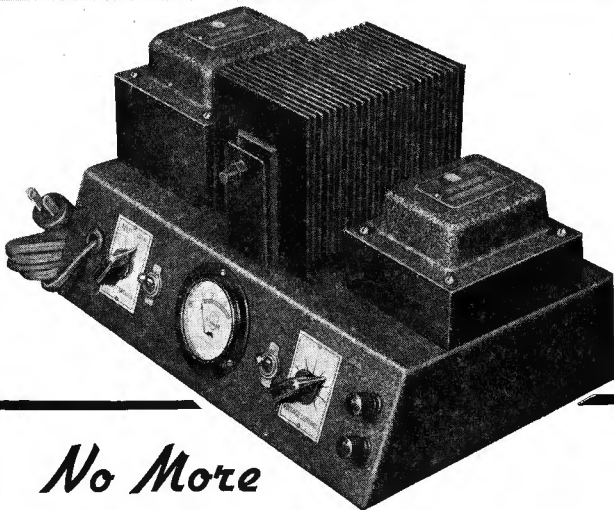

*No More*

**LOST SALES from  
POOR DEMONSTRATION**

Take all the fuzz and blur out of your auto radio demonstrations . . . get clear, top-notch reproduction *all the time* with instant, dependable power from a Stancor Auto Radio Pack.

Full protection against overload and voltage surge . . . highly accurate meter . . . conservative Stancor design.

You can't afford to leave demonstration power supply to chance. It loses sales. It costs you money.

*Three Models:*

**JUNIOR**—Power output, 5 to 7½ volts at 5 amperes, suitable for operating one average auto radio **\$16.95**

**STANDARD**—Power output, 5 to 7½ volts at 12½ amperes, or enough current for two average auto radios **\$19.95**

**DELUXE**—Output, 2 to 8 volts at 15 amperes, enough for four average auto radios. This model is equipped with Hi-Lo Switch and Continually Variable Voltage Control **\$26.50**

*All prices net to dealer*

**STANDARD  
TRANSFORMER  
CORPORATION**

850 BLACKHAWK STREET CHICAGO



**55,000 FANS**

**HEAR EVERY WORD!**

MAGNAVOX High Fidelity "EA Special" Speakers are the heart of the famous Electro-Acoustic Sound System at Wrigley Field, Home of the Chicago Cubs—just as they are at—

- **NAVIN FIELD**—Home of the Detroit Tigers.
- **EBBETS FIELD**—Home of the Brooklyn Dodgers.
- **ARLINGTON PARK**—Scene of America's Greatest Racing.
- **U. OF MICHIGAN STADIUM** — Seating 80,000 Spectators.
- **CHICAGO STADIUM**—World's Largest Indoor Arena.

YOUR SOUND JOB—large or small—indoors or outdoors—will give peerless performance—last longer—cost less with an Electro-Acoustic High Fidelity System and Magnavox "EA Special" Speakers—expressly designed for sound distribution.

**COMPLETE SYSTEMS from \$59.50 up**  
FULLY LICENSED

Insist on Electro-Acoustic High Fidelity Sound Equipment and Magnavox "EA Specials." Look for "EA Special" on the speaker nameplate.

*Consult your distributor or use the coupon.*

**COUPON**

ELECTRO-ACOUSTIC PRODUCTS CO.      Date.....  
Fort Wayne, Ind.

Please send me information and the name of my nearest distributor. I am interested in

Electro-Acoustic Systems       Magnavox "EA Special" Speakers  
 Electro-Acoustic Amplifiers

NAME .....

ADDRESS .....

CITY ..... STATE .....

# TEST EQUIPMENT...

## METER ACCURACY By SAMUEL C. MILBOURNE\*

MANY Service Men have a mistaken idea about the accuracy of meter movements used in commercially-built test instruments. Very often they complain, "I believe this meter is not accurate enough. I tested all the ranges on the 110-volt a-c line and the higher I went the greater the inaccuracy became."

This statement shows a misunderstanding of the standard rule which all meter manufacturers use in expressing meter accuracy. Meter accuracy is always considered as a certain percentage of full-scale value, never as a percentage at any individual point on the scale.

For example, the average meter movement which the manufacturer has guaranteed to be accurate within 2 percent means within 2 percent of full-scale value. If the basic scale was 0 to 5 volts, d-c, this would mean that the meter is accurate within 0.1 volt at any point on the scale.

At midscale, or 2.5 volts, this would mean an accuracy of 4 percent. At  $\frac{1}{4}$  scale it would be 7 percent and at  $\frac{1}{10}$  scale, 20 percent.

There are several technical reasons for adopting this standard of indicating the accuracy of meter movements. The principal reason is because of inherent design every meter may err greatly over the first  $\frac{1}{5}$  of its scale length. It is practically impossible to build meters on

a production basis with hairline accuracy over the entire meter scale. To offset this, meter manufacturers include a multiplicity of ranges so that measurements need not be taken below  $\frac{1}{5}$  of the meter's scale, and better models are designed so that few measurements need be taken on the first  $\frac{1}{5}$  to  $\frac{1}{2}$  scale length.

The Supreme Model 550 radio tester, shown in Fig. 1, is a typical example of a multi-range test instrument. Full-scale ranges for 7, 35, 140, 350, 700 and 1400 volts for both a-c and d-c are provided. In most cases the overlap of ranges is between 30 and 50 percent.

Voltages between 0 and 7 would be tested on the 7-volt range. Those between 7 and 35, on the 35-volt range, etc.

If 5 volts were measured on the 35-volt range a certain inaccuracy should be expected since it would read within the first  $\frac{1}{5}$  of the meter's scale. If the 110-volt line was used to check the 350-, 700- and 1400-volt scales, as Service Men sometimes attempt to do, the indications would naturally grow more inaccurate as the range was increased.

Practically all the manufacturers of the meters used in the construction of test instruments manufacture them to within 2 percent of full-scale value. When multiplier resistors are added more inaccuracies result, ranging from  $\frac{1}{2}$  of 1 percent to as high as 5 percent. This error, however, is not necessarily additive.

Tolerance percentages are always

considered plus or minus the specified value. At full scale a meter may be 2 percent low and be so balanced by a resistor, which is a certain percentage high, that a more accurate result is obtained. Meters may, however, be matched only at one point on the scale and are progressively inaccurate above and below this point.

In Supreme instruments the ranges are actually calibrated at about  $\frac{3}{4}$  to  $\frac{1}{2}$  scale, or approximately in the center of the portion which is customarily used on each range. (It is likely that other manufacturers employ somewhat the same method, but in this discussion only the methods used by Supreme engineers, to accomplish a maximum of accuracy, will be mentioned.) It may be seen that no one potential may be used as a criterion by which a multiplicity of ranges can be tested for accuracy.

When dealing with a-c another problem presents itself: that of the inherent error of instrument rectifiers. Recent

A			B		
Range	2%	5%	Range	2%	5%
5	0.10	0.25	7	0.14	0.35
25	0.50	1.25	35	0.70	1.75
125	2.50	6.25	140	2.80	7.00
250	5.00	12.50	350	7.00	17.50
500	10.00	25.00	700	14.00	35.00
1250	25.00	62.50	1400	28.00	70.00

Fig. 2. Voltage tolerance at any point for various meter ranges of given percentage accuracy.

test instrument design has favored more and more the elimination of a multiplicity of meters and the combination of functions and ranges on one meter. Such a meter must, of necessity, be basically a d-c movement and, for a-c measurements, use a rectifier to change the alternating current to direct current so that the effect may be read on a d-c movement meter.

The design of rectifier type a-c potential measuring circuits has been dealt with in detail in preceding articles so that this subject is not within the confines of this article. It is sufficient to point out the fact that instrument rectifiers have inherent inaccuracies due to variations in rectifier resistance, temperature, humidity, etc.

Usually, through good circuit design, it is possible to keep any variables within a narrow inaccuracy limitation. However, it can be assumed that there may be present, under certain sets of conditions, inaccuracies in a-c potential measuring circuits as high as 5 percent. Once again, by properly matching ranges, these inaccuracies may be held to a smaller value.

Another method of assuring a maximum of indication accuracy is to design the various ranges so that the

(Continued on page 314)

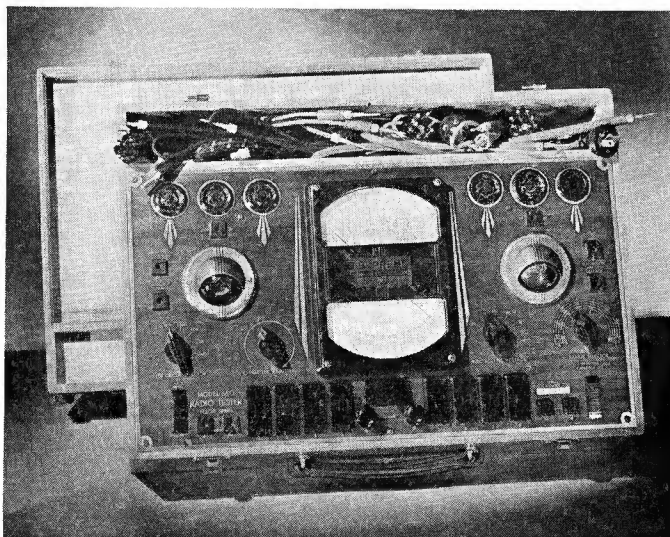
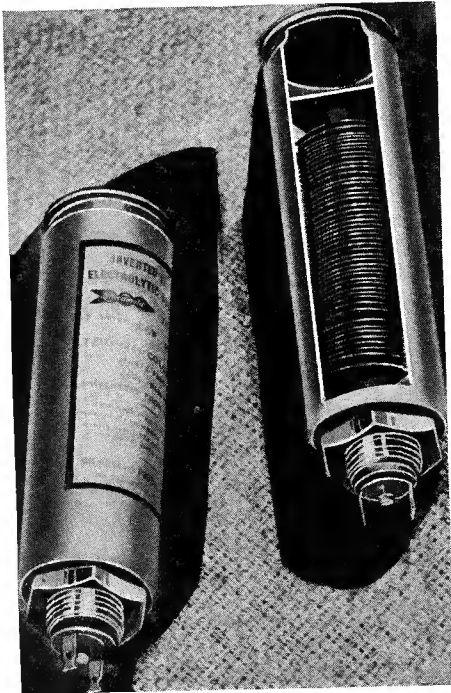

Fig. 1. Supreme 550 radio tester, an example of a multi-range instrument.



# A NEW PRODUCT



## WET ELECTROLYTIC CONDENSERS

These condensers incorporate a new design in the anode structure that closely approaches the theoretically perfect form. The current has the shortest average path from the can to all points on the anode surface resulting in

### REDUCED POWER FACTOR

Another important improvement is that it is not necessary to have a hard rubber liner as the anode cannot touch the can. The elimination of the hard rubber liner not only reduces the power factor but eliminates a material that often contains sulphides which cause anode corrosion and resultant malfunctioning.

More capacity for a given working voltage can be put into standard size cans (very high capacity electrolytics are demanded by the new circuits).

The condensers are made in cans of standard dimensions in all standard capacities and voltage ratings.

### SEE US AT THE SHOW

Chicago, June 10, 11, 12, 13, Hotel Stevens, Booth 98. Complete line of Micamold products will be on display at this NATIONAL RADIO TRADE SHOW.

## MICAMOLD PRODUCTS CORP.

FLUSHING and PORTER AVENUES  
 BROOKLYN, NEW YORK

# 6 VOLT D.C. 110 VOLT A.C.

## 25-35 WATTS

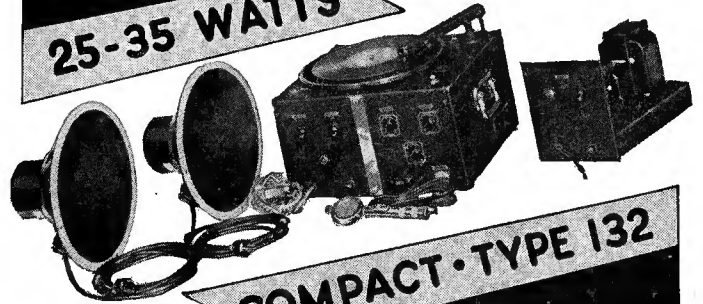

## RUGGED • COMPACT • TYPE 132 MOBILE P.A. SYSTEM

Uses Beam Power Tubes . . . Electronically mixes one Microphone and one Phonograph . . . Includes Dual Diaphragm Crystal Microphone Hand Type . . . Two 12" Heavy Duty Permanent Magnet Speakers . . . Interchangeable Power Packs . . . can be used in conjunction with Radio Set by using a Model A-3960 Radio Matching Unit.

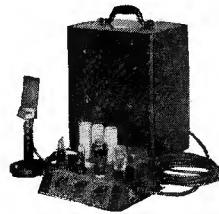

Model 108

### 8-15 Watt Portable Unit

Complete with Model 813 Amplifier, veleton microphone with combination hand and banquet stand, 10" Electrodynamic speaker and \$83<sup>00</sup> tubes . . . . .

Model 813 Amplifier alone including \$38<sup>00</sup> Tubes . . . . .

● Extremely rugged, compact and ready to go in every case where a temporary installation is required. A simple change of parts and it's ready for 110 Volt A. C. or 6 Volt D. C. Beautifully finished in baked black stipple, this unit never falls down on the job expected of it.

PRICE—Unit only, 6 Volt D.C. \$142<sup>50</sup> operation including Tubes . . . . .

Additional for two 12" Permanent Magnet Speakers and Crystal Micro- \$75<sup>00</sup> phone . . . . .

A. C. Power Unit only, with Tubes. \$22<sup>50</sup>

(Above prices subject to usual jobbers' and dealers' discounts.)

The Most COMPLETE Line of Intercommunicating Systems, P. A. EQUIPMENT, P. A. SPEAKERS AND RADIO REPLACEMENT SPEAKERS THE MARKET AFFORDS. EASY TIME PAYMENT PLAN.

## THE PRICED RIGHT LINE . . . THE LIBERAL DISCOUNT LINE . . . THE 1937 PROFIT LINE!

For NEW 1937 Illustrated Catalog address Dept. 55

Something of Unusual Interest Awaits You at Our Booth  
 94 and Demonstration Room 505

AT THE PARTS CONVENTION

# OPERADIO

## MANUFACTURING COMPANY

ST. CHARLES . . . ILLINOIS

# ON THE JOB . . .

## Selling Through Service

Too many radio dealers look upon their service department as a necessary evil, yet it holds the key to successful merchandising in the radio business—be it large department store or small radio shop.

The service department is the first point of contact with the customer after the sale is made. The treatment he receives will largely determine his good-will for the dealer when he is again in the market for merchandise offered by the dealer. If he receives prompt and efficient service the good impression left is invaluable. If he is given poor service he will undoubtedly go elsewhere the next time he is in the market.

Many radio dealers insist "Customers will not pay for service and like it. The only way to keep good-will is to give free service." This thought has been proven untrue on innumerable occasions in the radio business and in other similar businesses. These dealers can take a lesson from the automobile business where the service department is a profitable enterprise. With that as an example, we can safely say that the public will gladly pay for *good* service.

Through careful management any service department can pay its own way and produce golden dividends in actual sales as well as customer good-will.

Most people are reasonable when they have their radio repaired. They can understand that tubes require replacement; that speaker cones wear, and that a receiver may need realignment at intervals. A little tact by the Service Man, and the customer will obtain an impression of thoroughness and reliability that smooths the way toward easily collecting for the call.

To help create an impression on the customer the Service Man should handle the receiver gently and avoid any indication of haste. The customer bought the best set he could afford and it represents an article of which he is proud. He will appreciate careful treat-

ment. If the chassis needs cleaning he surely knows this but is afraid to tackle the job, thinking he might be shocked or that he might damage something.

When it is necessary to remove the chassis to the shop for repairs tell the customer just when you will return it and be sure to have it there as promised. Whenever possible loan the customer another set while his is being repaired.

Courtesy in answering the customer's questions also helps to hold his confidence. He may not understand it all—but this is no excuse for impatience. A few descriptive, well-chosen remarks will go far toward pleasing even the most inexperienced layman, and, after all, he is paying the bill.

The Service Man and the Service Department should be given credit for every sale they make, both directly and indirectly. These sales efforts are especially valuable to the smaller dealer who must depend upon personal contacts with his customers for sales rather than by newspaper advertising and other mass sales efforts made by the larger stores.

*From "The Radiolab News"*

## Wet Electrolytics

Occasionally the electrolyte from wet electrolytic capacitors will leak out of the container, run down the side and harden, leaving an unpleasant deposit. This is entirely natural due to chemical action in capacitors of this type.

In the manufacture of wet electrolytics several small holes are provided in the top of the container to act as safety valves, in case this action takes place. This small leakage does not affect the efficiency of the condenser or change its value and may be cleaned off with a damp cloth.

*Stromberg-Carlson Telephone Mfg. Co.*

## Increasing the Line Voltage

There are occasions when it may be necessary to step up the power line voltage. A simple and economical

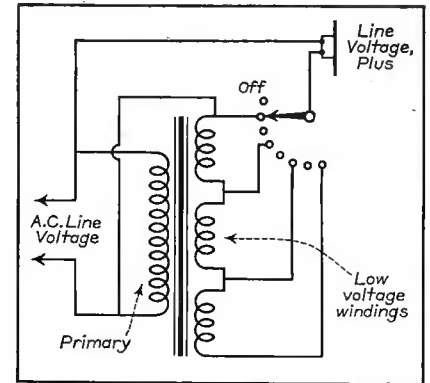

method is shown in the accompanying diagram. A power transformer with several low voltage windings can be connected to an inductance switch in such a manner that these low voltages are added to line voltage as may be required. The windings are connected in series in the proper phase so that they are additive. If, upon connection, the primary voltage is reduced the connections to the low voltage winding should be reversed.

On a receiver which fades in the customer's home but works O. K. in the shop, fading can often be brought on again by stepping up the input a-c voltage to the receiver in the manner described.

*C. H. Ramm*

## Ground Dangerous as Aerial

Using the ground as an aerial has resulted in many cases of a partial or complete burn-out of a radio set. Distributors have from time to time received from dealers and Service Men burned antenna coils which show clearly that the antenna terminal of the radio was connected to a ground for an aerial. Such a ground might be a radiator or a water pipe.

The antenna circuit in some receivers is protected from the power line voltage by a small condenser. If for any reason this condenser should become shorted, either accidentally during the servicing of the chassis or for any other reason, the antenna section of the chassis will go up in smoke very quickly. In addition to the danger which results from using the ground as an aerial in this way, there is also considerable noise which is not obtained when a good aerial is employed. This is particularly true in the case of a second- or third-floor installation where there would be considerable noise pickup in the ground system between the level of the radio set and the actual earth itself. It is recommended in every case that an aerial be employed for radio reception. When the ground is used as an aerial, the customer's radio is being subjected to unnecessary dangers.

*The Philco Serviceman*

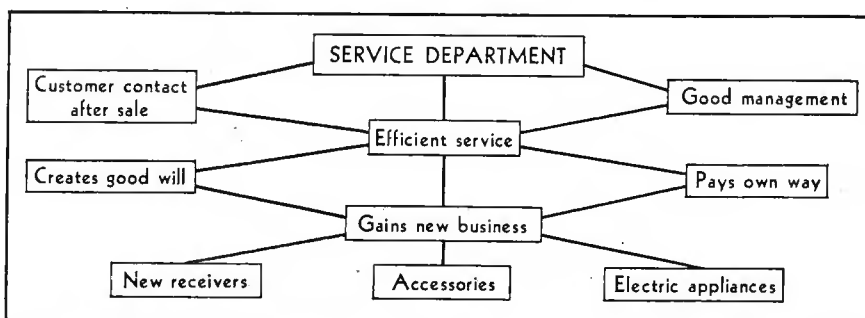

NEW TUBES NEVER MAKE ANY RADIOTECHNIC TESTER OBSOLETE - *it is always* **NON-OBSOLESCE**NT

ONLY ONE OF 15 **ERTLS** FEATURES



NEW TUBES never make Radiotechnic testers antiquated. Models sold before metal tubes were thought of still handle the 90 new types which have since appeared. The total cost to users has been \$1.50 for material, instructions and diagrams. The one time-proven safeguard against obsolescence. There are fourteen other real advantages. Learn about ALL of them!

ASK FOR FOLDER 1271

See Radiotechnic Display at National Radio Trade Show, Stevens Hotel, Chicago, June 10-11-12—BOOTH

**THE RADIOTECHNIC LABORATORY**  
1328 Sherman Ave., Dept. S., EVANSTON ILL.

SEE YOUR JOBBER

A Complete Line of Tube Test Equipment

**RADIOTECHNIC**

# The NEW SUEDE CABINET

Made of steel, yet having a soft Suede finish that is delightful to the eye and touch, these cabinets are causing the sensation they are entitled to.

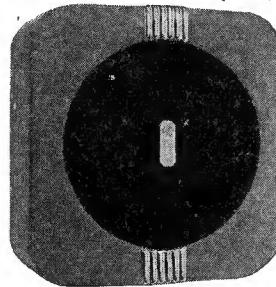

Equipped with the famous Nokoil Speakers, they are perfect for hotels, apartment houses, call systems, automobiles, "Talk-Bak" systems, etc. etc.

The 8" Suede Vehicle Cabinet with its taupe finish and black grille enhanced by the bright polished ornaments.

See how adaptable it is. Either base or single stud mounting, yet no bolt is screwed into the Speaker pot to throw the pole piece off center.

Wall cabinets are finished in taupe with a light brown grille which blends perfectly. Our new novel method of fastening the cabinet to the wall makes it unremovable without a special tool.

Write for complete information on our Suede Cabinets with Nokoil Speakers. Wright-DeCoster distributors are always anxious to cooperate.

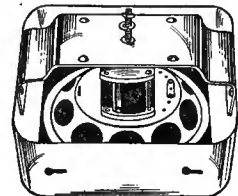

## WRIGHT-DECOSTER, Inc.

2253 UNIVERSITY AVENUE, ST. PAUL, MINN.

Export Dept.: M. Simons & Son Co., N. Y.  
Cable Address: "Simonrice."

Canadian Office: Associated Sales Co., Guelph, Ont.

## FOR PERFECT DEMONSTRATION OF AUTO AND OTHER D.C. RADIOS



### Epc STORAGE BATTERY ELIMINATOR

REPRESENTS A FULL CHARGED BATTERY THAT NEVER RUNS DOWN

Provides 6 volt-10 amps. filtered D.C. from 110 volt A.C. Assures instant, adjustable current at minimum power consumption. Ends forever the messy battery-charging nuisance. Also efficient as a battery charger. Write for further details.

**\$19.75** As Illustrated Variable Voltage List Price **\$15.75** Model B 6 volt-5 amps. Fixed Voltage

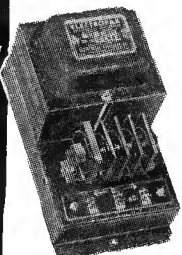

### ELECTROPAK

Supplies rectified D.C. for operating relays, solenoids and remote controls. Voltage ranges from 6 to 24 volts, rated at 2 to 15 amps Operates on 110 volt A.C.

### ADAPTOPAK

Operates A.C. radios in D.C. districts and 110 volt A.C. radios in autos and trailers.

## ELECTRICAL PRODUCTS CO.

6529 Russell St. DETROIT, MICH.

## NOISE-MASTER Kills "Man-made" Static

"NOISE-MASTER" No. 14 List Price \$6.75

Brings in overseas signals stronger, and eliminates "man made" static on broadcast as well as short-wave band. For better reception in EVERY location.

"NOISE-MASTER" No. 18 List Price \$3.40

First time at this popular price a SELF-SELECTING antenna of the simple doublet type, designed to clear up short-wave reception.

"NOISE-MASTER" No. 19 List Price \$4.30

This is another SELF-SELECTING model of the doublet type, with function-box in the antenna line. Assures finer all-wave reception.



This trademark guarantees the best in antenna and radio wire products.

## CORNISH WIRE CO., Inc.

30 CHURCH STREET

NEW YORK CITY

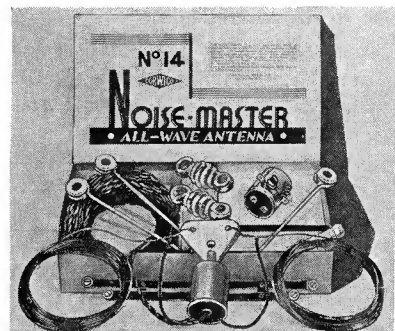

On Broadcast as Well as on Shortwave Frequencies

Licensed by Amy, Aceves & King, engineered by Corwico . . . every Service Man knows that's plenty to say about any antenna! Try one of these modern units on your next installation . . . a real good will builder for YOU!

Write for descriptive literature



Template for Chassis Screw Holes

A number of pointed screws, similar to the one shown in the accompanying illustration, become handy in making a template for mounting a radio or amplifier chassis in a cabinet.

The heads of a number of screws, with the proper size threads, are cut off and one end of each is ground to a point. These screws may then be screwed into the mounting holes of the chassis bottom with their points down. By placing the chassis on a card-

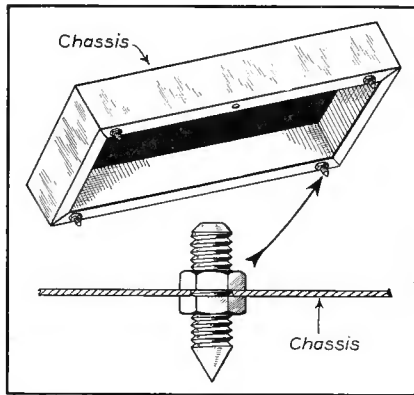

Locator for chassis mounting holes.

board—or in its proper place in the cabinet, if possible—an exact template of the holes can be made.

*Frixo Stathopoulos.*

RCA Portable Victrola

The Service Man in his daily repairing of radio receivers often encounters phonograph motors of the hand-wound type which need attention. The accompanying service data should prove helpful in servicing the RCA Portable Victrola Model 0-1 and similar RCA portables.

**Motor:** The drive motor is of simple design and substantial construction. It should require little or no service if properly maintained. Attention to lubrication of the moving parts and occasional cleaning of the mechanism will go far to prevent faulty operation. Should it become necessary to repair the motor, the following procedure should be applied: **Caution:** Allow the motor mechanism to run down completely before attempting adjustment, repairs, or replacements.

**Removing motor from cabinet:** Remove the winding key. To dismount the motor, unscrew the spindle cap with a screwdriver and remove turntable, slightly tapping the spindle while exerting an upward lift on the turntable.

Remove the five screws holding the motor board and the two screws holding lid support to cabinet and lift motor board assembly from case. Loosen the screw holding the speed-regulating lever and remove the latter. The three screws holding motor to motor board should then be loosened to permit removal of motor assembly.

**Replacing main spring barrel:** In case of main spring failure, the entire spring barrel and gear should be replaced. Remove the spring-barrel spindle screw by *unscrewing to right*. Remove the C washer and two pillar screws holding bottom plate. Remove bottom plate, intermediate spindle shaft, and spring barrel. Reassemble parts in reverse sequence.

**Winding shaft spring:** This spring functions as a friction ratchet. It may be removed as follows: remove pin holding winding worm on shaft; remove screw holding spring. Replace in reverse sequence.

**Governor adjustments:** The mesh of the worm and fiber gears is adjusted by rotation of the eccentric spindle bearings. The adjustments should be made so that the worm meshes properly with the fiber gear and rotates freely without binding. The bearings should be accurately aligned with each other. The minimum of spindle end-play which per-

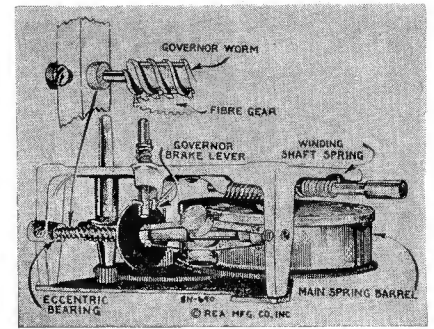

RCA portable Victrola motor assembly.

mits smooth operation should be used.

**Speed regulator lever:** After assembly, adjust the speed regulator until the turntable rotates at 78 rpm; loosen the speed regular screw and set pointer to center of speed indicator scale; tighten screw and recheck turntable speed.

**Lubrication:** All moving parts of the motor should be thoroughly cleaned and lubricated every six months to prevent excess wear and to assure proper operation. A small amount of grease should be applied to the worm gear of the governor, the gear of the winding shaft, and on the small pinion gear. All other points, including regulator friction pad, should be lubricated with light oil. All motor parts should be covered with a light film of oil to prevent rusting.

STROMBERG-CARLSON SPEAKER DATA

Speaker Pc. No.	Cone Pc. No.	Size Ins.	Voice Coil Imp. Ohms	Field Res. Ohms	Models used on
18870	18746	12	15	7300	642, 652, 654, 846
19410	18746	12	15	7300	10, 11, 12, 14, 25, 26, 27
19410-S	23049	12	15	7300	19, 20
21506	21505	10	15	2500	22, 24
22603	22605	10	15	1950	38, 39, 40, 41
22738	21505	10	15	1050	82
23048	23049	10	15	1950	48, 49, 50, 51, 52, 54
23132	23181	8 1/4	4.5	6	33
23180	23181	8 1/4	4.5	1950	Precinct
23899	23049	10	15	1950	55, 56, 65
24095	23049	10	15	1950	64
24282	23181	8 1/4	4.5	1950	60-T, L
24531	23181	8 1/4	4.5	1100	60-DC
24773	23049	10	15	1950	68
24777	24780	10	24	1950	Low Frequency 70, 72 (No. 2)
24819	24826	5 1/4	11	1950	Tweeter 70, 72, 74 (1 and 2)
24855	24924	13 1/4	8	2880	Low Frequency 74 (No. 1)
25047	23049	10	15	1950	60-LL, H
25061	23049	10	15	1620	58-W
25217	23049	10	15	1950	60-H, DC
25464	25492	8 1/4	1.5	1200	61-AC and DC
25683	25730	10	24	1050	83, 84
25896	25492	8 1/4	1.5	1200	61-AC and DC
25994		10	4	P.M.	115 Battery
26053	26096	6	5	1800	125
26170	26250	10	1.5	1050	130-M, 140-K, L, P, M, 145-L, P, 150-L, 160-L, P, 180-L
26171	25492	8 1/4	1.5	1050	130-H, R, U, 140-H
26886		8	5	P.M.	126-H
26887		10	5	P.M.	126-L, 127-H, L

*See Radio's Latest Developments*

*at the*

**BIGGEST RADIO PARTS SHOW EVER HELD!**

*130 Booths, Filling the HUGE EXHIBITION HALL*

*At the* **STEVENS HOTEL**



*Every Conceivable Kind of Apparatus for the Service Man,  
the Amateur, and the Public Address Man*

CONDUCTED BY

**RADIO PARTS MANUFACTURERS  
NATIONAL TRADE SHOW**

*and Endorsed by*

**RADIO MANUFACTURERS ASSOCIATION and THE SALES MANAGERS CLUB**

# RECEIVER CASE HISTORIES

## Arvin A2 Antenna

**Motor noise elimination:** Type A2 antenna is always installed on the front door hinge on the same side of the car on which the radio chassis is installed.

A 7/32-in hole is sufficiently large to accommodate the lead-in wire. The hole should be drilled in the door sill close to the door hinge in such a manner that when the door is closed the hole through which the lead-in passes is covered by the front edge of the door.

The "Phantom Filter" box should be *securely grounded* to the instrument panel or the metal part of the dash *close to* the point of entry of the antenna leading into the car.

Shield the antenna lead wire from the "Phantom Filter" to the point where the lead passes out of the car. Ground one end of the shield to the "Phantom Filter." Ground the other end to the automobile chassis or body.

If motor noise is present after this operation it is generally caused by the car hood being ungrounded and may be remedied by placing a 6-in length (or longer if necessary) of braided shielding over the fabric strip attached to the cowl on which the rear edge of the hood rests. Solder both ends of the braid to the cowl and if the fabric hood strip is fastened in place by metal screws, remove these and drive them through the shielding to hold it in a permanent position. Clean the paint off the hood at the spot where it rests on this braided shielding so that it will be *securely grounded*.

Usually no suppressors—not even distributor type—are needed if the foregoing instructions are followed.

## Arvin Auto Radios

**Transmission lines:** All Arvin auto-radio chassis produced after March 10, 1936, are color coded with a red band placed around the A connection cable. This indicates that the antenna coils in these sets were designed to match the type S transmission line which has replaced the type T line supplied for earlier sets. The type S transmission line is likewise coded with a red band close to the antenna connection plug on the cord.

The earlier chassis are not color coded and should be used with type T transmission lines only. Chassis marked with red bands should be used with type S lines only.

**Mechanical hum in the vibrator:** In some of the first few sets delivered this

season a mechanical noise developed, caused by the vibrator chattering against the radio chassis.

This may be eliminated by removing the vibrator from the set and increasing the tension of the vibrator grounding spring cup which is riveted in the radio chassis over the vibrator socket.

**Switch remains in on position:** In some remote control units the switch has a tendency to remain in the on position. This difficulty may be avoided by removal of the small stop pin located just above the volume control on the rear of the remote control head. This pin may be extracted by prying it up with a screwdriver and removing it with a pliers.

**Vibrator noise:** Vibrator noise, which may occasionally increase to an undesirable level after a period of operation of an Arvin auto radio, may be corrected by tightening the four screws that hold the power transformer to the chassis after the receiver has been allowed to warm up for about a half hour.

The braid grounding the tuning condenser may be cut as an additional remedy for r-f interference. This particular grounding braid is located close to the point of entry of the flexible tuning shaft. Cutting other grounds, however, would result in motor noise.

## Arvin 19, 29

**Dual speaker installations:** Provision is made on all Arvin model 19 and 29 auto-radio chassis for both external and in-the-set type speaker installations, operating simultaneously.

For dual speaker installations on Buick and Oldsmobile cars select either an Arvin model 19 or 29 chassis, a "tailor-fit" remote control and a type H9 instrument panel speaker. Choose also either B1 or C6 in-the-set type speakers. (Type B may be used with the model 19.)

Similar installations may be made on the 1937 Chevrolet, on all 1935 and 1937 General Motors cars, 1935-36-37 Fords, 1936-37 Studebaker, Nash, LaFayette and 1935 Dodge, Plymouth, Chrysler and DeSoto.

## Arvin 19, 29, 39

**Chassis pickup (motor noise):** Motor noise occurring with the antenna disconnected from an auto-radio receiver is known as chassis pickup. This may usually be overcome by removing the

radio chassis front cover and sandpapering the rim of the cover to remove grease and a slight amount of paint which occasionally is found on the inside rim of Arvin auto-radio top covers or speaker fronts.

Persistent chassis pickup may be

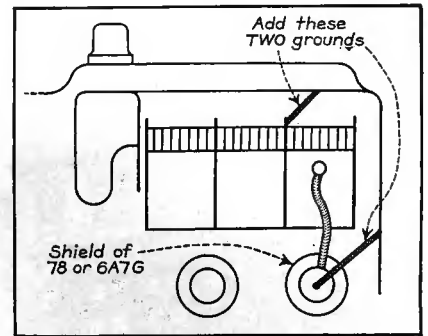

remedied by addition of the grounds shown in the accompanying diagram. Narrow copper braiding should be used for making these connections.

## Arvin 29

**Oscillation with volume control in the full-on position:** Occasionally this model will oscillate with the volume control in the full-on position and the tone control at a low pitch setting. This condition may be overcome by moving the 0.1-mfd r-f by-pass condenser from the position A as indicated in the ac-

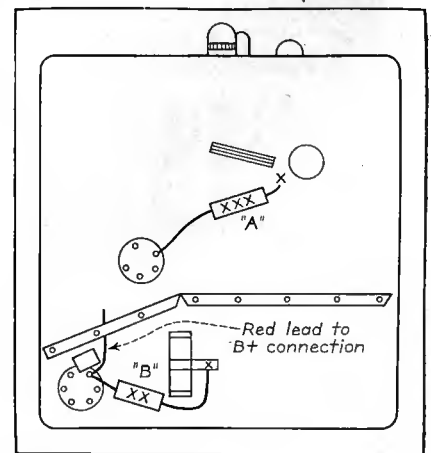

companying diagram and connecting it in position B in the power pack.

Receivers of this type bearing serial numbers over A28200B already have this change incorporated.

Walter E. Peek  
NOBLITT-SPARKS INDUSTRIES, INC.



# DUMONT

ELECTROLYTIC CONDENSERS  
**GUARANTEED QUALITY**  
 NOW AT REDUCED PRICES



## MR. SERVICE MAN

Regardless of the prices you pay for condensers, you will find DUMONT QUALITY far superior. Self-healing prevents any possibility of breakdown even if overloaded. This exclusive feature (patent pending) is found only in DUMONT Electrolytics. Try an assortment today and be convinced. Used by the U. S. Government in large quantities—ample testimony of their true quality.

*Exact duplicates for every radio.*

Licensed under U. S. A.  
 Patent reissue No. 19604.

For free catalog and your nearest Dumont jobber, write to us.

Manufactured by  
**Dumont Electric Co., Inc.**

514-516 BROADWAY  
 NEW YORK, N. Y.

Paper — Mica — Electrolytic Capacitors



## STEWART Auto Radio Shaft Service Kit

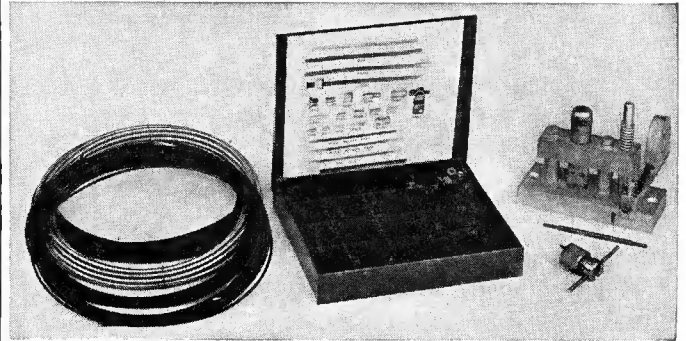

**T**HE outfit illustrated above consists of a tool for attaching end fittings to both sizes of radio housing and cable and a tool for removing old cable ends so they may be used again; 25 feet each size housing and cable material and an assortment of popular end fittings, in a metal box.

*Send Your Order Today!*

**No. 5298 Shaft Outfit Complete (Net) \$37.50**

**F. W. STEWART MFG. CORP.**

344 W. HURON ST. EST. 1913 CHICAGO, U.S.A.

# TRIAD

INVITES THE TRADE  
 TO VISIT  
**Booth No. 102**

•  
**National Trade Show  
 Radio Parts Manufacturers**

AT

**STEVENS HOTEL—CHICAGO  
 JUNE 10-13, INCL.**

**TRIAD MANUFACTURING CO., INC.  
 PAWTUCKET RHODE ISLAND**

THE QUALITY NAME IN RADIO TUBES

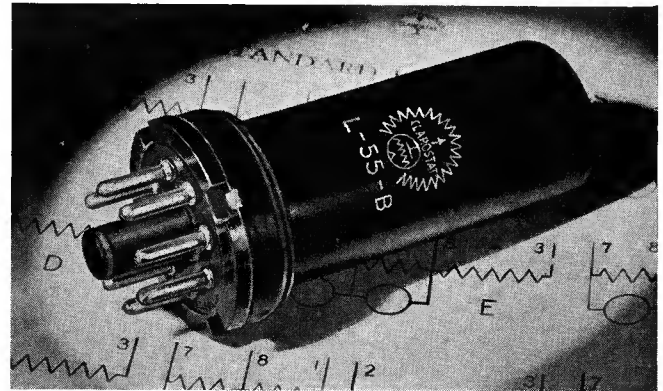

## Exact Duplicate Replacements

• Handy form of line-dropping resistor.

• Coded and base wired according to R.M.A. standards.

• Any total voltage drop and all pilot lamp combinations.

Having originated and produced the bulk of the Metal-Tube Resistors now in use, CLAROSTAT is best equipped to provide your replacements. • Exceptionally complete listings. • Over 100 types to choose from.

**Send for DATA:**

Handy replacement chart available on request. Also volume control replacement guide.

**CLAROSTAT** Manufacturing Co. Inc.



285-287 NORTH SIXTH STREET  
 BROOKLYN, NEW YORK, U.S.A.

• OFFICES IN PRINCIPAL CITIES •

# ASSOCIATION NEWS . . .

## IRSM REPORTS

THE IRSM convention committee, headed by Joe Marty, Jr., of Chicago, reports that progress has been made in the setting up of the program for the fifth annual convention of the Institute of Radio Service Men to be held at the Stevens Hotel, Chicago, June 10 to 13. A lecture hall in which the sessions will be held is located in one corner of the Exhibition Hall where the 1937 National Trade Show will be staged.

The lectures for the forthcoming convention will be of a more varied type than the Institute has arranged at its previous meetings. Technical lectures on timely subjects, clinics and similar sessions will be supplemented by inspirational talks delivered by men whose names have made radio.

Among those who will appear on the fifth annual convention program are E. T. Cunningham, former president of RCA Manufacturing Co., Walter Jones of Hygrade-Sylvania, Harold Olsen of Weston, Robert G. Herzog, Editor of SERVICE magazine and (although not as yet confirmed, no doubt) H. G. Weiss of Hickok. All have appeared on IRSM convention programs in the past.

Keeping pace with developments in the electronic industry and in response to repeated inquiries from Service Men, arrangements have been made for a discussion of the use of radio frequency in intercommunicating systems for offices and homes. The speaker on this subject will be either Herbert H. Frost, known to old-timers as the maker of plugs, jacks and the like, and now head of the Frost-Minton Corporation in New York City, or, in the event of his inability to be present, the lecture will be delivered by Frank Hayes, his chief engineer.

It is planned also to devote an evening to a set clinic to allow technical representatives of the set manufacturers to explain in an informal manner the engineering and service aspects of their apparatus. Clinics on test apparatus and public address are also being planned.

### Cleveland Chapter

The officers of the Cleveland chapter are working with an insurance broker to secure insurance for IRSM members on their equipment and on the customers sets while in the shop and in transit.

A first-class freight car has been chartered to convey the Cleveland delegation to the National Trade Show to be held in Chicago. The gang will arrive in the windy city early Sunday morning. (Note: We couldn't get a parlor car after last year's fiasco.)

At the April 21 meeting John R. Martin, assistant professor of Electrical Engineering at the Case School of Applied Science, favored us with a discussion of "Distortion." It was well worth listening to this lecture and the boys undoubtedly obtained much of value.

John Rose, national president of IRSM, dropped in to visit us last week. We hear that he is moving to Cleveland to work

for Ward Products Corporation. Lots of luck in your new job, John!

Neal Bear was also in town long enough to make the last meeting . . . seemed like old times again.

Here's a tip to non-members—you can get reservations for the Chicago Show train by contacting any officer of the Cleveland chapter.

See you all at the show!

*L. Vangunten*

### Freeport Chapter

At a meeting of the Freeport chapter held in March, Lloyd LeBaron was elected chairman, S. A. Frank, vice chairman, and W. F. Meyer, secretary-treasurer. Gerald O'Connell was appointed librarian.

At the same meeting it was decided to hold clinics on radios of different makes or models at each meeting. Each member, in turn, will be responsible for the presentation of the material. The radios to be chosen are to be either a new model of some popular make; an older model on which the member has done considerable work and is familiar with the problems that might be encountered; a particular set on which the member has had some peculiar trouble and has satisfactorily repaired it or some radio with which the member is having considerable difficulty.

This idea was tried out at the February meeting and it is believed that it will prove to be very popular.

Mr. Foy of the Noeske Radio and Appliance Company is scheduled to give the next talk, his subject being the new Philcos.

Gerald O'Connell, librarian, became the proud father of a baby girl, Patricia Ann, recently. Mother and daughter are doing well.

### CHICAGO TRADE SHOW PLANS

Three national technical organizations will collaborate in the presentation of a technical program in conjunction with the showing of component radio parts.

The American Radio Relay League, the Institute of Radio Engineers, and the Institute of Radio Service Men will share the use of the lecture hall provided at the 1937 National Trade Show being held at the Stevens Hotel, Chicago, June 10 to 13.

Except for the fact that arrangements have been made for the Institute of Radio Engineers to use the hall for the evening session on Friday, June 11, the assignment of time for the organizations has not yet been made. The IRSM and ARRL are developing the program to suit their requirements.

The Chicago section of the Institute of Radio Engineers is taking charge of the Friday evening session. Lt. R. H. G. Mathews, a member of the Board of Directors of the ARRL, is arranging for the Ham sessions, and the Convention Committee of the IRSM, headed by Joe Marty, Jr., chairman of the Chicago chapter, is setting up the program for Service Men.

An open invitation is extended to every-

one who is interested in the technical aspects of radio to attend any or all of the sessions, no matter under whose auspices they may be held.

### RTG OF NEW ENGLAND

The RTG invited three of the local jobbers to the meeting held April 26, at the Hotel Lenox, in Boston, to address the meeting with the purpose in mind to establish a closer and better understanding among Service Men and jobbers and among the jobbers themselves.

Mr. Childs, of the Electrical Supply Co., Cambridge, Mass., Mr. Mayer, of A. W. Mayer Co., Boston and Mr. Lloyd, of the Sager Electric Co., Boston, each gave short and enlightening talks on trade discounts and who can obtain them.

Mr. Childs invited the boys to voice their complaints . . . but it would seem that all is serene, since none were expressed.

Mr. Mayer stressed the point that the Service Man, to succeed, must learn to be a good salesman.

Mr. Lloyd announced that the Sager Electric Co. would not give trade discounts to anyone who could not produce membership cards to one of the various recognized Service Men's organizations . . . or other proper credentials showing his affiliation. The announcement was met with no small amount of enthusiasm, as can well be imagined.

The jobbers are so enthused about the get-together that they are now planning a real slam-bang affair with a dinner. Some of the larger manufacturers will be invited to send their representatives to talk to the gang. . . . Get in touch with your jobber and find out when and where the dinner will be held.

*George W. Feldman*

### ASSN. OF RADIO SERVICE ENGINEERS

A special meeting was called for March 30, by the Association to hear John Rider, publisher, and Harry Kaulker of Sprague Products. Both Mr. Kaulker and Mr. Rider spoke most interestingly and at quite some length on various phases of radio service.

The attendance has improved considerably of late and was high at this meeting. The meeting continued (formally and informally) until 4:30 a.m.

At the regular meeting of April 5, at the Hotel Statler, Billy Thomas, of Radiart, presented an informal discussion on the subject of auto-radio vibrators.

A bowling party was held April 8, and a cabaret party on April 26.

A free party is scheduled for May 12.

Walter Jones, of Hygrade-Sylvania was the guest speaker at the meeting held on April 20. The attendance at this meeting was also outstanding.

Awards were presented for success in the membership drive. Frank Bestine stole the honors and was given first prize. President Telaak took second prize. A total of 44 members were obtained as a direct result of the drive.

*Anthony Schreiber, Exec. Sec'y.*

List of Exhibitors — National Trade Show — Hotel Stevens, Chicago — June 10 to 13, 1937

Exhibitor	Booth No.	Exhibitor	Booth No.	Exhibitor	Booth No.
Aerovox Corporation.....	62	Electronic Design Corp.....	10	Radio City Products Co., Inc.....	67
Aladdin Radio Industries.....	108	Electronic Laboratories, Inc.....	32	Radiotechnic Labs., The.....	127
Alpha Wire Corp.....	18	Federal Microphone Stand Mfg.....	"C"	RADIO ENGINEERING.....	111
American Microphone Co.....	R-28	General Transformer Corp.....	100-101	Radio Retailing.....	103
American Phenolic Corp.....	65	Guthman & Co., Inc., Edwin I.....	106	Radio Today.....	122
American Radio Hardware Co.....	14	Hallicrafters, Inc., The.....	82-83	Radio Weekly.....	97
Amperex Electronic Products.....	64	Hammarlund Mfg. Co.....	68	Raytheon Production Corp.....	91
Amperite Company.....	36	Hickok Elec. Instr. Co.....	130	RCA Manufacturing Co., Inc.....	38-39
Arcturus Radio Tube Co.....	110	Hygrade Sylvania Corp.....	56-57	Readrite Meter Works.....	123
Astatic Microphone Labs.....	118	Indiana Steel Products Co.....	7	Rider, John F.....	34
Audak Company, Inc.....	43	International Resistance Co.....	84	Rola Co., The.....	50
Belden Mfg. Co.....	80-81	Insuline Corp. of America.....	2	Shure Brothers.....	71-72
Bendix Products Corp.....	46-47	Jackson Electric Instr. Co., The.....	76-99	SERVICE.....	111
Bogen Co., David.....	12	Jefferson Electric Co.....	116	Simpson Electric Co.....	109
Brand & Co., Wm.....	4	Jensen Radio Mfg. Co.....	53-54	Solar Mfg. Corp.....	75
Bruno Laboratories, Inc.....	3	Johnson Co., E. F.....	63	Sprague Products Co.....	49
Brush Development Co.....	95	Ken-Rad Tube & Lamp Corp.....	61	Standard Transformer Corp.....	73-74
BRYAN DAVIS PUBLISHING Co., INC.....	111	Kenyon Transformer Co., Inc.....	45	Supreme Instruments Corp.....	51-52
Bud Radio, Inc.....	78	Kraeuter & Co., Inc.....	37	Technical Appliance Corp.....	L-28
Burton-Rogers Co.....	31	Kester Solder Co.....	1	Thordarson Electric Mfg. Co.....	128
Breez-Electric Corp.....	"D"	Lenz Electric Mfg. Co.....	60	Transducer Corp.....	44
Cardwell Mfg. Co., The Allen D.....	29	Magnavox Co., The.....	15-16	Transformer Corp. of America.....	6
Carron Mfg. Co.....	66	Mallory & Co., P. R.....	89-90	Triad Mfg. Co.....	102
Centralab.....	124-125	Meissner Mfg. Co.....	121	Triplett Electrical Instr. Co.....	79
Cinaudagraph Corp.....	19	Micamold Products Corp.....	98	Triumph Mfg. Co.....	96
Clarostat Mfg. Co.....	120	Micarta Fabricators, Inc.....	77	Turner Company.....	24
Clough-Brengle Co.....	33	Million Radio & Tele. Labs.....	L-88	United Catalog Publishers.....	42
Continental Carbon Co.....	112	Muter Co., The.....	129	United Transformer Corp.....	126
Continental Diamond Fibre Co.....	35	Miller Co., J. W.....	R-88	Utah Radio Products Co.....	69-70
Continental Motors Corp.....	30	National Union Radio Corp.....	104-105	Ward Leonard Electric Co.....	107
Cornell-Dubilier Corp.....	86	National Company, Inc.....	"B"	Ward Products Corp., The.....	5
Crowe Name Plate & Mfg. Co.....	92-93	Ohmite Mfg. Co.....	117	Webber Company, Earl.....	119
Tobe Deutschmann Corp.....	20-21	Operadio Mfg. Co.....	94	Webster Company, The.....	114-115
Drake Electric Works, Inc.....	23	Oxford Tartak Radio Corp.....	48	Webster Electric Company.....	25-26
Eby, Hugh H., Inc.....	85	Park Metalware Co., Inc.....	9	Weston Elec. Instr. Corp.....	40-41
Eddie Mfg. Co.....	11	Pioneer Gen-E-Motor Corp.....	59	White Dental Mfg. Co., The S. S.....	87
Electrad, Inc.....	113	Parris-Dunn Corp.....	8	Wirt Company.....	27
Electro-Acoustic Products Co.....	17	Quam-Nichols Co.....	22	Wright-DeCoster, Inc.....	58
Electro-Motive Mfg. Co., Inc.....	13	Radiart Corp., The.....	55	Zenith Radio Corp.....	"A"



**MODEL 430**

**Positively Checks All Type Radio Tubes According to Data Contained in Latest Recommendation of Tube Engineers**

- Has Line Voltage Adjustment
- Has Leakage and Short Test
- Uses Triplett Direct Reading Instrument (GOOD-BAD Scale)

*Only*  
**\$1800**  
 for this TUBE TESTER

Model 430 is an up-to-the-minute 1937 Tube Tester. Five flush type sockets provide for all tubes. The tester operation is very simple and indicates condition of the tube for dealer and customer on Direct Reading GOOD-BAD colored scale of Triplett instrument. Will also test for inter-element shorts and leakages. Complete in attractive, sturdy, quartered-oak case. Sloping panel of silver and black. Suitable for portable and counter use.

Dealer Price .....\$18.00

Model 431 same as 430 except has Readrite GOOD-BAD meter.

Dealer Price .....\$14.40

SEE YOUR JOBBER WRITE FOR CATALOG

Readrite Meter Works  
 517 College Drive, Bluffton, Ohio

Without obligation please send me more complete information ..... Model 430; ..... Model 431; I am also interested in.....

Name .....

Address .....

City ..... State.....



# HIGHLIGHTS . . .

## TOBE FILTERETTE CATALOG

Tobe Deutschman Corp., Canton, Mass., have issued an 8-page illustrated catalog describing their latest line of Filterettes. This catalog is part of an intensive promotional campaign to start shortly.

Copies of the catalog may be obtained by Service Men and distributors directly from Tobe.

## AMPERITE CONTEST

The Amperite Co., 561 Broadway, New York City, offers a microphone and stand as first prize for the best name received for the stand. Duplicate prizes will be awarded in case of ties. The ten next best names will receive a stand free. The contest closes July first. John F. Rider, publisher, and Joseph Kaufman, of National Radio Institute, will be the judges.

Entries should be submitted directly to Amperite.

## WHOLESALE RADIO CATALOG

Wholesale Radio Service Co., 100 Sixth Ave., New York City, have prepared an 8-page booklet describing the Lafayette Facsimili-Tone sound systems and is offering it free to anyone interested in theater sound equipment.

## ELECTRONIC VIBRATOR CATALOG

The Electronic Laboratories, Inc., Indianapolis, Ind., have released a 20-page, 1937 catalog. The catalog contains a complete listing of Electronic Laboratories' replacement vibrators and converters as well as additional information on the general subject.

Electronic manufactures vibrators and vibrator power supplies exclusively.

Copies of the catalog are available from the manufacturer.

## C-D COLOR CODE CHARTS

A chart of vest pocket size illustrating the standard RMA mica capacity color code has been made available by the Cornell-Dubilier Corp.

The compactness of the modern mica capacitor has necessitated the substitution of a color code for the usual numeral capacity identification. This chart, therefore, will be found of value to the Service Man, engineer and amateur. A quantity sufficient to meet all demands has been prepared; a C-D mica capacitor color code chart may be obtained, free of charge, from Cornell-Dubilier Corp., South Plainfield, N. J.

## CROWE REMOTE CONTROL BULLETIN

A bulletin showing auto-radio remote controls for installation on instrument panels in 1935, 1936 and 1937 cars or under dash in any car, is announced by the Crowe Name Plate & Mfg. Co., 1775 Grace St., Chicago. These remote controls can, the manufacturer states, be used with practically any auto radio. Bulletin includes a ready reference data sheet, showing exactly what controls to use with each of 100 different models of auto radios. The whole group of panel controls is known as series 700, which are illustrated and described in Bulletin 202.

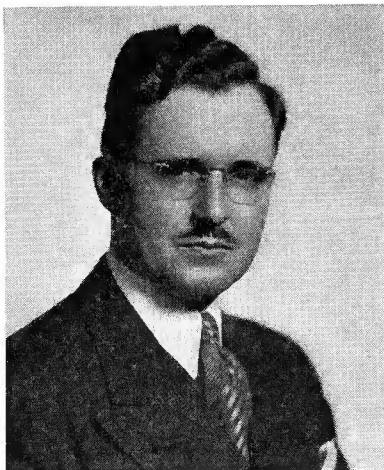

## MECK PRESIDENT ELECTRONIC DESIGN

The board of directors of this newly formed entry into the radio-electric field has announced the appointment of John S. Meck as president and general sales manager.

Factory and general offices are located at 164 N. May St., Chicago, where their "Vocagraph" sound equipment line is now in production. Plans call for manufacturing and merchandising through regular jobber channels of a complete array of sound amplifiers and accessory equipment.

## ARCTURUS WINDOW DISPLAY

A display printed in colors on metal foil is being distributed to the trade by the Arcturus Radio Tube Co., Newark, N. J. A 2-plane effect gives the illusion of a large size tube of actual rounded shape. The display measures 24 by 18 inches.

This is one of a series of promotional helps to assist Service Men and dealers in selling Arcturus tubes.

## WRIGHT-DECOSTER BULLETIN

Wright-DeCoster, St. Paul, Minn., have issued an illustrated bulletin describing their line of universal electro-dynamic loudspeakers; their "Nokoil" permanent magnet dynamics as well as other types of their varied speaker lines.

Copies of the bulletin may be obtained directly from Wright-DeCoster.

## CLOUGH-BRENGLE HOUSE ORGAN

Clough-Brengle Co., 2817 W. 19th St., Chicago, are publishing a house organ entitled "InstrumentTopics," with timely news concerning their line of test instruments, etc.

Copies of the organ may be obtained directly from the manufacturer.

## ARHCO CATALOG

The American Radio Hardware Co., 476 Broadway, New York City, have released their latest catalog containing illustrations and descriptions of more than 2,000 items.

ARHCO manufactures steel, brass, copper and bakelite hardware and similar items as well as mycalex and ameroid parts. Special work is also solicited.

Engineers, hams and Service Men are invited to write for the catalog.

## CLARION CORPORATION FORMED

A new company has purchased the radio trade name Clarion and has begun manufacture of radio receivers.

The new company will be known as the Clarion Corp. and have leased executive office space in the Pure Oil Building, Chicago, where the sales and advertising division will make their permanent headquarters.

## ALLIED CATALOG

Allied Radio Corp., 833 W. Jackson Blvd., Chicago, have released their 1937 catalog to the service trade.

Copies of the 156 page booklet may be obtained directly from Allied.

## JOHNSON JOINS ARCTURUS

Wm. ("Bill") J. Johnston has recently joined the equipment sales division of the Arcturus Radio Tube Co., Newark, N. J. With headquarters at the company's branch office located at 1301 So. Michigan Ave., in Chicago, Mr. Johnston will contact radio receiver and equipment manufacturers in the middle west.

## HYTRON SALES MANAGER

Lloyd Coffin, president of Hytron Corp., Salem, Mass., has announced the appointment of Greg Hallam as sales manager of the corporation.

Hytron has recently opened their new plant in Salem at the corner of New Derby and Lafayette Streets.

## HAMMARLUND BROADSIDE

Lewis Winner, director of Publicity, of the Hammarlund Manufacturing Co., Inc., 424 W. 33rd St., New York City, announces the release of an illustrated broadside giving technical and price information on the Hammarlund "Super-Pro" receiver. Performance and selectivity curves are also given in the broadside.

Copies of the broadside may be obtained directly from Hammarlund.

## TURNER CATALOG

The Turner Co., Cedar Rapids, Iowa, have issued a 34-page catalog covering their line of microphones, amplifier systems and interoffice equipment. Copies may be had upon request.

The Turner Co. have recently announced the appointment of R. L. Thompson as chief engineer.

## BENDIX SERVICE FLEET

The first of a fleet of Bendix Day-rad service system educational cars left South Bend, Indiana, equipped with an ensemble of testing instruments.

The fleet faces a nation-blanketing itinerary which will result in educational contacts with Service Men and distributors throughout the country.

## MODELL CATALOG

Modell's, 58 Cortlandt St., New York City, has issued a catalog and discount schedule including over 500 models of well known receivers. The catalog is offered to Service Men without charge. It may be obtained by writing directly to Modell.

# HERE'S QUALITY THAT'S RUGGED



AR-43, \$75.00

• Quality alone is worth the price, but quality and ruggedness as found in Brush crystal sound cell mikes has no limit of value.

*Details on request.*

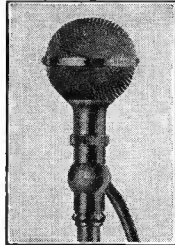

BR25—\$37.50

**The BRUSH**  
DEVELOPMENT COMPANY  
3317 PERKINS AVENUE  
CLEVELAND, OHIO

## A COMPLETE **NEW** LINE FOR SALES AND PROFITS

GENERAL ELECTRIC  
**PRE-TESTED**  
METAL  
TUBES

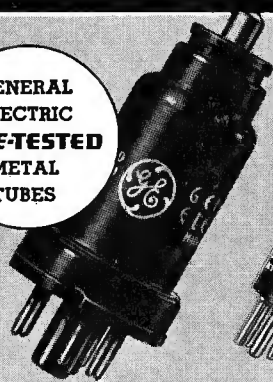

GENERAL ELECTRIC  
**PRE-TESTED**  
GLASS  
TUBES



FOR CUSTOMER SATISFACTION  
Use G-E RADIO TUBES

*Memo to:*  
**Dealers and Servicemen**  
Ask your G-E Radio Distributor for details of the G-E Radio Tube Merchandising Plan, or write to Radio Tube Sales Section, General Electric Company, Bridgeport, Conn.



**GENERAL ELECTRIC**

APPLIANCE AND MERCHANDISE DEPARTMENT  
GENERAL ELECTRIC COMPANY, BRIDGEPORT, CONN.

# NOW DU MONT KNOWS THAT SERVICE ENGINEERS APPRECIATE A REAL OSCILLOGRAPH

The reaction to the new Du Mont Type 164 is **AMAZING**. And—**WHY NOT?**

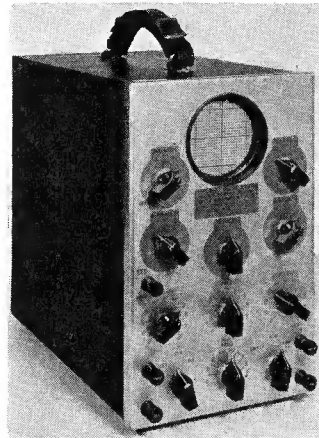

**\$54.50**

Complete

- A Three Inch New Type 34-XH Du Mont Cathode Ray Tube—Fine Uniform Focus.
- Vertical and Horizontal Amplifiers Individual Controls—Flat 30 to 30,000 cycles.
- High and Low Voltage Power Supplies, Bright Pattern, No Interaction of Controls.
- Amplified Sweep.
- Allows Observation of Single Wave From 15 to 30,000 Cycle Per Second.
- Internal or External Positive Synchronization.
- Direct Connection to Horizontal and Vertical Plates of Cathode Ray Tube.
- Separate Positioning Controls on Front Panel.
- Designed to Operate with Any Standard Type Frequency Modulated Oscillator.
- Removable Calibrated Scale.

*Ask Your Jobber*

**Allen B. Du Mont Laboratories, Inc.**  
Upper Montclair, New Jersey

# First Aid for HURRY-UP JOBS

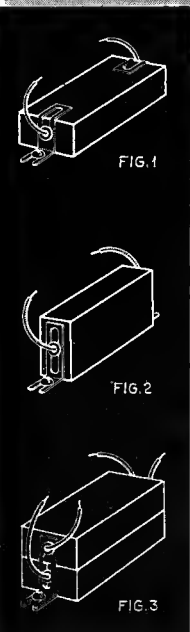
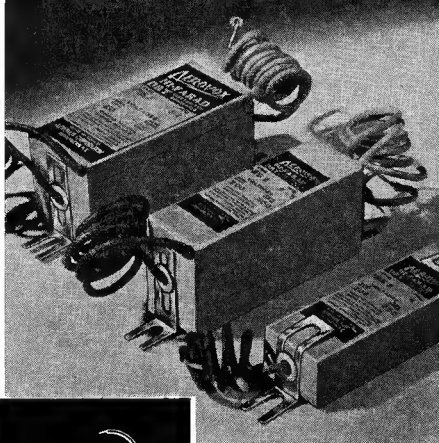

Handy AEROVOX  
PBS Cardboard-Case  
Electrolytics.

Made still handier  
with new Adjust-  
mount Flanges.

Match any mounting-  
hole spacing. Mounted  
singly or stacked.

In 200 and 450 v.  
working. All standard  
capacities. Single, dual  
and triple sections.

More for your money.  
More value to your  
trade. More good will  
for you.

● For those emergency repairs  
—when every minute counts—  
use these handy *general utility*  
AEROVOX PBS Electrolytics.  
But for the best grade of serv-  
icing—for that fussiest trade—  
insist on AEROVOX Exact Du-  
plicate Replacements.



## Ask for CATALOG...

Covers complete line of condensers and  
essential resistors. Your jobber has  
your copy—or write us direct.



## PUBLIC ADDRESS—continued

maintained when the voice of the user  
is lowered or at a distance from the  
instrument.

To call all the remote stations at  
once, turn the selector switch to the  
“on” position. In this position all the  
remote phones will hear the master  
phone and the master phone will receive  
a call from any one of them.

To be ready to receive a call from  
any of the remote stations, leave switch  
on the master phone in the “on” posi-  
tion.

When a call is received from any  
remote phone, press the “talk-listen”  
switch to “talk” and inquire which sta-  
tion is calling; then turn the selector  
switch to that number. This excludes  
the other stations from the conversa-  
tion.

When finished talking, be sure to re-  
turn the selector switch to the “on” po-  
sition so as to be ready to receive fu-  
ture calls from any of the stations.

## TEST EQUIPMENT—continued

maximum number of readings will fall  
at or near  $\frac{3}{4}$  to  $\frac{1}{2}$  full-scale deflection.  
Let us take as an instance the 7-volt  
range. Maximum use for this range  
will occur in measuring the filament  
voltage of tubes having 5 and 6.3-volt  
filaments. True, many tubes do have  
2.5 volt filament potentials, but more  
recent radio receiver design is based,  
almost completely, on the 5 and 6.3-volt  
tubes. Bias potentials of from 20 to 35  
volts are the majority of measurements  
which will be taken on the 35-volt scale.  
Inasmuch as most communities operate  
from a-c or d-c supply potentials of  
from 105 to 125 volts, the 140-volt scale  
is a logical range. Plate supply poten-  
tials run in the neighborhood of from  
250 to 300 volts; the 350-volt range is  
also logical.

A graphic illustration of the allow-  
able inaccuracies, in volts, of 2 and 5  
percent on two sets of ranges is given  
in the accompanying table. Any poten-  
tial measured on the 5-volt range with  
2 percent allowable inaccuracy may  
actually be plus or minus 0.1 volt of the  
value read on the meter, whereas the  
same voltage measured on the 125-volt  
range may actually be plus or minus  
2.5 volts of the value read on that scale.  
For example, 4 volts measured with the  
5-volt range may read anywhere be-  
tween 3.9 and 4.1 volts. On the 125-  
volt range, however, the same 4 volts  
may indicate anywhere between 1.5 and  
6.5 volts and the meter range would  
still be within its specified accuracy.  
Similarly, 110 volts measured on the

# AUTO-RADIO Re-Installations

Get your share of these  
1,016,313 new jobs!

Field estimates reveal a vast new market  
for dealers and service men in trans-  
ferring old radio sets to new cars—mod-  
ernizing, replacing, converting, etc.

## TRANSFER

ANY SET TO ANY CAR

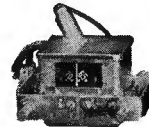

With patented UNIVERSAL  
CONTROLS you can get your full  
share of this valuable new business.  
Installations are made quickly and  
easily—without cutting or drilling  
the dash.

Pre-Assembled!



UNIVERSAL gives you a pre-  
assembled, single-unit control to fit  
any car radio—together with the  
proper plate to perfectly match the  
instrument board.

Send for the Catalog TODAY!

# Universal

## DASHBOARD CONTROLS

UNIVERSAL CONTROLS, INC.  
21-07 40th Ave., Long Is. City, N. Y.



Please send your new  
Catalog D-3.

Name .....

Address .....

Dealer  Service Man  Jobber

# New "PRECISION" MULTIMETER SERIES 830

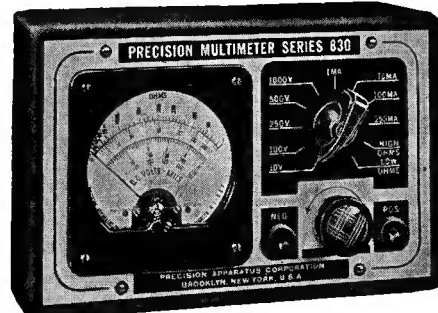

This 11 range “PRECISION” service  
instrument contains a large 3 inch  
D’Arsonval type meter of 2% accuracy.  
5 D.C. voltage ranges: 0-10; 0-100;  
0-250; 0-500; 0-1000 at 1000 ohms per  
volt. 4 D.C. current ranges; 0-1 ma;  
0-10 ma; 0-100 ma; 0-250 ma. 2 resis-  
tance ranges: Low ohms shunt method.  
0-500 ohms. As low as  $\frac{1}{2}$  ohm. High  
ohms reading. 0-300,000 ohms. Selector  
controlled throughout. Small in size:  
 $4\frac{1}{2} \times 7 \times 2\frac{1}{2}$ .

This “PRECISION” instrument has won  
instant acceptance. See  
it on display at your  
own local jobber.

**\$10.95**

**Precision Apparatus Corp.**

821 EAST NEW YORK AVE., BROOKLYN, N. Y.



**INSIST  
ON THE  
ORIGINAL**



**GENUINE TOBE**

**Filterette**

You've got a date to meet TOBE FILTERETTE JUNIORS at your jobber's counter any day this month! They'll be waiting there to meet you. This is the famous ORIGINAL filter for stopping radio interference. The only one approved by Underwriters' Laboratories! For use on any 110 volt circuit up to 15 amperes.

A cinch to install! No special tools needed. For eliminating radio noise caused by any small-motored apparatus, such as vacuum cleaners, cash registers, hair dryers, drink mixers, floor polishers, etc.

**ALSO . . . A FILTERETTE  
FOR ELECTRIC RAZORS**

Ask your jobber to show you another TOBE product that fits a real need. . . . THE NEW TOBE ELECTRIC RAZOR FILTERETTE! Electric razors are great shaving devices, but . . . they've ruined many an early morning program. This unit reduces interferences remarkably. List price, only \$1.00!

Of course, there's a complete line of larger TOBE FILTERETTES carried by many jobbers. TOBE is widely acknowledged as the leader in noise reduction. Don't think that just any filter will do. . . . BE SURE YOU INSIST ON THE ORIGINAL and the BEST . . . TOBE FILTERETTES!



**FILTERETTES**

*Skillfully Manufactured By*

Tobe Deutschmann Corp., Canton, Mass.

MAY, 1937 •

**TEST EQUIPMENT—continued**

140-volt scale (column B) with 5 percent allowable inaccuracy may measure between 103 and 107 volts, close enough for routine service measurements. If the same 110 volts were measured on the 700-volt range it could read anywhere between 75 and 145 volts and the meter's range could not be considered outside its tolerance.

**SENSITIVITY TONE CONTROL**

*(Continued from page 278)*

conditions where signals are not too weak and noise pickup is only a minor problem.

In the street car position the sensitivity switch is open and all three resistors are connected in the cathode circuits. The average sensitivity is reduced to 15 microvolts for 1-watt output, the minimum for the receiver. In congested areas, where man-made static is a serious problem—but signal strength is sufficient to override it, the receiver should be played with the control in this position.

**TONE-**

The other section of the control is also a tap switch arranged to vary the frequency response as indicated in the curves given in Fig. 3.

Referring to the diagram on the front cover, when the tone switch is in the voice position the switch is open and response is normal. In the bass position a 0.03-mfd condenser is connected from the plate of the output stage to the chassis. This condenser offers a low impedance to the high-frequency notes and effectively shorts them permitting the bass tones to be predominant in the loudspeaker.

It can be seen on the cover diagram that the signal in traversing from the plate of the 75 first audio stage to the grid of the 42 output stage can travel either of two paths. The higher frequencies find little impedance to their travel through the 0.02- and 0.00075-mfd condensers. For the lower and middle frequencies, however, the impedance of the 0.00075-mfd condenser is too great, by comparison, and these travel to the grid through the two 100,000-ohm resistors. When the tone control switch is in the music position some of the middle frequencies are by-passed by the 0.0055-mfd condenser connected to the junction of the 100,000-ohm resistors. The particular values of resistors and condensers used in the plate and grid network of the model 70 produce the response curve indicated in Fig. 3 for the music position of the control.

**ARCTURUS  
ENGINEERING . . .  
Assures Superiority in  
Every Characteristic**



**6D6**

*Smooth, Dependable  
Amplification . . .*

It is not a matter of luck that "quiet as a shadow" operation of the ARCTURUS 6D6 Tube has made it the choice of discriminating radio technicians. For, following the most painstaking care in manufacture, every tube receives a final test in a special circuit several hundred times more sensitive than the ordinary commercial A. C.—D. C. set. Simultaneously it is severely vibrated by means of a "tapper" test to uncover even the slightest possibility of noise. Any tube failing to meet our most exacting requirements is immediately rejected.

Annoying microphonic response is reduced to an absolute minimum by extremely rigid structure and close clearances in the spacing of members. Uniform sensitivity is assured by a 100% test for mutual conductance. Moreover, the sensitivity of AVC receivers is unimpaired because of the extremely low values of grid current in the Arcturus 6D6—values which remain low through many hours of useful service.

**ARCTURUS PIONEERED "G" TUBES**

**ARCTURUS  
RADIO TUBE CO.  
Newark, N. J.**

**ARCTURUS**

**INDEPENDENT TUBES FOR DEALERS WHO  
DO THEIR OWN INDEPENDENT THINKING**

SAY YOU SAW IT IN SERVICE

# THE MANUFACTURERS . . .

## BELL P-A SYSTEM

Bell Sound Systems, Inc., 61 E. Goodale St., Columbus, Ohio, announce their model PA-4-C 20-watt portable p-a system. The amplifier is arranged in a carrying case so that it can be set up by removing the cover. The two speakers provided are of the infinite baffle type. G type glass tubes are

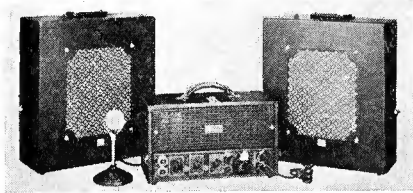

supplied with the equipment, but metal tubes may be substituted. The amplifier is of the high-gain type and may be used with a velocity, dynamic or crystal microphone. Two input channels are provided so that two microphones or a microphone and phonograph pickup may be used simultaneously. A crystal type microphone is supplied as standard equipment.

The tubes used in the amplifier are 2-6F5G, 2-6N7G, 2-6N6G and 1-5V4G.

Additional information may be obtained from the manufacturer.

## UNITED SOUND SPEAKER CABINET

The type H-302 streamlined cabinet is designed with due consideration given to the effect of the cavity to the rear of the speaker. The cabinet is finished in telephone black and ivory and can be used either for wall mounting or portable work. Complete sound systems using the H-302 speaker are listed in catalog No. 107 recently published by the United Sound Engineering Co. of St. Paul, Minn.

## WET ELECTROLYTIC

Micamold Products Corp., Flushing and Porter Aves., Brooklyn, N. Y., announce a wet electrolytic condenser in which the usual hard rubber liner has been eliminated. With this type of design more capacity for a given voltage can be put into a standard size can. Additional design

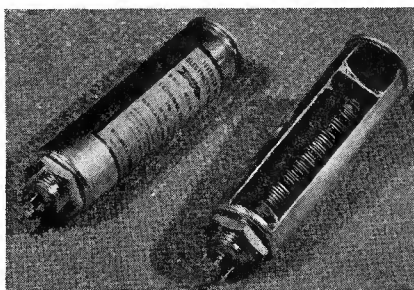

features and improvements are claimed for the new type of unit.

## WARD AUTO ANTENNA

The Ward Products Corp., Ward Building, Cleveland, Ohio, are introducing the "Chieftain," their latest model auto-radio antenna. It is called the model F. M.

The "Chieftain" is telescopic and is

made of brass and stainless steel and brass-chromium plated. The top of the car need not be drilled to install the "Chieftain."

Additional information and prices can be

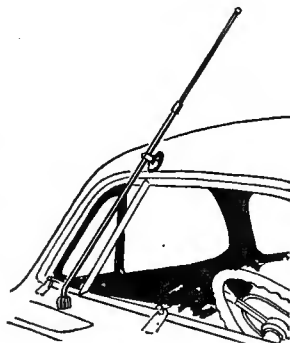

obtained directly from the Ward Products Corp.

## AMPERITE DESK STAND

The Amperite Co., 561 Broadway, New York City, are introducing a new type of desk stand with a leaf spring suspension. The suspension acts as a shock absorber; the microphone is mounted so that it can be rotated into any position. The horizontal position shown in the accompanying illustration is suitable for pulpit, desk and footlight installations. A name plate

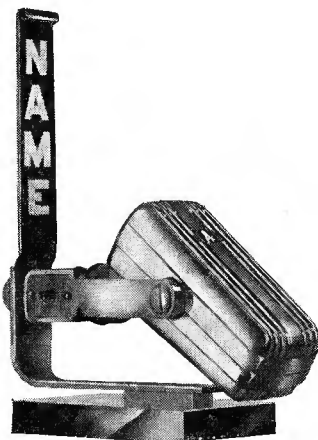

can be provided as shown with any number of letters up to ten.

The base is finished in black and the spring is chrome plated.

Additional information can be obtained directly from Amperite.

## G. E. REPLACEMENT TUBE LINE

A new line of 103-glass types and 19-metal types of radio tubes bearing the G-E name and monogram, is announced by Henry A. Crossland, recently appointed radio tubes sales manager of General Electric's radio division.

Included in the line are: all the metal types, all the octal base types (G tubes), and practically all the standard base glass tubes. The type not included are those obsolete ones which accounted for less than

1/10 of 1 percent of the total tube sales last year.

Additional information and prices can be obtained from the General Electric Co., Bridgeport, Conn.

## OPERADIO MOBILE P-A SYSTEM

The model 132-BAC, 25-watt p-a sys-



tem uses beam power tubes; has provision for mixing microphone and phonograph inputs; can be used with low-output microphones; includes crystal hand microphone and two 12-inch pm dynamic speakers and has provision for either 6-volt or 110-volt operation.

This combination mobile p-a system has been designed to give the sound man a unit compact and ready to go in almost every instance where a temporary installation is required. It may be used for 110-volt a-c or 6-volt d-c by interchange of packs. By the removal of two thumb screws and a face plate, one pack is slid out of the unit and the other which is carried in an extra carrying case is slipped into place, the face plate returned, the screws tightened and the equipment is ready to go.

Additional information may be obtained from Operadio Mfg. Co., St. Charles, Ill.

## STAR REMOTE CONTROL

The Star Machine Manufacturers, Inc., 1381 E. Bay Ave., New York City, have announced a universal auto-radio remote control head which is adaptable to all radios and all cars without drilling or filing.

The tuning and volume control shafts, of the new instrument are adjustable on a preassembly mounting plate to fit the instrument board of any recent model auto

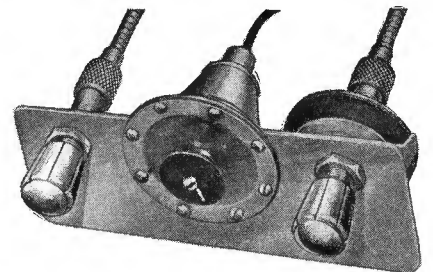

mobile. One dial and one head can accommodate either counterclockwise or clockwise rotation of the tuning condenser or the various drive ratios encountered in present auto-radio receivers.

Custom matched plates are available to fit practically all 1935, 1936 and 1937 cars.

A descriptive folder can be obtained directly from the manufacturer.

(Continued on page 318)

• SERVICE FOR

# ELECTRONIC PRODUCTS SPECIALTIES CO.

1623 SO. HILL STREET, LOS ANGELES, CALIFORNIA.

9 FT. HIGH  
ALL DURAL  
TELESCOPIC  
PERFECT RECEPTION  
ON ALL BANDS



LIST \$ 5.00  
TYPE G.T.

THE  
WHISK BROOM  
ENTIRELY NEW

18" HIGH, OVER 50 FT. OF AERIAL  
FITS ANY CAR, RUBBER SUCTION  
CUP WITH CEMENT HOLDS  
PERMANENTLY. LIST \$ 1.25  
TYPE W.B.

HEAVY CASTING

4 1/2 FT. HIGH  
ALL DURAL  
TELESCOPIC

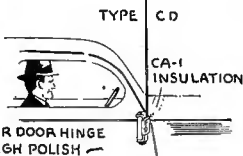

FITS OVER DOOR HINGE  
HIGH POLISH

ALL ALUMINUM  
TOPTENNA  
FASTENS WITH RUBBER  
SUCTION CUPS



LIST \$ 5.00  
COUPE \$ 4.50

SEDAN TYPE-ST  
COUPE " CT

9 FT. HIGH  
ALL DURAL  
TELESCOPIC.  
LIST \$ 5.00  
TYPE HT.

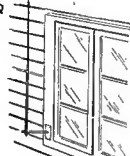

MADE FOR—  
HOTELS, APARTMENTS,  
AND OFFICES. FITS ANY  
WINDOW AND GIVES  
PERFECT RECEPTION.

**DISTRIBUTORS QUANTITY PROPOSITION**  
SOME REPRESENTATIVE TERRITORIES OPEN

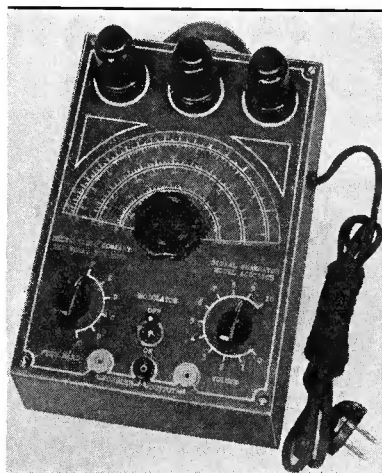

### Signal Generators, Kits and Complete

**FOUNDATION KIT S-1A.** Consists of 6 coils and switch, tuning condenser, metal-etched panel with all scales. Delta transparent bakelite pointer and directions. Wt. 3 lbs. ....\$6.93  
**COMPLETE KIT S-1B.** All parts in kit S-1A, also modulation transformer, 3 sockets, 380 ohm line cord, drilled and tapped bakelite strip for mounting coils, volume control, knobs, all condensers and resistors, sub-panel, hardware, toggle switch, pin-jacks, crackle-finished steel cabinet with handle, 3-6C5 metal tubes and direction. Wt. 5 lbs. ....\$13.45  
**COMPLETE WIRED & TESTED SIGNAL GENERATOR.** 1833 tubes. Wt. 6 lbs. ....\$14.15  
**COMPLETE GENERATOR.** Lined-up to its tubes, ready to plug-in as shown. ....\$15.95  
WRITE FOR DESCRIPTIVE CIRCULARS

**DELTA RADIO CO.**

135 Liberty Street  
Dept. S-5 New York, N. Y.

## QUALITY PLUS !!

### ATR REPLACEMENT VIBRATORS

for AUTO and FARM RADIOS

A COMPLETE LINE  
FEATURING

- Longer Life
- Precision Construction
- Improved Performance
- Lower Prices

*Backed by More Than Six Years of Experience in  
Vibrator Design and Research, Development and  
Manufacturing.*

Insist on ATR Vibrators—*The Best by Test*

Mail the coupon TODAY for your FREE copy of the ATR VIBRATOR GUIDE along with the name of your nearest ATR Jobber.

### AMERICAN TELEVISION & RADIO CO.

St. Paul, Minnesota, U. S. A. Cable Address: "Likex," New York  
Manufacturers of D.C.-A.C. Inverters, "A" Battery Eliminators,  
Battery Chargers and Inverter Vibrators.

American Television & Radio Co., St. Paul, Minn.

Gentlemen:

Please send me a FREE copy of the ATR Vibrator Guide and the name of my nearest ATR Jobber.

Name .....

Address .....

City..... State.....

Check here:  Dealer  Serviceman  Experimenter

## HOW DO YOU DO IT ?

How do you solve the many servicing problems with which you have to contend . . . what special kinks have you worked out which help you in servicing receivers . . . have you developed shortcut schemes for testing, or built test devices that do the work better and faster?

No matter what the scheme or the device, there are many Service Men who would like to know the how's and why's—just as you would like to know about the schemes and devices employed by others.

All you have to do is give us the outstanding points, and a rough pencil sketch of the device if it happens to be such—and we will do the rest.

Write up those ideas now and send them into the . . .

## ON THE JOB DEPARTMENT

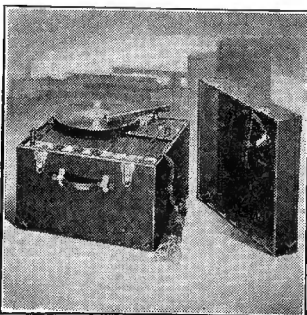

## NEW

Ultra-modern design features incorporated in all ACA Amplifiers. Models available for every application. Power outputs ranging from 10 to 300 watts. Designed for portable, semi-portable, mobile, and permanent systems. Special universal amplifiers available for operation from 6 volts dc or 110 volts ac. Backed by a 5 Year Guarantee.

Free Engineering Help to aid you plan any sound system.  
Send complete details for expert advice.

Send for Free Catalog  
Public Address Division

**AMPLIFIER CO. of AMERICA**  
39 WEST 20th STREET NEW YORK CITY

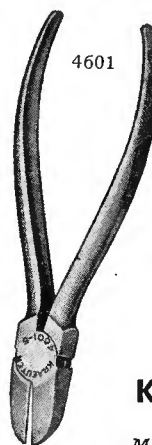

## "ASK ANY MECHANIC" he'll tell you

THE DIFFERENCE  
BETWEEN  
KRAUTER PLIERS  
AND THE  
ORDINARY KIND  
MEANS MONEY  
IN MY POCKET

That's because Krauter Pliers do the job quicker and better. As, for example, the diagonal cutting pliers 4601 shown here, made especially for close cutting and precisely fitted for exact work.

**KRAUTER & CO., Newark, N. J.**  
(Pronounced KROY-TER)

Manufacturers of Highest Quality Pliers and Tools Since 1860





**CROWE**  
**Auto Radio**  
**PANEL**  
**CONTROLS**  
 for 1935-1936-1937  
**CARS**  
 NEW DOUBLE UNIT DESIGN

**New Designs!**

**. . . New Features!**

**Plus CROWE QUALITY!**

WITHOUT cutting or filing instrument panel, CROWE Auto-Radio Controls can be easily and quickly installed.

**Quick, Easy Assembly**

Assembly of all parts on sub-panel bracket previous to installation in car panel assures perfect alignment and correct operation. Flexible connection from tuning control to dial is adjustable for smooth performance.

**Same Controls for All Cars!**

Same controls and shafts can be put on any car and used again when moving radio to another car. A panel kit is the only new part required on re-installation jobs.

**Volume and Tuning Controls**

Volume and tuning controls are supplied as separate, independent units for installation in any car, regardless of panel arrangement. SAME controls fit ALL cars.

Ask for **NEW Bulletin 202**

which gives complete details on these controls.

**CROWE NAME PLATE & MFG. CO.**  
 1775 Grace Street  
 CHICAGO, ILLINOIS

**MANUFACTURERS—continued**

**COMBINATION POWER PLANT**

The "Kato Quietlight," model 21A, provides both a-c and d-c in one unit. It will provide 300 watts standard 110-volt, 60-cycle, a-c and about 200 watts d-c at six volts. This unit has just been placed on the market by the Kato Engineering Co., Mankato, Minn.

**DELTA SIGNAL GENERATOR**

The Delta Radio Co., 135 Liberty St., New York City, announces a low priced a-c, d-c all-wave signal generator. The frequency range from 90 kc to 31 mc is covered in six bands. Individually calibrated coils assist in maintaining the guaranteed accuracy of + or - 1 per cent, it is said. A feature of the instrument is the dial scale on which the higher frequencies are calibrated on the outer rim.

Additional information can be obtained from the manufacturer.

**WEBSTER-CHICAGO MOBILE P-A SYSTEM**

Webster-Chicago has announced a 30-watt all-purpose sound system that can be used on either 110-volt a-c or 6-volt d-c. The only change needed from 6-volt d-c to 110-volt a-c is to change the plug-in type power pack.

This principle has become popular among Service Men in the past.

The complete system consists of a 30-

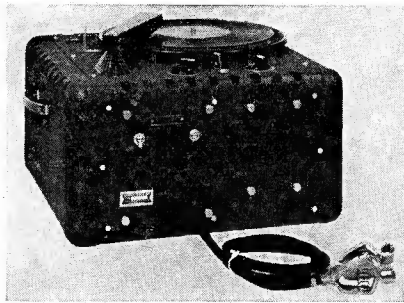

watt amplifier with phonograph turntable, an integral part of the amplifier housing; crystal microphone and two heavy-duty permanent magnet speakers.

Full information can be obtained by writing the Webster Co., 5623 Bloomingdale Ave., Chicago.

**AUTO-RADIO ANTENNAS**

Electronic Products Specialties Co., 1623 S. Hill St., Los Angeles, Cal., are manufacturing a complete line of auto-radio antennas.

The "Whiskbroom," a unique type uses over 50 feet of wire with a polished chromium base and a vacuum cup insulator for mounting on the car roof. Design stress is given to ease of installation in the balance of the line.

Descriptive and illustrative literature is available upon request.

**913 OSCILLOSCOPE KIT**

Service Men anxious to build the Thordarson oscilloscope can find the necessary information in Bulletin SD-266.

This bulletin may be obtained from the Thordarson Electric Mfg. Co., Dept. S-74, 500 W. Huron St., Chicago.

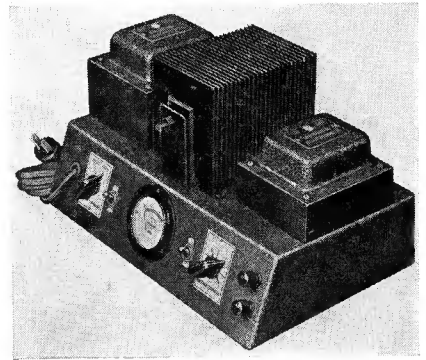

**STANCOR 6-VOLT PACK**

Standard Transformer Corp., 850 Blackhawk St., Chicago, announce the Stancor auto-radio test pack. It is designed to fill the need for a continuous metered source of d-c for demonstrating auto radios and accessories.

Three models are available: the Junior, with a power output of from 5 to 7½ volts at 5 amperes; the Standard, with an output of from 5 to 7½ volts at 12½ amperes and the De Luxe, from 2 to 8 volts at 15 amperes. This latter model is equipped with a high-low switch and a continuously variable voltage control.

Each model is protected with a circuit breaker in the primary and is equipped with a calibrated meter. A surge suppressor is employed to prevent damage through voltage feedback to the rectifier and to protect the condenser from line surges. All models are electrostatically shielded to prevent line noises from entering the output circuit.

**HALLDORSON VARI-VOLT TRANSFORMER**

The Halldorson Co. has announced a transformer which the Service Man can use at his bench for adjusting the line voltage. Besides permitting adjustments in line voltage it will also supply practically all of the ranges of voltages needed for receiver testing. The Halldorson vari-volt transformer will supply voltages from 0-250 volts in 2-volt steps or from 0-128 volts in 1-volt steps. The power output is 250 watts, maximum.

Complete information can be obtained from The Halldorson Co., 4500 Ravenswood Ave., Chicago.

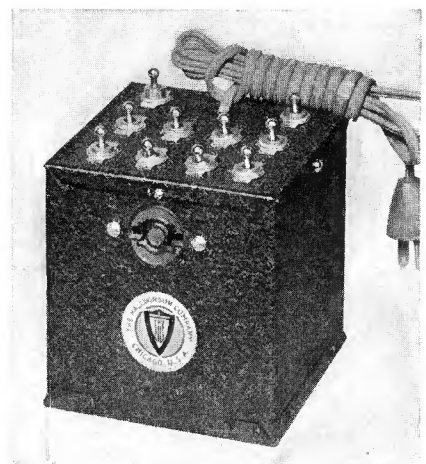

# JUST OUT!

## The New SPRAGUE CONDENSER Catalog



### FREE!

The handiest, most helpful Condenser Catalog yet produced! Includes a complete listing of famous Sprague Condensers for every radio service and amateur need. Hundreds of exact duplicate replacements—new small size dry electrolytics — new Trimmers, Mica Condensers, Rectangular Transmitting Units, etc., etc.

Don't miss it!

# SPRAGUE

*The Standard of Condenser Quality*

**SPRAGUE PRODUCTS CO.**  
North Adams, Mass.

## PUSH P.A. FOR REAL PROFIT

LOOK AT THIS BUY—  
**20**

WATT PORTABLE SYSTEM WITH SLIP-IN CASE  
NOTHING ELSE TO BUY—READY FOR OPERATION

**\$82.95**  
MODEL 860-F

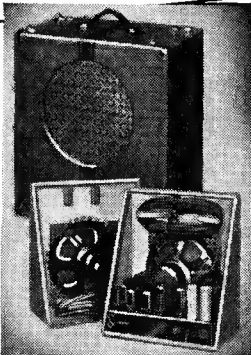

The above is a typical value in the most complete line of P.A. Systems in the world. Three or four rentals will pay for the complete LAFAYETTE system — and after that the alert servicer is "pushing" up his bank balance. Remember—just around the corner from almost anywhere is a P.A. prospect. There is gold in them that P.A. jobs—start "pushing."

**WHOLESALE RADIO SERVICE CO. INC.**  
NEW YORK, N. Y., CHICAGO, ILL., ATLANTA, GA.,  
100 SIXTH AVENUE • 901 W. JACKSON BLVD. • 330 W. PEARLREE ST., N. W.  
BRONX, N. Y. • NEWARK, N. J. • JAMAICA, L. I.  
542 E. FORDHAM RD. • 219 CENTRAL AVE. • 90-08 166th STREET  
(MINERVA ROAD)

**WHOLESALE RADIO SERVICE CO., INC.**  
100 Sixth Avenue • New York, N. Y.

Send for FREE Catalog No. 68-5E7.

NAME.....  
ADDRESS.....  
CITY..... STATE.....



**FREE**

## MANUFACTURERS—continued

### STEWART REMOTE CONTROLS

The F. W. Stewart Mfg. Corp., 340 W. Huron St., Chicago, have released a catalog of auto-radio remote control units, panel plate kits to match the individual instrument board of the various makes of cars, shafts, etc.

Copies may be obtained directly from the manufacturer.

### AMERICAN DYNAMIC MICROPHONE

The American Microphone Co., 1915 S. Western Ave., Los Angeles, Cal., have added a dynamic microphone to their line. The new microphone is available in both low and high impedance models. The low

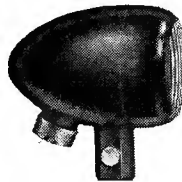

impedance model, D-5, has an average output of —85 db and an impedance of 50 ohms. The high-impedance model, D-5-T, has an average output of —55 db and an impedance of 10,000 ohms.

A descriptive and illustrative folder may be obtained directly from the manufacturer.

### DU MONT OSCILLOGRAPH

The Du Mont Laboratories, Inc., Upper Montclair, N. J., have developed a low-priced Service oscillograph. The instrument is designed especially for the Service Man to be used with any standard frequency modulated oscillator and will serve the purposes of a portable oscillograph.

The 164 employs a Du Mont type 34-XH 3-in. cathode-ray tube; has separately controlled horizontal and vertical high gain amplifiers, flat from 30-30,000 cycles per second, internal or external positive synchronization; high and low voltage power supplies, assuring a brilliant pattern and no interaction of controls.

Provisions for applying signals directly to

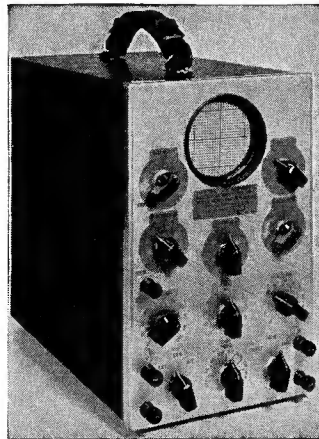

the deflection plates have been made at the rear of the unit. All controls including horizontal and vertical positioning controls are on the front panel. The unit has an amplified sweep with a frequency range which allows observation of a single wave from 15-30,000 cycles per second.

# GET YOUR COPY TODAY!

## Chock-Full of Helpful Information



**FREE!**

Learn the truth about so-called "bargain" condensers — get the facts about power factor, leakage, etc. This new 1937 Catalog also includes the famous Sprague Tel-U-How Condenser Guide; complete data on Radio Interference Elimination, duplicate replacements, etc., etc. Get your copy today!

# CONDENSERS

*USE SPRAGUES... and Note the Difference*

**SPRAGUE PRODUCTS CO.**  
North Adams, Mass.

## Improved Tone

with  Audios

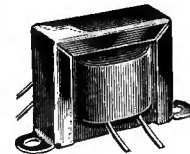

Inputs  
Outputs  
Chokes

Exceptionally flat response curve assures true reproduction at all frequencies. Often your customer will say "The set sounds better now than when it was new." That's good for your reputation....and profits!

The Multi-tap Output has universal primary, and secondary tapped in 2 ohm steps from 2 to 30 ohms—fits nearly all circuits.

**PULL-PUSH**  
**MOISTURE PROOFED**

All coils are vacuum-baked to extract every last trace of moisture, and then impregnated with special 9X Moisture-Proofing Compound forced into windings under tremendous pressure. Sealing is perfect. No dripping of high melting-point Compound, and subsequent shorting, under normal operation in the hottest, most humid sea-coast climate. Ask your jobber, or write for FREE Bulletin, Form 31.

**GENERAL TRANSFORMER CORP.**  
502 S. Throop St. Chicago, Ill.

# ELECTROLYTICS For Your Every CIRCUIT REQUIREMENT



The type KR series is enclosed in aluminum containers with convenient wire leads. The type JR series is available in silvered containers with wire leads and mounting feet. Both the type KR and JR series is available in single, dual and multiple capacity combinations.

There is no electrolytic replacement required for the servicing of the modern A.C.-D.C. receiver that cannot be successfully accommodated by either the types KR or JR dry electrolytic capacitors.

For a neat, profitable job and complete customer satisfaction standardize on C-D electrolytics. Complete catalog free on request.  
MICA - DYKANOL - PAPER  
WET and DRY ELECTROLYTICS  
**CORNELL - DUBILIER CORP.**  
1026 Hamilton Blvd., So. Plainfield, N. J.

# CORNELL-DUBILIER

# Money Makers and Prestige Builders



Bell Sound amplifying systems bring you equipment that has won the confidence of America. Built to the highest standards, for maximum performance, dependability and tone quality. And this new 20 watt portable system is no exception with its heavy duty infinite baffle speakers, wide range crystal microphone, octal tubes and dual in-put channel, in addition to other advanced principles of design. And it is low priced, too! You can depend on Bell Systems to bring you quick cash returns on your efforts. Others are cashing in on quick sales and profitable rentals . . . you might as well, too.

## BELfone

Another red hot seller. An inter-communicating system that is needed in every office. Low in cost and sells on sight. Write for details.

## JOBBERS

Write for details and territory information on Bell's complete line of P. A. equipment and communicating systems.

## For Portable or

## Permanent Use

From 6 volt mobile installations to regular 110 volt auditorium uses . . . models with output from 5 to 30 watts.

# BELL

**SOUND SYSTEMS, Inc.**

61-62 East Goodale St.  
COLUMBUS, OHIO

Export } 308 W. Washington  
Offices } Chicago, Illinois



## INDEX TO ADVERTISERS

A	G	S
Aerovox Corp. . . . . 314	General Electric Co. . . . . 313	Solar Mfg. Corp. . . . . Third Cover
American Appliance Associates, Inc. . . . . 322	General Transformer Corp. . . . . 319	Sprague Products Co. . . . . 319
American Microphone Co., Inc., Ltd. . . . . 322	H	Standard Transformer Corp. . . . . 301
American Television & Radio Co. . . . . 317	Hygrade Sylvania Corp. . . . . 291	Star Machine Mfgs., Inc. . . . . 321
Amperite Co. . . . . 272-322	K	Stewart Mfg. Corp., F. W. . . . . 309
Amplifier Co. of America . . . . . 317	Ken-Rad Tube & Lamp Corp., Inc. . . . . 321	Supreme Instruments Corp. . . . . 281
Arcturus Radio Tube Co. . . . . 315	Kraeuter & Co. . . . . 317	T
Audak Company . . . . . 268	M	Technical Appliance Corp. . . . . 269
B	Mallory & Co., Inc., P. R. . . . . Second Cover	Tobe Deutschmann Corp. . . . . 315
Bell Sound Systems, Inc. . . . . 320	Micamold Prod. Corp. . . . . 303	Triad Mfg. Co., Inc. . . . . 309
Birnback Radio Co. . . . . 322	Mueller Electric Co. . . . . 322	Triplett Elec. Inst. Co. . . . . 291
Brush Development Co., The . . . . . 313	N	Tung-Sol Lamp Works, Inc. . . . . 283
C	National Union Radio Corp. . . . . 299	U
Centralab . . . . . 289	Noblitt-Sparks Industries, Inc. . . . . 285	United Transformer Corp. . . . . 271
Clarostat Mfg. Co., Inc. . . . . 309	O	Universal Controls, Inc. . . . . 314
Cornell-Dubilier Corp. . . . . 320	Ohmite Mfg. Co. . . . . 321	Universal Microphone Co., Ltd. . . . . 321
Cornish Wire Co., Inc. . . . . 305	Operadio Mfg. Co. . . . . 303	Utah Radio Products Co. . . . . 299
Crowe Name Plate & Mfg. Co. . . . . 318	P	W
Curtis Condenser Corp. . . . . 322	Precision Apparatus Co. . . . . 314	Ward Products Corp. . . . . 322
D	R	Webster-Chicago . . . . . 295
Delta Radio Co. . . . . 317	RCA Mfg. Co., Inc. . . . . Fourth Cover	Weston Elec. Inst. Corp. . . . . 293
Dunmont Electric Co. . . . . 309	Racon Elec. Co., Inc. . . . . 322	Wholesale Radio Service Co., Inc. . . . . 319
DuMont Labs, Inc., Allen B. . . . . 313	Radiotechnic Lab., The . . . . . 305	Wright-DeCoster, Inc. . . . . 305
E	Raytheon Production Corp. . . . . 297	Y-Z
Electrical Products Co. . . . . 305	Readrite Meter Works . . . . . 311	Yaxley Manufacturing Division . . . . . Second Cover
Electronic Products Specialties Co. . . . . 317	Rider, John F., Publisher . . . . . 295	Z & S Products Co. . . . . 321
Electro-Acoustic Products Co. . . . . 301		
Electro-Voice Mfg. Co. . . . . 321		
Electronic Design Corp. . . . . 283		
F		
Fox Sound Equip. Corp. . . . . 321		





# AUTO RADIO CONTROL

THE ONLY CONTROL UNIT WITH ALL RATIOS SELF CONTAINED

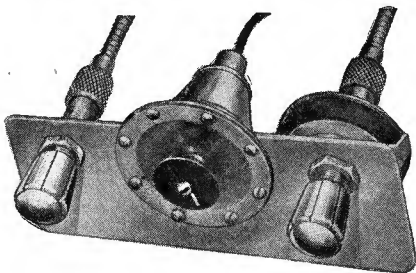

- Fits all car instrument panels
- Fits all radios, regardless of ratio, with one unit
- Fits all condensers, clockwise or counter clockwise, with one dial
- Fits all panel thicknesses—with adjustable indicator and adjustable control shafts
- No holes to drill or file—100% universal for all panel openings
- No trouble to install, preassembled, simply bolt in place
- No adjustments necessary—automatic calibration
- No excessive stock—same unit fits every job
- Custom matched plates to fit all 1935, '36 and '37 cars.

Sold through recognized jobbers only.  
Write for illustrated catalog No. 371.

**STAR MACHINE MFGRS., Inc.**

Precision Instrument Makers Since 1913

1381 E. Bay Avenue

Bronx, N. Y.

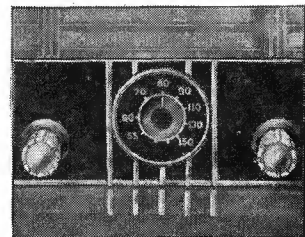

Several territories open for sales representatives

## ELECTRO-VOICE

### Velocity MICROPHONES Carbon "V" SERIES

An efficient all-feature velocity microphone, preferred by broadcast, sound and public address engineers throughout the world. Three models —\$35.00 to \$75.00, list

Write for complete descriptive literature immediately.

**"K" SERIES.**  
Three models with genuine quality, listing from \$19.50 to \$29.50. Also a Static-Velocity model at \$20 list.

Five popular carbon "mikes" from \$5 to \$25 list. Repair service on all makes.

Ask Your Jobber

**ELECTRO-VOICE MFG. CO.**

332 E. COLFAX AVE., SO. BEND, IND.



## WIREWATT RESISTORS RATED AT 1 WATT



*They Protect My Earnings*  
says Bill Finit

WIREWATTS have no voltage or temperature characteristics. Same size as composition units... fit nearly all radio circuits. Rated at 1 watt, values from 100 through 25,000 ohms. Ask your jobber or write for catalog 16—FREE!

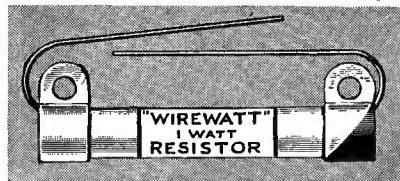

## OHMITE

MANUFACTURING CO.

Manufacturers of Rheostats, Resistors and Tapswitches  
4827 Flournoy Street  
CHICAGO, ILL.

## FOX SOUND EQUIPMENT

THE CHOICE OF RADIO ENGINEERS

Sells on demonstration and stays sold because it "stays on the job," rendering long satisfactory service.

- Fox One-Piece Metal Diaphragm
- Fox Electro Dynamic Unit
- Fox Aluminum Trumpet Horns
- Fox B-5 Universal Baffle Type Horn
- Fox Low Level Speaker

Write for catalog sheets and prices on complete line.  
It points the way to greater profits.

**FOX**  
SOUND EQUIPMENT CORPORATION  
3121 MONROE ST. TOLEDO, O. U.S.A.

## THE SENTINEL POPULAR PRICED AUTO AERIAL

Improves Reception — Increases Volume  
— Reduces Interference — Neatest Ap-  
pearing.

Fits all cars — easily attached to door  
hinge. No holes to drill — rust-proof.

Retails: \$1.95 (cadmium plate), \$2.45  
(chromium). Usual trade discounts.

## Z & S PRODUCTS CO.

1215 JACKSON STREET

TOLEDO, OHIO

**★ ALWAYS CARRY**  
**Ken-Rad**  
**Radio Tubes**

Ken-Rad genuine all-metal radio tubes are dependable. They give outstanding performance. Write for information.

**KEN-RAD TUBE & LAMP CORP., INC.**  
Owensboro, Ky.

Also manufacturers of Ken-Rad Incandescent Electric Lamps



## UNIVERSAL MODEL "W"

The Microphone of a Thousand Uses—for small address installations, intercommunicating systems, detective devices, ordering phones, etc., etc.—A Perfected Watch Model Microphone—full, clear speech reproduction—Light—Compact—Sensitive.

SPECIAL PRICES TO ASSEMBLERS AND  
MANUFACTURERS IN QUANTITIES

**UNIVERSAL MICROPHONE CO., Ltd.**  
424 WARREN LANE INGLEWOOD, CALIFORNIA

# New! AC-DC AMPERITE WITH STARTING RESISTOR! Prevents Untimely Burnouts



When your set is turned on, the Patented Automatic Starting Resistor allows only 75 volts to pass through. . . Then it increases the voltage to normal as the tubes warm up, thus preventing sudden overloading and burnouts.

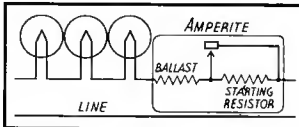

WRITE FOR CHART CVS

Only 3 types of AC-DC AMPERITE are required to replace any of the 60 types of AC-DC ballast tubes. NEW LOW PRICE: List \$1.00. [Also new low price on replacements for 2-Volt Battery Sets, List \$1.25.]

**AMPERITE Company** 561 BROADWAY NEW YORK

## Here is the CORONATION

MODEL C.O.—\$2.45



### WARD'S SENSATIONAL HINGE AERIAL

Telescopic Extends to 54 inches. Made of Stainless Steel and Chromium Plated Brass. Molded Power House Type Insulation.

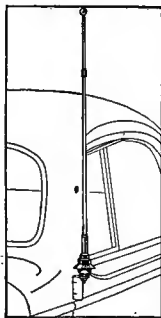

WARD PRODUCTS CORPORATION MANUFACTURES THE WORLD'S FINEST LINE OF AERIALS TOP — POLE — UNDERCARS

SEND FOR CATALOG TODAY—PROMPT DELIVERIES

**The WARD PRODUCTS Corp.**  
WARD BUILDING CLEVELAND, OHIO

## American's New DYNAMIC

(High or Low Impedance)

**D-5** 50 Ohms List 27.50      **D-5-T** 10,000 Ohms List 32.50  
(Both include 25' Cable and Plug)

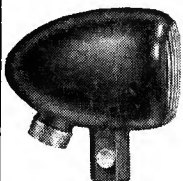

- Rugged
- Excellent Frequency Response
- High Output
- Low Price
- MULTI-PURPOSE

Write for Catalogue on DYNAMIC, CRYSTAL, CARBON, and CONDENSER MICROPHONES, STANDS, and ACCESSORIES.

**AMERICAN MICROPHONE COMPANY, Inc., Ltd.** 1915 S. Western, Los Angeles, Cal.

## Switch-O-matic All Wave Antenna

Here is an all-wave antenna kit that really will improve reception because it has been factory connected and soldered to eliminate incorrect and poor connections.

**FEATURES:** Easy to install. Antenna Transformer matches impedance to transmission. No signal loss in transmission to receiver coupler. No switching for s.w. or broadcast.

No. 375—All Wave Antenna. \$4.25 ea. list.

No. 376—All Wave Antenna for sets with built-in aerial selector. \$3.50 ea. list.



See your jobber. If he cannot supply you, write direct to Dept. S-5.

**BIRNBACH RADIO CO.**  
145 HUDSON ST. BIRCO NEW YORK, N. Y.

## Here's an ALLIGATOR

You Can Keep for 

a Pet Around Your Own Shop

Send for him—he's FREE. You can dress him in a rubber insulator and he's absolutely harmless! Mueller Alligator Clips are trained to crawl into any kind of a hole and bite hard.

WRITE FOR CATALOG 690 AND FREE SAMPLES  
Mueller Clips Are Stocked by Jobbers Everywhere

**Mueller Electric Co.**  
1583 East 31st Street, Cleveland, Ohio

## BETTER SERVICE

A Complete Line of Radio Parts For Service Men Under One Trade Name



## MORE PROFIT

Condensers  
Resistors  
Tubes  
Transformers  
Vibrators  
Volume controls  
Antenna Kits

SERVICE TO THE RADIO INDUSTRY

If You Are Handicapped in Rendering SERVICE to Your Customers and or—if You Are Handicapped in Realizing Sufficient PROFIT for Yourself and—if Your Reputation Warrants Our Assistance—

Send for Details and Application Blank to  
**AMERICAN APPLIANCE ASSOCIATES, INC.**  
Central Terminal Bldg., Albany, N. Y.

# Curtis Electrolytic CONDENSERS



If You have high voltage problems in filter condensers, don't fail to use our Blue Ribbon 630-Volt Condensers.

Write today for complete catalog.

**CURTIS CONDENSER CORPORATION**

3088 WEST 106TH ST. CLEVELAND, OHIO

## RACON PIONEERS AGAIN!

### Permanent Magnet Horn Units

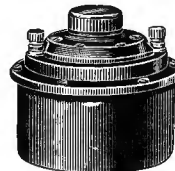

These efficient P.M. units require no outside excitation. Available in two types; both the 36% Cobalt steel and the newest high flux Alnico type magnets are used to supply maximum flux density in the air gap.

Cast bronze case, completely enclosed, makes unit water tight. Continuous operating capacity 10 watts. Peak load capacity 30 watts. 15 ohm impedance at 1000 cycles.

Electro-dynamic type units also available in all sizes. RACON'S catalog S-5 describes the complete line of Horns, Electro-dynamic Units and Acoustical Sound Projectors.

**RACON ELECTRIC CO., INC.**  
52 EAST 19th STREET NEW YORK CITY

*Solar*  
**DOMINO**

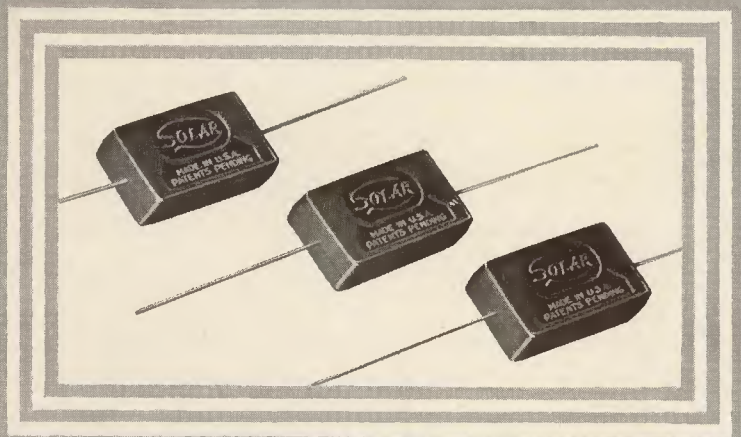

*molded BAKELITE paper capacitors*

**QUALITY  
ABOVE ALL!**

“DOMINO” paper capacitors are far superior to ordinary paper tubulars. They are small, flat, easy to use and highly resistant to heat and moisture.

Molded in Bakelite, “Dominoes” are the last word in appearance, safety and economy.

Your jobber has them in a wide range of capacities and voltages.

Play safe—with “Dominoes”!

SOLAR MANUFACTURING CORP., 599-601 BROADWAY, NEW YORK



# New RCA Magic Wave Antenna System

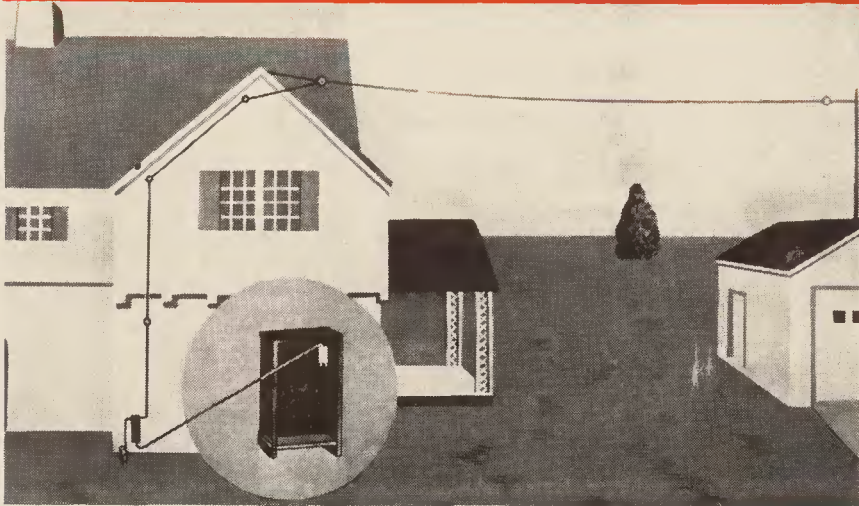

**\$695**  
List Price

Assembled in one complete unit, ready for installation.

STOCK No. 9812

## Check these exclusive Magic Wave FEATURES:

- Up to 16 outlets on 1 antenna—provided through use of additional special distribution and set coupling transformers.
- Noise reduction on both standard and international short-wave bands (530 to 23,000 kcs.) due to new magnetite core transformer and the transmission line.
- Easily installed with antenna lengths from 20 to 120 feet.
- Transmission line can be cut to any length without loss of efficiency.
- No doublets, on critical lengths, adaptable to existing installations.
- Ask your RCA Parts Distributor about the new RCA Magic Wave Antenna System and other accessories. Get the new RCA Test Equipment and Accessory Catalogue just off the press.

*RCA presents the "Magic Key" every Sunday, 2 to 3 P.M., E.D.T., on NBC Blue Network*



## CONTENTS OF KIT

(Completely Assembled)

- 1 Antenna Coupling Transformer
- 1 Receiver Coupling Transformer
- 60 ft. Antenna Wire
- 45 ft. Transmission Cable
- 5 ft. Ground Wire
- 5 Porcelain Insulators
- 1 Ground Clamp

## VERTICAL INSTALLATION

By using several lengths of ordinary iron pipe and reduction couplings a high efficiency vertical antenna may be used in conjunction with the RCA Magic Wave System. By using Stock No. 12429 Submarine Cable the transmission line may be buried and all unsightly wiring eliminated. Such an installation can be conveniently located remote from interference.

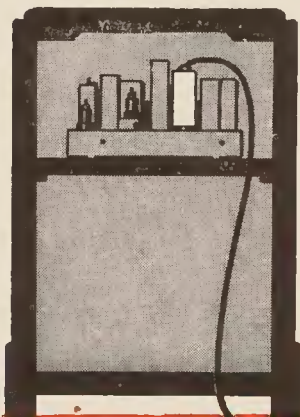

# Parts

## FOR PROFIT

RCA MANUFACTURING CO., INC., CAMDEN, NEW JERSEY  
*A Service of the Radio Corporation of America*

