

# SERVICE

## A MONTHLY DIGEST OF RADIO AND ALLIED MAINTENANCE

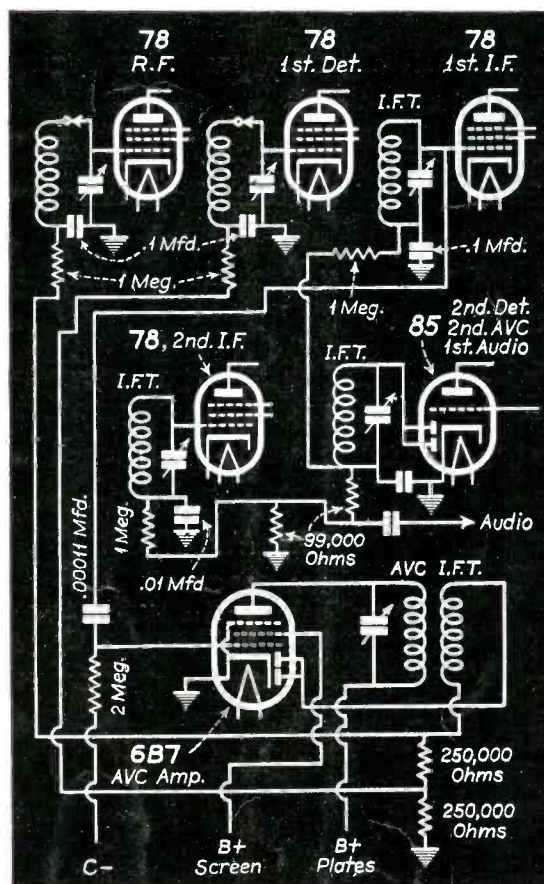

Double Automatic Volume Control  
(See Page 161)

PER COPY  
25 CENTS

APRIL  
1936

# Precision is a quality you can bank on in all **MALLORY-YAXLEY** Replacement Parts



Only Mallory precision engineering could make possible the small sizes of Mallory Replacement Condensers without loss of quality — sizes exact and without bulge. Only precision engineering could make practical universal mountings for both carton type and round can condensers.



In volume controls—only precision engineering could make possible the development and construction of accurate tapers to service thousands of receivers through Yaxley Replacement Volume Controls.



In vibrators—only precision engineering in producing contacts that meet the exacting requirements of the manufacturers of millions of auto radio sets could develop the highly satisfactory service given by Mallory Replacement Vibrators.

Mallory-Yaxley Precision Engineering is no accident. It is the outgrowth of many years' experience in meeting precision requirements of manufacturers. And it benefits jobber, dealer and service man by providing universal application of parts essential to prompt and efficient servicing.

P. R. MALLORY & CO., Inc.  
INDIANAPOLIS INDIANA  
CABLE ADDRESS — PELMALLO

# MALLORY

# YAXLEY



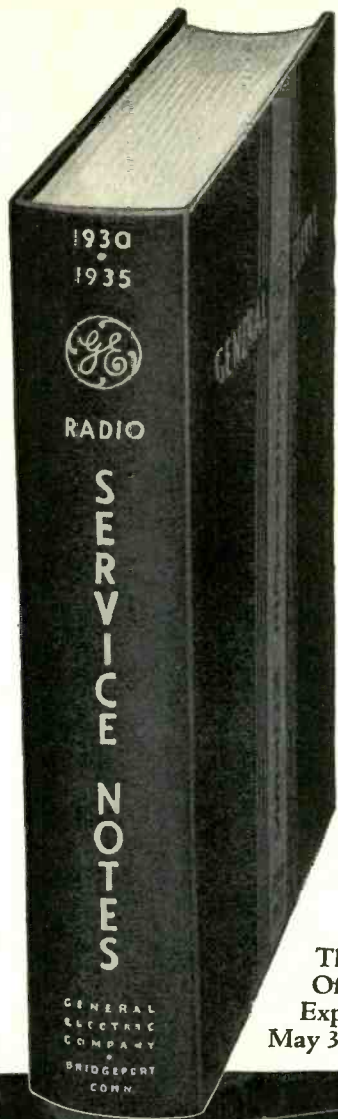

# SERVICE NOTES

1930—1935

*FREE . . . to Service Men*

UPON THE RECEIPT OF  
10 "V-DOUBLET"  
ANTENNA CARTON LABELS

● Here's an opportunity for radio service men to get a free copy of service notes on all radio receivers sold by General Electric during the past six years. This practical, 887-page volume, just released, is sold at the regular price of \$2.00. Every radio service man, who sells 10 G-E "V-doublet" All-wave Antennas, may have a copy free. Just return CARTON LABELS FROM 10 G-E "V-DOUBLET" ANTENNA KITS, to your G-E Radio Distributor, and this valuable new book will be yours.

This Offer Expires May 30, 1936

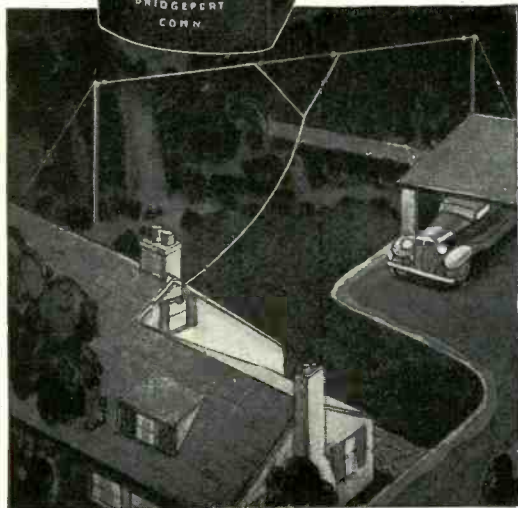

## THE GENERAL ELECTRIC "V-DOUBLET" ALL-WAVE ANTENNA Points the Way to Make Money

Do you want to cash in on radio's most neglected market? Then, sell and install the G-E "V-doublet" All-wave Antenna System. You'll find it pays big dividends in sales and profits. Canvass for prospective buyers every chance you get. Insist that a G-E "V-doublet" All-wave Antenna be included with every set. Get your share of this large and profitable market. Tune in on its profit possibilities.

*For complete information see your nearest General Electric Radio Distributor.*

# GENERAL ELECTRIC

**The Original Metal-tube Radio**

**APPLIANCE AND MERCHANDISE DEPARTMENT, GENERAL ELECTRIC COMPANY, BRIDGEPORT, CONN.**

# SERVICE

A Monthly Digest of Radio and Allied Maintenance  
Reg. U. S. Patent Office. Member, Audit Bureau of Circulations

APRIL, 1936

EDITOR  
Robert G. Herzog

VOL. 5, No. 4

## EDITORIAL CONTENTS

### FEATURES

Double Automatic Volume Control.....	161
Elastic Vibrations of Quartz By G. W. Willard.....	159
Modernized Analyzer .....	174
The Human Ear .....	171

ANTENNA .....	156
---------------	-----

ASSOCIATION NEWS .....	182
------------------------	-----

### AUTO RADIO

DeWald 517 .....	167
Ignition Interference .....	168
The Undercar Spring Aerial .....	168

### CIRCUITS

DeWald Model 517 .....	167
Double Automatic Volume Control... Front Cover	
Kadette 53 and 553 Circuit Changes.....	178
Modernized Analyzer .....	174
Phonograph Connection Sparton 1116X....	164
Pilot-Light Circuit for A-C, D-C Sets.....	172
RCA Victor T 9-7 Circuit Changes .....	180
Short Tester for Tubes.....	172
Sparton 1116X, 1166, 1176, 1186, 1196.....	163
Stewart Warner 142A .....	165

### GENERAL DATA

Double Automatic Volume Control.....	161
Modernized Analyzer .....	174
Philco 680 Note .....	165
Sparton 1116X, 1166, 1176, 1186, 1196....	162
Stewart Warner 142A .....	164
Technical Features of Atwater Kent Radio Receivers for 1936 .....	166
Testing AVC Action .....	172

HIGHLIGHTS .....	184
------------------	-----

MANUFACTURERS .....	186-188
---------------------	---------

### ON THE JOB

Exact Duplicates Save Money By Chas. Golenpaul .....	172
Reducing Free Calls By Al Beers .....	172
Short Tester for Tubes .....	172
Solder Holder .....	172
Solving Pilot-Light Problems .....	172
Testing AVC Action .....	172

### PUBLIC ADDRESS

The Human Ear .....	171
---------------------	-----

RECEIVER CASE HISTORIES.....	178-180
------------------------------	---------

### TEST EQUIPMENT

Modernized Analyzer .....	174
---------------------------	-----

BRYAN S. DAVIS  
President

JAS. A. WALKER  
Secretary

Chicago Office—608 S. Dearborn St.—C. O. Stimpson, Mgr.  
Telephone: Wabash 1903  
Wellington, New Zealand—Tearo Book Depot.

Published Monthly by the

Bryan Davis Publishing Co., Inc.  
19 East 47th Street  
New York City

Telephone: Plaza 3-0483



SANFORD R. COWAN  
Advertising Manager  
PAUL S. WEIL  
Eastern Advertising  
Manager  
A. B. CARLSEN  
Circulation Manager

Cleveland Office—10515 Wilbur Ave.—J. C. Munn, Mgr.

Telephone: Republic 0905-J

Melbourne, Australia—McGill's Agency.

Entered as second-class matter June 14, 1932, at the Post Office at New York, N. Y., under the Act of March 3, 1879. Subscription price \$2.00 per year in the United States of America and Canada; 25 cents per copy. \$3.00 per year in foreign countries; 35 cents per copy.



QUALITY AT A POPULAR PRICE . . . A  
 COMPLETE WESTON SHOP AND FIELD  
 TESTER . . . \$45<sup>00</sup> NET IN U. S. A.



*The*

# WESTON CHECKMASTER

Tests all tubes . . . spare sockets . . . Neon short  
 check . . . cathode leakage test . . . individual tests  
 on diodes . . . point-to-point voltage ranges . . .  
 resistance-conductivity features . . . Neon high re-  
 sistance leakage test . . . positive line voltage  
 control . . . the famous WESTON 301 Meter . . .  
 striking design and finish.

Send coupon for full data on Model 771, and  
 the new WESTON Tube Base Chart.

Weston Electrical Instrument Corporation  
 604 Frelinghuysen Ave., Newark, N. J.

Please send bulletin on the WESTON Model 771 Checkmaster.  
 Also a copy of the new WESTON Tube Base Chart.

Name \_\_\_\_\_

Address \_\_\_\_\_

City \_\_\_\_\_ State \_\_\_\_\_

# THE ANTENNA . . .

---

## PHONOGRAPH PICKUPS

WITHOUT AFFECTING THE RADIO reception, a phonograph pickup may be added to any radio receiver. In cases where the customer can not be sold because of the price of the auxiliary motor and turntable, the pickup can be used with an old hand-wound spring motor. Not only can a sizable profit be made on the pickup, but a source of additional revenue is opened through the phonograph record requirements of the customer. With the high-fidelity reproduction now obtainable from crystal and similar pickups, a demonstration under suitable conditions will convince any lover of good music. Most music lovers are never happy unless they can select the particular piece of their favorite player. If these pieces are used in the demonstration the equipment will sell itself.

. . .

## HOME RECORDING

RECORDING OF INDIVIDUAL SOUND and voice pictures is gradually making its debut in the American home. Like photography, home recording began as a fad. Again like the camera, with the simplifying of the equipment and the improving of the processes, home recorded sound pictures are becoming accepted additions to the photograph album.

Both acetate and aluminum discs are now available, already grooved, which are suitable for making good reproductions with inexpensive equipment. The wide-awake Service Man need not be urged to investigate this growing field. Another profitable source for continuous income is created by each installation, what with the customer's need for new discs, special needles, etc.

The fascination of hearing one's own voice, the permanent recording of Junior's first coherent murmurs, or the pleasure afforded by the reproduction of the glorious voice of the young hopeful are some of the many angles the Service Man can play up in his advertising.

. . .

## REMOTE SPEAKERS

WITH THE DECIDED IMPROVEMENT in permanent-magnet dynamic speakers, the field for multiple speaker installations is again opened. The coming of summer is quite helpful to this extra business. People will spend more time on the front porch, in the backyard garden, or similar places away from the radio receiver. Some of these may be customers for an additional set, perhaps of the midget type. Those with an ear to acoustics, how-

ever—especially those with high-fidelity receivers—will more than likely spend considerably more than the price of the midget to obtain high-fidelity reception at the remote point.

The improved permanent-magnet dynamics now available, when properly installed, are capable of giving exceptional quality. Ardent radio listeners (depending, of course, upon the layout of their home) will rarely stop at one such installation—often having remote speaker connections for every room in the house.

. . .

## RADIO SETS ON YACHTS

AUTO-RADIO IS TAKEN FOR granted nowadays—but we wonder if the Service Man near the larger lakes and the seashore has given proper thought to the owners of yachts in his neighborhood. The names and addresses of these yacht owners may be obtained easily, and can be used for direct-to-the-customer advertising.

Most yachts are equipped with 6- or 12-volt storage batteries (some of the larger yachts have 32-volt lighting systems) which can be suitably tapped to supply power for automobile type receivers. Antenna installation is seldom a problem on such receivers when they are used on board a yacht and excellent reception is obtainable.

. . .

## AUTOMATIC FREQUENCY CONTROL

WE NOTE WITH INTEREST that the program for the Institute of Radio Engineer's convention in Cleveland next month includes a paper on automatic frequency control. It seems evident at this point, that afc will be one of the innovations included in next year's radio receivers. Most likely some remote-control feature will also be added, since the afc feature makes its operation more successful. Some rumor has been advanced, concerning a 24-hour clock, that will automatically turn the receiver on, pick any given station, adjust the volume, or turn the receiver off, any number of times for which it is set, for the full 24-hour period, and continue through the next if not reset. The rumor if correct, presents something almost human in automatic control.

As is customary SERVICE will be among the first publications to feature these ultra-modern developments as soon as they are announced, giving reliable information with circuit diagrams and technical descriptions.

SERVICE will also be among the first publications to print the circuit diagrams of factory-built receivers which include these features.

• SERVICE FOR



# Increase the Fidelity Range of your Receiver or Amplifier by using the VARITONE

The Varitone Audio Unit Is the Only Transformer of Its Kind Giving Continuously Variable Low End, High End, or Low and High End Equalization

*Does your amplifier, or set, sound...*

TINNY LIKE THIS?

OR DULL LIKE THIS?

OR LACKING HIGHS AND LOWS LIKE THIS?

5 types of Varitone units are now available to meet circuit requirements in receivers, amplifiers or telephone lines.

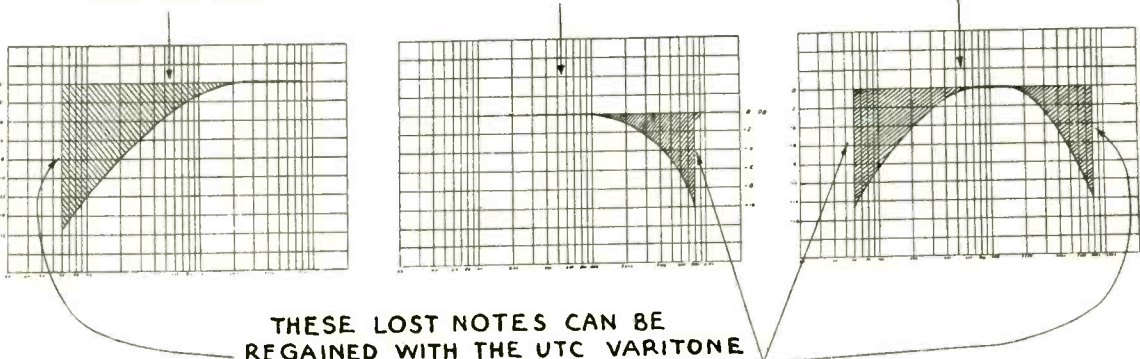

THESE LOST NOTES CAN BE REGAINED WITH THE UTC VARITONE

## HUM-BALANCED INPUT TRANSFORMERS AT A POPULAR PRICE

The true hum-balancing audio transformer is an original and exclusive development of the UTC engineering department. The coil structure in these transformers is so balanced that practically any linear form of magnetic flux will cut opposing coil sections in opposite directions and cause neutralization of inductive pickup. The hum-balanced transformer is further shielded by a husky sheet metal case of soft magnetic iron of such proportions and dimensions as to give maximum shielding effect.



PA 134 Shield

Proper use of "A" metal nickel iron alloy core material has made possible a frequency characteristic unusually fine for material of this price range.

	List Price	Net Price
PA134—500, 200, or 50 ohm line to single grid.....	\$6.50	\$3.90
PA135—500, 200 or 50 ohm line to push pull grids.....	7.50	4.50
PA136—Single plate and 500, 200 or 50 ohm line to one or two grids .....	7.50	4.50

	List Price	Net Price
VT-1—Designed to work from a single plate or low impedance line of 200 or 500 ohms to one or two grids. Highs or lows can be augmented or diminished to equalize frequency range of receiver or amplifier.....	\$8.50	\$5.10
VT-2—Designed for insertion across a 200 or 500 ohm line or across a 5,000 to 20,000 ohm plate.....	6.00	3.60
VT-3—A complete self-contained unit adjusted for 10 DB equalization at 80 and 7000 cycles. Will increase depth and brilliance of average receiver or amplifier.	5.00	3.00
VT-4—A complete unit including variable control so arranged that with the control at one end high fidelity performance is effected by the increase of low and high frequencies, and with the control at the other end the high response is reduced to decrease static line noises and heterodyne whistles. Used with triode tubes	6.00	3.60
VT-5—Same as VT-4, but used with screen grid tubes, pentodes or high mu triodes.....	6.00	3.60

For complete description of Varitone circuit applications write for Varitone 1120 Bulletin.

## Three Outstanding Chromshield Amplifier Kits for the Ham or PA Engineer



List Price \$22.00

**CK-7 Metal Tube Preamp Kit.** Uses two metal 6C5 tubes in cascade amplification. A third 6C5 is used as a rectifier. Can be operated on AC or DC current. Hum free, noise free, and trouble free in operation. Overall gain 55 DB. Input and output impedance 50, 200 or 500 ohms. CK-7 Preamp kit fully mounted on chassis, including all necessary resistors, condensers, sockets, line cord, plug, hardware, ready to wire.

Net Price \$13.20



List Price \$35.00

**CK-3 Class B 46 Amp Kit.** Uses a high mu 57, 46 driver and class B 46's. Output will match an RF load of 5000 or 3000 ohms. Gain 84 DB. Normal output 30 watts. CK-3 Amplifier Kit fully mounted on chassis, including all accessories, except tubes, ready to wire.

Net Price \$21.00



lines. CK-4 amplifier kit fully mounted on chassis, including all accessories, except tubes, ready to wire.  
List Price \$44.50  
Net Price \$26.70

**CK-4 Super Power A Prime Amplifier Kit.** Uses 1-57, 2-56's, 4-45's in A prime or 4-2A3's. Normal output 30 watts, peak output 40 watts. Gain 85 DB. Output will match RF load of 10,000, 7,000, or 5,000 ohms. Different output will match 500, 15, 8, 4, 2 ohm lines.

## MAIL YOUR 25c . . . NOW . . . FOR THESE TIMELY AND VALUABLE ITEMS

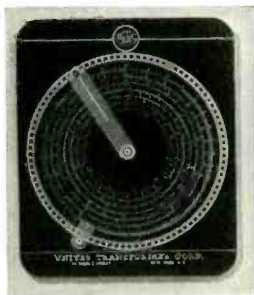

### THE NEW UTC CIRCULAR SLIDE RULE

The most useful instrument a radio engineer could have. Here are some of the electrical and mathematical problems to which it gives direct answers: Multiplication . . . Division . . . Proportion . . . Reciprocals . . . Squares . . . Square Roots . . . Voltage Drop in Resistors . . . Wattage in a Resistor for Given Voltage or Current . . . Impedance of an Inductance at Any Frequency . . . Impedance of a Condenser at Any Frequency . . . Resonance Calculations . . . Effective Capacity of Condensers in Series . . . Effective Resistance of Resistors in Parallel . . . Calculation of Bias Resistors . . . Power Level Conversion to DB . . . Voltage or Current Ratio Conversion to DB Gain . . . Sound and Light Calculations . . . Circumference and Area of Circles . . . Stroboscopes for Checking 33-1/3 or 78 RPM Turn-tables. Due to its 16-inch effective length, the accuracy of this rule is greater than many of the standard rules selling at 30 times its price.

### NEW TRANSMITTER BULLETIN

Covering circuits and laboratory built transmitters from 5 watts to 1,000 watts output.

### ALL LABORATORY CIRCUITS

As they are released over a period of one year covering new amplifiers and variactor controlled carrier RF transmitters.

### NEW 48 PAGE TECHNICAL BULLETIN

which includes data and circuits on amplifiers from one half watt to 1,000 watts output, chapters on audio transformer design, application of power transformers and filters, also charts on decibel conversion in terms of watts and conversion of power or voltage ratios to DB, reactance data, filter ripple calculations, etc.

# UNITED TRANSFORMER CORP.

72 SPRING STREET

NEW YORK, N. Y.

EXPORT DIVISION - 15 LAIGHT STREET, NEW YORK, N. Y.

In the Electrad Volume Control—the shoe is in direct friction contact with the carbon resistance element

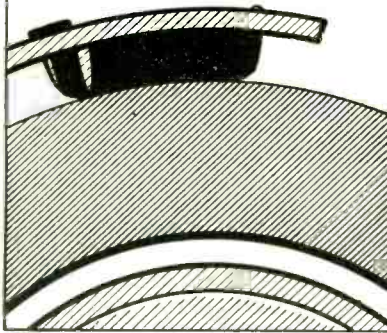

In an Electric Train—the overhead mechanism is in direct friction contact with the power wires

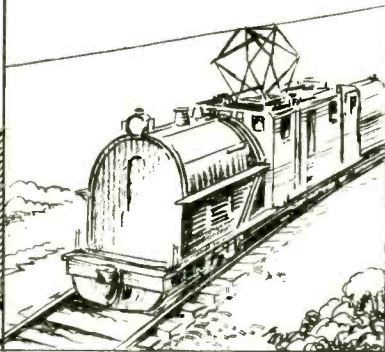

## Not FRICTION-LESS but FRICTION-RIGHT

The direct friction contact principle used in the Electrad Carbon Volume Control is the basic reason for its smooth, quiet, electrically perfect operation.

Contact with the carbon resistance element is uniform and uninterrupted. There are no gaps to cause noise or stuttering. You can actually feel this steady, even contact as you turn the shaft.

Moreover, this friction contact has a self-cleaning and self-polishing action on the resistance element. The longer an Electrad Volume Control is used, the quieter it gets!

Use an Electrad on your next replacement job—and you'll have no kick back! Long aluminum shaft easily cut to required length, standard end covers instantly interchangeable with power switch assembly. All Electrad controls noise tested at the factory and fully guaranteed.

### FREE—100 Page VOLUME CONTROL GUIDE

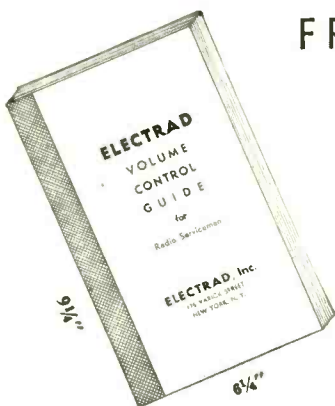

100 pages, listing in alphabetical order all receiver models for which Electrad standard or special replacement controls are made. Gives names of receiver manufacturers, model numbers, resistance values and list prices.

Mailed FREE if you send us the carton of any new type Electrad Carbon Volume Control, together with your business letterhead or card.

Address Electrad, Dept. S4  
175 Varick St., N. Y. C.

### *Volume Control Hints for the Radiola 17 Receiver Using the Electrad 401 Control*

Considerable difficulty has been experienced with the earlier models of the Radiola 17 receivers due to improper shielding. The volume control is connected in the antenna circuit and in sections where high signal levels are encountered, the volume of the receiver cannot be reduced sufficiently due to pick-up by the R. F. coils. In some cases, there is sufficient pick-up by even the third I. F. tube to cause difficulty.

A satisfactory solution may be found by lining the inside of the receiver cabinet with tin foil and grounding this. The lead from the rotating arm of the volume control to the grid of the first 26 tube is then shielded. This procedure will eliminate all pick-up and assure satisfactory volume control operation.

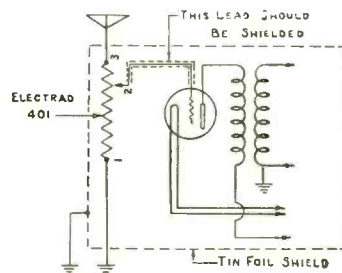

# ELECTRAD

RESISTOR SPECIALISTS IN RADIO AND ELECTRICAL INDUSTRY SINCE 1923



# SERVICE

A Monthly Digest of Radio and Allied Maintenance

FOR APRIL, 1936

## ELASTIC VIBRATIONS OF QUARTZ<sup>†</sup>

By G. W. WILLARD\*

THE great utility of quartz crystals, in stabilizing the frequency of oscillators, and as elements in filters and other electrical networks, is due primarily to two properties of quartz. In the first place the substance, when in a crystalline form, is piezo-electric: it may be set into vibration by applying an alternating potential across it, and conversely its vibration reacts upon the circuit through which the potential is applied. In the second place, its internal losses are extremely low. These two virtues result in circuit elements which, though mechanical, are intimately associated with the electrical circuit; and which, because of the low losses, show very little damping.

Roughly speaking a quartz plate, like any other physical object, has a natural frequency of vibration, dependent on its dimensions, its density, and its elasticity. In this respect it is mechanical-

ly analogous to a tuned circuit, and this is the feature of it that is put to practical use. But, again, like any other physical object, a quartz plate has not only one but many natural frequencies of vibration. In other words, such a plate has quite a few modes of vibration; there are many different ways in which the plate can vibrate at a fundamental frequency and various overtones, when appropriately excited. Moreover, many of these modes are so coupled to one another mechanically that the excitation of one tends to excite others, and their combined behavior under excitation is of the complicated sort whose electrical analog is provided by coupled circuits.

A simple illustration of such behavior is given in Fig. 1. At A in that figure is shown a thin plate, face on, which is supposed to be vibrating along one direction in its fundamental compressional mode. Arrows indicate what the motion of the particles of the plate

would be during one-half of the cycle of vibration; during the other half the direction of motion would reverse. The crystal expands and contracts, as though it were a block of rubber. The dotted line N is the nodal region, in which the particles would remain stationary.

Evidently there is possible another compressional mode of vibration, in the other direction across the crystal as shown at B, similar to the first except that its natural frequency is in general different. It can readily be seen that these two are closely interconnected, for when the plate is elongated in one direction, it tends to grow thinner in the other. The actual resulting motion involves both modes, elastically coupled. Indeed, simple compressional vibrations such as those diagrammed can only be approximated in very long thin bars.

The modes of vibration shown in Fig. 1 are called *longitudinal* because the particles move along the direction in which the vibration wave is propagated, as they do in sound waves. There are other possible modes, called *transverse* or *shear*, in which the particles move perpendicularly to the direction of propagation of the wave. In Fig. 3 is shown such a mode of vibration in a plate. Between most of these and many other modes, elastic couplings exist.

These considerations apply, no matter what the substance of the plate may be. So also does the fact that the elastic constants, determining the vibration characteristics of the various modes and

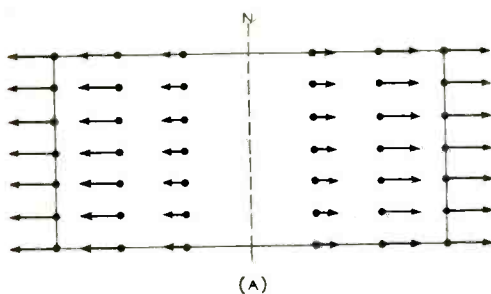

(A)

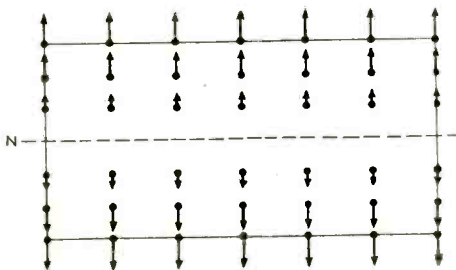

(B)

Fig. 1. Simple longitudinal modes of vibration of a quartz crystal plate.

Fig. 3. Transverse modes of vibration of quartz plate.

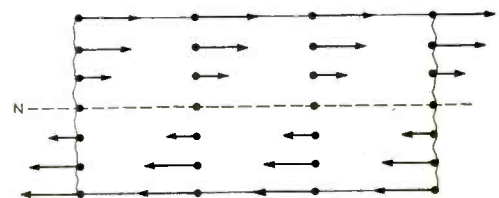

the couplings between them, vary with temperature. In the case of quartz, as of many other crystalline substances, there is the further complication that these elastic constants, and the piezoelectric constants as well, vary with the direction in which they are measured with respect to the crystal axes. For example, Fig. 2 shows for different directions through quartz the variation of Young's modulus, the constant which determines how much a given compressive force will compress the material. The range of variation is so large that it includes the values of the moduli for aluminum, brass, copper, gold and silver. Since the value of this constant is obviously one of the factors determining the frequency of vibration in the modes diagrammed in Fig. 1, the natural frequency of compressional vibrations in a quartz plate may be expected to vary considerably according to the orientation of the plate with respect to the axes of the crystal from which it was cut.

The complexity of this situation makes one wonder how it could ever be possible to manufacture quartz plates of predictable properties, simple to operate. For ease of manufacture, the

Fig. 6. Orientations of the Y-cut and AT-cut plates, referred to the X—(electric), Y (mechanical) and Z (optic) axes of the quartz crystal.

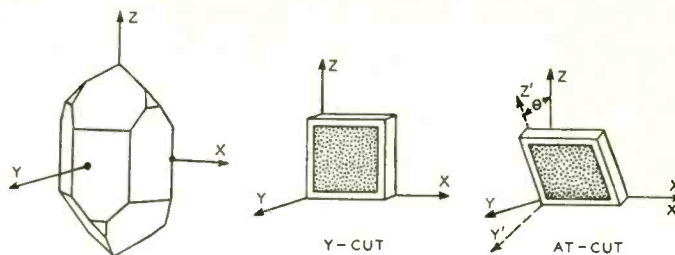

frequency of a quartz plate should be a simple continuous function of the dimensions, preferably of a single dimension. It is desirable that the frequency be independent of temperature, or if there is a change that it be linear and continuous. Moreover the plate must be associated with a holder comprising the electrodes; and in the many uses where it must be held rigidly in position with respect to those electrodes, the rigid clamping must be accomplished without appreciably increasing the naturally low damping of the quartz plate.

Theoretically it is possible to clamp a plate at its vibration nodes without affecting its vibration. Moreover, in many of the simple modes of vibration, the frequency is a continuous function

of a single dimension. When, for example, the simple compressional mode diagrammed in Fig. 1A is approximated, the frequency varies inversely as the horizontal dimension of the plate. The values of the various elastic constants are also simple functions of the temperature.

In practice, however, the various modes of vibration are often so coupled that the vibration of a plate will "hop" from one frequency to another as the controlling dimension or the temperature is changed. The effects of coupling are most marked when the frequencies of the several modes would be so close to one another if uncoupled. If these frequencies depend on different dimensions, the effects of coupling can be somewhat reduced by changing the dimensional ratio. But the prevalence of overtones limits the value of this expedient. The curve in Fig. 4 typifies the behavior of a plate in which the upper overtones of several low-frequency modes are coupled to a high-frequency mode, and the dimension controlling the latter is varied. The discontinuities, which arise when the high frequency is close to the various overtones, make it difficult to prepare such a plate for operation at a given frequency. For the same sort of oscillator (the Y-cut), Fig. 5, shows the large and discontinuous variation of frequency with temperature, which would require extremely close temperature control when the oscillator was operated. To minimize both these difficulties, the coupling must be reduced.

Fortunately one of the complications of quartz can be turned to advantage in such an attempt. The fact that the elastic properties of quartz vary in different directions makes it possible to vary the values of the different elastic coupling constants by varying the orientation of the plate when it is cut. Of course, it is not possible to vary all these constants independently, nor without limit. Moreover care must be taken that a favorable decline in coupling is not accompanied by an unfavorable decline in the piezo-electric constant.

A simple example of how the vibrating properties of a quartz oscillator can be varied by changing merely its orientation is furnished by a very thin quartz

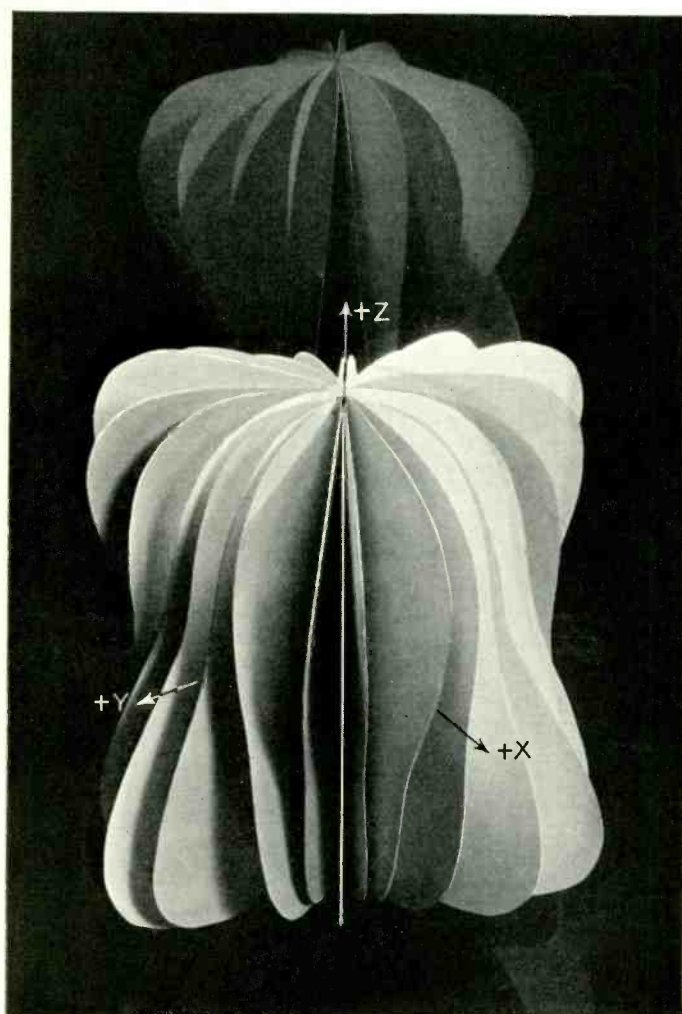

Fig. 2. Young's modulus varies greatly with direction, as shown by this 3-dimensional polar model.



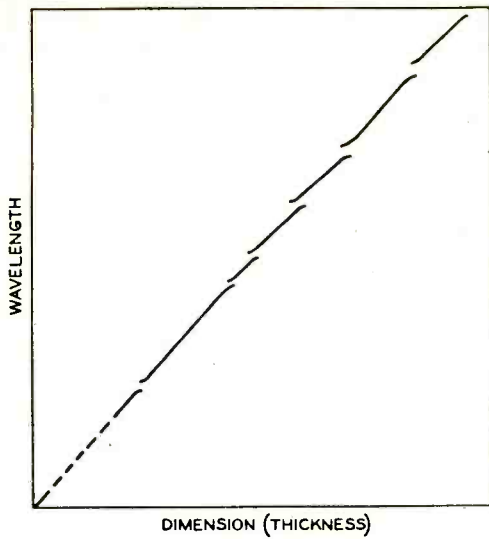

Fig. 4. Frequency-thickness relationship, showing hop as the dimension is varied.

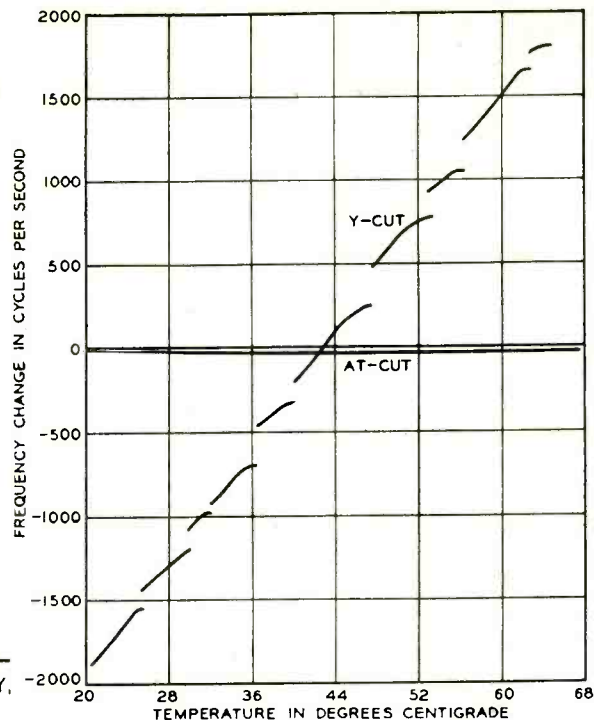

Fig. 5. Frequency-temperature relationship of Y- and AT-cut plates.

bar twelve millimeters long, vibrating in the compressional mode diagrammed in Fig. 1. By cutting such bars at different orientations, Young's modulus, its temperature coefficient, and the coefficient of thermal expansion, all take on different values. The varying modulus changes the frequency from 200 to 300 kilocycles, and the varying coefficients change the variation of frequency with temperature from zero to fifteen cycles per degree centigrade.

A more complicated example, but one of great practical interest, is the AT-cut quartz oscillator developed in the Bell Laboratories. In contrast to the familiar Y-cut plate, which is perpendicular to the Y-mechanical axis, the

AT-cut is rotated thirty-five angular degrees in a positive direction from this about the X-electric axis, as shown in Fig. 6. Both vibrate primarily in a transverse mode at a high frequency, of which the piezo-electric constant is high, and the vibration is not seriously damped by clamping at the edges of the plate. But a great improvement has been obtained merely by the new orientation, in the frequency-temperature relation, as shown in Fig. 5, and in the frequency dimension relation.

A large part of the misbehavior of the Y-cut plate is due to a single elastic coupling constant. It was the discovery that this constant could be reduced to zero, without introducing other cou-

plings, by rotating the cut thirty-one degrees in a positive sense, that led to the invention of the AT-cut. At the thirty-five-degree rotation actually used, the frequency-temperature coefficient also reduces to zero, while the coupling still remains inappreciable.

The AT-cut plate is already finding wide application in controlling the frequency of oscillators. It can be accurately manufactured with greater ease than its predecessors, and in many applications can be operated without temperature regulation over a wide range of temperatures. It forms an instance of the results which may be expected from research into the elastic and piezo-electric properties of quartz plates.

## DOUBLE AUTOMATIC VOLUME CONTROL

(See Front Cover)

DOUBLE automatic volume control is by no means new. It was used on receivers such as the G.E. M-125, described as far back as November, 1934, in that month's issue of SERVICE. The Philco 680X, super high-fidelity, all-wave superheterodyne, is one of the most recent receivers to use this advantageous automatic-volume-control system to its fullest extent.

In this model the normal second-detector avc is used to control the first and second i-f stages only, while the r-f and first detector is controlled by a completely separate avc amplifier and rectifier.

Double avc should not be confused with separate avc as used in the G.E. A-125 and the RCA C15-3 receivers. In these receivers the automatic-volume-

control function is merely separated from the second-detector tube, which acts only as a detector—or, as in the RCA C15-3 where it supplies avc action for the magic eye, as well as detection.

In the Philco 680X, two individual avc systems are used. Referring to the circuit diagram on the front cover, it will be noticed, that a portion of the signal is picked off the first i-f grid and fed to the control grid of the 6B7 combination amplifier-avc stage through the 0.00011-mfd condenser. The 2-megohm resistor is the load for the 6B7 grid, and is returned to a negative portion of the voltage divider. In the pentode section of the 6B7 the signal is amplified and passed on through the doubly tuned avc

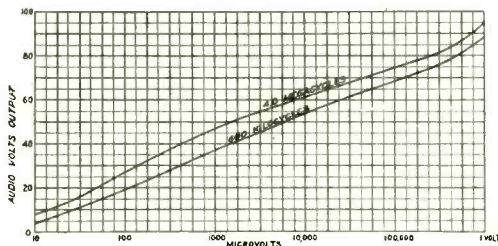

Fig. 1. The avc voltage developed at the second detector for various signal levels for two bands.

(Continued on page 176)

# General Data . .

Sparton Models 1116X, 1166, 1176, 1176XP, 1186, 1196

These are eleven-tube, five-band, high-fidelity, superheterodynes. The chassis in conjunction with an additional super power audio amplifier using two 6A6's and a 5Z3 as well as three speakers is also used in the models 1466 and 1476.

Fig. 1 shows the complete schematic diagram of the eleven-tube models with the tubes and their functions specified. The voltages encountered throughout the receiver are also marked on the diagram. A Weston Selective Analyzer No. 665, Type 1 was used. The volume control and noise suppressor were turned up for full output with the antenna disconnected and the band selector switch in the broadcast position when these measurements were made. 15% plus or minus is allowed on all measurements.

## ALIGNMENT PROCEDURE

For proper alignment of these chassis, the procedure should be followed in the same order given.

It is advisable to retard the interstation noise suppressor so that the output of the receiver is reduced as the i-f circuits are aligned, otherwise the receiver will be too sensitive to obtain an accurate reading on the output meter.

The dial pointer should be exactly parallel with the horizontal lines of the dial scale when the condenser plates are fully meshed. If the pointer does not read correctly, loosen the set screws in the brass collar on the drive shaft,

hold the rotor plates fully meshed with the stator plates, setting the pointer so that it is parallel with the horizontal lines, and then tighten the set screws.

## ALIGNMENT OF I-F STAGES

(1) Turn on the receiver and the test oscillator and allow both to operate several minutes before attempting to adjust any condensers.

(2) Turn the band selector switch to the No. 2 position (broadcast) and turn the station selector knob until the rotor plates are completely out of mesh with the stator plates.

(3) Connect "antenna" of the test oscillator to the grid cap of the type 6L7 first detector tube and "ground" of the oscillator to the chassis. Connect output meter "high tap" to plates of the 6F6 tubes.

(4) Tune test oscillator to obtain a signal of 456 kc.

(5) Turn the volume control of the receiver on full and adjust i-f condensers C4, C3, and C2 in the order mentioned. (See Fig. 2). The output meter should be kept in the center of the scale by means of the output control on the test oscillator.

*Note:* The i-f circuits are quite selective and extreme care must be taken to insure proper adjustment; otherwise the set will be weak on the high frequency bands.

## ALIGNMENT OF BROADCAST BAND

(1) Disconnect "antenna" lead of oscillator from grid cap of Type 6L7 tube and connect in series with the 150

mmfd. condenser dummy antenna to the antenna terminal of the chassis.

(2) Tune the test oscillator and receiver to a frequency of 1350 kilocycles and adjust condensers C9B, C7A and C5A. (See Fig. 2).

(3) Tune test oscillator and receiver to a frequency of 600 kilocycles and adjust condenser C12B. (See Fig. 2).

(4) Retune the receiver and test oscillator to 1350 kilocycles and make any necessary readjustments on condensers C9B, C7A and C5A.

(5) Calibration and sensitivity of the broadcast band should also be checked at 600 kilocycles, 900 kilocycles and 1350 kilocycles.

## ALIGNMENT OF BAND No. 1

(1) Turn the band selector switch to Band No. 1 (orange band).

(2) Tune test oscillator and receiver to a frequency of 345 kilocycles and adjust condensers C13B, C15 and C14.

(3) Tune test oscillator and receiver to a frequency of 150 kilocycles and adjust condenser C13A.

(4) Retune test oscillator and receiver to 345 kilocycles and retrim condensers C13B, C15 and C14.

(5) Calibration and sensitivity of this band should also be checked at 150 kilocycles, 172.5 kilocycles and 345 kilocycles.

## ALIGNMENT OF BAND No. 3

(1) Replace the 150 mmfd. condenser dummy antenna with a 400-ohm non-inductive resistor dummy antenna.

(2) Turn the band selector switch to the No. 3 Band position (green section of the dial).

(3) Tune test oscillator and receiver to a frequency of 3 megacycles (3000 kilocycles) and adjust condensers C10A, C8A and C6A.

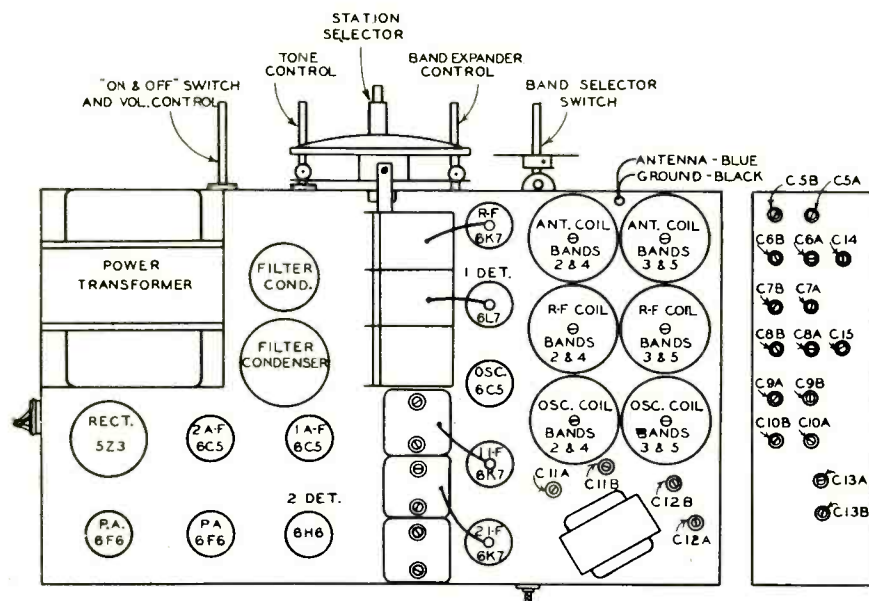
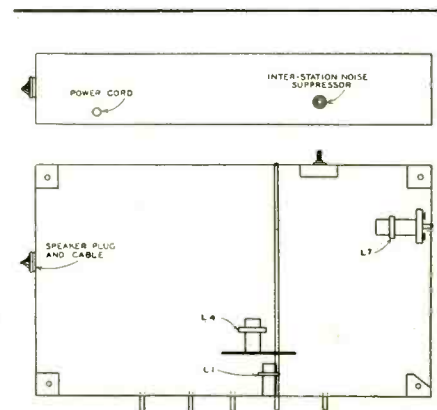

Fig. 2. Top, rear, and under-chassis views showing trimmer locations.





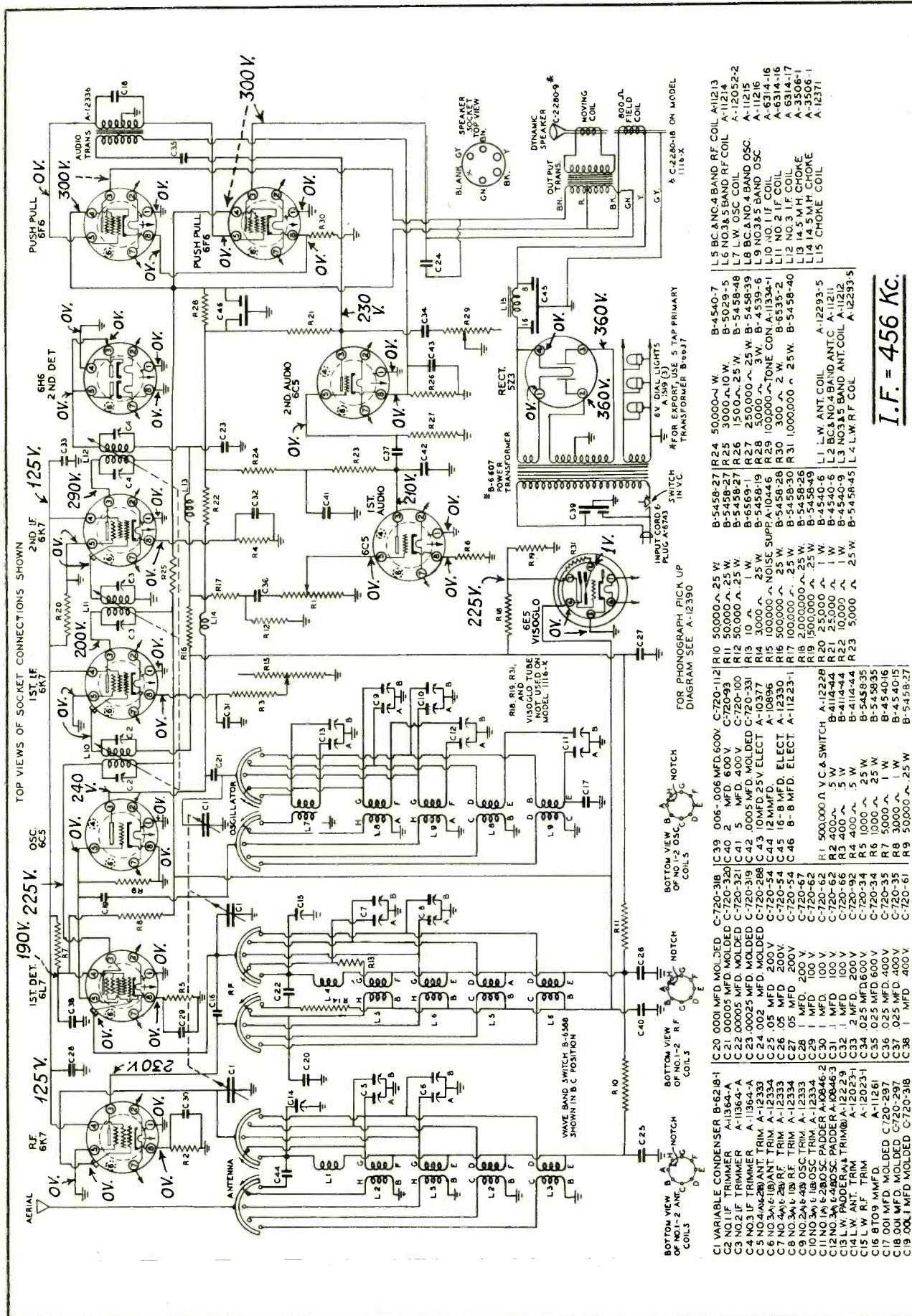

Fig. 1. The complete circuit diagram Sparton 1116-X.

## GENERAL DATA—continued

(4) Tune test oscillator and receiver to a frequency of 1.7 megacycles (1700 kilocycles) and adjust condenser C12A.

(5) Retune test oscillator and receiver to 3 megacycles and check the adjustment of the condensers C10A, C8A and C6A.

(6) Calibration and sensitivity of this band should also be checked at 1.7 megacycles and 3 megacycles.

### ALIGNMENT OF BAND No. 4

(1) Turn the band selector switch to the No. 4 Band position (red section of the dial).

(2) Tune test oscillator and receiver to a frequency of 7.2 megacycles and adjust condensers C9A, C7B and C5B.

(3) Tune test oscillator and receiver to a frequency of 3.6 megacycles and adjust condenser C11B.

(4) Retune test oscillator and receiver to 7.2 megacycles and re-adjust condensers C9A, C7B and C5B.

(5) Calibration and sensitivity of this band should also be checked at 7.2 megacycles, 6 megacycles and 3.6 megacycles.

*Warning:* Extreme care must be taken when adjusting condenser C11B in order that adjustment is not made to the image of the signal rather than the fundamental. The image signal is equal to the fundamental minus twice the intermediate frequency of the receiver. A set that is adjusted to the image frequency instead of the fundamental may be detected by tuning over the band and checking the sensitivity at various points. If a dead spot appears near the center of the band, the adjustable condensers for that band have probably been adjusted to the image instead of the fundamental.

This type of mis-alignment may also be detected by tuning the test oscillator to a frequency of 6 megacycles and the station selector to approximately 6900 kilocycles. If a strong signal is found approximately at this frequency, it indicates that the band has been adjusted

to the image frequency. The normal image frequency for 6000 kilocycles would be 6000 kilocycles minus twice 456 kilocycles or approximately 5100 kilocycles. Therefore, a signal of this frequency may be found with a test oscillator generating a 6000 kilocycle signal.

### ALIGNMENT OF BAND No. 5

(1) Turn the band selector switch to the last short-wave band (No. 5 Band position).

(2) Tune test oscillator and receiver to a frequency of 18 megacycles and adjust condensers C10B, C8B and C6B.

(3) Tune test oscillator and receiver to a frequency of 9 megacycles and adjust condenser C11A.

(4) Retune test oscillator and receiver to 18 megacycles and re-check the adjustment of condensers C10B, C8B and C6B.

(5) Calibration and sensitivity of this band should also be checked at 9 megacycles, 12 megacycles and 18 megacycles.

*Warning:* This band, like Band No. 4, may easily be aligned to the image frequency instead of the fundamental. This may be checked by tuning the test oscillator to a frequency of 15 megacycles and the station selector to approximately 15900 kilocycles. If a strong signal is found approximately at this frequency, it indicates that the band has been adjusted to the image frequency. The normal frequency for 15 megacycles would be 15,000 kilocycles minus twice 456 kilocycles or approximately 14,100 kilocycles. Therefore, the signal of this frequency may be found with a test oscillator generating a 15 megacycle signal.

### Stewart-Warner 142A and 142AS

The Stewart-Warner chassis Models 142A and 142AS differ only in that the 142AS chassis includes a speaker that is mounted directly on the chassis.

### CIRCUIT DESCRIPTION

These receivers employ a superheterodyne circuit using 5 metal tubes and an i-f of 456 kc. The tuning range includes, in addition to the standard broadcast band, the two police radio bands. The circuit diagram is shown in Fig. 1.

The signal picked up by the antenna is impressed on the primary of the antenna transformer, which has connected across it a wave trap for the purpose of eliminating 456-kc interference. The signal is then tuned and impressed on the control grid of the 6K7 oscillator and first detector. The suppressor, or No. 3 grid of the 6K7, is used as the oscillator grid. The 456 kc output of the first detector is amplified in the i-f stage, using a 6K7 tube.

The second detector is of the grid-leak type, and uses a 6J7 tube. The 6J7 is resistance coupled to the 6F6 pentode power amplifier. Bias for the output tube is obtained by grid return connection to the negative end of a resistor connected between the center tap of the power transformer's high-voltage winding and ground. The bias potential so obtained is filtered by a resistance-capacity filter.

When tuning on the short-wave band, local broadcast stations can be heard in the background at their regular positions on the dial. This is a normal condition, and is due to the tapped coil method of tuning the antenna coil secondary to the short-wave band. No aligning adjustments are required on the short-wave band.

### I-F ALIGNMENT

The step-by-step routine given below should be carefully followed. The trimmer numbers referred to are shown in the illustration.

1. Connect the output meter in series with a .25 mfd condenser between the plate of the 6F6 tube and ground, or across the voice coil, depending on the type of meter.

2. Turn the volume control to the maximum volume position. (Note: The volume control should be kept in this position throughout the entire alignment procedure.) Ground the antenna lead to the chassis.

3. Turn the range switch to the right (clockwise) to the broadcast position.

4. Adjust the test oscillator to exactly 456 kc and connect its output to the control grid of the 6K7 first detector tube and the chassis.

5. Align i-f trimmers Nos. 1, 2, 3, and 4, for maximum output as indicated

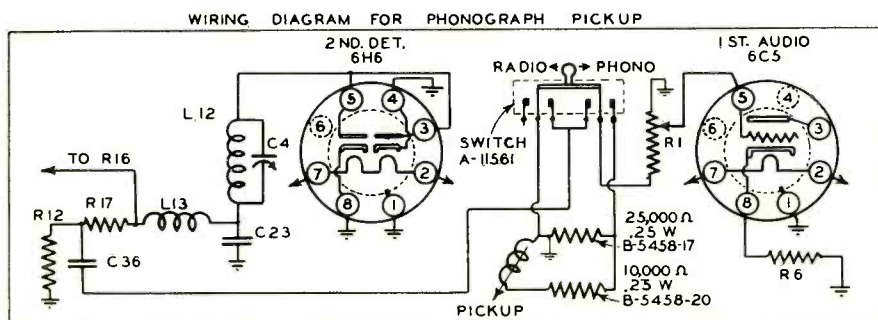

Fig. 3. Phonograph connections Sparton 1116X.



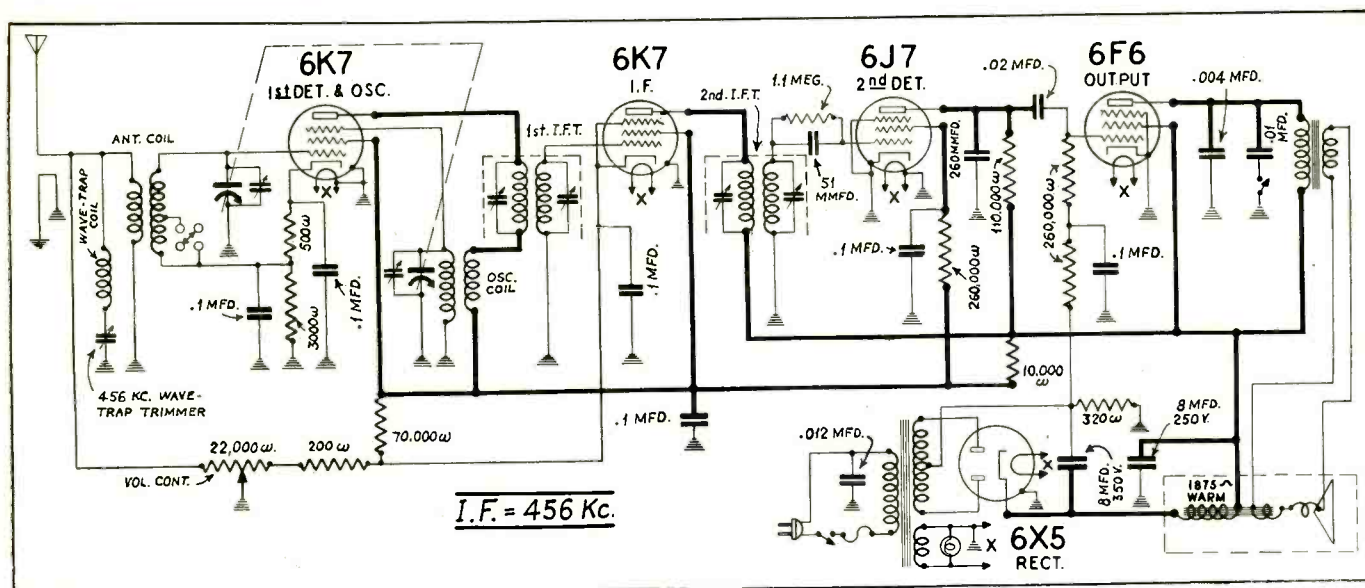

Fig. 1. Complete circuit diagram Stewart Warner 142A, 142AS.

on the output meter. No inward or side-ward pressure should be applied to the alignment tool or the condenser may spring back to a different setting as soon as the tool is removed.

6. Repeat all i-f trimmer adjustments since the changing of each trimmer will affect the others to a certain extent.

456 KC WAVE-TRAP ADJUSTMENT

1. Disconnect the antenna lead from ground.

2. Connect the test oscillator output in series with a 400-ohm carbon resistor to the receiver antenna lead, and connect the test oscillator ground lead to the receiver chassis. Ground the chassis.

3. Without changing the test oscillator from the frequency setting used in aligning the i-f stage, adjust trimmer No. 5 for *minimum* output. Increase the test oscillator output as a minimum is reached, in order to obtain a clearly defined setting of the trimmer. *Note:* If

code interference is troublesome on a frequency in the neighborhood of 456 kc, the wave trap should be adjusted for *minimum* output with the test oscillator set to the same frequency as the signal that is causing interference.

DIAL CALIBRATION

If the receiver should require calibration, proceed as follows:

1. Turn the gang condenser to full mesh and check to see that the dial pointer indicates 530 kc. If not, remove the dial knob and turn the pointer to the correct position by means of a sharp tool inserted in the pointer slots which may be reached through the dial glass. Replace the dial knob.

2. Adjust the test oscillator to 1400 kc.

3. Turn the condenser gang until the dial pointer indicates 1400 kc.

4. Adjust trimmer No. 6 (oscillator shunt trimmer) for maximum output without changing the setting of the gang condenser.

R-F ALIGNMENT

1. Set the test oscillator to 1400 kc and apply the signal to the receiver antenna lead through a 400-ohm carbon resistor.

2. Tune the receiver to the signal for maximum output.

3. Adjust trimmer No. 7 (detector shunt trimmer) for maximum output.

SOCKET VOLTAGES

An under chassis view is given in Fig. 2, showing the voltages encountered at the various socket prongs. A voltmeter having a resistance of 1000 ohms per volt was used in making the measurements. In connection with this diagram the following notes are referred to:

*Note A.* The bias on the 6F6 is minus 14 volts and is measured across the 320-ohm flexible wire-wound resistance.

*Note B.* The cathode voltage varies, with the setting of the volume control, from 2.5 volts to 30 volts.

*Note C.* Grid voltage for the 6K7 first detector is 17 volts and is measured across the 3000-ohm carbon resistor in the cathode circuit. Grid bias is 3 volts and is the drop in the 500 wire-wound resistor in the same circuit.

Philco 680

*Distortion:* Distortion on high volume, especially with the tone control on bass, may be caused by a defective 1.0-mfd condenser (C172) in the plate circuit of the second a-f and abc amplifier. This condenser is one of four in a can.

H. H. Schock.

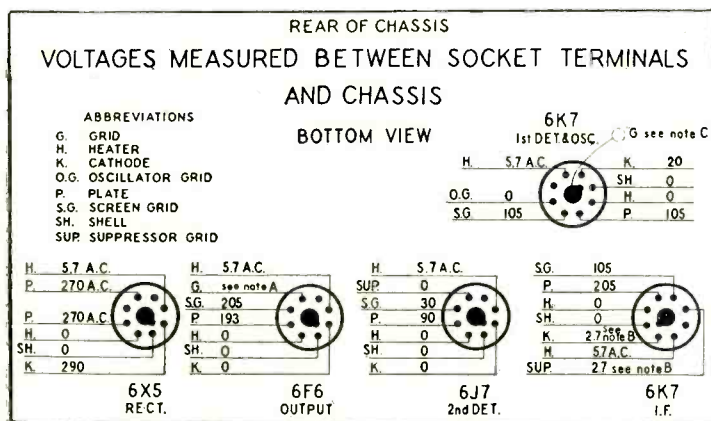

Fig. 2.

GENERAL DATA—continued

MODEL NUMBER	184	535	725	456	676	515Q	485Q	305Z	565Z	717	637	237Q	467Q	657Q	747Q	328	649	649RP	810	509		
CABINET	COMPACT	CONSOLE	COMPACT	COMPACT	CONSOLE	COMPACT	CONSOLE	COMPACT	CONSOLE	CONSOLE	COMPACT	COMPACT	CONSOLE	COMPACT	CONSOLE	CONSOLE	CONSOLE	CONSOLE	CONSOLE	CONSOLE	"TUNE-O-MATIC"	
LINE SUPPLY	110 V. 60 C.	110 V. 60 C.	110 V. 60 C.	110 V. 60 C.	110 V. 60 C.	2 V. 115 V. 225 V. C.	2 V. 115 V. 225 V. C.	22 VOLTS DC	1.6-4.8 MC 5.3-18 MC	110 V. 60 C.	110 V. 60 C.	6 V. BATTERY	6 V. BATTERY	160 V. B.	110 V. 60 C.	110 V. 60 C.	110 V. 60 C.	110 V. 60 C.	110 V. 60 C.	110 V. 60 C.	110 V. 60 C.	110 V. 60 C.
PHONOGRAPH TERMINALS		YES		YES						YES											YES	
FREQUENCY	540-1712 KC	540-1712 KC 5.4-18 MC	540-1712 KC 5.4-18 MC	540-18000 KC	540-18000 KC	540-18000 KC 5.4-18 MC	540-18000 KC 5.4-18 MC	540-18000 KC 5.4-18 MC	540-18000 KC 5.4-18 MC	540-18000 KC	540-18000 KC	540-18000 KC	540-18000 KC	540-18000 KC	540-18000 KC	540-18000 KC	540-18000 KC	540-18000 KC	540-18000 KC	540-18000 KC	540-18000 KC 5.4-18 MC	
LINE WATTS	45	60	60	70	70	25 MA "B"	25 MA "B"	40	40	60	60	2 AMPS.	2 AMPS.	30 MA "B"	30 MA "B"	90	120	120	120	120	125	
OUTPUT WATTS	2	3.3	3.3	3.3	3.3			2	2	3.3	3.3					4.5	6.6	6.6	6.6	19	6.6	
I. F. FREQUENCY	450 KC	450 KC	450 KC	264 KC	450 KC	450 KC	450 KC	264 KC	450 KC	472 1/2 KC	472 1/2 KC	472 1/2 KC	472 1/2 KC	472 1/2 KC	472 1/2 KC	472 1/2 KC	472 1/2 KC	472 1/2 KC	472 1/2 KC	472 1/2 KC	472 1/2 KC	
SPEAKER	DYNAMIC 8 1/2" 52500	DYNAMIC 11" 41800	DYNAMIC 8 1/2" 41900	DYNAMIC 8 1/2" 41800	DYNAMIC 11" 41800	MAGNETIC 8 1/2" 55500	MAGNETIC 8 1/2" 55500	DYNAMIC 8 1/2" 42700	DYNAMIC 11" 42800	DYNAMIC 11" 41800	DYNAMIC 8 1/2" 41900	MAGNETIC 50700	MAGNETIC 50800	MAGNETIC 50700	MAGNETIC 50800	DYNAMIC 11" 41800	DYNAMIC 11" 50100	DYNAMIC 11" 50100	DYNAMIC 11" 50100	DYNAMIC 11" 53500	DYNAMIC 11" 46600	
TO NE CONTROL	2-POINT	3-POINT	3-POINT	3-POINT	3-POINT	3-POINT	3-POINT	3-POINT	3-POINT	3-POINT	3-POINT	3-POINT	3-POINT	3-POINT	3-POINT	4-POINT	4-POINT	4-POINT	4-POINT	4-POINT	4-POINT	
SELECTIVITY: FIDELITY SWITCH																	YES	YES	YES	YES	YES	
SHADOW METER																	YES	YES	YES	YES	YES	
DUAL-SPEED TUNING DRIVE					YES			YES		YES				YES			YES	YES	YES	YES	YES	
VARIABLE CONDENSERS	2	2	2	3	2	2	2	3	3	3	3	3	3	3	3	3	3	3	3	3	3	
NUMBER OF TUNED CIR. CUTS	4	6	6	7	8	8	8	7	7	7	7	9	9	9	9	9	9	9	9	9	12	
TYPE DIAL	ILLUMINATED WINDOW IN CABINET	AEROPLANE	AEROPLANE	AEROPLANE	AEROPLANE	AEROPLANE	AEROPLANE	AEROPLANE	AEROPLANE	AEROPLANE	AEROPLANE	AEROPLANE	AEROPLANE	AEROPLANE	AEROPLANE	AEROPLANE	AEROPLANE	AEROPLANE	AEROPLANE	AEROPLANE	FULL VISION SCALES	
RADIO FREQUENCY	6C6	6A8	6A8	6A8	6A8	6A8	6A8	6A7	6A7	6K7	6A8	6K7	6A8	6K7	6A8	6K7	6A8	6K7	6A8	6K7	6A8	
1st DETECTOR & OSCILLATOR	6C6	6A8	6A8	6A8	6A8	6A8	6A8	6A7	6A7	6K7	6A8	6K7	6A8	6K7	6A8	6K7	6A8	6K7	6A8	6K7	6A8	
INTERMEDIATE FREQUENCY	6C6	6K7	6K7	6K7	6K7	(2) 1A4	(2) 1A4	78	78	6K7	6K7	34 (2)	34 (2)	34 (2)	34 (2)	34 (2)	34 (2)	34 (2)	34 (2)	34 (2)	6K7(2)	
2nd DETECTOR	6C6	6K7	6K7	6K7	6K7	6K7	6K7	6K7	6K7	6K7	6K7	6K7	6K7	6K7	6K7	6K7	6K7	6K7	6K7	6K7	6K7	
AUTOMATIC VOL. CONTROL		75	75	6H6	6H6	1B5	1B5	75	75	6H6	6H6	1B5	1B5	1B5	1B5	6H6	6H6	6H6	6H6	6H6	6H6	
1st AUDIO	42	6F6	6F6	6F5	6F5	33	33	43	43	6F5	6F5	6F6	6F6	6F5	6F5	6F5	6C5	6C5	6C5	6C5	6C5	
2nd AUDIO		6F6	6F6	6F6	6F6	33	33	43	43	6F6	6F6	6F6	6F6	6F6	6F6	6F6	6F6(2)	6F6(2)	6F6(2)	6F6(2)	6F6(2)	
3rd AUDIO																						
RECTIFIER	80	80	80	5Z4	5Z4			6Z4	6Z4	5Z4	5Z4	6Z4	6Z4	5Z4	5Z4	5Z4	5Z4	5Z4	5Z4	5Z4	5Z4	

Technical features of 1936 Atwater Kent radio receivers.

\* With doublet terminals.  
\*\* Model 649RP phonograph combination is available with standard and automatic record changer.



# Auto-Radio . .

## DeWald Model 517

The 517 is a five-tube superheterodyne with a tuning range from 540 to 1550 kc. The complete circuit diagram is shown in Fig. 1. The resistance and capacity values, as well as the voltages encountered, are lettered on the diagram. A chassis layout is given in Fig. 2, with the various trimmer condensers pictured.

### THE CIRCUIT

The 6A7 detector-oscillator, and the 6D6 i-f, are cathode biased. The bias voltage is equal to the combined drop in the 150-ohm and the 50-ohm resistors. (See Fig. 1.) The i-f frequency difference is maintained through the special cut of the oscillator section of the gang condenser. The plate of the 6A7 mixer feeds the doubly-tuned, sectionalized, i-f transformer; which in turn supplies the signal to the 6D6 i-f tube. The second detector i-f transformer is primary tuned; the secondary feeding the diode plates. The d-c drop in the diode load is used to supply avc to both the i-f stage and the r-f portion of the 6A7. The audio developed across this resistor is fed to the

triode section of the 75, through a resistance-coupled network, which in turn amplifies it and passes it on to the 41 output pentode.

The bias for the 75 is taken from the drop in the 50-ohm section of the r-f bias resistor. Because of the very small value of this resistance the large bypass condenser, usually necessary in such circuits, may be omitted.

Plate and screen supply is obtained from the storage battery-vibrator-step-up transformer system which employs the new Raytheon OZ4 metal-glass rectifier. This is of the filamentless, gaseous type; and is largely responsible for the low drain of the receiver. The rectifier has a constant voltage drop of only 25 volts, which when considered along with the saving in filament power, makes for efficiency.

### ALIGNMENT PROCEDURE

The output meter is connected across the primary of the output (speaker) transformer. Turn on the receiver and the signal generator. Short out the oscillator (cut) section of the gang condenser. Set the volume control at the maximum position.

Connect the antenna lead of the test oscillator to the grid of the 6A7. Connect the ground lead of the test oscillator to the chassis ground. Tune the test oscillator to 456 kc. Adjust its signal so that the output meter reads on the center of the scale.

Peak the second detector i-f trimmer mounted to the rear of the speaker assembly. (See Fig. 2.) Peak both i-f trimmers on top of the aluminum shield. (See Fig. 2.) Repeat these adjustments to assure correct alignment.

### R-F ALIGNMENT

Remove the short from the oscillator section of the variable condenser. Connect the antenna lead from the test oscillator to the antenna lead-in of the receiver. Set the test oscillator on 1500 kc and tune the receiver to 1500 kc (on the dial).

First, adjust the trimmer on the oscillator section of the condenser gang, and then adjust that for the r-f section; until maximum output is indicated. The level of the test oscillator should be lowered, as the stages are brought into alignment, so as to keep the output meter in the center of the scale.

It is advisable to seal the trimmers, with a wax or similar compound, to prevent shifting due to vibration.

### INSTALLATION AND NOISE SUPPRESSION

It is important that all items and connections in the electrical system of the car be in good condition. If exces-

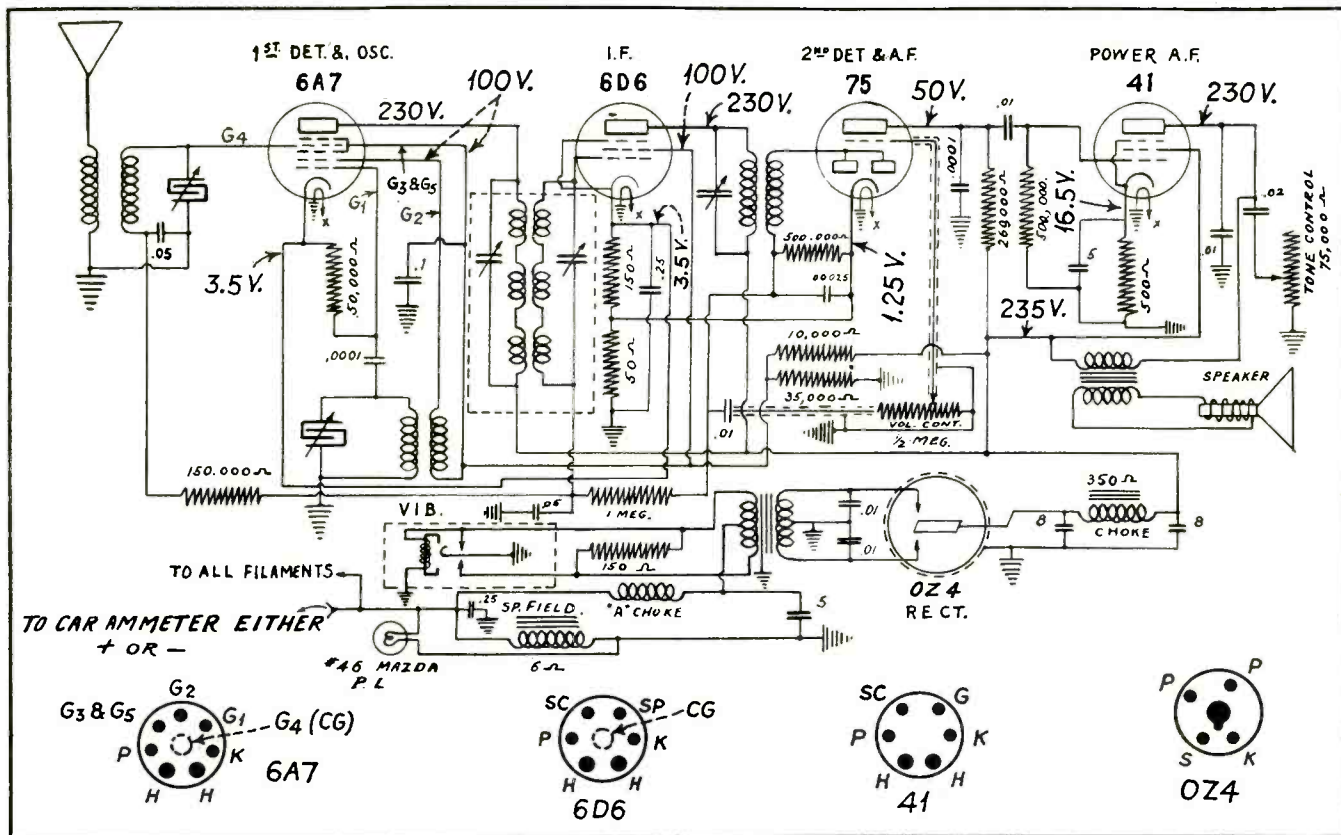

Fig. 1. Complete circuit diagram DeWald 517.

sive noises are present it may be well to examine the following points:

1. *Antenna lead:* A shielded antenna lead is connected to the set. If any connections, extensions or alterations are made to this lead care should be taken to see that the lead is well shielded to a point outside the field of interference. It is also necessary to ground the "far" end of the antenna lead-in shield.

2. *Battery:* The battery should be kept in a fully charged condition and the terminals cleaned of corrosion. Check generator charging rate to keep battery in charged condition.

3. *Ignition coil:* In cases where noise is originating from the ignition coil, it may be overcome by placing a copper shield around the coil and grounding same.

4. *Battery cables:* May be corroded at the battery and are making imperfect contact. Keep all battery cables and wires away from the high-tension system. It may also be of advantage to place a choke coil of about 50 turns of No. 16 wire in series with the main battery lead to the set.

5. *Wires under car:* Where wires run along chassis or other metal parts below the car they should be inspected for quality of insulation and general condition. It may be well to place a condenser at the stop-light switch and at the tail-light.

6. *Distributor:* Points may be burned or improperly adjusted. Rotor arm may be making poor contact with cap.

7. *Distributor cables:* Cables may be leaking due to poor or burned insulation. In some installations it may be necessary to shield the high-tension leads with copper braid. If ignition cables are insulated with plain rubber insulation it is not advisable to place shielding directly over the wire. In this case the wire should be first covered with a varnished composition covering or loom. The battery lead from the ammeter to

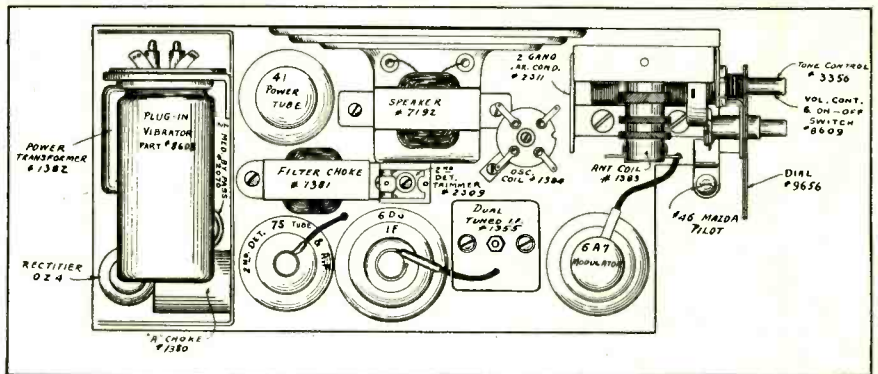

Fig. 2. Chassis layout DeWald 517.

the distributor coil and the battery lead to the generator should be shielded.

8. *Dome light wire:* If dome light wire is radiating, it may be necessary to shield this wire. A .5 mfd condenser or a choke in series with this lead bypassed at either side of choke to chassis may help considerably. These connections should be made at the point where the dome light enters the upright post.

9. *Bonding:* Although metal joints on the car, such as dash panel to side of car, etc., may appear to be solid they may not make good electrical contact and cause noise. Paint and other material may get into seams and cause poor or intermittent contacts and for this reason it may be necessary to bond certain parts of the car. The brake rods, drive shaft tubes and parts around the motor should be bonded.

tach the two units it is but necessary to remove one nut, slip the fitting over the end of the "U" bolt and then replace the nut.

The antenna itself, has been made in the form of a spring. This spring is covered by a weatherproof material and the front end of the spring is fitted with an insulator as well as a hook and lock device which permits the Service Man to attach this end to the car, at any convenient spot, in a jiffy.

If the car is such that an antenna of more or less triangular form is desired the two hooks on the front ends of the antenna may be attached to some projection on the under part of the car. If, however, it is desirable to separate the front ends of the units they may be separated as shown in the dotted lines in the accompanying illustration.

An automobile antenna will generally function better when it is coupled to the receiver by means of a matched-impedance transmission line. This type of line may be employed with this aerial.

**The Undercar Spring Aerial**

As will be seen from the accompanying illustration the antenna now manufactured by Arthur H. Lynch, Inc., 227 Fulton St., New York City, is made so that it may be attached to the front side of the "U" bolts which hold the chassis to the rear axle. In order to at-

**Ignition Interference**

Probably the greatest single help to clearing up ignition interference after suppressors and capacitors have been attached is the proper shielding of the antenna lead. This should be shielded for a distance of at least 2 feet and grounded at each end to the car frame. The shield must cover the lead right up into the receiver, not just up to it. One-half inch of exposed lead at the receiver end can pick up considerable interference, even though the shield is well grounded. The length of shield is not critical after about 2 feet and several feet of unshielded antenna lead—on the antenna end is not harmful. "Zero-length" pigtailed are the goal of all auto radio designs.

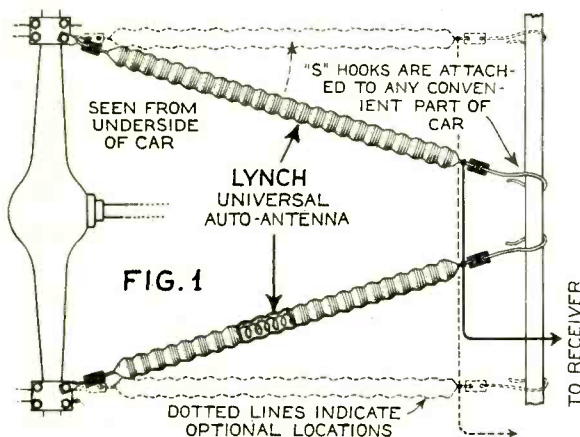

Undercar Aerial.

RCA Radio Service Tip File



# NOW!

# GET THIS AMAZINGLY VERSATILE SUPREME INSTRUMENT

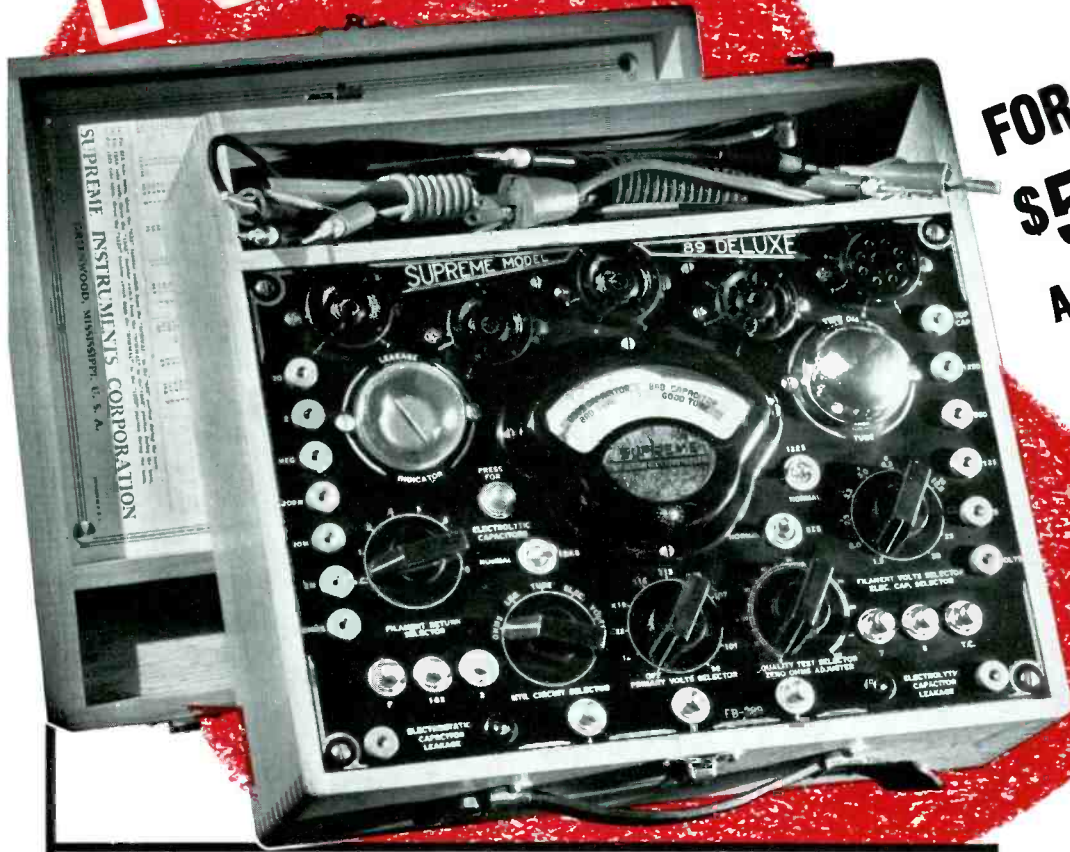

**FOR ONLY \$5.00 DOWN AND \$4.55 PER MONTH**

**FROM YOUR OWN JOBBER**

You can still get SUPREME instruments on the easiest terms ever offered. Our own S. I. C. Payment Plan allows you to select whatever equipment you need—either portable or counter type—and pay for it in ten easy monthly payments. **NO RED TAPE!** Just go (or write) to your jobber NOW—order any Supreme Instrument you want—fill out the S. I. C. form—and we will take care of everything! Don't pass up this opportunity!

### TERMS AND SCHEDULE OF PAYMENTS

Model	Cash Price	Time Pay't Price	Deposit	Monthly Payment
385 Automatic	77.95	85.75	8.50	7.72 (10 months)
89 De Luxe	45.95	50.55	5.00	4.55 (10 months)
339 De Luxe	39.95	43.95	4.50	3.94 (10 months)
189 Signal Generator	36.95	40.65	4.00	3.66 (10 months)

Other SUPREME instruments may be purchased on equally convenient terms.



The full line of SUPREME Instruments and all the details on the easiest payment plan in history are described and illustrated in a new folder just off the press! Write for your **FREE** copy TODAY!

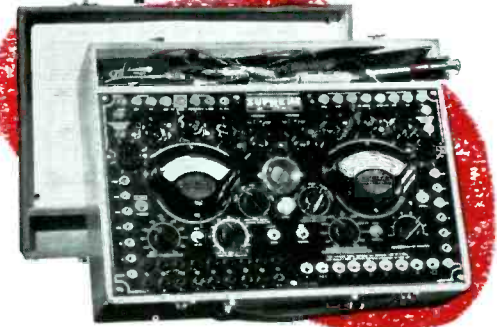
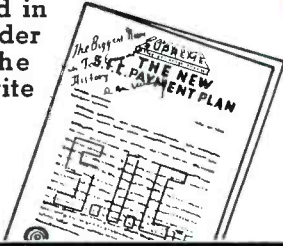

**SUPREME INSTRUMENTS CORP.,** Greenwood, Miss., U. S. A.  
 Export Dept., Associated Exporters Co., 145 W. 45th St., New York City, N. Y. Cable Address, LOPREH, N. Y.



## A BRIEF MESSAGE

... from an organization which understands your problems and is working closely with the Service Fraternity.

### "NOISE-MASTER"

makes every receiving set a BETTER set

Electrically  
**AUTOMATIC**  
in Operation

List Price  
**\$6.75**

with special transformers for European broadcast bands... List \$7.00

Also

### "EMPEROR"

Cat. No. 11

Price List **\$4.30**

### "CONQUEROR"

Cat. No. 12

Price List **\$3.40**



has always stood as a symbol of **QUALITY** and scientific precision. No better antenna materials or radio wire can be had at any price.

## NOISE-MASTER

• ALL-WAVE ANTENNA •

This problem of NOISE, Public Enemy No. 1 to All-Wave Reception, is ours and yours alike. With the splendid "NOISE-MASTER" unit, you can really build **QUIET** into any set, anywhere. "NOISE-MASTER" picks up and strengthens weak oversea signals, eliminates "man-made" static, improves broadcast as well as short-wave reception. It is the most flexible and effective unit of its kind, and should be in your "bag of tricks." May we suggest that you specify this remarkable aid to good radio performance on your next installation.

*Write for Special Antenna Literature*

**CORNISH WIRE CO.**  
30 Church Street New York City



# Public Address . . .

## The Human Ear

THROUGHOUT sound measurements results are reduced to physical units capable of specification and comparison. Such specifications neglect the physiological characteristics of the human ear.

It is comparatively difficult to treat the ear as a piece of acoustical apparatus and give descriptive data and curves, because of the wide variation of such data as taken on individual ears.

### THRESHOLD OF HEARING

The curve shown in Fig. 1 is an attempt to treat the ear as a piece of apparatus. It represents the upper and lower limits or thresholds of audibility as averaged from a number of normal ears. Sound pressures greater than those indicated by the upper curve produce the sensation of pain, and pressures less than those indicated by the lower curve are inaudible. Frequencies below the lower junction of the curves, if perceived at all, are felt rather than heard. Few ears are capable of responding to frequencies above 20,000 cycles. All ears are most sensitive to frequencies between 1000 and 4000 cycles.

The response to variation in sound pressure is almost a constant percentage of the original intensity over the frequency range from 100 to 8000 cycles. In other words, loudness as perceived by the human ear is proportional to the logarithm of the sound intensity.

The perception of frequency change (in the range from 500 to 8000 cycles), for practical purposes, can be considered a constant percentage of the initial frequency. The exact value of the ratio is somewhat dependent upon the pitch as well as the frequency.

Examination of the lower curve in Fig. 1 will explain the apparent change in quality when music is reproduced at a level other than that at which it was originally played. If the intensity is decreased, a loss in low and high frequency tones will result.

In designing volume-expander circuits care must be exercised to prevent frequency distortion by the human ear. In discussing the auto-expressionator in last month's SERVICE, mention was made of the permanently unbalanced part of the circuit designed to prevent the attenuation of lower-frequency tones. These tones, if suppressed, will drop

below audibility before those of the middle register.

The lower curve in Fig. 1 also explains why the communication type microphone, described in last month's SERVICE, sounded best on actual test. Its response curve is practically a reciprocal of the threshold curve reproduced in Fig. 1.

### SUBJECTIVE TONES

Subjective tones, the name given harmonics and beat notes produced by the ear itself, result from sound waves of large amplitude. These sum and difference frequencies and harmonics are not present in the original wave train and yet are detected by the hearing organs and transmitted to the brain. If the fundamental of a powerful sound wave train is removed, without upsetting the wave form of the remaining sound, the volume will drop, but the pitch will remain substantially the same. The harmonics of the fundamental will combine in the ear to produce a difference frequency. The resulting wave train transmitted to the brain will, therefore, contain the missing fundamental in the form of a subjective tone.

The reduction of the sensitivity of the human ear by the presence of interfering sounds or noises is called masking. Although the interfering wave train may be simple in makeup, the detection of beats and the generation of harmonics in the ear itself will create subjective tones which will cover a substantial portion of the audible

range, and effectively deafen the ear to sounds of any frequency having low intensity, as compared to the interfering vibrations.

The generation of subjective tones in the ear is responsible for the passably acceptable tone character of some of the cheaper radio receivers and loudspeakers. The ear supplies many of the missing frequencies, as explained above.

Masking explains why it is necessary to raise the intensity of the voice in noisy locations, even if the wave form or frequency makeup of the noise is simple.

### THE BINAURAL EFFECT

If a sound is heard by *both* ears, the direction of the source can be distinguished. However, if either ear is blocked the ability to locate the sound is lost. G. W. Stewart, in the Physical Review, finds that the apparent position of the source of the sound is dependent only upon the difference in time of arrival of like phases at the two ears.

It has been found that this characteristic of the human ear exists only for the lower frequencies. The average person can no longer locate the source of a sound if the frequency is above 1500 cycles.

A very interesting experiment is suggested by Olson and Massa, in their text, "Applied Acoustics," to demonstrate the binaural phase effect. Supply each ear with a sound source of slightly different frequency. The combination results in an apparent single source which appears to move about the head as the phase difference between the tone as heard by each ear changes. The source will not move in a complete circle around the head, but will suddenly jump from one side to the other and move around in a semi-circle.

Upper and lower hearing limits for average human ears.

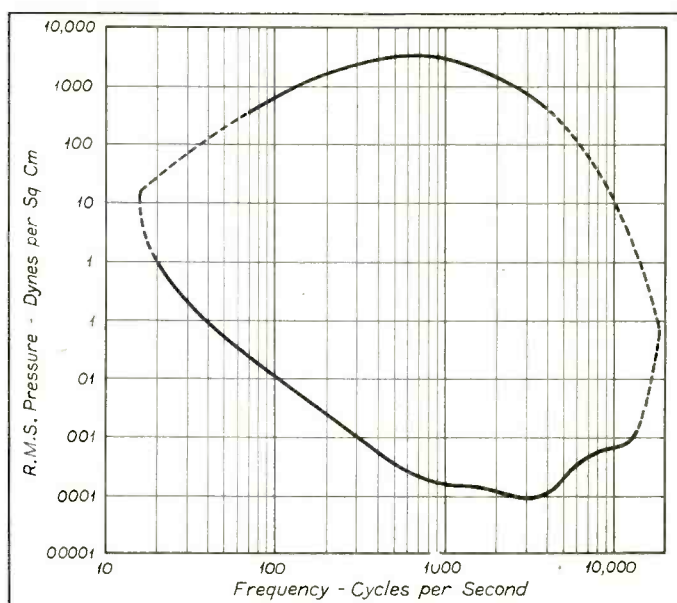

# ON THE JOB . . .

## Short Tester For Tubes

A short tester for tubes, which really indicates a short between any two elements of the tube can be made with a  $\frac{1}{4}$  watt neon bulb, several 1-meg resistors, and an 0.25-mfd condenser.

Eight or nine 1-meg resistors are connected in series with the neon tube, the 0.25-meg condenser, and the a-c line. The *fewest* number that will cause the tube to remain black is used. Shorting out one resistor should cause the

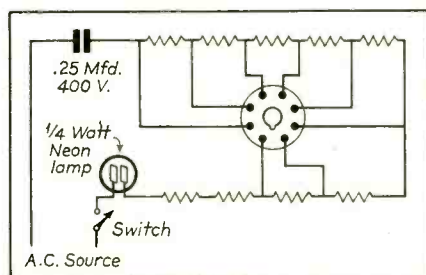

bulb to glow. By connecting the junction between each two resistors to a separate prong on the short tester socket, a short between elements will be indicated by a glowing of the neon bulb. Lacquered wire should be used in wiring the tester to prevent leakage between the wires from causing the neon to glow.

The condenser is used so that emission currents (d-c) should have less effect.

Higher values of resistance may be used if a secondary voltage higher than the line voltage is available. This will prevent glowing due to leakage between the tube prongs.

## Reducing Free Calls

A. Keep a file of Receiver Case Histories, and *use it* on every job. Do more than just replace the one part that happens to have failed. Remember condensers may be leaky, resistors may be partly cooked, and values may change. They usually fail just after the set has been fixed.

B. Before returning the set to customer:

1. Install new pilot lamp.
2. Install 0.05- or 0.1-mfd line filter condensers in chassis, if not already there. This prevents hum pickup from a-c lines.
3. Align every job before delivery.
4. Check speaker cones for filings, alignment of voice coil, and dried up cemented seams.
5. Clean and tighten tuning-con-

denser wiper contacts, clean dial-scale.

6. Tap chassis and tubes to check for intermittent or noisy operation.

7. Replace old audio coupling-condensers with same or preferably higher capacity units, 0.1- to 0.25-mfd condensers will improve bass on many receivers.

C. When returning the set to customer:

1. Inspect aerial and ground connections, replacing lead-in strip and clamp if needed.
2. Screw tuning knobs on shafts in a secure manner.
3. See that dial calibration is right.
4. Check a-c cord plug and receptacle for good contact.
5. Examine nearby lamps and fixtures for loose or arcing bulbs.
6. Explain the causes of noise and interference between adjacent stations so your customer knows what to expect.
7. Tighten all cable connections (if any) securely. *Al. Beers.*

## Solving Pilot Light Problems

A unique method of obtaining a voltage source for the pilot light in an a-c, d-c receiver is shown in accompanying illustration. This gives initial protection against the high starting currents encountered because the cold resistance of the heaters is considerably lower than the resistance at operating temperatures.

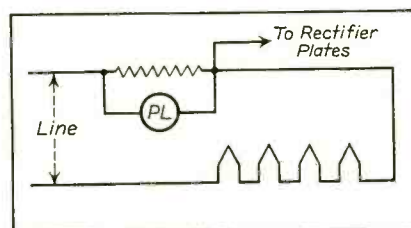

This scheme depends upon the fact that plate current does not flow until the heaters have warmed up. Thus a lower value fixed resistor may be employed for the same operating voltage on the lamp.

*Radio Engineering, March 1936.*

## Exact Duplicates Save Money

Although every one agrees that the logical replacement is a condenser absolutely matching the original, few Service Men realize that exact duplicates generally save money as well.

In the usually crowded chassis every inch of space is utilized by the set designer. There is probably room only for the original condenser. If it is a multiple-section unit, its replacement with

several standard units not only may not fit the available space but the job cannot be as neat. The set owner is quick to find fault with a mess of condenser taped together in place of the original single business-like unit. Such improvisation, may serve in an emergency, but is not the ultimate aim of radio servicing.

The Service Man should check the costs of the exact duplicate replacement



and the improvised group of units in each case. Generally, the exact duplicate unit will be found to cost less than the assortment of corresponding units.

Ultra-compact general utility electrolytics have been made available during the past year, but in no sense can they be considered as doing away with exact duplicate replacements in better grade servicing.

The Aerovox Corporation prepares 4 pages of listings, of exact duplicates, which may be obtained upon request.

*Chas. Golenpaul*

## Testing AVC Action

AVC voltage applied to the control grid of the r-f tube causes a drop in plate current, which in turn causes less voltage drop across the cathode resistor. By using this information and measuring this cathode drop, the amount of avc action can be quickly determined. This does not disturb the circuit balance.

All that is needed to make this test is a low reading voltmeter with test leads. By using a lead with a ring at one end to slip over the cathode prong, the set may be tested in the cabinet.

*RCA Radio Service Tip File*

## Solder Holder

A length of dial cable run through two screwhooks, as shown, with a

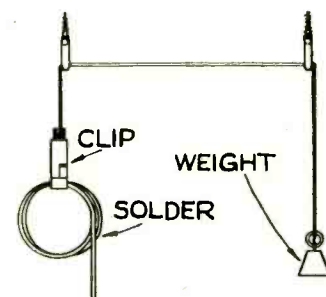

weight on one end and a clip on the other, will keep solder handy but out of the way when not needed.

*R. C. A. Radio Service Tip File.*



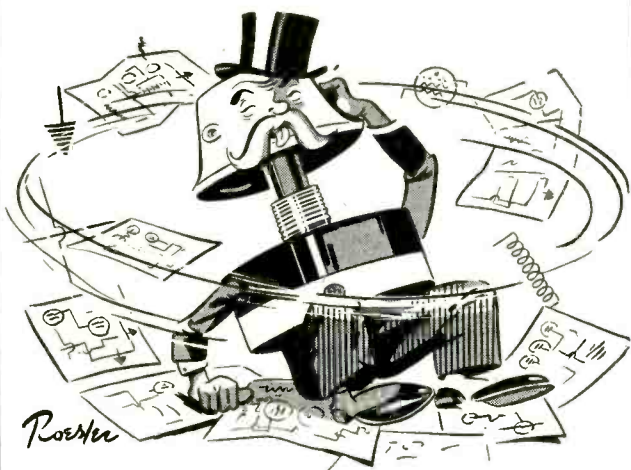

## —“the Circuits go 'round & 'round

Service any set with a song . . . no matter how involved the circuit . . . that is, if you've been tipped off to use **CENTRALAB** replacement parts wherever **Volume Controls** and **Fixed Resistors** are indicated.

Get off the "merry-go-round" of service headaches. Ask for and insist on **CENTRALAB**.

The New 1936 **CENTRALAB** Volume Control Guide is ready with up-to-the-minute data never before shown. All listings extremely accurate.

See your jobber for **FREE** copy.

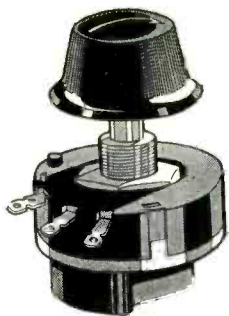

Every Radio Service Man should be a member of the Institute of Radio Service Men

# Centralab

MILWAUKEE, WIS.

**RADIOHMS SUPPRESSORS**  
**FIXED RESISTORS**

# A SENSATION THE SYLVANIA TECHNICAL MANUAL!

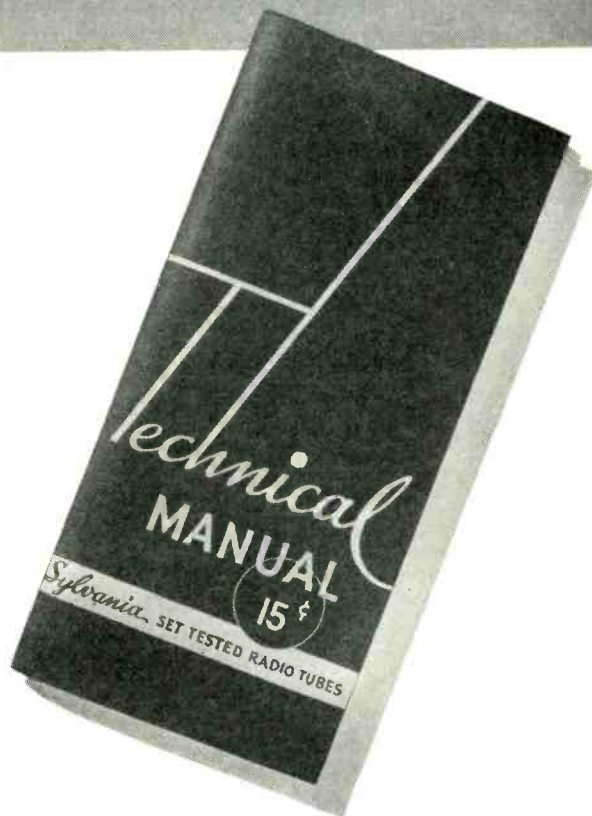

IN JUST 30 DAYS . . . THE SYLVANIA TECHNICAL MANUAL HAS CAUSED A SENSATION AMONG RADIO MEN ALL OVER THE COUNTRY!

● And why not? It's the most complete and informative manual Sylvania has ever published! Here are just a few of the features of this book:

1. A 50% increase in contents.
2. 141 tube types listed with important circuit application information given on each type.
3. Characteristics on all types are the latest, including all the standard types of metal tubes.
4. A section on circuits has been increased to include 13 typical radio receiver and amplifier circuits which show proper use of the most popular types of tubes now being employed.
5. Curve data on ballast tubes for battery sets.
6. The convenient pocket-size has been retained in spite of the large increase in material.

Send 15c for this new Technical Manual NOW!  
It will mean cash in your pocket.

*Hygrade Sylvania Corporation, makers of Sylvania Radio Tubes and Hygrade Lamps. Factories at Emporia, Pa., Salem, Mass., and St. Mary's, Pa.*

## SYLVANIA

HYGRADE SYLVANIA CORPORATION  
Emporium, Pa.

S-46

Please send me the new Sylvania Technical Manual. I enclose 15c in stamps.

NAME .....

ADDRESS .....

CITY..... STATE.....

# TEST EQUIPMENT...

## Precision Modernized Analyzer

MANY Service Men are finding that a rapidly changing market is making it increasingly difficult for them to render maximum efficiency, largely because their equipment hasn't kept pace with these changes. The Service Man operating under such a handicap is not doing justice to himself, since the equipment he is using, which is gradually becoming obsolete, still retains most of its inherent value and can be modernized into master selective instruments.

Good set analyzers such as the Weston types 537, 547, 565, 566; the Jewell types 198, 199, 408, 409, 444; or the Supreme types 99A, 400A, 400B, 401, 91, etc., can be modernized. The Service Man should decide whether they are worth keeping up-to-date.

### THE CIRCUIT

The Precision Modernized Analyzer, shown in the illustrations, (circuit diagram Fig. 1) can be constructed from one of the types mentioned above. Two meters are used to assure more permanent calibration, usually not available with rectifier type meters. The original instruments should be used after thorough cleaning, balancing, and adjusting. Capacity scales can be included on the a-c meter for the purpose of directly reading the capacity of condensers without referring to charts or graphs.

The analyzer should be made as flex-

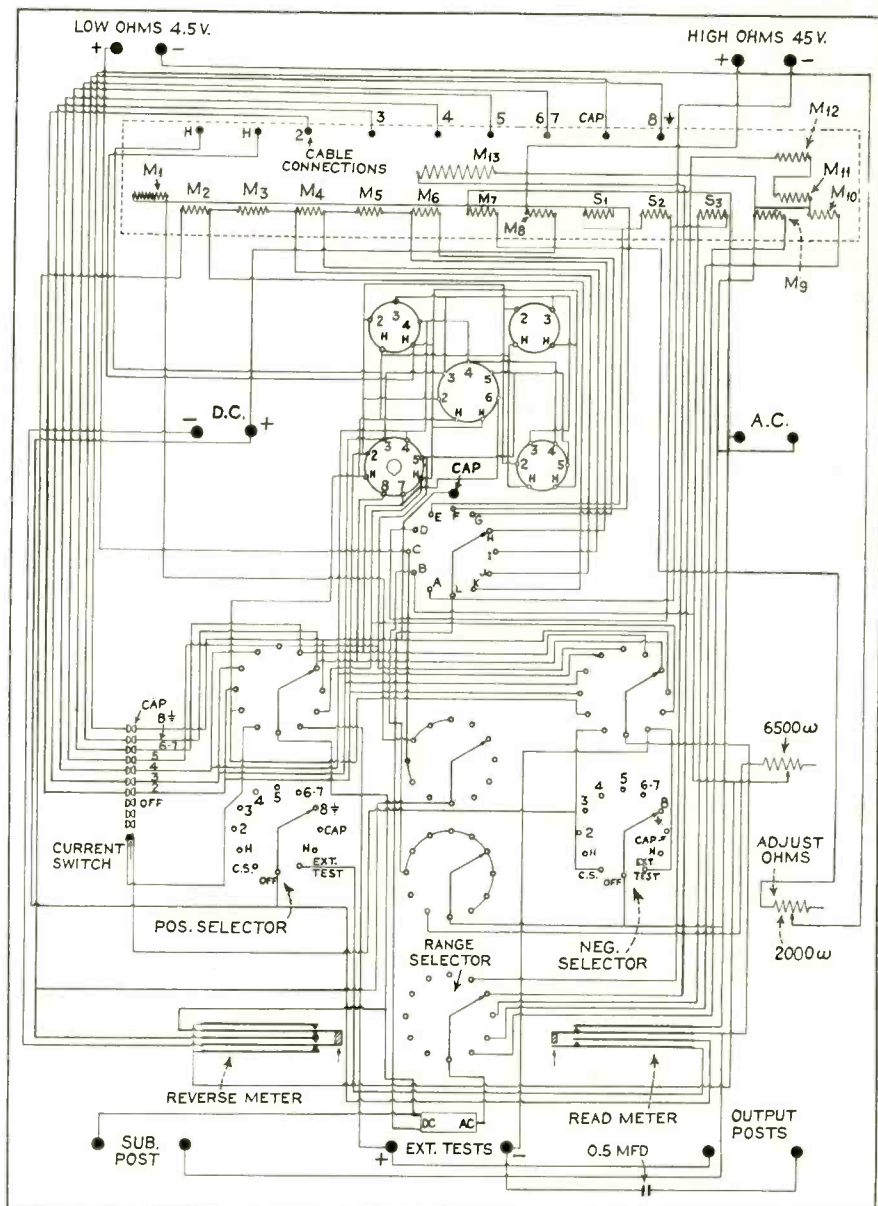

Fig. 1. Complete circuit diagram.

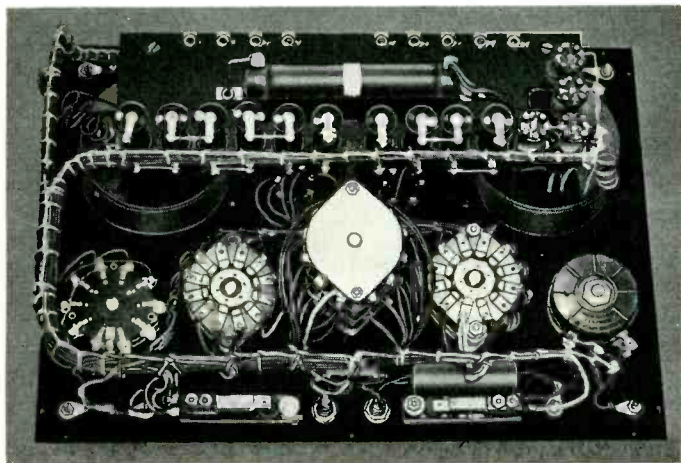
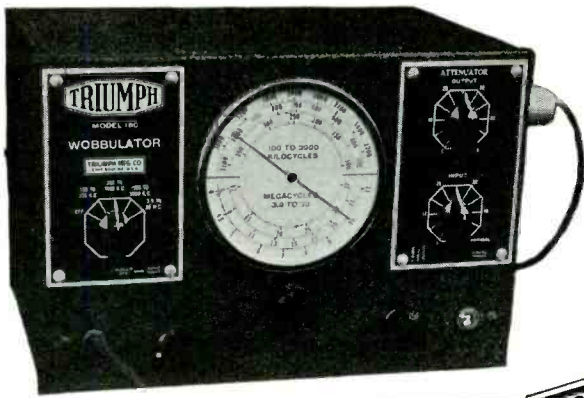

Fig. 2. Under panel view.

ible as possible, to allow for future developments. A selective system should be employed throughout. In the instrument pictured, the 9 cabled connections are wired in parallel with the contacts of the negative selector, the positive selector, and the pin positions of the individual 4, 5, 6, combination 7, and octal-base type sockets located on the analyzer panel. This circuit arrangement is the nucleus of free point analysis. It enables any socket pin to be analyzed, and current and voltage relationships to be determined merely by rotating the positive and negative selectors to the desired positions. These two selectors can be considered as two circuit selecting





## MODEL 180 WOBULATOR

We announce the perfect companion to the famous TRIUMPH 800 Oscillograph, the Model 180 WOBULATOR. *Unequaled.* The only commercial electronically driven, frequency modulated signal generator, giving constant band widths, band limit beacons, direct calibrations and precise synchronization. An absolute necessity to every radio production line and radio service shop. Six tubes—dual attenuator—100 K.C. to 30 M.C.—Selective Modulation and Spotted Frequencies. This instrument is as sensational in price as it is in operation. . . . **\$57.50**  
F.O.B. Factory Complete . . . . .



## Model 800 OSCILLOGRAPH

Radio and electrical engineers the world over are acclaiming the TRIUMPH 800 Oscillograph the greatest sensation of the year. The only Oscillograph with "Top Deck" controls—connections—top canopy viewing screen and perfect image locking. The Model 800 gives absolute linearity and has "Snap in Sweep"—Dual Amplifiers—Widest Sweep Range—Safety Switch—Calibrated Scale and Designated Controls. . . . Already an acknowledged leader, this great testing device for only **\$79.50**  
F.O.B. Factory Complete . . . . .

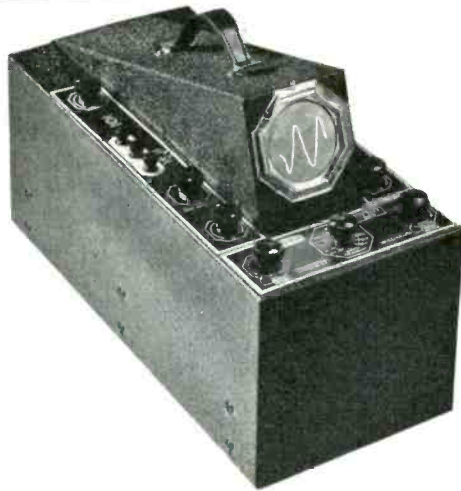

**TRIUMPH MANUFACTURING COMPANY**  
4017 W. LAKE STREET CHICAGO, ILLINOIS

# SURE, I'LL SPEND AN HOUR A DAY WITH RIDER!

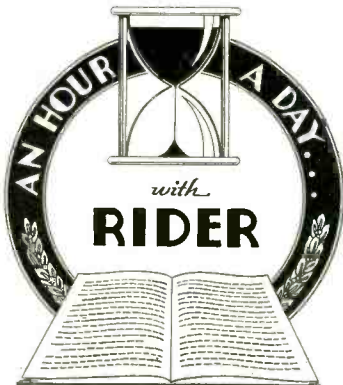

"I've studied radio, but there's so much new stuff and so much I've forgotten that I must do something to catch up with the times."

**ALTERNATING CURRENTS IN RADIO RECEIVERS.** Book No. 1  
How and why the components of a set function, with a clear explanation of a.-c. principles and practice.

**RESONANCE AND ALIGNMENT.** Book No. 2  
What happens when you align a receiver and the correct way to do it. All the types of resonant circuits that should be understood by the Serviceman.

**D.-C. VOLTAGE DISTRIBUTION.** Book No. 3  
A clear explanation of how the networks that supply operating voltages to tubes function, and how the sizes of the resistors are calculated.

**AUTOMATIC VOLUME CONTROL.** Book No. 4  
The functioning and servicing of all the new circuits that come under the head of automatic volume control. Handy pocket size. . . . 64-80 pages. . . . Hard cover. . . . Profusely illustrated.

"and I've got ALL SIX RIDER MANUALS

Sixty cents each book.

Buy them from your jobber.

which makes me a member of the 100% Rider Club."

## TEST EQUIPMENT—continued

Fig. 3. Modernizing test equipment.

test prods. The current switch allows d-c current readings to be taken at any position.

### VOLTAGE AND CURRENT RANGES

Ten voltage and three d-c current ranges are provided. Three resistance ranges, a low range using the meter shunt method; an intermediate range, 0 to 250,000-ohms; and a high range, 0 to 2½-megohms; provide enough flexibility for average radio work. The

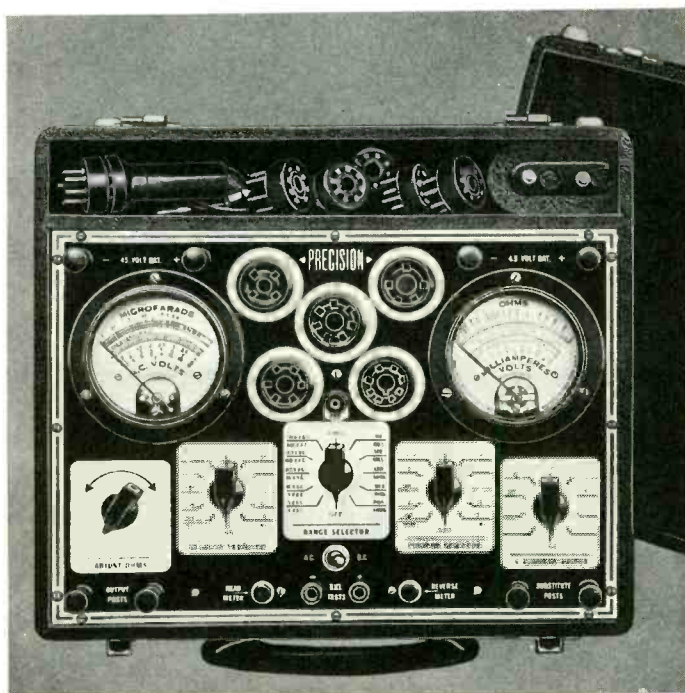

Fig. 4  
Complete modernized analyzer.

low ohmeter range will vary depending upon the type of d-c meter available. For the Jewell 198-199, this range will be from 0 to 3000-ohms; whereas the range for the Weston 0-1 ma, 100 mv drop meter the range will be from 0 to 1,000-ohms.

### RESISTANCE VALVES

The various resistance values labeled M 1, M 2, etc., are also variable depending upon the meter used. Values for the Jewell 198,199 meter follow: M<sub>1</sub>—0, M<sub>2</sub>—4,750, M<sub>3</sub>—5,000, M<sub>4</sub>—90,000, M<sub>5</sub>—400,000, M<sub>6</sub>—500,000, M<sub>7</sub>—3,000, M<sub>8</sub>—40,000, M<sub>9</sub>—40, M<sub>10</sub>—120, M<sub>11+12</sub>—1,560, M<sub>13</sub>—7,960, S<sub>1</sub>—25, S<sub>2</sub>—2.23, S<sub>3</sub>—0.55. For the Weston meter mentioned above the values are as follows: M<sub>1</sub>—150, M<sub>2</sub>—4,900, other values as listed above. Since the accuracy of the instruments depends, to a large measure, upon the tolerance in these resistors, these values should be closely followed.

## DOUBLE AUTOMATIC VOLUME CONTROL

(Continued from page 161)

i-f transformer to the diode plates of the same tube. The avc i-f is, of necessity, not as selective as the signal i-f transformers. The full d-c voltage developed across the diode load resistors (the two 250,000-ohm resistors in the lower right corner of the cover diagram) is impressed upon the grid return of the r-f stage, whereas only half of it is impressed on that of the first detector. Similarly, the full avc developed by the second detector is applied to the first i-f, while the second i-f receives only half of that voltage. By this distribution of control better regulation of fading stations on all bands is obtained.

One of the chief advantages claimed

for double automatic-volume-control is that blasting of powerful stations is prevented. Because of the exceptional selectivity of receivers of this type, signal cannot reach the second detector, (and consequently no avc voltage could be developed there) until the receiver is tuned to the peak of that signal. In sets having only one avc system the signal could blast before the avc can come into action to prevent it. In receivers having double avc, the first avc stage because of its reduced selectivity can come into action before the peak position (on the dial) is reached. This premature action of the first avc, properly applied, will, consequently, prevent blasting.

Since local stations are usually plentiful over the dial, on the broadcast band, this avc stage will be active almost at

any point to which the receiver is tuned. For this reason double automatic-volume-control will act somewhat to suppress interstation noise, without some of the disadvantages of a squelch stage.

Another advantage claimed for this avc system is its ability to suppress tweets (or birdies). The most frequent cause of tweets is the beating of harmonics of powerful local stations with such harmonics of the receiver oscillator that make a sum or difference equal to the intermediate frequency. Since the signal so produced is weak compared to the actual station signals, these tweets appear only at off station positions. The first avc, however, is not as selective as the normal avc, and can come in to full action should harmonics appear and suppress any tendency to tweet.



# IF YOU WANT THE BEST

AT NO HIGHER PRICE—  
GET ONE OF THESE NEW

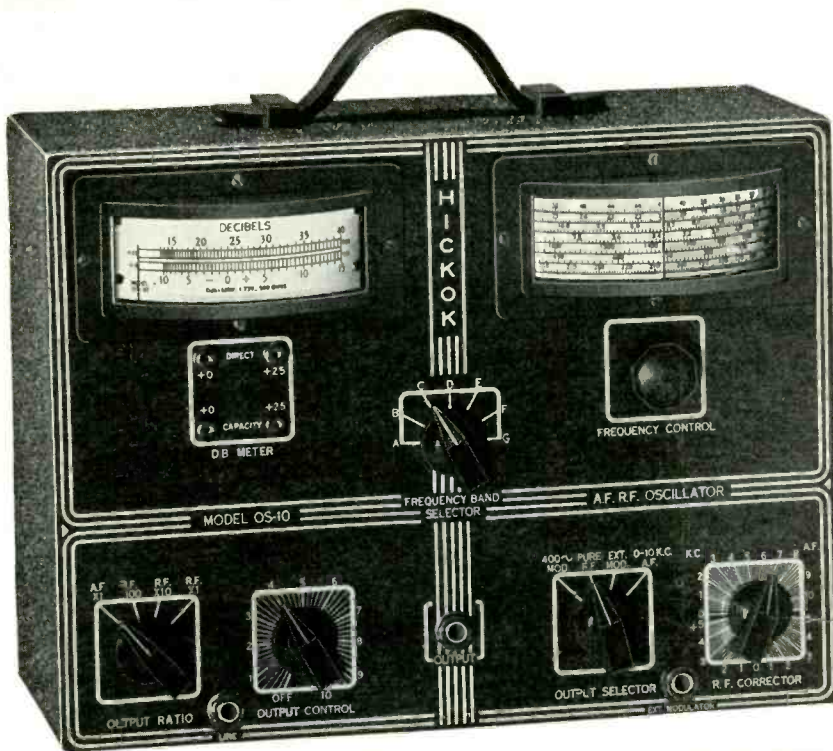

**HICKOK**

## OS-10 OSCILLATORS

Look at these Exclusive Features

- Electron Coupled R.F. Oscillator.  
½ micro-volt to 3 volts output.  
85 kilocycles to 50 megacycles—7 ranges.  
Accuracy better than ½ of 1%.
- Two Negative Resistance Audio Frequency Oscillators.  
(a) 400 cycle fixed.  
(b) 0-10,000 cycle variable.  
Output variable from 0 to 2 volts.
- Horizontal Edgewise Decibel Output Meter—2 Ranges.  
-10 to +15 D.B.  
+12 to +40 D.B.  
Direct and Capacity Connections.
- Large Horizontal Edgewise Direct Reading Frequency Dial, accuracy 0.2 of 1%.
- R.F. Corrector—Insures Precision of R.F. Adjustment and permits micrometer band spreading.
- External Electronic (no motor) frequency modulator available for Oscilloscope use.

Dealers Net Price (as shown—with leads) \$48.00

Write for details of this and the HICKOK OSCILLOGRAPH

THE HICKOK ELECTRICAL INSTRUMENT CO., 10517 Dupont Avenue, Cleveland, Ohio

Simplified Decade  
Resistance and Capacity  
Circuits Use Semi-Precision

## CONTINENTAL Carbon Resistors and Condensers

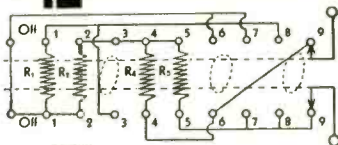

Four CONTINENTAL Carbon insulated semi-precision resistors per decade do the work of nine in this simplified decade resistance box circuit developed by CONTINENTAL Carbon.

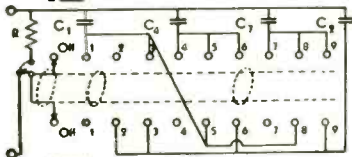

Only four CONTINENTAL Carbon semi-precision condensers required per decade! Build these R and C standards for your lab! Send for your FREE plans and parts list.

**CONTINENTAL CARBON Inc.**

13912 Lorain Ave.

Cleveland, Ohio

## RESULTS are proving 'CORONETS' the biggest SALES IDEA the tube industry has ever seen

You're probably asking yourself, "How do these Metal Tubes work in the old glass tube sets?" Space permits only a few comments:

"One 27 'CORONET' in detector socket of Crosley Model 77-1 increased volume and enabled owner to get stations he hadn't heard for a year."<sup>o</sup>

"Installing one 24 'CORONET', one 80 'CORONET' and two 51 'CORONETS' in American Bosch Model 205 cut noise inset down 90%."<sup>o</sup>

"Replaced two-weeks old glass tubes on Model R-11 RCA with 'CORONETS'. For accurate check sent steady signal through set with oscillator using output meter connected to voice leads on speaker. . . . noticeably increased output and improved reception."<sup>o</sup>

<sup>o</sup> Names upon request.

'CORONETS' immediately put your tube business back on a profitable basis. Act now — write for details.



**ARCTURUS**  
**'CORONET'**  
**METAL TUBES**  
ARCTURUS RADIO TUBE CO.  
Newark, New Jersey

# RECEIVER CASE HISTORIES

## A-C, D-C Sets

*Hum:* Hum in these and other sets is often caused by leakage between the cathode and heater elements of the detector, audio, or rectifier tubes.

*J. E. Steoger.*

## Airline 1955, Apex Series 10

*Noisy reception:* A scratching, rumbling noise in these models accompanied by inability to control volume on strong stations is often caused by the failure of the 8-mfd 275-volt detector plate return filter.

*Intermittent operation* in these models, with all tubes and operating voltages checking perfectly, is often caused by an open 0.01-mfd condenser connected from the plate of the oscillator tube to a lug on the oscillator coil. This is the feedback condenser and when open the oscillator is dead.

*Distortion,* blasting and poor tone at high volume levels, although reproduction is fair at low or medium levels, is generally caused by one, or both, 8-mfd filters having lost its capacity. This distortion will occur when the total capacity is less than 12-mfd. This loss hardly affects the plate voltages and introduces so little additional hum that the trouble is difficult to locate.

*Hygrade Sylvania Service Hints*

## Atwater Kent 61 D-C

*Noisy reception:* Noisy reception in this model is often caused by loosening of the winding on the filament resistance. Should this be the case, the replacement resistance is wound somewhat tighter.

## Bosch 48

*Noisy when dial is turned:* Remove shield from variometer, and from tuning-condenser. Loosen the two hex nuts holding the variometer to the assembly, and remove the unit. The outside shaft has a pigtail, and should not be disturbed. The inner shaft should be removed and the wiper blade and brass-contact surface carefully cleaned and bent to exert more pressure. When replacing the variometer, care should be taken that the rotor is in exactly the same position as before. The pigtail on the condenser section next to the variometer often breaks, and should be lengthened about 1½ inch.

*E. M. Prentke*

## Bosch 60

*Inoperative:* The r-f plate by-pass condenser C14, located beneath the tube sockets to the rear of the r-f tuning unit, when shorted will stop reception. Check and replace if necessary; value 0.25 mfd.

*E. M. Prentke*

## Brunswick 14, 21, 31

*Weak reception:* With all the voltages and resistances checking O. K., weak reception was obtained. The condensers across the two grid terminals of the 45 power tubes developed enough leakage to cause noticeable loss of signal. In this particular instance point-to-point resistance measurements will not show the trouble, since the resistance of the defective condenser will still be greater than the winding across which it is connected. Replacement is recommended; value 0.00025-mfd.

*R. C. A. Radio Service Tip File*

## Earl 21, 31

*Noisy reception:* The variometer on these models is insulated from the chassis by means of a narrow bakelite strip. This strip as well as the variometer is held in place by two screws. Loosening of the screws will cause noisy reception.

## Fada 10 and 30

*Oozing pitch from power transformer:* If the pitch melts out of the power transformer don't blame it on the transformer immediately. The 80 tube is only ⅜ in. away and the heat generated by this tube may be causing the trouble. A no load wattmeter test of the transformer should prove its condition. (The transformer should draw less than 10 watts at no load.) The pitch may be melted back by putting the transformer in a slow oven. Allow at least five hours to cool. An asbestos shield between the tube and transformer will end this trouble.

*Hygrade Sylvania Service Hints*

## Freed 95

*Low volume:* This model has an a-c operated dynamic speaker. Low volume may be caused by a defective field-supply filter-condenser or rectifier.

## International Model P (A-C, D-C)

*Weak volume, distortion:* Replace 0.05-mfd bypass condenser (part No. A323 in schematic) between plate of 1V rectifier and one leg of line. Also double

5-mfd, 35-volt cathode bypass (part No. A408). Check both 4-mfd, 175-volt filter condensers (part No. A407). If the receiver has been in use for about 1500 hours, replacement of latter condensers will save a call back.

*Al. Beers.*

## Kadette 53 and 553

*Overloading:* As stated in the service bulletin covering these models, the circuit using the 6J7 second detector does not incorporate automatic volume control. When operated in the vicinity of powerful broadcast stations a tendency toward overloading may be found on strong signals. It is evidenced by blocking out of the signal as the volume control is advanced. This condition may be corrected easily by making the simple change illustrated.

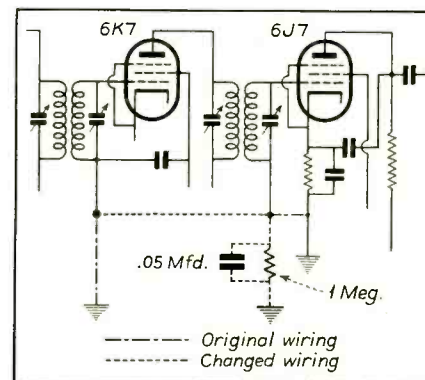

Originally the grid returns of the 6K7 and 6J7 tubes go direct to ground. These should be removed from ground, tied together and returned to ground through a 1-megohm resistor shunted by a condenser of 0.05 mfd or larger capacity.

In making this change be sure the cathode of the 6J7 tube is connected as shown and not left connected to the low end of the second i-f transformer grid winding.

## Kolster K-21

*Oscillation:* Due to leaky neutralizing condensers across suppressor resistors in r-f amplifier grid leads. Replace with new trimmer condensers and decrease their capacity to just beyond the point of regeneration.

*H. A. Lewis*

## Lewol LW4

*Low sensitivity:* Resistor in screen-grid lead of 6C6 detector was found to be 5 megohms. Replace with 2 meg resistor.

*H. A. Lewis*



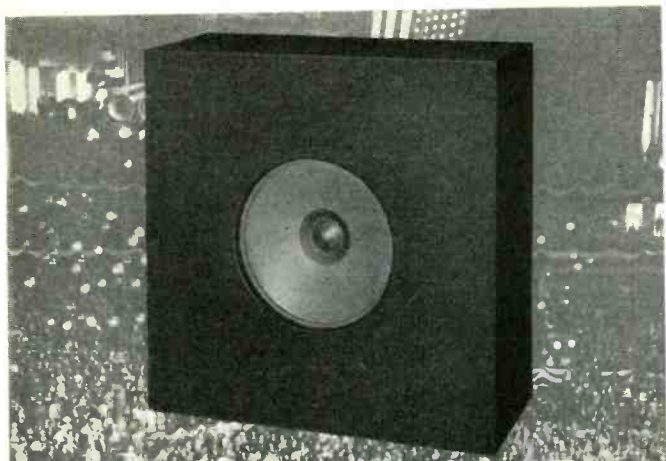

Around this great  
**MAGIC MAGNET  
 SPEAKER**  
 YOU CAN BUILD THE STRONGEST  
 SPEAKER SALES STORY IN YEARS

Write today for complete details on the Magic Magnet Speaker line!  
 CINAUDAGRAPH CORP. • STAMFORD, CONN.  
 Speaker Div. Dept. "T"

**CINAUDAGRAPH**

**Free!**

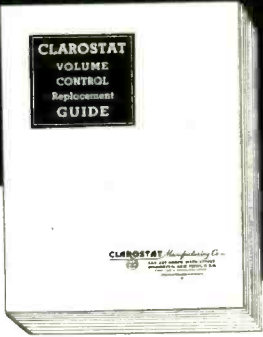

Just issued. A most complete and practical Volume Control Replacement Guide. 80 pages of indispensable data.



Composition-element Clarostat Control.



Wire-wound bakelite-case Clarostat Control.

- ★ Lists hundreds of sets and their exact duplicate replacement controls.
- ★ Indicates respective applications for composition-element and wire-wound controls.
- ★ Provides many pages of useful data on volume controls, circuits, resistance calculations, tapers, etc.
- ★ Enables you to handle any volume control replacement in a positive, fool-proof profitable manner.

**Get Your Copy!** Just drop us a post-card or letter requesting Bulletin No. 2. Your jobber can furnish standard and exact duplicate controls specified.

**CLAROSTAT**  
 MANUFACTURING CO., Inc.  
 285-7 N. SIXTH ST. :-: BROOKLYN, N. Y.



**ELECTRONIC**  
*by long odds*  
**The Accepted Best**



The Electronic line is the most condensed full line of replacement vibrators on the market. For the jobber this means a smaller investment in stock, quicker turnover and greater profits. Service men like the idea too, for Electronic products are accepted everywhere as the best. They are easy to sell, easy to install, guarantee customer satisfaction and are extremely profitable. In 1936 Electronic again leads the field. Get complete facts and new catalog with 1936 replacement guide and cross index by writing direct.

**FREE A Handsome Slide Rule**  
 will be given to every auto radio service man who sends to us only 20 ELECTRONIC vibrator box tops with his name and address. This handy, easy to operate, imported vest pocket slide rule regularly retails for \$2.50. Start saving your Electronic Vibrator carton tops today. This offer is made for a limited time only.

**ELECTRONIC LABORATORIES, Inc.**

*World's Largest Exclusive Manufacturer of Vibrator and Vibrator Power Supplies.*

INDIANAPOLIS, INDIANA



**"MY TIME AND MY REPUTATION ARE ALL I HAVE TO SELL"**

*says Bill Fixit*

"That's why I always use BROWN DEVIL resistors. They never let a fellow down. They cut out the

*call-backs* which cost good money. I'll never switch from 'Brown Devils'."

"Brown Devils" are wire-wound units coated with a moisture resisting vitreous enamel. At rated wattages, they are guaranteed not to deteriorate, warranted to maintain constant resistance value.

Practical in almost any radio circuit. Solidly anchored 1½" tinned lead wires permit easy installation. 10 and 20 watt sizes in resistance values through 100,000 ohms. Ask your jobber or write for OHMITE Catalog 14.

**OHMITE**



**MANUFACTURING COMPANY**  
 4827 Flournoy Street  
 Chicago, Illinois  
*Manufacturers of Resistors of All Types*

## RECEIVER CASE HISTORIES—continued

### Majestics Using 59B Tubes

**Replacing 59B:** Several requests have been received as to whether there is a tube that will replace the type 59B used in Majestic receivers. In a survey of the use of this tube it was found that it was employed in only a limited number of receivers. Also, the tube is very similar to a regular 59 except that it is of the filament type rather than of the indirect heater type. Therefore, it is suggested that a regular 59 be used by making only one wiring change. The simplicity of this change can be made the source of income to Service Men through extra tube sales, as it is quite probable that in some sections of the country there is quite a demand for replacement of the original 59B.

The only change necessary to employ a type 59 is to connect the cathode terminal of the socket to the suppressor grid terminal, which is the adjacent contact terminal on the socket. This connection provides a return for the cathode back through the center tap of the filament. If it is desired, the cathode may be wired to the center point of the potentiometer across the filament circuit, but this is not necessary since the suppressor grid is at the same potential. Originally the cathode terminal of the socket was left open since the 59B did not contain a cathode, but did employ a 7-pin base with the cathode pin open. No other change in the receiver is necessary as the characteristics of the 59 when operated as in this circuit are practically identical with the original tube. The filament type 59B was originally used because trouble with secondary emission was experienced when using a heater type 59. Proper precautions have been taken in the heater type 59 to make it especially suitable as a replacement tube; therefore, satisfactory performance can be expected when making a substitution for the 59B.

*Reprinted from Sylvania News*

### Majestic 20

**Caution:** Do not attempt to remove the bottom plate of this receiver until the sides have been removed and the necessary wires disconnected. In these models many of the major parts were fastened to the bottom plate. Serious damage to the wiring will result should the Service Man fail to disconnect these wires.

### Montgomery Ward 62-1, 62-2

**Continuous crackling:** Noise persists even with volume control at minimum. This condition is often caused by flash-

ing between the windings in the first audio transformer. (The one riveted to the speaker frame.) *J. E. Mason.*

### Philco 16

**Fading:** Condensers and resistors checked with no success. The trouble was located in an intermittent open in the third i-f transformer.

*H. J. Hicks.*

### RCA Victor T9-7

**Circuit changes:** On some instruments the following changes affecting the schematic circuit and chassis wiring diagrams have been made.

Capacitor C42 is disconnected from the side of the power line which connects to R24 and R23 and is reconnected to the external ground terminal. The other lead of this capacitor remains connected to the side of the power line which connects to C41 and R22. (See Figs.)

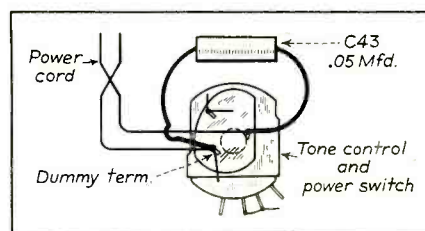
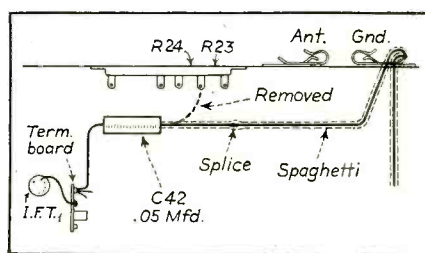
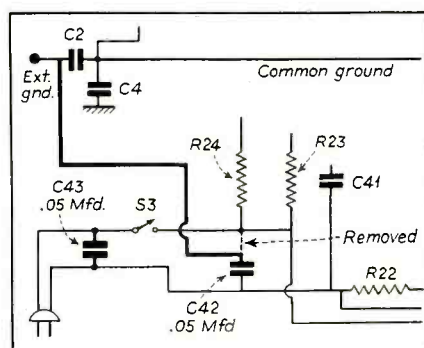

An additional capacitor (Stock No. 12480—0.05 mfd—C43) is connected across the power line circuit. It is mounted on the power switch and connected between the dummy terminal and the lug to which the other lead of the power cord connects. (See Figs.)

### Radiola 64

**Hum:** Hum in this model is often induced from the receiver power supply to the speaker field supply. A suggested remedy, which has proven successful, is to remove the terminal covers between the two, thus eliminating their common connection. *H. H. Schock.*

### Silvertone Earlier Models

**Replacing drive gears:** Original production of many models used a celluloid gear for the condenser drive. In later production a metal gear was used.

Any trouble with dial drives, due to shrinkage of the celluloid gear, can be corrected by substituting a metal gear. Such metal gears may be obtained from the manufacturer.

### Silvertone 1967C

**Modulation hum:** To prevent modulation hum in this model the following changes were introduced in later production: A 75,000-ohm resistor (R33) has been added between the screens of the r-f and translator tubes and the B plus. A 0.2-mfd condenser (C38) has been added from the screens of the r-f and translator tubes to ground. The two-watt, 20,000-ohm section (R3) of the voltage divider has been changed to 10,000-ohm two watt.

While these changes preclude any possibility of modulation hum, the Service Man need not make them unless such hum is present.

### Taco All-Wave Antenna

**Intermittent reception:** The twisted lead-in, at times, breaks inside the insulation at the point where it goes into the can housing the antenna-matching transformer. This is caused by constant swinging in the wind. Take down the antenna, resolder the connections, slipping a piece of spaghetti over the wire and into the can at least 1/2 inch of its length. About 5 inches of spaghetti should be used so that there will be no abrupt bending at this point.

*J. E. Steoger.*

### Zenith 70

**Fading:** Look for an open or shorted 0.25-mfd dual plate by-pass condenser on the first and second r-f stages, or a 0.03-mfd by-pass condenser coupling the plate of the first a-f tube to the primary of the a-f transformer. If signals vary from weak to normal, suspect the first. If they are always weak check the second. *Acrad "Kink-Aids"*

• SERVICE FOR



**KAY** auto-radio control heads fit every make of auto-radio . . . truly universal custom instrument-panel units . . .

**BIG PROFITS  
FAST SALES**

Kay Universal Control permits new car purchasers to easily re-install auto-sets, bought previously, in the instrument panel without the necessity of cutting, drilling or otherwise marring appearance of dash. No bolts or screws visible.



Illustrated  
FORD 1935-1936  
LINCOLN-ZEPHYR 1936

Bring your left-over stock of auto-radios right up to the minute. Kay Universal Controls, geared in various ratios to fit all makes and models of auto-radios, make this very easy for you.

**DISTINCTIVE KAY FEATURES:**

- Handsome "wrist-watch" design
- Airplane dial-calibrated in kilocycles
- New INDIRECT pilot lighting
- Escutcheons match every car
- Control with two chrome knobs to match all interiors

**KAY CONTROLS** assure quick sales and real profit for distributors, retailers, servicemen and automobile agents.

*Write for complete new catalog showing all Kay Universal Controls and giving prices.*

**KAY PRODUCTS OF AMERICA, Inc.**  
566 DEKALB AVENUE                      BROOKLYN, N. Y.

**INSIST**

**UPON**

EXACT DUPLICATE

**Radiart**

REPLACEMENT VIBRATORS



*Preferred by Those  
Who Know!*



MAIL THIS COUPON NOW.

**THE RADIART CORPORATION**  
SHAW AVE. AT E. 133 ST.                      CLEVELAND, O.

*Please send your latest Vibrator Catalog. Include information on all Radiart Service helps.*

NAME \_\_\_\_\_ CITY \_\_\_\_\_  
ADDRESS \_\_\_\_\_ STATE \_\_\_\_\_

**THE RADIART CORPORATION**  
Shaw Ave. at East 133rd St.                      Cleveland, Ohio

**Curtis** Electrolytic  
**CONDENSERS**

MADE IN OVER  
**370**  
REGULAR SIZES  
and over  
**195**

EXACT DUPLICATES  
for Receiving Sets  
now on the Market.

**"STANDARD"**  
6 volt to 550 volt

**"BLUE RIBBON"**  
630 volt



Patent  
No. 1950352

*Tested in Millions of Installations.  
Satisfaction Guaranteed.*

**CURTIS CONDENSER CORPORATION**

3088 WEST 106TH ST. CLEVELAND, OHIO

- 10 WATTS OUTPUT.
- 3-STAGE, 10 WATT AMPLIFIER, USING ALL METAL TUBES, 1-5Z4, 2-6C5, 2-6F6 (FURNISHED).
- MIXES MICROPHONE AND PHONOGRAPH.
- 2-BUTTON CARBON MICROPHONE—STRETCHED DURALUMINUM DIAPHRAGM—BANQUET STAND—25 FT. CABLE.
- HIGH GRADE 8" D.C. DYNAMIC SPEAKER. (SYSTEM HANDLES ONE OR TWO SPEAKERS.)



System C-10 is light, compact and economical. No external accessories such as batteries, are needed. Weight only 24 lbs.



C-10 System

Suitable for store advertising, medium size theatres, churches, undertaking establishments, outings, lodges, banquets, etc. Handles crowds indoors up to 1200 people; outdoors half this number or more, depending on conditions. This system is very compact in size, light in weight, attractive and well constructed. Total weight complete 24 lbs. Despite its light weight and small size, the powerful five metal tube amplifier gives this system unusual performance.

Fully Licensed—Strict Dealer Policy—Time Payment Plan

FREE—"A Short Course in Sound Engineering"

Webster-Chicago is now preparing a limited edition on the above. Every sound man; jobber, dealer, service man will want one of these up-to-date pamphlets covering engineering and sales details. If you wish one, send in your name. Printing will be limited to those desiring this information.

The Webster Company  
Section A5  
3825 W. Lake St.  
Chicago, Ill.  
Without obligation  
please send me  
More information on System C-10. Copy of "Sound Engineering."

**The Webster Company**

Section A5  
3825 W. Lake St. Chicago, Ill.

Name \_\_\_\_\_  
Address \_\_\_\_\_  
City \_\_\_\_\_ State \_\_\_\_\_

# ASSOCIATION NEWS . . .

## INSTITUTE OF RADIO SERVICE MEN REPORTS

### TRADE SHOW SUCCESSFUL

Thousands were invited; thousands came!

The 1936 National Radio Trade Show, held at the Hotel Sherman in Chicago, March 27 to 29, was without precedent. A registration of right at 4,000—if not over that figure—which, interpreted into attendance figures would represent a total attendance of nearly 15,000, sets this meeting out as a record-breaker.

Such a large registration was not anticipated, either by the Institute or the exhibitors. The supply of 4,000 identification badges was exhausted Sunday, within two hours after the events opened. The exhibitors, basing their requirements for literature on a normal increase over last year's show, found their supply going so rapidly that by Saturday afternoon they began to cache some of it for the Sunday crowds.

When the Pinkerton guard at the door honored the entrance credentials at 2:00 p. m., there was no confusion; trucks were out of the way; everything was in its place. Exhibitors and their booth attendants were ready to meet the guests of the show. With no technical session during the afternoon of the first day, the Trade Show had full sway; there was a six-hour period in which those present could view the displays.

### IRSM Board Meets

The Board of Trustees held its first regular 1936 meeting on the opening day of the Trade Show and Convention. Practically every chapter was represented.

In accordance with the by-laws of the Institute, the Board of Trustees selected J. T. Rose, Endicott, N. Y., to succeed E. C. Arnold as president; H. Nitze, Sheboygan, Wis., to succeed V. Gassere as vice-president, and Jos. E. Kamys, Chicago, was again selected sec.-treasurer.

### Fourth Annual Convention

The Fourth Annual Convention was called to order at 8:00 p. m., Friday, by the retiring president, Edgar C. Arnold.

Following the reading of letters from officers and members of the Institute who had sent their regrets at their inability to be present, and from other national associations in the radio field, President Arnold formally installed the new officers.

In his final message, the retiring president reviewed the status of the Service Man of today as compared with his position a little more than four years ago when the Institute took up the task of rectifying the conditions that existed in the service field.

The close of President Arnold's message was dramatic. The hall was in darkness save for the reading lamp over the rostrum. The new officers of the Institute and the members of the Board of Trustees were on the platform. Arnold mentioned a letter that had been received, and which was flashed upon the screen in order that all might see.

The scene can best be described by quoting from President Arnold's message:

"That letter, ladies and gentlemen, comes from a man who has without doubt been instrumental in creating more calls for radio Service Men than any other one person. It shows an understanding of our aims and our purposes. It sets forth the need for efficient operation of the radio receiver set as well as the transmitter. It evidences appreciation of our efforts in the matter of establishing and maintaining ethical standards.

"That letter, friends, extends to all of you hearty felicitations and good wishes from—none other—than

"Franklin Delano Roosevelt, President of the United States."

(Applause as a picture of President Roosevelt was flashed on the screen.)

"Ladies and gentlemen, it gives me great pleasure to thus terminate my tenure of office as president of the IRSM. Little did I dream when I took the helm of this organization in January, 1935, that I would be privileged to read to you the first message of encouragement to come from the chief executive of our great land. I feel that our efforts have not been in vain. Fellow members of the Institute, we can well be proud of ourselves."

*Ken Hathaway, Executive-Secretary.*

### THE R. T. G. OF NEW ENGLAND

The Amperite Corp. has donated a velocity microphone, which will be given away along with hundreds of dollars worth of other door prizes, at the R. T. G. Exposition, April 27, at the Hotel Lenox in Boston. Now will you attend!

### Rhode Island Chapter

The R. T. G. of Rhode Island has elected the following to office: J. O'Leary, president; J. Barta, vice-president; P. Provost, secretary; A. Gilstein, treasurer; S. Hoffman, librarian.

### New Bedford Chapter

The Guild has been running an ad in the local paper for the last month. The New Bedford listeners should take advantage of this on-the-level service.

New Bedford and Rhode Island boys met in Providence at the last RCA meeting held there.

### THE C. R. T. OF CALIFORNIA

The Certified Radio Technicians Association holds regular meetings each Thursday at its headquarters in Los Angeles. They publish a journal called the "Technician" under the editorship of Norman B. Neely, with J. A. Orme as advertising manager.

At the March 19 meeting, Mr. Templin, of Electrical Research Products Co., delivered a lecture on Auditorium Acoustics. Additional items of interest to the members were also discussed at this meeting.

Each week the program committee attempts to obtain an interesting speaker in

the field of radio. In the past such noted personalities as Dr. August Hund, Mr. R. G. Leitner, and others, have been heard by the members.

### N. R. I. ALUMNI

The publicity committee is working hard to get new speakers lined up for future meetings. Mr. Olmstead is in charge of this work, and recently visited national headquarters and outlined plans. The executive secretary is preparing a list of radio organizations which may be contacted with the view of providing speakers at later meetings.

### Philadelphia-Camden Chapter

The Philadelphia-Camden chapter has established a cooperative service store, called the Philcam Radio Sales and Service, for the benefit of its members. The following officers and directors were selected: C. J. Fehn, president; A. Schiavoni, secretary; C. W. Stokes, treasurer; directors include B. Camm, J. Marshall, P. J. Walsh, A. Fish—others to be appointed.

### Detroit Chapter

Mr. P. Barlow, chairman, reports that the Detroit chapter's last meeting went over with a bang. The evening was timed so that two speakers could be put on the program. Mr. Resie, who is local distributor for Clough-Brengle, gave the boys plenty to think about.

Mr. Moore, Preceptor representative, later went to some length in explaining efficient tube analyzing. While it is the general opinion of the members that all radio troubles will never be cured in a "jiffy," it is hoped present servicing time will be cut, thereby lowering costs.

The chapter is making arrangements to publish a local bulletin—National headquarters offer to print the first issue free.

### St. Louis Wants Chapter

Mr. E. Myers, vice-president of the N. R. I. A. A., is keenly interested in establishing a local unit of the alumni association in St. Louis, Mo.

National headquarters is endeavoring to cooperate with Mr. Myers in the project, and any N. R. I. men living in St. Louis or vicinity are urged to get in touch with him by telephoning Riverside 0451-M, or writing, 4517 Alaska Avenue, St. Louis, Mo.

### New York Chapter

A general rally was the order of the evening at the last meeting in the Hotel New Yorker.

Changes in the officers have been made, and the following is a revised list: A. Arndt, chairman; J. Holub, vice chairman; J. Struble, financial secretary; T. Kohrherr, recording secretary; L. J. Kunert, membership, secretary.

### IRE CONVENTION

The Statler Hotel in Cleveland, Ohio, is the scene of the eleventh annual convention of the Institute of Radio Engineers. The convention is scheduled for May 11, 12, and 13.





**EXACT  
DUPLICATE  
ELECTROLYTIC CONDENSERS**

*Cut Your Servicing Time*

Each label bears complete color code information permitting *fast* installation! Basic stocks of these TOBE Condensers are available at leading jobbers everywhere.

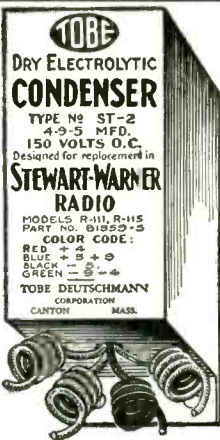

**The BROWNING '35**  
with  
**ALL METAL TUBES**

is still a real money maker for hundreds of Radio Servicemen who use the Tobe Modernization Plan.

Write us today for the latest dope on the Browning '35 with all Metal Tubes and the Tobe Modernization Plan!

**TOBE DEUTSCHMANN CORP.**  
CANTON, MASSACHUSETTS

**P.S.**

Keep your eyes open for a big announcement next month on the newest form of Bridge and Component Part Tester. The sensation of the IRSM show!



*What do you mean, I'm passing up*

**PROFITS?**

I go my way and you go yours. I'm doing my service work the best I know how and if I run into the red or find it hard to make both ends meet, that's my worry. Well . . . that was six months ago.

Today I feel foolish every time I think how bull-headed I was about my own business.

It happened this way. One of the Operadio boys dropped in, and before he left he kind of sold me on the P. A. business I was passing up in my neighborhood. Well, the long and the short of it was that I *was* passing up profitable business. Now I'm a P. A. man as well as a Radio Service man . . . and making *real* profits.

OPERADIO Portable P. A. Units and UNIT-Matched P. A. equipment are the *real* goods.

Get their catalog No. 10 and give them a whirl. Address Dept. S.



**OPERADIO**  
**MANUFACTURING COMPANY**  
Unit-Matched P. A. Equipment at its Finest  
ST. CHARLES, ILLINOIS

**"Looking for Trouble?"**



**WHAT RADIO MAN ISN'T?**

"Sure, I'm looking for trouble. And what's more, I'll find it and fix it quick. Since I've been doing my radio buying 100% from ALLIED, there's no job too complicated, no replacement part too scarce for ALLIED to help me out. Whether I need a hard-to-get power transformer or an XXX volume control I can get it from ALLIED. Trouble-shooting is no trouble for me. The new ALLIED Catalog lists everything I need—and ALLIED'S Special Order Service never lets me down. Take it from me—there's no more trouble for the Serviceman who depends on ALLIED'S Catalog and ALLIED SERVICE—"

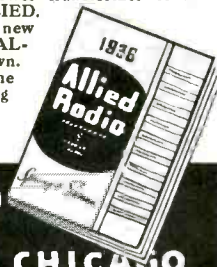

**ALLIED RADIO CORPORATION**  
833 W. JACKSON BLVD. CHICAGO

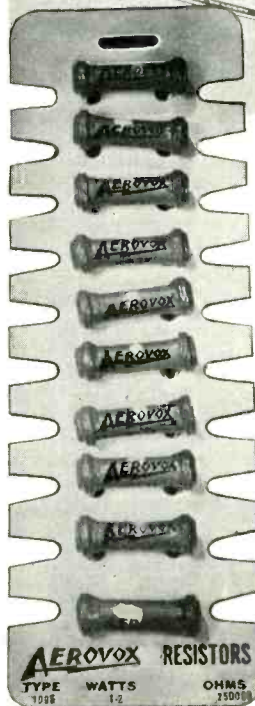
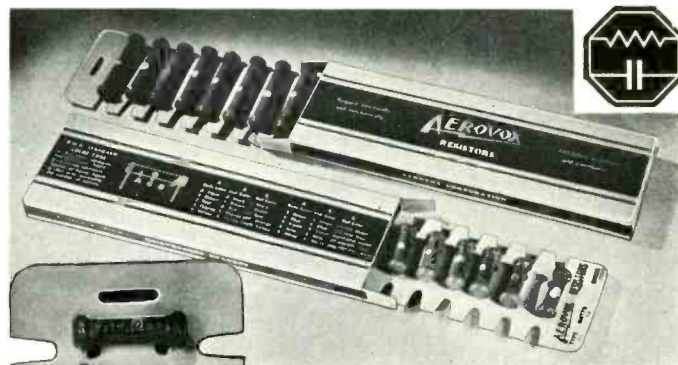

**So Handy!**

Those AEROVOX Carbon Resistors—the best that money can buy—come packed in handy boxes of ten units mounted on handy display cards. • R.M.A. Color-Coded and stamped with resistance values. • In 1/3, 1/2 and 1 watt ratings. • Use them and eliminate return calls to "make good."

Write for new catalog covering complete line of condensers and resistors. Also sample copy of monthly Research Worker.

**AEROVOX**

CORPORATION

74 Washington St. Brooklyn, N. Y.

# HIGHLIGHTS . . .

## MACHINE GUN NO MATCH

"Electronic bullets" are fired 21,000 times faster than those of a machine-gun, according to Alfred A. Ghiradi, in his book, "Modern Radio Servicing."

Ghiradi points out that the "bullets," which constitute the beam in a cathode-ray tube, such as is used in a service oscilloscope, are projected at a velocity of approximately 42,000,000 miles per hour and spattered on the tube's fluorescent screen where they cause visible light to be emitted. On the other hand, bullets leave the muzzle of an ordinary machine-gun at a velocity of only about 2,000 miles per hour.

Many other interesting facts about cathode-ray tubes are revealed by Ghiradi in this section of his radio servicing book.

## OPERADIO CATALOG

Operadio Mfg. Co., St. Charles, Ill., announce a new p-a equipment catalog. Copies may be had by requesting Catalog 10, directly from the manufacturer.

The Operadio replacement speaker cartons, now used, are designed with the effort to help the dealer and Service Man sell more speakers.

## G.E. BRANCH IN NEW YORK CITY

The establishment of a radio factory sales and service branch at the G. E. warehouse, 585 Hudson Street, New York City, is announced by the General Electric Radio Division, Bridgeport, Conn. The branch will serve as the G-E radio distributing agency for the metropolitan New York area.

Inventories, sales, billing, credit and service departments will be established. Direction of sales will be under Earle Poorman and D. W. May, who will continue in their present location at 570 Lexington Avenue, New York City.

This arrangement is predicated upon a recognition of the competitive conditions prevailing in metropolitan New York, and the need for measures to meet them. It is in no way indicative of a nation-wide policy.

## CORNELL-DUBILIER KITS

The Cornell-Dubilier Corp., 4377 Bronx Blvd., New York City, have instituted Handymike Kits in response to the demand for emergency replacement units.

Cornell-Dubilier has three principal kits: HK-3, containing two each of the following capacities: 1, 2, 4 and 8 mfd Handymike units; HK-2 the same capacity assortment, but of higher voltage rating; and HK-4 containing 10 assorted capacities, 4 to 25 mfd, of various voltage ratings. These kits are described in full detail in their general catalog No. 128, sent on request.

## RADIO SERVICE LABS MOVE

The Radio Service Labs of New Hampshire, after six years at their former location, have moved their entire organization to 1187-1191 Elm Street, Manchester, New Hampshire. In celebration of this event they held a 3-day open house party, March 2-4, in their new building.

The Radio Service Labs is a wholesale service to amateurs, dealers and Service Men.

## CLAROSTAT REPLACEMENT GUIDE

The proper replacement for a defective volume or tone control in practically any manufactured set can be quickly determined by referring to the listings in the Clarostat Volume Control Replacement Guide just issued. This 80-page manual represents a review of all available service data, the many orders received from manufacturers during the past ten years, and a survey of hundreds of different sets in general use, in determining volume control data. In addition to the listing of sets and their volume control requirements, the manual includes practical data on all types of controls and fixed resistors, resistance formulae, resistance self-calculators, circuits, etc. A copy may be had by any recognized Service Man through his local jobber, or by writing on his business letterhead to the Clarostat Mfg. Co., Inc., 285 North 6th St., Brooklyn, N. Y.

## RADOLEK CATALOG

The Radolek radio catalog for 1936 is just off the press. This "Profit Guide" contains 160 pages of Service Men's needs, sound systems, radio sets, etc. A number



of technical tables and other useful data are also included.

Copies of this catalog may be obtained from Radolek Co., 601 W. Randolph St., Chicago.

## OHMITE CATALOG

Ohmite's Catalog 14 is now available and may be had on request from the factory of the Ohmite Manufacturing Co., 4835 Flournoy St., Chicago, Ill.

The Ohmite Co. manufactures the Red Devil, Wirewatt, and Brown Devil line of resistors and controls.

## AERIAL NEWS

Ward Products Corp., 2139 Superior Ave., Cleveland, Ohio, publish the leaflet "Aerial News." Copies are available to any Service Man that writes for it.

The Ward Products Corp. manufactures a complete line of automobile antennas, and antenna accessories.

## WHOLESALE RADIO CATALOG

A 64-page catalog featuring a large assortment of radio receivers, public-address amplifiers, radio service replacement parts, etc., has been brought out by Wholesale Radio Service Co., Inc., 100 Sixth Ave., New York City.

Copies are obtainable free at any of the Wholesale Radio branch offices.

## ALLIED RADIO CATALOG

Allied Radio Corp., 833 W. Jackson Blvd., Chicago, Ill., has issued a 136-page spring and summer radio catalog. It shows their latest lines of receivers, sound equipment, test instruments, replacement parts, etc. Sent free on request to radio dealers, Service Men, amateurs and experimenters.

## HANDYPROBE DISTRIBUTER

The Burton-Rogers Co., 755 Boylston St., Boston, Mass., have been appointed distributors of the Handyprobe. The Handyprobe is an instrument made in the shape of a test prod, and can be used as a short-cut in trouble-shooting.

Literature describing the instrument may be obtained from the distributor.

## DAYRAD CATALOG

The Radio Products Company, 125 Sunrise Place, Dayton, O., publish an 8-page folder describing their Dayrad Radio Service Instruments. Copies may be had by requesting Dayrad catalog 54.

## SPRAGUE CATALOG

Many condenser developments as well as price reductions on standard items are featured in the 1936 Sprague condenser catalog just issued by Sprague Products Co., North Adams, Mass.

For those who desire it a separate catalog is available listing exact duplicate replacements made by Sprague for a large number of receivers now in use.

A copy of the catalog will be sent free, upon request.

## IRC MOVES TO LARGER QUARTERS

Following its fifth expansion move in fourteen years, International Resistance Company now occupies the top floor quarters at 401 North Broad St., Philadelphia, Pa., where space a city block long and half a block wide is utilized for the manufacture and development of IRC resistors and volume controls. Descriptive literature of the IRC line will be sent upon request.

## RIDER TO TOUR

In response to demands of Service Men's organizations John F. Rider has begun a nation-wide lecture tour. His itinerary follows: April 23, New Haven Radio Servicemen's Association, Hotel Garde, New Haven, Conn. April 27, Radio Technicians' Guild, Hotel Lenox, Boston, Mass. April 28, Worcester Servicemen's Association, Worcester, Mass. May 4, Association of Radio Service Engineers, Buffalo, N. Y. May 5, Youngstown Valley Servicemen's Association, Youngstown, O. May 23, Tennessee Servicemen's Association, Fort Knox, Tenn. May 25, National Radio Service Ass'n, National Convention, Galveston, Texas.

Mr. Rider will be armed with the facts shown by his recently completed survey. Record turnouts have been promised by the various organization spokesmen.



The Season's Big Money Maker...

**TACO** ELECTRON-EYE  
TUNING INDICATOR

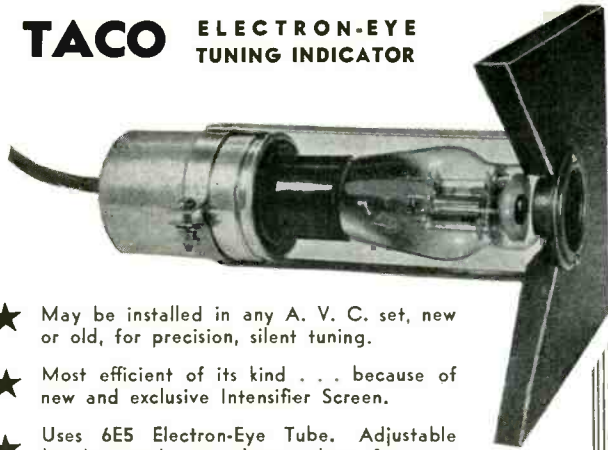

- ★ May be installed in any A. V. C. set, new or old, for precision, silent tuning.
- ★ Most efficient of its kind . . . because of new and exclusive Intensifier Screen.
- ★ Uses 6E5 Electron-Eye Tube. Adjustable bracket and escutcheon plate for neat mounting.
- ★ Demonstrate it . . . and you'll sell it! A nice profit maker. Only \$1.50 list (less tube).

**Write** for technical and merchandising facts. Better still, order one today from your jobber. Be sure to insist on TACO—the kind with NEW Intensifier Screen!

• **TECHNICAL APPLIANCE CORP.**  
Pioneers in Noiseless Antenna Systems  
17 EAST 16TH STREET :: NEW YORK CITY



**POLITICS PAYS  
P.A. PROFITS**

*It's  
Free*

Sound trucks . . . portable P.A. systems . . . permanent P.A. installations . . . are all in greater demand this year because it is a presidential campaign year.

Political organizations of all parties are going to rent, or purchase outright, various types of public address equipment. Lafayette has prepared a special LIST PRICE cata-

logue to help YOU sell P.A. equipment. And most important of all Lafayette engineers have spent months in the development of new, finer P.A. equipment. Send for your FREE copy of Lafayette's complete P.A. list price catalog No. 64. Get on the political band wagon with Lafayette for profits in P.A.! Simply address Dept. LS-46.



**LAFAYETTE RADIO MFG. CO., INC.**  
100 SIXTH AVENUE ••• NEW YORK, N. Y.

Only  
**\$1800**  
for this TUBE TESTER

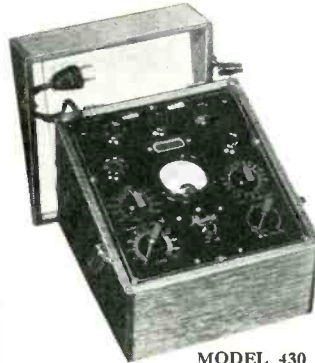

MODEL 430  
Mail Coupon Now



RELIABILITY  
AT LOW COST

- ★ Tests all type tubes — Metal, Glass, Glass-Metal.
- ★ Line voltage adjustment.
- ★ Leakage and Short Test.
- ★ Triplett Direct Reading Instrument (GOOD-BAD Scale).

An up-to-the-minute 1936 Tube Tester. Five flush mounted sockets provide for all type tubes. The tester operation is very simple and indicates condition of tube for dealer and customer on Direct Reading GOOD-BAD Triplett colored meter scale. The Tester is designed to indicate all inner element shorts and make leakage tests.

Complete in attractive, sturdy quartered-oak case. Sloping panel of silver and black. Suitable for portable and counter use.

MODEL 430—DEALER NET PRICE . . . . . \$18.00

MODEL 431—same as 430 except has Readrite GOOD-BAD meter—DEALER NET PRICE \$14.40

**READRITE METER WORKS**  
417 College St., Bluffton, Ohio

Without obligation please send me more information on . . . . . Model 430. . . . . Model 431. . . . . Send complete catalogue.

Name . . . . .  
Address . . . . .  
City . . . . . State . . . . .

Bank your  
Job  
Profits...

The Service Man who uses Ward Leonard Wire Wound Replacement Resistors does not have to waste his job profits making good resistor failures. You have known these resistors for many years and know they stand up. They are conservatively rated. The line is complete. Bulletin 507A gives a complete line of resistors with list prices. Send for a copy today.

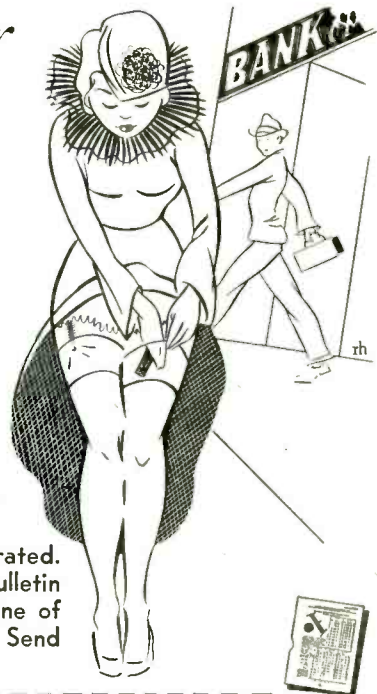

**WARD LEONARD ELECTRIC CO.**  
South Street, Mount Vernon, N. Y.

Please send me your new Bulletin 507A.

Name . . . . .  
Address . . . . .  
City . . . . . State . . . . .  
Jobber's Name . . . . . S

# THE MANUFACTURERS . . .

## BELL MOBILE P-A SYSTEM

A 6-volt mobile p-a system, known as model M-6 has recently been introduced by Bell Sound System, Inc., Columbus, Ohio. The model M-6 is entirely operated by a 6-volt storage battery, making it suited for sound trucks, cars or any other place where 110 volts a-c is not available.



The turntable and amplifier are built into one compact unit, but with each having its separate volume control. A special leveling arrangement maintains the unit in a level position when placed on the seat by the operator.

The amplifier has 4 stages, class A, with a gain of 97 db, and an output of 18 watts. It is equipped with two speakers.

The overall size of the turntable-amplifier unit is 16½" wide, 19½" long and 8½" high. For further information write for model M-6 bulletin.

## CHEKATUBE C111

J-M-P Mfg. Co., Inc., Milwaukee, Wis., initiate a novel method in English reading tube checking. In their model C111 Chekatube, the line voltage holds the needle on the center of the meter scale until the value lever is thrown; the needle then swings to the left for a poor tube or to the right for a good tube.



The C111 Chekatube is made in two case models, the C111 and the C111 Deluxe. Complete information may be had from the manufacturer.

## BATTERY CHARGING RACK

A battery-charging rack, accommodating any standard wall-model, garage-type Tungal charger together with 4 all-rubber trays holding 3 six-volt batteries each, has been introduced by the General Electric Company's Appliance and Merchandise Department, Bridgeport, Conn. Occupying 4 square feet of floor space, it is constructed of steel, protected with acid-resisting paint. A complete set of battery jumpers for twelve batteries is included with each rack.

## INTENSIFIER SCREEN

A color filter disc placed before the 6E5 electron-eye tube augments the contrast between luminous ring and dark segment for quicker and more critical observation in the Taco tuning indicator. Known as the intensifier screen, the disc is held by means of two sharp prongs at the inside end of the escutcheon shadow box. The intensifier screen is now a regular feature of the Taco tuning indicator offered by the Technical Appliance Corp., 17 E. 16th St., New York City.

## KEN-RAD TYPE 1F4

The commercial engineering department of the Ken-Rad Corp., Owensboro, Ky., announces the type 1F4, a new low battery drain output tube designed for operation in battery receivers.

Samples and data are being supplied to interested set manufacturing customers.

This tube which is an addition to the glass line is somewhat similar to the type 33 but offers certain advantages over that type.

## ARCTURUS 6N6 AND 6R7

The Arcturus Radio Tube Co., Newark, N. J., announces the types 6N6 and 6R7 Coronet metal tubes.



The type 6N6 is a duplex-triode output tube, permitting circuit simplicity. Its special characteristics rank it among the most efficient tubes for p-a systems and other amplifier work.

The 6N6 has a good overload characteristic, no grid current being detected even when the tube is overloaded 60% above its rating. 15-volts input produces 4 watts output with a total distortion of about 5% when worked into 7,000 ohms. 7 watts output can be obtained with a distortion of only 9%. This tube can be used in push-pull and permits the use of resistance coupled input since the tubes have a high impedance.

The 6R7 Coronet is a duplex-diode triode, somewhat similar to the type 75 but has a mutual conductance of 1,900 and a mu of 16.

## CROWE REMOTE CONTROLS

The Crowe Name Plate & Mfg. Co., 1749 Grace St., Chicago, Ill., announce a new line of remote controls and accessories for automobile radios.

Complete information concerning these products may be had by writing for Catalog 12.

## SOUND SYSTEMS AMPLIFIER

A unit offered by Sound Systems, Inc., Cleveland, Ohio, contains amplifier, automatic turntable, and loudspeaker in one cabinet. The automatic record changer plays two sizes of records, 33½ or 78 rpm. The amplifier has tone control, volume control, and an output impedance-matching switch. The standard unit includes a heavy duty 12" dynamic speaker. Permanent magnet dynamic speakers may be obtained for remote rooms. The impedance-matching switch permits accurate adjustment for their addition.

## D-C, A-C INVERTERS

The American Television & Radio Company, St. Paul, Minn., in presenting the



1936 line of d-c, a-c inverters announces the following features: interference-free all-wave radio operation, long-life vibrators and four-point voltage-regulators.

ATR d-c, a-c inverters are manufactured in 16 types, with or without built-in filter and are used on d-c input voltages ranging from 6 to 220 volts d-c and supply a-c output voltages of both 110 and 220 volts for the operation of standard 110- and 220-volt a-c equipment.

American Television & Radio Company inverters are equipped with the ATR plug-in type vibrator unit with ¼" diameter contacts.

## VOLT-OHM-MILLIAMMETER

The Model 1200 Triplett volt-ohm-milliammeter contains the twin instrument having separate a-c and d-c movements.



A tilting feature is incorporated to adjust the instrument for easy reading. One switch selects all instrument readings. Scale readings—d-c, 10-50-250-500-1000 volts at 2000 ohm-per-volt; 1-10-50-250 ma; 1500 ohms, 1.5 and 3 meg; a-c, 10-50-250-500-1000 volts. Furnished in black metal cast with a wrinkle finish. Model 1200.



# NAME CONTEST ENDED MIDNIGHT, APR. 15th

JUDGES NOW SELECTING WINNERS

PHENOMENAL INTEREST SHOWN IN  
NEW AUDAX PICK-UP SYSTEM

Prize Winner, Name of New Product and  
Details of Revolutionary Wide Range  
Principle to Be Announced Soon

The large number of names suggested for the new Audax Pick-Up in response to the "best name" contest, which closed April 15th, was dwarfed by a far larger volume of inquiries about its revolutionary principle.

Confidence thus indicated in the company's ability to eliminate moving mass in a pick-up is considered by Audak officials to be a gratifying recognition of Audak's long established leadership as pioneers in the electro-acoustical field.

Have you the complete AUDAX catalog of models listing  
from \$9.50 to \$390.00

Special recording cutters made to order

## AUDAX PICK-UPS

The standard by which others are judged and valued

AUDAK COMPANY, 500 Fifth Av., New York

Creators of High Grade Electrical and Acoustical  
Apparatus since 1915

### LOW PRICES on Baffles

HOPE ALL-ALUMINUM PARABOLIC WEATHERPROOF DEFLECTOR Baffles are constructed of heavy gauge spun aluminum—they assure effective sound distribution, and are free from metallic resonance. They also minimize feedback difficulties. Bell opening, 17"; Length of bell, 10"; Overall length, 20". HOPE Baffles accommodate cone speakers from 8" to 12".



Wall  
Mounting Bracket

#### DEALERS' NET PRICES

All-Aluminum Baffle (Model 100A)	\$5.25
Baffle Stand—black wrinkle finish—extends from 4 to 9 feet	9.95
Baffle Mounting Bracket	3.00
Wall Mounting Bracket	5.00

Write Dept. TS for new illustrated literature on HOPE Baffles, Trumpets, Microphone Floor Stands and accessories. Jobbers write for our distribution plan and prices.

HOPE MANUFACTURING CO.  
98 PARK PLACE NEW YORK, N. Y.

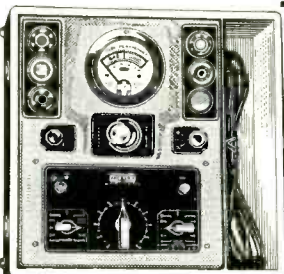

## The Finest TUBE TESTER money can buy

Yet costs **\$39.50**  
only

MAKES A BETTER TEST  
ON EVERY TUBE

Send for Literature

JACKSON ELECTRICAL INSTRUMENT CO., Dayton, Ohio

# JACKSON

## Write for all the details of this - - PRECISION ELECTRONOMETER

### No. 500



A tube analyzer purchase is an investment that will bring profits as long as the instrument continues to "do the job." Precision engineers have constructed this ELECTRONOMETER No. 500, incorporating the use of a FREE POINT TUBE ANALYSIS SYSTEM to provide extreme flexibility

for FUTURE tube releases without the necessity of wiring.

This analyzer accommodates more than 300 tube numbers, including the new Coronet octal base replacements of existing glass types. Line voltage is checked on the meter. "HOT" inter-electrode short and "HOT" CATHODE NEON LEAKAGE tests. Simple, direct reading scale. Condenser leakage tests. Individual tests of each diode section of Pentode Diodes, Triode Diodes and Duo Diodes. All tubes are tested under properly rated loads. Separate tests obtained on each section of multi-element tubes.

WRITE for Photographs—All Details—Circuit Diagram

## PRECISION APPARATUS

CORPORATION

821 EAST NEW YORK AVE., BROOKLYN, N. Y.

## BRUSH Spherical MICROPHONE

● A specially designed, general purpose microphone for remote pickup, "P. A." and commercial interstation transmission work. Low in price... but built to Brush's traditionally high mechanical and electrical standards. Wide frequency response. Non-directional. No diaphragms. No distortion from close speaking. Trouble-free operation. No button current and no input transformer to cause hum. Beautifully finished in dull chromium. Size only 2 1/8 inches in diameter. Weight 5 oz. Output level minus 66 D. B. Locking type plug and socket connector for either suspension or stand mounting furnished at no extra cost. Full details, Data Sheet No. 13. Free. Send for one.



## BRUSH Lapel MICROPHONE



● For after dinner and convention speakers, lecturers, etc. Gives great mobility—the smallest, lightest microphone on the market. Size 1 1/2 x 1 1/4 x 3/8. Weight with coat attachment less than 1 oz. Special internal construction and rubber jacketed outer case insures quiet operation. No interference from breathing noises, etc. Typical Brush sound cell response and trouble-free operation. Details on request.

The **BRUSH** DEVELOPMENT COMPANY  
1882 E. 40th St. CLEVELAND, O.  
MICROPHONES • MIKE STANDS • TWEETERS • HEAD PHONES • LOUD SPEAKERS

## MANUFACTURERS—continued

### KINK-AIDS

The Akrad Products Co., 362 Wooster Ave., Akron, O., have compiled a collection of indexed service kinks. The aids are

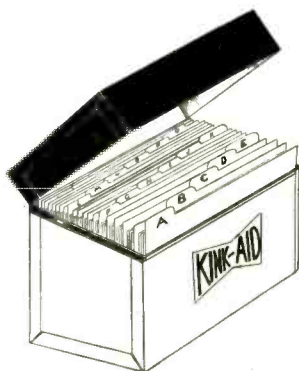

filed in an enameled filing case, and are titled "Kink-Aids."

Each aid is individually indexed as to set and model number, the symptom is described, and a remedy offered.

Sample aids may be obtained from the publisher.

### AMERICAN TYPE AG CRYSTAL MICROPHONE

The American Microphone Company, Los Angeles, Calif., announces the introduction of an improved diaphragm-type crystal microphone. The features of this unit are unusually high output level, wide-angle pickup, and rugged construction, it is stated.

This microphone is said to meet the demand for present-day requirements of a self-energizing microphone requiring no polarizing voltage. The unit is enclosed in a chromium-plated housing and is well protected against moisture and temperature changes.

### RCA VIBRATION PICKUP

By means of the RCA vibration pickup, any mechanical vibration or motion may be converted into electrical currents of identical characteristics. If this motion is recurrent in character, the resulting electrical currents may be presented visually on a cathode-ray oscillograph for study and an-



alysis. The RCA vibration pickup, which functions through the piezo-electrical properties of a rochelle salt crystal, is an instrument of value to all physical, mechanical and sound laboratories.

### COTO-COIL CONTROL WHEEL

Coto-Coil Co., Inc., 229 Chapman St., Providence, R. I., now manufactures a line of polished bakelite control wheels and dial scales for transmitters. A feature of the dial scales is the provision for an indicator plate to become an integral part of the dial scale.

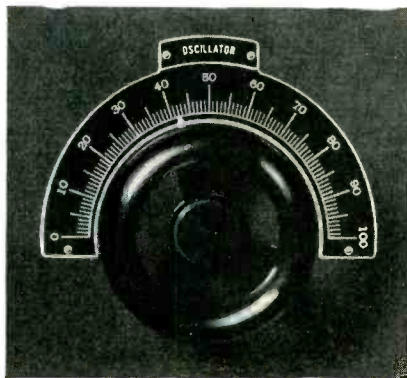

Complete information may be had by writing to the manufacturer.

### NEW SHURE CARBON MICROPHONES

A new series of inexpensive two-button carbon microphones with improved constructional features is announced by Shure Brothers, 215 W. Huron St., Chicago.



III. They have a frequency characteristic which compares favorably with that of much higher priced instruments. The new series is suggested for low-cost public-address systems and similar applications.

Model 3B is designed for spring suspension in standard carbon microphone rings. The unit has a rigid cast frame 3 inches in diameter, with a protective grill in front through which sound is admitted to the diaphragm. The finish is bright nickel-plate overall. Net weight  $\frac{1}{2}$  lb.; shipping weight  $\frac{3}{4}$  lb.

Model 10B is a convertible hand microphone which is readily adapted for stand mounting with spring suspension, by removing the head and inserting four "quickway hooks." The microphone is finished in bright nickel-plate with black enameled handle, and measures  $8\frac{7}{8}$  inches in length overall. Furnished complete, with 6 feet of 3-conductor cordage and 4 "quickway hooks" for stand mounting. Net weight  $\frac{3}{4}$  lb.

Model 10BS is similar to Model 10B, but includes a built-in concealed switch which automatically cuts out the microphone when the unit is placed in a horizontal position.

### JACKSON MULTI-METER

The Jackson Electrical Instrument Co., Dayton, O., is marketing a low-priced d-c



volt-ohm-meter. The instrument has 2-ohm-meter and 4 voltmeter scales. Its sensitivity is given as 1,000-ohms-per-volt. A d'Arsonval type meter with a  $2\frac{3}{4}$ -in. bakelite case, a knife-edged pointer, and a two-color scale is used. Additional information may be had from the manufacturer.

### TWO NEW OXFORD PRODUCTS

The Oxford-Tartak Radio Corp., Chicago, makers of Oxford Speakers, announce 2 new products. A fabricated exponential horn for truck, auditorium, or p-a installations and a "changeable field" replacement dynamic speaker series are the items introduced into the Oxford family. Complete details may be obtained from the manufacturer.

### OPERADIO 6-VOLT SOUND SYSTEM

Operadio Mfg. Co., St. Charles, Ill., present to the trade the Model 112 mobile public address system which offers a complete system including a 20-watt class A amplifier; a dual speed turntable with high grade electro-magnetic pickup; a complete complement of latest type tubes; a hand type crystal microphone of the contact type; a false bottom for leveling purposes; storage battery cable with clips; mixing ar-



rangements for phonograph and microphone inputs; and a strong steel case with cover for the portable unit.

The entire equipment is described in catalog 10A, which may be obtained from the manufacturer.



**PORTABLE SYSTEMS  
FOR  
FUNERAL  
PARLORS**



A Rapidly Growing  
Field for Sound  
Systems.

**SOUND  
SYSTEMS  
INC.**

6545 Carnegie Avenue  
Cleveland, Ohio

**EASTERN SOUND  
TRANSVERSE VELOCITY MICROPHONE**



2 1/2" Diam.  
P. D. 42 Directional  
List Price \$42.00

The internal construction is such that the baffle area is extremely small, thereby insuring true high frequency response. In other models, this has resulted in decreased output, but in the "Transverse" special pole piece design as well as special alloy magnets have been used to achieve the highest output.

Due to its smaller physical size and correct shape, closer talking distances are possible without the difficulties encountered in the common type of ribbon microphone. This is of great importance in reducing feedback conditions in public address work.

Compare with ANY make at ANY price. High and Low Impedance Available. Write for particulars and discounts.

**EASTERN SOUND COMPANY**

94 PORTLAND STREET

BOSTON, MASS.

**SERVICE MEN**

Here's the most useful tool on your service bench.

**KINK-AIDS**

A new servicing technique. Your most perplexing service jobs Solved and Filed for Immediate Use.

**KINK-AIDS**

- Over 2000 Symptoms and successful repairs for hundreds of home and auto radios.
- Filed by set name and model number.
- Clearly printed on wear-resisting cards.
- Enameled steel cabinet, bench size.
- Supplements issued quarterly.

Send for Bulletin 7-B and Sample Card

At your jobbers or postpaid \$1.50

Jobbers write for attractive proposition

**AKRAD PRODUCTS COMPANY**

FACTORY: AKRON, OHIO

NATIONAL SALES OFFICES

Carl M. Lertzman, 700 Prospect Fourth Bldg., Cleveland, Ohio

**RACON  
BROAD-BAND  
BULLET  
SPEAKER**

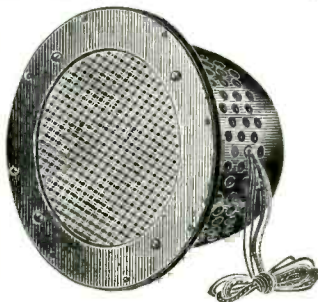

RACON'S new BULLET SPEAKER, a small, compact speaker assembly, permits concentration of sound within limited areas without effecting the tone quality. Equipped with RACON BROAD-BAND cone speakers, these extremely rugged units are suitable for indoor or outdoor use.

Send for RACON catalog S-4 describing the complete line of RACON Horns, Electro-dynamic Units, and Acoustical Sound Projectors.

**RACON ELECTRIC MFG. COMPANY**  
52 EAST 19TH STREET NEW YORK CITY

Great Interest Was Displayed at the Chicago I. R. S. M. Show in the Na-Ald Socket Testing Machine.

Over one and three-quarter million contacts without failure and still going strong is the record of the Na-Ald "Tuning Fork" Contact Socket.

Be sure that your instruments all use this socket. If not, we suggest changing so that you will not have contact failure at some inconvenient time.



436TF



438TF

1-3/16" panel hole, 1-19/32" mtg. spacing

All single types . . . . . List price 40¢

Composite types . . . . . List price 50¢

Write for literature giving complete information on the 908 Analyzer Plug and several other models of analyzer Kits.



Write today for new 1936 general catalog.

**ALDEN PRODUCTS COMPANY**  
715 CENTER ST., DEPT. S-4, BROCKTON, MASS



Here Is the Kit that Requires the Least Time to Install



You want the "eye" directly over the dial. Because of the small overall size of the connector and mounting foot which can be rotated, the most difficult space requirements are met.

Because it installs directly from the back and can be adjusted instantly from the back you can work fast and conveniently.

Meets Underwriters requirements. Bezel gives most effective brilliancy to sector.

2206FECHB "Magic Eye" Outfit as illustrated with 24" cable and complete instructions less tube. List Price \$1.15 Na-Ald discounts to Jobbers are such as to insure your getting the fullest possible value for your money. Insist on genuine Na-Ald products.

**HOW DO YOU DO IT?**

How do you solve the many servicing problems with which you have to contend . . . what special kinks have you worked out which help you in servicing receivers . . . have you developed shortcut schemes for testing, or built test devices that do the work better and faster?

No matter what the scheme or the device, there are many Service Men who would like to know the how's and why's—just as you would like to know about the schemes and devices employed by others.

All you have to do is give us the outstanding points, and a rough pencil sketch of the device if it happens to be such—and we will do the rest.

Write up those ideas now and send them into the . . .

**ON THE JOB DEPARTMENT**

**MUTER**

**Cardohms**

**ARMORED  
WIREWOUND  
RESISTORS**

OVER TWELVE MILLION IN USE  
WRITE TODAY FOR COMPLETE CATALOG

**THE MUTER COMPANY**  
1135 SO. MICHIGAN AVENUE, CHICAGO



**T**HE Group Subscription Plan for SERVICE enables a group of service men, dealers or jobbers to subscribe at one-half the usual yearly rate. The regular individual rate is \$2.00 a year. In groups of 4 or more, the subscription rate is \$1.00 a year. (In foreign countries, \$2.00.)

---

The service departments of thousands of radio dealers, independent service men, etc., have used this Group Plan for years, in renewing their subscriptions to SERVICE.

---

Each subscriber should print his name and address clearly and state his occupation—whether a dealer, jobber, independent service man, service organization, etc.

**Remember this**  
when *Your* Subscription Expires

*(Service)*

**BRYAN DAVIS PUBLISHING CO., Inc.**

19 East 47th Street, New York, N. Y.



# ELECTRO-VOICE

## ELECTRO - VOICE VELOCITY MICROPHONES



- \* Cavity-less. An attractive, extra-durable, formed screen surrounds the ribbon head. Harmful side wall reflection and cavity resonance are eliminated.
- \* Hum-free. Ingenious design allows use within 18" of a power supply or within six inches of an a-c line.
- \* Faithful. A curve that is substantially flat, extending to 14,000 c.p.s.
- \* Complete. Built-in shock absorber, 20 feet of cable, locking cradle are all included.
- \* Adaptable. Available in high impedance or 200 ohms.
- \* Beautiful Appearance. Attractively finished in black and chromium. Refinement of details and trim, modern lines matches its convincing performance.
- \* Priced from \$25.00 to \$75.00 list. Sold by reputable distributors, everywhere.

Electro-Voice Mfg. Company, Inc.  
332 East Colfax Ave. South Bend, Ind., U. S. A.

RAYTHEON PRODUCTION CORP.,  
Dept. F4B, 30 E. 42nd St., New York, N. Y.  
Please send 1935 Tube Chart

Name \_\_\_\_\_

Address \_\_\_\_\_

City \_\_\_\_\_

**RAYTHEON**  
TRADE MARK  
4-PILLAR RADIO TUBES

## RADIO AMATEUR CALL BOOK



is the only publication listing all radio amateurs throughout the entire world. It also includes a complete list of High Frequency Commercial Stations, International Abbreviations and "Q" Signals, High Frequency Press and Weather Schedules, "Q", "R" and "T" Signals, U.S. Radio Inspection Districts, International Prefixes.

Every radio amateur should have a copy of this valuable book. Always up-to-date, published quarterly, single copies \$1.25, annual subscription \$4.

RADIO AMATEUR CALL BOOK, Inc.

612 So. Dearborn Street

Chicago, Illinois



## ANNOUNCEMENT!

Time Payments Now Available  
on CLOUGH-BRENGLE Instruments

For as little as 33c per day you can completely modernize your shop on the new C-B "Pay-As-You-Earn" Plan. Ask your jobber or write for new booklet.

**The CLOUGH-BRENGLE CO.**

1134-X W. Austin Ave., Chicago, U. S. A.

## NEW OXFORD "CHANGEABLE FIELD" REPLACEMENT SPEAKERS

offer you a new convenience, flexibility and economy in speaker replacements.



- Completely new and improved type of Electro-Dynamic Replacement Speaker by OXFORD! Permits quick, easy change of field coil to give you the proper combination of transformer and field for the "job", when you need it. Universal transformer matches any tube. Voice coil remains centered! Available in 6", 8" and 11" models.

Ask your Jobber—or Write TODAY for Bulletin 361A.

**OXFORD-TARTAK RADIO CORP.**  
915 W. VAN BUREN ST. • CHICAGO, U. S. A.

# MOBILE

REMEMBER! — Build STENTORIAN way — for powerful, clear volume and lowest cost.

### 10 Watt Amplifier Nucleus

Matched transformers for better sound reproduction over a wide tonal range.

MOBILE—for Political or Publicity motor cars, sound trucks, motor boats, etc.

MOBILE STENTORIAN NUCLEUS includes genuine "Pull-Push" moisture-proofed matched transformer, chokes, audios, and outputs. The beautiful chassis has lettered terminal strips and marked tube sockets installed—ready for wiring. Full directions with each NUCLEUS.



Send for Free Illustrated Bulletin on MOBILE and 6, 10, 15 and 30 watt STENTORIAN Sound Amplifier Nuclei and the name of our nearest distributor.

*Free for the Asking!*

GENERAL TRANSFORMER CORP., 502 South Throop Street, Chicago  
Manufacturers of Replacement Units

## WRIGHT-DECOSTER NOKOIL DYNAMIC REPRODUCER

← NO FIELD COIL OR CURRENT →

The tremendous demand for the Nokoil Dynamic Reproducer more than repaid us for the many hours of strenuous study and work in developing this high quality unit.

*First in the field and still superior*

- FOR CAR RADIOS
- FOR BATTERY RADIOS
- FOR SOUND INSTALLATIONS

Write for complete catalog, prices and name of nearest distributor. Wright-DeCoster distributors are always anxious to cooperate.

**WRIGHT-DECOSTER, Inc.** 2253 University Ave., St. Paul, Minnesota

Export Dept.: M. Simons & Son Co., New York.

Cable Address: "Simontrice."

Canadian Office: Wright-DeCoster, Inc., Guelph, Ontario.

# J O B B E R S !



- Write for our FREE 1936 catalogue showing complete line of replacement parts
- Short wave parts
- Amplifiers & Kits
- Experimenters parts
- Ham parts and full accessory lines.

Because we supply over 80 percent of the parts purchased by several large distributors we can offer YOU a line of radio parts, giving immediate shipment, at prices as low or lower than you can obtain elsewhere.

**BOND RADIO CO.**

Dept. 234

11702 Livernois Ave., Detroit, Mich.

Several profitable territories are still open for Sales Representatives. Write stating particulars.



# This Is A Big Year For Mobile P. A. Equipment

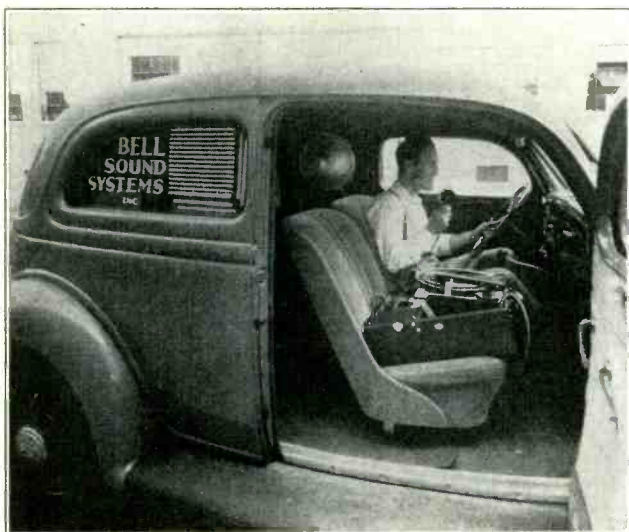

Get Your Share of the Business with This Complete Bell System

The Bell Twin Speaker Mobile P. A. System—Model M-6. Complete, powerful and moderately priced. Operates entirely from 6-volt storage battery. Crystal microphone. Ingenious leveling device for car use. The ideal unit for places where 110 current is not available.

Write Today for prices and details on this, and other Bell Systems.

**BELL** Sound Systems, Inc.  
61-62 East Goodale St.  
Columbus, Ohio



A GIANT IN PERFORMANCE  
BUT A MIDGET IN PRICE

## ATLAS "SILVER TOP" DRIVER UNIT

EFFICIENT  
POWERFUL  
TROUBLE-  
PROOF  
DEPENDABLE

Conservative  
rating, 20 watts  
continuous.



List \$25.00

**YOUR  
COST**

**\$14.70**

## 6 FOOT EXPONENTIAL TRUMPET

Guaranteed 100% weather-  
proof. 6 ft. long—Bell 27x27"



List \$25.00

**YOUR \$14.70  
COST**

STURDY  
DEMOUNTABLE  
UNBREAKABLE  
EFFICIENT  
STORM PROOF  
NON-RESONANT

Shipped Partly Demounted

## ATLAS SOUND CORPORATION

1449—39TH STREET

BROOKLYN, N. Y.

Write for detailed description. Get our complete P.A. Catalog.

## INDEX TO ADVERTISERS

**A**  
Aerovox Corp. .... 183  
Akrad Products Co. .... 189  
Alden Products Co. .... 189  
Allied Radio Corp. .... 183  
Arcturus Radio Tube Co. .... 177  
Atlas Sound Corp. .... 192  
Audak Co. .... 187

**B**  
Bell Sound Systems, Inc. .... 192  
Bond Radio Co. .... 191  
Brush Development Co., The... 187

**C**  
Centralabs ..... 173  
Cinaudagraph Corp. .... 179  
Clarostat Mfg. Co., Inc. .... 179  
Clough-Brengle Co., Inc. .... 191  
Continental Carbon, Inc. .... 177  
Cornell-Dubilier Corp. .... 194  
Cornish Wire Co. .... 170  
Curtis Condenser Corp. .... 181

**E**  
Eastern Sound Co. .... 189  
Electrad, Inc. .... 158  
Electro-Voice Mfg. Co., Inc., The 191  
Electronic Labs., Inc. .... 179

**F**  
Federated Purchaser, Inc. .... 194

**G**  
General Electric Co. .... 153  
General Transformer Corp. .... 191

**H**  
Hickok Elec. Instrument Co. .... 177  
Hope Mfg. Co. .... 187  
Hygrade Sylvania Corp. .... 173

**J**  
Jackson Elec. Inst. Co. .... 187

**K**  
Kay Products of America, Inc. 181  
Ken-Rad Corp., The. .... 189

**L**  
Lafayette Radio Mfg. Co., Inc. 185

**M**  
Mallory & Co., Inc., P. R.  
Second Cover  
Muter Co., The. .... 189

**O**  
Ohmite Mfg. Co. .... 179  
Operadio Mfg. Co. .... 183  
Oxford-Tartak Radio Corp. .... 191

**P**  
Precision Apparatus Corp. .... 187-193

**R**  
RCA Mfg. Co., Inc. .... Fourth Cover  
Racon Elec. Mfg. Co. .... 189  
Radiart Corp., The. .... 181  
Radolek Co., The. .... 193  
Raytheon Production Corp. .... 191  
Readrite Meter Works. .... 185  
Rider, John F. .... 175  
Royal Typewriter Co., Inc. .... 193

**S**  
Solar Mfg. Corp. .... Third Cover  
Sound Systems, Inc. .... 189  
Sprague Products Co. .... 193  
Supreme Instruments Corp. .... 169

**T**  
Technical Appliance Corp. .... 185  
Tobe Deutschmann Corp. .... 183  
Triumph Mfg. Co. .... 175

**U**  
United Transformer Corp. .... 157  
Universal Microphone Co., Ltd. 193  
Utah Radio Products Co. .... 194

**W**  
Ward Leonard Electric Co. .... 185  
Ward Products Co. .... 193  
Webster Co., The. .... 181  
Weston Elec. Instrument Corp. 155  
Wright-DeCoster, Inc. .... 191





## UNIVERSAL VELOCITY and CARBON MICROPHONES

Universal's latest achievement—Ideal for stage use—Not affected by temperature or humidity—Flat frequency response curve from 40 to 10,000 c.p.s.; Output —63 db; Low impedance or direct to grid types. Compact, 2 3/4 x 4 3/4 in. by 1 1/2 in. thick—Weight, less than 18 oz.—Head swings to any desired angle—Beautifully finished in black enamel and artistic chrome plate—Ask for new catalog sheet describing Models RL, RP, RH and CB—List \$22.50—Latest model music type sectional stand for above microphones—List \$10.00.

UNIVERSAL MICROPHONE CO., Ltd.  
424 Warren Lane                      Inglewood, Calif., U. S. A.

## BUSINESS VOTES ROYAL FIRST



First in Speed, First in Ease,  
First in Capacity, First in  
Economy, First in Durability.

17 exclusive improvements—more than 100 refinements.  
Phone for a demonstration of the New Royal. . . .  
Compare the Work!

ROYAL TYPEWRITER COMPANY, INC.  
2 PARK AVENUE, NEW YORK CITY  
Branches and Agencies the World over.

EASY-WRITING ROYAL

## HOME RECEPTION IN AUTOMOBILES with "LONG-RANGE TWINS" Aerials Sealed in Leak-Proof Rubber

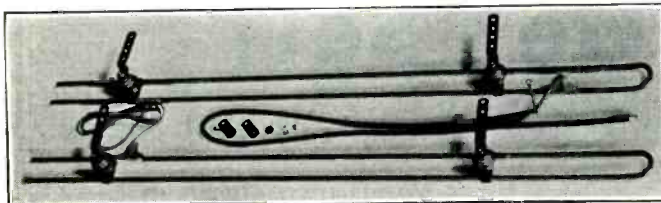

SIX NEW FEATURES ELIMINATE SIGNAL LEAK IN AUTO AERIALS  
93% Signal Strength Efficiency according to Certified Laboratory Tests  
JUST OFF THE PRESS-- Free Copies Available-- 'AERIAL NEWS' All About  
NEWEST DEVELOPMENTS In Automotive Antenna. Write for yours today.

WARD PRODUCTS CORP. 2139 Superior Ave.  
CLEVELAND, O.

## A MUSICIAN CAN'T PLAY ON A BROKEN FIDDLE...

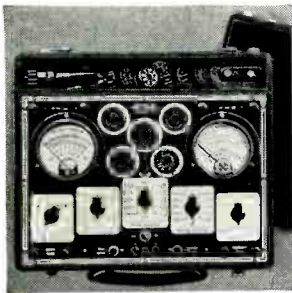

Neither can a service man  
work with "obsolete" in-  
struments. To those having  
valuable, but "obsolete" test  
equipment, we offer this op-  
portunity to rebuild along ad-  
vanced "Precision" engineer-  
ing principles, AT A NOM-  
INAL PRICE

WRITE FOR OUR PLAN  
Mention make and model  
number of your old SET AN-  
ALYZER or TUBE CHECKER.

MODERNIZATION DIVISION—DEPT. S.  
PRECISION APPARATUS CORP.  
821 EAST NEW YORK AVE., BROOKLYN, N. Y.

## TRY SPRAGUES... and note the difference



### DON'T MISS THIS!

Hot off the press comes the new 1936 Sprague Catalog brimful of new condensers, new ideas, new low prices, new service helps. Write for yours today! Save time by making duplicate replacements the Sprague Way! Get the new dope on Interference Elimination! See the complete new line of 450 volt condensers—the finest ever! Learn about the new Sprague mounting flange—and countless other features you can't afford to miss!

Remember: No need to check surges when you use Sprague's. You know they're right.

SPRAGUE PRODUCTS CO.  
North Adams, Mass.

SPRAGUE <sup>600 LINE</sup> CONDENSERS  
AMERICA'S FINEST LINE OF QUALITY UNITS



SEND FOR YOUR COPY!  
The Radolek New 1936 Radio Profit Guide is just off the press . . . completely revised—right up to the minute . . . Everything in Radio—at the right prices. Contains over 10,000 individual Radio Repair Parts—hundreds of new items—a complete new selection of Radio Receivers, Amplifiers, Tools, Tubes, Books and Instruments. Everything you need—always in stock . . . ready for prompt shipment to you. This Big Radio Parts Catalog is FREE. Send for it! Rely on Radolek for Radio. Radolek endeavors to restrict distribution of The Profit Guide to those actively and commercially engaged in the Radio Business. Please enclose your Business Card or Letterhead.



## RADOLEK

597 W. RANDOLPH — CHICAGO  
Send Me The Radolek Radio Profit Guide Free.  
Name .....  
Address .....  
Serviceman?  Dealer?  Experimenter?

# CORNELL-DUBILIER makes A BETTER CONDENSER..

for instance

THE TYPE

## JR

### ELECTROLYTIC

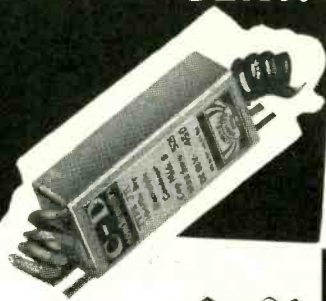

TWENTY-SIX YEARS experience in manufacturing quality condensers. TWENTY-SIX YEARS of continuous research and development . . . all this and more is incorporated in the design of the latest addition to the C-D family of electrolytics . . . THE JR. SERIES.

EXCEPTIONALLY SMALL • COMPACT • CONVENIENT and ECONOMICAL

Built to fill one thousand and one jobs! Supplied with mounting feet and color coded wire leads.

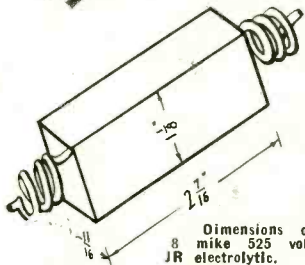

Get the "dope" on how to service 5,000 sets with only thirty C-D condensers. Available at all C-D authorized distributors. Write today for catalog.

## CORNELL-DUBILIER CORPORATION

4375 BRONX BOULEVARD  
NEW YORK

# ACRATONE SOUND SYSTEMS

## Get In The Money!

There's a STEADILY GROWING MARKET for Acratone public address equipment for political rallies, hotels, churches, theatres, dance halls, musicians, amusement park, schools and police work.



YOU make more money with ACRATONE equipment—a complete line covering every type of installation.

Use our FREE ADVISORY SERVICE—we will help you as we have aided thousands of Federated customers. Also our entire sales organization is at your service to help you "land" contracts. No installation too large—none too small!

## FREE

## FEDERATED PURCHASER INC.

Catalog No. A-56 showing complete line of sound amplification systems, also latest developments in radio receivers and parts.

NEW YORK CITY 25 Park Place  
ATLANTA, GA. 546 Spring St., N.W.  
JAMAICA, L. I. 92-26 Merrick Road  
CHICAGO, ILL. 1331 S. Michigan Av.  
NEWARK, N. J. 230 Central Avenue  
PITTSBURGH, PA., 343 Blvd. of the Allies

ORLEANS ST.  
CHICAGO, ILL.

# Utah Flash

UTAH RADIO PRODUCTS CO.

URPC S TWS CHICAGO, ILL.

SEND YOUR CONSTANT IMPEDANCE ATTENUATOR PROBLEMS TO US STOP COMPLETE CONSULTING SERVICE FREE IF THIS AD IS PINNED TO YOUR LETTER.

UTAH RADIO PRODUCTS CO.  
CARRINGTON

TEAR OUT THIS AD—PIN TO YOUR LETTERHEAD AND MAIL TO DEPT. S.  
FOR COMPLETE DETAILS AND FREE CATALOG

# Get Set!

Auto-radio sales and installations swing into stride in May. SERVICE will tell you all the latest developments in the May Issue.

## Send Your Copy In!

Advertising Forms Close  
May 10th  
(First forms close May 5th)

SERVICE 19 East 47th Street  
NEW YORK CITY





*Quick  
as a  
Wink!*

ALL READINGS direct from color-coded panel . . . eliminating necessity for cross-reference to complicated charts or graphs. A real scientific instrument, and a real time-, trouble- and money-saver.

NEW IMPROVED TYPE

*Precision*

## CAPACITOR-ANALYZER and RESISTANCE-BRIDGE

A better, more accurate, more dependable capacitor and resistor Analyzer, designed to meet the requirements of engineers and service men alike.

### 10 OUTSTANDING FEATURES

**1. MEASURES CAPACITY:**

Accurately measures the capacity of all types of electrolytic, paper, mica and air condensers by means of a built-in Wien Bridge. Also measures capacity between circuit wiring, etc. Capacity range .00001 to 70.0 mfd.

**2. MEASURES POWER FACTOR:**

The power factor of all types of electrolytic condensers can be read directly from a scale which is calibrated zero to 50% power factor. Thus the filtering efficiency of condensers can be determined.

**3. MEASURES RESISTANCE:**

Accurately measures the resistance of all types of carbon and wirewound resistors by means of a built-in bridge. Two large scales provide accurate resistance measurements from 50 to 2,000,000 ohms.

**4. MEASURES INSULATION RESISTANCE:**

Quickly measures leakage resistance of paper, electrolytic condensers and all types of insulation up to 1,000 megohms. This test may be made at voltages up to 450 volts D.C., provided by a built-in power supply.

**5. DETECTS DEFECTIVE CONDENSERS:**

Directly indicates leaky, shorted, low capacity, high capacity, and high power factor condensers of both the usual and intermittent types.

**6. CONTINUITY METER:**

The Solar Capacitor Analyzer may also be used as a continuity meter for testing all types of circuits.

**7. COLOR-CODED SCALES:**

More than 45 linear inches of accurately calibrated markings on five color-coded scales, for convenient capacity and resistance measurements.

**8. DIRECT READING:**

All measurements are made simply and directly and no calculations or references to complex graphs or charts are necessary. Overlapping scales eliminate "blind spots" and assure accurate readings at all times.

**9. VISUAL BRIDGE BALANCE:**

The operation of this instrument is unusually simple. A type 6E5 cathode ray tube, used as a visual bridge detector, gives a positive indication of balance on all capacity, resistance, and power factor measurements.

**10. COMPLETE, COMPACT, PORTABLE:**

Complete in itself and requires no external meters, standards, headphones, or similar accessories. Supplied in an attractive cabinet, with removable top and strong carrying handle.

9½ by 7½ by 6¼ inches . . . weight 7 pounds

**TYPE CB-1-60**

110 volts 60 cycles

List Price - - \$32.00

Dealer's Net **\$19.20**

**TYPE CB-2-U**

110-220 volts  
25 - 60 cycles

List Price - - \$40.00

Dealer's Net **\$24.00**

WRITE - -  
for literature

SOLAR MFG. CORP.



599-601 BROADWAY  
NEW YORK CITY

MANUFACTURING AFFILIATES IN

LONDON, PARIS, BERLIN, MILAN



*These figures show why  
Service Engineers say*

**"MY NEXT INSTRUMENT  
IS THE OSCILLOGRAPH  
BY RCA"**



These four actual, unretouched photographs show conclusively that the RCA Cathode Ray Oscillograph makes it possible for you to align receivers with an accuracy impossible with the conventional output meter. For an aligning job that duplicates factory practice, it is necessary to align not merely for output, but for frequency and symmetry. Only an Oscillograph enables you to do this. Remember that the RCA Oscillograph not only speeds up your work and makes it more accurate, but can be used for many other types of service work—and has great effect on set sales. People prefer to deal with experts, and the RCA Oscillograph is the most impressive instrument in radio service work today. Put it to work in both shop and store. Write for details.

**FOR PROFITS — RCA 3-POINT SYSTEM**

How to make more money—(1) get more business, (2) handle it more quickly and perfectly, (3) make the proper charges. RCA 3-Point System gives you assistance on all 3 points. You get it for less than the increased profit on a single job. Ask your distributor for details.

★ Attend RCA Service Meetings —ask distributor for dates.

RCA Cathode Ray Oscillograph

**\$84.50**  
NET  
f. o. b. Camden



This amplifier was aligned with output meter. Oscillograph shows distortion



And this is the proper alignment obtainable in a minute or two with the RCA Oscillograph



Proper alignment of amplifier that is overcoupled, showing broad peak



In seeking for the results of No. 3 with a meter, you're apt to do this—peak the transformers at different frequencies

**PARTS DIVISION**

**RCA Manufacturing Co., Inc., Camden, N. J.**

A Service of Radio Corporation of America