

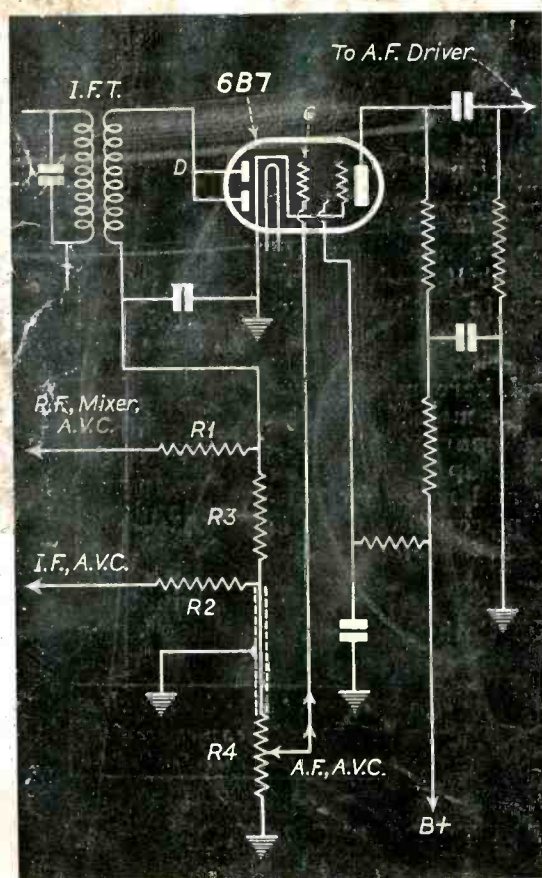

SERVICE

A MONTHLY DIGEST OF
RADIO
AND ALLIED MAINTENANCE



Audio - Frequency AVC

(See Page 163)

PER COPY
25 CENTS

APRIL
1935



LABORATORY CONTROL on the PRODUCTION LINE

REPLACEMENT
EXACT
DUPLICATE
TRANSFORMERS

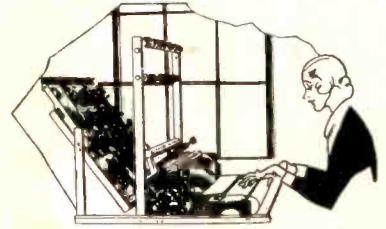

WHEN you replace the transformer in the set of a customer with a STANCOR EXACT-DUPLICATE Replacement Transformer, and say "Now you'll have original performance again," you say it with that confidence in your voice that "gets over," and makes that customer feel you've done him a service beyond your technical skill.

You know STANCOR EXACT-DUPLICATE Replacement Transformers will back you up, but perhaps you don't know just why. Maybe you'd be interested in just one of the reasons.

STANCOR EXACT-DUPLICATE Replacement Transformers are actually Laboratory-Controlled in production . . . right on the production line. They're tested after so many of the operations that go into their making, that you'd wonder how it would be possible for human skill and human fallibility to measure up to such rigid requirements.

For, Laboratory Control here means just that, and nothing less. It means that the same test equipment customarily seen only in the Laboratory is right up there on the production line passing and rejecting hundreds and thousands of pieces exactly as is done in the laboratory in developing one unit.

For instance, there's the Cathode Ray Os-

cilloscope. It's only one of a number of the precision instruments used all along the STANCOR production line. Here, not only the right of the coil to pass on to another operation is determined, but, the reason why that coil may or may not pass is pictured on the fluorescent screen . . . is seen. The operators who have worked on that coil are checked and the fault remedied.

Such inspection is good for us, of course, but it's good for you particularly. You are assured of the kind of inspection that really means Laboratory Controlled Production of precision-made units . . . Replacement Transformers that will actually renew original performance—if that was the trouble.

STANCOR EXACT-DUPLICATE Replacement Power, Audio and Choke Transformers are identical to the originals in every electrical and physical characteristic. There is no re-drilling or re-wiring to be done. STANCOR Universal Power and Audio . . . AC-DC Chokes and general purpose replacement audios and chokes have been designed and developed to give to the service man a complete Replacement Transformer Service on which he could rely implicitly. All are packaged in distinctive boxes and accompanied by planograph diagram with standard color code.

Distributed by authorized STANCOR distributors all over the United States, Canada and our Island possessions.

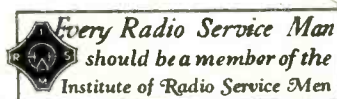

STANDARD TRANSFORMER CORPORATION . . . 866 Blackhawk St., Chicago, Ill.

10 points of OSCILLATOR difference

-OF VITAL INTEREST TO YOU!

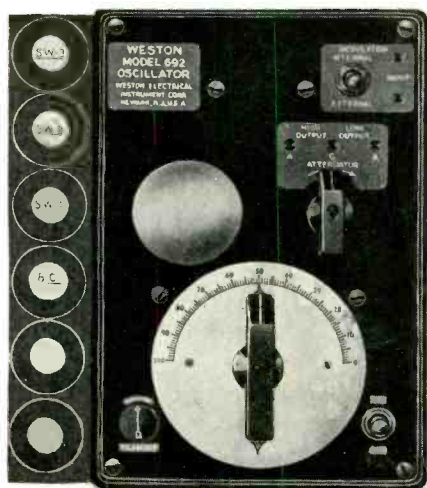
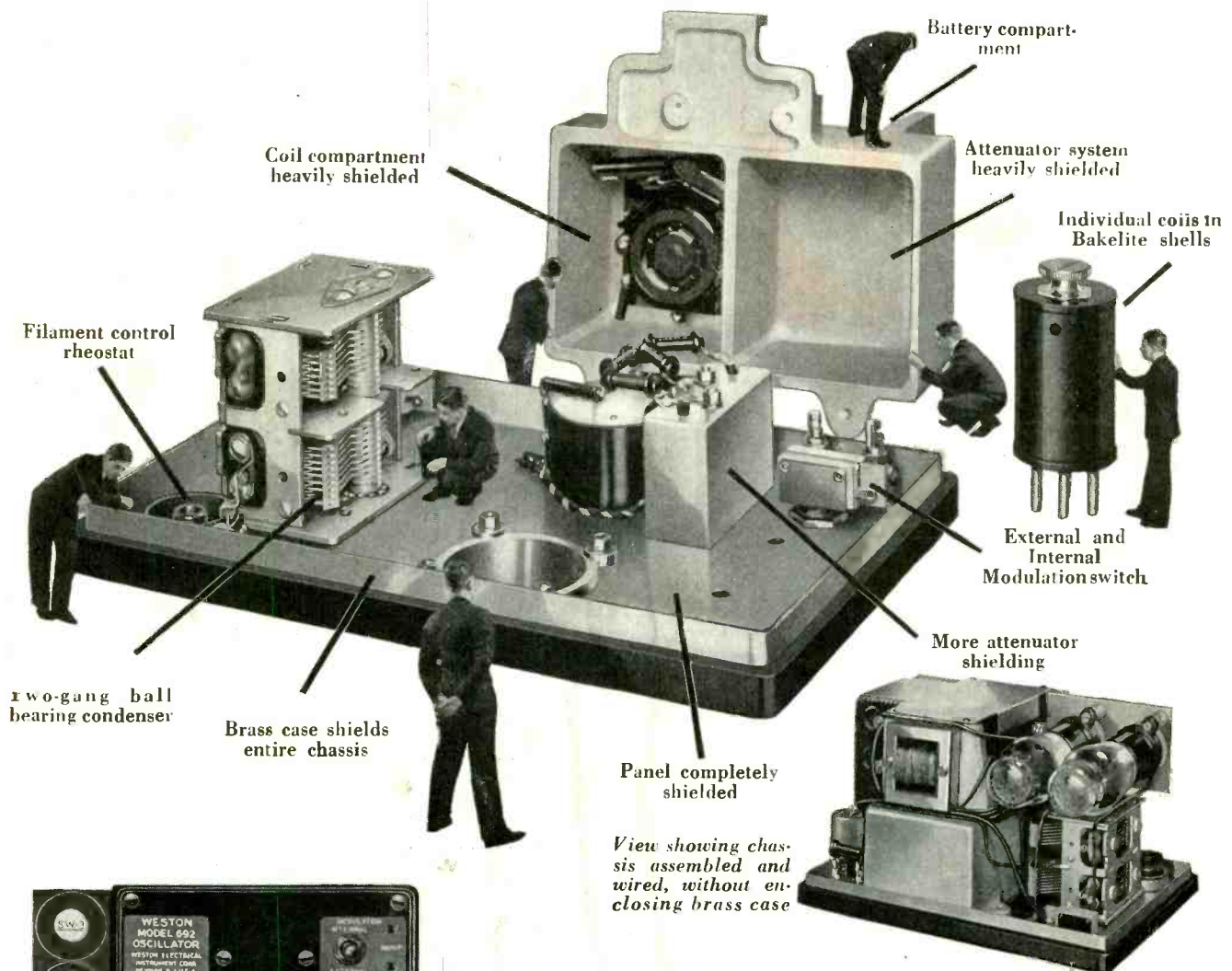

THE WESTON ALL-WAVE OSCILLATOR

Compare this Weston Model 692 All-Wave Oscillator . . . in all details of design and construction . . . part for part . . . with any the market affords. Note particularly that each part in Model 692 has been carefully designed for its special purpose. You'll agree that here is an oscillator you can safely stake your reputation on . . . that will enable you to do accurate servicing on all modern receivers. See Model 692 at your jobber's, or write for descriptive bulletin . . . Weston Electrical Instrument Corporation, 604 Frelinghuysen Avenue, Newark, New Jersey.

WESTON 
Radio Instruments

SERVICE

A Monthly Digest of Radio and Allied Maintenance

Vol. 4, No. 4
APRIL, 1935

EDITOR
M. L. Muhleman

ASSOCIATE EDITOR
Ray D. Rettenmeyer

EDITORIAL CONTENTS

FEATURES

- Audio-Frequency AVC..... 163
Noise-Suppression Antennas, Part II
By William F. Osler..... 161
Standardized Alignment Methods
By V. E. Jenkins..... 159
The Motorola Magic Eliminode
By E. H. Wavering..... 171

ANTENNA

- Receiver Case Histories..... 156

ASSOCIATION NEWS

- 178

AUTO RADIO

- Code Reception with Sparton Model 333
Auto Radio..... 171
The Motorola Magic Eliminode
By E. H. Wavering..... 171

CIRCUITS

- Antenna with "Twisted Pair" Transmission
Line..... 161
Audio-Frequency AVC..... Front Cover
Crosley Chassis 5C2..... 168
Howard "Grand" Power-Supply Unit..... 167
Howard "Grand" Pre-Amplifier Unit..... 166
Howard "Grand" Receiver Unit..... 165
RCA Victor Model PG-62D1..... 174
RCA Victor TMV-128-A Frequency
Modulator..... 170

- Sparton Model 655..... 170
Switching Unit..... 172
Transposed Transmission Line with Balancing
Coil..... 162
Typical Noise-Reducing Antenna System.... 163

GENERAL DATA

- Addition of Resistor in Sparton Models
61 and 62..... 167
Audio-Frequency AVC..... 163
Crosley Chassis 5C2..... 168
Howard "Grand" Receiver..... 164
Possible Cause of Slipping of Sparton Plane-
tary Drive..... 167
RCA Victor Model PG-62D1..... 174
RCA Victor TMV-128-A Frequency
Modulator..... 169
Sparton Model 655..... 170
Switching Unit..... 172

HIGHLIGHTS

- 180

MANUFACTURERS

- 182-184

ON THE JOB

- Switching Unit
By Al. Beers..... 172

PUBLIC ADDRESS

- RCA Victor Model PG-62D1..... 174

BRYAN S. DAVIS
President

JAS. A. WALKER
Secretary

New York Telephone: Plaza 3-0483

Chicago Office—608 S. Dearborn St.—C. O. Stimpson, Mgr.

Telephone: Wabash 1903

Cleveland Office—10515 Wilbur Ave.—J. C. Munn, Mgr.

Telephone: Garfield 0905-J

Published Monthly by the

Bryan Davis Publishing Co., Inc.
19 East 47th Street
New York City

SANFORD R. COWAN
Advertising Manager

A. B. CARLSEN
Circulation Manager

Los Angeles Office—2743 San Marino St.—J. E. Nielsen, Mgr.

Telephone: Drexel 0718

St. Louis Office—505 Star Bldg.—F. J. Wright, Mgr.

Wellington, New Zealand—Tearo Book Depot.

Melbourne, Australia—McGill's Agency.

Entered as second-class matter June 14, 1932, at the Post Office at New York, N. Y., under the Act of March 3, 1879. Subscription price \$2.00 per year in the United States of America; 25 cents per copy. \$3.00 per year in Canada and foreign countries; 35 cents per copy.



*The Whole Radio World is Singing
the praise of this Sensational
100% RADIO CATALOG*

**AUTO
RADIOS**

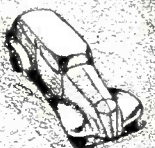

Certainly it's the TOP CATALOG of the Radio Industry—because there are more items listed (over 50,000); more specialized departments; more pages of special BARGAINS; more special summer items; more nationally known lines; the greatest line of S.W. and All-Wave Receivers (24 pages of them); and 30 pages packed with the most all-inclusive array of Public Address Equipment ever assembled!

This Strictly 100% Radio Catalog is largest ever published anywhere by anyone to meet the needs of the Spring and Summer Radio Buyer. It lists every last minute price advantage as well as every latest development in the world of Radio. Get your FREE copy of this Encyclopedia of Radio in which everything is listed at Lowest WHOLESALE Prices!

AUTO RADIOS and ACCESSORIES

Featuring Lafayette Receivers to meet every requirement. Prices from \$19.95 up. . . . A New SUPPRESSORLESS Type receiver. . . DASHBOARD Type and the New SELF ALIGNING Types which are so easily serviced. Also a complete selection of Auto Aerials—including those designed for the all metal turret-topped cars, noise suppressors, etc. This big section is a complete Auto Radio Catalog in itself!

S.W. and ALL-WAVE RECEIVERS

For world-wide reception. No matter what you're looking for you'll find it in this great 24-page section. Receivers from 5-12 tubes; latest circuits beautiful cabinets; phono-radio combinations . . . all at amazingly low prices.

WORLD'S GREATEST P.A. Department

Featuring 30 pages of the famous Lafayette Equipment—in use by the foremost companies throughout the world. Anything and everything in Amplifiers from 3½ watts to 100 watts. Complete systems suggested and illustrated for each amplifier! Permanent systems. Portable systems, Mobile units, Hi-Fidelity Amplifiers, Theater Amplifiers, Amplifiers for 6 volt storage battery and 110 volt current . . .

—all this PLUS pages devoted to speakers, trumpets, field supplies, input stages, microphones of every description, phono pick-ups and motors! No wonder this is the greatest Catalog of Sound Equipment ever published!

REFRIGERATION FOR PROFIT

In 1935 Servicemen are going into this money making field as never before! Here at Radio Headquarters we have created a special Refrigeration Department . . . and have prepared a special Refrigeration Parts Catalog, listing hundreds of essential parts, tools and equipment. When sending for your copy of Catalog No. 57—reserve your copy of this Refrigerator Parts Catalog in which everything is listed at lowest WHOLESALE Prices.

**SOUND
AMPLIFIERS
AND
SYSTEMS**

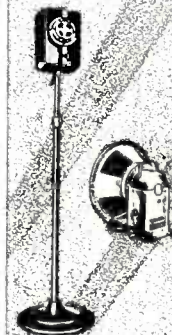

WHOLESALE RADIO SERVICE CO.
NEW YORK, N.Y. - 100 Sixth Avenue

ATLANTA, GA. 430 W. Peachtree St.

NEWARK, N.J. 219 Central Ave.

Mail this now — TODAY

WHOLESALE RADIO SERVICE CO.
100 Sixth Ave., Dept. S-45, New York, N. Y.
 Send me your 1935 SPRING and SUMMER Catalog No. 57.
 Reserve Copy of your Refrigerator Catalog.
 Reserve Copy of your Specialized S.W. Catalog.

Name
Address
City State

THE ANTENNA . . .

Receiver Case Histories

BACK in March, 1933, there appeared a letter in the "Forum" of SERVICE, which contained the suggestion that we publish short, non-technical notes dealing with typical receiver faults. You will remember that we were very much against the inclusion of such data in SERVICE for two reasons: First, because such notes might permit the screwdriver-mechanic type of Service Man to get by with no special knowledge or training, and, second, because it has long been the policy of SERVICE to cater to the trained Service Man and offer technical data on new circuits and engineering features that will permit him to keep up-to-date. Moreover, it was, and still is, our opinion that the best equipped Service Man is the one who can determine for himself what is wrong with a receiver without having to resort to non-technical notes which provide the specific fault but fail to give reasons.

At the time of the publication of the above mentioned letter, we were well-supported in our stand by a huge number of readers, who were kind enough to write us their opinions on the subject. It was generally agreed that SERVICE should remain a technical magazine and should continue to keep the reader informed of technical advancements rather than provide cut and dried short-cuts.

Now, as we review in our mind the two years that have passed and left with us much in the way of technical progress, new methods of manufacturing and new methods of servicing, we wonder if that momentary flare-up to which we have referred, should not be re-analyzed and viewed in a new light. For some time we have had the discomfiting feeling that we have been bending over backwards with regard to notes on receiver faults and changes, and have only just learned the reason for this irksome impression. Here it is:

Granted that cut and dried notes leave us all wide open to the competition of the "kid next door" and for this reason, if no other, should be given the go-by. However, the fact remains that nowadays there are any number of receiver case histories that are of value to even the best-trained Service Man. For instance, many manufacturers make production changes in the middle of a run, and unless we report such alterations, any Service Man may be put on the spot at some time because he has not been appraised of the change. Moreover, receiver design engineers do not by any means hit the nail on the head every time they put out a new set. Quite often they find after the receivers have gotten into the field, that everything isn't as it should be—with the result that some portion of the circuit is changed. Now, if an engineer states that improved action can be obtained from the bias-type volume control in a certain model receiver, by the addition of a specific value of bleeder resistor, the "kid next door" isn't any better off than he was before he read the statement—but the trained Service Man can apply the data not only to the re-

ceiver model specified, but to many other receivers of similar design.

We have received a very interesting letter from Mr. Francis C. Wolven, of Saugerties, New York, which covers just this point. Mr. Wolven is of the opinion—and so are we—that the *right kind* of receiver notes would be highly valued. We quote below a portion of his letter:

"I would like to suggest that a column or page in SERVICE be devoted to case notes contributed by bona-fide Service Men. Everyone engaged in servicing knows that there are certain things learned only by experience and which apply only to one case in a thousand. The sharing of such information, would, I think, be a great move for the common good.

"I believe this section should cater only to the technically-minded Service Man and not to the novice. Not that this would be done for selfish reasons, for we all must learn somehow, but simply because the novice is at best an apprentice and definitely not a Service Man. It stands to reason that SERVICE should not cater to the new beginner any more than a medical journal should teach elementary biology.

"I believe that material accepted for this section should be reliable and that any methods recommended be in keeping with standard servicing practice. The emphasis should be upon the highest type of procedure and every effort made toward helping the technician and freezing out the tinkerer.

"The notes should be out of the A-B-C class. Parts should be designated by their rating and function and not by appearance and position. The real Service Man will understand such terminology. Let's get away from saying, 'the mauve and orange resistor in the northwest corner' and talk our own professional language. Let's get away from obsolete designations and methods and go professional with a vengeance. I believe that's the only course for the man who feels that his future lies in radio."

Now, you may ask why we are making such a point of this matter when each issue of SERVICE carries numerous receiver notes. Well, there are four reasons: First, we believe the time has come for a bigger and better section given over to such notes; second, we feel that all the notes published should come closer to meeting the "standards" as outlined by Mr. Wolven; third, we think it might be a splendid idea if *all* such notes were placed into one section, and run in alphabetical order by receiver trade name, instead of spread through the "General Data" and "On The Job" sections as they now are; and fourth, that, as usual, we do not wish to carry through such a plan, which will require a different form of handling, until we are quite sure that you feel the data would be of real value to you.

Won't you let us have your opinions and suggestions? The sooner we know what you fellows want, the sooner we can get going.

Springtime for Henry

... means PROFIT-time for the smart service man who's posted up to the last dot-and-dash on auto radios ... which brings us to the BIG news ...

Rider's SPECIALIZED AUTO RADIO

Manual ... Vol. II

A whopper! Taking up right where Vol. I left off, and priming you to the pumphandle with facts ... facts ... FACTS! 350 pages, nearly 70 manufacturers (everybody that's anybody), and no duplication whatever 'twixt this and good old Vol. I. How can anyone hope to get along without 'em both?

Vol. I—350 pages \$3.50
Vol. II—350 pages \$3.50

ALSO
For April
Publication

Up-to-the-minute data, revealing all the ins and outs of building cathode equipment and utilizing it to maximum advantage. No service man should be without it.

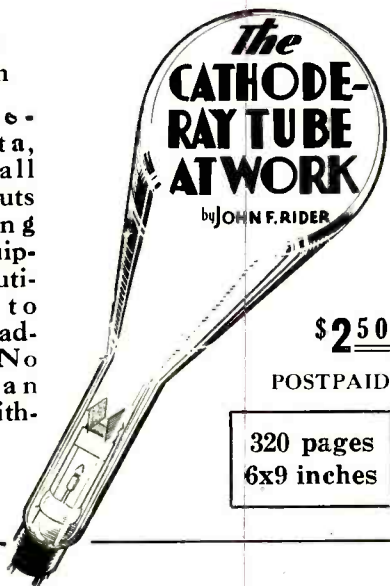

\$2.50

POSTPAID

320 pages
6x9 inches

See another RIDER Announcement
on page 181

FREE "Successful Servicing," our 8-page monthly house organ, with valuable data pertaining to RIDER's Service Manuals, should be reaching you regularly. Be sure you are on our list, if you are interested in successful radio servicing.

JOHN F. RIDER, Publisher
1440 Broadway, N. Y. City

For Those Who Demand the Finest . . . THE **TRIPLET** TEST SET

No.
1205



DEALERS and servicemen who are equipped with Triplet Master Units can handle every servicing operation quicker and more accurately than ever before—no matter how difficult or complicated. Nothing has been spared to make the 1205 Test Set an outstanding instrument for present-day and future needs.

TRIPLET MASTER TEST SET, NO. 1205, INCLUDES:
No. 1200 Volt-Ohm-Milliammeter. DC scales readings: 1/5 to 1,000 volts (2,000 ohms per volt)—20 microamperes to 250 milliamperes—0 to 3,000,000 ohms. AC scale readings: 1 to 1,000 volts. Capacity charts furnished. Dealer's net price, unit only.....\$21.67

No. 1210 Tube Tester. Contains the most efficient short check known. This unit incorporates an improved load control which places the proper load on the tube under test. The new and exclusive circuit in this tester is approved by leading tube engineers, embodying every essential for a dependable emission test of tube values. Dealer's net price, unit only. \$20.00

No. 1220 Free-Point Tester. Makes all series or parallel meter connections to the set sockets. Dealer's net price, unit only.....\$8.33

No. 1230 All-Wave Signal Generator. Frequencies: 100 KC to 18 Megacycles. Perfect attenuation. Modulated or unmodulated. Dealer's net price\$15.33

No. 1205. Complete with above four units in case. Dealer's net price\$71.33

Triplet Interchangeable Master Units make possible different combinations of test equipment to suit every servicing requirement. These units can be used as furnished, or, placed in convenient portable cases that hold one, two, three or four units.

Your Jobber Can Supply You

TRIPLET ELECTRICAL INSTRUMENT CO.
150 Main Street Bluffton, Ohio

MAIL TODAY FOR DETAILS

Triplet Electrical Instrument Company
150 Main Street, Bluffton, Ohio

Gentlemen:

Please send your latest literature. I am particularly interested in receiving information on Triplet Instrument No. 1205.

Name

Address

City

State

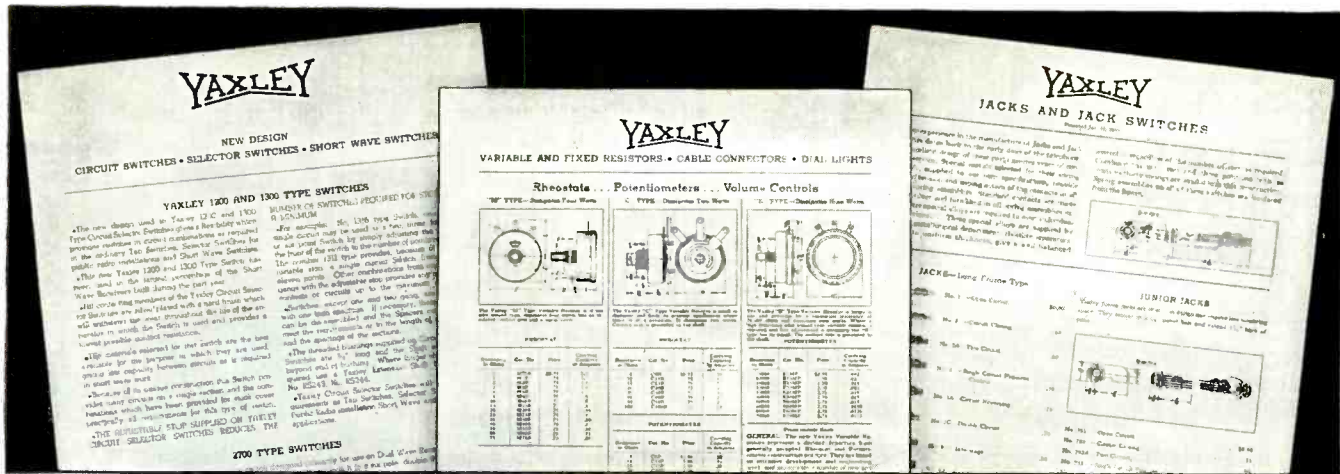

Make the Yaxley Jobber Your Friend

by STANDARDIZING on

Genuine Yaxley Replacement Parts

DON'T MISS THIS SPECIAL OFFER



The Yaxley Kit of 6 Volume Controls that service more than 2500 set models.



This handy wrench is FREE with each kit.

A copy of this complete and authoritative Replacement Manual is yours for the asking.



There is no better way to insure better profits in your radio service business than to give your customers still better service. And every service man knows that Yaxley Distributors who carry the Yaxley line 100% can give him the best service obtainable anywhere.

By being able to supply your needs promptly with a complete line of high quality parts, the Yaxley Jobber acts as your friend, and in so doing helps you build a profitable service business. He makes your job easier by being able to provide you with a product for which a wide acceptance has long been established by an extensive and sustained program of national advertising.

Mail the coupon today for your free copies of Yaxley catalogs Y-201, Y-202 and Y-203, illustrated above, which give full information and prices on the complete line of Yaxley parts. They will be very helpful in enabling you to give still better service.

YAXLEY MANUFACTURING COMPANY, INC.
 Division of P. R. Mallory & Company, Incorporated
 INDIANAPOLIS, INDIANA Cable Address: *Pelmallo*

YAXLEY MANUFACTURING CO., INC.
 Indianapolis, Indiana

Gentlemen:

Please send me free copies of Catalogs Y-201, Y-202, Y-203.

I enclose \$3.60 (which is 40% less than the regular list price of individual controls) for kit of 6 Volume Controls, which entitles me to FREE Wrench.

I enclose 6 carton tops for FREE Wrench.

Please send free copy of Yaxley Replacement Volume Control Manual.

Name.....

Address.....

My Jobber's Name is.....

SERVICE

A Monthly Digest of Radio and Allied Maintenance

FOR APRIL, 1935

STANDARDIZED ALIGNMENT METHODS

For Tuned-Radio-Frequency and Superheterodyne Receivers

By V. E. JENKINS*

ALTHOUGH it is impossible to standardize alignment procedure in the sense that any single routine can be set up for all types of receivers, there are a number of fundamental principles which always apply. The first of these is the necessity for controlled test conditions. The Service Man who must trust his ear rather than an output meter, or depend upon the varying characteristics of broadcast signals for test input, faces unsurmountable obstacles right from the start. Modern receivers, particularly those of the all-wave type, involve enough complexities without the introduction of external variables during the adjustment.

Assuming, however, that controlled test conditions are available in the form of an accurate test oscillator and output meter, it seems desirable to set up general methods of alignment, standardized in the sense that they should be modified only for definite scientific reasons known to the tester. (The necessity for working continuously below the volume level affected by automatic volume control devices, for instance, may seem to complicate the routine, but failure to follow this precaution makes accurate alignment impossible.)

A specific step-by-step alignment routine for (A) tuned-radio-frequency receivers, and (B) superheterodyne receivers is given below in tabular form:

ALIGNING TUNED-RADIO-FREQUENCY RECEIVERS

(1) Connect output posts of test oscillator to antenna and ground posts of the receiver.

(2) Connect output meter through

its series condenser from the plate of the output tube to the ground. (Or from plate to plate of the push-pull output tubes, if this type of output circuit is encountered.)

(3) Turn on receiver with volume control in maximum position; turn on the oscillator, and adjust the receiver dials to bring in the test signal at approximately 1,400 kilocycles.

(4) Adjust the oscillator attenuator to provide a workable reading on the output meter. (In the case of receivers equipped with automatic volume control, use the lowest possible signal which provides an observable reading.)

(5) Using an insulated screw-driver, adjust the trimmer condenser on the detector stage condenser section until the output indicator reaches a peak deflection and begins to decrease. Then re-adjust the trimmer screw to provide the peak reading.

(6) Now adjust the trimmer condenser on the condenser section preceding the detector stage in the same way, and repeat the procedure step-by-step back to the first radio-frequency tube. (Note: The indications on the output meter will constantly increase as the trimmers are adjusted, and the pointer may even tend to go off the scale. This reading should be lowered by adjusting

the oscillator attenuator, leaving the volume control of the receiver in the maximum position. In the case of AVC receivers, keep the output reading constantly at the lower end of the scale in this way.)

(7) After adjusting all the trimmers, it is best to go back and make a final re-adjustment for exact resonance at each stage.

(8) The receiver should next be tuned to approximately 1,000 kilocycles, and the oscillator controls set to provide a workable output on the output meter at this frequency.

(9) (Do *not* adjust the trimmer condensers again at this frequency or the receiver will not track correctly at the high-frequency end of the band. Slotted end plates are provided on each condenser section for such adjustment.) Using a fibre rod or similar non-conductor, simply deflect the sections of these slotted end plates that are in mesh with the stationary plates at this condenser setting, and note the effect upon the output reading. Bend the plates slightly as required to give the maximum output at this point. This adjustment should be made first on the detector section, and then repeated on each of the gang sections back to the first radio-frequency stage.

For modern radio receivers, the old "finkering" type of so-called alignment is definitely inadequate. The operation now requires a considerable amount of time and accurate test equipment, and the legitimate Service Man deserves proportionate compensation for a job well done.

The alignment methods which Mr. Jenkins outlines in step-by-step form not only furnish a handy operating routine, but indicate standards of servicing practice which sooner or later must be adopted for this operation.

*Radio Division, Weston Electrical Instrument Corp.

(10) Repeat this adjustment at a setting of 600 kilocycles, this time bending the additional slotted sections of the end plates that have moved into mesh with the new condenser setting. Again the trimmer condensers should be left untouched. If this procedure has been followed with reasonable care using insulated tools, the set should now be well aligned.

NEUTRALIZING ADJUSTMENTS ON T-R-F RECEIVERS

Note: Many receivers of the tuned-radio-frequency type also require neutralizing adjustments. These should in all cases be made *after* the trimming of the condenser gang. The following neutralizing routine may be carried out directly after the alignment:

(1) Connect the antenna and ground terminals of the receiver to the high output and ground posts of the oscillator.

(2) Connect the output meter as before, through a series condenser from the plate of the output tube to the ground, or across the plates of the push-pull tubes.

(3) Turn on the set and oscillator, tuning in a signal at approximately 1,000 kilocycles.

(4) Remove the first radio-frequency tube and substitute a dummy (one with the filament burned out), or insulate one of the prongs with a piece of paper so that the filament does not heat up.

(5) When the oscillator and receiver volume controls are at full setting, a signal should be indicated on the output meter. The neutralizing trimmer for this stage is then adjusted to reduce this signal to zero, or to a minimum value.

(6) Now move the dummy tube to the second stage (restoring the first stage to operation) and adjust the neutralizing trimmer on this stage until the signal is again reduced to zero or a minimum.

(7) Successive r-f stages should be neutralized in the same way, up to and including the detector stage.

ALIGNING SUPERHETERODYNE RECEIVERS

(1) First determine whether the receiver is equipped with automatic volume control. If it is, and the avc is actuated by a separate tube, this tube should be removed before proceeding with the alignment. (Be sure, however, that this tube does not serve a double function in the receiver, as in this case it must be left in the socket and the alignment carried out with the avc functioning.)

(2) Short circuit the antenna and ground posts of the receiver, and make connections from the service oscillator

to the grid of the first detector tube and the chassis. (When a converter tube such as type 2A7 is employed in the receiver circuit, internal oscillation is cut off by placing a shorting clip across the stationary and rotary condenser plates of the oscillator tuning section.)

(3) Connect the output meter to the receiver in the regular way, and turn on the set and oscillator.

I-F ADJUSTMENTS

(4) Adjust the tuning controls of oscillator to the intermediate frequency specified by the receiver manufacturer. (The calibration curve supplied with Weston test oscillators permits this setting to be made *exactly*, an important factor in the results subsequently obtained.)

(5) Now increase the signal volume by means of the oscillator attenuator until a reading is indicated on the output meter. *Important:* If no reading is obtained even with the oscillator volume at a maximum, *do not change the oscillator tuning control from the specified frequency setting in order to obtain a signal.* The absence of an output reading at this point means that the intermediate-frequency transformers are far out of alignment, and the trimmers should be given a preliminary adjustment to obtain an initial output reading. If such a reading is obtained by varying the oscillator tuning control, the receiver will be lined up at an intermediate setting inconsistent with its design, and will never track correctly with the radio-frequency section.

(6) If the set is equipped with automatic volume control which operates in conjunction with some other function and thus cannot be made inoperative, adjust the oscillator attenuator so that the signal used for alignment is as low as possible. Then the secondary trimmer condenser on the intermediate-frequency transformer should be adjusted to give a peak deflection on the output meter.

(7) Repeat this procedure for each intermediate-frequency transformer, working back to the first detector section. Where low volume signals must be utilized because of avc on the receiver, it may be necessary to go over these adjustments a second time to determine the peak resonance at each stage.

FLAT-TOPPING

(8) *Flat-Topping* (Optional)—For receivers of high quality, where the operator is anxious for fidelity of reproduction at the expense of great sensitivity, the intermediate-frequency transformers may be "flat-topped" so that a band width of approximately 5 kilocycles is obtained in equal volume

through the i-f amplifier. This is accomplished as follows:

(a) Set the tuning control of the test oscillator 2.5 kilocycles below the specified intermediate frequency of the receiver. This will cause the output meter to drop a few degrees if the set has already been accurately aligned. Then adjust one of the intermediate-frequency stages to bring the output meter back to within a degree or two of what it originally read.

(b) Now set the tuning control of the oscillator 2.5 kilocycles *above* the specified frequency setting. The decrease in output which results should again be partially offset by adjusting *another* of the intermediate-frequency transformer trimmers.

(c) Now rotate the oscillator tuning control back and forth over this 5-kilocycle band, noting the effect on the output meter. If proper adjustment has been made, the resonance point should be less sharp, and a fairly constant output maintained over this band.

R-F AND OSCILLATOR ADJUSTMENTS

(9) The intermediate-frequency amplifier should now be satisfactory as a result of the previous operations, and attention should be given to the radio-frequency and oscillator adjustments.

(10) Connect the test oscillator directly to the antenna and ground posts of the receiver; turn on the oscillator and adjust the frequency to approximately 1,400 kilocycles.

(11) Remove the shorting clip from the receiver oscillator gang section and tune in the signal to obtain a peak reading on the output meter. (If the receiver dial has slipped out of calibration on the condenser shaft, it should be readjusted at this point).

(12) Decrease the output reading to a good working level with the oscillator volume control, and adjust the high-frequency trimmer on the condenser section tuning the mixer circuit. When the peak output has been obtained at this point, make similar adjustments on the trimmer for the radio-frequency section. (Some receivers have both a high- and low-frequency trimmer for each condenser section, and in such cases only the high-frequency trimmer should be adjusted at this frequency setting. Other condensers have but one trimmer, along with slotted end plates. Only the trimmer should be adjusted in this case, leaving the end plates for low-frequency alignment.)

(13) After aligning the mixer and radio-frequency section, adjust the high-frequency trimmer of the receiver

oscillator in a similar way. (These adjustments, all made at 1,400 kilocycles, should suffice to bring the high-frequency end of the broadcast band into good alignment. For high-frequency adjustment of the short-wave bands, individual trimmers are sometimes used on each coil, but these should be left untouched until a final alignment is made on each of the short-wave bands.)

(14) To align the low-frequency end of the band, tune the test oscillator to approximately 600 kilocycles and adjust the receiver dial until a peak indication is obtained on the output meter.

(15) If the receiver is equipped with low-frequency trimmer condensers, they should be adjusted on the r-f and mixer sections for maximum output reading. If slotted end plates on the condenser sections are used instead, then the slotted sections of these end plates that are in mesh with the stationary plates should be bent to produce the maximum output. (The trimmer condensers on the condenser gang should *not* be adjusted at this point, as they control only the high-frequency end of the band.)

(16) As the trimmer on the oscillator condenser section affects the frequency setting of the entire receiver, the tuning of the main condenser dial will vary with this adjustment. Therefore, the main condenser control should be moved back and forth and the trimmer adjusted to give a maximum output-meter reading irrespective of the dial setting.

SHORT-WAVE ADJUSTMENTS

(17) If there are separate trimmer condensers on the various short-wave coils these can now be re-aligned for the short-wave bands covered. All the adjustments made up to this time on the high- and low-frequency trimmers and oscillator padders should remain fixed, and all additional adjustments made on these high-frequency *coil trimmers* only.

(18) To adjust the first short-wave band, tune in on oscillator signal at the high-frequency end of this particular band, and adjust the small trimmer condenser associated with the particular coil connected in the circuit on this band

as before. Then make this same adjustment on the r-f, mixer and oscillator coils.

(19) Finally, repeat the procedure outlined in step (18) at the high-frequency end of each short-wave band in turn, wherever trimmer condensers are available on the various coils for making such adjustments. If the coil constants have remained substantially the same as when the receiver was manufactured, the short-wave bands should now track correctly, and the receiver show a real improvement in selectivity and sensitivity.

As the circuits used in short-wave receivers vary widely in design and operation, detailed instructions for aligning these bands are usually supplied by the manufacturer. These instructions should be obtained by the Service Man either from the owner of the receiver or from the manufacturer if a satisfactory job is to be done in every case. The general routine outlined, however, will meet the requirements of most receivers, and result in an alignment job that may well be classed as "standard."

NOISE-SUPPRESSION ANTENNAS

By WILLIAM F. OSLER *

PART II

IN a previous article was considered something of the nature of the propagation of electric waves such as are the vehicle of transmission of radio signals, and brief suggestion was made as to what must be done in providing a suitable antenna structure for the reception of those waves and, more particularly, but most briefly, what special provisions might be made in such reception for the suppression of the radio noises inevitably present to the end that weak signals may be received through strong local electrical noises.

SIGNALS—NOISE—STATIC

It is the purpose of this article to consider this problem of noise suppression in receiving antennas in greater detail, and to point out some of the means that have been adopted for this accomplishment as well as the mode of operation of these expedients, in addition to some of their unavoidable limitations.

Basically, all noise-suppression antennas operate, if they operate at all, because of the fact that the radio signals from a remote radio station are stronger at points well above the earth than at lower levels, while, on the other hand, commonly-encountered radio noises, i.e.,

man-made static, are strongest near their sources, and hence, usually, are strongest near the earth's surface. Thus the problem of securing substantially noise-free reception reduces itself to one of providing a receiving antenna which is sufficiently elevated to be in the region of strong radio signals and weak noise and, at the same time, of providing the means whereby the strong signal may be carried down to the receiving equipment, presumably located near the ground, without picking up any serious amount of the disturbing noise.

It is to be remembered in this that such a noise-suppression system is, by no means, a static-elimination system, since, like the signal, the static originating at a remote point is of greatest intensity at points well elevated above the ground, and the elevation of the an-

tenna tends to increase not only the intensity of the signal intercepted by the antenna, but the natural static as well. There is, however, a positive differentiation against the static, and in favor of the signal resident, in the directionality of strong static. As a result of this the use of a horizontal antenna to intercept the horizontally polarized component of waves from a remote radio station—as more completely described in the previous article—provides a rather more unfavorable condition for the reception of the static than usually is present in the conventional vertical antenna. In practice, this is usually found to be of marked advantage, but it is by no means a universal panacea for the many troubles that result from the presence of natural static.

TRANSMISSION LINES

The means for the transmission of the signal power from the antenna to the receiving equipment next requires attention, the mode of evolution of which explains much of its technical properties.

In the early attempts to accomplish noise suppression, it was quite natural that the designer of receiving antennas should take for his work the elements

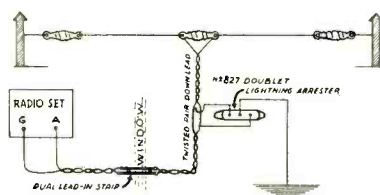

Fig. 1. Antenna with "twisted pair" transmission line.

* Vice-President, Cornish Wire Co.

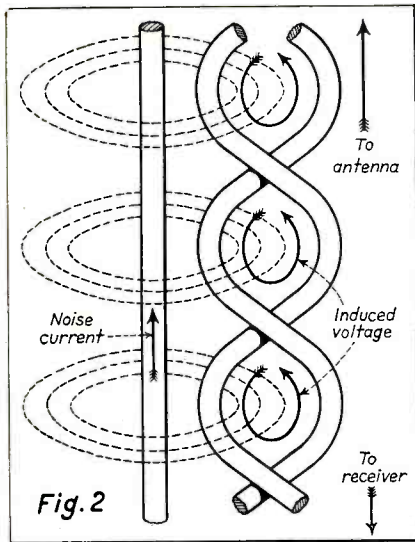

Fig. 2
Illustrating function of transposed transmission line.

that had long since been worked out by the transmission engineer in the form of highly efficient transmission lines. These transmission lines were invariably of the form of uninsulated wires separated several inches from one another, and equipped with the usual "transposition blocks" of one kind or another at frequent intervals along their length. Such expensive, as well as cumbersome, construction was well justified in the transmission of radio power, where the high voltage between the wires required generous spacing of them, one from the other, and where the extremely high cost of the power—radio-frequency power being the most costly form of all electrical power—well justified considerable expenditure for the materials and installation of a highly efficient line. In the reception of radio signals, however, neither the high-voltage capacity of the open-wire line nor its high transmission efficiency is of importance: first, because the voltage of the signal power to be transmitted along the line from the antenna to the receiver is always of completely negligible value, and, in fact, far below the voltage breakdown point of the thinnest possible layer of any insulating material; and second, because of the fact that even the most modest radio receiver is usually provided with such a high degree of amplification as will more than compensate for any reasonable degree of line loss.

SHIELDED LINE

Thus, the application to radio reception of the open-wire, transposed, transmission line of the radio-transmitter art neither justified its complication nor cost, and was soon, in the development of special receiving antennas, replaced by a newer form—the shielded concentric line, consisting of a copper shielding braid, sometimes acting as one of the line conductors as well as enclosing

at least one well-insulated conductor. The simplicity of such a transmission line soon resulted in its substitution for the cumbersome and expensive open-wire line but, unfortunately, brought with it considerable cost, due to the supposed need for the expensive, continuous, closely-wound copper shielding braid and, what is equally important, certain performance disadvantages. These reside in the fact that while the shielding braid usually serves quite well for the protection of the inner conductor against noise pick-up, the shielding itself unavoidably provides noise pick-up and requires such special treatment in its termination at the radio receiver as makes its employment costly and less effective and, in general, has resulted in the development of the non-shielded, two-conductor, "twisted pair" transmission line which is now used almost to the complete exclusion of the earlier developed types. This type of line has all of the advantages of the more expensive and cumbersome types of line along with certain inherent technical advantages, in addition to its markedly greater economy. It consists, commonly, of a pair of well-insulated wires twisted about a common axis—and hence about one another—each of the pair making a complete turn, or twist, in at least every inch of the conductor length. For reasons of mechanical rigidity as well as for further protection against the effect of the elements, the pair of twisted conductors are usually covered with an outer protective and insulating covering.

"TWISTED PAIR" APPLICATION

The method of its application to a simple antenna construction problem is illustrated in Fig. 1, in which is shown one of the simpler but less effective forms of noise-suppression antennas. It will be noted that the twisted pair merely connects the simple horizontal antenna to the radio set with none of the intermediate mechanisms which later development have shown to add so largely to the effectiveness of the whole.

EFFECTIVENESS OF SYSTEM

The noise-suppression effectiveness of such a simple system will be more clearly evident from an examination of Fig. 2, in which is shown a greatly enlarged view of a few twists of the conductor extremely closely coupled to a conductor carrying the noise making current. Practically, such coupling is provided by a noise source in which large current is flowing and which is rapidly changing in value. The gas-filled rectifier, such as is employed in battery chargers, is typical of this sort of thing. As in all magnetic coupling, the transfer of the interfering energy or power is effected

through the linking of the magnetic flux of the noise current with the turns constituted of the twisted portions of the line, as shown in the figure. It will be noted how the magnetic flux from the noise source is linked with the line and that, as a result of this linkage, a voltage is induced in the line. In fact, there is a small voltage induced in each of the small loops constituted of each of the twists of the conductor. Each of these voltages is induced in the same direction as indicated in the figure and, if the conductor is carefully constructed of wire of uniform diameter and of precisely equal length of twist, these induced voltages will be equal. Further, since the twist of the conductor reverses the position of the two conductors in adjacent twists, relative to one another and hence relative to the noise source, the voltages induced in either one of the two conductors in adjacent twists are equal and opposed. Thus, all the induced voltages balance one another out over any reasonable length of the conductor, or at worst, leave unbalanced in the line only the small voltages induced in the end loops of the line which are in the fringe of the field of the magnetic flux. This fringe effect is, of course, usually found to be of small importance, and the use of a twisted pair as here described is usually found completely effective in the balancing out of magnetic coupling to any nearby noise source.

BALANCING COIL

A markedly different condition is shown in Fig. 3, in which electrostatic coupling between the line and the noise source is shown. Such a noise source is one in which relatively little current flows, but which is generating relatively high voltages. In practice, this occurs in any magnetic device in which the circuit is opened while current is flowing, such as in a magnetic or vibrating

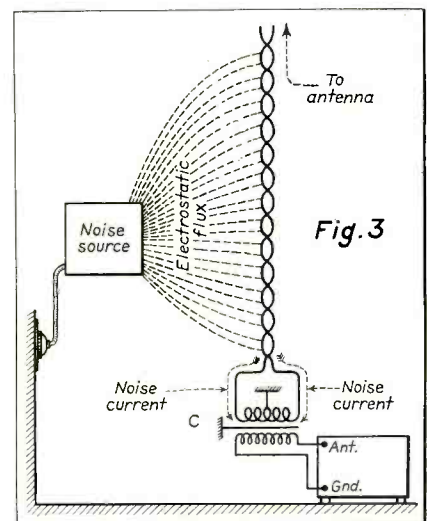

Fig. 3
Transposed transmission line used with balancing coil, C.

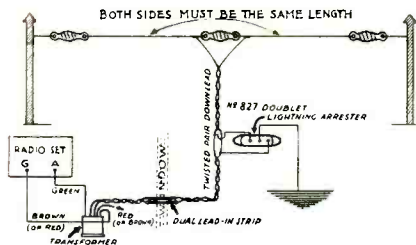

Fig. 4. Typical noise-reducing antenna system using balanced receiver transformer.

battery charger, any small motor-driven device, such as a vacuum cleaner, food mixer, etc., or even an electric light bulb loose in its socket, or with a partially fractured filament about to burn out. It will be noted here that the voltages induced in either side of the line, or in adjacent loops of the line, are all in such a direction as to give rise to current flowing to a ground and thus do *not* cancel out. The net effect is that voltages induced along either side of the line add directly to one another and thus provide a relatively large induced voltage that will give rise to noise currents passing to ground through the line and, of course, noise in the radio receiver to which the line is attached, unless special means are provided for its elimination.

This latter can most conveniently and economically be provided in the form of a balancing coil, as shown at C in Fig. 3. It will be noted that the line terminates in a coil which, as implied by this discussion, must consist of two halves that are as nearly identical in their physical and electrical properties as it is possible to make them. To the outer terminals of this coil, the two sides of the line are connected, while the center point is connected to ground, or to such other datum point as will drain the system of the induced noise current without impressing any of this voltage upon the radio receiver. This requirement justifies more extended discussion and will be given further attention later but at this juncture it need be pointed out only that if sufficiently close approach to symmetry in the entire antenna system, and especially in this terminating coil, is realized, it is obvious that the currents resulting from the electrostatically-induced voltages are opposed to one another in their effect on the receiver, and their influence largely eliminated.

While Fig. 3 shows a simple magnetic coupling between the balancing coil and the radio receiver, this simple arrangement is of value only under certain limited conditions. For this reason, a host of coupling circuits and coil arrangements have been developed; the characteristics of which cannot, for lack of space, be discussed here. It is sufficient for the moment to say that regardless of the detailed receiver-coupling arrangements which must be provided, they

must include complete symmetry insofar as the noise currents picked up by the line are concerned, and that these currents must be drained from the system through couplings to the radio receiver which are completely symmetrical and opposed with respect to noise currents.

The practical circuit arrangements employed in one type of receiver-line coupling unit are shown in Fig. 4, in which the coupling unit in addition to providing termination for the line is provided with terminals for connection to the radio receiver and, in addition, is provided with a drain connection to the ground terminal of the radio receiver.

REQUIREMENTS

Such a system as this latter provides all that can be expected in the way of noise elimination or suppression and, in general, will be found to be a satisfactory solution to the problem of the reception of radio signals through relatively high local noise levels where the line has been designed with care as to conductor size, insulation, spacing and twist and where the receiver-line coupling unit has incorporated in it, not only efficient line-to-receiver coupling windings, but provides this coupling with such complete symmetry as to eliminate the coupling of the noise currents into the receiver.

ALL-WAVE SYSTEM

For the further improvement of a noise-suppressing receiving antenna system there is left, then, no avenue for further improvement other than the means provided for coupling the antenna into

the line. Great improvement of antenna performance can be secured through the proper choice of the antenna-to-line coupling mechanism where the system is to be operated over a wide range of frequencies—as in connection with any all-wave receiver—but since the expedients that can and must be resorted to to provide the most effective all-wave coupling mechanism are far too many and too complicated to allow of their inclusion in this brief discussion, it is planned to present them in a future article.

It should, however, be pointed out that where only a limited range of frequencies are to be received—as included in the normal American broadcast band—satisfactory reception may be accomplished by means of the simple connection of the line to the antenna. This is the direct and fortunate result of the special characteristics of horizontal antennas raised well above the earth and of properly chosen length. This happy condition no longer obtains where, with a given length of antenna, a much wider range of frequencies are to be received, thus requiring a special and carefully designed coupling circuit between the antenna and the line, which, whatever may be its nature, must provide not only for the efficient pick-up of the signal power by the antenna, but must, as well, provide for the efficient transfer of signal power from the antenna to the line over a very wide range of frequencies. This, as well as the several other details suggested above, will be discussed in a later article.

(To be continued)

AUDIO-FREQUENCY AVC

(See Front Cover)

Though audio-frequency avc (diode-biased a-f amplifier) is not exactly new, it is only recently that this system has been put to good use.

The circuit on the front cover shows the arrangement used in the new RCA Victor Model M-109 receiver. There is little in the circuit itself to explain, it being quite matter-of-fact, except that there is no blocking condenser in series with the grid, G, of the pentode section of the 6B7 and the diode load circuit composed of the resistor R-3 and the potentiometer R-4.

OPERATION

It will be noted that the cathode of the 6B7 tube connects directly to ground so that, to all intents and purposes, there is no bias on the control grid, G. This is quite true under no-signal conditions—but as soon as a signal is impressed on the diode plates, D, a voltage is developed in the load circuit R-3,

R-4. Therefore, a voltage of negative value will also appear on the grid, G, since there is nothing to block it. Moreover, the greater the signal voltage, the greater the bias on this grid.

REASONS FOR SYSTEM

This function would have no great value were it not for the fact that different broadcast stations have different percentages of modulation. Though the avc system in a receiver operates on an incoming carrier and serves to adjust the receiver gain in accordance with the strength of the incoming signal, it does not serve to maintain a constant audio output because of the differences in the percentage of carrier modulation. The result is that, although the avc is maintaining a constant receiver gain, it is still necessary to readjust the volume control for stations having different percentage modulations. What is re-

(Continued on page 176)

General Data . . .

Howard "Grand" Receiver

Here is a receiver with 19 tubes and a lot of interesting circuit features. For all of its 19 tubes, however, the circuits are not half so complicated as one would be led to believe.

THE RECEIVER UNITS

The receiver consists of four units inter-connected with cables—the receiver proper (Fig. 1), the power amplifier (Fig. 2), the power-supply unit (Fig. 3) and the loudspeaker. Any one of the units may be removed for servicing without having to disturb the others.

THE RECEIVER

The complete receiver circuit is shown in Fig. 1 on the opposite page. Twelve of the 19 tubes are used in this unit, which, it will be noted, has its own high-voltage power supply.

It will be seen from the diagram that there are two r-f stages, both using type 78 tubes. The first stage—marked "S. W. Ant. Unit"—is used only in the highest frequency band, while the second stage—marked "R. F. Unit"—is used in all bands. These type 78 r-f tubes are shown one above the other in the upper left corner of the diagram.

To the right of the first r-f tube is the type 76 oscillator tube and directly below the oscillator is the mixer unit which employs another type 78 tube. This concludes the high-frequency section of the receiver. Now that we have a picture of it as a whole, let's analyze the circuit arrangement.

HIGH-FREQUENCY CIRCUITS

The waveband switch is composed of six composite sections—one for the antenna circuit, one for the second r-f stage, one for the mixer, *two* for the oscillator and one for the waveband indicating lights. The first section is composed of two units, S-1. The upper unit really has but two electrical positions; one for connecting the output of the first r-f stage to the input of the second r-f stage when the waveband switch is set for the 18- to 5.5-megacycle band; and one for cutting out the first r-f stage on all of the other three bands and instead connecting the control grid of the second 78 r-f tube to the primary of the antenna coil through a fixed condenser of low capacity. No switching is required at the input circuit of the first r-f stage since this is used only in the shortest wavelength band.

The lower unit of the S-1 section of the waveband switch increases the gain of the first i-f stage when the contact is in the 18- to 5.5-mc position (position shown in diagram). Since this contact connects to the midpoint of the 1,000- and 10,000-ohm resistors in the cathode circuit of the first i-f tube, and since the arm of S-1 is grounded, these two resistors are thrown in parallel with a resultant decrease in the total resistance value and a consequent reduction in grid-bias voltage. And, of course, with a lower grid bias, the gain of the i-f stage is increased. For all other positions of the arm of switch S-1, the 1000- and 10,000-ohm cathode resistors are in series to ground with the result that the voltage drop will be greater and a larger value of grid bias placed on the i-f tube, thus reducing the gain. Therefore, the gain of the first i-f stage is increased for the highest frequency band and reduced for all other bands.

When the arm of switch S-1 is placed on either the second or third contact, the lower portion of the antenna coil is shorted out and only the upper section of the coil comes into play in the 5.5- to 1.7-mc band and the 1700- to 550-kc band. When the switch arm is on the fourth contact, which is open, both coils are in series so that their inductance is additive. This covers the 390 to 150 kc weather-report band.

The other waveband switch units require no special comment except that the units connected to the r-f, mixer and oscillator tuned circuits have double arms for the purpose of progressively shorting out coil sections to prevent absorption; and the left-hand unit of section 4 which reduces the voltage on the plate of the oscillator tube in two of the band positions. This serves to reduce the oscillator voltage impressed on the mixer tube for the lowest wavebands, to prevent pull-in.

It should be noted that the voltage from the oscillator is fed to the suppressor grid of the mixer tube. Since this is a high-impedance circuit, practically no load is placed on the mixer tube.

THE I-F CIRCUITS

Now we come to something new: Note that there are two separate i-f amplifiers; the first, composed of two stages with high gain and selectivity; and the second a single, low-gain, broad-channel stage, for high-fidelity reception of local stations.

The connection to the i-f stages is easy to follow as it is shown in the diagram as a heavy line, from the plate of the mixer tube to a single-pole double-throw switch. Let's follow this through.

The signal from the output of the mixer tube is always at a frequency of 465 kc, and for this reason it is obvious that both i-f amplifiers are peaked at the same frequency.

Now, with the i-f amplifier selector switch in the upper position, as shown, the signal from the mixer tube is fed into the highly selective two-stage i-f amplifier using type 78 tubes. Selectivity in these stages is increased considerably through the use of high Q coils in the i-f transformers and through the use of air dielectric aligning condensers shunted across the primary and secondary coils of all three i-f transformers. Thus, there are six tuned circuits in the selective i-f amplifier.

The selective i-f amplifier—which also has high gain—is used for reception in the short-wave bands and for the reception of weak signals in the broadcast band. In such cases where the signal level of a broadcast station is comparatively high, and in cases where transmissions are of a high-fidelity character, the broad-band i-f amplifier may be brought into play. It is selected by throwing the single-pole double-throw switch to the lower contact, in which case the output of the mixer tube is fed into the single-stage i-f amplifier shown in the lower left corner of the diagram.

The broad-band or "high-fidelity" i-f amplifier employs but two i-f transformers. These also use air dielectric aligning condensers, but the transformer coils do not have as high a Q as the ones used in the selective i-f amplifier. Moreover, the primary and secondary coils of the input transformer are closely coupled to provide a broad resonance curve. The result is an i-f stage with comparatively low gain and low selectivity, which are just the conditions required in an i-f amplifier for high-fidelity reception. The low gain, it might be added, practically acts as an automatic check against the misuse of this stage, for, if the broadcast station signal level is too low, there will be a disturbing noise background.

Now, it should be noted that the double-pole double-throw i-f amplifier selector switch is really a tandem affair, with four other similar switches on the same shaft. Working towards the right in the diagram, there is a second switch unit which removes the high-voltage supply from the plate and screen circuits of one or the other i-f amplifier, depending upon which one is not in use. A third switch lights one of two lamps which indicate to the listener which i-f amplifier is in use or, in other words,

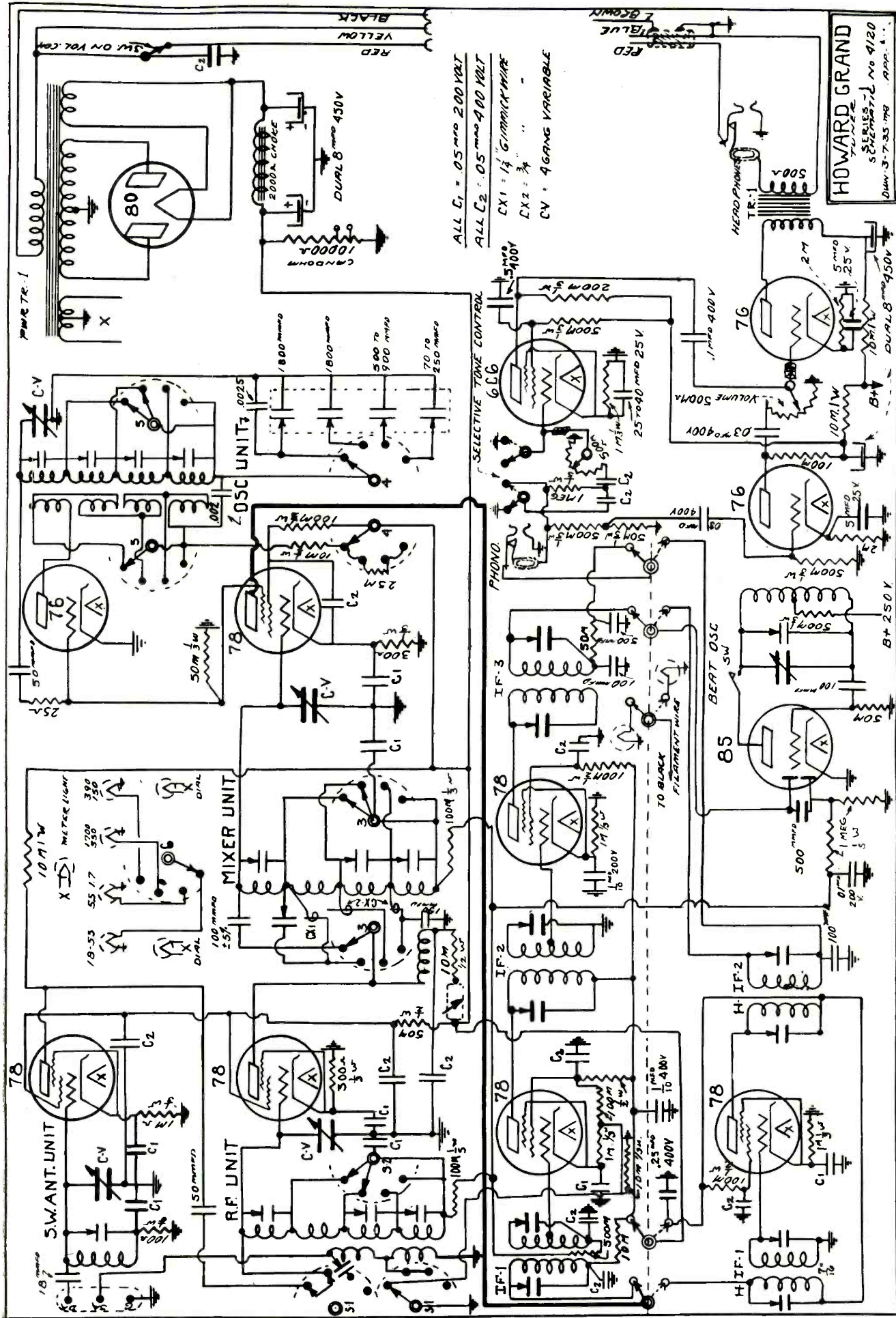

Fig. 1. Complete schematic diagram of the Receiver Unit of the Howard "Grand."

GENERAL DATA—continued

whether the receiver is set for distance or high-fidelity reception. A fourth switch section, the arm of which connects to the diode plates of the second detector-avc tube, connects the detection circuit to one or the other of the two i-f amplifiers. A fifth unit of the same tandem switch takes care of the second detector return circuit so that it may be connected to the low end of one or the other of the output i-f transformers.

DETECTOR-AVC-BEAT OSCILLATOR

Now we come to the type 85 tube, which is just to the right of the broadband i-f amplifier stage in the diagram. The diodes of this tube are used separately, the upper one being employed solely for linear detection and the lower one for avc.

It will be seen that the avc diode is connected to ground through a one-megohm resistor. The avc line leads directly from the diode and connects through the usual filter to the grid-return circuits of the second r-f tube, the mixer tube and the type 78 tube in the first stage selective i-f amplifier. Thus, full automatic volume control is

in use on all wavebands when using the selective i-f amplifier, but is in effect only on the second r-f tube and mixer tube when the high-fidelity i-f amplifier is in use.

It should be noted that the cathode of the type 85 tube connects directly to ground. This means that no bias is placed on the diode plates with the result that there is no delayed action in the avc functioning nor in the detector action.

The triode section of the type 85 tube is used as the beating oscillator or station finder. The oscillator voltage is injected directly into the second detector circuit by electronic coupling inside the tube. A switch is provided in the plate circuit of the beating oscillator so that oscillation may be stopped at will. The beating oscillator may also be used for the reception of cw signals.

DUAL A-F AMPLIFIER

And now we come to another very interesting feature—this receiver has two separate a-f amplifiers, one for low-frequency amplification and one for high-frequency amplification.

It will be noted from the diagram that the load circuit of the second detector diode may appear in the output of either one of the two i-f amplifiers. Irrespective of which amplifier is in use, the diode load circuit is composed of the 500,000- and 50,000-ohm resistors in series with the phonograph jack. The lower end of the latter resistor connects to ground and it is across these two resistors that the diode audio voltage appears.

To begin with, note that there is a connection from the mid-point of these two resistors which connects, through a fixed condenser, to the grid of the type 76 high-frequency a-f amplifier tube. The grid of this tube is biased by a cathode resistor in the usual way. Since the grid of this tube connects to the mid-point of the diode load resistors, it does not receive the full audio voltage, but merely enough to provide the proper amount of high audio-frequency amplification.

Now take a second look at the diode load resistors, and note that a lead from the top of the 500,000-ohm unit connects through a low-pass filter to the grid of a type 6C6 tube. This is the low-frequency a-f amplifier tube. And right here is another interesting feature.

First of all, it will be seen that there is a selective tone-control switch. In one position of this double switch, the low-pass filter is in operation and the 6C6 tube amplifies the very low audio frequencies. In the other switch position, the first condenser C-2 is ungrounded so there is no loss of high-frequency voltages, and at the same time the grid of the 6C6 tube is grounded. In this position, the 6C6 tube is inoperative and the usual range of audio frequencies are handled by the type 76 high-frequency a-f tube.

Now here is the interesting situation: When the 6C6 tube is in operation, its output may be controlled by the potentiometer in the grid circuit, since this determines the degree of audio voltage impressed on the grid. Now, since the output of both the low-frequency 6C6 tube and the output of the high-frequency 76 tube are virtually paralleled and together feed their outputs to a second a-f tube, it is possible to obtain a very wide range of audio frequencies. For instance, in most receivers, tone is controlled by cutting out the high audio frequencies, but in the present arrangement the high audio frequencies are not attenuated at all and greater low-frequency response is gained by actually increasing the amplification of the low audio frequencies through the 6C6 tube.

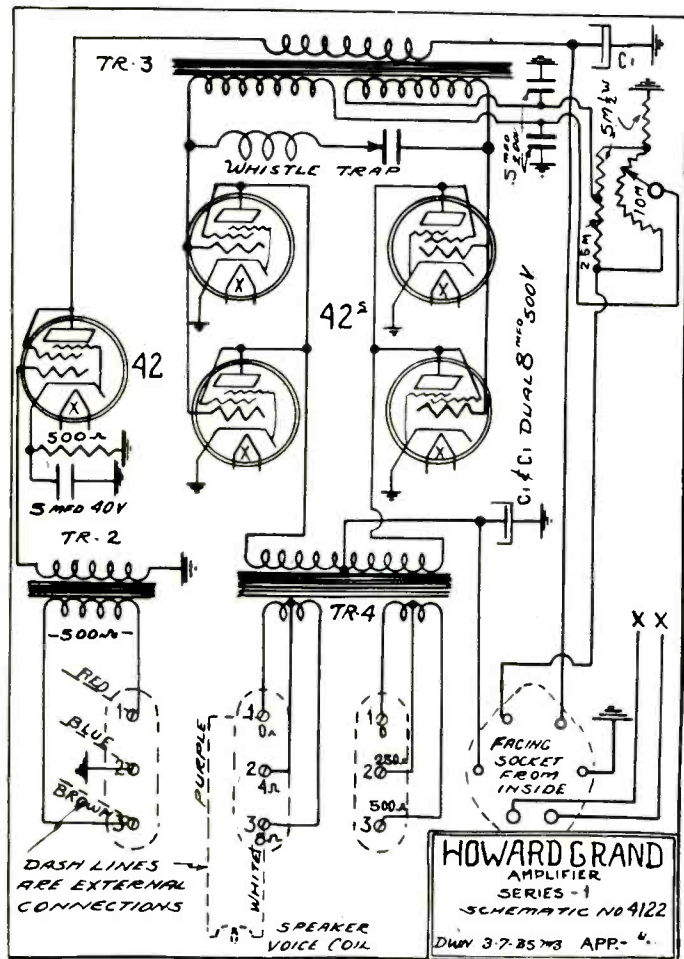

Fig. 2. Circuit of the Howard "Grand" power amplifier, using a 42 Class A driver and four 42's in Class A Prime push-pull.

GENERAL DATA—continued

Thus low-frequency response is not obtained at the expense of the attenuation or elimination of higher audio frequencies.

The volume control is seen to be in the grid circuit of the second a-f stage. This operates in the usual manner and requires no explanation. The output of this cathode-biased triode is transformer-coupled to a type 42 triode-connected driver in the amplifier unit through a 500-ohm transmission line. A separate impedance-matching transformer is used at the input of the driver tube. Note that a jack for headphones is placed in the low-impedance output circuit of the type 76 a-f transformer.

RECEIVER POWER SUPPLY

In the upper right corner of the diagram will be seen the high-voltage power-supply unit for the receiver proper. A type 80 full-wave rectifier tube is used and has a filter composed of a choke and a dual 8-mfd electrolytic condenser. A separate winding on the power transformer supplies the heater voltage for all 12 tubes in the receiver.

THE POWER AMPLIFIER

The circuit of the power amplifier is shown in Fig. 2. As mentioned previously, there is a type 42 driver whose input looks into a 500-ohm transmission line through the transformer TR-2. The output of the driver is transformer coupled to a push-pull stage employing four type 42 tubes also triode connected, operating as Class A Prime amplifiers. It should be noted that the input push-pull transformer has a split secondary winding in series with which is a potentiometer. The potentiometer functions as a hum balancer. The shaft arm extends out the right side of the amplifier chassis and should be turned either way with the ear close to the speaker to a point where the hum is gone. Further adjustment is not required unless a power tube is changed.

The input circuit of the push-pull also contains a "whistle trap"—a filter for eliminating high-frequency squeals, caused by station carrier interference, which would otherwise be evident when employing the high-fidelity i-f amplifier.

The grid of the type 42 driver tube is self-biased. However, the grids of the four 42 Class A Prime tubes have a fixed bias impressed on them, this bias being obtained from a C-bias supply in the power unit.

The output push-pull transformer has two low-impedance secondary windings.

The one to the left in the diagram is used for feeding the voice coil of the speaker used in the receiver, and has a 4-ohm and an 8-ohm tap. The winding to the right, with 250- and 500-ohm taps, is for use with external speakers. Two extra speakers may be used.

THE POWER-SUPPLY UNIT

The circuit of the power-supply unit is shown in Fig. 3. This unit is used only for supplying the necessary voltages for the power amplifier and the speaker fields. Plate and speaker field voltages are supplied by the 5Z3 full-wave rectifier which has its own individual filter. The bias voltage for the grids of the type 42 power tubes is supplied by the 6Z4 (or 84) full-wave rectifier just to the right of the 5Z3. This also has its own filter unit. The negative voltage required for the grids is taken off from the center tap of the secondary winding of the 6Z4 power transformer. The same low-voltage winding on this transformer that supplies the heater of the 6Z4, also supplies the heaters of the type 42 tubes in the power-amplifier unit.

Addition of Resistor in Sparton Models 61 and 62

Effective March 12, 1934, a 50-ohm, 2-watt, resistor (Part B-6061-1) was added to the Sparton Models 61 and 62.

The resistor should be connected in series with the type 25Z5 plate lead shown nearest the speaker field coil in the schematic diagram. The resistor protects the type 25Z5 tube against voltage surges.

It is advisable to put this resistor in any Models 61 or 62 not so equipped that you may service.

Possible Cause of Slipping of Sparton Planetary Drive

In case any planetary drives, such as are used on the Sparton Models 65, 67, 83, 104, etc., are found to slip, the condition may be corrected by pinching, very carefully, the lugs which hold the planetary drive assembly together.

Extreme care must be exercised when doing this. Use a small pair of pliers and do not pinch the lugs too much as the planetary drive action will then be made rough.

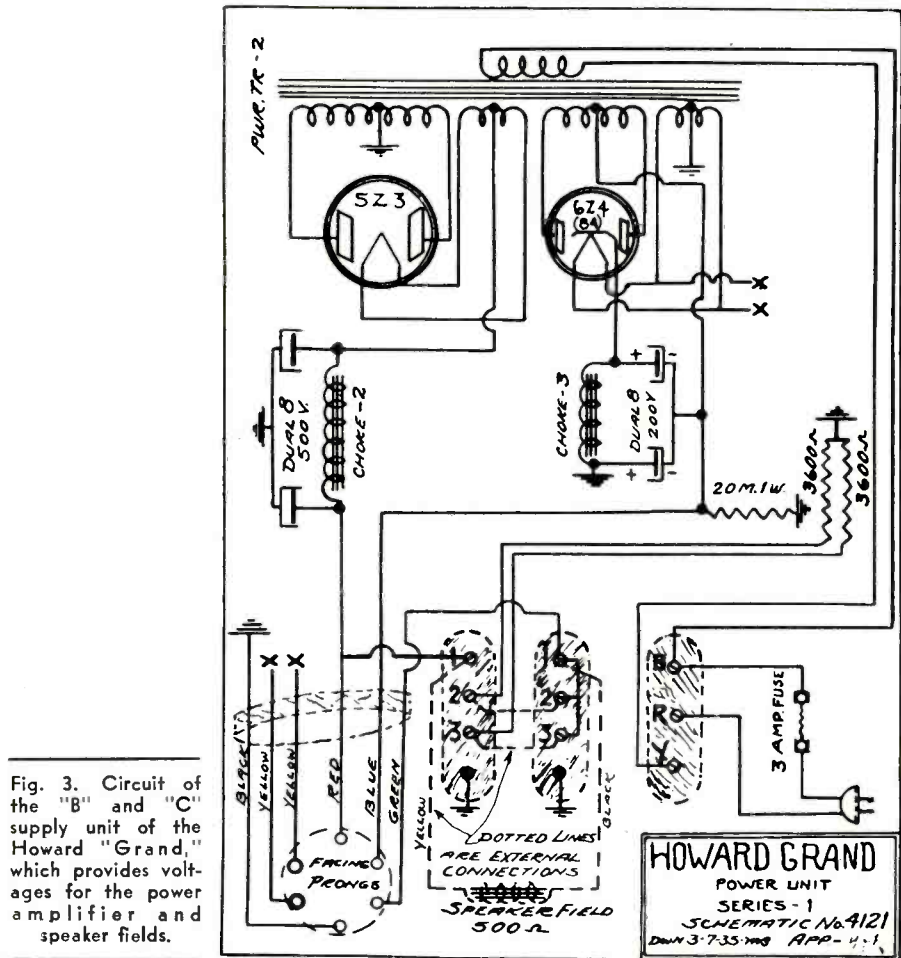

GENERAL DATA—continued

Crosley Chassis 5C2

Chassis 5C2 is used in the Model 51 Receiver. It is a 5-tube, ac-dc super having a frequency range from 535 to 1750 kc.

DESCRIPTION OF CIRCUIT

Referring to the accompanying diagram, it will be seen that a preselector, with two variable condensers, is used in the input circuit. The preselector feeds the pentode section of a 6F7 tube which functions as the mixer. The triode section of the same tube is used as the oscillator. The mixer section of the 6F7 obtains its bias from the 750-ohm cathode resistor, while the oscillator section of the same tube obtains the major portion of its bias from the grid condenser and leak combination (the 0.25-mfd condenser and 25,000-ohm resistor).

The shape of the oscillator section of the gang condenser is such that a constant intermediate frequency of 181.5 kc is generated when the signal is applied and this intermediate frequency is present across the primary of the first i-f transformer.

The output of the type 78 i-f tube is impressed on the paralleled diode plates of the 6B7 tube. A portion of the voltage developed in the diode load circuit is fed back and used as control bias for the mixer tube—the i-f tube is not in on the avc circuit and is self-biased.

DIODE BIASING

The pentode section of the 6B7 tube is used as an audio amplifier and it

should be noted that the control grid is diode biased, as explained in connection with the circuit shown on the front cover of this issue. This prevents audio overload and permits predetermination of the setting of the volume control for practically all stations. An initial bias is also used—this being supplied by the 1400-ohm cathode resistor—and this bias also tends to delay somewhat the diode detector action.

The output of the 6B7 pentode is resistance coupled to a type 43 pentode, which in turn is coupled to the dynamic speaker, the field of which is energized by one section of the 25Z5 double half-wave rectifier. The other section of the rectifier supplies voltage for the receiver tubes. Bias for the 43 pentode is obtained from the drop across the filter choke.

A-F REGENERATION

A very important part of the audio-frequency amplifier is the 500,000-ohm resistor connected between the plate of the 43 pentode and the screen of the 6B7 pentode. Naturally, some audio frequency is fed through this resistor, as well as the direct-current voltage which supplies the 6B7 screen. However, at the screen of the 6B7 is located a bypass condenser so that the higher audio frequencies do not affect the screen of this tube, while the lower audio frequencies are not bypassed, and the effect, therefore, is a regenerative one so far as the lower audio frequencies are concerned. The result of

this circuit is that, in spite of the very small proportions of the cabinet and speaker, a desirable amount of lower notes are reproduced by the set.

ALIGNMENT PROCEDURE

To align the i-f amplifier, it is necessary that there be available a suitable modulated oscillator capable of adjustment to 181.5 kc with good accuracy. This oscillator should have an attenuator, so that strength of the oscillator output can be regulated. Connect the high side of the output of the modulated oscillator, which has been adjusted to 181.5 kc to the receiver antenna wire, as close to where it enters the cabinet as possible, through a .02-mfd series condenser. The low side of the oscillator is to be connected to the receiver chassis. It will be found that the best way to make this connection to the antenna wire is with a sharp, pointed prod, so that the insulation on the antenna wire is not permanently damaged. The unused dead-end portion of the antenna wire should be rolled up on its reel. With the oscillator set to a convenient level, adjust the four i-f transformer tuning-condenser adjustment nuts available through the front flange of the chassis for maximum signal output. To make these adjustments, it is necessary that a standard 1/4" (across flats) hexagon socket wrench be used for the adjustment nut. The wrench should be insulated. It may be necessary to move the tuning dial slightly for best results. Always make these i-f adjustments very

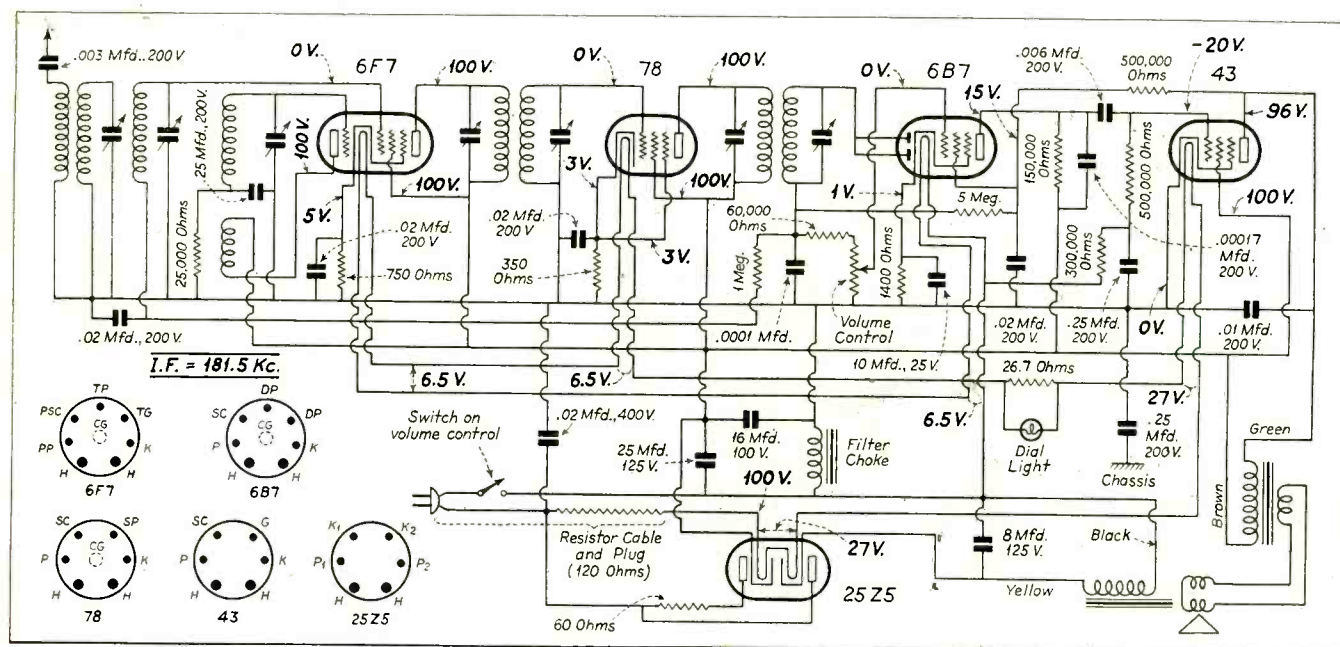

Circuit of Crosley Chassis 5C2.

carefully and go over the adjustments several times to be sure that the peak has been reached.

To align the receiver at broadcast frequency, it is necessary that an adjustable oscillator, having frequencies of 1400 and 600 kc, together with a suitable attenuator and dummy antenna be available. Set the oscillator at 1400 kc and turn the tuning control of the receiver to 140 on the dial. Connect the high side of the oscillator to the receiver antenna through a .001-mfd (dummy antenna) condenser. Now adjust the oscillator section trimmer on the gang condenser (the oscillator section is the rear-most section of the gang) until the signal is heard best. Then adjust the remaining two r-f trimmers on top of the gang condenser for best signal. It is necessary that these adjustments be gone over several times until no further improvement can be made. Always work with the weakest possible signal from the modulated oscillator for best accuracy. The set is now aligned at 1400 kc and by adjusting the modulated oscillator to 600, the set may be rechecked at this point. It will sometimes be found that a slight bending of the gang condenser plates will help the sensitivity at 600 kc. This operation should be done with extreme care, however, so that no short circuiting of the condenser plates results.

RCA Victor TMV-128-A Frequency Modulator

The Type TMV-128-A Frequency Modulator is a device for use with a test oscillator to "sweep" the oscillator frequency and at the same time provide a voltage for synchronizing the timing axis of a cathode-ray oscilloscope with the position of the sweep condenser. It consists of a driving motor coupled to a sweep condenser and an impulse generator. Two ranges of sweep capacity are provided—a "high range" from 25 to 70 mmfd, and a "low range" from 15 to 37 mmfd. There is also a cable fitted with plugs at each end, for connection to the test oscillator. The capacity of the connection cable is 40 mmfd. The

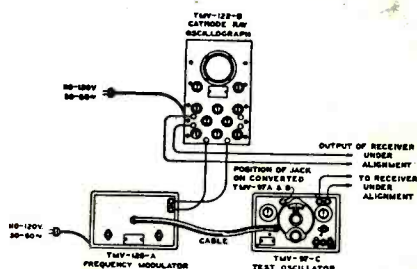

Fig. 1. Connections of Frequency Modulator to Oscilloscope and Test Oscillator.

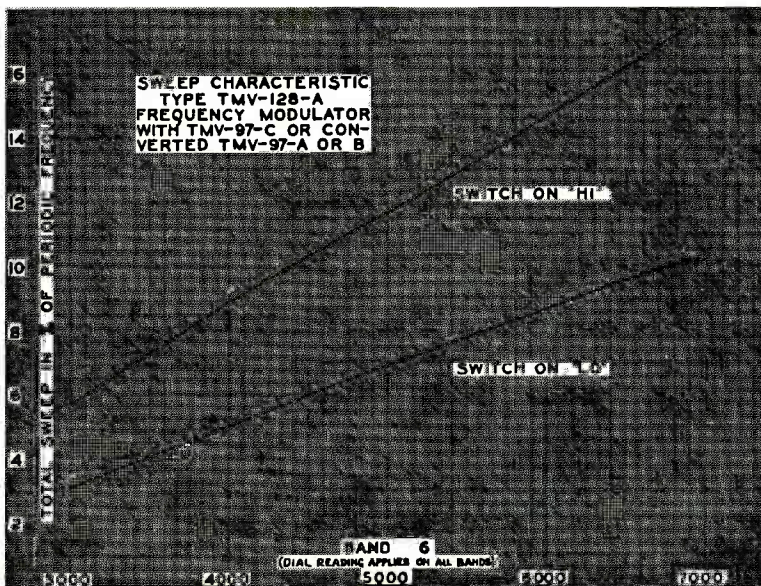

Fig. 2. Sweep Characteristics of TMV-128-A Frequency Modulator with TMV-97-C Oscillator.

unit operates entirely from a 110/120-volt, 50/60-cycle ac supply.

The TMV-128-A Frequency Modulator was designed for use in connection with the TMV-97-C Test Oscillator and the TMV-122-B Cathode-Ray Oscilloscope, but may be used equally as well with other types of oscillators and oscilloscopes.

Fig. 1 shows the interconnection of the Frequency Modulator with the Test Oscillator and Cathode-Ray Oscilloscope. This arrangement is commonly used for making r-f and i-f alignment of a radio receiver. For other applications, this set-up may be modified according to the requirements of the particular case.

OPERATION

When the units are properly interconnected, select the "Hi" or "Lo" position of the range switch according to the percentage sweep desired (see curve of Fig. 2), and turn the motor "On." When through operating, turn the motor switch to the "Off" position.

The power consumption of the unit is 25 watts. The drive motor is a 1/200 hp, shaded pole induction type, with a speed of 1550 rpm. The output of the impulse generator is 1.5 volts.

BEARING LUBRICATION

The small induction drive motor has oil holes at each of its waste-packed bearings. Light engine oil should be used at these points. A ball-bearing support is used at the impulse generator. It is packed with vaseline, which should be replenished after every 100 hours of operation.

SWEEP CONDENSER

This element of the assembly consists of two conventional type rotary condensers, each having a single rotor plate attached to a revolving shaft (see Fig. 3). The stators are wired so that one remains connected at all times and a switch is used to parallel the two in order to increase the range of the sweep.

The rotor plates should be exactly centered between the stator plates when the mechanism is operating at its normal speed of 1550 rpm. If the plates change their relation, they should be re-centered by adjusting the drive shaft in the coupling, or shifting the rotor plates on the shaft. The line-up of the rotor plates in respect to the armature of the impulse generator is important in that it governs the synchronization of the system. The proper adjustment is obtained when the two rotor plates are either at maximum or minimum capacity, and the armature sets horizontal (air gap minimum). A slight shift may be necessary to center the resonance curve on the screen of the oscilloscope.

IMPULSE GENERATOR

A small induction generator is used to furnish means of controlling the frequency of the "saw-tooth oscillator" of the oscilloscope. It is necessary to maintain a definite polarity on the output connections of this generator. The horse-shoe magnet should therefore be replaced as originally installed, if it has been removed for repair or service. It is also important to retain the original relation of the coils. Correct polarity exists when a positive swing is obtained

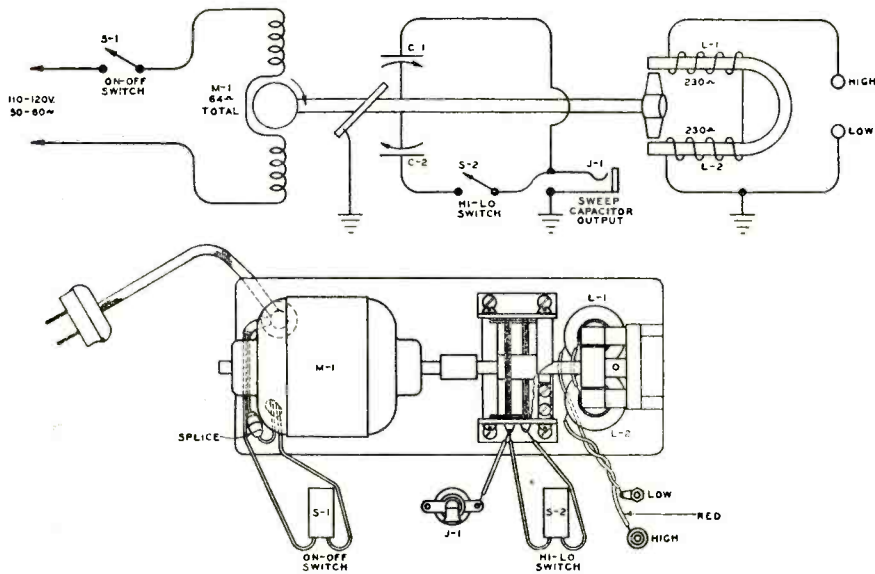

Fig. 3. Diagram and layout of TMV-128-A Frequency Modulator.

on a 200-microampere dc meter with its plus terminal connected to "high," and the mechanism rotated by hand in such a direction as to cause a decrease in air gap.

MECHANICAL ALIGNMENT

The drive motor, sweep condenser and impulse generator must be in correct physical relations to each other, inas-

much as they all rotate on the same shaft. The motor mounting screws are arranged to permit small lateral adjustments of the motor position. Both the stator and rotor plates of the sweep condenser may be adjusted to obtain the correct centering alignment. End-play of the shaft should be kept at a minimum without affecting the freedom of rotation.

Sparton Model 655

This is an ac-dc super released in the early part of 1935. It is of the skip-band type, covering the standard broadcast band and the principal foreign short-wave broadcast bands.

CIRCUIT DESCRIPTION

Referring to the accompanying diagram, it will be seen that a type 78 tube is used as mixer and oscillator. The grid circuit of the mixer is fed from a preselector, L-1, C-1, with the waveband selector switch in the broadcast position. With the switch in the short-wave position, the preselector becomes an ordinary tuned circuit. The antenna circuit contains a wave trap, L-8, C-23, tuned to the same frequency as the i-f amplifier. The purpose of this trap is to eliminate interference from commercial stations operating on, or in the vicinity of 456 kc, the i-f frequency.

Grid bias for the 78 mixer-oscillator tube is provided by the voltage drop in the cathode resistors R-9, R-10 and R-12. (R-12 also supplies the bias for the type 75 tube.)

The two i-f stages employ type 78 tubes, both of which are supplied with an initial bias by the cathode resistors R-8 and R-11. The output of the second i-f tube feeds the diode section of the (Continued on page 176)

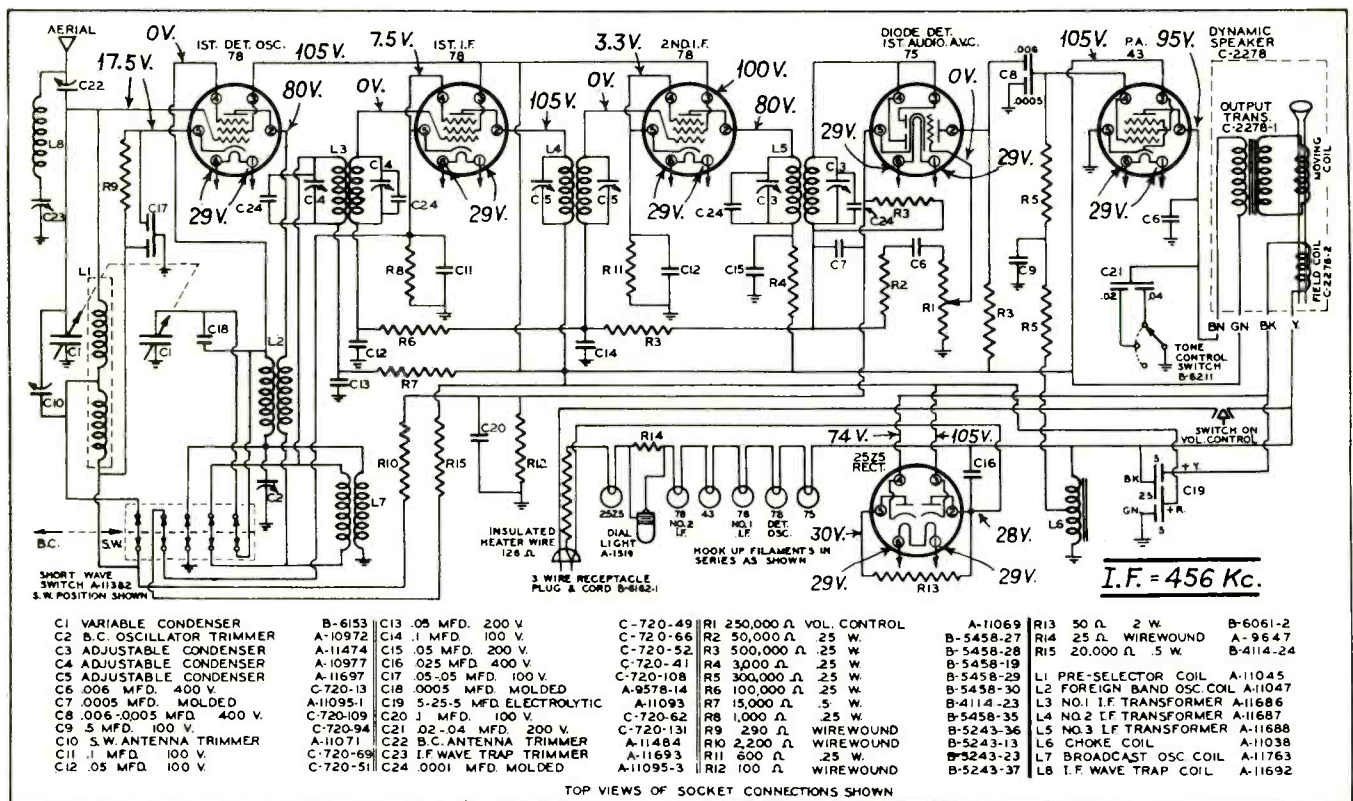

Circuit and parts list of Sparton Model 655.

Auto-Radio . . .

THE MOTOROLA MAGIC ELIMINODE

By E. H. WAVERING*

SINCE the beginning of auto radio we have all recognized the necessity of the development of a means of reducing the installation of an auto radio to a purely mechanical procedure. That is, to develop a system that would allow you fellows to install the set, apply the suppressors, and that would complete the job without having to keep your fingers crossed before finding that hours of additional work would be required to finally lick the interference.

THE MAGIC ELIMINODE

With this thought in mind, Motorola engineers set to work many months ago to develop such a system. The result of their efforts is the now famous "Magic Eliminode," which not only does away with the variable time element in installation, but also completely eliminates the use of spark-plug suppressors. The Magic Eliminode is a device designed into the 1935 Motorola that consists of a combination high-frequency filter and balancing circuit. It is enclosed in the rear of the set.

The accompanying view shows the Model 100 with the rear cover removed, exposing the complete Magic Eliminode.

FILTER SYSTEM

In the left half of the view can be seen the individual filter that filters the ignition interference from every wire entering the set. These include: Power-supply 6-volt wire; speaker field; voice coil; tone control and dial light. This is accomplished without the use of shielding on any wire.

Housed in the two compartments of the upper right quarter is the high-frequency filter, a two-stage unit in series with the aerial lead entering the set. In the lower right quarter can be seen the balancing section. As will be seen from the photograph, it consists of two coils, one of them mounted stationary also connected in series with the aerial lead-in, while the other may be moved back and forth along its screw-drive track, but always parallel to the stationary one.

The same type fitting and receptacle is provided for operation of this mechanism as that on the volume control. Therefore, the Magic Eliminode balancer may be operated by plugging the volume-control flexible shaft into the Eliminode receptacle. This, of course,

avoids the need for special tools when installing the set.

OPERATION OF BALANCER

The movable coil is connected to an interference feeder. This feeder has a small clamp attached to its other end that may be clamped to any point on the car body, motor, or ignition system; such as, choke rod, throttle rod, instrument panel, dash, motor block, ignition manifold, high tension wire, etc., that will feed into the radio set an interference level higher than that feeding in over the car aerial.

Since the movable coil is connected in an out-of-phase relation to the stationary coil, it is only necessary to move it back and forth along its axis until, by inductive coupling, it induces a sufficient amount of out-of-phase interference in the stationary coil to produce cancellation.

ADVANTAGES OF SYSTEM

It can readily be seen, then, that a system of this type has a number of outstanding advantages over any other system that may be employed. These are:

(1) The high-frequency filter may be designed and tuned so as not to affect the efficiency of the receiver in any way.

(2) The balancing system operates irrespective of the frequency of the interference so that it is not affected in any way by different frequency charac-

teristics encountered in different cars.

(3) Regardless of changes in the intensity of the interference due to deterioration of the ignition system, etc., the electrical balance will not change, because, if an increase occurs in a car antenna a corresponding increase will always occur in the interference feeder.

(4) The Magic Eliminode is just as effective on under-car antenna as on roof antenna.

(5) It is not affected by vibration or temperature changes.

INSTALLATION

To install a Motorola using the Magic Eliminode, it is only necessary to complete the mechanical installation according to instructions with the set. Then turn on the set to full power, start the car motor, and tune the interference in to its *highest* level.

Remove the volume-control shaft from its volume-control receptacle at the receiver. Plug the shaft into the receptacle provided for balancing the Magic Eliminode and rotate the volume-control knob to the right or left until exact balance is reached.

Replace the volume-control shaft back in the volume-control receptacle and the job is finished.

This adjustment will not change and no further adjustment of the Magic Eliminode is required unless the set is transferred to another car at some future time.

Code Reception With Sparton Model 333 Auto Radio

Reception of Code or Police signals with the Sparton Model 333 Auto-Radio Receiver can be caused by the breaking of the wire which runs from the Antenna Equalizing Condenser to the r-f section of the condenser gang.

In the schematic diagram, this is the connection between L-1 and C-1.

To correct, remove the broken wires and solder in a 6-inch length of flexible wire (a piece of the antenna wire used with the Models 61 and 62 is satisfactory). It is advisable to form a loop in this wire by winding a few turns around a lead pencil. This will allow sufficient slack, and the flexibility of the wire will prevent future breaks caused by the normal movement of the condenser assembly.

In the event that the wire connecting the grid cap of the type 6F7 first detector-oscillator tube to the Antenna Equalizing Condenser breaks, the repair connection should be made by a longer flexible wire run from the grid cap down under the condenser gang and then to the Antenna Equalizing Condenser.

Warning: The law of some States forbids the use of short-wave auto-radio receivers. Therefore, do not allow any Model 333 receiver to remain in such a defective condition.

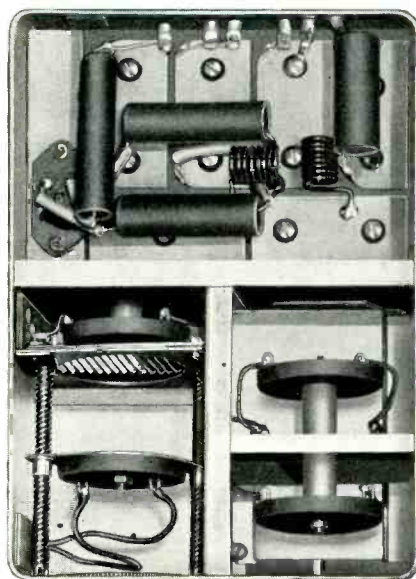

Interior view of Motorola auto-radio receiver.

*Service Manager, Galvin Mfg. Corp.

ON THE JOB . . .

Switching Unit

The accompanying diagrams are those of a switching unit for use with a single meter of the universal type or any other meter with a 1-mil movement. This device permits easy, fast and fool-proof tests when used with a single meter, and it was made up for the following reasons: First, to provide an auxiliary voltage and current unit, and second to make it unnecessary to pack along a couple of hundred dollars' worth of test equipment to service one of those \$8.90 pee-wee noise boxes (which are the curse of the radio trade and everybody concerned).

GENERAL DESCRIPTION

A general description of this unit follows:

First, Fig. 2 shows the approximate size of this switching device. Toggle switches in a break-one make-two connection were used to keep down the size, while insulated-top pin jacks for reference points and meter ranges are mounted on one side.

The adapter shown in Fig. 3 plugs in 7-7 socket when testing 4-5-6 prong tubes. Fig. 4 shows a wafer adapter which slips over tube prongs, the tube then being inserted in its socket. This unit is not necessary but is handy in taking socket-to-chassis voltage tests without disturbing normal operation. These adapters plug into reference-point jacks, the latter units being arranged correctly to accommodate the 4-5-6-7-7 adapter plugs necessary. Fig.

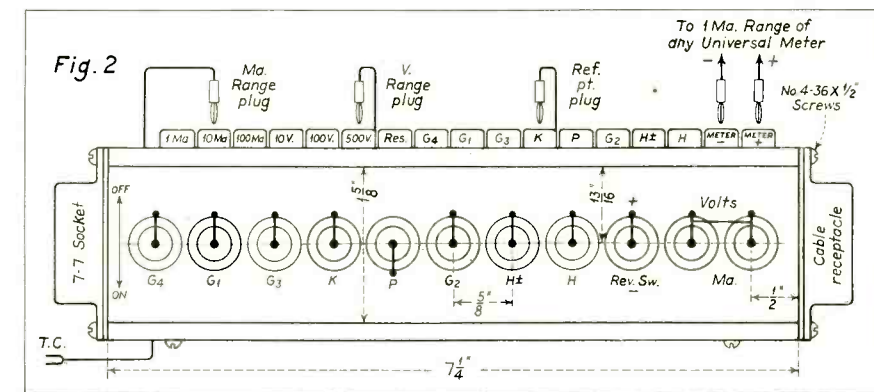

Details of single-meter switching unit.

4 is for use with four-prong tubes. A 5-prong plug would have another banana plug corresponding to K, a 6-prong plug would have 2 more banana plugs corresponding to K and G₃ etc. All multipliers and shunts are contained within the unit, which therefore connects directly to the 1-mil movement of the meter, and as most universal meters are equipped with a 1-ma range, no alterations are necessary there.

Attention should be called here to the "V-MA" switch shown in Fig. 1. As a 3-pole unit was not available, double-pole double-throw and single-pole single-throw units were used with their tumblers connected together. An examination of this switch will show that when it is in the volts position the meter is across the circuit, shunts are disconnected from the negative side,

and the current path is shot straight through to the tube elements; while in the "MA" position the meter is cut in the circuit, shunts tied across, and the negative voltage-leg opened. This arrangement makes it impossible to apply volts when the meter is set to read mils. The single reversing switch reverses either volts or mils, depending upon which is passed to it via the "V-MA" switch.

OPERATION

The operation of this unit is simple. Let us say the tube is a type 47. The adapter shown in Fig. 3 is plugged in 7-7 socket and tube in adapter. The "MA"-range plug goes in the 100 jack (refer to Fig. 2), the "V" range plug in 500-volt jack, reference-point plug in H± jack, and the 1-ma range of the meter to meter jacks, cable connected. Now flip P switch to ON position and either volts or mils will read, depending upon the position of the "V-MA" switch. (If this latter switch is in the "V" position, plate volts may be read, while if it should have been in the "MA" position, plate current could have been read.) Flipping the P switch to OFF and the K switch ON, with the "V-MA" switch in the MA position, gives screen current, etc.

The only caution in testing is: *Do not pull "MA" range plug with "V-MA" switch on MA and with circuit hot.* This procedure opens the shunt and "shoots the works" through the 1-mil movement of the meter. Further, *do not leave "V" range plug in resistance jack and apply volts.*

Fig. 5 simply shows how simultaneous voltage and current readings may be obtained.

The other customary tests to chassis are easily followed from Fig. 1. Simply

(Continued on page 176)

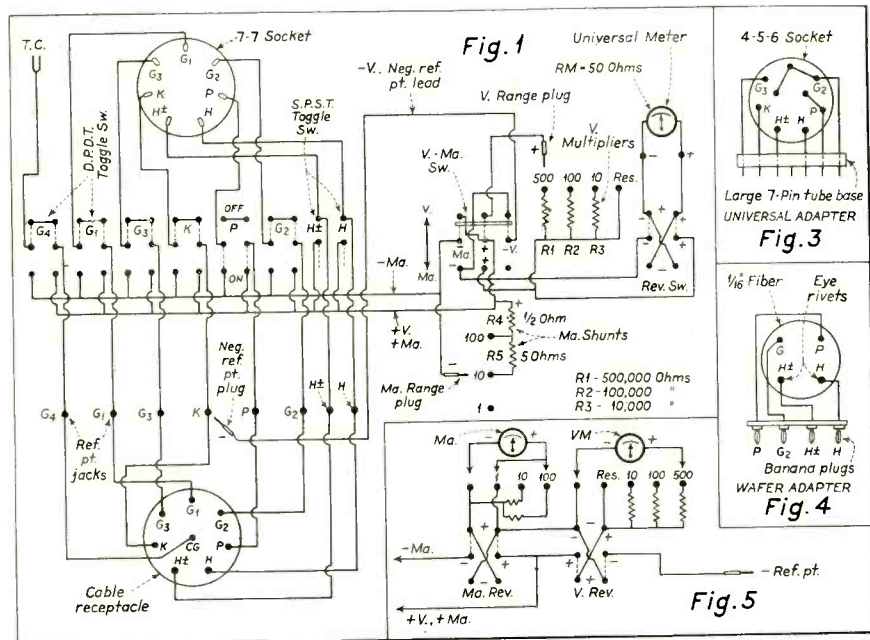

Circuit of single-meter switching unit, and adapter connections.

TAKE A TIP FROM AN OLD TIMER



Send for this valuable book today!

● You may be an old timer in radio or the field may be a new one for you . . . it doesn't matter. We believe you'll find that this latest Sylvania Service booklet will come in mighty handy in helping you with your work.

It contains 104 pages of *real* information . . . descriptions of various tubes, each with its circuit application. It also includes diagrams showing plainly a lot of problems that may come up in your work . . . and how to solve these problems.

With the help of this pocket manual, you'll find fewer "blind alleys" . . . fewer times when you're up against it. That's why we say that this book *will actually put money in your pocket* . . . money that you wouldn't be able to get if you didn't know how to get around these troubles.

Send for it today . . . you'll feel like patting yourself on the back, once you've seen how useful it is . . . how crammed with information that will help you take the guess work out of tube application. Don't wait! It's yours for 10c in stamps.

Sylvania
REGISTERED U. S. PAT. OFF.
THE SET-TESTED RADIO TUBE

Makers of
 Sylvania Tubes
 Hytrade Lamps



Factories
 Emporium, Pa.
 Salem, Mass.
 St. Mary's, Pa.

10c. — *Technical Manual* — 10c.

HYGRADE SYLVANIA CORPORATION (C21)
 Emporium, Pa.

Please send me the new Sylvania Technical Manual. I enclose 10c. in stamps.

Name
 Address
 City State

Public Address . . .

RCA Victor Model PG-62DI

The RCA Victor Portable Public-Address System, Type PG-62, is a complete amplifying system consisting of an amplifier, a microphone and two loudspeakers. It is designed for use as a sound-reinforcing system in auditoriums, theatres and churches or for outdoor gatherings. The equipment is entirely ac operated, power for its operation being obtained from any 110-volt, 50- or 60-cycle line. The maximum undistorted power output is 20 watts, which is sufficient to meet the average requirements of sound reinforcement in auditoriums with a capacity up to 2,500 seats.

The amplifier consists of two units, the voltage and power-amplifier units being mounted in a carrying case. The loudspeakers are each mounted in a wooden housing and fit together to form a carrying case when they are to be transported.

A velocity-type microphone is used and provision is made for placing the microphone and stand, together with the microphone interconnecting cables in the amplifier case.

All the controls, except the power-

control switch, are mounted on the voltage-amplifier base and are easily accessible to the operator. The controls consist of the power-control switch mounted on the power-amplifier base, the microphone volume control, amplifier volume control, the speech-clarity-switch and the tone switch.

Facilities are provided for operating the equipment with a phonograph turntable. If it is desired, phonograph music may be played as a background for the microphone pickup, the volume of each being controlled independently of each other.

THE CIRCUIT

The velocity microphone is coupled to the first stage of the voltage amplifier, using a type 57 tube, by means of an input transformer located on the amplifier base (See Fig. 1). The link circuit between the microphone transformer and the input transformer is of 250 ohms impedance. A potentiometer is provided in the grid circuit of the 57 tube to vary the input voltage applied to the grid.

The 57 tube is resistance coupled to the type 56 in the second stage. An-

other potentiometer is provided in the grid circuit of this tube to control the output volume of the entire equipment. The 56 tube is in turn resistance coupled to the 56 in the third stage of the voltage amplifier. The last stage of the voltage amplifier is coupled to a single type 59, which functions as the driver for the two 59's in the Class B output stage. The output stage supplies power to two loudspeakers through a step-down transformer. This transformer has an output impedance of 15 ohms, with a tap at 7.5 ohms.

POWER SUPPLY

The power supply for both the voltage and power amplifiers is obtained from a type 83 full-wave rectifier and a filter system located on the power-supply base. The field coil of one speaker is used as a filter choke in the power-supply system in the power amplifier.

The complete diagram of the p-a system is shown in Fig. 1. The voltage values given in this diagram are the actual values at which each tube should operate. In circuits containing high resistance, voltages read on a set analyzer will not agree with the values in the diagram, due to relatively low resistance of the meter employed. Therefore, a correction must be applied to the meter reading to obtain the correct voltage at each socket. Usually, an ap-

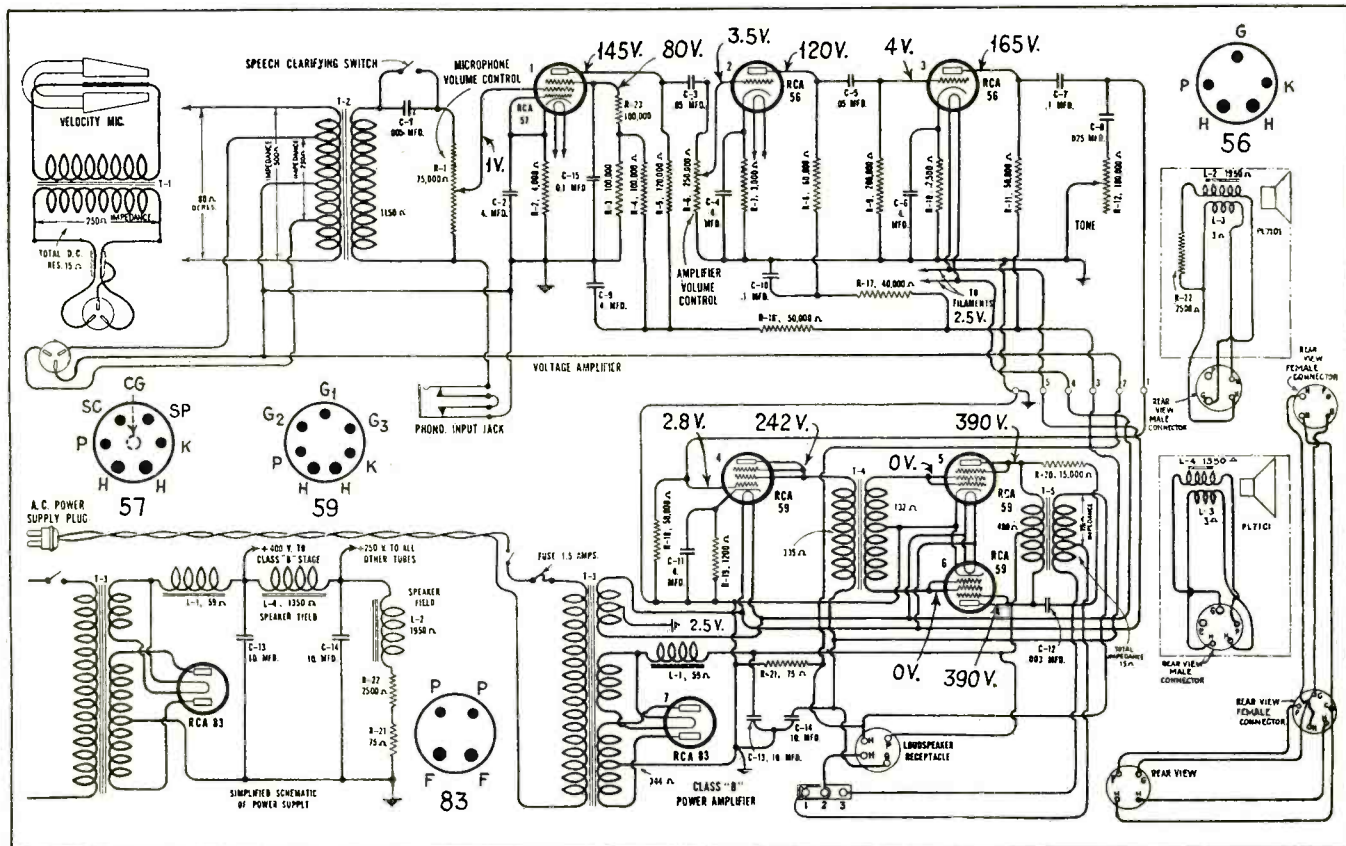

Fig. 1. Schematic diagram of the RCA Victor PG-62DI Portable Public-Address System.

SANITY

Arcturus Radio Tubes are built for performance... and are worthy of a quality price.

Yet they are sold to jobbers, dealers and service-men at competitive prices.

Arcturus asks no increase, but the quality list price gives dealers and service-men a greater profit.

To those interested in maintaining a stable business, write for complete details. Arcturus Radio Tube Company, Newark, N. J.

ARCTURUS RADIO TUBES

Another **DAYRAD** ACCOMPLISHMENT...



A NEW ALL WAVE SIGNAL GENERATOR

60 KC to 60,000 KC—5 METERS

Again DAYRAD pioneers the way. This time with an ALL WAVE SIGNAL GENERATOR that is alone in its field... made specially for those sets of today of the future, that have 5 meter band. Only this DAYRAD covers these bands—all fundamentals—three tubes—AC operated. And it includes an output indicator.

Price only
\$31.75
complete with
tubes

Consider these Features:

DIRECT READING AIRPLANE DIAL, NO CHARTS—NO HARMONICS, MULTIPLES OR SKIP BANDS—SIX RANGES—NEON TYPE OUTPUT INDICATOR BUILT IN, NO EXTRA COST—MODULATED OR UNMODULATED RADIO FREQUENCY—THREE SECTION ATTENUATOR CONTROLS BOTH "HIGH" AND "LOW" OUTPUTS—ABSOLUTE MINIMUM SIGNAL—MAXIMUM SIGNAL SUFFICIENT FOR ANY SET—CAST ALUMINUM CASE, COMPARTMENTS FOR INDIVIDUAL CIRCUITS—SIZE: 10" x 7" x 4 1/2"—WEIGHT: 10 POUNDS.

SEND COUPON FOR CATALOG or see your local distributor. Our new Catalog explains this new ALL WAVE SIGNAL GENERATOR in detail. Also contains full information on complete DAYRAD LINE including full facts on the new Tri-Test Tube Checker.

**Dayrad flexible circuit will test the new
METAL TYPE TUBES.**

THE RADIO PRODUCTS CO.

125 SUNRISE PLACE

DAYTON, OHIO

CLIP—MAIL TODAY

THE RADIO PRODUCTS CO.
Dept. 5—125 Sunrise Place
Dayton, Ohio

Please send at once and without obligation your new CATALOG OF DAYRAD RADIO SERVICE INSTRUMENTS including full information on your new ALL WAVE SIGNAL GENERATOR.

Name
Street
City State

plication of Ohm's law will give an approximate value of the voltages at which each tube is operating, assuming that the resistance of the meter is known, which is usually the case.

PHASING LOUDSPEAKERS

If either of the loudspeaker cones are replaced, the two speakers must be properly phased after the replacement work is done. That is, the motion of both cones must be in the same direction at a given instant when a signal is impressed on them. The following procedure may be used to phase the loudspeakers:

(1) Place the two speakers side by side and connect them together by means of the plug and cord provided.

(2) Turn the equipment on so that field coils are energized. Apply 6 volts dc intermittently to the voice-coil terminals at one loudspeaker (red lead and white lead on either PL71C1 or PL71D1). If both cones do not move in the same direction, reverse the voice-coil leads to the terminal board of one loudspeaker only.

Caution: The loudspeaker fields are at approximately 400 volts above ground. Therefore care must be taken in making tests on the speakers.

DIRECTIONAL BAFFLE SPEAKERS

It is sometimes desirable to use a directional baffle type of speaker with this amplifying equipment. In this case it is necessary to compensate for the difference between the frequency response of the flat baffle and the directional baffle. The compensation should consist of a .0005-mfd condenser (No. 21648) connected in series with the .005-mfd condenser C-1, and a 250,000-ohm resistor (No. 23114) shunted across the speech-clarifying switch.

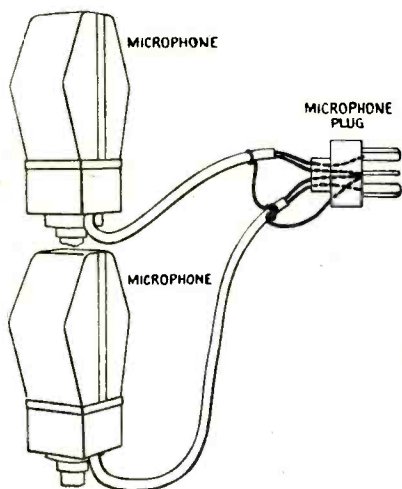

Fig. 3. Connections for two-microphone operation.

TWO-MICROPHONE OPERATION

In general, the use of more than one velocity microphone with the PG-62 equipment is not recommended. This would presume a microphone mixer which is undesirable, as the overall gain is sufficient to overcome the attenuation in the mixer.

If it is necessary to use two micro-

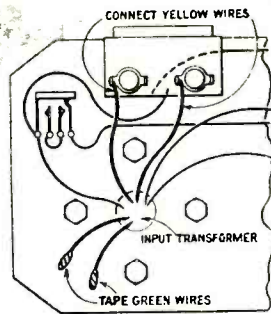

Fig. 2. Transformer connections for two-microphone operation.

phones (not more than two) and keep both in the circuit at the same time, using no fading or mixing arrangement other than the volume controls on the voltage amplifier, the connections and changes in the amplifier wiring are as follows:

(1) Disconnect and tape the two green leads between the microphone receptacle on the voltage amplifier and input transformer.

(2) Connect the two yellow transformer leads (500 ohms) to the microphone receptacle, as shown in Fig. 2.

(3) Connect the two microphones in series to the microphone plug, as shown in Fig. 3.

AUDIO-FREQUENCY AVC

(Continued from page 163)

quired, therefore, is some form of automatic audio limiting device so that it will not be necessary to readjust volume for different stations. That's where the audio-frequency avc system steps in.

PREVENTS AUDIO OVERLOAD

Aside from maintaining constant audio volume, the arrangement shown on the front cover has one other advantage, in that the pentode section of the 6B7 is a variable-mu tube. Because of this, and the increase in bias with signal, the circuit prevents audio overload irrespective of the position of the volume control (within reasonable limits) or the percentage of modulation of the station carrier.

SPARTON MODEL 655

(Continued from page 170)

75 tube and a portion of the voltage developed in the diode load supplies the automatic bias for both i-f tubes. The audio component is picked off the potentiometer R-1 and fed to the grid of the 75 triode. The output of this triode is resistance coupled to a type 43 power pentode in the output, grid bias for which is supplied by the voltage drop across a portion of the filter choke L-6. The output of the 43 pentode feeds a dynamic speaker the field coil of which is energized by one section of the 25Z5 double half-wave rectifier tube, the other section of the rectifier supplying high voltage for the receiver tubes.

VOLTAGES

All parts values, socket connections and voltages are given in the diagram. Voltages are based on an ac line voltage of 119 and should be read with the antenna disconnected, volume control full on and band selector switch in the short-wave position (position shown in diagram). Readings of plus or minus 15% are allowable. The plate and diode voltages on the 75 tube, and the grid and cathode voltages on the 43 pentode, cannot be measured with an ordinary voltmeter.

SWITCHING UNIT

(Continued from page 172)

switch meter to ohms or capacity, reference point to chassis, and put voltage range plug in resistance jack which goes direct to plus meter jack. The "V-MA" switch should be set in "V" position.

The actual layout of jacks is slightly different from that shown in Fig. 2. These jacks are in two rows, the reference point jacks (8 in number) are in one row and meter jacks (9 in number) in the other row. This has not been shown in Fig. 2 since it would require a side sketch of the unit.

The unit can be made up in any style desired. If the layout shown in Fig. 2 is followed the size of the pieces needed are as follows:

- 2 pieces 3/16" bakelite 7-1/4" x 1-5/8" (top and bottom)
- 2 pieces 3/16" bakelite 7-1/4" x 1-1/2" (sides)
- 2 pieces 1/16" fibre 2" x 1-1/2" (ends)

The unit is fastened together by drilling and tapping for 1-1/2"-4/36 brass machine screws.

Al. Beers.

• SERVICE FOR

The Gates Mobile Sound System Is Really Built —

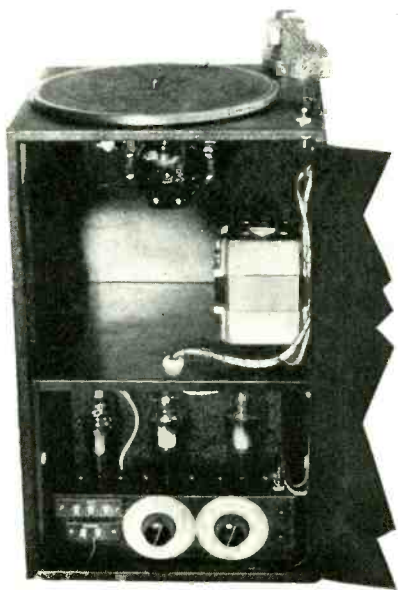

Model MB-253 Mobile Sound System

to bring summer-time profits to you that will completely eclipse the usual warm weather radio slump which has been with you other years.

Yes—and the GATES Mobile System Model MB-253 has some real features! No more complaints about a run-down car battery with the MB-253, as duplex tubes are used, bringing lower battery drain, yet leaving a generous output wattage.

Of course, it all operates from the six-volt car battery and is built into an all-steel cabinet with door and lock that makes the MB-253 something more than just another car amplifier and gives it an eye value that makes the customer half sold before he even hears it.

Write for Bulletin 1003 and obtain full details.

(Use your letterhead when writing.)

MANUFACTURED BY

GATES RADIO & SUPPLY COMPANY

MANUFACTURING ENGINEERS SINCE 1922

CABLE ADDRESS: "GATESRADIO"

QUINCY, ILL., U. S. A.

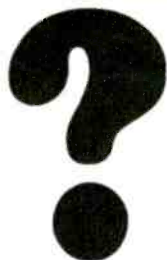

Is it worth 1¢ to you
to get up-to-date
Resistor information?

Every real business man knows that he must keep himself informed of new developments in his industry. In the business of servicing radio receivers, you as a service engineer, should be familiar with the latest resistors, resistor coatings, and prices. This information, and much more, is contained in the new Ohmite Catalog Number 11 which lists thousands of stock resistors and rheostats. A penny postcard will bring your copy at once; send your name and address to

OHMITE

MANUFACTURING COMPANY

627 North Albany Avenue

Chicago, Ill.

Low-Priced Performance

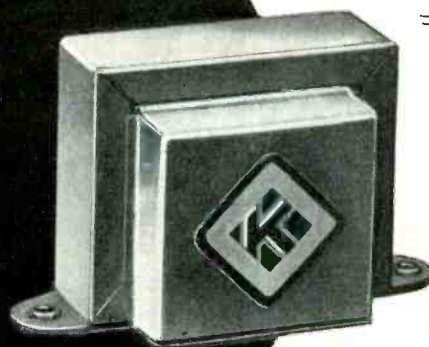

KENYON
"SILVER
GROUP"

A complete
new line of Audio,
Power Transformers,
and Filter Reactors.

The Silver Group embodies many distinct advantages heretofore found only in the more expensive units. Bulletin C-1 contains complete specifications of all these components.

If your jobber cannot supply you, write direct for a copy of this bulletin. It describes these new units in detail and shows suggested p-a applications.

KENYON TRANSFORMER CO., Inc.

840 BARRY STREET

NEW YORK CITY

ASSOCIATION NEWS . . .

INSTITUTE OF RADIO SERVICE MEN REPORTS

NEARLY 7,000 ATTEND THIRD NATIONAL IRSM CONVENTION

When the curtain rang down on the Third National IRSM Convention and Trade Show at the Hotel Sherman in Chicago, it was found that the attendance during the three-day period had been nearly 7,000.

The registration lists showed that Service Men, Amateurs, Engineers, Distributors, Manufacturers' Representatives, Manufacturers and others from all corners of the country—and from Canada—had come to Chicago for the purpose of visiting this, the largest and most auspicious show of its kind that has ever been held.

Exhibition Space Enlarged

The management of the Convention and Trade Show was forced at the last minute to do that which had previously been considered impossible—expand the space. The fifty booths of 1934 were made into fifty-one spaces for the 1935 show, but during the last week, in order to take care of most of the manufacturers who had been too late in making their reservations, another lot of six display units was set up outside the main exhibition hall.

The actual registration at the Convention was 1739, but a count of the attendance taken at the door showed that nearly 7,000 persons entered the Convention Hall, an average of more than four times for each person registered.

The IRSM Conventions and Trade Shows have become an institution; they have become a national institution. In response to repeated demands made by the exhibitors during the Convention last month, arrangements have already been made for the use of the Exhibition Hall and

the Grand Ball Room at the Hotel Sherman for the 1936 National Convention and Trade Show.

Remote Chapters Represented

A large number of the IRSM Chapters were represented at Chicago; in fact, practically every one of them from Scranton, Pennsylvania, to Omaha, Nebraska. Members outside of Chapter areas from an even wider area were present, from as far as the west coast.

Edgar C. Arnold, of Rochester, N. Y., President of the Institute, presided over all sessions of the Convention.

Soharsm Moves Forward

The Soharsm Drill Team, assisted by other members of the 20th Region, made good use of the paraphernalia of the order and a large number of IRSM members crossed the burning sands.

New Chapters Formed

Service Men in the following cities have applied for permission to form a Chapter of the Institute, and the application has either been approved or is being voted on by the Board of Trustees at this writing:

Butte, Montana, with 13 new applications for membership, making a total of 14.

LaCrosse, Wisconsin, with 19 new applications for membership, making a total of 20.

Ithaca, N. Y., with 9 new applications for membership, making a total of 12.

Syracuse, N. Y., with 20 new applications for membership, making a total of 27.

Quiz Conferences

Practically all of the Chapters of the Institute are devoting a part of each meeting—

and in many instances, the entire meeting—to a study of the questions and answers that have been prepared by the Committee on Professional Status for use in the forthcoming Certification Examinations.

After the Committee had completed the first draft of the questions and answers—more than 2,000 of them—it called upon the Chapters to cooperate by taking the questions in groups and discussing them for the purpose of making revisions, and also to enable the members to make a thorough review of the study of radio. The Chapters report an enthusiastic reception of the opportunity to pass judgment on the questions and to discuss them in their meetings.

Following the completion of the quiz conferences the questions and answers will be revised in accordance with the reports received by the Committee, and will be published in book form for distribution to individual members.

New York Fall Convention

Plans are being laid for the New York Convention to be held this fall at the Hotel Pennsylvania. A definite announcement of dates will be made next month.

A. R. S. E. MEETING

The Association of Radio Service Engineers, of Buffalo, N. Y., held their regular meeting on March 19 at the Hotel Statler. Mr. J. H. Vawter of the Raytheon Corporation was the speaker of the evening. His subject, entitled "The Sales Angle of Servicing," gave the members a lot of new ideas that will help them to increase their sales as well as the size of their repair jobs.

It will be of interest to Service Men generally that this association is making a very strong effort at this time to bring about the issuance of so-called discount cards. Cards of this type will entitle the bearer to purchase radio repair parts locally at the regular trade discounts. Through the cooperation of the parts distributors and the association, a carefully compiled list of legitimate radio Service Men will be developed to whom such cards will be used.

The association understands that similar movements are under way in other cities and will be glad to receive any suggestions that may serve to bolster its efforts.

A. A. Reiser, Publicity Committee.

P. R. S. M. A. WARS ON GYPS

No more will it be an easy job for the unscrupulous to "take" the public with such items as "static eliminators," "aerial eliminators" and gyp tubes. The first battle has been fought and the first blood goes to Service Men in the Quaker City.

Through the efforts of the Association, represented by Al Prow and Paul Ziesmer, a man operating a business in the vicinity of 6th and Market Streets who was selling alleged "static eliminators" and "aerial eliminators" has been arrested for fraud, indicted, and held under bail for court.

We would appreciate having brought to our attention any unethical practices occurring in our territory and will cooperate to our fullest extent in exterminating anything of this sort.

(Continued on page 184)



One of the interesting exhibits of the IRSM Chicago Convention is pictured above. It emphasized in a series of graphic moving displays the latest developments in radio test equipment, the unusual applications of the cathode-ray oscillograph in practical radio service work, the latest profit-making opportunities for the Service Engineer in new all-wave antenna installations, phonograph modernization, public address, etc. An interesting feature of the display pictured, was a moving photo-mural depicting the progress of the Radio Service profession from the early days of hit-or-miss radio repair through the period of too-many-meters, to the modern type of scientific servicing with unified efficient test equipment and accurately rated standard replacement parts.

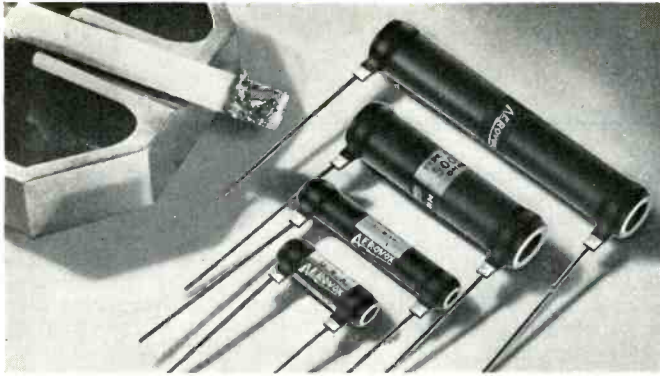

5-10-15-20 WATT RESISTORS

... smaller than a Cigarette!

Genuine wire-wound vitreous-enamelled units reduced to most compact dimensions. Nothing sacrificed except troublesome bulk. Another Aerovox engineering achievement! And new low prices that can't be beat!

Quality wire. Crack-proof refractory tubing. Wire ends brazed to lugs. Pigtails soldered to terminal bands. Heavy vitreous porcelain enamel coating. Permanently sealed. Moisture-proof and damage-proof. Longest life.

Get the Facts! See your most progressive jobber about Aerovox products. Or write us for new 1935 catalog of condensers and resistors; also sample copy of Research Worker. Remember AEROVOX—more quality for less money.



AEROVOX

CORPORATION
80 Washington St. Brooklyn, N. Y.



Series A-30 and B-50 — Self-Contained!

NEW! Amplifiers — Complete!

SAVE TIME! Specify—install—Webster-Chicago sound equipment. New amplifiers. Self-contained. Complete in one unit! High output! Tone quality! Performance!

More Jobs! More Profit!

The A-30 and B-50 are for large indoor and large outdoor jobs. All accessories combined in well ventilated, attractive case. Completely unitized, with perfected engineering built into them, these amplifiers simplify selling and installation.



Write for
NEW Catalog!

Write for Details

New products embodying new, advanced features of design, are shown in the NEW Webster Catalog.

THE WEBSTER COMPANY

3827 West Lake Street
CHICAGO, ILL.

MAKE MORE CALLS

and
BIGGER PROFITS

with this
new
NO. 720

Readrite Tester



HERE is the tester that every serviceman needs for properly servicing radio receivers. The new Readrite No. 720 Tester enables you to make more calls per day at less cost per call — and make bigger profits because of its speed, its accuracy and its dependability.

The new No. 720 unit operates *faster* . . . more *efficiently* and with *less manipulation*. It tests all resistances, continuities, voltages, current and capacities from the set socket by the reliable point-to-point method. And it is built to withstand severe field service.

Two highly developed Vane-type AC and DC meters are incorporated into this new tester. They are simple in design and dependably accurate. The DC scales are 15, 150, 300 and 600 volts, 15-150 milliamperes. AC scales 10, 25, 150 and 750 volts.

Your Jobber Can Supply You . . .

With the Readrite No. 720 Tester at Dealer's net price of only \$15.00. Write direct for literature to

READRITE METER WORKS

157 COLLEGE AVENUE

BLUFFTON, OHIO

MAIL COUPON FOR CATALOG

READRITE METER WORKS

157 College Avenue, Bluffton, Ohio.

Send me catalog on Readrite No. 720 Tester and folder proving Readrite leadership.

Name

Address

City..... State.....

HIGHLIGHTS . . .

RCA VICTOR APPOINTS NEW HEADS

Mr. G. K. Throckmorton, Executive Vice-President of the RCA Manufacturing Company, announced the appointment of James E. Francis, formerly Manager of the RCA Victor Photophone Department, as Manager of the Company's Hollywood operations; Edward M. Hartley, formerly Service Manager, is now Manager of the Photophone Department; and F. B. Ostman, formerly assistant to the Service Manager, has been appointed Service Manager. Mr. Throckmorton also announced the consolidation of the Company's rapidly growing parts sales activities with the Receiver and Phonograph Department.

L. AND L. ELECTRIC CO. BULLETIN

The L. and L. Company, 336 Madison Avenue, Memphis, Tenn., have recently issued a bulletin covering their Model 22 Tube Tester, Model 24-B Complete Combination Testing Unit, Volt-Ohm meters ac-dc, Counter Type Tube Tester Model 26, L & L Rotary Switch (11 points—17 points—24 points—35 points), Essential Kit (consisting of parts used in construction of Model 22 Tube Tester), and ac-dc Meter.

All articles are illustrated and complete technical data given for each.

"SERVICEMEN'S GUIDE"

The Thordarson Electric Manufacturing Company, 500 West Huron Street, Chicago, has recently made available Bulletin No. 342-A. This bulletin, which is priced at 10 cents, is entitled "Servicemen's Guide"; and it contains much valuable and interesting information—wiring diagrams, tables, charts, graphs, etc., being far from uncommon in its 24 pages. A few of its features follow: Eight audio circuits; inductance measuring methods; transformer impedance, matching by ratio tables; transmission lines, T pads and ratio charts; graphic illustration of decibel relations; fundamental power-supply circuits; rectifier tables; tube tables; procedure to follow in trouble shooting; resonance curves; etc.

"VOLTAGE TABLES"

Something new in service manuals. "Voltage Tables for Radio Receivers", the latest publication of F. L. Sprayberry, 2548 University Place, N. W., Washington, D. C. is fresh from the press. The first printing of this book has been confined to 5000 copies, but the advance demand for it is said to indicate an early second edition.

This book offers the Service Man, in one volume, all the information essential to quick and accurate servicing of radio receivers, it is stated. It is planned to eliminate guesswork and loss of time incurred in searching for voltage information in scattered sources.

Sprayberry's "Voltage Tables", in its more than 250 pages contains over 1500 complete voltage tables on radio broadcast receivers made in the United States and Canada from 1927 to the present time. These figures, obtained direct from the manufacturers' service information, are said to have been well checked for accuracy. They include the normal voltage values for

each tube element of a set, thus reducing the actual servicing work to a simple form. The completeness of the information instantly available in this book is said to enable the Service Man to tell at a glance exactly what voltage should be measured at each socket . . . helps him to get immediately at the cause of the trouble.

RADOLEK ANNOUNCEMENT

W. C. Braun, President of the Radolek Company, 601 West Randolph Street, Chicago, announced the purchase of the entire radio stock of the Harry Alter Company, February 11. Refrigeration parts will be featured exclusively by the Harry Alter Company.

The rapidly growing Randolph Street firm becomes one of the largest exclusive



W. C. BRAUN
President, Radolek Co.

wholesale radio-parts distributors in the central states, with the addition of the Alter stock to its present large line. Mr. Braun states that he more firmly than ever believes in his established policy of distribution exclusively to the trade, consisting of radio dealers, radio Service Men, technical schools, municipal and government departments. His constantly increasing business attests to the splendid response of the trade to this policy of restricted selling at wholesale.

A revised Radolek parts catalog listing many new items and the new line of high-gain amplifiers manufactured by the Radolek Company will be off the press in a few weeks.

NEW CORNISH WIRE FOLDER

A new mailing piece, designed and published by Cornish Wire Co., 30 Church Street, N. Y. C., is just off the press, and dealers and service organizations are well come to their quota for local distribution.

It is an envelope-size folder telling the story of Noise-Master Antenna Kit, with schematic and technical data.

"Travel First Class with Noise-Master," is the title of the folder, and the importance of the Service Man in making aerial set-ups is emphasized in accordance with Cornish Wire's custom of co-operating with the servicing fraternity.

NEW TOBE LITERATURE

The Tobe Deutschmann Corporation, Canton, Mass., have recently made available for distributors, dealers, and Service Men a new mailing piece describing a complete and accurate list of Tobe exact duplicate electrolytic condensers. This literature is available on request.

WEBSTER CATALOG

The Webster Company, 3825 West Lake Street, Chicago, now have available copies of their latest catalog, No. S-35, which describes a complete line of public-address equipment starting in with the microphone and ending with the loudspeaker.

An effort has been made to make this catalog one that will assist in selecting the proper type of co-ordinated equipment for public-address installation work. The equipment listed has been designed and selected to centralize the responsibility in one manufacturer for the results that will be obtained in installation work with properly made installations, it is stated.

While this catalog does not include the entire Webster line, it is more complete than anything they have offered up to this time. Of course, supplementary bulletins describing other Webster products will be issued from time to time.

FLECHTHEIM BOOKLET

In celebration of their tenth anniversary in the radio industry the A. M. Flechtheim Co., 136 Liberty Street, New York City, have released an illustrated testimonial booklet which they feel should be of interest to the trade. They have also added to their list of products a complete line of auto-radio suppressors and condensers. This new booklet and descriptive literature on their new products will be mailed on request.

LEE ROBINSON WITH STANCOR

Mr. J. Kahn, President of the Standard Transformer Corp., Chicago, has announced the appointment of Lee Robinson, formerly Advertising Manager of *Radio Merchant*, to the office of New York District Manager, with headquarters at 11 East 44 St., New York City. Mr. Robinson will handle Stancor's eastern affairs.

NEW NAME, NEW ADDRESS

Due to a continued increase in business the Bests Radio Service and Supply Co., announce that they have been compelled to move to larger quarters. With the move they are changing their name to one more descriptive of their business. However, this change in name in no way produces any change in the structure of the company or personnel.

The new name is Standard Radio Parts Co., and the new address is 25 North Jefferson Street, Dayton, Ohio.

• SERVICE FOR

NO WORSE



THAN BEING WITHOUT

RIDER'S MANUAL'S

Might just as well try to move a piano on a kiddy-car as try to do a 100% radio servicing job without RIDER'S Manuals. Richer, fuller, more accurate than any similar manuals, RIDER'S alone enable you to handle any and all the tough problems that come your way today. No other manuals contain so many manufacturers, models, I-F peaks, chassis views, voltage data . . . and there's none so permanent . . . that you can use YEAR AFTER YEAR! RIDER'S Manuals are BEST for EVERY service man!

| | | |
|----------|------------|--------|
| Vol. I | 1000 pages | \$7.50 |
| Vol. II | 800 pages | 6.50 |
| Vol. III | 1070 pages | 7.50 |
| Vol. IV | 1060 pages | 7.50 |
| Vol. V | 1200 pages | 7.50 |

\$1.00 **SERVICING SUPERHETERODYNES**
288 pages of accurate analysis, a boon to the service-man with superhet problems. This valuable little treatise has been called the "bible" in its field.

\$1.00 **SERVICING RECEIVERS BY MEANS OF RESISTANCE MEASUREMENT**
203 pages, telling you how to use the ohm-meter in diagnosing trouble . . . a scientific aid to greater profits, enabling you to cut corners to the solution of many a bothersome problem.

\$1.00 **RADIO SERVICE QUESTIONS AND ANSWERS**
168 pages of pure factual experience, boiled down to indispensable reference-data for the serviceman on his daily rounds.

COMBINATION
Contains Volumes I, II and III, with Carrying Handles, \$25.00

2870 pages with cumulative index. Steel-backed stiff cover binder with patented Herculox mechanism. Also available without carrying handles for \$21.50.

Important — See another RIDER announcement, page 157

JOHN F. RIDER, Publisher
1440 Broadway, N. Y. City

**"Dog-gone!
Where's that
!!* Resistor
?"**



No use doing a nose-dive under the service bench—or digging into a bunch of old cigarette tins for that umphy-ump ohm resistor. . . .

Get this new **CENTRALAB HANDY RESISTOR RACK** that's **FREE** with an assortment of 40 **CENTRALAB RESISTORS**.

You'll like the way you can instantly "spot" just the resistor you're looking for . . . or tell just what resistance values are missing.

See your jobber "right away pronto," or if you're from Missouri . . . mail the coupon for more information and a picture of what this RACK looks like.

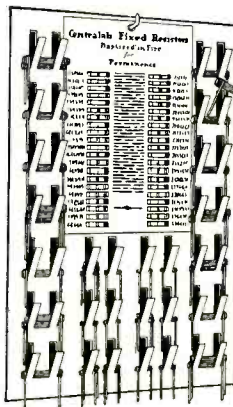

15x9½ inches . . . sturdy steel, and includes an R M A Color Chart in **FULL COLORS**.

Assortment includes 20 —1½ watt type 316 and 20—½ watt type 310 resistors in all the important values.

Free! Centralab HANDY FIXED RESISTOR RACK

The new Centralab Volume Control Guide

is now out . . . better than ever before . . . much new dope . . . and a special section on **SOUND PROJECTION CONTROLS** . . . suppressor information . . . circuits and graphs. Ask your jobber for a copy.

MAIL COUPON NOW!

CENTRALAB
900 E. Keefe Ave., Milwaukee, Wis.

Please send me information about your special deal which includes a **FREE HANDY FIXED RESISTOR RACK**.

Name

Address

City State

My Jobber Is.....Service

MANUFACTURERS—continued

NEW "RECEPTOR" DYNAMIC MIKES

The Radio Receptor Co., Inc., 106 Seventh Ave., New York City, have announced

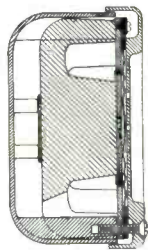

their new Series "6" Dynamic Microphones, a cross-sectional view of one of these units being shown in the accompanying illustration.

The Model 6A is suitable for both voice and high-fidelity music reproduction; for public address, broadcasting and recording. It covers the widest tonal range, and its sensitivity is said to make unnecessary the amount of amplification required by other types of self-generating mikes.

The Model 6B is especially adapted for public-address work and remote pickup for broadcasting, has a high output, and may be substituted in most cases for a carbon microphone without use of a pre-amplifier.

The Model 6C is designed for public-address and amateur transmitter work where price is the important consideration. It is not as sensitive as the 6A or 6B but is said to give good results for the use specified.

NEW "TROUBLE-SHOOTING GADGET"

A "gadget" to assist Service Men in trouble-shooting has just been designed by A. A. Ghirardi and B. M. Freed, authors of a forthcoming publication on "Modern Radio Servicing." This gadget is now on the market.

According to the symptom detected by the Service Man, the "gadget" lists according to source 275 possible troubles in the receiver. The general types of symptom shown are: Hum; Weak; Noisy; Inoperative (no signals); Intermittent Reception; Fading; Oscillation and Distortion. The trouble sources are classified according to whether their location is in the Power Unit, Receiver Circuits Proper, Tubes, Reproducer, Antenna Ground, "A" Battery (if used), "B" Battery (if used), and General.

The "gadget" is being sold by Radio and Technical Publishing Co., 45 Astor Place, New York.

NEW SPEAKER REPAIR KITS

Multiplex Radio Service, Inc., 88 Fourth Ave., Brooklyn, N. Y., are presenting to the trade their new speaker repair kits. These kits are intended primarily as a first-aid kit in speaker work.

The larger kits include all the necessary material for this purpose. Ambroid cement, thinner for dissolving cemented parts, brushes, shims for lining up the voice coils in the gaps and a complete assortment of spiders suitable for all speakers.

The cement is by no means usable only in speaker work, but will be found useful in coating r-f coils, and hundreds of other uses that will suggest themselves to the Service Man. The thinner, besides being useful for dissolving cement, is also good for washing out the gaps of speakers that have become thick with grease and dirt, a condition that will very often be found on auto dynamics.

The prices on the kits and speaker materials are reasonable and a descriptive folder may be had on request.

LYNCH AUTO-RADIO ANTENNA KITS

Arthur H. Lynch, Inc., 227 Fulton Street, New York City, has made available his Auto-Radio Antenna Series in kit form. One of these kits is shown in one of the accompanying illustrations, while the other illustration shows how the antenna is installed under the car.

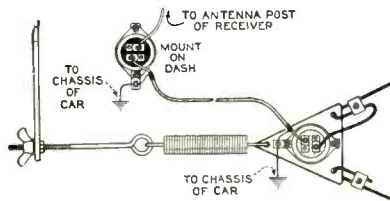

antennas are said to feature easy installation, greatly increased signal strength, and marked noise reduction. An added item of interest lies in the fact that with an installation of this nature it is unnecessary to disturb the upholstery in the car.

Further information relative to these antennas will gladly be furnished by Arthur H. Lynch, Inc.

REPLACEMENT CONES

Leotone Radio Co., Inc., 63 Dey Street, New York City, has just announced a new and complete line of replacement cones. These units are said to be especially adaptable for all types of amplifiers and public-address equipment as well as for all standard auto radios. Complete information will be mailed to those interested.

New and improved manufacturing facilities permits the carrying of complete stocks at all times and thus assuring prompt delivery, it is said.

NEW GATES CRYSTAL MIKE

The Gates Radio and Supply Company of Quincy, Illinois, announces the release

of a new crystal microphone for general broadcast and high-quality public-address service. This microphone incorporates a genuine Brush sound unit of latest design. The frequency response is said to be uniform from 30 to 10,000 cycles.

The microphone is supplied complete with pre-amplifier, which incorporates a pair of 6C6 tubes. The output impedance is 200 ohms. It is supplied with 20-foot cable, plug and socket and requires 6 volts A supply and 180 volts B supply. It is finished in baked black lacquer with fittings of nickel.

This mike is fully described in Bulletin 6D, which can be obtained by writing the Gates Radio and Supply Company, Quincy, Illinois.

SHIELDED PLUG-IN COILS

Shielded "handle type" plug-in coils, which fit on the front panel of the radio receiver instead of inside the chassis, have been made available to short-wave set constructors by the Insuline Corporation of America, 25 Park Place, New York, N. Y.

These coils are supplied in sets of four, to cover the entire short-wave range from 16 to 217 meters. Low-loss ribbed forms of bakelite are employed. Two-winding and three-winding types are made, to fit in all standard regenerative and t-r-f regenerative circuits.

SHUNTS FOR AUTO-RADIO SERVICING

Recently, the Triplett Electrical Instrument Company, Bluffton, Ohio, announced that the growth in popularity of the auto radio had resulted in a large demand for their Radio Shunts.

Triplett Shunts are designed for severe service and are made from heavy strips of shunt material that are mounted on pin-jack tips, which are plugged directly into tester jacks. Shunts Nos. 1115 and 1215 (capacity, 15 amperes) are used to detect power-pack and vibrator troubles in automobile radio sets. Shunts Nos. 1116 and 1218 (capacity, 30 amperes) are used to set the generator at the correct value in order to prevent the battery running down and the generator burning out when installing auto radios. These units are equipped with binding posts.

ASSOCIATION NEWS

(Continued from page 178)

At the March 5 meeting of the Association, two Philco engineers talked on up-to-the-minute developments. Mr. Jackson explained in detail the development and characteristics of the new all-wave aerials, followed by Walt Goldacker, who gave us some interesting dope on aligning the Philco models—especially on the Model 200's. After Mr. Jackson's talk, it seems as if the old hunk of wire won't be good enough any more, and Walt Goldacker, by way of advising us to use our oscillators more, left us with a parting thought: "Don't get the continuity complex."

Among the door prizes coveted by yours truly and none of which he got were a Philco all-wave oscillator, Philco service notes, a set of resistors and a set of condensers, all of which were presented by the Motor Parts Co., our Philadelphia Philco distributors.

J. C. Van Horn, Executive Secretary.



Puts Public Address To Work for You!!

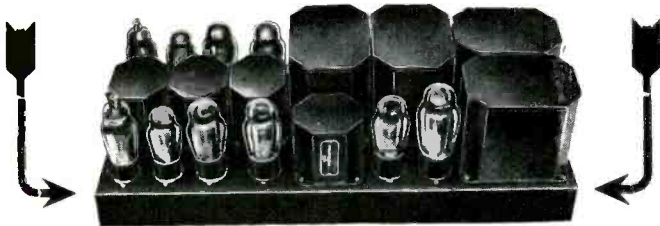

(With shielded protection cover removed.)

High Quality Public Address Audio Components in a Parallel Push-Pull 45A Prime Amplifier—Output 38 Watts, Gain 90 DB

SPECIFICATIONS:

Input will match 50, 200, and 500 ohm lines Center tap on 200 and 500 ohm lines for double button microphone. Output will match 500, 200, 16, 8, 5, 3, and 1.5 ohms. Three balanced push-pull audio stages. Tubes used: 2—57's triode connected; 2—56's, 4—45's in parallel push-pull fixed bias; 1—83; 1—45. Stable fixed C bias for output stage. Trap resonant filter affords maximum filtering efficiency.

List price, including transformers mounted on shielded, stamped chassis, with perforated protective cover, \$77.25.

Your Net Cost—\$46.35

Write for Laboratory series sheet No. 10 which fully describes the construction and circuits for 45A prime amplifiers.

UNITED TRANSFORMER CO.

264 CANAL STREET

NEW YORK, N. Y.

Service Dealers!

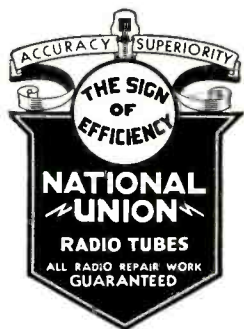

DO you know that this emblem stands for a bigger, better business for you? Do you know of all the shop equipment National Union gives you, has given to thousands of your fellow service experts everywhere? Do you know about National Union business building helps and plans? Do you know why National Union means a more profitable radio service business? You can't afford not to find out all about National Union tubes and why they are sold by more service men than any other make. Find out! Send the coupon!

National Union Radio Corporation of N. Y.
570 Lexington Ave., N. Y. C.



Send me your free book "Merchandising Radio Service" and tell me about free shop equipment.

Name.....
Street.....
City..... State.....

Mail the Coupon Now!



APRIL, 1935 •

SAY YOU SAW IT IN SERVICE

SHOOT



TRouble TRouble

With a THORDARSON Probing Light



Have Plenty of Light Where

You Need it and When You Want it!

Fountain Pen Size! Six-volt Pilot Light operated from 115 volt A.C. or D.C. line! A dependable batteryless light for your workshop, garage, or radio service calls.

At all THORDARSON Distributors

List Price \$1.50

THE SERVICEMEN'S GUIDE

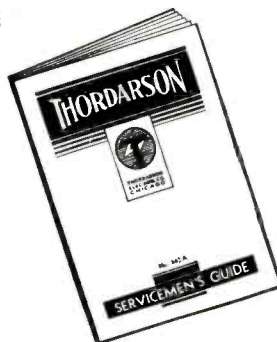

Valuable Technical Data, Charts, Diagrams, Tables, Plans, and Trade Secrets never before published!

How to Build It Information: For a Condenser-Capacity-Leakage Tester; an Output Indicator; and several other useful items.

Circuits of Audio Systems with relative Db. gain. An easy method of calculating Db. gain.

Tables for selecting the proper output transformer! How to Survey and Replan Your Radio Business! These are only a few of the high lights from the Servicemen's Guide. It is not a catalog—no merchandise is listed for sale in it. Price 10c.

Send for Your Copy Today!

THORDARSON ELECTRIC MFG. CO.

500 W. Huron Street, Dept. J, Chicago, Ill.

Please send me the following new THORDARSON literature:

THORDARSON Servicemen's Guide—No. 342-A. Price 10c. postpaid. (Catalog 341-A included Free.)

THORDARSON Transformer Manual—No. 340-A. (Includes the Servicemen's Guide with the Sound Amplifier Manual and Transmitter Guide bound in heavy covers.) Price 50c. postpaid.

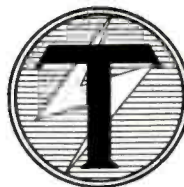

Name
Address
City
State

183

THE MANUFACTURERS . . .

MIKE STANDS WITH COPY HOLDERS

Stock-model microphone stands from the Universal Microphone Co., Inglewood, Cal., will hereafter come equipped with a detachable lightweight copy holder for attaching announcers' notes, music and lecture memos, etc. There will be no increase in the net price for the stands.

The frame, fashioned of frosted cadmium, is curved at the bottom to securely hold letterhead or smaller size sheets with sufficient room for pencils. It operates on a flexible arm and is easily and quickly adjusted or removed.

It has been designed as the result of a survey among broadcasters to determine what improvement, if any, could be made on floor-model microphone stands, it is said.

The Universal factory in March changed design on the base of its manufacturers-model floor stand. The new type will be a two-piece base with four projections to give a wider and more secure spread and lessen the possibility of a tip-over.

The new base is finished in crystalline silver and, like the improvement of the copy holder on the microphone stands, entails no increase in the selling price.

NEW BURTON EQUIPMENT

The unit shown in the accompanying illustration is the new Burton Model 20 Tube Tester, a product of the C. W. Burton Company, 755 Boylston Street, Boston, Mass. This Tube Tester is said to have the following features: Neon-tube detection of shorts and leakage up to $\frac{1}{4}$ megohm, each element of tube receiving a separate test for shorts and leakage with the neon tube indicating defects; accurate meter test of tube condition, detection being on the basis of tube amplification, emission, plate current or excessive gas; separate tests for each section of dual-section tubes; and line-voltage adjustment between 100 and 130 volts. The case for this unit is quartered oak and is provided with a removable lid. Overall measurements approximate 12" x 12" x 5", and the weight is 10 pounds.

Another new unit of the C. W. Burton Company is the Model 30 Radio Set Analyzer. This instrument measures 9" x 11"

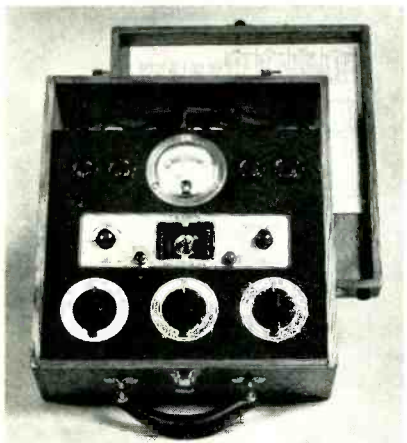

x5", weighs 6 pounds, and is equipped with a $\frac{3}{4}$ " d'Arsonval type meter. The ac voltage ranges are: 15/150/1500. Volts dc or ma are measured on the following ranges: 7.5/15/75/150/750. And, ohms may be determined on the following ranges: 0-1000, 0-100,000, and 0-1,000,000.

When this unit is used as an output meter the 15-volt ac range is employed. Any range can be connected to any socket point in the receiver, and all are available for external use.

The C. W. Burton Company will supply further information on request.

MOBILE PUBLIC-ADDRESS SYSTEM

The Operadio Manufacturing Co., St. Charles, Illinois, are introducing their Model 62 Mobile Public-Address System. This unit, which has a power output of 18 watts, is storage-battery operated, all power being obtained from a 6-volt supply, and has been designed for service in cars. A false bottom which is adjustable to the pitch of the seat permits placing the unit on any seat still maintaining a level turntable. All the controls are next to the



driver and accessible for instant control.

Three power switches are provided to control the turntable motor, the amplifier filaments, and the amplifier B supply. Substantial current saving is possible through judicious use of these switches, particularly the one controlling the B supply and the speaker fields, it is stated.

The Model 62 is a Class A three-stage system using two 76's and two 2B6's. The overall gain is 75 db. The dimensions are 20 x 15- $\frac{1}{2}$ x 10- $\frac{3}{4}$ inches and the shipping weight is 94 pounds. Further information may be obtained by writing for Bulletin 94.

NEW WESTON TEST OSCILLATOR

A new test oscillator specifically designed to meet the servicing requirements of modern all-wave radio receivers has been announced by the Weston Electrical Instrument Corporation, Newark, N. J. This unit is shown in the accompanying illustration.

This oscillator has a frequency range from 100 kilocycles to 22 megacycles, and a special attenuator system which makes possible an approximate output of one microvolt. This low minimum signal is a factor of increasing importance in servicing operations, as it permits alignment of receivers equipped with automatic volume control below the avc level.

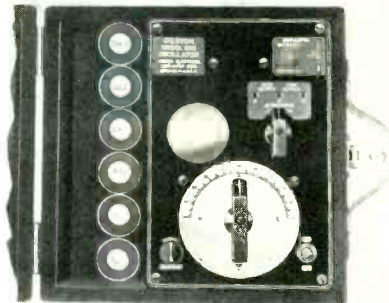

Constant output over the frequency range is provided by means of six individual coils, which are plugged into a doubly-shielded compartment for operation on each of six frequency bands. The use of plug-in coils eliminates switching leads, thus reducing electro-magnetic and electro-static fields within the oscillator. Complete shielding of the coil in use, in addition to overall shielding, prevents interaction and resonance effects with coils not in use on other parts of the circuit.

Output of the Model 692 oscillator may be attenuated from a 0.2-volt maximum to approximately one microvolt, a constant impedance of 200 ohms being maintained at the output jack pins throughout this attenuator range. Thus the attenuator setting does not affect input impedance at the antenna and ground posts of the receiver, and alignment may be carried out without upsetting the first tuned circuit of the receiver by subsequent changes in attenuator adjustment. All attenuation is done ahead of the constant output resistance, so that inaccuracies resulting from the common practice of short-circuiting the output posts to obtain a signal of low value are said to be eliminated.

The unit is equipped with two type 30 tubes, one of which operates in a separate modulator circuit to provide constant internal modulation of 50 percent at all frequencies. Tests have shown that only an independent modulator circuit will provide this constant modulation on high-frequency bands. A switch cutting out internal modulation permits the unit to be used as a pure r-f oscillator for tuning receivers by the Hiss or Tuning Meter method. In addition, two pin jacks are provided on the panel for introducing external modulation when desired. This feature is said to be particularly useful for making fidelity measurements on receivers by means of constant-frequency phonograph records now available.

The oscillator is battery operated, thus preventing any possibility of signal feedback into the receiver through the line, or variations in frequency or amplitude due to sudden fluctuations in the power supply. Each unit is individually calibrated against a crystal-controlled standard. A card showing the calibration curves is mounted directly in the cover of the carrying case. The oscillator with all coils and batteries forms a complete self-contained unit weighing approximately 12 pounds. It is available in a handy carrying case.

NEW

COMPLETE MANUAL

AUTO RADIO

INSTALLATION AND SERVICING

It tells you special tricks in interference suppression for tough installations. Standard routines for elimination of interference in all cars classified by types of electrical systems—the seven quickest, best and easiest methods of installing aerials depending upon the construction of the car—list of which side of the battery is grounded in any make of automobile, etc. It is invaluable.

Tear out this ad, pin it to your letterhead—or write your name and address in the margin—SEND IT TO US WITH 12c IN STAMPS to cover mailing expenses, etc., for your copy. No obligation.

LENZ *Wire*

LENZ ELECTRIC MANUFACTURING CO.
1751 N. Western Avenue, Chicago



FACTS

You should know about
Condensers

WE PROVE IT!

FREE!

You owe it to yourself to write today for a copy of this BOOKLET.

Just what does the Power Factor rating really mean in the condensers you buy?

... What is the truth, and the whole truth, about leakage claims—capacity and voltage ratings?

As serviceman or amateur, how can you be SURE you are getting the most filtering, the best performance for the least money?

These and many other bothersome condenser questions are clearly explained in our new free booklet illustrated above. It will show you that we not only claim Sprague condensers are best—but explain exactly how we PROVE it! Write for a copy. SPRAGUE PRODUCTS CO., North Adams, Mass.

SPRAGUE CONDENSERS

MADE RIGHT



PRICED RIGHT



Announcing The new RACON Unbreakable P. A. Horns

A radically different type of sound projector combining great strength and ruggedness with high transmission efficiency. Made of RACON ACOUSTIC STORM-PROOF MATERIAL with full length reinforcement. The last word in trumpet design. 25 of these new projectors are being installed at the San Diego Exposition.

Racon Electro Dynamic Units and Horns are manufactured under 14 exclusive Racon Patents.

Write Dept. S-4 for
Complete Details

RACON ELECTRIC CO. INC.

52 East 19th Street, New York, N. Y.

London, Eng.

Toronto, Can.



Higher temperatures are employed in manufacture . . . than are ever reached in use

The very nature of Vitrohm insulation (vitreous enamel) necessitates that the tubes and wires be baked at temperatures high enough to make the glass flow, much higher than temperatures ever reached during use. Furthermore, Vitrohm is acid and moisture resisting and tough. It holds the wires rigidly and protects them from oxidation or mechanical damage.

Ward Leonard Vitrohm Units are made to meet every special requirement for electrical resistance.

WARD LEONARD RESISTORS

WARD LEONARD ELECTRIC CO.
South St., Mount Vernon, N. Y.

Please send me bulletin featuring Resistors.

Name
Address
City State
Jobber S

IT STOLE THE SHOW!



This latest Operadio-strike was easily the feature attraction at the Radio Service Men's convention in Chicago last month. For the first time in their experience, service men saw and heard an amplifier powered by a 6-volt storage battery deliver 18 watts of undistorted Class A amplification. They raved about its performance and marvelled at its reasonable price. In it they recognized the fulfillment of a long-existing need for a really practical mobile amplifying unit. As with all other Operadio products, this job is engineered for greater efficiency in operation and ease of handling—an outstanding value at its reasonable price.

NEW MODEL 62 MOBILE P. A. SYSTEM—A compact, economical, high-efficiency complete unit for automobile service. Derives its power from a 6-volt storage battery. Delivers 18 watts undistorted Class A amplification. All contained in beautiful steel crystallac cabinet. Has false bottom with turntable leveling adjustment for operation from driver's seat. Total net weight 65 pounds.

Write for Bulletin 94 with full specifications, attractive prices and discounts.

Operadio Manufacturing Company

St. Charles, Ill., U. S. A.

Export Division—347 Madison Ave., New York, N. Y.

MODERNIZE YOUR ONE MILLIAMPERE METER with



New Semi-Precision Meter Multiplier Resistors made by CONTINENTAL CARBON INC.

Study this modern circuit! You can rebuild your 1 milliammeter into a seven range high resistance voltmeter and a dual scale ohmmeter, using the New CONTINENTAL CARBON Volt-Ohmmeter Kit for Weston 301 and Jewell 88, 444, 408, 409, 54, 199, 133, 133A, 210, 538, 137, 137A meters.

Kit consists of 9 fixed resistors with close tolerance limits, paper dial scales and a length of resistance wire. List \$3.60.

Switch, batteries, and potentiometer are standard items available from CONTINENTAL CARBON Distributors. Jobbers, order your stock now! Get extra copies of Bulletin 102!

Resistor Engineering Bulletin 102 FREE!

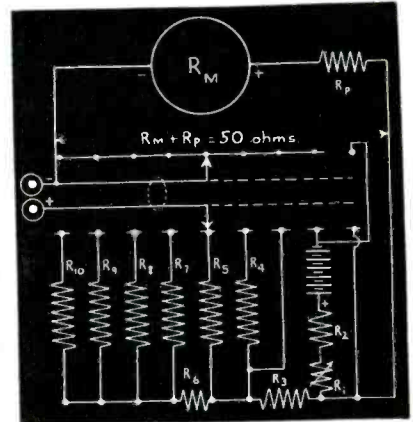

CONTINENTAL CARBON Inc.

13912 Lorain Ave., Cleveland, Ohio

Toronto, Canada

CORWICO
"NOISE-MASTER"
ANTENNA

Goodbye, "man-made" static! For clear, pure, NATURAL reception on both broadcast and shortwave bands. "NOISE-MASTER" makes every radio a better radio. Service men . . . INVESTIGATE!



"TRAVEL FIRST CLASS," our new folder, sent free . . . write for your copy at once.

CORNISH WIRE CO.
 30 CHURCH STREET, NEW YORK CITY

"E. H. Rietzke SPEAKING!"

Mr. E. H. Rietzke, President of CREI and originator of the first thorough course in Practical Radio Engineering.

RADIO IS on the UPTURN are YOU?

• Radio sales . . . radio production . . . radio broadcasting . . . are all on the upswing . . . business is good. Of course, that doesn't guarantee you a job or an advancement. . . . UNLESS YOU ARE ACTUALLY TRAINED FOR BETTER THINGS. The foremost engineers will tell you that TECHNICAL TRAINING is essential . . . and the progress of CREI graduates certainly proves that!

• NOW, while opportunity beckons every radio man, is the time to investigate the famous CREI one-year Residence Course. Here in our Washington school men from all over the country are being trained on modern transmitting and receiving equipment in our extensive laboratories with trained engineer-instructors. Next course begins September 23rd; classes now forming.

3 CONVENIENT PLANS OF STUDY—
 CREI training covers every type of Radio Engineering in our RESIDENCE COURSE . . . the original HOME STUDY Course . . . or the COMBINATION of RESIDENCE AND HOME STUDY Instruction.

FREE! Write for 44-Page Illustrated Booklet with full details of ALL courses, and any special information you may desire.



Capitol Radio Engineering Institute

Dept. S-4

14th & Park Rd., N.W., WASHINGTON, D. C.

• SERVICE FOR

SPEAKER REPAIR KITS

DEALERS AND SERVICEMEN

Here is your opportunity to secure a Kit or a complete assortment of Kits suitable to your particular needs. Our own experience in this field has enabled us to design Kits which will simplify your speaker repair work and increase customer satisfaction.

You can't afford to be without it.

MULTIPLEX RADIO SERVICE, INC.
88—4th AVENUE BROOKLYN, N. Y.



RADIO SERVICING

Residence course, 6 months, modern methods, new courses, special work on service equipment and super-heterodyne servicing; instruction on public address systems, photo cell and cathode ray tubes included. Other courses obtainable: Radio Engineering—9 months; Marine Radio—6 months; Morse telegraphy—6 months; Combination Engineering and service courses—12 months. School established 1874. All expenses low. Catalog free.

DODGE'S INSTITUTE, Thirteenth Street, Valparaiso, Ind.

A FEW GOOD TERRITORIES STILL OPEN REPRESENT US — THERE IS GOOD MONEY IN IT!

MAKERS OF



FREE EDGE
CONE AND VOICE
COIL ASSEMBLIES



BAKELITE BOBBINS
FIELD COILS FOR
ALL DYNAMIC SPEAKERS

We also Manufacture Various Types of Magnetic Speakers
We can Supply and Remedy Your Speaker Needs
SPEAKER MANUFACTURERS SINCE 1921
LEOTONE RADIO CO. 63 Day Street, New York City

Federal CONDENSER ANALYZER



LIST PRICE \$20

40% off to SERVICE MEN
Ask your distributor or write direct
Write for catalog of Federal "Quality"
Replacement Transformers, Tubulars,
P.A. Equipment and other products.

FEDERAL ENGINEERING CO., INC.
286 MERCER STREET NEW YORK, N. Y.

For Every Service Man

TESTS them quickly and efficiently by applying D.C. voltage equal to working voltage of condenser.

Easily determines voltages of unmarked condensers.

Quick reading of good or bad units. Neon tube glows whenever unit being tested has more than normal leakage. Also tests tube leakage.

Attractively housed in a steel container, shrivelled black baked enamel lacquer finish. Engraved sloping panel for easy reading.

22% Greater Signal Strength Efficiency!

WITH THE **WARD Magic Super Auto Antenna**

ESPECIALLY DESIGNED FOR TURRET TOP CARS

Approved for all Turret Top Cars and many others.

The ordinary type of under-car antenna gives only 60% Signal Strength Efficiency.

The **WARD Magic Super Antenna** gives 82% Signal Strength Efficiency!

To further insure Perfect Auto Reception use **WARD No-Loss SUPPRESSORS**



DEALERS! JOBBERS! SERVICEMEN!
Write for Illustrated Catalog!

MFG. BY THE **WARD PRODUCTS CORP.** WARD BLDG. 7135 SUPERIOR AVE. CLEVELAND, OHIO, U. S. A.

Service Aids—You Need!

Eveready Speaker Cement



This is the best cement for cementing new cones, and repairing torn or rattling cones. It dries fast, and is vibration proof and flexible. It can also be used for other Radio Work.
List Price 50c

The R-S Speaker Shims

You need speaker shims to center voice coils and cones on speakers. The R-S Shims are a permanent tool and best shims you can buy, because they are made of Swedish Steel. Four sizes in a leather case, 16 shims in a kit.
List Price 65c



A Pocket Tool Case



This Genuine Leather Case will fit in your hip pocket and hold all tools needed on the job. This case will save your pockets, and prevent loss of tools. A very neat case that you will be proud of.
List Price \$1.00

Write for catalog of other Service Aids

Buy from your jobber, if he cannot supply you write us.
General Cement Mfg. Co., Rockford, Illinois

Service Trade Discount 30%

SERVICE ENCYCLOPEDIA OF ACTUAL RADIO TROUBLES

Bertram M. Freed has compiled all his important service notes into a book consisting of 200 pages and 46 diagrams. It is closely packed with information covering the weak points in over 500 different model receivers with their symptoms and corrections.

Price includes one **FREE** Supplement which contains over 200 additional Models, Diagrams, and Illustrations. **\$1**

If your regular Jobber or Mail Order House cannot supply you, write direct to—

SERVICEMEN'S PUBLISHING COMPANY
136 LIBERTY STREET NEW YORK CITY



MAKE EXTRA MONEY

A rich new field is open to the Service Man in installing group hearing aids for the Hard of Hearing in theatres and churches. Daily, more theatres are putting in this equipment. **YOU** are the logical man to sell it to them and to install it.

Become an authority on group hearing installation. Write **TODAY.**

TRIMM

RADIO MFG. CO.
Dept. S-4
1528 Armitage Ave.
Chicago



**SERVICE ENGINEERS:
Send for this NEW
100% RADIO CATALOG**

Just out—the new 1935 Spring and Summer ALLIED Catalog. You need this Double-Value Profit Guide. It's packed with thousands of exact duplicate parts—all leading lines of test equipment, tools, etc. Offers many new money-making ideas. Send for this FREE valuable Catalog now. Consult it always before you buy it—will repay you in bigger profits!

ALLIED RADIO

ALLIED RADIO CORPORATION
833 W. Jackson Blvd., Chicago, Ill. Dept. N.
 Send me your FREE 1935 Spring & Summer Catalog.
Name.....
Address.....



**FREE
WRITE NOW!**

New
**BIRNBACH
AUTO Antenna KIT**
GETS RESULTS

SPECIALLY designed to pick up maximum signal with minimum noise. Bakelite insulated. Easily, quickly installed underneath car between shackle bolts and flywheel housing. Shielded lead-in. Includes all required accessories. A real buy for \$2.50 list, complete.

Write Dept. S-4 for complete catalog of Birnbach Auto-Radio Accessories, Insulators and General Radio Equipment.

\$2.50
Complete

Birnbach Radio Co., Inc.
145 Hudson St. New York City

Macy Directional Baffle

Ideal for all P. A. requirements, indoor and out, controlled sound distribution eliminates feed back difficulties, improves the fidelity and increases "speaker efficiency"; constructed of reinforced spun aluminum; free from all metallic resonance, 100% weatherproof; overall size, bell 17 in., length 20 in. Available for all speaker cone sizes up to 12 in. in diameter.

Shipping weight 5 lbs. Model MB-10 Net Price \$8.82 List Price \$15.00

Macy Engineering Co., 1452 39th St., Brooklyn, N. Y.
Write for complete P. A. Catalogue—desirable territory available for representatives.

RIGHT OFF THE PRESS

NEW 1935 CATALOG

Including the largest assortment of PUBLIC ADDRESS Equipment ever assembled in a catalog.

ALSO: Replacement Parts, Sets, Tubes and Accessories.
Be sure to write for your copy to-day. We sell to the trade only.

We Manufacture an Amplifier for Every Purpose.

Wholesale Merchandisers, Inc.
626 Broadway, Dept. E, New York City

**Ken-Rad
Radio Tubes**
DEPENDABLE LONG LIFE

Ken-Rad Radio Tubes are made to give clear, dependable reception. They satisfy customers and build good will for dealers. Write for full information.

THE KEN-RAD CORPORATION, Inc., Owensboro, Ky.
Division of The Ken-Rad Tube and Lamp Corporation
Also Mfrs. of Ken-Rad Incandescent Electric Lamps

**7-POINT MIKE =
NO FEEDBACK**
with speakers full blast

For the first time in America, the new SUPER-FLUX NICKEL ALUMINUM MAGNETS ARE USED—the most powerful magnets available—more powerful than even 36% Cobalt... You get 8 times more VOLUME without feed-back, than you can get with any diaphragm mike. Not affected by temperature, altitude, or moisture... THOROUGHLY SHIELDED against hum pickup. Rugged.

PRE-AMPLIFIER
Humless A.C. pre-amp. 30-14000 cycles (1db). Hum level—100 db. Write for Bulletin S-3

AMPERITE Corporation 561 BROADWAY NEW YORK

**AMPERITE
VELOCITY MICROPHONE**

NEW PHOSPHOR BRONZE DIAL CABLE
The Handiest Spool Made
Nothing Like on the Market

SAMPLE SPOOL 25 FT.....50c
Only One to a Dealer

ALL OTHER ORDERS THRU YOUR JOBBER
We Can Furnish Your Complete Requirements for Wire Goods and Antenna Equipment

ALL WAVE ANTENNA KITS..\$2.16
Send for Catalogue Sheet
Regular Aerial Kits, Complete...49c

RIVARD MFG. CO.
1014 MADISON AVE. TOLEDO, OHIO

SOLAR

WET AND DRY ELECTROLYTIC PAPER AND MICA CONDENSERS

RECOGNIZED FOR SUPERIOR QUALITY IN ALL CLIMATES THE WORLD OVER

SOLD BY LEADING JOBBERS EVERYWHERE

SOLAR MFG. CORP.
599 BROADWAY NEW YORK

BEST BY TEST!

ASK FOR CATALOG OF EXTREMELY COMPACT TYPES HANDY FOR SERVICE

There Is No Substitute for Experience

Radiart

Exact Duplicate Replacement Vibrators have proven their ability to perform in thousands and thousands of sets.

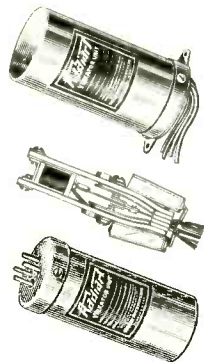

Any way you look at it, Radiart is the acknowledged leader in this field. Radiart built the ORIGINAL line of exact duplicate replacement vibrators. More than 300 jobbers throughout the country are now selling Radiart replacement vibrators, a great many of them exclusively. More than 70,000 receivers have now been served with a Radiart replacement. Why gamble with your customer's good will when you can get a genuine Radiart at no greater cost? A pound of experience is worth more than a ton of printed words—Radiart has that experience.

Ask Your Jobber

THE RADIART CORPORATION

Shaw Ave. at E. 133rd

Cleveland, Ohio

FOR FINEST P.A. RESULTS

you must use

**RADIO RECEPTOR
DYNAMIC (moving coil)
MICROPHONES**

*Highest Fidelity
Greatest Sensitivity
Extreme Ruggedness*

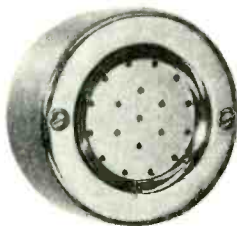

... Weatherproof ... blastproof ... wide angle pickup ... no background noise ... small and compact ... uniform ... can be operated 1000 ft. from amplifier ... no change in frequency response in close up talking ... no spring suspension needed for P.A. work ... reasonably priced from \$33. list up.

Interesting "mike" data supplied on request. Write

RADIO RECEPTOR CO. Inc., 106 7th Ave., New York



NEW! Essential Tools in COLOR!

SERVICEMEN! You need these tools. Neutralizing tool and compensating screw drivers made of AMEROLD in attractive colors—model shades. Won't chip or break in normal use. Easily identified in your service kit.

FOUNTAIN PEN STYLE

Contains insulated screw driver; 1/4" and 5/16" insulated wrenches for compensating and balancing I.F. Transformers, Variable and equalizing Condensers, etc. Clip for vest pocket. **60c**

COMPENSATING SCREW DRIVER

Colors correspond with Neutralizing Tools, knurled end assures non-slip grip. List price **30c**

PACKING—12 of each tool mounted on attractive display card. Your Jobber can supply you at 40% discount or write us direct for name of nearest distributor. Address Dept. S-45.



**INSULINE CORP. OF AMERICA
23-25 PARK PLACE NEW YORK, N.Y.**

for better
AUTO RADIO
reception
on **ANY AUTO**

LYNCH

HI-GAIN

ESPECIALLY
"TURRET TOP CARS"

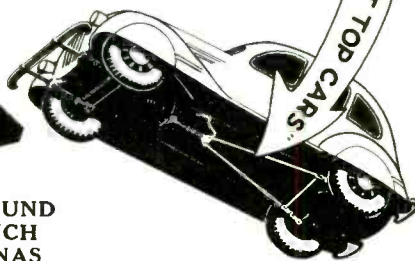

**FEATURES FOUND
ONLY IN LYNCH
AUTO ANTENNAS**

- Patented for your protection
- Installed in a jiffy
- Greatly increased signal strength
- Marked noise reduction
- Upholstery untouched
- Satisfaction or your money back
- Clear reception

A new series of auto-radio antenna systems now ready. Priced from \$3.50 to \$8.00 list. Attractively packaged, each part plainly marked. Write for Lynch aerial installation data—it's chock full of vital information—FREE.

ARTHUR H. LYNCH, Inc. 227 Fulton St.,
New York, N.Y.

QUALITY ELECTROLYTICS

More Than You Realize!



The importance of a quality electrolytic condenser in which you have the utmost confidence cannot be overestimated.

No need to be called back on profitless service calls when you can use C-D hi-formation electrolytics in the first place. . . . BECAUSE . . .

- Only the finest quality raw materials used in construction.
- Careful double test and inspection on each condenser.
- Hi-formation electrolytic construction assures longevity.
- Negligible leakage characteristics 300 micro-amperes for 8 MFD at 450 v.
- Low power factor—Approximately 3%.



Write for free data on a complete range of electrolytic exact duplicate replacements. Your catalog No. 128 now available.

CORNELL-DUBILIER

CORPORATION

4375 BRONX BOULEVARD
NEW YORK

Don't Miss It



A Complete Radio Encyclopedia — Thousands of items accurately illustrated and clearly described. Charts, data, diagrams, and valuable technical data—distribution of the new Profit Guide is limited to active and legitimate Radio Servicemen. Send your business card or letter-head to be assured of getting your copy immediately.

THE RADOLEK CO.
607 W. RANDOLPH STREET CHICAGO



Model 390 VC

Replace Speakers For Profit

GONE are Cone Replacements!

Now you can install a WRIGHT-DeCOSTER Chassis for practically the same price as it costs to install a Cone . . . and the WRIGHT-DeCOSTER assures a thoroughly satisfied customer, more profit and dollars ahead in sales. There is one to fit every radio. No dirt, grit or filings can get into the air-gap of a Wright-DeCoster Speaker due to the patented solid center spider.

Model 390 VC—5-inch Chassis—\$3.90

REAL PROFIT IN SEPARATE SPEAKERS

All high priced car sets have separate speakers. Now the smaller less expensive sets can have all the finer tone qualities of the larger sets by installing a separate Wright-DeCoster Vehicle Speaker. The difference in quality of tone will be astounding.

Model 780 VS 8" Vehicle Speaker—\$7.80

Write for complete catalog, dealer's discount and name of nearest distributor. You will find the Wright-DeCoster distributor anxious to cooperate in every way possible.

Wright-DeCoster

Incorporated

2253 University Ave.
ST. PAUL, MINN.

Export Dept.: M. Simons & Son Co.

Cable Address:
SIMONTRICE, New York



Model 780 VS

INDEX TO ADVERTISERS

| | |
|--------------------------------------|-----|
| A | |
| Aerovox Corp. | 179 |
| Allied Radio Corp. | 188 |
| Amperite Corp. | 188 |
| Arcturus Radio Tube Co. | 175 |
| B | |
| Birnbach Radio Co., Inc. | 188 |
| C | |
| Capitol Radio Eng. Inst. | 186 |
| Centralabs | 181 |
| Continental Carbon, Inc. | 186 |
| Cornell-Dubilier Corp. | 189 |
| Cornish Wire Co. | 186 |
| D | |
| Dodge's Institute | 187 |
| F | |
| Federal Engineering Corp. | 187 |
| G | |
| Gates Radio & Supply Co. | 177 |
| General Cement Mfg. Co. | 187 |
| General Transformer Corp. | 191 |
| H | |
| Hygrade Sylvania Corp. | 173 |
| I | |
| Insuline Corp. of America | 189 |
| K | |
| Ken-Rad Corp., The | 188 |
| Kenyon Transformer Co., Inc. | 177 |

| | |
|---|--------------|
| L | |
| Lenz Elec. Mfg. Co. | 185 |
| Leotone Radio Co. | 187 |
| Lynch, Inc., Arthur H. | 189 |
| M | |
| Macy Engineering Co. | 188 |
| Mallory & Co., Inc., P. R. | 158 |
| Multiplex Radio Service, Inc. | 187 |
| N | |
| National Union Radio Corp. of N. Y. | 183 |
| O | |
| Ohmite Mfg. Co. | 177 |
| Operadio Mfg. Co. | 186 |
| R | |
| RCA Mfg. Co., Inc. | Fourth Cover |
| Racon Elec. Mfg. Co. | 185 |
| Radiart Corp., The | 189 |
| Radio & Technical Pub. Co. | 191 |
| Radio Products Co., The | 175 |
| Radio Receptor Co. | 189 |
| Radolek Co., The | 190 |
| Raytheon Production Corp. | Third Cover |

| | |
|---|--------------|
| Readrite Meter Works. | 179 |
| Rider, John F. | 157-181 |
| Rivard Mfg. Co. | 188 |
| S | |
| Servicemen's Publishing Co. | 187 |
| Solar Mfg. Corp. | 188 |
| Sonochorde Sales Co. | 191 |
| Sprague Products Co. | 185 |
| Standard Transformer Corp. | Second Cover |
| T | |
| Thordarson Elec. Mfg. Co. | 183 |
| Tobe Deutschmann Corp. | 191 |
| Trimm Radio Mfg. Co. | 187 |
| Triplett Elec. Inst. Co., The | 157 |
| U | |
| United Transformer Corp. | 183 |
| W | |
| Ward Leonard Elec. Co. | 185 |
| Ward Products Corp. | 187 |
| Webster Co., The | 179 |
| Weston Elec. Inst. Corp. | 153 |
| Wholesale Merchandisers, Inc. | 188 |
| Wholesale Radio Service Co. | 155 |
| Wright-DeCoster, Inc. | 190 |
| Y | |
| Yaxley Mfg. Co., Inc. | 158 |

SEALED AGAINST MOISTURE!

A secondary impregnation of special sealing compound effectively prevents the entrance of moisture in

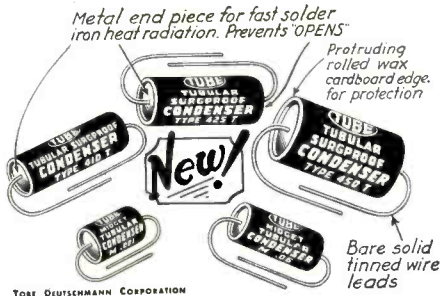

TOBE DEUTSCHMANN CORPORATION

TOBE TUBULAR CONDENSERS

DANGER—MOISTURE AHEAD!

Thousands of condenser breakdowns are due entirely to moisture getting inside the condenser, lowering its resistance, increasing leakage current, and carbonizing the paper dielectric. In "shelf life" or in service, condensers are always in danger. Use the

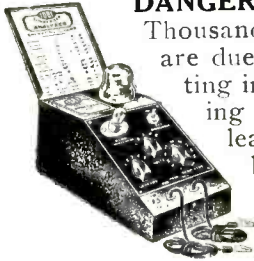

TOBE CONDENSER ANALYZER

to test condensers for "moisture leakage."

Only \$11.40 net to servicemen.

TOBE DEUTSCHMANN CORPORATION
CANTON, MASSACHUSETTS

"GENERAL" Auto-Radio "B" VIBRATORS

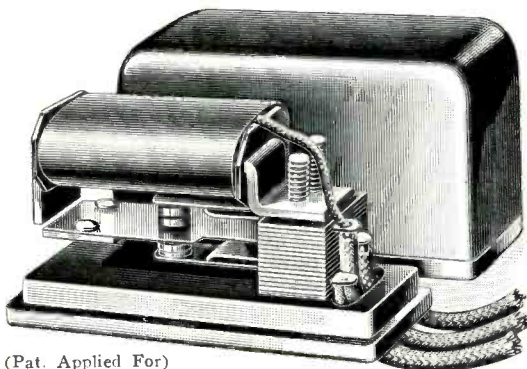

(Pat. Applied For)

Actual Size Replacement Unit

Mountings and Connections to fit 156 Models of Auto Radios

To insure the most permanent and dependable service possible in equipment of this kind, the General full-wave vibrator is provided with the highest grade Swedish spring steel reed and with oversized tungsten contacts—assuring long life. The springs are firmly clamped between bakelite insulation supported with the coil on a rigid metal base to which is snapped a low resistance non-magnetic metallic enclosing case—no liability of mechanical injury to springs.

MAIL THIS TODAY

GENERAL TRANSFORMER CORPORATION

502 S. Throop St., Chicago, Ill.

Send me without charge a copy of "General" "B" Vibrator Guide for 156 Models Auto-Radio sets, with name of nearest distributor.

Name
Address
City State

SONOCHORDE Electro-Dynamic Reproducers

Now Available to

DEALERS AND SERVICEMEN

The kind of Speaker Service you have been waiting for—prompt service on four sizes: 5"—6"—8"—11", with 741 "specifications" from which to choose. Two sizes replacement Auto Speakers and speakers with re-inforced voice-coils for P.A. work. Sonochorde Speakers possess unusual tonal quality and frequency response.

New Low Prices!

Write for catalog and net-price sheets, TODAY!

Sonochorde Sales Company
200 Boston Ave. Medford, Mass.



New!



Check These Features—

- Complete descriptions and illustrations of latest 1935 testing instruments and servicing methods (including cathode-ray oscillographs).
- Trouble-shooting table—Symptoms and Remedies for over 500 receivers, listed by manufacturer and model number.
- 1935 auto radio installation and servicing.
- Elimination of noise and interference in all broadcast, all-wave and auto radios.
- Table of intermediate frequencies for all superhets.
- AVC and QAVC circuits and servicing problems.
- Sales, advertising and merchandising tips.
- And dozens of other exclusive features—a million ideas you can put to use right away!

MODERN Radio SERVICING

by GHIRARDI and FREED

Supplemented by

FIELD SERVICE DATA AND ANSWER BOOK

The book of the day!—and the book of tomorrow, too! A book you'll want to have with you all the time, because it's just crammed full of new ideas, the latest tips and angles, the most up-to-date methods used by successful technicians. The most complete book of its kind ever put out—written in simple, easy-to-understand language—profusely illustrated with diagrams and charts. Send for the free circular right now and find out how useful and practical this book will be in your business.

Modern Radio Servicing—\$4.00. Field Service Data Suppl.—\$1.50.—Special Combination Offer—Both books (if purchased together) \$5.00.

Ghirardi and Freed's Trouble-Shooting Gadget shows you at a glance every remedy for every symptom. Keep one in your pocket out on the job. Only 25c.

MAIL TODAY To Radio & Technical Publishing Company, 45 Astor Place, New York City, Dept. S-4

Please send free circular on MODERN RADIO SERVICING.

Enclosed find 25c for the Trouble-Shooting Gadget.
NAME
ADDRESS



RADIO ENGINEERING

Covering the design, production, engineering and test of Radio Receivers, Tubes, Parts, Amplifiers, Recording and Sound Projection Equipment. Published monthly.

Subscription, \$2.00 Yearly
(Foreign, \$3.00)



COMMUNICATION AND BROADCAST ENGINEERING

Covering Radio Communication, Broadcasting, Police, Marine and Aeronautical Radio, Telephony and Telegraphy, Facsimile and Television. Published monthly.

Subscription, \$3.00 Yearly
(Foreign \$4.00)

BRYAN DAVIS PUBLISHING CO., INC.

19 EAST 47th STREET, NEW YORK CITY



A FAIR DEAL TO ALL..

RAYTHEON'S New Price Plan effective April 1st, 1935 is built upon this keystone: "A Fair Deal to All"—consumer, dealer, service man and jobber. Its need was never more acute—a sixty-five million dollar replacement tube market slashed during the last five years to twenty-four million dollars—reduced prices and profits—loss of public confidence.

THE AVERAGE list price per tube on January 1st, 1930 was \$2.63; the average price per tube on April 1st, 1935 was \$.80 and no increase in consumer sales. An \$.89 price will sell no more tubes than a \$1.00 price.

RADIO TUBES are service items, not ordinary shelf or counter merchandise; tubes must be tested and installed; purchasers require information and advice, service questions arise; and for all this work the trade must be fairly compensated.

RAYTHEON'S new selling plan was built after weighing these factors; it incorporates the answer the trade is seeking and includes the only tube distinctly different in design—4-Pillar Construction—unexcelled quality, consumer acceptance and competitive trade prices—not price-slashing lures, but profit-building list prices. All 4-Pillar Tubes bear the Raytheon name; the story is easy to tell—the 4-Pillars are plainly visible to the consumer. Reputable dealers and service men everywhere recommend, endorse and sell them.

Ask your Jobber for complete details of Raytheon's plan, or use the coupon.

RAYTHEON PRODUCTION CORPORATION

30 East 42nd Street
New York

55 Chapel Street
Newton, Mass.

445 Lake Shore Drive
Chicago

555 Howard Street
San Francisco

RAYTHEON PRODUCTION CORPORATION,
Dept. F5, 30 E. 42nd Street, New York:
Please send Details New Price Plan Display Material

NAME _____

ADDRESS _____

CITY _____

FOUR PILLAR

RAYTHEON

RADIO TUBES



WHY CONSIGNMENT FAILED

The Agency System is the only legal means by which a manufacturer can control trade re-sale and consumer prices on his product. It is primarily a means of establishing the ideal in orderly marketing with price as a competitive weapon removed.

Our attempt to accomplish the above objective in the badly disorganized radio market could not succeed without aggressive, active, loyal support from the trade. The majority of our wholesalers and dealers did not give us this kind of support. Competitive manufacturers and their distributing organizations short-sightedly intensified their price selling, thus aggravating market conditions and making it impossible for RCA Radiotron alone to carry the burden of stabilizing and limiting price competition.

Stabilized price marketing very evidently went contrary to "human nature" in the radio business and during a severe depression. Sales effort by Agents decreased. Many of our Wholesale Agents, finding their sales effort limited to stimulating the activity of their served dealers only, took on other brands to be sold at greater discounts to Radiotron Agents served by competitive jobbers. As this "cross fire" spread, Dealer-Agent volume decreased. Radiotron consigned stocks were looked on as a convenience and not as an obligation and an opportunity. This was a short-sighted policy but was sound "human nature" in the present state of the radio business.

Most of our wholesalers distribute radio receivers. Their set dealers and Radiotron Agency appointments did not coincide, further aggravating jobber-dealer relations and weakening sales effort on our tubes.

Consigned stocks and Agency selling were more expensive for us to handle and many of our wholesalers felt similarly. A market stressing low prices requires low-cost operation.

The Agency System—to be kept in legally approved form—requires considerable "red tape," with resulting inflexibility. Competitive radio tube conditions require speed, quick action and therefore the utmost flexibility.

Many classes and types of retailers sell tubes. We found it impossible to construct Agency Contracts that would appeal to the great variety of competitive dealers that dominate the tube business.

Much more could be said on "Why Consignment Failed." But need more be said?

PRESIDENT, RCA MANUFACTURING CO., INC.