

SERVICE

—

A MONTHLY DIGEST OF
RADIO
AND ALLIED MAINTENANCE

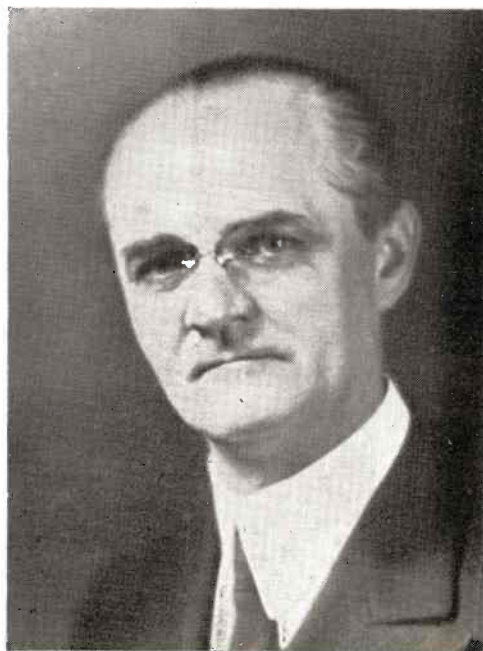

In the footsteps of Sherlock Holmes---
(see page 56)

PER COPY
15 CENTS

APRIL
1932

PRESENTING

John F. Rider's

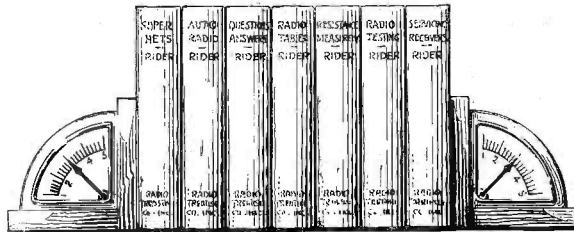

\$1.00 RADIO SERVICE LIBRARY

Practical • Informative • Up-to-Date • Accurate

SERVICING SUPERHETERODYNES

Do you know all that you should to enable you to service superhets at a profit? . . . Are you familiar with the various kinds of superheterodyne circuits? . . . Do you know the function of the individual parts of a standard superheterodyne receiver—of an autodyne superhet? . . . Do you know what is meant by "image frequency"? . . . Can you adjust the Atwater-Kent "double spot" interference-eliminating system?

Servicing Superheterodynes answers all of these questions and many more. It gives you all of the information you need have about superhet receivers. This book is a Best Seller. 10,000 copies have been sold within the 3 months since it was announced. 163 pages, type set, profusely illustrated, cloth bound.

SERVICING RECEIVERS BY MEANS OF RESISTANCE MEASUREMENT

Radio receiver servicing methods will undergo a change. The measurement of resistance in a radio receiver offers the most logical method of servicing because it is independent of tube conditions, line voltage, tube constants, etc. When you check a receiver by measuring the resistance between points you eliminate all guesswork.

Do you know how to check receivers by means of resistance measurement? Let Rider explain this method in his easy-to-understand language. Servicing a receiver by means of resistance measurements is the coming thing. It is modern in every sense of the word. . . . It affords a means of checking a complete receiver without removing the chassis. This volume is educational . . . practical . . . valuable.

160 pages. Type set. Profusely illustrated. Cloth bound.

USEFUL RADIO TABLES FOR SERVICE MEN

Do you know the number of turns required upon a $\frac{1}{2}$ -inch tube so that the coil will resonate over the 130 kc. to 180 kc. band with a condenser of .0002 mfd.? Do you know what value of condenser to connect across a filter choke of 20 henrys so that it will resonate at the major hum frequency in a 25-cycle receiver power pack?

Rider's Useful Radio Tables for Service Men will give you this information and much more. Every table of value in connection with radio service work will be found in this volume. The most handy reference book for the radio service technician. No theory. . . . No charts. . . . All tables.

144 pages. Type set. Cloth bound.

RADIO SERVICE QUESTIONS AND ANSWERS (2 Volumes)

How many times have you been stumped because you did not have the answer to a service problem?

Radio Service Questions and Answers have been compiled from the many thousands of letters received by Rider during the past 5 years. Each volume is just crammed full of everyday data—just what you want and need. The many thousands of service men in the field experience the troubles you find during your daily work. Here are the answers to such questions. . . . Right to the point every time! No wasted words, but practical, easy to understand information in every line—every page. Suggestions—solutions—the answers to your service problems.

160 pages in each volume. Type set. Well illustrated. Cloth bound.

PRACTICAL TESTING SYSTEMS

Service work requires the testing of coils, transformers, resistances, tubes, condensers. . . . It requires the construction of tube testers, resistance measuring units, capacity testing units, tube voltmeters, inductance measuring output, output indicating systems, multi-range meters, oscillators, etc.

Do you know how to build such units? Do you know what circuit to use to increase the range of a d-c. voltmeter, milliammeter or a-c. voltmeter? How many times have you wished for a circuit and constants for a broadcast r-f. and intermediate frequency self-modulated oscillator?

Practical Testing Systems will supply you with all of the above test data and much more which you will be able to use in the future. It makes a marvelous reference book.

149 pages, type set, 99 illustrations, cloth bound.

Price each, \$1.00 Postpaid

Sold on Money-Back Guarantee

Here is your opportunity to start a Radio Service Library. The cost is low. The information is modern and valuable. The books are handsomely bound. They make a proud possession. Add to your library as you go along. The books are

well constructed. No paper covers. Every book is bound in cloth which makes for permanency. The color of each cover is different, making it easy to recognize each book.

Place your order with us or your nearest radio dealer

Radio Treatise Co., Inc.

1440 Broadway

New York City

WANTED » »

Competent Service Men

to install **SCOTT**

ALL-WAVE RECEIVERS

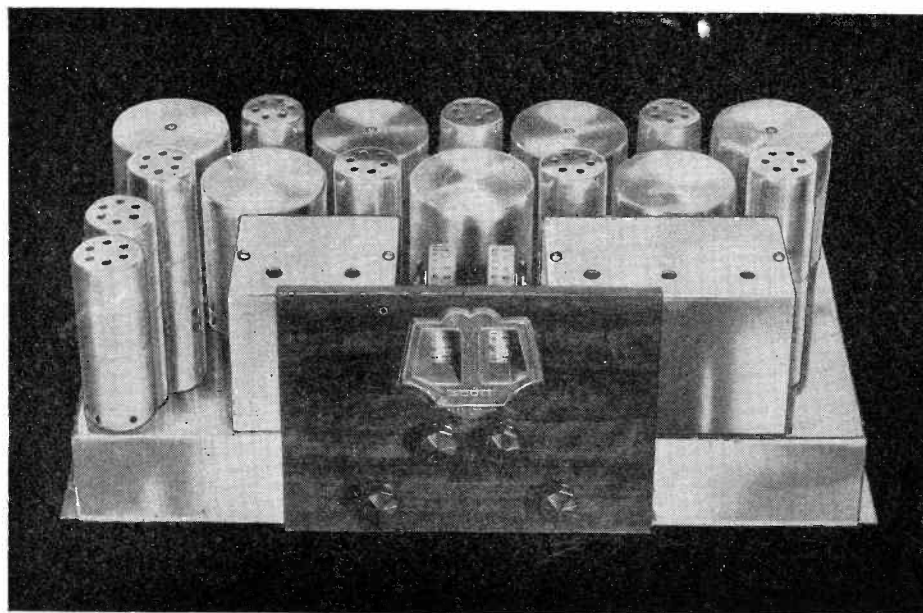

The Scott All-Wave 15-550 meter superheterodyne is the one receiver that makes dependable, daily 'round the world reception possible. It spans both oceans, bringing in stations 12,000 miles away with perfect clarity and full auditorium volume—in any season.

Naturally, however, the Scott All-Wave delivers the fullest measure of satisfaction when installation is made with more than ordinary care. For that reason, we want every Scott All-Wave to be installed by technically trained radio men—and *we will pay a substantial fee for this work!*

Make Application Now

If you are interested in this opportunity to increase your income, write us today, giving full particulars of your qualifications. We will, in turn, furnish you with complete information and advise you of the basis upon which our installation work is assigned. Write at once to

***The* E. H. SCOTT RADIO LABORATORIES, INC.**

4450 Ravenswood Ave.

Dept. S42

Chicago

HICKOK

ANNOUNCES

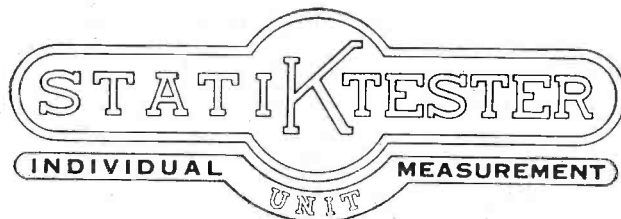

And Presents

A New Method of Radio Receiver Servicing

RAPID—ACCURATE—MODERN

Service Men!

*You will want the complete details of this
revolutionary idea. Write now to*

HICKOK ELECTRICAL INSTRUMENT CO.

10514 Dupont Ave.

Cleveland, Ohio

(See our Exhibit Booth No. 84, Exhibition Hall, Stevens Hotel, R. M. A. Show)

Say you saw it in Service

SERVICE

A Monthly Digest of Radio and Allied Maintenance

APRIL, 1932
Vol. 1 No. 3

EDITOR
John F. Rider

MANAGING EDITOR
M. L. Muhleman

Editorial Contents

FEATURE

The Facts About Air-Cell Receiver Conversion,
Part 2 55
By G. M. Reed

ANTENNA (Editorial) 54

AUTO-RADIO

"B" Batteries, Location of 66
Electrical Interference in Auto-Radios* 64
Measured Storage Battery Voltage 66
Mallory Auto-Radio B-Eliminator 66
Output Tubes 66
Philco Transitone Aerial Installation Data 65

FORUM (The Reader's Page) 70

GENERAL DATA

Aerial Installations 59
Bleeder Resistors, Locating 59
Chattering Loud Speakers 60
Color Coding 62
Continuity Testing* 61
High Control-Grid Bias 61
High Voltage Measurement 60
Hum Bucking Coils 60
Majestic Ballast Specifications 60
Mercury Vapor Tubes 61
Movable R-F. Primaries 60
Open Grids and Cathodes 59
Pentode Adapters 58
Permanent Magnet Dynamic Speakers* 61
Philco Tone Control Condenser 59

Quasi-Fading 59
Resonant Circuits* 60
Vacuum Tubes* 60
Voice Coil Resistance 60
Voice Coil Short Circuit 59
Wunderlich Tube, Notes on * 57

HOME TALKIES

Photoelectric Cell Amplifiers 69
Projectors for 16 MM. Film* 68
RCA. PG-38 Home Talkie Outfit 69
Sound on 16 MM. Film* 68

INDEX OF MONTHLY LITERATURE 74

MANUFACTURERS 72

PUBLIC ADDRESS

Microphone Amplifiers 63
Phasing Voice Coils 63
Remotely Located Speakers 63
Transformer Turns Ratio 63

SHORT WAVES

Converter Voltages 67
Erratic Operation 67
Hammarlund Comet 67
High Sensitivity 67
Pepping Up Converters 67
Series Antenna Condenser 67
Space-Charge-Grid 67

Published monthly by

Advertising Director

Robert N. Mann

1440 Broadway, N. Y. C.

Tel: CHickering 4-4542

John F. Rider Publications, Inc.

1440 Broadway, New York City

Officers

JOHN F. RIDER, Pres. and Treas. M. L. MUHLEMAN, Vice-President
J. SCHNEIDER, Secretary

Western Representative

Charles H. Farrell

333 N. Michigan Ave., Chicago

Tel: Central 6826

Copyright 1932, by John F. Rider Publications, Inc. Contents must not be reproduced without permission. Printed monthly at Fair Lawn, New Jersey. Yearly subscription rate \$1.00 in United States; 15 cents per copy. \$2.00 per year in Canada and foreign countries; 25 per copy.

THE ANTENNA...

RUMOR has it that resistance measurement will constitute a major consideration in future service operations. Recognizing the limitations present during a voltage test, major of which is the fact that tube voltage tables are prepared at fixed line voltages and that it is more than likely that the line voltage in the home will be different than specified by the receiver manufacturer, it stands to reason that some form of service procedure is required which will have minimum tolerances; which will not be subject to a multitude of variations and which is applicable to standard equipment. The most logical method is the measurement of resistance, in as much as the various resistors can be checked without pulling the chassis; are not dependent upon the line voltage or the condition of the tubes, and last but by far not the least, can be checked when the receiver is in that difficult position, known as "dead". We will see what the future holds in store.



SEVERAL LETTERS commenting upon the "Respectability" editorial in the March issue, have been received. There seems to be an undercurrent of antipathy against the mention of sales activities to a technically-minded individual. Our aim is anything but to make the Service Technician a Salesman.

But, and it's quite important—the combination is not so bad. There are several reasons to defend the stand. Let us start with the premise that first and last, the individual is a Service Technician. As such, he is a consultant to his clientele—the customer and in many instances to his employer, the radio dealer. Whether or not the radio industry—that is, the manufacturers, wish to admit the above, the fact remains that millions of tubes, hundreds of thousands of speakers and many tens of thousands of receivers are purchased by people on the recommendations of the Service Technician.

It is difficult to find a man who is better fitted to sell a product than the one whose opinion is asked. Particularly so when the one who asks for the opinion is the prospective customer. The greater the technical education of the man who functions as a Service Technician, the greater will be the respect accorded his opinions; the greater will be his service activity and the financial return from that direction. Educational advancement, technically speaking, means advancement in the service field.

Combining sales effort with service activity is not difficult. Recognition by the industry at large that the radio Service Technician is responsible for the sale of tubes, accessories and radio receivers means

the advancement of the Service Technician. Sales activity means increased financial income. The Service Technician is not a door-bell pusher. He has entry without any trouble. His opinion is asked. He can make recommendations. He is the radio industry's greatest salesman and should realize that fact.

You—you—and you—Mr. Service Technician... keep your eyes and ears open. Increase your technical knowledge so as to maintain a high standard of service work, so that you will be recognized as knowing your business. The Service Technician is the greatest aid the average radio dealer has to advise him of what is good and what is bad. Make the dealer recognize your worth as a Service Technician—then as a Salesman. Make your customers recognize your worth as a Service Technician—then as a consultant and as a salesman. Be a consultant first—then a salesman.

The service department of the radio dealer is destined to be one of the best, if not the best paying branch of his entire business. This is so because the Service Technician is destined to become the most powerful influence in the purchase and sale of equipment.

Despite 12 years of radio, the general public knows very little about the subject. The Service Technician is the nation's consultant. Combine service and sales with honest effort and your destiny is within your hands.



THERE EXISTS a difference of opinion concerning the association between the average radio man and electrical contractors who purchase public-address and multi-antenna systems. There is every reason to believe that the large public-address installations, as for example in major auditoriums or large hotels, are beyond the sphere of the average Service Technician. However, small installations should be his meat. Some association with the electrical contractor is required because of the statutory laws in certain states governing electrical conduit wiring and installations. Why not tie up with one or two architects and electrical contractors in your town? Of course, you should be familiar with public-address work. After you have made your contacts look for likely prospects. Your contacts—at least with the contractor—are essential for several reasons. The first is financial. If you can establish satisfactory credit with this man, he no doubt will finance you in all public-address installations, because he too shares in the work.

John F. Rider.



The Facts About Air-Cell Receiver Conversion

BY G. M. REED

Part 2

THERE is still another item to be considered. This is the purchase of the air-cell battery. Let it be said that it is not generally available. At the outset, its distribution was limited to jobbers who were known to be handling commercial receivers specifically designed for use with this type of battery. In some cases the batteries were supplied by the receiver manufacturer. Now that the battery has been on the market for about 18 months, there has developed a legitimate call for replacement. Accordingly, it

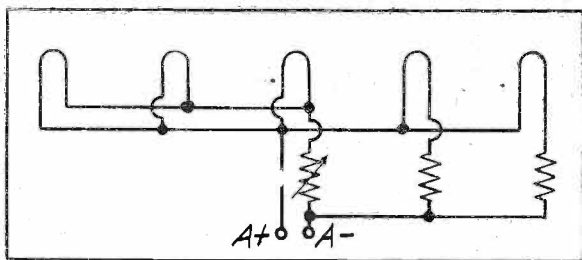

In converting a receiver for Air-Cell operation the fixed and variable filament resistors should be removed from the circuit and replaced with a single fixed resistor, as shown in the sketch below.

may be possible to secure these batteries from dealers who have sold air-cell battery receivers and have a stock of batteries on hand. However do not rashly promise to convert a receiver unless you feel certain that you will be able to secure the battery. Also that you are familiar with the complexities of such conversion.

Converting Receivers

Where there exists a definite desire for such conversion, the following will be of interest. As far as tubes are concerned, the '30 is the general utility tube, suitable for replacing the '12A and the '01A. The '31 is the output tube, suitable for replacing the '12A used as an output tube. The '32 is the screen grid amplifier which may be used for radio frequency amplification or as the detector in place of the '22. Of course, it is understood that these 2 volt tubes will be used with the proper operating potentials.

As far as the suitability of these tubes for use with the equipment originally used, the '30 and '31 can be used with whatever equipment was used with the '01A and '12As. This also applies to the output transformer, in as much as the plate impedance of the '31 at 135 volts upon the plate and the correct grid bias is substantially the same as that of the '12A with 135 volts upon the plate and the correct grid bias.

There exists a slight difference between the operating characteristics of the '22 and the '32, but the latter may be used with r-f transformers designed for use with the former tube. Of course when a commercial receiver is specifically designed for use with the 2 volt tubes, the maximum efficiency is secured from each circuit.

At all times, the number of tubes used in the system should be within the limits set by the ampere-hour capacity of the filament battery so as to supply the minimum of 1,000 hours life. This means a maximum filament current consumption of 600 milliamperes.

Paralleled Filaments

In view of the fact that all of the tubes require like filament voltages, all of the tubes are connected in parallel. This is usually the case in all old battery receivers, but in the majority of these systems several variable or fixed resistors are also used. The illustration shown depicts the filament circuit of a conventional storage battery receiver. The variable resistance is used to control the volume. The number of such resistances and the number of tubes they control are of no consequence. All of these resistors are removed and arrangements are made for the use of a single resistance, as shown below.

The problems of determining the correct value for this resistor have been mentioned in the first part of this resume.

Minimizing Regenerative Effects

The grounds upon the various filaments are used so as to provide a proper path for the r-f currents in the respective grid circuits. The various tuning condensers are at ground potential, as shown. The respective r-f transformer secondaries are isolated from ground through the blocking condensers (C).

The single fixed resistor in the filament circuit for Air-Cell operation must be of a definite and accurate resistance value. This is important.

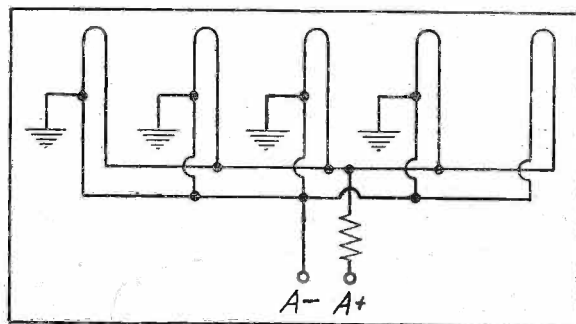

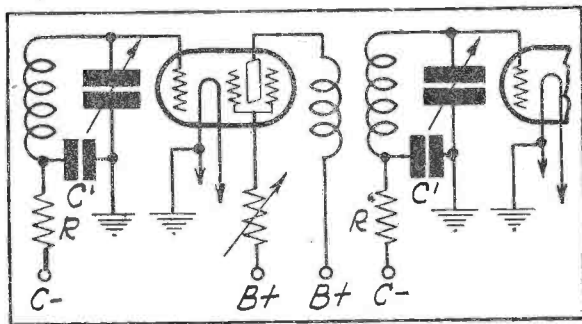

By arranging the tuned circuits in the manner shown above separate control-grid bias may be applied to the r-f. tubes, and regeneration minimized.

By arranging the tuned circuits in this fashion, separate control-grid bias may be applied to the r-f tubes. The grid filter resistances R , function to isolate the tuned circuits from the common "C" battery and thus minimize regeneration. The value of C' for ordinary tuned circuits operative over the broadcast band is .2 mfd. The value of the grid filter resistances may range from 25,000 to 50,000 ohms. In some instances r-f chokes are used in the various grid return leads and a single grid filter resistance is employed in the common grid bias lead.

A condenser of about .2 mfd. is usually connected between the positive leg of each filament and ground. The junction to the filament circuit is right at the socket.

There is great need for the minimization of regenerative effects in highly sensitive receivers of the screen grid type. The batteries used for the "B" and "C" supply do not always remain at their original values of low internal resistance. Accordingly proper bypassing and substantial use of filter resistances is essential. As to the life of the plate supply devices, a low limit of about 17 volts per 22.5 volt section is customary. When the voltage under load reaches this value, the battery should be discarded in as much as it may become noisy and may cause excessive regeneration by virtue of its high internal resistance and the fact that this resistance is common to several circuits.

Volume Control

The volume control usually employed in an alternating current receiver is not as easily employed in a converted battery receiver. Variation of the control grid bias in a self biased system is a relatively simple matter. In a battery receiver this type of control would require the use of a potentiometer across the "C" battery with its accompanying bypass condenser and switch which would open the potentiometer circuit when the receiver is inoperative. The usual form of filament current control used in some old battery receivers is out of the question and shunt resistances across the r-f or a-f transformer secondaries is also obsolete.

Two methods are suitable. One is the shunt voltage divider system across the antenna coil and the other is the use of a variable screen grid voltage in screen grid receivers. Naturally, the latter arrangement cannot be used in a receiver not equipped with screen grid tubes. This would limit the control to the antenna system or possibly to a voltage divider

in the form of a potentiometer across one of the a-f grid circuits. While the latter is not very well liked, it is preferable to the use of a variable plate voltage system, and makes a good supplementary control when the antenna system method is not sufficiently effective.

With respect to the variable screen grid voltage system, care must be exercised to limit the reduction of the screen grid voltage so that it does not interfere with the action of the tube as an r-f amplifier. It is understood that this system would be used in the screen grid circuit and that it would be properly bypassed. The value of this resistance would approximate 500,000 ohms to 2,000,000 ohms. Even higher values are used.

We cannot conclude without again referring to the necessity of determining the filament circuit resistance before selecting the correct filament circuit control resistance. Reference to the "Index of Monthly Literature" in the March issue of SERVICE will bring to light the names of various publications which have described various methods of measuring low values of resistance.

From this point on, the conversion is up to you. I wish you lots of luck.

The Man on the Cover

H. E. FENNER

Service Manager, United American Bosch Corp.

HE has been places and seen things. Received his technical education in Germany, and then hopped over here to pick up his first bit of practical experience with Westinghouse, at Pittsburgh.

Some time after his fancy was taken by high tension transmission work, and he barged into the position of Inspector Engineer for the Niagara, Lockport & Ontario Power Company, at Buffalo.

High tension sparks aroused his interest in ignition systems, and so his spirit of scientific adventure landed him in the position as head of the Factory Research Laboratory of the Splintdorf Electrical Company, in New Jersey, and later to the then Robert Bosch Magneto Company, as Chief Inspector.

His first crack at servicing came when he joined the Motor Parts Company, of Philadelphia as Service Manager, and he duplicated this position again later with the Philadelphia Marmon Automobile Agency.

In 1920 Mr. Fenner became Chief Inspector of the Gray & Davis Lamp Company plant at Amesbury, Mass.

In 1921 he returned to the American Bosch Magneto Corporation, now the United American Bosch Corporation, as Service Manager, and since 1925, when this Corporation entered the radio field, Mr. Fenner has managed the service end of both their automotive and radio line throughout the world.

Mr. Fenner's principal avocations are golf and detective stories. When he isn't stalking a golf ball he is hot on the scent of a crime suspect!

General Data . . .

Notes on the Wunderlich Tube

ACUUM tube design has by no means reached its limits. A new type of tube, known as the Wunderlich tube, has appeared upon the market. As far as the Service Technician is concerned, the major difference between this tube and the conventional tube is as a detector of a new variety. The primary function of this

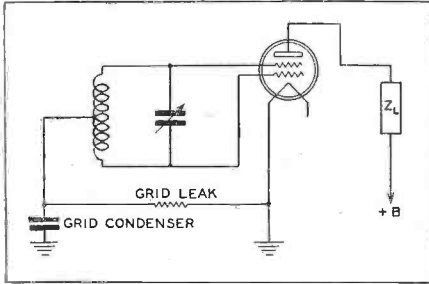

Fig. 1. General circuit connections for the Wunderlich Tube. Note that the secondary winding of the r-f transformer is center tapped.

tube is as detector of a new variety. Supplementary functions are as an automatic volume control and also as an amplifier.

Balanced Input Circuit

As a detector, a balanced input circuit is used and operated with two grids. The usual grid winding is tuned in conventional fashion, but it is tapped at the mid-point and the grid leak-condenser combination is connected into this lead. See Fig. 1. The function of the two grids and the center tapped winding is to accomplish two aims. The first is related to the elimination of all radio-frequency energy from the plate circuit of the detector. This means that receivers equipped with this type of detector tube do not require the use of the conventional radio-frequency choke and condenser type of r-f. filter in the plate circuit, connected between the plate of the tube and the audio coupling unit. The idea behind the elimination of all rectified r-f. energy in the plate circuit is founded upon the fact that the input circuit is "balanced", since the radio-frequency signal voltages applied to the two grids are of equal magnitude but of opposite phase, and consequently neutralize or balance out each other, with respect to any effect upon the plate circuit. This condition can be appreciated, when we realize that the second grid is wound between the meshes of the first grid and that both grids are located between the cathode and the plate. Consequently the total field due to the r-f. voltages upon the grids is, with respect to the plate, substantially zero. Another function of the "balanced

input" idea is to eliminate simultaneous grid and plate rectification, thereby enabling approximately twice the normal signal voltage output from the tube.

At first glance, particularly after learning the fact that the applied r-f. signal voltage has very little, if any, effect upon the plate circuit, one is confused about the function of the plate. This is even more true when one learns that the rectification action (detection) in this tube is practically independent of the voltage applied to the plate. This can be explained in the following manner. In the usual form of detector tube, the rectification and amplification are simultaneous functions. In the Wunderlich tube, these functions are separate. The detector or rectification action takes place in the grid circuit. A simple analogy of the action of these two grids is that of the two plates in a full-wave rectifier. (See Fig. 2). The grid leak in Fig. 1, represents the usual load across the rectifier output, and actually is the equivalent of the load across the r-f. rectifier system in this tube.

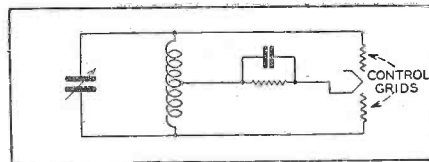

Fig. 2. With the grid leak representing the load, the detection circuit is identical to that of a full-wave rectifier.

Rectified grid current flows in the grid circuit and develops a voltage across the grid leak-condenser system. The voltage developed across the grid leak-condenser is exactly proportional to the instantaneous radio-frequency voltages, consequently, is a faithful reproduction of the modulation envelope of the original modulated r-f. carrier. Since the modulation envelope represents the audio frequencies superimposed upon the radio-frequency carrier, we say that the voltage developed across the grid leak-condenser consists of two components or parts. One is the d-c. component which is proportional to the amplitude of the carrier frequency and the other is the a-c. component representing the audio modulation frequencies originally superimposed upon the r-f. carrier. The a-c. component is the equivalent of the usual rectified audio-frequency signals to be found in the plate circuit of the conventional rectifier.

Now, the d-c. component is a steady current and consequently applies a negative bias to the grids of the tube. The a-c. component is superimposed up-

on this steady bias. This a-c. voltage is then applied to the plate and in view of its source, the two grids now function as if they were connected in parallel and produce the desired effect upon the plate current. Consequently the tube now functions as a normal amplifier and provides the detector output.

Distortion

The detector output should be a faithful reproduction of the modulation envelope of the radio frequency signal, and insofar as this is not the case, distortion results. This distortion can be divided into two distinct types. The first of these is distortion introduced by the rectification process, as a result of which the alternating voltage developed across the leak-condenser combination fails to be a true replica of the modulation envelope. The second is amplified distortion, and is present when the amplified output of the detector is not an exact reproduction of the voltage which the leak-condenser combination applies to the grids.

The rectification process may cause a distorted voltage to be developed across the grid leak as a result of: (1) improper grid leak, grid condenser proportions, and (2) variation of rectification efficiency with signal amplitude. Improper leak and condenser proportions makes it impossible for the voltage developed across the leak-condenser combination to follow the variations in the modulation envelope of the signal at high audio frequencies when the degree of modulation is high, and thus introduces a discrimination against the higher frequencies that is also accompanied by an excessive second harmonic distortion. Variation of rectification efficiency with signal amplitude is always present to the extent that the relation between d-c. voltage developed across the grid leak to the amplitude of an unmodulated signal fails to be linear over the range of signal amplitudes represented by the variations in amplitude covered during the modulation cycle. This type of distortion is greatest when the degree of modulation is high, and when the carrier amplitude is small.

The grid leak resistance and grid condenser capacity for use with the Wunderlich detector should be chosen with regard to distortion, rectification efficiency, input resistance to radio frequencies, and the radio-frequency

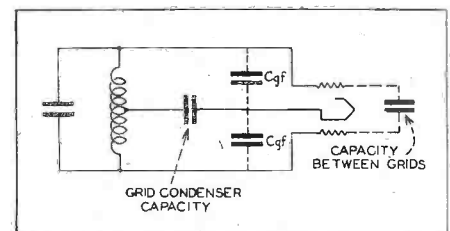

Fig. 3. In designing the input circuit the inter-element tube capacities must be taken into consideration.

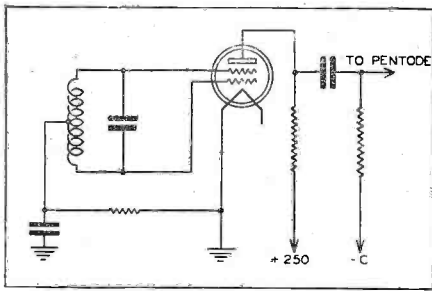

Fig. 4. Connections for the Wunderlich Tube when feeding into a resistance-coupled amplifier stage. No r-f. filter chokes or by-pass condensers are necessary.

input circuit to the tube. The first and most important requirement is that the voltage across the leak-condenser combination be able to follow the variations in the modulation envelopes of the signal.

Checking for Distortion

A convenient method of checking for distortion in the rectification process is to insert a d-c. micro-ammeter in series with the grid leak and to note whether or not the d-c. rectified grid current varies with the modulation. If the d-c. grid current changes by only a small percentage as the modulation of the signal is put on and taken off, then it is safe to assume that the distortion is small.

The power capacity of the Wunderlich detector is determined by the maximum audio voltage that the tube can amplify without excessive distortion when the two grids are connected in parallel. The characteristics of the tube under these conditions are essentially those of a general purpose triode having an amplification factor of the order of 9 to 12 and a plate resistance ranging between 10,000 and 20,000 ohms, the exact values depending upon the electrode potentials.

The voltage output obtainable from a triode amplifier without distortion, depends upon the plate potential and as understood, is greater the higher the plate voltage and load impedance. The plate voltage that can be applied to the Wunderlich detector is limited by the fact that the grids have zero bias when no signal is impressed on the input. When a high voltage supply

Fig 5. Connections for the Wunderlich Tube when feeding into a transformer-coupled amplifier stage. No r-f. filter choke or by-pass condensers are necessary.

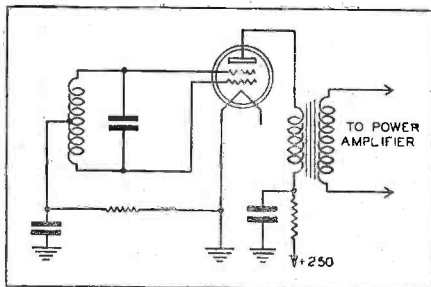

is available, such as the 250 volts commonly present in broadcast receivers, the most satisfactory arrangement is to employ either resistance coupling as shown in Fig. 4 or transformer coupling with a series resistance as in Fig. 5. With these arrangements, the resistance in series with the d-c. supply limits the plate current at zero bias. At the same time, when a radio signal places a negative bias on the tube, the resulting reduction in plate current causes the potential actually applied on the plate to exceed the value permissible with no bias, and in this way increases the output voltage obtainable without distortion.

Automatic Volume Control

The d-c. voltage developed across the grid leak by the rectified carrier wave can be utilized for automatic volume control purposes. Inasmuch as there is an audio-frequency voltage developed across the grid leak as well as the d-c. bias, it is necessary to employ some type of filtering to prevent the automatic volume control bias from varying with the modulation of the wave. A simple method for doing this

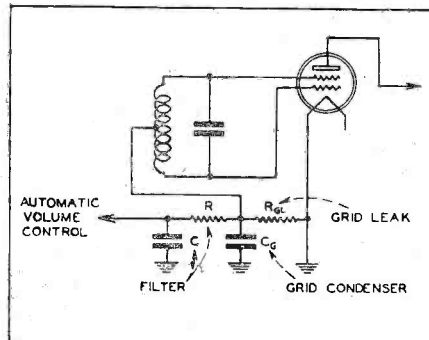

Fig. 6 The d-c. voltage developed across the grid leak can be used for automatic volume control purposes. Here are the connections.

is shown in Fig. 6. The condenser C should have sufficient capacity to be a virtual short circuit to all modulation frequency voltages when compared with the resistance R, but should at the same time have a leakage resistance much higher than R. The resistance R should also be at least several times as great as the grid leak resistance R_{GL} if the rectifying efficiency is not to be lowered. The amount of negative d-c. voltage available for automatic volume control purposes depends upon the way in which the plate circuit is arranged, and in the case of the Wunderlich tube can be of the order of 15 volts if desired.

Relative Advantages

When compared with the plate rectifier commonly employed in broadcast receivers, the Wunderlich detector has the advantage of a somewhat greater rectification efficiency, particularly when the signal voltage is in the order of several volts. The Wunderlich tube has ample power capacity to excite the power amplifier of any broadcast

receiver now on the market, and also supplies a voltage which can be used directly for automatic volume control purposes. When compared with the triode type of grid leak power detector, the Wunderlich power detector has about the same efficiency, introduces less distortion because the balanced input circuit prevents simultaneous grid plate rectification, and develops approximately twice as much output voltage. The only disadvantage when compared with the corresponding triode rectifier is that the center tapped input circuit requires twice as great a signal voltage for excitation.

(From a paper prepared by Frederick E. Terman, Sc. D.)

Pentode Adapters are being offered. There is nothing against such offers except for the following: The statement is often made that the only change required in order to allow the use of a pentode instead of a -45 tube is the insertion of the pentode adapter. Such is not the case. In order to realize perfect operation with the pentode tube it is necessary to replace the output transformer; and also to change the bias resistance. The reason for the bias resistance change is quite evident when we consider the plate current in the pentode tube and the required control-grid bias. Recognizing that the plate current consumption of both types of tubes is substantially the same although not exactly so, the difference is found in the fact that the pentode tube requires approximately 16.5 volts control-grid bias, whereas the -45 tube requires a control-grid bias ranging from approximately 45 to 55 volts, depending entirely upon the exact plate voltage and plate current in the system. By no extent of wild dreaming is it possible to accomplish such a tube change without changing something in the circuit, although such statements are made in advertising. As a matter of fact it is also necessary to add the lead whereby the screen-grid voltage in the pentode tube secures its proper potential.

In cases where the control-grid bias is secured by virtue of the voltage drop developed by passing the plate current through one of the two field coils utilized in a dual field coil speaker, it is necessary to rewire this coil into the filter system so that it will function as an additional filter choke, and to add a separate bias resistance for the pentode tube. When this second field winding is connected into the filter system, it is necessary to take into consideration its d-c. resistance. Thus, while such changes are not difficult, it is necessary that the man who is going to make such changes realize that they are required. A poor tone will be the result if the tube change is accomplished merely by use of the adapters.

Vacuum tubes there are many. Only a comparatively short time ago, one or two tubes were referred to as general purpose tubes and a few were classed as being suitable for the audio output stage. Today, we have a varied assortment of tubes, each designed to perform a special function.

Tubes are divided into four classes. The first is the A.C. tube, which secures its filament or heater current from some a-c source and operates upon raw a-c. The second class is the D.C. tube of the storage battery type, which requires d-c. excitation of the filament and is operative from a storage battery type of supply. The third class is the tube designed specifically for automobile use. The fourth class represents the low voltage dry cell or air-cell tube.

The author shows a compilation of tubes classified as above complete with the operating constants and voltages. (Ed. For some unknown reason the '26 and '27 types of tubes have been omitted.) Another table shows the equivalent type numbers employed by the various radio tube manufacturers. In every instance the last two figures designate the type irrespective of the prefix letters or the first numeral. Thus a type '47 bears the "47" designation as the last two numbers in the type specification of every manufacturer who makes this pentode tube.

In general the article describes the various tubes and their applications. This is Part 1 of a series.

Calcaterra, Radio News, April 1932.

The movable r-f primaries should be examined when receivers which use such systems seem afflicted with excessive regeneration in the r-f system. Oscillation in such systems may be due to close coupling between the flexible leads to these primaries. The result is interstage coupling. Oftentimes oscillation may be caused by wrong connection to the primaries. Try changing the polarity of the leads connected to one of the primaries. The function of these variable primaries is to change the volume.

Ballast specifications for some of the old Majestic power units are as follows:

Power Unit	Frequency	Ballast Marking	Line Voltage	Primary Voltage	Ballast Color
7P6	60	B	115	80	Black
7P3	20-30-40	B	115	60	Black
7BP6	60	7BP6	115	80	Black
7BP6	60	7BP6	230	160	Blue
7BP3	25	7BP3-25	115	80	Red
7BP3	30	7BP3-30	115	80	Red
7BP3	40	7BP3-40	115	80	Red
8P6	60	8P6	115	90	Green
8P6	60	8P6	230	180	Yellow
8P3	25	8P3-25	115	90	Orange
8P3	25	8P3-30	115	90	Orange
8P3	25	8P3-40	115	90	Orange

High a-c. voltage, such as that obtained from a power transformer secondary, can be measured without the use of a voltmeter. The measuring circuit consists of a fixed resistance of known value and proper rating and an a-c. milliammeter. The resistance and meter are connected in series and joined across the winding terminals. This is shown in the accompanying illustration. With the resistance known and the current flow indicated, it is simple to determine the effective voltage by applying Ohm's

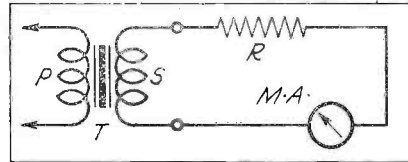

The voltage across a transformer winding can be determined by the use of a milliammeter and a resistor of known value.

Law for voltage. The a-c. milliammeter need not have a range in excess of 25 milliamperes. For voltages between 1,000 and 2,000 volts effective or R.M.S., use a fixed resistance of 100,000 ohms. For voltages between 500 and 1,000 volts R.M.S., use a resistance of 50,000 ohms. For voltages between 100 and 500 volts R.M.S., use a resistance of 15,000 ohms. The effect of voltage is equal to the current indicated upon the meter times the resistance of the known unit. Thus, if the current indicated upon the meter is 12 milliamperes and the resistance used is 100,000 ohms, the product of this value of current and this value of resistance, is 1200 volts.

Hum bucking coils in dynamic speaker circuits serve their purpose. However, it is possible to have a short circuit across the hum bucking coils without the introduction of a hum. This is a matter of design. It is possible that the hum bucking coil is a part of the complete circuit, but the normal level of hum is so low that the presence of this additional suppressor unit does not in any way influence the operation of the receiver. Thus, it is possible to short circuit this winding without impairing the operation of the receiver. The usual

electrical position of this coil is in series with the voice coil. Under the circumstances any defect in this system will have no influence upon the operating voltages in the receiver. The exception, of course, is a short circuit across the entire voice coil system, just discussed.

Chattering of loud speakers is in most cases due to a combination of excessive signal input and improper alignment or centering of the voice coil. If chattering is accompanied by a wavering and expanding blue glow within the housing of pentode output tubes, it is frequently accompanied by arcing between the elements and is a sign of overloading. In other words, the voltage input that is signal voltage input is excessive. If allowed to continue for any period of time, it will not only damage the pentode tube but it will also damage the speaker. In this connection a slight blue glow may exist during normal operation without any chattering of any kind. As the signal voltage is increased the intensity of the glow will likewise increase and if a visual inspection of the tube is made during operation, arcing across some of the terminals will no doubt be noted.

Resonant circuits are numerous. They are found in power packs, radio frequency amplifiers, audio frequency amplifiers, public address systems and in many other places. A graph properly planned is the simplest and most readily applicable type of information relative to the various constants of a resonant circuit. Such constants as capacity, inductance, resonant frequency, reactance and impedance are determinable at a glance.

A recent article devoted to filter design, which in reality is nothing more than resonant circuit design delves into the elementary details of alternating current as encountered in such circuits. The usual spring-weight analogy of a resonant circuit is given, but in such language that it may be visualized and the few concluding words in that paragraph convey a great amount of practical information relative to what is to be expected when a current of other than the resonant frequency is passed into a resonant circuit. (Also see Radio Call Book, December 1931)

A capacity, inductance, frequency and reaction graph is shown covering a normal range of from .006 mfd. to .1 mfd.; 10 millihenry's to 1. henry; zero to 8,000 ohms and from zero to 6,000 cycles. By suitable multiplication of the constant of the circuits, each of these ranges may be extended. Methods of applying the graph are described. This article is Part 1 of a series.

Radio Call Book, pp 36, April 1932.

Quasi-Fading: If the 100,000 ohm resistor connected between the r.f. screen grid voltage lead and ground in the Colonial 36 and 36-P receivers becomes open circuited, the volume decreases and the operation of the receiver becomes erratic. A symptom may also be a wavering of the signal, that is, it may increase and then decrease as if it were fading.

A good installation is half the victory in the service battle. While it is true that quite a few modern receivers do not require outside or indoor aerials, it is necessary to remember the following when working upon a receiver which does require an outdoor aerial. A poor aerial will cause much grief. Carry out the following and you can leave that job with the satisfaction that you have installed a very good aerial:

Locate the aerial as high as possible. Try to place it above all other aerials upon the roof. Run the lead at right angles to all other aerials. If such is not possible, deviate from a parallel condition as much as you can. Do not run the aerial parallel to power lines or telephone lines. This applies to the lead-in as well as to the flat top. Insulate both ends of the flat top as best as you can. Stretch the aerial as tightly as you can without placing too much strain upon the supporting poles or masts. An aerial which is loose and has a tendency to sway in the wind may cause troubles of various types. In the first place it may contact other aerials and cause a clicking sound in the receiver. When swaying, the capacity to ground of the aerial system may vary and thus cause a wavering or fluctuating signal.

A high-resistance leak between the aerial flat top and some grounded object may cause broad tuning and noise. If the aerials are close and parallel to aerials of other receivers, tuning of the receivers connected to the latter aerials may react upon the tuning of the receiver connected to the aerial which you erected. Keep the aerial as far removed as possible from all large masses of steel. Such masses cast "electrical" shadows and thus interfere with the pickup of the signal by the aerial. In sum and substance this means low signal output from the receiver.

With respect to the lead-in, keep it at least six inches away from the wall of the building. If possible do not run the lead-in adjacent to steel beams. Proximity of a steel beam to the lead-in will cause broad tuning in the aerial circuit and low signal input. Make certain that the contact between the lead-in wire and flat top of the aerial is perfect. If it is at all possible, this connection should be soldered and well taped. Twisting one wire around the other without solder-

ing may result in a fairly satisfactory connection during the first few months of operation. However, as time passes this connection becomes poorer and poorer. After a period of time has elapsed, it is detrimental to the satisfactory operation of the receiver.

A lightning arrestor should be part of every antenna installation. If possible the arrestor should be shielded, that is, enclosed within a metal housing so that there can be no accumulation of dirt and dust between the various terminals and thus short the aerial or at least create a high resistance leak across the antenna-ground system. Such leaks are sources of noise and have a tendency to reduce the signal output from the receiver.

Last, but by far not the least, make sure that you have a good ground. Do not use a gas pipe or radiator if it can be avoided. Wherever possible use a water pipe as the ground. Winding a few strands of wire around a painted water pipe is a very poor ground. In every case use a recognized and specially designed ground connection. Scrape the paint from the pipe so that the metal band of the ground connection makes good contact with the pipe. Do not place the ground connection around a calked joint. If you have a choice between the cold water and hot water pipes, select the former. Solder the ground wire to the ground connection. If the ground connection is of the screw type, make this screw as tight as possible. Try to penetrate through the outer coating of the pipe. All of these items are quite simple, but a reminder is necessary every so often, because it is the simple things which we forget. In many instances we overlook rather than forget.

Bleeder resistances are difficult to locate. This is particularly true when the bleeder resistance is connected between one side of the plate circuit and the cathode of the tube. When such a unit is used, it is possible to find a condition where a control-grid bias is available and there is no plate current, or where the cathode of the tube within the tube, is defective yet

A voltage reading across R is an indication of the presence of a bleeder resistor, (R-1), but not the voltage divider (R-2).

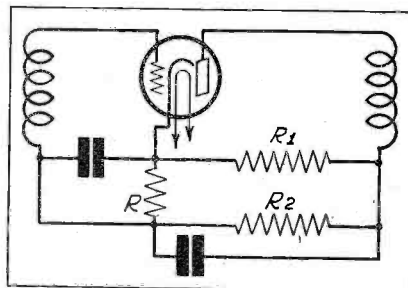

the control-grid bias is available between the control grid of the tube and the cathode. A means of checking such a condition is to remove the tube and measure the voltage between the control-grid and the cathode. If a bias is indicated, it is a sign of the presence of a bleeder resistance as shown upon the accompanying diagram.

A short circuit across the two terminals of a voice coil of a dynamic speaker will interfere with reception, but it will always produce total cessation of operation of the receiver in the form of absolute lack of output. Generally speaking the internal resistance of the voice coil is so low that an absolute short circuit is required in order that the shorting link be the actual pass of the maximum amount of current. In the usual run of cases the current divides between the voice coil and the shorting link so that while there exists a short circuit across the voice coil, the sound still issues from the speaker. Naturally the sound quality has suffered and the output has decreased an appreciable amount.

An idea of whether or not the voice coil of a dynamic speaker is short circuited (which in effect is the same as a short circuit across the secondary of the output transformer) can be had by observing the actions of the plate current meter connected into the plate circuit of the output tube. Place the plate current meter into the plate circuit and advance the volume control to maximum. Under normal conditions the position of the needle for minimum or maximum volume would remain fairly steady during the operation of the receiver. However, in the case of a short circuit across a voice coil, the meter pointer will move radically across the scale and fluctuate during the passage of the signal. Invariably this is a sign of a short circuit across the secondary of the output transformer and across the voice coil of the speaker. In the event that the last two systems have been isolated, such a condition is indicative of a short circuit across the secondary of the output unit.

The tone control condenser used in the early production Philco 35 was of .02 mfd. The later production was changed to .01 mfd. In addition a .002 mfd. fixed condenser is connected between the plate of the pentode and ground. An improvement in tone control is noted when this plate to ground condenser is added. Accordingly, it might be a good idea to make these changes when servicing this model receiver.

High control-grid bias and no plate current is a confusing condition. In the majority of instances it is due to an open filament bias resistance or to the bias resistance located in the cathode circuit. The control-grid voltage indication is a function of the internal resistance of the meter being used to carry out the measurement. As a rule, a high control-grid bias is indicated when the resistance of the meter is low or when, if of a multi-range type, the low range is used. If one of the higher ranges of that meter is used and the meter resistance approximates between 500,000 and 1,000,000 ohms, the meter indication will be zero. This condition offers a means of checking the grid bias, to determine if the high bias indication is actually a high bias or if it is due to the drop across the meter itself. The test is the measurement of the bias on the low and the high range scale of the meter. If the low range shows a high bias, and the high range shows no bias, it is a fairly sure sign of an open bias resistance.

Continuity testing of radio receivers is allied with many branches of radio service work. A large number of answers and queries and requests for data have been compiled in order to show the character of radio service data requested by men in the service field. There is shown a need for standardization among the instrument manufacturers who now are producing test equipment for service work, so that service men will be able to purchase one unit, such as an ohmmeter, and find universal application without the present limitations relative to range.

One of the most frequently mentioned problems is given attention. This is the need for means of determining low values of resistance from a fraction of one ohm to about ten ohms. Such measuring ability should be a part of the standard continuity and resistance measuring units.

The information requested so as to enable the most rapid and effective testing is set forth. The replies received in response to a questionnaire mailed to practicing service men, shows that the majority request data was of the following character:

1. The electrical wiring diagram.
2. Electrical values of the parts.
3. Color coding of wires and parts.
4. Internal connections of units sealed in cans.
5. Socket layouts.
6. Factory or chassis diagrams.
7. Operating voltage data.
8. Tolerance limits in values and voltage data.

Whether or not a tabulation of this type may influence the structure of future service manuals printed by the receiver manufacturers, only the future knows.

The suggestion was made in connection with the method of presenting continuity test data, that preference be given to resistance values and capacity values. Inductance values of r-f coils are not desired because general replacement of such units is not possible. The exception to the omission of inductance values is that found in the case of filter chokes and possibly r-f chokes.

The suggestion is made that a standard form of presentation be used, so that one type of measuring equipment be applicable to all receivers without need for any special units with limited utility. This is intended to effect economy with respect to the financial outlay on the part of the service man and yet make possible the utmost efficiency during testing, so as to offer the greatest aid to the manufacturer in the effort to keep his sets sold.

Rider, Radio Engineering, March, 1932

CONCERNING "ABSTRACTS"

IN ORDER to avoid confusion in classification, the "Abstracts" Section of SERVICE has been discontinued. Hereafter, short reviews of articles appearing in other publications will be found in the Departments to which they refer. For example, under "Home Talkies" in this issue will be found an abstract of a paper on 16 MM. Projectors, originally published in the Journal of the Society of Modern Picture Engineers.

The Editors believe that this change will make it much easier for the readers of SERVICE to locate just the data they want. Now you can be assured that everything published on, say, short waves, will be listed under "Short Waves" on the Contents Page. If the data happens to be an abstract, you will find that the title is followed by an asterisk (*). You can then trace the source of the original article by referring to the abstract itself.

Permanent magnet dynamic speakers are coming into vogue. The demand for secondary speakers in the home, the battery receivers for the automobile and the tendency to employ Class "B" amplifiers in the output systems of battery receivers for the home and the automobile has created the demand for a speaker possessing the advantages of electro-dynamic speakers yet not requiring the power to produce the flux in the gap. In the electro-dynamic speaker the flux is produced by passing direct current through the field winding. The power required for this excitation ranges from about 3 to 4 watts

in small speakers to as high as 10 watts in the larger speakers.

The permanent magnet type of dynamic requires neither a field coil or such excitation. The flux in the gap is produced by a powerful permanent magnet. Thus the speaker is of the moving coil type without the field coil. (Ed. One speaker of this type is said to employ approximately 16 pounds of magnet material.)

While the sensitivity of the average permanent magnet type of dynamic speaker is not as great as that of the larger electro-dynamic units, the increased output available from Class "B" output amplifiers compensates to a great measure for this difference, and a very respectable amount of power output is secured. This is of particular interest when this new type of speaker is used in rural communities, where a fair amount of volume is desired, yet the required a-c voltages for an a-c operated receiver are not available. It further is of interest in connection with auto-radio receivers where a fair amount of power is required to overcome the losses due to the upholstery absorption and the other noises (not ignition) which are unavoidable when motoring.

Because of the cost of the magnet material, the permanent magnet type of dynamic speaker is somewhat more expensive than the d-c type of electro-dynamic, but less expensive than the latter speakers equipped with their own field current supply in the form of self-contained tube or disc rectifiers and filters.

Knowles, Radio Call Book, April 1932

Mercury Vapor Tubes

Investigation discloses that the mercury vapor tube referred to as the '82 and the '66 by manufacturers and in periodicals is not interchangeable with the '80. Rumors to the contrary have been prevalent, perhaps because a few isolated examples of such replacement have worked out well, but the fact remains that the mercury vapor tube is not a replacement for the conventional filament-type, full-wave rectifier. Before describing the tube and its current and voltage ratings, we shall enumerate some reasons why this tube is suitable only for power packs and receivers, or amplifiers specially designed to accommodate the tube.

The development of the tube is based upon the demand for a rectifier which will possess certain characteristics. The trend towards Class B output stage audio amplifiers requires a power pack system wherein a fairly constant output voltage is available over a wide range of current drain. Such a condition is imposed upon the system because the tubes used as Class B amplifiers are heavily biased

(Continued on next page)

and the plate current during no-signal input, is substantially zero. The application of the signal increases the plate current by a large amount. It is logical that the plate voltage applied to the tube must not undergo a change during the operation of the amplifier.

For Class B Amplifiers

The mercury vapor tube offers a rectifying medium, wherein the internal drop is substantially constant over the current operating range of the tube. Such is not obtainable with the '80 type of rectifier. Up to the present time Class B amplifiers have been used solely in battery-operated radio receivers, of course with the exception of transmitter systems, which have no bearing upon this discussion. Now that the mercury vapor tube has been placed upon the market, Class B amplification will find application in regular a-c. receivers. If rumors in the radio industry are to be trusted, several receivers to be announced will have Class B amplification in the output audio stages.

One of the conditions which prohibits the use of the '82 in place of the '80 in the conventional power pack designed for the latter is the greater voltage output from the mercury vapor tube. The average receiver designed for operation with the '80 is designed to function with certain rated control-grid, screen-grid and plate voltages. If the mercury vapor tube is used instead of the '80, the tube operating voltages as named will increase and invariably the result will be lack of stability and excessive regeneration. Now, there have been a few isolated instances where the use of the mercury vapor tube improved the operation of the receiver originally utilized with the '80. This can be accounted for by the statement that the sensitivity condition of the original receiver was very poor and the application of increased tube operating voltages increased the sensitivity of the complete receiver and the increase in regeneration was not sufficient to overcome the losses in the receiver and cause instability. Thus the opinion may be created that the '82 is interchangeable with the '80. Engineering opinion substantiates experimental verification of this statement.

Tube and Circuits Isolated

Another consideration in connection with the use of the mercury vapor rectifier and its use in place of the '80 is that presented by the condition that current flow in the mercury vapor tube does not take place until the voltage across the anode-cathode circuit reaches a critical value. Then there is a sudden surge of current. Thus the waveform of the rectified current is very steep. Such operation means the generation of radio-frequency impulses of variable frequency. These impulses are present in the form of noise. The power pack specially designed for the '82 or similar tube will have means of

limiting the generation of such noises. The receiver part of the complete system will be properly isolated from the power pack so as to minimize all coupling. The power pack designed for the '82 will no doubt contain r-f. chokes in the various rectifier anode circuits so as to limit the steepness of the current wave and thus minimize the generation of noise impulses. This rectifier will no doubt be contained in a well ventilated shield, properly grounded so as to minimize any fields and external coupling.

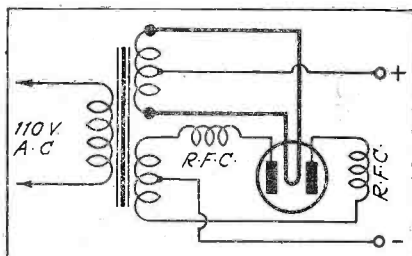

The filament leads should be short and heavy, and r-f. chokes (R.F.C.) should be placed in the anode circuits.

Ordinary tube shields will not be satisfactory around the mercury vapor rectifier. When in operation, this tube becomes quite hot and suitable ventilation is required.

In receivers of low sensitivity, originally designed for the '80, the use of an '82 may be possible without much trouble, but to attempt the use of an '82 in a receiver of high sensitivity designed for the '80, is courting trouble and plenty of it, at that.

Design of Transformers and Chokes

It is also necessary to remember, as previously mentioned, that a certain voltage is required before conduction will take place. For correct operation of the tube and the complete system, it is imperative that the transformers be so designed as to provide the correct voltage during a certain part of the cycle. In order to fully realize upon the excellent voltage regulation characteristics of the mercury vapor tube, it is necessary that the transformer and filter windings be of low resistance. The voltage drop in the tube is about 15 volts, and the drop in the transformer winding and filter windings should likewise be low. Such is not the case in transformers and filter chokes designed for use with the '80 tube. A normal filter system may represent a resistance of from 400 to perhaps 1000 ohms. This is too high for use with a mercury vapor rectifier employed with a Class B amplifier wherein there may be a current change from 20 to perhaps 50 milliamperes between no-signal and signal input conditions.

The general ratings of type 82 full-wave mercury vapor tubes are as follows:

Filament Voltage, 2.5 volts.
 Filament Current, 3.0 amperes.
 Maximum a-c. plate voltage, 500.0 r.m.s. per plate.
 Maximum d-c. output current, 125.0 milliamperes continuous.
 Maximum peak plate current, 400.0 milliamperes.
 Tube voltage drop, internal, 15.0 volts approximate.
 Base, 4 pin medium.

Color coding of resistances used in receivers is not always according to the standard recommended by the RMA. Most of the manufacturers now are using this code. The following is a partial tabulation of receiver manufacturers and comments concerning their use of the body, tip and dot system. Particular attention is called to the first model receiver wherein the code was applied.

All-American Mohawk has been using the code since January 1931.

Andrea, F.A.D. (Fada) does not employ the RMA code. They have their own coding. They feel that they are too deep in their own system to risk a change.

Audiola radio has been using the code since the production of their model 31 superheterodyne.

Automatic Radio Mfg. Co. of Boston has been using the code since the season of 1930.

Balkeit Radio, since 1930. All resistances bear the code.

Colonial Radio, for the past 10 months, since the production of the model 44 receiver. The output tube bias resistances do not bear RMA coding.

Commonwealth Radio Mfg. Co., RMA code has been used for about 2 years.

Columbia Phonograph Co. of N. Y. in practically all cases since 1931, with the possible exception of a few vitreous low resistance units.

Crosley Radio, use the color code as far as possible. The majority of resistors used are coded, but nearly every set contains some resistors which are not in this category.

Echophone Radio Mfg. Co. started using the code with their model S-5 receiver.

Electric Research Lab. (Earla) started employing the code about 10 months ago. The first chassis was 248. All resistors except few wire wound units bear code.

Freed Television and Radio Corp. In use since August 1931. First model FE-91.

General Electric. See RCA-Victor. General Motors started the code in their chassis models S-1-A, S-2-A and S-3-A.

Graybar Electric. See RCA-Victor. (Further listings are being compiled, and will appear in the May issue.)

Public Address . . .

Microphone Amplifiers

The usual run of blocking condensers used in resistance coupled microphone amplifier stages varies from 0.01 mfd. to 0.1 mfd. In the majority of instances, screen grid stages with about 100,000 ohms to 150,000 ohms as the plate load and between 300,000 ohms and 500,000 ohms as the grid leak, use 0.01 mfd.

As to the volume controls, two positions are available. In some instances, the control is across the output transformer of the complete system, where it usually is of the constant impedance type so as not to disturb the balance of the circuit. In other instances where but a single microphone is used, it is connected across the input of the first amplifying tube grid-cathode or filament circuit and is of the potentiometer type. In the case of several microphones, a constant impedance type of volume control is connected between the secondary winding of the microphone transformer and the primary of the mixer transformer. Each microphone has its own volume control. Thus two volume controls will be used with two microphones, two microphone transformers and a mixer. (Ed. See reference in Index of Monthly Literature to "Attenuators" in Public Address Systems classification, March issue).

As a general rule, small power public address systems make use of but one microphone, in which case the aforementioned systems are applicable. In such cases the mixer transformer is not required. All that is necessary is the microphone-to-tube transformer with an input impedance equal to that of the microphone. The output transformer used with the pre-amplifier must have an output impedance suitable for the input impedance of the major amplifier.

In the event that the installation of the microphone amplifier results in poor quality of speech reproduction, do not immediately consider the application of tone control and tone filter circuits. Such units are not always required. Check the system for feedback. Maybe one of the tubes is oscillating. Check for grid current without speech input. See that the operating potentials are normal and that the bypass condensers are properly connected. Check for open grounds. Then be certain that the proper input and output transformers are used. As previously stated, incorrect impedance matching will not only reduce the gain or power output of the system but it will also interfere with the quality of reproduction.

Remotely located speakers should be joined to the power amplifier by means of low impedance circuits. By so doing, the by-passing effect of the capacity of the leads is reduced. Furthermore, the voltage induced from nearby sources of interference are reduced to a minimum. This means that the output transformer in a public-address system should be located at the amplifier and a low impedance line should link the output winding with another transformer connected to the voice coil in the speaker. It is not imperative that another transformer be located between the output transformer and the speaker voice coil. In many installations wherein the speakers are not more than 200 or 300 feet distant from the amplifiers, the voice coil can secure its voltage directly from the output transformer in the amplifier. The wire used for such connections need not be heavier than No. 12 B&S, rubber covered, carried through a conduit.

In view of the fairly high values of current to be experienced in voice coil circuits rated at from 10 to 20 ohms impedance, all leads should be soldered. Avoid ordinary binding post contacts.

The field coil excitation current cables should be carried through a separate conduit and thick wire should be used so as to cause minimum voltage drop. Excessive voltage drop will cause low voltage across the field windings.

Phasing Voice Coils: Where several dynamic speakers are used and are pointed in the same or similar directions, phasing of the voice coils is an advantage relative to sound output. By phasing is meant that the direction of current flow through the voice coils for any one impulse is the same through all of the coils. Phasing is accomplished in the following manner. Disconnect the voice coil circuit from the output transformer secondary. Arrange a low-voltage battery, say of 4.5 volts, so that a momentary flow of current can be passed through the voice coils. Now have an observer stationed so as to visually observe the direction of movement of the diaphragm when the battery is momentarily connected across the voice coil system. Where several speakers are used, the voice coils will be connected in series or series-parallel. Assuming that these connections are made, watch the movement of one speaker diaphragm at a time. All the speakers should move "in" or all should move "out". If some move "in" during the

impulse and the remainder move "out", reverse the connections to the fewer number, so that all move in a like direction.

Transformer Turn Ratio: In reply to numerous inquiries requesting the relation between turn ratio, d-c. resistance and impedance of transformers, the following should be value.

The turn ratio has nothing to do with the d-c. resistance of the windings. It is impossible to determine turn ratio by measuring the d-c. resistance of the primary and secondary windings. The turn ratio is a function of the primary and secondary impedances. When these two impedances are known, the turn ratio is determinable by solving the following equation:

$$\text{Turn ratio} = \sqrt{Z_s/Z_p}$$

where Z_s is the impedance of the secondary winding and Z_p is the impedance of the primary winding. In all of this work, the design of the primary winding is considered first on a basis of providing the required impedance with a certain core, d-c. flow, etc. It is significant to note that the square root of the ratio shown must be determined and not the ordinary quotient of the term.

The impedance looking into a transformer which is loaded, such as an output transformer is determinable as follows:

$$Z = \frac{Z_p}{Z_s} \times Z_r$$

where Z_p is the impedance of the primary; Z_s is the impedance of the secondary and Z_r is the impedance of the load. Thus, if we have an output transformer which has an input impedance of 400 ohms and the impedance of the secondary winding is 20 ohms and the speaker voice coil connected to the winding has an impedance of 20 ohms, the impedance looking into the system is:

$$\begin{aligned} Z &= \frac{4000}{20} \times 20 \\ &= 200 \times 20 \\ &= 4000 \text{ ohms.} \end{aligned}$$

This simple solution allows an approximation of the impedance of an output system when some value different than the optimum is involved. Suppose that the output transformer has a secondary winding rated at 200 ohms and the input impedance of the output transformer is 4000 ohms. A voice coil rated at 20 ohms is used with this transformer. The output will be distorted because the correct relations for maximum undistorted output do not obtain. The impedance of the system is as follows:

$$\begin{aligned} Z &= \frac{4000}{200} \times 20 \\ &= 20 \times 20 \\ &= 400 \text{ ohms} \end{aligned}$$

Auto-Radio

Electrical Interference in Auto-Radios

Interference in auto-radio receivers has been a problem for the Service Technician ever since this type of set was first introduced. Lately, due to the increased sensitivity of auto-radio sets, the electrical interference set up by ignition systems and other electrical circuits has become even more of a problem.

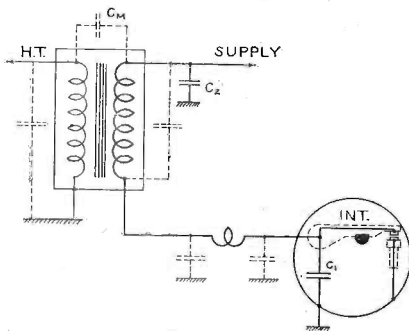

Fig. 1. The condensers C-1 and C-2 are usually sufficient to eliminate interference from the low-tension circuit.

A great deal of research has been carried on in order to determine first, all sources of interference in an automobile which have an effect on the auto-radio set, and second, the best possible means of eliminating these interference effects without affecting the normal performance of the automobile.

Practically all troublesome forms of interference originate in the ignition system, and are due to spark discharges. The origin of the interference may be

- (1) at the spark plugs,
- (2) at the high tension distributor or at poorly connected leads in its circuits,
- (3) at the low tension interrupter, or
- (4) at the generator brushes.

These various forms of discharges produce oscillations at an audio rate, and are of sufficient intensity to be picked up by the car antenna even though the supply leads to the radio are filtered or shielded. These oscillations may also be picked up by the receiver by conduction along the car wiring and other insulated conductors.

Shielding

Such interference may be reduced by completely shielding the entire electrical system of the car. However, this is rather a difficult proposition in most cars, and a better way to go about the elimination of the interferences is to attack them at their sources just as most Service Technicians go about the elimination of electrical disturbances from household appliances.

You can begin by taking it for granted that most, if not all, the interference occurs in the engine compartment. . .right under the hood. The principal source of disturbance is the high-tension ignition wiring. Next in line is any wiring from the engine compartment to the radio set or space near the set. Also, any long leads that would tend to couple the aerial with the high tension source. Two bad actors are the primary breaker or interrupter and the lighting generator. And, believe it or not, the steering column and gear shift lever are not above suspicion, and it may be necessary to ground one or both to the frame of the car if interference persists.

Means of Reducing Interference

There is no need to say much about ignition suppressors as they are a part of the original installation. However, it is required that these suppressors, which are usually connected directly to the top of the spark plugs, carry high instantaneous currents, and sometimes they deteriorate. One or more may have to be replaced.

Interference in the low tension circuit may be reduced or eliminated by the use of fixed condensers. As shown in Fig. 1, one condenser (C-1) should be connected from the movable arm of the interrupter to ground. This reduces sparking at the contacts. Another condenser (C-2) should be connected from the supply lead of the primary winding of the ignition coil to ground. This condenser effectively grounds the high-frequency impulses at this point and prevents their conduction along the supply lead. In some cases it is necessary to place shielding on this supply lead and ground it at the interrupter and coil housings.

Figure 2 shows a typical circuit of a third brush lighting generator. A fixed condenser C connected across the contacts of the cut-out is usually sufficient to eliminate any surges produced by sparking at the commutator of the generator. The condenser C should be grounded to the frame of the generator.

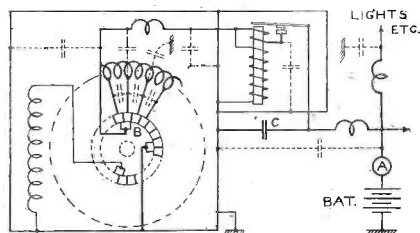

Fig. 2. Typical circuit of third brush lighting generator. Condenser C eliminates the possibility of voltage surges.

Procedure in Installation

In making an auto-radio installation it is well to proceed in the following manner:

- (a) Install the receiver chassis, speaker, and accessories. Use a shielded antenna lead and make sure that both the chassis and shielding braid are carefully grounded.
- (b) Check the ignition system for the condition of the spark plugs and the interrupter contacts. Make sure that all high-tension cables actually contact with the terminals at the distributor, plugs, or coil. Replace all leaky high-tension cables.
- (c) Connect the rotor and spark plug suppressors, the generator condenser, and the condenser on the supply side of the coil. Make sure that resistors, when used, are close to the proper terminals, and keep the condenser leads short.
- (d) If the coil supply lead passes through the same conduit with the high-tension cables move it to a position where it will be coupled to them as little as possible.
- (e) Make sure that the interrupter mechanism is actually grounded—if necessary shunt it to the engine frame.

If interference still exists proceed in the following order:-

- (f) If the coil is far from the distributor, move it if it is allowed.
- (g) If the coil must remain remote from the distributor, shield the lead from the coil to the interrupter and ground the metal braid to the coil and distributor housings.
- (h) Be sure that the coil housing is well grounded to the engine block. If it is still mounted on the bulkhead, ground it through flexible braided lead.
- (i) Clamp all the low-voltage wiring as close to the car frame as possible.
- (j) Shield the 6-volt supply leads to the receiver and carry them back to the battery terminals.
- (k) Check the interference with the dome light leads disconnected as near the source of interference as possible. If this reduces the interference insert a filter in these leads.
- (l) Check the grounding of the steering column. If necessary add a flexible copper braid between the tube or column, and the car frame.
- (m) If the common high-tension lead is long, shield it with copper braid, grounding the braid as often as possible along its length.
- (n) Try other logical expedients suggested by the particular installation.

If you are working on a receiver already installed, it is a good idea to check the whole installation against the installation notes above, before taking any steps to eliminate interference, which might afterwards prove to be so much waste effort.

(L. F. Curtis, *Proceedings, I. R. E., April, 1932*)

Philco Transitone Aerial Installation Data

(Continued from April issue.)

Within certain limits, a large antenna will deliver greater signal strength than a small one. The signal impressed on the antenna is directly proportional to its length and its effective height, and inversely proportional to its resistance. The effective height does not necessarily mean the distance between earth and the flat top portion of the antenna, for in the automobile no earth connection is used. The body and chassis of the car are used as a counterpoise and function in much the same manner. The effective height can be considered as the distance between the antenna and the metallic body of the car.

This means that best reception is secured when the largest possible antenna is installed in the top of the car, when it is farthest separated from the ground used and when the antenna and lead-in wires are soldered and offer the least resistance.

Experiments conducted over a period of years have established the fact that the antenna should be separated from the nearest metal of the car body by at least three inches.

Car Top Construction

Before considering the installation of antenna, it is well to consider the top construction of the cars of today. They may be divided roughly into the following groups:

1. Slat Top.
2. Poultry Wire.
3. Fabric.
4. Metal Bow and Cross Braces.
5. Open and Convertible.

The slat type top consists of the conventional wood bow across the top with the slats running lengthwise and fastened to the bows. The top padding is supported by the slats. In the second group, the slats are replaced with poultry wire which is stretched tightly over the bows and fastened to the roof rails. The padding in this case is laid over the poultry wire. The third group uses muslin or some other fabric stretched over the bows for supporting the top padding.

Metal bows may be encountered in a few cars, or there may be metal reinforcement brackets on some of the bows. In a few cases, metal diagonal cross braces are used. Open and convertible model car tops have practically all the same construction, the top material is fastened over the bows.

By maintaining clearance between the poultry wire and the metal quarters of the body during the construction of the car, the car manufacturers have been able to build in a good car antenna. A few of the car factories install a wire antenna in the roof.

Cars With Slat Top Construction

The headlining should be lowered from front to back so that a copper screen antenna can be installed in the roof.

1. Use a good grade of copper screen. No. 14 or No. 16 mesh, 36-inches wide is satisfactory and can be used in practically all installations.

2. Maintain three inches clearance between the screen and the car body and all metal work in the top. Cut out a section of the screen to get this clearance around the dome light.

3. The wiring in the top to the dome light and switch must be run along the side of the top frame, then along the top edge of the side of a bow to the dome light fixture.

4. An 18-gauge stranded copper, rubber and cotton covered antenna lead-in should be soldered to a front corner of the antenna screen. If the receiver is to be located on the right side of the car, solder the lead-in to the right front corner of the antenna; if the receiver is to be located on the left side the antenna lead-in should be soldered to the left front corner. It is a good plan to solder or bond the whole front edge of the antenna screen.

5. The copper screen must be tacked securely so that it cannot come loose.

6. The headlining and all trim must be carefully replaced.

Tack the screen to the farthest bow in the rear that will give three inches clearance from the rear metal apron. With the edge of the screen lined up with the bottom front edge of the bow, the screen is tacked against the face of the bow, close to the top. It is necessary to tack the screen in this manner, so that the listing strip used to support the headlining can be tacked to the face of the bow. On bows on which the listing strip is not tacked, it will be quite all right to tack the screen along the bottom of the bow. Tack the screen to each bow from the back to the front of the screen. Do not come closer than three inches to the metal aprons along the sides and the metal frame above the windshield.

The lead-in should be concealed behind the windshield moulding, or if the front corner post is hollow, it can be run down the inside of the post. In a few cases, it may be necessary to bring the lead-in down through the wind hose along the side of the corner post.

After the antenna and lead-in have been installed, test the antenna for grounds.

Use a high resistance volt-meter and a 45-volt battery, testing between the antenna lead-in and the body of the car. Do not hold the test connections

to the antenna and the car body with your fingers,—as the leakage across your body will cause a high reading on the meter.

Having made certain that the antenna system is clear of grounds and leaks, proceed with replacing the headlining and trim.

Cars With Poultry Wire Reinforcement

The poultry wire when cleared of grounds may be used as an antenna. This may be done in either of two ways. The top deck may be removed and the netting cleared where the edges ground on the car body. The more practical way is to drop the headlining the entire length of the car and clear from beneath.

A strip three inches wide is cut from the poultry wire reinforcement around the four sides. The poultry screen is then laced securely in place using double strands of number six waxed linen cord. Use short lengths of cord and fasten securely. The poultry wire must be held taut so the top will not sag. Care must be taken to keep the sharp ends of the screen bent back so they will not puncture the padding and the top deck material and will not extend through the headlining. On standard installations, the antenna lead-in must be soldered across the front end of the screen and brought down the front right corner post. In cases where the post is solid, the lead-in may sometimes be brought down inside the windshield moulding or down the hollow rubber wind hose which is used in many cars.

Rearrange the dome light wiring so that there is a minimum coupling between the wires and the poultry wire antenna. Test the installation for grounds, using a 45-volt "B" battery and a high resistance voltmeter. Replace the headlining and trim carefully.

Fabric Top Construction

In a few cars, the top padding is supported by muslin strips stretched over wood bows. An antenna can be easily installed in these cars in much the same manner used in cars with the slat top construction. Instead of tacking the screen under the bows however, the screen can be placed over the bows and tacked only at the rear and the front. Otherwise the procedure is the same.

Cars With Metal Braces

In case there are metal diagonal braces in the top, the braces must be freed of grounds or the efficiency of the antenna will be greatly impaired.

Usually the rear ends of the braces are fastened to the wood top frame while the front ends are fastened by means of brackets to the front corner posts.

Drop the headlining and work from the inside of the car. Release the front end of the braces. Ream out the

hole in the bracket and use fibre washers and sleeve bushing to insulate the cross brace bolts from the brackets.

Usually the dome light is connected to one of the braces. Disconnect the lead from the brace and run a new ground to the car body.

When both braces have been insulated, the antenna can be installed in the standard manner.

Cars With Metal Bows

In a few cars in which metal bows are encountered, a different kind of antenna is used.

After the headlining has been lowered, provisions are made to install a wire antenna. Screw eyes or staples should be securely fastened around the wood top frame of the car and separated from the bows by at least three inches. They should be so spaced that the wire will be parallel to the bows and the loops two to three inches apart. Using 18 gauge stranded rubber covered wire, lace the wire through the screw-eyes or staples. The antenna lead must be brought down one of the front corner posts, depending on the location of the receiver.

Test the antenna and lead-in for any possible grounds and then carefully replace the headlining and trim.

Open and Convertible Models

The tops of the open and convertible models are designed to fold back. Since the antenna cannot in any manner interfere with this, a wire antenna is the only practical one.

Remove the top material and lay it back, leaving the side flaps in place. Secure a piece of top fabric, matching that removed, and fasten it properly in place over the cross ribs and over the side flaps.

Cut a piece of drill cloth or muslin approximately three inches smaller than the width of the top and about the length of it. Punch holes in the drill cloth through which the antenna wire is to be woven. The holes should be in rows, three inches apart, parallel to the cross ribs. Space the holes about ten inches apart in each row.

Use 18-gauge stranded rubber covered wire and weave it back and forth through the holes in the cloth. When completed, the cloth is fastened to the front and rear bows only.

The antenna lead-in must be brought down in the rear so the top may be lowered easily.

The top material and all trim must be carefully replaced. While it is hardly probable that the antenna is grounded, check it with a voltmeter to make sure.

Shielding

In the past, a great number of service men were prone to shield the high tension leads indiscriminately. This gave rise to numerous complaints on the car performance. There is never any need for shielding the high tension leads. The only possible exception to this is when the coil is mounted on the instrument panel and practically

touches the receiver. The high tension coil lead should be shielded in such cases in the following manner:

First cover the lead with a piece of loom similar to that used on the "B" cables. Then cover this with hollow copper braid. The shielding on the cable should start one inch from the coil terminal and be carried on through the engine compartment. Ground the shielding with a pigtail at the dash.

Shielded Antenna Lead

If a stubborn case of interference is encountered, shielding the antenna lead between the receiver housing and the point where the lead-in leaves the front corner post will usually be very effective. The shield must extend from the corner post to the receiver housing and be bonded to it.

Do not use the so called shielded antenna lead-in wire as the losses are too great. The best lead suitable for this is 7 m/m Beldenlace shielded secondary cable made by Belden.

Additional Suppression

The intense high frequency field present under the hood is sometimes carried beyond the dash by pipe lines, rods and wires. To prevent this, some precautions are necessary.

Isolate the high tension leads from the rest of the car wiring. Never run low tension wires from the coil, horn wires or other cables in the high tension manifold or close to the high tension cables and parallel to them.

Additional interference condensers may sometimes be needed on fuse blocks, on the ammeter, or possibly on the dome light lead where it enters the front corner post. Always connect the "A" lead to the car battery. Unnecessary interference will most likely be encountered if the "A" lead is connected elsewhere.

Occasionally it will be necessary to bond the dash to engine block. Use heavy copper braid for this, bolting the braid to both the dash and the engine block. Use a smaller copper braid for bonding rods and pipe lines, fastening the braid to the dash with self-tapping screws, and soldering the other end to the parts to be bonded. Keep all bonds as short as possible, but allow sufficient slack so as not to interfere with the operation of choke rods, etc.

Mallory B-Eliminators: The following are the specifications for the new Mallory Auto-Radio B eliminators.

When checking these eliminators for servicing, never connect the eliminator to a storage battery until there is a load resistor connected across the B minus to B plus terminals of the

eliminator. If the storage battery is ungrounded, that is, is not in the car, then connect the A plus terminal to eliminator terminal 1, and the A minus terminal to the eliminator terminal 2, using not smaller than No. 14 B and S wire. When testing the eliminator the load resistor should be rated at 6000 ohms and 25 watts. While it is true that a 10-watt resistor is within the actual current rating, the 25-watt resistor is preferred. Resistances rated at less than 10 watts, will overheat very badly. The 6000 ohm load resistance is the equivalent of the average radio receiver.

Output tubes used as Class B amplifiers in auto-radio receivers must be of identical characteristics. For that matter, all such systems irrespective of their use, in automobiles or otherwise must use tubes with operating characteristics which differ as little as possible.

"B" batteries should not be located near the exhaust pipe. Too much heat will greatly reduce the operating life of the plate voltage source. Make certain that the "B" battery box completely houses the batteries, otherwise there is danger of ruining the batteries during spraying of the springs of the car or when passing through puddles.

Measured voltage: One peculiar condition noted in connection with automobile radio receivers is that relating to the measured voltage across the filaments of the tubes in the receivers. Assuming 6.3 volt tubes, tests have shown that tubes in receivers operated when the generator was charging at a rate of about 10 amperes, were being subjected to a potential of from 8.5 to about 9 volts. Normally the open circuit voltage of the average generator used to charge car batteries is about 30 to 35 volts. However, when this generator is connected across a 6 volt battery, one would expect that the voltage output of the battery would not be greater than that to be obtained right after full charge, or about 6.8 volts. Tests have shown that the battery voltage during gassing will rise as high or slightly above 7 volts, but the reason for a 9 volt output is mystifying. A possible reason for such a condition lies in undue agitation of the electrolyte, caused by the vibration conveyed to the battery when the car is in motion, or even when standing idle, when the motor is accelerated up to a speed equivalent to about 25 miles per hour.

Type	Amperes Input	Current At 180 V	Current at 135 V.
6	2.45	35 ma.	46 ma.
5	2.1	30 ma.	40 ma.
4	1.8	25 ma.	33 ma.
3	1.5	20 ma.	27 ma.
2	1.2	15 ma.	20 ma.
1	1.1	12 ma.	16 ma.

Short Waves

Converter Voltages: Quite a few converters are so arranged that the plate voltage is secured from the rectifier tube in the receiver proper. The lead terminates in a wafer-type connector which is placed over one of the filament prongs of the rectifier tube.

While this method of operation is satisfactory, it is still necessary to observe precautionary measures relative to the value of the plate voltage applied to the tubes in the converter. It should be realized that the value of the d-c. voltage available across the output of the rectifier is much higher than is to be secured from the voltage divider of the receiver power pack. The converter or adapter may or may not be provided with the proper means of reducing this voltage.

If the plate voltages for the converter are secured from the pentode output tube by means of a wafer connection, it is usually customary to connect the wafer to the screen-grid or space-charge-grid and not to the plate of the tube. The voltage obtained from the space-charge-grid is higher than that obtained from the plate. Recognizing that the space-charge-grid and plate terminals upon the pentode tube base are diametrically opposite, it is a fairly simple matter to confuse the terminals and make the incorrect junction. The usual result is reduced signal response. The reason for the difference in voltage is the drop across the output transformer primary due to the resistance of this winding and the plate current.

Pepping Up Converters: Quite a few converters and other short wave systems are arranged for use with an untuned antenna system. As a matter of fact, the antenna system contains nothing more than a fixed resistance. Improved response can be had by replacing the aerial resistance by means of a simple and broadly tuned circuit. The fact that it is broadly rather than sharply tuned, naturally reduces the response of the tuned circuit, but board as it may be, it still affords greater output than the arrangement utilizing the fixed resistor. (See the accompanying diagram).

Series Antenna Condenser: Quite a few short wave receivers and converters are equipped with series antenna condensers. In some instances these condensers are marked "volume", "sensitivity" or another such name. At any rate, correct manipulation of this control can be of marvelous aid in the effort to get the most out of the system. There have been times, when certain desired signals were very weak

and nothing but critical operation of this control helped increase the output. The sensitivity of the system is dependent upon the capacity of this condenser and the frequency band. The higher the frequency band adjustment of the receiver the less should be the capacity adjustment of this condenser. As you change frequency bands, follow the changes by readjustment of the antenna series condenser. In some instances, one adjustment will suffice for the entire band. Then again it may be necessary to continually vary this signal. Whichever is required, it pays.

The Hammarlund Comet All-Wave Superheterodyne Receiver employs two oscillators. The first oscillator assumes the usual function of an oscillator in any superheterodyne. The second oscillator is used only for CW reception,

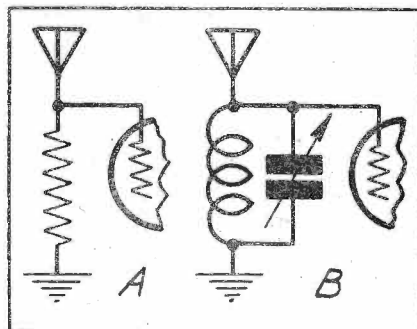

A Broadly tuned circuit, as in B is far superior to the resistance input, as in A.

and is started and stopped by a single pole switch. It consists of a 227 tube, associated circuits and its output is loosely coupled capacitively to the grid of the second detector. Its circuits are adjusted to oscillate at one approximate frequency only—465 kc., which is the frequency to which the intermediate-frequency amplifier is tuned. Inasmuch as all incoming signals, of whatever frequency, are shifted to 465 kc. by the action of the heterodyne oscillator and the first detector (or mixer) it will be evident that starting the 465 kc. oscillator will produce an audible beat note, since the signal (coming through the i-f. amplifier at approximately 465 kc.) and the output of the beat oscillator are both impressed on the grid of the second detector. Thus, it permits the reception of CW signals. The pitch of the CW signals can be increased or decreased by a small vernier condenser which varies the frequency of the beat oscillator within narrow limits.

High Sensitivity in a short-wave converter is not necessarily of value. When

used in conjunction with a good broadcast receiver the ratio of sensitivity to background noise may well be so great that even fair reception becomes out of the question. It should be remembered that the amplification with such an arrangement is tremendous at these high frequencies. So much so, in many cases, that the ignition systems of passing autos beat a spasmodic tattoo on the loud speaker... to say nothing of interference from other sources.

In making recommendations, it is well to suggest a standard make, short-wave set or converter. Most of them are well engineered.

Erratic Operation of early models of short-wave sets is often due to improper by-passing. It is a good idea to by-pass with 0.1 mfd. fixed condensers the plate leads, the screen-grid leads, grid bias resistor or battery, and one leg of the filament when a-c. tubes are used.

Use mica condensers. The paper wound type of condenser has a definite inductance value and will cause trouble by resonating somewhere in the shortest waveband. Wire-wound resistors of low value will also cause trouble. When possible use carbon type resistors.

High-resistance carbon resistors will function satisfactory as r-f. chokes and in most cases are superior to the usual form of radio-frequency choke whose distributed capacity is much too high at the short wave-lengths. Tuned chokes are better yet, but prove to be quite a nuisance as they must be changed for each waveband.

Space-Charge-Grid: Complete short-wave receivers, or adapters, using either a regenerative detector, or regenerative detector plus an untuned r-f. input, can sometimes be improved upon greatly by the use of a space-charge-grid connection. This is particularly true if the detector does not go into oscillation smoothly.

If a screen-grid tube is already being used as the detector, the only necessary changes are a reversal of the two grid connections and a reduction in the "screen-grid" voltage. In this arrangement the screen-grid becomes the control grid, and the control grid becomes the "space-charge-grid." The approximate voltages should be; plate, 135 to 180; control grid, negative 1.5; space-charge-grid, 15 to 25.

When a screen-grid tube is used in a space-charge-grid connection, the output impedance is considerably increased. Therefore, it is most satisfactory to have it feed into a resistance-coupled audio stage that the high plate impedance of the tube may be simulated. However there are no objections to working the tube into a transformer-coupled stage. Even in this case the sensitivity of the arrangement is much greater than the usual screen-grid connection.

Home Talkies . . .

Projectors For 16 MM. Film

Apparatus designed to project motion pictures from 16 mm. film must be compact and light, and the number of adjustments necessary to operate it reduced to a minimum. Most 16 mm. projectors for home use meet these requirements, but the necessary compactness of the equipment has proven a disadvantage insofar as the light source is concerned.

Projection optical systems consist of a source of light, a collective system for directing the light through the film gate, and an objective lens for imaging the film upon the screen.

Tungsten filament lamps are used for the light source. The bulb is $1\frac{1}{4}$ inches in diameter, and this size has been adopted as standard for 16mm. equipment.

Bulb diameter is an important dimension from the optical point of view, for the efficiency of the condenser and reflector lenses depend on the angular size of the cone of light that they can take in from the source and transmit through the system. (A shorter distance between filament and condenser would be helpful, therefore, in that it would permit a larger angle to be used by a condenser of given diameter.)

The collective system may be either a condenser or a reflector lens. Both methods have been applied to the illumination problem in projection, but more space is required by a reflector, for the same useful angle of radiation, than by a condenser lens with rear mirror. Therefore, the condenser has been the preferred form in 16 mm. machines, and will be the one most often found by the Service Man.

Explanation of Condenser

It is well for the Service Man to know the exact function of the condenser lens. If a solid source of light of sufficient size and uniform distribution could be placed at the film gate, no condenser would be needed. A tungsten filament is not solid, however, nor can a lamp bulb be placed right at the film gate. By using a condenser lens a *source image* is substituted for the source itself; by locating the image in front of the film plane the unevenness of the source light can be equalized. Fig. 1 is a sketch showing the condenser lens in its relation to other parts of the system. The condenser, L-1, produces a magnified image of the filament of such size as to fill the projection lens, L-2. In doing this it takes in the large angle of radiation marked a and forms the image at a smaller angle a' . The radiation can now be transmitted through

the projection lens L-2, as a result of this change in its direction. In this way the condenser makes useful the radiation from a small source through a large solid angle in space. Otherwise, a very large source would be needed to produce the same effect, and this is quite out of the question, particularly in a small, compact 16 mm. machine.

Condenser lenses are still found to differ considerably in efficiency, due to differences in their correction for spherical aberration. This is a well-known defect, found in all simple lenses, that causes in this instance a loss from the marginal portion of the light beam as it is converged to the image point by the condenser. The loss is not so serious in 16 mm. projection systems as in cases where the source image is located at the film gate. It can be corrected to a large extent by proper condenser design.

Screen Illumination

The final screen illumination produced by a 16 mm. projection system depends on the effectiveness of the four elements that have been described: the light source, the rear mirror, the condenser system, and the projection objective. Increases can be obtained by using a brighter light source, by improving the condenser correction, and by increasing the aperture ratio of the entire optical unit. Recent attempts at improvement in the 16 mm. field have been mainly directed toward the light source, and this choice is a logical one for the equipment manufacturer because it involves the least amount of redesign on his part. To meet this demand lamps of greater brightness have been developed, the increase being due to the use of larger wire size in the filaments operated at a lower voltage than previously used.

There are two points about lamp filaments which are of particular interest to Service Men. One is the fact that filament supporting wires cause illumination loss unless they are placed outside

the angular field of both the condenser and the rear mirror. Assuming that original design of the equipment was correct, the same effect would take place if the lamp were not set properly in its socket. The second point concerns the filament itself. The aperture of a projection system must be filled with light if it is to work at its best efficiency. With a filament lamp, the source acts as a discontinuous surface, and the openings in its area cause a real loss of light. The result is in this case an image of the lamp filament on the projector lens looking something like the coils in an electric toaster, with dark space in between. In order to get away from this in 16 mm. machines the image of the filament is moved forward enough to produce the desired effect of a uniformly illuminated screen. It actually amounts to imaging the light source between the projection lens and the aperture.

(A. A. Cook, *Journal Society of Motion Picture Engineers*, April, 1932)

Sound on 16 millimeter film is being spoken about. The consensus of opinion among men who have taken a definite interest in the possibilities of home talking movies is that sound on film is required for the success of the project. To the Service Man this means but one thing; the long exploited photo-electric cell (pec) so much discussed in motion picture and other commercial fields, will find its way into the home as an adjunct to the radio receiver.

There is no doubt about the fact that sound on film offers a valuable convenience and one of financial value. The present home talkie system requires the rental of not only the film but the disc carrying the sound. The possibility of damaging the disc adds to the tribulations of operation.

Of course the addition of a "pec" amplifier will increase the cost of the installation and no doubt the rental of a sound on film reel will be more expensive than that of a reel of silent film, but considering all details, there is no doubt of the success of the sound on film system, providing, (and this is a matter of importance) that the sound track when reduced from a 35 mm. film onto a 16 mm. film, will be satisfactory.

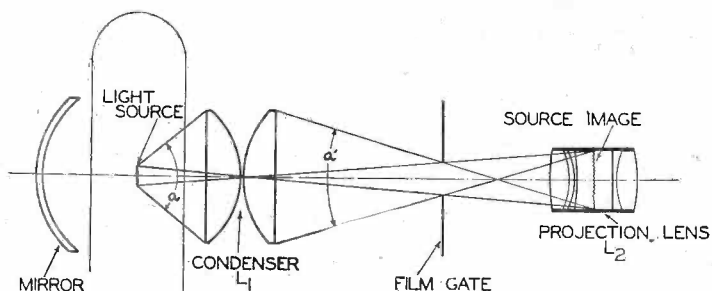

Fig. 1. Showing the elements which go to make up the projection optical system for 16 mm. film projectors.

RCA.PG-38: 16 mm. sound-on-film is here in the form of the RCA PG-38 home talking movie outfit. The system uses a photoelectric cell, which is resistance coupled to a 224-A amplifier. This tube in turn is resistance coupled to a 227. The output stage consists of two 245s, transformer coupled, and arranged in push-pull.

Sound-on-film systems require an exciter lamp as the source of the light passed through recorded sound track. In view of the fact that the complete amplifier is intended for a-c. operation some special method of filament supply for the exciter lamp was required. This problem was solved by employing the current output of an oscillator. As is evident in the wiring diagram, a

voltages higher than the latter figure. If the line voltage is higher than this voltage a voltage-reducing resistor should be used. The appearance of the speaker, is shown in Fig. 1. (For an idea of the optical system used in 16 mm. projectors see abstract elsewhere in this section)

In contrast to the usual single optical system used in home talking movie installations where the sound is on disc, the sound-on-film system utilizes two optical systems. One is that related to the picture and the other is that related to the sound track. All RCA Photophone recording is of the constant intensity, variable width type wherein the sound track resembles a

Synchrony between sound and picture in such a system is therefore influenced by the correct threading of the film, the movement of the various rollers and the arrangement of loops of correct size. Low output may be caused by any one of the faults associated with any audio amplifier. In addition, it is necessary to add the photoelectric cell,* dirt in the sound optical system, upon the lenses; carbonization of the exciter lamp housing; imperfect operation of the oscillator tube; insufficient oscillator output; defective oscillator tube; improper adjustment of the sound optical system; improper adjustment of the photoelectric cell. Any one of the defects here mentioned may cause total lack of sound output.

*The photoelectric cell is the RCA 868 (Servicing data on the RCA. PG-38 will be published in the May issue)

Photoelectric cell amplifiers in home talking movie systems employ at least one resistor, usually in the plate circuit, which has a value of from 5. megohms to 10. megohms. The position of this resistor in the system is one of all importance and has a great deal to do with the strength of the sound signal and also with noise in the system. A defective resistor in this position will cause low output. If the resistor is noisy, the signal output will have a noise background. The service technician who hopes to service such equipment will require an ohmmeter which will indicate at least 10. megohms and it would be quite advantageous to be able to check as high as 25. megohms. There exists a need for a simple method of checking resistances for noise. In view of the absence of such testing devices, the simplest test is replacement!

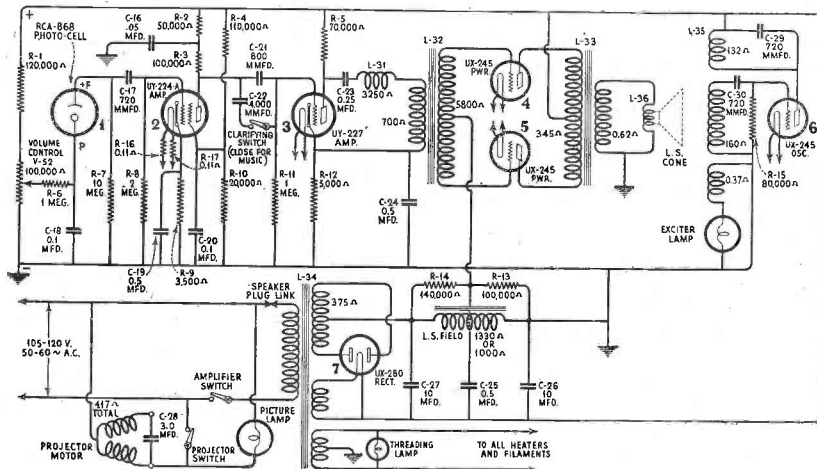

Complete schematic diagram of the RCA PG-38 Home Talkie Outfit. Note that an oscillator tube (6) supplies the filament of the exciter lamp.

tickler feedback oscillator resonated to 15 kc. is coupled to a circuit consisting of a coil shunted by the exciter lamp filament. This arrangement eliminates the need for rectifiers, filters, batteries, etc.

The projection lamp is rated at 110 volts and 100 watts. The exciter lamp is rated at 4 volts and 0.75 ampere. The projection motor is of the capacitor type revolving at a speed of 1725 r.p.m. The power consumption of the complete system is 200 watts. The power consumption of the speaker field is 10 watts.

The complete system may be used for silent or sound film. Certain models can be made applicable to sound-on-disc installations by means of an extension shaft permitting the use of a single synchronous turntable. On such models the two pin jacks are provided for connecting the magnetic pickup to the amplifier. The wiring diagram does not show these pin jacks, but their location is the control grid terminal of the 224-A and ground. The pickup requires its own volume control but no input transformer.

The projector lamp is rated at 110-120 volts and must not be used at line

cross section of a mountain range. In view of the need for different positions for the sound and picture apertures, the sound track leads its associated picture. As a rule, the sound leads the picture by about 21 frames. Of course the sound is in synchrony with the picture but it leads the picture on the film.

Fig. 1. A view of the PG-38 sound and projector unit.

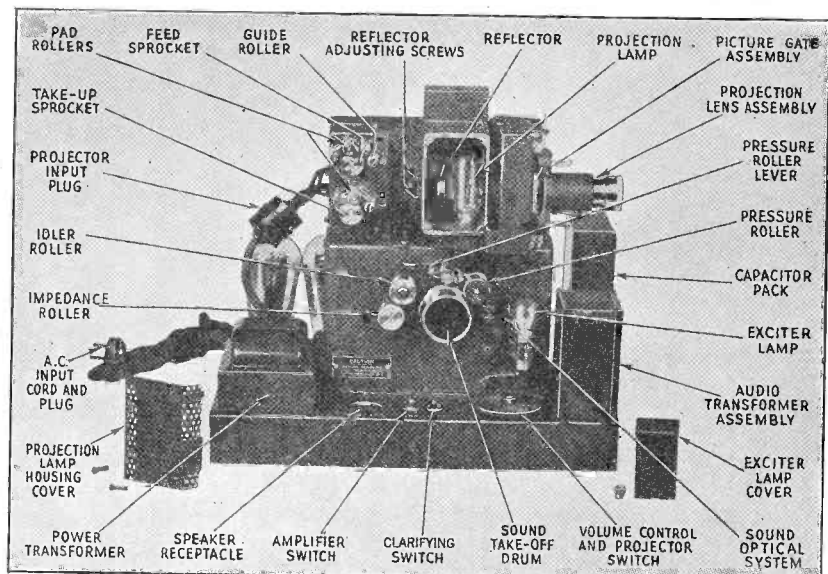

THE FORUM . . .

Careless Installations

Editor, SERVICE:

I think that there is a demand for a good service magazine. I am not sure just what form this magazine should take but I don't think that any which have been published so far have been very satisfactory.

Personally, I think that there are more actual cases of dissatisfied owners because of careless installations and interference than there are from actual defects in the radio itself. Because of this, we are devoting more and more time to the question of "how to get better installations."

A lot can be done in the elimination of interference by the use of special care in the installation, especially of the aerial and lead-in, and I think that this subject should be emphasized. Sending out but once information of this kind does no good, but continued repetition from a number of different sources will impress it on Dealers and Service Men.

Robert F. Herr,
Service Engineer, PHILCO.

Many Thanks

Editor, SERVICE:

I have received the February issue of SERVICE and am very much pleased with its contents. The policies which you set forth in your editorial are, I believe, highly commendable and worthwhile.

I like in particular the complete "Contents-Index," the Abstracts, and the Index of Monthly Literature. They should be great time savers for the busy Service Man. That veiled promise of the future with the expectation of useful charts and tables strikes a very vibrant chord here. Such things are of lasting value.

The General Data of this issue is excellent and I hope that future issues will contain at least an equal amount of good material. I do not care so much for detailed information such as contained in "Installation Notes for RCA, M-30" or information of this type.

Alfred E. Teachman,
Woonsocket, R. I.

(Do you agree with Mr. Teachman regarding Installation Notes? Do you find such notes of value? We would be pleased to have your frank opinions.—The Editors.)

Manufacturers' Catalogs

Editor, SERVICE:

May I suggest that Dealers and Service Men desiring catalogs from

manufacturers may have their names and addresses published in your columns. If you decide to adopt this feature, kindly enter my name.

F. G. Gamble,
Honolulu, T. H.

(In this particular case it is far easier to have the mountain come to Mohammed. SERVICE will carry listings of all catalogs and bulletins issued by manufacturers. Readers may then communicate directly. The manufacturers appreciate such a direct expression of interest in their products.—The Editors)

"Tubeatrophy"

We gratefully acknowledge receipt of a clever piece of advertising copy, (reprinted on this page) from the Harriman Radio Service, 413 N. Clark St., Chicago. Sophisticated copy with a touch of sly humor has, we believe, tremendous pulling power. Why not try something similar on your clientele?

TUBEATROPHY*

*(that "gone" condition in radio tubes)

It's a social blunder for any radio to have Tubeatrophy—and yet four out of five radios that have been places and seen life are paying for it with this obnoxious condition.

*Does your radio complain in the morning (and all day?)
Has your radio lost its voice (so you can't find it?)
Does your radio whoop and howl?*

Do your friends leave when you try to tune in?

Then your radio is suffering from Tubeatrophy, and only the immediate attention of our radio physician can cure it.

Why make your radio (and your friends) suffer longer?

It's an urgent operation but not a costly one. Act Now!

To Mr. W.

Dear Mr. W.

We have your highly interesting letter at hand (to which was attached one dollar for a year's subscription to SERVICE) and really don't know what to do with it. We have tried filing it, but the thing pops up in our dreams.

And it's all because you say that SERVICE looks too much like a woman's magazine!

Mr. W., old man, we had a conference. We inspected SERVICE from cover to cover, and none of these great minds here can detect the slightest particle—not even a micro-microvolt—of the feminine touch.

We're he-men, Mr. W., and take this to heart. We shudder when we think of your accusing finger. . . and yet we are helpless.

Be a sport, Mr. W. and stop pointing. Come out in the open and tell us where you see signs of the opposite sex in this here magazine. Just to ease our curiosity.

Expectantly
The Editors.

Cut Rate Service

Editor, SERVICE:

I certainly enjoyed reading your first offering in SERVICE, on the Editorial Page. I think that therein are some of the best hints about Sales and Service one can offer.

As to your editorial on Cut Rate Service, it hit the nail on the head. I wish more of our Service Men here in Milwaukee could see it. And I should like to show it to some of the Department Stores who consistently undersell the individual Service Men in this locality.

B. J. Narauis,
BERNARD'S RADIO SERVICE,
Milwaukee, Wis.

One Up!

Editor, SERVICE:

I have read with great interest the February and March issues of SERVICE and feel that at last we Service Men have come into our own. We have needed for a long time a "personal" magazine, interested only in our problems and our business, and I think the proof will come in time in the form of a larger circulation.

Now, it occurs to me that if SERVICE is to be the Service Man's Magazine, there ought to be at least a small corner some place where he can have his say about his problems and his business. I know that if you were to include a reader's column I would feel even closer to SERVICE than I do now.

Other magazines have reader's columns—why not SERVICE? I hope you take to the idea, anyway.

Joseph Neilson,
Chicago, Ill.

(Pardon us for beating you to it—but many thanks for the idea just the same.—The Editors.)

SERVICEMEN save TIME MONEY



with
**CLAROSTAT
ad-a-switch
VOLUME CONTROLS**

DON'T lose service business. You need never be stuck in an emergency if your bag contains AD-A-SWITCH. You can convert from plain to switch control in a jiffy. Snaps on without tools. Ask your jobber or write us direct.

FREE! Write for your copy of the most complete handbook on every type of variable resistance—from tiny Center Taps and Volume Controls up to Heavy Motor Speed Controls.

Every experimenter, service man and engineer should have a copy of the Clarostat Control Handbook.

CLAROSTAT MFG. Co.
285-287 N. 6TH ST. BKLYN. N.Y.

BUILD THIS

ACCURATE UNIVERSAL TESTER



Uses the new "VAN" Shunts and Precision Resistors; and a Weston 301 Universal Meter. Easy to build. . . . Easy to use. . . . Inexpensive to buy! Combines a three scale ohm-meter reading 0-1000, 0-10,000 and 0-100,000 ohms; a three scale A.C.-D.C. Voltmeter reading 0-50, 0-250, and 0-1000 volts; and a four scale A.C.-D.C. Milliammeter reading 0-1, 0-5, 0-25, and 0-100 milliamperes—all in one compact instrument measuring only 4x6 3/4 inches. Meets practically every testing requirement of the service man.

COMPLETE LIST OF PARTS

- 1—Weston 301 Universal Meter
- 1—D. P. D. T. Reversing P. B. Switch
- 1—Three Position 3 Pole Switch
- 1—Ten Position 3 Pole Switch
- 1—"On-Off" Switch
- 3—Combination Binding Posts and Jacks
- 1—1000 ohms Rheostat
- 1—10 M. "VAN" Shunt
- 1—5 M. "VAN" Shunt
- 1—25 M. "VAN" Shunt
- 1—100 M. "VAN" Shunt
- 1—400 ohm "VAN" Resistor
- 1—5000 ohm "VAN" Resistor
- 1—45,000 ohm "VAN" Resistor
- 1—245,000 ohm "VAN" Resistor
- 1—Eveready "C" Battery
- 1—No. 4 "VAN" Meter Face
- 1—Engraved Panel
- 1—Hardware Assortment
- 1—Blue Print and Instructions.

Write

Write for Special Service Men's Price on this Kit and Particulars of Other "VAN" Shunts, Resistors and Meter Faces

WHOLESALE RADIO SERVICE CO., INC.
Dept. D50 100 Sixth Avenue
Just North of Canal Street
New York N. Y.

Make a **PROFIT** from Every Service Call



S COMMADORE, at 200 E. 104th St., New York, sold 60 AMPERITES during the month of February. Other service men earn \$90 to \$110 EXTRA every month, installing this wonderful, easy-selling radio improvement. AMPERITE is recommended by R.C.A., Victor, Zenith, Steinite, General Motors, Bosch and other quality manufacturers.

You, too, can make extra profits installing AMPERITE.
Mail Coupon, or Write Letter and Learn How.

AMPERITE Corporation
561 BROADWAY, NEW YORK

AMPERITE

Self-Adjusting
LINE VOLTAGE CONTROL

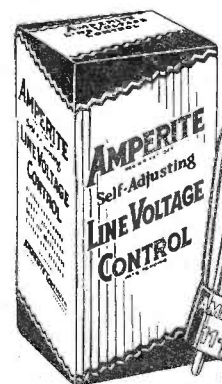

AMPERITE Corporation
561 Broadway, New York, N. Y.

Enclosed \$1.62 for dealers' sample AMPERITE and money-making sales helps.

Name

Address

S-4

THE MANUFACTURERS . . .

I. C. A. Multiple Antenna System

THE INSULINE CORPORATION of America has placed on the market a new Multiple Antenna System, using a Master Antenna Coupler, which permits as many as 20 radio receivers to operate effectively, and without the possibility of interference, from a sin-

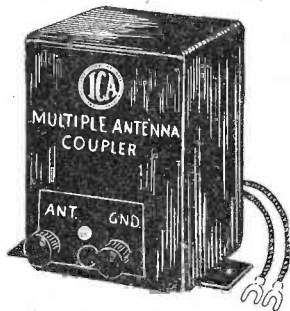

gle antenna. Such a system is highly desirable in apartment houses, hotels, office buildings, etc., and calls for the knowledge of the Service Technician for its proper installation.

The action of the I. C. A. Multiple Antenna System is simple, but positive. A Master Antenna Coupler is attached to a single outside aerial on the roof. This serves as the connecting link between the single aerial and the numerous radio sets within the building. One Master Antenna Coupler can operate up to twenty sets from a single aerial, when used in conjunction with the Multiple Antenna Coupler. The latter device is placed at each radio set.

The Master Antenna Coupler functions through the action of condensers and

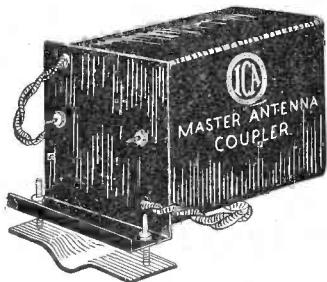

chokes which tune the antenna circuit to a frequency above the broadcasting range. The Multiple Antenna Coupler results in sharper tuning and acts as a band-pass filter, eliminating extraneous noises. In addition, this unit also acts as a lightning arrester.

The single aerial used with the I. C. A. Multiple Antenna System should be approximately 100 feet long. Any good copper or phosphor-bronze aerial wire may be used. The aerial should be placed in the most advantageous position on the roof, away

from surrounding objects if possible, and also as distant as possible from sources of local interference. In other words, the aerial should be located in such a position as to intercept the maximum amount of radio signal energy. This energy is then fed into the Master Antenna Coupler, which may be located in a penthouse near the antenna. Separate lead-in wires are run from the Master Coupler to each Multiple Antenna Coupler at the various radio sets. The use of I. C. A. shielded lead-in wire is desirable, although not absolutely essential, except where local interference is encountered. In such cases, the power supply to the radio receivers may also have to be filtered by means of suitable Filtevolts.

The New Wunderlich Tube

RADIO ENGINEERS who have had an opportunity to experiment with the Wunderlich Tube, acclaim it as the first innovation in detection since the advent of the a-c. radio set. The tube is specifically designed to overcome the weaknesses apparent in tubes that have been used as detectors, though developed for other purposes.

The Wunderlich Tube, with one "auto-balanced" set of elements, gives full-wave grid detection with a minimization of overloading, full automatic volume control, and a stage of audio-frequency amplification without adding to the cost of the radio receiver, nor requiring major mechanical changes. Thus it provides an essential and efficient self-governor or floating-control of tone and quality. All signals, weak or strong, are detected and maintained with equal fidelity under the most favorable operating conditions. Tone is not sacrificed with volume, nor mellowness lost through suppression.

It is claimed that the Wunderlich Tube has four times the detector power output of the triode. Because of its three-fold function, this new tube improves tone quality, provides automatic volume control which minimizes fading and practically eliminates detector distortion thereby preventing blasting and choking due to detector overload.

Reports from the field indicate that several of the large set manufacturers are incorporating the Wunderlich Tube and System in their 1932 receivers, in line with the tendency to banish overloading and include automatic volume control in new sets.

The Wunderlich Tube is described as the modern "auto-balanced" detector employing a construction developed by the Arcturus Radio Tube Company, known as the Unitary Structure Prin-

ciple. This rugged construction locks all of the elements within the tube at the top and bottom so that proper inter-relation of the elements is constantly maintained through inter-dependence.

Mr. Wunderlich, the inventor of this tube, announces that arrangements have been completed with the Arcturus Company for the manufacture and production of this new tube which will be built in blue glass and have a red base to distinguish it from present day types.

(A more detailed description of this tube will be found in this issue, under "General Data")

Electrad Resistor Hand Book

ELECTRAD, INC., of New York City, have announced the first edition of their perpetual, loose leaf "Resistor Replacement Hand Book." This flex-

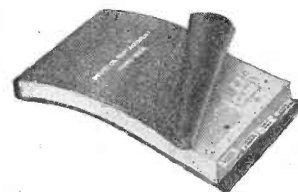

ible binder contains the correct resistor values for all resistors in standard model receivers.

The Hand Book, as issued, contains 72 pages and covers Volume Control Instructions, Volume Control Circuits, Volume Control List, Tandem Volume Control List, Bias Resistor Instructions, Bias Resistor List, Voltage Divider Instructions, Voltage Divider List, Grid Suppressor Instructions, Grid Suppressor List; Catalogue Sheets on Standard and Special Replacement Controls, Tandem Replacement Controls, Truvolt Replacement Resistors, Truvolt Flexible Resistors, and a section on Amplifier Service Data.

Additions to the loose leaf Hand Book are mailed out four times each year, so that the Hand Book is always up-to-date.

The "Resistor Replacement Hand Book" should be of great value to the Service Technician in his daily work. It is of such size that it may easily be slipped into one's coat pocket.

A Newcomer

The Solar Manufacturing Corporation, a new "parts" company formed by executives well known to the radio industry, has gone into the specialized production of all types of wet and dry electrolytic condensers, and molded mica condensers. Other products will be added to the line as engineering developments are completed.

In the SPOTLIGHT

SERVICE

In February _____ an Idea

In March _____ a Reality

In April _____ a FORCE

Proof of the real need for a publication edited exclusively for the service technician is shown by the remarkable reception afforded this new magazine.

Starting as an idea in February, SERVICE had 1,400 circulation. 3,600 yearly subscriptions—a 30% return from the mailings, brought SERVICE to 4,000 readers in March—5,000 guaranteed in April.

7,000 established Service Technicians will be reading SERVICE by June—10,000 by September.

WATCH THIS EXTRAORDINARY MAGAZINE

RADOLEK

The Radio Serviceman's Supply House
WHERE

QUALITY · SERVICE
Lowest Wholesale Prices
Are Combined

Complete lines of finest quality, new radio and electrical merchandise—carefully selected for you from the offerings of the most reliable, standard manufacturers.

Test Equipment, Tubes, Batteries, Repair Parts, Accessories of all Kinds, Public Address, Lighting Fixtures, Electrical Supplies, and many other items to make money for you, are carried in stock—always ready for you.

Fastest, Most Reliable Service

Practically every mail order shipped same day.
VERY PROMPT, COURTEOUS COUNTER SERVICE
Our store is convenient—Plenty of parking space.
Get your copy of our 1932 Serviceman's Price Guide.
SEND FOR IT NOW!

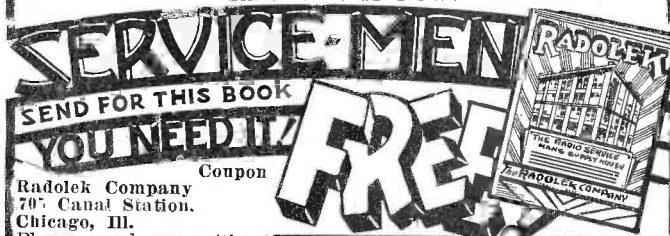

Coupon

Radolek Company
707 Canal Station,
Chicago, Ill.

Please send me without obligation your Serviceman's Supply Book.

Name _____
Address _____
City _____ State _____

RADOLEK CO.
601 W. RANDOLPH ST.
CHICAGO, ILL.

A NEW BOOK!

SERVICING SUPERHETERODYNES

by JOHN F. RIDER

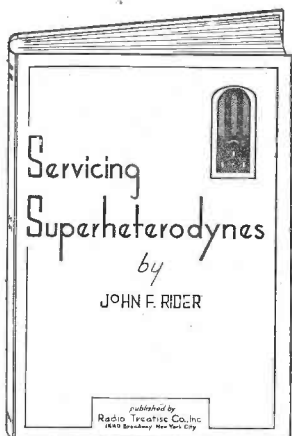

is the book the entire radio servicing industry has been awaiting for a long time. . . This book will give you all of the superheterodyne service information you desire and need in order to service superhets at a profit. . . Written in clear and easily understood language.

A best seller! 10,000 Copies have been sold during the last 3 months. This book is guaranteed to be absolutely up-to-the-minute.

Principles underlying the operation of superheterodynes—Explanation of different types of superhet circuits inclusive of the latest systems.—Breakdown of the superhet receiver—Function of the individual parts—Troubles and symptoms encountered in superhets—short wave converters—peculiarities of superheterodynes—application of RF and IF oscillators—application of set testers—EVERYTHING about superhet servicing. . .

You Need this book. . . Money Back Guarantee.

Type Set—Bound in Cloth—163 Pages.

Get it from us or your nearest radio dealer.

Price \$1.00 Postpaid

RADIO TREATISE CO., Inc.
1440 Broadway New York City

A NEW OSCILLATOR

FOR
SERVICING SUPERHETERODYNES

THE NEW **DAYRAD** TYPE 175

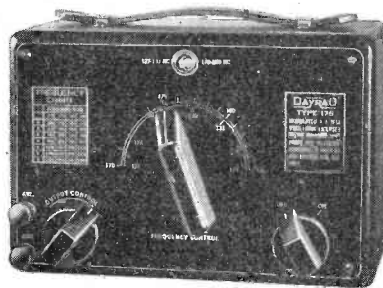

CAST ALUMINUM CASE 8½ x 6 x 5
CONTINUOUSLY VARIABLE—ALL FREQUENCIES
BETWEEN

127 TO 133 KC - - - 170 TO 185 KC - - - 254 TO 266 KC
ACCURATE TO WITHIN ¼ OF 1 PER CENT
ALL BROADCAST RANGES WITH POWERFUL HARMONICS
—COMPLETELY SHIELDED—FULL RANGE—ATTENUATOR
—ALL SELF-CONTAINED

SEE YOUR
JOBBER TODAY
OR WRITE TO

\$1975
LESS TUBE AND
BATTERIES

NET PRICE
TO DEALERS
AND SERVICE MEN

THE RADIO PRODUCTS CO. DAYTON, OHIO

Index of Monthly Literature

All articles listed on this page are cross-indexed for your convenience. Titles given are not necessarily the titles of the original articles, but in each case serve to determine the substance of the article. Listings marked with an asterisk (*) are abstracted in this issue. The material in each issue of SERVICE is alphabetically indexed on the Contents Page.

AUTOMOBILE RADIO

Interference

Electrical Interference in Motor Car Receivers.*

L. F. Curtis, *Proceedings I.R.E.*, pp 674, April, 1932

Opportunities

Cash in Automotive Radio,
Arthur Lynch, *Radio-Craft*, pp 665,
May, 1932

BROADCAST RECEIVER OPERATION

Amplifiers, A-F.

C Bias Elimination,
Robert M. Ellis, *Radio Call Book*,
pp 31, May, 1932

Output Amplifiers for D-C Receivers,
J. R. Nelson, *Electronics*, pp 128,
April, 1932

Power Amplifier Tubes,
Electronics, pp 118, April, 1932
Joseph Calcaterra, *Radio News*, pp
918, May, 1932
Louis Martin, *Radio-Craft*, pp 652,
May, 1932

Webster Amplifier Model 6043-R,
Radio Call Book, pp 28, May, 1932

Amplifiers, R-F.

Automatic Suppression of Inter-carrier Noise,
Paul O. Farnham, *Radio Engineering*, pp 21, April, 1932

Accurate R-F. Standards,
J. E. Anderson, *Radio World*, pp 3,
April 9, 1932

R-F. and I-F. Amplifier Tubes,
Electronics, pp 118, April 1932
Joseph Calcaterra, *Radio News*, pp
918, May, 1932
Louis Martin, *Radio-Craft*, pp 652,
May, 1932

Broadcast Ranges

Ranges of Radio Waves,
J. H. Dellinger, *Radio Engineering*,
pp 18, April, 1932

Conquering Street-Railway Interference,
Tobe Deutschmann, *Radio News*, pp
921, May, 1932

Adjustments

(See "Testing Systems")

Receivers

The Silver Two-Volt "Super",
McMurdo Silver, *Radio News*, pp
931, May, 1932

Volume Controls

Theory and Construction of,
Hy Levy, *Radio-Craft*, pp 660, May,
1932

Volume Control Design,
W. S. Parsons, *Radio Engineering*,
pp 25, April, 1932

PRACTICAL THEORY AND DESIGN

Filter Design

Filter Design by Graphs, Part 2,
Radio Call Book, pp 36, May, 1932

Design of Line Filters,
Hy Levy, *Radio-Craft*, pp 660, May,
1932

Graphs and Charts

(See "Filter Design")

Resistance and Power Consumption,
John M. Borst, *Radio News*, pp 940,
May, 1932

Matching Transformers

Design of,
Hy Levy, *Radio-Craft*, pp 660, May,
1932

Equipment

(See "Testing Systems")

Light-Sensitive Unit, Construction,
B. J. Montyn, *Radio News*, pp 936,
May, 1932

Sound Transmission for the Hard-of-Hearing,
Henry L. Williams, *Projection Engineering*, pp 18, April, 1932

PUBLIC-ADDRESS SYSTEMS

Amplifiers

(See "Amplifiers, A-F")
(See "Tubes, Amplifier")

Electric Phonographs,
Electronics, pp 121, April, 1932

Sound Transmission for the Hard-of-Hearing

Henry L. Williams, *Projection Engineering*, pp 18, April, 1932

Microphones

The Microphone in Public-Address Systems,
Charles Felstead, *Projection Engineering*, pp 9, April, 1932

TESTING SYSTEMS

Construction

Capacity Decade Box,
Radio Call Book, pp 32, May, 1932

Multi-Range Voltmeter and Milliammeter,
B. Gallup, *QST*, pp 42, April, 1932

Oscillator, A Serviceman's,
M. R. Rathborne, *Radio News*, pp
942, May, 1932

Set Tester, a Simple,
Joseph Leeb, *Radio-Craft*, pp 658,
May, 1932

Signal Generator for Service Men,
Radio Call Book, pp 32, May, 1932

Design and Use

(Also see "Construction")

Design of New Tube Tester,
B. J. R. Williams, *Radio-Craft*, pp
671, May, 1932

Using the V. T. Voltmeter, Part 1,
Beryl B. Bryant, *Radio-Craft*, pp
676, May, 1932

Improved Continuity Test for Enamel Insulation on Wires,
C. L. Erickson, *Bell Labs. Record*,
April, 1932

TUBES

Amplifiers, A-F,

'46 Double Grid, Triple-Twin,
Electronics, pp 118, April, 1932

Heater Output Pentode, Auto Pentode, Type '64,
Louis Martin, *Radio-Craft*, pp 652,
May, 1932

Amplifiers, R-F.

2-Volt Pentode,
Louis Martin, *Radio-Craft*, pp 652,
May, 1932

Detectors

Wunderlich Tube
Electronics, pp 118, April, 1932

G-2S Duodiode, Type '64,
Louis Martin, *Radio-Craft*, pp 652,
May, 1932

Rectifiers

Type '82 Full-Wave Mercury Vapor,
Electronics, pp 118, April, 1932

Tube Applications, Characteristics, Tables

More New Tubes,
Louis Martin, *Radio-Craft*, pp 652,
May, 1932

New Tubes, Detectors, Rectifiers, Amplifiers,
Electronics, pp 118, April, 1932

Power Detection Characteristics of Pentode Tubes,
H. A. Brown & C. T. Knipp, *Electronics*, pp 126, April, 1932

The "Twin-Grid" Tube, Part 2,
M. W. Taylor, *Radio News*, pp 929,
May, 1932

What Tube Shall I Use?
Joseph Calcaterra, *Radio News*, pp
918, May, 1932

I.R.C. Service . . .

A FORMULA FOR GREATER PROFITS

In this issue we are bringing to your attention three very important service helps, (see illustrations adjoining), which, when used together pave the way to quicker handling of resistor problems. So simple and effective is this combination in replacement work that it has been aptly called the *I.R.C. Formula for Greater Profits*.

First, however, we wish to devote a few words in this column to the quality of Metallized Resistors. You men who are engaged in daily repair jobs will naturally want to know something of the resistance units you are working with.

Metallized Resistors are made by a house which specializes on resistance units you are working with.

Metallized Resistors are made by a house which specializes on resistance units, and have long been standard equipment with leading set manufacturers. The Metallized principle, developed by the International Resistance Company, has made possible an extremely low noise level and a permanence of resistance values that has brought these units into widespread use in electrical apparatus requiring the closest accuracy. What is also very important to the radio service technician, is the fact that these resistors are so impervious to moisture. They are not affected by humidity or climatic influences.

I.R.C. Service, which is now provided to over 10,000 repair men throughout the country, depends first and foremost on the quality and accuracy of I.R.C. Resistors. We are doing our best to supply you with units which will help to build your business and prestige—resistors that will stay put over long periods of time under all conditions.

With absolute quality to rely on, we find that our friends in the field welcome the service helps we supply, such as the Resistor Replacement Guide and Color Code Chart—and the Handy Kit idea shown on this page. The Resistor Guide, which was introduced several years ago, is now used by successful Servicemen in every State in the Union, and if you do not own it we trust you will avail yourself of the easy method placed at your disposal for obtaining it.

In next month's issue we expect to start a series of articles on the

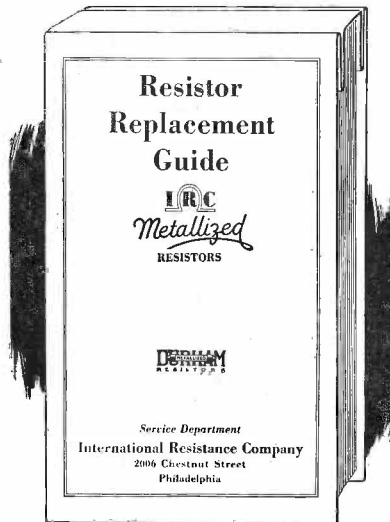

various phases of your replacements business—practical hints on the servicing of your sets with the least trouble. You are in business to please your customers and also to capture the elusive shekel—and it will be our aim to help you do both.

What would it mean to you to have each resistor question answered right off the bat, no matter what set you are servicing? The I.R.C. Resistor Replacement Guide does just that. Once you know it's resistor trouble, you simply turn to the page on which the set in question is listed—and in an instant you have the value and code and position in the circuit of each defective unit. No need to guess or worry over the proper units as in the old hit or miss days.

The Guide is a loose-leaf book which lists all leading makes of receivers (over 200 circuits), with the types to use in each. It fits easily in your pocket, and every so often new sheets come along to keep it up to date. The Manual and the new sheets are supplied without charge by the International Resistance Company to any Serviceman with his order for twenty Metallized Resistors. Or it may be purchased singly for \$1.

Practically all set manufacturers are using the R.M.A. Color Code. It is therefore essential for Servicemen to have a chart or guide to tell the resistance value of any particular resistor. The Color Code Chart here shown is given away by the International Resistance Company. Keep one in your pocket or your service kit, and you will know in a jiffy what the color coding signifies.



This is the Certified Kit that has made a ten-strike with Servicemen because of its convenience and the thousands of values possible from its 20 popular-sized Resistors. What a comfort to know that no matter what range you find necessary in any replacement job, it can be produced from this little kit, by using the simple formulas that go with it!



The three articles shown above go to make up the I.R.C. Formula for Greater Profits. The Resistor Guide plus the Color Code Chart plus the Certified Kit equals Speed plus Accuracy plus Profit.

It simply requires your check or money order for \$3.50 (\$4.80 in Canada), the price of the Certified Kit, to bring you all three articles so that you can put the formula into immediate operation for yourself! The Guide and the Chart are given free with the Kit.

Metallized

Resistors for Replacements

Precision Wire Wound Resistors For Meters and Test Equipment

INTERNATIONAL RESISTANCE COMPANY

2006 Chestnut Street, Philadelphia
74 Wellington St., West, Toronto, Canada

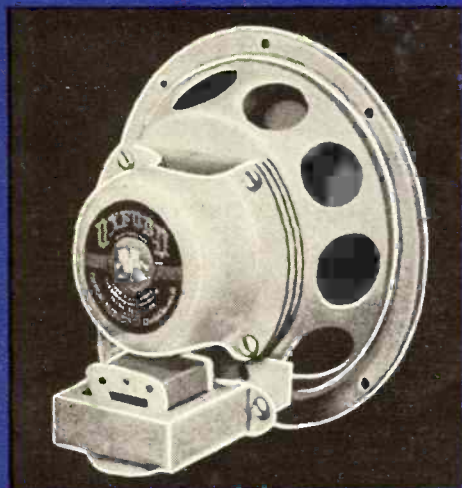
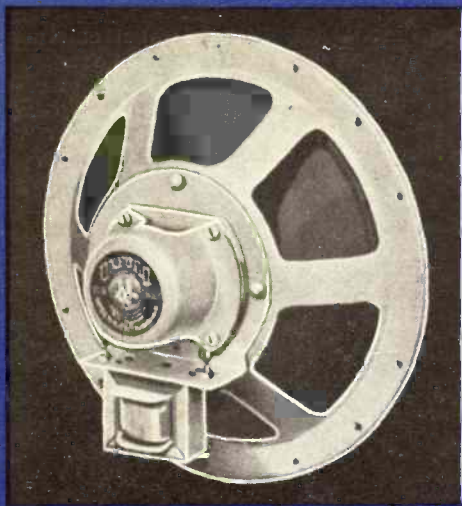

SPEAKER

OXFORD SPEAKERS include every useful model.

BY

The sizes are:

6", 8", 11" and 12",

Singles, dual combinations, large cups, medium cups, A.C. types, Auditorium and

AUTOMOBILE MODELS

In tone range, sensitivity, rugged dependability, eye-value, advanced engineering, Oxford sets a new high mark in the speaker art.

Made under the patents and designs of Frank Reichmann, oldest speaker manufacturer in America.

Write for our complete Bulletins.

Manufactured by

OXFORD PRODUCTS COMPANY

Division of THE POTTER COMPANY

North Chicago, Illinois

CONDENSERS

BY

7650 different specifications of Condensers were furnished during 1931

by The Potter Company to parts jobbers, and 97% were shipped within 48 hours.

This unique service for the Serviceman is possible only because of our large plant and experienced personnel.

Replacements of any type, size, rating specification and mounting are available with every detail correct.

When high quality Potter Replacements are available, why take a chance? Insist upon Potter Condensers.

Write for our Replacement Chart.

THE POTTER COMPANY

NORTH CHICAGO, ILLINOIS

OXFORD POTTER

