

RCA

Volume III

Television

PICT-⊕-GUIDE

An aid to TV Trouble Shooting
by picture analysis



RCA

Volume III

Television

PICT--GUIDE

By JOHN R. MEAGHER

Copyright, 1952 RADIO CORPORATION of AMERICA



RADIO CORPORATION OF AMERICA
TUBE DEPARTMENT,
HARRISON, N. J.

Volume III

RCA Television PICT--GUIDE

By John R. Meagher



RADIO CORPORATION OF AMERICA
TUBE DEPARTMENT HARRISON, N. J.

Copyright, 1952, Radio Corporation of America

3F10 Litho'd in U.S.A

INTRODUCTION

Volume III

The photographs and text in Volume III are new and different from Volumes I and II. Volume III does not replace the earlier volumes, but is to be used in conjunction with them.

As in previous volumes, the text is written from a strictly practical viewpoint, and the explanations are clear and concise. Several different receivers were used in making the photographs, which are not retouched.

The Pict-O-Guide Volumes provide a simple and logical system for TV servicing:

Most troubles in TV receivers produce noticeable effects, or visible symptoms, in the picture. Troubles in one section of the receiver produce certain visible symptoms. Troubles in a different section produce different symptoms. All of the *basic* visible symptoms are illustrated and explained in the Pict-O-Guide Volumes. By learning to recognize these visible symptoms, the technician can quickly localize almost any trouble to a particular section of the receiver. Once the trouble has been localized, it is up to the technician to apply

his knowledge, experience, and testing equipment in order to find the exact fault in the suspected section.

The basic visible symptoms of trouble shown in the Pict-O-Guide apply to all television receivers. These basic symptoms have not changed to any appreciable extent since the first RCA Victor home television receivers were introduced in 1939. The basic visible symptoms used in localizing troubles are the same in sets with separate-sound-channel, in intercarrier sets, in sets with various types of gated and non-gated or pulsed AGC, in sets with pulse-type and oscillator-type high-voltage supply, in sets with direct- and indirect-drive horizontal deflections, etc., etc.

Large sections of the Pict-O-Guide are devoted to general troubles, such as: The effects of poor rf-if alignment; the effects of poor video response; localization of sync troubles; the effects of heater-cathode leakage; the causes and remedies for interference; etc. These subjects apply not only to past and present receivers, but very likely will apply to future receivers for a long time to come.

Readers who are worried about keeping pace with the steady stream of changes in television circuits should remember that *the information in the Pict-O-Guide is of BASIC importance in television servicing.*

Thousands of technicians have expressed their appreciation for the practical assistance and knowledge gained from Volumes I and II. It is our sincere hope that Volume III will prove equally helpful to all television technicians.

TO OWNERS OF VOLUMES I AND II

To arrange the Pict-O-Guide cards of all three volumes in sequence, remove the cards from the three binders and arrange them in a single stack according to the letter and number coding. Divide the stack into three decks to fit the binders, with P-1 starting Volume II, and TVI-1 starting Volume III.

The contents card supplied with Volume III applies to all three volumes and should be inserted at the front of Volume I text.



IN RCA TUBES, the difference is
Top Quality Control

The secret of RCA leadership is *top-quality control* . . . all along the line. By constant vigilance at *all* stages of manufacture, RCA closely guards its own reputation for quality . . . and yours as well.



Stocking and recommending RCA tubes is good business, because no other brand enjoys greater customer confidence . . . and customer confidence is your stock in trade. That is why successful dealers have found that installing RCA tubes means fewer call-backs, more dependable repair work, and, in the long-run, greater prestige and profit.



KEEP AHEAD—KEEP IN TOUCH WITH YOUR RCA DISTRIBUTOR

RCA BLUE RIBBON LINE . . .

The TEST EQUIPMENT of The *Professionals*

More than anything else, the test equipment in the serviceman's shop is the key to his future and his reputation. Any compromise with quality can mean the difference between accurate, dependable analysis, and frequent call backs with consequent loss of time, money, and reputation.

Unmatched in versatility—RCA Blue Ribbon Test Equipment meets every TV servicing need. Each instrument is manufactured to exacting requirements and designed for simplicity of operation. Only the finest RCA products bear the name—RCA Blue Ribbon—the test equipment of the professionals.



WR-39-C
TV Calibrator



WV-77A
Junior VoltOhmyst



WR-59-B
TV Sweep Generator

CONTENTS

Volumes I, II and III

Subject	Letter Code
Introduction.....	A
Automatic Gain Control.....	AGC
Built-in and External Ghosts.....	GHO
Horizontal deflection circuit.....	HD
Horizontal oscillator circuit.....	HO
Visible symptoms of hum trouble.....	HUM
Kinescope.....	K
Power supply circuit.....	P
Rf-if circuit.....	R
Sync circuit.....	S
Station troubles.....	ST
Test pattern.....	TP
Television interference.....	TVI
Video circuit.....	V
Vertical deflection and vertical oscillator circuits.....	VO

TOPICAL CONTENTS FOR ARTICLES

Volumes I, II and III

Subject	Code Section
Automatic Gain Control Troubles	rear of AGC-1
Built-in and External Ghosts	GHO-1
Insufficient Width	rear of HD-13
Visible Symptoms of Hum Troubles	HUM-1
Focusing Adjustments	rear of K-5
Scanning-Line Structure	rear of K-8
Effect of RF and IF Alignment on Picture Quality	rear of R-5
Alignment for Weak-Signal Areas	rear of R-5d
Sweep Display on Kinescope	rear of R-6
Localizing Sync Troubles	rear of S-5
Analysis of Blanking Troubles	rear of S-6
Significance of the Test Pattern	TP-1b
Analysis of and Remedies for Television Interference	rear of TVI-1a
Television Interference	TVI-2
Vertical Deflection Failure	rear of VO-1a
Analysis of Vertical Oscillator Troubles	rear of VO-7a
Interlacing Considerations	rear of VO-8

CONTENTS
Volume III

<u>Subject</u>	<u>Letter Code</u>
Automatic Gain Control	AGC
Built-in and External Ghosts	GHO
Horizontal Deflection Circuit	HD
Visible Symptoms of Hum Troubles	HUM
Kinescope	K
Power Supply Circuit	P
Rf-if Circuit	R
Sync Circuit	S
Television Interference	TVI
Video Circuit	V
Vertical Deflection and Vertical Oscillator Circuits	VO

The photographs of the WFIL Test Pattern are reproduced with permission of the station management. The pictures were made by using a receiver in good operational condition except for the specific faults purposely introduced. The quality of the test patterns in no way reflects upon the quality of the transmitted signal of WFIL or the station personnel.

RCA Television PICT-⊗-GUIDE

AGC-1

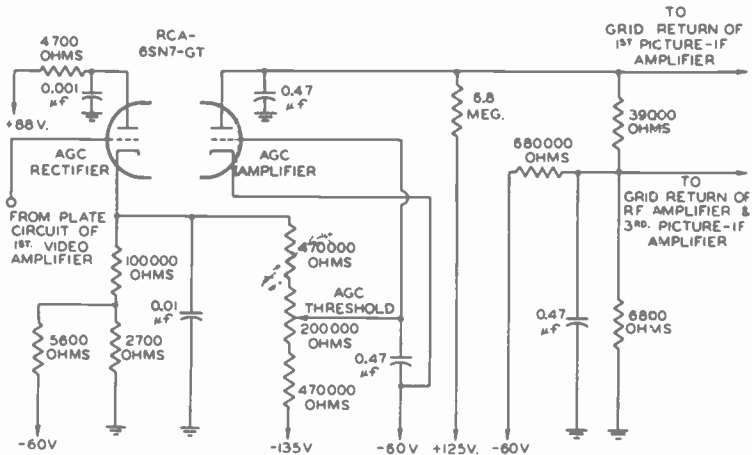

Diagram of AGC circuit used in RCA Victor model T-164 and numerous other models. In all TV receivers, the AGC section furnishes negative bias voltages, ranging up to about -10 volts, to the



grids of the rf and some of the picture-if amplifier tubes. The bias voltage controls the gain of the rf-if amplifiers. When the bias voltage is low, the rf-if gain is high. When the bias voltage is high, the rf-if gain is low. The bias voltage, and hence the gain, depends on the strength of the TV input signal. Weak signals produce low bias voltage and high gain. Strong signals produce high bias voltage and low gain.

AUTOMATIC-GAIN-CONTROL TROUBLES

Automatic gain control (AGC) is used to regulate the gain of the rf and picture-if amplifiers in order to maintain approximately the same peak amplitude of signal input to the picture second-detector and video amplifier on weak, medium, and strong TV signals. The AGC circuit is normally inoperative on extremely weak signals.

The gain of the rf and picture-if amplifiers is controlled by varying the negative grid bias on some of the tubes in these amplifiers. The controlling negative bias voltages are furnished by the AGC circuit.

Typical symptoms of AGC trouble include:

1. Loss of picture and sound, caused by excessive negative bias

Continued on Page 12

RCA Television PICT-Ⓢ-GUIDE

AGC-2

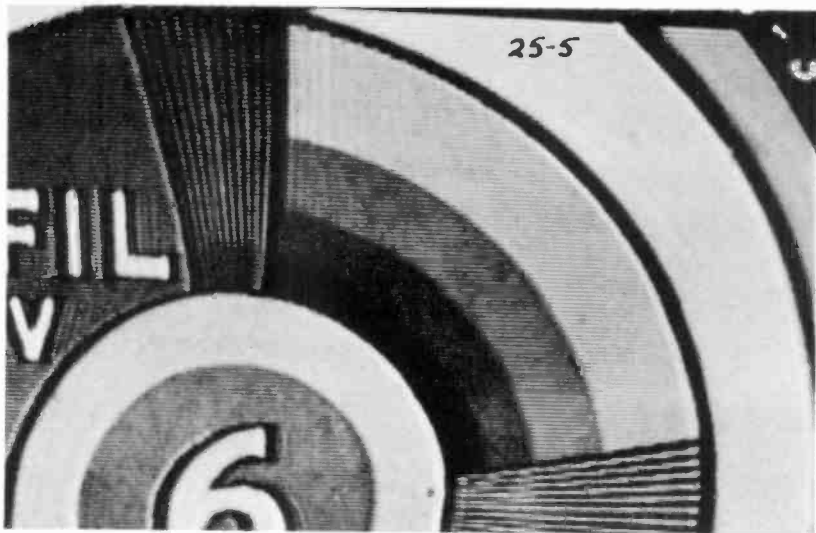

Horizontal pulling at top of picture, due to compression of sync amplitude, caused by incorrect setting of AGC threshold adjustment (or AGC switch in some models). In this example, the bias voltages



are too low, resulting in excessive gain in the rf and picture-if amplifiers. The excessive signal input to the video amplifier results in limiting action which clips or compresses the amplitude of the sync pulses. The reduction of sync amplitude can be detected by inspection of the vertical sync signals as they appear on the picture tube, as shown in AGC-2c.

Continued from Page 10

- voltage from the AGC circuit. Excessive bias cuts off the rf and picture-if amplifiers, thereby preventing the passage of signals.
2. Horizontal pulling in picture, as shown in AGC-2, caused by compression of sync amplitude due to insufficient bias voltage from the AGC circuit. Insufficient bias results in excessive rf-if gain and excessive signal input to the video amplifier.
 3. Overloading on strong TV picture signals, as shown in AGC-2a, caused by incorrect setting of AGC threshold adjustment, or trouble in the AGC circuit.

Trouble in the AGC circuit may produce either excessive or insufficient negative control bias voltage. When the bias voltages are too high, the rf and picture-if amplifiers become partially or completely cut off, thereby reducing or preventing the passage of TV signals,

Continued on Page 14

RCA Television PICT-⊗-GUIDE

AGC-2a

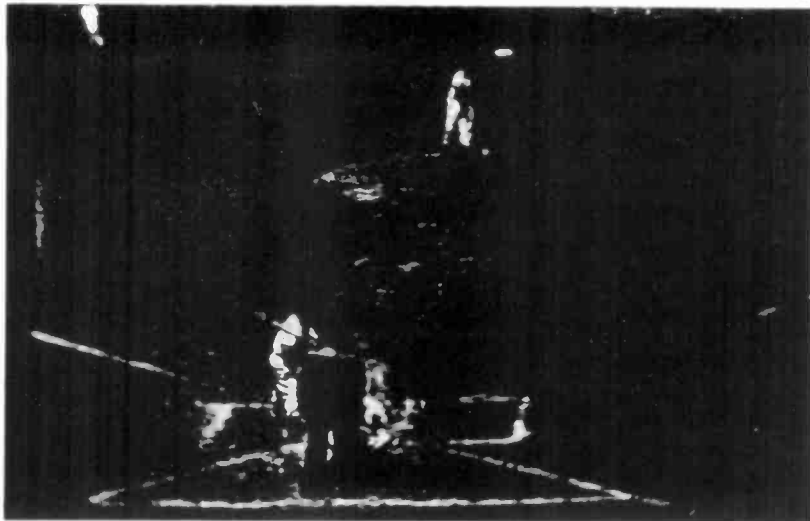

When the AGC threshold control is advanced slightly more than shown in AGC-2, the grey and black picture elements become compressed, as shown above. Further advancement may result in com-



plete loss of picture, except on very weak stations, for which the AGC is inoperative and the threshold adjustment has no effect.

Continued from Page 12

and resulting in loss of picture and possibly of sound. When the bias voltages are too low, the gain of the rf and picture-if amplifiers becomes excessive for the incoming TV signals, and overloading may occur in the picture-if or video amplifier. Usually, the first symptom of overloading, or limiting, is compression of sync amplitude, resulting in poor sync action as shown in AGC-2.

Some AGC circuits include a threshold control or switch that must be set correctly to avoid both excessive and insufficient gain in the rf and picture-if amplifiers. Effects of incorrect adjustment are shown in AGC-2, -2a, -2b, and -2c.

In receivers in which the input signal for the AGC circuit is taken directly (not through a blocking capacitor) from a direct-coupled video amplifier, certain troubles in the video amplifier can cause excessive negative bias voltages to be delivered by the AGC circuit. In such receivers, a trouble in the *video amplifier* may result not only in loss of picture, and possibly raster, but also in loss of sound.

There are many different varieties of AGC trouble, some obvious

Continued on Page 16

RCA Television PICT-⊗-GUIDE

AGC-2b



At left, normal intensity of snow on a weak-signal picture, with AGC threshold adjustment set correctly. At right, intensity of snow is increased, without a corresponding increase of picture signals, when the AGC threshold adjustment is advanced too far.



Continued from Page 14

and some obscure. Very frequently the obvious symptoms of trouble appear to have no possible connection with the AGC circuit. *The technician's salvation in such cases is the fact that it is always possible to over-ride the AGC voltages temporarily by means of an external battery and potentiometer.* In many cases the use of a battery and potentiometer will restore the picture or sound, or both, and thereby permit an intelligent diagnosis of the trouble. When both the picture and sound are missing, it may be difficult to begin localizing the fault.

Two different "bias box" circuits are shown in AGC-2d. It is convenient to have both types available for use in the shop. Circuit A is satisfactory for TV receivers in which the output impedance of the AGC circuit is relatively high. Circuit B is recommended for sets in which the output impedance of the AGC circuit is low. In circuit B, the potentiometer provides control over a range of $1\frac{1}{2}$ volts; adjustment in steps of $1\frac{1}{2}$ volts is obtained by shifting the battery connection.

For purposes of trouble shooting it is usually satisfactory to use the same voltage for biasing both the rf and the picture-if amplifiers, even though different AGC voltages are used in the receiver for each amplifier. In extremely strong signal areas, it may be necessary to

Continued on Page 18

RCA Television PICT-⊗-GUIDE

AGC-2c

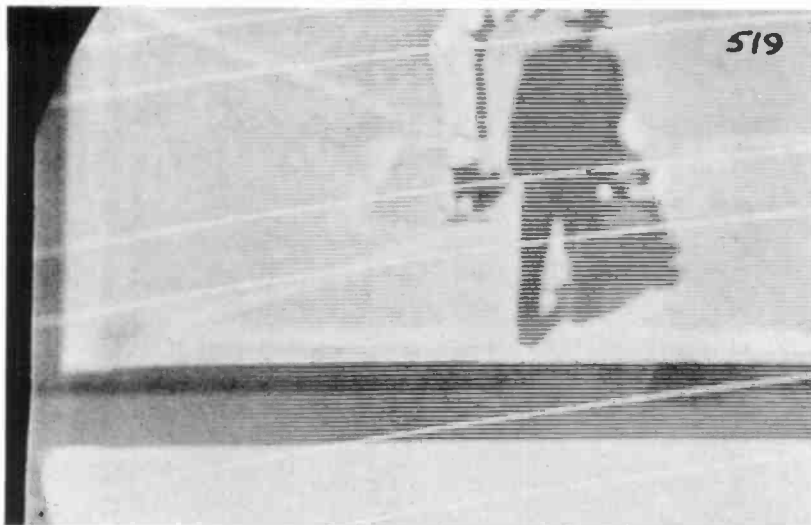

Reduction of sync amplitude due to incorrect setting of the AGC threshold adjustment. The vertical sync shown above is only slightly darker than vertical blanking, indicating that the sync amplitude



has been reduced (compressed, limited, or clipped). The effect of this condition on the picture is shown in AGC-2. The sync must be considerably darker than the blanking, as shown in S-2.

Continued from Page 16

provide additional bias, up to a total of about -15 volts, for the rf amplifier.

When a bias box is used it may be helpful in certain cases of AGC trouble to isolate the AGC circuit by disconnecting its input and output leads.

It is advisable to make a habit of checking the AGC voltages in different receivers on both weak and strong signals. The voltages should be measured at the grids of the controlled tubes and also at the output of the AGC circuit, in order to reveal possible troubles between these points. An RCA VoltOhmyst such as the WV-97A is recommended for AGC measurements because its isolating probe introduces negligible resistive and capacitive loading in the grid circuits.

RCA Television PICT--GUIDE

AGC-2d

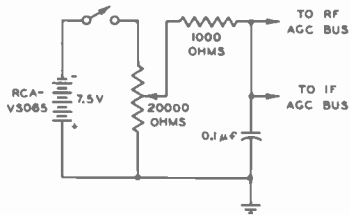

A

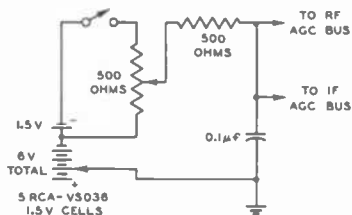

B



The visible symptoms of AGC trouble are often confusing and misleading. For this reason, a "bias box", connected as shown above, is extremely helpful in determining whether the AGC circuit is at

fault. The bias box is used to over-ride the bias voltages furnished by the AGC circuit. Circuit A is satisfactory for TV receivers in which the output impedance of the AGC circuit is relatively high. Circuit B is recommended for sets in which the output impedance of the AGC Circuit is a few thousand ohms or less.

"BUILT-IN" AND EXTERNAL GHOSTS

The chief purpose in the first part of this section on ghosts is to show how "*built-in*" ghosts can be distinguished from external ghosts. Many technicians, including the writer, have had the unhappy experience of wasting several hours in reorienting and repositioning an antenna, and even trying different antennas, in a futile effort to eliminate ghosts that are eventually found to be caused by trouble in the receiver or in the antenna system. After one experience of this sort, a technician needs no special urging to study the subject.

An expert technician should be able to identify internal or built-in ghosts. He should be able to locate and correct any faults that produce such ghosts. He should be well acquainted with the directivity pattern and front-to-back ratio of available antennas, and he should know how these characteristics change on different channels, so that he can reduce or eliminate external ghosts, wherever possible, by selecting the correct antenna for the particular conditions.

Built-In Ghosts

Troubles that produce built-in ghosts include:

- (1) *Regeneration* in the picture-if amplifier, as shown in GHO-1a and R-2.
- (2) *Poor frequency and phase response* in the rf-if amplifiers, as shown on GHO-1b and R-5h.
- (3) *Excessive ringing* in the video amplifier, as shown on GHO-1c and V-10a, rear.
- (4) In rare cases, *horizontal displacement of the interlaced fields*, as shown on GHO-1d.
- (5) *Any defect in the antenna system or in the rf-input circuits* that reduces the antenna signal to a level comparable to the signal picked up directly in the rf tuner.
- (6) In rare cases, *incorrect termination at both ends of an unusually long transmission line*. Reflections in the line may produce one or more closely-spaced ghosts of diminishing amplitude.

The symptoms and remedies for the first four troubles are fully described in the captions on GHO-1a to -1d respectively. No addi-

Continued on Page 24

RCA Television PICT-⊗-GUIDE

GHO-1a

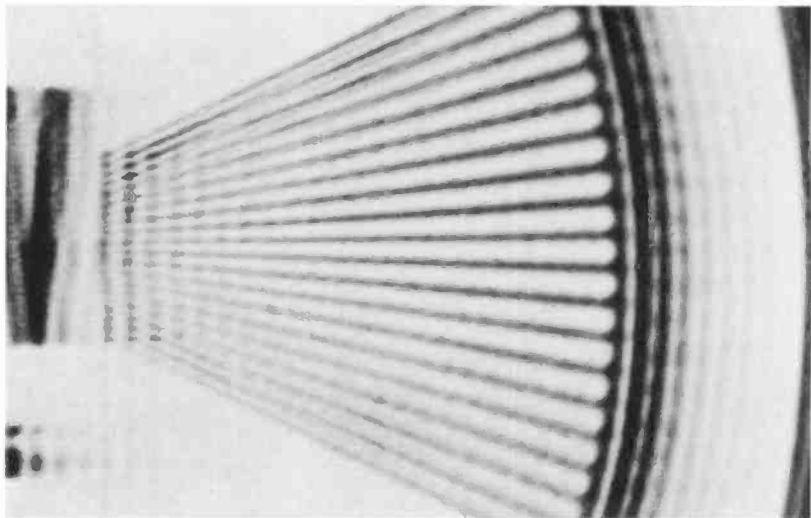

Multiple ghosts or “ringing” produced by regeneration in the picture-if amplifier. The fact that the ghosts are *uniformly spaced and progressively weaker* is a positive indication that they are



NOT caused by external signal reflections from buildings, hills, etc. Ghosts resulting from regeneration are usually present on only the weaker stations, because any tendency toward regeneration is strongest when the amplifier is operated at high gain; but, if the regeneration is occurring in a stage that has fixed bias (not controlled by AGC action), the ghosts may be present on strong stations also. (When multiple ghosts are caused by ringing in the *video amplifier*, as shown in GHO-1c, the effect is present on all stations, both strong and weak.) Regeneration in the picture-if amplifier is usually caused by incorrect alignment, open bypass capacitors in the screen, plate, or grid circuits, incorrect lead dress in and around the picture-if amplifier, and occasionally by tube trouble. Another photograph of regenerative ringing is shown on R-2.

Continued from Page 22

tional information is required except the following note for troubles 1 and 2:-

In order to detect any tendency toward regeneration in the picture-if amplifier, when the over-all rf-if response is checked, the output voltage of the sweep generator should be set approximately to the same level as the weakest station. The sweep output may be set correctly by measuring the AGC voltage on the weakest station, and

Continued on Page 28

RCA Television PICT--GUIDE

GHO-1b

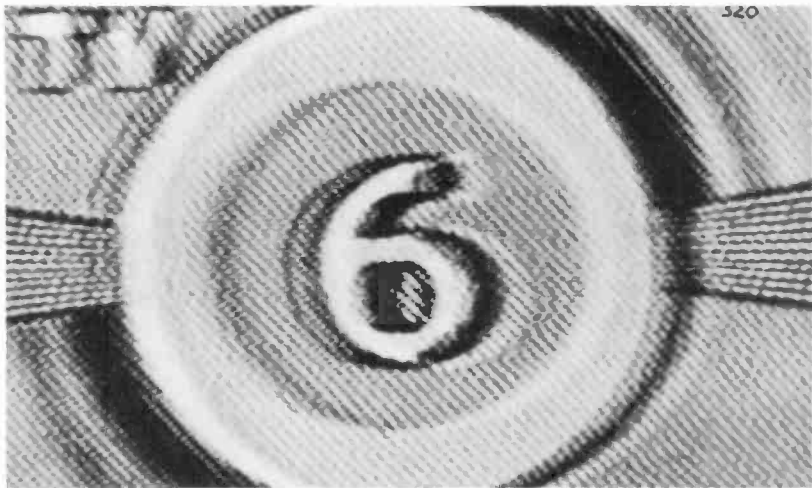

Example of "tunable ghosts" caused by phase shift due to poor rf-if alignment. (The 4.5-Mc sound-in-picture beat pattern in this photo is an incidental effect that happened to be present at the time the photo was made.) When the receiver is tuned over its normal



range around the correct tuning point, the appearance of tunable ghosts is altered, as follows:

- (a) The *spacing* between the direct signal and the ghost changes.
- (b) The *relative intensity* of the ghost changes.
- (c) The *polarity* of the ghost may change from black to white, or vice versa.

The fact that the ghosts are tunable indicates that they are NOT caused by external signal reflections: The relative spacing, intensity, and polarity of external ghosts are NOT altered by normal adjustment of the tuning control.

It should be noted that many receivers have additional gain or "high-peaking" in the video amplifier at about 3 or 4 Mc. High-peaking is used to increase the apparent definition or sharpness of the picture. If there is a large amount of high-peaking, it is likely to produce a white outline on the trailing or right-hand edges of black picture elements. This effect is termed "trailing reversal". Adjustment of the receiver tuning control, which acts to move the picture carrier up or down on the slope of the response curve, alters the over-all amount of high-peaking, and changes the intensity of the trailing white outline. This effect, which is fairly common, should not be mistaken for tunable ghosts. (White trailing outlines are present in some kinescope-recorded films, and are visible in the TV picture whether the receiver has high-peaking or not.)

RCA Television PICT--GUIDE

GHO-1c

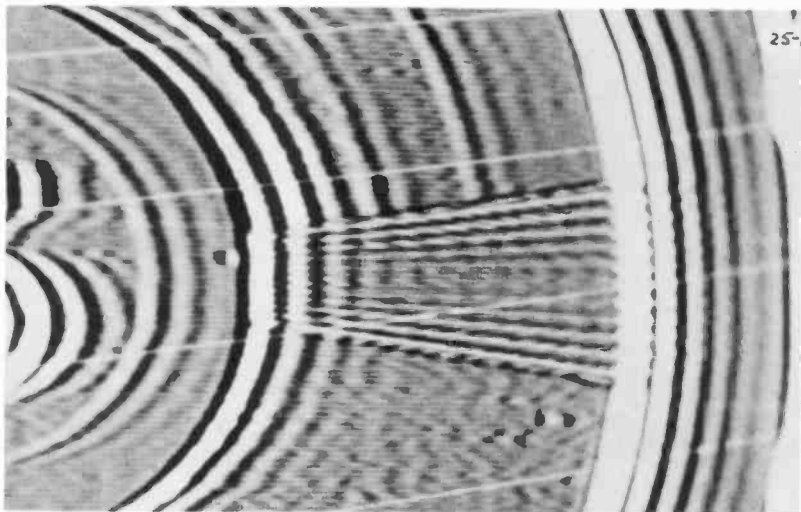

Multiple ghosts caused by ringing due to trouble in a video amplifier. The ghosts are present on all stations. The fact that the ghosts are *uniformly spaced and progressively weaker* indicates that the



ghosts are NOT produced by external signal reflections from buildings, hills, etc. The fact that the same ghosts are present on all stations is reason to suspect that the trouble is in the video amplifier. The remedy in this case is to locate and correct the defect in the video amplifier. The trouble in this example was caused by a shorted load resistor in a video plate circuit. Another photograph of this same effect is shown on the rear of V-10a.

Continued from Page 24

adjusting the sweep output to produce the same AGC voltage. The sweep should have a continuously-adjustable attenuator, with sufficient range to reduce the output voltage to a few microvolts. The shielding of the sweep generator must be effective, and the output cable should be correctly terminated. The author earnestly recommends the RCA WR-59B Sweep Generator for this purpose and for all other TV alignment work.

Ghosts Caused by Defects in the Antenna System or RF-Input Circuits

Because ghosts are fairly common in strong-signal metropolitan areas, *the fifth type of ghost trouble often escapes detection:*

Continued on Page 30

RCA Television PICT--GUIDE

GHO-1d

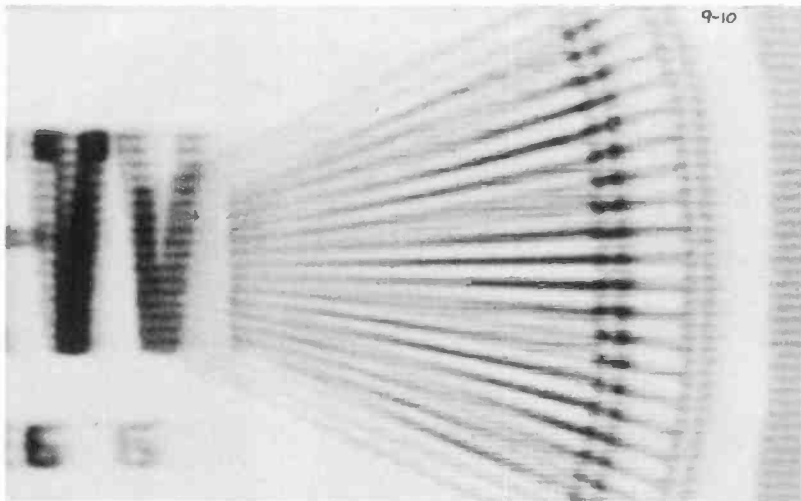

Double image produced by horizontal displacement of the interlaced fields, usually caused by incorrect adjustment of the horizontal-peaking or drive control, or by a low-value grid resistor in the



horizontal-output stage. *The displacement of picture elements in alternate horizontal scanning lines* is a definite indication that the double image is NOT caused by external signal reflection. When this trouble exists, and cannot be corrected by adjustment of the horizontal-peaking or drive control, it is necessary to try new tubes and check the components and voltages in the horizontal-deflection circuit. Another photograph of this same effect is shown in HD-2b, rear.

Continued from Page 28

Usually the ghosts that result from such trouble are naturally, but erroneously, blamed on the "bad location". It is the writer's belief, based on personal experience, that the fifth type of trouble occurs more frequently than the other five types combined.

Ghosts that are brought into the picture, as a result of defects in the antenna system or in the rf-input circuits, *actually arrive from external reflection surfaces*, but because the presence of the ghosts is due to trouble at the receiver, we have classified these ghosts as "built-in".

For the sake of brevity, the term "antenna signal" is used in this section to mean *the signal delivered from the antenna to the grid of the converter tube.*

Continued on Page 32

RCA Television PICT-⊗-GUIDE

GHO-1e

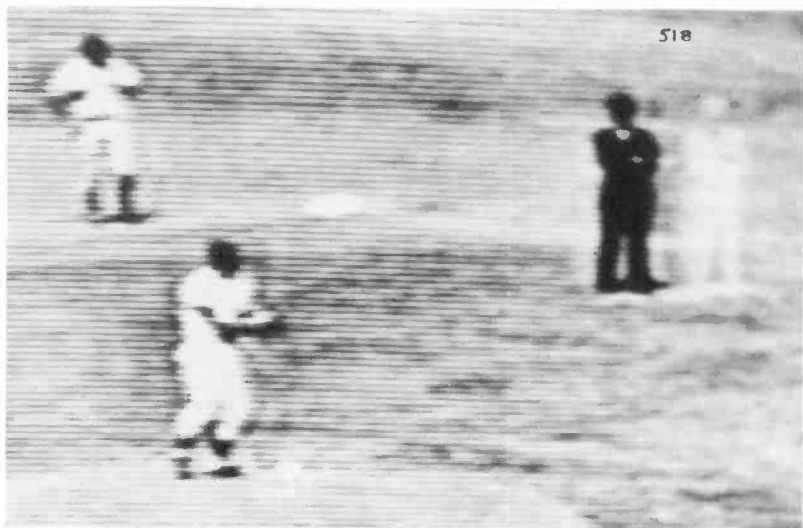

This photograph might be entitled "The strange case of the lonely ghost", because the umpire has a negative ghost but the players have none! The ump's ghost is not caused by external signal reflec-



tion, but is due to "sticking" or "memory" in the TV camera tube. Some types of camera tubes have a tendency to retain an impression of *stationary* objects in the original scene for a few seconds after the camera is "panned" or shifted to a different view. This photograph, which is a small portion of the complete scene, was snapped an instant after the TV camera was shifted slightly. The ump's ghost faded away a few seconds later. The dark heads, forearms, and legs of the players have not left ghost impressions because the players were constantly in motion, and their images did not have time to "burn" into the camera tube.

Continued from Page 30

The following information is based on the use of an outdoor antenna or an "attic" antenna, but with certain obvious exceptions, most of this information can be applied in cases where a built-in or indoor antenna is used.

The fifth type of ghost trouble is not illustrated because it produces a wide variety of effects, as described later. The trouble may be caused by any of the following defects in the antenna system or in the rf-input circuits:

- (a) Antenna oriented for a null on the particular station.

Continued on Page 36

RCA Television PICT-Ⓢ-GUIDE

GHO-2

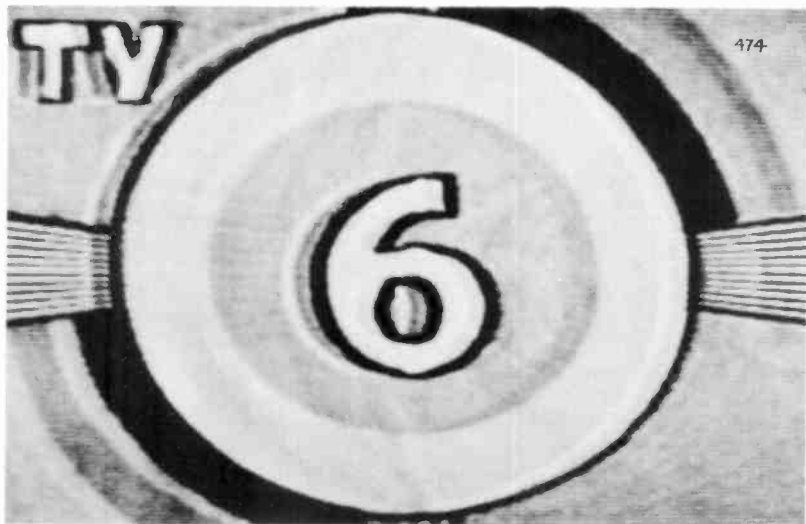

The photographs on GHO-2 to 2-c inclusive show how external ghosts are altered by orienting and positioning the antenna at a particular receiving location. With best orientation, the picture is



comparatively "clean" or free from ghosts, as shown in GHO-2c. In the photograph above, the white 6, at the left of the black 6, appears as a negative leading ghost, but it is actually the direct signal from the station. The black 6 which appears to be the direct signal, is a reflected signal or ghost. Time progresses from left to right on each horizontal scanning line: The signals for the white 6 arrive first, and must therefore come by the shortest path, direct from the station. In this particular example, the direct signals form a negative image because: (1) Due to incorrect antenna orientation, the reflected signal is stronger than the direct signal, and the strongest signal always forms an image of correct polarity; (2) The relative rf phases of the direct and reflected signals are opposite at any instant and oppose each other. If the antenna is moved toward or away from the station, the relative rf phase changes, and the direct and reflected signals may either aid or oppose each other, producing a positive or negative image, respectively, of the weaker signal.

RCA Television PICT-⊗-GUIDE

GHO-2a

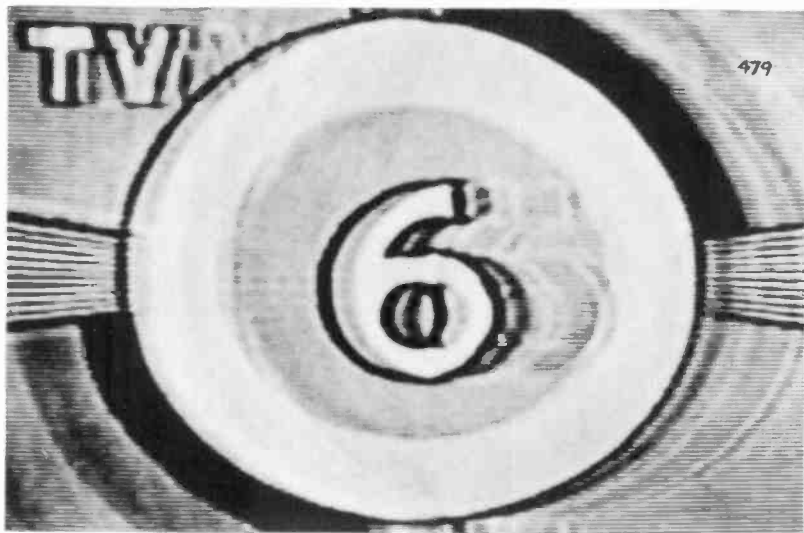

In the previous example, GHO-2, the direct signal is weaker than the reflected signal. By turning the antenna slightly, the direct signal becomes stronger than the reflected signals, and its polarity



becomes correct, as shown above. In this example there is one positive trailing ghost, and three weak negative trailing ghosts. Note that the ghosts are not uniformly spaced, and are not progressively weaker, as in the case of the built-in multiple ghosts shown on GHO-1a and 1c.

Continued from Page 32

- (b) Short circuit across the antenna terminals.
- (c) Transmission line disconnected from antenna.
- (d) Short-circuit or open circuit in transmission line.
- (e) Defective transformer, resistor, switch, or wiring in an antenna-distribution system.
- (f) Inoperative, defective, or weak rf amplifier in an antenna-distribution system.
- (g) Excessive attenuation in a distribution system.
- (h) Undesired presence of a stub acting as a short circuit across the receiver input terminals at the picture-carrier frequency of the particular station.
- (i) Open circuit or short circuit in an rf-input coil or transformer.

Continued on Page 38

RCA Television PICT--GUIDE

GHO-2b

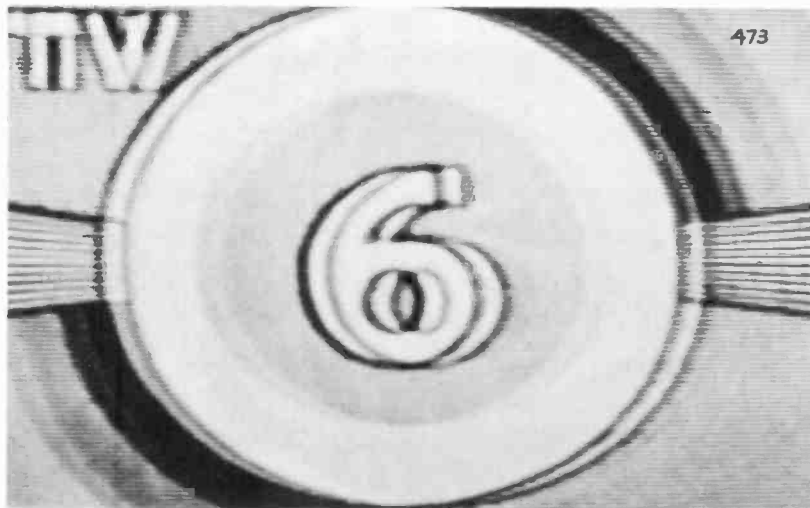

Slight additional rotation of the antenna practically eliminates the three negative trailing ghosts shown in GHO-2a, but there is still a strong positive trailing ghost, which is eliminated when the antenna is correctly oriented as shown in GHO-2c.



Continued from Page 36

- (j) An open in the circuit between the rf-input terminals and the grid of the rf amplifier.
- (k) Dead rf stage, due to circuit trouble or to a weak tube.
- (l) RF amplifier biased off, due to AGC trouble.
- (m) Loss of coupling between the rf amplifier and the converter.
- (o) Excessive signal pickup directly in the rf tuner, due to inadequate shielding, insufficient isolation, or other trouble.

Normally, when there is no defect in the antenna system or in the rf-input circuits, the antenna signal is very much stronger than the signals (from the same station) that are picked up directly in the rf tuner. The strong antenna signal acts through the AGC circuit to reduce the gain of the rf and picture-if amplifiers in the receiver. With reduced gain, there is not enough amplification to make the weak direct-pickup signals appear in the picture. Hence, *under normal conditions, the direct-pickup signals have no noticeable effect in the picture.* If, however, there is a defect in the antenna system, or in the rf-input circuits, the strength of the antenna signal may be reduced to approximately the same level as the direct-pickup signals. In this case, with weak input signals, the receiver operates at nearly full gain, due to AGC action, and the

Continued on Page 40

RCA Television PICT-O-GUIDE

GHO-2c

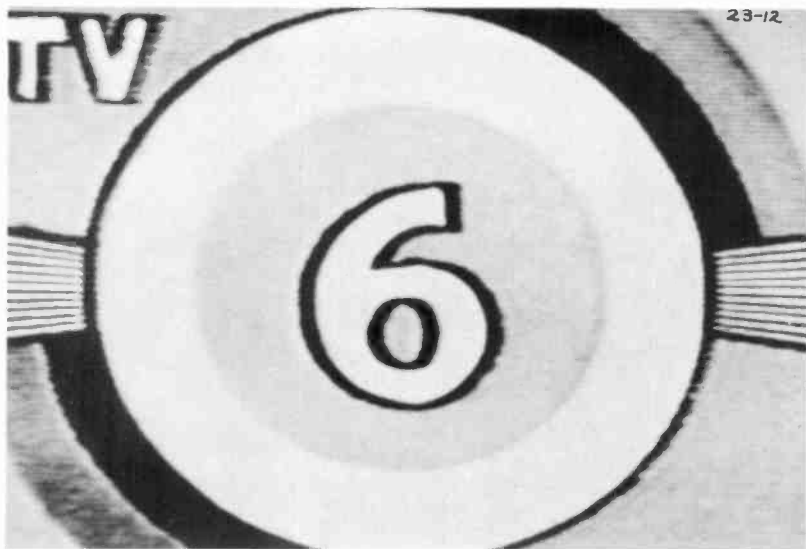

At the best angle of orientation for the particular location, there is only one faint trailing ghost as shown above. The reflected signals in this and the previous examples came from nearly the same



direction as the TV station. To obtain a ghost-free picture it was necessary to use a narrow-beam Yagi antenna with two directors and one reflector, cut for channel 6. With broader beam antennas, the trailing ghost is noticeably stronger.

Continued from Page 38

direct-pickup signals then appear in the picture. The resulting picture may be very weak or fairly strong; it may have good quality or poor quality; it may have no ghosts, one ghost, or numerous ghosts.

In weak-signal areas, any serious defect in the antenna system or in the rf-input circuits usually makes the picture extremely weak. The same result is produced in strong-signal areas if the rf tuner is perfectly shielded and isolated, or if the receiver is located in a room that is effectively shielded from direct and reflected signals.

The shielding and isolation of the rf tuner are seldom perfect. *In strong-signal areas, if the strength of the antenna signal is greatly reduced because of some defect, there is usually enough signal picked up in the rf tuner to produce a picture that seems to have normal strength.* The quality of the picture may be poor, and there may be ghosts, but these symptoms are fairly normal in strong-signal metropolitan areas, even with receivers and antennas that are in perfect operating condition. Under these cir-

○ cumstances, it is natural for the technician to assume that the ghost signals are being picked up on the antenna, and that the poor picture quality is due to the "bad location".

○ In strong-signal areas, there is usually a fairly high signal level inside the room in which the receiver is located. In metropolitan areas, a portion of the signal in the room may arrive in a direct path from the TV station, while other portions may arrive with various amounts of time delay after reflection from different surrounding buildings. The rf tuner usually has some slight pickup on all of these signals, *regardless of their incoming direction*. Hence, *when the antenna signal is seriously weakened, because of some defect, the picture produced by direct pickup in the rf tuner is likely to have one or more ghosts*. The weak signal from the antenna also produces an image.

○ In some cases, depending on the shielding effect of the building and the location of the room, one of the signals in the room may be very much stronger than the rest, and in this case the resulting picture produced by direct pickup in the rf tuner is free from ghosts.

○ In cases where there is a weak signal from the antenna and a signal of comparable strength due to pickup in the rf tuner, if the antenna transmission line is of normal length, the two signals do not form separate images, but merge together into a single image. The picture

quality in this case is likely to be poor, and the quality usually alters with change in position of persons in the room or near the receiver. Such change in position alters the intensity and rf phase of the direct-pickup signal, which aids or opposes the antenna signal and changes the picture quality.

When the picture quality or the ghosts are altered by movement of persons near the receiver, it is a positive indication that the outdoor-antenna signal is not sufficiently stronger than the direct-pickup signal. This condition is usually caused by a defect, such as listed previously, in the antenna system or in the rf-input circuits of the receiver.

In antenna distribution systems, where a single antenna array is used to feed several receivers, there may be ghosts or poor picture quality on some receivers in some rooms even though the distribution system and the receivers are in perfect operating condition. Such trouble occurs whenever the antenna signal is not sufficiently stronger than the direct-pickup signal. In this case it is necessary to increase the signal delivered to the receiver from the antenna system, or reduce the direct pickup in the receiver. In some receivers, the direct pickup can be reduced by installing additional shielding around the rf tuner and other rf-input components and wiring, or around the inside of the cabinet. In locations where there is likely to be trouble from direct pickup, it is usually advisable to use

coaxial cable in the distribution system and also between the distribution outlets and the input terminals on the rf tuners.

When confronted with a ghost-ridden picture, the technician's first inclination is to try reorienting the antenna. If it is not easy to reach the antenna, or if reorientation does not improve the picture, it is advisable to make some or all of the following checks:

1. Tune in one of the TV stations on which the ghosts are severe.
2. Move an arm around the receiver, toward and away from the rf tuner, and walk around in front of the receiver. If the ghosts or the intensity and quality of the picture change with movement of the arm or body, it is a definite indication that the antenna signal is not sufficiently stronger than the direct-pickup signal.
3. Disconnect the antenna transmission line from the receiver. If the picture quality and the ghosts are substantially the same with the line disconnected, it is further confirmation that the antenna signal is too weak.
4. Use a vacuum-tube voltmeter, such as the RCA VoltOhmyst WV-97A, to measure the voltage on the AGC bus, with the transmission line connected to the receiver, and with the line disconnected. The AGC voltage should be appreciably higher when the line is connected to the receiver. If there is no change,

or very little change in AGC voltage, it is an indication that the antenna signal is too weak.

5. When the antenna signal is found to be too weak, it is necessary to determine whether the trouble is in the antenna system or in the receiver. It is possible to try a new antenna and a new transmission line, or a new receiver. Usually it is easier to try a new antenna and line. Use an indoor antenna, a window antenna, or a temporary antenna on the roof, depending on the signal and reflection conditions and the shielding effects of the building in the particular location.
6. If the new antenna and line produce a better picture and reduce the number and intensity of ghosts, or make a very definite increase in AGC voltage, it is proof that the trouble is in the original antenna system. Typical faults are listed earlier in this section.
7. If the new antenna and line do not improve the picture and the ghosts, or do not make any noticeable increase in AGC voltage, the trouble is probably in the receiver, between the antenna input terminals and the converter grid. Check this portion of the receiver, or try a new receiver.
8. If there is a serious fault in the antenna system or in the rf-input circuits *at the time of initial installation*, and if the picture

that appears on the kinescope is produced by direct pickup in the rf tuner, it is difficult or impossible for the installation technicians to determine the correct angle of orientation for the antenna. The technicians will select an angle that seems to be best, but when the fault is eventually detected and corrected, the original orientation usually proves to be wrong. For this reason, *if there are still some ghosts in the picture after the fault has been corrected, it is necessary to reorient and/or reposition the antenna* to reduce the ghost signals that are being picked up on the antenna.

9. At the time of installation, or at any later date, if orientation of the antenna has little or no effect on the number and intensity of the ghosts, the installation men should make a simple check by temporarily short-circuiting the terminals on the antenna, or the transmission line. If the short circuit has little effect on the ghosts, it is almost always a definite sign of trouble in the antenna system or in the rf-input circuits.

The simple checks described above (movement of the arm; disconnection of the transmission line; check on AGC voltage with the line connected and disconnected; short circuit across the terminals of the antenna) often enable a technician to detect faults that are responsible for unsatisfactory ghost-ridden pictures. Technicians who work in strong-signal metropolitan areas, and technicians who

work on antenna-distribution systems, will find that these checks are very helpful in their work.

Another check to determine whether ghosts are caused by direct pickup, or are being received on the antenna, can be applied as follows:

- (a) Connect a low-resistance adjustable-bias voltage to the rf and if AGC bus in order to over-ride the AGC action.
- (b) Adjust the bias voltage for normal contrast on the particular station. Do not change this bias voltage in the following steps.
- (c) Disconnect the transmission line from the receiver, and if necessary, increase the brightness slightly to bring the raster into view.
- (d) If the picture disappears when the transmission line is disconnected, it indicates that the ghost signals are being picked up on the antenna. In this case it may help to reorient the antenna, use a more directive antenna, or use an antenna that has better front-to-back ratio on the particular channel.
- (e) If the picture and ghosts are still present when the antenna transmission line is disconnected from the receiver (with fixed bias voltage applied to the receiver), it indicates that the antenna signal is not sufficiently stronger than the direct-pickup signal. In this case, check for faults in the antenna system and

in the rf-input circuits.

In older receivers that do not have AGC, the above check can be made simply by setting the contrast control, which is an rf-if bias adjustment.

External Ghosts

Except for the built-in varieties described previously, most ghosts are caused by reception of signals that have been reflected to the receiving antenna from buildings, hills, or other large objects. Any reflected signal travels further than the signal that comes directly from the TV transmitter. It takes a little more time for the reflected signal to travel the additional distance. The reflected signal therefore arrives slightly later than the direct signal, and it forms a ghost or secondary image on the right-hand side of the direct-signal picture.

The only practical available method for reducing or eliminating external ghosts is to use an antenna with suitable directivity in order to minimize pickup of the reflected signals, and permit reception of the direct signal. This method cannot be applied if the reflected signal is coming from the same direction as the TV station, or from almost the same direction.

Most of the usual reflection conditions can be handled satisfactorily

by careful orientation of any good conventional type of multi-channel antenna, or by using a rotor to change the orientation for each station. In cases where multi-channel antennas are found to be unsatisfactory for certain reflection conditions, it is usually necessary to use a separate antenna for each of the channels on which the ghosts are troublesome. Each antenna should be designed for the particular channel to provide the best directivity. Sometimes the use of separate antennas is not practical, due to cost, space limitations, or other reasons, and the technician must attempt to find a satisfactory compromise.

The following brief pointers may be helpful to technicians who have to find the answers to external reflection problems:

1. In areas where ghosts are a serious problem, it is very important to know that the directional pattern and the front-to-back ratio of multi-channel TV antennas are considerably different on different channels. Most multi-channel antennas are "cut" for channel 2. The front-to-back voltage ratio of such antennas is about 4 to 1 on channel 2, but the ratio becomes less on each higher channel, and is usually only about 1 to 1 on channel 6. Hence, although the antenna has a reflector, it serves no purpose on channel 6, and has little effect on channels 4 and 5. A few multi-channel antennas are cut for channel 3. When these antennas are used on channel 2, the reception may be better from

the rear than from the front, because the reflector is too short for channel 2 and it acts as a director on this channel. Many types of multi-channel antennas, when used on channels 7 to 13, receive equally well from four or more different directions. *These changes in characteristics are of little or no importance in the vast majority of installations, but they may be responsible for failure in handling certain reflection problems and also certain interference problems, such as interference from two TV stations on the same or adjacent channels.*

2. Again it is emphasized that when the reflected signal is coming from the same direction as the TV station, or from almost the same direction, there is no practical antenna design (or other practical method) available for reducing or eliminating the ghost.
3. When the reflected signal is coming about ten degrees or more away from the direction of the TV station, use a narrow-beam Yagi antenna designed for the particular channel.
4. When the reflected signal is coming from a direction that is roughly at right-angles to the direction of the TV station, use any suitable antenna in which the response "off the ends" is very low for the particular channel.
5. When the reflected signal is coming from the rear (roughly 180

degrees from the direction of the station), use an antenna and reflector that is designed for the particular channel. If greater attenuation is necessary, use a Yagi antenna that is designed for best front-to-back ratio on the particular channel.

6. When several reflected signals are coming from various directions, use a Yagi antenna that is designed for the narrowest directivity pattern and the best front-to-back ratio on the particular channel.
7. When the previous 6 conditions are present on several channels, use a separate Yagi antenna for each channel, and use a separate transmission line for each antenna. If ribbon-type line is used, space the lines at least six inches apart to minimize cross coupling. If the antennas are stacked on one mast, space the antennas a half-wave or more apart.

Not all makes of Yagi type antennas are equally good. Try to select (by experiment, if necessary) a make that has satisfactory response at the picture-carrier frequency of the particular channel, good front-to-back ratio, narrow directivity pattern, and satisfactory match for the transmission line.

RCA Television PICT--GUIDE

HD-13

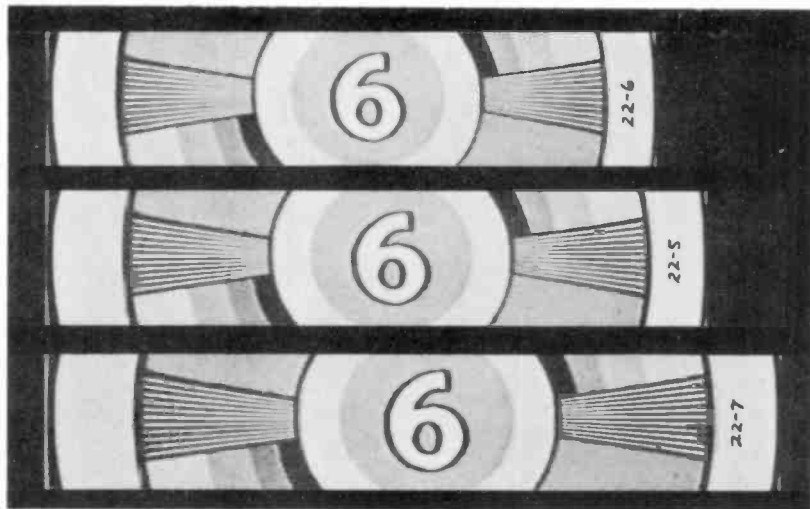

The width of the picture is effected by the line voltage as shown in these three photographs taken with line voltages of 105V (at top), 115V (center), and 125V (at bottom). When sufficient width cannot



be obtained by means of the horizontal adjustments (width, drive, and linearity), or by replacement of the power-rectifier tubes, it is advisable to check the line voltage.

INSUFFICIENT WIDTH

Insufficient width may be caused by one or more of the following faults:

1. Reduced amplitude of the output signal from the horizontal oscillator. Weak output from the horizontal oscillator may be caused by a defective tube or other component, or reduced plate voltage in the oscillator circuit.
2. A weak tube, a defective component, or reduced plate voltage in the horizontal-discharge or horizontal-output circuits.
3. Low line voltage, a weak power rectifier, or other defect in the B+ circuit.

The effect of reduced line voltage on the size of the picture is shown in the three photographs of HD-13, which were taken at three different values of line voltage: 125, 115, and 105 volts. *An RCA TV Isotap, WP-25A, was used to obtain the three different voltages.* (The Isotap has many valuable applications in TV ser-

Continued on Page 54

RCA Television PICT--GUIDE

HD-13a

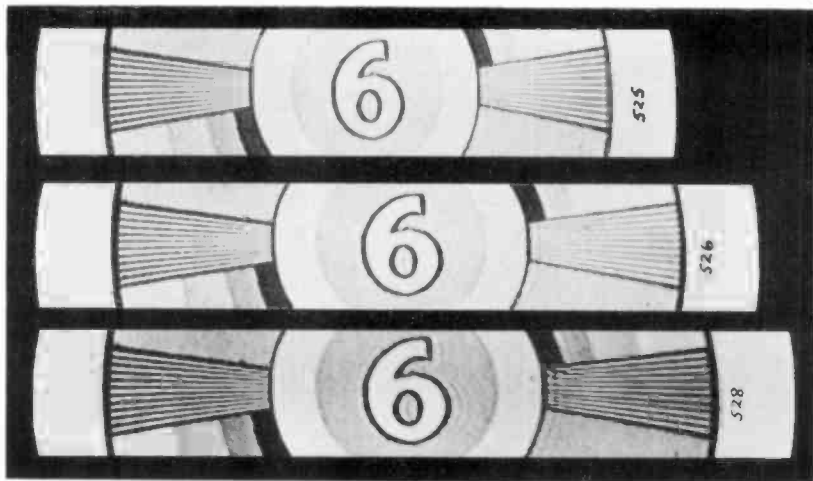

Showing how width of picture is affected by adjustment of width coil in 630TS type of horizontal-deflection circuit. At top; coil adjusted for minimum width. Center; coil adjusted for maximum width. At bottom; increased width obtained by opening the width coil.



Continued from Page 52

ving: It is particularly useful in revealing oscillator failure at low line voltage, and in accelerating certain intermittent troubles by application of high line voltage.) The brightness control was readjusted slightly in each case to maintain approximately the same brightness level. Other controls were not touched.

The fact that it is possible to increase the height of the picture beyond the top and bottom of the picture tube should not be regarded as an indication that the line voltage and B+ voltages are adequate.

To locate the cause of insufficient width, it is advisable to try new tubes in the horizontal oscillator, discharge, output and damper circuits, and in the B+ rectifier circuit. Also check the line voltage.

If the line voltage is normal, and if a new tube does not correct the condition, check the voltages and components in the horizontal oscillator and deflection circuits. If possible, check the peak-to-peak input and output voltage of each tube in the horizontal circuits, using a voltage-calibrated cathode-ray oscilloscope, such as the RCA WO-56A, or an electronic voltmeter that can read peak-to-peak voltage, such as the RCA WV-97A.

Continued on Page 56

RCA Television PICT-O-GUIDE

HD-13b

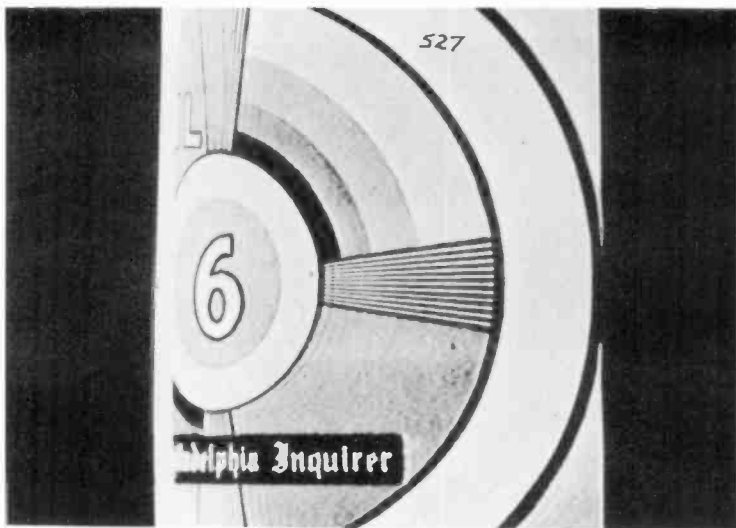

Fold-over at left due to short-circuited width coil in 630TS type of horizontal-deflection circuit.



Obtaining Increased Width

Occasionally it is necessary to obtain more width than was provided in the original design of the receiver. For example, more width is required when the mask is changed from a straight-sided shape to one with curved sides. If there is insufficient reserve power for the extra horizontal deflection, it is necessary to alter the deflection circuit slightly. In horizontal-deflection circuit similar to that used in the RCA model 630TS, additional width can be obtained by connecting a capacitor of approximately $0.05 \mu\text{f}$ across the width coil, or by opening the width coil. The comparative effect of opening the width coil in this deflection circuit is shown in HD-13a. In some projection-type receivers, it is possible to obtain appreciable increases in width and height by moving the deflection yoke slightly back toward the socket-end of the picture tube. This expedient is seldom practical on other types of receivers due to beam cutoff by the neck of the tube.

RCA Television PICT-O-GUIDE

HD-14

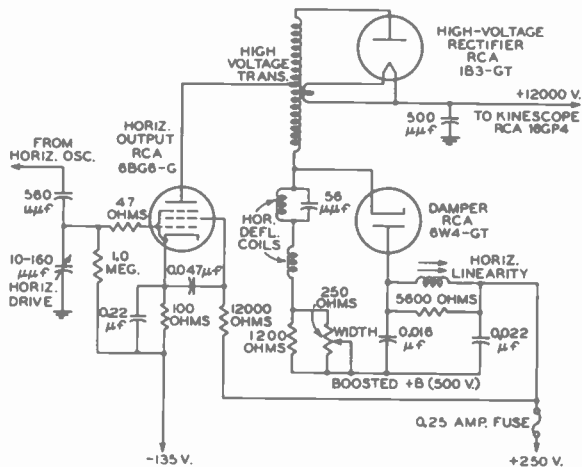

Direct-drive horizontal-deflection circuit used in many TV receivers. The horizontal-deflection coils are connected in *series* with the plate winding of the high-voltage transformer. Photographs of troubles in this circuit are shown on the reverse side and on HO-14a and -14b.



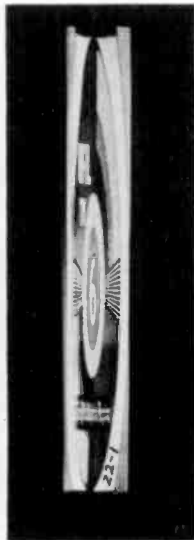
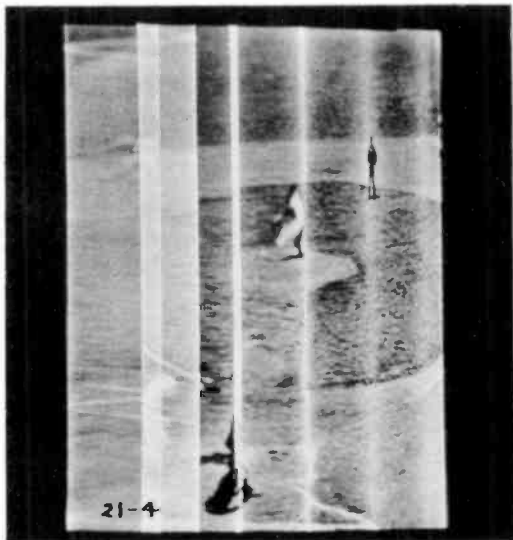

Effects of open circuit and short circuit in the $0.018\text{-}\mu\text{f}$ capacitor in damper circuit shown on reverse side of this card.

RCA Television PICT--GUIDE

HD-14a

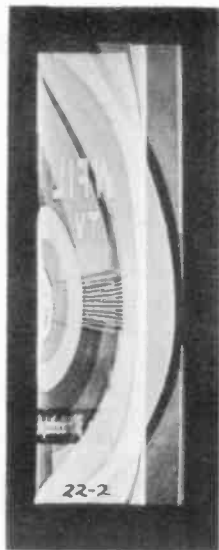

Effects of open circuit and short circuit in 0.022- μ f capacitor in damper circuit shown on HD-14.



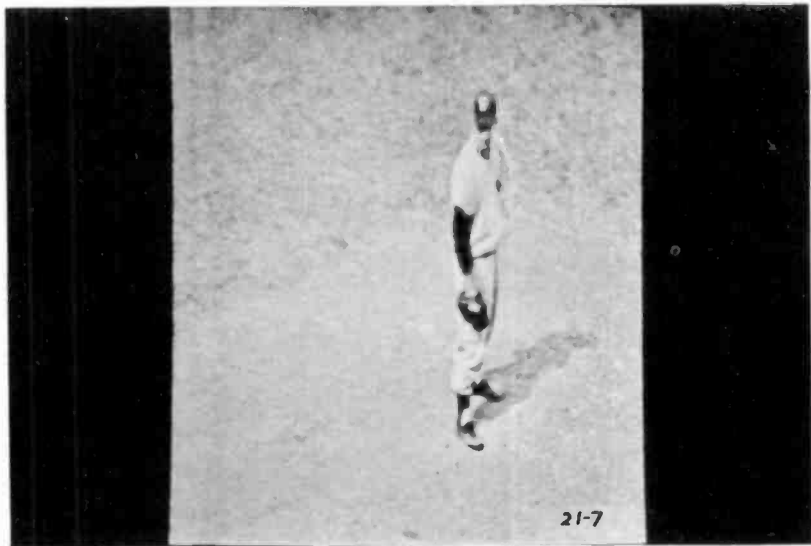

Narrow picture width produced by an open linearity coil in the damper circuit shown on HD-14.

RCA Television PICT-O-GUIDE

HD-14b

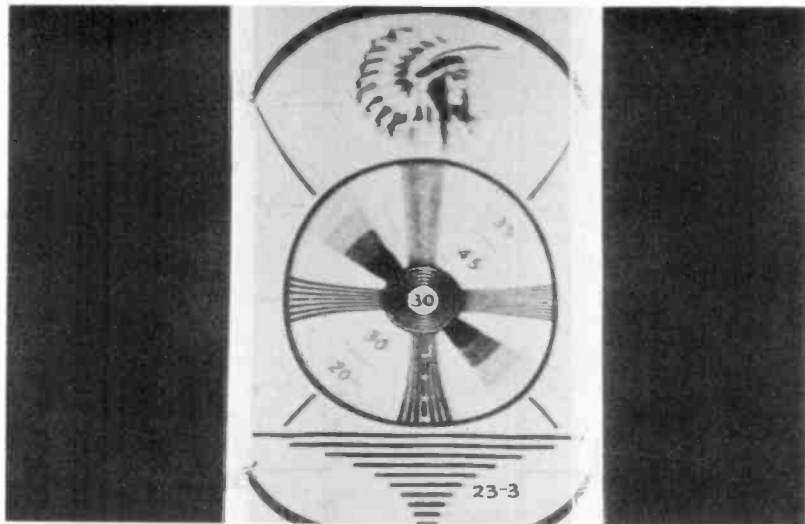

Fold-over at left and right sides of raster produced by changing grid resistor of horizontal-output tube from 1.0 megohm to 40,000 ohms in circuit shown on HD-14.





Fold-over at left and right sides of raster produced by leakage of 400,000 ohms across grid coupling capacitor in circuit shown on HD-14.

VISIBLE SYMPTOMS OF HUM TROUBLES

Undesired hum voltages in a television receiver may produce either visible or audible symptoms, or a combination of both. This section covers the localization of hum troubles that produce visible symptoms in the picture, with or without any accompanying audible effects.

Success in visual analysis of hum troubles depends on the correct answers to the following questions:

1. Do the visible hum symptoms occur at 60 cycles, or at 120 cycles?
2. Are there changes of brightness between the top and bottom of the picture?
3. Is there horizontal pulling (one or two cycles) between the top and bottom of the picture?
4. Are the symptoms in items 2 and 3 *both* present in the picture?
5. Do the visible symptoms in items 2 and 3 remain in view on the raster, or disappear, when the picture signal is removed?
6. Are the visible symptoms accompanied by excessive audible hum from the speaker?

Each of these symptoms furnishes a definite clue, and the combination of such clues generally points unerringly to a particular section of the receiver. After the trouble has been localized, a routine check of the tubes, (and other components) and voltages in the suspected section will reveal the exact fault.

To become expert in recognizing and isolating the sources of hum trouble, it is advisable for the technician to duplicate the conditions shown in the accompanying photographs. The effects of leakage between the heater and cathode of a tube can be simulated by connecting an adjustable resistor from the cathode to the ungrounded heater terminal. This method does not always duplicate the exact effects of emission-type leakage, but it is entirely satisfactory for purposes of study.

For simplicity in this article, it is assumed that the receiver is operated from a 60-cycle supply, in which case visible hum symptoms occur at either 60 or 120 cycles per second. If the receiver is operated on a 50-cycle supply, which is used in some areas, the hum symptoms will occur at 50 or 100 cycles. When the receiver is operated through an inverter from a dc supply, the rate of any visible hum symptoms depends on the frequency of the inverter output.

Continued on Page 66

RCA Television PICT-O-GUIDE

HUM-1a

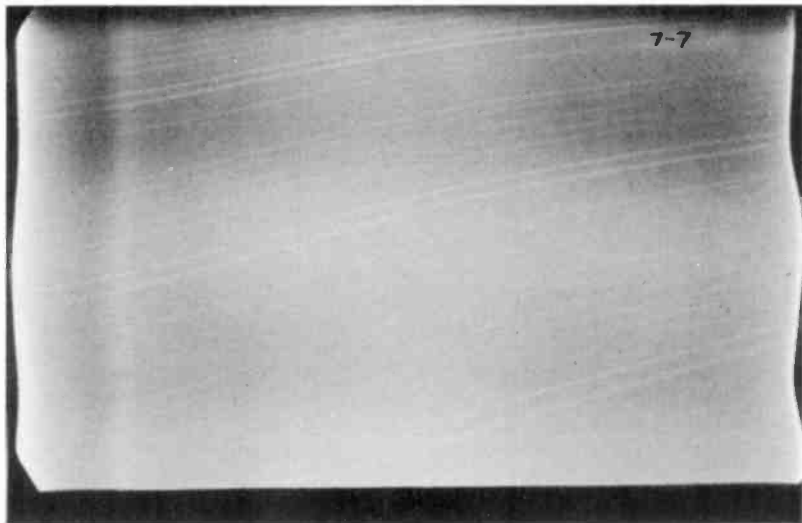

Two cycles of change in width, and two cycles of change in brightness (hum bars) between the top and bottom of the raster (vertical oscillator running at 60 cycles). The two cycles occur in $1/60$ th



second, indicating that the hum trouble is 120 cycles and that it originates in the B supply. The trouble was caused by open B+ filter capacitors, which resulted in excessive 120-cycle ripple in the B-voltage, changing the width and brightness of the raster at a 120-cycle rate. HUM-1b to 1i, show examples of 60-cycle hum trouble caused by heater-cathode leakage.

Continued from Page 64

Two Principal Types of Hum Symptoms

One of the first steps in localizing the source of hum trouble is to determine, from an analysis of the visible symptoms, whether the hum is occurring at a 60- or 120-cycle rate.

Hum at a 60-cycle rate generally indicates heater-cathode leakage in a tube.

Hum at a 120-cycle rate usually indicates trouble in the B-supply circuit.

A few exceptions to these general rules are mentioned later.

It is easy to determine whether the visible symptoms are occurring at 60 cycles, or at 120 cycles:

Continued on Page 68

RCA Television PICT-⊗-GUIDE

HUM-1b

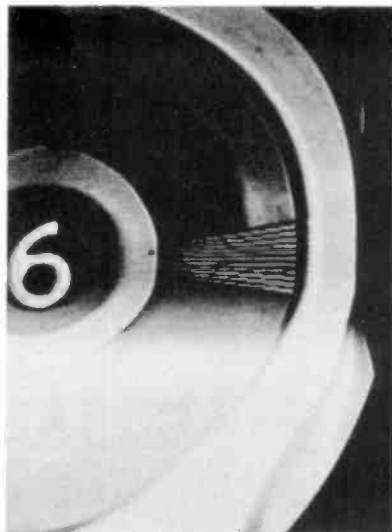
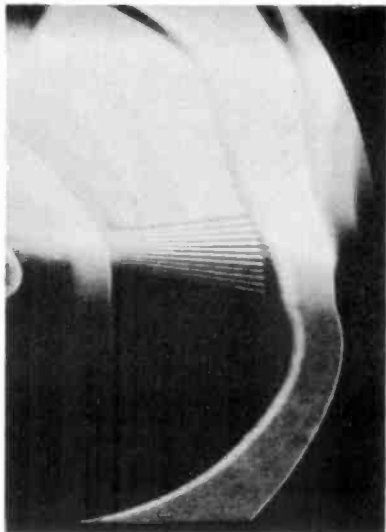

One cycle of change in brightness (60-cycle hum bars) and one cycle of horizontal pulling, between top and bottom of picture, indicates heater-cathode leakage in the rf, if, or video amplifiers. The trouble



in this example was caused by a defective tube in the picture-if amplifier. The 60-cycle leakage current flows through the cathode resistor and modulates the TV signal. The position of the hum symptoms is shifted, as shown above at left and right, by reversing the power-cord plug.

Continued from Page 66

If there is only one cycle of hum bars, and/or one cycle of horizontal pulling, between the top and bottom of the picture, the trouble is caused by 60-cycle hum.

If there are two cycles of hum bars, and/or two cycles of horizontal pulling, between the top and bottom of the picture, the trouble is caused by 120-cycle hum.

120-Cycle Hum Symptoms

Most television receivers utilize full-wave rectification in the B-supply circuit. The output of a full-wave rectifier, operating from a 60-cycle supply, consists of 120-cycle pulsating dc. The pulsations are normally smoothed into pure dc by the action of filter capacitors and chokes. However, if there are any serious defects in the filtering circuits, such as open filter capacitors, some or all of the B+ and B-

Continued on Page 70

RCA Television PICT--GUIDE

HUM-1c

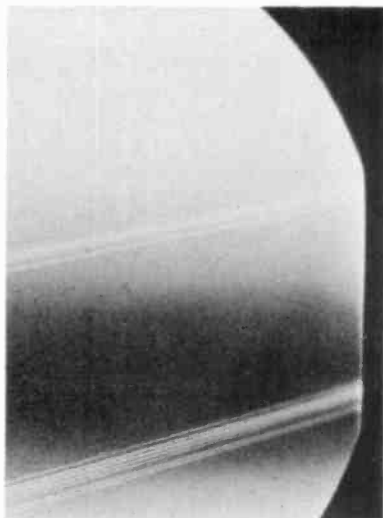
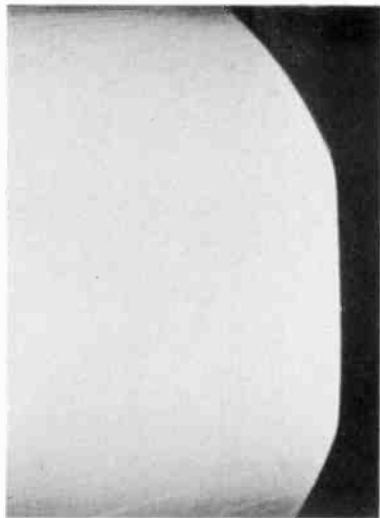

The presence of 60-cycle hum bars on the raster alone (without TV or other signal) indicates heater-cathode leakage in the video amplifier section, which includes the 2nd detector, dc restorer, and



kinescope. Normally, the vertical oscillator tends to sync on the leading edge of the dark bar, as shown above at left. The entire dark bar may be brought into view by adjusting the vertical hold control, as shown above at right. The leakage in this example was simulated by connecting a 1000-ohm resistor from the cathode to the ungrounded heater terminal in a video stage that has a 330-ohm cathode resistor. (Refer to HUM-1d.)

Continued from Page 68

voltages will have excessive 120-cycle ripple, or variation in voltage, which may produce 120 cycle hum trouble in several sections of the receiver.

Open filter capacitors in the B- filter circuit produced the visible hum symptoms shown in HUM-1a where there are two cycles of change in the amplitude of horizontal deflection (two cycles of variation in the length of the horizontal scanning lines), between the top and bottom of the raster. Also, there are two cycles of hum bars, or graduation in brightness, between the top and bottom of the raster.

When the photograph for HUM-1a was made, the vertical-hold control was adjusted for the correct vertical-deflection rate of 60 cycles while a TV station was received, and the rf-if gain was

Continued on Page 72

RCA Television PICT--GUIDE

HUM-1d

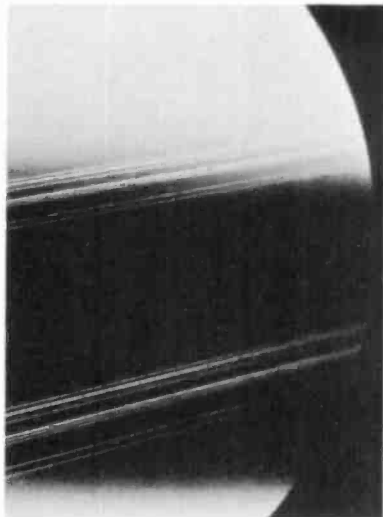
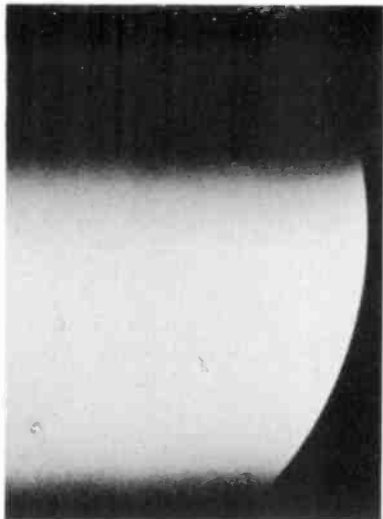

Same trouble as in HUM-1e, except that the heater-cathode leakage is 400 ohms instead of 1000 ohms; note that the 60-cycle hum bars are more pronounced.



Continued from Page 70

reduced until the TV picture became invisible, leaving only the raster in sight on the kinescope. As the gain was reduced, the vertical-hold control was slightly readjusted to maintain the vertical-deflection rate of 60 cycles. *There are two cycles of change in width (and also in brightness) in 1/60th second, indicating that the hum voltage is occurring at 120 cycles per second, and that the trouble, therefore, is in the B- filter circuit. If the hum symptoms occurred at 60 cycles, there would be only one cycle of change in width (and brightness) between the top and bottom of the raster.*

Excessive hum voltage on some or all of the B-output taps usually affects more than one section of the receiver, and results in some or all of the following symptoms:

1. Excessive audible hum from the speaker, caused by hum voltage on the B+ or B- leads to the audio amplifier. The intensity of the hum is not affected by turning the audio volume control.
2. 120-cycle hum bars (two cycles of change in brightness between the top and bottom of the raster), caused by hum voltage in the B-supply to the video amplifier. *The hum bars in this case are present on the raster with or without a picture.* If there is 120-cycle hum on the B-supply to the rf-if amplifiers, but none

Continued on Page 74

RCA Television PICT-⊗-GUIDE

HUM-1e

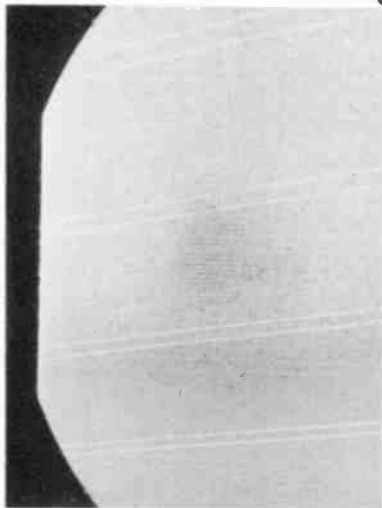
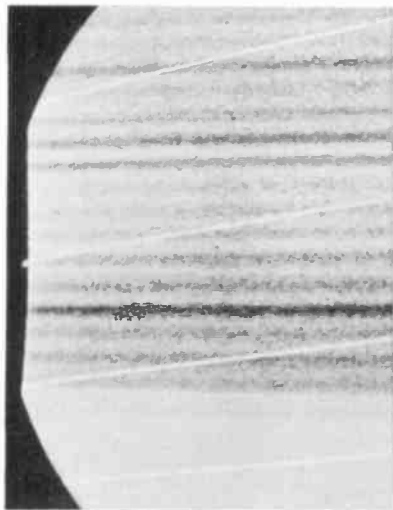

Heater-cathode leakage in a tube in the rf or picture-if amplifier modulates any signal passing through these amplifiers, including "grain noise" or "snow" signals, as shown at left, or FM signals, as



shown at right. Note that in each case the top portion of the raster is devoid of signal. The leakage current reduces the gain of the stage during the time corresponding to the blank portion.

The same effect is evident at the center of HUM-1f and the top and bottom of HUM-1g. Like many other troubles in electronic equipment, heater-cathode leakage can be intermittent, starting or stopping as the tube warms up. The particular tube used when these photographs were made had intermittent heater-cathode leakage.

Continued from Page 72

on the video amplifier, the hum bars disappear when the TV picture is "killed" by removing or disabling one of the tubes in the picture-if amplifier. (It should be noted that faint hum bars can be seen on almost any receiver when the raster is viewed in a darkened room at low-brightness level.)

3. 120-cycle change in width between the top and bottom of the raster, caused by hum voltage in the B-supply for the horizontal-deflection section. The change in raster width is present *with* or *without* a TV picture. Under normal conditions, the left- and right-hand edges of the raster are substantially straight and parallel.

Continued on Page 76

RCA Television PICT-⊗-GUIDE

HUM-1f



In addition to 60-cycle change in picture brightness, heater-cathode leakage in the rf, if, or video amplifiers may also produce 60-cycle horizontal pulling in the picture. Both effects are evident in this



example, which was produced by heater-cathode leakage in a tube in the picture-if amplifier (Refer to HUM-1g and the note at the end of the caption for HUM-1i).

Continued from Page 74

4. 120-cycle horizontal picture pulling (two cycles of variation in horizontal-sync phasing), caused by hum voltage in the B-supply for the horizontal-afc section, the sync-separator section, the video amplifier, or the rf-if amplifier.

If the hum voltage is present only in the horizontal-afc or sync-separator sections, the pulling is not accompanied by hum bars. If the hum voltage is present in the rf-if or video amplifiers, the pulling is generally accompanied by hum bars.

When some or all of the above symptoms are present, it is advisable to check the B-supply filter circuit. A simple check can be made by connecting an external electrolytic capacitor temporarily across each of the suspected filter capacitors, in turn, and noting whether the symptoms disappear.

60-Cycle Hum Symptoms

It is well to remember that 60-cycle supply voltage is present only

Continued on Page 78

RCA Television PICT-⊕-GUIDE

HUM-1g



Same condition as in HUM-1f except that the position of the hum symptoms has been shifted by reversing the power-cord plug.



Continued from Page 76

in the power transformer, the power-rectifier plate circuit, and the heater circuits. The transformer and the rectifier plate circuit are rarely responsible for producing 60-cycle hum symptoms; a few exceptions are noted later. Visible symptoms of 60-cycle hum can almost always be traced to the heater circuits, or more specifically, to heater-cathode leakage in a tube. Such leakage permits the effect of the 60-cycle heater voltage to get into the television circuits via the cathode circuit of the tube.

Leakage between the heater and cathode of a tube may be caused by (a) faulty insulation between the two elements, or by (b) emission of electrons from heater to cathode, or vice versa, depending on the voltage difference and polarity of the two elements.

Leakage of any type between heater and cathode results in a flow of 60-cycle "hum" current through the cathode circuit during at least a portion of each 1/60th second. Such leakage current *may or may not* produce audible or visible hum symptoms, depending largely on the value of any resistance or 60-cycle impedance in the cathode circuit. Even a small amount of leakage current is likely to cause hum symptoms if there is a high value of resistance or 60-cycle impedance in the cathode circuit. Conversely, a large amount of leakage current is unlikely to cause hum trouble if there is no resistance or 60-cycle impedance in the cathode circuit.

Continued on Page 80

RCA Television PICT-⊗-GUIDE

HUM-1h

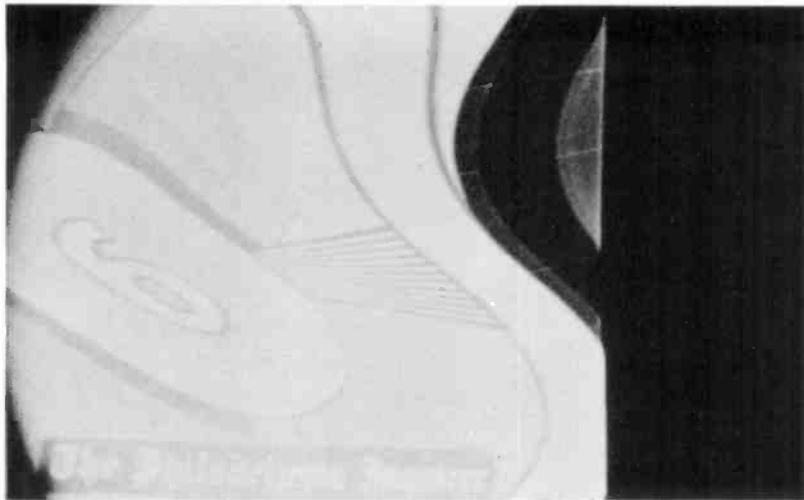

60-cycle horizontal picture pulling, without any 60-cycle change in brightness, indicates that the trouble is in the horizontal-afc or oscillator sections, or in the sync separator. The absence of 60-cycle hum bars indicates that the trouble is not in the rf, if, or video



sections. The horizontal pulling shown in this example was produced by heater-cathode leakage in a horizontal-afc tube. The pulling is evident only when a TV signal is being received; it is not present on the raster alone. (See the note at the end of the caption for HUM-1i.)

Continued from Page 78

The above factors (the voltage difference, and polarity, between heater and cathode, and the value of resistance or 60-cycle impedance in the cathode circuit) account for the fact that a particular tube may cause hum trouble when it is used in one circuit of a receiver, but may operate without any sign of hum trouble when transferred to a different circuit.

Diode circuits such as second detectors, dc restorers, horizontal-sync discriminators, and FM-sound discriminators, usually have a high value of resistance in the cathode circuit, and therefore are easily affected by heater-cathode leakage.

When the visible hum symptoms occur at 60 cycles, which generally indicates heater-cathode leakage, the following information may be applied in localizing the faulty tube:

- 1. 60-cycle hum bars, or one cycle of change in brightness between**

Continued on Page 82

RCA Television PICT--GUIDE

HUM-1i

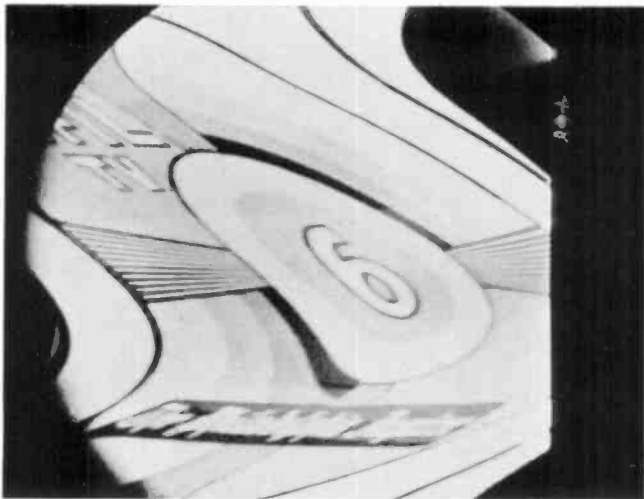

Severe 60-cycle horizontal picture pulling produced by heater-cathode leakage in a horizontal-afc discriminator. Horizontal picture pulling results from variation in horizontal sync phasing. (Note—In making the photographs for HUM-1f, -1g, -1h, and 1i, the picture on



the kinescope was intentionally moved toward the left in order to bring the right-hand edge of the raster into view to show that the edge of the raster is straight; horizontal picture pulling does not affect the shape of the raster.)

Continued from Page 80

the top and bottom of the picture, as shown in HUM-1b to HUM-1g inclusive.

Temporarily "kill" the picture by removing a tube from the picture-if amplifier if necessary. If the hum bars remain present on the raster, it indicates that the trouble is in the video amplifier, which includes the second detector, the dc restorer, and the kinescope. Try new tubes in this section.

When a tube with heater-cathode leakage is used in the video amplifier, which has good response at 60-cycles, the hum voltage passes through the amplifier and appears on the kinescope, regardless of whether a signal is passing through the receiver.

If the hum bars disappear when the picture signal is killed, it indicates that the trouble is in the rf or picture-if amplifiers, including the rf oscillator and the converter. Try new tubes in these sections.

60-cycle hum voltage, produced by heater-cathode leakage in an rf or picture-if tube, cannot by itself pass through these amplifiers which respond only to rf or if signals. However, such hum voltage, can and does act to modulate any rf or if signal that is passing through the amplifiers. *For this reason, the effects of heater-cathode leakage in the rf or if amplifiers do not appear on the kinescope unless a signal is being received.* The signal does not have to be from a TV station. It can be "grain noise," FM, or other signals, as shown in HUM-1e.

As mentioned previously, there is unlikely to be hum trouble from heater-cathode leakage in stages where the cathode is connected directly to the chassis or B—. This fact can sometimes be used to advantage in isolating a faulty tube. For instance, if the symptoms indicate that the hum trouble is caused by heater-cathode leakage in the rf or picture-if amplifiers, it is possible, in many receivers to temporarily short out the cathode resistor of each stage, in turn. The hum symptoms will disappear when the cathode resistor of the faulty tube is shorted out. This method is useful only where the normal operation of the stage is not seriously altered when the cathode resistor is short circuited. It is not advisable, in any case, to short out a cathode resistor permanently. The correct remedy, after isolating the faulty tube, is to install a new tube.

2. **60-cycle horizontal picture pulling, or one cycle of horizontal pulling between the top and bottom of the picture, as shown in HUM-1b, and HUM-1f to 1i.**

When 60-cycle horizontal picture pulling occurs, without accompanying 60-cycle hum bars, as shown in HUM-1h and 1i, the trouble is most likely to be found in the horizontal-afc and oscillator sections, or in the sync-separator section. Heater-cathode leakage in these sections may produce 60-cycle variation in horizontal-sync phasing, which appears as 60-cycle horizontal picture pulling. *The pulling is present only on the picture, not on the raster, and it disappears when the TV signal is removed.* The remedy is to try new tubes in these sections.

3. **Combination of 60-cycle hum bars, and 60-cycle horizontal picture pulling, as shown in HUM-1b, 1f, and 1g.**

The effects of hum voltage due to heater-cathode leakage in a tube in the rf, if, or video amplifiers may produce both 60-cycle hum bars and 60-cycle horizontal pulling. The presence of the 60-cycle hum bars indicates that the trouble is *ahead* of the kinescope (in the rf, if, or video amplifiers). The procedure for localizing the faulty tube is, therefore, the same as given previously under item 1 for "60-cycle hum bars."

Again it is pointed out that the second detector, dc restorer, and

○ kinescope are part of the video-amplifier section—*heater-cathode leakage in these tubes produces the same type of hum symptoms as those produced by the amplifier tubes in the video section.*

Stationary and Moving Hum Symptoms

○ Hum bars and horizontal pulling (resulting from hum trouble in the receiver may remain stationary or may move slowly or rapidly up or down on the picture. The symptoms remain stationary when the ac supplies for the TV station and the receiver are in sync. The symptoms move up or down when these supplies are not in sync.

“Hum Symptoms” Due to External Interference

External interfering signals with 60- or 120-cycle AM or FM modulation (such as generated by some types of diathermy equipment) may produce visible symptoms similar to internal hum. When the hum symptoms are produced by external interference, they are usually accompanied by a visible beat.

○ In the case of *60-cycle* hum symptoms, a simple and positive check can be made by reversing the power-cord plug. If the 60-cycle hum bars or horizontal pulling are caused by internal hum trouble, such

as heater-cathode leakage, the hum symptoms will shift in position by about one-half of the height of the picture whenever the plug is reversed. Reversal of the plug has no effect on the position of "hum symptoms" resulting from external interference.

A Few Exceptions

1. Visible hum symptoms resulting from trouble in the B-filter circuit normally occur at 120-cycles, but in the rare case where one-half of a full-wave rectifier circuit opens, any resulting hum symptoms occur at 60-cycles.
2. The filter capacitor at any one of the output taps on the B-supply usually serves to prevent common coupling between the sections of the receiver that are fed from the particular tap. If the capacitor opens, there may be interaction between the sections. For example, an open filter capacitor in the B-feed to the vertical-output section may permit vertical-deflection voltage to set up 60-cycle hum symptoms in other sections. In general, when it is observed that signals in one section are modulating other sections, it is advisable to check the filter capacitors.
3. If 60-cycle hum bars remain present on the raster when the picture signal is killed, it generally indicates heater-cathode leakage in the video amplifier.

RCA Television PICT--GUIDE

K-9

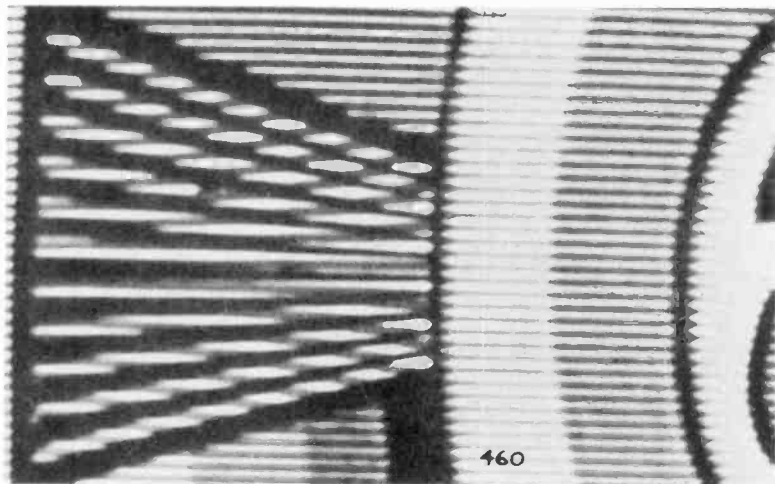

Enlarged section of photograph to show how grey is produced in the picture by a decrease in the diameter of the scanning spot. To note the general effect, view this photo from a distance of about 10 feet. Photo, taken with shutter speed of 1/60th second, shows only one field.



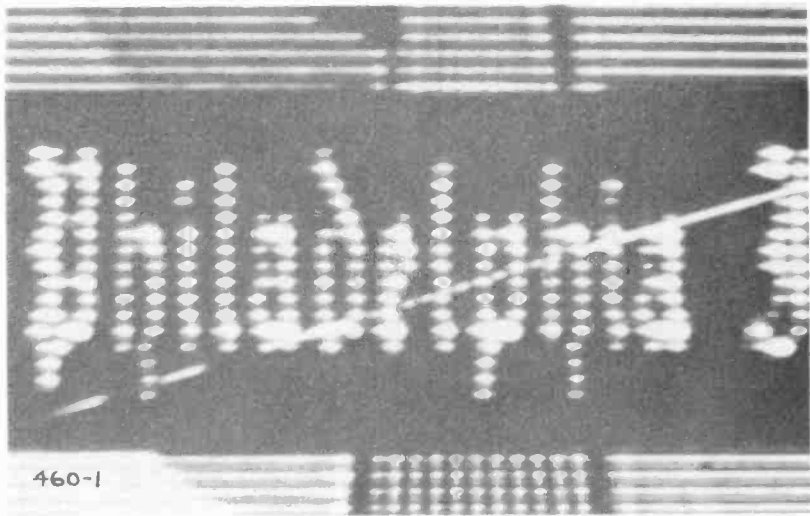

Enlarged section of photo to show how lettering is produced in picture. To note general effect, view this photo from a distance of about 10 feet. Photo, taken with shutter speed of $1/60$ th second, shows only one field.

RCA Television PICT-⊗-GUIDE

K-9a

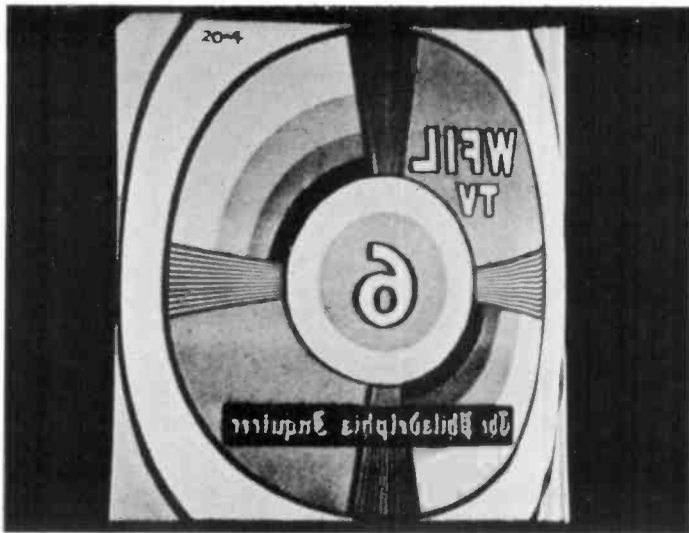

Picture is reversed from left to right by reversing the leads to the horizontal-deflection coils. See other side of this card for effect of reversing the vertical-deflection coil leads.





Picture is inverted from top to bottom by reversing the leads to the vertical-deflection coils, or to the primary or secondary of the vertical-output transformer.

RCA Television PICT-O-GUIDE

K-10

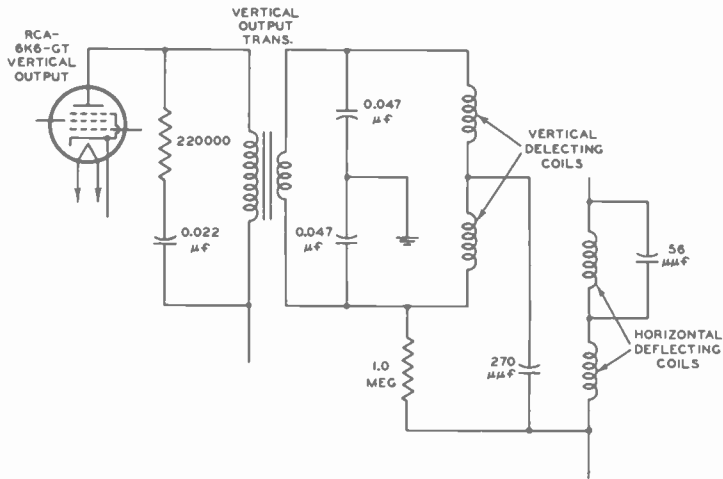

Portion of a vertical-deflection circuit: The horizontal-deflection circuit in the same receiver is shown on HD-14. See K-10a, -10b, and -10c for photographs of troubles in this deflection-coil circuit. Also refer to VO-9a.



The vertical bars on left side of raster are produced by ringing in the yoke circuits. The intensity of the ringing shown here is normal in many receivers. (Photo shows about one-half of total width and height of raster.)

RCA Television PICT--GUIDE

K-10a

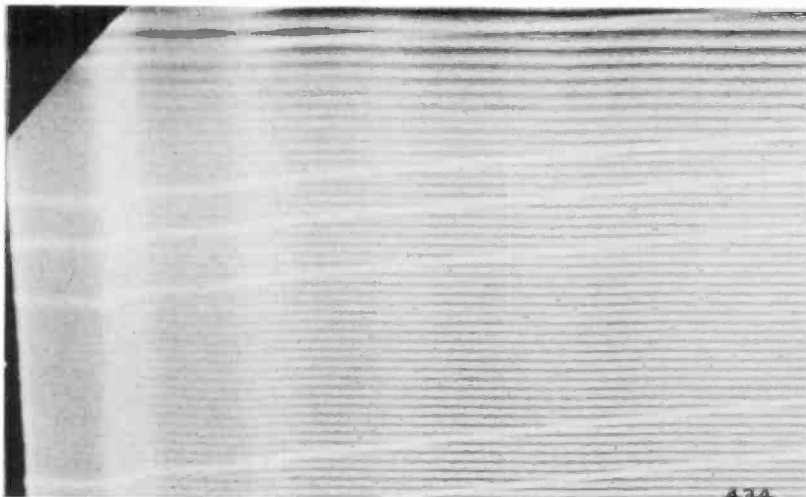

The intensity of the vertical bars on left side of raster is greatly increased by an open circuit in the capacitor connected across half of the horizontal deflection coils shown on K-10. (Photo shows about one-half the total width and height of raster.)



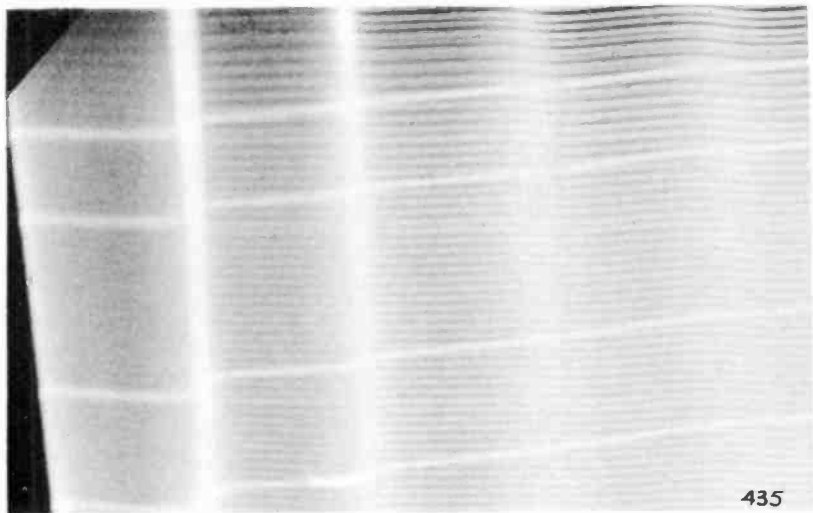

The intensity of the vertical bars on left side of raster is greatly increased when the 56-uuf capacitor is connected across the wrong half of the horizontal-deflection coils shown on K-10. (Photo shows about one-half the total width and height of raster.)

RCA Television PICT--GUIDE

K-10b

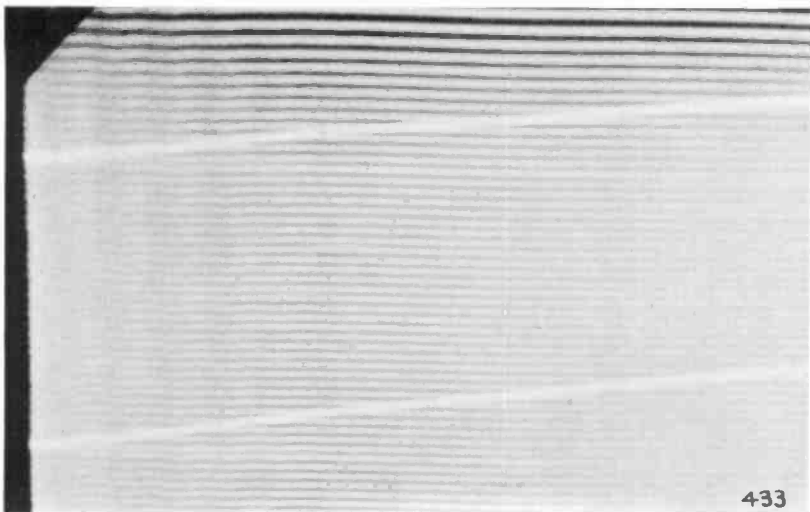

The intensity of the vertical bars on the left side of raster is changed slightly, by an open circuit in the 270-uuf capacitor shown on K-10. (Photo shows about one-half the total width and height of raster.)





Width of picture is decreased, and there is some keystone, when the 270-uuf capacitor shown on K-10 is short circuited.

RCA Television PICT-O-GUIDE

K-10c

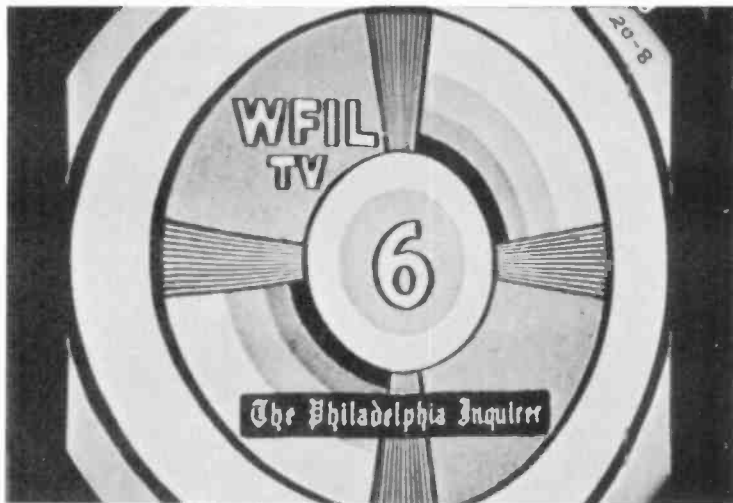

Width of picture is decreased slightly, and interlace is poor, when 1.0-megohm resistor shown on K-10 is shorted. There is little effect when resistor is opened. Interlace is also poor when both of the 0.047-uf capacitors shown on K-10 are opened.



RCA Television PICT-⊗-GUIDE

P-5

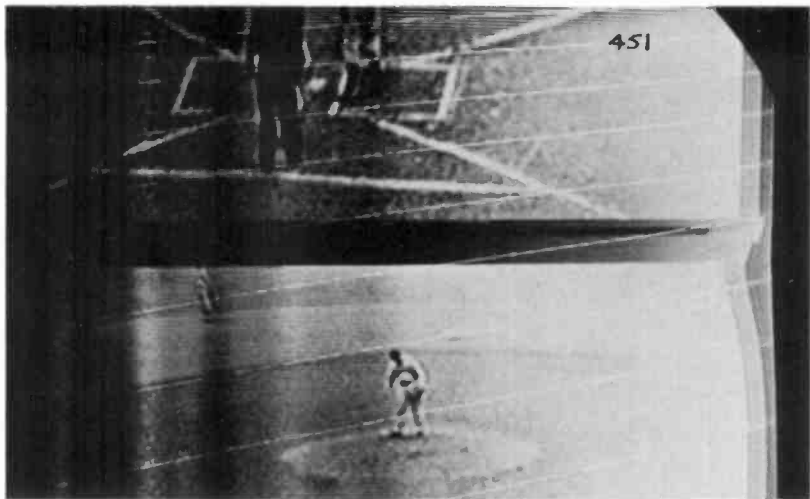

Dark vertical bars on left side of picture produced by open filter capacitors in B+ supply to horizontal and vertical output circuits. This trouble also produced hum and buzz in the sound. See reverse side for effect on raster alone.



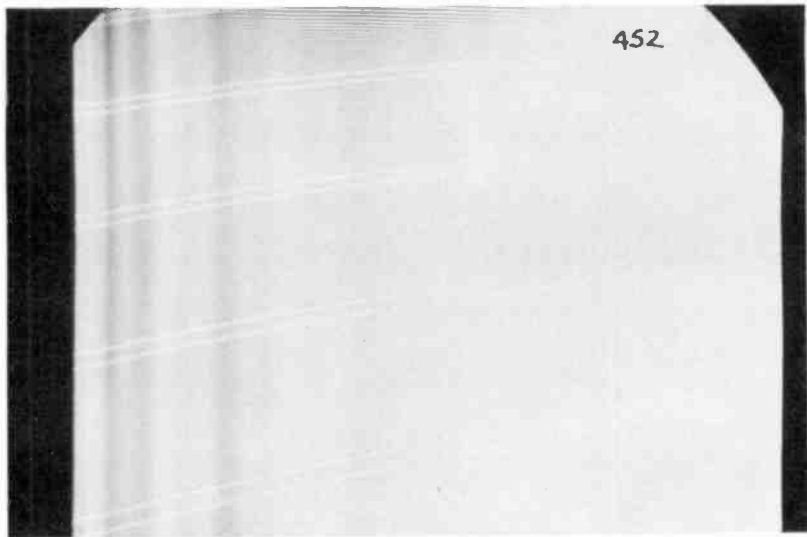

Dark vertical bars on left side of raster produced by open filter capacitors in B+ supply to horizontal and vertical output circuits.

RCA Television PICT--GUIDE

R-7

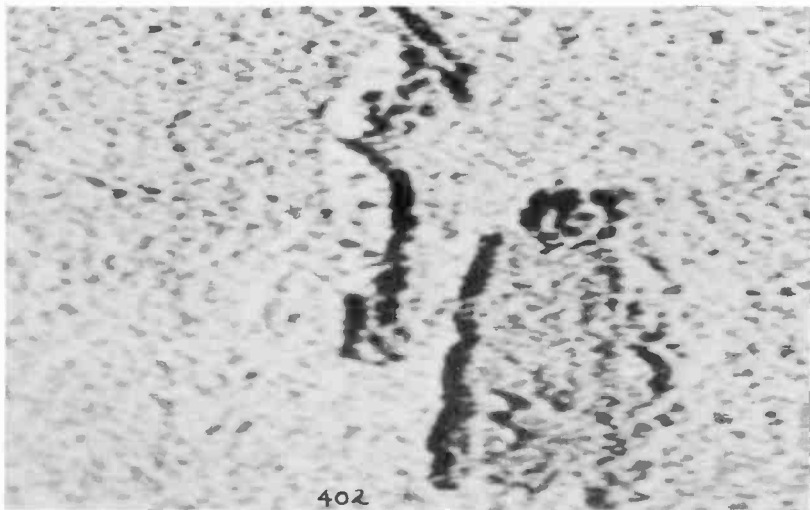

Compare this photograph and the one on the front of R-7a. All conditions were identical in each case, except for alignment. In the example above, the picture carrier is only 10% up the slope of the response curve. In R-7a, the picture carrier is at 70%.



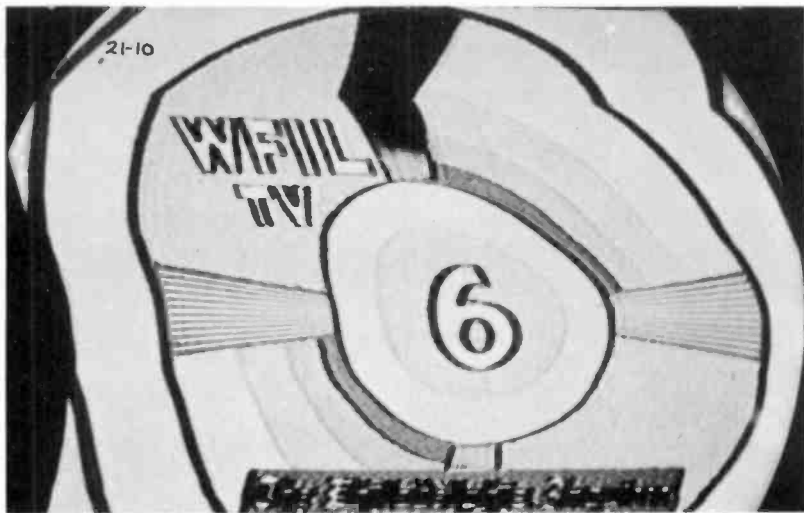

Effects of regeneration in picture-if amplifier. The black smearing on the vertical wedge is a definite indication of regeneration, which resulted in this case, from tuning the grid and plate circuit of one stage to the same frequency, instead of staggering the tuning as required in a stagger-tuned amplifier. See other symptoms of regeneration on rear of R-7a, and on front and rear of R-7b.

RCA Television PICT-Ⓢ-GUIDE

R-7a



Compare this photo and the one on the front of R-7. In the example above, the receiver was aligned to bring the picture carrier to 70%. Note the great improvement in picture quality and in signal-noise ratio. (The same weak signal was used in both cases.)



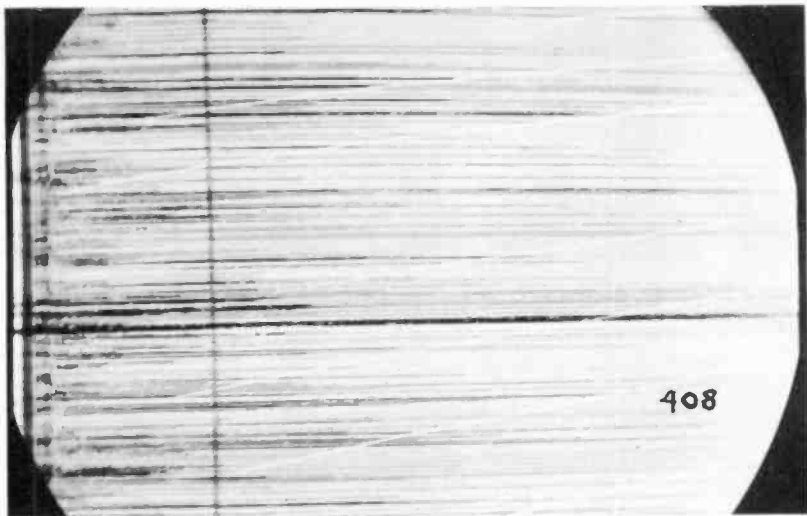

This photograph, and those on the front and rear of R-7b, show the typical symptoms of regeneration as seen on the raster, when the receiver is tuned to a blank channel. Regeneration is usually caused by incorrect alignment, open bypass capacitors, or incorrect lead dress in the picture-if amplifier.

RCA Television PICT-⊗-GUIDE

R-76



Another example of the typical symptoms produced by regeneration in the picture-tube amplifier. These symptoms are sometimes mistaken for external interference. Any question on this point can be settled by disconnecting the transmission line from the set: If the symptoms remain, it is an almost certain sign of regeneration.



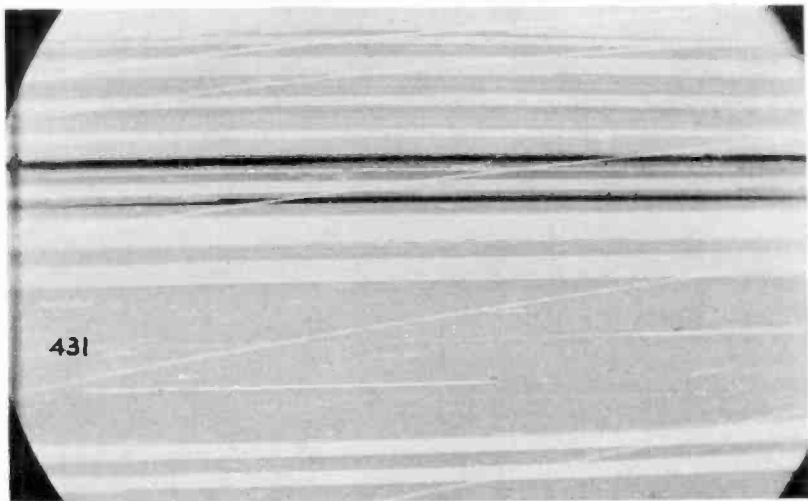

In this example the regeneration is causing a blocking action in the receiver, as evidenced by the white horizontal spaces. When the blocking occurs at a low rate, there is a "motor-boating" effect in the picture (and also in the sound on most receivers). If the blocking rate is very low, the picture may come on and go off repeatedly. In many cases, the regeneration is not present on the stronger stations.

RCA Television PICT-⊗-GUIDE

S-7

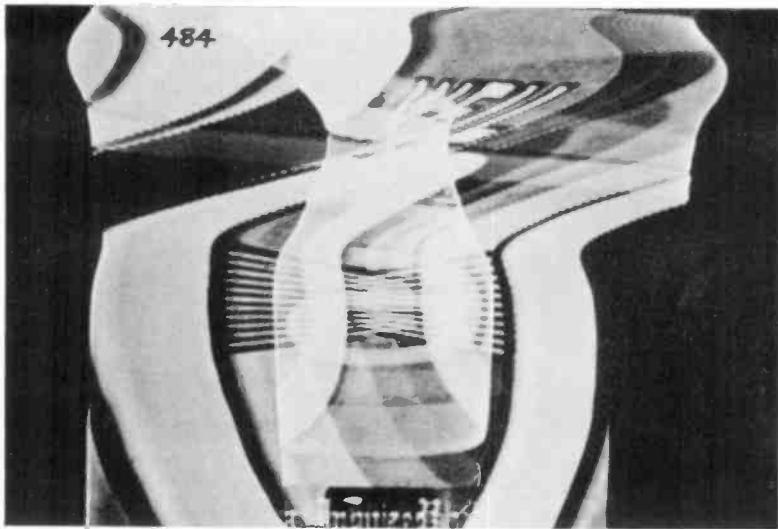

Incorrect horizontal frequency produced by a defective (open) diode limiter in a sync-separator circuit. See reverse side for another example of same trouble.



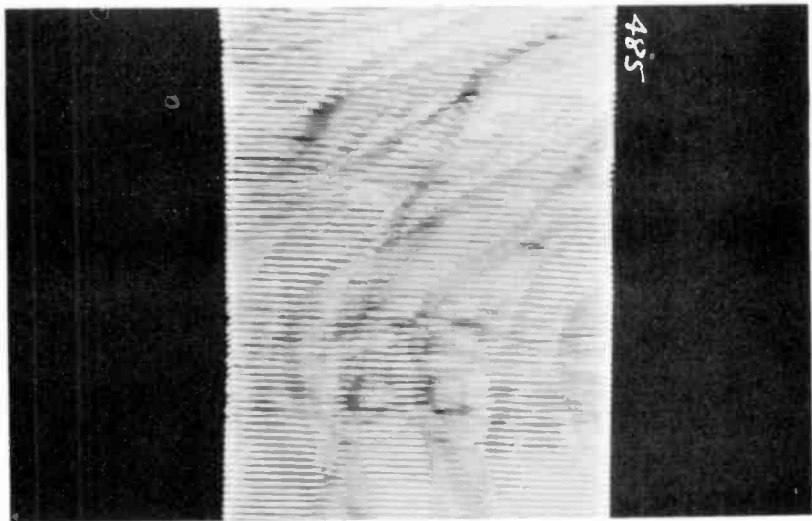

Incorrect horizontal frequency produced by a defective (open) diode limiter in a sync-separator circuit. The effect varies with adjustment of the horizontal frequency control.

RCA Television PICT-⊙-GUIDE

S-7a



When horizontal-sync phasing is correct, there are approximately equal widths of blanking on the left- and right-hand edges of the picture, as shown above. Adjustment of the horizontal hold control effects phasing. Refer to reverse side and to S-7b.



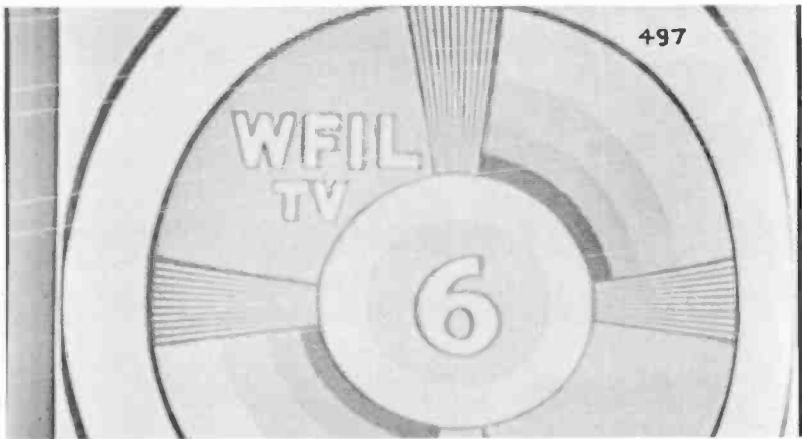

Example of incorrect horizontal-sync phasing. All of the visible blanking is on left edge of picture, none on right. With incorrect phasing, a portion of each horizontal return line is not blanked out, and the picture signals on the unblanked portions show up faintly but annoyingly in the picture.

RCA Television PICT-⊗-GUIDE

S-7b



Another example of incorrect horizontal-sync phasing: All of the visible blanking is at right edge of picture, none at left. (Contrast and brightness were adjusted to unblank the blanking signals in the photographs shown above and on the front and rear of S-7a.)



TELEVISION BLANKING & SYNC SIGNALS

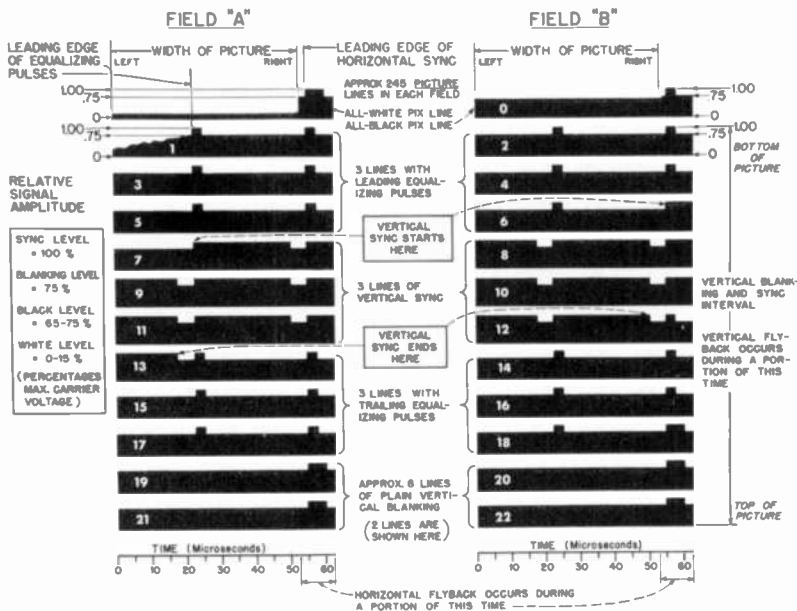

Waveform of television blanking and sync signals, drawn to scale in voltage amplitude and in time.

RCA Television PICT-⊕-GUIDE

S-7c

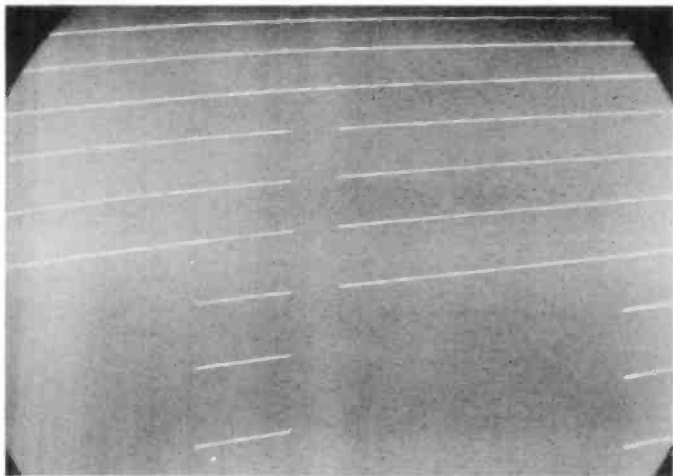

This photograph and the one on reverse side have been retouched to show the vertical return lines clearly. The short interruptions at the center of some of these lines are trailing equalizing pulses. The short white sections of return lines are serrations such as shown on line 9 in the waveform chart on rear of S-7b.



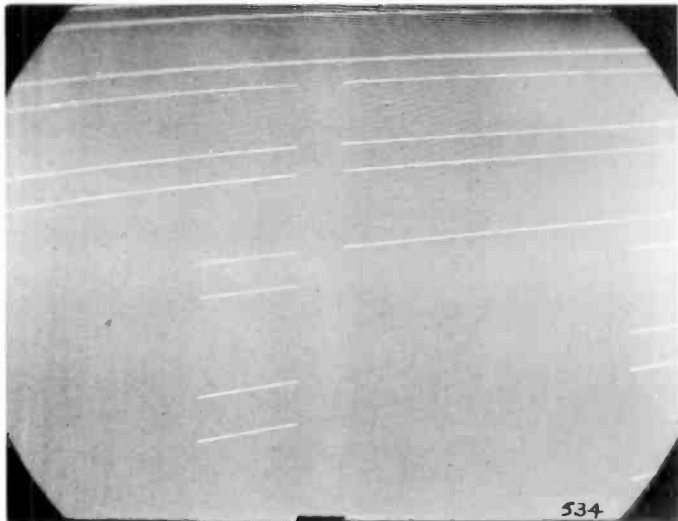

In the photograph above, the vertical hold control was set to produce poor interlacing, as evidenced by the pairing of the return lines. In the photograph on reverse side, the interlacing is good, as evidenced by uniform spacing of the vertical return lines of both fields.

TELEVISION INTERFERENCE

In the previous section of TVI, it was pointed out that there are two general types of interference:

1. *Rf-type interference*, from radio transmitters of all kinds, from oscillators in other receivers, and from oscillators in various types of electronic equipment.
2. *Noise-interference*, from ignition systems and from sparking or arcing contacts in many types of electrical devices.

Remedies for almost all varieties of rf-type interference can be applied at the receiver, but remedies for noise-interference must generally be applied at the source.

Rf-type interference usually occurs at frequencies in, or close to, the rf, if, and image bands of the TV receiver. *It is a simple fact that rf-type interference in the if and image bands, and in any other spurious response band, can always be reduced or eliminated.*

The only "hopeless" cases of rf-type interference are those that meet both of the following conditions:

- (a) The frequency of the interfering signal is too close to the rf picture or sound carrier to be trapped out.
- (b) The interfering signal is arriving from the same general direction as the TV station, so that it is not practical to null out the interference by orientation of a directive antenna.

This second section on TVI covers the following topics, all relating to rf-type interference:

1. List of remedies for external rf-type interference.
2. Diathermy interference.
3. Determining whether interference is in rf, if, or image band.
4. Applying remedies.
5. Push-pull and push-push interference pickup.
6. Interference from harmonics of sound-if and picture-if signals.

LIST OF REMEDIES FOR EXTERNAL RF-TYPE INTERFERENCE

The choice of suitable remedies for interference depends on the frequency of the interfering signal, as follows:

1. *Intermediate-frequency interference* (interference that is in, or close to, the if-band of the TV receiver):

Continued on Page 118

RCA Television PICT--GUIDE

TVI-2

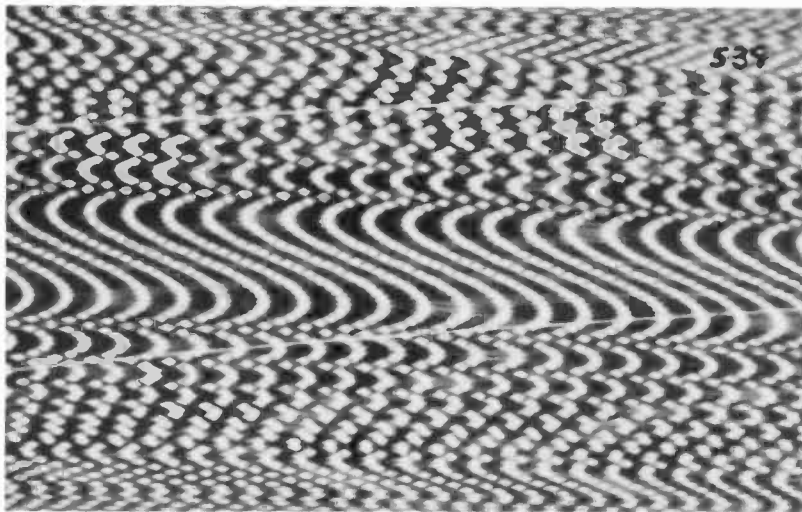

Characteristic "herring-bone" pattern produced by the beat between a diathermy signal and a CW signal. This photograph shows approximately one-half the width and height of the complete raster.



The beat frequency in this pattern varies from about 1.2 Mc at the top to 0.9 Mc at the center, and back to 1.2 Mc at the bottom. The change in beat frequency is due to the fact that the diathermy signal is frequency modulated. Remedies for diathermy interference are discussed in the text.

Continued from Page 116

- (a) Connect if rejection traps in each side of the antenna transmission line, between the line and the receiver input terminals, as shown on TVI-2y. Tune the traps to reduce the interference.
- (b) Connect a high-pass filter between the antenna transmission line and the receiver input terminals. The filter must have sufficient attenuation at the frequency of the interfering signal, and it must be effective for push-push as well as push-pull signals, as explained later.
- (c) If the interfering signal is slightly above or below the normal if band of the receiver, use one or two if traps in the picture-if amplifier to reduce the response of the amplifier at the frequency of the interfering signal.
- (d) Connect an rf, if filter between the 117-volt line and the TV receiver.
- (e) Route the antenna transmission line away from the converter

Continued on Page 120

RCA Television PICT--GUIDE

TVI-2a

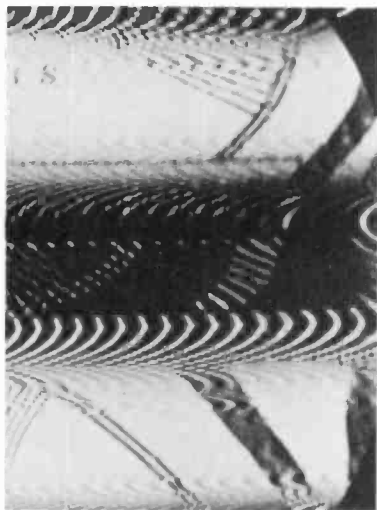
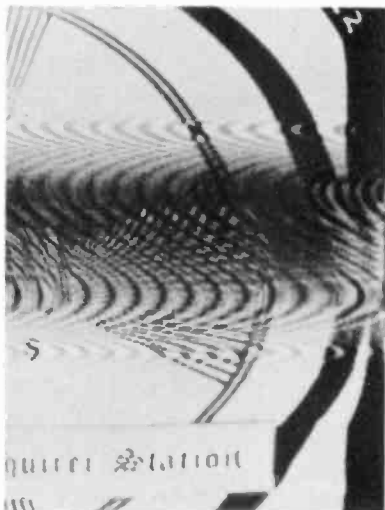

At left, the plate circuit of the diathermy oscillator is operated on "raw" (unrectified and unfiltered) 60-cycle ac, or on half-wave rectified but unfiltered 60-cycle ac. The oscillator operates and produces



interference during a portion of each positive half-cycle, or 60 times per second. At right, the diathermy oscillator is operating from a full-wave rectifier, without filtering, and produces interference during a portion of each half-cycle, or 120 times per second.

Continued from Page 118

circuit, and away from the input stages of the picture-if amplifier.

- (f) Try additional shielding around the rf tuner, the rf-input circuit components, and the input stage of the picture-if amplifier.
- (g) Check to determine whether the picture carrier is too low on the slope of the rf-if response curve. Realign, if necessary, to bring the carrier up to 50% or higher on the slope. Complete realignment of the picture-if amplifier, sound-if amplifier, and rf oscillator, to shift the if response band in the correct direction (away from the frequency of the interfering signal), may reduce or eliminate the interference, but it may also introduce new interference and other problems. In any event, shifting of the if band should not be undertaken without adequate alignment equipment and full knowledge of the problems involved.
- (h) Use of a shielded transmission line and orientation of the antenna are helpful in many cases of if interference.

Continued on Page 122

RCA Television PICT--GUIDE

TVI-2b

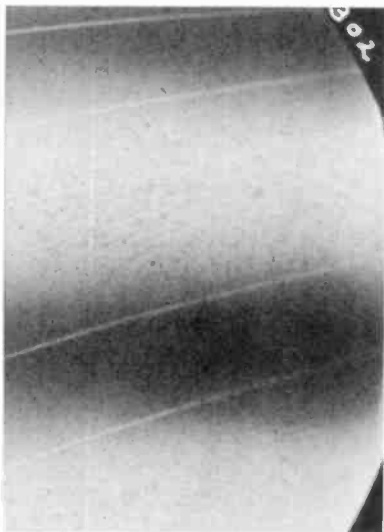

These photographs show the effects of the same diathermy signals illustrated in TVI-2a, but the characteristic herring-bone pattern is absent because there is no other signal in the particular channel



and consequently there is no beat. In this case, the diathermy signals produce one or two dark bars, which may range from faint grey to black, depending on the intensity of the interference. At left, the diathermy signals occur once during a portion of each 1/60th second. At right, the diathermy signals occur twice during each 1/60th second.

Continued from Page 120

2. *Radio-frequency interference* (interference that is in, or close to the rf band of a particular TV channel):
 - (a) Orient the antenna for a null on the interfering signal, or for the best ratio of signal-to-interference. It may be necessary to use a separate antenna for the particular channel in order to obtain best pickup of the desired TV signal, and least pickup of the interfering signal. Select an antenna, such as a Yagi, that provides the narrowest directivity pattern, narrowest bandwidth, best possible front-to-back ratio, and correct match for the transmission line.
 - (b) If the interfering signal is slightly above or below the particular rf channel, use one or more if traps in the picture-if amplifier, to attenuate the interference after it has been converted from rf to if.
 - (c) If the interfering signal is several megacycles above or below

Continued on Page 124

RCA Television PICT-⊗-GUIDE

TVI-2c

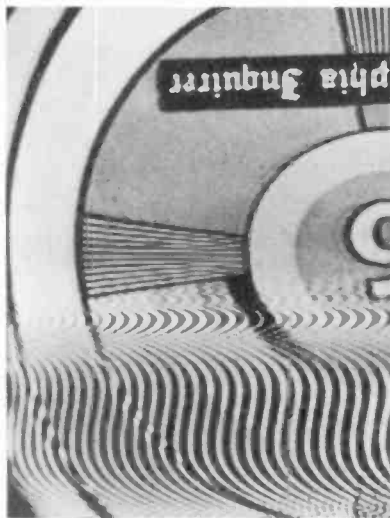
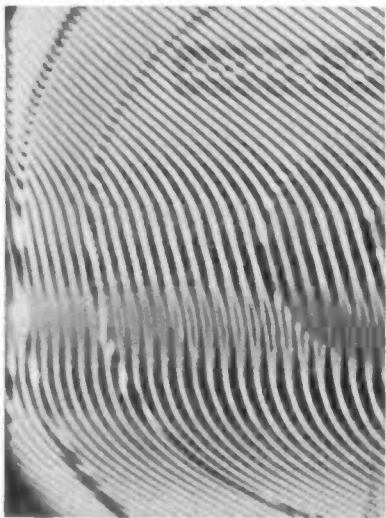

At left, interference from a diathermy oscillator utilizing a half-wave rectifier with no filtering. At right, interference from the same source after partial filtering of the oscillator plate supply with a 10 μ f capa-



citor. The oscillator now operates continuously, producing interference over the entire picture area. Due to insufficient filtering, there is a 60-cycle ripple in the oscillator plate supply which produces some frequency modulation, as evidenced by the change in beat frequency. With adequate filtering, there would be no frequency modulation, and it would be impossible to distinguish the resulting beat pattern from that produced by any other interfering CW signal.

Continued from Page 122

the particular rf channel, it may help to use rf stubs, or rf traps, at the receiver input terminals. Tune the stubs or traps to reduce the interference.

- (d) Check the rf-if response and realign, if necessary, to bring the picture carrier to 50% or higher on the slope of the response curve. No advantage is gained, in the case of rf interference, by shifting the frequency band of the if amplifier.
3. *Image-frequency interference* (interference that is in, or close to, the image band of a particular TV channel):
- (a) If the rf tuner has an adjustable trap or traps covering the FM broadcast range (which corresponds to the image band of some of the low-frequency TV channels), adjust the traps to minimize the interference.

Continued on Page 126

RCA Television PICT--GUIDE

TVI-2d

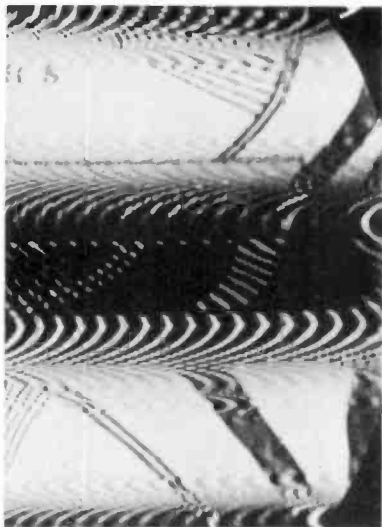
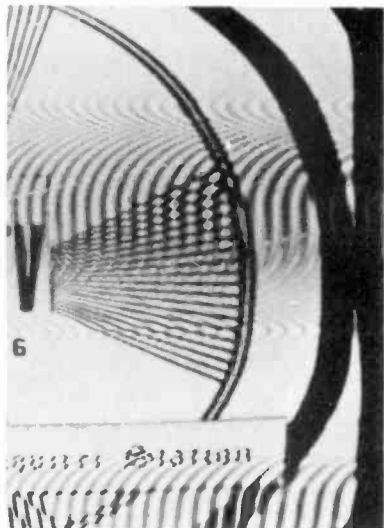

At left, the voltage amplitude of the TV picture signal is about four times greater than that of the diathermy interference. At right, the amplitude of the diathermy interference is about two times greater



than the TV picture signal. The relative voltage amplitudes are estimated from the relative blackness of the TV signal and the interference. Stronger diathermy interference blanks out large sections of the picture, as shown in TVI-2e.

Continued from Page 124

- (b) Connect an image rejection trap in each side of the antenna transmission line, between the line and the input terminals of the receiver. Tune the traps to the frequency of the interfering signal.
- (c) Connect a quarter-wave open, or a half-wave shorted stub across the receiver input terminals. Tune the stub to the frequency of the interfering signal by cutting the stub experimentally to the correct length.
- (d) Orient the antenna for least interference.
- (e) In cases of image interference it is possible, but not advisable, except as a last resort, to shift the frequency band of the if amplifier and thereby move the image band away from the frequency of the interfering signal.
- (f) Use of a shielded transmission line is sometimes helpful, especially when the interference is coming from a strong local station, and when the transmission line has long horizontal runs at any appreciable distance above the ground level.

Continued on Page 128

RCA Television PICT--GUIDE

TVI-2e

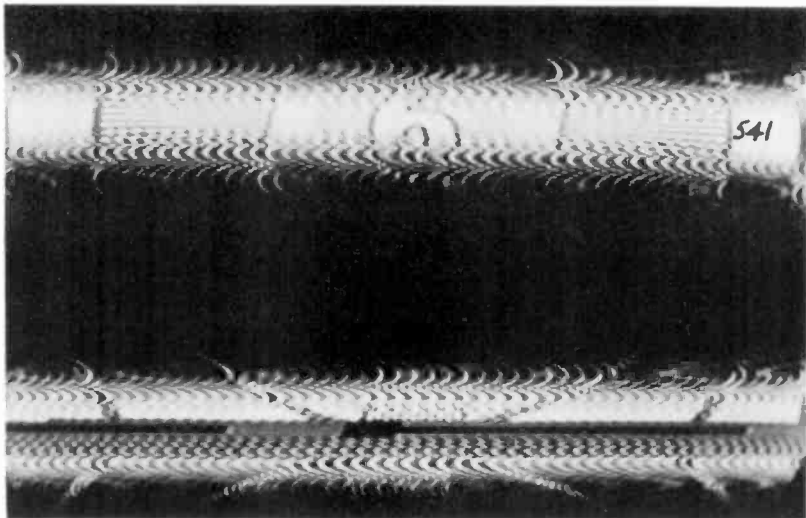

Diathermy interference that is very strong, compared with the TV signal, blanks out large sections of the picture, as shown above, where the interference occurs at a rate of 120 cycles per second. The



characteristic herring-bone pattern is in evidence at the top and bottom of the blank areas. When the diathermy signal is as strong, or stronger, than the TV signal, the diathermy over-rides the vertical sync signals and, as a result, the vertical oscillator syncs on the diathermy signal as shown above and also at the right in TVI-2d.

Continued from Page 126

4. *Cross-modulation interference*, from strong local low-frequency signals, such as AM broadcast stations:
 - (a) Check the rf input circuits of the TV receiver for possible faults that permit the low-frequency signals to reach the rf amplifier without sufficient attenuation. Check for an open in any small coil connected across the input circuit, and check for a short in any small capacitor connected in series with the input circuit.
 - (b) Connect a high-pass filter between the antenna transmission line and the receiver input terminals. To be effective the filter must attenuate push-push as well as push-pull signals.
 - (c) Connect a parallel-tuned trap in each side of the antenna transmission line. Tune the traps to the frequency of the interfering signal.

Continued on Page 130

RCA Television PICT--GUIDE

TVI-2f

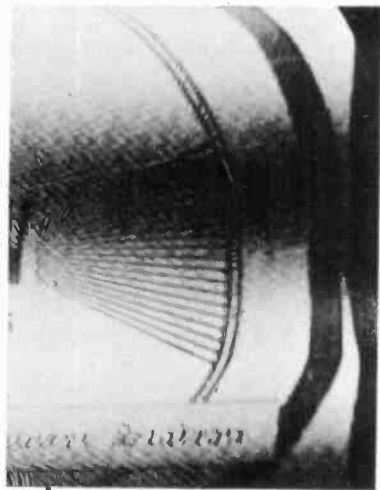
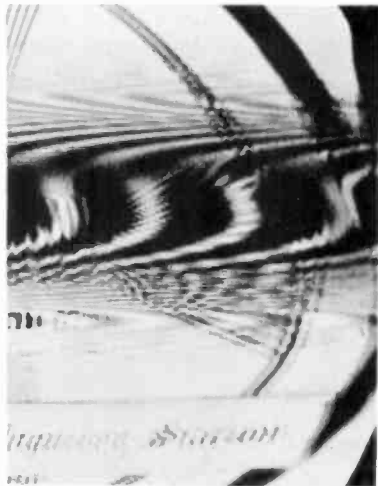

At left, diathermy interference produces a low-frequency beat, about 150 Kc at center. At right, diathermy interference produces a high-frequency beat, about 3 to 4 Mc. An example of a lower-frequency beat is shown in TVI-2g.



Continued from Page 128

5. *Other rf-type interference:*

Interference can be caused by signals that are not in or near the rf, if, or image bands: Such interference may be due to cross-modulation, double conversion, beats between two interfering signals (where the beat falls in the rf or image bands), and other reasons. A few varieties of such interference, and possible remedies are discussed later.

The reader is urged to duplicate some or all of the interference conditions illustrated in this section. Diathermy-type interference can be simulated, with any ac-operated signal generator that covers the television rf and if ranges, by opening the filter capacitors in the power supply of the generator. The resulting diathermy-type signals occur at a 120-cycle rate. To obtain a 60-cycle rate, it is also necessary to open the lead to one plate of the full-wave power rectifier in the generator. For classroom work, it is advisable to install switches on the signal generator so the filter capacitors and one plate of the power rectifier may be opened at will to produce either 60- or 120-cycle diathermy-type interference.

(The preceding section, TVI-1, includes photographs of patterns produced by interfering signals beating with the rf or if *picture* carrier. Interfering signals can also beat with the rf or if *sound*

Continued on Page 132

RCA Television PICT-Ⓢ-GUIDE

TVI-29



Although lacking the characteristic herring-bone pattern, this photograph shows an example of diathermy interference. The frequency of the diathermy signal is close to the picture carrier and



has a relatively slight percentage of frequency modulation, as evidenced by the fact that the beat does not extend beyond a low frequency.

Continued from Page 130

carrier, and thereby produce interference patterns in the picture. Such interference is relatively minor in receivers with separate sound-if channels that are correctly tuned to suppress the sound carrier in the picture-if amplifier, but the interference may become evident when the sound-if traps or the tuning control are misadjusted. In intercarrier receivers, where the if amplifier has about 5% voltage response for the sound-if carrier, the pattern produced by an interfering signal beating with the sound carrier is more noticeable. It is necessary to consider this point when endeavoring to determine the frequency of the interfering signal.)

DIATHERMY INTERFERENCE

The main purpose of the second section on TVI is to show how practical remedies can be used to reduce or eliminate rf-type interference. Before starting on this subject, however, it may be helpful to describe the nature and varieties of diathermy interference, which is one form of rf-type interference. Remedies that are successful in reducing other types of rf-type interference are equally satisfactory in cases of diathermy interference.

Continued on Page 134

RCA Television PICT-Ⓢ-GUIDE

TVI-2h

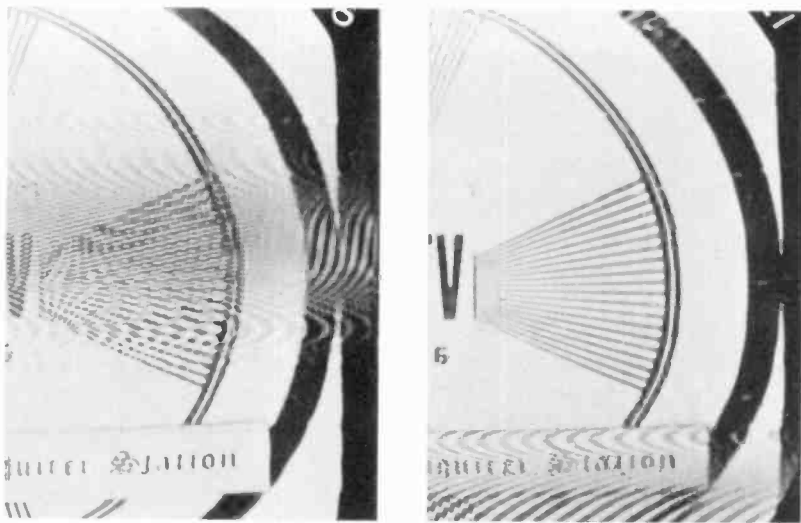

Reversal of the power plug on diathermy equipment which is producing interference at a 60-cycle rate, shifts the position of the beat pattern as shown in the two illustrations above. *Reversal of*



the power plug on the receiver has no similar effect. When the diathermy equipment, and the vertical sync of the TV station, are both operating from the same 60-cycle supply, the beat pattern does not drift up or down with respect to the picture. Under any other conditions, the beat pattern, or the picture, may move up or down, as explained in the text.

Continued from Page 132

Any interfering signal that produces a varying herring-bone pattern in horizontal bars over a portion of the picture area, but not over the entire area, may be classified as diathermy-type interference. Numerous photographs of diathermy interference are shown in this section. Interference that matches this description originates, in most cases, in certain types of diathermy equipment used in some hospitals and doctors' offices. The same form of interference can come from other diathermy equipment such as certain types of industrial rf-heating apparatus. Diathermy apparatus operated from a rectified and adequately-filtered power supply does not produce the characteristic herring-bone pattern, but emits a fixed-frequency constant-amplitude signal (CW) and the resulting interference pattern (TVI-2c) cannot be distinguished from that produced by any other source of CW interference.

The typical appearance of diathermy interference and the relatively

Continued on Page 136

RCA Television PICT-⊗-GUIDE

TVI-2i

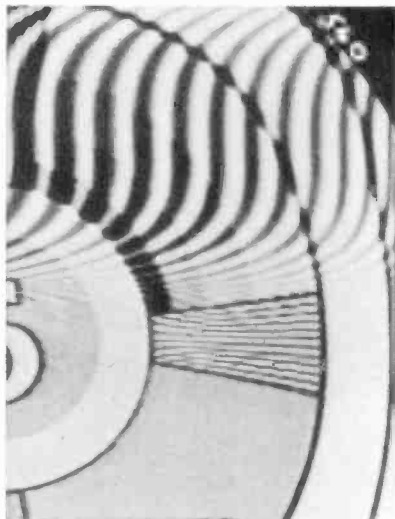
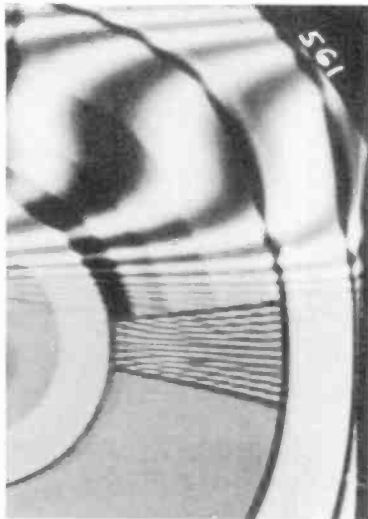

When an external interfering signal of any type, including diathermy, is arriving in the if or image band, the frequency of the beat pattern is altered by adjustment of the receiver tuning control. The photo-



graphs above show how the beat frequency is changed for two different settings of the fine-tuning control. When the interference is arriving in, or close to, the rf band, the frequency of the beat pattern is not altered by adjustment of the receiver tuning control. Refer to TVI-2j and to the accompanying text.

Continued from Page 134

broad band of frequencies occupied by those signals, may be attributed to the design of older types of equipment. The simplest type of diathermy equipment consists in essence of an rf oscillator with its plate supply furnished from "raw" ac instead of dc. The rf output is coupled through flexible leads to insulated metal pads, or applicators, which may be considered as the two plates of a capacitor. The applicators are placed on the patient in such a position that the rf energy flowing between the plates produces heat in the desired portion of the patient's anatomy. For instance, the applicators are placed on top and bottom of the wrist to produce heat throughout the entire thickness of the wrist. The significant advantage of this method is that, unlike conventional heating sources, such as electric heating pads and lamps, the heat is produced uniformly throughout the material, instead of being concentrated on the surface.

The elementary type of diathermy equipment just described can

Continued on Page 138

RCA Television PICT--GUIDE

TVI-2i

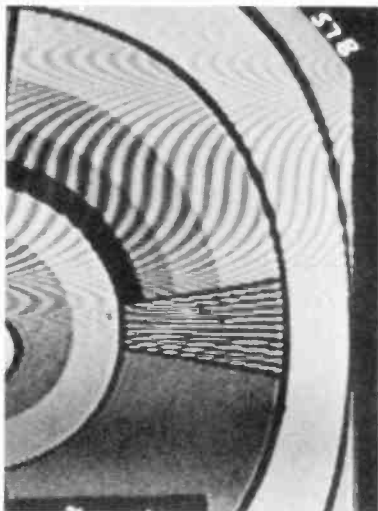
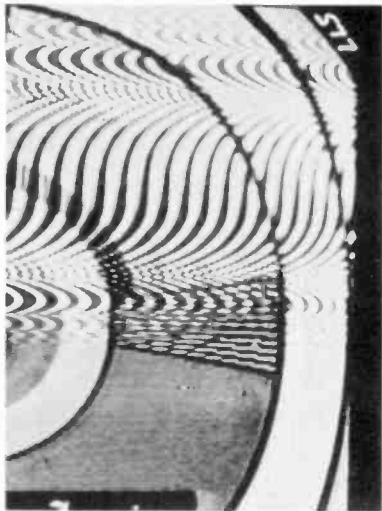

When an external interfering signal of any type, including diathermy, is arriving in, or close to, the rf band of a particular channel, the frequency of the beat pattern is NOT altered by adjustment



of the receiver tuning control. This important fact makes it possible to identify the frequency of the interference as being in, or close to, the rf band. The *intensity* of the beat pattern usually changes with adjustment of the tuning control, but the beat *frequency* does not change, as shown in these two photographs for two different settings of the fine-tuning control in a case of rf diathermy interference. Refer to TVI-2i, and to the accompanying text.

Continued from Page 136

have four objections from the standpoint of interference:

1. Because it is operated on raw ac, or on rectified but unfiltered ac, the diathermy oscillator does not operate continuously, but during only a portion of each positive half cycle of the ac voltage. During this period, the plate-supply voltage varies in amplitude, producing a change in frequency and amplitude of the rf output signal, which therefore has both frequency and amplitude modulation, and may spread over a relatively wide band of frequencies.
2. Harmonics of the fundamental frequency of the diathermy oscillator may produce rf interference in the TV channels. The extent of frequency modulation of the fundamental signal increases on each higher harmonic, occupying a progressively wider band of frequencies. For instance, when the deviation, or

Continued on Page 140

RCA Television PICT--GUIDE

TVI-2k

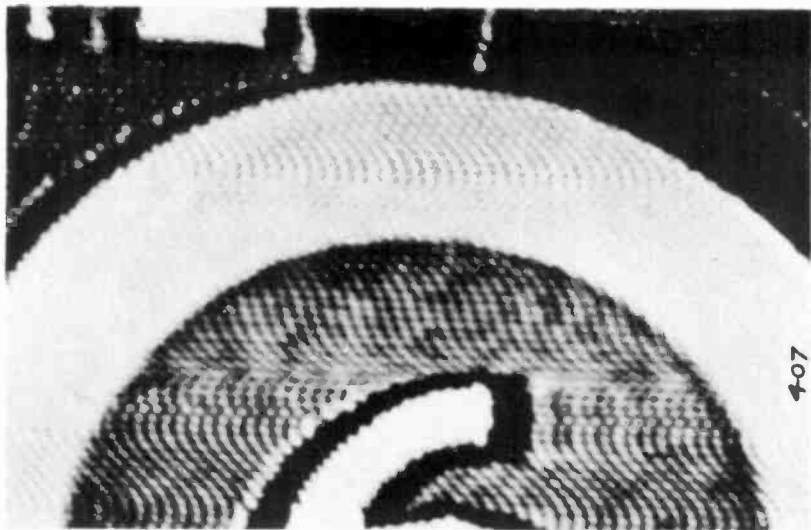

The fine-line beat pattern shown above is a 4.5-Mc beat between the intermediate-frequency picture and sound carriers, which are always separated by 4.5 Mc. Normally, with correct tuning of the



receiver, this beat is not visible, but it may be brought into view by adjustment of the tuning control. It provides a convenient means for adjusting the 4.5-Mc trap that is used in the video amplifier of some TV receivers for the purpose of suppressing this beat. Careful observation of this 4.5-Mc beat on a picture tube will reveal that it has a slight herring-bone pattern which varies in step with the frequency modulation of the TV station's sound carrier. At moments when the carrier is not modulated, the beat pattern is plain, with no evidence of a herring-bone pattern. This enlarged section of a photograph shows a portion of the inner circle and the top of the number "6" in the WFIL Test Pattern.

Continued from Page 138

swing, on the fundamental is 0.1 Mc, the swing on the 2nd harmonic is 0.2 Mc, and the swing on the 10th harmonic is 1.0 Mc, etc.

3. The applicators and their connecting leads, being tightly coupled to the oscillator circuit, alter the circuit constants as the applicators are moved about to reach different portions of the patient. Such change in capacitance and loading shifts the center frequency of the oscillator. The harmonics are again progressively affected to a greater extent. For instance, when the fundamental frequency is shifted by 0.2 Mc, the 2nd harmonic shifts 0.4 Mc,

Continued on Page 142

RCA Television PICT-Ⓢ-GUIDE

TVI-21

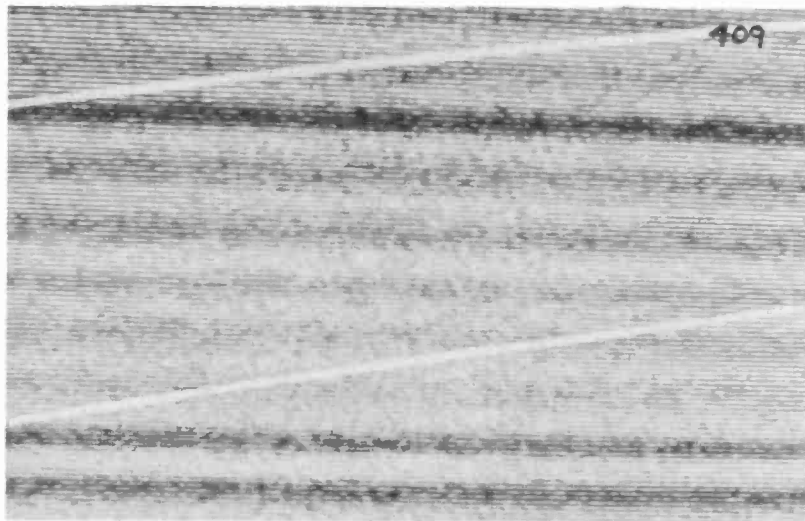

Signals from local FM-broadcast stations may be seen on certain channels in some TV receivers. The horizontal bars shown above vary in number and intensity in step with the frequency and ampli-



tude of speech and music from the FM station. Although the amplitude of FM signals is constant, the effects of the modulation can be made visible by tuning the receiver so that the FM carrier falls on either slope of the rf-if response curve. Image interference from FM-broadcast stations, in the 90 to 110-Mc range, can be reduced by means of traps or stubs, as described in the text. This photograph includes approximately one-half the total width and height of the raster. Refer to TVI-2M.

Continued from Page 140

the 10th harmonic shifts 2.0 Mc. etc. Any large shift in center frequency makes it difficult or impossible to trap out the interference at the receiver, because the interfering frequency does not remain fixed.

4. The applicator leads, which may be many feet in length, act as an antenna to radiate the diathermy signal and its harmonics into the surrounding neighborhood.

Improvements in the design of diathermy equipment include the use of stabilized-frequency oscillators, with minimum FM and AM modulation, restrictions on the power of harmonic radiation, and operation in specific narrow bands assigned by the FCC on the basis of least interference to all radio services, including TV.

Continued on Page 144

RCA Television PICT--GUIDE

TVI-2m

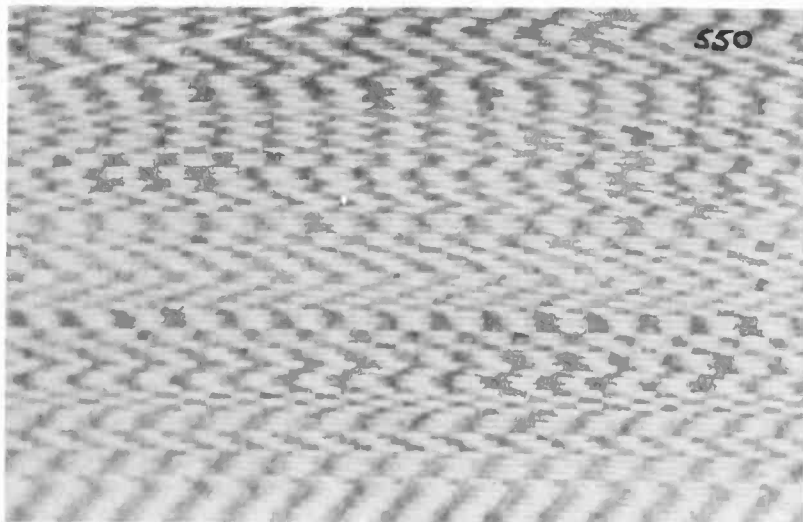

Appearance of signals from a local FM-broadcast station arriving in the image band of a low-frequency TV channel. The beat is produced by another signal that is also present in the image band.



The horizontal bars and the slight herring-bone pattern are produced by the frequency modulation. The bars vary in step with speech or music from the FM station and can, therefore, easily be distinguished from interference of similar appearance that is caused by incorrect tuning or alignment of the receiver, which permits the TV station's sound to interfere with the picture. Also, in the latter case, the beat frequency is always 4.5 Mc. This photograph includes approximately one-half the total width and height of the raster.

Continued from Page 142

After June 30, 1952, diathermy and industrial rf-heating equipment is confined to the following bands (only the bands that are of interest in the present discussion are listed below):

13.55322	to	13.56678	Mc
26.960	to	27.280	Mc
40.660	to	40.700	Mc

Although it may not be cheerful news to the technician who has to worry about television receivers that are installed near a hospital or doctor's office where diathermy treatments are given frequently,

Continued on Page 146

RCA Television PICT-⊗-GUIDE

TVI-2n

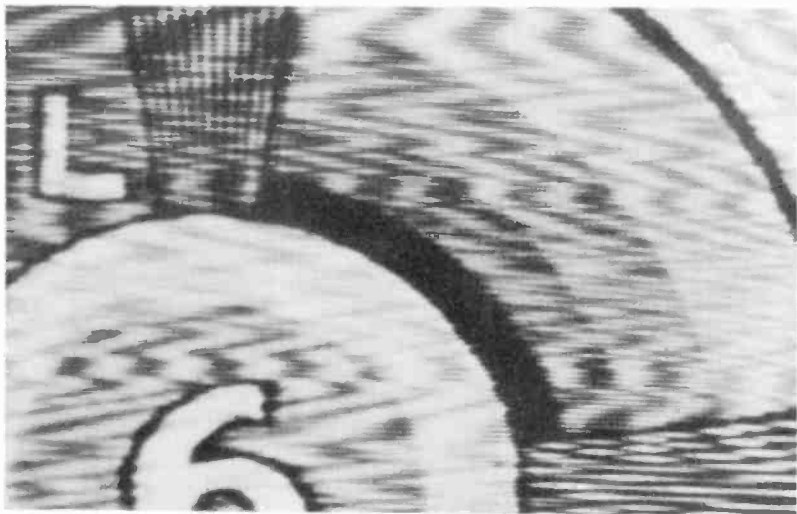

One example of interference produced by a harmonic of the sound-if signal falling in the particular rf band. In this case the harmonic energy was deliberately coupled from the output of the sound-if



amplifier into the rf-input circuit to produce this interference picture. In this receiver, the sound if is 21.25 Mc and the fourth harmonic is 85 Mc, which falls in channel 6. In receivers having a separate sound channel, the beat pattern changes with adjustment of the receiver tuning control. A positive check on this trouble is to remove one of the tubes in the sound-if amplifier: If the interference disappears, it is due to a harmonic of the sound-if signal. Interference may also be produced by harmonics of the picture-if signal. Refer to TVI-2o and TVI-2p.

Continued from Page 144

the writer has observed a substantial reduction in the prevalence of diathermy interference since 1946. Some of this improvement may be due to the fact that many of the owners of diathermy equipment have since become owners of television receivers and are now acutely aware of the effects of such interference. Part of the improvement may be due to replacement and modification of older types of diathermy apparatus. In addition, the design of many rf-tuners in TV receivers have been vastly improved to provide greater freedom from if and image interference.

Continued on Page 148

RCA Television PICT-⊗-GUIDE

TVI-20

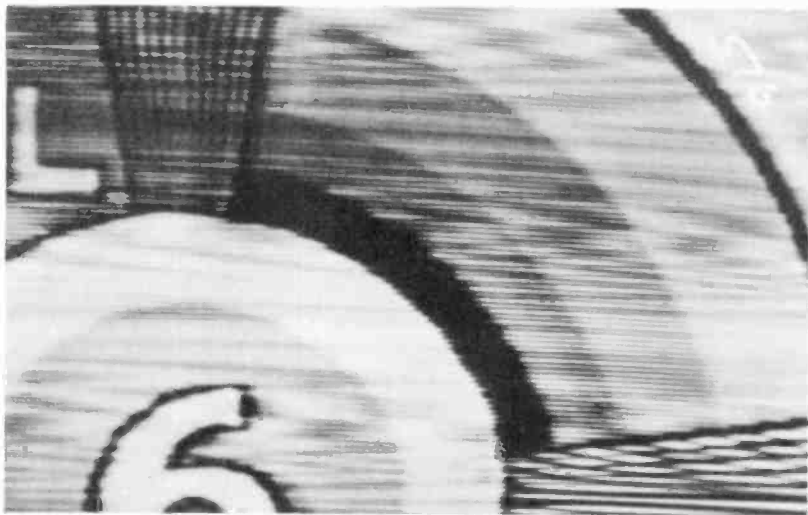

Second example of interference produced by a harmonic of the sound-if signal falling in a TV channel. In this case, the beat between the harmonic and the rf-picture carrier is a low frequency. The



interference conditions shown in TVI-2n, -2o, and -2p are identical, except for a slightly different adjustment of the receiver tuning control in each case. The receiver used in making these photographs has a separate sound channel (not intercarrier). The interference was intentionally made more severe than is usually experienced in order to have it show up clearly in these photographs.

Continued from Page 146

The herring-bone pattern

The previous section, under TVI-1, shows how any beat-frequency pattern in the picture depends on the difference in frequency between the interfering signal and the TV picture carrier. The photographs in TVI-1a to TVI-1f illustrate beat patterns in cases where the frequency of the interfering signal is essentially constant, or has no appreciable frequency modulation, and the beat is therefore constant in frequency, except for possible drift in the frequency of either signal. For example, in a case of if interference, with a picture-carrier of 25 Mc, and an interfering signal of 24 Mc, the beat frequency is 1.0 Mc, which produces 53 dark vertical or slanting bars. With an interfering signal of 23 Mc, in the same example, the beat frequency is 2.0 Mc, which produces 106 dark vertical or slanting bars.

Continued on Page 150

RCA Television PICT-⊗-GUIDE

TVI-2P



Third example of interference produced by a harmonic of the sound-if signal falling in a TV channel. In this case, the beat between the harmonic and the rf picture carrier is a high frequency. In intercarrier receivers, if a harmonic of the 4.5-Mc sound-if signal



causes interference, the beat frequency is not altered by adjustment of the receiver tuning control.

Continued from Page 148

When the interfering signal is frequency modulated, the beat has a corresponding variation in frequency, which is evident in the beat pattern. For example, with a picture-if carrier of 25 Mc, and a frequency-modulated interfering signal that swings up and down between 24 Mc and 23 Mc, the beat-frequency signal swings back and forth between 1.0 Mc and 2.0 Mc. As the beat-frequency changes, the lines in the beat pattern rotate clockwise or counterclockwise, from vertical, to slanting, and to horizontal, as described in the previous section, being vertical only at those moments when the beat-frequency is an exact multiple of the horizontal scanning rate of 15,750 cycles. It is this rotation of the lines in the beat pattern that produces the herring-bone appearance. The change from coarse to fine lines in the beat pattern is also due to the change in beat-frequency.

Usually in cases of diathermy interference, such as shown in TVI-2a, the interference exists over only a portion of the picture, and the remainder of the picture is clear. The clear portions correspond to the times when, (a) the diathermy oscillator is not operating, or

Continued on Page 152

RCA Television PICT-O-GUIDE

TVI-29

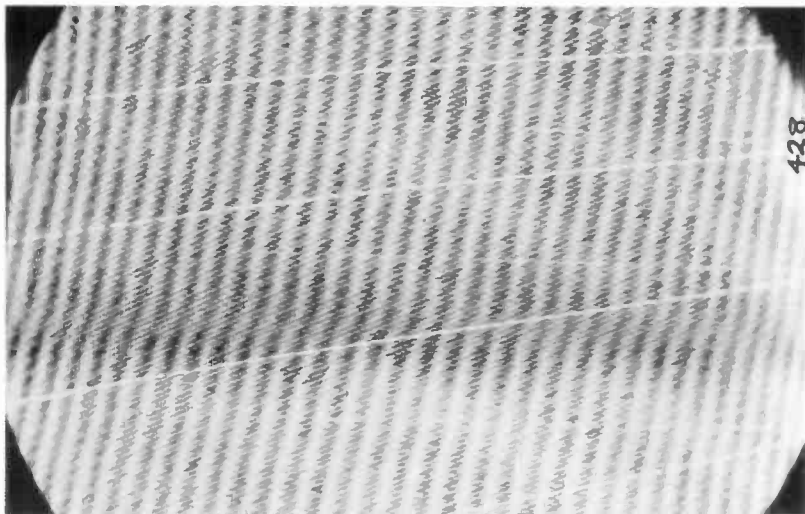

Certain defects in the input circuit of TV receivers may result in interference from local broadcast and other stations. Such interference usually appears on several of the TV channels. In such cases, check for possible open-circuit in any small coils connected



across the antenna input or rf-grid input circuit to chassis, and check for possible short-circuit in any low-value capacitors that are connected in series with the antenna input circuit. The photograph shows how the carrier of a strong local broadcast station at 610 Kc appears when a short length of wire is connected to the grid of the 1st-video amplifier: A similar interference appeared on several TV stations when the faults in the rf-tuning unit mentioned above were intentionally introduced into the receiver.

Continued from Page 150

(b) when the amplitude of the diathermy signal is not strong enough to cause noticeable interference, or (c) when the beat frequency is outside of the rf, if, or video response bands.

A section of a typical diathermy beat pattern is shown in TVI-2 for one positive half-cycle of the diathermy-oscillator plate-supply voltage. The central strip across the pattern has the greatest intensity and corresponds to peak voltage of the positive half-cycle. The top of the pattern corresponds to the point in the positive half-cycle at which the diathermy oscillator starts operating. The bottom of the pattern corresponds to the point in the positive half-cycle at which the oscillator stops operating.

The beat frequency, in megacycles, at any suitable point in the

Continued on Page 154

RCA Television PICT--GUIDE

TVI-2r

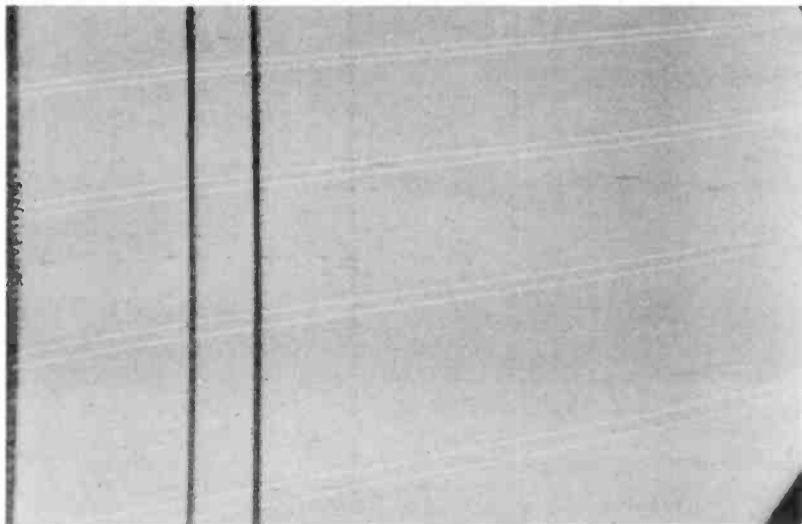

The dark vertical lines shown on the raster above are caused by spurious oscillation in the horizontal output circuit. Another example is shown in **HD-8**. This interference usually is most evident on weak stations, where the gain of the rf-if amplifier is maximum.



The use of built-in antennas has increased the severity and prevalence of this interference because:—(1) Built-in antennas have comparatively poor pickup for TV signals, necessitating operation at higher gain, and (2) built-in antennas are close to the horizontal output circuits and therefore pick up more of this interference. In most cases, the use of a good outdoor antenna reduces this interference and provides better reception in many other respects.

Continued from Page 152

diathermy interference pattern may be estimated by counting the number of cycles of beat across a horizontal scanning line (unblanked portion), and dividing this number by 53. In TVI-2, the beat frequency changes from about 1.2 Mc to top, to about 0.9 Mc at the center, and back to 1.2 Mc at the bottom.

Interference pattern may move up or down

When the 60-cycle vertical sync rate of the TV station is precisely the same as the 60-cycle supply for the diathermy oscillator, the position of the interference pattern remains stationary on the picture. This condition generally exists when a local station is transmitting a local program, and the diathermy equipment is operating on the same 60-cycle supply as the station.

Continued on Page 156

RCA Television PICT--GUIDE

TVI-2s

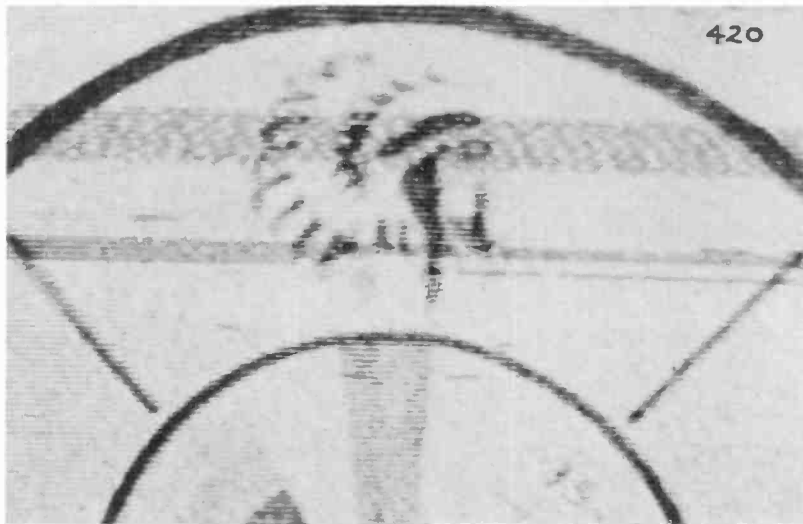

The horizontal bars of interference shown across the upper section of this weak-signal test pattern are caused by sparking at the brushes in a small household-appliance motor operating on 60-cycle ac.



When the vertical sync of the TV station, and the motor, are operating from the same 60-cycle supply, the interference remains stationary at some point on the picture. Otherwise, the interference moves slowly or rapidly up or down on the picture.

Continued from Page 154

In other cases, as for instance when a remote program relayed through a local station is received, or when a station in a distant city is received, the diathermy interference pattern may move up or down, slowly or rapidly, with respect to the picture. The interference pattern may remain nearly stationary at times, and may reverse its direction of motion.

When the diathermy equipment is operated in a building or large establishment that has its own locally-generated 60-cycle supply, which is not synchronized with the regular city supply, the interference pattern moves up or down even when a local program from a station in the same city is viewed.

On rare occasions, diathermy and other types of interference are picked up on TV radio-relay links. In such cases the engineers of the TV station strive to eliminate the interference. There is no practical remedy to apply at the receiver. Interference of this nature disappears when the station switches back to a local spot announcement or to a local program.

Continued on Page 158

RCA Television PICT-O-GUIDE

TVI-2f

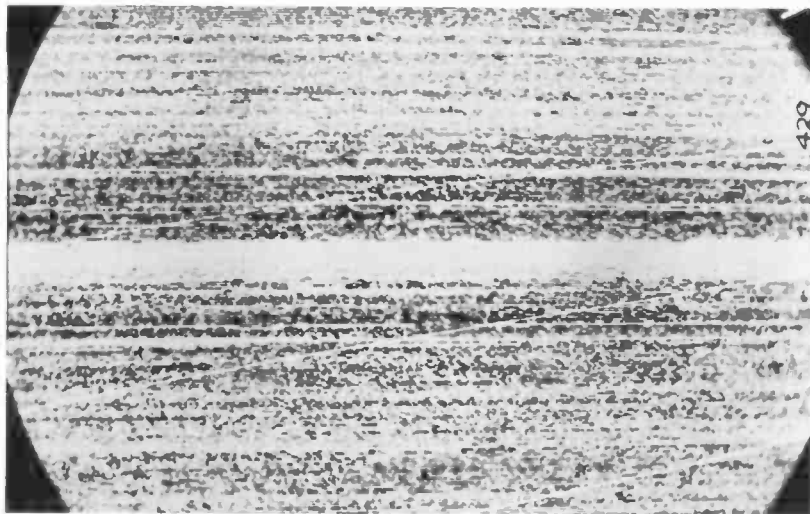

Interference produced by sparking at the brushes in a food mixer, as seen on a blank channel. The transmission line ran within a few yards of the mixer. The interference was greatly reduced by moving the transmission line away from the mixer. **Electrical interference**



usually has more effect on the low-band channels than on the high-band channels.

Continued from Page 156

Vertical motion of the diathermy interference pattern indicates a relative change in phase or frequency between the vertical sync rate from the station, and the 60-cycle supply for the diathermy equipment. *The power supply for the receiver does not enter into this motion.*

Vertical oscillator may sync on diathermy

When the diathermy interference is strong enough to override the vertical sync signals, the vertical oscillator in the TV receiver may be triggered by the diathermy, as illustrated in TVI-2e, and at the right in TVI-2d. When the diathermy signal and the TV signal are approximately equal in peak amplitude, they may alternate in taking control of the vertical oscillator.

In cases when the diathermy signal is strong enough to take control of the vertical oscillator, and the 60-cycle supply for the diathermy equipment is not the same as the vertical sync rate from the TV station, *the picture moves slowly or rapidly up or down, and the interference pattern remains stationary.*

Continued on Page 160

RCA Television PICT-⊕-GUIDE

TVI-2u

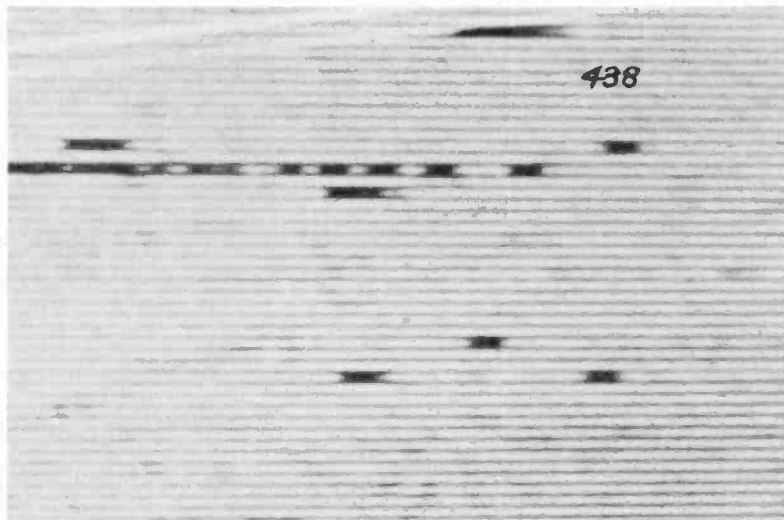

Enlarged section of raster, showing a few specks of ignition noise. Most photographs of ignition noise are faked, for various reasons. The one shown above is authentic. In weak-signal areas it is a



reasonable practice to position the antenna mast away from street traffic (providing that the selected position affords good TV signal pickup) and to run the transmission line down the side or rear of building farthest from the traffic. Shielded line may help in some cases.

Continued from Page 158

The signals radiated from diathermy equipment include some energy at harmonics (multiples) of the fundamental frequency. The harmonic energy radiated from new equipment is limited by FCC regulations to the lowest power that is feasible in actual practice, in order to minimize interference from the harmonics. It is an unfortunate fact, however, that even very weak harmonics can cause interference in weak-signal areas.

Signals at the fundamental frequency of the diathermy equipment, and the lower harmonics of the 13.55-Mc band, can cause direct if interference in television receivers. Harmonics of the diathermy signal can cause interference in the rf and image-frequency bands. Most of the possible remedies for if interference are entirely different from the remedies for rf and image interference. Consequently, one of the first steps in working on any interference problem is to determine, if possible, whether the interference is occurring in rf, if, or image-frequency bands.

Continued on Page 162

RCA Television PICT-Ⓢ-GUIDE

TVI-2v

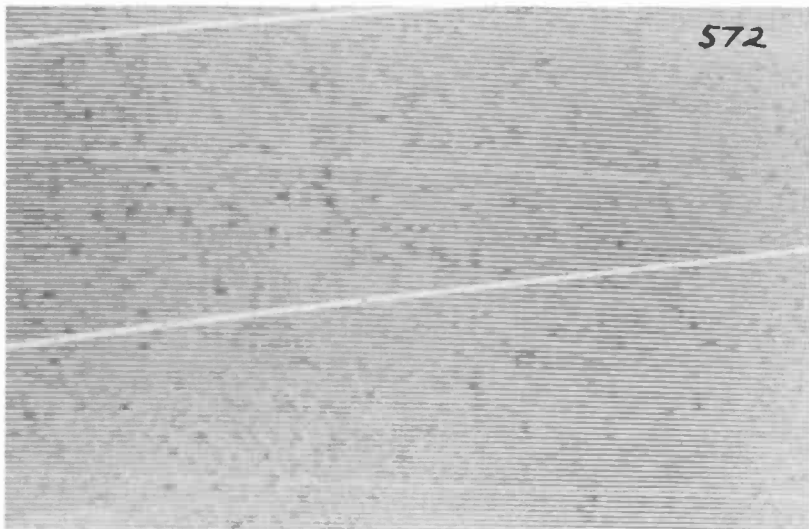

Normal specks, or snow, on the raster, produced by thermally-generated electrical noise in the input circuit of a sensitive TV receiver, with the antenna transmission line disconnected from the



receiver, and with rf-if gain at maximum. The quantity and intensity of snow varies in different sets, and on different channels in the same set. This photograph includes about one-half the total width and height of the raster. Refer to TVI-2w, and TVI-2x.

Continued from Page 160

DETERMINING WHETHER INTERFERENCE IS IN RF, IF, OR IMAGE BAND

Interference at intermediate frequency

When the frequency of the interfering signal is in, or close to, the if response band of the receiver, *the interference usually appears in some form at all settings of the channel selector*. The interference is least noticeable, and may not be visible, on channels with strong TV stations, because on such stations the if amplifier is operated at low gain due to AGC action. *On blank channels*, where there is *neither TV nor any other signal* present to beat with the interfering signal, there is of course no beat pattern, but the interference usually manifests itself in some form on the picture tube. For instance, if the interfering signal has AM sound modulation, the modulation appears as horizontal bars that vary in number and intensity in step with the frequency and amplitude, respectively,

Continued on Page 164

RCA Television PICT-⊗-GUIDE

TVI-2w

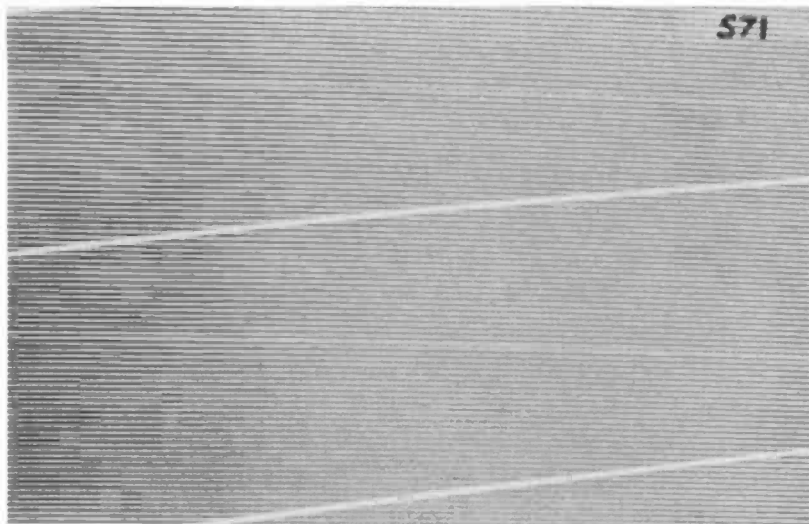

Lack of noise specks on the raster, with antenna transmission line disconnected from the receiver, and with rf-if gain at maximum, usually indicates that the receiver has low sensitivity, possibly due to trouble in the rf, if, or video amplifiers. This photograph includes



about one-half the total width and height of the raster. Refer to TVI-2v and TVI-2x.

Continued from Page 162

of the sound modulation. Even the modulation of an FM interfering signal may be seen, also as horizontal bars, if the FM carrier falls on a slope of the if response band ("slope" detection). In the case of diathermy, the 60- or 120-cycle modulation, which is both FM and AM, appears as dark horizontal bars, as shown in TVI-2b. If the interfering signal is CW, it causes a reduction in sensitivity and therefore a reduction in the intensity of noise speckles on the raster, in receivers with AGC.

With if interference, the frequency of the beat pattern is altered by adjustment of the receiver tuning control.

Interference at radio frequency

When the frequency of the interfering signal is in, or close to, a particular rf band, and the interfering signal is beating with the TV picture or sound carrier, *the frequency of the beat pattern is NOT altered by adjustment of the receiver tuning control.* The intensity of the pattern alters, but the *frequency* does not. Conse-

Continued on Page 166

RCA Television PICT--GUIDE

TVI-2x

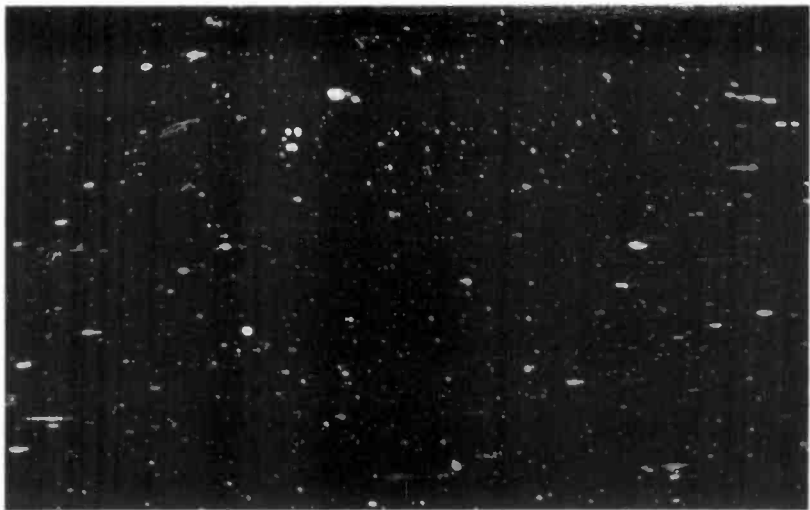

This section of a photograph, about three quarters of the total screen area, might be mistaken for an astronomical view of stars and nebulae. Actually, it is "white snow" on a normal TV receiver with the brightness control adjusted to black level. The effect is



seen best in a dark room. The larger flakes, thicker than a normal scanning line, are caused by blooming, or enlargement of the spot, due to excessive beam current and defocusing. Refer to TVI-2v and TVI-2w.

Continued from Page 164

quently, when the frequency of a beat pattern remains unchanged as the tuning control is adjusted, it is usually a definite indication that the interfering signal is in, or close to, the rf band of the particular channel on which the interference exists.

It is possible for one or more different rf harmonics of a lower-frequency source of interference, such as diathermy, to interfere on two or more TV channels. With harmonics of diathermy or harmonics of any other FM signal, careful observation will reveal that the *range* of frequencies in the beat pattern increases on the higher channels, due to the fact that the amount of frequency deviation increases progressively on each higher harmonic, as mentioned previously.

On rf interference, the beat frequency is equal to the difference in frequency between two *external* signals—the TV picture or sound carrier, and the interfering rf signal, (which may, of course, be a harmonic of a lower-frequency signal). *The beat frequency in the case of external rf interference is completely independent of*

Continued on Page 168

RCA Television PICT-Ⓢ-GUIDE

TVI-2y

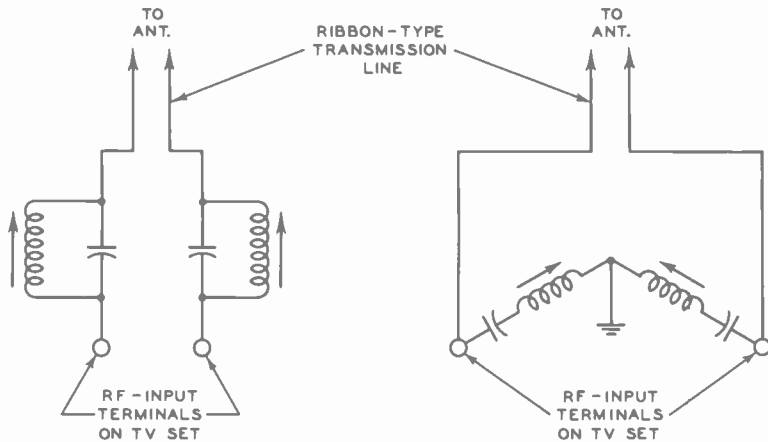

A stub, connected across the receiver input terminals, is not effective in reducing the intensity of an interfering signal that is picked up on the transmission line in push-push polarity. The remedy in this



case is to use parallel-resonant traps, connected as shown at left, or series-resonant traps, connected as shown at right. The subject of push-push and push-pull interference is discussed in the accompanying text.

Continued from Page 166

anything in the receiver. The beat frequency, therefore, remains constant unless the frequency of either of the two external signals is changed *at the source.*

The important point to remember in analyzing interference problems is that when the frequency of the beat pattern does not change as the receiver tuning control is adjusted, it usually indicates that the frequency of the interfering signal is in, or close to, the rf band of the particular channel. (An important exception to this general rule occurs in cases of cross modulation from a nearby station operating at a frequency below approximately 4.5 Mc, such as a strong local AM broadcast station. The cross modulation is a result of over-loading and rectification in the rf amplifier due to the high signal intensity from the interfering station. Such interference is usually evident on each of the TV stations, and the resulting pattern, which represents the carrier frequency of the interfering station, is

NOT altered by adjustment of the receiver tuning control. The interference may be present in receivers that are in normal operating conditions, but it is more frequently a result of trouble in the rf input circuits, as outlined in the caption for TVI-2q.)

Interference at Image Frequency

When the frequency of the interfering signal is in the image band of a particular channel, the frequency of the beat pattern changes as the receiver tuning control is adjusted. The beat frequency also changes in the case of if interference, but the latter interference usually produces some effect on all channels, while image interference does not. It is therefore usually a simple matter to distinguish between image and if interference.

Interference at other frequencies

Depending largely on the design of the rf-tuning unit, it is possible for interference to occur from a signal that is not in the rf, if, or image bands of the particular channel.

For example, the windshield-wiper interference on channel 6, shown on TVI-1j, was produced by a signal that is not in the rf, if, or image bands of channel 6. In this example, the receiver is tuned to channel 6, and the interference is from a local station on channel 10. The

rf-tuning unit in the receiver has ample selectivity to prevent the signal of channel 10 from getting through to the grid of the converter tube when the receiver is tuned to channel 6, but in this particular tuning unit, there is sufficient amplitude of signal from the local rf oscillator present at the grid of the rf-amplifier tube to produce a beat, by rectification in the rf stage, with the signal from channel 10. The frequency of this beat falls in channel 6 and can therefore pass through the rf tuned circuits ahead of the converter. The beat-frequency signal is then beat down in the converter, with the local rf oscillator signal, to produce a signal in the if band.

The frequencies involved in this example are as follows:

When the particular receiver is tuned correctly on channel 6, the rf oscillator frequency is 109 Mc. The picture carrier of channel 10 is 193.25 Mc. The difference-frequency beat (193.25 minus 109) is 84.25 Mc, which falls in channel 6 (82-88 Mc.)

With this particular type of tuning unit, interference can occur between other channels that have a corresponding relationship in frequency. Remedies include (1) the use of a series-resonant trap from each side of the rf-input circuit to chassis, in order to reduce the amplitude of the local rf-oscillator signal in the rf-input circuit and (2), use of a stub, connected by means of a switch to the receiver input terminals to reduce the strength of the high-frequency channel when it is desired to view the low-frequency channel.

APPLYING REMEDIES

It generally takes only a minute or two to make the observations outlined above, and to determine whether the frequency of the interfering signal is in the rf, if, or image band. There are always cases where it is difficult to arrive at a decision, and in such cases it may be necessary to determine the frequency of the interference experimentally by trying three remedies, one for rf, one for if, and one for image interference.

The following additional information may be helpful:

Reference to transmission lines in the following sections applies to unshielded ribbon-type line unless otherwise stated.

Direct if pickup

Under certain conditions, an interfering signal in the if band may be picked up directly in the converter or input stage of the picture-if amplifier. Actually, in such a case, the interfering signal is picked up in all of the circuits of the receiver, but the converter and the if-input stage have the greatest if gain following them, and are ordinarily the only ones that need be considered. It must be remembered, however, that the intensity of signal pickup is greatest on

long leads and on large or long metal parts. If such leads and parts are not effectively at chassis potential for if signals, and if they run close to the converter or if-input stage, or are coupled to these stages in any other way, these leads and parts may be primarily responsible for most of the direct if pickup. These same considerations can apply in certain cases of image and other spurious responses, in which interfering signals picked up on long leads or metal parts are coupled into the converter circuit after the rf tuned circuits. The 110-volt line is a possible source of trouble in this respect. To keep interfering signals that are present on the 110-volt line from getting into the rf and if circuits, it is customary in most receivers to bypass each side of the line to the chassis, and also to route the run of line inside the chassis away from the rf and if sections. Simple bypassing of the 110-volt line is not completely effective at all frequencies, and it is for this reason that an additional line filter may be helpful on if and other interference.

Interfering if signals that are present on the antenna transmission line, or on a built-in antenna, can be coupled into the converter or the if-input stage in receivers where the transmission line or the antenna are too close to these stages.

Not all if interference finds its way into the if amplifier by the path just described. Interfering if signals that are picked up on the antenna or on the transmission line may get through the rf tuned

circuits in the tuning unit and thus reach the converter. The necessary remedies to block interfering if signals from coming in on these two paths are different for each path. In some cases the interfering if signals arrive over both paths.

An example of a step-by-step procedure for handling an if interference problem may be helpful:

When there is any indication that the frequency of the interfering signal is in, or close to the if band, as, for instance, if the interference appears at all settings of the channel selector, try moving the transmission line farther away from the converter and if-input stages. If the intensity of the interference is reduced, it indicates that the interfering signal is in the if band, and that at least a portion of the interference is being directly coupled from the transmission line into the if amplifier.

As a double check, grasp the converter or the if-input tube in the fingers, or touch the tip of a small metal screwdriver on the grid terminal of the if-input tube, with a finger contacting the screwdriver shank. If the intensity of the interference is increased, it is further confirmation that the frequency of the interfering signal is in the if band. In this check, the if interference is picked up by the body, which acts as an antenna, and is fed into the if amplifier. While this check is performed, if the transmission line is grasped in

the other hand the interference will probably increase. There is a possibility (particularly when the receiver is tuned to a weak TV station, where the gain of the if amplifier is maximum) of setting up regeneration or oscillation in the if amplifier by touching the grid of the if-input stage. To avoid this possibility, use the strongest station on which the interference is noticeable, and keep the hands and body away from the other stages in the if amplifier.

Turn the channel selector to a blank channel, where there is no evidence of TV or any other signal except the modulation of the interfering signal. (In case the interference is CW, and the technician is not able to recognize its presence on the raster, it is possible to couple a TV generator very loosely to the if-input stage and tune the generator to a frequency in the vicinity of the picture-if carrier for the particular receiver, to provide a visible beat pattern.) Disconnect the antenna transmission line from the rf-input terminals, and move the line several feet away from the receiver. If removal of the line does not reduce the intensity of the interference, it indicates that the if interference is being picked up directly in the converter or in the if-input stage. The pickup may be due to the presence in the room of a strong field from the interfering source, or possibly to the fact that the interfering if signals are arriving via the 110-volt line, and are being coupled in some fashion from the line into the if amplifier. In any case, the existence of the if interference, with the antenna transmission line disconnected and moved away from the set, indi-

○ cates that the shielding of the converter or if-input stage may not be adequate for the particular conditions.

○ When the if interference is not reduced virtually to zero by disconnecting the transmission line and moving it away from the set, it is advisable to try a filter between the 110-volt-line and the chassis, even though the receiver may have some type of built-in line filter. The additional power-line filter should have rf-if chokes connected in series with each side of the line, and capacitors connected from each end of each choke to the filter shield case, which should be clamped in contact with the chassis.

If the interference is noticeably reduced by the addition of the power-line filter, leave it connected, at least temporarily. The use of other remedies later on may make the power-line filter unnecessary.

○ With the antenna transmission line disconnected and moved away from the set, if it is found that the power-line filter alone does not decrease the interference to a sufficiently low level, the next step is to try temporary shielding of the converter and if-input stage. Try regular shields on these tubes, making certain that the shields contact the chassis. If either or both of the shields are helpful in reducing the interference, leave them in place temporarily.

○ Next, try shielding the components and wiring of the converter-output and the if-input stage. A convenient type of electrostatic

shield is described later. For the conditions described up to this point, the shielding should reduce the interference to a very low level.

Reconnect the antenna transmission line to the input terminals of the set and check reception on the TV stations. If the if interference is still objectionable, it indicates that interfering if signal on the transmission line is getting through the rf-tuning unit to the converter.

We have considered the case where the interfering if signal is present with the antenna transmission line disconnected from the set. We will now consider the alternate case, where the interfering if signal disappears when the transmission line is disconnected from the set.

When the antenna transmission line is disconnected from the receiver input terminals and moved away from the set, if the interfering if signal disappears, and if the checks previously described showed that the interference is not being coupled directly from the transmission line to the converter or if-input stage, it is necessary to apply remedies that will prevent passage of the interfering if signals from the transmission line to the rf-input terminals. Such remedies include if-rejection traps, or a high-pass filter connected between the transmission line and the rf-input terminals. High-pass filters are described later. Connections for if traps are shown on TVI-2y.

If the traps or the high-pass filter reduce the interference to a sufficiently low level, so that it is not noticeable on the TV stations, try removing the power-line filter and the temporary shielding to determine whether they are still required. If it is found that the shielding is necessary, install a permanent rigid shield, preferably of non-magnetic metal, such as aluminum or brass. Space the shield at least one inch from components and wiring to minimize detuning effects. If it is found that either or both of the tube shields are still beneficial, check and realign the grid and plate circuits of the if-input stage to compensate for the slight detuning produced by the shielding and by the tube shields.

High-pass filter for if interference

On all complaints involving interference, it is advisable to carry several high-pass filters for 300-ohm ribbon line and for coax. A high-pass filter should attenuate signals at frequencies lower than channel 2, and pass signals at frequencies from channel 2 to 13. The filter should be connected between the transmission line and the receiver, preferably at the input terminals of the rf-tuning unit, rather than at the terminals in the rear of the cabinet, because the section of line between these two points may contribute to pickup of the interfering if signal. If the filter is shielded, the shield may be soldered directly, or through a short length of braid, to the receiver chassis at a point close to the input terminals of the rf-tuning unit.

The transmission line must be kept away from the converter and if-input stage to avoid direct coupling of the interfering if signal from the transmission line into the if amplifier.

To be effective, the high-pass filter must attenuate if signals that arrive in push-push as well as push-pull. This subject is covered later.

Temporary electrostatic shield

In working on if interference problems, it is often necessary to determine whether additional shielding of the if-input circuits will reduce the interference. A temporary shield for this purpose can be made easily as follows:

Sandwich a sheet of metal foil between two slightly larger sheets of thin flexible plastic (such as used in sleeves for metal-shell kinescopes) and bind the edges with cellulose tape. Before binding, solder a 3-inch flexible lead to the foil. Attach a clip to the other end of the lead for grounding to the chassis.

The shield may be of any desired size, such as 5 x 5 inches, or larger. It may be folded to any size and shape to fit the section of the receiver that is to be shielded. In cases where it is found that additional shielding is necessary, it is advisable to install a permanent and rigid shield of aluminum or brass.

PUSH-PULL AND PUSH-PUSH INTERFERENCE PICKUP

Almost every technician has encountered baffling cases of interference in which conventional remedies, such as stubs and traps connected across the receiver input terminals, fail to decrease the interference to any appreciable extent, and there appears to be no reason for the failure. For instance, it may be known definitely that a certain interference condition on channel 2 is caused by the signal from a local FM-broadcast station which operates at a frequency in the image band of channel 2 on the particular receiver. In such cases, if a stub of the correct length is connected across the input terminals it may be found to have very little, if any, effect. Or if the antenna is oriented for a null on the FM station, it also may have practically no effect. Yet on other installations in the same area, with the same model of receiver, these two remedies may be very effective in reducing the same interference.

The explanation for the failure of the usual remedies in certain cases is to be found in a subject that should be recognized and understood in order to handle interference problems intelligently. It is the subject of push-pull and push-push signals in the receiver input circuit.

Signals picked up on a TV antenna travel along the transmission line in push-pull polarity, and appear across the receiver input

terminals in push-pull. Push-pull means that, at any instant, the signal voltage at one terminal is equal in amplitude, but opposite in polarity, to the signal voltage at the other terminal. For example, if, at some instant, the signal voltage at one terminal is -5 units, the signal voltage at the other terminal is $+5$ units. In each case the voltage is measured with respect to a nearby point on the chassis.

The voltage amplitude of a push-pull signal can be reduced practically to zero by putting a short circuit, such as the tip of a screwdriver, across the terminals, or across the two conductors at any point along the line. Such a short circuit, however, treats all push-pull signals alike, reducing the amplitude of desired signals as well as undesired ones. To reduce the intensity of an undesired push-pull signal of a particular frequency, without greatly effecting desired signals at other frequencies, it is customary to use a "frequency-selective short circuit", in the form of a $\frac{1}{4}$ -wave open stub, or a $\frac{1}{2}$ -wave shorted stub, connected across the receiver input terminals. The stub acts as a short circuit for push-pull signals at the frequency for which the stub is cut, and also at certain multiples of this frequency. At certain other multiples, the stub acts as an open circuit and has no effect. At all other frequencies, the stub acts as an inductive or capacitive reactance.

Signals that are picked up *on the transmission line* usually travel along the line in push-push polarity, and appear across the receiver

input terminals in push-push. This means that there is no voltage difference between the two conductors at any point along the line, or at the receiver input terminals. For example, if, at some instant, the signal voltage at one terminal is -5 units, the signal voltage at the other terminal is also -5 units. In each case the voltage is measured with respect to a nearby point on the chassis. Because there is no voltage difference across the terminals with a push-push signal, it makes no difference if the terminals are short-circuited. A push-push signal is not effected by a short-circuit across the transmission line or across the input terminals. *Obviously, therefore, it does no good to connect a stub across the receiver input terminals in an effort to reduce the intensity of a push-push signal.*

Signals from all sources are picked up partly on the TV antenna, in push-pull, and partly on the transmission line, in push-push. The relative amounts of these two components depend on numerous factors, which may be summarized briefly as follows:

On TV signals (which, in the U. S., are transmitted with horizontal polarization) the TV antenna acts as a good collector when it is correctly oriented on the station. If the transmission line runs vertically from the antenna to the receiver (or if it runs vertically from the antenna to a point near ground, where the field intensity is low, and then runs horizontally to the receiver) the line acts as a

poor collector for the TV signals. In this case, most of the TV signal at the receiver input terminals comes from the antenna and is push-pull.

On signals from local FM-broadcast stations, which also are horizontally polarized, and which fall in the image band of some channels in some TV receivers, a broad-band TV antenna acts as a good collector when it is oriented for the FM station. If the TV antenna is narrow-band, or if it is oriented for a null on the FM-broadcast station, it acts as a poor collector, but the signal pickup from the FM station on the transmission line remains unchanged. In the latter case, most of the signal appearing at the receiver input terminals is a result of pickup on the transmission line and is push-push. If, in this case, the transmission line runs horizontally at a considerable height above ground, the push-push pickup of FM signal on the transmission line may be relatively strong.

The TV antenna is a very poor collector for vertically-polarized signals in the if range, or at any other frequency. But the long transmission line, which usually has horizontal and vertical runs, is a good collector for if signals. Intermediate-frequency signals appearing at the receiver input terminals are partially or entirely in push-push.

As stated previously, signals picked up on the transmission line are

usually in push-push, and the line may be short-circuited at any point along its length without affecting the push-push signal. If this concept is carried to an extreme, the line can be short-circuited along its entire length without affecting the pickup on the line. In this respect, the line is equivalent to a single-wire antenna.

If, however, the transmission line is very close to a source of signal, it is possible for a portion of the signal picked up on the line to be in push-pull, and in this case the analogy to a single-wire antenna is not completely true. The "source" of signal in this case may be a secondary source, such as a nearby electric wire, telephone wire, water pipe, antenna mast, lightning rod, rain gutter, or other metal object, all of which act as antennas and carry rf currents produced by the fields from stations at all frequencies, and also from diathermy equipments, ignition systems, and sparking electrical devices, etc.

The practice of twisting ribbon-type transmission line (a turn or two per foot of length) is not intended to reduce the amount of signal picked up on the line, but is an effort to make this pickup completely push-push, with very little push-pull component. For example, suppose that a ribbon line, without twists, is run parallel to, and only about an inch away from a rod that is carrying signals of various frequencies. One conductor in the transmission line is closer to the rod than the other conductor, and the closer conductor picks up

more signal from the rod. As a result of the unequal pickup on the two conductors, there is a voltage difference between the two conductors, and between the receiver input terminals. The peak voltage of the signal picked up on the transmission line in this case might be -5 units at one terminal, and -4.5 units at the other terminal. The voltage difference between the terminals (0.5 units in this example) represents the push-pull component of the signal picked up on the transmission line.

If the ribbon-type transmission line is twisted, each conductor is alternately brought closest to the rod for equal distances, and each conductor picks up the same total amount of signal from the rod. In this case, there is no voltage difference, or virtually none, between the receiver input terminals. In other words, the signal pickup on the transmission line is entirely in push-push.

If narrow ribbon-type transmission line is spaced a foot or more from the rod, or other signal carrier, it is unlikely that one conductor will pick up appreciably more signal than the other conductor. In this case, little actual benefit is obtained from twisting the line, but, in general, it is a worth-while practice.

It should be noted that a portion of the push-pull component of signal pickup on the transmission line is due to the fact that the incoming signal may reach one conductor slightly before it reaches

the other conductor, resulting in a slight difference in phase and voltage between the two conductors. This effect also can be averaged out by twisting the line.

Remedies for push-push interference

Television receivers that are designed for use with ribbon-type transmission line have some degree of immunity to push-push input signals. The immunity may be inherent in the circuit, such as that provided by a balanced push-pull input circuit, or it may be obtained by some built-in device connected ahead of a single-ended rf amplifier, such as the "elevator" transformer which is used in many RCA Victor receivers. In addition to good immunity for push-push signals, the rf-tuning unit should have the greatest possible attenuation for signals in the if and image-frequency bands. Some rf-tuning units have an adjustable trap, covering the FM broadcast range from approximately 90 to 110 Mc, which may be adjusted to reduce image interference from a local FM station.

When interference is caused by pickup of interfering signals in push-push on the transmission line, one of the following remedies may be applied as shown in TVI-2y.

1. Connect two parallel-resonant traps, one in series with each side of the transmission line, between the line and the receiver input

terminals. Each trap consists of an inductance with an adjustable core, shunted with a fixed capacitor. The traps are tuned to the frequency of the interfering signal by adjusting for minimum interference in the picture. The traps provide a high impedance (equivalent to an open circuit) in series with each side of the transmission line, effectively disconnecting the line from the set for signals at the interfering frequency.

2. Connect two series-resonant traps, one from each of the two input terminals, to a closely-adjacent point on the chassis. Each trap consists of an inductance with an adjustable score, in series with a fixed capacitor. The traps are tuned to the frequency of the interfering signal and provide a low-impedance path (equivalent to a short circuit) from each terminal to the chassis, at the interfering frequency.

The dual-trap assembly used on the rf-tuning unit in RCA Model 630 and similar receivers may be used either as parallel or resonant traps, as described above, to reduce image interference from local FM stations which may appear on channels 2 and 3 in some receivers. The traps in this dual assembly are connected in series-resonance. When it is desired to use these traps in parallel resonance, each capacitor must be connected across its corresponding inductance.

In cases of if interference from signal pickup on the transmission line, parallel traps of the type that are used in the picture-if amplifier of TV receivers may be connected between each side of the transmission line and the input terminals. Select traps that are intended for frequencies close to that of the interfering if signal. It may be necessary to remove turns, or increase the value of the shunt capacitor, as necessary, in order to tune the traps to the interfering frequency.

It is usually advisable to mount the traps close to the input terminals of the rf-tuning unit, but care must be taken to prevent coupling the interference from the traps into the rf or if circuits. If necessary, the traps should be shielded. On receivers where the input terminals on the rf-tuning unit are not accessible unless the chassis is removed from the cabinet, it is advisable first to try connecting parallel-resonant traps between the transmission line and the input terminals at the rear of the cabinet. Series-resonant traps may be less effective unless connected at the terminals on the rf-tuning unit.

On installations where the transmission line is a coax cable, a parallel-resonant trap, connected between the inner conductor and the receiver input terminal, is usually effective in reducing if or image interference. On installations that employ twin coax (either two separate coax cables, or double-conductor shielded cable)

parallel-resonant traps should be connected between each of the inner conductors and the receiver input terminals.

Checks on push-pull balance and push-push immunity

Two simple checks, for push-pull balance and push-push immunity, may be employed to reveal possible troubles in the rf-input circuits that may be responsible for certain interference conditions. The technician should not rely on these checks until he has observed the results on several of each type of rf-tuning unit under various receiving conditions.

These checks apply to terminals for balanced push-pull input, not to terminals for single coax transmission line.

To check push-pull balance, disconnect the antenna transmission line, move it away from the set, and tune the receiver to the weakest TV station. It is preferable that the signal be so weak that it is scarcely visible on the picture tube. Using a metal screwdriver with insulated handle, touch the tip of the blade first on one input terminal, and then on the other input terminal. The position of the screwdriver, the position of the fingers gripping the handle, and the position of the technician's arms and body should not be changed while making this check. The screwdriver blade acts as a small antenna to feed a weak signal into each terminal. *The signal*

strength, as observed on the picture tube, should be approximately the same at each terminal, indicating satisfactory balance.

One condition that leads to false indications when this check is made is the existence in strong-signal areas, of fairly strong residual signal pickup in the rf-tuning unit, with the transmission line disconnected. The additional signal introduced by the screwdriver may *oppose* this residual pickup when one terminal is touched, and *aid* the residual pickup when the other terminal is touched, thus giving a false indication that the balance is poor. The additional signal should have at least five times greater voltage amplitude than the residual pickup. In cases where the residual pickup is relatively strong, it is necessary to use a more effective "antenna" than the screwdriver in order to provide more signal; a clip lead from a voltmeter may be satisfactory in some cases. The use of strong signals, however, makes it difficult or impossible to judge the relative gain at each terminal, due to AGC action. If necessary, the AGC should be temporarily replaced by an adjustable bias.

In weak-signal areas, where a screwdriver or a clip lead do not provide sufficient signal, it is convenient to use the regular antenna and transmission line. Touch one side of the transmission line first to one input terminal, and then to the other input terminal. *The*

picture strength at each terminal should be approximately the same. If not, it is advisable to check the rf circuits.

To check push-push immunity, it is necessary to have a source of push-push signal with negligible push-pull component. Such a signal can be obtained by using a length of ribbon-type transmission line, without antenna, to pick up the TV signals.

Disconnect the regular transmission line from the receiver, and move this line, together with any other lines or antennas, away from the vicinity of the set. Tune the set to a TV station on which the residual pickup in the rf-tuning unit provides a very weak picture.

Stretch a length of 300-ohm ribbon line, 10 feet or longer, horizontally across the room in clear space, away from metal objects and wiring. Suspend the line by means of strings, rather than insulators of any type. Attach clip connectors on the receiver-end of the line. Connect a $\frac{1}{4}$ -watt 300-ohm, or 270-ohm, carbon or composition resistor (not wire-wound) across the far end of the line. Cut the resistor leads about $\frac{1}{4}$ inch long and solder them to the two wires at the end of the line without spreading the wires. Use a good piece of line. This line will be referred to as the "test line."

Carefully note the strength of the picture signal provided by residual pickup in the rf-tuning unit. Then connect the clips on the end of the

test line to the receiver input terminals, thereby feeding a push-push signal into the set. *If the push-push immunity is good, the strength of the picture should not increase appreciably when the test line is connected to the receiver.*

After this check is made, if the receiver employs the RCA elevator transformer or similar device ahead of a single-ended rf amplifier, disconnect the test line from the receiver input terminals, and connect one side, or both sides, of the test line to the *output* lead from the elevator transformer. The picture signal should increase greatly. If the above checks show that the push-push immunity is not good, it is advisable to check the rf input circuit and components. When these checks are first performed on different receivers, it is helpful to introduce temporary short-circuits, open-circuits, and grounds in the rf input components in order to learn how these defects affect the balance and immunity.

(In receivers that employ the RCA elevator transformer, or similar device, it is essential to have a short circuit across two of the terminals on the input socket of the transformer when using 300-ohm line, as specified in the manufacturers' service data.)

Again the technician is cautioned against drawing hasty conclusions from these checks. It is necessary to gain experience in checking different rf-tuning units under various receiving conditions before

the results can be interpreted correctly. It is, however, definitely worth while, for technicians who must solve interference problems, to become expert in using these checks. *Obviously, there is no sense in installing traps, filters, and stubs, to overcome an interference condition that has been brought about by a service defect in the rf-input circuit of the receiver.*

INTERFERENCE FROM HARMONICS OF SOUND-IF AND PICTURE-IF SIGNALS

The output signals from the sound-if and picture-if amplifiers have some harmonic content. If the harmonic signals are coupled back into the rf-input circuits in any way, and if the frequency of any harmonic happens to fall in a TV channel that is used in the particular receiving area, the harmonic can cause interference.

Harmonic frequencies of sound and picture intermediate frequencies used in RCA Victor television receivers are listed on the following two pages.

<u>Harmonic No.</u>	<u>SOUND-IF, (Mc)</u>			<u>PICTURE-IF, (Mc)</u>		
Fundamental	21.0	21.25	41.25	25.5	25.75	45.75
2nd	42.0	42.50	82.50	51.00	51.50	91.50
3rd	63.0	63.75	123.75	76.50	77.25	137.25
4th	84.0	85.00	165.00	102.00	103.00	183.00
5th	105.0	106.25	206.25	127.50	128.75	228.75
6th	126.0	127.50	247.50	153.00	154.50	274.50
7th	147.0	148.75	288.75	178.50	180.25	320.25
8th	168.0	170.00	330.00	204.00	206.00	366.00
9th	189.0	191.25	371.25	229.50	231.75	411.75
10th	210.0	212.50	412.50	255.00	257.50	457.50

For convenience, television channels and carrier frequencies are also listed:

<u>Channel Number</u>	<u>Channel Frequency Mc</u>	<u>Picture Carrier Mc</u>	<u>Sound Carrier Mc</u>
2	54-60	55.25	59.75
3	60-66	61.25	65.75
4	66-72	67.25	71.75
5	76-82	77.25	81.75
6	82-88	83.25	87.75
7	174-180	175.25	179.75
8	180-186	181.25	185.75
9	186-192	187.25	191.75
10	192-198	193.25	197.75
11	198-204	199.25	203.75
12	204-210	205.25	209.75
13	210-216	211.25	215.75

When there is any reason to suspect that a particular interference condition may be caused by a harmonic of a sound-if or picture-if signal, simple computation will show whether any harmonic of the picture-if or sound-if signal falls within the frequency range of a particular channel.

For example, in a receiver having a sound-if carrier of 21.25 Mc, and a picture-if carrier of 25.75 Mc, if there is interference on channel 7 (174-180 Mc), computation (or reference to the previous tables) show that the closest harmonic of the sound-if signal is the 8th, at 170 Mc, and the closest harmonic of the picture-if signal is the 7th, at 180.25 Mc. Both of these harmonics are outside of channel 7. Hence, in this example, it is very unlikely that the particular interference is caused by a harmonic of the if-carrier signals, provided that receiver tuning control is correctly adjusted.

As another example, if there is interference on channel 6 in the same receiver, it may be caused by the 4th harmonic of the sound-if signal. The 4th harmonic is 85 Mc, which falls in channel 6 (82-88 Mc).

Interference from a harmonic of the sound-if signal appears as a faint or pronounced herring-bone beat pattern that varies in step with the voice or music modulation. The beat may have any frequency ranging from zero to about 4.5 Mc, depending on the difference in frequency between the harmonic and the picture or

sound rf carrier of the transmitter. In receivers that have a separate sound channel the beat frequency can be changed over wide limits by relatively slight adjustment of the receiver tuning control, which alters the frequency of the sound-if carrier and produces a progressively greater change in frequency for each higher harmonic. In intercarrier receivers, the beat frequency is not altered by adjustment of the receiver tuning control because the final sound-if remains constant at 4.5 Mc. Photographs of interference patterns produced by a harmonic of the sound-if signal are shown in TVI-2n, TVI-2o, and TVI-2p.

Sound-if harmonic interference sometimes resembles ordinary sound-in-picture interference, which results from incorrect adjustment of the receiver tuning control, or from incorrect alignment of the sound traps in the if and video amplifier. In these cases, however, the beat frequency is always 4.5 Mc, and it is not altered by adjustment of the receiver tuning control.

There is a simple check to identify this type of interference: Temporarily remove a tube from the sound-if amplifier. Removal of the tube "kills" the sound-if output and also the harmonics. If the interference disappears when the tube is removed, it may be assumed that the interference is caused by a harmonic of the sound-if signal getting into the rf circuits.

The harmonics are strongest in the last sound-if amplifier and discriminator (4.5-Mc amplifier and discriminator in intercarrier receivers). The harmonics may be coupled from these circuits to the rf input of the receiver by electrostatic coupling, by radiation, and or by common coupling which may be through heater, $B \pm$, and other leads, or through a common chassis path.

Possible remedies for sound-if harmonic interference include:

1. Route the antenna transmission line away from the sound-if amplifier and discriminator in order to reduce the intensity of harmonic-signal pickup on the transmission line.
2. *Use an outdoor antenna in place of a built-in or indoor antenna.* If it is not possible to use an outdoor antenna, locate an antenna in the attic, or on a window, or in any location that provides stronger TV signal pickup.

The required sensitivity (gain or amplification) of the receiver depends on the strength of the TV input signal. The gain is controlled by AGC action. With a weak TV input signal, the gain is greatest, and the receiver is most susceptible to interference from a harmonic of the sound-if signal. If the TV input signal is greatly increased by the use of a more effective antenna, the gain of the receiver is greatly reduced, and the harmonic of the sound-if

signal is not amplified enough to show up as interference in the picture.

This remedy is also valuable in reducing interference from a harmonic of the picture-if signal, and interference from Barkhausen oscillation in the horizontal output circuit.

3. Determine whether better grounding of the shields on the sound-if and discriminator coils reduces the interference. If necessary, spot solder or clamp the shields in some fashion to ensure good connection to the chassis. Shields should be used on the last sound-if and discriminator tubes. The shields must make good contact with the chassis. Try a temporary electrostatic shield around the components and wiring of these stages.
4. Check lead dress, bypass capacitors, and chassis ground connections in the last sound-if and discriminator circuits. Find out whether the manufacturer has issued special instructions on this subject. It has been found that certain types of bypass capacitors, which have sufficiently low reactance at the sound-if frequency, are ineffective for bypassing the higher harmonics of the sound-if signal. It is sometimes helpful to replace these capacitors with the type used in later-production receivers.
5. As a last resort, it is possible to shift the entire picture-if and sound-if band sufficiently in the correct direction so that the

troublesome harmonic is moved outside of the particular channel. Such a shift requires complete realignment of the picture-if and sound-if amplifiers and the rf oscillator.

Interference from a harmonic of the picture if signal appears as a faint or pronounced beat. The beat may be of any frequency, depending on the difference in frequency between the harmonic of the picture-if signal, and the picture or sound rf carrier of the transmitter. The beat frequency can be changed over wide limits by relatively slight adjustment of the receiver tuning control. The beat pattern seldom remains stationary because of drift of the picture-if carrier frequency. The drift is proportionately greater on each higher harmonic.

When computation shows that a harmonic of the picture-if carrier frequency occurs in the rf band of a particular channel, a double check, for positive identification of the interference, can be made as follows:

Provide additional temporary coupling between one side of the rf-input terminals and the last picture-if amplifier. This coupling may be provided by:

- (a) Touching a finger on one rf-input terminal, and holding a small piece of metal against the last picture-if tube, or by

- (b) using a short length of shielded wire, with one end of the wire connected to one rf-input terminal, and the other end of the wire placed alongside the last picture-if tube, or placed near the plate lead of this tube. The shield on the wire should extend to within an inch of each end, and the shield should be clamped in contact with the chassis. The reason for using a shielded wire is to reduce possibility of regeneration in the picture-if amplifier, and also to prevent pickup of extraneous signals.

If the *intensity* of the interference is increased by the additional coupling, it indicates that the interference is probably due to a harmonic of the picture-if signal. It may be necessary to reduce the strength of the TV signal by disconnecting one side of the transmission line from the terminal that is used for injecting the additional-coupling signal. The correct way to make this check is to arrange the shielded wire as outlined above, and then move the end of the wire away from the last picture-if tube or plate circuit. The intensity of the interference should decrease when the end of the wire is moved away, and it should increase when the end of the wire is again moved close to the last picture-if plate circuit. (This same type of check can be used for identification of sound-if harmonic interference.)

Remedies for picture-if harmonic interference are essentially the same as given above for sound-if harmonic interference, except that

the information applies to the last picture-if amplifier and the picture second detector, instead of the last sound-if amplifier and discriminator.

GUIDE OF APPROXIMATE LENGTHS FOR $\frac{1}{2}$ - and $\frac{1}{4}$ -WAVE STUBS, USING RCA "BRIGHT PICTURE" 300-OHM LINE

FREQUENCY IN MEGACYCLES	APPROXIMATE LENGTH—(INCHES)	
	$\frac{1}{2}$ -WAVE SHORTED STUB	$\frac{1}{4}$ -WAVE OPEN STUB
50	98	49
55	$89\frac{1}{8}$	$44\frac{1}{2}$
60	$81\frac{5}{8}$	$40\frac{7}{8}$
65	$75\frac{3}{8}$	$37\frac{3}{4}$
70	70	35
75	$65\frac{3}{8}$	$32\frac{3}{4}$
80	$61\frac{1}{4}$	$30\frac{5}{8}$
85	$57\frac{5}{8}$	$28\frac{7}{8}$
90	$54\frac{1}{2}$	$27\frac{1}{4}$
95	$51\frac{5}{8}$	$25\frac{7}{8}$
100	49	$24\frac{1}{2}$

Continued on Page 202

FREQUENCY IN MEGACYCLES	APPROXIMATE LENGTH—(INCHES)	
	$\frac{1}{2}$ -WAVE SHORTED STUB	$\frac{1}{4}$ -WAVE OPEN STUB
110	$44\frac{1}{2}$	$22\frac{1}{4}$
120	$40\frac{7}{8}$	$20\frac{1}{2}$
130	$37\frac{3}{4}$	$18\frac{7}{8}$
140	35	$17\frac{1}{2}$
150	$32\frac{3}{4}$	$16\frac{3}{8}$
160	$30\frac{5}{8}$	$15\frac{3}{8}$
170	$28\frac{7}{8}$	$14\frac{1}{2}$
180	$27\frac{1}{4}$	$13\frac{5}{8}$
190	$25\frac{3}{4}$	$12\frac{7}{8}$
200	$24\frac{1}{2}$	$12\frac{1}{4}$
210	$23\frac{3}{8}$	$11\frac{5}{8}$
220	$22\frac{1}{4}$	$11\frac{1}{8}$
230	$21\frac{1}{4}$	$10\frac{5}{8}$
240	$20\frac{1}{2}$	$10\frac{1}{4}$
250	$17\frac{5}{8}$	$9\frac{7}{8}$

RCA Television PICT-⊙-GUIDE

V-9

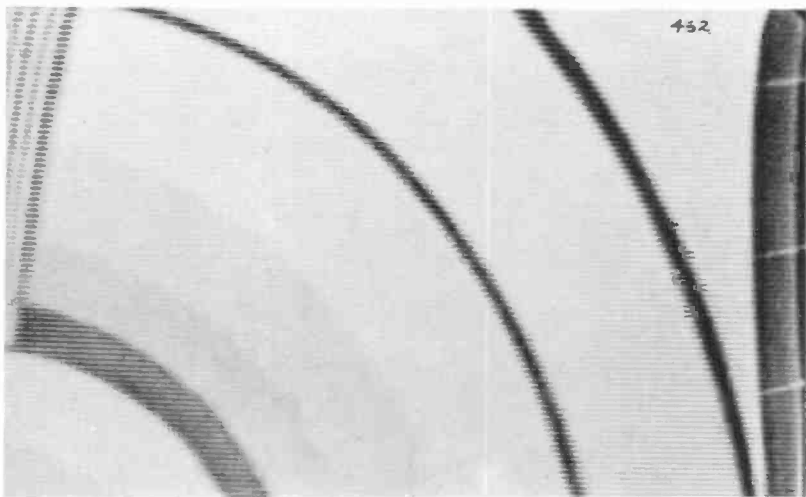

In receivers where signals for the input of the sync separator are taken from the dc-restorer circuit, a defective dc restorer may produce horizontal picture pulling as shown above. (Contrast and brightness were adjusted to show the blanking at right: with normal contrast, the pulling is more pronounced.)



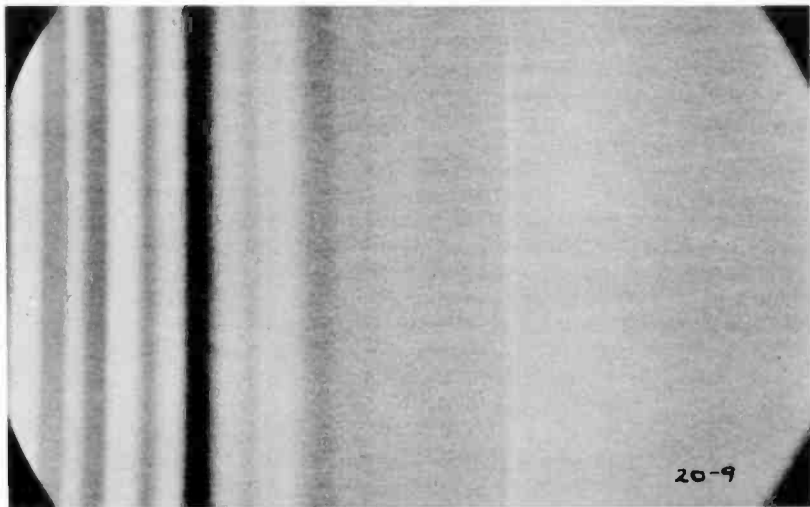

Vertical bars produced by stray electrostatic coupling between the kinescope grid lead and the horizontal-deflection section. A portion of the shielding around the horizontal section was missing. It is necessary to avoid any coupling between the horizontal-output section and the video amplifier.



Poor vertical sync and blanking due to poor low-frequency response produced by an opened 10-ohm resistor in the second-detector return circuit shown in diagram on reverse side.

RCA Television PICT-⊗-GUIDE

V-10a



Trailing reversal (white outline on right-hand side of black picture elements), and grey background instead of white, due to poor low-frequency response. This condition was produced by changing the second-video plate-load resistor from 8200 to 3000 ohms. Diagram shown on V-10.



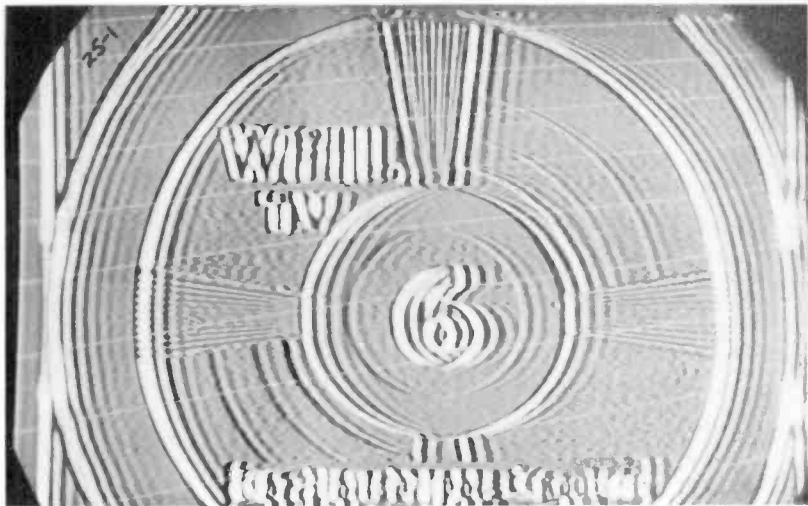

Multiple images caused by "ringing" in the second-video plate circuit shown on V-10. This condition was produced by short-circuiting the 8200-ohm plate-load resistor. Refer to GHO-1c.

RCA Television PICT--GUIDE

V-10b

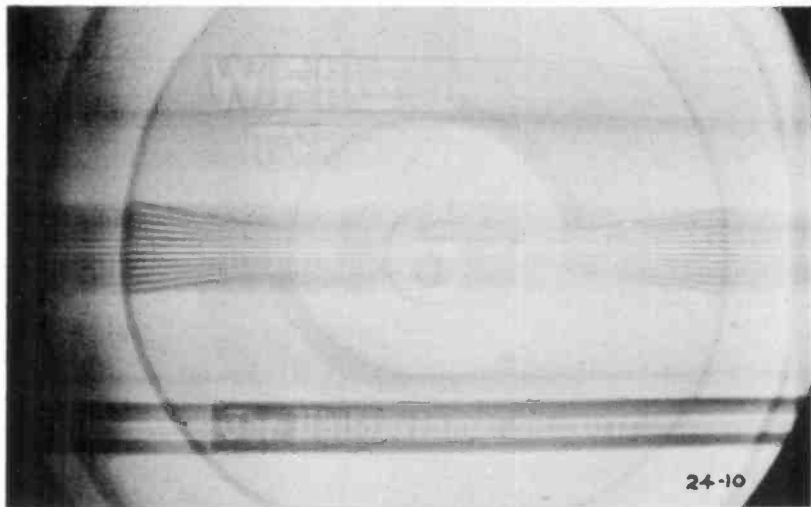

Severe streaking and bad picture quality due to low-frequency phase shift, produced by an open coupling capacitor ($0.047 \mu\text{f}$) in the kinescope grid circuit shown on V-10.





Streaking due to low-frequency phase shift produced by an open bypass capacitor ($0.1 \mu\text{f}$) in the cathode circuit of the picture tube. Diagram shown on V-10.

RCA Television PICT-⊗-GUIDE

V-10c

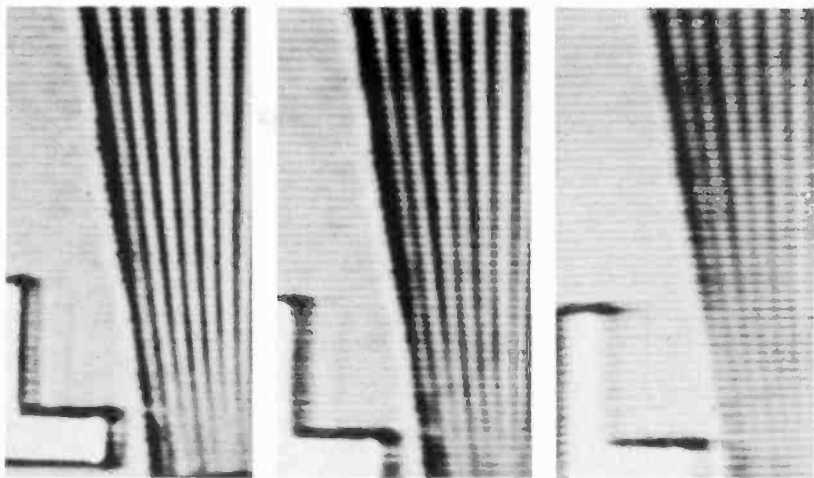

Effect on picture definition of shorted peaking coils in the video amplifier shown on V-10: At left, normal condition. Center, one peaking coil shorted. At right, all six peaking coils shorted. Note the poor definition in the vertical wedge, and the weakening of vertical portions of letter "L" which result when all the peaking coils are shorted.



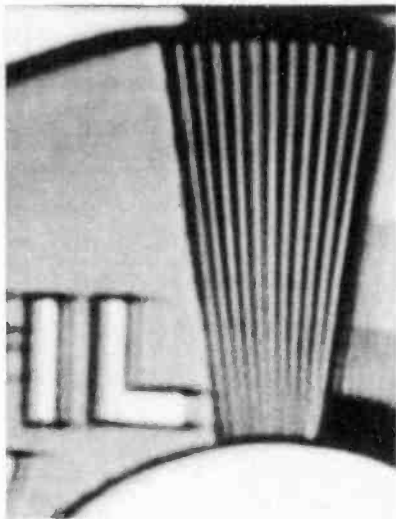
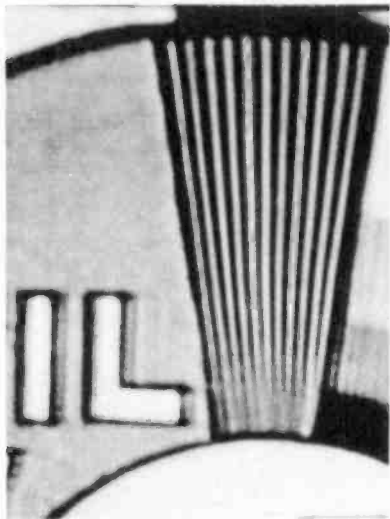

Effect on definition of lengthening the lead to the grid of the picture tube: At left, normal lead length. At right, reduced definition with ten-foot lead.

RCA Television PICT-8-GUIDE

VO-4b

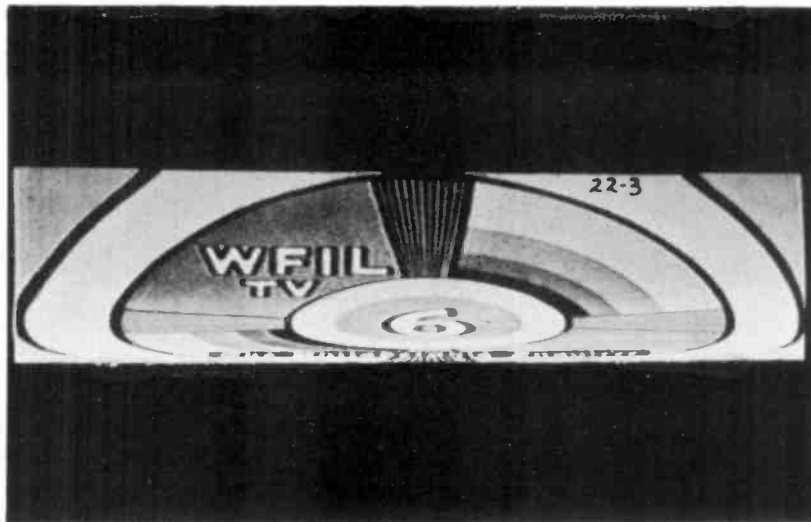

Bottom half of raster is compressed due to leakage (300,000 ohms) across vertical discharge capacitor ($0.05 \mu\text{f}$) in plate circuit of vertical oscillator and discharge tube shown on VO-1.



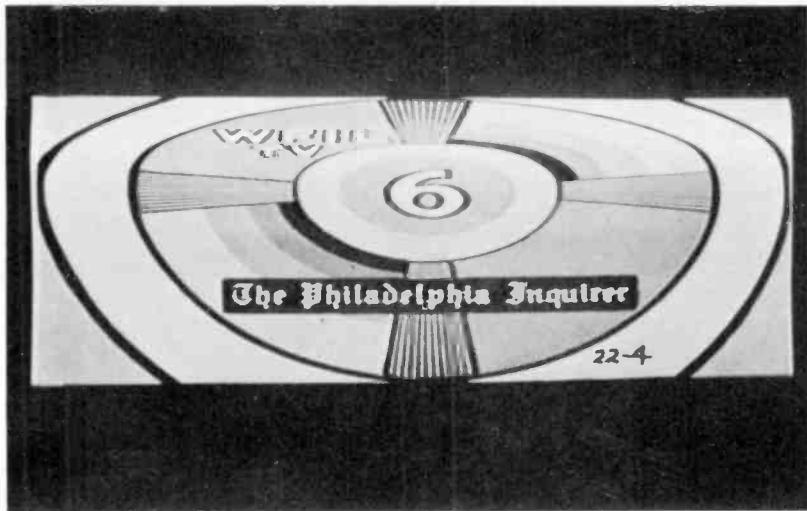

Top half of raster is compressed due to heater-cathode leakage in vertical-output tube. Diagram of typical vertical-output circuit is shown on VO-1.

RCA Television PICT-O-GUIDE

VO-9

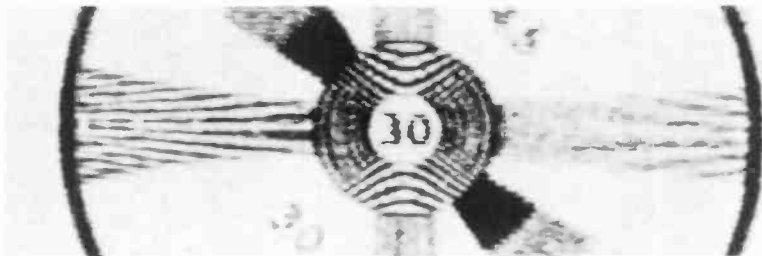
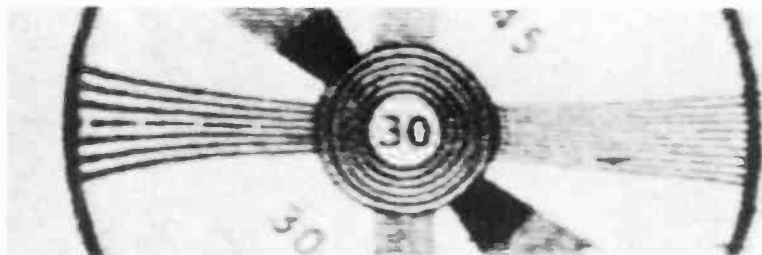

Bottom photo; lack of interlace produces moire pattern in the horizontal wedges and in the concentric circles. Top photo; interlacing is good.



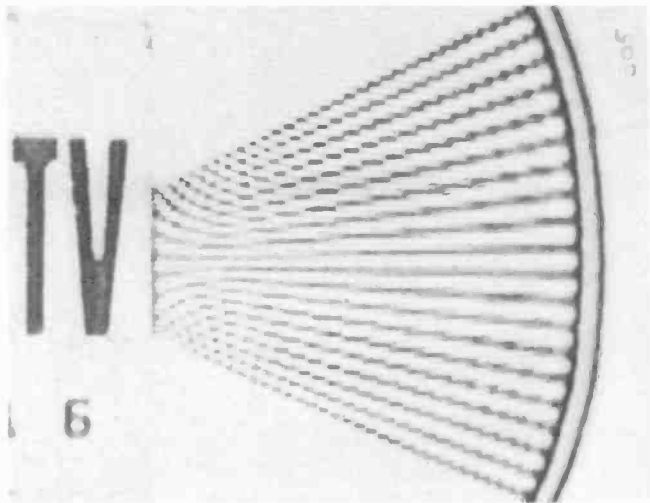

Photograph made with camera shutter speed of $1/100$ second to show how the horizontal wedge appears when formed by only one field: Every other horizontal scanning line is missing. The effect resembles, but is not the same as, an out-of-interlace condition.

RCA Television PICT-⊗-GUIDE

VO-9a

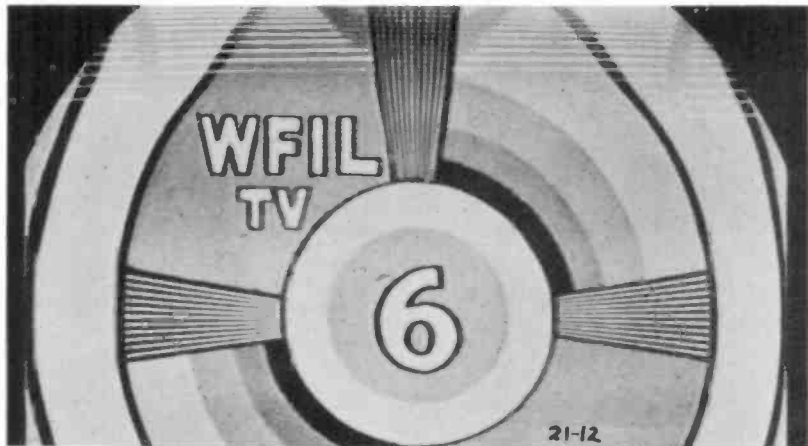

Example of excessive vertical-return time. The picture signals commence about 20 lines before the scanning beam reaches the top of raster. Trouble produced by a shorted 220,000-ohm resistor in primary circuit of vertical-output transformer shown on K-10. Refer to opposite side of VO-9a.



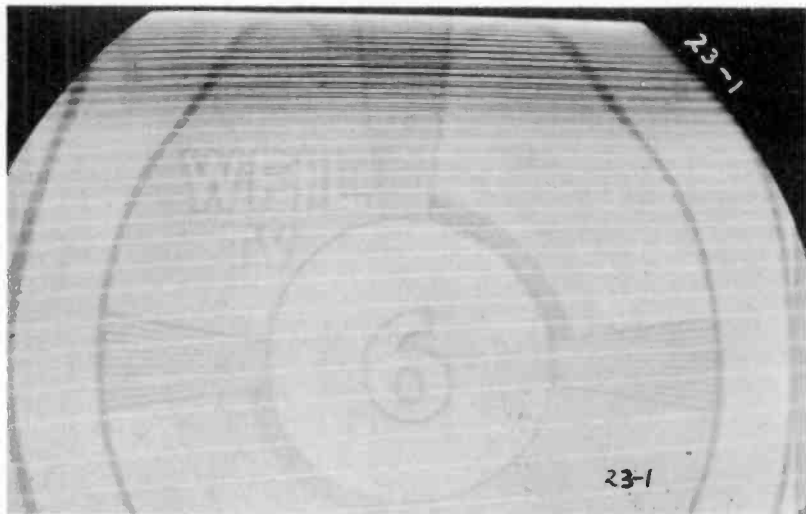

Same condition as shown on opposite side, but with contrast and brightness adjusted to show the vertical-return lines. Note the large number of return lines; compare with the normal fast return shown on VO-8a.

C YOU can BUILD VOLUME and PROFITS by selling MORE RCA RADIO BATTERIES

- COMPLETE, FAST-SELLING LINE puts you in volume business.
- COMPETITIVE PRICES keep you ahead!
- OUTSTANDING NATIONAL ADVERTISING creates ever-increasing demand for RCA RADIO BATTERIES and directs this valuable business to you . . . *the radio dealer-serviceman.*



● RCA RADIO TRADE DISTRIBUTION puts you out front in the radio battery replacement business. It means profitable repeat business for radio dealers because RCA sells "The Radio Battery for the Radio Trade."

● HARD-HITTING SALES AIDS give real selling power.

● RCA PACKAGE IMPACT means faster sales.

C TODAY—SEE YOUR RCA BATTERY DISTRIBUTOR

USE RCA *Originals*

TO RESTORE ORIGINAL PERFORMANCE

When you choose replacement parts—be sure; use RCA TV components. Original RCA TV components are performance-proved in millions of TV receivers of many makes. And with the same assurance of high quality, you can rely on more than 40,000 genuine RCA Service Parts, manufactured exclusively to maintain the highest standards of performance in RCA Victor instruments.

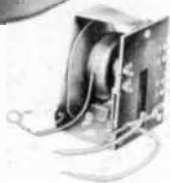

TMKS ®

KEEP AHEAD — KEEP IN TOUCH WITH YOUR RCA DISTRIBUTOR