

NEW EDITION!
 ALL DIAGRAMS CLEARLY PRINTED
 IN BLACK ON WHITE PAPER
 ... FOR QUICK, EASY READING

150 SHOP PRINTS AND WIRING DIAGRAMS

And How to Read Them

INCLUDING: Use of Plans and Symbols — Tracing Circuits — Technical Terms and Their Meanings — **D.C. and A.C. EQUIPMENT:** Motors, Generators, Meters, Controls — Armature and Stator Windings — Arc Welding Systems — Wiring — **RADIO CIRCUITS**—Frequency Modulation—Automatic Tuning—Trouble Shooting

If you've paid 10 to 25¢ for single prints, you'll be amazed at the quality and completeness of these 150 prints for only **\$1.95**

Published by COYNE ELECTRICAL SCHOOL • CHICAGO, ILL.



Practical ELECTRICAL & RADIO BOOKS

PUBLISHED BY COYNE ELECTRICAL SCHOOL
500-526 SOUTH PAULINA ST., CHICAGO, 12, ILL.

R. A. Snyder, Manager,
Technical Book Division,
Coyne Electrical School,
Chicago 12, Illinois.

Dear Friend:

HERE IS THE NEW COYNE SET - "APPLIED PRACTICAL ELECTRICITY" - YOU ORDERED FOR A 7-DAY FREE EXAMINATION!

We welcome the opportunity of sending you this set because we feel sure you will find these books the easy-to-understand complete Reference Books on Electricity you have been looking for.

We are proud of this set because our teaching staff of Electrical and Radio experts have spent years in accumulating the wealth of practical information contained in these books. These men who have spent their lives in teaching men, have put into these books, the most complete explanations of the many electrical subjects they have studied and taught for years. When you buy and use this set you actually get the benefit of their years of study in various Electrical and Radio subjects.

THESE BOOKS IDEAL FOR THE BEGINNER OR THE EXPERIENCED ELECTRICIAN OR MECHANIC

"APPLIED PRACTICAL ELECTRICITY" is not only ideal for the fellow who wants to learn Electricity at home, but it is of great value to the experienced electrician, mechanic or engineer.

In order to properly determine the value of these books, it is essential that you know the right way to study this Set. To begin with, we suggest that you try to set aside a few hours each week for regular study on these books.

THEN ----

MASTER EACH SUBJECT THOROUGHLY, STARTING AT THE BEGINNING OF VOLUME I AND PROGRESSING SYSTEMATICALLY THROUGH THE SET. The foundation for this set of Reference Books in Electricity is in Volume I -- so be sure to study that section first.

As you go through any of the sections of these books make frequent reference to the illustrations. An old Chinese philosopher once said, "One picture tells the story of 5,000 words" -- so be sure to refer to the pictures and diagrams constantly as you study this set.

RAS:ASSB
21.00-3

(Please turn to page two)

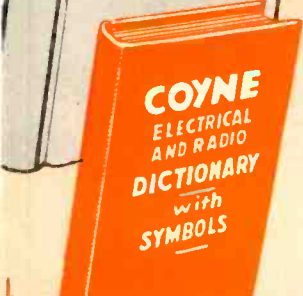

SPECIAL SELF EXAMINATION QUESTIONS THROUGHOUT THE BOOKS

One of the valuable features of this set are the special self examination questions to be found in all of the volumes. These have been especially developed so you can check your progress as you use these books. When you come to some of these questions be sure to answer them. Then check your answers with the material in the chapters. In this way you can see at all times that you are thoroughly understanding the material. We have found in 48 years of training experience that it is advisable to check your knowledge of one subject before proceeding to another. You'll find that answering these questions is one of the most interesting parts of the study and use of these books.

THE SET WILL PAY FOR ITSELF MANY TIMES OVER

Thousands of these sets have already been sold and are paying dividends practically EVERY day to those who bought them.

There are hundreds of letters in our files from fellows who have used these books to learn electricity at home as a means to a better job or for constant reference in the field on various electrical problems. One fellow who has a farm up in Wisconsin has used a set of our books for over 10 years and is able to take care of all the electrical problems on his modern farm just by referring to these books. His set has already saved him several hundred dollars in electrical work.

HOME OWNERS, HARDWARE STORE OWNERS, FARMERS, ELECTRICIANS, RADIO MEN, LABORERS, MECHANICS, ENGINEERS, STUDENTS, ETC. are just a few of the many types of fellows who have received a great deal of value out of this Electrical Set. Many of these fellows wouldn't part with their set for many times its cost if they couldn't replace it.

I am sure when you go over the first volume of these books you will say, "This is the set of Electrical books I've been looking for because everything is made so easy to understand."

\$1.25 SAVINGS IF YOU PAY CASH FOR YOUR SET

There are two ways you purchase this amazing Electrical set -- the CASH plan or the PAYMENT plan. On the cash plan you send us your personal check or money order for \$19.75 and save \$1.25 on the purchase -- on the payment plan you send us \$3.00 after 7 day's examination and then you send \$3.00 per month until \$21.00 has been paid.

The additional amount on the payment plan is to take care of the bookkeeping and handling. On the payment plan there is NO NOTE to SIGN -- NO SECURITY to put up -- YOUR PROMISE TO PAY IS ALL WE WANT because we are sure that now that you have these valuable books you won't part with them for any price.

ONE YEAR FREE CONSULTATION SERVICE AND TECHNICAL NEWS BULLETINS

With the purchase of "APPLIED PRACTICAL ELECTRICITY" now, you receive one full year of free Consultation Service which will also include a one year free subscription to the Coyne Technical News. This is a Technical Bulletin published periodically on new equipment and improved methods of electrical construction, operation and maintenance.

Page three

You may call on us at any time for a period of one full year for advice on any Electrical problems that may come up.

I am enclosing a Consultation Service Registration Card. When you send us your payment on these books, be sure to return this card so that we can register your name for the news Bulletins and the Consultation Service to which you are entitled for a period of one year. As soon as your payment is received this service is just an added effort on our part to see to it that you keep up-to-date on new developments in various phases of Electricity
- AND - THAT ISN'T ALL.

THE NATIONALLY FAMOUS COYNE "PUTTING YOURSELF OVER" SERIES FREE WITH YOUR COYNE SET - "APPLIED PRACTICAL ELECTRICITY"

To every purchaser of "APPLIED PRACTICAL ELECTRICITY" (for a limited time) we will give absolutely Free the Famous Coyne "Putting Yourself Over" Series of lessons. This is a series of 8 lessons, individually bound, that was primarily designed for students of our school. If you pay cash for your set of books, we will send you the complete series of 8 lessons. If you use the payment plan, we will send you lessons for each payment you make until you receive the entire series. BE SURE TO READ THE CIRCULAR I AM ENCLOSING WITH THIS LETTER DESCRIBING THIS VALUABLE SERIES OF LESSONS.

I am confident you will find "APPLIED PRACTICAL ELECTRICITY" highly interesting and will always prize it very highly. After you have had a chance to go over it, I'm sure you will not want to part with it for many times its small cost. So go over these books as soon as you can, so you can take advantage of the many features of our present special offer.

Very sincerely yours,

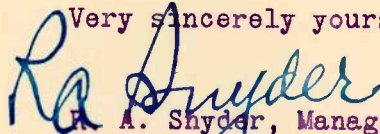

R. A. Snyder, Manager,
Educational Book Publishing Division.
Coyne Electrical School.

RAS:ASSB
21.00-3

P. S. I am also enclosing a new circular I've just prepared listing all of Coyne's Electrical & Radio books. If you'd like to see any of these other Coyne Books for 7 Days Free Trial, just fill in and mail the coupon. After you've read this circular, Please pass it on to some other fellow who should know about Coyne books.

R. A. S.

FREE CONSULTATION SERVICE AND COYNE TECHNICAL NEWS

Certificate

This will serve to Certify that:

Mr. _____

as a purchaser of a COYNE TECHNICAL PUBLICATION is entitled to ONE FULL YEAR of Consultation Service and Technical Advice.

We hereby agree to furnish technical advice on any problems that may arise with the exception of any direct questions on specific examinations for U. S. Civil Service or state or federal appointments.

This certificate also includes ONE YEAR FREE SUBSCRIPTION to the COYNE TECHNICAL NEWS, the official technical publication of the COYNE ELECTRICAL SCHOOL.

This service becomes effective from the date of the purchase.



Signed _____

H. Lewis

President

COYNE ELECTRICAL SCHOOL
500 South Paulina Street
Chicago 12, Illinois

Date _____

IMPORTANT: This certificate is to be returned to us bearing your name IN YOUR OWN HAND WRITING, also the date you purchased your book.

150 COYNE SHOP PRINTS *and* HOW TO READ THEM .

An Instruction and Reference Book

for

Radio Men and Electricians

PREPARED AND PUBLISHED FOR HOME STUDY AND
FIELD REFERENCE BY THE COYNE ELECTRICAL
SCHOOL, 500 S. PAULINA ST., CHICAGO, ILLINOIS. ALL
THE DATA IN THIS MANUAL, INCLUDING THE ACTUAL
SHOP PRINTS AND MOTOR DIAGRAMS HAS BEEN
FIELD TESTED IN THOUSANDS OF INDUSTRIAL CON-
CERNS THROUGHOUT THE COUNTRY.

HOW TO LOCATE THE VARIOUS SHOP PRINTS AND MOTOR DIAGRAMS

THE PURPOSE of this directory is to aid the user of this Shop Print Book in locating the prints he wants QUICKLY. The book is in sections, each section containing several valuable shop prints on a specific subject. Use this guide to find the prints you want—it will save time for you.

Section 1. Direct Current Equipment..... 63-158

Voltage Drop, Relays, Instructions for Tracing Diagrams, House Wiring, Electric Range, Meters, Standards of Illumination, Generators, Motors, Brushes and Brush Settings, Maintenance and Trouble Shooting, Starters, Motors, Series, Compound, Shunt, Universal Series, Generators, Brush Setting, Trouble Shooting, Voltage Control, Paralleling, Armatures and Stators, Growlers, Wattmeters, and Watt-hourmeters, Circuits, Starters, Controllers, Dynamic Braking, Amplidyne Generators, Arc Welding Systems.

Section 2. Alternating Current Equipment.....179-210

Transformers, Tesla Coil, Transmission, Power and Distribution System, Butt and Spot Welders, Neutralizers, Squirrel Cage Motors, Rotating Magnetic Field, Selsyns, Polyphase Motors, Speed Adjustment, Slip Ring Induction Motors, Synchronous Motors.

Section 3. Radio405-422

2 Tube Regenerative Circuit, Superheterodyne Receiver, Mechanical Layout, Principles, TRF Receiver, 3 Band Receiver, Transceiver, Frequency Modulation, Auto-Frequency Control, Auto-Volume Control, Automatic Tuning.

NOTE:—The **Coyne Electrical and Radio Trouble Shooting Manual** from which the material in this book was taken is especially prepared for men interested in learning how to read shop prints and motor diagrams. It is also a valuable book on the job, for Electricians and Radio men. The book has over 600 pages with more than 500 wiring plans and diagrams. For information on this book write to **Department TSP, Coyne Electrical School, 500 South Paulina Street, Chicago 12, Illinois.**

FOREWORD

IN determining the value of any manual, the thought to keep foremost in mind is—WHO PUBLISHED IT and WHAT EXPERIENCE HAVE THEY HAD IN THE SUBJECTS COVERED.

This book represents NOT JUST THE MATERIAL OF ONE INDIVIDUAL WRITER (as is the case with many books) but also the combined efforts of Coyne instructors, who are men with a wide field and teaching experience in all branches of **Electricity and Radio**.

In submitting the diagrams and instructions and material for this book, these men kept two thoughts in mind. **First—MAKE IT SIMPLE ENOUGH FOR THE "BEGINNER"—Second—MAKE IT COMPLETE, PRACTICAL AND VALUABLE TO THE "OLD TIMER."**

This book is comprised mainly of carefully selected shop prints and diagrams of motors, controllers, starters, generators, compensators, transformers and dozens of other types of Electrical and Radio equipment. It includes actual wiring diagrams of equipment manufactured by many of the leading Electrical and Radio manufacturing companies. The diagrams have been selected with a view of covering as much as possible the entire Electrical and Radio field.

Unlike ordinary diagrams that Electricians and Radio men purchase, the prints in this book have explanatory material. As an example, refer to page 137 and here you will note we have shown in detail the wiring diagram of a drum controller. Immediately beneath the diagram, we have explanatory material to outline what a drum controller is and its use and operation in an industrial plant. It is information of this kind which cannot be secured on any "commercial" diagram.

Another valuable shop print for DC testing can be found on page 116. Here you will note that we have 9 separate diagrams illustrating various armature growler tests on DC equipment. The explanatory information beneath each diagram enables the Electrician to quickly and accurately locate trouble in armatures by use of the growler.

To answer the problem of a man in an Electrical crew who has occasion to make growler tests but does not have a growler for such work, we have listed complete wiring specifications of a growler on page 115. Many Electricians have told us that this one diagram alone is worth many times the cost of the book, because it furnished wiring instructions for very practical testing instruments.

These few diagrams are mentioned to illustrate how practical this book can be for an Electrician on the job. The prints and diagrams provide a man

in the Electrical field a tremendous advantage as they contain material that will enable him to diagnose and remedy Electrical and Radio problems. One buyer amply described this book by saying "THE COYNE BOOK OF 150 SHOP PRINTS AND MOTOR DIAGRAMS IS TO THE ELECTRICIAN WHAT A SET OF LAW BOOKS IS TO THE LAWYER—it provides the answer to hundreds of problems in the Electrical field." This book could likewise be compared to a set of medical books that a Doctor uses. Regardless of whether a Doctor, or a lawyer is just starting his practice or whether he is an "old timer" and has been in the profession for many years, HE HAS MANY OCCASIONS TO REFER TO HIS REFERENCE BOOKS on certain cases in order TO BE SURE. A lawyer will look up some similar case to that upon which he is working, to see what decision was rendered, the same as a Doctor in diagnosing an ailment for a patient, and prescribing the proper treatment, WILL REFER TO HIS BOOKS TO GUIDE HIM ON THE MATTER.

This same situation prevails in the Electrical and Radio industry. When a man has an important problem to handle involving the installation, care and maintenance of Electrical or Radio equipment, he NEEDS A REFERENCE BOOK TO MAKE SURE that he has the proper knowledge to proceed with the job.

This book provides diagrams as well as installation and maintenance data that is not found in many books at many times the cost.

All of the diagrams and shop prints in this book have been "shop tested." We have had a chance to put them through actual field tests to determine whether they are Electrically correct. Now, many diagrams today haven't undergone the TEST OF ACTUAL SHOP AND FIELD USE and therefore, stand the possibility of being incorrect. This is a very important point to keep in mind in using the prints in this book—they are **ELECTRICALLY CORRECT**, because they have been field tested.

Regardless of what kind of work you may be doing—whether you are a "beginner" or an "old timer" in the Electrical or Radio Field, you will find the material we have covered in this book to be of extreme value to you.

We have tried to prepare the greatest amount of up-to-date instruction on the subject of Electrical and Radio Shop print reading and tracing and have "geared" it to modern industrial and domestic needs. Yet, we have always made the material simple enough so that a fellow who is learning Electricity can readily understand and follow the instructions and information.

IMPORTANT—READ CAREFULLY

There are many ways that this book can be used. To get the maximum benefit from it, we want you to know just how to use this book for whatever purpose you have in mind. If you are an experienced Electrician at work in the field, there is a certain way that you can benefit most by the material in this book. On the other hand, if you are a "beginner," and interested in learning how to read shop prints and motor diagrams, then there is a definite way that we suggest that YOU study the material in this book. We will try to outline the best plan to follow for you individually, to get the most out of this material.

THE ELECTRICIAN'S JOB IS TO "KEEP 'EM ROLLING"

In every plant, there are Electrical motors, controllers, switches, starters, meters and dozens of other pieces of Electrical apparatus. The job of the Electrician is to keep the equipment operating and to get the greatest possible service out of it. The more information he has on his company's equipment, the more valuable he can be to his organization on his job.

PREPARE FOR A BIGGER PAY JOB

The important thing to consider as you go over the material and shop prints in this book is the fact that regardless of size or make the PRINCIPLES of ELECTRICITY apply on ALL ELECTRICAL EQUIPMENT. In most plants there are many motors, controllers, starters, transformers, etc., ranging from fractional horse power up to possibly several hundreds or thousands of horse power per unit. Now the Electrical principles embodied in the smallest motor are also the same in the largest motors. So, to the man employed as an Electrician, we suggest that he prepare in advance for the handling of more responsible Electrical jobs by studying ALL the diagrams and other material in this book. A very wise man once said, "The secret of success is to PREPARE TODAY FOR TOMORROW." This Trouble Shooting Manual enables you to PREPARE NOW for additional responsibility TOMORROW.

A study of the shop prints covered in this book will provide the necessary training for the job ahead and will also act as a guide to your knowledge of various phases of your trade.

HOW THE ELECTRICAL HELPER OR BEGINNER USES THIS BOOK

One of the questions the average fellow starting out to learn how to read shop prints, asks himself is:

"What education do I need to understand the reading of shop prints as used in the Electrical and Radio industry?" We have made these prints practical and easy to understand so that anyone should

have no difficulty with them. All that you have to do, is to understand a few simple rules and symbols. Shop Print reading, (once these few simple things are understood), is just as easy as reading a newspaper or a book. There is an old Chinese proverb which reads, "One picture tells the story of 10,000 words." It is conceivable then that one shop print can tell the story of 5,000 words. You see the basic principle of any shop print or diagram, is to tell a complete story by the use of lines and symbols that might otherwise require thousands of words of explanation.

One thing about shop print reading that is significant is the fact that there are many branches of this "sign writing" that you have probably already used from early childhood without being conscious of the fact. As you make a study of circuit tracing and shop print reading in this book, you will readily note this.

Although each section of the shop print book has complete explanatory instructions, we'd like to illustrate at this time how very simple the tracing of circuits and motor diagrams can be. To do this, let us use a common, every-day illustration that brings home a basic, elementary lesson.

The explanation we shall use, has nothing to do with Electricity, but it provides a very simple explanation of a diagram.

You have often heard the expression of baseball—"A CIRCUIT CLOUT"—that means a home run or a drive that has completed the circuit of bases. What actually happens when a home run is hit, is that a fellow hits the ball so far that he can complete the circuit of bases before the ball is returned.

Here's another example of a simple "LINE PICTURE." Suppose you wanted to explain to someone just how a baseball field was laid out. The easiest way to illustrate this would be to draw a diagram of a baseball field, such as we have indicated below. Then to indicate how baseball is played, you would place arrows indicating the progress around the bases in scoring a run. Your DIAGRAM or "Line Picture" would look like this:

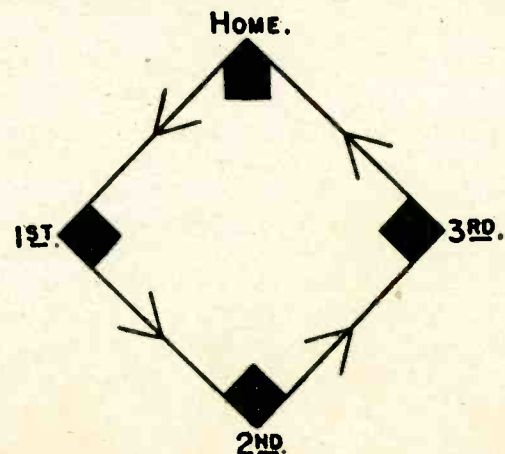

Now these are simple illustrations to give you an idea of DIAGRAMS. You can readily see that you don't need any advanced education to follow these simple instructions and that you have already actually drawn many diagrams or "line pictures" during your lifetime. If you will keep the thought in mind at all times that a diagram is always intended to simplify the explanation of any Electrical machinery or principle, you should have no trouble in understanding the shop prints in this book. These preliminary instructions as well as the detailed explanation in each section of the shop prints, will provide you with all the instructions you should need to thoroughly understand wiring prints for Electrical and Radio apparatus.

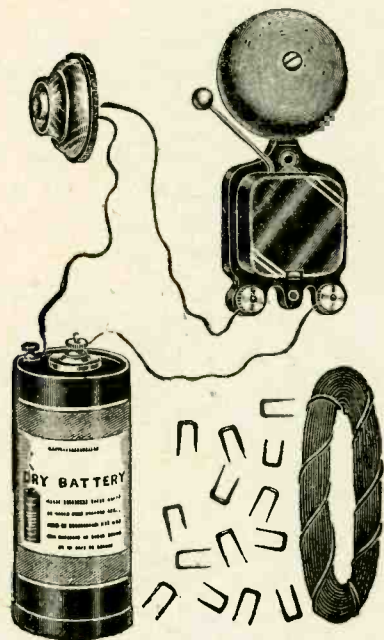

Fig. 1. Parts for a simple battery operated door bell.

USE OF PLANS AND SYMBOLS

When equipment for any signal system is **PICTURED** as in Figure 1, it is of course, easy to recognize each part and also to connect the wires as shown. But we must have some form of plan or sketch, from which to do such work and the plan must be made more quickly and cheaply, than a photograph. So instead of having actual pictures of the equipment, various symbols are used to designate different types of materials that go into any wiring job. The various symbols that are used, are discussed in detail in another section of this book. At this point, however, we'd like to give you some preliminary instruction in the very simple door bell wiring job. In Figure 1, we have shown by way of photographs, the various equipment in a simple battery operated doorbell signal system. In Figure 2, is shown a simple sketch of the same doorbell system, as in Figure 1.

This sketch, uses symbols for the various parts and can be quickly and easily made and also easily understood with a knowledge of the various symbols designating the equipment on this wiring job.

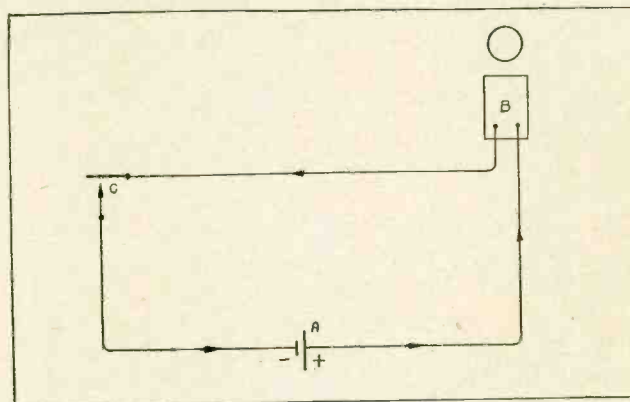

Fig. 2. Wiring diagram of equipment pictured in Figure 1.

The part marked "A" is the symbol for a cell, or battery the long line representing the positive terminal at which the current leaves, and the short line the negative terminal. "B" is the symbol for the bell and "C" is the symbol for the switch.

The heavy top line of the switch represents the movable contact. The arrow underneath represents the stationary contact. Note that the arrow does not touch the upper part, showing that the switch is open as it should be normally. Imagine that you were to press down this top part causing it to touch the arrow and close the circuit (that is like pressing the button in Figure 1). Current would immediately start to flow from the positive cell to the bell, and back to the switch, to the negative side of the cell. The arrows along the straight line representing wires, show the direction of the current flow.

This illustration is given so that you will understand in reading any Electrical diagrams in this book that the current flow should always be traced out in this manner.

TRACING CIRCUITS IN DROP RELAYS AND CONSTANT RINGING SIGNALS

In certain alarm and signal systems it is often an advantage to have the bell continue to ring until it is shut off by the person it is to call. For example a burglar alarm, in order to give a sure warning, should not stop ringing if the burglar stepped in through the window and then closed the window quickly. To provide continuous ringing of a bell, once the switch is closed, we use a device called a drop relay. Figure 3 shows a sketch of the connections of a drop relay with a bell, battery and switch, ready to operate. Study each part of this circuit and examine the parts of the device carefully, and its operation will be easily understood.

When the switch is closed, current first flows through the circuit as shown by the small arrows, causing the coils to become magnetized and to attract the armature. This releases the contact spring which flies up and closes the circuit through the stationary contact to the bell. Before being tripped, the contact spring is held down by a hook on the armature, which projects through a slot in the spring. The button "B" extends through the cover of the relay, being used to push the contact spring back in place, or reset it, and to stop the bell from ringing.

In tracing the bell-operating circuit, shown by the large black arrows, we find that the current flows through the frame of the device from "C" to "D." The marks or little group of tapered lines at "C" and "D" are symbols for GROUND connections. From this we see that a ground connection as used in Electrical work does not always have to be to the earth. Instead, a wire may be GROUNDED to the metal frame of any electrical device, allowing the current to flow through the frame, thus saving one or more pieces of wire and simplifying connections in many cases. This is a very common practice in low voltage systems and is extensively used in telephone and automobile wiring.

It is not our intention in these preliminary instructions, to go into detail concerning the tracing of circuits and diagrams. We merely wanted to present these explanations to illustrate how comparatively simple the subject, "Shop Prints and Motor Diagrams" reading is for anyone who has an interest in the subject.

Electrical shop print reading is the same as any other reading—the more you do of it, the more efficient you become. The Electrical Shop Prints in this book are especially valuable to you because they not only have the actual motor diagrams, but also carry valuable explanatory material. In going over any material in this book, if you do not get the thought immediately, go over it again and again until you thoroughly understand it. Remember that any Electrician or any man who hopes to hold a responsible Electrical job **MUST DEFINITELY KNOW AND UNDERSTAND SHOP PRINTS, DIAGRAMS, CIRCUIT TRACING, ETC.** It is as vitally essential to know these things, as it is to actually know the motors and Electrical

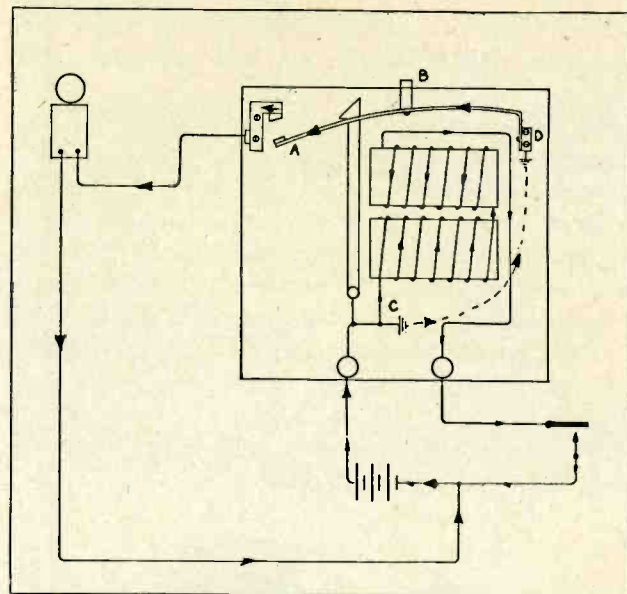

Fig. 3. Connections for drop relay.

equipment you work on, because the knowledge of these things provides a source for "short cuts" to trouble shooting and fault location in improperly operating Electrical equipment.

In concluding this introductory material, we'd like to leave this thought with you. Although the Coyne 150 Shop Print Book can be valuable to you almost every day on the job, nevertheless if you used this only occasionally for important Electrical or Radio problems and even one particular occasion might more than pay for the book. The value of a book isn't always regulated by how often you use it, but rather how important and how valuable it can be **WHEN YOU NEED IT.** This book can be the most valuable book you have ever owned because it will provide the help you need **WHEN YOU NEED IT.** Remember, if it pays a Doctor or a lawyer to spend hundreds of dollars on reference books, so that **HE CAN BE SURE** of his steps in important cases, it is equally important for the Electrician or the man aspiring to a good electrical job, to have his reference books for important problems that come up in his work. An investment, therefore, in a book of this type is an investment in your future success.

B. W. COOKE, Director
Coyne Electrical School

IMPORTANT**DIAGRAMS AND ILLUSTRATIONS IN THIS BOOK ARE
EXACTLY THE SAME AS USED IN
THE ELECTRICAL FIELD**

Because they have been proven correct through actual application over and over again the prints are presented without changes of any kind. Since these diagrams were specifically selected for this book, you will note a gap in the numerical sequence of the pages in a few places. This book was designed to include 150 of the best diagrams for job use. Actually, there are many more than that.

ACKNOWLEDGMENTS

Through our close cooperation with the Electrical and Radio industry for over 45 years we have received invaluable assistance in preparing the material for this Manual. We wish to acknowledge our sincere appreciation to the following companies for their help in supplying data, Illustrations and material for the preparation of the COYNE BOOK OF 150 SHOP PRINTS.

General Electric Co.
Westinghouse Elec. Mfg. Co.
Cutler Hammer Mfg. Co.
Allis Chalmers Mfg. Co.
Louis Allis Co.
Allen Bradley Co.
Emerson Electric Co.
Delta Star Mfg. Co.
Square D Mfg. Co.
Century Electric Co.
Allied Radio Corp.
P. M. Mallory Co.
Supreme Publications Co.

Farnsworth Radio &
Television Co.
Emerson Radio Mfg. Co.
Motorola Radio Mfg. Co.
Philco Radio & Television Co.
Stewart-Warner Mfg. Co.
Wells-Gardner Radio Mfg. Co.
Zenith Radio Corp.
Electrical Contracting
Nela Park Laboratories
Western Electric Co.
Crosley Radio Corp.
J. F. Rider Co.

SYMBOLS FOR WIRING PLANS

GENERAL OUTLETS

	CEILING	WALL
Outlet	○	○
Capped Outlet	⊙	⊙
Drop Cord	⊙	
Electrical Outlet—for use when confused with columns, plumbing symbols, etc.	⊙	⊙
Fan Outlet	⊙	⊙
Junction Box	⊙	⊙
Lamp Holder	⊙	⊙
Lamp Holder with Pull Switch	⊙ _{PS}	⊙ _{PS}
Pull Switch	⊙	⊙
Outlet for Vapor Discharge Lamp ..	⊙	⊙
Exit Light Outlet	⊙	⊙
Clock Outlet (Lighting Voltage) ..	⊙	⊙

CONVENIENCE OUTLETS

Duplex Convenience Outlet	⊙
Convenience Outlet other than Duplex. 1=Single, 3=Triplex, etc.	⊙ _{1,3}
Weatherproof Convenience Outlet	⊙ _{WP}
Range Outlet	⊙ _R
Switch and Convenience Outlet ..	⊙ _{\$}
Radio and Convenience Outlet	⊙ _R
Special Purpose Outlet (describe in specifications)	⊙
Floor Outlet	⊙

SWITCH OUTLETS

Single Pole Switch	\$
Double Pole Switch	\$ ₂
Three Way Switch	\$ ₃
Four Way Switch	\$ ₄

Automatic Door Switch	\$ _D
Electrolifer Switch	\$ _E
Key Operated Switch	\$ _K
Switch and Pilot Lamp	\$ _P
Circuit Breaker	\$ _{CB}
Weatherproof Circuit Breaker	\$ _{WCB}
Momentary Contact Switch	\$ _{MC}
Remote Control Switch	\$ _{RC}
Weatherproof Switch	\$ _{WP}

SPECIAL OUTLETS

Any standard symbol with the addition of a subscript letter designates some special variation of standard equipment.
 ○ a, b, c - etc.
 ⊙ a, b, c - etc.
 ⊙ a, b, c - etc.
 \$ a, b, c - etc.

List the key of symbols on each drawing and describe in specifications.

PANELS, CIRCUITS & MISCELLANEOUS

Lighting Panel	■
Power Panel	▨
Branch 2-Wire Circuit—Ceiling or Wall	—
Branch 2-Wire Circuit—Floor	- - -
Indicate a greater number of wires: - - - (3 wires), - - - (4 wires), etc.	
Feeders. Use heavy lines and designate by number from Feeder Schedule	—
Underfloor Duct & Junction Box—Triple System. For double or single systems eliminate one or two lines	⊞
Generator	⊙ _G
Motor	⊙ _M
Instrument	⊙ _I
Transformer	⊙ _T

Controller	⊞
Isolating Switch	⊞

AUXILIARY SYSTEMS

Push Button	⊙
Buzzer	⊞
Bell	⊞
Annunciator	⊞
Telephone	⊞
Telephone Switchboard	⊞
Clock (Low Voltage)	⊞
Electric Door Opener	⊞
Fire Alarm Bell	⊞
Fire Alarm Station	⊞
City Fire Alarm Station	⊞
Fire Alarm Central Station	⊞
Automatic Fire Alarm Device	⊞
Watchman's Station	⊞
Watchman's Central Station	⊞
Horn	⊞
Nurse's Signal Plug	⊞
Maid's Signal Plug	⊞
Radio Outlet	⊞
Signal Central Station	⊞
Interconnection Box	⊞
Battery	⊞
Auxiliary System 2-Wire Circuit	⊞

For a greater number of wires designate with numerals—12-No. 18W- $\frac{3}{4}$ "-C., or by listing in schedule.

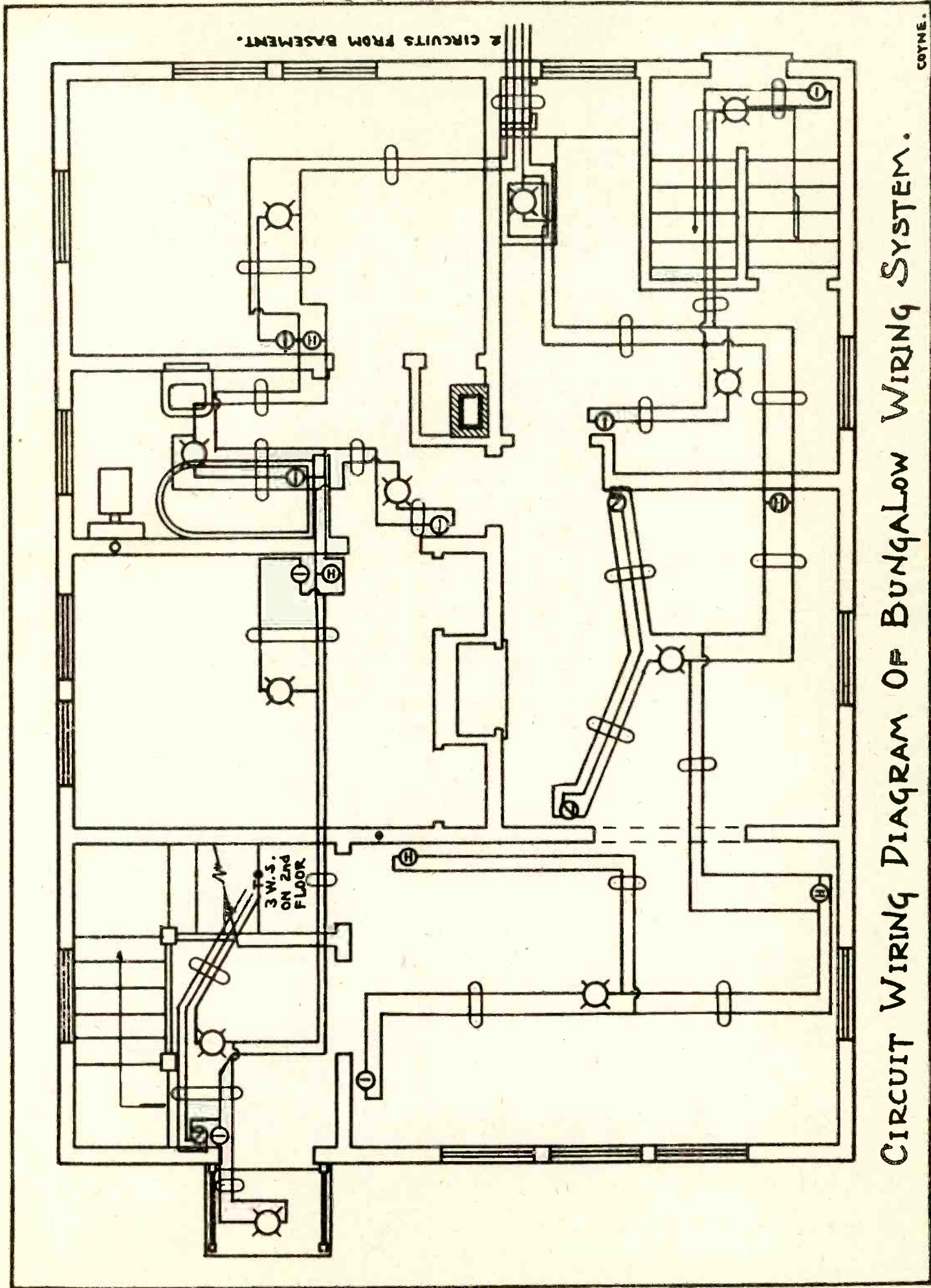

CIRCUIT WIRING DIAGRAM OF BUNGALOW WIRING SYSTEM.

ELECTRIC RANGE CIRCUITS AND INSTALLATION

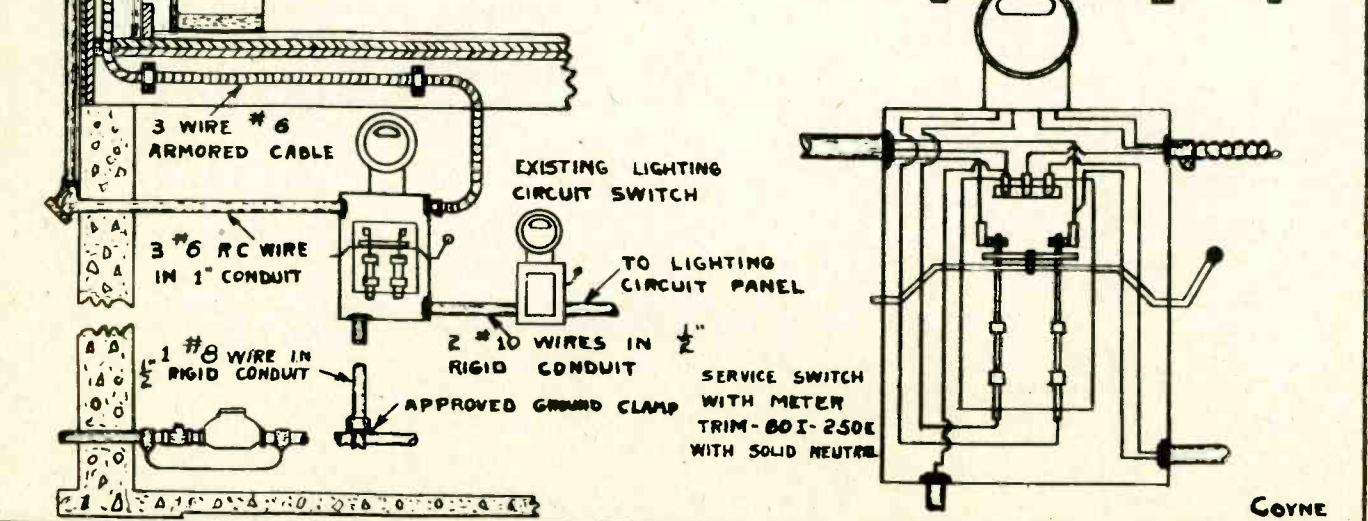
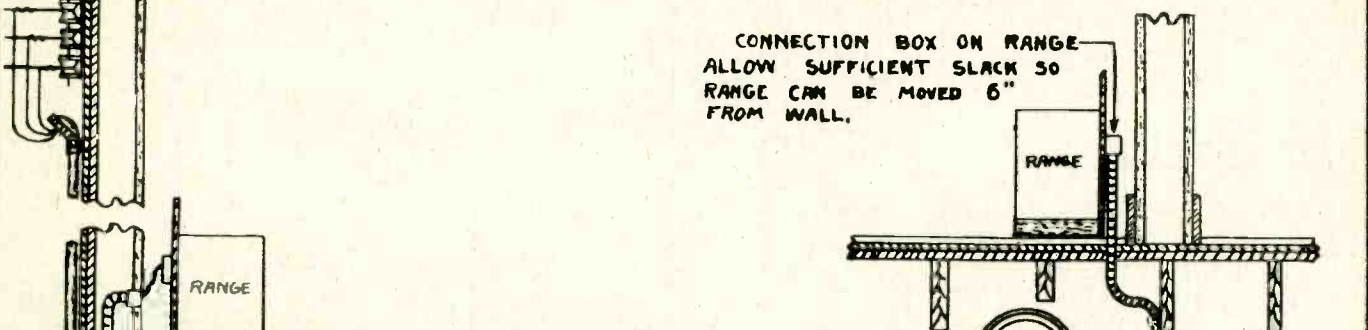
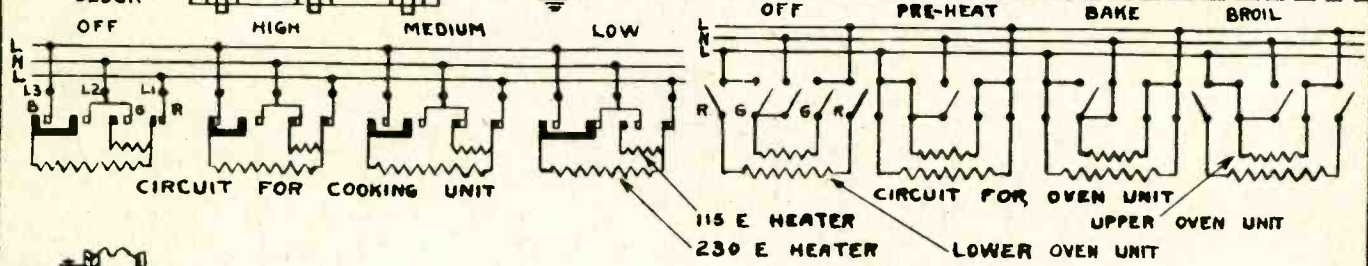
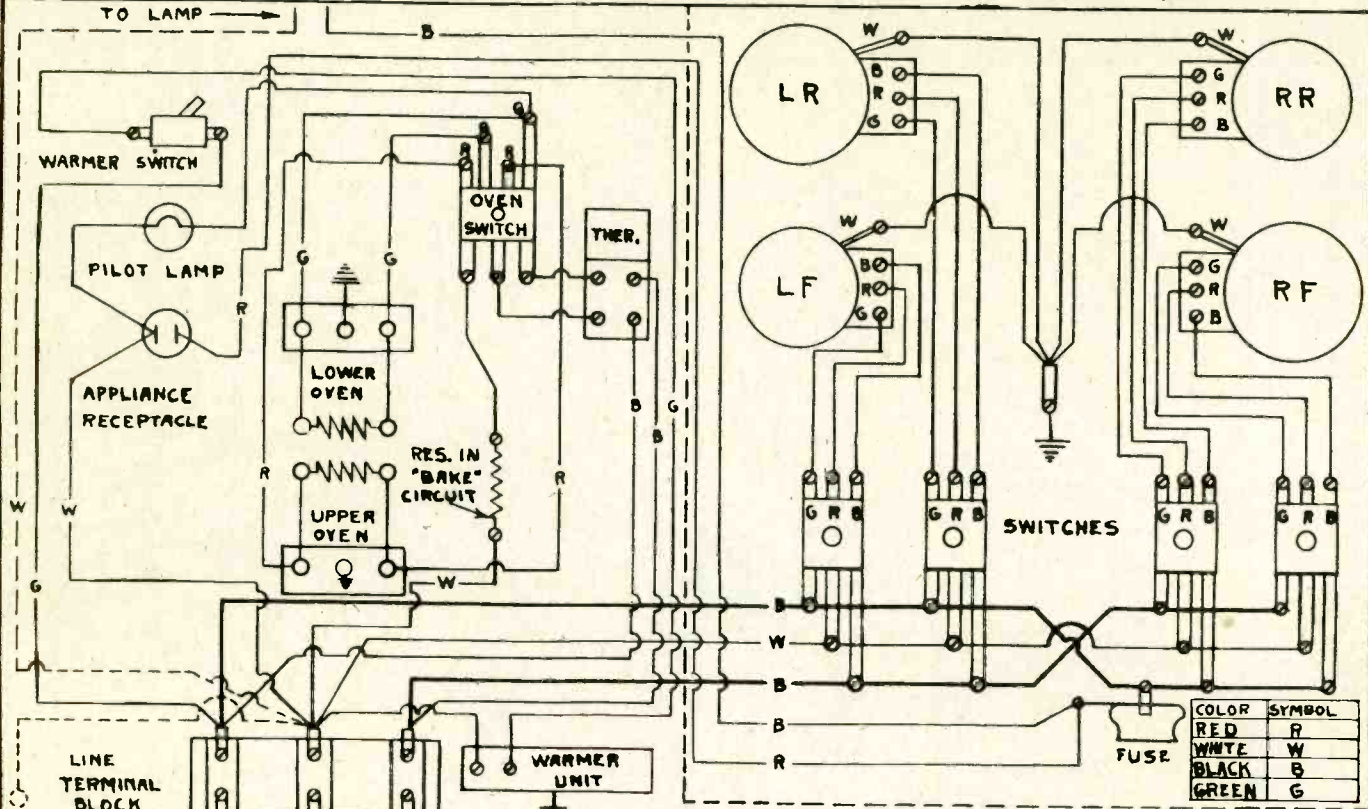

METER CONNECTIONS

2-WIRE SINGLE FUSED SWITCH,
TWO 2-WIRE SINGLE FUSED BRANCH CIRCUITS.

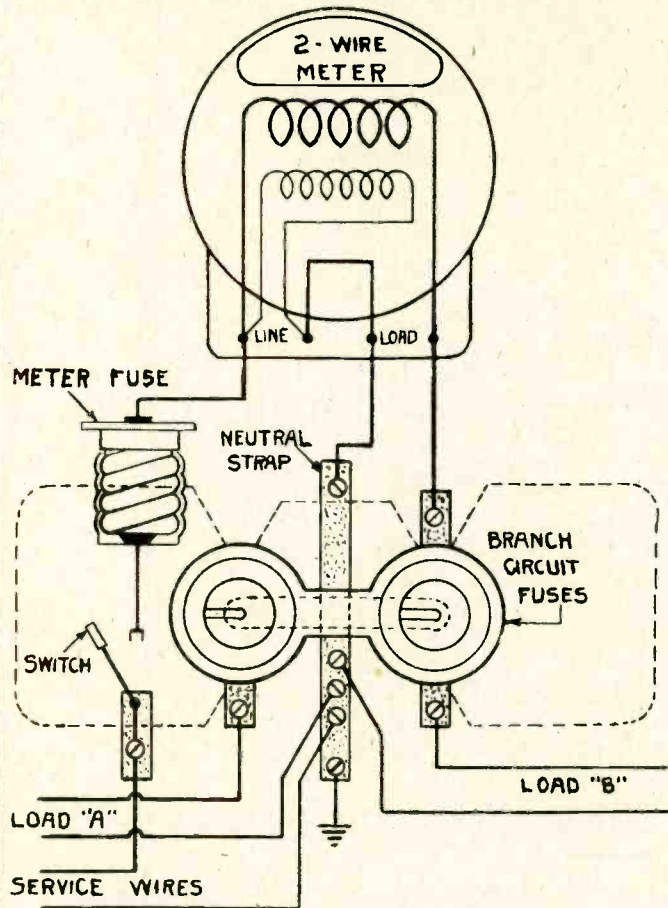

3-WIRE SOLID NEUTRAL SWITCH,
ONE 3-WIRE 2-FUSED BRANCH CIRCUIT.

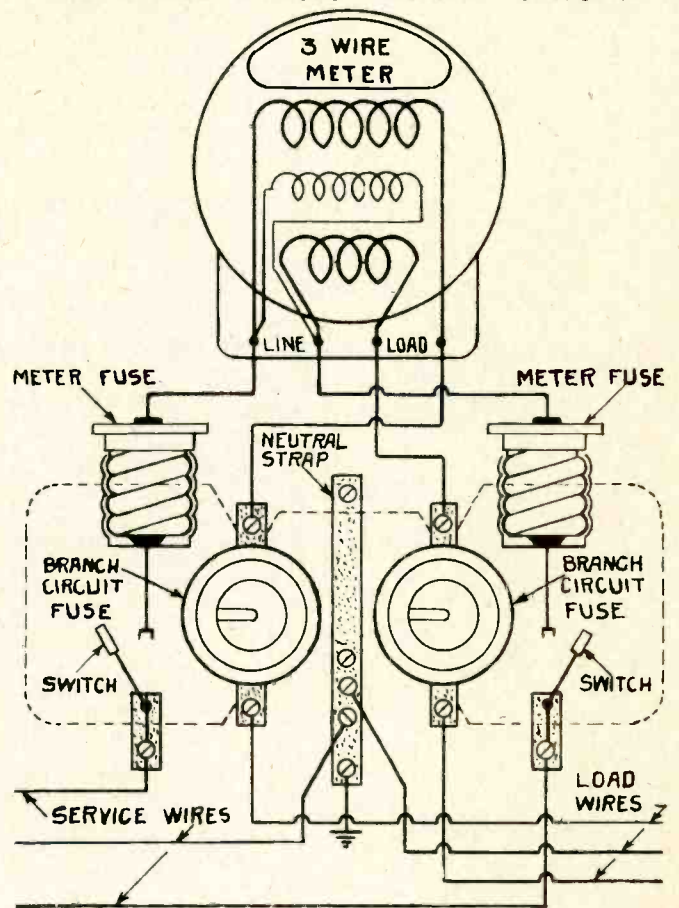

3-WIRE SOLID NEUTRAL SWITCH,
FOUR 2-WIRE SINGLE FUSED BRANCH CIRCUITS.

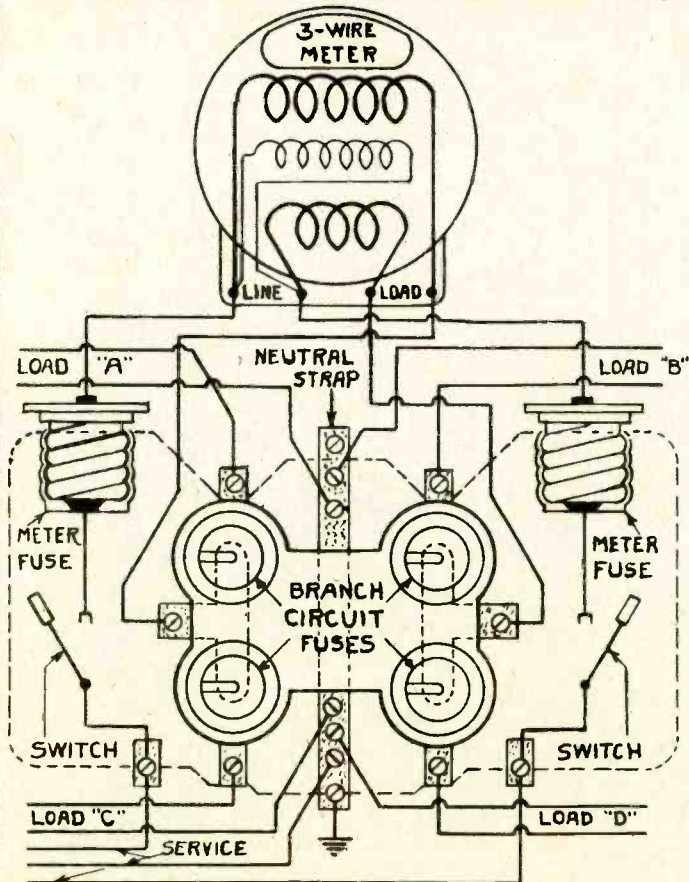

3 PHASE METER

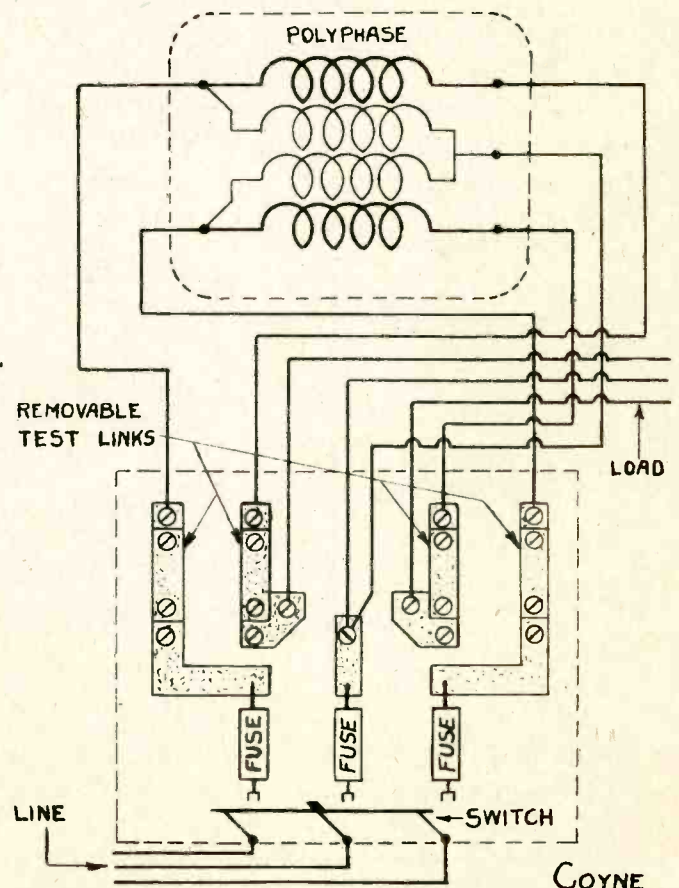

WIRING METER BASE FOR SOCKET TYPE METER

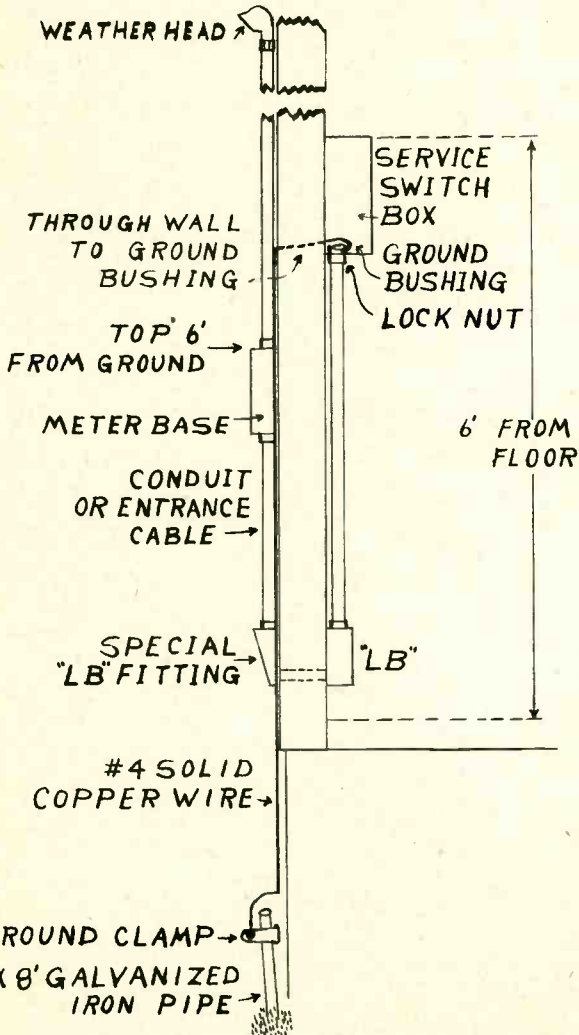
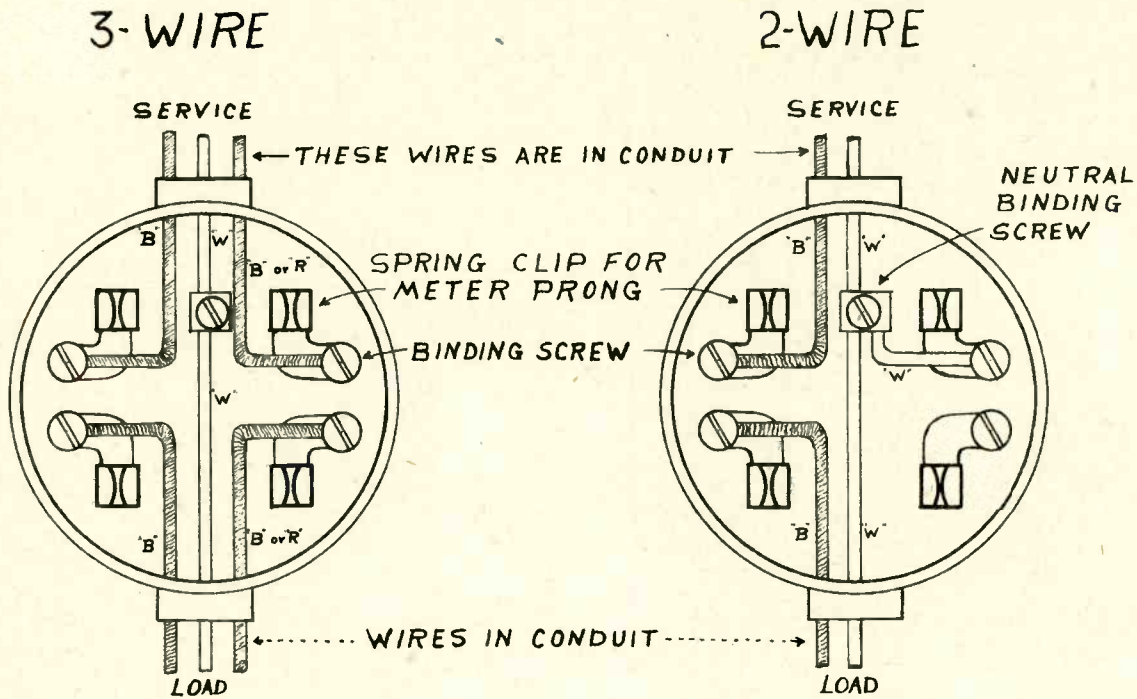

CONNECTIONS IN SERVICE BOX

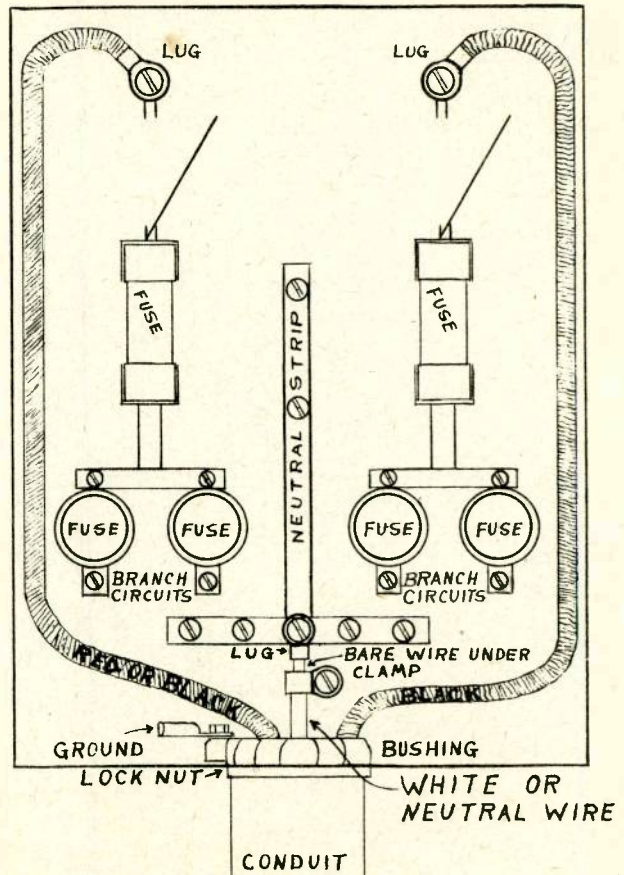

HIGH VOLTAGE TEST SET FOR WIRING INSTALLATIONS R.E.A. RECOMMENDATIONS

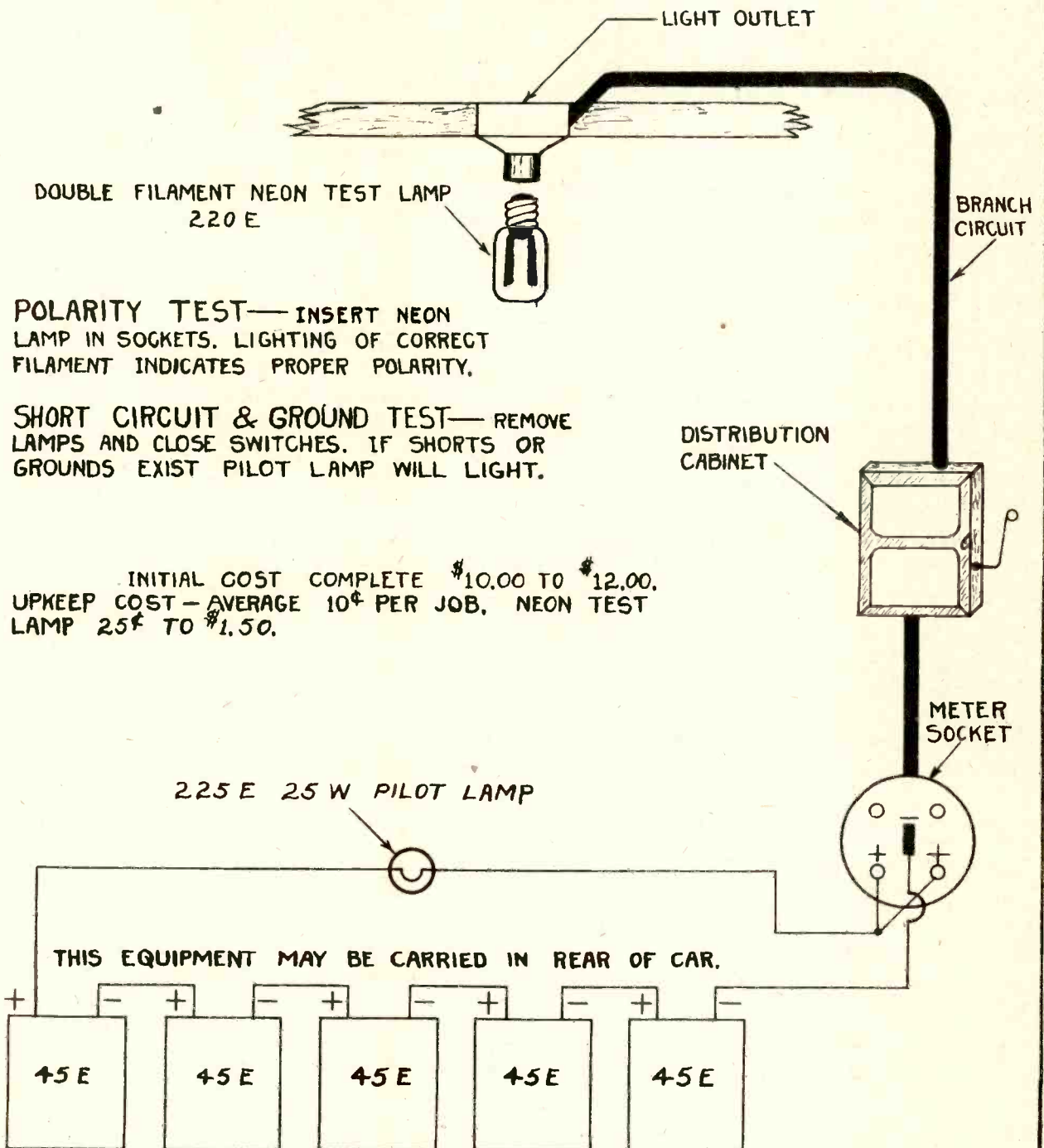

SUPPLY FOR TESTING — FIVE 45 E HOT-SHOT BATTERIES

ANY D.C. SUPPLY OF 220 E MAY BE USED, SUCH AS THE POWER PACK USED IN AUTO RADIO. THEN THE CAR BATTERY COULD BE USED AS A SOURCE. MALLORY VIBRAPACK #V.P. 552 MAY BE USED IN CONJUNCTION WITH A CAR BATTERY. THIS VIBRATOR POWER PACK HAS AN OUTPUT OF 225 VOLTS AND UP, AND 100 M.A. CAPACITY. MAY BE PURCHASED FOR \$11.00.

TECHNICAL TERMS AND THEIR MEANING

A clear understanding of Electricity can be acquired only if the terms employed to explain it and the units used to measure it are clearly understood. Words used in the technical sense have exact meanings frequently different from those associated with their every day use. Definitions here given refer to the technical meanings only. Some of the most important terms and their units of measurement are:

FORCE - Force is defined as "any agent that produces or tends to produce motion." Force may be mechanical, electrical, magnetic, or thermal in character. Note that force does not always produce motion: a relatively small force may fail to move a large body, but it **TENDS** to do so. The word "body" refers to any material object: it may be a stone, a building, an automobile, a dust particle, an electron, or anything that has size. Force is usually measured in pounds; therefore the **UNIT** of **FORCE** is the **POUND**.

ENERGY - This word refers to the ability or capacity for doing work. One may speak correctly of the **ENERGY** in a charged automobile battery, in a raised weight, in a compressed spring, in a tank of compressed air, etc., as work may be done by any one of these devices. Energy may be mechanical, electrical, magnetic, chemical, or thermal type, and the different kinds of energy may be readily converted from one form to another; however, each conversion results in a loss of some of the useful energy, although the total amount of energy remains the same. Since the energy of a device represents the total amount of work that it can do, the units for work and for energy are the same. The **UNIT OF ENERGY** most frequently used in electrical work is the **JOULE**. It is equal to approximately 0.74 foot pounds.

WORK - Work is equal to the force applied to an object multiplied by the distance through which the object is moved. If the force applied to a given object is insufficient to move it, no work is done. This definition illustrates the great difference that exists between the technical and the general meaning of the word **WORK**. The units used for measuring work are the same as those employed for energy. The most frequently used **UNITS OF WORK** are the **FOOT POUND** and **JOULE**.

POWER - Power indicates the rate at which work is done. It is equal to the amount of work done, divided by the time required to do it. This unit does not show how much work has been done, it merely indicates how rapidly, or at what rate, the work is being done. The fundamental **UNIT** of electrical **POWER** is the **WATT**. When the power in an electrical circuit is one watt, this means that work is being done in that circuit at the rate of one joule per second, or 0.74 foot pounds per second. Note that the **WATT** is not a quantity unit but a **RATE** unit. Larger power units are the horse-power and the kilowatt. The **HORSEPOWER** represents a rate of doing work equal to 746 **WATTS**, or 746 joules per second, or 550 foot pounds per second. Note that **TIME**, which is not mentioned in the definitions of force or energy, is always a factor in the measurement of **POWER**.

$$(a) \quad \text{POWER} = \frac{\text{WORK}}{\text{TIME}}$$

$$(b) \quad \text{WORK} = \text{POWER} \times \text{TIME}$$

$$(c) \quad \text{TIME} = \frac{\text{WORK}}{\text{POWER}}$$

With the aid of the above formulas any of the given quantities may be calculated when the other two are given. Thus if work and time are given, the power may be found by (a). If power and time are given, the work may be found by formula (b), and if the work to be done and the rate at which it is to be done (power) are specified, the time required to do it may be determined by formula (c).

A little time spent in studying the above definitions and formulas will be well repaid by an increased understanding and clearer conception of the units used.

1. The only technically correct definition of force is: (A) that agent which produces motion (B) that which indicates a group acting together, such as a police force (C) that agent which produces or tends to produce motion (D) that agent which overcomes opposition, as when one force overcomes another.
2. The only technically correct definition for the term energy is: (A) the rate at which work can be done (B) the total work done in a given time (C) the ability or capacity of some agent to do work (D) the rate at which work is done.
3. The technically correct definition for power is: (A) the force required to overcome opposition (B) the rate at which work is done (C) the total work done (D) the rate at which force is applied to an object.
4. Work is always done: (A) when force is applied to an object (B) when the applied force produces motion or a change in motion (C) when one force opposes another.
5. Of the four units given here the only one that measures force is the: (A) Watt (B) Pound (C) Joule (D) Foot-pound.
6. The unit of energy most frequently used in electrical work is the: (A) Watt (B) Joule (C) Foot-pound (D) magnetic only.
7. Force can be: (A) mechanical only (B) electrical only (C) magnetic, mechanical or electrical (D) magnetic only.
8. When the power used by an electrical circuit is one watt, work is being done in that circuit at the rate of (A) 0.74 ft. lb. per sec. (B) 1 ft. lb. per sec. (C) 550 ft. lb. per sec. (D) 75 ft. lb. per sec.
9. When the power used by an electrical circuit is one watt, work is being done in the circuit at the rate of .74 ft. lbs. per sec. (A) always (B) sometimes (C) never.
10. The watt, kilowatt, foot-pounds per sec., and joules-per-second all measure (A) work (B) Force (C) Power.
11. When a battery is fully charged it is capable of doing work, To indicate this capacity for doing work and battery is said to store: (A) power (B) force (C) energy (D) work.
12. To find the rate at which work is being done (power) divide the total work done by the time required to do it (true) (false).
13. To find the total work done multiply the rate at which work is being done (power) by the time (true) (false).
14. When work is being done in the electrical circuit at the rate of 0.74 foot pounds per second, the power absorbed is: (A) one watt (B) 74 watts (C) one watt-hour (D) one joule.
15. When one ampere of current is forced through a resistance of one ohm, work is being done in the circuit at the rate of (A) one kilowatt (B) one watt (C) one joule (D) one watt-hour.
16. The watt-hour, kilowatt-hour, joule, and foot-pound are all units of: (A) power (B) work (C) force.
17. The answers to the problems are A () B () C ()

Circuits and Wiring

Coulomb	q or Q	Unit of electrical quantity. The quantity which will deposit .0000116 oz. of copper from one plate to the other in a copper sulphate solution. The quantity of Electricity which must pass a given point in a circuit in one second to produce a current of one ampere.
Ampere	I or A	Unit of current. (Rate of Flow) One coulomb per second.
Milliampere	MI or MA	.001 I (The prefix "milli" means one-thousandth)
Microampere	μ I or μ A	.000001 I (the prefix "micro" means one-millionth)
Volt	E or V	Unit of pressure. (EMF - Electromotive Force) The pressure required to force current at the rate of one ampere through the resistance of one ohm.
Millivolt	ME or MV	.001 E One-thousandth volt.
Microvolt	μ E or μ V	.000001 E One-millionth volt.
Kilovolt	KV	1000 E (The prefix "kilo" means one-thousand)
Ohm	R or Ω	Unit of resistance. A measure of the opposition offered to the flow of current. The resistance offered by a column of mercury 106.3 centimeters long and 1 square millimeter in cross sectional area, at a temperature of 32 degrees Fah., or 0 degrees Cent.
Megohm	Meg.	1,000,000 R One-million ohms.
Microhm	μ R	.000001 R One-million ohm.
Mho	\mathcal{G}	Unit of conductance. A measure of the ease which a conductor will permit current to flow. It is the reciprocal of resistance.
Watt	W	Unit of power. One watt is equal to current at the rate of one ampere under the pressure of one volt. $W = I \times E.$
Horsepower	HP or $\mathcal{H}P$	746 W The power required to raise 33,000 pounds, one foot, in one minute.
Milliwatt	MW	.001 W One-thousandth watt.
Kilowatt	KW	1000 W Unit of power.
Watthour	WH	Unit of work. (Power x Time) $W \times H = WH$
Kilowatt-hour	KWH	1000 WH Unit of work.
Farad	C	Unit of capacitance. Capacity of condensers.
Microfarad	Mfd. or μ F	.00001 C One-millionth farad.
Micro-microfarad	MMF	.000001 mfd. One-millionth microfarad.
Henry	L or H	Unit of inductance.
Millihenry	ML or MH	.001 L One-thousandth henry.

DIRECT CURRENT APPARATUS

This section shows internal and external wiring for devices and equipment that operate with direct current. The pages are grouped in the following order of subjects:

Motors, also general principles	Testing
Generators or dynamos	Starters and controllers
Armature windings	

Except in the group devoted to starters and controllers most of the pages include explanations of the diagrams. The following additional notes apply to certain of the pages, as referred to by number.

PAGE 82

This sheet shows simple schematic diagrams for series, shunt and compound motors, and on the right-hand margin lists the connections from the power line to the motor terminals for counter-clockwise (CCW) rotation and for clockwise (CW) rotation. The following abbreviations are used:

A1 and A2. Armature connections	L1 and L2. D-c power line connections
F1 and F2. Shunt field connections	Comm. Commutating winding
S1 and S2. Series field connections	

PAGE 90

Here, on a single chart, is the whole story of motor operating characteristics and applications. Going from left to right on the chart you find the speed characteristics, kind of electric power, construction and windings, usual horsepower, starting and stalling torque as compared with normal full load torque, variations of speeds with loads, the principal performance features of the motor, and finally the drives or applications for which each motor is especially well suited. Careful study of this table will add greatly to your knowledge of motors and their uses.

PAGES 97 AND 98

These diagrams of General Electric direct-current

machines illustrate how winding connections and external terminal connections are shown.

PAGE 99

On this page is described a method for measuring the performance of a generator and plotting the performance as a curve showing the relations between current and voltage. Measurements are made with a voltmeter and ammeter, while the load is varied by using a rheostat consisting of metallic plates in a salt water bath. This description applies to methods followed in the Coyne shops, but illustrates the general procedure for similar work done elsewhere.

PAGE 111

This sheet shows how records are made and kept for armature winding repair jobs. Entries are made under the heading "REWIND DATA" as the armature is being stripped. Positions to which coil leads connect on the commutator are shown on the large central diagram. On this diagram are entered the numbers of the core slots in which lie the coil sides. Below the coil diagram are shown two sets of commutator bars as they would appear if laid out flat. On one set the center of a bar is on the center line of a coil. On the other set the insulation between bars is on the coil center line. Coil leads are run down to bars on whichever commutator arrangement is used on the armature being wound or repaired.

PAGE 115

This sheet shows the construction, winding, and connections for a growler. A growler is a device which generates voltages and currents in the coil windings of an armature laid on the field poles of the growler. Readings of armature currents are made as shown on the following page. Correct interpretation of readings allows determining the kind of trouble and its approximate location.

PAGE 122

These symbols are used in diagrams for motor starters and controllers for both direct-current and alternating-current. The following notes apply to

symbols as you read from left to right across the successive lines from top to bottom of the page.

N.O. means "normally open." N.C. means "normally closed." A blowout is a device, usually an electromagnet, which lessens sparking as current-carrying contacts separate. Main circuits are those carrying line power. Auxiliary circuits usually are control circuits. An interlock is a connection, either mechanical or electromagnetic, that causes certain contacts to operate when other contacts operate, or which cause any two actions to occur simultaneously.

Note that on double-circuit push buttons there are four small circles indicating the four terminal connections for the two lines. In a maintained contact push button one terminal always remains connected to the switch contacts. A limit switch is a switch operated automatically when some portion of a machine reaches the limit of its travel; as, for example, on a machine tool where the motor is to be stopped or reversed when the cutter reaches the end of its travel.

A thermal overload relay opens its circuit when excessive current has continued for long enough to heat and expand a member that releases the contacts.

An auto-transformer is a transformer in which part of the winding is in both the primary circuit and the secondary circuit. A potential transformer transfers voltage changes from one circuit to another without having conductive connections between the circuits. A current transformer transfers current changes from one circuit to another. Potential transformers and current transformers often are called instrument transformers, since their usual purpose is to connect voltage-operated and current-operated instruments to circuits in which changes of voltage and current are to be measured or indicated.

PAGE 131

The lower right-hand diagram shows the motor armature and field windings connected directly to one side of the line. The other side of the line, L1, connects through a starter to the remaining terminals of the motor. Either of the starters may be used. Both starters are of the "face plate" type on which the power arm or handle is moved slowly from left to right across contact points between

which are resistors mounted on the back of the starter face plate. When the handle reaches the right-hand end of its travel it is held there by an electromagnet marked "No E (voltage) or no field release coil." Should line voltage fail or should it drop below a safe operating value, this release coil is demagnetized to an extent that releases the arm. Then a spring moves the arm back to the left-hand off position.

The upper right-hand diagram shows a starter equipped with the no-voltage release coil, also with an overload release coil. The overload release coil is a magnetic switch that opens the line circuit should the current rise above a safe operating value.

PAGE 132

This is a setup diagram for testing the horsepower output of a motor with a prony brake and for testing the efficiency by measuring the amperage and voltage from which are computed the electrical power input in watts (amperes x volts). The voltmeter and ammeter are mounted on a separate panel shown at the upper right.

PAGE 133

The first movement of the power arm toward the right allows closing of the contacts shown at the bottom of the arm. Current from L1 at the line switch then flows through these contacts, through the starting relay winding, and to L2. The starting relay contacts close. Then current from L1 flows through the magnetic blowout coil, the relay contacts, and the power arm so that the starter operates as usual.

PAGE 134

The upper left-hand starter is used for starting the motor, then for increasing its speed above normal. The power arm consists of two parts. The motor is started by moving the arm slowly toward the right, as usual. At the extreme right-hand of the travel one part of the arm is held in place by the no-voltage release magnet. Then the other section of the arm is moved backward, to the left, to increase the motor speed. Moving this section of the arm to the left allows its contact to travel across contact points between which are sections of the field resistance. Thus more and more resistance is connected in series with the shunt field of the motor, which has the effect of increasing the motor speed.

The upper right-hand starter has resistors which are heavy enough and which will dissipate enough heat so that the power arm may be left at any position along its travel. The position of the arm determines the amount of resistance in series with the armature and the series field of the motor. The greater this resistance the slower the motor will run.

PAGE 138

The stationary contacts of the drum controller are shown by circles. The contact shoes which are on the drum and which move with the drum are shown by rectangular outlines. All the shoes move together, either to the right or to the left on the diagram.

PAGE 147

When the motor is to be started with the solenoid starter the start switch button (upper right) is pressed to close the switch contacts. Current from the line (L1) flows through the solenoid magnet winding to terminal C1, through the closed stop switch contacts, the closed start switch contacts, to terminal C3, and back through L2 to the other side of the line. The solenoid plunger rises, and with it the power arm. The power arm short circuits and cuts out more and more of the armature starting resistance as the motor starts and gains speed. Opening the stop switch by pressing its button opens the circuit through the solenoid winding, thus allowing the plunger and power arm to drop and open the motor circuit.

PAGE 149

In tracing the diagrams on this and following pages refer to the symbols shown and explained on page 124.

In relays Type J-30 and Type J-31 closing the contacts of the control device (any suitable switch) lets control circuit current flow through the relay magnet winding represented by a circle on the right-hand heavy conductor. The magnet closes the contacts shown above the circle and allows current to flow to the load.

On the right-hand side of the page the upper diagram is a connection diagram or wiring diagram for the starter, the start and stop push button switch, and the shunt wound motor. The lower diagram is a schematic in which it is easy to trace the current paths. On the lower line of the schematic diagram the contacts in series with the motor are marked M. These contacts are closed and

opened by the double wound electromagnet coil. One winding is energized by closing the start switch. Auxiliary contacts, shown inside the starter of the upper diagram, are holding contacts which close and maintain a circuit through the second coil until the stop button is pressed to open the entire control circuit.

PAGE 150

In this starter there is a relay, AR, on the moving plunger of which is a dashpot that allows the plunger to move only slowly while the coil is energized. The slow movement of the plunger successively closes contacts that short circuit resistor sections R2, R3 and R4, thus reducing resistance in the armature circuit as the motor gradually gains speed.

PAGE 151

Of the two upper diagrams the one at the left shows terminal connections and the one at the right shows the schematic circuits. Pressing the FOR (forward) button sends current through the armature and commutating (COM.) field in one direction and causes the motor to rotate say clockwise. Pressing the REV (reverse) button reverses the direction of current in the armature and commutating field, which reverses the direction of motor rotation. On the schematic diagram the forward contacts are marked F and the reversing contacts are marked R. There are two relay magnets, one forward and the other reverse, each operating its own set of contacts.

The two lower diagrams are schematic diagrams for starters providing both time limit and reversing features. A dashpot on the magnetic relays limits the rate at which they close their contacts, thus cutting out armature resistance in one step after another at definite time intervals. The reversing feature operates similarly to that shown in the upper diagrams.

PAGE 153

This is a speed regulator that reduces the speed of the motor below normal by inserting more and more resistance in series with the armature, and that increases the speed above normal by inserting resistance in series with the shunt field winding of the motor. Armature resistance is shown by heavy lines on the controller, while field resistance is shown by light lines. The action of this controller is similar to that of the ones shown on page 136.

D.C. MOTORS AND GENERATORS.

OPERATION

The D.C. motor operates on the first law of magnetism which states that like poles repel and unlike poles attract. Current flowing through the field coils produces the field poles, and current through the armature coils develops armature poles midway between the field poles. Attraction and repulsion between these two sets of poles produces rotation. Note that the armature poles remain stationary in space.

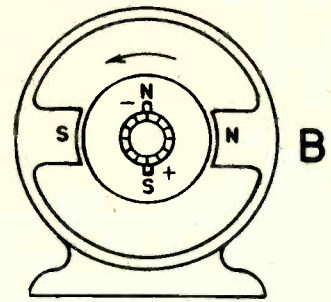
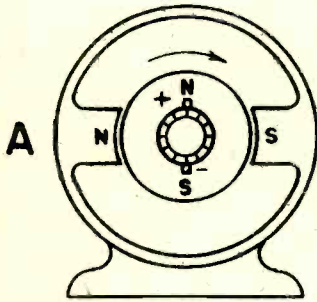

ROTATION

By reversing the direction of current flow through the fields or through the armature, the field poles or the armature poles will be reversed, and the direction of rotation changed. Compare A with B and C with D.

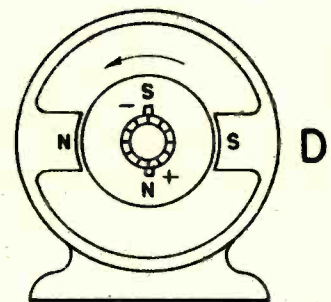
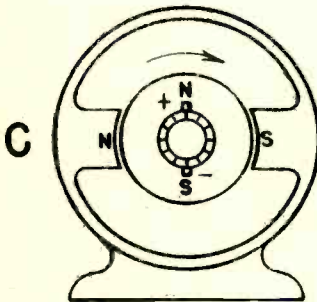

ARMATURE POLES

Diagrams E and F show a 4 pole motor. Note that the number of armature poles always equals the number of field poles, and that the armature poles are located midway between the field poles. From the above it is obvious that a 2 pole armature will not work in a 4 pole field. Note also that when the direction of current flow is reversed all poles are reversed.

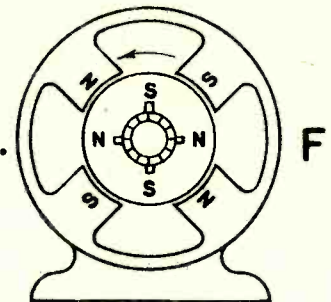
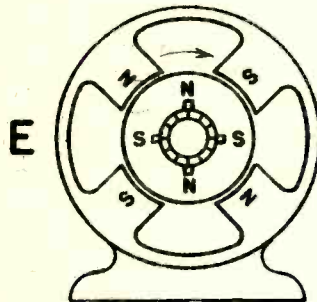

GENERATORS

Diagrams G and H show two generators, one arranged for clockwise and the other for counter clockwise rotation. Note that poles are set up on generator armatures also, but that in this case the poles oppose rotation. As more current is drawn from the armature, these poles increase in strength; this explains why an electric generator is harder to drive as the armature current increases.

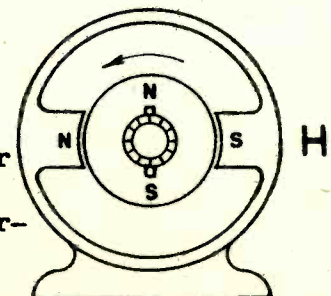
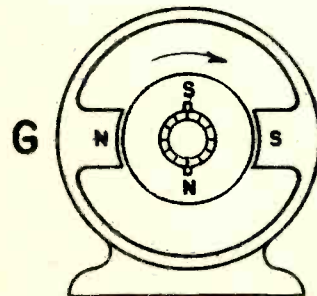

D.C. MOTORS AND GENERATORS.

INTERPOLES

To minimize sparking at the brushes, most D.C. motors are equipped with small poles placed midway between the main poles and called interpoles or commutating poles. For proper operation, these small poles must have the correct polarity. Reference to any of the diagrams will show that the polarity of the interpole is always the same as the armature pole adjacent to it.

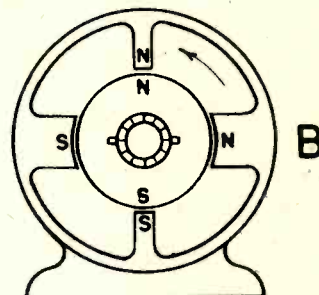
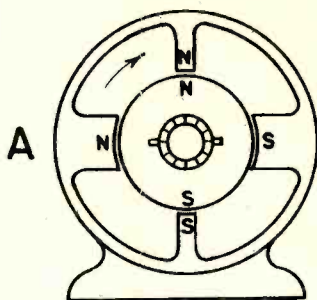

REVERSING ROTATION

The windings on the interpoles are always connected in series with the armature winding and are considered a part of the armature circuit. Therefore, when current through the armature is reversed, the interpole polarity is also reversed. This arrangement automatically preserves the proper relation between the armature poles and the interpoles when the armature current is reversed.

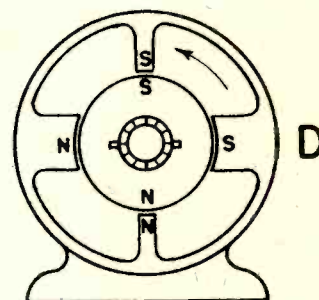
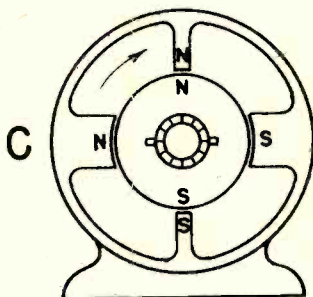

NUMBER OF INTERPOLES

Machines equipped with interpoles may have as many interpoles as main poles or one-half as many interpoles as main poles. As the interpole winding is always connected in series with the armature, the interpole strength will vary with the value of armature current.

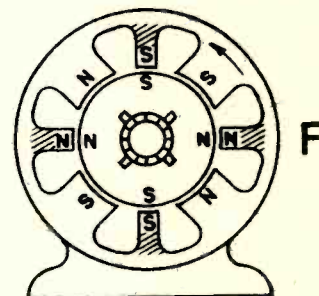
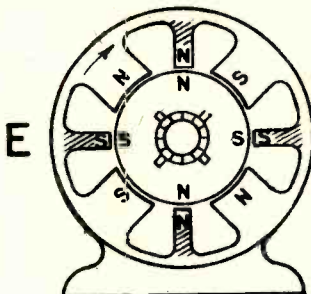

GENERATORS

Diagrams G and H show two generators equipped with interpoles. G is arranged for clockwise rotation and H for counter clockwise rotation. Note that the rule for the polarity of interpoles applies to generators as well as motors. Note too, that the armature poles oppose rotation and thus produce the force against which the prime mover must work to maintain rotation.

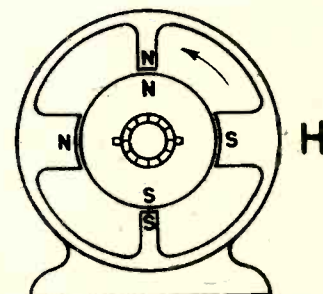
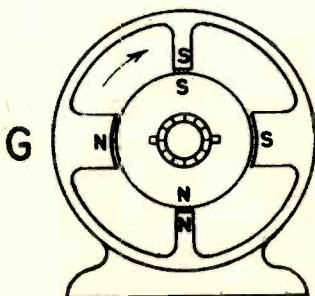

D.C. MOTOR PRINCIPLES

Electric motors are machines that change electrical energy into mechanical energy. They are rated in horse power. (H.P.)

The attraction and repulsion of the magnetic poles produced by sending current through the armature and field windings causes the armature to rotate. The armature rotating produces a twisting power called torque.

Fleming's Left Hand Rule For Motors

Place the thumb, first finger and remaining fingers at right angles to each other. Point the first finger in the direction of the field flux, remaining fingers in the direction of the armature current and the thumb will indicate the direction of rotation.

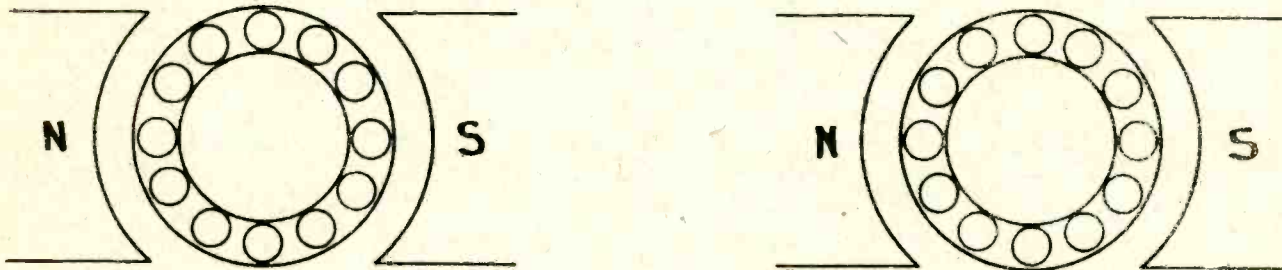

The direction of rotation can be reversed on any D.C. motor by reversing either the armature or field leads but not both. It is standard practice to reverse the armature leads to reverse the direction of rotation.

The amount of torque developed by a motor is proportional to the strength of the armature and field poles. Increasing the current in the armature or field winding will increase the torque of any motor.

The armature conductors rotating through the field flux has a voltage generated in them that opposes the applied voltage. This opposing voltage is called counter electro motive force, (C E M F) and serves as a governor for the D.C. motor. After a motor attains normal speed the current through the armature will be governed by the C E M F generated in the armature winding. This value will always be in proportion to the mechanical load on the motor.

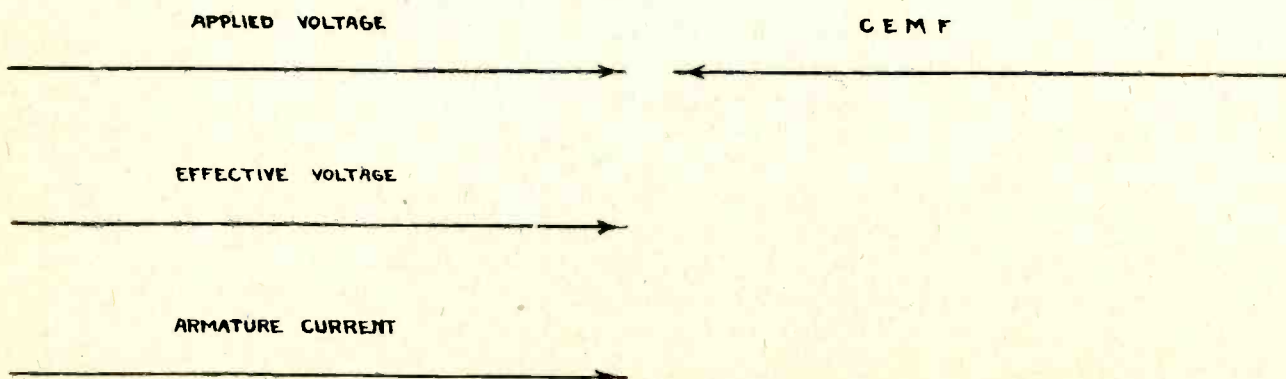

D.C. MOTOR PRINCIPLES

(CONTINUED)

The applied voltage is the line voltage. The effective voltage is the voltage used to force the current through the resistance of the armature winding. This value can be determined by multiplying the resistance of the armature by the current flow through it. To find the resistance of the armature measure the voltage drop across the armature and the current flow through it and use ohm law formula. R equals E over I

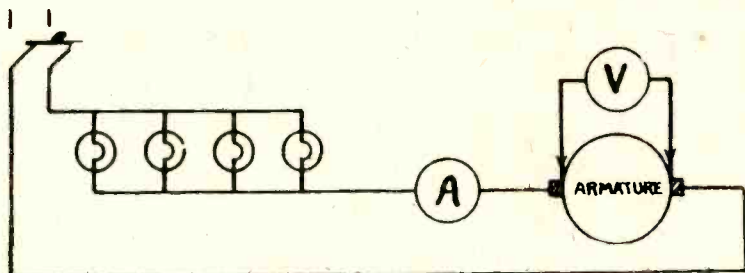

The lamps are used to limit the current through the armature winding.

The revolutions per minute of a D.C. motor can be varied over a wide range. The maximum safe speed for the average D.C. machine is 6000 ft. per minute peripheral speed of the armature. D.C. motors can be designed to operate safely up to 15,000 peripheral ft. per minute. Periphery means outer surface.

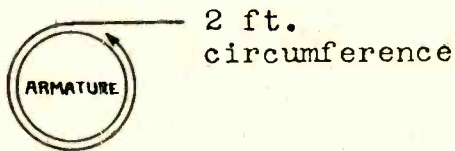

$2 \overline{6000}$
3000 R.P.M. is the maximum safe speed for the average D.C. machine that has an armature that is 2 ft. in circumference

The H.P. rating of a motor refers to the rate of doing work. The amount of H.P. output is proportional to the speed and torque developed by the motor. The Prony Brake Test is used to determine the H.P. output of a motor.

PRONY BRAKE FORMULA

$$H.P. = \frac{2\pi \times P \times L \times R.P.M.}{33,000}$$

- 2π equals 6.28
- P " Pull on the lever arm in lbs.
- L " Length of the lever arm in ft.
- R.P.M. equals Revolutions per minute.

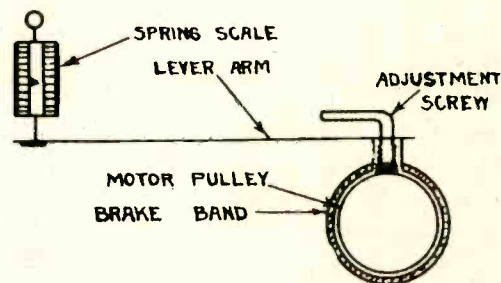

$$EFFICIENCY = \frac{OUTPUT}{INPUT}$$

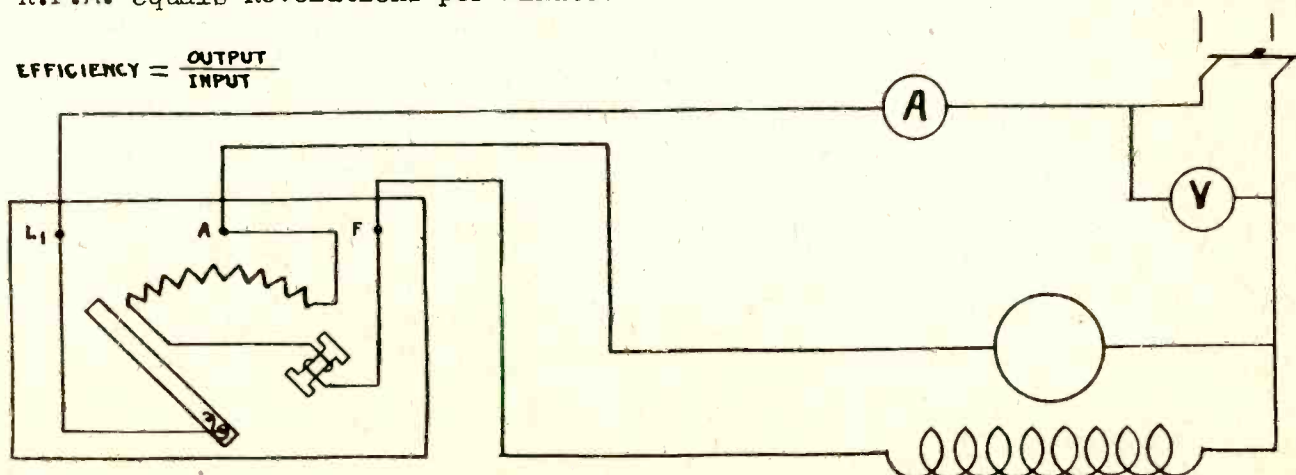

SHUNT MOTOR

A shunt motor is a motor that maintains nearly constant speed from no load to full load. The shunt field winding consists of many turns of small wire and is connected parallel with the armature winding or across the line. The diagrams below show the proper connection for the armature and field.

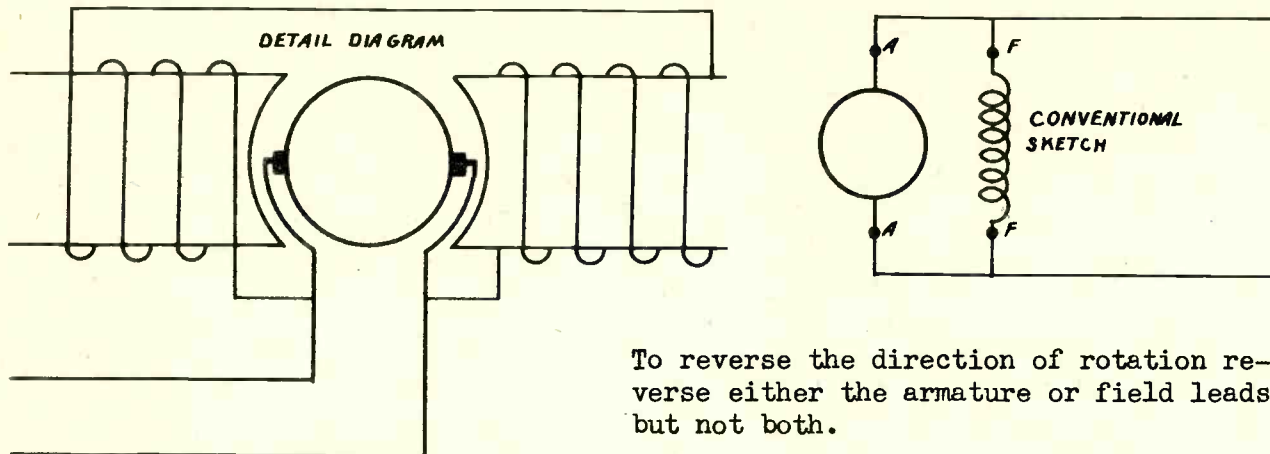

To reverse the direction of rotation reverse either the armature or field leads but not both.

The characteristic curves below show that the torque developed by a shunt type motor varies with the armature current. This is true because the torque is proportional to the armature and field flux. The field maintains constant strength because it is connected across the line and the armature flux will vary with the armature current. The torque of a shunt motor is considered to be fair in comparison to other D.C. motors. It will start about 50% overload before being damaged by excessive current.

The shunt type motor maintains nearly constant speed from no load to full load because the shunt field strength is constant. The characteristic curve shows that the speed varies about 10% from no load to full load which gives this motor very good speed regulation.

This motor is widely used where it is desired to control the speed above and below normal speed. A shunt field rheostat connected in series with the shunt field will cause the motor to increase in speed. A resistor connected in series with the armature will cause the motor to decrease in speed.

Shunt motors sometimes have a few turns of heavy wire wound on each field pole and connected in series with the armature. This winding produces the same polarity as the shunt field winding and produces a more stable operation when the motor is carrying a fluctuating load.

For applications of the shunt motor see Motor Application Chart Number 115.

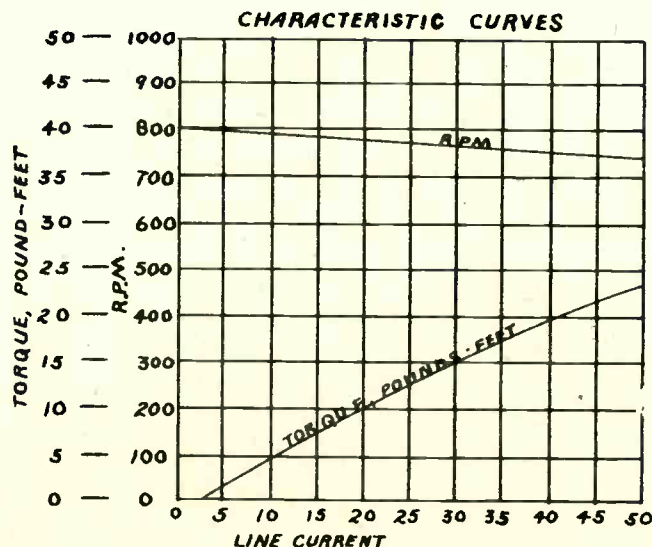

SERIES MOTOR

A motor that has its field and armature connected in series with each other is a series type motor. The field is constructed of a few turns of heavy wire or strap conductor. The field strength will vary with the armature current under normal conditions.

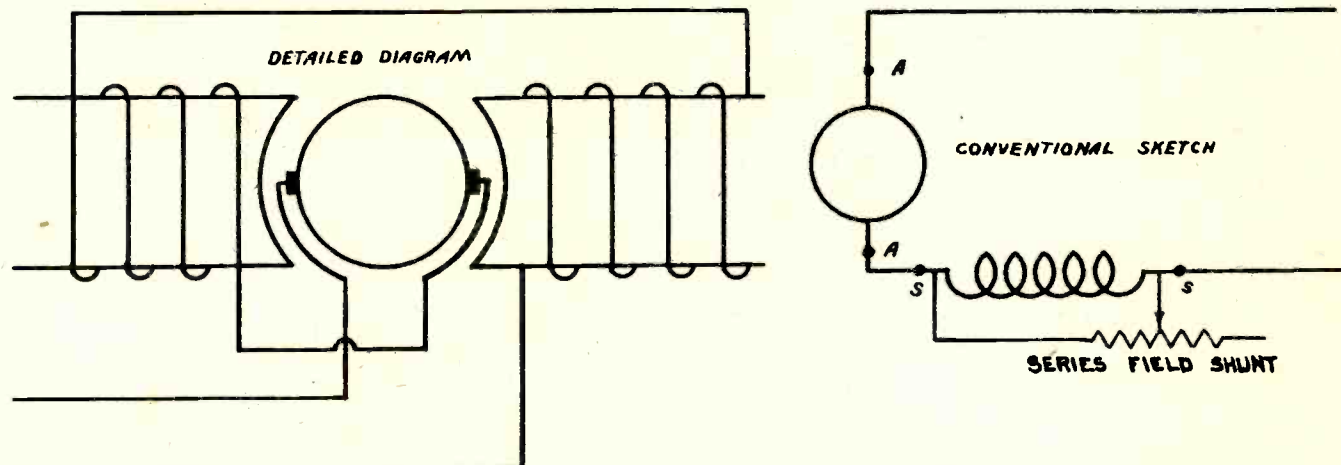

The starting and stalling torque is excellent. It will start or carry very heavy overloads. The torque of a series motor varies with the square of the armature current. This is true because the field strength varies with the armature current. Example - Doubling the armature current will likewise double the field strength and produce four times as much reaction between armature and field poles or produce four times as much torque.

The speed regulation is very poor. The speed varies inversely with the load which means more load less speed and less load more speed. Care must be taken to see that there will always be sufficient load on the motor to keep the speed within safe limits. If the load drop to zero the motor probably would run fast enough to destroy itself.

The series motor is limited in application because of its poor speed regulation. It is especially suitable for cranes, hoists, mine machines and electrical railway work. These loads can be handled more efficiently with a series motor because the speed will be slow if the load is heavy and a light load will be driven at a high speed,

The speed of a series motor can be controlled above normal speed by connecting a series field shunt parallel to the series field. The speed will vary inversely with the field strength. Controlling the speed above normal decreases the possible torque output but does not affect the H.P. output.

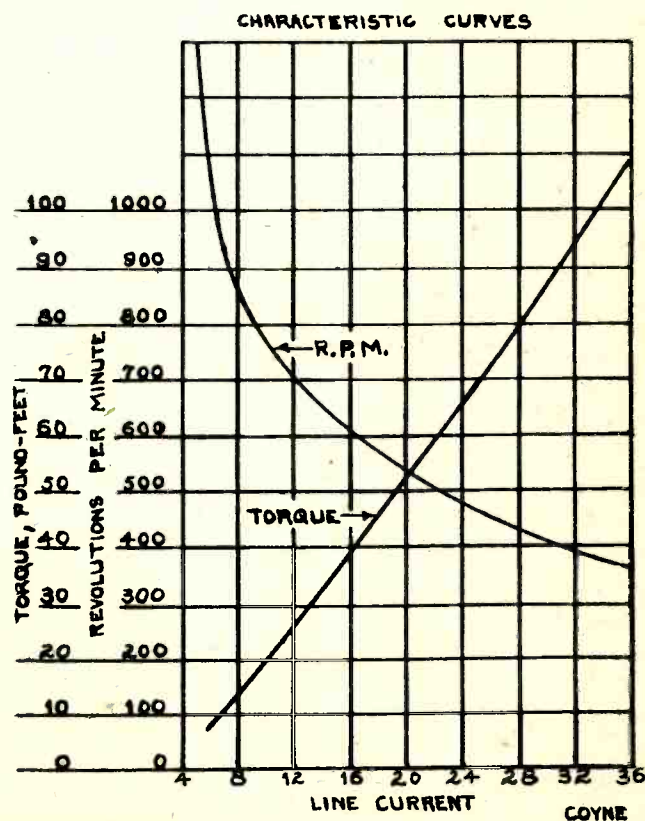

COMPOUND MOTOR

The field of a compound motor is made up of shunt and series coils placed on each field pole. The shunt winding is the main field winding. The series is the compound winding and its strength varies with the load current. If the shunt and series coils produce the same polarity at each field pole the connection is known as CUMULATIVE COMPOUND.

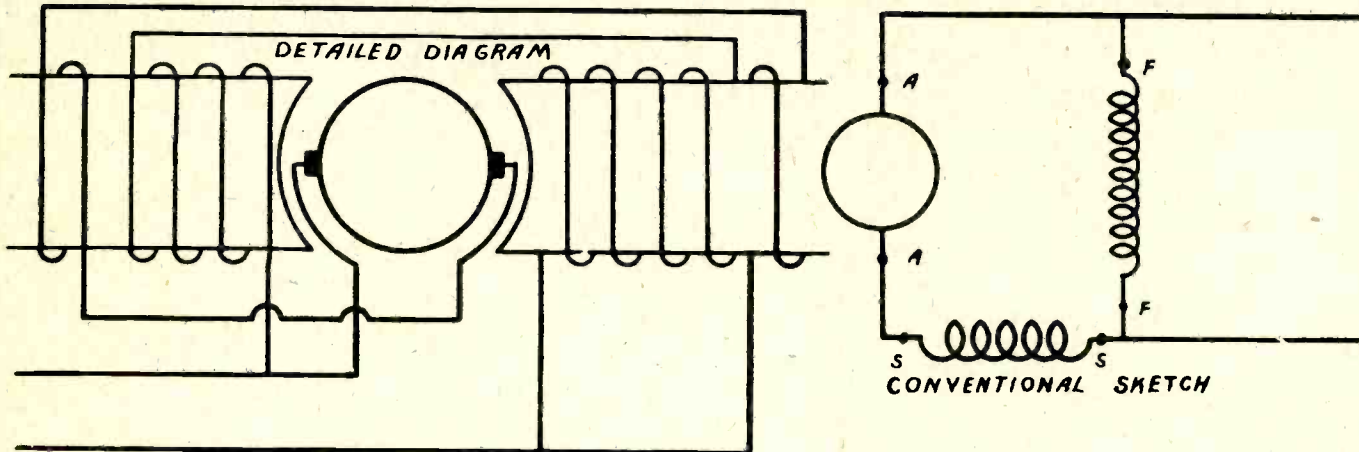

COMPOUND MOTOR CONNECTED CUMULATIVE

The TORQUE is very good. It will start to carry heavy overloads. The cumulative connected compound motor produces a better torque than the shunt motor but not as good as the series motor.

The SPEED REGULATION is fair. The speed will vary from 15 to 25% from no load to full load. The per cent variation in speed from no load to full load will be governed by the comparative strength of the shunt and series field.

The CUMULATIVE CONNECTED COMPOUND MOTOR is suitable for jobs, such as, compressors, crushers, steel mill roll, etc. For a complete list of applications see chart #115.

DIFFERENTIAL CONNECTED COMPOUND MOTOR

If the polarity of the series field oppose the shunt field the connection is known as differential compound.

The SPEED REGULATION of a differential connected compound motor is very good up to approximately 75% of full load rating. It is apt to slow down or stall if loaded beyond that point.

The TORQUE is very poor. It is apt to start and then reverse its rotation when starting a load.

There is very little use for the differential compound motor.

TESTS TO USE TO DETERMINE CONNECTION MADE FOR COMPOUND MOTOR.

1. Test the speed as connected. Reverse the series field leads and retest the speed. The connection producing the higher speed will be differential compound.
2. Operate the motor as a shunt motor. (series field disconnected) Observe the direction of rotation. Next operate the motor as a series motor. (shunt field disconnected) Again observe the direction of rotation. If each field connection produces the same direction of rotation. If each field connection produces the same direction of rotation, reconnect the fields the same as when testing and the motor will be cumulative compound.

CHARACTERISTIC CURVES

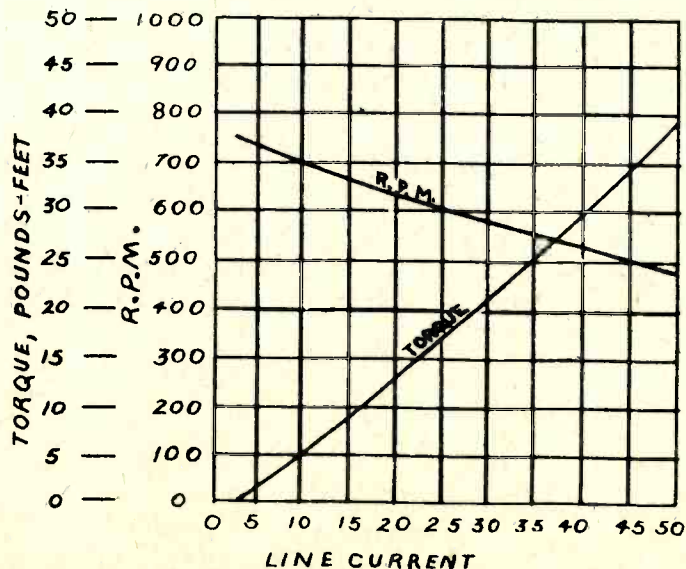

UNIVERSAL SERIES MOTOR

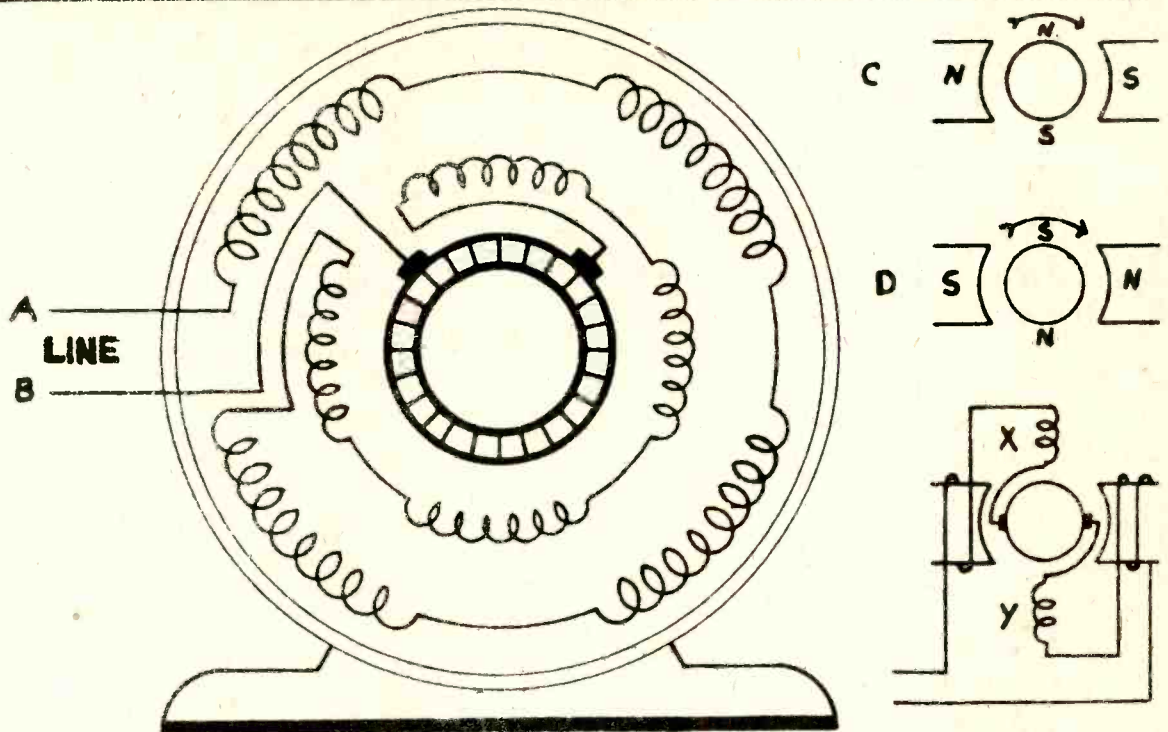

The above motor operates on the magnetic interaction between the armature and field poles, and runs in the same direction whether the current flows in on line A or line B, since reversing the flow of current in the line wires changes the polarity of both armature and field poles at the same instant as shown at C and D. Therefore, if such a motor be supplied with A.C. the torque developed will always be in the same direction. Since this machine operates on both D.C. and A.C. it is called a Universal motor. To operate satisfactorily on A.C. all parts of the magnetic circuit must be laminated to prevent undue heating from eddy currents, and element windings are usually desirable on the armature to ensure acceptable commutation. On the larger motors compensating windings are employed to improve operation and reduce sparking.

CHARACTERISTICS

This motor will produce about 4 times normal full load torque with 2 times normal full load current. The torque produced increases very rapidly with an increase in current as the curves below indicate. The variation in speed from no load to full load is so great that complete removal of load is dangerous in all motors of this type except those having fractional H.P. ratings.

APPLICATIONS

This motor is widely used in fractional H.P. sizes for fans, vacuum cleaners, kitchen mixers, milk shakers, and portable equipment of all types such as electric drills, hammers, sanders, saws, etc. Higher ratings are employed in traction work, and for cranes, hoists, and so on. In general, they are suitable for applications where high starting torque or universal operation is desired.

PRINCIPAL TROUBLES

Commutator, brushes, brush holders, bearings. Opens, shorts, or grounds in the armature, field, or associated apparatus. Loose connections.

To reverse the direction of rotation, reverse the armature connections or the field connections, but not both.

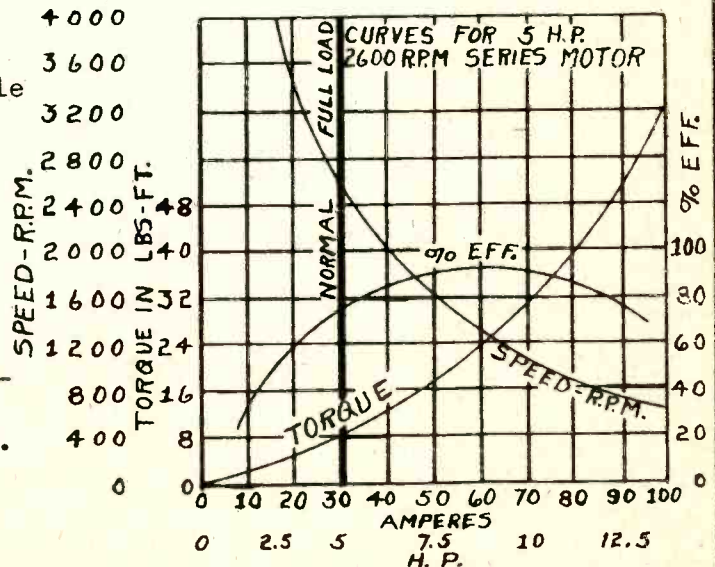



ENGINEERING INFORMATION
 CONNECTION DIAGRAMS FOR DIRECT CURRENT MOTORS
 SINGLE VOLTAGE, REVERSIBLE, WITHOUT OVERLOAD PROTECTION

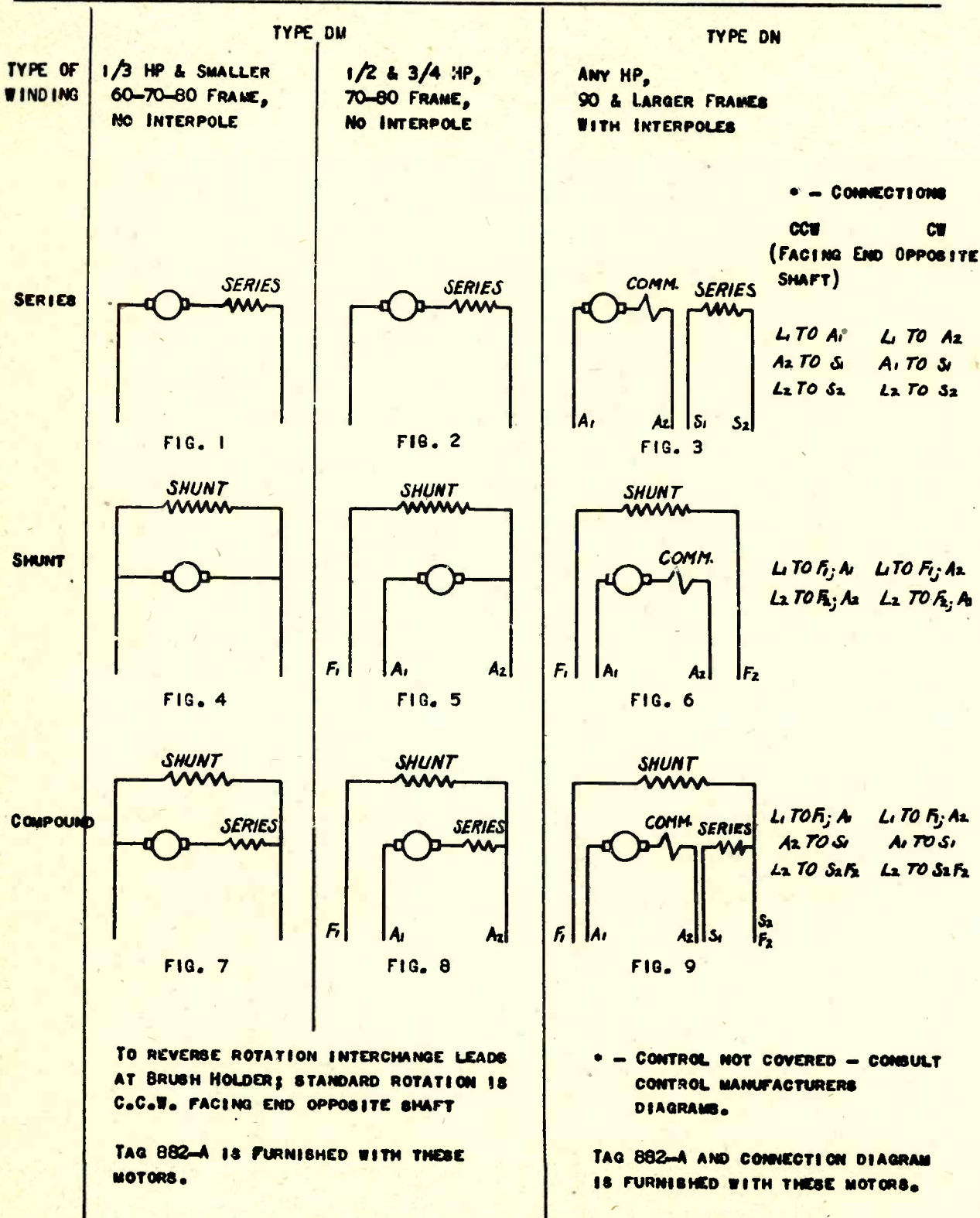

D.C. MOTOR & GENERATOR CONSTRUCTION

D.C. power is widely used in the industrial field. This type of power must be used for telephones, field excitation, lifting magnets and electro plating work. The characteristics of D.C. Motors make them especially suitable for loads that are difficult to start, where the speed must be varied over a wide range, and where the load must be started and stopped often; such as, traction work, milling machines, mine work, lathes, pumps, steel mill work, printing presses, elevators, etc.

Any D.C. machine may be used as a motor or generator. This construction information applies to both machines.

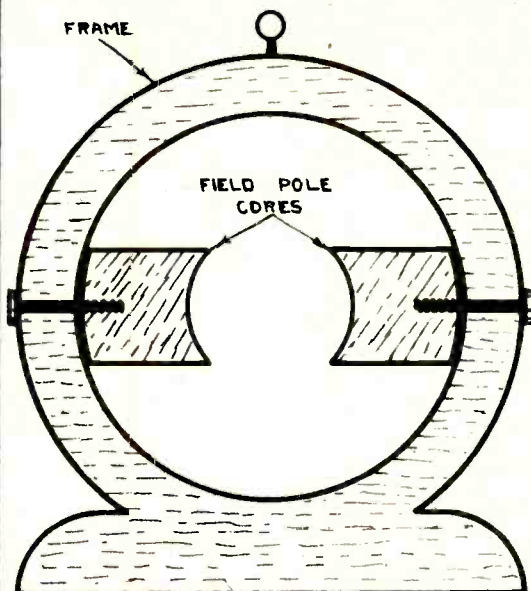

The frame is made of iron because it is used to complete the magnetic circuit for the field poles. Frames are made in three types; open, semi-enclosed and closed types. The open frame has the end plates or bells open so the air can freely circulate through the machine. The semi enclosed frame has a wire netting or small holes in the end bells so that air can enter but will prevent any foreign material entering the machine. The enclosed type frame has the end bells completely closed and the machine is air tight. Some machines are water tight which makes it possible to operate them under water. The closed type frame is used in cement plants, flour mills, etc. where the air is filled with dust particles that damage machine insulation.

The field poles are made of iron, either in solid form or built of thin strips called laminations. The iron field poles support the field windings and complete the magnetic circuit between the frame and armature core.

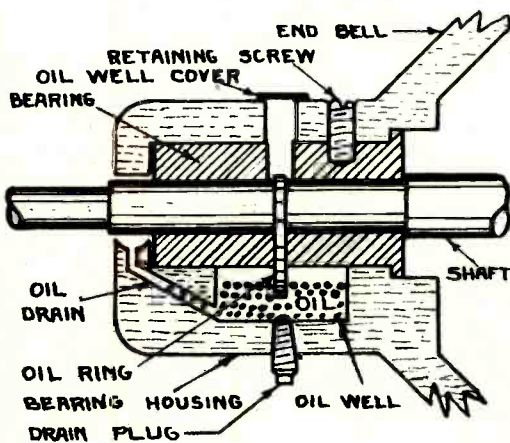

The bearings are the parts of the machine that fit around the armature shaft and support the weight of the armature. They are made in three general types; sleeve, roller, and ball bearings. Bearings will be discussed in detail later in the course.

The oil rings are small rings used with sleeve type bearings. They carry the oil from the oil well to the shaft. The oil ring must turn when the machine is operating otherwise the bearing will burn out.

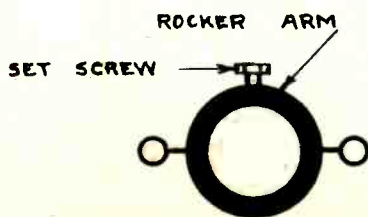

The rocker arm supports the brush holders. This arm is usually adjustable to make it possible to shift the brushes to obtain best operation. When the brushes are rigidly fastened to the end bell the entire end bell assembly is shifted to obtain best operation.

D.C. MOTOR & GENERATOR CONSTRUCTION (CONTINUED)

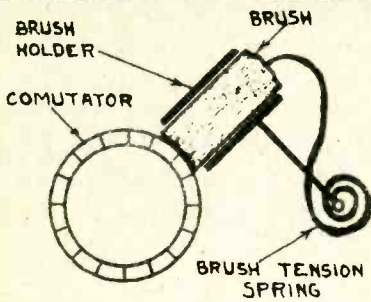

The brush holders support the brushes and hold them in the proper position on the commutator. The brushes should be spaced equi-distantly on the commutator when more than two sets of brushes are used. When only two sets are used they will be spaced the same distance as a pair of adjacent field poles.

The brush tension spring applies enough pressure on the brush to make a good electrical connection between the commutator and brush.

Brushes used on electrical machines are made of copper, graphite, carbon or a mixture of these materials. The purpose of the brushes is to complete the electrical connection between the line circuit and the armature winding.

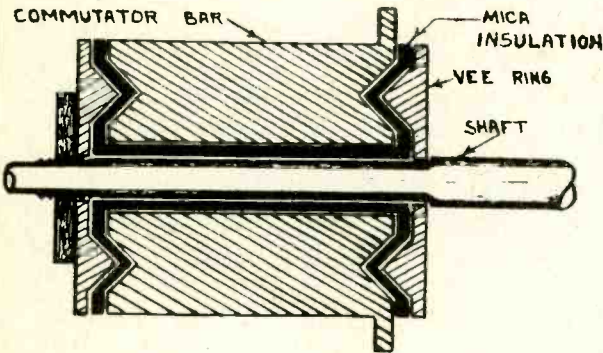

Commutators are constructed by placing copper bars or segments in a cylindrical form around the shaft. The copper bars are insulated from each other and from the shaft by mica insulation. An insulating compound is used instead of mica on small commutators. The commutator bars are soldered to and complete the connection between the armature coils.

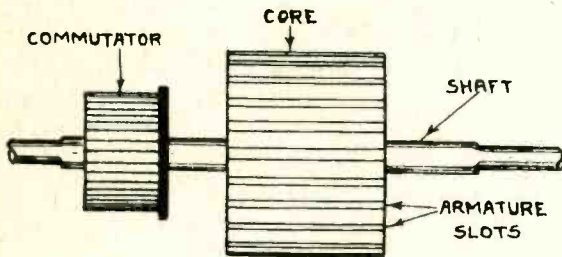

The armature core is made of laminated iron (thin sheets) pressed tightly together. The laminated construction is used to prevent induced currents (eddy currents) from circulating in the iron core when the machine is in operation. The iron armature core is also a part of the magnetic circuit for the field, and has a number of slots around its entire surface, in which the armature coils are wound.

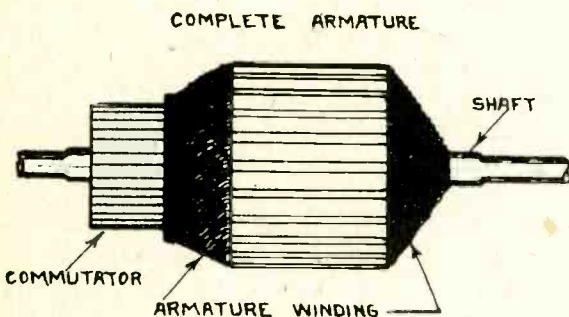

The armature winding is a series of coils wound in the armature slots and the ends of the coils connect to the commutator bars. The number of turns and the size of wire is determined by the size speed and operating voltage of the machine. The purpose of the armature winding is to set up magnetic poles on the surface of the armature core.

The field windings are made in three different types: shunt, series and compound wound fields. Shunt fields have many turns of small wire and series fields have a few turns of heavy wire. The compound field is a combination of the two windings. The name of the field winding depends on the connection with respect to the armature winding. The purpose of the field winding is to produce magnetic poles that react with the armature poles to produce rotation.

Brushes and Brush Setting

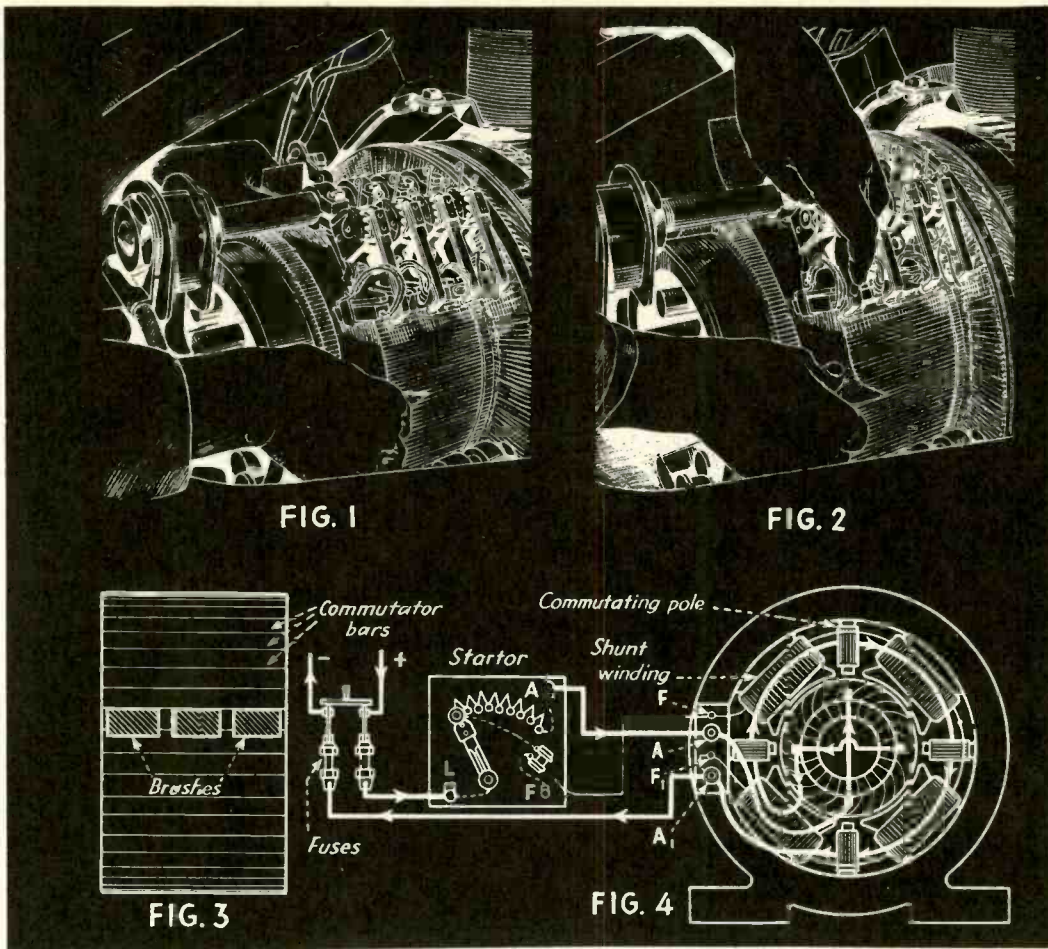

Figs. 1 and 2—Fitting brushes to commutator with sand paper. Fig. 3—Brushes in each group should be in line. Fig. 4—Field circuit open to test brush location on commutator

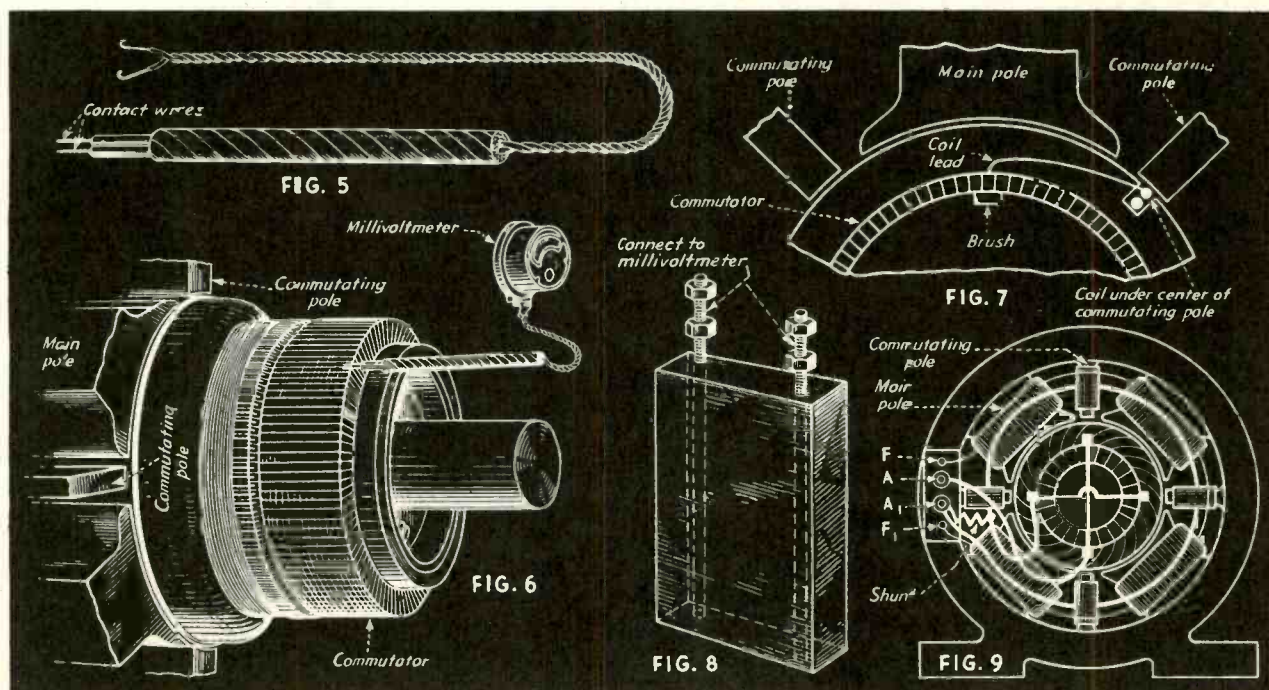

Figs. 5 and 6—Locating neutral on commutator with millivoltmeter. Fig. 7—Armature-coil lead locates neutral. Fig. 8—Fibre brush used with millivoltmeter. Fig. 9—Shunt across commutating-pole coil leads to adjust field-pole strength.

MAINTENANCE & TROUBLE SHOOTING

A MACHINE MAY FAIL TO START OR IMPROPERLY OPERATE DUE TO-

1. Opens, loose connections or high resistance contacts in the motor, line or starter. Use a test lamp or a voltmeter and make a continuity test as shown by sketch.

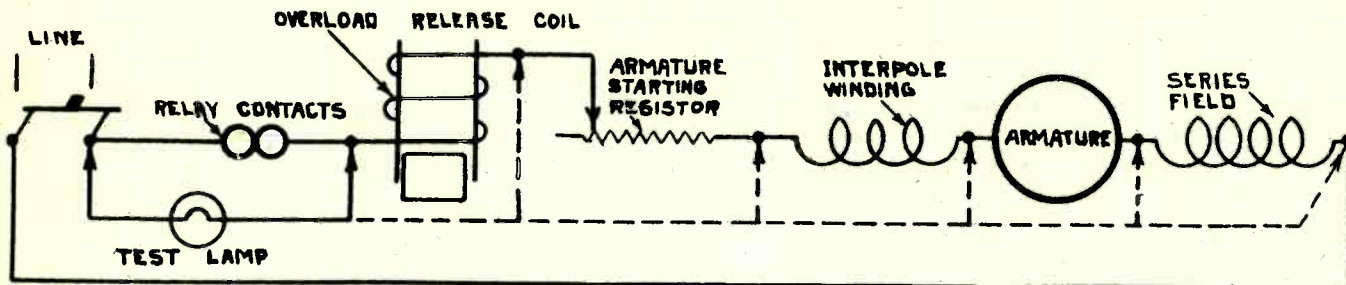

2. Worn bearings, on small machines and bearings can be tested by moving the shaft. If bearings are worn there will be a noticeable clearance between the bearing and shaft. For a more accurate test measure the air gap with an air gap or thickness gauge. For best condition the surface of all field poles should be the same distance from the armature core. Use the same position on the armature for all tests.

BEARINGS NOT WORN				WORN BEARINGS		
UPPER LEFT MEASUREMENT		.026"		UPPER LEFT MEASUREMENT		.044"
UPPER RIGHT	"	.026"	UPPER RIGHT	"	.044"	
LOWER	"	.026"	LOWER	"	.008"	
LOWER LEFT	"	.026"	LOWER LEFT	"	.008"	

3. Incorrect field pole polarity. Field pole polarity will not reverse itself. This trouble occurs when field connections are being made between coils. Adjacent poles should produce opposite polarity otherwise maximum field strength will not be produced. A weakened field will cause a motor to run at a speed higher than normal and decrease the amount of torque it will produce.

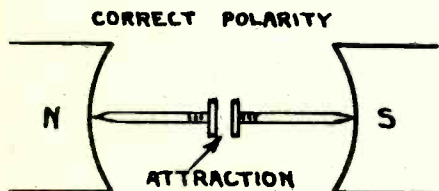

A magnetic compass or large nails can be used to determine if adjacent poles are opposite polarity.

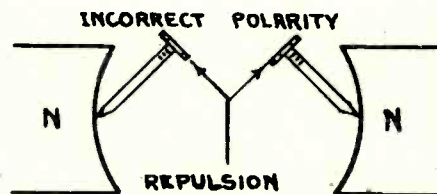

4. High or low line voltage. The armature of a shunt or compound motor will overheat if the line voltage is lower than normal if the motor is carrying its full load. High line voltage will cause the shunt field to overheat. Series motors will not be affected except the speed will vary with the voltage applied to the motor.

5. Operating temperatures. The temperature rating on the name plate is the amount of heat the machine will produce when operating with full load. The maximum operating temperature for any machine is the name plate temperature plus normal room temperature. Example - Name plate temperature 40 degrees centigrade - Normal room temperature is always considered to be 40 degrees centigrade. This machine will operate at a temperature of 40° plus 40° or 80° centigrade which is equal to 176 degrees fahrenheit. The following formulas are used to change fahrenheit to centigrade or vice versa. F equals (C times 1.8) plus 32 C equals (F minus 32) divided by 1.8.

MAINTENANCE & TROUBLE SHOOTING (continued)

6. Brushes not properly fitted to the commutator. Use sandpaper, brush jig or brush seater stone to fit or seat brushes.

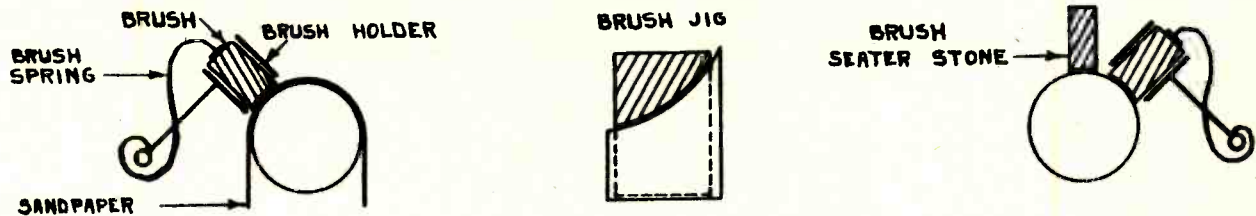

7. Brushes off neutral position. This condition will cause brush sparking and cause a motor to operate at a speed higher than name plate speed. The correct position can be located by using one of the following methods. 1. If the machine is operating with load shift the brushes to a position of sparkless commutation. 2. Connect a voltmeter across the brushes of a motor and the shunt field circuit. The brush position giving the lowest voltmeter reading will be the correct position. The motor must not rotate while the test is being made. For a generator the brush position giving the highest voltage will be the correct position. The generator should be operating without load when the test is made.

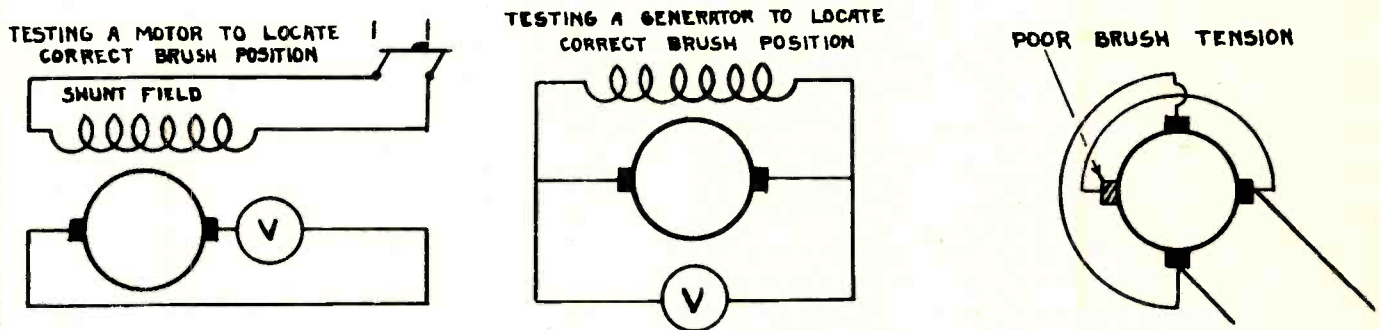

8. Poor or unequal brush tension. Apply equal tension of 1 to 3 lbs. per square inch of brush surface on the commutator. Measure brush tension by using a small spring scale.

9. High mica. Use hack saw blade or undercutting machine and undercut the mica about $1/16$ inch.

10. Wet or oily windings. All damaged windings must be properly cleaned and repaired before drying. Use carbon tetra chloride or other agents for cleaning. Dry windings by baking at 180 F. until dry. Motors can be dried out by operating them with an ammeter and a regulating resistor connected in series with the machine windings. Adjust the regulating resistor so the current through the chine windings will not exceed name plate value. After machine has been dried out make an insulation test to determine the condition of the insulation.

11. Rough or dirty commutator. Smooth commutator with sandpaper or commutator stone. True commutator by turning it in a lathe or using tools made for that purpose. After trueing a commutator in a lathe use #000 or #0000 sandpaper to smooth commutator. Clean commutator with fine sandpaper or use a cleaning agent such as carbon tetra chloride. It is best not to use a cutting agent for cleaning. Never use emery cloth or a lubricant of any kind on a commutator.

12. Incorrect grade of carbon brush. Carbon brushes vary in capacity from 40 I to 125 I per square inch of brush surface in the commutator. When renewing brushes always be certain that the brush used has sufficient capacity to carry the load without overheating.

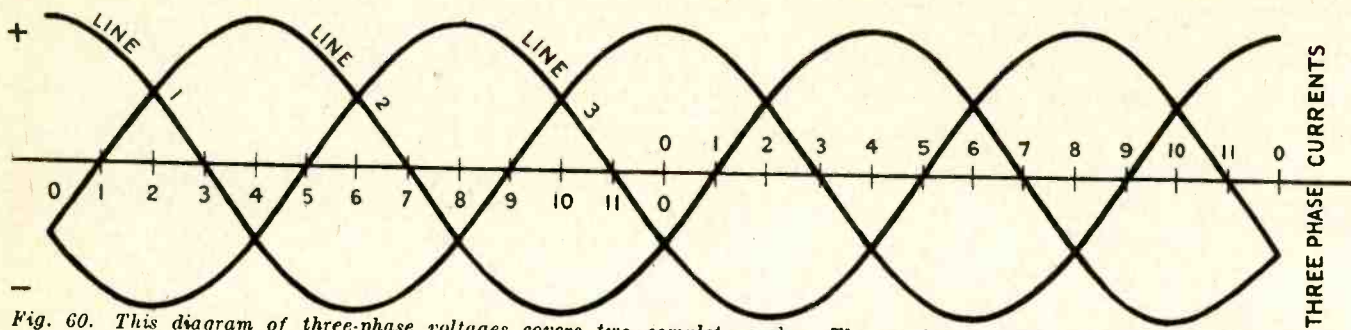
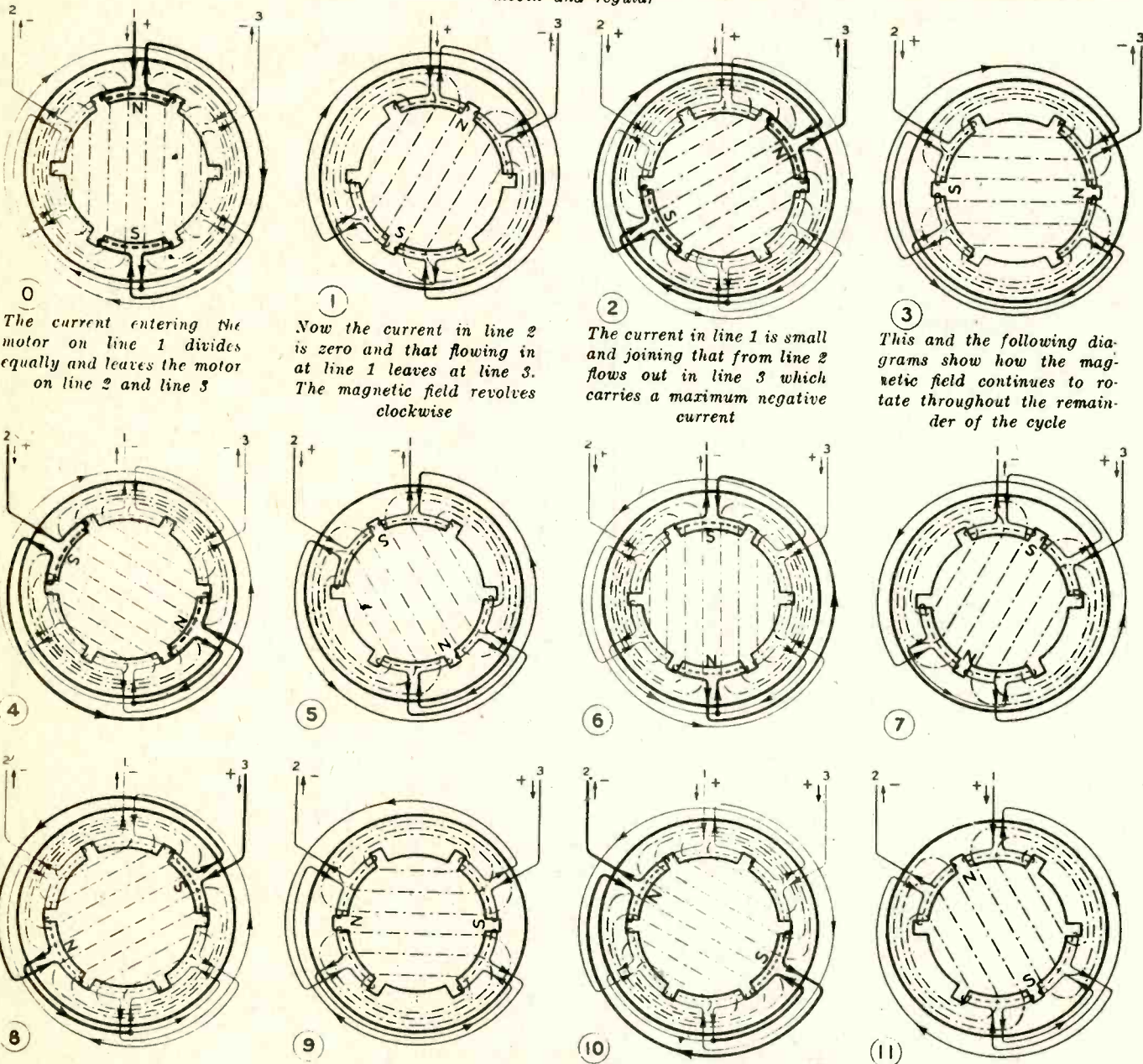

Fig. 60. This diagram of three-phase voltages covers two complete cycles. The numbers on it refer to the numbers on the diagrams below. Each diagram shows the condition in the armature at the instant indicated by the corresponding number on this curve. The action of the magnetic field is smooth and regular; the rise and fall of currents in the conductors is also smooth and regular



0
The current entering the motor on line 1 divides equally and leaves the motor on line 2 and line 3

1
Now the current in line 2 is zero and that flowing in at line 1 leaves at line 3. The magnetic field revolves clockwise

2
The current in line 1 is small and joining that from line 2 flows out in line 3 which carries a maximum negative current

3
This and the following diagrams show how the magnetic field continues to rotate throughout the remainder of the cycle

Fig. 61. This series of twelve diagrams shows the electric and magnetic conditions in a two-pole, three-phase motor at the end of twelve equal parts of one cycle

MOTOR CHARACTERISTICS

Type of Driven Machinery	Motor Type Designation	Speed R.P.M.	Approx. Starting Torque in % of Full Load Torque	Approx. Maximum Torque in % of Full Load Torque	Approx. Starting Current in % of Full Load Current	Approx. Speed Regulation % Slip	Starting Equipment	Load Conditions
Pumps (Centrifugal, Rotary and Turbine); Cotton Gins; Fans (Centrifugal and Propeller); Line Shafts; Motor Generator Sets; Shapers; Screw Machines; Planers; Milling Machines; Keyseating Machines; Lathes; Buffers; Drill Presses; Metal Grinders; Joiners; Molders; Sanders; Circular Saws (Small and Medium); Positive Pressure Blowers; Job Printing Presses; Brine Agitators; Pulp Grinders; Jordans; Laundry Washers; Small Stokers.	Type QZK	1800	125 To 180	200 To 250	450 To 550	2 To 4	Type QZK motors may be started across the line at full voltage with comparative low starting current. Starters may be reduced voltage or full voltage types. Manual or magnetic, non-reversing or reversing.	Require normal starting torque for continuous duty. Infrequent load fluctuations. Motor provides service factor for overload conditions. Constant speed. No special conditions.
		1200	125 To 180	200 To 250	450 To 550	2 To 4		
		900	115 To 140	200 To 225	450 To 550	2 To 4		
Pumps (Reciprocating and Displacement); Air Compressors; Refrigerating Compressors; Conveyors; Stokers; Crushers (without flywheels); Dough Mixers; Grinders, Hammer Mills; Ball Mills; Turn Tables; Car Pullers; Large Band Saws; Pug Mills; Dry Pans; Brick Presses; Gear Plungers; Brick and Tile Machines; Foundry Tumbling Barrels; Centrifugal Sand Mixers; Grain Elevator Legs; Bending and Straightening Rolls; Bucket-type Elevators; Conveyors starting loaded.	Type QOZK Ratings 3 H.P. & Larger	1800	225 To 275	200 To 250	450 To 550	3 To 5	Across the line, full-voltage manual or magnetic, non-reversing or reversing.	Compressors and pumps requiring less than 7½ Hp. under certain conditions may be successfully handled by type QZK Motors. Heavy starting, continuous or intermittent duty; service factor for overload conditions.
		1200	200 To 250	200 To 225	450 To 550	3 To 5		
		900	190 To 225	190 To 200	450 To 550	3 To 5		
Passenger and Freight Elevators.	Type QRZK	1800	300-400	300-400	300-350	15-20	Across the line, full-voltage reversing elevator control with master switches or drives.	Require high starting torque intermittent duty single speed reversing service.
		1200	300-400	300-400	300-350	15-20		
Hoists, Lifts, Small Cranes, Valves.	Type QLZK	1800	300-400	300-400	325-375	15-20	Same as for Type QRZK.	Intermittent duty single speed reversing.
		1200	300-400	300-400	325-375	15-20		
Punch Presses, Laundry Extractor, Shears, Power Hammers, Crushers with Flywheels, Bending Rolls with Flywheels.	Type QFZK	1800	300-350	300-350	375-450	Range 5-8 8-13	Across the line, full-voltage, manual or automatic reversing or non-reversing.	High starting torque. Heavy fluctuating loads, usually with flywheels or high inertia to accelerate; continuous duty.
		1200	300-350	300-350	375-450			
		900	300-350	300-350	375-450			
Pumps, Centrifugal and Turbine Blowers and Fans, Centrifugal and Propeller.	Type QBZK 40 H.P. & Larger	1800	75-100	150-160	350-400	3-5	Across the line, full-voltage, manual or automatic reversing or non-reversing.	Low starting and maximum torque. Low starting current. Continuous duty, service factor 1.0 and no overload capacity.
		1200	75-100	150-160	350-400	3-5		
		900	75-100	150-160	350-400	3-5		
Compressors; Conveyors; Elevators; Grinding Machinery; Hoists; Laundry Machinery; Machine Tools; Mills; Mixing Machines; Positive Displacement Blowers; Positive Displacement Pumps; Printing Presses; Pulverizing Machines; Woodworking Machines.	QXZK Multi-Speed Constant Torque	1800/900	125-180	200-250	450-550	2-4	Type QXZK motors may be started across the line at full voltage with comparative low starting current. Starters may be reduced voltage or full voltage types. Manual or magnetic, non-reversing or reversing.	Require normal starting torque for continuous duty. Infrequent load fluctuations. Motor provides service factor for overload conditions. Constant speed. No special conditions.
		1800/1200/900/600	125-180	200-250	450-550	2-4		
Machine Tools; Production Equipment; Punch Presses; Winches, Bending Rolls, etc.	QMZK Multi-Speed Constant Horsepower	1800/900	125-180	200-250	450-550	2-4	Type QMZK motors may be started across the line at full voltage with comparative low starting current. Starters may be reduced voltage or full voltage types. Manual or magnetic, non-reversing or reversing.	Require normal starting torque for continuous duty. Infrequent load fluctuations. Motor provides service factor for overload conditions. Constant speed. No special conditions.
		1800/1200/900/600	125-180	200-250	450-550	2-4		
Blowers, Fans and Pumps.	QNZK Multi-Speed Variable Torque	1800/900	125-180	200-250	450-550	2-4	Type QNZK motors may be started across the line at full voltage with comparative low starting current. Starters may be reduced voltage or full voltage types. Manual or magnetic, non-reversing or reversing.	Require normal starting torque for continuous duty. Infrequent load fluctuations. Motor provides service factor overload conditions. Constant speed. No special conditions.
		1800/1200/900/600	125-180	200-250	450-550	2-4		

SPEED CLASSIFICATION	POWER SUPPLY	N.E.M.A. CLASS.	L.A. TYPE	TYPE OF MOTOR	** RANGE OF HORSEPOWER RATINGS	STARTING TORQUE PER CENT OF FULL LOAD	MAXIMUM TORQUE PER CENT OF FULL LOAD	SPEED REGULATION PER CENT SLIP	GENERAL REMARKS	AGITATORS - MIXERS	BALL - ROD / PUG MILLS	BALING PRESSES	BENDING ROLLS	BLOWERS - POSITIVE PR.	BORING MILLS	BUCKET ELEVATORS			
CONSTANT SPEED	ALTERNATING CURRENT	3 & 2 PHASE	A	S	STANDARD SQUIRREL CAGE NORMAL TORQUE - NORMAL STARTING CURRENT	1/2 TO 300 HP	150	200 TO 250	2 TO 5	GENERAL PURPOSE WIDE APPLICATION	●				●	●			
			B	X	SQUIRREL CAGE NORMAL TORQUE - LOW STARTING CURRENT	7 1/2 TO 200 HP	125 TO 150	200 TO 225	2 TO 5	SIMPLE CONTROL	●					●	●		
			C	A	SQUIRREL CAGE HIGH TORQUE - LOW STARTING CURRENT	3 TO 100 HP	200 TO 250	175 TO 225	4 TO 5	HEAVY STARTING SIMPLE CONTROL		●						●	
			D	K	SQUIRREL CAGE HIGH TORQUE - HIGH SLIP	1/2 TO 100 HP	200 TO 300	200 TO 300	8 TO 15	HEAVY STARTING - INTERMITTENT AND FLUCTUATING LOAD		●	●	●				●	
			T	W	SQUIRREL CAGE LOW TORQUE - LOW STARTING CURRENT	40 TO 100 HP	50 TO 80	125 TO 150	4 TO 5	SPECIAL PURPOSE CONSTANT LOAD LIGHT STARTING						●			
			-	WX	SQUIRREL CAGE LOW TORQUE	1/2 TO 10 HP	100 TO 125	175 TO 200	4 TO 5	SPECIAL SERVICE SMOOTH REVERSAL									
			-	H	WOUND ROTOR	1/2 TO 300 HP	200 TO 250	200 TO 250	*	FREQUENT & HEAVY STARTING		●		●					●
			-	C	CAPACITOR - INDUCTION LOW TORQUE	1/2 TO 10 HP	50 TO 75	175 TO 200	4 TO 6	LIGHT STARTING DIRECT CONN. LOAD									
			-	CN CU	CAPACITOR - INDUCTION NORMAL TORQUE	1/2 TO 10 HP	150 TO 200	175 TO 200	4 TO 6	GENERAL PURPOSE INFREQUENT STARTING	●						●		
			-	NA	SHUNT WOUND	1/2 TO 75 HP	150	/	5 TO 10	GENERAL PURPOSE STEADY LOADS	●						●	●	
			-	NA	COMPOUND WOUND	1/2 TO 75 HP	175 TO 200	/	10 TO 25	HEAVY STARTING FLUCTUATING LOAD		●	●						●
			-	NA	SERIES WOUND	1/2 TO 75 HP	300 TO 400	/	*	HEAVY AND FREQUENT STARTING					●				
ADJUSTABLE SPEED	DIRECT CURRENT	A.C. 3 & 2 PHASE	-	M	CONSTANT HORSEPOWER 2 - 3 - 4 SPEEDS	1/4 TO 150 HP	125 TO 150	175 TO 200	4 TO 6	SPEED INDEPENDENT OF LOAD						●			
			-	M	CONSTANT TORQUE 2 - 3 - 4 SPEEDS	1/4 TO 200 HP	125 TO 150	175 TO 200	4 TO 6	SPEED INDEPENDENT OF LOAD	●	●			●		●		
			-	M	VARIABLE TORQUE 2 - 3 - 4 SPEEDS	1/4 TO 200 HP	125 TO 150	175 TO 200	4 TO 6	SPEED INDEPENDENT OF LOAD									
			-	NW	FIELD CONTROL	1/4 TO 50 HP	150	/	5 TO 10	WIDE RANGE FLEXIBLE CONTROL							●		
			-	NA	VARIABLE VOLTAGE CONTROL	1/4 TO 30 HP	150	/	*	EXTREME WIDE RANGE FLEXIBLE CONTROL									
			-	H	WOUND ROTOR	1/2 TO 300 HP	200 TO 250	200 TO 250	*	LIMITED RANGE HEAVY STARTING	●	●		●	●				●
VARIABLE SPEED	DIRECT CURRENT	A.C. SHUNT	-	NA	ARMATURE CONTROL	1/2 TO 75 HP	150	/	*	LIMITED RANGE DEPENDENT ON LOAD	●				●				
			-	NA	FIELD AND ARMATURE CONTROL	1/2 TO 50 HP	150	/	*	WIDE RANGE LIMITED APPLICATION									
			-	NA	VARIABLE VOLTAGE CONTROL	1/4 TO 30 HP	150	/	*	WIDE RANGE LOW EFFICIENCY									
			-	NA	ARMATURE CONTROL	1/2 TO 75 HP	175 TO 200	/	*	LIMITED RANGE DEPENDENT ON LOAD		●						●	
			-	NA	FIELD AND ARMATURE CONTROL	1/2 TO 50 HP	175 TO 200	/	*	WIDE RANGE LIMITED APPLICATION									
			-	NA	VARIABLE VOLTAGE CONTROL	1/4 TO 30 HP	175 TO 200	/	*	WIDE RANGE LOW EFFICIENCY									
			-	NA	ARMATURE CONTROL	1/2 TO 75 HP	300 TO 400	/	*	LIMITED RANGE HEAVY STARTING							●		
			-	NA	ARMATURE CONTROL	1/2 TO 75 HP	300 TO 400	/	*	LIMITED RANGE HEAVY STARTING									

* DEPENDENT UPON LOAD AT NORMAL SPEED.

** HORSEPOWER RATINGS, TORQUE AND REGULATION DATA IS FOR 4 POLE (1800 R.P.M.) 60 CYCLE A.C. MOTO

/ MAXIMUM TORQUE IS LIMITED BY COMMUTATION. UNDER NORMAL CONDITIONS D.C. MOTOR DEVELOPS 200 T

D. C. GENERATORS.

GENERATOR ACTION

An electrical generator is a device designed to change mechanical energy into electrical energy. Note that it does not generate energy, it merely converts it from the mechanical to the electrical form.

As no conversion device is 100% efficient, the power input to the generator must be greater than the rated generator output. For generators of 5 K W rating or above, a prime mover capable of supplying 1.5 H P for each KW of generator output is usually employed.

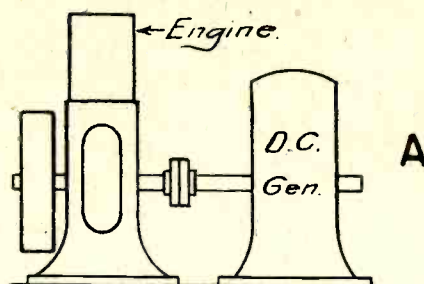

SEPARATELY EXCITED GENERATORS

The D. C. Generator produces voltage by rotating conductors through a magnetic field. In Figure B this field is produced by field coils that are energized from a separate source external to the machine. This type of generator may be driven in either direction, for the field excitation is independent. The polarity of the brushes will reverse when the rotation is changed, the positive brush becoming negative and vice versa.

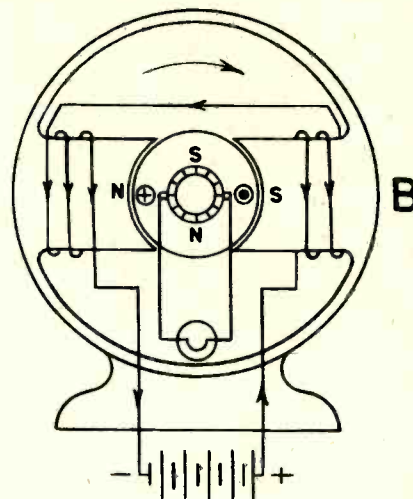

SELF EXCITED GENERATOR SHUNT TYPE

In this machine, the energy for the field is obtained from the armature and the generator is self exciting. The field poles retain some magnetism after having once been magnetized, and as the armature is rotated, the conductors cut this residual flux and generate voltage. This voltage is applied to the field, which is in parallel with the armature, and in this manner the field is strengthened. This increased field raises the voltage still further and this action continues until normal voltage is reached. The magnetic polarity set up by the field coils must be the same as the residual magnetism, otherwise the voltage will not build up.

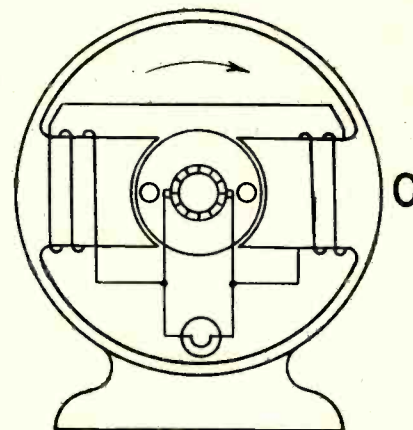

FAILURE TO GENERATE

The self excited type generator may fail to develop normal voltage due to: no residual field magnetism; magnetic effect of field coils opposing residual magnetism; poor brush contact; speed too low; wrong direction of rotation.

When the direction of rotation is changed, the brush polarity reverses and this reverses the current flow through the field coils, causing the coil magnetism to weaken the residual field. Under such conditions, the generator cannot build up a voltage. For operation in the opposite direction, the field leads must be reversed.

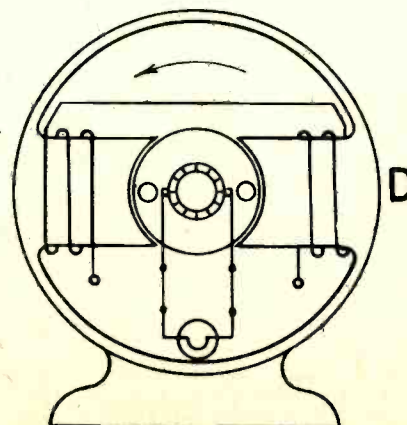

VARIABLE VOLTAGE CONTROL.

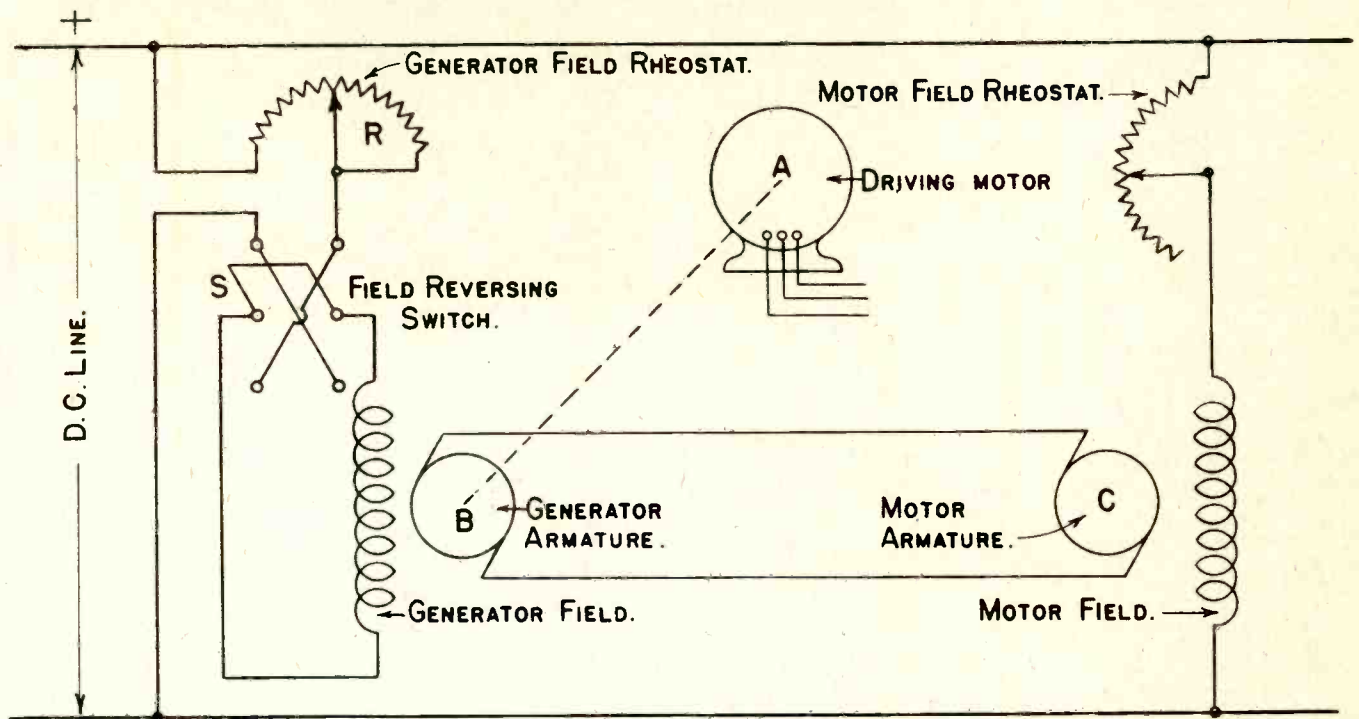

The variation in speed obtainable by field control on the ordinary D.C. motor will not, in the average case, exceed 4 to 1 due to the sparking difficulties experienced with very weak fields. Although the range may be increased by inserting resistance in series with the armature, this can be done only at the expense of efficiency and speed regulation.

With constant voltage applied to the field, the speed of a D.C. motor varies directly with the armature voltage; therefore, such a motor may be steplessly varied from zero to maximum operating speed by increasing the voltage applied to its armature. The sketch shows the arrangement of machines and the connections used in the Ward Leonard type of variable voltage control designed to change speed and reverse rotation. The constant speed D.C. generator (B) is usually driven by an A.C. motor (A) and its voltage is controlled by means of rheostat R. Note that the fields of both generator (B) and driving motor (C) are energized from a separate D.C.

supply or by an auxiliary exciter driven off the generator shaft. Thus the strength of the motor field is held constant, while the generator field may be varied widely by rheostat R.

With the set in operation generator (B) is driven at a constant speed by prime mover A. Voltage from B is applied to the D.C. motor (C) which is connected to the machine to be driven. By proper manipulation of rheostat R and field reversing switch S the D.C. motor may be gradually started, brought up to and held at any speed, or reversed. As all of these changes may be accomplished without breaking lines to the main motor, the control mechanism is small, relatively inexpensive, and less likely to give trouble than the equipments designed for heavier currents.

The advantages of this system lie in the flexibility of the control, the complete elimination of resistor losses, the relatively great range over which the speed can be varied, the excellent speed regulation on each setting, and the fact

that changing the armature voltage does not diminish the maximum torque which the motor is capable of exerting since the field flux is constant.

By means of the arrangement shown, speed ranges of 20 to 1—as compared to 4 to 1 for shunt field control—may be secured. Speeds above the rated normal full load speed may be obtained by inserting resistance in the motor shunt field. This represents a modification of the variable voltage control method which was originally designed for the operation of constant torque loads up to the rated normal full load speed.

As three machines are usually required, this type of speed control finds application only where great variations in speed and unusually smooth control are desired. Steel mill rolls, electric shovels, passenger elevators, machine tools, turntables, large ventilating fans and similar equipments represent the type of machinery to which this method of speed control has been applied.

PARALLELING D.C. GENERATORS.

POSITIVE BUS BAR

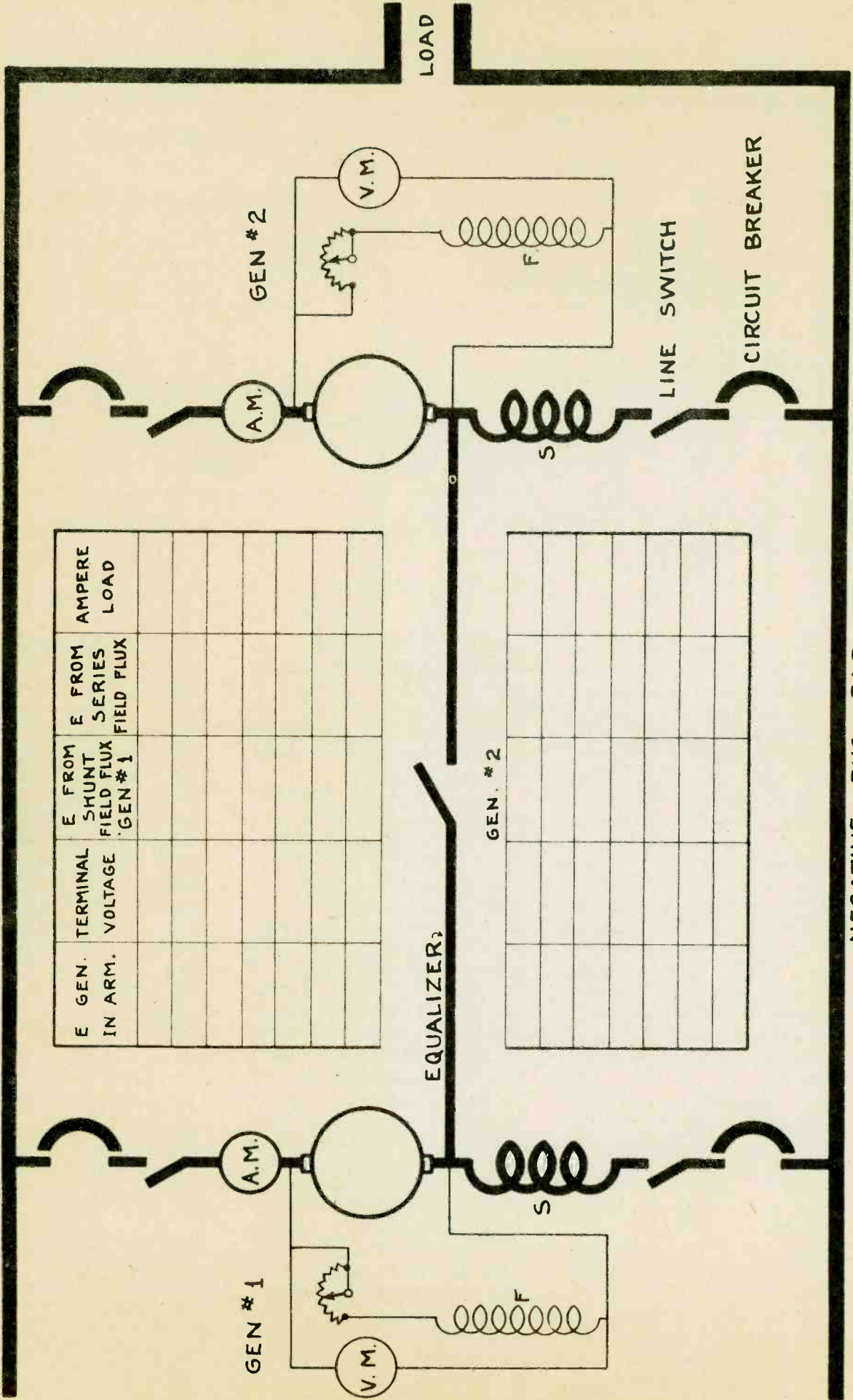

E GEN. IN ARM.	TERMINAL VOLTAGE	E FROM SHUNT FIELD FLUX GEN #1	E FROM SERIES FIELD FLUX	AMPERE LOAD

GEN. #2				

NEGATIVE BUS BAR

SERIES WELDING GENERATOR

CROSS FIELD DESIGN

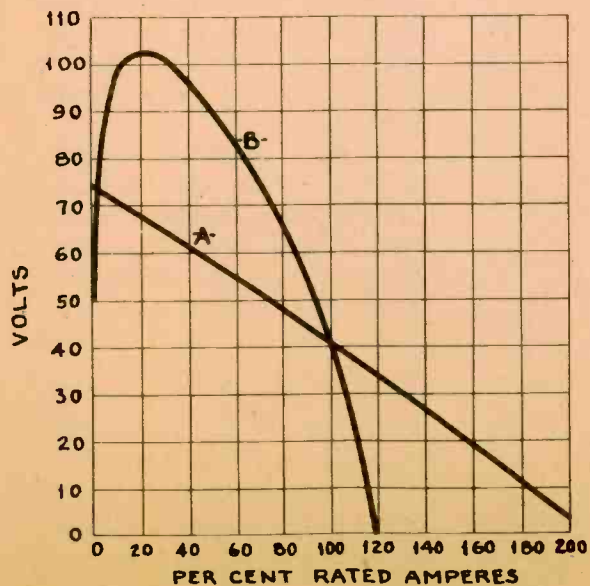
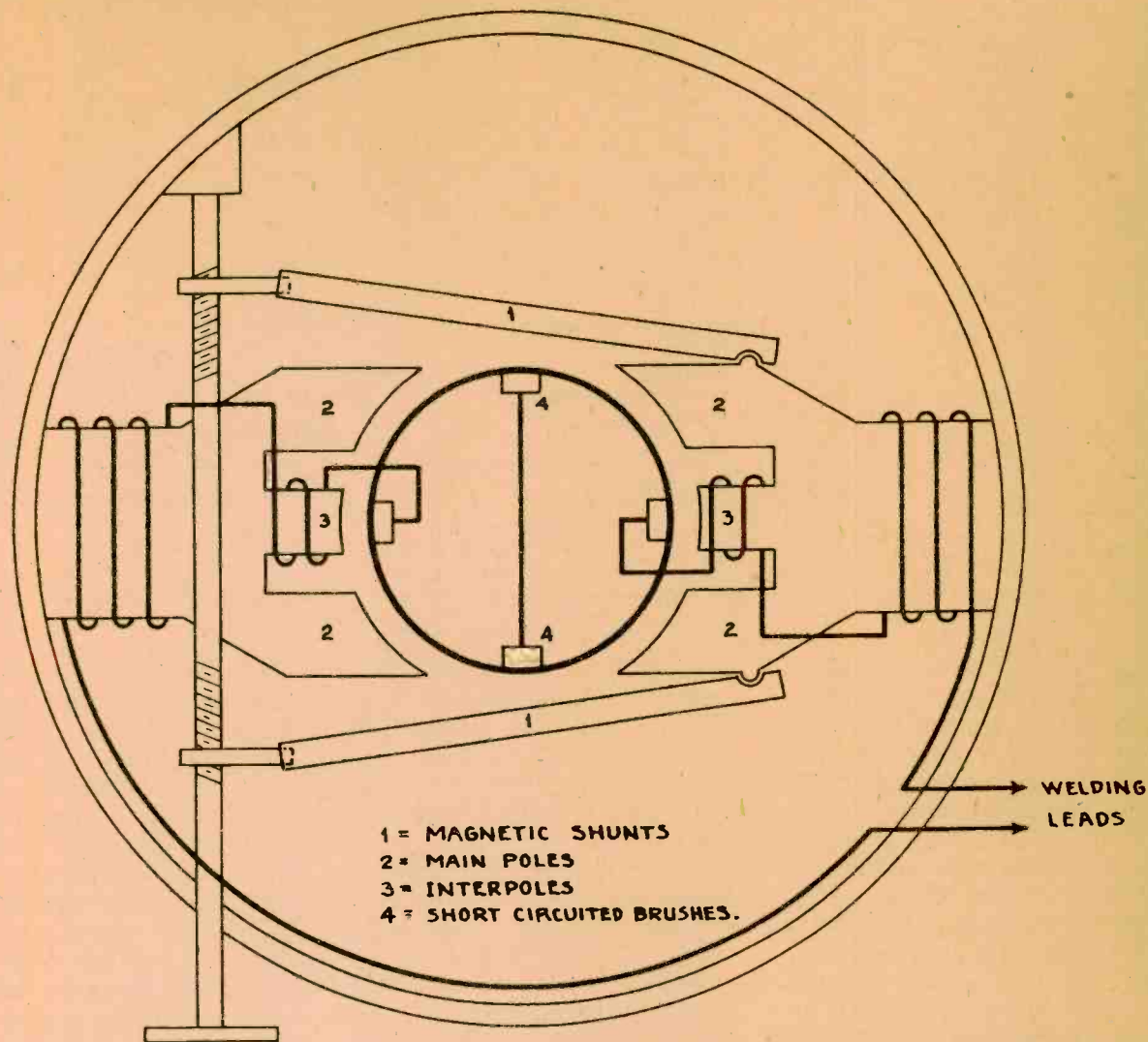

THIS WELDER ELIMINATES THE USE OF A REACTOR, EXCITER, VOLTMETER, AMMETER, METER SWITCHES, FIELD RHEOSTATS, AND FIELD DISCHARGE RESISTANCE. HOWEVER IT OPERATES VERY SATISFACTORILY HAVING FEWER PARTS THAN OTHER TYPES OF WELDING GENERATORS. THE MAINTENANCE COST IS CONSIDERABLY LOWER.

THE VOLT-AMPERE CURVE -A- IS A COMPOSITE, AND THE CURVE AT -B- IS THAT OF ONE OF THE CROSS FIELD WELDING GENERATORS.

VARIABLE VOLTAGE CONTROL.

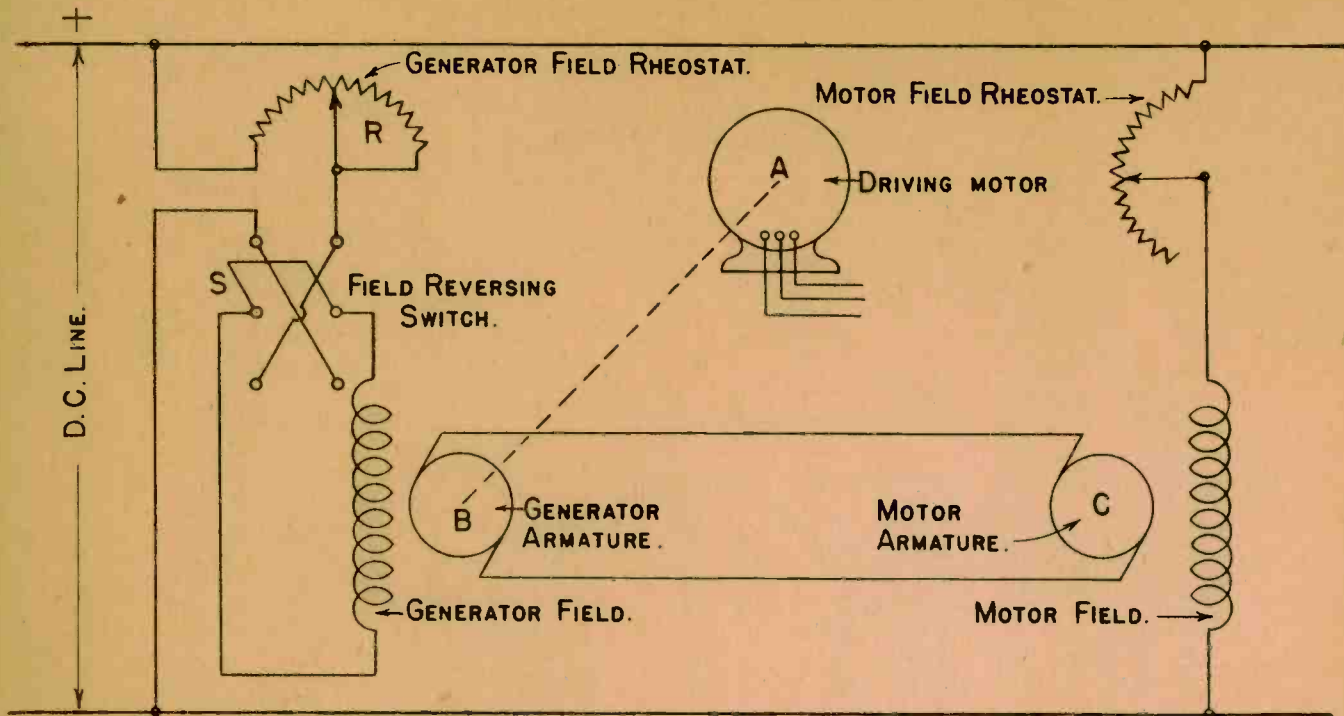

The variation in speed obtainable by field control on the ordinary D.C. motor will not, in the average case, exceed 4 to 1 due to the sparking difficulties experienced with very weak fields. Although the range may be increased by inserting resistance in series with the armature, this can be done only at the expense of efficiency and speed regulation.

With constant voltage applied to the field, the speed of a D.C. motor varies directly with the armature voltage; therefore, such a motor may be steplessly varied from zero to maximum operating speed by increasing the voltage applied to its armature. The sketch shows the arrangement of machines and the connections used in the Ward Leonard type of variable voltage control designed to change speed and reverse rotation. The constant speed D.C. generator (B) is usually driven by an A.C. motor (A) and its voltage is controlled by means of rheostat R. Note that the fields of both generator (B) and driving motor (C) are energized from a separate D.C.

supply or by an auxiliary exciter driven off the generator shaft. Thus the strength of the motor field is held constant, while the generator field may be varied widely by rheostat R.

With the set in operation generator (B) is driven at a constant speed by prime mover A. Voltage from B is applied to the D.C. motor (C) which is connected to the machine to be driven. By proper manipulation of rheostat R and field reversing switch S the D.C. motor may be gradually started, brought up to and held at any speed, or reversed. As all of these changes may be accomplished without breaking lines to the main motor, the control mechanism is small, relatively inexpensive, and less likely to give trouble than the equipments designed for heavier currents.

The advantages of this system lie in the flexibility of the control, the complete elimination of resistor losses, the relatively great range over which the speed can be varied, the excellent speed regulation on each setting, and the fact

that changing the armature voltage does not diminish the maximum torque which the motor is capable of exerting since the field flux is constant.

By means of the arrangement shown, speed ranges of 20 to 1—as compared to 4 to 1 for shunt field control—may be secured. Speeds above the rated normal full load speed may be obtained by inserting resistance in the motor shunt field. This represents a modification of the variable voltage control method which was originally designed for the operation of constant torque loads up to the rated normal full load speed.

As three machines are usually required, this type of speed control finds application only where great variations in speed and unusually smooth control are desired. Steel mill rolls, electric shovels, passenger elevators, machine tools, turntables, large ventilating fans and similar equipments represent the type of machinery to which this method of speed control has been applied.

REVISIONS	MATERIAL	PAT. MLD. DIE	V-5835197
DRAWN BY <i>T. Edsell</i>		EXTERNAL DIAGRAM	
INSPECTED <i>W. Lewis</i>		FIRST MADE FOR <i>BC GENERATOR</i>	
FIRST CALLED FOR ON <i>CPW-740834-89</i>			

THIRD ANGLE PROJECTION

V

GENERAL ELECTRIC FORT WAYNE WORKS

V-5835197

F. L. 12-22-37

PRINTS TO

HE

8442

B 15

357

3742

REVISIONS	MATERIAL	PAT. MLD. DIE	V-5837239
DRAWN BY <i>T. Edsell</i>		EXTERNAL DIAGRAM	
INSPECTED <i>W. Lewis</i>		FIRST MADE FOR <i>DC MOTORS - (CUMULATIVE COMPOUND GEN.)</i>	
FIRST CALLED FOR ON <i>STL-84280</i>			

THIRD ANGLE PROJECTION

V

GENERAL ELECTRIC FORT WAYNE WORKS

V-5837239

F. L. 12-22-37

PRINTS TO

B 3

8442

845

357

3742

G.E.J.
TAG
NONE

	MATERIAL	PAT. MLD. DIE	PART	V-5872093
①	②	③	④	EXTERNAL DIAGRAM
③	④	DRAWN BY <i>C. Howen</i> INSPECTED <i>C. Howen</i>		FIRST MADE FOR <i>DYNAMOTOR</i>

GEJ TAGS
NONE

FIRST CALLED FOR ON *5D46AB12A*

BB
B44:2
B57:3
B74:2
B106
B128-4

THIRD ANGLE PROJECTION	GENERAL ELECTRIC CO.	FORT WAYNE	WORKS
			V-5872093
			BC D-75 FILE

	MATERIAL	PAT. MLD. DIE	PART	V-5837402
EXTERNAL DIAGRAM				
REVISIONS		DRAWN BY <i>T. Edsell</i> INSPECTED <i>W. Edsell July 19 1940</i>		FIRST MADE FOR <i>AM GEN. SET</i>
①	②	③	④	FIRST CALLED FOR ON

GEJ TAGS
NONE

FIRST CALLED FOR ON

BB
B44:2
B57:3
B74:2
B106
B128-4

THIRD ANGLE PROJECTION	GENERAL ELECTRIC CO.	FORT WAYNE	WORKS
			V-5837402
			BC D 75

INFORMATION FOR WORKING GENERATOR CHARACTERISTIC JOB

The object of this job is to make voltage characteristic curves for the generator when it is connected shunt, cumulative compound and differential compound. Trace the armature and field circuits.

After the generator builds up a voltage adjust the shunt field rheostat to obtain no load voltage value for the cumulative compound connection. Next slowly lower the plate in the water rheostat and watch the voltmeter. If the generator maintains its voltage with increased load the connection is cumulative compound. If the voltage drops rapidly with increased load the connection is differential compound. To change from cumulative to differential or vice versa reverse the series field leads and to operate the machine as a shunt generator take off the two series field leads and twist them together.

To run the characteristic curves: 1st - connect the generator cumulative compound and adjust the shunt field rheostat to obtain the no load E value according to the chart on the reverse side of this sheet. 2nd - place a dot on the zero ampere line corresponding to the no load E value. 3rd - Lower the plate in the water rheostat until the ammeter reads 5 I. 4th - place a dot on the 5 I line corresponding to the voltmeter reading. 5th - lower the plate farther in the water rheostat until the ammeter reads 10 I. 6th - place a dot on the 10 I line corresponding to the voltmeter reading. Follow this procedure (increasing the load 5 I each time) until the generator is carrying full ampere load. Connect the dots together to make the characteristic curve. Follow the same procedure for differential and shunt connections.

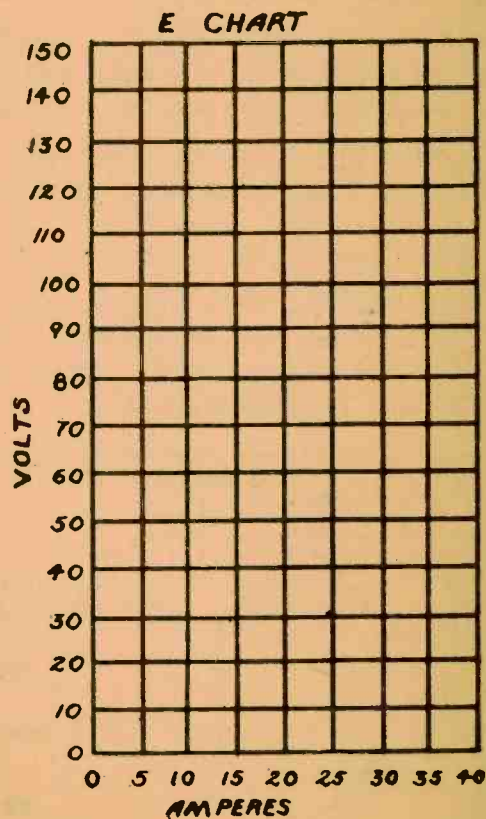
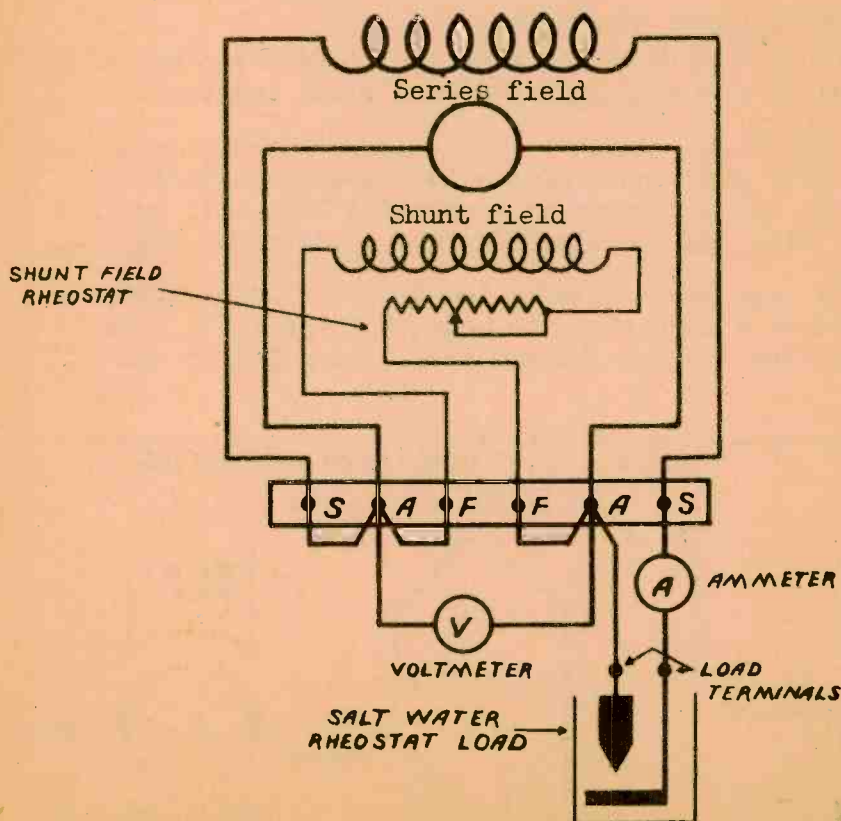

LAP WINDING AND ARMATURE CONNECTIONS

An armature winding is an electro-magnet having a number of coils connected to commutator bars. There must be at least one start and one finish lead connected to each commutator bar. There are two types of armature windings, LAP & WAVE wound. The coil leads of a lap wound armature connects to commutator bars that are near each other and the coil leads of a wave wound armature connects to commutator bars that are widely separated. See Fig. 1 & 2.

When current flows through the coil in a clockwise direction a south pole will be produced on the surface of the armature. Fig. 3. If the current flows in a counter clockwise direction a north pole will be produced on the surface of the armature. Fig. 4. A large number of coils are used to produce a strong magnetic pole and a smoother twisting action.

FIG. 1

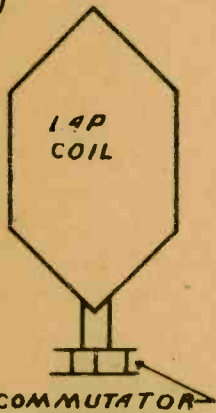

FIG. 2

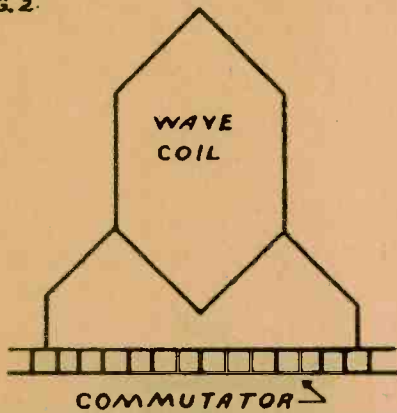
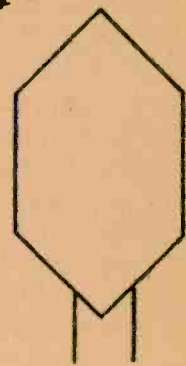

FIG. 3



FIG. 4



ARMATURE WINDING CONNECTIONS

Although there are only two types of D.C. armature windings there are a number of winding connections that apply to either a lap or a wave wound armature.

SYMMETRICAL & NON-SYMMETRICAL CONNECTIONS. If the coil leads connect to commutator bars that are on a line with the center of the coil the connection is symmetrical. Fig. 5. If the coil leads connect to commutator bars that are not on a line with the center of the coil the connection is non-symmetrical. Fig. 6.

The brushes must always short the coil when it is in the neutral plane which means that the brushes be located on a line with the center of the field pole if the coil is connected symmetrical and located between the field poles if connected non-symmetrical.

FIG. 5

SYMMETRICAL

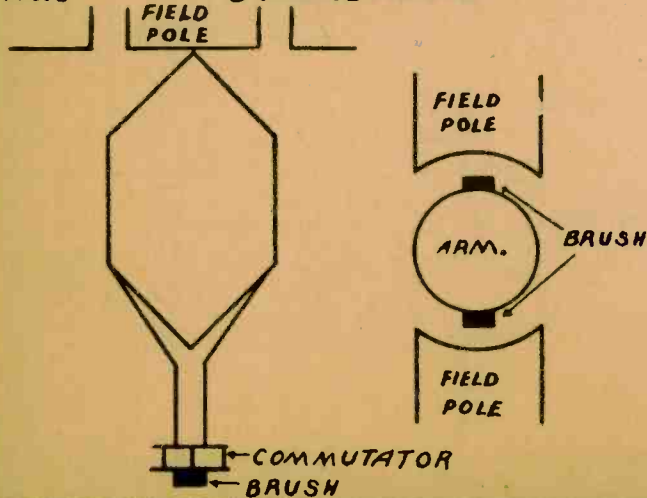
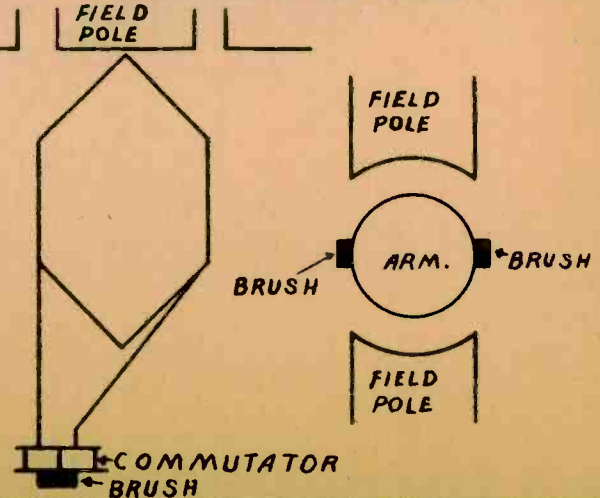

FIG. 6

NON-SYMMETRICAL



LAP WINDING AND ARMATURE CONNECTIONS (CONTINUED)

PROGRESSIVE & RETROGRESSIVE CONNECTIONS. If the start and finish leads of a coil, or the element of a coil, do not cross the connection is known as progressive. Fig. 7. If the start and finish leads of a coil, or the element of a coil, cross the winding is connected retrogressive. Fig. 8.

If a winding is changed from progressive to retrogressive, or vice versa, the effect will be reversed rotation on a motor and reversed brush polarity on a generator. Lap wound armatures are usually connected progressive and wave wound armatures retrogressive.

FIG. 7 PROGRESSIVE

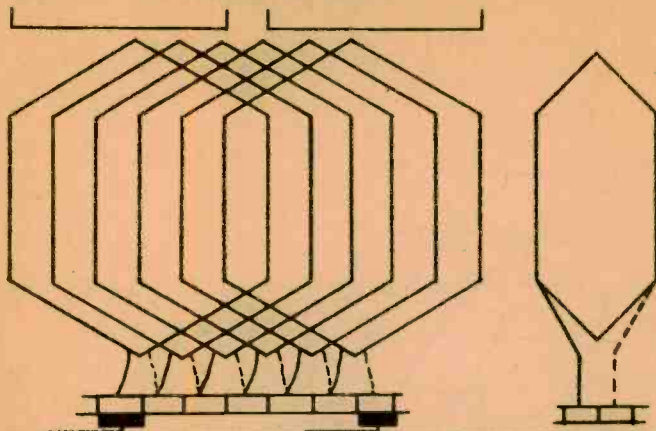
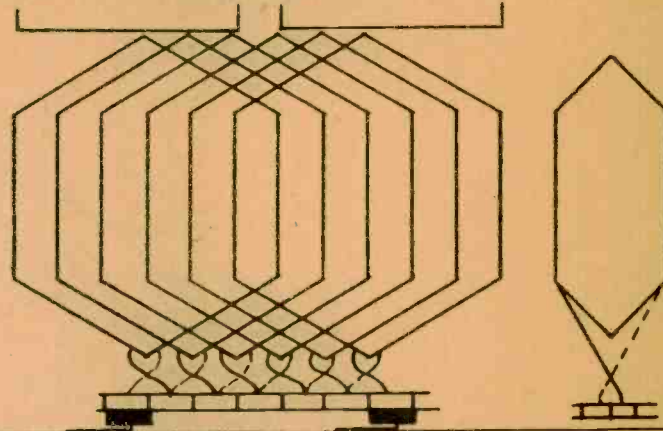

FIG. 8 RETROGRESSIVE



ELEMENT WINDINGS are used to reduce the voltage across adjacent commutator bars and decrease the tendency of brush sparking. Example - An armature has 30 turns per coil and the voltage per turn is 1 volt or 30 E per coil. If the coil were wound in one section and connected to adjacent commutator bars the voltage across the bars will be 30 E. Such a coil would have one start and one finish lead and there would be as many bars as slots. This would be a single element winding. Fig. 9.

If this coil were divided in two sections (15 turns per section) and each section connected to adjacent bars the voltage across adjacent bars would be 15 E. Such a coil would have two start and two finish leads and there would be twice as many bars as slots. This would be known as a two element winding. Fig. 10.

If the coil were divided in three sections (10 turns per section) and each section connected to adjacent bars the voltage across adjacent bars would be 10 E. Such a coil would have three start and three finish leads and there would be three times as many bars as slots. This would be known as a three element winding. Fig. 11.

Element windings are particularly desirable for high voltage machines. The practical limit is usually three or four elements.

SINGLE ELEMENT

FIG. 9

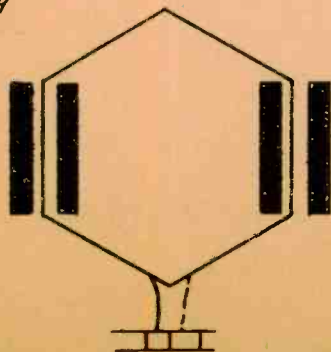

TWO ELEMENT

FIG. 10

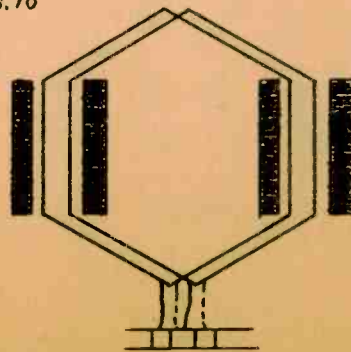

THREE ELEMENT

FIG. 11

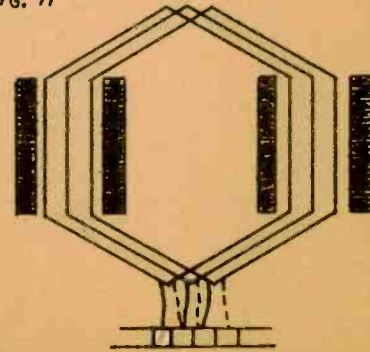

LAP WINDING
SIMPLEX
PROGRESSIVE
SYMMETRICAL
SINGLE ELEMENT

SLOTS = 24
BARS = 24
POLES = 4
COIL SPAN = 1-7

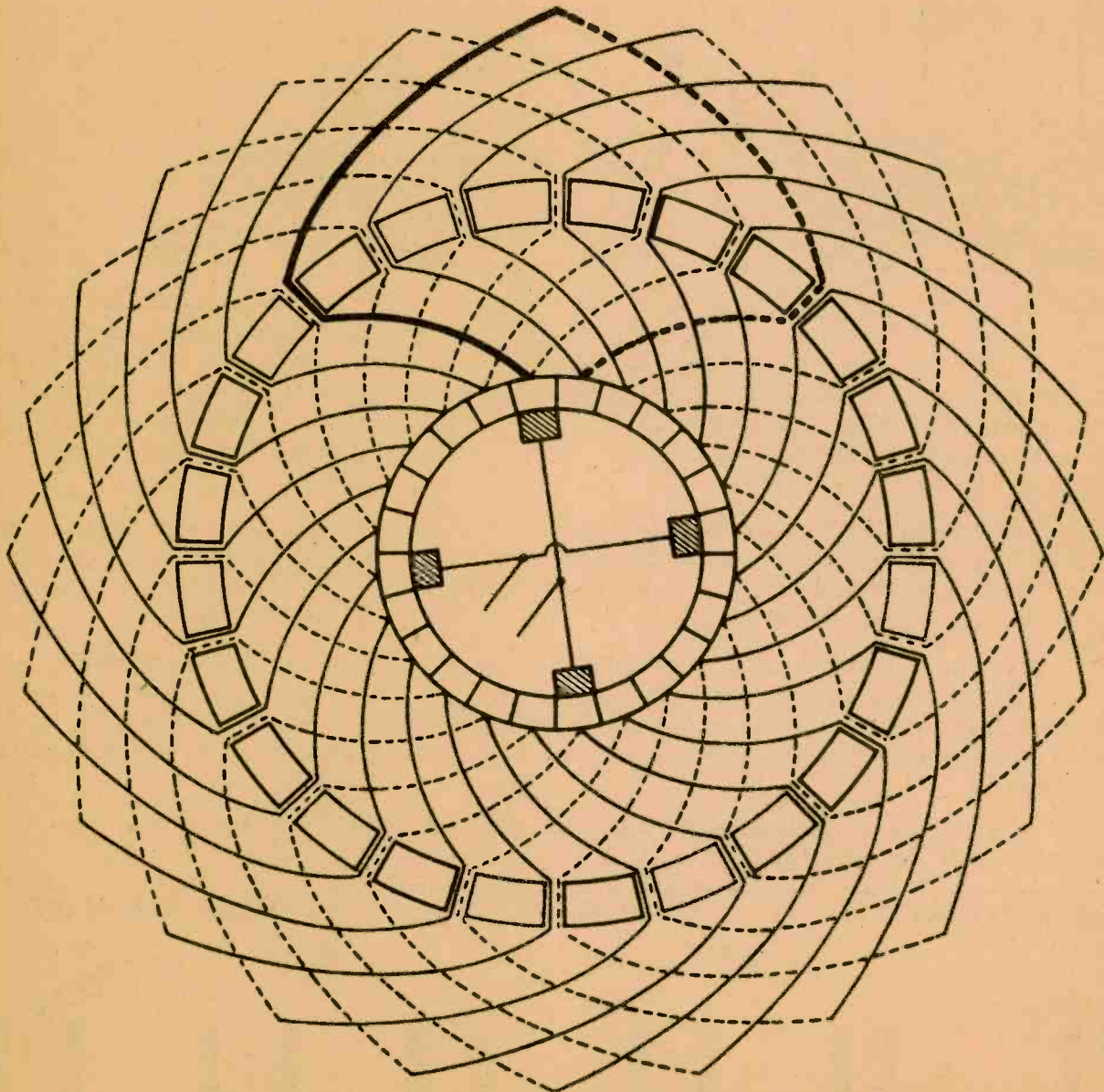

COIL SPAN = THE NEXT WHOLE NUMBER ABOVE $\text{SLOTS} \div \text{POLES}$

LAP WINDING
SIMPLEX
PROGRESSIVE
NON-SYMMETRICAL
TWO ELEMENT

SLOTS = 15
BARS = 30
POLES = 2
COIL SPAN = 1-8

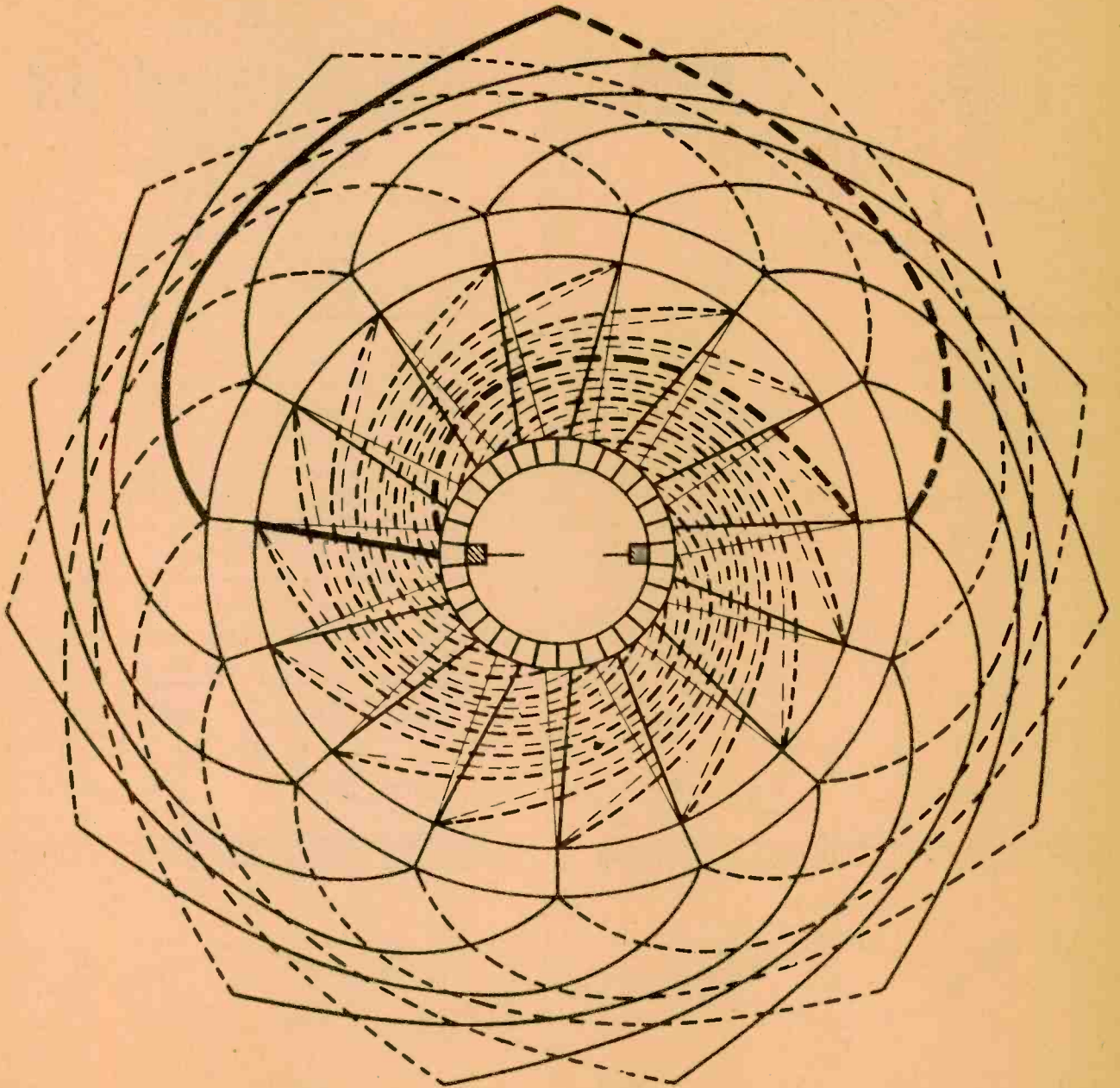

PRINCIPLES OF LAP AND WAVE WINDINGS

The lap winding is usually used on a circuit where the operating voltage is 220 E or less in value. This type of winding is desirable for general factory work. It is possible to design an armature for a higher ampere capacity by having it lap wound. The higher ampere capacity is obtained because there will be a greater number of parallel paths in the armature which increases its ability to carry current.

Fig. 1

SECTION OF A 4 POLE PROGRESSIVE LAP WINDING.

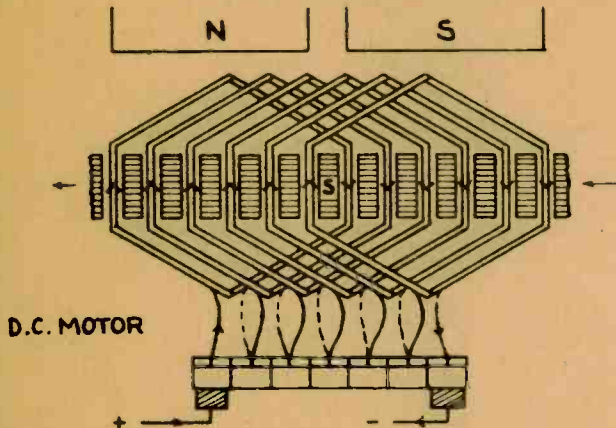
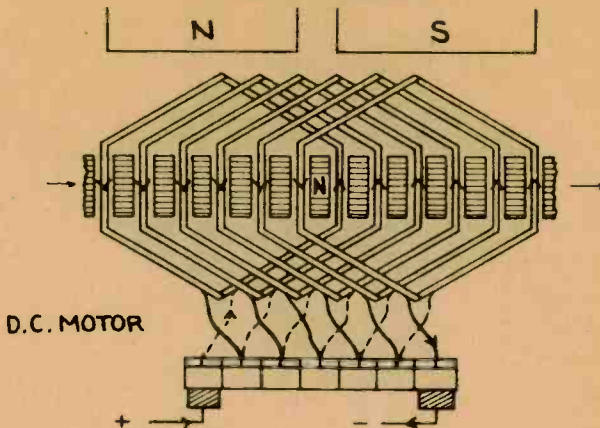

Fig. 2

SECTION OF A 4 POLE RETROGRESSIVE LAP WINDING.



The name wave wound is derived from the way the current circulates or waves through the armature. The wave type winding is usually used on a circuit where the operating voltage is 250 E or more in value. This type winding is desirable for traction work, steel mills & mine work. It is possible to design an armature for a higher operating voltage by having it wave wound. The higher operating voltage is obtained because there will be a greater number of armature coils in series between the brushes which increases the operating voltage.

Fig. 3

4 pole progressive wave winding.

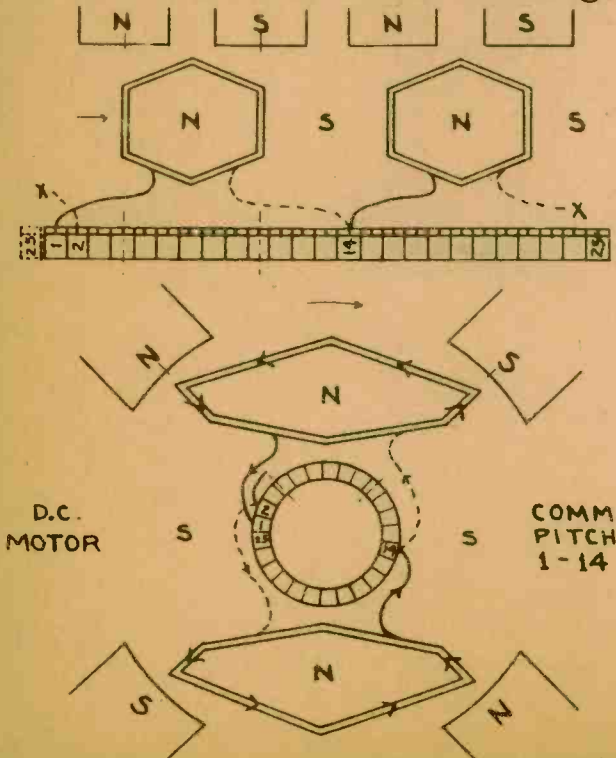
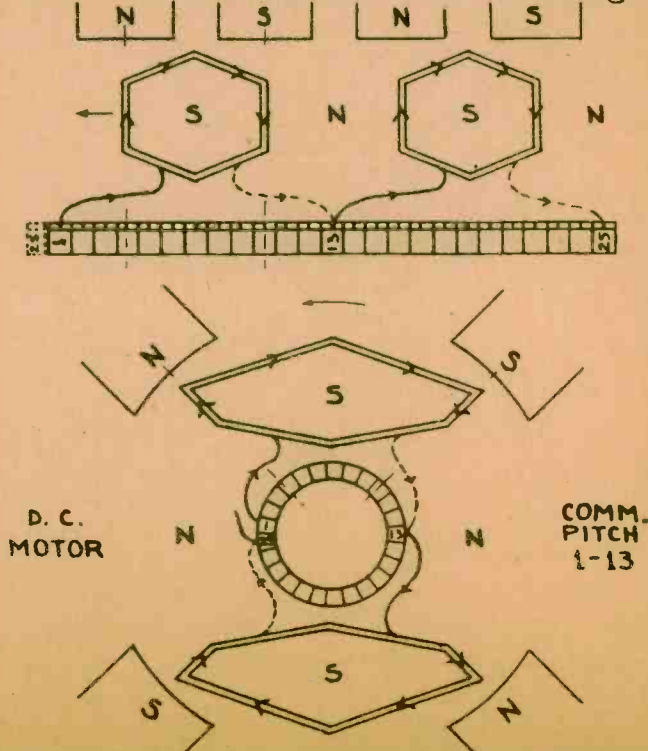

Fig. 4

4 pole retrogressive wave winding.



VARIOUS ARMATURE WINDING CONNECTIONS

-A-

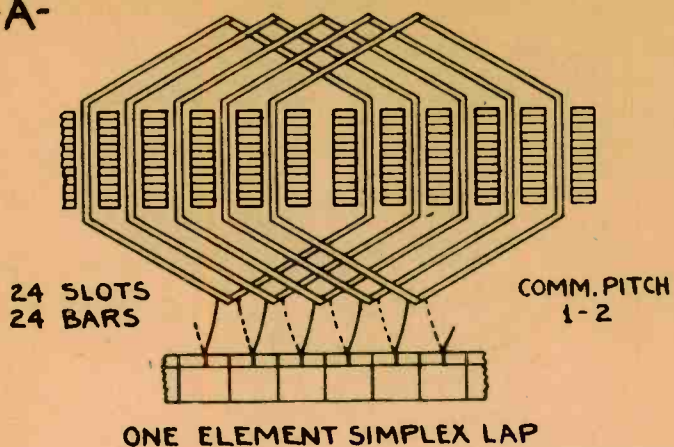

ONE ELEMENT SIMPLEX LAP

-B-

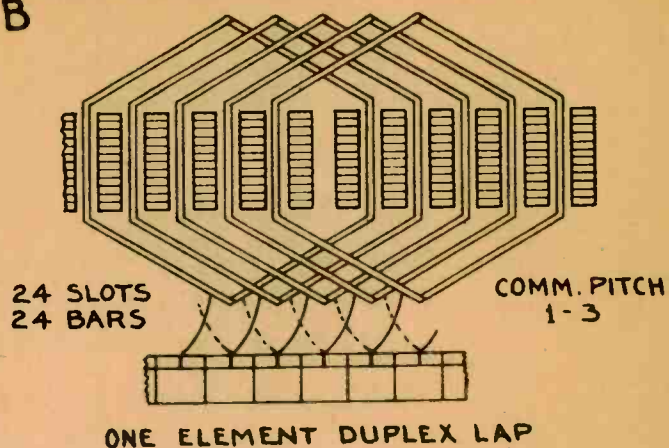

ONE ELEMENT DUPLEX LAP

-C-

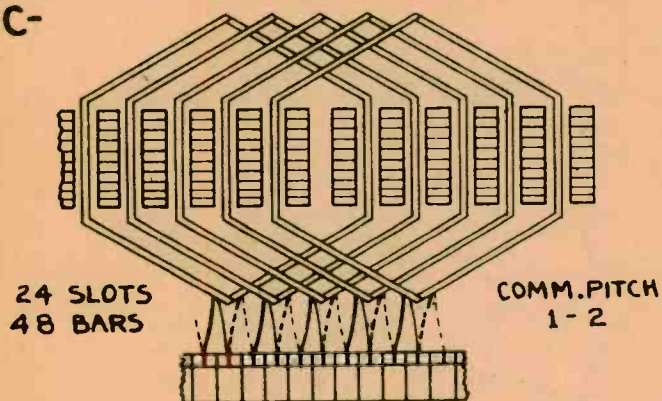

2 ELEMENT SIMPLEX LAP

-D-

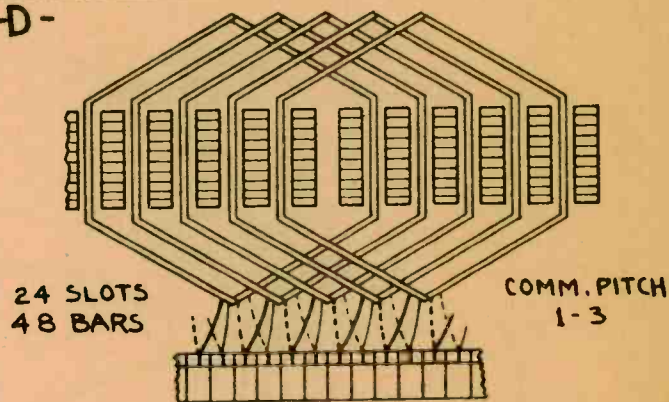

2 ELEMENT DUPLEX LAP

-E-

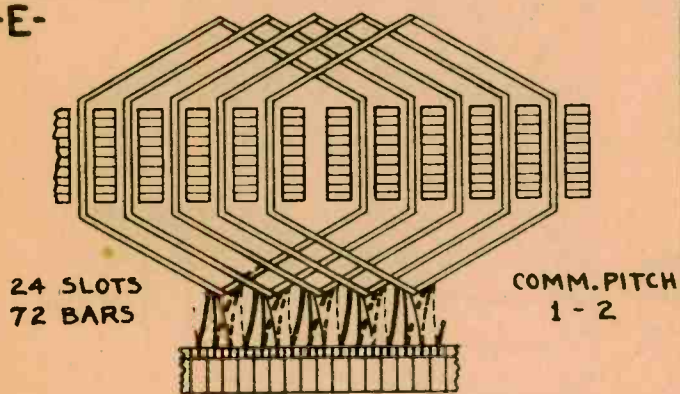

3 ELEMENT SIMPLEX LAP

-F-

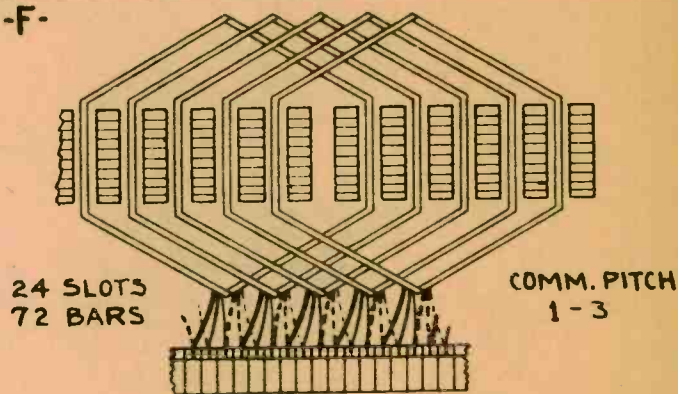

3 ELEMENT DUPLEX LAP

-G-

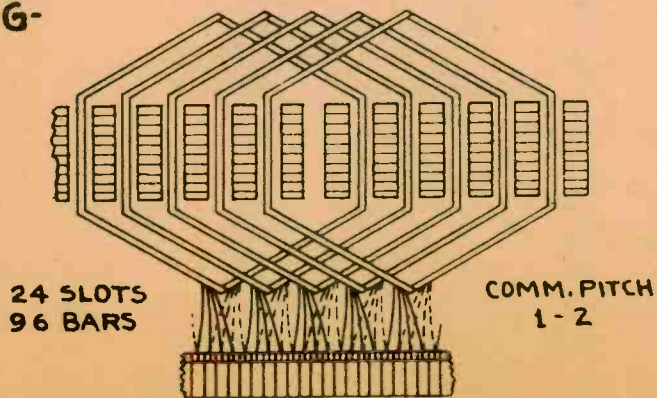

4 ELEMENT SIMPLEX LAP

-H-

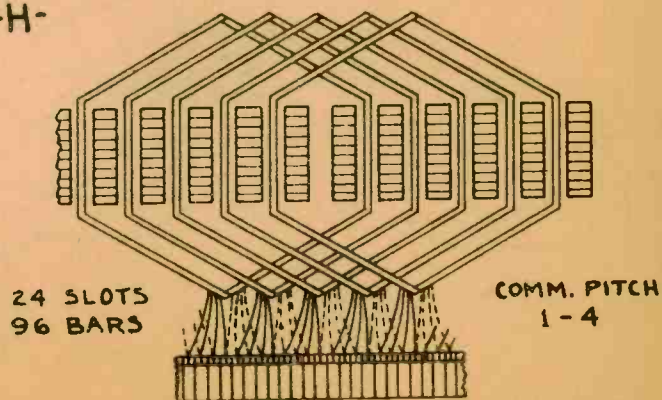

4 ELEMENT TRIPLEX LAP

LAP WINDING
DUPLEX
PROGRESSIVE
SYMMETRICAL
SINGLE ELEMENT

SLOTS = 24
BARS = 24
POLES = 4
COIL SPAN = 1-7

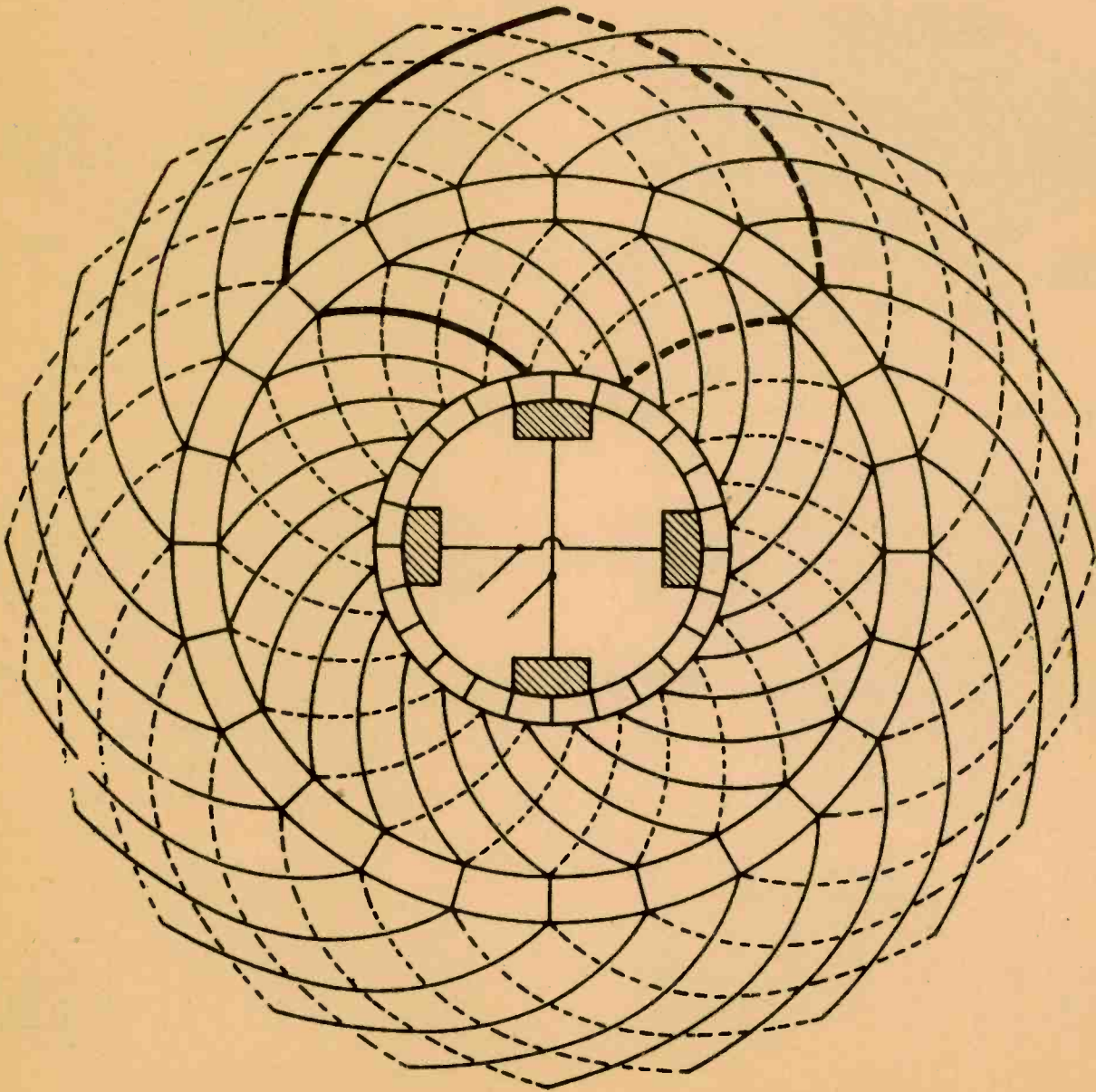

WAVE WINDING
SIMPLEX
RETROGRESSIVE
SYMMETRICAL
SINGLE ELEMENT

SLOTS = 25
BARS = 25
POLES = 4
COIL SPAN = 1-7
COMMUTATOR PITCH = 1-13

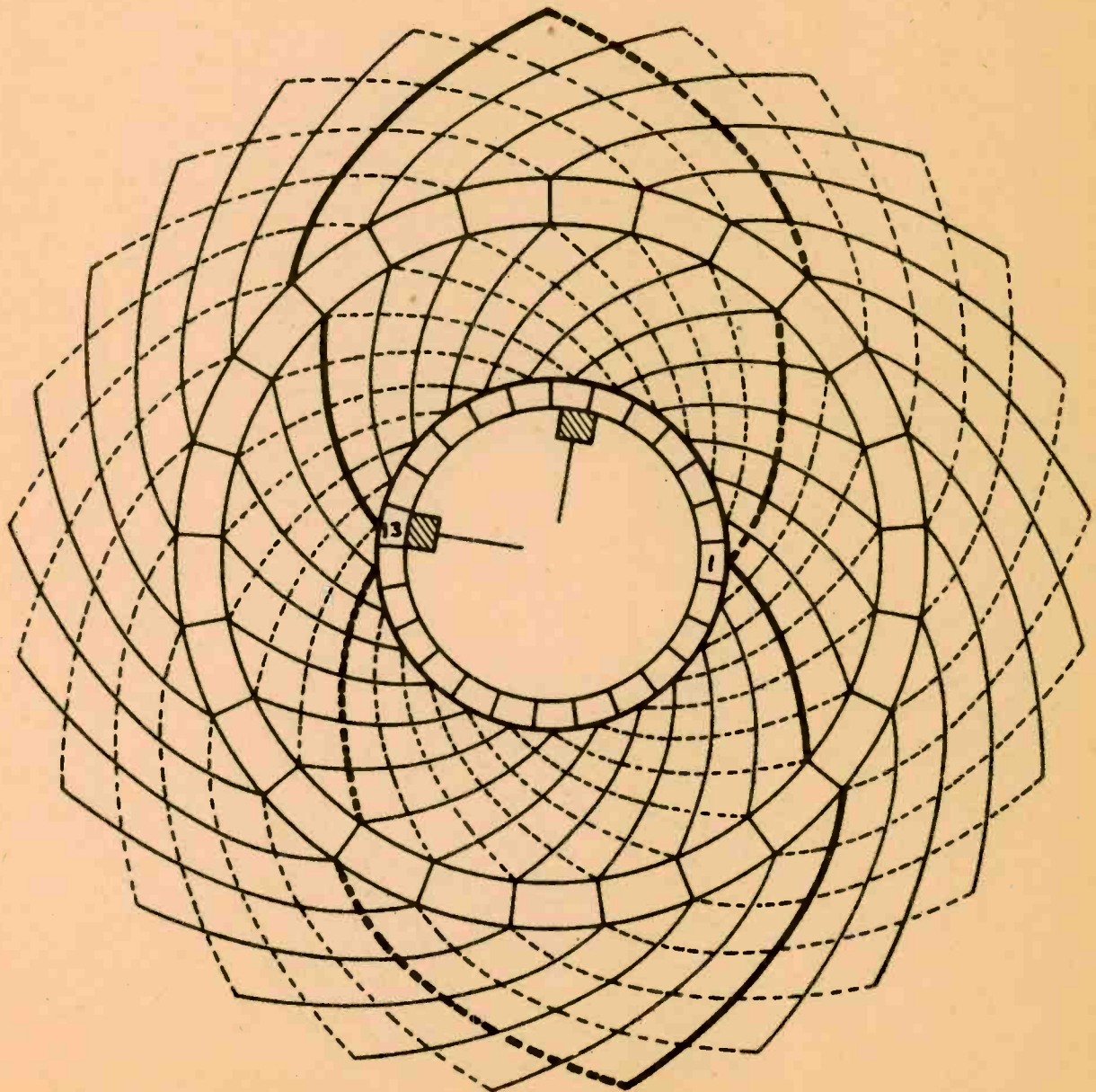

WAVE WINDING
SIMPLEX
PROGRESSIVE
SYMMETRICAL
SINGLE ELEMENT

SLOTS = 32
BARS = 32
POLES = 6
COIL SPAN = 1-6
COMMUTATOR PITCH = 1-12

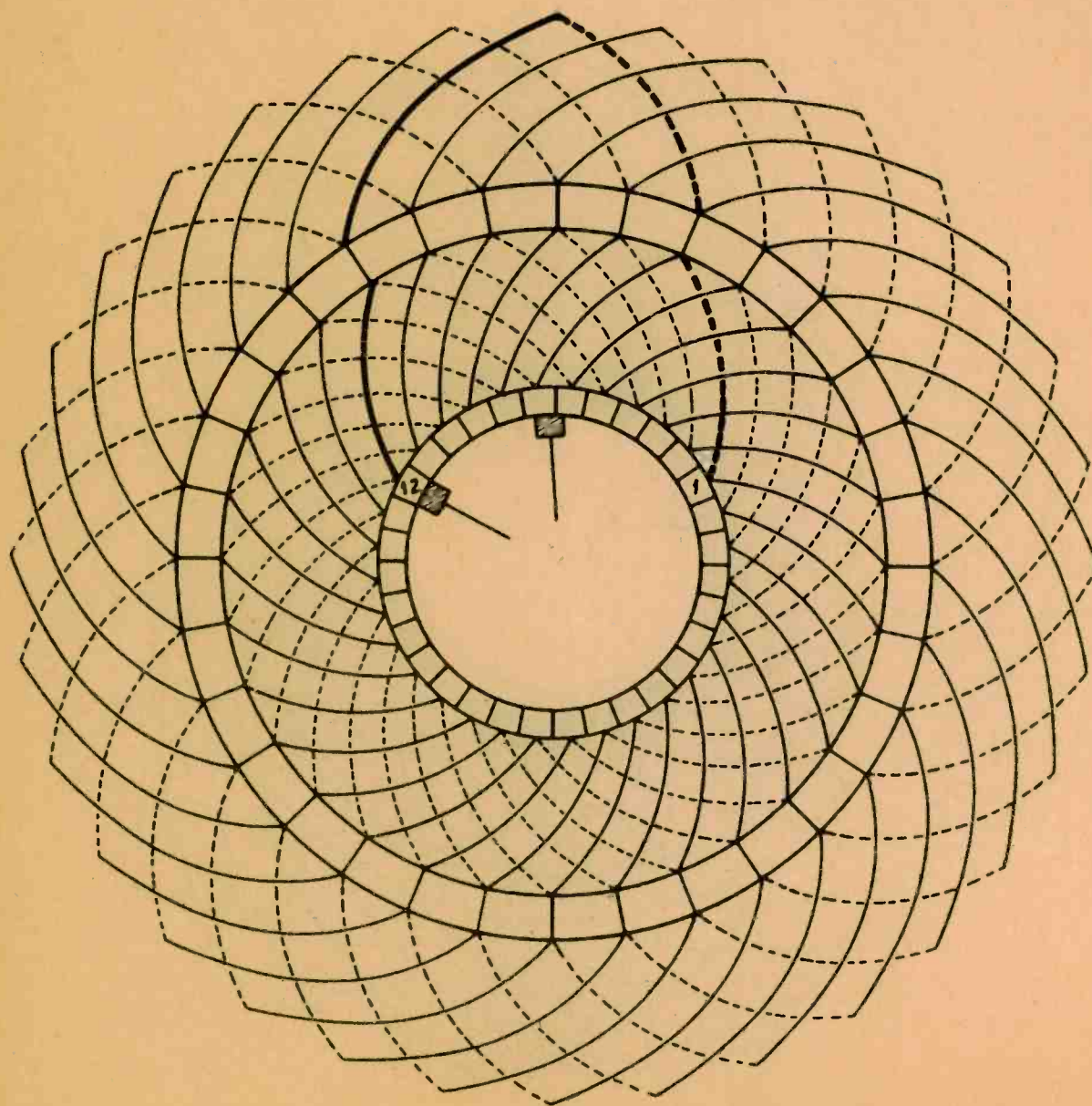

WAVE WINDING
SIMPLEX
RETROGRESSIVE
SYMMETRICAL
TWO ELEMENT

SLOTS = 13
BARS = 25
POLES = 4
COIL SPAN = 1-4
COMMUTATOR PITCH = 1-13

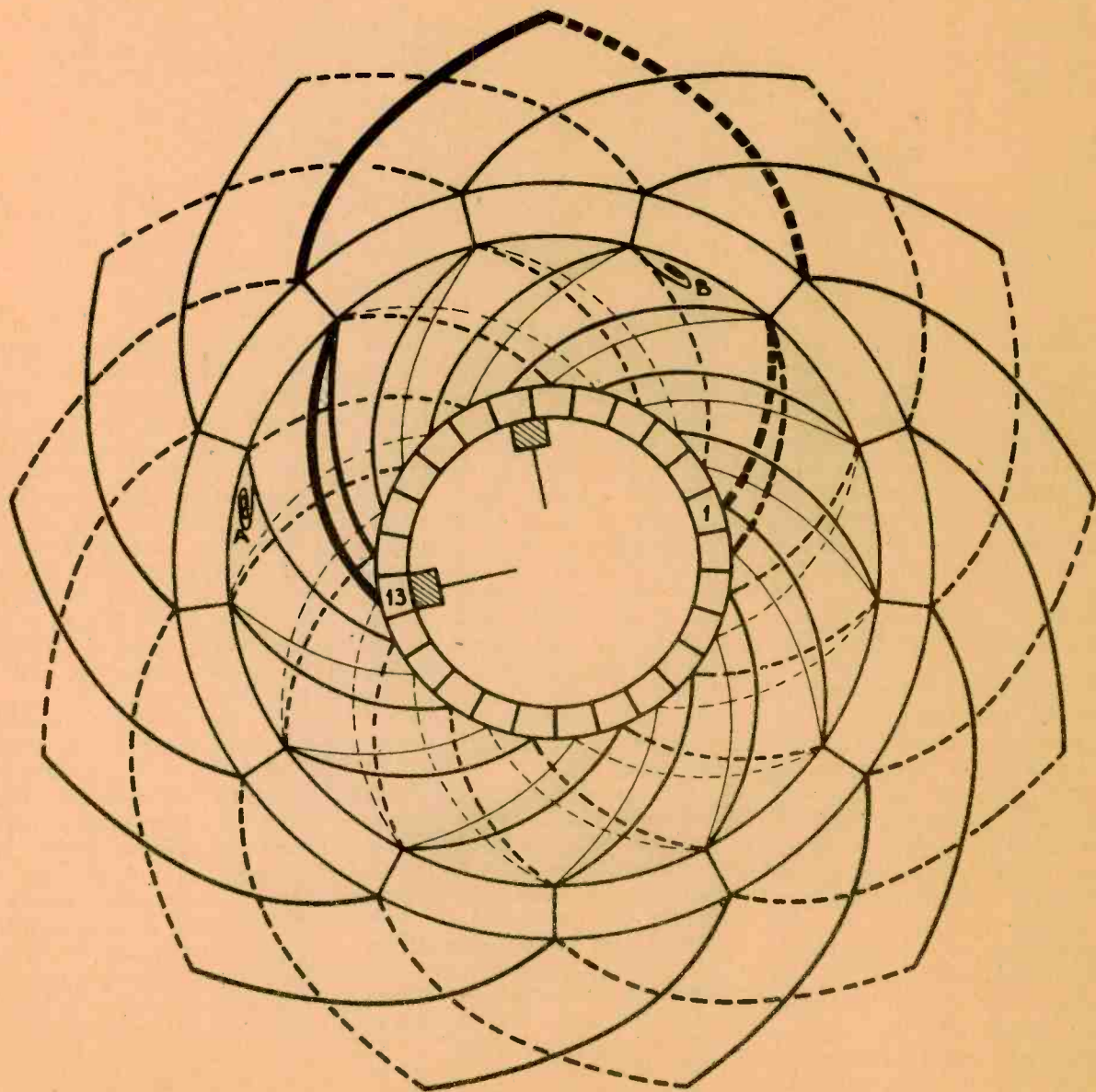

A - B ENDS OF DEAD COIL.

ARMATURE EQUALIZER CONNECTIONS.

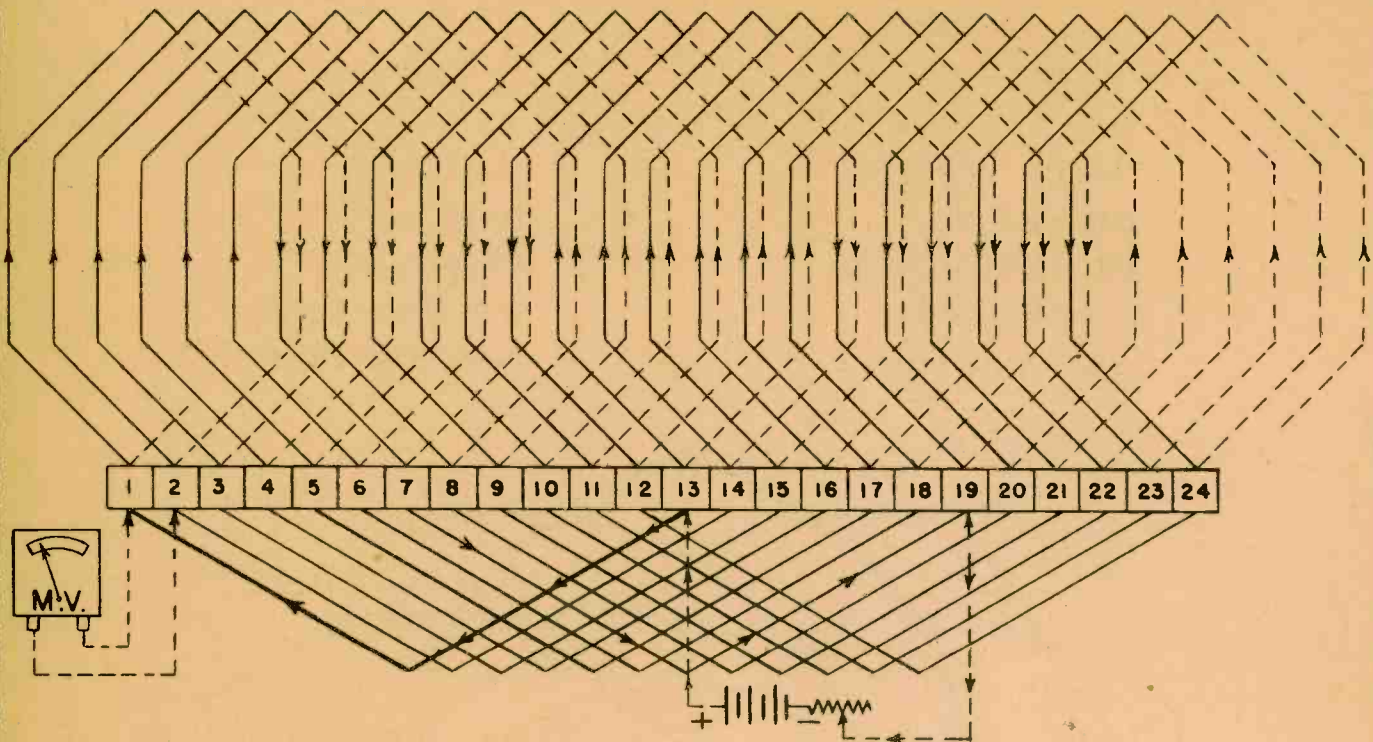

Although equalizers have been used on large armatures for many years, the application of these connections to small machines is a comparatively recent innovation that has raised questions regarding the advantages of such connections, and the method of testing such windings for faults.

Briefly, equalizer connections provide better commutation, make possible one-half the number of brushes usually used on the lap-wound machine, and provide the manufacturer with a means of avoiding the special slot and commutator bar relationships demanded by wave-type windings. Inasmuch as the equalizers here referred to are permanently connected to the commutator, and inasmuch as they make testing of the armature impossible by the regular procedure, the testing method and other information about these connections should prove of value to maintenance electricians and armature shop men.

The principal purpose of equalizers is to connect together on the armature those points which have the same polarity and which should

have equal potential. For a four-pole winding this means commutator bars 180 degrees apart; for a six-pole armature, bars 120 degrees apart; for an eight-pole machine, bars 90 degrees apart. The number of bars spanned by the equalizer will equal bars \div pairs of poles. For the armature shown in the diagram, each equalizer will span $24 \div 2$, or 12 bars, thereby making the connection 1 and 13, 2 and 14, etc. The pitch for any other number of bars or poles would be determined by the same method.

To test such an armature, current must be fed to the armature from an external low voltage D.C. supply, such as a battery, the leads being connected to commutator segments one-half the equalizer pitch apart. Since the equalizer pitch is 12 segments in this case, the leads will be spaced six bars apart or 1 and 7. Any pair of bars so spaced may be used, in a fully equalized armature; bars 13 and 15 being employed in the diagram.

The value of the test current is adjusted to give satisfactory deflection on the millivoltmeter, and volt drop readings are taken between all adjacent pairs of segments.

These readings are interpreted in the usual manner, low readings indicating shorts, high readings showing high resistance connections or opens. Tracing the winding and also by actual test, it will be noted that if the readings from bars 13 and 19 are forward, then the readings from 19 to 1 will be backward. 1 to 7 will be forward, and 1 to 13 backward. This is a normal indication obtained in all windings.

If the factors mentioned are kept in mind, the procedure given will produce consistently accurate results. It is to be noted such an armature will, when tested on a growler, give a shorted indication on all coils, even though the winding is in perfect condition. The reason for this can be seen by tracing from bar 1 through the coil to bar 2, through the equalizer to bar 14, through the coil to bar 13 and back through the equalizer to bar 2. Thus every coil on the armature is apparently short circuited by having another coil placed in series with it through the equalizer connections. This explains the need for a special testing procedure.

DATA SHEET FOR MOTOR AND GENERATOR REWINDING

Job No. _____ Customer _____
 Address _____
 Date received _____ Date promised _____
 How delivered _____ Send _____ Will call _____
 Terms of payment _____ Estimate _____
 Cost of materials used _____ Total hrs. labor _____

WORK TO BE DONE

Write out in detail _____

REWIND DATA

H.P. _____ Volts _____ Amps. _____ R.P.M. _____ Type _____
 Serial No. _____ Make _____
 No. of slots _____ Coil span _____ Turns per coil _____
 Size and kind of wire _____ Wdg. conn. _____
 No. of wires in parallel _____ Lbs. of scrap wire removed _____
 Slot insulation _____
 No. of comm. bars. _____ Comm. pitch _____
 Dead coils _____ Dead bars _____ Wires per bar _____
 Dia. of core _____ Length of core _____ End room _____
 Band wires _____ Size _____ No. of turns _____ Solder balance weights _____

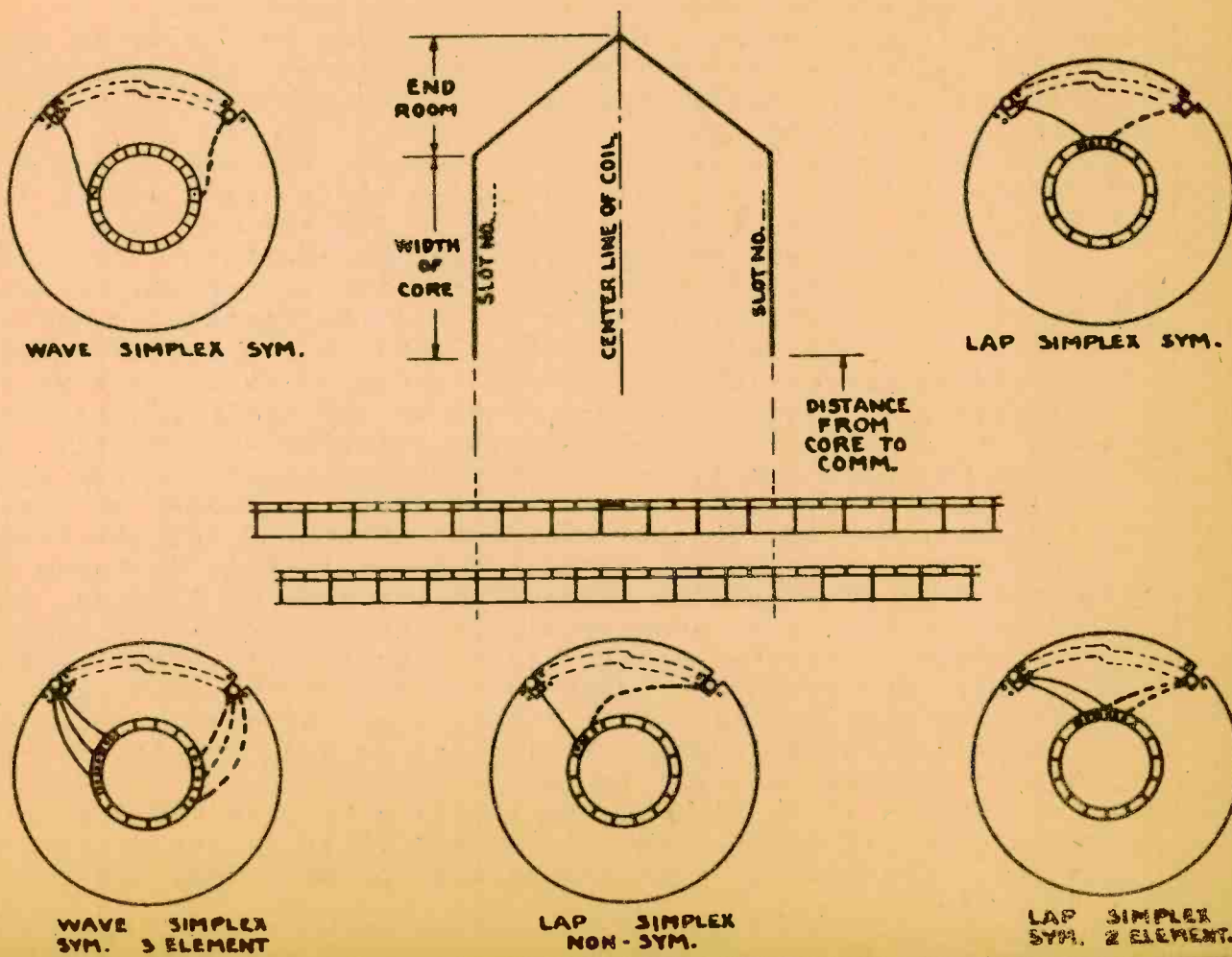

Coil Forming

The sketches show the method of making the right size coils for an armature winding.

The first step is to count the number of slots and commutator segments for determining the coil span and what element it is. After the coil span is found measurements should be according to Fig. 3 which shows the size a coil should be in relation to the average size armature. Notice particularly that the coil end extends $1/2$ " beyond the slot, $1/4$ " before spanning over to another slot. It can also be noticed that the twist (or curl) made in each end of the coil must be made at the exact center, otherwise the coils will not fit in properly.

Using a ruler, measure from a point $1/2$ " from the commutator in the exact center of the coil, (using a coil span of 1-7, slot #4, counting from #1 would be the center) to within $1/4$ " of slot #7. Referring to the armature in Fig. 3 this would be from C to D or $2-1/4$ ". Measuring from C to B would be $6-1/2$ ", and from A to B would be another $2-1/4$ " making a total of 11 inches for the length of the coil.

Set the coil winder (Fig. 1) at 11" and if the armature has twice as many segments as slots, or is two element, wind the two element coils with two wires in parallel, making both of the small coils in the two element coil in one operation. After the coils are wound on the winder they should be taped with cotton tape.

Referring to Fig. 2 which shows the method to use in forming the coil and bringing out the leads for both lap and wave wound coils note that coil should be taped before forming, assuming the approximate point where the lead should come out.

Extreme care must be taken in taping the coils to overlap exactly $1/2$ its width pulling each turn firmly against the wires of the coil (start taping the coil 1" from the end at which the leads are to be brought out).

The next step is shaping the coil. The slots in the coil former that will hold the coil while it is being shaped should be set $6-1/2$ " on the scale (the slot on the pull arm should also be the same width and height). To get the length of the coil from one point to the other, measure from the center of the coil along the 4th slot (starting within $3/4$ " of the commutator and letting the ruler extend out at the other end) to a point the same distance at the opposite side. Referring to Fig. 3 this would be from D to A or $8-1/2$ ". The adjustable rings on the shaft of the coil former will slide out so the holes in the knuckles will be held this distance ($8-1/2$ ") apart. Too much pressure should not be exerted in pulling the coil into position, as there is danger of breaking the insulation. When the coil has been stretched out the knuckles should be turned in the direction shown in Fig. 2, being very careful to see that the holes that the pins go through, to hold the coils in place, are exactly in the center of the coil.

Note:- The leads that extend from the coil when winding should be only long enough to reach to the end of the commutator bar opposite the riser. These ends should never be used to wind around the coil. Short lengths of wire may be used for this purpose, removing them as the coil is taped.

Note:- It is always good practice to make but one coil, shape it and try it on the armature to see if it is the exact size desired. Then if any alterations must be made only one coil will be wasted.

Coil Forming

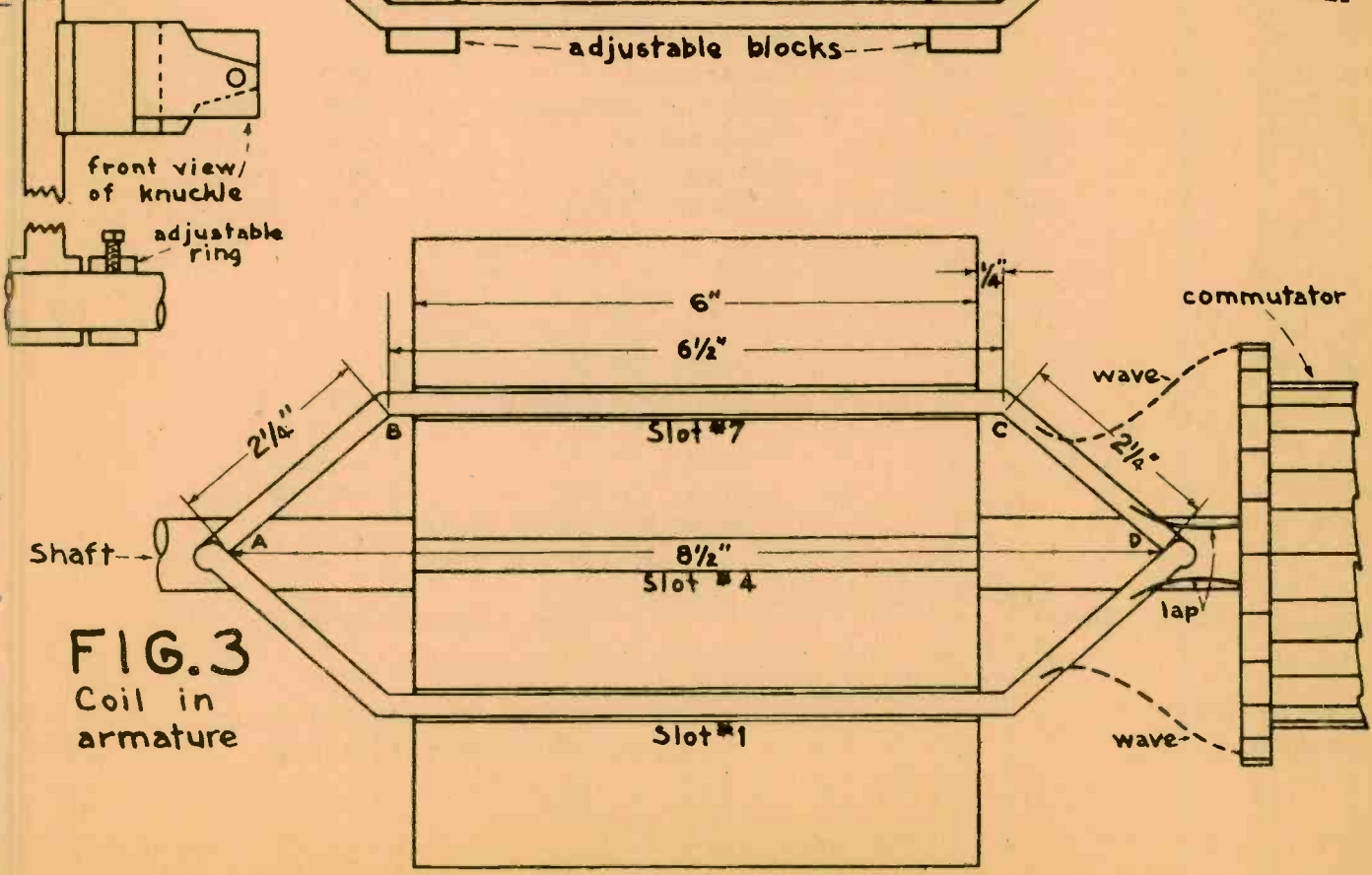
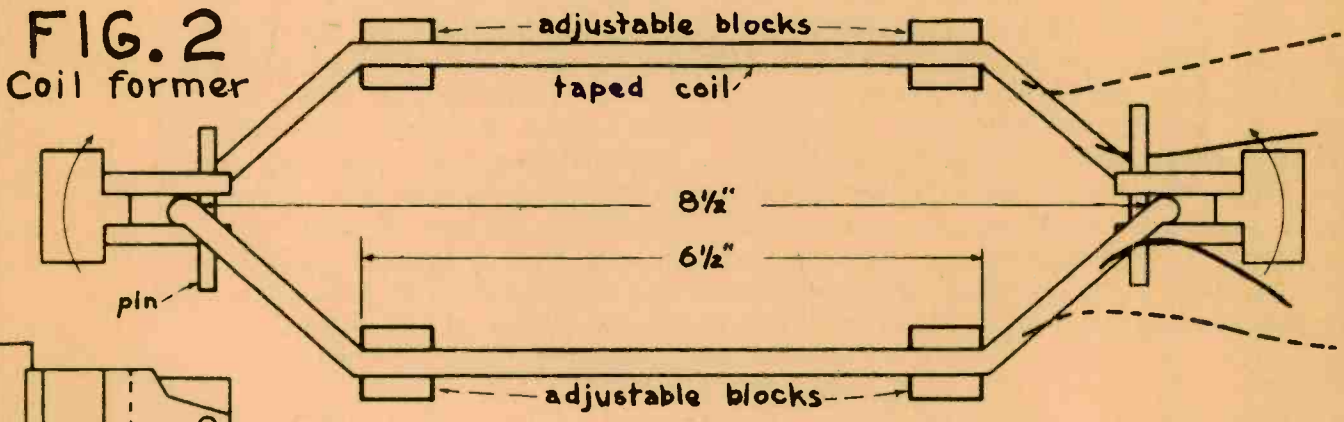
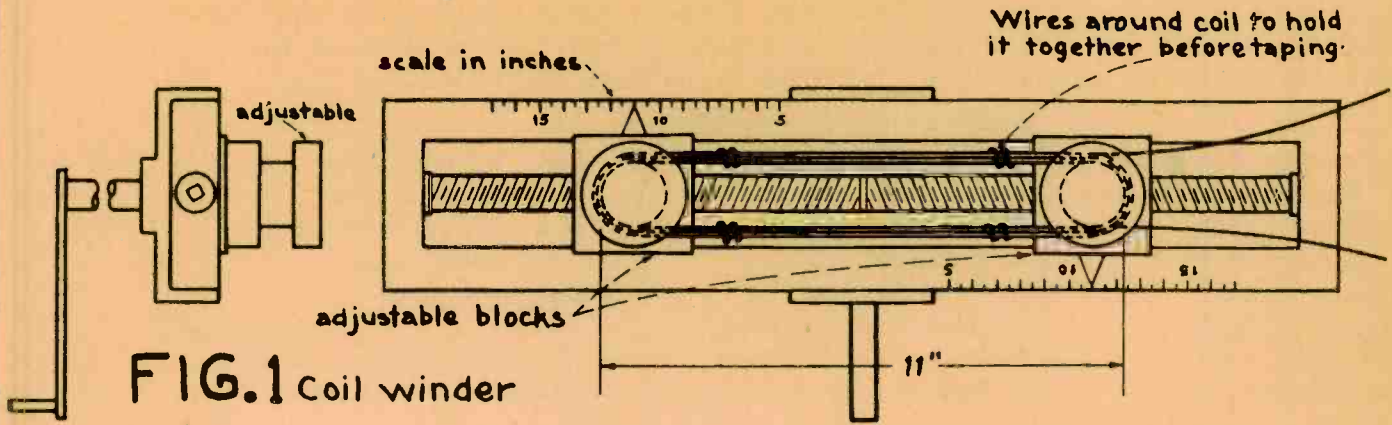

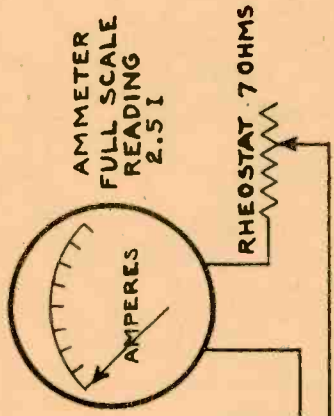
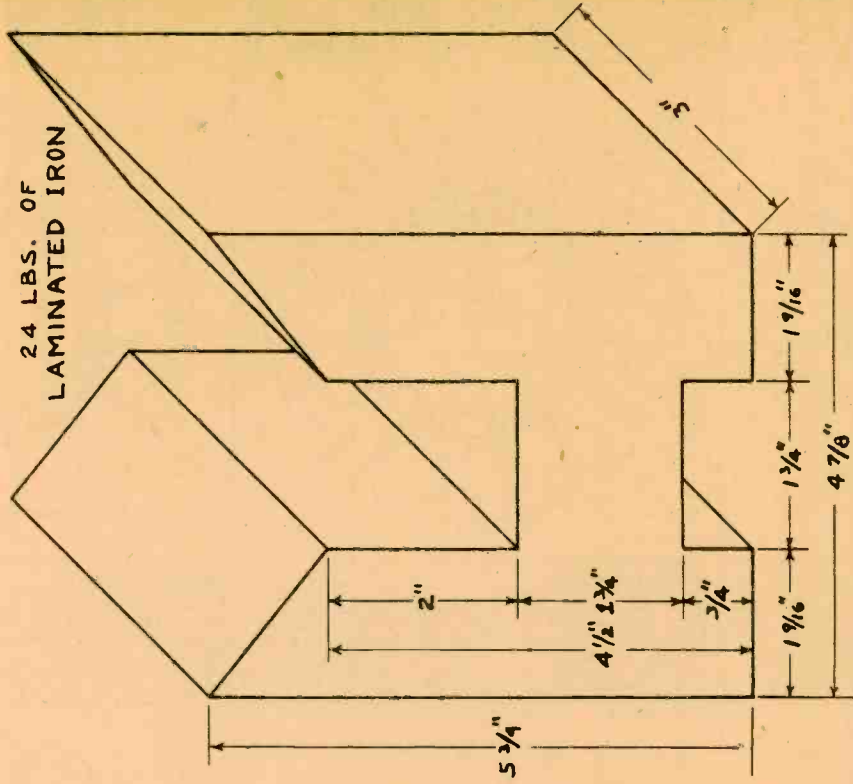

TWO COILS OF WIRE ARE USED EACH CONTAINING 250 TURNS OF # 17 S.C.E. WIRE. THE COILS ARE INSULATED FROM EACH OTHER BY TWO LAYERS OF FISH PAPER AND TWO LAYERS OF EMPIRE CLOTH. THESE COILS MAY BE WOUND ONE OVER THE OTHER OR IN TWO SECTIONS AS SHOWN.

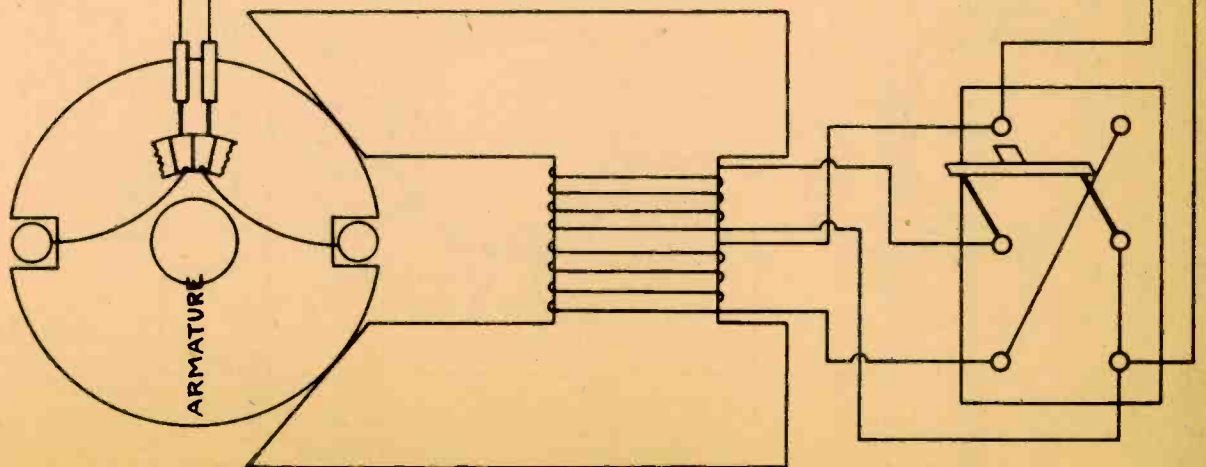

GROWLER SPECIFICATIONS

ARMATURE CROWLER TESTS

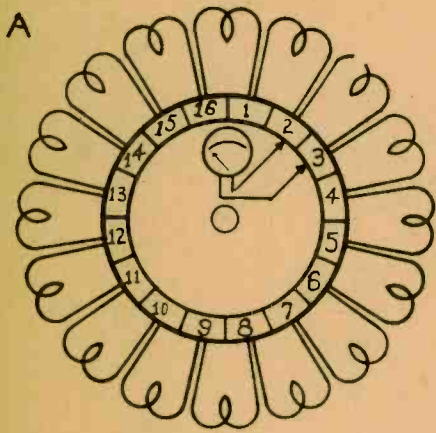

TROUBLE: OPEN COIL
THIS DEFECT SHOWS ITSELF ON THE OPERATING MACHINE BY EXCESSIVE SPARKING AT THE BRUSHES AND BURNING OF THE BARS ATTACHED TO THE COIL. WHEN TESTED ON THE CROWLER, THE METER READING BETWEEN BARS 1 AND 2 WILL BE ZERO. IF THE OPEN IS DUE TO POOR SOLDERING AT THE COMMUTATOR, RESOLDER. IF CAUSED BY AN OPEN IN THE COIL ITSELF, DISCONNECT THE LEADS, INSULATE THE ENDS, AND CONNECT A JUMPER FROM BAR 1 TO BAR 2.

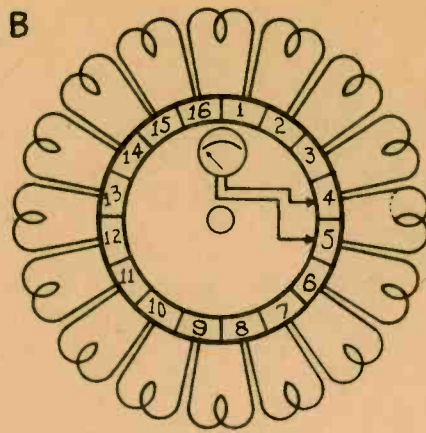

TROUBLE: SHORTED COIL
WHEN THE MACHINE IS IN OPERATION, A SHORTED COIL IS INDICATED BY THE EXCESSIVE HEAT IT GENERATES. WHILE OTHER COILS ON THE ARMATURE MAINTAIN A NORMAL TEMPERATURE, THE SHORTED COIL BECOMES SO HOT THAT IT BURNS THE INSULATION FROM THE WINDING. ON THE CROWLER, THE METER READING BETWEEN BARS 4 AND 5 WILL BE LOW OR ZERO. A HACKSAW BLADE WILL VIBRATE OVER THE SLOTS IN WHICH THE SHORTED COIL LIES.

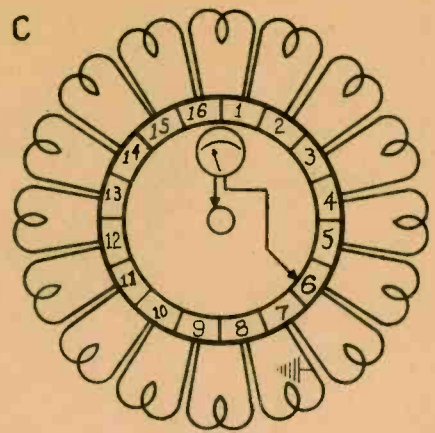

TROUBLE: GROUNDING COIL
A GROUNDING COIL WILL USUALLY GIVE NO INDICATION DURING OPERATION UNLESS THE FRAME OF THE UNIT BE UNGROUNDED; IN THIS CASE, A SHOCK MAY BE FELT WHEN TOUCHING THE FRAME. TWO GROUNDS ON THE ARMATURE PRODUCE A SHORT-CIRCUIT. ON THE CROWLER, A METER READING IS TAKEN BETWEEN THE COMMUTATOR BARS AND THE SHAFT. THE READING BECOMES LESS AS THE SHORTED BAR IS APPROACHED AND IS MINIMUM WHEN CONTACTED.

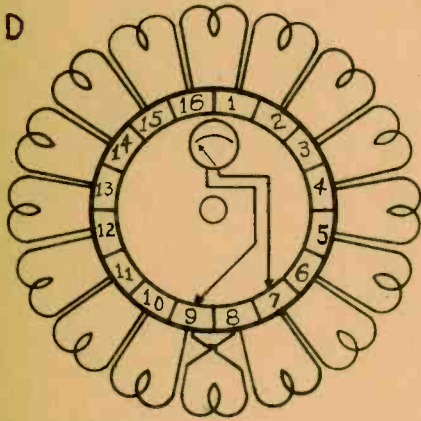

TROUBLE: REVERSED COIL LEADS
IN OPERATION, THIS DEFECT WOULD CREATE UNBALANCE IN THE ARMATURE CIRCUIT WITH THE RESULT THAT CIRCULATING CURRENTS WOULD FLOW AND TEND TO CAUSE OVERHEATING. ON THE CROWLER, MAKE A 1 TO 3 BAR TEST. WHEN TESTING BETWEEN BARS 7 AND 9, THE READING WOULD BE ZERO AND THE SAME READING WOULD BE OBTAINED BETWEEN BARS 8 AND 10. THIS WOULD INDICATE THAT THE LEADS OF THE COIL ATTACHED TO BARS 8 AND 9 ARE REVERSED.

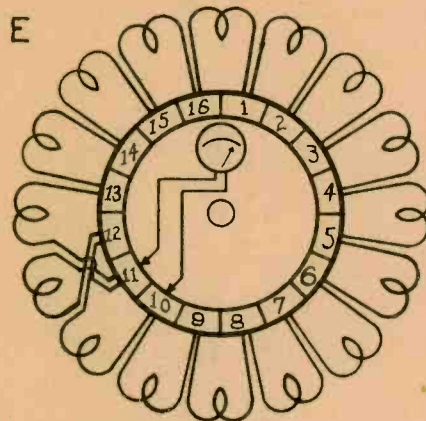

TROUBLE: REVERSED COIL LOOPS
THIS FAULT, WHICH USUALLY OCCURS IN A REMOUND MACHINE, MAY PRODUCE SPARKING AT THE BRUSHES DURING OPERATION. WHEN TESTED ON THE CROWLER, THE METER WILL SHOW A DOUBLE READING BETWEEN BARS 10 AND 11, A NORMAL READING ON 11 AND 12, AND A DOUBLE READING ON 12 AND 13. TO REMEDY, UNSOLDER LOOPS ON 11 AND 12 AND REVERSE THEM. HACKSAW WILL GIVE NO INDICATION OF THIS FAULT.

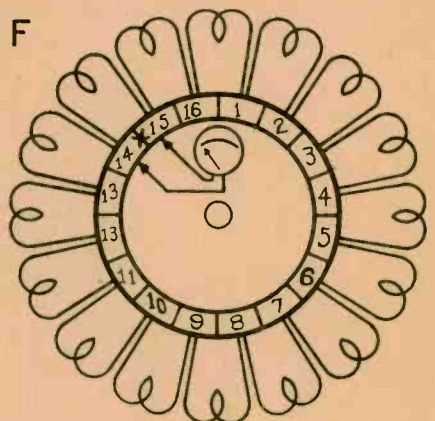

TROUBLE: SHORTED BARS
INDICATION DURING OPERATION IS OVERHEATING OF COIL ATTACHED TO BARS 14 AND 15 AND POSSIBLE SPARKING AT THE BRUSHES. ON CROWLER HACKSAW BLADE WILL VIBRATE OVER SLOTS CONTAINING COIL CONNECTED TO SHORTED BARS, AND METER READING BETWEEN 14 AND 15 WILL BE ZERO. REMEDY: REMOVE SHORT FROM BARS OR DISCONNECT COIL AND INSTALL A JUMPER FROM 14 TO 15.

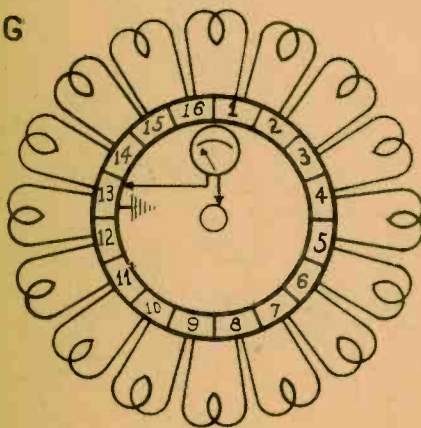

TROUBLE: GROUNDING BARS
IF THERE ARE NO OTHER GROUNDS ON THE MACHINE, THE FAULT WILL NOT AFFECT THE OPERATION OF THE MACHINE AT ALL. IF OTHER GROUNDS ARE PRESENT, SEVERE FLASHING AT THE BRUSHES WILL USUALLY OCCUR. THE TEST PROCEDURE IS THE SAME AS EMPLOYED IN DIAGRAM "C". TO DETERMINE IF GROUND IS COIL OR BAR, DISCONNECT WIRES FROM BAR 13 AND THEN TEST BAR FOR GROUND. REMEDY: REINSULATE BAR.

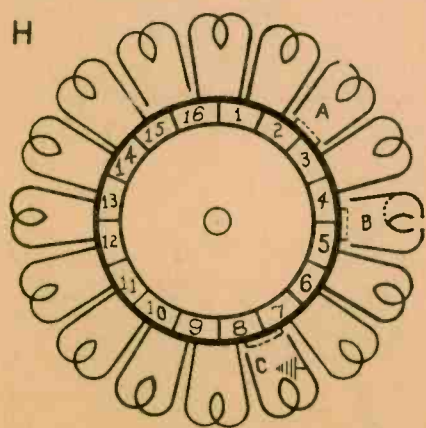

THIS SKETCH SHOWS HOW THE DIFFERENT FAULTS ABOVE LISTED ARE REMEDIED. THE LETTERS ON THE SKETCH REFER TO DIAGRAMS ABOVE IN WHICH THE FAULT IS GIVEN DETAILED TREATMENT. "A" SHOWS REMEDY FOR OPEN COIL, "B" FOR SHORTED COIL, "C" FOR GROUNDING COIL. DOTTED LINES BETWEEN BARS REPRESENT JUMPERS. NOTE THAT WITH A SHORTED COIL IT IS ESSENTIAL THAT THE COIL ITSELF BE CUT AS SHOWN IN "B" TO REMOVE THE SHORT CIRCUIT.

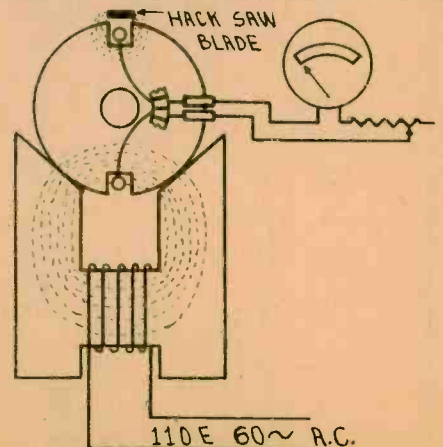

THE PURPOSE OF A CROWLER IS TO PRODUCE AN ALTERNATING MAGNETIC FIELD WHICH, CUTTING BACK AND FORTH THROUGH THE ARMATURE COILS, INDUCES IN THEM A LOW VOLTAGE MEASURABLE AT THE COMMUTATOR BARS WITH AN A.C. MILLIVOLTMETER. THE RESISTANCE "R" IS USED TO ADJUST THE READING TO APPROXIMATELY MIDSCALE. WHEN A SHORTED COIL IS PLACED BETWEEN THE CROWLER JAWS, THE HEAVY CURRENT SET UP IN THE COIL CAUSES PERIODIC MAGNETIZATION OF THE SLOT IN WHICH THE COIL LIES, RESULTING IN THE HACKSAW BLADE HELD NEAR THE SLOT BEING ALTERNATELY ATTRACTED AND RELEASED.

ARMATURE TESTS USING METER

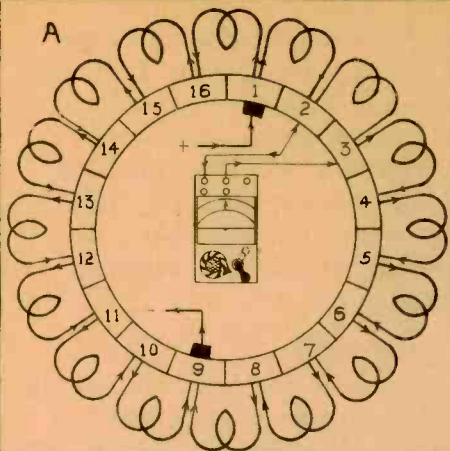

TROUBLE - OPEN COIL
TO PREVENT INJURY TO THE METER, THIS TEST MUST PRECEDE ALL OTHERS WHEN THE MILLIVOLT METHOD OF TESTING IS USED. SET METER ON THE 15 VOLT RANGE AND, WITH CURRENT FLOWING THROUGH THE ARMATURE, TAKE READINGS BETWEEN BARS 1-2, 2-3, 3-4, ETC., UNTIL ALL PAIRS OF SEGMENTS HAVE BEEN COVERED. A HIGH READING BETWEEN ANY PAIR OF BARS INDICATES AN OPEN COIL. NOTE THAT IN THIS METHOD OF TESTING THE METER IS USED TO MEASURE THE VOLTAGE DROP IN EACH ARMATURE COIL, AND THAT THIS IS DONE BY TAKING READINGS BETWEEN COMMUTATOR SEGMENTS.

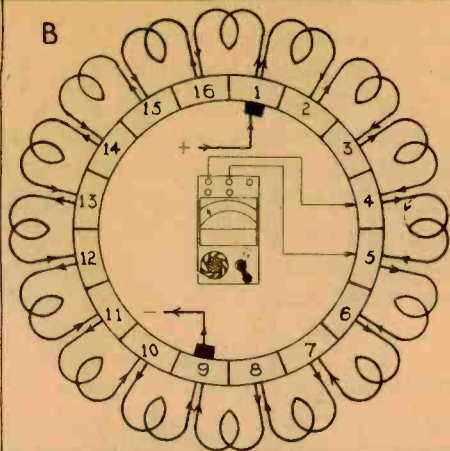

TROUBLE - SHORTED COIL
FOR THIS TEST SET METER ON THE M.V. RANGE THAT GIVES THE BEST DEFLECTION, STARTING WITH THE 300 SETTING AND WORK DOWN TO THE 50 M.V. RANGE IF NECESSARY. ADJUST CURRENT THROUGH ARMATURE UNTIL APPROXIMATELY MIDSCALE DEFLECTION IS OBTAINED ON A NORMAL COIL AND MAKE A BAR-TO-BAR TEST ON ALL SEGMENTS. THE DEFECTIVE COIL WILL GIVE A LOW OR ZERO READING DEPENDING UPON HOW MANY TURNS ARE SHORTED. IT SHOULD BE UNDERSTOOD THAT THIS METHOD OF TESTING IS MERELY A COMPARATIVE ONE, FOR IT IS HOW THE READINGS COMPARE THAT IS IMPORTANT.

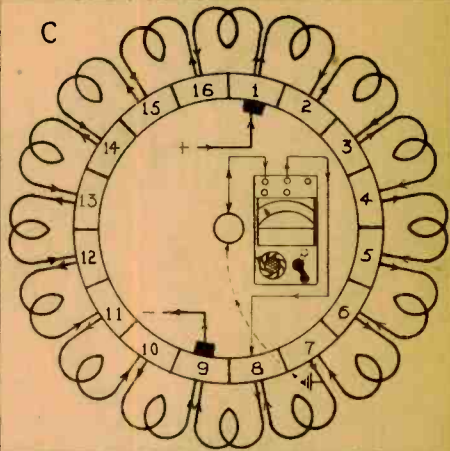

TROUBLE - GROUND COIL
TO MAKE THIS TEST, SEND A CURRENT OF SUITABLE VALUE THRU THE ARMATURE AND MEASURE THE VOLTAGE DIFFERENCE BETWEEN EACH SEGMENT AND THE ARMATURE SHAFT. IF THE WINDING IS GROUND, A READING WILL BE OBTAINED THAT BECOMES GRADUALLY LESS AS THE BARS TO WHICH THE GROUND COIL IS CONNECTED ARE APPROACHED. THE READING WILL BE LOWEST ON THE BARS TO WHICH THE GROUND COIL IS CONNECTED. IT SHOULD ALSO BE NOTED THAT AS THE GROUND COIL IS PASSED THE METER READING WILL REVERSE. TO DETERMINE IF THE BAR IS GROUND, DISCONNECT THE COIL LEADS AND REPEAT.

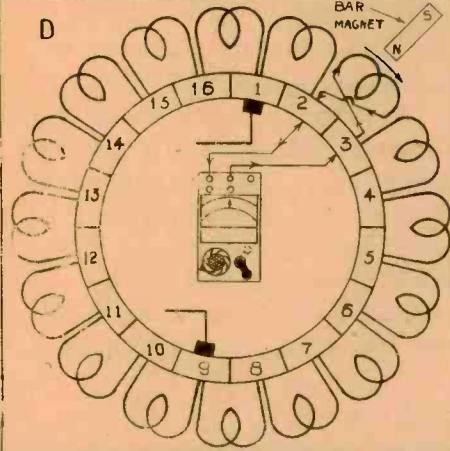

TROUBLE - REVERSED COIL LEADS
USUALLY ENCOUNTERED ON ARMATURES THAT HAVE JUST BEEN REWOUND, THIS FAULT REQUIRES A DIFFERENT TESTING METHOD. SET METER ON 50 M.V. RANGE, SELECT THE FIRST COIL TO BE TESTED, AND FIND THE SEGMENTS TO WHICH THE ENDS OF THIS COIL ARE CONNECTED. WITH THE METER LEADS ON THESE BARS DRAW A MAGNET SWIFTLY ACROSS THE SLOT IN WHICH ONE SIDE OF THE COIL LIES AND NOTE DEFLECTION ON THE METER. REPEAT THIS TEST ON ALL OTHER COILS, ALWAYS MOVING THE MAGNET IN THE SAME DIRECTION. WHEN DRAWN ACROSS A REVERSED COIL, THE METER WILL READ BACKWARDS.

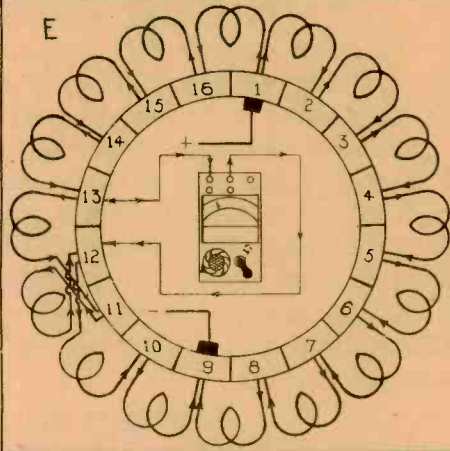

TROUBLE - REVERSED COIL LOOPS
USUALLY FOUND ONLY IN REWOUND MACHINES, THIS FAULT IS CHECKED BY THE REGULAR BAR-TO-BAR TEST. PROCEED IN EXACTLY THE SAME MANNER AS USED FOR LOCATING SHORTED COILS SINCE THE CURRENT IN PASSING FROM SEGMENT 10 TO SEGMENT 11 MUST FLOW THROUGH TWO COILS, IT FOLLOWS THAT THE VOLTAGE DROP BETWEEN BARS 10 AND 11 WILL BE DOUBLE THE VALUE OBTAINED ON A NORMAL COIL; THE SAME IS TRUE FOR BARS 12 AND 13. BARS 11 AND 12 WILL GIVE A NORMAL INDICATION; THUS REVERSED COIL LOOPS ARE INDICATED BY A DOUBLE READING, A NORMAL READING, AND A DOUBLE READING.

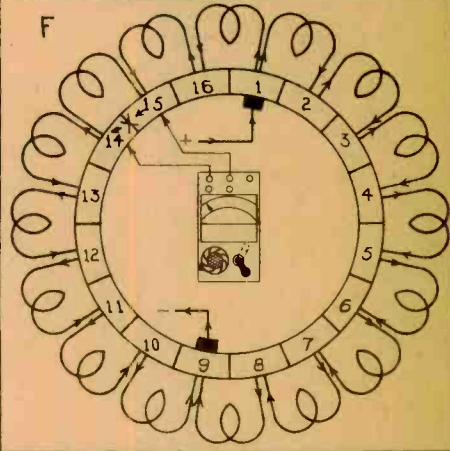

TROUBLE - SHORTED BARS
MAKE SAME TEST AS FOR SHORTED COIL. WITH CURRENT FLOWING THROUGH THE ARMATURE, MEASURE THE VOLTAGE DROP BETWEEN SEGMENTS. WHEN THE SHORTED BARS ARE ENCOUNTERED, THE METER WILL READ ZERO. INASMUCH AS THE SAME INDICATION WOULD BE OBTAINED IF THE COIL LEADS WERE SHORTED, IT WILL BE NECESSARY TO DISCONNECT THE LEADS FROM THE COMMUTATOR SEGMENTS BEFORE IT CAN BE DETERMINED WHETHER THE LOW READING WAS CAUSED BY SHORTED BARS OR SHORTED COIL LEADS. IF AFTER THE COIL IS DISCONNECTED A ZERO READING IS OBTAINED, THE BARS ARE SHORTED.

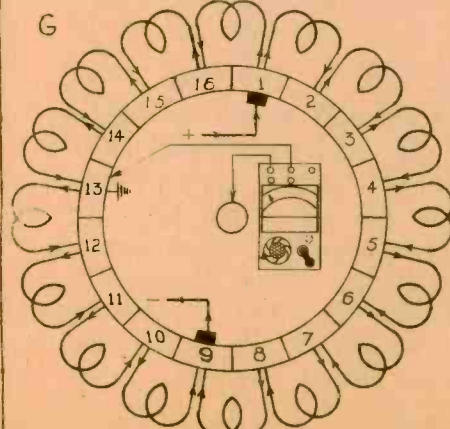

TROUBLE - GROUND BARS
TEST FOR THIS DEFECT IS THE SAME AS FOR A GROUND COIL. METER READING FROM BAR TO SHAFT WILL BE ZERO WHEN THE GROUND BAR IS CONTACTED. TO DETERMINE WHETHER THE BAR OR THE COIL IS GROUND, DISCONNECT THE COIL FROM THE BAR AND TEST AGAIN; IF BAR NOW TESTS CLEAR, COIL IS GROUND. WHEN MAKING THIS TEST, THE METER READINGS MAY CHANGE SO RAPIDLY AS THE GROUND IS APPROACHED, THAT A SATISFACTORY DEFLECTION CANNOT BE OBTAINED WITHOUT TURNING TO A DIFFERENT RANGE. THEREFORE, AS THE READING FALLS, THE METER SWITCH SHOULD BE MOVED TO A LOWER RANGE.

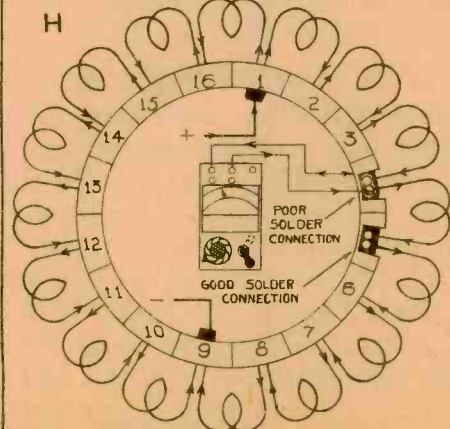

TROUBLE - BAD CONNECTIONS
TROUBLE FREQUENTLY DEVELOPS IN ARMATURES AS THE RESULT OF POOR ELECTRICAL CONNECTIONS BETWEEN THE COIL LEADS AND THE COMMUTATOR SEGMENTS DUE EITHER TO POOR SOLDERING OR TO OVERHEATING OF THE ARMATURE WHILE IN SERVICE. HIGH RESISTANCE CONNECTIONS OF THIS TYPE ARE INDICATED BY HIGH READINGS ON THE MILLIVOLTMETER. TO POSITIVELY LOCATE WHICH BAR HAS THE POOR CONNECTION, MAKE THE TEST INDICATED ABOVE. A POORLY SOLDERED JOINT WILL PRODUCE A READABLE DEFLECTION ON THE METER, WHEREAS A GOOD JOINT WILL GIVE NO READING.

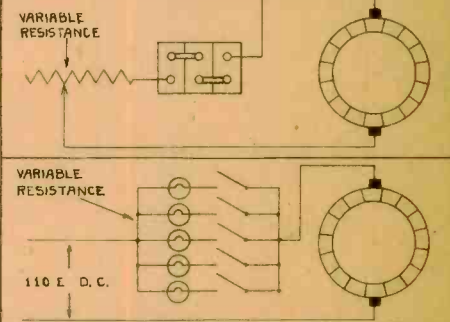

TESTING PROCEDURE
CONNECT THE ARMATURE TO A 6 VOLT, 110 VOLT, OR OTHER D.C. SUPPLY WITH A CONTROLLING RESISTANCE IN SERIES. THIS RESISTANCE MAY CONSIST OF A NUMBER OF PARALLEL-CONNECTED LAMPS ARRANGED TO BE SWITCHED IN OR OUT OF THE CIRCUIT AT WILL. FEED CURRENT INTO ARMATURE THROUGH BARS EXACTLY ONE POLE PITCH APART, AND ADJUST CURRENT UNTIL THE MILLIVOLTMETER GIVES A MIDSCALE READING ON A NORMAL COIL. THE AMOUNT OF D.C. CURRENT REQUIRED WILL VARY WITH THE SIZE OF THE ARMATURE, FRACTIONAL H.P. UNITS REQUIRING ABOUT 2-4 AMPS, MACHINES UP TO 20 H.P. ABOUT 10 AMPS, AND THE LARGEST ARMATURES CURRENTS AS HIGH AS 20 AMPS. AFTER THE CURRENT HAS BEEN ADJUSTED TO A SUITABLE VALUE, TAKE MILLIVOLT READINGS BETWEEN BARS 1-2, 2-3, 3-4, ETC. IF NO FAULTS ARE PRESENT, THE READINGS WILL BE APPROXIMATELY EQUAL. HIGH READINGS INDICATE HIGH RESISTANCE CONNECTIONS, USUALLY CAUSED BY POOR SOLDERING, WHILE LOW READINGS SHOW SHORTED COILS OR COMMUTATOR SEGMENTS.

ARMATURE AND FIELD TESTS

OPEN ARMATURE COIL TEST

Connect armature across line with current-limiting lamps in series. Place meter selector switch in the 50 volt or the 10 volt position and measure voltage across armature. Next make a bar-to-bar test; meter will read zero until open coil is bridged when total armature voltage will be registered. Example: 8E across armature; bars 11, 12 read zero; bars 1, 2 read 8E. To protect the meter, the test for spans should always be made before any other check involving bar-to-bar readings.

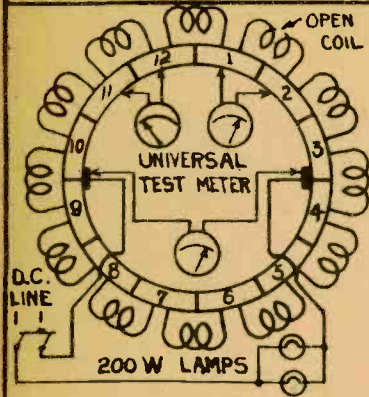

SHORTED ARMATURE COIL TEST

Connect armature to circuit, as directed above. Set meter selector switch to 250 M.A. and make a bar-to-bar test. If necessary, change selector switch to obtain about half-scale reading on a normal coil. A low or zero reading will then indicate a shorted coil; a high reading a poor connection - usually at the commutator riser. Example: Meter reads half scale on bars 11-12, 12-1, 1-2; gives low reading on 2-3, thereby indicating a shorted coil.

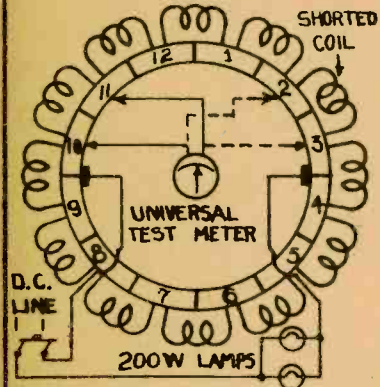

GROUNDED ARMATURE COIL TEST

With the test connection remaining the same as before, a meter reading between the commutator segments and the shaft indicates a grounded coil. As the segment to which the grounded coil is connected is approached, the reading will become less and will be minimum when the test prod is in contact with the segments connected to the grounded coil. Example: With meter selector switch set on 50 M.A., a reading from bar 10 to shaft is full-scale and this value is gradually reduced to a minimum on bars 1 and 2. Beyond this point, the reading reverses and starts to increase again.

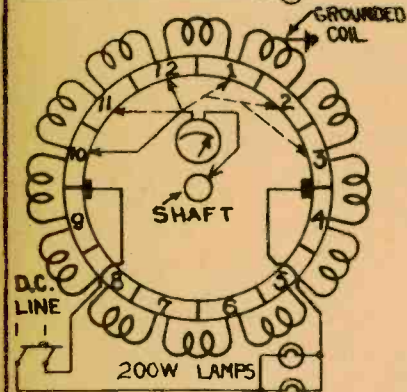

SHORTED FIELD COIL TEST

Connect shunt field to line as shown in sketch and take the voltage drop across each field coil with a D.C. voltmeter. If the voltage across all coils is the same, the field is O.K. A reading below normal indicates a shorted or partially shorted coil. The normal voltage across any field coil is equal to the line voltage divided by the number of poles. Example: Coil 1, 31Ed; coil 2, 17E; coil 3, 31Ed; coil 4, 31Ed; coil 2 is shorted.

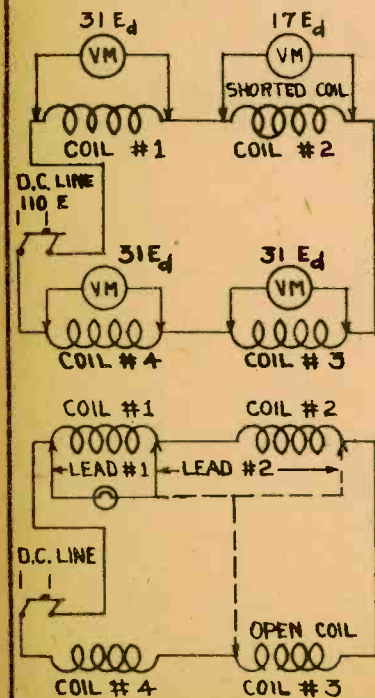

OPEN FIELD COIL TEST

Connect field as indicated in sketch and place voltmeter or test lamp across each field coil. If the field is open, no reading will be obtained until the open in the circuit is bridged. Then the open may be found by testing each coil individually, or by connecting one test lead to one of the circuit wires and moving the other lead around the field toward the other line until a light is obtained. The open will then be in between the point at which the light was obtained and the previous point tested.

GROUND FIELD TEST

Apply line voltage between the field leads and the frame with a suitable voltmeter or test lamp in series. If the meter indicates or the lamp lights, the field is grounded. To locate the ground, disconnect and test each coil separately.

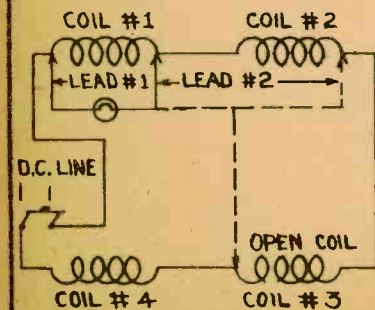

INSULATION TESTS

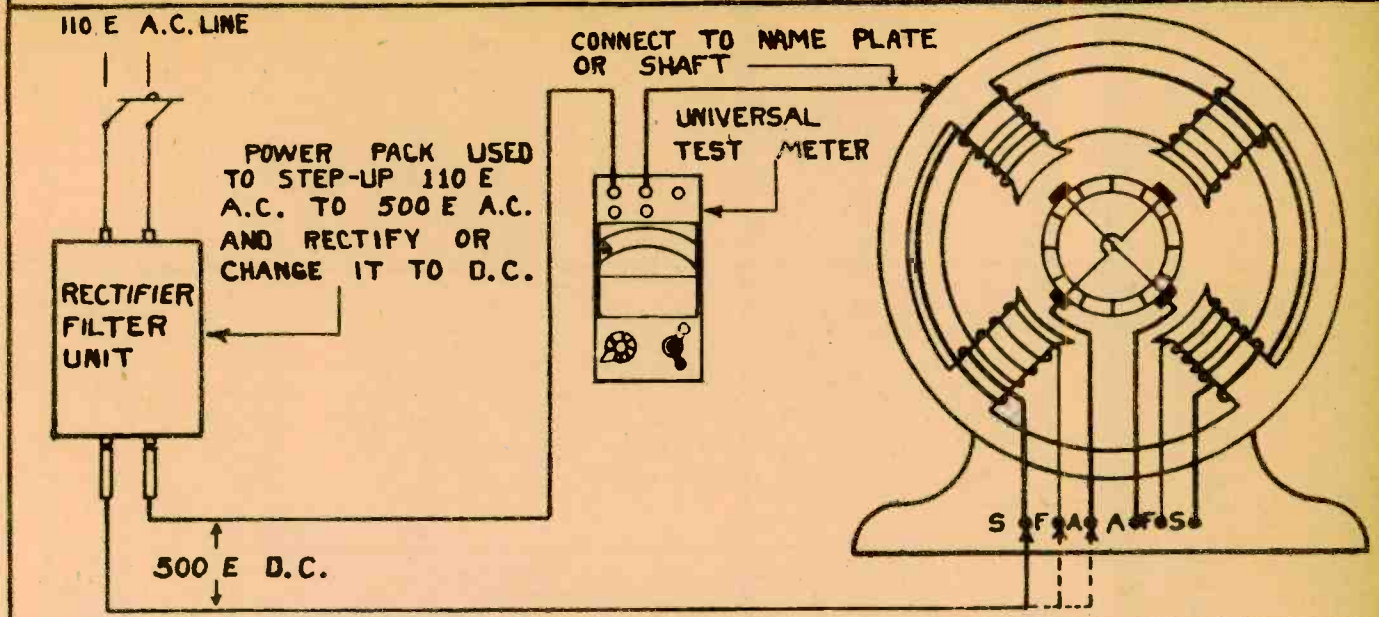

Since the quality of the insulating materials used on any electrical machine deteriorates with age, due to the action of moisture, dirt, oil, acids, etc., it is necessary to periodically test the electrical resistance of the insulation so that weaknesses may be detected and corrected before they result in complete failure.

Insulation resistance tests are usually made up applying 500 volts D.C. between the winding of the machine and the frame; the current which this pressure forces through or over the insulation to the frame is measured by a sensitive instrument, the scale of which is usually calibrated to read in megohms. The 500 volts D.C. may be developed by a hand-operated generator as in the megger, or it may be supplied from an A.C. source by a rectifier-filter combination as shown above.

The readings obtained on any given machine will vary greatly with the temperature of the insulation, a 10 degree Centigrade rise in temperature reducing the insulation resistance as much as 50%. The dampness of the location, and the amount of oil, dust, or dirt on the winding, will also materially affect the readings. Wherever possible, the test should be made when the insulation is at the maximum operating temperature, 167 degrees F., (75 degrees C.) The minimum safe insulation resistance at maximum operating temperature should not be lower than one megohm for equipment having a voltage rating below 1000 volts.

To make the test, connect the rectifier unit to 110 volts A.C., set the control switch on the meter to the one mil position, set switch in D.C. position, make the connections shown above, and read the insulation resistance on the top scale of the dial. Usually a general test is made between one lead of the machine and the frame, and if this proves to be too low, the windings are tested individually. So after the general test, test the armature, shunt field, series field, and brush holders separately. To do this, take the brushes from the holders, disconnect the windings from each other, and test the insulation resistance of each. In this manner, the faulty element can quickly be found. This same procedure is used on A.C. equipment also. If such readings are taken at regular intervals and the values recorded, a close check may be kept on the condition of the insulation resistance of all electrical equipment, and apparatus may be removed from service and reconditioned before breakdown occurs.

POWER PACK FOR INSULATION RESISTANCE TESTER

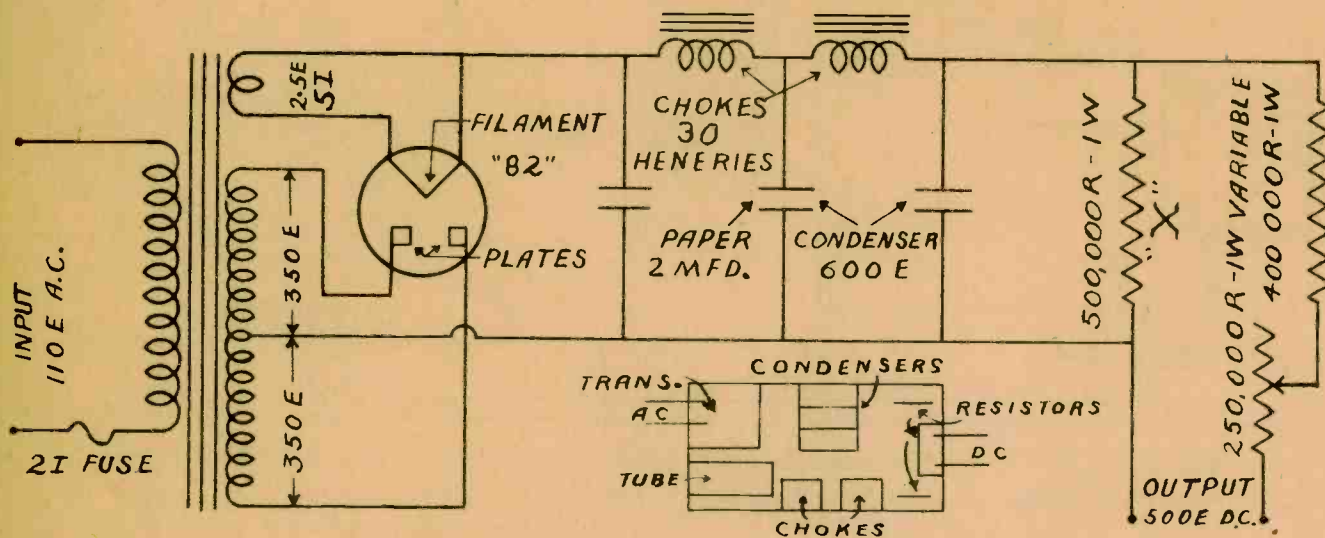

The connecting scheme employed on unit designed to convert 110 volt, 60 cycle A.C. to 500 volt D.C. for insulation resistance testing is shown above. Many of the parts required for this rectifying and filtering device may be obtained from old radio equipment; the remainder may be purchased from any radio supply store. The material needed is listed below.

- One power transformer with windings to produce voltages shown.
- Three 600 volt, 2 microfarad, paper condensers.
- Two 30 henry chokes. 50 milliampere rating.
- One 82 tube and socket for same.
- One wooden case approximately 5x5x8.
- One bakelite cover for wooden case.
- One 500,000 ohm 1 watt fixed resistor.
- One 400,000 ohm 1 watt fixed resistor.
- One 250,000 ohm 1 watt variable resistor.
- One control knob for variable resistor.
- One instrument fuse base and clips.
- One instrument fuse, 2 amperes.
- Two tip plugs for leads (one red, one black)
- Two pin jacks (one red, one black)

First experiment with parts to find the most suitable arrangement of the different items in the case. Small sketch shows one method that has proved satisfactory. Tube base must be so placed as to permit replacement of defective tube without the removing other parts. All connections must be soldered.

After the unit has been constructed, test the D.C. voltage output with a 0-1 mil voltmeter. If the voltage is too high, use a lower resistance at X. A little experiment and adjustment will probably be necessary before the correct output voltage is obtained. The meter to be used in conjunction with this supply device must not require more than one milliampere to produce full scale deflection. Higher current drain will result in lowering the output voltage of the power supply; this will introduce errors in the readings taken when the unit is being used for insulation resistance tests.

WATTMETER AND WATTHOURMETER DIAGRAMS

INDICATING WATTMETER.

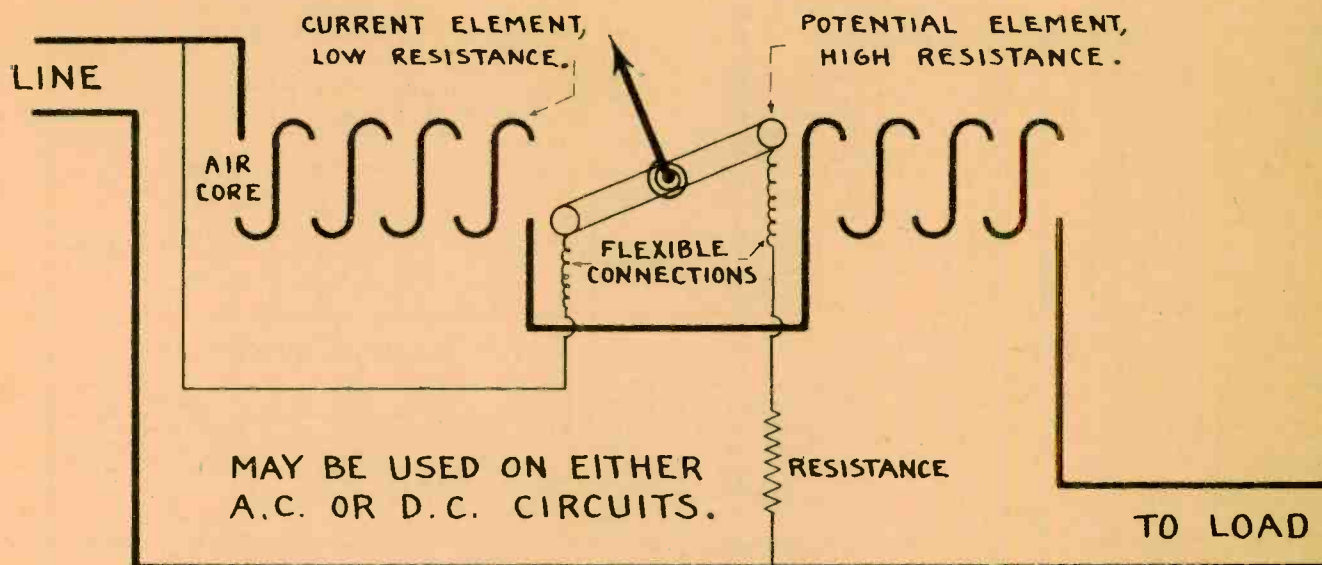

D.C. INTEGRATING WATTMETER.

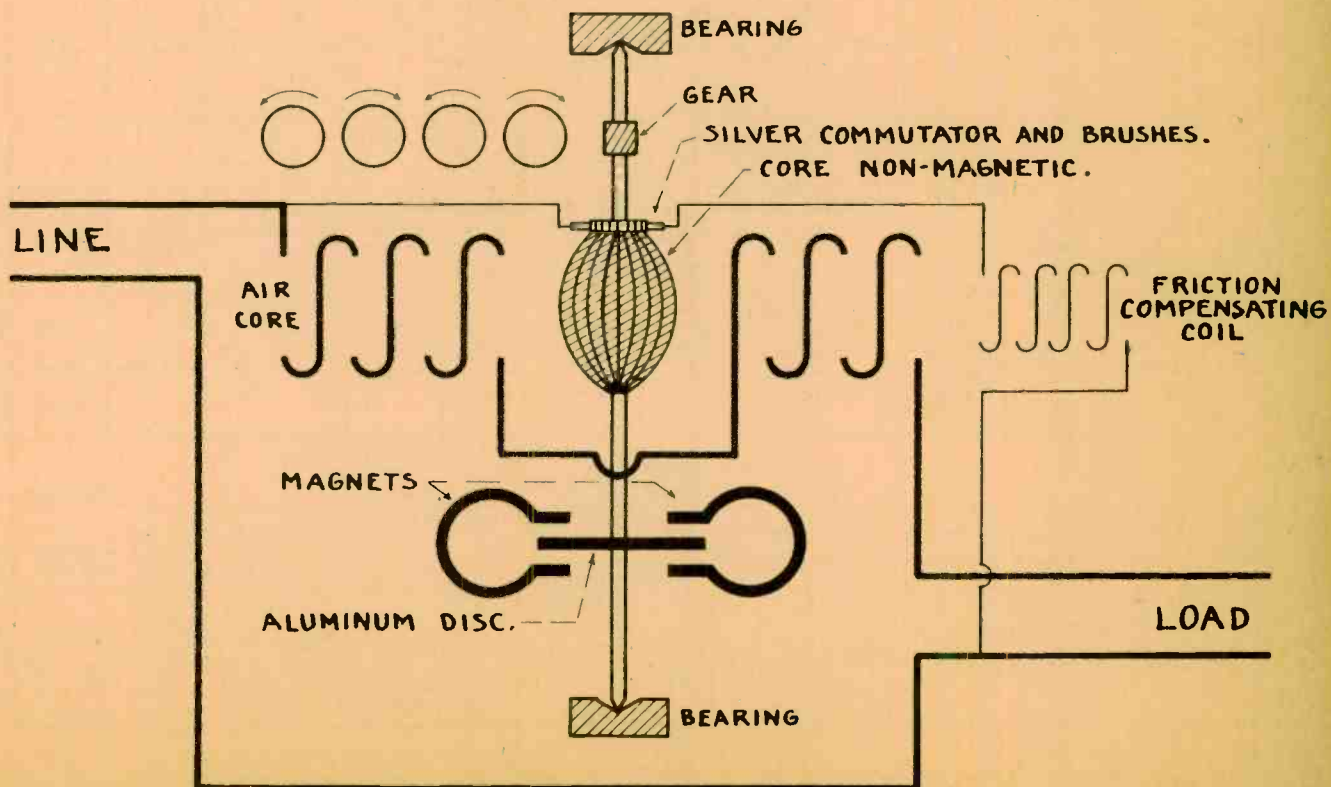

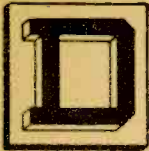

STANDARD LINE DIAGRAM SYMBOLS

CONTACTORS										KNIFE SWITCHES	AIRCIRCUIT BREAKERS	FUSE (POWER OR CONTROL CIRCUIT)
MAIN CIRCUIT CONTACTS						AUXILIARY CIRCUIT CONTACTS		MECH-ANICAL INTER-LOCK	SINGLE POLE	SINGLE POLE		
INSTANT. CLOSING		DELAYED CLOSING (DASHPOT TYPE)				N.O.	N.C.		MULTI POLE	MULTI POLE		
WITH BLOWOUT	WITHOUT BLOWOUT	N.O.	N.C.	WITH BLOWOUT	WITHOUT BLOWOUT	N.O.	N.C.					
PUSH BUTTONS						LIMIT SWITCHES						
SINGLE CIRCUIT		DOUBLE CIRCUIT		MAIN-TAINED CONTACT	THREE POINT N.O.	N.O.		N.C.				
N.O.	N.C.	N.O.	N.C.			INITIALLY-OPEN	INITIALLY-CLOSED	INITIALLY-OPEN	INITIALLY-CLOSED			
OVERLOAD RELAY CONTACTS				TIMING RELAY CONTACTS				MAINTAINED CONTACT SWITCHES		TERMINALS ON TERMINAL BLOCKS		
THERMAL	MAGNETIC				DASHPOT OR PNEUMATIC				SINGLE THROW		DOUBLE THROW	
	DASHPOT (DELAYED TRIP)		INSTANT. TRIP		ACTION RETARDED WHEN COIL IS -							
N.C.	N.O.	N.C.	N.O.	N.C.	N.O.	N.C.	N.O.	N.O.	N.C.			
MISCELLANEOUS												
PLUG (ZERO SPEED) SWITCH	SEPAR-ABLE CON-NECTOR	TEST JACK	METER	LIGHTS		FLOAT SWITCH		PRESSURE OR VACUUM SWITCH		BATTERY (STORAGE OR PRIMARY)	CON-DENSER	BELL
				SIGNAL	INCANDESCENT	N.O.	N.C.	N.O.	N.C.			
COILS												
CONTACTOR - RELAY					MISCELLANEOUS							
SHUNT	SERIES	THERMAL	SOLENOID	REACTOR	TRANSFORMERS			RESISTORS			METER SHUNT	
					AUTO.	POTENTIAL	CURRENT	FIXED	TAPPED	RHEOSTAT		
							SECONDARY	(DENOTE PURPOSE)				

1748-C3

Direct-Current Control Circuits

EASE IN SHOOTING TROUBLE on d.c. controls depends largely on a clear understanding of the basic principles and circuits used. It is the purpose of these data sheets to give that information.

In general, d.c. motors of less than 2-hp. rating can be started across the line, but with larger motors it is usually necessary to put resistance in series with the armature when it is connected to the line. This resistance, which reduces the initial starting current to a point where the motor can commute successfully, is shorted out in steps as the motor comes up to speed and the

countervoltage generated is sufficient to limit the current peaks to a suitable value. Accelerating contactors that short out successive steps of starting resistance may be controlled by countervoltage or by definite-time relays.

For small motors used on auxiliary devices the counter-c.m.f. starter is satisfactory. The definite time starter is more widely used, however, and has the advantage of being independent of load conditions.

The following diagrams illustrate some of the circuits commonly used for d.c. motor control.

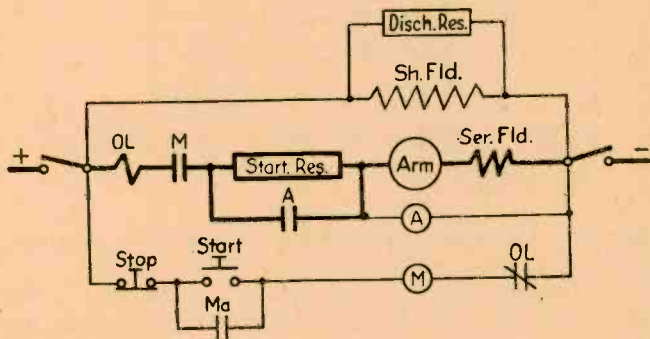

Figure 1. Basic requirements of a non-reversing d.c. starter in its simplest form.

When the start pushbutton is depressed line contactor M closes, energizing the motor armature through the starting resistance. As the motor comes up to speed the countervoltage, and the voltage across motor armature and series field, increases. At a predetermined value the accelerating contactor A closes, shorting out the starting resistance.

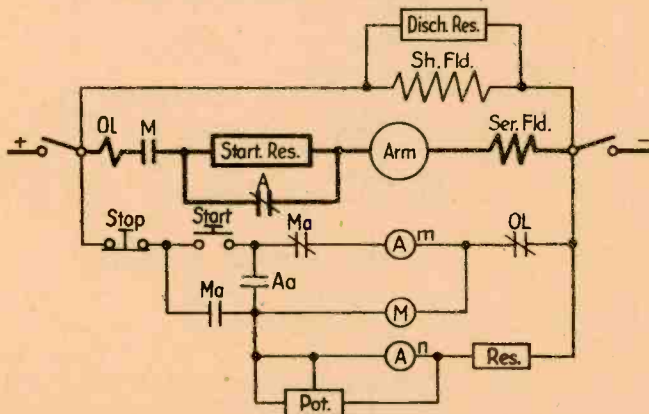

Figure 2. Typical, non-reversing constant-speed, definite-time starter. The accelerating contactor is equipped with a time-delay mechanism. This contactor, A, is of the magnetic-flux-decay type. It is spring-closed, equipped with two coils, and has a magnetic circuit that retains enough magnetism to hold the contactor armature closed and the contact open indefinitely. Main coil Am has sufficient pull to pick

up the armature and produce permanent magnetization. Neutralizing coil An is connected for polarity opposite to the main coil. It is not strong enough to affect the pick-up or holding ability of the main coil but, when the latter is deenergized, the neutralizing coil will buck the residual magnetism so that the contactor armature is released by the spring and the contacts close. By adjusting the potentiometer the voltage impressed on this coil and hence the time required for the contactor to drop out can be varied. When the start button is depressed accelerating contactor coil Am is energized, causing contact A to open and auxiliary contact Aa to close. Contact Aa energizes line contactor M, and normally open auxiliary contacts Ma establish a holding circuit. Neutralizing coil An is also energized. Opening of contact Ma deenergizes coil Am and contactor A starts timing. At the set time the main normally closed contacts on A close, shorting out the starting resistance and putting the motor across the line.

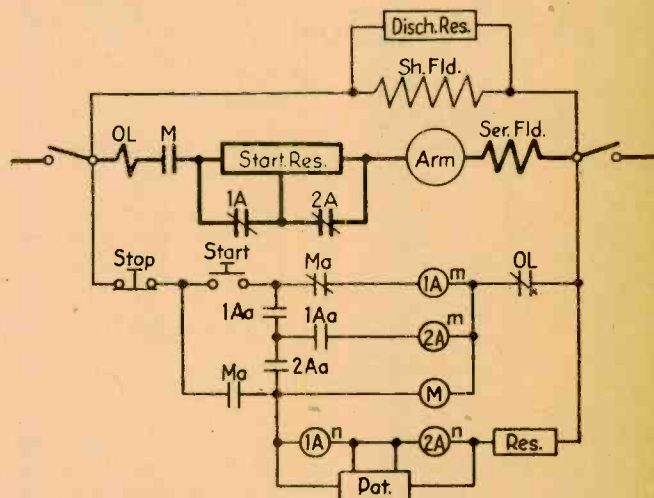

Figure 3. The same kind of a starter as in Figure 2 but designed for use with a motor of larger horsepower.

This starter provides two steps of definite-time starting. The operation is essentially the same as in Figure 2 but the first accelerating contactor, 1A, does not short out all the starting resistance. It also starts 2A timing, which finally

shorts out the remaining resistance. The normally open auxiliary contacts on the accelerating contactors in Figures 2 and 3 are arranged so that it is necessary for the accelerators to pick up before the line contactor can be energized. This is a safety interlocking scheme that prevents starting the motor across the line, if the accelerating contactors are not functioning properly.

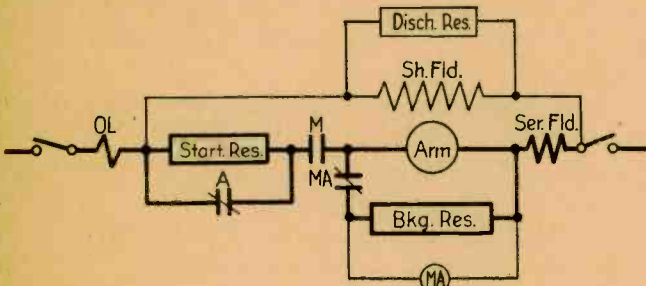

Figure 4. One way of producing dynamic braking. Control circuits have been omitted, since they are a duplicate of those shown in Figures 2 and 3. Line contactor *M* has two poles, one normally open and the other normally closed. Both poles are equipped with an operating coil and are on the same armature, which is hinged between the contacts. In starting, when line contactor *M* closes normally closed contact *MA* opens. When the stop button is depressed the line contactor drops out and contact *MA* closes. The motor, now acting as a generator, is connected to the braking resistor and coil *MA* is energized by the resultant voltage. It causes *M* to seal in tightly, establishing good contact pressure and preventing this contact from bouncing open.

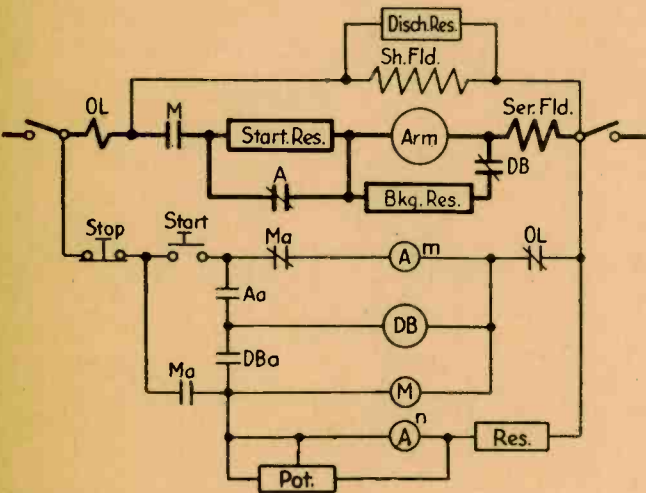

Figure 5. In the more modern types of controllers a separate spring-closed contactor is used for dynamic braking. Operation is similar to that described for Figure 2, except that the energizing of coil *Am* and the picking up of accelerating contactor *A*, closing contact *Aa*, energizes dynamic braking contactor *DB*, which in turn energizes line contactor *M* through its auxiliary contact, *DBa*. This arrangement not only insures that the dynamic braking contactor is open, but also that it is open before the line contactor can

close. In order to obtain accurate inching, such as is required for most machine tool drives, the motor must respond instantly to the operation of the pushbutton. In the scheme shown in Figure 5 the closing of the line contactor is delayed until the accelerating contactor and the dynamic braking contactor pick up.

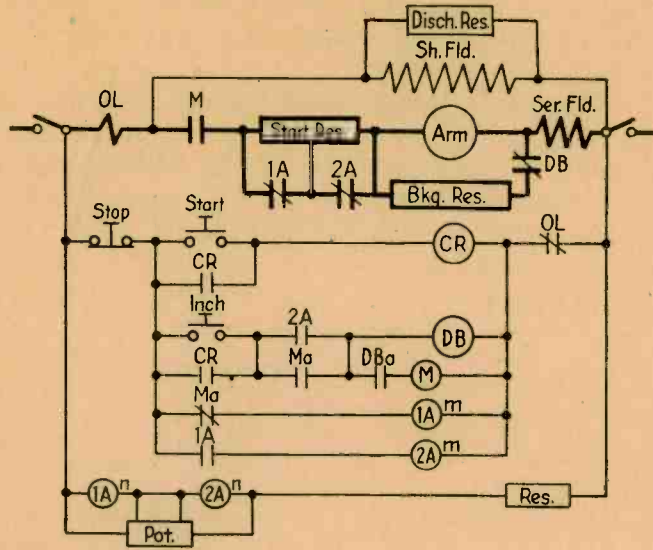

Figure 6. Arrangement to secure quicker response of motor, for more accurate inching. Accelerating contactors *1A* and *2A* are energized in the off position. Hence, when the start button is depressed, the dynamic braking contactor picks up immediately and its auxiliary contact *DBa* picks up *M* line contactor.

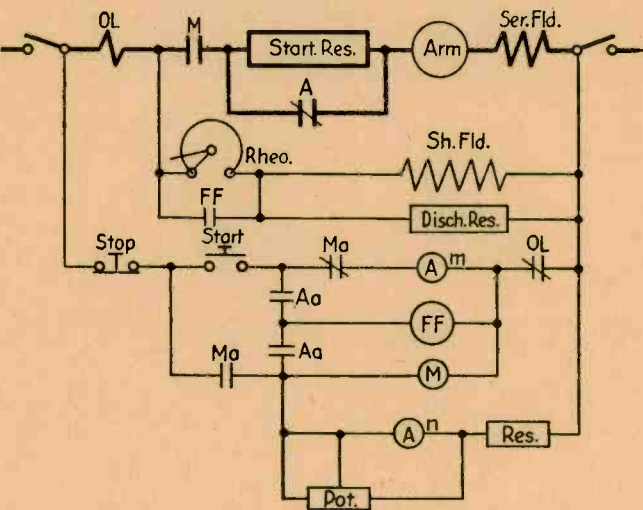

Figure 7. One method of connecting full field relay, used with adjustable-speed motors having a speed range in excess of 2 to 1. Coil *FF* is energized by the closing of the normally open auxiliary contact *Aa* and remains closed until the last accelerating contactor drops out. Contacts of the full field relay, *FF*, are connected to short out the field rheostat thereby applying maximum field strength to the motor during the starting period.

Direct-Current Control Circuits

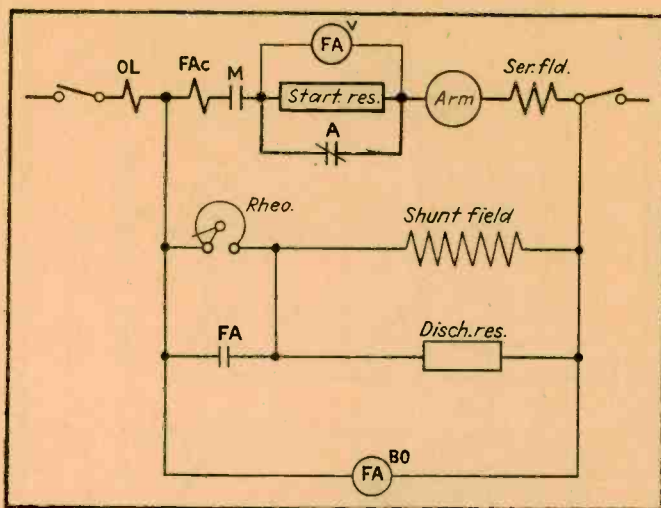

Figure 8. Another method of applying the full-field relay.

This arrangement insures full field on starting, and provides for limiting the armature current when the motor is accelerating from the full-field speed to the speed set by the rheostat. Field accelerating relay *FA* is equipped with two coils, one a voltage coil connected across the starting resistance, the other a current coil connected in series with the motor armature. See Figure 2 for the remainder of the circuit. When line contactor *M* closes the voltage drop across the starting resistor is practically line voltage, and relay *FA* is picked up quickly. When accelerating contactor *A* closes, voltage coil *FAv* is shorted, but closing of *A* produces a second current peak, and current coil *FAc* holds relay *FA* closed. As motor approaches full-field speed this current decays and allows the *FA* contacts to open, weakening the motor field. When the motor attempts to accelerate the line current again increases. If it exceeds the pick-up value of coil *FAc* the relay will close its contacts, arresting acceleration and causing a decay of line current, which again causes *FA* to drop out. High inductance of the motor field, plus inertia of the motor and drive prevent rapid changes in speed. Hence the motor will not reduce its speed, but the increased field current will reduce the armature current and cause *FA* to drop out. The fluttering action will continue until the motor reaches the speed set by the rheostat. Setting of the *FA* relay current coil determines the maximum current draw during this part of the acceleration period. Since relay *FA* must handle the highly inductive field circuit, a good blowout arrangement is necessary. Hence the relay is usually equipped with a shunt blowout coil, *FAbo*.

Figure 9. Connections of field loss relay, to prevent excessive speed if the shunt field is deenergized while voltage remains on the armature.

It usually consists of a current relay in series with the motor shunt field and is adjusted to pick up on full-field current and remain closed at any current within the operating range of the motor field current. Contacts of relay *FL*

are connected in series with the overload relay contacts so that the opening of its contacts will deenergize the control by opening the line contactor. This type of field loss protection does not protect against the possibility of a short

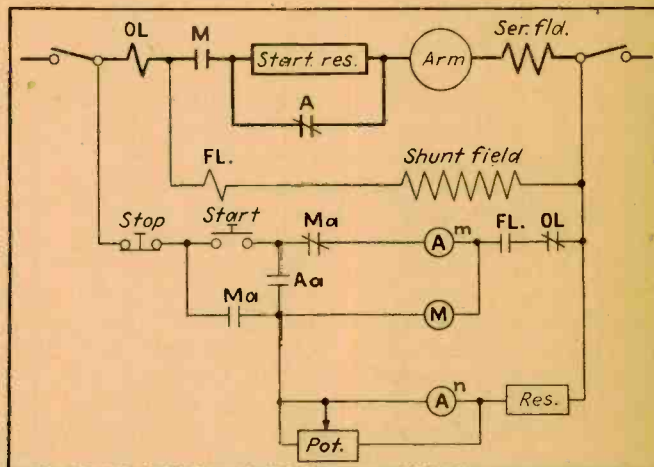

circuit across a part of the field, say across the one field coil. This would cause the motor speed to rise considerably but the current in the field circuit would also rise. Consequently, the series current relay would not respond.

Figure 10. Application of differential field loss protection.

The differential field loss relay *DFL* is equipped with two voltage coils connected to buck each other. Each is connected across one-half of the field winding. Normally the voltage across each coil is the same, hence the relay stays in the out position with its normally closed contacts closed. Shorting out of one field coil or other failure causing an un-

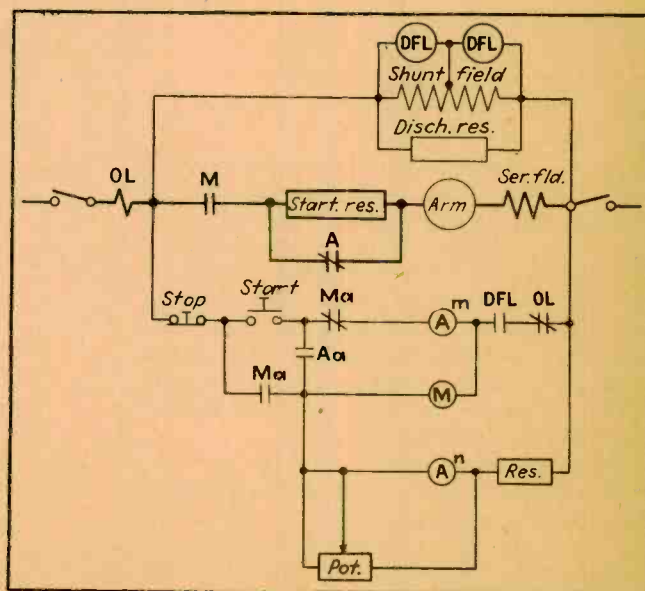

Direct-Current Control Circuits

balance of these voltages causes the relay to pick up, opening its contacts and dropping out the line contactor, deenergizing the motor.

Figure 11. One form of reversing dynamic braking control, consisting of multi-pole contactors having two poles normally open and one pole normally closed. Accelerating contactors 1A and 2A are energized in the off position, as in Figure 6. Depressing the forward button energizes forward contactor F, closing the two normally open contacts F and opening the normally closed contact FA. Opening of normally closed auxiliary contact Fa starts the timing cycle of the accelerating contactors. Closing of the normally open auxiliary contact Fa establishes a holding circuit. When the stop or reverse button is depressed contactor F drops out, closing normally closed contact FA and setting up a dynamic braking circuit through the braking resistors, which energizes coils FA and RA. These coils hold the normally closed contact closed, and the normally open contacts open until the braking current drops to a low value. This action prevents bouncing of the back contacts and plugging the motor, because if the reverse button were depressed during the braking period contactor coil R would not have sufficient strength to overcome the pull of the RA coil until the motor had almost stopped.

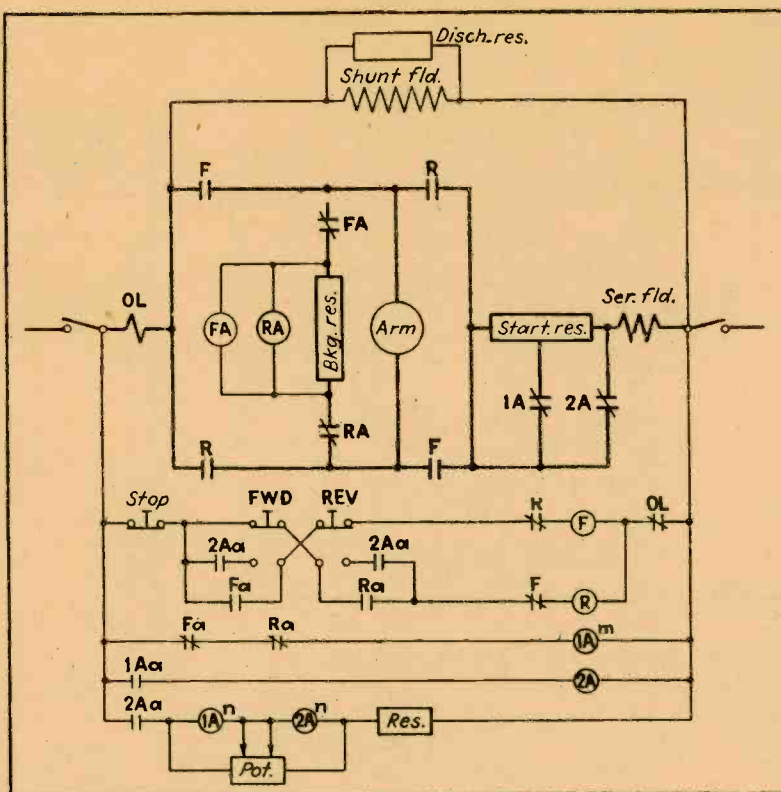
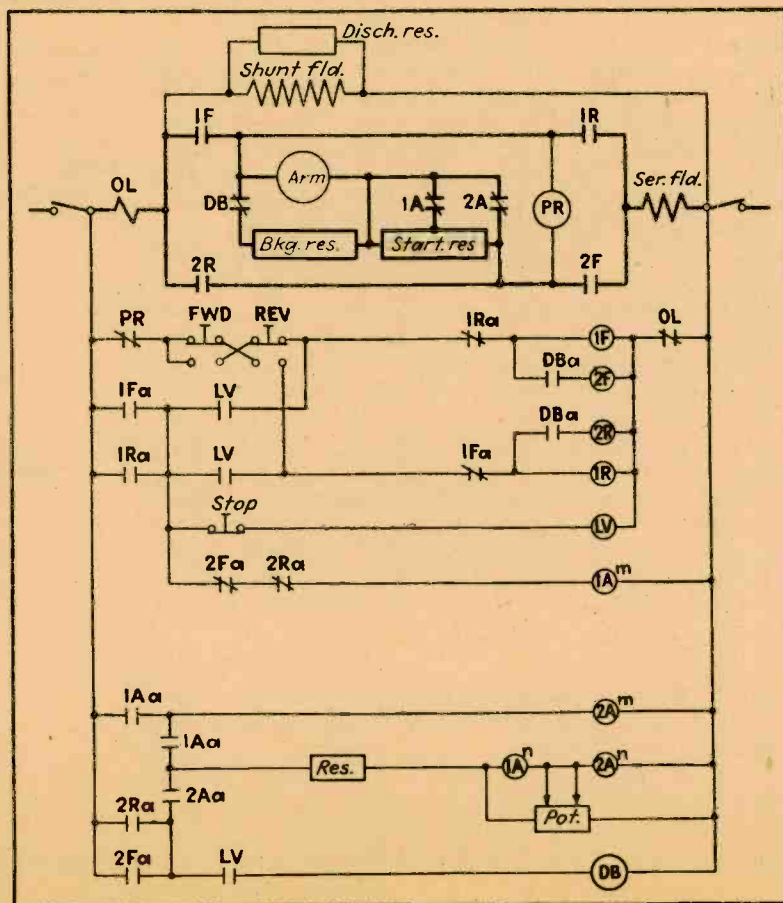

Figure 12. Another form of reversing dynamic braking starter using a spring-closed dynamic braking contactor and single-pole normally open directional contactors. When start button is depressed contactor IF is energized. Closing the normally open auxiliary contact IFa energizes relay LV to establish a holding circuit and also energizes accelerating contact 1A; 1A contactor energizes 2A, and 2A energizes DB. In turn, DBa energizes 2F and normally closed contact 2Fa starts the accelerating timing.

Depressing the stop button drops out LV, closing DB immediately. Plugging is prevented by relay PR, a voltage relay connected across the motor armature. Its normally closed contacts remain open, preventing the pick up of the reverse directional contacts until the armature speed drops down to a safe value for plugging.



STARTING AND CONTROLLING THE SPEED OF D. C. MOTORS.

Small D.C. motors (fractional H.P.) may be started across the line. The resistance of the armature winding is high in comparison to the resistance of larger armatures. Large armatures have low resistance because heavy wire is used to wind them.

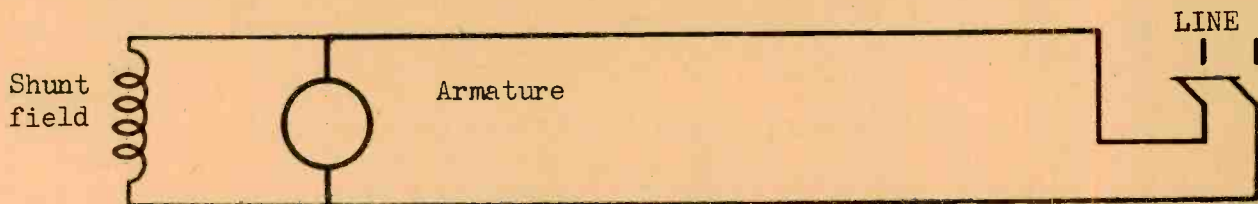

When starting a D.C. motor larger than fractional H.P. in size full line voltage should not be applied to the armature. A resistor should be connected in series with the armature to produce a voltage drop and apply a low voltage to the armature during the starting period. The starting period is from 10 to 45 seconds.

The starting current should be limited to $1\frac{1}{2}$ or 2 times full load current except when starting heavy torque loads which will require as much as 3 times full load current. After the motor attains normal speed the current through the armature can be determined by the formula; effective voltage divided by armature resistance. This value will be proportional to the mechanical load on the motor.

The shunt field must be connected so it will receive full line voltage when starting. The field must be maximum strength to produce good starting torque and for the armature to quickly generate CEMF.

FOUR POINT CONTROLLER

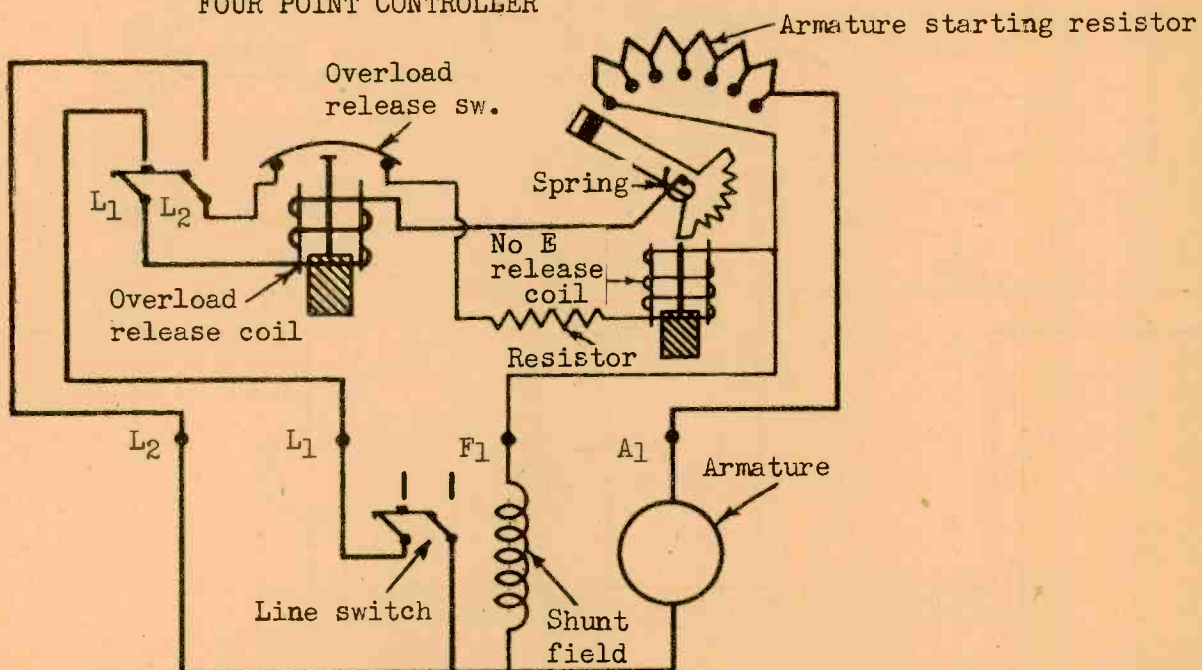

The NO VOLTAGE RELEASE COIL allows the spring on the power arm to return the power arm to the "off" position if the voltage on the line drops to a low or zero value.

OVERLOAD PROTECTION is provided by connecting an overload release coil in series with the load circuit. When the current reaches overload value the plunger will be drawn up and break the holding coil circuit. The spring on the power arm will return it to the off position.

STARTING AND CONTROLLING THE SPEED OF D.C. MOTORS (continued)

The speed of a D.C. motor varies in direct proportion to the voltage applied to the armature and in inverse proportion to the strength of the field flux.

When a motor is operating with the rated voltage applied to the armature and field (with or without load) it is operating normally and the speed obtained is called NORMAL SPEED.

SPEED CONTROL BELOW NORMAL SPEED (armature control)

The speed can be controlled below normal by connecting a regulating resistor in series with the armature. The speed will vary with the voltage applied to the armature. The torque will not be affected because connecting a resistor in series with the armature does not change the amount of current through the armature. This value will be constant if the mechanical load is constant. The H.P. output will vary with the speed because the H.P. output is proportional to the speed and torque.

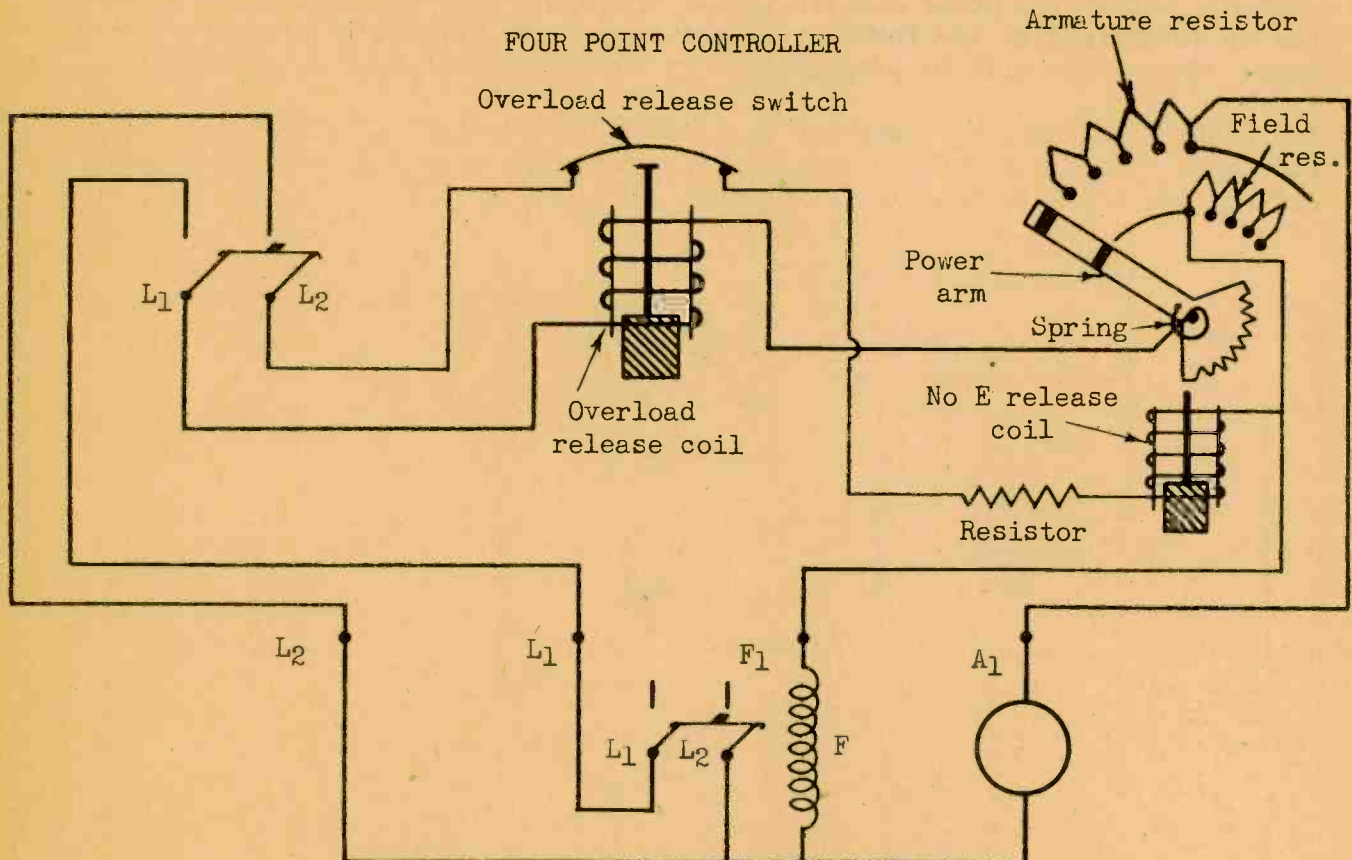

SPEED CONTROL ABOVE NORMAL SPEED (field control)

The speed can be controlled above normal on shunt and compound motors by connecting a shunt field rheostat in series with the shunt field. The speed will vary inversely with the field strength. Weakening the field will increase the speed because the armature must rotate faster to generate a sufficient amount of CEMF to limit the current through the armature in proportion to the mechanical load on the motor. Decreasing the field strength will decrease the torque. The H.P. output will not be affected because the H.P. output is always proportional to the speed and torque. When the speed increases and the torque decreases the product of the two will not change.

COYNE

3 POINT STARTER DIAGRAMS

3 point starter for starting duty only.

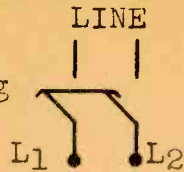

3 point starter for starting duty only. The overload release coil protects the motor against overloads.

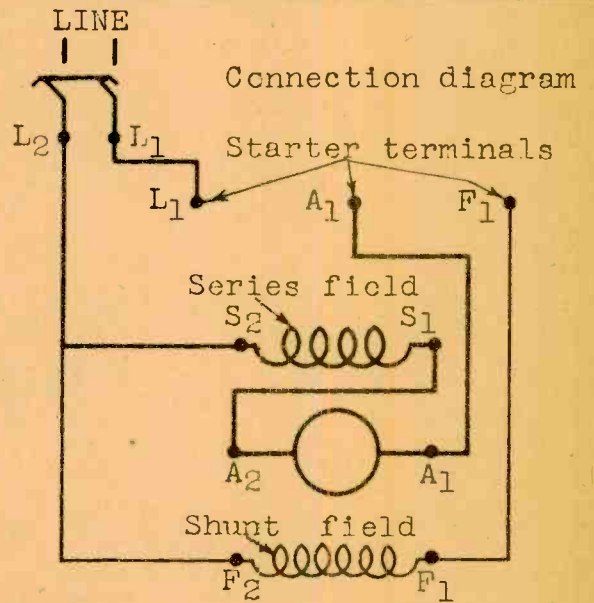
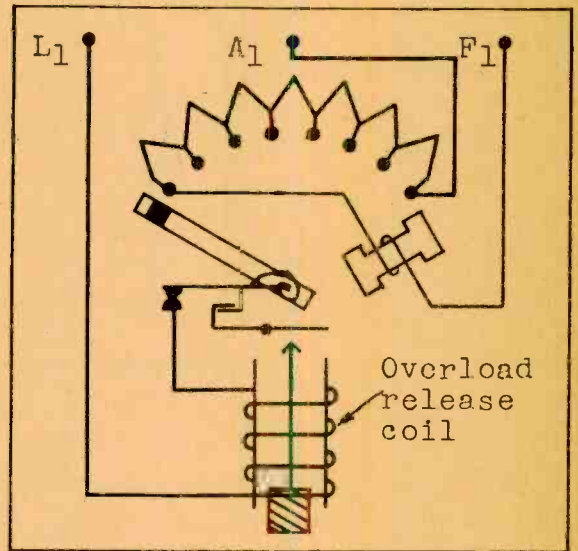
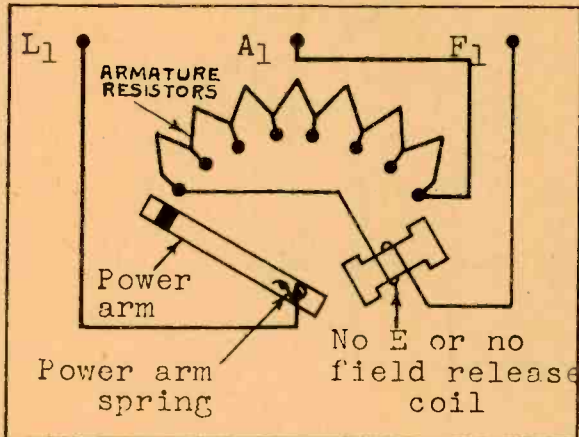

Connect as shown for compound motor. For shunt motor connect A2 to L2.

Draw a detailed diagram of the motor. Show all parts such as field poles, brushes, armature, terminals and the position of the terminal board. Test the motor terminals with test lamp to identify them. Connect the motor to the starter as shown by the connection diagram.

19273D

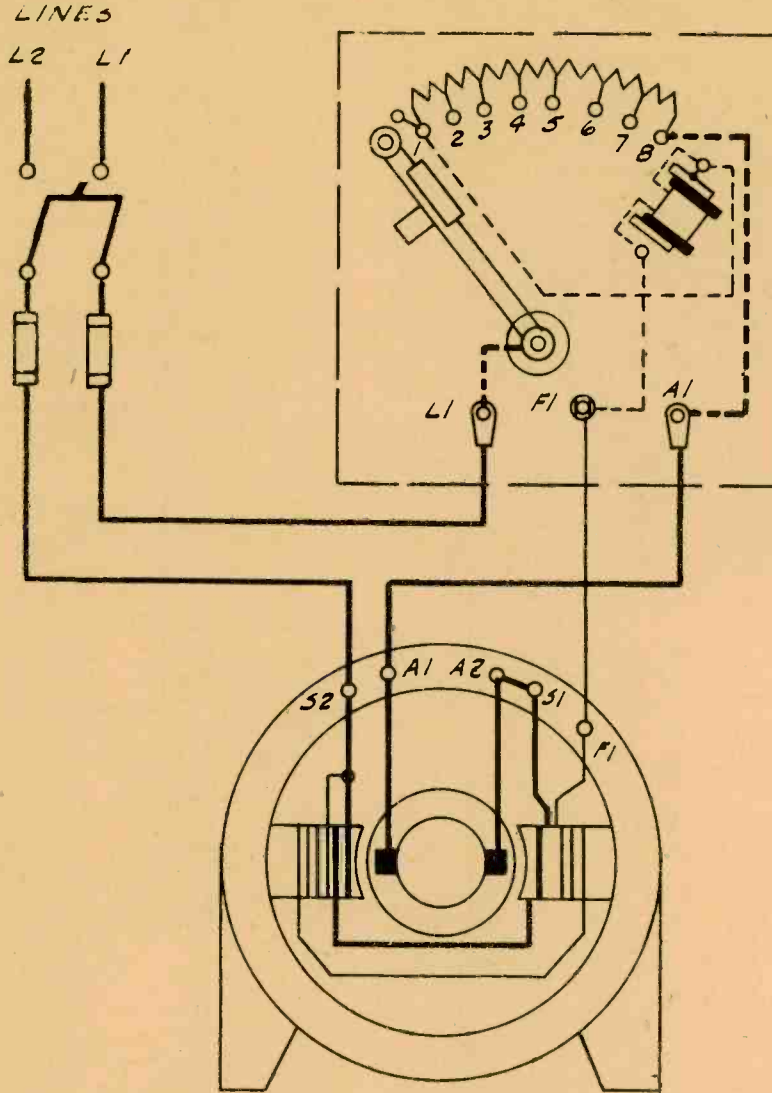

IF MOTOR IS SHUNT WOUND
 TERMINALS "51" AND "52"
 WILL BECOME COMMON

AN. 514. & PAGES CHANGED 9-9-30
 J. J. 9-3-26 H.D.
 82 MRO4

TITLE CONNECTIONS FOR DIRECT CURRENT MOTOR STARTING RHEOSTAT WITH LOW VOLTAGE PROTECTION.

RETRACED BY <i>G. J. Gysel</i>	TRACED BY LEO. M. ZEMAN	TYPE "A"	SUP. NO.
CHECKED BY	APPROVED BY <i>A. Dubs</i>	BULL. NO. 2110 & 2111	SLIP BY NO.
A	B	C	D
ORDER NO. STANDARD			19273D

CUTLER-HAMMER, INC. MILWAUKEE  NEW YORK

ORIGINAL TRACING FILED WITH PATENT DRAWINGS

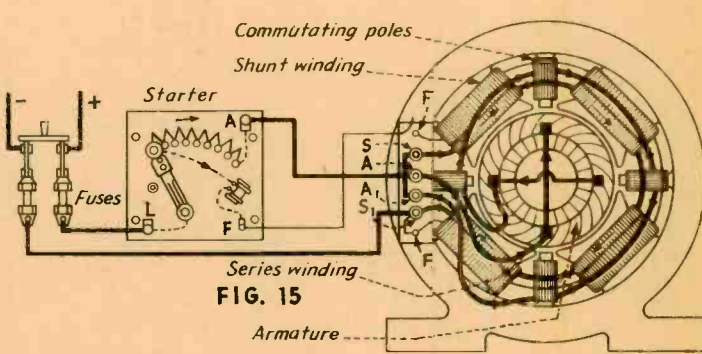
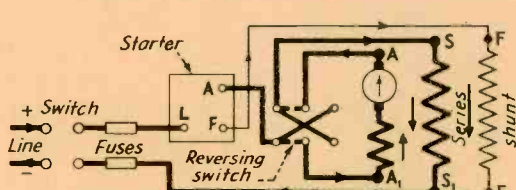
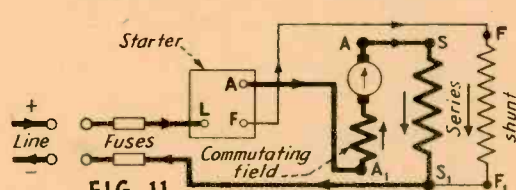
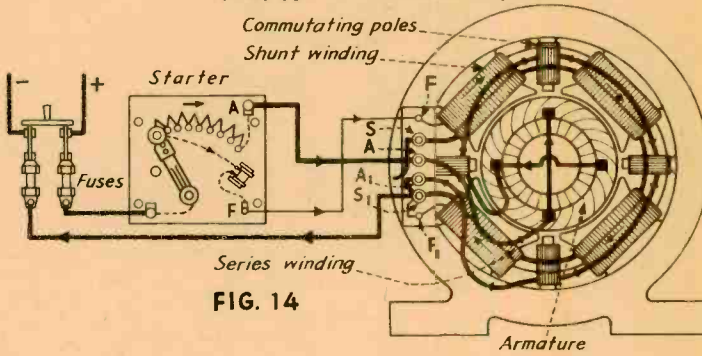
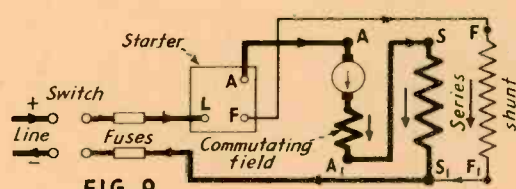
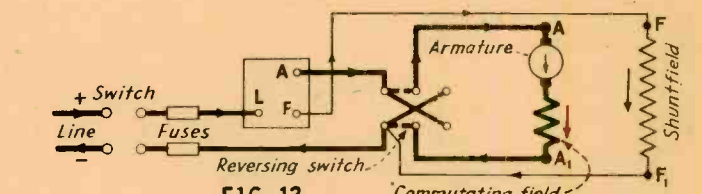
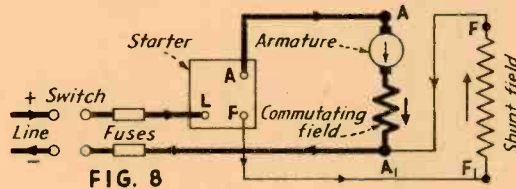
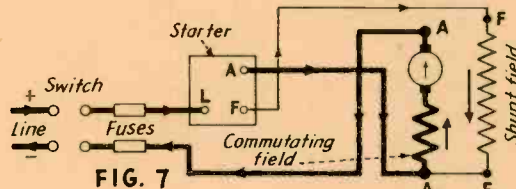
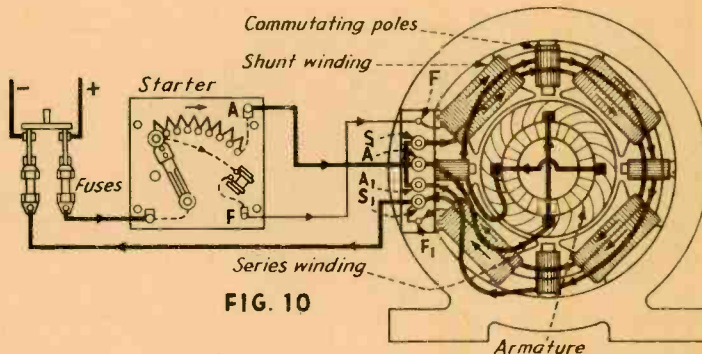
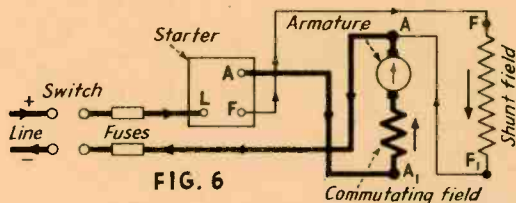
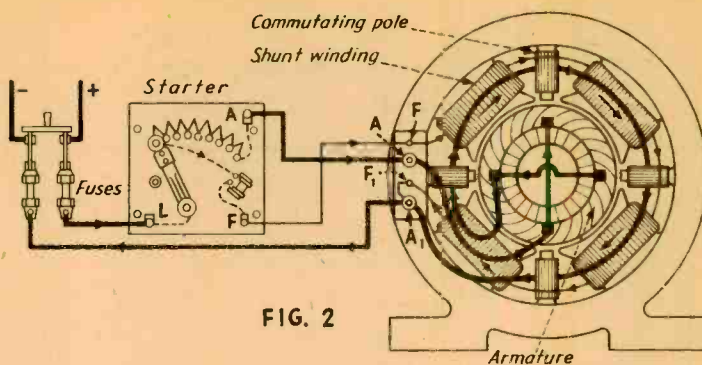
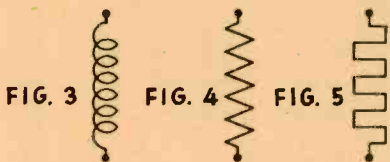
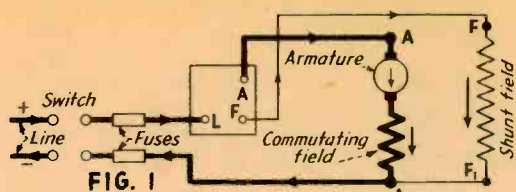
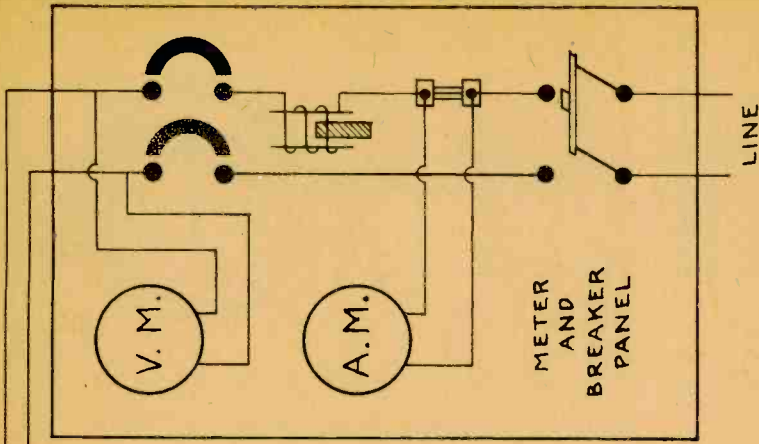

Fig. 1—Diagram of shunt motor and starter, Fig. 2. Figs. 3 and 4—Symbols for coils. Figs. 4 and 5—Symbols for resistance. Fig. 6—Same as Fig. 1, but current reversed in armature circuits. Fig. 7—Wrong connection for reversing shunt motor. Fig. 8—Same as Fig. 1, except current is reversed in shunt field coils. Fig. 9—Diagram of compound motor and starter, Fig. 10. Fig. 12—Reversing switch connected in armature circuit of shunt motor. Fig. 13—Reversing switch connected in armature circuit of compound motor to test polarity of shunt-field coils. Fig. 14—Series winding cut out of compound motor to test polarity of series coils. Fig. 15—Shunt winding cut out of compound motor to test polarity of series coils.



$$\text{H.P.} = \frac{2\pi \times P \times L \times \text{R.P.M.}}{33,000}$$

$$2\pi = 6.28$$

P = PULL ON LEVER IN LB.

L = LENGTH OF LEVER IN FT.

R.P.M. = REVOLUTIONS PER MINUTE.

$$\text{EFFICIENCY} = \frac{\text{WATT OUTPUT}}{\text{WATT INPUT}}$$

D.C. POWER DEPT.

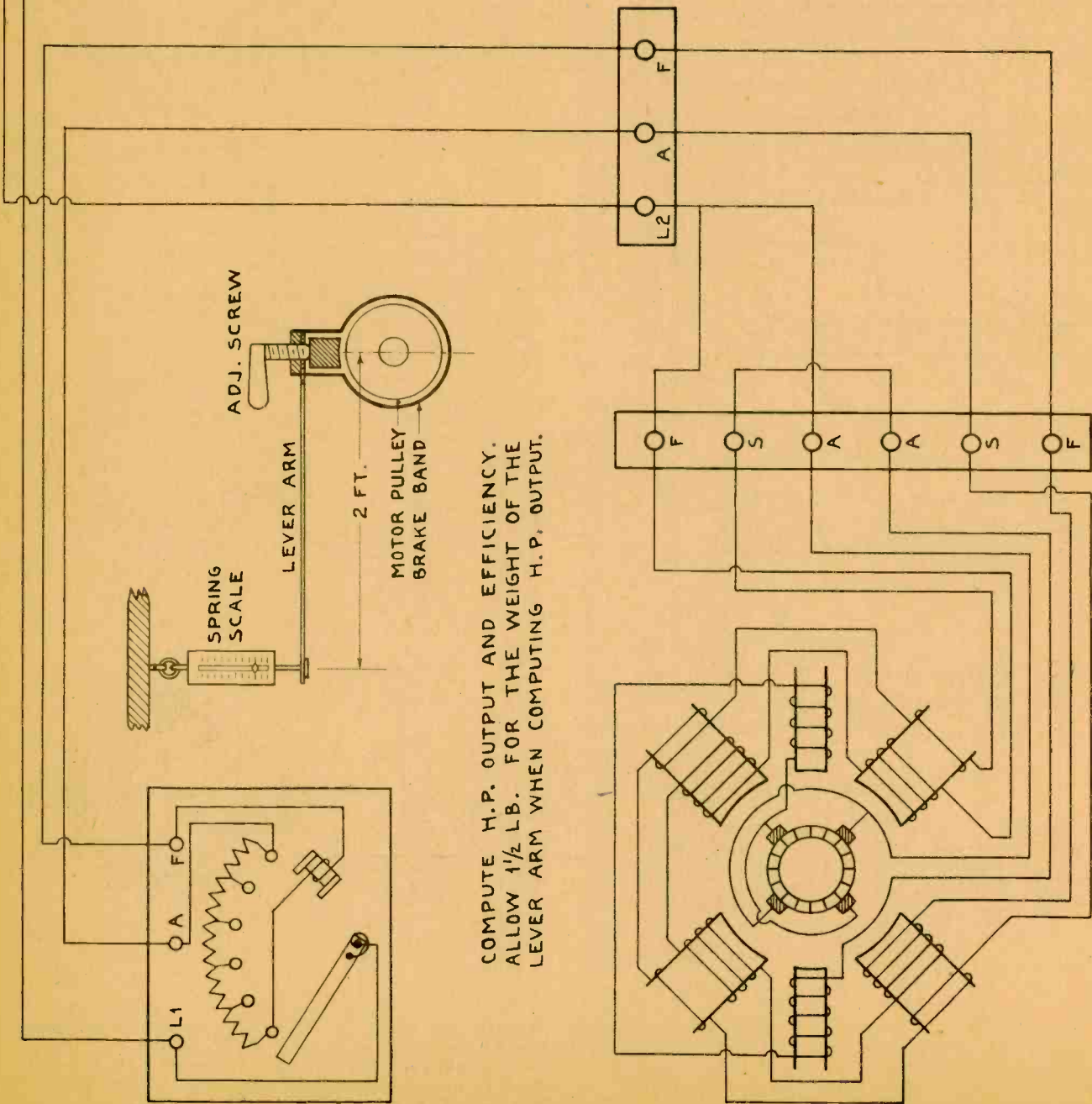

COMPUTE H.P. OUTPUT AND EFFICIENCY.
ALLOW 1/2 LB. FOR THE WEIGHT OF THE
LEVER ARM WHEN COMPUTING H.P. OUTPUT.

INDUSTRIAL CONTROLLER
Starting duty only

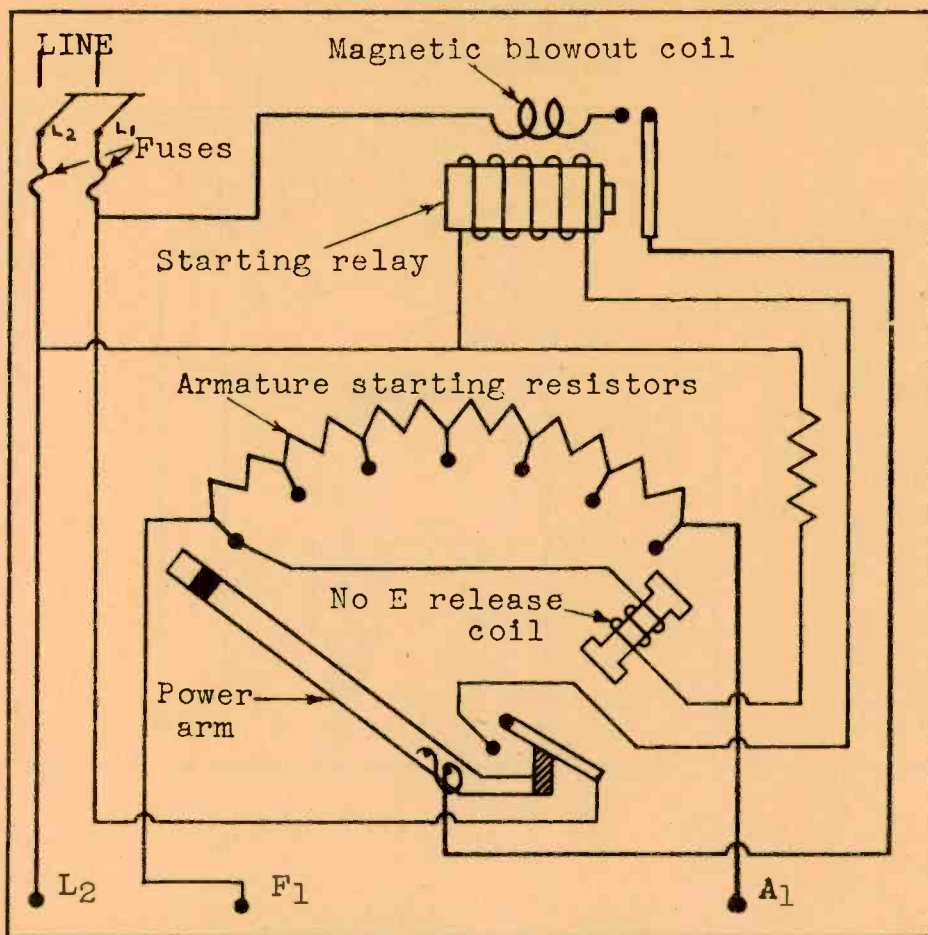

Draw a detailed diagram of the motor. Show all parts such as field poles, brushes, armature, terminals and the position of the terminal board. Test the motor terminals with test lamp to identify them.

Connect the motor to the controller as shown by the connection diagram. Trace the starting relay, field, armature and no E release coil circuits and have the diagram OKed by the instructor before wiring the job.

Connection Diagram

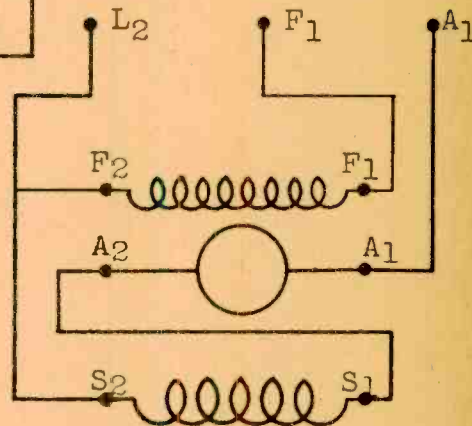

Connect as shown for compound motor.
For shunt motor connect A2 to L2

4 POINT CONTROLLERS

4 Point controller for starting & regulating duties.

4 Point controller for starting & regulating duties.

Speed control above normal.

Armature resistors

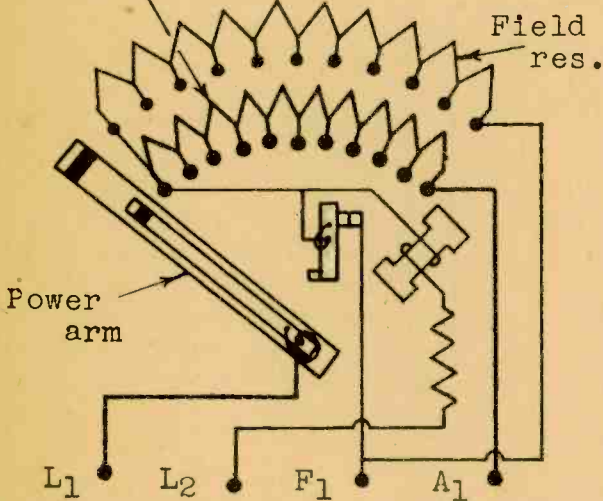

Speed control below normal.

Arm. res.

Power arm

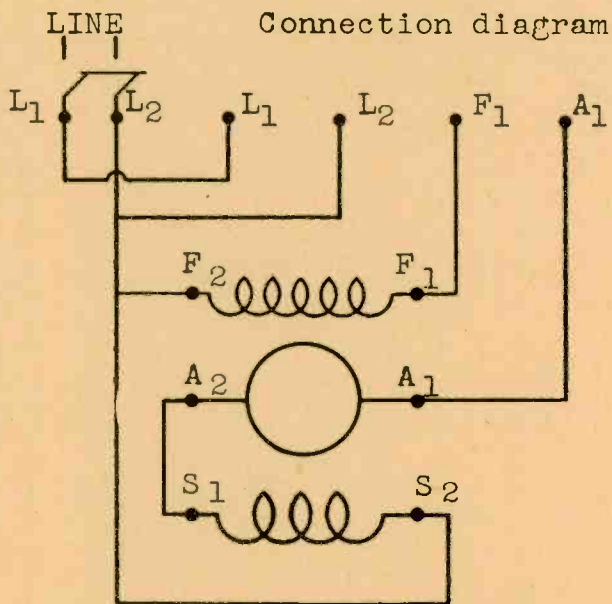
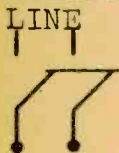

Connect as shown for compound motor. For shunt motor connect A2 to L2.

Draw diagram of motor in detail. Show all parts, such as, field poles, armature, brushes, terminal board and terminals. Test motor terminals to identify them. Trace armature, field and holding coil circuits. Have the diagram checked and OKed before wiring the job.

20311D

ORDER NO	NO. REQ'D	DEPARTMENT	RAW MAT. SPEC. WITH PART NO. & AMOUNT REQ'D
----------	-----------	------------	---

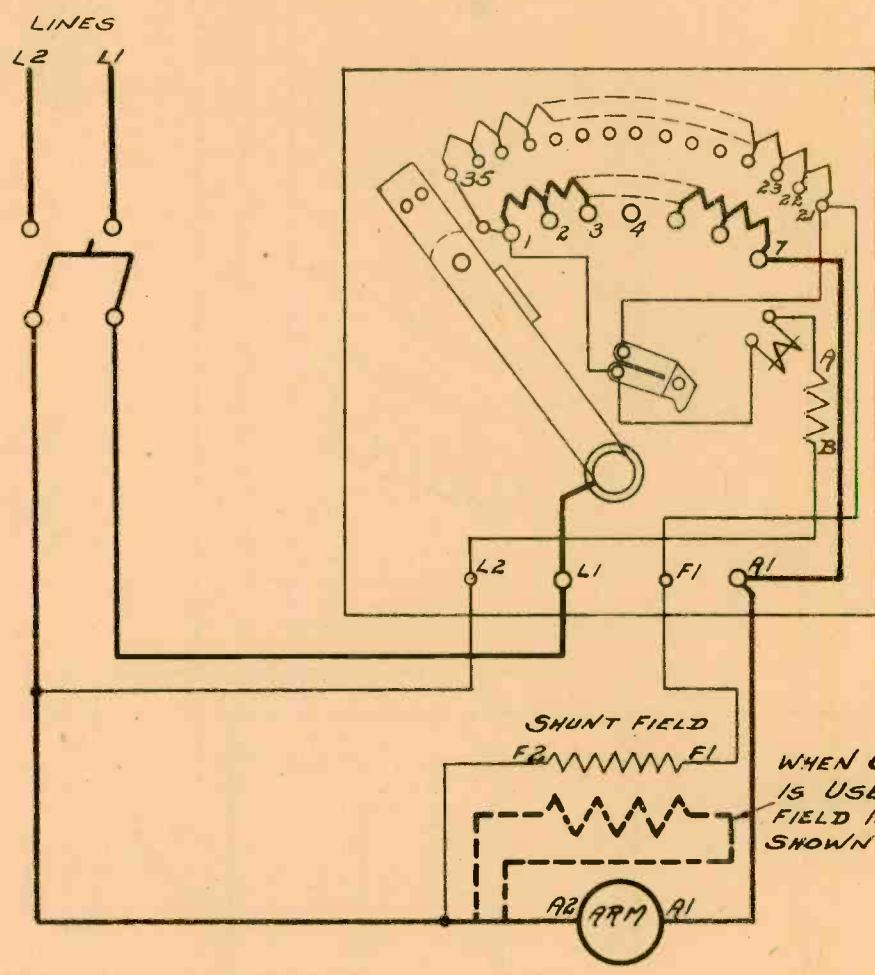

BULL. NO. 2230
 CLASS NO. 74446
 TYPE A

FORM 357-ORM. 35734

STANDARD CONNECTIONS FOR COMPOUND MOTOR STARTER WITH NO VOLTAGE

NAME RELEASE FOR SHUNT OR COMPOUND MOTOR		FINISHED PART NO.	FINISH
SUPERSEDES NO. T14163-D		SUPERSEDED BY NO.	
FIRST ASSEMBLY WHERE USED			
A		D	
B		E	
C		F	

SCALE: DRAWN BY: CHECKED BY: **H. P. HUTH** APPROVED BY: **H. P. HUTH**

TOLERANCES ON ALL FRACTIONAL MACHINED DIMENSIONS TO BE ± .015
 TOLERANCES ON ALL DECIMAL DIMENSIONS TO BE ± .005 UNLESS OTHERWISE SPECIFIED.

THE CUTLER-HAMMER MFG. CO., MILWAUKEE, WIS.

20311D

JOB NO. 15

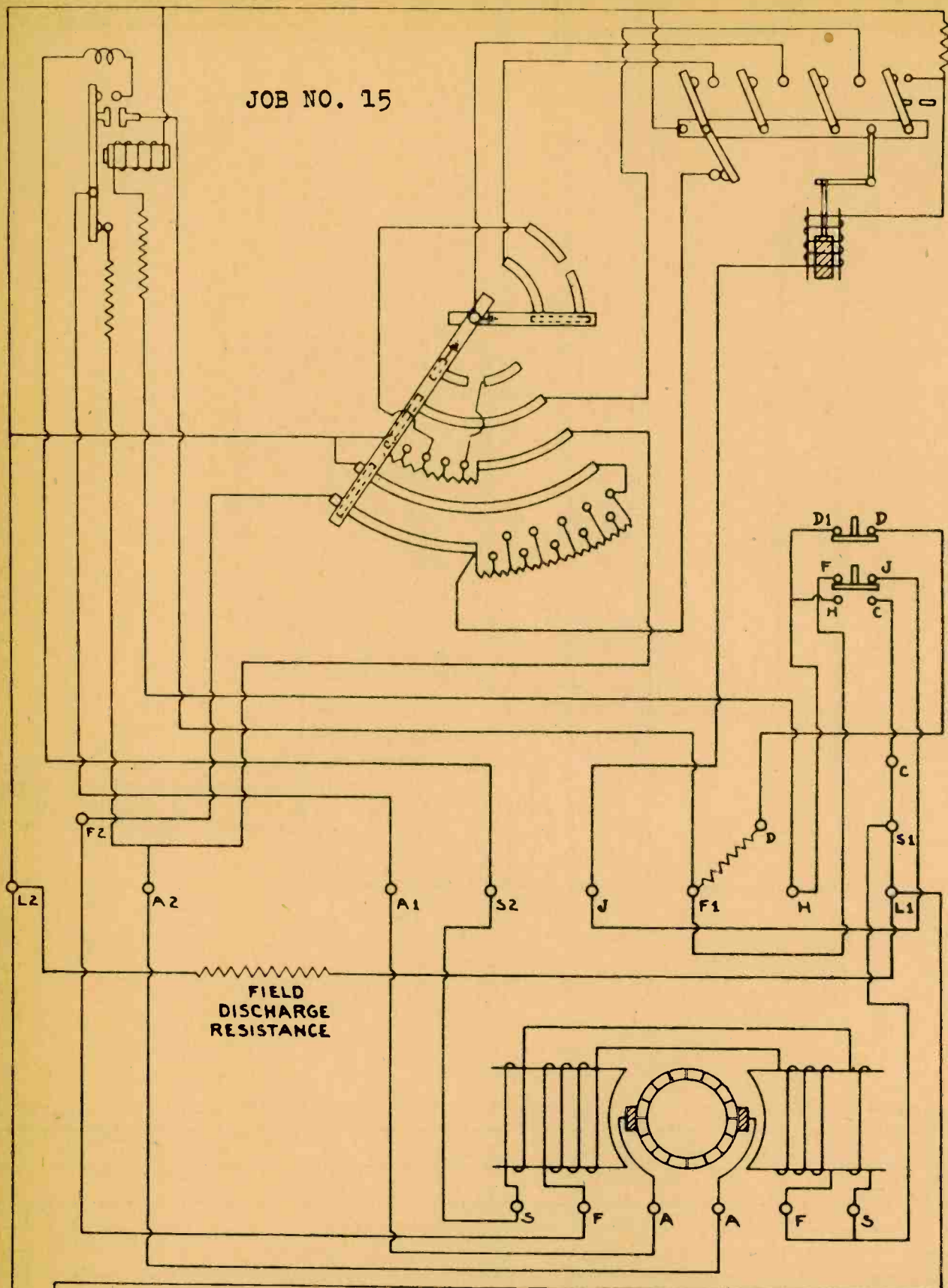

LINE

PRINTING PRESS CONTROLLER.

DRUM CONTROLLERS

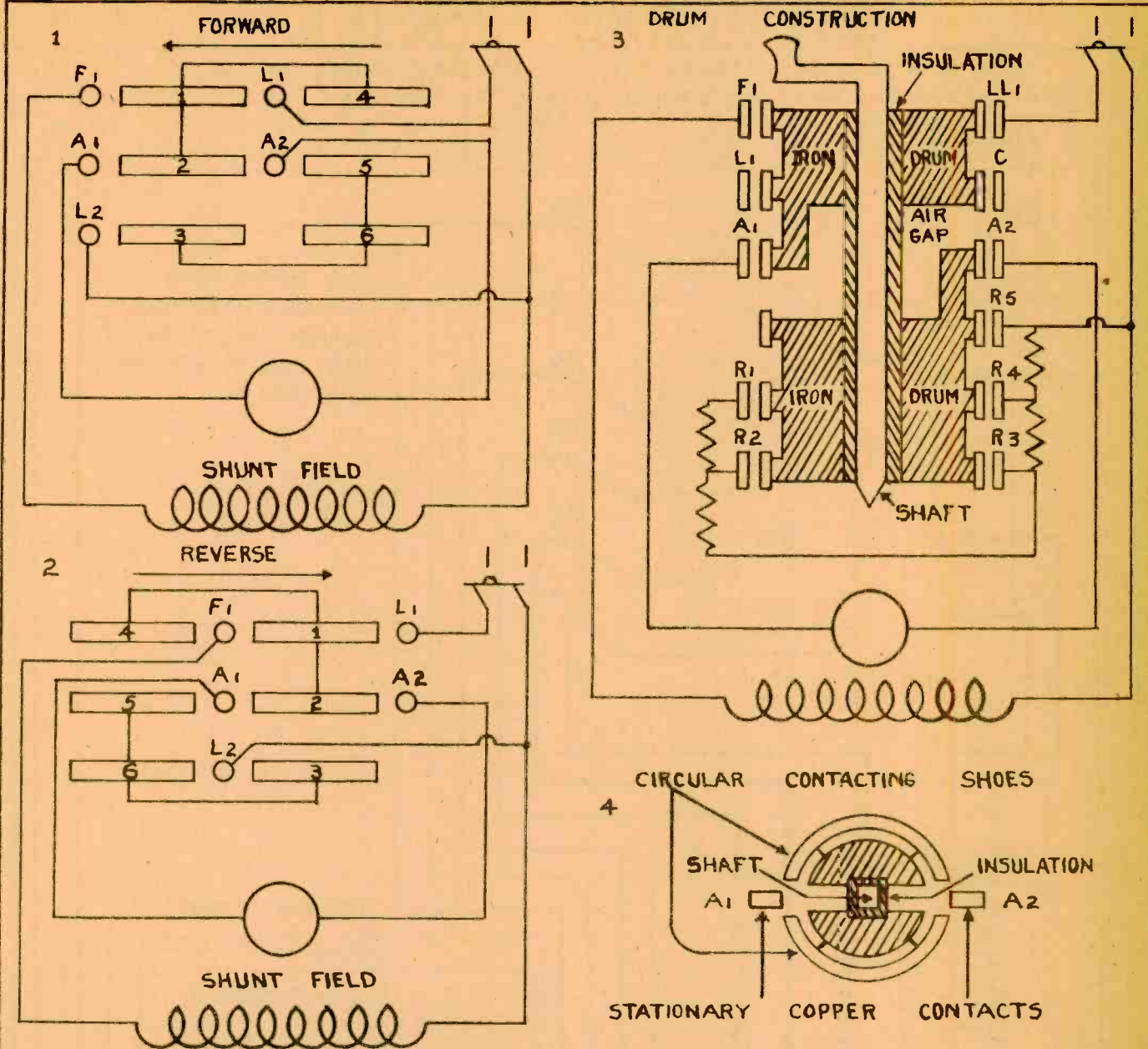

Drum controllers are used extensively in the operation of D.C. motors where they must be started, stopped, reversed, and have their speed varied, as on street cars, electric trains, hoists, cranes, etc.

The name is derived from their shape and the manner of mounting contacts on a round iron drum. The cylindrical arrangement of the contacts allows the drum to be rotated part of a revolution in either direction, and brings into connection one or more stationary contacts with the iron drum. The iron drum serves as a mechanical support for the shoes and forms a part of the conducting path.

A drum controller, designed for reversing duty, is divided into two parts, completely insulated from each other and from the shaft by fibre insulation.

When the controller in Fig. 2 is in running position, current will flow from positive line to stationary contact "L₁" (Called "contact finger") and enter the iron drum at circular shoe #1, and then flows through the iron drum to shoe #2, which is connected to "A₂", completing the circuit through the armature. The return circuit for the armature is from "A₁" to Shoe #5, through iron drum to shoe #3, which is connected to "L₂".

Drum controllers are very rugged and will give excellent service with a minimum of maintenance. The contact fingers and bars may be replaced when burned or worn. Drum controllers may be equipped with auxiliary contacts that close when the drum is in the "OFF" position. These contacts are used to complete a dynamic brake circuit or to operate relays for overhead protection.

DRUM CONTROLLER WITH OVERLOAD PANEL

This diagram illustrates how an overload panel is used to protect the motor against overload and "no voltage" conditions, by using contacts "L1" and "C" to complete the relay circuit when the controller is in the "off" position.

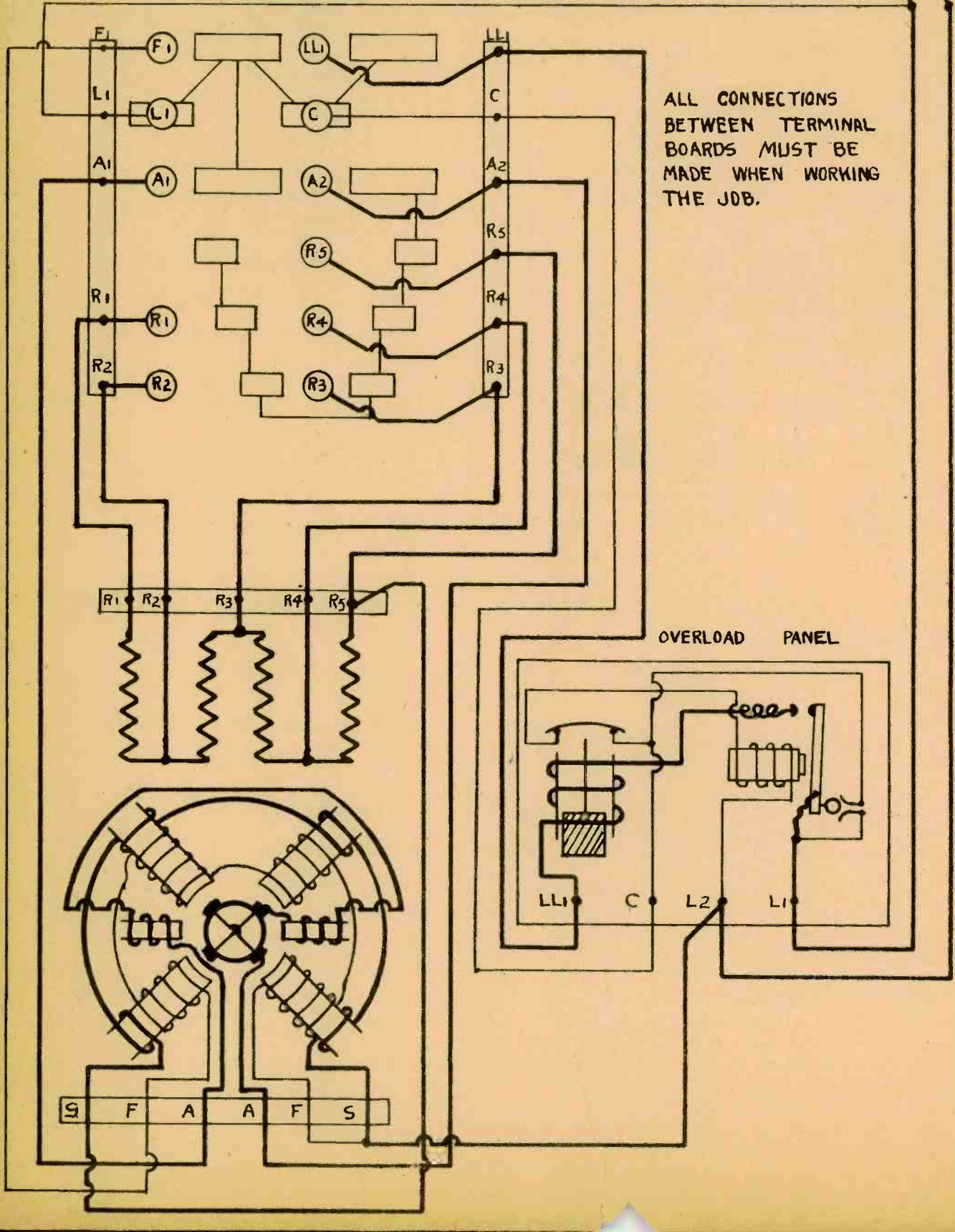

DRUM CONTROLLER & SERIES MOTORS.

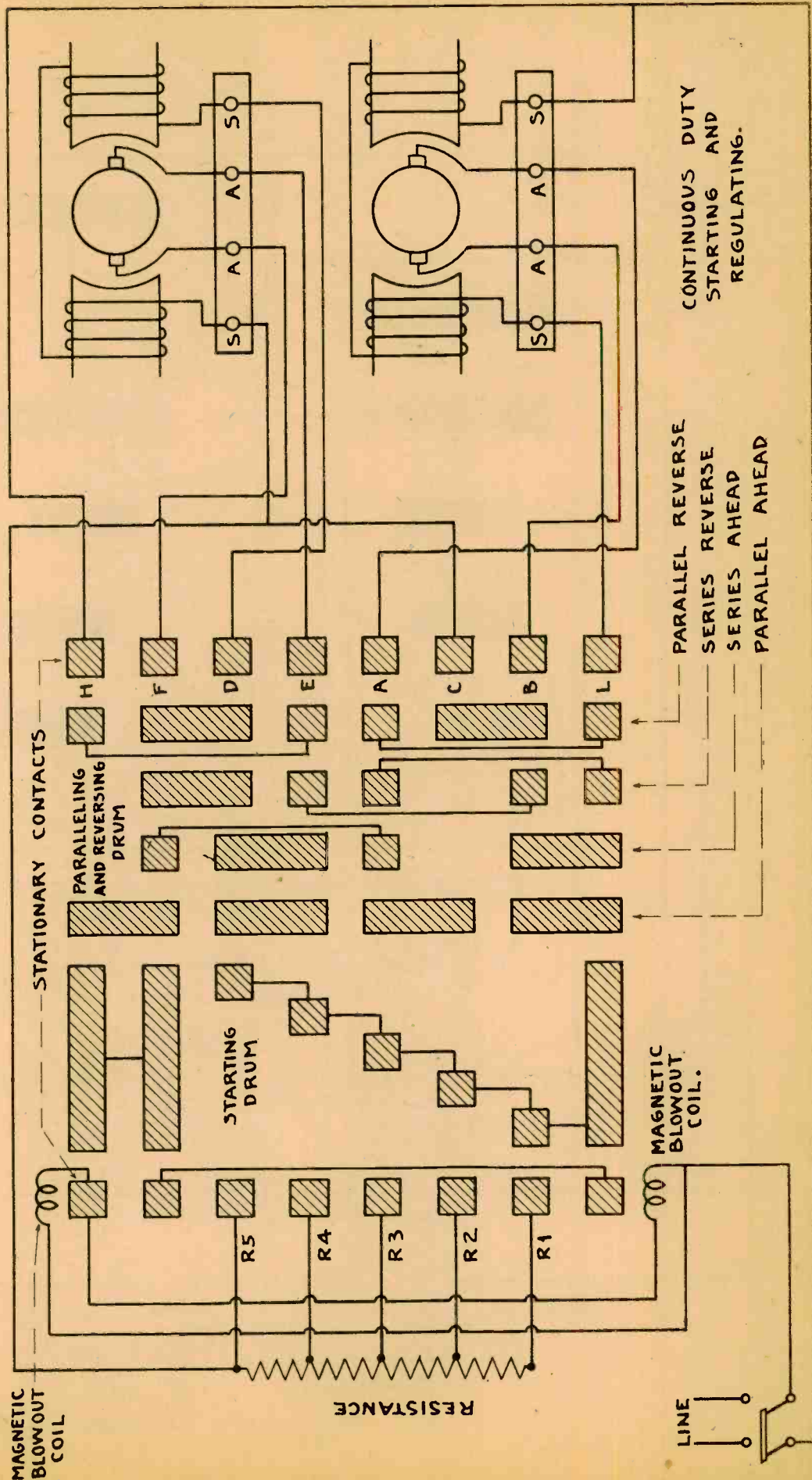

Drum controller for starting, regulating and reversing duties.

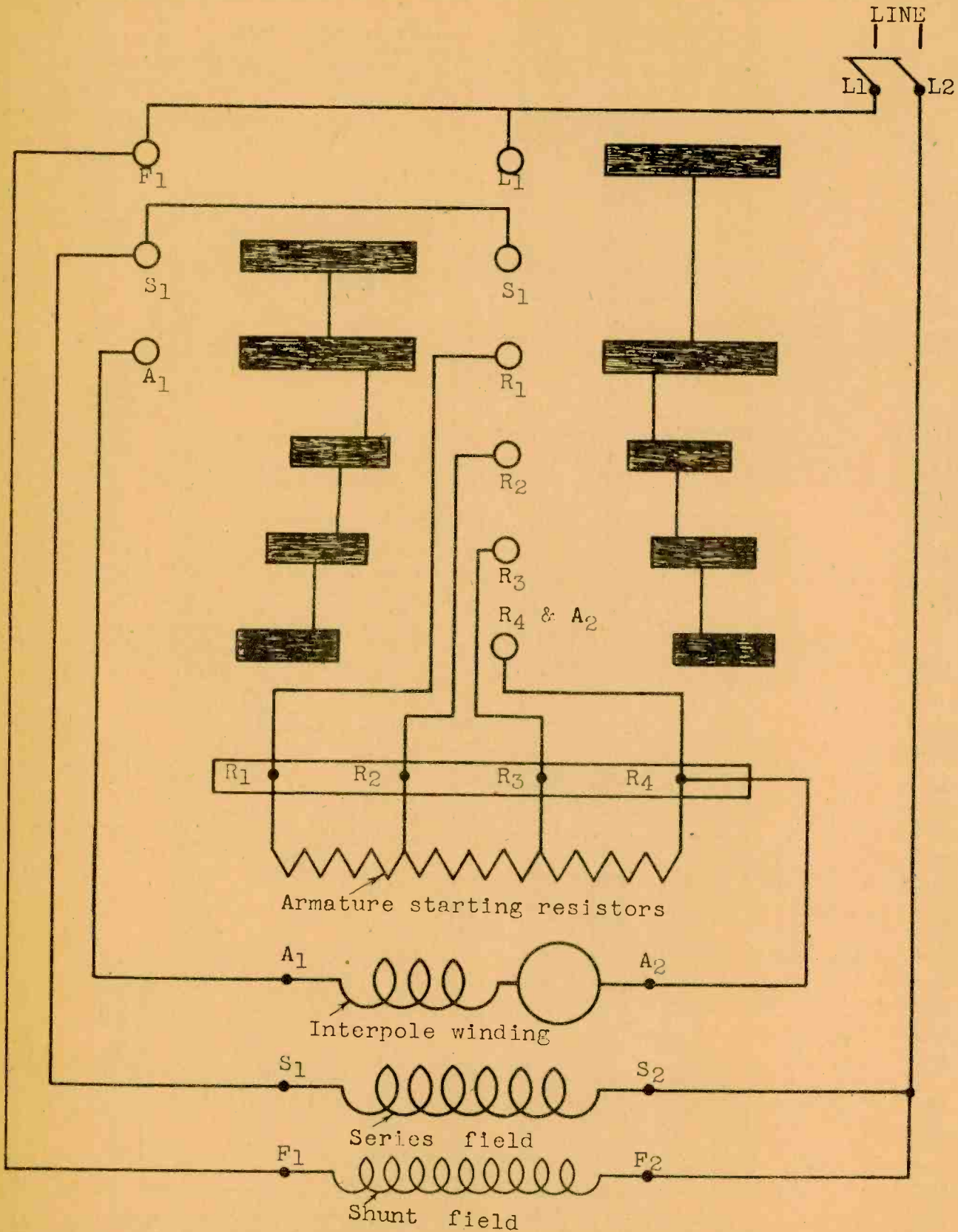

Trace forward armature, reverse armature and field circuits. Draw the terminal board on the diagram and test and identify the terminals. Do not show the terminals connected. Make all connections as shown if a compound motor is used. If shunt motor is used connect S1 to L2. If series motor is used omit F1 connection.

DRUM CONTROLLER
STARTING, REGULATING & REVERSING DUTIES

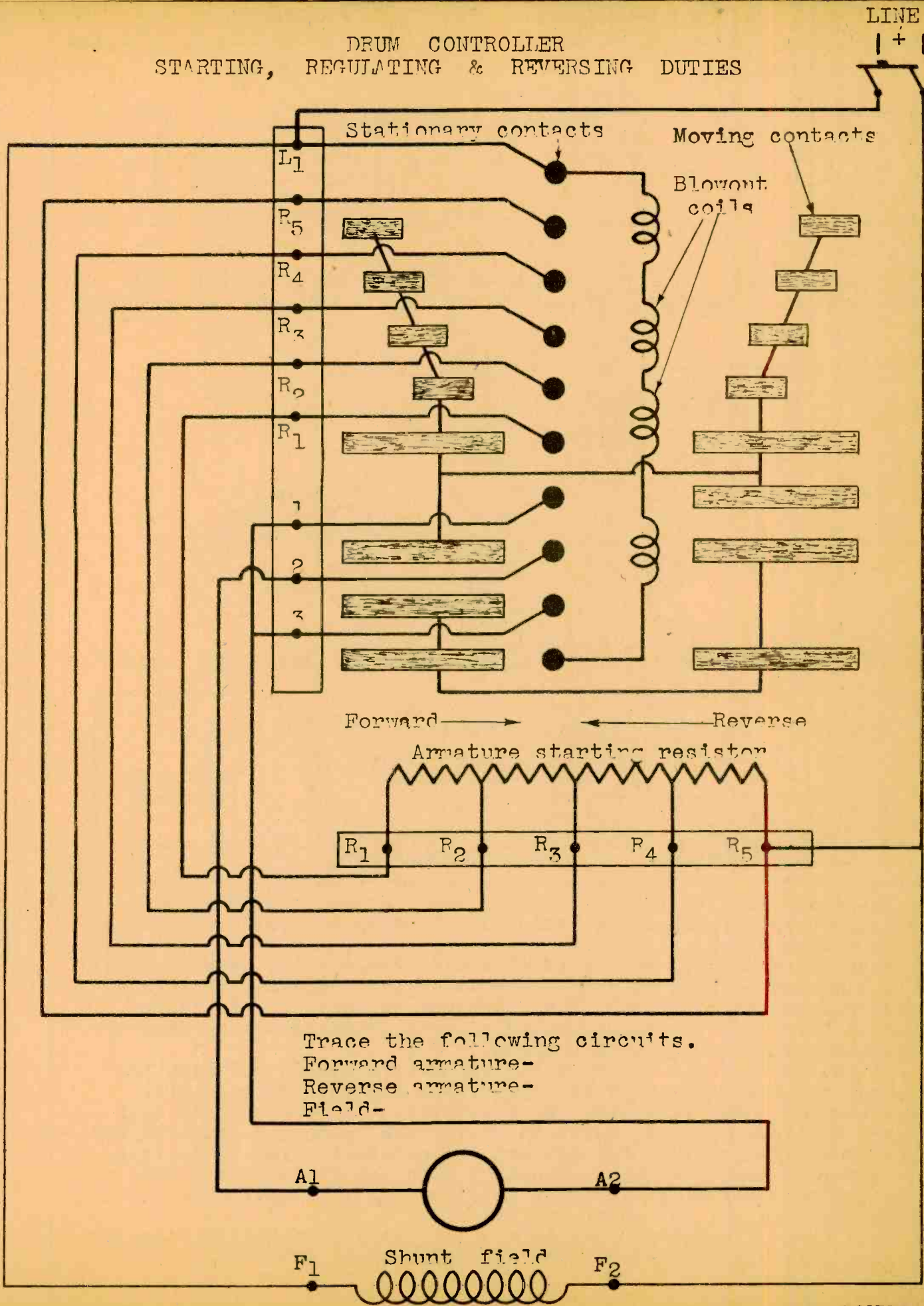

DYNAMIC BRAKING

RUNNING

BRAKING



IN FIGURES 1, 2 & 3 SWITCHES A & D ARE CLOSED AND B & C ARE OPEN WHEN RUNNING. SWITCHES B & C ARE CLOSED AND A & D OPEN WHEN BRAKING

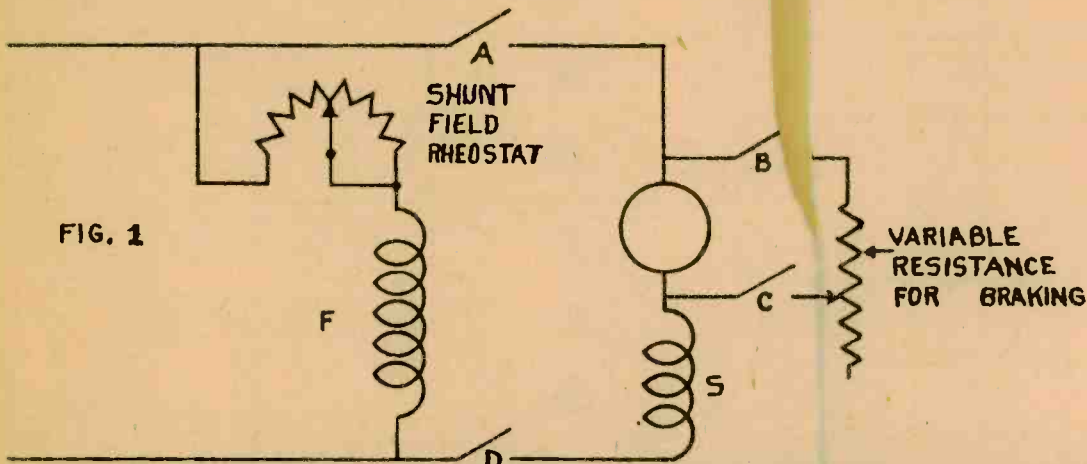

SCHEMATIC DRAWINGS SHOWING DYNAMIC BRAKE CONNECTIONS FOR SERIES MOTORS

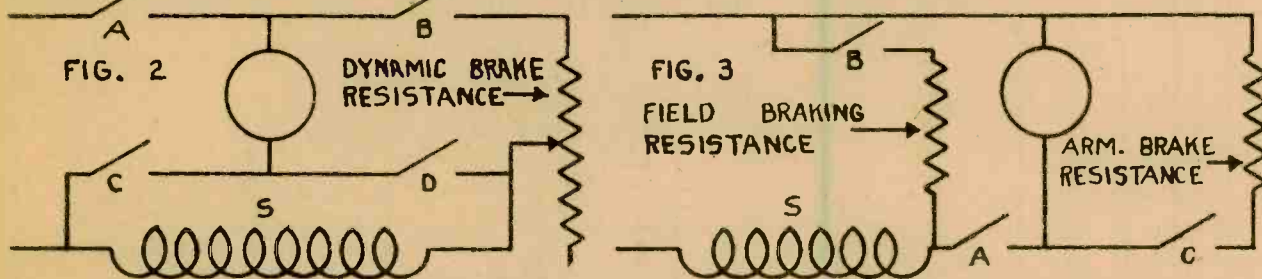

The above diagram in Fig. 1 shows the connection used in dynamic braking, using a compound motor. Fig. 2 shows similar connections for a series motor.

When the source of supply is shut off from a motor, the armature will continue to turn or coast because of its momentum. Any load connected to the motor will also continue to operate. In cases where motors must be stopped quickly, this momentum may be used to generate energy for dynamic braking.

If the shunt field of the motor is excited during the coasting period, the motor will act as a generator and the armature will generate EMF until it stops. By connecting a suitable resistance in the armature circuit, as shown above, the generated armature EMF will cause the armature current and the armature poles to reverse. The reversed armature poles, reacting with the field poles, will now tend to reverse the armature rotation and this action will result in stopping the motor and load.

This form of braking provides a quick, smooth, magnetic form of braking that has many advantages over mechanical methods.

DRUM CONTROLLER USED FOR DYNAMIC BRAKING

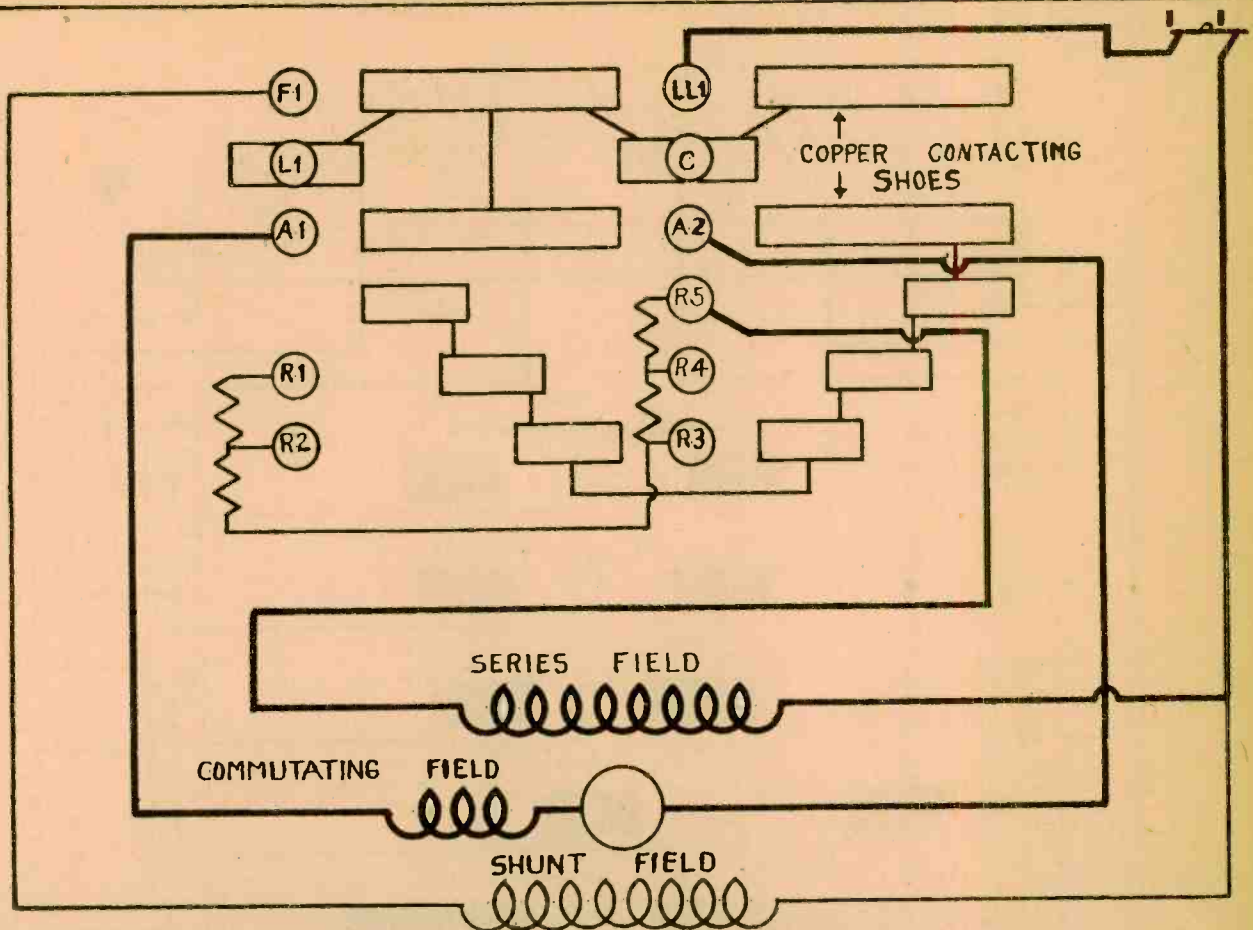

This diagram shows a compound motor controlled by a drum controller having auxiliary contacts for dynamic braking.

Advantages of this type of braking are: no mechanical wear, less maintenance, economical, effective and, although powerful, will not damage the motor is properly applied.

Caution must be used, when applying dynamic braking, to prevent an overload of current through the armature. This is accomplished by connecting a resistance in series with the armature braking circuit, or by decreasing the field strength to lower the CEMF generated.

Dynamic braking is known as "regenerative braking," when the current generated by the CEMF is fed back into the power line. By leaving the armature connected to the line and over-exciting the field, the CEMF becomes greater than the line voltage. This means that the motor will now act as a generator and will help to carry the line load. This method is used on electric trains which run down long grades. In some systems, as much as 35% of the power used is generated in this manner.

Dynamic braking, or regenerative braking, is only effective when the armature is rotating. Therefore, where it is necessary to hold a load which tends to revolve after brought to a stop, some form of magnetic or mechanical brake must be used in conjunction with dynamic braking.

DRUM CONTROLLER
STARTING, REGULATING, REVERSING AND DYNAMIC BRAKE DUTIES.

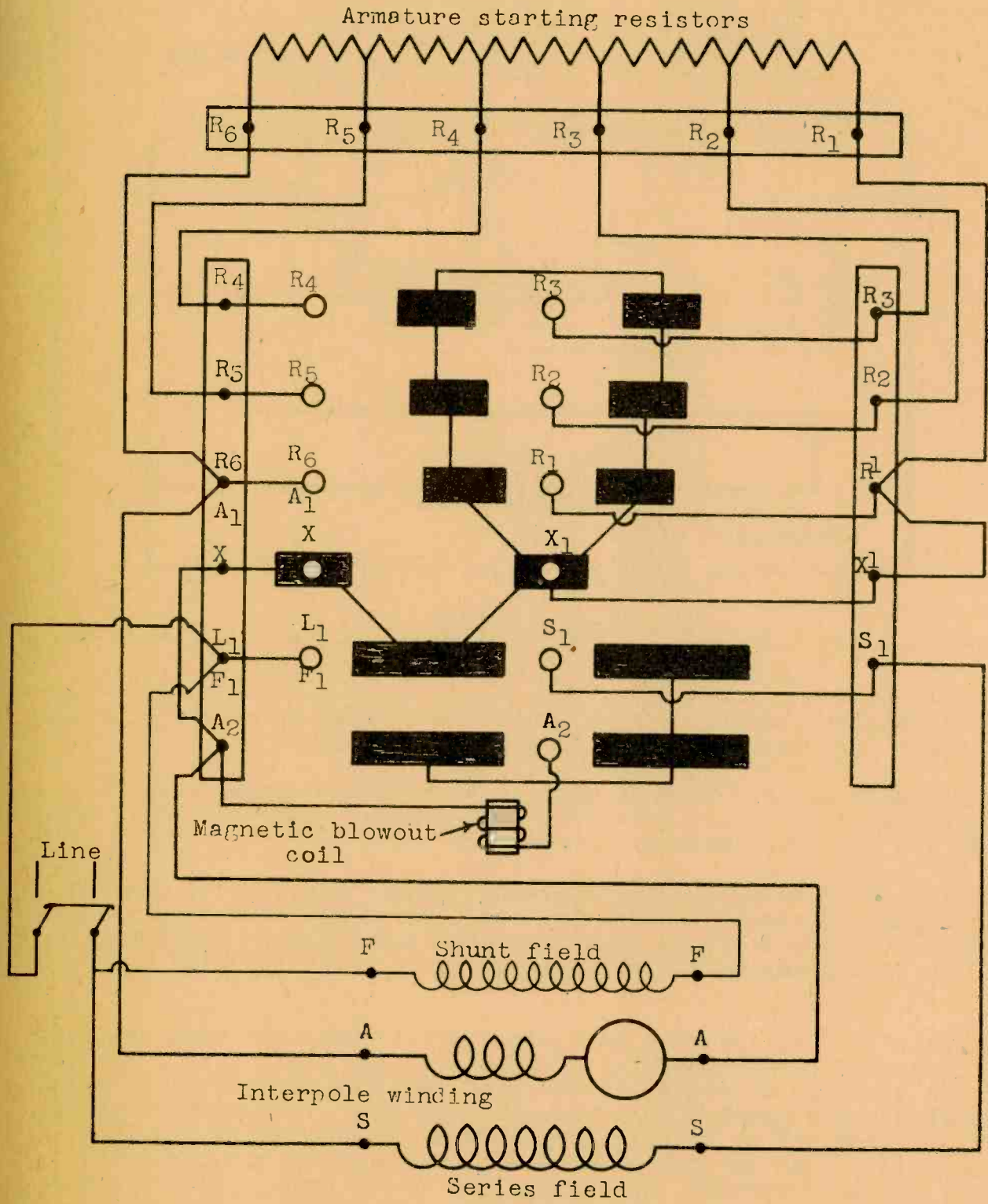

Trace armature, field and dynamic brake circuits.

STARTING, REVERSING AND REGULATING DUTIES

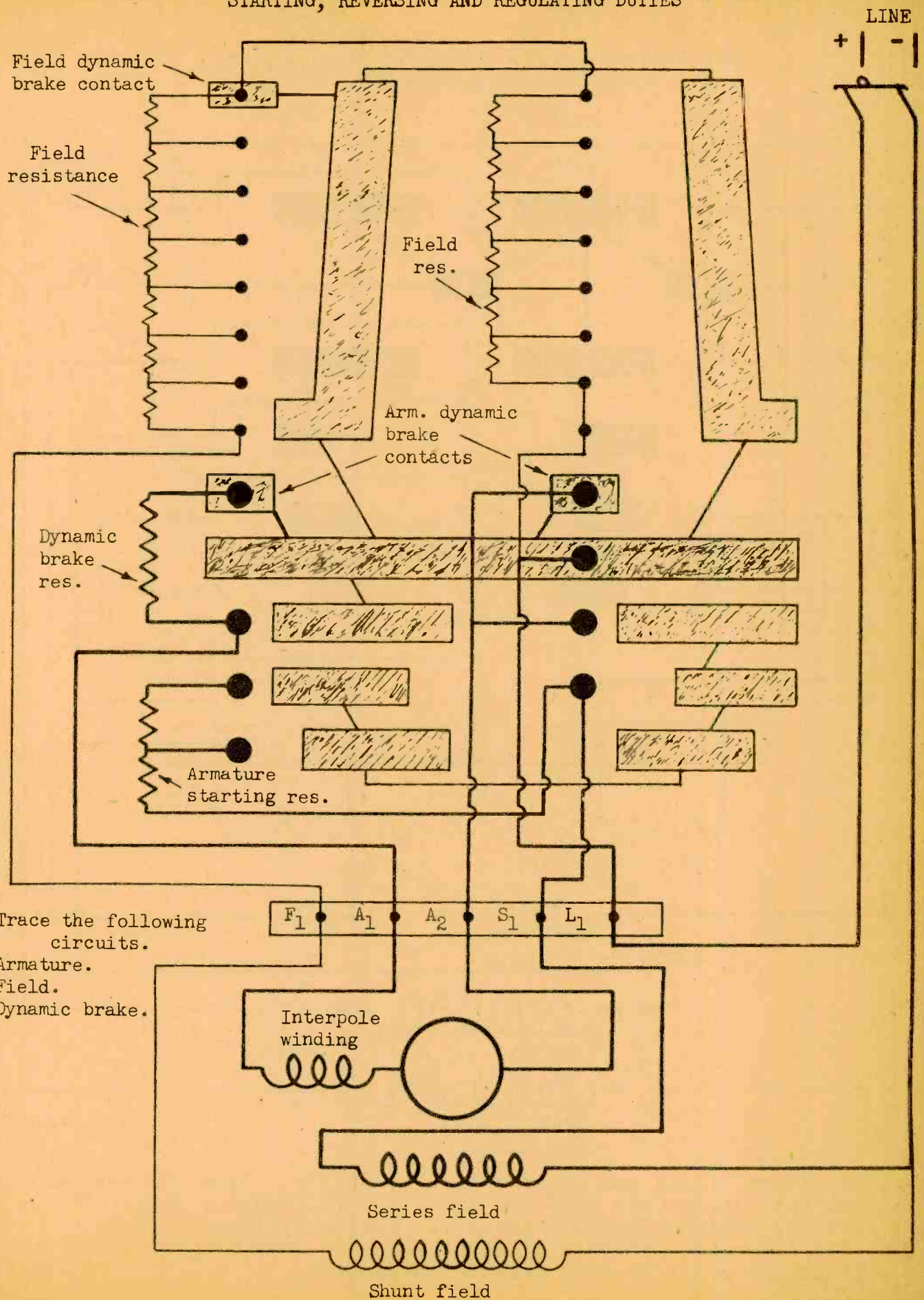

Trace the following circuits.
 Armature.
 Field.
 Dynamic brake.

Drum controller for starting, regulating, reversing and dynamic brake duties.

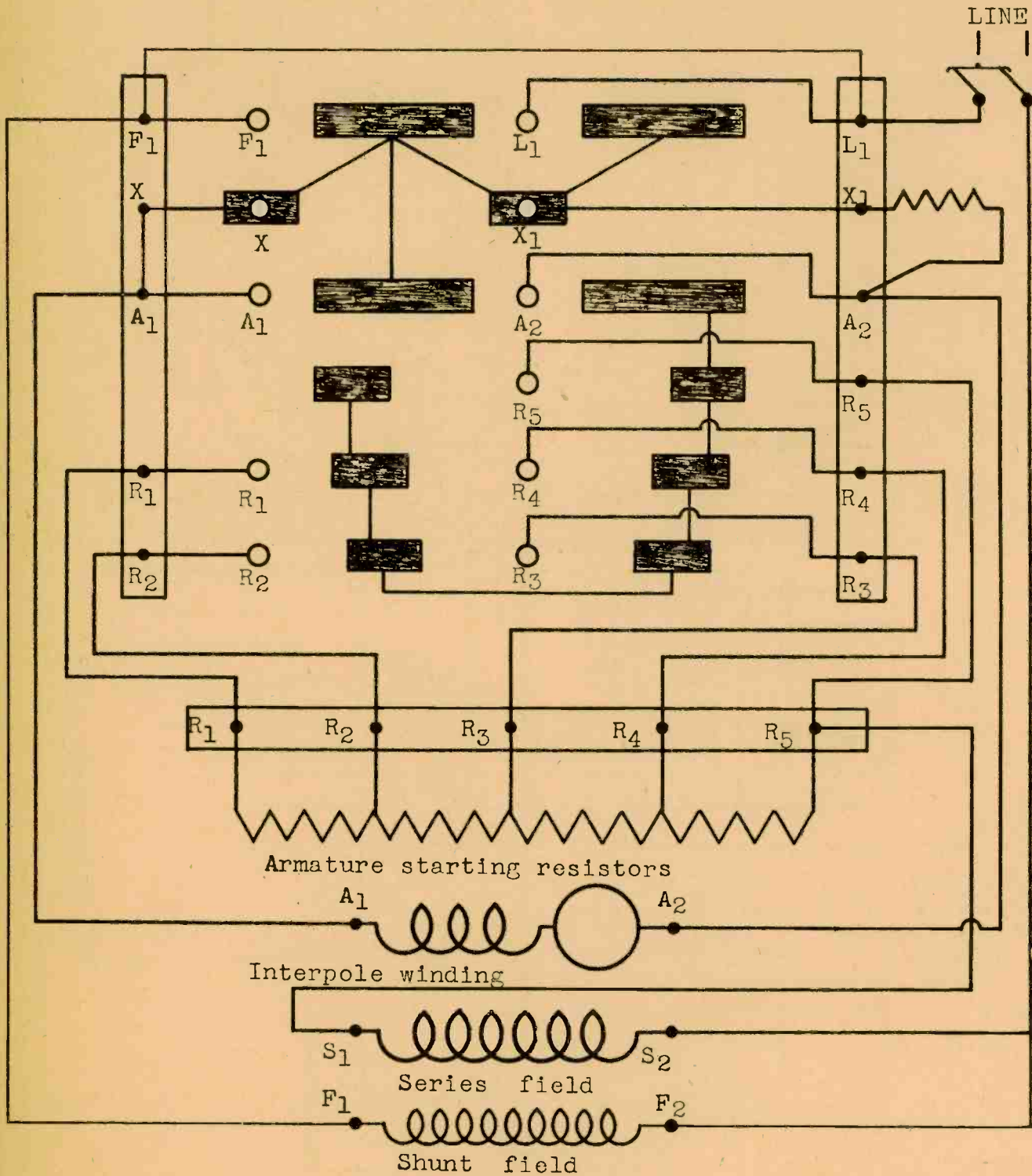

Trace armature, field and dynamic brake circuits. Draw the terminal board on the diagram and test the terminals to identify them. Do not show the terminal board connected. Make all connections as shown for a compound motor. If shunt motor is used connect R₅ to L₂. If series motor is used omit F₁ connection.

SOLENOID STARTER

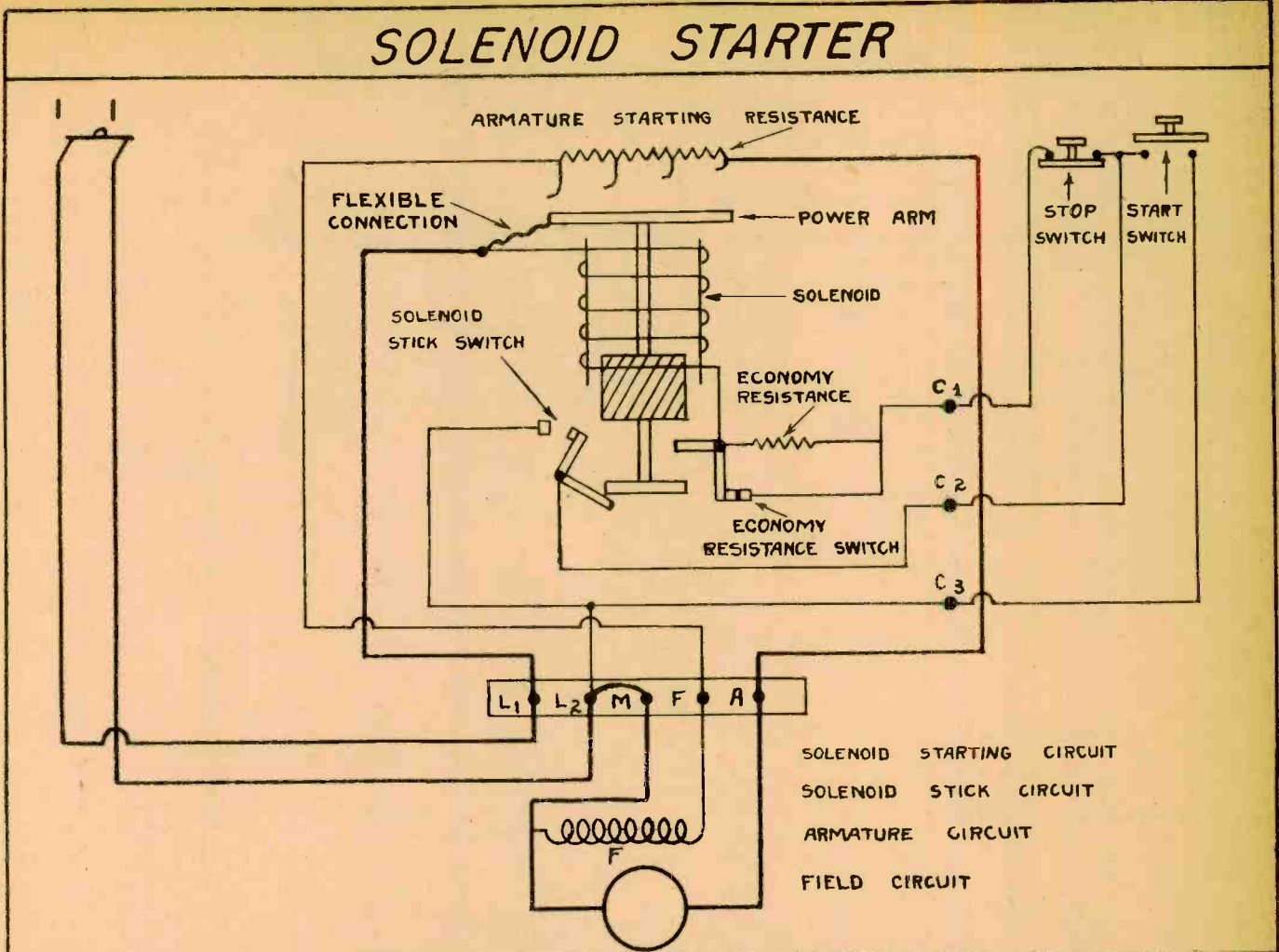

MAGNETIC BLOWOUT COIL

A magnetic blowout coil is for the purpose of providing a strong magnetic field to extinguish the arc drawn when the circuit is broken. It consists of a few turns of heavy wire wound on an iron core which has its poles placed on either side of the contacts where the circuit is broken. This arrangement provides a powerful magnetic field where the circuit is broken.

The arc is a conductor and has a magnetic field set up around it. This field will be reacted upon by the flux of the blowout coil distorting the arc so that it is quickly broken or extinguished. This prevents the arc from burning the contacts.

Magnetic blowout coils are connected in series with the line or in series with the contacts being protected.

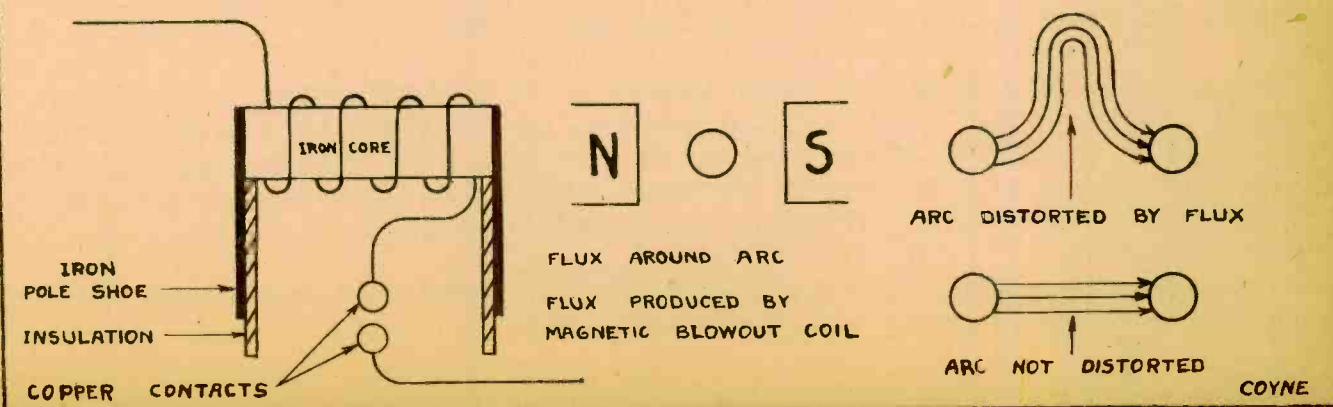

CARBON PILE STARTER (ALLEN - BRADLEY)

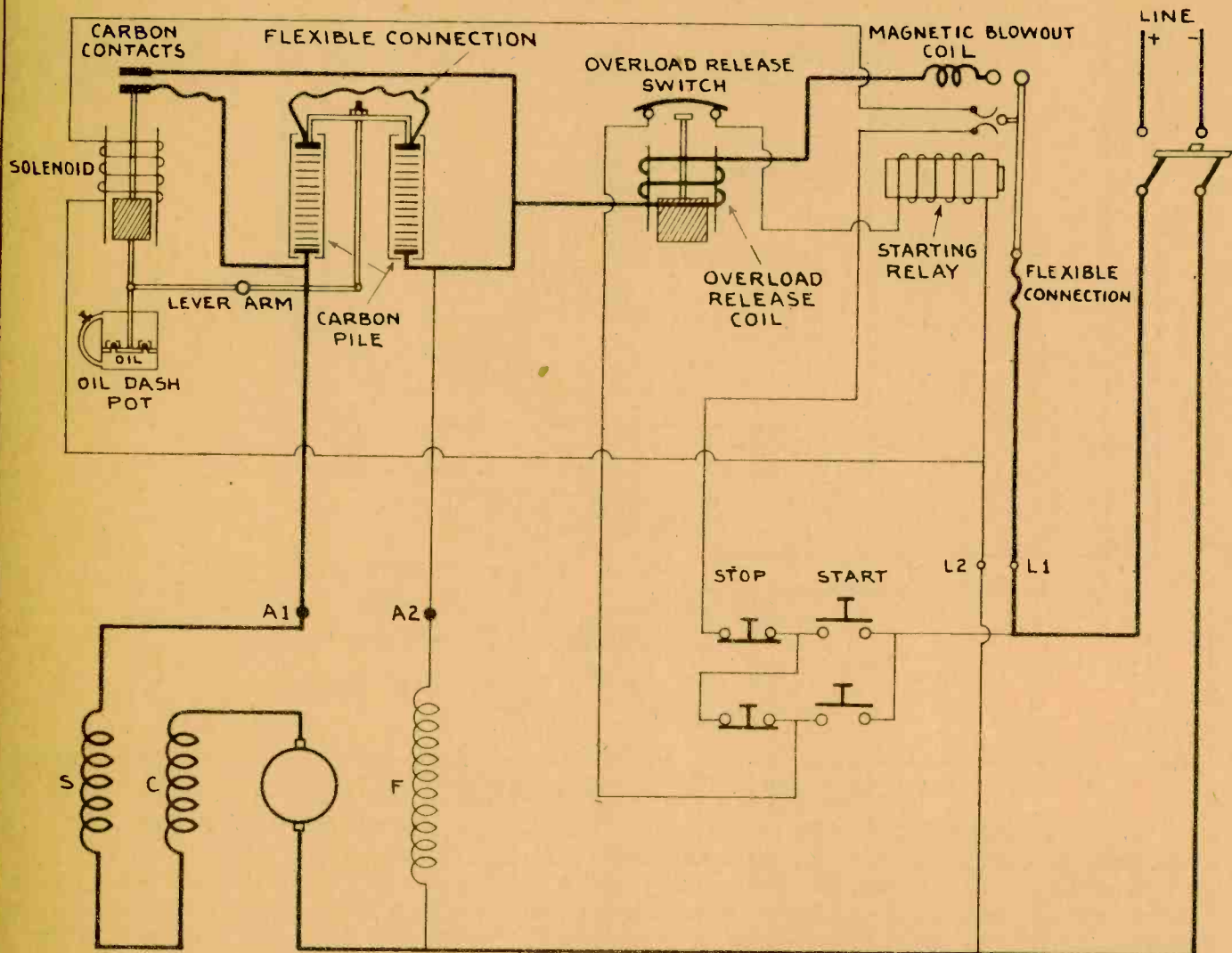

In certain classes of work it is desirable to have very gradual application of the starting torque of the motor when the machine is first put in operation. To accomplish this, it is necessary to start the motor with extremely high resistance in the armature circuit, and limit the starting current to a very low value.

For this purpose, carbon pile starters are made with resistance elements consisting of small carbon disks stacked in tubes of non-combustible material with an insulating lining.

As long as these disks are left loose in the tube, the resistance through them is very high. If pressure is applied to these carbon disks, their combined resistance will be lowered because the greatest resistance is at the contacts between disks. As pressure increases, resistance decreases allowing more current to flow.

This allows the motor to start very slowly, and its speed will gradually increase until normal speed is attained.



WIRING DIAGRAMS

D. C. MAGNETIC RELAYS AND LINE VOLTAGE STARTERS

CLASSES 7001, 7032

Class 7001

Class 7032

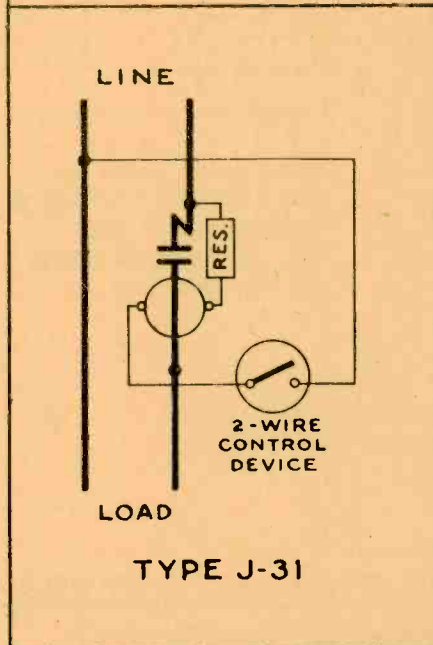
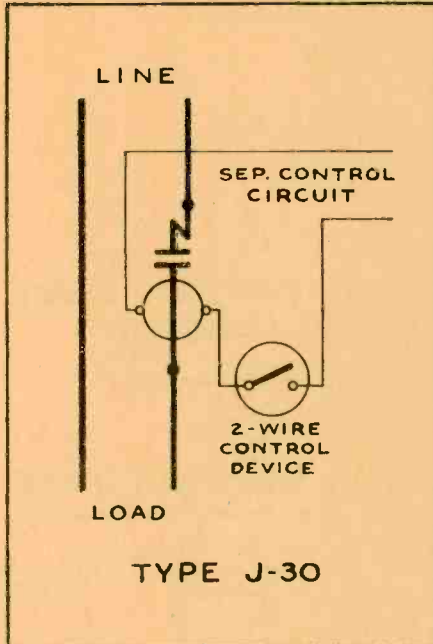

NOTE: CLASS 7001-TYPE K RELAYS ARE WIRED THE SAME AS CLASS 8501 TYPE K. SEE CLASS 8501 WIRING DIAGRAMS.

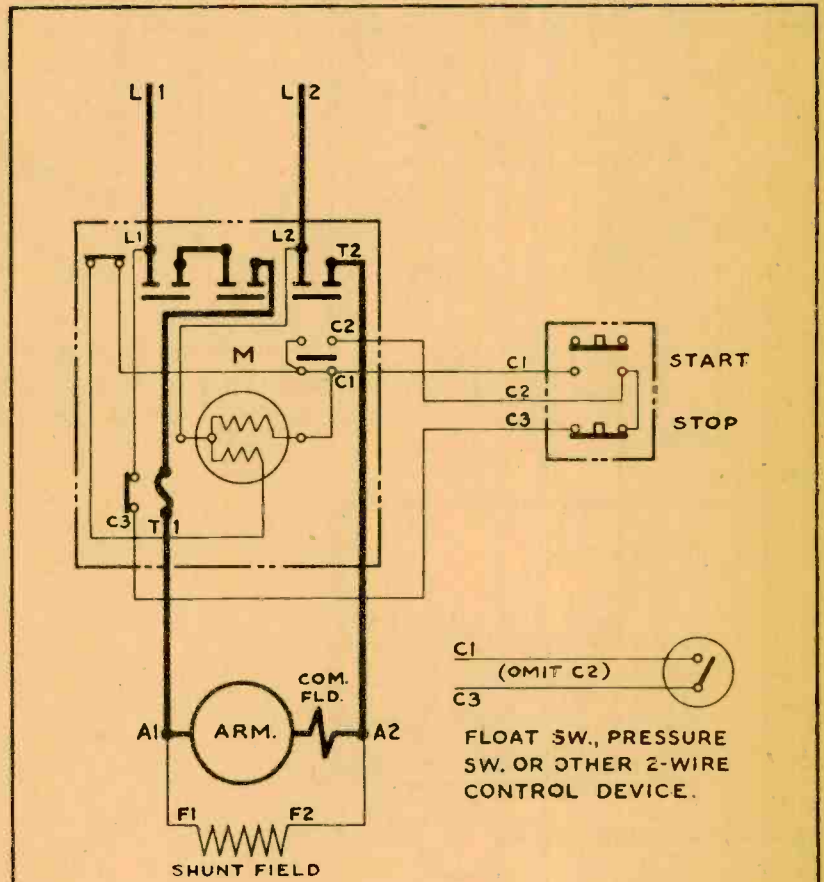

CLASS 7032 TYPE S-2 D.C. LINE VOLTAGE STARTER

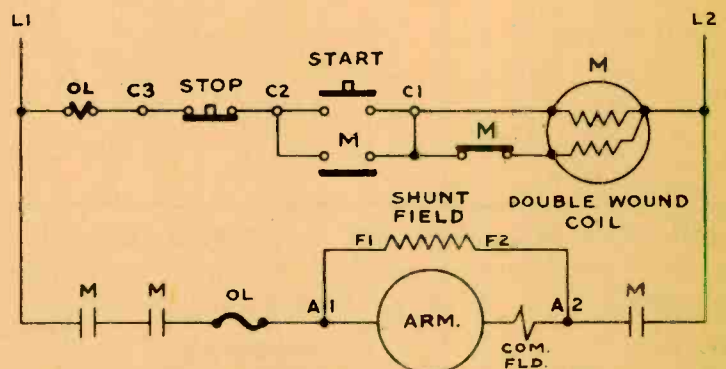

ON GROUNDED SYSTEMS, L2 IS GROUNDING LINE.

FRONT VIEW DIAGRAM

WHEN AUTOMATIC RESET
O.L. RELAY IS USED
2 WIRE PILOT DEVICE
SHOULD NOT BE USED

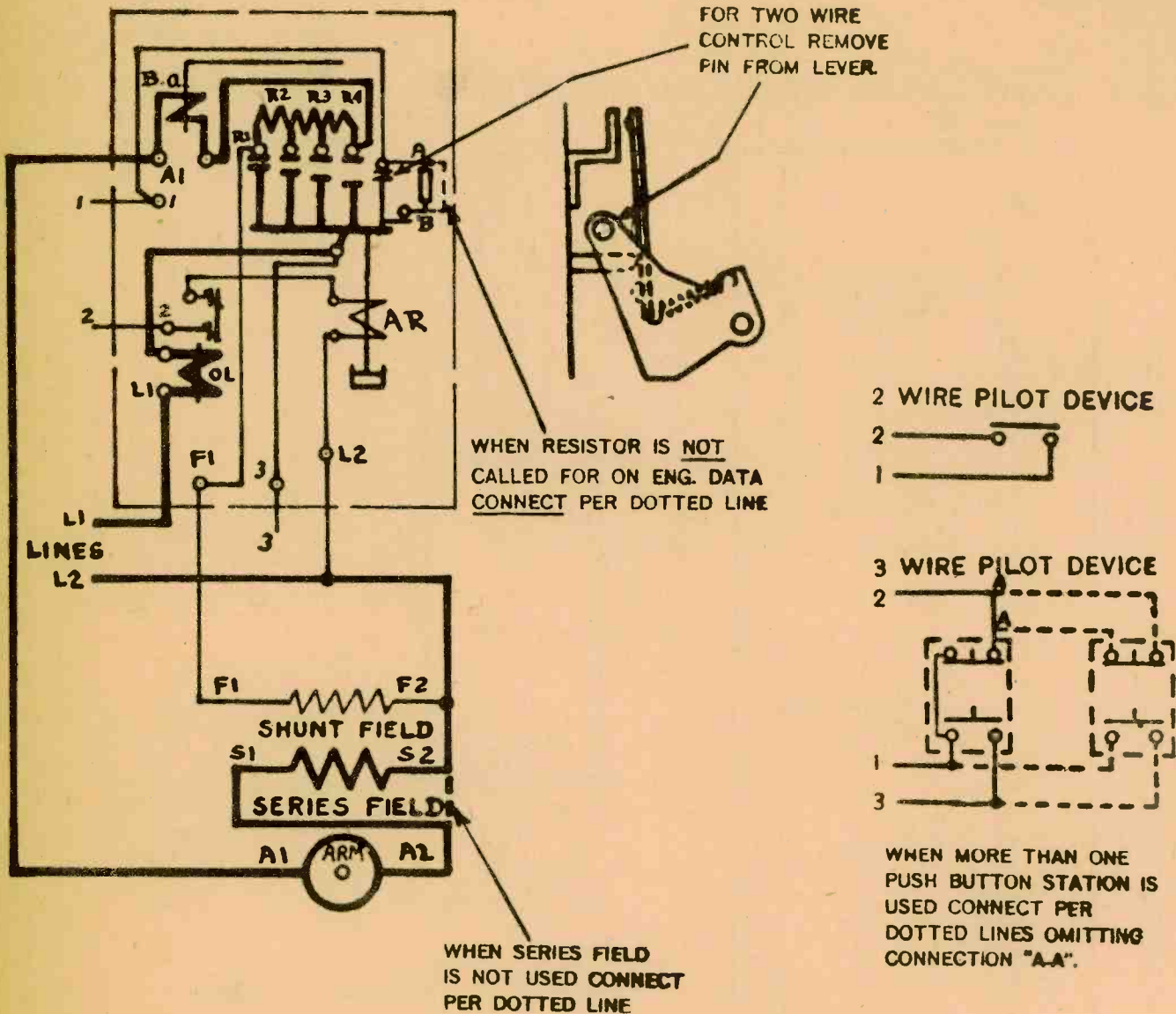

LINE DIAGRAM = 87026 D1

TITLE CONNECTIONS FOR D. C. TIME LIMIT AUTOMATIC STARTER.

DRAWN BY C. MINOR		TRACED BY N.W. LENTEN		TYPE A	SUP. NO. 50439 D1
CHECKED BY A.F. WEISS		APPROVED BY C. STANSBURY		BULL. NO. 6106	SUP. BY NO.
A G.M.H. R.E.M.	B G.M.H. L.R.B.	C R.N.C. R.S.	D L.R.S. W.G.F.	ORDER NO. DEV. 1378-11	39915 D1
CUTLER-HAMMER INC. MILWAUKEE  NEW YORK					



WIRING DIAGRAMS

D. C. REVERSING LINE VOLTAGE STARTERS

CLASS 7732

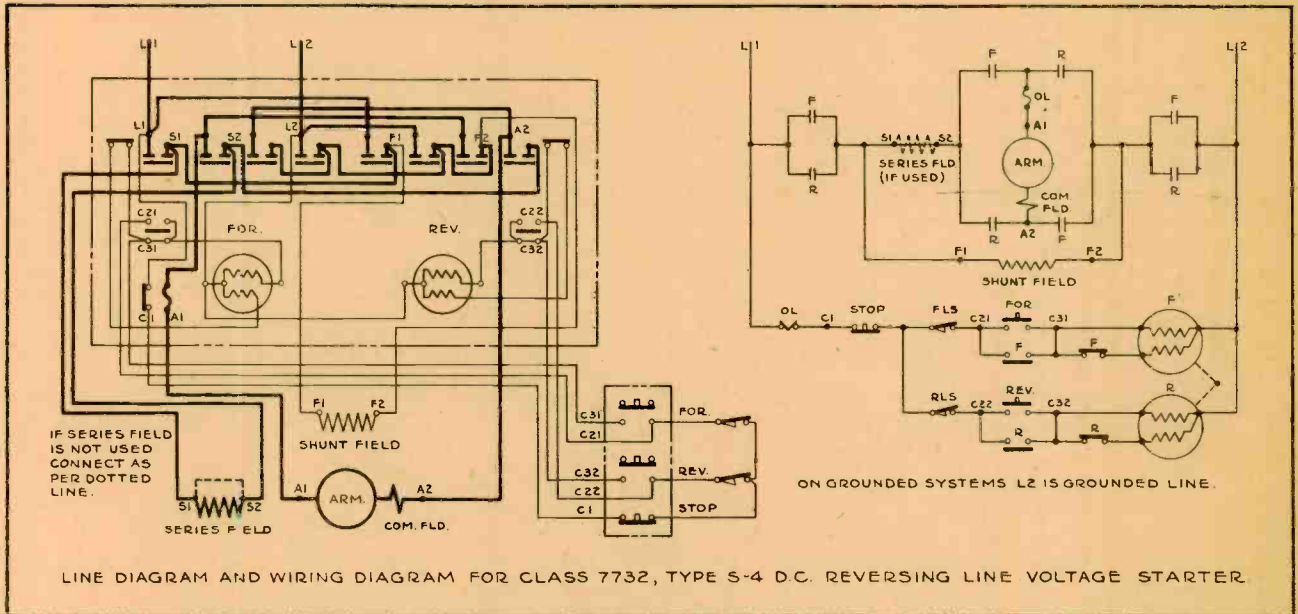

D. C. REVERSING TIME LIMIT ACCELERATION STARTERS

CLASSES 7735, 7736

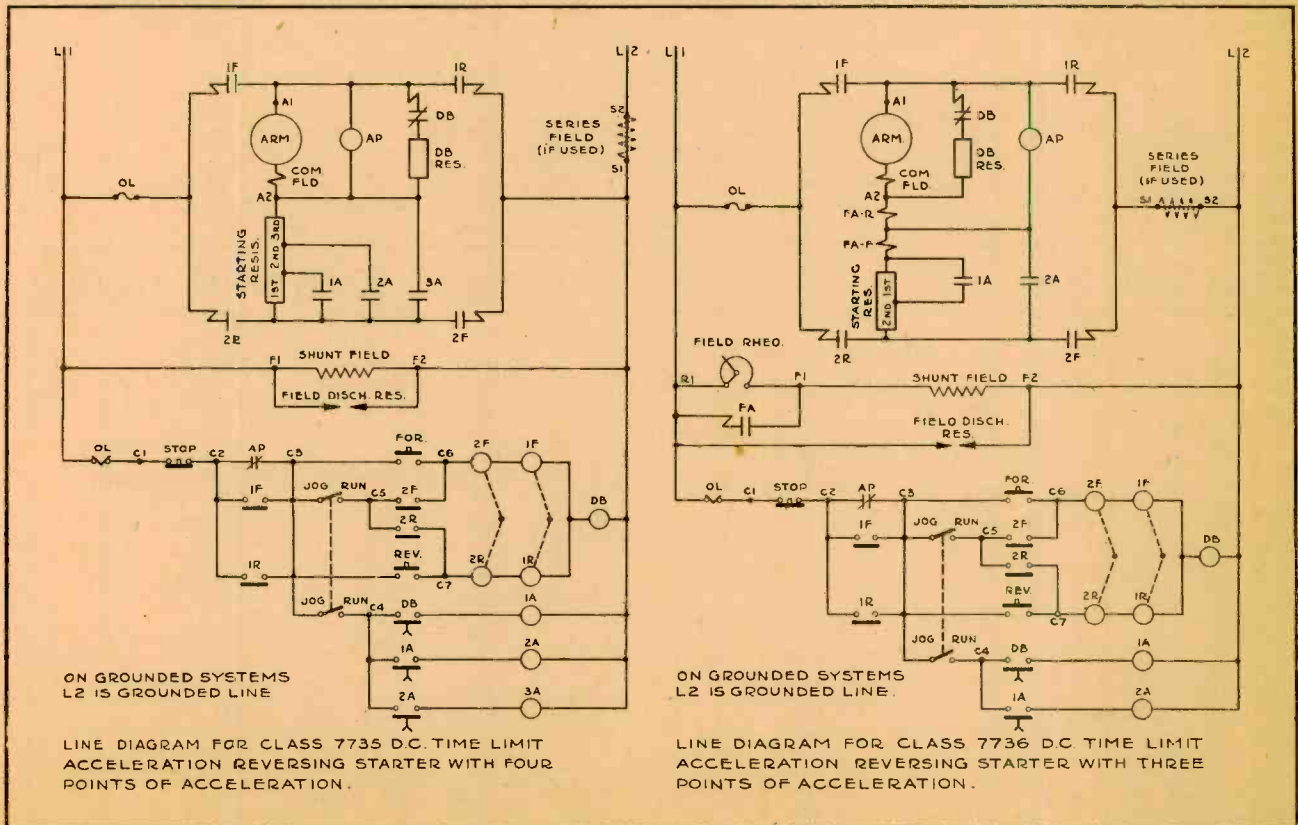

1748-B13

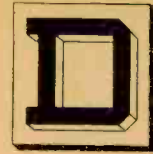

WIRING DIAGRAMS

CLASSES 7107, 7120

D. C. TIME LIMIT ACCELERATION STARTERS

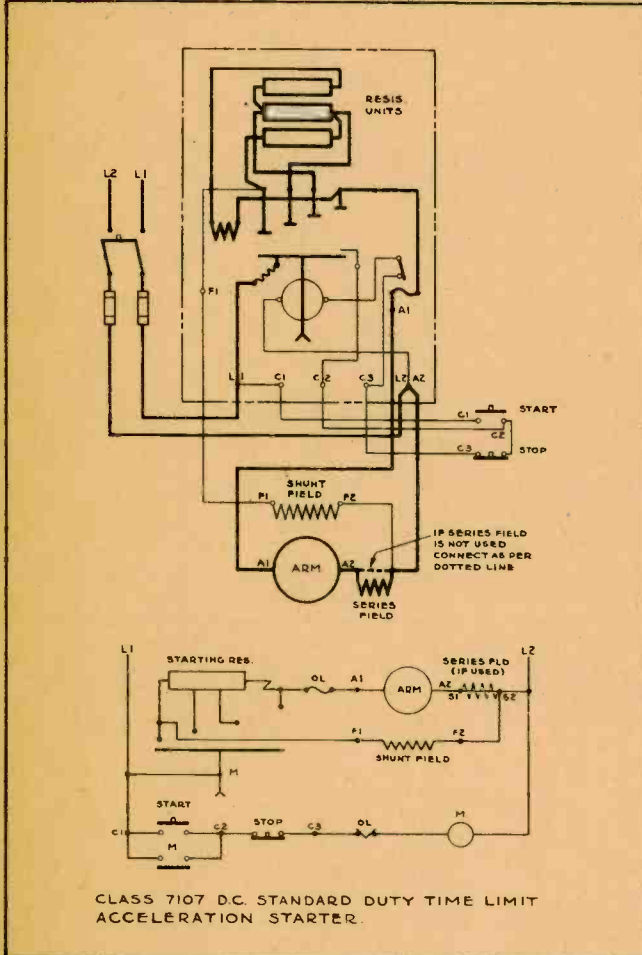

CLASS 7107 D.C. STANDARD DUTY TIME LIMIT ACCELERATION STARTER.

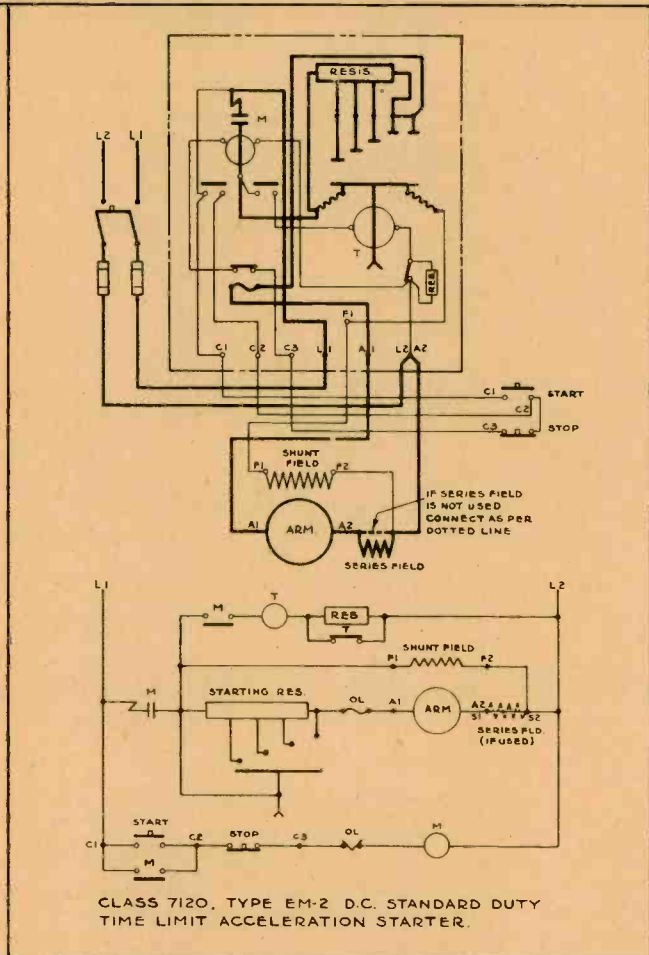

CLASS 7120, TYPE EM-2 D.C. STANDARD DUTY TIME LIMIT ACCELERATION STARTER.

CLASSES 7135, 7136

D. C. TIME ACCELERATION STARTERS

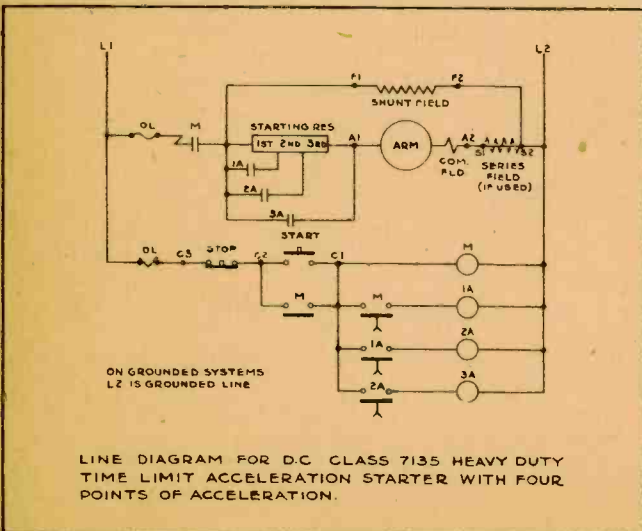

LINE DIAGRAM FOR D.C. CLASS 7135 HEAVY DUTY TIME LIMIT ACCELERATION STARTER WITH FOUR POINTS OF ACCELERATION.

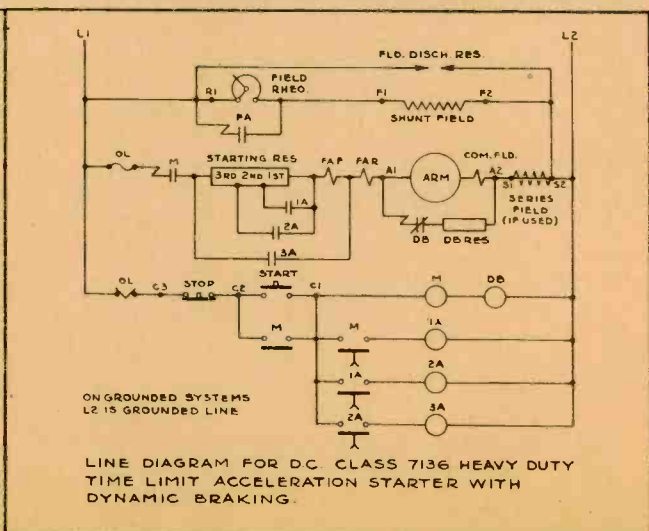

LINE DIAGRAM FOR D.C. CLASS 7136 HEAVY DUTY TIME LIMIT ACCELERATION STARTER WITH DYNAMIC BRAKING.

1748-B14

WHEN RESISTOR IS NOT CALLED FOR ON ENG. DATA CONNECT PER DOTTED LINE

WHEN RESISTOR IS NOT CALLED FOR ON ENG. DATA OMIT DOTTED CONNECTIONS

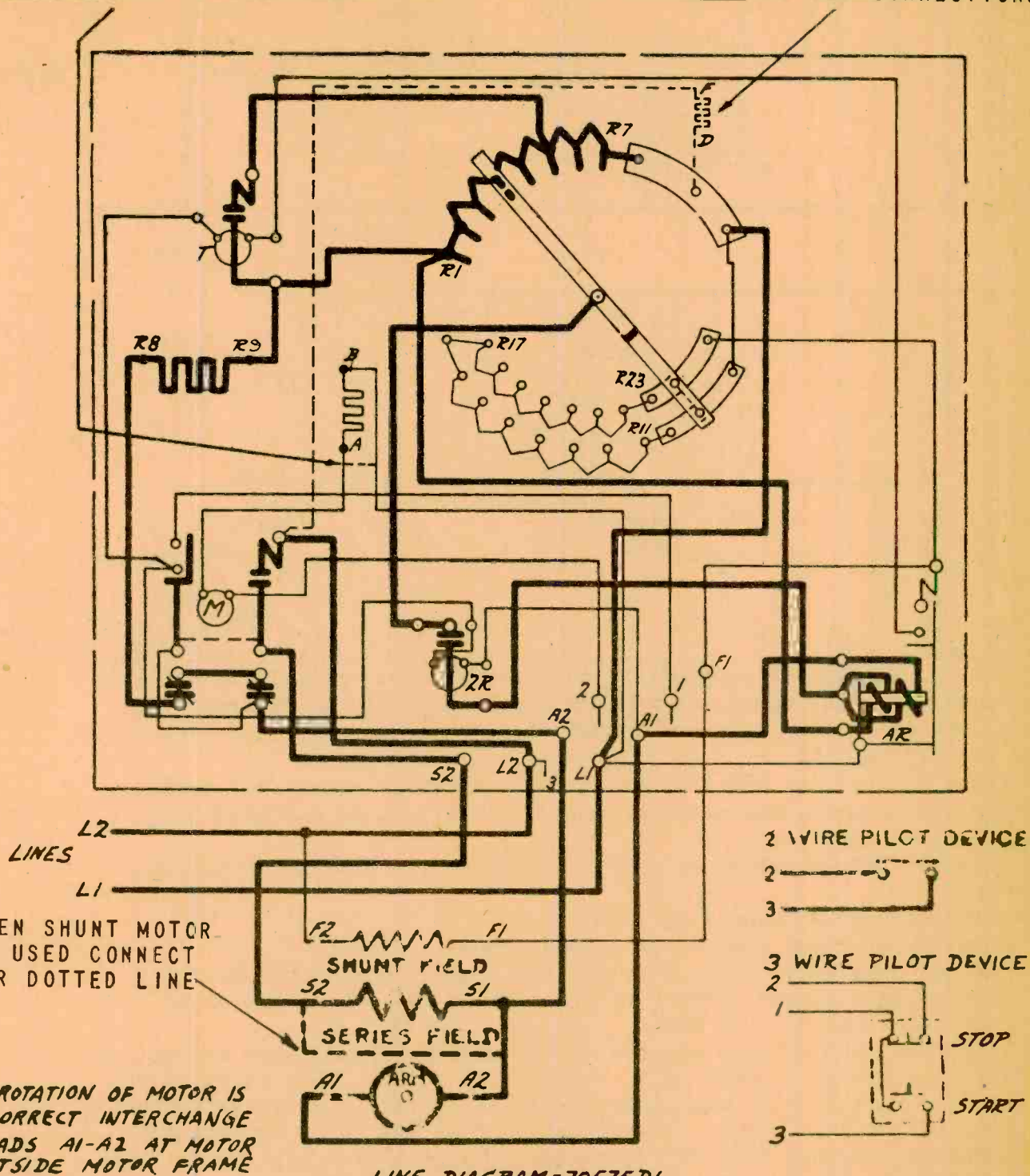

WHEN SHUNT MOTOR IS USED CONNECT PER DOTTED LINE

IF ROTATION OF MOTOR IS INCORRECT INTERCHANGE LEADS A1-A2 AT MOTOR OUTSIDE MOTOR FRAME

LINE DIAGRAM - 70575DI

TITLE CONNECTIONS FOR D.C. SPEED REGULATOR.

DRAWN BY <i>McMueller</i>		TRACED BY <i>McMueller</i>		TYPE	SUP NO
CHECKED BY <i>Redhausen</i>		APPROVED BY <i>[Signature]</i>		BULL. NO	S.P. BY NO
A	B	C	D	ORDER NO A696719	70577DI
CUTLER-HAMMER, INC. MILWAUKEE NEW YORK					

MAGNETIC CONTROLLER

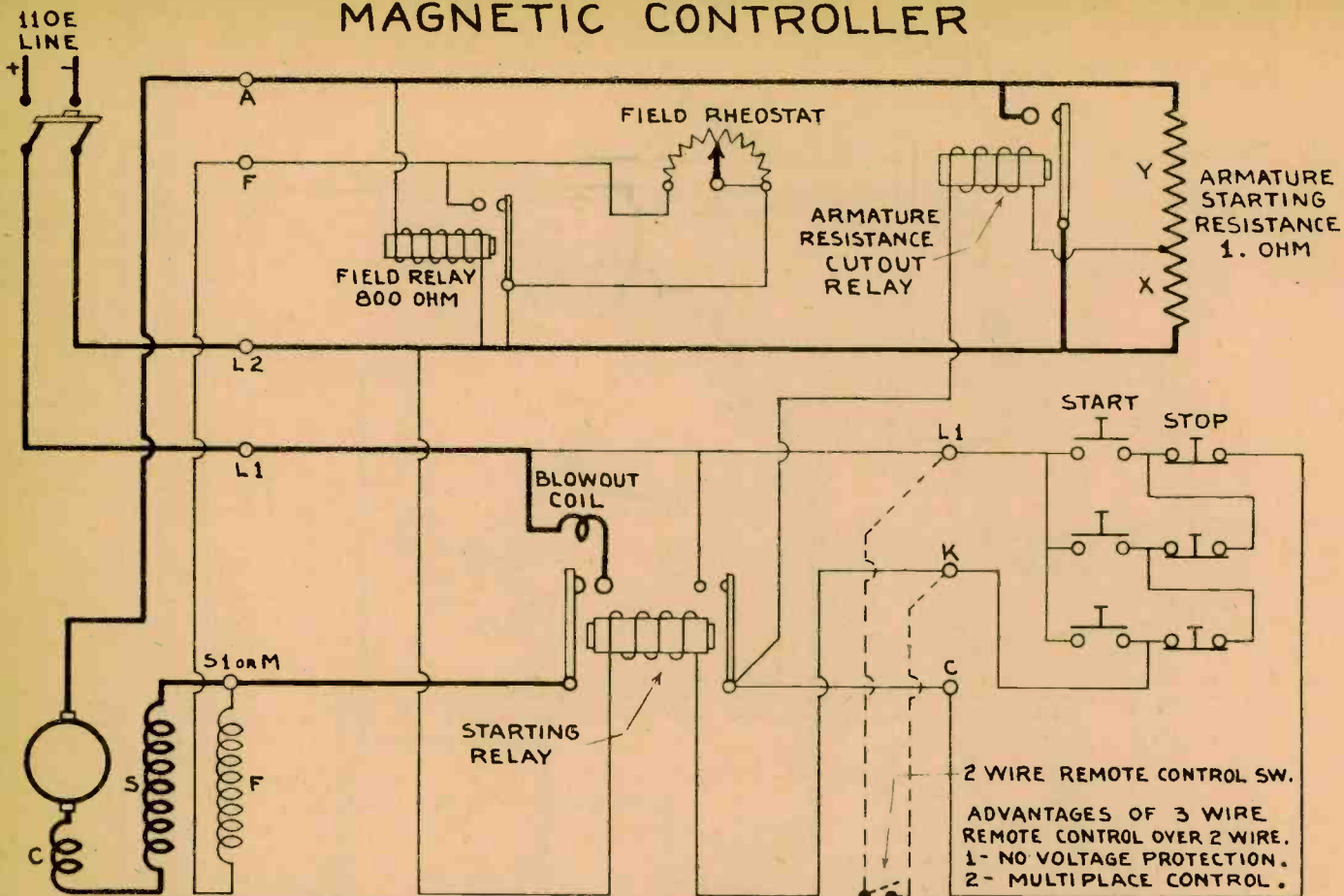

The term "magnetic controller" is commonly used to apply to controllers on which the operation depends almost entirely on relays. Controllers of this type have a number of separate circuits, each operated by a relay switch.

These controllers are used extensively on large industrial motors, steel mill motors, and elevator motors. They can be designed to give any desired operation.

Example: Let us assume we start a 110E, 40I, 5 h.p. motor without a load.

Starting current equals $1\frac{1}{2} \times 40I$ or 60I.

Armature starting resistance equals 1 ohm.

Voltage drop across arm. starting res. equals $60I \times 1R = 60Ed$.

Voltage drop across section of res. marked "X" equals $1/3$ of Ed across entire res. or $20Ed$.

Therefore, the voltage applied to the armature resistance cut-out relay when starting, equals $110E - 20Ed$ or 90 volts. This relay is adjusted so that it will not close its switch until it receives approximately full line voltage. The voltage across the relay increases as the current through "Y" + "X" decreases. Current flow will decrease to approximately 6I, because of C.E.M.F. built up in the motor as it increases in speed. This may be proven by the following figures:

Total voltage drop across "Y" + "X" after motor attains normal speed equals $6I \times 1R = 6Ed$.

Now the voltage drop across "X" will be $1/3$ of 6 or $2Ed$, leaving 110 minus 2 or 108E to operate the armature res. cut-out relay. This voltage is high enough to operate the relay and close its switch, which cuts out or shunts the armature starting resistance.

The field relay closes when starting to give full strength field. When the armature res. cut-out relay closes, the field relay is shorted out of the circuit. This allows the speed to be controlled above normal by adjusting the shunt field rheostat.

MAGNETIC CONTROLLER

FOR STARTING, REVERSING AND DYNAMIC BRAKE DUTIES

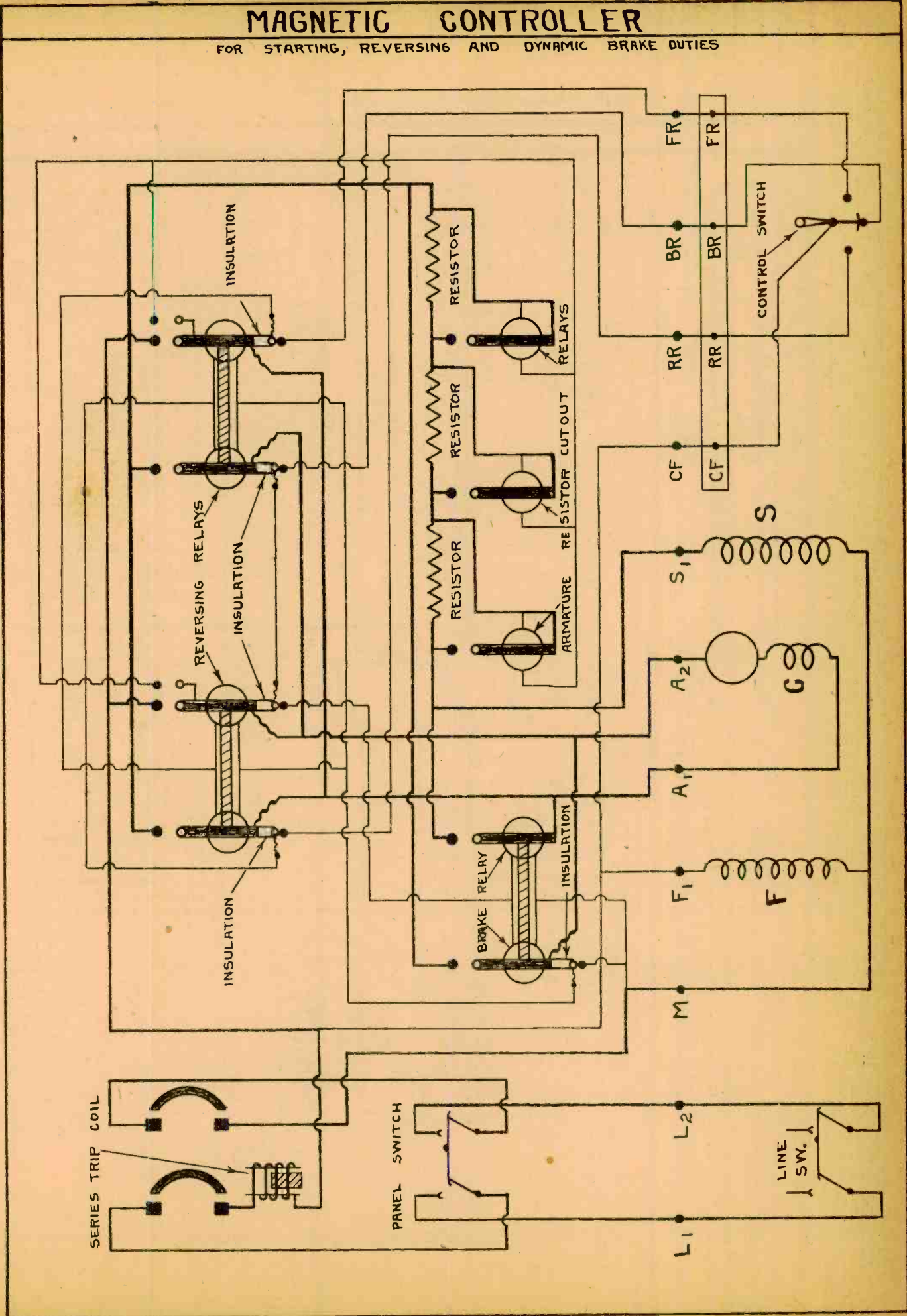

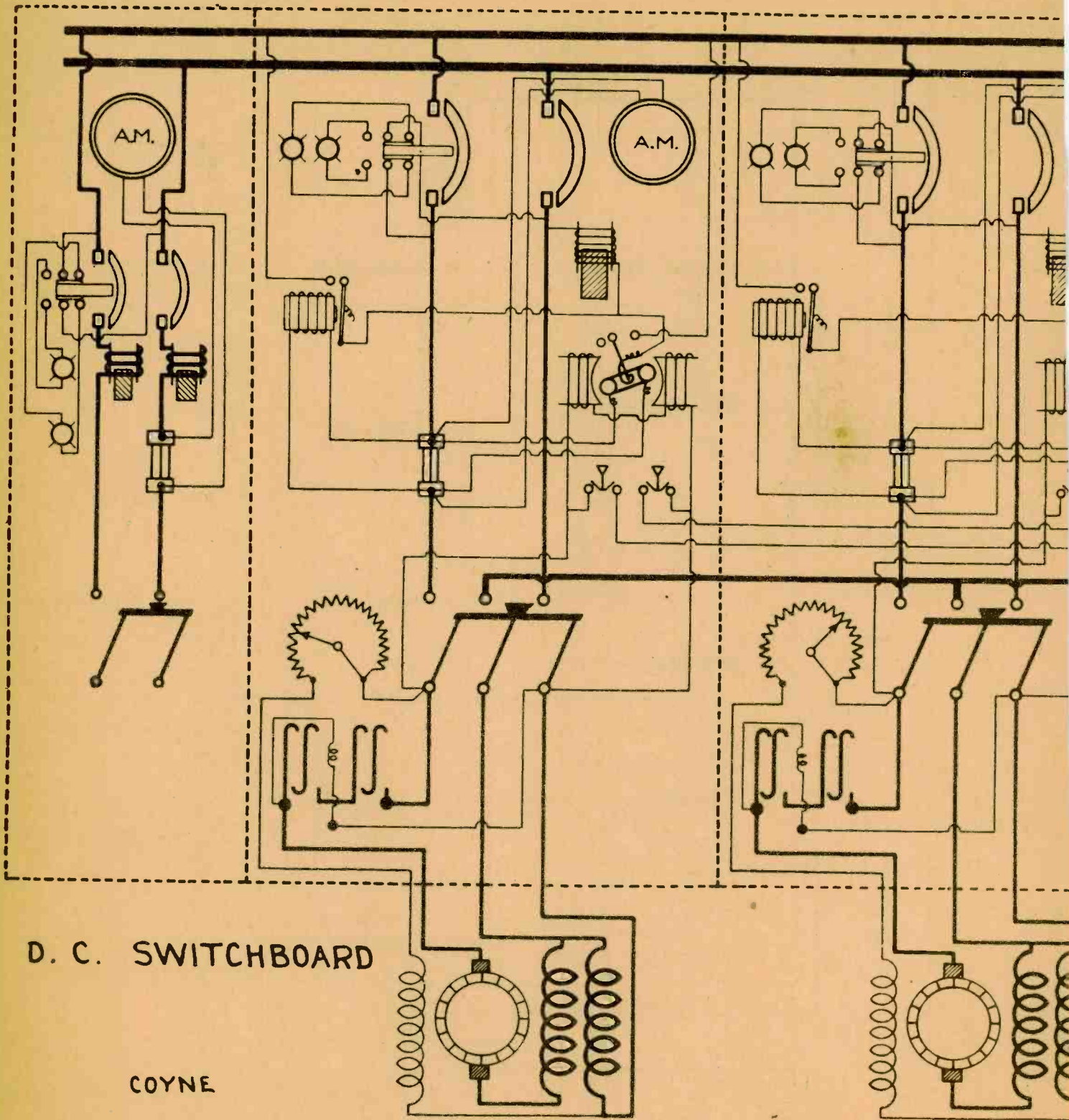

D. C. SWITCHBOARD

COYNE

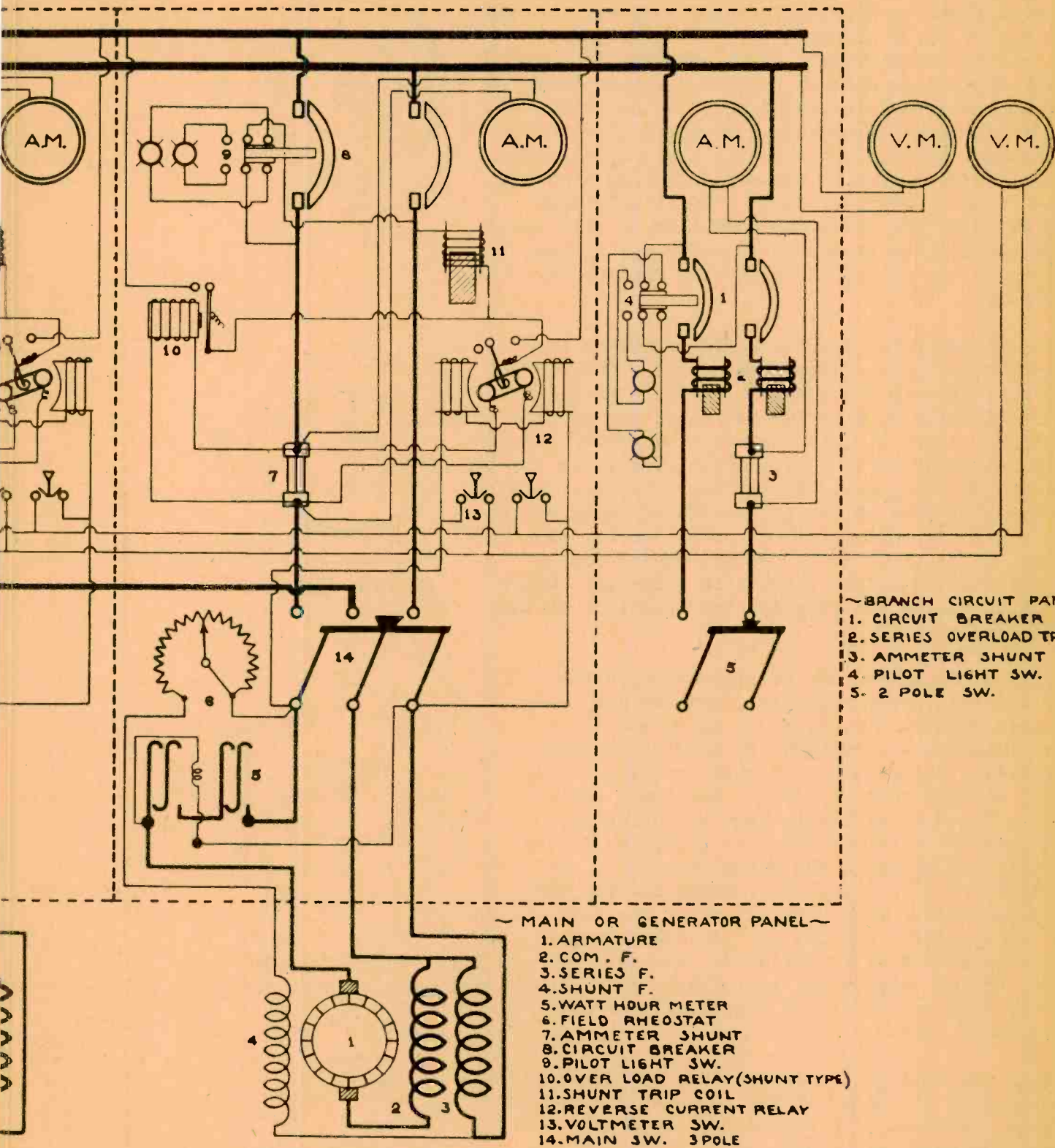

- ~ BRANCH CIRCUIT PANEL ~
- 1. CIRCUIT BREAKER
 - 2. SERIES OVERLOAD TRIP COIL
 - 3. AMMETER SHUNT
 - 4. PILOT LIGHT SW.
 - 5. 2 POLE SW.

- ~ MAIN OR GENERATOR PANEL ~
- 1. ARMATURE
 - 2. COM. F.
 - 3. SERIES F.
 - 4. SHUNT F.
 - 5. WATT HOUR METER
 - 6. FIELD RHEOSTAT
 - 7. AMMETER SHUNT
 - 8. CIRCUIT BREAKER
 - 9. PILOT LIGHT SW.
 - 10. OVER LOAD RELAY (SHUNT TYPE)
 - 11. SHUNT TRIP COIL
 - 12. REVERSE CURRENT RELAY
 - 13. VOLTMETER SW.
 - 14. MAIN SW. 3 POLE

AMPLIDYNE GENERATORS.

If a D.C. generator designed as shown and operated with a very weak field be driven at constant speed, the main brushes may be short circuited as indicated. This action results in relatively heavy currents in the armature that in turn produce an intense armature cross field with the polarities shown and, if the poles are especially designed to provide a magnetic circuit of low reluctance to this cross field, a strong magnetic field will be developed in the air gap. The armature, rotating in this field, produces a relatively high voltage at right angles to the normal brush axis and if extra brushes are placed as shown, power almost equivalent to the normal rating of the machine may be obtained.

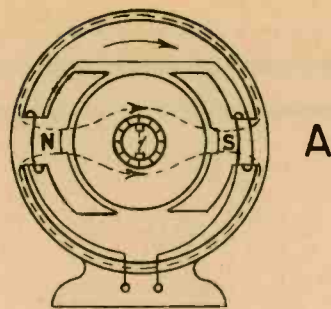

SIGNAL FIELD.

As the operating point for the field magnetism is set on the steep part of the magnetization curve, a small variation in the magnetizing force produced by the field coils will produce a relatively great change in the short circuit current produced by the armature, and this in turn will greatly increase the generated output voltage. Therefore, if special control coils be placed on the poles, and if these coils be fed from a low voltage or low power source, the variations which these coils produce may be caused to reappear in the output circuit in a greatly amplified form. This is the principle of operation of the Amplidyne Generator.

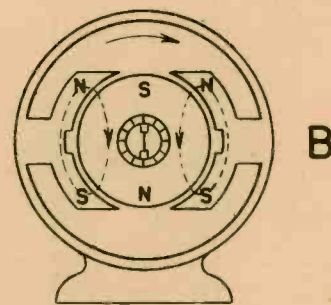

CROSS FIELD.

The Amplidyne Generator may be regarded as a two stage electrical power amplifier, and its use is concerned with control situations in which small controlling impulses are employed to handle equipment that demands a large amount of power to operate it. The small control power is fed to the field coils where it effects a relatively high variation in field magnetism; this variation is amplified in the cross field and again in the output circuit. Amplifications of 20,000 to 1 are common and 100,000 to 1 are possible. Thus a variation of one watt in the input control circuit may produce a change in generator output of 20 kilowatts, a range impractical for any electronic amplifier. The range may be extended by the use of a preamplifier using ordinary radio tubes.

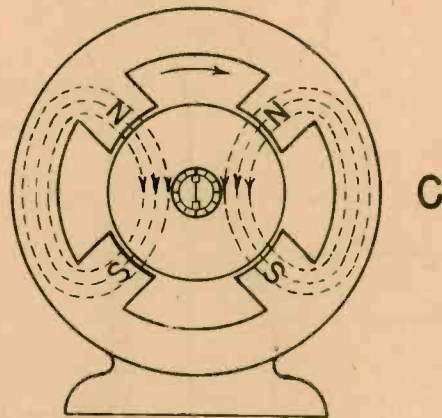

SPLIT POLE DESIGN SHOWING CROSS FIELD.

Instead of the split-pole construction shown above, the arrangement indicated in fig. C shows the constructional features of a modern amplidyne unit. Although four poles are shown, adjacent groups are wound with the same polarity, and the machine is therefore a two pole unit.

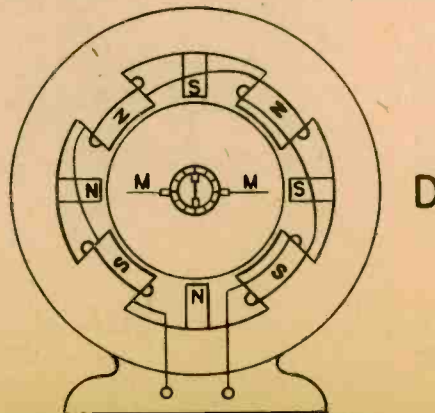

SIGNAL FIELD WINDING.

Figure D shows the construction of an Amplidyne unit using interpoles. Although several field windings are employed in an actual machine, only the signal winding is shown. The brushes M are the output brushes from which the amplified energy is obtained.

Job No. 13

TRANSFORMER

CONNECTIONS

This job is used to illustrate the different connections that may be made with single-phase transformers, and also to demonstrate the relationship that exists between the line and phase voltages for the various three-phase connections. Take the readings indicated below the diagram and enter them in the spaces provided. Make the delta connection first, then add the fourth wire and read from line to N.

Section 2 shows a delta-star connection with a four-wire secondary. Connect and read as indicated in Section 1. Note that on all connections, line voltages are obtained between L₁, L₂, L₃, and phase voltages from H₁ to H₂ or X₁ to X₂. In the four-wire secondary used here, phase voltages are also obtainable from any secondary line to the neutral wire. The neutral is usually grounded.

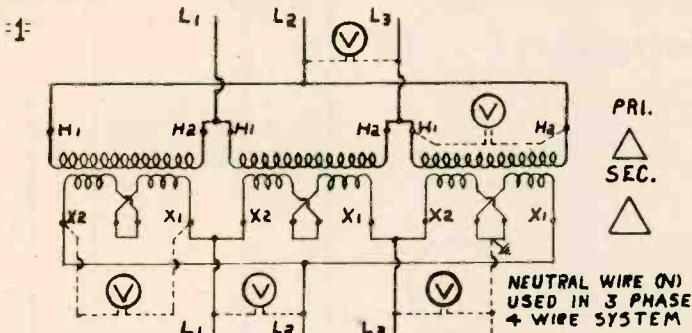

PRI. LINE E _____
 PRI. PHASE E _____
 RATIO _____
 SEC. PHASE E _____
 SEC. LINE E _____
 ADD NEUTRAL (N) & CHECK VOLTAGE
 L₁ to N L₂ to N L₃ to N

E BETWEEN L₁ to N, & L₃ to N = LINE E X 0.5
 E BETWEEN L₂ & N = LINE E X 0.866

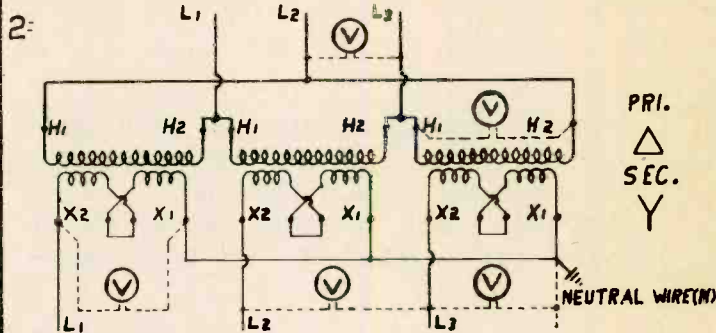
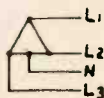

PRI. LINE E _____
 PRI. PHASE E _____
 RATIO _____
 SEC. PHASE E _____
 SEC. LINE E _____
 ADD NEUTRAL (N) & CHECK VOLTAGE
 L₁ to N L₂ to N L₃ to N

E BETWEEN L₁, L₂ & L₃ to N = LINE E X 0.58

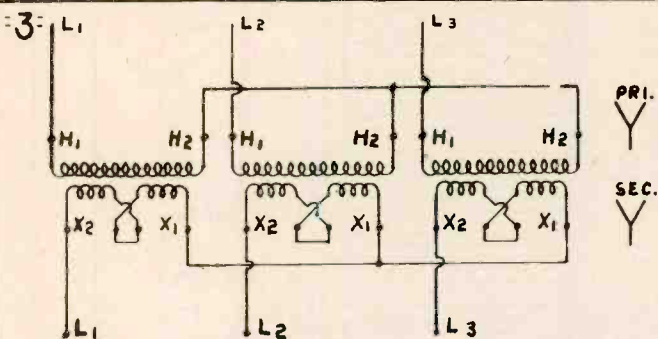

PRI. LINE E _____
 PRI. PHASE E _____
 RATIO _____
 SEC. PHASE E _____
 SEC. LINE E _____

In the above connection, which is the star-star arrangement, take all readings required, mark the starts and finishes on both primary and secondary. Also indicate that polarity each transformer has; that is, whether it is additive or subtractive. What voltage is obtained from the star point to the line wire on the primary - on the secondary? Does this voltage equal the phase voltage?

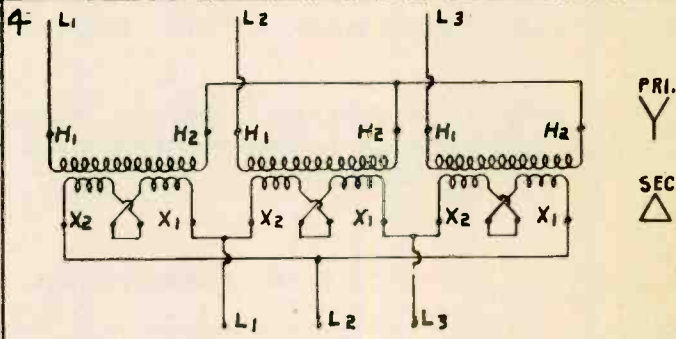

PRI. LINE E _____
 PRI. PHASE E _____
 RATIO _____
 SEC. PHASE E _____
 SEC. LINE E _____

Repeat all tests enumerated in Section 3. How do the line and phase voltages compare on the primary; on the secondary? If one transformer failed, could a three-phase supply be maintained by the connection used in Section 1; in Section 2; in Section 3; in Section 4? From the answers to the above questions, derive the advantages of the delta connection as compared with the star.

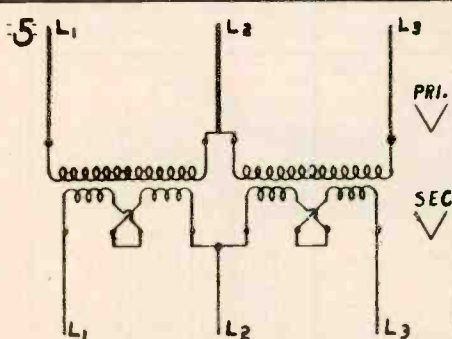

CONNECTED OPEN-DELTA
 PRI. LINE E _____
 PRI. PHASE E _____
 RATIO _____
 SEC. PHASE E _____
 SEC. LINE E _____

Note that this connection uses two single-phase transformers and that a true three-phase transformation is obtained. Particularly note the voltage readings between secondary lines. Explain this.

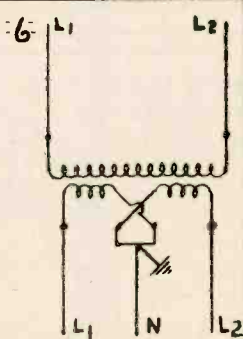

Single Phase 3 Wire System
 Pri. line E _____
 Ratio _____
 Sec. line E _____
 L₁ to N _____
 L₂ to N _____

Compare these readings with those obtained on open-delta and explain why they differ.

VOLTAGE AND CURRENT FORMULAS FOR STAR AND DELTA CONNECTIONS.

- STAR CONNECTED
 LINE I = PHASE I
 LINE E = PHASE E X 1.73
 PHASE E = LINE E X 0.58
- DELTA CONNECTED
 LINE E = PHASE E
 LINE I = PHASE I X 1.73
 PHASE I = LINE I X 0.58
- THESE FORMULAS ARE USED TO CHECK THE ACCURACY OF THE METER READINGS

Some discrepancy between the meter readings and the formulated values must be expected, since the formulas are based on ideal conditions rarely obtained in practice. Moreover, there is always the possibility of meter error to be considered. However, considerable departure from the theoretically correct values indicated by the formulas should be investigated, as they point either to serious meter defects or to improper connections.

When connecting the primary windings of single-phase transformers to the line, either end of any given primary winding may be regarded as a start, the other end then becoming a finish. After the primaries are connected, however, certain secondary ends are starts, the other ends being finishes, and these cannot then be interchanged since the secondary start and finish relationship is automatically established when the primary windings are connected.

TESLA COIL

THE SECONDARY CONSISTS OF 1000 TURNS OF NO. 24 D.C.C. WIRE, SPACE WOUND ON A FIBRE TUBE 1'-2" x 4'-6". THE ENTIRE COIL SHOULD BE GIVEN A COAT OF SHELLAC OR COLLODION.

THE PRIMARY CONSISTS OF 10 TURNS OF 1/2" COPPER TUBING, SPACE WOUND ON A WOODEN DRUM 2'-8" x 12". THE PRIMARY IS MOUNTED ON 7" PYREX INSULATORS.

A FLEXIBLE LEAD AND CLIP IS USED TO VARY THE NUMBER OF PRI. TURNS.

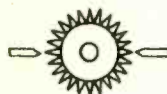

A ROTARY SPARK GAP WILL GREATLY IMPROVE THE OPERATION.

1 K-VA. TRANSFORMER.

110E. A.C. LINE

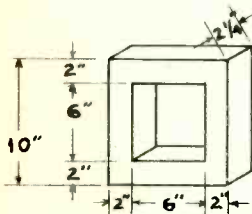
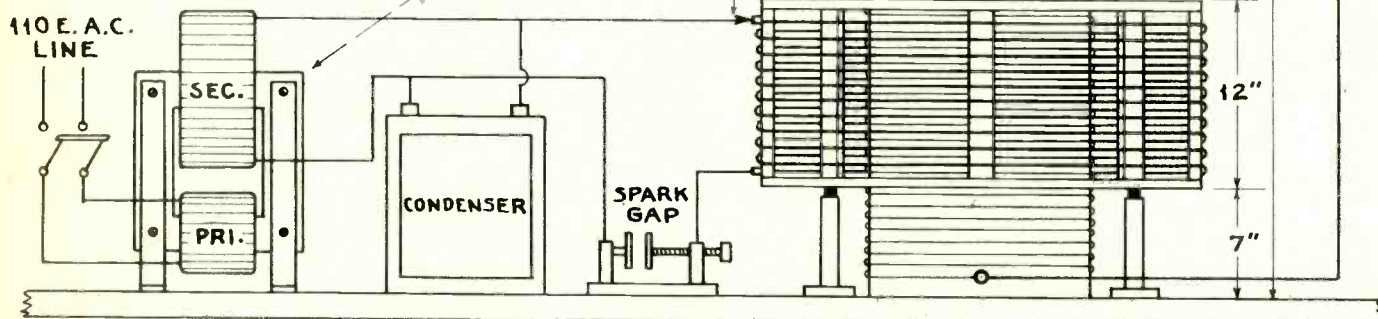

TRANSFORMER DETAILS.
 CORE - 40 LBS. OF IRON.
 PRI. - 130 TURN #14 S.C.E. WIRE. 2 LBS.
 SEC. - 29,500 T. #34 S.C.E. WIRE. 5 LBS.
 PRI.-110E. SEC.-25,000E.

THE 3 CELLS ARE CONNECTED IN PARALLEL.

THE CONDENSER CONSISTS OF 48 SHEETS .005" BRASS SEPARATED BY DOUBLE STRENGTH GLASS SHEETS AND ASSEMBLED IN A THREE CELL AUTO BATTERY CASE FILLED WITH TRANSFORMER OIL. DETAILS OF UNIT FOR ONE CELL ARE SHOWN AT THE RIGHT. IMPROVED PERFORMANCE MAY SOMETIMES BE OBTAINED BY INCREASING OR DECREASING THE NUMBER OF PLATES. THE BEST ARRANGEMENT WILL BE FOUND BY TRIAL.

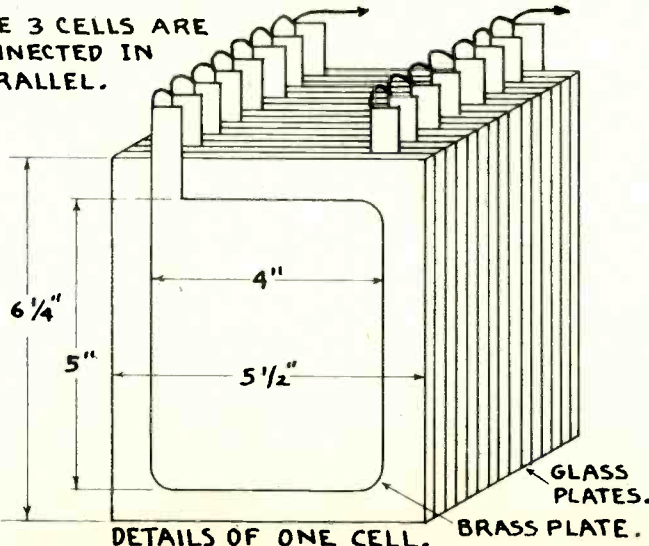

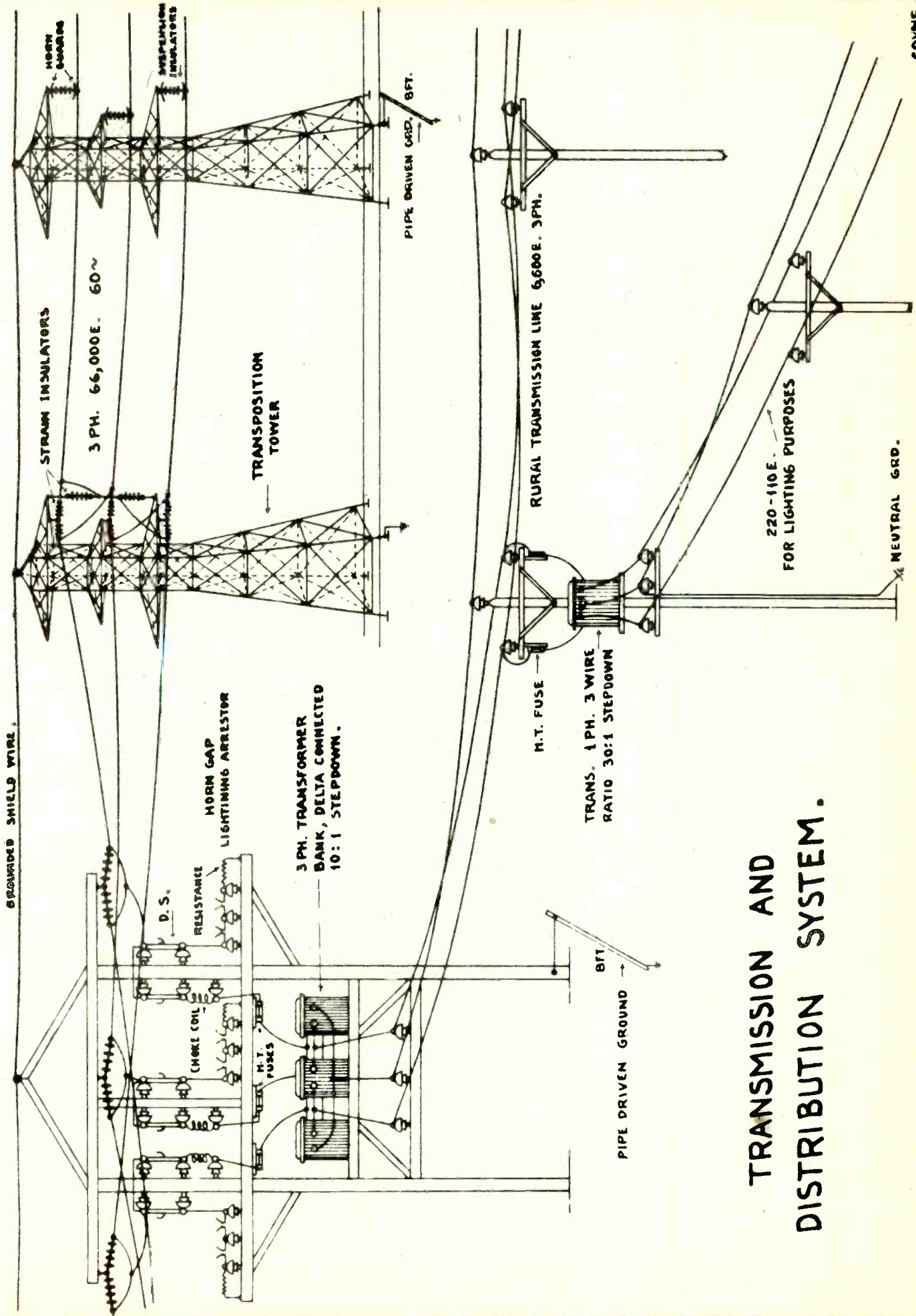

TRANSMISSION AND DISTRIBUTION SYSTEM.

COYNE

POWER & LIGHTING DISTRIBUTION SYSTEM

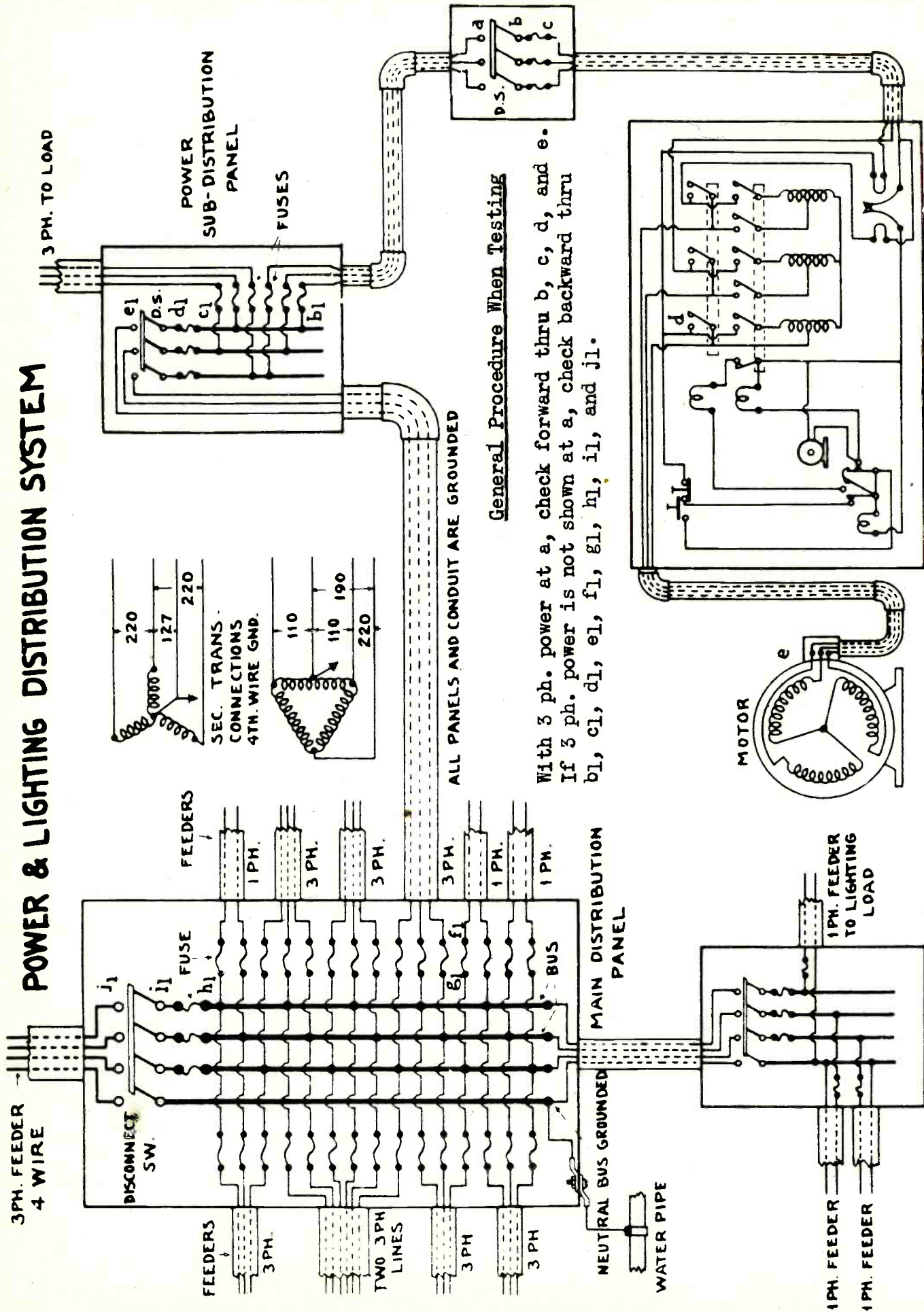

General Procedure When Testing

With 3 ph. power at a, check forward thru b, c, d, and e.
 If 3 ph. power is not shown at a, check backward thru b₁, c₁, d₁, e₁, f₁, g₁, h₁, i₁, j₁.

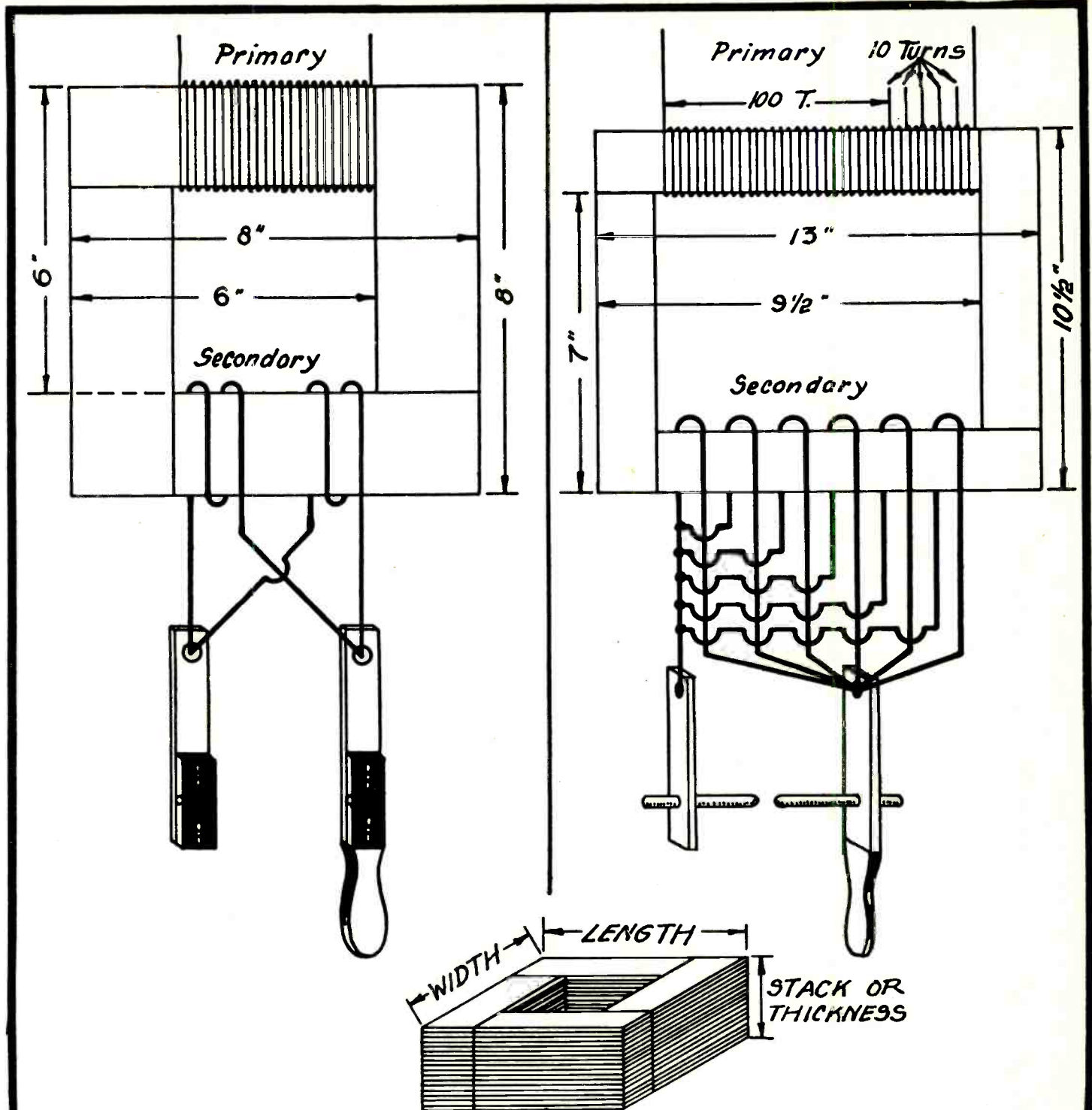

BUTT WELDER

PRIMARY: 220 E. 60~50 I. 126 Turns
7 D.C.C. Wire.

SECONDARY: 4 E. 60~3000 I. 2 Turns
of # 4/0 Cable. 2 Parallel.

CORE: 80 Lbs. of Laminated Iron
or Silicon Steel
Core Strips 2" x 6"
Stack 4" High or Thickness
of Core.

SPOT WELDER

PRIMARY: 220 E. 60~45 I. 150 Turns
4 D.C.C. Wire.

SECONDARY: 2 1/2 E. 60~2000 to 3000 I.
3/4 Turn # 4/0 Cable. 6
Parallel.

CORE: 120 Lbs. Laminated Iron.
Stack 4 1/2" High.

Starting at 100th Turn, on Primary
Winding, Take Taps Every 10 Turns.

HOW THE NEUTRALIZER QUENCHES A FAULT

Fig. 2. Ground-fault currents, isolated-neutral system

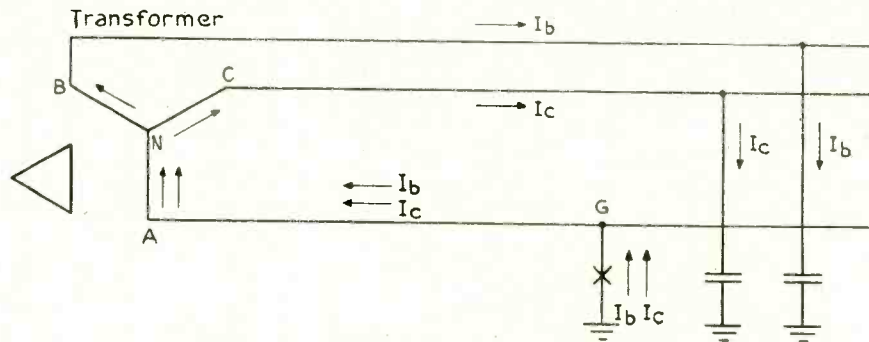

Fig. 3. Ground-fault currents, solidly grounded neutral system

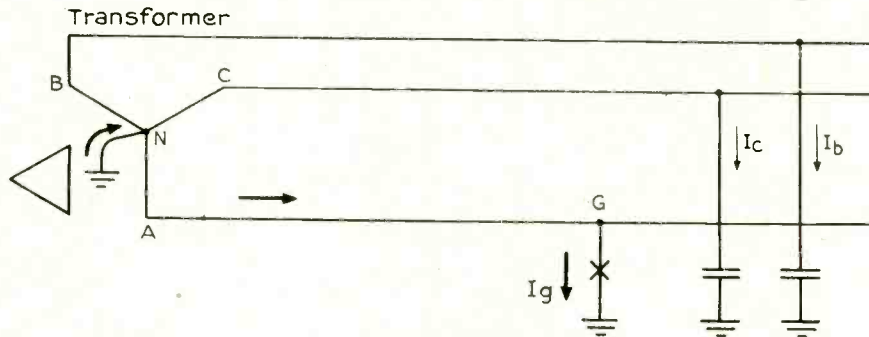
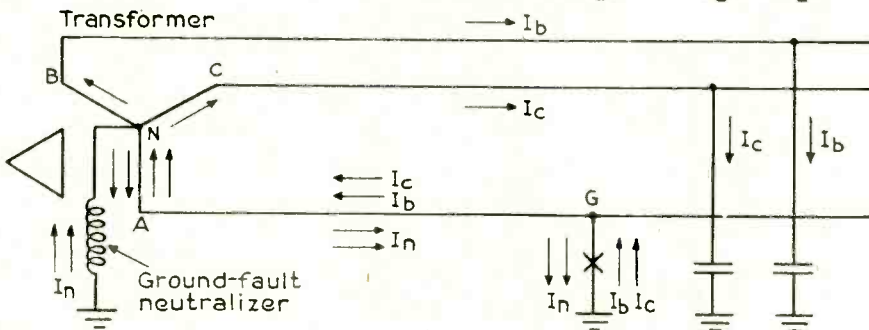

Fig. 4. Ground-fault currents, with neutralizer



● When the System Neutral Is Isolated, the current in a line-to-ground fault consists solely of charging current through the line-to-ground capacitances of the other two line conductors (Fig. 2). However, operating experience shows that such disturbances frequently result in transient over-voltages sufficient to cause a second flashover on one of the unfaulted phases, thus causing a short circuit and an interruption to service. Relaying is difficult because the second fault usually occurs at a point remote from the first—frequently in terminal apparatus—necessitating expensive repairs.

● When the System Neutral Is Solidly Grounded, a line-to-ground fault short-circuits the faulted phase, causing current to flow through the fault, as shown in Fig. 3. This short-circuit current, I_g , is lagging, and is usually so much greater than the charging current of the unfaulted lines (I_b and I_c) that the effect of the latter is negligible. The fault persists until the circuit-breaker is tripped. This means a service interruption.

● When the System Neutral Is Grounded through a Ground-fault Neutralizer, transitory arcs to ground are extinguished without an outage, without even a momentary interruption of service, and without the aid of any moving parts. The line-to-ground fault causes line-to-neutral voltage to be impressed across the neutralizer, which then passes an inductive current, I_n , 180 degrees out of phase and approximately equal in magnitude to the resultant of the system-charging currents from the two unfaulted phases, I_b and I_c (Fig. 4). These inductive and capacitive currents neutralize each other, and the only remaining current in the fault is due, mainly, to corona, insulator leakage, etc. This current is relatively small, and, as it is in phase with the line-to-neutral voltage, the current and voltage reach a zero value simultaneously, hence, the arc is extinguished without restriking. In this way, flashovers are quenched without removing the faulted line section from service.

Squirrel-Cage Motors

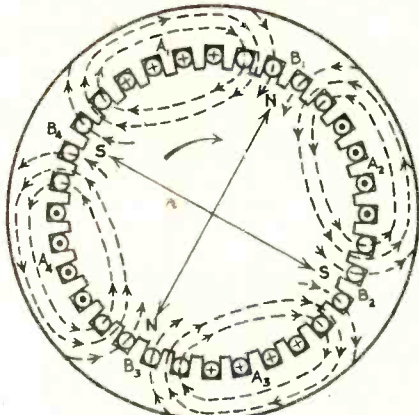

FIG. 4

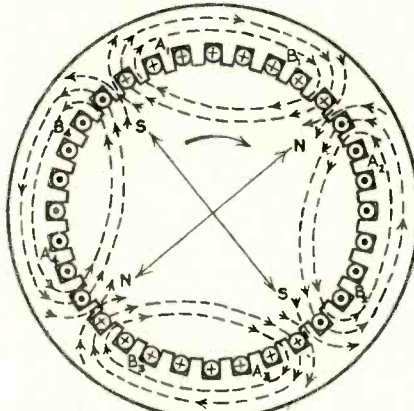

FIG. 5

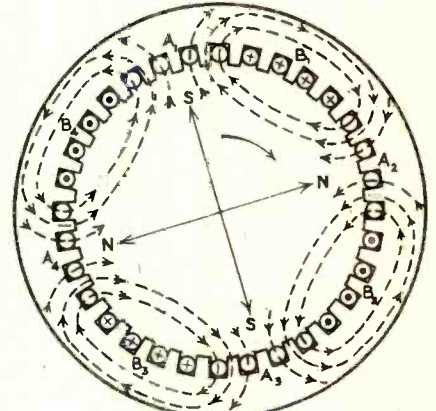

FIG. 6

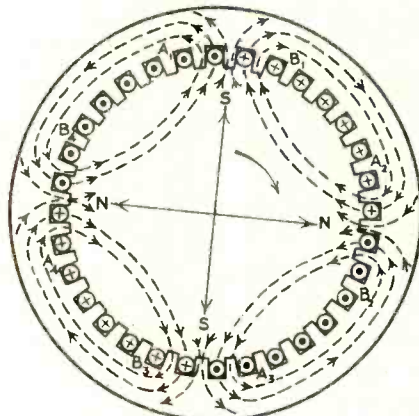

FIG. 7

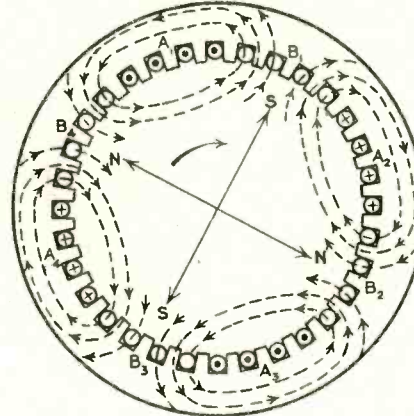

FIG. 8

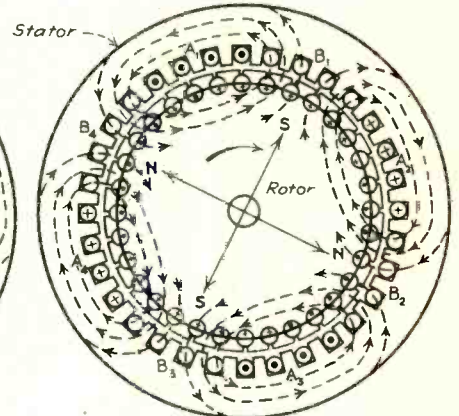

FIG. 9

Figs. 4 to 8—How the magnetic field in an induction-motor stator can be made to rotate when its windings are connected to a 2-phase circuit. Fig. 9—Direction of current generated in a rotor winding shown by dots and crosses on the rotor bars

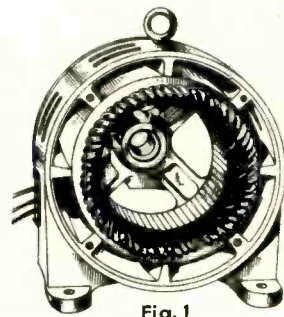

Fig. 1

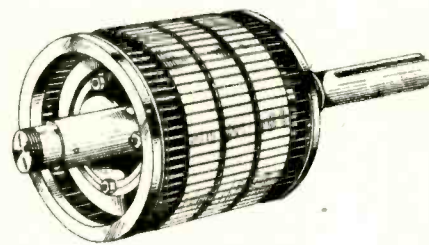

Fig. 2

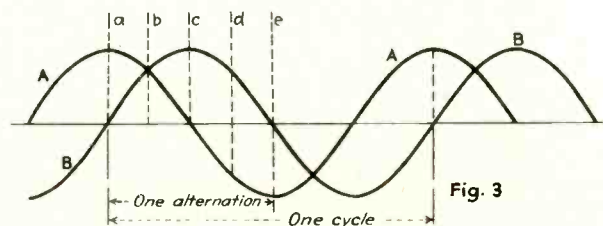

Fig. 3

Fig. 1—Stator of an induction motor. Fig. 2—Squirrel-cage rotor of an induction motor. Fig. 3—Two-phase voltage or current curves

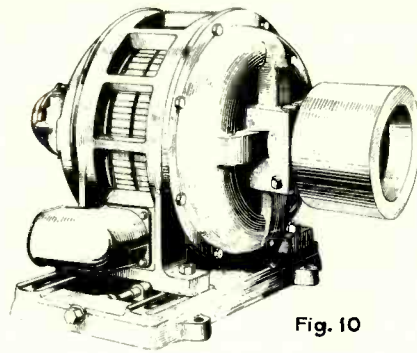

Fig. 10

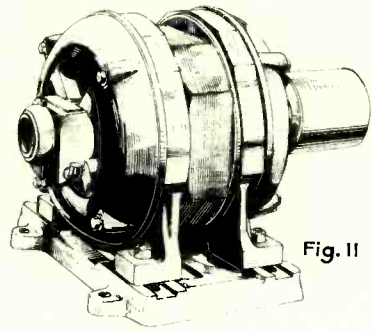

Fig. 11

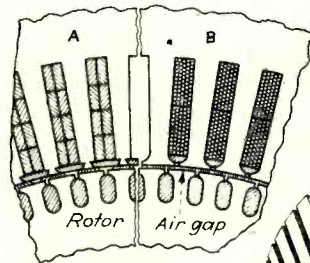

Fig. 12

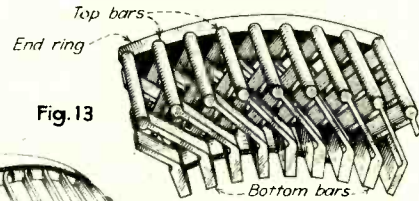

Fig. 13

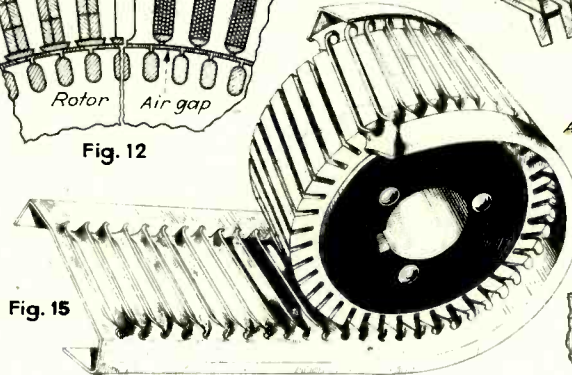

Fig. 15

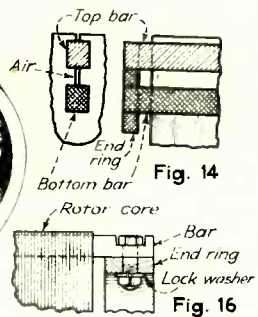

Fig. 14

Fig. 16

Fig. 10—Skeleton stator frame. Fig. 11—Riveted stator frame. Fig. 12—A, stator open slots; B, semiclosed slots. Fig. 13—Section of cast, interconnected double-squirrel-cage winding. Fig. 14—Section of simple double-squirrel-cage winding. Fig. 15—Squirrel-cage winding formed from a copper plate. Fig. 16—Joint between rotor bar and end ring

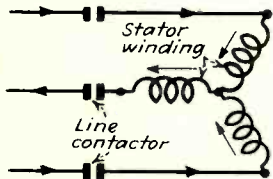

FIG. 1

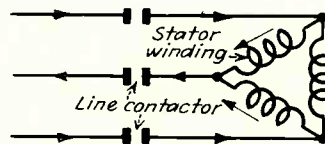

FIG. 2

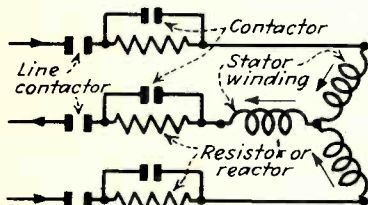

FIG. 3

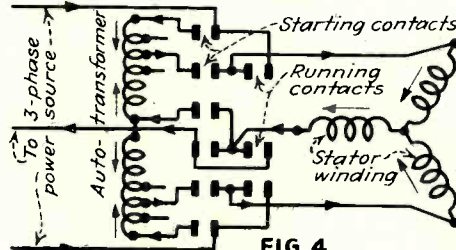

FIG. 4

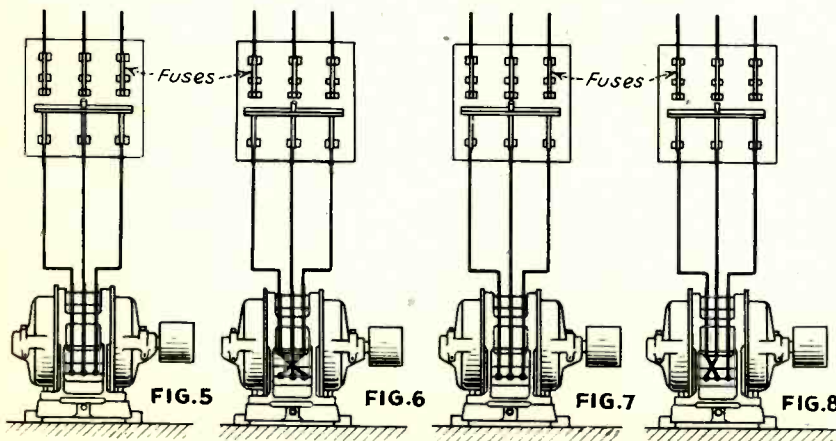

FIG. 5

FIG. 6

FIG. 7

FIG. 8

Fig. 1—Diagram of star-connected stator windings. Fig. 2—Stator windings connected delta. Fig. 3—Connections for starting with resistors or reactors in series with stator windings of a 3-phase motor. Fig. 4—Two auto-transformers connected to start a 3-phase motor. Fig. 5—Connections for one direction of rotation and Fig. 6, opposite direction of rotation of a 3-wire, 2-phase motor. Figs. 7 and 8—Connections for opposite directions of rotation of a 3-phase motor

ROTATING MAGNETIC FIELD.

NOTE; FLEMING'S RULE IS APPLIED TO MOTION OF THE CONDUCTOR.

FLUX MOVING UP IS EQUIVALENT TO CONDUCTOR MOVING DOWN.

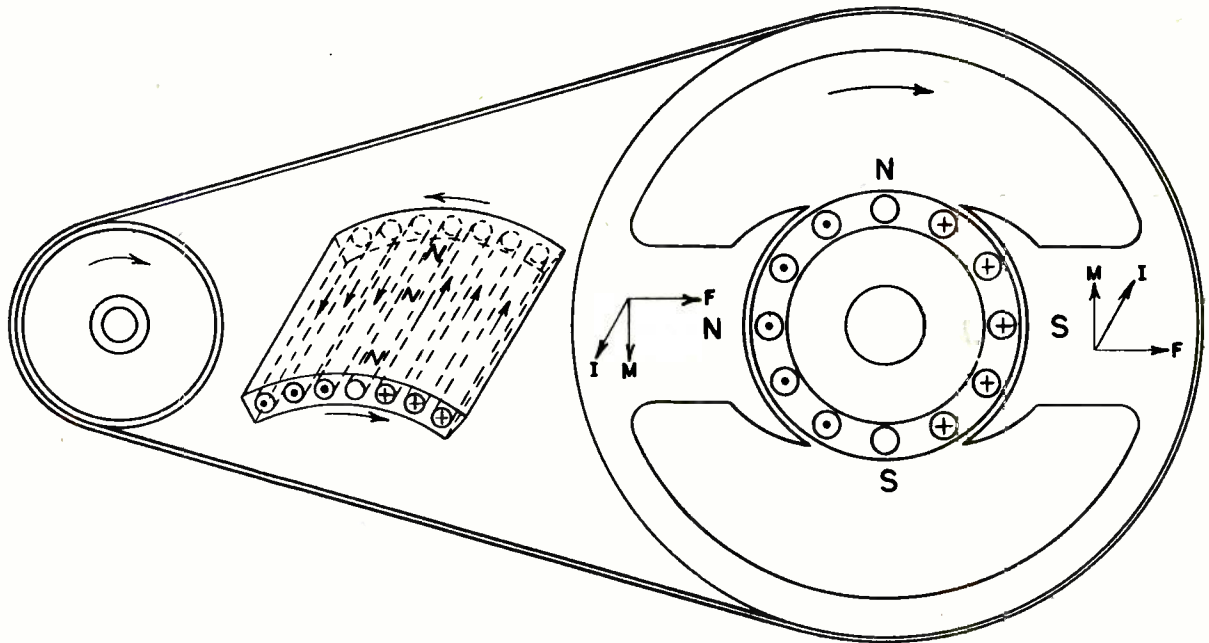

If a permanent magnet of the type shown above be rotated about a squirrel cage rotor, the flux of the magnet will cut across the squirrel rotor bars and induce voltage in them. The direction of these voltages at any instant may be determined by Fleming's Right Hand Rule. Application of this rule to the diagram above shows that currents will be flowing toward the observer under the North pole, and away from the observer under the South pole.

Viewed from above, current is circulating counter-clockwise around the rotor thereby establishing a North pole at the top and a South pole at the bottom. As the magnetic field is rotated, the rotor poles move at the same speed and in the same direction and maintain the same relative position; that is, midway between the stator poles.

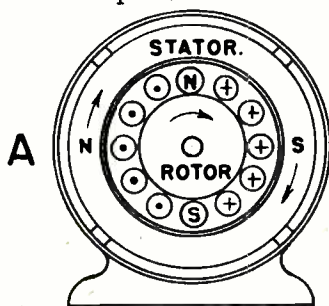

Diagrams A B C D show the relative position of the rotor and stator poles for four different points in one revolution.

In A there exists at the instant shown the same condition described above. In this case however, the rotating magnetic is produced by a different method.

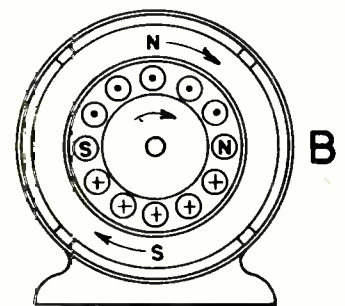

In B the revolving field has moved through one-quarter revolution. Note the change in current distribution in the rotor bars and the movement of the rotor poles. Diagrams C and D show the condition at later points in the revolution. Reversal of current in rotor bars causes rotor poles to revolve.

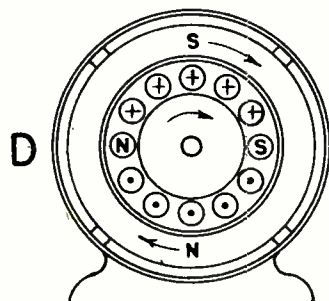

Although the diagrams show the current in the rotor bars changing direction in groups, the rotor bar currents actually reverse one at a time as the stator flux sweeps by. This produces a smooth progression of the poles around the rotor.

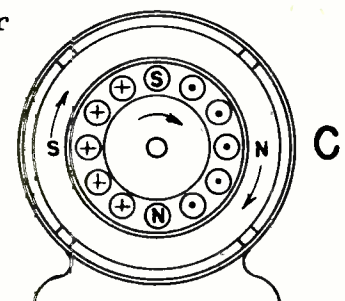

POSITION INDICATORS.

Position indicators are employed to transmit motion by electrical means between points which cannot be readily connected mechanically. In Figure A rotation of the arm on the sender rheostat varies the current through the receiver which is used as a receiver. When properly calibrated, the meter needle motion will be proportional to the motion at the sender. Thus the amount of gasoline in the tank may be indicated on the instrument panel of a car.

Figure B shows a similar arrangement except that clockwise rotation of the sender increases the voltage applied to the receiver and the deflection is in proportion to it.

Diagram C shows a bridge type circuit in which the meter needle is returned to zero by manipulating a rheostat at the receiving end. When balanced, both rheostat arms are in identical positions.

There are many other circuit arrangements but the basic operating principle is the same. The electrical method is particularly suited to most applications because the units may be any distance apart, and several receivers may be attached to one sender.

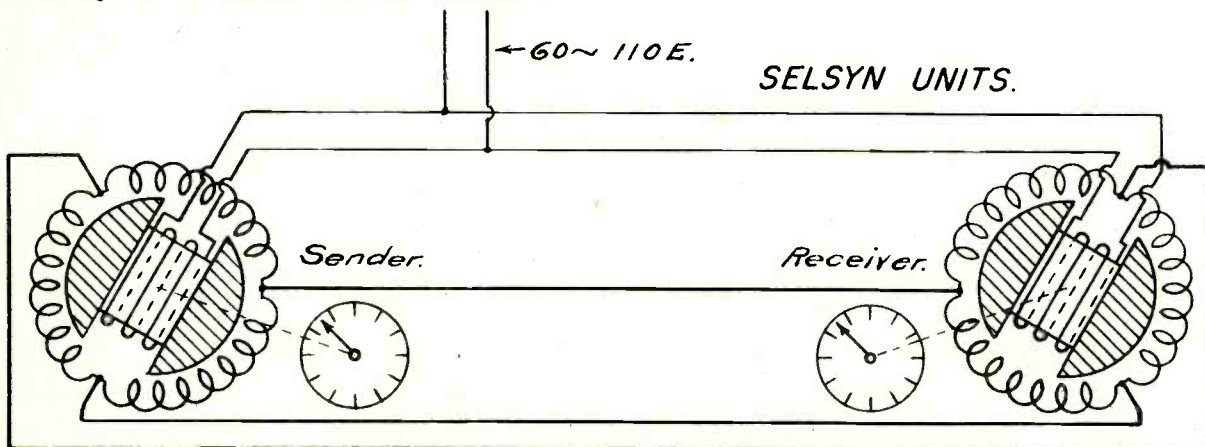
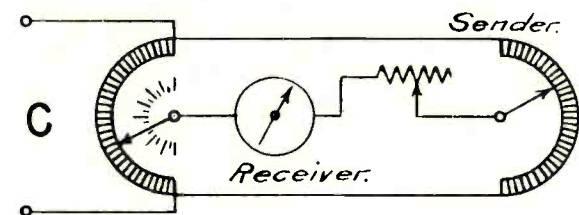
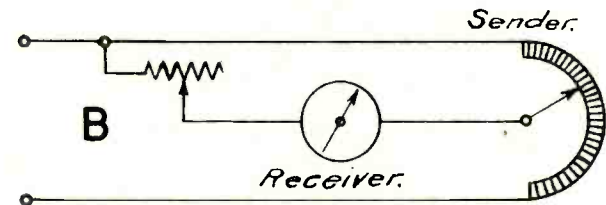
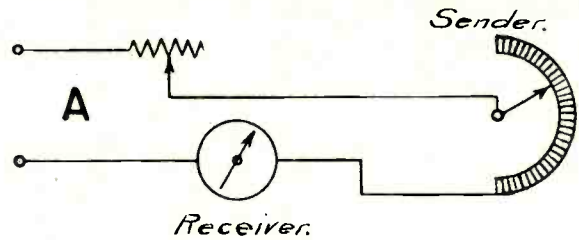

If two small motors of the type shown above are connected together and the rotors are energized from a single phase A.C. source, the varying flux produced by the rotors will induce voltages in the stator windings. If the rotors are in identical positions, the induced stator voltages will be in direct opposition and no current will flow in the leads connecting the stators together. Should one rotor be moved, this voltage balance is disturbed and current will flow through the other stator winding in such a direction as to cause its rotor to move to a corresponding position. This self synchronizing action which is characteristic of many types of A.C. motors is utilized in the Selsyn position indicator.

With the indicators arranged as shown, movement of the sender rotor is duplicated by the receiver and, whether the sender is rotated through a small angle or several revolutions, the receiver follows the motion exactly. Where several indications are required, several receivers may be attached to the same sender. In this way motion of the sender may be reproduced at any number of remote points.

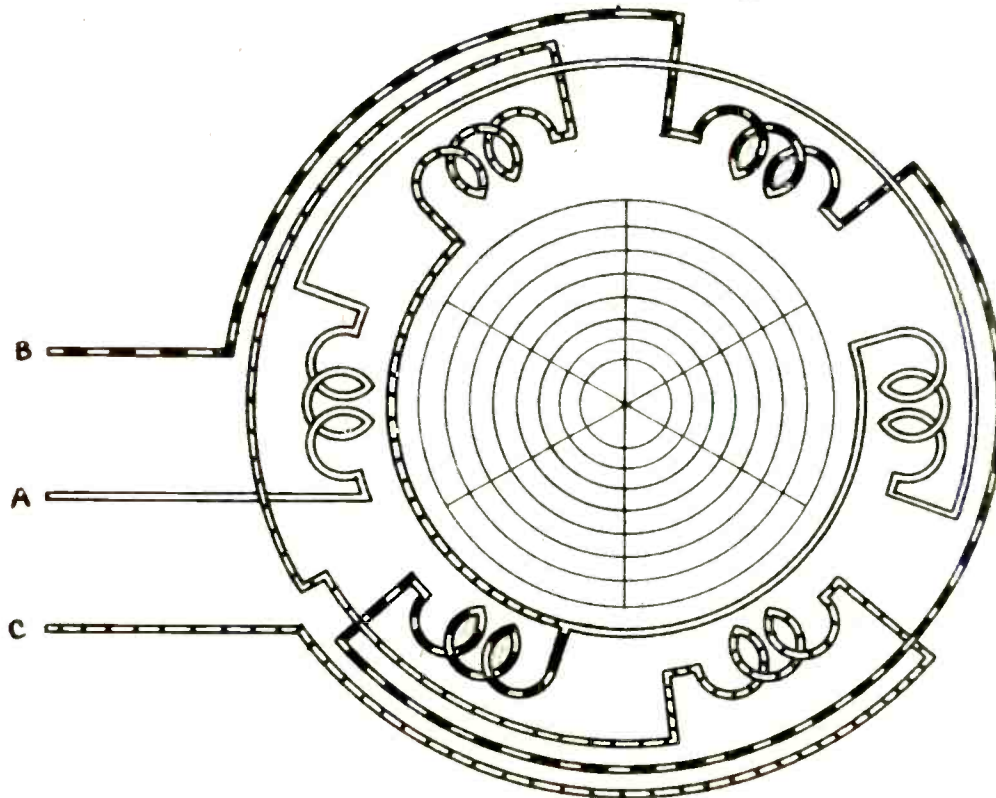
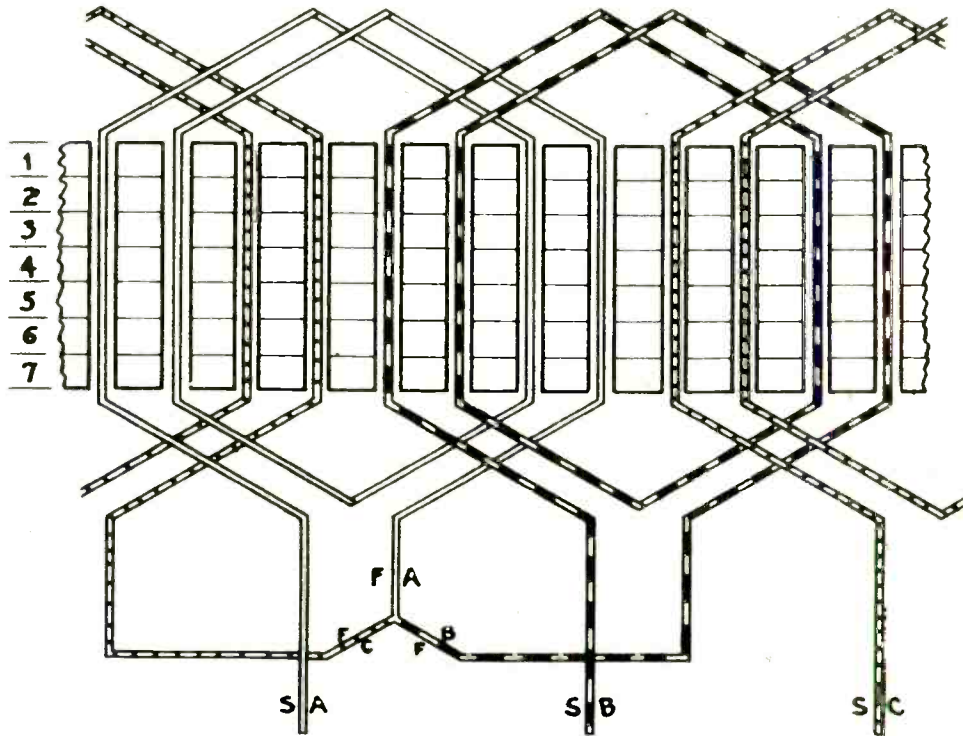
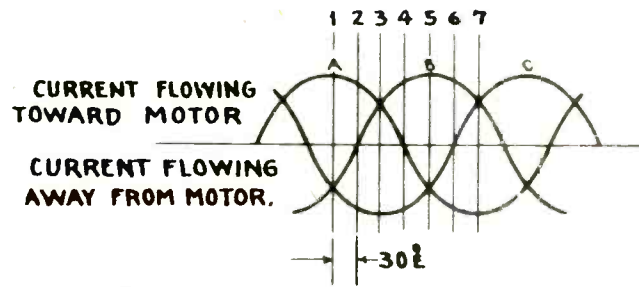
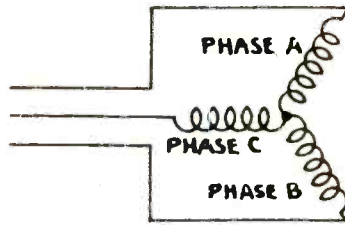

ASSUME CURRENT FLOWING CLOCKWISE TO SET UP A SOUTH POLE, AND CURRENT FLOWING COUNTER-CLOCKWISE TO SET UP A NORTH POLE

THREE PHASE, LAP WINDING, FULL PITCH, SLOTS = 24
 POLES = 4, PHASE = 3, COILS PER GROUP = 2
 FULL PITCH COIL SPAN=1-7, ELECT. DEGREES PER SLOT = 30

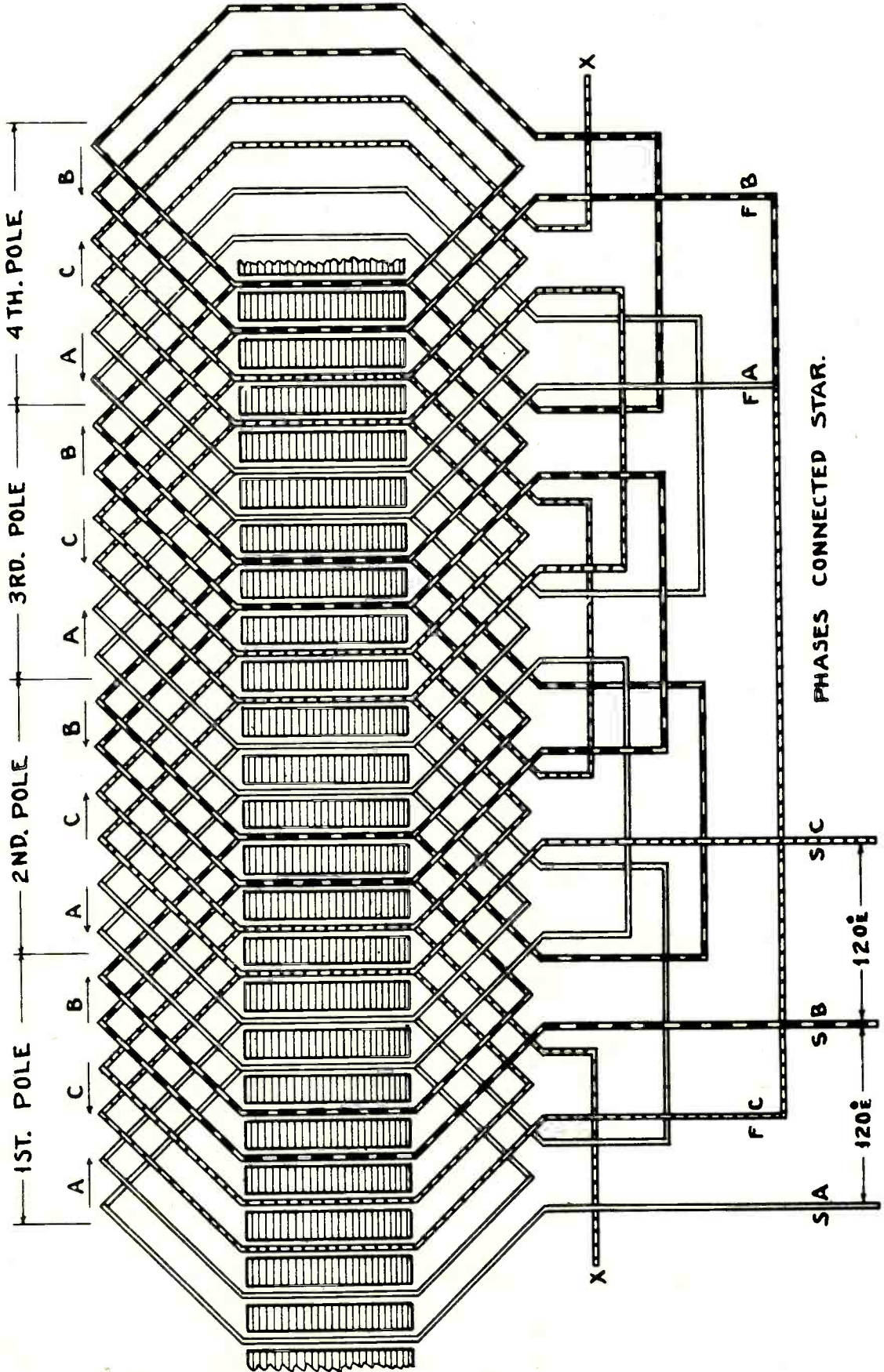
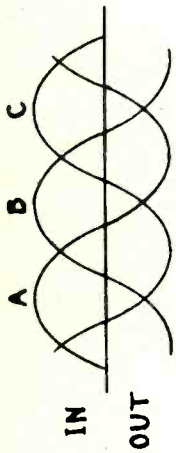

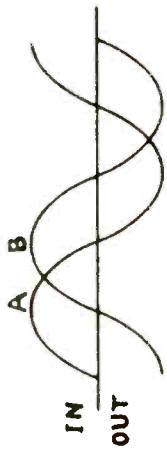

TWO PHASE, LAP WINDING, FULL PITCH, SLOTS = 24
 POLES = 4, PHASE = 2, COILS PER GROUP = 3
 FULL PITCH COIL SPAN = 1-7, ELECT. DEGREES PER SLOT = 30

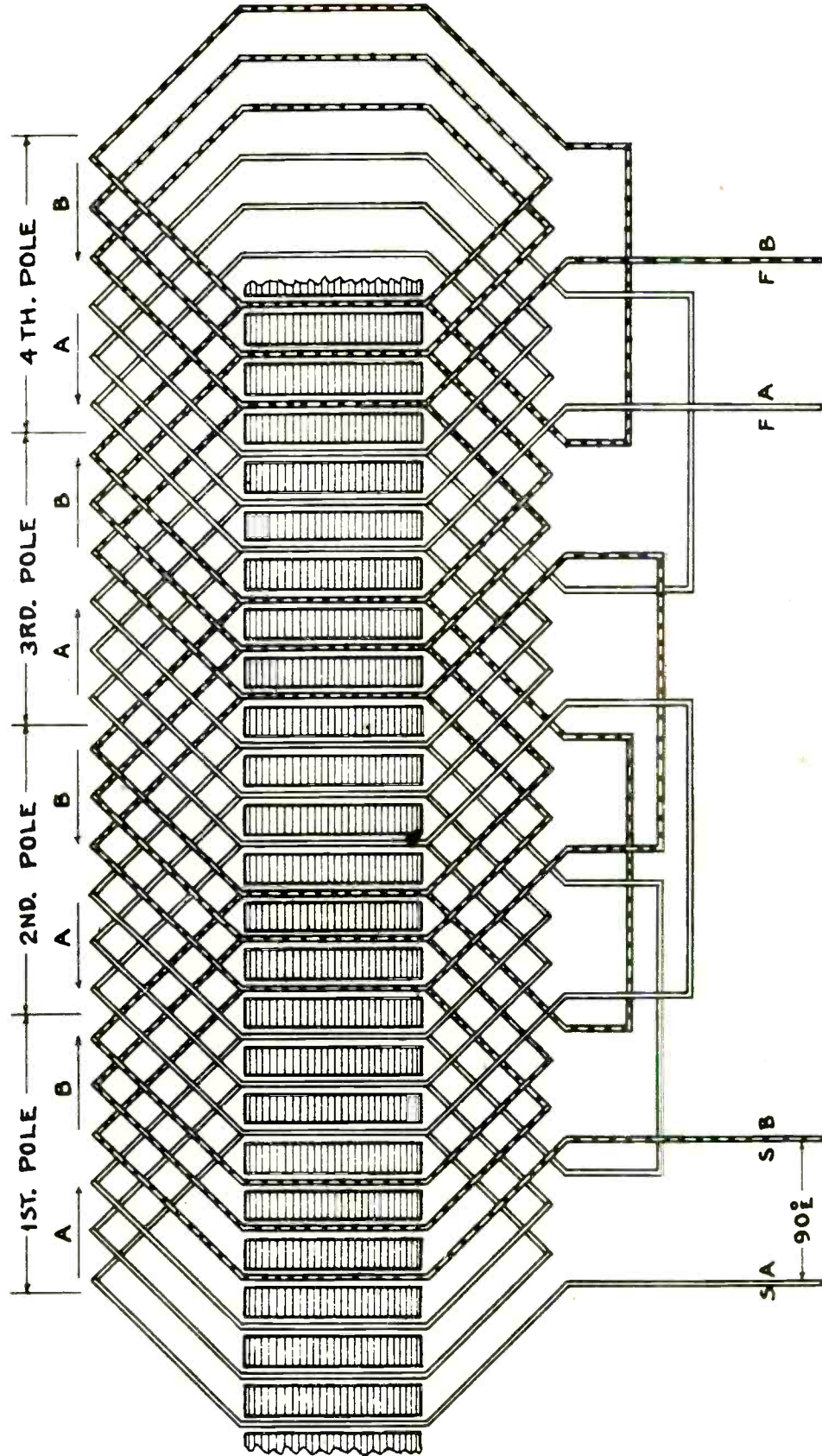

THREE PHASE, LAP WINDING, FULL PITCH, SLOTS = 24
 POLES = 4, PHASE = 3, COILS PER GROUP = 2
 FULL PITCH COIL SPAN=1-7, ELECT. DEGREES PER SLOT = 30

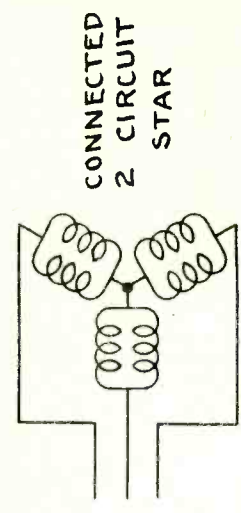
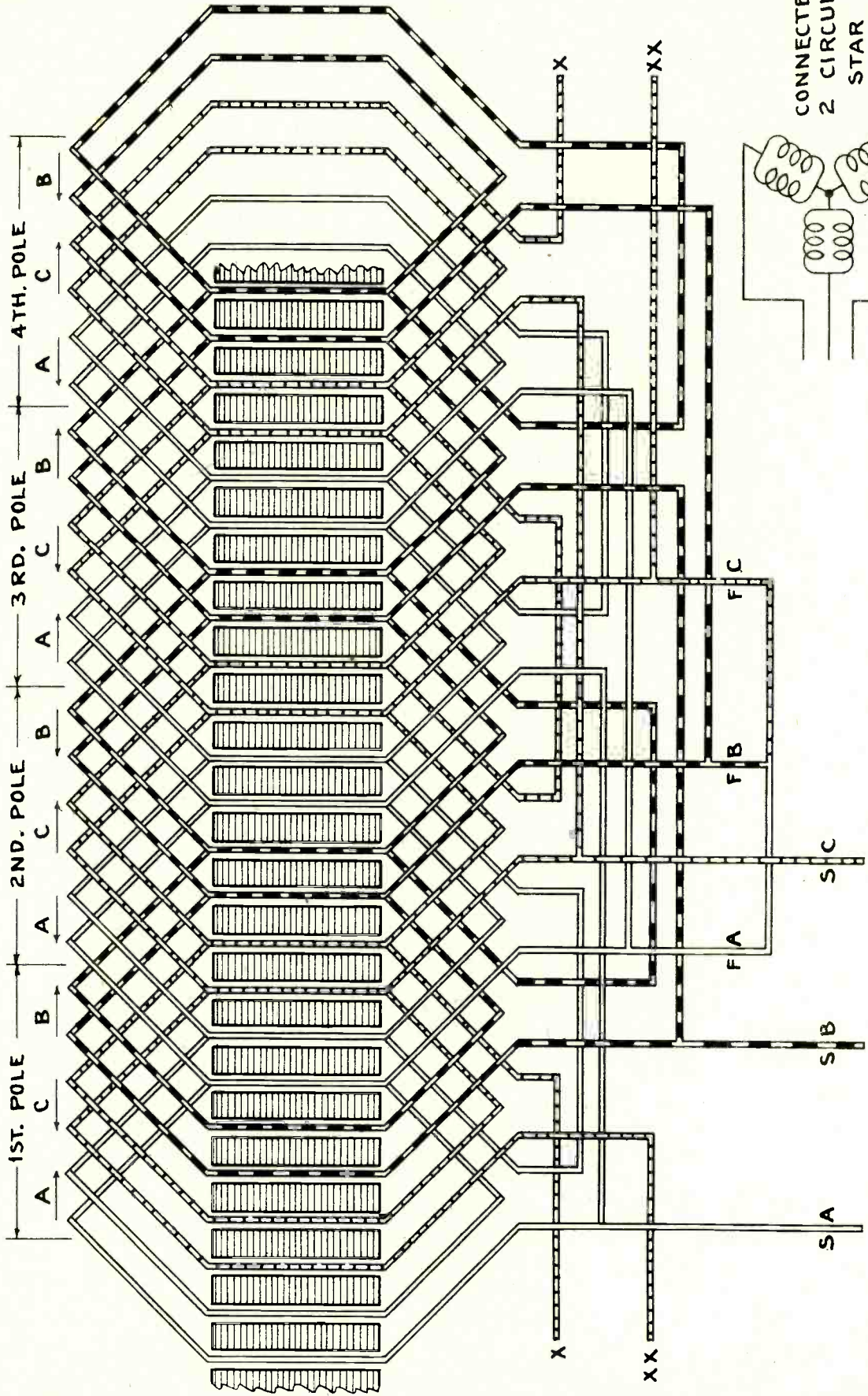
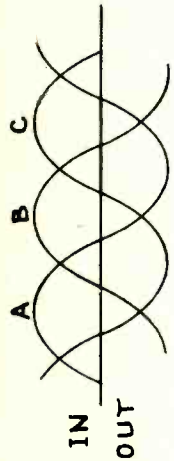

COYNE

THREE PHASE, LAP WINDING, FULL PITCH, SLOTS = 24
 POLES = 4, PHASE = 3, COILS PER GROUP = 2
 FULL PITCH COIL SPAN=1-7, ELECT. DEGREES PER SLOT = 30

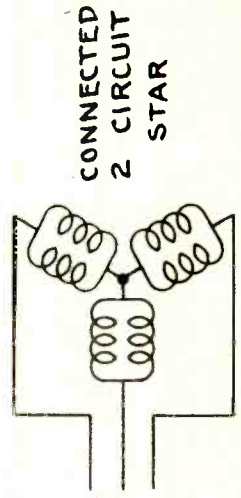
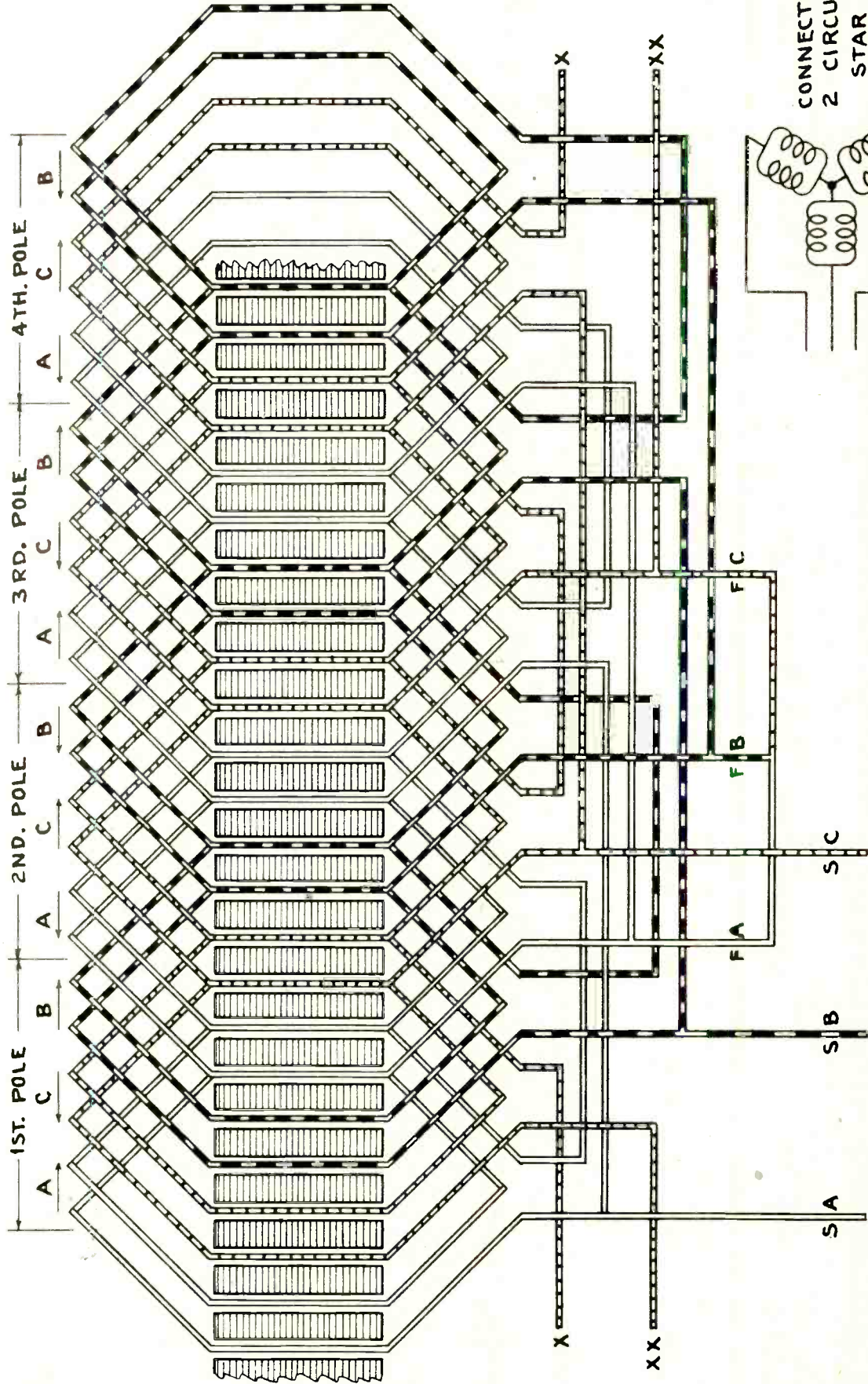
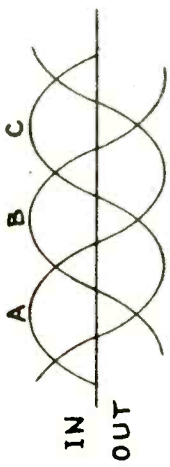

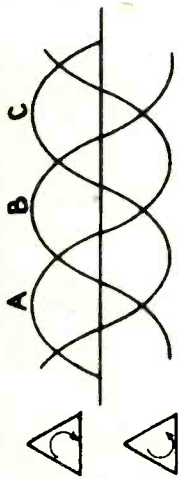

THREE PHASE, LAP WINDING, FRACTIONAL PITCH, SLOTS=24
 POLES = 4, PHASE = 3 COILS PER GROUP = 2
 FRACTIONAL PITCH COIL SPAN=1-5, ELECT. DEGREES PER SLOT = 30

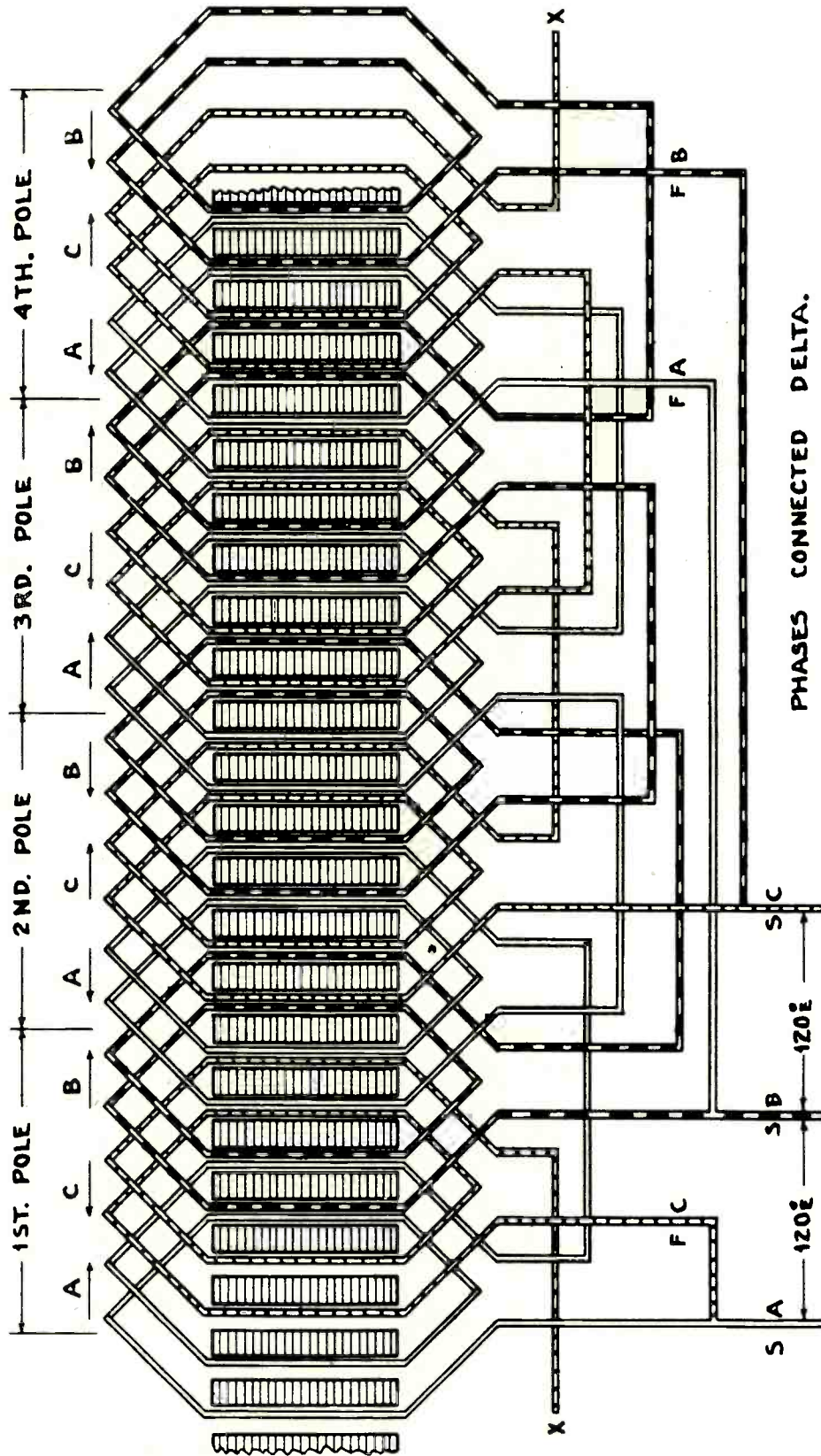

PHASES CONNECTED DELTA.

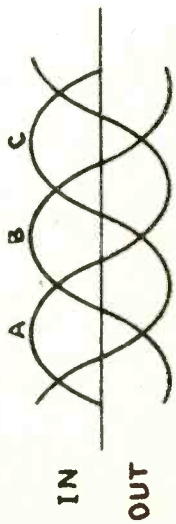

THREE PHASE, LAP WINDING, FULL PITCH, SLOTS = 36
POLES = 6, PHASE = 3, COILS PER GROUP = 2
FULL PITCH COIL SPAN = 1-7, ELECTRICAL DEGREES PER SLOT = 30

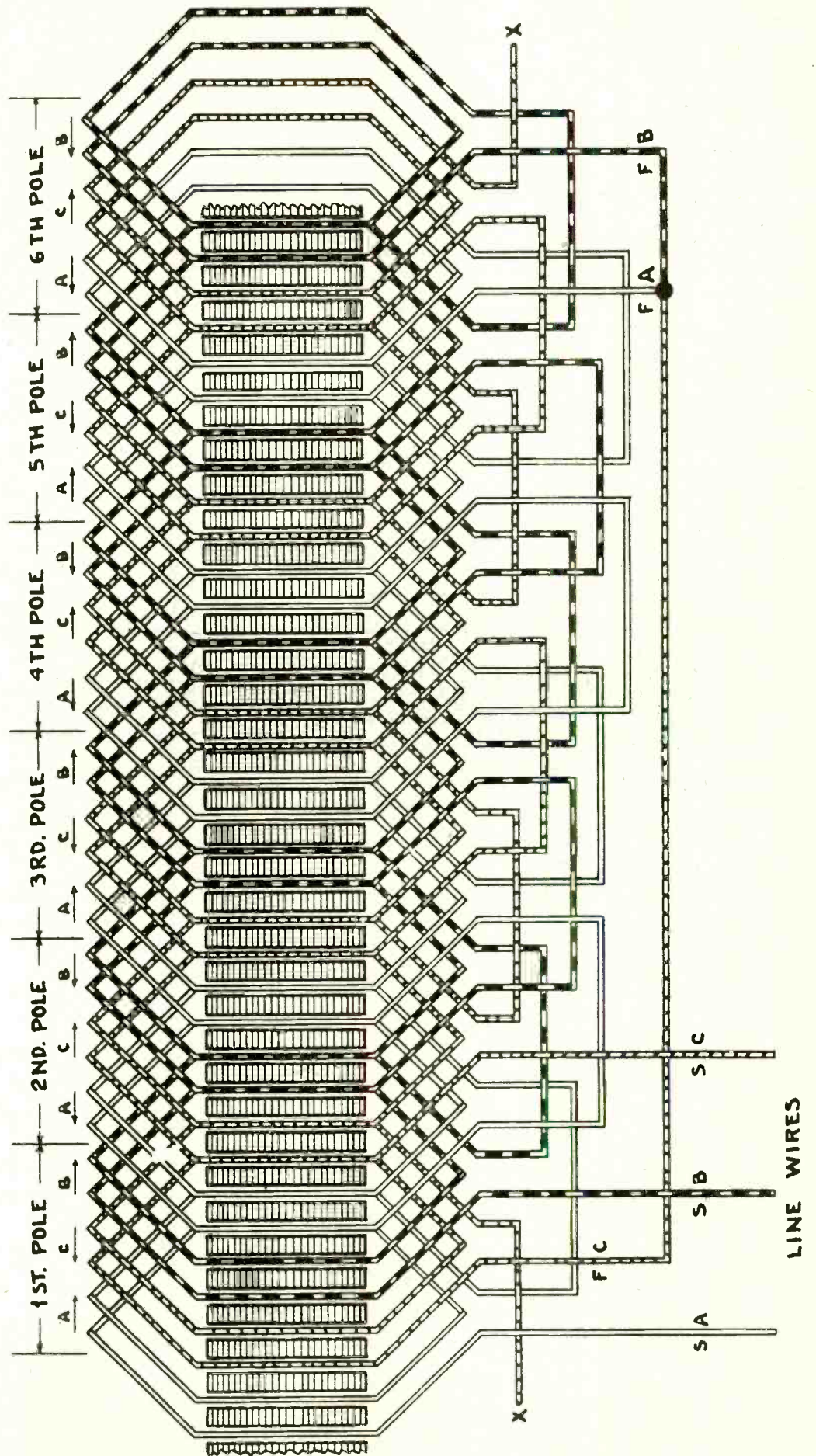

PRINCIPLES OF CONSEQUENT POLE WINDINGS FOR 3 PHASE INDUCTION MOTORS.

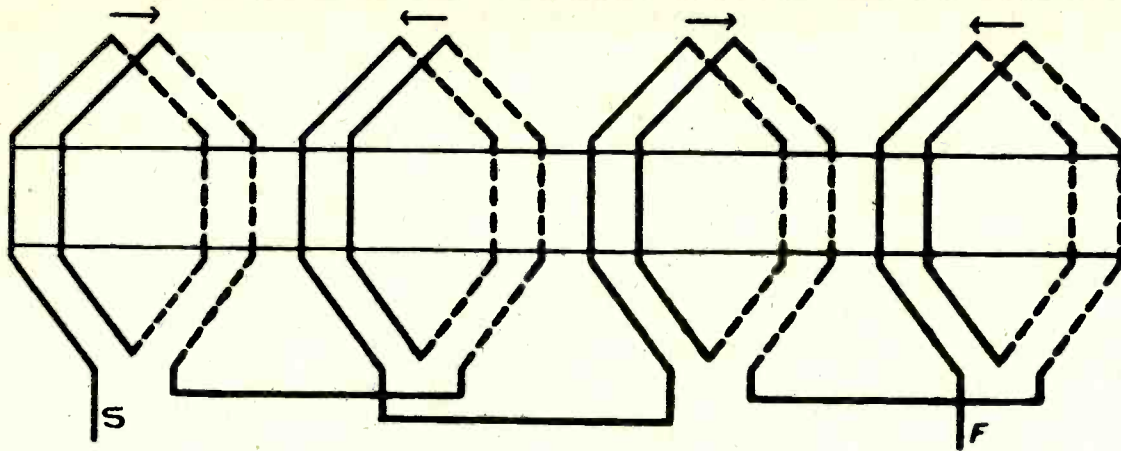

Slots = 24, Poles = 4, Fractional Pitch Coil Span = 1 to 5.

"A" Phase only of a 3 phase winding illustrating common method of short jumpers. (Top to Top, Bottom to Bottom) Trace the circuit and mark the polarities in the proper position. This type of jumper connection is not suitable for consequent pole windings.

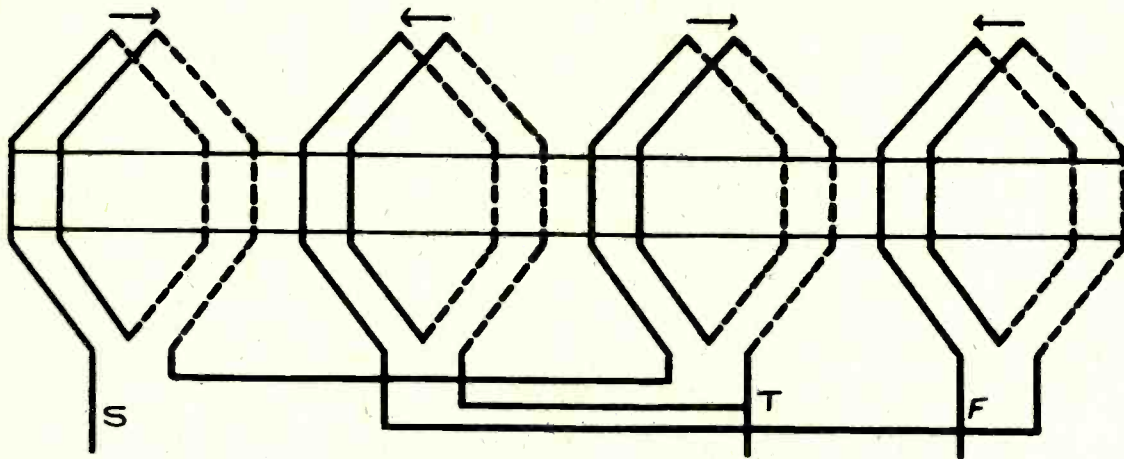

"A" Phase only of 3 phase winding illustrating long jumper method of connection. (Top to Bottom, Bottom to Top) Trace the circuit for 4 poles disregarding the center tap, and mark the polarities in the proper position. Note that the poles are established in the same position as for the common method of connection.

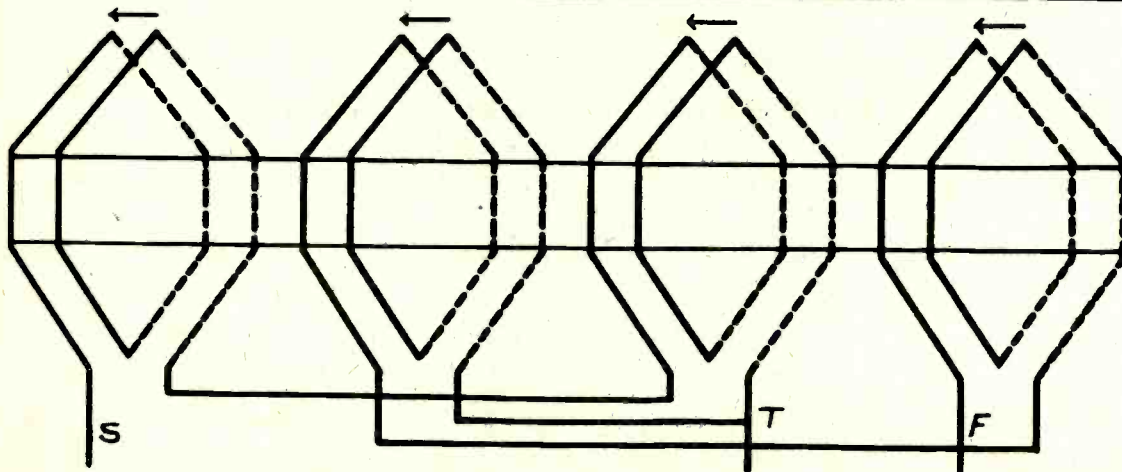

Same connection as shown above. Trace the circuit from the center tap. This places the 2 sections of the phase winding in parallel, reversing the current in $\frac{1}{2}$ of the coil groups, producing 4 regular & 4 consequent poles. Note that phase rotation is reversed and it will be necessary to reverse 2 leads on this connection to obtain the same rotor rotation.

SIMPLE DIAGRAM, 4-8 POLE, 3 PHASE CONSEQUENT POLE STATOR WINDING.

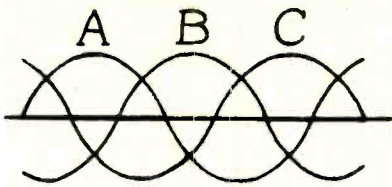

VARIABLE TORQUE, CONSTANT HORSEPOWER.
 3 PHASE, LAP WINDING, SLOTS = 24.
 POLES = 4-8, COILS PER GROUP = 2.
 FRACTIONAL PITCH COIL SPAN = 1 TO 5.
 COIL PITCH = 66.6% OF FULL PITCH.
 ELECTRICAL DEGREES PER SLOT = 30-60.

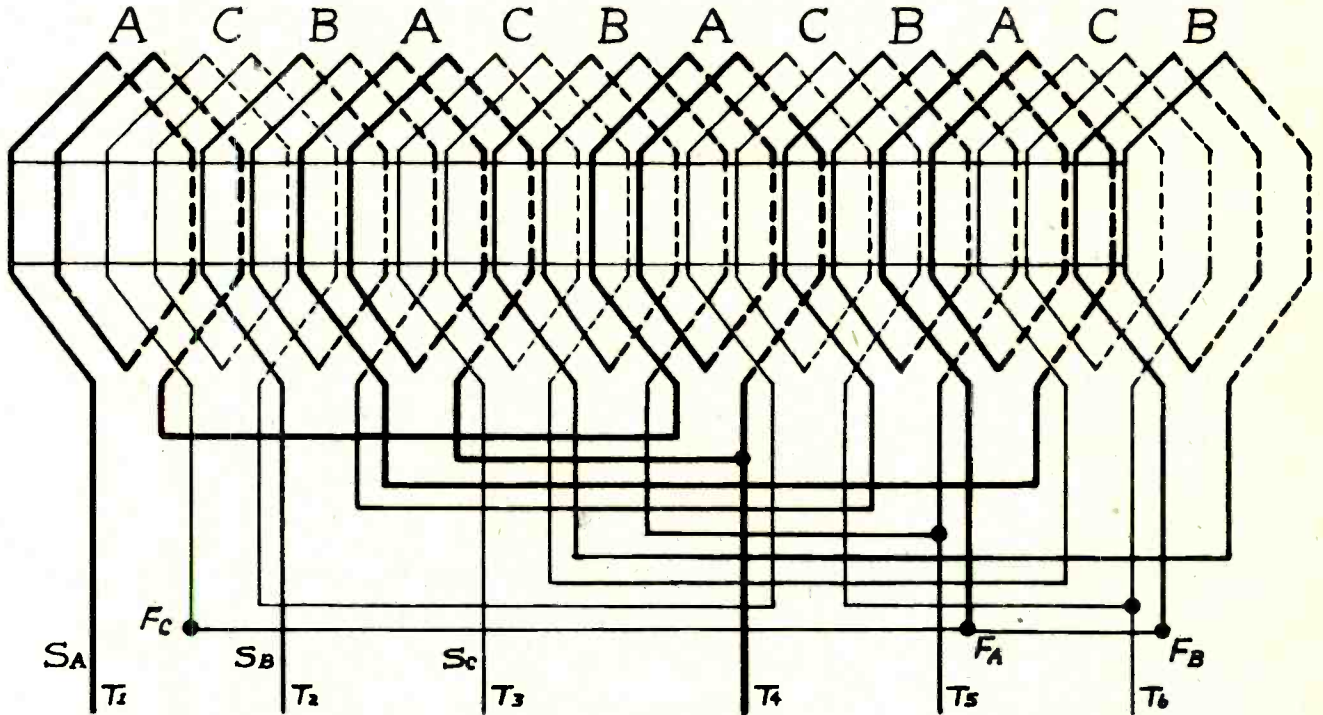

INDICATE DIRECTION OF I FLOW AND POLARITIES FOR 4 POLES IN SPACE BELOW.



INDICATE DIRECTION OF I FLOW AND POLARITIES FOR 8 POLES IN SPACE BELOW.

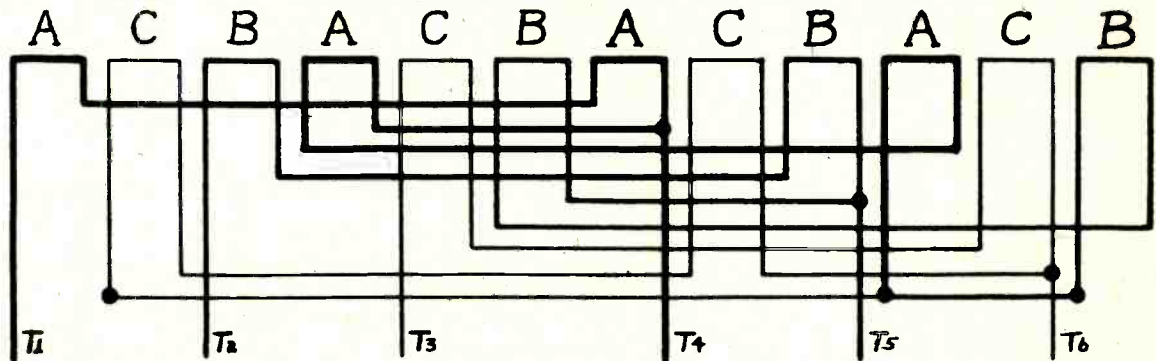

SERIES STAR
 4 POLES
 T₁, T₂, T₃ TO LINE
 T₄, T₅, T₆ OPEN

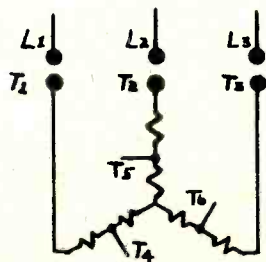

PARALLEL STAR
 8 POLES
 T₄, T₅, T₆ TO LINE
 T₁, T₂, T₃ SHORTED

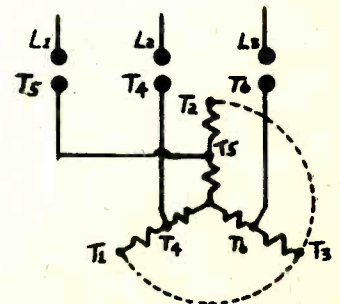

COMPARISON OF LAP AND WAVE WINDINGS.

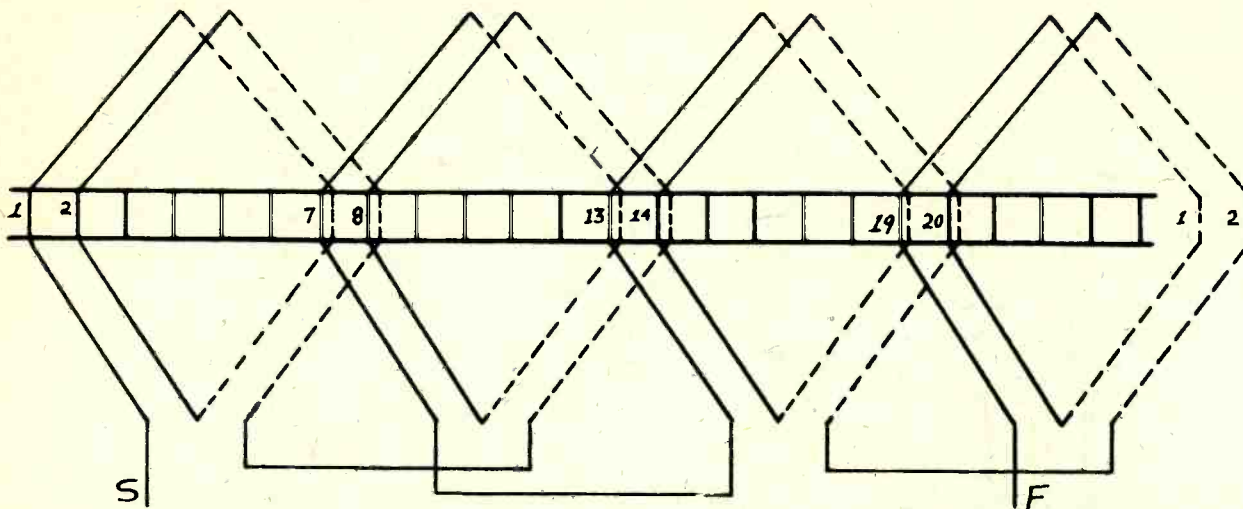

A LAP WINDING is one in which the coils of each pole phase group are connected directly in series with each other or forward and back on itself. Lap windings are generally used on A.C. machines because they are more readily adaptable to stators with various numbers of slots.

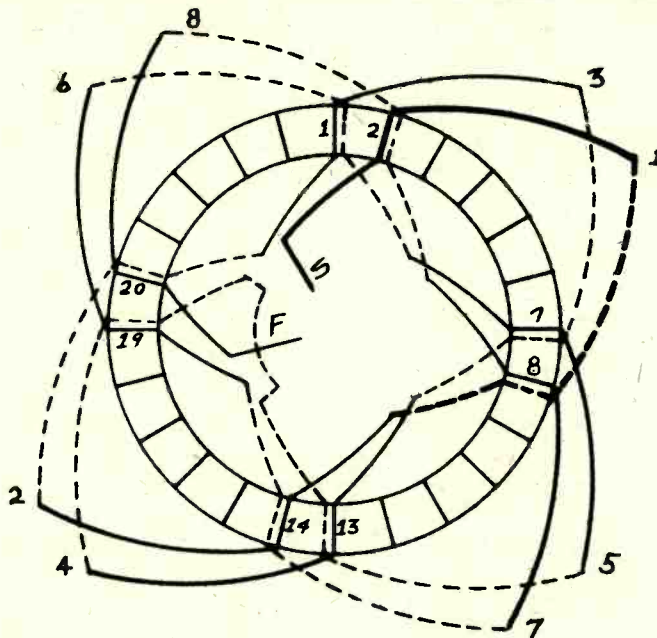

A WAVE WINDING is one in which correspondingly placed coils under adjacent poles are connected in series so that the circuit proceeds from pole to pole one or more times around the stator core, and not forward and back upon itself as on a lap winding. On a wave winding, the circuit re-enters the first coil group after it has passed thru at least one other coil group of the winding. The total number of these circuits must be a multiple of the number of phases and is ordinarily two times the number of phases. Wave windings in large machines are always of strap or bar copper coils with two layers. Principal use is for wound rotors of large slip ring motors because such windings have greater mechanical strength at end connections when made of bar or strap copper. WAVE WINDINGS in stators of induction motors must be electrically balanced, i.e., each phase must contain the same number of coils or turns. The number of active slots in each phase and section must be a multiple of poles times phases. For 4 pole, 3-phase, slots would have to be 12-24-36-48-60-72, etc.

THREE PHASE WAVE WINDING.

PHASES CONNECTED STAR.

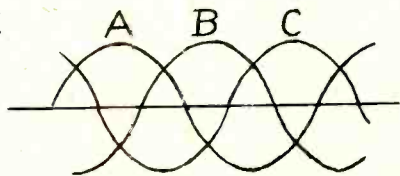
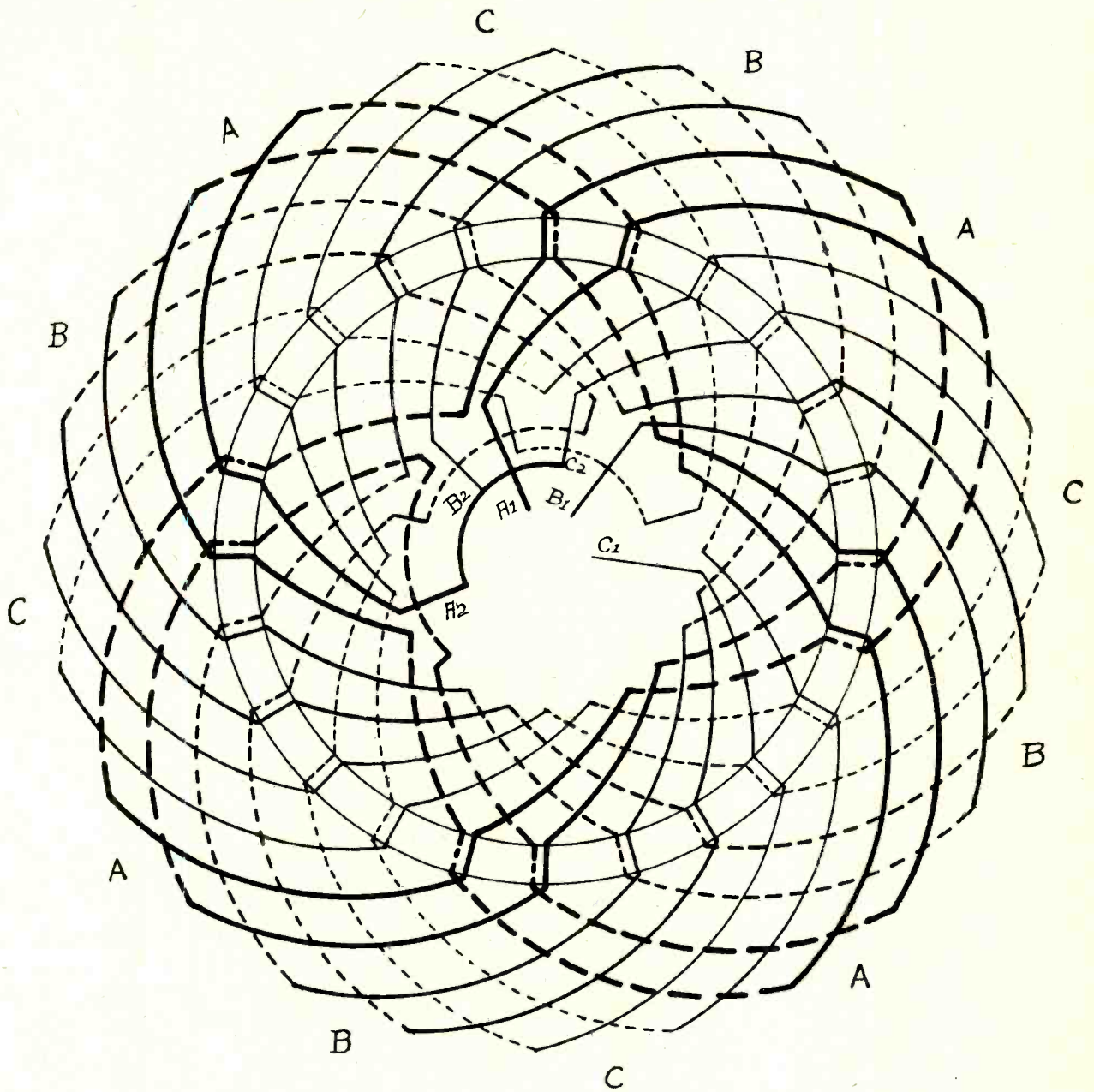

THREE PHASE, WAVE WINDING.

SLOTS = 24, POLES = 4.

FULL PITCH COIL SPAN = 1:7.

COILS PER POLE PHASE GROUP = 2.

ELECTRICAL DEGREES PER SLOT = 30.

CONNECTIONS FOR TWO VOLTAGE MOTORS.

NUMBERING SYSTEM USED BY WAGNER, GE., AND LOUIS ALLIS.
SUGGESTED STANDARD SYSTEM

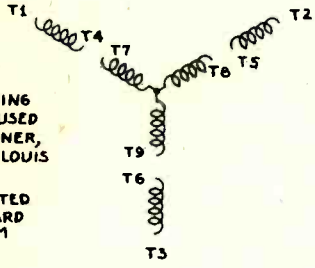

CONNECT
T1 TO LINE 1
T2 " " 2
T3 " " 3
T4-T7 TOGETHER
T5-T8 "
T6-T9 "

440E. 20I. LINE.
SERIES STAR

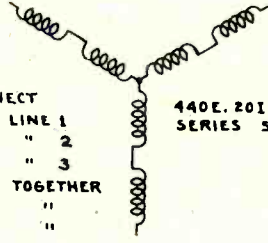

2 CIRCUIT STAR
220E. 40I.

CONNECT
T1 TO LINE 1
T2 " " 2
T3 " " 3
T1-T7 TOGETHER
T2-T8 "
T3-T9 "
T4-T5-T6 "

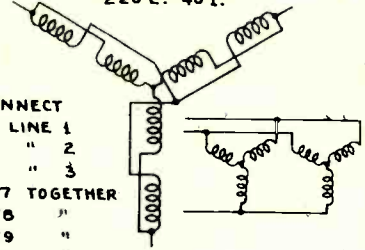

NUMBERING SYSTEM USED BY WESTINGHOUSE AND ALLIS CHALMERS.

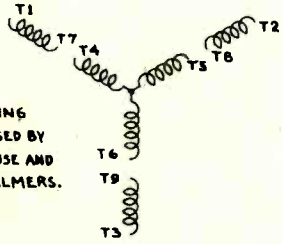

CONNECT
T1 TO LINE 1
T2 " " 2
T3 " " 3
T4-T7 TOGETHER
T5-T8 "
T6-T9 "

SERIES STAR

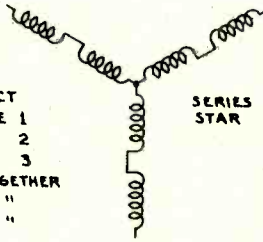

CONNECT
T1 TO LINE 1
T2 " " 2
T3 " " 3
T1-T4 TOGETHER
T2-T5 "
T3-T6 "
T7-T8-T9 "

2 CIRCUIT STAR

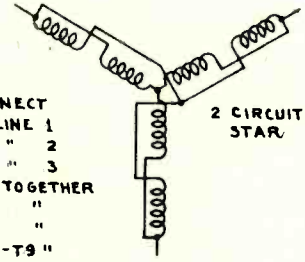

NUMBERING SYSTEM USED ON DELTA CONNECTED MOTORS BY ALL MANUFACTURERS

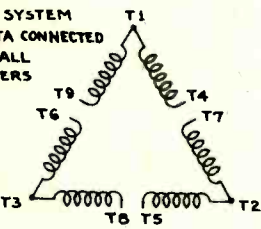

CONNECT
T1 TO LINE 1
T2 " " 2
T3 " " 3
T4-T7 TOGETHER
T5-T8 "
T6-T9 "

SERIES DELTA

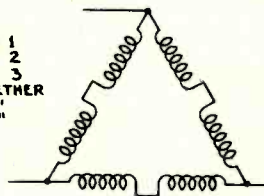

CONNECT
T1-T6-T7 TO LINE 1
T2-T4-T8 " " 2
T3-T5-T9 " " 3

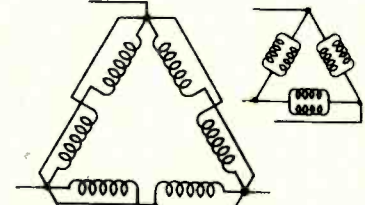

2 CIRCUIT DELTA

220E { 1-4 TO LINE
2-3 TOGETHER
SINGLE PHASE

1 H.P. 220E.
S.I. 1750 R.P.M.

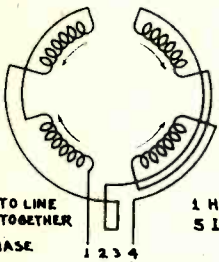

110E { 1-4 TO LINE
2-3 TOGETHER
SINGLE PHASE

1 H.P. 110E.
101. 1750 R.P.M.

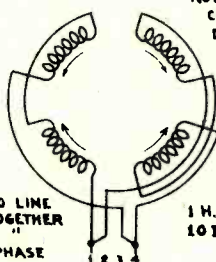

NOTE: CHANGING CONNECTION DOES NOT ALTER H.P. OR SPEED WHEN MOTOR IS DESIGNED FOR TWO VOLTAGES

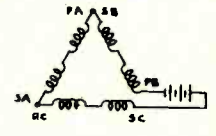
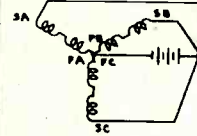

Connections for applying D.C. when testing an A.C. winding with a compass. If the winding is properly connected, the compass will reverse on each pole phase group and indicate three times as many poles as the machine actually has.

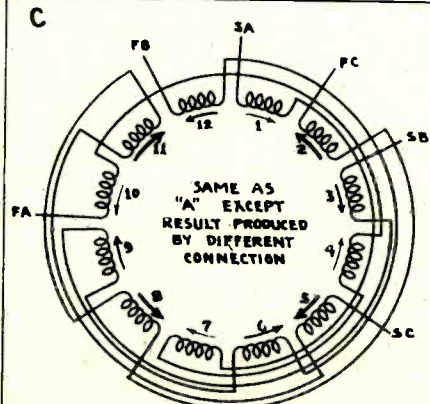
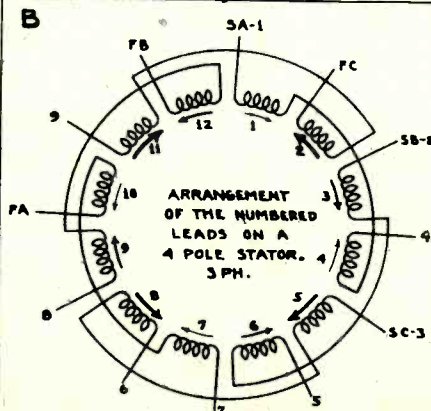
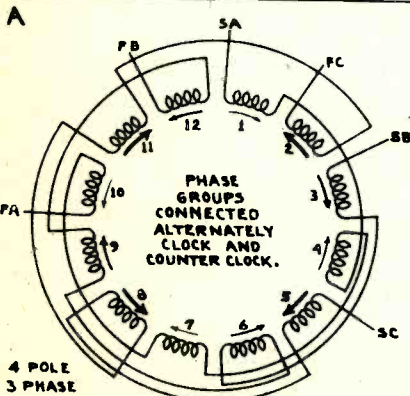

REDRAW "A," "B" AND "C" AND PRACTICE CONNECTING THEM FOR ALL ABOVE CONNECTIONS.

STAR OR Y
CONNECTED



ENGINEERING INFORMATION

POLYPHASE INDUCTION MOTORS

TYPES SC, SCN, SCH, SCT, SCX, AS, SR - 3 PHASE

Three Phase motors may be either Star or Delta connected and no general rule can be set down for use of either connection. Individual ratings must be checked by the general office.

Our standard method of marking leads and the schematic representation of circuits* is as follows:

DUAL VOLTAGE* (110/220, 190/380, 220/440 etc.)

Consider T_1 and T_4 (Fig. 1) as the end of one circuit* and T_7 and the center of the star as the ends of the other circuit, in one phase. Do the same for each of the other two phases. To connect the stator winding for the higher voltage, the circuits in each phase are connected in series; therefore, connect T_4 to T_7 , T_5 to T_8 , and T_6 to T_9 . Line connections will be made to T_1 , T_2 , and T_3 fig. 2 and 5 show these connections.

To connect the stator windings for the lower voltage, the circuits in each phase are connected in parallel, therefore connect T_1 to T_7 , T_2 to T_8 , and T_3 to T_9 . T_4 , T_5 and T_6 are connected together to form a point, thereby forming a second star in parallel with the star whose ends are T_7 , T_8 , and T_9 . Line connections, as before, will be made to T_1 , T_2 and T_3 . Fig. 3 and 6 show these connections.

These motors have permanent connection plate near terminal box.

SINGLE VOLTAGE* (199, 209, 220, 440, 550, 2200 etc.)

Only leads T_1 , T_2 and T_3 are brought out as shown in fig. 4 and 7 (Single voltage motors usually have single section windings rather than the double section winding shown in Fig. 1)

Connections are indicated on lubrication tags sent with motor.

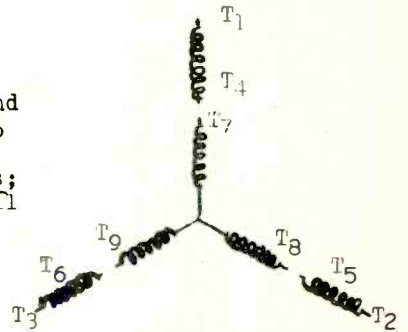

FIG. 1
All terminal lugs are stamped in accordance with this diagram.

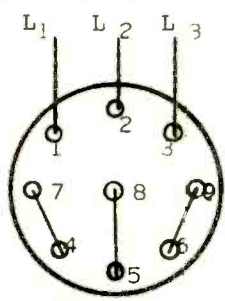

FIG. 2
High Voltage

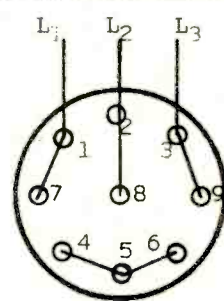

FIG. 3
Low Voltage

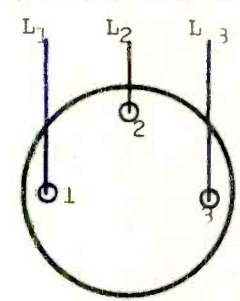

FIG. 4
Single Voltage

DUAL VOLTAGE CONNECTIONS (Similar to B6671 & B7203)

All Form A 204 and smaller; Form W, 224 to 326; Form T 204 and larger. (T superseded by W)

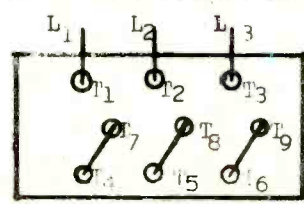

FIG. 5
High Voltage

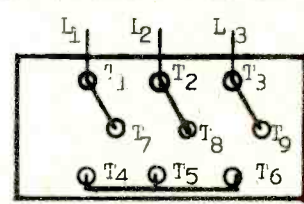

FIG. 6
Low Voltage

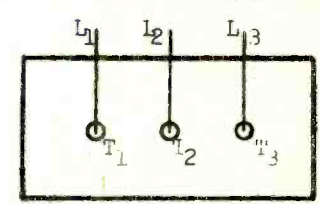

FIG. 7
Single Voltage

DUAL VOLTAGE CONNECTIONS (Similar to B4270 & B4271)

All Form S motors. Form T motors 444 and larger.



ENGINEERING INFORMATION
POLYPHASE INDUCTION MOTORS

DATA 23-65 Page 3
Dec. 4, 1940
Destroy 23-101 P.3.
Dated Dec. 7, 1935

TYPES SC, SCN, SCH, SCT, SCX, AS, SR - 2 PHASE

Our standard method of marking leads, and the schematic representation of circuits is as follows:

TWO PHASE FOUR WIRE

DUAL VOLTAGE* (110/220, 220/440 etc.)

Consider T₁ and T₅ (Fig.15) as the ends of one circuit *, and T₇ and T₃ as the ends of the circuits in the second phase. To connect the stator windings for the higher voltage, the circuits in each phase are connected in series; therefore, connect T₅ to T₇, and T₆ to T₈. Line connections will be made to T₁, T₂, T₃ and T₄. FIGS. 16 and 19 show these connections.

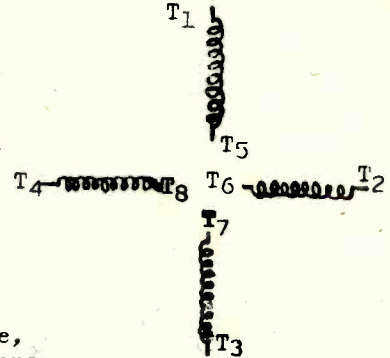

FIG. 15

All terminal lugs are stamped in accordance with this diagram.

To connect the stator windings for the lower voltage, the circuits in each phase are connected in parallel; therefore, connect T₁ to T₇, T₅ to T₃, T₂ to T₈, and T₆ to T₄. Line connection, as before, will be made to T₁, T₂, T₃ and T₄. Figs 17 and 20 show these connections.

These motors have permanent connection plate near terminal box.

SINGLE VOLTAGE* (199, 208, 220, 440, 550, 2200 etc.)

Only leads T₁, T₂ and T₃ are brought out as shown in Fig. 18 and 7 (Single voltage motors usually have single section windings rather than the double section winding shown in Fig. 15)

Connections are indicated on lubrication tags sent with motor

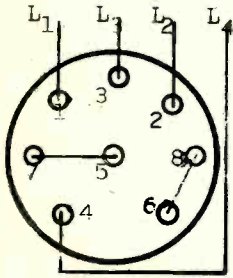

FIG. 16
High Voltage

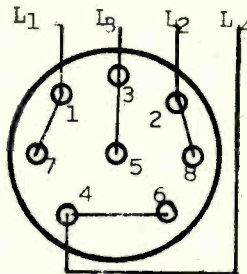

FIG. 17
Low Voltage

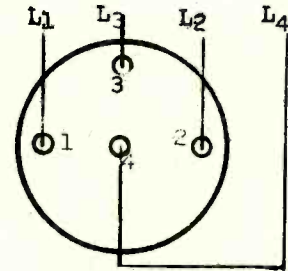

FIG. 18
Single Voltage

DUAL VOLTAGE CONNECTIONS (Similar to B6672 & B7204)

All Form A 204 and smaller; Form W, 224 to 326; Form T 204 and larger (T superseded W)

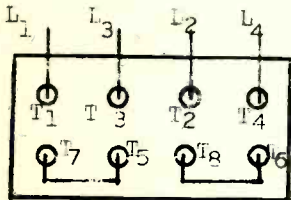

FIG. 19
High Voltage

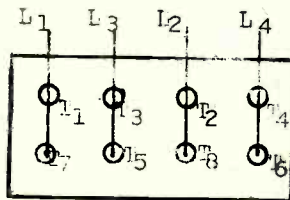

FIG. 20
Low Voltage

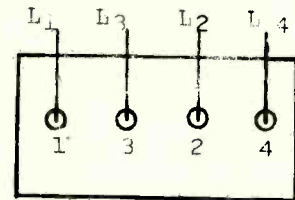

FIG. 21
Single Voltage

DUAL VOLTAGE CONNECTIONS (Similar to B4269 & B4272)

All Form S motors. Form T motors 444 and larger.

TWO PHASE THREE WIRE

For connection to a three wire system, connect motor leads T₃ and T₂, together. Line connections will then be made to T₁, T₃₋₂, and T₄; the common (or return wire) being connected to T₃₋₂.

* - The terms "circuit" as here used refers to one-half of the number of poles in one phase.
* - See price sheet for standard voltage and horsepower of individual ratings.



ENGINEERING INFORMATION
 CONNECTION PLATES MULTI-SPEED SQUIRREL CAGE MOTORS
 2 SPEED 1 AND 2 WINDINGS

THESE LEAD MARKINGS APPLY TO MOTORS MADE IN 1940 AND LATER

3 PHASE

STAMPING OF AUXILIARY NAME PLATE 2 SPEED 1 WINDING 3 PHASE

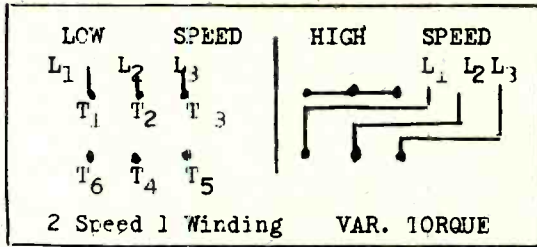

SIMILAR TO B4494

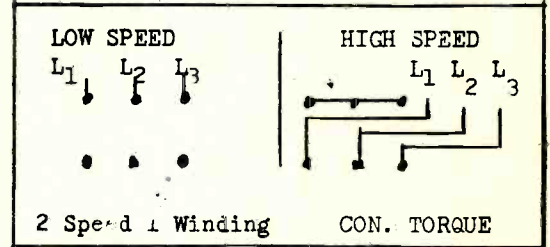

SIMILAR TO B4494

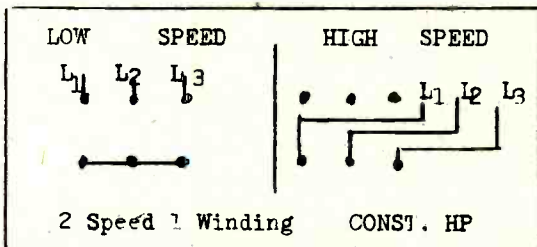

SIMILAR TO C17131

AUXILIARY NAME PLATE 2 SPEED 2 WINDING 3 PHASE

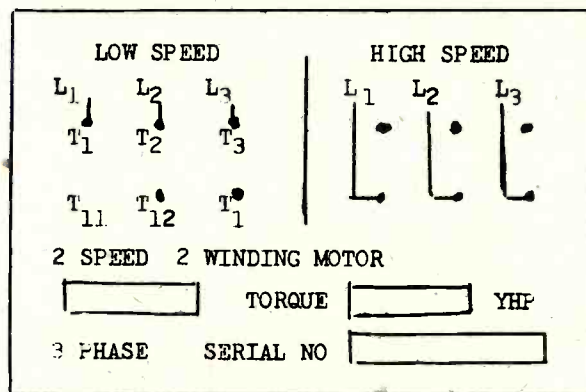

SIMILAR TO B4248

THESE DIAGRAMS ARE REPRODUCTIONS OF PLATES ATTACHED TO MOTORS WHEN THEY LEAVE THE FACTORY.

A.C. Single-phase Motors



ENGINEERING INFORMATION
CONNECTION PLATES MULTI-SPEED SQUIRREL CAGE MOTORS
3 SPEED - 2 WINDING - CONSTANT HP

THESE LEAD MARKINGS APPLY TO MOTORS MADE IN 1940 AND LATER

3 PHASE

AUXILIARY NAME PLATE 3 SPEED 2 WINDING CONSTANT HORSEPOWER
2-4-6; 4-8-12; 6-12-16 POLE

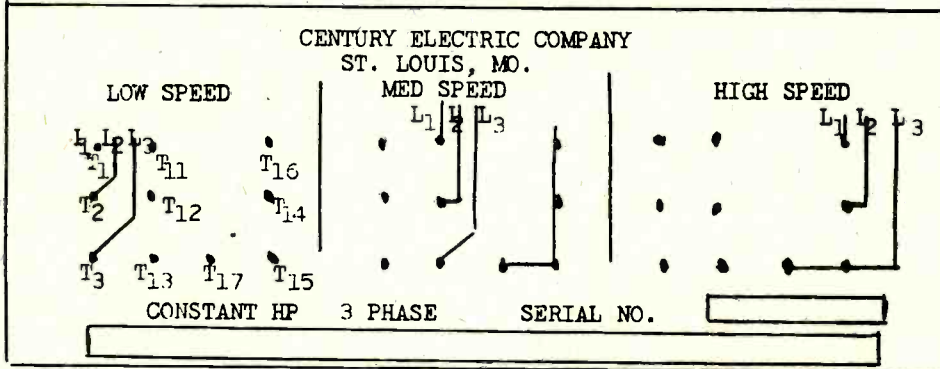

SIMILAR TO C17132

AUXILIARY NAME PLATE 3 SPEED 2 WINDING CONSTANT HORSEPOWER
4-6-8; 6-8-12; 8-12-16 POLE

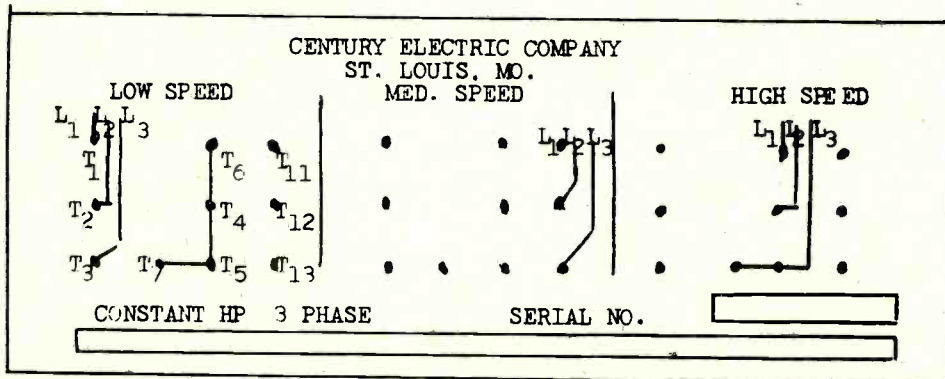

SIMILAR TO C17134

AUXILIARY NAME PLATE 3 SPEED 2 WINDING CONSTANT HORSEPOWER
4-6-12; 6-8-16 POLE

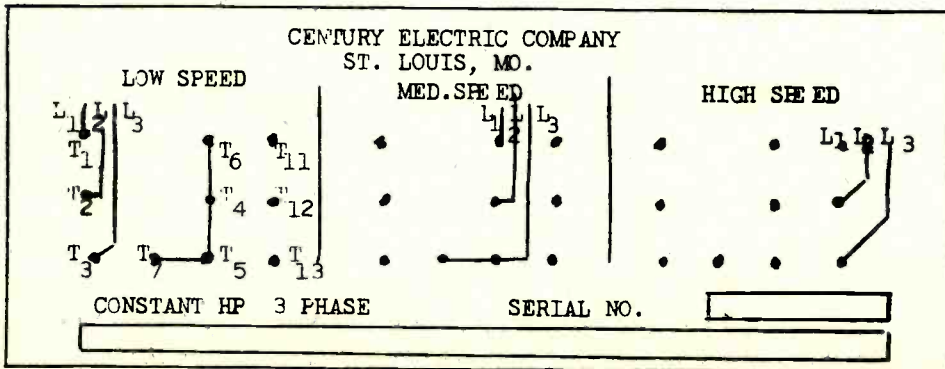



ENGINEERING INFORMATION
 CONNECTION PLATES MULTI-SPEED SQUIRREL CAGE MOTORS
 3 SPEED - 2 WINDING - VARIABLE TORQUE

3 PHASE

THESE LEAD MARKINGS APPLY TO MOTORS MADE IN 1940 AND LATER

AUXILIARY NAME PLATE 3 SPEED 2 WINDING VARIABLE TORQUE
 4-6-8; 6-8-12; 8-12-16 POLE

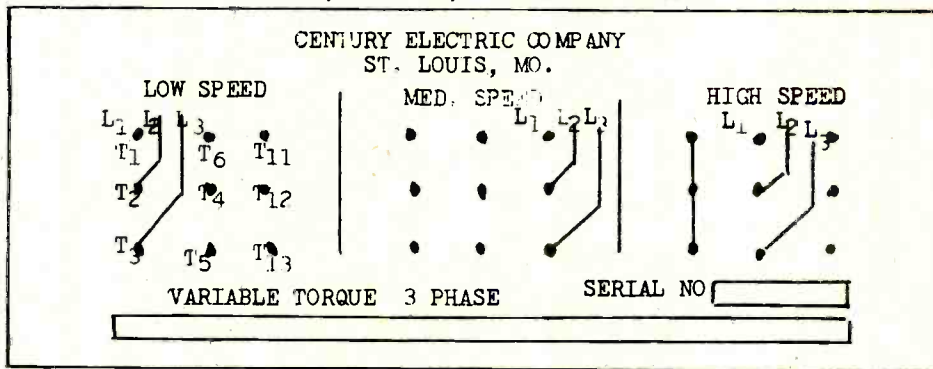

AUXILIARY NAME PLATE 3 SPEED 2 WINDING VARIABLE TORQUE
 4-6-12; 6-8-16 POLE

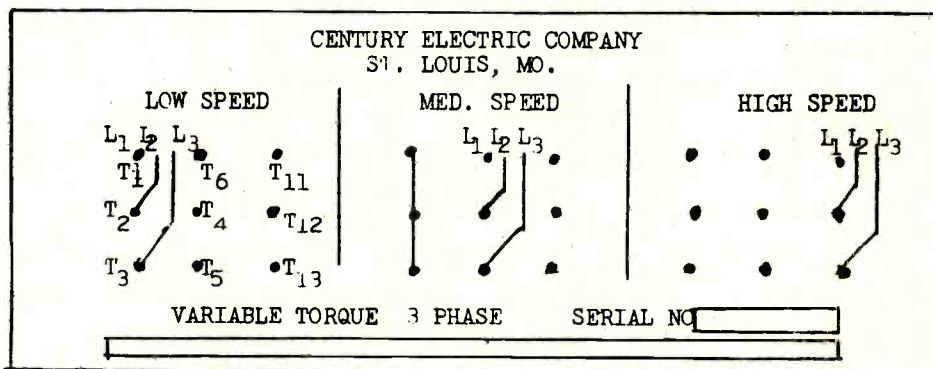

AUXILIARY NAME PLATE 3 SPEED 2 WINDING VARIABLE TORQUE
 2-4-6; 4-8-12; 6-12-16 POLE

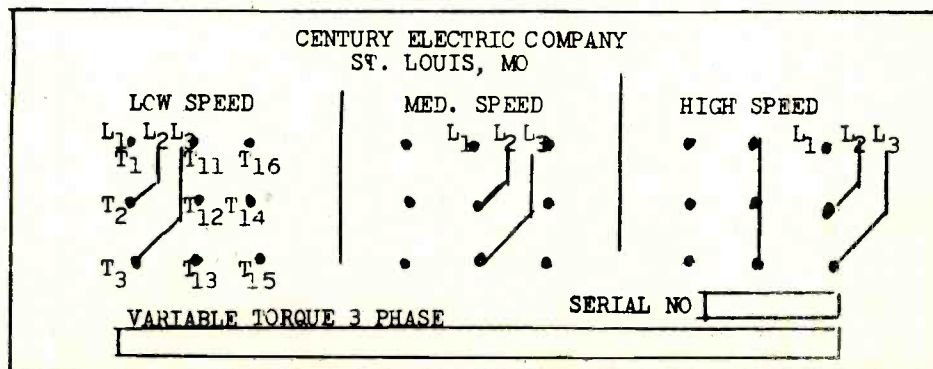

SLIP RING INDUCTION MOTOR

Job #7

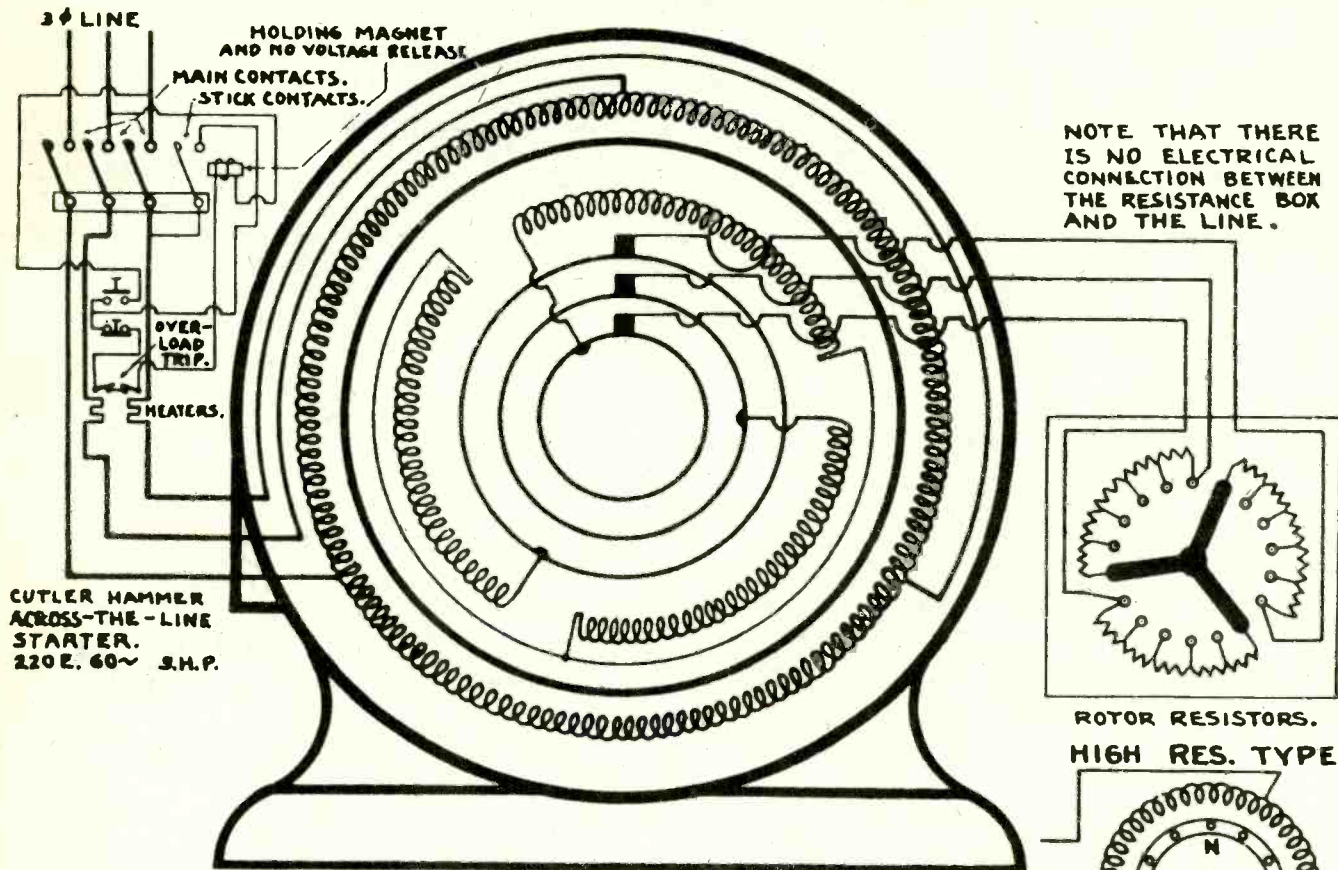

Diagrams A and B are used to show that an increase in rotor resistance causes the rotor poles to move into a more favorable position with respect to the stator poles thereby increasing the starting torque. If the rotor resistance is increased above a certain critical value, the torque will be reduced as indicated by the curves in the diagram below.

The slip ring induction motor operates on the same principle as the squirrel cage type, the revolving magnetic field set up by the stator winding reacting with the induced rotor poles to produce rotation. Insertion of resistance in the rotor circuit produces the following advantages: 1. High starting torque 2. Low starting current 3. Smooth starting action 4. Adjustable speed.

CHARACTERISTICS

The average slip ring motor will produce 3 times normal full load torque with 2.5 times normal full load current.

With all the external resistance cut out, the variation in speed from no load to full load will not exceed 5% of the full load speed. As resistance is inserted, the speed regulation becomes rapidly poorer

APPLICATION

Air compressors, large ventilating fans, conveyors, punch presses, printing presses, lathes, elevators, etc. may be used wherever a high starting torque, a smooth starting action, or adjustable speed is desired.

PRINCIPAL TROUBLES

Sliprings, brushes, brush holders, external rotor resistance, loose connections, bearings, insulation.

- CURVE "1" ROTOR RES. ALL CUT OUT.
- " "2" RES. FOR MAX. TORQUE.
- " "3" MORE RES. THAN "2"
- " "4" MORE RES. THAN "3"

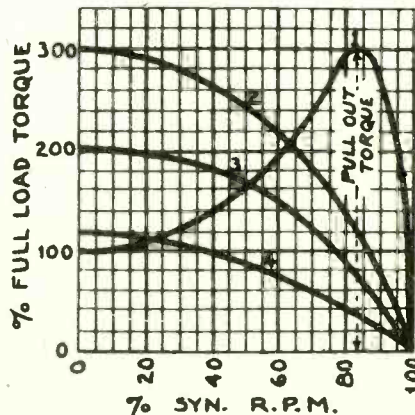

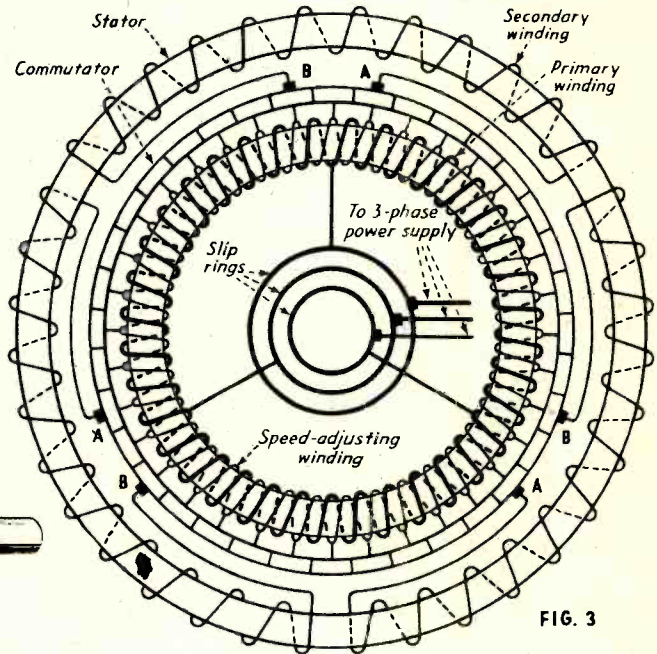
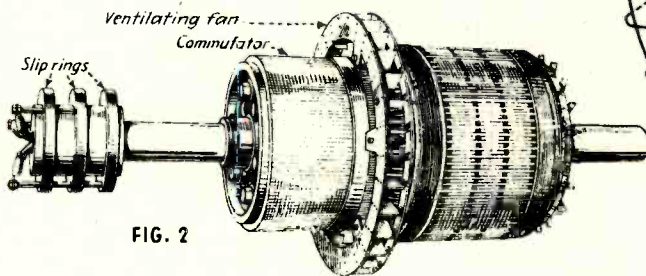
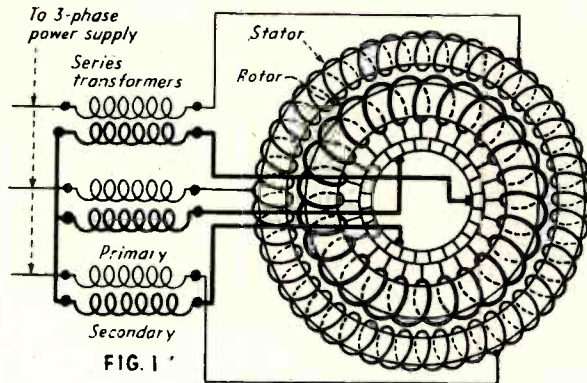

Fig. 1—Diagram of polyphase commutator motor, speed of which is varied by changing position of brushes. Fig. 2—Rotor for adjustable-speed polyphase motor. Fig. 3—Diagram of rotor and stator circuits for a polyphase adjustable-speed motor

Wound-Rotor Motors

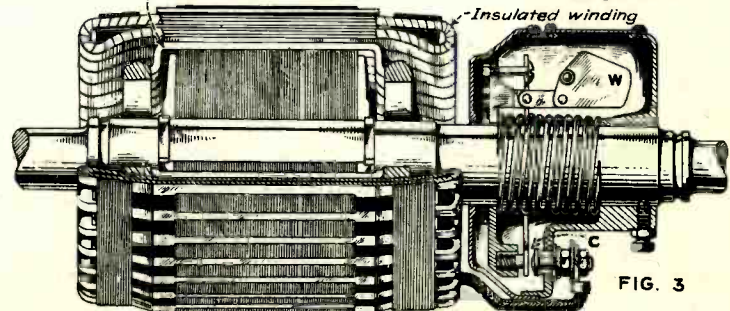
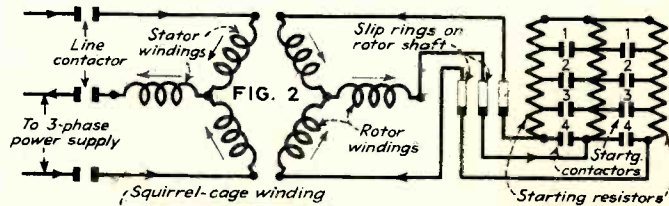
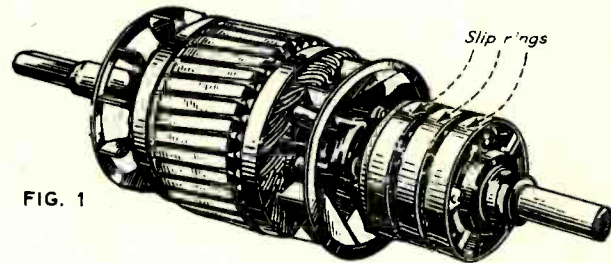

Fig. 1—Rotor for a wound-rotor or slip-ring motor. Fig. 2—Diagram of wound-rotor motor and its starting resistance. Fig. 3—Combination of a squirrel-cage and a coil winding on rotor, for automatic starting.

Synchronous Motors

How They Operate

Fig. 2 shows the rotor and stator assembly of a synchronous motor. When the stator winding is connected to a polyphase alternating-current source, it produces a rotating magnetic field as in an induction motor. When the rotor field coils are connected to direct current, their *N* and *S* field poles lock into step with *S* and *N* poles of the rotating magnetic field and both rotate at the same speed or in synchronism. This speed is fixed by line frequency and number of rotor poles.

Synchronous motors are designed for two standard full-load power factors: unity and 80% leading. Unity-power-factor motors, at full load and normal field current, have 100% power factor. At less than full load, their power factor is less than unity leading, but can be regulated by adjusting the field current.

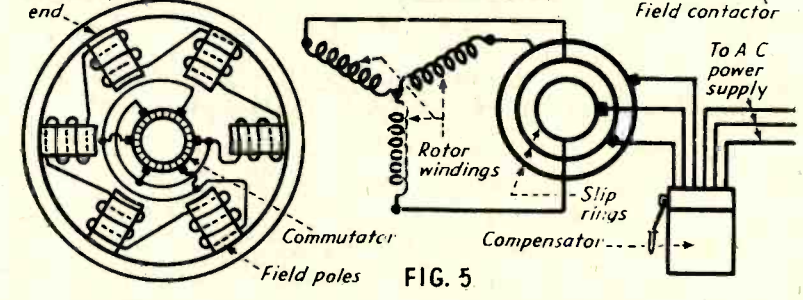
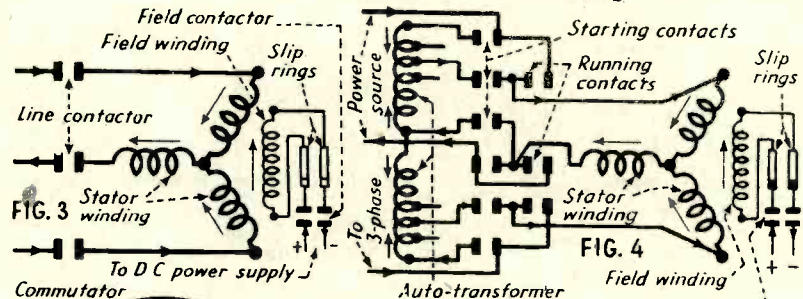
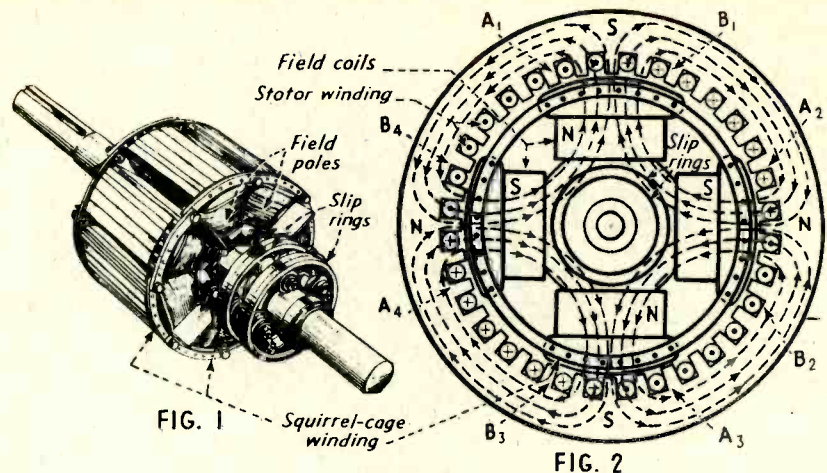

Fig. 1—Synchronous-motor rotor. Fig. 2—Diagram of synchronous-motor stator and rotor assembly. Fig. 3—Diagram of synchronous-motor connections for full-voltage starting. Fig. 4—Diagram of connections for reduced-voltage starting. Fig. 5—Diagrams of stator and rotor connections for self-synchronizing motor

TABLE II—HORSEPOWER AND SYNCHRONOUS-SPEED RATINGS OF GENERAL-PURPOSE INDUCTION MOTORS FOR DIRECT CONNECTION

Cycles	60	60	60	60	25	25
Hp	Rpm	Rpm	Rpm	Rpm	Rpm	Rpm
25	3,600					
30	3,600					
40	3,600					
50	3,600	1,800			1,500	
60	3,600	1,800			1,500	
75	3,600	1,800			1,500	
100	3,600	1,800	1,200		1,500	
125	3,600	1,800	1,200		1,500	
150		1,800	1,200	900	1,500	
200		1,800	1,200	900	1,500	750

ALTERNATING CURRENT DEPARTMENT

THE SYNCHRONOUS MOTOR

THE SYNCHRONOUS MOTOR is so named because the ROTOR revolves at the same speed as the REVOLVING MAGNETIC FIELD of the stator.

THREE WINDINGS ARE USED in this machine:

1. THE A.C. STATOR or armature winding, which produces a revolving magnetic field when polyphase A.C. is applied to it.
2. THE D.C. FIELD or rotor winding, which produces a fixed polarity. This winding must be excited from an outside source of D.C.
3. THE DAMPER or squirrel cage winding which consists of a few large copper bars imbedded in the D.C. field pole faces and shorted together by end rings. This winding serves 2 purposes: (a) It permits the motor to start as an induction tends to prevent hunting.

HUNTING is a periodical variation in the speed of the rotor with regard to the revolving magnetic field of the stator. It is caused by: (a) a sudden change in mechanical load. (b) a sudden change in A.C. line voltage. (c) a sudden change in D.C. field excitation. (d) hunting on the same system of other rotating electrical equipment.

THE FIELD DISCHARGE SWITCH and the field discharge resistor are arranged to protect the D.C. field from high transformer voltages induced by the stator field during the starting period, and also from high self-induced voltages generated by collapsing D.C. field flux when the field is disconnected from the source of excitation. The discharge resistor and switch form a closed circuit on the field when the switch is placed in the discharge position, and this greatly reduces the danger to the field insulation.

ADVANTAGES OF THE SYNCHRONOUS MOTOR: 1. Constant speed. 2. Variable power factor. The power factor may be varied by controlling the excitation current of of D.C. field. The P.F. will be UNITY of 100% at NORMAL excitation, LAGGING at UNDER excitation, LEADING at OVER excitation.

THE MOTOR WILL CORRECT POWER FACTOR because when the D.C. field is over excited the A.C. stator will draw a LEADING current which will neutralize a LAGGING current drawn by inductive apparatus connected to the same system. It will carry a mechanical load and correct P.F. of the system at the same time providing the full load current rating of the machine is not exceeded.

DISADVANTAGES OF SYNCHRONOUS MOTOR: Greater cost per H.P., low starting torque, subject to hunting, requires outside source of excitation, more auxiliary apparatus for control and indication, more intelligent handling, and may require some form of clutch to connect the load to it.

APPLICATIONS: Driving compressors for air conditioning and refrigeration, also for compressed air. Driving textile mill looms, cement grinding and rubber processing machines, paper pulp grinders, also M.G. sets, frequency changers, or in general any load of 25 H.P. or more not requiring heavy starting torque and which may be operated at a constant speed.

ROTATION may be reversed by changing any 2 of the 3 stator leads. The D.C. field polarity does not determine the direction of rotation.

PROCEDURE FOR STARTING THE MOTOR:

1. Reduce the exciter voltage to a minimum. (Turn field rheostat to right)
2. Place the field discharge switch in the discharge position.
3. Apply low voltage A.C. to the stator and allow motor to accelerate to almost full speed. (watch AM. to note when starting current is reduced to a minimum.)
4. Close the D.C. field switch to apply excitation current to the field.
5. Apply full voltage to the stator winding.
6. Adjust D.C. field excitation to obtain desired power factor.

PROCEDURE FOR STOPPING THE MOTOR: Remove the mechanical load if possible, then reduce field excitation and finally disconnect the stator from the A.C. supply.

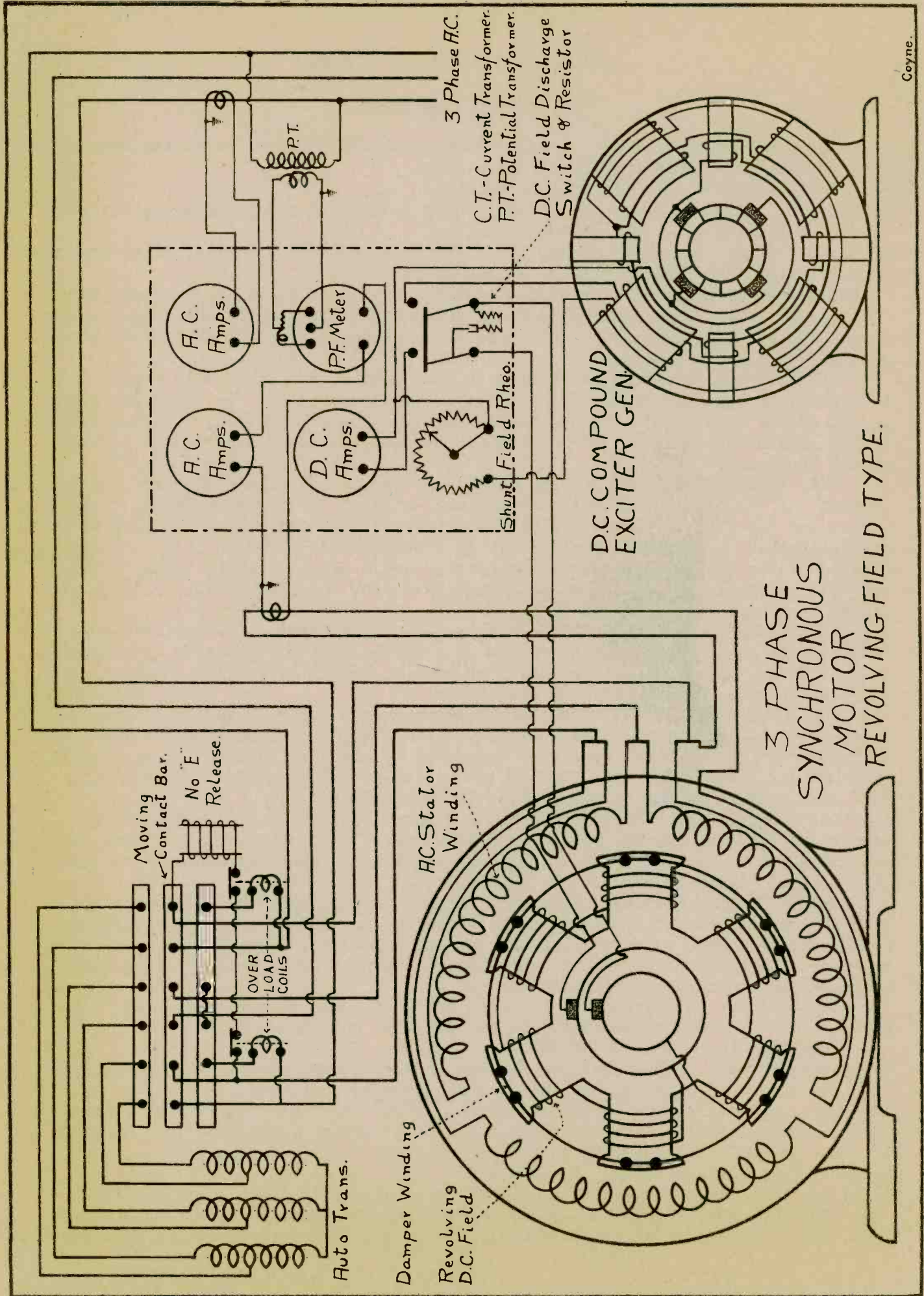

Coyne.

TWO TUBE REGENERATIVE CIRCUIT.

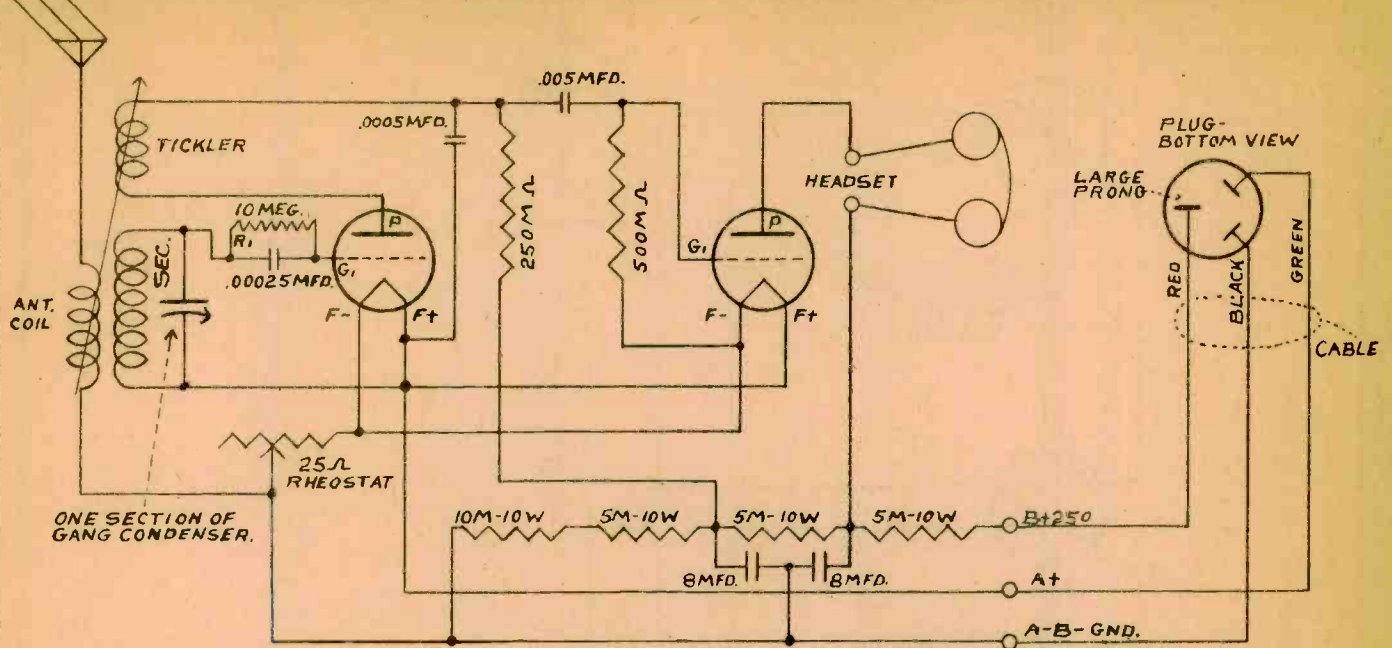

BASE BOARD LAYOUT.
BACK

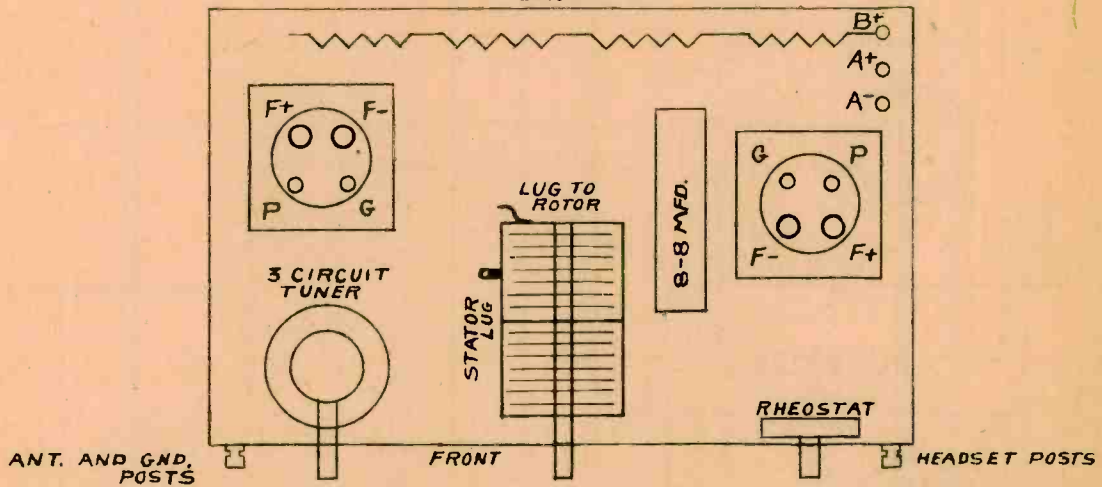

After the set has been wired make the tests indicated on the resistance chart and record the values attained. After resistance chart readings have been checked, put in tubes, apply power, and make readings indicated on voltage chart.

Resistance Chart.

Voltage Chart.

	Resistance Chart							Voltage Chart		
Detector Stage.	F- to A-	F+ to A+	G ₁ to A±	P to B+	A+ to A-	B+ to A±	Ant. to Gnd.	F+ to F-	G ₁ to F-	P to F-
			R ₁ Norm.	R ₁ Shtd.	Rheo on	Rheo off.		Rheo on	Rheo off.	
Audio Stage.	F- to A-	F+ to A+	G ₁ to A±	P to B+	A+ to A-	B+ to A±		F+ to F-		
					Rheo on	Rheo off.		Rheo on	Rheo off.	

5 TUBE T.R.F. CIRCUIT

3 GANG CONDENSER

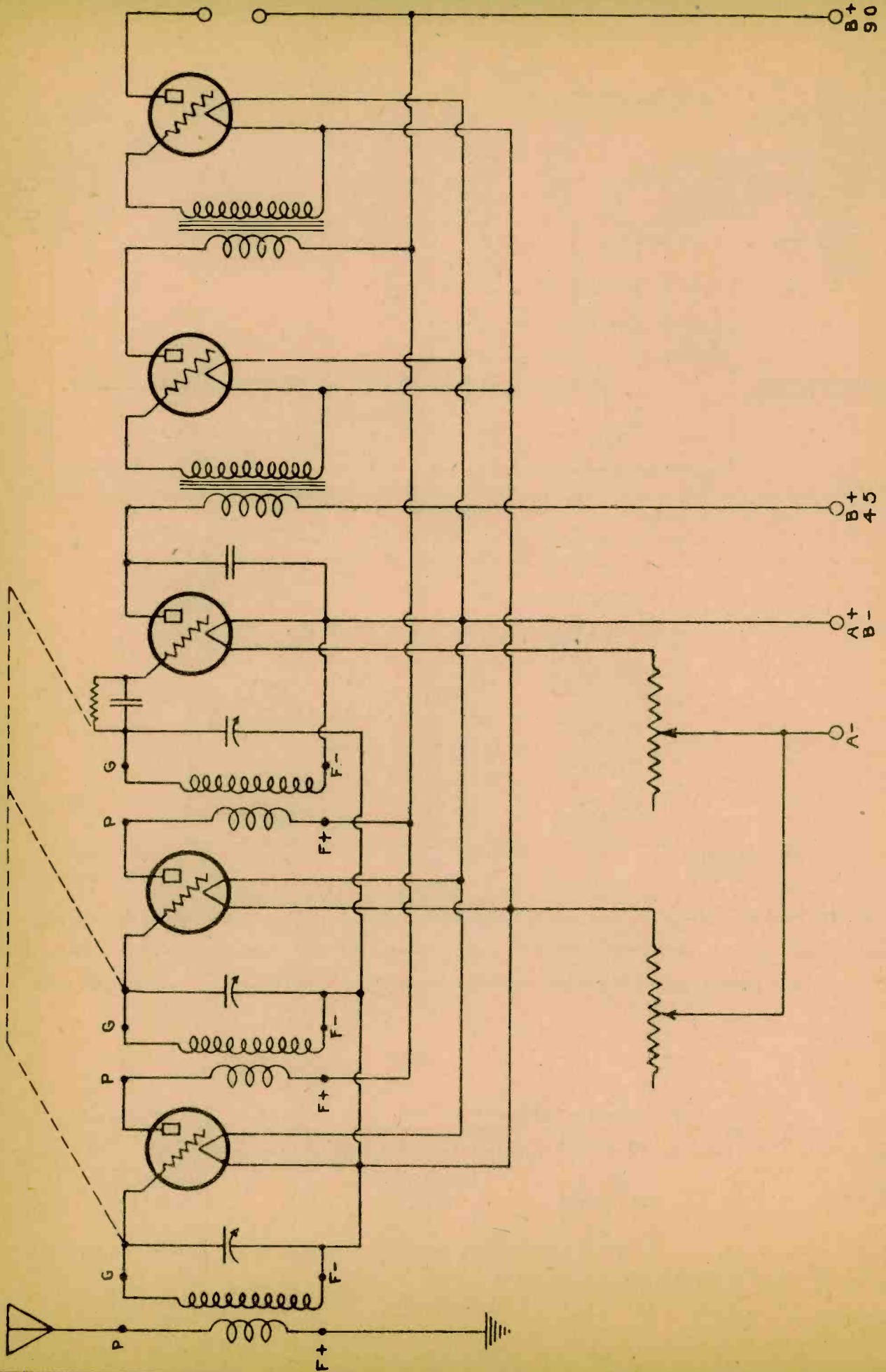

SUPERHETERODYNE RECEIVER.

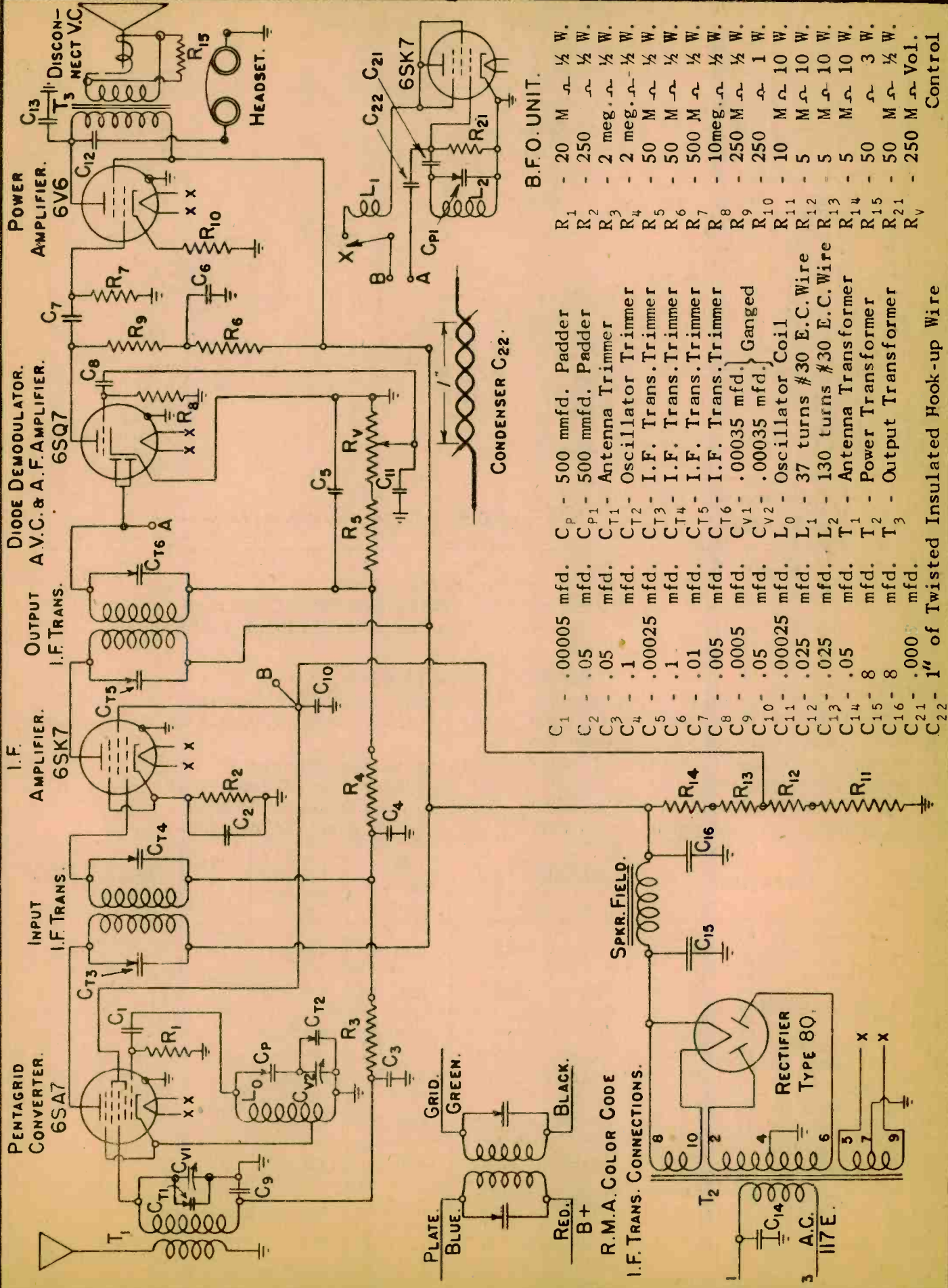

Component	Value	Power
C ₁	.00005 mfd.	
C ₂	.05 mfd.	
C ₃	.05 mfd.	
C ₄	.1 mfd.	
C ₅	.00025 mfd.	
C ₆	.1 mfd.	
C ₇	.01 mfd.	
C ₈	.005 mfd.	
C ₉	.0005 mfd.	
C ₁₀	.05 mfd.	
C ₁₁	.00025 mfd.	
C ₁₂	.025 mfd.	
C ₁₃	.025 mfd.	
C ₁₄	.05 mfd.	
C ₁₅	8 mfd.	
C ₁₆	8 mfd.	
C ₂₁	.000 mfd.	
C ₂₂	.1" of Twisted Insulated Hook-up Wire	
C _P	500 mmfd. Padder	
C _{P1}	500 mmfd. Padder	
C _{T1}	Antenna Trimmer	
C _{T2}	Oscillator Trimmer	
C _{T3}	I.F. Trans. Trimmer	
C _{T4}	I.F. Trans. Trimmer	
C _{T5}	I.F. Trans. Trimmer	
C _{T6}	I.F. Trans. Trimmer	
C _{V1}	.00035 mfd. Ganged	
C _{V2}	.00035 mfd. Ganged	
L ₀	Oscillator Coil	
L ₁	37 turns #30 E.C. Wire	
L ₂	130 turns #30 E.C. Wire	
T ₁	Antenna Transformer	
T ₂	Power Transformer	
T ₃	Output Transformer	
R ₁	20 M	1/2 W.
R ₂	250	1/2 W.
R ₃	2 meg.	1/2 W.
R ₄	2 meg.	1/2 W.
R ₅	50 M	1/2 W.
R ₆	50 M	1/2 W.
R ₇	500 M	1/2 W.
R ₈	10meg.	1/2 W.
R ₉	250 M	1/2 W.
R ₁₀	250	1 W.
R ₁₁	10 M	10 W.
R ₁₂	5 M	10 W.
R ₁₃	5 M	10 W.
R ₁₄	5 M	10 W.
R ₁₅	50 M	3 W.
R ₂₁	50 M	1/2 W.
R _V	250 M	Control

SPKR. FIELD.

R.M.A. COLOR CODE
I.F. TRANS. CONNECTIONS.

RECTIFIER
TYPE 80.

A.C. 117E.

MECHANICAL LAYOUT FOR SUPERHETERODYNE.

UNDERSIDE VIEW OF CHASSIS.

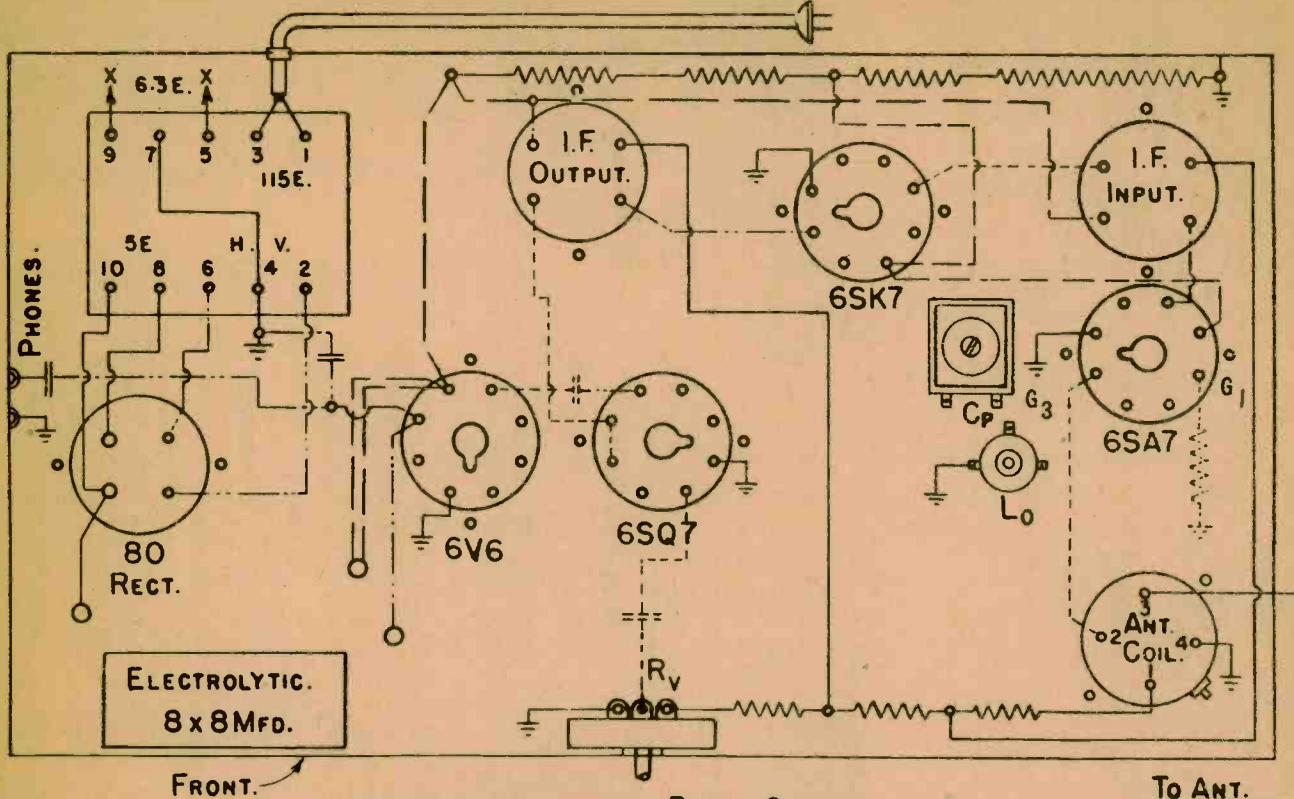

- - - - - PLATE CIRCUIT.
 - - - - - SCREEN GRID OR D.C. VOLTAGE CIRCUIT.
 - - - - - CONTROL GRID OR DIODE CIRCUITS.

ALIGNING PRECAUTIONS

- 1.-Always use an insulated screwdriver when adjusting I. F. trimmers.
- 2.-Always use both headsets and output meter as indicators. V.C. must be disconnected.
- 3.-Keep volume control of receiver full on.
- 4.-**BE SURE** to connect grounded lead of generator to the chassis.
- 5.-Keep attenuator and multiplier of signal generator turned down to the point at which signal is just strong enough to give an indication.
- 6.-**BE SURE** to make adjustments in proper sequence as given in table below.

Step No.	OPERATIONS		Connect Ungrounded lead of Signal Generator to	Set Receiver Dial to	Set Signal Generator to	Type of Signal	Adjust Cond. to obtain maximum indication	
							1st	2nd
1	Aligning I. F. Output Trans.	Short	G ₁ of 6SK7	600 KC	455 KC	Mod. IF	C _{T6}	C _{T5}
2	Aligning I. F. Input Trans.	Osc.	G ₃ of 6SA7'	600 KC	455 KC	Mod. IF	C _{T4}	C _{T3}
3	Check I. F. Alignment	Coil	G ₃ of 6SA7	600 KC	455 KC	Mod. IF	C _{T6} C _{T5}	C _{T4} C _{T3}
4	Aligning at high Freq. end of dial	Remove	Antenna Lead	1400 KC	1400 KC	Mod. RF	C _{T2}	C _{T1}
5	Aligning at low Freq. end of dial	Osc.	Antenna Lead	600 KC	600 KC	Mod. RF	C _P	
6	Re-align at high Freq. end of dial	Coil	Antenna Lead	1400 KC	1400 KC	Mod. RF	C _{T2}	C _{T1}
7	Re-align at low Freq. end of dial	Short	Antenna Lead	600 KC	600 KC	Mod. RF	C _P	
8	Final Checking		REPEAT ENTIRE PROCESS					

SUPER-HETERODYNE PRINCIPLES

BLOCK LAY-OUT OF T.R.F. RECEIVER

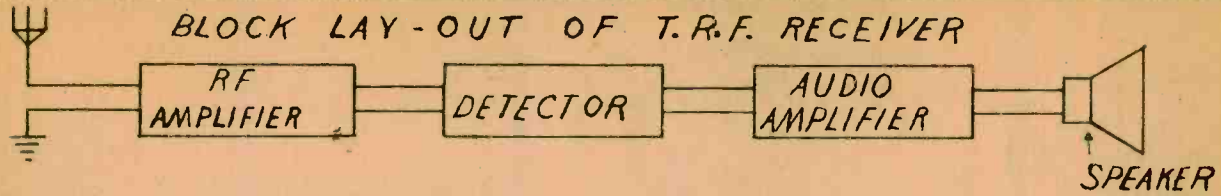

BLOCK LAY-OUT OF SUPER-HETERODYNE RECEIVER

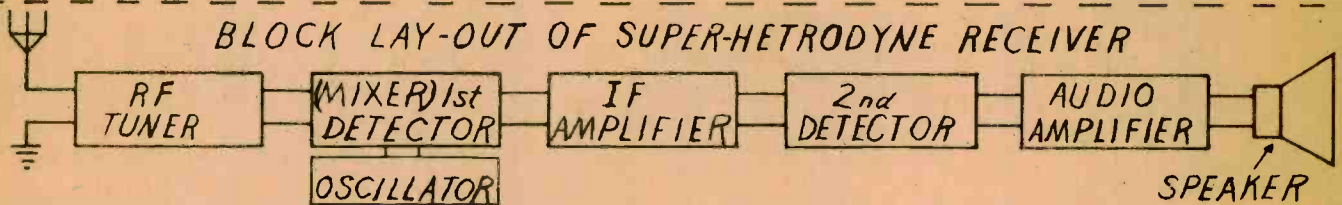

FIG. 1. MIXING TWO FREQUENCIES TOGETHER PRODUCES IF

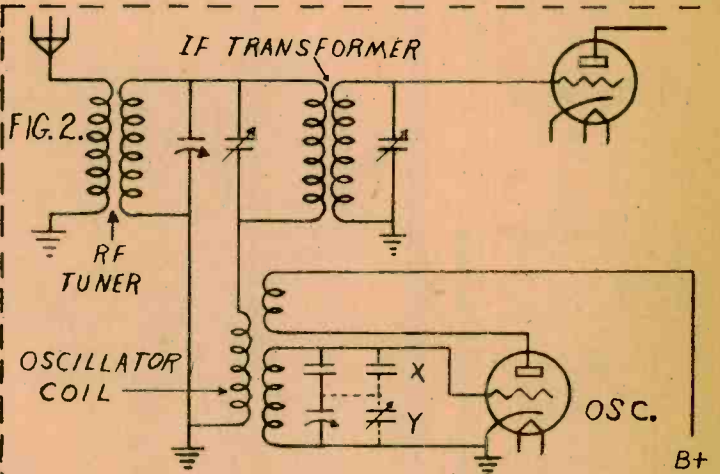
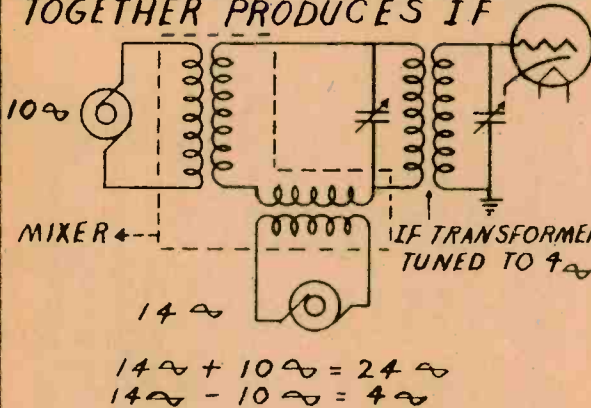

FIG. 3. ELECTRON COUPLED DETECTOR - OSCILLATOR

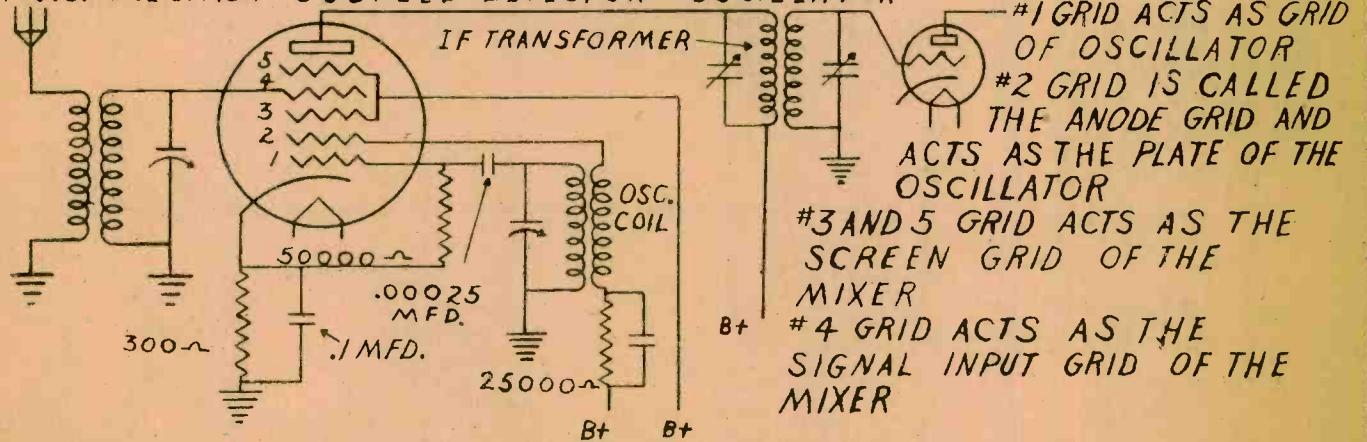

FIG. 4. SOUND CHANNEL MAKE-UP SHARP TUNING RANGE UP TO 5000 C.P.S. BROAD TUNING HIGH FIDELITY AUDIO RANGE UP TO 7500 C.P.S.

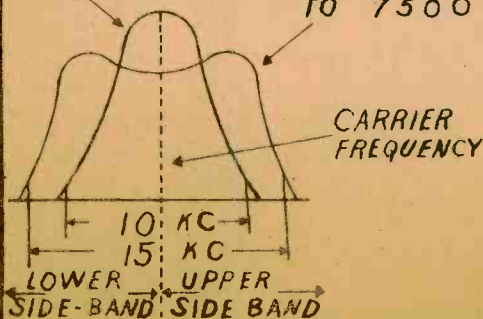
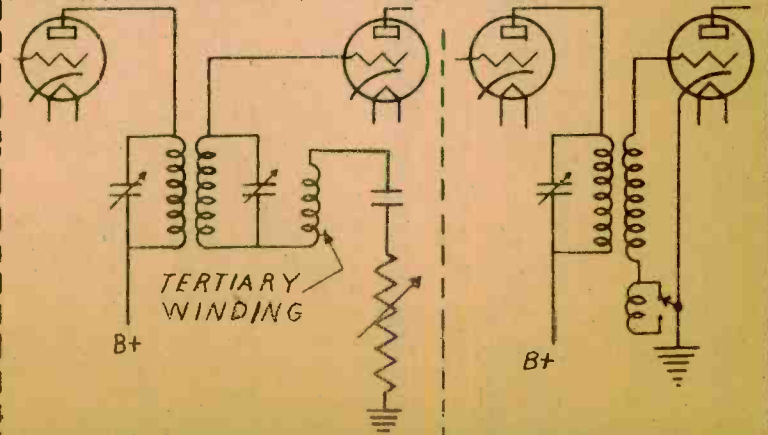
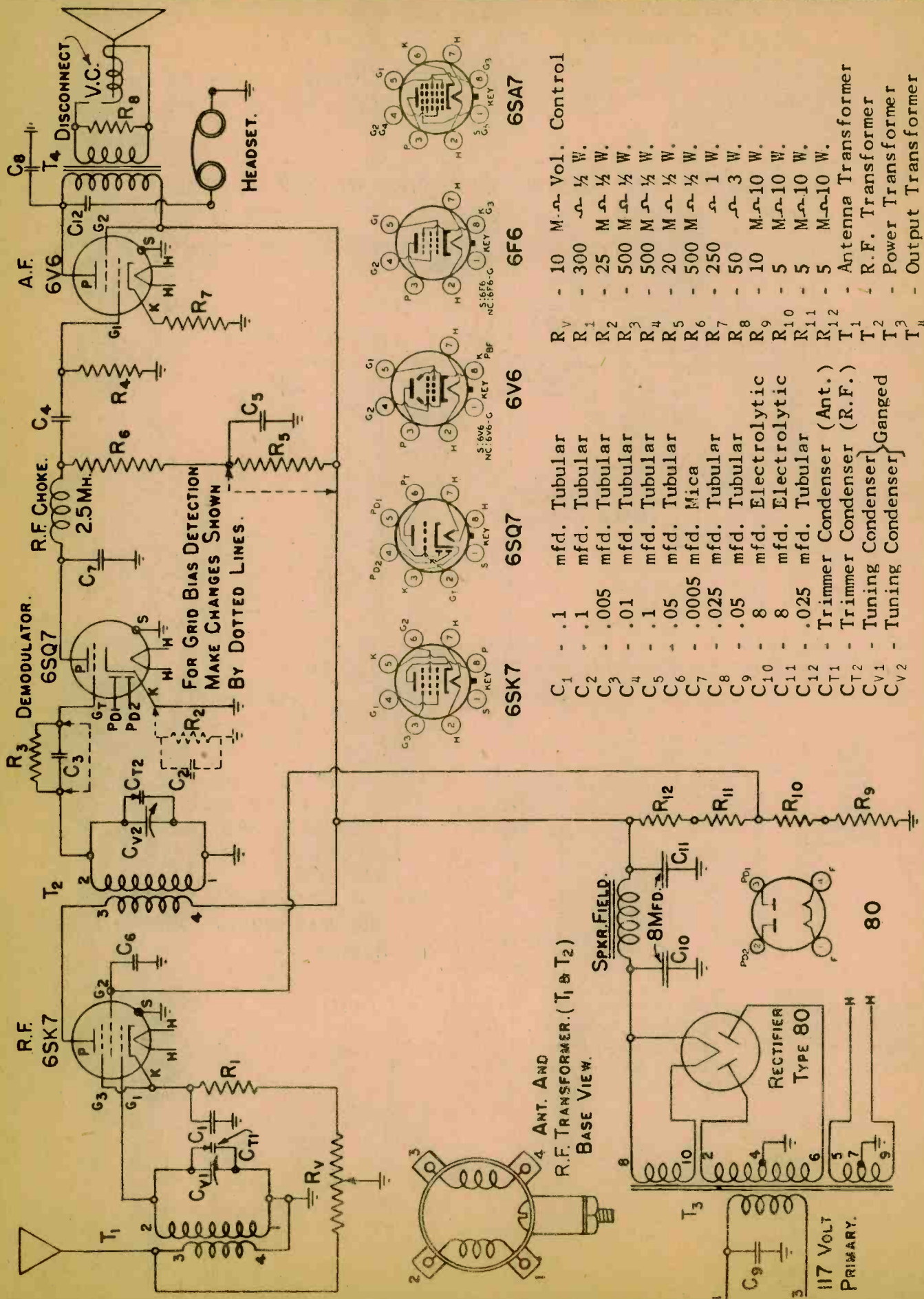

FIG. 5. HIGH FIDELITY IF TRANSFORMERS



T.R.F. RECEIVER.



R _V	-	10 M.Ω	Vol. Control
R ₁	-	300 Ω	½ W.
R ₂	-	25 MΩ	½ W.
R ₃	-	500 MΩ	½ W.
R ₄	-	500 MΩ	½ W.
R ₅	-	20 MΩ	½ W.
R ₆	-	500 MΩ	½ W.
R ₇	-	250 Ω	1 W.
R ₈	-	50 Ω	3 W.
R ₉	-	10 MΩ	10 W.
R ₁₀	-	5 MΩ	10 W.
R ₁₁	-	5 MΩ	10 W.
R ₁₂	-	5 MΩ	10 W.
T ₁	-	-	Antenna Transformer
T ₂	-	-	R.F. Transformer
T ₃	-	-	Power Transformer
C ₁	-	.1 mfd.	Tubular
C ₂	-	.1 mfd.	Tubular
C ₃	-	.005 mfd.	Tubular
C ₄	-	.01 mfd.	Tubular
C ₅	-	.1 mfd.	Tubular
C ₆	-	.05 mfd.	Tubular
C ₇	-	.0005 mfd.	Mica
C ₈	-	.025 mfd.	Tubular
C ₉	-	.05 mfd.	Tubular
C ₁₀	-	8 mfd.	Electrolytic
C ₁₁	-	8 mfd.	Electrolytic
C ₁₂	-	.025 mfd.	Tubular
C _{T1}	-	-	Trimmer Condenser (Ant.)
C _{T2}	-	-	Trimmer Condenser (R.F.)
C _{V1}	-	-	Tuning Condenser
C _{V2}	-	-	Tuning Condenser } Ganged

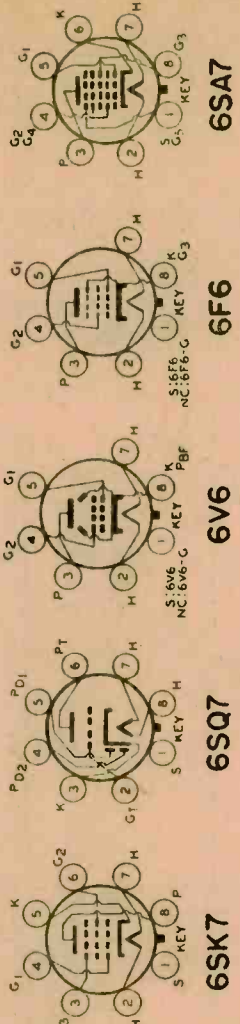

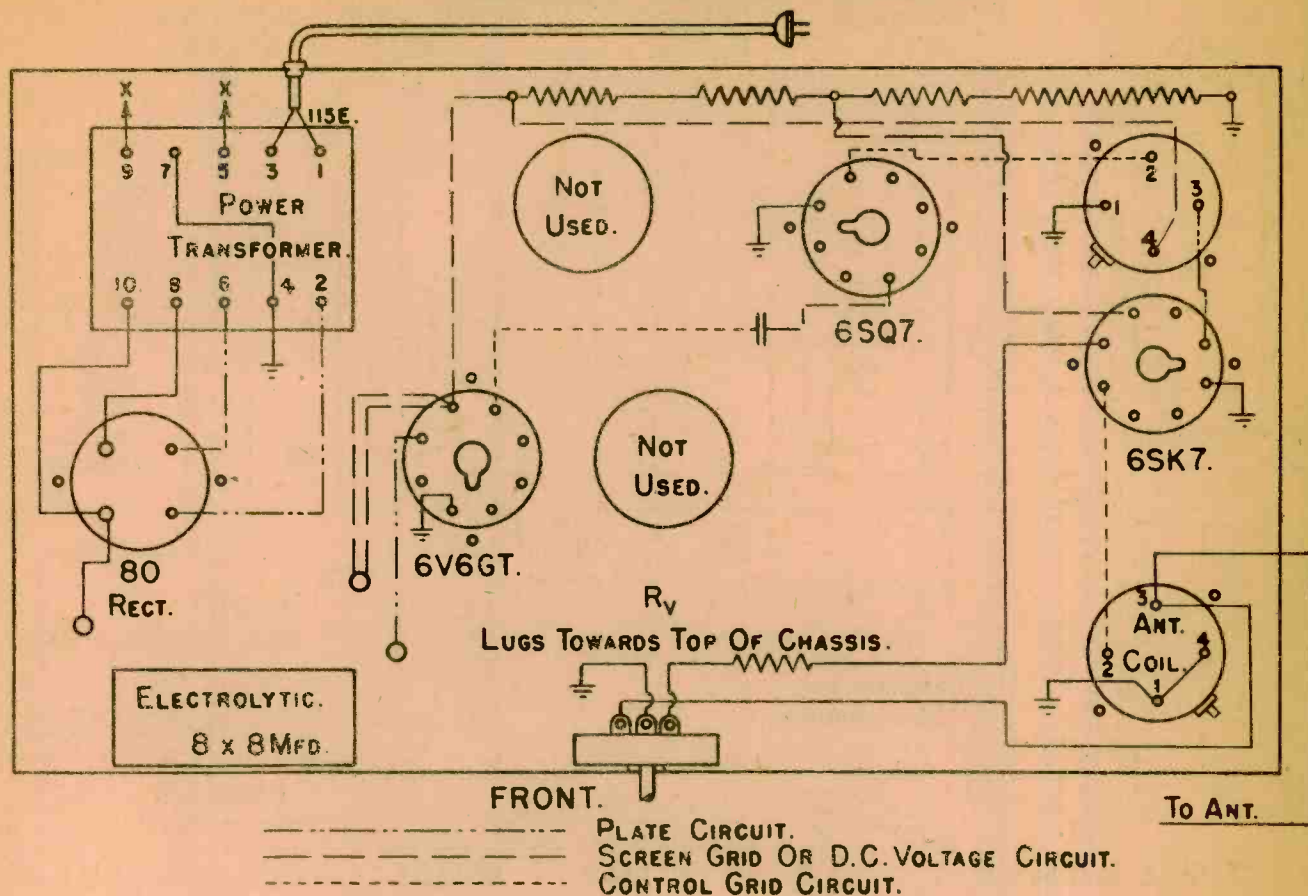
MECHANICAL LAYOUT FOR T.R.F. RECEIVER.**UNDERSIDE VIEW OF CHASSIS.****PRECAUTIONS & CONSTRUCTION PROCEDURE**

1. -Keep all parts in kit box until you are ready to mount them. This will prevent loss and breakage.
2. -Keep plates of tuning condenser fully meshed, except when tuning.
3. -Do not short C_v by using excessive solder when soldering to stator lugs. If it is necessary to remove surplus solder from lugs, hold C_v with lugs pointing down and run solder off. C_{v1} and C_{v2} are ganged on one shaft.
4. -Mount fibre plates on antenna and R. F. coils correctly.
5. -Always use headsets -- V.C. must not be connected. Resistor must replace V.C.
6. -In antenna and R.F. coils with high impedance primary, the ohmic R of the primary winding will be higher than the ohmic R of the secondary winding.
7. -Connect outside foil end of tubular condenser to chassis, if used for by-pass; to plate if used for coupling.
8. -Before applying power to the set, BE SURE the job has been checked by an instructor and your job card has been punched. Violation will earn demerits.
9. -Arrange sockets so that grid and plate wires will be short as possible. Refer to socket layout.
10. -Run wires straight using right angle bends. Keep G_1 and P wires away from each other and from all other wires to prevent coupling. Keep all wires close to the chassis except G_1 wires which should be one-fourth inch away.
11. -Never solder to a nut, screw, or chassis; always use a soldering lug.
12. -Wire all heater circuits in parallel twisting the heater wires.
13. -Connect circuit wires by wiring one circuit at a time. As each wire is inserted, score the line on the schematic diagram using same color pencil as used in diagram tracing. Order of wiring circuits is: 1st, heater; 2nd, cathode and suppressor grid; 3rd, screen grid; 4th, antenna; 5th, plate; and 6th, control grid.

THREE BAND RECEIVER.

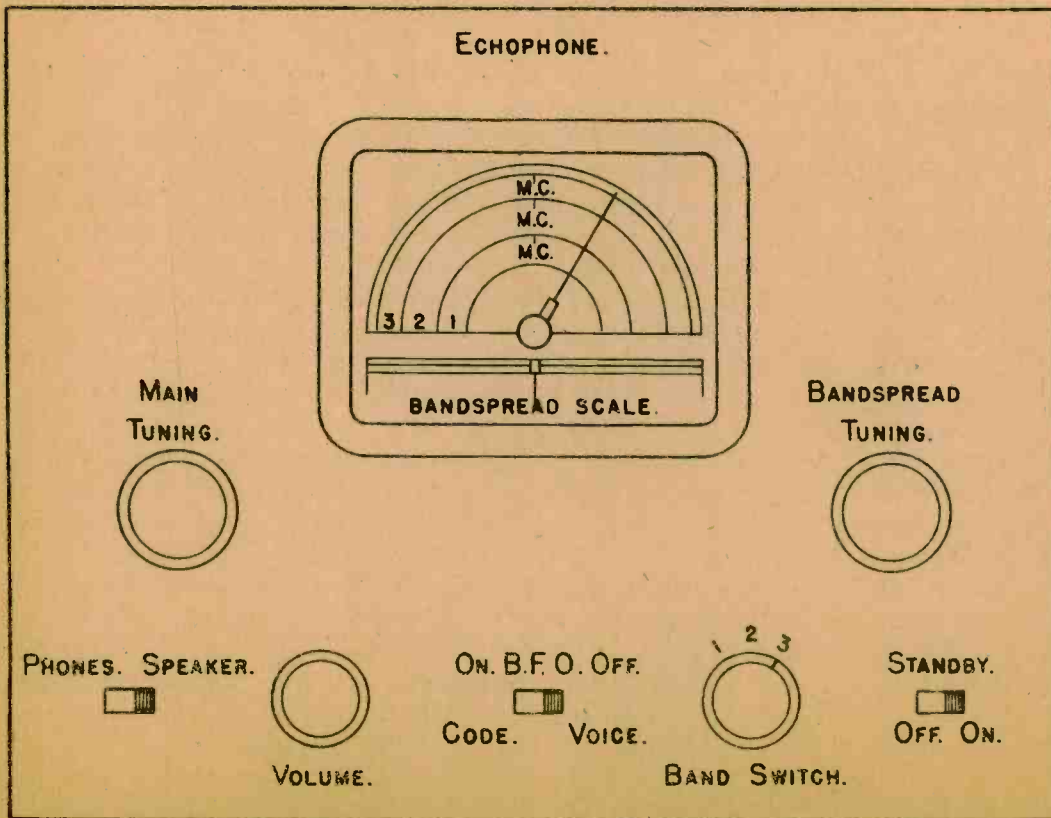
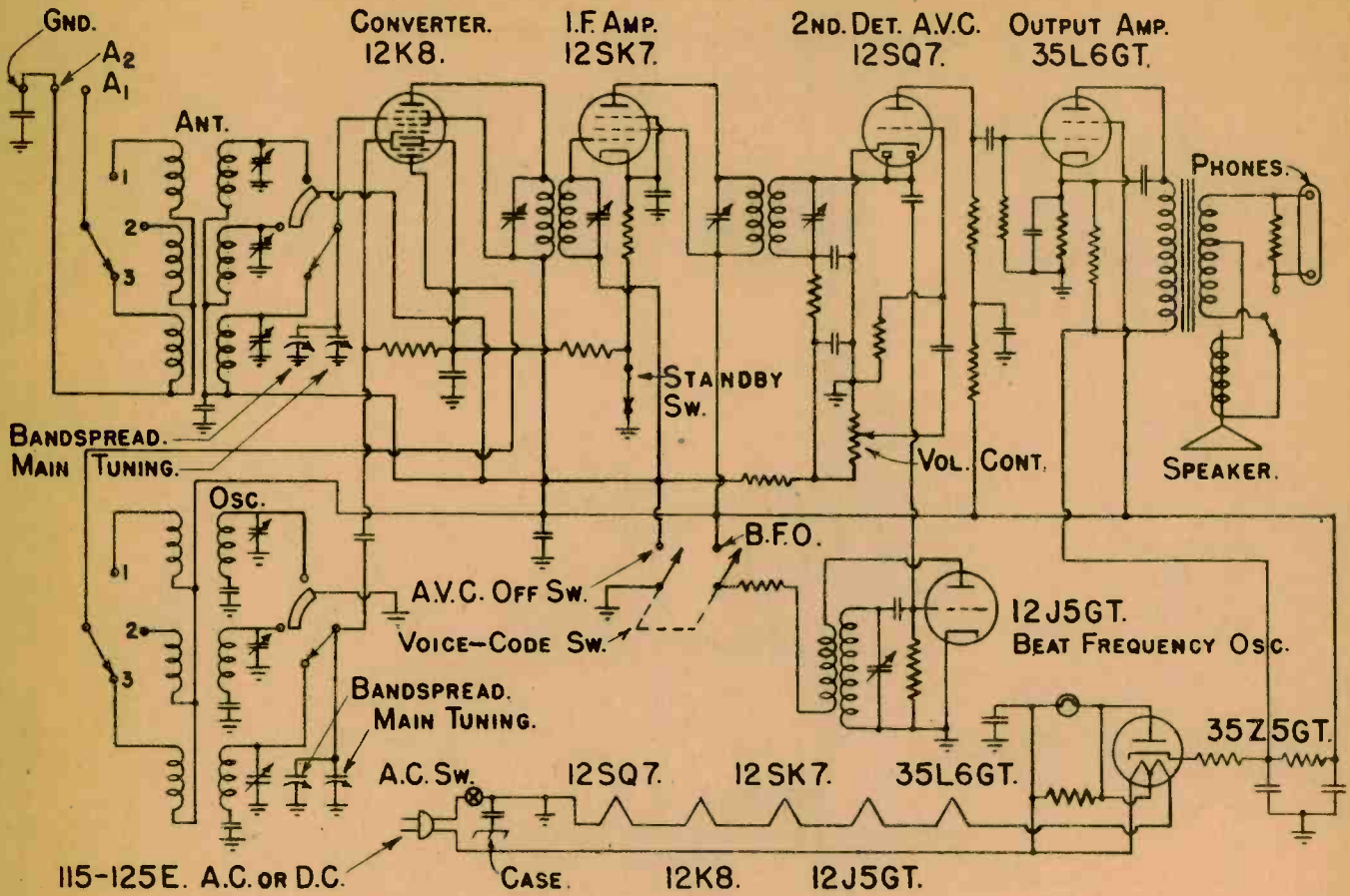

RADIO TRANSCEIVER 2.5 METERS.

CONSTRUCTION

A Transceiver is a combination of transmitter and receiver designed for both transmission and reception. The apparatus is usually enclosed in a metal case and provided with a self contained battery power supply.

OPERATION

RECEIVER

When the control switch is in the receive position, the unit uses the type 6J5GT tube as a super-regenerative detector. The type 6G6G is used as an audio amplifier to increase the volume of the received signal.

TRANSMITTER

When the control switch is in the transmit position, the unit operates as a transmitter, the 6F5GT functioning as a modulated oscillator using the class "A" Heising system of modulation. The power developed by this tube and circuit is fed to the antenna.

When operating as a transmitter the 6G6G tube functions as a modulated using the class "A" Heising system of modulation.

When transmitting, the antenna circuit is set for maximum output by adjusting the length of the telescopic antenna until the antenna bulb that is used as a current indicator shows maximum brilliancy.

The percentage of modulation, of the volume of the received signal, is varied by the volume control.

The frequency of this transceiver is 112 to 116 megacycles. The distance range varies from 3 to 30 miles depending upon the nature of the terrain and the elevation.

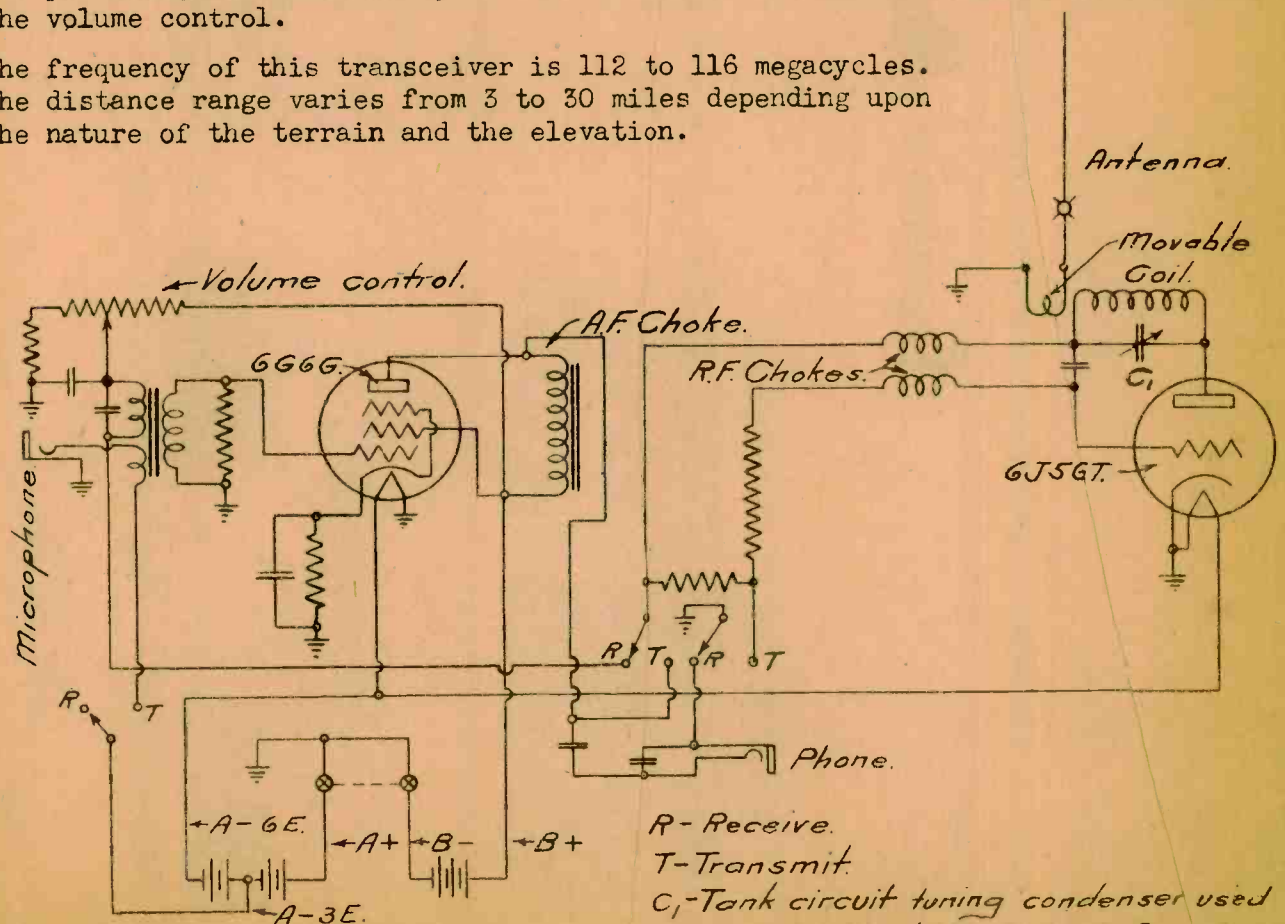

Coupling between tank circuit and antenna is varied by movable antenna coil.

SERVICE FREQUENCY MODULATION

A COMPARISON OF F-M AND A-M

FREQUENCY MODULATION IS A NEW METHOD OF USING A RADIO WAVE TO TRANSMIT A MESSAGE. SINCE IT IS ESSENTIALLY A DIFFERENT METHOD OF MODULATION, A CORRESPONDINGLY DIFFERENT METHOD OF DEMODULATION OR DETECTION MUST BE USED AT THE RECEIVER IN ORDER TO ENABLE THE RECOVERY OF THE ORIGINAL MESSAGE. THIS MESSAGE MAY BE SPEECH, MUSIC, FACSIMILE, TELEVISION OR ANY OTHER INTELLIGENCE WHICH CAN BE CONVERTED INTO AN ELECTRICAL SIGNAL.

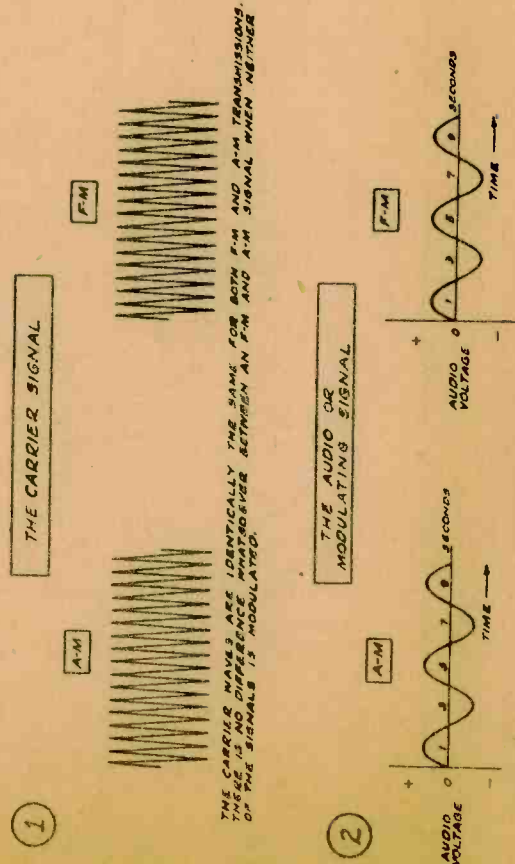

THE CARRIER WAVES ARE IDENTICALLY THE SAME FOR BOTH F-M AND A-M TRANSMISSIONS. THERE IS NO DIFFERENCE WHATSOEVER BETWEEN AN F-M AND A-M SIGNAL WHEN NEITHER OF THE SIGNALS IS MODULATED.

THE AUDIO OR MODULATING VOLTAGES ARE EXACTLY THE SAME FOR BOTH F-M AND A-M DIFFERENCES. HOWEVER, THE RESULTANT MODULATED WAVES ARE OF COURSE

6

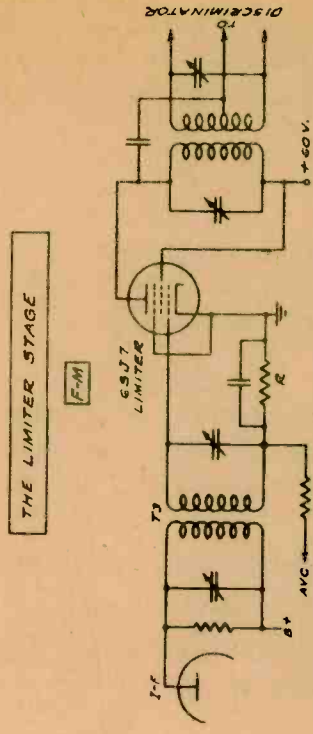

THE LIMITER STAGE IS USED IN F-M RECEIVERS TO REMOVE VARIATIONS IN AMPLITUDE OF THE FREQUENCY-MODULATED WAVE. LOW PLATE AND SCREEN VOLTAGES ARE EMPLOYED SO THAT THE LIMITER AND DISCRIMINATOR IS TYPICALLY BUILT IN THE SAME TUBE. VARIATIONS IN THE STRENGTH OF THE INCOMING SIGNAL DUE TO NOISE OR OTHER CAUSES. THE LIMITER IS NOT USED IN A-M RECEIVERS.

7

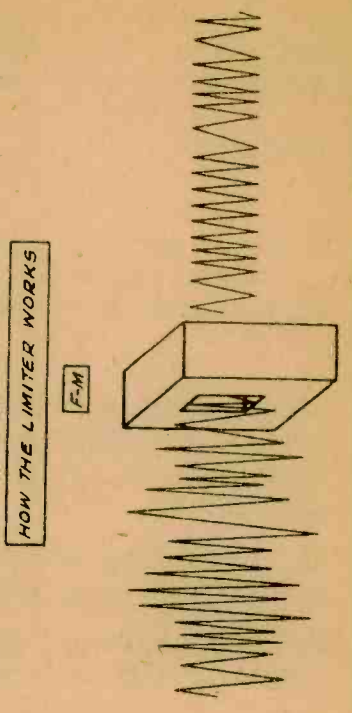

THIS FIGURE SHOWS IN PICTORIAL FORM HOW THE LIMITER FUNCTIONS TO SMOOTH OUT THE AMPLITUDE VARIATIONS IN THE FREQUENCY MODULATED SIGNAL.

EFFECT OF SIGNAL ON THE CARRIER

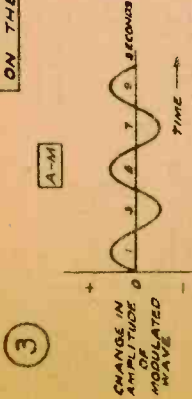

IN AMPLITUDE-MODULATION, THE AUDIO SIGNAL CAUSES THE AMPLITUDE OF THE MODULATED WAVE TO VARY IN ACCORDANCE WITH THE AUDIO (MODULATING) VOLTAGE.

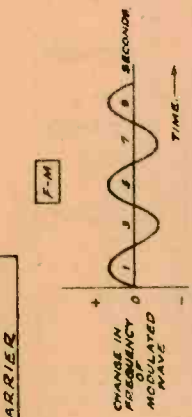

IN FREQUENCY-MODULATION, THE AUDIO SIGNAL CAUSES THE FREQUENCY OF THE MODULATED WAVE TO VARY IN ACCORDANCE WITH THE AUDIO (MODULATING) VOLTAGE.

THE SIGNAL AFTER MODULATION

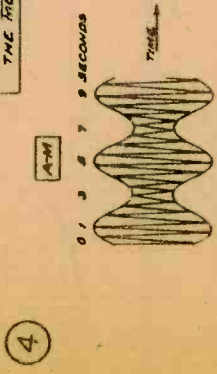

IN AMPLITUDE-MODULATION, THE AMPLITUDE OF THE WAVE VARIES IN ACCORDANCE WITH THE MODULATING VOLTAGE, THE FREQUENCY OF THE WAVE IS NOT SHIFTED.



IN FREQUENCY-MODULATION, THE FREQUENCY OF THE WAVE IS SHIFTED IN ACCORDANCE WITH THE MODULATING VOLTAGE, THE AMPLITUDE OF THE WAVE REMAINS CONSTANT.

HOW THE SIGNAL IS MODULATED

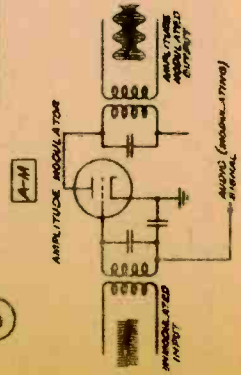

A TYPICAL METHOD OF AMPLITUDE MODULATION IS FED TO THE GRID OF THE MODULATOR TUBE.

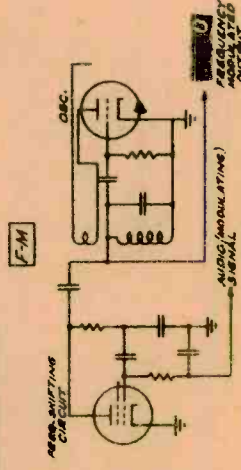

A TYPICAL METHOD OF FREQUENCY MODULATION IS FED TO THE CONTROL GRID OF THE TRANSMITTER OSCILLATOR.

HOW THE SIGNAL IS DEMODULATED

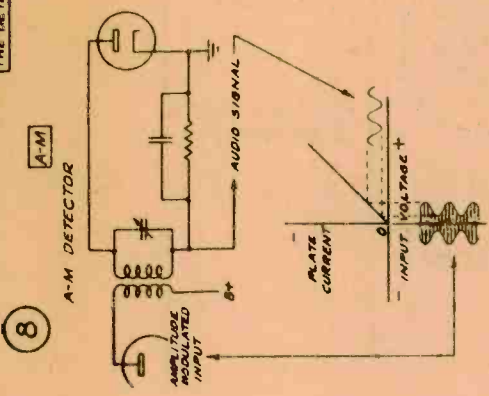

THE AMPLITUDE-MODULATION DETECTOR CONVERTS THE VARIATIONS IN THE AMPLITUDE OF THE MODULATED WAVE INTO THE ORIGINAL AUDIO SIGNAL.

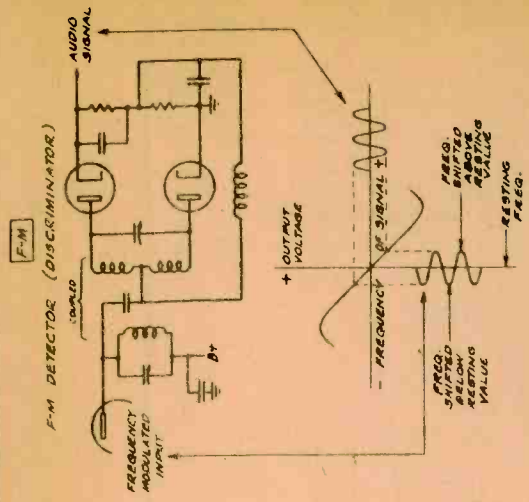

THE FREQUENCY-MODULATION DETECTOR CONVERTS THE VARIATIONS IN FREQUENCY OF THE F-M WAVE INTO THE ORIGINAL AUDIO SIGNAL. THE PHASE-SHIFTED SIGNAL IS PHASE-LOCKED TO THE ORIGINAL AUDIO SIGNAL, WHICH ACCOMPLISHES THIS AS SHOWN ABOVE.

SIDE BANDS & BANDWIDTH

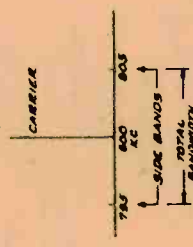
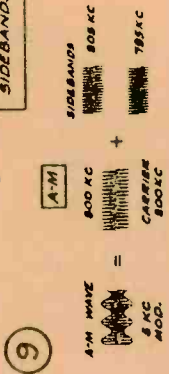

AN A-M WAVE IS COMPOSED OF A CARRIER & TWO SETS OF SIDE BANDS WHICH BECOME PROGRESSIVELY WEAKER AS THEIR FREQUENCY DEVIATES MORE FROM THE CARRIER. THE TOTAL BANDWIDTH REQUIRED BY AN A-M WAVE IS EQUAL TO TWICE THE HIGHEST AUDIO FREQUENCY TRANSMITTED. IF THE HIGHEST FREQUENCY TRANSMITTED IS 5 KC, THE REQUIRED BANDWIDTH IS 10 KC.

A F-M WAVE IS COMPOSED OF A CARRIER AND MANY SETS OF SIDE BANDS WHICH BECOME PROGRESSIVELY WEAKER AS THEIR FREQUENCY DEVIATES MORE FROM THE CARRIER. THE TOTAL BANDWIDTH REQUIRED BY AN F-M WAVE IS APPROXIMATELY EQUAL TO TWICE THE MAXIMUM FREQUENCY SHIFT OF THE MODULATED WAVE. IF THE MAXIMUM FREQUENCY SHIFT IS 5 KC, THE REQUIRED BANDWIDTH IS 10 KC.

AUTOMATIC FREQUENCY CONTROL-A.F.C.

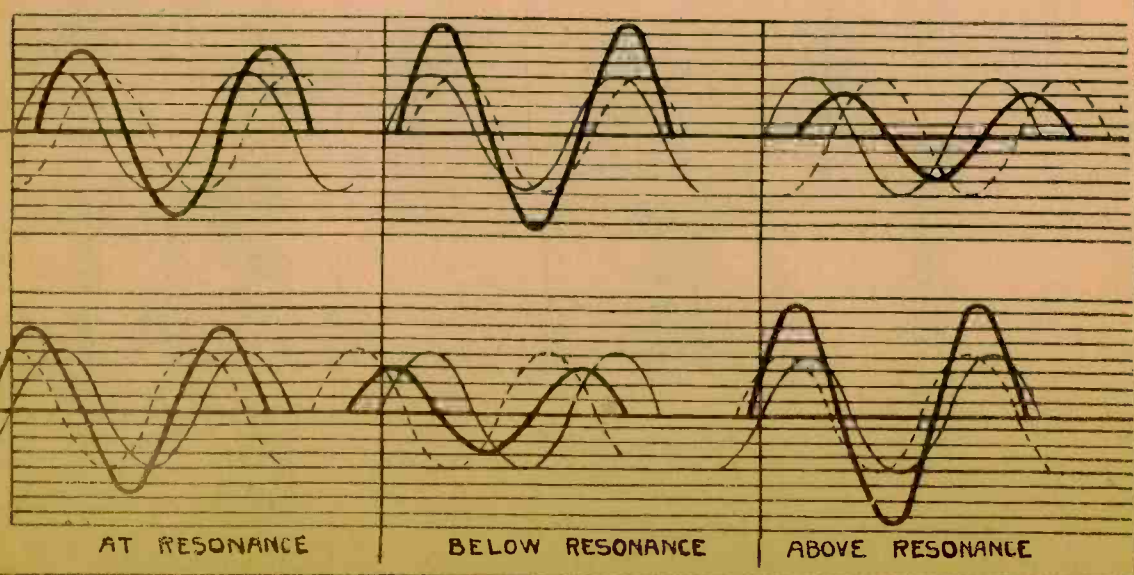
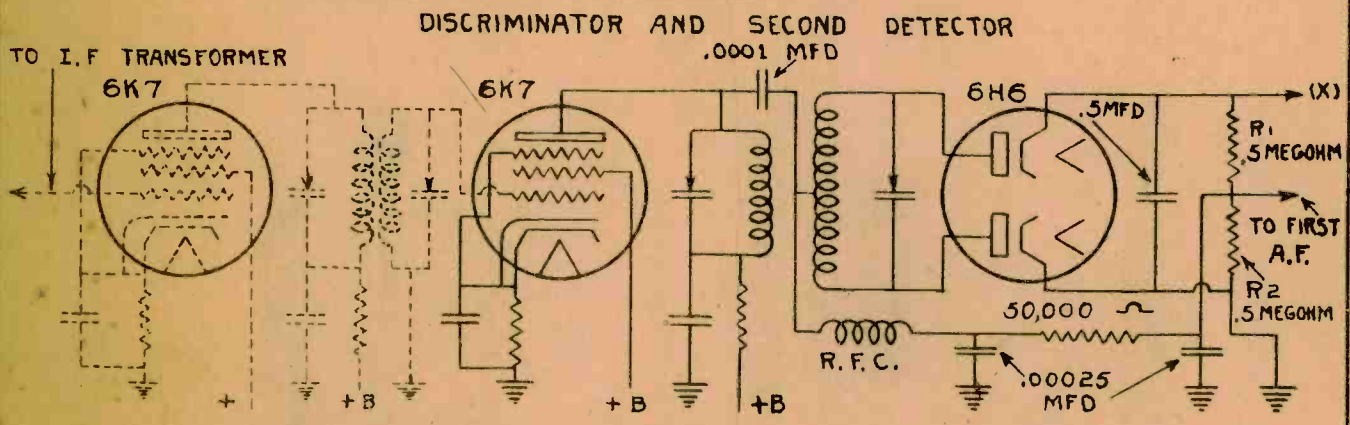
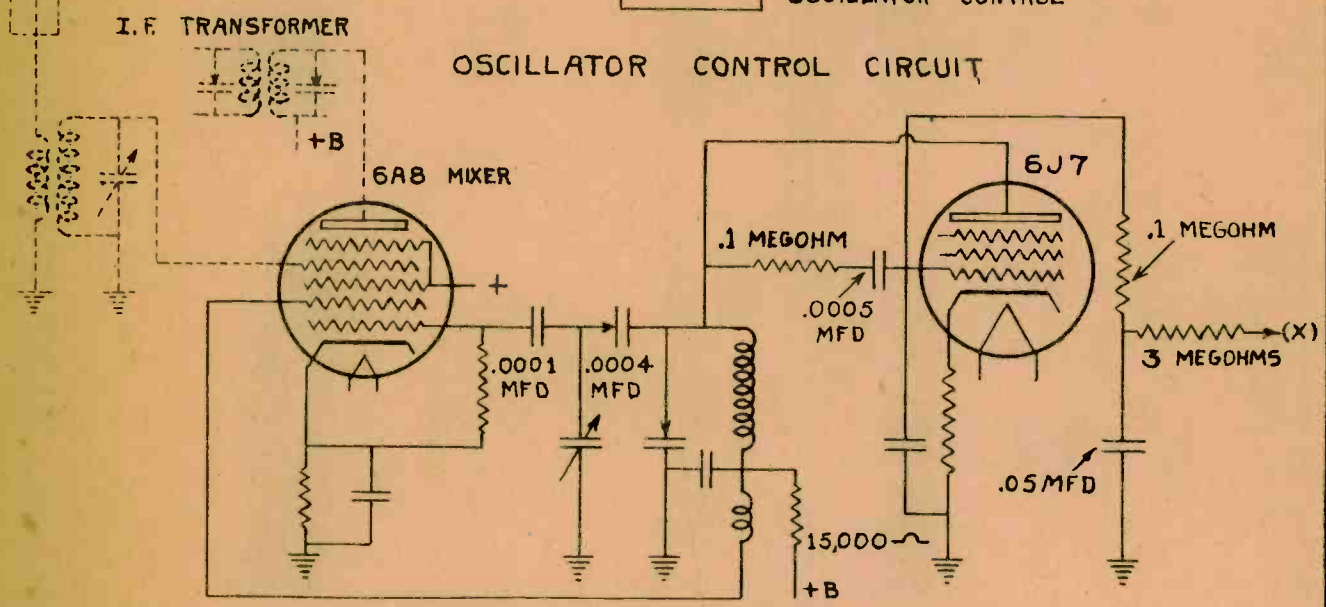
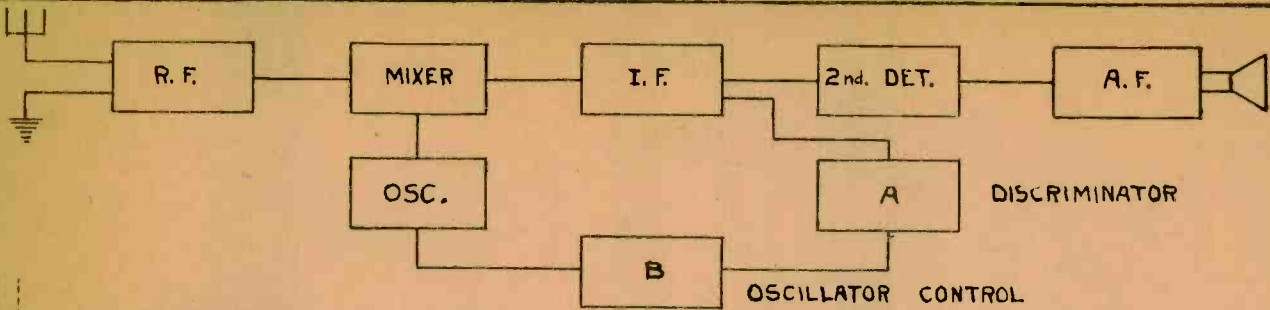

AUTOMATIC VOLUME CONTROL (A.V.C.) AND DIODE DETECTOR CIRCUITS

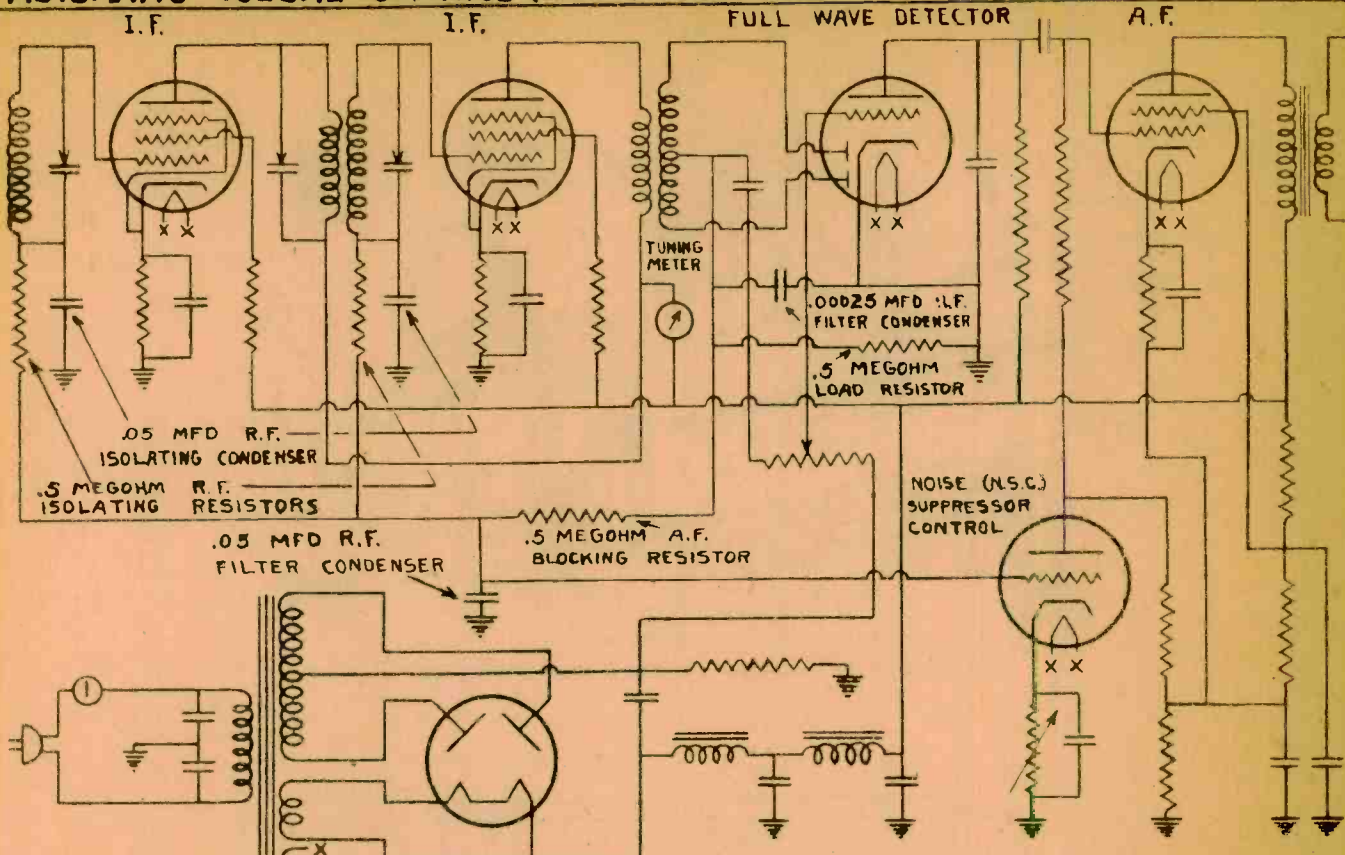

MODULATED BY A.F.

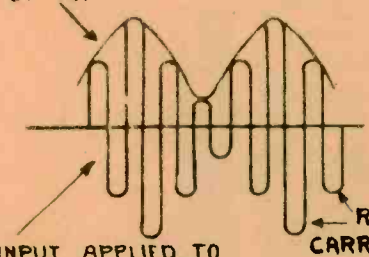

INPUT APPLIED TO DIODE DETECTOR



OUTPUT FROM DIODE DETECTOR
DELAYED A.V.C.

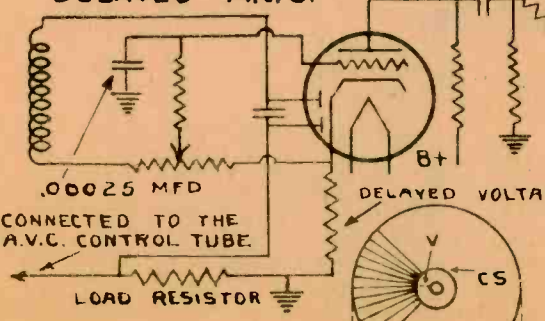

- K- CATHODE
- G- TRIODE GRID
- P- TRIODE FLATE
- V- RAY CONTROL VANE
- T- FLUORESCENT TARGET
- CS- CATHODE SHIELD

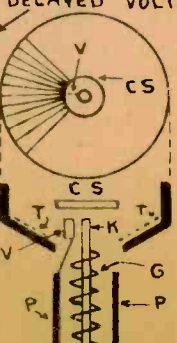

DUO-DIODE-TRIODE TYPE TUBE
HALF WAVE DETECTOR
55-75-85-ETC

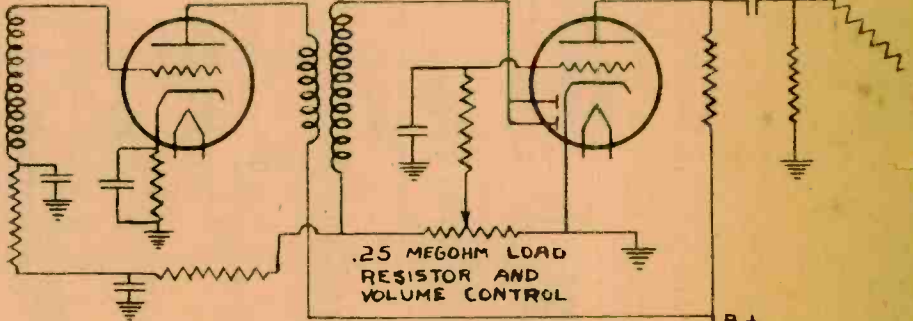

MAGIC EYE

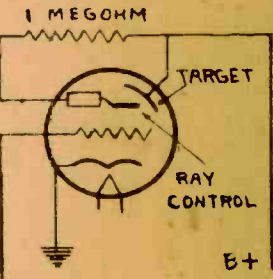

ZERO GRID BIAS,
MINIMUM SIGNAL

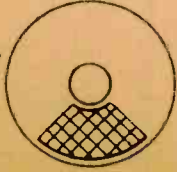

NEGATIVE GRID BIAS,
MAXIMUM SIGNAL

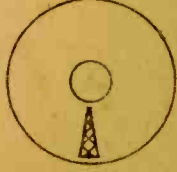

Radio Receivers and Controls

AUTOMATIC TUNING

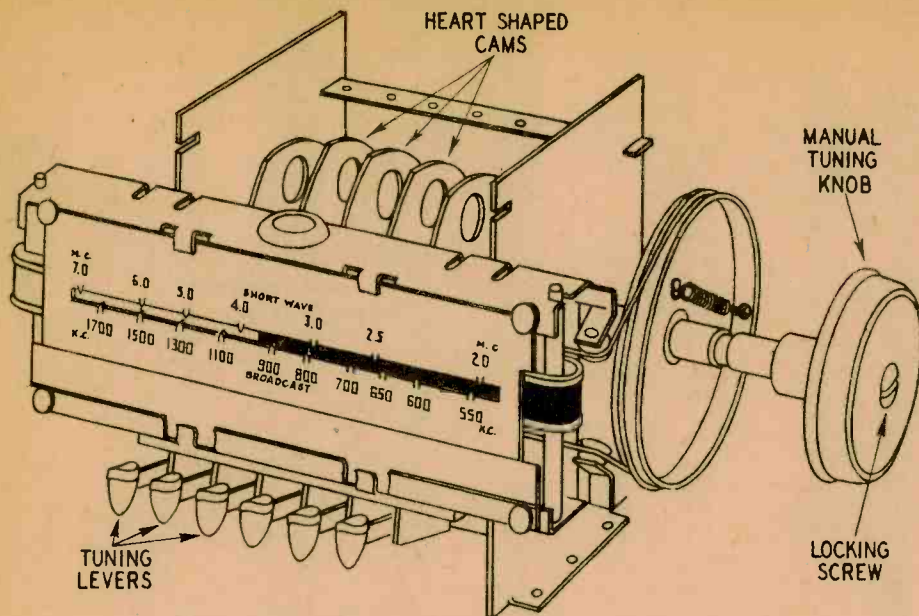
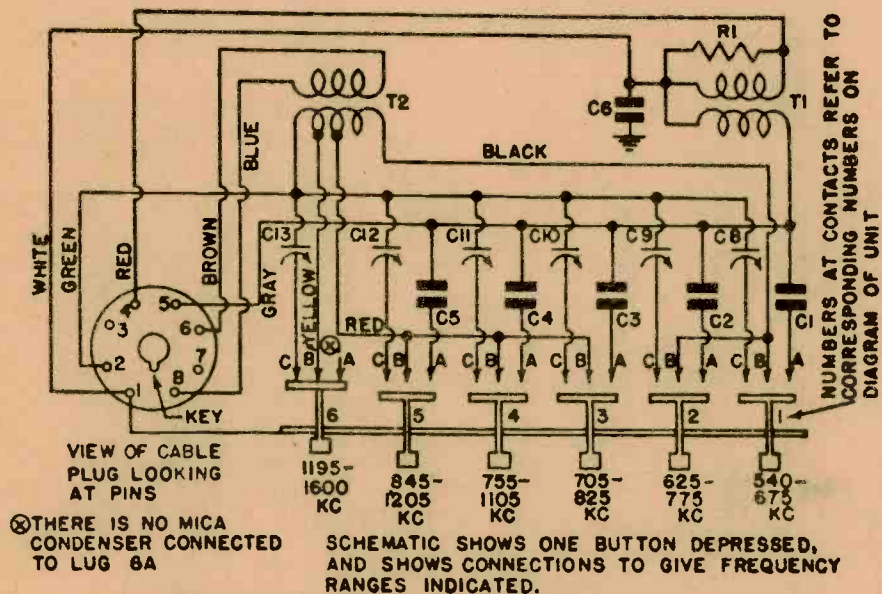
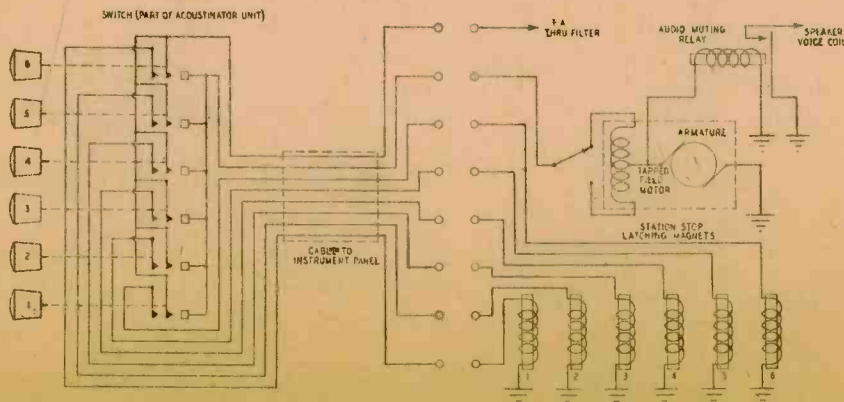

FIG. 1—Belmont "Belmonitor" Tuning System—Front View



EMERSON MIRACLE TUNING UNIT



—Galvin (Motorola) "Press-Button Tuning"—Circuit Diagram

AUTOMATIC TUNING

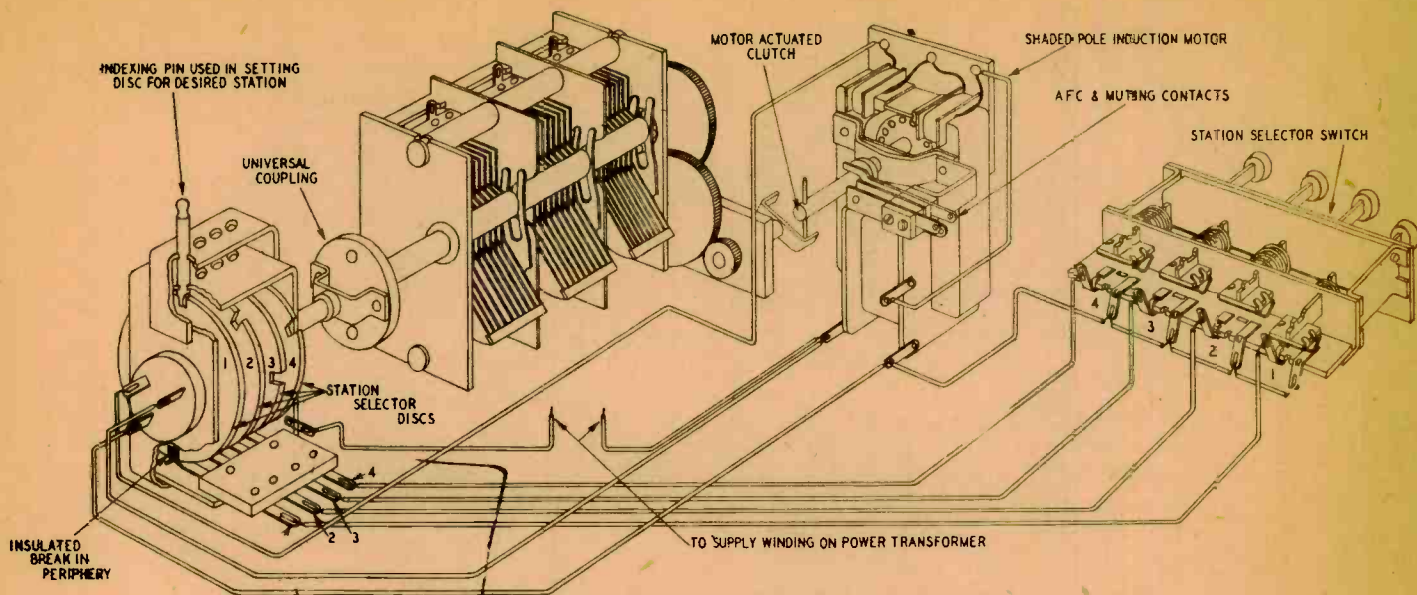

Fig. 31—Typical Motor-Tuned Automatic Station Selector System

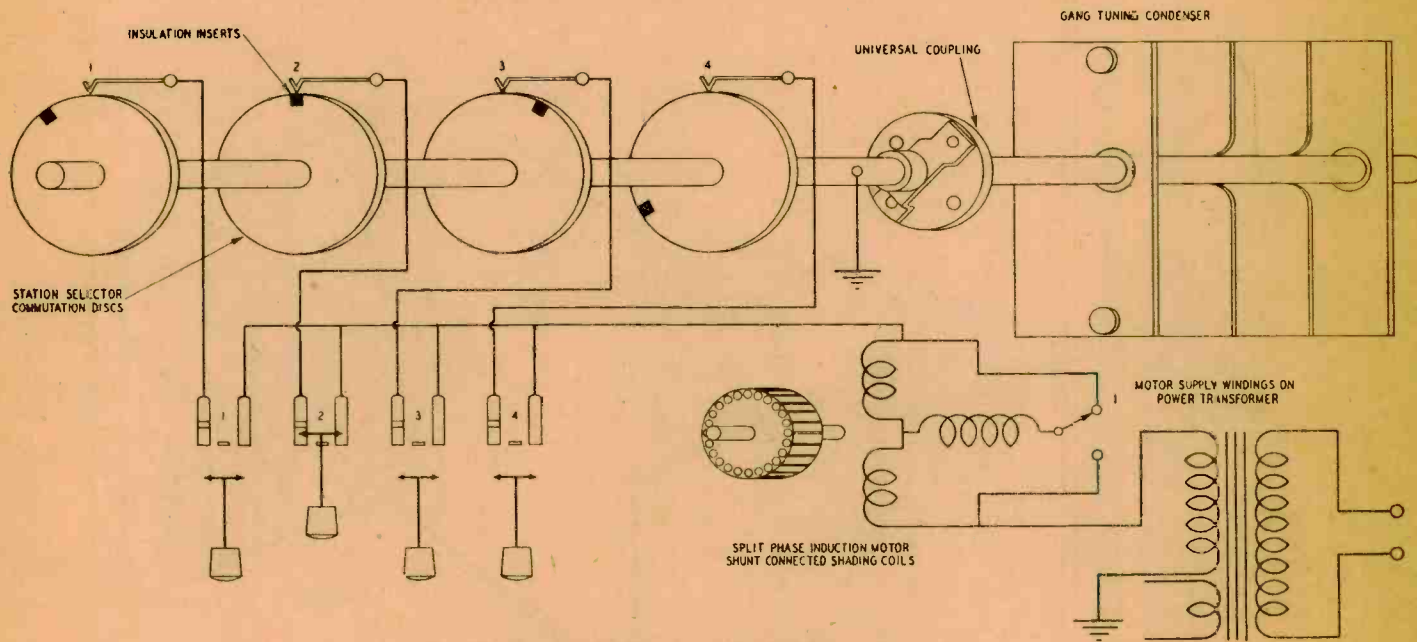
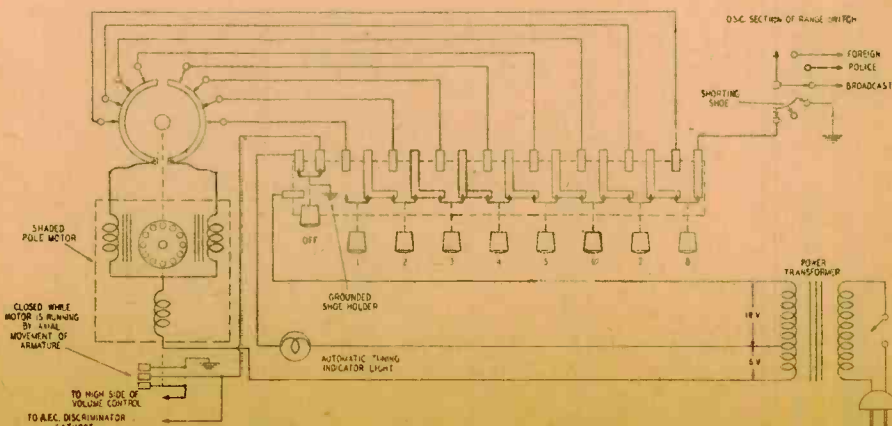

Fig. 32—Schematic Diagram of Typical Motor-Tuned System



—Admiral "Touch-O-Matic" Circuit Diagram

Radio Receivers and Controls

AUTOMATIC TUNING

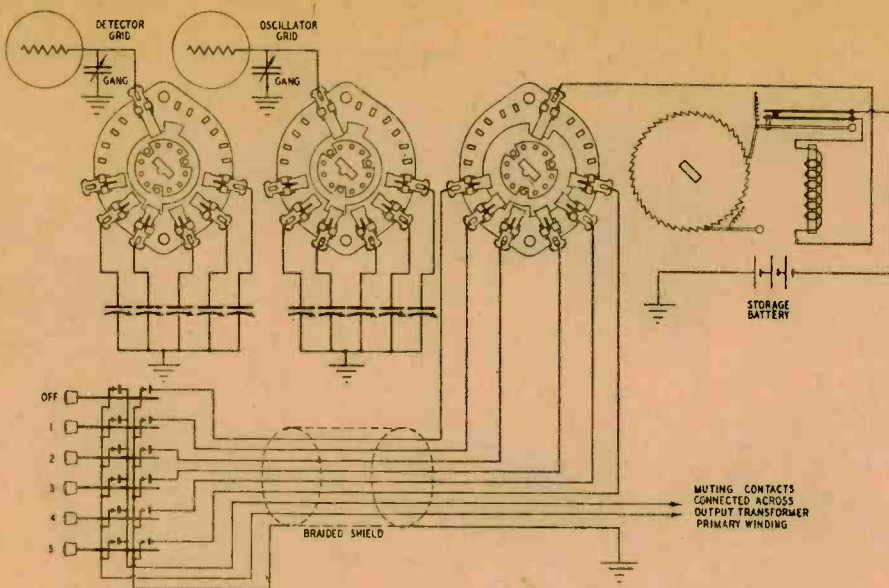

FIG. 47—Admiral "Touch-O-Matic" Motor Car Conversion Unit—Circuit Diagram

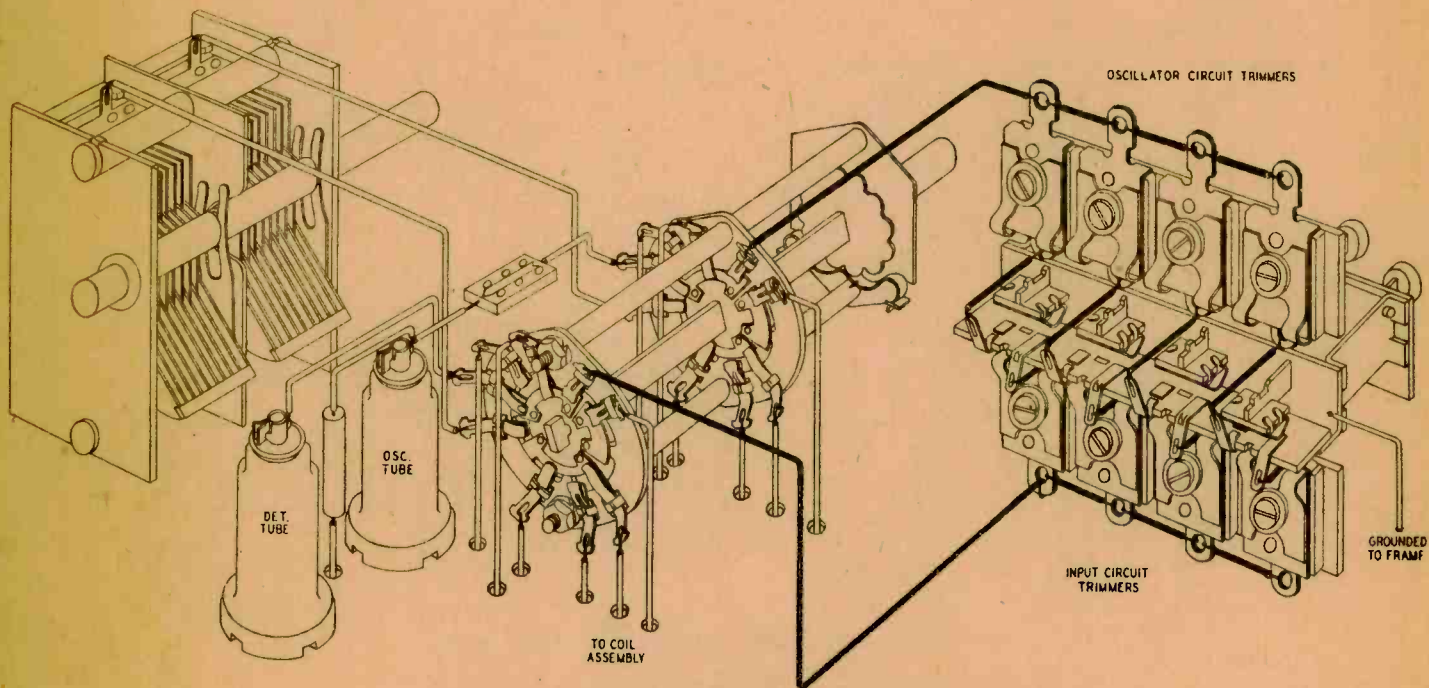

FIG. 21—Typical Condenser Substitution Tuning System

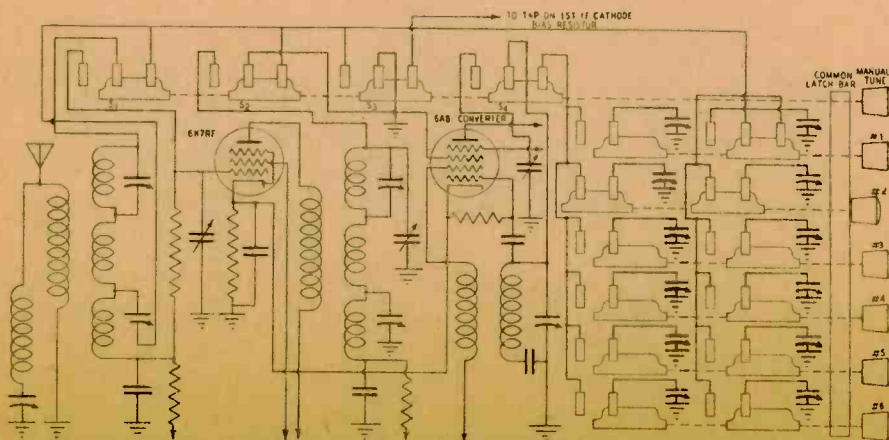

FIG. 73—General Electric "Touch-Tuning"—Circuit Diagram

