

COMPLETE INDEX
for
PERPETUAL TROUBLE SHOOTER'S MANUALS

Volumes I, II, III, IV, V, VI, VII, VIII, IX, and X

and
"HOW IT WORKS"

Special Section of Volume X

by
John F. Rider

404 Fourth Avenue

New York 16, N. Y.

Copyright 1939 by John F. Rider

Printed in the United States of America

A New Book by the Author of the System

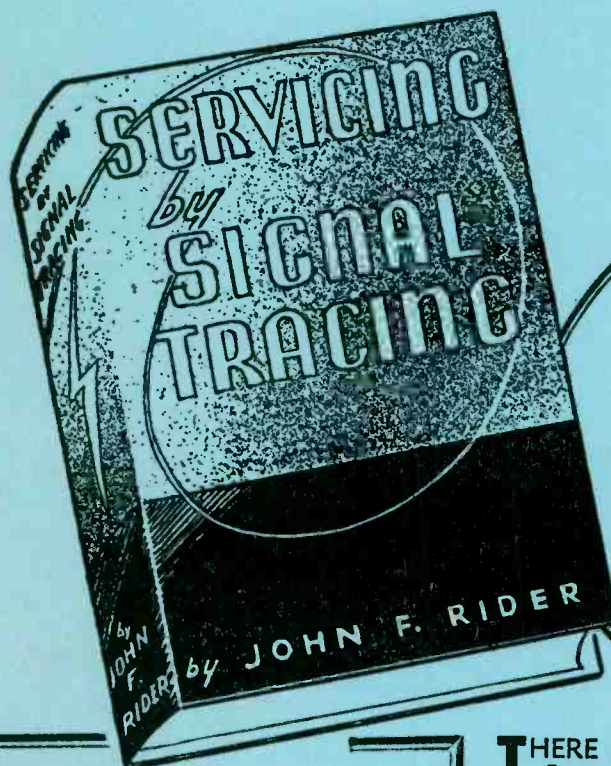

Explains
the system of
servicing that will
gear your shop to
modern and future
requirements

Contents

- Chapter I—INTRODUCTION TO SIGNAL TRACING
- Chapter II—AMPLIFIER OPERATION AND THE SIGNAL
- Chapter III—DIODE DETECTOR TUBE SYSTEMS
- Chapter IV—MULTI-ELEMENT DETECTOR SYSTEMS
- Chapter V—OSCILLATOR TUBE SYSTEMS
- Chapter VI—MIXER TUBE SYSTEMS
- Chapter VII—CONTROL CIRCUITS AND VOLTAGES
- Chapter VIII—COUPLING DEVICES
- Chapter IX—THE T-R-F RECEIVER
- Chapter X—THE SUPERHETERODYNE RECEIVER
- Chapter XI—TELEVISION AND FACSIMILE RECEIVERS
- Chapter XII—PUBLIC ADDRESS SYSTEMS
- Chapter XIII—LOCALIZING DEFECTS BY SIGNAL TRACING
- Chapter XIV—SIGNAL TRACING IN RECEIVER DESIGN

THERE are about 40,000,000 receivers in the United States. Each and every one of these receivers comes within the capabilities of signal tracing as a means of locating defects with the greatest speed and efficiency. There is no man connected with the radio servicing industry who can afford to miss reading "Servicing By Signal Tracing" It means actual dollars in the pockets of every radio serviceman because it gives him an insight to radio receiver operation and servicing that has never before been accomplished by any single book or combination of books.

Signal Tracing is destined to become the universally adopted method of locating defects in communication systems, no matter what the nature of the system—whether it is a home broadcast receiver, auto-radio receiver, police receiver, commercial, marine, navy or army receiver. Every public address system, every centralized radio system comes within the capabilities of signal tracing. . . . Television receivers, facsimile receivers and other systems intended for special application can be serviced with equal ease. . . . Signal Tracing, founded upon the signal itself, is the most basic, most fundamental method of trouble shooting ever devised. . . . It is free of every limitation which in the past has hindered speedy service operations. . . . Service operation at a Profit!

You can't afford to be without this book. . . . We mean every word of this statement. . . . It is vital to your immediate welfare—to your future. . . . See your jobber about your copy today—NOW!

360 Pages — Hard Covers
188 Illustrations — Price \$3.00

AUTHOR'S FOREWORD

Volume X is a continuation of the "Perpetual Trouble Shooter's Manual" series. In addition to this Volumes I, II, III, IV, V, VI, VII, VIII and IX have been published.

Inasmuch as owners of preceding volumes are familiar with the Manual and with the nature of its contents, an elaborate description is not required. However, it might be well to state that the information presented in Volume X is condensed as much as possible in accordance with the requests of owners of previous volumes of this publication. You will find that in many cases facts associated with a number of the receivers contained under any one manufacturer's heading have been grouped upon a single page, and references are made to this page in the description of the various models which employ a component, utilize the adjustment, and in general make use of the facts given upon this company's reference page. By arranging the contents in this manner we avoid duplication and make space available for the inclusion of a greater number of schematics. Examples of the foregoing are push-button tuning adjustments, dial cable adjustments, etc.

In a number of instances references are made to "conventional alignment." This term is used in conjunction with simple receivers which do not require elaborate alignment instructions. Such conventional alignment was described in the "How It Works" section of Volume VIII, and we feel that so many men are familiar with simple alignment that it would be a waste of space to include such alignment in conjunction with each of the receivers contained in the Manual.

We feel that reference to a given source of such information makes available additional space so badly needed for the inclusion of the large number of receiver models being manufactured. An example of the successful application of such space conservation is the fact that Volume X contains approximately 2600 models in its 1650 pages; whereas the number of models which hitherto have been incorporated in a Manual with an equivalent number of pages was roughly 1900.

We take this opportunity to request comments and criticism concerning the contents and make-up of Volume X.

JOHN F. RIDER.

HOW TO USE THIS INDEX

This index covers all Rider's Manuals issued thus far. The three columns of pages are used to identify the pages employed in the various series of manuals published up to the present time. The column headed "Revised Pages" covers the ten individual Volumes I, II, III, IV, V, VI, VII, VIII, IX, and X which were arranged with a new type of folio. With respect to earlier editions of Rider's Manuals, the revised folios appear only in Volumes I and II.

Hence any material which appears in Volumes I or II is shown in the columns marked "Revised" and also "Early," establishing the correct page in either of these issues of manuals. Thus if you own the early editions of Volumes I and II and the regular editions of Volumes III, IV, V, VI, VII, VIII, IX, and X you will refer to the "Early" column for material in Volumes I and II and to the "Revised" column for material in subsequent volumes. This work is simplified by the fact that the "Early" column has its equivalent in the "Revised" column only for the material which has been shown in Volumes I and II.

Referring to the folios listed in the "Revised" column and covering all manuals, the number 1, before the page number, establishes the data as being in Volume I. The numeral 2 before the page number establishes the material as being in Volume II. The numeral 3 before the page number establishes the material as being in Volume III and the numeral 4 before the page number establishes the material as being in Volume IV, etc.

Concerning the pages listed in the "Early" column, all page numbers preceded by an asterisk (*) are in Volume I. All numbers which do not have an asterisk are in Volume II. The word "Front" shown in the "Early" column establishes that the material was shown in the front end of Volume II.

An example of the use of this index is as follows:

Electrical Research Laboratories, Inc.

Model	Revised Pages	Early Pages	Radiotron Complete Pages
75, 77 (231)	2-6	252-I	870
81, 82 (245)	1-5	*252-C	871
81-P, 82-P, 30 (248)	3-2		872

The receiver model 75, 77 (231) is on page Erla 2-6 in the revised Volume II; on page 252-I of the early Volume II and on page 870 of the Radiotron Complete Manual. The receiver model 81, 82 (245) is on page Erla 1-5 in the revised Volume I; on page 252-C in the early Volume I and on page 871 in the Complete Manual. The model 81-P, 82-P, 30 (248) is on page Erla 3-2 in Volume III and on page 872 of the Complete Manual.

Volumes III, IV, V, VI, VII, VIII, IX, and X pages require no comment, since their identity is established by the numerals 3, 4, 5, 6, 7, 8, 9, or 10 which precede the page number.

When seeking any page, remember that the manufacturers' names are arranged alphabetically and that the trade names are shown in connection with the folios. Sometimes more than one model using the same chassis is listed upon the same line. Where a chassis is used in more than one model, the extra model numbers appear in their numerical order, referring back to the lowest model number. Chassis numbers are also listed numerically and cross indexed to the lowest model number.

INDEX

MODEL	ABC RADIO LABORATORIES	REVISED PAGE	EARLY COMPLETE PAGE	RADIOTRON COMPLETE PAGE	ADMIRAL	REVISED PAGE	EARLY COMPLETE PAGE	RADIOTRON COMPLETE PAGE
100	Schematic Misc. 7-1				See CONTINENTAL RADIO & TELEVISION CO. Schematic Misc. 5-1			
THE A-C DAYTON CO.								
Navigator	Schematic, socket, voltage.....1-8	*7	8					
XL-5	Schematic.....1-3	*1	1					
XL-10	Schematic.....1-3	*2-A	3				10-A	11
XL-20	Schematic.....1-1	*1	1				10-A	11
XL-25	Schematic.....1-1	*1	1				10-B	13
XL-30	Schematic.....1-1	*1	1					
XL-50	Schematic, socket.....1-4	*3	4					
XL-60	Schematic, socket.....1-2	*2	2					
XL-61	Schematic.....1-4	*2	2					
XL-61 Battery	Schematic, socket.....1-4	*3	4					
AC-63	Schematic, socket, voltage.....1-5	*4	5					
AC-65	Schematic, socket, voltage.....1-6	*5	6					
AC-66	Schematic, socket, voltage.....1-7	*6	7					
XL-70	Schematic.....1-3	*2-A	3					
ACE								
See RADIO CIRCULAR CO.								
ACME APPARATUS CO.								
"B" Eliminator	Schematic.....1-1	*727	9					
5-tube Reflex	Schematic.....1-1	*8	9					
ACME ELECTRIC & MFG. CO.								
Moto Midget	Schematic.....4-1	*9	13					
AC-7	Schematic, socket.....1-1		15					
E-60 (Power Pack)	Schematic, wiring diagram.....3-1		13					
SG-88	Schematic, socket.....1-1	*9	13					
AC-98	Schematic, values, voltage.....3-2		14					
ACRATEST PRODUCTS CO., INC.								
Also see FEDERATED PURCHASER								
37	Schematic, impedance.....6-1							
38	Schematic, impedances.....6-2							
47	Schematic, notes.....7-3							
85	Schematic, notes.....7-3							
108	Schematic, layout.....5-1							
120	Schematic.....6-4							
126	Schematic.....5-2							
194	Schematic, voltage, alignment.....7-1							
196, 197	Schematic, impedance.....6-1							
198, 199	Schematic, impedance.....6-2							
200	Schematic, notes.....7-2							
202	Schematic, notes.....7-2							
247	Schematic.....5-4							
418	Schematic, socket.....5-3							
728	Schematic.....6-3							
739	Schematic.....5-4							
770	Schematic.....6-4							
1416	Schematic, voltage.....8-1							
1800	Schematic, voltage.....8-1							
2020	Schematic, voltage.....8-2							
	Schematic, voltage.....8-2							
	Schematic.....7-4							
ACRATONE								
See FEDERATED PURCHASER								
AIR-CASTLE								
Also see RADIO PRODUCTS CORP. Also see SPIEGEL, INC.								
A31	Schematic.....Misc. 5-2							
AIR CHIEF								
See FIRESTONE TIRE & RUBBER CO.								
AIR KING PRODUCTS CORP.								
Armor	See model 211							
Atlas 5-Tube Universal	Schematic.....5-3							
All-Wave	See model 221							
Autocrat	See model 76							
Castle	See model 4-tube Comet							
Comet	See model 221							
Council	Schematic.....7-4							
Dynastic 2-Range	See model 76							
Earl	See model 213							
King	Schematic, notes.....7-1							
Knave	See model 10							
Lancer	See model 227							
Magnetic	See model 227							
Palace	See model 227							
Pirate	See model 209							
Premier	See model 76							
Prince	See model 221							
Queen	Schematic, notes.....7-2							
Regent	See model 211							
Royalty	See model 211							
Spear	Schematic.....5-1							
4-Tube Comet	Schematic.....5-2							
5-Tube Atlas Universal	Schematic.....5-3							
All-Wave	Schematic.....5-1							
6-Tube TRF L-W.	Schematic.....5-1							
7-Tube BC Super	Schematic, data.....9-1							
7-Tube TRF L-W.	Schematic.....7-4							
9E	Schematic, alignment.....8-1							
10, 21, 22, 41, 42 Magnetic	Schematic, layout, data.....8-2							
11F	Schematic, layout, data.....8-2							
21, 22, 522, 81 Series								

**AIR KING
ALL-AMERICAN**

MODEL	AIR KING PRODUCTS CORP.—(Cont.)	REVISED PAGE	EARLY COMPLETE PAGE	RADIOTRON COMPLETE PAGE
27, 28A	Schematic	7-8		
37, 39	Schematic	Misc. 4-1		
40	See model 10			
41, 42	Schematic	7-8		
47, 48, 57, 58	Schematic	4-1		
50	See model 47			
52-54	Schematic	6-2		
57, 58	Schematic	8-3		
66	Schematic, alignment	9-2		
70	Schematic	7-6		
72, 73	Schematic, notes	7-7		
76, 501 Queen, 503 Earl, 505 Castle	See model 21			
81	Schematic, notes	7-6		
209, Prince	Schematic, notes	7-7		
211, 224, 225	Lancer, Spear, Armor			
213, King	Schematic, notes	7-3		
214	Schematic, socket	8-8		
221, 222, 223	Schematic, notes	7-9		
222	Schematic, socket	9-4		
224, 225	See model 211			
227, 228, 229	Schematic	7-5		
250	Schematic	8-4		
250-B	Schematic, socket	9-4		
252	Schematic, voltage, socket, trimmers, alignment	10-2		
257	Schematic, alignment	8-4		
260	See model 76	8-5		
501, 503, 505	See model 21			
600	Schematic	7-10		
688, 886	Schematic	9-5		
699	Schematic, socket	9-6		
700	Schematic	9-7		
700 LW, 702, 703	Schematic	9-6		
704	Schematic, socket	8-6		
705	Schematic, socket	8-7		
710, 715	Schematic, alignment	8-8		
720, 721, 770, 771, 870, 871	Schematic	9-7		
725	Schematic, alignment	8-5		
730, 731, 850 (Early)	Schematic	9-9		
777	Schematic	9-10		
X-780B	Schematic	9-10		
801	Schematic	9-11		
810	Schematic	9-12		
815	Schematic	9-13		
822, 822X, 826X, 832	Schematic	9-13		
823, 833	Schematic	9-13		
824, 834	Schematic	9-8		
X-895	Schematic, alignment	9-11		
828, 838	Schematic, alignment	9-15, 16		
X-837	Schematic, alignment	9-15, 16		
X-837S	Schematic, alignment	9-14		
850 (Late)	See model 720			
870, 871	See model 688			
886	Schematic, socket	9-17		
908	Schematic, socket	9-17		
909	Schematic	9-9		
910 Early	Schematic, socket, notes	9-14		
911	Schematic	10-1		
912	Schematic, tuner data	10-1		
1000, 2000	Schematic, socket	8-7		
1001, 2001 Early, Late	Schematic, socket	8-8		
1001B, 2001B	Schematic, socket	9-12		
2006	Schematic, socket	9-12		
3905	Schematic, voltage, alignment, socket	10-2		
3910	Schematic, socket	10-2		
X-8912	Schematic, alignment	9-18		
	AIRLINE			
	See MONTGOMERY WARD			
	ALL-AMERICAN MOHAWK CORP.			
	Also see WURLITZER			
D	Schematic, socket, voltage	1-14		
F	See model 60			
F	Schematic, socket, voltage	1-15		
H	Schematic, socket, data	1-16		
J	Voltage, values	1-17		
K	Schematic, socket	1-18		
P	Schematic, socket, data	1-19		
R	Schematic, socket	3-9		
DC	Schematic	1-27		
VA	Schematic, socket	3-1		
All-Amaz Junior	Schematic	3-7		
All-Amaz Senior	Schematic	3-7		
Cherokee	Schematic, data	3-2		
Chieftain	Schematic, socket	3-2		
Forde, 1926	Schematic, socket	1-5		
Mohawk All-Electric (Kellogg type)	Schematic, socket, cable connections	3-3		
Mohawk 1926 All-Electric	Schematic	3-3		
Mohawk Volume Control (2 types)	Schematic, chassis	3-4		
Navajo	Schematic, chassis	3-1		
Screen Grid, 110-volt DC	Schematic	3-17		
Sextette, Duet (Battery)	Schematic, socket	3-9		
Sextette, All-Electric	Schematic	3-10		
7-tube, 110-volt DC	Schematic	3-16		
8-tube, Battery	Schematic	3-15		
8-tube, 110-volt DC	Schematic	3-20		
A-1, A-3, A-4 Eliminator	Schematic, color code	3-8		
C-6 Studio	Schematic, socket	1-20		
S-6	Schematic, socket, data	1-21		
S-7	Voltage, data	1-22		
S-8	Schematic, socket, data	1-23		
S-9	Voltage, data	1-24		
S-10	Schematic, socket	3-21		
S-11	Schematic, socket	3-22		
DC-7, 220 volts	Schematic, color code	3-8		
DC-7, 110 volts	Schematic, socket, data	1-25		
A-8 Eliminator	Voltage, data	1-26		
S-8	Schematic, socket	3-23		
SW-8	Schematic, chassis wiring, color code	3-11		
A-9 ABC Power Pack	Schematic, color code	3-6		
A-10 Power Pack	Schematic, chassis wiring, color code	3-14		
S-10	Schematic	3-24		
B 30-31	Schematic, socket	3-19		
S-40	Schematic	3-25		
44	Schematic, socket	1-5		
S-50	Schematic	3-25		
U-55, AC-DC, 25 or 60 cycles	Schematic, data	3-40		
60, 61, 62, 65, 66, F, AO	Schematic, socket, voltage	1-6		
60, 61, 62, 65, 66, F, SPU	Schematic, wiring, plug	1-7		
S-63	Schematic, socket, voltage, data	3-26		
DC-65, 110 volts	Schematic, socket, voltage, data	3-28		
DC-65, 220 volts	Schematic, socket, voltage	3-29		
SA-65, 220 volts	Schematic, socket, data, voltage	3-27		
65, 66 AC	See model 60			
70, 73, 75	Schematic, socket, voltage, data	1-8		
77 (Simplified)	Schematic, data, socket	3-13		
B-80	Schematic, socket, voltage	3-30		
S-80	Schematic, socket, voltage, data	3-31		
SW-80	Schematic, socket, voltage, data	3-32		
90, 25-cycle	Schematic, socket, voltage	1-9		
90, 83, 84, 85, 86, 88	Schematic, voltage	1-10		
90, 60-cycle	Schematic, socket, voltage	1-11		
90 (25 & 60 cycles) SPU	Chassis, plug connections	1-13		
SA-90	Schematic, socket, voltage, data	3-33		
SA-91	Schematic, socket, voltage	3-34		
96, 60-cycle	Service notes	3-35		
SA-110	Schematic, socket	1-12		
115-1926 Battery	Schematic	3-46		
115-1926 All-Electric	Schematic, socket	3-12		
SA-150	Schematic	3-12		
	Schematic, socket, voltage, data	3-5		
	Service notes	3-36		
	Schematic, socket, voltage, data	3-39		
	Service notes	3-38		
	Socket layout	3-5		

Mohawk 228

See MONTGOMERY WARD

RADIOTRON
EARLY COMPLETE
PAGE

REVISED
PAGE

ALLIED RADIO CORP.—(Cont.)

MODEL

G-9551 Schematic, voltage, alignment, notes.....6-6
 G-9553 Schematic, voltage.....6-7
 F-9555 Schematic.....5-8
 G-9557 Schematic, voltage, alignment, notes.....6-6
 Schematic.....6-7
 G-9561, G-9563, G-9565, G-9567, G-9565, G-9565, Above serial #61700.....6-8
 G-9575, G-9605 incl. Schematic, notes.....7-2
 See model F-9531 Schematic, data, voltage.....6-9
 Schematic, voltage, alignment.....6-10
 G-9599 Schematic.....7-3
 G-9611, G-9613 Schematic.....7-4
 Alignment, parts, voltage.....7-4
 G-9617, 9619, 9621, 9623, 9625, 9627 Schematic, voltage, alignment, parts list.....7-5
 G-9629, 9631, 9633, 9635, 9637, 9639 Schematic.....7-9, 7-10
 Alignment, part 1.....7-11
 Alignment, part 2, voltage, parts list.....7-12
 Schematic.....7-6
 G-9643, 9645 Alignment, part 1.....7-7
 Alignment, part 2, voltage, parts list.....7-8
 Schematic.....8-1
 A9701, A9702, A9703, A9704, A9715, A9716, A9717, A9718, A9718, A9718, A9705, A9735 Schematic.....8-1
 Schematic.....10-1
 Schematic.....10-1
 Schematic.....8-2
 See model A9701 Schematic.....8-2
 Schematic.....8-3
 Schematic.....8-3
 Schematic.....8-3
 See model A9705 Schematic.....8-4
 Schematic, socket, voltage, layout.....9-1
 Alignment, coils, parts.....9-2
 Schematic, voltage.....9-3
 Socket, trimmers, layout, alignment, trimmers, voltage.....9-4
 Socket, trimmers, layout, notes.....9-6
 Alignment.....9-2
 Schematic, voltage.....9-9, 9-10
 Socket, trimmers, layout.....9-11
 Alignment, tuner.....9-12
 Dial assembly, data, parts.....9-13
 Parts list.....9-14
 Schematic, voltage, socket, trimmers, layout.....9-15
 Alignment, coils, parts.....9-16
 Schematic, trimmers, voltage.....9-7
 Socket, layout, coils, trimmers.....9-8
 Alignment.....9-26
 Schematic, socket, trimmers, alignment.....8-5
 Schematic, socket, trimmers, alignment.....8-6
 Schematic, alignment, socket, trimmers.....10-2
 Schematic, socket, trimmers, alignment.....8-7
 Schematic, alignment, socket, trimmers.....10-3
 Schematic, socket, trimmers.....9-17
 Alignment, parts.....9-18

RADIOTRON
EARLY COMPLETE
PAGE

REVISED
PAGE

ALL AMERICAN MOHAWK CORP.—(Cont.)

MODEL

Mohawk 226, 7-contact SPU Schematic, cable connections.....3-4
 Mohawk 226, 12-contact SPU Schematic, color code.....3-6
 606 Battery Schematic, socket, data.....3-18
 ALLIED RADIO CORP.
 5-tube Dual Wave AC Schematic.....4-1
 6-tube Dual Wave Batt. Schematic.....4-1
 6-tube Auto Set Schematic, parts list.....3-18
 6-tube Dual Wave Schematic.....3-10
 7-tube Superhet '32 Chassis, voltage, parts.....3-11
 Schematic, voltage.....3-15
 Alignment data, notes, color code.....3-16
 Schematic.....3-17
 Schematic.....3-14
 See model A9857 B1 Chassis.....3-3
 See model A9851 B2 Chassis.....3-3
 See model A9870 Z3 Chassis.....3-3
 See model A9891 AM4 Chassis.....3-3
 See model A10505 M5 Chassis.....3-3
 See model A10500 5X Chassis.....3-3
 See model A9776 Z5 Chassis.....3-3
 Schematic, socket.....3-3
 Schematic, socket.....3-3
 A-5-30 SG, Rosmer Auto Set.....3-3
 B6 Chassis See model A9780.....3-3
 6P Chassis See model A10508.....3-3
 U6 Chassis See model 9880.....3-3
 6W Chassis See model A10506.....3-3
 6Y Chassis See model A10502.....3-3
 B-6-30 Battery Schematic, socket.....3-3
 AM7 Chassis See model A9788.....3-3
 AM Chassis See model A9782.....3-3
 AM Chassis See model A10507.....3-3
 B8 Chassis See model A9784.....3-3
 8K Chassis See model A10510.....3-3
 8T Chassis See model A10515.....3-3
 AM8 Chassis See model A9785.....3-3
 SG-8 Schematic.....3-4
 Chassis, wiring, voltage.....3-5
 Schematic, socket.....3-1
 Schematic, socket.....3-6
 Schematic.....3-7
 See model A9752 46-A Chassis.....3-7
 See model A9530 47AE Chassis.....3-7
 See model A9760 60B Chassis.....3-7
 See model A9833 66B, 66BE Chassis.....3-7
 See model A9848 68 Chassis.....3-7
 See model A9768 68B, 68BE Chassis.....3-7
 See model A9740 69U Chassis.....3-7
 See model A9741 72A Chassis.....3-7
 See model A9757 76A Chassis.....3-7
 Schematic.....7-1
 See model A9820 B102 Chassis.....3-8
 Schematic, socket.....3-8
 Chassis, voltage, alignment data 3-9
 See model A9848 Schematic, alignment.....5-1
 Schematic, alignment.....5-1
 Schematic, alignment.....5-2
 Schematic, alignment.....5-2
 Schematic, alignment.....5-2
 Schematic, alignment.....5-3
 Schematic.....6-2
 Schematic.....6-3
 Schematic, alignment.....5-3
 Schematic, alignment.....5-4
 Schematic.....7-1
 Schematic, alignment.....5-5
 Schematic.....5-6
 Schematic, alignment.....5-6
 Schematic, voltage.....6-5
 Schematic.....5-7

REVISED
PAGE

MODEL

266, 268 Chassis F-9501 Schematic.....9-1
 G-9503 Schematic.....9-1
 F-9505 Schematic.....9-1
 G-9505 Schematic.....9-1
 F-9511 Schematic, alignment.....9-1
 G-9511-13 Schematic, alignment.....9-1
 F-9515, G-9881 Schematic.....9-1
 G-9517, G-9882 Schematic.....9-1
 F-9521, F-9527 Schematic, alignment.....9-1
 F-9521, F-9527 Schematic, alignment.....9-1
 F-9531, F-9591 Schematic, alignment.....9-1
 G-9533 (two types) Schematic, alignment.....9-1
 F-9541 Schematic, voltage.....9-1
 G-9545, G-9547, G-9549 Schematic.....9-1

A9788, A9789, A9852, A9854 Chassis AM7	Schematic, socket, trimmers.....	9-19			
A9802	Alignment parts	9-20			
A9805	Schematic	8-8			
A9807	Schematic	8-8			
A9809	Schematic	8-4			
A9811	Schematic	10-4			
A9815	See model A9724	10-4			
A9820, Chassis B102	Schematic	10-5			
A9825	See model A9740				
A9826, A9828	See model A9760				
A9830, A9831 Chassis 47AL	Schematic, voltage, trimmers	9-21, 22			
E-9830 (8-tube Super)	Alignment, parts	9-25			
E-9831 (10-tube Super)	Schematic	3-12			
A9833, A9834, A9835, A9836, A9837, A9838 Chassis 66B, 66BE	Schematic, trimmers, voltage, coils	3-13			
A9848, A9849, Chassis 68	Schematic, trimmers, layout	9-27			
A9848, A9849 Chassis 266	Alignment, parts	9-28			
A9848, A9849 Chassis 268	Schematic	9-29			
A9848, A9849, Chassis 266, 268	Socket, voltage, trimmers	9-29			
A9851, Chassis B2	Alignment	9-32			
A9852, A9854	Schematic, socket, trimmers	9-32			
A9855, A9856	See model A9788	10-6			
A9857, A9857E, Chassis A1	Schematic, socket, trimmers, alignment	10-7			
A9860, A9861, A9862, A9863, A9864, A9865, A9866, A9870, Chassis Z3	See model A9775				
A9880, Chassis U6	Schematic, socket, trimmers, alignment	10-8			
G-9881	Schematic, socket, trimmers, alignment	8-9			
G-9882	Schematic, socket, trimmers, alignment	8-10			
A9891, Chassis AM4	See model G-9515				
A10500, A10501 Chassis 5Z	Schematic, socket, trimmers, alignment	10-9			
A10502, A10503, Chassis 6Y	Schematic, socket, trimmers, alignment	10-10			
A10505, Chassis 5X	Schematic, socket, trimmers, alignment	8-11			
A10506, Chassis 6W	Schematic, socket, trimmers, alignment	8-12			
A10507, Chassis 7M	Schematic, socket, trimmers, alignment	8-13			
A10508, Chassis 6P	Schematic, socket, trimmers, alignment	8-14			
A10510, A10511, A10512, A10513, Chassis 8K	Schematic	10-11			
A10515, A10516, A10517, A10518, Chassis 8T	Alignment, socket, trimmers, tuner	10-12			

Industrial	Schematic	1-4			
AC-5 and Power Pack	Schematic	1-4			
AC-6, AC-60	Schematic, socket	1-6			
DC-6, DC-60	Schematic, socket	1-6			
AC-7, AC-70	Schematic, socket	1-3			
DC-7, DC-70	Schematic, socket	1-3			
70, 82, 83	Schematic, socket, voltage	1-8			
80, 82, 83	Schematic, socket	1-4			
81 Bel-Canto	Schematic, socket, data, voltage	3-1			
84	Condenser data	3-2			
171 ABC Power Pack	Schematic, socket	1-5			
F-516	Schematic, socket	1-2			
S-522	Schematic, parts	7-1			
F-546	Socket, trimmers, voltage, alignment	7-2			
F-616	Schematic	1-1			
F-625	Socket, trimmers, voltage, alignment	7-3			
S-733	Socket, trimmers, voltage, alignment	7-4			
3500-1, Tuner #3475, Amplifier #2634	Schematic, parts	7-5			
3500-2, Tuner #3730, Amplifier #2634	Socket, trimmers, voltage, alignment	7-6			
3590	Schematic, parts	7-7			
7100	Socket, trimmers, voltage, alignment	7-8			
7191	Schematic, socket	1-1			
MI Chassis	Schematic	1-1			
PUE-L Chassis	See model CA5				
PUE-S Chassis	See model 1531				
1A5, 5A5, Chassis A5L	See model 1530				
1A7, 3A7, Chassis A7L	Schematic, coils	8-1			
1B6, 3B6, Chassis B6L	Schematic, coils	8-2			
1B8, 2B8, Chassis B8L, 1B8S	Schematic, trimmers, coils, alignment	8-3, 8-4			
105, 205, 510, 511 (AC Models), Chassis C5L, C5S, UC5L, UC5S	Schematic, trimmers, alignment, parts	9-3			
1D7, 3D7, 5D7, 7D7, Chassis D7L	Schematic, coils, parts	9-1			
1D8, 3D8, 5D8, 7D8, Chassis D8L, 2D8, 4D8, 6D8, 8D8, Chassis D8S	Alignment, trimmers, notes	9-2			
1D10, 3D10, 5D10, 7D10, 9D10, Chassis D10L	Schematic, trimmers, coils, alignment	8-5			
1E6, 2E6, Chassis PE6L	Notes, alignment	8-6			
1E6, 2E6, Chassis PE6S	Schematic, trimmers, alignment, tuner	9-7			
1F8, 3E8, 5E8, 7E8, 9E8, Chassis FE8L, 2FE8, 4E8, 6E8, 8E8, 10E8, Chassis FE8S	Alignment, tuner	9-5			
1F5 Television	Schematic, trimmers, coils, parts	9-6			
	Alignment, tuner	9-7			
	Schematic, trimmers, coils, parts	9-7			
	Alignment, tuner	9-6			
	Schematic, coils, trimmers, alignment, tuner, data, parts	9-9, 10			
	Schematic, coils	10-1, 2			

U	Schematic	7-1			
X	Chassis wiring	7-2			
80	Schematic	7-1			
	Chassis wiring	7-2			
	Schematic	7-1			
	Chassis wiring	7-2			

American Power Pack (A unit)	Schematic	1-1			
25-A Power Amplifier (PA unit)	Schematic	1-1			
25-A Power Amplifier (P unit)	Schematic	1-1			
210 Power Amplifier	Schematic	1-1			
250 Amertran Power Amplifier	Schematic	1-2			

AMRAD CORPORATION					
Also see CROSLEY					
MI Chassis	Schematic	1-4			108
AC-5 and Power Pack	Schematic	1-4			108
AC-6, AC-60	Schematic, socket	1-6			110
DC-6, DC-60	Schematic, socket	1-6			110
AC-7, AC-70	Schematic, socket	1-3			107
DC-7, DC-70	Schematic, socket	1-3			107
70, 82, 83	Schematic, socket, voltage	1-8			112
80, 82, 83	Schematic, socket	1-4			108
81 Bel-Canto	Schematic, socket, data, voltage	3-1			113
84	Condenser data	3-2			114
171 ABC Power Pack	Schematic, socket	1-5			109
F-516	Schematic, socket	1-2			109
S-522	Schematic, parts	7-1			106
F-546	Socket, trimmers, voltage, alignment	7-2			106
F-616	Schematic	1-1			105
F-625	Socket, trimmers, voltage, alignment	7-4			109
S-733	Socket, trimmers, voltage, alignment	7-5			105
3500-1, Tuner #3475, Amplifier #2634	Schematic, parts	7-6			105
3500-2, Tuner #3730, Amplifier #2634	Socket, trimmers, voltage, alignment	7-7			105
3590	Schematic, parts	7-8			109
7100	Socket, trimmers, voltage, alignment	7-8			105
7191	Schematic, socket	1-1			105
MI Chassis	Schematic	1-1			105
PUE-L Chassis	See model CA5				
PUE-S Chassis	See model 1531				
1A5, 5A5, Chassis A5L	See model 1530				
1A7, 3A7, Chassis A7L	Schematic, coils	8-1			
1B6, 3B6, Chassis B6L	Schematic, trimmers, coils, alignment	8-2			
1B8, 2B8, Chassis B8L, 1B8S	Schematic, trimmers, coils, alignment	8-3, 8-4			
105, 205, 510, 511 (AC Models), Chassis C5L, C5S, UC5L, UC5S	Schematic, trimmers, alignment, parts	9-3			
1D7, 3D7, 5D7, 7D7, Chassis D7L	Schematic, coils, parts	9-1			
1D8, 3D8, 5D8, 7D8, Chassis D8L, 2D8, 4D8, 6D8, 8D8, Chassis D8S	Alignment, trimmers, notes	9-2			
1D10, 3D10, 5D10, 7D10, 9D10, Chassis D10L	Schematic, trimmers, coils, alignment	8-5			
1E6, 2E6, Chassis PE6L	Notes, alignment	8-6			
1E6, 2E6, Chassis PE6S	Schematic, trimmers, alignment, tuner	9-7			
1F8, 3E8, 5E8, 7E8, 9E8, Chassis FE8L, 2FE8, 4E8, 6E8, 8E8, 10E8, Chassis FE8S	Alignment, tuner	9-5			
1F5 Television	Schematic, trimmers, coils, parts	9-6			
	Alignment, tuner	9-7			
	Schematic, trimmers, coils, parts	9-7			
	Alignment, tuner	9-6			
	Schematic, coils, trimmers, alignment, tuner, data, parts	9-9, 10			
	Schematic, coils	10-1, 2			

AMERICAN FOUNDATION FOR BLIND					
U	Schematic	7-1			
X	Chassis wiring	7-2			
80	Schematic	7-1			
	Chassis wiring	7-2			
	Schematic	7-1			
	Chassis wiring	7-2			

ANDREA RADIO CORP.—(Cont.)

MODEL	REVISED PAGE	EARLY COMPLETE PAGE	RADIOTRON
1F5 Television			
Service chart	10-3		
Socket, alignment, video block diagram	10-4		
Schematic, coils	8-1		
Schematic, trimmers, coils, alignment	8-3, 8-4		
See model 1B8			
See model 1C5			
Schematic, coils, trimmers, alignment, parts	9-13		
Alignment data	9-16		
Schematic, coils, parts	9-14		
Alignment, trimmers	9-16		
Schematic, trimmers, coils, alignment	8-5		
Notes, alignment	8-6		
See model 1D8			
Schematic, coils, data, trimmers	8-8		
Alignment	8-9		
See model 1E6			
See model 1F8			
See model 1A7			
See model 1B6			
See model 2D5			
See model 1D7			
See model 1E8			
See model 1D8			
See model 1D10			
Schematic, coils, trimmers, alignment, tuner, parts	9-11, 12		
See model 400			
See model 2B6			
See model 2D5			
See model 2D7			
See model 2D8			
See model 2D10			
See model 1E8			
See model 3E11			
See model 410			
See model 411			
See model 1A5			
See model 2A5			
Schematic	8-10		
See model 1C5			
See model 2D5			
See model 1D7			
See model 1D8			
See model 1D10			
Schematic, phonograph notes	9-8		
See model 1E8			
See model 3E11			
See model 6D5			
See model 6D5X			
See model 500			
See model 1C5			
See model 1C5			
See model 511			
See model 511			
See model 511			
See model 511			
See model 521			
See model 521			
See model 62X			
See model 2A5			
See model 1B6			
See model 2B6			
See model 610			
See model 616			
Schematic, coils, parts	9-15		
Alignment, trimmers	9-16		
See model 2D7			
See model 2D8			
See model 2D10			
See model 5E6			
See model 1E8			

MODEL	REVISED PAGE	EARLY COMPLETE PAGE	RADIOTRON
6E11			See model 3E11
6E6			See model 62B
PE6L Chassis			See models 1E6 or 5E6
PE6S Chassis			See models 1E6 or 6E6
PUE6L Chassis			See models 630 or 635
PUE6S Chassis			See models 630 or 634
UB6 Chassis			See model 600
UD6L Chassis			See model 621
UD6S Chassis			See model 620
A7L Chassis			See model 1A7
D7L Chassis			See model 1D7
D7S Chassis			See model 1D7
7D7			See model 1D7
7D8			See model 1D8
7E8			See model 1E8
7E11			See model 3E11
B8L, B8S Chassis			See model 1B8
D8L, Chassis			See model 1D8
D8S, Chassis			See model 1D8
8D5			See model 6D5
8D7			See model 2D7
8D10			See model 2D10
8E8			See model 1E8
3E11			See model 3E11
PE8L, PE8S Chassis			See model 1E8
9D10			See model 1D10
9E8			See model 1E8
9E11			See model 3E11
D10L Chassis			See model 1D10
D10S Chassis			See model 2D10
10D10			See model 2D10
10E8			See model 1E8
10E11			See model 3E11
11E6, 12E6, 14E6, Chassis			Schematic, trimmers, coils, parts
PE66L			Schematic, trimmers, coils, parts
11E6, 12E6, 14E6, Chassis			Schematic, trimmers, coils, parts
PE66S			Schematic, trimmers, coils, parts
PE11L Chassis			Alignment, notes
PE11S Chassis			Alignment, notes
UD14L Chassis			See model 3E11
UD14S Chassis			See model 4E11
C32B Chassis			See model 1401
55 Amplifier			See model 1402
62X, Chassis XD5			See model 610
62PX, Chassis XD5			Schematic
PE66L, PE66S Chassis			Schematic, trimmers, coils, alignment, parts
400, 401, Chassis B4			See model 11E6
410, Chassis UC4			Schematic, socket, trimmers, coils, alignment, parts
411, Chassis UC4L			Schematic
600, Chassis UB5			Schematic, coils, alignment, parts
510, 511 AC			Schematic
510, Chassis UC5S, AC-DC			See model 1C5
511, Chassis UC5L AC-DO			Schematic, coils, alignment, parts
520, Chassis UD5S			Schematic, alignment, coils, trimmers
521, Chassis UD5L			Schematic, alignment, coils, trimmers
600, Chassis UB6			Schematic, alignment, parts
610, 611, 612, 613, Chassis C6B			Schematic, coils, parts
610, 611, 612, 613, Chassis C32B			Alignment, trimmers
616, 617, 618, Chassis D6B			Schematic, coils
620, Chassis UD6S			Alignment, trimmers
621, Chassis UD6L			Schematic, coils
626, 627, 628, Chassis E6BS			Schematic, coils, alignment, parts
630, 631, Chassis PUE6L			Schematic, trimmers, parts
			Socket, trimmers, alignment, parts
			Schematic, coils, alignment, parts
			Alignment data

ANDREA ATWATER

RADIOTRON EARLY COMPLETE PAGE

Schematic	123
Chassis layout	125
Schematic	127
Schematic, SPU chassis	126
Chassis layout	124
	124

REVISED PAGE

Schematic	1-1
Chassis layout	1-3
Schematic	1-1
Schematic, SPU chassis	1-2
Chassis layout	1-3

ATOLSON RADIO MFG. CO.

MODEL

5-AO	Schematic
5-DO	Chassis layout
5-DO	Schematic
6-4O	Schematic, SPU chassis
6-4O	Chassis layout

RADIOTRON EARLY COMPLETE PAGE

32-Volt DC Sets	116
1934 Sets	
1935 Sets	
Doublet Antenna	
General Notes	
Phonograph pickup	
Test Circuit	
Tubular Resistors	
Tun-O-Matic	
Chassis D-1, D-2, F, L-1,	
L-2, P, Q	
Chassis H-1, H-2	
10-B	
12	
19, #4880	
20, #4640	
20 #7570	
20 #7960	
21 #7780	
30, 35, 48	
30, Early, late	
32	
33, 49	
35 (2 volt airmail)	
36, Early, Late, Power Pack	
36 Power Pack, Model Y,	
Serial #260,000	
36 Power Pack, Above	
serial #260,000	
36 Early, Below serial	
#2,610,000	
36 Late, Above serial	
#2,610,000	
37 Early, Below serial	
#1,385,000	
37 Late, Above serial	
#1,385,000	
37, 37-F, 37-C	
38 Power Pack, Early, late	
40, 42, 52, 56, 57	
40, 42, 52, Power Pack	
40, 42, 44, 52, Power Pack	
40, 42, 52	
40, 45 Power Pack	
(2nd type)	
41 DC	
41 Power Pack, 3 types	
41, 51	
42	
43	
44 Power Pack	

REVISED PAGE

5-AO	1-1
5-DO	1-3
5-DO	1-1
6-4O	1-2
6-4O	1-3

ATWATER KENT MFG. CO.

SUFFIXES:

D	DC
F	25 cycles
Q	Battery operated
Z	82 volts DC
E	European long wave range
P	Phonograph conn.
Installation data	7-66
Model specifications	5-84
Model specifications	5-46
Data	5-16
	7-6
	5-22
	2-19
	2-20
	3-28
	3-178

See model 70 Series	
See model 72 Series	
Schematic, socket	91
Schematic, socket	91
Schematic, socket	91
Schematic, socket	92
Schematic	92
Condenser and resistor data	92
Schematic, socket	92
Condenser, resistor data	93
Schematic, socket	93
Condenser and resistor data	93
Schematic, socket	93
Schematic, socket	94
Data	94
Schematic, socket	94
Data	94
Schematic, socket	94
Schematic, socket	94
Data	94
Schematic	95
Resistor changes	96
Schematic, socket	96
Schematic, data	96
Schematic, socket	96
Data	96
Schematic, socket, voltage	96
Schematic	100
Chassis layout	101
Data	101
Filter condenser data	101
Chassis layout	101
Schematic, socket	102
Schematic, voltage	103
Data	103
See model 40	158
Schematic test data	158
Schematic, chassis wiring, data	158
See model 40—Chassis layout	158

ANDREA RADIO CORP.—(Cont.)

330, 631 Chassis PUE6S	Schematic, coils, alignment, parts	9-32
	Alignment data	9-7
634, Chassis, PUE6S,	Schematic, phonograph data	9-33
635, Chassis, PUE6L	Schematic, trimmers, coils, alignment	8-12
1401, 1403, 1405, 1407,	Schematic, coils, alignment, parts	9-34
1409, Chassis UD14L	Schematic, coils, trimmers	9-35, 36
1402, 1404, 1405, 1408,	Schematic, coils, trimmers, data, parts	9-35, 36
1410 Chassis UD14S		
1530, 1534, 1536, 1538,	Alignment, notes	9-37
Chassis PUE-S 1531,	Tuner and phonograph data	9-38
1533, 1535, 1537, Chassis PUE-L		

ANSLEY RADIO LABORATORIES

DC Electric Set	Schematic	2-1
B-1, Early, Late	Schematic	7-1
D-1, Dynaphone, Type 8	Schematic	7-2
D-1, Dynaphone, Type 2	Schematic	6-1
D-1, D1A, D16, D20, D26	Schematic	8-1
MD-1	Schematic, socket, chassis	2-2
U-1, AC-DC	Schematic	2-3
U-2, AC-DC	Schematic	2-4
D-3, D-4, D-6	Schematic	5-1
U-8	Schematic	5-2
D-9, D10, D17, D18, U10,	Schematic	8-2
U11		
U-10, Revised	Schematic, socket	6-2
D-12, Dynaphone	Schematic, socket	7-4
D-12	Schematic	7-2
D-16 (Early)	Schematic	8-3
D20	Schematic	7-3
D21, D22	See Model D1	
D24, D25, Chassis 7152	Schematic, trimmers, alignment	Misc. 9-1
D26	Schematic, trimmers, alignment	Misc. 8-4
7152 Chassis	See Model D1	
	See model D24	

AFEX

See U. S. RADIO & TELEVISION

APPEL-HENDERSON	Schematic, notes	2-1
Silver-King DC Combination	Schematic	2-2
Silver-King AC Combination	Schematic	2-3
4-tube AC	Schematic	2-4
4-tube Portable	Schematic	2-4
5-tube Battery, midget	Schematic	2-4
5-tube AC	Schematic	2-3

ARBORPHONE

45	Schematic	Misc. 3-1
----	-----------	-----------

ARCADIA

See WELLS-GARDNER

ARGUS RADIO CORP.

B-125	Schematic	1-1
B-165	Schematic	1-1
	Chassis	1-2

ARIEL RADIO, INC.

101	Schematic	Misc. 6-2
	Chassis Wiring	Misc. 7-2

ARKAY

See R-K. RADIO LABORATORIES

ARVIN

See NOBLITT-SPARKS

MODEL	ATWATER KENT MFG. CO.—(Cont.)	REVISED PAGE	EARLY COMPLETE PAGE	RADIOIRON COMPLETE PAGE
44, 45	Schematic, color code.....	3-19	157	212 & 214
44	Power Unit, (2nd type)	3-19	157	214
45	See model 40 (2nd type)			215
46, 47, 53	Schematics—Similar to model 43			
46, 58	Description, data.....	2-2	154	
47	Data.....	3-17	155	
48	See model 80		156	
49	Schematic, socket, data.....	3-20		
50	See model 80			
51	See model 41			
52	Schematic—See model 43			
53	Data—See model 46			
55	Additional data ..Changes 7-1, 7-10	3-21		
55, 55-C, Early	Schematic, voltage, data.....	3-22		
55, 55-C, Late	Schematic, chassis.....	3-23		
55-F, 55-FC, Early	Schematic, voltage, data.....	3-24		
55-F, 55-FC, Late	Chassis wiring.....	3-25		
56, 57	Schematic, chassis layout.....	3-26		
60, 60-C	Chassis wiring.....	3-27		
60, 60-C	See model 40			
60, 60-C, Early	Comparison of the three types.....	3-28		
60, 60-C, Late	Additional data ..Changes 7-10	3-29		
60, 60-C, 3rd type	Schematic, data.....	3-30		
60, 60-C, Early	Chassis wiring.....	3-31		
60, 60-C, Late	Schematic, chassis layout.....	3-32		
60, 60-C, 3rd type	Schematic.....	3-33		
60, 60-C, three types	Chassis wiring.....	3-34		
61, 61-C, DC, Early	Data.....	3-35		
61, 61-C, Early	Voltage, notes.....	3-36		
61, 61-C, Late	Schematic, condenser data.....	3-37		
66	Chassis wiring.....	3-38		
66, Late	Schematic, socket, voltage.....	3-39		
67, 67-C, Battery	Chassis wiring.....	3-40		
67, 67-C, Early, late	Schematic, condenser data.....	3-42		
70, 74, 76, Chassis D-1	Voltage, socket.....	3-42		
70, 74, 76, Chassis D-2	Schematics.....	3-43		
70, 74, 76, Chassis F	Chassis wiring.....	3-44		
70 Series	Chassis wiring.....	3-45		
70, 74, 76, Chassis L-1	Schematic, data.....	3-47		
70, 74, 76, Chassis L-2	Schematic, data.....	3-47		
70, 74, 76, Chassis L-2, P	Chassis wiring.....	3-51		
72, Chassis H-1	Schematic, voltage, data.....	3-50		
72, Chassis H-1, Below serial #5,855,201	Chassis wiring.....	3-51		
72, Chassis H-1, H-2	Chassis wiring.....	3-52		
72, Chassis H-1	Trimmer notes, service notes.....	3-51		
72, Chassis H-2	Schematic, data.....	3-52		
72, Chassis H-2	Chassis wiring.....	3-53		
72, Chassis H-2, Above serial #5,855,201	Schematic, data.....	3-53		
72, Chassis H-2	Assembly data.....	3-54		
72, Chassis H-2	Voltage, socket, data.....	3-55		
72, Chassis H-2	Schematic, chassis layout.....	3-56		
72, Chassis H-2	Schematic.....	3-57		
72, Chassis H-2	Chassis layout, data.....	3-59		
72, Chassis H-1, H-2	Voltage, chassis, rotor adjust-ments.....	1-48		
72, Chassis H-1	Trimmer condenser adjust-ments.....	3-60		
72, Chassis H-2	Trimmer condenser adjust-ments.....	3-61		
72, Chassis H-2	Voltage, chassis, speaker con-nections.....	1-50		
72, Chassis H-2, Above serial #5,855,201	Schematic.....	3-63		
72, Chassis H-2	Chassis layout, condenser data.....	3-64		
74	Trimmer condenser adjust-ments.....	3-65		
6, Chassis P	See models 70			
6, Chassis P	Schematic, data.....	3-60		
30, 80-F, 83, 88-F	See models 70			
	Schematic.....	3-67		
	Chassis layout, voltage, data.....	3-68		
	MODEL	ATWATER KENT MFG. CO.—(Cont.)	REVISED PAGE	EARLY COMPLETE PAGE
	80-F	Voltage.....	3-66 & 3-68	212 & 214
	81, 81-B, 81-C, Auto Set	Schematic.....	3-68	214
		Chassis layouts, battery containers.....	3-69	215
	81, 1st type	Voltage.....	3-70	216
	81, 2nd type	Voltage.....	3-66	212
	81-B, 81-C	Voltage.....	3-83	220
	82, 82-F	Schematic.....	3-83	220
		Chassis layouts, condenser data.....	3-75	221
	82	Voltage.....	3-66	222
	82-D	Schematic.....	3-71	212
		Chassis layouts, data.....	3-72	217
		Changes.....	7-2	218
	82-D, 1st type	Voltage.....	3-66	212
	82-D, 2nd type, Above serial #5,760,301	Schematic.....	3-73	219
	82-Q, 1st type, Below serial #2,550,940	Chassis layouts, data.....	3-74	220
	82-Q, 1st type, Below serial #2,550,940	Voltage.....	3-83	220
	82-Q, 2nd type, Above serial #2,550,940	Schematic.....	3-77	223
		Chassis layouts, condenser data.....	3-78	224
	82-Q, 2nd type, Above serial #2,550,940	Voltage.....	3-66	212
		Schematic.....	3-79	225
	83, 83-F	Chassis layouts, condenser data.....	3-80	226
	84	Voltage.....	3-83	229
	84, 84-F, Early	Schematic—See model 80		229
	84, 84-F, Late	Voltage.....	3-66	212
	84, 84-F, Early, late	Schematic.....	3-84	230
	84-D	Chassis layouts.....	3-85	231
		Schematic.....	3-86	232
		Chassis layout, chassis view, data.....	3-81	227
	84-Q, Early, late	Voltage.....	3-82	228
		Schematic.....	3-66	212
		Chassis layout, chassis view, data.....	3-87	233
	85, 85-F	Voltage.....	3-66	212
	85-Q, 1st type, Below serial #163,767	Chassis layout, chassis view, data.....	3-88	234
	85-Q, 2nd type, Above serial #163,767	Voltage.....	3-66	212
		Schematic.....	3-89	235
		Chassis layouts, condenser data.....	3-90	236
	86, 1st type	Schematic.....	3-91	237
	86, 80-F, 1st type, Below serial #5,876,861	Chassis layouts, condenser data.....	3-92	238
	86, 80-F, 1st type, Below serial #5,876,861	Voltage.....	3-66	212
	86, 2nd type	Schematic.....	3-93	239
	86, 86-F, 2nd type	Chassis layouts, condenser data.....	3-94	240
	87, 1st type	Voltage.....	3-83 & 3-126	229 & 272
	87, 1st type, Below serial #2,525,871	Schematic.....	3-66	212
	87, 3rd type	Chassis layout, condenser data.....	3-95	241
	87, 3rd type, Above serial #2,525,871	Voltage.....	3-83 & 3-126	229 & 272
	87-D, DC Superhet	Schematic.....	3-101	247
		Chassis layouts, condenser data.....	3-102	248
		Schematic.....	3-103	249
		Chassis layouts, tone control, volume control, data.....	3-104	250
	89, 89-F, 80-P, 1st type	Change.....	7-20	351
	89, Below serial #6,755,181	Schematic.....	3-105	252
	89-F, Below serial #1,585,395	Chassis layout, condenser data.....	3-106	
	89-P, Below serial #1,935,304			

MODEL	ATWATER KENT MFG. CO.—(Cont.)	REVISED PAGE	RADIOTRON EARLY COMPLETE PAGE
89, 3rd type	Chassis layout, condenser	3-83 & 3-126	259 & 272
89, 89-F, 89-P, 3rd type	Chassis layouts, condenser data	3-83 & 3-107	253
90, 90-F	Chassis layout, condenser	3-83 & 3-126	254
90, 90-F, Early, late	Chassis layouts, condenser data	3-83 & 3-109	255
90 Late	Schematic changes	3-110	256
91, 91-B, 91-C	Schematic, speaker connection	3-110	256
92, Early, late	Chassis layouts	3-111	257
92-F	Voltage	3-112	258
92, 92-F	Chassis layout	3-126	272
92, 92-F	Chassis layouts	3-113	259
93, SW Converter	Chassis layout	3-114	260
94	Chassis layouts	3-115	261
94, 94-F	Chassis layout	3-116	262
94 Late	Bypass condenser data	3-83 & 3-126	259 & 272
96, 1st type, Below serial #7,289,385	Chassis layout	3-117	263
96, 2nd type, serial number #7,289,385 to #7,291,674	Chassis layouts	3-118	264
96, 3rd type, Above serial #7,291,674	Voltage	3-83 & 3-126	259 & 272
96, 96-F	Chassis layout	3-83 & 3-126	259 & 272
96-F	Chassis layout	3-119	265
99, 1st type, Below serial #4,882,380	Chassis layout, condenser data	3-120	266
99, 2nd type, from serial #4,882,380 to #4,884,901	Chassis layout, condenser data	3-121	267
99, 3rd type	Chassis layout, condenser data	3-122	268
99, 99-F, 99-P	Chassis layout	3-83 & 3-126	270
99, 2nd and 3rd types	Chassis layout	3-124	270
99-F, 99-P	Schematic	3-125	271
99-F, 99-P	Schematic	3-83 & 3-126	229 & 273
99-P	Chassis layouts, condenser data	3-127	274
112	Schematic	3-128	275
126, 126, 416, 446	Chassis layout, condenser data	3-130	276
135Z, 215Z	Socket layout	3-130	276
137	Voltage	3-83 & 3-126	229 & 277
145, 325, Early and late	Chassis layouts	3-131	278
	Condenser data	3-132	279
	Filter circuit schematic	3-133	279
	Phonograph switching circuit	3-133	279
	Alignment	5-28	279
	Schematic, voltage, notes	6-1, 6-2	279
	Trimmer notes	6-3	279
	Alignment, trimmers, socket	6-4	279
	Chassis wiring	6-5	279
	Parts list	6-6	279
	Schematic	6-6	279
	Socket, trimmers, chassis, alignment parts	7-3	279
	Installation data	7-4	279
	Schematic, voltage	7-5	279
	Trimmers, socket, alignment	6-8	279
	Chassis layouts	6-10	279
	Parts list	6-11	279
	Schematic, socket, trimmers	7-7	279
	Chassis	7-8	279
	Parts list	7-9	279
	Schematic, voltage	5-7	279
	Socket, trimmer, chassis	5-8	279
	Alignment	5-28	279
	Parts List	5-30	279
	Chassis layout, condenser data	3-139	285
	Schematic	3-140	286
	Chassis layout	3-141	287
	Socket bypass condenser data	3-142	288
	Schematic	3-142	288
	Chassis layouts, data	3-143	289
	Schematic	3-144	290
	Chassis layouts, condenser data	3-145	291
	Schematic	3-146	292
	Socket, trimmers, chassis	7-23	292
	Parts list	7-24	292
	Chassis layout, socket	3-137	272
	Changes	4-3	281
	Schematic, socket	4-2	282
	Parts list	4-3	283
	Schematic, socket, voltage	5-9	272 & 283
	Socket, trimmer, parts	5-10	
	Schematic, voltage	4-23	
	Socket, trimmers, parts	5-1	
	Schematic	7-13	
	Parts list	7-9	
	Socket, trimmers, chassis	7-14	
	Schematic	7-15	
	Socket, trimmers, chassis	7-8	
	Parts list	7-12	
	Schematic, voltage	5-11	
	Socket, trimmers, parts	5-12	
	Schematic	3-135	
	Chassis layout, socket	3-136	
	Voltage	3-126 & 3-136	
	Schematic	3-137	
	Chassis layout, socket	3-138	
	Voltage	3-126	
	Some circuit Model 317 except that Model 200 has terminals for phone connection	3-126	
	Parts list	7-12	
	Schematic, voltage	5-13	
	Socket, trimmers, parts	5-14	
	Alignment, trimmers	5-29	
	Parts Lists	5-15	
	Schematic	7-17	
	Socket, trimmers, chassis	7-16	
	Parts list	7-12	
	Schematic	7-18	
	Parts list	7-12	
	Parts list	7-12	
	Schematic	7-19	
	Parts list	7-12	
	Parts list	7-12	
	See model 135Z	7-12	
	Parts list	7-12	
	Socket, trimmers, chassis, alignment	7-22	
	Schematic	7-21	
	Schematic, voltage	4-4	
	Socket, trimmers, parts	5-3	
	Changes	7-20	
	Schematic, voltage	4-5	
	Socket, trimmers, parts	5-4	
	See Model 435	3-139	
	Schematic	3-140	
	Chassis layouts	3-141	
	Schematic	3-141	
	Socket bypass condenser data	3-142	
	Schematic	3-142	
	Chassis layouts, data	3-143	
	Schematic	3-144	
	Chassis layouts, condenser data	3-145	
	Schematic	3-146	
	Socket, trimmers, chassis	7-23	
	Parts list	7-24	

ATWATER KENT MFG. CO.—(Cont.)		ATWATER KENT MFG. CO.—(Cont.)	
MODEL	REVISED PAGE	MODEL	REVISED PAGE
237-Q, 467-Q, Early	Schematic, voltage 6-12 Trimmers, alignment 6-46 Insulation notes, dry cell data 7-27 Parts list 7-28 Schematic, voltages across resistors 3-147 Chassis layouts, voltage, con. denser schematic 3-148 Schematic, voltage 4-6 See Model E208 Schematic 7-25 Parts list 7-32 Same as model 137 but with a 2A5 instead of a 47 Schematic 3-149	P412, E412, P412X, E412X	Schematic, voltage 7-35 Socket, trimmers, chassis 7-81 Coil data 7-1 Parts list 7-30 See model 285Q Socket, chassis, parts list 4-10 Schematic, voltage 7-36 Changes 4-11 Schematic, voltage 4-24 Socket, trimmers, parts 5-2 See model 217 427-D 427-Q 427-Q, above serial #1,948,501
246	Chassis and socket layouts 3-150 Schematic 3-151	415-Q 416 424, 584	Socket, trimmers, parts 5-18 Schematic, voltage 6-21 Parts list 7-32 Schematic, voltage 7-37 Socket, trimmers, chassis layout 7-38 Parts list 7-32 See model 126 Alignment, trimmers 5-29 Schematic, voltage 7-39 Chassis layout 7-40 Parts list 7-30 Schematic, voltage, socket 4-12 Parts list, chassis 4-13 Similar to model 856 Schematic, voltage 6-23 Trimmers, socket, chassis 6-24 Speaker data, alignment 6-25 Parts list 6-26
246, 266 (2nd type)	Chassis layout, bypass con. denser data 3-152 Schematic 3-153	425, 665	See model 237Q Voltage 3-120 & 3-134 Schematic 3-155 Chassis layout, socket 3-156
E248	Chassis layout, socket 3-154 Voltage 3-126 & 3-134 Voltage 3-126	427	467-Q 469
255	See model 246 2nd type	427-Q, above serial #1,948,501	469, 469-F (1st type) 469, 469-F (2nd type), Above serial #5,498,122 469-F, (2nd type), Above serial #6,186,242 469-D, 558-D
257	Schematic, voltage 4-7 Socket, trimmers, parts 5-5 Schematic, voltage 6-13 Trimmers, chassis, alignment 6-14 Parts list 7-28	435, Early 435, 2nd Type	469-D, 469-Q 469-F 469-Q, 558-Q 475, 735
260, 260-F (1st type), Below serial #8,422,101	Schematic, voltage 6-15 Trimmers, chassis, alignment 6-16 Parts list 6-22	435, 2nd Type	480
260, 260-F (2nd type), Above serial #8,422,101	Parts list 6-8 Schematic, voltage, SPU layout 6-9 Chassis layouts 6-11 Parts list 6-11 Same as model 318 but with a long wave range instead of police wave range and long wave oscillator tracking condenser is 50 MAF	445-Q, 655-Q	485Q, 515Q
260, 260-F, (3rd type), Above serial #6,188,342	Schematic, voltage 6-18 Trimmers, socket, alignment 6-8 Schematic, voltage, SPU layout 6-9 Chassis layouts 6-11 Parts list 6-11 Same as model 318 but with a long wave range instead of police wave range and long wave oscillator tracking condenser is 50 MAF	446 447	487
260	Schematic, voltage 6-18 Trimmers, chassis, alignment 6-16 Parts list 6-22	448	509
260-F	Parts list 6-8 Schematic, voltage, SPU layout 6-9 Chassis layouts 6-11 Parts list 6-11 Same as model 318 but with a long wave range instead of police wave range and long wave oscillator tracking condenser is 50 MAF	456 465Q, 655-Q	510 511, Tun-O-Matic
273D	Schematic, voltage 6-17 Trimmers, alignment 6-16 Socket, trimmers, chassis 7-31 Parts list 7-12 Changes 7-11 Similar to 447	469-Q, 558-Q	511
275 (1st type)	Chassis layout, socket 3-154 Voltage 3-126 & 3-134 Voltage 3-126	475, 735	511
285-Q, 415-Q	See model 246 2nd type	480	511
286, 356	Schematic, voltage 4-7 Socket, trimmers, parts 5-5 Schematic, voltage 6-13 Trimmers, chassis, alignment 6-14 Parts list 7-28	480	511
305-Z, 565-Z	Schematic, voltage 6-15 Trimmers, chassis, alignment 6-16 Parts list 6-22	480	511
E308	Parts list 6-8 Schematic, voltage, SPU layout 6-9 Chassis layouts 6-11 Parts list 6-11 Same as model 318 but with a long wave range instead of police wave range and long wave oscillator tracking condenser is 50 MAF	480	511
310, 510	Schematic, voltage 6-18 Trimmers, socket, alignment 6-8 Schematic, voltage, SPU layout 6-9 Chassis layouts 6-11 Parts list 6-11 Same as model 318 but with a long wave range instead of police wave range and long wave oscillator tracking condenser is 50 MAF	480	511
312, E312	Schematic, voltage 6-17 Trimmers, alignment 6-16 Socket, trimmers, chassis 7-31 Parts list 7-12 Changes 7-11 Similar to 447	480	511
317, 337, Early	Chassis layout, socket 3-154 Voltage 3-126 & 3-134 Voltage 3-126	480	511
318	See model 145	480	511
325	Trimmers, alignment 6-47 Chassis layout 7-34 Parts list 7-30	480	511
328, Early	Schematic 6-18 Trimmers, alignment 6-47 Chassis layout 7-34 Parts list 7-30	480	511
328 (110v.), 328X (230v.) 2nd Type, above serial #6438750	Schematic 7-33	480	511
P336, P336X	Chassis layout 7-34 Parts list 7-30 See model P216, P216X See model 317 Same as model 649 See model 286 See model 206 See model 206D Schematic, voltage 6-19 Trimmers, socket, chassis, alignment 6-20 Parts list 6-22 Schematic, voltage 4-9 Schematic, voltage 5-17	480	511
339	Chassis layout 7-34 Parts list 7-30	480	511
346	Chassis layout 7-34 Parts list 7-30	480	511
376	Chassis layout 7-34 Parts list 7-30	480	511
376D	Chassis layout 7-34 Parts list 7-30	480	511
385-Q, 625-Q	Chassis layout 7-34 Parts list 7-30	480	511
387, 427-Q	Chassis layout 7-34 Parts list 7-30	480	511
387, above serial #7,873,966	Chassis layout 7-34 Parts list 7-30	480	511

Socket, R-F, wiring4-18
Parts list4-19
Chassis4-20
Changes7-20
Schematic7-65
Parts list7-30
Speaker data, parts list7-64
Schematic, voltage4-21
Chassis wiring5-35
Socket, trimmers, parts5-36
R-F, transformers5-39
See model 317

710

See model 317

725, P725, P725X
725 (110V), 725X (230V)

Schematic, voltage7-57
Socket, trimmers7-58

785

See model 475

747Q

See 657Q

P755, P875

Socket, trimmers, chassis, align-
ment7-60
Speaker data, parts list7-64

P755, P755X, P875,

P875X

Schematic, voltage3-183

756, 756-B

Chassis layout, trimmers3-184

E765

Schematic, voltage7-61

Socket, trimmers, chassis, align-
ment7-62

E765, E765X

Speaker data, parts list7-64

765Q, 978Q

Chassis, alignment6-30

Schematic, voltage6-38

Socket, trimmers, battery
connections6-40

776

Schematic, voltage6-41

Socket, trimmers, chassis,
changes6-42

Alignment, parts6-43

Schematic, voltage5-37

Chassis wiring5-38

R-F, Transformers, trimmers5-39

Parts list5-40

See model 708

Schematic, voltage4-22

808

Chassis wiring5-41

808A

R-F, transformers, parts list5-42

Changes7-20

810

Schematic, voltage6-44

Trimmers, alignment6-47

Parts list7-30

Coil data7-1

818

Speaker data, parts list7-64

Schematic3-175

Chassis layout, socket3-176

Voltage3-134

Schematic, booster amplifier,
change7-63

Change, phono, connections7-50

Schematic, voltage5-43

Socket, trimmers, parts, SPU
schematic5-44

Parts list5-45

885 A-C-DC

Schematic, voltage5-47

Socket, trimmers, parts layout5-48

826

Parts list—See model 206

828

See model 328

866, 976, Early

Schematic, voltage6-45

Trimmers, alignment, socket6-46

Chassis layout7-53

Speaker data, parts list7-64

ChangesChanges 7-11

Same as E765 but with metal tubes

See model P755

See model 816

Schematic, voltage5-49

Socket, trimmers, parts layout5-50

Alignment data5-30

Parts list, see model 206

See model 856 Early

976 Early

978Q

See model 768Q

Chassis wiring6-32
Changes7-48
Schematic6-83

511, Automatic tuning,
clock, remote control
units

Trimmers, socket, alignment
data6-34

See model 485Q

525Q (2nd type)

See model 169 2nd type

534

See model 424

534 (2nd type)

Schematic, voltage5-23

Socket, speaker, trimmers,
parts5-24

535

Same as model 435 but the short
wave range goes to 18 MC

535, 726, P726, P725X

Parts list7-54

545

Schematic, voltage6-35

Trimmers, socket, chassis,
alignment6-36

556

Schematic, voltage, chassis,
socket4-14

Schematic, voltage4-15

555 (2nd Type) above
serial #5063260

566

Schematic, voltage7-49

Socket, trimmers, chassis, align-
ment, parts7-4

568

Installation data7-5

Schematic3-169

Chassis layout, socket3-170

568D

See model 469D

568-Q, 568-Q

Voltage3-131

568-Q

See model 469-Q

569

Schematic, voltage5-25

Chassis wiring5-26

Socket, trimmers, alignment

notes (1), balancing gadget 5-27

Alignment

parts list—See model 206

See model 805Z

565Z, 667-F

Schematic3-167

Chassis layout, socket, bypass
condenser data3-168

627

Circuit changes in late type3-168

Schematic, voltage7-51

E608, E646

Socket, trimmers, alignment7-52

Parts list7-54

618

Schematic3-171

Chassis layout, socket3-172

637

Voltage3-134

Change, General phono, con-
nections7-50

626Q

See model 985Q

627

Schematic3-178

Chassis layout, socket3-174

636

Voltage3-134

Schematic, socket, voltage3-181

Trimmers, chassis3-182

Parts list4-16

637

Same as model 317

648

Similar to 649 but with glass tubes

Parts list7-54

E648

See model E608

649, Early

Schematic, voltage6-37

Trimmers, alignment6-47

649, P649

Chassis, parts7-53

Changes7-2

655Q

See model 465Q

657Q, 747Q

Schematic, voltage7-55

Socket, trimmers, chassis, align-
ment7-56

Parts list7-28

665

See model 495

666

Schematic, voltage5-91

Socket, trimmers, parts layout5-92

Parts list5-33

667

See model 217

667D

See model 217D

676

See model 856

708, 808

Schematic, voltage4-17

Audiola, Jr.	1-7	333
Intermediate Frequencies	Changes 7-4	
SW Converter	3-1	341
4-tube Pentods 31	2-2	341
4-tube 32	3-1	
5-tube Pentode 31	2-2	332
6-tube Pentode	1-7	333
6-tube Jr. #1	2-6	334
6-tube Jr. #2	Changes 7-4	
7-tube Super Pentode 31	Changes 7-4	334
8-tube Super Pentode 31	Changes 7-4	335
9-tube Super Pentode 31	2-1	336
9-tube Super Pentode 31	1-8	337
9-tube Super (2) Pentode	1-9	338
31, 13-S-9	2-4	
10-tube Super 31	2-3	339
B-6	See model 346	
6-T (1927)	Schematic	326
8-T (1927)	Changes 7-4	
9-T-45 Super 31	Schematic	326
13-S-6	Changes 7-4	
13-S-9, 91031	Sockets layout	326
	Changes 7-4	
	Sockets layout	
	Changes 7-4	
	Schematic	
	Misc. 6-3	
13-T-5	Penode 31	339
23-S-7	Schematic, socket	
23-S-8	Schematic	342
23-S-8	Schematic	343
23-S-8 (Two types)	Schematic	344
23-S-8Q	Schematic	
23-S-10	Schematic	
23-S-10 (Two types)	Changes 7-4	345
23-S-12	Schematic	
23-S-12, Revised	Schematic	346
23-T-5	Schematic	
23-T-5-SW	Socket layout	346
30-B, 7330	Schematic	340
31 Series	Schematic, voltage	329
31 Super	Socket layout	330
	Changes 7-4	
	Service notes	331
	Misc. 6-3	
32-S-11	Schematic	
33-S-5	Schematic	
33-S-5, Revised	Socket layout	
33-A-6	Changes 7-9	
33-S-6	Schematic	
33-S-6B	Changes 4-5	
33-S-7	Socket layout	
33-S-8	Changes 7-9	
33-S-10 SW	Schematic	
33-T-4	Changes 4-5	
34-C-5 AGDC	Socket layout	
34-S-5 AVO	Changes 7-9	
346, B-6	Schematic	
347	Schematic, socket	
527	Socket layout	
627	Changes 7-9	
869	Socket layout	
7330	Changes 7-4	
8430	See model 30-B	
	Schematic, socket, voltage	
	Changes 1-3	

AUSTIN RADIO MFG. CORP.

Schematic, voltage 6-1
Schematic, voltage 6-1

A J

Alignment	6-4	
Schematic	6-2	
Schematic	6-3	
Alignment, voltage	6-4	

AUTOCRAT RADIO CO.

4 Jr.	4-2	
4 LW	4-3	
4-SA	5-2	
5	Misc. 5-1	
5M	Schematic, parts	9-2
5-SA	Schematic	5-1
6	Schematic	4-3
6, Revised	Schematic	5-2
6-D-32	Schematic	5-2
41 TRF	Schematic	4-1
56SW, 57SW	Schematic, parts	Misc. 9-2
57-O	Schematic	4-4
80	Schematic	4-4
90-SL	Schematic	5-3
406	Schematic, socket	7-2
505	Schematic, socket	7-1
518, 618	Schematic, socket	7-2

AUTOMATIC RADIO MFG. CO.

Junior	Misc. 6-3	
Tom Thumb, Screen	Schematic	1-1
Grid 4 (Battery)	Schematic	3-1
Tom Thumb Midget	Schematic	4-1
Tom Thumb Steering Post	Schematic	4-2
	Notes	4-2
Tom Thumb, 933 Series 2	Schematic	9-1
C-4	Schematic	7-1
A-5	Schematic	7-3
D-3	Schematic	7-2
R-6	Schematic, socket	10-1
S-6	Schematic	7-1
M10, M20	Schematic, parts, alignment	8-1
P-25	Schematic	3-2
B30, Series I	Schematic, parts, alignment	8-3
B30, Series II	Schematic, parts, alignment	8-3
P-35, 34	Schematic	2-2
B40, Series II	Schematic, parts, alignment	9-1
44, V-45, V-46, C-45, P-46	Schematic	7-3
J-50	Schematic	9-1
D-55	Schematic	9-1
J-60	Schematic	7-3
M60	Schematic, parts, alignment, data	8-5
B70, B80	Schematic, parts, alignment	8-6
M80	Schematic, parts, alignment	7-4
845, 960, 963	Schematic, layout	8-7
850	Schematic, layout	9-2
855	Schematic, parts, alignment	8-8
878	Schematic, alignment, tuner	9-3
	Schematic, trimmers, alignment	9-4
892	Schematic, trimmers	9-4
933 Ser. 2	Alignment, tuner	9-6
933, 935	See Tom Thumb	
950, 955	Schematic, layout	9-2
960, 963	Schematic, layout	9-2
960-A	See model 845	
	Data	Changes 10-1

Receiver	Misc. 8-2	
Notes	Schematic, voltage	

AZTEO RADIO CO.

Receiver	Misc. 8-2	2746
Notes	Schematic, voltage	

BAIRD

See GENERAL ELECTRONICS CORP.

NATHANIEL BALDWIN & CO.

45	Schematic	4-1
47	Schematic	4-1
80	Schematic	Misc. 1-1

A J

<p>BALKHEIT RADIO CO.</p> <p>Schematic, socket, voltage, parts list.....1-3 Chassis, two views.....3-3 Schematic.....3-4 Schematic, socket, voltage, parts list.....1-4 Chassis, two views.....3-1 Schematic.....3-5 Schematic.....4-2 Schematic, voltage, chassis.....1-2 Schematic, socket.....4-3 Schematic.....4-1 See Model A-3 Schematic, chassis, ditta.....1-1 Schematic, socket.....3-6 Schematic.....4-9 Schematic.....6-1 Schematic.....6-2 Schematic.....6-3 Schematic, alignment.....6-4 Schematic.....5-1 Schematic.....6-1 Schematic, socket.....4-5 Schematic.....5-2 Schematic.....4-6 Schematic, socket.....4-7 Schematic.....5-3 Schematic, parts.....5-4 Schematic.....5-3 Schematic.....4-8 Schematic.....4-8 Schematic, socket, trimmers.....6-5 Alignment, ditta.....6-6 See Model GT-20</p> <p>BALKITE PRODUCTS CO.</p> <p>Specifications.....1-1 B Form D.....1-10 B-H.....1-10 Schematic.....1-10 Schematic.....1-9 B-W Form D.....1-10 Schematic, wiring.....1-7 Schematic, wiring.....1-8 Schematic, wiring.....1-11 Schematic, wiring.....1-11 Schematic.....1-8 Schematic, wiring.....1-6 Schematic, wiring.....1-5 Schematic, wiring.....1-4 B-135 Form A.....1-9 Schematic, wiring.....1-3 B-180, Form B.....1-4</p> <p>BARKER BROS.</p> <p>Schematic, voltage, alignment.....6-1 Schematic, voltage, alignment.....6-1 Schematic, voltage.....6-2 Alignment.....6-1</p> <p>BELMONT RADIO CORP.</p> <p>Series 40, Models 45, 46.....3-1 Series 40, 41, 42, AC.....3-7 Series 40-A, 41-A, 42-A, AC.....3-7 See Series 40 Series 50.....3-2 Schematic, voltage, speaker cable code.....3-3 Schematic.....3-4 Schematic.....3-8 Series 50-B.....5-1 Series 50-C.....3-5 Schematic, voltage, data.....3-6 Series 70.....5-1 70-A.....5-2 71-C.....5-1 100.....5-1</p>	<p>•128</p> <p>•127</p> <p>•125</p> <p>•126</p> <p>368</p> <p>369</p> <p>370</p> <p>366</p> <p>367</p> <p>371</p> <p>364</p> <p>365</p> <p>372</p> <p>353</p> <p>353</p> <p>362</p> <p>362</p> <p>361</p> <p>362</p> <p>360</p> <p>359</p> <p>354</p> <p>363</p> <p>360</p> <p>358</p> <p>357</p> <p>356</p> <p>361</p> <p>355</p> <p>356</p> <p>728</p> <p>737</p> <p>737</p> <p>736</p> <p>737</p> <p>734</p> <p>729</p> <p>735</p> <p>735</p> <p>733</p> <p>732</p> <p>731</p> <p>736</p> <p>730</p> <p>731</p> <p>6-1</p> <p>6-1</p> <p>6-2</p> <p>6-1</p> <p>3-1</p> <p>3-7</p> <p>3-7</p> <p>3-4</p> <p>3-4</p> <p>3-8</p> <p>5-1</p> <p>3-5</p> <p>3-6</p> <p>5-1</p> <p>3-6</p> <p>5-2</p> <p>5-1</p> <p>5-1</p> <p>5-2</p> <p>4-8</p> <p>4-8</p> <p>6-5</p> <p>6-6</p> <p>1-1</p> <p>1-10</p> <p>1-10</p> <p>1-9</p> <p>1-10</p> <p>1-7</p> <p>1-8</p> <p>1-11</p> <p>1-11</p> <p>1-8</p> <p>1-6</p> <p>1-5</p> <p>1-4</p> <p>1-9</p> <p>1-3</p> <p>1-4</p> <p>6-1</p> <p>6-1</p> <p>6-2</p> <p>6-1</p> <p>3-2</p> <p>3-3</p> <p>3-4</p> <p>3-8</p> <p>5-1</p> <p>3-5</p> <p>3-6</p> <p>5-1</p> <p>5-2</p> <p>5-1</p> <p>5-1</p>	<p>Series 110</p> <p>401</p> <p>401, Series B</p> <p>403, Series A</p> <p>404, Above serial #5D115200A</p> <p>408, Series A</p> <p>415, Series A</p> <p>415, Series B</p> <p>418, Series A</p> <p>420</p> <p>425</p> <p>430</p> <p>435 Export Chassis</p> <p>440</p> <p>444</p> <p>X466 Television</p> <p>489, Series A, Above Serial 7J852300</p> <p>489, Series B, Above Serial 8C136800</p> <p>501, Series A</p> <p>504, Series A</p> <p>505, Series A, Above Serial 7J851300</p> <p>517, Series A</p> <p>519</p> <p>520, Series A</p> <p>521, Series A</p> <p>522</p> <p>523</p> <p>523B</p> <p>524, Series A; Export Chassis 435</p> <p>525 AC-DO</p> <p>526</p> <p>527, Series A</p> <p>529</p> <p>530</p> <p>531 Series B, Above Serial 187500</p> <p>540</p>	<p>3-9</p> <p>6-1</p> <p>6-2</p> <p>7-1</p> <p>10-1</p> <p>10-2</p> <p>6-3</p> <p>6-4</p> <p>9-1</p> <p>8-1</p> <p>8-2</p> <p>10-3</p> <p>10-2</p> <p>5-3</p> <p>5-4</p> <p>4-1</p> <p>5-3</p> <p>5-4</p> <p>5-5</p> <p>5-6</p> <p>6-5</p> <p>6-8</p> <p>10-39, 40</p> <p>10-41</p> <p>9-3</p> <p>9-4</p> <p>9-2</p> <p>9-5</p> <p>9-6</p> <p>9-4</p> <p>9-7</p> <p>10-4</p> <p>10-5</p> <p>10-6</p> <p>10-7</p> <p>10-8</p> <p>7-2</p> <p>9-8</p> <p>9-9</p> <p>9-10</p> <p>3-8</p> <p>9-11</p> <p>10-9</p> <p>10-10</p> <p>10-11</p> <p>10-12</p> <p>4-2</p> <p>9-12</p> <p>5-7</p>
---	---	--	---

**RADIOTRON
EARLY COMPLETE
PAGE**

BELMONT RADIO CORP.—(Cont.)

BELMONT RADIO CORP.—(Cont.)

**RADIOTRON
EARLY COMPLETE
PAGE**

BELMONT RADIO CORP.—(Cont.)

**RADIOTRON
EARLY COMPLETE
PAGE**

MODEL	REVISION	REVISION	MODEL	REVISION	REVISION
	PAGE	PAGE		PAGE	PAGE
541	Schematic, voltage, socket, trimmers 67	633, Series A	Schematic, socket, trimmers, voltage 10-19		
544, 545	Alignment, parts, notes 68	634, Series A	Alignment, tuner, parts 10-20		
550	Schematic, voltage, socket, trimmers, parts 6-9	640	Schematic, socket, trimmers, voltage, alignment 10-21		
551, Series A	Alignment, notes 6-10	650	Tuner, phono data, parts 10-22		
553, Series A	Schematic, voltage, socket, trimmers 4-3	600	Schematic, socket, trimmers 5-9		
555	Notes, socket, parts list 4-4	601	Alignment 5-10		
556 (Export)	Schematic, voltage, socket, trimmers 10-13	606	Schematic, socket, parts list, voltage 5-11		
575	Alignment 10-14	661	Schematic, socket, parts list, voltage, voltage, socket, trimmers, parts 4-6		
577 Series A	Schematic, voltage, socket, trimmers, tuner, alignment 10-15	665, Series A, 705	Alignment, assembly, wiring diagram 8-7		
577C Above Serial 203070	Alignment, tuner data, notes 10-16	666	Schematic, voltage, trimmers, parts 8-8		
578, 2 types, Serial 5K133670A to 5K173250A and Above	Trimmers, alignment, notes 6-11	667	Schematic, voltage, socket, trimmers, parts 7-13		
578, Series A	Schematic, socket, trimmers 6-12	670	Alignment, notes 7-14		
580, Revised, Above serial 11501	Schematic, socket, trimmers 7-3	670-A	Schematic, voltage, socket, trimmers, parts 9-21		
582, Series A, Above Serial 71894500	Alignment, parts 7-4	675	Alignment, tuner, trimmers, notes 9-22		
582, Series B, Above Serial 5B106200	Schematic, socket, trimmers, parts 7-5	677	Data Changes 10-3		
583 Export	Alignment, notes 7-6	677, Issue C, Above Serial 50672	Schematic, socket, trimmers, parts 7-13		
585, Series A, B, C	Schematic, alignment, socket, trimmers, tuner, alignment 5-8	680	Alignment, notes 7-14		
585, Series D	Schematic, voltage, socket, trimmers, tuner, alignment 9-13	685, Series A	Alignment, notes 9-23		
586, Series A, above serial 6E248475	Schematic, voltage, socket, trimmers, tuner, alignment 10-17	686, Series A & B	Schematic, voltage, socket, trimmers, parts 9-23		
587, Series A	Alignment, tuner, notes 10-18	691, Series A	Alignment, notes 9-25		
588, Series A	Schematic, voltage, socket, trimmers, parts 6-13	740	Installation, alignment, tuner, trimmers, parts 9-26		
589	Alignment, tuner, notes 9-15	746, Series A	Schematic, socket, trimmers, voltage, notes 10-23		
589 Series A Above Ser. No. 8E-189200	Schematic, voltage, socket, trimmers, parts 9-16	750	Tuner data, notes 10-24		
601, Series A & B	Schematic, voltage, socket, trimmers, parts list 7-7	751, Series A	Installation 10-18		
602	Schematic, voltage, socket, trimmers, parts 7-8	755	Schematic, voltage, socket, trimmers, voltage, notes 9-26		
602B, 602C	Alignment, parts 7-8	761, Series A	Alignment, notes, tuner, trimmers 10-25		
611 Series A	Schematic, socket, alignment, parts 7-9	767, Series A	Alignment, notes, tuner, trimmers, parts 10-26		
625	Schematic, socket, trimmers, parts 7-11	770, Series A	Alignment, notes, tuner, trimmers, parts 10-27		
632 Series A	Alignment, tuner, trimmers, parts 7-12	775	Tuner data, notes 10-28		
	Schematic, voltage, socket, trimmers, parts 8-3		Alignment, notes, tuner, trimmers 10-26		
	Schematic, socket, trimmers, voltage, alignment, notes 8-5		Tuner data, notes 10-27		
	Changes Changes 9-1		Schematic, voltage, socket, trimmers 10-27		
	Schematic, socket, parts, alignment, notes 7-10		Alignment, notes, tuner, trimmers 10-25		
	Schematic, socket, voltage, trimmers, alignment, parts 8-6		Tuner data, notes 10-26		
	Schematic, voltage, socket, trimmers, alignment, parts 9-29		Tuner data, notes 10-24		
	Schematic, socket, trimmers, parts 9-17		Installation 10-18		
	Voltage, alignment, tuner, notes 9-18		Schematic, voltage, socket, trimmers, voltage, notes 9-26		
	Schematic, socket, parts list 4-5		Alignment, notes, tuner, trimmers 10-25		
	Schematic, voltage, parts 9-19		Tuner data, notes 10-24		
	Socket, trimmers, alignment, notes 9-20		Installation 9-26		

775	Alignment	5-18	
777, Series A, B	Schematics, voltage	6-29	
	Trimmers, socket, parts, layouts	6-30	
	Alignment	6-31	
777, Series C	Socket, trimmers, notes	7-20	
	Schematic, voltage, changes, parts	7-19	
	Socket, trimmers, notes	7-20	
	Alignment (same as 777, Series B)	6-31	
778, Series A	Schematic, socket, trimmers, parts	7-21	
	Alignment, notes	7-22	
786, Series A	Schematic, socket, trimmers	7-15	
787, Series A	Alignment, notes	7-16	
	Schematic, voltage, socket, trimmers, parts	8-11	
804	Alignment	8-12	
	Schematic, socket, voltage, parts	8-13	
822	Alignment, trimmers	8-14	
	Schematic, socket, trimmers, parts	8-15	
823	Alignment	8-16	
	Schematic, voltage, socket, trimmers, parts	9-31	
840	Alignment, trimmers	9-32	
	Schematic, voltage, socket, parts	8-17	
842, Series A	Alignment, trimmers	8-18	
	Schematic, voltage, socket, trimmers, parts	9-33	
845, Series A	Alignment, trimmers	9-34	
	Schematic, socket, trimmers	7-23	
848, 849	Alignment, notes, parts	7-24	
	Schematic, voltage, socket, parts	8-19	
856, Series A	Alignment, trimmers	8-20	
	Schematic, voltage, socket, trimmers, parts	8-21	
860, Series A	Alignment	8-22	
	Schematic, voltage, socket, trimmers, parts	9-35	
867, Series A	Alignment, tuner	9-36	
	Schematic, voltage, tuner data	10-33	
878, Series A	Tuner data	10-28	
	Alignment, socket, trimmers	10-34	
878, Series B	Schematic, voltage, socket, trimmers, parts	8-23	
878, Series A & B	Schematic, voltage, socket, trimmers, parts	8-24	
879, Series A	Alignment	8-25	
	Schematic, voltage, parts, socket, trimmers	8-26	
880, Series A, B	Alignment	8-12	
880, Series C	Schematics, voltage	6-37	
880, Series A, B, C	Schematic, voltage, data	6-34	
	Socket, trimmers	6-34	
881	Alignment, parts	6-35	
	Schematic, socket, trimmers, alignment, parts	9-39	
888, 889	Schematic, voltage, socket, trimmers, parts	9-37	
890, Series A	Alignment, trimmers, notes	9-38	
	Schematic, voltage, socket, trimmers, parts	8-27	
910 Export	Alignment	8-28	
	Schematic, parts, phonograph notes	9-41	
	Alignment	9-40	
	Socket, trimmers, voltage, tuner	9-42	
1050	Schematic, voltage	4-8	
	Alignment, socket	5-20	
1070, Series A & B	Schematics, socket, trimmers	7-25	
	Alignment, notes, parts	7-26	
1075, Series A, B	Schematic	10-35	
	Alignment	10-36	

1075, Series A, B	Socket, trimmers, voltage, phono, notes	10-37	
	Tuner data, notes, parts	10-38	
1170, 1172	Schematic, voltage, socket, trimmers, parts	8-29	
1170B	Alignment	8-30	
	Schematic, voltage, socket, trimmers, parts	8-31	
1170C, Above Serial 7C561750	Alignment	8-32	
	Schematic, socket, trimmers, parts	9-43	
1171, Series A	Alignment, trimmers	9-44	
	Schematic, voltage, socket, trimmers, parts	9-45	
1174	Alignment, notes	9-46	
	Schematic, voltage, socket, trimmers, parts	8-33	
1175, Series A	Alignment	8-34	
	Schematic, voltage, parts	9-47	
	Alignment	9-40	
	Trimmers, tuner	9-48	

BLACKHAWK

6-U	Schematic	Misc. 5-3
-----	-----------	-----------

DAVID BOGEN CO., INC.

Mastertone Amplifier	Schematic	8-1
Supreme Amplifier	Schematic	8-1
2.5-5-10 Meter Superhet	Schematic, data	8-2
2SC Communicator	Schematic, data	8-2
2W Communo-Phone	Schematic, data	8-2
3A Communo-Phone	Schematic, data	8-2
5SC Communo-Phone	Schematic, data	8-2
	Instructions	8-3
B-20 Amplifier	Schematic, notes	8-7
SX50 Amplifier	Schematic, notes	8-9

BOSCH

See UNITED AMERICAN BOSCH

BRANDES PRODUCTS CORP.

Also see KOLSTER RADIO, INC.

A-1	Schematic	3-2	*485
B-10	Schematic	1-1	*485
	Voltage, socket, data	1-2	*485
B-11, B-12	Schematic	3-1	
B-15, B-16	Schematic	1-3	*486
	Voltage, socket, data	1-4	*486

BREMER-TULLY MFG. CO.

ABC Power Pack	Schematic	3-4	
B-T 6	Schematic	2-1	*129
6-40 Power Converter	Schematic	1-5	*132
6-40, 6-41	Schematic, socket, voltage	1-1	*129
7-70	Schematic, chassis wiring	3-1	
7-70 Power Converter	Schematic, socket, voltage	3-2	
8 Counterphase	Schematic	1-3	*131
8-12 Counterphase	Schematic, socket	2-1	132-A
8-20, 8-21	Schematic, socket, voltage	1-3	*131
80	Schematic, socket	2-2	132-A
81-A	Schematic, socket	1-5	132-B
81, 82	Schematic, socket, voltage	1-6	133
	Resistor, condenser, transformer connections	3-4	
81, 82 Power Unit	Chassis wiring	3-3	
S-81, S-82 R.F.	Schematic, socket	1-7	*134
S-81, S-82 A.F.	Chassis wiring	2-3	
S-81, S-82 A.F. 60 cycles	Schematic, choke and condenser connections	3-5	
S-81, S-82 A.F. & SPU, 25 cycles	Schematic	3-6	
83-A	Schematic	2-2	

BRENNARD MFG. CO.

Heraldryne	Schematic	Misc. 6-4
------------	-----------	-----------

MODEL	BREITING RADIO MFG. CO.	REVISED PAGE	EARLY COMPLETE PAGE	RADIOTRON COMPLETE PAGE
12	Schematic, alignment	Misc. 6-5, 6-6		
14	Schematic, trimmers	8-1, 8-2		
	Alignment, Notes	8-1, 8-2		
BRUNSWICK				
Bronawick	Schematic, socket	Misc. 4-2		
BROWNING-DRAKE CORP.				
Junior	Schematic	3-4	408	
5-tube AC Kit	Schematic	1-1	*195	421
20	Schematic	3-1	407	468
34, 36, 88	Schematic	1-1	*195	186-2
40	Schematic	3-2	406	467
50 Series	Schematic, alignment	Misc. 8-1		465
54	Schematic	3-4	408	466
60	Schematic	1-2	*196	444
70, 71	Schematic	1-3	*197	470
80	Schematic	9-3	409	469
100	Schematic	3-4	408	472
BRUNSWICK DIVISION—MERSMAN BROS.				
1669, 1689, 2669, 2689,	Schematic, alignment, parts	9-1		476
3689, 4689, 5689,				
Chassis M27				
8109, Chassis M21	Tuner data	9-2		
	Schematic, alignment parts	9-2		
	Tuner data	9-3		
BRUNSWICK RADIO CORP.				
AC Speaker	Connections	8-14	484	
Radiola Superhet,	Schematic	1-1	411	
UV Catacomb	Panel wiring	1-2	*138	477
Superheterodyne	Schematic	1-3	417	478
8-tube Cordova	Schematic	1-6	*144	479
8-tube, 2-D Battery	Schematic	1-7	*146	483
R-1	Schematic, data	1-27	449	
	Chassis wiring	1-28	*172	
	Voltage, data	3-3	450	
	See model 5-KR			
2-KRO, RF & SPU,	Schematic	1-14	*154	483
3-KRO, SPU	Schematic, voltage	1-10	422	484
3-KR8, RF	Chassis wiring, voltage	1-11	*151	480
3-KR8, SPU	Chassis wiring	1-18	*164	481
3-NC8, 5-NC8 AF	Schematic	1-19	*163	481
	Alignment data	2-21	488	481
3-NC8, 5-NC8	Alignment data, concluded	3-1	489	481
	Trimmer locations. See model 5-NO			
8-NC8	Trimmer locations	3-4	454	
8-NW8	data	3-4	458	
	Voltage, servicing notes	3-5	456	
	Service notes, part 1	3-6	457	
	Service notes, part 2	3-7	457	
P-3	See RPA-5			
RPA-3A	Chassis wiring	1-25	*169	492
RPA-4A	Schematic	1-25	*169	492
RPA-5	Schematic	2-22	446	492
RPA-5A, Panatrops	Schematic, wiring	1-8	*147	492
Connections	Schematic, socket, voltage	1-12	*153	492
5-KR, 5-KRO, 5-KR6,	Schematic	1-13	*155	492
2-KRO RF,				
2-KRO, SPU	Schematic	1-13	429	501
5-NC8 RF	Schematic, voltage	1-17	*159	499
5-NO RF	Schematic, socket, voltage	1-15	431	499
5-NO, SPU	Chassis wiring	1-16	*157	499
5-NO, 5-NC8, 3-NC8	Trimmer locations	3-2	440	499
PK-6	Schematic	1-26	*141	499
PK-6, 6-tube, 1-B Panel	Schematic	1-3	*142	499
PK-6, 6-tube, 1-C Panel	Schematic	1-4	*143	499
10	Schematic, voltage, data	2-1	186-C	499
	Chassis layout and wiring	2-2	186-D	499
	Schematic	2-3	186-E	499
11, 12, 16, 33 AC	Voltage, socket, data	2-4	186-F	499
11, 12, 16, 18, 33, AVC,	Schematic, socket, voltage	2-5	186-G	499
Chassis D				
BRUNSWICK RADIO CORP.—(Cont.)				
MODEL		REVISED PAGE	EARLY COMPLETE PAGE	RADIOTRON COMPLETE PAGE
P-11, P-13	Cabinet wiring	1-9	*148	499
14, 21, 31 DC	Socket, voltage, data	2-6	186-2	499
	Schematic	2-7	186-1	499
14, 21, 31, 81, 82 AC	Service notes	3-9		499
	Chassis, hum, data	3-10		499
14, 21, 31 SPU	R-F, Schematic	Misc. 7-3		499
P-14, S-21, S-31 RF	Schematic	Misc. 7-3	*168	499
S-14, S-21, 60-Cycles, AF	Schematic, cabinet wiring	1-24	*181	499
and SPU	Schematic	1-29	*182	499
S-14, S-21, S-81, S-81 RF	Chassis wiring	1-30	*185	499
S-14, S-21, S-81, S-82, 25	Chassis wiring	1-31	*185	499
cycles, AF	Schematic	1-32	*184	499
S-14, S-21, S-81, S-82, 60	Chassis wiring	1-33	*183	499
cycles, AF	Voltage, chassis, service data	3-12		499
S-14, S-21, S-31, S-81	Service notes, filter condenser connections	3-11		499
S-82	Schematic	2-8	186-B	499
15-B	Voltage, socket	2-9	186-4	499
15, 22 AC. Also 32, 42 AC	Schematic	1-34	*180	499
	Chassis layout and wiring	3-13		499
15, 22, 32 DO used in	Voltage, socket	3-14	186-A	499
42 DO	Schematic	2-11		499
16	Chassis, voltage, data	2-10	186-B	499
17, 24, 25 AC	See model 11			499
PR-17-8, 2 types	Schematic, socket	3-15	*165	499
(BRP-5)	Wiring diagrams	1-21		499
SPU-18 for PR-17-8	Schematic	1-22	*166	499
18	Chassis wiring	1-23	*167	499
21	See model 11, AVC			499
S-21	See model 14			499
22	See model S14			499
24, 25	See model 15			499
31	See model 17			499
S-31, 60-cycle AF	See model 14			499
32	See model S14			499
33	Chassis wiring	1-35	*186	499
42 AC	See model 15			499
42 AC-DO	See model 11			499
	See model 15			499
	See model 15			499
	See model 15			499
	Adjustment notes	2-18	186-B-1	499
	Sketches of details	2-14	186-B-2	499
	Wiring diagram, notes	2-15	186-B-3	499
	Notes, continued	2-16	186-B-4	499
	Notes, concluded	2-17	186-B-5	499
	Schematic, wiring diagram	2-18	186-B-6	499
	Details of assembly, wiring diagram	2-19	186-B-7	499
81, 82 AC	See model 14 AC			499
S-81, S-82	See model S-14			499
100 SW Converter	Schematic	2-12	186-H	499
BUCKINGHAM RADIO CORP.				
80, 80-B	Schematic, socket, voltage	Misc. 1-2	*187	501
227, 245 AC	Schematic	Misc. 7-4		501
BUICK				
980393	See also UNITED MOTORS SERVICE			
	Schematic	5-1		
	Voltage, trimmers, socket	5-2		
	Alignment	5-3		
	Test data	5-4		
	Test data	5-5		
BULOVA WATCH CO.				
Automatic clock control	Chassis wiring	2-4	187-D	503
M-501	Schematic, test data	2-1	187-A	503

M-501	Chassis layout, assembly wiring, voltage	2-2	187-B	504
600, 601, 605, 610	Schematic, voltage, socket	5-1		
M-701, G-781	Alignment, trimmers	5-2	187-C	505
	Schematic, chassis, voltage	2-3	187-D	506
	Test data	2-4	187-E	507
C-751	Schematic, socket	2-5	187-F	508
	Voltage, service data	2-6		
BUSH & LANE PIANO CO.				
10	Schematic	1-1	*189	609
	Voltage, socket, tests	3-1		511
12	Chassis layout	3-2	*188	510
	Schematic, socket, voltage	1-2		512
O. R. C.				
24-37	Schematic	4-1		
24-45	Schematic	4-1		
24-47	Schematic	4-2		
58-47	Schematic	4-2		
CABLE-NELSON				
See HOWARD RADIO				
CADILLAC DIV.—GENERAL MOTORS				
5X	Schematic, voltage, socket, trimmers	8-1		
	Alignment, notes	8-2		
06W	Notes on mounting, Part 2	5-1		
	Notes on mounting, Part 1	5-2		
	Schematic, socket, alignment	5-3		
	Parts list	5-4		
6KB	Schematic, voltage, socket, trimmers	8-3		
	Alignment, notes	8-2		
6-Q	Schematic	7-1		
	Voltage, resistances, socket, trimmers, transformer data	7-2		
6R	Circuit data, parts, alignment	7-3		
	Schematic	8-5		
6S	Alignment, voltage, socket, trimmers, data	8-6		
	Schematic, parts	8-7		
	Alignment, voltage, socket, trimmers, changes, notes	8-8		
6T	Schematic, notes	8-9		
	Alignment, voltage, trimmers, socket, data	8-10		
6U2	Schematic	8-4		
C-8	Schematic, voltage, sensitivity	10-1		
	Socket, trimmers, chassis	10-2		
	Tuner, alignment notes	10-3		
	Schematic	10-4		
56V1	See Deico Radio 3026	5-12		
2029, 2029A, 2080	Schematic	5-5		
2721 (072)	Voltage, socket, assembly	5-6		
	Chassis wiring	5-11		
	Parts, trimmer data	5-8		
	Power pack data	5-7		
2722 (072A)	Trimmer data	5-8		
	Chassis wiring	5-11		
	Power pack data	5-7		
	Trimmer data	5-8		
	Voltage, parts list, special notes	5-9		
1425470, 1425471	Schematic	5-10		
	Socket, trimmers, layout, voltage, alignment	9-1		
7232502	Schematic	9-2		
	Socket, trimmers, layout, voltage, alignment	9-3		
		9-4		
CALVERT MOTORS ASSOCIATES				
A-50-A	Schematic, voltage	6-1		
A-51-A, A-52-A	Schematic, voltage, parts	6-2		
	Tuner schematic, voltage alignment	10-1		
	Amplifier schematic, voltage	10-2		
	Schematic	10-3		
	Chassis, service notes, Part I	2-1	192-D	525
	Service notes, part 2	2-2	192-D-1	526
	Service notes, part 3	2-3	192-D-2	527
	Service notes, part 4	2-4	192-D-3	528
	Adjustments, Part 1	10-25		
	Adjustments, Part 2	10-26		
	Adjustments, Part 3	10-27		
	Notes	10-28		
	Complete assembly	10-29		
	Chassis views	10-30		
	Chassis views	10-31		
	Chassis views	10-32		
	Chassis views, parts	10-33		
	Chassis views	10-34		
	Cabinet wiring	3-1	517	
	Complete wiring	3-2	518	
	Schematic	5-1		
	Wiring diagram	3-3	519	
	Tuner schematic	10-5		
	Trimmers, chassis, alignment	10-4		
	Amplifier schematic	10-6		
	Wiring diagram	3-4	520	
	See model 100			
	Wiring diagram	3-5	521	
	Wiring diagram	3-6	522	
	Wiring diagram	3-7	523	
	Wiring diagram	3-8	524	
	Schematic—See 110G	8-1		
	Alignment, voltage	7-1		
	Amplifier and power pack schematic	7-2		
	Tuner schematic, voltage	7-3		
	Schematic	1-1	192-A	513
	Chassis wiring	1-2	192-C	514
	Chassis wiring	1-3	192-B	515
	Complete wiring diagram	1-4	192-D	516
	Schematic	4-1		
	Schematic	4-2		
	Schematic	4-3		
	Schematic	5-2		
	Schematic	5-3		
	Schematic	5-4		
	Tuner schematic, voltage	7-4		
	Bass Amplifier schematic, voltage	7-5		
	Treble amplifier schematic, voltage	7-6		
	Schematic, voltage, alignment	10-7, 8		
	Trimmers, layout	10-11		
	Schematic	8-2		
	Schematic	8-3		
	Schematic	8-3		
	Remote control installation	10-9, 10		
	Mixing panel chassis, notes	10-18		
	Mixing panel notes	10-19		
	Trimmers, chassis	10-17		
	Extended control wiring	10-20		
	assembly	10-21		
	Tuner schematic, voltage	10-13		
	Assembly wiring	10-12		
	Bass amplifier schematic, voltage	10-14		
	Volume control schematic, data, parts list	10-22		
	Tuning meter adjustments, chassis, assembly	10-16		

THE CAPEHART, INC.—(Cont.)

MODEL
400-G

Remote control, cable notes 10-24
Trebble amplifier, schematic, alignment, voltage 10-15
Play control, assembly, adjustments 10-23

Generator
113A, 1180A, 1680A
1635A, 4680A, 4635A

CHEVROLET DIV.—GENERAL MOTORS

See also UNITED MOTORS SERVICE

See United Motors 4037
Schematic, voltage 10-1
Socket, trimmers, chassis, changes, alignment 10-2
Schematic, voltage, changes 10-3
Socket, trimmers, chassis, alignment, parts 10-4
Schematic, voltage 10-5
Socket, trimmers, alignment, chassis, parts 10-6
Schematic, voltage 10-7
Socket, trimmers, chassis, alignment, parts 10-8
Tuning unit notes, Part 1 10-9
Tuning unit notes, Part 2 10-10
Socket, trimmers, alignment, chassis 10-10
Schematic 10-11
Socket, trimmers, chassis, views 10-12
Tuning unit wiring, condenser assembly, voltage 10-13
Alignment 10-14
Schematic 10-15
Socket, trimmers, voltage, chassis, alignment, tuner 10-16
Schematic, alignment 10-17
Voltage, socket, trimmers, alignment, chassis 10-18

600153
601525
601586
985200
985254
985283
985400
985424
985425
985426

CHRYSLER

See PHILCO RADIO & TELEVISION CORP.

CLAGO RADIO CORP.

Radiochron "B"
531 "Heritage"

Schematic Misc. 4-9
Schematic Misc. 9-3

CLARION

See TRANSFORMER CORP. OF AMERICA

CLEARSTONE RADIO CORP.

60 Goldcrest
70 Clearodyna
80 (Improved)
100 Series
110
112

Schematic 1-1
Schematic 1-1
Schematic 1-2
Schematic 1-2
Schematic 1-3
Schematic 1-3

CLIMAX RADIO & TELEVISION CO., INC.

Diamond
Duke
Lee
Opal
Opal
AA
AA
AB, ABX, Early
ABX, Late
AH, AHE
AJ
AKE
AL
AL
AR

Schematic, parts 8-1
Schematic, parts 8-5
See Model SW-5
Schematic 8-1
Schematic, socket 7-3
Schematic, socket 7-3
Schematic, socket 7-4
Schematic, parts 7-5
Schematic, parts 8-2
Schematic, socket, trimmers, alignment 8-4
Schematic, parts 8-5
Schematic, socket, alignment 9-1
Schematic, socket, alignment 9-2

534
535
529
530
531
532
583

RADIOOTRON

EARLY COMPLETE PAGE

REVISED PAGE
10-24
10-15
10-23

CASE ELECTRIC CORP.

Also see U. S. RADIO & TELEVISION CO.

Planetary Drive Assembly
601, Chassis 16 SM
701, Chassis 16 SME
710, 713, 714, 715, 716, 718, 719, Chassis 17
801, 802, Chassis 27 SME
1001, Chassis 19 RSME
1101, 1102, Chassis 110 RSME
Schematic 7-16
Notes 7-7
Schematic 7-2
Alignment, trimmers 7-1
Voltage, parts, chassis 7-3
Schematic 7-4
Alignment, trimmers 7-5
Voltage, parts, chassis 7-6
Voltage, chassis, parts 10-1
Schematic, trimmers, alignment 10-2
Schematic 7-7
Alignment, trimmers 7-8
Voltage, parts, chassis 7-9
Schematic 7-11
Trimmers, alignment 7-10
Voltage, parts, chassis 7-12
Schematic 7-13
Trimmers, alignment 7-14
Voltage, parts, chassis 7-15

387
359
3511

CAVALCADE RADIO CO.

Schematic, data 6-1
Schematic, installation data 6-2
Schematic, socket, trimmers 6-3
Alignment data 6-4

CENTURY RADIO PRODUCTS CO.

Schematic 3-6
Schematic 3-7
Schematic 3-1
Schematic 3-2
Schematic 3-3
Schematic 3-4
Schematic 3-5

CHAMPION RADIO

Auto Radio Power Sup- Schematic, data 8-8

Ceil Connections
4-Tube, AC-DC
5-Tube, 3-Band
6-Tube, 3-Band
30
40
40-R, 40-DW, 40-RM, 40-DWN
40UM
42
50A2M
50UP
52 (47 output)
52 (42 output)
52-DWG
54, 55
307, 317
400
500
501
521UD
525DWG
526DW
5431.D.
558

Data 7-10
Schematic 7-3
Schematic 7-1
Schematic 7-2
Schematic 9-1
Schematic 8-1
Schematic, notes 7-5
Schematic 7-4
Schematic 9-2
Schematic 9-3
Schematic 7-6
Schematic 7-7
Schematic 8-5
Schematic 8-6
Schematic 8-7
Schematic 8-2
Schematic 7-7

5190
537
538
538
539
539

CLIMAX RADIO & TELEVISION CO., INC.—(Cont.) EARLY COMPLETE PAGE REVISED PAGE Schematic, socket, alignment... 9-1 Schematic, socket, alignment... 9-1

CLIPPER See RADIO PRODUCTS SALES CO. COAST TO COAST Schematic Misc. 3-3 Schematic Misc. 3-4

COLONIAL RADIO CORP. 16" spkr. used instead of 8" Alignment, image frequency... 5-1

CLIMAX RADIO & TELEVISION CO., INC.—(Cont.) EARLY COMPLETE PAGE REVISED PAGE Schematic, socket, voltage... 1-12 Schematic, socket, voltage... 1-13

CLIPPER See RADIO PRODUCTS SALES CO. COAST TO COAST Schematic Misc. 3-3 Schematic Misc. 3-4

COLONIAL RADIO CORP. 16" spkr. used instead of 8" Alignment, image frequency... 5-1

CLIMAX RADIO & TELEVISION CO., INC.—(Cont.) EARLY COMPLETE PAGE REVISED PAGE Schematic, socket, voltage... 1-12 Schematic, socket, voltage... 1-13

CLIPPER See RADIO PRODUCTS SALES CO. COAST TO COAST Schematic Misc. 3-3 Schematic Misc. 3-4

COLONIAL RADIO CORP. 16" spkr. used instead of 8" Alignment, image frequency... 5-1

COLONIAL RADIO CORP.—(Cont.)			RADIOTRON		
MODEL	REVISED PAGE	EARLY COMPLETE PAGE	MODEL	REVISED PAGE	EARLY COMPLETE PAGE
106-B	Interference data, general notes, power supply.....	4-5	501 AC	Schematic.....	4-45
	Schematic.....	4-8	C-595	Socket layout, parts location.....	4-46
	Voltage.....	4-10		Schematic, parts coding.....	3-36
	Socket layout, parts location.....	4-10		Revised schematic.....	3-37
	Parts list.....	4-7		Spkr. notes, parts. See model T-397.....	630
	Schematic.....	4-7		Voltage, service notes.....	631
	Layout, test data.....	4-6		Supplementary service notes (A).....	3-34
106-B Power Supply	See model 86.....		600, 600-A	Circuit notes, voltage.....	3-35
114	See model 38.....			Parts list, block schematic.....	4-47
117	See model 39.....			Schematic.....	4-48
125	Circuit notes.....	4-11	601	Parts location, socket layout.....	4-50
136	Voltage, parts list.....	4-12		Circuit notes.....	4-51
	Schematic.....	4-13		Voltage, parts list.....	4-52
	Socket layout, parts location.....	4-14		Schematic.....	4-53
142 Chassis	See Sears Roebuck 1712 & 1713 Notes.....	4-15	602	Parts location, socket layout.....	4-54
150	Notes, voltage.....	4-16		Circuit data.....	5-13
	Parts location, socket layout, parts list.....	4-17		Schematic.....	5-14
	Schematic.....	4-18		Socket, trimmers, coil data.....	5-16
150, 164, 182	Supplementary data.....	5-2		Voltage, alignment.....	5-17
164	Schematic, voltage, parts layout.....	5-3		Parts list.....	5-18
	Remote control, alignment.....	5-4		Schematic, voltage, interference data.....	5-19
	Vibrator data, noise.....	5-5		Socket, trimmers, alignment.....	5-20
	Socket, assembly, speaker.....	5-6		Changes.....	7-6
	Service data.....	5-8		Schematic, circuit data.....	5-21
164-B, above serial #50300	Schematic, parts.....	5-7	604	Voltage, alignment.....	5-22
182	Service data.....	5-8		Socket layout, trimmer data.....	5-23
	Circuit data.....	5-9		Parts list.....	5-24
	Schematic, parts layout, assembly.....	5-10		Schematic, socket, trimmers.....	6-1
	Remote control data, parts list.....	5-11		Schematic, voltage, notes.....	5-25
	Supplementary data. See model 150 Notes.....	4-19		Parts layout, socket, trimmers, notes.....	5-26
182, 279, 300, 801, 500 AC-DC	Voltage, tube data.....	4-20		Schematic, voltage, trimmer data.....	5-27
	Parts location.....	4-21		Alignment, socket, trimmers.....	5-28
	Schematic "A".....	4-22		Changes.....	7-4
	Schematic "B".....	4-23		Schematic, voltage, data.....	5-29
	Parts list.....	4-24		Socket, alignment, trimmer data.....	5-30
	Notes.....	4-25		Schematic, voltage.....	5-31
250 AC, 279 AC, 800 AC, 301 AC, 250-300 AC	Voltage.....	4-26		Alignment, socket, parts list, trimmers.....	5-32
	Parts list.....	4-33		Schematic, voltage.....	5-33
	Schematic.....	4-27		Alignment, socket, trimmers, parts.....	5-34
	Parts location.....	4-28		Schematic, trimmers, socket, parts layout, notes.....	5-35
250-300 AC-D0	Schematic.....	4-29		Voltage, alignment.....	5-36
250-300 AC	Notes & Voltages. See model 250 AC.....	4-30		Changes.....	7-4
250 AC, 300 AC, Extended Range	Schematic.....	4-31		Schematic, voltage, trimmer data.....	5-37
250 AC, 300 AC, 250-300, 279, 300, 301 Extended Range	Parts location.....	4-32		Alignment data.....	5-38
	Parts list.....	4-34		Parts list, socket layout, trimmers.....	5-39
	See model 250.....			Changes.....	7-6
T-345, C-399	Voltage, service notes.....	3-29	625	Schematic, voltage, trimmers.....	5-40
T-345, C-399, C-995	Schematic, parts coding.....	3-30	626	Alignment.....	5-41
	Speaker replacement, notes, parts list.....	4-65		Socket layout, trimmers, parts list.....	5-42
T-397, C-495	Schematic, voltage.....	3-31		Changes.....	7-4
T-397, C-495	Parts coding.....	3-32		Schematic, voltage.....	5-43
T-397, C-495, C-696	Parts list.....	3-33		Alignment, trimmers, socket layout.....	5-44
	Speaker replacement notes, parts list.....	4-66		Schematic, voltage.....	5-45
C-399	See model T-345.....			Alignment, parts, socket, trimmers.....	5-46
400	Voltage, notes.....	4-35		Schematic, voltage, socket, trimmers.....	6-2
	Schematic.....	4-36		Alignment, notes.....	6-3
	Socket layout.....	4-37		Alignment part 2, parts list.....	6-4
	Coil wiring data, parts list.....	4-38		Schematic.....	3-37
	See model 250.....			Spkr., notes, parts. See model T-397.....	3-37
	Circuit notes.....	4-39		Voltage, notes. See model C-595.....	4-55
C-495	Condenser drive data.....	4-40		Voltage, mechanical notes.....	4-56
500	Voltage, parts list.....	4-41		Voltage, mechanical notes.....	4-57
501 AC-DC, 501 A0	Parts list.....	4-42		Schematic.....	4-57
	Socket layout, parts location.....	4-44		Chassis view, parts list.....	4-58
501 AC-D0			700, 701, 703		

COLONIAL
CONTINENTAL

MODEL	CONTINENTAL RADIO CORP.—(Cont.)	REVISED PAGE	EARLY COMPLETE PAGE	RADIOTRON COMPLETE PAGE
700, 701, 702	Paris location	4-59		
700 AC, 701 AC, 702 AO	Parts list, terminal board data	4-60		
	Circuit notes, voltage	4-61		
	Schematic	4-62		
	Parts location, speaker terminal data	4-63		
	Socket layout, parts list	4-64		
	Voltage, service notes	3-38		
	Parts coding	3-39		
	Supplementary service notes			
	Schematic (A)	3-40		
	Schematic (B)	3-41		
	Sprkr., notes, parts. See model T-345			
C-995				634
				635
				636
				637
COLUMBIA PHONOGRAPH CO.				
C-1, C-3	Schematic, socket	1-1	*437	639
C-2, C-4	Schematic, socket	1-2	*437	640
C-5 (205)	Schematic, socket, voltage	1-3	*438	641
C-5 (310)	Schematic, socket	1-3	*438	641
C-6, C-7	Schematic, socket	1-4	*439	642
CM-16-A, C-19-A	Dynamic speakers data	3-6		635
C25-31, C25-32, C31, C32 (Chassis C101)	Schematic, socket, voltage	2-2	218-A	650
	Chassis test data	2-1	218-B	651
33, 34 (Chassis C102)	Chassis layouts	2-3	218-C	653
C-80-A	Schematic	3-2		654
C-80-B	Schematic	3-2		655
	Power transformer data	3-5		657
	Chassis, notes	3-5		658
C-80-A, C-80-B, C-800-A	Voltage	3-6		657
C-80-A, C-800-A	Power transformer data	3-6		658
C-90	Power transformer data	3-5		657
	Schematic	3-7		659
	Silent tuning notes	3-8		660
	Voltage, tuning notes	3-9		661
C-100	Schematic, tuning notes	3-10		662
C-101 Chassis	Schematic, voltage, socket	3-10		662
C-102 Chassis	See model C-25-31			
120-B	See model 33, 34			
	Schematic, alignment data, notes	3-11		663
	Voltage, notes	3-12		664
C-800	Schematic	3-4		656
C-800-A	Voltage, pwr. data. See model C-80-A			
900, 901	Schematic, socket	1-4	*438	642
902	Schematic, socket	1-5	*440	643
920, 990	Schematic	1-6	*440	644
930	Schematic, socket	1-6	*440	644
930-300	Schematic, socket	1-7	*441	645
931	Schematic, socket	1-7	*441	645
940	Schematic, socket	2-4		646
950	Schematic, socket	1-8	*443	647
961	Schematic, socket	1-9	*443	648
980	Schematic, socket	1-10	*442	649
990	See model 920			
COLUMBIA RADIO CORP.				
SG-5 1930	Schematic	3-1		665
SG-8	Chassis wiring, voltage	1-1	*211	667
	Schematic	1-2	*210	666
	Chassis	3-2		668
SG-9 1930	Schematic, socket	3-3		669
SG-10	Schematic	3-4		670
150	Schematic	Misc. 5-5		
COMMONWEALTH RADIO MFG. CO.				
8-In-Line	Schematic	Misc. 6-4		
CONSONELLO				
Star Raider	Schematic	Misc.		
Slagle 9 with '71-A	See model R-20			
Slagle 10, A and B with '71-A Power Pack	Schematic, socket, voltage	1-1	*212	671
R-20, R-30, R-40, Star Raider	Schematic, socket	1-2	*215	672
	Schematic	1-6	*217	676
CONTINENTAL RADIO CORP.				
Slagle 29-C with '71-A Power Pack	Schematic, socket	1-3	*214	673
Slagle 29-A and 29-B with '50 Power Pack	Schematic, socket	1-4	*213	674
Slagle 29-C and 29-D with '50 Power Pack	Schematic, socket	1-5	*216	674
R-40	See model R-20			
CONTINENTAL RADIO & TELEVISION CORP.				
Touch-O-Matic, Type T-21	Schematic, assembly	8-21		
	Installation, notes, adjustments	8-22		
M-1	Schematic, voltage, socket, trimmers	7-9		
L2, ML156, ML266	Alignment, parts	7-10		
Z-2	Schematic	6-2		
	Schematic, voltage, socket, trimmers	7-13		
4A, 4B, Early, Late, 4C	Alignment, parts	7-14		
4D, Early, Late	Schematic	10-1		
4D-PH	Alignment, socket, trimmers	10-2		
4	Schematic	10-3		
4H	Alignment, socket, trimmers	10-2		
	Schematic	10-3		
L4, ML4	Alignment, socket, trimmers	10-2		
Z-4	Schematic, voltage, socket, trimmers	6-1		
5A	Alignment, parts	7-15		
5AZ	Schematic, socket, trimmers, alignment, tuner, parts	9-1		
5B	Schematic, socket, trimmers, alignment	9-2		
5C	Schematic	10-5		
5CU	Socket, trimmers, alignment tuner, voltage, phono data	10-6		
5D, 5DL	Schematic, socket, trimmers, alignment, parts	9-3		
5E	Schematic	10-5		
5EA	Socket, trimmers, alignment	10-6		
5F	Schematic, socket, trimmers	10-2		
5G	Alignment, socket, trimmers, alignment, parts	9-5		
5J	Schematic, socket, trimmers, alignment	9-6		
5L, 5LL	Schematic	10-1		
I-5	Alignment, socket, trimmers	10-2		
5LL Phono	Schematics, voltage	10-7		
5M Chassis	Alignment, socket, trimmers	10-2		
5VU	Schematic, socket, trimmers, alignment	7-3		
5X Chassis	Schematic, voltage	10-7		
5Z Chassis	Alignment, parts	7-4		
6A	Schematic, socket, trimmers, alignment	8-1		
6B	Schematic, socket, trimmers, alignment	9-7		
6C	See model 160-5X			
	See model 150-5Z			
6D	Schematic, socket, trimmers, alignment	10-8		
6E	Schematic, socket, trimmers, alignment	10-9		
6F	Tuner data	10-10		
6G	Schematic, socket, trimmers, alignment	10-11		
6H	Tuner data	10-10		
	Schematic, socket, trimmers, alignment	9-9		
	Tuner data	10-12		
	Schematic, socket, trimmers, alignment	10-10		
	Schematic, socket, trimmers, alignment	9-9		

CONTINENTAL RADIO & TELEVISION CORP.—(Cont.)

MODEL **REVISED PAGE**

Schematic, socket, trimmers, voltage, alignment10-13

6K Schematic, socket, trimmers, alignment9-10

6L Schematic, socket, trimmers7-5

L-6 Alignment, parts7-6

6P Chassis Schematic, alignment8-5

6PU Socket, trimmers, notes, parts8-6

6Q Chassis Schematic, socket, trimmers, alignment9-11

Schematic, socket, trimmers, alignment, battery con- nections8-4

See model 165-6W

6Y Chassis See model 150-6Y

7A Schematic, socket, trimmers9-12

Alignment9-8

Schematic, socket, trimmers, alignment, tuner9-13

7J Chassis Schematic, socket, trimmers, alignment, parts8-9

L-7 Schematic, socket, trimmers7-7

Alignment, parts7-8

7M Chassis Schematic, socket, trimmers8-10

7MU Chassis Schematic, socket, trimmers8-12

8A Schematic, alignment8-14

Schematic, alignment10-14

Tuners, tuner, parts10-15

Schematic, alignment10-16

8AU Socket, trimmers, tuner, parts10-15

Alignment10-14

Schematic, alignment8-13

Socket trimmers, dial ad- justments8-14

8K Chassis Schematic, socket, trimmers8-15

Alignment, dial adjustments8-16

8T Schematic, socket, trimmers, alignment, tuner9-14

Schematic, socket, trimmers, alignment, tuner9-15

8TU Schematic, socket, trimmers, alignment, tuner9-15

X-8 Schematic, voltage, socket, trimmers7-11

Alignment, parts7-12

Schematic, socket, trimmers, alignment, tuner9-16

9G Schematic, socket, trimmers, alignment10-17

11A Alignment10-14

Tuner data, parts10-13

Schematic, layout, notes10-19

Schematic, socket, trimmers, parts8-17

Alignment, notes8-16

Electric tuner, data8-19

16R Schematic9-17, 18

Socket, trimmers, alignment, tuner9-19, 20

R-F schematic10-20

Tuner data, parts10-18

16S Tuner, A-F and S.P.U. sche- matic10-18

Socket, trimmers, align, notes, parts10-22

See Touch-O-Matic, Type T-21

T-21 Touch-O-Matic Schematic, socket, trimmers, alignment7-1

66, 660 Schematic, socket, trimmers, alignment9-21

69 Schematic, socket, trimmers, alignment9-22

77, 78, 770, 780 Schematic, socket, trimmers, alignment8-20

78, 780 DataChanges 9-1

88, 880 Schematic, socket, trimmers, alignment9-24

137X, 150X, 171X Schematic, alignment6-3

150-5Z, 155-5Z, 985-5Z Schematic, socket, trimmers, alignment8-3

990-5Z, Chassis 5Z

RADIOTRON

EARLY COMPLETE PAGE

REVISED PAGE

COMPLETE PAGE

150-6Y, 155-6Y, 985-6Y Schematic, socket, trimmers, alignment, parts8-8

ML150 See model L2

160-5X, 980-5X, Chassis 5X Schematic, socket, trimmers, alignment8-2

165-6W, 975-6W, Chassis 6W Schematic, socket, trimmers, alignment, parts8-7

ML266 See model L2

X-541 Schematic, alignment6-4

X-641, X-741 Schematic, alignment7-4

660 See model 66

770 See model 77

780 See model 78

880 See model 88

980-5Z, 985-5Z See model 165-6W

985-5Z, 990-5Z See model 160-5X

985-5Z, 990-5Z See model 150-5Z

985-6Y, 990-6Y See model 150-6Y

CONTINENTAL WIRELESS SUPPLY CORP.

Voice of the Road Schematic Misc. 3-1

CORONA RADIO AND TELEVISION CORP.

106 Schematic, socket7-2

108 Schematic, alignment9-1

110 Schematic, socket7-1

203 Alignment7-2

209 Schematic9-2

219 Schematic, parts9-3

212 Schematic, parts9-4

214 Schematic8-1

Schematic8-2

CORONADO

See GAMBLE-SKOGMO, INC.

COURIER

See UNITED REPRODUCERS

CRANE

28-T-8 LW Schematic Misc. 5-6

CROSLEY CORP.

V Schematic, socket, chassis2-7

XJ, XL wiring1-1

AC-DC Fiver See model 577

Bandbox See model 601 or 602

Battery Fiver See models 401 or 401-A

Battery Forty See model 5A3 or 5B3 or 527

Battery Six See model 4B1

Battery 8 See model 6B1

Buccaneer See model 815

Buddy, Chum See model 635

Carrier Schematic, socket, voltage, data1-17

Centurion See model 586

Chairside Fiver See model 1014

Clippet See model 567

Constitution See model 915

Corsair See model 1055

Cruiser See model 715

De Luxe Fiver L-B See model 615

Dynatrol Six See model 5V1

Eleven See model 617

Fiver See model 1127

Fiver, Jr. See model 515 or 517

Fiver Console See model 512

Fiver Deluxe See model 5V2

Fiver Roamio See model A157

Fiver Teletone See model 517

Gembox See models 609 or 610

Intermediate Amplifiers Alignment dataChanges 7-4

L-F peaksChanges 7-4

Jewelbox See models 704, 704A, 704B

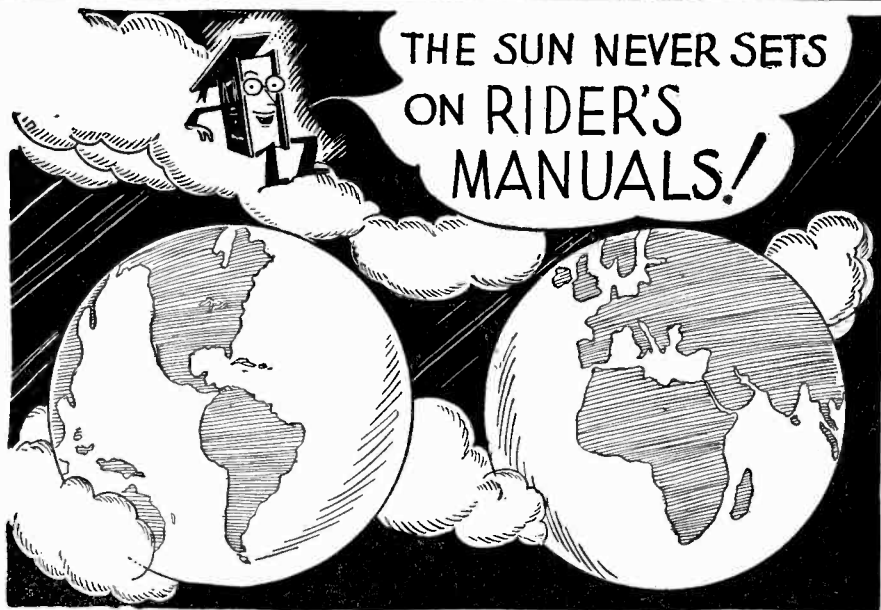

EVERY MINUTE OF EVERY DAY

RIDER'S MANUALS

**ARE BEING CONSULTED BY SERVICEMEN
TO SOLVE THEIR PROBLEMS**

Over 18,000 pages of servicing information comprise the greatest aid ever made available to servicemen. ¶ In every country RIDER'S MANUALS are recognized as the ONLY source of reliable information. ¶ And this data can be easily and quickly found, for EVERYTHING ON EVERY PAGE of Rider's nine volumes is listed in the revised 200 page Index that is cross-referenced. ¶ The products of hundreds of manufacturers covered in Rider's Manuals make them absolutely essential to every serviceman.



MODEL	REVISI PAGE	EARLY PAGE	CROSLLEY CORP.—(Cont.)	MODEL	REVISED PAGE	EARLY COMPLETE PAGE
126-1	Schematic, socket	2-14	A-177	Schematic, voltage, socket, trimmers	8-5	
127	Schematic, socket, voltage, data	2-15	178	Chassis, parts, alignment	8-6	
127-1	Parts list, data	2-16	179	Schematic, voltage, parts, socket, voltage, parts	5-6	
128	Schematic, voltage, alignment	3-11	180	Schematic	5-8	
129	Schematic, socket	3-12	181	Voltage, parts list	5-9	
129-1	Schematic, voltage, notes	3-13	182	Schematic, socket	5-10	
130	Schematic, voltage, notes	3-14	183	Voltage, parts list	5-11	
130-1	Schematic	4-5	184	Schematic	5-12	
131	Schematic, socket	4-6	A-258	Parts list	5-13	
132-1	Schematic, voltage, notes	3-15	A-256	Schematic, voltage	5-14	
133	Schematic, voltage, socket, notes	3-16	A-267, Roamio	Schematic, voltage, parts list	5-15	
134	Schematic, voltage, notes	3-17	A-268	See model A158		
134-1	Schematic, voltage, socket	3-18	A-358, Roamio	Schematic, socket, trimmers, chassis, voltage	7-5	
135	Schematic, voltage, socket, notes	3-19	A-366	Alignment, parts	7-6	
136-1	Schematic, voltage, specifications	3-20	401 Bandbox Jr.	Schematic, socket, parts	9-7	
137	Schematic, voltage, socket, notes	3-21	415	Socket, trimmers, layout, voltage, alignment	9-8	
141	Schematic, voltage, socket, notes	3-22	401 A Bandbox Jr.	Schematic, socket, trimmers, voltage, layout	7-7	
148	Schematic, voltage	4-7	416	Socket, trimmers, voltage, alignment	7-8	
148	Schematic, voltage, socket	4-7	418, Vanity	Schematic, socket, chassis	1-4	*221
146-1	Schematic, voltage, socket, notes	3-23	425	Schematic, socket, voltage	1-4	682
147	Schematic, voltage, changes	3-24	428 Vanity DeLuxe	Schematic, socket, trimmers	7-9	
148	Schematic, voltage, notes	3-25	435	Socket, trimmers, chassis, parts, alignment	7-10	
150	Schematic, voltage, notes	3-26	438, 438M, 486	Schematic, voltage, socket	7-10	
151	Schematic, voltage, notes	3-27	448	Alignment	8-7	
154	Schematic, voltage, notes	3-24	458, Battery Vanity	Chassis, parts	8-8	
155	Schematic, voltage, notes	3-28	505, 525	Schematic, socket, trimmers	8-8	
156	Schematic, voltage, notes	3-29	506, Below Serial #1308741	Socket, trimmers	8-8	
A-156	Schematic, socket, voltage	7-1	506, Above Serial #1308741	Alignment, tuner, voltage, layout	9-11	
157	Trimmers, chassis, alignment, parts	7-2	507	Schematic, socket, trimmers	9-12	
A-157, Fiver Roamio	Schematic, voltage, notes	3-30	515, 5515, Flyer	Alignment, tuner, voltage, parts	9-12	
158	Schematic, voltage, parts	8-1	516, 5516, 6516	Socket, trimmers, chassis, parts, alignment	7-11	
A-158, A258 Roamio	Schematic, socket, layout, trimmers, voltage	8-2	517 (Early), 547 (Early), Teletune Flyer	Schematic, socket, trimmers, alignment	7-12	
159	Schematic, voltage, notes	8-3		Schematic, socket, trimmers, voltage, layout	9-13	
160	Tuner assembly, voltage, parts	9-2		Tuner, alignment, voltage, parts	9-14	
161	Schematic, voltage, chassis	4-8		Schematic, voltage	7-13	
162	Schematic, voltage, chassis	8-82		Socket, trimmers, alignment, parts	7-14	
163	Data	Changes 7-16		Schematic, parts	9-15	
164	Data	Changes 9-1		Phono chassis, voltage, alignment, drive data, phono data, tuner	10-1	
165	Schematic, voltage	4-11		Schematic, parts	10-2	
A-166	Schematic, voltage	4-12		Combination, socket, trimmers, voltage, alignment, phono data, tuner	10-3	
167, Series 2	Schematic, voltage	4-12		Schematic, socket, trimmers, voltage, chassis	10-4	
A-167	Socket, trimmers, chassis, parts, alignment	7-3		Alignment, tuner, notes, parts	10-4	
168	Schematic, parts list	7-4		Schematic, parts	6-18	
A-168, A268, Sixer Roamio	Schematic, voltage	4-9		Voltage, chassis, trimmers, alignment	6-14	
169	Schematic, voltage, socket, trimmers	4-10		Schematic, socket, parts	8-9	
169, Revised	Chassis, alignment, parts	8-3		Trimmers, Chassis, alignment, voltage	8-10	
170	Schematic, voltage, socket, trimmers, layout	4-13		Schematic, socket, voltage, parts	8-11	
171	Tuner assembly, parts	9-5		Trimmers, chassis, alignment	8-12	
172	Alignment, dial data	9-6		Schematic, voltage, socket	10-5	
173, 173-5	Schematic, voltage	4-14		Trimmers, chassis, alignment, parts	10-6	
174	Voltage, parts list	5-3		Schematic, socket, parts	10-6	
175	Schematic, socket layout	5-4		Voltage, trimmers, alignment, chassis	6-12	
176	Schematic, voltage	4-15		Schematic, voltage, socket, parts	7-58	
	Schematic, voltage	4-12		Schematic, socket, parts	8-13	
	Schematic, voltage	4-17				
	Schematic, voltage	4-18				
	Schematic, voltage	4-19				
	Schematic	4-11				

CROSLEY CORP.—(Cont.)			RADIOTRON		
MODEL	REVISID PAGE	EARLY COMPLETE PAGE	MODEL	REVISID PAGE	EARLY COMPLETE PAGE
517 (Early), 547 (Early), Teletone Fiver	Trimmers, chassis, voltage, alignment 8-14	8-14	602 AO Bandbox	Schematic, socket 1-7	228
517 (Late), Fiver; 547 (Late), Quiktone Fiver; 5517, Fiver Console	Schematic, socket 9-17	9-17	602 Power Pack	Schematic voltage 1-7	224
			605	Socket, trimmers, chassis, parts alignment 7-29	
	Voltage, alignment, data, changes 9-16	9-16	608 Gembox	Schematic, socket, voltage, chassis 1-8	226
	Socket, trimmers, layout, parts 9-18	9-18	609 Gembox, 610 Gembox	Schematic, socket, voltage, chassis 1-9	
526, 5526	Schematic, voltage 7-15	7-15	614, 6H3	Schematic, socket, parts 6-18	226
	Socket, trimmers, chassis, parts 7-16	7-16	615, Cruiser	Socket, trimmers, chassis, parts, alignment 7-32	
527, Battery Fiver	Schematic, voltage 9-19	9-19	616	Schematic, voltage, trimmers 7-33	
	Socket, trimmers, alignment, layout, parts 9-20	9-20	617, Dynatrol Six	Socket, trimmers, chassis, parts, alignment 7-34	
534	Schematic, socket 6-15	6-15		Schematic, socket 9-31	
	Chassis, trimmers, parts 6-16	6-16		Socket, trimmers, layout, voltage, tuner, phonograph data 9-32	
535	Voltage, alignment, data 6-17	6-17	626	Parts list 9-33	
	Schematic, socket, voltage 7-17	7-17		Schematic, parts 9-34	
	Socket, trimmers, chassis, parts, alignment 7-18	7-18	628, 638	Socket, trimmers, chassis, voltage, alignment 7-36	
536, 5536	Schematic, voltage 7-19	7-19	628, 638 (Late), 5628	Schematic, socket, parts 9-42	
	Socket, trimmers, chassis, parts, alignment 7-20	7-20	636, Buccaneer	Socket, trimmers, layout, parts 9-37	
537	Schematic, voltage, socket, parts 8-15	8-15	636	Schematic, socket 7-37	
	Trimmers, chassis, alignment 8-16	8-16	637, Super Six	Alignment, socket, voltage, chassis, parts 7-38	
545	Schematic, voltage 7-21	7-21		Schematic, socket, voltage 9-35	
	Socket, trimmers, chassis, parts, alignment 7-22	7-22	638	Alignment, phonograph data 9-36	
546	Schematic, voltage 7-23	7-23	645, 32 DC Six	Socket, trimmers, layout, parts 9-37	
	Socket, trimmers, chassis, parts, alignment 7-24	7-24	646	Schematic, socket 7-39	
547 (Early & Late)	See model 517			Alignment, chassis, parts 7-40	
548, 5548	Schematic, socket, parts 9-38	9-38		Schematic, trimmers, voltage, socket 7-41	
557	Schematic, socket 9-21	9-21	647	Socket, trimmers, chassis, parts, alignment 7-42	
	Alignment, voltage, data 9-22	9-22		Schematic, socket, trimmers, voltage, socket, trimmers 9-39	
555, 5555	Socket, trimmers, layout 9-23	9-23	648, Super Sextette	Layout 9-40	
	Parts list 9-24	9-24		Alignment, parts 9-41	
	Schematic, voltage, socket 9-25	9-25	655, Olympia	Schematic, voltage, data 10-15	
	Socket, trimmers, chassis, parts, alignment 7-26	7-26		Socket, trimmers, chassis, alignment, notes, parts 10-16	
556	Schematic, voltage 7-27	7-27	656, 5656	Schematic, socket, trimmers, voltage, chassis 7-43	
	Socket, trimmers, chassis, parts, alignment 7-28	7-28		Alignment, parts 7-44	
566	Schematic, voltage, parts 8-17	8-17	656, 5666	Schematic, voltage, notes 8-23	
	Trimmers, socket, chassis, alignment 8-18	8-18		Socket, trimmers, chassis, alignment, parts 8-24	
567, Chairside Fiver	Schematic, socket, voltage, data, trimmers, layout 9-25	9-25		Schematic, voltage 8-25	
	Alignment 9-26	9-26	667	Socket, trimmers, alignment, parts 8-26	
	Parts list 9-27	9-27		Schematic 10-19	
568 Trouper	Schematic, voltage, chassis, socket, trimmers 10-7	10-7	676	Socket trimmers, chassis, voltage 10-18	
577, Early, Late, AC-DC Fiver	Alignment, notes, parts 10-8	10-8		Alignment, parts, data 10-20	
	Changes 9-29	9-29	704 Jewelbox	Schematic, socket, voltage 8-27	
	Parts list 9-27	9-27	704-A Jewelbox	Trimmers, alignment, parts 8-28	
586, Carrier	Socket, trimmers, layout, alignment 9-30	9-30	704-B Jewelbox	Schematic, socket 1-10	227
	Schematic, voltage, socket 8-19	8-19	705	Voltage 1-11	228
587, 5587	Trimmers, chassis, alignment, parts 8-20	8-20		Schematic, socket, chassis, chassis 1-12	
	Schematic, voltage, socket, parts 10-9	10-9	706	Schematic, socket, chassis, data 1-13	229
588, Super Vanity Fiver 588BC, 588BD, 588BE 596	Socket trimmers, chassis, alignment, notes 10-10	10-10	714	Schematic, socket, voltage, chassis 1-14	229
	Schematic, socket, trimmers, alignment, voltage, chassis 10-11	10-11	715, Coronair	Schematic, socket, parts 6-21	
	Schematic, socket, parts 8-21	8-21		Alignment, chassis 6-22	
	Trimmers, chassis, voltage, alignment 8-22	8-22		Schematic, socket, voltage 6-23	
597, 5597	Schematic, parts 10-13	10-13		Schematic, socket, voltage 8-24	
	Socket, trimmers, chassis, alignment, notes 10-14	10-14		Schematic, socket, voltage 8-29	
598, Vanity, 598BB, 598BD	Schematic, socket, trimmers, alignment, voltage, chassis 10-12	10-12			
601 Bandbox	Schematic, socket, voltage, chassis 1-5	1-5			
602 AC Power Converter for Models 104, 105, 106	Schematic, data 1-6	1-6			

688
689
690
691
692

227
227
228
228
229
229

683
684

222
225

CROSLLEY DAY FAN

RADIOTRON
COMPLETE
PAGE

REVISED
PAGE

CROSLLEY RADIO CORP.—(Cont.)

MODEL

RADIOTRON
COMPLETE
PAGE

REVISED
PAGE

CROSLLEY RADIO CORP.—(Cont.)

MODEL

716	Trimmers, chassis, alignment, parts	8-30	1117 (Late) Super Eleven	Schematic, socket	9-48
718	Schematic, parts	9-46	1117 Early and late	Alignment, changes, data	9-49
	Socket, trimmers, voltage, chassis, data	10-21		Socket, trimmers, layout, voltage, phonograph data, parts	9-50
725, Viking	Alignment, drive data	10-23	1118, 1128	Schematic	10-33
	Schematic, voltage	7-45		Parts list	10-34
	Socket, trimmers, chassis, parts, alignment	7-46		Alignment, tuner, notes, drive data	10-35
726	Schematic, voltage	8-31		Voltage, socket trimmers, chassis, drive data	10-36
	Socket, trimmers, chassis, alignment, parts	8-32	1126	Schematic, socket, notes	8-41
736	Schematic, voltage	8-33		Parts, notes	8-42
	Socket, trimmers, alignment, chassis, parts	8-34		Socket, trimmers, voltage, resonance curves, phono, pick-up, data	8-43
758	Schematic, socket, trimmers, chassis	10-23	1127, Dynatone Eleven	Alignment, notes	8-44
804	Schematic, socket, voltage, chassis	1-15		Schematic, socket	9-51
814	Schematic, socket, parts	6-26		Motor assembly, transformer layout	9-52
815	Data	Changes 7-13		data, phonograph data	9-53
815, Battery 8	Schematic	7-47		Alignment, data, parts	9-54
	Socket, trimmers, chassis, parts, alignment, voltage	7-48	1128	See model 1118	
816	Socket, trimmers, voltage, chassis, alignment	7-49	1137, Prestotune Eleven	Schematic, socket	9-55
	Socket, trimmers, voltage, chassis, alignment	7-50		Socket, trimmers, voltage, layout	9-56
817, Super Flight	Schematic, socket	9-43		Motor assembly, tuner, phonograph data, transformer	
	Voltage, socket, trimmers, layout	9-44		Alignment, tuner, parts	9-57
818	Alignment, phonograph data, parts	9-45	1155	Schematic	7-69
	Schematic	10-25		Socket, trimmers	7-70
	Socket, trimmers, chassis, voltage, phono	10-24	1216	Voltage, parts, alignment	7-71
828	Alignment, notes, parts	10-26		Schematic, socket	8-45
	Schematic, phono	10-27		Parts	8-46
	Chassis, parts	10-28		Socket, trimmers, voltage, resonance curves, pick-up data, notes	8-47
	Socket, trimmers, voltage, alignment, drive data	10-29	1217, 1227	Alignment, notes	8-48
855, Merrimac	Schematic, voltage, socket	7-51		Schematic	10-37
	Socket, trimmers, chassis, parts, alignment	7-52		Tuner, parts list	10-38
865	Schematic, voltage	7-53	1316	Socket, trimmers, chassis, drive data, phono	10-39
	Socket, trimmers, chassis, parts, alignment	7-54		Voltage, alignment, notes	10-40
915, Clipper	Schematic, voltage	7-55		Schematic	7-73
	Socket, trimmers, chassis, phono	7-56	1336	Voltage, trimmers, socket, chassis	7-72
	Alignment, parts	7-57		Alignment, parts	7-74
916	Schematic, parts	7-59		Schematic, socket	8-49
	Socket, trimmers, chassis, voltage, alignment	7-60		Parts	8-50
926	Schematic, socket, voltage	8-35		Socket, trimmers, chassis, voltage, resonance curves	
955	Trimmers, alignment, parts	8-36	1516	phono, pick-up, notes	8-51
	Schematic, parts	7-61		Alignment, notes	8-52
	Socket, trimmers, chassis, voltage, alignment	7-62		Schematic, socket	8-53
1014, Centurion	Schematic, socket, parts	6-26		Parts, notes	8-54
	Chassis, trimmers, voltage, data	6-27		Socket, trimmers, chassis, voltage, resonance curves	
	Alignment, data	6-28	5515	phono, pick-up, notes	8-55
1016	Schematic, socket	7-63		Alignment, notes	8-56
	Alignment, voltage, parts	7-65	5516	See model 515	
	Socket, trimmers, chassis, phono	7-64	5517	See model 516	
1018	Schematic, notes	10-31	5526	See model 517	
	Voltage, alignment, drive data, notes, tuner	10-30	5536	See model 526	
1026	Socket, trimmers, parts	10-32	5548	See model 536	
	Schematic, socket	8-37	5555	See model 548	
	Parts	8-38	5628	See model 555	
	Socket, trimmers, voltage, chassis, resonance curves		5656	See model 628 (Late)	
1055, Constitution	phono, pick-up	8-39	5866	See model 656	
	Alignment, notes	8-40	6116	See model 666	
	Schematic	7-67	6315	See model 516	
	Socket, trimmers, chassis, voltage	7-66		Schematic, parts	7-75
	Alignment, parts	7-68	6925	Socket, chassis, trimmers, voltage, alignment	7-76
	Schematic, socket	9-47		Schematic	7-77
1117 (Early) Super Eleven	Schematic, socket	9-47		Socket, chassis, trimmers, parts, alignment, voltage	7-78

DAY FAN ELECTRIC CO.
See GENERAL MOTORS RADIO CORP.

MODEL	DAYRAD	REVISED PAGE	EARLY COMPLETE PAGE	DETROLA RADIO & TELEVISION CORP.—(Cont.) REVISED PAGE	EARLY COMPLETE PAGE
	See RADIO PRODUCTS CO.				
	DeFOREST RADIO CORP.				
F-5	Schematic	Misc. 1-3	763	Schematic	7-4
CS-5	Schematic	Misc. 1-3	*240	Schematic, socket	7-5
D-10	Schematic	Misc. 1-3	*240	Schematic, socket	6-1
D-17	Schematic	Misc. 1-3	*240	Schematic, socket	7-6
	DELCO APPLIANCE CORP.			Schematic, socket	7-7
RB-B, RA-B	Schematic	3-1	767	Schematic, socket	7-7
	Voltage, color codes	3-2	768	Schematic, socket	7-8
RB-1, RC-1	Schematic	3-4	770	Schematic, socket	7-9
	Voltage, color codes	3-5	771	Schematic, socket	7-1
RB-3, RA-3	Schematic, voltage, color code, notes	3-3	769	Schematic, socket	7-12
	DELCO RADIO CORP.			Schematic, socket, alignment	7-11
3002	See also UNITED MOTORS SERVICE			parts	8-2
	Schematic, socket, chassis wiring, voltage	1-1	*843	Schematic, socket	7-1
3026	Chassis layout, control wiring, data	1-2	*843	Schematic, notes	8-3
	Schematic	4-1		Schematic, socket	8-4
	Socket layout, cable data	4-4		Schematic, socket	8-3
	Terminal data	4-5		Schematic, socket, trimmers, alignment	8-4
	Control drive data	4-6		Schematic, socket, parts	8-5
	Voltage, resistance, plug data	4-7		Schematic, socket	8-7
	Values, changes	4-8		Schematic, socket, alignment, trimmers, parts	8-8
3026 below serial #1400	Chassis layout	4-3		Schematic, socket, trimmers, alignment, parts	8-9
3026 above serial #1400	Chassis layout	4-8		Schematic, socket	8-10
	DE SOTO			Schematic, socket	8-11
	See PHILCO RADIO & TELEVISION CORP.			Schematic, socket, trimmers, alignment, parts	8-12
	DETROLA RADIO & TELEVISION CORP.			Schematic, socket	8-7
E = Tuning Eye (Other letters indicate cabinet styles)				Schematic, socket, parts	8-13
Detrola Jr. Peevee	See model 210, 280			See model 136	8-14
Peevee	See model 197, 218			Schematic, socket, trimmers, alignment, parts	8-15
Roadchief	Schematic	5-8		Schematic, parts	8-16
Roadmaster	Schematic	5-2		Socket, trimmers, alignment	8-17
	I.F. peak	Changes 7-8		Schematic, socket	8-8
Super Peevee	See model 219, 276U, 281			Schematic, socket	8-11
Warwick	Schematic, socket	6-1		Schematic, socket	8-19
4-Tube TRF '92	Schematic	5-1		Schematic, socket	8-11
5-Tube Super. Midget	Schematic, socket	5-3		Schematic, socket	8-19
4C	Schematic, socket	5-1		Schematic, parts	8-18
4-D	Schematic, socket	6-2		Socket, trimmers, alignment	8-17
4-F	Schematic, socket	6-2		Schematic, trimmers, parts	8-21
4-H	Schematic, socket	6-1		Alignment, socket, trimmers, alignment, parts	8-22
4-I	Schematic, socket	6-2		Schematic, socket, trimmers, alignment, parts	8-20
4-V	Schematic, socket	6-2		Schematic, socket, trimmers, alignment, parts	8-23
4-W	Schematic, voltage, socket, data	6-3		Schematic, socket	8-19
4-Y	Schematic, voltage, socket, data	6-2		alignment, parts	8-24
5B	Alignment, parts	6-4		Schematic, socket, trimmers, alignment, parts	8-19
5D	Schematic, voltage, socket, data	6-5		Schematic, socket, trimmers, alignment, parts	8-23
5L	Alignment, parts	6-2		Schematic, socket, trimmers, alignment, parts	8-24
5W	Schematic, socket	6-2		Schematic, socket, trimmers, alignment, parts	8-21
5-WG	Schematic, voltage, parts	7-9		Schematic, socket, trimmers, alignment, parts	8-19
5X	Schematic, voltage, parts	6-9		alignment, parts	9-1
5Y	Alignment, socket	6-1		Schematic, socket	9-2
6A	Schematic, socket	6-1		Schematic, socket, trimmers, alignment, parts	9-3
6M, 6R	Schematic, voltage, alignment	6-10		Tuner data, s.w. alignment	9-4
	Schematic	6-11		Schematic, socket, alignment	9-5
	Installation data, voltage, parts, alignment	6-12		See model 175	9-3
6W	Schematic, voltage, parts	6-13		Schematic, socket, trimmers, alignment, parts	9-6
6X	Alignment, parts	6-9		Tuner data, alignment	9-7
6ZM	Schematic, voltage, parts	6-9		parts	9-6
7A	Schematic, voltage	7-2		Tuner data, alignment	9-7
	Alignment, parts	7-3		See model 175	9-3
7ZM	Schematic	7-3		Schematic, socket, trimmers, alignment, parts	9-8
	Alignment	7-5		Schematic, socket, trimmers, alignment, parts	9-9

207 Converter	Schematic, socket	9-2
208A	Schematic, socket, trimmers	9-9
208AP	Schematic, socket, trimmers	9-9
211	Schematic, socket, trimmers	9-9
212	Schematic, socket, trimmers	9-10
216, Detrola Jr. Peevee	Schematic, socket, trimmers	9-10
218, Peevee	Schematic, socket, trimmers	9-11
219, Super Peevee	Schematic, socket, trimmers	9-11
220	Schematic, socket, trimmers	9-10
221	Schematic, socket, trimmers	9-11
222	Schematic, socket, trimmers	9-12
223	Schematic, socket, trimmers	9-12
225 Series	tuner, alignment, parts	9-13
	Schematic, socket, trimmers	9-14
	alignment, parts	9-14
226	Schematic, socket, trimmers	9-12
227	Schematic, socket, trimmers	9-12
228 Series	Schematic, socket, trimmers	9-12
	alignment, parts	9-14
231 Series	Schematic, socket, trimmers	9-15
	parts	9-15
233	Schematic, socket, trimmers	10-1
	alignment, tuner	10-1
235 Phonograph	Schematic, socket, trimmers	9-12
248, 251	Schematic, socket, trimmers	10-2
249, 254	Schematic, socket, trimmers	10-2
250	Schematic, socket, trimmers	10-2
251, 256	Schematic, socket	10-3
	Alignment	10-1
257	Schematic, socket, trimmers	10-2
258	Schematic	10-5
	Socket, trimmers, alignment, tuner	10-6
259	Schematic	10-5
	Socket, trimmers, alignment, tuner	10-6
260	Schematic socket, trimmers	10-4
262	Schematic, socket, trimmers	10-4
	alignment	10-4
266	Schematic, socket, trimmers	10-4
267	Schematic, socket, trimmers	10-7
	alignment	10-7
268	Schematic, socket, trimmers	10-4
270	Schematic, socket, trimmers	10-4
	alignment	10-8
	alignment	10-8
272	Alignment, tuner	10-6
274	Schematic, socket, trimmers	10-4
	Schematic, socket, trimmers	10-4
276U Super Peevee	alignment	10-9
	alignment	10-9
280, Jr. Peevee	Schematic, socket, trimmers	10-10
282, 288	Schematic, socket, trimmers	10-10
	alignment	10-8
283	Schematic, socket, trimmers	10-10
	alignment	10-10
284, Super Peevee	Schematic, socket, trimmers	10-10
286	Schematic, socket, trimmers	10-10
	alignment	10-8
R300A Converter	Schematic	9-16
503	Schematic, voltage, alignment	5-4
1200	Schematic	5-5
	Voltage, alignment	5-6
1900	Schematic	5-6
2741	Schematic, socket, trimmers	9-16
2742	Schematic, socket, trimmers	10-10
	alignment	10-9
	alignment	10-9

DEWALD RADIO

Intermediate Frequencies Electrocall	I.F. Peaks	Changes 7-4
	See Models 200A, 202A, 202M, 203A Electrocall	
A Phono. Converter	Schematic, data	10-2
Phonoscope	See model 411	
Radio-Phone. Combin.	Schematic, alignment	10-6

Schematic	8-8
Schematic	8-9
Schematic	3-10
Schematic, socket	5-20
Schematic	4-16
Schematic	3-10
Schematic	3-11
Schematic	5-21
Socket layout. See model BAH-9	
Schematic	5-19
Socket layouts	5-22
B-A-C	8-8
B-A-C	3-9
B-A-H	3-10
B-A-M	5-20
B-L-G	4-16
K-A-D	3-10
K-A-F	3-11
K-R-E	5-21
KRE	Socket layout. See model BAH-9
B-A-H-9	Schematic
BAH-9, KRE, 501, 503-4, 553-4-S, 600-A, 601-A, 630, 811-A	Schematic
AC-14-45	Schematic
AC-24-45	Schematic
40	Schematic
41	Schematic
42, 42-R	Schematic
50	Schematic
51	Schematic
52	Schematic
53	Schematic
54	Schematic
55	Schematic
55-R	Schematic
55-X	Schematic
56	Schematic
56	Schematic
58-R	Schematic
58-L, 59	Schematic
60	Schematic
60 Ex	Schematic
61	Schematic
	Socket layout, alignment
	Notes
	Vibrator data
	Parts list, alignment
62 Batt.	Schematic
80	Schematic
81	Schematic
81-R	Schematic
100	Schematic
AC-145	Schematic
AC-171-2	Schematic
DC-173-4	Schematic
200, 202M Electrocall	Connections, data
200A, 202A, 202M, 203A	Schematic, installation, notes
Electrocall	Schematic
AC-245	Schematic
DC-273	Schematic
400, 405	Schematic, notes
402	Schematic, socket
403-4, Type 1	Schematic, socket
405	Schematic, notes, parts
406, 406LW	See model 400
408R, 412	Schematic, parts
411, Phonoscope	Schematic
430	Schematic, data
435-R, 440	Schematic, data
AC-447-M	Schematic, socket
500-A	Schematic, socket
501	Schematic
501, 503-4	Schematic
503-4	Socket layout. See model BAH-9
505	Schematic
505-F	Schematic
505-R	Schematic, socket, alignment
506	Schematic, socket, alignment
506-R	Schematic, notes, parts
510	Schematic, socket, parts
	alignment
515	Schematic
517	Schematic, socket, trimmers
	alignment, notes, parts
518	Schematic, alignment
520	Schematic, alignment
522	Schematic, alignment
AC-524	Schematic, notes, alignment

MODEL	DEWALD RADIO—(Cont.)	REVISED PAGE	EARLY COMPLETE PAGE	RADIOTRON	MODEL	DEWALD RADIO—(Cont.)	REVISED PAGE	EARLY COMPLETE PAGE	RADIOTRON
527	Schematic, socket, chassis, in-stallation, notes	8-5			811-A	Schematic	5-18		
528, 528LW	Schematic	8-6			1002, 1003	Socket layout. See model BAH-9			
529, 529LW	Schematic, alignment	8-7			1004	Schematic, alignment, parts	9-6		
530, 530LW, 531, 531LW, 534, 534LW	Schematic, alignment	9-2			1100, Early	Data	Changes 10-2		
531, Phono.	Schematic	10-3			1100, Late	Schematic, data	7-11		
532, 532LW	Schematic	10-3			1102-3	Schematic, socket, trimmers, alignment	7-12		
DC-532-3	Schematic	10-3			1104, 1105	Schematic, socket, trimmers	10-6		
533, 533LW	Schematic, alignment	2-5	240-5	777	1106	Alignment, parts	9-1		
AC-535-6	Schematic	9-2	240-6	778	1200	Data	Changes 10-1		
537, 537LW, 538, 538L, 538LW, 539, 539LW	Schematic, notes	10-4			1201	Schematic, alignment	8-6		
AC-547	Schematic	2-6	240-6	779			9-3		
AC-547-A	Schematic	2-7	240-7		91134, 91134A	DICTOGRAPH PRODUCTS CO., INC.			
553-48	Socket layout. See model BAH-9	5-11			91168, 91175	Schematic, parts	8-1		
555	Schematic, socket	5-12				Socket, trimmers, alignment	8-2		
570	Schematic, socket	5-13				Schematic, parts	8-3		
600	Schematic	5-14				Socket, trimmers, alignment	8-2		
600-A, 601-A	Socket layout. See model BAH-9	5-14							
605	Schematic	6-9				DODGE			
	Alignment, socket, trimmers, parts	6-10				See PHILCO RADIO & TELEVISION CORP.			
606, 617 (Early and Late)	Schematic, parts, notes	7-3				ALLEN B. DUMONT LABS., INC.			
607	Socket trimmers, alignment	7-4				180, 781, 782, 783	Video and A-F Receivers, schematic		
609	Schematic, socket, trimmers	6-8				<i>Televisions, Early</i>			
609, Late	Schematic, data, parts	6-11					Separator and Sweep, voltage divider, schematics, notes	10-3	
610, 610-LW	Schematic, socket, alignment, parts	7-11					S.P.U. schematic, voltage, notes	10-4	
611, 611-LW	Schematic, socket, alignment, parts	6-12					Circuit data, controls, trouble chart	10-5	
612, 612-LW, 615, 615-LW	Schematic, socket, alignment, parts	6-13					Class views	10-1	
616	Schematic, alignment	7-6					Service data, parts	10-2	
617 (Early and Late)	See model 606	7-6					Antenna data	10-7	
618, 618LW	Schematic, alignment	7-7				EARL RADIO CORP.			
619	Schematic, alignment	7-6			21, 22 AC	Schematic, socket, voltage	1-2	796	
620, 620LW	Schematic, alignment	7-7				Data	2-1	797	
621, 621LW	Schematic, alignment, notes	7-8			21-DC, 22-DC	Schematic, socket	1-1	795	
623, 623LW, 703, 703LW	Schematic, alignment	9-7			24-DC, 31-DC, 32-DC	Schematic, socket	1-3	800	
630	Schematic	9-15			31, 32 AC	Schematic, socket, voltage	1-4	798	
DC-632	Socket layout. See model BAH-9	5-15				Data	2-2	799	
633, 633LW, 633S	Schematic, socket	2-8	240-8	780	33-S, AC	Schematic	1-3	800	
635, 635LW	Schematic, alignment	8-8			41, 42 AC	Schematic, socket, voltage	1-5	801	
636, 636LW, 636S, 636LW-S	Schematic, alignment	9-3			121	Data	2-3	802	
637, 637LW, 637S, 637LW-S	Schematic, alignment	9-3				Schematic	1-1	795	
DC-637-8	Schematic	2-7							
640	Schematic, socket	5-16				ECHOPHONE RADIO MFG. CO.			
645, 645LW, 652	Schematic, alignment	9-4	240-7	779	F	Voltage	2-1	240-L	
648, 648LW, 650, 650LW	Schematic, socket, tuner, alignment	9-5			Dynatron	Schematic, socket, data	2-2	240-K	
649, 649 LW, 651, 651LW	Schematic, socket, tuner, alignment	9-9			Echoette	See model 40			
652, 655LW, 656, 656LW	See model 645	10-5			8-3	Schematic, socket	1-1	240-A	
700, 700LW	Schematic, alignment	8-9				Voltage, data	1-2	240-B	
700-A, 700A-LW	Schematic, alignment	8-9				Chassis views	1-3	240-C	
701, 701LW	Schematic, tuner, alignment	9-7				Schematic	1-1	240-A	
702	Schematic, socket, trimmers, alignment, parts	8-10				Schematic, socket, voltage	3-12	240-E	
703, 703LW	See model 629	2-9				Voltage, data	1-5	240-F	
AC-724	Schematic	2-9				Chassis views	1-6	240-D	
DC-724-1	Chassis views	2-10				Data	3-1	240-G	
DC-727	Schematic	3-1	240-9	781		Schematic, socket, data	3-2	809	
AC-746-7M	Schematic	3-2	240-10	782		Schematic, socket, data	1-8	810	
802, 803	Schematic layout, oscillator coil	3-4				Voltage, chassis layout	1-9	811	
804, 805	Schematic, voltage	5-17				Schematic, socket, voltage	3-4	818	
	Socket, trimmers, alignment, data	6-15				Circuit notes	3-6	820	
	Schematic, parts, voltage	6-16				Schematic	3-7	821	
	Alignment, socket, trimmers, data	7-9				Voltage, circuit notes	3-8	822	
	Schematic, alignment	7-10				Schematic	3-3	817	
		9-8				Data—See model 5			
						See model 10			
						Voltage	3-4	818	
						Schematic	3-5	819	
						Circuit notes	3-6		
						See model 10			
						Schematic, socket	3-9	823	

ECHOPHONE ELECTROACOUSTICAL

**RADIOTRON
COMPLETE
PAGE**

**REVISED
PAGE**

ELECTRIC AUTOLITE CO.

MODEL

062A, 8622A Schematic4-1
072A, 3722A Schematic4-2
Assembly wiring4-3
Installation notes4-4

ELECTRIC & AUTOMOTIVE PRODUCTS CO.

4M Schematic6-1
IL-5 Schematic6-3
6-AW, 35-AW Schematic6-4
SW-6 Schematic6-2
25-AW Schematic6-1
30-AW Schematic6-3
IL-55 Schematic6-3
303 ILW Schematic6-4
303-SW Schematic6-5
405 Schematic6-6
405-LW Schematic6-6

ELECTRICAL RESEARCH LABORATORIES, INC.

(Also all models listed under SENTINEL RADIO CORP.)

SV Converter Schematic5-10
R-1 Schematic, socket1-1
R-2, RF Unit Schematic, socket1-2
A-2, A.F. Unit Schematic, socket1-2
A-13 Amplifier Schematic2-1
30, 31, 32, AR-3 Schematic, socket, voltage2-5
35, 37, 38, 39 (230) Schematic, socket1-1
S-61 Schematic, socket3-2
61, 62, 63 (250) Schematic, socket2-2
74, 76, (210) Schematic, socket2-6
75, 77 (231) Schematic, socket1-5
81, 82 (245) Schematic, socket3-2
81-P, 82-P, 30(248) See model, 74
210 Chassis Schematic, socket1-3
224 AC Chassis, voltage1-4
224-B Schematic, socket2-3
225 Schematic2-4
230 Chassis See model 35
231 Chassis See model 75
245 Chassis See model 81-P
248 Chassis See model 61
250 Chassis Schematic2-7
271-A Schematic, socket1-6
335 Schematic2-8
336 Schematic5-1
603 Voltage, alignment, parts list5-2
5700, 5721 Schematic, voltage, parts list5-3
6100 Alignment data5-4
Schematics, power pack (2 types)5-5
Voltage, alignment, parts list5-6
DataChanges 7-7
6200 Schematic5-7
6300, 6315, 6317, 6323 Alignment, voltage5-8
Parts list, notes5-9
7700, 7732, 7741 Schematic, voltage5-11
Alignment, parts list5-12
ChangesChanges 7-7
DataChanges 7-7

ELECTRIC SPECIALTIES EXPORT CO.

38 Schematic5-1
48 Schematic5-1
46 Schematic5-3
66 Schematic5-4
R-502 Schematic5-4

ELECTROACOUSTICAL PRODUCTS

A1832 Amplifier Schematic, voltage8-1
A2023 Amplifier Chassis layout8-2
A2232 Amplifier Chassis layout8-2
A3041 Amplifier Schematic, voltage8-5
Chassis layout8-6

**RADIOTRON
COMPLETE
PAGE**

**REVISED
PAGE**

ECHOPHONE RADIO MFG. CO.—(Cont.)

MODEL

Voltage notes3-9
Circuit notes3-11
Schematic3-10
See model 12
Schematic, socket, data2-3
Voltage2-1
Schematic, socket, data2-3
See model 4
Schematic, socket3-13
Voltage, circuit3-14
Schematic, socket, data2-4
Voltage2-6
Schematic, voltage, socket3-16
Circuit notes3-15
Schematic, socket, data2-5
Voltage2-5
Schematic, socket, voltage2-8
Schematic, socket, voltage2-7
Voltage, notes2-8
Schematic, voltage3-17
Schematic, data3-1
Schematic, alignment, Paris list5-2
Schematic, alignment5-3
Schematic, alignment5-3
Schematic, data5-1
Schematic, socket, trimmers6-1
Alignment6-2
Schematic, alignment, parts5-4

THOMAS A. EDISON, INC.

Cable drive data4-1
Cable drive data, Part 2*251
Cable drive data, Part 3*250
Cable drive data, Part 4*241
Schematic, socket*242
Schematic, socket1-11
Schematic, socket, voltage1-1
Chassis wiring1-2
Chassis wiring1-3
Schematic, socket, voltage1-4
Schematic, chassis wiring1-5
SchematicMisc. 6-31
Chassis wiring1-6
Schematic, socket, voltage1-7
Chassis views2-1
Parts list1-8
Chassis wiring1-9
Chassis views2-2
Schematic3-1
Schematic, socket, voltage3-10
Resistance data3-2
Schematic, socket1-12
Schematic1-13
Schematic, socket1-12
Schematic, socket1-12
Schematic5-1
Schematic5-1
Schematic5-2
Schematic5-3
Schematic5-4
Schematic5-5
Schematic5-6

EDISON-BELL CO., INC.

36 Schematic5-1
53 Schematic5-1
53-LW Schematic5-2
55 AW Schematic5-3
63 LW Schematic5-4
66 AW Schematic5-5

ELECTRAD, INC.

Loftin-White '45 Schematic1-1
245 Amplifier Misc. 8-6
A-250 Schematic2-1
C-250 Schematic2-1
D-250 Schematic2-2
E-250 Schematic6-7
D-450 Misc. 6-7
E-450 Amplifier Misc. 7-5

EMERSON RADIO & PHONOGRAPH CORP.—(Cont.)

MODEL EARLY COMPLETE PAGE REVISED PAGE

RADIOTRON EARLY COMPLETE PAGE

ELECTRONIC LABORATORIES, INC. REVISED PAGE

"Electronic B" Schematic, notes 4-1
10-82-Volt Converter Schematic Misc. 6-21
831 6-volt Eliminator Schematic 4-2
837 32-volt Eliminator Schematic 4-2
838, 839 D-O Converters Schematic 4-3

ELKON

See P. R. MALLORY & CO.

EL-BEY RADIO MFG. CO.

4-Tube Midset Schematic Misc. 5-14
7-Tube A-W Superhet. Schematic 6-2
10, 15 Schematic 6-1
20 Schematic 6-1
644 Schematic 6-3
845 Schematic 6-4

EMERSON RADIO & PHONOGRAPH CORP.

Mickey Mouse See model 409
A Chassis See model A130
AA Chassis See model A131
AB Chassis See model AB178
with phono- See model AB184
A graph See model AC130
AC Chassis See model AC202
with phono- See model AD108
A graph See model AE163
AE Chassis See model AF171
AF Chassis See model AG151
AG Chassis See model AH162 or AH166
AH Chassis See model AJ130
AJ Chassis See model AL130
AL Chassis See model ALI64
AL Chassis (Combination) See model ALI64 Late
ALL Chassis Late See model ALLW130
ALLW Chassis See model AM131
AM Chassis See model AP165 or AP171
AP Chassis See model AR165 or AR171
AR Chassis See model AS179
AS Chassis See model AT170
AT Chassis See model AV190
AV Chassis See model AW171
AW Chassis See model AX214C
AX Chassis See model AX240
See model AX211
See model AX211
See model AY194
AY Chassis See model AZ196
AZ Chassis See model B131
B Chassis See model BA199
BA Chassis See model BB208
BB Chassis See model BD197
BD Chassis See model BE198
BE Chassis See model BF131 Late
BF Chassis See model BG138
BG Chassis See model BJ200
BJ Chassis See model BJ218
See model BL200
BL Chassis See model BL218
See model BM206
BM Chassis See model EM216
EM Chassis with phono- See model BN206
BN Chassis with phono- See model BN216
B graph See model BQ223
BQ Chassis See model BR225
BR Chassis See model BR226
See model BR227
BS Chassis See model BT245
BT Chassis See model BU239
BU Chassis See model BV231
BV Chassis See model BX208
BX Chassis See model BY233
BY Chassis See model C134
C Chassis
CA Chassis See model CA208
CB Chassis See model CB243
CD Chassis See model CD206
CE Chassis See model CE259
CF Chassis See model CF255
CG Chassis See model CJ211
CH Chassis See model CH213
CI Chassis See model CI246
CL Chassis See model CLW334
CM Chassis See model CM260
CN Chassis See model CR261
CO Chassis Schematic, socket, voltage, 5-4
See model CT275
See model DI34
DI Chassis See model DI34LW
DLW Chassis See model E128
E Chassis Schematic, socket, voltage, 1-1
Parts list 1-1
See model F117
F Chassis See model G127
G Chassis See model H130
H Chassis See model J106
J Chassis Schematic, voltage, socket, 3-3
JS Chassis Schematic, socket, voltage, 3-3
KS, E See model LI43 or LI17
L Chassis See model LI17LW
LLW Chassis See model M134
M Chassis See model P117
P Chassis See model Q157
Q Chassis See model R152 Late
R Chassis, Early See model S147
S Chassis, Late Schematic, voltage, socket, 3-2
TS Schematic, voltage, socket, 3-2
U Chassis Schematic, voltage, socket, 3-2
V Chassis See model V154
See model V155
See model XI46
See model XI75
X Chassis, Late, with phonograph
Z Chassis See model Z117
See model 409
See model 23
See model 20A
See model 20A Schematic, socket, voltage, 3-1
Schematic, voltage, socket, 3-2
See model 109
See model 118
See model 19
See model 420
See model 420 Schematic 6-1
Alignment, voltage 6-2
See model 36
See model 117
See model 99
See model 107AC
See model 103
See model 116
See model 30
See model 28 Schematic 4-5
See model 117LW
See model 108, socket, 3-1
See model 108LW
See model 82
Schematic, voltage 6-1
Alignment 6-2
See model 45
See model 34C
See model 290
See model 89
See model 89
See model 107
See model 119
See model 106
See model 107LW
See model U6
See model U6
6BD Chassis
C6, D6 Chassis
F6D Chassis
T6 Chassis
U6, U6D Chassis
U6A Chassis Revised
U6B Chassis
U6C Chassis
U6D Chassis
U6F Chassis

MODEL	See model 71	888
A-11 Chassis	See model 34F7	
F7 Chassis	Schematic, socket, voltage	3-5
M-AC-7	See model 102LW	
A8 Chassis	Schematic, socket, voltage	3-7
B8 Chassis	See model 105	
B-AC-10	Schematic, voltage, parts	6-3
	Schematic, voltage	3-9
	Schematic, voltage, parts list	5-1
	Schematic, voltage	4-1
	Socket layout	Changes 7-3
	Schematic, voltage, parts list	5-2
	Schematic, socket	3-6
	Schematic, voltage, socket	4-5
	Schematic, voltage, socket	4-2
	Schematic, voltage, socket layout	4-5
	Schematic, voltage, parts	6-4
	Schematic, voltage	6-5
	Alignment, parts	6-6
	Schematic	7-1
	Alignment, voltage, notes, parts list	7-2
	Schematic	4-3
	Socket layout	Changes 7-3
	Voltage	Changes 8-1
	Schematic, voltage	6-7
	Schematic, voltage	6-10
	Alignment, voltage	5-3
	Schematic, voltage	5-4
	Alignment, parts list	5-5
	Schematic	5-6
	Alignment, voltage	4-6
	Parts list	Changes 7-3
	Socket layout	Changes 7-3
	Schematic	5-7
	Alignment, voltage	5-8
	See model 88	
	See model L755	
	See model M755	
	See model S755	
	Schematic, socket, voltage	3-4
	See model 39	
	Schematic, condenser data	1-2
	Voltage, data	3-8
	See model 101U	
	Schematic, voltage, socket	5-9
	Schematic, layout, voltage	4-4
	See model 84G	
	See model 34F7	
	Schematic	7-3
	Alignment, voltage, notes, parts list	7-4
	Schematic	7-5
	Alignment, voltage, changes, parts list	7-6
	Schematic	7-7
	Alignment, voltage, notes, parts list	7-8
	Schematic, voltage	6-8
	Schematic	6-11
	Alignment, voltage, parts	6-13
	Schematic	6-13
	Alignment, parts, voltage	6-14
	Schematic, voltage, alignment, data	7-9
	Schematic, voltage	6-15
	Alignment, parts, changes	6-16
	Schematic, voltage, notes	7-10
	Schematic, alignment, voltage, changes, parts	7-11
	Schematic	7-13
	Alignment, parts, voltage	6-14
	Schematic, voltage, alignment, data	7-9
	Schematic, voltage	6-15
	Alignment, parts, changes	6-16
	Schematic, voltage, notes	7-10
	Schematic, alignment, voltage, changes, parts	7-11
	Schematic	7-13
	Alignment, parts, voltage	6-14
	Schematic, voltage, alignment, data	7-9
	Schematic, voltage	6-15
	Alignment, parts, changes	6-16
	Schematic, voltage, notes	7-10
	Schematic, alignment, voltage, changes, parts	7-11
	Schematic	7-13

MODEL	Alignment, voltage, notes, parts	7-14
107LW, 111LW, Chassis U6C	Schematic, socket, trimmers	6-17
108, 110, Chassis U5A	Alignment, voltage, parts	6-18
	Changes	7-10
	Schematic, voltage	8-1
AD108, AD110, AD125 Chassis AD	Alignment, notes, parts	8-2
	Schematic	7-15
108LW, 110LW, Chassis U5B	Alignment, voltage, notes, parts	7-16
	Schematic	7-15
109, Chassis U4A	Alignment, voltage, notes, parts	7-16
	Schematic	7-15
110	See model 108	
AD110	See AD 108	
110LW	See model 108LW	
111	See model 107	
111LW	See model 107LW	
112	See model 102	
113	See model 105	
114	See model 107AC	
116, 121, Chassis G5	Schematic, voltage, parts	7-17
K116, K121, K123, Chassis K	Alignment, changes	7-18
	Schematic, voltage	7-19
117, Chassis G5	Alignment, parts	7-20
	Schematic	7-21
	Alignment, voltage, changes, notes, parts	7-22
	Changes	7-22
	Schematic	7-23
117LW, L117LW, L122LW, L133LW, L135LW, L141LW, Chassis K5 & L1W	Notes, voltage, parts, alignment	7-24
F117, F122, F133, F135, F141, Chassis F	Schematic	7-25
	Alignment, voltage, notes, parts, changes	7-26
	Changes	9-1
	Schematic	7-27
L117, L122, L133, L135, L141, L150, Chassis L	Alignment, voltage, notes, parts	7-28
	Changes	8-1
	Schematic, connections	8-3
	Voltage, alignment, notes, parts	8-4
	Schematic, voltage	8-5
P117, F135, Chassis P	Alignment, notes, changes, parts	8-6
Z117, Z122, Z133, Z135, Z141, Z150, Z169, Z160 Chassis Z	Schematic, voltage, alignment, parts	7-12
	Schematic, voltage, alignment	7-29
	See model L16	
	See model K116	
	See model F117	
	See model L117	
	See model L17LW	
	See model Z117	
	See model AD108	
	See model 118	
	Schematic, voltage	8-7
	Alignment, notes, changes, parts	8-8
	Schematic, voltage, alignment	7-30
	Schematic	7-31
	Voltage, alignment, notes, parts	7-32
	Schematic, voltage, changes	8-9
	Alignment, notes, parts	8-10
	Changes	9-1
	Schematic, voltage	8-11
	Alignment, notes	8-12

EMERSON RADIO & PHONOGRAPH CORP.—(Cont.)
REVISÉD PAGE
EARLY COMPLETE PAGE
RADIOTRON

MODEL	EARLY COMPLETE PAGE	REVISÉD PAGE	RADIOTRON
D138, D139, D140			
D138LW, D139LW, D140LW	See model D134		
M138, M139, M140	See model M134		
CG139LW	See model CG134LW		
CG140	See model BG138		
CG140LW	See model C134LW		
F141	See model F117		
L141L, L141W	See model L117		
Z141	See model Z117		
BG142	See model BG138		
C142	See model C134		
CG142LW	See model CG134LW		
CLW142	See model CLW134		
D142	See model D134		
D142LW	See model D134LW		
M142	See model M134		
L143, Chassis L, Early, Late	Schematic	8-23	
Alignment, voltage, parts, Notes, changes		8-24	
BG146	See model BG138		
D146	See model D134		
D146LW	See model D134LW		
M146	See model M134		
X146, X178, X183, Chassis X Early	Schematic, voltage	8-25	
Alignment, notes, parts		8-26	
Schematic, voltage, changes		9-25	
Alignment, parts		9-26	
Schematic, voltage, changes		8-27	
Alignment, notes, parts		8-28	
See AI180			
See model AC130			
See model AJ130			
See model AL149			
See model ALLW130			
See model L117			
See model Z117			
Schematic, trimmers, phono, data		8-29	
Alignment, notes, parts		8-30	
See model S147			
Schematic, voltage		8-31	
Alignment, notes, changes, parts		8-32	
Schematics		9-5	
Changes, alignment, voltage, parts		9-6	
See AM131 Late			
Schematic, voltage		8-33	
Alignment, notes, parts		8-34	
Changes		9-2	
Schematic, voltage, notes		9-7	
Alignment, changes, notes, parts		9-8	
Schematic, voltage		9-9	
Alignment, notes, parts, changes		9-10	
See model R152			
Schematic, changes, voltage, alignment, parts		9-24	
See model Z117			
Schematic, changes, parts		8-35	
Voltage, alignment, notes		8-36	
Changes		9-1	
Schematic, parts, changes		8-37	
Voltage, alignment, notes		8-38	
Schematic, voltage		8-39	
Alignment, notes		8-40	
Schematic		9-11	
Alignment, voltage, changes, notes, parts		9-12	

EMERSON RADIO & PHONOGRAPH CORP.—(Cont.)
REVISÉD PAGE
EARLY COMPLETE PAGE
RADIOTRON

MODEL	EARLY COMPLETE PAGE	REVISÉD PAGE	RADIOTRON
AI130, AI132, AI149, AI168, Chassis AL		8-13	
Schematic, voltage			
Alignment, parts, notes		8-14	
ALLW180, ALLW132, ALLW149, ALLW168, Chassis ALLW		8-13	
Schematic, voltage			
Alignment, parts, notes		8-14	
Schematic, voltage, trimmers		7-39	
Alignment and Data—Changes		9-1	
Schematic, voltage		8-15	
AA131, Chassis AA Early, Late		8-16	
Alignment, notes, parts		8-17	
Schematic, voltage, changes		8-17	
AM131, AM169, AM187 Chassis AM		8-18	
Alignment, notes, parts		9-1	
Schematic, voltage		9-1	
AM131, AM169, AM187 Late, AM153 Chassis AM BF191, Chassis BF			
Changes, alignment, notes, parts		9-2	
Schematic		7-33	
B131, Chassis B			
Schematic, notes, voltage, parts, changes		7-34	
See model AI130			
See model ALLW130			
See model F117			
See model L117			
See model Z117			
See model Z171W			
See model Z117			
Schematic, socket		7-36	
Alignment, voltage, notes, parts		7-35	
Changes		8-1	
Changes 8-1		9-2	
Alignment and Changes		9-2	
Similar to Chassis C		8-1	
Chassis CLW			
D134, D136, D138, D139, D140, D142, D146, Chassis D		7-37	
Schematic			
Alignment, voltage, socket, trimmers, notes		7-38	
Changes		8-19	
Schematic, trimmers		8-19	
Alignment, voltage, notes, changes, parts		8-20	
Schematic, trimmers, phono, notes		8-21	
Alignment, voltage, changes, notes, parts		8-22	
See model F117			
See model L117			
See model I17LW			
See model P117			
See model Z133			
See model C134			
See model CG134LW			
See model CLW134			
See model D134			
See model D134LW			
See model M134			
See model AJ130			
See model H130			
Schematic, voltage		9-3	
Changes, alignment, parts		9-4	
See model C134			
See model CG134LW			
See model CLW134			
See model CLW134LW			
See model CG142, BG142, BG146, BG178, BG182, BG183, Chassis BG			
Alignment, parts		9-4	
See model C134			
See model CG134LW			
See model CLW139, CLW140			

AP165, AP166, AP177, Chassis AP	Schematic	9-13
Alignment, changes, voltage, parts	9-14	
Schematics, changes, parts	9-15	
Schematic, voltage, changes, parts	9-18	
Schematic, voltage	9-16	
Parts, changes, alignment	9-17	
Schematics, voltage	9-3	
Changes, alignment, parts	9-4	
See model R152 Late		
See model AC130		
See model AL130		
See model ALLW130		
See model AM131		
Schematic, changes, voltage	8-41	
Automatic dial details	8-42	
Automatic dial notes	8-43	
Alignment, notes, parts	8-44	
Schematic, voltage, changes, parts	9-18	
Alignment	9-17	
Schematic, voltage	8-45	
Alignment, notes	8-46	
Changes	9-2	
Data	9-2	
See model AH166		
Schematic, voltage	8-47	
Alignment, notes, parts	8-43	
See model AT170		
Data	Changes 9-2	
See model AR165		
Schematic	9-19	
Alignment, voltage, parts, notes	9-20	
See model AT170		
See model AF171		
See model AH166		
See model AP171		
See model AR171		
See model AW171		
See model AH166		
See model AH170		
See model AH166		
Schematic, voltage, notes	9-21	
Changes, parts	9-22	
Alignment	9-23	
See model AH166		
See model AW171		
See model AP165		
See model AR165		
See model X-146 Late		
See model BG138		
See model X146		
Schematic	8-49	
Alignment, voltage, notes	8-50	
Changes	9-1	
See model AU166		
See model AW171		
See model AB173		
See model BG138		
See model Y146		
See model X175		
See model X175 Late		
See model R152 Late		
Schematic	9-27	
Alignment, voltage, notes, parts	9-28	
See model AM131 late		
Schematic, voltage, tuner	9-29	
Alignment, notes, parts	9-30	
Tuner data	9-32	
Schematic	9-33	
Alignment, voltage, changes, parts	9-34	
Schematic, voltage	9-35	
Alignment, changes, notes, parts	9-36	
Tuner data	9-32	
Schematic	9-33	
Tuner data	9-32	
Alignment, voltage, changes, notes	9-31	
Schematic	9-37	
Alignment, voltage, changes, parts	9-38	
Tuner data	9-39	
Schematic, voltage, alignment, parts	9-31	
Schematic, voltage, notes	9-41	
Alignment, parts	9-42	
Schematic, voltage, notes	9-43	
Alignment, parts	9-44	
See model BA199		
Schematic, voltage, coils	9-45	
Alignment, changes, notes, parts	9-46	
See model AL164		
Schematic, voltage, parts, alignment	9-47	
Schematic, voltage, alignment, parts	9-47	
Schematic, voltage, alignment, parts	10-1	
Schematic, alignment, tuner, voltage, parts	9-40	
Schematic, voltage, alignment 10-2 notes	10-3	
Tuner data, parts	10-4	
See model BJ200		
See model BL200		
Schematics, voltage	9-51	
Alignment, notes, parts	9-52	
Schematic, voltage, alignment, notes	10-5	
Schematic, voltage, alignment 10-6		
See model BJ200		
See model BL200		
See model BM206		
See model AU166		
See model AW171		
See model AB173		
See model BG138		
See model Y146		
See model X175		
See model X175 Late		
See model R152 Late		
Schematic	9-27	
Alignment, voltage, notes, parts	9-28	
See model AM131 late		
Schematic, voltage, tuner	9-29	
Alignment, notes, parts	9-30	
Tuner data	9-32	
Schematic	9-33	
Alignment, voltage, changes, parts	9-34	
Schematic, voltage	9-35	
Alignment, changes, notes, parts	9-36	
Tuner data	9-32	
Schematic	9-33	
Tuner data	9-32	
Alignment, voltage, changes, notes	9-31	
Schematic	9-37	
Alignment, voltage, changes, parts	9-38	
Tuner data	9-39	
Schematic, voltage, alignment, parts	9-31	
Schematic, voltage, notes	9-41	
Alignment, parts	9-42	
Schematic, voltage, notes	9-43	
Alignment, parts	9-44	
See model BA199		
Schematic, voltage, coils	9-45	
Alignment, changes, notes, parts	9-46	
See model AL164		
Schematic, voltage, parts, alignment	9-47	
Schematic, voltage, alignment, parts	9-47	
Schematic, voltage, alignment, parts	10-1	
Schematic, alignment, tuner, voltage, parts	9-40	
Schematic, voltage, alignment 10-2 notes	10-3	
Tuner data, parts	10-4	
See model BJ200		
See model BL200		
Schematics, voltage	9-51	
Alignment, notes, parts	9-52	
Schematic, voltage, alignment, notes	10-5	
Schematic, voltage, alignment 10-6		
See model BJ200		
See model BL200		
See model BM206		

EMERSON RADIO & PHONOGRAPH CORP.—(Cont.)

MODEL	REVISED PAGE
BR215	See model BN206
BR216	See model CD206
BM242, Chassis BM with phonograph	Schematic9-18
BN216, Chassis BN with phonograph	Voltage, alignment, parts9-17
AX217, AX219	Schematic, voltage, alignment, parts9-50
BQ225, BQ226, Chassis BQ; BU229, BU230, Chassis BU; BW231, Chassis BW	Schematic, voltage, parts9-53
BJ218, BJ220, Chassis BJ	Alignment, tuner, notes9-54
BL218, BL220, Chassis BL	Schematic, voltage, changes, alignment10-7
AX221 AC, AX221 AC-DC, AX222 AC-DC, AX232 AC, AX232 AC-DC, Chassis AX	Schematic, voltage, changes, alignment10-8
BQ223, Chassis BQ	Schematics, voltage, changes10-9
BR224, BR224A, Chassis BR	Alignment, notes, parts10-10
BR224A	Schematic, voltage, changes, alignment10-11
	Tuner data10-12
	Schematic, notes10-13
	Alignment, voltage10-12
	Record changer data10-14
	Record changer adjustments10-15
	Record changer, diagrams, notes10-16
BR226, Chassis BR	Schematic, voltage9-55
BS227, Chassis BS	Alignment, tuner, parts9-56
BQ228	See model BQ225
BU229	See model BQ225
BW231	See model BQ225
BY233, Chassis BY	Schematic9-48
	Alignment, voltage, notes, parts9-49
AX235, AX237, AX238, Chassis AX	See model AX211
AXLW235, AXLW237, AXLW238	See model AXLW211
AX240, Chassis AX	See model CJ211
BM242	Schematic, voltage, alignment, changes10-17
CB243, Chassis CB	See model BM216
	Schematic, voltage, notes10-19
CH243, CH246, CH256, Chassis CH	Alignment, socket, trimmers, parts10-20
BT245, Chassis BT	Schematic, voltage, alignment10-18
CL246, CL253, CL256, Chassis CL	Schematic, voltage, alignment, parts10-21
BM-247	Schematic, voltage, alignment, data10-22
250 AW	See model BM-206
250 LW	See model 80 AW
250 LW	See model 80 LW
CF255, Chassis CF	Schematic, voltage, alignment, parts10-23
CJ257	See model CJ211
BM258	See model BM206
CE259, CE260, Chassis CE	Schematic, voltage, batt. wiring, changes10-25
CM260, CM266, CM267, Early, Late, Chassis CM Above & below Serial 2690200	Socket, trimmers, alignment, parts10-26
CR261, CR262, CR274, Chassis CR	Schematics, voltage, alignment, changes, parts list10-24
FT275, Chassis FT	Schematic, voltage, notes, alignment10-27
650, Chassis F6D	Schematic, voltage, alignment6-19
300	Alignment, parts, voltage, data 6-20
321 AW	See model 30
321 LW	See model 30 AW
	See model 90 LW

EMERSON RADIO & PHONOGRAPH CORP.—(Cont.)

MODEL	REVISED PAGE
320 AW	See model 30 AW
330 AW	See model 30 AW
350 LW	See model 30 LW
375-LW	See model 40
	Schematic, voltage4-7
409, 410, 411 (A-4) (Mickey Mouse)	Socket layoutChanges 7-3
409, 410, 411, Chassis U40	Socket layoutChanges 7-3
	Schematic, voltage, alignment, parts7-40
415, 416	Schematic, layout, voltage4-9
415, 416 (Revised)	Schematic, voltage5-10
420 (V-4)	Schematic, voltage, socket layout, notes4-10
420	Parts list4-20
667	Schematic5-11
	Voltage, alignment, installation data5-12
678	Schematic Type 14-11
	Schematic Type 24-12
	Installation notes4-13
	Installation notes, part 24-14
	Voltage, socket, adjustments4-15
	Notes, changes4-16
L-755, 50-L	Schematic, voltage, socket layout, notes4-17
	Parts list4-20
M-755, 50-M	Schematic, voltage, parts list4-18
S-755, S-50	Schematic, voltage, socket layout, notes4-19
770	Parts list4-20
965	See model 71
	Schematic, socket5-13
	Voltage, alignment5-14

EMPIRE ELECTRICAL PRODUCTS

10	Schematic4-1
20	Schematic4-3
30	Schematic4-3
40	Schematic4-4
40 SW	Schematic5-1
51	Schematic5-2
60	Schematic4-5
71	Schematic5-3
74	Schematic4-6
400 AC	Schematic, socket3-2
400 DC	Schematic, socket3-1
450-A	Schematic5-4
460-B	Schematic5-5
470-C	Schematic5-6
480-C	Schematic5-7
500 AC	Schematic, socket3-3
500 DC	Schematic, socket3-1
550 AC	Schematic, socket3-4
575	Schematic4-7
600 AC	Schematic, socket3-5
700 DC	Schematic5-8

ERLA

See ELECTRICAL RESEARCH LABORATORIES

ESPEY MFG. CO., INC.

674	Schematic, trimmers, alignmentMisc. 7-6
675	Schematic, trimmers, alignment8-1
5111	Schematic, alignment8-2
7111	Schematic, trimmers, alignment8-3
7151, 7153	Schematic, trimmers, alignment8-4

EVEREADY

See NATIONAL CARBON CO.

EXPERIMENTERS INFORMATION SERVICE

Navy C-10	SchematicMisc. 1-4
	892
	891
	893
	891
	895

MODEL	FADA RADIO & ELECTRIC CORP.—(Cont.)	REVISED PAGE	EARLY COMPLETE PAGE	RADIOTRON EARLY COMPLETE PAGE
105, 106, 107 (RN)	Voltage, point-to-point data	4-9		
108, 109, 125 (RX)	Socket layout	4-10		
112 (RS)	Socket layout	4-11		
122 (KE)	Socket layout	4-11	88-F	960
126, 127, 128, Chassis NK	Schematic, socket	2-8		
131, 132 (RU)	Schematic	4-12		
139, 134, 135, 78-10, 79-10, 97-10 (RW)	Alignment notes	4-13		
141 (NA)	Schematic	4-14		
141, 141-Z (NA)	Alignment, trimmers, socket	5-8		
150, 2 types	Alignment, trimmers, voltage, socket	4-15		
151, 152 (NE)	Schematic	6-2		
155	Socket layout	4-16		
156	Schematic, socket, trimmers	6-3		
157	Alignment, voltage	6-4		
157	Schematic	6-5		
160 Series	Schematic	6-6		
160, Neutrodyne Reflex	Socket trimmers, alignment, voltage	6-7		
166, Motocet	Schematic	6-8	*68	898
167	Alignment, socket, trimmers	1-28		
168	Schematic	6-9		
170	data	6-10		
171, 173 (KOO) 110-volt DC	Schematic, parts list	7-1		
E180, E180Z Units	Schematic, changes, parts	7-2		
192	Schematic	6-11		
192-A (192S, 192BS)	Socket, trimmers, alignment, voltage	6-12		
211, 220 volts	Schematic	2-9	88-H	961
211B, 220 volts	See model 50			
212	Socket, trimmers, alignment	6-13		
216, Early, Late	Socket, trimmers, alignment	6-14		
216, 3rd Production	Alignment, part 2, voltage	6-15		
216, 220 volts, Early, Late	Schematic	6-17		
242	Socket, trimmers, alignment, voltage	6-18		
246	Schematic, chassis wiring, data	1-28	*64	898
M-250, M-250Z Units	Schematic, voltage, parts	7-3		
250, 2 types, Early, up to Serial 50698, Late, from Serial 50699	Alignment, changes, socket, trimmers	8-1		
254	Schematic, parts	8-2		
255	Schematic, parts	8-3		
260	Schematic, voltage, parts	8-4		
261	Alignment, socket, trimmers	8-8		
262	Schematic, parts	8-5		
	Alignment, socket, trimmers	8-8		
	Schematic, parts	8-6		
	Alignment, socket, trimmers	8-8		
	Schematic, parts	8-7		
	Alignment, socket, trimmers	8-8		
	Schematic, parts	8-9		
	Alignment, socket, trimmers	8-10		
	Schematic, parts	8-11		
	Alignment, socket, trimmers	8-11		
	See model 25			
	Schematic, parts list	7-4		
	Socket, trimmers, voltage, alignment	9-2		
	Schematic, voltage, socket, trimmers, alignment	8-12		
	Schematic, parts	8-13		
	Schematic, parts	7-5		
	Alignment, voltage, socket, trimmers	7-6		
	Schematic, parts list	8-14		
	Schematic, parts list	7-7		
262	Socket, trimmers, voltage, alignment	9-2		
	Schematic, socket, data	1-5	*69	903
	Schematic, parts, socket, trimmers, alignment, voltage	8-15		
	Schematic, voltage	8-16		
	Socket trimmers, alignment, parts	8-17		
	Schematic, parts list	8-18		
	Alignment, voltage, socket, trimmers	7-9		
	Schematic, parts list	7-10		
	Schematic, parts list	7-11		
	Schematic, parts list	7-12		
	Socket, trimmers, voltage, alignment	9-3		
	Schematic, parts list	7-13		
	Socket, trimmers, voltage, alignment	9-3		
	Schematic, parts list	7-14		
	Socket, trimmers, voltage, alignment	9-3		
	Schematic, parts list	7-15		
	Socket, trimmers, voltage, alignment	9-3		
	Schematic, voltage, parts list	7-16		
	Schematic, parts list	7-17		
	Schematic, parts list	7-18		
	Schematic, parts	8-19		
	Schematic, parts	8-20		
	Schematic, parts	8-21		
	Schematic, parts	8-22		
	Schematic, changes, parts	8-23		
	Schematic, coils, parts	8-24		
	Schematic, parts	9-4		
	Schematic, parts	8-25		
	Schematic, coils, parts	9-5		
	Schematic, coils, parts	9-6		
	Alignment, voltage, socket, trimmers	10-15		
	Schematic, coils	10-14		
	Alignment, voltage, socket, trimmers	10-15		
	Flash-O-Matic data	10-6		
	Schematic, coils, parts	9-7		
	Schematic, coils, parts	9-8		
	Schematic, coils, parts	9-9		
	Schematic, socket, trimmers, coils, parts	9-10		
	Alignment, voltage	9-11		
	Alignment table	9-13		
	Schematic, socket, trimmers, coils, parts	9-12		
	Alignment, voltage	9-11		
	Alignment table	9-13		
	See model 50			
	Schematic, coils, parts	9-14		
	Alignment, voltage, socket, trimmers	10-7		
	Schematic, coils, parts	9-15		
	Alignment, voltage, socket, trimmers	10-7		
	Schematic, coils, parts	9-16		
	Alignment, voltage, socket, trimmers	10-7		
	Schematic, coils, parts	9-17		
	Alignment, socket, trimmers, voltage	10-2		
	Schematic, socket	1-1	*65	899
	Schematic, coils, parts	9-18		
	Alignment, socket, trimmers, voltage	10-2		
	Schematic, voltage, alignment trimmers, socket	10-16		
	Schematic, voltage, alignment trimmers, socket	10-17		
	Schematic, socket, parts list	10-17		
	Schematic, socket, parts list	1-6	*70	904

475-A, SF 45-75	Schematic, socket, data.....	1-2	900
480-A	See model R-80A		
480-B, SF 50-80-B	Schematic, socket.....	1-4	902
490	Schematic.....	10-18	
554	See model 6A54		
761, 762, 764, 766, 767 (KG)	See model 43		
1255	Schematic, socket, trimmers, alignment, parts.....	8-26	
1262	Schematic, socket, trimmers, alignment, parts.....	8-27	
1265	Schematic, socket, trimmers, alignment, parts.....	8-28	
1462, 2 types	Schematic.....	6-19	
	Socket, trimmers, alignment, voltage.....	6-20	
1462, Revised, above	Schematic, parts.....	7-19	
1463	Schematic, parts list.....	7-20	
1556	Schematic.....	6-21	
1582	Schematic.....	6-22	
1583	Schematic.....	6-16	
FAIRBANKS MORSE & CO.			
4A, 4B	Schematic, notes.....	9-1	
	Socket, trimmers, alignment, voltage, resistance.....	9-2	
5A	Parts list.....	9-3	
	Schematic, socket, trimmers.....	9-5	
	Parts list.....	9-4	
	Alignment, voltage, resistance.....	9-6	
	Data.....	Changes 10-2	
5B	Schematic, socket, trimmers.....	9-7	
	Alignment, voltage, resistance.....	9-8	
	Parts list.....	9-9	
5C, 6A	Schematic, socket, trimmers, color code.....	8-1	
	Alignment, voltage, resistance.....	8-2	
5D	Schematic, battery connections.....	8-3	
6A	Alignment, socket, trimmers.....	8-4	
6B	See model 5C		
6C	Schematic, socket, trimmers.....	8-5	
	Alignment, voltage, resistance.....	8-6	
	Data.....	Changes 10-2	
C-6 Auto	Schematic.....	6-2	
	Alignment, socket, trimmers.....	7-17	
7A	Schematic, socket, trimmers.....	10-1	
	Alignment, voltage, tuner, phono.....	10-2	
8A	Schematic, trimmers.....	8-7	
	Alignment, voltage, resistance.....	8-8	
9A	Alignment, voltage, resistance.....	8-9	
	Data.....	Changes 10-1	
	Schematic.....	8-10	
	Socket, trimmers, alignment, voltage, resistance.....	8-10	
	Automatic dial notes.....	8-13	
9C	Data.....	Changes 10-1	
	Schematic, socket, trimmers, tuner layout.....	10-3	
	Alignment, voltage, tuner, phono.....	10-4	
12A	Schematic.....	8-11	
	Socket, trimmers, voltage, resistance.....	8-12	
	Alignment, automatic dial notes.....	8-13	
12B	Schematic, socket, tuner, trim- mers, voltage, phono.....	10-5, 6	
	Alignment.....	10-7	
	Tuner data, parts, Naturalizer notes.....	10-8	
12C6, Chassis 120	Schematic.....	8-15	
	Socket, trimmers, voltage, resistance.....	8-14	
	Alignment.....	8-16	
40	Schematic.....	6-1	
	Voltage, resistance.....	7-1	
	Socket, trimmers, alignment, chassis, transformer data.....	7-2	
	Schematic.....	6-1	
	Socket, alignment, trimmers.....	6-1	
	Schematic, notes.....	7-3	
	Socket, trimmers, alignment, battery connections.....	8-17	
	Schematic, notes.....	8-18	
	Alignment, voltage, socket, trimmers, resistance.....	8-19	
	See model 5106		
	See model 5212		
	See model 5312		
	Schematic.....	6-4	
	Socket, voltage, resistance.....	7-4	
	Alignment, notes, transformer data.....	7-5	
	Schematic.....	6-2	
	Voltage, transformer data, parts list.....	7-6	
	Alignment, socket, chassis, trimmers.....	7-7	
	Schematic, voltage, resistance.....	8-21	
57T0, Chassis 57	Alignment, socket, trimmers, notes.....	8-22	
	Schematic, voltage, resistance.....	8-23	
	Alignment, socket, trimmers, notes.....	8-24	
60 Chassis	See model 6010		
61	Schematic.....	5-6	
62 Chassis	See model 6210		
63	Schematic.....	6-3	
	Socket, chassis, trimmers, voltage, resistance.....	7-8	
	Alignment, AVC data, trans- former data.....	7-9	
64 Battery	Schematic.....	6-4	
64, Auto	Schematic.....	6-3	
	Voltage.....	7-10	
	Alignment.....	7-17	
65 Export	Schematic, socket, trimmers, voltage, resistance.....	9-10	
66	Alignment, notes, transformer data.....	7-11	
	Schematic, voltage, resistance, socket, trimmers, chassis.....	7-5	
67	Circuit data, alignment, notes.....	7-12	
	Schematic.....	8-25	
68T6, Chassis 68	Socket, trimmers, alignment.....	8-26	
	Voltage, resistance.....	8-27	
69T7	Schematic, socket, trimmers, alignment.....	8-28	
	Voltage, resistance.....	8-27	
70 Chassis	See model 7014		
71	Schematic.....	6-5	
	Voltage, socket, trimmers, chassis, resistance.....	7-14	
	Alignment, AVC data, trans- former data.....	7-0	
72C2, 72C3, 72T3, Chassis 72	Schematic, voltage, resistance.....	8-29	
	Alignment, socket, trimmers, data.....	8-30	
73C3B, 73T3B, Chassis 73	Schematic, voltage, resistance.....	8-31	
	Socket, trimmers, alignment, data.....	8-32	
74 Auto	Schematic.....	6-5	
	Alignment.....	7-17	
	Schematic, voltage.....	7-10	
81 Chassis	See model 8110		
82	Schematic.....	6-6	
	Voltage, socket, trimmers, chassis, resistance.....	7-15	
	Alignment, oscillograph notes, Notes.....	7-16	
	Circuit and AVC data, tuning indicator and transformer notes.....	7-17	
90	Schematic.....	7-18	
	Voltage, socket, trimmers, chassis, resistance.....	6-7	
	7-19		

FAIRBANKS MORSE & CO.—(Cont.)

MODEL	REVISION	EARLY COMPLETE PAGE	RADIO TRON COMPLETE PAGE
90	Circuit and AVC data, tuning indicator and transformer notes	7-18	
	Notes	7-17	
	Alignment, oscillograph notes	7-16	
91C4, 91C5, 91T4, Chassis 91	Schematic, voltage, resistance	8-33	
	Socket, trimmers, alignment, data	8-34	
100	Schematic	6-8	
	Voltage, socket, trimmers, chassis, resistance	7-20	
	Circuit, AVC, tuning indicator notes	7-21	
	Alignment, trap, transformer data	7-22	
	Schematic	7-23	
	Voltage, socket, trimmers, resistance	7-24	
	Alignment, trap, transformer data	7-22	
	Circuit, AVC, tuning indicator notes	7-21	
	See model 120C		
346, B-6	Schematic, voltage, socket	5-12	
347	Schematic, voltage, socket	5-12	
816, 840, 32-Volt	Schematic	5-13	
	Voltage, parts, alignment	5-14	
	Schematic	5-1	
5106, 5107, 5108, 5109, 5111, 5112, 5141, 5143 (51)	Alignment, color code, notes	5-3	
	Voltage	5-4	
	Parts list	5-5	
5212, 5212-A, 5241 (52)	Schematic	5-1	
	Alignment, color code, notes	5-3	
	Voltage	5-4	
	Parts list	5-5	
5312, 5312-A, 5341 (53)	Schematic, coil data	5-2	
	Alignment, color code, notes	5-3	
	Voltage	5-4	
	Parts list	5-5	
6010, 6044, Chassis 60	Schematic, trimmers, socket	6-11	
	Resistance test, voltage, data	6-10	
	Alignment, coil data	6-12	
6210, 6244, Chassis 62	Schematic, parts	6-13	
	Voltage, alignment	6-14	
7014, 7040, 7052 (70)	Schematic, coil data	5-7	
	Alignment, parts	5-8	
	Socket, trimmers, parts view	5-9	
	Voltage data	5-10	
	Voltage data, part 2	5-11	
8110, 8141, Chassis 81	Schematic, parts, trimmers	6-15	
	Alignment, data	6-16	

FANSTEEL
See BALKITE PRODUCTS CO.

MODEL	REVISION	EARLY COMPLETE PAGE	RADIO TRON COMPLETE PAGE
B Eliminator	Schematic	Misc. 1-5	
7-Tube AO	Schematic	Misc. 6-8	
	Schematic	Misc. 6-8	

FARRAND MFG. CO.

MODEL	REVISION	EARLY COMPLETE PAGE	RADIO TRON COMPLETE PAGE
A-10, 59, 102	Schematic, socket	1-1	
A-10	Chassis wiring	1-2	
B	Schematic	1-3	
	Chassis wiring	1-4	
C	Schematic, socket	1-5	
	Chassis wiring	1-6	
	Schematic, socket	1-7	
D, Code 68-070	Chassis wiring	1-8	
D Battery	Schematic, socket, data	1-9	
D, Code 79-070	Chassis wiring	1-10	
D (50 cycles)	Schematic, socket	1-11	
E, Code 68-060	Schematic, socket	1-12	
I, DO	Schematic, socket	1-12	

FEDERAL RADIO CORP.

MODEL	REVISION	EARLY COMPLETE PAGE	RADIO TRON COMPLETE PAGE
A-10, 59, 102	Schematic, socket	1-1	
A-10	Chassis wiring	1-2	
B	Schematic	1-3	
	Chassis wiring	1-4	
C	Schematic, socket	1-5	
	Chassis wiring	1-6	
	Schematic, socket	1-7	
D, Code 68-070	Chassis wiring	1-8	
D Battery	Schematic, socket, data	1-9	
D, Code 79-070	Chassis wiring	1-10	
D (50 cycles)	Schematic, socket	1-11	
E, Code 68-060	Schematic, socket	1-12	
I, DO	Schematic, socket	1-12	

FEDERAL RADIO CORP.—(Cont.)

MODEL	REVISION	EARLY COMPLETE PAGE	RADIO TRON COMPLETE PAGE
F, Code 79-080	Chassis wiring	1-13	
	Schematic, socket	1-14	
F-10 DC, F-11 DC	Schematic, socket, data	1-15	
F (25 cycles)	Schematic, socket	1-16	
G, Code 71-030	Schematic, socket, data	1-17	
H, Code 71-030	Schematic, socket, voltage	1-18	
H Receiver	Chassis wiring	1-19	
H Power Unit	Chassis wiring	1-20	
K	Schematic, socket	1-21	
	Voltage data	Changes 7-10	
M	Schematic, socket, voltage	1-22	

FEDERATED PURCHASER

Also see ACRATEST

Cathedral Tone	Schematic	3-2	
Acratone 2	Schematic	2-1	
Acratone 5	Schematic	2-2	
6-A, 12-A	Schematic	5-2	
7-A, 13-A, 24-A	Schematic, voltage	5-1	
8-A	Schematic, voltage	5-1	
8B, 9B, 11B	Schematic, voltage	7-1	
Royal 9-A	Schematic	6-3	
14-A	Schematic, voltage	5-2	
Acratone 17	Schematic	Misc. 4-3	
24-A	See model 7-A		
29C, 30C, 31C	Schematic, voltage, socket, trimmers	7-3	
31-40	Alignment, parts list	7-4	
32-A, 36-A	Schematic, color code, parts list	3-1	
32C, 33C	Schematic, voltage	5-3	
	Schematic, voltage, socket	5-4	
	trimmers	7-5	
35, 40	Alignment, parts list	7-6	
38-A	Data	3-2	
39-A, 43-A, 44-A, 86, 87	Schematic, voltage, alignment	5-5	
	Schematic, voltage, trimmers, socket	5-6	
	Alignment data	5-7	
40	Schematic	6-4	
49	Schematic	8-1	
52-A, 54, 58, 59	Schematic	5-8	
65, 66	Schematic	5-8	
79, 80	Schematic	6-1	
	Schematic, voltage, socket	6-2	
	Schematic, voltage, socket	5-9	
86, 87	Alignment	5-10	
88	See model 59-A		
92	Schematic, voltage, socket	6-3	
93, 94, 96, 97	Schematic, voltage, socket, trimmers	5-11	
100	Schematic	5-12	
117	Schematic, parts	6-1	
	Voltage, alignment	6-5, 6-6	
121	Schematic, socket	6-7	
215	Schematic, socket	6-8	
228, 229	Schematic	6-8	
248	Schematic, socket, trimmers, alignment	6-4	
1940	Schematic	7-2	

FENWAY

Superheterodyne, Early, late	Schematic	Misc. 1-5	
250, B-3	Schematic	Misc. 1-6	
250-C	Schematic	Misc. 1-6	

FERRANTI, INC.

250, B-3	Schematic	Misc. 1-6	
250-C	Schematic	Misc. 1-6	

FIRESTONE TIRE & RUBBER CO.

AIRCHIEF

R-1922, Chassis R-132	See Stewart-Warner		
R-1932, Chassis R-133	See Stewart-Warner		
R-1431	See Stewart-Warner		

MODEL	REVISION	REVISION	REVISION
R-1651AS, R-1651WS, Air Chief, Chassis R-165	Schematic, voltage, parts	7-1	
	Circuit data, alignment, trimmers	7-2	
R-1661, Air Chief, Chassis R-166	Schematic, voltage, parts list	7-3	
	Alignment, socket, trimmers, parts	7-4	
R-3051, Chassis R-305	Schematic, socket, voltage, parts	9-1	
	Trimmers, alignment, dial data	9-2	
3061, 3062, 3063, 3064, 3065, 3066, 3067, 3068, 3069 Chassis R-306	Schematic, socket, voltage, parts	9-3	
	Trimmers, alignment, dial data	9-4	
3071, 3072, 3073, 3074, 3075, 3076, 3077, 3078, 3079 Chassis R-307	Schematic, socket, voltage, parts	9-5	
	Trimmers, alignment, parts, dial data	9-6	
Chassis R-307-X	Phonograph schematic	9-5	
3085, Chassis R-308	Schematic, socket, voltage, parts	9-7, 8	
	AFC test, trimmers, tuner, parts	9-9	
	Alignment	9-10	
7405-1	Schematic, socket, notes, parts	8-1	
7406-1	Schematic	8-2	
7407-1	Schematic	8-2	
7407-3, Chassis 536	Schematic, voltage, socket, trimmers, chassis, alignment	10-1	
S7407-5	Schematic, voltage, socket, trimmers, alignment, tuner	10-2	
7422-3	Schematic, socket, notes, parts	8-3	
S7424-3	Schematic, socket, trimmers, alignment	10-3	
S7425-4, S7425-5, S7426-5	Schematic, socket, trimmers, alignment	10-4	
S7426-6	Schematic, socket, trimmers, alignment, voltage	10-5	
S7426-7, Roamer (Jan. 1939)	Schematic, socket, trimmers, alignment	10-6	
S7426-7 (Mar. 1939)	Schematic, socket, trimmers, alignment, voltage	10-7	
S7426-9	Schematic, socket, trimmers, alignment, voltage	10-8	
S7427-5	Schematic, socket, trimmers, alignment, voltage	10-9	
S7427-6	Schematic, socket, trimmers, alignment, voltage	10-5	
S7428-1	Schematic, socket, trimmers, alignment	10-10	
S7428-2	Schematic, socket, trimmers, alignment, voltage	10-7	

**FIRST NATIONAL RADIO CORP.
See BALKEIT RADIO CO.**

**FORD MOTOR CAR CO.
See also PHILCO RADIO & TELEVISION CORP.**

N, Center Control	Schematic, parts	6-2
	Installation, data	6-3
N, Center Control	Socket, alignment, service notes	6-4
Ford Lincoln Auto Set	Schematic	5-4
Built by Zenith		
Glove Box (Police Radio)	Schematic	5-1
Built by Grigsby Grunow		
Police auto radio, built by Grigsby Grunow	Schematic	6-1
40-18805, Glove Box	Schematic	5-3
Built by Grigsby Grunow		
111	See Majestic 114	
B-18605, Built by Grigsby Grunow	Schematic	5-2

MODEL	REVISION	REVISION
FP (330001 up)	Schematic, alignment voltage	5-1
FP Battery (173501 up)	Schematic, alignment voltage	5-1
FP 32-volt (350001 up)	Schematic, alignment voltage	5-2
FR (189001 up)	Schematic, alignment voltage	5-3
FU	Schematic, alignment voltage	5-4
FW	Schematic, alignment voltage	5-5
Goldentone 6T	Schematic	Misc. 3-5

FRANKLIN RADIO CORP.

H-33	Schematic	4-2
6-tube Super	Schematic	3-3
1	Schematic	4-2
D-32	Schematic	4-1
H-32	Schematic	4-1
English reading Tube Checker	Schematic	4-2
33-A Checker-Analyzer	Schematic	4-3
33-B Analyzer	Schematic	4-4
43 AB or C-L	Schematic	4-6
53	Schematic	4-5
54-L	Schematic	4-6
	Socket layout	Changes 7-3
63-L	Schematic	4-7
64	Schematic	4-8
	Socket layout	Changes 7-3
94	Schematic	4-9
	Notes	4-10
	Notes, part 2	4-11
	Notes, part 3	4-12
	Voltage, notes	4-13
100	Schematic, socket	2-2
	Service notes	Changes 7-3
	I-F Peak	Changes 7-3
102	Schematic, socket	3-1
	I-F Peak	Changes 7-3
104	Schematic, socket	3-4
105	Schematic	4-14
	Socket layout	Changes 7-3
106	Schematic	4-14
	Socket layout	Changes 7-3
200	Schematic, installation notes	4-15
	Installation notes, part 2	4-16
	Socket layout	Changes 7-3

FREED MFG. CO., INC.

FE 24A	Schematic	9-1
27-D	Schematic	9-2
30-D	Schematic	9-2
FE-30L	Schematic	7-1
FE-33	Schematic	8-1
FE-48	Schematic	8-1
FE-50	Schematic, socket	8-2
FE-51L, P351L	Schematic, socket	8-2
FE-52, FE-56, FE-58	Schematic, socket	7-2
FE-60	Schematic, socket	8-3
FE-62	Schematic, socket	8-3
FE-69X	Schematic	8-4
96	Schematic	9-1
FE97	Schematic	9-1
351	Schematic, socket	6-1
351-L	Schematic, socket	6-1
351-P	Schematic, socket	6-2
P351L	See model FE-51L	
357-L	Schematic, socket	6-3
357-P	Schematic, socket	6-2
358-L	Schematic, socket	6-3
369-S	Schematic, socket	6-4

FREED TELEVISION & RADIO CORP.

Intermediate Frequencies	I-F, Peaks	Changes 7-4
ABC Power Pack	Schematic	1-5
MB-5	Schematic, socket	3-3
NR-5	Schematic	1-1
NR-6	Schematic	1-1
NR-7	Schematic, socket	1-2
A-7	Schematic	4-1
MB-7	See model 72	

*306
*302
*802
*808

1001
1021
997
997
998

MODEL	CHARLES FRESHMAN CO., INC.—(Cont.)	REVISED PAGE	EARLY COMPLETE PAGE	RADIOTRON PAGE
L	Schematic, socket	1-7	*294	1045
M	Schematic, socket, voltage	1-6	*293	1044
N	Schematic, socket, voltage	1-7	*294	1045
Equaphase	Schematic	1-1	*287	1039
Masterpiece	Schematic	1-1	*287	1039
2N with 2N-60-S Power Unit	Schematic	1-8	*292	1046
9-Q-15, 9-Q-16	Schematic, socket, voltage	1-10	*298	1048
Q-15, Q-16	Schematic, socket	1-9	*295	1047
QD-16-S	Schematic, socket, voltage	1-11	*297	1049

FROST-MINTON

4-PW	Schematic, voltage, socket	4-1		
	Electrical values, transformer notes	4-2		
FM-4	Schematic	4-3		
FM-5	Schematic	4-3		

FULTON RADIO CORP.

Pre	Schematic	6-1		
Z	Schematic	6-1		
13B	Schematic	6-2		
15B	Schematic	6-1		
35B	Schematic	6-2		

GALVIN MFG. CO.

Acousticator	Notes	8-14		
Golden Voice (1936)	Schematic	7-1		
	Alignment, sensitivity, magic eliminode notes, service data	7-5		
	Changes, chassis	7-6		
	Coil & Transformer connections	7-7		
	Parts list	7-9		
	Additional data	Changes 7-10		
Golden Voice, 1937 Early	Schematic, alignment, sensitivity, voltage, chassis	8-1		
Golden Voice, 1937 Late	Schematic, voltage, sensitivity, alignment	8-2		
	Coil data	9-12		
	See Model 8-80			
Golden Voice (1938)	Notes	8-14		
Magic Eliminode	Test data, alignment data	4-16		
Motorola	Installation notes	3-16		
	Antenna data	4-1		
	General installation data	7-8		
	Notes	4-2		

1068

*452-O

*452-D

1058

MODEL	FREED TELEVISION & RADIO CORP.—(Cont.)	REVISED PAGE	EARLY COMPLETE PAGE	RADIOTRON PAGE
NR-8, NR-8A	Schematic, socket	1-2	*303	998
A-9	Schematic	4-1		
NR-9, 90	Schematic	3-5		
NR-9, NR-9A	Schematic, socket	1-3	*304	1023
NR-10	Schematic, socket	1-3	*304	999
NR-11	Schematic, socket	1-4	*305	1000
NR-11 Power Pack	Schematic	1-5	*305	1001
NR-12	Schematic	1-4	*305	1000
FE-15	Schematic	1-6	*307	1002
FE-18	Schematic	1-6	*307	1002
NR-20	Schematic	1-7	*307	1002
FE-30	Schematic	1-7	*308	1003
40N, 48N	Schematic	1-7	*308	1003
50	Schematic	1-8	*309	1004
51 DO	Schematic, socket	3-1		
NR-53	Schematic	3-1	*323	1018
54, 56, 59	Schematic, socket	3-3	*310	1021
NR-55 DO	Schematic, socket, voltage	1-9	*310	1005
NR-55, NR-56 AO	Schematic, socket, voltage	1-10	*311	1008
NR-57	Schematic, socket	1-11	*312	1007
	Power Unit	1-11	*312	1007
58 AC	Schematic, socket	3-1		
59	See model 54			
NR-60 DO	Schematic	1-12	*313	1008
NR-60 AO	Schematic, socket	1-13	*314	1009
FE-63 DO	Schematic	3-8		
NR-66, 66-A	Schematic, socket	1-14	*315	1010
NR-70 AO	Schematic, socket	1-15	*316	1011
72, 74, MB-7	Schematic, socket	3-4		
NR-77 DG, NR-79 DO	Schematic, socket, voltage	1-10	*317	1012
NR-78 AC, NR-79 AO	Schematic, socket, voltage	1-17	*318	1013
NR-80 AC, NR-80 DO	Schematic, socket, voltage	1-18	*319	1014
NR-80 AO	Schematic, socket, voltage	1-19	*320	1015
NR-85 AO	Schematic, socket, voltage	1-20	*321	1016
90	Schematic, socket, voltage	1-21	*322	1017
NR-90-S	See model MB-9			
91 DO	Schematic	1-22	*328	1018
92 AC	Schematic, socket	3-6		
NR-95 AO	Schematic, socket	3-7		
FE-96 DO	Schematic, socket, voltage	1-23	*324	1025
FE-98	Schematic, socket	3-9		
FE-99 DO	Schematic, socket	3-10		
346-4	Schematic, socket, parts list	4-2		
354	Schematic, socket	4-3		
355	Schematic, socket	4-4		
360, 360X	Schematic, socket	4-5		
365, 365X	Schematic, socket	4-6		
NR-457	Power Unit—See NR-57			
NR-460 AO Power Unit	Schematic	1-13	*314	1009
NR-470 AO	Schematic	1-15	*316	1011
800	Schematic	1-16	*317	1012

JESSE FRENCH EXPORT CO.

5X, 6X, 7X	Schematic	5-1		
	Socket, voltage, parts list	5-2		

JESSE FRENCH & SONS PIANO CO.

8-tube AO	Schematic, socket, voltage, data	1-1	*405	1029
G Junior	Schematic	2-1	*406-A	1031
H-1	Voltage, service notes	2-2	*406-B	1032
D-1	Schematic	2-4	*406-C	1035
	Service notes, voltage	2-6	*406-F	1030
H-2 Pentode AO	Schematic	2-5	*406-E	1037
H-2 Pentode, 110-volt DO	Service notes, voltage	2-6	*406-D	1030
H-2 Junior	Schematic	2-3	*406-F	1033
8-2	Schematic	3-1	*403	1034
6-093	Schematic	3-2	*403	1038
	Schematic, socket, voltage	1-2	*406	1030

*314

*316

*317

*328

*324

*405

*406-A

*406-B

*406-C

*406-E

*406-F

*403

*403

*406

*290

*288

*289

*290

*291

CHARLES FRESHMAN CO., INC.

ABC Power Unit	Schematic	1-4	*280	1042
G with G-60-S Power Unit, (2 types)	Schematic, socket, voltage	1-2	*288	1040
H (2 types)	Schematic, socket, voltage	1-3	*289	1041
H	Schematic, socket, voltage	1-4	*290	1042
K	Schematic, socket, voltage	1-5	*291	1043

1054

6A, Chassis 6-1	Schematic, voltage, parts8-6	9-49	Schematic, voltage10-9
F6T	Socket, trimmers, alignment8-4		Alignment10-8
6T, 6Y, Chassis 6-2	See Model 15F		Alignment, sensitivity, socket, trimmers, gain10-6
6T-12 PL	Voltage, socket, trimmers, alignment8-8	9-49 (E5T)	Procedure, Part 2, schematic of tuner, assembly, parts list10-2
7T-88	Schematic3-3		Elec. Automatic tuner, data, procedure, assembly10-1
	Parts list7-9	9-69	Schematic10-10
	Schematic3-4		Sensitivity, gain, socket, trimmers, alignment, voltage10-8
	Test data, socket3-5		Procedure, Part 2, schematic of tuner, assembly, parts list10-2
7T-38-A	Parts list7-9		Elec. automatic tuner, data, procedure, assembly10-1
7T-47-A	Schematic3-6		Parts list4-4
	Schematic3-7		Schematic, Parts, trimmers8-11, 8-12
	Connection data3-8		Socket, trimmers, alignment, voltage, sensitivity8-13
	I.F. PeakChanges 7-3		Dial data, trimmers, alignment 9-17
J-8	Parts list4-3		Tuner assembly9-18
8-80	Schematic, parts9-1		Tuner notes, Part 19-19
	Sensitivity and gain notes9-5		Tuner notes, Part 29-20
	Tuner notes9-6, 9-8		Tuner notes, Part 39-21
	Voltage, sensitivity and gain measurements9-9		Schematic, parts9-15
	Alignment9-10		Socket, trimmers, voltage9-16
	Tuner adjustments9-11		Dial data, trimmers, alignment 9-17
8-40	Schematic, parts9-3		Tuner assembly9-18
	Sensitivity and gain notes9-5		Tuner notes, Part 19-19
8-50	Tuner notes9-6, 9-8		Tuner notes, Part 29-20
	Voltage, sensitivity and gain measurements9-9		Tuner notes, Part 39-21
	Alignment9-10		Schematic10-11
8-60	Tuner adjustments9-11		Sensitivity, gain, voltage, alignment, socket, trimmers10-12
	Schematic, sensitivity and gain notes9-5		Procedure, Part 2, schematic of tuner, assembly, parts list10-2
	Parts, tuner notes9-6, 9-8		Elec. automatic tuner, data, procedure, assembly10-1
	Voltage, sensitivity and gain measurements9-9		Schematic, socket, trimmers10-13
	Alignment9-10		Sensitivity, gain, voltage, alignment, drive data10-14
	Tuner adjustments9-11		Schematic10-15
8-70	Schematic, parts9-4		Alignment, voltage, gain, sensitivity, drive data10-16
	Sensitivity and gain notes9-5		Schematic10-15
	Tuner notes9-6, 9-8		Alignment, voltage, gain, sensitivity, drive data10-16
	Voltage, sensitivity and gain measurements9-9		Schematic10-15
	Alignment9-10		Alignment, voltage, gain, sensitivity, drive data10-16
	Tuner adjustments9-11		Schematic, socket, trimmers10-17
8-80, Golden Voice (1938)	Schematic9-7		Voltage, sensitivity, gain, alignment, drive data10-18
	Parts list9-8		Schematic, socket, trimmers10-19
	Voltage, sensitivity and gain measurements9-9		Alignment, voltage, gain, sensitivity, drive data10-20
	Alignment9-10		Alignment, socket, trimmers10-21
	Tuner adjustments9-11		Schematic10-22
9A, Chassis 9-3, 9R, Chassis 9-2, 9Y, Chassis 9-1	Schematic, trimmers, voltage, alignment8-10		Elec. automatic tuner, data, procedure, assembly10-1
9-24	Schematic10-3		Procedure, Part 2, schematic of tuner, assembly, parts list10-2
	Alignment, socket, trimmers, voltage, sensitivity, gain, dial cord data10-4		Parts list7-10
9-24A	Schematic10-3		Parts list7-10
	Alignment, socket, trimmers, voltage, sensitivity, gain, dial cord data10-4		Schematic5-8
9-29	Schematic, socket, trimmers, alignment10-5		Parts list7-10
	Voltage, sensitivity, gain10-6		Schematic, voltage, sensitivity, alignment8-15
9-44	Schematic, voltage, gain, sensitivity10-7		Coil data9-12
	Socket, trimmers, drive, alignment10-8		Schematic4-5
			Data4-6
			Voltage, resistance data, adjustment notes4-7
			Chassis views4-8
			Parts list7-10

45	MODEL	GALVIN MFG. CO.—(Cont.)	REVISED PAGE
		Schematic, voltage, sensitivity, alignment	8-16
		Coil data	9-12
		Parts list	7-10
H-45		Schematic	7-2
50		Alignment, sensitivity, magic eliminode notes, service data	7-5
		Changes, chassis	7-6
		Coil & Transformer connections	7-7
		Parts list	7-10
		Schematic, alignment	7-10
		Parts list	7-10
		Schematic	6-1
		Parts list (for 57)	7-11
		Parts list (for 62)	7-11
		Schematic	9-22
		Schematic, parts	9-23
		Trimmers, alignment, sensitivity, gain, voltage	9-24
		Schematic, parts	9-25
		59T3, Chassis 59R3	
		59T1 Early, Chassis 59R1, Schematic, parts	9-24
		59T3, Chassis 59R3	
		59T1 Late, 59T1 with Per- manic Speaker, Chassis 59R1	9-24
		Trimmers, alignment, sensitivity, gain, voltage	9-24
		Schematic, parts	9-24
		Trimmers, alignment, sensitivity, gain, voltage	9-24
		Schematic	7-3
		Alignment, sensitivity, magic eliminode notes, service data	7-5
		Changes, chassis	7-6
		Coil & Transformer connections	7-7
		Parts list	7-11
		Schematic, notes	3-15
		I.F. Peak	7-3
		Parts list	7-11
		See model 57	
		Schematic, voltage, sensitivity, alignment	8-17
		Coil data	9-12
		Schematic, socket	4-10
		Parts list	7-10
		Schematic	9-28
		Trimmers, alignment, sensitivity, gain, voltage	9-24
		Schematic	9-29
		Trimmers, alignment, sensitivity, gain, voltage	9-24
		Schematic, voltage, sensitivity, alignment	8-18
		Coil data	9-12
		Parts list	7-11
		Schematic	6-1
		Alignment, data	6-2
		Schematic	4-11
		Chassis views	4-14
		Nodes	4-15
		Parts list	7-12
		Schematic	4-12
		Parts list	7-12
		Schematic	4-13
		Parts list	7-12
		Schematic, alignment, data— See model 75	7-12
		Parts list	7-12
		Schematic	7-4
		Alignment, sensitivity, magic eliminode notes, service data	7-5
		Changes, chassis	7-6
		Coil & Transformer connections	7-7
		Parts list	7-12
		80	
		77-A	
		77-A, Series B	
		79	
		Schematic, alignment, data— See model 75	7-12
		Parts list	7-12
		Schematic	7-4
		Alignment, sensitivity, magic eliminode notes, service data	7-5
		Changes, chassis	7-6
		Coil & Transformer connections	7-7
		Parts list	7-12
		80	
		2007, 2008	
		22-CM-576	
		Schematic	7-11
		Color coding, socket, trimmers, voltage, phono, connections	7-12
		Alignment, phono, data	7-13
		2007, 2008	
		22-CM-576	
		Schematic	7-11
		Color coding, socket, trimmers, voltage, phono, connections	7-12
		Alignment, phono, data	7-13
		11B	
		15C6	
		2007, 2008	
		22-CM-576	
		Schematic	7-11
		Color coding, socket, trimmers, voltage, phono, connections	7-12
		Alignment, phono, data	7-13
		6J Series, "A" issue	
		Schematic, voltage, sensitivity, data	10-2
		Socket, coils, trimmers, data	8-3
		Alignment, changes, data	8-5
		Schematic, voltage, sensitivity, data	8-6
		Coils, socket, trimmers, data	8-5
		Alignment, changes, data	8-6
		Schematic, coils, socket	9-1
		Schematic, socket, voltage, trimmers	7-5
		Schematic, voltage, socket, trimmers, alignment, parts	7-4
		Schematic	7-7
		Voltage, socket, trimmers, color coding, phono, data	7-6
		Circuit data, changes, alignment	7-8
		Schematic, trimmers, changes	8-7
		Alignment, voltage, data	8-8
		Schematic, voltage, data	10-3
		Alignment, drive data, changes, notes, socket	10-4
		Schematic, parts	6-1
		Voltage, socket, trimmers, alignment, resistance data	6-2
		Schematic	7-11
		Color coding, socket, trimmers, voltage, phono, connections	7-12
		Alignment, phono, data	7-13
		6J Series, "B" & Later issues	
		Schematic, voltage, sensitivity, data	8-3
		Socket, coils, trimmers, data	8-5
		Alignment, changes, data	8-6
		Schematic, voltage, sensitivity, data	8-6
		Coils, socket, trimmers, data	8-5
		Alignment, changes, data	8-6
		Schematic, coils, socket	9-1
		Schematic, socket, voltage, trimmers	7-5
		Schematic, voltage, socket, trimmers, alignment, parts	7-4
		Schematic	7-7
		Voltage, socket, trimmers, color coding, phono, data	7-6
		Circuit data, changes, alignment	7-8
		Schematic, trimmers, changes	8-7
		Alignment, voltage, data	8-8
		Schematic, voltage, data	10-3
		Alignment, drive data, changes, notes, socket	10-4
		Schematic, parts	6-1
		Voltage, socket, trimmers, alignment, resistance data	6-2
		Schematic	7-11
		Color coding, socket, trimmers, voltage, phono, connections	7-12
		Alignment, phono, data	7-13
		6J Series, "A" issue	
		Schematic, voltage, sensitivity, data	10-2
		Socket, coils, trimmers, data	8-3
		Alignment, changes, data	8-5
		Schematic, voltage, sensitivity, data	8-6
		Coils, socket, trimmers, data	8-5
		Alignment, changes, data	8-6
		Schematic, coils, socket	9-1
		Schematic, socket, voltage, trimmers	7-5
		Schematic, voltage, socket, trimmers, alignment, parts	7-4
		Schematic	7-7
		Voltage, socket, trimmers, color coding, phono, data	7-6
		Circuit data, changes, alignment	7-8
		Schematic, trimmers, changes	8-7
		Alignment, voltage, data	8-8
		Schematic, voltage, data	10-3
		Alignment, drive data, changes, notes, socket	10-4
		Schematic, parts	6-1
		Voltage, socket, trimmers, alignment, resistance data	6-2
		Schematic	7-11
		Color coding, socket, trimmers, voltage, phono, connections	7-12
		Alignment, phono, data	7-13
		6J Series, "B" & Later issues	
		Schematic, voltage, sensitivity, data	10-2
		Socket, coils, trimmers, data	8-3
		Alignment, changes, data	8-5
		Schematic, voltage, sensitivity, data	8-6
		Coils, socket, trimmers, data	8-5
		Alignment, changes, data	8-6
		Schematic, coils, socket	9-1
		Schematic, socket, voltage, trimmers	7-5
		Schematic, voltage, socket, trimmers, alignment, parts	7-4
		Schematic	7-7
		Voltage, socket, trimmers, color coding, phono, data	7-6
		Circuit data, changes, alignment	7-8
		Schematic, trimmers, changes	8-7
		Alignment, voltage, data	8-8
		Schematic, voltage, data	10-3
		Alignment, drive data, changes, notes, socket	10-4
		Schematic, parts	6-1
		Voltage, socket, trimmers, alignment, resistance data	6-2
		Schematic	7-11
		Color coding, socket, trimmers, voltage, phono, connections	7-12
		Alignment, phono, data	7-13

26-B-5	Schematic, socket, parts, power unit7-15	489	Schematic, socket, trimmers, voltage10-5
26-FM-552	Alignment, voltage, resistance, parts7-16	501	Alignment, trimmers10-6
	R-F chassis schematic7-17	504	Schematic, alignment7-41
26-R-1	A-F. & power unit schematic7-18	510, 511	Schematic, voltage, alignment, socket, trimmers10-7
	Color coding, changes, chassis layout, phono, connections7-19	516, Symphony	Schematic, socket, trimmers, alignment8-26
26S1	Chassis views, voltage, trimmers, switch data7-20	Z516	Schematic, socket7-41
	Circuit data, alignment, phono, data7-21	521	Schematic, alignment, parts8-27
2701, 2705	Parts list7-22	Z-521	Schematic, socket, trimmers, voltage, parts9-6
	Schematic, alignment7-23	525	Schematic, socket, trimmers, alignment, parts7-44
30-A	Voltage, socket, trimmers, color code, resistance, mounting7-24	526	Schematic, parts7-42
	Schematic6-3	527A	Schematic, socket, trimmers, alignment, voltage, parts9-5
31-BT	Installation details6-4	527C	Schematic, voltage, alignment, socket, trimmers10-8
	Voltage, alignment, socket, trimmers, resistance data6-5	Z-530	Tuner procedure10-20
34BT	Schematic, voltage, socket, trimmers, parts6-7	540 (Early)	Schematic, voltage, alignment, socket10-9
	Drive cord adjustment alignment, resistance data6-8	541A	Socket, trimmers, tuner10-10
36-L	Schematic, trimmers7-91	550	Schematic7-45
	Alignment, parts list7-27	552	Schematic, socket, alignment, parts7-46
42DL670	Schematic, trimmers, voltage7-28	558	Schematic, alignment6-11
	Alignment, parts list7-30	566	Schematic, socket, trimmers, parts9-7
46L	Schematic, socket, trimmers, voltage7-31	575	Alignment, dial data9-8
	Alignment, voltage, parts7-32	578 (2 types) Serial	Schematic, socket, voltage, alignment6-12
46-L-1	Schematic, sensitivity8-9	5G133670A to	Schematic, voltage parts7-47
	Socket, trimmers, coils, phono, data8-10	5K173250A and above	
47LL	Alignment, voltage, notes8-11	578, Series A	Socket, trimmers, alignment7-48
	Schematic, coils, data8-13	586-A	Schematic, voltage, socket, trimmers, data7-51
47P608	Alignment, voltage, parts8-14	587, Series A	Alignment, installation data7-52
	Schematic, socket, trimmers, coil data7-33	600	Schematic, voltage7-55
47R, 47RL	Alignment, circuit, voltage, mounting, socket, data7-34	602B	Socket, trimmers, parts, changes7-56
	Alignment, trimmers, voltage, coils, phono, data8-16	602C	Schematic, voltage, socket, trimmers7-54
47P608	Schematic, data8-17	623	Alignment, parts7-57
	Voltage, trimmers, socket, coils, data8-18	645	Schematic, voltage, socket, trimmers10-11
51-O	Alignment, power supply notes8-19	648	Schematic, voltage, trimmers, alignment, parts9-9
	Schematic8-21	650 A-B-C	Schematic, voltage, socket, trimmers, alignment, parts10-13
70	Voltage, socket, trimmers, coils, sensitivity8-22	660	Alignment, voltage10-14
	Schematic8-23	666	Schematic, socket, trimmers, alignment, voltage10-11
71C	Schematic, voltage, socket, alignment, notes, parts7-42		Schematic, socket, trimmers, voltage, parts, alignment9-10
	Alignment, chassis8-13		Schematic, socket, trimmers, voltage, alignment, parts9-11
72, Chassis 8, 8X	Voltage, alignment, data, parts9-2		Schematic, socket, trimmers, voltage, tuner, parts9-12
	Schematic, socket, trimmers, voltage, alignment9-3		Alignment9-13
77	Schematic, socket, trimmers, parts9-4		Schematic, socket, trimmers, alignment, voltage10-13
	Schematic, alignment, parts7-14		Schematic, socket, trimmers, voltage, alignment, parts9-11
85	Schematic, socket, trimmers, alignment, socket, trimmers, voltage7-85		Schematic, socket, trimmers, voltage, tuner, parts9-12
	Voltage7-86		Schematic, alignment8-30
90	Schematic, socket, notes8-20		Schematic, voltage, socket, trimmers, parts list7-63
	Schematic, socket, voltage, data8-24		Schematic, voltage, socket, trimmers, parts, notes10-15
92D, 92M	Schematic, socket, alignment, parts, chassis, coil data7-87		
	Schematic, socket, trimmers, parts9-5		
400-A, 410-B	Schematic, socket, voltage, trimmers, alignment7-88		
	Schematic7-40		
401, 402	Schematic6-9		
	Alignment, parts7-39		
404	Schematic7-40		
	Schematic, socket, voltage, trimmers, alignment7-88		
425	Schematic6-9		
	Alignment, parts7-39		
457, Regal	Schematic7-40		
	Schematic, socket, parts8-25		
460	Schematic, socket, parts8-25		

GAMBLE-SKOGMO, INC.—(Cont.)

RADIOTRON
EARLY COMPLETE
PAGE

RADIOTRON
EARLY COMPLETE
PAGE

MODEL	REVISED PAGE	EARLY COMPLETE PAGE
803A	10-30	Schematic
803B	10-30	Schematic
806A	10-29	Schematic, parts
807B	10-18	Schematic, alignment
810	8-48	Schematic, voltage
810(1938)	10-31	Schematic, voltage, socket, tuner, coils, sensitivity
813A	10-32	Alignment, trimmers
813B	10-29	Schematic, parts
822	10-29	Schematic, parts
850B	8-43	Schematic, socket, trimmers, parts
867A	8-44	Alignment, notes
	8-52	Schematic, trimmers, alignment
	10-33	Schematic, voltage, parts
	10-34	Alignment, trimmers
	10-35	Socket, trimmers, tuner data, notes
1050	7-77	Schematic, voltage
	7-78	Socket, alignment, notes
1170	8-46	Schematic, voltage, socket, trimmers, parts
	8-45	Alignment, notes
	8-47	Parts
2056AW	10-36	Schematic, socket, voltage, alignment
2078-D	7-79	Schematic, socket
	7-80	Alignment, chassis, parts
	7-81	Voltage, data, resistance
	7-82	Schematic, notes
2090	7-83	Circuit data, alignment, part 1
	7-84	Alignment, part 2, socket,olt- age, speaker connections,
	7-85	age, transformer data
2092, 2094	7-86	Schematic
	7-90	Voltage, alignment, notes, change
3128	7-90	Schematic
3132, 3134, 3140	9-12	Schematic, socket, alignment
	9-16	Voltage, resistance
5953A	8-49, 8-50	Schematic, voltage, trim- mers
	8-51	Alignment, parts
6100	9-17	Schematic, parts, power pack
	9-18	Voltage, notes, alignment, parts
6953-A	7-88, 7-88	Schematic, voltage, trimmers, notes, parts list
7735, 7742, 7755	7-89	Alignment
	7-91	Schematic
	7-92	Alignment, voltage, parts list

GAROD RADIO CORP.

MODEL	REVISED PAGE	EARLY COMPLETE PAGE
Intermediate Frequencies	7-10	I.F. Peaks
Challenger I	8-3	Schematic, socket, alignment, voltage
Challenger II, Challenger III	9-1	Schematic, voltage, trimmers, alignment
EA	3-1	Schematic, color code, voltage
Garod EM	3-2	Schematic
Neutrodyne	3-2	Schematic
2B2, 2B2-1, 2B6, 2B6-1	9-2	Schematic, socket, trimmers, voltage, alignment
25	6-1	Schematic
26	7-1	Schematic
27	6-2	Schematic
31, 31LW, M-33, M-33LW	7-3	Schematics
M-32, M-32LW	7-4	Alignment, voltage
	7-5	Schematic
	7-5	Alignment, voltage
33	6-3	Schematic
33JLW	6-3	Schematic
M-33, M-33LW	7-6	See model 31
358W	10-1	Schematic, voltage
37B, 37D	10-2	Alignment, socket
49, 49M	7-7	Alignment, voltage
	7-8	Alignment, socket, trimmers
58	6-4	Schematic

777C, 777L, Series A & B

778-A

780, 780B

787

802A

MODEL	REVISED PAGE	EARLY COMPLETE PAGE
666	10-16	Speaker data, alignment
667	10-17	Schematic, voltage, socket, trimmers, alignment, parts
670	6-13	Schematic, voltage, socket, trimmers
670-A	7-61	Schematic, voltage, socket, trimmers
675	7-62	Alignment, installation data
675A, 685B	6-15	Schematic, voltage, socket, trimmers
677A	10-18	Schematic, alignment
	10-19	Schematic, parts
	10-19	Alignment, socket, trimmers
677B	10-20	Automatic tuner procedure
	10-19	Schematic, parts
	10-20	Automatic tuner procedure
680	7-64	Alignment, socket, trimmers, automatic tuner procedure, Schematic, voltage, socket, trimmers, alignment
685B	7-64	nourning
686, A & B	7-65	See model 675A
	7-66	Schematic, voltage, socket, trimmers, parts list
690B	7-66	Alignment, parts
715B	10-21	Schematic, alignment
735	10-22	Schematic, alignment
	9-14	Schematic, alignment, parts
	9-13	Tuner, voltage
740	8-31	Schematic, socket, trimmers, voltage, parts
	8-32	Alignment, trimmers
750	7-67	Schematic, voltage
	7-68	Alignment, socket
761A	10-23	Schematic, voltage, socket, trimmers
	10-6	Alignment, tuner
762	8-33	Schematic, data
	8-34	Socket, chassis, voltage, coils
	8-35	Alignment, trimmers, data
	8-36	Circuit data, notes, parts
	10-24	Telephone dial, adjustments, data
	10-25	Phantom light dial, assembly views, data, parts list
	10-26	Telephone dial, parts
770	7-69	Schematic, voltage, socket, trimmers
	7-70	Alignment, parts list
774	8-37	Schematic
	8-38	Alignment, trimmers
	8-39	Voltage, socket, chassis, coils
	8-40	Notes, parts
	10-24	Telephone dial, adjustments, data
	10-25	Phantom light dial, assembly views, data, parts, telephone dial, data, parts
776	10-27	Schematic, phono., speaker
	10-24	Telephone dial, adjustments, data
	10-25	Phantom light dial, assembly views, data, parts, tele- phone dial data, parts
	10-28	Alignment, socket, trimmers, voltage, coils, notes
777C, 777L, Series A & B	7-71	Schematic, voltage
	7-72	Socket, trimmers, parts list
	7-73	Alignment
778-A	7-75	Schematic, voltage, socket, trimmers, parts list
	7-76	Alignment
780, 780B	6-14	Schematic
	7-74	Alignment, parts list
787	8-41	Schematic, voltage, socket, trimmers, parts
	8-42	Alignment, notes
802A	10-29	Schematics, parts

**GAROD
GENERAL ELECTRIC**

**RADIOTRON
EARLY COMPLETE
PAGE**

**GAROD RADIO CORP.—(Cont.)
REVISED
PAGE**

MODEL

60 Schematic, voltage, alignment 7-2
66 Schematic 6-5
73, 73LW Schematic 7-13
83 Schematic 6-6
83-LW Schematic 6-6
100 Television Schematic 10-3, 4
Chassis wiring, top 10-5, 6
Chassis wiring, bottom 10-5, 6
Chassis view, socket controls 10-7
Circuit data, assembly, wiring notes 10-9
S.P.U. chassis wiring, voltage 10-10
Alignment, operating, antenna notes 10-11
Schematic, voltage 7-9
Alignment, socket, trimmers 7-10
Schematic 8-1, 8-2
Schematic, socket, trimmers 10-2
Schematic, voltage, alignment 9-3
Schematic 9-4
Schematic, voltage, alignment 9-5
Schematic, socket, trimmers 10-13
Alignment 10-14
Schematic, socket, trimmers 9-6
Schematic 9-7
104 Early & Late, 104M
115
159
205C, 205L, 205-1, 206L, 206C, 206-1, 206P-4
237, 337
250
259, 269
307L, 307T, 307-1, 307, 307E
309L, 309T, 309E-1, 309-2, Schematic
309-3, 309E-2, 309E-3,
309P-5, 309P-7, 309E-P-5,
309E-P-7

310 Socket, trimmers, voltage, alignment 9-3
311 Schematic 8-1, 8-2
317 Schematic 8-4
369 See model 237
Schematic 10-12
Alignment 10-14
Schematic 8-5
Schematic 8-5
Schematic 10-15
Socket, trimmers, tuner data 10-16
Schematic 8-6
Alignment, voltage, socket, trimmers 8-7
Schematic 8-6
Alignment, voltage, socket, trimmers 8-7
Schematic, voltage 7-11
Alignment, socket, trimmers 7-12
Schematic 7-15, 7-16
Alignment, voltage 7-14
Schematic 7-17, 7-18
Schematic 7-19
Alignment, voltage, socket, trimmers 7-20
Schematic, voltage, alignment 9-9
Schematic 8-8
Alignment 10-17
Schematic 10-14
Schematic 9-10
Schematic, notes 8-9
Schematic, socket, trimmers 10-18
Alignment 10-14
Schematic, voltage, alignment, tuner 9-13
Schematic, voltage, socket, trimmers 9-12
Alignment, tuner 9-12
Schematic, socket, trimmers 10-19
Schematic 8-10
Schematic 8-11
Schematic 8-10
Schematic 8-11
Schematic 10-20
Schematic 9-15
Socket, trimmers, voltage, alignment 9-16

**REVISED
PAGE**

**GAROD RADIO CORP.—(Cont.)
MODEL**

930, 930D, 930KC
930, 930D, 930KC
930A
931, 931D, 931KC
931A
1203L, 1203T, 1203-3
1203-P-6, 1203-P-7,
1204ET, 1204EL, 1204-3,
1204E-P-6, 1204E-P-7
1240, 1240E, 1240LC
1240A
1603, 1604-4
1649
1650, 1650H, 1650LC
1650A
3119
3012L, 3012T, 3012-3
3012-P-6, 3012-P-7,
4012ET, 4012EL, 4012E-F-3,
4012E-P-6, 4012E-P-7
3016, 4016-4
3790
4110, 4110E, 4110KC
4159
5140
5240
7390
P-1 SPU
40-B Amplifier
40-C Amplifier
R-100 Amplifier
105-GR Amplifier
120-B Amplifier
125-P SPU
A-300
500-A
901-A

Schematic, socket, trimmers, voltage 8-12
Voltage 8-13
Schematic, voltage, socket 8-14
Alignment, socket, trimmers 8-13
Schematic 8-12
Alignment, socket, voltage, trimmers 8-13
Schematic, voltage, socket 8-14
Alignment, socket, trimmers 8-13
Schematic 9-17
Socket, trimmers, voltage, alignment 9-18
Schematic, voltage 8-15
Socket, trimmers, alignment 8-16
Schematic, socket, voltage 8-17
Alignment 8-16
Schematic, voltage 9-19
Socket, trimmers, alignment 9-20
Tuner data 9-14
Schematic, socket 10-21
Alignment, trimmers 10-22
Tuner data 10-26
Schematic, voltage 8-18
Socket, trimmers, alignment notes 8-19
Schematic, voltage, socket 8-20
Alignment 8-19
Schematic 10-23
Schematic 9-21
Socket, voltage, trimmers, alignment 9-22
Schematic, socket, trimmers 9-23
Voltage, alignment 9-24
Tuner data 9-14
See Model 379
Schematic, voltage 9-25
Socket, trimmers, alignment 9-26
Schematic 10-26
Alignment, tuner 10-16
Socket, trimmers 10-16
Schematic, voltage 9-27
Socket, trimmers, alignment 9-28
Schematic, voltage 8-21, 8-22
Socket, trimmers 8-23
Alignment 8-24
Schematic 10-24
Alignment 10-14
Schematic Misc. 7-7
Schematic Misc. 7-7
Schematic Misc. 7-7
Schematic Misc. 7-7
Schematic Misc. 6-1
Schematic Misc. 7-7
Schematic Misc. 7-7
Schematic Misc. 6-2
Schematic 6-2

GATES RADIO & SUPPLY CO.

P-1 SPU
40-B Amplifier
40-C Amplifier
R-100 Amplifier
105-GR Amplifier
120-B Amplifier
125-P SPU
A-300
500-A
901-A
Schematic Misc. 7-7
Schematic Misc. 7-7
Schematic Misc. 7-7
Schematic Misc. 7-7
Schematic Misc. 6-1
Schematic Misc. 7-7
Schematic Misc. 7-7
Schematic Misc. 6-2
Schematic 6-2
See RCA R-17-M
See G.E. model KV-100
See RCA Radiola 21
See RCA Radiola 22
Schematic, chassis 8-1
Circuit data, operation, notes 8-2
Voltage, parts 8-3
Schematic, operating notes 10-1
See RCA R-5
See RCA R-5-X
See RCA R-5 DC
See RCA R-7
BX
V-Doublet Antenna
B-1
B-2
FS-5 Remote Station
GM11, Wireless Record Player
T-12
T-12-F
T-12-DC
S-22, S-22-X

GENERAL ELECTRIC CO.

See RCA R-17-M
See G.E. model KV-100
See RCA Radiola 21
See RCA Radiola 22
Schematic, chassis 8-1
Circuit data, operation, notes 8-2
Voltage, parts 8-3
Schematic, operating notes 10-1
See RCA R-5
See RCA R-5-X
See RCA R-5 DC
See RCA R-7

RADIOTRON
EARLY COMPLETE
PAGE

GENERAL ELECTRIC CO.—(Cont.)

MODEL	REVISED PAGE	EARLY COMPLETE PAGE
B-52	See RCA M-116	
D-52	See RCA M-108	
E-52	Data	Changes 9-3
F-52	See model E-50	
FB-52, FB-53, FB-56, FB-57	Schematic, battery connections,	
	power adaptor	8-17
	Voltage, chassis	8-18
	Alignment, trimmers	8-19
	Drive cord data, notes, parts	8-20
	Schematic, voltage, socket,	
	alignment, trimmers	10-3
GD52	See RCA 110	
K-52	See RCA 112	
L-52	See RCA 119	
M-52	Schematic	6-4
A-53	Chassis wiring	6-5
	Circuit data, alignment	6-6
	Alignment part 2, voltage,	
	socket	6-7
	Voltage, parts	6-8
	Schematic, resistance, voltage,	
	transformer data	8-21
F-53	Socket, trimmers, alignment,	
	parts	8-22
FB-53	See model FB-52	
G-53, G-56	Schematic, socket, trimmers,	
	dial data, chassis wiring	9-9
	Alignment, specifications	9-10
	Circuit data, voltage, pick-up,	
	parts	9-11
K-53	See RCA 111	
K-53-M	See RCA 115	
L-53	See RCA 114	
A-54	Schematic, voltage, transformer	7-5
	data	7-4
	Circuit data, alignment, parts	7-4
	Chassis wiring, socket,	
	trimmers	7-6
K-54	See RCA RE-40	
K-54-P	See RCA RE-40-P	
A-55	See model A-52	
G-55	See model G-50	
K-55	See RCA 210	
M-55	See RCA 214	
U-55	See model U-51	
FB-56, FB-57	See model FB-52	
G-56	See model G-53	
M-56	See RCA 211	
G-57	Data	Changes 10-1
K-58	See RCA 810	
A-60	See RCA M-82	
C-60	See RCA M-107	
FA-60, FA-61	Schematic, socket, trimmers,	
	resistance	8-23
	Chassis and speaker layouts	8-24
	Voltage, installation	8-25
	Alignment, installation, parts	8-26
	Schematic, voltage, socket,	
	trimmers, alignment	10-3
GD60	See RCA R-37	
K-60	See RCA R-37-P	
K-60-P	Schematic	7-7
N-60	Circuit data, coils, alignment,	
	socket, trimmers, voltage, re-	
	sistance data	7-8
C-61	See RCA M-123	
E-61, E-62, E-68	Schematic, data	7-9
	Chassis wiring, circuit data,	
	coil data	7-10
	Socket, trimmers, circuit data,	
	part 2	7-11
	Voltage, alignment, parts list	7-12
FA-61	See model FA-60	
G-61, G-66, G-68, G-69	Schematic	10-5, 6
	Socket, trimmers, chassis, dial,	
	phono. connections	10-7
	Voltage, alignment, coils,	
	parts	10-8
	Phono. connections, motor	
	data, changer assembly	10-10

RADIOTRON
EARLY COMPLETE
PAGE

GENERAL ELECTRIC CO.—(Cont.)

MODEL	REVISED PAGE	EARLY COMPLETE PAGE
S-22-A	See RCA R-7-A	
S-22-D	See RCA R-7 DO	
C-30	See RCA 91-B	
H-31	See RCA Radiola 80	
H-32	See RCA R-50	
B-40	See RCA M-34	
F-40	Data	Changes 9-3
	Schematic, voltage	9-1
	Circuit data, socket, trimmers,	
	alignment, voltage	9-2
K-40	See RCA R-27 (Revised)	
K-40-A	See RCA R-27-W	
M-40	See RCA 102	
C-41	See RCA M-105	
FM-41 Handy Phone	Schematic, chassis	8-1
	Circuit data, operation, notes	8-3
	Voltage, parts	8-3
	Schematic, voltage, alignment,	
	parts, specifications	9-6
GD-41, GD-41U	See RCA R-17-M	
K-41	See RCA 100, 101	
M-41	See RCA 109	
M-42	See RCA 48	
T-41	See RCA R-9	
S-42	See RCA R-43	
S-42-B	See RCA R-9 DO	
S-42-D	See RCA R-7 AC, Radiola 86	
SZ-42-P	See RCA 100	
K-43	See RCA 100	
GD-44A, GD-44U, GD-44B, GD-44BU	Schematic, voltage, alignment	10-2
K-48	See RCA 800	
M-49	See RCA 801	
D-50	See RCA M-101	
E-50, E-52	Schematic, socket, trimmers,	
	voltage	8-5
	Chassis wiring	8-4
	Alignment, parts	8-6
	Schematic, coils	9-3
G-50, G-55	Circuit data, voltage, tuner,	
	specifications	9-4
	Socket, trimmers, chassis,	
	alignment, parts	9-5
K-50-P, K-51-P	See RCA R-28-P	
K-50, K-51	See RCA R-28	
L-50, L-51	See RCA R-22	
M-50	See RCA 117	
U-50	Schematic, socket, trimmers,	
	voltage	8-7
D-51	Alignment, dial drive data	8-8
D-51, D-52	See RCA M-104	
E-51	Data	Changes 9-3
	Schematic, socket, voltage,	
	trimmers	8-9
	Chassis wiring	8-10
F-51	Circuit data, alignment,	
	voltage, parts	8-11
	Schematic, socket, trimmers,	
	dial data, chassis wiring	9-7
	Alignment, parts, voltage,	
	specifications	9-8
	Schematic, socket, voltage,	
	alignment, trimmers	10-11
GD-51	See RCA 82	
H-51	See RCA Radiola 82, 82-R	
H-51-B	See K-50	
K-51	See L-50	
M-51	See RCA 118 (Revised)	
M-51-A	See RCA 118 (Revised)	
U-51, U-55	Notes, parts	8-13
	Schematic	8-12
	Coils, resistance, vibrator,	
	notes	8-14
	Socket, trimmers, voltage,	
	dial assembly	8-15
	Alignment, notes, drive	
	cord data	8-16
	Schematic, voltage, socket,	
	trimmers	7-1
A-52, A-55	Chassis wiring data	7-2
	Circuit data, alignment, parts	7-3

U-70, U-75	Trimmers, voltage, resistance, coils	8-34
	Alignment, drive data	8-35
	Parts	8-36
	Schematic, data	7-13
E-71, E-72, E-76	Chassis wiring, transformer data	7-14
	Circuit data, alignment, socket, trimmers, voltage	7-15
	Parts list	7-16
H-71, H-71-R	See RCA 86, 86-R	
D-72	See RCA M-109	
E-72	See model E-71	
FB-72, FB-73, FB-76, FB-77	Schematic, battery connections, switch assembly, adapter, socket, trimmers, alignment, notes	8-37
	Chassis, voltage	8-38
	Dial assembly, notes, parts	8-39
	See RCA RAE-59	8-40
H-72	See RCA R-70	
H-73, H-77, H-79	Schematic, socket, alignment, trimmers	10-43
F-74, F-77	Schematic, resistance, voltage, transformer data	9-15
	Socket, trimmers, chassis wiring	9-16
	Alignment, voltage, parts	9-17
	See G.E. model A-70	
A-75	See RCA 235-B	
C-75	See model F-70	
F-75	Schematic, chassis wiring	10-17
G-75	Schematic, voltage, socket, alignment, dial and phono, data	10-18
I-75	See RCA R-6	
U-75	See model U-70	
E-76	See model E-71	
FB-76, FB-77	See model F-70	
G-76	Schematic, socket, trimmers, alignment	10-21
H-77, H-79	See Model H-73	
G-78	Schematic, socket, trimmers, chassis wiring, voltage	10-19
	Alignment, dial and phono, data	10-20
K-78	See RCA 330	
E-79	Schematic	8-41
	Chassis wiring	8-42
	Voltage, socket, trimmers	8-43
	Circuit data, alignment, dial data	8-44
	Phono, data	8-45
	Parts	8-46
K-79	See RCA 331	
F-80, F-85	Alignment, voltage, parts, transformer data, voltage, schematic, socket, trimmers, resistance	9-18
	Specifications, circuit data, chassis wiring	9-20
	Schematic, resistance	8-47
	Socket, trimmers, chassis, voltage	8-48
	Circuit data, alignment, installation	8-49
	Parts	8-50
J-80	See RCA R-8	
K-80, K-80-X	See RCA 140 series	
A-81	See RCA P-31	
B-81	See RCA 142-B	
E-81, E-86	Schematic	7-17
	Chassis wiring	7-18
	Circuit data	7-19
	Alignment, parts, voltage, dial data	7-20
F-81, F-86	Schematic, resistance	8-51
	Voltage, chassis	8-52
	Alignment, trimmers, socket	8-53
	Dial data, notes	8-54
	Parts	8-55

G-61, G-66, G-68, G-69	Automatic record changer data	10-9
M-61	See RCA 128	
M-61 (Revised)	See RCA 128 (Revised)	
C-62	See RCA 126-B	
E-62	See model E-61	
FD-62, FD-625	Schematic, coils, voltage, resistance, trimmers, alignment, parts	9-13
	Specifications, alignment notes, voltage, circuit data, chassis wiring	9-12
	Schematic, voltage, socket, alignment, trimmers	9-14
GA-62	Schematic, voltage, socket, alignment, trimmers	10-12
GD-62, GD-67	Schematic, voltage, socket, alignment, trimmers	10-13
K-62	See RCA R-11	
K-62 (Revised)	See RCA R-11 (Revised)	
M-62	See RCA 125	
KZ-62-P	See RCA RE-18, RE-18-A	6-9
A-63, A-65	Schematic, data	6-10
	Chassis wiring	6-11
	Circuit data, alignment	6-12
	Alignment, voltage	6-13
	Voltage, parts	6-13
	Additional data	Changes 7-1
	Schematic, resistance, voltage	8-27
F-63, F-65, F-66	Socket, trimmers, chassis, alignment	8-28
	Schematic, socket, voltage, alignment, trimmers	10-14
GD-63	See RCA 120	
K-63	See RCA 124	
M-63	Schematic	6-14
A-64, A-66, A-67	Chassis wiring	6-15
	Circuit data, trimmers, alignment, socket	6-16
	Alignment part 2, voltage, dial data	6-17
G-64, G-65	Parts	6-18
	Additional data	Changes 7-12
	Schematic, chassis wiring	10-15
	Alignment, voltage, socket, trimmers, dial data, phono, connections, parts	10-16
K-64	See RCA 121	
K-64-D	See RCA 127	
F-65	See model F-63	
K-65	See RCA R-38	
K-65-P	See RCA R-38-P	
M-65	See RCA 221	
A-66	See model A-64	
F-66	See model F-63	
G-66, G-68, G-69	See Model G-61	
K-66	See RCA 220	
K-66-M	See RCA 222	
M-66	See RCA 226	
A-67	See G.E. model A-64	
C-67	See RCA 223	
M-67	See RCA 224	
GD-67	See model GD-62	
E-68	See model E-61	
M-68	See RCA Duo 821	
M-69	See RCA 322	
A-70, A-75	Schematic	6-19
	Chassis wiring	6-20
	Alignment, trimmers, socket, voltage	6-21
	Circuit data, dial data	6-22
	Voltage, parts	6-23
	Changes	Changes 7-1, 7-16
	See RCA 135-B, 235-B	
C-70, C-75	Schematic, resistance	8-29
F-70, F-75	Alignment, socket, trimmers	8-30
	Chassis, voltage	8-31
J-70	See RCA R-4	
U-70, U-75	Schematic	8-33
	Socket, vibrator, dial assembly, data	8-32

M-81 (Revised)	See RCA 143		
A-82, A-86, A-87	See RCA 143 (Revised)		
J-83	Schematic	6-24	
A-85	Chassis wiring, Sentry Box	6-25	
F-85	Circuit data, alignment	6-27	
G-85	Alignment part 2	6-28	
	Sentry Box data, dial data	6-29	
	Voltage, parts	6-30	
J-83	See RCA R-71		
A-85, A-85	Schematic, data	7-21	
	Chassis wiring, coil data	7-22	
	Circuit data, alignment, coil locations	7-23	
	Socket, trimmers, voltage, dial data, parts list	7-24	
J-83	See RCA R-73		
J-83-A	See model A-83		
A-85	See model F-80		
G-85	Schematic, socket, trimmers, mechanism	10-22	
	Chassis wiring, coil data, dial	10-23	
	Alignment, voltage, parts, phono, data	10-24	
J-85	See RCA R-12		
K-85	See RCA 240, 140		
M-85	See RCA 243		
A-86	See model A-82		
B-86	See RCA 241-B		
E-86	See model E-81		
F-86	See model F-81		
G-86	Schematic, voltage, socket, trimmers	10-25	
	Alignment, chassis wiring, dial and phono, data, "Beam-A," Scope, data	10-26	
J-86	See RCA R-72		
K-86	See RCA 143		
A-87	See G.E. model A-82		
J-87	See RCA R-75		
J-87-A	See RCA R-75		
F-88	Schematic, socket, trimmers, voltage, transformer data, resistance	9-21	
	Changes, voltage	9-22	
	Specifications, chassis wiring	9-23	
	Circuit data, alignment, phono-graph data	9-24	
	Alignment, parts	9-25	
J-88	See RCA R-71		
K-88	See RCA 340		
K-88-X	See RCA 340-E		
M-89	See RCA 341		
A-90	See RCA M-30		
E-91, E-95	Schematic	7-25	
	Circuit data, voltage, alignment	7-27	
	Chassis wiring, coil data	7-28	
	Visual alignment, socket, trimmers, dial data, parts	7-28	
H-91	Schematic	4-2	
	Chassis wiring of receiver	4-6	
	SPU Chassis wiring	4-8	
	Assembly wiring	4-11	
H-91-R	Schematic	4-4	
	Chassis wiring of receiver	4-7	
	Assembly wiring	4-10	
	SPU Chassis wiring	4-9	
	Specifications	4-1	
H-91, H-91-R	Notes	4-3	
	Remote control notes, voltage data	4-5	
	Parts list	4-12	
	Parts list continued	4-13	
	Parts list concluded	4-14	
E-95	See model E-91		
G-95, Radioforte	Schematic, chassis wiring, voltage, socket, trimmers	10-27, 28	
	Alignment, phono, parts	10-29	
	Tuner and remote control schematics, data	10-30	
	Circuit data, specifications	9-26	
	Schematic, resistance	9-27	
	Chassis wiring	9-28	
	Socket, trimmers, alignment	9-29	
	Voltage, dial data	9-30	
	Parts list	9-31	
G-97	Schematic, socket, trimmers, resistance, dial mechanism	9-47	
	Specifications, circuit data	9-48	
	Alignment, tuner, parts	10-31	
G-99	Schematic, socket, trimmers	10-31	
	Voltage, chassis wiring, dial mechanism	10-32	
	Alignment, phono, notes, parts	10-33	
J-100	See RCA R-74		
KV-100, V-Doublet Antenna	Installation data	6-1	
E-101, E-105, E-106	Installation part 2, parts	6-2	
	Wiring details	6-3	
	Schematic	7-29	
	Chassis wiring, coil data	7-30	
	Circuit data, alignment, dial data, visual alignment	7-31	
	Socket, trimmers, voltage, parts list, colorama tuning	7-32	
G-105	Schematic, dial data	9-33, 34	
G-105, G-106	Specifications, tuner data	9-32	
	Chassis wiring, socket, trimmers, dial mechanism, volume control motor data	9-37	
	Circuit data, alignment	9-38	
	Voltage, parts	9-39	
J-105	See RCA R-76		
K-105	See RCA 251		
E-106	See model E-101		
G-106	Schematic	9-35, 36	
	Other Data, See model G-105		
K-106	See RCA R-90		
K-106-P	See RCA R-90-P		
M-106	See RCA 262		
M-106 (Revised)	Changes	7-14	
F-107	See RCA 262 (1935 Production)		
	Parts list	9-40	
	Schematic, resistance, specifications	9-41, 42	
	Chassis wiring	9-43	
	Socket, trimmers, alignment, voltage	9-44	
	Dial mechanism, tuner data	9-45	
	Relay data	9-46	
J-107	See RCA R-77		
K-107	See RCA 260		
M-107	See RCA 263		
J-109	See RCA RE-81		
E-115	Schematic, resistance	8-57	
	Colorama data, dial data, voltage	8-56	
	Chassis wiring	8-58	
	Alignment, socket, trimmers, notes	8-59	
	Parts	8-60	
	Schematic, socket, alignment, trimmers	10-44	
H-116, H-118 Preliminary	Schematic	7-33	
A-125	Chassis wiring, transformer data	7-34	
	"Sentry Box" chassis wiring	7-35	
	Socket, trimmers, voltage, dial mechanism	7-36	
	Circuit data, alignment, part 1	7-37	
	Alignment, part 2, "Sentry Box" coil locations	7-38	
	Visual alignment, dial data	7-39	
	Parts list	7-40	
	Schematic, voltage	10-35	
	Power supply and operating notes	10-34	

GENERAL ELECTRIC
GENERAL HOUSEHOLD

RADIOTRON
EARLY COMPLETE
PAGE

REVISED
PAGE

GENERAL ELECTRIC CO.—(Cont.)

MODEL

GD-400	Schematic, socket, trimmers, alignment	10-37
H-400 Preliminary	Schematic, socket, trimmers, alignment	10-45
GD-500	Schematic, socket, trimmers, voltage, alignment	10-38
H-500, H-500W, H-500-X	Schematic	10-47
H-510, H-510W, H-510X	Alignment, socket, trimmers, parts	10-48
H-501, H-501W, H-501X, H-511, H-511W, H-511X	Schematic	10-47
	Alignment, socket, trimmers, parts	10-48
GD-520, GD-521	Schematic, socket, trimmers, alignment, voltage	10-89
H-520, H-520W, H-520X	Schematic	10-47
	Alignment, socket, trimmers, parts	10-48
H-521, H-521W, H-521X	Schematic	10-47
	Alignment, socket, trimmers, parts	10-48
GD-600	Schematic	10-41
	Socket trimmers, voltage, alignment	10-42
H-600, H-601, H-610, H-611 Preliminary	Schematic, socket, alignment, trimmers	10-46
GD-610, GD-620	Schematic, socket, trimmers, voltage, alignment	10-40
H-620, H-621, H-630, H-631, H-632, H-633	Schematic, socket, trimmers, alignment	10-49
H-625 Preliminary	Schematic, socket, alignment, trimmers	10-50
FD-625	See model FD-62	10-41
GD630	Schematic	10-42
	Alignment, voltage, socket, trimmers	10-42
M-655	See RCA 225	
JZ-822	See RCA R-24	
JZ-822-A	See RCA R-24-A	
JZ-835	See RCA RO-23	
9500A	Antenna system, data, installation	7-41
	Installation notes, parts list	7-42

Baird AW-50
Schematic Misc. 5-7

GENERAL ELECTRONICS CORP.

Sumfizes:
W = 115 volts, 50-60 cycles
X = 115 volts, 25-50 cycles
Z = 110-135-220-250 volts, 50-60 cycles

2A Chassis	See model 1101
4A Chassis	See model 450
4A, Revised Chassis	See model 450
4B Chassis	See model 460
4B, 4BX, Revised Chassis	See model 460
4C Chassis	See model 470
4C, Revised Chassis	See model 470
4NB Chassis	See model 410
5A Chassis	See model 500
5B Chassis	See model 501 and 550
5C Chassis	See model 502
5D, 5DX, 5DZ Chassis	See model 570
5E Chassis	See model 560
5G Chassis	See model 580
5G, Revised Chassis	See model 580
5H Chassis	See model 532
5J Chassis	See model 542
5K Chassis	See model 551
5L Chassis	See model 555
5M Chassis	See model 590
5N Chassis	See model 592
5NB Chassis	See model 510
5P Chassis	See model 587

RADIOTRON
EARLY COMPLETE
PAGE

REVISED
PAGE

GENERAL ELECTRIC CO.—(Cont.)

MODEL

Alignment, socket, trimmers.....	10-36
See RCA R-78	
See RCA R-78	
See RCA 281	
Schematic, resistance	8-61, 8-62
Chassis wiring	8-63, 8-64
Sentry Box wiring	8-65
Socket, trimmers, voltage	8-66
Dial mechanism, alignment	
oscillograms	8-67
Alignment, dial notes	8-68
Circuit data	8-69
Parts	8-70
See RCA 281	
See RCA 280	
See RCA Duo 380	
Schematic, resistance	8-71, 8-72
Chassis wiring	8-73, 8-74
Sentry Box wiring	8-75
Dial mechanism, alignment	
oscillograms	8-76
Socket, trimmers, voltage	8-77
Alignment	8-78
Circuit data	8-79
Phonograph data	8-80
Parts	8-81
See RCA 381	
See RCA R-10	
Schematic, resistance	9-49, 50
Socket, trimmers, alignment	9-51
Voltage, chassis wiring	9-52
Specifications, circuit data, dial mechanism	9-53
Tuner data, Part 1	9-54
Tuner data, Part 2	9-55
Parts list	9-56
Schematic, resistance	8-83, 8-84
Circuit data	8-85, 8-86
Chassis wiring	8-85, 8-86
Sentry Box wiring	8-87
Dial mechanism, alignment	
oscillograms	8-88
Socket, trimmers, voltage	8-89
Alignment	8-90
Dial data	8-91
Parts	8-92
See Model A205E	
Schematic	9-57, 58
Chassis wiring, coil data	9-59
Speaker and power unit wiring	9-60
"Sentry Box" wiring	9-65
Socket, trimmers, voltage	9-66
Parts list, pick-up data	9-72
Parts list, concluded	9-73
Specifications, circuit data, alignment, Part 1	9-69
alignment, Part 2	9-70
"Sentry Box" notes, dial and phonograph data	9-71
Specifications, "Colorama" data, voltage	9-74
Schematic	9-75, 76
Trimmers	9-77
Phonograph data, installation notes	9-78
Parts list	9-79
Parts list, concluded	9-80
Automatic record changer adjustments	9-68
Circuit data, alignment, Part 1	9-69
alignment, Part 2	9-70
"Sentry Box" notes, dial and phonograph data	9-71
Pick-up data	9-72
Schematic	9-61, 62
Chassis wiring, coil data	9-63
Speaker and power unit wiring	9-64
Assembly wiring	9-67
Automatic record changer adjustments	9-68

A-205, A-208

A-205E, A-208E

A-208

GENERAL HOUSEHOLD UTILITIES CO.—(Cont.)

GENERAL HOUSEHOLD UTILITIES CO.—(Cont.)

MODEL

59 Chassis 573 See model 564 See model 566 See model 576 See model 587 See model 583 See model 650 See model 650 See model 622 See model 660 See model 670 See model 663 See model 690 See model 680 See model 632 See model 620 See model 640 See model 623 See model 631 See model 654 See model 622 See model 700 See model 750 See model 760 See model 720 See model 723 See model 711 See model 755 See model 801 See model 821 See model 861 See model 871 See model 823 See model 901 See model 1101 See model 921 See model 941 See model 1067 See model 1091 See model 1151 See model 1171 See model 1191 See model 1181 See model 1241 See model 1291 See model 1297 See model 1544 Schematic, socket trimmers, alignment, voltage, chassis, parts 8-1 Alignment, parts list 5-1 Schematic, trimmers 5-2 Schematic, socket trimmers, voltage, resistance, parts 7-1 Alignment data 5-3 Schematic, trimmers 5-4 Schematic, socket trimmers, voltage, resistance, parts list 7-2 Schematic, socket trimmers 6-1 Alignment 6-2 Schematic, socket trimmers, chassis, parts 7-3 Schematic, condenser assembly 4-1 Parts list 4-2 Schematic, condenser assembly 4-3 Parts list 4-4 Trimmers, schematic, socket 6-3 Alignment 6-4 Additional data 7-11 Schematic 4-5 Parts list 4-6 Schematic, socket trimmers, chassis, voltage, alignment 8-2 See model 501 Schematic, socket trimmers, alignment 8-24

GENERAL HOUSEHOLD
GENERAL MOTORS

MODEL	GENERAL HOUSEHOLD UTILITIES CO.—(Cont.)	REVISI PAGE	RADIO COMPLETE PAGE
660, 661, 662, Chassis 6C, Revised	Schematic, voltage, resistance, notes	7-13	
663, Chassis 6E	Socket, trimmers, chassis	7-14	
670, 671 (6D), Temporary	Schematic, parts	9-8	
	Alignment data	5-11	
670, 671, Revised Chassis 6D; 690, 691, Chassis 6E	Schematic	5-12	
	Schematic, voltage	6-13	
680, 681, Chassis 6G	Schematic, trimmers	6-15	
	Alignment, notes	6-16	
680, 681, Chassis 6G, Revised	Schematic, voltage	7-15	
690, 691, Chassis 6F	Socket, trimmers, chassis, alignment, parts list	7-16	
700 w/8A1 Spkr. (Chassis 7-A)	Alignment, parts	6-14	
700, 701 (Chassis 7-A)	Schematic, condenser assembly	4-7	
700, 701, 801, 901, 902, Chassis 7A, 8A, 9A	Parts list	4-8	
	Alignment of I.F.	4-13	
	Alignment	4-14, 4-15	
	Socket layouts	4-16	
701 w/10A2 Spkr. (Chassis 7-A)	Schematic, condenser assembly	4-7	
711, Chassis 7NB	Schematic, voltage, parts	8-25	
	Socket, trimmers, chassis, vibrator	8-27	
	Alignment	8-28	
720, 721, Chassis 7DB	Schematic, notes	7-17	
	Socket, trimmers, chassis	7-18	
	Alignment, parts	7-19	
728, 731, 739, 735, Chassis 7M	Schematic, voltage, parts	8-21	
	Socket, trimmers, chassis	8-22	
	Alignment	8-23	
750, 751, 752, 758 (7B)	Service notes, socket	5-13	
	Schematic, voltage	5-14	
	Trimmers, coil data	5-15	
	Alignment, parts	5-16	
755, Chassis 7Q	Schematic, voltage, align- ment, parts	8-29	
	Socket, trimmers, chassis	8-30	
	Schematic, voltage	7-21	
760, 761, Chassis 7C	Socket, trimmers, chassis, switch & coil assembly	7-20	
	Alignment, parts	7-22	
801, (Chassis 8A)	Alignment—See model 700	4-9	
	Schematic, data	4-10	
821, (Chassis 8B)	Parts list	4-10	
	Schematic, trimmers, socket parts	6-17	
828, 831, 833, 836, Chassis 8H	Alignment	6-18	
	Schematic, voltage, parts	8-31	
861, (Chassis 8D)	Socket, trimmers, chassis	8-32	
	Alignment	8-33	
	Switch and coil assembly	8-34	
	Schematic, voltage	6-19	
	Switch and coil assembly, trimmers, chassis layout	6-20	
	Circuit data, socket layout	6-21	
	Alignment, parts	6-22	
871, Chassis 8E	Schematic, voltage	7-23	
	Socket, trimmers, chassis	7-24	
	Alignment, parts list	7-25	
901, 902 (Chassis 9A)	Alignment—See model 700	4-11	
	Schematic, data	4-12	
	Parts list	4-13	
901, 902 (9A) Revised	Schematic	5-19	
921, Chassis 9C	Schematic, parts, alignment	7-26	
941, Chassis 9E	Schematic, voltage, parts	8-35	
	Switch and coil assembly	8-34	
	Socket, trimmers, chassis	8-36	
	Alignment, notes	8-37	
1067, Chassis 10D	Schematic, parts	9-9, 10	
1091, Chassis 10G	Schematic, parts	9-11, 12	
	GENERAL HOUSEHOLD UTILITIES CO.—(Cont.)		
	MODEL		
	1101 (Chassis 9-B, 2-A)	Schematic, data	4-17
		Alignment	4-18
		Socket layout, alignment	4-19
		Parts list	4-20
	1101 (9B-2A) Revised	Parts list	4-21
	1151, 1152 (11A), Temporary	Schematic	5-20
		Schematic	5-17
	1151, 1152, Chassis 11A (Final)	Alignment	5-18
		Schematic, voltage	6-23
		Switch and coil assembly, trimmers, chassis layout	6-24
		Switch data, socket	6-25
		Alignment, parts	6-26
		Switch and coil assembly, notes	8-39
		Socket trimmers, chassis	8-40
		Schematic, voltage, data	6-27
	1151, 1152, 1161, 1162, Chassis 11A (type 2), Chassis 11B	Parts list	6-28
		Schematic, voltage	7-27
		Socket, trimmers, chassis, switch & coil assembly	7-28
	1171, Chassis 11C	Mechanical alignment, parts details	7-29
		Alignment, parts	7-30
		Schematic, parts	9-13, 14
	1181, 1183, 1185 Chassis 11H	Schematic, voltage, parts	8-41
	1191, 1191B, Chassis 11G	Socket trimmers, chassis	8-42
		Alignment, notes	8-43
		Schematic, voltage	7-31
	1241, Chassis 12A	Socket trimmers, chassis	7-32
		Alignment, notes, parts list	7-33
		Schematic, parts	7-35
	1291, 1297, Chassis 12B, 12W (Preliminary)	Socket trimmers, chassis	7-34
		Alignment	7-36
		Schematic, parts, voltage	8-45
	1291, 1297, Chassis 12B, Chassis 12W, Final	Socket trimmers, chassis	8-44
		Alignment, Teledial parts	8-46
		Schematic	7-37
	1541, Chassis 15W	Range & Fidelity switches, sche- matic, range switch & coil schematic, speaker	7-38
		Socket trimmers, parts details	7-39
		Chassis alignment curves	7-40
		Alignment, part 2	7-41
		Alignment, part 2	7-42
	GENERAL MOTORS RADIO CORP.		
	B and C SPU	Schematic	1-9
	Little General	See model 110	1079
	E-2 Chassis	See model 200	
	R-1A Chassis	See model 281	
	S-1A, S-1B Chassis	See model 216	
	S-2A, S-2B Chassis	See model 251	
	S-3A, S-3B Chassis	See model 252	
	S-4A, S-4B	See model 292	
	Day-Fan 5-AO	Schematic	1-3
		SPU Schematic, data	1-3
	Day-Fan 6	Schematic, socket	1-3
	Day-Fan 6 Jr.	Schematic, socket	1-3
	Day-Fan 6-61 (5050)	Schematic, socket	1-4
	OEM-7 (4 tube)	Schematic, socket, data	1-4
	OEM-7 Super-Sel	Schematic, socket	1-1
	S-9A, S-9-B Chassis	Schematic, socket	1-1
	S-10A, S-10B	See model 211	1078
	OEM-11 (3 tube)	See model 220	1073
	Day-Fan 25, 26, 27, 28, 43, 48	Schematic, socket, voltage	1-10
	Day-Fan 35	Schematic, socket	1-10
	110, 180, 190, Little General	Schematic, socket, data	3-1
	120, 130, 140 Below Serial #29100A-1700B	Divider data, notes	3-2
		Schematic, socket, voltage	1-14
			1071
			1080
			1088
			1095
			1096
			1086

RADIO TRON
EARLY COMPLETE
PAGE

GENERAL TELEVISION & RADIO CORP.—(Cont.) REVISED
PAGE

MODEL			
543	Schematic		8-2
557	Schematic	Misc.	10-3
745	Schematic		8-2
PR-4	Schematic, notes	Misc.	9-4
GILFILLAN BROS.			
4T, 30	Schematic, socket, alignment		5-3
5B8	Schematic, socket, parts		9-1
5C, 5T, 32, 35, 41	Schematic, socket, alignment		5-3
5B3, 5B9	Schematic, socket, parts		9-1
58T, 54S	Schematic, socket		10-2
586	Schematic, socket, parts		9-2
5Y, 34, 55A, 55B	Schematic, socket		5-4
6C, 6T	Schematic, alignment		5-1
6X, 6	Schematic, socket		3-1
6X6, 700	Schematic, socket, parts		9-2
7A, 700	Schematic, socket		6-7
7T8	Schematic, socket, trimmers		9-3
8C, 8T, 47, 50	Alignment data		5-1
	Schematic		5-4
	Socket layout		5-4
	Schematic, socket, trimmers		9-4
8CR, 8TR	Schematic, socket, trimmers		9-5
8CEP, 8TE	Schematic, socket, trimmers		9-5
8X	Alignment, tuner		7-1
13C8E	Schematic, socket, trimmers		9-7
	Alignment, tuner		9-6
30	See model 4T		
32	See model 6C		
33	Schematic, socket		1-1
34	See model 6X		
35	See model 5C		
35, 100, with p.p. 71s	Schematic		6-1
41	See model 5C		
42A	Schematic, socket		6-2
43A	Schematic, socket		6-2
47, 50	See model 8C		
52A, 54A	Schematic, socket		6-5
54S	See Model 5SJ		
55A, 55B	Schematic		6-3
	Schematic, socket. See model 5X		
56S	Schematic, socket, voltage		10-1
	Tuner data		10-2
60	Schematic, socket		1-2
62B, X	Schematic, socket		6-4
63E, 63X	Schematic, socket		6-4
66	Schematic, socket		1-2
66S	Schematic, socket, voltage		10-1
	Tuner data		10-2
78 B, 78X	Schematic, socket		6-5
100	Schematic, socket		1-1
100, with p.p. 71s	See model 35		
105, 106, 107 Early	Schematic, socket		3-1
116B, 116X	Schematic, socket, voltage		6-4
117B, 117X	Schematic, socket, voltage		6-5
402T	Schematic, socket		7-2
410	Schematic, socket		6-7
412T	Schematic, socket		7-2
501T	Schematic		9-8
510, 520	Schematic, socket, alignment, data		6-8
515, 525	Schematic, socket, alignment, data		6-9
	Schematic		8-1
521T-C	Schematic, socket, alignment, data		6-10
615, 625	See model 7A		
700	Schematic		8-2
711T	Schematic, socket, alignment, data		6-9
715, 725	Schematic, socket		7-2
723T-C	Schematic		8-3
731T-C	Schematic, socket, alignment, data		6-10
815, 825	Schematic, socket		7-3
831T-C	Schematic, socket		7-4
1331C	Schematic		8-4

RADIO TRON
EARLY COMPLETE
PAGE

GENERAL MOTORS RADIO CORP.—(Cont.) REVISED
PAGE

MODEL			
120, 130, 140 Between	Schematic, socket, voltage		1-15
Serials #29100A-62100A			
and 1700B-1964B			
120, 130, 140 Above Serial	Schematic, socket, voltage		1-16
#62100A-1964B			
120, 130, 140	Service notes		2-3
120, 130, 140	Service notes		2-4
150, 160, Pick-up	Service notes, Part 1		2-5
150, 160 Induction Motor	Service notes, Part 2		2-6
170-E	Schematic, socket, voltage		1-17
	Chassis wiring, data		1-18
180, 190	See model 110		
180, 190	Schematic, socket		3-3
200, 201 (E-2)	Voltage, parts values		3-4
211 (S-9A, S-9B)	Schematic, socket, voltage		3-5
	Chassis layout, tracking pro-		
	cedure		3-6
216, 217, 219, 250 (S-1A, S-1B)	Schematic, socket		2-7
	Voltage, data		2-8
220 (S-10A, S-10B)	Schematic, socket, voltage		2-13
	Chassis layout, service data		2-14
250	See model 216		
251 (S-2A, S-2B)	Schematic, socket		2-9
	Voltage, data		2-10
	Changes		7-5
252, 253, 254, 255, 256, 257, 258	Schematic, socket		2-11
	Voltage, data		2-12
	Changes		5-2
281 (R-1A) Converter	Schematic, voltage, service notes		3-7
	Diagrams, data		3-8
292, 293 (S-4A, S-4B)	Schematic, socket		5-1
	Changes		5-2
527 (5 tube)	Schematic, socket		1-12
Day-Fan A-5003, A-5010	Schematic, socket		1-12
Day-Fan A-5005, A-5020	Schematic, socket, voltage		2-1
	Chassis wiring, parts list		2-2
5044 (5 tube)	Schematic, socket		1-2
5050	See Day-Fan G-61		
Day-Fan 5050 Battery	Schematic		1-9
Day-Fan 5050-7	Schematic, socket		1-9
Day-Fan 5051 (MG Set)	Schematic, socket, data		1-3
Day-Fan 5052 (110-volt DC)	Schematic, socket		1-8
Day-Fan 5053	Schematic, socket		1-6
Day-Fan 5057	Schematic, data		1-6
Day-Fan 5057 SPU	Schematic		1-6
Day-Fan 5060 (32-volt DC)	Schematic, socket		1-8
Day-Fan 5065 AC	Schematic, socket, data		1-7
Day-Fan 5066	Schematic, data		1-7
Day-Fan 5077	Schematic		1-11
Day-Fan 5080	Schematic, socket, voltage		1-11
Day-Fan 5091	Schematic, socket, voltage		1-13
Day-Fan 5524, 5525 SPU	Schematic		1-7

GENERAL RADIO CO.

210 Amplifier	Schematic		1-1
250 Amplifier	Schematic		1-1
320 Oscillator	Schematic		1-3
360 Oscillator	Schematic		1-3
360-A Oscillator	Schematic		1-3
361-B	Schematic diagrams		1-2
390 Eliminator	Schematic		1-1
403-C	Schematic		1-2
GENERAL TELEVISION, INC.			
A, B, C, E	Schematic	Misc.	6-9
G, GSW, M, MSW	Schematic	Misc.	6-9

GENERAL TELEVISION & RADIO CORP.

457	Schematic	Misc.	10-5
510	Schematic		8-1
533	Schematic		8-1

Wings All Weather Wings Junior 404	See model 101501 Schematic, voltage, socket, trimmers, alignment	10-1	01020, Chassis 881	Schematic, socket, trimmers, alignment	10-23
415A Chassis	See Model 010219, Run 1		01029, Chassis 860	Schematic, voltage, socket, trimmers	10-24
415B Chassis	See Model 010219, Run 2		01030, Runs 1, 2 Ch. 58 ^A , Series A,B	Tuner, alignment Schematic, voltage, socket, trimmers, alignment	10-19
489 Chassis	See Model 010219, Run 3, 4		1070, Runs 1, 2	Tuner Schematic, socket, trimmers, changes	10-34
504	Schematic, voltage, socket, trimmers, alignment	10-2	1170, 1171	Alignment, parts Schematic, socket, trimmers, alignment	10-13 10-14 10-15
505 Chassis	See Model 01554		1173 Chassis	See Model 010217	
523 Chassis	See Model 010220		1174 Chassis	See Model 010218	
523B Chassis	See Model 010220, Run 2		1175	Schematic, voltage Socket, trimmers, tuner data	10-17
526E Chassis	See Model 01009		01554, Chassis 505	Alignment Schematic, voltage, socket, trimmers	10-18 10-19
526I Chassis	See Model 01010		010110, Chassis 667	Schematic, voltage, socket, trimmers, parts	10-25
540	Schematic, voltage, socket, alignment, parts	6-1	010211, Chassis 602E	Schematic, voltage, socket, trimmers, alignment	8-6
550	Schematic, voltage, socket, trimmers, alignment	10-3	010212, Chassis 588	Schematic, voltage, socket, trimmers, parts	8-3
575	Schematic, voltage, socket, trimmers, alignment	10-3	010217, Chassis 1173	Alignment, notes Schematic, socket, trimmers, parts	8-4 8-4 8-9
578, Series A	Schematic, voltage, socket, trimmers, alignment	6-2	010218, Chassis 1174	Alignment, notes Schematic, voltage, socket, trimmers, parts	8-10 8-5 9-5
580	Schematic, voltage, socket, trimmers, alignment	10-4	010219, Run 1, Chassis 415A	Alignment Schematic, voltage, socket, trimmers, alignment	9-6 10-27
582 Chassis	Schematic, parts list	7-4	010219, Run 2	Schematic, voltage, socket, trimmers, alignment	10-28
585	See Model 01030		010219, Runs 3, 4, Chassis 489, Series A Issues A and B	Schematic, voltage, socket, trimmers	10-29
585, Run 1	Schematic, voltage, socket, trimmers, alignment	10-5	010220, Chassis 523	Socket, trimmers, alignment	10-30
585, Run 2	Schematic, voltage	9-1	010220, Run 2	Schematic, socket, trimmers, alignment, voltage, parts	8-1
585, Run 1, Run 2	Socket, trimmers, alignment	9-1	Chassis 523B	Schematic, voltage, socket, trimmers, alignment	10-33
587	Schematic, voltage, socket, trimmers, alignment	9-2	010221, Chassis 804	Schematic, voltage, socket, trimmers	10-31
588 Chassis	See Model 010212	10-6	010222, Chassis 602I	Trimmers, alignment	10-32
601, Runs 1, 2	Schematic, voltage, socket, trimmers, alignment	10-7	015040	Schematic, voltage, socket, trimmers, alignment	10-35
602	Schematic, socket, trimmers, alignment, voltage, parts	8-2	015050	Tuner data Schematic, voltage, socket, trimmers, alignment	10-37 10-36
602, Runs 1, 2	Schematic, voltage, socket, trimmers, alignment	10-8	015060	Tuner data Schematic, voltage, socket, trimmers, alignment	10-37 10-37
602E Chassis	See Model 010211		015070	Schematic, voltage, socket, trimmers	10-38
602I Chassis	See Model 010222		015080	Tuner data Alignment Schematic, voltages, socket, trimmers	10-42 10-41 10-39
661 Chassis	See Model 01019		015090	Tuner data Schematic, voltage, socket, trimmers	10-42 10-41 10-40
666, Runs 1, 2	Schematic, voltage, socket, trimmers, changes	10-9	015100	Tuner data Alignment Schematic, voltage, socket, trimmers, alignment	10-42 10-41 10-43 10-44
667 Chassis	Speaker connections, align- ment	10-10	015110	Schematic, voltage, socket, trimmers, alignment	10-44 10-37
670	See Model 01010		015120	Tuner data Schematic, voltage Socket, trimmers	10-45 10-37 10-46
675	Schematic, voltage, socket, trimmers	6-3	015130	Alignment Schematic, voltage	10-43 10-37
681	Alignment, elimination notes	6-4			
687	Schematic, voltage, socket, trimmers	6-5			
691	Alignment Schematic, voltage, socket, trimmers	6-6 10-11 10-12			
741	Alignment Schematic, voltage, socket, trimmers, parts	8-7 8-7			
749	Alignment, trimmers	8-8			
777, Run 1	Schematic, voltage, socket, trimmers, tuner	10-20			
787	Schematic, voltage Trimmers, socket, parts, layout	7-1 7-3			
804 Chassis	Alignment, voltage, socket, trimmers	10-16			
860 Chassis	See Model 010221	10-12			
880 Chassis	See Model 01029				
881 Chassis	See Model 01018				
886, 889	See Model 01020				
01009, Ch. 526E	Schematic, voltage, socket, trimmers, parts	9-3			
01010, Ch. 626I	Schematic, socket, voltage, trimmers, alignment, tuner	10-21			
01016, Runs 1, 2	Schematic, socket, voltage, trimmers, alignment, tuner	10-21			
Chassis 880	Schematic, voltage, socket, trimmers, alignment	10-22			
01019 Chassis 661	Schematic, voltage, socket, trimmers, alignment, parts	.8-5			

MODEL	GRIGSBY-GRUNOW CO.—(Cont.)	REVISED PAGE	EARLY COMPLETE PAGE	RADIOTRON	
50 Chassis, 51, 52	Chassis views	1-19	1171	1171	
F-50	Schematic	5-1			
55 Chassis, 56, 57, 58	Schematic, color code	3-1	1189	1189	
	Chassis views, voltage	3-2	1190	1190	
55, 59, 75, 195, 560, 566 (Chassis 500)	Chassis view, alignment, parts list	4-23			
	Schematic, parts list, point-to- point data, coil resistances, sockets	4-24			
56, 57, 58	See chassis 55				
58	See chassis 10				
59 (Chassis 500)	See model 55				
60 Chassis, 61, 63	Schematic, socket	1-20	1173	1173	
	Voltage, data	1-21	1173	1173	
	Chassis views	1-22	1174	1174	
66	Schematic	4-1			
	Chassis view	4-2			
	Point-to-point data	4-3			
	Installation notes	4-4			
	Voltage, installation notes	4-5			
	Parts list	4-6			
70 Chassis, 71, 72	Schematic, socket, voltage	1-1	1149	1149	
	Power Pack—See 7-P-6 & 7-P-3				
70-B Chassis, 71, 72	Schematic, socket, voltage	1-5	1153	1153	
	Chassis views	2-1	1159	1159	
	Data	1-10			
75 (Chassis 500)	Power Pack—See 7-BP-6 & 7-BP-3				
77	See model 55 (500)				
85, 86, 998 (Chassis 800)	See chassis 330				
	Chassis view, voltage, notes, parts list	4-30			
	Schematic, parts list, socket, point-to-point data	4-31			
90 Chassis, 91, 92	Schematic	1-11	1161	1161	
	Chassis	2-3	1163	1163	
	Power Pack—See 9-P-6 & 9-P-3				
90-B Chassis, 90, 91, 93	Schematic, socket, voltage	1-12	1164	1164	
95, 105 (Chassis 520)	Notes	4-25			
	Voltage, alignment, coil resistances	4-26			
	Schematic, socket, condenser assembly	4-27			
	Point-to-point data	4-28			
	Parts list	4-29			
100 Chassis, 101	Schematic	1-11	1161	1161	
	Power Pack—See 9-P-6 & 9-P-3				
100-B Chassis, 102, 108	Chassis	2-3	1163	1163	
105	See model 95		1164	1164	
110 Auto Set	Schematic, chassis, data	2-17	1191	1191	
	Chassis view, voltage, parts list	4-7			
114	Schematic, socket, voltage	3-48	1234-F	1234-F	
	Chassis view, voltage, parts list, notes	4-8			
116	Chassis views, alignment data	4-9	1234-B	1234-B	
	Data	3-44	1234-A	1234-A	
	Parts list	3-43	1234-C	1234-C	
Duro-Mite for 116	Schematic, socket, voltage	3-45	1234-D	1234-D	
116, Type 1	Schematic, socket, voltage	3-46	1234-E	1234-E	
116, Type 3	Schematic, socket, voltage	3-47			
116, Type 4	Schematic, socket, voltage	5-2			
118	Schematic, voltage	2-13	1192	1192	
120 Chassis, 121	Chassis (Bottom view)	2-19	1193	1193	
	Chassis (End view), service notes	2-20	1194	1194	
120-B Chassis, 123	Schematic, alignment, voltage	6-10			
130-A, 130, 131, 132	Schematic, socket, voltage	1-13	1165	1165	
150	Schematic	2-21	1195	1195	
151, 153, 154, 156	See chassis 15				
160 Chassis, 163	Schematic, socket	1-23	1175	1175	
	Voltage, data—See Chassis 60				
180 Chassis, 181	Schematic, socket, voltage	1-8	1156	1156	
	Chassis views	2-2	1160	1160	
	Data	1-10			
194	Power Pack—See 8-P-6 & 8-P-3				
195 (Chassis 500)	See model 44				
	See model 55 (500)				
	MODEL	GRIGSBY-GRUNOW CO.—(Cont.)	REVISED PAGE	EARLY COMPLETE PAGE	RADIOTRON
200 Chassis, 201, 203, 204	Schematic	3-3	1196	1196	
	Chassis views, values	3-5	1197	1197	
	Voltage, speaker data, color code	3-6	1198	1198	
204	See chassis 10 and chassis 200		1199	1199	
210 Chassis, 211, 214, 215	Schematic	3-7			
	Chassis views, values	3-8	1200	1200	
	Voltage, color code	3-9	1201	1201	
220 Chassis, 221, 223	Schematic, transformer data, notes	3-10	1202	1202	
	Chassis views, values	3-11	1203	1203	
	Chassis view, voltage	3-13	1205	1205	
	Speaker data, record changer notes	3-12	1204	1204	
230-A, 239	Schematic, socket	1-13	1165	1165	
251, 253, 254	See chassis 25				
251-B, 253-B, 254-B	See chassis 25-B				
290 Chassis, 291, 293, 294	Schematic, voltage	3-16	1208	1208	
	Silent tuning data	3-17	1209	1209	
294	See chassis 10 and chassis 290				
300 Chassis, 303, 304, 307	Schematic, power transformer data	3-18	1210	1210	
	Chassis layout, notes	3-19	1211	1211	
	Continuity and resistance check	3-20	1212	1212	
	Chassis	Changes 7-11	1213	1213	
	Schematic	3-21	1214	1214	
310-A Chassis, (2 types), 311	Continuity and resistance check	3-24	1216	1216	
310-A, 310-B	Chassis layout	3-23	1215	1215	
310-B	Continuity and resistance check, data	3-25	1217	1217	
	Data	Changes 9-2	1218	1218	
310-B Chassis, (2 types), 314, 315	Schematic	3-22	1219	1219	
320 Chassis, 324	Schematic, data	3-26	1220	1220	
	Continuity and resistance check	3-27	1221	1221	
	Chassis layout	3-28	1222	1222	
330 Chassis, 331, 336, 77	Schematic, voltage, data, notes	3-29	1223	1223	
	Chassis layout, test data	3-30	1224	1224	
340 Chassis, 344	Schematic, color code	3-31	1188	1188	
	Chassis layout, voltage, test data	3-32	1225	1225	
351, 353	See chassis 35		1226	1226	
353 Record Changer	Notes	386-Q-8	1227	1227	
360 Chassis, 363	Schematic, voltage, transformer color code, speaker data	2-16	1228	1228	
	Chassis layout, test data	3-33	1229	1229	
	Resistance tuning indicator notes	3-34	1230	1230	
370 Chassis, 371, 373	Schematic, speaker data, align- ment data, transformer color code	3-35	1231	1231	
	Chassis layout, voltage	3-36	1232	1232	
	Continuity and resistance test data	3-37	1233	1233	
380 Chassis, 381	Schematic, voltage	3-38	1234	1234	
390 Chassis, 393	Schematic, voltage, transformer color code	3-39	1235	1235	
	Chassis layout, continuity and test data	3-40	1236	1236	
400 Chassis, 411, 413	Schematic, voltage, alignment data	3-41	1237	1237	
	Socket layout	Changes 7-1	1238	1238	
	Changes	7-15	1239	1239	
400-A Chassis, 411-A, 413-A	Schematic, notes	4-10	1240	1240	
Chassis 440	See model 44				
460, 461, 463	Chassis view, voltage, parts list, notes	4-13	1241	1241	
	Schematic, alignment, color codes, notes	4-14	1242	1242	
490, 491, 493	Circuit notes	4-15	1243	1243	
	Vibrator notes, voltage	4-16	1244	1244	
	Coil resistances, vibrator notes	4-17	1245	1245	

	GRIGSBY-GRUNOW CO.—(Cont.)	GULBRANSEN CO.—(Cont.)	RADIOTRON EARLY COMPLETE PAGE	RADIOTRON EARLY COMPLETE PAGE
MODEL 490, 491, 493	Alignment, voltage4-18 Schematic, socket, condenser assembly4-19 Point-to-point data4-20 Parts list4-21 Parts list concluded4-22 See model 65	200, 291, 292, 295, 9950	Voltage, socket, data1-5 Schematic, socket1-6 Schematic, chassis layout, noise suppressor data3-11 Voltage, alignment data, notes1267 Schematic, voltage, chassis layout1263 Parts list1264 Schematic, socket, voltage, assembly wiring3-7	1239 1238 1267 1263 1264 1269
Chassis 500 Chassis 520 560, 566 570 600 A.C.D.O Chassis 800 998	See model 65 See model 65 (Chassis 500) Schematic5-3 Schematic5-4 See model 85	362 Auto Set 392 872 9950	Schematic, socket, voltage2-14 Schematic, voltage socket, trimmers Misc. 6-11 Schematic, changes, socket5-1 Alignment, voltage, parts list5-2 See Model 200	
Inverse Duplex, type 4-DL Inverse Duplex, 1927 New Yorker, 110-volt DO	DAVID GRIMES, INC. Schematic Misc. 1-9 Schematic Misc. 1-9 Schematic Misc. 1-9	Commercial Sky Rider Dual Diversity Sky Buddy Sky Challenger Sky Chief Skyrider Defiant Skyrider Marine Super Skyrider (Early) Super Skyrider (Late) Super Skyrider, 1937 Super Skyrider, 1938 Super Skyrider, 23 Ultra Skyrider DD-1, Dual Diversity	See model S-12 See model DD-1 See model 5T See model S-19R See model S-15 See model S-14 See model SX-24 See model S-22 Schematic7-1 Alignment, socket, trimmers7-2 See model SX-17 See model S-11 See model SX-16 See model SX-23 See model S-10 Schematic10-1, 2 Detailed schematics10-3 A-F schematic, parts10-4 Alignment, S.P.U. schematic10-5 Alignment, Part 2, socket, trimmers10-6 Schematic, alignment, trimmers8-1 Schematic, socket, trimmers, alignment8-2 Schematic7-3 Voltage, parts, alignment7-4 Schematic, socket, trimmers7-5 Circuit data, alignment, parts7-6 Schematic9-1 Socket, trimmers9-2 Alignment9-3 Schematic, changes8-3 Alignment8-4 Socket, trimmers8-5 Schematic8-6 Alignment8-4 Socket, trimmers8-7 Schematic, socket, trimmers, alignment8-8 Schematic8-9 Socket, trimmers8-10 Alignment8-4 Schematic, voltage, parts8-11 Socket, trimmers, alignment8-12 Schematic, changes9-7 Schematic, changes9-8 Alignment, voltage9-9 Socket, trimmers, alignment, parts9-10 Schematic10-7 Socket, trimmers, parts10-8 Alignment, notes10-9 Socket, trimmers9-4 Schematic9-4 Alignment, parts9-2 Schematic, notes10-11 Operating data, antenna notes10-10	
06-W	GULBRANSEN CO. Schematic, voltage, socket4-9 Alignment4-10 Mounting data4-11 Mounting data4-12 Speaker data4-13 Flexible drive notes4-14 Service notes4-15 Schematic, voltage, socket4-17 Alignment, wiring4-18 Antenna, mounting notes4-19 Mounting notes4-20 Control unit4-21 Flexible drive4-22 Service notes4-23 Parts list4-24 Schematic, voltage4-1 Alignment, antenna notes4-2 Service notes4-3 Service notes4-4 Parts list4-5 Mounting notes4-6 Flexible drive notes4-7 Control unit data4-8 Schematic3-4 Voltage, condenser data3-3 Schematic, socket2-1 Chassis wiring2-2 Voltage, data, phonograph schematic2-3 Color code, installation data2-4 Alignment data2-13 Schematic2-5 Voltage, alignment data2-6 Chassis layout, parts list2-7 Schematic, socket2-9 Chassis wiring2-8 Voltage, notes, phonograph schematic2-11 Parts list, phonograph data2-10 Alignment data2-13 Chassis layout, revisions2-12 Chassis wiring3-1 Schematic, voltage, data3-2 Schematic, socket, notes3-9 Voltage, parts3-10 Schematic, socket, voltage1-1 Chassis wiring, data1-2 Schematic, chassis wiring, data9-6 Voltage, data3-7 Schematic, data1-3 Schematic, voltage1-4			
10 Series 13	GRUNOW See GENERAL HOUSEHOLD UTILITIES CO.	5T, Sky Buddy HSPA S8A S9, SX9 S-10, Ultra Skyrider S11 Super Sky Rider 1937, Early, Late S12, Commercial Sky Rider S14, Sky Chief S15, Sky Challenger SX16, Super Sky Rider 1938 SX-17, Early, Super Skyrider S-17, SX-17 Late, Super Skyrider S-19B, Sky Buddy S-22, Skyrider Marine SX-23, Super Skyrider, Skyrider 23	5T, Super Sky Rider 1937, Early, Late Schematic, changes8-3 Alignment8-4 Socket, trimmers8-5 Schematic8-6 Alignment8-4 Socket, trimmers8-7 Schematic, socket, trimmers, alignment8-8 Schematic8-9 Socket, trimmers8-10 Alignment8-4 Schematic, voltage, parts8-11 Socket, trimmers, alignment8-12 Schematic, changes9-7 Schematic, changes9-8 Alignment, voltage9-9 Socket, trimmers, alignment, parts9-10 Schematic10-7 Socket, trimmers, parts10-8 Alignment, notes10-9 Socket, trimmers9-4 Schematic9-4 Alignment, parts9-2 Schematic, notes10-11 Operating data, antenna notes10-10	
160, 161 (60 cycles) 160, 163 (25 cycles)				
20 Series, Early, Late 20 Series				
28				
53 Battery				
53 A. C.				
60, 68				
92, 93				
	388 388 388	3763 3768 3768		
	392-G 392-H 392-I 392-J 392-O 1255 1255 1257 1249 1250 1251 1252 1253 1254 1259 1258 1265 1243 1244 1264 1265 1265			
	*392-B *392-E *880 *390			

HALLICRAFTERS HARRIS

**RADIOTRON
EARLY COMPLETE
PAGE**
1273

HALSON RADIO CORP.—(Cont.)

MODEL

**RADIOTRON
EARLY COMPLETE
PAGE**

THE HALLICRAFTERS INC.—(Cont.)

**RADIOTRON
EARLY COMPLETE
PAGE**

Model 615	Schematic	3-3
620	Socket layout	Changes 7-9
630	Schematic, socket, alignment	5-5
711	Schematic, socket, alignment	5-6
770-AW	See model 310	6-6
770-AW Late	Schematic, socket	9-8
1200	Schematic, parts	9-9, 10
1300	Schematic, parts	9-9, 10

Model 615	Schematic	3-3
620	Socket layout	Changes 7-9
630	Schematic, socket, alignment	5-5
711	Schematic, socket, alignment	5-6
770-AW	See model 310	6-6
770-AW Late	Schematic, socket	9-8
1200	Schematic, parts	9-9, 10
1300	Schematic, parts	9-9, 10

HAMMARLUND MFG. CO.

AC & DC Converters	Schematic	1-1
Comet Pro, Dec., '31	Schematic	3-1
Comet Pro, July, '32	Schematic	3-1
Comet Pro, Sept., '32	Schematic	3-2
Comet Pro, Oct., '32	Schematic	3-2
Comet Pro, Feb., '33	Schematic	2-1
"Comet Pro", AVC	Schematic, voltage	5-1
	Alignment, socket	5-2
"Comet Pro" (Crystal)	Schematic	4-5
	Chassis view	4-6
	Service notes	4-7
	Service notes	4-8
	Schematic	4-1
	Chassis view	4-2
	Service notes	4-3
	Service notes	4-4
DeLuxe Hawk	Schematic	1-1
Super Pro	Schematic	1-1
	Schematic, voltage	1-1
	Parts list	7-1, 7-2
	Alignment, part 1	7-3, 7-4
	Alignment, part 2, socket, chassis	7-5
	Circuit data, operating notes	7-6
Trans-Oceanic Two	Schematic	1-1
Z-4 Commander	Schematic	1-1
SPR110X, SPR120X	Schematic, trimmers, crystal circuit, terminal voltages	9-1, 2
Super Pro Standard Model SP110 Series		

HARRIS MFG. CO.

Model 100, "A"	Schematic, socket	Misc. 9-4
500, 600, 700	Schematic, socket, trimmers, voltage	8-1
501W, 701W, 900, 1201W	Schematic, socket, trimmers, voltage	8-1
800	Schematic, socket, trimmers, voltage	8-2
1000	Schematic, socket, trimmers, voltage	8-3
1201W	Schematic, socket, trimmers, voltage	8-4
	See model 501W	

HAMMARLUND-ROBERTS, INC.

H-R 5-tube	Schematic	1-1
H-R "HI-Q"	Schematic	1-1
H-R "HI-Q" 6	Schematic, chassis wiring, data	1-2
H-R "HI-Q" 29 Jr.	Schematic, socket, data	1-3
H-R "HI-Q" 29 Master	Schematic, socket, data	1-4
H-R "HI-Q" 30 (30-R Battery)	Schematic	1-5
H-R "HI-Q" 30 AC	Schematic, socket	1-5
H-R "HI-Q" 30 DO	Schematic, socket, voltage	1-6
H-R "HI-Q" 31	Schematic	1-6

Model 104, 106	Schematic, socket, trimmers, alignment, parts	8-3
161, 162	Schematic, socket, trimmers, alignment, parts	8-4
163	Schematic, socket, trimmers, alignment, voltage, parts	8-5
310, 711	See model C-6	
410	Schematic, socket, trimmers, alignment, voltage, parts	8-6
412	Schematic, socket, trimmers, alignment, parts	5-1
515 SW	Schematic, parts	9-5
515	Schematic	3-1
516	Socket layout	3-3
520	Schematic, socket, alignment	5-2
530	Schematic, socket, alignment	5-3
535	Schematic, socket, parts	6-4
536	Schematic, socket	7-10
530	Schematic, socket, parts	6-5
606	Schematic, socket, trimmers, alignment, parts	9-6
610 Dual Wave	Schematic, socket, alignment	5-4
610	Schematic	4-4
612	Schematic, socket, trimmers, alignment, parts	9-7

HALSON RADIO CORP.

Model 5X23, Super Skyrider, Skyrider 23	R-F switching schematic	10-12
5X24, Skyrider Defiant	Socket, trimmers, parts	10-13
	Alignment, notes	10-14
	Schematic	10-15
	Autenna notes	10-10
	Socket, trimmers, alignment, parts	10-16

HALSON RADIO CORP.

Model 5X23, Super Skyrider, Skyrider 23	R-F switching schematic	10-12
5X24, Skyrider Defiant	Socket, trimmers, parts	10-13
	Alignment, notes	10-14
	Schematic	10-15
	Autenna notes	10-10
	Socket, trimmers, alignment, parts	10-16

Model 20-A	Schematic	3-2
20-B	Schematic	4-5
20-B European	Schematic	7-9
25	Schematic	4-1
30	Schematic, socket, trimmers, alignment, parts	8-1
35	Schematic, socket, trimmers, alignment, parts	9-4
N.S. 40	Schematic, socket, trimmers, alignment, voltage, parts	8-2
45	Schematic	4-3
N.S. 60	Socket layout	Changes 7-9
60S	Schematic	4-3
50X	Socket layout	Changes 7-9
52	Schematic, socket	7-4
54	Schematic, socket	7-5
60L	Schematic, socket	6-1
60M	Schematic, socket	6-2
MA63	Schematic	7-7
66-AW	Schematic	7-6
100, 100M	Schematic, socket	7-8
102, 103	Schematic, socket, trimmers, alignment, parts	7-9
104, 106	Schematic, socket, trimmers, alignment, parts	8-3
161, 162	Schematic, socket, trimmers, alignment, parts	8-4
163	Schematic, socket, trimmers, alignment, voltage, parts	8-5
310, 711	See model C-6	
410	Schematic, socket, trimmers, alignment, voltage, parts	8-6
412	Schematic, socket, trimmers, alignment, parts	5-1
515 SW	Schematic, parts	9-5
515	Schematic	3-1
516	Socket layout	3-3
520	Schematic, socket, alignment	5-2
530	Schematic, socket, alignment	5-3
535	Schematic, socket, parts	6-4
536	Schematic, socket	7-10
530	Schematic, socket, parts	6-5
606	Schematic, socket, trimmers, alignment, parts	9-6
610 Dual Wave	Schematic, socket, alignment	5-4
610	Schematic	4-4
612	Schematic, socket, trimmers, alignment, parts	9-7

Model 104, 106	Schematic, socket, trimmers, alignment, parts	8-3
161, 162	Schematic, socket, trimmers, alignment, parts	8-4
163	Schematic, socket, trimmers, alignment, voltage, parts	8-5
310, 711	See model C-6	
410	Schematic, socket, trimmers, alignment, voltage, parts	8-6
412	Schematic, socket, trimmers, alignment, parts	5-1
515 SW	Schematic, parts	9-5
515	Schematic	3-1
516	Socket layout	3-3
520	Schematic, socket, alignment	5-2
530	Schematic, socket, alignment	5-3
535	Schematic, socket, parts	6-4
536	Schematic, socket	7-10
530	Schematic, socket, parts	6-5
606	Schematic, socket, trimmers, alignment, parts	9-6
610 Dual Wave	Schematic, socket, alignment	5-4
610	Schematic	4-4
612	Schematic, socket, trimmers, alignment, parts	9-7

HATRY & YOUNG
MODEL EARLY COMPLETE PAGE
RADIOETRON EARLY COMPLETE PAGE
REVISD PAGE

HATRY & YOUNG
MODEL EARLY COMPLETE PAGE
RADIOETRON EARLY COMPLETE PAGE
REVISD PAGE

HATRY & YOUNG
MODEL EARLY COMPLETE PAGE
RADIOETRON EARLY COMPLETE PAGE
REVISD PAGE

HATRY & YOUNG
MODEL EARLY COMPLETE PAGE
RADIOETRON EARLY COMPLETE PAGE
REVISD PAGE

HATRY & YOUNG
MODEL EARLY COMPLETE PAGE
RADIOETRON EARLY COMPLETE PAGE
REVISD PAGE

HATRY & YOUNG
MODEL EARLY COMPLETE PAGE
RADIOETRON EARLY COMPLETE PAGE
REVISD PAGE

MODEL	EARLY COMPLETE PAGE	RADIOETRON EARLY COMPLETE PAGE	REVISD PAGE
A, B Tuners			4-7
6-Tube AC			2-1
6-Tube AC-DO			3-1
8-Tube Superhet			3-2
9-Tube Air-Ace			4-1
F5, F6, F7, F8 6LB, 6SB			4-1 4-1 4-1 4-1 4-2 4-6 4-7 4-3 4-3 4-4 4-5 4-8

HERBERT H. HORN

1934	Schematic	5-2
4T	Schematic	9-1
5	Schematic	6-1
5A	Schematic	7-1
5MT	Schematic	6-2
5MTD	Schematic	7-2
7MT	Schematic	6-3
9MT, 9MTC, Revised	Schematic	6-4
10MT	Schematic	7-3
11A	Schematic	7-4
15	Schematic, voltage, data	3-1
15M	Service data	3-2
16MT	Schematic, voltage, socket	6-5
17MT	Schematic	8-1
21, 25	Schematic	7-5
24	Schematic	4-1
26	Schematic	4-2
50, 50B	Schematic	4-2
51	Schematic	9-1
52	Schematic	7-7
53	Schematic	6-1
58	Schematic	5-3
58, 158	Schematic, socket	4-2
59, 69, 90	Schematic, socket, voltage	5-3
62	Schematic	7-8
63	Schematic	6-6
66	Schematic	6-9
66MT, Revised	Schematic	7-1
67	Schematic	9-3
69	See model 59	
70, 71	Schematic	3-4
76	Voltage, socket, data	3-5
77	Schematic	7-4
79, 99, 109	Schematic, voltage, socket	6-1
83	Alignment, changes	6-8
87	Schematic	7-8
90	Schematic	9-4
97	See model 59	
101, 110	Schematic, socket, data	9-4
101-B, 102	Voltage, alignment data	2-1 2-2
109	Voltage, socket	3-6 3-7
110	See model 79	
112-A	See model 101	
156	Schematic	5-1
156AW	Schematic	4-4
	Schematic	6-2

HERBERT H. HORN

1934	Schematic	5-2
4T	Schematic	9-1
5	Schematic	6-1
5A	Schematic	7-1
5MT	Schematic	6-2
5MTD	Schematic	7-2
7MT	Schematic	6-3
9MT, 9MTC, Revised	Schematic	6-4
10MT	Schematic	7-3
11A	Schematic	7-4
15	Schematic, voltage, data	3-1
15M	Service data	3-2
16MT	Schematic, voltage, socket	6-5
17MT	Schematic	8-1
21, 25	Schematic	7-5
24	Schematic	4-1
26	Schematic	4-2
50, 50B	Schematic	4-2
51	Schematic	9-1
52	Schematic	7-7
53	Schematic	6-1
58	Schematic	5-3
58, 158	Schematic, socket	4-2
59, 69, 90	Schematic, socket, voltage	5-3
62	Schematic	7-8
63	Schematic	6-6
66	Schematic	6-9
66MT, Revised	Schematic	7-1
67	Schematic	9-3
69	See model 59	
70, 71	Schematic	3-4
76	Voltage, socket, data	3-5
77	Schematic	7-4
79, 99, 109	Schematic, voltage, socket	6-1
83	Alignment, changes	6-8
87	Schematic	7-8
90	Schematic	9-4
97	See model 59	
101, 110	Schematic, socket, data	9-4
101-B, 102	Voltage, alignment data	2-1 2-2
109	Voltage, socket	3-6 3-7
110	See model 79	
112-A	See model 101	
156	Schematic	5-1
156AW	Schematic	4-4
	Schematic	6-2

HICKOK ELECTRICAL INSTRUMENT CO.

48 Volt-Ohmmeter		1285
4600 Tester		1285
4700 Tester		1285
4949 Volt-Ohm-Capacity Meter		1286

HIGH FREQUENCY LABORATORIES

A-C Special		1287
Mastertone 1929		1288
Mastertone 1931		
4-Tube Pentode		
9-in-Line		
Isotone 10		
117-4		
160-6		
200		
222		

Schematic	4-4	Schematic, changes	3-12
Socket, schematic—See model 58		Schematic, voltage, notes	10-1
Schematic	9-1	Alignment	10-7
Schematic	7-7	Socket, trimmers, tuner data,	10-8
Schematic	5-2	dial	10-2
		Alignment	10-7
		Socket, trimmers, tuner data,	10-8
		dial	10-8
		Schematic, socket, voltage	2-12
		Schematic, socket, alignment	6-12
		Alignment data	4-6
		Schematic, voltage	4-7
		Schematic, socket	1-1
		Schematic, phonograph and	9-1
		headphone circuits	9-3
		Alignment, trimmers	8-1
		Trimmers	8-2
		Schematic	8-3
		Alignment, notes	1-1
		Schematic, socket	1-1
		Schematic, parts list	7-3
		Alignment, notes, socket,	7-4
		trimmers	7-4
		Installation data, noise notes	7-5
		Parts list, notes	7-6
		Installation data	7-7, 7-8
		Schematic, voltage, parts list	7-9
		Alignment, socket, trimmers,	7-10
		speaker	9-4
		Schematic, parts	9-4
		Schematic, alignment, parts	9-5
		Schematic, voltage, alignment	10-3
		See model S-2	
		Schematic, socket	1-2
		Schematic, voltage	9-6
		Schematic, voltage	6-17
		Schematic, voltage, alignment	10-3
		See model X-2	
		See Model HA-7	
		Schematic	5-1
		Parts layout, socket, trimmers	5-2
		Alignment data	5-3
		Schematic, socket	2-10
		Chassis views, parts list,	2-11
		data	2-11
		Schematic, socket	6-1
		Schematic, socket	6-1
		Schematic, alignment	6-2
		Schematic, socket	2-8
		Chassis views	2-13
		Voltage, service data	2-9
		Schematic, socket	6-3
		Schematic, socket	6-3
		Schematic, socket	6-3
		See model 20	
		See chassis H	
		Schematic	3-11
		Schematic, socket	2-7
		Alignment data	2-6
		Chassis view	3-10
		Data	3-10
		Schematic, voltage	7-11
		Alignment, parts	7-12
		Schematic, voltage	7-11
		Alignment, parts	7-12
		Schematic, voltage	7-11
		Alignment, parts	7-12
		Schematic, socket, trimmers,	7-12
		notes	6-10
		Schematic, voltage	8-2
		Schematic, voltage	7-13
		Parts list	7-12
		Notes	7-14
		Schematic, voltage	7-13
		Schematic, voltage	7-13
		Alignment, parts	7-12
		Schematic, voltage	7-15
		Alignment, socket, trimmers,	7-16
		parts list	7-16

HOWARD RADIO CO.

Intermediate Frequencies	Changes 7-4	1333	
A (SW Converter)	Schematic, socket	3-9	
AVH, AVH-P Chassis	See models 45 & 60		
AVO Chassis	See model 35-A		
D-F	Chassis wiring	6-5	
	Alignment	6-6	
	Schematic, socket	3-2	
EX, Dual Range	Schematic, voltage	6-4	
F Pentode	Schematic	2-1	
H Chassis (35-40)	Chassis views	2-5	404 G
Pushpull 47s	Schematic, socket	2-3	404 F
	Adjustment data	2-4	404 F
H Chassis, (35, 40) Push-	Schematic, socket	3-3	1327
pull '45	Alignment data	3-4	1328
K Chassis	See model 400		
L Chassis	See model 420		
M Chassis	Revisions	3-6	1330
M Chassis 1st type	Schematic	3-6	1330
Q Chassis	See model 20		1331
	Alignment data	4-2	
	Schematic, voltage	4-3	
	Socket layout	Changes 7-9	
	Schematic	1-6	
	Schematic	1-6	
	Schematic	1-7	
	Schematic	1-7	
	Schematic, socket	1-7	
	Schematic, socket	2-14	
	Schematic, socket	2-10	
	Chassis views, parts list,		
	data	2-11	
T Chassis	See model 10		1323
W, Explorer (Type 1)	Schematic	5-4	
W, Explorer (Type 2)	Schematic	5-5	
W, Explorer Power	Schematic	5-6	
W, Explorer Receiver	Schematic	5-6	
Amplifier	Socket layout, trimmers	5-7	
	Socket layout, trimmers	5-8	
	Notes, alignment	5-9	
	I-F, Alignment, R-F, Oscillator		
	alignment	5-10	
	Power amplifier notes, parts		
	list	5-11	
	Parts list	5-12	
	Schematic, voltage	6-13	
	Power pack schematic	6-14	
	Socket layout	Changes 7-9	
	Schematic	6-15	
	Amplifier & SPU schematic	6-16	
	Schematic	7-1	
	Socket, trimmers, alignment	7-2	
	Schematic, socket, voltage		
	data	1-3	
	Schematic, socket, voltage		
	data	1-4	
	Schematic, socket, voltage		
	data	1-5	
	Adjustments	10-16	
	Changes	10-17	
	See model 670-A		
	See model 52		
	Schematic	4-1	
	Socket layout	Changes 7-9	
	Alignment data	4-4	
	Schematic, voltage	4-5	
	Socket layout	Changes 7-9	
	Schematic, socket, alignment,		
	notes	6-11	

RADIOTRON
EARLY COMPLETE
PAGE

HOWARD RADIO CO.—(Cont.)

HOWARD RADIO CO.—(Cont.)

HOWARD RADIO CO.—(Cont.)

RADIOTRON
EARLY COMPLETE
PAGE

MODEL	REVISION	REVISOR	REVISED PAGE	MODEL	REVISION	REVISOR	REVISED PAGE	MODEL	REVISION	REVISOR	REVISED PAGE
59	Schematic, voltage		9-26	260, S260	Trimmers, alignment, Part 2		9-14	260, S260	Trimmers, alignment, Part 2		9-14
60	Schematic, voltage, socket, notes		7-14	266	Socket, trimmers		8-4	266	Socket, trimmers		8-4
60 (AVH)	See model 45			268	Schematic		8-6	268	Schematic		8-6
60-SW	Phonograph data		3-1	270	Socket, trimmers		8-1	270	Socket, trimmers		8-1
67C, 67T	Schematic, voltage, socket, notes		7-14	271	Alignment		8-6	271	Alignment		8-6
68	See model 626			275C, 275T, 280	See model 221			275C, 275T, 280	See model 221		
68 (Revised)	Schematic, voltage		7-17	X275	Schematic, voltage		9-11	X275	Schematic, voltage		9-11
77 Long Wave	Circuit data, notes, parts		7-18	285	Alignment, Part 1		9-12	285	Alignment, Part 1		9-12
77-C, 77-T	Schematic, voltage		8-5	318, 325	Alignment, Part 2		9-13	318, 325	Alignment, Part 2		9-13
99 Long Wave	Socket, trimmers		8-4	318D, 325D, 375	Schematic, voltage		10-11	318D, 325D, 375	Schematic, voltage		10-11
99-C, 99-T	Alignment		8-6	400	Alignment, trimmers, parts		10-12	400	Alignment, trimmers, parts		10-12
E-107	Schematic, voltage, socket, notes		7-21	400-A	Alignment, trimmers, part		10-13	400-A	Alignment, trimmers, part		10-13
118, 218	Schematic, voltage, socket, trimmers		7-19	400 (K)	Schematic		9-15	400 (K)	Schematic		9-15
135 A. C.	Alignment, chassis		7-20	400X	Socket, trimmers, alignment		10-4	400X	Socket, trimmers, alignment		10-4
135 DC	Alignment, chassis		7-22	420 (L) 1st type	Phono. data		10-20	420 (L) 1st type	Phono. data		10-20
200	See model E-14			425	Phono. data		10-20	425	Phono. data		10-20
210, Push-Button Adapter	Schematic, voltage		8-7	425-A	Phono. data		10-20	425-A	Phono. data		10-20
211, Push-Button Converter	Socket, trimmers		8-8	430, Series 2	Phono. data		10-20	430, Series 2	Phono. data		10-20
214	Alignment		8-9	438	Phono. data		10-20	438	Phono. data		10-20
218	See model 395			440, Series 1, 2	Phono. data		10-20	440, Series 1, 2	Phono. data		10-20
220, 270	Schematic, socket, data		2-2	450	Phono. data		10-20	450	Phono. data		10-20
221, 271	Schematic, voltage		9-26	450A	Phono. data		10-20	450A	Phono. data		10-20
225, S225, 250, S250	Schematic, instructions, parts		10-5		Phono. data		10-20		Phono. data		10-20
240-1	Instructions, tuner		10-7		Phono. data		10-20		Phono. data		10-20
240-2	Instructions, tuner		10-7		Phono. data		10-20		Phono. data		10-20
250, S250	Schematic, voltage		10-8		Phono. data		10-20		Phono. data		10-20
E256	Socket, trimmers, tuner data		9-9		Phono. data		10-20		Phono. data		10-20
S-256	Schematic, voltage		9-9		Phono. data		10-20		Phono. data		10-20
256	Socket, trimmers, alignment		9-13		Phono. data		10-20		Phono. data		10-20
E259	Part 1		9-13		Phono. data		10-20		Phono. data		10-20
S-259	Schematic, voltage		9-14		Phono. data		10-20		Phono. data		10-20
259	Schematic, voltage		9-7		Phono. data		10-20		Phono. data		10-20
360, S260	Phonograph data, tuner data		9-7		Phono. data		10-20		Phono. data		10-20
	Alignment, notes		9-8		Phono. data		10-20		Phono. data		10-20
	Schematic, voltage		9-8		Phono. data		10-20		Phono. data		10-20
	Phonograph data, tuner data		9-7		Phono. data		10-20		Phono. data		10-20
	Alignment, notes		9-8		Phono. data		10-20		Phono. data		10-20
	See model 225				Phono. data		10-20		Phono. data		10-20
	Schematic, voltage		9-18		Phono. data		10-20		Phono. data		10-20
	Phonograph and headphone circuits		9-1		Phono. data		10-20		Phono. data		10-20
	Schematic, voltage		8-10		Phono. data		10-20		Phono. data		10-20
	Trimmers		8-2		Phono. data		10-20		Phono. data		10-20
	Alignment		8-3		Phono. data		10-20		Phono. data		10-20
	Schematic, voltage		8-10		Phono. data		10-20		Phono. data		10-20
	Trimmers		8-2		Phono. data		10-20		Phono. data		10-20
	Alignment, notes		8-3		Phono. data		10-20		Phono. data		10-20
	Schematic, voltage		9-2		Phono. data		10-20		Phono. data		10-20
	Phonograph and headphone circuits		9-1		Phono. data		10-20		Phono. data		10-20
	Schematic, voltage		8-13		Phono. data		10-20		Phono. data		10-20
	Trimmers		8-2		Phono. data		10-20		Phono. data		10-20
	Alignment		8-3		Phono. data		10-20		Phono. data		10-20
	Schematic, voltage		8-13		Phono. data		10-20		Phono. data		10-20
	Trimmers		8-2		Phono. data		10-20		Phono. data		10-20
	Alignment		8-3		Phono. data		10-20		Phono. data		10-20
	Schematic, voltage, phonograph data, parts		9-10		Phono. data		10-20		Phono. data		10-20
	Trimmers, alignment, Part 1		9-13		Phono. data		10-20		Phono. data		10-20

HOWARD INTERNATIONAL

MODEL **REVISION** **EARLY COMPLETE PAGE** **RADIOTRON COMPLETE PAGE**

468	Schematic, voltage phono, data	10-19	Schematic	4-3
502	Socket, trimmers, alignment	10-20	Schematic	5-5
525	"Perm-A-Matic" tuner adjustments	10-16	Schematic	2-1
	See model 52	10-32	Schematic	2-405
	Schematic, voltage, socket	10-16	Schematic	2-405
	"Perm-A-Matic" tuner adjustments	10-16	Schematic	2-405
626, 1626, 67-C, 67-T	Socket, trimmers, alignment, phono, data	10-20	Schematic	3-405
	Schematic, voltage, parts	8-15	Schematic	4-405
670-A, HA-1	Socket trimmers, chassis	8-14	Schematic	1850
	Alignment	8-14	Schematic	1850
	Schematic, voltage, parts	6-7	Schematic	1850
	Alignment, notes	6-8	Schematic	1850
1626	Socket, trimmers, parts details	6-9	Schematic	1845
	See model 626			

HUDSON MOTOR CAR CO.

OB-6	Schematic, socket, trimmers, alignment, data	9-1	Schematic	5-405
	Chassis wiring	9-2	Schematic	5-405
	Voltage, alignment	9-3	Schematic	5-405
	Alignment, concluded	9-4	Schematic	1345
H-6	See RCA model HL-6			1349
DB-37	Schematic, socket, trimmers, specifications	9-5	Schematic	
	Alignment, Part 1	9-3	Schematic	
	Alignment, Part 2	9-4	Schematic	
	Chassis wiring	9-6	Schematic	
SA-37	Voltage, parts	9-7	Schematic	
	Schematic, socket, trimmers, specifications	9-9	Schematic	
	Voltage, parts	9-3	Schematic	
	Alignment, Part 1	9-3	Schematic	
	Alignment, Part 2	9-4	Schematic	
	Chassis wiring	9-6	Schematic	
DB-38	Schematic, socket, trimmers, alignment	9-10	Schematic	1846
	Chassis wiring, voltage, connections	10-1	Schematic	
	Alignment procedure	10-2	Schematic	1847
SA-38	Schematic, socket, trimmers, alignment	10-4	Schematic	1846
	Chassis wiring, voltage, connections	10-1	Schematic	
	Alignment procedure	10-3	Schematic	
650HD, 651HE, 660TD, 661TE	Alignment procedure	10-4	Schematic	6-405
680	See Zenith model 650HD			
	See Zenith model 680			

HUDSON-ROSS

Legion	Schematic	Misc. 6-13	
38	Schematic	5-1	
48	Schematic	5-1	
59	Schematic	5-2	
69	Schematic	5-3	
80	Schematic	5-4	

HUMPHREY

Auxiliary Tube Checker	Schematic	4-1	
"Classic"	Chart	4-2	
Conqueror SW AC	Schematic	5-6	1348
Conqueror, SW Bat.	Schematic	2-6	1352

HOWARD RADIO CO.—(Cont.)

MODEL	REVISION	EARLY COMPLETE PAGE	RADIOTRON COMPLETE PAGE
DC 110-volt AVC, Super Broadcast			
"Elite"			
Envy 6 Tube AC			
Envy Midjet DC			
(Rev) 1st			
Envy Midjet DO			
(Rev) 2nd			
Envy Broadcast-LW DC			
Envy Broadcast-LW AC			
Envyette			
Envyette, 5-tube AC			
Envyette, 5-tube DC			
Envyette, Long Wave AC			
IGA-ette			
"Icasix" (2 bands)			
"Icasix" (3 bands)			
Inaulette-4 Tube Midjet AC			
Inaulette, Broadcast-LW AC			
Mascot, Broadcast-Long Wave, 4-tube Midjet			
Mascot 4 Tube Midjet AC			
Super-Conqueror, Short-Long Wave			
"Super-Conqueror" AC, 108-250 volts, w/Noise Suppressor			
Super Six AVC, Long Wave			
Super Six AVC, Broadcast			
"Supersix" AC, Long Wave			
"Trans-Atlantic"			
"Trans-Pacific"			
"Una-Radio Nine" AC-DO			
Universal Companion, AC-DC-Batt.			
Universal Companion, AC-DC-Batt. (Revised)			
Universal Mascot Super			
5-Tube Unaradio Super			
AC-DC "Aerona"			
5-Tube Unaradio Super			
AC-DC "Algon"			
5-Tube Unaradio Super			
AC-DC "Atlantic"			
5-Tube Unaradio Super			
AC-DC "Bijou"			
5-Tube Unaradio Super			
AC-DC "Latinic"			
5-Tube Unaradio Super			
AC-DC "Mignon"			
5-Tube Unaradio Super			
AC-DC "Gnome"			
5-Tube Unaradio Super			
AC-DC "Pacific"			
6-tube Superhet. AC			
7-tube Superhet. 220-v. DO			

INTERNATIONAL INDUSTRIES, INC.

Classic	See model 10		
A, B Kaydette	Schematic, parts list	4-1	
BW, OD	Alignment data	4-2	
CB (Battery)	See model A-7		
CM	Schematic	5-3	
	Schematic, voltage	5-4	
CMS	Alignment data	5-8	
CS (SW)	Schematic	5-3	
CS	Alignment data	3-3	
	Schematic, socket, voltage, data	8-4	
P, DSP Chassis	See model DA-8		
DAC Chassis	See model A-7		
DAS Chassis	See model A-8		

ES Chassis	See model ES-19		
F Kaydette, Jr. (Four Types)	Schematic, parts list	4-3	
F Kaydette, Jr.	Voltage, condensers, notes	4-4	
	Parts list, notes	4-5	
J	Schematic, socket, voltage	3-5	1357
JS (SW)	Alignment data	3-2	1354
	Schematic, socket, voltage	3-1	1353
KS	Schematic, socket, voltage	3-1	
L Chassis	See model L		
M Chassis	See model K-40		
P	Schematic, notes	9-8	
T, TS	Schematic, socket	3-5	1357
Jewel	See model 40		
Kadette	Schematic, chassis views, adjustments	3-2	1354
Regal	See model K-40		
St. Regis	See model K-60		
ARC-2, Tunemaster	Schematic	10-1	
	Alignment	10-2	
K-6 Chassis	See model K-60		
A-7, BW, CD (DAC)	Schematic, voltage	5-5	
	Alignment data	5-3	
A-8, A-9, A-10, AD-11, AD-12 (Chassis DAS)	Schematic, voltage	5-6	
	Alignment data	5-8	
DA-8, DA-9, DA-10, D-11, D-12, D-14 (Chassis D, DSP)	Schematic, voltage	5-7	
	Alignment data	5-8	
10, 11, 12, 13, 14, 15, 16, Classic, Chassis L	Schematic, voltage	8-1	
10 (1938)	Schematic, socket, alignment, voltage	9-1	
AD-11, AD-12	See model AS		
D-11, D-12, D-14	See model DA-8		
ES-19, ES-20, ES-30 (Chassis ES)	Schematic, alignment	5-8	
KR (20, Autimo)	Schematic, voltage, alignment	10-2	
21, 22, 23	Schematic, voltage	8-1	
25, 56	Schematic, socket, alignment, voltage	6-3	
25, 26, 27, 28 (1938)	Schematic, socket, alignment, voltage	9-1	
ES-25	Schematic	6-3	
26, 226	Schematic, parts list	6-1	
35	Voltage, alignment, data	6-2	
36	Schematic, voltage, alignment	8-2	
40, Jewel (Early)	Schematic, socket, alignment, voltage	8-3	
40, 41, 43, 44, 45, 46, 47, K-40 Regal (M)	Schematic, parts	7-1	
41, 43 (1938)	Schematic, voltage, data, alignment	3-6	
50	Schematic, voltage, socket	6-5	
52	Schematic, parts	6-4	
	Voltage, alignment	6-6	
53, 558, Early and late	Alignment	6-7	
	Schematic	6-8	
53, 559	Trimmers, parts, voltage	6-9	
55	Changes	6-10	
AW-55	Schematic, voltage, alignment	6-10	
56	See model 25		
56X, 86X	Schematic, socket, voltage	3-4	
60	Schematic, voltage	8-1	
K-60, St. Regis (Chassis K-6)	Schematic	6-10	
	Schematic	5-1	
61, 661	Voltage, alignment	5-2	
65	Schematic, parts	6-11	
66X, 86, 96	Voltage, trimmers, alignment	6-12	
	Schematic	6-13	
	Schematic, parts	7-2	
70	Socket, voltage, alignment	7-1	
71	Schematic	6-13	
71C	Schematic	6-14	
72	Schematic, alignment	6-15	
	Parts list	6-16	
76X, 676X	Schematic, voltage	8-4	
77, 777, 778, 779	Schematic, voltage, changes	7-3	
	Alignment, parts	7-4	
85	Schematic	6-17	
	Alignment, voltage, parts	6-18	
86	See model 66X		
86X	See model 56X		
87	Schematic	7-5	
	Voltage, socket, alignment, parts	7-6	
90	Schematic	7-6	
	Alignment, voltage, parts	6-19	
96	See model 66X		
105, EL-105, 1050	Schematic	6-21	
105, 1050	Alignment, voltage, trimmers, parts	6-22	
120, 1200, 2200	Schematic, trimmers, voltage	6-23	
	Alignment, parts	6-24	
150, 151	Schematic, socket, voltage, alignment	8-5	
210 Converter	Schematic, notes	9-8	
226	See model 26		
400	Schematic, socket	7-7	
	Alignment, parts	7-8	
500	Schematic, parts	7-9	
	Alignment, socket, battery connections	7-10	
553	See model 53		
617	Schematic, voltage, socket, alignment	9-2	
630	Schematic, socket	9-3	
	Alignment, voltage	9-4	
634, 635, 3734	Schematic, socket	9-3	
	Alignment, voltage	9-4	
661	See model 61		
676X	See model 76X		
735	Schematic	9-3	
739	Alignment, voltage	9-4	
	Schematic, socket	9-5	
777, 778, 779	Voltage, alignment	9-6	
845	See model 77		
950	Schematic, socket	10-1	
	Voltage, alignment	9-5	
1019, 1024	Schematic, socket, trimmers, voltage, alignment	9-6	
1030, 1035	Schematic, socket	8-5	
1050	See model 105		
1129, 1149	Schematic, socket	9-9	
	Voltage, alignment	9-7	
1140	Voltage, alignment	9-6	
	Alignment, voltage	9-10	
1159	Schematic, socket	9-9	
	Alignment, voltage	9-10	
1200, 2200	Schematic, socket	9-7	
3734	Voltage, alignment	9-6	
	See model 120		
	See model 634		
202	Schematic, voltage, socket, alignment, trimmers	10-1	
204	Schematic, socket, trimmers, voltage, alignment	10-2	
500, 515, 516, Chassis 2037	Schematic, socket	7-1	
505	Voltage, alignment, parts list	7-2	
	Schematic, alignment	10-2	
508, 522, 525, 525A	Socket, trimmers	10-1	
Chassis 508	Schematic, voltage, trimmers	10-3	
511, 524, 527, 527A	Alignment, socket	10-4	
Chassis 511	Schematic, voltage, trimmers	10-3	
520, 521 (Chassis 2035)	Alignment, socket	10-4	
	Schematic	5-1	
530, 531, 533 (Chassis 2038)	Voltage, socket, parts list	5-2	
	Schematic	5-3	
	Voltage, socket, alignment	5-4	
INTEROCEAN RADIO CORP.			
202	Schematic, voltage, socket, alignment, trimmers	10-1	
204	Schematic, socket, trimmers, voltage, alignment	10-2	
500, 515, 516, Chassis 2037	Schematic, socket	7-1	
505	Voltage, alignment, parts list	7-2	
	Schematic, alignment	10-2	
508, 522, 525, 525A	Socket, trimmers	10-1	
Chassis 508	Schematic, voltage, trimmers	10-3	
511, 524, 527, 527A	Alignment, socket	10-4	
Chassis 511	Schematic, voltage, trimmers	10-3	
520, 521 (Chassis 2035)	Alignment, socket	10-4	
	Schematic	5-1	
530, 531, 533 (Chassis 2038)	Voltage, socket, parts list	5-2	
	Schematic	5-3	
	Voltage, socket, alignment	5-4	

**JACKSON-BELL
KENNEDY**

MODEL	REVISION	EARLY COMPLETE PAGE	RADIO TRON COMPLETE PAGE
4	Schematic	7-1	1380
5-A	Schematic	5-1	1379
24	Schematic	5-1	1379
25	Schematic	3-2	1379
25-A, 25-U	Schematic	3-3	1379
26	Schematic	3-4	1380
26-SBL	Schematic	3-4	1381
27, 1st type	Schematic	3-5	1382
27, 2nd type	Schematic	3-6	1383
28	Schematic	3-7	1384
29	Alignment, service notes	3-8	1384
	Schematic	3-9	1380
	Alignment data	3-10	1380
33	Schematic	2-1	1388
Junior 50	Schematic	2-2	1388
59	Schematic	7-2	1388
60	Schematic	7-3	1388
	Alignment, voltage	7-5	1388
	Schematic	7-5	1388
62, 63, 64, (Early)	Schematic	3-3	1388
	Schematic, socket	7-4	1388
62, 2nd & 3rd Series	Alignment, voltage	7-5	1388
	Schematic, voltage, socket, trimmers	7-6	1388
68	Schematic	7-5	1388
	Alignment, voltage	7-5	1388
84	Schematic	6-1	1388
	Schematic, voltage, alignment	6-2	1388
86	Schematic	5-2	1388
87	Schematic, socket, voltage, alignment	6-2	1388
88	Schematic	6-3	1388
	ment	6-3	1388
89	Schematic	4-1	1388
89-A	Schematic, socket, voltage, alignment	6-4	1388
96	Schematic	5-2	1388
99	Schematic	5-1	1388
205 Auto Set	Schematic	3-1	1388
845S	Schematic	7-1	1388

JACKSON RADIO & TELEVISION CO.

J-104, 401-A, 447	Schematic	Misc. 5-8	1392
J-105, 504-B, SF-547	Schematic	Misc. 4-4	1394

JACKSON RESEARCH LABORATORY

NJ-8	Schematic	Misc. 6-15	1394
------	-----------	------------	------

J. E. JENKINS & S. E. ADAIR

A (2 types)	Schematic	1-2	1403
Level Indicator	Schematic	1-2	1406
Monitor Amplifier	Schematic	1-2	1405
Pushpull Amplifier	Schematic	1-2	1407
3B Mixing Panel	Schematic	1-1	1408
3C Mixing Panel	Schematic	1-1	1408

KADETTE

See INTERNATIONAL INDUSTRIES, INC.

56	Schematic, socket	Misc. 5-9	1409
----	-------------------	-----------	------

KARADIO CORP.

	Schematic, socket	Misc. 5-9	1409
--	-------------------	-----------	------

KETTLER-FULLER

F	Schematic	3-1	1420
M	Schematic	3-1	1420
Radlette F-12	Schematic	3-2	1420
Radlette F-14	Schematic	3-2	1420
Radlette F-14-A	Schematic	3-3	1420
Radlette F-14-B	Schematic	3-3	1420
Radlette 50	Schematic	3-4	1420
Radlette 40	Schematic	3-5	1420
Radlette 50	Schematic	3-5	1420
Radlette 60	Schematic	3-6	1420
Radlette 70	Schematic	3-6	1420

KELOG SWITCHBOARD AND SUPPLY CO. REVISED PAGE

Chassis B	Schematic, voltage	1-2	1408
Wave Master	Schematic	1-1	1408
6-tube Battery	Schematic	1-1	1407
7-tube Cascade	Schematic	1-1	1407
AC-7-tube	Schematic	1-1	1408
523, 524, 525, 526, 527, 528 RF	Schematic	1-3	1409
523, 526 Power Unit	Schematic, socket, voltage	1-4	1410
524, 525, 527, 528 Power Unit	Schematic, socket, voltage	1-5	1411
533, 534, 535, 536, RF	Schematic, socket	1-6	1410-A
RFL 701	Schematic	1-2	1407

COLIN B. KENNEDY CORP.

See model 42 & 7 DC

See model 54	Schematic	1-5	1416
Coronet	Schematic	1-2	1418
Globe Trotter	Schematic	1-2	1418
Royal	Schematic	1-2	1413
5	Schematic	1-2	1413
6, Type 420	Schematic	1-2	1413
6, Type 421	Schematic	1-2	1413
7-Coronet DC	Schematic	1-3	1414
10	Schematic, socket, voltage	1-4	1415
15, 16 (Type 430-49)	Schematic	1-1	1412
20, Type 440	Schematic	1-3	1412
20	Schematic, socket, voltage	1-4	1415
22, 36, 38, 40 DO	Chassis layouts	2-1	1416-2
24	Schematic, parts list, data	2-2	1416-1
	Schematic, voltage, chassis, data	2-3	416-3, 4
26	Schematic, chassis, notes	1-6	416-C
30, Type 485	Schematic, voltage	1-8	416-D
30, 32	Schematic chassis	1-7	416-A
34	Schematic, voltage	1-8	416-F
	Chassis wiring	1-9	416-B
	Changes, data	1-10	416-H
Coronet 42	Schematic, chassis, voltage	1-11	416-E
42-B	Schematic	4-1	
44	Schematic	2-4	416-I
48	Schematic	2-4	416-J
50	Schematic, chassis, alignment	2-5	
52	Schematic, socket, voltage, data	2-6	416-K
53-SW, 54-SW	Schematic, socket, voltage, data	2-7	
	Parts list, data	2-8	416-L
	Schematic, chassis calibration	2-8	416-L-2
	Scales	2-9	
54 "Globe Trotter"	Schematic, chassis, data	2-10	416-L-1
54-A	Schematic, chassis, data	2-11	416-M
55	Voltage, socket, data, schematic	4-2	416-L-3
56	Schematic, socket, voltage, parts list	2-12	
Royal 60	Schematic, socket	1-5	416-N
62	Schematic, voltage, parts list	2-13	*416
62-A	Chassis, alignment data	2-14	1389
	Schematic, data	3-1	416-O
62-D	Chassis views, alignment data	3-2	416-P
63, 63-A Chassis	See model 563-A		
64	Schematic, socket, alignment		
	Misc.	8-4	
64-B Chassis	See model 164-B		
66, 66-A	Schematic, data	3-11	1423
	Chassis views, alignment data	3-12	1424
66-B Chassis	See model 266-B		
Royal 80	Schematic, socket	1-12	1427
164-B (Chassis 64-B)	Schematic, data	3-7	1419
	Chassis layout, alignment data	3-8	
175 to 25,000 Meters	Schematic	1-1	1420
220	Schematic	1-1	1366
266-B, 366-B (Chassis 66-B)	Schematic, data	3-13	1385
	Chassis layout, alignment data	3-14	1425
281	Schematic	1-1	1426
420, 421 Typ*	See model 6		1885

RADIO TRON COMPLETE PAGE

*408	1380
*407	1379
*407	1379
*407	1379
*408	1380
*409	1381
*410	1382
*411	1383
*410-A	1384
*407	1380

RADIO TRON COMPLETE PAGE

*416	1389
*418	1386
*413	1386
*413	1386
*414	1386
*414	1387
*415	1388
*412	1385
*414	1387
*415	1388
416-2	1391
416-1	1390
416-3, 4	1392
416-C	1394
*416-D	1387
*416-A	1393
*416-F	1396
*416-B	1397
*416-H	1398
*416-E	1395
416-I	1399
416-J	1400
416-K	1401
416-L	1402
416-L-2	1404
416-L-1	1403
416-M	1406
416-L-3	1405
416-N	1408
*416	1389
416-O	1409
416-P	1410
416-P	1411
416-P	1412
412	1423
*412	1424
*412	1427
*412	1419
*412	1420
*412	1366
*412	1385
*412	1425
*412	1426
*412	1885

RADIO TRON COMPLETE PAGE

1361	1361
1359	1359
1360	1360
1361	1361
1362	1362
1364	1364
1363	1363
1364	1364
1365	1365
1366	1366
1367	1367
1368	1368
1369	1369
1371	1371
1372	1372
1372	1372
1372	1372
1371	1371
1371	1371
1372	1372
1373	1373
1374	1374
1374	1374
1375	1375
1375	1375
1376	1376
1377	1377
1377	1377
1378	1378
1378	1378

430-43 Type 1415
 435 Type 1416
 440 Type 1417
 568-A (Chassis 63, 63-A) 1418
 826-B 1419
 882-62-D (Chassis 62-D) 1420
 882-64-C 1421
 1000 Misc. 7-1

KING MFG. CO.

See model 98
 See model 101
 See model 97

Schematic, socket 1-2
 Schematic, socket 1-2
 Schematic, socket 3-1
 Schematic, socket 1-3
 Schematic, socket 1-4
 Schematic, socket 1-1
 Schematic, socket 1-1
 Schematic, socket 1-8
 Schematic, socket 1-8
 Schematic, socket 1-8
 Schematic, socket 1-4
 Schematic, socket 1-5
 Schematic, socket 1-5
 Schematic, socket 1-6
 Voltage 1-7
 Schematic, socket 1-6
 Schematic, socket, voltage 1-7
 Schematic, socket, voltage 1-7

10 Kl, 10-SK 1429
 25 1429
 30 1430
 61 1430
 62, 63 1430
 71 1430
 80 1430
 81 1430
 82 1430
 Royal (97) 1431
 Imperial (98) 1432
 Monarch (101) 1432
 218 1433

See model 98
 See model 101
 See model 97

Schematic, socket 1-2
 Schematic, socket 1-2
 Schematic, socket 3-1
 Schematic, socket 1-3
 Schematic, socket 1-4
 Schematic, socket 1-1
 Schematic, socket 1-1
 Schematic, socket 1-8
 Schematic, socket 1-8
 Schematic, socket 1-8
 Schematic, socket 1-4
 Schematic, socket 1-5
 Schematic, socket 1-5
 Schematic, socket 1-6
 Voltage 1-7
 Schematic, socket 1-6
 Schematic, socket, voltage 1-7
 Schematic, socket, voltage 3-2

KINGSTON PRODUCTS CORP.

"Gypsy" 5-1
 55 5-1
 500, 500-A 5-2
 600-A, 600-B, 610-B 5-3
 700, 700-A, 700-B 5-3, 5-4

KNIGHT

Schematic Misc. 5-10

KNIGHT RADIO

See ALLIED RADIO CORP.

KODEL RADIO CORP.

Improved Gold-Seal Home-Schematic Misc. 6-16
 charger
 15, A & B Supply 7-1
 61, B Transifier 7-1
 101, Radiola Transifier 7-2
 103, A Transifier 7-2
 106, A & B Transifier 7-2
 108 ABC Transifier Misc. 6-16
 110B Transifier Misc. 6-16
 161, B Transifier 7-1

KOLSTER RADIO, INC.

Also see BRANDES PRODUCTS CORP.

Power Amplifier Schematic Misc. 6-18
 SW Converter Schematic 3-12
 6D, 6E, 6G, 6H, (1927) Schematic, socket 1-1
 6-F, 6-J, 6-K, 6-L, 6-M, 6-B Schematic, socket, voltage 1-2
 7-A, 7-B (1926) Schematic, socket 1-1
 8-A, 8-B, 8-C (1926) Schematic, socket 1-1
 K20, K22, K27 Schematic, socket, voltage 1-8
 K21, K23, K28 Schematic, socket, voltage 1-4
 K-23 Rectifier Schematic 1-3

430-43 Type 1415
 435 Type 1416
 440 Type 1417
 568-A (Chassis 63, 63-A) 1418
 826-B 1419
 882-62-D (Chassis 62-D) 1420
 882-64-C 1421
 1000 Misc. 7-1

KING MFG. CO.

See model 98
 See model 101
 See model 97

Schematic, socket 1-2
 Schematic, socket 1-2
 Schematic, socket 3-1
 Schematic, socket 1-3
 Schematic, socket 1-4
 Schematic, socket 1-1
 Schematic, socket 1-1
 Schematic, socket 1-8
 Schematic, socket 1-8
 Schematic, socket 1-8
 Schematic, socket 1-4
 Schematic, socket 1-5
 Schematic, socket 1-5
 Schematic, socket 1-6
 Voltage 1-7
 Schematic, socket 1-6
 Schematic, socket, voltage 1-7
 Schematic, socket, voltage 3-2

KINGSTON PRODUCTS CORP.

"Gypsy" 5-1
 55 5-1
 500, 500-A 5-2
 600-A, 600-B, 610-B 5-3
 700, 700-A, 700-B 5-3, 5-4

KNIGHT

Schematic Misc. 5-10

KNIGHT RADIO

See ALLIED RADIO CORP.

KODEL RADIO CORP.

Improved Gold-Seal Home-Schematic Misc. 6-16
 charger
 15, A & B Supply 7-1
 61, B Transifier 7-1
 101, Radiola Transifier 7-2
 103, A Transifier 7-2
 106, A & B Transifier 7-2
 108 ABC Transifier Misc. 6-16
 110B Transifier Misc. 6-16
 161, B Transifier 7-1

KOLSTER RADIO, INC.

Also see BRANDES PRODUCTS CORP.

Power Amplifier Schematic Misc. 6-18
 SW Converter Schematic 3-12
 6D, 6E, 6G, 6H, (1927) Schematic, socket 1-1
 6-F, 6-J, 6-K, 6-L, 6-M, 6-B Schematic, socket, voltage 1-2
 7-A, 7-B (1926) Schematic, socket 1-1
 8-A, 8-B, 8-C (1926) Schematic, socket 1-1
 K20, K22, K27 Schematic, socket, voltage 1-8
 K21, K23, K28 Schematic, socket, voltage 1-4
 K-23 Rectifier Schematic 1-3

430-43 Type 1415
 435 Type 1416
 440 Type 1417
 568-A (Chassis 63, 63-A) 1418
 826-B 1419
 882-62-D (Chassis 62-D) 1420
 882-64-C 1421
 1000 Misc. 7-1

KING MFG. CO.

See model 98
 See model 101
 See model 97

Schematic, socket 1-2
 Schematic, socket 1-2
 Schematic, socket 3-1
 Schematic, socket 1-3
 Schematic, socket 1-4
 Schematic, socket 1-1
 Schematic, socket 1-1
 Schematic, socket 1-8
 Schematic, socket 1-8
 Schematic, socket 1-8
 Schematic, socket 1-4
 Schematic, socket 1-5
 Schematic, socket 1-5
 Schematic, socket 1-6
 Voltage 1-7
 Schematic, socket 1-6
 Schematic, socket, voltage 1-7
 Schematic, socket, voltage 3-2

KINGSTON PRODUCTS CORP.

"Gypsy" 5-1
 55 5-1
 500, 500-A 5-2
 600-A, 600-B, 610-B 5-3
 700, 700-A, 700-B 5-3, 5-4

KNIGHT

Schematic Misc. 5-10

KNIGHT RADIO

See ALLIED RADIO CORP.

KODEL RADIO CORP.

Improved Gold-Seal Home-Schematic Misc. 6-16
 charger
 15, A & B Supply 7-1
 61, B Transifier 7-1
 101, Radiola Transifier 7-2
 103, A Transifier 7-2
 106, A & B Transifier 7-2
 108 ABC Transifier Misc. 6-16
 110B Transifier Misc. 6-16
 161, B Transifier 7-1

KOLSTER RADIO, INC.

Also see BRANDES PRODUCTS CORP.

Power Amplifier Schematic Misc. 6-18
 SW Converter Schematic 3-12
 6D, 6E, 6G, 6H, (1927) Schematic, socket 1-1
 6-F, 6-J, 6-K, 6-L, 6-M, 6-B Schematic, socket, voltage 1-2
 7-A, 7-B (1926) Schematic, socket 1-1
 8-A, 8-B, 8-C (1926) Schematic, socket 1-1
 K20, K22, K27 Schematic, socket, voltage 1-8
 K21, K23, K28 Schematic, socket, voltage 1-4
 K-23 Rectifier Schematic 1-3

KRAKAUER BROS.

Electone Piano Amplifiers Schematics, pick-up connections 8-1
 PR3-P03, Super Electone Piano Wiring assembly, delay switches and power stage circuits 9-1, 2
 Pre-amplifier and amplifier circuits, radio tuner circuit 9-3
 Phasing tone and volume control circuits 9-4
 Service notes 9-5

KROHLER MFG. CO.

Schematic, voltage, chassis Misc. 6-19

KYLECTRON

See UNITED REPRODUCERS CORP.

L & L ELECTRIC CO.

Schematic Misc. 8-6

R. E. LACAUPT

L-2 Ultradyne Schematic Misc. 1-11
 LR-4 Schematic Misc. 1-11
 All-Wave Electric 9 Schematic, parts list Misc. 1-11

LAFAYETTE RADIO MFG. CO.

See also WHOLESale RADIO SERVICE, INC.
 Fireside #1 Schematic 8-1
 Fireside #2, 2Y2280 Schematic 8-1
 First Minstrel See model 2A5
 Midjet Minstrel See model M-31
 Mighty Atom Schematic 9-2
 Minstrel (1932) See model 2001
 Orthonone Schematic 6-1
 Pigmy See model M-99
 Thriller Schematic 9-8

MODEL	REVISED PAGE
P.A. Tuner	7-1
P.R. Receiver	9-5
S.W. Converter	7-1
L-1, L-2, L-3, L-4	5-9
2A5, First Minstrel	9-1
JB-3	9-2
AS-5	9-3
AS-6	9-3
A-7, M-69, M-70	5-2
AM-8	5-1
EB8	8-2
EB9	8-2
AM-10	5-1
D10	9-3
LW-10	5-7
10C10, Early	5-8
	5-3
	6-3
	6-2
10C10, Late	6-5
	6-4
10-12	7-2
A-11	Misc. 4-5
D11	8-3
L-11, L-12	5-10
A-12	Misc. 4-5
A-14	Misc. 4-6
M-14-20	6-6
A-15	5-2
M-15	7-7
L-16, L-17, L-18, L-19	5-11
	5-12
A-18	8-4
A-19	4-6
A-20	Misc. 4-6
A-20, AM20A, A60,	6-7
AMTC50	6-8
E-20, E-204	10-1
	7-3
	7-4
E20	8-5
T-21, Early	9-4
T-21, Late	9-4
AM-25	5-3
C25	8-4
AM-26	5-3
B20, B32	10-3
	10-2
	10-4
D30, D31	8-6
L-30	8-6
	5-13
M31 (1935)	5-14
	8-6
M-31 (1936)	9-3
M-31-71, Midget Minstrel	9-5
B35, B36	9-6
	10-5
	10-6
	10-7
M-35, 37, 53	6-9
M37	8-7
40A	10-8
C40	8-8
M41, M43	8-7
M44	8-8
SL45	8-8
M-47	6-10
U50	10-1
TC50	See model AM20
B-51, B-52, B-53, B-54	Schematic, socket, parts, voltage
	alignment, trimmers 5-4
A60	See Model AM20

MODEL	REVISED PAGE
B-60	Schematic, voltage, socket,
	parts 5-5
	Alignment, parts list 5-5
	Schematic, socket, align- ment 6-11
S-61, S-62	Schematic 9-7
B-62	Schematic, socket, trimmers, voltage, resistance test 6-12
M65	Schematic 10-9
M-69, M-70	See model A-7 8-9
SL71	Schematic 10-10
A-77	Schematic, socket 10-11
B78	Schematic 10-11
	S.P.U. schematic 10-12
	Voltage, trimmers, chassis 10-13
	Trimmers, color code, changes, phono. 10-14
	Alignment, resistances 10-15
C-78, C-78L	Schematic 9-8
C-79, C-80	Schematic 7-5
	Alignment, voltage, socket 7-6
80-M, 2 types, 40A	Schematics 6-13
	Alignment, parts 6-14
	Socket, voltage, alignment, pickup data 6-15
A81, A81L	Schematic, socket 10-10
B90(R) Early	Schematic 10-17
	Voltage, socket, trimmers, coils, resistances 10-16
B90(N) Late	Schematic, socket, trimmers 10-18
	Voltage, alignment, coils, resistances 10-19
B92(K) Early	Schematic, socket, trimmers, voltage, alignment, coils 10-20
B97-98	Schematic 8-11
	Socket, trimmers, coils, phono. 8-10
	Alignment, voltage, notes 8-12
M-99, Pigmy	Schematic 9-7
100A	Schematic 6-16
102A	Schematic 6-16
106A	Schematic 6-17
115A	Schematic 6-18
120-A	Schematic 7-8
132-A, 133-A	Schematic 7-9
135-A	Schematic 7-9
137-A	Schematic 7-9
137-X, 150-X, 171-X	Schematic, alignment, notes 7-10
143, 144, 149	Schematic, alignment, notes 7-11
U-145	Schematic 9-9
151, 154, 186, 188	Schematic, voltage 7-13
	Chassis layout 7-12
	Alignment 7-14
U-155	Schematic 9-9
158P	Schematic, voltage 6-18
171-X	See model 137-X
186, 188	See model 151
E-204	See model E-20
324	Schematic 7-15
480	Schematic 9-10
2001, Minstrel (1932)	Schematic 7-16
P-15754	Schematic 9-1
XP-15949	Schematic 7-16
S-17762	Schematic 5-15
	Socket, alignment, trimmers 5-16

LANG RADIO CO.

MODEL	REVISED PAGE
B-A-5	Schematic, socket 1-1
UG-5B	Schematic, alignment, parts list 5-1
BA-5-P	Schematic, socket 2-2
BD-5-P	Schematic, socket 1-1
BD-6	Schematic, socket 1-1
BD-6-P	Schematic, socket 1-2
F-7, 110-volt DO	Schematic, socket 2-1
J-7	Schematic, socket 1-2
M-7	Schematic, socket 1-3
MA-7	Schematic, socket 2-3

MODEL	LANG RADIO CO.—(Cont.)	REVISED PAGE	EARLY COMPLETE PAGE	RADIOTRON COMPLETE PAGE
MD-7	Schematic, socket	23	446-A	1482
SA-7	Schematic	24	446-B	1480
MA-8	Schematic, socket	3-1		1481
MD-8	Schematic, socket	3-1		1481
R-8	Schematic, socket	1-3	*446	1479
SA-8	Schematic, socket	2-4	446-B	1480
F-9	Schematic, socket	1-2	*445	1478
40-UL	Schematic, alignment	6-1		
50-AS	Schematic, alignment	6-2		
50-UP, 60-UP	Schematic, alignment	6-2		
50-US	Schematic, alignment	6-1		
60-AA	Schematic	6-3		
80-UA	Schematic, alignment, parts list	6-4		
502-US	Schematic, alignment, parts list	5-2		
503-US	Schematic, alignment	5-1		
503-AS	Schematic, alignment, parts	5-3		
503-UT, 528-UT	Schematic, alignment	6-5		
703-US	Schematic, alignment, parts	5-4		
84				
88	Schematic	Misc. 620		
90	Schematic, socket	5-1		
91	Schematic	5-2		
LAEKIN CO., INC.				
	Schematic	Misc. 620		
	Schematic, socket	5-1		
	Schematic	5-2		
LA SALLE See CADILLAC MOTOR CAR CO.				
LAUREHK MFG. CO.				
L4B "Laurette"	Schematic	10-7		
L44-T	Schematic	Misc. 7-8		
L-55-T	Schematic	Misc. 7-8		
L-60	Schematic, alignment	Misc. 8-5		
L600	Schematic, alignment	Misc. 8-5		
LEAR-WUERFUL CO.				
Suprex Six	Schematic	Misc. 5-11		
C. R. LEUTZ, INC.				
C	Schematic	1-1	*788	1483
Seven Seas	Schematic	1-2	*447	1484
Silver Ghost	Schematic	1-1	*788	1483
Trans-Oceanic	Schematic	1-2	*447	1484
C-10 Navy Model	Schematic	1-1	*783	1483
LEWOL MFG. CORP.				
LW-4	Schematic, voltage	5-1		
LW-4-DW	Schematic, voltage	5-1		
60-MS	Schematic, socket	5-2		
63	Schematic	5-3		
	Alignment, voltage	5-4		
64	Schematic, socket	5-2		
LINCOLN RADIO CORP.				
DC SW-8	Schematic	4-1		
Hollister AC 8	Schematic, chassis wiring	4-4		
Hollister DC 8	Schematic	4-4		
8-80	Schematic	4-4		
R-9	Schematic	1-1	*448	1485
DeLuxe 10	Schematic	4-1		
31	Schematic	3-1	1486	1486
SW-32	Schematic	3-1	*448	1486
DeLuxe SW 83	Schematic, socket, coil assembly	4-2		
	Bottom view, terminal connections	4-3		
LOFTIN-WHITE See ELECTRAD, INC.				
LYRIO See ALL AMERICAN MOHAWK CORP.				
R. H. MACY & CO.				
MB-5	Schematic, socket	3-1		1487
MB-56, MB-58	Schematic	3-1		1487
MB-92	Schematic	3-3		1489
410 AC-DC	Schematic, trimmers, alignment	7-1		
706-70623	Schematic, alignment	7-2		
MB-710	Schematic	3-2		1488
MADISON-MOORE				
One-Spot Super Superheterodyne	Schematic	Misc. 1-12	*790	2757
	Schematic	Misc. 1-12	*790	2757
THE MAGNAVOX CO.				
A	Schematic	Misc. 1-13	*449	1491
D	Schematic	Misc. 1-13	*449	1491
One Dial	Schematic	Misc. 1-13	*449	1491
THE MAGNOVOX CO., INC.				
	Model numbers in which the figure 30 appears are housed in the Playfellow cabinet			
	Model numbers in which the figure 31 appears are housed in the Concerto cabinet			
	Model numbers in which the figure 32 appears are housed in the Chairside cabinet			
	Model numbers in which the figure 33 appears are housed in the Duette cabinet			
	Model numbers in which the figure 34 appears are housed in the Berkeley cabinet			
	Model numbers in which the figure 35 appears are housed in the Regent cabinet			
	Model numbers in which the figure 36 appears are housed in the Windsor cabinet			
	Model numbers in which the figure 38 appears are housed in the Hepplewhite cabinet			
	Model numbers in which the figure 40 appears are housed in the Swedish Console			
OR101 Chassis	Model 37			
	Style ETR308			
CR101A Chassis	Model 35			
	Style OPAR301			
	Model 35A			
	Style OPAR312			
	Model 36			
	Style OPAR302			
	Schematic, voltage	10-1		
	Socket, trimmers, chassis, dial	10-2		
	Alignment, dial data	10-3		
	Changes, notes	10-4		
CR102 Chassis	Model 31			
	Style TPR307			
CR103 Chassis	Model 32			
	Style EPR306			
CR104 Chassis	Model 31			
	Style TPR309			
CR105 Chassis	Model 32			
	Style EPR 310			
CR106 Chassis	Model 31			
	Style TPR316			
CR109 Chassis	Model 32			
	Style EPR313			
	Model 33			
	Style CPR305			
	Schematic	10-5		
	Socket, voltage, chassis, trimmers	10-6		
	Alignment	10-6		

MODEL	THE MAGNAVOX CO., INC.—(Cont.)	REVISED PAGE	RADIOTRON EARLY COMPLETE PAGE
CR111 Chassis Model 34, Style CPAR315 Model 34A, Style CPAR321			
CR107 Chassis Model 31, Style TPR335 Model U31, Style TPR331 Model U31A, Style TPR361 Model U31B, Style TPR339 CR110 Chassis Model 32, Style EPR336 Model U32, Style EPR314 Model U32, Style EPR355 Model U33, Style GPR317 CR112 Chassis Model U34, Style CPAUR313 CR119 Chassis Model U34A, Style CPAUR 328 Model U34B, Style GPR 332 CR120 Chassis Model U30, Style PRU331 CR125 Chassis Model U34A, Style CPAUR 359 CR127 Chassis Model U38, Style GPR 344 Model U38, Style GPR 375 Model U38B, Style CPAUR 347 Model U38E, Style CPAUR 374			
CR108M Chassis Model 35, Style CPAR310 Model 35A, Style CPAR320 Model 35C, Style CPAR320 Model 36A, Style CPAR333 CR122 Chassis Model 35A, Style CPAR 356 Model 36, Style CPAR 352			
CR113 Chassis Model 31, Style TPR323 Model 31A, Style TPR349 CR114 Chassis Model 32, Style EPR324 Model 32, Style EPR358 Model 32A, Style EPR334			
CR115 Chassis Model 33, Style GPR325 Model 33A, Style GPR341 CR118 Chassis Model 34, Style CPAR326 Model 34A, Style CPAR327 Model 34B, Style GPR330 Model 34C, Style GPR342 CR125 Chassis Model 34A, Style CPAR351			
CR117 Chassis Model 30, Style PR322 Model 30A, Style PR348			
CR121 Chassis Model 34D, Style CPAR353 Model 34D, Style CPAR364 Model 38, Style CPR343 Model 38, Style CPR371 Model 38A, Style CPR345 Model 38A, Style CPR372			
CR123 Chassis Model 31B, Style TPR338 Model 31C, Style TPR340 Model 31D, Style TPR360 Model 31E, Style TPR363 Model 32B, Style EPR350 Model 32C, Style EPR362 Model 38B, Style CPAR346 Model 40, Style GPR366 CR128 Chassis Model 38B, Style CPAR370 Model 38B, Style CPAR373			
CR124 Chassis Model 34E, Style CPAR354 Model 34E, Style CPAR365			
CR111 Chassis Model 34, Style CPAR315 Model 34A, Style CPAR321			
Schematic, voltage10-7 Socket, trimmers, chassis, filter adjustments10-8 Alignment10-16			
Schematic, voltage10-11, 12 Alignment, notes10-13 Notes, Part 2, dial data10-14 Socket, trimmers, chassis10-15			
Schematic, voltage10-19 Socket, trimmers, chassis10-10 Alignment10-16			
Schematic, voltage10-11, 12 Socket, trimmers, chassis10-25 notes10-26 Alignment10-30			
Schematic, voltage10-17 Socket, trimmers, chassis10-18 Alignment10-16			
Schematic, voltage10-19 Socket, trimmers, chassis10-20 Alignment10-30			
Schematic10-21, 22 Voltage, socket, trimmers, chassis10-23, 24 Alignment10-16			
Schematic, voltage10-25 Socket, trimmers, chassis, notes10-26 Alignment10-30			
Schematic, voltage10-27, 28 Socket, trimmers, chassis10-29 Alignment10-16			

MAJESTIC

See GRIGSBY-GRUNOW CO.

11656X, Chassis 11656X	Socket, trimmers, alignment, phono, tuner data	10-13	
	Parts list	10-14	
1673 Chassis	See model 67		
1870 Chassis	Schematic, voltage	9-9	
11056, 11057, 11058	Tuner data	9-8	
	Socket, trimmers, alignment, parts	9-10	
	Alignment	Changes 10-2	
11856	Schematic, voltage	9-11	
	Tuner data	9-8	
	Socket, trimmers, alignment, parts	9-12	
	Tuner data	Changes 10-2	
11356X Chassis	See model 1356X		
11656	Schematic, voltage	9-13	
	Socket, trimmers, alignment, parts	9-14	
	Tuner data	9-8	
11656X Chassis	See model 1656X		

MAJOR LABORATORIES

12	Schematic	Misc. 1-14	*703
MI-210 Amplifier	Schematic	Misc. 1-14	*703
250 Amplifier	Schematic	Misc. 1-14	*703
250 Amplifier Power Unit	Schematic	Misc. 1-14	*703

P. R. MALLORY & CO.

Elkon Auto "B" Eliminator	Power Connections	4-4	
Elkon Standard Type	Schematic	4-1	
Auto "B" Eliminator	Schematic	4-2	
Elkon Type "C" Eliminator	Notes	4-3	
	Notes	5-5	
Elkonode	Repairs	5-7	
50 Series Elkonodes	Repairs	5-6	
60, 70, 80 Series Elkonodes	Repairs, Part 2	5-8	
60, 70, 80 Series Elkonodes	Repairs, Part 2	5-8	
B-Eliminator Types			
Single-reed Elkonodes	Data	5-1	
1932 Type	Dual-reed Elkonodes	5-2	
1933-34 Type	Dismantling, repairs	5-3	
1933-34 Type Dual-reed Elkonodes	Dismantling, adjustments	5-4	

MARCONIPHONE INC.

D, DE (1937)	Schematic	10-2	
Vanity 1937	Schematic	10-1	
Vanity 1938	Schematic	10-1	
D8, 1938	Schematic	10-3	
D10, 1938	Schematic	10-4	

MARTI RADIO

"T"	Schematic	Misc. 4-10	
2R-10	Schematic	Misc. 4-10	

MASTER RADIO & MFG. CO.

50, 70 "Mighty Midget"	Schematic, voltage	Misc. 3-9	
------------------------	--------------------	-----------	--

McMILLAN RADIO CO.

8 (2 types) AC Series 900	Schematic, socket, voltage	1-1	*450
	Schematic, socket, voltage	1-2	*451

McMURDO SILVER, INC.

World-Wide Nine	Schematic, socket	Misc. 5-12	
-----------------	-------------------	------------	--

MID-WEST RADIO CORP.

Imperial	See 18(1935) Imperial	8-65, 8-66	
Regal (1936)	Schematic, voltage	8-65, 8-66	
	Alignment, trimmers	8-67	
	Socket, chassis	8-68	

Charlie McCarthy 1, 2	Schematic, socket, trimmers, parts	9-1	
1A59, 1A59B, P1A59, 1B59, P1B59	Schematic, socket, trimmers, alignment	10-1	
3PW Record Player	Schematic, socket, trimmers, parts	10-2	
42	Schematic, socket, trimmers, parts	9-1	
50	Schematic, socket, trimmers, voltage, alignment, parts	8-1	
51B, 51P, 51W, Chassis 151	Schematic, voltage, socket, trimmers	10-3	
52	Schematic, socket, trimmers, parts	9-1	
55B, 55P, 55W, Chassis 155	Schematic, socket, trimmers, alignment	10-4	
56, Chassis 156	Schematic, voltage, socket, alignment, trimmers, parts	10-5	
60	Schematic, voltage, parts, socket, trimmers, alignment	8-2	
62A	Schematic, socket, trimmers, parts	8-3	
65, 66, 650	Schematic, socket, tuner, parts, parts list	9-2	
	Schematic, parts list	7-1	
	Trimmers, voltage, alignment	8-5	
	Socket, layout	8-6	
67, 68, 670, 671, 672, 673	Schematic, voltage, socket, trimmers, alignment	10-6	
Chassis 167 and 1673	Schematic, parts list	7-2	
75, 76, 750	Trimmers, voltage, alignment	8-5	
85, 86, 850	Socket, layout	8-6	
	Schematic, parts list	7-3	
	Trimmers, voltage, alignment	8-5	
	Socket, layout	8-6	
149I, 149N, 149W	Schematic, socket, trimmers, alignment	10-1	
151 Chassis	See model 51B		
153 Chassis	See model 55B		
156 Chassis	See model 56		
167 Chassis	See model 67		
511, 511A, 519P	Schematic, socket, trimmers, parts	9-3	
551	Schematic, socket, trimmers, parts	9-3	
620	Schematic, voltage, parts	8-4	
	Socket, trimmers, alignment	8-3	
639, 639B	Schematic, socket, trimmers, tuner, parts	9-4	
650	See model 65		
651	Schematic, socket, trimmers, alignment	10-2	
651-EB	Schematic, tuner	10-7	
670, 671, 672, 673	See model 67		
739	Schematic, socket, trimmers, voltage, parts	9-5	
	Tuner data	9-4	
	Alignment, phonograph data	9-6	
750	See model 75		
800	Schematic, voltage	8-7	
	Socket, trimmers, alignment, parts	8-8	
850	See model 85		
870, 875, Chassis 1870	Schematic, socket trimmers, voltage, alignment	10-8	
939	Schematic, socket, trimmers, tuner, parts	9-7	
	Alignment, phonograph data	9-6	
1050	Schematic, parts list	7-4	
	Socket, trimmers, voltage, alignment	8-6	
1250	Schematic, parts	8-9	
	Socket, trimmers, voltage, alignment	8-10	
1056X, 1058X	Schematic, voltage	10-9	
	Socket, trimmers, alignment, phono, parts	10-10	
	Piano, and tuner data	10-13	
	Schematic	10-11	
1356X, Chassis 11356X	Socket, trimmers, alignment, phono, tuner data	10-13	
	Parts list	10-14	
	Schematic	10-12	

1656X, Chassis 11656X	Socket, trimmers, alignment, phono, tuner data	10-13	
	Parts list	10-14	
	Schematic	10-12	

SERVICING ESSENTIALS

The CATHODE-RAY TUBE AT WORK

THE cathode-ray oscillograph is rapidly becoming one of the most important tools in the serviceman's kit. It is essential that the progressive service man be thoroughly familiar with all the phases of this instrument, so that he can service complicated sets by modern methods.

The theory underlying the functioning of the cathode-ray tube and the circuits that accompany it receive full consideration. One idea alone was kept foremost: the man who works with the cathode-ray oscillograph must know what is occurring within the tube and in the associated apparatus. This is covered in the first part of the book.

The second half is devoted to practical applications of commercial oscillographs to servicing and adjustment problems. Each example is made clear by the use of oscillograms photographed in the author's "Successful Servicing" Laboratory.

This book and an oscillograph will enable you to speed up the servicing of jobs in your shop—this means greater profits.

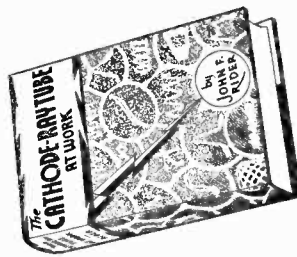

Over 450 illustrations
336 Pages, Price \$3.00

By

John F. Rider

MORE than 90% of the receivers coming into service shops are superheterodynes. If you are going to locate the trouble in these sets quickly, you must be familiar with every part of the circuit. . . . You must diagnose quickly in order to show a profit on every job.

First you should know how the various parts of the set function—the first detector—the oscillator—the i-f. amplifier—the second detector, etc. Then you should be familiar with the many variations of the fundamental circuits, . . . the various combinations of oscillator and first detector—the second detector, a.v.c., and first audio combinations, etc.

"Servicing Superheterodynes" not only gives you all this, but much more. An entire chapter is devoted to the generation and relation of harmonics. This subject is all-important in superheterodynes and it has to be understood. Then the subject of signal generators is covered and the various types of vibrator units.

The most important portion of the book is that which is devoted to the various troubles that occur in superheterodynes and how these troubles are discovered and fixed. These pages have helped thousands of servicemen all over the world to speed up their work and to turn sets back to the customers in first-class condition. Get "Servicing Superheterodynes" at your jobbers and let it help you, too.



Profusely Illustrated
288 Pages, Price \$1.00

CONTENTS

- Chapter 1—The Theory of the Tube
- Chapter 2—Sweep Circuits
- Chapter 3—A-C. Voltages on Both Sets of Plates
- Chapter 4—Commercial Cathode-ray Tube Oscillographs
- Chapter 5—Practical Application of the Cathode-ray Oscillograph
- Chapter 6—Alignment of Tuned Circuits
- Chapter 7—The A-F. Frequency Modulator
- Chapter 8—Auto Radio Vibrator Testing
- Chapter 9—Transmitter Adjustment
- Chapter 10—Other Applications of the Cathode-ray Oscillograph

CONTENTS

- Chapter 1—The Principles Underlying the Operation of the Superheterodyne Receiver
- Chapter 2—The Generation of and the Relation between Harmonics
- Chapter 3—Explanation of the Different Types of Superheterodyne Circuits
- Chapter 4—Function and Characteristics of Individual Parts of the Superheterodyne Receiver
- Chapter 5—Special Circuits and Tube Applications
- Chapter 6—Troubles and Symptoms Encountered in Superheterodynes
- Chapter 7—Application of Test Oscillators
- Chapter 8—Vibrator Units
- Appendix —Intermediate Peak Frequencies of Commercial Receivers with Model Numbers

John F. Rider, Publisher, 404 Fourth Avenue, New York, N. Y.

MID-WEST RADIO CORP.—(Cont.)

RADIOTRON
EARLY COMPLETE
PAGE

REVISÉD
PAGE

MID-WEST RADIO CORP.—(Cont.)

RADIOTRON
EARLY COMPLETE
PAGE

REVISÉD
PAGE

MODEL	MID-WEST RADIO CORP.—(Cont.)	REVISÉD PAGE	EARLY COMPLETE PAGE	
Regal-37 AFC	Schematic, parts 9-19 Socket, trimmers, voltage 9-20 Alignment, trimmers 9-18 Schematic 7-1 Alignment 7-4 Schematic 8-5 Schematic 8-4	9-31 (4SG) 9-32 9-34 9-38 AC-DC	8-32 9-9 8-33 9-9 6-1 8-34 8-36 9-7 8-35 8-36 9-7 6-5 6-3 6-4	
Royale	Schematic 4-1 Schematic 9-1 Schematic, socket, trimmers 9-3 Alignment 9-5 Schematic, alignment, voltage 8-1 Schematic, socket, voltage, alignment 8-2 Schematic, voltage 8-3 Socket, trimmers, alignment 8-4 Socket, trimmers, alignment 8-4 Schematic, voltage, alignment, trimmers 8-6 Schematic, voltage 8-7 Socket, trimmers, alignment 8-8 Schematic, socket 8-18 Trimmers 8-36 Voltage 9-7 Alignment 9-7 Schematic, socket 7-2 Alignment 7-4 Voltage data Changes 0-3 Schematic, voltage, alignment 8-10 Socket, trimmers, alignment 8-11 Schematic, voltage 8-12 Schematic, voltage 8-13 Socket, trimmers 8-14 Schematic, voltage 8-15 Socket, trimmers 8-16 Alignment 8-17 Schematic, voltage 8-19 Socket, trimmers, alignment 8-20 Schematic, socket 8-21 Trimmers 8-36 Voltage 9-6 Alignment 9-7 Schematic, socket, voltage 10-1 Schematic 3-1 Schematic 8-24 Socket, trimmers 9-4 Schematic, voltage, alignment 8-26 Socket, trimmers, alignment 8-27 Schematic, trimmers 8-28 Alignment 8-27 Alignment 8-29 Schematic, socket 8-36 Trimmers 8-36 Voltage 9-5 Alignment 9-7 Schematic, socket 8-30 Trimmers 8-36 Voltage 9-7 Alignment 9-7 Schematic, socket 8-31 Trimmers 8-36 Voltage 9-5 Alignment 9-7 Schematic, socket, voltage 10-2 Schematic, voltage, alignment 8-61 Socket, trimmers 8-63 Schematic, socket, trimmers 7-5 Alignment 7-4 Schematic, voltage 8-59	1500 1497	1500 1497	
Miraco Ultra 7 7-36, Early, Late	Schematic, voltage 6-4 Trimmers, alignment 6-12 Schematic, voltage 6-13 Schematic, voltage 8-37 Socket, trimmers, alignment 8-38 Schematic, socket 8-39 Trimmers 8-36 Alignment 9-7 Voltage 9-6 Schematic, voltage, alignment 8-40 Schematic, socket 7-3 Alignment 7-4 Schematic, voltage 8-41 Socket, trimmers 8-43 Alignment 8-44 Schematic, voltage 8-42 Trimmers 8-43 Alignment 8-41 Schematic, voltage 8-45 Socket, trimmers, alignment 8-46 Schematic 8-47 Socket, trimmers 8-49 Alignment 9-7 Voltage 9-12 Schematic 8-48 Socket 8-49 Trimmers 8-36 Schematic, socket, voltage, parts 9-10 Schematic, voltage, socket 10-3 Schematic, voltage 8-50 Trimmers, alignment 8-51 Socket 8-51 Schematic, voltage 8-51 Trimmers, alignment 8-54 Schematic, voltage 8-54 Trimmers, alignment 8-54 Socket 8-54 Schematic 5-1 Schematic 4-3 Schematic 3-3 Voltage, socket, trimmers, alignment 6-2 Schematic, socket 6-7, 6-8 Trimmers, voltage Changes 6-11 Alignment data 6-9, 6-10 Schematic, socket 6-14 Alignment, trimmers 6-14 Schematic, voltage 8-55 Socket, trimmers 9-13 Schematic, parts 9-13 AFC-2nd Detector schematic 9-12 Schematic 8-57 Socket, trimmers 9-11 Alignment 9-12 Voltage 10-2 Schematic, socket, voltage, alignment 8-61 Socket, trimmers 8-63 Schematic, socket, trimmers 7-5 Alignment 7-4 Schematic, voltage 8-59	11-31 11-36 11-37 11-37 AC-DC 12-33 12-38 AC 12-38 Batt. 12-39 14-Z-9 14-37 14-37 (Intermediate) 14-37A J-16, L-16, M-16, S-16, EP-16 RT-16, A-16, B-16, D-16, PR-16, RM-16, (16-34) 16-33 16-84 16-35 16-37 AC 16-37 AFC, Type 1 16-38 AC 17-39 18 (1935) Imperial 18-36 18-36A (Intermediate)	1499	1499
Miraco AC-9 Miraco AC-9-4SG RT-9, G-9, F-9, H-9 (9-34) 9-31 (3SG)	Schematic, socket, voltage 9-8 Parts 3-4 Schematic 3-2 Schematic 4-2 Schematic 8-24	8 AC-DC '39 Miraco Unitone 8 8-31 Batt. 8-33 Early 8-33 (2 Gang, 4 Band) 8-33 (2 Gang, 5 Band) 8-38 AC-DC 8-38 AC-DC (Export) 8-38 Batt. 8-39 Miraco AC-9 Miraco AC-9-4SG RT-9, G-9, F-9, H-9 (9-34) 9-31 (3SG)	1500 1498	1500 1498

MID-WEST
MONTGOMERY-WARD

MODEL	MID-WEST RADIO CORP.—(Cont.)	REVISED PAGE	RADIO TRON EARLY COMPLETE PAGE
18-36A (Intermediate)	Socket, trimmers, alignment	8-60	
18-37	Schematic	7-6	
	Socket, trimmers	9-14	
18-37 AFO	Alignment, voltage	9-15	
	Schematic, parts	9-16	
18-38 AC	Socket, trimmers, voltage	9-17	
	Alignment, trimmers	9-18	
	Schematic	8-64	
	Trimmers	8-36	
	Socket	8-70	
20-38 AC	Alignment, voltage	9-11	
	Schematic	8-69	
	Socket	8-70	
	Trimmers	8-36	
35 SW	Alignment, voltage	9-11	
	Socket, trimmers, voltage, alignment, notes	8-58	
35-5-SW	Schematic	6-5	
	MIBACO		
	See MID-WEST RADIO CORP.		
	MISSION BELL RADIO MFG. CO., INC.		
	Phonograph Oscillator		
4-A	See model 399		
6-A	Schematic	3-1	
10-A	Schematic	3-2	
10-A, 19, 19-A	Schematic	4-1	
11	Vibrator data	4-3	
14	Schematic	5-1	
16	Schematic	5-2	
17, 18	Schematic	6-1	
25-A	Schematic, notes	7-2	
35	Schematic	5-3	
40	Schematic	6-1	
40 All Wave	Schematic	5-8	
41 AW	Schematic	4-2	
41, Skip Band	Schematic	6-2	
384, 384 Special	Schematic	10-1	
386, Above and below Serial 40461	Schematic	10-1	
386 AW	Schematic	10-2	
392	Schematic	10-3	
395	Schematic	10-2	
399 Phonograph Oscillator	Schematic	10-4	
400	Schematic	10-4	
401, 402	Schematic	10-3	
501	Schematic	10-5	
638A, 3817A	Schematic	10-6	
3710	Schematic	10-7	
3716	Schematic	10-8	
3817A	See model 638A		
3849, 3859	Schematic	10-10	
3869, 3891	Schematic	10-7	
3871	Schematic	10-9	
3871A	See model 638A		
	MOHAWK		
	See ALL-AMERICAN MOHAWK CORP.		
	MONARCH		
A-81	Schematic	Misc. 5-18	
1000	Schematic, socket	Misc. 7-9	
	MONARCH MFG. CO.		
All Wave Signal Generator	Schematic	Misc. 6-21	
	MONTGOMERY-WARD & CO.		
Movie Dial Drive	Assembly, chassis Lamp and Take-up assembly, Drive cord diagram	8-1	
	Adjustments, notes	8-2	
	Replacing parts	8-4	
	MONTGOMERY-WARD & CO.—(Cont.)		
MODEL			
Auto Radio	Schematic, voltage, assembly wiring	9-11	
	Installation notes	3-13	
Baboo	See model 2822		
Cavalier, Commander	See model 14000		
Challenger	See model 11000		
Challenger, Jr.	See model 62-060		
Collegiate	See model 1500		
Commandore	See model 62-040		
DeSoto	See model 2822		
Dictator	See model 500		
Fantasy	See model 1111		
Minstrel	See model 1355		
Princess	See model 62-070		
Radiola	See model 839		
Serenader	See model 500		
Solo	See model 1111		
Sovereign	See model 62-040		
Troubadour	See model 62-030		
Washington	See model 62-34 or 62-36		
AE-10	See model 2655		
11-12	See model 62-29		
13, 15, 16, 16X, 17, 18, 18X	Schematic	4-1	1516
17	Schematic, socket	3-13	1548
21, 22	See model 839		
27W	See model 1500		
49	See model 62-055		
51 Chassis	See model 62-020		
62-010	Schematic, socket, voltage	3-8	1536
62-020 (51)	Schematic, socket, voltage	3-7	1535
62-030, 62-232, Troubadour	Schematic, socket, voltage, notes	2-1	1505
62-040, Commandore,	Schematic, socket, voltage, chassis, data	2-2	1506
62-181, Sovereign	Schematic, socket, voltage, chassis, data	1-1	1507
62-056, 49, 1522, 1922, 1562	Chassis wiring	2-3	1508
62-060, Challenger, Jr. (1800), 62-070, Princess	Schematic, socket, voltage, notes	2-7	1531
62-1, 62-2	Schematic, voltage, notes	3-14	1544
62-7, 62-8	Schematic, socket, voltage	3-15	1545
62-9	Schematic, socket, voltage	3-15	1545
62-11, 62-12, 62-14, 62-27, 62-19 (1st type)	Schematic, voltage, notes	2-4	1509
62-11, 62-14, 62-19, 62-27 (2nd type)	Chassis layout, servicing data	2-5	1511
62-16, 62-26 (62-25)	Schematic, notes	2-6	1510
62-20, 62-26 (62-25)	Schematic, voltage, parts data	6-8	
62-22, 62-30 (62-21)	Schematic, voltage, parts data	2-23	1513
	Schematic, chassis layout, voltage, data	2-24	1512
	Alignment notes, assembly data	3-2	1514
62-27	See model 62-11	3-1	1515
62-29 (11-12) 1st type	Schematic	3-4	1532
62-29 (11-12) 2nd type	Socket, voltage, alignment data	3-5	1533
62-34, Washington	Schematic, socket	3-6	1534
62-36, Washington	Schematic, voltage, socket, trimmers	9-1	
62-38, 62-40, 62-50, 62-54, 62-58	See model 62-40		
62PO43	Schematic, chassis layout, speaker data	3-9	1539
62PO55	Voltage, alignment data	3-10	1540
62PO64	Schematic, voltage, parts	6-18	
62PO68	Schematic, voltage, alignment	6-22	
62-70, 62-70X, 62-72, 62-72X	Schematic, voltage, parts	6-38	
	Schematic, voltage, alignment	6-30	
	Schematic, parts	7-1	
62-89	Socket, circuit data, voltage, alignment	7-2	
	Schematic, socket, values	4-2	

RADIOTRON
EARLY COMPLETE PAGE

REVISED PAGE

MONTGOMERY-WARD & CO.—(Cont.)

MODEL

62-152	See model 62-123
62-153	DataChanges 7-2
62-154	See model 62-135
62-155	DataChanges 7-2
62-156	See model 62-147
62-157	See model 62-136
62-158	See model 62-123
62-160	DataChanges 7-2
62-162	DataChanges 7-3
62-165	DataChanges 7-3
62-166	Schematic6-19
	Alignment, voltage, socket, trimmers, resistance test.....6-20
	parts list6-21
	ChangesChanges 7-16
62-167	See model 62-134
62-169, 62-171	Schematic, socket, trimmers, voltage, alignment7-12
62-173, 62-175, 62-176, 62-177, 62-188, 62-193	Schematic6-23
	Voltage, trimmers, socket, color coding, resistance data6-24
	Resistance test, parts6-25
	Alignment, data6-26
	Schematic6-27
62-178, 62-181, 62-189, 62-211	Alignment, data6-28
	Voltage, socket, trimmers, resistance test, parts6-29
	Schematic6-31
62-179, 62-194, 62-206, 62-216, 62-218	Alignment, changes, data6-32
	Voltage, trimmers, socket, data6-33
	Resistance test, parts6-34
	See model 62-040, 62-178
	Schematic, trimmers6-35
62-181	Voltage, socket, color code.....6-36
62-185, 62-187, 62-190, 62-196, Three types	Alignment, changes, data6-37
	See model 62-173
	SchematicChanges 7-15
62-188, 62-193	See model 62-178
62-189	Schematic7-8
62-192, 62-195	Socket, trimmers, voltage, phono, changes7-4
	Coil data, resistance7-5
	Alignment, parts7-6
	See model 62-179
	Schematic7-7, 7-8
62-194	Trimmers, voltage, socket, chassis views7-9
62-197	Alignment, phono, changes7-10
	Resistance, coil data7-11
62-199	Schematic, voltage, trimmers, socket, parts6-39
	Alignment, service notes6-40
	Schematic, alignment7-13
62-202	Voltage, resistance, socket, trimmers, coil data7-14
	Schematic, trimmers6-41
62-203, 62-205, 62-208, 62-212, 62-217, 62-219	Voltage, socket, data6-42
	Alignment, drive cord, changes, data6-43
	Resistance test, color coding, data6-44
62-206	See model 62-179
62-207, 62-209, 62-221	Schematic7-15
	Voltage, socket, trimmers, battery data7-16
	Coil data, resistance7-17
	Alignment, parts7-18
62-208	See model 62-203
62-209	See model 62-207
62-211	See model 62-178
62-212	See model 62-203
62-215	Schematic7-19
	Voltage, socket, trimmers, battery data7-20

RADIOTRON
EARLY COMPLETE PAGE

REVISED PAGE

MONTGOMERY-WARD & CO.—(Cont.)

MODEL

62-89	Voltage, alignment data4-3
62-91	Schematic, socket4-4
	Voltage, alignment4-13
62-93	Schematic, voltage, socket4-5
	Noise elimination4-6
62-96	Schematic, socket, voltage4-7
62-97, 62-99, 62-97X, 62-99X	Schematic, socket, voltage4-10
	Voltage, alignment4-11
	Schematic, hum notes4-8
62-98	Voltage, alignment, socket4-9
62-101, 62-101X	Schematic, socket4-12
62-101	Voltage, alignment4-13
62-103, 62-105	Schematic, socket, changes4-14
	Voltage, alignment4-15
62-104	Schematic, socket, voltage4-16
62-106, 62-107, 62-121	Schematic, voltage4-17
62-114, 62-116	Schematic, socket, parts6-1
	Voltage, resistance test, alignment data6-2
	Wiring changes, schematic6-3
	Chassis view of changes, data6-4
62-118	Schematic, voltage, socket, parts5-1
	Alignment, data5-2
62-120, 62-122, 62-124, 62-128	Schematic, socket, parts5-3
	Alignment, voltage5-4
62-121	See model 62-106
62-123, 62-131, 62-133, 62-142, 62-144, 62-152, 62-158	Schematic, socket, trimmers, alignment, Part 110-1
	Alignment, Part 2, voltage, drive data, changes, parts10-2
62-124, 62-129	Schematic, parts, coil resistance5-5
	Alignment5-6
62-126, 62-128	Voltage, socket, drive-cord data6-7
62-130	See model 62-120
	Schematic, voltage, socket, trimmers, parts8-14
62-131	See model 62-123
62-132, 62-137	Schematic, parts5-8
	Alignment, voltage5-9
	Socket, trimmers, drive-cord data5-10
62-133	See model 62-123
62-134, 62-134X, 62-139, 62-139X, 62-167	Schematic, parts6-5
	Resistance test, socket, trimmers, voltage6-6
62-135, 62-135X, 62-150, 62-150X, 62-164, 62-164X	Alignment, data6-7
	Schematic, voltage, parts6-9
62-136, 62-138, 62-151, 62-157	Socket trimmers, alignment6-10
	Schematic, parts6-11
	Voltage, socket, data, alignment6-12
62-137	See model 62-132
62-139	See model 62-134
62-140, 62-140X, 62-148, 62-148X	Schematic, socket5-11
	Alignment, parts list5-12
62-142, 62-144	See model 62-123
62-147, 62-147X, 62-156, 62-156X, 62-164, 62-164X, Series A	Schematic, voltage, alignment, trimmers, socket6-13
	Alignment6-14
62-147, 62-147X, 62-156, 62-156X, 62-164, 62-164X, Series B & C	Schematic, voltage, socket, trimmers6-15
	Alignment, notes6-16
62-147, 62-147X, 62-156, 62-156X, 62-164, 62-164X, Series A, B & C	Parts list6-17
62-148, 62-148X	See model 62-140
62-149	DataChanges 7-3
62-150, 62-150X	See model 62-135
62-151	See model 62-136

MODEL	MONTGOMERY-WARD & CO.—(Cont.)	REVISED PAGE	EARLY COMPLETE PAGE	RADIOTRON
62-215	Coil data, resistance	7-21		
	Alignment, drive cord, parts list	7-22		
62-216, 62-218	See model 62-179			
62-217, 62-219	See model 62-203			
62-221	See model 62-207			
62-226, 62-228, 62-259, 62-308, 62-318, 62-408, 62-418	Schematic	8-5		
	Trimmers, voltage, socket, coils, sensitivity, phono. data	8-6		
	Alignment, notes	8-7		
62-229	Schematic	7-23		
	Alignment, parts, drive cord, and noise data	7-24		
	Voltage, socket, resistance, coil data	7-25		
62-230, 62-240	Schematic, voltage, socket, trimmers, alignment	9-2		
62-232	See model 62-030			
62-233	Schematic, socket, trimmers, alignment	7-26		
62-235, 62-248	Schematic, voltage, socket, trimmers	7-27		
	Alignment	7-28		
62-236	Schematic, socket trimmers	8-9		
	Voltage, coils, panel mtg. kits	8-8		
	Alignment, notes	8-10		
62-242	Schematic	8-11		
	Resistance, voltage, coils, socket, trimmers	8-12		
	Alignment, notes, panel mtg. kits	8-13		
62-251, 62-255, 62-328, 62-335, 62-428	Schematic, socket, trimmers, parts	9-3		
	Alignment	9-14		
62-254	Schematic, voltage, socket, trimmers	8-15		
	Alignment, parts, battery data	8-16		
62-259	See model 62-226			
62-261, 62-311, 62-411	Schematic	9-5		
	Socket, trimmers, voltage, coils	9-6		
	Alignment, phonograph notes	9-7		
	Notes, parts	9-8		
62-264	Schematic, voltage, parts, socket, trimmers, alignment	9-4		
62-267, 62-277	Schematic, socket, voltage, coils	8-17		
	Alignment, circuit data	8-18		
	Movie dial data	8-19		
	Movie dial adjustments and replacements	8-20		
62-273, 62-283	Schematic, chassis wiring	8-21		
	Tuning Eye Installation	8-29		
62-274, 62-288, 62-290, Issue A	Schematic, socket, trimmers, voltage, parts	9-9		
	Alignment	9-10		
62-274, 62-288, 62-290, Issue B Above Serial 207500	Tuner data	9-11		
	Schematic, voltage, socket, trimmers, parts, alignment	9-10		
62-276	Tuner data	9-11		
	Schematic, voltage, socket, trimmers, parts	9-13		
	Trimmers, alignment	9-14		
62-277	See model 62-267			
62-280 Series A	Schematic, voltage, socket, trimmers, alignment, parts	9-12		
	Tuner data	9-11		
62-280, 62-282, 62-284, Series B Above serial 439000	Schematic, voltage, socket, alignment, trimmers	10-3		
62-288, 62-290	Tuner data	10-4		
62-292, 62-294, 62-373, 62-374	See model 62-274, Early or Late Schematic	10-5		
	Alignment, voltage, coils			
	socket, trimmers, drive data, notes	10-6		
	Schematic, phonograph data, specifications	9-15		
	Socket trimmers, alignment, voltage, coils, notes	9-16		
	Description	9-17		
	Assembly, schematic, parts, data	9-20		
	Schematic, socket, trimmers	9-21		
	Alignment	9-22		
	Schematic, voltage, socket	9-23		
	Coils, trimmers, alignment	9-24		
	Schematic, coils, battery data, drive cord data	9-25		
	Socket, trimmers, voltage, alignment	9-24		
	Schematic, socket, trimmers, parts	9-26		
	Trimmers, alignment	9-22		
	Schematic, voltage, socket, alignment, trimmers	10-9		
	Schematic, voltage, parts	9-27		
	Socket, trimmers, alignment	9-28		
	See model 62-226			
	Schematic	8-23		
	Battery data	8-22		
	Socket, trimmers, coils, voltage, sensitivity	8-24		
	Alignment, data	8-25		
	See model 62-261			
	See model 62-302			
	Schematic	8-27		
	Voltage, socket, trimmers, coils, phono. data	8-26		
	Alignment, notes	8-28		
	Schematic, voltage, socket, trimmers, parts	9-29		
	Alignment	9-61		
	Schematic, voltage, parts	9-30		
	Socket, trimmers, alignment, notes	9-31		
	See model 62-226			
	Schematic, voltage, socket, alignment	9-32		
	Schematic, socket, tuner, voltage	9-33		
	Trimmers, alignment	9-34		
	Schematic, voltage, socket, trimmers	10-7		
	Alignment, notes	10-8		
	Tuner data	10-4		
	Schematic, voltage, socket, alignment, trimmers	10-10		
	Tuner data	10-4		
	See model 62-320			
	Schematic, voltage, socket, trimmers	8-31		
	Coils, battery connections	8-32		
	Alignment, notes	8-33		
	Battery data, Drive cord replacements	8-34		
	Circuit data, parts	8-35		
	Schematic, sensitivity	8-37		
	Socket, trimmers, coils, voltage, battery connections	8-36		
	Alignment, data, parts	8-38		
	See model 62-251			
	Schematic, specifications	9-35		
	Socket, trimmers, coils, voltage, alignment, vibrator data	9-36		

62-334	Schematic, socket, trimmers, alignment, coils, specifications	9-37	See model 62-307	
62-336	Antenna, mounting data, tuner, notes	9-38	See model 62-226	
62-337	See model 62-326		See model 62-310	
62-338	See model 62-251		See model 62-261	
62-345	Schematic, voltage, socket, trimmers, parts, alignment	9-39	See model 62-305	
62-346	Schematic, voltage, socket, trimmers, parts, alignment	9-40	See model 62-315	
62-350, 62-351, 62-352	Schematic, voltage, socket, trimmers, parts, alignment	9-41	See model 62-316	
62-353	Tuner data	9-11	See model 62-226	
62-357	See model 62-323		Schematic, voltage, alignment, parts	9-57
62-361, Issue A	Schematic, socket, trimmers, voltage, parts	9-42	See model 62-251	
62-361, Issue B	Schematic, socket, trimmers, voltage, parts	9-44	Schematic, voltage, parts, socket, trimmers	9-58
62-362	Alignment, notes	9-43	Alignment, tuner	9-50
62-363, 62-463, 62-550	Tuner data	9-44	See model 62-331	
62-364	Schematic, voltage, socket, trimmers, parts	9-45	See model 62-302	
62-367	Alignment, notes	9-46	Schematic, socket, voltage, trimmers, parts, alignment	9-63
62-369	See model 62-297	10-11	See model 62-302	
62-370, 62-470, 62-700	Schematic, socket, trimmers, alignment	10-12	Schematic, voltage, socket, trimmers, alignment	10-18
62-372	Schematic, voltage, socket, coils, phono data	10-13	Tuner data	10-4
62-373, 62-374	Alignment, trimmers	10-14	See model 62-445	
62-487, 62-607, 62-617	Schematic, socket, voltage, parts	10-15	See model 62-297	
62-380, Series A	Tuner data	9-49	Schematic, voltage, socket, trimmers	10-21
Above serial 90618200	Alignment, trimmers	9-50	See model 62-370	
62-381 S.P.U.	See model 62-292		Schematic	10-19
62-385	Schematic, specifications	9-51	Socket, trimmers, alignment	10-20
62-386, 62-636, 62-646	Socket, trimmers, alignment	9-51	Schematic, voltage, socket, coils, parts	9-65
62-387	coils, voltage, dial drive data	9-52	Alignment, trimmers	9-67
62-390, 62-490, 62-900	Schematic, voltage, socket	10-16	Schematic, voltage, socket, coils, parts	9-66
62-401, 62-1100	Alignment, trimmers	10-8	Alignment, trimmers	9-67
62-403	Schematic	10-61	See model 62-445	
62-404	Chassis	10-62	Schematic, socket, trimmers, alignment, voltage, parts	9-68
62-405	See model 62-305		See model 62-377	
62-406	Schematic, voltage, alignment, resistances	10-17	Schematic, voltage, socket	9-69
	See model 62-377		Trimmers, coils, alignment, specifications	9-70
	Schematic, socket, trimmers, voltage, parts	9-53	See model 62-377	
	Alignment	9-54	See model 62-390	
	Remote control installation data	9-18	See model 62-305	
	Tuner data	9-17	See model 62-297	
	Schematic, coils, socket, specifications, phonograph data, tuner data	9-55	Schematic, socket, trimmers, alignment, voltage, socket	9-71
	Remote control installation data	9-19	Alignment, trimmers	9-72
	Trimmers, alignment	9-54	Schematic, voltage, socket, phonograph data	10-22
	Schematic, voltage, socket, phonograph data	9-56	Tuner data	10-4
	Trimmers, coils, alignment, notes	9-34	Schematic, voltage, socket, trimmers, alignment, changes	10-23
	Schematic, voltage, socket, alignment notes	9-59, 60	Tuner data	10-4
	Remote control installation data	9-19	Schematic, trimmers, socket, voltage, parts	9-62
	Trimmers, alignment	9-61	Alignment, trimmers	9-72
	See model 62-304		Schematic, voltage, socket, trimmers	10-25
	See model 62-305		Alignment	10-26
	See model 62-306		Schematic, voltage, socket, trimmers, alignment	10-24
			Schematic, voltage, socket, trimmers	10-27
			Tuner data	10-4
			Alignment	10-18
			Schematic, voltage, socket, trimmers	10-23
			Alignment	10-4
			Alignment	10-18
			Schematic, voltage, socket, trimmers	10-23
			Alignment	10-4
			Alignment	10-18

62-554	Schematic, socket, trimmers, voltage, alignment	10-29
62-555, 62-557, 62-2555, 62-2557	Schematic, voltage, socket, alignment, trimmers	10-30
62-558, 62-1558, 62-2558 Series A, Issue A, Above serial 591000	Schematic, voltage, socket, trimmers	10-32
62-601, Series A, Above serial 545900	Tuner data	10-4
62-606	Alignment	10-4
62-607	Schematic, voltage, socket, trimmers	10-28
62-616	Tuner data	10-33
62-617	Alignment	10-4
62-636, 62-646	See model 62-476	10-18
62-650	See model 62-476	
62-651, 62-652, Series A Above serial 8M498700	See model 62-386	
62-653	See model 62-363	
62-654, 62-655, 62-1654, 62-1655, 62-2654, 62-2655, Series A, Above serial 509200	Schematic, socket, trimmers	10-35
62-700	Tuner data	10-34
62-701, Early or Late	Voltage, alignment, trimmers	10-36
62-702, 62-703, Series A, Issue B, Above serial 5H262200	Tuner data	10-34
62-704, 62-705, 62-706, 62-707, 62-708, 62-709, 62-710, 62-711, 62-712	Schematic, voltage, socket, trimmers	10-34
62-750, 62-751, Series A, Above serial 8M499800	Alignment	10-39
62-752, 62-753	Tuner data	10-40
62-900	See model 62-370	
62-901, Issues A, B	See model 62-478 Early or Late	
62-902	Schematic, voltage, socket, trimmers	10-41
62-905	Alignment	10-42
62-1100	Schematic, voltage	10-43
62-1101	Tuner data	10-15
62-1550	Socket, trimmers, alignment	10-15
62-1551	Drive data	10-46
62-1558	Schematic, voltage, socket, trimmers	10-49
62-1611, 62-1711	Alignment, trimmers	10-44
62-1654, 62-1655	Tuner data	10-36
62-1838	Schematic, voltage, socket, trimmers, notes	10-34
	Alignment, drive data	10-45
	Schematic, voltage, socket, changes	10-47
	phono, data	10-42
	Alignment, trimmers, dial, notes	10-48
	data	10-49
	Schematic, socket, voltage, coils	10-15
	Tuner data	10-50
	Alignment, trimmers	10-15
	See model 62-401	
	See model 62-402	
	See model 62-570	
	See model 62-551	
	See model 62-558	
	See model 1111	
	See model 62-654	
	See model 62-656	
	See model 1238	

62-1955	See model 1355	
62-2550	See model 62-550	
62-2551	See model 62-551	
62-2555, 62-2557	See model 62-555	
62-2654, 62-2655	See model 62-654	
62-2656	See model 62-656	
62-2558	See model 62-558	
77, 96	Schematic, voltage, socket, Alignment data	4-18
87	Schematic, voltage, socket, Alignment, wiring	4-6
	Antenna, mounting notes	4-21
	Control unit	4-22
	Flexible drive notes	4-23
	Parts list	4-24
	Schematic, voltage, socket, trimmers	4-25
93BR454A, 93BR1455A, Series A	Alignment	10-51
93BR460A, 93BR1460A	Schematic, voltage, socket, trimmers	10-40
93BR508A, 93BR509A	Alignment, battery data	10-52
	Schematic, voltage, socket, trimmers	10-56
93BR560A	Tuner data	10-53
	Schematic, voltage, socket, trimmers	10-51
93WG562	Alignment	10-4
	Schematic, voltage, socket, trimmers	10-55
93BR564A	Tuner data	10-56
	Schematic, voltage, socket, trimmers	10-15
93WG602, 93WG603	Alignment	10-57
	Schematic, voltage, socket, trimmers	10-30
93BR657A	Tuner data	10-58
	Schematic, voltage, socket, Alignment	10-4
93BR713A	Alignment	10-61
	Tuner data	10-62
	Schematic, voltage, socket, trimmers	10-15
93BR1455A	Alignment	10-60
93BR1460A	Tuner data	10-40
500, Dictator, 10,000 Sorenader	See 93BR454A	10-15
	Chassis wiring	452-B-8
811	Schematic, socket, voltage, notes	452-B-7
839, 921, 923, 924 (Radiola 21, 22)	See model 1111	1519
839, 921, 923, 924 (Radiola 21, 22)	Schematic, socket, notes	452-B-9
811 (62-1711) Fantasy, 811 (62-1711) Solo	Conversion data, battery wiring	1520
1238 (62-1838)	Voltage, socket, parts list, notes	452-B-14
1355 (62-1955) Minatrel	Schematic, chassis wiring	1521
	voltage, data	452-B-18
	Schematic, voltage, notes	452-B-21
	Chassis layout, servicing notes	452-B-22
1500 (27-W, 15,000) Collegian	Schematic, servicing data	1524
1522, 1562, 1922	See model 62-055	1526
1800 Chassis	See model 62-060	
2655, AE-10	Voltage, socket, data	1598
2655, AE-10 (1st and 2nd types)	Schematic, socket	1657
2822, 2827, Balboa, 2895, 2897 DeSolo	Schematic, socket, voltage, data	452-B-9
2955-X, 2957-X, 25 cycles	Schematic, voltage	1547
11,000 Challenger (2 types)	See model 500	1549
	Schematic, socket, voltage	452-B-15

See Arvin Pages

1935 Receivers	Installation data	6-4
General Service Notes	Data	5-20
Arvin	Car data	4-13
	Car data, part 2	4-14
Presto Station Changer	Instructions, notes	9-19
5	Push-Button tuner	9-19
	Socket trimmers, alignment	9-1
	Socket trimmers, voltage, lay-	9-2
	out, specifications	9-2
6	Schematic, parts, voltage, align-	9-3
	specifications, tuner	9-3
	Socket trimmers, layout	9-4
7	Schematic, voltage, resistance,	6-1
	parts, changes	6-2
	Chassis layouts	6-3
	Schematic, voltage	10-1
7A, Chassis RE44	Alignment, socket, trimmers,	10-1
	sensitivity	10-2
	Antenna data	10-3
	Schematic, alignment, socket,	10-3
	trimmers	10-4
	Antenna data	10-3
	Schematic, parts	8-9
9-A	Alignment	9-9
	Voltage	10-5
	Socket, trimmers, chassis	10-6
Arvin 10-A	Schematic	4-1
	Notes	4-3
	Notes	4-3
	B supply schematic	4-13
	Alignment data	5-14
Arvin 10-A (2nd Type)	Schematic	5-1
	Voltage, test data, coil resist-	5-2
	ance	5-2
Arvin 15	Schematic, parts list	5-3
	Voltage, test data, coil resist-	5-3
	ance	5-4
	Installation notes	5-6
Arvin 16	Alignment data	5-18
	Schematic, parts list	5-19
	Voltage, test data	6-5
Arvin 17	Installation data, parts list	6-6
	Schematic, voltage, resistance,	6-7
	parts	6-8
Arvin 17, 27	Chassis layouts	6-8
Arvin 17, 17A, 27, 37	Changes layouts	6-9
Arvin 18	Alignment, parts	6-15
	Schematic, parts, voltage,	7-1
	resistance, coil data	7-1
19	Socket trimmers, chassis,	7-2
	alignment	7-2
	Schematic, voltage, resistance,	8-1
	parts	8-1
	Socket trimmers, chassis,	8-2
	alignment	8-2
Arvin 20-A, Type 1	Schematic	4-5
Arvin 20-A, Type 2	Schematic	4-4
Arvin 20-A	Control schematic	4-15
	Voltage	5-5
	Alignment data	5-14
	Notes	4-10
	Notes, part 2	4-11
	Notes, part 3	4-12
Arvin 20-A, 30-A	Schematic	4-16
	Voltage, test data, coil resist-	5-5
	ance	5-5
Arvin 20-B	Alignment data	5-14
	Schematic, parts, voltage,	9-5
22-A	Socket, trimmers, layout,	9-6
	specifications	9-6
Arvin 25	Installation notes	5-6
	Schematic, parts list	5-7
	Voltage, test data, coil resist-	5-8
	ance	5-8
	Alignment data	5-18
	See model 68	

14,000 Commander	Schematic, socket, voltage,	2-22
62,000 Cavalier	See model 1500	452-B-16
15,000	See model 1500	1580
MOTO-METER GAUGE & EQUIPMENT CO.		
Moto-Vox 10-A, above	Schematic	4-1
#500	Chassis wiring	4-2
Moto-Vox 10-A	Assembly wiring	4-3
Moto-Vox 10-A, 10-E	General notes	4-4
	General notes, part 2	4-5
	Special notes	4-9
	Parts list	4-10
Moto-Vox 10-E	Schematic, voltage	4-6
	Chassis data, socket	4-7
Moto-Vox 10-E, Batt.	General notes	4-8
	MOTOROLA	
	See GALVIN MFG. CO.	
	WILLIAM J. MURDOCK CO.	
Neutrodne, 3 control	Schematic	Misc. 1-15
7-tube, Single control	Schematic, socket	Misc. 1-15
7-Tube Battery	Schematic	Misc. 6-22
8-Tube AO	Schematic	Misc. 6-22
	MUSETTE	
52, 53	Schematic, data	3-1
Musette 810	Schematic, data	3-2
	MUSIQUE	
	See LAUREHK MFG. CO.	
	NASH	
	See PHILCO RADIO & TELEVISION CORP.	
	NASSAU RADIO	
DLPS	Schematic	3-1
	NATIONAL CARBON CO.	
1, 2, 8	Schematic, socket	1-1
20, 21	Schematic, socket	1-1
31, 32, 33, 34	Schematic, socket, voltage,	1-2
	parts list	1-2
42, 43, 44	Schematic, socket, voltage,	1-3
	parts list	1-3
52, 53, 54	Schematic, socket, voltage,	1-4
	parts list	1-4
	Changes	4-1
	THE NATIONAL COMPANY	
Auto Box	Schematic	1-2
Auto Box Connections	Wiring diagram	1-1
Thell Box AC, SW	Schematic	1-2
AGS	Schematic, chassis layout	3-1
FBX, FBXA	Schematic, notes	8-2
GRDPU Power supply	Schematic, notes	3-1
HRKO	Schematic, socket, trimmers,	8-1
	alignment	8-1
S-G Tuner	Schematic	1-1
S-G Tuner with '71	Schematic	1-1
S-G 5	Schematic	1-1
S-G 6	Schematic	1-1
MB-29	Schematic	1-2
MB-30	Schematic, chassis	1-2
DCSW-34	Schematic, notes	8-2
ACSW-58	Schematic, notes	8-2
NC-100	Schematic, parts	8-3
	Chassis, trimmers, alignment,	8-4
	socket	8-4
	NATIONAL TRANSFORMER CO.	
Midget 6	Schematic	3-1
Screen Grid 6	Schematic	3-1

NOBLITT SPARKS INDUSTRIES—(Cont.) REVISED PAGE EARLY COMPLETE PAGE

MODEL	NOBLITT SPARKS INDUSTRIES—(Cont.) REVISED PAGE	EARLY COMPLETE PAGE
Arvin 27	Schematic, voltage, resistances, parts	6-11
	Chassis layouts	6-12
	Changes—See model 17	
RE27 Chassis	See model 89	
Arvin 28	Schematic, voltage, resistance, alignment	7-3
	Socket trimmers, chassis	7-2
	Socket trimmers, chassis	7-4
	parts	8-3
	Socket trimmers, chassis, alignment	8-4
	See model 58	
RE29 Chassis	Schematic	4-6
Arvin 30-A, Type 1	Schematic	4-7
Arvin 30-A, Type 2	Resistance data, voltage	4-8
	Condenser data, control data	4-9
Arvin 30-A (3rd Type)	Schematic	5-9
	Voltage, test data, coil resistance	5-10
	Alignment data	5-14
	Notes—See model 20-A	
	Schematic, parts, voltage, alignment	9-7
	Socket trimmers, layout, specifications	9-8
Arvin 33	Schematic, voltage, resistance, coils, parts	7-5
	Alignment	7-2
	Changes	7-3
	Socket trimmers, chassis	7-6
	Schematic, parts list	5-11
Arvin 35 below aerial	Voltage, resistances	6-10
#E31577H	Schematic, parts list	5-12
Arvin 35, above aerial	Voltage, test data, coil resistance	5-13
E31577H	alignment	5-18
Arvin 35	Schematic, voltage, notes	5-13
	alignment	5-18
Arvin 37	Schematic, voltage, resistance, parts	6-13
	Chassis layouts	6-14
	Changes	6-15
RE37 Chassis	Alignment—See model 17	
39	See model 78	
	Schematic, voltage, resistance, parts	8-5
	Socket trimmers, chassis, alignment	8-6
Arvin 41	Schematic, parts	6-16
	Voltage, resistance, socket trimmers, alignment, coil	7-7
42	Schematic, parts, voltage	9-9
	Socket trimmers, layout, specifications	9-10
44C. Chassis RE46	Alignment	9-7
	Schematic, voltage	10-1
	alignment, socket trimmers, sensitivity	10-2
RE44 Chassis	Antenna data	10-3
Arvin 45 below aerial	See model 7A	
#E40356L	Schematic, parts list	5-15
Arvin 45, above aerial	E40356L	
Arvin 45	Voltage, resistances	6-17
	Schematic, parts list	5-16
	Voltage, test data, coil resistance	5-17
	alignment, notes	5-18
RE45 Chassis	See model 8A	
RE46 Chassis	See model 41C	
Arvin 51	Schematic, parts	6-18
	Voltage, resistance, socket trimmers, alignment, coil	7-7
Arvin 51-B	Schematic, socket, trimmers, voltage, resistance, coils, alignment, parts	7-8

NOBLITT SPARKS INDUSTRIES—(Cont.) REVISED PAGE EARLY COMPLETE PAGE

MODEL	NOBLITT SPARKS INDUSTRIES—(Cont.) REVISED PAGE	EARLY COMPLETE PAGE
58, 58A, 88, Chassis RE29, RE85	Schematic, parts, voltage, alignment, specifications	9-11
Arvin 61, 62	Socket trimmers, layout	9-12
	Schematic, parts	6-19
	Voltage, resistance, alignment, coils	7-9
Arvin 61-B, 62-B	Socket trimmers, chassis	7-10
	Schematic, voltage, alignment, resistance, coils, parts	7-11
Arvin, 61M, 62M	Socket trimmers, chassis	7-12
	Voltage, resistance, alignment, coils	6-20
68, Chassis RF26	Socket trimmers, chassis	7-9
	Schematic, voltage, parts, alignment, specifications	7-13
78, Chassis RE37	Socket trimmers, layout	9-13
	Tuner data	9-14
Arvin 81	Schematic, voltage, trimmers, alignment, parts	9-15
	Socket layout	9-16
	Schematic, parts	6-21
	Voltage, resistance, alignment, coils	6-22
Arvin 81M	Socket trimmers, chassis	7-9
	Voltage, resistance, coil data	7-14
	Schematic, parts	7-16
	Voltage, resistance, alignment, coils	6-22
89, 91, Chassis RE27	Socket trimmers, chassis	7-9
92, Chassis RE31	Voltage, resistance, coil data	7-15
Arvin 417, 467	Schematic, voltage, alignment, trimmers, sensitivity	10-7
	Schematic, alignment, trimmers, sensitivity	10-8
	Schematic, voltage, resistance, coils, parts list	7-17
508 AC-DC	Socket trimmers, chassis, alignment	7-18
Arvin 517, 527	Schematic, voltage, resistance, parts	8-7
	Socket trimmers, alignment	8-8
	Schematic, voltage, resistance, coils, parts	7-19
Arvin 517-B, 527-B	Socket trimmers, chassis, alignment	7-20
	Schematic, voltage, resistance, coils, parts	7-21
518, 518A, 518DW, 528CS, 568, 568A, 568DW	Socket trimmers, chassis, alignment	7-22
	Schematic, parts	7-22
518B	Socket trimmers, chassis	8-12
578B	Voltage, resistance, alignment, sensitivity	8-13
608	Data	9-3
	Schematic, parts	8-11
	Schematic, parts	8-10
	Socket trimmers, chassis	10-10
	Alignment, voltage, data	10-5
	Schematic, parts	8-14
	Voltage, alignment, resistance, specifications	9-17
Arvin 617, 627	Socket trimmers, layout	9-18
	Schematic, voltage, resistance, coils, parts	7-23
Arvin 617-B, 627-B	Socket trimmers, chassis	7-24
	Alignment	7-32
	Schematic, voltage, resistance, coils, parts	7-25
618, 618A, 628, 628CS, 638, 638CS	Socket trimmers, chassis	7-32
	Alignment	8-10
618B, 628B	Schematic, parts	8-10
	Voltage, resistance, alignment, sensitivity	8-15
	Socket trimmers, chassis	8-16
	Data	Changes 10-1
	Schematic, voltage, alignment, parts	8-17

NOBLITT SPARKS INDUSTRIES—(Cont.)

318B, 628B	Socket trimmers, chassis, alignment	8-18
918, 828, 828A, 838CS	Schematic, voltage, alignment; sensitivity, resistance, parts	8-19
328AT, 838AT, Chassis 818AT	Socket, trimmers, chassis; Schematic, voltage, resistances	10-9
	Alignment, tuner data, sensitivity	10-3
848CS	Socket trimmers, chassis	10-6
Arvin 927	Schematic, alignment, parts	8-21
	Schematic, voltage, resistance, coils, parts	7-27
Arvin 1127	Socket, trimmers, chassis; Alignment	7-28
	Schematic, voltage, resistance, parts	7-32
	Socket, trimmers, chassis	7-30
	Coil data, data, power supply layout	7-31
1237, 1247, 1247A	Schematic, alignment, parts	9-22
1237, 1237D, 1247, 1247D	Alignment, notes; Schematic, parts, voltage, coils	9-20, 9-21, 22
1427, 1427D	Chassis views; Trimmers	9-23
	Schematic, alignment	10-11, 12
	Trimmers, socket	10-10
	Voltage, resistances	10-13
	Chassis views	10-14

NORCO MFG. CO.

Also see REMLER CO., LTD.

4 Combination Dual Wave Super	Schematic, voltage, notes	3-1
	Schematic, voltage, notes	3-2

NORDEN-HAUCK, INC.

Super DX-5	Schematic	1-1
Super DX-5A	Schematic	1-1
C-7	Schematic	1-3
Super 10	Schematic	1-3
Admiralty Super 12	Schematic	1-2
Super 15, RF Chassis	Schematic	3-2
Super 15, Power Pack and Amplifier	Schematic	3-1

OLDSMOBILE DIV.—GENERAL MOTORS

See UNITED MOTORS SERVICE
See BUICK 980393

982043 Early	Schematic, voltage, notes; Socket, trimmers, chassis; Alignment, parts	9-1, 9-2
	Data; Changes	10-1
982043 Late, Above Serial 420,000	Schematic, socket, voltage, chassis, parts	9-3
982044 (3 Types)	Schematic, voltage, changes; Socket, trimmers, alignment	9-5
982045 (3 Types)	Schematic, voltage; Socket, trimmers, chassis notes	9-7, 9-8
	Alignment	9-6
982083, Early, Late	Schematic; Socket, trimmers, chassis, condenser schematic	10-1, 10-2
	Remote control head details, parts	10-3
	"Hash" elimination, changes, notes	10-4
	Voltage, alignment	10-17
	Conversion control units, assembly, parts	10-18
982084, Early, late	Schematic, notes; Socket, trimmers, chassis; Alignment, voltage	10-5, 10-6, 10-7

OLDSMOBILE DIV.—GEN. MOTORS—(Cont.)

982084, Early, Late	Remote control head assembly, details, condenser schematic; "Hash" elimination, changes, notes	10-8, 10-4
982085 Early, Late	Conversion control units assembly, parts; Schematic, changes; Socket, trimmers, notes, chassis	10-18, 9-9
982126 (3-wire speaker)	Alignment, voltage	9-10
982126 (4-wire speaker)	Parts, data	9-11
982126 (3 and 4-wire speaker models)	Remote control head details, parts	9-12
982127	Conversion control units assembly, parts	10-3
982153	Schematic	10-18
	Schematic	10-9
	Socket, trimmers, chassis, alignment	10-10
	Voltage, chassis, control assembly	10-11
	Schematic	10-12
	Socket, trimmers, alignment	10-13
	Control assembly	10-14
	Schematic	10-12
	Voltage, socket, trimmers, chassis	10-15
	Alignment	10-16
	Conversion control units assembly, parts	10-17

OPERADIO CORP.

1925	Schematic	Misc. 1-16
1926	Schematic	Misc. 1-16
7	Schematic	Misc. 1-16
478-A, 478-AH, 2478-A	Schematic	6-1
483-A, 2483-A, 5-483-A, 5-2483-A	Schematic	6-2
484, 484-A, 484-B	Schematic	6-3
660, Amplifier	Schematic	8-6
677-A, 2677-A	Schematic	7-2
678-A	Schematic	7-3
683-A	Schematic	7-1
823-A	Schematic	7-4
2677-A	See model 677-A	

OZARKA, INC.

SW Converter	Schematic, chassis views	2-3
Viking 6-A	Schematic	2-1
S-5	Schematic	2-1
S-7	Schematic	2-1
V-16	Schematic, socket	3-1
78 Battery	Schematic, socket	2-2
89 AC	Schematic, socket, voltage	2-2
Viking 90 AC	Schematic, chassis, socket, voltage	2-2
91 Battery	Schematic, chassis	1-2
91 AC	Schematic, socket, chassis, voltage	1-1
92 AC	Schematic, socket, chassis, voltage	3-1
93 Batt., Superhet.	Schematic, socket, chassis, voltage	2-5
93-A	Schematic, socket, voltage	2-6
93-B	Schematic, chassis	2-7
94-AVC	Schematic, socket, voltage	2-8
	Schematic, socket, voltage	2-9

PACENT REPRODUCER CORP.

HFA 112 Amplifier	Schematic	Misc. 6-23
MDA Service	Schematic	4-2
PEC Booster	Schematic	4-11
PEC Booster, Heater Supply	Schematic	4-12
PEC-Xiter Piping and for	Layout	4-23
PEC-Xiter and Projector	Service diagrams with booster	4-24
PEC-Xiter Service	Schematic	4-3
Disc. Film and Fader Service	Schematic	4-3

Schematic	8-6
Schematic	8-7
Schematic	8-8
Schematic	9-8
Alignment	9-6
Schematic, alignment	8-9
Schematic, alignment	8-10
Schematic, socket, trimmers	9-8
Alignment	9-6
Schematic, alignment	7-4
Schematic, socket, trimmers	10-9
Alignment	9-6
Schematic, alignment	10-10
Schematic, alignment	7-3
Schematic, alignment	7-6
Schematic, alignment	7-7
Schematic, alignment	7-8
Schematic, alignment	7-9
Schematic, alignment	7-10

PACKARD BELL CO.

5B Schematic	10-1
5D Schematic, socket	10-2
5 Kompak Schematic, socket, trimmers	8-1, 8-2
5M 35M Schematic	9-1
5MP Schematic	10-3
5N Schematic	10-4
5TP Schematic	10-4
J5 Schematic	9-1
J6 Schematic	10-1
25, Early & late Schematic	6-1
34 Additional data	Changes 7-13
35 Schematic	6-4
35, Late Alignment data	Changes 7-5
35A Schematic, socket	7-1
35H Schematic	6-2
35L Schematic, socket	8-3
35M Schematic, socket, trimmers	10-5
35N Schematic, socket, trimmers	10-4
36 Schematic	6-3
40 Portable Schematic, socket, trimmers	10-2
41 Schematic, socket, trimmers	10-1
45M Schematic	6-4
46 Alignment data	Changes 7-5
46B Schematic, socket, alignment	7-2
46D Schematic, socket	8-3
46E Schematic	9-1
46DP Schematic	9-2
47M Schematic	10-3
48 Schematic, socket	7-1
48B Schematic, socket	7-3
48BP Schematic	9-2
48D Schematic	10-7
48DC 48DC, 48DK Schematic, socket, trimmers	10-2
50 High Fidelity Schematic, socket, trimmers	8-1, 8-2
58 Schematic	10-6
63 Auto Schematic, socket, notes	7-4
66 Schematic, socket, tuner	6-2
67 Schematic, socket, notes	7-4
75 Auto Schematic, socket, trimmers, alignment	10-5
76 Schematic, socket, trimmers, alignment	6-5
76 Auto Schematic, socket, trimmers, alignment	8-4
78 Schematic, socket, alignment	9-4
86 Schematic	6-6
120 Console Schematic, alignment	8-1, 8-2
120-AB Schematic	9-3
160 Schematic, socket, trimmers, alignment, tuner	10-7

See PHILCO RADIO & TELEVISION CORP.

Fader Units, (Two types) Schematic	4-1
Percent Rectifiers, (Two types) Schematic	4-5
Sprk-Amplifier A0 Service Schematic	4-4
2-MDA-F Assembly wiring	4-5
2-MDA-F Control Box Schematic	4-16
2-MDA-F Harness Schematic	4-2
2-MDA-F Piping Layout	4-4
2-MDA-F Piping for Disc-Film Schematic	4-5
2-MDA-F Piping for Disc-Film Schematic	4-22
4-MDA Piping for Disc Layout	4-20
4-MDA-F Harness Layout	4-14
4-MDA-F Amplifier Assembly wiring	4-15
4-MDA-F Piping Layout	4-17
4 Spkr-MDA Service Schematic	4-13
C-62 (102), C-66 (20) Schematic	4-10
63 PEO Amplifier Schematic	4-9
65 Amplifier Schematic	4-10
70 Amplifier Schematic	4-11
See model HFA	
500 DDA-Jr. Piping for Disc Layout	4-19
500 DDA-Jr. Piping for Disc-Film Layout	4-21
C-1000, Jr. Schematic	4-9
1005 Amplifier Schematic	4-8
1010 SPU Schematic	4-8
1015 Amplifier Schematic	4-7
1020 SPU Schematic	4-7
1063 PEO Amplifier Schematic	4-12
1070 Amplifier Schematic	4-13

PACIFIC RADIO EXCHANGE

Sperro Four Schematic	Misc. 6-24
Sperro Super Schematic	Misc. 6-25

PACIFIC RADIO CORP.

Midget Super TRF Midget Schematic	9-4
3 Schematic	10-10
5SW Schematic, alignment	9-2
H6 Schematic, alignment	8-1
H7 Schematic, alignment	7-1
M7 Schematic	9-3
8T-6V Schematic	9-3
Socket, trimmers, parts Alignment	9-4
11 Schematic	9-6
12 Schematic	9-1
14 Schematic	10-1
15, 16 Series 37 Schematic	10-1
20, Series 37 Schematic	10-2
21, 22, 23 Schematic	10-2
25 Schematic, alignment	9-5
30 Schematic	10-3
35 Schematic, socket, trimmers, alignment	8-2
36 Schematic, socket	9-6
40 Alignment	10-4
41 Schematic, alignment	9-6
42 Schematic, socket, trimmers	10-5
43 Schematic, socket, trimmers	10-7
50 Schematic, alignment	9-5
60 Schematic, alignment	9-7
A60B Schematic	8-3
61 Schematic, alignment	8-4
80 Schematic	10-5
81A Schematic, alignment	7-2
101 Schematic, alignment	7-3
101 (Late) Schematic, alignment	10-8
Schematic, socket	8-6

Rev. C
EKE

See PHILCO RADIO & TELEVISION CORP.

MODEL	PATERSON RADIO CO.—(Cont.)	REVISED PAGE
129; Chassis 127A	See model 127A	
130	See model 87	
168, 268	Schematic, socket, trimmers, voltage	9-3
	Alignment, part 1	9-5
	Alignment, part 2, voltage	9-6
	See model 75-AW	
175-AW	See model 75-AW-A	
175-AW-A	See model 85-AW	
185-AW	See model 85-AW-A	
185-AW-A	See model 86-AW	
186-AW	Schematic, socket, trimmers, voltage	9-3
198, 298	Alignment, part 1	9-5
	Alignment, part 2, voltage	9-6
	See model 70-AW	
207-AW	Schematic, notes	9-4
208, 308, 408		
212, 312, 412		
228 Chassis	Alignment, part 1	9-5
	Alignment, part 2, voltage	9-6
268	See model 128	
275-AW	See model 168	
275-AW-A	See model 75-AW	
285-AW	See model 75-AW-A	
285-AW-A	See model 85-AW	
286-AW, 386-AW	See model 85-AW-A	
298	See model 186-AW	
308	See model 198	
312-AW	See model 208	
312-AW	See model 212	
375-AW	See model 75-AW	
375-AW-A	See model 75-AW-A	
385-AW	See model 85-AW	
385-AW-A	See model 85-AW-A	
386-AW	See model 386-AW	
408	See model 308	
412	See model 312	
428 Chassis	See model 428	
507-AW	See model 70-AW	
508-AW	See model 80-AW	
510-AW	See model 104-AW	
1105-AW	See model 105-AW	
1106-AW	See model 106-AW	
1126-AW	See model 120-AW	
2105-AW	See model 105-AW	
2106-AW	See model 106-AW	
2126-AW	See model 1126-AW	
3105-AW	See model 105-AW	
3106-AW	See model 106-AW	
3126-AW	See model 1126-AW	

PERLESS

See UNITED REPRODUCERS

PERFECTIONE, INC.

See model 5-15

PETER PAN

Also see JACKSON-BELL CO., LTD.

4-Tube Receiver Schematic

B 4-8 Schematic

4 (w. Tone Cont.) Schematic

25AV, 25UV Schematic

34 Schematic

45 Schematic

56 Schematic

84 Misc. 8-3

MODEL	PACKARD RADIO CO.	REVISED PAGE
4-Tube Superhet	Schematic	3-1
6-Tube Auto	Schematic	4-2
5 Auto Set	Schematic, data	3-1
4, 24, 24-C	Schematic	4-1
5, AO	Schematic, parts	Misc. 6-26
1, 18	Schematic	4-1
35	Schematic	4-2
Laurel Tone	Schematic	Misc. 5-14
PARAMOUNT RADIO CO.		
Pre-Selector	Schematic, data	5-1
PR-10	Schematic, socket	5-2
PR-16, Series A	Schematic	6-1
PR-16, Series C	Schematic, notes	7-1
60 Series	Socket, trimmers, notes	7-2
70-AW, 107-AW, 207-AW, 210-AW	Alignment, voltage	7-3
70-AW, 74-AW, 507-AW	Schematic	5-1
	Schematic, data	3-1
75-AW, 175-AW, 275-AW, 375-AW	Schematic, alignment, test data	4-1
75-AW-A, 175-AW-A	Schematic, alignment	8-1
275-AW-A, 375-AW-A	Schematic	8-3
78B, 79B, 80B, Chassis 77B, 77BA	Trimmers, alignment	8-4
80-AW, 84-AW, 508-AW	Schematic, socket, trimmers phono, notes	9-1
	Schematic, alignment, test data	4-2
85-AW, 185-AW, 285-AW, 385-AW	Schematic	8-5
	Trimmers, alignment	8-6
85-AW-A, 185-AW-A	Schematic	8-3
285-AW-A, 385-AW-A	Trimmers, alignment	8-4
86-AW, 186-AW, 286-AW, 386-AW	Schematic	6-3
	Trimmers, alignment, part 1	6-2
	Voltages, alignment, part 2, parts	6-4
87, 87-A	Schematic	8-7
	Socket, trimmers, voltage, alignment	8-8
88, 89; Chassis 87	See model 87	
90; Chassis 87A	See model 87A	
104-AW, 510-AW with #46 power tubes	Schematic	4-3
104-AW, 510-AW with #59 power tubes	Schematic, data	4-4
105-AW, 1105-AW	Schematic, socket	8-2
2105-AW, 3105-AW	Alignment, trimmers	8-6
	Schematic	6-3
106-AW, 1106-AW	Trimmers, alignment, part 1	6-2
2106-AW, 3106-AW	Voltages, alignment, part 2, parts	6-4
107, 107-A	Schematic	8-7
	Socket, trimmers, voltage, alignment	8-8
107-AW	See model 70-AW	
108, 109; Chassis 107	See model 107	
110; Chassis 107A	See model 107A	
111	See model 87	
126-AW, 1126-AW, 2126-AW, 3126-AW	Schematic	6-3
	Trimmers, alignment, part 1	6-2
	Voltages, alignment, part 2, parts	6-4
127, 127-A	Schematic	8-7
	Socket, trimmers, voltage, alignment	8-8
128; Chassis 127	See model 127	
128; Chassis 228, 428	Schematic, voltage, trimmers	9-2
	Alignment, part 1	9-5
	Alignment, part 2, voltage	9-6

PHILCO RADIO & TELEVISION CORP.
B = Baby Grand Cabinet
C = Compact
A (batt. sets) = all dry battery models
A (A.C. sets) = 25-cycle chassis
X = Slopless beam type of cabinet
Notes, parts

Automatic Tuning
Coils, compensating condensers

RIDER Publications

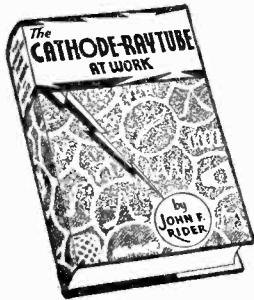
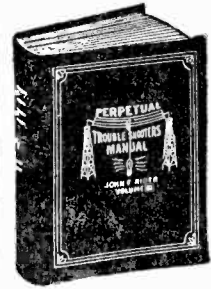

THE CATHODE-RAY TUBE AT WORK

A new era in the servicing of radio receivers, public-address systems, transmitters, etc., is in the offing. It is the use of the cathode-ray tube and the progressive serviceman will prepare himself now for the change that is coming.

The theory underlying the functioning of the cathode-ray tube and the circuits that accompany it receives full consideration in this book. The second half of the volume is devoted to specific and practical applications of commercial oscilloscopes to servicing and adjustment problems. Order your copy today!

CONTENTS

I—The Theory of the Tube. A complete explanation of the different types of cathode-ray tubes. How the spot is focussed and how the beam of electrons is deflected. **II—Sweep Circuits.** How and why the spot moves across the screen and forms the image. **III—A-C. Voltages on Both Sets of Plates.** An explanation of the patterns formed on the cathode-ray tube screen when a.c. voltages are applied. **IV—Commercial Cathode-Ray Oscillographs.** A detailed description of the various cathode-ray oscillographs that are on the market. **V—Practical Application of the Cathode-Ray Oscillograph.** General directions for adjusting the cathode-ray oscillograph for all tests. **VI—Alignment of Tuned Circuits.** Understandable explanation of the theory of the frequency modulated oscillator and how it is used in testing with the cathode-ray oscillograph. **VII—The A-F. Frequency Modulator.** How overall a-f response curves of audio units are developed and what they mean. **VIII—Auto Radio Vibrator Testing.** The connections for testing vibrators with the cathode-ray tube oscillograph. **IX—Transmitter Adjustment.** How the modulation of a wave is measured and the trapezoidal pattern is developed on the screen. **X—Other Applications of the Cathode-Ray Oscillograph.** Beat patterns, c-w. reception and detection.

338 Pages . . Profusely Illustrated . . Net Price \$3.00



SERVICING SUPERHETERODYNES

No other circuit in the radio field has undergone all the changes that have been incorporated in the superheterodyne. In order to service these receivers with profitable speed, you must be able to analyze the different portions of the circuit quickly and this is just what Rider tells you how to do in this book. Not only is the theory of all types of Superhets thoroughly covered, but actual servicing details are most complete. Many thousands of Servicemen are using "Servicing Superheterodynes" daily and are finding the investment one that paid dividends in increased profits.

CONTENTS

I—The Principles Underlying the Operation of the Superheterodyne Receiver. **II—The Generation of and the Relation Between Harmonics.** **III—Explanation of the Different Types of Superheterodyne Circuits.** **IV—Function and Characteristics of Individual Parts of the Superheterodyne Receiver.** **V—Special Circuits and Tube Applications.** **VI—Troubles and Symptoms Encountered in Superheterodynes.** **VII—Application of Test Oscillators.** **VIII—Vibrator Units.** **Appendix—Intermediate Peak Frequencies of Commercial Receivers with Model Numbers.**

288 Pages . . Profusely Illustrated . . Net Price \$1.00

Alternating Currents in Radio Receivers

Are you familiar with the different forms of alternating currents which are present in a radio receiver? When once you understand the basic facts relating to the cycle—frequency—sine waves—harmonics—complex waves—modulated waves—phase relations—you will have no trouble in understanding the servicing problems which involve these factors.

D.C. Voltage Distribution

Only a casual glance at the schematics of some of the 1939 multi-tube sets will convince you that the distribution of the D.C. voltage to the tube elements is complicated. The many different forms these systems take should be recognized at a glance and understood. You should know thoroughly how the value of resistance and wattage rating of each resistor is calculated and why.

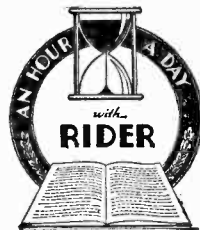

96 Pages Each
Net Price 90c Each

Resonance and Alignment

Do you know what happens when you tune a circuit to resonance? In order to align a receiver, oscillator, or transformer properly, so that maximum efficiency is attained, you must be familiar with more than just the mechanical operation. Are you familiar with I.F., oscillator, R.F. and detector alignment for all types of circuits—single, double and triple tuned systems?

Automatic Volume Control

Automatic volume control has now become a standard feature of every well made receiver. Are you familiar with every type in use and can you recognize one system from another by examining the schematic? Do you know how various types of tubes are used in each circuit? Noise suppression systems, time delay circuits—audio-frequency volume expander systems and other such networks have greatly increased servicing problems.

HARD COVERS TYPE SET PROFUSELY ILLUSTRATED HANDY POCKET SIZE

SERVICING RECEIVERS BY MEANS OF RESISTANCE MEASUREMENT

Take the guesswork out of servicing by using an ohmmeter in your trouble shooting. This book tells you how to make and correctly interpret point to point resistance measurements. It will simplify your servicing problems and enable you to use the resistance data furnished in RIDER MANUALS to the best advantage. Now that more and more manufacturers are supplying resistance data, you need this book to speed up your servicing with greater accuracy. Let Rider show you how to use a modern servicing procedure on the complicated receivers—you will find in this book the usual Rider clarity of explanation, how theory is applied to practice.

203 Pages Net Price \$1.50



ALIGNING PHILCO RECEIVERS Two Volumes

Everything you need for aligning Philco receivers . . . I.F. peaks—adjustment frequencies—trimmer and padder locations—complete and detailed information for aligning every Philco model from 1929 to 1941. These two volumes, prepared with the cooperation of the engineering staff of the Philco Radio & Television Corp., are the authentic source of alignment information and the data are presented in a brand new way that makes alignment easier and quicker. You will find all the necessary data arranged so that every step in the alignment procedure is carried out in a definite and systematic manner. The necessity for referring back and forth is eliminated completely in this radically new style of presenting alignment data.

Vol. I — 1929 to 1936 — 176 pages — \$1.50
Vol. II — 1937 to 1941 — 200 pages — \$1.75

AUTOMATIC FREQUENCY CONTROL SYSTEMS

From the simplest type of A.F.C. circuit to the most complicated push pull control circuit . . . you will find them all clearly explained in Rider's book. The first part of the book is devoted to a review of the combination of D.C. voltages, the phase relations in inductive, capacitive, and transformer circuits, with particular reference to the manner in which these principles appear in A.F.C. circuits. The remaining chapters cover the operation of all types of discriminator circuits, the operation of the various types of control tube circuits, including the push-pull type, the reflected reactance type, and the mutual inductance type. Let Rider tell you all about A.F.C. in this up-to-the-minute book that combines theory and practice.

144 Pages Net Price \$1.25

**RADIOTRON
EARLY COMPLETE
PAGE**

**PHILCO RADIO & TELEVISION CORP.—(Cont.) REVISED
MODEL PAGE**

Adjustments—See model 5
Additional dataChanges 7-2
See model 9
Chassis layout, voltage, speaker connections, data3-29
Schematic, parts list3-30
Voltage, chassis view, socket, data4-1
Schematic, parts list4-2
Changes—See model 91
14, 14-1214-17
14-LZX, 91, 23, 14, 19-LZ, Changes3-50
15 Voltage, socket, data3-10
Schematic, changes3-11
Chassis layout, speaker data, notes3-12
Alignment, trimmers8-10
Schematic, voltage, data4-3
Chassis view, socket4-4
Parts list4-5
Adjustment notes4-6
Adjustment notes4-7
Changes4-9
Changes4-10
Changes5-15
Changes4-8
Schematic, socket, voltage6-1
Chassis, parts6-3
Alignment, trimmers6-2
ChangesChanges 7-8
Changes4-9
Changes4-10
Voltage, chassis view, socket, data4-11
Schematic, trimmer data4-12
Alignment, parts list4-13
Changes, parts list4-14
Changes, parts list4-14
Schematic, data, voltage, socket4-15
Chassis view, alignment, parts list4-16
Changes4-17
Alignment, voltage, parts5-9
Schematic, socket, chassis layout5-10
Changes5-15
Notes5-16
Changes4-43
Socket, voltage, data4-18
Schematic, parts list4-19
Chassis view, trimmer notes, adjustments4-20
Changes, See model 14-LZX1-6
Voltage, chassis view1-6
Voltage, socket, values2-3
Circuit changes, chassis view2-4
Schematic similar to model 120 Same as model 71(221) but with phonograph3-45
Schematic, changes3-43
Alignment, trimmers8-10
Changes—See model 14-LZX3-45
Alignment—See model 91(221)
See model 51
See model 43-AC
Similar to model 89 Early
Alignment, parts list5-11
Schematic, layouts, voltage5-12
Alignment, voltage, layouts5-13
Schematic, layout, parts list5-14
Changes7-147
Changes5-15
Schematic, socket, chassis views1-7
Voltage, values, data2-5

**RADIOTRON
EARLY COMPLETE
PAGE**

Connections, color code2-25
Data7-151
Details, notes7-152
See model 5701690
Data3-46
Changing I.F. Peaks...Changes 8-2
Installation notes3-52
Data, part 14-44
Data, part 24-45
Data, part 34-46
Data, part 13-53
Data, part 23-54
Adjustment notes3-38
Data2-14
Adjustment notes2-17
Vibrator data, steering column4-47
Drive controls4-48
Drive controls, part 24-49
Control shafts data4-50
Chassis layout1-2
See model 10
Specifications—See model AB-468
Schematic, chassis, parts, changes8-136
Socket, trimmers, alignment8-137
See model 10
Data4-52
Wiring, diagram, values3-5
Terminal arrangements3-6
Data3-7
Schematic, parts list3-9
Installation data, service data5-1
Alignment, adjustment, socket5-2
Schematic, chassis layout, parts5-4
Additional dataChanges 7-1
See model 11
See model 700
Schematic, instructions10-12
Voltage, electrical values3-1
Schematic, compensating data3-2
Chassis layout, parts list, data2-1
Schematic, socket, voltage, data2-2
Schematic, chassis layout, data3-8
Parts list3-9
Changes4-5
Adjustments4-53
Speaker cones, adjustments3-51
Schematic, voltage, socket3-55
Schematic, chassis layout3-3
Alignment data3-4
Adjustments4-54
See model 806
Schematic, data3-5
Chassis layout, alignment data3-6
Condenser data3-7
Schematic, layout, parts list3-56
Data4-52
Adjustments—See model 5
Schematic, chassis, parts list4-57
Service notes, chassis layout4-57
Adjustments—See model 7
ChangesChanges 7-12
Alignment, socket5-5
Schematic, chassis, parts5-6
ChangesChanges 7-12
Alignment, socket5-7
Schematic, chassis, parts5-8
Schematic, parts, chassis data6-43
Alignment, socket, trimmers6-44
Schematic, chassis, notes—See model 8

**PHILCO RADIO & TELEVISION CORP.—(Cont.) REVISED
MODEL PAGE**

Condensers1686
Dial Drive Assemblies1686
Grand Father Clock1690
Increasing Range and Interference Notes1714
Lazy X Speakers1678
Philco Tubes1684
Shadow Tuning1660
Standard Bypass Condensers466-B-3
Superheterodynes466-B-4
Transistone*466-M
B part of AB Unit1592
DB*745
DP, DPV466-L
E466-K
EA, EG1595
EA Dynamotor1596
EF Full-wave Vibrator1605
G1604
G (Code 122)1602
J, R1603
RP-1 Wireless Record Player1596-A
3 Transistone1597
4, 40 SW Converter1598
5 Transistone1599
5, 6, 7, 8, 9, 121600
5, 6, 91601
6, B6, 6F Transistone1602
7 Transistone1603
7, 101596-A
TV-NT7, TS-NT81597
8, 121598
9, 12 (122)1600
10, O, E1601
10, C, E (Code 122)1602
11, J, E1603
11, J, R (Code 122)1604
121605

**RADIOTRON
EARLY COMPLETE
PAGE**

Adjustments—See model 5
Additional dataChanges 7-2
See model 9
Chassis layout, voltage, speaker connections, data3-29
Schematic, parts list3-30
Voltage, chassis view, socket, data4-1
Schematic, parts list4-2
Changes—See model 91
14, 14-1214-17
14-LZX, 91, 23, 14, 19-LZ, Changes3-50
15 Voltage, socket, data3-10
Schematic, changes3-11
Chassis layout, speaker data, notes3-12
Alignment, trimmers8-10
Schematic, voltage, data4-3
Chassis view, socket4-4
Parts list4-5
Adjustment notes4-6
Adjustment notes4-7
Changes4-9
Changes4-10
Changes5-15
Changes4-8
Schematic, socket, voltage6-1
Chassis, parts6-3
Alignment, trimmers6-2
ChangesChanges 7-8
Changes4-9
Changes4-10
Voltage, chassis view, socket, data4-11
Schematic, trimmer data4-12
Alignment, parts list4-13
Changes, parts list4-14
Changes, parts list4-14
Schematic, data, voltage, socket4-15
Chassis view, alignment, parts list4-16
Changes4-17
Alignment, voltage, parts5-9
Schematic, socket, chassis layout5-10
Changes5-15
Notes5-16
Changes4-43
Socket, voltage, data4-18
Schematic, parts list4-19
Chassis view, trimmer notes, adjustments4-20
Changes, See model 14-LZX1-6
Voltage, chassis view1-6
Voltage, socket, values2-3
Circuit changes, chassis view2-4
Schematic similar to model 120 Same as model 71(221) but with phonograph3-45
Schematic, changes3-43
Alignment, trimmers8-10
Changes—See model 14-LZX3-45
Alignment—See model 91(221)
See model 51
See model 43-AC
Similar to model 89 Early
Alignment, parts list5-11
Schematic, layouts, voltage5-12
Alignment, voltage, layouts5-13
Schematic, layout, parts list5-14
Changes7-147
Changes5-15
Schematic, socket, chassis views1-7
Voltage, values, data2-5

37-604	Socket, trimmers, voltage, chassis	7-43
	Circuit data, parts list	7-41
	Schematic, coil data	7-45
37-610 (Codes 121, 122)	Circuit data, voltage, transformer data	7-46
	Trimmers, alignment	7-47
	Chassis, parts list	7-48
37-611	Schematic, parts list	7-49
	Voltage, socket, trimmers, alignment	7-50
37-620	Schematic, coil data	7-51
	Circuit data, voltage, transformer data	7-52
	Trimmers, alignment	7-53
	Chassis, speaker data, parts list	7-54
37-623	Schematic, parts, coils	7-55
	Chassis, voltage, socket, trimmers, alignment	7-56
37-624	Changes	8-3
	Schematic, parts	8-23
	Alignment, trimmers, voltage, chassis	8-24
37-680	Changes	9-3
	Schematic, coils, change	9-3
	Trimmers, alignment	7-57
	Circuit data, voltage, socket, transformer data	7-58
37-640	Chassis, parts list	7-59
	Schematic, coil data	7-60
	Trimmers, alignment	7-61
	Voltage, socket, transformer data, notes	7-62
37-641	Chassis, parts list	7-63
	Schematic, voltage, chassis	7-64
37-643	Alignment, trimmers, parts	8-26
	Schematic	8-27
	Alignment, trimmers, notes	8-28
37-650	Chassis, parts	8-29
	Schematic, coil data	7-65
	Trimmers, alignment	7-66
	Voltage, socket, transformer data, notes	7-67
37-660	Chassis, parts list	7-68
	Schematic, coil data	7-69
	Trimmers, alignment	7-70
	Voltage, socket, notes	7-71
37-665	Chassis views, parts list	7-72
	Schematic	8-31
	Voltage, notes, speaker wiring	8-30
	Alignment, trimmers	8-32
37-670	Chassis, parts	8-33
	Schematic, coil data	7-73
	Trimmers, alignment, speaker data	7-74
	Trimmers, voltage, socket, data	7-75
	Chassis views, parts list	7-76
37-675 (Codes 121, 122)	Schematic, coil and switch data	7-137, 138
	Trimmers, alignment	7-139
	Chassis views	7-140
	Voltage, speaker, adjustments	7-141
	Parts list	7-142
37-690	Schematic	8-35, 8-36
	Chassis views	8-34
	Trimmers, SPU chassis	8-37
	Alignment	8-38
	Voltage, notes	8-39
	Coil & switch connections, speaker wiring, notes	8-40
37-2620	Parts	8-41
	Schematic, parts	8-43
	Alignment, trimmers, voltage, chassis	8-42
37-2650	Schematic	8-45
	Chassis, parts	8-44
	Alignment, trimmers	8-46
	Voltage, notes, speaker wiring	8-47
37-2670	Schematic	8-49
	Voltage, notes, speaker wiring	8-48

37-604	Noise notes	5-17
	Alignment, layouts, voltage	5-18
	Schematic	5-19
	Layouts, parts list	5-20
	Changes	5-24
	Changes	7-14
37-611	Schematic, layouts	5-21
	Alignment, voltage, socket	5-22
	Chassis layout, parts list	5-23
	Changes	5-24
	Changes	7-8
37-620	Schematic, voltage, data	1-8
	Alignment, trimmers	8-10
37-623	Chassis, data	1-9
	Test data	2-7
	Chassis layout, socket, data	3-19
37-624	Schematic, notes	3-20
	Changes	4-36
	Changes—See model 14-LZX	
	Alignment, trimmers	8-10
37-624	Schematic, parts	8-11
	Alignment, voltage, chassis, trimmers	8-12
	Changes	9-3
37-680	Schematic	8-13
	Alignment, trimmers	8-14
	Voltage, speaker data, notes	8-15
	Chassis views, parts	8-16
37-640	Schematic, trimmers, parts	7-15
	Socket, chassis, alignment, voltage	7-16
	Changes	8-2
	Changes	9-3
37-641	Schematic, parts	8-17
	Alignment, trimmers, chassis, voltage	8-18
37-643	Changes	9-3
	Schematic, parts, coils	7-17
37-650	Socket, trimmers, voltage, alignment	7-18
	Changes	8-3
	Changes	9-3
37-660	Schematic, coils	7-19
	Voltage, socket, circuit data, transformer data	7-20
	Trimmers, alignment	7-21
	Chassis, parts	7-22
	Changes	8-3
37-665	Schematic, coil data	7-23
	Trimmers, alignment	7-24
	Chassis, voltage, transformer data, notes, parts	7-25
	Changes	8-3
37-670	Schematic, parts	8-19
	Alignment, trimmers, voltage, chassis	8-20
37-675 (Code 122)	Schematic, parts list	7-27
	Socket, trimmers, voltage, alignment	7-28
37-690	Schematic, coils, parts	7-29
	Socket, trimmers, voltage, alignment	8-21
37-93	Schematic, parts	8-22
	Chassis	7-31, 7-32
37-116 (Codes 121, 122)	Coils, voltage, trimmers, notes	7-33
	Chassis views	7-34
	Alignment	7-35
	Parts list	7-36
	Changes	8-3
37-600	Schematic, socket, trimmers, parts list	7-37
	Voltage, chassis, alignment, transformer data	7-38
	Changes	8-3
37-603	Schematic, parts	7-39
	Voltage, socket, trimmers, chassis, alignment	7-40
37-604	Schematic	7-41
	Alignment, notes	7-42

37-2670	Alignment, trimmers	8-50
	Chassis, parts	8-51
88, 88-A	Chassis view, socket, alignment	4-21
	Schematic, changes, parts list	4-22
	Changes	4-43
	Notes	5-16
	Changes	5-24
88 (Code 122)	Schematic	8-53
88 (Code 123)	Chassis, parts	8-52
88-1 (Code 121)	Alignment, trimmers, voltage	8-54
	Schematic	8-55
38-2 (Code 121)	Alignment, trimmers, voltage	8-56
	Chassis, parts	8-57
	Changes	9-5
38-3	Schematic	8-59
	Chassis, parts	8-58
38-4, 88-5 (Code 121)	Alignment, voltage, trimmers	8-60
	Schematic, notes	8-61
	Alignment, parts	8-62
	Trimmers, voltage, chassis	8-63
	Changes	9-3
	Data	10-3
	Schematic	8-65
88-7 (121, 124), 88-8 (121) 88-9 (121)	Voltage, trimmers, chassis	8-64
	Alignment, parts	8-66
	Changes	9-3, 9-5
	Schematic, voltage, trimmers, chassis	8-67
38-10 (Code 121)	Alignment, parts	8-68
38-10 (Codes 121, 124)	Data	10-2
38-12 (Code 121)	Schematic, trimmers, voltage, chassis	8-69
	Alignment, parts	8-70
	Data	10-3
38-14 (Codes 121, 124)	Schematic, voltage, trimmers, chassis	8-71
	Alignment, parts	8-72
	Data	10-3
38-15 (121, 124)	Schematic, socket, trimmers, voltage, coils, layout	9-1
38-22, 38-23 (121)	Alignment, specifications, parts	9-2
	Schematic, coils	9-23
	Chassis, trimmers, alignment	9-24
	Voltage, socket, trimmers, tuner, parts	9-25
38-33 (121)	Schematic, chassis, parts	9-3
	Socket, trimmers, alignment, notes, voltage	9-4
38-34 (125)	Data	10-3
	Schematic, chassis, parts	9-5
	Socket, trimmers, alignment, specifications, voltage	9-6
38-35 (121)	Schematic, chassis, parts	9-7
	Socket, trimmers, voltage, alignment, notes, specifications	9-8
38-38 (Code 121)	Schematic, voltage, trimmers, chassis	8-73
	Alignment, parts	8-74
	Changes	9-4
38-39 (Code 121)	Schematic, voltage, trimmers, chassis	8-75
	Alignment, parts	8-76
	Changes	9-3
38-40 (121)	Schematic, chassis, parts	9-9
	Socket, trimmers, voltage, alignment, notes, specifications	9-10
38-60 (Code 125)	Schematic, voltage, trimmers, chassis	8-77
	Alignment, parts	8-78
38-89 (Code 125)	Schematic, voltage, chassis	8-79
	Alignment, trimmers, parts	8-80
38-116 (Code 121)	Schematic	8-81, 8-82
	Trimmers, alignment, Part 1	8-83
	Alignment, Part 2, voltage	8-84
	Chassis, notes	8-85
	Parts	8-86
	Schematic, voltage, data	8-86
88-116 (125)	Schematic, coils	9-11, 12
	Chassis layouts, speaker wiring, transformer data	9-13
	Socket, voltage, specifications, notes	9-14
	Alignment, tuner	9-15
	Trimmers, parts	9-16
88-620 (121, 125)	Schematic, coils	9-17
	Parts list	9-18
38-690 (125)	Alignment, tuner	9-19, 20
	Schematic, coils	9-19, 20
	Chassis layouts, socket, trimmers	9-21
	Parts list	9-22
39, 39-A	Voltage, socket, trimmers, alignment	6-4
	Schematic	6-5
	Alignment, part 2, chassis, parts	6-6
39-6, 39-7 (Code 121)	Schematic, voltage, socket, trimmers	10-1
	Alignment, parts	10-2
39-17 (Codes 121, 122)	Schematic, chassis, parts	10-3
	Socket, trimmers, alignment, voltage	10-4
39-18 (Codes 121, 122)	Schematic, chassis, parts	10-5
	Socket, trimmers, alignment, voltage	10-6
39-19 (Codes 121, 122)	Schematic, chassis, parts	10-7
	Socket, trimmers, alignment, voltage	10-8
39-25 (Code 121)	Schematic	10-9
	Alignment, chassis, tuner	10-10
	Socket, trimmers, voltage, parts	10-11
39-30, 39-35 (Code 121)	Schematic	10-13
	Voltage, socket, trimmers, chassis, parts	10-14
	Alignment	10-15
	Tuner data	10-16
39-36 (Code 121)	Schematic, voltage	10-17
	Alignment, socket, trimmers, chassis, parts, tuner chassis	10-18
39-40 (Code 121)	Tuner data	10-21
	Schematic, voltage	10-19
	Alignment, tuner data	10-21
39-45 (Code 121)	Socket, trimmers, chassis, tuner chassis, drive data, parts	10-20
	Schematic, voltage	10-23
	Alignment, tuner data	10-21
39-55	Socket, trimmers, chassis, tuner chassis, drive data, parts	10-24
	Schematic	9-55
	Parts list, control frequency amplifier adjustments	9-56
	Chassis layout, trimmers, dial drive, "Mystery Control" schematic	9-57
	Alignment	9-58
	Specifications, "Mystery Control" adjustments	9-62
39-70 (Code 121), 39-75 (Code 121, 122)	Schematic, socket, trimmers, chassis	10-25
39-71	Alignment, parts	10-26
	Schematic, voltage, socket, alignment, trimmers, chassis, parts	10-22
39-80 (Code 121)	Schematic socket, trimmers, chassis, parts	10-27
	Alignment	10-26
39-116	Schematic	9-59, 60
	Control frequency amplifier adjustments	9-56
	"Mystery Control" schematic, trimmers, dial drive	9-57
	Alignment	9-58
	Chassis, parts list	9-61
	"Mystery Control" adjustment, specifications	9-62
	Schematic, voltage, data	9-62

PHILCO RADIO & TELEVISION CORP.—(Cont.) REVISED EARLY COMPLETE PAGE

40-120, 40-125	Schematic, voltage, parts	10-28
	Alignment, trimmers	10-16
40-150, 40-155	Schematic, socket, trimmers	10-29
	Alignment	10-30
	Socket, trimmers, chassis, parts	10-31
40-160	Tuner data	10-16
	Schematic, socket, trimmers, chassis, voltage, parts	10-33
	Tuner data	10-16
40-180, 40-185, 40-180	Alignment	10-34
	Schematic, socket, trimmers	10-29
	Alignment	10-30
	Socket, trimmers, chassis, parts	10-31
	Tuner data	10-16
	Schematic, voltage, socket, trimmers	10-35
40-195, 40-200	Tuner data	10-16
	Chassis, tuner chassis, parts	10-36
	Alignment	10-37
41 DC, 42 D0	Schematic, socket, voltage, data	1-11
	Chassis, data	1617
	Voltage, socket, data, notes	2-8
48 AC, 25 AC	Schematic, changes	3-13
	Chassis layout, single and twin speaker connections	3-14
	Alignment data	3-15
48-121	Changes	3-16
44	Voltage, trimmers, socket	4-36
	Schematic, condensers	4-23
	Chassis view, adjustment data	4-24
45	Parts list	4-25
	Alignment, voltage, layouts	4-26
	Changes	5-25
	Chassis	5-15
	Schematic, parts, socket	5-24
46, 46-E D0	Chassis, voltage, parts list	5-25
	Schematic, voltage, data	1-12
47 DC (121-221)	Schematic, voltage, resistor data	1-13
	Chassis layout, speaker connections	3-47
	Alignment, trimmers	3-48
48 D0	Socket, resistor data, voltage, notes	8-87
49	Schematic, chassis layout	3-21
	Alignment, trimmers	3-22
	Alignment, parts list	8-87
	Schematic, voltage, layouts	5-27
	Changes	5-28
50, 50-A	Schematic, chassis, data	5-33
	Voltage, values	1-14
	Adjustments, parts list	1-15
	Test data	2-9
51, 51-A, 52, 24, 551	Schematic, socket, data	2-10
	Voltage, data	2-11
	Chassis, adjustment, parts list, notes	2-12
53 AC:D0	Schematic, alignment	2-13
	Chassis layout, voltage for AC and DC	3-17
54	Voltage, data	3-18
	Schematic	3-57
	Changes	3-58
	Changes	4-36
57	Alignment, trimmers	7-147
	Voltage, parts view	8-6
	Schematic, parts list	4-27
	Trimmers, alignment	4-28
58	Similar to model 57	4-29
59	Alignment, voltage, parts list	5-29
	Schematic, chassis, parts list	5-30
	Changes	8-2
	Changes	5-40
60	Voltage, parts view, adjustment	4-30
	Schematic, parts list	4-31
	Changes	4-32
	Changes	7-147

PHILCO RADIO & TELEVISION CORP.—(Cont.) REVISED EARLY COMPLETE PAGE

65	Schematic, socket, voltage	1-16
	Changes	8-2
66	Alignment, voltage, parts	5-31
	Schematic, layouts	5-32
	Changes	5-33
70, 70-A (Below #B-22,000)	Schematic, socket, voltage, data	1-17
	Chassis, parts values	1-18
	Parts list, data	2-15
	Alignment, trimmers	8-88
	Voltage, values	3-32
71 Series, 22	Chassis layout	2-16
	Alignment	2-17
	Schematic, wiring changes	3-31
	Voltage, socket, twin speaker connections	3-23
	Schematic, notes	3-24
	Alignment, trimmers	8-1
	Shadow tuning data	4-33
76	Changes	4-33
	Schematic, socket, voltage, data	2-19
77, 77-A	Schematic, socket, alignment	1-20
	Voltage, values	4-60
80	Socket, voltage, electrical data	3-25
	Schematic, chassis layout, notes	3-26
81	Alignment, trimmers	8-84
	Chassis layout, voltage, data	3-27
	Schematic, parts list	3-28
	Alignment, trimmers	8-88
82, 86	Schematic, socket, voltage	1-21
84	Adjustment, voltage, parts view	4-33
	Schematic, parts list	4-34
87	Schematic, socket	1-22
	Voltage, data	2-20
89	Notes	5-16
	Changes	5-40
89, 19 (121-2-3)	Schematic, alignment data, changes	3-33
	Chassis layout, socket, voltage, data	3-34
89 (Code 123)	Schematic, socket, trimmers	7-77
	Voltage, trimmers, alignment	7-78
89 (126-126B)	Chassis, parts list	7-79
90, 90-A (with two '45s)	Changes	4-43
	Chassis layout, parts values, data	2-22
	Schematic, socket, voltage	2-23
	Parts list, data	2-24
	Alignment data with Jewell 560 Oscillator	2-30
90, 90-A (with one '47)	Schematic, socket, voltage	2-20
	Chassis layout, parts values, data	2-27
	Socket, test data	2-28
	Parts list	2-29
	Alignment, trimmers	8-87
90, 90-A (with two '47s)	Schematic, changes, data	3-35
	Voltage data	3-36
91, 14, 91-122	Chassis, parts list	3-37
91 (121-221)	Changes	4-43
	Changes—See model 14-LZX	
	Schematic, data	3-39
	Voltage, socket, speaker connections	3-40
	Chassis layout, adjustment notes	3-41
91 (126-226)	Parts list	3-42
91-A (121)	See model 14	
95	Changes	4-43
	Schematic, socket, voltage, data	1-23
96, 96-A	Alignment, trimmers	8-89
	Schematic socket	1-24
	Chassis	2-21
	Alignment, trimmers	8-89
97	Schematic, voltage, socket, data	6-7

RADIOTRON EARLY COMPLETE PAGE

*459	1698
*466-C	1651
*466-D	1652
	1653
	1654
	1656
	1655
	1689
	1640
*460	1659
*460	1661
	1643
	1644
	1645
	1646
*462	1663
	1665
	1666
466-D-2	1668
466-D-1	1667
	1669
466-D-5	1674
466-D-3	1670
466-D-4	1671
Front	1672
	1673
	1675
	1676
	1677
	1679
	1680
	1681
	1682
*462	1689
*463	1691
	1693

MODEL	REVISIONS	EARLY COMPLETE PAGE	REVISED PAGE
97	Alignment, trimmers, data.....	6-8	
	Chassis, parts.....	6-9	
98	Schematic.....	8-51	
	Chassis, parts.....	8-90	
101	Alignment, voltage, trimmers.....	8-92	
	Schematic, socket, trimmers, alignment, parts.....	10-32	
105	Schematic, voltage, socket, trimmers, chassis, alignment, parts.....	10-38	
108 (Code 121)	Schematic, voltage, parts.....	10-39	
	Tuner data.....	10-16	
	Socket, trimmers, chassis, tuner unit chassis, alignment.....	10-34	
111, 111-A	Voltage, values, data.....	2-32	1696
	Schematic, socket, data.....	2-35	1695
	Chassis layout.....	2-34	1697
	Parts list, changes.....	2-32	1698
	Alignment, trimmers.....	8-10	
	Voltage, parts values.....	1-25	1703
112, 112-A (Below #174,001)	Schematic, socket.....	1-26	1701
	Parts list.....	2-35	1705
	Alignment notes.....	2-37	1707
112, 112-A (Both types)	Chassis layouts.....	2-36	*466-F, I
112, 112-A (Above #174,001)	Parts values, voltage.....	2-38	466-J
	Schematic, socket, parts list.....	2-39	1706
	Alignment, trimmers.....	8-10	
	Changes.....	4-58	
	Chassis.....	Changes 9-3	
112-X	Schematic, socket, voltage, trimmers, data.....	6-10	
116-B (Code 121)	Alignment, parts.....	6-11	
	Changes.....	7-147	
116-X (Code 122)	Schematic.....	6-13	
	Voltage, chassis, socket, parts, data.....	6-14	
	Alignment.....	6-12	
	Changes.....	7-147	
118	Changes of layout, changes.....	5-34	
	Parts list.....	5-35	
	Schematic, socket.....	5-36	
	Chassis layout, trimmer locations.....	5-37	
	Alignment, voltage.....	5-38	
118 (Code 123-RX)	Changes.....	5-34	
144	Changes.....	5-40	
	Schematic, transformer.....	5-41	
	Alignment data.....	5-42	
	Parts list.....	5-43	
	Voltage, chassis and socket layouts.....	5-44	
	Changes.....	Changes 7-8, 7-13	
180-B Power Unit	Schematic.....	1-2	1592
200, 200-X	Alignment data.....	5-45	
	Schematic, parts.....	5-46	
201 (Code 121)	Voltage, socket, data.....	6-15	
	Alignment, trimmers.....	6-17	
211, 212, 220, 270, 296	Pickup data.....	4-59	
211, 211-A	Schematic, socket, data.....	1-27	1699
	Parts list, changes.....	2-32	1698
	Alignment, trimmers.....	8-10	
	Schematic.....	1-26	
212, 212-A, Radio-Phonograph	Alignment, trimmers.....	8-10	
220, 220-A	Schematic, socket, notes.....	3-51	
220, 270	Pickup data—See model 211		
233-G, 233-AG	Schematic, chassis, parts.....	8-93	
	Alignment, trimmers.....	8-94	
245	Schematic, parts, chassis.....	8-95	
	Trimmers, socket, voltage, alignment, transformer data.....	8-96	
B-253 Power Unit	Schematic, data.....	1-1	*748
	Alignment, part 2, chassis, socket, trimmers.....	6-24	
	Changes.....	7-145	
	Schematic, socket, chassis, alignment, parts.....	8-97	
	Voltage, socket, trimmers, chassis, alignment.....	8-98	
	Schematic, chassis, trimmers, parts.....	8-99	
	Socket, voltage, alignment.....	8-100	
	Schematic, chassis, parts.....	8-101	
	Voltage, alignment, trimmers.....	8-94	
	Schematic, chassis, parts, trimmers.....	8-103	
	Socket, voltage, alignment.....	8-104	
	Pickup data—See model 211		
270	Schematic, data.....	1-28	*466-O
270, 270-A	Alignment, trimmers.....	8-10 & 8-88	
	Data.....	Changes 9-3	
	Pickup data—See model 211		
296	Schematic, socket, data.....	1-30	
296, 296-A	Alignment, trimmers.....	8-89	*493
	Alignment, trimmers.....	8-10	
370	Schematic similar to model 70	Early	
	Schematics and layouts of power units.....	1-3	
	Specifications.....	1-4	*744
	Schematic, socket, chassis.....	2-40	1593
	Voltage, parts values.....	2-41	466-D-6
	Parts list.....	2-42	1712
	Alignment—See model 4 & model 70		1711
	Schematic, socket, voltage.....	2-43	466-D-7
	Chassis layouts, data.....	2-44	1715
	Parts list.....	2-45	466-D-8
	Alignment—See model 4 & model 90		1716
	Schematic, chassis wiring.....	1-29	466-D-11
	Schematic, data.....	4-37	1717
500 Series	Parts list.....	4-38	*459
503	Alignment, trimmers.....	8-80	
	Schematic.....	4-39	
504	Parts list.....	4-40	
	Alignment, trimmers.....	8-89	
505	Schematic.....	4-41	
	Parts list, data.....	4-42	
	Alignment, trimmers.....	8-89	
506	Schematic.....	8-106	
	Notes, parts.....	8-106	
507	Schematic, notes.....	5-39	
	Alignment, trimmers.....	8-102	
509-X	Schematic, data.....	6-18	
	Alignment, trimmers.....	8-102	
	Schematic, chassis, parts.....	8-107	
511	Data.....	Changes 9-4	
521	See model 51		
551	See model 70 (Below B-22000)		
570	Schematic, socket, trimmers, parts list.....	7-81	
600	Schematic, socket, chassis, alignment.....	7-80	
	Voltage, socket, chassis, alignment.....	7-83	
602	Schematic, parts list.....	7-82	
	Voltage, socket, trimmers, chassis, alignment.....	Changes 9-3	
	Changes.....	Changes 1-1	
B-608 Power Unit	Schematic, data.....	7-85	*743
604	Voltage, socket, chassis, parts.....	7-84	
	Trimmers, coils, alignment.....	7-86	
610	Schematic, voltage, data.....	6-19	
	Socket, trimmers, alignment, data.....	6-20	
	Chassis, parts.....	6-21	
	Changes.....	7-147	
	Changes.....	Changes 9-3	
	Schematic.....	7-87	
	Alignment.....	6-20	
	Changes, parts.....	7-88	
610B	Changes.....	7-148	
610F	Changes.....	7-148	
611	Parts, alignment.....	6-22	
	Schematic.....	6-23	
	Alignment, part 2, chassis, socket, trimmers.....	6-24	
611 (Code 121)	Changes.....	7-145	

611F	Changes	7-148	660	Socket, chassis, parts	6-42
620	Schematic, voltage, data	6-25	AB-668	Parts catalog changes	7-150
	Chassis, parts	6-26		Schematic, Power Unit—See model AB-423	
	Alignment, data, socket, trimmers	6-27	665	Specifications—See model AB-463	
620, Late	Schematic	7-80		Socket, voltage, trimmers, alignment	7-117
	Changes, parts	7-90	680	Chassis, parts	7-119
	Changes, parts	7-90		Schematic	7-121
628	Chassis, parts	7-148		Chassis	7-120
	Schematic, socket, trimmers	6-28	680 (Code 122)	Socket, voltage, alignment	7-122
	Alignment, data	6-29	700, Q	Trimmers, parts list	7-123
	Changes	7-148, 7-149		Parts catalog changes	7-150
AB-628	Schematic, Power Unit—See model AB-423		800	Alignment, socket	6-47
	Specifications—See model AB-468			Schematic, chassis layout, parts	5-48
628B	Changes	7-149		Schematic, parts list, chassis layout	5-48
628F	Changes	7-149	800 (Code 122)	Socket, trimmers, alignment	4-61
624	Schematic	7-149		Schematic, chassis, parts	5-49
	Voltage, socket, trimmers, alignment	7-92	802	Alignment, socket layout	5-50
625	Chassis, parts list	7-93		Schematic, parts	5-45
	Schematic, transformer data	7-95	805	Additional data	Changes 7-2
	Socket, chassis, parts list	7-94		Alignment, socket, trimmers	6-46
680	Trimmers, voltage, alignment	7-96	805, T7-NT7, T7-ST7, T8-NT8	Schematic, chassis, parts	6-47
	Schematic	6-31		Parts details, parts	6-52
	Voltage, trimmers, chassis, alignment, part 2, socket, parts	6-32		Schematic, parts, chassis, alignment	6-49
680, 680PF, 2nd Type	Changes	6-33		Socket, trimmers, alignment, data	6-48
635	Schematic	7-149		Parts details, parts	6-52
	Changes	7-149	808	Changes, parts numbering system	7-26
	Schematic, parts	7-97		Schematic, parts, notes	6-51
	Schematic	7-98	809	Installation data	6-50
	Socket, trimmers, voltage, alignment, transformer data	7-100		Parts details, parts	6-52
640	Chassis, parts list	7-101		Trimmers, alignment	6-54
	Chassis, parts	6-35		Changes, parts numbering system	7-26
	Socket, voltage, trimmers, alignment	6-31	810PA, 810PB	Chassis	7-16
640B	Changes	6-36	810PY	Schematic, chassis, parts	6-53
641	Changes	7-149	810PA, 810PB, 810PY	Parts details, parts	6-52
	Schematic	7-149		Trimmers, alignment	6-54
	Chassis, parts list	7-102	811PA, 811PB	Changes, parts numbering system	7-26
642	Socket, voltage, trimmers, notes, alignment	7-104		Schematic, trimmers, data	6-57
	Changes	7-149	811PV	Schematic, chassis	6-55
	Schematic	8-109		Parts list	6-55
	Chassis, parts	8-108	816	Data, alignment	6-55
	Voltage, socket, trimmers, alignment	8-110		Schematic, parts	7-127
648	Changes	7-149		Notes	7-125
	Schematic	7-105		Socket, trimmers, chassis, alignment	7-124
	Socket, voltage, trimmers, notes, alignment	7-106		Schematic, parts	7-126
	Chassis, parts list	7-107	817	Alignment, notes	7-125
645	Changes	7-149		Socket, trimmers, chassis	7-126
	Schematic	7-109		Schematic, socket, trimmers, chassis, parts, parts list	7-127
	Socket, voltage, chassis, parts	7-108		Alignment	7-129
	Trimmers, coil data, alignment	7-110		Remote controls, parts list, part 1	7-135
650	Changes	7-110		Remote controls, parts list, part 2	7-136
	Schematic	6-37		Schematic, chassis, notes, parts list	7-128
	data	6-38	818	Socket, trimmers, alignment	7-129
	Chassis, sockets, parts, data	6-39		Remote controls, parts list, part 1	7-135
651	Parts catalog changes	7-150		Remote controls, parts list, part 2	7-136
	Schematic	7-150		Schematic, chassis, notes, parts	7-131
	Socket, trimmers, alignment	7-111		Socket, trimmers, alignment	7-130
655	Voltage, chassis, parts list	7-113		Remote controls, parts list, part 1	7-135
	Changes	8-7		Remote controls, parts list, part 2	7-136
	Schematic, voltage	7-115		Schematic, chassis, notes	7-131
	Coil data, parts	7-114		Socket, trimmers, alignment	7-130
	Socket, trimmers, chassis, alignment	7-116		Remote controls, parts list, part 1	7-135
660	Changes	8-2		Remote controls, parts list, part 2	7-136
	Schematic	6-41		Alignment, trimmers	6-41

PHILCO RADIO & TELEVISION CORP.—(Cont.) REVISED EARLY COMPLETE PAGE RADIO TRON EARLY COMPLETE PAGE

MODEL
818K Schematic, chassis, notes, parts list 7-132
 Socket, trimmers, alignment..... 7-130
 Remote controls, parts list,
 part 1 7-135
 part 2 7-136
819, 819H Schematic, chassis, notes, parts list 7-133
 Socket, trimmers, alignment..... 7-134
 Remote controls, parts list,
 part 1 7-135
 part 2 7-136
821P Schematic, chassis, parts 7-136
 Alignment, trimmers 8-111
821PV Notes 8-114
 Schematic, chassis, parts 8-113
 Alignment, trimmers, notes 8-114
 Schematic, chassis, parts, notes 8-115
 Socket, trimmers, alignment..... 8-116
 Chevrolet control parts 8-117
 Standard control parts 8-118
827 Schematic, chassis, parts 8-119
 Socket, trimmers, alignment..... 8-116
 Chevrolet control parts 8-117
 Standard control parts 8-118
827K Schematic, chassis, parts 8-121
 Socket, trimmers, alignment..... 8-122
 Chevrolet control parts 8-117
 Standard control parts 8-118
828 Schematic, chassis, parts 8-120
 Socket, trimmers, alignment..... 8-124
 Chevrolet control parts 8-117
 Standard control parts 8-118
828K Schematic, chassis, parts 8-123
 Socket, trimmers, alignment..... 8-124
 Chevrolet control parts 8-117
 Standard control parts 8-118
920 Schematic, parts chassis 9-26
 Alignment, trimmers 9-27
921, 922 (Run 2) Trimmers, alignment 9-28
 Schematic, parts, chassis 9-23
926 Schematic, chassis, parts 9-29
 Socket, trimmers, alignment,
 standard controls 9-30
927 Schematic, parts, chassis 9-31
 Socket, trimmers, alignment..... 9-32
 Standard controls details, parts 9-30
928K Socket, trimmers, alignment..... 9-33
 Schematic, parts, chassis 9-33
 Standard controls details, parts 9-30
936 Schematic, socket, trimmers,
 chassis, parts 10-40
937 Alignment, trimmers 10-42
 Schematic, socket, trimmers,
 chassis, parts 10-41
938K Trimmers, alignment..... 10-43
 Schematic, chassis, parts 10-43
 Alignment, socket, trimmers 10-44
S-1416 See model 826
2620 Schematic, parts 8-149
 Socket, trimmers, alignment..... 8-150

CHRYSLER-PHILCO

D-CDS
G (121)-CGD See Nash model D-NDD
 Chrysler Codes CA & CB
 Installation data 5-1
G (122)-CGD Installation data, notes 5-2
 Alignment, adjustments, socket..... 5-2
 Schematic, chassis layout, parts..... 5-4
 Schematic, chassis, parts 6-62
 Installation data 5-1
 Installation data, notes 5-2
 Alignment, trimmers 5-4

MODEL
G (122)-CGD, Chrysler
 Codes CU & CV, Air-
 flow Custom Built
 Schematic, chassis layout, parts..... 6-62
 Installation data 6-63
 Installation data, part 2, parts 6-64
 Alignment, trimmers 8-4
 See model 11(121)
R (121)-ORD
R (122)-ORD See model 11(121)
T2-CT2, Chrysler DeLuxe
 Airflow Codes CZ & C-6
 Installation data 6-67
 Schematic, chassis, parts 6-68
 Changes, parts, numbering sys-
 tem 7-26
 Alignment, trimmers 8-6
 Schematic, chassis, parts,
 socket 6-95
 Installation data, part 1 6-69
 Installation data, part 2, parts..... 6-70
 Changes, parts numbering sys-
 tem 7-26
 Alignment, trimmers 8-6
 Schematic, chassis, parts 8-7
 Alignment, trimmers 8-8
 Schematic, chassis, parts 7-3
 Socket, trimmers, alignment..... 7-4
 Schematic, socket, trimmers,
 layout, parts, alignment..... 9-45
 Schematic, chassis, parts 8-146
 Socket, trimmers, alignment..... 8-148
 Schematic, chassis, parts 8-147
 Socket, trimmers, alignment..... 8-148
 Schematic, parts, chassis 9-53
 Socket, trimmers, alignment,
 controls, parts 9-54
 Schematic, chassis, parts 10-49
 Socket, trimmers, tuner, align-
 ment 10-50
 Schematic, chassis, parts 10-51
 Socket, trimmers, alignment..... 10-52

DESOTO-PHILCO

G (121)-CGD, DeSoto
G (122)-CGD-DeSoto
 Code SF, Airflow Custom Built
 See Chrysler G (121)-CGD
 Schematic, chassis, parts 6-61
 Installation data, part 1 6-65
 Installation data, part 2 6-66
 Alignment, trimmers 8-4
 See Chrysler T2-CT2
T2-CT2
T5-CT5, DeSoto
 Code SF
 Schematic, chassis, parts 6-68
 Installation data 6-67
 Alignment, trimmers 8-6
 Schematic, chassis 6-63
 Installation data, parts 6-71
 Changes, parts numbering sys-
 tem 7-26
 Alignment, trimmers 8-6
 See Chrysler T10-CT10
 See Chrysler T11-CT11

DODGE-PHILCO

Dodge, Code DU
G (121)-CGD, Dodge
 Codes DR & DS
 Installation data 5-1
 Installation data, notes 5-2
 Alignment, adjustments, socket..... 5-2
 Schematic, chassis, parts 6-62
 Installation data 5-1
 Installation data, notes 5-2
 Alignment, trimmers 5-4

DODGE-PHILCO			
R-ORD	See Chrysler R-ORD		
T2-CT2	See Chrysler T2-CT2		
T11-CT11	See Chrysler T11-CT11		
FORD-PHILCO			
N-FND (V8, 1934)	Schematic, chassis, parts, changes	8-5	6-78
T6-FT6	Alignment, trimmers	8-4	6-80
	Schematic, chassis, parts, socket	6-59	6-84
	Trimmers, alignment	6-58	6-83
	Changes, parts numbering system	7-26	6-81
T9-FT9, FT9X	Schematic, chassis, parts	6-61	6-85
	Alignment, data, chassis, trimmers	6-60	6-86
F-1440	Schematic, chassis, parts, changes	8-144	6-84
F-1442	Socket, trimmers, alignment	8-133	7-5
F1540	Schematic, chassis, parts, changes	8-145	7-6
	Socket, trimmers, alignment	8-138	7-11
	Schematic, parts, chassis	9-49	
	Socket, trimmers, alignment	9-52	
	Control details, antenna	9-50	
F-1640	Schematic, chassis, parts	10-59	
	Alignment, socket, trimmers	10-60	
GRAHAM-PHILCO			
G-1418	Schematic, chassis, parts	8-131	8-140
G-1436	Socket, trimmers, alignment	8-129	8-137
G1528	Schematic, chassis, parts	8-142	8-130
	Socket, trimmers, alignment	8-137	8-141
	Schematic, parts, chassis	9-37	8-131
	Socket, trimmers, alignment	9-43	8-129
	Socket, trimmers, alignment, control, parts	9-44	8-130
HUPMOBILE-PHILCO			
G(121)-CGD	See Chrysler G(121)-CGD		
G(122)-CGD, Hupmobile for J, T & W Cars	Schematic, chassis, parts	6-72, 6-73	6-87
H-HHD, Hupmobile for J, T & W Cars	Installation data	6-76	6-88
	Alignment, trimmers	8-4	8-3
	Schematic, chassis, parts	6-75	8-3
	Changes	Changes 7-2	6-89
H(122)-HHD, Hupmobile for J, T & W Cars	Installation data	6-76	6-90
	Alignment, trimmers	8-3	8-3
	Schematic, chassis, parts	6-74	6-91
	Installation data	6-76	6-92
	Changes	Changes 7-2	7-26
	Alignment, trimmers	8-3	8-3
R-HRD, Hupmobile for J, T & W Cars	Installation data	6-76	6-95
	Alignment, trimmers	8-4	6-97
R(122)-HRD	See model 11(122)		
T2-HT2	See Chrysler T2-CT2		
HT11X	Schematic, chassis, parts, changes	8-9	6-98
	Alignment, trimmers	8-8	6-99
LINCOLN-PHILCO			
LT14X3 Lincoln	Schematic, chassis, parts list	7-9	8-127
L-1420, L-1424, L-1425	Socket, trimmers, alignment	7-10	8-128
L-1427, L-1429, L-1460	Schematic, chassis, parts	8-132	8-129
L1560 (Lincoln Zephyr)	Socket, trimmers, alignment	8-135	7-143
	Socket, trimmers, alignment	8-133	7-144
	Schematic, parts, chassis	9-51	8-133
	Control details, parts	9-48	8-134
L-1660 Lincoln Zephyr	Socket, trimmers, alignment	9-52	8-138
	Schematic, chassis, parts	10-61	8-138
	Alignment, socket, trimmers	10-62	8-128
NASH-PHILCO			
O-NCD: D-NDD, Nash (AC-989)	Schematic, parts	6-79	8-139
	Installation data	6-80	8-137
	Alignment, trimmers	6-83	8-137
NASH-PHILCO			
D(122)-NDD, Nash (AC-989)	Schematic, parts	6-78	6-87
	Installation data	6-80	6-88
	Alignment, trimmers	8-3	8-3
	Schematic, parts	6-84	6-89
J-NJD, Nash (AC-1189) Lafayette 110 Series	Installation data	6-83	6-90
	Alignment, trimmers	8-4	8-3
	Schematic, parts	6-81	6-91
J-NJD, Nash (AC-1289)	See model 11(122)		
J-NJD(122)	Schematic, parts	6-85	6-95
Q-NQD, Nash (AC-1089) for Lafayette 110 Series	Installation data	6-86	6-97
	Alignment, trimmers	8-4	6-98
	See model 806		
T7-NT7: TS-NT8	Schematic, chassis, parts	7-5	7-26
T12-NT12X, NT12Y2, Lafayette	Socket, trimmers, alignment	7-6	8-137
T15-NT15, NT15X, Nash, Lafayette	Schematic, chassis, parts	7-11	8-130
N-1418	Socket, trimmers, alignment	7-12	8-131
N-1434H (Two-units)	Schematic, chassis, parts	8-131	8-131
N1514	Socket, trimmers, alignment	8-129	8-137
N1524	Control parts	8-130	9-34
	Schematic, chassis, parts, changes	8-140	10-45
	Socket, trimmers, alignment	8-137	10-45
	Control, parts	8-130	9-39
	Schematic, chassis, parts	8-141	9-40
	Socket, trimmers, alignment	8-137	9-40
	Schematic, parts, chassis	9-34	10-45
	Control details	9-40	10-45
	Socket, trimmers, alignment	10-45	10-45
	Schematic, parts, chassis	10-45	10-45
	Control, parts	10-45	10-45
	Socket, trimmers, alignment	10-45	10-45
	Schematic, chassis, parts	10-45	10-45
	Control details	10-45	10-45
PACKARD-PHILCO			
A-PAD, A-PAL	Schematic, chassis, parts	6-87	6-87
B-PBD	Installation data	6-88	6-88
	Alignment, trimmers	8-3	8-3
	Schematic, chassis, parts, socket	6-89	6-89
H(122)-PHD	Installation data	6-90	6-90
	Alignment, trimmers	8-3	8-3
	Schematic, chassis, socket, parts	6-91	6-91
	Installation data	6-92	6-92
	Changes, parts numbering system	7-26	7-26
PHXD	Alignment, trimmers	8-3	8-3
T5-PT5, Packard 120 Cars	Schematic, chassis, parts	6-93	6-93
	Socket, trimmers, alignment	6-94	6-94
	Schematic, socket, chassis, parts	6-95	6-95
	Installation data	6-96	6-96
	Changes	Changes 7-11	7-11
T14-PT14	Alignment, trimmers	8-6	8-6
P-1417	Alignment, socket, trimmers	6-98	6-98
	Schematic, chassis, parts, changes	8-127	8-127
P-1421	Control parts	8-128	8-128
P-1422, P-1439	Socket, trimmers, alignment	8-129	8-129
P-1420	Schematic, chassis, parts list	7-143	7-143
	Socket, trimmers, alignment	7-144	7-144
	Socket, alignment, trimmers	8-133	8-133
	Schematic, chassis, parts, changes	8-134	8-134
P-1430	Socket, alignment, trimmers	8-138	8-138
	Schematic, chassis, parts	8-138	8-138
	Socket, trimmers, alignment	8-137	8-137
	Control, parts	8-128	8-128
	Schematic, chassis, parts, changes	8-139	8-139
P-1432H	Socket, trimmers, alignment	8-137	8-137
P-1439	See model P-1422		

PACKARD-PHILCO

P1517 Schematic, parts, chassis 9-37
 Socket, trimmers, alignment 9-38
 Controls, details 10-40
 Schematic, parts, chassis 9-36
 Socket, trimmers, alignment 9-38
 Schematic, parts, chassis 9-37
 Socket, trimmers, alignment 9-41
 Controls, details 10-47
 Schematic, chassis, parts 10-55
 Socket, trimmers, alignment 10-54
 Schematic, chassis, parts 10-56
 Alignment, socket, trimmers 10-54
 Schematic, chassis, parts 10-57
 Alignment, socket, trimmers 10-58

PIERCE-ARROW-PHILCO

E-MED, Pierce-Arrow Schematic, parts 6-79
 Installation data 6-82
 Alignment 5-5
 See model 10 (122)
 Schematic, socket, chassis, parts 6-99
 Installation data, service notes 6-102
 Changes Changes 7-12
 Alignment trimmers 8-6
 See Packard T14-PT14

T14-MT14X4

PLYMOUTH-PHILCO

G (121)-GGD, Plymouth Schematic, chassis, parts 5-4
 Installation data 5-1
 Installation data, notes 5-2
 Alignment, adjustment, socket 5-3
 Schematic, chassis, parts 6-62

G (122)-GGD, Plymouth Schematic, chassis, parts 5-1
 Installation data, notes 5-2
 Alignment, trimmers 8-4
 Schematic, chassis, parts 6-68
 Installation data 6-67
 Similar to T2-CT2
 Alignment, trimmers 8-6
 See Chrysler T14-PT14
 See Chrysler T2-CT2

Plymouth, Code PJ

R-CRD Schematic, socket, chassis, parts 6-99
 T2-OT2 Installation data, parts 6-101
 Changes Changes 7-12
 Alignment, trimmers 8-6
 See Chrysler T11-CT11
 See Packard T14-PT14
 Schematic, chassis, parts 8-125
 Socket, trimmers, alignment 8-126

STUDEBAKER-PHILCO

C (122)-SCD See model 10 (122)
 C-SCD See Nash C-NQD
 D-SDD See Nash model D-NDJD
 J-SJD (121) Schematic, chassis, parts 6-103
 Installation data 6-104
 Alignment, trimmers 8-4
 See model 11 (122)
 See Nash Q-NQD
 See Pierce-Arrow T3-MT3
 Changes, parts numbering system 7-26

T7-ST7 See model 805
 T12-ST12, Studebaker Schematic, alignment 7-7
 Socket, trimmers, chassis, parts, alignment, part 2 7-8
 Schematic, chassis, parts list 7-13
 Socket, trimmers, alignment 7-14
 Schematic, parts 6-79
 Installation data 6-81
 Alignment, similar to AC-206, Code 122

REO-PHILCO

T3-RT3, Reo DeLuxe, (Part No. 5485) Schematic, socket, chassis, parts 6-99
 Installation data, parts 6-101
 Changes Changes 7-12
 Alignment, trimmers 8-6
 See Chrysler T11-CT11
 See Packard T14-PT14
 Schematic, chassis, parts 8-125
 Socket, trimmers, alignment 8-126

WILLYS-OVERLAND

W-1419 Schematic, chassis, parts 8-125
 Socket, trimmers, alignment 8-126

PIERCE-AIBO, INC.

See DE WALD RADIO

PIERSON-DELANE CO.

PR15C, PR15M, PR15R, Schematic, data 9-1
 PR15UH, PR15X Trimmers, socket 9-2
 Alignment, filter data, oscillograms 9-3
 Noise-suppressor notes 9-4

PILGRIM ELECTRIC CORP.

D, DE Schematic, voltage 10-1
 DA, DAE Schematic 9-1
 DB, DF Schematic 9-1
 G, GE Schematic, voltage 10-2
 GB, GBE, GF, GFE Schematic, voltage 10-1
 GH, GHE Schematic, voltage 8-1
 XT, NTE Schematic, voltage 8-2
 NTW, NYTHE Schematic, voltage 10-3
 RJ, RJE Schematic 10-3
 RJH, RHE Schematic, voltage 10-3
 200 Schematic 9-1
 210 Schematic 9-2
 313, 314 Schematic 10-3
 623, 624, 643, 644 Schematic 9-2
 713, 714, 753, 754 Schematic 10-4
 800 Schematic 10-1
 950 Wireless Record Player Schematic 10-1

PILOT RADIO & TUBE CORP.

4-Tube DC Superbet Schematic 4-3
 Air Hound (All Electric) Schematic 1-3
 Air Scout (All Electric) Schematic 1-3
 Captain Kidd Chest See model 55
 Country Special See model K-121
 Dragon 8 tube See model L-8
 Dragon AC Super See model 10
 Dragon AW Super See model 1010
 Dragon DC See model 8
 Dual-Wave Midget, (200-2,000 Meters) Schematic 2-1
 Jumbo ABC Schematic 1-2
 Jumbo Four Pack Schematic 1-2
 Pilotone (Electric) Schematic 1-3
 Pilotone B Pack Schematic 1-2
 Public-Address System Schematic 1-1
 Rainbow See model 31-81, 81

STUDEBAKER-PHILCO

C (122)-SCD See model 10 (122)
 C-SCD See Nash C-NQD
 D-SDD See Nash model D-NDJD
 J-SJD (121) Schematic, chassis, parts 6-103
 Installation data 6-104
 Alignment, trimmers 8-4
 See model 11 (122)
 See Nash Q-NQD
 See Pierce-Arrow T3-MT3
 Changes, parts numbering system 7-26

T7-ST7 See model 805
 T12-ST12, Studebaker Schematic, alignment 7-7
 Socket, trimmers, chassis, parts, alignment, part 2 7-8
 Schematic, chassis, parts list 7-13
 Socket, trimmers, alignment 7-14
 Schematic, parts 6-79
 Installation data 6-81
 Alignment, similar to AC-206, Code 122

REO-PHILCO

T3-RT3, Reo DeLuxe, (Part No. 5485) Schematic, socket, chassis, parts 6-99
 Installation data, parts 6-101
 Changes Changes 7-12
 Alignment, trimmers 8-6
 See Chrysler T11-CT11
 See Packard T14-PT14
 Schematic, chassis, parts 8-125
 Socket, trimmers, alignment 8-126

WILLYS-OVERLAND

W-1419 Schematic, chassis, parts 8-125
 Socket, trimmers, alignment 8-126

PIERCE-AIBO, INC.

See DE WALD RADIO

PIERSON-DELANE CO.

PR15C, PR15M, PR15R, Schematic, data 9-1
 PR15UH, PR15X Trimmers, socket 9-2
 Alignment, filter data, oscillograms 9-3
 Noise-suppressor notes 9-4

PILGRIM ELECTRIC CORP.

D, DE Schematic, voltage 10-1
 DA, DAE Schematic 9-1
 DB, DF Schematic 9-1
 G, GE Schematic, voltage 10-2
 GB, GBE, GF, GFE Schematic, voltage 10-1
 GH, GHE Schematic, voltage 8-1
 XT, NTE Schematic, voltage 8-2
 NTW, NYTHE Schematic, voltage 10-3
 RJ, RJE Schematic 10-3
 RJH, RHE Schematic, voltage 10-3
 200 Schematic 9-1
 210 Schematic 9-2
 313, 314 Schematic 10-3
 623, 624, 643, 644 Schematic 9-2
 713, 714, 753, 754 Schematic 10-4
 800 Schematic 10-4
 950 Wireless Record Player Schematic 10-1

PILOT RADIO & TUBE CORP.

4-Tube DC Superbet Schematic 4-3
 Air Hound (All Electric) Schematic 1-3
 Air Scout (All Electric) Schematic 1-3
 Captain Kidd Chest See model 55
 Country Special See model K-121
 Dragon 8 tube See model L-8
 Dragon AC Super See model 10
 Dragon AW Super See model 1010
 Dragon DC See model 8
 Dual-Wave Midget, (200-2,000 Meters) Schematic 2-1
 Jumbo ABC Schematic 1-2
 Jumbo Four Pack Schematic 1-2
 Pilotone (Electric) Schematic 1-3
 Pilotone B Pack Schematic 1-2
 Public-Address System Schematic 1-1
 Rainbow See model 31-81, 81

STUDEBAKER-PHILCO

AC-206 (Code 122) Schematic, chassis, parts 5-6
 Studebaker DeLuxe Alignment, socket 5-5
 Similar to model 10 (122) Schematic, parts 6-84
 Installation data 6-81
 Similar to J-NJD Schematic, socket, parts 6-99
 Installation data 6-100
 Similar to T3-ST3 Schematic, chassis, parts list 7-145
 Socket, trimmers, alignment 7-146
 Schematic, chassis, parts 8-143
 Socket, trimmers, alignment 8-137
 Schematic, parts, chassis 9-35
 Socket, trimmers, controls, alignment, parts 9-36
 Schematic, parts, chassis 9-41
 Socket, trimmers, controls, alignment, parts 9-42
 Schematic, chassis, parts 10-48
 Socket, trimmers, alignment 10-52
 Schematic, chassis, parts 10-55
 Alignment, socket, trimmers 10-15

WILLYS-OVERLAND

W-1419 Schematic, chassis, parts 8-125
 Socket, trimmers, alignment 8-126

PIERCE-AIBO, INC.

See DE WALD RADIO

PIERSON-DELANE CO.

PR15C, PR15M, PR15R, Schematic, data 9-1
 PR15UH, PR15X Trimmers, socket 9-2
 Alignment, filter data, oscillograms 9-3
 Noise-suppressor notes 9-4

PILGRIM ELECTRIC CORP.

D, DE Schematic, voltage 10-1
 DA, DAE Schematic 9-1
 DB, DF Schematic 9-1
 G, GE Schematic, voltage 10-2
 GB, GBE, GF, GFE Schematic, voltage 10-1
 GH, GHE Schematic, voltage 8-1
 XT, NTE Schematic, voltage 8-2
 NTW, NYTHE Schematic, voltage 10-3
 RJ, RJE Schematic 10-3
 RJH, RHE Schematic, voltage 10-3
 200 Schematic 9-1
 210 Schematic 9-2
 313, 314 Schematic 10-3
 623, 624, 643, 644 Schematic 9-2
 713, 714, 753, 754 Schematic 10-4
 800 Schematic 10-4
 950 Wireless Record Player Schematic 10-1

PILOT RADIO & TUBE CORP.

4-Tube DC Superbet Schematic 4-3
 Air Hound (All Electric) Schematic 1-3
 Air Scout (All Electric) Schematic 1-3
 Captain Kidd Chest See model 55
 Country Special See model K-121
 Dragon 8 tube See model L-8
 Dragon AC Super See model 10
 Dragon AW Super See model 1010
 Dragon DC See model 8
 Dual-Wave Midget, (200-2,000 Meters) Schematic 2-1
 Jumbo ABC Schematic 1-2
 Jumbo Four Pack Schematic 1-2
 Pilotone (Electric) Schematic 1-3
 Pilotone B Pack Schematic 1-2
 Public-Address System Schematic 1-1
 Rainbow See model 31-81, 81

PILOT RADIO & TUBE CORP.—(Cont.)		PILOT RADIO & TUBE CORP.—(Cont.)		PILOT RADIO & TUBE CORP.—(Cont.)		PILOT RADIO & TUBE CORP.—(Cont.)	
MODEL	REVISION PAGE	MODEL	REVISION PAGE	MODEL	REVISION PAGE	MODEL	REVISION PAGE
Schematic	1-6	Schematic	6-10	Schematic	6-10	Schematic	6-10
See model K-115		Socket, trimmers, voltage, alignment	7-2	Socket, trimmers, voltage, alignment	7-2	Socket, trimmers, voltage, alignment	7-2
See model K-110		Schematic	1-4	Schematic	1-4	Schematic	1-4
See model K-117		Schematic	4-1	Schematic	1-2	Schematic	1-2
See model K-136		Schematic	3-8	Alignment, socket, trimmers	6-16	Alignment, socket, trimmers	6-16
See model 3-SW		Schematic	4-1	Schematic, voltage	6-15	Schematic, voltage	6-15
Schematic	4-1	Schematic	3-9	I.F. Peak	Changes 7-3	I.F. Peak	Changes 7-3
Schematic	3-8	Schematic	7-14	Similar to H14, H15	Changes 10-1	Similar to H14, H15	Changes 10-1
Schematic	4-1	Schematic	7-14	Data	1-4	Data	1-4
Schematic	3-9	See model K-122	1-2	Schematic, socket	1-4	Schematic, socket	1-4
Schematic	7-14	Schematic	5-2	Schematic, socket	1-5	Schematic, socket	1-5
Alignment data	5-3	Alignment data	5-3	Schematic, socket	1-5	Schematic, socket	1-5
Socket, voltage, trimmers	5-4	Socket, voltage, trimmers	5-4	Voltage, parts, alignment	6-17	Voltage, parts, alignment	6-17
Schematic	5-1	Schematic	5-1	Schematic, parts	6-18	Schematic, parts	6-18
Schematic	4-2	Schematic	4-2	Socket, trimmers, voltage, alignment	7-3	Socket, trimmers, voltage, alignment	7-3
Schematic, voltage, socket, alignment data	3-7	Schematic, voltage, socket, alignment data	3-7	Schematic, socket	7-4	Schematic, socket	7-4
Schematic, socket, trimmers, alignment	10-1	Schematic, socket, trimmers, alignment	10-1	Schematic	1-5	Schematic	1-5
Schematic	4-4	Schematic	4-4	Schematic, socket	10-13	Schematic, socket	10-13
Schematic, socket, trimmers, alignment	10-2	Schematic, socket, trimmers, alignment	10-2	Voltage, socket, trimmers, alignment	10-14	Voltage, socket, trimmers, alignment	10-14
Schematic	4-3	Schematic	4-3	Alignment procedure	10-15	Alignment procedure	10-15
Schematic	4-4	Schematic	4-4	Chassis layout, chassis wiring	2-2	Chassis layout, chassis wiring	2-2
Schematic, parts	8-1	Schematic, parts	8-1	Schematic	2-1	Schematic	2-1
Alignment	8-3	Alignment	8-3	Schematic, socket, wiring, data	1-6	Schematic, socket, wiring, data	1-6
Schematic	4-5	Schematic	4-5	Schematic, socket, voltage, alignment, trimmers	10-4	Schematic, socket, voltage, alignment, trimmers	10-4
Schematic	5-5	Schematic	5-5	Schematic	2-1	Schematic	2-1
Schematic	4-6	Schematic	4-6	Schematic, voltage, socket, alignment, trimmers	10-9	Schematic, voltage, socket, alignment, trimmers	10-9
Schematic, voltage, socket, alignment data	3-2	Schematic, voltage, socket, alignment data	3-2	Schematic, socket, trimmers, voltage, alignment, parts	7-5	Schematic, socket, trimmers, voltage, alignment, parts	7-5
Schematic, voltage, alignment, socket, trimmers	6-1	Schematic, voltage, alignment, socket, trimmers	6-1	Schematic, socket	2-8	Schematic, socket	2-8
Schematic	4-7	Schematic	4-7	Schematic, socket	2-4	Schematic, socket	2-4
Schematic, voltage, socket, trimmers, alignment	7-1	Schematic, voltage, socket, trimmers, alignment	7-1	Schematic, socket	3-3	Schematic, socket	3-3
Schematic	4-8	Schematic	4-8	Schematic, socket	3-4	Schematic, socket	3-4
Schematic, voltage, alignment	6-2	Schematic, voltage, alignment	6-2	Schematic, socket, notes	3-4	Schematic, socket, notes	3-4
Additional data	Changes 7-11	Additional data	Changes 7-11	See model S-148		See model S-148	
Schematic, parts, battery connections	8-2	Schematic, parts, battery connections	8-2	Schematic, socket, trimmers, parts	8-9	Schematic, socket, trimmers, parts	8-9
Alignment	8-3	Alignment	8-3	Alignment	8-12	Alignment	8-12
Schematic, socket, trimmers, parts	8-4	Schematic, socket, trimmers, parts	8-4	Alignment	8-10	Alignment	8-10
Voltage, alignment	8-6	Voltage, alignment	8-6	See model C-162		See model C-162	
Schematic, socket	5-6	Schematic, socket	5-6	Schematic	1-1	Schematic	1-1
Alignment data	5-7	Alignment data	5-7	Schematic, socket, trimmers, voltage, parts, alignment	6-20	Schematic, socket, trimmers, voltage, parts, alignment	6-20
Schematic	4-6	Schematic	4-6	Schematic, parts	8-11	Schematic, parts	8-11
Schematic	5-8	Schematic	5-8	Alignment	8-12	Alignment	8-12
Alignment data	5-7	Alignment data	5-7	Schematic, socket, trimmers, parts	2-4	Schematic, socket, trimmers, parts	2-4
Schematic	3-10	Schematic	3-10	Schematic, socket	7-7	Schematic, socket	7-7
Schematic, socket, trimmers, parts	8-5	Schematic, socket, trimmers, parts	8-5	Voltage, alignment	7-8	Voltage, alignment	7-8
Alignment	8-6	Alignment	8-6	Schematic, socket, trimmers, alignment, parts	8-13	Schematic, socket, trimmers, alignment, parts	8-13
Schematic, voltage	6-3	Schematic, voltage	6-3	Schematic, socket, trimmers, chassis, parts	9-1	Schematic, socket, trimmers, chassis, parts	9-1
Socket, trimmers, alignment	6-4	Socket, trimmers, alignment	6-4	Voltage, alignment	9-2	Voltage, alignment	9-2
Schematic, socket, trimmers, voltage, parts, alignment	6-6	Schematic, socket, trimmers, voltage, parts, alignment	6-6	Schematic, voltage, socket, trimmers, alignment, parts	7-6	Schematic, voltage, socket, trimmers, alignment, parts	7-6
Schematic, voltage, socket, trimmers, alignment	10-3	Schematic, voltage, socket, trimmers, alignment	10-3	Schematic, socket, trimmers, voltage, alignment	6-21	Schematic, socket, trimmers, voltage, alignment	6-21
Schematic	5-9	Schematic	5-9	Schematic, voltage	8-14	Schematic, voltage	8-14
Schematic, socket, trimmers, voltage, parts, alignment	6-8	Schematic, socket, trimmers, voltage, parts, alignment	6-8	Schematic, voltage, socket, alignment, trimmers	10-5	Schematic, voltage, socket, alignment, trimmers	10-5
Schematic	6-9	Schematic	6-9	Similar to 213, 215	10-6	Similar to 213, 215	10-6
Schematic, socket, trimmers, voltage, parts, alignment	6-11	Schematic, socket, trimmers, voltage, parts, alignment	6-11	Additional data	Changes 7-11	Additional data	Changes 7-11
Schematic	3-9	Schematic	3-9				
See model 8		See model 8					
Schematic	5-10	Schematic	5-10				
Additional data	Changes 7-2	Additional data	Changes 7-2				
Schematic, voltage	6-13	Schematic, voltage	6-13				
Socket, trimmers, alignment	6-14	Socket, trimmers, alignment	6-14				
Schematic, socket, trimmers, parts	8-7	Schematic, socket, trimmers, parts	8-7				
Voltage, alignment	8-8	Voltage, alignment	8-8				

PILOT RADIO & TUBE CORP.—(Cont.)

PILOT RADIO & TUBE CORP.—(Cont.)

MODEL	REVISED PAGE	EARLY COMPLETE PAGE	RADIO TRON
253, 255	Schematic, socket, trimmers, voltage	7-9	
	Alignment	7-8	
G284	Schematic, parts	9-3	
	Alignment, notes	9-4	
293, 295	Schematic, socket, trimmers, voltage	7-11	
	Alignment	7-12	
S-295	Schematic, socket, trimmers, parts	8-15	
	Alignment	8-17	
304, 305	Schematic, parts	7-13	
	Voltage, alignment	7-14	
X-304, X-305	Schematic, parts	8-16	
	Voltage, alignment	8-17	
G352, G353	Schematic, socket, trimmers, parts	9-5	
	Voltage, alignment	9-2	
364, 365	Schematic, parts	7-15	
	Socket, trimmers, voltage, alignment	7-16	
H372, H373, Chassis H370	Schematic	10-7	
	Voltage, socket, alignment, trimmers	10-8	
H384, H385, Chassis H380	Schematic, voltage	10-17	
	Socket, alignment, trimmers	10-18	
393, 395	Schematic, parts	7-10	
	Alignment	7-14	
S-393	Schematic, trimmers, alignment, parts	8-18	
403, 405	Schematic, socket, trimmers, parts	9-6	
	Voltage, alignment	9-8	
423, 425	Schematic, parts	9-7	
	Alignment	9-8	
H454, H455, Chassis H450	Schematic	10-10	
	Socket, trimmers, voltage	10-11	
	Alignment	10-12	
H474, H475, Chassis H470	See model H134		
H484, H485, Chassis H480	See model H384		
G-528, G-529	Schematic, parts, changes	8-19	
	Socket, trimmers, phono. data	8-20	
H554, H555	Schematic, parts	9-11	
	Socket, trimmers, specifications	9-12	
BG562, BG563	Voltage, alignment	9-13	
	Schematic, socket, trimmers, parts	9-9	
G-576, G-577	Voltage, alignment	9-10	
	Schematic, socket, trimmers, parts	8-23	
G-584, G-585	Alignment	8-20	
	Schematic, trimmers, parts	8-21	
H594, H597	Alignment	8-22	
	Schematic, tuner, parts	9-15	
	Voltage, alignment	9-14	
623, 625	Socket, trimmers, specifications	9-16	
	Schematic, parts	8-24	
S-623, S-623-J	Alignment	8-27	
	Schematic, parts	8-25	
H650, H651, Chassis H650	Alignment	8-27	
	Schematic, voltage, socket, alignment, trimmers	10-16	
H664, H665	Schematic, parts	9-17	
	Alignment	9-13	
	Socket, trimmers, voltage, specifications	9-18	
H710	Schematic, voltage	10-19	
	Socket, trimmers, alignment	10-20	
G-752, G-753	Schematic, socket, trimmers, parts	8-26	
	Alignment	8-27	
H762, H763, Chassis H760	Schematic	10-21	
	Voltage, socket, trimmers, alignment	10-22	
H874, H875, Chassis H870	Schematic, voltage	10-23	
	Alignment procedure	10-24	
	Socket, trimmers	10-25	
H974, H975, Chassis H970	See model H874		
T1252, All-Wave Dragon	Schematic, voltage	3-6	
	Schematic, socket, trimmers, alignment	10-25	

MODEL	REVISED PAGE	EARLY COMPLETE PAGE	RADIO TRON
T1452	Schematic, trimmers, alignment, changes	10-26	
M-2203, M-2205	Schematic, socket, trimmers, alignment, voltage, parts	8-23	
X-2253, X-2255	Schematic, socket, trimmers, parts	8-29	
	Alignment	8-30	
H6204, Chassis H6200	Schematic, voltage	10-27	
	Alignment, socket, trimmers	10-28	
60-A Series			
	PIONEER RADIO CORP.		
	Schematic	Misc. 6-27	
500	PLA-RIGHT		
	See United Motors model 630 Delco		
	PLAZA MUSIC CO.		
6-Tube Long Wave	Schematic	3-2	1742
6-Tube TRF	Schematic	3-3	1743
7-Tube Super	Schematic	3-3	1743
24 Standard	Schematic	3-4	1744
49-A	Schematic	3-1	1741
54-9	Schematic	3-1	1741
711 Junior	Schematic	3-2	1742
711 Super	Schematic	3-2	1742
	PONTIAC		
	See UNITED MOTORS SERVICE		
	See BUICK 980393		
	PORT-O-MATIC CORP.		
18A, 18C, 18R, 80A, 80F, 80C, 210C, 210F, 210R, 212C, 212F, 212R, Chassis P8	Schematic, alignment	10-1	
25A, 25C, 25R, 250C, 250F, 250R, Chassis P8LW	Schematic, alignment	10-2	
500	POVERTONE		
	See United Motors model 630 Delco		
6-Tube A-W Superhet	Schematic	6-1	1754
8-Tube A-W Superhet	Schematic	6-2	1753
511	Schematic	6-3	1753
	PRECISION RADIO PRODUCTIONS MFG. CO.		
Antenna Length	Chart	5-210	
Automatic Record Changer	See RF-73		
Premax	See P-1		
Public Address Notes	Part #1	4-119	
	Part #2	4-120	
Radio, Balanced Amplifier	Schematic, socket	1-6	*473
Radio Senior Amplifier	Schematic, socket	1-6	*473
Radio Grand	Schematic, socket	1-5	*472
Radio Senior	Schematic, socket	1-5	*472
Radio Superette	See model R-7		
Radio AR	Schematic, socket	1-5	*472
Radio RS	Schematic, socket	1-5	*472
Radio II (AR-800)	Schematic, socket	1-6	*473
Radio III	Schematic, socket	1-6	*473
Radio III-A	Schematic, socket	1-7	*474
Radio IV	Schematic, socket	1-7	*474
Radio V (AR-885)	Schematic, socket	1-7	*474
Radio VI (AR-897)	Schematic, socket	1-7	*474
Radio VII	Schematic, socket	1-8	*475
Radio VII-B	Schematic, socket	1-8	*475
Radio Super VIII	Schematic, socket	1-8	*475
Radio IX	Schematic, socket	1-9	*476
Radio IX	Schematic, socket	1-8	*475
Sealed Vibrator Test	Data	5-244	
Short Wave Adapter	See model SW-10		
Short Wave Converter	See models SW-2 & SW-3		
Thermin	Schematic, socket	1-70	*505
Tuning Condensers	Realignment data	2-78	
Victor Alhambra I (7-1)	Schematic, socket	1-57	*509
Victor Alhambra II (7-2)	Schematic, socket	1-57	*509

FREQUENCY MODULATION

The latest development in radio—**FREQUENCY MODULATION**—is on the air. More and more stations all over the country are making provision for “staticless” broadcasting and the number of F-M receivers on the market is increasing. . . . Here is your chance to get in at the start—Rider’s newest book explains the transmission and reception of frequency-modulated signals with especial attention given to the different types of f-m receivers now available—their adjustments and maintenance. . . . This is a “must” for every serviceman who has an eye on the future. . . . It is an investment that will pay real dividends!



CONTENTS

Chapter I. Frequency Modulation.—An introduction to the subject with comparisons drawn between the frequency-modulation and amplitude-modulation forms of transmission and reception. Chapter II. What Happens at the Transmitter.—A non-mathematical explanation of how frequency-modulated signals are broadcast, including a discussion of phase modulation. Chapter III. What Happens in the Receiver.—How the f-m signal progresses through the receiver and how it is affected by the limiter discriminate tubes. Chapter IV. Wave Propagation and Service Areas.—How the ultra-high frequency waves are used for f-m transmission and the area covered. Chapter V. F-M Receiving Antennas.—Explanations and data concerning the best types of antennas for the reception of f-m signals. Chapter VI. Servicing F-M Receivers.—Valuable instructions for the adjusting and maintenance of the receiver including numerous oscillograms that will guide you in your servicing problems.

136 PAGES TYPE SET FLEXIBLE CLOTH PROFUSELY ILLUSTRATED NET PRICE \$1.50

THE METER AT WORK

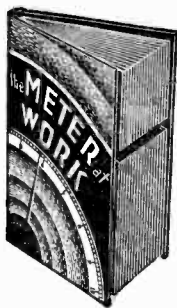

Here is a practical book for all who employ electric meters in radio and the allied electronic arts.

It is only through knowledge of the principles underlying the functioning of any piece of apparatus that a man can get the utmost use from it. To that end, it will be found that the subject matter of this book is treated from an entirely new angle, the theory upon which each meter is based is separate and distinct from any other type and complete in itself.

Inasmuch as some types of meters can do several jobs, the practical aspects of the meter are confined to the latter portion of the book. Thus, you can cover whichever phase of the subject you are interested in, and with the new construction of the book—the separation of text and illustrations—you will be able to obtain the information quickly and with the minimum of effort.

CONTENTS

I—General Considerations. II—Moving-Iron Meters. III—Moving-Coil Meters. IV—Electrodynamometer Meters. V—The Electrostatic Meter. VI—Thermal Meters. VII—Components of Meters. VIII—Characteristics of Meters. IX—Rectifiers and Thermocouples. X—Practical Applications of Meters.

152 Pages 138 Illustrations \$1.50

THE OSCILLATOR AT WORK

Do you get your money’s worth out of your present-day oscillator? Do you derive maximum utility from that unit? Do you know how to test your oscillator and establish if it is working properly? Would you know how to repair it if it went bad? Do you know how many different types of oscillators can be used in the servicing field?

Here is your opportunity to get the true facts about oscillators! Rider’s “The Oscillator at Work” is worth many times the price asked because it helps protect the investment you have made in oscillator equipment.

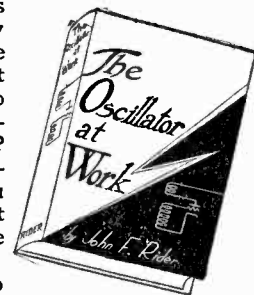

CONTENTS

I—How an oscillator works. II—Alternating Currents. III—Triode Oscillators. IV—Electron-Coupled Oscillators. V—Ultra-High Frequency Oscillators. VI—Negative-Resistance Oscillators. VII—Electro-Mechanical Oscillators. VIII—Relaxation Oscillators. IX—Superheterodyne Oscillators. X—R-F Signal Generators. XI—Audio-Frequency Oscillators. XII—Modulation of Oscillators. XIII—Wobblers. XIV—Adjustment of Transmitters. Bibliography.

256 Pages 167 Illustrations \$2.00

A.C. CALCULATION CHARTS

146 charts 7" x 11" printed in two colors, covering all alternating current calculations from 10 cycles to 1000 megacycles. A tremendous time saver for all engineers and others who work on power, audio, supersonic, high frequency and ultra high frequency problems. Eliminates the slide rule.

160 PAGES 9½ x 12 INCHES CLOTH BINDING \$7.50

RADIOTRON
EARLY COMPLETE
PAGE

REVISED
PAGE

RCA MFG. CO., INC.—(Cont.)

MODEL

EARLY COMPLETE
PAGE

REVISED
PAGE

RCA MFG. CO., INC.—(Cont.)

MODEL

RADIOTRON
EARLY COMPLETE
PAGE

Victor Borgia (9-40)	Schematic, socket	1-65	1981	T4-8A, T4-9A	Schematic, chassis wiring	7-5	1763
Victor Borgia I (9-3)	Schematic, socket	1-68	1974	T4-10	Voltage, socket, data, parts list	7-4	1764
Victor Borgia II (9-2)	Schematic, socket	1-60	1976	4X, 4X8, 4X4	Socket, alignment, parts, data	6-76	1765
Victor Cromwell (12-1)	Schematic, socket	1-60	1976	5BT	Schematic, voltage, trimmers	6-78	1766
Victor Firenze (9-1)	Schematic, socket	1-57	1973		Chassis wiring	7-7	
Victor Hyperion (15-1)	Schematic, socket	1-58	1974		Schematic, data, chassis wiring	6-72	
Victor Tuscan (12-2)	Schematic, socket	1-60	1974		Chassis wiring	7-7	
World Wide Antenna	Installation data	5-211			Circuit data, alignment, parts, resistance	7-6	
9-Tube General Purpose A-W, AR-5A	Notes, parts list	5-212			Socket trimmers, voltage	7-8	
	Schematic, voltage	5-165			Schematic, socket, chassis wiring, resistances, notes	8-1	
	Chassis wiring	5-166			Trimmers, voltage, alignment	8-2	
	Coils wiring diagram	5-167			Phono. data, notes, parts	8-3	
	Alignment data	5-168			Schematic, socket, trimmers	7-9	
	Transformer data, trimmer locations	5-169			Chassis wiring	7-10	
	Parts list	5-170			Socket, voltage, loudspeaker, trimmers	7-11	
AVR-1	See model 140				Circuit data, alignment, notes	7-12	
HF-1	Schematic, fidelity switch data	9-1			Parts list	7-13	
	Socket, trimmers, voltage, chassis wiring, specifications, notes	9-2			Changes	9-6	
Premax P-1	Alignment, tuner, parts list, data	4-1			Schematic, transformer data, lead dress, specifications	10-31	
	Schematic, voltage, data, chassis	4-2			Socket, trimmers, voltage, scale, drive cord data	10-32	
HF-2, HF-4, U130	Tuner adjustments, specifications	9-4			Alignment, parts	10-33	
	tions	9-4			Parts list, notes	1-10	
	Schematic	9-5			Schematic, chassis wiring, voltage	1-11	
SWA-2, SW Converter	Chassis wiring, voltage, transformer data, lead dress	9-6			Test data	2-5	
2-19 Portable Victrola	Socket, trimmers, tuner, dial drive data, notes	9-7			Schematic, chassis wiring, socket, voltage	3-79	
2-25 Portable Victrola	Alignment, tuner data, antenna notes	9-8			Schematic, chassis wiring, voltage	2-4	
2-65 Turntable	Automatic record changer notes	9-9			Parts list, socket, notes	2-6	
KC-3 Television chassis	Parts list	9-10			Test data	2-5	
KC-3A Television chassis	Chassis wiring, parts list, data	2-96			Schematic, chassis wiring, transformer	7-15	
SW-3 AC	Schematic, data	2-97			Parts list	7-14	
SW-3 Batt.	Notes	2-213			Socket, trimmers, voltage, resistance, loudspeaker, pickup	7-16	
SW-3 Converter	Parts list, assembly	2-214			Circuit data, alignment	7-17	
	Notes	2-99			Data	Changes 10-4	
	See model TRK-5	2-100			Victrola attachment data	10-101	
	See model TRK-5				Schematic	10-1, 2	
	Schematic	4-5			Chassis wiring, data	10-3, 4	
	Chassis wiring	4-9			Operating notes, Kinescope installation	10-5	
	Chassis wiring	4-9			Antenna, transmission line data, voltage	10-6	
	Notes on oscillator	4-6			Socket, voltage, data, antenna data, rear view of model TRK-5	10-7	
	Detector adjustment	4-7			Test patterns	10-21	
	General notes	4-8			Video band switch wiring	10-23	
	Data	4-8			Parts list	10-12	
	Parts list	4-14			Specifications, dial data	10-8	
	Assembly wiring	4-4			Schematic, lead dress	10-9	
SW-8 w/R-24	Assembly wiring	4-10			Socket, trimmers, tuner, alignment	10-10	
SW-3 w/R-24-A	Assembly wiring	4-11			R-F chassis wiring, voltage	10-11	
SW-3 w/R-24-B	Assembly wiring	4-11			Schematic	10-11	
SW-3 w/R-78 SW	Assembly wiring	4-12			Schematic, socket, trimmers, chassis wiring	8-5	
SW-3 w/RF-81	Assembly wiring	4-13			Voltage, alignment	8-6	
SW-3 w/RAE-84	Assembly wiring	4-13			Victrola attachment data	10-101	
HF-4	See model HF-2				Schematic, socket, speaker, data, trimmers	6-79	
KC-4	See model TRK-12				Chassis wiring	6-80	
KC-4A Television chassis	See model TRK-9				Alignment, trimmers, voltage	6-81	
R-4, R-6	Chassis wiring, voltage, data	2-1			Alignment part 2, parts list	6-82	
	Schematic, parts list	2-2					
	Test data	2-3					
	Schematic, socket, chassis wiring, trimmers, loud speaker, transformer	7-1					
4T	Voltage, resistance, transformer	7-2					
	Circuit data, alignment, parts list	7-3					
T4-8, T4-9	Schematic, socket, interference note	6-73					
	Alignment, trimmers, voltage	6-74					
	Alignment part 2, parts list	6-75					

MODEL
6K, 6T

Voltage, loudspeaker, universal transformer 7-39
Circuit data, alignment, parts..... 7-40
Victrola attachment data 10-101
Changes Changes 9-6
Victrola attachment data 10-101
Schematic, socket, pickup, chassis wiring, loudspeaker..... 7-41
Voltage, socket, trimmers, resistance, transformer data..... 7-42
Circuit data, alignment, parts..... 7-43
Victrola attachment data 10-101
Schematic, chassis wiring 8-19
Socket, trimmers, parts 8-20
Schematic, phono, data, speaker and transformer wiring 8-21
Chassis wiring 8-22
Socket, trimmers, voltage, alignment 8-23
Data, parts 8-24
Victrola attachment data 10-101
Data Changes 8-4
Data Changes 9-6
Schematic, socket, trimmers, speaker 7-24
Voltage, data, visual alignment 7-25
Chassis wiring 7-26
Circuit data, alignment 7-27
Data, parts list 7-28
Changes Changes 9-6
See model 5Q5A

607, Chassis RC-414A
R-6 (Export)
6T5

See model R-4
Schematic, socket, trimmers, speaker, wiring 8-25
Chassis wiring 8-26
Voltage, alignment 8-27
Data Changes 9-6
Schematic 6-83
Victrola attachment data 10-101
Chassis wiring 6-84
Circuit data, socket, alignment 6-85
Voltage, data, parts list 6-86
Changes Changes 8-4
Victrola attachment data 10-101
Schematic 7-48
Chassis wiring 7-49
Voltage, socket, trimmers, loudspeaker 7-50
Circuit data, alignment 7-51
Parts list 7-52
Schematic, socket 6-91
Chassis wiring 6-92
Circuit data, alignment 6-93
Alignment part 2, voltage, parts, speaker & transformer data 6-94
Victrola attachment data 10-101
Schematic, voltage, socket, trimmers 7-53
Chassis wiring 7-54
Circuit data, alignment, transformer, parts 7-55

T6-10, C6-2

See model 6K3
Chassis wiring 1-12
Schematic, voltage, service notes 1-13
Resistance data, socket 2-8
Schematic, socket, voltage, data 2-9
Chassis wiring, parts list 2-10
Schematic, chassis wiring, voltage 2-11
Resistance data, voltage, socket 2-12
Notes, schematic 4-15
Chassis wiring 4-16
Alignment 4-17
Voltage, parts list 4-18

T6-7, C6-8

See model 6K3
Chassis wiring 6-92
Circuit data, alignment 6-93
Alignment part 2, voltage, parts, speaker & transformer data 6-94
Victrola attachment data 10-101
Schematic, voltage, socket, trimmers 7-53
Chassis wiring 7-54
Circuit data, alignment, transformer, parts 7-55

T6-9

See model 6K3
Chassis wiring 6-92
Circuit data, alignment 6-93
Alignment part 2, voltage, parts, speaker & transformer data 6-94
Victrola attachment data 10-101
Schematic, voltage, socket, trimmers 7-53
Chassis wiring 7-54
Circuit data, alignment, transformer, parts 7-55

T6-11, C6-12

See model 6K3
Chassis wiring 6-92
Circuit data, alignment 6-93
Alignment part 2, voltage, parts, speaker & transformer data 6-94
Victrola attachment data 10-101
Schematic, voltage, socket, trimmers 7-53
Chassis wiring 7-54
Circuit data, alignment, transformer, parts 7-55

7K1
R-7, R-9 AC, Superette

*504-D 1770
*504-C 1769
Front 1771

R-7, R9 DC, Superette

504-D-8 1772
504-D-4 1773
Front 1774

R-7-A AC

504-D-1 1775
Front 1776

R-7-LW

504-D-1 1775
Front 1776

MODEL
5T4

Schematic, phono, data 8-7
Chassis wiring 8-8
Socket, trimmers, voltage, resistance, speaker wiring 8-9
Alignment 8-10
Victrola attachment data 10-101
Schematic, phono, data 8-11
Chassis wiring, trimmers, socket 8-12
Voltage, resistance, speaker wiring 8-13
Alignment, parts 8-14
Victrola attachment data 10-101
Schematic, socket, trimmers, transformer data 8-15
Chassis wiring, phono, data 8-16
Alignment, voltage 8-17
Parts 8-18
Victrola attachment data 10-101
Schematic 9-11
Chassis wiring, coils 9-12
Assembly wiring 9-13
Socket, trimmers, pick-up, motor details, phonograph assembly wiring 9-14
Voltage, resistance, speaker wiring 9-15
Alignment, phonograph data, parts 9-16
Parts list, concluded 9-17
Schematic, chassis wiring 7-19
Circuit data, alignment, parts..... 7-18
Socket, trimmers, voltage, resistance, drive mechanism..... 7-20
Data Changes 10-4
Schematic, socket, voltage, chassis wiring, resistance 8-4
Schematic, chassis wiring, socket, trimmers, loudspeaker 7-21
Voltage, resistance 7-22
Circuit data, alignment, parts, drive mechanism 7-23
Schematic, tuner, voltage, socket, trimmers 10-35
Alignment, parts 10-34
Schematic, socket, pickup connections, battery cable 7-29
Chassis wiring, coil data 7-30
Voltage, resistance, trimmers, power unit wiring 7-31
Circuit data, alignment, notes, battery, parts list 7-32
Schematic 6-87
Circuit & alignment data, socket voltage 6-88
Battery connections, parts list 6-90
Schematic, socket, trimmers 7-44
Chassis wiring 7-45
Voltage, trimmers, vibrator data 7-46
Alignment, parts 7-47
See model B16-3
Schematic, visual alignment 7-33
Chassis wiring, socket 7-34
Circuit data, alignment 7-35
Voltage, parts, installation 7-36
Schematic 9-18, 20
Motor, gear mechanism 9-18
Automatic record changer 9-19
Chassis wiring, voltage 9-23
Socket, trimmers 9-25
Specifications, circuit and tuner data 9-26
Tuner mechanism, transformer data, tuner data 9-27
Fidelity control data, alignment, lead dress 9-28
Parts list 9-29
Schematic, chassis wiring 7-37
Socket, trimmers, resistance, data 7-38

6X, 5X8, 5X4

See model 6K3
Chassis wiring 6-92
Circuit data, alignment 6-93
Alignment part 2, voltage, parts, speaker & transformer data 6-94
Victrola attachment data 10-101
Schematic, voltage, socket, trimmers 7-53
Chassis wiring 7-54
Circuit data, alignment, transformer, parts 7-55

5XA, 5XA3, 5XA4

See model 6K3
Chassis wiring 6-92
Circuit data, alignment 6-93
Alignment part 2, voltage, parts, speaker & transformer data 6-94
Victrola attachment data 10-101
Schematic, voltage, socket, trimmers 7-53
Chassis wiring 7-54
Circuit data, alignment, transformer, parts 7-55

5X2

See model 6K3
Chassis wiring 6-92
Circuit data, alignment 6-93
Alignment part 2, voltage, parts, speaker & transformer data 6-94
Victrola attachment data 10-101
Schematic, voltage, socket, trimmers 7-53
Chassis wiring 7-54
Circuit data, alignment, transformer, parts 7-55

5X51, 5X5W, Chassis KC-400

See model 6K3
Chassis wiring 6-92
Circuit data, alignment 6-93
Alignment part 2, voltage, parts, speaker & transformer data 6-94
Victrola attachment data 10-101
Schematic, voltage, socket, trimmers 7-53
Chassis wiring 7-54
Circuit data, alignment, transformer, parts 7-55

6BT, 6BK, 6BT6, 6DK6

See model 6K3
Chassis wiring 6-92
Circuit data, alignment 6-93
Alignment part 2, voltage, parts, speaker & transformer data 6-94
Victrola attachment data 10-101
Schematic, voltage, socket, trimmers 7-53
Chassis wiring 7-54
Circuit data, alignment, transformer, parts 7-55

BT6-3, BC6-4, BT6-10

See model 6K3
Chassis wiring 6-92
Circuit data, alignment 6-93
Alignment part 2, voltage, parts, speaker & transformer data 6-94
Victrola attachment data 10-101
Schematic, voltage, socket, trimmers 7-53
Chassis wiring 7-54
Circuit data, alignment, transformer, parts 7-55

BT6-5, BC6-6

See model 6K3
Chassis wiring 6-92
Circuit data, alignment 6-93
Alignment part 2, voltage, parts, speaker & transformer data 6-94
Victrola attachment data 10-101
Schematic, voltage, socket, trimmers 7-53
Chassis wiring 7-54
Circuit data, alignment, transformer, parts 7-55

BT6-10
H-6 Hudson

See model 6K3
Chassis wiring 6-92
Circuit data, alignment 6-93
Alignment part 2, voltage, parts, speaker & transformer data 6-94
Victrola attachment data 10-101
Schematic, voltage, socket, trimmers 7-53
Chassis wiring 7-54
Circuit data, alignment, transformer, parts 7-55

HF-6, U132

See model 6K3
Chassis wiring 6-92
Circuit data, alignment 6-93
Alignment part 2, voltage, parts, speaker & transformer data 6-94
Victrola attachment data 10-101
Schematic, voltage, socket, trimmers 7-53
Chassis wiring 7-54
Circuit data, alignment, transformer, parts 7-55

6K, 6T

See model 6K3
Chassis wiring 6-92
Circuit data, alignment 6-93
Alignment part 2, voltage, parts, speaker & transformer data 6-94
Victrola attachment data 10-101
Schematic, voltage, socket, trimmers 7-53
Chassis wiring 7-54
Circuit data, alignment, transformer, parts 7-55

RCA MFG. CO., INC.—(Cont.)

8CA MFG. CO., INC.—(Cont.)

RCA MFG. CO., INC.—(Cont.)

RCA MFG. CO., INC.—(Cont.)

RCA MFG. CO., INC.—(Cont.)

RCA MFG. CO., INC.—(Cont.)

MODEL	REVISÉD PAGE	MODEL	REVISÉD PAGE												
7T, 7K, 8T, 8K	Schematic, socket, trimmers, phono.....7-56 Chassis wiring.....7-57 Voltage, socket, trimmers, resistance, loudspeaker.....7-58 Circuit data, alignment, part 1.....7-59 Alignment, part 2, parts list.....7-60 Victrola attachment data.....10-101 See model 6K3 Victrola attachment data.....10-101 Schematic, chassis wiring.....7-61 Resistance, voltage, socket, trimmers, speaker, transformer.....7-62 Motor board adjustments.....7-63 Assembly wiring, pickup details.....7-64 Circuit data, alignment, pickup data, part 1.....7-65 Pickup data, part 2, socket, parts list.....7-66 Schematic, socket, trimmers.....8-29 Phono, data, notes.....8-30 Chassis wiring.....8-30 Parts.....8-31 Schematic, voltage, socket, trimmers, alignment, resistance.....8-33 Alignment, parts.....8-34 Chassis wiring.....10-101 Victrola attachment data.....10-101 Victrola attachment data.....10-101 See Victor Alhambra I Schematic, socket.....1-62 Schematic, socket, trimmers.....7-67 Chassis wiring.....7-68 Voltage, socket, trimmers, transformer, loudspeaker.....7-69 Circuit data, parts, alignment, data.....7-70 Speaker data.....7-72 Victrola attachment data.....10-101 Schematic, socket, trimmers.....7-67 Chassis wiring.....7-68 Voltage, socket, trimmers, transformer, loudspeaker.....7-69 Circuit data, parts, alignment, data.....7-70 Victrola attachment data.....10-101 Schematic, socket, trimmers.....7-71 Assembly wiring, pickup, speaker, transformer, circuit, alignment, part 1.....7-73 Alignment, part 2, parts list.....7-74 Additional data.....Changes 7-6 Schematic, socket, trimmer, data.....6-95 Chassis wiring.....6-96 Parts, circuit data, alignment, data.....6-97 Alignment part 2, voltage, trimmers.....6-98 See model TRK-12 See model TRK-9 Schematic, chassis wiring.....7-75 Data, parts list.....7-76 Victrola attachment data.....10-101 Schematic, socket.....1-59 Schematic, socket, voltage.....1-59 Schematic, socket.....1-59 Schematic, socket.....1-62 See Victor 7-3 Schematic, socket, trimmers, phono, data, speaker wiring, resistance, voltage.....8-35 Alignment.....8-38 Notes, parts.....8-39 Battery cable, chassis wiring.....8-36 Power unit and chassis wiring.....8-36	8C8-15	Schematic, socket, trimmers, speaker.....7-77 Chassis wiring.....7-78 Voltage, transformer, visual alignment, data.....7-79 Circuit data, alignment.....7-80 Parts list.....7-81 Victrola attachment data.....10-101 Schematic, socket, trimmers.....7-83 Chassis wiring.....7-84 Voltage, trimmers, transformer, visual alignment.....7-85 Alignment, parts.....7-86 Schematic, chassis wiring, parts.....8-52 Schematic, socket, trimmers.....7-89 Chassis wiring pickup.....7-90 Voltage, assembly, wiring, phono, adjustments, data.....7-91 Alignment, parts, loudspeaker, transformer.....7-92 Schematic.....9-21, 22 Automatic record changer.....9-9 Motor gear mechanism.....9-18 Chassis wiring, voltage.....9-24 Socket, trimmers.....9-25 Specifications, circuit data, tuner notes.....9-26 Tuner mechanism, transformer data, tuner data.....9-27 Fidelity control data, alignment, lead dress.....9-28 Parts list.....9-29 Changes.....9-6 Victrola attachment data.....10-101 See model 7T Schematic, socket, voltage, trimmers, chassis wiring.....9-31 Alignment, specifications, data, parts.....9-32 Schematic, socket, trimmers, voltage.....9-33 R-f chassis wiring, parts layout.....9-35 Alignment, parts, specifications, data.....9-36 Schematic, changes, power unit changes.....9-34 Socket, trimmers, voltage.....9-33 R-f chassis wiring, power unit and parts layouts.....9-35 Alignment, parts, specifications, data.....9-36 Schematics, socket, trimmers, specifications, R-F chassis wiring.....9-38 Alignment, trimmers, voltage, data.....9-39 Parts list.....9-40 Data.....Changes 10-1 Schematic, socket, voltage.....2-13 Chassis wiring, parts list.....2-14 Resistance data, socket, voltage.....2-15 Schematic, socket, phono, data.....8-41 Parts.....8-40 Chassis wiring.....8-42 Voltage, resistance, trimmers.....8-43 Circuit data, alignment, transformer wiring.....8-44 Data.....Changes 10-4 Victrola attachment data.....10-101 Data.....Changes 8-4 Data.....Changes 9-6 Victrola attachment data.....10-101 Schematic, socket, trimmers, speaker.....7-77 Chassis wiring.....7-78 Voltage, transformer, visual alignment, data.....7-79	CV-8, "Pak-O-Powr"	D8-28	HF-8, U134	8K1	8K, 8T 8M	8M1	8M2	8M3, 8M4	R-8, R-12 AC	8T2, 8T11, 8K11	8T10	TS-14

9K1, 9K3	Voltage socket, trimmers.....8-63 Alignment trimmers.....8-64 Notes, dial data, parts, page 1.....8-65 Parts, page 2.....8-66 Victrola attachment data.....10-101 Schematic, socket, trimmers.....8-60 Chassis wiring.....8-60 Schematic, transformer data, speaker wiring.....8-61 Chassis wiring.....8-62 Victrola attachment data.....10-101 Schematic, pickup.....7-99 Chassis wiring.....7-100 "Magic Brain," chassis wiring.....7-101 Socket, trimmers, visual align- ment, dial mechanism, trans- former, speaker.....7-102 Resistance, voltage, trimmers.....7-103 Circuit data, alignment, part 1.....7-104 Alignment, part 2, notes.....7-105 Parts list.....7-106 Victrola attachment data.....10-101 Data.....Changes 8-4 Data.....Changes 9-6 Victrola attachment data.....10-101 Schematic, voltage, specifica- tions, tuner views.....9-41 Socket, trimmers, chassis wir- ing, alignment, parts, tuner and drive cord data.....9-42 Schematic, voltage, socket, trimmers, chassis wiring.....9-43 Tuner, alignment, specifica- tions, parts.....9-44 See model R-7 9SX1, 9SX2, 9SX3, 9SX4, 9SX5, 9SX6, 9SX7, 9SX8, "Little Nipper" Parts.....10-38 See model 9K2 Schematic, socket, trimmers.....7-115 loudspeaker pickup.....7-116 Chassis wiring.....7-117 Voltage changes.....7-117 Circuit data, alignment, parts 7-118 Schematic, pickup.....7-119 Chassis wiring.....7-120 Socket trimmers, loudspeaker, voltage.....7-121 Circuit data, alignment, data.....7-122 Parts list.....7-122 See model C9-6 (Late) See model C9-4 (Late)
9K1	Schematic, voltage.....10-13, 14 Video chassis wiring.....10-13, 16 Cabinet wiring, socket layout 10-18 Video voltage.....10-19 Assembly, specifications.....10-17 operating controls.....10-21 Test patterns.....10-21 Operating data.....10-22 Video band-switch wiring.....10-23 operating controls.....10-30 Kinescope data.....10-30 Parts list.....10-24 Chassis wiring.....10-20
9K3	Parts list.....10-30 Schematic.....10-25, 26
9K3, 9T	Speaker connections, socket.....10-23 R-F chassis wiring, voltage.....10-27 Alignment, switching data, calibration scale.....10-28 Electric Tuning data.....10-29

T8-14	Circuit data, alignment.....7-80 Parts list.....7-81 Speaker data.....7-82 Victrola attachment data.....10-101 Schematic, socket, trimmers.....7-83 Speaker data.....7-82 Chassis wiring.....7-84 Voltage, trimmers, transformer.....7-85 visual alignment.....7-86 Alignment, parts.....7-86 Victrola attachment data.....10-101 Schematic, changes.....7-87 Chassis wiring.....7-88 Victrola attachment data.....10-101 Schematic, transformer data, speaker wiring.....8-45 Chassis wiring.....8-46 Voltage, resistance, socket, trim- mers.....8-47 Phono wiring, motor details.....8-48 Alignment, Page 1.....8-49 Alignment, Part 2, phono data, parts.....8-50 Data.....Changes 8-51 Schematic, transformer data.....8-53 Chassis wiring.....8-54 Voltage, resistance, socket, trimmers.....8-55 Assembly wiring, phono details, pickup.....8-56 Alignment, parts, page 1.....8-57 Parts, page 2.....8-58 Schematic, socket, trimmers, voltage, alignment, phono data.....10-37 Motor assembly, parts.....10-36 Socket layout.....1-4 Schematic, socket.....1-63 Schematic, speaker data.....6-99 Chassis wiring.....6-100 Trimmers, socket, alignment connections, voltage.....6-101 Alignment.....6-102 Alignment, part 2.....6-103 Victrola attachment data.....10-101 Schematic.....7-107 Chassis wiring.....7-108 Parts list.....7-109 Victrola attachment data.....10-101 Schematic.....7-110 Chassis wiring.....7-111 Socket, voltage, trimmers, speaker, transformer.....7-112 Circuit data, alignment.....7-113 Visual alignment, parts list.....7-114 Victrola attachment data.....10-101 Schematic, chassis wiring.....5-217 Assembly wiring, parts list.....5-218 See model 96BK6 Schematic.....7-123 Chassis wiring.....7-124 Socket, trimmers, voltage, pickup, loudspeaker.....7-125 Assembly wiring, motor details.....7-126 Circuit data, alignment, part 1.....7-127 Alignment, part 2.....7-128 Parts list.....7-129 Schematic, changes.....9-45 Chassis wiring, parts.....9-46 Schematic, pickup.....7-93 Chassis wiring.....7-94 Socket, trimmers, dial mech- anism, transformer, speaker, visual alignment.....7-95 Resistance, voltage.....7-96 Circuit data, alignment, part 1.....7-97 Alignment, part 2, data, parts list.....7-98 Victrola attachment data.....10-101
T9-16	*472 *513 1753 1979
T8-18, 08-19, 08-20	
8U	
8U3	
U8M, U8W, Chassis RC-404A	
Victor 8-60 Victor Electrola 8-60 C9-4	
C9-4 (Late), T9-10	
C9-6, T9-9	
CRD-9	
CV9 AC S.P.U. D9-19	
D9-19 Late	
9K	

MODEL	RCA MFG. CO., INC.—(Cont.)	REVISED PAGE	EARLY COMPLETE PAGE	RADIOTRON COMPLETE PAGE
13K	Alignment, page 1, oscillograms, 8-88 Alignment, page 2, notes, 8-89 Alignment, page 3, notes, parts, 8-90 Victoria attachment data, 10-101 See Radiola 42			
R-14 16-1 O16-8	See Victor Hyperion Schematic, 6-129 Parts list, 6-128 Chassis wiring, 6-130 Trimmers, voltage, speaker data, transformer data, 6-131 Circuit data, alignment, 6-132 Alignment part 2; cathode ray oscillograph alignment, 6-133 Alignment, part 3; phono-graph, dial, transformer notes, 6-134 Victoria attachment data, 10-101 Similar to C15-3 Victoria attachment data, 10-101 Data, 7-156 Schematic, pickup, 7-149 Chassis wiring, 7-150 "Magic Brain" chassis wiring, 7-151 Resistance voltage transformer, 7-152 Socket, trimmers, transformer, dial mechanism alignment, 7-153 Circuit data, alignment, part 1, 7-154 Alignment, part 2, parts list, 7-155 Victoria attachment data, 10-101 Schematic, parts list, 4-131			
PK 15 B1 Speaker Field Supply	Assembly wiring, 4-182 Schematic, 3-59 Schematic, socket, voltage, data, 1-14 Schematic, socket, trimmers wiring, 8-91, 8-92 Chassis wiring, 8-93 "Magic Brain" chassis wiring, 8-94 Power amplifier wiring, pickup, speaker wiring, 8-95 Specifications, notes, 8-96 Resistance, 8-97 Voltage, socket, trimmers, 8-98 Automatic record changer, details, notes, 8-99 Alignment, page 1, 8-100 Alignment, page 2, 8-101 Alignment, page 3, notes, oscillograms, 8-102 Parts, page 1, 8-103 Parts, page 2, dial change mechanism, 8-104 Schematic, assembly wiring, 5-219 Parts list, 5-220 Pickup data, 5-221 Schematic, socket, data, 1-15 Data, Changes 7-15 Schematic, notes, 4-19 Assembly wiring, 4-20 Schematic, parts list, 5-222 Pickup data, 5-221 Schematic, 5-223 Pickup data, parts list, 5-224 Schematic, socket, voltage, data, 1-15 Combination R-15 and RE-57 notes, 4-21 Schematic, chassis, voltage, parts list, 4-22 Schematic, socket, voltage, 1-16 Schematic, socket, voltage, 1-16 Schematic, socket, data, 2-23 Assembly wiring, 2-24 Resistance data, socket, voltage, 2-25			
PT-15 Turntable R-16 15U	Alignment, page 1, oscillograms, 8-88 Alignment, page 2, notes, 8-89 Alignment, page 3, notes, parts, 8-90 Victoria attachment data, 10-101 See Radiola 42			
PT-16-A1, PT-16-A2 Radiola 16 RE-16 RE-16-A	Alignment, page 1, oscillograms, 8-88 Alignment, page 2, notes, 8-89 Alignment, page 3, notes, parts, 8-90 Victoria attachment data, 10-101 See Radiola 42			
PT-17-A1, PT-17-A2 Radiola 17 RE-17 R-17-M	Alignment, page 1, oscillograms, 8-88 Alignment, page 2, notes, 8-89 Alignment, page 3, notes, parts, 8-90 Victoria attachment data, 10-101 See Radiola 42			
Radiola 18 AO Radiola 18 DO RE-18	Alignment, page 1, oscillograms, 8-88 Alignment, page 2, notes, 8-89 Alignment, page 3, notes, parts, 8-90 Victoria attachment data, 10-101 See Radiola 42			
RE-18-A R-18-W	Alignment, page 1, oscillograms, 8-88 Alignment, page 2, notes, 8-89 Alignment, page 3, notes, parts, 8-90 Victoria attachment data, 10-101 See Radiola 42			
RE-19 AC (AVC) Radiola 20 RE-20 Electrola PK 21 A1 Speaker Field Supply	Alignment, page 1, oscillograms, 8-88 Alignment, page 2, notes, 8-89 Alignment, page 3, notes, parts, 8-90 Victoria attachment data, 10-101 See Radiola 42			
R-20 Radiola 20 RE-20 Electrola	Alignment, page 1, oscillograms, 8-88 Alignment, page 2, notes, 8-89 Alignment, page 3, notes, parts, 8-90 Victoria attachment data, 10-101 See Radiola 42			
R-22 D22-1	Alignment, page 1, oscillograms, 8-88 Alignment, page 2, notes, 8-89 Alignment, page 3, notes, parts, 8-90 Victoria attachment data, 10-101 See Radiola 42			
R-24, R-24-A, R-24-B with SW-3 Radiola 24 RK-24 25 DO Photophone PK-25 Radiola 25 (104 Power Pack)	Alignment, page 1, oscillograms, 8-88 Alignment, page 2, notes, 8-89 Alignment, page 3, notes, parts, 8-90 Victoria attachment data, 10-101 See Radiola 42			

MODEL	RCA MFG. CO., INC.—(Cont.)	REVISED PAGE	EARLY COMPLETE PAGE	RADIOTRON
Radio 26	Schematic, socket	1-19	*481	1813
RAE-26	Assembly wiring	2-44	504-K	1816
	Resistance data, socket	2-43	504-L	1817
	Front			
R-27 AC-DO	Schematic, speaker types	2-45		1818
	Chassis wiring, two types	3-1		1819
	Parts list, voltage	3-3		1820
R-27, Revised	Schematic, chassis wiring	5-1		1821
	Voltage, parts list	5-2		
R-28	Schematic, chassis wiring	3-5		1822
	Parts list, voltage, data	3-5		1823
	Schematic, socket	1-23	*485	1825
Radio 28 AC (104 SPU)	Schematic, wiring	1-22		1824
Radio 28, Battery	Schematic, chassis wiring	5-3	*484	
R-28-BW	Voltage, parts list	5-4		
R-28-BWC	Schematic, chassis wiring	5-5		
	Voltage, parts list	5-6		
R-28-P	Schematic, chassis wiring	4-20		
	Voltage, parts list, alignment	4-30		
CE-29	Schematic, socket	3-55		1955
	Chassis wiring	3-56		1956
	Specifications, notes, voltage	3-57		1957
	Assembly wiring diagram	3-58		1958
	Schematic, voltage, notes	3-68		1966
	Notes	3-69		1987
	Schematic, socket	2-46	504-Y	1830
	Chassis wiring	2-47	504-Y-1	1831
	Notes, part 1	2-48	504-Y-2	1832
	Notes, part 2	2-49	504-Y-3	1833
	Notes, part 3	2-50	504-Y-4	1834
	Notes, part 4	2-51	504-Y-5	1835
	Notes, part 5	2-52	504-Y-6	1836
	Notes, part 6	2-53	504-Y-7	1837
	Notes, part 7	2-54	504-Y-8	1838
	Notes, part 8, voltage	2-55	504-Y-9	1839
	Installation wiring, notes, part 9	2-56	504-Y-10	1840
	Parts list	2-57	504-Y-11	1841
	Resistance data, voltage, socket	2-58	Front	1842
	Schematic, wiring, data	1-24	*486	1826
Radio 30 AO (104 SPU)	Schematic	3-70		1988
Photophone PG-30 (1st type)	Chassis wiring	3-72		1990
PG-30, PG-31 Remote Volume Control	Power amplifier, chassis wiring	3-72		1990
Photophone PG-30, PG-31	Voltage amplifier, chassis wiring	3-73		1991
	connections	3-74		1992
	Schematic, voltage	3-75		1993
Photophone PG-30 High Fidelity	Schematic, socket, voltage	1-25	*487	1827
Radio 30-A Power Pack	Schematic	1-25	*487	1828
Radio 30-A DC SPU	General service notes, voltages	3-7		1829
	Schematic, data	10-17		
U30, Chassis RC-335KR, U129, Chassis RC-335K	Calibration scale	10-28		
	Voltage, chassis wiring, transformer, notes	10-48		
	Alignment, socket, trimmers, tuner and antenna data	10-49		
	Tuning mechanism, data, Arm chair control unit	10-50		
	Automatic record changer, data, adjustments	10-51		
	Record changer assembly, details	10-52		
	Parts	10-53		
	Schematic	3-71		1989
Photophone PG-31 (1st type)	See Photophone PG-30			1994
Photophone PG-31 High Fidelity	Schematic, socket	3-76		
	See Photophone PG-30			
	Front			
	Schematic, voltage, data	10-55		
	Terminal voltage	1-35		1869
	Schematic	1-36		1868
	Schematic, socket, voltage, data	1-37		1870
	Resistance data, voltage, chassis	1-38		1871
	Schematic, voltage, data	2-70		1872
	Schematic, voltage, data	10-55		
	Terminal voltage	1-35		1869
	Schematic	1-36		1868
	Schematic, socket, voltage, data	1-37		1870
	Resistance data, voltage, chassis	1-38		1871
	Schematic, voltage, data	2-70		1872
	Schematic, voltage, data	10-55		
	Terminal voltage	1-35		1869
	Schematic	1-36		1868
	Schematic, socket, voltage, data	1-37		1870
	Resistance data, voltage, chassis	1-38		1871
	Schematic, voltage, data	2-70		1872
	Schematic, voltage, data	10-55		
	Terminal voltage	1-35		1869
	Schematic	1-36		1868
	Schematic, socket, voltage, data	1-37		1870
	Resistance data, voltage, chassis	1-38		1871
	Schematic, voltage, data	2-70		1872
	Schematic, voltage, data	10-55		

MODEL	RCA MFG. CO., INC.—(Cont.)	REVISED PAGE	EARLY COMPLETE PAGE	RADIOTRON COMPLETE PAGE
M50, Chassis RC-357J	Chassis wiring, socket, trimmers Alignment Tuner and antenna data Drive data, parts Schematic, chassis wiring Chassis layouts, voltage, socket notes Schematic, voltage, R-F chassis wiring Speaker connections, switch mechanism, parts Socket trimmers, dial data Schematic, chassis Voltage, alignment, parts list See Victor R-32 See Victor R-50 See Victor R-35 Units specifications Chassis wiring Schematic Schematic, socket, data Assembly wiring Schematic Chassis wiring, socket, trimmers, voltage Alignment Tuner and antenna data Drive data, parts Schematic, socket, voltage, data Assembly wiring 4-134 4-135 4-136 4-137 4-138 4-139 4-140 4-141 4-142 4-145 4-146 3-60 3-61 3-62 5-233 5-234 5-235 5-236 5-237 5-238 4-143 4-144 5-239 5-240 Schematic, chassis Schematic, socket, voltage, data Additional data Notes View Chassis view Notes Schematic Notes Voltage, parts list Chassis wiring Schematic Schematic	10-56 10-57 10-58 10-59 2-71 2-72 10-61 10-60 4-37 4-38 5-228 5-229 5-230 2-73 2-74 10-63 10-64 10-57 10-58 10-59 1-39 4-134 4-135 4-136 4-137 4-138 4-139 4-140 4-141 4-142 4-145 4-146 3-60 3-61 3-62 5-233 5-234 5-235 5-236 5-237 5-238 4-143 4-144 5-239 5-240 1-71 1-40 4-147 4-148 4-149 4-150 4-151 4-152 4-156 4-151 4-153 4-155 1-71 1-41 3-21 3-22 3-23	504-8 504-9	1873 1874
U50, Chassis RC-4140	Panel wiring Units specifications Rack assembly wiring Schematic, socket, voltage, data Schematic, socket, trimmers, speaker and transformer connections Chassis wiring Voltage, alignment Parts list Schematic, socket, trimmers, speaker Chassis wiring, transformers and vibrator connections Voltage, alignment, trimmers Parts list Changes Schematic, data Voltage, socket, condenser connections Data Schematic Voltage, chassis wiring, tuner Alignment, socket, trimmers, turret adjustments, antenna and drive cord data Data, parts list Schematic, voltage, chassis wiring Voltage, data Schematic Chassis wiring Parts list Voltage, data Schematic Chassis wiring Parts list Schematic, chassis wiring Alignment, voltage Parts list Alignment, voltage, speaker data Schematic, chassis wiring Schematic—Similar to R-35 Assembly wiring, data Parts list Record changer, part 1 Record changer, part 2 Record changer, part 3 Record changer, part 4 Locations of parts Chassis wiring Schematic, socket Voltage, speaker wiring Parts list Schematic, chassis wiring Alignment, voltage Parts list Schematic, chassis wiring Alignment, voltage See Victor R-32 Schematic, socket Chassis wiring See model R98 Schematic, socket Socket, wiring changes, service data Chassis wiring Alignment data Schematic, voltage, alignment, notes Schematic	5-243 5-241 5-242 1-42 9-47 9-48 9-51 9-52 9-49 9-50 9-51 9-52 Changes 7-3 1-43 3-24 7-14 10-65 10-66 10-67 4-39 4-40 3-25 3-26 3-27 3-28 3-29 3-30 3-31 3-32 5-7 5-8 5-9 4-41 4-42 4-43 2-75 2-76 2-79 2-80 2-81 2-82 2-77 3-34 3-33 3-35 5-10 5-11 5-12 5-10 5-13 5-14 3-33 3-36 3-37 3-38 3-39 3-40 3-41 7-166 3-42	*499	1888
R-51-B, R-53-B	67M1, 67M2, 67M3	9-47 9-48 9-51 9-52 9-49 9-50 9-51 9-52 Changes 7-3 1-43 3-24 7-14 10-65 10-66 10-67 4-39 4-40 3-25 3-26 3-27 3-28 3-29 3-30 3-31 3-32 5-7 5-8 5-9 4-41 4-42 4-43 2-75 2-76 2-79 2-80 2-81 2-82 2-77 3-34 3-33 3-35 5-10 5-11 5-12 5-10 5-13 5-14 3-33 3-36 3-37 3-38 3-39 3-40 3-41 7-166 3-42		1885
R-52		9-47 9-48 9-51 9-52 9-49 9-50 9-51 9-52 Changes 7-3 1-43 3-24 7-14 10-65 10-66 10-67 4-39 4-40 3-25 3-26 3-27 3-28 3-29 3-30 3-31 3-32 5-7 5-8 5-9 4-41 4-42 4-43 2-75 2-76 2-79 2-80 2-81 2-82 2-77 3-34 3-33 3-35 5-10 5-11 5-12 5-10 5-13 5-14 3-33 3-36 3-37 3-38 3-39 3-40 3-41 7-166 3-42		1886
R-55		9-47 9-48 9-51 9-52 9-49 9-50 9-51 9-52 Changes 7-3 1-43 3-24 7-14 10-65 10-66 10-67 4-39 4-40 3-25 3-26 3-27 3-28 3-29 3-30 3-31 3-32 5-7 5-8 5-9 4-41 4-42 4-43 2-75 2-76 2-79 2-80 2-81 2-82 2-77 3-34 3-33 3-35 5-10 5-11 5-12 5-10 5-13 5-14 3-33 3-36 3-37 3-38 3-39 3-40 3-41 7-166 3-42		1887
RAE-59		9-47 9-48 9-51 9-52 9-49 9-50 9-51 9-52 Changes 7-3 1-43 3-24 7-14 10-65 10-66 10-67 4-39 4-40 3-25 3-26 3-27 3-28 3-29 3-30 3-31 3-32 5-7 5-8 5-9 4-41 4-42 4-43 2-75 2-76 2-79 2-80 2-81 2-82 2-77 3-34 3-33 3-35 5-10 5-11 5-12 5-10 5-13 5-14 3-33 3-36 3-37 3-38 3-39 3-40 3-41 7-166 3-42		1888
PG-59		9-47 9-48 9-51 9-52 9-49 9-50 9-51 9-52 Changes 7-3 1-43 3-24 7-14 10-65 10-66 10-67 4-39 4-40 3-25 3-26 3-27 3-28 3-29 3-30 3-31 3-32 5-7 5-8 5-9 4-41 4-42 4-43 2-75 2-76 2-79 2-80 2-81 2-82 2-77 3-34 3-33 3-35 5-10 5-11 5-12 5-10 5-13 5-14 3-33 3-36 3-37 3-38 3-39 3-40 3-41 7-166 3-42		1889
PG-62		9-47 9-48 9-51 9-52 9-49 9-50 9-51 9-52 Changes 7-3 1-43 3-24 7-14 10-65 10-66 10-67 4-39 4-40 3-25 3-26 3-27 3-28 3-29 3-30 3-31 3-32 5-7 5-8 5-9 4-41 4-42 4-43 2-75 2-76 2-79 2-80 2-81 2-82 2-77 3-34 3-33 3-35 5-10 5-11 5-12 5-10 5-13 5-14 3-33 3-36 3-37 3-38 3-39 3-40 3-41 7-166 3-42		1890
PG-62-C, Universal Amplifier		9-47 9-48 9-51 9-52 9-49 9-50 9-51 9-52 Changes 7-3 1-43 3-24 7-14 10-65 10-66 10-67 4-39 4-40 3-25 3-26 3-27 3-28 3-29 3-30 3-31 3-32 5-7 5-8 5-9 4-41 4-42 4-43 2-75 2-76 2-79 2-80 2-81 2-82 2-77 3-34 3-33 3-35 5-10 5-11 5-12 5-10 5-13 5-14 3-33 3-36 3-37 3-38 3-39 3-40 3-41 7-166 3-42		1891
Photophone SPU 62		9-47 9-48 9-51 9-52 9-49 9-50 9-51 9-52 Changes 7-3 1-43 3-24 7-14 10-65 10-66 10-67 4-39 4-40 3-25 3-26 3-27 3-28 3-29 3-30 3-31 3-32 5-7 5-8 5-9 4-41 4-42 4-43 2-75 2-76 2-79 2-80 2-81 2-82 2-77 3-34 3-33 3-35 5-10 5-11 5-12 5-10 5-13 5-14 3-33 3-36 3-37 3-38 3-39 3-40 3-41 7-166 3-42		1892
PG 63		9-47 9-48 9-51 9-52 9-49 9-50 9-51 9-52 Changes 7-3 1-43 3-24 7-14 10-65 10-66 10-67 4-39 4-40 3-25 3-26 3-27 3-28 3-29 3-30 3-31 3-32 5-7 5-8 5-9 4-41 4-42 4-43 2-75 2-76 2-79 2-80 2-81 2-82 2-77 3-34 3-33 3-35 5-10 5-11 5-12 5-10 5-13 5-14 3-33 3-36 3-37 3-38 3-39 3-40 3-41 7-166 3-42		1893
PG 63 (PB 100 B1) Universal Amplifier		9-47 9-48 9-51 9-52 9-49 9-50 9-51 9-52 Changes 7-3 1-43 3-24 7-14 10-65 10-66 10-67 4-39 4-40 3-25 3-26 3-27 3-28 3-29 3-30 3-31 3-32 5-7 5-8 5-9 4-41 4-42 4-43 2-75 2-76 2-79 2-80 2-81 2-82 2-77 3-34 3-33 3-35 5-10 5-11 5-12 5-10 5-13 5-14 3-33 3-36 3-37 3-38 3-39 3-40 3-41 7-166 3-42		1894
Photophone SPU 69		9-47 9-48 9-51 9-52 9-49 9-50 9-51 9-52 Changes 7-3 1-43 3-24 7-14 10-65 10-66 10-67 4-39 4-40 3-25 3-26 3-27 3-28 3-29 3-30 3-31 3-32 5-7 5-8 5-9 4-41 4-42 4-43 2-75 2-76 2-79 2-80 2-81 2-82 2-77 3-34 3-33 3-35 5-10 5-11 5-12 5-10 5-13 5-14 3-33 3-36 3-37 3-38 3-39 3-40 3-41 7-166 3-42		1903
Photophone SPU 64		9-47 9-48 9-51 9-52 9-49 9-50 9-51 9-52 Changes 7-3 1-43 3-24 7-14 10-65 10-66 10-67 4-39 4-40 3-25 3-26 3-27 3-28 3-29 3-30 3-31 3-32 5-7 5-8 5-9 4-41 4-42 4-43 2-75 2-76 2-79 2-80 2-81 2-82 2-77 3-34 3-33 3-35 5-10 5-11 5-12 5-10 5-13 5-14 3-33 3-36 3-37 3-38 3-39 3-40 3-41 7-166 3-42		1904
PG 68		9-47 9-48 9-51 9-52 9-49 9-50 9-51 9-52 Changes 7-3 1-43 3-24 7-14 10-65 10-66 10-67 4-39 4-40 3-25 3-26 3-27 3-28 3-29 3-30 3-31 3-32 5-7 5-8 5-9 4-41 4-42 4-43 2-75 2-76 2-79 2-80 2-81 2-82 2-77 3-34 3-33 3-35 5-10 5-11 5-12 5-10 5-13 5-14 3-33 3-36 3-37 3-38 3-39 3-40 3-41 7-166 3-42		1905
PG 68 (PB 100 B1) Universal Amplifier		9-47 9-48 9-51 9-52 9-49 9-50 9-51 9-52 Changes 7-3 1-43 3-24 7-14 10-65 10-66 10-67 4-39 4-40 3-25 3-26 3-27 3-28 3-29 3-30 3-31 3-32 5-7 5-8 5-9 4-41 4-42 4-43 2-75 2-76 2-79 2-80 2-81 2-82 2-77 3-34 3-33 3-35 5-10 5-11 5-12 5-10 5-13 5-14 3-33 3-36 3-37 3-38 3-39 3-40 3-41 7-166 3-42		1909
Photophone SPU 69		9-47 9-48 9-51 9-52 9-49 9-50 9-51 9-52 Changes 7-3 1-43 3-24 7-14 10-65 10-66 10-67 4-39 4-40 3-25 3-26 3-27 3-28 3-29 3-30 3-31 3-32 5-7 5-8 5-9 4-41 4-42 4-43 2-75 2-76 2-79 2-80 2-81 2-82 2-77 3-34 3-33 3-35 5-10 5-11 5-12 5-10 5-13 5-14 3-33 3-36 3-37 3-38 3-39 3-40 3-41 7-166 3-42		1910
PG 68		9-47 9-48 9-51 9-52 9-49 9-50 9-51 9-52 Changes 7-3 1-43 3-24 7-14 10-65 10-66 10-67 4-39 4-40 3-25 3-26 3-27 3-28 3-29 3-30 3-31 3-32 5-7 5-8 5-9 4-41 4-42 4-43 2-75 2-76 2-79 2-80 2-81 2-82 2-77 3-34 3-33 3-35 5-10 5-11 5-12 5-10 5-13 5-14 3-33 3-36 3-37 3-38 3-39 3-40 3-41 7-166 3-42		1911
PG 63 (PB 100 B1) Universal Amplifier		9-47 9-48 9-51 9-52 9-49 9-50 9-51 9-52 Changes 7-3 1-43 3-24 7-14 10-65 10-66 10-67 4-39 4-40 3-25 3-26 3-27 3-28 3-29 3-30 3-31 3-32 5-7 5-8 5-9 4-41 4-42 4-43 2-75 2-76 2-79 2-80 2-81 2-82 2-77 3-34 3-33 3-35 5-10 5-11 5-12 5-10 5-13 5-14 3-33 3-36 3-37 3-38 3-39 3-40 3-41 7-166 3-42		1912
Photophone SPU 69		9-47 9-48 9-51 9-52 9-49 9-50 9-51 9-52 Changes 7-3 1-43 3-24 7-14 10-65 10-66 10-67 4-39 4-40 3-25 3-26 3-27 3-28 3-29 3-30 3-31 3-32 5-7 5-8 5-9 4-41 4-42 4-43 2-75 2-76 2-79 2-80 2-81 2-82 2-77 3-34 3-33 3-35 5-10 5-11 5-12 5-10 5-13 5-14 3-33 3-36 3-37 3-38 3-39 3-40 3-41 7-166 3-42		1913
Photophone SPU 64		9-47 9-48 9-51 9-52 9-49 9-50 9-51 9-52 Changes 7-3 1-43 3-24 7-14 10-65 10-66 10-67 4-39 4-40 3-25 3-26 3-27 3-28 3-29 3-30 3-31 3-32 5-7 5-8 5-9 4-41 4-42 4-43 2-75 2-76 2-79 2-80 2-81 2-82 2-77 3-34 3-33 3-35 5-10 5-11 5-12 5-10 5-13 5-14 3-33 3-36 3-37 3-38 3-39 3-40 3-41 7-166 3-42		1914
PG 68		9-47 9-48 9-51 9-52 9-49 9-50 9-51 9-52 Changes 7-3 1-43 3-24 7-14 10-65 10-66 10-67 4-39 4-40 3-25 3-26 3-27 3-28 3-29 3-30 3-31 3-32 5-7 5-8 5-9 4-41 4-42 4-43 2-75 2-76 2-79 2-80 2-81 2-82 2-77 3-34 3-33 3-35 5-10 5-11 5-12 5-10 5-13 5-14 3-33 3-36 3-37 3-38 3-39 3-40 3-41 7-166 3-42		1914

RAE-79	Schematic, socket, data.....	2-83
	Receiver chassis wiring, data.....	2-84
	Assembly wiring.....	2-85
	Remote control notes.....	2-86
	Motor adjustments.....	2-87
	Chassis wiring diagrams.....	2-88
	Schematic, socket, voltage.....	1-44
	Trimmers, chassis wiring of SPU.....	2-89
	Assembly wiring.....	2-90
	Resistance data.....	2-91
	Alignment, voltage, speaker data, notes.....	4-44
	Schematic, chassis wiring.....	4-45
	Assembly wiring.....	4-46
	Pickup data.....	4-47
	Parts list.....	4-48
	Specifications.....	3-43
	Schematic, values.....	3-44
	Chassis wiring.....	3-45
	Assembly wiring, diagram.....	1-46
	Schematic, socket.....	1-45
	Chassis wiring.....	2-92
	Resistance data, socket, voltage.....	2-94
	Chassis wiring.....	2-93
	Schematic, notes.....	1-47
	Assembly wiring.....	1-46
	Receiver chassis wiring.....	1-48
	SPU Chassis wiring.....	1-49
	Remote control units, data.....	1-50
	See models TRK-9, TRK-12 chassis wiring.....	9-53
	Voltage, alignment, lead dress, notes.....	9-55
	Specifications, parts.....	9-56
	Schematic, socket, trimmers, chassis wiring.....	9-54
	Voltage, alignment, lead dress, notes.....	9-55
	Specifications, parts.....	9-56
	Receiver chassis wiring.....	3-47
	Service notes.....	3-48
	Service notes.....	3-49
	AF Chassis wiring.....	3-50
	Assembly wiring diagram.....	3-51
	Parts list.....	3-52
	Schematic.....	8-103
	Chassis wiring, socket, trimmers.....	8-106
	Alignment, voltage.....	8-107
	Notes, parts.....	8-108
	Schematic, socket, trimmers, specifications.....	9-57
	R-F chassis wiring.....	9-58
	Lead dress, notes, trimmers, voltage.....	9-59
	Alignment, parts.....	9-60
	Schematic, chassis wiring, transformers.....	9-61
	Socket, trimmers, voltage, specifications, pick-up and motor details.....	9-62
	Lead dress, alignment, pick-up and motor notes, parts.....	9-63
	Data.....	Changes 9-6
	Schematic, chassis wiring.....	8-109
	Alignment, voltage, socket, trimmers.....	8-110
	Notes, parts.....	8-111
	Schematic, chassis wiring.....	8-113
	Notes, parts.....	8-112
	Alignment, socket, trimmers, voltage.....	8-114
	Changes.....	9-6

RAE-84	Specifications, parts.....	9-72
	Receiver chassis wiring.....	9-73
	Service notes.....	9-74
	Service notes.....	9-74
	AF Chassis wiring.....	9-75
	Assembly wiring diagram.....	9-76
	Parts list.....	9-77
	Schematic.....	8-130
	Chassis wiring, socket, trimmers.....	8-131
	Alignment, voltage.....	9-78
	Notes, parts.....	9-79
	Schematic, socket, trimmers, specifications, phonograph lead dress.....	9-80
	Voltage, alignment, parts.....	9-81
	Victrola attachment data.....	10-101
	Schematic.....	9-79
	Chassis wiring, lead dress, phonograph data.....	9-84
	Socket, voltage, trimmers, tuner.....	9-85
	Alignment, parts.....	9-86
	Victrola attachment data.....	10-101
	Data.....	Changes 10-4
	See model 87EY.....	8-133
	Schematic.....	8-132
	Alignment, parts.....	8-134
	Chassis wiring.....	8-134
	Voltage, socket, trimmers, notes.....	8-135
	Victrola attachment data.....	10-101
	Specifications, installation data.....	9-87
	Schematic, voltage, chassis wiring, notes, parts.....	9-88
	See model TRK-5.....	

85BT5	Schematic, chassis wiring.....	8-115
	Alignment, socket, trimmers.....	8-116
	Voltage, parts.....	8-117
	Victrola attachment data.....	10-101
	Schematic, socket, trimmers.....	8-119
	Notes, parts.....	8-118
	Chassis wiring.....	8-120
	Voltage, alignment.....	8-121
	Schematic.....	8-123
	Voltage, socket, trimmers.....	8-127
	Socket, trimmers, alignment.....	8-128
	Notes, parts.....	8-122
	Victrola attachment data.....	10-101
	Chassis wiring.....	8-124
	A-F Circuit schematics.....	1-51
	Schematic, data.....	1-52
	Assembly wiring.....	2-95
	See model 82 (Remote Control).....	
	See Radiola 82 Remote Control.....	
	Chassis wiring.....	8-126
	Alignment, parts.....	9-64
	Schematic, socket, trimmers, notes.....	9-65
	Chassis wiring, voltage, trimmers.....	9-66
	Victrola attachment data.....	10-101
	Schematic, specifications.....	9-67
	Chassis wiring, coils.....	9-68
	Socket, trimmers, lead dress, voltage, notes.....	9-69
	Alignment, parts.....	9-70
	Victrola attachment data.....	10-101
	Schematic, socket, trimmers, specifications, transformer data.....	9-71
	Chassis wiring, lead dress, phonograph.....	9-72
	Voltage, trimmers, tuner.....	9-73
	Alignment, parts.....	9-74
	Victrola attachment data.....	10-101
	Schematic, socket, chassis, wiring, trimmers.....	8-129
	Alignment, voltage.....	8-130
	Notes, parts.....	8-131
	Schematic, socket, trimmers, specifications.....	9-75
	Chassis wiring.....	9-76
	Alignment, phonograph data, lead dress.....	9-77
	Voltage, trimmers, parts.....	9-78
	Victrola attachment data.....	10-101
	Schematic.....	9-79
	Chassis wiring, coils.....	9-80
	Socket, trimmers, voltage, alignment, lead dress.....	9-81
	Specifications, phonograph data, parts.....	9-82
	Victrola attachment data.....	10-101
	Schematic.....	9-83
	Chassis wiring, lead dress, phonograph data.....	9-84
	Socket, voltage, trimmers, tuner.....	9-85
	Alignment, parts.....	9-86
	Victrola attachment data.....	10-101
	Data.....	Changes 10-4
	See model 87EY.....	8-133
	Schematic.....	8-132
	Alignment, parts.....	8-134
	Chassis wiring.....	8-134
	Voltage, socket, trimmers, notes.....	8-135
	Victrola attachment data.....	10-101
	Specifications, installation data.....	9-87
	Schematic, voltage, chassis wiring, notes, parts.....	9-88
	See model TRK-5.....	

85BK, 85BT	Specifications, parts.....	9-72
	Receiver chassis wiring.....	9-73
	Service notes.....	9-74
	Service notes.....	9-74
	AF Chassis wiring.....	9-75
	Assembly wiring diagram.....	9-76
	Parts list.....	9-77
	Schematic.....	8-130
	Chassis wiring, socket, trimmers.....	8-131
	Alignment, voltage.....	9-78
	Notes, parts.....	9-79
	Schematic, socket, trimmers, specifications, phonograph lead dress.....	9-80
	Voltage, alignment, parts.....	9-81
	Victrola attachment data.....	10-101
	Schematic.....	9-79
	Chassis wiring, lead dress, phonograph data.....	9-84
	Socket, voltage, trimmers, tuner.....	9-85
	Alignment, parts.....	9-86
	Victrola attachment data.....	10-101
	Data.....	Changes 10-4
	See model 87EY.....	8-133
	Schematic.....	8-132
	Alignment, parts.....	8-134
	Chassis wiring.....	8-134
	Voltage, socket, trimmers, notes.....	8-135
	Victrola attachment data.....	10-101
	Specifications, installation data.....	9-87
	Schematic, voltage, chassis wiring, notes, parts.....	9-88
	See model TRK-5.....	

85BK, 85BT	Specifications, parts.....	9-72
	Receiver chassis wiring.....	9-73
	Service notes.....	9-74
	Service notes.....	9-74
	AF Chassis wiring.....	9-75
	Assembly wiring diagram.....	9-76
	Parts list.....	9-77
	Schematic.....	8-130
	Chassis wiring, socket, trimmers.....	8-131
	Alignment, voltage.....	9-78
	Notes, parts.....	9-79
	Schematic, socket, trimmers, specifications, phonograph lead dress.....	9-80
	Voltage, alignment, parts.....	9-81
	Victrola attachment data.....	10-101
	Schematic.....	9-79
	Chassis wiring, lead dress, phonograph data.....	9-84
	Socket, voltage, trimmers, tuner.....	9-85
	Alignment, parts.....	9-86
	Victrola attachment data.....	10-101
	Data.....	Changes 10-4
	See model 87EY.....	8-133
	Schematic.....	8-132
	Alignment, parts.....	8-134
	Chassis wiring.....	8-134
	Voltage, socket, trimmers, notes.....	8-135
	Victrola attachment data.....	10-101
	Specifications, installation data.....	9-87
	Schematic, voltage, chassis wiring, notes, parts.....	9-88
	See model TRK-5.....	

85BK, 85BT	Specifications, parts.....	9-72
	Receiver chassis wiring.....	9-73
	Service notes.....	9-74
	Service notes.....	9-74
	AF Chassis wiring.....	9-75
	Assembly wiring diagram.....	9-76
	Parts list.....	9-77
	Schematic.....	8-130
	Chassis wiring, socket, trimmers.....	8-131
	Alignment, voltage.....	9-78
	Notes, parts.....	9-79
	Schematic, socket, trimmers, specifications, phonograph lead dress.....	9-80
	Voltage, alignment, parts.....	9-81
	Victrola attachment data.....	10-101
	Schematic.....	9-79
	Chassis wiring, lead dress, phonograph data.....	9-84
	Socket, voltage, trimmers, tuner.....	9-85
	Alignment, parts.....	9-86
	Victrola attachment data.....	10-101
	Data.....	Changes 10-4
	See model 87EY.....	8-133
	Schematic.....	8-132
	Alignment, parts.....	8-134
	Chassis wiring.....	8-134
	Voltage, socket, trimmers, notes.....	8-135
	Victrola attachment data.....	10-101
	Specifications, installation data.....	9-87
	Schematic, voltage, chassis wiring, notes, parts.....	9-88
	See model TRK-5.....	

85BK, 85BT	Specifications, parts.....	9-72
	Receiver chassis wiring.....	9-73
	Service notes.....	9-74
	Service notes.....	9-74
	AF Chassis wiring.....	9-75
	Assembly wiring diagram.....	9-76
	Parts list.....	9-77
	Schematic.....	8-130
	Chassis wiring, socket, trimmers.....	8-131
	Alignment, voltage.....	9-78
	Notes, parts.....	9-79
	Schematic, socket, trimmers, specifications, phonograph lead dress.....	9-80
	Voltage, alignment, parts.....	9-81
	Victrola attachment data.....	10-101
	Schematic.....	9-79
	Chassis wiring, lead dress, phonograph data.....	9-84
	Socket, voltage, trimmers, tuner.....	9-85
	Alignment, parts.....	9-86
	Victrola attachment data.....	10-101
	Data.....	Changes 10-4
	See model 87EY.....	8-133
	Schematic.....	8-132
	Alignment, parts.....	8-134
	Chassis wiring.....	8-134
	Voltage, socket, trimmers, notes.....	8-135
	Victrola attachment data.....	10-101
	Specifications, installation data.....	9-87
	Schematic, voltage, chassis wiring, notes, parts.....	9-88
	See model TRK-5.....	

85BK, 85BT	Specifications, parts.....	9-72
	Receiver chassis wiring.....	9-73
	Service notes.....	9-74
	Service notes.....	9-74
	AF Chassis wiring.....	9-75
	Assembly wiring diagram.....	9-76
	Parts list.....	9-77
	Schematic.....	8-130
	Chassis wiring, socket, trimmers.....	8-131
	Alignment, voltage.....	9-78
	Notes, parts.....	9-79
	Schematic, socket, trimmers, specifications, phonograph lead dress.....	9-80
	Voltage, alignment, parts.....	9-81
	Victrola attachment data.....	10-101
	Schematic.....	9-79
	Chassis wiring, lead dress, phonograph data.....	9-84
	Socket, voltage, trimmers, tuner.....	9-85
	Alignment, parts.....	9-86
	Victrola attachment data.....	10-101
	Data.....	Changes 10-4
	See model 87EY.....	8-133
	Schematic.....	8-132
	Alignment, parts.....	8-134
	Chassis wiring.....	8-134
	Voltage, socket, trimmers, notes.....	8-135
	Victrola attachment data.....	10-101
	Specifications, installation data.....	9-87
	Schematic, voltage, chassis wiring, notes, parts.....	9-88
	See model TRK-5.....	

85BK, 85BT	Specifications, parts.....	9-72
	Receiver chassis wiring.....	9-73
	Service notes.....	9-74
	Service notes.....	9-74
	AF Chassis wiring.....	9-75
	Assembly wiring diagram.....	9-76
	Parts list.....	9-77
	Schematic.....	8-130
	Chassis wiring, socket, trimmers.....	8-131
	Alignment, voltage.....	9-78
	Notes, parts.....	9-79
	Schematic, socket, trimmers, specifications, phonograph lead dress.....	9-80
	Voltage, alignment, parts.....	9-81
	Victrola attachment data.....	10-101
	Schematic.....	9-79
	Chassis wiring, lead dress, phonograph data.....	9-84
	Socket, voltage, trimmers, tuner.....	9-85
	Alignment, parts.....	9-86
	Victrola attachment data.....	10-101
	Data.....	Changes 10-4
	See model 87EY.....	8-133
	Schematic.....	8-132
	Alignment, parts.....	8-134
	Chassis wiring.....	8-134
	Voltage, socket, trimmers, notes.....	8-135
	Victrola attachment data.....	10-101
	Specifications, installation data.....	9-87
	Schematic, voltage, chassis wiring, notes, parts.....	9-88
	See model TRK-5.....	

85BK, 85BT	Specifications, parts.....	9-72
	Receiver chassis wiring.....	9-73
	Service notes.....	9-74
	Service notes.....	9-74
	AF Chassis wiring.....	9-75
	Assembly wiring diagram.....	9-76
	Parts list.....	9-77
	Schematic.....	8-130
	Chassis wiring, socket, trimmers.....	8-131
	Alignment, voltage.....	9-78
	Notes, parts.....	9-79
	Schematic, socket, trimmers, specifications, phonograph lead dress.....	9-80
	Voltage, alignment, parts.....	9-81
	Victrola attachment data.....	10-101
	Schematic.....	9-79
	Chassis wiring, lead dress, phonograph data.....	9-84
	Socket, voltage, trimmers, tuner.....	9-85
	Alignment, parts.....	9-86
	Victrola attachment data.....	10-101

MODEL	RCA MFG. CO., INC.—(Cont.)	REVISED PAGE	MODEL	RCA MFG. CO., INC.—(Cont.)	REVISED PAGE	
R-90	PA 90 A1 Amp.	Schematic, voltage, parts list...4-123 Chassis wiring...4-124 Schematic...3-53 Voltage, trimmers, speaker wiring, voltage...3-54 Alignment, data...4-49 Schematic, voltage, trimmers, speaker...4-50 Chassis wiring...4-51 Parts list...4-52 Schematic, chassis wiring...5-15 Capacitor adjustment, voltage, parts...5-16 Schematic, voltage...5-17 Chassis wiring...5-18 Assembly wiring, pickup adjustments...5-19 Pickup adjustments, parts list...5-20 Service notes...5-21 Pickup data, parts list...5-22 Models listing, connections...5-23 Schematic, motor details...5-24 Schematic, diagram, pickup wiring, details (Late), typical layout...7-158 Lead connections...7-159 Connection data, pickup data, parts...7-160 Pick-up details, schematics...8-137	95X, 95XL	Schematic, socket, alignment, chassis wiring, lead dress, parts...9-108 Schematic, socket, voltage, alignment, chassis wiring, specifications, tuner, lead dress...9-112 Schematic, tuner data...10-77	95X, 95XL	1947
R-90-P			95X1		1948	
91-B			96BK6, 96BT6, Chassis RC-392 with model CV-9 A-C S.P.U.			
R-92 Recorder			96E, 96T, 96T1			
R-93 Phonograph			96E2, 96K5, 96K6, 96T7, Chassis RC-351L, 97K2, 97T2, Chassis RC-351K			
R-98			96K, 96T2			
R-98 (3rd Production)			96K2, 96T3, 97E, 97K6, 97T			
R-99A, R-99-2, R-99-S, R-99			R-96, R-97			
94BK, 94BT			96T4, 96T5, Chassis RC-389, 96T6, Chassis RC-399A			
94BK1, 94BT1, Chassis RC-333B			96X1, 96X2, 96X3, 96X4, Chassis RC-400, 96X11, 96X12, 96X13, 96X14, Chassis RC-400A			
94BK2, 94BT2, Chassis RC-390			TMY-97-A Oscillator			
94BP4, Chassis RC-410			97K, Chassis RC-351F, RC-351F "M"			
94BP61, 94BP62, 94BP64, 94BP66, 94BP80, 94BP81, Chassis RC-407			97K, Chassis RC-351F, "R"			
94BT6			97K2, 97T2			
94BT61, Chassis RC-330						
94X						
94X1, 94X2						
95T						
95T5						

MODEL	RCA MFG. CO., INC.—(Cont.)	REVISÉD PAGE	EARLY COMPLETE PAGE	RADIOTRON
97X	Schematic, specifications, lead dress, notes, socket, trimmers, alignment, tuner	9-105		
97Y, Chassis RC352A, 98EY 98X 98YG, Chassis RC 352	Voltage, chassis wiring, drive cord data, notes, specifications	9-110		
98K	Socket, trimmers, parts, alignment, tuner, specifications, socket, trimmers	9-111		
	Voltage, lead dress, chassis wiring, notes, transformers, electric tuning, notes	9-113		
	Alignment, antenna data, parts	9-115		
R98, Chassis RS-77	Schematic, voltage, socket, speaker connections	9-116		
	Motor data, switch assembly, parts	10-95		
98T, 98K2, Chassis AC-386A	Schematic, socket, trimmers, transformer, speaker data	10-96		
	Voltage, chassis wiring, alignment, drive data	10-97		
	Dial calibration	10-98		
99K, 99T	Tuner adjustments, parts, schematic, socket, trimmers, transformers	10-99		
	Voltage, chassis wiring, tuner	9-117		
R-99	Lead dress, alignment, electric tuning data, specifications	9-118		
	Drive data, parts, notes	9-119		
	Schematic, loudspeaker	7-161		
	Chassis wiring, pickup, socket	7-162		
	Resistance, voltage	7-163		
	Motor adjustments, assembly wiring	7-164		
R-100 Victrola attachment	Circuit data, adjustments, parts	7-165		
	Motor data, tone compensation, pick-up details, receiver connections	10-100		
ROA-100, 101	Alignment, speaker, schematic, voltage	10-101		
100-A, 100-B, 103, 104 AC, Loudspeakers PB 100 B1 M-101	Chassis wiring, parts list	4-53		
	Schematic, socket, data	4-54		
	See Model Univ. Amp. PG 63	1-55		
	Schematic, transformer data	6-1		
	Alignment, voltage, socket, trimmers	6-2		
	Chassis wiring, service notes	6-3		
	Parts	6-4		
	Schematic	8-147		
	Alignment, socket, trimmers	8-148		
	Voltage	8-149		
	Parts	8-152		
	Chassis wiring	8-177		
	Motor details	8-149		
	Changes	9-6		
102	Schematic, chassis wiring	5-25		
	Voltage, parts list	5-26		
U102E 103	See model 85E			
	Schematic, voltage	6-5		
	Circuit data, socket, trimmers, voltage, alignment, parts	6-6		
	See 100-A Speaker			
	Schematic, voltage, parts list	5-231		
103, 104 AC Speakers PA-103-A1	Panel wiring	5-232		
	Chassis wiring	8-148		
	Automatic record changer, adjustments, details	8-150		
U-103	Motor details, notes	8-151		
	Changes	9-5		
	Schematic, socket, notes	3-6		
	General service notes, voltage	3-7		
	See Radiola 25, 28, 30			
	Circuit notes	6-8		
	Schematic, speaker wiring	6-9		
	Chassis wiring, voltage, socket, alignment, notes	6-10		
	Parts list	6-11		
	Schematic, voltage, chassis wiring, alignment, procedure	6-12		
	Chassis wiring, lead dress, pick-up, phono	10-103		
	Schematic, socket, wiring	1-56		
	Alignment data, voltage, service data	5-27		
	Installation data	5-28		
	Schematic, installation details	5-29		
	Installation details	5-30		
	Chassis wiring	5-31		
	Parts list	5-32		
	Chassis wiring	9-123		
	Automatic record changer details, adjustments and	9-124		
	Schematic	9-121		
	Circuit data, lead dress, pick-up data, specifications	9-122		
	Socket, trimmers, voltage, pick-up data, phonograph motor data	9-126		
	Alignment	9-127		
	Parts list	9-128		
	Schematic, specifications	9-129		
	Chassis wiring	9-130		
	Socket, trimmers, circuit data, notes	9-131		
	Automatic record changer adjustments, views, tuner	9-132		
	Alignment, transformer data, parts	9-133		
	Schematic, service details	5-33		
	Chassis wiring	5-34		
	Alignment data	5-35		
	Vibrator data, trimmer locations, socket	5-36		
	Voltage, chassis wiring	5-37		
	Parts list	5-38		
	Chassis wiring, coils	9-125		
	Automatic record changer adjustments, views, tuner	9-132		
	See Model M-104			
	Schematic	6-13		
	Chassis wiring	6-14		
	Alignment notes	6-15		
	Socket, trimmers, circuit notes	6-16		
	Parts list	6-17		
	Circuit data	9-134		
	Schematic	9-135		
	R-F Chassis wiring, coils, specifications	9-136		
	Power amplifier, chassis and tuner wiring	9-137		
	Voltage, socket, trimmers	9-138		
	Socket, trimmers, current readings	9-139		
	Lead dress, amplifier adjustments	9-140		
	Tuner mechanism, principles, adjustments	9-141		
	Tuner adjustments, Part 2	9-142		
	Alignment	9-143		
	Assembly wiring, compensator connections	9-144		
	Automatic record changer, views	9-145		
	Automatic record changer adjustments, data, pick-up data	9-146		

Alignment, voltage, trimmer locations4-66
Schematic4-67
Chassis wiring4-68
Parts list4-69
Schematic, chassis wiring, voltage10-107

U-121, Chassis RC-348J,
U-123, Chassis RC-348H
(Single Band), U-127E,
Chassis RC-348L

Alignment, socket, trimmers, phono data10-109
Automatic record changer ad-justments, notes10-110
Specifications, tuner data, record changer details10-111
Parts10-112
See model U119
Alignment data, voltage, trimmers5-47
Schematic, socket layout5-48
Service details5-49
Chassis wiring5-50
Vibrator data5-51
Parts list5-52
Schematic, chassis wiring, voltage10-108
Alignment, socket, trimmers, phono data10-109
Automatic record changer ad-justments, notes10-110
Specifications, tuner data, record changer details10-111
Parts10-112
Alignment data, voltage10-113
Schematic, chassis wiring5-54
Parts list5-55
See model U119
Schematic, speaker data6-29
Chassis wiring6-30
Alignment transformer data6-31
Socket, trimmers, voltage, parts, speaker wiring6-32
Victrola attachment data10-115
Schematic, voltage10-115
Alignment, tuner data10-114
Chassis wiring, voltage10-116
Socket, trimmers, speaker connections, drive data, transformer data, parts10-118
Automatic record changer ad-justments, data10-51
Record changer assembly, de-tails10-52
Parts10-117
See model U-121
Schematic, socket layout5-57
Chassis wiring5-58
Alignment data, voltage5-59
Parts list5-60
See model 910KG
Schematic, trimmer locations5-61
Chassis wiring5-62
Socket layout, voltage5-63
Alignment data, parts list5-64
Schematic, transformer data5-65
Chassis wiring5-66
Trimmer layout, socket layout, circuit data5-67
Alignment data5-68
Alignment data, part 25-69
Voltage, parts list5-70
Victrola attachment data10-101
Schematic, parts, speaker wiring6-33
Chassis wiring6-34
Victrola attachment data10-101

U122E
M-123

U-123, Chassis RC-421
(2 Bands)

124
U124
125, 325

U-125, Chassis RC-386

U-127E
126-B

U126
127
128, 224 (1934
Production)

128, 226 (1935 Produc-
tion)

Parts list9-147
Chassis wiring, coils9-148
Schematic9-149, 150
Tuner unit, chassis wiring, coils9-152
Socket trimmers, voltage, antenna9-153
R-F and I-F trimmers, sockets9-154
Alignment table9-155
Selectivity control curves9-156
Dial data, selectivity, speaker wiring9-157
Notes, operation9-158
Adjustment, notes9-159
Circuit data, transformer data9-160
Parts list9-161
Alignment, voltage, parts list4-35
Schematic, data, chassis wiring4-56
Schematic, voltage, chassis wiring9-169
Socket, trimmers, alignment, lead dress, phonograph data, parts9-170
Alignment, parts list4-57
Schematic, voltage, trimmer locations4-58
Chassis wiring4-59
DataChanges 10-4

RCA 110, 111, 115

U111

112 AC-DC 220 volts

U-112, Late U-111 and
U-112

114

U-115, Chassis RC-348E,
RC-348E "M," RC-348E
"MOD"

M-116

117, 214

118, 211

118, 211 (1935 Produc-
tion)

TMV-118-B

119

U119, U122E, U124

120

Voltage, alignment4-60
Schematic, chassis wiring4-61
Parts list4-62
Schematic, chassis wiring, socket, trimmers, voltage, transformer data10-105
Alignment, phono data, tuner adjustments*10-106
Parts10-104
Voltage, alignment data5-39
Chassis wiring5-40
Schematic5-41
Installation notes, parts list5-42
Circuit notes, loud speaker data, voltage, trimmers, socket wiring6-18
Schematic6-20
Alignment, parts6-21
Schematic, trimmer locations5-43
Chassis wiring5-44
Voltage, socket, loud speaker wiring5-45
Alignment data, parts list6-46
Parts list6-22
Schematic, voltage, speaker wiring6-23
Chassis wiring6-24
Schematic, socket, voltage, data7-167
Chassis wiring, transformer, data, regulating circuits7-168
Schematic6-25
Chassis wiring6-26
Trimmers, socket, voltage, alignment, circuit data6-27
wiring6-28
Schematics, specifications9-171
Voltage, chassis wiring, lead dress, transformer data9-172
Tuner and phonograph data9-173
Alignment, motor data, parts9-174
Alignment, voltage, speaker data4-63
Schematic, chassis4-64
Parts list4-65

118E, 224E
211
214
220, 222
221
228

See model 118
See model 117
Voltage, alignment, trimmer location 4-84
Schematic, chassis wiring 4-85
Parts list 4-86
Trimmer data, alignment, voltage 5-91
Chassis wiring 5-92
Schematic 5-93
Parts list 5-94
Circuit data, alignment, voltage 5-95
Noise suppression, assembly wiring 5-96
Schematic 5-97
Chassis wiring 5-98
SPU chassis wiring 5-99
Parts list 5-100

224 (1934 Production)
224E
225
226 (1935 Production)
235-B
236-B

See model 128
See model 128E
See model 125
See model 129 (1935 Production)
See model 135-B
Alignment, parts 6-48
Schematic, voltage, trimmers, socket 6-49
Chassis wiring 6-50
See model 140
See model 140 Revised
See model 142-B
See model 143
Alignment, voltage 4-87
Schematic, trimmers, speaker data 4-88
Chassis wiring 4-89
Parts list 4-90
Alignment, voltage, speaker wiring 4-91
Schematic, notes, trimmer location 4-92
Chassis wiring 4-93
Parts list 4-94
Circuit data 5-101
Socket and trimmer layouts 5-108
Alignment data 5-109
Voltage, parts list 5-110
Schematic 6-51
Chassis wiring 6-52
Schematic 6-53

240
240 Revised
241-B
242, 243
260

140, 141, 141-E, 240
Revised

Voltage, wave band data 5-76
Schematic, trimmers 5-77
Chassis wiring 5-78
Coils connections 5-79
Parts list 5-80
Alignment, voltage 4-77
Schematic 4-78
Chassis wiring 4-79
Parts list 4-80
Circuit data 5-81
Speaker data, circuit data 5-82
Alignment data, voltage 5-83
Trimmer layout, alignment data 5-84
Parts list 5-90
Socket layout, parts' schematics 5-87
Schematic 5-86
Chassis wiring 5-88
Schematic 5-85
Chassis wiring 5-89
Schematic, speakers 6-45
Chassis wiring 6-46
Parts list 6-47
Transformer and antenna data 9-162
Schematic, socket 9-163
Chassis wiring 9-164
Selectivity control curves 9-156
Voltage, trimmers, power ratings, band spread 9-165
Alignment, controls, circuit data 9-166
Controls data, antenna, parts 9-167
Parts list, concluded 9-168
Schematic 1-71
Alignment, voltage, speaker wiring 4-81
Schematic, chassis wiring 4-82
Parts list 4-83

142-B, 241-B

Alignment, voltage 4-77
Schematic 4-78
Chassis wiring 4-79
Parts list 4-80
Circuit data 5-81
Speaker data, circuit data 5-82
Alignment data, voltage 5-83
Trimmer layout, alignment data 5-84
Parts list 5-90
Socket layout, parts' schematics 5-87
Schematic 5-86
Chassis wiring 5-88
Schematic 5-85
Chassis wiring 5-89
Schematic, speakers 6-45
Chassis wiring 6-46
Parts list 6-47
Transformer and antenna data 9-162
Schematic, socket 9-163
Chassis wiring 9-164
Selectivity control curves 9-156
Voltage, trimmers, power ratings, band spread 9-165
Alignment, controls, circuit data 9-166
Controls data, antenna, parts 9-167
Parts list, concluded 9-168
Schematic 1-71
Alignment, voltage, speaker wiring 4-81
Schematic, chassis wiring 4-82
Parts list 4-83

143, 242

Alignment, voltage, speaker wiring 4-81
Schematic, chassis wiring 4-82
Parts list 4-83

148, 242 with Fidelity
Change

Alignment, voltage, speaker wiring 4-81
Schematic, chassis wiring 4-82
Parts list 4-83

143, 242 with Sensitivity
Change Control
143, 242, 243 (1935 Pro-
duction)

Alignment, voltage, speaker wiring 4-81
Schematic, chassis wiring 4-82
Parts list 4-83

ACR175

Alignment, voltage, speaker wiring 4-81
Schematic, chassis wiring 4-82
Parts list 4-83

Photophone SPU 206
210

Alignment, voltage, speaker wiring 4-81
Schematic, chassis wiring 4-82
Parts list 4-83

138E, 224E

Schematic, transformer data 6-35
Chassis wiring 6-36
Trimmers, socket, voltage, speakers 6-37
Alignment, voltage 6-38
Parts list 6-39
Victrola attachment data 10-101
Schematic, wiring charac-
teristics, parts list 7-170
Data 7-169
See model 910KG
See model U-30
See model HF-2
See model HF-6
See model HF-8
Schematic, trimmer layout 5-71
Socket layout, voltage 5-72
Chassis wiring 5-73
Alignment data, parts list 5-74
Parts list 6-40
Schematic, data 6-41
Chassis wiring 6-42
Socket, trimmers, voltage, alignment 6-43
Circuit data, voltage, trans-
former data 6-44
Alignment, voltage 4-70
Alignment, switch data 4-71
Schematic, voltage 4-72
Chassis wiring 4-73
Coil assembly wiring 4-74
Power transformer wiring 4-75
Parts list 4-76
Circuit data, alignment data 5-75
Voltage, wave band data 5-76
Schematic, trimmers 5-77
Chassis wiring 5-78
Coils connections 5-79
Parts list 5-80
Alignment, voltage 4-77
Schematic 4-78
Chassis wiring 4-79
Parts list 4-80
Circuit data 5-81
Speaker data, circuit data 5-82
Alignment data, voltage 5-83
Trimmer layout, alignment data 5-84
Parts list 5-90
Socket layout, parts' schematics 5-87
Schematic 5-86
Chassis wiring 5-88
Schematic 5-85
Chassis wiring 5-89
Schematic, speakers 6-45
Chassis wiring 6-46
Parts list 6-47
Transformer and antenna data 9-162
Schematic, socket 9-163
Chassis wiring 9-164
Selectivity control curves 9-156
Voltage, trimmers, power ratings, band spread 9-165
Alignment, controls, circuit data 9-166
Controls data, antenna, parts 9-167
Parts list, concluded 9-168
Schematic 1-71
Alignment, voltage, speaker wiring 4-81
Schematic, chassis wiring 4-82
Parts list 4-83

TMV-128-A

Alignment, voltage, speaker wiring 4-81
Schematic, chassis wiring 4-82
Parts list 4-83

U128
U-129
U-130
U132
U134
185-B, 235-B

Alignment, voltage, speaker wiring 4-81
Schematic, chassis wiring 4-82
Parts list 4-83

ACR-186

Alignment, voltage, speaker wiring 4-81
Schematic, chassis wiring 4-82
Parts list 4-83

140, 141, 141-E, 240,
AVR-1

Alignment, voltage, speaker wiring 4-81
Schematic, chassis wiring 4-82
Parts list 4-83

140, 141, 141-E, 240
Revised

Alignment, voltage, speaker wiring 4-81
Schematic, chassis wiring 4-82
Parts list 4-83

142-B, 241-B

Alignment, voltage, speaker wiring 4-81
Schematic, chassis wiring 4-82
Parts list 4-83

143, 242

Alignment, voltage, speaker wiring 4-81
Schematic, chassis wiring 4-82
Parts list 4-83

148, 242 with Fidelity
Change

Alignment, voltage, speaker wiring 4-81
Schematic, chassis wiring 4-82
Parts list 4-83

143, 242 with Sensitivity
Change Control
143, 242, 243 (1935 Pro-
duction)

Alignment, voltage, speaker wiring 4-81
Schematic, chassis wiring 4-82
Parts list 4-83

ACR175

Alignment, voltage, speaker wiring 4-81
Schematic, chassis wiring 4-82
Parts list 4-83

Photophone SPU 206
210

Alignment, voltage, speaker wiring 4-81
Schematic, chassis wiring 4-82
Parts list 4-83

341

Schematic 5-157
 Chassis wiring 5-158
 Socket and trimmer layouts 5-159
 Assembly wiring, circuit data 5-160
 Alignment data 5-161
 Alignment and pickup data 5-162
 Pickup data, record changer
 data 5-163
 Voltage, parts list 5-164
 Data Changes 84
 See model U-104
 See model U-115

342

RC-345H chassis
 RC-348E, RC-348E "M,"
 RC-348E "MOD",
 chassis
 RC-348H chassis
 RC-348J chassis
 RC-348L chassis
 RC-351F, RC-351F "M,"
 RC-351F "R," chassis
 RC-351K chassis
 RC-351L chassis
 RC-357K chassis
 RC-357K chassis
 Duo 380

See model U-123 (Single Band)
 See model U-121
 See model U-127E
 See model 97K
 See model 97K2
 See model 96E2
 See model M 50
 See model M 60
 Alignment data, voltage 5-171
 Phonograph data 5-172
 Schematic 5-173
 Pickup data 5-174
 Chassis wiring 5-175
 Assembly wiring, record
 changer data 5-176
 Parts list 5-177
 Parts list, part 2 5-178
 Alignment data 5-179
 Schematic 5-180
 Chassis wiring 5-181
 A-F circuits 5-182
 Assembly wiring 5-183
 Pickup data 5-184
 Phonograph data 5-185
 Phonograph data, voltage 5-186
 Neon lamp and switching data,
 record changer data 5-187
 Parts list 5-188
 Schematic 5-189
 R-F assembly wiring 5-190
 Chassis wiring 5-191
 A-F circuits 5-192
 Assembly wiring 5-193
 Circuit data, record changer
 data 5-194
 Circuit data 5-195
 Alignment data 5-196
 Alignment data, part 2 5-197
 Neon lamp test, voltage 5-198
 Pickup data, socket layout 5-199
 Pickup data, part 2 5-200
 Parts list 5-201
 Parts list, part 2 5-202

See model 981
 See model 94BK2
 See model 96BK6
 See model M70
 See model 5Q5A
 See model 96T4
 See model 96T6
 See model 96X1
 See model 96X11
 See model 9TX21
 See model U8M
 See model 9TX31
 See model 5X51
 See model 94BP61
 See model BT40
 See model 94BP4
 See model 5Q5A
 See model U-50
 See model U-123 (2 Bands)
 See model TRK-12
 See model TRK-9

Duo 880-HR

Duo 881

RC-386 chassis
 RC-386A chassis
 RC-390 chassis
 RC-392 chassis
 RC-394 chassis
 RC-396 chassis
 RC-399 chassis
 RC-399A chassis
 RC-100 chassis
 RC-103, RC-403A chassis
 RC-404A chassis
 RC-405, 405A, 405B chassis
 RC-406 chassis
 RC-407 chassis
 Chassis RC-408
 RC-410 chassis
 RC-414A chassis
 RC-414C chassis
 RC-421 chassis
 RC-427 chassis
 RC-427A chassis

300

Assembly wiring 4-101
 Phonograph motor data 4-102
 Schematic, chassis wiring 5-119
 Voltage, alignment, pickup
 data 5-120

301

Assembly wiring, phonograph
 data 5-121
 Parts list 5-122
 Alignment, pickup data 4-103
 Schematic, chassis wiring 4-104
 Assembly wiring 4-105
 Voltage, parts list 4-106
 Alignment data, voltage 5-123
 Schematic 5-124
 Chassis wiring 5-125
 Assembly wiring 5-126
 Pickup data 5-127
 Parts list 5-128
 Alignment data, voltage 5-129
 Schematic 5-130
 Chassis wiring 5-131
 Assembly wiring 5-132
 Pickup data 5-133
 Parts list 5-134
 Parts list 6-60
 Schematic 6-61
 Chassis wiring 6-62
 Assembly wiring, transformer
 data 6-63
 Alignment, trimmers 6-64
 Pickup data, voltage, socket 6-65
 Parts list 6-66
 Schematic, speaker data 6-67
 Chassis wiring 6-68
 Assembly wiring, transformer
 data 6-69
 Trimmers, alignment 6-70
 Pickup data, voltage, socket 6-71
 Schematic 5-135
 Chassis wiring 5-136
 Voltage, alignment, assembly
 wiring 5-137
 Pickup data, trimmer and
 socket layouts 5-138
 Pickup data 5-139
 Parts list 5-140
 Alignment, voltage, trimmer
 location 4-107
 Schematic, voltage 4-108
 Chassis wiring 4-109
 Assembly wiring 4-110
 Pickup data 4-111
 Parts list 4-112
 Schematic 4-114
 Chassis wiring 4-115
 Assembly wiring 4-116
 Voltage, alignment, trimmer
 location 4-113
 Record changer data 4-117
 Parts list 4-118
 See model 94BK1
 See model U30

302-E

Schematic 5-141
 Chassis wiring diagram 5-142
 Coils' wiring diagram 5-143
 Assembly wiring, alignment,
 voltage 5-144
 Alignment data 5-145
 Controls data, transformer
 data 5-146
 Pickup data 5-147
 Parts list 5-148
 Schematic 5-149
 Chassis wiring 5-150
 Coils' wiring diagram 5-151
 Assembly wiring, voltage,
 circuit data 5-152
 Alignment data 5-153
 Transformer data 5-154
 Pickup data 5-155
 Parts list 5-156

303

RC-333B Chassis
 RC-335K, RC-335KR
 "All Wave Duo" 840,
 340-E

310

Duo 820

Duo 821

Duo 822

327

880

331

840, 840-E

#G	Schematic	10-3
	Socket, trimmers, alignment	10-4
	Schematic, socket, trimmers, alignment	9-6
L-5 Chassis	See model 6-Tube Batt. Super	
	Schematic, socket, trimmers, alignment	9-7
L-6 Chassis	Schematic, socket, trimmers, alignment, voltage	8-1
7A	Schematic, socket, trimmers	9-8
7G	Alignment	9-7
	Schematic, socket, trimmers, alignment, tuner data	9-9
L-7 Chassis	Schematic, socket, trimmers, alignment, voltage, socket	8-2
X8	Schematic, alignment	10-5
55 Auto	Schematic, socket, trimmers, tuner	9-10
69 Auto	Schematic, socket, trimmers, alignment	9-1

RADIO PRODUCTS SALES CO.

140, 170 Clipper	Schematic, voltage, alignment	Misc. 8-7
178 Clipper	Schematic, voltage, alignment	Misc. 8-7

RADIO RECEPTOR CO.

PMA-1	Schematic	2-1
PMA-2	Schematic	3-1
AK, R-20	Schematic	3-2
	Misc.	6-28
R 25-59	Schematic	6-28
P-50-W	Schematic	2-1
PX-245	Schematic	3-2
PYP-245	Schematic	3-1
PYP-250	Schematic	3-1

RADIO VISION CORP.

AX96	Schematic	Misc. 8-10
-------------	-----------	------------

RADIOBAR CO. OF AMERICA

505	Schematic	4-1
508, 528, 210-B	Schematic	4-1
510 w/46s	Schematic	4-2
510 w/59s	Schematic	4-2
510	Service notes	4-3

RADIOIROPE

G Console	Schematic, socket	3-2
R Console	Schematic, wiring diagram	3-2
S-2 (2 types)	Schematic, socket, voltage	3-1
27-R, Early and late	Schematic, socket, voltage	1-2
62, 64	Schematic, socket, voltage	3-3
70-R	See U. S. Radio & Television	
71-R, 72-R, 73-R	Series 1	
	Series 8	
74-R (1st type)	Schematic, socket, voltage	8-4
74-R (2nd type)	Schematic, socket, voltage	1-1

RADOLEK

Little Leader	Schematic	3-4
Little Master	Schematic	3-4
Monroe-Marvelo Tritone	Schematic	3-1
Marvelo-Tri-Dynamic	Schematic	3-2
Octomatic	Schematic	6-1
3-Watt A-C Amplifier	Schematic	6-2
15-Watt A-C Amplifier	Schematic	6-1
30-Watt A-C Amplifier	Schematic	6-2
3-tube Deluxe	Schematic	3-3
3-tube Super Compact	Schematic	3-3

Reaco 8	Schematic	Misc. 4-7
Reaco SW-5 AC	Schematic	Misc. 4-7

RADIO MFG. ENGINEERS, INC.

RME LS-1 Noise Suppressor	Schematic	10-1
RME LS-2 Noise Suppressor	Schematic	10-1
RME DB-20 Amplifier	Schematic	10-1
RME-69	Schematic	Misc. 7-10
	Socket, trimmers, controls	10-2
	Chassis, trimmers, panel	10-3
	Alignment, Part 1	10-4
	Alignment, Part 2	10-5
	Alignment, Part 3	10-6
RME 69-A, AC or Battery	Parts	8-1
RME 69-B Battery	Parts	8-2

RADIO PRODUCTS CO.

Dayrad HR	Schematic	3-1
Dayrad 8-80	Schematic	1-1
11-A Tester	Schematic	4-3
Dayrad 21 Output Meter	Schematic	1-2
31 Oscillator	Schematic	4-3
51 (3001-W) Tester	Schematic	4-2
Dayrad 180	Schematic	3-1
Dayrad 809 Volt-Ohm-meter	Schematic	3-2
830-Mmf. Oscillator	Schematic	1-2
Dayrad 400-W Output-meter	Schematic	3-2
Dayrad 870	Schematic	3-1
Dayrad 875	Schematic	3-1
3151 Tester	Schematic	4-1

RADIO PRODUCTS CORP.

6-Tube AG Super, Chassis A-1	Schematic, voltage, socket, trimmers	7-1
	Alignment, parts list	7-2
6-Tube AC-DC Super, Chassis B-2	Schematic, socket, trimmers	7-3
	Alignment, parts list	7-4
6-Tube AC Super, Chassis L-2	Schematic	7-5
6-Tube AC-AW Super, Chassis Z-3	Schematic, voltage, socket, trimmers	7-7
	Alignment, parts list	7-8
6-Tube Batt. Super, Chassis Z-5	Schematic, socket, trimmers	7-9
	Alignment, parts	7-10
7-Tube AC Super, Chassis L-4	Schematic	7-6
A-1 Chassis	See model 5-Tube AC Super	
M-1 Chassis	Schematic, socket, trimmers, alignment, voltage	8-3
B-2 Chassis	See model 6-Tube AC-DC Super	
L-2 Chassis	See model 6-Tube AC Super	
Z-2 Chassis	Schematic, socket, trimmers, alignment, voltage	8-4
Z-3 Chassis	See model 6-Tube AC-AW Super	
A-3	Schematic, trimmers, socket, alignment	10-1
4A	Schematic, socket, trimmers, alignment	9-1
4H	Schematic, trimmers, socket, alignment	10-2
L-4 Chassis	See model 7-Tube AC Super	
Z-4 Chassis	Schematic, socket, trimmers, alignment	9-2
5A	Schematic, socket, trimmers, alignment, tuner	9-3
5C	Schematic, socket, trimmers, alignment	9-4
5CPH	Schematic, socket, trimmers, alignment	9-4
5E	Schematic, socket, trimmers	9-5
5F	Alignment	10-3
	Alignment	9-1
	Socket, trimmers	10-4

RADOLEK (Cont.)		REMLER CO., LTD.—(Cont.)		RADIOTRON	
MODEL	REVISION PAGE	MODEL	REVISION PAGE	MODEL	REVISION PAGE
Schematic	3-3	Schematic, socket, voltage,		11	
Schematic	3-2	chassis layouts	3-4		2013
Schematic	3-1	Schematic, socket, chassis,		14	
Schematic	3-2	chassis layouts			2012
Schematic	2-1	voltage, data			2012
Schematic	2-1	Schematic, socket, voltage,			2011
Schematic	2-1	chassis layout			2015
Schematic	3-1	Chassis. See model 10			
Schematic	2-1	Schematic, socket, voltage		19, 21	
Schematic	2-1	Schematic, socket, voltage		19	
Schematic	2-1	Schematic, socket, voltage		21	
Schematic	4-2	Schematic, socket, voltage		21-3	
Schematic	4-2	Schematic, socket, voltage		21-4	
Schematic	4-2	Schematic, voltage, alignment		26 A-C-DC	
Schematic	4-2	notes			2011
Schematic	8-2	Schematic, voltage, service			2015
Schematic	8-2	Schematic, voltage, alignment	8-6	26, Above Serial 54760	
Schematic	8-2	Schematic, voltage, alignment	6-1	27	
Schematic	5-1	Schematic, voltage, alignment	4-2	28 "Scottie," Above Serial	
Schematic	5-2	Schematic, voltage, alignment	9-1	77089	
Schematic	5-3	Schematic	1-2	29	
Schematic	5-4	Schematic, voltage, alignment	4-3	30, 40	
Schematic	5-5	Schematic, socket, voltage,		35 Auto	
Alignment data	5-6	installation	5-3		
Schematic, notes	7-1	Schematic, chassis, voltage	6-2	36	
Schematic, notes	7-2	Schematic, socket, voltage	7-1	37	
Schematic, notes	7-4	Schematic, voltage, align-		39, Above serial 115439	
Schematic	7-5	ment	10-1		
Schematic	5-7	Schematic	2-1	40 KC	
Alignment, voltage	5-8	Schematic, voltage, align-		40, Above Serial 53410	
Schematic	5-11	ment	6-3		
Schematic	5-9	Schematic, voltage, data	7-2	40 (Late), Beginning	
Schematic	5-10	Schematic, voltage, data		Serial #66746	
Schematic, voltage	5-12	Schematic, voltage, data		41, Beginning Serial	
Schematic, voltage, alignment	5-13	Schematic, voltage, data		#60411	
Schematic, voltage, alignment	5-13	Schematic, voltage, align-		42, Above Serial 53968	
Schematic, voltage	5-14	ment	6-4		
Schematic, voltage, alignment	5-12	Schematic, voltage, data		42SW, Beginning Serial	
Schematic, service data	5-11	Schematic, voltage, changes,		#57061	
Schematic, socket	7-7	data	7-4	43, Beginning Serial	
Schematic, notes	7-7	Schematic, voltage, data		#62761	
Schematic, alignment	7-8	Schematic, voltage, data		44, Early Serial	
Schematic	7-9	Schematic, voltage, data		#68915, Late, Serial	
Schematic, alignment	7-9	Schematic, voltage, data		#69773	
Schematic, alignment	7-10	Schematic, voltage, data		45, Beginning Serial	
Schematic, alignment	7-10	Schematic, voltage, trimmers,		#72409	
Schematic	3-1	alignment	8-1	46, Above Serial #83786	
Schematic	3-1	Schematic, voltage, alignment	9-1		
Schematic	3-1	Schematic, voltage, alignment	9-2	46 "Scottie," Serials	
Schematic	2-1	Schematic, voltage, alignment	9-2	9, 35, 15, 10, 107767	
Schematic	2-1	Schematic, voltage, alignment	9-2	46 "Scottie," Above	
Schematic	2-1	Schematic, voltage, alignment	9-2	Serial 107767	
Schematic	3-2	Schematic, voltage, alignment	9-3	47, "Worldwide Scottie,"	
Schematic	4-1	Schematic		Above Serial 92942	
Schematic	3-2	Schematic, parts	8-3	49, J71 Beginning Serial	
Schematic	2-2	SC-50, SWC-50 call-back		115014	
Schematic	2-2	connections	8-3	M-50 Communication Sys-	
Schematic	3-1	X-50 Switch wiring	8-3	tem	
Schematic	3-2	7-SC cable and 18T Terminal	8-4		
Schematic	4-2	Box wiring, data	8-5		
Schematic	4-2	Master unit, call-back switch	8-6		
Schematic	4-2	wiring, data	8-6		
Schematic	2-2	Installation, operation	8-8		
Schematic	2-2	Schematic, voltage, data	7-5		
Schematic	3-2	Schematic, voltage, trimmers,			
Schematic	3-2	alignment	8-1		
Schematic	3-1	Schematic, voltage, align-		51	
Schematic	1-2	ment	6-5	52, Above Serial #78143	
Schematic	2-1	Schematic, voltage, align-		53, Above Serial 54862	
Schematic, socket, voltage	3-2	Schematic, voltage, align-		53-C, Above Serial 56208	
Chassis layouts, trimmers	3-1	Schematic, voltage, align-		55, Above Serial 114626	
Schematic, voltage	2-2	Schematic, voltage, alignment,		60, Beginning Serial	
Alignment, data	4-1	tuner	9-4	#72250	
Schematic, voltage, socket,	5-1	Schematic, voltage, data	7-6	61, Above Serial 113701	
alignment		Schematic, voltage, data		62, Beginning Serial	
				#60600	

RADOLEK (Cont.)		REMLER CO., LTD.	
MODEL	REVISION PAGE	MODEL	REVISION PAGE
7-tube Super		Schematic	3-1
Marvelo 7-tube Super		Schematic	3-1
9-tube Battery Super		Schematic	3-1
Radolek 10-tube Super		Schematic	2-1
Marvelo 6 Midget		Schematic	2-1
Marvelo-Monroe 6-7		Schematic	3-2
Marvelo-Monroe 8-9		Schematic	4-1
Monroe-Marvelo 30		Schematic	3-2
35 Common Talk System		Schematic	2-2
45 Selective System		Schematic	3-1
SR-230		Schematic	3-2
SR-233		Schematic	2-2
SR-234		Schematic	2-2
SR-236		Schematic	3-2
SR-241 Amplifier		Schematic	3-1
SR-247 Amplifier		Schematic	3-2
951		Schematic	3-1
956		Schematic	3-1
958		Schematic	3-1
10926		Schematic	3-1
10927		Schematic	3-1
10928		Schematic	3-1
10931		Schematic	3-1
10943		Schematic	3-1
10951		Schematic	3-1
10953		Schematic	3-1
10956		Schematic	3-1
10962		Schematic	3-1
10963 (60 cycles)		Schematic	3-1
10964 (25 cycles)		Schematic	3-1
10966		Schematic	3-1
10967		Schematic	3-1
10968, 92 v. D.C.		Schematic	3-1
10969		Schematic	3-1
10970		Schematic	3-1
11908		Schematic	3-1
11910		Schematic	3-1
11911		Schematic	3-1
11935		Schematic	3-1
11947		Schematic	3-1
6		Schematic	3-1
15		Schematic	3-1
245		Schematic	3-1
400 Tube Tester		Schematic	3-1
405 Tube Checker		Schematic	3-1
407 Tube Tester		Schematic	3-2
410 Tube Checker		Schematic	4-1
502 Ohmmeter		Schematic	3-2
550 Oscillator		Schematic	2-2
600, 700 Testers		Schematic	2-2
610, 710 Set Analyzer		Schematic	3-1
705 Set Tester Adapter		Schematic	3-2
710 Set Tester		Schematic	4-2
800 Capacity Meter		Schematic	2-2
850 Capacity Meter		Schematic	2-2
900 Elec. Refrigerator		Schematic	3-2
Tester		Schematic	3-2
1000 Set Tester		Schematic	3-1
Best 115 KC.		Schematic	3-1
"Scottie"		Schematic	1-2
"Worldwide Scottie"		Schematic	2-1
1927 Infradyne		Schematic	2-1
1928 Infradyne		Schematic	3-2
10		Schematic	3-2
10, 11, 15, 19, 21 Su-		Chassis layouts, trimmers	3-1
pers		Schematic, voltage	2-2
10-3		Alignment, data	4-1
10-4		Schematic, voltage, socket,	5-1
		alignment	

REMLER SEARS-ROEBUCK

RADIOTRON
EARLY COMPLETE PAGE

MODEL	REVISÉD PAGE	EARLY COMPLETE PAGE
63, Beginning Serial #69116	Schematic, voltage, data 7-7	712-H
64, Beginning Serial #79514	Schematic, voltage, data 7-7	712-I
65, Above Serial 109217	Schematic, voltage, alignment 9-4	712-I
M-70 Communication System	Master unit and S-50 secondary unit wiring 8-7	712-J
	Installation, operation 8-8	712-K
71, Beginning Serial #75639	Schematic, voltage, data 7-2	712-L
72, Above Serial 104459	Schematic, voltage, alignment, data 9-5	
73	Schematic, voltage, tuner, alignment 10-3	*713
88	Schematic, data 7-8	
89, 89C, Above Serial 99582	Schematic, voltage, alignment, phonograph 9-6	
91, Beginning Serial #72535	Schematic, data 7-8	
140, 170 Norco	Schematic, voltage, alignment Misc. 8-8	
171	See model 49	
178 Norco	Schematic, voltage, alignment Misc. 8-8	
179, Above Serial 113701	Schematic, alignment 10-4	

RADIOTRON
EARLY COMPLETE PAGE

MODEL	REVISÉD PAGE	EARLY COMPLETE PAGE
PAM-22	Schematic	2050
PAM-23	Schematic	2051
PAM-24	Schematic	2051
PAM-25	Schematic	2051
PAM-25-D	Schematic	2051
PAM-29	Schematic	2052
PAM-39	Schematic	2052
PAM-45	Schematic	2053
PAM-48	Schematic	2053
PAM-59	Schematic	2054
MIX-80	Schematic	2055
PAM-80	Schematic	2055
S-100	Schematic	2048

E. M. SARGENT CO.

Schematic, notes Misc. 7-9

SAVIL RADIO ENGINEERING CORP.

557 Schematic 4-1

589 Schematic 4-1

715 Schematic 4-2

SCOTT TRANSFORMER CO.

All-Wave Super, Receiver Schematic 2-3

Scott's Symphony AC Chassis wiring 2-2

1933 DeLuxe AVC Super Schematic, power supply, re-cording, mechanism and schematic 3-1

Shield Grid 9 Schematic 3-2

World Record 10 Schematic 2-1

World Record, Shield-Grid 10 AC Schematic 3-1

All-Wave Super, 145 Power Pack Schematic, chassis wiring 2-4

All-Wave Super, 150 Power Pack Chassis views, schematic, control box 1-5

REPUBLIC INDUSTRIES

MS & Jr. Schematic, notes Misc. 3-7

Sky Hawk Patricia Schematic Misc. 6-12

BP-5E Schematic, voltage, socket 5-1

TR-5B Schematic, voltage, socket 5-4

"Skyhawk" RC-5, RC-6 Schematic 4-1

"Skyhawk" SL-5-D Schematic, voltage, socket 4-2

CS-6 Schematic, voltage, socket 4-3

"Skyhawk" SL-6 Schematic, voltage, socket 4-4

"Skyhawk" SL-6-D Schematic, voltage, socket 5-3

42 Schematic, socket, voltage, parts 7-1

51 Schematic, socket, voltage, parts 7-2

ROCKE INTERNATIONAL ELECTRIC CORP.

Arlab 51 Schematic Misc. 4-8

BOOTH'S AUTO RADIO MFG. CORP.

55 Auto Schematic, data Misc. 5-16

ROYAL

Schematic Misc. 5-17

SAMSON ELECTRIC CO.

Amplifier Schematic 1-1

MIX-1 Schematic 2-12

MIX-1D Schematic 2-12

PAM-1 Schematic 2-1

HA-2 Schematic 2-12

PABC-2 Schematic 2-2

PABC-3 Schematic 2-2

PABC-4 Schematic 1-3

PABC-5 Schematic 1-3

PAM-5 Schematic 2-3

PAM-5-D Schematic 2-3

PAM-8, 18 Schematic 2-4

PAM-9 Schematic 2-4

PAM-11, 12, 13, 14 Schematic 2-5

PAM-16, 17 Schematic 2-6

PAM-16-N, 17-N Schematic 2-6

PAM-19 Schematic 1-1

PAM-19-N Schematic 2-7

PAM-19-Q Schematic 2-7

SEARS-ROEBUCK & CO.

General Notes Alignment data 5-2

Loud Speakers Repair notes 5-14

Wave Trap Cone replacement data 5-54

9-Tube Superhet-AVO Data Changes 8-5, 8-6

Silvertone E See Sentinel 114 Schematic, socket 3-14

Silvertone FF Schematic, socket 3-14

Silvertone G Schematic, socket 3-15

Silvertone J Schematic 3-16

A1 Schematic, voltage, socket, trimmers, alignment 9-1

36 Schematic, socket 10-14

36-P Schematic, socket 10-14

44, 45, 90 Schematic, voltage 7-3

46-47, 91 Schematic, voltage 5-1

49-50, 92 Schematic, voltage 7-3

52, 95 Schematic, voltage 6-1

53, 54, 94, 99 Socket trimmers, chassis views 9-2

56, 100 Schematic, voltage 6-1

90 Schematic, voltage 6-2

91 See model 44

92 See model 46

93 See model 51

94 See model 51

95 See model 52

96 Note 7-3

99 See model 53

100 See model 56

Silvertone 105, F Schematic, socket 3-14

106 Schematic, voltage 6-3

107 Schematic, voltage 6-3

108 Schematic, socket, voltage 2-17

Silvertone, 109, 218 Schematic, voltage 6-3

110 Schematic, voltage 6-4

111 Schematic, voltage 6-4

112 Schematic, voltage 6-4

SEARS-ROEBUCK & CO.

General Notes Alignment data 5-2

Loud Speakers Repair notes 5-14

Wave Trap Cone replacement data 5-54

9-Tube Superhet-AVO Data Changes 8-5, 8-6

Silvertone E See Sentinel 114 Schematic, socket 3-14

Silvertone FF Schematic, socket 3-14

Silvertone G Schematic, socket 3-15

Silvertone J Schematic 3-16

A1 Schematic, voltage, socket, trimmers, alignment 9-1

36 Schematic, socket 10-14

36-P Schematic, socket 10-14

44, 45, 90 Schematic, voltage 7-3

46-47, 91 Schematic, voltage 5-1

49-50, 92 Schematic, voltage 7-3

52, 95 Schematic, voltage 6-1

53, 54, 94, 99 Socket trimmers, chassis views 9-2

56, 100 Schematic, voltage 6-1

90 Schematic, voltage 6-2

91 See model 44

92 See model 46

93 See model 51

94 See model 51

95 See model 52

96 Note 7-3

99 See model 53

100 See model 56

Silvertone 105, F Schematic, socket 3-14

106 Schematic, voltage 6-3

107 Schematic, voltage 6-3

108 Schematic, socket, voltage 2-17

Silvertone, 109, 218 Schematic, voltage 6-3

110 Schematic, voltage 6-4

111 Schematic, voltage 6-4

112 Schematic, voltage 6-4

REPUBLIC INDUSTRIES

MS & Jr. Schematic, notes Misc. 3-7

Sky Hawk Patricia Schematic Misc. 6-12

BP-5E Schematic, voltage, socket 5-1

TR-5B Schematic, voltage, socket 5-4

"Skyhawk" RC-5, RC-6 Schematic 4-1

"Skyhawk" SL-5-D Schematic, voltage, socket 4-2

CS-6 Schematic, voltage, socket 4-3

"Skyhawk" SL-6 Schematic, voltage, socket 4-4

"Skyhawk" SL-6-D Schematic, voltage, socket 5-3

42 Schematic, socket, voltage, parts 7-1

51 Schematic, socket, voltage, parts 7-2

ROCKE INTERNATIONAL ELECTRIC CORP.

Arlab 51 Schematic Misc. 4-8

BOOTH'S AUTO RADIO MFG. CORP.

55 Auto Schematic, data Misc. 5-16

ROYAL

Schematic Misc. 5-17

SAMSON ELECTRIC CO.

Amplifier Schematic 1-1

MIX-1 Schematic 2-12

MIX-1D Schematic 2-12

PAM-1 Schematic 2-1

HA-2 Schematic 2-12

PABC-2 Schematic 2-2

PABC-3 Schematic 2-2

PABC-4 Schematic 1-3

PABC-5 Schematic 1-3

PAM-5 Schematic 2-3

PAM-5-D Schematic 2-3

PAM-8, 18 Schematic 2-4

PAM-9 Schematic 2-4

PAM-11, 12, 13, 14 Schematic 2-5

PAM-16, 17 Schematic 2-6

PAM-16-N, 17-N Schematic 2-6

PAM-19 Schematic 1-1

PAM-19-N Schematic 2-7

PAM-19-Q Schematic 2-7

REPUBLIC INDUSTRIES

MS & Jr. Schematic, notes Misc. 3-7

Sky Hawk Patricia Schematic Misc. 6-12

BP-5E Schematic, voltage, socket 5-1

TR-5B Schematic, voltage, socket 5-4

"Skyhawk" RC-5, RC-6 Schematic 4-1

"Skyhawk" SL-5-D Schematic, voltage, socket 4-2

CS-6 Schematic, voltage, socket 4-3

"Skyhawk" SL-6 Schematic, voltage, socket 4-4

"Skyhawk" SL-6-D Schematic, voltage, socket 5-3

42 Schematic, socket, voltage, parts 7-1

51 Schematic, socket, voltage, parts 7-2

ROCKE INTERNATIONAL ELECTRIC CORP.

Arlab 51 Schematic Misc. 4-8

BOOTH'S AUTO RADIO MFG. CORP.

55 Auto Schematic, data Misc. 5-16

ROYAL

Schematic Misc. 5-17

SAMSON ELECTRIC CO.

Amplifier Schematic 1-1

MIX-1 Schematic 2-12

MIX-1D Schematic 2-12

PAM-1 Schematic 2-1

HA-2 Schematic 2-12

PABC-2 Schematic 2-2

PABC-3 Schematic 2-2

PABC-4 Schematic 1-3

PABC-5 Schematic 1-3

PAM-5 Schematic 2-3

PAM-5-D Schematic 2-3

PAM-8, 18 Schematic 2-4

PAM-9 Schematic 2-4

PAM-11, 12, 13, 14 Schematic 2-5

PAM-16, 17 Schematic 2-6

PAM-16-N, 17-N Schematic 2-6

PAM-19 Schematic 1-1

PAM-19-N Schematic 2-7

PAM-19-Q Schematic 2-7

RADIOTRON
EARLY COMPLETE PAGE

63, Beginning Serial #69116 Schematic, voltage, data 7-7

64, Beginning Serial #79514 Schematic, voltage, data 7-7

65, Above Serial 109217 Schematic, voltage, alignment 9-4

M-70 Communication System Master unit and S-50 secondary unit wiring 8-7

Installation, operation 8-8

71, Beginning Serial #75639 Schematic, voltage, data 7-2

72, Above Serial 104459 Schematic, voltage, alignment, data 9-5

73 Schematic, voltage, tuner, alignment 10-3

88 Schematic, data 7-8

89, 89C, Above Serial 99582 Schematic, voltage, alignment, phonograph 9-6

91, Beginning Serial #72535 Schematic, data 7-8

140, 170 Norco Schematic, voltage, alignment Misc. 8-8

171 See model 49

178 Norco Schematic, voltage, alignment Misc. 8-8

179, Above Serial 113701 Schematic, alignment 10-4

RADIOTRON
EARLY COMPLETE PAGE

63, Beginning Serial #69116 Schematic, voltage, data 7-7

64, Beginning Serial #79514 Schematic, voltage, data 7-7

65, Above Serial 109217 Schematic, voltage, alignment 9-4

M-70 Communication System Master unit and S-50 secondary unit wiring 8-7

Installation, operation 8-8

71, Beginning Serial #75639 Schematic, voltage, data 7-2

72, Above Serial 104459 Schematic, voltage, alignment, data 9-5

73 Schematic, voltage, tuner, alignment 10-3

88 Schematic, data 7-8

89, 89C, Above Serial 99582 Schematic, voltage, alignment, phonograph 9-6

91, Beginning Serial #72535 Schematic, data 7-8

140, 170 Norco Schematic, voltage, alignment Misc. 8-8

171 See model 49

178 Norco Schematic, voltage, alignment Misc. 8-8

179, Above Serial 113701 Schematic, alignment 10-4

**RADIOTRON
EARLY COMPLETE
PAGE**

SEARS-ROEBUCK & CO.—(Cont.)

**RADIOTRON
EARLY COMPLETE
PAGE**

SEARS-ROEBUCK & CO.—(Cont.)

**RADIOTRON
EARLY COMPLETE
PAGE**

MODEL	REVISED PAGE	MODEL	REVISED PAGE
218	See model 109	1652, 1654	Voltage, transformer data.....6-10
334, 334X	See model 1923		Schematic.....6-11
343X	See model 1010	1660	Socket, trimmers, transformer data, coil data.....6-12
359	See model 1036, Early	1670	Schematic, circuit data.....6-13
359X	See model 1036, Late	1670 (Early)	Socket, trimmers, coil data.....6-14
388	See model 1046, Early	1670 (Late)	Voltage, hum data, alignment.....6-15
388X	See model 1046, Late	1700, 7062	Trimmers, socket, coil data, transformer data.....6-16
591Y	See model 1942		Voltage, changes.....6-17
709, 719	Schematic, voltage, alignment.....8-3		Schematic "A".....6-18
	Schematic, trimmers, alignment.....8-1		Schematic "B".....6-19
	Voltage, trimmers, alignment.....8-2	1702	Voltage, socket, data.....4-2
	Socket, alignment notes, line voltage data.....8-3	1703, 1728, 7064	See Model 7057
	Socket, trimmers, alignment, transformer data.....9-4	1704, 7070, 7071, 7072, 7078, 7074	Schematic, socket, parts layout.....4-3
	Schematic, phonograph, data.....9-5		Schematic.....4-4
	Trimmers, voltage.....9-6	1705	Voltage, socket, parts layout.....4-5
	See Sentinel 11	1706, 1707	Schematic.....4-6
1130	Schematic.....2-1		Voltage, socket, coil data.....4-7
1150, 1170	Voltage, socket, data.....2-2		Schematic.....4-8
1152, 1174, 1420	Schematic, socket.....2-3	1708	Socket, trimmers, parts layout, voltage.....4-9
1250	Chassis wiring, voltage.....2-4	1708, 1709	Schematic.....4-11
1252	Schematic, socket.....2-3	1708-A	Socket, trimmers, coil data.....4-10
1260	Chassis wiring, voltage.....2-5	1709	Circuit notes, voltage.....4-13
1280, 1282	Schematic, socket, data.....2-1	1710	See model 7118
1290, 1300	Chassis wiring.....2-7		Schematic.....4-12
1290, 1292, 1300, 1302	Schematic, socket, data.....2-8	1711-A, 1744, 1745, 1852, 1855, 7080-A	Speaker data.....4-14
1292, 1302	Chassis wiring.....2-9		Schematic.....4-15
1310, 1312	Schematic, socket.....2-7		Notes, socket, voltage, parts layout.....4-16
1320, 1322, 1324, 1326, 1386, 1450, 1452	Voltage, data.....2-10		Schematic, socket, parts layout, voltage.....4-17
	Schematic, socket, voltage.....2-11		Schematic.....4-5
1370, 1371	Chassis wiring.....2-12		Voltage, socket, alignment, parts.....5-6
1370	See Sentinel 11	1712, 1718	Schematic, coil data.....4-18
1390, 1400, 1402, 1404, 1406	Schematic, socket, voltage, data.....2-13	1714	Voltage, socket, trimmers.....4-19
1420	Schematic, socket, voltage, data.....2-14	1715	Schematic, voltage.....4-20
1430, 1510	See model 1182		Socket, trimmers.....4-21
1450, 1452	Voltage data.....2-15		Schematic, voltage.....5-7
1462	Schematic, socket.....2-16	1720, 1725, 7065	Socket, trimmers locations, parts.....5-8
1480, 1482, 1484	Schematic, socket.....2-18		Schematic.....4-22
1506	Voltage.....2-19	1721, 1726	Socket, trimmers, voltage.....4-23
1510	Schematic, voltage.....2-20		Additional data.....Changes 7-15
1512X, 1520, 1522, 1522X, 7000, 7001, 7002, 7012	Trimmers, socket, alignment.....6-8	1722, 1732	Schematic, data.....4-24
1564	See Sentinel 118		Socket, trimmers, voltage, coils.....4-25
1570, 1572, 1574	See Colonial 56	1722, 1732 Revised	Schematic, coils.....4-26
1580, 1582, 1584	Schematic, notes.....3-5		Adjustment data.....4-28
1590, 1592	Voltage, socket, data.....3-7	1722X, 1782X	Schematic.....5-9
1597, 1598, 7050	Additional data.....Changes 7-11		Voltage, socket, changes in circuit.....5-10
1600	Voltage, socket.....3-3	1724	Schematic.....4-29
1620, 1622	For other data see Colonial model 62	1725, 7065	Voltage, socket, trimmer data.....4-30
1626	Changes.....3-8	1726-X	Schematic, voltage.....5-11
1630	Schematic, voltage, alignment.....7-1		Socket layout, chassis.....5-12
1640	Socket, coil data.....3-1		Schematic See model 1720
1650	Schematic, voltage.....3-4		Illum Elimination.....5-13
	See Sentinel 521,261		See model 1721
	Schematic, #1, data.....3-9	1728	Schematic.....5-15
	Schematic, #2.....3-10	1728-A, 7185	Voltage, alignment data.....5-16
	Voltage, alignment data.....3-11	1729	See model 1703
	Schematic, data.....3-12		Schematic, parts list.....5-17
	Voltage, chassis layout.....3-13	1780	Schematic, voltage.....5-19
	Additional data.....Changes 7-6		Socket, chassis view, parts.....5-20
	Schematic.....6-7		Schematic, voltage.....5-21
	Voltage, transformer data.....6-8		Socket, trimmers, adjustments, parts.....5-23
	Socket, trimmers, transformer notes.....6-9	1731	Schematic, alignment, parts.....5-24
	Additional data.....Changes 7-6	1732	See model 1722
		1732X	See model 1722X
		1733	Schematic.....5-23
		1743, 7140	Voltage, socket, chassis, parts.....5-24
		1743A	Schematic, alignment, parts.....5-25
		1744, 1745	Schematic, socket, alignment.....7-64
			See model 1711-A

MODEL	SEARS-ROEBUCK & CO.—(Cont.)	REVISED PAGE	EARLY COMPLETE PAGE	RADIOTRON
1760	Socket, voltage.....	4-31		
	Socket, trimmers, chassis changes.....	4-32		
1760 (Type 1)	Schematic.....	5-26		
1760 (Type 2)	Voltage.....	5-27		
1800	Socket layout, chassis, parts.....	5-28		
1801, 1801A	Schematic, notes, parts.....	5-29		
1802, 1803	Schematic, alignment, parts.....	5-30		
	Schematic, voltage.....	5-3		
1802-A, 1803-A, 1807	Socket layout, alignment.....	5-4		
	Schematic.....	5-31		
1804, 1805, 1808, 1820, 1826	Voltage, alignment, socket.....	5-32		
	Schematic, circuit changes.....	5-33		
1805A, 1808A, 1826A, 1841	Wavetrap data, voltage, alignment, socket, parts.....	5-34		
	Alignment.....	6-20		
1806, 1828, 1829	Schematic, voltage.....	6-21		
	Schematic.....	5-35		
1809, 1811, 1833, 1845	Alignment, voltage, socket.....	5-36		
	Alignment, socket, trimmers, voltage.....	6-22		
	Schematic.....	6-23		
1820	See model 1804			
1821, 1827	Schematic.....	5-37		
1822, 1824, 7164	Alignment, voltage, socket, parts.....	5-38		
	Socket, trimmers, transformer data.....	6-24		
	Schematic.....	6-25		
	Alignment, parts.....	6-26		
1824, 1880	Additional data.....	7-1, 7-6		
	Schematic.....	6-27		
	Alignment, parts.....	6-28		
	Socket, trimmers, transformer data.....	6-29		
1825, 1828	Additional data.....	Changes 7-1		
	Schematic.....	5-39		
	Voltage, alignment, socket, parts.....	5-40		
1825-A	Alignment, voltage, socket, trimmers.....	6-80		
1826	Schematic.....	6-31		
1826-A	See model 1804			
1827	See model 1805-A			
1828	See model 1821			
1829	See model 1825			
1830	See model 1804			
1831	See model 1822			
1832	Socket, trimmers, clock unit tests, drive unit test.....	6-32		
1832-A	Schematic.....	6-33		
	Alignment, pre-selector data.....	6-34		
	Schematic.....	6-35		
	Alignment, socket, trimmers, voltage.....	6-36		
1833	See model 1809			
1835	Schematic, voltage.....	7-5		
1840, 1842	Socket, trimmers, alignment.....	7-6		
	Schematic.....	6-37		
	Wave trap data, alignment, voltage.....	6-38		
	Socket, trimmers.....	6-39		
	Additional data.....	Changes 7-15		
1841	See model 1805-A			
1845	See model 1809			
1850, 1851, 1862, 1868, 1870	Schematic.....	5-41		
	Voltage, alignment, socket, parts.....	5-42		
1852, 1858	See model 1711-A			
1854	Schematic.....	5-43		
1854A	Alignment, voltage, socket.....	5-44		
	Schematic, voltage.....	7-7		
	Socket, trimmers, chassis, alignment, parts.....	7-8		
1855	Schematic.....	5-45		
	Voltage, alignment, socket, parts.....	Changes 7-6		
	Schematic, socket.....	5-47		
	Alignment, voltage, parts.....	5-48		
	Additional data.....	Changes 7-8		
	Socket, trimmers, alignment, voltage.....	6-40		
	Schematic.....	6-41		
	Schematic, alignment.....	5-49		
	Alignment, voltage, socket, parts.....	5-50		
1859-A	See model 7117			
1860	See Sentinel model 5000			
1862, 1868, 1870	See model 1850			
1863	Schematic, socket, trimmers, alignment.....	7-9		
1864	Generator data, parts.....	7-10		
1867	Alignment, socket, trimmers.....	6-42		
1868, 1870	Alignment, socket, trimmers.....	6-43		
1869X, 7157	See model 1857-A			
1870	See model 1850			
1900	Schematic, alignment.....	7-4		
1900, 1910	See model 1850			
	Notes, change.....	7-67		
	Schematic, socket, trimmers, alignment.....	10-28		
1903, 1953, Early, Late	Schematic, socket, trimmers, alignment.....	7-11		
1904, 1904-A, 1906, 1908, 1911, 1914, 1938, 1954, 1964, 1964-A, 1984	Alignment, chassis layout.....	6-44		
1905, 1915, 1955, 1965, Early and Late	Schematic.....	6-45		
	Changes.....	Changes 7-14		
	Schematic, voltage, notes.....	7-13		
1908	Alignment, chassis, trimmers.....	7-14		
1909	Dual Ratio Drive Data.....	7-12		
1910	See model 1904			
	Schematic, voltage, note.....	7-15		
	Alignment.....	7-16		
	Notes, change.....	7-67		
1911	See model 1900			
1912	See model 1904			
1914	See model 1904			
1915	See model 1905			
1917, 1967, 1967A	Schematic, changes.....	7-17		
	Chassis, trimmers, notes.....	7-18		
	Alignment, note.....	7-19		
	Dual ratio drive data.....	7-12		
	Schematic, voltage.....	7-20		
	Trimmers, chassis, notes.....	7-21		
	Alignment.....	7-22		
	Dual ratio drive data.....	7-12		
	Schematic, voltage.....	7-23		
	Chassis, trimmers, note.....	7-24		
	Alignment.....	7-25		
	Dual ratio drive data.....	7-12		
	Schematic, voltage.....	8-5		
1918, 1968	Chassis, alignment, data, sensitivity.....	8-6		
1918A, 1968A	Schematic.....	6-46		
1919, 1929, 1982A, (Late), 1999, Chassis 345X	Alignment, chassis, parts.....	6-47		
	Similar to Colonial model 659			
	Notes, changes.....	7-69		
	Alignment, socket, trimmers, chassis.....	6-48		
	Schematic.....	6-49		
	Schematic, changes.....	7-25		
	Chassis, alignment, parts, notes.....	7-27		
1920, 1926, 1980	See Sentinel model 31B			
1922, 1932, 1982, 1992	Schematic, voltage.....	7-28		
1922-A, 1932-A, 1982-A, Early, 1992-A	Chassis, alignment, notes.....	7-29		
1923, 1933, 1983, 1993, Chassis 334, 334X	Schematic, voltage.....	7-30		
1924	See Sentinel model 31B			
1925, 1935, 1985, 1995, Early, Late	Schematic, voltage.....	7-31		
1926, 1928, 1978, 1980A, Early and Late	Chassis, alignment, notes.....	7-29		
1927X, 1937X	Schematic, voltage.....	7-30		
	Schematic, voltage, trimmers.....	7-31		

MODEL	SEARS-ROEBUCK & CO.—(Cont.)	REVISED PAGE	RADIOTRON EARLY COMPLETE PAGE
1927X, 1937X	Alignment	7-44	
1929	See model 1919		
1930, 1940, 1956, 1970A	Schematic	7-32	
1932-A	See model 1922-A		
1933	See model 1923		
1933A, 1963A	Schematic, voltage	7-33	
	Chassis, alignment, sensitivity	7-34	
	See Sentinel model 31B		
1934	Schematic, voltage	7-35	
1936	Chassis, alignment, changes	7-36	
1936, 1996, Early	Dual ratio drive data	7-12	
Chassis 359X, Late	See model 1927X		
1937X	See model 1904		
1938	See model 1930		
1940	See model 1981		
1941	See model 1909		
1942, Early	Schematic, voltage	8-4	
1942, 1972, 1994, Late,	Chassis, alignment, sensitivity	9-14	
Chassis 391X	See model 1909		
1944	Schematic, socket, voltage	7-97	
1945	Trimmers, chassis, data, alignment, sensitivity	7-98	
	Dual ratio drive data	7-12	
	Changes	8-5	
	Schematic, socket, voltage, changes	7-39	
1946, Early Chassis	Chassis, trimmers, alignment, sensitivity	7-40	
388, Late, Chassis	Dual ratio drive data	7-12	
385X	Schematic, voltage	8-7	
1947, 1948	Chassis, trimmers, alignment, sensitivity	8-8	
1949 Auto	Schematic, socket	8-9	
1949A Auto	Schematic, parts	8-10	
1953	See model 1903		
1954	See model 1904		
1954X	Schematic, trimmers	7-41	
1955	Alignment, parts	7-42	
1956	See model 1905		
1957	See model 1930		
1959	See model 1909		
1961, 1964A	See model 1904		
1965, 1967A	See model 1905		
1967, 1967A	See model 1917		
1968	See model 1918		
1968A	See model 1918A		
1970	Schematic	8-11	
	Alignment, socket, trimmers, voltage	8-12	
1970A	See model 1930		
1972, Early	See model 1909		
1972, Late	See model 1942 Late		
1978	See model 1926		
1980	See model 1920		
1980A	See model 1926		
1981, 1981C, 1941	Schematic	7-43	
1982	See model 1922		
1982-A, Early	See model 1922-A		
1982A, Late	See model 1919 Late		
1983	See model 1923		
1983A	See model 1933A		
1984	See model 1904		
1985	See model 1925		
1986, 1987, 4403, 4463, 4484, 4563, 4564, 4570, 4571, 4572, 4584, Three Types, (Colonial)	Schematic, voltage	7-45	
1986, 1987, 4403, 4463, 4464, 4484, 4563, 4564, 4584, Chassis 100150	Socket, chassis, alignment, changes	7-46	
	Schematic, socket, voltage	8-13	
1986, 1987, 4403, 4463, 4464, 4484, 4563, 4564, 4584, Chassis 100150	Socket, trimmers, chassis, alignment	8-14	
1988, 4401, 4402, 4461, 4462	Schematic, alignment, voltage, data	7-47	
1988, 4401, 4402, 4461, 4462	Socket, trimmers, notes, chassis	7-48	
	Schematic, voltage, alignment, sensitivity	7-49	
	Trimmers, chassis, data	7-50	
1992	See model 1922-A		
1992-A	Schematic, voltage, trimmers	7-51	
1992X	Alignment	7-44	
1993	See model 1923		
1993X	Schematic, voltage, trimmers	7-52	
	Alignment	7-44	
	See model 1942 Late		
	See model 1925		
	See model 1936		
	Schematic, voltage	7-53	
	Alignment, chassis, sensitivity, changes	7-54	
	See model 1919 Late		
	Schematic, voltage, chassis, color code	10-1	
	Alignment, socket, trimmers	10-2	
	See Howard model HA6 (Early)		
	See Howard model HA6 (Late)		
	See model 1988		
	See model 1986		
	Schematic, voltage, data, sensitivity	7-55	
	Socket, trimmers, chassis, alignment	7-56	
	Schematic, voltage, data	7-57	
	Chassis, socket, trimmers, alignment	7-58	
	Schematic, socket, trimmers, chassis view, voltage	9-7	
	Alignment, specifications, data	9-8	
	See model 4404		
	See model 4405		
	See model 1989		
	Schematic, voltage, alignment, notes	7-59	
	Chassis, socket, trimmers, sensitivity	7-60	
	Schematic, voltage, data, sensitivity	7-55	
	Socket, trimmers, chassis, alignment	7-56	
	See model 4409		
	Schematic, socket, chassis, alignment	8-15	
	Data	Changes 10-5	
	Schematic, voltage, specifications, alignment	9-9	
	Socket, chassis, transformer, data, parts	9-10	
	Schematic, voltage	8-16	
	Schematic, speaker wiring, interference data	8-17	
	Socket, trimmers, chassis, alignment, sensitivity	8-18	
	See model 1989		
	Schematic, socket	8-19	
	Alignment, voltage	8-20	
	Socket, trimmers, chassis	8-21	
	Schematic, voltage, data	8-23	
	Socket, trimmers, chassis, alignment, sensitivity, interference data	8-22	
	See model 4404		
	See model 4410		
	Schematic, voltage	8-25	
	Alignment, sensitivity, interference data	8-26	
	Socket, trimmers, chassis	8-27	
	Schematic, voltage	8-25	
	4406		
	4425		
	4426, 4427, 4446, 4447, 4526, 4546		
	4426A, 4526A, 4546A		
	4418, 4430		
	4419, 4439, 4519, 4559		
	4420		
	4421, 4434, 4521		
	4422, 4423, 4524A, 4532, 4542A		
	4413		
	4414, 4415, 4500, 4505, 4506, 4509, 4510, 4511, Chassis 101,393		
	4416		
	4410, 4411, 4425, 4445, 2-Volt models		
	4407		
	4408		
	4409, 4413, 4442, 4443, 4522, 4523, 4542, 4543		
	4405, 4407, 4428, 4448, 4548, Two Types		
	4405A, 4428A, 4433, 4448A, 4453, 4528A, 4548A		
	4406		
	4408		
	4409, 4413, 4442, 4443, 4522, 4523, 4542, 4543		
	4410, 4411, 4425, 4445, 2-Volt models		
	4413		
	4414, 4415, 4500, 4505, 4506, 4509, 4510, 4511, Chassis 101,393		
	4416		

See model 4437
See model 1986
See model 4485
Schematic, voltage, phono.
pick-up data, interference
data 8-43
Whistle elimination, data 8-42
Socket, trimmers, chassis,
alignment, sensitivity 8-44
Schematic, changes 9-29
Changes, notes 9-30
Data Changes 10-5
Schematic, voltage, 8-45
Socket, trimmers, chassis,
color code 8-46
Alignment, sensitivity, dial
drive parts 8-48
AFC notes, page 1 8-49
AFC notes, page 2, dial lamp
data 8-50
Interference elimination,
phono pick-up jack data 8-51
Changes notes 8-52
Changes schematics 8-53
Revised alignment, AFC ad-
justment 8-56
Schematic, voltage 8-57
Color code 8-46
Socket, trimmers, chassis
Alignment, sensitivity, dial
drive parts 8-47
AFC notes, page 1 8-48
AFC notes, page 2, dial drive
data 8-50
Interference elimination,
phono pick-up jack data 8-51
Changes notes 8-52
Changes schematics 8-53
Revised alignment, AFC ad-
justment 8-57
Schematic, voltage 8-55
Socket, trimmers, chassis 8-54
Changes 8-56
Alignment, AFC adjustment 8-57
See model 4468
Schematic, voltage, notes 8-59
Socket, trimmers, notes,
alignment, sensitivity 8-60
See model 4414
Schematic, voltage, notes 8-61
Socket, trimmers, parts,
alignment, notes 8-62
Schematic, voltage, notes 8-58
Socket, trimmers, chassis,
alignment, parts 9-26
Data Changes 10-5
See model 4414
See model 4501
See model 4502
See model 4419
See model 1989
See model 4421
See model 4409
See model 4404
See model 4423
See model 4428
See model 4428A
See model 4405A
See model 4429
See model 4431
See model 4421
See model 4472
See model 4477
See model 4489
See model 4409
See model 4422

4477, 4478
4484
4485
4486, 4586, 4586A

4487

4488, 4588

4488A, 4588A

Alignment, sensitivity, inter-
ference data 8-26
Socket, trimmers, chassis 8-27
See model 4405
Schematic voltage 7-61
Alignment, data, transformer 7-62
Socket, trimmers, chassis,
Changes 8-5
Changes Changes 9-4
See model 4405A
Schematic, voltage, specifica-
tions speaker connections 9-11
Socket, trimmers, chassis 9-12
Alignment, notes 9-13
See model 4418
Schematic, voltage,
specifications 9-15
Alignment, sensitivity, socket,
trimmers, chassis 9-16
Notes, parts 9-17
See model 4405A
See model 4421
Socket, trimmers, chassis,
parts 9-18
Schematic, voltage, notes 9-19
Alignment, sensitivity, notes 9-20
Schematic, voltage, data 8-28
Socket, trimmers, chassis,
alignment, sensitivity 8-29
Schematic, voltage, align-
ment, sensitivity, inter-
ference data 8-31
Socket, trimmers, chassis,
notes 8-30
See model 4409
See model 4404
See model 4410
See model 4426
See model 4405
See model 4428A
See model 4405A
See model 4429
Schematic, voltage, data 8-33
Socket, trimmers, chassis,
sensitivity notes, data 8-32
Alignment, sensitivity, whistle
elimination 8-34
See model 4441
See model 4405A
See model 4439
See model 4419
See model 1988
See model 1986
See model 1986 (Chassis
100150)
Schematic, socket, voltage,
specifications, speaker
connections 9-21
Socket, trimmers, chassis,
alignment, sensitivity 9-22
Schematic, voltage, notes 8-35
Distortion elimination,
sensitivity, data 8-36
Alignment, socket, trimmers,
chassis 8-37
Phono jack connections, in-
terference data, notes 8-38
Schematic, specifications 9-23
Alignment, sensitivity, voltage 9-24
Socket, trimmers, chassis 9-25
Schematic, voltage, data 8-39
Alignment, sensitivity, notes 8-40
Socket, trimmers, chassis 8-41
See model 4466
Schematic, voltage, specifica-
tions, socket, trimmers,
alignment, notes 9-27
Alignment, sensitivity, notes,
parts 9-28

4426A, 4526A, 4546A

4428
4428A, 4448A, 4528A,
4548A

4428A (Late)
4429, 4449, 4529, 4549

4430
4431, 4432, 4435, 4436,
4531

4433
4434
4437, 4438, 4477, 4478,
4537, 4577

4439, 4440, 4455, 4456,
4539

4441, 4451

4442, 4445
4444
4445
4446, 4447
4448
4448A
4448A (Late)
4449
4450, 4550

4451
4453
4455, 4456
4456
4461, 4462
4463 (Chassis 100150)
4464 (Chassis 100150)

4465, 4485, 4565, 4585
Chassis 100151

4465, 4485, 4565, 4585
Chassis 101410

4466, 4467, 4469, 4567

4468, 4470, 4490

4469
4472, 4473, 4533

4502, 4502A, 4504, 4508,
4512, 4513, 4514,
Chassis 101427

4505, 4506
4507
4508
4509
4519
4520
4521
4522, 4523
4524
4524A
4526
4526A
4528A (Late)
4529
4531
4532
4533
4539
4542, 4548
4542A

MODEL	SEARS-ROEBUCK & CO.—(Cont.)	REVISED PAGE	EARLY COMPLETE PAGE	RADIOTRON
4544	See model 4404			
4546	See model 4426			
4546A	See model 4426A			
4548	See model 4405			
4548A	See model 4428A			
4548A (Late)	See model 4405A			
4549	See model 4429			
4550	See model 4450			
4559	See model 4419			
4563, 4564, 4584	See model 1986			
4565	See model 4465			
4566	Schematic, voltage, speaker connections, transformer	9-31		
	Socket, trimmers, chassis, alignment, changes,			
	sensitivity	9-32		
4567	See model 4466			
4569, 4589	Schematic, voltage	8-63		
	Socket, trimmers, alignment, sensitivity	8-64		
4570, 4571, 4572	See model 1986 (Colonial)			
4577	See model 4437			
4584	See model 1986			
4585	See model 4465			
4586, 4586A	See model 4486			
4587	Schematic, voltage, data	8-65		
	Socket, trimmers, chassis, notes	8-66		
	Alignment, sensitivity, jack	8-67		
	Installation	8-68		
	Dial data	8-68		
	Circuit data	8-69		
	Dial data, flash tuning, notes	8-70		
	Changes	8-74		
	Changes	9-29		
	Changes, notes	9-30		
	Data	Changes 10-5		
4587A	Schematic	8-71		
	Socket, trimmers, chassis	8-72		
	Alignment, sensitivity, notes	8-73		
	Changes	8-74		
	Data	Changes 10-5		
	See model 4488			
4588A	See model 4488A			
4588B	See model 4488B			
4589	See model 4569			
4593	Schematic, voltage, transformer data, specifications	9-33		
	Socket, trimmers, alignment, chassis, sensitivity	9-34		
4598	See model 4498			
4600, Chassis 101.458	Schematic, voltage	9-35		
	Socket, trimmers, alignment, chassis, sensitivity	9-36		
	Data	Changes 10-2		
	Data	Changes 10-5		
4601	Schematic, voltage	8-75		
	Socket, trimmers, alignment, sensitivity	8-76		
	Data	Changes 10-2		
	Data	Changes 10-5		
4602-3, 4620-1, 4630-1, 4720, 4730	Schematic, voltage, socket, trimmers, chassis, alignment, notes	8-77		
4604-5, 4624-5, 4634-5, 4724	Schematic, voltage, socket, trimmers, chassis, alignment	8-78		
4606-7, 4626-7, 4646-7, 4726, 4746, Chassis 101.473	Schematic, voltage, specifications	9-37		
	Socket, trimmers, chassis, alignment, data, sensitivity	9-38		
4608A, 4609A, 4629A, 4638A, 4639A, 4643A, 4649A, 4728A, 4748A, Chassis 101.472X	Schematic, voltage, socket, trimmers, chassis	10-3		
	Alignment, notes	10-4		
MODEL	SEARS-ROEBUCK & CO.—(Cont.)	REVISED PAGE	EARLY COMPLETE PAGE	RADIOTRON
4610, 4669, 4769, 4789	Schematic, voltage, socket, specifications, transformer data	9-53		
Chassis 101.482	Socket, trimmers, chassis, alignment, sensitivity	9-54		
	Phonograph installation, wave-trap data	9-55		
	Tuner data	10-25, 26, 27		
4611, 4660, Chassis 101.487	Schematic, voltage, socket, transformer data	9-39		
	Socket, trimmers, chassis, alignment, notes, sensitivity	9-40		
4612A, 6162, Chassis 101.533	Schematic, voltage	10-5		
	Alignment, socket, trimmers, chassis	10-6		
4613, 4623, 4643, 4673, 4723, Chassis 100.157	Schematic, voltage, socket	9-47		
	Trimmers, chassis, specifications, alignment, sensitivity	9-48		
4614, 4651, Chassis 101.497	Schematic, voltage, socket, transformer data	9-41		
	Socket, trimmers, chassis, alignment, notes, sensitivity	9-42		
4619, Chassis 101.478	Schematic, voltage, socket, specifications, speaker data	9-43		
	Socket, trimmers, chassis, alignment, notes, sensitivity	9-44		
4620-1, 4630-1	See model 4602-3			
4622, 4722, Chassis 100.179	Schematic, socket, voltage, specifications	9-45		
	Socket, trimmers, chassis, alignment	9-46		
4623	See model 4613			
4624-5, 4634-5	See model 4604-5			
4626-7, 4636-7	See model 4606-7			
4628A, 4629A	See model 4608A			
4632A, 4633A, 6014, 6015, 6014, 6045, 6064, 6144, 6164, Chassis 101.505, 101.505X	Schematic, voltage, socket	10-7		
4638A, 4639A	Alignment, notes	10-6		
4640, 4650, 4740, 4750	Chassis socket notes	10-8		
Chassis 101.476	See model 4608A			
	Schematic, voltage, socket specifications, transformer and speaker data	9-49		
4643	Socket, trimmers, chassis, alignment, notes, sensitivity	9-50		
4644A, 4645A, Chassis 101.504	See model 4613			
	Schematic, voltage, socket	10-9		
4646-7	Alignment, chassis, socket	10-10		
4648A, 4649A	See model 4606-7			
4650	See model 4608A			
4651	See model 4610			
4660	See model 4614			
4664, 4764, 4784, Chassis 101.480	Schematic, voltage, phonograph installation	9-51		
	Socket, trimmers, chassis, alignment, phonograph notes	9-52		
4667, 4677, 4767, 4777, Chassis 101.498	Schematic, voltage, jack changes	10-11		
	Socket, trimmers, chassis, alignment, transformer data	10-12		
	Tuner condensers, drive data	10-8		
	Tuner data, jack installation	10-13		
	Schematic, voltage	10-15		
4668, Chassis 103.AR166	Socket, trimmers, alignment	10-16		
4669	See model 4610			
4677	See model 4667			
4680, 4790, Chassis 101.479	Lo-Noise Control data and notes	9-56		
	Schematic, voltage, socket, phonograph data	9-57		
	Socket, trimmers, alignment, chassis, sensitivity, notes	9-58		
4681, 4781, Chassis 101.499	Schematic, voltage, color code	10-17		
	Tuner data	10-13		

4681, 4781, Chassis 101.499	Phone and phono. jacks in- station, schematic10-18	5731, Moto-Matic Tuner for Adjustments, Part 110-35	Models 6000, 6001, 6100, Adjustments, Part 2, parts10-36
	Chassis, antenna, wave-trap data10-19	6101, Part 128.15600	6002, 6021, 6031, 6121, 6131 Chassis 100.195
4684, Chassis, 101.502	Socket, trimmers, alignment, chassis10-20		Schematic, voltage10-37
	Schematic, voltage, phonograph installation9-59		Socket, trimmers, chassis, alignment10-38
4688, 4788, 4799 Chassis 100.159	Socket, trimmers, chassis, alignment, notes sensitivity.9-60	6003, 6004, 6024, 6034, 6124, 6134, Chassis 101.510	Tuner data10-38
	Schematic9-61		Tuner data10-38
	Socket, trimmers, speaker connections9-62		Alignment, jacks installation schematic10-40
	Alignment, sensitivity9-63		Socket, trimmers, chassis10-42
	Moto-Matic Tuner adjust- ments, operation9-64	6005, 6071, 6076, 6171, 6176, Chassis 101.507	Schematic, voltage, socket10-43
	Moto-Matic Tuner adjust- ments, operations, concluded 9-65		Alignment, notes10-6
	Voltage, tuner motor data9-66	6008, 6009, 6018, 6019, 6048, 6049, 6068, 6069, 6148, 6168, Chassis 101.524	Socket, trimmers, chassis10-42
	Drive data9-67		Schematic, socket, trimmers, drive data, notes10-45
	Switch data9-68		Tuner data10-58
	Dial mechanism9-69		Alignment10-44
	Tuner faults and remedies, Part 19-70	6010, 6040, Chassis 101.519	Schematic, voltage, socket, trimmers, changes10-51
	Part 29-71		Notes10-46
	Tuner faults and remedies, Part 39-72	6014, 6015 6016, 6017, 6046, 6047, 614c, Chassis 101.512	Alignment, notes10-47
	Parts list9-73		Schematic, voltage, drive data10-47
	Parts list, concluded9-74		Alignment, notes10-6
	Schematic, adjustments alignment9-80	6018, 6019	Socket, trimmers, chassis10-48
	Alignment procedure, notes10-4	6022, 6122, 6132, Chas- sis 101.509	Tuner data10-58
	See model 4602-3		See model 6008
4720, 4730	See model 4622		See model 6002
4722	See model 4613		Schematic, voltage, drive data 10-49
4723	See model 4604-5		Alignment10-6
4724	See model 4606-7		Socket, trimmers, chassis10-50
4728A	See model 4608A		Tuner data10-58
4740	See model 4640		See model 6003
4746	See model 4606-7		See model 6002
4748A	See model 4608A		Schematic, voltage, color code, data10-56
4750	See model 4640		Phone and phono. jacks, drive data, notes10-57
4761, 4771, Chassis 101.490	Schematic, voltage, socket, specifications, notes9-75	6023, 6123, Chassis 101.506	Alignment Socket, trimmers, chassis, tuner data10-58
	Socket, trimmers, chassis, alignment, sensitivity9-76		Schematic, voltage, socket, drive data, color code10-59, 60
	See model 4666		Alignment, motor data10-44
4764	See model 4607	6024	Tuner data10-58
4767, 4777	See model 4610	6028, Chassis 126.204	See model 6010
4769	See model 4701		See model 6016
4771	Schematic, socket, voltage, specifications9-77		See model 6008
4776, Chassis 126.200	Phonograph data9-78		See model 6003
	Socket, trimmers, alignment, chassis, sensitivity9-79	6031	Schematic, voltage, color code, data10-56
	See model 4681	6034	Phone and phono. jacks, drive data, notes10-57
4781	See model 4664	6036, 6136, Chassis 101.511	Alignment Socket, trimmers, chassis, tuner data10-58
4784	Schematic, voltage, wave-trap data, socket10-21, 22		Schematic, voltage, socket, drive data, color code10-59, 60
4786, Chassis 100.196	Alignment, socket, trimmers, chassis10-23	6038, 6138, Chassis 101.517	Alignment, motor data10-44
	Jacks installation, color code, wave trap10-24		Tuner data10-58
	Automatic tuner data, Part 1 10-25		See model 6010
	Automatic tuner data, Part 2 10-26		See model 6016
	Automatic tuner data, Part 3 10-27		See model 6008
	See model 4688		Schematic, voltage, socket, data10-61
4788	See model 4610		Alignment Socket, trimmers, chassis10-10
4789	Schematic, voltage10-29		Schematic, voltage, socket, trimmers, chassis10-62
4790	Alignment, data10-30		Alignment Socket, trimmers, chassis, tuner data10-58
4796, Chassis 126.201	Socket, trimmers, chassis10-31		See model 6010
	Phono. wiring, details10-32		See model 6016
	See model 4688		See model 6008
4799	Schematic, details, data10-33		Schematic, voltage, socket, data10-61
5656A	Schematic, voltage10-34	6054, 6055, Chassis 101.532	Alignment Socket, trimmers, chassis10-10
5731, Moto-Matic Tuner for Models 6000, 6001, 6100, 6101, Part 128.15600	Schematics, details, data10-34		Schematic, voltage, socket, trimmers, chassis10-65
			Alignment10-10

**RADIOTRON
EARLY COMPLETE
PAGE**

**SEARS-ROEBUCK & CO.—(Cont.)
REVISED
PAGE**

**MODEL
SEARS-ROEBUCK & CO.—(Cont.)
REVISED
PAGE**

**RADIOTRON
EARLY COMPLETE
PAGE**

**SEARS-ROEBUCK & CO.—(Cont.)
REVISED
PAGE**

6051, 6055, Chassis 101.532	Tuner data	10-81	6140, Chassis 101.534, 6152, 6153, Chassis 101.587	Socket, trimmers, chassis	10-84
6054, 6069	See model 4632A		6144	Alignment	10-44
6070, 6170, Chassis 100.189	See model 6008		6146	Tuner data	10-58
	Schematic, voltage, coils	10-63	6148	See model 4632A	
	Socket, trimmers, chassis, alignment	10-64	6152, 6153, Chassis 100.198	See model 6016	
6071, 6076, 6172, Chas- sis 101.513	See model 6005	10-66		See model 6008	
	Schematic, voltage	10-66		See model 6070	
	Socket, trimmers, chassis	10-68		See model 6005	
6073, 6173, Chassis 101.528	Alignment, notes	10-6		See model 6072	
	Tuner data	10-58		See model 6078	
	Socket, trimmers, chassis	10-54		Schematic, voltage, socket, trimmers, alignment	10-85, 86
	Schematic, voltage	10-67		Sockets, coils	10-39
6074, 6079, Chassis 101.515	Socket, trimmers, chassis	10-6		Alignment, trimmers	10-87
	Alignment, notes	10-44		Tuner data, drive data	10-88
	Socket, trimmers, chassis	10-84		See model 4612A	
	Tuner	10-58		See model 6008	
6077	See model 6072			See model 6070	
6079	See model 6074			See model 6005	
6100, Chassis 101.495	Schematic, voltage, color code 10-69			See model 6072	
	Socket, trimmers, chassis, alignment	10-70		Schematic, voltage, socket, trimmers, alignment	10-91
	"Moto-Matic" Tuner details, schematic	10-34		Schematic, notes	10-89
	Part 1	10-35		Operating and setup pro- cedure notes, parts	10-90
	"Moto-Matic" adjustments, Part 2	10-36		Schematic changes, notes	10-89
	Schematic, voltage, color code	10-72		See Sentinel 118	
6101, Chassis 101.496	Socket, trimmers, chassis, an- tenna coil, trimmers	10-68		See Sentinel 513	
	Alignment	10-70		Schematic, socket, alignment	5-51
	"Moto-Matic" Tuner details, schematic	10-34		Voltage, parts, resistance test	5-52
	Part 1	10-35		Schematic, voltage, alignment, resistance	5-53
	"Moto-Matic" adjustments, Part 2	10-36		Schematic, socket, trimmer	5-55
	Schematic, voltage, alignment, tuner changes	10-73		Resistance test data, voltage, socket	5-56
6102, 6102A, 6103, 6103A, 6105, 6105A, Chassis 101.526, 101.526-1	Socket, chassis	10-74		See model 1597	
	Schematic, voltage, data	10-75		See Sentinel 570	
6104, Chassis 126.203	Tuner assembly, data	10-76		See model 1700	
	Chassis wiring, socket, trim- mers, alignment	10-77		See model 1703	
6110, 6111, Chassis 101.508	Schematic, voltage	10-78		See model 1720	
	Socket, trimmers, chassis, alignment	10-62		Schematic, resistance test	5-57
	Schematic, voltage, tuner socket, chassis	10-79		See model 1704	
	Schematic, voltage, chassis, socket, alignment, tuner	10-80		Schematic	4-88
6112, 6113, 6118, Chas- sis 101.521	See model 6112			Voltage, trimmers, parts location, socket	4-84
6114, 6115, Chassis 101.522	See model 6002			See model 1711	
6118	See model 6022			See model 1711-A	
6121	See model 6022			Schematic, alignment, parts	5-63
6122	See model 6023			See Sentinel 5000, 5100	
6123	See model 6003			Schematic, parts, service notes 5-58	
6124	Schematic, voltage, tuner	10-81		Schematic, voltage	5-59
6125, Chassis 101.527	Alignment, notes	10-6		Alignment, parts, installation notes	5-60
	Socket, trimmers, chassis, notes	10-74		Schematic, voltage	5-61
6131	See model 6002			Socket, chassis, parts	5-62
6132	See model 6022			Schematic, notes, parts	5-64
6134	See model 6003			Schematic, alignment, parts	5-65
6136	See model 6036			Additional data	Changes 7-5
6138	See model 6038			Schematic, parts, service notes 5-66	
6140, Chassis 101.534	Schematic, voltage, color code, notes	10-82		Schematic changes, socket	7-63
6152, 6153, Chassis 101.537	Phone and phono, jacks data	10-83		Schematic changes, socket	7-63
				Data	Changes 10-5
				Schematic	5-67
				Alignment, voltage, socket, parts	5-68
				See model 7126	
				See model 7124	
				See model 7127, Late	
				See model 1728-A	
				Schematic, socket, alignment	7-64
				See model 7127, Late	
				See model 1743, 1743A	
				Schematic, socket, trimmers, voltage	6-50

MAKE SERVICING EASY

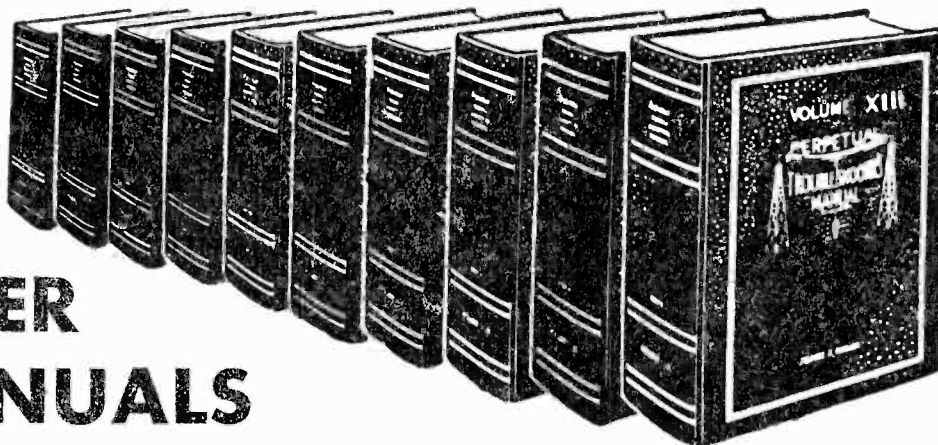

RIDER MANUALS

The greatest collection of servicing data ever assembled. No serviceman can anticipate the year, make and model of the next set that will come to his bench. For this reason you **must** have the volume of Rider Manuals that contains the servicing information on that particular set. Benefit from the **complete** servicing information that only Rider Manuals can give you: Data on alignment, I-F peaks,

operating voltages, parts lists and parts values, voltage ratings of condensers, wattage ratings of resistors, coil resistance data, and all the other information that is vital if you are to know exactly what the manufacturer put in that receiver. No more new receivers after April 22nd! The old sets will now come into the service shop. **So be prepared!**

ABRIDGED MANUAL

Volumes I-V

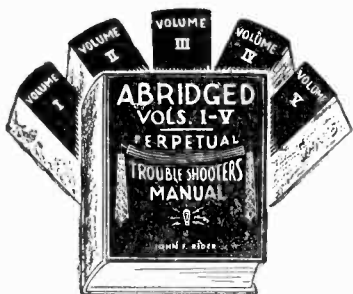

The servicing information you need to service the old receivers will be found in the Abridged Manual, Volumes I-V. It is a compilation of the most widely distributed receivers released after 1929 that formerly appeared in Volumes I-V.

As can be readily appreciated, it is by no means as complete as the original first five individual volumes; these contained a total of approximately 5000 pages, whereas the Abridged Volume contains 2000 pages.

In order to select the proper receivers for inclusion in the Abridged Manual, all the manufacturers who were responsible for the sale of the greatest number of sets between 1930 and 1935 were contacted, and information was obtained as to the most widely distributed receivers. The Abridged Manual was then compiled.

2,000 Pages Net Price \$12.50

- VOL. XIII. This newest Rider Manual covers the servicing data on receivers manufactured as late as March, 1942. Because of the curtailment of receiver manufacturing, every effort was made to include information on those receivers produced during the latter months of 1941 and the early months of 1942. This addition of Rider's Volume XIII makes available to the radio industry more than 18,000 pages of authentic servicing information.1672 pages, Net Price \$11.00
- VOL. XII. Covers receivers manufactured up to April 1941. . . . New arrangement provides for maximum number of sets. Clarified schematics give breakdowns of complicated r-f and a-f switching circuits. Also double spread pages for complicated diagrams and cumulative index for Volumes XI and XII.1,648 pages, Net Price \$11.00
- VOL. XI. Covers receivers manufactured up to June 1940. Includes vest pocket manual containing push-button frequency ranges of all automatically tuned receivers and other handy servicing data. Also double-spread pages and new How It Works section devoted to explanations of the electrical and mechanical operations of the more complicated 1940 receivers including television, facsimile, and frequency modulation.1,652 pages, Net Price \$11.00
- VOL. X. Complete information on receivers manufactured up to August, 1939. Also a special 64-page How It Works Section and double-spread pages for the complicated diagrams. Includes a separate 188-page index with lists of exactly what appears on every page in Volume X and all preceding volumes.1,664 pages, Net Price \$11.00
- VOL. IX. Contains installation and servicing instructions on 1889 models manufactured up to October, 1938. Also a special 36-page "How It Works" section and double-spread pages for the complicated diagrams.1,672 pages, Net Price \$11.00
- VOL. VIII. Receivers manufactured up to October, 1937 will be found in this volume. Contains installation and servicing instructions on many types of intercommunication systems. Also a special 64-page "How It Works" section and double-spread pages for the complicated diagrams.1,650 pages, Net Price \$11.00
- VOL. VII. In this volume will be found sets manufactured up to October, 1936, together with data on older receivers hitherto unavailable. Data on more than 1,700 models—complete information.1,600 pages, Net Price \$11.00
- VOL. VI. In this volume will be found sets manufactured up to November, 1935, together with data on older receivers hitherto unavailable. Data on more than 950 models—complete information.1,240 pages, Net Price \$8.25
- VOL. V. In this volume will be found sets manufactured up to October, 1934, together with data on older models, hitherto unavailable. Data on more than 940 models are presented—not only electrical data, but information on the mechanical intricacies of the sets.1,200 pages, Net Price \$8.25
- VOL. IV. Receivers manufactured up to March, 1934, will be found in this volume. Herein will be found the more complicated superhets with QAVC, noise gates, duo-diode pentodes, automatic tone controls, and all the other new designs. A special 24-page section explains some of the more complicated sets.1,060 pages, Net Price \$8.25
- VOL. III. The receivers produced between the middle of 1932 up to June, 1933, are included in Volume III. Herein will be found the early Superheterodyne receivers, which were introduced in this period.1,070 pages, Net Price \$8.25

Vol. I and Vol. II out of print—no longer available

RIDER'S MANUALS HAVE more schematics . . . more I.F. peaks . . . more alignment data . . . more circuit descriptions. . . MORE EVERYTHING THAN ANY OTHER MANUALS.

MODEL	7143	Schematic, voltage, socket, trimmers, alignment	8-79
	7144	Schematic, socket, alignment	7-65
	7150	Schematic, socket, alignment	7-66
	7152	Notes, change	7-67
	7153	Schematic, socket, voltage, alignment	10-92
	7154	Schematic, socket, trimmers, alignment	7-9
	7155	Schematic, socket, alignment	7-66
	7157	See model 1869X	7-67
	7158	Schematic, trimmers, socket, alignment	7-68
	7164	See model 1822	7-65
	7165	Schematic, socket	7-65
	7166	Schematic, socket	7-63
	7166A	Schematic, socket, voltage	7-69
	7167	Schematic, voltage, alignment, parts	7-70
	7168	Schematic, voltage, data	7-69
	7170	Schematic, socket	10-93
	7171	Schematic, voltage, socket, trimmers	10-95
	7172	Chassis wiring	10-94
	7172X	Alignment	10-96
	7173	Schematic, socket, alignment	10-97
	7176	Schematic, alignment	8-80
	7177	Schematic, voltage, socket, alignment	9-81
	7181	Schematic, socket, trimmers, alignment	10-98
	7211	Schematic	10-99
	7212	Socket, trimmers	9-82
	7213	Schematic, voltage	9-83
	7214	Alignment	9-84
	7215	Schematic, socket, trimmers, alignment	10-100
	7220	Schematic, socket, trimmers, alignment, tuner	10-110
	7221	Alignment, tuner data	10-102
	7225	Schematic, notes	10-103
	7226	Socket, trimmers, alignment	10-104
	7226	Schematic, voltage, drive data, specifications	10-105, 106
	7225	Socket, trimmers, alignment, phono, data	10-107
	7226	Chassis wiring	10-108
	7225	Record changer assembly	10-109
	7226	Schematic, socket, trimmers, voltage, alignment	10-111
	7226	Tuner data	10-81
	7226	Alignment	10-64
	7226	Schematic, voltage, alignment	10-112
	7226	Socket, trimmers, alignment, Part 2	10-104
	100.150	See model 1986	
	100.151	See model 4465	
	100.157	See model 4613	
	100.159	See model 4688	
	100.179	See model 4622	
	100.189	See model 6070	
	100.195	See model 6002	
	100.196	See model 4786	
	100.198	See model 6157	
	101.410	See model 4465	
	101.458	See model 4600	
	101.472A	See model 4608A	
	101.473	See model 4606-7	
	101.476	See model 4640	
	101.478	See model 4619	
	101.479	See model 4680	
	101.480	See model 4664	
	101.482	See model 4610	
	101.487	See model 4611	
MODEL	101.490	Chassis	See model 4761
	101.493	Chassis	See model 6100
	101.496	Chassis	See model 6101
	101.497	Chassis	See model 4614
	101.498	Chassis	See model 4667
	101.499	Chassis	See model 4681
	101.502	Chassis	See model 4684
	101.501	Chassis	See model 4644A
	101.505	101.505X Chassis	See model 4632A
	101.506	See model 6023	
	101.507	See model 6005	
	101.508	Chassis	See model 6110
	101.509	Chassis	See model 6023
	101.510	Chassis	See model 6003
	101.511	Chassis	See model 6036
	101.512	Chassis	See model 6016
	101.513	Chassis	See model 6072
	101.515	Chassis	See model 6074
	101.517	Chassis	See model 6038
	101.519	Chassis	See model 6010
	101.521	Chassis	See model 6112
	101.522	Chassis	See model 6114
	101.524	Chassis	See model 6008
	101.525	Chassis	See model 6052
	101.526	101.526-1 Chassis	See model 6102
	101.527	Chassis	See model 6125
	101.528	Chassis	See model 6073
	101.532	Chassis	See model 6054
	101.533	Chassis	See model 4612A
	101.534	Chassis	See model 6140
	101.537	Chassis	See model 6152
	103.ARI.66	Chassis	See model 4668
	104.235	Chassis	See model 4700
	109.216	Chassis	See model 6195
	110.255	Chassis	See model 7225
	110.880	Chassis	See model 7226
	110.7211	Chassis	See model 7211
	110.7212	Chassis	See model 7212
	110.7213	Chassis	See model 7213
	110.7214	Chassis	See model 7214
	110.7215	Chassis	See model 7215
	110.7220	Chassis	See model 7220
	113.972	Chassis	See model 3972
	126.200	Chassis	See model 4776
	126.201	Chassis	See model 4796
	126.202	Chassis	See model 7221
	126.203	Chassis	See model 6104
	126.204	Chassis	See model 6028
	134.802	134.802-1 Chassis	See model 6226

SENTINEL RADIO CORP.

"Automatic Tune" Wheel	Assembly, details, notes	10-1
Dial	Installation, details, parts	10-2
Push-Button Dial	Assembly, instructions, parts	10-12
6A	Schematic, voltage, trimmers, alignment, parts	8-1, 8-2
8, 9	Schematic, socket voltage	3-1
10M	Schematic, voltage, alignment, parts	8-5
10MF	Schematic, voltage, alignment, parts	8-3, 8-4
11, 12, 14, 16 (104)	Schematic, socket, voltage	1-1
11M	Schematic, voltage, alignment, parts	8-6
14A	Schematic, parts, trimmers	9-1, 2
19A	Alignment, socket, voltage	9-5
20A	Schematic, voltage, alignment, trimmers, parts	8-7
30A	Schematic, voltage, trimmers, alignment	7-1
31, 38	Schematic, alignment, voltage, parts	8-8
31B	Schematic	2-9
32B	Schematic, voltage, trimmers	6-1
33B	Alignment, parts	6-2
	Schematic, alignment, parts	8-9
	Schematic, alignment, trimmers, parts	8-10

*624

2105

2106

2116

80B	Schematic, voltage, socket	10-11
	Alignment, trimmers, chassis	10-8
82A, 82AE	Schematic, parts, socket, voltage	9-21
	Socket, trimmers, chassis, alignment	9-22
	"Automatic Tune", Wheel assembly, details	10-1
	"Automatic Tune", Wheel installation, details	10-2
83UE	Push-Button Dial assembly, instructions, parts	10-12
85, 85UE	Schematic, voltage, socket	10-13
	Alignment, trimmers, chassis	10-14
86AE	Schematic, parts, socket, voltage, alignment	9-20
	Schematic, voltage, socket	10-15
	Alignment, trimmers, chassis	10-16
	"Automatic Tune", Wheel assembly, details	10-1
	"Automatic Tune", Wheel installation, details	10-2
87AE	Push-Button Dial assembly, instructions, parts	10-12
88BE	Schematic, voltage, socket	10-17
	Alignment, trimmers, chassis	10-18
90B	Schematic, voltage, socket	10-19
	Alignment, trimmers, chassis	10-20
	Schematic, parts, socket, voltage	9-23
	Socket, trimmer, chassis, alignment	9-24
91B	Schematic, voltage, socket, alignment	10-21
	"Automatic Tune", Wheel assembly, details, notes	10-1
	"Automatic Tune", Wheel installation, details	10-2
92AE	Push-Button Dial assembly, instructions, parts	10-12
	Schematic, voltage, socket	10-22
93L	Alignment, trimmers, chassis	10-23
	Schematic, parts, socket, voltage	9-25
	Socket, trimmers, chassis, alignment, 32-volt interfer-ence data	9-26
95B	Schematic, voltage, socket	10-24
	Alignment, trimmers, chassis	10-23
	"Automatic Tune", Wheel assembly, details, notes	10-1
	"Automatic Tune", Wheel installation, details	10-2
96BE	Push-Button Dial assembly, instructions, parts	10-12
	Schematic, voltage, socket	10-25
97L	Alignment, trimmers, chassis	10-26
	Schematic, parts, socket, voltage	9-27
	Socket, trimmers, chassis, alignment	9-28
98AE	32-volt interference data	9-26
	Schematic, voltage, socket	10-27
99AE	Alignment, trimmers, chassis	10-28
	Schematic, voltage, socket	10-29
	Trimmers, chassis	10-30
100X	Alignment	10-31
	Schematic, parts, socket, voltage	9-29
	Socket trimmers, chassis, alignment	9-30
103-A	See model 8	
104 Chassis	See model 11	
106A	Schematic, voltage, socket	10-32
	Trimmers, chassis	10-26
	Alignment	10-33
106-B	Schematic	1-2
107AE	Schematic, voltage, socket	10-34
	Alignment	10-33
	Tuner data	10-35
	Trimmers, chassis	10-36

84B	Schematic, trimmers, alignment, parts, changes, voltage	8-11
85-B	Schematic, trimmers	6-3
36L	Alignment, parts	6-4
37B	Schematic, voltage, alignment, trimmers, parts	8-12
38B	Schematic, alignment, parts, voltage	8-13
39B	Schematic, trimmers, alignment, parts	8-14
40B	Schematic, trimmers, alignment, parts, changes	8-15
44A	Schematic, parts, voltage, alignment	8-16
46A	Schematic, parts, trimmers, socket, voltage	9-7, 8
47A	Alignment	9-11
48A	Schematic, parts, socket, voltage, alignment	9-9, 10
49B	Trimmers, alignment	9-11
50B	Schematic, trimmers	7-3, 7-4
52A	Voltage, alignment	7-2
53A	Schematic, voltage, alignment, parts	8-17
54A	Schematic, voltage, trimmers, alignment, parts	8-18
55U	Schematic, voltage, alignment, trimmers, parts	8-19, 8-20
56U	Schematic, voltage, alignment, trimmers, parts	8-21
60B	Schematic, voltage, alignment, trimmers, parts	8-22
63B	Schematic, voltage, alignment, parts	8-23
65B	Schematic, voltage, alignment, trimmers, parts	8-24
66B	Schematic, voltage, socket, trimmers	10-3
67L	Alignment	10-4
68B, 68BE	Schematic, voltage, alignment, parts	8-25
70A	Schematic, voltage, alignment, parts	8-26
71U	Schematic, trimmers, voltage, alignment, parts	8-27
72A, 72AE	Schematic, parts, socket, voltage, trimmers	9-3, 4
73B	Alignment, trimmers	9-6
74A, 74AE	Schematic, voltage, socket, trimmers	10-5
76A	Schematic, voltage, socket, trimmers	10-4
78B, 78BE	Alignment	10-6
	Schematic, voltage, alignment, parts	10-4
	Schematic, voltage, alignment, trimmers	8-28
	Schematic, voltage, trimmers, alignment, parts	8-31
	Schematic, parts, socket, voltage	9-13
	Socket, trimmers, chassis, alignment	9-14
	Schematic, voltage, socket	10-7
	Alignment, trimmers, chassis	10-8
	Schematic, parts, socket, voltage	9-15
	Socket, trimmers, chassis, alignment	9-16
	Schematic, parts, socket, voltage	9-17
	Socket, trimmers, chassis	9-18
	Alignment, notes	9-19
	Schematic, voltage, socket	10-9
	Alignment, trimmers, chassis	10-10
	"Automatic Tune", Wheel assembly, details	10-1
	"Automatic Tune", Wheel installation, details	10-2
	Push-Button Dial assembly, instructions	10-12

MODEL	SENTINEL RADIO CORP.—(Cont.)	REVISED PAGE	RADIOTRON EARLY COMPLETE PAGE	MODEL	SENTINEL RADIO CORP.—(Cont.)	REVISED PAGE	RADIOTRON EARLY COMPLETE PAGE
108	Schematic, socket	1-3	2107	167U	Schematic, voltage, socket	10-80	
108-A, 110	Voltage, alignment	Changes 7-7		177U	Trimmers, chassis	10-78	
109	Schematic, socket	2-1	2109	178BL	Alignment	10-81	
110A	Voltage, data	2-2	2110	261, 262, 521	Schematic, voltage, socket	10-82	
	Schematic, voltage, data	2-3	2108		Alignment	10-81	
	Schematic, voltage, data	10-37			Trimmers, chassis	10-70	
111	Trimmers, socket	10-39		261, 262, 521	Schematic, voltage, socket	10-83	2114
112	Trimmers, chassis	10-39			Alignment	10-78	
	Schematic, socket, voltage, data	2-4	2111	440	Trimmers, chassis	10-76	
	Voltage, chassis, data	2-5	2113	444	Schematic	3-2	
	Schematic, socket	2-8	2112	501, 502	Schematic, voltage, socket	5-6	2124
	Schematic, changes, socket	5-1		513	Battery data, parts list	5-7	2115
	Alignment data, parts list	5-2		521	Alignment data	5-8	
	Schematic, socket, alignment	7-22		550	Schematic	1-5	
116	Schematic, voltage	5-3		550 (Revised)	Schematic, socket, voltage	1-5	2124
118	Alignment, socket, parts list	5-4			Schematic, alignment, parts	4-1	2115
118B	Schematic, voltage, socket	10-40			Schematic, parts list	4-2	
119B	Alignment, trimmers, chassis	10-41			Socket, voltage, alignment	4-3	
124A, 124AE	Schematic, voltage, socket	10-42			See model 261		
125	Alignment, trimmers, chassis	10-42			Schematic	2-8	2116
125AE	Schematic, voltage, socket	10-43			Socket layout	Changes 7-7	
127B	Alignment, trimmers, chassis	10-44			Schematic	5-9	
	Schematic, voltage	5-5			Voltage, alignment	5-10	
	Schematic, voltage, socket	10-45			Alignment, parts list	5-11	
	Alignment, trimmers, chassis	10-46			Installation and connection de-		
	Schematic, voltage, socket	10-47			tails	5-12	
	Trimmers, chassis	10-48			Schematic	3-3	2117
	Alignment	10-81			Installation notes	3-4	2118
	Schematic, voltage, socket	10-49			Voltage, notes, part 1	3-5	2119
	Trimmers, chassis	10-50			Voltage, alignment data, notes,		
	Schematic, voltage, socket	10-51			part 2	3-6	
130B, 130BE	Alignment	10-81			Socket layout	Changes 7-7	
137U	Schematic, voltage, socket	10-51			Schematic	5-13	
	Alignment, trimmers	10-52		560 (Type 2)	Schematic, circuit notes	4-4	
	Schematic, voltage, socket	10-61		570	Voltage, alignment	4-5	
	Trimmers, chassis	10-43		599 Chassis 590	Schematic	4-6	
138AE	Alignment	10-81			Voltage, alignment	4-7	
	Schematic, voltage, socket	10-53			Schematic	5-14	
	Trimmers, chassis	10-54			Schematic	4-8	
139UE	Alignment	10-81			Voltage, alignment	4-9	
	Schematic, voltage, socket	10-55			Installation notes	5-15	
	Trimmers, chassis	10-56			Installation notes, part 2	5-16	
	Schematic, voltage, socket	10-57			Alignment, parts list	5-18	
	Trimmers, chassis	10-58			Socket layout	Changes 7-7	
141AE	Alignment	10-81		614	Schematic	4-10	2121
	Schematic, voltage, socket	10-59		622, 623, Chassis 620	Schematic, voltage, notes	4-11	
	Trimmers, chassis	10-60			Alignment	4-12	
142A, 142AE	Alignment	10-81		634, 635, Chassis 630	Voltage, alignment	4-13	
	Schematic, voltage, socket	10-62			Alignment, parts list	4-14	
	Trimmers, chassis	10-63			Schematic	1-6	2122
143L	Alignment	10-81		660 AC	Socket layout	Changes 7-7	
	Schematic, voltage, socket	10-64			Schematic	5-19	
	Trimmers, chassis	10-64		660 Battery	Alignment, parts list	5-20	
144X, 144XE	Alignment	10-81		666-C	Schematic, socket	1-6	2122
	Schematic, voltage, socket	10-65		1010	Schematic	7-5, 7-6	
	Trimmers, chassis	10-66		1020, 1030	Schematic, chassis wiring	7-5, 7-6	
145AE	Alignment	10-81		1020A, 1030A	Schematic	4-15	2123
	Schematic, voltage, socket	10-67			Alignment	4-18	
	Trimners, chassis	10-68			Alignment	4-18	
147U	Alignment	10-81			Alignment, voltage, parts list	4-17	
	Schematic, voltage, socket	10-69			Socket layout	Changes 7-7	
	Trimmers, chassis	10-70			Schematic	5-21	
148A	Alignment	10-81		1040	Parts list	5-22	
	Schematic, voltage, socket	10-71			Socket layout	Changes 7-7	
149A, 149AE, 159AE	Alignment, trimmers, chassis	10-72			Voltage, alignment	5-23	
	Schematic, voltage, socket	10-73		4100	Socket layout	Changes 7-7	
	Trimmers, chassis	10-74		4100-B	Schematic, voltage, socket,		
151BL	Alignment	10-72		4300	alignment	6-5	
	Schematic, voltage, socket	10-75		4500	Schematic	5-24	
158AE	Alignment	10-81		4800	Socket layout	Changes 7-7	
	Schematic, voltage, socket	10-76		5000, 5100	Schematic, socket, voltage,		
159AE	Alignment	10-81			alignment	6-6	
163UL	See model 149A				Schematic, socket, alignment,		
	Schematic, voltage, socket	10-77			voltage	6-8	
	Trimmers, chassis	10-74			Schematic	4-19	
	Alignment	10-75			Voltage, alignment, parts list	4-20	

SENTINEL
SILVER-MARSHALL

MODEL	SENTINEL RADIO CORP.—(Cont.)	REVISED PAGE	EARLY COMPLETE PAGE	RADIOETRON
5500	Schematic Voltage, alignment, parts Socket layout.....Changes Schematic, voltage, alignment, socket..... Schematic, socket, voltage, alignment.....	5-25 5-28 7-7 6-7		2159
5700-B	Schematic, socket, voltage, alignment.....	6-12		2163
5700, 5721	Schematic, voltage.....	5-27		2164
5800	Alignment, parts list Schematic, voltage, trimmers, alignment.....	5-28 7-11, 7-12		2165 2166
6101, 6102	Schematic..... Service notes, voltage, align- ment.....	5-29		2167
6200, 6234, 6241	Parts list.....	5-30		2168
6315, 6317, 6321	Schematic.....	5-34		2169
6700	Schematic..... Voltage, alignment.....	5-32 5-33		2172
6700	Parts list.....	5-31		2175
6800	Schematic, voltage, trimmers, alignment.....	7-7		2176
6900	Schematic, voltage, trimmers, alignment.....	7-8		2177
7100	Schematic, voltage, trimmers, alignment, parts.....R-29	8-30		
7100B	Schematic, voltage, trimmers, alignment.....	7-9		
7200	Schematic, voltage.....	7-10		
7200-B	Alignment, trimmers.....7-13, 7-14 Schematic, voltage, trimmers, alignment, parts.....	7-15 8-32		2127
7700, 7732, 7741	Schematic, socket.....6-9, 6-10 Alignment, voltage.....5-31 Schematic.....5-32 Voltage, alignment, parts.....5-33 Socket layout.....Changes 7-7 Schematic, voltage.....7-17, 7-18 Alignment, trimmers.....6-13, 6-14	6-11 6-11 5-31 5-32 7-7, 7-18 6-13, 6-14		2129 2129 2130 2130 2128
8100B	Alignment.....	6-15		2131
8200-B	Schematic, voltage, trimmers, alignment.....	6-16		2132
9100	Schematic, voltage, trimmers, battery data.....	7-19, 7-20		2133 2134
	Alignment.....	7-21		
	BETCHELL-CARLSON, INC.			
PA 13 Amplifier	Schematic.....	8-1		2137
PA 25 Amplifier	Schematic.....	8-1		2138
55 Portable	Schematic, socket, trim- mers.....	Misc. 10-8		2139
PA 115 Amplifier	Schematic.....	8-2		2136
332	Schematic.....	9-1		2135
600	Schematic.....	9-2		2135
620	Schematic.....	9-2		2135
622	Schematic.....	9-1		2135
Shamrock "28-29"	Schematic.....	Misc. 4-10		2135
	SHAMROCK RADIO			
	Schematic.....	Misc. 4-10		2135
	SHELLY RADIO CO.			
5 Kompak	Schematic.....	7-1		2140
25	Schematic.....	9-3		2145
35-O	Schematic, socket.....	Misc. 8-1		2141
35C-AW, 87-O	Schematic, socket, alignment.....	8-2		2141
48	Schematic, socket.....	7-1		2141
48-A	Schematic, socket.....	8-1		2147
65	Schematic, socket.....	7-2		2142
67	Schematic, socket.....	7-2		2143
75 Auto	Schematic, socket, alignment.....	8-2		2143
	SILVER KING			
	See APPEL & HENDERSON			2144
	SILVER-MARSHALL, INC.			
	See model 737			2146
Bearcat	See model 87			2147
Bearcat Midget	See model 773			2148
Broadcast-Long Wave				2149
				2150
	SILVER-MARSHALL, INC.—(Cont.)			
MODEL				
Little Red Rooster	Schematic.....	Misc. 8-9		2159
Long-Wave Receiver	Schematic.....	710		2163
Sargent Raymond 7	See model 739			2164
SW Converter	See model 739			2165
Tune Signal Amplifier	See model 440			2166
A	Schematic, socket.....	1-30		*542-O
B	Schematic, socket, data.....	2-6		*542-K
C	Schematic, socket.....	2-7		*542-L
D	Parts list.....	2-8		
E	Schematic, parts list.....	4-3		*542-D
F	Schematic, socket, voltage.....	1-31		*542-O
G	Schematic, socket.....	1-30		*542-F
H	Schematic, socket.....	2-9		*542-G
I	Schematic, socket.....	2-10		*542-P
J	Schematic, socket.....	2-11		*542-O
K	Parts list.....	2-11		
L	Schematic, socket.....	2-12		
M	Schematic, socket, parts list.....	4-4		542-R
N	Schematic, socket, parts list.....	4-5		542-Q
O	Parts list.....	2-13		
P	Schematic, socket.....	2-14		
Q	Schematic, socket.....	3-4		
R	Parts list.....	3-5		
S	Schematic.....	4-1		
T	Schematic.....	6-29		
U	Schematic, parts list.....	4-6		
V	Schematic, parts list.....	4-7		
W	Schematic, parts list.....	4-8		
X	Schematic, parts.....	Misc. 9-5		*597
Y	Schematic, socket, voltage.....	1-1		*597
Z	Schematic, data.....	1-3		*598
AA	Schematic, data.....	1-3		*599
AB	Schematic, data.....	1-4		*540
AC	Schematic, data.....	1-4		*541
AD	Schematic, socket, voltage.....	1-2		
AE	Schematic, socket, voltage.....	Misc. 8-9		
AF	Schematic, socket, voltage.....	1-5		
AG	Schematic, socket.....	1-6		*542
AH	Schematic, socket.....	1-6		*542
AI	Schematic, socket, voltage.....	1-7		*543
AJ	Schematic, voltage.....	1-8		*542-A
AK	See model 80-B			
AL	Schematic.....	1-1		*537
AM	Schematic.....	1-32		*526
AN	Schematic.....	1-32		*527
AO	Schematic.....	1-32		*527
AP	Schematic.....	1-10		*749
AQ	Schematic.....	1-9		*714
AR	Schematic.....	1-10		*749
AS	Schematic.....	1-9		*714
AT	Schematic.....	1-9		*714
AU	Schematic, chassis wiring.....	1-10		*749
AV	Schematic, chassis wiring.....	1-11		*750
AW	Schematic, chassis wiring.....	1-11		*750
AX	Schematic, chassis wiring, parts list.....	1-12		*751
AY	Schematics, chassis wiring.....	1-13		*716
AZ	Schematic, voltage.....	1-17		*529
BA	Schematic, chassis wiring.....	1-14		*717
BB	Schematic.....	1-14		*717
BC	Schematic, socket, data.....	2-2		542-F-1
BD	Schematic.....	2-1		*718-A
BE	Schematic.....	2-12		*718
BF	Schematic.....	1-15		*718
BG	Schematic.....	1-15		*718
BH	Schematic, chassis view, data.....	1-15		*718
BI	Schematic, chassis view, data.....	1-16		*528
BJ	Schematic, socket, chassis view.....	1-17		*529
BK	Schematic, socket, voltage, chassis views.....	1-18		*590
BL	Schematic, socket data.....	2-2		542-F-1
BM	Schematic.....	1-19		*531
BN	Schematic, chassis view.....	1-19		*531
BO	Schematic, socket, voltage, data.....	1-20		*532
BP	Schematic, chassis wiring.....	1-21		*533

RADIOTRON
EARLY COMPLETE
PAGE

SIMPLEX RADIO CO.—(Cont.)

MODEL

724 AO
724 DO
726
727 SW-All-Wave
728 SW
729 SW
730, 731
735 AC
735 DO
737 AC Bearcat
738 AC, SW Converter
739 SW Superhet Converter
740 DO
740 AC
770 Auto Set
773 Broadcast-Long Wave
782 Midset
4801, 4802

Schematic, socket, voltage, chassis view	1-22	534	Schematic	4-6
Schematic, socket	1-23	*542-B	Schematic, voltage, alignment	5-1
Schematic, socket, voltage, parts list	1-24	*542-E	Schematic, voltage	5-1
Schematic, socket, data	2-3	542-N	Schematic, voltage	7-1
Schematic, speaker connections	2-4	542-M		
Schematic, parts list	3-1	2156		
Schematic	4-2	*796		
Schematic	1-25	*796		
Schematic	1-25	*796		
Schematic	1-25	*796		
Schematic, socket	1-26	*797		
Schematic, data	1-26	*797		
Schematic, data	1-27	*542-F		
Schematic, chassis	1-28	*535		
Schematic	1-28	*535		
Schematic, socket, chassis view	1-29	*536		
See model 37	2-5	542-F-3		
Schematic, voltage, parts	5-1	2162		

2197
2198
2187
2188
2189
2190
2191
2192
2193
2194
2195
2196
2199
2201
2202
2203
2200
2206
2205
2208
2207

*557
*544
*545
*546
*547
*548
*549
*550
*551
*552
*553
*554

063

Playette
D.M. Automatic Stop
2-RR, 2-5 Cycles
3R, 4R
7P
A-30, A-32
B-31, 25 Cycles
A-36, A-46
A-40
Deluxe 44
70
71, 72, 73
74
84, 85
86, 87
P-101 Amplifier
PR-101, PR-202
PR-101, AC-DC
P-300 Amplifier
PR-300 AC-DC
PR-400 AC-DC

Schematic	8-2		Schematic	8-2
Schematic	6-90		Schematic	8-2
Schematic, parts details	1-11		Schematic	1-11
Schematic	1-12		Schematic	1-12
Schematic	1-1		Schematic	1-1
Schematic	1-2		Schematic	1-2
Schematic	1-3		Schematic	1-3
Schematic	1-4		Schematic	1-4
Socket, voltage, chassis wiring	1-5		Socket, voltage, chassis wiring	1-5
Schematic, socket	1-6		Schematic, socket	1-6
Schematic, socket, voltage	1-7		Schematic, socket, voltage	1-7
Schematic	1-8		Schematic	1-8
Chassis wiring, socket, voltage	1-9		Chassis wiring, socket, voltage	1-9
Schematic, voltage	1-10		Schematic, voltage	1-10
Schematic, voltage, chassis layout	3-1		Schematic, voltage, chassis layout	3-1
Schematic, notes	3-3		Schematic, notes	3-3
Chassis layout, voltage, data	3-4		Chassis layout, voltage, data	3-4
Schematic	2-1		Schematic	2-1
Schematic, voltage, chassis layout	3-2		Schematic, voltage, chassis layout	3-2
Voltage, chassis layout, data	2-2		Voltage, chassis layout, data	2-2
Schematic, data	2-3		Schematic, data	2-3
Voltage, data	2-4		Voltage, data	2-4
Schematic, chassis, data	2-5		Schematic, chassis, data	2-5
Schematic	8-2		Schematic	8-2
Schematic	8-1		Schematic	8-1
Schematic	8-2		Schematic	8-2
Schematic	8-1		Schematic	8-1
Schematic	8-1		Schematic	8-1

2296
2274
2292
2293
2294
2297
2295
2296
2276
2210
2283

568-R
568-X
568-S
568-T
568-A
568-Q
568-W
568

063

Amplifier and Connector Units
Antenna Trimmer
Carbon Resistors
Carbon, Wire-wound Resistors
Intermediate Frequencies Power Converters
Resistors
Selector Unit
Tubes
Vacuum Tubes
5, 9
5-15, 5-26

Chassis views	2-58		Chassis views	2-58
Service notes	2-42		Service notes	2-42
Values, color coding	2-28		Values, color coding	2-28
Values, types, color coding, etc.	2-29		Values, types, color coding, etc.	2-29
I-F, Peaks	7-10		I-F, Peaks	7-10
Chassis views	2-56		Chassis views	2-56
Chassis views	2-59		Chassis views	2-59
Standard color coding	2-51		Standard color coding	2-51
Chassis views	2-57		Chassis views	2-57
Characteristics and data	2-60		Characteristics and data	2-60
Chart and data	5-6		Chart and data	5-6
Schematic, chassis layout, voltage, data	2-1		Schematic, chassis layout, voltage, data	2-1
Schematic	1-3		Schematic	1-3

SPARKS WITHINGTON

MODEL	SPARKS WITHINGTON CO.—(Cont.)	REVISED PAGE	EARLY COMPLETE PAGE	RADIOTRON
6-15, 6-26	Schematic	1-3	2283	
AC-7, AC-62, AC-68	Schematic, socket, voltage	1-5	2209	
9-A, 800-A, 610-A, 620-A	Schematic, socket, voltage	2-2	2211	
9X, 13, 14, 14-A, 15X, 620X	Schematic	2-7	2215	
10	Voltage, chassis, data	2-6	2216	
12	Alignment data	4-1	2213	
14, 14A	Chassis, voltage, data	2-3	2212	
15	Schematic, chassis, voltage	2-4	2214	
15X	See model 9X	2-5	2218	
16, 16-AW (BO Rec.)	Chassis, voltage, data	2-8	2217	
16-AW, 26-AW (SW Rec.)	See model 9X	2-9	2219	
17, 18, 28X, 111X, 750-A, 760X, 870-A, 870X	Schematic, voltage	2-11	2220	
AR-19, 19-A	Additional data	Changes 7-4	2221	
25, 26	Schematic	4-2	2222	
26 AW (SW Rec.)	Voltage, chassis, trimmers	4-3	2223	
26-AW, Revised #2	Alignment data	4-1	2224	
27, 27-A, 28	Schematic	4-1	2226	
27-A	Chassis view	2-12	2227	
27X	Schematic	4-4	2228	
28	Voltage, socket, trimmers	4-5	2231	
28X	Data	Changes 7-13	2230	
30, 30A, 30B	Schematic	4-6	2232	
30-A	Additional data	Changes 7-4	2233	
31, 32	See model 17	2-16	2234	
33	Chassis, voltage	3-1	2235	
35-A, 38-B	Schematic	3-2	2236	
34	Alignment data	4-1	2237	
35	Schematic	4-4	2238	
36	Voltage, socket, trimmers	4-5	2240	
39	Data	Changes 7-13	2241	
40, 40-A	Additional data	Changes 7-4	2242	
41	See model 17	2-17	2243	
41-A, 43	Chassis, voltage	2-18	2244	
41A	Schematic	2-18	2245	
42	Service notes, part 1	2-19	2246	
48	Service notes, part 2	2-20	2247	
45	Parts list	2-21	2248	
	Chassis views	2-21	2249	
	Alignment data	2-22	2245	
	Schematic	4-1	2244	
	Chassis views	2-23	2245	
	Voltage, notes, socket	4-7	2244	
	Schematic, voltage, resistance	7-1	2244	
	Trimmers, alignment	7-2	2244	
	Schematic	3-3	2243	
	Voltage, battery and assembly	3-4	2243	
	connections, notes	3-4	2243	
	Alignment data	4-1	2243	
	Service data	2-24	2246	
	Service data, continued	2-25	2247	
	Service data, concluded	2-26	2248	
	Chassis views	2-27	2249	
	Schematic	3-5	2245	
	Chassis layout, voltage	3-6	2244	
	I-F, Peak	Changes 7-8	2244	
	Schematic, voltage, resistance	4-9	2244	
	Changes	Changes 7-8	2244	
	Trimmers, alignment	7-2	2244	
	Schematic	1-4	2240	
	Schematic, voltage, socket	2-30	2250	
	Alignment, trimmers	7-3	2251	
	Schematic, socket, voltage	2-31	2251	
	Alignment, trimmers	7-3	2251	
	Alignment data	4-1	2251	
	Trimmers, additional alignment	7-3	2251	
	Schematic, voltage	5-8	2251	
	Schematic, voltage	5-8	2251	
	Voltage	4-8	2251	
	Schematic, changes	4-10	2251	
	Alignment, trimmers	7-3	2251	
	Schematic	2-32	2251	
	Chassis, voltage, data	2-33	2251	
	Schematic, parts, voltage, resistance, trimmers, alignment	9-1	2209	
	Schematic	1-5	2223	
	Chassis	1-1	2224	
	Schematic, socket, voltage	2-12	2223	
	Service data	2-34	2254	
	Schematic	2-35	2254	
	Voltage, chassis view	5-1	2255	
	Alignment data	5-2	2255	
	Voltage, chassis layout	3-8	2256	
	Schematic	3-7	2257	
	Alignment data	4-1	2257	
	Schematic	2-36	2258	
	Alignment, trimmers	7-3	2258	
	Schematic	2-37	2241	
	Voltage, chassis, data	2-38	2260	
	Schematic	5-4	2260	
	Alignment data	5-3	2260	
	Voltage, chassis view	5-5	2260	
	Additional data	Changes 7-14	2260	
	Schematic, parts	6-1	2260	
	Voltage, socket, trimmers	6-2	2260	
	Schematic, socket, voltage	2-39	2260	
	Additional data	Changes 7-4	2260	
	Schematic, voltage	4-11	2260	
	Changes	Changes 7-15	2260	
	See model AC-7	5-7	2260	
	Schematic	5-7	2260	
	Voltage, chassis view	5-8	2260	
	Alignment data	5-9	2260	
	Additional data	Changes 7-8	2260	
	Note	5-7	2260	
	Alignment data	5-9	2260	
	Schematic	5-11	2260	
	Alignment data	5-10	2260	
	Voltage, chassis view	5-12	2260	
	Data	Changes 7-13	2260	
	Schematic, voltage	1-7	2260	
	Schematic, parts	6-3	2260	
	Voltage, socket, trimmers	6-4	2260	
	Schematic, voltage, resistance	4-12	2260	
	Trimmers, alignment	7-2	2260	
	Schematic, voltage, resistance	4-13	2260	
	Trimmers, alignment	7-2	2260	
	Schematic, trimmers	7-4	2260	
	Voltage, alignment	7-6	2260	
	Schematic, trimmers, parts	7-5	2260	
	Voltage, socket, trimmers, alignment	7-6	2260	
	Data	Changes 7-13	2260	
	Schematic, voltage, resistance	4-14	2260	
	Schematic	5-13	2260	
	Voltage, notes	5-14	2260	
	Alignment	8-2	2260	
	Schematic, voltage, socket, trimmers, changes, parts	8-1	2260	
	Alignment	8-2	2260	
	Voltage, resistance, socket, trimmers, speaker wiring	7-8	2260	
	See model 70	4-15	2260	
	Schematic, voltage, resistance	4-15	2260	
	See model 69	5-16	2260	
	Schematic	5-16	2260	
	Voltage, chassis view, notes	5-16	2260	
	Alignment data	6-17	2260	
	Trimmer locations, frequency tables	5-18	2260	
	Additional data	Changes 7-4	2260	
	Data	Changes 7-4	2260	
	Schematic, voltage, resistance	4-16	2260	
	Schematic, socket, voltage, resistance	7-18	2260	

SPARKS WITHINGTON CO.—(Cont.)		RADIOTRON	
MODEL	REVISED PAGE	EARLY COMPLETE PAGE	FULL COMPLETE PAGE
81-A	Additional data Changes 7-14		
81X	Data Changes 7-13		
82	Schematic, voltage, resistance data 4-17		
82X	Data Changes 7-13		
83	See model 80		
83 84	Schematic, chassis view, notes 5-15		
85X	Voltage, chassis view, notes 5-16		
	Alignment data 5-17		
	Trimmer locations, frequency tables 5-18		
	Phonograph data, part 1 7-9		
	Phonograph data, part 2 7-10		
	See model 80		
	See model 69		
	Schematic, voltage 1-7	2262	
88-A	Ensemble wiring 1-10	2264	
89	Schematic 1-11	2268	
101	Voltage, assembly wiring 4-18	2266	
	Schematic 4-19	2265	
103, 578	Assembly wiring, voltage, chassis 2-40	2268-J	
	Schematic 2-41	2267	
	Schematic 5-10		
104, 135	Voltage, chassis view, notes 5-20		
	Alignment 5-17		
	Additional data Changes 7-14		
	Schematic 5-19		
	Voltage, chassis view, notes 5-20		
	Alignment 5-17		
	Phonograph data, part 1 7-9		
	Phonograph data, part 2 7-10		
	Schematic 1-12	2269	
109 DeLuxe	Schematic 1-13	2271	
110, 111, AC (2 types)	Schematic 2-43	2278	
111-A, 574, 870	See model 17		
111X	Alignment data 4-1		
	Schematic, parts 6-5		
	Voltage, socket, trimmers 6-6		
134, 136	See model 104		
	Schematic, voltage, adjustments, changes 10-1		
135	219-P, 219-PD, Wireless Phonograph		
	Schematic, voltage 2-44	2276	
235	Schematic, voltage 1-14	2277	
301 AC	Schematic, voltage, resistance data 2-45	2278	
301 DC			
333			
409-GL	Schematic, voltage, socket, trimmers, alignment 10-2		
410, 420 AC	Chassis layout 2-46		
	Schematic 2-47		
410, 420 DC	Chassis layout 2-48		
	Schematic 2-49		
417X	Schematic, parts, voltage, resistance, socket, trimmers, 9-9		
	Schematic, resistance, voltage, trimmers, parts 8-3		
427X, 437X, 457X	Socket, trimmers, alignment 8-4		
475-A, 478-A	See model 75-A		
475-A, 478-A, 478	See model 75-A		
	See model 78		
500DG, 500DR, 500W, 500BV, 500BW	Schematic, voltage, socket, trimmers, alignment 10-3		
506, 506, 594	Schematic, parts 6-7		
	Voltage, socket, trimmers 6-8		
510DG, 510DR, 510W, 510BV, 510BW	Schematic, voltage, socket, trimmers, alignment 10-4		
516, 516X, 540X	Schematic, parts, transformer 7-11		
	Voltage, alignment, socket, trimmers, resistance 7-12		
	Schematic, trimmers, resistance, voltage, parts 8-5		
517, 517B, 517W, 517X, 557, 567	Schematic, parts 8-6		
	Socket, trimmers, alignment 8-6		
518, 518X, 558B, 558BX, 558C, 568, 568X, 578 (1938) 578X	Schematic, parts, voltage 9-2		
527-2, 587-2	Alignment, socket, trimmers 9-3		
	Schematic, voltage, socket, trimmers 10-5		
	Alignment 10-10		

SPARKS WITHINGTON CO.—(Cont.)		RADIOTRON	
MODEL	REVISED PAGE	EARLY COMPLETE PAGE	FULL COMPLETE PAGE
528-2, 588-2	Socket, trimmers, alignment 9-3		
	Schematic, parts, voltage 9-4		
536, 586X	Schematic, socket, voltage, resistance 7-13		
	Alignment, trimmers 7-14		
537, 577	Schematic, socket, trimmers, voltage, resistance, parts 8-7		
	Alignment 8-6		
	Schematic, parts 9-5		
538, 538X, 628, 628X, 668, 668X, 678, 678X, 678A (Selectronne)	Voltage, alignment, socket, trimmers 9-6		
	Selectronne data 9-22		
546X	See model 516		
547X	Schematic, voltage, socket, trimmers, resistance, parts 8-11		
548X	Alignment 8-14		
	Schematic, parts 9-7		
	Voltage, alignment, socket, trimmers 9-8		
	Schematic, voltage 10-7		
	Alignment, socket, trimmers 10-8		
557	See model 517		
558	See model 518		
564, 570, 740, 750 AC	See model 518		
564, 570, 600, 610, 620, 737, 740, 750 DC	Schematic, voltage 2-50	568-L	
	Schematic 2-53	568-O	
566	See model 506		
567	See model 517		
568	See model 518		
570	See model 564		
574	See model 111-A		
577	See model 537		
578	See model 103 or 518		
587-2	See model 527-2		
588-2	See model 528-2		
589 AC	Schematic, voltage 1-19	*564	2285
591, 593 AC	See model 506	568-K	2286
594	See model 566		
600, 610, 620 DC	Schematic, see model 564 DC		
600, 610, 620, 737 AC	Schematic, voltage 1-20		
600-A, 610-A	See model 9-A		
608B, 608K, 608G, 608W, 608H, 608X, 608V	Schematic, parts, voltage 9-10		
616, 616-X, 666, 666-X	Socket, trimmers, alignment 9-11		
	Schematic, parts 6-9		
616-M, 616-MX, 666-M, 666-MX	Voltage, socket, trimmers 10-10		
	Alignment, trimmers 7-16		
	Schematic, parts 7-15		
617, 617-X, 667, 667-X	Alignment, trimmers 7-16		
	Socket, voltage, resistance 7-17		
	Schematic, socket, voltage, trimmers, parts 8-9		
620	Alignment 8-10		
620-A	See model 564		
620-A, 620-AC, Below #6502	See model 9-A		
620 DC	See model 600 AC		
620X	See model 564 DC		
628	See model 9X		
636-MX	Alignment data 4-1		
	See model 538		
	Schematic, parts 7-19		
	Voltage, resistance, socket, trimmers, alignment 7-20		
637-6, 687-6	Schematic, voltage 10-9		
638-6, 688-6	Alignment, socket, trimmers 10-10		
	Socket, trimmers, voltage, alignment 9-11		
649-6L, 649-6S	Schematic, parts 9-12		
	Schematic 10-11		
	Voltage, socket, chassis 10-12		
	Alignment, trimmers 10-13		
	Schematic, parts 6-11		
655	Voltage, socket 6-13		
668, 666X	See model 616		
668-M, 666-MX	See model 616-M		
667, 667X	See model 617		
	See model 538		

MODEL	SPIEGEL, INC.—(Cont.)	REVISED PAGE	RADIOTRON EARLY COMPLETE PAGE
AM 3 Chassis	See model 6506		
Z4 Chassis	See model 102		
L-5 Chassis	See model 170		
M-5 Chassis	See model 178		
Z-5 Chassis	See model 167		
6A60 Chassis	See model 4505		
AM 6 Chassis	See model 6508		
L-6 Chassis	See model 130		
6-P Chassis	See model 4404		
6-O Chassis	See model 2154		
6-W Chassis	See model 2000		
X-6 Chassis	See model 1901		
7AC Chassis	See model 6502		
AM 7 Chassis	See model 5054		
L-7 Chassis	See model 4400		
L-7 Chassis	See model 144		
X-8 Chassis	See model 2058		
11-S Chassis	See model 100		
11-X Chassis	See model 4010		
12AC Chassis	See model 4006		
14 Chassis	See model 1903		
14-112S Chassis	See model 6803		
14-127ES Chassis	See model 2080		
14-129 Chassis (1936)	See model 2212		
14-136EA, 14-152ES Chassis	See model 6525		
14-142ES Chassis	See model 6512		
16R Chassis	See model 2060		
20C5 Chassis	See model 4508		
22B7 Chassis	See model 4509		
23E Chassis	See model 2204		
X-23 Chassis	See model 2204		
25Y Chassis	See model 6030		
27D Chassis	See model 6030		
29B Chassis	See model 3914		
37B Chassis	See model 1506		
40 Chassis	See model 1906		
BA-11 Chassis	See model 2000		
43 Chassis	See model 1901		
46A Chassis	See model 2066		
58 Chassis	See model 134		
65B Chassis	See model 132		
66-660 Chassis	See model 4210		
73 B Chassis	See model 2222		
78-780 Chassis	See model 2302		
88-880 Chassis	See model 4212		
90B Chassis	See model 2112		
100, Chassis X-8	Schematic, socket, voltage, trimmers9-1		
102, 104, 112, 114, 124, Z4	Alignment, parts9-2		
172, 6750, 6752 Chassis	Schematic, socket, trimmers, alignment10-5		
109B Chassis	See model 2100		
120, 140, Chassis L-5	Schematic, voltage, socket, trimmers9-3		
	Alignment, parts9-4		
124	See model 102		
130, 134, 146, 190, Chassis L-6	Schematic, voltage, socket, trimmers9-5		
	Alignment9-4		
132, Chassis 58	Schematic, voltage9-7		
	Alignment, socket, trimmers, parts9-8		
134, Chassis 46A	Schematic, trimmers10-1		
	Alignment, voltage, socket, tuning eye notes10-2		
144, 152, 178, Chassis L-7	Schematic, voltage, socket, trimmers9-5		
	Alignment9-4		
145E Chassis (1938)	See model 2212		
146 Chassis (1938)	See model 130		
147 Chassis (1938)	See model 2080		
150, 188, 1910, Chassis 37-B	Schematic, alignment, parts9-11		
152	See model 144		
160, 180, 184, 6500, 6504, 6518, 6546, 6550, 6562, 6564, Chassis 603 (1936)	Schematic10-3		
	Alignment, socket, trimmers10-4		
MODEL	SPIEGEL, INC.—(Cont.)	REVISED PAGE	RADIOTRON EARLY COMPLETE PAGE
167, 182, 189, Chassis Z-5	Schematic, socket, trimmers9-9		
169, Chassis H1	Alignment9-4		
	Schematic, voltage, alignment10-6		
172	See model 102		
178	See model 144		
178, 6708, 6754, Chassis M-5 (1936)	Schematic, voltage, socket, trimmers10-7		
	Alignment10-4		
180, 184	See model 160		
182, 183	See model 167		
188	See model 150		
190	See model 130		
202 Chassis	See model 1100		
211 Chassis	See model 1108		
212 Chassis	See model 1150		
216 Chassis	See model 1010		
218 Chassis	See model 1052		
219 Chassis	See model 1002		
220 Chassis	See model 1104		
601 Chassis	See model 6504		
603 Chassis	See model 160		
603 (1934) Chassis	See model 4519 Auto		
613 Chassis	See model 5058		
633 Chassis	See model 6590		
701 Chassis	See model 5200		
745 Chassis	See model 5256		
745 (1937) Chassis	See model 2064		
871 Chassis	See model 4004		
883 Chassis	See model 4068		
1002, 1009, Chassis 210	Schematic, socket, trimmers, alignment10-8		
1010, 1011, Chassis 216	Schematic, socket, trimmers, alignment10-9		
1052, 1053, Chassis 218	Schematic, socket, trimmers, alignment10-10		
1060B Chassis	See model 6600		
1070B Chassis	See model 5102		
1072AB Chassis	See model 4002		
1090B Chassis	See model 2108		
1100, 1101, 1102, 1103, Chassis 202	Schematic, alignment10-11		
1104, 1105, 1106, 1107, Chassis 220	Schematic, socket, trimmers10-12		
	Alignment10-10		
1105 Chassis	See model 2070		
1108, 1109, 1110, 1111, Chassis 211	Schematic, socket, trimmers, alignment10-13		
1150, 1151, 1152, 1153, Chassis 212	Schematic, alignment10-11		
1154, 1155, 1156, 1157, Chassis 220	Schematic, socket, trimmers10-12		
	Alignment10-10		
1901, 1907, 1911, 1921, 1932, 1955, 1957, 1961, 1981, Chassis X-6, BA-11	Schematic, socket, trimmers, alignment10-14		
1903, 1960, Chassis 14A	Schematic, trimmers10-15		
	Alignment, voltage10-16		
1906, 1954, Chassis 39B	Schematic, trimmers, alignment10-22		
1910	See model 150		
1911	See model 1901		
1921, 1932	See model 1901		
1954	See model 1906		
1955, 1957	See model 1901		
1960	See model 1903		
1961, 1981	See model 1901		
2000, 2001, 2003, 2009, 2018, 2019, 2050, 2051, Chassis 40	Schematic, socket, trimmers, alignment10-17		
2000, 2001, 2050, 2051, 2072, 2073, Chassis 6-W	Tuner data10-18		
2058, 2059 (1938), 4054 (1937) Chassis 11-S	Schematic, socket, trimmers, alignment, parts9-12		
	Schematic, socket, parts, trimmers9-13		
	Alignment, notes9-14		
	Electric tuning data9-15		

2060, 2061, 4056, 4074, Chassis 10R	Schematic	10-19, 20
2064, 2065, 4014, 4064, 4066, Chassis 745 (1937)	Socket, trimmers, tuner data, alignment Schematic, voltage, socket, trimmers, alignment	10-21 10-23
2066, 2067, 2068, Chassis 109B	Tuner data Schematic, alignment	10-18 10-10
2070, 2071, 4076, Chassis 1105	Socket, trimmers Schematic, voltage, socket	10-12 10-24
2080, 2081, Chassis 147 (1938) Also chassis 14-127ES	Tuner data Alignment Schematic, socket, trimmers, alignment, parts	10-18 10-28 9-16
2100, 2101, 2102, 2103, Chassis 109B	Schematic, voltage, socket	10-25
2108, 2109, 2110, 2111, Chassis 1090B	Alignment, trimmers, chassis Schematic, voltage, socket	10-26 10-27
2112, 2113, 2120, 2121, Chassis 90B	Socket, trimmers, chassis Schematic, voltage, socket	10-28 10-27
2150, 2151, 2152, 2153, Chassis 109B	Socket, trimmers, chassis Schematic, voltage, socket	10-38 10-25
2154, 2155 (1938), 4500, 4502, 4504, 4550, 4512, 4514 (1936) Chassis 6-Q	Alignment, trimmers, chassis Schematic, socket, trimmers, alignment	10-26 9-17
2200, 2201, 2202, 2203, 2220, 2221, 2230, 2231, 2232, 2233, Chassis X23	Schematic, alignment, notes	10-31
2204, 2205, 2206, 2207, Chassis 23E	Alignment procedure Schematic, alignment, notes	10-36 10-31
2212, 2213, 2214, 2215, 2254, 2255, 2256, 2257, 2280, 2281, Chassis 145E (1938) Also chas- sis 14-129 (1936)	Alignment procedure Schematic, socket, trimmers, alignment, parts	10-36 9-18
2220, 2221, 2224, 2225, 2226, 2227, 2228, 2229 Chassis 73B	See model 2200 Schematic, voltage	10-29
2230, 2231, 2232, 2233 2209, 2203, Chassis 7S	Socket, trimmers, chassis, alignment See model 2200 Schematic, socket, trimmers, alignment	10-30 10-32
4005, 4050, 5020, Chassis 1072AE	Schematic, voltage	10-33
4004, 4052, Chassis 87I	Socket, trimmers, chassis, alignment	10-34
4006, 4070, Chassis 12AC	Schematic, socket, trimmers, voltage, alignment	10-35
4010, Chassis 11X	Alignment procedure Schematic, alignment, trim- mers	10-28 10-36
4014	Schematic, alignment	10-37
4050	See model 2064	
4052	See model 4002	
4054 (1937) Chassis 11-S	See model 4004	
4056	See model 2058	
4064, 4066	See model 2060	
4068, Chassis 885	Schematic, voltage, socket Alignment	10-38 10-28
4070	See model 4006	
4074	See model 2060	
4076	See model 2070	
4210, Chassis 66-660	Schematic, socket, trimmers, alignment, connections	10-39
4212, Chassis 88-880	Schematic, socket, trimmers, alignment, connections	10-40
4400, 4420, Chassis 7-J	Schematic, socket, trimmers, alignment, parts	9-19

4404, 4452, Chassis 6-P	Schematic, alignment	9-21
4500 (1935), Chassis 4536	Socket, trimmers, notes, parts	9-22
4500, 4502, 4504 (1936), Chassis 6-Q	Schematic, socket, voltage, alignment	9-20
4505, Chassis 6A60	See model 2154	
4508, 9905, 9911, Chassis 20C5	Schematic, alignment, trim- mers, voltage	10-41, 42 9-23
4509, 9912, Chassis 22B7	Socket, voltage, resistance, alignment, drive cord data	9-24
4510, 4516, 4533, 9923, Chassis 6246	Schematic, socket, trimmers, parts	9-25
4512, 9914, 9915, 9932, 9938 (1935) Chassis 7700	Voltage, alignment, resistance, sensitivity	9-26
4512, 4514 (1936) Chassis 6-Q	Schematic, voltage, alignment	9-32
4514, Chassis 9148	Schematic, voltage, parts	9-28
4519 Auto, Chassis 603 (1934)	Schematic, voltage, trimmers, battery data	9-29, 30 9-31
4533, Chassis 6246	Alignment	10-43
4536 Chassis	Alignment, voltage	10-44
4550 (1936) Chassis 6-Q	See model 4510	
5006, 5052, 6544, 6568, Chassis 14-127ES	See model 2154 See model 2080	
5020	See model 4002	
5054, 5062, 6570, 6580, 6582, 6590, Chassis AM 7	Schematic, socket, alignment, trimmers	10-19
5058, 5060, Chassis 613	Schematic, socket, voltage, trimmers, parts, alignment	9-35
5062	See model 5054	
5102, Chassis 1070B	Schematic, voltage, socket	9-33
5106, 5110, Chassis 65B	Alignment, parts, battery con- nections	9-34
5200, 5210, 5214, 5216	Schematic, voltage, socket, trimmers, alignment	10-45
5218, 6712, 6716, 6766, Chassis 65A	Schematic, voltage	9-36
6712, Chassis 14-129 (1936)	See model 2212	
6776, 6776, 6770, Chassis 700	Schematic, socket, alignment	10-50
6800 Chassis	See model 9907	
6846 Chassis	See model 9902	
6502, 6552, Chassis 7AC	See model 4510	
6504, Chassis 601	See model 160	
6506, 6554, Chassis AM 3	Schematic, socket, trimmers, alignment	10-47
6508, 6556, Chassis AM 6	Schematic, socket, trimmers, alignment	10-48
6510, 6514, 6520, Chassis B-1	Schematic, socket, trimmers, alignment	9-87
6512, 6542, 6566, Chassis 14-142ES	Schematic, socket, trimmers, alignment	10-51
6518	See model 160	
6525, 6532, 6540, 6560, Chassis 14-136EA, 14-152ES	Schematic, socket, trimmers, alignment	9-41
6542	See model 6512	
6544, 6568, Chassis 14-127ES	See model 2080	
6546, 6550	See model 160	
6552	See model 6502	
6554	See model 6506	

4404, 4452, Chassis 6-P	Schematic, alignment	9-21
4500 (1935), Chassis 4536	Socket, trimmers, notes, parts	9-22
4500, 4502, 4504 (1936), Chassis 6-Q	Schematic, socket, voltage, alignment	9-20
4505, Chassis 6A60	See model 2154	
4508, 9905, 9911, Chassis 20C5	Schematic, alignment, trim- mers, voltage	10-41, 42 9-23
4509, 9912, Chassis 22B7	Socket, voltage, resistance, alignment, drive cord data	9-24
4510, 4516, 4533, 9923, Chassis 6246	Schematic, socket, trimmers, parts	9-25
4512, 9914, 9915, 9932, 9938 (1935) Chassis 7700	Voltage, alignment, resistance, sensitivity	9-26
4512, 4514 (1936) Chassis 6-Q	Schematic, voltage, alignment	9-32
4514, Chassis 9148	Schematic, voltage, parts	9-28
4519 Auto, Chassis 603 (1934)	Schematic, voltage, trimmers, battery data	9-29, 30 9-31
4533, Chassis 6246	Alignment	10-43
4536 Chassis	Alignment, voltage	10-44
4550 (1936) Chassis 6-Q	See model 4510	
5006, 5052, 6544, 6568, Chassis 14-127ES	See model 2154 See model 2080	
5020	See model 4002	
5054, 5062, 6570, 6580, 6582, 6590, Chassis AM 7	Schematic, socket, alignment, trimmers	10-19
5058, 5060, Chassis 613	Schematic, socket, voltage, trimmers, parts, alignment	9-35
5062	See model 5054	
5102, Chassis 1070B	Schematic, voltage, socket	9-33
5106, 5110, Chassis 65B	Alignment, parts, battery con- nections	9-34
5200, 5210, 5214, 5216	Schematic, voltage, socket, trimmers, alignment	10-45
5218, 6712, 6716, 6766, Chassis 65A	Schematic, voltage	9-36
6712, Chassis 14-129 (1936)	See model 2212	
6776, 6776, 6770, Chassis 700	Schematic, socket, alignment	10-50
6800 Chassis	See model 9907	
6846 Chassis	See model 9902	
6502, 6552, Chassis 7AC	See model 4510	
6504, Chassis 601	See model 160	
6506, 6554, Chassis AM 3	Schematic, socket, trimmers, alignment	10-47
6508, 6556, Chassis AM 6	Schematic, socket, trimmers, alignment	10-48
6510, 6514, 6520, Chassis B-1	Schematic, socket, trimmers, alignment	9-87
6512, 6542, 6566, Chassis 14-142ES	Schematic, socket, trimmers, alignment	10-51
6518	See model 160	
6525, 6532, 6540, 6560, Chassis 14-136EA, 14-152ES	Schematic, socket, trimmers, alignment	9-41
6542	See model 6512	
6544, 6568, Chassis 14-127ES	See model 2080	
6546, 6550	See model 160	
6552	See model 6502	
6554	See model 6506	

SPIEGEL, INC.—(Cont.)

MODEL	REVISED PAGE	EARLY COMPLETE PAGE	RADIOTRON COMPLETE PAGE
6556			
6562			
6566			
6570			
6590			
6590			
6600			
6708			
6712			
6750			
6754			
6760			
6805			
6815			
6896			
6946			
7700			
9118			
9902			
9904			
9905			
9907			
9912			
9914			
9916			
9923			
9930			
9932			

See model 6508
See model 160
See model 6512
See model 5054
See model 5054
Schematic, voltage9-36
Schematic, voltage, alignment, parts, socket9-38
See model 178
See model 2212
See model 102
See model 178
See model 5256
Schematic, socket, trimmers, alignment10-51
Schematic, voltage, trimmers, alignment, parts9-39, 9-40
See model 4512
See model 4514
Schematic, socket, voltage, alignment, socket, trimmers, alignment9-42
Voltage, circuit changes, parts, drive, cord data9-44
See model 4508
Schematic, voltage, alignment10-52
See model 4509
See model 4512
Schematic, socket, trimmers, parts9-45
Voltage, resistance, alignment9-46
Schematic, socket, trimmers, voltage, parts9-47
Alignment, resistance, drive cord data9-48
See model 4512

SPLITDORF ELECTRIC MFG. CO.
See THOMAS A. EDISON, INC.

STANDARD RADIO CORP.

Standardyne 29 AC	Schematic, socket	Misc. 1-19	2999
6-U	STAR Schematic		
062	Schematic, voltage, wiring	Misc. 5-2	

STAR RAIDER
See CONTINENTAL RADIO CORP.

STEINITE RADIO CO.

8-Tube Pentode	Schematic	Misc. 6-32	
10 Chassis	See model 70		
15, 17 Chassis	See model 420		
21 Chassis	See model 421		
22 Chassis	See model 203		
23 Chassis	See model 423		
26 Chassis	See model 642-B		
28 Chassis	See model 700		
40, 40-A, 50, 50-A, 102, 102-A	Schematic	Misc. 1-1	2901
40-C, 60-C, 102-C	Schematic, socket, voltage	Misc. 1-2	2902
40, 45, 60-A, 45-A, 50-A, 102 SPU	Schematic, socket, voltage	Misc. 1-2	2902
70, 80, 95 (Chassis #10)	Schematic, socket, chassis wiring	Misc. 1-3	2914
102 Series	See model 40 Series		
203, 600, 605, 630, 635, 642, 643 (Chassis #22)	Schematic	Misc. 2-1	2903
261, 262, 263, 264, 265	Schematic, socket, voltage	Misc. 1-4	2904
420, 450 (Chassis #15)	Schematic, socket	Misc. 2-3	2905
420, 450 (Chassis #17)	Schematic, socket	Misc. 2-2	2905

STEINITE RADIO CO.—(Cont.)

MODEL	REVISED PAGE	EARLY COMPLETE PAGE	RADIOTRON COMPLETE PAGE
421, 425 (Chassis #21)	Chassis layout, data	576-D	2908
423 (Chassis #23)	Schematic	576-C	2907
600, 605, 630, 635, 642, 643	Schematic	576-F	2909
642-B, 700, 705, 706, 725, (Chassis #26)	See model 203		
700, 701 (Chassis #28)	Schematic	576-G	2911
990, 991, 992, 993	Voltage, data	576-H	2912
	Schematic, data, voltage	576-I	2910
	Schematic, socket, voltage	*576	2913

STENODE RADIOSTAT

Stenode Radiostat	Schematic	Misc. 1-18	2763
-------------------	-----------	------------	------

STERLING MFG. CO.

A (DO)	Schematic		2919
C	Schematic		2923
F	Schematic		2920
M-N	Schematic	*579	2920
P-Q	Schematic		2921
V-A	Schematic		2921
Miniature	Schematic		2919
	Schematic, voltage	*578-A	2917
8-tube Receiver	Chassis views, data	*578-B	2918
3-A	Schematic	*577	2920
B-3	Schematic		2915
4	Schematic		2923
B-4	Schematic	*578	2916
RT-41, R-81, R-96-M, R-96, R-97, R-98, R-100, R-100-M	Schematic		2923
R-100 MV	Schematic		2924
R-402	Schematic		2925
R-403	Schematic		2925
R-404	Schematic		2925
R-406	Schematic		2925
R-407	Schematic		2925
R-409	Schematic		2925
R-410	Schematic		2927
R-411	Schematic		2927
R-412	Schematic		2927
R-509	Schematic		2927
R-510	Schematic		2927
R-511	Schematic		2927
R-522	Schematic		2922
R-807-A	Schematic	*781	2922
R-810 (1st type)	Schematic	*781	2926
R-810 (2nd type)	Schematic		2926
R-880	Schematic		2926

STEWART-WARNER CORP.

NOTE: The second figure of the new system model numbers in Volume X indicates the voltage rating of the receiver as follows:
1—117 volts, 50-60 cycles
2—2-volt battery
3—117 volts, AC-DC Underwriters Approved
7—117 volts, AC-DC
8—117 volts, 25 cycles
10—100-240 volts, 50-133 cycles

AC-DC Sets	Data	Changes 10-6	
A-F Transformers	See model A6		*580-A
Air Pal	See models R-1922, R-1932		
Firestone	Variable and fixed, part 1	1-13	*580-C
Resistors	Fixed part 2	1-14	*580-D
Wave Trap	Installation data	5-4	
1937 Models	Speaker cone replacements	10-14	
01-521, 01-522, 01-523, 01-524, 01-525, 01-526, 01-527, 01-528, 01-529, Chassis 01-52	Schematic, voltage, sockets, coils, tuner switch	10-55	
01-531, 01-532, 01-533, 01-534, 01-535, 01-536, 01-537, 01-538, 01-539, Chassis 01-53, 01-531S, 01-532S, 01-533S, 01-534S, 01-535S, 01-536S, 01-537S, 01-538S, 01-539S, Chassis 01-53S	Alignment, trimmers, tuner	10-56	
	Schematic, voltage, socket, tuner switch, coils	10-57	
	Alignment, trimmers	10-56	

08-811, 08-812, 08-813, Schematic, voltage, socket
08-814, 08-815, 08-816, tuner switch, coils10-61, 62
08-817, 08-818, 08-819, Chassis 08-81
Alignment, trimmers10-63
Tuner drive cord data10-64
See models 108, 108-X (Chassis)
Schematic, voltage, socket, tuner switch, coils10-55
10 to 20 inc.
010-521, 010-522, 010-523, Schematic, voltage, socket, tuner switch, coils10-56
010-524, 010-525, 010-526, 010-527, 010-528, 010-529, Chassis 010-52
010-531, 010-532, 010-533, Schematic, voltage, socket, tuner switch, coils10-57
010-534, 010-535, 010-536, 010-537, 010-538, 010-539, Chassis 010-53
010-531S, 010-532S, 010-533S, 010-534S, 010-535S, 010-536S, 010-537S, 010-538S, 010-539S, Chassis 010-53S
010-541, 010-542, 010-543, 010-544, 010-545, 010-546, 010-547, 010-548, 010-549, Chassis 010-54
010-541S, 010-542S, 010-543S, 010-544S, 010-545S, 010-546S, 010-547S, 010-548S, 010-549S, Chassis 010-54S
Alignment, trimmers10-56
Schematic, voltage, socket, coils10-58
Tuner, drive cord data10-63
Schematic, voltage, socket notes10-64
Alignment, trimmers10-59
Schematic, voltage, socket, coils10-61, 62
Alignment, trimmers10-63
Tuner, drive cord data10-64
Schematic, voltage, socket notes10-65
Alignment, trimmers, loop, battery data10-66
Schematic, voltage, socket10-1
Alignment, trimmers, antenna notes, change10-2
Schematic, voltage, socket, coils, changes10-67
Alignment, trimmers, antenna notes10-68
Schematic, voltage, socket, coils, changes10-67
Alignment, trimmers, antenna notes10-68
Schematic, voltage, socket, notes10-69
Alignment, trimmers, antenna data10-70
Schematic, voltage, socket, notes10-69
Alignment, trimmers, antenna data10-70
Schematic, voltage, socket10-71
Alignment, trimmers, drive cord data10-72
Schematic, voltage, socket, tuner switch, coils10-55
Chassis 08-52
08-521, 08-522, 08-523, 08-524, 08-525, 08-526, 08-527, 08-528, 08-529, Chassis 08-52
08-541, 08-542, 08-543, 08-544, 08-545, 08-546, 08-547, 08-548, 08-549, Chassis 08-54
Alignment, trimmers10-59
data, tuner10-22

01-541, 01-542, 01-543, Schematic, voltage, socket10-58
01-544, 01-545, 01-546, 01-547, 01-548, 01-549, Chassis 01-54
01-541S, 01-542S, 01-543S, 01-544S, 01-545S, 01-546S, 01-547S, 01-548S, 01-549S, Chassis 01-54S
01-541WT, 01-542WT, 01-543WT, 01-544WT, 01-545WT, 01-546WT, 01-547WT, 01-548WT, 01-549WT, Chassis 01-54WT
Alignment, trimmers, tuner, drive cord data10-59
Schematic, voltage, socket, coils10-60
Alignment, trimmers10-59
Schematic, voltage, socket, coils10-61, 62
Alignment, trimmers10-63
Tuner, drive cord data10-64
Schematic, voltage, socket notes10-65
Alignment, trimmers, loop, battery data10-66
Schematic, voltage, socket10-1
Alignment, trimmers, antenna notes, change10-2
Schematic, voltage, socket, coils, changes10-67
Alignment, trimmers, antenna notes10-68
Schematic, voltage, socket, coils, changes10-67
Alignment, trimmers, antenna notes10-68
Schematic, voltage, socket, notes10-69
Alignment, trimmers, antenna data10-70
Schematic, voltage, socket, notes10-69
Alignment, trimmers, antenna data10-70
Schematic, voltage, socket10-71
Alignment, trimmers, drive cord data10-72
Schematic, voltage, socket, tuner switch, coils10-55
Chassis 08-52
08-521, 08-522, 08-523, 08-524, 08-525, 08-526, 08-527, 08-528, 08-529, Chassis 08-52
08-541, 08-542, 08-543, 08-544, 08-545, 08-546, 08-547, 08-548, 08-549, Chassis 08-54
Alignment, trimmers10-59
data, tuner10-22

98-641, 98-642, 98-643, 98-644, 98-645, 98-646, 98-647, 98-648, 98-649, Chassis 98-64

98-711, 98-712, 98-713, 98-714, 98-715, 98-716, 98-717, 98-718, 98-719, Chassis 98-71

98-811, 98-812, 98-813, 98-814, 98-815, 98-816, 98-817, 98-818, 98-819, Chassis 98-81

98-821, 98-822, 98-823, 98-824, 98-825, 98-826, 98-827, 98-828, 98-829, Chassis 98-82

98-1111, 98-1112, 98-1113, 98-1114, 98-1115, 98-1116, 98-1117, 98-1118, 98-1119, Chassis 98-111

R-100-A, B, E AC

R-100-A DC

R-101-A, R-101-B

R-101, R-102

102-D (7 Tubes)

102-D (8 Tubes)

R-102-A, B, E (1st type)

R-102-A, B, E (Revised)

R-104-A, B, E

104 Chassis

105 Series

R-106

R-108, 108-X (10 to 20 incl.)

R-109 Chassis

R-110

R-111, R-115

R-112 Chassis

R-113, R-114

R-115

R-117 Chassis

R-118 Chassis

R-119

R-120 (1201, 1209)

R-123, R-123A Chassis

R-125 Series

R-126 Series

Schematic, voltage, socket10-23

Alignment, trimmers, tuner, phono, connections10-24

Schematic, voltage, coils, tuner switch, notes10-25

Alignment, trimmers10-26

Tuner data, drive cord data, parts10-27

Schematic, voltage, socket, tuner switch, coils10-29

Tuner data, drive cord data10-28

Alignment, trimmers, parts10-30

Schematic, voltage, socket, tuner switch10-31, 32

Alignment, trimmers, antenna data10-33

Tuner data, phono, notes10-34

Schematic, voltage10-5, 6

Tuner, drive cord data, notes, parts10-7

Alignment, trimmers, coils10-8

Schematic, voltage, socket10-85

Alignment, trimmers10-36

Tuner, drive cord data10-10

Schematic, voltage, socket10-37

Alignment, trimmers10-38

Parts10-39

Schematic, voltage, socket, changes10-41

Tuner data10-38

Alignment, trimmers, parts, antenna notes10-42

Schematic, trimmers, alignment10-9

Voltage, socket, tuner, drive cord data10-10

Schematic, voltage, socket, tuner switch, coils10-11

Alignment, trimmers10-12

Tuner data, parts10-13

Schematic, socket, voltage, coils10-15, 16

Alignment, trimmers, tuner10-17

Schematic, voltage, socket, tuner switch, coils10-19

Tuner data10-17

Alignment, trimmers, parts10-20

Schematic, voltage, socket, coils, notes10-21

Alignment, trimmers, phono, data, tuner10-22

Schematic, voltage, coils, tuner switch, notes10-25

Alignment, trimmers10-26

Tuner and drive cord data10-28

Alignment, trimmers, parts10-30

Schematic, voltage, socket, tuner switch10-31, 32

Alignment, trimmers, antenna data10-33

Tuner and phono, data10-34

Schematic, voltage10-5, 6

Tuner and drive cord data, notes, parts10-7

Alignment, trimmers, coils10-8

Schematic wiring, voltage1-10

Continuity tests1-11

Schematic, socket, voltage1-12

Schematic, socket, voltage2-1

Chassis layout, servicing notes2-2

Servicing notes, concluded2-3

Schematic10-3

Schematic, socket, voltage2-4

Schematic, socket, voltage2-5

Schematic, socket, voltage3-1

Service data, parts list3-2

Schematic, socket, voltage, parts list3-3

Service data, part 13-4

Service data, part 23-5

Schematic, voltage, parts list, socket4-1

Alignment4-2

Schematic, socket, voltage, parts list3-6

See model 1090

Schematic, voltage, parts list, socket4-3

Alignment4-4

Schematic, voltage, socket, parts list4-5

Alignment4-6

Schematic, voltage, socket, Alignment, notes4-7

Schematic, voltage, Alignment, notes4-8

Schematic, voltage, socket, parts list4-10

Alignment4-11

See model 1171

See model 1181

Schematic, voltage, socket, parts list4-12

Alignment4-13

Schematic, socket, voltage, Alignment4-14

Alignment4-15

Alignment4-16

See model 1231

See model 1231

See model 1261

*588-B

*588-B

*588-C

*588-D

588-F

588-H

588-I

2338

2338

2339

2340

2341

2342

2343

2344

2345

2347

2348

2349

2350

2351

2352

91-618, Chassis 91-61

(With "S" stamped on chassis)

91-711, 91-712, 91-713, 91-714, 91-715, 91-716, 91-717, 91-718, 91-719, Chassis 91-71

91-811, 91-812, 91-813, 91-814, 91-815, 91-816, 91-817, 91-818, 91-819, Chassis 91-81

91-821, 91-822, 91-823, 91-824, 91-825, 91-826, 91-827, 91-828, 91-829, Chassis 91-82

91-1111, 91-1112, 91-1113, 91-1114, 91-1115, 91-1116, 91-1117, 91-1118, 91-1119, Chassis 91-111

Tuner, drive cord data, notes, parts10-7

Alignment, trimmers, coils10-8

Schematic, voltage, socket10-85

Alignment, trimmers10-36

Tuner, drive cord data10-10

Schematic, voltage, socket10-37

Alignment, trimmers10-38

Parts10-39

Schematic, voltage, socket, changes10-41

Tuner data10-38

Alignment, trimmers, parts, antenna notes10-42

Schematic, trimmers, alignment10-9

Voltage, socket, tuner, drive cord data10-10

Schematic, voltage, socket, tuner switch, coils10-11

Alignment, trimmers10-12

Tuner data, parts10-13

Schematic, socket, voltage, coils10-15, 16

Alignment, trimmers, tuner10-17

Schematic, voltage, socket, tuner switch, coils10-19

Tuner data10-17

Alignment, trimmers, parts10-20

Schematic, voltage, socket10-23

Alignment, trimmers, tuner, phono, connections10-24

Schematic, voltage, coils, tuner switch, notes10-25

Alignment, trimmers10-26

Tuner data, drive cord data, parts10-27

Schematic, voltage, socket, tuner switch, coils10-29

Tuner data, drive cord data10-28

Alignment, trimmers, parts10-30

Schematic, voltage, socket, tuner switch10-31, 32

Alignment, trimmers, antenna data10-33

Tuner data, phono, notes10-34

Schematic, voltage10-5, 6

Tuner, drive cord data, notes, parts10-7

Alignment, trimmers, coils10-8

Schematic, voltage, socket10-85

Alignment, trimmers10-36

Tuner, drive cord data10-10

Schematic, voltage, socket10-37

Alignment, trimmers10-38

Parts10-39

Schematic, voltage, socket, changes10-41

Tuner data10-38

Alignment, trimmers, parts, antenna notes10-42

Schematic, trimmers, alignment10-9

Voltage, socket, tuner, drive cord data10-10

Schematic, voltage, socket, tuner switch, coils10-11

Alignment, trimmers10-12

Tuner data, parts10-13

Schematic, socket, voltage, coils10-15, 16

Alignment, trimmers, tuner10-17

Schematic, voltage, socket, tuner switch, coils10-19

Tuner data10-17

Alignment, trimmers, parts10-20

91-501, 91-502, 91-503, 91-504, 91-505, 91-506, 91-507, 91-508, 91-509, Chassis 91-50

91-502S, 91-503S, 91-504S, 91-505S, 91-506S, 91-507S, 91-508S, 91-509S, Chassis 91-50S

91-571, 91-572, 91-573, 91-574, 91-575, 91-576, 91-577, 91-578, 91-579, Chassis 91-57

91-511, 91-512, 91-513, 91-514, 91-515, 91-516, 91-517, 91-518, 91-519, Chassis 91-51

91-531, 91-532, 91-533, 91-534, 91-535, 91-536, 91-537, 91-538, 91-539, Chassis 91-53

91-611, 91-612, 91-613, 91-614, 91-615, 91-616, 91-617, 91-618, 91-619, Chassis 91-61

91-621, 91-622, 91-623, 91-624, 91-625, 91-626, 91-627, 91-628, 91-629, Chassis 91-62

Schematic, voltage, socket10-23

Alignment, trimmers, tuner, phono, connections10-24

Schematic, voltage, coils, tuner switch, notes10-25

Alignment, trimmers10-26

Tuner data, drive cord data, parts10-27

Schematic, voltage, socket, tuner switch, coils10-29

Tuner data, drive cord data10-28

Alignment, trimmers, parts10-30

Schematic, voltage, socket, tuner switch10-31, 32

Alignment, trimmers, antenna data10-33

Tuner data, phono, notes10-34

Schematic, voltage10-5, 6

Tuner, drive cord data, notes, parts10-7

Alignment, trimmers, coils10-8

Schematic, voltage, socket10-85

Alignment, trimmers10-36

Tuner, drive cord data10-10

Schematic, voltage, socket10-37

Alignment, trimmers10-38

Parts10-39

Schematic, voltage, socket, changes10-41

Tuner data10-38

Alignment, trimmers, parts, antenna notes10-42

Schematic, trimmers, alignment10-9

Voltage, socket, tuner, drive cord data10-10

Schematic, voltage, socket, tuner switch, coils10-11

Alignment, trimmers10-12

Tuner data, parts10-13

Schematic, socket, voltage, coils10-15, 16

Alignment, trimmers, tuner10-17

Schematic, voltage, socket, tuner switch, coils10-19

Tuner data10-17

Alignment, trimmers, parts10-20

*588-B

*588-B

*588-C

*588-D

588-F

588-H

588-I

2338

2338

2339

2340

2341

2342

2343

2344

2345

2347

2348

2349

2350

2351

2352

Data1271
 Data1271
 See model 1281D
 See model 1301
 See model 1311
 See model 1322
 See model 1332
 See model 1341
 See model 1361
 See model 1371
 See model 1381
 See model 1391D
 See model 1401
 See model 1421
 See model 1441
 See model 1451
 See model 1461
 Phonograph connections, uni-
 versal transformer10-18
 See model 1471
 Phonograph connections, uni-
 versal transformer10-18
 See model 1481
 Phono. connections8-3, 8-4
 See model 1491
 See model 1601
 See model 1611-D
 See model 1621-D
 See model 1631-D
 See model 1641-D
 See model 1671
 See model 1691
 See model 1711
 See model 1691
 See model 1731
 See model 1801
 See model 1811
 See model 1821
 See model 1831
 See model 1841
 See "Magic Keyboard" Models
 1845 etc.
 See model 1851
 See model 1861
 See model 1881
 See model 1901
 See model 1911
 See model 1921
 Schematic, socket1-1
 Schematic, servicing notes.....2-6
 See model 3041
 Schematic, socket1-1
 Schematic, socket1-1
 Schematic, socket1-1
 Schematic, socket1-1
 Schematic, socket1-1
 Schematic, socket1-2
 Schematic, socket1-2
 Schematic, socket1-2
 Schematic, socket1-2
 Schematic, socket1-2
 Schematic, socket1-3
 Schematic, socket1-3
 Schematic, socket1-3
 Schematic, socket1-4
 Schematic, socket, voltage.....1-4
 Schematic1-4
 Schematic, socket1-5
 Schematic, socket1-5

Schematic, socket1-5
 Schematic, socket, voltage, chassis1-7
 Schematic, trimmers, alignment10-9
 Voltage, socket, tuner, drive cord10-10
 Schematic, voltage, socket, tuner switch, coils10-11
 Alignment, trimmers10-12
 Tuner data, parts10-13
 Schematic, voltage, socket, coils10-15, 16
 Alignment, trimmers, tuner10-17
 Schematic, voltage, socket, tuner switch, coils10-19
 Alignment, trimmers, parts10-20
 Tuner data10-17
 Schematic, voltage, socket, coils, notes10-21
 Alignment, trimmers, phono-
 data, tuner10-22
 Schematic, voltage, coils, tuner switch, notes10-25
 Alignment, trimmers10-26
 Tuner, drive cord data, parts10-27
 Schematic, voltage, socket, tuner switch, coils10-29
 Tuner and drive cord data10-28
 Alignment, trimmers, parts10-30
 Schematic, voltage, socket, tuner switch10-31, 32
 Alignment, trimmers, antenna data10-33
 Tuner data, phono. notes10-34
 Schematic, voltage10-5, 6
 Tuner, drive cord data, notes, parts10-7
 Alignment, trimmers, coils10-8
 Schematic, socket, voltage1-5
 Schematic, socket1-8
 Schematic, socket, chassis1-6
 Voltage1-5
 Schematic1-9
 Schematic1-9
 Schematic, socket, voltage, parts list3-7
 Service data3-8
 See Chassis R-111
 See Chassis 112
 Schematic, socket, parts5-1
 Voltage, alignment5-2
 Schematic, voltage, socket, parts6-11
 See model R-120
 Video schematic10-73, 74
 Sound schematic10-75, 76
 Schematic, socket, parts.....5-3

*580
 588-J, K
 2820
 2855
 *580
 *580
 *580
 *581
 *581
 *581
 *581
 *582
 *582
 *582
 *582
 *582
 *583
 *583
 *583
 *584
 *584
 *584
 *584
 *584
 *584
 *584
 *585

*585
 *586
 *587
 *588
 *588
 *588-A
 *588-B
 2833
 2836
 2834
 2837
 2854

MODEL	STEWART-WARNER CORP.—(Cont.)	REVISED PAGE	EARLY COMPLETE PAGE
1231, 1232, 1233, 1234, 1235, 1236, 1237, 1238, 1239, Chassis R-123, R-123A	Schematic, socket, voltage, parts	6-1	
1251, 1252, 1253, 1254, 1255, 1256, 1257, 1258, 1259, Chassis R-125 Series, Chassis R-125A and 125X	Circuit data, alignment, trimmers, parts Schematic, parts list, circuit changes	6-2 5-5	
1251, 1252, 1253, 1254, 1255, 1256, 1257, 1258, 1259, Chassis R-125, Late	Alignment data, part 1 Alignment data, part 2, trimmer locations Alignment data, part 3 Schematic, socket, voltage, parts	5-6 5-7 5-8 6-3	
1261, 1262, 1263, 1264, 1265, 1266, 1267, 1268, 1269, Chassis R-126 Series, Chassis R-126A, R-126P, R-126X	Alignment, trimmers Schematic, socket, changes, parts	6-4 5-9	
1261, 1262, 1263, 1264, 1265, 1266, 1267, 1268, 1269, Chassis R-126 Late	Alignment data, part 1 Alignment data, part 2 Alignment data, part 3 Alignment data, part 4 Schematic, socket, voltage, parts	5-10 5-11 5-12 5-13 6-5	
1271, 1272, 1273, 1274, 1275, 1276, 1277, 1278, 1279, Chassis R-127 Series, Chassis R-127-X	Circuit data, trimmers, alignment Alignment part 2, parts list Schematic, socket, voltage, parts Circuit data, trimmers, alignment Alignment part 2, parts Schematic, socket, circuit changes, parts	6-6 6-7 6-8 6-9 6-10 5-15	
1281D, 1282D, 1283D, 1284D, 1285D, 1286D, 1287D, 1288D, Chassis R-128D	Alignment data, part 1 Alignment data, part 2 Alignment data, part 3 Alignment data, part 4 Schematic, socket, parts	5-14 5-16 5-17 5-18 7-1	
1301, 1302, 1303, 1304, 1305, 1306, 1307, 1308, 1309, Chassis R-130	Trimmers, alignment Schematic, voltage, socket, parts	7-3 6-12	
1311, 1312, 1313, 1314, 1315, 1316, 1317, 1318, 1319, Chassis R-131	Alignment, trimmers, parts Schematic, voltage, socket, parts	8-6 6-13	
Firestone R-132, Chassis R-132, Firestone R-133, Chassis R-133	Circuit data, parts, alignment Schematic, socket, voltage, parts Schematic, socket, voltage, parts Alignment Schematic, voltage, socket, trimmers, parts	6-14 6-15 6-16 6-10 6-17	
1341, 1342, 1343, 1344, 1345, 1346, 1347, 1348, 1349, Chassis R-134 (Temporary)	Final schematic note, trimmers, alignment	7-3	
1361, 1362, 1363, 1364, 1365, 1366, 1367, 1368, 1369, Chassis R-136 (Temporary)	Schematic, socket, trimmers	6-18	
1361, 1362, 1363, 1364, 1365, 1366, 1367, 1368, 1369, Chassis R-136 (Final)	Final schematic note, alignment, changes	7-4	
1361, 1362, 1363, 1364, 1365, 1366, 1367, 1368, 1369, Chassis R-136-P, R-136X	Phonograph circuits	7-4	
1371, 1372, 1373, 1374, 1375, 1376, 1377, 1378, 1379, Chassis R-137 (Temporary)	Schematic, socket, parts, trimmers	6-19	
1371, 1372, 1373, 1374, 1375, 1376, 1377, 1378, 1379, Chassis R-137P, R-137X	Final schematic note, alignment	7-5	
1381, 1382, 1383, 1384, 1385, 1386, 1387, 1388, 1389, Chassis R-138 (Temporary)	Phonograph circuits	7-5	
1381, 1382, 1383, 1384, 1385, 1386, 1387, 1388, 1389, Chassis R-138 (Final)	Schematic, socket, parts, trimmers	6-20	
1381, 1382, 1383, 1384, 1385, 1386, 1387, 1388, 1389, Chassis R-138P, R-138X	Final schematic note, alignment	7-6	
1391D, 1392D, 1393D, 1394D, 1395D, 1396D, 1397D, 1398D, 1399D, Chassis R-139D	Phonograph circuits	7-6	
1401, 1402, 1403, 1404, 1405, 1406, 1407, 1408, 1409, Chassis R-140	Schematic, socket, data, alignment, parts	7-7	
1421, 1422, 1423, 1424, 1425, 1426, 1427, 1428, 1429, Chassis R-142A, R-142AS	Schematic, voltage, socket, trimmers	7-9	
R-1431 Firestone Auto	Alignment, parts Schematic, voltage, parts	7-10 7-11	
1441, 1442, 1443, 1444, 1445, 1446, 1447, 1448, 1449, Chassis R-144AS	Circuit data, alignment Schematic, voltage, parts Alignment, parts Schematic, voltage, parts	7-12 8-15 8-16 7-13	
1451, 1452, 1453, 1454, 1455, 1456, 1457, 1458, 1459, Chassis R-145	Trimmers, alignment, circuit data, parts Schematic, voltage, parts	7-14 7-15	
1451, 1452, 1453, 1454, 1455, 1456, 1457, 1458, 1459, Chassis R-145X	Socket, trimmers, alignment, parts Phonograph circuit	7-16 7-15	
1461, 1462, 1463, 1464, 1465, 1466, 1467, 1468, 1469, Chassis R-146	Schematic, voltage, parts	7-17	
1471, 1472, 1473, 1474, 1475, 1476, 1477, 1478, 1479, Chassis R-147	Trimmers, alignment, parts Schematic, socket, trimmers, voltage, change	7-18 8-1	
1481, 1482, 1483, 1484, 1485, 1486, 1487, 1488, 1489, Chassis R-148	Alignment, parts Hum elimination Schematic, socket, voltage, trimmers, change	8-2 10-14 8-3, 8-4	
1491, 1492, 1493, 1494, 1495, 1496, 1497, 1498, 1499, Chassis R-149	Alignment, parts Hum elimination Schematic, voltage, parts	8-5 10-14 7-19, 7-20	
	Socket, trimmers, alignment, notes, parts	7-21, 7-22	

STEWART-WARNER STROMBERG-CARLSON

RADIOTRON
EARLY COMPLETE
PAGE

REVISED
PAGE

STEWART-WARNER CORP.—(Cont.)

MODEL

"Magic Keyboard" for
models 1845 to 1860
Chassis R-184, R-185,
R-186

Trouble chart, concluded,
back switch 9-27, 28

Bakelite and side switches 9-29, 30
Clutch, pawls, cams, keys, coil
lock, bar and arm 9-31, 32
Key stop bar, kick-out arm, star
wheel, motor, gears, coupling,
motor connections, dial
mechanism 9-33, 34
AFC and mechanism notes,
manual tuning, parts 9-35, 36
Dial mechanism and miscellane-
ous parts 9-37
Mechanism details 9-38
Phonograph data 9-18
Schematic, voltage, socket,
dimmer data 10-43, 44

Chassis R-1845-W
1851, 1852, 1859, 1854,
1855, 1856, 1857, 1858,
1859, Chassis R-185
1851A, 1852A, 1853A,
1854A, 1855A, 1856A,
1857A, 1858A, 1859A,
Chassis R-185A
1851B, 1852B, 1853B,
1854B, 1855B, 1856B,
1857B, 1858B, 1859B,
Chassis R-185B
1851W, 1852W, 1853W,
1854W, 1855W, 1856W,
1857W, 1858W, 1859W,
Chassis R-185W

Alignment 10-45
Trimmers, phono, data, "Ma-
gic Keyboard" data, parts 10-46
Schematic, socket, voltage,
parts, tuner data, speaker
data 9-19, 20
Alignment 9-21
AFC data, trimmers, tuner,
parts 9-22
Phonograph data 9-23
See "Magic Keyboard" models
1845 etc
Schematic, socket, voltage,
parts 9-23
Alignment, trimmers, circuit
data 9-24
Schematic, voltage, socket,
notes 10-47
Alignment, trimmers, battery
connections 10-48
Schematic, voltage, socket 10-49
Alignment, trimmers, circuit
data 10-50
Schematic, voltage, socket 10-51
Alignment, trimmers 10-52
Schematic, voltage, socket 10-53
Alignment, trimmers, drive
cord data, notes 10-54

*590
2360
*591

RADIOTRON
EARLY COMPLETE
PAGE

REVISED
PAGE

STEWART-WARNER CORP.—(Cont.)

MODEL

Phonograph circuit 7-19, 7-20

Schematic, voltage, parts 7-8

Data Changes 10-6
Schematic, socket, trimmers,
voltage 8-7
Alignment, parts, notes 8-8
Schematic, socket, trimmers,
voltage 8-9
Alignment, parts, notes 8-10
Schematic, socket, trimmers,
voltage, notes 9-1
Alignment, parts, notes 9-2
Schematic, socket, trimmers,
voltage, notes 9-1
Alignment, parts, notes 9-2
Schematic, voltage, socket,
trimmers 9-3
Circuit data, alignment, parts 9-4
Schematic, socket, trimmers,
voltage, notes 8-11
Alignment, parts 8-12
Schematic, socket, voltage,
trimmers 9-5
Alignment, parts 9-6
See model 1691

Phono. connections 8-11
Schematic, socket, trimmers,
voltage 8-13
Alignment, parts 8-14
Phono. connections 8-14
Schematic, socket, voltage,
parts 9-7
Alignment, trimmers, parts 9-8
Schematic, socket, voltage,
parts 9-9
Alignment, trimmers, parts,
dial data 9-10
Data 9-9
Phonograph schematic 9-9
Schematic, socket, voltage,
parts 9-11
Alignment, trimmers, dial data 9-12
Data 9-11
Phonograph data 9-11
Schematic, socket, voltage,
parts, dimmer connections 9-13
Alignment, trimmers, dial data 9-14
Schematic, socket, voltage,
parts, data 9-15, 16
Alignment 9-17
AFC data, socket, trimmers,
tuner data 9-18
Notes, trouble chart 9-25, 26

1491, 1492, 1493, 1494,
1495, 1496, 1497, 1498,
1499, Chassis R-149X
1601, 1602, 1603, 1604,
1605, 1606, 1607, 1608,
1609, Chassis R-160

1611-D, 1612-D, 1613-D,
1614-D, 1615-D, 1616-D,
1617-D, 1618-D, 1619-D,
Chassis R-161-D

1621-D, 1622-D, 1623-D,
1624-D, 1625-D, 1626-D,
1627-D, 1628-D, 1629-D,
Chassis R-162-D

1631-D, 1632-D, 1633-D,
1634-D, 1635-D, 1636-D,
1637-D, 1638-D, 1639-D,
Chassis R-163-D

1641-D, 1642-D, 1643-D,
1644-D, 1645-D, 1646-D,
1647-D, 1648-D, 1649-D,
Chassis R-164-D

1671, 1672, 1673, 1674,
1675, 1676, 1677, 1678,
1679, 1680, 1681, 1682,
1683, 1684, 1685, 1686,
1687, 1688, 1689, Chas-
sis R-167S and R-168

1691, 1692, 1693, 1694,
1695, 1696, 1697, 1698,
1699, Chassis R-169

1711, 1712, 1713, 1714,
1715, 1716, 1717, 1718,
1719, Chassis R-171

1721, 1722, 1723, 1724,
1725, 1726, 1727, 1728,
1729, Chassis R-172

Chassis 172X
1731, 1732, 1733, 1734,
1735, 1736, 1737, 1738,
1739, Chassis R-173

Chassis 173X
1801, 1802, 1803, 1804,
1805, 1806, 1807, 1808,
1809, Chassis R-180

1811, 1812, 1813, 1814,
1815, 1816, 1817, 1818,
1819, Chassis R-181

Chassis R-181A, R-181B
Chassis R-181W
1821, 1822, 1823, 1824,
1825, 1826, 1827, 1828,
1829, Chassis R-182

R-182A, R-182B
R-182W
1831, 1832, 1833, 1834,
1835, 1836, 1837, 1838,
1839, Chassis R-183

1841, 1842, 1843, 1844,
1845, 1846, 1847, 1848,
1849, Chassis R-184

*590
2360
*591

*590
2360
*591

STROMBERG-CARLSON

STROMBERG-CARLSON TEL. MFG. CO.

Compact Police Receiver

Wiring, socket 4-1
Schematic 4-2

STORY & CLARK RADIO CORP.

C-108 Clock model

Schematic, socket, chassis 1-1
Schematic, socket 1-2
Schematic Misc. 5-19

STRAFFIELD

See ELECTRIC SPECIALTIES EXPORT CO.

Wiring, socket 4-1
Schematic 4-2

Multiple-Record Phonograph Phonograph Pick-up	MODEL	64	Chassis assembly	4-19
1-A		65, 66, 67	Selector notes	4-20
1-B		68	Schematic, socket, voltage	7-5
10, 11			Chassis wiring	7-6
			Specifications, parts	5-5
			Schematic, socket, voltage	5-6
			Chassis wiring	5-7
			Socket layout, chassis views	5-7
			Chassis wiring	5-9
12, 14		68 Amplifier	Chassis views	5-10
			Chassis wiring	5-8
16, 17 DO		68 Selector	Data	Changes 7-8
19, 20 AO		68-X	Schematic, notes	5-11
		69 All Wave Selector	Chassis wiring	5-12
			Socket layout, voltage, parts list	5-13
22, 22-A		70, 70B, 72, 72B, 72D, 74, 74B, 74D	Chassis views	5-14
			Circuit data, parts, speaker data	6-7
25, 26 AO			Chassis assembly	6-8
			Schematic	6-9
			Chassis wiring	6-10
			Voltage	6-11
			Trimmers	6-12
27 AO		80	Alignment	6-13
			Schematic, voltage	7-7
			Chassis wiring	7-8
29		82, 82-B	Socket, trimmers, parts list	7-9
			Circuit data, voltage	6-15
			Chassis assembly	6-16
			Schematic, chassis wiring	6-17
			Socket, trimmers, parts	8-18
38		88, 88-B	Alignment	6-19
			Circuit data, voltage	6-20
			Chassis, wiring	6-21
			Schematic, chassis assembly	6-22
38-A		84, 84-B	Socket, trimmers, parts	7-10
37			Alignment	7-11
			Schematic, voltage	7-12
38, 89, 40, 41 (1st type)		115	Chassis views, circuit data, trimmers	7-13
			Schematic, socket, trimmers, voltage	7-14
38, 89, 40, 41 (2nd type)		125A-O-DO	Chassis wiring	7-15
			Schematic, socket, trimmers, voltage	7-16
48, 49, 50, 51		126H, 126L	Chassis wiring	7-17
			Chassis views, alignment, parts	7-18
52, 54		127H, 127M	Schematic, parts	8-1
			Alignment, voltage	8-2
55, 56			Socket, trimmers, chassis	8-3
			Chassis wiring	9-25
			Schematic, parts	8-5
			Socket, trimmers, chassis	8-4
			Alignment, voltage	8-6
58L, 58LB, 58T, 58TB, 58W, 58WB		180H, 180HB, 180L, 180LB, 180M, 180MB, 180R, 180RB, 180U, 180UB	Chassis wiring	10-12
			Schematic, socket, trimmers, sensitivity control data	7-19
60		140H, 140HB, 140K, 140L, 140KB, 140LB, 140P, 140PB	Chassis wiring	7-20
			Voltage, alignment	7-21
			Socket, trimmers, parts, cir- cuit data	7-22
61L, 61LB, 61T, 61TB, 61W, 61WB		145L, 145LB, 145P, 145PB	Schematic, parts	8-15
			Voltage, alignment, trimmers	8-16
61Y, 61Z			Socket, trimmers, chassis, notes	8-17
62, 63, 62B, 63B			Chassis wiring	9-1
			Schematic, socket, trimmers	7-23
			Chassis wiring	7-24
64		150L, 150LB	Circuit data, chassis, align- ment voltage	7-25
			Parts list	7-26
			Schematic, parts	8-7, 8-8
			Socket, trimmers, chassis	8-9

STROMBERG-CARLSON

STROMBERG-CARLSON TEL. MFG. CO.—(Cont.)	REVISED PAGE	RADIOTRON EARLY COMPLETE PAGE
MODEL 150L, 150LB 160L, 160LB, 160P, 160PB 180L, 180LB 225 AC-DC 228H, 228HB, 228L, 228LB 229P 230H, 230HB, 230L, 230LB 231F, 231FB, 231R, 231RB, 231P, 231PB 235H, 235HB, 235L, 235LB 240H, 240HB, 240L, 240LB, 240M, 240MB, 240R, 240RB, 240S, 240SB, 240W, 240WB, 240P, 240PB 245L, 245LB, 245M, 245MB, 245R, 245RB, 245P, 245PB 250L, 250LB 255L, 255LB	Alignment 8-10 Data Changes 8-10 Chassis views 9-2 Circuit data, chassis wiring 9-3, 4 Schematic, parts 8-11, 8-12 Alignment 8-10 Socket, trimmers, chassis 8-13 Voltage, chassis 8-14 Circuit data, chassis wiring 9-5, 6 Schematic 8-19 Socket, trimmers, chassis 8-18 Alignment, voltage 8-20 Parts 8-21 Chassis wiring 9-7, 8 Chassis views 9-9 Schematic, parts 8-23 Socket, chassis 8-22 Voltage, alignment, trimmers, notes 8-24 Chassis wiring 9-10 Schematic, socket, trimmers 8-25 Voltage, alignment, parts 8-26 Chassis wiring 9-11 Chassis views 9-12 Schematic, socket, trimmers 8-27 Voltage, alignment 8-28 Socket, chassis, notes 8-29 Parts 8-30 Chassis wiring, specifications 9-18 Schematic 8-31 Socket, chassis, parts 8-32 Trimmers 8-35 Alignment, voltage 8-36 Chassis wiring 8-33 Chassis wiring 8-34 Schematic, specifications 9-13 Chassis wiring 9-14 Socket, trimmers, voltage, alignment 9-15 Alignment, phonograph data, tuner adjustments 9-16 Tuner adjustments, concluded, parts 9-17 Continuity test 10-34 Schematic, circuit data, specifications 9-19 Chassis wiring 9-20 Voltage, socket, trimmers 9-21 Chassis views, specifications 9-22 Alignment, trimmers 9-23 Parts list 9-24 Schematic, specifications 9-25 Chassis wiring, tuner 9-37, 28 Socket, trimmers, voltage, alignment 9-29 Alignment, concluded, tuner, parts 9-30 Schematic 8-37 Voltage, trimmers, phono. data 8-38 Alignment 8-39 Chassis, parts 8-40 Continuity test 10-5 Schematic 10-1 Chassis views 10-2 Chassis wiring 10-3, 4 Socket, trimmers, voltage, continuity 10-5 Flash tuner assembly, phono-graph data 10-6	Alignment, Part 1 10-7 Alignment, Part 2; Parts list 10-8 Schematic, specifications 9-31 Chassis views 9-32 Chassis wiring, phonograph data 9-33, 34 Voltage, alignment 9-35 Alignment, concluded, AFC tuner data 9-36 Tuner assemblies and parts 9-37 Socket, trimmers, parts 9-38 Schematic 1-3 Schematic, socket, trimmers 10-9 Chassis wiring, voltage 10-10 Alignment, parts 10-11 Schematic, socket, trimmers 10-13 Chassis wiring 10-14 Voltage, alignment, phono-graph data 10-15 Electric tuning data 10-16 Alignment 10-16 Schematic 10-17 Chassis wiring 10-18 Electric tuning data 10-16 Voltage, socket, trimmers 10-30 Schematic 10-19 Chassis wiring 10-20 Alignment, phonograph, tuner data 10-21 Voltage, socket, trimmers 10-22 Schematic 10-23 340F, 340FB, 340H, 340HB, 340MB, 340V, 340VB, 340P, 340PB, 341R, 341RB, 341P, 341PB 345F, 345FB, 345M, 345MB 350M, 350MB, 350R, 350RB, 350P, 350PB, 350V, 350VB 360M, 360MB 370M, 370MB 408-408-A 408-B 408-AA 404-RA 501, 501-A, 501-B, 502, 502-A, 502-B 523, 524 AC 601, 602 638, 634 635, 636 (2 type) 638 AC Alignment, Part 1 10-32 Alignment, Part 2, voltage, tuner 10-43 Socket, trimmers, circuit data 10-39 Schematic 1-3 Schematic, socket 1-2 Power Unit, Schematic 1-11 Schematic, socket 1-1 Schematic, socket 1-2 Schematic, socket 1-4 Schematic, socket, voltage 1-5 Chassis wiring 1-6 Schematic, socket, voltage 1-7 Chassis wiring 10-24 Voltage, socket, trimmers, circuit data 10-25 Alignment 10-26 Electric tuning data 10-16 Schematic 10-27 Chassis wiring 10-28 Voltage, alignment 10-29 Socket, trimmers, bass response data 10-30 Electric tuning data 10-16 Schematic 10-31 Chassis wiring 10-32 Alignment 10-33 Voltage, socket, trimmers 10-22 Electric tuning data 10-16 Schematic 10-37 Chassis wiring 10-35, 36 Voltage, socket, trimmers 10-39 Tuner data 10-44 Schematic 10-44 Chassis wiring 10-41, 42 Alignment, Part 1 10-43 Alignment, Part 2, voltage, tuner 10-44 Socket, trimmers, circuit data 10-39 Schematic 1-3 Schematic 1-3 Schematic, socket 1-2 Power Unit, Schematic 1-11 Schematic, socket 1-1 Schematic, socket 1-2 Schematic, socket 1-4 Schematic, socket, voltage 1-5 Chassis wiring 1-6 Schematic, socket, voltage 1-7 *596 *596 *594 *597 *598 *599 *601 *598-A *604 *608 *596 *596 *594 *597 *598 *599 *601 *598-A *604 *608

TRANSFORMER TRAV-LER

TRANSFORMER CORP. OF AMERICA—(Cont.)	REVISED PAGE	EARLY COMPLETE PAGE	RADIOTRON MODEL	TRANSFORMER CORP. OF AMERICA—(Cont.)	REVISED PAGE	EARLY COMPLETE PAGE	RADIOTRON MODEL
Schematic, voltage	7-3		TC-20, TC-21	Chassis layouts, notes	3-8	2468	300 Series (SW Converter)
Schematic, voltage	7-2		TC-22, TC-23	Schematic, socket, voltage, notes	3-4	2469	AO 220, 25-220
Alignment data, parts list	5-7		25-60	Chassis layouts, socket, voltage	3-5	2465	
Schematic, voltage	7-3		25-61	Resistance table, notes	3-5	2466	
Schematic	9-3		25-81	Schematic, chassis layout, socket	3-6	2464	
See AC 60			25-81	Breakdown analysis, trimmer notes	3-7	2466	
See AC 61			25-94	Schematic, chassis layout, breakdown	2-12	2467	
See model AC 160			TC-28, TC-29	Voltage, resistance, trimmer data	4-1		
See model AC 220			TC-30	Schematic, socket, alignment, point-to-point data	5-2		
See model 260			TC-31	Schematic, socket, chassis view	4-8		
See model AC 280			TC-35A, TC-35LW Early	Voltage, chassis view, resistance data	4-2		
Schematic, voltage	7-8		TC-35LW Late	Chassis layout, voltage, breakdown	3-8		
Schematic, socket, trimmers	8-2		TC-36	Schematic, socket, chassis layout	3-9		
Alignment	8-3		TC-36A, TC-36LW	Schematic, voltage, resistance	4-4		
Schematic, parts list	5-6		TC-37	Schematic, voltage, resistance, chassis	4-5		
Schematic, alignment	10-1		TC-37A, TC-37LW	Schematic, voltage, chassis, resistance	4-6		
Schematic, voltage	7-4		TC-39	Schematic, point-to-point data, parts	5-3		
Schematic	10-2		TC-39A, TC-39LW	Schematic	5-8		
Schematic	10-3		TC-40	Schematic, voltage, parts list	4-7		
Schematic	10-4		TC-42, TC-48, TC-44	Schematic, voltage, parts list	4-8		
Schematic	9-4		TC-50	Schematic, voltage, parts list	4-9		
Schematic	9-5		51, 53, 55 AO	Schematic, voltage, parts list	4-10		
Schematic	10-2		TC-52	Schematic, voltage, parts list	4-11		
Schematic	9-9		TC-53A	Schematic, voltage, parts list	4-12		
Voltage, alignment, parts	8-5		AO 60, 25-60	Schematic, voltage, parts, battery data	5-4		
Schematic	9-7		TC-60	Schematic, battery data, parts, 5-5	5-5		
Chassis, socket, voltage, chassis data	1-1		TC-61	Schematic, voltage, parts list	4-7		
Chassis data	4-2		TC-62	Schematic, voltage, parts list	4-8		
Schematic	5-9		TC-66	Schematic, voltage, parts list	4-9		
Schematic, socket	8-5		TC-75, TC-76	Schematic, voltage, parts list	4-10		
Alignment	8-4		AO 60, 81	Schematic, voltage, parts list	4-11		
Schematic	8-4		AO 84, 85	Schematic, voltage, parts list	4-12		
Schematic, voltage, alignment	10-1		AO 90, 90A, 91	Schematic, voltage, parts list	4-13		
Chassis layout	1-10		AO 94, 95	Schematic, voltage, parts list	4-14		
Voltage, breakdown analysis	1-12		AO 94, 25-94	Schematic, voltage, parts list	4-15		
Schematic, voltage	2-1		AO 100 Series	Schematic, voltage, parts list	4-16		
Chassis layout, speaker	2-3		100-AR	Schematic, voltage, parts list	4-17		
Alignment data	2-3		120-189	Schematic, voltage, parts list	4-18		
Parts list	2-4		AO 160, 25-160	Schematic, voltage, parts list	4-19		
Schematic, socket	1-10			Schematic, voltage, parts list	4-20		
Chassis layouts	1-11			Schematic, voltage, parts list	4-21		
Voltage breakdown analysis	1-12			Schematic, voltage, parts list	4-22		
Speaker	2-2			Schematic, voltage, parts list	4-23		
Alignment data	2-3			Schematic, voltage, parts list	4-24		
Schematic, voltage	2-5			Schematic, voltage, parts list	4-25		
Chassis layouts, socket, test data	2-6			Schematic, voltage, parts list	4-26		
Schematic, socket, voltage, data	2-7			Schematic, voltage, parts list	4-27		
Chassis layouts, speaker, test data	2-8			Schematic, voltage, parts list	4-28		
Parts list, test data	2-9			Schematic, voltage, parts list	4-29		
Schematic, voltage, parts list	5-1			Schematic, voltage, parts list	4-30		
Schematic, chassis layout data	2-11			Schematic, voltage, parts list	4-31		
Chassis layouts	3-1			Schematic, voltage, parts list	4-32		
Schematic, socket, voltage, data	3-2			Schematic, voltage, parts list	4-33		
Schematic, socket, voltage, data	3-3			Schematic, voltage, parts list	4-34		
Schematic, socket, voltage, data	3-4			Schematic, voltage, parts list	4-35		
Schematic, socket, voltage, data	3-5			Schematic, voltage, parts list	4-36		
Schematic, socket, voltage, data	3-6			Schematic, voltage, parts list	4-37		
Schematic, socket, voltage, data	3-7			Schematic, voltage, parts list	4-38		
Schematic, socket, voltage, data	3-8			Schematic, voltage, parts list	4-39		
Schematic, socket, voltage, data	3-9			Schematic, voltage, parts list	4-40		
Schematic, socket, voltage, data	3-10			Schematic, voltage, parts list	4-41		
Schematic, socket, voltage, data	3-11			Schematic, voltage, parts list	4-42		
Schematic, socket, voltage, data	3-12			Schematic, voltage, parts list	4-43		
Schematic, socket, voltage, data	3-13			Schematic, voltage, parts list	4-44		
Schematic, socket, voltage, data	3-14			Schematic, voltage, parts list	4-45		
Schematic, socket, voltage, data	3-15			Schematic, voltage, parts list	4-46		
Schematic, socket, voltage, data	3-16			Schematic, voltage, parts list	4-47		
Schematic, socket, voltage, data	3-17			Schematic, voltage, parts list	4-48		
Schematic, socket, voltage, data	3-18			Schematic, voltage, parts list	4-49		
Schematic, socket, voltage, data	3-19			Schematic, voltage, parts list	4-50		
Schematic, socket, voltage, data	3-20			Schematic, voltage, parts list	4-51		
Schematic, socket, voltage, data	3-21			Schematic, voltage, parts list	4-52		
Schematic, socket, voltage, data	3-22			Schematic, voltage, parts list	4-53		
Schematic, socket, voltage, data	3-23			Schematic, voltage, parts list	4-54		
Schematic, socket, voltage, data	3-24			Schematic, voltage, parts list	4-55		
Schematic, socket, voltage, data	3-25			Schematic, voltage, parts list	4-56		
Schematic, socket, voltage, data	3-26			Schematic, voltage, parts list	4-57		
Schematic, socket, voltage, data	3-27			Schematic, voltage, parts list	4-58		
Schematic, socket, voltage, data	3-28			Schematic, voltage, parts list	4-59		
Schematic, socket, voltage, data	3-29			Schematic, voltage, parts list	4-60		
Schematic, socket, voltage, data	3-30			Schematic, voltage, parts list	4-61		
Schematic, socket, voltage, data	3-31			Schematic, voltage, parts list	4-62		
Schematic, socket, voltage, data	3-32			Schematic, voltage, parts list	4-63		
Schematic, socket, voltage, data	3-33			Schematic, voltage, parts list	4-64		
Schematic, socket, voltage, data	3-34			Schematic, voltage, parts list	4-65		
Schematic, socket, voltage, data	3-35			Schematic, voltage, parts list	4-66		
Schematic, socket, voltage, data	3-36			Schematic, voltage, parts list	4-67		
Schematic, socket, voltage, data	3-37			Schematic, voltage, parts list	4-68		
Schematic, socket, voltage, data	3-38			Schematic, voltage, parts list	4-69		
Schematic, socket, voltage, data	3-39			Schematic, voltage, parts list	4-70		
Schematic, socket, voltage, data	3-40			Schematic, voltage, parts list	4-71		
Schematic, socket, voltage, data	3-41			Schematic, voltage, parts list	4-72		
Schematic, socket, voltage, data	3-42			Schematic, voltage, parts list	4-73		
Schematic, socket, voltage, data	3-43			Schematic, voltage, parts list	4-74		
Schematic, socket, voltage, data	3-44			Schematic, voltage, parts list	4-75		
Schematic, socket, voltage, data	3-45			Schematic, voltage, parts list	4-76		
Schematic, socket, voltage, data	3-46			Schematic, voltage, parts list	4-77		
Schematic, socket, voltage, data	3-47			Schematic, voltage, parts list	4-78		
Schematic, socket, voltage, data	3-48			Schematic, voltage, parts list	4-79		
Schematic, socket, voltage, data	3-49			Schematic, voltage, parts list	4-80		
Schematic, socket, voltage, data	3-50			Schematic, voltage, parts list	4-81		
Schematic, socket, voltage, data	3-51			Schematic, voltage, parts list	4-82		
Schematic, socket, voltage, data	3-52			Schematic, voltage, parts list	4-83		
Schematic, socket, voltage, data	3-53			Schematic, voltage, parts list	4-84		
Schematic, socket, voltage, data	3-54			Schematic, voltage, parts list	4-85		
Schematic, socket, voltage, data	3-55			Schematic, voltage, parts list	4-86		
Schematic, socket, voltage, data	3-56			Schematic, voltage, parts list	4-87		
Schematic, socket, voltage, data	3-57			Schematic, voltage, parts list	4-88		
Schematic, socket, voltage, data	3-58			Schematic, voltage, parts list	4-89		
Schematic, socket, voltage, data	3-59			Schematic, voltage, parts list	4-90		
Schematic, socket, voltage, data	3-60			Schematic, voltage, parts list	4-91		
Schematic, socket, voltage, data	3-61			Schematic, voltage, parts list	4-92		
Schematic, socket, voltage, data	3-62			Schematic, voltage, parts list	4-93		
Schematic, socket, voltage, data	3-63			Schematic, voltage, parts list	4-94		
Schematic, socket, voltage, data	3-64			Schematic, voltage, parts list	4-95		
Schematic, socket, voltage, data	3-65			Schematic, voltage, parts list	4-96		
Schematic, socket, voltage, data	3-66			Schematic, voltage, parts list	4-97		
Schematic, socket, voltage, data	3-67			Schematic, voltage, parts list	4-98		
Schematic, socket, voltage, data	3-68			Schematic, voltage, parts list	4-99		
Schematic, socket, voltage, data	3-69			Schematic, voltage, parts list	4-100		

260, 261	Alignment data, socket trimmers	5-22	460 A, B, R; 461 A, B, R; 464 A, B, R	Socket, trimmers, alignment, voltage, parts	6-23
305 Ed. 1, 305-A	Schematic, resistor color code	3-13	Ed. 1	Schematic, resistances	6-23
305 Ed. 2, 405	Voltage, alignment, data	3-14	Ed. 2	Socket, trimmers, alignment, parts	6-24
306	Socket, chassis, trimmers	7-2	462A, 462Y	Schematic, voltage	7-6
	Schematic, parts, voltage	7-3	470 G, U; 471 G, U; 474 G, U	Socket, trimmers, chassis	7-9
	Socket, trimmers, alignment	7-4	480, Ed. 1; 480, Ed. 2; 481, 484	Alignment, parts	7-10
	Schematic, voltage, resistor	7-4		Schematic, voltage, resistor data	6-27
	ance	8-1		Schematic	6-25, 6-26
	Circuit data, socket, trimmers, chassis	8-2		Socket, trimmers, alignment, parts	6-28
	chassis	8-3		Chassis wiring	7-2
307	Alignment, parts	8-4		Schematic	5-45
	Schematic	5-23		Socket, chassis, trimmers	7-2
	Socket, trimmers, voltage, alignment	7-7		Schematic, socket	5-37
810, 310A	Schematic	5-25		Voltage, alignment data	5-38
	Socket, voltage, parts	5-26		Schematic, socket	5-39
	Socket, trimmers, alignment	7-7		Voltage, parts	5-40
312, 313 (AO)	Schematic, socket, voltage	3-1		Socket, trimmers, alignment	7-2
	Adjustments	2-16		Schematic, socket	5-41
350	Schematic, voltage, socket, parts	4-9		Schematic, socket	5-42
	Socket, trimmers, voltage, alignment	7-22		Schematic, socket	5-43
352	Schematic, socket, voltage	5-27		Voltage, notes	5-44
355	Alignment, parts	5-28		Socket, trimmers, alignment, parts	6-29
	Schematic, voltage, parts list	4-10		Schematic, voltage, socket	6-30
	Socket, trimmers, voltage, alignment	7-22		Trimmers, alignment	6-31
357	Schematic	5-24		Schematic, voltage	6-32
	Socket, trimmers, voltage, alignment	7-22		Schematic, voltage	8-5
360	Alignment data, part 1	5-29		Socket, trimmers, chassis, alignment, notes, parts	8-6
	Alignment data, part 2	5-30		Service data, parts, alignment	6-31
360 Late, 861, 364	Schematic, socket, voltage, parts	4-11		Schematic, voltage, socket, trimmers, resistance data	6-35
	Schematic, data	7-5		Schematic, parts list	7-11
	Socket, trimmers, alignment, parts, voltage	7-6		Socket, trimmers, chassis, alignment, vibrator data, notes	7-12
370	Schematic, voltage, socket, parts	4-12		Schematic, voltage, parts list	7-13
	Alignment data, part 1	5-31		Socket, trimmers, chassis, alignment	7-14
	Alignment data, part 2	5-32		Schematic, voltage, coil data	7-15, 7-16
376	Schematic	5-33		Socket, trimmers, alignment	7-17
376BT, 876F, 876S	Schematic, parts	6-1		Parts list	7-18
	Socket, trimmers, alignment, voltage	6-2		Schematic, voltage, resistor data	6-35, 6-36
	Data	Changes 10-6		Schematic, voltage, resistor data	6-37, 6-38
885	Schematic, voltage, parts	6-3		Centr-O-Matic data, alignment, trimmers	6-39
886	Socket, trimmers, alignment	6-4		Socket, trimmers, parts list	6-40
	Schematic, voltage	6-5		Schematic, voltage, resistor data	6-41, 6-42
	Socket, trimmers, alignment	6-6		Centr-O-Matic data, socket trimmers, alignment	6-43
402, Ed. 1, 2, 8	Speaker data, trimmers, parts	6-7		Trimmers, parts	6-44
	Schematic, socket, trimmers	6-9		Schematic, voltage, parts	7-19
	Alignment, voltage, parts, data	6-10		Socket, trimmers, alignment, chassis, notes	9-2
402	Schematic	5-34		Schematic, voltage, parts	7-20
405	See model 305, Ed. 2	5-35		Socket, trimmers, chassis, alignment, change	8-6
420	Schematic	5-35		Schematic, voltage, parts	7-21
420, 421	Schematic, parts, socket, trimmers	6-11		Socket, trimmers, chassis, alignment, notes	9-3
	Trimmers, voltage, alignment, parts	6-12		Schematic, voltage	7-23
	Schematic, resistors	6-13		Schematic, voltage	7-24
430, 430J, 430T	Trimmers, socket, parts, alignment	6-14		Socket, trimmers, chassis, alignment, parts	8-7
431, 431J, 431T	Schematic, voltage	6-15		Schematic, voltage	8-8
434, 434J, 434T	Socket, trimmers, parts, voltage	6-16		Schematic, voltage	7-25
440C, 440T, 441C, 441T, 444C, 444T	Socket, trimmers, parts, alignment	6-17		Socket, trimmers, parts list	7-26
450L, 450H, 451L, 451H, 454L, 454H	Schematic, voltage	6-18		Socket, trimmers, chassis, alignment, parts	8-7
	Socket, trimmers, resistance data	6-19		Schematic, voltage	8-8
460	Alignment, parts	5-36		Schematic, voltage	7-25
460 A, B, R; 461 A, B, R; 464 A, B, R	Circuit data, schematic	6-21		Socket, trimmers, parts list	7-26
Ed. 1					

UNITED AMERICAN UNITED MOTORS

RADIOTRON
EARLY COMPLETE
PAGE

REVISED
PAGE

UNITED MOTORS SERVICE—(Cont.)

MODEL

RADIOTRON
EARLY COMPLETE
PAGE

REVISED
PAGE

UNITED AMERICAN BOSCH CORP.—(Cont.)

605 (Preliminary)	Final schematic data...Changes 8-6	8-6	
610 (Preliminary)	Schematic, voltage, parts	7-38	
610A (Final)	Socket, trimmers, alignment, notes	9-4	
620, 625 (Preliminary)	Schematic, voltage	7-27	
620 (Final)	Socket, trimmers, alignment, parts	7-28	
634A	Schematic, voltage, resistor data	6-45	
636, 687	Socket, trimmers, alignment, parts	6-46	
640 (Preliminary)	Schematic, voltage, coil data, alignment, vibrator adjustment	7-29	
640 (Preliminary)	Schematic, voltage	7-30	
640 (Preliminary)	Socket, trimmers, alignment, parts	7-31	
650 (Preliminary)	Final schematic data...Changes 8-6	7-32	
650 (Preliminary)	Schematic, voltage	7-33	
650 (Preliminary)	Socket, trimmers, alignment, parts	7-34	
660C, 660T (Preliminary)	Final schematic data...Changes 8-6	7-34	
660C, 660T (Final)	Schematic, voltage, coil resistances	7-35, 7-36	
670C, 670 (Final)	Socket, trimmers, circuit data, parts, alignment	7-37	
670C, 670S	Socket, trimmers, chassis	9-5	
670C, 670S	Schematic, voltage, coil resistances	7-39, 7-40	
670C, 670 (Final)	Parts list	7-41	
680 (Preliminary)	Socket, trimmers, alignment, data	7-42	
680 (Preliminary)	Chassis, notes	9-6	
680 (Final)	Schematic, voltage, parts list	7-43, 7-44	
738A2, 737A2, 738A3	Schematic data, circuit data, alignment, specifications, notes	9-7	
813	Socket, trimmers, chassis, parts	9-8	
825 Power Pack	Schematic, voltage, coil resistances, parts list	7-47	
838 (Preliminary)	Socket, trimmers, circuit data, changes, alignment, notes	7-48	
866	Schematic, parts, voltage, alignment	7-45	
500	See model 29 AC		
626 Delco	Schematic, voltage, parts, coil resistances	7-46	
627 Delco	Schematic, voltage	8-1	
628 Delco	Socket, trimmers, resistance	8-2	
629, Below Serial #40100	See model 630 Delco		
629, Above Serial #40100	Schematic, voltage	6-1	
630, 500, Delco	Alignment, circuit notes	6-2	
631	Socket, trimmers, chassis layout	6-3	
631	Parts list	6-4	
631	Schematic	6-4	
631	Socket, trimmers, chassis	7-4	
631	Alignment, voltage	7-5	
631	Schematic	7-6	
631	Socket, trimmers, voltage, chassis	7-7	
631	Alignment	7-8	
631	Schematic	7-9	
631	Socket, trimmers, chassis, voltage	8-17	
631	Age	8-18	
631	Alignment	8-21	
631	Schematic	8-19	
631	Socket, trimmers, chassis, voltage	8-20	
631	Alignment	8-21	
631	Schematic	7-10	
631	Socket, trimmers, chassis, voltage	7-11	
631	Alignment	7-12	
631	Schematic, voltage	8-3	
631	Socket, trimmers, chassis, alignment	8-4	
631	Schematic, voltage	8-5	
631	Socket, trimmers, alignment	8-6	
631	Schematic, voltage	8-7	
631	Socket, trimmers, alignment	8-8	
631	Schematic, voltage	8-9	
631	Socket, trimmers, alignment	8-10	
631	Schematic, voltage	8-11	
631	Socket, trimmers, alignment	8-12	
631	Schematic, voltage	8-13	
631	Socket, trimmers, alignment	8-14	
631	Schematic, voltage, alignment	9-1	
631	Parts list	9-4	
631	Schematic	9-5	
631	Socket, trimmers, chassis, alignment, voltage	9-6	
631	Schematic, alignment	9-2	
631	Socket, trimmers, chassis, alignment	9-3	
631	Voltage, parts	9-4	
631	Schematic	9-7	
631	Socket, trimmers, chassis, voltage, alignment	9-8	
631	Schematic	9-9	
631	Socket, trimmers, chassis, voltage, alignment	9-10	
631	Schematic, voltage	10-1	
631	Socket, trimmers, alignment, chassis	10-2	
631	Schematic, change	10-3	
631	Voltage	10-4	
631	Socket, trimmers, chassis	10-5	
631	Alignment	10-2	
631	Socket, trimmers, chassis	10-6	
631	Socket, trimmers, chassis	10-5	
631	Alignment	10-5	
631	Voltage	10-2	
631	Schematic, socket, changes, trimmers, chassis	10-7	
631	Alignment	10-2	
631	Voltage	10-4	
631	Delco-Matic Tuner (for model R-667 only) schematic, parts	10-8	
631	Delco-Matic Tuner parts layout	10-9	
631	Delco-Matic Tuner operating service notes, Part 1	10-10	
631	Delco-Matic Tuner service notes, Part 2	10-11	
631	Schematic, socket, trimmers, chassis	10-12	
631	Alignment	10-2	
631	Voltage	10-4	
631	Delco-Matic Tuner (for Model R-669 only) schematic, parts	10-8	
631	Delco-Matic Tuner parts layout	10-9	
631	Delco-Matic Tuner operating service notes, Part 1	10-10	
631	Delco-Matic Tuner service notes, Part 2	10-12	
631	Schematic	10-13	
631	Voltage, socket, trimmers, chassis	10-14	
631	Alignment	10-15	
631	Schematic	6-5	
631	Alignment, data, socket, trimmers, voltage, parts	6-6	
631	Schematic	6-8	
631	Schematic	6-7	
631	Socket, trimmers, chassis layout	6-9	
631	Alignment, voltage, parts	6-10	
631	Schematic	6-8	
631	Schematic	6-7	
631	Socket, trimmers, chassis	6-9	
631	Alignment, voltage, parts	6-10	
631	Schematic	6-8	
631	Schematic	6-7	

RADIOTRON
EARLY COMPLETE
PAGE

REVISED
PAGE

UNITED MOTORS SERVICE—(Cont.)

MODEL

R-1143	Alignment, tuner	10-22
	Socket, trimmers, voltage, chassis	10-26
R-1144 Delco	Schematic, notes	10-27
	Socket, trimmers, chassis, voltage	10-28
	Tuner data	10-22
	Alignment	10-29
R-1145 Delco	Schematic	10-31
	Socket, trimmers, chassis	10-32
	Voltage	10-30
	Alignment	10-29
	Schematic, changes	3-1
2035 (Below serial #1,207,005)	Schematic	3-1
2035 Revised	Resistance data	3-2
R-2050 Delco	Schematic, voltage, socket, notes	9-39
	Socket, trimmers, chassis, alignment	9-40
R-2055 Delco	Schematic, voltage, changes, battery notes	9-41
	Socket, trimmers, chassis, alignment	9-42
	Schematic, voltage	6-15
3201, 3202, Delco, Above Serial 800,000	Alignment, data, socket, trimmers, chassis	6-16
3201, 3202, Delco, Below Serial 800,000	Schematic, voltage	6-15
3203, 3204, Delco	Alignment, socket, trimmers, parts	6-14
	Schematic	6-17
	Alignment, voltage	6-18
	Socket, trimmers, chassis, parts	6-19
3205 Delco	Schematic, voltage	7-31
	Socket, trimmers, chassis	7-32
	Alignment	7-33
	Schematic	7-34
3206, 3207 Delco	Socket, trimmers, chassis	7-35
	Alignment, voltage	7-36
R-3208, R-3209 Delco	Schematic, socket, trimmers, chassis, notes, voltage	9-43
	Alignment	9-44
R-3210 Delco	Schematic, socket, trimmers, chassis, voltage, alignment	9-14
R-3212 Delco	Schematic, voltage, alignment	9-45
	Socket, trimmers, chassis, notes	9-46
	Alignment	9-47
	Schematic	10-33
R-3215 Delco	Voltage	10-30
	Alignment	10-17
	Socket, trimmers, chassis	10-34
4036, B-O-P	Schematic	4-1
	Voltage, socket, chassis layout	4-2
	Alignment data	4-3
	Resistance data	4-4
4087	Schematic, voltage	4-5
	Alignment, hints	4-6
	Schematic, voltage	4-7
4038, 600249	Alignment, changes	4-8
4048	Schematic, voltage	4-9
4049, 4050	Schematic, alignment	4-10
4051, 52 Volts	Schematic, voltage, alignment	7-38
4052 AO-DO	Schematic, socket	5-1
6010 Delco	Alignment, voltage	5-2
	Schematic	7-39
	Socket, trimmers, chassis, alignment, voltage	7-40
R-6011 Delco	Socket, trimmers, chassis, changes	7-41
	Schematic, voltage, changes, notes	9-48
	Alignment, voltage	9-49
R-6012 Delco	Schematic, voltage, changes	9-50
	Socket, trimmers, chassis, notes	9-51
	Voltage, alignment	9-52

RADIOTRON
EARLY COMPLETE
PAGE

REVISED
PAGE

UNITED MOTORS SERVICE—(Cont.)

MODEL

1104 Delco	Schematic	6-11
	Alignment, voltage, socket, trimmers, chassis, parts	6-12
1105 Delco	Schematic	7-13
	Socket, trimmers, chassis, voltage	7-14
	Alignment	7-15
1106 Delco	Schematic	7-16
	Socket, trimmers, chassis	7-17
1107 Delco	Alignment, voltage	7-18
	Schematic	7-19
	Voltage, socket, trimmers, chassis	7-20
	Alignment	7-21
1108 Delco, Glass Tubes	Schematic, voltage	7-22
	Socket, trimmers, chassis	7-23
	Alignment	7-24
	Schematic, voltage	7-25
1109 Delco	Socket, trimmers, chassis, dial parts	7-26
	Alignment	7-27
	Schematic	7-28
1110 Delco	Socket, trimmers, chassis, dial parts	7-29
	Alignment	7-30
	Schematic, socket, voltage	9-11
R-1115 Delco, Below Serial 100,000	Socket, trimmers, chassis, alignment	9-12
R-1115 Delco, Above Serial 100,000	Schematic, socket, trimmers, chassis, voltage, alignment	9-13
R-1116, R-1117 Delco	Schematic, socket, chassis, trimmers, voltage, transformer and phonograph connections	9-15
	Alignment, notes	9-16
R-1118 Delco	Schematic, chassis, voltage, changes	9-17
	Socket, trimmers, alignment, notes	9-18
R-1119 Delco	Schematic, voltage	9-19
	Socket, trimmers, chassis, alignment	9-20
R-1120 Delco	Schematic, voltage	9-21
	Socket, trimmers, chassis, alignment	9-22
R-1125 Delco	Schematic, socket, trimmers, chassis, voltage, alignment	9-23
R-1126 Delco	Schematic, socket, trimmers, chassis, voltage, alignment	9-24
R-1127 Delco	Schematic, trimmers	9-25
	Voltage, alignment	9-26
R-1128, R-1129 Delco	Schematic, socket, trimmers, chassis	9-27
	Voltage, alignment	9-28
R-1130 Delco	Schematic, voltage	9-29
R-1131 Delco	Trimmers, alignment	9-30
	Schematic, voltage	9-31
R-1132 Delco	Trimmers, alignment	9-32
	Schematic	9-33
	Voltage, trimmers, alignment notes, dial drive data	9-34
	Adjustments	9-35
	Adjustments, notes	9-36
"Delcomatic" Tuner for model R-1132	Switch data	9-37
	Assembly views	9-38
R-1134, R-1135, R-1139 Delco	Schematic, voltage, socket, trimmers, chassis	10-16
	Alignment, tuner	10-17
R-1140 Delco	Schematic, socket, trimmers, chassis	10-18
	Voltage, alignment, tuner data	10-19
R-1141 Delco	Schematic	10-20
	Voltage, socket, trimmers, chassis	10-21
	Alignment, tuner	10-22
R-1142 Delco	Schematic, notes	10-23
	Socket, trimmers, chassis	10-24
	Voltage	10-30
	Alignment, tuner	10-22
R-1143 Delco	Schematic	10-25

MODEL	REVISI	UNITED MOTORS SERVICE—(Cont.)	REVISED
R-6015 Delco	9-55	Schematic, chassis, notes	9-55
	9-56	Socket, trimmers, voltage, alignment	9-56
364441 Chevrolet	6-21	Schematic, voltage, service, notes	6-21
	6-20	Alignment, parts	6-20
	6-22	Socket, trimmers, chassis	6-22
393884 Oldsmobile	6-26	Alignment, circuit notes, parts	6-26
	6-25	Parts layouts, changes	6-25
	6-23	Schematic, voltage	6-23
393884 Oldsmobile, Below Serial 1748809	6-24	Schematic, changes	6-24
393884 Oldsmobile, Above Serial 1748809	8-15	Schematic, voltage, note	8-15
393885 Olds, 544246 Buick-Pontiac, 1291344 Buick	8-16	Socket, trimmers, alignment, changes	8-16
405045 Oldsmobile 544289 Late	7-42	Schematic	7-42
405046 Olds, Above Serial #1791092	7-43	Socket, trimmers, chassis	7-43
544267, Above Serial #1750000, 544289 Pontiac, 601586 Chevrolet	7-44	Alignment, voltage	7-44
	8-23	Schematic, voltage	8-23
405057, 405062, Olds Early and Late 544290, 544291, 544297, 544298 Pontiac	8-24	Socket, trimmers, chassis, alignment, changes	8-24
	8-25	Schematics	8-25
405063, Early, Late Oldsmobile	8-26	Socket, trimmers, voltage, chassis, alignment	8-26
544245 Buick-Pontiac 1291345 Buick	9-57	Schematic, socket, chassis, trimmers, voltage, changes	9-57
544245 Buick-Pontiac, Below Serial 1748809	9-58	Alignment, parts	9-58
544245 Buick-Pontiac, Above Serial 1748809	6-25	Parts layouts, changes	6-25
1291345 Buick	6-26	Alignment, circuit notes, parts	6-26
544245 Buick-Pontiac 1291345 Buick	6-23	Schematic, voltage	6-23
544267 (Above Serial #1750000	6-24	Alignment, changes	6-24
544268 Pontiac	7-42	Schematic	7-42
544289 Pontiac (Early)	7-43	Socket, trimmers, chassis	7-43
544289 Pontiac (Late)	7-44	Alignment, voltage	7-44
544290, 544291 Pontiac, Serials with prefix "A"	9-59	See model 405045 Olds trimmers, voltage	9-59
544290, 544291 Pontiac, Serials with prefix "O"	9-60	Alignment, data, parts	9-60
544297, 544298 Pontiac 600153 Chevrolet	7-45	See model 405057 Olds Schematic	7-45
600249	7-46	Alignment, voltage	7-46
600565, Chevrolet	9-61	Same as 4033 Schematic	9-61
600566 Chevrolet	9-62	Voltage, alignment, trimmers	9-62
601038 Chevrolet	6-27	Schematic, voltage	6-27
	6-28	Alignment, notes	6-28
	6-29	Schematic, voltage	6-29
	6-30	Parts locations, data	6-30
	6-31	Alignment, test data	6-31
601176, 601525 Chevrolet	8-27	Socket, test data, parts	8-27
	8-28	Socket, trimmers, voltage, alignment, changes	8-28
601177 Chevrolet, Below Serial 1748809	9-63	Schematic, voltage	9-63
	9-65	Socket, trimmers, chassis, changes	9-65
	9-66	Alignment	9-66

MODEL	REVISI	UNITED MOTORS SERVICE—(Cont.)	REVISED
601177 Chevrolet, Late Above Serial 1748809	9-64	Schematic, voltage	9-64
601574 Chevrolet	9-65	Socket, trimmers, chassis, changes	9-65
	9-66	Alignment	9-66
	6-33	Schematic, voltage	6-33
	6-34	Parts layout	6-34
	6-35	Circuit data	6-35
	6-36	Alignment, parts	6-36
	9-6	Changes	9-6
601586 Chevrolet 601662 Chevrolet	7-1	See model 405046 Olds Schematic	7-1
	7-2	Socket, trimmers, chassis	7-2
	7-3	Alignment, voltage	7-3
	8-22	Schematic, voltage, socket, trimmers, alignment	8-22
982000 Chevrolet	8-29	Schematic, alignment	8-29
980393 B-O-P	8-30	Alignment, voltage, parts	8-30
980455 B-O-P	8-31	Schematic, voltage, alignment	8-31
980459 B-O-P	9-6	Data	9-6
980507, 980508 Buick 980509, Buick	6-37	Similar to 4037 Schematic, voltage	6-37
980525, 980529, Buick	6-38	Alignment, service notes, parts	6-38
980526, Buick	6-39	Schematic	6-39
980534, 980535, Buick	6-40	Alignment, voltage, parts	6-40
	9-67	Schematic, voltage, alignment	9-67
	9-68	Schematic, voltage	9-68
	9-69	Alignment	9-69
	9-70	Schematic, voltage	9-70
	9-71	Socket, trimmers, chassis	9-71
	9-72	Schematic, voltage	9-72
	9-73	Socket, trimmers, chassis	9-73
	9-74	Chassis wiring	9-74
	9-75	Alignment	9-75
	8-33	Schematic, voltage	8-33
	8-32	Alignment, change	8-32
	8-34	Socket, trimmers, chassis, note	8-34
	8-35	Schematic, voltage	8-35
	8-36	Alignment, change	8-36
	8-37	Socket, trimmers, chassis	8-37
	8-38	Schematic, voltage, alignment	8-38
	9-54	Socket, trimmers, chassis	9-54
	8-39	Schematic, voltage, alignment	8-39
	9-54	Socket, trimmers, chassis	9-54
	9-77	Schematic, voltage	9-77
	9-78	Socket, trimmers, chassis, alignment	9-78
	9-79	Schematic, voltage, socket, trimmers, chassis	9-79
	9-80	Alignment	9-80
	9-81	Schematic	9-81
	9-82	Socket, trimmers, chassis, voltage, alignment	9-82
	9-83	Schematic, vibrator, condenser data	9-83
	9-84	Socket, trimmers, chassis	9-84
	8-41	Schematic, voltage	8-41
	8-40	Alignment	8-40
	8-42	Socket, trimmers, chassis, notes	8-42
	9-85	Schematic, socket, trimmers, chassis	9-85
	9-86	Alignment, voltage	9-86
	9-87	Schematic, voltage, socket	9-87
	9-88	Trimmers, chassis	9-88
	9-90	Alignment, voltage, socket	9-90
	9-91	Alignment, notes	9-91
	9-92	Schematic	9-92
	9-93	Socket, trimmers, chassis, voltage, tuner assembly	9-93
	9-94	Schematic, socket, chassis, trimmers, voltage	9-94
	8-43	Schematic, socket, chassis, trimmers, condenser data	8-43
	8-40	See model 985252 Schematic, voltage	8-40
	8-40	Alignment	8-40

MODEL	REVISI	UNITED MOTORS SERVICE—(Cont.)	REVISED
601177 Chevrolet, Late Above Serial 1748809	9-64	Schematic, voltage	9-64
601574 Chevrolet	9-65	Socket, trimmers, chassis, changes	9-65
	9-66	Alignment	9-66
601586 Chevrolet 601662 Chevrolet	7-1	See model 405046 Olds Schematic	7-1
	7-2	Socket, trimmers, chassis	7-2
	7-3	Alignment, voltage	7-3
	8-22	Schematic, voltage, socket, trimmers, alignment	8-22
982000 Chevrolet	8-29	Schematic, alignment	8-29
980393 B-O-P	8-30	Alignment, voltage, parts	8-30
980455 B-O-P	8-31	Schematic, voltage, alignment	8-31
980459 B-O-P	9-6	Data	9-6
980507, 980508 Buick 980509, Buick	6-37	Similar to 4037 Schematic, voltage	6-37
980525, 980529, Buick	6-38	Alignment, service notes, parts	6-38
980526, Buick	6-39	Schematic	6-39
980534, 980535, Buick	6-40	Alignment, voltage, parts	6-40
	9-67	Schematic, voltage, alignment	9-67
	9-68	Schematic, voltage	9-68
	9-69	Alignment	9-69
	9-70	Schematic, voltage	9-70
	9-71	Socket, trimmers, chassis	9-71
	9-72	Schematic, voltage	9-72
	9-73	Socket, trimmers, chassis	9-73
	9-74	Chassis wiring	9-74
	9-75	Alignment	9-75
	8-33	Schematic, voltage	8-33
	8-32	Alignment, change	8-32
	8-34	Socket, trimmers, chassis, note	8-34
	8-35	Schematic, voltage	8-35
	8-36	Alignment, change	8-36
	8-37	Socket, trimmers, chassis	8-37
	8-38	Schematic, voltage, alignment	8-38
	9-54	Socket, trimmers, chassis	9-54
	8-39	Schematic, voltage, alignment	8-39
	9-54	Socket, trimmers, chassis	9-54
	9-77	Schematic, voltage	9-77
	9-78	Socket, trimmers, chassis, alignment	9-78
	9-79	Schematic, voltage, socket, trimmers, chassis	9-79
	9-80	Alignment	9-80
	9-81	Schematic	9-81
	9-82	Socket, trimmers, chassis, voltage, alignment	9-82
	9-83	Schematic, vibrator, condenser data	9-83
	9-84	Socket, trimmers, chassis	9-84
	8-41	Schematic, voltage	8-41
	8-40	Alignment	8-40
	8-42	Socket, trimmers, chassis, notes	8-42
	9-85	Schematic, socket, trimmers, chassis	9-85
	9-86	Alignment, voltage	9-86
	9-87	Schematic, voltage, socket	9-87
	9-88	Trimmers, chassis	9-88
	9-90	Alignment, voltage, socket	9-90
	9-91	Alignment, notes	9-91
	9-92	Schematic	9-92
	9-93	Socket, trimmers, chassis, voltage, tuner assembly	9-93
	9-94	Schematic, socket, chassis, trimmers, voltage	9-94
	8-43	Schematic, socket, chassis, trimmers, condenser data	8-43
	8-40	See model 985252 Schematic, voltage	8-40
	8-40	Alignment	8-40

UNITED MOTORS SERVICE—(Cont.)				RADIO TRON	EARLY COMPLETE
MODEL	REVISION PAGE	REVISION PAGE	REVISION PAGE	EARLY COMPLETE	PAGE
985301 Chevrolet	Schematic, voltage.....	8-45			2591
	Socket, trimmers, chassis, notes.....	8-46			2592
985400 Chevrolet	Schematic, voltage.....	8-44			2592
1291344 Buick	See model 983885 Olds				2593
1291345 Buick	Schematic, voltage, socket, trimmers, chassis.....	9-76			2595
1394873 (980566) Buick	Schematic, voltage, trimmers.....	9-95			2597
7232563 (983570) Pontiac	Socket, trimmers, chassis.....	9-96			2598
UNITED REPRODUCERS CORP.					
20 Series	Schematic.....	1-1			2604
66	Schematic, socket, data.....	1-2			2596
70, 71, 72	Schematic, socket.....	1-8			
U. S. ELECTRIC CORP.					
17	Schematic, socket.....	Misc. 1-21			
87	Schematic, socket.....	Misc. 1-21			
U. S. RADIO AND TELEVISION CORP.					
5-A AO	Schematic, socket.....	3-1			2599
7 AO	Resistance data, voltage.....	3-2			2600
	Schematic, socket.....	2-1			
	Chassis, alignment data, voltage.....	2-2			
	Service notes, data.....	2-3			
	Chassis, parts list.....	2-4			
7-D, Chassis 700	Schematic, socket.....	4-1			
	Voltage, alignment.....	4-2			
8 Series	Schematic, socket.....	2-5			
	Chassis layout, voltage data.....	2-6			
	Chassis, parts list.....	2-7			
	Schematic, data.....	3-3			
9, 19 (Class B) Chassis	Voltage, transformer data.....	3-4			
900, 902	Schematic, data.....	2-8			
10	Chassis layout, voltage.....	2-9			
	Chassis views, parts list.....	2-10			
10-C (Chassis 1000-1001)	Schematic, chassis layout, speakers.....	2-11			
	Voltage, speaker notes.....	2-12			
	Chassis view, data.....	2-13			
	Parts list.....	2-14			
	Schematic.....	4-3			
12 and 120, Class "B," Chassis 1200	Changes, voltage.....	4-4			
19	See model 9				
20	Schematic, socket.....	1-1			
	Voltage, service notes, data.....	2-15			
	Alignment data.....	1-2			
24 (Chassis 400)	Schematic, chassis, voltage.....	8-5			
	Continuity test.....	3-6			
	Schematics.....	4-5			
25, Chassis 500, (Two types)	Voltage, oscillation.....	4-6			
25, Chassis 500	Schematic, socket, voltage.....	1-3			
	Chassis wiring.....	1-4			
26-P	Schematic, socket, voltage.....	1-3			
	Parts list, voltage data.....	1-4			
27 Early	Schematic, socket, voltage.....	1-5			
27 Late	Schematic, socket, voltage.....	1-5			
27-P	Schematic, chassis wiring.....	1-6			
28 Early	Schematic, socket, voltage.....	1-7			
28 Late	Schematic, socket, voltage.....	1-7			
28	Chassis wiring.....	1-8			
29	Schematic, voltage.....	1-9			
30 Auto	Schematic, voltage, assembly.....	2-16			
31 Apex, 31 Remote Control	Schematic, socket, voltage.....	1-10			
32 Series	Chassis wiring.....	1-10			
33 DC	Schematic, socket, voltage.....	1-11			
	Schematic, notes.....	3-7			
	Chassis, voltage notes.....	3-8			
36 Apex	Schematic, socket, voltage.....	1-12			
37 Apex	Schematic, voltage.....	1-12			
41-60, 43-25	Schematic, socket, voltage.....	1-13			
42-60, 44-25	Schematic, socket.....	1-13			
46, 47 Apex	Schematic, socket, voltage, data.....	1-14			
U. S. RADIO AND TELEVISION CORP.—(Cont.)					
MODEL	REVISION PAGE	REVISION PAGE	REVISION PAGE	EARLY COMPLETE	PAGE
46-A, 47-A Apex	Schematic, socket, voltage, data.....	1-14			*635
48, 48-A, 48-W, 48Z	Schematic, socket, voltage.....	1-15			*637
49	Schematic.....	1-15			*637
69 (Chassis 906)	Schematic, socket, voltage, data.....	3-9			*629
80 Chassis	Schematic, socket, voltage.....	1-16			
99 Series	See model 160				
	Schematic, socket, data.....	2-17			632-H
	Alignment data, voltage, chassis.....	2-18			632-I, K
	Schematic, voltage.....	4-7			2603
112-A SW Converter, Chassis 300 used in Model 712	Alignment data.....	4-8			2604
	See model 12				
120	Schematic, socket, voltage.....	9-10			2596
160, 250 (Chassis 90)	See model 112-A				
300 Chassis	See model 24				
400 Chassis	See model 48				
482	See model 25				
500 Chassis	See model 3040				
507 Chassis	See model 3092				
513 Chassis	See model 7-D				
700 Chassis	See model 9				
900, 902 Chassis	See model 69				
906 Chassis	See model 10-C				
1000, 1001 Chassis	Schematic.....	4-9			2599
1006, 1007, Class "B"	Voltage, alignment data.....	4-10			2600
1009 Chassis	See model 3070				
1200 Chassis	See model 12				
3040, 3056 (Chassis 507)	Schematic, socket, resistance.....	3-11			2601
	Voltage, alignment, notes.....	3-12			2602
3070, Chassis 1009	Schematic, voltage, layout.....	4-11			
	Resistance test data.....	4-12			
3092, Chassis 513	Schematic.....	5-1			
UNIVERSAL BATTERY CO.					
613V	Schematic, socket, parts Misc.	6-35			
802	Schematic, socket.....	7-1			
803	Schematic, socket.....	7-1			
5010	Schematic, socket.....	7-1			
5092	Schematic, socket.....	7-1			
690, 6910	Schematic, socket.....	7-2			
7332, 7332	Schematic, socket, parts Misc.	6-35			
8210, 8410	Schematic, socket.....	7-2			
VALLEY ELECTRIC CO.					
MB "A" Power Unit	Schematic.....	Misc. 1-22			*754
VAN DYKE					
1000	Schematic.....	Misc. 7-2			
VICTOR					
	See RCA-VICTOR				
VICTOREEN					
	See GEORGE W. WALKER CO.				
VIKING					
	See OZARKA				
VOCO RADIO MFG. CO., INC.					
V-41-N	Schematic.....	Misc. 6-36			
V-60	Schematic.....	Misc. 6-36			
V-80	Schematic.....	Misc. 6-37			
V-100	Schematic.....	Misc. 6-37			
WALGREEN CO.					
HE Chassis	See model 360				
R Chassis	See model R-31				
M-8, 800, Chassis M, ME	Schematic.....	10-1			
10, 12	Schematic.....	10-2			
B25-RS	Schematic, socket, trimmers, alignment, parts.....	8-1			
30	Schematic.....	10-1			
R-31, Chassis R	Schematic.....	10-3			
32B	Schematic, alignment.....	10-4			
34B	Schematic, voltage, alignment, trimmers, changes.....	10-5			

9-46	Schematic, voltage, socket, trimmers, chassis, tuner assembly	10-4
	Tuner data	10-30
	Alignment, wave-trap notes, tuner data	10-5
9-53	Schematic, voltage, socket, alignment, trimmers	10-7
9-58	Schematic, voltage, socket, trimmers, chassis	10-6
	Alignment, tuner data	10-5
	Schematic, socket, trimmers, alignment	10-8
	Schematic, voltage, socket, trimmers, alignment	10-9
9-220, 9-221, 9-222, 9-223, 9-224, 9-225, 9-226, 9-227, 9-228, 9-229	Schematic, socket, trimmers	10-10
9-480, 9-481, 9-482, 9-483, 9-484, 9-485, 9-486, 9-487, 9-488, 9-489	Schematic, voltage, socket, trimmers, alignment	10-11
9-550, 9-551, 9-552, 9-553, 9-554, 9-555, 9-556, 9-557, 9-558, 9-559	Schematic, voltage, socket, alignment, trimmers	10-12
9-670, 9-671, 9-672, 9-673, 9-674, 9-675, 9-676, 9-677, 9-678, 9-679	Schematic, socket trimmers, voltage, alignment	10-12
9-680, 9-681, 9-682, 9-683, 9-684, 9-685, 9-686, 9-687, 9-688, 9-689	Schematic, voltage, socket, trimmers, alignment	10-11
400	Schematic, socket, trimmers, alignment	9-2
401	Schematic, socket, alignment, trimmers	10-13
401 LW	Schematic, socket, alignment, trimmers	10-13
404	Schematic, socket, alignment, trimmers	10-14
419, 420	Schematic, socket	7-3
453, 553	Schematic, voltage, socket, trimmers, alignment	10-15
501	Schematic, socket, trimmers, alignment	8-1
510-C	Schematic, socket, alignment, trimmers	10-14
518	Schematic, voltage, socket, trimmers, alignment, parts	8-2
520	Schematic, socket	7-3
525	Schematic, socket, trimmers, alignment	9-3
530	Schematic, socket	7-4
536	Schematic, voltage, socket, trimmers, alignment, parts	8-2
542	Schematic, socket	7-4
542, Late	Schematic, socket, trimmers	10-10
550-C	Tuner data	10-80
	Schematic, socket, alignment, trimmers	10-13
551	Schematic, socket, trimmers, alignment	8-1
553	See model 453	
559, 579 (with 150-cycle vibrator)	Schematic, voltage, socket, alignment, trimmers	10-16
	Tuner data	10-80
600	Schematic, socket, trimmers, alignment	9-4
601	Schematic, voltage, socket, trimmers, alignment, parts	8-3
604, 606, 653	Schematic, socket	10-7
610	Schematic, voltage, socket, alignment, trimmers	10-17
613	Schematic, voltage, socket, trimmers, alignment, parts	8-3
629	Schematic, voltage, socket, alignment, trimmers	10-13
633	Schematic, voltage, socket, trimmers, alignment, parts	8-4
646 Auto	Schematic, socket, trimmers, alignment	8-1
648, 648B, 655B	Schematic, voltage, socket, alignment, trimmers	10-19
	Tuner data	10-30

41, 42	Schematic	10-2
41A, 42A	Schematic	10-2
56-BS	Schematic, socket, trimmers, alignment, parts	8-2
57-RS	Schematic, socket, trimmers, alignment, parts	8-3
166 BIS	Schematic, socket, trimmers, alignment, voltage	10-6
255	Schematic, socket, notes, parts	9-1
308, Chassis 801, 802	Schematic, socket, trimmers, alignment, voltage	10-7
360, Chassis HE	Schematic, socket, trimmers, alignment, parts	10-3
370	Schematic, socket, trimmers, alignment, parts	8-4
400	Schematic, socket	10-8
401	Schematic, voltage, alignment	10-9
500 (2 and 3 Bands)	Schematic, voltage, alignment	10-10
540	Schematic, socket, alignment, trimmers	10-11
550 Auto	Schematic, alignment	10-11
550 A-C	Schematic, socket, trimmers, alignment	10-11
575	Schematic, socket, alignment, trimmers, voltage	10-12
585, Series A	Schematic, socket, alignment, trimmers, voltage	10-13
630, 635, 652	Schematic, socket, alignment, trimmers, voltage	10-14
651	Schematic, voltage, alignment, trimmers	9-1
660 Auto	Schematic, voltage, alignment, trimmers	10-15
675	Schematic, voltage, socket, trimmers	10-8
700	Schematic, voltage, socket, trimmers, alignment	10-16
800	Schematic, alignment	9-2
801, 802 chassis	See model 808	
1050	Schematic, socket, alignment, voltage	10-17
4154	Schematic, voltage, socket, alignment	10-18
GEO. W. WALKER CO.		
Victoreen "Standard"	Chassis wiring	Misc. 1-23
Victoreen "Universal"	Chassis wiring	Misc. 1-23
WALTHAM		
Waltham '32	Schematic	3-1
WARE MFG. CO.		
TA	Schematic	2-1
SB-A	Schematic	2-4
SB-B	Schematic, notes	3-1
SB-F	Schematic	2-5
4 Tube Music Master	Schematic	2-1
7 Tube Music Master	Schematic	2-2
B-1, B-2 Bantam	Schematic	2-5
S-1	Schematic	3-3
SB-7	Schematic	3-2
SB-8	Schematic	2-3
SB-45	Schematic	2-3
WARNER ENGINEERING CORP., LTD.		
Qualiphone R-34	Schematic	Misc. 3-10
WARWICK MFG. CO.		
0-407	Schematic, socket, trimmers, alignment, voltage, battery data	10-1
4-Tube AC	Schematic, socket	7-4
5-Tube A-C Superheterodyne Auto	Schematic, socket, trimmers, alignment	9-1
6-Tube A-C Superheterodyne	Schematic, alignment	7-1
6-Tube Auto	Schematic, socket, trimmers, alignment	9-1
7-Tube Auto	Schematic, alignment	7-2
9-23 Wireless Record Player	Schematic, socket	7-3
9-43, 9-45	Schematic, voltage, socket, trimmers, alignment	10-2
	trimmers, alignment	10-3

14, 15, 16 Electric Drive Dials	Motor connections, motor-silencer spring data Motor notes, Part 2, gear train data Discs and buttons adjustments, Part 1 Discs and buttons adjustments, Part 2 Motor switch, drive cable data Cable data, Part 2, clutch assembly and electric-manual lever data Electric-manual lever notes Part 2, locking plate and reversing switch notes Parts list Adjustments	9-6 9-7 9-8 9-9 9-10 9-11 9-12 9-13 9-1	
17-Button Telephone Dial and Phantom Light Dial	Replacement data Data, parts list Schematic, socket Voltage, socket, data Schematic, parts list Alignment, socket, voltage Schematic Voltage, socket, trimmers, coil data Alignment, data, resistance, phono Additional data Schematic, sensitivity Socket, trimmers, voltage, coils Alignment, phono, data, notes Notes, parts Dial and drive parts data Dial and drive parts list Schematic, sensitivity Socket, trimmers, voltage, coils, notes Alignment, parts, notes, data Schematic, layout, voltage, notes Coils, phonograph socket notes, parts Schematic, specifications, sensitivity, phonograph data Alignment, trimmers, circuit data, voltage Schematic, voltage, socket, trimmers, alignment Schematic, voltage Alignment, trimmers Schematic, layout, voltage, notes	9-2 9-3 8-7 1-1 1-2 5-1 5-2 7-1 7-2 7-8 7-12 8-1 8-2 8-3 8-4 8-33 8-34 8-5 8-6 8-7 4-1 9-14 9-15 9-16 10-9 10-10 10-11 4-2 9-21 9-22 9-23 10-1, 2 10-5, 6 6-1 6-2 10-13 10-14 10-12 10-11 10-42 10-15 10-42 10-16 7-4	
1936 Receiver	Changes	8-7	2627
O, CG (1st and 2nd types)			640
O-C Series (20C5)			640
ODM Series			
OEL			
OF			
00A			
A-1 Series			
B1 Series			
S1 Series			
02A			
A-2 Series			
A2 Series, 7-Station Automatic Tuning Panel			
2B Series (22B6)			
B2A Series			
S2 Series			
T2 Series			
20M Series			

651	Schematic, voltage, socket, trimmers, alignment, parts	8-4	
653	See model 604		
654	Schematic, voltage, socket, trimmers, alignment	10-20	
655B	See model 648		
659	Schematic, socket, trimmers, voltage, alignment	10-21 10-30	
668, 668B	Schematic, voltage, socket, trimmers, alignment	10-22 10-30	
683	Schematic, socket, voltage, alignment, trimmers	10-23	
700	Schematic, socket, trimmers, alignment	9-5	
701	Schematic, socket, voltage, alignment, trimmers, parts	9-6	
725	Schematic, socket, trimmers, alignment	9-7	
741	Schematic, socket, trimmers, voltage, alignment, parts	9-8	
746	Schematic, socket, trimmers, voltage, alignment	10-24	
747	Schematic, socket, trimmers, voltage, alignment	10-25	
749	Schematic, socket, trimmers, voltage, tuner adjustments	9-9	
749, 749B Late	Schematic, socket, trimmers, voltage, alignment	10-26 10-30	
751	Schematic, socket, trimmers, alignment, parts	9-10	
761	Schematic, socket, trimmers, Alignment	10-27 10-30	
768, 768B	Schematic, voltage, Alignment, socket, trimmers, tuner data	10-27 10-30	
846	Schematic, socket, alignment, trimmers	10-28	
872	Schematic, voltage, socket, trimmers, alignment	10-29	
650	Schematic, alignment, Misc.	8-2	

WATTEBSON RADIO MFG. CO.

WEBSTER CO.

B Communication System OC-2 and OC-2A Amplifiers	Schematics, notes	8-1	
C Communication System, OXC and OXM	Schematics, notes	8-2	
D Communication System, OC-3 to OC-10	Schematics, notes	8-2	
PA-17	Schematic	5-1	
PA-42	Schematic	5-1	
P-53	Schematic	5-2	
A-66	Schematic	5-2	
B-79	Schematic	5-3	
WR-85	Schematic	5-3	
K-858-A	Schematic	5-4	
K-859-A	Schematic	5-4	
HG-417	Schematic	Misc. 6-33	
HMS, HMT, Teletalk	Schematic	Misc. 8-10	
B-37-50 AC	Schematic	Misc. 8-10	
ICS-1241	Schematic	Misc. 8-10	
6005	Schematic	3-1	
6009	Schematic	3-1	
6018	Schematic	3-1	
6026-JD	Schematic	3-2	
6030-JE	Schematic	3-2	

WEBSTER ELECTRIC CO.

5 Tube A.C. DC Models	Data	9-6	
14, 15, 16 Electric Drive Dials	Service notes	9-4	
	Notes, changes, replacement data	9-5	

WELLS-GARDNER & CO.

2620			
2619			
2619			
2620			
2620			

MODEL	REVISED PAGE
2CM Series	Socket, trimmers, voltage, coil data7-5
2CM-3A Series	Alignment, resistance7-6
2DL Series	Changes dataChanges 8-7
	Schematic7-7
	Socket, trimmers, coil data, phono7-8
	Alignment, voltage, drive, phono, notes7-9
	Dial and drive parts data8-33
	Dial and drive parts list8-34
	ChangesChanges 8-7
	Schematic coils, phonograph and speaker connections, specifications, sensitivity 9-17, 18
A-3, A-6 Series	Voltage, trimmers, alignment, notes9-19
	Circuit data, socket, parts9-20
A3 Series, 7-Station Automatic Tuning Panel	Installation data, panel view, details10-1, 2
B3 Series (Portable)	Schematic, voltage, socket, trimmers, alignment, coils 10-19
T3 Series	Schematic, voltage, socket, trimmers, coils, notes10-17
	Alignment, drive cord data10-18
A-4 Series	Phonograph data, coils, parts9-24
	Schematic, specifications, sensitivity9-25
	Trimmers, alignment, circuit data, socket9-26
A4 Series, 7-Station Automatic Tuning Panel	Installation data, panel view, details10-1, 2
B4 Series (Table Models)	Schematic, voltage, socket, alignment, trimmers, coils10-19
4B5 Series	Schematic, voltage, alignment, socket, trimmers10-20
05A	Schematic, layout, voltage4-3
05AA	Schematic, voltage4-4
A-5 Series	Schematic, specifications, sensitivity, phonograph data 9-27
	Trimmers, alignment, circuit data, voltage9-28
A5 Series, 7-Station Automatic Tuning Panel	Socket, coils, data, parts9-29
	Installation data, panel view, details10-1, 2
05BA	Schematic, layout, voltage4-5
5B	Schematic, layout, voltage4-5
C5, 6CH5 Series	Schematic, socket, trimmers, alignment4-12
5C10 Series	Schematic, voltage, socket, alignment, trimmers10-22
5D Series	Tuner data, trimmers10-21
	Schematic, voltage, parts10-24
	Alignment, socket, trimmers, resistances, drive cord data, notes6-4
5-E Series (25E1, 25E5)	Schematic, socket, parts6-5
5F, 5FL	Voltage, alignment5-3
	Schematic, sensitivity5-4
	Alignment, parts8-9
5G Series (85G510, 85G560)	Socket, trimmers, voltage, coils8-10
	Schematic6-6
	Voltage, alignment, battery data6-7
5H	Socket, trimmers, resistance data, parts6-8
	Schematic, data8-11
	Socket, trimmers, voltage, coils, resistance8-12
5K, 5KL	Alignment, notes8-13
	Schematic, sensitivity8-15
	Alignment, parts8-14
5Y Series (25Y1)	Socket, trimmers, voltage, coils8-16
	Schematic, voltage, socket, trimmers, parts6-9
	Alignments, resistances, drive cord data6-10

MODEL	REVISED PAGE
5Y Series (25Y1)	Mounting notes6-11
06A	Schematic, layout, notes4-6
06B Series (26B1, 26B6)	Schematic, socket, parts, data6-12
	Voltage, circuit data, resistances, parts6-13
6C Series	Alignment, notes6-14
	Circuit data, voltage, alignment6-15
	Schematic6-16
	Socket, trimmers, condenser data, parts6-17
C-6 Series	Parts, changes9-30
	Schematic, coils, specifications 9-31
	Socket, circuit data, drive cord data, alignment9-32
6CH5	See model C5
6OI	Schematic, socket, trimmers, voltage8-17
	Coils, mounting data8-18
6C9 Series	Alignment, parts, notes8-19
	ChangesChanges 9-6
	Schematic, voltage, socket, trimmers10-23
6D Series	Alignment, tuner10-24
	Schematic, alignment7-10
6F Series	Socket, trimmers, voltage, coil and drive data7-11
	R-F chassis schematic7-12
	A-F chassis schematic7-13
	Socket, trimmers, coil data, phono, changes7-14
	Voltage, trimmers, chassis views7-15
	Circuit data, alignment7-16
	Resistance, parts7-17
6G Series	Schematic, trimmers7-18
	Voltage, alignment, socket, coil data, parts lists7-19
6J Series	Schematic, notes, speaker connections9-33
	Socket, trimmers, alignment, changes9-34
6K Series	Schematic, socket, coil data7-20
	Voltage, alignment, data, parts list7-21
6L Series	Schematic, socket, coil data7-22
	Alignment, voltage, parts list7-23
	ChangesChanges 8-7
6N Series	Schematic, socket, trimmers7-24
	Voltage, coil data, resistance, notes7-25
6R Series	Alignment, notes7-26
	Schematic, alignment7-27
	Voltage, socket, trimmers, coil data, resistance7-28
6S	ChangesChanges 8-7
	Mounting, parts8-21
	Alignment, voltage, socket, trimmers, resistance, notes8-22
6-U Series (26U1)	Schematic5-5
	Alignment, wiring instructions 5-6
	Installation data5-7
06W	Schematic, layout, voltage4-7
V6Z2	Alignment, speaker data4-8
Z6Z1	Schematic, voltage4-13
07A	Schematic, layout, voltage, alignment data4-14
	Schematic, voltage, alignment data4-9
07, C11 Series	Additional dataChanges 7-14
	Schematic, voltage, socket, alignment, trimmers10-29
7O Series (27O1, 27O5)	Schematic, socket, voltage, trimmers6-18
	Alignment, resistances, drive cord data6-19
7-D Series (27D1, 27D5)	Schematic, socket, alignment6-9
	Voltage, parts, circuit changes 6-10

MODEL	REVISED PAGE	EARLY COMPLETE PAGE	RADIOTRON COMPLETE PAGE
7E	Schematic 8-23 Socket, trimmers, voltage, data..... 8-24 Alignment, coils, drive cord data 8-25 Resistance, parts 8-26 Schematic, sensitivity, phono. connections 8-27 Socket, trimmers, voltage, coils..... 8-28 Alignment, phono. data, parts..... 8-29 Schematic, trimmers, parts..... 6-20 Voltage, trimmers, coil data, changes 6-21 Resistances, data 6-22 Circuit data, alignment..... 6-23 Additional data Changes 7-12 Schematic 6-24		
7F, 7FL	Voltage, socket, trimmers, coil data 6-25 Drive cord data, resistances..... 6-26 Schematic 8-31 Phono. connections, parts..... 8-30 Alignment, socket, trimmers, voltage, resistance, coils, changes 8-32 Schematic 7-29 Socket voltage, trimmers, coil data 7-30 Alignment, phono. resistance..... 7-31 Dial and drive parts data..... 8-33 Dial and drive parts list..... 8-34 Schematic, socket, phono. data..... 10-25 Alignment, trimmers, voltage, parts 10-26 Schematic, socket 5-11 Service notes, parts 5-12 Voltage, alignment 5-13 Schematic 7-32 Voltage, socket, coil data, trimmers 7-33 Alignment, resistance 7-34 Schematic, trimmers, voltage, alignment, tuner, drive cord data 10-28		
7K Series	Schematic, voltage, alignment, 10-30 See C7 series Schematic, socket, phonograph data, voltage, specifications, coils 9-35 Circuit data, alignment, trimmers 9-36 Tuner and drive cord data, phonograph data 9-37 Parts list 9-38 Schematic, voltage, socket, trimmers, changes, tuner switches 10-31, 32 Tuner data 10-42 Schematic, voltage, socket 10-33 Alignment, trimmers, coils, specifications 10-34 Tuner data 10-42 Schematic, voltage, coils, socket, phonograph data, specifications, sensitivity 9-39, 40 Circuit, tuner data, changes, phonograph data, notes, parts 9-41 Trimmers, alignment, parts 9-42 Schematic, voltage, socket, coils, phono. data 10-35 Alignment, trimmers, specifications 10-36 Tuner data 10-42 Schematic, voltage, socket, alignment, notes 10-37, 38 Alignment, trimmers, changes, phono. data, movie dial data 10-39		
7L			
A8 Series			
9-B Series (29B5)			
9C Series			
A10 Series			
A11 Series			
C11 Series			
A-12 Series			
A12 Series, Late			
A13 Series			
A-14 Series			
A15 Series			
A16 Series			

MODEL	REVISED PAGE	EARLY COMPLETE PAGE	RADIOTRON COMPLETE PAGE
A17 Series	Schematic, socket, voltage, phono. data 10-40 Alignment, trimmers, coils, notes 10-16 Schematic, voltage, socket, coils, specifications 10-41 Alignment, phono. data, trimmers, drive cord data 10-42 See O-D Series Schematic, layout, voltage..... 4-10 Schematic, voltage, socket, coils, phono. data 10-43 Tuner data 10-42 Alignment, trimmers 10-44 See 2B Series Schematic, voltage, phono. data 10-45 Alignment, trimmers 10-18 Tuner data 10-42 Drive data 10-44 Schematic, voltage, phono. data 10-46 Tuner data 10-42 Socket, coils, phono. data 10-43 Alignment, trimmers 10-44 See 5-E Series See 5Y Series See 6B Series See 6U Series See 7C Series See 7D Series See 9B Series See 5-G Series See 7G Series See 7H Series Schematics 5-15 Alignment, socket, voltage..... 5-16 Schematic, layout, voltage..... 4-15 Schematic, chassis layout, voltage 2-1 Schematic, assembly wiring, voltage 3-1 Schematic 5-8 Schematic, socket 1-3 Schematic, layout, voltage..... 4-11 Schematic, socket, data 1-4 Schematic, chassis, voltage..... 3-2 Schematic, socket, voltage..... 5-14 Schematic, layout, voltage..... 4-16 Schematic, chassis layout, data..... 3-3 Parts list, voltage, alignment data 3-4		
A20 Series			
20C5 Chassis			
022			
A22 Series			
22B5 Chassis			
A23 Series			
A24 Series			
25E1, 25E5 Chassis			
25Y1 Chassis			
26B1, 26B5 Chassis			
26U1 Chassis			
27C1, 27C5 Chassis			
27D1, 27D5 Chassis			
39B5 Chassis			
35G510, 35G560 Chassis			
37G508, 37G566 Chassis			
37H508, 37H566 Chassis			
40, 40-A			
50			
052 Series			
042 Auto Set			
042-A			
72			
073			
80, 82-A			
092 Series, Battery			
92, 99			
502			
573 A0			
6-U			
Z6Z1			
062			
670			
D689			
D690			
D691			
S-691			
D692 Early			
D692 Late			

WESTERN AUTO SUPPLY CO.

See TRUETONE

6-U	Schematic, voltage 5-2
Z6Z1	Schematic, voltage 5-3 Alignment, parts 5-4 Schematic, voltage, assembly wiring 5-1 Schematic, socket, trimmers..... 6-1 Alignment, service notes..... 6-2 Schematic, voltage, coils, socket, sensitivity 10-1, 2 Circuit and tuner data, changes, phono. data 10-4 Schematic, socket, trimmers 10-5 Alignment, tuner, data 10-6 Schematic, socket, trimmers, alignment 10-7 Tuner data, alignment 10-8 Schematic 7-1 Alignment, socket, trimmers 10-9 Schematic, alignment 10-10 Schematic, alignment 10-11 Socket, trimmers, antenna data 10-12

MODEL	WESTINGHOUSE ELECTRIC SUPPLY CO., INC.—(Cont.)	REVISED PAGE
WR472	Alignment, phono. data	10-12
WR-500	Schematic	6-15
WR-501	Schematic, alignment, part 2	5-12
WR-601	Schematic, voltage	6-4
WR603, WR606	Voltage, socket, alignment, parts	5-14
WR604, WR607	Schematic, socket, trimmers, parts	6-1
WR605, WR608	Schematic, changes, parts	6-2
WR700 Television	Alignment, voltage	6-3
WR701 Television	Schematic, voltage	7-1
WR702 Television	Alignment, parts	7-2
WR703 Television	Schematic, socket, trimmers, voltage, alignment, chassis	8-1
	Socket trimmers, chassis	8-2
	Alignment, parts	8-3
	Socket trimmers, chassis	8-4
	Socket trimmers, chassis	9-1, 2
	Alignment, specifications, parts	9-3
	Alignment, voltage, alignment, trimmers, socket, data	10-10
	Schematic, voltage	6-4
	Schematic, voltage	6-5
	Alignment, data, parts	6-8
	Schematic, voltage, resistance	6-7, 6-8
	Alignment, service notes	6-9
	Socket, trimmers, parts	6-10
WR-205, WR-305	Schematic, voltage, resist	6-12
	ance data	6-11, 6-12
	Socket, trimmers, data	6-13
	Alignment, service notes, parts	6-14
WR-208	Schematic, voltage, color coding	7-3
	Alignment, changes, parts	7-4
WR-211	Schematic, socket, trimmers, chassis, alignment, voltage	8-9
WR-212, WR-312	Schematic, voltage, resist	8-5, 8-6
	Socket, trimmers, chassis	8-7
	Alignment, parts	8-8
WR-214, WR-314	Schematic, voltage, resist	9-5, 6
	ances	9-7
	Socket, trimmers, chassis	9-8
	Alignment, specifications, parts	9-9
WR-222	Schematic, voltage, resistance	9-9
WR226, WR326, WR333	Alignment, specifications, parts	9-10
	Schematic, voltage, resistances	10-1
	Socket, trimmers, alignment, parts	10-2
	Schematic, voltage, resistances	10-3
WR228, WR328	Socket, trimmers, alignment, parts	10-4
WR256	Schematic, voltage, alignment, socket, data, trimmers	10-19
WR264	Schematic, socket, trimmers, speaker, drive cord data	10-5
	Chassis wiring, voltage	10-6
	Alignment, phono. data, tuner, lead dress	10-13
WR-306	Schematic, voltage, resist	7-5, 7-6
	ance	7-7
	Alignment, parts	7-7
	Circuit data, socket, trimmers, chassis	7-8
WR-315	Schematic, voltage, resist	8-11, 8-12
	ance	8-10
	Socket, trimmers, chassis	8-13
	Circuit data, alignment	8-14
	Parts	8-14
WR326	See model WR226	
WR328	See model WR228	
WB330	Schematic, voltage, resistances	10-7, 8
	Socket, trimmers, alignment, parts	10-9
WR938	See model WR226	
WR472	Schematic, voltage, socket, trimmers, pick-up, transformer data, motor coils	10-11

MODEL	WESTINGHOUSE ELECTRIC SUPPLY CO., INC.—(Cont.)	REVISED PAGE
WR-28, WR-29	Voltage, socket, alignment data, part 1	5-11
WR-30	Schematic, alignment, part 2	5-12
	Schematic	5-13
	Voltage, socket, alignment, parts	5-14
WR-100	Schematic, socket, trimmers, parts	6-1
WR-101	Schematic, changes, parts	6-2
WR-101, Chassis U6F	Alignment, voltage	6-3
WR-102-A	Schematic, voltage	7-1
WR-103, WR-103-A	Alignment, parts	7-2
WR-116, WR-316	Schematic, socket, trimmers, voltage, alignment, chassis	8-1
WR154	Socket trimmers, chassis	8-2
WR-201	Alignment, parts	8-3
WR-203, WR-303	Socket trimmers, chassis	8-4
WR-204, WR-304	Socket trimmers, chassis	9-1, 2
	Alignment, specifications, parts	9-3
	Alignment, voltage, alignment, trimmers, socket, data	10-10
	Schematic, voltage	6-4
	Schematic, voltage	6-5
	Alignment, data, parts	6-8
	Schematic, voltage, resistance	6-7, 6-8
	Alignment, service notes	6-9
	Socket, trimmers, parts	6-10
	Schematic, voltage, resist	6-12
	ance data	6-11, 6-12
	Socket, trimmers, data	6-13
	Alignment, service notes, parts	6-14
	Schematic, voltage, color coding	7-3
	Alignment, changes, parts	7-4
	Schematic, socket, trimmers, chassis, alignment, voltage	8-9
	Schematic, voltage, resist	8-5, 8-6
	Socket, trimmers, chassis	8-7
	Alignment, parts	8-8
	Schematic, voltage, resist	9-5, 6
	ances	9-7
	Socket, trimmers, chassis	9-8
	Alignment, specifications, parts	9-9
	Schematic, voltage, resistance	9-9
	Alignment, specifications, parts	9-10
	Schematic, voltage, resistances	10-1
	Socket, trimmers, alignment, parts	10-2
	Schematic, voltage, resistances	10-3
	Socket, trimmers, alignment, parts	10-4
	Schematic, voltage, alignment, socket, data, trimmers	10-19
	Schematic, socket, trimmers, speaker, drive cord data	10-5
	Chassis wiring, voltage	10-6
	Alignment, phono. data, tuner, lead dress	10-13
	Schematic, voltage, resist	7-5, 7-6
	ance	7-7
	Alignment, parts	7-7
	Circuit data, socket, trimmers, chassis	7-8
	Schematic, voltage, resist	8-11, 8-12
	ance	8-10
	Socket, trimmers, chassis	8-13
	Circuit data, alignment	8-14
	Parts	8-14
	See model WR226	
	See model WR228	
	Schematic, voltage, resistances	10-7, 8
	Socket, trimmers, alignment, parts	10-9
	See model WR226	
	Schematic, voltage, socket, trimmers, pick-up, transformer data, motor coils	10-11

WESTINGHOUSE INTERNATIONAL

WR-6-R	See RCA 82-R	
WR-7-R	See RCA 86-R	
WR-13	See RCA RE-16	
WR-13-A	See RCA RE-16-A	
WR-14-CR	See RCA R-5-X	
WR-15-A	See RCA R-10	
WR-16	See RCA R-28	
WR-17	See RCA R-4	
WR-18	See RCA R-8	
WR-19	See RCA R-71	
WR-20	See RCA R-74	
WR-21	See RCA R-70 & R-70-N	
WR-22	See RCA R-73 (47)	
WR-23	See RCA RE-80	
WR-24	See RCA R-24-A	
WR-25	See RCA RE-80-SW	
WR-26	See RCA R-27-M	
WR-26-M	See RCA R-17-M	
WR-27	See RCA R-28-T (A to G)	
WR-28	See RCA R-37-T-P	
WR-29	See RCA RE-40-P	
WR-30	See RCA 140 & 140-E	
WR-31	See RCA 141 & 141-E	
WR-32	See RCA 100	
WR-33	See RCA M-34	
WR-34	See RCA 112	
WR-35	See RCA 111	
WR-36	See RCA 120	
WR-37	See RCA 121	
WR-38	See RCA 340	
WR-39	See RCA 340-E	
WR-41	See RCA M-105	
WR-42	See RCA M-116	
WR-45	See RCA 143	
WR-45-A	See RCA-Victor 143 (Revised)	
WR-46	See RCA 128	
WR-46-A	See RCA-Victor 128 (Revised)	
WR-47	See RCA 118	
WR-48	See RCA 135-B	
WR-48-A	See RCA-Victor 118 (Revised)	
WR-49	See RCA 322	
WR-50	See RCA 128-E	
WR-93	See RCA-Victor R-93	
WR-102 (Preliminary)	Schematic, voltage	7-1
WR102	Alignment, socket, trimmers, chassis	10-1
WR-116, WR-116X, WR-316, WR-316X	Schematic, voltage	8-1
WR-209 (Preliminary)	Alignment, parts	8-2
WR-209, WR-209X Final	Schematic, voltage, alignment	8-8

WESTINGHOUSE INTERNATIONAL
WILCOX-GAY

WESTINGHOUSE INTERNATIONAL—(Cont.) MODEL	REVISED PAGE	EARLY COMPLETE PAGE	RADIO TRON COMPLETE PAGE
WR209 Alignment, socket, trimmers, chassis	10-2		
WR-210, WR-310 Schematic, voltage	7-3		
WR-211, WR-211A, WR-211X Schematic, voltage	8-3		
WR-211U, WR-311, WR-311X, Final	8-4		
WR-212, WR-212X, WR-312, WR-312X Schematic, voltage	8-5, 8-6		
WR214X, WR314X Alignment, parts	8-7		
Socket, trimmers, chassis	9-1, 2		
Alignment, specifications, parts	9-3		
Schematic, voltage, resistances	9-4		
Socket, trimmers, chassis	10-3, 4		
Alignment, parts	10-5		
See model WR-210	10-6		
Schematic, voltage	7-4		
See model WR214X			
See model WR-116			
WESTON ELECTRIC INSTRUMENT CORP.			
Jewell Test Panel Schematic	1-1	2648	
Jewell 133 Schematic	1-2	2644	
Jewell 133-A Schematic	1-2	2644	
Jewell 137 Schematic	1-3	2645	
Jewell 198, 199 (2nd type) Schematic	2-1	2646	
Jewell 209 Schematic	2-1	770-C	
Jewell 214 Schematic	2-2	770-D	
Jewell 408, 409 (1st type) Schematic	1-5	764	
Jewell 408, 409 (2nd type) Schematic	1-6	763	
Jewell 444 Schematic	2-3	770-I	
444, Type 2 Schematic	5-1		
444, Type 3 Schematic	5-2		
Weston 526, Type 7 Schematic	1-7	756	
Jewell 533 Schematic	2-4	770-E	
Jewell 534 Schematic	2-4	770-F	
Weston 537 Schematic	1-8	757	
Jewell 538 Schematic	2-5	770-G	
Jewell 540 Schematic	2-6	770-H	
540 Type 2 Schematic	5-7		
Weston 547 Schematic	1-10	758	
Weston 555 Schematic	1-11	759	
Jewell 560 Schematic	2-6	770-H	
563, Type 2 Schematic	5-8		
Weston 564 Schematic	1-11	759	
Weston 565 Schematic	1-12	760	
Weston 566 Schematic	3-1	761	
Jewell WD-566 Schematic	3-2		
Weston 566, Type 8 Schematic	5-4	2662	
Weston 660 Schematic	3-3	2663	
660, Type 3 Schematic	5-5		
661, 673 Schematic	5-6		
662, Type 2 Schematic	3-4	2664	
Weston 663 Schematic	5-7		
664 Capacity-Voltmeter Schematic	3-4	2664	
665 Selective Analyzer Schematic	4-1		
665, Type 2 Schematic	4-1		
672, Type 2 Schematic	5-4		
673 Schematic	5-8		
674 Tube Checker Schematic	4-2		
674, Type 2 Schematic	5-9		
675 Tube Checker Schematic	2-2		
Weston 676 Schematic	2-7		
676 Schematic	5-10		
676-R, 677-R, 678-R Schematic	5-11		
677, 678 Schematic	5-12		
692 Oscillator, Type 1 Schematic	6-1		
694 Schematic	5-6		
695 Schematic	5-3		
770 Tube Checker Schematic	6-2		
780 Capacity Meter Schematic	6-1		
WESTON RADIO CORP.			
See model 70			
Schematic	6-3		
Schematic	6-1		
Schematic	6-1		
Schematic	6-2		
Misc. 8-3			
WESTON RADIO & KNIGHT RADIO			
See ALLIED RADIO & KNIGHT RADIO			
WHOLESALE RADIO SERVICE CO., INC.			
Auto Radio Superhet Schematic, socket, voltage, assembly wiring	3-4		
Duo-Symphonic 1930 Schematic, socket, voltage, data	1-2		2676
Duo-Symphonic Junior 1931 Schematic, socket, voltage	1-1		2674
Great Duo-Symphonic Schematic, socket, voltage	1-1		2675
L-1 AC Schematic, chassis layout, voltage	3-1		2669
05A Series, AC-DC, L-20 Schematic, voltage, parts list	3-2		2670
AC Schematic	3-3		2671
M-35, 37, 53 AC Schematic	3-3		
WILCOX-GAY CORP.			
Road Mate See 4-B-26			
Thin Man See model A53			
2-S-5 Schematic	3-1		2677
2-T-5 Schematic	3-2		2678
2-V-A-7 Schematic	4-1		2679
2-VB-7 Schematic, socket	4-2		
A3, A4, Chassis 5A6 Schematic	9-1		
3-D-5 Schematic	4-3		
3-F-7 Schematic	4-4		
9J4 Schematic, socket, parts list	7-4		
3-J-5, 3-K-5 Schematic	7-3		
3JC5 Schematic, socket, parts	4-7		
3JD5, 3JG5 Schematic, socket, voltage	7-1		
3JE5 Schematic, socket, parts	6-1		
3JF5 Schematic, socket, voltage	7-1		
3JG5 Schematic, socket, voltage	6-2		
3-JM6, 8JQ6 Schematic, voltage, socket, parts	7-2		
3-K-5 Schematic, voltage, socket	7-3		
3KE5 Schematic, socket, voltage	5-1		
3LB-7 Schematic	6-2		
3-PA-6-66 Schematic	4-5		
3-R-6-66 Schematic	4-7		
3-S5-66 Schematic	4-6		
3SB-5 Schematic	4-8		
3TV-6 Schematic, voltage, socket	5-2		
3VB-6 Schematic, voltage, socket	4-8		
3-V-6 (BO & SW), 3-VA-6 Schematic, socket, voltage	5-3		
(BO only) Schematic, voltage, alignment	5-5		
4-B6, Road Mate Schematic, voltage, socket	5-6		
4-C-5, 4-CB-5 (BO & SW), 4-CA-5 (BO Only) Schematic, voltage, socket	5-7		
4-CD-5 Schematic, voltage, socket	5-8		
4-D-10 Schematic, voltage, socket	5-8		
4-DB-10 Schematic, voltage, socket	5-10		
4-F-6 Schematic, socket, voltage, parts	6-5		
Alignment data	Changes 7-5		
Schematic, socket, voltage, parts	6-6		
Alignment data	Changes 7-5		
Schematic, socket, voltage, parts	6-8		
Alignment data	Changes 7-5		
Schematic, socket, voltage, parts	6-4		
Alignment data	Changes 7-5		

MODEL	Schematic, socket	9-2
A5, A6, Chassis 5F8	Schematic, socket, parts list	7-4
5B5, 5B06	Schematic, socket, parts	7-5
5BA5	See model 5B5	7-5
5BC5	Schematic, socket, parts	7-6
5BE6	Schematic, socket, voltage, parts	6-7
5E7	Schematic, socket, voltage, parts	6-8
5EA7	Schematic, socket, parts	7-5
5E8, 5E9	See model A5	7-5
5F8 Chassis	Schematic, voltage, socket, alignment, parts	8-1
A6	Schematic, voltage, socket, alignment, parts	8-2
6A5	Schematic, voltage, alignment, socket, parts	8-3
6B8	Schematic, voltage, socket, alignment, parts	8-4
6D6	Schematic, socket, parts	9-3
6F6, 6FB6	Alignment, trimmers, voltage	9-4
6T11	Schematic, voltage, alignment, socket, trimmers	10-1
7E5	See model A41	10-1
7R5 chassis	See model A48	10-2
7S5 chassis	See model A48	10-2
7T5 chassis	See model A49	10-3
8D5 chassis	See model A50	10-3
8E5 chassis	See model A52	10-4
8J5 chassis	See model A53	10-4
8L7 chassis	See model A54	10-5
8N7 chassis	See model A55	10-5
A41, A42, Chassis 7R5	Schematic, voltage, socket, alignment	10-2
A48, Chassis 7S5	Schematic, voltage, socket, alignment	10-3
A49, Chassis 7T5	Schematic, voltage, socket, alignment	10-3
A50, Chassis 8D5	Schematic, voltage, socket, alignment	10-4
A52, Chassis 8E5	Schematic, voltage, socket, alignment	10-5
A53, Thin Man, Chassis 8J5	Schematic, voltage, socket, alignment	10-6
A54, Chassis 8L7, A55, Chassis 8N7	Schematic, voltage, socket, alignment	10-7
	Schematic, voltage, socket, alignment	10-8

WILLARD STORAGE BATTERY CO.

B Unit 3095	Schematic	2-1
AB 3301 G. E. Charger	Schematic	2-2
AB 3301 Westinghouse	Schematic	2-2
B Unit, 3310, 4310	Schematic	2-1
B Unit 4095	Schematic	2-1
AB 6301	Schematic	2-2

WINGS

See GOODYEAR SERVICE

WORKRITE MFG. CO.

See U. S. ELECTRIC CORP.

THE RUDOLPH WURLITZER CO.

C-4, M-4	Also see ALL-AMERICAN MOHAWK CORP.
Schematic, data	4-1
Notes, alignment data	5-10
Schematic, data	4-2
Alignment data	5-11
Schematic, data	4-3
Alignment data	5-12
Schematic, data	4-5
Alignment data	5-15
Schematic, socket, voltage	4-4
Schematic, data	5-19
Alignment data	4-4
Schematic, data	5-13
Schematic, data	4-6
Schematic, data	4-7
Alignment data	4-8
Alignment data	5-16

MODEL	Schematic, data	4-9
SA-91-A	Alignment data	5-14
SA-120	Schematic, data	4-10
SA-138	Schematic, data	4-11
	Schematics, details	5-17
	Alignment data	5-18
316, 416, 616, 716 AC	Schematic, voltage, parts	8-1
316, 416, 616, 716 DC	Schematic, voltage, parts	8-2
400, Serial #110001 to 110000	Schematic, voltage, parts	8-3
400, Serial #111001 to 111500	Schematic, voltage, parts	8-4
416	See model 316	
450	Schematic, socket, voltage, alignment, parts	5-1
453 Amplifier	Schematic, socket, circuit details	5-3
454	Schematic	5-4
460	Schematic, socket, voltage	5-5
470	Alignment data	5-6
471	Schematic, socket, voltage	5-7
480	Schematic	5-8
U-500	Schematic, data	5-9
550	Schematic, parts data	4-12
616	See model 316	
660 Sound System	Schematic, parts, voltage, Misc.	7-12
716	See model 316	

ZANEY-GILL CORP.

Viaphone 54	Schematic, notes	Misc. 1-24
-------------	------------------	------------

ZENITH RADIO CORP.

4 Tube 2 volt Receivers	Data	Changes 9-5
5 Tube 2 volt Receivers	Data	Changes 9-5
5-Tube Zenette, Type 2009-C, L Chassis	Schematic, parts list	1-27
6-tube Zenette, Chassis A, B, C, D (2004)	Schematic, socket, parts list	1-26
Changes		7-32
Data		Changes 9-6
Schematic, notes		9-48
Push-button ranges, alignment data, service hints		9-44
See model 6 tube Zenette		
Schematic, socket, chassis, voltage		1-23
Notes		1-24
Service data, parts list		7-22
Schematic, socket, parts list		2-11
See model 5 tube Zenette		
See 5 tube Zenette		
Schematic, socket data		2-12
Schematic, socket, parts list		1-25
See model 680		
Hypermetron		
Phonograph pickup		10-10
Remote Control		3-10
Stratosphere (16 Tubes)		
Stratosphere (25 Tubes)		
Super Zenith, Battery Terraplane Hudson		
ZE-3		
4-B-106, 4-B-131, 4-B-132, Chassis 5406		2-14
Schematic		2-1
Voltage, socket, trimmers		7-2
Schematic, voltage, socket, trimmers, alignment, parts		8-1
Phono. circuit		8-6
Schematic, parts		9-1
Socket, trimmers, voltage, alignment		9-2
Circuit changes for phono. pickup		10-40
Schematic, parts		9-3
Socket, trimmers, voltage, alignment		9-2

ZENITH RADIO CORP.

2681	Schematic	2-1
2682	Schematic	2-2
2682	Schematic	2-2
2681	Schematic	2-1
2682	Schematic	2-2

MODEL	REVISIONS	REVISED PAGE	MODEL	REVISIONS	REVISED PAGE
4-F-133, Chassis 5407	Schematic, voltage, socket, trimmers, alignment, parts, battery connections	8-2	6-S-29, 5-S-56, Chassis 5513, 5513A	Schematic, socket, trimmers, parts	7-5
4-F-227, Chassis 5408	Schematic, socket, trimmers, voltage, alignment, parts	8-3	6-S-119, 5-S-126, 5-S-127, 5-S-150, 5-S-151, 5-S-161, Chassis 5516	Voltage, alignment Schematic, parts Voltage, socket, trimmers	7-5 7-7 7-2
4K310, 4K331, 4K355, Chassis 5412	Phono circuit	8-6	6-S-201, 5-S-218, 5-S-220, 5-S-228, 5-S-237, 5-S-250, 5-S-252, Chassis 5521	Alignment Schematic, socket, trimmers, alignment, voltage, parts	10-3 8-22
4K329, Chassis 5413	Schematic, trimmers, socket, trimmers, voltage, alignment	10-5	5S218AT, 5S228AT, 5S237AT, Chassis 5521AT	Phono circuit	8-6 9-9
4P26, 4P26, 4P51, 4T51 Chassis 5401	Schematic, trimmers, voltage, alignment, parts	6-17	5S313B, Chassis 5535BT	Socket, trimmers, voltage, alignment	9-10
4T26, 4T51, Chassis 5403 Early	Voltage, socket, trimmers, alignment, parts	6-18 10-7	5S319, 5S327, 5S330, 5S338, 5S339, Chassis 5529	Schematic Socket, voltage Alignment, trimmers, socket Schematic, parts	9-10 10-13 10-12 10-14 9-11
4T26, 4T51, Chassis 5403 Late with Improved Short Wave	Alignment, voltage, socket, trimmers	10-8 10-7	5X230, 5X248, 5X274, Chassis 5523	Socket, trimmers, voltage, alignment Circuit changes for phono	9-12 10-40
4V31, 4V59 Chassis 5405	Alignment, voltage, socket, trimmers	10-8 6-19	ZE-5 6A203, 6A233, 6A229, 6A239, 6A241, Chassis 5640AT	Schematic, alignment, socket, trimmers Voltage Schematic	10-16 10-10 10-10 10-19
ZE-4 5A119, 5A126, 5A127, 5A151, Chassis 5517A	Voltage, socket, trimmers, alignment, parts	6-20	6-B-107, 6-B-129, 6-B-164, Chassis 5685	Voltage Alignment, socket, trimmers Schematic, parts	10-39 10-18 7-8
5A318, 5A325, Chassis 5522A	Schematic	10-15	6B321, Chassis 5653	Alignment Schematic, parts, voltage Socket, trimmers, alignment Circuit changes for phono	7-9 8-36 9-14 9-17 10-40 7-10
5-F-134, 5-F-166, Chassis 5518	Voltage, tuner, socket, alignment, socket, trimmers, alignment, parts, battery connections	10-12 10-14	6-D-116, 6-D-117, 6-D-118, Chassis 5688	Voltage, socket, trimmers	7-9
5-F-233, 5-F-251, Chassis 5522	Schematic, voltage, socket, trimmers, alignment, parts, phono circuit	8-4 8-5	6-D-202, 6-D-219, 6-D-221, 6-D-238, Chassis 5639	Phono circuit Voltage, alignment, socket, trimmers Schematic, parts, voltage, socket, trimmers, alignment	8-6 8-6 8-16 9-4
5-J-217, 5-J-247, 5-J-255, Chassis 5524	Data	9-5	6D302, 6D311, 6D326, 6D336, 6D360, Chassis 5646	Circuit changes for phono	10-40
5L228, 5L237, Chassis 5525A	Schematic, parts	8-7	6D312, 6D316, 6D317, 6D337, Chassis 5647	pick-up Schematic, socket, trimmers, parts Voltage, alignment Circuit changes for phono	10-40 10-40 9-13 9-15
5M-90, Chassis 5510	Phono circuit	8-6	6D315, Chassis 5657	pick-up Schematic, voltage, socket, alignment, trimmers	10-40 10-17 10-19
5-M-191, Chassis 5620	Voltage, socket, trimmers, alignment	8-8	6DL120, 6DL121, 6DL122, Chassis 5636 AC-DC	Voltage Alignment, socket, trimmers Schematic, parts	10-39 10-20 8-17
5M-191, Chassis 5620	Schematic, parts	9-5	6-J-230, 6-J-257, Chassis 5642	Phono circuit Voltage, alignment, socket, trimmers	8-6 8-18
5M291, Chassis 5527	Socket, trimmers, voltage, alignment	9-6 10-15	6J322, 6J357, Chassis 5654	Voltage, socket, trimmers, alignment	9-19
5M294, Chassis 5530	Schematic, voltage, changes, parts, trimmers, chassis, drive data	7-4 8-9	6-M-908, 6-M-90D, Chassis 5690	Circuit changes for phono	9-20
6-R-128, 5-R-135, 5-R-165, Chassis 5519	Socket, trimmers, chassis, drive data	8-10	Socket, trimmers, voltage, alignment	pick-up Schematic, parts list Alignment	10-40 7-13 7-4
6-R-216, 5-R-226, 5-R-236, Chassis 5526	Alignment, tuner data	10-11			
5R203, 5R212, 5R316, 5R317, 5R337, Chassis 5525	Schematic, socket, voltage, trimmers, alignment, parts	8-13 8-14			

ZENITH RADIO CORP.—(Cont.)		ZENITH RADIO CORP.—(Cont.)	
MODEL	REVISIONS	MODEL	REVISIONS
MODEL	REVISIONS	MODEL	REVISIONS
MODEL	REVISIONS	MODEL	REVISIONS
6-M-91D, Chassis 5631	Schematic, parts 7-14 Socket, trimmers, voltage 7-13 Alignment 7-4 Schematic, parts 7-15 Socket, trimmers, voltage 7-13 Alignment 7-4	7-D-119, 7-D-126, 7-D-127, Schematic, parts 7-18 7-D-138, 7-D-151, Voltage, socket, trimmers 7-11 7-D-168, 7-D-162, Alignment 7-11 7-D-168, Chassis 5707 Schematic, parts 7-25	7-D-203, 7-D-222, 7-D-223, Voltage, socket, trimmers 7-11 7-D-229, 7-D-239, Alignment 7-11 7-D-244, 7-D-243, Schematic, parts 7-25 7-D-253, Chassis 5710 AC-DC
6-M-192, Chassis 5637	Alignment, notes 8-19 Socket, trimmers, chassis 8-11 Parts 8-12 Schematic, voltage, changes, parts 8-20 Alignment, notes 8-11 Socket, trimmers, chassis 8-21 Parts 8-12 Schematic, voltage 10-21	7DA119, 7DA126, 7DA127, Chassis 5715 7DA138, 7DA148, Voltage, socket, trimmers 10-20 7DA162, 7DA168, Schematic, changes, parts 10-37 Chassis 5708E	Phono, circuit 8-6 Voltage, alignment, socket, trimmers 8-26 Schematic, voltage 10-27
6M292, 6M293, Chassis 5645	Alignment, socket, trimmers 10-22 Schematic, voltage 10-23 Alignment 10-22 Socket, trimmers, antenna, data, tuner 10-24 Schematic, voltage, socket, trimmers, tuners 10-25 data 10-26	7-J-232, 7-J-259, Chassis 5711	Alignment, socket, trimmers 10-20 Voltage 10-37 Schematic, changes, parts 8-27
6M295, Chassis 5650	Alignment, socket, trimmers 7-16 Parts 7-20 Alignment, voltage 7-20 Schematic, parts 7-17	7J232T, 7J259T, Chassis 5711T	Phono, circuit 8-6 Voltage, alignment, socket, trimmers, circuit changes for phono 10-40 Schematic, parts 9-25
6M390	Alignment, socket, trimmers 7-16 Parts 7-20 Alignment, voltage 7-20 Schematic, parts 7-17	7J323, 7J368, Chassis 5715	Voltage, socket, trimmers, alignment 9-26 Schematic, parts 9-27 Voltage, socket, trimmers, alignment 9-28 Schematic, socket, trimmers, parts 7-19 Alignment, voltage 7-20 Schematic, socket, trimmers 7-21 Alignment, voltage 7-20 Schematic, parts 8-29
6-S-27, 6-S-52, Chassis 5619	Voltage, socket, trimmers 7-9 Alignment 7-9 Schematic, parts 8-23	7-M-91D, 7-M-91S, Chassis 5706	Phono, circuit 8-6 Voltage, alignment, socket, trimmers 8-30 Schematic, parts 9-29
6-S-128, 6-S-137, 6-S-147, 6-S-152, 6-S-157, Chassis 5634	Phono, circuit 8-6 Voltage, alignment, socket, trimmers 8-24 Schematic, voltage, socket, trimmers, alignment, parts 8-33 Phono, circuit 8-6 Schematic, parts 9-21	7-S-28, 7-S-58, Chassis 5704	Voltage, socket, trimmers, alignment 9-30 Schematic, parts 9-31
6-S-203, 6-S-222, 6-S-223, 6-S-229, 6-S-239, 6-S-241, Chassis 5638	Voltage, alignment 9-14 Circuit changes for phono, pickup 10-40 Installation, operation 10-1	7-S-204, 7-S-232, 7-S-240, 7-S-242, 7-S-258, 7-S-260, 7-S-261, Chassis 5709	Voltage, socket, trimmers, alignment 9-32 Circuit changes for phono, pickup 10-40 Changes 8-8 Schematic 10-29
6-S-254, 6-S-256, Chassis 5644	Adjustments, notes 10-2 Chassis, details 10-3 Details, notes 10-4 Schematic, socket, trimmers, parts 9-16 Voltage, alignment 9-17 Circuit changes for phono, pickup 10-40 Schematic, parts 9-23 Voltage, socket, trimmers, alignment 9-24 Circuit changes for phono, pickup 10-40	7S232AT, 7S240AT, 7S242AT, 7S258AT, 7S260AT, Chassis 5709AT	Phono, circuit 8-6 Voltage, alignment, socket, trimmers 8-30 Schematic, parts 9-29
6S254AT, 6S256AT, Chassis 5644AT	Adjustments, notes 10-2 Chassis, details 10-3 Details, notes 10-4 Schematic, socket, trimmers, parts 9-16 Voltage, alignment 9-17 Circuit changes for phono, pickup 10-40 Schematic, parts 9-23 Voltage, socket, trimmers, alignment 9-24 Circuit changes for phono, pickup 10-40	7S232, 7S342, 7S343, 7S363, 7S364, 7S366, Chassis 5714	Voltage, socket, trimmers, alignment 9-30 Schematic, parts 9-31
JS301, 6S304, 6S305, 6S306, 6S321, 6S322, 6S340, Chassis 5631	Adjustments, notes 10-2 Chassis, details 10-3 Details, notes 10-4 Schematic, socket, trimmers, parts 9-16 Voltage, alignment 9-17 Circuit changes for phono, pickup 10-40 Schematic, parts 9-23 Voltage, socket, trimmers, alignment 9-24 Circuit changes for phono, pickup 10-40	ZE-7, ZE-8, ZE-6-P, 8A129, 8A147, 8A154, 8A157, Chassis 5802A	Voltage, socket, trimmers, alignment 9-32 Circuit changes for phono, pickup 10-40 Changes 8-8 Schematic 10-29
6S306, Automatic Record Changer Model 169-31	Adjustments, notes 10-2 Chassis, details 10-3 Details, notes 10-4 Schematic, socket, trimmers, parts 9-16 Voltage, alignment 9-17 Circuit changes for phono, pickup 10-40 Schematic, parts 9-23 Voltage, socket, trimmers, alignment 9-24 Circuit changes for phono, pickup 10-40	8A232, 8A242, 8A244, 8A262, Chassis 5804AT	Voltage, socket, trimmers, alignment 9-30 Schematic, parts 9-31
6S330, 6S361, Chassis 5648	Adjustments, notes 10-2 Chassis, details 10-3 Details, notes 10-4 Schematic, socket, trimmers, parts 9-16 Voltage, alignment 9-17 Circuit changes for phono, pickup 10-40 Schematic, parts 9-23 Voltage, socket, trimmers, alignment 9-24 Circuit changes for phono, pickup 10-40	8-M-195, Chassis 5808	Voltage, socket, trimmers, alignment 9-32 Circuit changes for phono, pickup 10-40 Changes 8-8 Schematic 10-29
6S341, 6S362, Chassis 5649	Adjustments, notes 10-2 Chassis, details 10-3 Details, notes 10-4 Schematic, socket, trimmers, parts 9-16 Voltage, alignment 9-17 Circuit changes for phono, pickup 10-40 Schematic, parts 9-23 Voltage, socket, trimmers, alignment 9-24 Circuit changes for phono, pickup 10-40	8-S-129, 8-S-154, Chassis 5801	Voltage, socket, trimmers, alignment 9-32 Circuit changes for phono, pickup 10-40 Changes 8-8 Schematic 10-29
6V27, 6V62, Chassis 5621	Adjustments, notes 10-2 Chassis, details 10-3 Details, notes 10-4 Schematic, socket, trimmers, parts 9-16 Voltage, alignment 9-17 Circuit changes for phono, pickup 10-40 Schematic, parts 9-23 Voltage, socket, trimmers, alignment 9-24 Circuit changes for phono, pickup 10-40	8S359, Chassis 5807	Voltage, socket, trimmers, alignment 9-32 Circuit changes for phono, pickup 10-40 Changes 8-8 Schematic 10-29
6VA27, 6VA32, Chassis 5629	Adjustments, notes 10-2 Chassis, details 10-3 Details, notes 10-4 Schematic, socket, trimmers, parts 9-16 Voltage, alignment 9-17 Circuit changes for phono, pickup 10-40 Schematic, parts 9-23 Voltage, socket, trimmers, alignment 9-24 Circuit changes for phono, pickup 10-40	V-8	Voltage, socket, trimmers, alignment 9-32 Circuit changes for phono, pickup 10-40 Changes 8-8 Schematic 10-29
ZE-6, 7, 7-JE	Adjustments, notes 10-2 Chassis, details 10-3 Details, notes 10-4 Schematic, socket, trimmers, parts 9-16 Voltage, alignment 9-17 Circuit changes for phono, pickup 10-40 Schematic, parts 9-23 Voltage, socket, trimmers, alignment 9-24 Circuit changes for phono, pickup 10-40		Voltage, socket, trimmers, alignment 9-32 Circuit changes for phono, pickup 10-40 Changes 8-8 Schematic 10-29

RADIOTRON EARLY COMPLETE PAGE

REVISD PAGE

ZENITH RADIO CORP.—(Cont.)

MODEL

RADIOTRON EARLY COMPLETE PAGE

REVISD PAGE

ZENITH RADIO CORP.—(Cont.)

MODEL

Table with columns for Model, Description, Revised Page, and Radiotron Early Complete Page. Rows include various radio models like 15S308, 15U-246, 16-A-61, etc., and their corresponding page numbers.

RADIOETRON
EARLY COMPLETE
PAGE

REVISED
PAGE

ZENITH RADIO CORP.—(Cont.)

MODEL

EARLY COMPLETE
PAGE

REVISED
PAGE

ZENITH RADIO CORP.—(Cont.)

MODEL

MODEL	EARLY COMPLETE PAGE	REVISED PAGE	ZENITH RADIO CORP.—(Cont.)	MODEL	EARLY COMPLETE PAGE	REVISED PAGE	ZENITH RADIO CORP.—(Cont.)
108			Chassis view, parts list2-17	462			ChangesChanges 9-6
112, 123			Chassis layout, voltage2-19	470			See model 215
169-31 Automatic Record Changer			See models 6S306, 9S307, 15S308	472			See model 250
200			Schematic10-33	473			Schematic, socket, voltage4-8
210, 211, 220, 221, 270, 291, 292, Chassis 2022 A & B			Schematic, socket3-2	474, 585, 715, 755, 756, 785, Chassis 2053			Schematic, socket, voltage4-11
210-5, 211-5, 270-5			Socket, trimmers, volt. ageChanges 8-8	475, 757, 760, 765, 767, Chassis 2054			Schematic, socket, voltage4-12
215, 216, 217, 225, 263, 470, Chassis 2044			Schematic3-1	476, 476-A, 770, 775, 780, Chassis 2032			Schematic4-13
215, 216, 225, Chassis 2044			Schematic7-30	476-B, 479, 770-B, 775-B, 777, 788, Chassis 2059 (1933)			Schematic4-14
220, 221			Socket, trimmers, voltage7-13	478, Chassis 2051			Voltage, socket4-14
225			See model 215	478, Chassis 2056			See model 258
230, 240, 241, 244, 245, 271, Chassis 2036			Schematic, socket3-3	500, 501, 503, 514, 515, 516, 600, 604, 606, 610, 616, 618, (2037)			Parts list, voltage2-21
250, 251, 252, 259, 260, 261, 262, 269, 272, 299, 472, 516, 517, 518, Chassis 2031			Voltage, parts list3-4	516, 517, 518			Schematic, socket2-22
			Schematic, data2-20	520, 521, 602, 605, 608, 611, 616, Chassis 2035			See model 250
			Alignment, voltage, socket, trimmers7-02	530, 531, 532, 533, 603, 612, 617, 620, 623, Chassis 2038			Schematic, socket, voltage, trimmers, alignment8-48
			Schematic3-6	538, 568			Schematic, socket, voltage, trimmers, alignment8-50
			Schematic, voltage, socket, trimmers, alignment8-45	563 DO			Parts8-49
			Parts8-47	577			Parts8-50
			Schematic, voltage, socket, trimmers, alignment8-46	588, 589, 590 Early, Chassis 2051 Early			See model 258
			Parts8-47	588, 593			See model 277
			Schematic, voltage, socket, trimmers, alignment8-46	589, 590			See model 258
			Parts8-47	600			See model 500
			Schematic, voltage, socket, trimmers, alignment8-47	M-601 (P51) (Export Only)			Schematic5-1
			Parts8-47	602, 605, 608			Parts list5-2
			Schematic, voltage, socket, trimmers, alignment8-47	603, 605, 610			See model 60
			Parts8-47	604, 606, 610			See model 520
			See model 250	611, 615			See model 550
			See model 215	612, 613, Chassis 1929			See model 600
			See model 258	612, 617, 620, 623			See model 920
			See model 210	616, 618			See model 500
			See model 210-5	619			See model 480
			See model 230	622, 642			See model 60
			Schematic, socket3-5	650-HD, 651-HE, 660-TD, 661-TE			See model 462
			Alignment, voltage, socket, trimmers7-02	Terraplane Hudson			Schematic4-5
			Schematic3-6	660, 666, Chassis 5615, 668, Chassis 5626			Voltage, socket, alignment4-6
			Schematic, voltage, socket, trimmers, alignment8-45	668, 664			Schematic, alignment6-1
			Parts8-47	668			Voltage, socket, trimmers, parts6-3
			Schematic, voltage, socket, trimmers, alignment8-46	668			Schematic, socket, trimmers, parts7-31
			Parts8-47	672			Voltage, alignment7-6
			See model 250	680 Hudson			DataChanges 9-6
			See model 215	701 AC-DO			See model 60
			See model 258	702, 706, 707, 711, 712, 750, Chassis 2052 A, B & C			Schematic, alignment6-3
			See model 210	712, 722, 732			Voltage, socket, trimmers, parts6-4
			See model 230	730, 735			Schematic, socket, alignment5-4
			Schematic, socket3-5	740			Schematic, chassis, notes3-9
			Alignment, voltage, socket, trimmers7-02	750			Schematic, socket, alignment5-4
			Schematic3-6	755, 758			Schematic, socket4-7
			Schematic, voltage, socket, trimmers, alignment8-45				See model 70
			Parts8-49				See model 474
			Schematic, voltage, socket, trimmers, alignment8-50				Schematic, socket, alignment, voltage4-9
			Parts8-50				Schematic, socket, voltage, alignment4-10
			See model 258				See model 705
			See model 277				See model 474
			See model 258				
			See model 500				
			See model 920				
			See model 500				
			See model 500				
			See model 480				
			See model 60				
			See model 462				
			Schematic4-5				
			Voltage, socket, alignment4-6				
			Schematic, alignment6-1				
			Voltage, socket, trimmers, parts6-3				
			Schematic, socket, trimmers, parts7-31				
			Voltage, alignment7-6				
			DataChanges 9-6				
			See model 60				
			Schematic, alignment6-3				
			Voltage, socket, trimmers, parts6-4				
			Schematic, socket, alignment5-4				
			Schematic, chassis, notes3-9				
			Schematic, socket, alignment5-4				
			Schematic, socket4-7				
			See model 70				
			See model 474				
			Schematic, socket, alignment, voltage4-9				
			Schematic, socket, voltage, alignment4-10				
			See model 705				
			See model 474				

757, 760, 765, 767	See model 475	
770, 775	See model 476	
770-B, 775-B	See model 476-B	
772, 778	See model 70 Series	
777, 788	See model 476-B	
780	See model 476	
785	See model 474	
801	Schematic, socket, alignment.....5-5	
804	Schematic, alignment, socket trimmers.....10-31	
805, 845, Chassis 5502	Schematic, socket, voltage, alignment.....5-6	
806, 807, 8847, 850	Schematic.....5-7	
Chassis 5304, 5506	Voltage, socket, alignment.....5-8	
808, 809, 860, 861	Schematic.....5-9	
Chassis 5605, 5607	Voltage, socket, alignment.....5-10	
810, 811, 862, 865, 866, 863, 1115, 1162, Chassis 5609	Schematic, voltage, socket, parts.....6-5	
912, 816, 817, 819, 962, 1112, 1116, Chassis 5608	Alignment, socket.....7-22	
	Schematic.....5-11	
814, 815, 864, 1161	Voltage, socket, alignment.....5-12	
Chassis 5611, 5612	Schematic, socket, parts.....6-6	
825, 827, 829, 870	Schematic.....5-13	
Chassis 5701-2-3	Voltage, socket, alignment.....5-14	
S-827, S-829, S-870, S-871, 1170, Chassis 5701-R, 5702-R, 5703-R	Schematic, parts.....6-23	
834, 1102, 1106, Chassis 1002	Voltage, socket, trimmers, alignment.....6-24	
835, 880, 881, 885, 978, 983, 1101, 1105, Chassis 1001, 1001-A	Schematic.....10-38	
	Alignment, notes.....10-33	
	Schematic.....5-15	
845	Voltage, socket, alignment, notes.....5-16	
8847, 850	See model 805	
860, 861	See model 806	
862, 866, 866	See model 808	
864	See model 810	
870	See model 814	
S-870, S-871	See model 825	
880	See model S-827	
908, 909, 960, 961, 1117	See model 885	
Chassis 5614	Schematic, parts.....6-15	
S-908, S-909, S-961, 1167	Voltage, socket, trimmers, parts.....6-16	
Chassis 5618	Schematic, parts.....6-23	
945, 950	Voltage, socket, trimmers, alignment, parts.....6-26	
Chassis 5508, 5509	Schematic.....6-7	
960, 961	Voltage, alignment, socket, trimmers, parts.....6-8	
S-961	See model 908	
962	See model S-908	
963	See model 812	
970, 975	See model 810	
Chassis 5902	Schematic.....6-9	
978, 983	Voltage, alignment, socket, trimmers.....6-10	
980, 985, 990	See model 835	
Chassis 1201, 1201-A	Schematic, parts.....6-11, 6-12	
Stratosphere 1000Z	Voltage, socket, trimmers.....6-10	
Chassis 2501-C, 2501-P	Alignment, service notes.....6-14	
	Schematic, parts.....6-29, 6-30	

Stratosphere 1000Z	Service data, socket trimmers.....6-31
Chassis 2501-C, 2501-P	Circuit data, voltage, alignment.....6-32
1000Z Revised, Chassis 2501C, 2501P	Schematic.....10-35, 36
1001, 1001-A, Chassis 1002	Alignment, trimmers, voltage, resistors.....10-37
1004, Chassis 1101, 1105	See model 835
1102, 1106	See model 835
1112, 1116	See model 812
1117	See model 810
1161	See model 908
1162	See model 814
1167	See model S-908
1170	See model S-827
1201, 1201-A, Chassis 1202, 1202A, Chassis 1203	See model 980
1204, Chassis 1206	See model 12-L-57
1501, Chassis 1502	See model 12-U-158
1601-O, 1601-P, Chassis 1601-C, 1601-P, Chassis 2009-O Series, Chassis 2009-C.P. Chassis 2012	See model 12-S-205
2012, Chassis 2017	See model 12-S-345
2021, Chassis 2022	See model 15-U-246
2022, A & B	See model 15-S-303
2030-3043, Chassis 2031	See model 16-A-61
2032, Chassis 2033	See 5 tube Zenette
2035, Chassis 2036	See model L.P.
2037, Chassis 2038	See model AH
2044, Chassis 2047	See model 103
2051, Chassis 2052	See model BH
2053, Chassis 2054	See model LH
2056, 2056-I, Chassis 2057	See model 210
2501Q, 2501P, Chassis 5401	See model 273
5403, Chassis 5405	See model 250
5406, Chassis 5407	See model 476
5408, Chassis 5409	See model 480
5410, Chassis 5411	See model 520
5412, Chassis 5413	See model 500
5502, Chassis 5504, 5505	See model 530
5506, 5509, Chassis 5513, 5513A, Chassis 5516	See model 460
5517A, Chassis 5518	See model 258
5519, Chassis 5520	See model 705
5521, Chassis 5521A, Chassis 5522	See model 474
	See model 475
	See model 277
	See model 462
	See model 476-B
	See model 1000Z
	See model 4P26
	See model 4T26
	See model 4V31
	See model 4-B-106
	See model 4-F-133
	See model 4-F-227
	See model 4-B-231
	See model 4-B-313
	See model 4-B-314
	See model 4K210
	See model 4K229
	See model 805
	See model 806
	See model 945
	See model 5-M-90
	See model 5-S-29
	See model 5-S-119
	See model 5-A119
	See model 5-F-134
	See model 5-R-123
	See model 5-M-191
	See model 5-S-201
	See model 5S218AT
	See model 5-F-233

See model 8-S-129
See model 8-A-129
See model 8-M-195
See model 8-A-232
See model 8-S-359
See model 9-70
See model 9-S-90
See model 9-S-203
See model 9-S-204AT
See model 9-S-265
See model 9-S-307

ZEPHYR RADIO CO.

Schematic9-1
Schematic9-1
Schematic, voltage10-1
Schematic, voltage10-1
Schematic, voltage7-1
Schematic, voltage7-2
Schematic, voltage10-1
Schematic, voltage9-2
Schematic, Voltage7-2
Schematic10-3
Schematic10-3
Schematic9-2
Schematic7-1
Schematic, voltage8-1
Schematic, voltage8-1
Schematic, voltage8-2
Schematic10-4
Schematic, voltage8-2
Schematic10-4
Schematic, socket10-5
Schematic, socket10-5
Schematic10-6
Schematic, socket10-7
Schematic, alignment10-11
Schematic10-8
Socket, trimmers10-9
Tuner10-9
Socket, trimmers10-10
Schematic10-10
Schematic, tuner, socket, trimmers10-9
Schematic, alignment10-12
See model 33X5
Schematic10-7
See model 2M7
Schematic, socket, trimmers, alignment10-2

5823 Chassis
5824 Chassis
5824T Chassis
5825A Chassis
5826 Chassis
5827 Chassis
5828 Chassis
5829 Chassis
5830 Chassis
5832A Chassis
5835BT Chassis
5805, 5607 Chassis
5808 Chassis
5809, 5610 Chassis
5811, 5612 Chassis
5814 Chassis
5816 Chassis
5818 Chassis
5819 Chassis
5821
5826
5829 Chassis
5830 Chassis
5831 Chassis
5832 Chassis
5833 Chassis
5834 Chassis
5835 Chassis
5836A-C-D-G Chassis
5837 Chassis
5838 Chassis
5839 Chassis
5840AT Chassis
5842 Chassis
5844 Chassis
5845 Chassis
5846 Chassis
5847 Chassis
5848 Chassis
5849 Chassis
5850 Chassis
5851 Chassis
5853 Chassis
5854 Chassis
5857 Chassis
5701-3-Chassis
5701R, 5702R, 5703R Chassis
5704 Chassis
5706 Chassis
5707 Chassis
5708E Chassis
5709 Chassis
5709AT Chassis
5710 Chassis
5711 Chassis
5711T Chassis
5714 Chassis
5715 Chassis

5X-230
See model 5-L-217
See model 5-P-17T
See model 5-L-228
See model 5-R-216
See model 5-M-291
See model 5-R-303
See model 5-S-310
See model 5-M-314
See model 5-S-318
See model 5-S-318B
See model 808
See model 812
See model 810
See model 814
See model 908
See model 666
See model S-908
See model 6-S-27
See model 6V27
See model 660
See model 6VA27
See model 6-M-908
See model 6-M-91D
See model 6-M-92
See model 6-D-116
See model 6-S-128
See model 6-B-107
See model 6DL120
See model 6-M-192, 6-M-198
See model 6-S-203
See model 6-D-202
See model 6A203
See model 6-F-230
See model 6-S-254
See model 6S254AT
See model 6M292
See model 6D311
See model 6D312
See model 6S330
See model 6S341
See model 6M295
See model 6S301
See model 6B321
See model 6B322
See model 6D315
See model 925
See model S-827
See model 7-S-28
See model 7-M-91D
See model 7-D-119
See model 7D-119
See model 7-S-204
See model 7-S-292AT
See model 7-L-293
See model 7-L-297
See model 7-232T
See model 7-8323
See model 7J323

RIDER

Publications



Just what the Servicing Industry ordered!

RIDER'S
"Automatic
Record Changers
and Recorders"

800,000 record changers are providing an important source of profit for the wide-awake service shops of the country and creating a need for adequate and ready reference data to speed up trouble shooting and repair. Rider anticipated this need and has prepared—just when you need it—a sturdily bound volume containing everything you need know on any automatic record changer or recorder coming to your shop.

Heretofore, the serviceman's prime interest has revolved around the invisible defects which accompany the operation of electrical devices. Mechanics in radio receivers was limited to a lesser degree. However, with the introduction of the automatic record changer, some knowledge of the development of motion by means of gears, levers and cams has become necessary. Hence the birth of Automatic Record Changers and Recorders. Printed on 8 1/2 x 11 paper, the same size as Rider Manuals, the book covers, by means of explanatory text, mechanical and electrical diagrams, all the information you must have to service these high cost instruments quickly and profitably.

CONTENTS

Chapter I—MOTORS AND DRIVES. D-C Motors. A-C Motors. Universal Motors. Maintenance of Motors. Commonplace Troubles. SPEED REGULATORS and REDUCTION DRIVES. Chapter II—RECORDERS AND PHONOGRAPHS. The Cutting Head. The Groove. Recording Needles. Pick-ups. Phonograph Needles. Chapter III—AUTOMATIC RECORD CHANGERS. Mechanisms. Troubles. Chapter IV—ANALYSIS OF RCA MODEL RP-152-C RECORD CHANGER. MANUFACTURERS' SERVICE DATA.

744 PAGES BOUND IN BUCKRAM \$6.00

SERVICING BY SIGNAL TRACING



Signal Tracing is destined to become the universally adopted method of locating defects in communication systems, no matter what the nature of the system—if it is a home broadcast receiver, auto-radio receiver, police receiver, commercial, marine, navy or army receiver. Every public address system comes within the capabilities of signal tracing. . . . Television receivers, facsimile receivers and other systems intended for special application can be serviced with equal ease. . . . Signal Tracing, founded upon the signal itself, is the most basic, most fundamental method of trouble shooting ever devised. . . . It is free of every limitation which in the past has hindered speedy service operations. . . .

You can't afford to be without this book. . . . We mean every word of this statement. . . . It is vital to your immediate welfare—to your future. . . . Get your copy today—NOW!

CONTENTS

Chapter I—Introduction to Signal Tracing. Chapter II—Amplifier Operation and The Signal. Chapter III—Diode Detector Tube Systems. Chapter IV—Multi-Element Detector Systems. Chapter V—Oscillator Tube Systems. Chapter VI—Mixer Tube Systems. Chapter VII—Control Circuits and Voltages. Chapter VIII—Coupling Devices. Chapter IX—The T-R-F Receiver. Chapter X—The Superheterodyne Receiver. Chapter XI—Television and Facsimile Receivers. Chapter XII—Public Address Systems. Chapter XIII—Localizing Defects by Signal Tracing. Chapter XIV—Signal Tracing in Receiver Design.

360 PAGES . . . 188 ILLUSTRATIONS . . . \$3.00
SPANISH EDITION . . . \$3.50

VACUUM TUBE VOLTMETERS



The vacuum-tube voltmeter has been rapidly forging to the front as a favorite tool of engineers, research workers and servicemen. By its proper use, dynamic measurements can be made under any and all conditions with a minimum of effort and time. Here is a book that is a perfect mine of information for everybody who wants to know all about these important instruments. Not only is the theory explained upon which the functioning of the different types of v-t voltmeters is based, but the practical applications of these instruments are completely described. Like nearly all types of voltmeters, multipliers and shunts are employed with vacuum-tube voltmeters to extend their ranges. These and their uses are explained, as is the calibration of the different types.

For those men who are interested in the construction of v-t voltmeters, adequate information will be found for v-t voltmeters were built in the author's laboratory, and constants are given for the components of many types, as well as a wealth of other useful data.

CONTENTS

Chapter I. Fundamentals of Vacuum-Tube Voltmeter. Chapter II. Diode Vacuum-Tube Voltmeters. Chapter III. Triode Vacuum-Tube Voltmeters. Chapter IV. Slide-Back Vacuum-Tube Voltmeters. Chapter V. Rectifier-Amplifier Vacuum-Tube Voltmeters. Chapter VI. Tuned Vacuum-Tube Voltmeters. Chapter VII. Audio-Frequency and Logarithmic Vacuum-Tube Voltmeters. Chapter VIII. Vacuum-Tube Voltmeters for D-C Voltage, Current, and Resistance Measurements. Chapter IX. Design and Construction of Vacuum-Tube Voltmeters. Chapter X. Calibration and Testing of V-T Voltmeters. Chapter XI. Applications of V-T Voltmeters. Bibliography.

180 PAGES . . . 111 ILLUSTRATIONS . . . \$2.00

HOW IT WORKS

Special Section of Volume X RIDER'S MANUAL

CONTENTS

	PAGE		PAGE
TELEVISION—HOW IT WORKS	3	Average Brightness and D-C Restorer	
Comparison with Sound Broadcasting	3	Circuits	38
Scanning	4	D-C Restorer Circuits	39
The Picture Tube	8	Brightness Control	41
The Camera Tube	11	Grid Leak-Condenser Restorer	41
Scanning and Synchronization	13	The Contrast Control	42
Flicker and Hum on the Raster	14	Synchronizing Circuits	42
Scanning Waveform	14	Sync Separator Circuit	43
Overall View of a Television System	15	Horizontal and Vertical Sync Selectors	44
The Television Signal	16	Deflection Circuits	45
Signal and Sync Pulses	18	Electromagnetic Circuits	45
RMA Standard Television Signal	19	Blocking Oscillator	46
Range of Frequencies in Video Signal	20	Width and Height Controls	47
The Modulated Wave	22	Damping Tube	47
Channel Make-up	23	Electrostatic Deflection	48
Television Receiver Circuits	24	Power Supplies	48
R-F and Oscillator Circuits	26	Antennas and Installation	50
High-Frequency Section of Belmont X-466..	27	FREQUENCY MODULATION	52
High-Frequency Section of DuMont 180-183..	28	Advantages	52
I-F Circuits	28	How Noise is Reduced	52
Video I-F Circuits	30	What the Limiter Does	53
Video I-F Circuit in Andrea 1F5	31	Special Detector Used	53
Video I-F Circuit in RCA TRK-12	32	How the Discriminator Detects	54
Video Second Detector Circuits	34	The G.E. GM-125 Receiver	54
Video Second Detector in DuMont 180-183..	34	Alignment	55
Video Second Detector in RCA TRK-12	34	WIRELESS RECORD PLAYERS	55
Video AVC Circuits	35	General Service Notes	56
Video AVC in RCA TRK-12	36	FACSIMILE RECEIVERS	57
Video Amplifiers	37	SERVICING BY SIGNAL TRACING ..	58

PREFACE

1939 witnessed the start of commercial exploitation of modern television. With two stations in operation, one at each end of the continent and other stations under construction in a number of the larger centers of population, television received a very definite stimulus. As a matter of fact, a number of different makes of television receivers are being demonstrated here in New York, with the NBC station W2XBS as the source of signals.

It therefore is only natural that television receivers be included in Rider's Manual Volume X and concurrently with the appearance of these service notes, we feel that an explanation of the subject of television transmission and reception should be a part of this "How It Works" section.

In this discussion you will find not only an explanation of the "how" of television but also a breakdown of some of the circuits to be found in the commercial television receivers contained in Rider's Volume X. Inasmuch as a certain amount of standardization in television transmission has been accomplished, the facts given herein will be found of interest at least for several years to come.

The presentation of facts is by no means complete. To cover the subject fully would take volumes. However, we feel that what is here presented is the actual "meat" and will be sufficient to give an insight to the *modus operandi* of television.

You also will find some facts pertaining to another development in transmission, one with myriad possibilities, namely frequency modulation. At present only a few receivers suitable for the reception of such signals are in use, but if what the originators say is true, we can look forward in the years to come to a general transition from the present amplitude-modulated form of transmission to the frequency-modulated form of transmission, with a corresponding radical change in receivers.

COPYRIGHT, 1939, BY JOHN F. RIDER

Printed in the United States of America

TELEVISION—HOW IT WORKS

No comments can be made on advances in the radio art during the past year without recognizing that after many years of development, television has finally reached the stage where servicemen can no longer afford to ignore its existence. In some parts of the country television is already an accomplished fact; hundreds of receivers have been installed and sold, and all signs point toward the gradual expansion of television facilities into sections which do not have coverage at the present time.

Recognizing, then, that the radio serviceman's job is being extended to include not only radio servicing as we know it today, but also the servicing of television receivers, this section explaining the fundamentals of television is being offered in the belief that it will be of help to many of you in dealing with the problems introduced by television. Throughout you will find that it is written from the viewpoint of the man who is called upon to install and service television receivers; and yet, although there is this emphasis on the practical aspects of television, you will find that an essential amount of theory is included. Lest any of you feel that this inclusion of what might be called "theoretical" material is unnecessary, it should be pointed out that television is an extremely complicated subject, much more so in fact than is radio, and that television receivers cannot be serviced efficiently by any one who does not understand the principles underlying the operation of the system. The different situations which can arise are so numerous that it is indeed impossible to list them, to explain the reasons for each,

and in the case of faulty operation to locate the source of the trouble. As in radio servicing, so it is in television servicing: a thorough understanding of the fundamental principles of operation is invaluable.

Fortunately for the radio serviceman, the advent of television does not mean that an entirely new field must be learned. The more you study television, the more you will come to realize that television embodies every principle that has ever been used in radio—and more besides. You will marvel at the ingenuity of television engineers in using the same old time-proved principles of radio, in adapting these to the needs of television, and in discovering new principles and new techniques wherever the available ones were inadequate. Thus, for example, you will find the simple diode rectifier being used in clipping circuits, in d-c restoring circuits, in video detector circuits, and in many other applications. If you understand how the diode rectifier operates, then you will recognize in each one of these "new" circuits an old friend. True, it will take some time before you become familiar with the need for these circuits and the specific modifications to achieve certain results, still you will be amply repaid for the effort in the new opportunities which television offers to the trained serviceman and technician.

Comparison with Sound Broadcasting

Just as it is the problem of radio broadcasting to recreate sound at places distant from the actual sound, so it is the problem of television to recreate a scene at

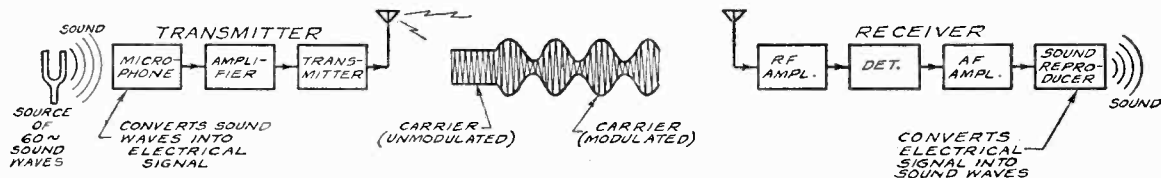

FIG. 1A—SOUND TRANSMISSION SYSTEM

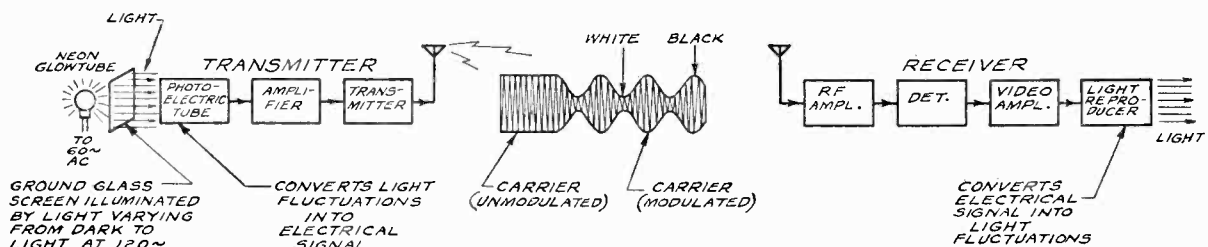

FIG. 1B—TELEVISION TRANSMISSION SYSTEM

FIGS. 1A, 1B.—A television system uses an arrangement similar to that employed in sound broadcasting. Note that in the television system the photoelectric tube replaces the microphone and the light reproducer replaces the speaker.

places distant from the original scene. In the case of sound broadcasting, as Fig. 1A shows, sound vibrations produced by, let us say, a tuning fork are picked up by a *microphone* which converts these vibrations into corresponding electrical vibrations. This electrical signal, which now carries an electrical image of the sound vibrations, is amplified, used to modulate the carrier, the radio wave is radiated, picked up by the receiver, amplified, detected and finally, as you know, the electrical impulses (similar in shape to those which were originally produced by the microphone) are used to actuate the speaker which in turn recreates the original sound.

Fig. 1B shows that a system very similar to this is used in television and that in general a very close resemblance exists between sound broadcasting and television. To simplify the explanation at the present time, we assume that only a very small part or element of a scene is being televised. For example, we might allow the light from a neon tube operated from the 60-cycle power line to fall on a small piece of ground glass. The illumination on the ground glass would then change from dark through various shades of brightness and back again to dark, and repeat this cycle 120 times per second. (Note that the rate is 120 cycles because both positive and negative cycles cause the neon tube to illuminate the screen.) In the same way that sound broadcasting uses a *microphone* to convert the sound pressure variations into electrical variations, so the heart of any television broadcasting system is the "*television camera*" which converts the time-variations in illumination of the scene into corresponding electrical variations. In the simple illustrations we have chosen, because only a single small area is being televised, an ordinary photoelectric cell can serve as the television camera.

Once the varying light values have been changed into corresponding electrical values by the television camera, the process of transmitting the information

follows exactly the same procedure as in the case of sound broadcasting. Note that the carrier is modulated in the same way, and that it remains stationary in amplitude during the period before the screen is illuminated. Once the neon tube is turned on and illuminates the screen, the amplitude of the carrier varies in proportion to the amount of illumination. Note that the maximum amplitude of the carrier corresponds to a black image, and that the image gets progressively lighter as the amplitude of the carrier is decreased. In passing we might say that this is called negative modulation about which we shall have a great deal more to say later on.

For the present, the important thing to note is the similarity between the two systems, the one for transmitting information on light values, and the other for transmitting information on sound values. At the output of the television receiver, we of course have an important change. Whereas the output of the sound receiver is a speaker which converts the electrical impulses into corresponding sound impulses, the output of the television receiver is a "*picture tube*" or other device which converts the electrical impulses into corresponding light values.

We see then, that the sound system and the television system are identical with the exception that the television camera is substituted for the microphone and the picture tube for the loudspeaker. We might also mention here that in the RCA television system, the trade-mark name "Iconoscope" is used for the television camera tube and the trade-mark name "Kinescope" is used for the picture tube. As will be explained in detail later on, the Iconoscope consists of a very large number of minute photoelectric cells which create an *electrical* picture of the scene being televised, while the Kinescope consists of a cathode-ray tube on the screen of which is built up a visible image.

SCANNING

No doubt you have noticed by this time that in comparing television with sound broadcasting we limited ourselves to televising the simplest type of object, one which was uniformly illuminated over its entire area. We then showed that the two systems are identical provided that the television camera replaces the microphone and the picture tube replaces the loudspeaker. Unfortunately, however, television is not as simple as this or television would have "arrived" many years ago. In television, we are confronted with the problem of conveying information on the light value not at one point but at every point over the com-

plete area of the scene being televised. Thus, the scene must be broken up into a great many elements or elemental areas and information on the light values over each one of these elements must be conveyed to the receiver and finally to the picture tube. And not only must this information be conveyed, but it must be reassembled in the correct order at the receiver and the corresponding light value reproduced for every one of the many elements into which the image has been broken down.

As a matter of fact, this process of breaking down a picture into a great number of elements is nothing

new but is as old and as fundamental as the process of seeing itself. For, in viewing a scene, the image is carried to the brain by the eye over a huge network of transmission lines which tells the brain the intensity and the color of the light at every point in the field of vision. Because the number of elements into which the retina of the eye breaks down the scene is so great, we are not conscious that the picture is made up in this way but receive the impression that the picture is perfectly blended or continuous.

Some of you will be surprised to know that even photographs are made up of elementary particles even though they too appear to be continuous upon casual inspection. Actually the light and dark parts of a photograph are the result of the presence of black particles of silver which vary in number over the area of the picture. Where the picture is dark, these particles of silver are more numerous than where the picture is light. Because these particles are so small they are not ordinarily visible. We might note in passing that where photographs are to be enlarged appreciably so-called fine-grain film and special developers are used so that the individual grains or particles will not become visible.

Number of Elements Required

It is important for an understanding of television to appreciate how the number of particles or areas into which a picture is broken up affects the type and quality of the reproduction which is obtained. As we should expect from the preceding discussion the quality of the picture will be improved as the number of elements is increased. In order to compare the effect of breaking up a picture into a varying number of elements, let us consider the two reproductions shown in Fig. 2a and Fig. 2b. These are reproductions of the same photograph, the only difference being the number of elements into which the picture is divided. If you examine these figures closely, you will see that they are composed of a large number of black dots of different sizes, and that Fig. 2b contains a larger number of dots than Fig. 2a. As a matter of fact, in printing as well as in the processes of seeing and photography, it is necessary for the picture to be broken down into a series of small areas before it can be printed. The engraver in making his halftone, places a fine mesh screen in front of his camera so that the image is broken down into a series of dots, the actual size of any one dot depending upon the amount of light on the area which the dot represents. Where the picture is dark, the size of the corresponding dot is large, and where the image is light the size of the black dot is correspondingly small. The number of dots into which Fig. 2a is broken down is 50

per inch, while Fig. 2b is broken down into 100 per inch.

The great improvement effected by breaking down the picture into a larger number of dots or elements is clearly apparent in the superiority of Fig. 2b over Fig. 2a. Because of the larger number of elements, the former presents more detail, appears finer, more blended and more continuous than the picture with the fewer number of elements.

The actual number of elements into which a picture

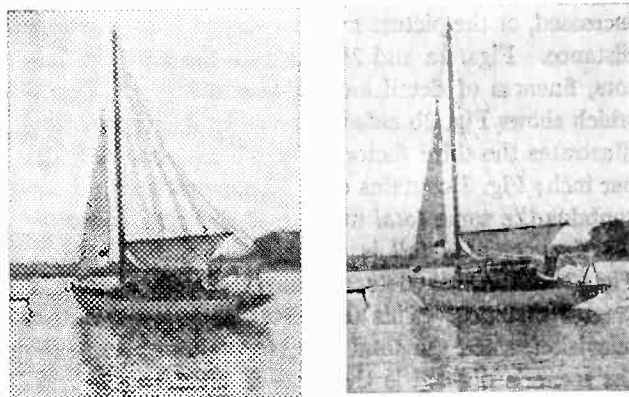

FIGS. 2a, 2b.—Fig. 2a is a halftone reproduction of a photograph using a 50 screen; in Fig. 2b greater detail is obtained by using a 100 screen.



FIG. 3.—Fig. 2b enlarged to twice its original size. Note that this illustration can be viewed from twice the distance and still the same detail will be seen as in Fig. 2b.

must be divided depends upon several factors: the fineness of detail which it is desired to reproduce, the distance from which the picture is viewed and the size of the picture. Fineness of detail, as we have seen, requires a large number of elements for a given portion of a scene. In addition, the more closely the picture is viewed, the smaller must be the individual elements. This is necessary so that the individual elements will appear to the eye to merge into smooth lines and shades. If a picture of a given scene is enlarged, either the total number of elements must be increased, or the picture must be viewed from a greater distance. Figs. 2a and 2b illustrate the first two factors, fineness of detail and viewing distance. Fig. 3, which shows Fig. 2b *enlarged* to twice its original size, illustrates the third factor. Fig. 2b contains 100 dots per inch; Fig. 3 contains only 50 dots per inch. Each contains the same *total* number of elements, therefore the *fineness of detail* is the same in each. Because Fig. 3 has *larger* dots, it must be viewed from a greater distance. This consideration is important in television, since the total number of lines into which the scene is divided is the same at all times. Therefore, large pictures should be viewed from a greater distance than small ones to get the same effect.

An idea of the number of elements needed to reproduce fine details can be obtained from Fig. 2b. This has 100 dots or "elements" per inch in an area 1.5 by 2 inches, giving $150 \times 200 = 30,000$ total elements, or 10,000 elements per square inch. Television pictures may be considered to contain about 224,000 elements, regardless of picture size. Although this does not work out to be so great a number per square inch on large picture-tube screens, the fact that the scene is usually in motion compensates for some loss of detail. A point to remember about television is that increasing the number of elements increases the frequency bandwidth which must be transmitted. Thus there are technical and economic limitations to the degree of detail that may be provided.

We can now begin to appreciate the complexity of the problem with which television is confronted. For not only must information on the light value of each one of many thousands of elements be transmitted to the receiver, but also information as to the order or sequence in which these light values must be assembled to form the picture. To make the problem even more complex, all this information must be transmitted in approximately 1/30th of a second in order to prevent blurring due to movement in the scene and in order to make way for the next picture impression or "frame." In this respect the problem of television is more difficult than that of facsimile, since in the latter a still picture is transmitted and the time con-

sumed may be ten minutes or more instead of 1/30th second.

Need for Scanning

By this time we have seen that to make television possible, the picture must be broken down into a large number of elements and information transmitted on the light value at each one of the elements. At the receiver this information is reassembled in the proper space relationship to form the original picture. How to transmit this information is the next problem.

Previously we saw that using a conventional system of radio we could transmit information on the light value at any *one* element of a scene by using a photoelectric cell pickup to convert the light value to an electrical value, and that this process was essentially the same as that of sound broadcasting and involved essentially the same transmitting and receiving equipment. This was shown and explained in Fig. 1. The first thought that arises is this: Why not use individual channels of the type shown in Fig. 1b to transmit information on the light values at each one of the points into which the picture is divided? But then, this would require some 100,000 individual pickups and transmission systems each of which would be similar to the system of Fig. 1b. Quite obviously such a system would be far too complex and expensive to be practicable, even if other problems of great difficulty at the receiving end did not exist.

Another more promising solution, which is the one that is used in all television systems today, works on the basic idea of transmitting information on the light value of one element at a time. In this way the picture is covered or "scanned" in a systematic way until finally the image is said to be completely scanned when information on the light values at every point in the picture has been obtained. In this way the need for more than one channel is avoided. However, the information must still be reassembled in the proper order at the receiving end before the picture can be obtained.

Scanning a scene is sometimes compared with the manner in which we read a printed page. For instance as you read this page your eyes start at the upper left-hand corner of the page and successively sweep to the right-hand side while examining every letter on the line; when the first line has been completed the eye snaps over rapidly to the left hand side, jumps down one line, and in the same way, examines every letter on the second line as it progresses at a uniform rate toward the right. This procedure continues until finally the eye reaches the last letter on the lower right-hand side of the page, at which time we can consider that the whole page has been scanned.

This same procedure is used when a television camera scans a scene which is to be televised. The only difference is that the television camera breaks down the scene into finer elements than the letters of a page and that the camera produces electrical impulses which vary in proportion to the amount of light on each element of the scene being scanned.

The following simple example will help to clarify the fundamental principles and requirements involved in scanning. Suppose we wish to reproduce by television the pattern shown at the left of Fig. 4. Let us assume in this example that a television camera (consisting essentially of a photoelectric cell with the proper lens equipment) is available which can be focused so as to pick off the light values on any one of the squares into which the picture has been divided. Let us also assume that we have a mechanical arrangement for moving the camera both horizontally and vertically so that it will scan the object. That is, it is possible to start with the camera focused on element 1 and to move it at a uniform rate across the screen until it reaches element 6. At this point the camera snaps back rapidly to element 7 at the beginning of the second line and moves at a uniform rate along the second line until it reaches element 12. The camera then returns very rapidly to the left and starting at element 13 on line 3 it scans the third line. In this manner the procedure continues until the entire pattern is scanned. Note that at any one instant the camera receives light only from the particular element at which it is aimed and focused and produces an electrical impulse which is proportional to the amount of light reflected by this element.

So much for the scanning at the transmitting end where the picture is being televised. At the receiving end let us assume that we have a projector which

projects a narrow pencil of light on the screen equal in area to one of the square elements. This projector like the camera can be moved horizontally and vertically so that the light can be focused on any part of the screen. Suppose further that the electrical impulses from the television camera are fed to the projector and arranged to control the intensity of the light emitted by the projector in accordance with the amount of light registered by the camera at any particular instant.

Under these conditions before a picture can be obtained at the receiver, the motion of the camera at the scene being televised and the motion of the projector at the receiver must be properly coordinated or "synchronized." This means that the television camera and the projector must go through the same movements together, that the projector must at all times be focused on exactly the same element in the picture as that on which the camera is focused. In the figure we have assumed a sort of mechanical linkage between the camera and the projector to accomplish this; actually no such mechanical linkage is possible in television and we shall see later that electrical *synchronizing pulses* are used to control the camera at the transmitting end and the projector (or picture tube) at the receiver, so that both the scene being televised and the image which is being reproduced at the receiver are scanned in unison—so that the scanning is *synchronized*.

In the picture shown the image has been scanned only as far as element 13; element 14 is about to be scanned. As a result the image at the receiver is totally dark beyond this point since the lower elements have not yet been scanned and hence have not yet been illuminated. We shall explain later on that the observer sees the complete image at one time even

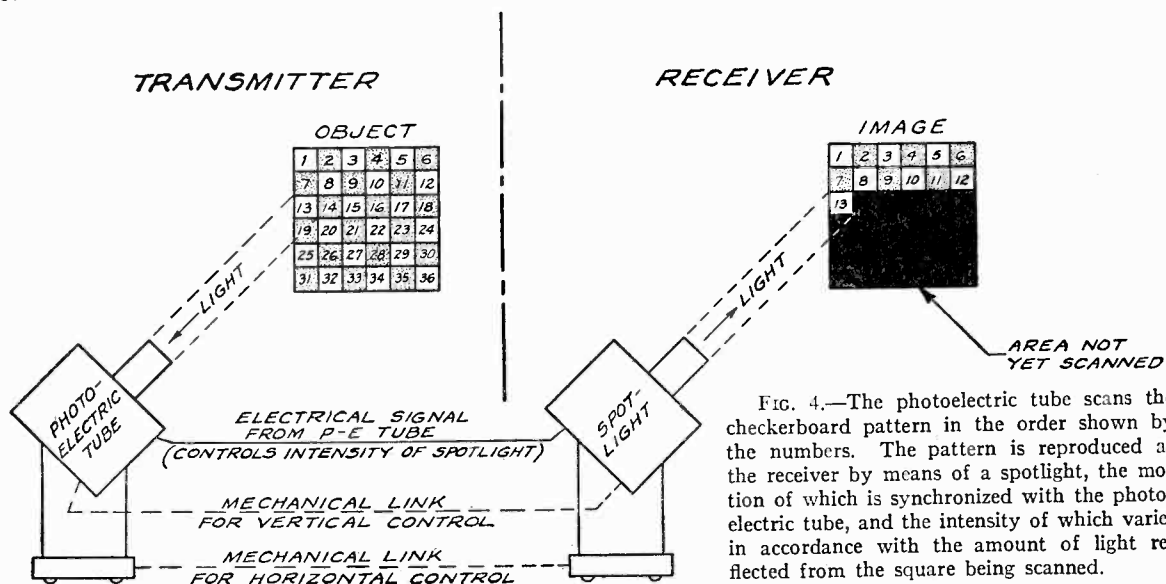

FIG. 4.—The photoelectric tube scans the checkerboard pattern in the order shown by the numbers. The pattern is reproduced at the receiver by means of a spotlight, the motion of which is synchronized with the photoelectric tube, and the intensity of which varies in accordance with the amount of light reflected from the square being scanned.

though only one element of it is receiving light at any particular instant. This is because the entire scanning process is repeated some thirty or more times a second, and the eye tends to see the image after it is no longer illuminated.

We can now summarize the requirements which must be met before a scene can be transmitted by television:

1. The scene must be systematically scanned by the television camera which interprets the light values at every element of the scene in terms of corresponding electrical values.

2. The image must be scanned at the receiving end

according to the same systematic plan used by the television camera and the intensity of the light emitted by the light source in tracing the image must vary at every instant in accordance with the amount of light which the camera is receiving at that instant.

3. At every instant the camera and the light tracing the image must be synchronized so that the identical portion of the image is being traced out which corresponds to the element of area being scanned by the camera.

4. This scanning procedure or process must be completed over and over again at a rate of at least 30 times per second so that as far as can be determined by the eye a continuous image of the scene is formed.

THE CAMERA TUBE AND THE PICTURE TUBE

We have already seen that a complete television system, like a complete broadcasting system, requires a pickup at the transmitter and a reproducer at the receiver, and that the pickup is a photoelectric tube and the reproducer is a cathode-ray tube similar to those used in oscillographs. To avoid confusion of trade names let us call the pickup a "camera tube" (it "takes" the television picture) and the reproducer a "picture tube" (it reproduces the picture). Since we want to get a good general idea of how a television system works, we shall consider both these tubes here, although the serviceman in the field will naturally come in contact with only the picture tube.

The Picture Tube

Essentially the television picture tube is similar to the familiar cathode-ray oscillograph tube, so that those who have read Rider's "The Cathode-Ray Tube at Work" will have a good basis for understanding television picture tubes. For those who have not we will review the subject here.

Let us assume that television (video) signals are coming into a receiver; as we have said before, the amplitude of these signals is proportional to the light reflected by the object being televised. We want to use these signals to produce a picture. In sound work we know that the signals can be made to move the diaphragm of a loudspeaker, thus producing sound waves similar to the original. The picture tube, then, must be capable of converting the electrical video signals into *light* to produce a picture. It is a property of certain substances called fluorescent materials that they will glow when they are struck by a beam of electrons, and that the more electrons striking such a substance at a given instant, the brighter will be the glow. A picture tube, then, can be made if we have a source of electrons, means for controlling their motion and their quantity, and a fluorescent screen.

The external appearance of some typical picture tubes is shown by the photograph, Fig. 5. These are glass vacuum tubes specially shaped to withstand the high pressure exerted by the surrounding air, due to the high vacuum within the glass envelope. Servicemen should remember this, and handle picture tubes with great care. Even scratching the glass or careless handling may cause them to *collapse* as violently as if they exploded! The white appearance of the large end of these tubes is caused by the film of fluorescent

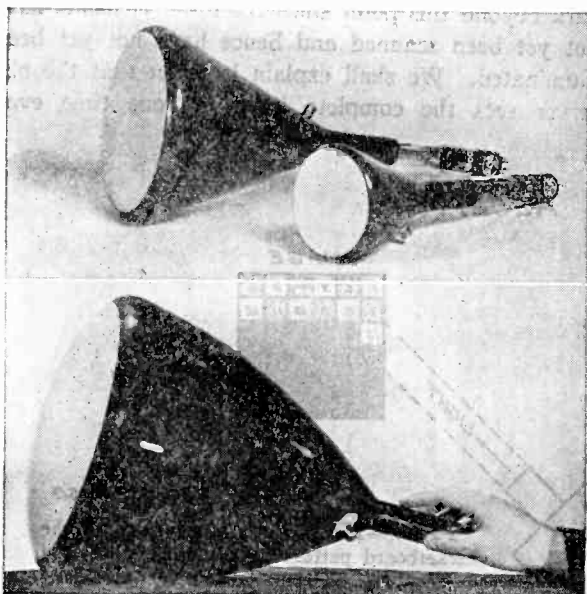

Courtesy RCA Mfg. Co.

FIG. 5.—The left-hand Kinescope shown above has a 9-inch screen and the smaller has a 5-inch screen. Below is a 12-inch Kinescope.

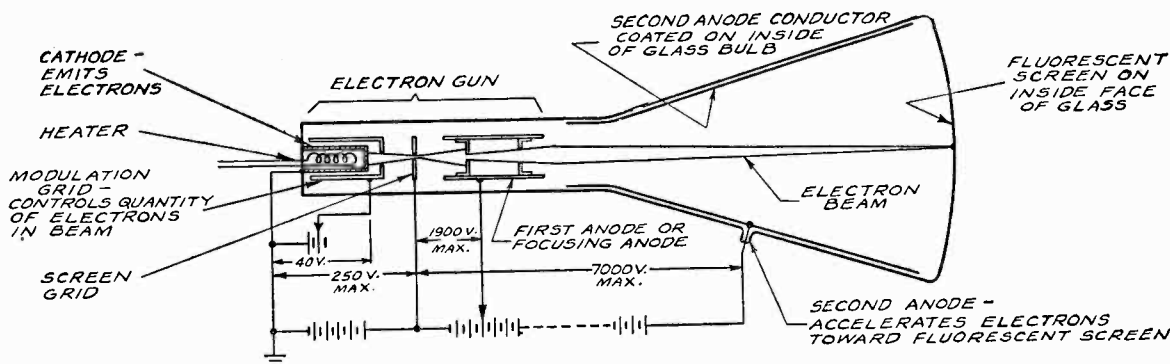
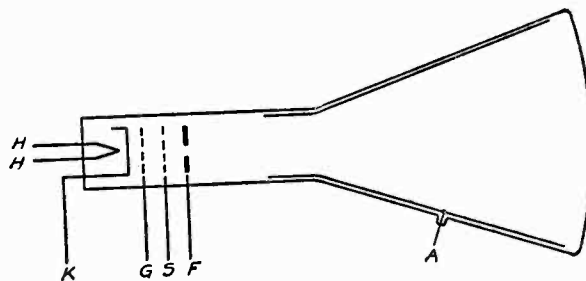

FIG. 6a.—The different elements of a picture tube are designated in the above sketch with typical voltages shown. Fig. 6b on the right shows a common schematic representation; where K is the cathode; G, the modulation grid; S, the screen grid; F, the focusing anode, and A, the second anode.



material deposited on the inside surface; this, of course, is where the television pictures are built up.

A cross-sectional view of a picture tube is shown in Fig. 6. As in the usual radio tube, the heater causes the cathode to emit electrons and the second anode (like the plate of the ordinary tube) strongly attracts them, giving them a high velocity. The modulation or control grid regulates the number of electrons which pass through it in a given time. In the picture tube are some additional elements such as a focusing anode, which forms the electrons into a narrow beam so that they will strike the fluorescent screen in a small round spot; in some tubes a screen grid is inserted between the modulation grid and the focusing anode to prevent the focusing action from affecting the modulating action. Fig. 6a shows the general arrangement of parts inside the tube, and Fig. 6b shows a common way of representing these in schematic form.

With the parts so far mentioned, the tube can produce a beam of electrons which will hit the center of the fluorescent coating on the inside of the picture tube and produce a small spot of light which can be seen through the glass end. We can focus this spot by varying the potential on the first (focusing) anode, and we can vary its brightness by applying a suitable potential to the modulation grid. The more negative the modulation grid becomes relative to the cathode, the dimmer the spot becomes; the less negative the grid, the brighter the spot. It now remains to provide some means for moving this spot rapidly enough over the fluorescent screen to give us a complete picture . . . in other words to provide scanning.

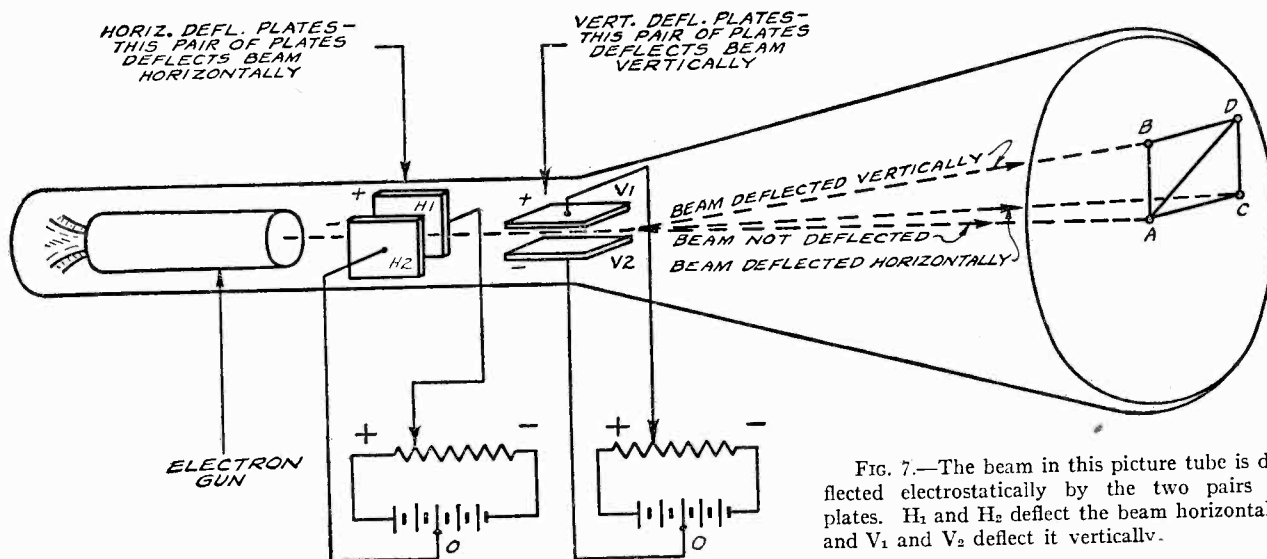

FIG. 7.—The beam in this picture tube is deflected electrostatically by the two pairs of plates. H_1 and H_2 deflect the beam horizontally and V_1 and V_2 deflect it vertically.

Two methods of deflecting the electron beam are now commonly used: *electrostatic* deflection and *electromagnetic* deflection. The first of these methods, which is probably the simplest to understand, takes advantage of the familiar fact that particles of matter having like charges of electricity repel each other, while particles having unlike charges attract each other. Since the electron beam consists of negative charges, we see immediately that the beam can be deflected by means of suitably shaped electrodes which are charged either positively or negatively as the case may require. In picture tubes, as in oscillograph tubes, this is done by building into the tube two pairs of metallic plates, arranged approximately as shown in Fig. 7.

The figure shows that plates H_1 and H_2 are parallel to each other but in a plane at right angles to plates V_1 and V_2 . If no potential is applied to any of these plates, the electron beam will pass straight along the axis of the tube and cause a spot to appear on the screen at A. Now if we leave plates H_1 and H_2 alone, but make plate V_1 positive with respect to plate V_2 , plate V_1 will tend to attract the negative electrons which make up the beam, thus causing the beam to bend, so that it strikes the screen at a new point, say at point B. We have thus deflected the beam upward in a vertical direction a distance AB. Similarly, if we leave V_1 and V_2 alone, but make H_1 positive with respect to H_2 , H_1 will deflect the beam horizontally to the right until we get a spot at a point such as C.

If we combine these effects, by making both V_1 and H_1 positive at the same time, the beam will bend sideways and upwards, causing the spot to appear at D. If the potentials of V_1 and H_1 have been the same as used in the first two tests, D will be located so that the distance AD is the hypotenuse of a right triangle whose sides are equal to AB and AC. Naturally, if V_2 is made positive with respect to V_1 , the beam will be deflected vertically downward, and if H_2 is made positive with respect to H_1 , the beam will be deflected horizontally to the left. The whole process of electrostatic scanning is simply a matter of varying the potentials on the deflecting plates in the picture tube so that the spot on the screen traces out the desired picture according to a regular plan. In a later section, we shall study the details of the plan actually used.

The second method of deflecting the electron beam is called *electromagnetic deflection*, because coils of wire carrying current act on the beam the way a magnet would. See Fig. 8a: The magnetic lines of flux from a permanent magnet pass from the north pole (N) to the south pole (S); the electron beam passes between the poles. If the magnet were not present, the beam would produce a spot at point A on the screen. When the magnetic field acts on the beam as in Fig. 8a, however, the beam is deflected vertically upward to produce a spot at point B. Compare this effect with that produced by the electrostatic field in Fig. 7, and you will notice that in Fig. 7 the electron beam was deflected *in the direction of the lines of elec-*

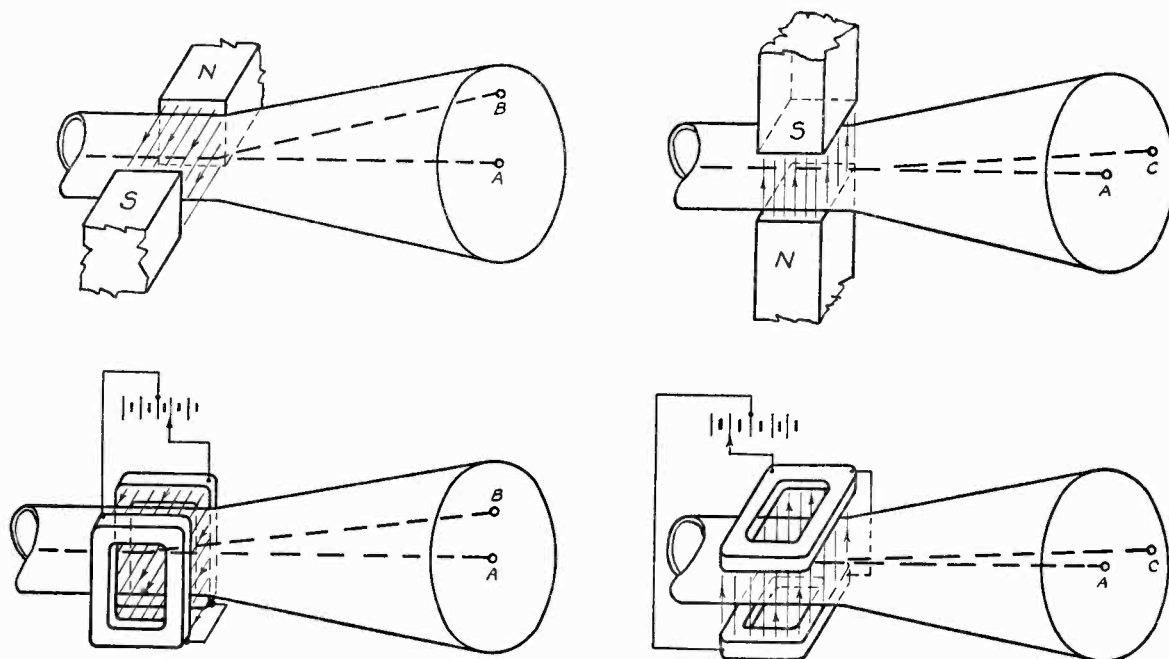
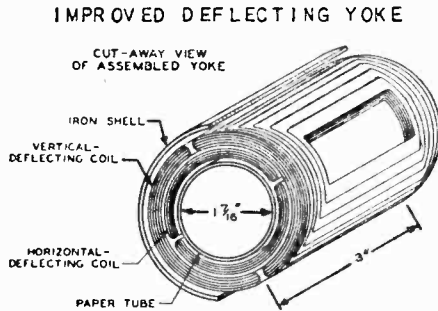

FIG. 8.—The magnetic deflection coils in Figs. 8c and 8d provide a magnetic field similar to that of the permanent magnets in Figs. 8a and 8b above. Note that the beam is deflected at right angles to the lines of force.

trostatic flux existing between plates V_1 and V_2 , whereas in the case of magnetic deflection, the beam is deflected *at right angles to the lines of magnetic flux*. Thus in Fig. 8b the beam is deflected horizontally to the right, when another magnet is introduced whose influence is at right angles to the one shown in Fig. 8a.



Courtesy RCA Mfg. Co.

FIG. 9.—The magnetic deflecting yoke contains the horizontal and vertical deflection coils which are designated in the above sketch.

Of course, a permanent magnet gives a steady field and would therefore produce a constant deflection, whereas in television we must be able to vary the extent of the deflection from zero to maximum in various directions. Since we can also produce a magnetic field by passing a current through a coil, and in addition, can vary the strength of the field by varying the current, we use coils for electromagnetic deflection, as shown in Figs. 8c and 8d. Two pairs of coils are used, and these are often combined in a single compact cylindrical unit called a "deflecting yoke." Fig. 9 shows a partial cutaway view of an RCA deflecting yoke.

A point to remember about deflection systems is that when one tube has *electrostatic* deflection, a change of voltage on the deflecting plates is required to move the beam, whereas in *electromagnetic* deflection, a change of current through the deflecting coils is required.

The Camera Tube

Whereas the picture tube contains a fluorescent screen to convert an electric current into light, the camera tube contains a photosensitive screen to convert light into an electric current. The RCA type of camera tube, called the Iconoscope, the type in general use in this country at the present time, is illustrated in Fig. 10. The essential parts of this tube are shown in the cross-sectional view in Fig. 11: these are the mosaic, the signal plate, the collector and the electron gun. The important accessories external to the tube are the lens, the deflecting yoke, and the load resistor.

The mosaic consists of millions of individual photo-sensitive globules like metallic droplets deposited on one side of a thin sheet of mica. Each globule is like a minute island on the mica, so that the globules are insulated from each other. On the other side of the mica there is a layer of conducting material . . . the signal plate. Because the globules are separated from the signal plate by the mica, the mosaic consists of a myriad of mica-dielectric condensers, all having one plate in common. Fig. 12 shows in a general way what the mosaic looks like when viewed from the edge and enormously magnified. The collector ring is a metallic coating applied in the form of a ring around the inside of the tube and also extended down the neck of the tube near the electron gun.

Briefly the action of the Iconoscope is as follows: An optical image of the scene to be televised is focused on the mosaic by the lens. The electron gun projects

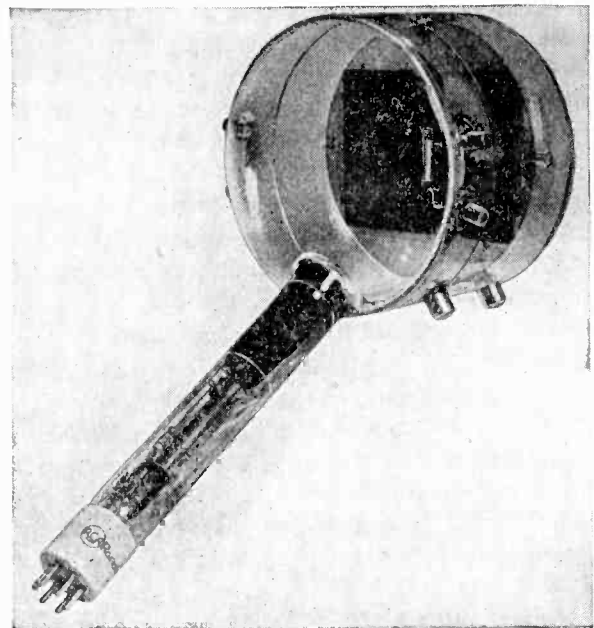

Courtesy RCA Mfg. Co.

FIG. 10.—Light images formed on the plate of the Iconoscope, the camera tube, are transformed into electrical energy by a scanning electron beam.

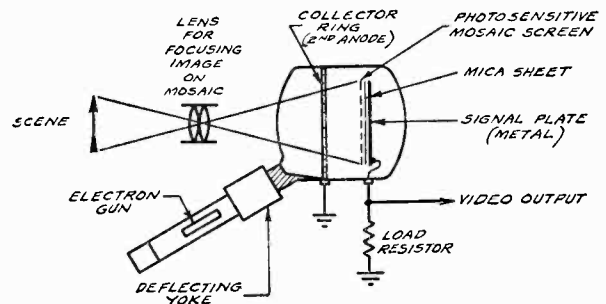

FIG. 11.—The elements of the Iconoscope can be identified in this sketch.

a stream of electrons over the mosaic, scanning it under control of the deflecting yoke, as already described in connection with the picture tube. The electron beam in traversing the mosaic causes a succession of voltages to appear on the signal plate which are proportional to the distribution of light in the image of the scene. The resultant current which flows in the load resistor causes a voltage drop. This constitutes the *video signal*. This signal is then amplified and used to modulate the television transmitter.

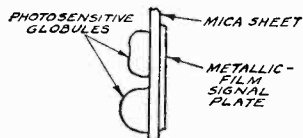

FIG. 12.—An enlarged view of how the photosensitive mosaic is arranged with respect to the signal plate of a picture tube.

The following more detailed description of the action of the Iconoscope is presented for those interested. When a scene is focused on the mosaic, each photosensitive globule emits electrons in proportion to the amount of light falling upon it; the more light that falls on a given area the more electrons are emitted from that area. This process is called "photoemission." Since a loss of electrons means a more positive charge, photoemission sets up a variety of different charges over the surface of the mosaic in accordance with the distribution of the light it is receiving. So far no video signal has been produced because the globules are insulated from the signal plate.

Since the path from the mosaic to the signal plate is through a condenser, the only way to get a signal across is to produce a sudden *change* of potential. In the Iconoscope type of camera tube, this change of potential is produced by the action of the electron beam from the gun. (The necessary orderly scanning action from left to right and top to bottom is provided by suitable currents through the deflecting yoke, as in the case of a magnetically deflected picture tube.) In order to understand the effects produced by this scanning beam, let us first consider three possible conditions on the surface of the mosaic *before* scanning. It has been found that the ordinary Iconoscope mosaic in *total darkness* (black scene) assumes a potential of -1.5 volts relative to the collector ring. When strong light (white scene) falls on a portion of the mosaic, a considerable number of electrons are lost by photoemission, and the potential is changed from, say, -1.5 volts to 0 volts. Illumination of medium intensity (gray scene) may cause the potential to change from -1.5 volts to -0.8 volt. These potentials of the mosaic, then, may be approximately as follows for

these portions of the mosaic: black area, -1.5 volts; gray area, -0.8 volt; white area, 0 volts.

The electrons in the scanning beam travel so rapidly that when they strike a surface such as the Iconoscope mosaic, they knock off a great many electrons, more, in fact, than even bright light does. This kind of action is called "secondary emission." So many electrons are thus lost by secondary emission, that the portion of the mosaic directly under the action of the scanning beam is driven to a *positive* potential of $+3$ volts. Each portion of the mosaic is driven to $+3$ volts *during the instant the scanning beam acts upon it* and this $+3$ -volt potential is reached *regardless of the light conditions prevailing* . . . a black area goes to $+3$ volts as well as a white or gray area. Although the *peak* potential reached by every area as the scanning beam passes over it is the same, the *change in potential* which this area undergoes at this time *will depend on the illumination* it has received. Thus the black area will change from -1.5 to $+3$ volts, a change of 4.5 volts; the gray area will change from -0.8 to $+3$ volts, a change of 3.8 volts; the white area will change from 0 to 3 volts, a change of 3 volts. It is this sudden *change of potential* which is induced on the signal plate that causes the video signal current to flow through the load resistor. The *difference between the changes* for black, gray and white areas is what indicates the difference in the illumination over the mosaic surface as it is scanned, and this difference is proportional to the distribution of light over the mosaic.

The important things to notice here are: (1) that we get a video signal across the load resistor (Fig. 11) only when a *change of potential* is produced on the mosaic, and that this is accomplished by the scanning beam; and (2) that the resultant *video signal is proportional to the light coming from the scene being televised*, the signal being of *maximum* amplitude for *black* portions of the scene, *minimum* amplitude for *white* portions.

The collector ring (2nd anode) serves to accelerate the electrons in the scanning beam, and also to collect some of the electrons emitted from the mosaic. In Fig. 11 you will notice that this element is grounded; it is, however, 500 to 1000 volts *positive* with respect to the cathode of the electron gun, because the gun is at a corresponding potential *negative* with respect to ground. This will not be the last time that you will find television tubes with elements at very high negative potentials, and the possibility of such circuits existing must always be borne in mind as a safety measure.

SCANNING AND SYNCHRONIZATION

In previous sections we discussed (1) the necessity for scanning both the camera tube and the picture tube, (2) the essential requirement that these operations must be synchronized, and (3) the devices which make it possible to control the motion of the electron beam in these tubes. In this section we shall describe the details of the path of the scanning beam on the tube screen, the waveshapes necessary to produce this path and some of the problems which arise in connection with scanning.

The Scanning Pattern

As we have already mentioned, the usual scan is from left to right and from top to bottom. In certain cases this order must be reversed, but the principle is the same. In Fig. 13 is shown a simplified diagram of a scanning pattern; this is often called a "raster." The rectangular diagram formed by the light lines connecting points A, B, C and D represents what we may call the "picture space." The width of this rectangle (AB) is drawn so as to be $4/3$ times the height (AC); this is the proportion used in motion pictures. The ratio of width to height is called the "picture aspect ratio" and its value of $4/3$ is one of the proposed RMA television standards. On a picture tube, the heavy lines ab, cd, etc., are caused by the fluorescent glow which occurs as the electron beam moves from point a to point b (in the direction of the arrow on line ab). You will notice that points a and A coincide, while point b is slightly *below* point B. In fact, *all* the lines in Fig. 13 slant downward. This slant is necessary to provide the *vertical* (top-to-bottom) part of the scanning process. In fact, the left-to-right component of scanning is called "horizontal scanning" or "line scanning"; the top-to-bottom component is called "vertical scanning" (also called "frame scanning" or "field scanning," for reasons which will be clear later on). This slant-line system of scanning is used because the characteristics of the electrical circuits which provide scanning make it impossible to scan in a series of truly horizontal lines, with an abrupt vertical drop at the end of each line.

After the beam reaches point b it is deflected back along the dotted line bc to start a new line, cd. On the picture tube the line bc would be much fainter than line ab because the *time* allowed for the beam to move from b to c is only about one-tenth the time allowed for it to travel from a to b. Lines like ab, cd, etc. are called "line traces"; lines like bc, de, etc. are called "line retraces" or "line flybacks."

Here some questions may arise: Why does the motion of the spot across the screen appear as a line? Why is the flyback dimmer than the trace? The eye is responsible for these effects. Any one who has ever swung a flashlight or a "sparkler" in a circle must have noticed that as the speed of the swinging is increased, the individual spot of light merges into an apparently continuous circle of light. The velocity of the scanning spot across the picture tube screen is so rapid (several thousand miles per hour) that the eye cannot distinguish the spot from a continuous streak. This property of the eye is called "persistence of vision."

The difference in brilliance between the trace and the flyback is due to the fact that the brilliance of the fluorescence produced on the picture-tube screen depends on the *time* during which the electron beam acts upon it. Although in both cases the actual time is very short, the *difference* in time (about 10 to 1) does result in a very marked difference in brilliance.

A complete set of lines such as shown in Fig. 13 is called a "frame." This particular frame is completed when the spot reaches point l; it then returns to point a to start a new frame. A frame like that shown in Fig. 13 is said to be built up by "progressive scanning" (the lines follow each other in a continuous chain). Six complete lines (retraces are not counted) are shown in this figure; a complete technical description of this figure would be: "A six-line frame (or raster) produced by progressive linear scanning." Of course, so few lines as we have shown would be insufficient to give a good picture, and a very great many more are actually used. In order to give the eye the illusion of motion, many complete frames must be

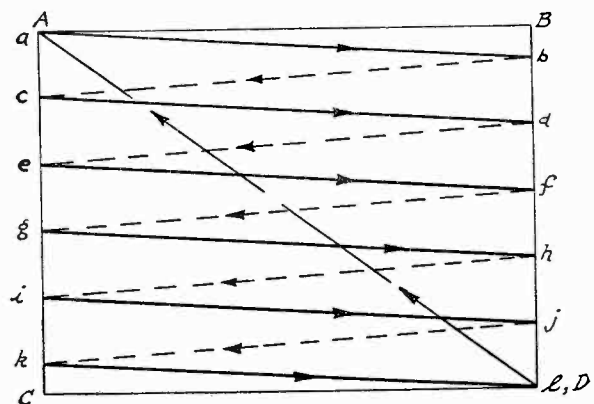

FIG. 13.—A simple progressive scanning pattern in which the picture is scanned in a series of lines which start at the upper left and slope down to the right.

traced out every second. The standard American procedure is to trace 30 complete frames every second; each frame consists of 441 lines.

Flicker and Hum on the Raster

It has been found that if the raster is bright a *flicker* will be observed when the number of frames per second (frame frequency) is less than a certain critical value. Although a satisfactory illusion of motion might be produced by about 12 frames per second, as many as 48 frames per second may be required to remove objectionable flicker. The more frames per second a television transmitter sends out, each having a large number of lines, the higher the modulation bandwidth required. One way to keep the bandwidth down is to send twice as many frames per second, each frame having half the number of lines. But a large number of lines is necessary for detail in the picture. It was therefore decided to divide the total number of lines in each frame between two rasters (called "fields"), each containing half the total number of lines required to make up a frame. These fields, transmitted at the rate of 60 per second, get rid of the flicker effect. The required number of lines per frame is supplied by sending the odd-numbered lines along with one field and the even-numbered lines along with the following field. The fields are transmitted so rapidly that as far as the eye can see, all the necessary lines appear in their proper positions on the raster simultaneously.

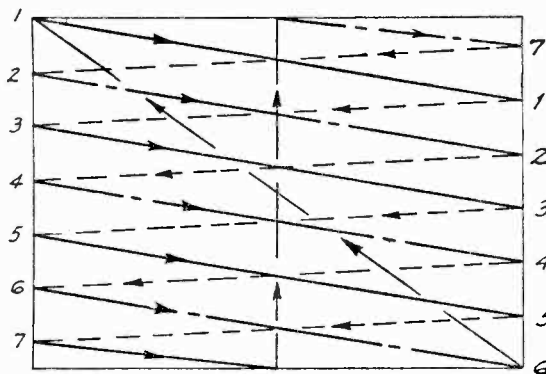

FIG. 14.—An interlaced scanning pattern in which the odd and even lines are scanned on successive fields.

The method of scanning just described is called "interlaced scanning," and is the system now in use. A simplified pattern of a frame produced by interlaced scanning is shown in Fig. 14. The general principles are the same as for progressive scanning; in fact, each *field* is itself progressively scanned. The lines transmitted during the first field scan, referring to Fig. 14, are lines 1, 3, 5 and the first half of line 7. The beam is then deflected to the top of the picture

space to begin the second field. During the second field, line 7 is completed and lines 2, 4 and 6 are traced, thus completing the entire seven-line frame in two steps. (As in Fig. 13, the arrows show the direction of travel of the beam spot.) The use of an odd number of lines has been found advantageous in interlaced scanning; this method is called "odd-line interlacing." American practice calls for 220.5 lines in each field, making 441 total lines per frame. Sixty fields are transmitted each second, giving a field frequency of 60 per second.

The frame frequency chosen depends upon the a-c power-line frequency; it must be an even multiple or submultiple thereof. The reason for this is that if there is some hum present in the deflecting circuits, a certain amount of distortion will appear in the picture. If this distortion appears to be stationary, and is not excessive, it can probably be tolerated. On the other hand if the distortion moves so that the picture appears to have moving ripples in it, even slight distortion is most objectionable. By making the frame frequency an even submultiple of the power-line frequency, this type of hum pattern can be rendered stationary. Since most American power lines use 60-cycle a.c., the frame frequency chosen was 30 per second. (In England, with 50-cycle a.c., the frame frequency is 25.)

Scanning Waveform

In describing the picture tube, we showed that the beam can be deflected by applying suitable potentials to the deflecting plates or suitable currents through the deflecting coils. The nature of these voltages and currents depends on the kind of deflection to be produced. In Fig. 14 is shown the kind of deflection required in television scanning. The trace deflection required is a steady motion from left to right along a line slanting slightly downward to the right; the retrace travels from right to left along a line slanting downward to the left. We found out that such a motion will occur when both sets of deflecting plates or coils are in operation simultaneously. Thus in scanning, two deflection circuits are acting at once, one moving the beam horizontally (horizontal deflection circuit), the other moving it vertically (vertical deflection circuit).

The shape of the voltage (or current) wave which has to be applied to the deflecting plates (or coils) to produce the desired scan is shown in Fig. 15. At (a) is shown the waveform for horizontal or line scanning; at (b) the waveform for vertical or field scanning. Notice that the time of the line wave is equal to the time of the field wave divided by the number of lines per field (1/60 second divided by

220.5 = 1/13230 second). Also notice that the line retrace is allowed only about 1/6 the time allowed to the line trace; the field retrace is allowed 1/13 the time of the field trace. The total time-intervals allowed for these waves indicate that the line-scan fre-

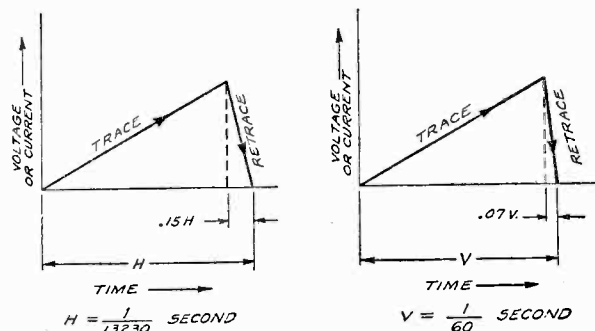

FIG. 15.—At the left is shown the sawtooth waveform required for horizontal scanning. A similar waveform, but of much lower frequency, is required for vertical deflection; it is shown at the right.

quency is 13,230 cycles and the field-scan frequency is 60 cycles. These waveforms are called sawtooth waves; circuits for generating them are described in a later section.

Overall View of a Television System

We are now in a position to obtain a bird's eye view of a complete television system. Such a step is advisable at this time because of the complexity of the system and the desirability of not losing sight of the function of the principal parts in the maze of detail associated with all the individual elements of the system.

Fig. 16 shows the general role played by each of the major units of a television system in causing the picture of the televised scene to appear on the screen of the picture tube. Referring to this illustration, you will note that the camera tube is focused on the scene to be televised with the result that an image of the scene is formed on the photoelectric mosaic of the camera tube. In this way each point of the mosaic

takes on a voltage which is proportional to the light value associated with this point of the image. In order to transmit this information, the electron beam of the camera tube completely scans the image on the photoelectric surface 30 times in each second. As a result of this the video portion of the television signal is produced in which the electrical variations correspond with the light variations on the screen of the camera tube.

In order to fulfill the requirements of synchronization, the need for which has already been explained, a synchronizing signal (abbreviated "sync" signal) is applied to the camera tube deflecting circuits so that the scanning of the electron beam is at all times under the timing control of this sync signal.

At the same time this sync signal must also form a part of the television signal which is broadcast in order that the scanning at the picture tube in the receiver can be kept in synchronism (in step) with the scanning at the camera tube. For this reason you will note that the sync circuit also feeds the same sync signal to the video amplifier, and as a result the complete signal contains information not only on the light values but also the necessary control signals to synchronize the scanning at the picture tube with that at the camera tube.

The complete television signal is amplified by the video amplifier circuits in the transmitter and fed to the modulating circuits of the transmitter where it modulates the high-frequency radio wave which serves as the carrier. According to the present frequency allocations assigned by the Federal Communications Commission, the carrier frequencies used lie within the range between 44 and 108 megacycles, with the lower values being in greater use. The reasons for the use of carrier frequencies in the ultra-high frequency range and the actual make-up of the signal will be discussed later in detail.

The signal which is radiated by the transmitting antenna is picked up by the receiving antenna and fed to the television receiver. The television signal is

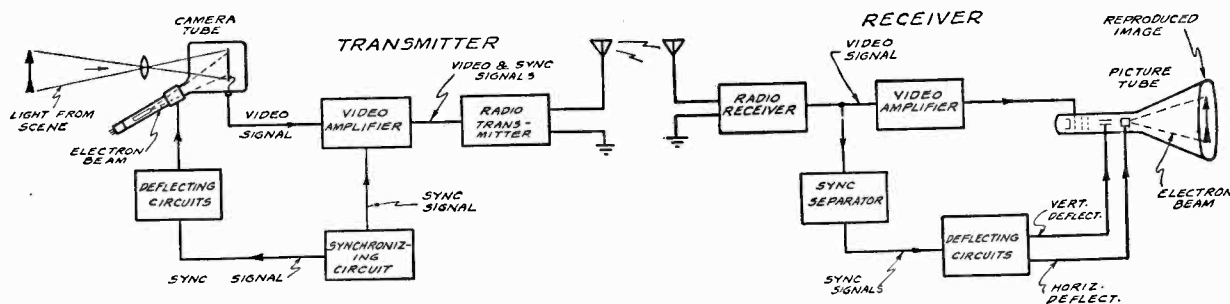

FIG. 16.—The principal elements of a complete television system. Note the provision made for synchronizing the scanning at the picture tube with that at the camera tube.

amplified in this receiver which incidentally is almost invariably of the superheterodyne type. After sufficient amplification the signal is demodulated in the second detector of the receiver and the video and sync signals are recovered. The video amplifier following the detector further amplifies the signal which is finally impressed on the control grid of the picture tube. The fluctuations of voltage on the control grid of the picture tube cause the intensity or brightness of the scanning spot to vary in accordance with the amount of light on that element in the scene which at that particular instant is being scanned by the electron beam of the camera tube.

The receiver contains separate circuits for deflecting the beam of electrons horizontally and vertically so as to accomplish the scanning of the image at the picture tube. In general these circuits are similar to those used to deflect the electron beam at the camera tube. To insure absolute synchronization between the scanning at the picture tube and that at the

camera tube, the receiver contains circuits (called sync separator circuits) for separating the synchronizing pulses from the complete television signal. As is noted in the figure, these impulses are applied to the deflection circuits in the receiver and keep the two scanning beams—the one in the camera tube at the transmitting end and the other in the picture tube at the receiving end—in perfect synchronism. In this way the image of the scene is traced out by the moving spot of light on the screen of the picture tube.

In the above description we have omitted a consideration of the sound broadcasting which almost invariably is a part of the television broadcast. For the present, it will be sufficient to understand that the sound is transmitted and received in the same way as a conventional sound broadcast even to the extent that an entirely separate carrier is used to carry the modulation of the sound accompanying the television broadcast.

THE TELEVISION SIGNAL

One of the most important factors delaying the commercial introduction of television in this country was the necessity for establishing definite standards. You can appreciate that standards are of tremendous importance in television—and in this respect television is unlike radio—because of the close relationship which exists between the design of the receiver and conditions at the transmitting end. Thus the manner in which the image is scanned and the manner in which the synchronizing information is conveyed influence both the design and operation of the receiver.

To avoid the danger of establishing transmitting standards which would tend to prevent progress in television, the entire problem in all its aspects was investigated by the television committee of the Radio Manufacturers Association—the RMA. After several years of careful study, the standards were arrived at which are the basis of television in the United States today. It is believed that these standards have been made flexible enough to permit gradual improvements without requiring radical changes in receivers now being distributed and sold. Thus improvements which will be made will probably be improvements in the present basic system rather than radical changes in the system itself. The primary contribution of the present RMA standards is that they have started television out along the path which appears to hold the greatest promise for the future.

The Video Signal

We are now in a position to consider more fully the nature of the signal which is used to transmit the television image. Up to this point we have explained in a general way that this signal contains the electrical image of the scene being televised and in addition contains the information required to synchronize the scanning at the camera tube with that at the picture tube. We will now go into greater detail as to the structure of this signal because of the bearing which it has on the operation and servicing of television receivers.

It will be helpful in understanding the nature of the television signal to review briefly the audio signal used in sound broadcasting and later to compare the two. In Fig. 17a is shown a typical sound or audio signal. As you know, the amplitude of this audio signal represents the intensity (loudness) of the sound, and the number of cycles per second represents the frequency (pitch) of the sound. During periods when the sound intensity is zero, the amplitude of the sound wave is of course zero; on the other hand, during periods when the sound intensity is high, this is represented by a proportionate increase in the amplitude of the signal. An important characteristic which you should note is that in a sound wave, the amplitude of the wave has both positive and negative peaks and extends equally in both directions from the zero axis.

A typical video or picture signal, that is, the electrical signal which represents the variations in brightness over the elements of a scene, is shown in Fig. 17b. The horizontal line in the left-hand portion of the signal shown represents the signal voltage produced by an *unilluminated* or *black* portion of the scene, which is called the "black level." In discussing video signals this black level is used as a reference from which the light values corresponding to all other signal voltages are measured. The reason for this is apparent from inspection of the rest of Fig. 17b, which represents various signal voltages corresponding to parts of the scene reflecting varying degrees of brightness. Note that as the brightness of the scene increases from black, the voltage of the video signal decreases, and that in any case the picture brightness never results in a signal voltage greater than the black level. The black level is therefore a suitable reference, because its voltage is fixed and easily reproduced. "White" would not be a suitable reference because the signal voltage corresponding to "whitest white" depends upon the maximum intensity of illumination available.

A video signal in which the signal voltage decreases (from the black level) as the picture brightness increases toward white is said to have a "negative picture polarity." The signal of Fig. 17b, as we have seen, is of this type. If we call the black-level voltage zero volts in Fig. 17b, all other shades of brightness will produce negative voltages, the whitest part of the scene having the greatest negative voltage. A signal having negative picture polarity is used to mod-

ulate the television carrier in present-day American television. Of course it is perfectly possible to have a video signal in which the signal voltage increases as the picture brightness increases; in this case the signal is said to have a "positive picture polarity." In fact we shall see later on, in considering receiver circuits, that the signal undergoes a reversal of polarity in passing through each stage of the video amplifier.

The important difference between the audio signal and the video signal is that the *video signal is always located on only one side of the black reference level*, whereas the audio signal contains variations on both sides of the zero-signal level. The video signal is therefore a pulsating voltage with a d-c component, not an a-c wave like the audio signal.

Let us now consider the video signal in greater detail. Fig. 18a shows the output of the camera tube for two successive lines of the image. At the same time Fig. 18b shows these two lines as they appear on the scanning pattern or raster. Starting at a, the beginning of the field, the beam traces the first line a-c; referring to the signal (Fig. 18a) it can be seen that the image is black at a, changes gradually to a brilliant white at b, and finally changes gradually to black at the end of the line c.

During the retrace time c-d, the signal level is maintained at a uniform black level as shown by c-d on Fig. 18a. This "black" interval during which the retrace is carried out is called the "horizontal blanking period," and the pulse c-d is called the "horizontal blanking pulse," or the "horizontal blanking pedestal."

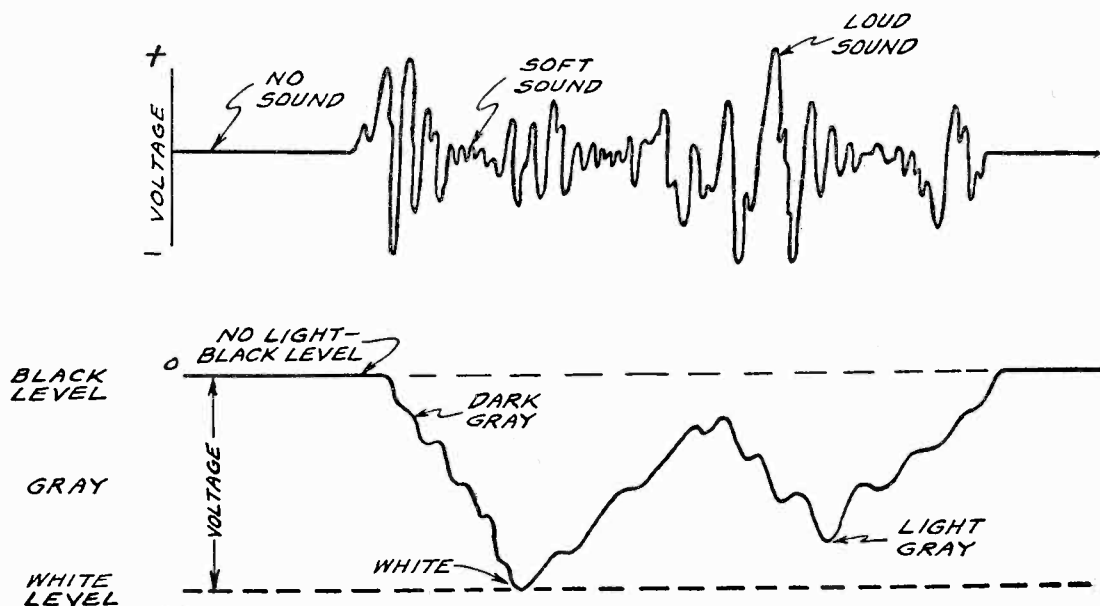

FIG. 17a, 17b.—Comparison between a sound and video signal. In the video signal black is represented by a fixed level, and various shades of brightness by voltages which are displaced proportionately from the black reference level.

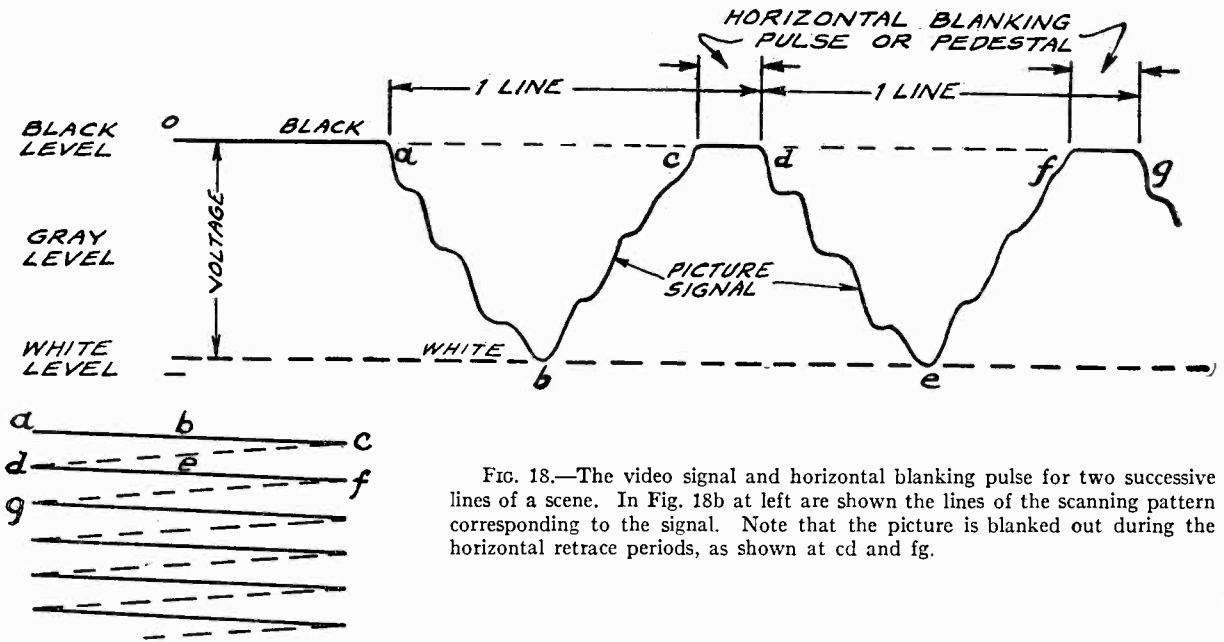

FIG. 18.—The video signal and horizontal blanking pulse for two successive lines of a scene. In Fig. 18b at left are shown the lines of the scanning pattern corresponding to the signal. Note that the picture is blanked out during the horizontal retrace periods, as shown at cd and fg.

As we shall see later in more detail, the pedestal performs two functions: (1) It blacks out the return trace so that it will not appear on the screen of the picture tube and (2) it provides a platform on which the horizontal synchronizing pulse is erected. Note that the second scanning line d-e-f is essentially the same as the first line and again the line is terminated on the signal wave by a blanking pulse f-g. In this way the entire field is scanned and the picture signal corresponding to the light and dark variations of the field is produced.

Signal and Sync Pulses

In the previous section we showed the video signal without discussing the modifications which must be made in the signal in order to provide the necessary synchronization. We shall now describe how this synchronizing information is added to the signal.

Consider the video wave shown in Fig. 19. This shows the wave for the last two lines of the field, just preceding the vertical retrace period during which the beam returns to the upper portion of the field. Starting at the left of the figure, the first thing you will note is the addition of a pulse which is erected on top of the horizontal blanking pulse; this is called the "horizontal sync pulse." As we shall see later in the discussion of receiver sync circuits, this small rectangular pulse provides the means which keeps the horizontal line or scanning oscillator in the receiver in synchronism with the scanning at the camera tube. An important thing to note is that this sync pulse is located in the "blacker-than-black" region so that the screen of the picture tube is kept dark during the period of the horizontal retrace. Thus the portion of the signal more positive than black is used for synchronizing information, whereas the voltage more neg-

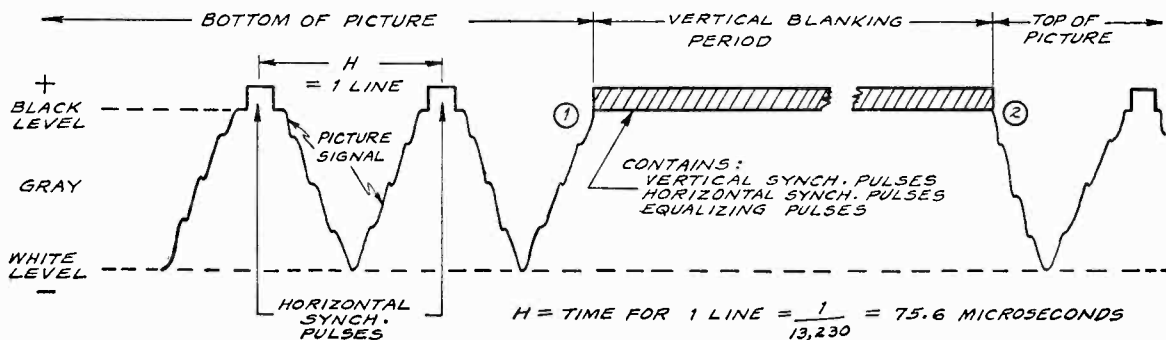

FIG. 19.—The video signal, showing the last two lines of a field followed by a vertical blanking period. Horizontal sync pulses have been erected on the horizontal pedestals and during the vertical blanking period the vertical sync pulse is transmitted.

ative than the black level is used for the picture information. It is also important to observe that this line-synchronizing pulse appears at the end of each line so that constant synchronization of the line oscillator is maintained.

At the end of the last line at the bottom of the field represented by point 1 in Fig. 19, the beam is ready to return to the upper edge of the field. As in the case of horizontal scanning, a sync pulse is required to return the beam to the top at the proper instant. All the information associated with the end of the field, required to return the beam to the top of the field in preparation for the one to follow, is contained in the interval designated as the "vertical blanking period." Essentially the following three functions are performed during the vertical blanking period: (1) A field synchronizing pulse is provided (the exact nature of this pulse is described later) so that the beam will be returned to the start of the frame at the proper instant. (2) The entire signal is blacked out so that the field retrace and lines scanned during this interval will not be apparent to the observer. (Actually, of course, the line-scanning circuits continue to function, but the beam does not exist because of the negative voltage on the control grid of the picture tube during this interval.) (3) The line synchronizing pulses are maintained during the vertical blanking period, which lasts for about 15 lines, so that the horizontal deflecting circuit in the receiver will not slip out of synchronism during this period. In addition to the vertical and horizontal sync pulses, two groups of so-called "equalizing pulses" are transmitted during the vertical blanking period; these are required for reasons which will be explained later.

RMA Standard Television Signal

It is desirable at this point to show the complete signal which has been recommended by the RMA to be used as the standard for this country. To illustrate the makeup of this signal, Fig. 20 shows the signal for two successive fields in the neighborhood of the vertical blanking pulse. Accordingly the left-hand portion of A shows the last four lines of any one field. This is followed by the vertical blanking period which contains equalizing pulses both preceding and following the vertical sync-pulse interval. After the last equalizing pulse the horizontal sync pulses are resumed; by this time the beam has been returned to the upper portion of the screen so that shortly thereafter the normal video signal is resumed. To summarize, the first line, A, shows the complete signal as it exists for any one field both before and after the transmission of the vertical blanking period.

Part B of this figure describes the signal as it exists 1/60 second later for the following field. Since the scanning is interlaced, note that the line-sync pulses in B appear *between* the line-sync pulses in A, thus providing the timing which is essential for interlacing. Again the last line in this field is followed by a vertical blanking period at the end of which the video signal is resumed. Note that for both parts of the figure, the reference point from which time is reckoned is the beginning of the vertical sync pulse, which is designated as taking place at any time represented by $t = t_1$. Using this time reference, it of course follows that the vertical sync pulse for the next field must begin 1/60 second later (since there are 60 fields per second); this is shown by part B of the figure so that the two vertical sync pulses are directly below each other but 1/60 second apart in time.

The description which follows shows in greater detail those parts of the complete video signal which have already been described. The specifications throughout are those of the RMA.

Horizontal Blanking and Synchronization

As shown in Fig. 20, the horizontal sync signal is transmitted at the end of each line and consists of an essentially rectangular pulse erected on the horizontal blanking pedestal. The amount of time allowed for the blanking pedestal is specified as 15% of the total time from the beginning of one line to the beginning of the next line. Since the time for each line (including the retrace) is 75.6 microseconds (1/13230 second), the time devoted to horizontal blanking is about 11 microseconds. This interval of 11 microseconds has been found to be just large enough to allow for the retrace time, to allow the spot to assume normal scanning speed at the left edge of the picture and to maintain reliable synchronization.

The whole of the horizontal blanking interval is not utilized for the synchronizing pulse as can be seen by examining the enlarged view of the wave between C-C (Part A) shown in the detail view, Part C of the figure. Actually only about half the total blanking time is used, and the front or leading edge of the sync signal is placed as close as possible to the beginning of the blanking pulse. The small allowance which is made takes care of some variation in timing and insures that the sync pulse will not run into the video portion of the signal and thus upset the line timing.

Vertical Blanking and Synchronization

The vertical blanking interval follows the last line of each field and consists of the following four parts which will be considered separately.

(1) *Equalizing-Pulse Interval*: Six equalizing pulses one-half line apart precede the sync pulse and accomplish (a) the maintenance of horizontal or line synchronization and (b) the "equalization" of the intervals preceding the vertical sync pulse so that *conditions preceding the vertical sync pulse are identical for alternate fields*. The need for these equalizing pulses arises because of the interlacing of alternate fields. As you can see from Fig. 20, the lines in the second field (B) are interlaced between those of the preceding field (A). If the equalizing pulses were eliminated and the vertical sync pulses were inserted in A at the end of the last line, then the vertical sync pulse would have to appear in the next field B at the middle of the line; the reason for this is that 1/60 second later the beam is in the middle of the line because of the interlacing. Thus *without the equalizing pulses*, the conditions preceding the vertical sync pulse would be different for each of the two fields. This would tend to produce a different type of vertical sync pulse for alternate fields, upset the synchronization and give rise to the distortion known as "pairing of the interlace." In a paired interlace, the even-scanned lines do not lie midway between the odd-scanned lines, because of the difference in timing on alternate fields.

In connection with the maintenance of line synchronization during the vertical blanking interval, note that the leading edges of the equalizing pulses function to maintain synchronization. Not all the pulses are used for each field, however. Thus note that because of the interlacing, the first, third and fifth equalizing pulses are used on the first field (A), and the second, fourth and sixth pulses are used on the succeeding field (B). This explains why six pulses are used, each spaced one-half line apart, rather than three pulses spaced one line apart. It would, of course, be possible to use three different pulses in each field, but if this were done the signal preceding the vertical sync pulse would be different for succeeding fields and there would be a resulting absence of equalization.

(2) *Vertical Sync Pulse*: The vertical sync pulse follows directly after the equalizing pulse interval and consists of six broad pulses in which the edges are serrated or cut at one-half line intervals. The function of the vertical sync pulse is to provide the control signal which tells the vertical oscillator that it is time to begin the retrace and thus to return the beam to the top for the beginning of the next field. The pulses in the vertical sync-pulse interval are considerably broader than the line pulses so that the sync separator circuit will be able to distinguish between the two types of pulses and thus be able to separate the vertical sync pulses from the horizontal sync pulses. At the same time the edges of the serrations

at half-line intervals provide the necessary control for maintenance of horizontal synchronization. The serrations are required at half-line intervals because of the interlacing; the reasoning used in connection with the equalizing pulses also applies here.

(3) *Lagging Equalizing Pulses*: It was explained previously that in order to provide identical conditions for the two successive fields preceding the vertical sync pulses, six equalizing pulses were inserted in front of the vertical sync pulse in each field. It is just as necessary to keep the conditions following the vertical sync-pulse interval the same for the two successive fields A and B; for this reason six lagging equalizing pulses appear in both A and B after the vertical sync pulse. If you examine the vertical sync-pulse interval in both A and B you will see that, although the lines in the two fields are displaced by one-half line because of the interlacing, nevertheless the conditions in the neighborhood of the vertical sync-pulse interval are the same for both fields. Note that the lagging equalizing pulses are also one-half line apart so that line synchronization is maintained for both the "odd" and "even" fields.

(4) *Normal Horizontal Sync Pulses*: The lagging equalizing pulse interval is terminated before the end of the vertical blanking period so as to prepare the line oscillator for the normal horizontal sync pulses which are to follow. In practice, the video signal is blanked out for a period of from 7 to 12 lines following the last equalizing pulse so that the line oscillator (which may have been operating at double line frequency during the preceding period) has a chance to settle down to being under control of the normal type of sync signal. At the end of the vertical blanking interval, the blanking is of course removed and the video portion of the signal again controls the intensity of the beam in the picture tube.

Range of Frequencies in Video Signal

Unlike audio signals which contain frequency components ranging from a low value of about 20 cycles per second to a high value of about 12,000 cycles per second, video signals include a range from practically zero frequency (produced over areas where there is little variation in light intensity) to as high as 4 or more megacycles (produced over areas where there is a very rapid variation in light intensity).

It is interesting to examine the manner in which the maximum frequency required in the video signal is related to the amount of detail which is reproduced. This can be arrived at from the following considerations: Let us assume that we wish to transmit a picture in which the same resolution or detail is desired in the horizontal direction as in the vertical direction.

Now in the vertical direction we have a total of 441 lines or 441 elements. Since a horizontal line is 4/3 times as long as a vertical line (the picture is 4/3 times as wide as it is long), it follows that there are 4/3 as many elements in a horizontal line as there are in a vertical line. This makes a total of 441 x 441 x 4/3 or 260,000 elements in the complete picture.

Since we wish to calculate the maximum frequency which is required to reproduce the light and dark variations over each one of these 260,000 elements, let us assume that alternate elements in the picture are black and white so that the image resembles a checkerboard pattern. This type of scene requires the highest possible frequency for faithful reproduction because of the rapid variation in light intensity as the beam goes from one element to the next. The exact opposite of this type of scene would be one which was uniform over its entire area, for in this case it would be necessary for the system to transmit only very low frequen-

cies. For the checkerboard pattern under discussion, the variation from black to white in scanning two adjacent elements requires a certain amount of time. This amount of time represents the duration of one complete cycle and 1 divided by this number represents the highest frequency which must be transmitted.

Let us calculate this time interval required for the beam to scan two adjacent black and white elements. Since there are 260,000 elements in a complete picture and it requires 1/30 second to transmit this picture, the time allotted to the transmission of information on two elements (1 cycle) is equal to

$$\frac{2}{260,000} \times \frac{1 \text{ second}}{30 \text{ cycle}} = \frac{1}{3,900,000} \text{ second cycle}$$

The frequency generated when the scanning beam passes over these two elements is thus equal to 3,900,000 cycles per second, or 3.9 megacycles.

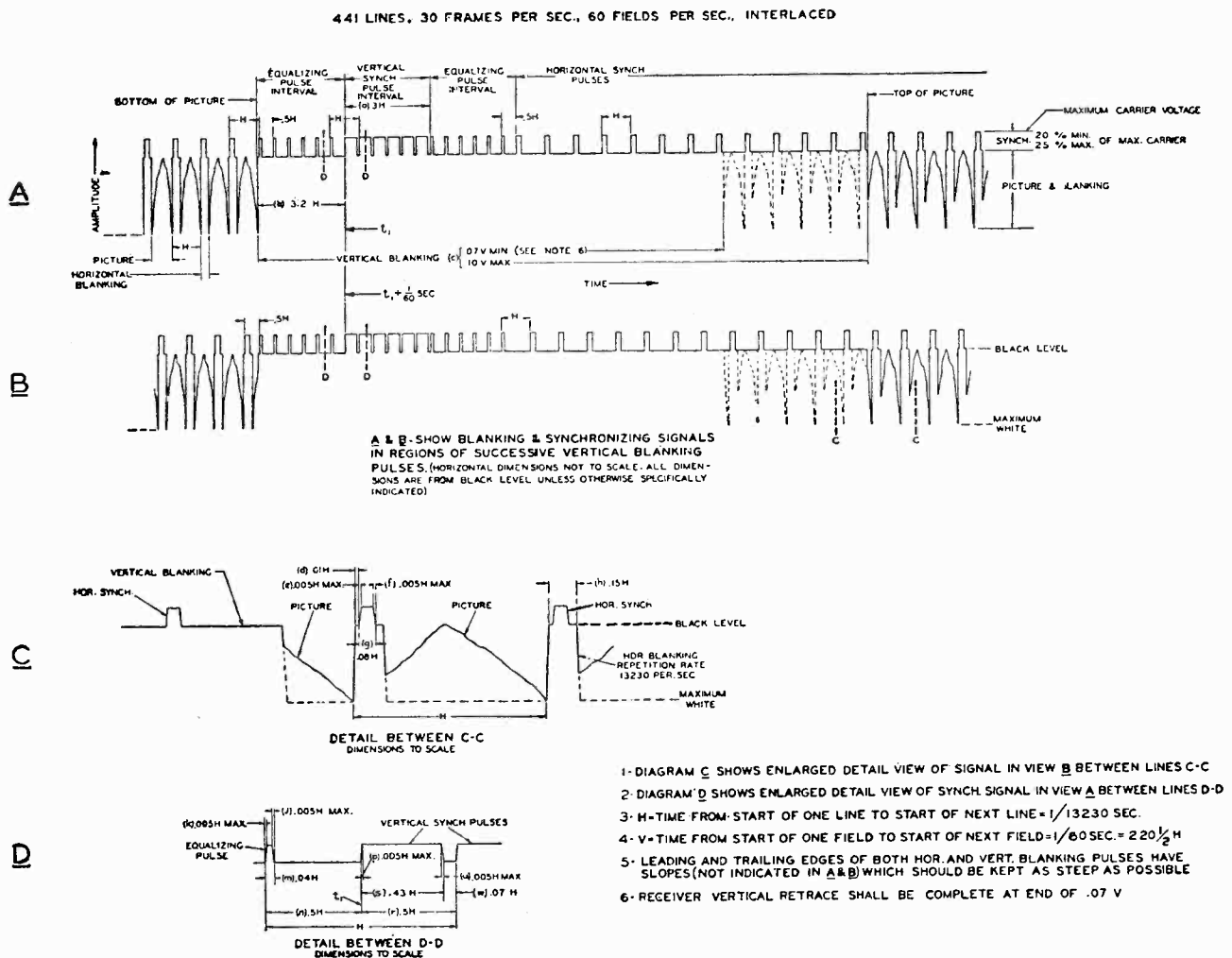

FIG. 20.—The standard RMA television signal. Diagram A shows the signal at the bottom of any one field; diagram B shows the signal at the bottom of the next field, 1/60 second later. Note the interlacing of the lines in the two successive fields shown by A and B.

As we have previously seen, the maximum frequency which is present in the video signal is related directly to the amount of detail required in the image. It has been found that for the smaller picture tubes satisfactory detail is obtained when frequency variations up to 2.5 megacycles are transmitted and that little is gained by transmitting the high frequency components produced in the scanning at the camera tube. However, where a comparatively large picture tube is used, additional detail and a finer image can be produced by transmitting frequency components ranging up to about 4 megacycles.

The Modulated Wave

In previous sections we have described the video wave produced when a scene is scanned and the modifications which are made in this wave in order to provide for both line and field synchronization. We now need to consider the make-up of the modulated wave which is produced when this video wave is arranged to modulate a high-frequency carrier.

First let us review the result of modulating a carrier with a conventional audio signal. As Fig. 21a shows, if we modulate a 1000-kc carrier with an audio signal which contains frequency components ranging up to 5 kc, then the resulting modulated wave contains, in addition to the carrier frequency, new frequencies which extend to the limits of 5 kc below the carrier frequency and 5 kc above it. In other words, the process of modulating the carrier results in the introduction of two sets of *sidebands* which extend outward from the carrier to a value equal to the highest frequency in the modulating wave. The sideband which

contains frequencies lower than the carrier frequency is called the "lower sideband," and that which contains the frequencies higher than the carrier is called the "upper sideband."

It would be impossible to use a broadcast-band carrier for television work. This can be seen from the fact that unlike sound, the video modulating frequencies would themselves be higher than the carrier frequency. In order to make the modulation process work, it is necessary that the carrier frequency be at least several times the highest frequency of modulation. For this reason the carrier frequency in television must be several times as high as the maximum video frequency, or several times 4 mc. Actually the carrier frequencies which have been chosen for television are at least ten times the highest video frequency since the lowest carrier frequency which is being used for 441-line television is 44 mc.

Some of you may recall that a few years ago, carrier frequencies only a little higher than the broadcast-band were assigned to experimental television. This merely illustrates our point, however, since those early low-definition pictures contained comparatively few elements and consequently had maximum video frequencies far below those found in present-day high-definition work (for example, 100-line picture has a top video frequency only 1/16 as high as that of a 400-line picture).

Returning to the comparison between a broadcast-band carrier modulated by a sound wave and a modulated television carrier, we show in Fig. 21b the wave which results when a 44-mc carrier is modulated with a video signal. As in the case of the 1000-kc carrier, the process of modulation introduces two sets of sidebands, and for the example shown the two sidebands extend to 4 mc below and 4 mc above the 44-mc carrier.

It is interesting to compare the bandwidth required for the transmission of a scene by television with the bandwidth required in sound broadcasting. As Fig. 21 shows, a sound broadcast requires only a 10-kc channel whereas the television channel (arranged for double-sideband modulation) requires 8000 kc or 800 times as much space as the sound channel. Although it is possible to locate approximately 100 sound channels in the broadcast band it would require more than 8 times the space provided by the entire broadcast band for the transmission of a single television channel with double-sideband modulation. The large amount of the radio spectrum required for television is one of the reasons for the choice of the ultra-high frequency range for television.

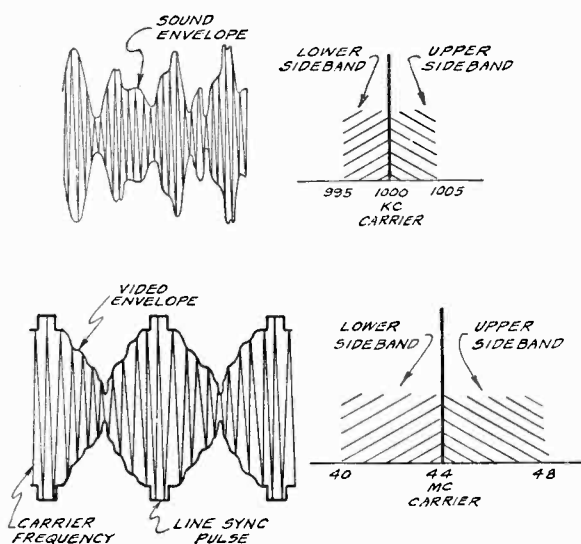

FIGS. 21a, 21b.—The sidebands in a sound signal occupy a bandwidth of only about 10 kc whereas the sidebands in a television signal require a bandwidth of about 8 mc or 8000 kc.

Positive and Negative Modulation

In discussing video signals we pointed out that the video signal is said to have a positive or negative picture polarity depending upon whether the changes from the black level take place in a positive or a negative direction, respectively. In modulation we run into somewhat similar terms—positive and negative modulation—which are related not to the polarity of the video signal but to the modulated wave itself. A television carrier is said to have positive modulation when an increase in carrier amplitude corresponds to a brighter area in the scene being scanned. Thus for a wave with *positive* modulation, the *lowest* carrier amplitude corresponds to *black* while the maximum carrier amplitude corresponds to the brightest part of the image. On the other hand, for negative modulation, a decrease in carrier amplitude corresponds to an increase in the brightness of the image. Thus for a wave with *negative* modulation, the lowest carrier amplitude corresponds to maximum white in the image and the *highest* carrier amplitude corresponds to *black*.

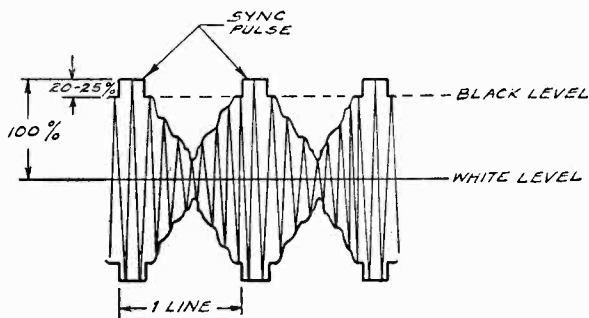

FIG. 22.—A modulated video wave. The sync pulses are located in the blacker-than-black region and occupy from 20 to 25% of the maximum carrier amplitude.

Because negative modulation offers certain advantages in improved performance and simplified receiver design, it has been recommended by the RMA as standard for this country. All television transmissions in this country therefore use negative modulation, although in England positive modulation is being used. As shown in Fig. 22, the maximum amplitude of the carrier is used for the synchronizing pulses and lies in the blacker-than-black region. The term "blacker-than-black" merely means that the sync signals have higher amplitude than black picture signals. It has been found that reliable synchronization can be secured so long as the amplitude of the synchronizing pulses is from 20 to 25 percent of the maximum carrier amplitude; this recommendation is also part of the RMA standards. Actually, then, not more than 80% of the total carrier amplitude is available for

transmitting information on the light values in the scene, the rest of the wave being used for synchronization.

Channel Make-up

The standard RMA television channel is laid out so that the complete video signal and its accompanying sound signal can be transmitted as close together as possible, thus making for a compact channel which takes up a minimum amount of space in the radio spectrum. As shown in Fig. 23, the complete channel is 6 mc wide and the video carrier is placed 1.25 mc from the low-frequency end of the channel. The sound is transmitted on a separate carrier which is located 4.5 mc higher than the video carrier or 0.25 mc from the upper end of the band.

In order to use the minimum possible channel width, the major part of the lower sideband is *suppressed* and only the portion shown is transmitted. In this type of transmission, which is known as "vestigial sideband transmission," the transmission is essentially double-sideband for the *low* modulating frequencies (up to approximately 1.25 mc) and then becomes single-sideband for the higher modulating frequencies (above approximately 1.25 mc). This tends of course to overemphasize the *lower* frequencies (since they receive contributions from both the partially suppressed lower sideband and the upper sideband). Such overemphasis is avoided by designing the selectivity of the receiver to attenuate the carrier and the lower (double-sideband) frequencies. The difference between the transmitter selectivity curve and the receiver selectivity curve is shown by the dotted line in Fig. 23.

The advantage of this type of transmission is that it reduces the channel width required for a given maximum amount of detail in the image. We might mention here that earlier RMA proposed standards called for a double-sideband transmission which—although using the same 6-mc channel—made it possible to transmit video frequencies up to only 2.5 mc because both sidebands (occupying a 5-mc total bandwidth) were transmitted.

It is interesting to note the relatively small part of

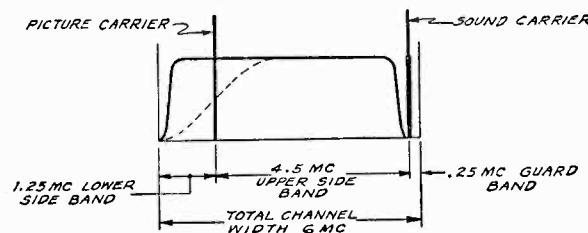

FIG. 23.—Make-up of the standard RMA television channel, showing the position of the picture and sound channels. The dotted line shows the receiver selectivity characteristic.

the total channel width occupied by the sound carrier. Even assuming that radio frequencies up to a maximum of 10 kilocycles are transmitted, this would make the total bandwidth (including both upper and lower sidebands) equal to 20 kc or 0.02 mc. It is thus apparent that the guard band of 0.25 mc is more than enough to prevent the sound modulation from spreading into the next channel. In practice, to take care of oscillator drift, the sound-carrier bandwidth is often about 100 kc.

Frequencies Assigned to Television

The Federal Communications Commission has assigned a total of nineteen channels for television transmissions, each of these channels being 6 mc wide in accordance with the description in the preceding sections. The distribution of these channels is noted in

FIG. 24 <i>Channels Assigned to Television</i>		
44-50 MC	156-162 MC	234-240 MC
50-56	162-168	240-246
66-72	180-186	258-264
78-84	186-192	264-270
84-90	204-210	282-288
96-102	210-216	288-294
102-108		

Fig. 24; seven of the channels are located between 44 mc and 108 mc; the remaining 12 lie between 156 and 294 mc. At present, only the lower-frequency channels are in use, but it is expected that the higher-

frequency channels will be employed as television services expand.

For a number of reasons the ultra-high frequency bands are the most logical choice for television. In the first place, a relatively high-frequency carrier is required to accommodate the wide sidebands. Even if this requirement did not prevent the use of lower frequencies it would still not be feasible to use the lower radio frequencies because these are practically all in use already for other services. The ultra-short waves used for television have the advantage that the waves are not usually reflected by the ionosphere so that multiple signals and fading from this source are eliminated. This is desirable because the time difference in the reception of the direct image and each of the multiple reflected images causes a displaced "ghost" pattern to appear on the screen of the picture tube. The absence of *natural* static is another important feature in making the frequencies above 40 megacycles suitable for television work.

The fact that ultra-short waves travel essentially in straight lines and so do not follow the curvature of the earth limits the effective radius of a television station to a "horizon" which depends upon the height of the transmitting and receiving antennas. In the case of the transmitter atop the Empire State Building in New York City (about 1250 feet above street level) the expected range for reliable reception is about 40-45 miles. Although this is a disadvantage in that the coverage of any one station is limited, there is the slight compensating advantage that the same frequencies can be reassigned in various sections of the country which have a reasonable geographical separation.

RECEIVER CIRCUITS: GENERAL

Having examined the fundamental principles of television, let us now investigate the operation of receiver circuits. These circuits are especially important because primarily the work of servicemen in the field deals with the installation and maintenance of receivers. In order to show the interrelationship between the many components that make up a receiver, we shall first break down the receiver into its major sections and later consider the functioning of these in more detail.

Fig. 25 shows a block diagram of a typical television receiver, this being arranged to show the general character of the signal and the function performed by each section. For convenience we shall assume that the receiver is tuned to the 44-50 mc channel. In accordance with the preceding description, this means

that the frequency of the video carrier is 45.25 mc (1.25 mc above the low-frequency end of the channel) whereas the frequency of the audio carrier is 49.75 mc (0.25 mc below the high-frequency end of the channel).

Both these signals, together with their sidebands, are picked up by the antenna and fed through a transmission line to the input of the r-f amplifier. Essentially the function of the r-f amplifier is the same as that of the r-f amplifier in any superheterodyne receiver—to amplify the signal and to reject unwanted signals in adjacent and other channels. In this case, the r-f amplifier is broadly tuned so that both the video and sound carriers, which are separated by 4.5 mc, are amplified equally.

After being amplified in the r-f amplifier, both sig-

nals are fed to the *first detector* circuit where the conversion of the signals to the intermediate frequencies takes place. Since there are two radio frequencies, it of course follows that two separate intermediate frequencies are produced.

In accordance with a proposed RMA standard, and general present practice, the oscillator operates at a frequency *12.75 mc above the video carrier frequency*. For the channel being received, the frequency of the oscillator in the receiver is thus equal to $45.25 \text{ mc} + 12.75 \text{ mc}$, or 58 mc . Since the oscillator frequency is 12.75 mc above the video carrier frequency, it follows at once that the video intermediate frequency produced is equal to 12.75 mc . In the same way, the intermediate frequency of the sound signal is equal to the difference between the oscillator frequency and the sound carrier frequency, $58 \text{ mc} - 49.75 \text{ mc}$, or 8.25 mc .

Following the first detector, the sound channel is entirely independent of the rest of the receiver and in practically every detail is similar to a conventional broadcast receiver. Thus the 8.25-mc sound i-f signal passes through the sound i-f amplifier (the selectivity of which is broader than usual to minimize the effects of oscillator drift, as mentioned above) and is demodulated at the sound second detector. The avc voltage is supplied in the usual manner to control the gain of the stages in the sound i-f amplifier. The design of the audio amplifier and the reproducer is also conventional so that no further comment is required.

Returning to the video signal, we have seen that a 12.75-mc i-f signal is produced by the first detector and that this signal carries the video modulation. As the diagram shows, this signal is amplified in the *video i-f amplifier*, which usually consists of several stages, and finally reaches the *video second detector* where

the signal is demodulated. The video signal recovered at this point is essentially the same as the output of the camera tube so that it contains all the information required to reproduce the picture, and in addition, includes the blanking and sync pulses. The video second detector is followed by the *video amplifier* which in terms of a sound receiver, corresponds to the audio amplifier. The function of the video amplifier is to amplify the video signal so that its amplitude will be great enough to "swing" the modulation grid of the picture tube. For the average picture tube this requires approximately 25 volts, peak-to-peak.

Note in the diagram that the polarity of the video signal is reversed 180 degrees for a single stage of video amplification and that the receiver is arranged so that the signal which reaches the control grid of the picture tube has a positive polarity. As a result the synchronizing impulses appear in the blacker-than-black (highly negative grid-bias) part of the picture-tube characteristic so that the beam is blocked during the retrace part of the line and field sweeps.

In addition to supplying the video signal and the signal which actuates the avc system, the second detector supplies the video signal to the *synchronizing separator*. The purpose of this separator is to remove the picture component from the complete video signal, and then to separate the horizontal sync pulses from the vertical sync pulses. As is shown, the horizontal sync pulses are arranged to control the timing of the horizontal deflection circuit, while the vertical sync pulses are arranged to control the timing of the vertical deflection circuit.

The power supply is not shown in the block diagram. As a general rule, a single low-voltage power supply is used to take care of all voltage requirements throughout the receiver with the exception of the high-

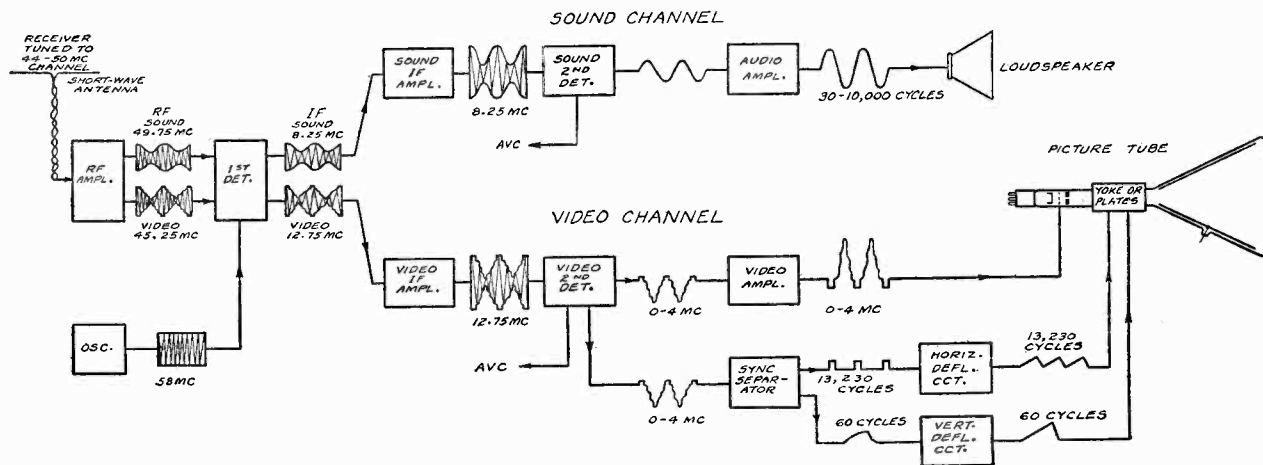

FIG. 25.—A block diagram of a typical television receiver showing the principal sections of which it is composed. Note the changes in the signal as it passes through the receiver.

voltage requirements for the picture tube. The latter, which may include voltages as high as 9000 volts, is

supplied by a separate high-voltage power supply which has its own transformer, rectifier and filter.

RECEIVER CIRCUITS: DETAILS

The serviceman who examines a television receiver schematic for the first time is likely to be discouraged. Considering the size of the schematic, the large number of components, and the newness of many of the circuits, this is not at all surprising. Even the man who understands the basic ideas associated with television may find himself unable to understand immediately the operation of some of the circuits. Fortunately, however, the circuits are not actually as complicated as they appear on first sight. What is really required is an explanation of how the basic principles of radio have been applied in television receivers. With this explanation as a guide and with the aid of experience, the serviceman will find that the apparently complex television receiver schematic will begin to look more like an old friend.

We can best explain the circuits being used in television receivers by breaking down the complete receiver circuit into separate sections and considering the function and operation of each section separately. By this means we can for the time being eliminate the complications introduced by the related parts of the circuits and also eliminate unessential detail which tends to obscure the operation of the circuit. Since without exception all television receivers in this country are of the superheterodyne type, the divisions which will be followed are those characteristic of superheterodyne receivers.

R-F Circuits

The action in a receiver circuit can well be considered as beginning at the antenna, for it is at this point that the signal enters the receiver. Since we shall consider antennas in more detail under the head of "Antennas and Installation," for the present it is sufficient to note that the function of the antenna is to provide the maximum signal pickup with a minimum of noise. To do this, the antenna must be located as high and as far away from sources of man-made noise as possible and placed for maximum pickup. The signal is fed from the antenna to the receiver input by means of a transmission line.

Since the complete television signal consists of a band of frequencies extending over a 6-mc channel, it is clear that the antenna and transmission line must be broad enough to pass the 6-mc band. A sharply tuned antenna system is undesirable because it discriminates against the different frequencies present in the signal and as a result produces distortion.

The characteristics of the r-f circuits in television receivers are the same as for ordinary broadcast receivers. As in any superheterodyne receiver, the function of the r-f circuits is to select and amplify the wanted signals and to reject all other signals. As a general rule, most television receivers do not use an r-f stage but rely on the selectivity of the tuned circuit which feeds the signal from the transmission line to the mixer input to provide the required selectivity and image rejection. In some receivers, however, an r-f stage is provided so that additional gain, selectivity and a higher signal-to-noise ratio are obtained.

In most cases you will observe that the r-f tuned circuits as well as tuned circuits in the i-f amplifier are shunted by resistors of comparatively low value. The function of these resistors is to damp the circuits so that sideband cutting will not take place and so that the complete television signal will be passed. Although these resistors lower the gain, this reduction in gain must be tolerated in order to broaden the circuits sufficiently.

Without exception all commercial receivers use push-button or switch-controlled tuning rather than conventional continuous tuning with a large variable condenser. This is feasible because the short-wave channels which have been assigned for television are limited in number and do not require continuous coverage as is the case, for instance, in the broadcast band. At the present time the lower channels are most in use and will probably be the only ones in use for some time.

As a general rule, a small vernier condenser is provided to permit a fine adjustment of the tuning. This condenser is placed across the oscillator tuned circuit and compensates for drift in the trimmers and other effects which tend to change the oscillator frequency. No external tuning adjustments are required for the r-f circuits since these are not critical of adjustment.

Oscillator Circuits

As has been previously pointed out, the oscillator in a television receiver beats with both the sound and video carriers of the signal to form two separate intermediate-frequency signals: the video i.f. and the sound i.f. According to present standards, the oscillator frequency for any given channel is 14 mc above the low-frequency end of the channel, which in turn makes it 12.75 mc above the video carrier and 8.25 mc above the audio carrier. As a result, the frequency of the

signals produced by heterodyning with the oscillator signal is 12.75 mc for the video i.f. and 8.25 mc for the sound i.f.

Combination oscillator and mixer tubes are not satisfactory for the comparatively high frequencies at which the oscillator must operate, because of low conversion gain and because these tubes do not oscillate readily at the high frequencies required. For these reasons a separate tube is generally used for the oscillator circuit. The type 6J5 tube is more widely used than any other tube because of its high mutual conductance, low capacitance, and because it oscillates readily at frequencies up to 120 megacycles.

In the design of oscillator circuits much attention is given to the problem of minimizing frequency drift. Because of the high frequencies at which the oscillator operates, a comparatively small percentage change in the oscillator frequency, such as might be caused by drift, has the effect of spoiling the picture and causing the sound i.f. to drift out of the range of the sound i-f channel. Although the effect of oscillator drift is minimized because of the comparatively high intermediate frequencies, the problem of oscillator stability and freedom from drift is an important one. In commercial receivers, drift is minimized through proper circuit design and by the use of coils and condensers which are independent of changes in temperature and humidity.

Mixer

As has previously been pointed out, combination oscillator-mixer tubes such as are satisfactory at lower frequencies are not satisfactory at frequencies above 40 mc. It is general practice to use one of the new high mutual conductance tubes in the mixer circuit, such as the type 1852. The 1852 is especially adapted for frequency conversion and provides high conversion efficiency. For proper mixer operation, it is essential that the output of the separate heterodyning oscillator be coupled to the mixer tube and that the mixer receive approximately the same value of voltage from the oscillator on all bands.

Typical R-F, Oscillator, and Mixer Circuits

Belmont Model X-466

The circuit shown in Fig. 26 is that of the high-frequency section of the Belmont Model X-466 receiver. This receiver does not use an r-f stage but the signal is coupled directly to the grid of the 1851 mixer tube through a double-tuned closely coupled band-pass circuit. This bandpass circuit provides the required selectivity without sacrifice in gain. Five of the assigned television channels are covered, beginning

with the 44-50 mc channel, the highest channel being the 84-90 mc channel. The three highest-frequency channels are shunted by resistors having a value between 1000 and 2000 ohms in order to obtain the required pass band. These resistors do not have the loading effect that might be expected offhand, since the loading of the input resistance of the tube is itself of the order of 1000 ohms. In addition to improving the gain and selectivity of the input circuits, the tuned primary windings of the input transformers aid in proper matching of the transmission line and in eliminating reflections. These reflections are undesirable because they tend to produce more than one image on the screen of the picture tube.

The oscillator circuit, which uses a 6J5 tube, is conventional in design, with the tank circuit located in the grid circuit. Note the comparatively small value of grid condenser—25 mmf. The major portion of the total capacitance in the tank circuit of the oscillator is selected by means of the 5-position switch which is of course ganged with the r-f selector switch. A small vernier tuning condenser across the grid coil provides an adjustment which compensates for small variations due to oscillator drift. This control appears on the panel and is designated as the tuning control.

A type 1851 tube is used as the mixer tube. This is a pentode having a high mutual conductance, and is similar to the 1852 but has the grid cap on the top. It is used in preference to a 6J7 because it provides higher gain and a higher signal-to-noise ratio.

There is no direct coupling connection between the oscillator circuit and the mixer; the required coupling is provided inductively by placing the oscillator coil close to the mixer input coil.

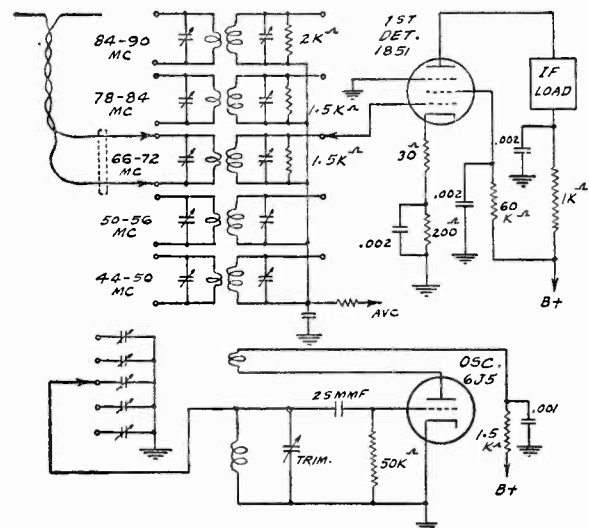

FIG. 26.—The high-frequency section of the Belmont Model X-466 receiver. The signal from the oscillator coil is inductively coupled to the mixer input coil.

DuMont Models 180-183

The DuMont Models 180-183 use a tuned r-f stage preceding the mixer stage, as shown in Fig. 27. In this receiver the transmission line feeds directly into an untuned primary winding which is the same for all four channels. The secondary winding is tuned by one of the four trimmers, depending upon the channel selected. The secondary winding is loaded on all bands by the 3000-ohm shunt resistor which is required to obtain the necessary 6-mc pass band; on one of the bands, an additional shunt resistor of 10,000 ohms is provided.

The signal voltage developed across the secondary tuned circuit is fed to the grid of the 1853 tube used as the r-f tube. Note the small values of capacity—600 mmf—used for the cathode and screen bypasses. These condensers although they seem small in capacitance provide the same relative bypassing action at 50 mc as would be provided by a .06-mf condenser at 500 kc. The tuned circuit used in the grid of the mixer tube is similar to that used in the input circuit of the r-f tube. The r-f tube receives its plate voltage through the 3000-ohm resistor. This resistor, as far as r.f. is concerned, is effectively shunted across the coil in the mixer tube grid circuit, and thus provides the damping necessary to broaden the selectivity. Note that this type of circuit is not used at lower frequencies, such as the broadcast band, because the values of tuned-circuit impedance are much larger at the lower frequencies, and to attempt to use a high value of resistance would introduce a large voltage drop. For this reason, transformers are generally used at the lower radio frequencies rather than the resistive-tuned circuit coupling arrangement shown in Fig. 27.

The oscillator circuit used here is a conventional Hartley oscillator with the feedback obtained by re-

turning the cathode to a tap on the coil. Vernier tuning for each one of the four channels is provided by the small condenser C which appears on the panel as the tuning control. The oscillator coil and the mixer input coil are close to each other so that the oscillator voltage is coupled to the mixer magnetically.

I-F Circuits

As a result of the action in the mixer circuit, we have seen that two intermediate frequencies are produced and that one of these—the video i.f.—carries the picture signal, while the other one—the sound i.f.—carries the sound signal. As in the conventional superheterodyne receiver, it is necessary to amplify both of these i-f signals before they are finally demodulated in the second detectors. These functions are performed by the video i-f and the sound i-f amplifiers. In this section we shall discuss the design of i-f circuits for television receivers and illustrate the principles with circuits taken from typical receivers on the market at the present time.

Signal Output of Mixer

The frequencies which must be handled by the two i-f amplifiers are illustrated in Fig. 28. Let us assume that a signal in the 44-50 mc channel is being received. In this channel, the video carrier is at 45.25 mc and the sound carrier is at 49.75 mc; the local oscillator frequency, which is 14 mc above the low-frequency end of the channel, is therefore at 58 mc ($44 + 14$). As a result of beating with the oscillator, the video i-f signal at 12.75 mc ($58 - 45.25$) and the sound i-f signal at 8.25 mc ($58 - 49.75$) are produced. It is important to note, as the figure shows, that whereas the video r-f carrier is lower in frequency than the sound r-f carrier,

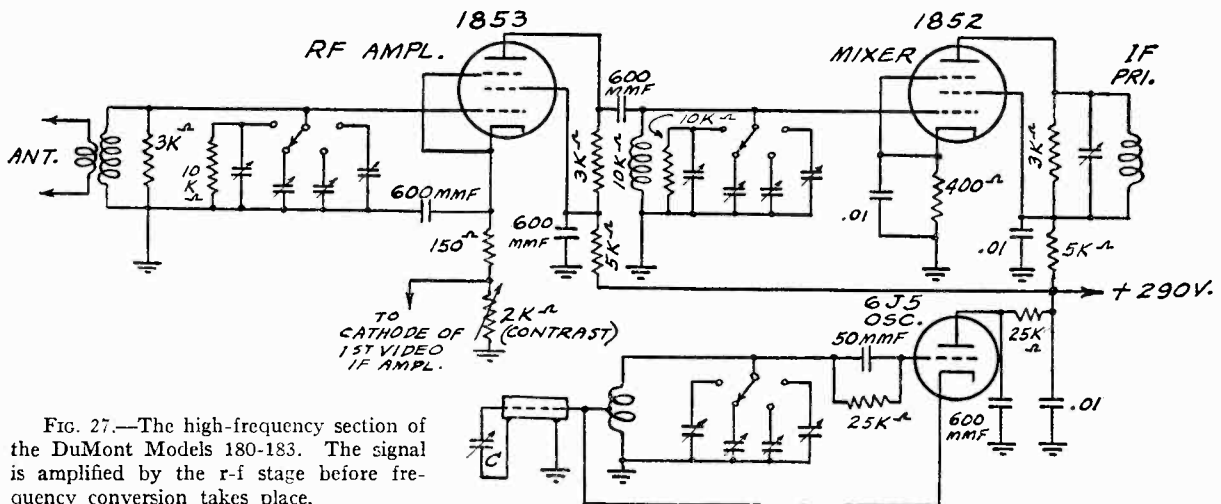

FIG. 27.—The high-frequency section of the DuMont Models 180-183. The signal is amplified by the r-f stage before frequency conversion takes place.

the video i.f. is higher in frequency than the sound i.f. However, the relative placement of the various components of the complete signal is the same in the i-f signal as in the r-f signal. Thus the frequency separation between the two carriers is constant at 4.5 mc in both cases as is also the separation from the two ends of the channel.

The intermediate frequencies used in television receivers have a number of desirable qualities which are the result of careful planning by television engineers.

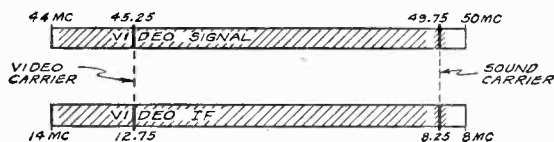

FIG. 28.—The upper part of this figure shows the make-up of a video signal in the 44-50 mc band. The lower part shows that the same frequency separation of the components of the signal is maintained in the i-f signal as in the r-f signal.

Thus the frequencies are high enough to give good image rejection; this is especially important because many receivers do not use an r-f stage. At the same time, the video i.f. is high enough so that there is sufficient space for the sidebands and the sound i.f. is high enough so that the sound selectivity is not too sharp. The effect of too sharp selectivity in the sound i-f amplifier is to make tuning critical, to exaggerate the effect of the slightest drift in the oscillator frequency and to prevent adjustment for the best picture detail without losing the sound signal.

Like any other superheterodyne, television receivers are subject to interference due to pickup by the antenna of frequencies within the range of the i-f amplifier. In the case of broadcast receivers, such interference shows itself in the form of squeals, code signals, and general distortion. Similarly, in the case of television receivers such pickup may distort either the picture, the sound, or both, depending upon the frequency of the interference. The range of intermediate frequencies between 8 and 14 mc has been especially chosen to minimize i-f interference; the fact that the amateur bands lie outside of this range is of considerable assistance in this respect.

Sound I-F Channel

It is the function of the sound i-f amplifier to separate the sound component of the i-f signal from the video component and to amplify this signal before it is demodulated at the sound second detector. Because of the comparatively high frequencies involved, however, the design of a television sound i-f amplifier is somewhat more difficult than that of the conventional i-f amplifier in a radio receiver. Thus there is a

greater tendency toward regeneration and more attention must be paid to stray wiring and tube capacitance.

The bandwidth which must be passed is comparatively small and does not present the same problem as does the video i-f amplifier. Actually, of course, a bandwidth of from 10 to 20 kc is sufficient to transmit all the frequencies present in the audio signal. However, in practice, the bandwidth of the sound i-f amplifier is made approximately 100 kc. Primarily this larger bandwidth is necessary to allow for normal drift in the frequency of the oscillator. The significance of this is that if the bandwidth of the sound i-f amplifier were held to 10 kc, then a change of 10 kc in the oscillator frequency would cause the sound signal to drift completely out of the range of the sound i-f amplifier. However, a change of 10 kc, in an oscillator operating at a frequency of the order of 60,000 kc and up, represents a frequency drift in the oscillator of only one part in 6000, whereas in practice it is not possible to design receiver oscillators which will have a reliable frequency stability of better than one part in 1000. Therefore, instead of resorting to voltage regulation and expensive design to prevent oscillator drift, the bandwidth of the sound i-f amplifier is intentionally made about ten times as great as that required for the sound modulation, thus allowing for reasonable drift in the oscillator. Assuming that the receiver is initially tuned to the center of the sound i-f amplifier, a drift in the oscillator frequency as high as 25 kc will not cause any appreciable change in the quality of the audio signal. This is illustrated in Fig. 29, which shows that the effect of a change in the frequency of the oscillator is merely to shift the location of the sound signal within the band passed by the sound i-f amplifier.

Although the bandwidth of approximately 100 kc is sufficiently great to compensate for normal oscillator drift, this bandwidth is still small enough so that the receiver can be tuned by listening to the sound accompanying the picture. At the same time there is enough latitude so that the tuning can be varied slightly in

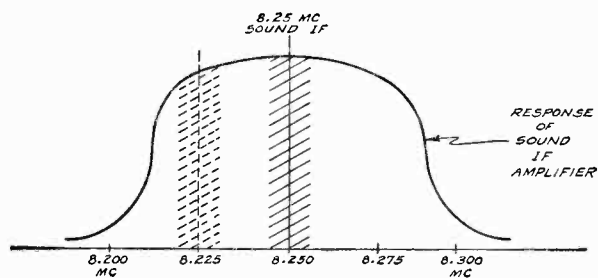

FIG. 29.—The frequency response of a typical sound i-f amplifier. The dotted signal shows that the sound signal can be detuned appreciably without falling outside the pass band of the amplifier.

order to improve the detail of the picture without losing the accompanying sound signal. Although we shall see later that a special type of AVC circuit is required in the video i-f amplifier, the AVC circuits used in the sound i-f amplifier are conventional.

Sound I-F Amplifiers in RCA and Westinghouse Receivers

The circuit of the sound i-f amplifier used in the RCA Models TRK-9 and TRK-12 is shown in Fig. 30; these receivers are also used in the Westinghouse Models WRT-702 and WRT-703. The tuned circuit L18-C19 is part of the load circuit of the mixer tube and is tuned to 8.25 mc so that the sound i-f signal is developed across this tuned circuit. This signal is fed to the grid of the first sound i-f tube, a 6SK7, which is similar to the 6K7 with the exception that the control grid is terminated at one of the base pins so there is no top cap. A double-tuned interstage transformer is used to feed the second sound i-f stage, which employs an 1853 tube. Because the gain obtainable with this tube is approximately twice that which can be obtained with an ordinary r-f pentode, no further amplification is required and the output of the 1853 feeds directly into the 6H6 second detector. The circuit beyond the second detector is not shown but this is a conventional high-quality audio system and requires no comment.

The i-f transformers in this circuit are especially designed so as to provide an overall selectivity of approximately 100 kc. The 68,000-ohm resistor shunting the primary winding of the last i-f transformer loads this circuit so as to aid in obtaining the proper response.

The AVC circuit is similar to one which has been extensively used in other RCA receivers. This circuit has been described in detail in the book "An Hour a

Day with Rider on AVC." Briefly, one of the diodes is used as the second detector and AVC tube, while the second diode of the 6H6 provides a delayed AVC action and permits the minimum bias of approximately -2 volts to be fed to the grids through the AVC bus. Both i-f tubes are controlled by the AVC circuit.

Because of the high frequencies being amplified and the low shunt capacitances across the tuned circuits, it is important that there be no change in the effective tube capacitances to cause detuning to take place as the AVC bias changes in accordance with the strength of the incoming signal. This effect, ordinarily not important in broadcast receivers, is avoided in this receiver by using *unbypassed* cathode resistors. The negative feedback introduced by these resistors tends to keep the tube input capacitance constant and independent of the voltage on the control grid.

Video I-F Circuits

The design of the video i-f amplifier is more complicated than that of the sound i-f amplifier because of the wide band of frequencies which the video i-f amplifier must pass. Thus the video i-f amplifier often must handle frequencies extending from approximately 8.7 mc to 14.0 mc, a range of over 5 mc. Not only must the amplifier have an almost flat response over this range, but at the same time it must reject interfering signals close to the edges of the pass band.

The use of the so-called vestigial sideband transmission, in which all of one sideband and a small portion of the other sideband are transmitted, makes it necessary for the selectivity of the i-f amplifier to depart from the uniform selectivity which might at first be expected. To avoid overemphasis of the lower video frequencies, which receive contributions from both the upper and lower sidebands, the selectivity of the i-f

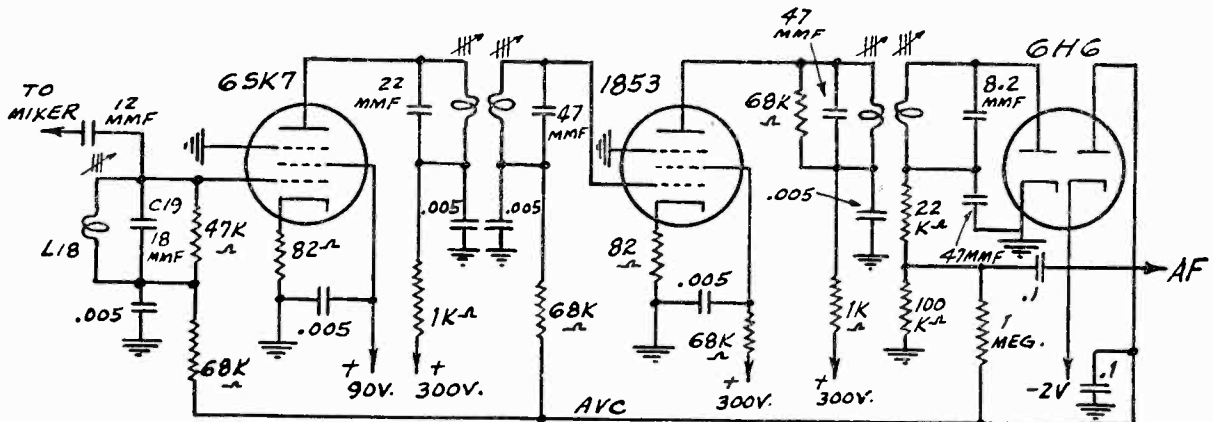

FIG. 30.—The sound i-f amplifier used in the RCA Models TRK-9 and TRK-12. The transformers are designed so that the overall bandwidth of the amplifier is approximately 100 kc.

amplifier is designed to have a sloping characteristic in the neighborhood of the video i-f carrier at 12.75 mc. This is illustrated in Fig. 31 which shows a typical *overall* selectivity curve for a video i-f amplifier.

The amplification which the i-f carrier receives is only 50% of the maximum amplification received by the upper sidebands and the lower sidebands, which are only partially transmitted, also do not receive the full amplification. In this way overemphasis of the lower video frequencies is avoided by shaping the overall selectivity so that the contribution of the lower sideband plus the contribution of the upper sideband is equal to the gain for the higher video frequencies. Since the upper video frequencies receive contributions only from the one sideband, the selectivity, as Fig. 31 shows, is such that the full gain is received by these frequencies.

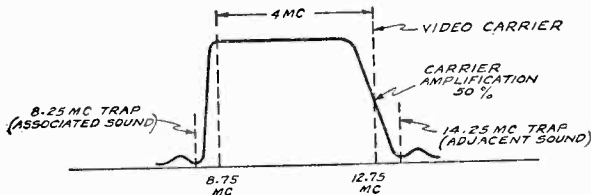

FIG. 31.—The overall frequency response of a typical video i-f amplifier. Note that the carrier receives only 50% of the maximum amplification.

If video frequencies up to a maximum of 4 megacycles are to be received, which is usual for the higher-priced sets using large picture tubes, then the i-f amplifier should cut off at about 8.75 mc ($12.75 - 4.0$). Since the sound i-f carrier is located close by, at 8.25 mc, it is necessary that this cutoff be sharp in order to prevent the sound carrier and its sidebands from causing interference with the video signal. In practice this rejection of the sound carrier is secured by the use of rejection or trap circuits which generally are part of the video i-f coupling transformers.

In addition to rejecting the sound i-f carrier of the *associated* channel at 8.25 mc, it is desirable that the i-f amplifier have a sharp cutoff at the high-frequency end of the band. This is required in order to prevent the sound signal on the *lower adjacent* television channel from getting through the video amplifier. Because of the reversal of high and low frequencies which takes place in the mixer, the sound carrier of the lower adjacent channel will beat with the oscillator and cause an interfering signal which is located 0.25 mc above the edge of the channel, at 14.25 mc. These frequency relationships just described are shown in Fig. 32. A trap of the same general type as that used to reject the 8.25 mc carrier is used to reject possible interference from the adjacent sound carrier at 14.25 mc.

The maximum gain which can be obtained in a video i-f stage is considerably lower than that in an ordinary broadcast i-f stage because of the wide band of frequencies which must be passed and because of the high carrier frequency. This is true even where high mutual conductance tubes of the 1851 series are used, so that it is not unusual for as many as five separate stages to be used in the video i-f amplifier.

The transformer design is especially complicated in video i-f amplifiers because of the wide pass band of from 2.5 to 4.0 mc which must be obtained. To obtain close coupling so as to increase the pass band, direct coupling of the primary and secondary windings by means of a common inductance is often used. Loading of the tuned circuits with resistors so as to broaden the circuits is very common and will be found in practically all the circuits. Video i-f transformers are further complicated because the rejector circuits for the associated and adjacent sound channels are often an integral part of the interstage coupling transformers. Because of the comparatively high frequencies, the only capacitance used to tune the circuits is often that of the wiring and tube capacitance so that no condenser as such appears on the schematic. Nevertheless this capacitance forms a resonant circuit with the related windings of the transformer and should be taken into consideration. Since the wiring capacitance is an important part of the total circuit capacitance, it is important that no changes be made in the wiring when servicing is required.

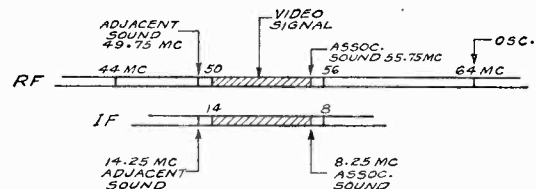

FIG. 32.—The sound signal of the associated channel at 8.25 mc and the sound signal of the adjacent channel at 14.25 mc are both close to the edges of the video band. Traps are provided to prevent interference from these signals.

AVC is often used in video i-f amplifiers, but as will be explained later under "AVC Circuits," the manner in which the AVC voltage is produced differs from that in radio receivers and in the sound i-f amplifier.

Video I-F in Andrea Model 1F5

In the Andrea Model 1F5 receiver, shown in Fig. 33, the video i-f amplifier employs two stages of amplification both of which use type 1852 tubes. In order to separate the sound i-f part of the signal from the video part, a separate secondary circuit L2-C2 is tuned to 8.25 mc so that the sound i-f signal appears across this circuit. The sound i-f signal is fed directly to

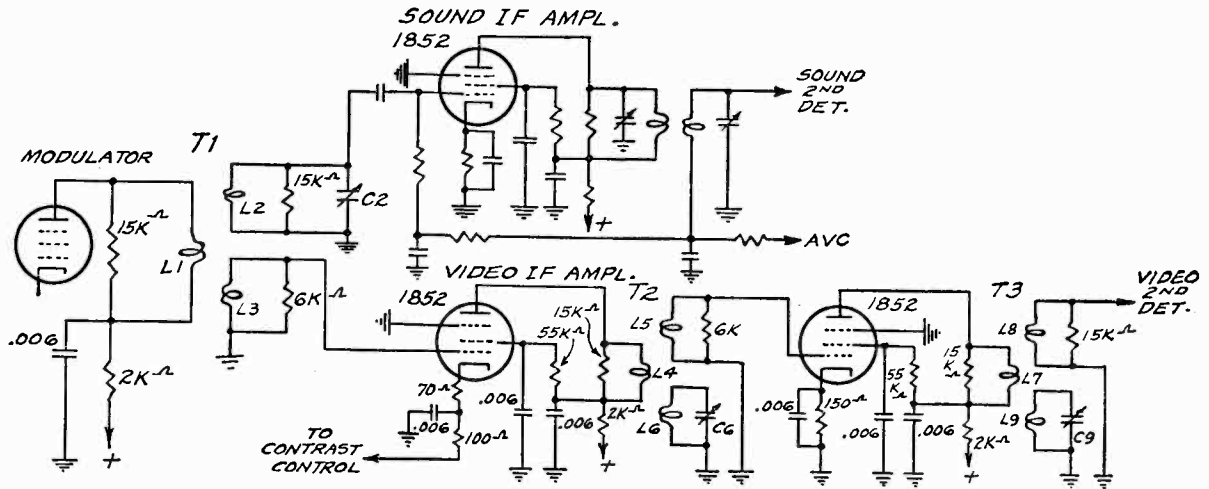

FIG. 33.—The video and sound i-f amplifiers in the Andrea Model 1F5 receiver.

the sound i-f channel which is conventional and requires no further comment.

The video component of the i-f signal is developed across L3. No trimmer condenser is used on this winding and the circuit is heavily loaded by the 6000-ohm resistor in order to pass the required band of frequencies. The video signal is applied directly to the grid of the type 1852 tube used in the first i-f stage. To obtain negative feedback and the increased stability which it makes possible, an unbypassed 70-ohm resistor is placed in the cathode circuit. The other end of this resistor is connected to a variable resistor—the “contrast control”—by means of which the gain of the i-f stage is controlled. Since no AVC is used, the control grid is returned directly to ground. The band of frequencies passed by this amplifier is approximately 2.5 mc; this pass band is generally considered to provide sufficient detail for the small picture tube used with this receiver.

The signal is coupled to the grid of the second i-f tube by means of the transformer T2. The windings L4 and L5 of this transformer function as the primary and secondary windings of the interstage transformer and are loaded by means of the 15,000-ohm resistor across the primary and the 6000-ohm resistor across the secondary. The only capacitance used to tune these windings is the tube and circuit capacitance.

The third winding L6 is tuned to 14.25 mc by means of the trimmer C6 and eliminates possible interference from the sound carrier of the lower adjacent television channel, as was previously shown in Fig. 32. This circuit acts as a trap by absorbing all the energy in the neighborhood of 14.25 mc so that it is not passed on to the grid of the following tube.

The second i-f stage feeds directly into the video i-f

second detector through the transformer T3 which is similar to T2. The circuit L9-C9 is likewise tuned to 14.25 mc so that it acts as a trap circuit for this frequency.

No AVC is used in the video i-f amplifier in this receiver and accordingly the grids of the two i-f tubes are returned directly to ground. The gain is controlled by means of the “contrast control” which varies the bias of both the first i-f stage and the first detector stage.

Video I-F Amplifier in the RCA Model TRK-12

The partial schematic in Fig. 34 shows the video i-f amplifier used in the RCA Model TRK-12 receiver, which is also used in the Westinghouse Model WRT-703. In contrast to the video i-f amplifier described above, this amplifier is designed so as to obtain a pass band of approximately 4 mc. As a result of the higher modulating frequencies which are passed, the detail in the image is increased correspondingly. A large 12-inch picture tube is used with this receiver; this permits finer detail, so that it utilizes the additional detail which the wide response of this more elaborate amplifier provides.

Unfortunately it is not possible to increase the pass band of the i-f amplifier without decreasing the gain obtained in each stage. As a consequence of this it is necessary to use a larger number of stages in the i-f amplifier; five stages are used in the receiver being described. In addition to the large number of stages required, the complexity of the coupling transformers is increased both as a consequence of the larger bandwidth and the fact that the trap circuits must be more effective. Thus the frequencies accepted by the i-f

amplifier are very close to the sound carrier so that the rejection must be more nearly perfect than in the case of a video i-f amplifier which passes a smaller band.

The transformers used in this receiver can be broken down into three basic elements which are shown in Fig. 35: the primary winding L1, the coupling winding L3 and the secondary winding L2. Inductive coupling between the primary and secondary is not used, but instead the primary and secondary are coupled directly by means of the inductance L3 which is common to both circuits. The primary circuit is resonated by C1 near one end of the pass band, whereas the secondary circuit is resonated by C2 near the opposite end of the band. R1 and R2 are loading resistors used to broaden the response.

Although the i-f transformers in the RCA TRK-12 use the relatively simple basic design shown above, the circuits are further complicated because of the blocking condenser required to keep the plate voltage off the grid and because of the presence of the trap circuit. The condensers C1 and C2 do not appear as such in the schematic because they are represented by the plate-to-ground and grid-to-ground capacitances, which include the stray wiring capacitances in addition to the tube capacitances.

Referring again to Fig. 34, let us consider the several transformers separately. The first-detector transformer assembly is more complicated than the others because the sound i-f signal is present at this point, and must be separated from the video i-f signal. This separation is accomplished by means of the circuit L18-C19 which is resonated to 8.25 mc, the sound i-f. The sound i-f signal is coupled to this circuit by means of the 12-mmf condenser C24; the resistor R10 is used to broaden the selectivity of the sound i-f channel.

With respect to the video section of this transformer, L17 and L20 are the primary and secondary windings which are tuned by the plate and grid capacitances as explained in connection with Fig. 35. These circuits are coupled to each other by the common coupling

condenser C23. A trap circuit is made an integral part of the transformer assembly. This circuit is tuned by L19 to 14.25 mc and prevents frequencies close to this value from getting into the video i-f amplifier. There are thus four adjustments required for proper operation of this transformer which can be

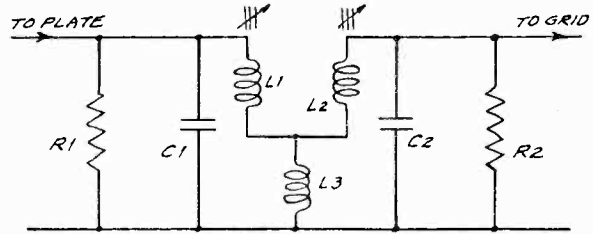

FIG. 35.—A simplified diagram of the video i-f transformers used in RCA television receivers. Direct coupling by the inductance L3 which is common to both primary and secondary circuits.

summarized as follows: L17 and L20 control the primary and secondary tuning and are resonated at opposite ends of the pass band of 4 mc; L18 tunes the sound pickup circuit and is resonated at 8.25 mc; L19 tunes the trap circuit so as to reject interference in the neighborhood of 14.25 mc.

The first and second i-f transformer assemblies are practically identical, and are somewhat similar to the first detector unit. In the first i-f assembly, L21 and L25 are the primary and secondary inductances which are again resonated at opposite ends of the pass band. L24 provides the direct coupling between the primary and secondary as shown in the simplified drawing of Fig. 35. L23 is part of a trap circuit which is tuned to 8.25 mc, so that, in all, two sharply tuned trap circuits are provided at this frequency. These are required because the wide pass band necessitates passing video frequencies which are close to the sound carrier frequency; at the same time this sound carrier and its sidebands must be rejected and this is effected by means of the tuned circuits associated with L23 and L28.

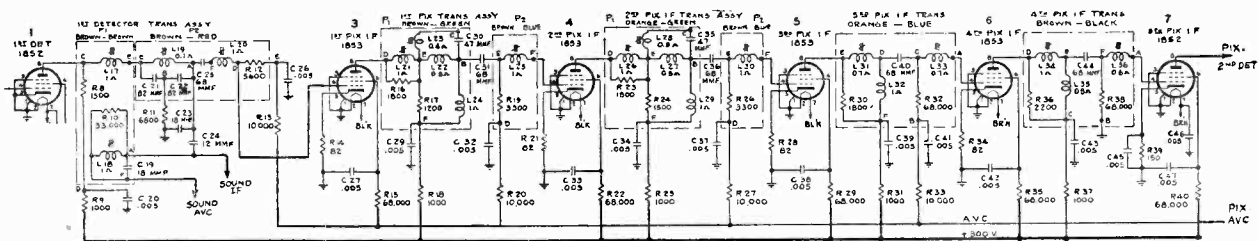

FIG. 34.—The video i-f amplifier in the RCA Model TRK-12. Five i-f stages are used to obtain a pass band of 4 mc. Traps are provided at 8.25 mc and 14.25 mc to prevent interference from the associated and adjacent sound channels.

The third and fourth transformer assemblies do not incorporate any trap circuits and are similar to the transformer shown in Fig. 35. The condensers C40 and C44 are blocking condensers which prevent the plate voltage from being applied to the control grid of the following tube. The plate of the fifth i-f tube feeds through a special coupling transformer to the video second detector; this transformer is not shown in the figure but will be discussed later in connection with video second detector circuits.

As the schematic of Fig. 34 shows, the first, second, third and fourth video i-f tubes are controlled by the video AVC circuit; the grids of these tubes are each returned to the common AVC bus through a filter combination consisting of a 10,000-ohm resistor and a .005-mf condenser. In addition, the gain of the first detector tube is controlled by the same AVC voltage, so that effectively there are five stages under control. This makes for a very effective AVC action which keeps the signal applied to the video second detector and sync separating circuits essentially constant.

Video Second Detector Circuits

In a radio receiver the second detector rectifies the i-f signal and as a result the audio signal corresponding to the variations in the carrier is recovered. In the same way, the video second detector in a television receiver rectifies the video i-f signal and as a result the video signal corresponding to the variations in the amplitude of the carrier is recovered. This video signal is of course that produced by the camera tube and contains in addition the pulses required for synchronization; it is similar to the standard RMA signal shown in Fig. 20.

Generally speaking, video second detectors are similar to the second detectors of the diode rectifier type used in radio receivers. However, because modulating frequencies as high as 4 mc (in the larger receivers) must be passed, a lower value of load resistance is used in order to prevent the attenuation of the higher video frequencies. The value of load resistance generally used is of the order of 2500 ohms; on the other hand, the values used in radio receivers are of the order of 250,000, or approximately 100 times as

great. Because of the low value of diode load resistance, receivers are generally designed so that the signal level at the second detector is approximately 5 volts or more. This minimizes distortion due to the curvature of the diode characteristic, which is more pronounced when low values of diode load resistance are used.

Video Second Detector in DuMont Models 180-183

The video second detector circuit used in the DuMont Models 180-183 receivers is shown in Fig. 36. A full-wave rectifier circuit is used so that both halves of the signal are rectified. Since the cathodes are connected to the ends of the centertapped secondary, each diode will draw current when its cathode is negative with respect to ground (the diode plates both return to ground through the 3000-ohm load resistor). As a result the current flow through the load resistor will be in the direction shown. Thus when a video signal is applied to the primary of the transformer, the plate end of the load resistor will become negative in proportion to the amplitude of the carrier. When the carrier amplitude is greatest, as it is for the sync pulses, the greatest negative voltage will be produced at A. The various shades of white and gray in the signal will produce lesser values of voltage at A, zero voltage of course corresponding to whitest white. In accordance with the definition of signal polarity previously given, the video signal produced at A is said to have *positive polarity*.

It is worth while noting that if the diode plates, instead of the cathodes, had been connected to the ends of the coil, then the polarity of the video signal would have been reversed. As we shall see in the discussion of video amplifiers, whether or not the diodes are connected to give a signal of positive or negative polarity depends upon the number of stages in the video amplifier. The controlling factor is that the amplified signal which is finally applied to the grid of the picture tube must of course have a positive polarity since a more positive voltage on the grid produces a brighter spot on the screen of the tube.

Video Second Detector in RCA Model TRK-12

The video second detector in the RCA Model TRK-12 (also used in the Westinghouse Model WRT-703) is shown in Fig. 37. The signal is coupled through an autotransformer arrangement from the plate of the last video i-f tube into the full-wave diode rectifier circuit. Thus the signal voltage between A and the centertap C is stepped up so that the voltages across each half of the coil L38 are equal. The sec-

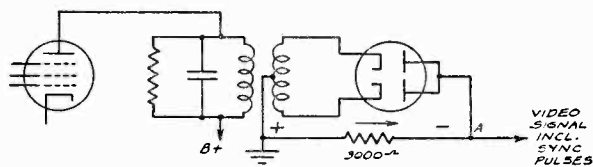

FIG. 36.—The video second detector circuit in the DuMont Models 180-183. A full-wave rectifier circuit is used.

tions in transmission from the transmitting antenna to the receiving antenna, but in general these variations are not sufficiently alike to permit the use of sound AVC voltages on all the video stages.

Video AVC Circuit in the RCA Model TRK-12

The video second detector and AVC circuit used in the RCA Model TRK-12 is shown in Fig. 38. Although the second detector has been described previously, it is shown here because the action of the AVC circuit is connected with the detector. When a signal is being received, full-wave rectification takes place in the 6H6 and as a result the demodulated video signal is produced across the 4000-ohm load R45 in series with the peaking coil L39. The polarity of this signal is indicated by the insert wave which shows that point B of the load is positive with respect to point A; B can be considered as being at a fixed reference voltage since it is tied down to -33 volts through the filter resistor R47.

The circuit used to obtain the AVC voltage from the signal across AB is essentially a peak voltmeter using one section of the 6F8-G tube as a diode. As the circuit shows, the grid is used as the diode plate and is connected directly to B; the cathode is bypassed to ground by a 1-mf condenser C54 and is returned to A through a 470,000-ohm resistor, R46.

During the sync intervals, the grid of the diode is highly positive with respect to its cathode so that a current flow takes place through R46 and a positive charge is stored in C54. Because the sync pulses are repeated rapidly, 13,230 times per second, this charge

is continually replenished and C54 remains charged to the peak value of the video signal. If, for example, we assume a 10-volt peak signal, then C would charge up to a potential 10 volts greater than that at A or -23 volts (-33 + 10).

Since the voltage produced in this way is proportional to the peak value of the carrier, it is a suitable measure of the signal level at the second detector. However, its polarity must be reversed in order that an increase in signal input will produce a more *negative* rather than a more positive control voltage. This reversal of polarity is effected by means of the second section of the 6F8-G which is used as a d-c amplifier.

This tube receives its plate voltage through a 680,000-ohm load resistor R50 which is 2 volts negative with respect to ground. Since the cathode is returned to -23 volts on the bleeder, the net plate voltage with no input signal is equal to 21 volts (-2 + 23). The grid bias is equal to the voltage at the grid minus that at the cathode or -10 volts (-33 + 23). When no signal is present this value of bias is so great that the cathode current is completely cut off and as a result the voltage at D is equal to -2 volts. This is the minimum bias with no signal and in combination with the drop of 0.7 volt across the 82-ohm cathode resistor of each of the controlled tubes, provides a net bias of 2.7 volts for each of the video i-f tubes.

On the other hand, when a signal is being received, C54 charges up positively to the peak value of the signal and this positive voltage is applied to the grid of the AVC triode amplifier. If the signal is strong enough, the plate current will increase, the voltage drop across R50 will increase, and D will become more

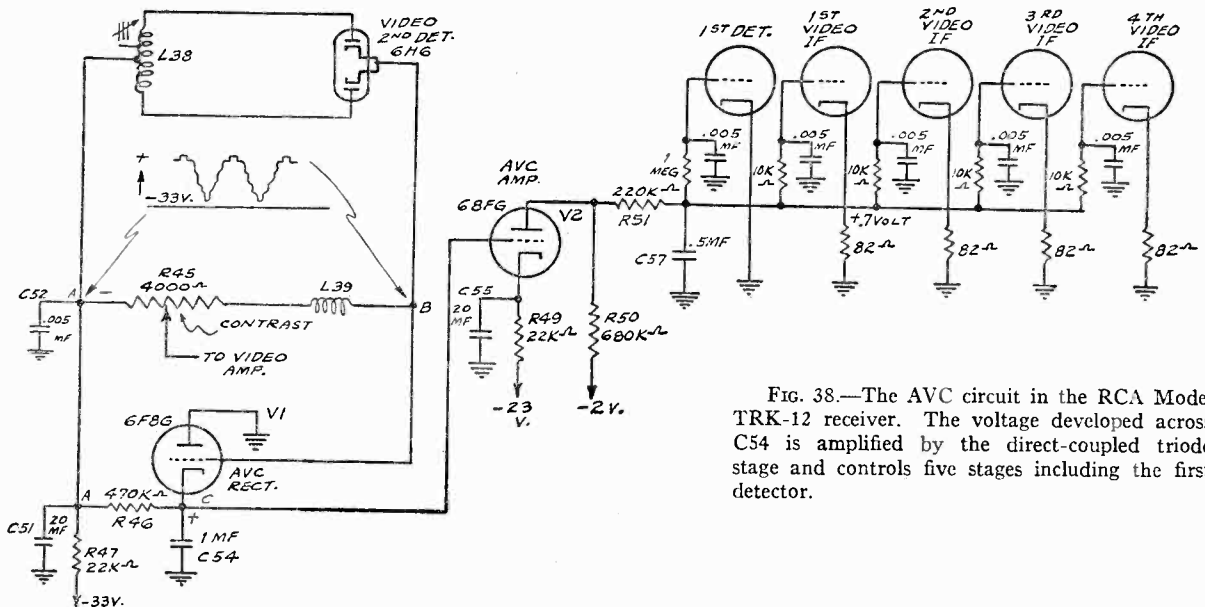

FIG. 38.—The AVC circuit in the RCA Model TRK-12 receiver. The voltage developed across C54 is amplified by the direct-coupled triode stage and controls five stages including the first detector.

negative than -2 volts. The amount of negative voltage produced at D is proportional to the strength of the signal and hence the voltage is available for AVC.

A delayed AVC action is secured because the negative bias of 10 volts, which exists with no signal, drives the grid of the AVC amplifier tube considerably beyond cutoff. Thus the signal level must reach a certain minimum value before the plate current will flow and the AVC voltage be produced.

In addition to the delay action, the fact that five stages are controlled results in a very effective AVC action which maintains the signal level at the second detector essentially constant.

Video Amplifiers

In the same way that the audio signal in a radio receiver requires amplification before it has sufficient power to drive the speaker, so the video signal in a television receiver requires additional amplification following the video second detector before it has sufficient amplitude to swing the grid of the picture tube. This amplification is supplied by the video amplifier which works between the video second detector and the grid of the picture tube.

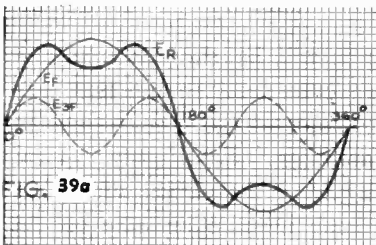
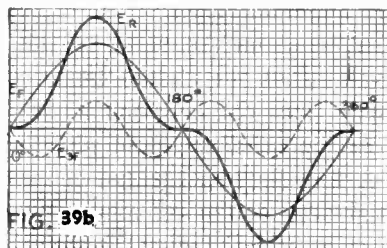

FIG. 39a, on the left, shows the resultant wave (E_R) when a 1000-cycle sine wave (E_F) and a 3000-cycle sine wave (E_{3F}) are added in phase.

FIG. 39b, on the right, shows how the resultant wave (E_R) is distorted when the 3000-cycle sine wave (E_{3F}) is retarded half a cycle.



The problems associated with the video amplifier, like most television problems, are considerably more difficult than the corresponding problems for a radio receiver. Thus the video amplifier must amplify uniformly frequencies ranging from a few cycles to frequencies as high as 2 to 4 mc. Whereas phase shift is not important in an audio amplifier, in a video amplifier all the frequencies in the signal must take the same time to pass through the amplifier from input to output. This is important because distortion of the waveform, and hence of the picture, is produced when

the different video frequencies do not all take the same time to pass through the amplifier. This type of distortion is illustrated in Fig. 39 which shows the difference in waveform produced when a 3000-cycle wave is retarded half a cycle in passing through the amplifier. That the uniformity of time delay plays an important part can be seen from the fact that it takes only approximately seven one-millionths of a second for the cathode-ray beam to move one inch across the screen of the picture tube. Thus even a small non-uniformity in time delay can cause serious distortion of the image.

The video amplifiers being used in television receivers now on the market have successfully met the problems outlined above. By using low values of load resistance, the shunting effect of tube and circuit capacitances has been minimized and the upper frequency limit extended. Fig. 40 shows how the use of a low value of plate load resistance, although it lowers the maximum amplification obtainable, makes possible a more uniform gain over a wide range of frequencies. The sacrifice in gain accompanying the use of low values of load resistance has been partially compensated for by the use of the new high mutual conductance tubes which provide approximately three times as much amplification for a given value of load resistance, as was previously possible with the older tubes.

The most common method for obtaining uniform gain is to use so-called "peaking coils" in series with the plate load resistor. These are small inductances of the order of 100 microhenries, which are resonated with the tube and wiring capacitance near the high-frequency limit of the video amplifier. Peaking coils permit higher values of plate load resistor for a given uniformity of amplification, and consequently make possible reasonably high gains per stage.

In most video amplifiers, filter resistors and condensers are used in the plate and screen leads to provide low-frequency compensation for both gain and time-delay. These filter resistors and condensers are

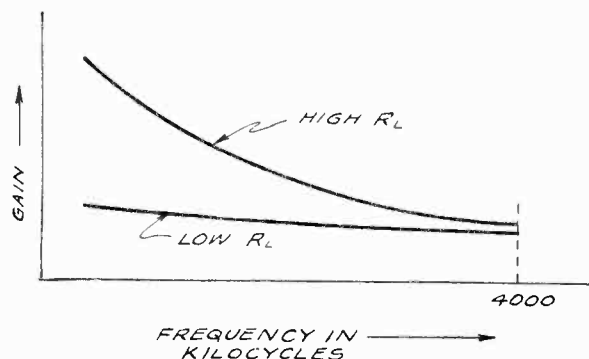

FIG. 40.—The use of a small value of load resistance provides a more uniform gain over a wide range of frequencies, although the maximum gain is decreased.

more critical in value than they are in a radio receiver where the primary purpose is to reduce hum and prevent circuit interaction through the common power supply. For this reason, whenever replacement becomes necessary, the resistors and condensers should be replaced with the correct value. Although a larger plate filter condenser, for example, will cause no harm and may even do some good in reducing hum in a radio receiver, the same procedure followed in a video amplifier may cause serious distortion of the picture.

Average Brightness and D-C Restorer Circuits

In our previous discussion of the video signal, we looked upon this signal as containing a series of voltage values each of which corresponded to a particular value of light intensity in the televised image. We considered that in the same way that light values can be reckoned from black as a reference level, so a particular voltage value can be assigned to black and then each light value represented electrically by assigning a higher (or lower) voltage to the signal, depending upon the brightness of the light value at the scanned area. This method of looking upon a video signal is shown in Fig. 41 (a), in which it is clear that all light values are with reference to the black level—which is taken as the zero-voltage axis.

Insofar as video amplifier operation is concerned, the important thing about Fig. 41 (a) is that it shows that a video signal is inherently a pulsating d-c voltage. In other words (as in the case of a rectified a-c voltage which is also a pulsating voltage) all the light values are represented by electrical values on one side of the zero-voltage axis. The video signal must therefore contain both a d-c and an a-c component in the same way that a rectified a-c voltage representing the output of a power supply contains a d-c component—the d-c voltage of the power supply, and an a-c component—the hum ripple of the power supply.

Physically what does it mean to say that a video signal contains a d-c as well as an a-c component? Actually it is only another way of looking at the sig-

nal, as Fig. 41 (b) clearly shows. In this figure we describe the signal by saying that the light values are represented by fluctuations in both directions from an average level which we can call the "average brightness," or the "picture background." Thus instead of describing the light value at any point in the scene by stating how much brighter it is than black, as in (a), in (b) we accomplish exactly the same thing by stating how much brighter or blacker is the particular light value than the *average brightness*. In (a) we use the black level as the reference level whereas in (b) we use the average brightness as the reference level.

Electrically speaking, the average brightness level represents the average value of the video signal or in other words the d-c component of the signal. On the other hand, the fluctuations in the signal on either side of the average brightness level, which is electrically the a-c axis of the signal, represent the a-c component of the signal. An important characteristic of the average brightness or a-c axis is that the area between the positive part of the cycle and the a-c axis is equal to the area included between the negative part of the cycle and the same a-c axis. This is shown in Fig. 41 (b), where it can be seen that area 1 is equal to area 2 + area 3.

From the preceding it will be clear to you that proper operation of the picture tube requires that both the d-c and a-c components of the video signal be passed by the video amplifier. For if only the a-c component reaches the grid of the picture tube, then the picture tube will have information only on the fluctuations in light values *with reference to the average brightness level* but it will have no information whatsoever on the value of this average brightness level. Thus the picture cannot be reproduced accurately since the same variations (represented by the a-c component) might be superimposed on say either a dark or light background of any shade. The average brightness, or the d-c component of the video signal, must be present before the picture can be reproduced.

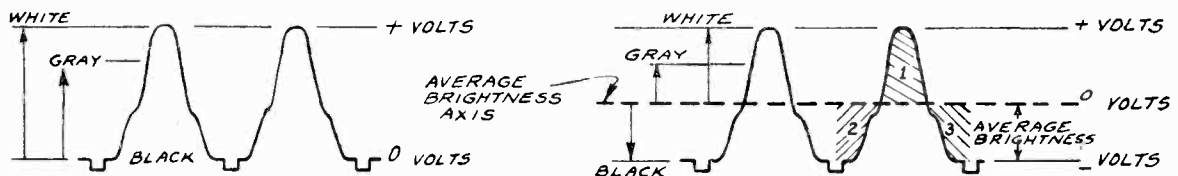

FIGS. 41a, 41b.—The light values in a video signal can be reckoned in two ways: In (a) the various light values are described with reference to the black level, whereas in (b) the same light values are described with reference to the average brightness of the signal.

D-C Restorer Circuits

Unfortunately it is not possible to transmit the d-c component of any signal without using a direct-coupled amplifier. However, the use of direct-coupled amplifiers is not practical in television receivers because of their comparative instability and high cost. For this reason, television engineers have developed circuits which make possible the use of conventional a-c amplifiers with condenser coupling and at the same time provide for the restoration or *recreation* of the d-c component after the a-c component has been amplified by itself.

It will be helpful at this time to consider several video signals which have different values of average brightness and to describe the action which takes place when these signals pass through an amplifier which employs a blocking condenser as a coupling element between stages. It is because of the presence of the blocking condenser that only the a-c component is passed and that the d-c component is lost.

In Fig. 42, the picture being scanned is a white triangle on a black background, with the vertex of the triangle near the top. Part (a) shows two lines scanned near the top of the picture; part (b), near the middle of the picture; and part (c), near the bottom. Thus (a), (b) and (c) represent three sections of the picture where the average brightness is

low, medium, and high respectively. Fig. 42 can be said to represent the signal as it is at the output of the camera tube or as it is recovered at the video second detector. Of special importance is the fact that all the blacks are lined up so that the d-c component of the signal is represented in all cases. Note that the d-c component, like the average brightness which it represents, is successively larger in (a), (b), and (c).

Now what happens to this signal when it is passed through an a-c amplifier which contains coupling condensers and therefore will not pass the d-c component? This is clearly illustrated in Fig. 43 which shows that the blacks are no longer lined up, but instead the separate average-brightness or a-c axes are all lined up. In other words, when the d-c component is lost, only the fluctuations on either side of the average brightness are transmitted and this axis must of necessity be the zero voltage axis in all instances because no d-c component can get through the amplifier.

Having investigated the video signal both with and without the d-c component, let us now examine the manner in which the picture tube is affected by the presence or absence of the d-c component. In Fig. 42, we see that black in every case corresponds to the same definite voltage value and that is also true for white and every intermediate shade between black and white. Thus when the voltage of Fig. 42 is applied to

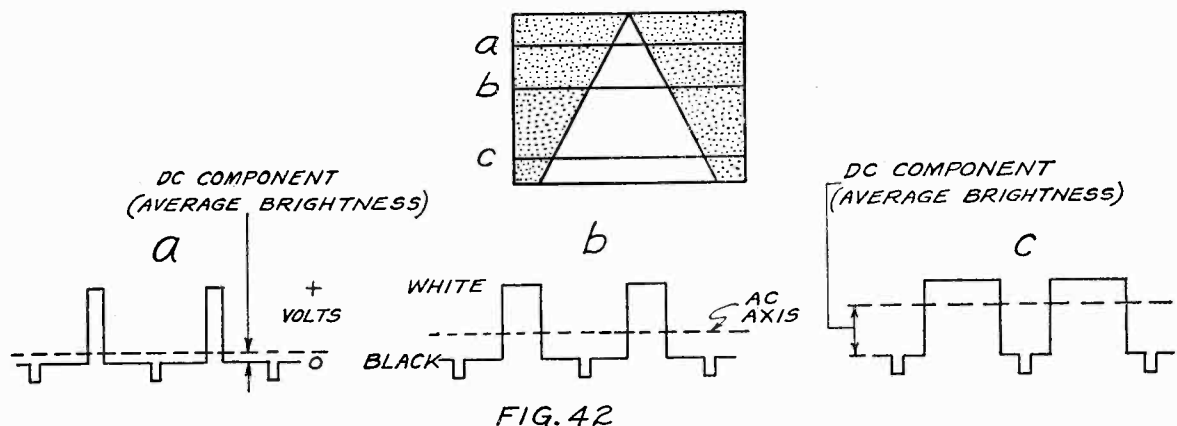

FIG. 42

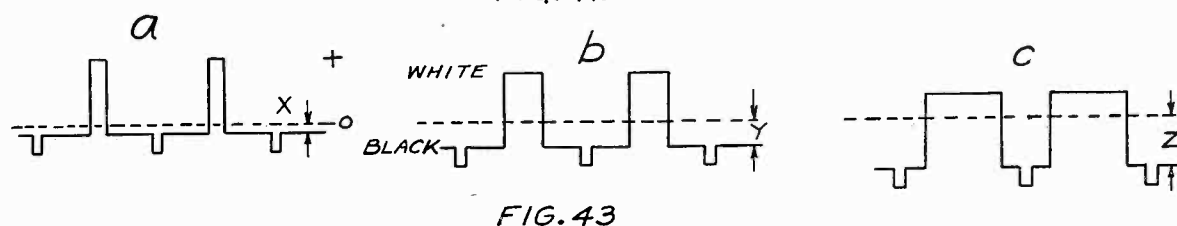

FIG. 43

FIGS. 42, 43.—FIG. 42 shows the video wave produced when two lines are scanned at a, b, and c of the white triangle on a black background. Since the black level is the same for all three cases, this signal contains the d-c component. FIG. 43 shows the same signal after it has passed through an a-c amplifier; note that the d-c component has been lost so that black in the signal no longer corresponds to a fixed voltage level as it does in FIG. 42.

the grid of the picture tube, the picture will be reproduced without any distortion.

This, however, is not true of the signal in Fig. 43, from which the d-c component has been removed. Black no longer corresponds to the same value in all instances, but instead the signal voltage associated with black takes on a value which is entirely dependent upon the average brightness of the strip being scanned. In the same way, this figure shows that white, and in fact every intermediate shade as well, has a different voltage value which is also dependent upon the average brightness of the strip being scanned. A little reflection will show you that this gives rise to serious distortion because the same light value in different parts of the picture does not correspond to the same voltage value in the signal. Thus, for example, the grid of the picture tube receives a *different voltage* for the *same shade* of gray in (a), (b) and (c) of Fig. 43 and as a result this shade is reproduced differently in the three instances.

In order to remove this source of distortion, it is apparent that the average brightness or the d-c component must be restored. At first glance this seems impossible, for how can the d-c component be restored after it has once been lost in the video amplifier? As a matter of fact, it is generally not possible to restore the d-c component of a pulsating wave after the d-c component has been lost in transmission, because no information relative to the d-c component is contained in the a-c component; the two are entirely independent of each other. Fortunately, however, the sync pulse is transmitted at the end of each line, and the pedestal on which the sync pulse stands corresponds to a definite black reference level. These facts make it possible to restore the lost d-c component. Thus to restore the d-c component to the signal of Fig. 43 it is only necessary to modify the signal so that all the synchronizing pulses are lined up. When this is done, the signal in Fig. 43 is exactly the same as that in Fig. 42 and the d-c component has been completely restored.

The solution of the problem depends upon finding this varying d-c voltage and adding it to the signal. This is accomplished in a very simple manner by using a diode to rectify the "black" half of the a-c video signal (which contains the sync signal) and in this way the required voltage is produced. Thus in Fig. 43, at (a) this rectification produces the voltage x; at (b) it produces the voltage y; and at (c) it produces the voltage z. In general, the addition of this varying d-c voltage lines up all the pedestals to produce the original signal (Fig. 42) with the d-c component restored.

Basic D-C Restorer Circuit

In Fig 44 we show a straightforward circuit which is used to restore the d-c component in the video signal before the signal is applied to the control grid of the picture tube. The video signal is developed across the 3000-ohm plate resistor R1 and fed to the control grid through a 0.1-mf coupling condenser C1. As the sketch shows, the signal has the required positive polarity both at the plate of the video amplifier and the grid of the picture tube. However, the d-c component is not present at the plate side of C1, whereas the diode circuit shown in heavy outline has restored the d-c component on the grid side.

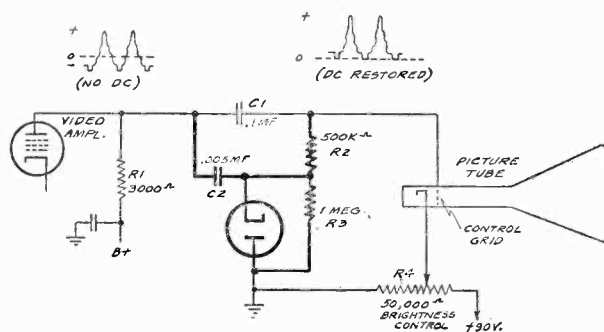

FIG. 44.—The heavy outline shows a typical d-c restorer circuit arranged to restore the d-c component to the video signal before it is applied to the control grid of the picture tube.

Let us see just how the diode circuit restores the d-c component. Considering the series circuit composed of the video voltage across R1, the .005-mf condenser C2, and the diode in shunt with a 1-meg resistor,—we can see that the following takes place: On the positive half of the cycle the cathode of the diode is swung positive with respect to its plate so that no current flows in the diode circuit. On the negative half of the cycle, however, the cathode is swung negative with respect to the diode plate, and current flows in the diode circuit through R3. It is this current flow which charges C2 and makes the cathode end of R3 positive, and as a result provides the d-c restoring bias.

Note that the d-c voltage across R3 satisfies all the conditions required to line up the sync pulses so as to restore the d-c component. Essentially the action in the diode circuit is such that the *negative* part of the video wave is rectified and that the diode current charges C2 positively to a value equal to the amount by which the sync pulses in (a) are depressed below the a-c axis. Since the grid of the picture tube is returned to this d-c voltage through the 50,000-ohm resistor R2, the d-c voltage is added to the video signal at (a) and "raises" the pedestal so that it lies along the zero-voltage axis, as shown at (b).

Now suppose, as in Fig. 43 (c), that the average brightness is higher than that shown at (a) in Fig. 44. This results in the pedestal being more negative with respect to the a-c axis, so that the diode produces a more positive voltage which again raises the pedestal to the same zero-voltage axis as at (b) in Fig. 44. Thus the action is entirely automatic so that all the pedestals are lined up at the grid of the picture tube, *regardless of the value of the average brightness.*

It is important to understand that the voltage produced at the cathode varies constantly throughout the scanning and that its value at any time depends upon the average brightness of the *portion* of the picture being scanned at that particular time. The time constant (RC) of the diode circuit is designed so that C2 will not discharge appreciably during the interval between successive sync impulses. At the same time, the time constant is sufficiently small so that when the average brightness changes, the condenser is able to change its charge rapidly enough to respond to the new conditions.

Insofar as the grid of the picture tube is concerned, it receives the a-c component of the video signal through C1, and *only* the d-c component through R2. Although the a-c component is also present at the cathode of the diode, R2 acts as a filter resistor to prevent that portion of the video signal present at the cathode from reaching the picture-tube grid through R2.

Brightness Control

We have just seen how the d-c restorer circuit automatically lines up all the sync pulses so they are at the same voltage level. For correct operation of the

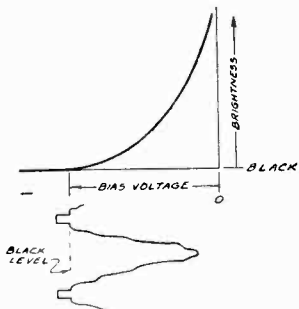

FIG. 45.—The effect of bias voltage on the brightness of the image. The brightness control (see Fig. 44) should be adjusted so that the black level on the signal occurs approximately at the cutoff of the picture tube characteristic.

picture tube, the bias on the picture tube must be so adjusted that these aligned pedestals occur at the cutoff or black level. The sync pulses will then lie in the blacker-than-black region and the various shades of gray and white will be reproduced correctly.

Fig. 45 shows the illumination characteristic of a picture tube and the manner in which the brightness of the scanning spot depends upon the bias voltage on the control grid. Referring again to Fig. 44, it will

be observed that the cathode of the picture tube is returned to a potentiometer which makes it possible to vary the bias voltage from 0 to 90 volts.

When the bias is highly negative, the tube is cut off and the spot intensity is zero. As the bias becomes more positive, the intensity of the spot increases. For correct operation, the brightness control should be adjusted manually so that the pedestals occur at the black or cutoff points. Once the brightness control has been set, the d-c restorer circuit automatically keeps the pedestals in alignment so that no further adjustment is required.

Grid Leak—Condenser Restorer

Another type of d-c restorer circuit which is very widely used is shown in Fig. 46. In this circuit the

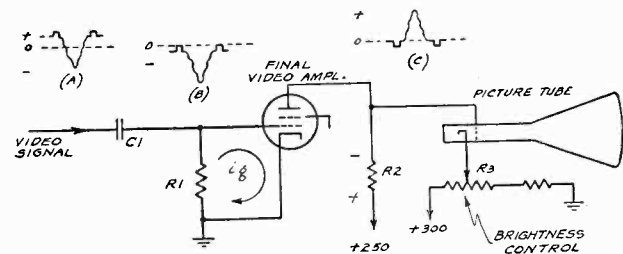

FIG. 46.—A widely used type of d-c restorer circuit in which the video amplifier output tube is operated at zero bias so that the grid-cathode elements function as a diode to reinsert the d-c component.

output video amplifier tube is operated at zero bias and the grid-cathode elements are used as a diode to insert the missing d-c component. To prevent the loss of the newly restored d-c component which would occur if condenser coupling were used in coupling the plate to the picture tube, the plate is coupled *directly* to the picture tube grid.

From the explanation already given of the process of d-c restoration, it is easy to understand how circuits of this type operate. The waveform of the video signal of this type operate. The waveform of the video signal on the left side of C1 is shown at (a); at this point the signal has a negative polarity and of course the d-c component is missing. When this a-c signal is impressed on the grid of the output tube through C1, the positive parts of the video cycle (including the sync pulses) place the grid positive with respect to its cathode so that grid current flows through R1. The direction of this grid-current flow is such that the grid becomes negative with respect to ground.

When the average brightness of the signal is small, the a-c axis of the signal will be near the black level, the positive peaks will be small in amplitude, only a small value of grid current will flow, and consequently the grid will be displaced only slightly negative. On the other hand, when the average brightness is great,

the a-c axis is away from the black side, the positive peaks will be large in amplitude, a relatively large flow of grid current will take place, and the grid will be made highly negative. *In each instance, the grid will be made more negative by an amount equal to the height of the sync pulses above the a-c axis of the wave.* As a result of this action all of the pedestals in the signal are depressed by an amount sufficient to align them to the same zero-voltage level at the grid. This is shown by the signal waveform at (b). Essentially the action here is the same as that previously described for the circuit using a separate diode. The condenser C1 performs the same function of storing the grid charge as in the previous method.

At the plate of the output tube, the polarity of the video signal is reversed and as (c) shows, the signal at this point has the required positive polarity. Since no blocking condensers are interposed between the plate and the grid of the picture tube, the sync pulses remain in alignment.

As in the previous circuit, provision must be made for initial adjustment of the bias of the picture tube so that the pedestals of the signal will occur at cutoff (black level) on the picture-tube characteristic. To accomplish this, the cathode of the picture tube is returned to a bleeder-potentiometer which makes it possible to place up to a maximum of +300 volts in the cathode. Since the grid can at most have a potential of +250 volts, this makes a bias of -50 volts available on the grid of the picture tube. Under actual operating conditions, the voltage drop across R2 makes the grid more negative; this is compensated for by making the cathode of the picture tube less positive by adjusting the brightness control R3.

When the receiver is first turned on, there is no voltage drop across the plate-load resistor R2 until the output video tube warms up and draws plate current. The final adjustment of the brightness control therefore should not be attempted until the receiver has been turned on for a few minutes. In particular the brightness control should be all the way to the left (with the rotor at +300) until the receiver has warmed up; this is done to avoid possible damage to the picture tube because of excessive beam current.

The Contrast Control

The "contrast control" is the gain control which determines the magnitude of the video signal applied to the grid of the picture tube. Its counterpart in a sound receiver is the volume control, and in the same way that the sound volume control determines the range of intensities between the loudest sound and the softest sound, so the video contrast control determines the range of light intensities between the highlights

and the shadows of the picture. Referring to Fig. 45, the setting of the contrast control determines how much of the picture tube characteristic is used and how bright will be the brightest element of the scene. When the contrast control is not advanced far enough, the picture lacks brilliance and the highlights are comparatively dark; when the contrast control is advanced too far, the picture becomes blurred, there is a loss of detail in the highlights, and in general the intermediate shades are lost.

Synchronizing Circuits

The circuits devoted to synchronization in a television receiver are those which remove the sync information contained in the complete video signal and utilize it to control the timing of the horizontal and vertical deflection oscillators. To perform these functions, the sync part of the signal must first be separated from the picture part of the signal. In addition the vertical sync pulses must be separated from the horizontal sync pulses so that each can be applied to the respective deflection oscillator which it controls.

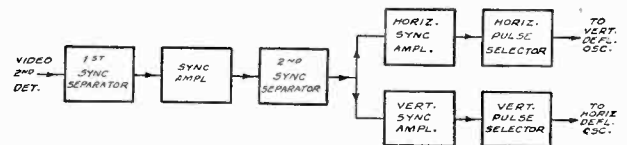

FIG. 47.—Block diagram of the sync circuits used in the RCA Model TRK-12 receiver.

The circuits used to separate the synchronizing pulses from the picture portion of the signal are called "sync separators" or "clippers." These circuits are designed so that they are responsive only to the sync pulses which lie above the pedestals; thus they reject the picture portion of the signal. The clipper or sync separator is generally followed by additional amplification and finally the sync signal is fed to a frequency-selecting circuit which separates the horizontal sync pulses from the vertical sync pulses. This separation is accomplished by circuits which depend for their action upon the difference in the time duration of the two types of pulses.

To illustrate the principles involved in sync circuits, we shall describe the circuits used in the RCA Model TRK-12 receiver. As the block diagram in Fig. 47 shows, the video signal is taken directly from the second detector and passes through the *first sync separator* which removes most of the video signal from the sync signal. The sync signal is then amplified in a *sync amplifier* stage and fed to a *second sync amplifier* stage which completes the separation of the sync signal. The output of the second clipper is fed to two

separate stages, the horizontal sync amplifier and the vertical sync amplifier. The output of the horizontal sync amplifier feeds the sync pulses to a circuit—the *horizontal pulse selector*—which selects the vertical sync pulses; the output of the vertical sync amplifier also feeds the sync pulses to the *vertical pulse selector* which selects the vertical pulses.

On the whole, the block diagram presents quite an imposing array of circuits considering that it represents but a small part of all the circuits in the complete receiver. However, synchronization is so important in the operation of the television system that great care must be taken to make the synchronization positive in action.

Sync Separator Circuit

Referring to the partial schematic in Fig. 48, the video signal is fed from the second detector directly into the grid of the first sync separating tube. This stage uses one section of the 6N7 dual triode. The distinguishing features of this stage are that the tube is operated at the very low plate voltage of 15 volts and at zero bias (when no signal is present). When a signal is being received the grid leak-condenser combination R75-C77 provides a bias voltage as a result of the rectified grid current. As the waveform shows, the polarity of the video signal applied to the grid is negative so that the grid bias is supplied by the sync pulse part of the signal. As previously explained in connection with d-c restorer circuits, the bias at the grid varies in accordance with the average brightness and the result is that all the sync pulses are lined up with the zero-voltage axis at the grid of the first sync separator. This is illustrated in Fig. 49 which shows the plate current-grid voltage characteristic of the first sync separator stage.

Because of the low plate voltage of only 15 volts, plate-current cutoff is reached at a low value of nega-

tive grid voltage. Consequently the picture part of the signal lies beyond cutoff, and only the sync pulses are effective in causing the plate current to change. Thus the picture part of the signal is removed and so does not appear in the plate circuit of the first sync amplifier tube. An important part of the action in this circuit is the operation with grid leak bias so that all the sync pulses are lined up. As in the d-c restoring circuits, the time constant of the input circuit is sufficiently large so that the bias is maintained during the interval between sync pulses.

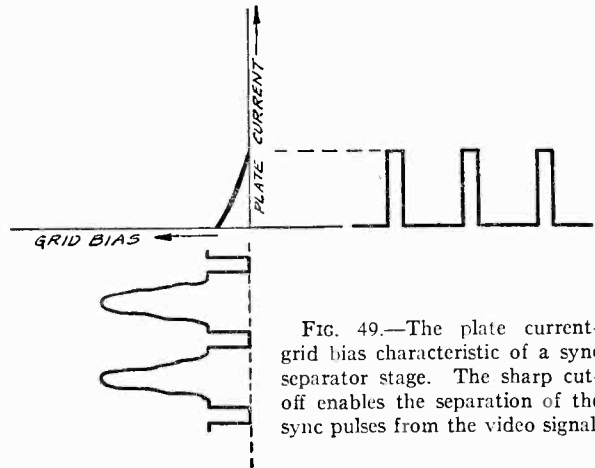

FIG. 49.—The plate current-grid bias characteristic of a sync separator stage. The sharp cutoff enables the separation of the sync pulses from the video signal.

The signal produced in the plate circuit of the first sync separator no longer contains the picture part of the signal but instead the latter has been removed because of the sharp cutoff of this stage. A term often used to describe the action of a circuit similar to the first sync separator is the term "clipper." This term is appropriate because the stage can be thought of as clipping the video portion of the signal and leaving only the sync pulses.

The clipped sync signal is next fed to the grid of the second triode of the 6N7 which is arranged to func-

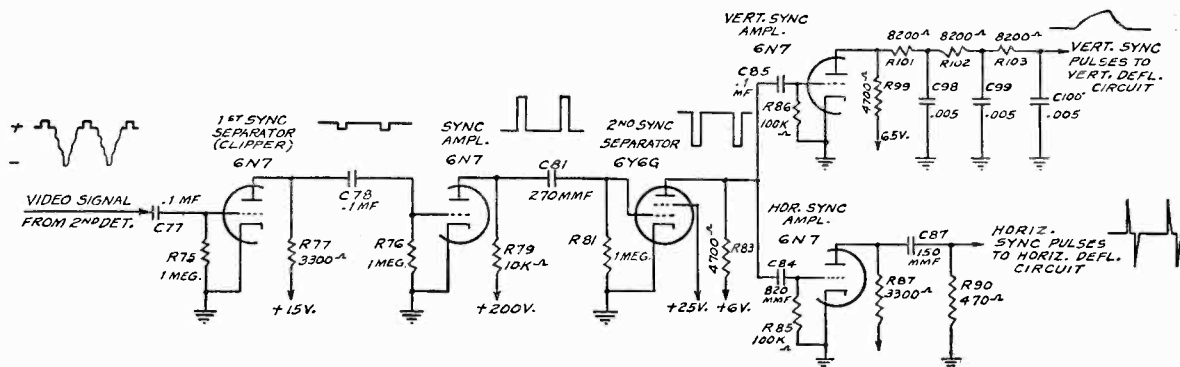

FIG. 48.—Schematic of the sync circuits used in the RCA Model TRK-12 receiver.

tion as an amplifier. For this reason a high value of plate voltage, 200 volts, is used. Note that the sync pulses have been reversed in polarity so that the grid of the amplifier tube goes negative on the peaks of the sync pulses. However, the operating characteristics of the amplifier stage are such that the sync pulse waveform in the plate circuit of the sync amplifier is simply an amplified version of the signal in the grid circuit. The polarity of the signal is of course reversed 180 degrees so that the sync signal in the grid circuit of the following clipper tube is negative in polarity.

The action in the second sync separator is similar to that in the first sync separator. A screen grid tube is used with the screen placed at a higher voltage than the plate and with both these voltages comparatively low. Thus the screen voltage is only 25 volts and the plate voltage about 6 volts. Under these conditions the stage has a very effective clipping action on both the positive and negative peaks of the sync pulse. In this way, if any video signal still remains it is clipped sharply by the plate-current cutoff; at the same time, the positive peaks of the sync pulses are again clipped as in the previous sync separator. As a result of this second clipping of the sync pulses, the waveform is made flat and any noise components that may have been added to the signal are removed. Thus noise is prevented from interfering with the synchronization.

The output of the second sync separator feeds the

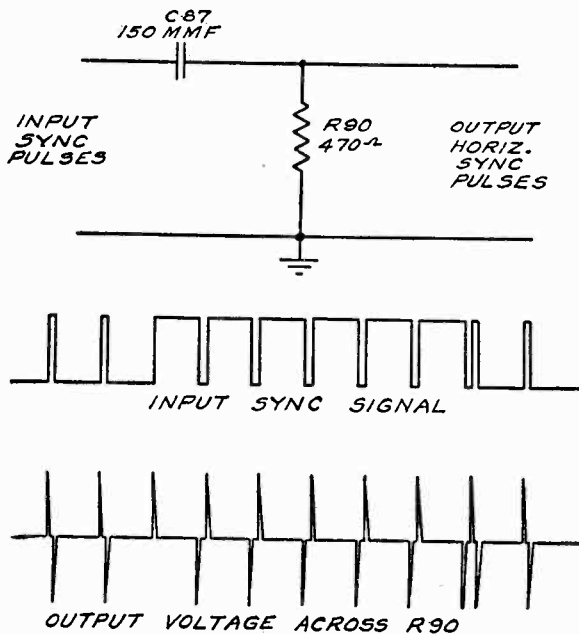

FIG. 50.—Circuit used for separating the horizontal sync pulses from the complete sync signal. The waveform of the sync signal at the input of the circuit and the corresponding waveform at the output are shown below the circuit.

sync pulses to two separate amplifier stages, a vertical sync amplifier and a horizontal sync amplifier. These individual stages provide further amplification of the sync pulses and at the same time act as buffer stages to isolate the vertical sync circuits from the horizontal sync circuits. The circuits used in the output of these stages are frequency-selecting circuits which differentiate between the two types of sync pulses by making use of the fact that the duration of the vertical sync pulses is greater than that of the horizontal sync pulses.

Horizontal Sync Selector

The signal is coupled to the horizontal sync amplifier through the 820-mmf condenser C84. The amplified signal appears across R87 and is fed to the selector circuit consisting of C87 (150-mmf) and R90 (470 ohms). This circuit separates the horizontal sync pulses, which appear across R90.

The manner in which this selector circuit operates requires some explanation. Essentially the current which passes through R90 is limited by C87 because of the small value of capacitance and the low value of resistance. As a result the current through R90 is proportional to the rate of change of the sync pulse voltage and in this way sharp voltage pulses are produced across R90. This is clearly illustrated in Fig. 50 which shows the input sync signal during the interval between successive fields. Note that at each edge of the sync signal where the waveform changes abruptly, this rapid change results in a pulse of current through C87 and R90, which produces the voltage drop across R90 shown in the figure. As explained later, only the positive pulses across R90 are effective in synchronizing the deflection circuit; those below the axis have no effect. As Fig. 50 shows, horizontal sync pulses are also produced during the vertical blanking period because the leading edge of each vertical sync pulse represents a rapid change of voltage and therefore produces a pulse through R90.

Vertical Sync Selector

The complete sync signal is also fed from the second sync separator into the grid of the vertical sync amplifier. The amplified sync signal appears across R99 and is fed to the selector circuit consisting of R101 and C98. Two additional sets of resistor-condenser combinations are used in series in order to increase the effectiveness of the vertical pulse selection.

The action of R101 and C98 in differentiating between the vertical and horizontal sync pulses is a direct result of the longer duration of the vertical pulses. Thus Fig. 51 shows that each one of the sync

impulses, including the horizontal impulses, contributes a small amount of charge which is stored in the condenser. The greater the duration of the pulse, the greater the voltage across the condenser. During the

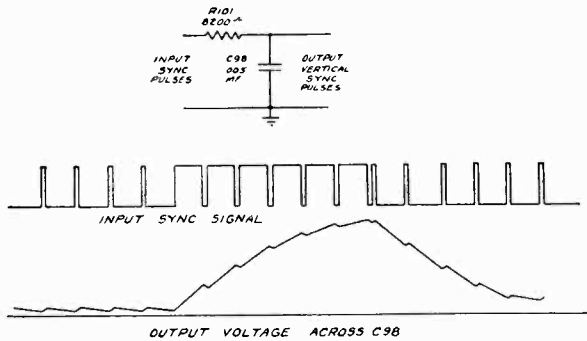

FIG. 51.—Circuit used for obtaining the vertical sync pulses required for field synchronization. The corresponding waveforms at the input and output are shown below the circuit.

transmission of the long vertical sync pulses, the accumulation of charge on the condenser is greater than during the transmission of the short line sync pulses. As a result, the voltage across the condenser C98

builds up to a peak once during each field or 60 times in each second. As the figure shows, the vertical pulse builds up to a maximum at the end of the last vertical sync pulse and then steadies down to an average value of voltage which remains constant until the beginning of the next field pulse.

To increase the circuit effectiveness, two more similar resistor-condenser combinations are used in series as shown in Fig. 48. These circuits accomplish a further selection of the two pulses so that a sharper pulse is produced once during each field. The peak of this pulse is used to synchronize the vertical deflection oscillator.

For exact interlacing it is important that the vertical pulses produced at the output of the vertical selector circuit be the same on alternate fields. The equalizing pulses, previously described, accomplish this by making the transmission of the actual broad vertical sync pulses. As a result, the condenser charges up to the same value of peak voltage on both the odd and even fields so that the vertical oscillator is maintained in perfect timing.

DEFLECTION CIRCUITS

In describing the picture tube we explained how the electron beam can be deflected by sawtooth waves applied to the deflecting elements of the picture tube. The previous sections have explained the necessity for synchronizing these waves and how the sync signals are selected at the receiver. The next problem is to generate the sawtooth waves, control them by the sync signals and to apply them to the deflecting system of the picture tube.

The block diagram of Fig. 52 shows the essential parts of a common type of deflection circuit for television. From the sync separator described in the previous section, horizontal sync pulses are applied to the horizontal deflection circuits and vertical sync pulses to the vertical deflection circuits. Both sets of deflection circuits contain the same type of elements, the principal difference being the operating frequencies.

The sawtooth waves shown in Fig. 15 are formed in the *discharge circuit*. This circuit includes a condenser which is slowly charged from the B supply and then rapidly discharged through a vacuum tube. The voltage across this condenser varies in such a way as to form a sawtooth voltage wave similar to that shown in Fig. 15. The exact moment at which the discharge tube operates is determined by the *blocking oscillator* which provides pulses to the grid of the discharge tube of sufficient amplitude to "trip" it. The frequency of

the blocking action is itself synchronized with the incoming signal by pulses from the *sync separator*. The sawtooth voltage wave formed in the discharge circuit

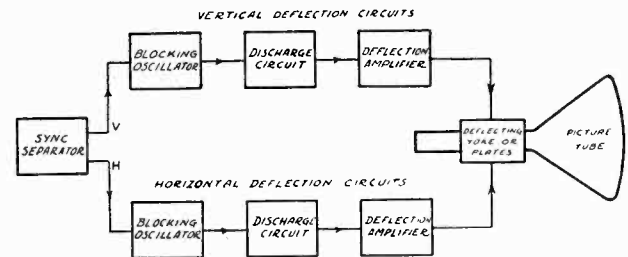

FIG. 52.—Block diagram of the essential parts of a widely-used type of deflection circuit.

is amplified in the *deflection amplifier* and then applied to the deflecting yoke or plates which cause the scanning action of the beam in the *picture tube*.

Circuits for Electromagnetic Deflection

The schematic, Fig. 53, shows the deflection circuits used in the RCA Model TRK-12 and Westinghouse Model WRT-703 receivers. These are examples representative of circuits for use with a picture tube deflected by the electromagnetic method.

To describe the formation of the sawtooth wave, let us assume that the grids of the 6N7 tube (in the horizontal circuit) are biased to cutoff so that the tube

is non-conducting. The plate voltage starts to charge the .001-mf condenser C90 through resistors R93, R94 and R95 in series. The voltage across C90 (from D to ground) rises as shown by the line designated "trace" in Fig. 15a. About 65 microseconds later, a positive pulse of voltage is applied to the grids of the 6N7 and the tube "trips" or starts conducting. The triode section, whose plate is connected to D, then acts as a short to ground and discharges C90 in about 11 microseconds. The voltage across C90 falls as shown by the line designated "retrace" in Fig. 15a. The discharge is stopped after 11 microseconds by a sudden blocking of the grids, and the charging cycle starts again. The relatively short time allowed for the charge and discharge of condensers C90 (horizontal) and C103 (vertical) assures that the sawtooth wave will be essentially linear.

Blocking Oscillator

The periodic blocking and tripping of the 6N7, which has just been mentioned, is accomplished by the blocking oscillator. In connection with the latter, the question naturally arises as to why the sync pulses could not be used directly to trip the discharge tube. Actually, the sync pulses could be used directly, but it has been found more satisfactory to use the blocking oscillator circuit being described. The blocking

oscillator provides a steep pulse of high amplitude which is more readily adapted to the control of the discharge tube than is the sync pulse itself. The necessary timing of the blocking oscillator is of course obtained from the sync pulses.

As the name implies, the blocking oscillator is a regenerative oscillator in which the feedback is so large that the oscillator is blocked on the first cycle of oscillation. Thus when oscillation starts, the amplitude is so great that the negative charge which accumulates on the grid condenser drives the tube to cutoff. Before the oscillations can start up again, the charge on the grid condenser must leak off. The rate at which this charge leaks off determines the rate at which the steep pulses are produced by the blocking oscillator. Because the circuit constants are such that the natural frequency at which the oscillator attempts to work is higher than the frequency of blocking, the pulse produced when oscillations start has a very steep waveform which is advantageous in controlling the discharge tube.

The rate of blocking, and hence also the rate at which the pulses for the discharge tube are produced, is controlled by R91 and R92. The lower the value of this grid resistance, the more rapidly the charge leaks off so that the oscillations can begin again and produce another pulse. The "free-running" frequency of

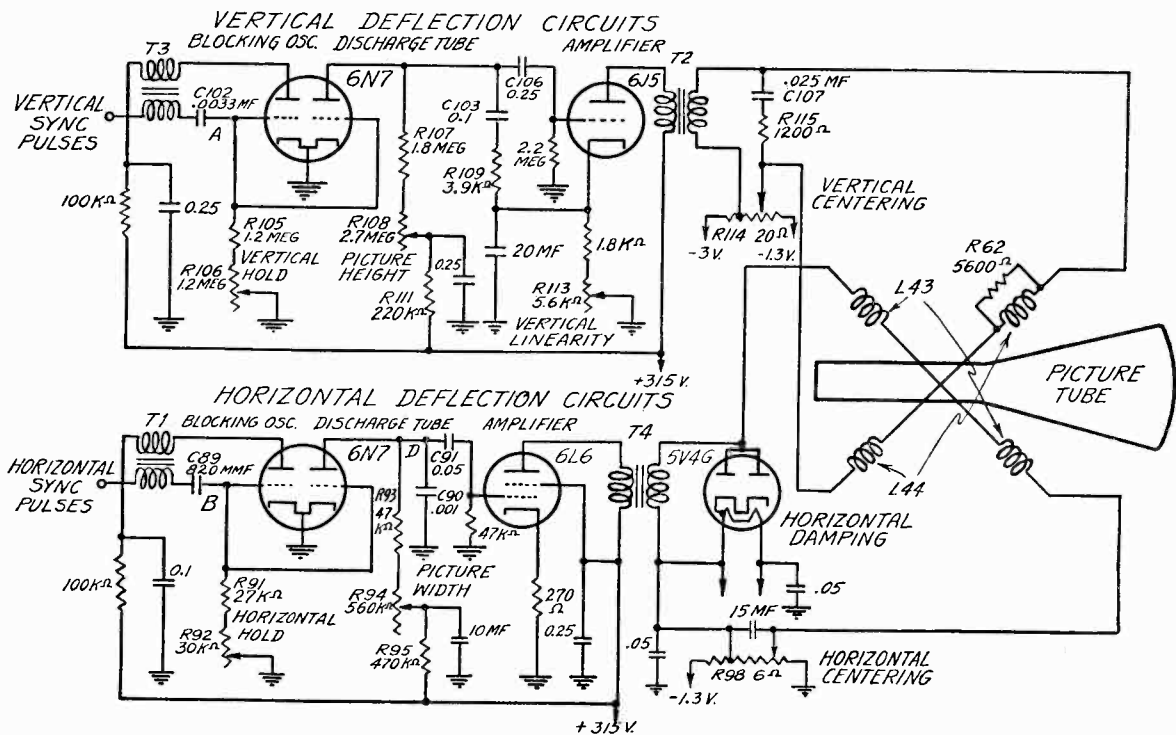

FIG. 53.—Deflection circuits used in the RCA Model TRK-12 receiver. Compare with the block diagram shown in Fig. 52.

the blocking oscillator is thus controlled by the value of C89, which determines the amount of charge stored in the grid circuit, and R91 and R92 which determine the rate at which this charge leaks off.

In practice, the free-running frequency is adjusted by means of the *horizontal hold control* R92 so that it is lower than the line frequency of 13,230 cycles. The application of the horizontal sync pulse to the grid circuit, as shown, will then introduce a positive pulse into the grid circuit and cause the blocking oscillator to start operating slightly before the instant when it would normally resume operation. In this way the sync pulse keeps the blocking oscillator exactly in synchronism with the frequency of the scanning at the camera tube.

The circuit for the vertical deflection operates in the same manner. In this case R106, the *vertical hold control*, is adjusted so that the free-running frequency of the vertical oscillator is slightly less than 60 cycles. The introduction of the vertical sync pulse trips the oscillator just before it would otherwise resume oscillation so that the frequency is kept in synchronism with the vertical sync pulses.

Width and Height Controls

The peak value of the sawtooth voltage which is developed across C90 depends on the setting of R94. Since the peak value of the voltage across C90 determines the magnitude of the horizontal scan and therefore the picture width, R94 is called the *picture*

width control. Similarly R108 controls the vertical sawtooth amplitude and therefore is called the *picture height control*.

The *vertical linearity control* R113, which is in series with the vertical wave-forming condenser C103, corrects the waveshape so that a sawtooth wave of current will be obtained through the deflecting coils.

Centering

As a result of the circuits described, accurately timed sawtooth voltages are available at points C and D. These waves are amplified and coupled to the deflecting coils L44 and L43 by transformers T2 and T4 respectively. The picture is centered on the picture-tube screen by sending a small direct current through the deflecting coils. Potentiometers are provided for making the vertical and horizontal centering adjustments.

Damping Tube

The 5V4G diode shunted across the secondary of T4 is provided so as to prevent transient voltages being set up when the scanning current changes abruptly. This diode acts as an automatic switch so that the transformer is loaded only during the trace period, and the load removed during the retrace period. It is not possible to use a permanently-connected resistor load in place of the diode switch because this continuous loading would tend to prolong the retrace period by an excessive amount.

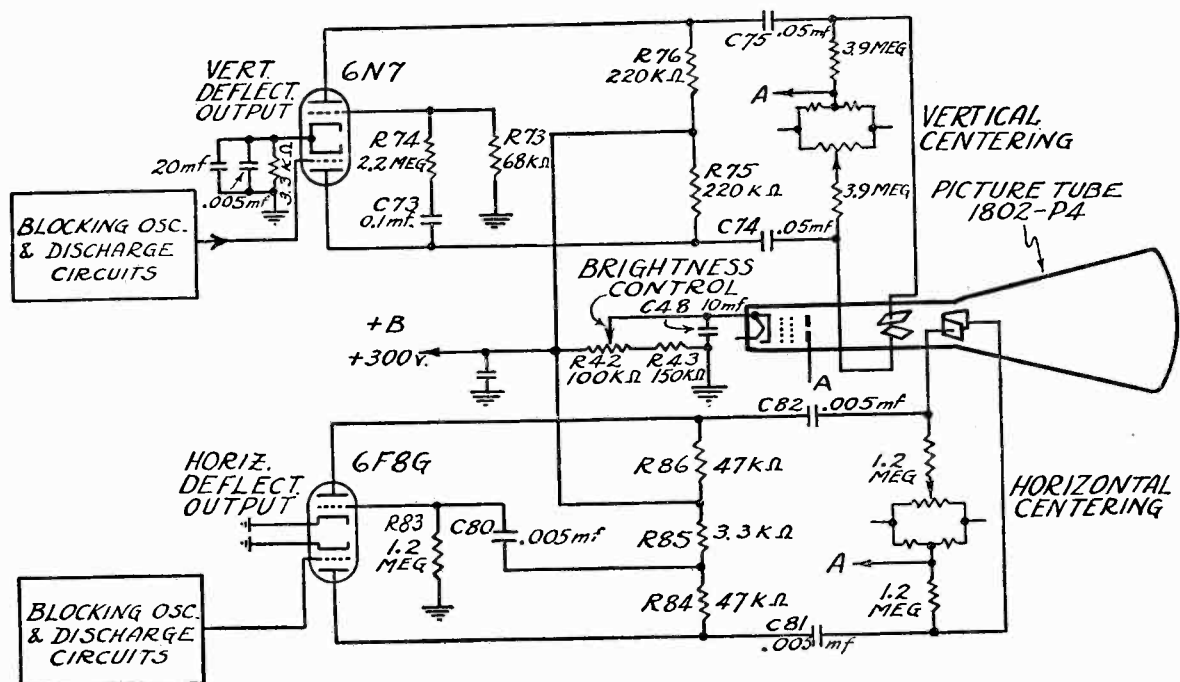

FIG. 54.—Circuits used for electrostatic deflection in the RCA TRK-5 receiver. Note the push-pull output in both the horizontal and vertical channels.

Electrostatic Deflection

In electrostatic deflection systems for television, it is usual to use the same type of sawtooth-wave generator as is used for electromagnetic deflection. The output systems, however, are quite different. To avoid distortion of the raster and defocusing of the spot, the sawtooth waves on each plate of any pair must be alike but 180 degrees out of phase. A balanced amplifier using a phase inverter is used to furnish these deflecting voltages. The force acting on the electron beam is thus due to the difference between the potentials of the two plates, since at any one instant the positive voltage on the one plate attracts the electron beam at the same time that the corresponding negative voltage on the other plate repels the electron beam. Thus, if at any instant the deflecting voltage on one plate is +50 volts, then the voltage on the other plate is -50 volts and the effective deflecting voltage is the sum or 100 volts.

Electrostatic Deflection Circuits

Fig. 54 shows the output circuits of the electrostatic deflection circuits used in the RCA TRK-5 and Westinghouse WRT-701 receivers. The blocking oscillator and discharge circuits are shown in block form because they are similar to those shown in Fig. 53. In the vertical circuit the signal across R75 is fed to one of the vertical deflecting plates through con-

denser C74. This same signal is also fed to the grid of the phase inverter section of the 6N7 tube through condenser C73 and a voltage divider consisting of R74 and R73. The signal across the phase inverter load R76, which is 180 degrees out of phase with the signal across R75, is fed through condenser C75 to the other vertical deflecting plate. The voltage divider R74, R73 is used to compensate for the gain of the phase inverter section of the 6N7 so that the signal amplitude applied to each deflecting plate is the same except for the phase reversal. In the case of the horizontal deflecting circuit, the action is similar; here the voltage divider consists of R84 and R85.

Centering Control

Fig. 54 also shows the type of centering circuit used with electrostatic deflection. One plate of each pair is returned to the second anode through a high resistance. The second plate is returned through a high resistance to the potentiometer which permits a d-c voltage, either zero, plus or minus with respect to the first plate, to be applied to the second plate in order to center the raster on the screen of the picture tube. These potentiometers, called *centering controls*, are usually adjusted during installation and seldom need readjustment. The details of this type of circuit are shown in Fig. 55 in the following section on power supplies.

POWER SUPPLIES

As a general rule, two separate rectifiers are used to supply the d-c voltages for television receivers. A low-voltage supply provides approximately 300 volts for the tubes associated with the amplifier, deflection, and sync circuits of the receiver. A separate high-voltage power supply provides the high voltages—from approximately 2000 to 10000 volts—required for the picture tube.

Since the low-voltage power supplies are very similar to those used in radio receivers, a separate low-voltage schematic is not shown here. The regulation in a television low-voltage power supply is generally better than that in a radio receiver because of the importance of preventing variations in the numerous circuits from interfering with each other and with the picture. The hum level is also kept down to a lower value because of the large number of circuits and stages, and because hum which would be inaudible in a sound receiver may cause appreciable distortion of the picture.

Unlike the low-voltage power supply, a half-wave rectifier is invariably used in the high-voltage supply.

The advantages of the half-wave rectifier are that the transformer does not have to be as large and that the peak voltage is reduced to about one-half the value required for full-wave rectification. Ordinarily the half-wave rectifier is not used in radio receiver power supplies because its output is harder to filter and because it cannot supply as much current to the load as the full-wave rectifier. However, these characteristics are not disadvantages in television receivers because only a very small current is drawn and a resistor-condenser filter can be used.

High-Voltage Power Supply in RCA TRK-5, Westinghouse WRT-701

The high-voltage power supply used in the RCA Model TRK-5 and Westinghouse WRT-701 receivers is shown in Fig. 55. A type 879 high-voltage half-wave rectifier is used, the complete path of the rectified current being from the low-voltage end of the secondary, through the secondary winding, the 879 rectifier tube, the first filter resistor R91, the second filter resistor R92, and the bleeder resistors from R93

to R98, inclusive, and back to the low-voltage side of the secondary.

R91 acts as a filter resistor and also limits the voltage and current through the first filter condenser C86. Good filtering is secured by using a high value of filter resistance; R92 is 470,000 ohms, and in combination with the two .05-mf condensers provides adequate filtering. Note that large values of filter resistance rather than large values of capacitance are used to obtain the required filtering. The advantage of this is the reduced cost and size of the condensers; in addition, the smaller the size of the filter condenser, the less is the danger of fatal shock if one accidentally comes in contact with a charged or partly-discharged condenser. Nevertheless, the high-voltage filter condensers should always be discharged before any measurements are made so as to guard against the possibility of an open bleeder circuit.

In the circuit being described the cathode of the picture tube is near ground potential while the second anode is 2000 volts positive with respect to the cathode. The focusing anode is returned to the focusing control which places approximately 500 volts on this electrode. Centering of the beam horizontally and vertically is accomplished by returning one plate of each of the pairs to point M which is at a voltage slightly lower than the maximum output of the power supply. The remaining plates are then returned to

the sliding taps on the horizontal and vertical centering potentiometers so that the voltages can be varied either positively or negatively with respect to the other plates. These circuits should not be tested while the power is on since the maximum high voltage is present on all the deflection plates and centering adjustments. The deflecting plates are capacitively coupled to the horizontal and vertical deflection output tubes through .05-mf and .005-mf condensers as shown in Fig. 54; these condensers are of course rated to withstand the full high-voltage output.

The high-voltage supply is not entirely independent of the low-voltage power supply in the sense that the entire high-voltage power supply is returned to ground through the brightness control in the low-voltage power supply. If the connection to the brightness control at R42 were broken, then the entire high-voltage power supply would "float." In actual operation, the potential at the cathode is approximately 200 volts above ground potential, depending upon the setting of the brightness control; as a result the low end of the high-voltage rectifier circuit, including the cathode of the picture tube, is above ground potential by this same amount. The control grid of the picture tube, which is tied to the plate of the 6V6 video output tube, is approximately 175 volts above ground potential so that the proper average brightness can be secured by means of the setting of R42.

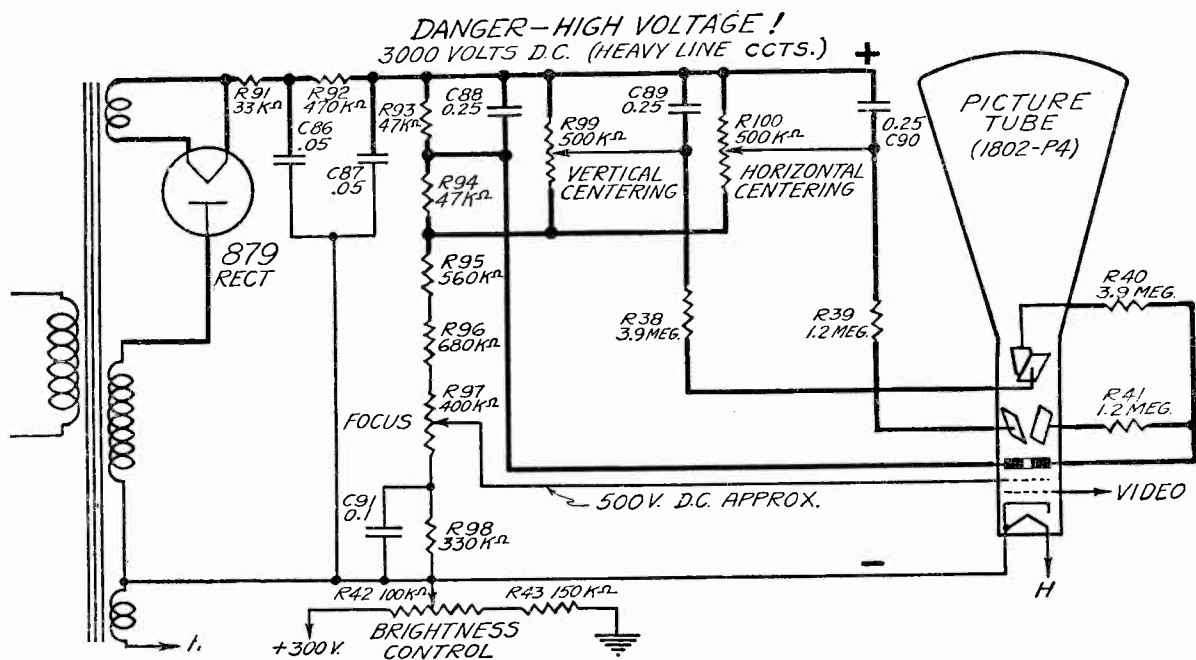

FIG. 55.—High-voltage power supply used in the RCA Model TRK-5 receiver. The heavy black lines represent the high-voltage circuits. Extreme caution should be observed to avoid coming in contact with high-voltage points.

Grounding of High-Voltage Power Supply

The high voltage difference required between the cathode and second anode of the picture tube can be obtained with either the positive or negative side of the high-voltage power supply near ground potential. In receivers using the electromagnetic method of deflection, it is usual for the negative side of the power supply to be grounded since this enables coupling the video output tube to the modulation grid without the use of a high-voltage condenser. This same system is also used in some receivers which use electrostatic deflection, as for example in the RCA Model TRK-5 receiver. Where electrostatic deflection is used, however, high-voltage blocking condensers are required in the circuits which couple the deflection output tubes to the horizontal and vertical deflection plates.

To avoid the use of high-voltage blocking condensers in the deflection plate circuits and at the same time maintain the deflection plates at the same potential as the second anode (which is necessary to avoid distortion in the picture tube), the positive side of the high-voltage power supply is sometimes grounded and the cathode is then several thousand volts negative with respect to ground. The DuMont Models 180-183 are examples of receivers using this type of circuit. Although high-voltage condensers are not required in the deflection circuits, a high-voltage blocking condenser must be used between the plate of the video output tube and the modulation grid.

Regardless of whether the positive or negative side of the power supply is grounded, the usual precautions against electrical shock must be observed.

ANTENNAS AND INSTALLATION

The proper operation of a television receiver depends to a very great extent upon the care with which the installation is made. No matter how well designed the receiver may be, its performance will be poor unless proper attention is given to the type of antenna, its location, and the installation of the receiver itself.

The receiver should be placed where no direct light will fall on the cathode-ray tube viewing screen. Although television pictures can be seen satisfactorily without total darkness, the vicinity of the receiver should be capable of being darkened readily. The location chosen should permit adequate ventilation and be close enough to a power outlet to avoid the use of extensions to the power cord. A good ground connection is also important. If the receiver is of the type intended to be used with a broadcast receiver, it should be placed in such a way that the sound appears to come from the picture, and the connections between the receivers should be as short as possible. The relation between the receiver location and the length of the antenna lead-in should also be considered, since the antenna location itself is usually determined by external conditions which cannot readily be changed.

The most important problem is the choice and installation of the antenna. The various manufacturers offer different types of antennas, some types being recommended for suburban areas, others for city use. All are of special design suitable for the ultra-short waves used in television, an ordinary broadcast antenna not being suitable for television use.

The necessity for special antennas for television is more apparent when we consider some of the differences between the short waves used in television and the comparatively long waves used in ordinary broadcasting. The shorter the wavelength of a radio wave, the more it behaves like light. For example, we know that light travels in straight lines through space. For this reason we cannot see objects far enough away to be "below the horizon." Clearly a taller object can be seen from a greater distance than one closer to the surface of the earth since it projects above the horizon. In the same way, the "coverage" of a television transmitter depends upon the height of both the transmitting antenna and the receiving antenna. In addition to increasing the range of reception, placing the receiving antenna as high as possible has the important advantage of increasing the signal pickup and decreasing the noise pickup. It is interesting to note that the television transmitter of the National Broadcasting Company in New York, which is located atop the Empire State Building (1250 feet high), covers a radius of about 40 miles or an area of about 5000 square miles.

In ultra-short wave transmissions as in light, buildings, mountains and other opaque objects cast "shadows" which result in no signal or very weak signal

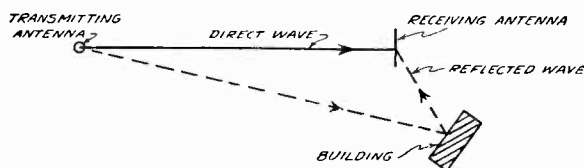

FIG. 56.—The same signal may reach the receiving antenna by two different paths. The dotted line shows the signal being reflected from a building. The example in the text is for a case in which the reflected (dotted) signal travels two miles farther than the direct signal.

within the shadow area. In addition such objects can cause reflections which may result in distorted pictures because of the small but appreciable difference in the time of arrival of the direct wave and reflected wave. Fig. 56 shows how this reflection may occur. The transmitter sends out waves in all directions, one of which may be considered as going directly to the receiver. Another wave reaches the receiver indirectly by going first to a building or other reflector and then to the receiver. The important point here is the difference in the total length of the path which the reflected wave has to travel as compared with the path of the direct wave. Here the difference is 2 miles. Since both waves travel at the same velocity of 186,000 miles per second, the reflected wave will arrive $\frac{2}{186,000}$ second, or approximately $\frac{1}{100,000}$ second later than the direct wave. The time required for the electron beam to travel 1 inch horizontally across the picture tube is also about $\frac{1}{100,000}$ second. Therefore the reflected wave will cause a second image which is displaced about 1 inch horizontally to the right of the image due to the direct wave. Smaller time differences may produce only lack of sharpness in the picture, but in any case, when installing the antenna the serviceman should try to avoid multiple images due to reflections. This effect can often be reduced or eliminated by slight changes in the position of the antenna, or by the use of a special antenna.

In general, since American television transmitting antennas will be mounted horizontally, the receiving antenna should also be approximately horizontal, and placed broadside to the direction of the transmitter. During installation, however, the best procedure is to watch an actual picture on the receiver, comparing different locations and positions of the antenna on the basis of the results obtained at the receiver. An inter-communication set between the man working on the antenna and another observing the received picture is obviously a useful accessory for antenna installation.

Automobile ignition systems and diathermy apparatus emit short-wave signals covering at least part of the television spectrum. Antennas should therefore be erected as far as possible away from these sources of interference.

The antenna should be erected at as high a point as conditions permit, since, other things being equal, the signal strength increases when the elevation of the antenna is increased. A high antenna is also likely to reduce local interference. Both these effects of course, tend to improve the signal-to-noise ratio.

Most television antennas consist of two rods or tubes of conducting material placed in a straight line end to end, but with some separation between them. Each section is about $\frac{1}{4}$ wavelength (roughly 5 feet) long, making the total length about $\frac{1}{2}$ wavelength. Such an antenna, shown in Fig. 57, is called a simple *half-*

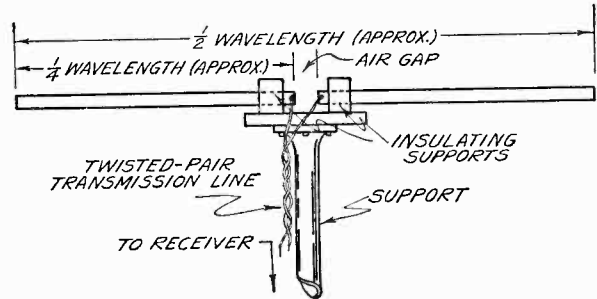

FIG. 57.—A half-wave dipole antenna—a type very widely used for television reception.

wave dipole. The lead-in or transmission line is usually a twisted pair of wires specially insulated against weathering; one wire of the pair is connected to each rod near the air gap. Some manufacturers have different kinds of transmission line for special purposes. The simple dipole is generally satisfactory, but improved performance can often be obtained from two such dipoles connected in parallel. Such double dipoles are mounted one above the other like the cross arms on a telephone pole.

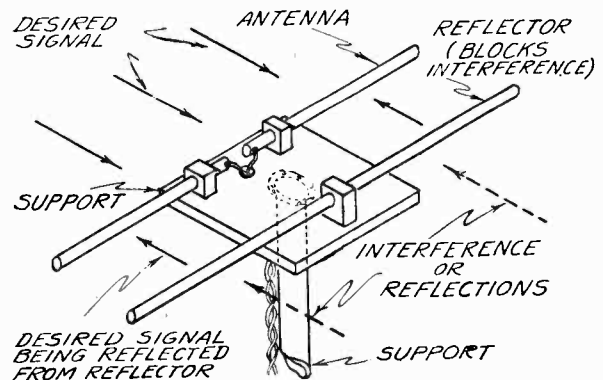

FIG. 58.—A half-wave dipole antenna with a reflector for increasing the signal pickup and reducing interference from reflections.

Where trouble is encountered from reflections or low signal strength, or both, a reflector element may be added to the antenna system. As shown in Fig. 58, the reflector is a continuous rod somewhat longer than the antenna and placed *behind* it; that is, the reflector is at the same elevation as the antenna and is parallel to it, but placed on the side of the antenna *away from* the transmitting station whose signal it is desired to receive. The reflector serves two desirable purposes:

it blocks interference or reflections coming from "behind" the dipole, and it strengthens the desired signal by reflecting it back to the dipole. The spacing between antenna and reflector is determined from the manufacturer's instructions or by experiment. The double dipole described previously may be provided with a double reflector.

No dipole of fixed dimensions can be equally efficient for all the television channels. The reason for this is that maximum efficiency requires that the length of the dipole (and also the reflector, if used) should have a fairly definite relation to the wavelength of the desired signal. We have mentioned, for example, that it should be about $\frac{1}{2}$ wavelength long

overall. For the first two television channels (44 to 56 mc) the middle frequency is 50 mc and the corresponding wavelength is 6 meters, or almost 20 feet. A 10-foot half-wave dipole is therefore quite efficient for these two channels. It is not so efficient, however, for the 66-72 mc and 78-90 mc channels, since the mid-channel wavelengths for these are respectively about 14.3 and 11.7 feet. If all these channels are to be received on one antenna, they will not be received with equal efficiency. Depending upon the local conditions, it is possible to choose the antenna length suitable for either (1) the mid-point of the whole band, (2) the mid-point of the most popular station or stations, or (3) to provide an antenna of adjustable length.

FREQUENCY MODULATION

Up to the present time all broadcast stations have used amplitude modulation for program transmission. In this method of transmitter operation the frequency of the carrier is maintained constant, usually by crystal control, while the amplitude of the carrier is varied by the audio modulation impressed upon it. A new system of broadcast transmission by frequency modulation is now being introduced by a few stations in the East. This system was devised by Major E. H. Armstrong and differs from amplitude modulation in that the carrier *frequency* is varied by the impressed audio modulation, while the carrier amplitude is held constant.

Advantages of Frequency Modulation

The principal advantages of frequency modulation over amplitude modulation are an improved signal-to-noise ratio, particularly in poor reception areas where the signal strength of the transmitter is weak, and a reduction in interference when two frequency-modulated transmitters are geographically separated but operating on the same frequency. In receiving, better fidelity is usually more easily obtained from frequency-modulated transmissions.

Since the carrier frequency in frequency-modulated broadcasting is varied over a wide band, wide channels are necessary for transmission. Present channels are 200-kc wide and have been allocated in ultra-high frequency bands to avoid interference with other services which would result if channels of such width were assigned within the standard broadcast band. The actual carrier frequency variation is limited to one-half the channel width, as with amplitude modulation, since the frequency of the carrier varies above and below the nominal assigned value when audio modulation is applied. In present frequency-modulated

broadcast transmissions, the maximum frequency deviation is held to approximately plus or minus 75 kc during audio modulation.

How Noise is Reduced

The manner in which frequency modulation reduces noise may be understood by remembering that most electrical noises change the amplitude of the signal but not its frequency. Now, in the amplitude modulation method of broadcasting, both noise and audio modulation act to vary the carrier signal voltage so that the two are combined in the signal detected by the receiver. In frequency modulation, however, the audio modulation varies only the frequency of the carrier signal and not its amplitude. Noise, on the other hand, will cause no change in the carrier frequency, though it will affect its amplitude. If, then, the receiver is designed to detect only variations in signal frequency and not variations in amplitude, noise resulting from amplitude modulation is eliminated. Frequency modulation is not perfect, but a very great reduction in noise is secured by this method.

Special Receivers Necessary

Conventional broadcast receivers are designed only for the reception of amplitude-modulated transmissions and therefore are not suitable for receiving frequency-modulated broadcast signals. The principal differences in the latter are in the design of the detector and in the limiter stage which precedes the detector.

A typical stage-by-stage lineup for a frequency modulation receiver is shown in Fig. 1. This shows an r-f amplifier, converter, 3-stage i-f amplifier, limiter, detector and a-f amplifier.

Since the transmitted frequency varies about 75 kc

above and below the point to which the receiver is tuned and flat amplification is necessary for high-quality reproduction, the carrier-amplifying stages and the converter must be designed to pass a 150-kc band without frequency discrimination. Ordinary tuned circuits are usually far too sharp for this purpose, particularly in i-f circuits, so we find in the frequency modulation receiver that low-Q circuits are necessarily employed to achieve broad tuning.



FIG. 1.—Block diagram of a receiver designed for the reception of frequency-modulated signals. With the exception of the limiter stage, the lineup is similar to that of a conventional superheterodyne receiver.

In the i-f stages, broad-band reception is secured by using a high intermediate frequency, usually of the order of 3 megacycles, and by broadening the i-f transformer response by resistance shunted across one or more windings.

What the Limiter Does

The limiter stage requires detailed consideration. Its purpose is to smooth out any variations in carrier amplitude so that it may pass on to the detector circuit a signal which is constant in voltage but varies in frequency. This is done by designing the circuit and operating the tube so that it overloads even when a weak signal is being received. Then any increase in signal voltage will not cause an increase in the carrier signal voltage which appears across the tuned circuit forming the limiter stage plate load. The high gain in the r-f, converter and i-f stages provides sufficient amplification for even weak signals so that the actual signal voltage at the limiter grid during reception will always be several volts. Any applied signal voltage greater than the overload point causes rectification in the grid circuit. A resistor in series with the grid return of the limiter input circuit is installed so that the grid current resulting from rectification in this circuit causes a voltage drop across the resistor which can be utilized to provide AVC action. This AVC voltage is applied, through appropriate filters, to preceding i-f, converter and r-f stages.

Special Detector Used

Since, in frequency modulation, the a-f modulation causes a variation in carrier frequency, we need a type of detector which will convert these frequency variations into the a-f signal voltages which originally produced these carrier frequency variations, and in this way restore the original modulation. Ordinary

detector circuits are not suitable, since they give an output voltage which is proportional to the amplitude of the carrier modulation and not to the carrier frequency. Since the voltage output of the discriminator circuits employed in AFC designs varies with the frequency shift of the applied carrier signal, it serves as an ideal device for the detection of frequency-modulated signals.

A typical AFC discriminator circuit is shown in Fig. 2. The primary coil, L1, of the discriminator transformer is connected in the plate circuit of the limiter tube and is closely coupled to the center-tapped secondary L2, L3. When the transformer secondary circuit is tuned to resonance with the alignment frequency of the i-f system, the voltages E2 and E3 are equal but opposite in phase. Since the d-c voltage across the discriminator load resistors, R1 and R2, occurs as the result of rectification of $E2 + E1$ and $E3 + E1$, then, at resonance, the d-c voltage from point B to ground is equal to that from point B to A, as both R1 and R2 are similar resistors. However, because of the manner in which the diodes are connected, the resulting d-c voltages will be opposite in polarity. Therefore, the voltage across R1 will cancel that across R2 and a measurement from point A to ground will show zero voltage between these two points when the circuit is tuned to resonance with the alignment frequency. This is the normal condition for perfect alignment of an AFC circuit.

When the signal voltage applied to the discriminator transformer is higher or lower in frequency than that to which it is tuned, the voltages E2 and E3 will remain equal but their phase relationship with respect to E1 will change. As a result, E2 plus E1 will no longer equal E3 plus E1. Since this becomes the case, the resulting d-c voltages across R1 and R2 will no longer be equal and opposite in polarity and a voltage with respect to ground will accordingly appear at Point A. As the frequency of the carrier signal becomes higher or lower than that to which the discriminator is tuned, the voltages developed across R1

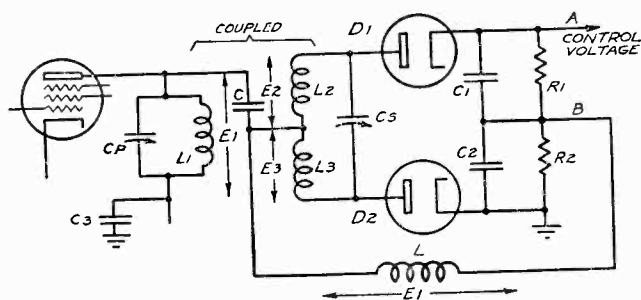

FIG. 2.—The second detector of a receiver for frequency-modulated signals is similar to the discriminator circuit shown.

and R2 add or subtract. Since point A is at zero voltage at resonance, this signal frequency variation causes point A to assume a potential with respect to ground which varies in a positive or negative direction in accordance with these frequency variations. The change in voltage of point A with respect to ground as a result of this shifting frequency is represented in the diagram, Fig. 3.

How the Discriminator Detects

Now let us see how this characteristic of the AFC circuit serves to supply an audio signal to actuate the a-f amplifier of the receiver. We have seen, in frequency-modulated transmissions, that the carrier frequency changes at a rate which is in accordance with the audio modulation impressed upon the carrier. Let us assume that a 400-cycle audio note is being broadcast and the nominal frequency of the transmitter is 42 mc. On the positive half of the 400-cycle modulation, the carrier frequency may be increased while on the negative half it may decrease. If the modulating voltage is sufficient, this may cause a maximum increase of carrier frequency of 75 kc so that the maximum frequency at the peak of the positive half of the wave becomes $42 \text{ mc} + 75 \text{ kc}$ and, at the peak of the negative half of the cycle, to $42 \text{ mc} - 75 \text{ kc}$. Now, referring again to Fig. 3, we see that a carrier frequency shift in a negative direction will cause the output voltage of the discriminator to become positive whereas an increase in carrier frequency will cause this output voltage to become negative. Since a 400-cycle note is being broadcast, the carrier frequency increases and decreases and the output voltage of the discriminator becomes positive and negative at the

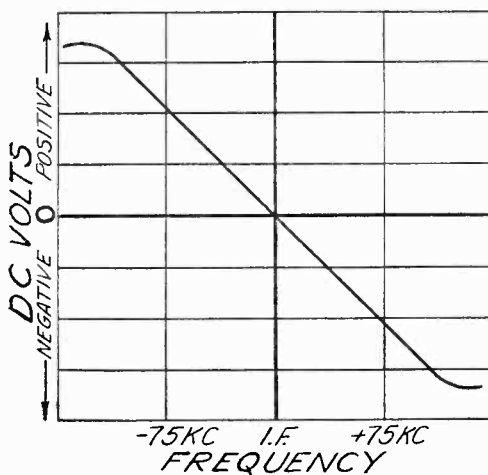

FIG. 3.—The output voltage of the frequency demodulator or second detector varies in accordance with the amount by which the signal frequency differs from the intermediate frequency.

same rate, 400 cycles per second, as that of the original broadcast note. Now, if we apply this rapidly-varying voltage to the grid of an amplifying tube, the voltage across its output load will vary at the same rate. Since this is precisely what occurs when an a-c signal is applied to a grid, we see that in this manner detection of frequency-modulated signals is effected.

Once the frequency-modulated signal is converted into audio frequencies, any type of conventional audio amplifier is suitable. Since the fidelity of reproduction in a carefully-designed receiver is exceptional, high-grade a-f amplifiers and speakers are usually employed.

The G-E Model GM125 Receiver

The schematic (see page 10-35) shows the circuit of the G-E model GM125 receiver, which is designed for frequency-modulation reception. This is a 12-tube, single-band receiver which covers a frequency range of from 37 to 44 megacycles. A single r-f stage feeds the 6K8 converter; four i-f stages are employed, the fourth stage acting as the "limiter." The detector is similar to the AFC discriminator previously described. The triode section of a 6Q7G is employed as the first a-f amplifier and feeds a 6J5G phase inverter which drives the push-pull 6L6G output tubes.

The r-f and converter stages are similar to those which could be employed in conventional designs for the same frequency band, except that no effort has been made to acquire selectivity in the tuned stages since this would be undesirable in a receiver which is required to pass a wide frequency band without frequency discrimination.

The i-f stages are designed to give a band width of 300 kc. This is done by using a high intermediate frequency (3000 kc) and by shunting each i-f transformer primary winding with a 15,000-ohm resistor.

The last i-f stage operates as a limiter. The limiting effect is secured by using a 6SJ7 tube in this stage and operating it with zero control grid bias and only 65 volts on the plate and screen. Under these operating conditions, the tube overloads with a relatively small applied signal. The high overall gain of the stages preceding the limiter tube provides sufficient amplification so that even a weak signal in the antenna circuit is built up to a voltage sufficient to overload the limiter.

When the signal strength is sufficient to overload the limiter stage, grid current flows through the 330,000-ohm resistor, R15, in the grid return circuit of the 6SJ7. The resulting voltage drop across R15 is used to provide AVC action and thus prevent overloading of preceding stages. By incorporating AVC in this stage, there can be no AVC action until the

limiter is overloaded, which is its required operating condition. When such is the case, an increase in signal voltage applied to the limiter grid will cause no increase in the output signal voltage across its plate load but the grid current will increase, thereby assuring an increasing AVC voltage.

The discriminator-type detector is similar in action to that reproduced in Fig. 2. It converts the frequency variations of the i-f signal output to a voltage which varies in amplitude at the audio frequency rate. The essential difference between this type of discriminator and one used solely for AFC purposes is that the audio component is not filtered out. This must be done when such circuits are used for AFC applications to avoid modulating the oscillator at the audio frequency. The discriminator load by-pass condensers, C18, C19, are accordingly only 22 mmfd each in this circuit, so there is no by-passing of the higher audio frequencies.

The output of the frequency-demodulator is coupled to a tone control network composed of R11, R20, R40 and the shunt and series condensers C39 and C17. Operation of R40 provides attenuation of either high or low frequencies, as desired. The output of this network connects to the volume control, R21, which returns to ground through an inverse-feedback network composed of R37 shunted by C16 in series with R22. The balance of the audio system is conventional.

Alignment Procedure

To align the i-f amplifier, connect an electronic voltmeter (or any other d-c voltmeter which has a

high input resistance) across R15. Feed a 3-mc signal to the grid of the third i-f tube. Temporarily shunt the secondary winding of T7 with a 10,000 or 15,000-ohm resistor and adjust C48 until the voltmeter reading is a maximum. Then remove the secondary shunting resistor and adjust C49 for maximum reading on the voltmeter. Then connect the shunting resistor across T6 secondary, feed the 3-mc signal to the second i-f grid and peak the trimmers of T6 in the same manner. Repeat this process for each of the i-f transformers in turn until all are aligned.

The frequency demodulator circuit may also be aligned with the voltmeter and signal generator. Feed a 3-mc signal to the input of the i-f amplifier and connect the voltmeter from the cathode connection of R18 to ground. A small voltage reading usually will be indicated if the circuit is slightly out of adjustment. If not, adjust C51 until a reading is secured. Then adjust C50 until the voltage reading is a maximum. After this is done, adjust C51 until the voltmeter reads zero. The discriminator alignment is then complete.

The r-f and oscillator stages are aligned by feeding a 42.8 mc signal to the antenna terminals and, with the receiver tuned to this point on the dial scale, adjusting the oscillator trimmer C4 for maximum reading on the voltmeter, which should be connected across R15. Then peak the antenna and r-f trimmers (C2 and C3) in the same manner.

The receiver may also be aligned with a frequency-modulated signal generator as described in the service notes given in Volume X of Rider's Manual.

WIRELESS RECORD PLAYERS

A number of different wireless record players are described in Volume X. These were first announced about the middle of 1938, although phonograph oscillators were available commercially as far back as 1935. Contributing to the present popularity of these record players is that fact that no direct connection is required between the record player and the receiver, as well as the element of mystery which is introduced because of the absence of any wire connection to the radio. Although specific service data are shown in Volume X for the models listed in the index, there are certain general considerations which apply to all wireless record players.

Essentially a wireless record player is a low-powered transmitter which provides a signal much in the same way as an ordinary broadcast transmitter. However, instead of the modulation being obtained from a

studio microphone, the phonograph pickup converts the vibrations on the record into an audio signal and this voltage is used to modulate the oscillator contained in the wireless record player. The modulated signal is radiated to the receiver which is tuned to the signal and as a result the record is reproduced by the receiver in the conventional manner. Note that the entire receiver is used rather than just the audio section. Unlike the phonograph oscillators which preceded wireless record players, there is no direct connection to the receiver and hence the name "wireless" record player.

In general, the design of the radiating system in these record players is such that the effective range of pickup is approximately fifty feet. Since excessive radiation will cause interference in other radio receivers, the Federal Communications Commission has

limited the amount of radiation to a value which is high enough to permit satisfactory operation of the record player in a typical installation, and which at the same time is not so high as to cause interference in neighboring receivers. In general a long antenna should not be attached to the record player to supplement the built-in antenna, but where the signal input to the receiver is too small the coupling between the record player and the receiver should be increased. This can be accomplished by running the antenna of the record player closer to the antenna lead-in of the receiver.

Most wireless record players use two tubes, one tube as a combination oscillator and modulator, and the other tube as the rectifier tube. The 6A7 and the 25Z5 (or their newer equivalents) are commonly used to perform these functions. In some cases a single combination tube, such as the 12A7, is used both as an oscillator-modulator and as a rectifier.

The power supply design for the most part follows conventional practice and is not unlike the power supplies used in midget receivers. In some cases a small power transformer is used, but in general the d-c voltage for the oscillator-modulator tube is obtained by means of half-wave rectification of the line voltage. In the latter case, the voltage for the heaters and the pilot bulb are obtained through a line cord or ballast tube, although in some instances the heaters are in series with the motor windings so that no ballast resistor is required.

Where the 6A7 tube is used as the oscillator-modulator, the first two grids are not used to form the oscillating circuit, as is the case in the pentagrid converter. Instead, the tuned circuit of the oscillator is connected to the signal grid (the #4 grid) and the feedback circuit is through the plate of the tube, which carries the feedback or tickler winding. Essentially, then, as far as the action of the tube as an oscillator is concerned, the tube may be considered as an ordinary regenerative triode oscillator, in which the signal grid acts as the control grid and in which the feedback is supplied through the plate.

The unmodulated signal produced by this oscillator is modulated by means of the audio signal from the phonograph pickup. The action which takes place here is similar to that which takes place in the pentagrid converter. In the pentagrid converter, the local oscillator signal is produced by the first two grids of the tube, and the incoming signal (applied to #4 grid) is modulated by means of this local oscillator signal so as to produce the intermediate frequency. In wireless record players, however, the signal to be modulated is the oscillator signal (produced as explained above by connecting a tuned circuit to the #4 grid) and the

modulation is accomplished by feeding the audio signal to the #1 grid. Both grids #2 and the screen grid (#3 and #5) are connected to B+.

As a general rule a crystal pickup is used in wireless record players and, where the type 6A7 tube is used, the pickup is connected to the #1 grid. The output of these pickups is of the order of 1 volt or more, so that with average circuit conditions the percentage of modulation is fairly low. In order to prevent distortion as a result of non-linearity of the modulation, some designs do not apply the full value of the pickup output to the grid, but use a high value of series resistance to form a voltage divider. Where a volume control is used in the record player, this control appears in the input circuit so that it is possible to control the level of the audio signal which is fed to the modulator grid.

General Service Notes

The servicing of wireless record players is similar to that of radio receivers so that no special instructions are required. However, the following notes will be found helpful in dealing with the specific conditions which are enumerated below and which are peculiar to these record players.

1. *High Noise Level:* A condition wherein the noise level is excessively high can generally be eliminated by coupling the record player more closely to the receiver. As a result of the closer coupling, the signal input from the record player to the receiver is increased, so that the noise level is correspondingly decreased. It is preferable, in coupling more closely to the receiver, to bring the antenna wire of the record player in close proximity to the lead-in of the receiver, rather than to extend the antenna of the record player in a random direction. In places where the noise level is especially high and it is difficult to find a clear channel, it will be found helpful to wind several turns of the antenna wire around the lead-in of the receiver. In no case should a direct connection be made to the antenna post of the receiver.

An alternative method of increasing the signal input to the receiver is to couple a wire to the tuned circuit of the record player through a 20-mmf condenser and to wrap several turns of this wire around the antenna lead in.

In some cases it will be helpful to tune the receiver over the range of the record player as it may turn out that a more quiet channel is clear which can be used advantageously. The record player should be off while this check is made. If a more quiet channel is found, then the record player should be tuned to this frequency.

Hum: Reversing the line cord plug has been found of help in reducing hum and in some instances a further reduction of hum can be effected by using the same receptacle for both the record player and the receiver. Aside from the usual causes of hum such as defective filtering in the power supply, excessive hum may be caused by proximity of the pickup leads (or the leads in the tuned circuit) to the line cord or rectifier leads.

Distortion: Where distorted operation is encountered, a check should be made to determine whether the distortion is being introduced by the record player or by the receiver. It should be remembered that in the last analysis the quality of reproduction can, at best, be equal to that of the receiver when it is operating on ordinary broadcast signals. This follows inasmuch as the entire receiver, and not just the audio section, is used to reproduce the signal.

If the operation of the receiver is good on broadcast signals but the output is distorted when the record player is used, then the distortion is most likely in the record player. A probable cause of distortion is a defective oscillator-modulator tube and this should be replaced to see whether another tube makes any dif-

ference. Other possible causes of distortion are a worn needle, defective crystal cartridge, or improper operating conditions. The actual cause of the distortion can be localized by following usual service procedure. It should be noted that in some cases placing the record player too close to the radio may cause microphonic action to take place with resulting distortion. On records which are deeply cut, distortion may sometimes be encountered as a result of amplitude distortion. This can be eliminated by changing to a softer needle or by reducing the setting of the volume control in order to feed a weaker signal to the modulating grid of the record player. The resulting decrease in volume which results can be compensated for by advancing the volume control setting in the radio receiver and, if necessary, by increasing the coupling between the wireless record player and the receiver in the manner previously described. In general, the volume control in the receiver should be adjusted for the highest volume that will be required and the volume control in the record player should only be used for further control of volume. The quality of reproduction will generally be better when the volume control in the record player is not fully advanced.

FACSIMILE RECEIVERS

On Crosley pages 10-41 to 10-44 of Rider's Manual Volume X there are included service notes on the Crosley Models 118, 119 facsimile receivers. Although these service notes are complete in themselves, they assume that the reader understands the theory and operation of the vasic system. For this reason the following description of facsimile as used in the Crosley-Finch system will be of interest.

As the name implies, facsimile transmission is the transmission of an exact copy of original material which may be composed of black and white characters of various shades of gray. This, of course, includes all printed material, line drawings, sketches, or photographs.

It is, therefore, necessary to prepare the copy which you desire to send by facsimile transmission. In the Crosley-Finch system, this represents the printing of copy on a sheet of plain white paper of the same size as is used in the Reado printer. Sketches or drawings are also made directly on this piece of paper, or may be pasted on as half-tone photographs usually are handled. It is essential that all characters of this copy be sharply defined, if best results are to be obtained.

This copy is then fed through the scanning mechanism by means of a paper feed system practically identical to the one used in the Reado Receiver. As the

paper is fed through the machine at the rate of 1/100 of an inch per second, it is scanned from left to right by a small, intensely bright point of light 1/100 of an inch in diameter. This light strikes either the characters which are black or some shade of gray, or the white spaces between the characters, and reflects back off the copy on the plate of a photoelectric cell. Optical lenses are used to obtain the small point of light from the 50 candle power 6 volt automobile headlamp, and a lens is also used to gather the reflected light from the copy and focus it on the plate of the photoelectric cell. The photoelectric cell emits electrons when light falls upon its plate, and these electrons form a small current which, as it flows through a very high value resistor, produces a voltage which regulates the amount of signal from a 2000-cycle oscillator that will pass through the 1851 modulator tube. When the tiny point of light falls on black characters, most of the light is absorbed and very little is reflected; but when the light falls on white paper, most of the light is reflected, and in this way the photoelectric cell may differentiate between black and white. Shades of gray reflect light according to their degree of whiteness, and so they are also detected by the photoelectric cell. We, therefore, have obtained from the black and white characters on the paper small pulses of electrical waves

(2000 cycles) which are proportional in intensity to the blackness of the characters and proportional in time duration to the length of the particular black character scanned by the small spot of light on its journey from left to right on its narrow path of 1/100" across the paper.

Synchronizing

Since even such small type as 6 or 8 point is from .040 to .060" in height, it is readily apparent that the small light spot from the scanner will have to make from four to six journeys from left to right to complete one line of type. In a like manner in the Reado printer the small stylus which travels from left to right across the recording paper is only 1/100" in diameter, and therefore must make the same number of journeys from left to right to print the same line of type. It is apparent, therefore, that both the spot of light and the recording stylus must move across the paper in perfect synchronism, if the characters are to be built up as they appear in the original copy.

Various systems of synchronism have been used in facsimile. One of the simplest systems makes use of the fact that two synchronous motors running on the same power line will run exactly at the same speed, and therefore if both are started at the same instant, will remain together. However, if the scanner and printer are on separate power lines, serious distortion occurs since one or the other may be going faster or slower. In the Reado system, the printer is geared to run 2% faster than the scanner. It will, therefore, complete one journey from left to right and back from right to left in a shorter time than will the scanner. The stylus arm is then held over at the left side of the copy by slipping a clutch between the motor and the stylus arm. This clutch is released by a small pulse of 500 cycles which is set up by the scanner just before

it starts on the journey from left to right across the copy, thereby insuring that both the small spot of light and the stylus needle start on their journey in perfect synchronism. It is perfectly true since the recording stylus travels 2% faster than the small spot of light, it will arrive at the right side of the copy sooner than the spot of light, but this difference in speed is constant and so slight that no distortion is noticed.

This, of course, means that the Reado printer will receive perfect transmission regardless of its power source and makes possible the transmission of facsimile from a phonograph record, as the records have not only the small electrical impulses represented by the black and white characters but also the small pulse of 500 cycles which releases the clutch in the receiver impressed upon them.

The simplicity of the Crosley Reado printer is due primarily to the ability of the Reado paper to turn black or some shade of gray as the small current emanating from the stylus point passes through this paper. This does away with expensive types of ink, chemically treated paper which must be used in a slightly moist condition, or carbon paper pressure recording systems. This white-coated electro-sensitive paper is a development of the Crosley laboratories. It is capable of reproducing some five or six shades of half-tone as well as sharp definite characters which, of course, is necessary in handling small type size.

The paper feeds through the machine at the rate of 1/100 inch per second, which means that three feet of copy should be received during an hour broadcast from stations using the Finch system of facsimile.

Two small coils are mounted on the left side of the printer which actuate the small pawl to release the clutch, which makes possible the synchronization of the printer and scanner at the beginning of each stroke.

SERVICING BY SIGNAL TRACING

This business of radio servicing has been in existence now for a good many years and the one subject that is of primary importance to every man actively connected with it is how a defective receiver should be tested or inspected in order that the fault may be found accurately, quickly, and easily, because unless the test be conducted so that these conditions are met, the chances are good that the serviceman will not show a reasonable profit on any one particular job.

Ream after ream of paper has been covered describing all manner of test procedures—some good—some fair—and others decidedly not so good. There have been advocates of one system or another and they

apparently find one suited to their needs for they have built up a successful business. Yet when each and every one of these systems of testing be analyzed—taken apart to see upon what it is based, it will be found that there are almost as many bases as there are systems. Now to our way of thinking—and we feel sure that you will agree with our premise—there is just one way to test any machine or system—no matter what its variations may be—and that is to decide what is the essential factor that is responsible for the functioning of the system; then when that has been determined, to investigate its behavior as it progresses through the system and performs useful

work. All too often this thought of the power itself is sidetracked and because of some reason, a multitude of minor procedures come into practice that check the *parts* of the system but not the fundamental or driving force itself.

For example, when a steam generating plant is tested, upon what are the observations made? The live steam itself—the moving force that performs work. If you were to look in at such a test, you would find the engineers reading gauges and thermometers, watching flow meters—inspecting the condition of the steam as it progresses through the system . . . watching the force itself, as it were. True, you would find men taking the temperature of the fire with a pyrometer—checks being made on the gases going up the flue with a CO₂ analyzer—records made of the amounts of the coal and water being consumed—but these are only to calculate the overall efficiency of the installation—it is the steam itself that is the important factor.

Now apply this same line of reasoning to the testing of a radio receiver—*any* receiver, mind you—old or new or yet to be designed—a-c or d-c operated—trf or superhet. . . . Just what is the one essential factor upon which the functioning of every radio receiver ever built or ever to be built, is based? What is this common denominator of all receiving systems—the fundamental—the elemental? It is the signal itself.

What is it that is superimposed upon the carrier wave? The signal. What is it that every condenser, resistor, transformer, tube or any other part in a receiver works on? The signal. When you are called into a customer's home, you are wanted because the receiver is not functioning as it should and the *signal* has been affected in some way or other. Perhaps it has become distorted—perhaps hum is superimposed upon it—maybe there is a reduction in the sensitivity or a loss of control or maybe no signal at all. . . . Any way you approach it, the signal, and the signal alone, is the all-important factor. And this is what you as a serviceman must restore to its normal state. . . . No matter *how* you do it, it is your job to fix the trouble as easily and as quickly as you can.

Diagnosis All-Important

But before the signal can be brought back to normality, the condition or conditions causing the trouble—and they may be external as well as in the set itself, although the chances are that they will be the latter—must be discovered. And that brings us back to our starting point: the testing of the receiver—the diagnosis of the condition that is affecting the signal. You know as well as we do that it is the

ability of a serviceman to diagnose trouble that makes him valuable to his business. . . . The locating of the fault is 90% of the whole job of bringing back the signal and if the time to do this great percentage can be reduced, even a few minutes, then that will automatically make for increased profits.

And that is what we have been striving to do and it is our belief that we have found a way that you can localize the faulty condition in a receiver more quickly and more efficiently than it has been possible to do heretofore.

First of all, if one method of finding out what is causing the signal's abnormality could be equally well applied to *any* type of receiver, matters would be simplified enormously. Furthermore, if this method could be applied to any *new* receiver as well as those now on the market, then it would be unnecessary to clutter up your mind with a thousand and one details. Now taking the premise that in every radio receiver essentially the identical things happen to the signal, a good start towards universality has been made.

In general terms the signal in every receiver is detected, amplified at audio frequencies, and then the electrical energy is delivered to the actuating mechanism of a loud speaker. If the signal be amplified at radio frequencies before detection that still does not spoil the picture . . . it is just an additional step—just as the introduction of AVC or AFC would be. . . . Also if a locally generated current be mixed with the signal before it is detected that is just one more step that does not detract from the main idea. Think in generalities and you will find nothing complicated. If you will look into the future a bit, you will see that unless the whole system of broadcasting be entirely changed—and there is little chance of that coming to pass—receivers of the future will have exactly the same features as those of today . . . perhaps a few refinements and embellishments, but nothing to affect the main idea. It is just like the automobile industry: new models are introduced annually with knee action, improved brakes, balloon tires and what have you, but still the same old fundamentals are there—you have a motor in which the expanding gases push a piston down and that mechanical energy makes the rear wheels revolve.

Signal Tracing

Granting that all receivers are alike fundamentally in their action on the signal, some way had to be found whereby the signal could be inspected from the instant it enters the receiver at the antenna until it arrives at the output. Moreover if some practical way of doing this existed, it would make possible the locating of the point at which the signal departed from

normal . . . where it became distorted . . . where it weakened or where something else happened to it. Yet no matter how desirable such a procedure might prove to be, with the equipment available to the serviceman such a method was out of the question. Therefore, in order to employ this signal-checking procedure, which we consider to be universally practical, it was first necessary to develop some apparatus that would give the information required under actual operating conditions and without influencing the signal in its passage through the receiver. Moreover, theoretical analysis of the problem showed that if such apparatus could be developed, it would not only localize the fault in some particular circuit, but it would also go a long way in tracking down the part that caused the signal to depart from its normal condition.

Accessibility of Parts

We then turned our attention to the physical side of the receivers themselves. Granting the signal-tracing system of testing to be the best, would it be possible to get at the different points in the sets where connections would have to be made and what effect would such connections have not only on the readings but on the operation of the receiver? Schematics of all kinds were examined as well as the chassis of a large number of existing receivers. . . . Design engineers were consulted concerning the electrical and physical trends in the sets to come; what would be the result if the ideas of today were incorporated in the sets of tomorrow? All our findings were encouraging; the further we went, the firmer were our convictions that we were on the right track. As far as we were able to discover the parts in the new receivers were to be as accessible as possible in order to assure simple and economical maintenance. And it goes without saying that if the parts are easily reached, then the paths along which the signal flows will also be accessible. Furthermore, as our method offered no interference with the receiver's operation, the complex interlocked circuits would not offer any problem in respect to its application.

The problem was also considered from the point of view of the servicemen's technical capabilities in relation to the new design of receivers. It was clear that a new attack—a new method of approach was in order so that the trouble in a receiver could be diagnosed systematically, efficiently, and quickly. As our readers will admit, although receiver design has advanced with gigantic strides in the last few years, the serviceman's methods of trouble localization might well be described as belonging to the Stone Age. It has been conceded that some new method must be devised if the service industry is going to survive by mastering the

problems presented by the new receivers. We wish that you would think back over the last few months' work and remember the number of conditions that you were unable to check in late receivers or the number of things you had to assume—mainly because it was impossible for one reason or another to check them.

Three Essentials

With all these facts marshalled before us, we arrived at the conclusion that this signal-tracing method of testing required three major items in order to be effective; it must have universal application, positive identification, and speedy operation. In no one of the methods in use up to the present time are these three factors incorporated and you can readily see that they are necessary for rapid and accurate work. Although the signal is really the basis of the system, yet its tracing through the receiver is the primary, but not the only test. It is supplemented by a voltage test which although secondary, plays an important part. The primary test locates the trouble in some certain portion of the receiver—sometimes the exact defective part. The supplementary test identifies the defective part in many cases—but in every case furnishes the required information.

Now what must we be able to do in finding the portion of the receiver that is not functioning correctly and locating the faulty component? First we must be able to trace the passage of a signal entering the receiver through the antenna post throughout the various signal-current-carrying circuits, no matter if it be at radio frequency, intermediate frequency or audio frequency. Then the signal must be traced throughout the receiver without altering the constants of the circuits and as a consequence, impairing the operation of the receiver and so nullifying the observations. Simultaneously, the operation of the receiver oscillator also is checked. The voltage tests must be of such a kind that they will take care of the operating voltages and also the control voltages that are developed by the signal. These voltage measurements can be made simultaneously with the observation of the signal and at points common to both the signal and the voltage. The measurement of the d-c voltages must be made with reasonable accuracy with respect to the true voltage present at the point under test without changing the constants of the circuit.

It is our belief that you will agree that the different points outlined above would go far towards helping servicemen over many difficult spots, if it were possible to perform the signal-tracing tests and make the various voltage measurements. And all this *is* possible.

Rider's Manuals

HAD TO BE BETTER

to become the "standard"

Vol. XIII	. 1672 Pages	. \$11.00
Vol. XII	. 1648 Pages	. \$11.00
Vol. XI	. 1652 Pages	. \$11.00
Vol. X	. 1664 Pages	. \$11.00
Vol. IX	. 1672 Pages	. \$11.00
Vol. VIII	. 1650 Pages	. \$11.00
Vol. VII	. 1600 Pages	. \$11.00
Vol. VI	. 1240 Pages	. \$ 8.25
Vol. V	. 1200 Pages	. \$ 8.25
Vol. IV	. 1060 Pages	. \$ 8.25
Vol. III	. 1070 Pages	. \$ 8.25

Vols. I to V abridged . 2000 Pages . \$12.50



John F. Rider Publisher, Inc.

404 Fourth Avenue, New York 16, N. Y.
