

DECEMBER, 1946

RADIO

MANUFACTURING
AND
BROADCASTING

The Journal for Radio & Electronic Engineers

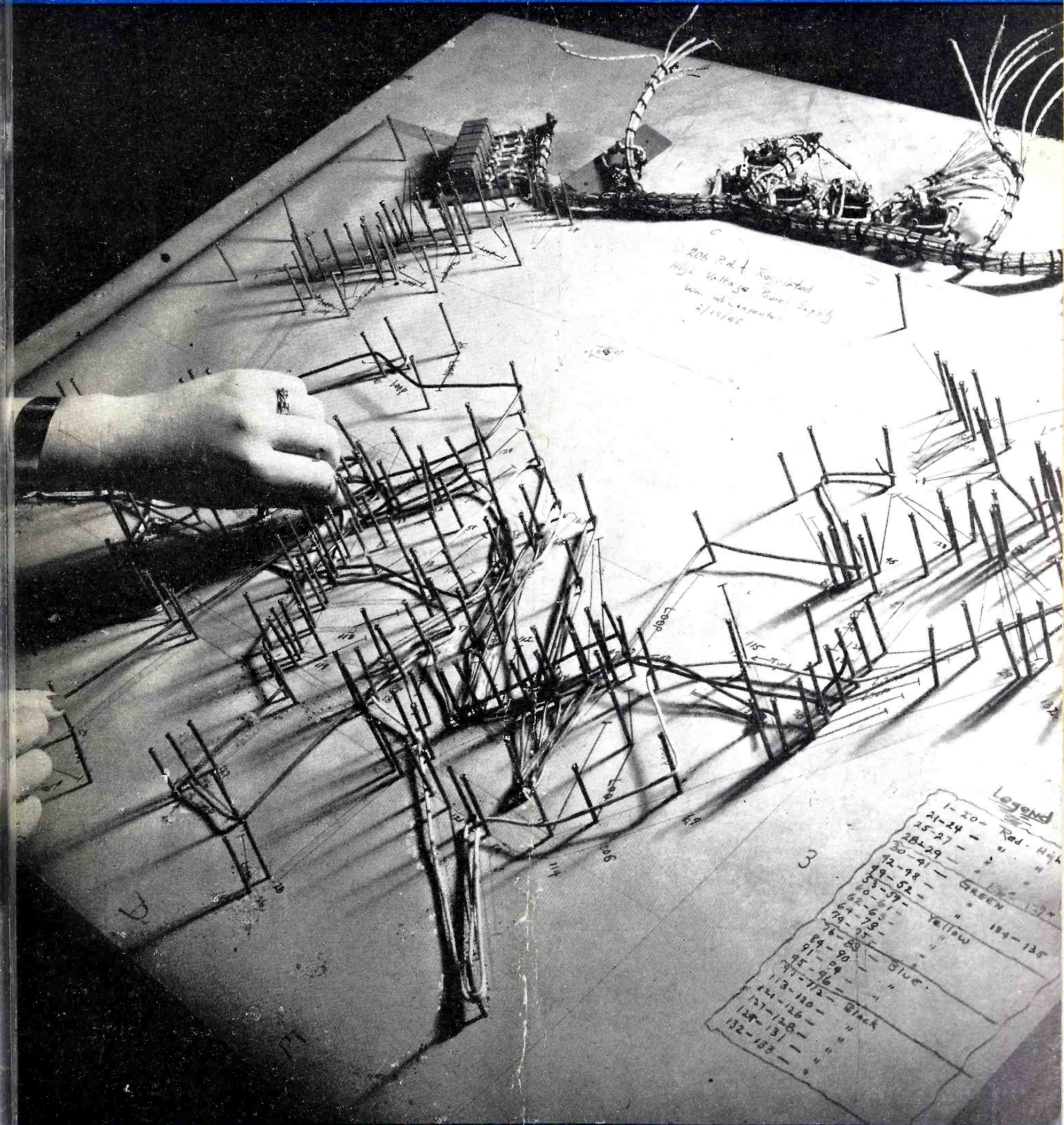

Design • Production • Operation

FOR AN HONORED PLACE IN THE HALL OF FAME

Perhaps no other single transmitting tube has such a great and rightful claim to fame as has the Eimac 450T triode.

This tube, one of the original members of the Eimac family, has consistently established records for plus performance in some of the world's most gruelling applications.

Long before the war the Eimac 450T established a high standard of dependability and performance in the ground stations of leading commercial airlines. Because of their outstanding dependability and inherently superior capabilities, these tubes were snapped up for wartime duty in many vital applications.

UNUSUAL VERSATILITY

The Eimac 450T is perfectly suited to a wide variety of uses as a modulator, oscillator, or amplifier. It is available as a high-mu (450TH) or low-mu (450TL) type. In every capacity, the Eimac 450T is tops in its power range; stable, rugged, and above all, proven over years of successful use.

LONG DEPENDABLE LIFE

When the first Eimac 450T's were installed in several major broadcasting stations, operators consistently reported better than 15,000 hours of service, top-notch performance. They were astounded to see such a compact tube do a giant's job. Eimac

450T's in airline ground stations located everywhere from sub-zero mountain passes to steaming jungles have been reported going quietly and efficiently about their jobs after 20,000 hours on the air!

PERFORMANCE PLUS

Performance is, after all, the ultimate criterion of electron tubes. The unusual capabilities and low interelectrode capacitances of the Eimac 450T are two of the reasons for its widespread use in 1 Kw to 5 Kw stations at frequencies up to 60 Mc. And even at frequencies up to 150 Mc, the 450T triode will provide a useful output.

HIGH POWER-GAIN

In a class B audio amplifier, a pair of Eimac 450TL's will provide 2200 watts plate power output with a driving power of but 15 watts! Or, in a class-C application, a *single* Eimac 450TL will provide an r-f plate power output of 1800 watts with but 42 watts driving power.

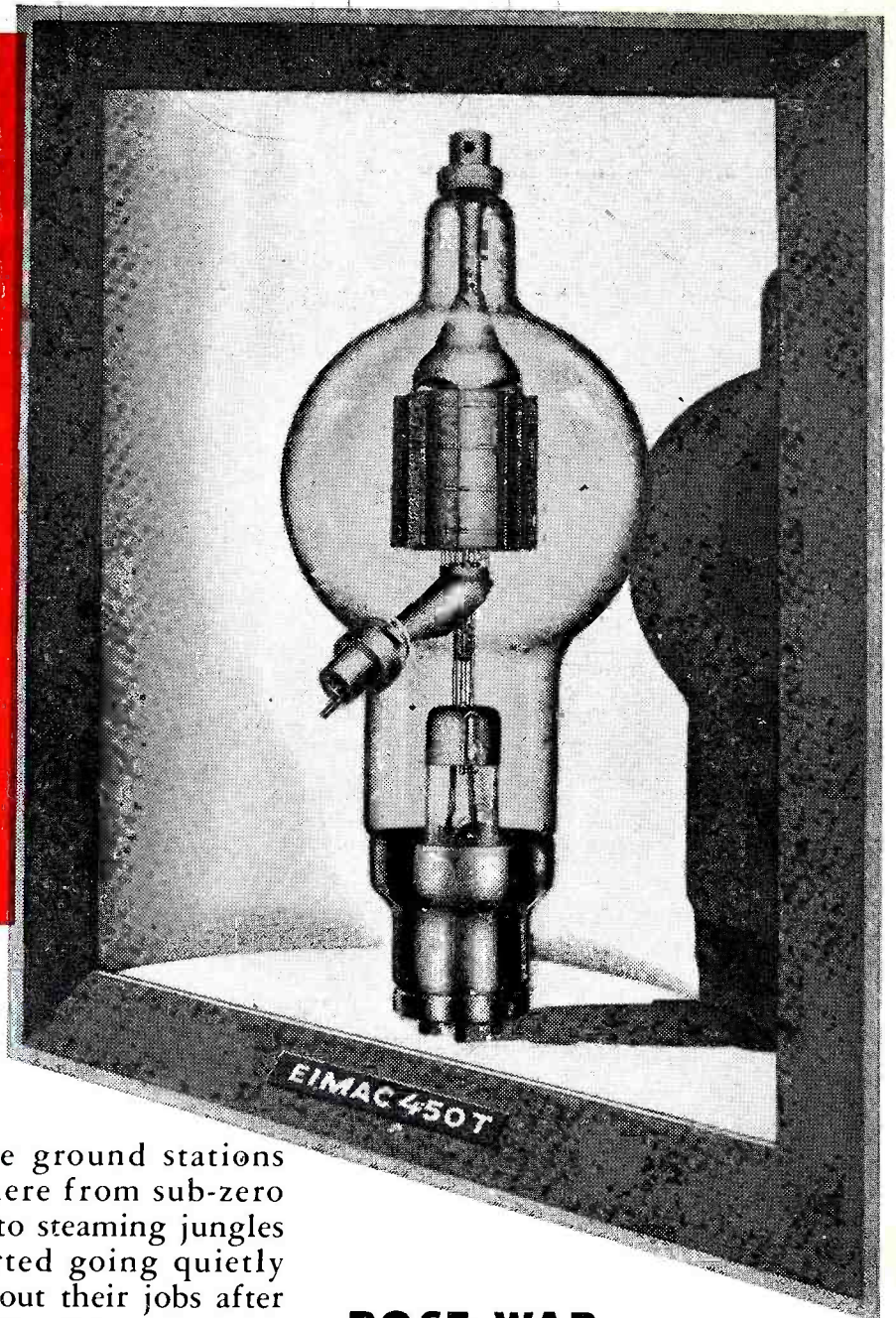
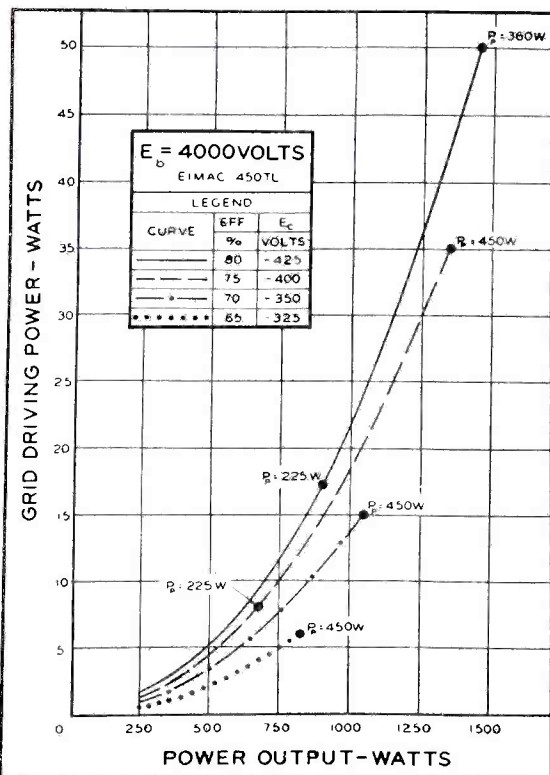

POST-WAR IMPROVEMENTS

The 450T, proven before war and during war, stands today as a greater tube than ever before. Post-war developments, the result of steady, intensive research in Eimac's laboratory, has brought to today's 450T new electrodes for higher thermionic efficiencies and even longer life.

With these facts in mind, it's easy to see why the Eimac 450T is accepted over any other triode of like rating. This veteran tube has stood the acid test of time and rugged duty around the world. Today a still better 450T awaits your order. Inquire!

EITEL-McCULLOUGH, INC.
1305 G San Mateo Ave., San Bruno, Calif.

Export Agents:

Frazar and Hansen, 301 Clay St., San Francisco 11, Calif.

Follow the Leaders to

Eimac
REG. U. S. PAT. OFF.
TUBES

THE COUNTERSIGN OF DEPENDABILITY IN ANY ELECTRONIC EQUIPMENT



RADIO

Published by RADIO MAGAZINES, INC

DECEMBER, 1946

Vol. 30, No. 12

John H. Potts..... Editor

Sanford R. Cowan..... Publisher

CONTENTS

COVER

Assembling cable harness. Wires laid out over the drawing; when completed, they are tied in bunches to form cables. The tied-up cable, at top of board, shows the final appearance.

(Courtesy of Cambridge Thermionic Corp.)

Transients (<i>Editorial</i>)	3
TECHNICANA	4
Width Modulation	4
Sneak Circuit	4
Cold-Cathode Tubes	4
Room Space Vs. Hi-Fi	6
Cathodes for Pulse Work	6
Theater P.A. Systems	7
Signal-Noise Ratio for Matched Lines	7
Designing a One-KW Amplifier for the New FM Band— <i>John H. Battison</i>	9
<i>Many broadcast stations are unable to change over to the new FM band because of delay in receiving equipment on order. This simple r-f amplifier will serve excellently for interim use on the new band pending arrival of manufactured apparatus.</i>	
Center Frequency Control for FM Transmitters, Part 2— <i>Philip H. Stewart</i>	11
<i>More data on methods of stabilizing the center frequency of FM transmitters.</i>	
The Parallel-T Network as a Power Supply Filter— <i>E. M. McCormick</i>	14
<i>This unique circuit provides excellent power supply filtration at low cost.</i>	
Recent Radio Inventions	16
Improved A-F-C Circuit	16
Attenuator for Coaxial Transmission Lines	17
Portable T-V Modulation System	17
Rotating Joint for U-H-F Line	17
Chart — Ratio of Current in Complex Termination to that in Resistance Termination as Function of Reactance in Termination	18
Radio Design Worksheet No. 55 — Narrow-Band FM Side Frequencies	19
This Month	20
New Products	21
Book Reviews	27
Advertising Index	32

John H. Potts.....President-Editor

Sanford R. Cowan....Sec'y-Treas.—Adv. Mgr.

Robert G. Middleton.....Associate Editor

Evelyn A. Eisenberg.....Assistant Editor

Sanford L. Cahn.....Adv. Sales Mgr.

Harry N. Reizes

David Saltman

Miriam Birnbaum.....Circl. Manager

MIDWEST OFFICE

H. S. Laufman, Manager

82 West Washington St., Chicago 2, Ill.
ANDover 1395

PACIFIC COAST REPRESENTATIVE

JAMES C. GALLOWAY

816 W. 5th St., Los Angeles 13, Calif.

FOREIGN SUBSCRIPTION REPRESENTATIVES

Radio Society of Great Britain, New Ruskin House, Little Russell St., London, W.C. 1, England. Harris & Floyd, 297-299 Swanston, St., Melbourne, C. 1. Victoria, Australia

RADIO Magazine (title registered U. S. Pat. Off.) is published monthly at Boston Post Road, Orange, Connecticut, by Radio Magazines, Inc. Executive and Editorial Offices at 342 Madison Avenue, New York 17, N. Y. Subscription rates—United States, U. S. Possessions & Canada, \$3.00 for 1 year, \$5.00 for 2 years; elsewhere \$4.00 per year. Single copies 35c. Printed in U.S.A. All rights reserved, entire contents Copyright 1946 by Radio Magazines, Inc. Entered as Second Class Matter May 10, 1945 at the Post Office at Orange, Conn., under the Act of March 3, 1879.

Listen!

2 NEW Jensen

Extended Range High-Fidelity PM SPEAKERS

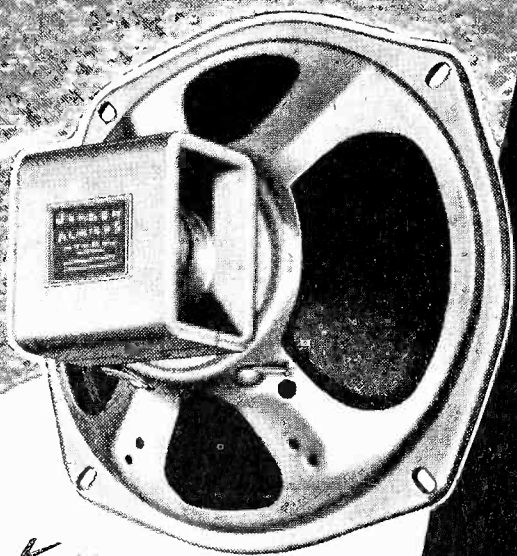

These two Jensen speakers, with *ALNICO 5* PM design, provide excellent high-fidelity performance. Excellent as replacement and modernizing units for FM and television receivers, radio-phonograph combinations, for studio monitoring, wired music, and for similar applications. Installed in Jensen Bass Reflex* cabinets, they provide exceptionally high-quality reproduction with added octaves of bass response.

*Trade Mark Registered

Listen ...it's a Jensen SPEAKER

Model P12-SH (Superseding PM12-CT). A new 12-inch high-fidelity *ALNICO 5* PM speaker. Designed for use with Jensen Model A-121 or Model D-121 Bass Reflex cabinets. Maximum power handling capacity in speech and music systems, 8 watts. Voice coil impedance, 6-8 ohms.

Standard Fidelity Model P12-S. Voice coil impedance 6-8 ohms. Power handling capacity in speech and music systems, 10 watts.

Listen ...it's a Jensen SPEAKER

Model P8-SH (Superseding PM8-CT). A high-fidelity 8-inch *ALNICO 5* PM speaker. Recommended for use with Jensen Model A-81 Bass Reflex cabinet. Maximum power handling capacity in speech and music systems, 6 watts. . . . Voice coil impedance, 6-8 ohms.

Standard Fidelity Model P8-S. Voice coil impedance, 3-4 ohms. Maximum power handling capacity in speech and music systems, 8 watts.

BASE REFLEX CABINETS

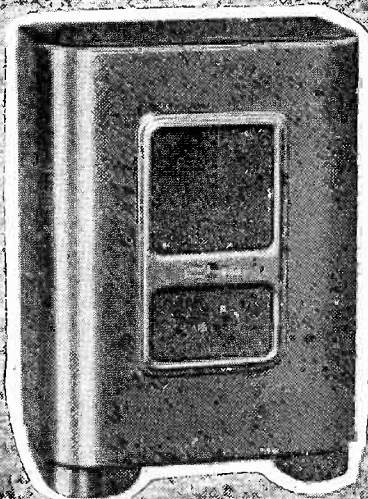

Model A-81
for Model P8-SH speaker
Model A-121
for Model P12-SH speaker

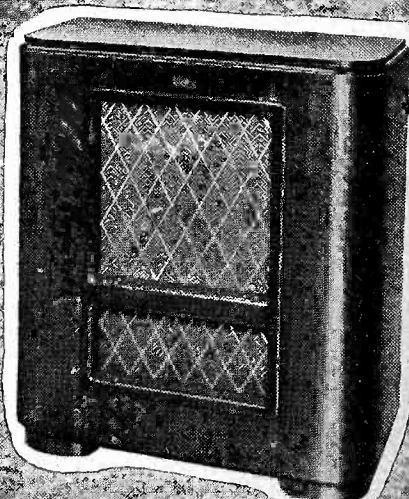

Model D-121
for Model P12-SH speaker



Jensen

SPEAKERS
WITH
ALNICO 5

Designers and Manufacturers of Fine Acoustic Equipment ©1946

JENSEN MANUFACTURING CO., 6615 S. LARAMIE AVE., CHICAGO 38, U. S. A.
In Canada: Copper Wire Products, Ltd., 11 King St., W., Toronto, Ont.

DECEMBER, 1946 ★ RADIO

Transients

VOLUME EXPANSION

★ Methods of increasing the dynamic range of radio and record reproduction enjoyed some popularity before the war, particularly in England. We feel that now is a good time to revive, and improve these systems of volume expansion. The public is going to expect some improvements in radio performance over that provided by prewar receivers, otherwise there is bound to be a slump in sales in the near future. Addition of volume expansion is well worth careful consideration. . . there is no more striking demonstration than to compare the performance of a receiver equipped with volume expansion with one which does not possess this feature.

Improvements in non-linear resistance design during the past few years should enable some of the limitations of volume expansion to be overcome. A little intensive research should take care of the other shortcomings. Properly used on suitable programs, this feature enables greatly improved reproduction.

PROFIT-SHARING PLANS

★ Now that reconversion in the radio industry is practically over, it is time to give thought to methods of improving the quality of production and reducing costs. Employee profit-sharing plans, though largely abandoned by large organizations where production is mainly a function of machine speed, have been found advantageous in small plants, and in production line assemblies where most of the operations are performed by hand, rather than by machine.

Radio production falls into this category, and if experience in other lines is a criterion, profit-sharing plans should pay out well for all concerned. It has been frequently found that the reduction in waste of time and material with such plans covers the cost, while employee morale is greatly improved.

UNIVERSAL ANTENNAS

★ FM-TV antennas containing motors and gearing in the dipole housing for the purpose of directing the antenna and resonating it at will by remote control are most useful gadgets. With them, maximum signal-to-noise ratio is assured for each frequency and ghosts may be minimized. But at the present time these devices are rather costly.

It is interesting to speculate on possible ways of accomplishing the same results electronically, rather than

mechanically. If such a system can be worked out, cost of construction would be greatly reduced, thus creating a far greater potential market.

One method which has been suggested to accomplish this is to use a step relay to switch incremental reactance in and out of the dipole system to resonate it to the desired frequency. This would eliminate the need for telescoping dipoles and associated motor and gearing. For directivity, a turnstile-type antenna could be mounted in a fixed position and this job could likewise be performed electrically. One possible way is to insert a phase-shifting network between the lead-in and dipoles, using a switching system to cut in incremental phase shifts as required.

Development of efficient antennas at reduced cost will greatly hasten public acceptance of FM and television, which suffer now from high initial cost and restricted reception.

FM PROGRESS

★ Increased production of receivers incorporating FM bands is stimulating the demand for FM. In fact, there is now some danger of over-production of receivers designed solely for AM reception, and manufacturers and dealers should watch the market carefully. It would be disastrous to have the market glutted at this time with high-priced receivers which people don't want. Greater proportionate production of AM-FM sets in the moderate-priced range seems indicated as conditions now stand.

It should be recognized that there is considerable propaganda against FM which is gathering momentum. It is asserted that FM is expensive and doesn't meet the claims made for it. Manifestly any receiver capable of top-notch reproduction cannot be cheap, whether AM or FM, since the major portion of the cost is in the audio reproducing system and cabinet, which would be substantially the same for either AM or FM sets. We feel that this situation should receive far more publicity than it has.

With the stepped-up schedule of deliveries of FM transmitters, a far wider choice of good programs than has formerly existed promises to be available to purchasers of FM receivers. By supplying the market with an increasing number of really good FM receivers at the present time, dangers of a serious sales slump can be greatly minimized.

J.H.P.

TECHNICANA

WIDTH MODULATION

★ Pulse-width modulation, which claims increasing attention, is extensively discussed in an article by D. I. Lawson, *et al.*, entitled "A Method of Transmitting Sound on the Vision Carrier of a Television System," appearing in the July-August issue of the *Journal of the Institution of Electrical Engineers* (London).

It is asserted that width-modulated pulses inserted during the line-synch periods make possible a simpler receiver with reduced bandwidth requirements for a given degree of fidelity. Video a-v-c problems are likewise relieved, the author points out, since the fixed height of the width-modulated pulses can be used as a reference level.

It is well established that the highest modulating frequency cannot exceed half the line repetition rate, and suitable receiver designs incorporate low-pass filters with this cut-off frequency. In the British system this allows an audio response of 5 kc, which has proved acceptable to the majority of broadcast listeners, according to studies by Chinn and Eisenberg, as published in the *I. R. E. Proceedings* and quoted by Mr. Lawson.

He regards height modulation schemes with disfavor, because limiters cannot be used in the receiver to clip the pulses and improve the signal-noise ratio. However, when the width-modulated pulses have a higher amplitude than the synch pulses, they are easily separated at the receiver with suitably biased tubes.

The circuit suggested for this pur-

pose is shown in *Fig. 1*, with typical input and output signal amplitudes indicated. Capacitor C_5 serves to develop the higher frequencies, increasing the ratio of pulse-to-picture voltage. The time-constant of C_1R_2 is made long with respect to the repetition rate. No bias is used in the last section of T_1 so that sound pulses cause C_1 to charge up to a negative potential equal to the peak amplitude of the sound pulses. Resistor R_4 serves to remove noise along the top of the pulse, by limiting grid current.

Output from the second section of T_1 therefore consists only of the sound-pulse (width-modulated) waveform. The specified 5-kc cut-off is accomplished in part by R_3C_2 .

Sound is recovered in T_2 by means of the frequency-selective negative feedback circuit included in the cathode. L_1C_3 resonates to the pulse repetition frequency (10,125 cps) for purposes of rejection. The Q of this circuit is made about 20, so that it is also effective in attenuation of inversion components between 5 and 10 kc. To obtain improved filtering at 5 kc, C_4 is made to resonate with the leakage reactance seen at the primary terminals of T_0 .

The author also considers circuits for developing the sound when the width-modulated pulse lies below the synch in amplitude. Waveform generators are discussed at some length, and an appendix provides numerous mathematical derivations of importance in this type of pulse work.

This article called forth much discussion which is presented at its conclusion.

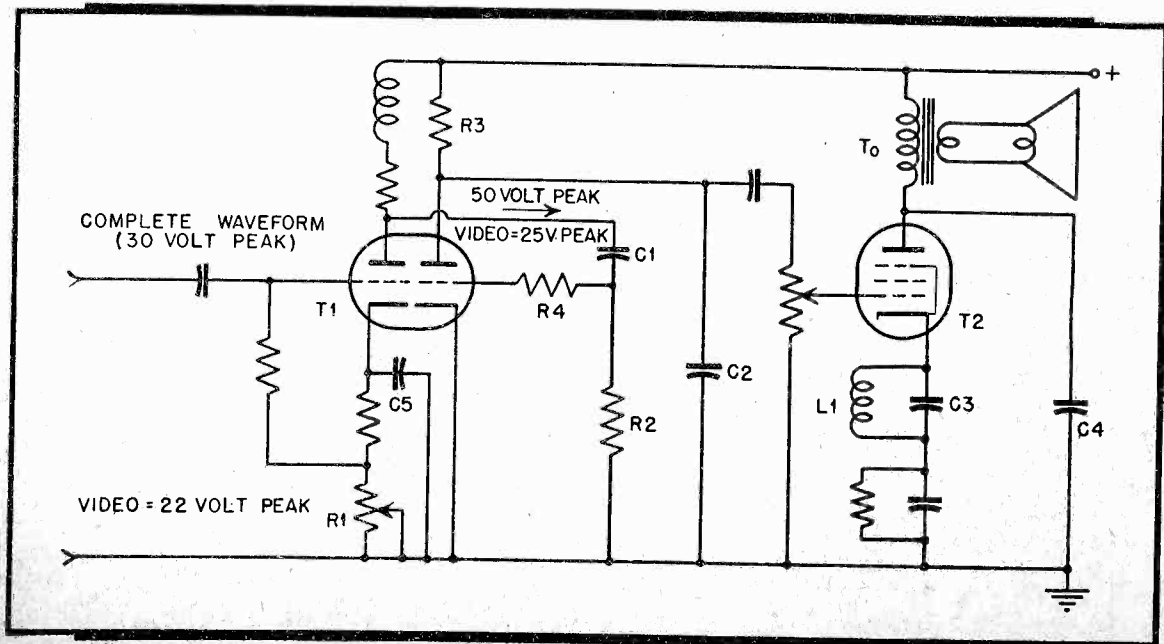

Figure 1

SNEAK CIRCUIT

★ Erratic and inconsistent readings obtained from a megger form the basis of an interesting technical note by J. Piggott, entitled "Measuring Insulation Resistance" which appears in *Wireless World* for August 1946. In the course of routine searches for an open-line fault, the author found that a varying

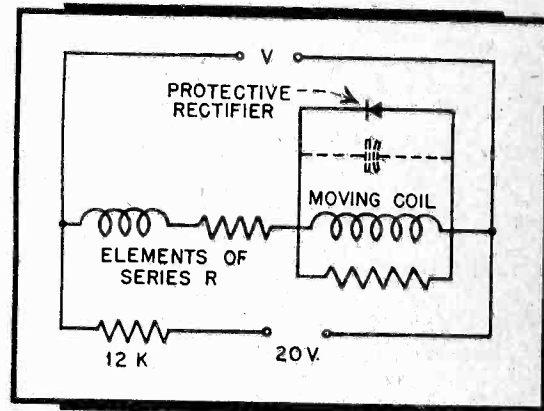

Figure 2

d-c resistance of 3000 to 4500 ohms was measured from each line to ground, while the resistance from line-to-line was in excess of 10,000 ohms.

The answer was finally traced to the 450-kc resonant circuit formed by the moving coil of the megger in shunt with the effective capacitance of the protective rectifier. (See *Fig. 2*.) The open-wire line was operating as a broadcast receiving antenna, and the megger was operating as a receiver.

In newer models of British manufacture, it is stated that redesign has eliminated the anomalous response.

COLD-CATHODE TUBES

★ German research on cold cathode tubes and their use for flare fuzes and experimental time and proximity fuzes are described in two reports on sale by the Office of Technical Services, Department of Commerce.

One report (PB-16719; photostat, \$3; microfilm, 50 cents; 39 pages, including diagrams) describes cold cathodes produced by the Siemens Reiniger Werke, Rudolstadt, as well as research directed toward designing a cold tube that would fire fuzes without delay. All the cold cathode tubes manufactured at this plant consisted basically of a metal cathode, coated with pure potassium, and other uncoated metal electrodes. These were sealed in a glass envelope filled with pure argon at a pressure determined by the electrical characteristics required.

Diode and triode tubes could be used as quick-acting, reliable fuze trigger mechanisms when small quantities of radium were introduced into the tube. Because of manufacturing problems and the shortage of radium, this type of tube was never put into regular production in Germany. To overcome these difficulties, research workers developed a tetrode which had the triggering properties of a triode without requiring the

KAAR

INSTANT
HEATING

MOBILE FM

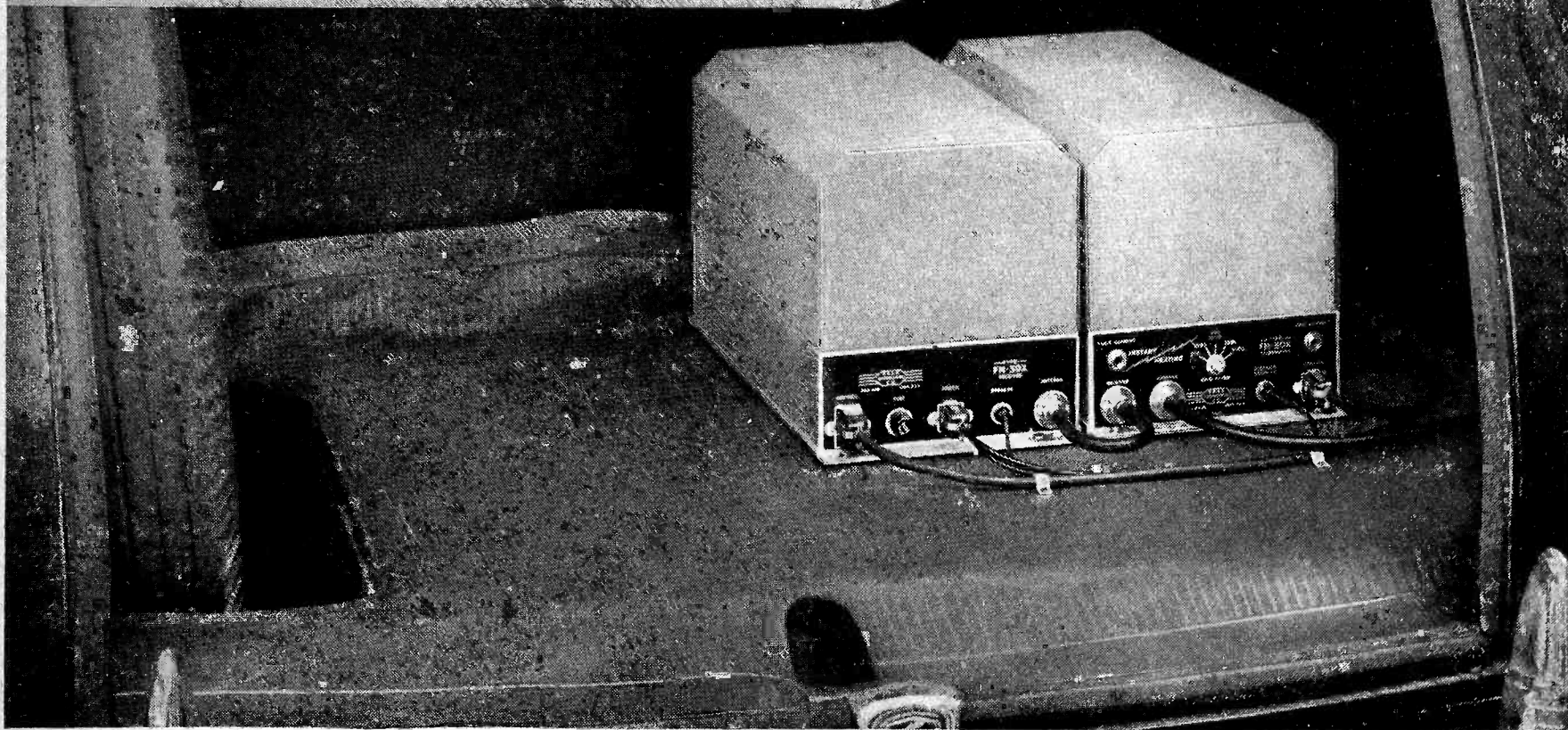

Now available! An FM Radiotelephone with a truly NATURAL voice quality!

New KAAR FM radiotelephones offer an improvement in tone quality which is surprising to anyone who has had previous experience with mobile FM equipment. The over-all audio frequency response through the KAAR transmitter and receiver is actually within plus or minus 5 decibels from 200 to 3500 cycles! (See graph below.) This results in vastly better voice quality, and greatly improved intelligibility. In fact, there is appreciable improvement even when the FM-39X receiver or one of the KAAR FM transmitters is employed in a composite installation.

KAAR FM transmitters are equipped with instant-heating tubes, thus making it practical to operate these 50 and 100 watt units from the standard 6 volt ignition battery without changing the generator. Inasmuch as standby current is zero, in typical emergency service the KAAR FM-50X (50 watts) uses only 4% of the battery current required for conventional 30 watt transmitters. Battery drain for the KAAR FM-100X (100 watts) is comparably low.

For full information on new KAAR FM radiotelephones, write today for Bulletin No. 24A-46.

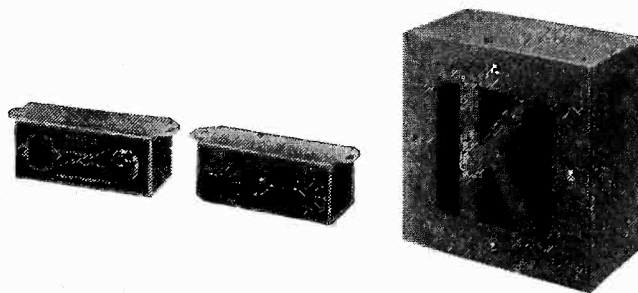

KAAR LOUD SPEAKER, remote controls for transmitter and receiver (illustrated above) and the famous Type 4-C push-to-talk microphone are among the accessories furnished with the equipment.

IMPROVED OVER-ALL FREQUENCY RESPONSE THROUGH KAAR FM TRANSMITTER AND RECEIVER

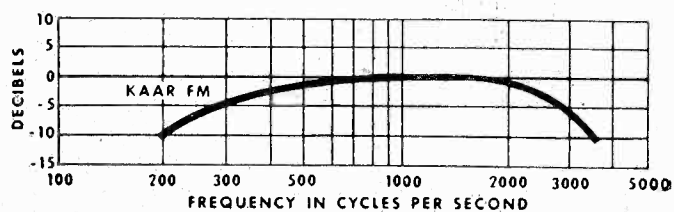

KAAR ENGINEERING CO.
PALO ALTO • CALIFORNIA



TECHNICANA

[Continued from page 4]

Are You a "Pre-War" Model?

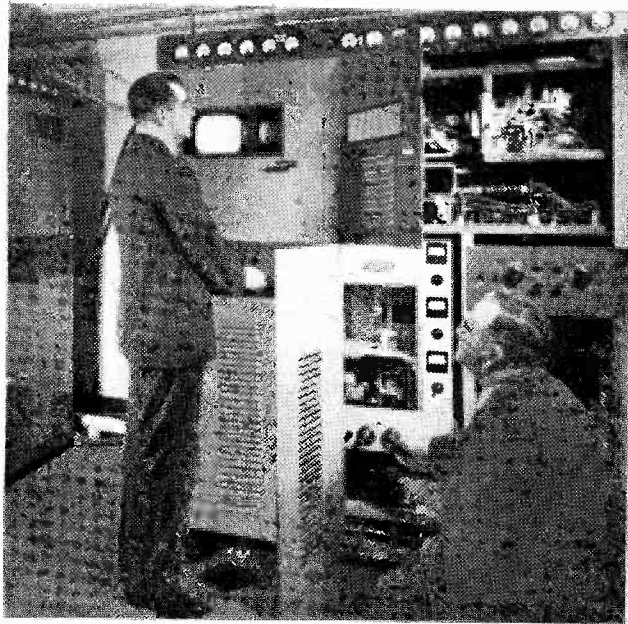

Face the Facts! You Must Keep Pace—or Be Left Behind Because You Lack the Understanding of New Techniques

**CREI Technical Training NOW Will Enable You to Gain the Ability
to Choose Your Job Tomorrow—Right in Your Own Home Town**

You have even greater advantages today! Never before have men like you had the chance to step into brand new jobs in brand new fields. FM, Television, Facsimile and other electronic communications systems for both government and industry will require thousands of highly trained, expert radio communications engineers and technicians.

NOW is the time to take the time to prepare yourself for these important career jobs. CREI home study training can show you the way by providing you with the "tools" with which to build a firm foundation of *ability* based on a planned program of modern technical training.

This is real, honest-to-goodness practical radio engineering training that leads to better jobs and more rapid promotions . . . the type of training for which many thousands of professional radiomen have enrolled during the past 19 years.

Mail coupon for free booklet today. (CREI training for veterans is available under the "G.I." Bill.)

INDUCTANCE

Funny how many men are like an electrical conductor that becomes electrified when near a charged body. Expose them to the right training, thinking and study and they turn out "first rate." Men who are looking ahead, place themselves in positions where they are continuously preparing for a better job, tomorrow.

E. H. Rietzke
President of CREI

Capitol Radio Engineering Institute

E. H. RIETZKE, President

Dept. RA-12, 16th and Park Road, N.W., Washington 10, D. C.

Branch Offices:

New York (7): 170 Broadway

San Francisco (2): 760 Market St.

Chicago (2): 30 N. LaSalle St.



MAIL COUPON
FOR FREE 36-PAGE
BOOKLET

If you have had professional or amateur radio experience and want to make more money, let us prove to you we have the training you need to qualify for a better radio job. To help us intelligently answer your inquiry — PLEASE STATE BRIEFLY YOUR BACKGROUND OF EXPERIENCE, EDUCATION AND PRESENT POSITION.

RA-12

Capitol Radio Engineering Institute
16th and Park Road, N. W., Washington 10, D. C.

GENTLEMEN: Please send me your free booklet, "Your Opportunity in the New World of Electronics", together with full details of your home study training. I am attaching a brief resume of my experience, education and present position.

Name

Address

City Zone State

Occupation

I am entitled to training under the G.I. Bill.

use of radium. However, German scientists disagreed on the efficiency of this tube. A two-diode circuit was also being developed but apparently with less success. The report summarizes test results and also includes circuit diagrams.

ROOM SPACE VS. HI-FI

★ After the amplifier and the speaker have been properly designed, there remains the important question of where it will be used. Considerations of acoustics thus enter in the overall picture of high fidelity reproduction. For this reason, an article entitled "Note on Normal Frequency Statistics for Rectangular Rooms," by R. H. Holt in the July-October issue of the *Journal of the Acoustical Society of America* will prove of interest to audio workers.

The author previously published a statement of his problem and a preliminary approach in the same journal a year ago. A detailed paper on the subject will be forthcoming, and at the present time he presents some useful working charts. He observes that proportioning of rooms to yield a smooth low-frequency response has been guided in the past by the empirical rule that room dimensions should be related by ratios of $2^{1/3}$ or its various powers.

Room proportions appear to be less important when dimensions exceed approximately ten wavelengths, as adequate diffusion can then be attained by shape irregularities and absorption. For smaller rooms, an analytical basis for the $2^{1/3}$ law is investigated, and it is concluded that while the law gives results in the low-frequency region, it is apparently not a unique measure of optimum smoothness.

The author presents his conclusions in the form of charts applicable to rooms of various sizes, from which normal frequency distribution functions may be determined and the acoustical merit of a given rectangular room evaluated.

CATHODES FOR PULSE WORK

★ Increasing use of pulse techniques in radio transmission will cause more than passing interest in an article by Edward A. Coomes of M.I.T. entitled "The Pulsed Properties of Oxide Cathodes" which appears in the *Journal of Applied Physics* for August 1946. Pulsed measurements indicate that unusually large electron currents may be obtained from suitable oxide type cathodes in microsecond pulses.

While inferior to newly developed types of cathode structures, space-charge-limited microsecond pulses up to

5 amp/cm² were yielded by pre-war oxide cathodes. The screen type of cathode, formed by firmly bonding nickel mesh to a supporting nickel sleeve and impregnating the mesh interstices with cathode coating, provided pulses of 35 amp/cm² in test diodes. Cathode temperatures remained below 850° C.

Correlations of a simple nature between d-c and pulsed properties of the diodes do not appear to exist either on the basis of earlier work, or as the result of this investigation. For example, in a certain life test, it was found that three groups of cathodes with selected structural differences all yielded ½ amp/cm² of d-c emission at 800° for 500 hours of life. The first group, however, afforded a microsecond pulsed emission of 60 amp/cm², while the second group yielded 20 amp/cm², and the third group delivered only ½ amp/cm². These three groups of cathodes exhibited the same useful life.

When large pulsed currents are taken at a relatively high pulse-recurrence frequency, the cathode temperature was observed to rise, exceeding 1000° C at a p.r.f. of 1000 and a current of 25 amp/cm². Heating may be minimized, however, by going to lower duty cycles, when using microsecond pulses at 60 p.r.f. no observable rise in temperature was indicated on an optical pyrometer.

The second most serious limitation in pulsed operation was found to be physical transfer of oxide particles from cathode to anode, causing sparking. This sparking is found to be greater for shorter pulse widths, when current flow is space-charge limited.

THEATER P.A. SYSTEMS

★ Power-handling capabilities, frequency response, and minimization of acoustic feedback all require attention in the average theater PA system, it is pointed out by M. K. Stephan in an article entitled "Correct P. A. System Technique" in the *International Projectionist* for July 1946. Mr. Stephan has little fault to find with theater sound reinforcement systems, but comments extensively on installations using microphones in front of the proscenium. In these systems a limit is imposed upon the amount of amplification which can be used before encountering excessive feedback. As a result, performers must speak within a foot of the microphone in many cases, as less than 100 db gain can be used.

Assuming that acoustic feedback could be entirely eliminated, modern microphones are useful up to 100 feet when sufficient amplification is provided. The feedback problem is somewhat relieved when the microphone may be placed far backstage thus insuring ample pickup.

During an average feature picture in an auditorium of 3600 seats, power de-

mands on the final amplifier were observed to vary from 7.5 watts average to 25 watts peak. An average stage show from in front of the proscenium imposed power requirements from 12.5 to 25 watts, with peaks from 50 to 100 watts.

While the picture channel had a capacity of 150 watts, the PA installation was capable of handling only 50 watts, and radiated a surprising amount of power above 300 cps. This public address system is taken as typical of those encountered.

The author recommends a minimum of 100 watts power in auditoriums of the size cited, use of cardioid or other types of directional microphones, as well as suitable limiting amplifiers. He likewise observes that theaters make a practice of operating their PA systems louder than necessary, since performers are not in a position to judge suitable sound levels and accordingly demand excessive output.

SIGNAL-NOISE RATIOS FOR MATCHED LINES

★ Signal-noise ratios may decrease when an antenna with a substantial reactive component is coupled to the receiver through a transmission line, particularly if the magnitude of the reactive component is greater than the characteristic impedance of the line. An extensive investigation of this topic is reported in *Wireless Engineer* for August 1946, in an article entitled "Aerial-to-Line Couplings", by R. E. Burgess.

Direct connection to the line, coupling with constant-resistance networks, and use of a cathode-follower unit are discussed. When used under suitable conditions, the signal at the receiver is generally improved. Criteria are derived to determine under what conditions each of the systems is preferable. Findings are expressed in terms of line attenuation α and the ratio of antenna reactance to characteristic impedance of the line, $|X|/R_0$.

When $|X|/R_0$ is less than unity, direct connection is indicated unless line attenuation is quite large, in which case an advantage is realized with constant-resistance networks. When $|X|/R_0$ is greater than 3, the cathode follower is preferred, its advantage increasing with line attenuation.

It is interesting to note that noise at the end of the line is less than at the cathode of the cathode-follower, when this system is used, since the noise from the tube at temperature nT is attenuated and replaced by noise from the line at the lower temperature T .

Conclusions of the article apply to frequencies up to 30 mc. Network specifications are given, as well as a numerical example of a broad-band capacitive antenna installation.

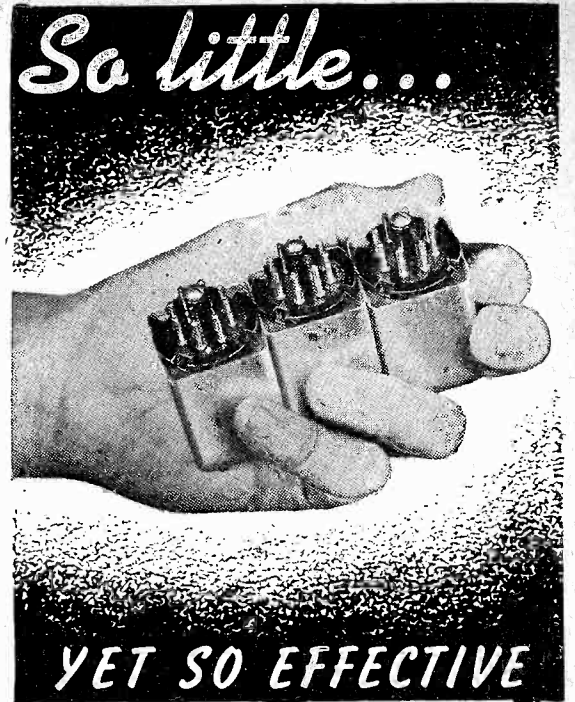

**Plug-In Sensitive Relays--
More Compact
Than Ever Before**

SIGMA Type 41 RO (DC); 41 ROZ (AC)

NEW FEATURES OF THIS DESIGN:

- Fits octal socket.
 - Outline dimensions: 1¼" x 1¼" x 2" above socket.
- Permits lining up contiguous relays as close together as the smallest octal sockets will permit.

Features of All SIGMA Series 41 Relays:

- DC sensitivity: — 0.020 watts (min. input.)
 - AC sensitivity: — 0.1 volt-ampere (min. input.)
- One standard 110 volt AC model draws about 1.5 milliamperes.
- Contact ratings up to 15 amperes on low voltage.
 - High quality construction — mechanically rugged.
 - Very low cost.

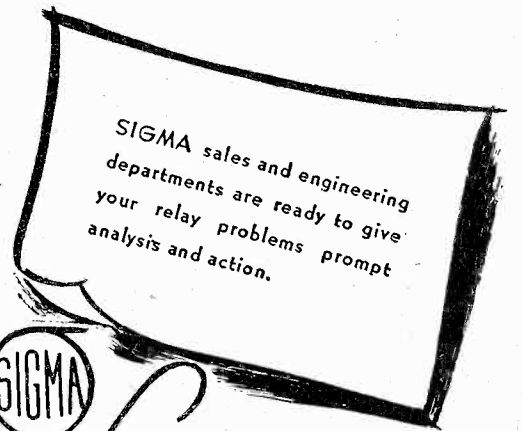

Sigma Instruments, INC.
Sensitive RELAYS
66 Ceylon St., Boston 21, Mass.

RACON IS THE BEST IN SOUND EQUIPMENT



Leading Soundmen everywhere specify RACON Horns, Speakers and Driving Units when quoting on potential sound installation sales or rental contracts because RACONS deliver maximum output and response for size of driving unit used. There's a RACON sound reproducer for every conceivable purpose. Each affords more dependable and efficient service and they are competitively priced.

SEND FOR CATALOG
OF COMPLETE LINE

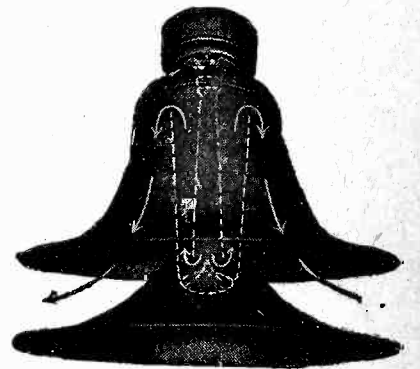

RADIAL HORN SPEAKER; a 3 1/2' re-entrant type horn. Projects sound over 360° area. Storm-proof. Made of RACON Acoustic Material to prevent resonant effects.



PAGING HORN; extremely efficient 2' trumpet speaker for use where highly concentrated sound is required to override high noise levels. Uses P.M. unit.

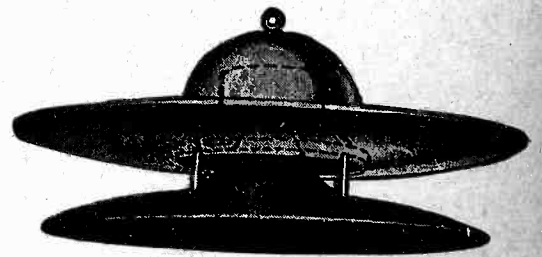

RADIAL CONE SPEAKER; projects sound over 360° area. Cone speaker driven. Will blend with ceiling architecture. RACON Acoustic Material prevents resonant effects.

RACON ELECTRIC CO., INC. 52 EAST 19th ST. NEW YORK, N. Y.

Designing a One-KW Amplifier for the new FM Band

Problems encountered in designing an interim FM amplifier and how they were overcome

JOHN H. BATTISON

Research Engineer, KMBC

THIS AMPLIFIER was designed for interim FM operation on a frequency of 97.9 megacycles pending delivery of a 10-kw transmitter. When the FCC changed the FM band to 88-to-108 megacycles, KMBC went on the air with a composite 250-w transmitter which was a revamped model of our old low-band transmitter. Deliveries on commercial equipment appeared to be so poor that it was decided to go ahead and drive a composite 1-kw amplifier from the old 250-w transmitter.

The 250-w transmitter has as its output tube one Eimac 4-250 operating as a last doubler final with 2,500 volts on the plate. This tube had been delivering approximately 200 watts to the antenna, so there was very much more drive available than was required for the tubes chosen for our 1-kw amplifier; i.e., two Eimac X404s in push-pull. These tubes require a drive of only fifteen watts per grid, and with 2,500 anode volts and 700 ma will deliver 1100 watts at 97.9 megacycles.

Design

The obvious design was one employing linear tanks, using the anode tank lines to conduct cooling air to the finned anodes of the X404s. Therefore our first layout consisted of a horizontal copper plate approximately 20 inches square with the two tubes sitting side by side on 5-inch centers and with two-inch copper pipes $\lambda/4$ long forming the anode tank. The characteristic impedance with these lines was approximately 183 ohms while for the grid tank one-inch copper tubing was used also $\lambda/4$ long and on two-and-a-half-inch centers. Tuning was effected by a movable shorting bar controlled by worm drive from outside the cabinet.

The input capacity of the X404 is approximately 11 μf and the output capacity 3.5 μf . This meant that the inductance required to tune the grids would be about a third of that required for the anodes and, therefore, there was

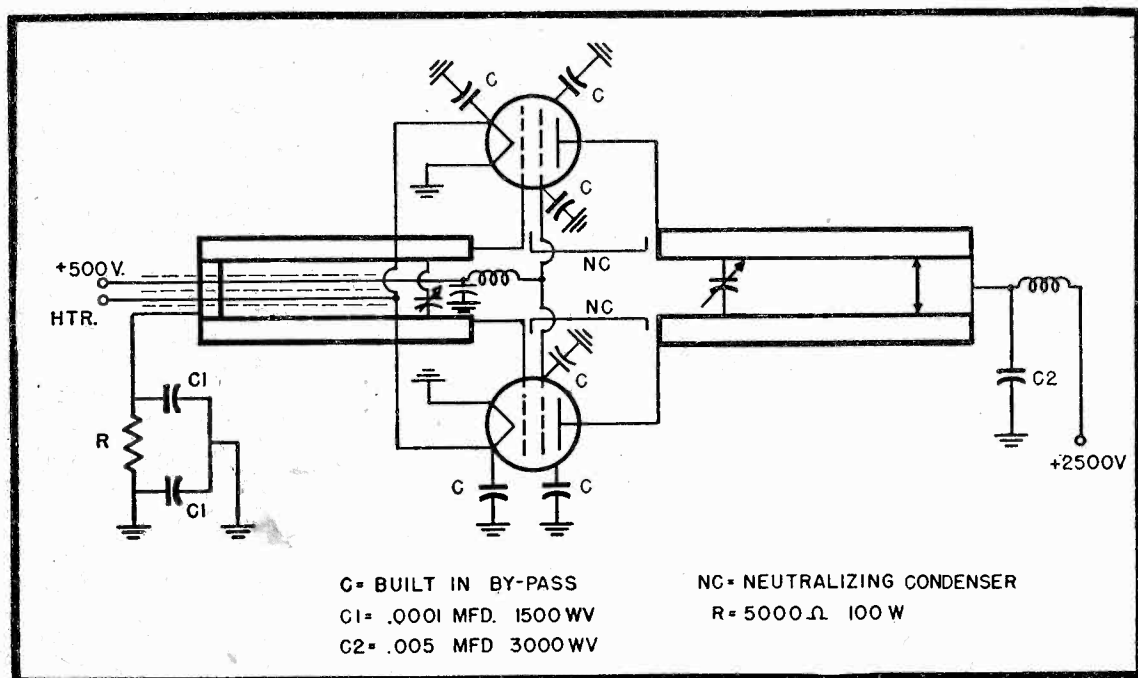

Fig. 1. Schematic of 1-kw r-f amplifier

a large amount of shorted grid tank. The equipment was connected without neutralizing, as the X404 is a tetrode and theoretically should not require neutralization. However, it was found impossible to obtain stable operation and freedom from parasitics and instability. Screen grid neutralizing was attempted, but unstable operation was still encountered. Conventional C_{gp} and cross-over neutralizing was tried, but it was still impossible to obtain satisfactory performance.

The equipment was mounted in a cabinet about 5-ft. high, and as the length of the sides and vertical pillars approached that of a $\lambda/2$ at 97.9 megacycles it was thought that magnetic coupling existed between grid and plate and, therefore, no amount of neutralizing would overcome this. The design was eventually scrapped in favor of the following. The circuit is shown in Fig. 1.

A chassis was made of $1/8$ " quarter-hard copper 20 \times 14 \times 5 inches. The tubes were mounted at one end in a pair of the Wilcox Electric Company's sockets with built-in by-pass condensers (Fig. 2). This, of course, precluded the

possibility of screen grid neutralizing, but it was felt that as the by-pass condenser leads would be so short, much more efficient by-passing would be obtained which would outweigh any advantages of the latter method. Grid tuning is effected by adjustment of the shorting bar and fine tuning by adjustment of the condenser plates at the grid end. In operation, the pre-set plate is set approximately and the input balance by use of the manual control. It will be noticed that there are two copper tubes strapped to the bottom of the chassis below the center of the grid lines. These carry the "hot" heater lead, and the "B" plus to the screen.

The plate tank retains many of the old features; i.e., the anodes lines are used to carry cooling air to the tubes from the blowers mounted on the end (at the time of taking this photograph, the copper elbows and junction couplings had not been silver-plated, but after they were plated, no improvement in operation was noted). The characteristic impedance of the anode tank lines remains the same; viz., 183 ohms, and calculations showed that with the shorting bar two inches from the end, a

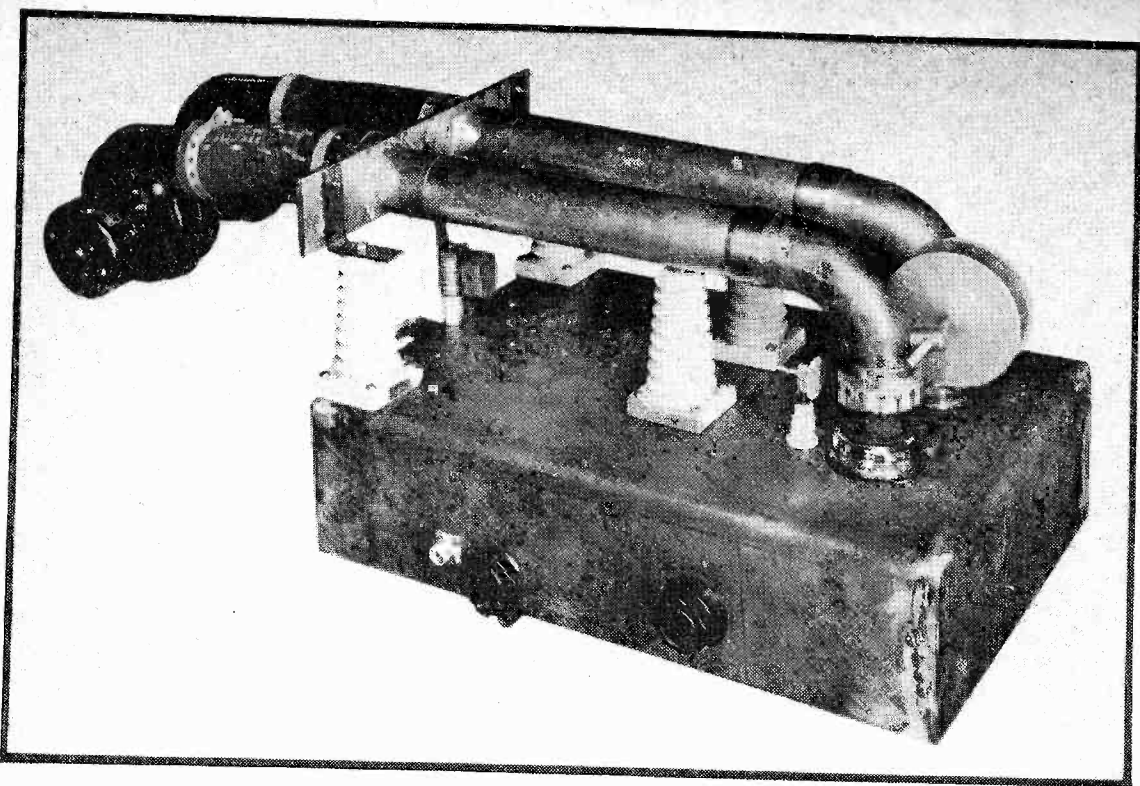

Fig. 3. Top view of amplifier chassis. The anode lines are used to carry cooling air from blowers to tubes

capacity of 9 μf would be required to tune to resonance. In order to obtain this capacity, the condenser spacing would have to be $\frac{1}{4}$ inch, which was too close for safety considering the r-f potential expected at this point. However, when the amplifier was tuned up, it was found to tune with the spacing shown in the photo (about $1\frac{1}{4}$ ") (Fig 3).

Tuning Adjustments

Heater and screen voltages were applied to the amplifier and drive to the grids. No difficulty was found in tuning the grid circuit to resonance and a grid current of 50 ma was obtained with a screen grid current of 100 ma at 300 volts. The anode tank was then tuned and a very sharp dip in grid current at resonance was noted, indicating the need for neutralizing. Therefore, the drive and voltages were removed and Cgp neutralizing was incorporated. No connection was made either to plate or grid. The plate element was a one-inch silver-plated disc. The grid element was a $\frac{3}{8}$ copper strip spaced $\frac{1}{4}$ inch from the appropriate grid line. However, when the chassis was installed in its cabinet, less capacity was required to neutralize and the discs were removed. Final neutralizing was obtained with only $\frac{1}{2}$ " of rod protruding above the "stand-off".

On reconnecting power and drive, no dip in grid current could be obtained when tuning the anode through resonance. Therefore, reduced anode volts were applied and the amplifier tested for self-oscillation. None was apparent, so 2,500 volts were applied to the anodes and again it was checked for self-oscillation. This happy state persisted and not a trace of self-oscillation could be found. Neither were there any signs of sustained or shock-starting excita-

tion with the application or removal of drive, or anode voltage. The grid current remained at zero and the screen current was approximately 50 ma. It is a peculiarity of tetrodes of this type that the screen current is very dependent upon drive and output. It has been the writer's experience that screen dissipation is usually below the maximum limitations of the manufacturers.

Drive was then applied to the grids, and a grid current of 30 ma for the two was obtained. The anode current was 500 ma and the screens 60, and on re-tuning the anode, current dropped to 300 with a screen current of 110 and

grid 20. The grid coupling was adjusted to increase the current to 30, which resulted in no change in screen current, but a rise of anode current to 400 ma. The amplifier was connected to a dummy antenna consisting of a $\frac{3}{4}$ turn of $\frac{1}{2}$ inch copper strip, a 400 ohm non-inductive resistance and a thermal ammeter. Upon readjustment of the drive and tuning controls, an output of approximately 1100 watts was obtained into the load.

Completely stable operation was obtained and the harmonic output was so low that a Faraday shield was not found to be necessary. The amplifier was then installed in the transmitter and connected with a $\frac{1}{4}$ wave matching stub to the antenna via a 70-ohm coaxial $1\frac{5}{8}$ " diameter line. A thermo-ammeter indication of an antenna current of 4 a. was obtained without any difficulty. This gives a figure of 1120 watts. At this frequency, thermal meter readings are unreliable as indicators of power. However, the reading was twice the amount obtained in the line from the 250-w transmitter with the meter in the same electrical position. Subsequent tests with more critical adjustment of the antenna coupling and grid and plate tuning resulted in the following figures: grid, 30 ma; screens, 60 ma; and plate, 620 ma with 2,500 volts. The antenna meter indicated 90 a., but this figure is not considered correct as it implies an output of 5,670 watts for an input of only 1,500 watts! But, as mentioned above, antenna meters are notoriously incorrect at this frequency.

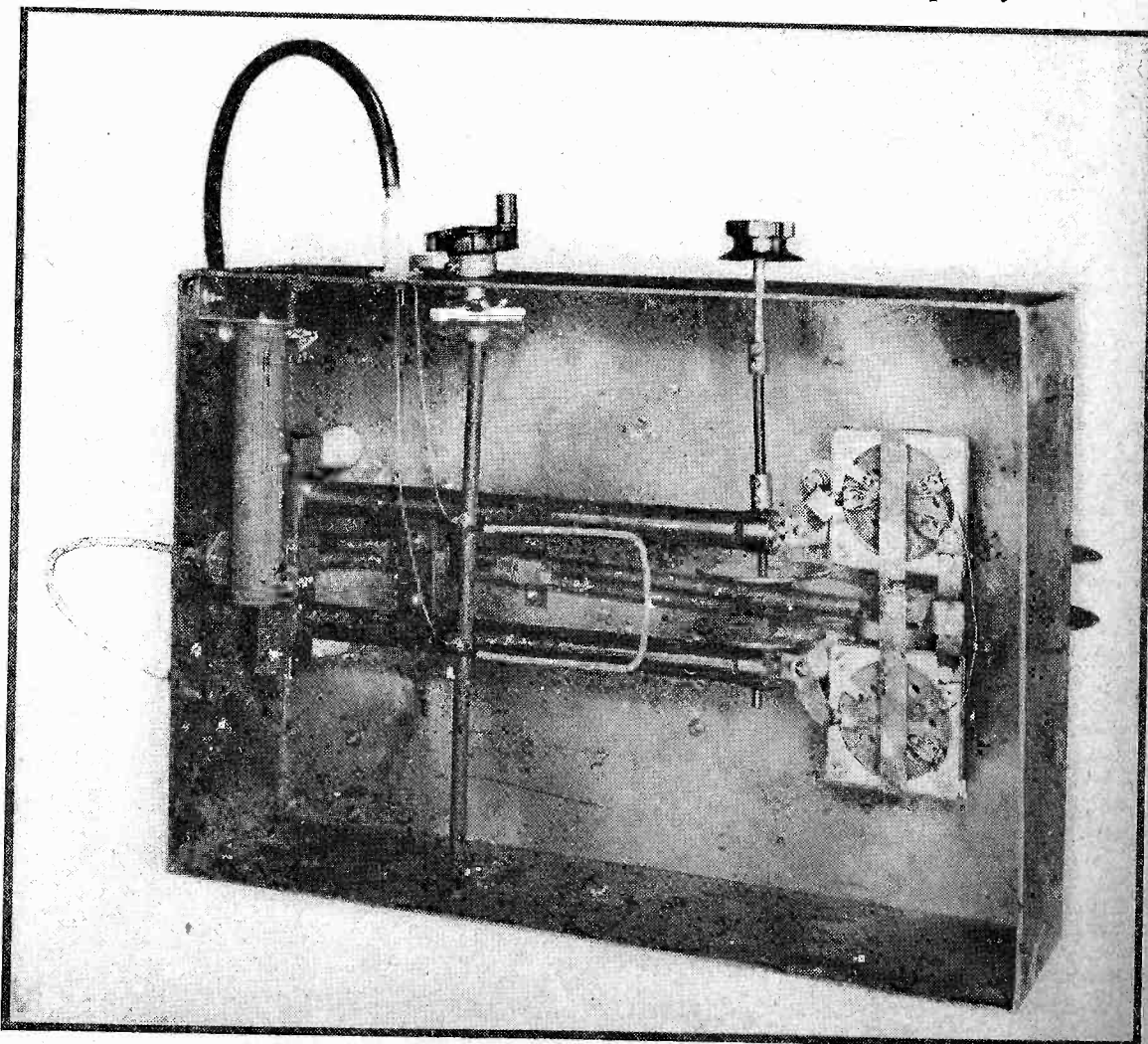

Fig. 2. Bottom view of amplifier chassis

Fig. 4. Crystal-controlled FM transmitter by Raytheon using indirect system of FM

Center-Frequency Control for FM Transmitters

PHILIP H. STEWART

Describing electro-mechanical, duplex carrier spacing, precision crystal, and counter-circuit techniques for FM carrier control for automatically monitoring the center frequency of a modulated FM carrier to meet FCC regulations

REACTANCE-TUBE MODULATION of a medium-frequency master oscillator is one of the most popular methods of obtaining frequency modulation of an r-f carrier. With this arrangement, a change in voltage on the grid of the reactance tube shown in *Fig. 1* causes a change in the reactance which it places across the tank circuit of the oscillator. This results in a change of the oscillator frequency. When an audio modulating voltage is fed to the grid of the reactance tube, the frequency of the oscillator is caused to vary in accordance with the modulating frequency.

Control System

Frequency stability is maintained by comparing a subharmonic of the modulated signal with a standard frequency, developed by a temperature-controlled quartz-crystal oscillator. Any difference between the mean frequency of the modulated signal and that of the standard actuates a two-phase motor which drives a frequency-compensating capacitor mounted on its shaft, connected across the tuned circuit of the modulated oscillator. A block diagram of the control sequence is shown in *Fig. 2*. The motor

PART 2

turns through a 90° arc until the capacitor reaches a position at which the center frequency is identical with the proper multiple of the standard frequency.

In the output of each balanced modulator is obtained a beat frequency corresponding to the difference between the crystal reference frequency and that of the master oscillator. The signal output from the crystal oscillator is divided as indicated in *Fig. 2* and feeds through phase-shift networks designed to give a 90° displacement in phase between the inputs to the two modulators. The signal from the master oscillator is of the same phase in both modulators. This 90° phase displacement in the crystal-oscillator signal results in a 90° displacement of the beat frequencies in the outputs of the two modulators.

Not so obvious, but nevertheless important, is the fact that the direction of rotation of the two 90° vectors, which may be considered as generating the two beat-frequency outputs, changes from

clockwise to counter-clockwise (or vice versa) depending on whether the master-oscillator frequency is higher or lower than the crystal frequency. That is, there is a reversal of one phase of the two-phase output of the two modulators when the MO frequency passes through zero beat with the crystal frequency. If the two-phase output of the two modulators is utilized to energize the field windings of a two-phase motor, the direction of rotation of the motor shaft will be clockwise when the MO frequency is higher than that of the crystal frequency, or counter-clockwise when the MO frequency is lower than that of the crystal frequency. In this manner, the motor rotation may be utilized for center-frequency correction.

Each balanced modulator has a pair of 6L6 tubes, biased to cut-off and connected in push-pull. The induction motor has high-impedance center-tapped windings on each phase, so that it can work in the plate circuit of the balanced modulator tubes without use of matching transformers, making it possible to operate the motor down to the d-c beat frequency.

By means of a dial mounted on the

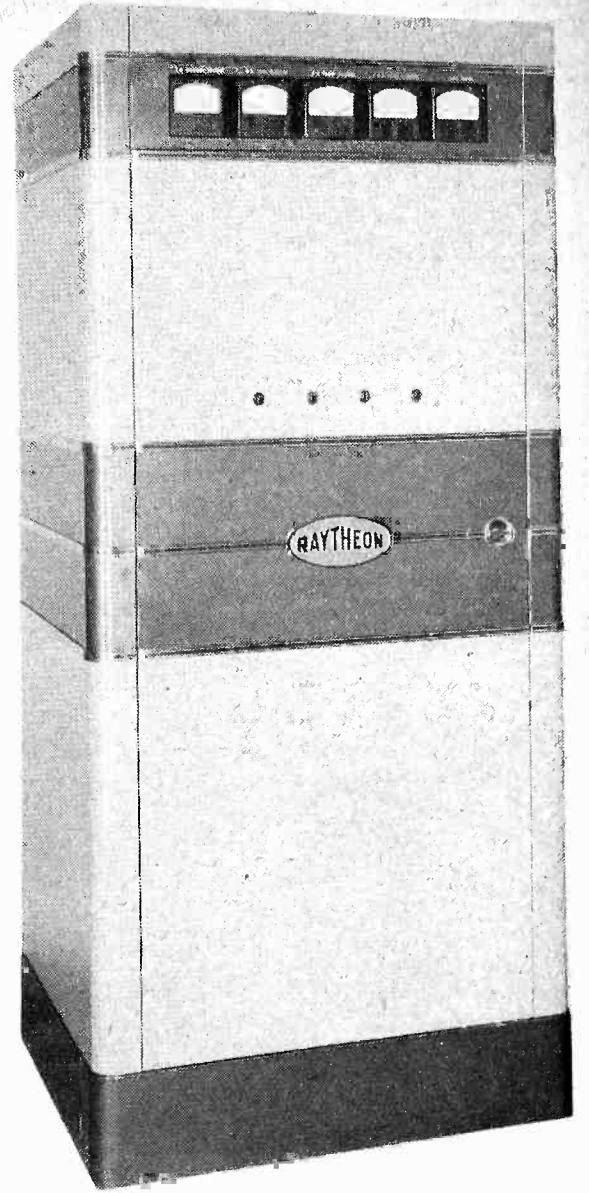

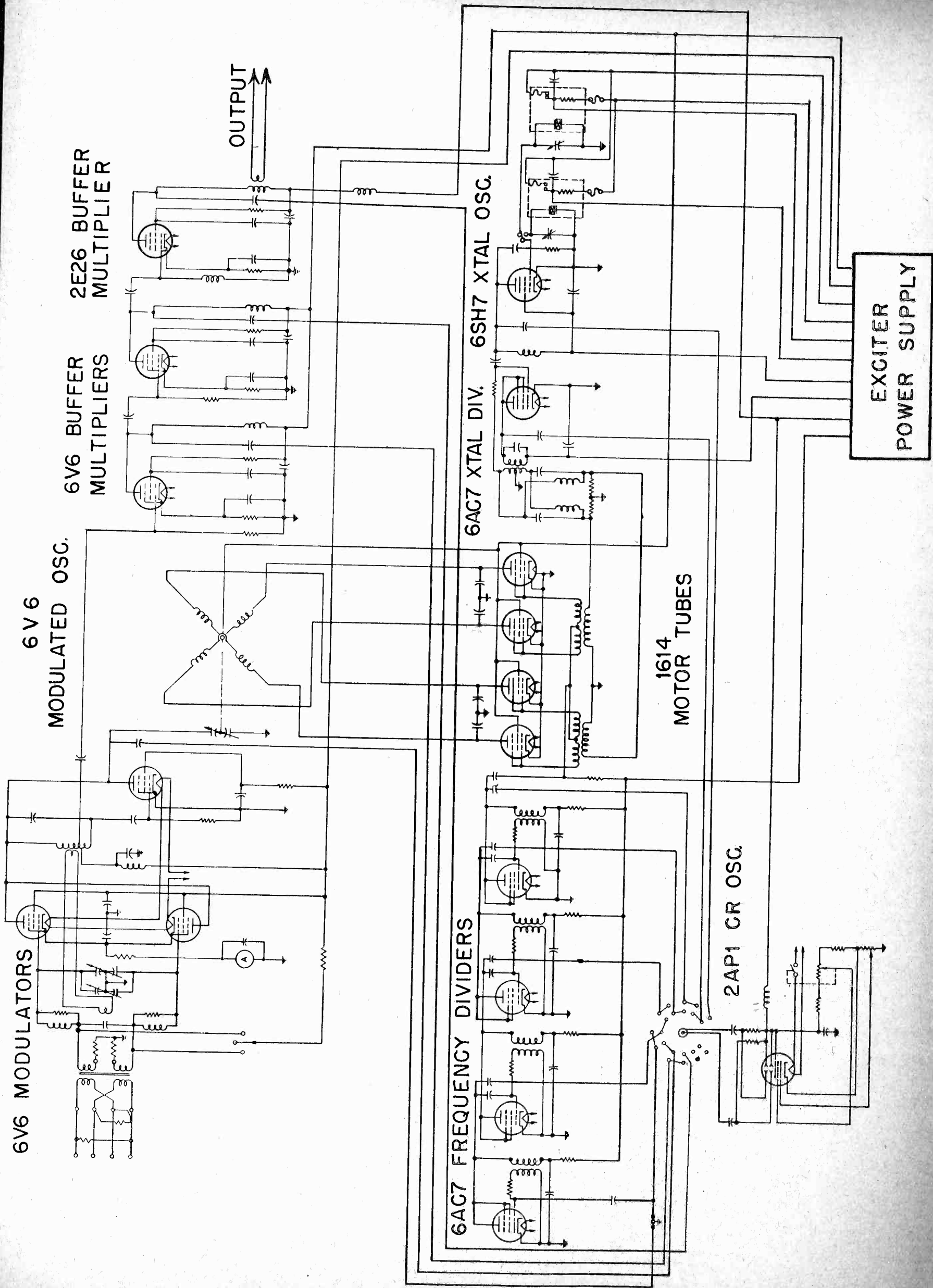

Fig. 1. Schematic diagram of modulated oscillator and center-frequency-control system used in RCA FM transmitter

frequency-control motor shaft, it is possible to observe the relative rotation of the shaft required to correct the artificial frequency shift. This operation permits a rapid check of performance of the reactance tubes and the frequency-control mechanism. A meter is provided to read the plate current of the reactance tubes and the MO. To make the system more certain, a buzzer operated by a cam switch on the capacitor shaft gives warning if for any reason the frequency control goes off-scale.

AFC in Duplex Working

An interesting possibility of center-frequency control originally suggested by Monner and Trew¹ and more lately developed by E. E. Suckling for narrow-band FM duplex working² maintains the outgoing carriers from the two transmitters 455 kc apart continuously, although drift of the absolute center frequencies may be taking place. In this system, the oscillator of the superheterodyne receiver is used as a signal source for its accompanying transmitter, meanwhile the superhet oscillator is maintained 455 kc from the received frequency by a discriminator-reactance tube network of conventional design.

This system does not conform to the usual conception of center-frequency-control, and while it makes satisfactory communication possible where sufficient channel space is available, its application is necessarily limited for the same reason. The system has been proven practical for narrow-band u-h-f duplex telephony, without the use of crystal control.

Crystal Center-Frequency Control

A crystal-controlled carrier may readily be maintained constant in frequency, although the modulating circuits become more complex. These systems are based upon the original Armstrong

Fig. 3. (right) Front panel affords ready access to metering units, exciter assembly, r-f modulator, and power supply of the 3-kw FM installation shown in Fig. 1

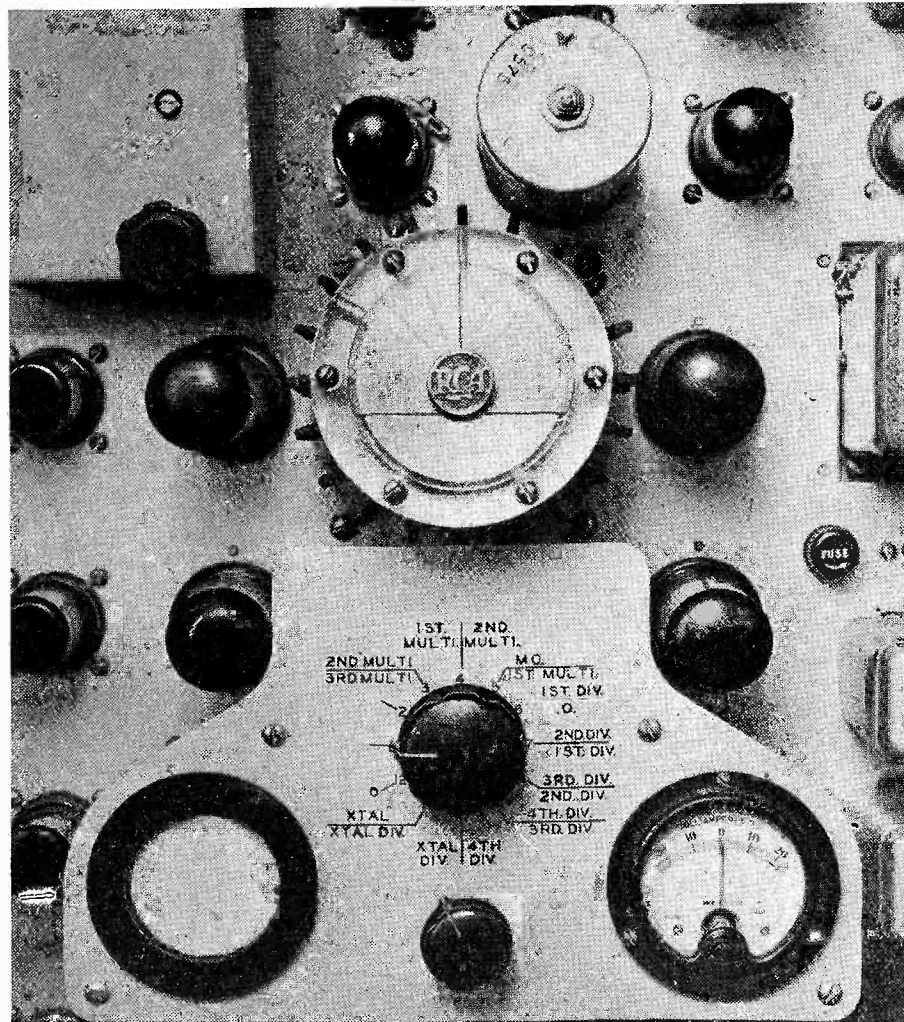
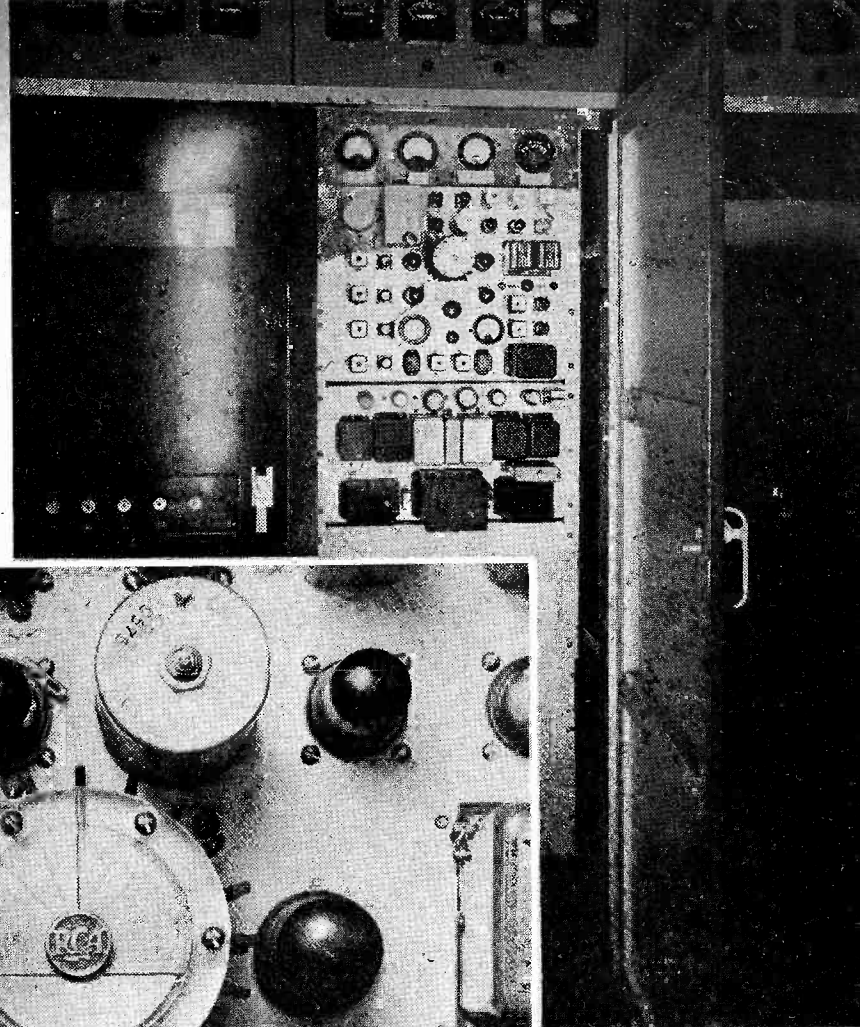

(Left) Closeup of test and metering panel mounted on exciter unit, showing built-in test equipment. CRO is at lower left, with selector switch at center; CRO makes possible quick checks of each divider and tripler. Milliammeter at lower right shows reactance tube current.

design, which modulate the crystal-controlled frequency by dividing it into two portions, one of which passes through a 90° phase-shift network, while the other portion is impressed

upon the grids of a balanced modulator. The audio modulating voltage is fed to the balanced modulator, driving both tubes with the same magnitude and polarity of a-f potential. The output of the balanced modulator is mixed with the carrier component which has been shifted 90°, resulting in phase modulation with spurious AM subsequently removed by a limiter.

To obtain frequency modulation from the system, the modulating voltage is fed initially through a reactive network which yields an output inversely proportional to frequency. Thus, to obtain close center-frequency control it is only necessary to provide a crystal oven. This method has found favor with various manufacturers, and a typical FM transmitter of this type is illustrated.

Counter-Type Control

Another type of center-frequency control is based upon the principles of counter circuits. If the total number of cycles produced while the oscillator is on the high side of the assigned fre-

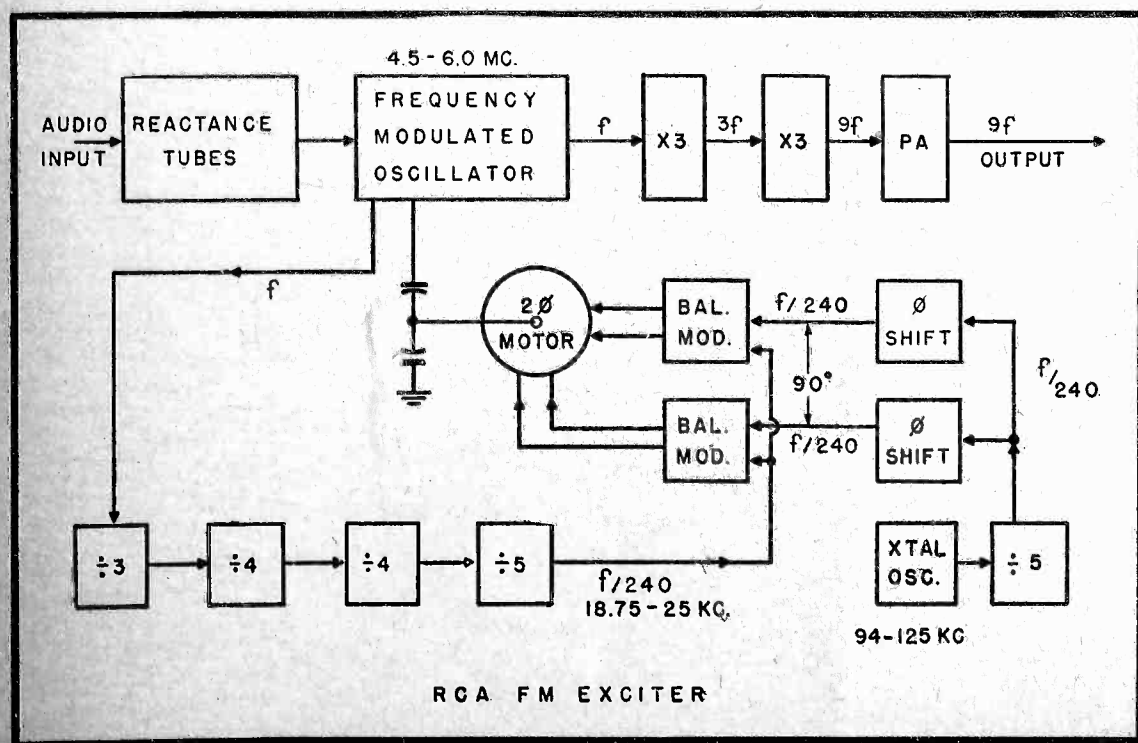

Fig. 2. Block diagram of frequency-control sequence for circuit of Fig. 1

[Continued on page 30]

THE PARALLEL T NETWORK

E. M. McCORMICK
National Radio Institute

AN RC FILTER for a power supply is desirable because it is small, light in weight, and inexpensive. In the usual type of RC power supply filter, for adequate filtering the time constant must be large with respect to the time for one cycle of the rectified wave. When large condensers are used to obtain this time constant, size and cost make their use impractical in many applications. When large series resistors are used, the voltage drop and power dissipation become excessive for usual load currents. Thus, this type of RC filter can be used only where the load current is small or when a large voltage drop in the filter is desirable or can be tolerated.

Parallel-T Network

The parallel-T network of *Fig. 1* does not have these limitations. Adequate filtering can be obtained with condensers of ordinary size and yet the voltage drop need not be excessive for normal load currents. A parallel-T filter is a "band reject" network with zero transmission at a frequency determined by the size of the condensers and resistors used. The observed response of a network of this type is given in *Fig. 2*.

The unfiltered output of a power supply, by Fourier analysis, consists of the fundamental ripple frequency and harmonics of it as well as the d-c component. Since this network rejects at only one frequency the filtering action cannot be complete, but it will be adequate for many purposes. It has been found that the best over-all filtering occurs when the network reject frequency is 2.67 times the fundamental ripple frequency. Thus when the output of a 60 cps half-wave rectifier is to be filtered, the network is designed for 160 cps. For 60 cps full-wave operation, the network reject frequency should be 320 cps.

Analysis

From a practical viewpoint, the series condensers C_2 and the shunt condenser C_1 are known and it is desired to cal-

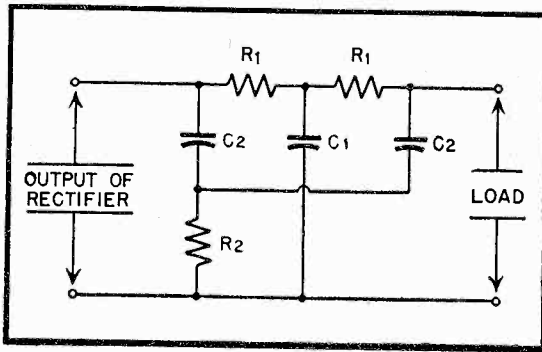
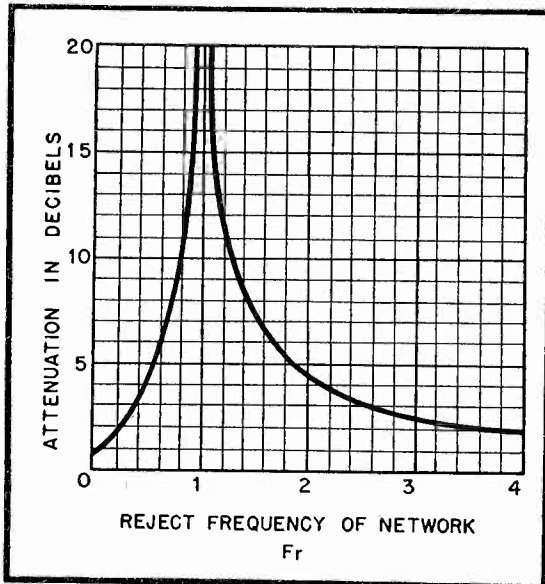

Fig. 1. (above) Schematic of the parallel-T network

Fig. 2. (below) Observed frequency response of a parallel-T network



culate the series (voltage dropping) resistors R_2 and the shunt resistor R_1 .

It may be shown that the general formula for the ratio of e_o (the output voltage) and e_i (the input voltage) is

$$\frac{e_o}{e_i} = \frac{M(M+P) + N(N+Q) + j(MP - NQ)}{(M+P)^2 + (N+Q)^2} \quad (1)$$

where, under these circumstances,

$$M = \omega R_2 C_2 [2 - \omega^2 R_1^2 C_1 C_2] \quad (2)$$

$$N = C_2 [\omega^2 2R_1 R_2 C_2^2 - 1] \quad (3)$$

$$P = \omega R_1 [C_1 + 2C_2] \quad (4)$$

$$Q = \omega^2 R_1 C_1 C_2^2 [R_1 + 2R_2] \quad (5)$$

For complete suppression at one frequency both the real and imaginary parts of (1) must be zero, that is,

$$M = 0 \quad (6)$$

$$N = 0 \quad (7)$$

from which the two conditions for zero transmission are

$$2 = \omega^2 R_1^2 C_1 C_2 \quad (8)$$

$$1 = 2\omega^2 R_1 R_2 C_2^2 \quad (9)$$

In the half-wave case for 60 cps we find that (8) and (9) reduce to

$$R_1 = \frac{710}{\sqrt{C_1 C_2}} \quad (10)$$

$$R_2 = 177 \sqrt{\frac{C_1}{C_2^3}} \quad (11)$$

In the full-wave case, the resistor values will be one-half of these.

Nomograph

The easiest way to determine the values of R_1 and R_2 for given values of C_1 and C_2 is by means of the nomograph given in *Fig. 3*. To use it, simply connect the two points corresponding to the known values with a straight edge. Then observe the values of the unknown quantities at the intersection of the lines representing them with the straight edge. Notice on the R_1 and R_2 lines that the values for the half-wave case are given on the left side of the lines and the values for the full-wave case are given on the right side.

Let us take two examples to illustrate the use of the nomograph. Assume a half-wave power supply for 60 cps operation where C_1 is 10 μf and C_2 is 20 μf . We find that the R_1 must be 100 ohms and the shunt resistor R_2 must be 12 ohms. For 60 cps full-wave operation, R_1 would be 50 ohms and R_2 , 6 ohms.

This nomograph can also be used when the line frequency is not 60 cps. It is only necessary to multiply the values obtained by the factor k where

$$k = \frac{60}{f} \quad (12)$$

and f is the line frequency. As a second example, let us assume a 25 cps full-wave supply where C_1 is to be 8 μf and C_2 is to be 30 μf . We find from the nomograph that R_1 is 46 ohms and R_2 is 3 ohms for 60 cps operation. The conversion factor k from (12) will be 2.4, so that for 25 cps R_1 should be 110 ohms and R_2 , 7 ohms.

AS A POWER SUPPLY FILTER

The parallel-T network serves as a most economical power-supply filter, providing excellent filtration with relatively small values of capacitance. In this article, full design data are presented

Practical Application

A power supply using this type of filter has been in use for some time. The values used are $C_1 = 1 \mu\text{f}$, $C_2 = 8 \mu\text{f}$, $R_1 = 250 \text{ ohms}$, and $R_2 = 7 \text{ ohms}$.

The ripple voltage was observed to be less than $\frac{1}{4}$ per cent for load currents up to 50 ma which is the maximum rating of the transformer used. At this maximum load the voltage drop across each of the series resistors is 12.5 volts and the power lost in each is somewhat more than $\frac{1}{2}$ watt. This voltage drop compares favorably with that of some inexpensive filter chokes.

Conclusion

It is felt that this type of power supply filter does have definite uses that make it worthwhile. In comparison with other RC networks generally used for this purpose, the parallel-T provides more filtering for given total values of R and C .

When compared to LC filters: the filtering action is not as thorough; the voltage drop and power loss in the filter can be made comparable; and in size, weight, and cost the parallel-T is superior. Thus the parallel-T will be chosen for many purposes.

Bibliography

Herbert W. Augustadt, U. S. Patent 2,106,785

E. M. McCormick, "An Unbalanced Bridge RC Oscillator", *RADIO*, January 1945, p. 27

A. E. Hastings, "Analysis of a Resistance-Capacitance Parallel-T Network and Applications", *Proc. IRE*, March 1946, p. 126P

Leonard Stanton, "Theory and Application of Parallel-T Resistance-Capacitance Networks", *Proc. IRE*, July 1946, p. 447P

Alfred Wolf, "Note on a Parallel-T Resistance-Capacitance Network", *Proc. IRE*, September 1946, p. 659P

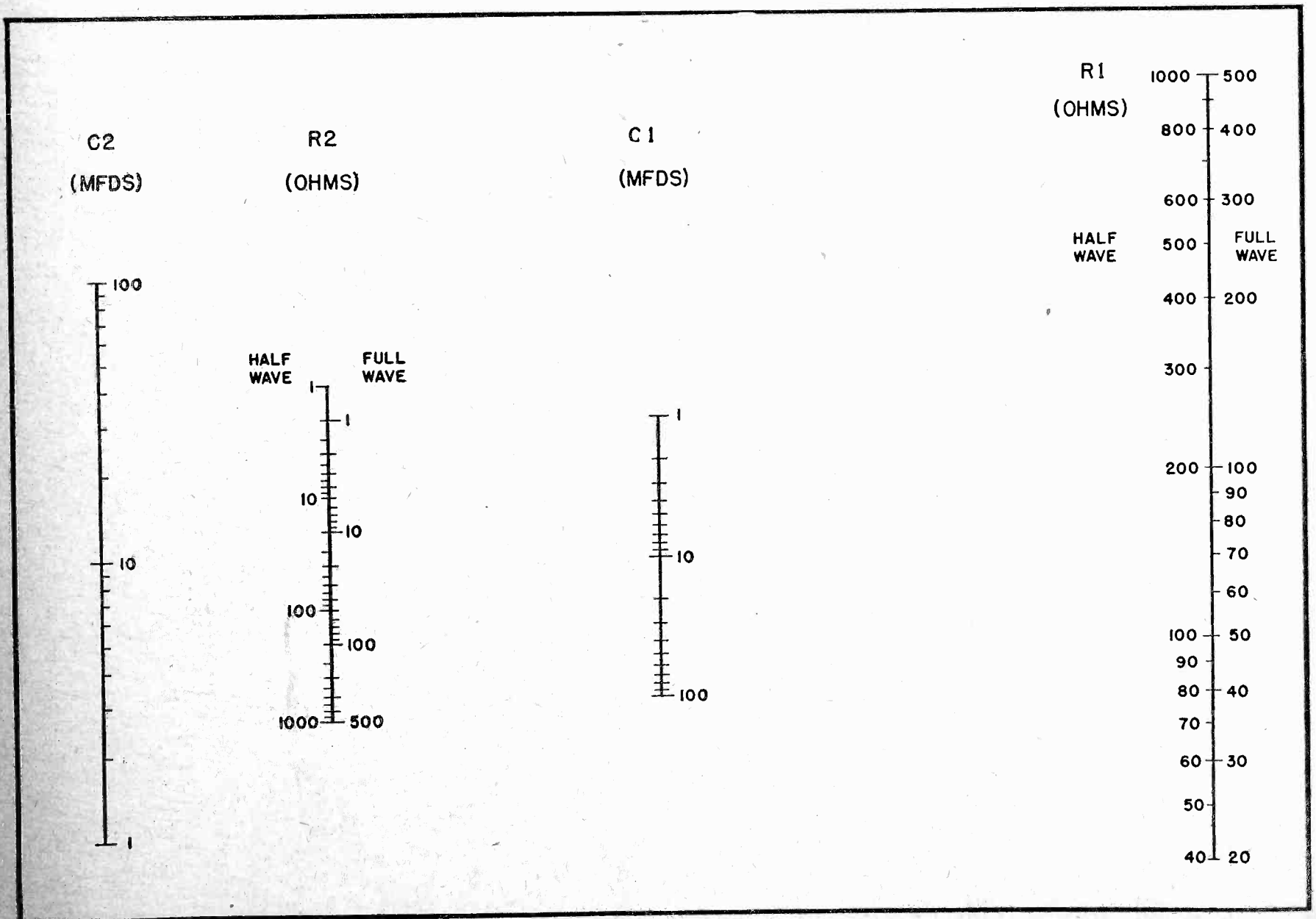

Fig. 3. Nomograph for determining constants of parallel-T network for half-wave and full-wave power supply filters

RECENT RADIO INVENTIONS

These analyses of new patents in the radio and electronic fields describe the features of each idea and, where possible, show how they represent improvements over previous methods

IMPROVED A-F-C CIRCUIT

★ An improved automatic frequency control circuit for beat oscillators in radio receivers was patented June 4, 1946, by John L. Hysko. The inventor points out that in conventional systems with a-f-c circuits following filters, the a-f-c circuit will not operate unless the starting transmission is within the pass-band of its associated filter. The present invention is designed to overcome this objection by using a bias-controlled circuit across the a-f-c filter input. This by-pass circuit becomes operative when the frequency of the heterodyned wave is outside a predetermined range. The current is shown in *Figs. 1* and *2*. Referring to *Fig. 1*, the received r-f carrier, modulated by shifting its frequency either plus or minus 425 cps for mark and space, appears at the antenna and energizes a preamplifier and converter to form the first i-f frequency of 450 kc. The second converter next produces the 50-kc i-f frequency, followed by a

50-kc modulator which operates in conjunction with a 400-kc oscillator and a 52,550-cycle oscillator, as indicated.

The 52,550-cycle oscillator delivers its output to the 50-kc modulator for modulation of signal frequencies of 50 kc \pm 425 cps, which are accordingly converted into difference frequencies of 2,550 \pm 425 cps. The output of the 50-kc modulator thus consists of 2125 cps, which is the mark frequency, or 2975 cps, which is the space frequency. These two frequencies are passed by the band-pass filter, which is followed by limiters for mark and space frequencies, respectively, and go thence to the balance of the receiving system.

If the frequencies of the received waves depart appreciably from their nominal values, the band-pass filter will reject the resulting outputs. To correct this situation, the a-f-c circuit is included as shown, receiving its input from the 50-kc modulator. A d-c control voltage is thereby obtained, as dis-

cussed in greater detail below. This d-c control voltage varies the frequency of the 400-kc oscillator by means of an associated reactance tube. Mixture of outputs from the 400-kc oscillator and the 50 kc i-f amplifier results in mark and space frequencies of 2125 and 2975 cps. The filter accordingly receives frequencies within its pass band in spite of drifts which would make a-f-c control become inoperative in a circuit utilizing a-f-c following the filter.

The a-f-c unit of *Fig. 1* is shown in detail in *Fig. 2*. Since the 850-cps separation between the marking and spacing waves is practically constant, use of only one group of waves in the a-f-c circuit affords satisfactory operation. The marking wave is preferred, which is admitted by the indicated filter, with a pass band of 1600-2600 cps. Following amplification, the transformer passes the incoming frequencies to the low- and high-pass filters, which being connected in parallel, operate as a discrim-

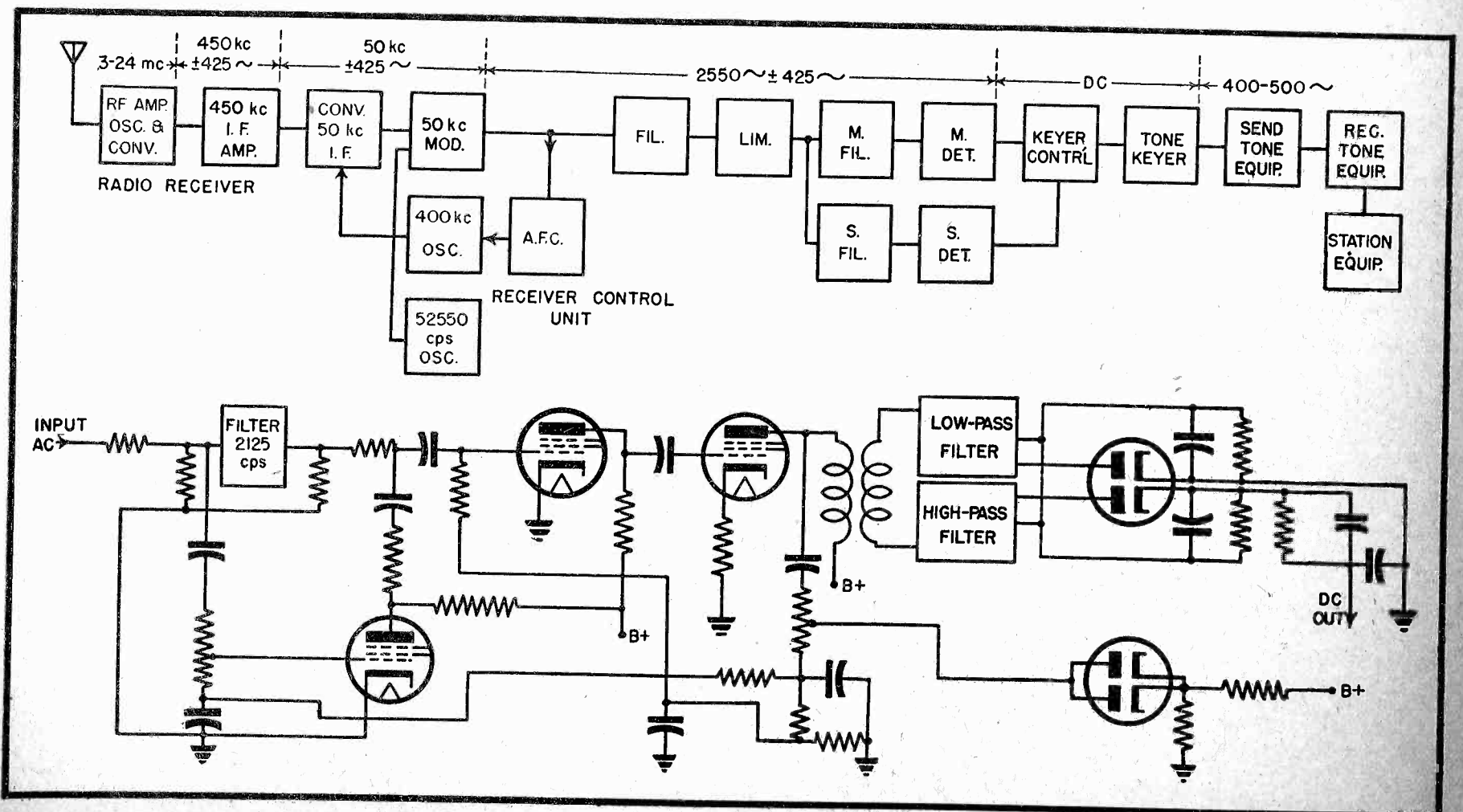

Patent No. 2,401,355. Figure 1, top; Figure 2, bottom.

inator. The potentiometer at this point serves to equalize the insertion loss of the filters at 2125 cps.

Filter outputs proceed to the rectifiers, and at 2125 cps it is seen that there is no d-c output; for higher and lower frequencies, respectively, positive or negative d-c output potentials appear. These potentials are utilized to control the effective reactance of a reactance tube (not shown) shunting the 400-kc oscillator circuit

The patent, No. 2,401,355, is assigned to Bell Telephone Laboratories.

Attenuator for Coaxial Transmission Lines

★ Simplicity of construction and minimum influence upon the characteristic impedance of the line are claimed for a new coaxial line attenuator in patent 2,401,296, issued June 4, 1946 to George L. Fernsler. Design of the attenuator is indicated in the accompanying drawing; the modified line section includes a pair of enlarged electrodes forming a gap in the center conductor, with an adjustable mechanical conducting iris centered in this gap. Variation of iris diameter is utilized to control the degree of attenuation.

Spacing of the gap between the enlarged electrodes is smaller than the spacing between inner and outer conductors of the coax; these enlarged electrodes provide capacitance-coupling across the attenuator section. As the aperture diameter is varied, the coupling is varied in a linear manner. To obtain this linear characteristic, the enlarged electrodes are designed as semi-prolate spheroids. It is noted that extreme iris variations will produce discontinuities.

An improved attenuator design is also described. Modified contours of the electrodes provide for constant characteristic impedance in the vicinity of the gap by control of spacing between electrode and outer conductor. In this design, the ratio of the diameters of the outer and inner conductors is maintained approximately constant, while avoiding small radii or sharp corners along the contours.

Optional carbon rings are described. When used, they constitute terminating resistors of value equal to the characteristic impedance of the line. The iris used may be either an adjustable stop aperture, or continuously adjustable as a camera iris diaphragm.

The invention is assigned to the Radio Corporation of America.

Portable T-V Modulation System

★ Grid modulation is used for the picture signal, and plate modulation for synch pulses, in a portable a-m television system patent issued June 4, 1946, to Henry N. Kozanowski. The new system is designed to obtain maximum

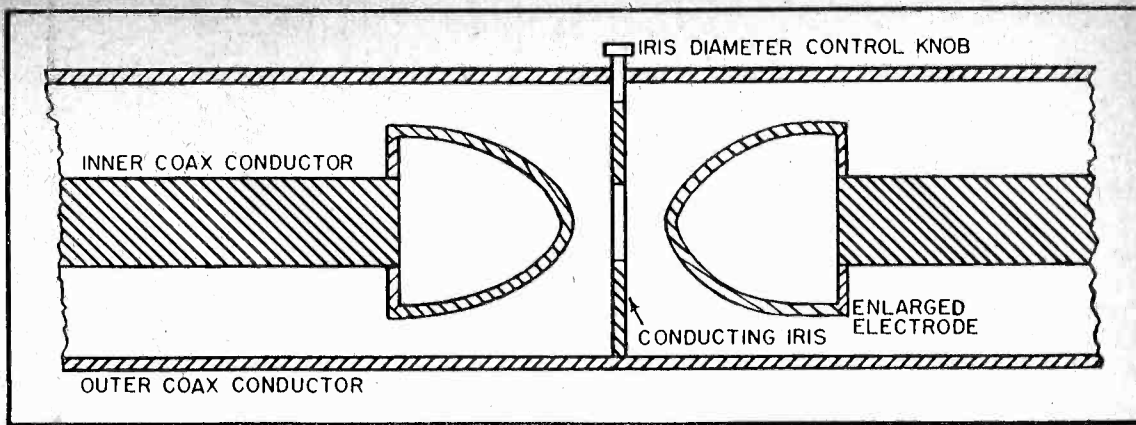

Patent No. 2,401,296

synch signal output with a minimum weight of equipment.

Peak-clipping of synch pulses due to slight mistuning of circuits, or due to a change in signal level, is avoided by use of plate modulation for the synch pulses; likewise, more pulse power output is realized. Grounded-grid circuits are utilized to avoid neutralization problems.

A circuit diagram showing the modulation system appears below. The high-frequency oscillator and power amplifier each have tuned-grid, tuned-plate tanks. Coupling of oscillator and amplifier is indicated by the curved arrow. The plate supply for the power amplifier is obtained through a constant-Z network, as shown. The power amplifier is grid-modulated by the picture signal, and plate-modulated by the synch pulses. These latter cannot be clipped as a result of the picture signal increasing in amplitude sufficiently to move the "black" side of the signal into or beyond the upper knee of the curve obtained by plotting p-a grid voltage against r-f output voltage.

D-C restoration is not provided, and the "black" side of the picture signals may also move beyond the knee as a result of increase in overall picture lightness. More synch power can be obtained from the power amplifier, since the synch pulses may momentarily drive the plate voltage beyond a point that would damage the tubes if continuously applied. Maximum performance is obtained, in this manner, for a minimum of weight.

The patent, No. 2,401,573, is assigned to Radio Corp. of America.

Rotating Joint for U-H-F Line

★ Rotation of one section of a coaxial line about another fixed section without loss of r-f energy is claimed in patent 2,401,344, issued June 4, 1946 to Dennis Clark Espley. Application of the design is intended for systems operating on less than 10 meters wavelength.

A cross-section of the rotating joint is shown, from which it is seen that a spaced quarter-wave section is utilized

[Continued on page 32]

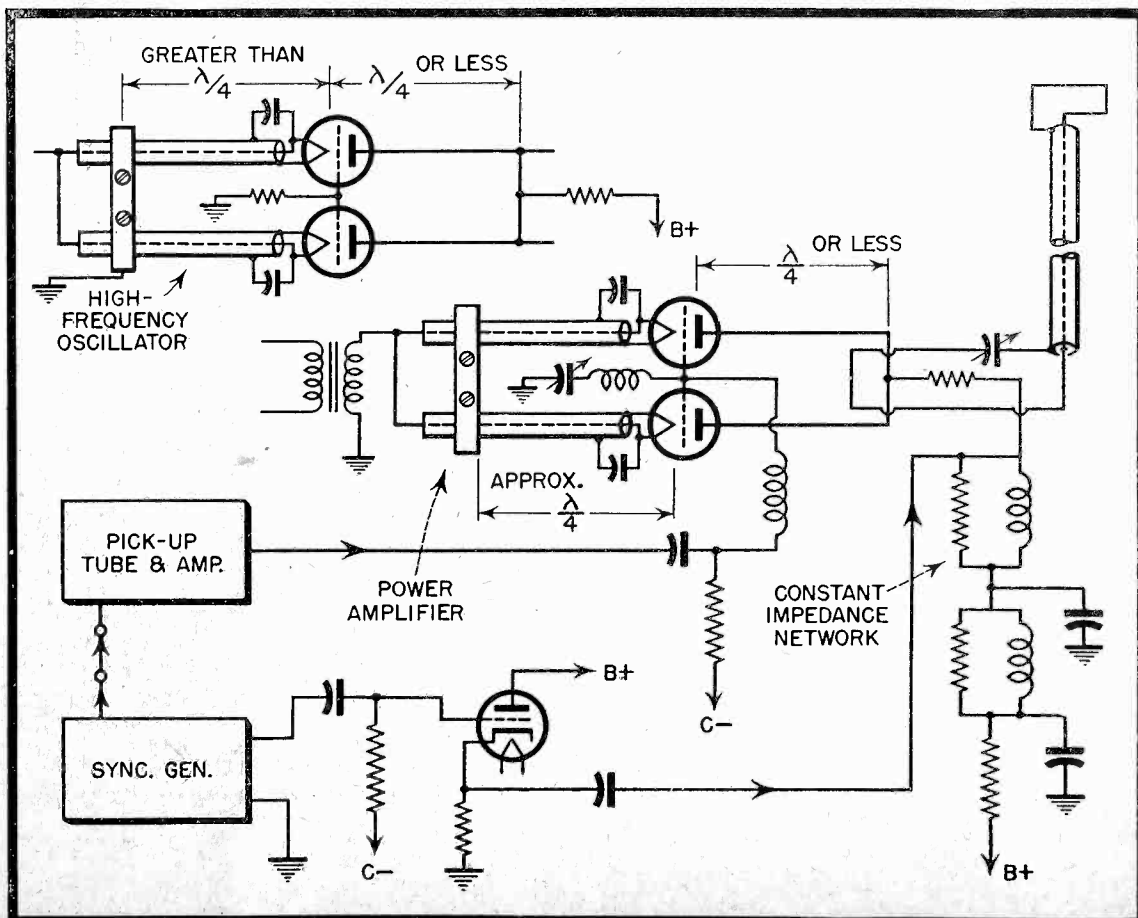

Patent No. 2,401,573

RATIO OF CURRENT IN COMPLEX TERMINATION TO THAT IN RESISTANCE TERMINATION AS FUNCTION OF REACTANCE IN TERMINATION

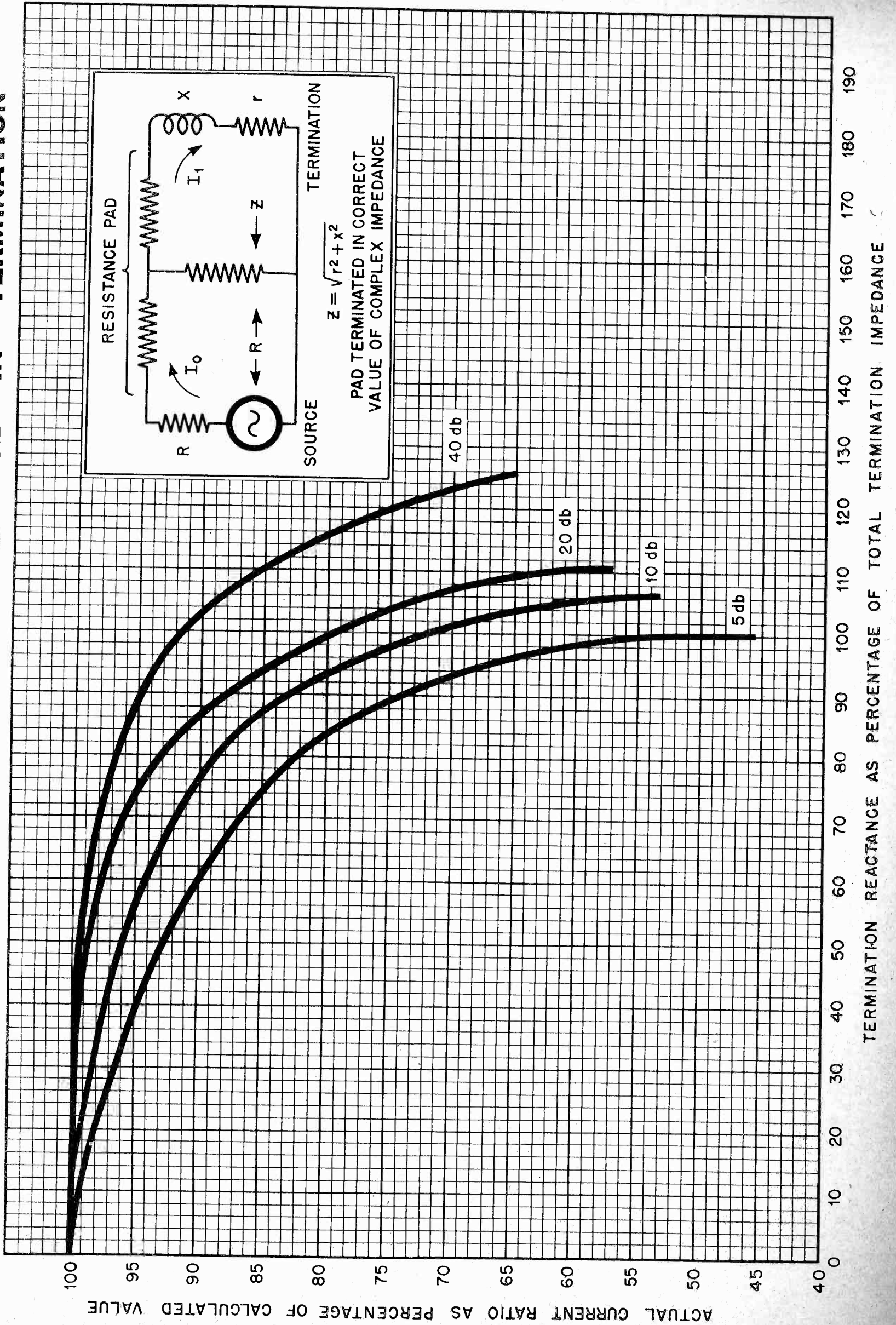

RADIO DESIGN WORKSHEET

NO. 55 — NARROW-BAND FM SIDE FREQUENCIES

• When a carrier is amplitude-modulated by a pure sine wave, side frequencies are generated which are equal to the sum and difference of the carrier and modulating frequencies. Amplitude modulation of the carrier by a complex wave consisting of two frequencies produces two pairs of sideband frequencies likewise equal to the sums and differences of the carrier and the modulating frequencies.

The sideband frequencies generated in FM, however, are a function of the modulation index as noted in the foregoing worksheet.¹ When the ratio of carrier deviation to the modulating frequency is unity or less, only the first order sidebands are of practical interest usually, and the bandwidth requirement may be considered to be the same as that for AM. (Use highest a.f.)

It is interesting to note the width of the channel and the sideband distribution for complex-wave modulation in a narrow-band FM system. The number of sideband frequencies present is then greater than in AM, because beat frequencies are also present which generate sidebands. These beat frequencies are those which are found in the detection process, consisting of the sum and difference of the two modulating frequencies present in the complex wave, plus all the harmonics of these modulating frequencies, plus their further sums and differences.

However, it is readily established that the width of the channel becomes less in the presence of the lower modulating frequency, for a constant deviation, than when the higher modulating frequency is impressed by itself. The magnitude of the carrier itself is lessened, being proportional to the *product* of the zero-order Bessel functions for both modulating indices. Likewise, the magnitude of the sideband frequencies are proportional to the *products* of the Bessel functions for those frequencies having orders equal to the side frequency orders.

A chart presenting the necessary factors in convenient graphical form is shown in *Fig. 1*, showing Bessel functions for various orders. A narrow-band FM system with a modulating index

of unity is next inspected for sidebands in the presence of a single modulating frequency, and then for two modulating frequencies, both at full deviation.

The modulator is adjusted to obtain a carrier deviation of 10 kc at maximum modulator output. With a modulating frequency of 10 kc and modulation index of unity, the carrier amplitude is 78%, first-order sideband 44%, second-order sideband 12%, third-order sideband 2%, fourth order 0.23%, and fifth order 0.022%. The first-order sideband is 10 kc from the carrier, the second-order 20 kc, and so on.

When the 10-kc deviation is the result of two modulating frequencies, such as 5 kc and 10 kc, the lower frequency will in general be expected to contain more energy and to produce a greater percentage of the total deviation. However, let it be assumed that both the 5-kc and the 10-kc components each produce one-half the total deviation. The 10-kc and 5-kc components have modulation indices of 0.5 and 1, accordingly. There results a pair of sidebands 10 kc from the carrier with a magnitude of 22%, and another pair 5 kc from the carrier with a magnitude of 44%. The 10-kc sideband has been reduced one-half in magnitude.

The carrier magnitude is the product of the zero-order Bessel functions for both modulation indices, or 73%. Another pair of sidebands results from second-order modulation products, and these have magnitudes of 3.4% and 12%, respectively. Thus the 20-kc sideband is less than 1/3 of its magnitude when total deviation resulted from the single 10-kc frequency. As more modulating frequencies are brought into consideration, keeping the maximum deviation constant, the channel width requirement is correspondingly reduced.

Beat frequencies are produced by intermodulation of those frequencies already noted. These have a relatively small magnitude. The difference frequency between the two modulating frequencies is 7500 kc, and its magnitude is 4%. As higher order beat frequencies are considered, their magnitudes will be seen to be entirely negligible.

While the channel requirement is reduced by complex-wave modulation under the conditions above noted, it is further true that the bulk of the energy in voice waves exists in the lower frequencies, further reducing the channel requirement. With pre-emphasis of high modulating frequencies, however, the latter observation holds to lesser degree.

Figure 1. Chart showing sideband magnitudes for narrow-band frequency modulation as a function of the modulation index.

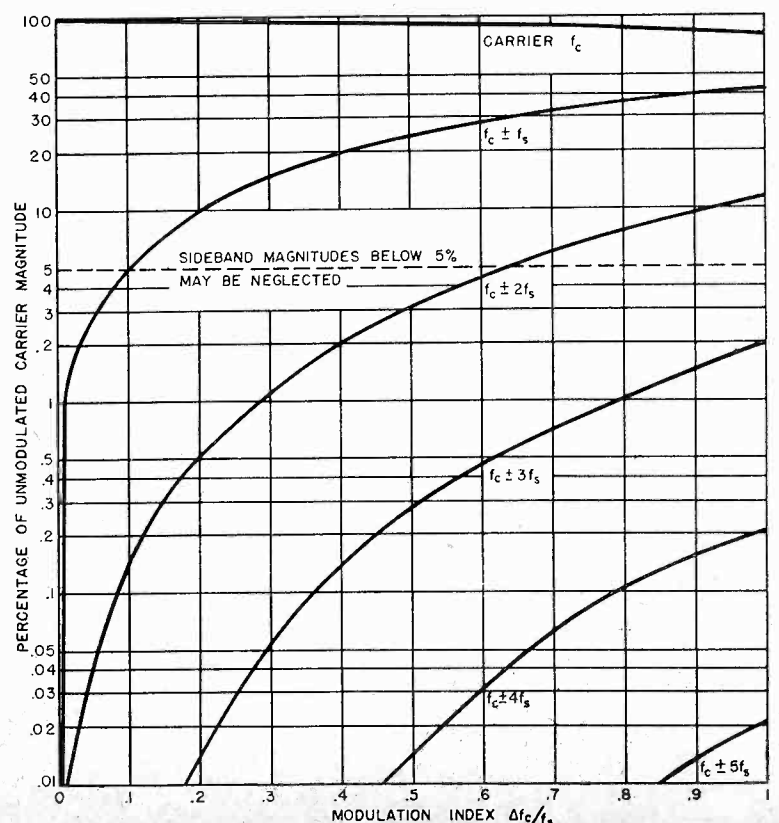

¹RADIO, Nov. 1946

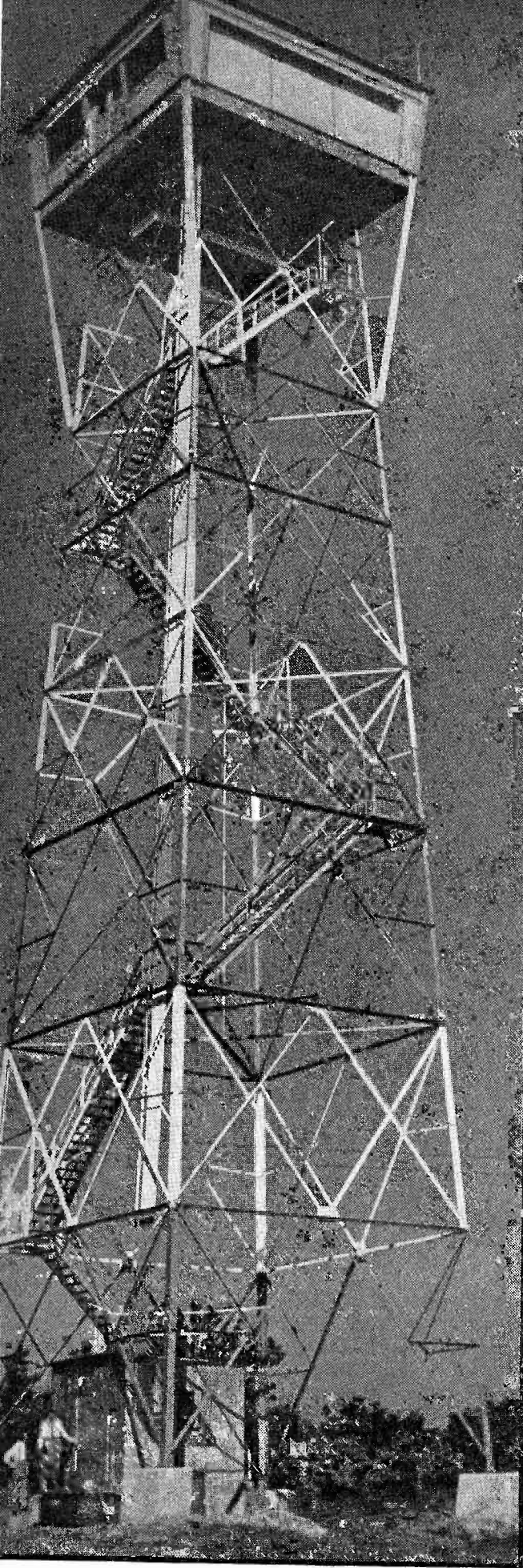

130 foot-steel tower in the Helderberg mountains 12 miles from Schenectady, N. Y. The "house" atop the tower contains antennae, transmitting and receiving apparatus for experimental microwave two-way radio relay network to operate between New York City and Schenectady as a carrier for television and FM radio programs, facsimile, and business machine circuits.

[Courtesy of General Electric]

Federal FM on the Air

Noise-free, high fidelity FM broadcasts provided by transmitters manufactured by the Federal Telephone and Radio Corp. are gradually covering the nation.

These have been purchased by radio stations located in twelve states covering the larger part of the area between and including the states of New York and Minnesota on the north and Texas and Florida

This Month

in the south. For the most part the installations are 3 kw, but some are 10 kw. At least 25 FM transmitters are expected to be on the air by January 1.

The stations on the air or soon to be in operation with Federal FM transmitters are: KWK, St. Louis, Mo.; WWL, New Orleans, La.; WSAP, Portsmouth, Va.; WBEN, Buffalo, N. Y.; WINC, Winchester, Va.; WMBH, Joplin, Mo.; WHIS, Bluefield, W. Va.; WJLS, Beckley, W. Va.; WOAI, San Antonio, Texas; WMPG, Palm Beach, Fla.

Also WEW, St. Louis, Mo.; WMRC, Greenville, S. C.; WTCN, Minneapolis, Minn.; WSVA, Harrisonburg, Va.; WPAD, Paducah, Ky.; KOWH, Omaha, Neb.; WELD, Columbus, Ohio, and WHLD, Niagara Falls, N. Y.

Hi-Fi Phonograph

The first public showing in this country of the London Full Frequency Range Reproducer was given recently in New York City.

Designed by H. F. Schwarz, St. Louis-born technical director of the British parent company, the London reproducer has a response range of 30 to 14,000 cps, 9000 cycles beyond the range of conventional pre-war phonographs.

Other advanced features in the instrument include a record changer which will play 10 and 12-inch records interchangeably and a loading system which makes it possible to put discs on the changer while the machine is playing. Six 12-inch speakers in the Knightsbridge, the larger model, and three in the Mayfair, the smaller, are acoustically arranged to give 180-degree sound diffusion.

An additional claim made for the London reproducer by the manufacturer is that it will add to the life of records by means of a pick-up arm placing only a half-ounce of weight on a disc, reducing the wear and tear on the platters.

I. R. E. Convention

The Annual Radio Engineering Show, a part of the 1947 national convention of The Institute of Radio Engineers, will be held in Grand Central Palace, New York City, instead of at the 34th Street Armory as previously announced. The dates, March 3 to 6, 1947, will remain the same.

Dr. James E. Shepherd, Chairman of the Convention Committee, in explaining the move, reports that the needs of exhibitors could not be met in the smaller exhibition hall. 152 exhibitors had asked for booths at the radio engineering show and now all can be provided adequate space to properly display radio and electronic equipment.

The move to Grand Central Palace does

not change the character of the Convention and Show. No home model radios will be shown. The displays are of an engineering nature, transmitter equipment, instruments, component parts and radio direction and location devices. There is a registration fee to non-members.

The new location also provides additional halls greatly needed for the valuable program of technical papers already being scheduled. The convention headquarters, banquet, and some sessions will be at the Hotel Commodore.

Microwave Spectroscope

Radar waves from 1.2 to 1.6 centimeters in length have found a new use in a microwave spectroscope developed for the analysis of chemical substances. Like the infrared spectroscope to which it is analogous, the microwave spectroscope can identify the more complicated molecules such as hydrocarbons without the laborious chemical processes involved in breaking them down and analyzing their various components.

Identification of whole molecules is accomplished by beaming microwaves through the vapor of the substance to be analyzed. Just as all the colors of the visible spectrum except blue and yellow are absorbed by a green screen certain wavelengths of these microwaves are absorbed by those molecules which they cause to rotate in resonance. Molecules of different substances absorb a different series of wavelengths. Thus for each substance there is a characteristic pattern of absorption lines which when projected electronically on a screen present an easily identifiable fingerprint of the vapor under investigation.

The basic elements of the microwave spectroscope as developed by Drs. William E. Good, Donald K. Coles and T. W. Dakin of the Westinghouse Research Laboratories are an oscillator tube or radar tube, waveguide, crystal detector, oscilloscope and sweep generator.

Microwaves emitted by the oscillator tube are directed through a rectangular waveguide which contains the sample gas or vapor to be analyzed in a gas cell section that is sealed off with plastic tape. At the far end they are picked up by a sensitive crystal detector which relays the impulse received to the oscilloscope. For clearer definition of the absorption lines the vapors in the gas cell are held to a pressure of about 0.1 mm of mercury.

The oscillator tubes used to obtain microwaves in wavelengths varying from 1.2 cm to 1.6 cm reflex klystrons tuned by changing the size of the resonant cavity. Several tubes are used to cover the band of frequencies required.

[Continued on page 28]

New Products

COAXIAL DIPOLE

A coaxial dipole is claimed to be superior to simple antennas in the following respects: Reduces feeder radiation, low radiation angle, neat appearance, simple, quick installation.

Radiation from the transmission line tends to combine with radiation from the antenna and thus raise the angle of radiation; hence the coaxial dipole has been developed to overcome this. A center conductor of the coaxial transmission line is extended 1/4 wave beyond the end of the line and acts as the top half of a half-wave antenna. A quarter-wave sleeve provides the bottom half. The sleeve shields the transmission line; thus very little current is induced on the outside of the line by the antenna field. The characteristic impedance of the line is the same as the center impedance of the radiator therefore the line is non-resonant.

Good results may be obtained on 2 meters by attaching this antenna on the side of the car with the standoff insulators provided, although for best results the top 1/4 wave should extend beyond the roof of the car.

The dipole is supplied with two standoff insulators, feed thru bolts, adjustable top section and 4 feet of coaxial transmission line. The transmission line is connected within the antenna and is ready for immediate use by connecting the opposite end to the transmitter. For fixed station use, the antenna may be mounted on any suitable rod or pole by the use of the two standoff insulators provided.

Manufactured by Engineering Electronics Co., 50 Fairfield St., Montclair,

Gm READING TUBE TESTER

Micromho (dynamic mutual conductance) readings and simplified testings — are two of the 20 exclusive features found in the new model 2425 tube tester. Transconductance readings are made possible through a simple measurement directly pro-

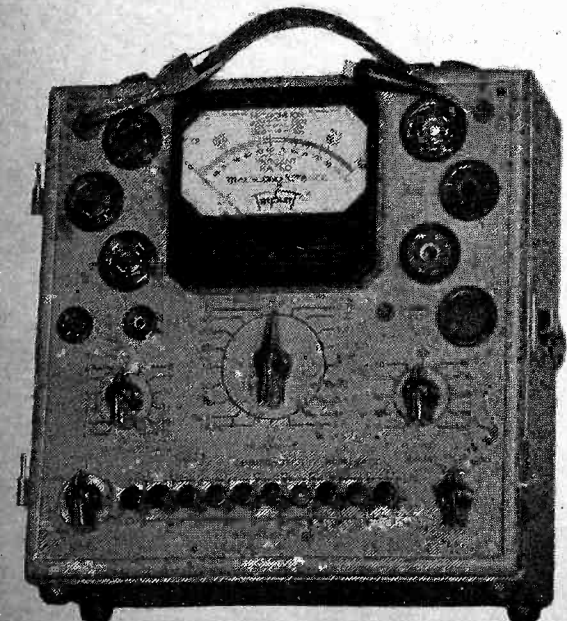

portional to Gm and a properly calibrated measuring instrument. There is no possibility of grid overloading. "Short" and "open" tests of every tube element. Gas test rounds out full check of all tubes. New Easy-Test Roll Chart also available.

For further data, write Triplett Electrical Instrument Co., Bluffton, Ohio.

LECTROFILM CAPACITORS

Lectrofilm capacitors in case styles 65 and 70 with the most popular ratings are now being offered by the Transformer

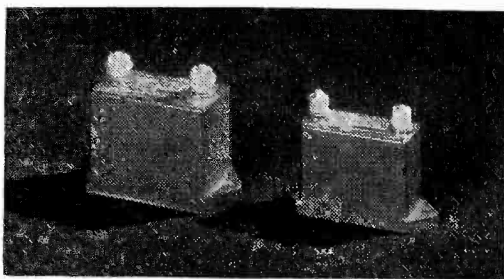

Division of the General Electric Company.

Supplied in low-loss plastic cases, these high-capacitance units are especially adaptable for radio-frequency blocking and bypass applications where Q and temperature coefficients are not critical.

Four ratings are listed in the case 65 style: 0.0001 μf at 3000 volts d.c., to 0.1 μf at 500 volts d.c. In the case 70 style, four ratings are also listed: 0.0001 μf at 5000 volts d.c., to 0.1 μf at 750 volts d.c.

Bulletin GEA 4295A is available upon request.

METALS AND ALLOYS

For engineers and designers in communications, electronics, and other fields, a guide to the properties and applications of 18 recent metallurgical developments is presented in a new booklet announced by the Westinghouse Electric Corp.

Section 1 of the new 48-page illustrated booklet is a detailed discussion of the physical and electrical characteristics of Westinghouse magnetic metals and alloys, including hipernik, conpernik, hiperco, hipersil and puron. In Section 2, which covers electrode, filament and contact metals, properties and applications of tungsten, molybdenum and cupaloy are described. Two glass sealing alloys, kovar "A" and dumet, are outlined in Section 3, and Section 4 covers brazing and soldering alloys, including phos-copper, 35-alloy and tin-lead and pure tin solders. Physical and mechanical properties of K-42-B, a high temperature alloy, are charted in Section 5 of the booklet.

Sketches, diagrams, curves and tables throughout the booklet present detailed data on the properties and applications of each material. A copy of the new booklet (B-3369) may be secured from the Westinghouse Electric Corp., Box 868, Pittsburgh 30, Pa.

CORNING BULLETINS

Corning Glass Works has issued three interesting folders entitled "Glass Components for the Electronic Industry," "Metallized Glassware," and "Vycor 96% Silica Glass."

Specifications, physical values and characteristics are listed and illustrations shown of electronic glassware products such as headers, relay enclosures, tubing, terminals, insulating and miscellaneous forms, microwave windows, coil forms, and metallized bushings. The folders are finely printed in two colors.

General technical descriptions and applications of the various components are included. Copies of the folders may be obtained upon request from the Corning Glass Works, Corning, N. Y.

MINIATURE RADIOHM

Centralab's new Model 1 Radiohm is specifically designed as a high quality volume attenuator for hearing aids, pocket radio receivers and miniature amplifiers. It is smaller than a dime and is designed to accommodate many variations in specifications. The new type unit will be available in 500 ohms to 5 megohms. Six tapers available.

Photos, construction, drawings and more complete information are contained in a temporary bulletin, form number 934. Write Centralab, 900 E. Keefe Ave., Milwaukee 1, Wis., for your copy.

RADIO TUBE COOLER

The Trane Radio Tube Cooler has been designed expressly to lower the temperature of water used to cool the transmitter tubes in radio broadcasting stations. Outside air is brought into the unit by means of a fan. This fan is forced over a coil

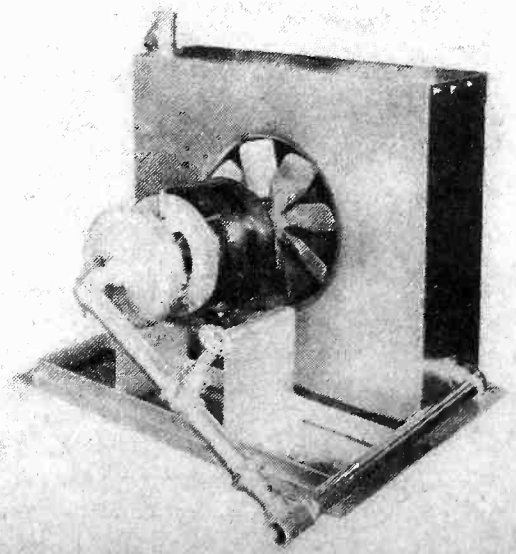

in which the water being cooled is circulated. The cooled water is stored in a reservoir until needed. Some of the larger installations of the radio tube cooler have been made at stations which transmit nationwide network programs.

For further data, write the Trane Co., La Crosse, Wis.

TUNABLE DIPOLE

A new type of dipole for television and FM reception has been announced by Kings Electronics, Brooklyn, New York. Its efficiency is claimed to be considerably higher than other conventional dipoles or reflectors because the arms of the dipole are adjustable and can be harmonized with the wave length of broadcast stations.

The adjustable feature of this dipole

consists of a u-h-f element, calibrated from 1.0 to 21.5 in half-steps. After facing antenna in direction of great signal strength, should any weak stations develop, this element can be moved in or out, according to a carefully calculated table, and then locked into position. This setting need be made once only — to boost the weak stations. If the calculations have been carefully and correctly made, no further adjustments should be necessary.

DAVEN ATTENUATOR

The Daven Company, 191 Central Avenue, Newark 4, N. J., announces that their line of attenuators is now available with a built-in cueing control.

The control itself serves to transfer program material to a separate cueing amplifier, thus eliminating the need for additional

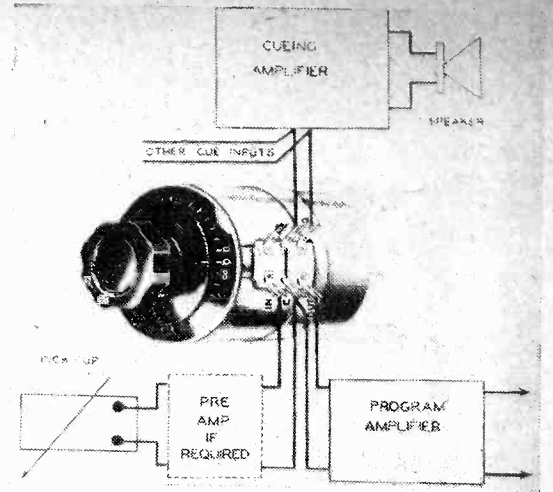

switching devices. Provision is made at the extreme attenuation position for connecting the incoming signal to a cue circuit before "fading in" the signal. As a result, a program can be smoothly "brought in" at the right time without the operation of any additional switches. A lug on the terminal board is provided for connection to the cueing system.

This cueing feature may be supplied on any type of Daven attenuator. However, it is primarily recommended on those controls used for mixing purposes, which are provided with a taper to infinity.

For further information on these units write to the Sales Department of the Daven Company, 191 Central Avenue, Newark 4, N. J.

TELEVISION TEST EQUIPMENT

Test equipment for mass production of television receivers and transmitters is now being made available by the RCA Engineering Products Department. This equipment is already being used as essential studio components for the transmission of television pictures over the air.

VARIO-TUNER

This new permeability tuning unit was designed for household radio receivers to cover the frequency range from 540 to 1620 kc. It consists of an r-f unit and oscillator section, with the following specifications:

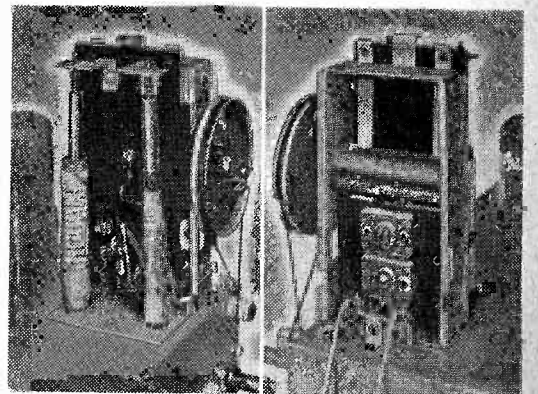

- R-F coil, 220 μ h, $\pm 2\%$, tapped at 53 μ h $\pm 2\%$.
- R-F trimmer capacitance; 30 μ mf, plus approximately 12 μ mf stray C).
- Oscillator trimmer capacitance, 170 μ mf.
- I-F frequency, 445 kc.
- Maximum tracking error, 5 kc.
- Average tracking error, 2 kc.
- Maximum backlash, 0.04%.
- Rotation of shaft to cover band, 270°
- Dial pointer travel, 4.75 inches.
- Diameter of drive pulley, 1 15/16 inches.
- Diameter of drive shaft, 1/4 inch.
- A loop antenna of 146 μ h $\pm 2\%$ is required, connected in parallel with the tuned



FREE

MAIL
COUPON
TODAY

25th ANNIVERSARY

LAFAYETTE'S BIG NEW CATALOG

RADIO & ELECTRONIC EQUIPMENT

SEND NOW for your free copy of this giant-size, 144-page catalog which offers you America's latest, largest line of top-quality ham gear, parts, communication equipment, tubes, tools, test equipment, amateur kits and accessories. Page after page of post war radio developments — plus a special bargain section that lists surplus and standard-make radio and television parts at famous Lafayette economy.

SUPER HAM BARGAIN

STOCK NO. HR 99

Heavy-duty filament transformer plus two brand new 872A tubes complete with sockets. Transformer primary 115 volts, 50/60 cycles. Secondary has two 5 volt, 6.75-amp windings, one 5 volt, 13.5 amps. 3500 volt test. Size: 3" x 5" x 6" H Shpg. Wt. 15 lbs. Units would cost much more if bought separately. Special price while supply lasts. . . . Items shipped day order is received. **\$8.95**

FILL OUT
AND MAIL
TODAY

LAFAYETTE RADIO, Dept. BL-6
100 Sixth Ave., New York 2

Rush my free copy of your big new catalog. Please enter my order for your big bargain

offer No. HR99. Check enclosed.....

Money order..... Send C.O.D.....

Name.....

Address.....

City.....Zone.....

State.....

Lafayette Radio

RADIO WIRE TELEVISION INC.
100 Sixth Ave., NEW YORK 13
110 Federal St., BOSTON 10
24 Central Ave., NEWARK 2

r-f coil, across the 53 μ h tap. Coils are mounted in rubber to prevent microphonics.

The Vario-Tuner is manufactured by Electronic Laboratories, Inc., Indianapolis, Indiana.

PLASTIC CAPACITOR

Just announced is a new small size Amcon Plastic Capacitor. Measuring only 2 1/8" high and with a diameter of only 1 3/8", this new unit is specifically intended for top chassis mounting where space is extremely limited. Self insulating because of its molded plastic case, the unit resists high temperatures, has a wide climatic range and will bear the Underwriter's Laboratories Approval.

Designed and manufactured by the American Condenser Company of 4410 N. Ra-

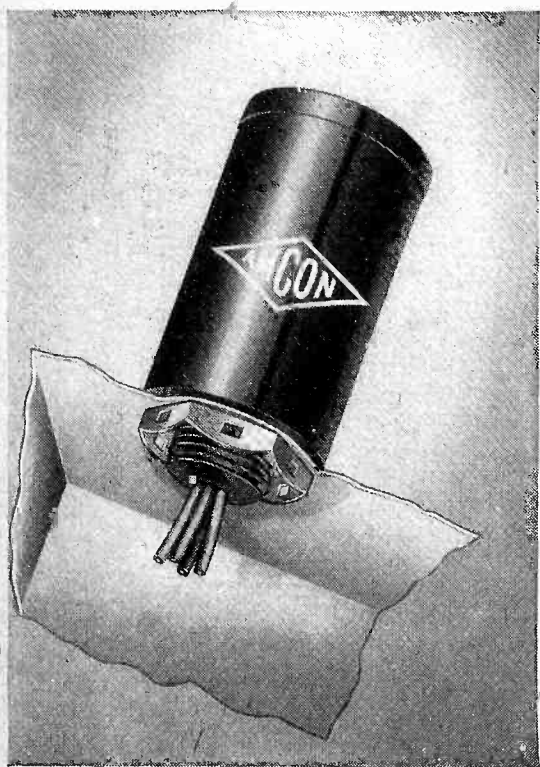

venswood Ave., Chicago 40, Illinois, the new unit will be designated as the Amcon Little PL. Additional information may be had by writing the manufacturer.

NEW W-E MIKE

A new type of studio microphone, not much larger in diameter than a quarter but capable of picking up orchestral music and voices with improved fidelity, was exhibited by the Western Electric Company at the N. A. B. Convention in Chicago. Called the 640AA microphone, the instrument was designed by Bell Telephone Laboratories and manufactured by the Western Electric Company. It saw considerable service during the war both as a laboratory and field instrument for testing and measuring the performance of sound pick-up and sound reproducing devices for the Armed Forces.

The 640AA microphone utilizes the two-plate capacity principle of operation, which is essentially a condenser made up of two metal plates with an air space between them. A design feature which contributes considerably to its high fidelity is the fact that the diaphragm is flush with the end of the microphone. This factor prevents any possibility of cavity resonance which might occur if the diaphragm were recessed below the outside edge as in other types.

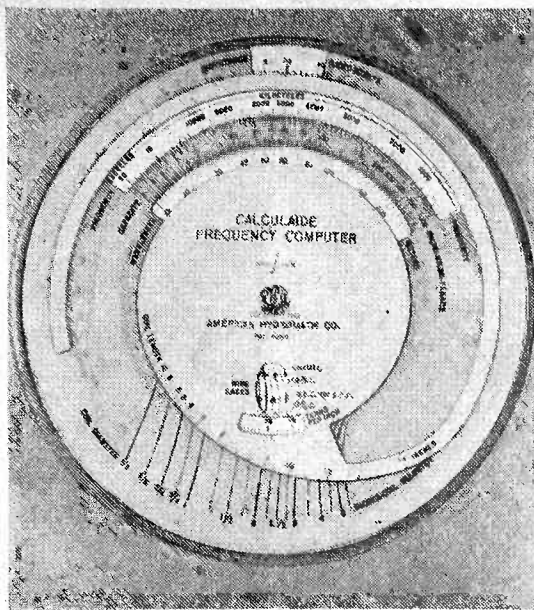

FREQUENCY COMPUTER

Problems involving frequency, inductance and capacity are quickly solved with the "Calculaide" frequency computer devised by American Hydromath Company, 145 West 57th St., New York 19, N. Y. This new frequency computer correlates, in one setting, the natural frequency and wave length of a circuit comprising a coil and condenser with the physical dimensions of the coil and the capacity of the condenser.

The "Calculaide" frequency computer is produced from three sheets of vinylite plastic. (Photo at left)

WIRE STRIPPER KIT

The insulation of any wire from size 8 to 30 can be quickly stripped with the new

Ingenious New Technical Methods

To Help You Simplify Production

Variable Speed Drive Attachment Offers Instant Speed Control for Drill Press Work!

Now you can adjust drill press speeds from high to low—or any intermediate speed—as easily as shifting gears in your car! The Era Variable Speed Drive Attachment enables the operator to provide the correct speed for large or small drills by merely moving a lever. This saving in time results in greater work volume, better work, and lower production cost. The Era Attachment fits all popular makes of drill presses, and is easily installed without the necessity of drilling holes or changing present equipment.

To also help save time on the job, many plant owners make chewing gum available to workers. Chewing gum seems to make work go easier, time go faster. Wrigley's Spearmint Gum may be used even when both hands are busy, eliminating work interruptions, and thus promoting greater safety for the operator.

You can get complete information from
Era Meter Co.
3940 N. Kilpatrick Ave., Chicago 41, Ill.

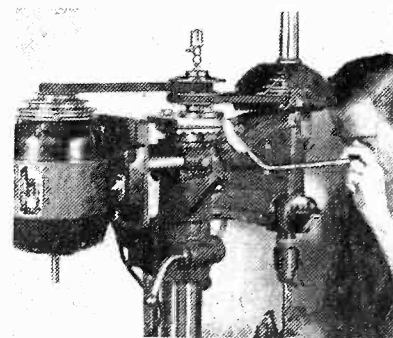

Era Variable Speed Drive



AA-203

GROUP SUBSCRIBERS SAVE UP TO \$1.50 Each

Form A Group Today!

You and your co-workers can now save up to half the regular cost of a RADIO subscription by using the Group Plan. The more men in a Group the more each saves, up to 50%.

Present subscriptions may be RENEWED or EXTENDED as part of a group.

The combination of exclusive, fine and timely articles plus this low-rate subscription offer makes RADIO a must-have publication. So fellows, form a Group today and send it to—



RADIO MAGAZINES, INC

342 MADISON AVENUE NEW YORK 17, N. Y.

TEAR OUT—MAIL TODAY!

RADIO MAGAZINES, INC.
342 Madison Ave., New York 17, N. Y.

Kindly enter the following subscription to RADIO Magazine. Remittance of \$..... is enclosed. (1 to 6 subscriptions may be ordered on this form).

- One 1-year subscription \$3.00
- Two 1-year subscriptions \$5.00
- Three 1-year subscriptions \$6.00
- Four 1-year subscriptions \$7.00
- Five 1-year subscriptions \$8.00

Groups of 6 or more subscriptions in the U.S.A. and Canada will be accepted at the rate of \$1.50 each. For Foreign groups add \$.50 to each subscription ordered.

PLEASE PRINT

Name

Address

Position Company

Name

Address

Position Company

Name

Address

Position Company

Name

Address

Position Company

Name

Address

Position Company

Name

Address

Position Company

NOTE: If you do not wish to tear out this order blank, print or type a list giving each subscriber's name, address, employer's name and their respective positions. Mail it in today!

Speedex Type 733-K Stripper Kit.

The Speedex and seven interchangeable blades are put up in a permanent steel case small enough to be conveniently car-



ried in a tool box. Speedex Wire Stripper Kits are manufactured by the General Cement Manufacturing Co., 919 Taylor Avenue, Rockford, Ill.

WATER-COOLED RESISTOR

Designed for frequencies up to 100 mc and powers to 5 kw, the new water-cooled resistor of The International Co., 401 Broad St., Philadelphia, Pa., is available from 35 to 1500 ohms. A spirally directed stream of water effects rapid cooling rates.

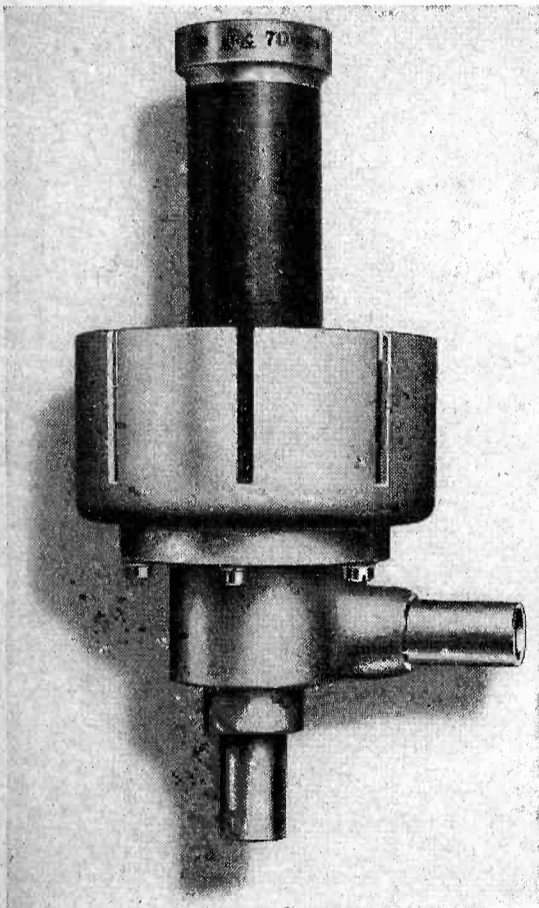

CENTRALAB TEMPORARY BULLETINS

Because of changing conditions in the radio manufacturing industry at present, CRL has begun a policy of issuing temporary bulletins that will bring pertinent information to its customers and prospects as quickly as possible. The information contained in these bulletins will be incorporated later into permanent catalogs, but in the meantime it represents working material for engineers and planning departments.

The first of these bulletins is form 933 on the new Centralab B C (by-pass and coupling) capacitors. This bulletin includes part numbers, standard values, tolerances, working voltages, power factor limits, leakage resistance color code and dimensions of the new parts.

For a copy, contact Centralab, Division of Globe-Union Inc., 900 East Keefe Avenue, Milwaukee 1, Wis. and ask for form 933.

FOREIGN PATENTS

Alien Property Custodian James E. Markham has announced that complete files of patents seized from German and Japanese nationals are now available in the patent departments of the Chicago and Boston public libraries and at the APC's San Francisco office.

The files are located in the main building of the libraries, he said, and are arranged according to patent-office classification to facilitate searching.

The APC patent libraries were transferred to the public institutions as a result of the closing of APC patent division field offices in those two cities, Mr. Markham explained. The APC patent library located in the Los Angeles Public Library has also been closed, he said.

Patent libraries are maintained by the APC at its Washington office in the National Press Building, its New York office at 120 Broadway, and now at its San Francisco office at 417 Montgomery Street.

Abstracts of the patents seized by the APC are still available and may now be obtained from the Office of Alien Property Custodian, National Press Building, Washington 25, D. C., instead of from the APC's Chicago office.

DIE-LESS DUPLICATING

Various models of bending machines which find extensive application in model shops, experimental laboratories, and production shops, are described and illustrated in a 40-page bulletin issued by the Di-Acro division of the O'Neil-Irwin Mfg. Co., Minneapolis, Minn.

The bender embodies an original process for die-less duplicating of parts to die accuracy without time delay or expense of dies. The manufacturer states that accuracy to a tolerance of 0.001" is obtainable with the machines because all bending, forming, folding, rolling and shearing to shape is around, against or between positively located contact surfaces. In most cases, girls may operate the machines successfully, it is reported.

The bulletin treats its subject in a thorough manner, and is handsomely printed.

FLAMENOL WIRE

Insulated wire and cable with exceptional wear-resistive qualities and which is likewise refractory to acids, alkalis, oils, and heat, is described in a 16-pp bulletin published by the General Electric Co. at Schenectady, N. Y.

ALLOYS

Numerous varieties of nickel alloys are discussed in a 24-pp catalog released by the Alloy Metal Wire Co., Graybar Bldg., New York City. Graphs, tables, and illustrations present the electrical and mechanical properties of the various alloys in an effective and interesting manner.

ELECTRO-VOICE

Interesting technical information as well as catalog items are contained in a 20-page 2-color bulletin offered by Electro-Voice Corp., South Bend 24, Ind. Microphones described include broadcast, public-address, communications, and recording types.

JOBBER-S-WHOLESALE

QUANTITY-BUYERS!

MID-AMERICA'S UNBEATABLE LOW PRICES DOUBLE Your Profits!

WHOLESALE ONLY!
Quantity buyers! MID-AMERICA has 70,000 square feet of warehouse space jam-packed with radio parts, electronic equipment, etc. Items at UNBELIEVABLY LOW PRICES—that will save and make you money. Listed below are a few samples!



Universal Output Transformer
will match voice coil to any tube, single or push-pull. Strap mounting on 2 1/4" centers. Size: 2 1/4" high, 2" wide, 2" deep.
Minimum order—100
98c each

AC-DC CHOKE 15 henry, 50 MA, 120 ohms DC resistance. Size: 1 1/2" x 2" x 1 1/2"
Minimum order—50
59c ea.

ACORN TUBE SOCKET Low loss ceramic socket with rugged spring contacts for 954 and 955 tubes
Minimum order—100
\$7.50 Per 100

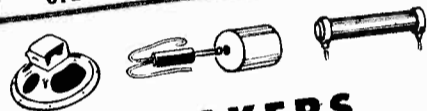

SPEAKERS

5" Alnico V PM Speaker with 4 ohm voice coil, less output transformer.
Minimum order—100
\$1.37 ea.

6" Alnico V PM Speaker with 2.15 Alnico V slug.
Minimum order, **\$1.79 ea.**

PL-68 PLUG Jack Set with 4 ft. of 3-conductor rubber-covered cable with PL-68 plug on one end and 3-way open circuit jack, at other end.
Minimum order—100
15c each

10 Watt RESISTORS — any ohmage — per size or assorted
Minimum order—100
\$7.00 Per 100

GUARANTEED

All items shown in this ad are guaranteed as rated by nationally-advertised manufacturers and are new, unused and in perfect condition.



Millimeters—GE & Westinghouse

0-300 MA DC. 2 1/2" flange, 2 1/2" dia. body, 1 1/2" deep.
0-20 MA DC. 2 1/2" flange, 2 1/2" dia. body, 1 1/2" deep. Both types with white scale, black markings.
(Minimum order each type—10.)
\$1.95 1 ea.

RELAYS—Write for 12-page book illustrating more than 250,000 relays. 24c each, and up.

DYNAMOTORS—79c, and up! Write for complete listing of dynamotors. Our prices will 'shock' you!

APC CONDENSERS—8c each, and up!
We have large quantities of unused APC condensers—all at ridiculously low prices! Ask for special condenser listing!

FREE CATALOG

TERMS: We extend usual credit to rated accounts. Others send 25% with order, balance C.O.D. All prices shown are f.o.b. Chicago warehouse.



Mail orders and catalog requests to store address—Dept. F-128

You ain't seen nothin' yet! Rush firm name and address for MID-AMERICA'S big catalog listing hundreds and hundreds of hard-to-get radio parts, transmitters, etc.—ALL AT UNBEATABLE LOW PRICES!

MID-AMERICA CO. Inc.

STORE 2412 S. MICHIGAN AVE. CHICAGO 16, ILL. WAREHOUSE 2307 S. ARCHER AVE. CHICAGO 16, ILL.



UNCLE



AUNT



GRANDMA

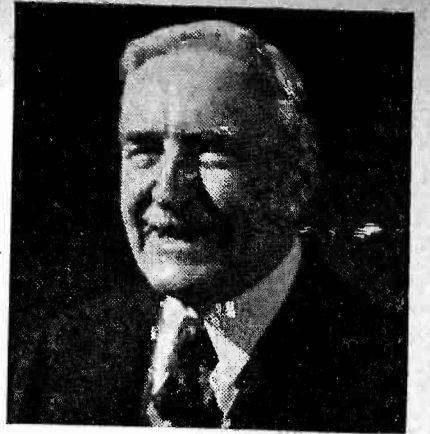

GRANDPA



FATHER



MOTHER



BROTHER



SISTER



NEPHEW



NIECE



SON



DAUGHTER

What one gift would please them all?

No matter what their tastes . . . their hobbies . . . their likes or dislikes . . . there's *one* gift that will please them, each and every one.

That gift is a United States Savings Bond.

This Christmas, put at least one Savings Bond under the tree for someone you love.

*Contributed by this magazine in co-operation
with the Magazine Publishers of America as a public service.*



BOOK REVIEWS

RADIO TUBE VADE MECUM, Editions Techniques. Published by P. H. Brans, 28 Rue du Prince Leopold, Anvers (Borgerhout), Belgium, 232 pages, paper binding, \$2.50. Distributed in America by Editors and Engineers, 1300 Kenwood Road, Santa Barbara, Calif.

Considerable work has gone into the preparation of this book, which represents a reasonably complete listing of the receiving tubes encountered throughout the world. Tube parameters are given, and the recommended operating voltages. Basing diagrams and miscellaneous supplementary information such as tube equivalences have been included.

The volume should prove of considerable use to American workers who are concerned with tubes of foreign manufacture.

ELECTRICAL TRANSMISSION IN STEADY STATE, by Paul J. Selgin. Published by McGraw-Hill Publishing Co., 330 West 42nd St., New York, 416 pages, 100 illustrations, cloth binding, \$5.00.

Primarily aimed at broadening and strengthening the technical knowledge already possessed by students with some experience in industrial work, this volume is essentially an overhaul of fundamental theory. The author is a former instructor in radio engineering at Polytechnic Institute of Brooklyn, and is now a research engineer with Farnsworth Television and Radio Corp.

This book is particularly satisfying because it treats important concepts on an adequate mathematical framework, without indulging in derivations and transformations for their own sake. Topics include network theory, lines, fields, coupling, four-pole vacuum-tube theory, and high-frequency power transfer. These are discussed from the standpoint of the development engineer who must work in terms of powerful general concepts before evolving a specific application.

It is a most useful volume for the advanced student and the practicing radio engineer.

RADIO'S CONQUEST OF SPACE, by Donald McNicol. Published by Murray Hill Books, Inc., 252 Madison Ave., New York 16, N. Y., 465 pages cloth binding, \$4.00.

Romantic treatment might be expected from the title of this book, which is actually down-to-earth and interesting reading for technical men. No mathematics are included, as the book is basically a documented historical account of the science of radio.

The author, a past president of the I.R.E., has a very readable style, understandable to both the practicing engineer and the non-technical executive.

Laboratory Standards

FM

MODEL 78

SIGNAL GENERATOR

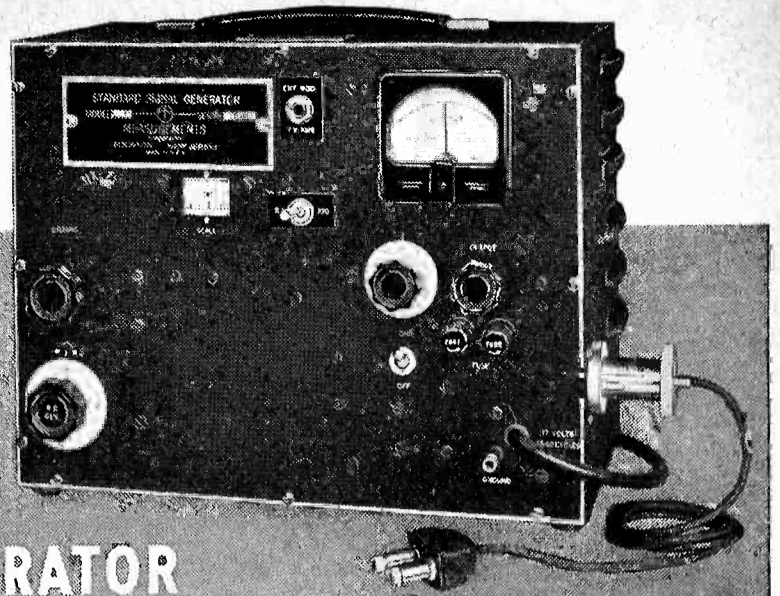

SPECIFICATIONS:

CARRIER FREQUENCY RANGE: 86 to 108 megacycles.
Individually calibrated dial.

OUTPUT SYSTEM: 1 to 100,000 microvolts
with negligible carrier leakage.

OUTPUT IMPEDANCE: Constant at 17 ohms.

MODULATION: 400 cycle internal audio oscillator.
Deviation directly calibrated in two ranges: 0 to 30 kc. and 0 to 300 kc.

Can be modulated from external audio source.

Audio fidelity is flat within two db from d.c. to 15,000 cycles.

Distortion is less than 1% at 75 kc. deviation.

PROMPT DELIVERY

MANUFACTURERS OF
Standard Signal Generators
Pulse Generators
FM Signal Generators
Square Wave Generators
Vacuum Tube Voltmeters
UHF Radio Noise & Field
Strength Meters
Capacity Bridges
Megohm Meters
Phase Sequence Indicators
Television and FM Test
Equipment

MEASUREMENTS CORPORATION

BOONTON



NEW JERSEY

FOR **VHF**

30 TO 200 MC

170-A

**Q
METER**

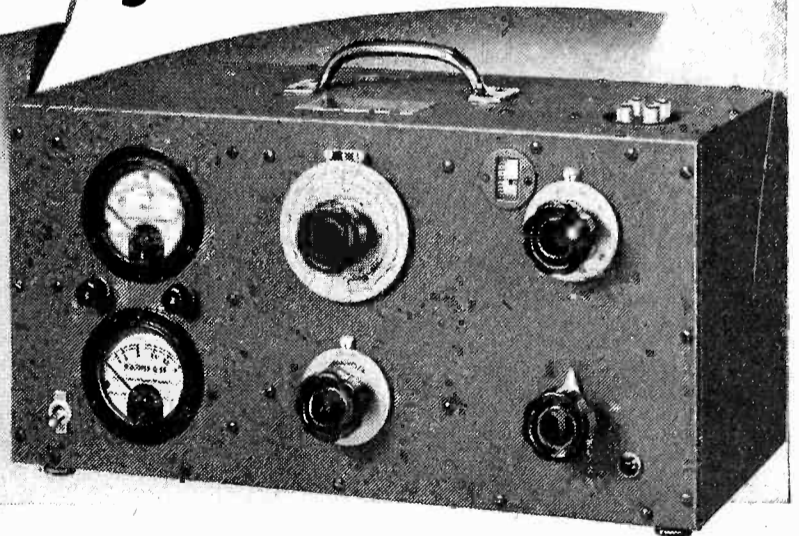

A ruggedly constructed direct reading laboratory instrument specially designed to measure Q, inductance, and capacitance values quickly and accurately. Invaluable in selecting proper low loss components for high frequency applications.

SPECIFICATIONS:—FREQUENCY RANGE: 30-200 mc, accuracy 1%

RANGE OF Q MEASUREMENT: 80 to 1200

© CAPACITOR RANGE: 11-60 mmf; accuracy $\pm 1\%$ or 0.5 mmf, whichever is greater

WRITE FOR
CATALOG "D"

BOONTON RADIO

BOONTON · N · J · U · S · A ·

Corporation 

RADIO PARTS ELECTRONIC NEEDS!

Check These CONCORD VALUES!

Concord has them! Radio and Electronic Parts, Supplies and Equipment of every kind, for every need... long awaited, hard-to-get items... new merchandise, just received... Hundreds of bargains... in stock NOW for IMMEDIATE SHIPMENT from CHICAGO or ATLANTA.

Write for catalog of Radio Parts and Electronic Equipment. Packed with Radio Needs—new and scarce items — Bargains. Write Dept. F-126.



WELLS-GARDNER BC-348-N Communications Receiver. 6 Bands—200-500 KC. and 115 MC. to 18 MC. in 5 Bands. 2 stages RF., 3 stages IF., Beat Frequency Oscillator, Crystal IF. Filter, Manual or Automatic A.V.C. Complete with tubes and 21 V.D.C. input dynamotor power supply, but supplied with complete instructions and diagrams for converting to 110 V.A.C. 60 cycle operation. **BC-348-N . . . \$53.95**

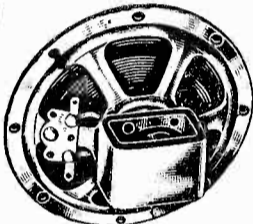

ALNICO V 5" P.M. SPEAKER

New Alnico V magnet provides maximum performance with minimum weight. Normal wattage 3, peak wattage 4½. V.C. impedance 3.2 ohms. depth 27/16". **SB7009 . . . \$1.98**

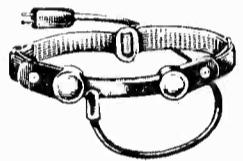

CARBON THROAT MICROPHONE

Will work into any 200 ohm impedance input circuit. Has adjustable strap to fit any neck. Ideal for ultra high frequency mobile work for hams. Supplied with strap, 10' cord and plug. **SB7060 . . . 49¢**

9003 VHF Midget Super Pentode Tube Control RF **95¢**

HEAVY DUTY LINE FILTER Solar Elim.-O-Stat. Completely shielded. Type EN106. **SB3218 Each \$1.79**

WIRE STRIPPER Strips wire instantly! Fastens to bench or other support. Wire stripped to any length. Strips wire up to 12 MM diam. Each **98¢** **C15268**

TUNER UNIT TU-10-B

Continuous frequency range from 10 MC. to 12.5 MC. VFO oscillator tuning section, buffer, coupling, capacitors and choke & buffer output matching tapped coil & condenser. Size 16½" lg. x 7½" h. 5½" deep. **A54132 \$2.95**

T-17-B 200 Ohm Carbon Mike. Lightweight, with press-to-talk button. Built-in filter to suppress carbon hiss. 5" rubber covered cable and PL-68 3-circuit plug supplied. **SB7062 \$2.49**
Midget Volume Control — 1 Meg. ohm Standard ¾" Bushing, ¼" dia. Shaft, ¾" long, with split spline for push-on knob. **C3154 35¢**

STANCOR Universal Output Transformer Type A3856. Primary for all single or push-pull plates. Secondary adjustable from 1 to 30 ohms. Two-inch mounting centers. 4 watts at 35 mils. **C1675. SPECIAL \$1.32**

CONCORD

RADIO CORPORATION
LAFAYETTE RADIO CORPORATION

CHICAGO 7 ATLANTA 3
901 W. Jackson Blvd. 265 Peachtree Street

Numerous well-chosen illustrations and diagrams have been included. Circuit diagrams are presented in basic form to illustrate principles of operation rather than complete equipments.

Anyone concerned with the technical aspect of radio will find this book interesting and informative.

COYNE RADIOMAN'S HANDBOOK, by the technical staff, Coyne Electrical School, 500 South Paulina Street, Chicago 12, Ill., 321 pages, flexible leatherette binding, illustrated, \$3.25.

This is a reference and data book containing formulas, methods, charts, rules, diagrams, circuits, laws, specifications, tests, emergency repair data and numerous technical aids. The book is directed to men engaged in radio manufacture, shop assembly and design, installation, or servicing.

To make the volume useful on the job, it has been printed in 8-point type, with a page size of 4½x7 in. It is competently written throughout in a clear and coherent style, and effectively achieves its intended purpose. The volume is recommended to technically employed radio men.

COMMUNICATION THROUGH THE AGES, by Alfred Still. Published by Murray Hill Books, Inc., 232 Madison Ave., New York 16, N. Y., 190 pages line illustrated, cloth binding, \$2.75.

Mr. Still has produced a history of radio and its background techniques with broad cultural content as well as technica. He is concerned with semantics and epistemology in their relation to engineering designs, and the result is an unusual type of book in this field. His account will appeal to those concerned with the humanities as well as workers immersed in circuits and measurements. It is a competently written history from both points of view, amply documented. An interesting feature of the book is a chronological table tracing the key dates in the history of communication from 1084 to 1936.

A fellow of the A.I.E.E. and member of the I.E.E., the author has written other books including *Electrical Power Transmission* and *Soul of Lodestone*, which have enjoyed wide acceptance.

Correction

In formulating a practical problem to illustrate the derivations contained in "Improved Analysis of the R-C Amplifier," by J. Roorda, Jr., October issue, p. 15, a decimal-point error occurred in the f_{if_2} product, which should have been 10^6 . Upon relocating the decimal point, the resonant frequency becomes 10^8 cps, corresponding to $R = 76,000$ ohms, $L = 1250$ henrys, and $C = 20 \mu\text{f}$. Maximum amplification is 380, and $R_1 = 89,300$ ohms, choosing $R_2 = 0.5$ megohm. C_2 may be $0.033 \mu\text{f}$ or any larger value.

THIS MONTH

[from page 20]

The frequency of the oscillator tube, or klystron, is swept in synchronism with the horizontal sweep of the oscilloscope tube, and the output of the crystal detector is applied directly to the vertical plates of the oscilloscope so that absorption at a particular frequency will be recorded as a vertical deflection of the oscilloscope trace.

Ammonia has been found to have a pattern of 30 distinct absorption lines in this region which is its "fingerprint." Other compounds that have been tagged by this method are water vapor, acetone, cyanogen bromide, and carbonyl sulfide. Although its limitations are not yet known, the microwave spectroscopy promises to be a very valuable tool in the study of molecules and even of the atomic nuclei within the molecule.

Mobile Television Unit

Development of a lightweight, self-contained mobile television unit was announced by W. W. Watts, vice-president in charge of the RCA Engineering Products Department.

The new mobile television unit, mounted on a standard 1½ ton truck chassis, can be used to transport all the equipment required for picking up, monitoring, and relaying to the studio remote television events such as boxing and wrestling matches, football, hockey, and baseball games, horse races, and newsworthy events such as parades, public ceremonies, and floods, fires, and other disasters.

2-Way V.H.F. for Aircraft

In line with the recent establishment by FCC of 108-132 mc as a permanent v-h-f frequency allocation for aviation service, Aircraft Radio Corporation announces its new Type 17 2-way v-h-f aircraft communication system.

Believed to be the first two-way v-h-f equipment of sufficiently small size and weight to permit its use in small aircraft or as auxiliary v-h-f equipment in larger aircraft, the Type 17 system includes a tunable v-h-f receiver covering the entire aviation band from 108-135 mc and a crystal-controlled 5 channel v-h-f transmitter which may be tuned for five adjacent frequencies anywhere between 121.5 and 132 mc.

The system is controlled from a small remote tuning unit which is all that must be mounted near the pilot, and comes complete with headset, microphone, v-h-f antenna, cables and mounting bases.

Request has been made for the CAA Approved Type Certificate for airline use of this equipment.

Hickok Service Depot

A new service station for servicing and repairing of all types of Hickok equipment, under the management of Mr. Kenneth E. Hughes, district representative of the Hickok Electrical Instrument Company, is located at 339 West 44th Street, New York City. It is equipped to give efficient, rapid service on Hickok precision instruments.

Personal Mention

Baker Elected President of I.R.E.

Dr. W. R. G. Baker of Syracuse, N. Y., a vice-president of General Electric Company in charge of electronics, has been elected president of the Institute of Radio Engineers, it was announced recently at a meeting of the board of directors.

He succeeds Frederick B. Llewellyn of Bell Telephone Laboratories and will take office shortly after the first of the year.



W. R. G. Baker

according to George W. Bailey, executive secretary.

Dr. Baker is well-known in the expanding electronics industry, particularly in the fields of FM radio and television. He holds many other important offices such as director of the engineering department of the Radio Manufacturers Ass'n.; and Chairman of the electronics committee of the American Institute of Electrical Engineers. He has held other prominent positions as chairman of the National Television Systems Committee of the television industry, and was the first chairman of the electronics industry's Radio Technical Planning Board.

Born in Lockport, New York, Dr. Baker spent most of his youth in Schenectady, New York, where he was graduated from Union College with bachelor and master's degrees in electrical engineering. The honorary degree of Doctor of Science was conferred by the college in 1935.

William H. Myers

★ Appointment of William H. Myers as chief engineer of the receiver division, Farnsworth Television & Radio Corporation, has been announced by B. R. Cummings, Farnsworth vice president in charge of engineering.

Mr. Myers succeeds J. H. Pressley, who has been retained as a consultant to the company.

Dr. Felix Yertzley

★ Mycalex Corp. of America announces the appointment of Dr. Felix L. Yertzley as director of research and engineering of

VACUUM TUBE VOLTMETER

MODEL 62

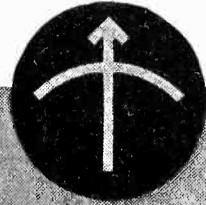
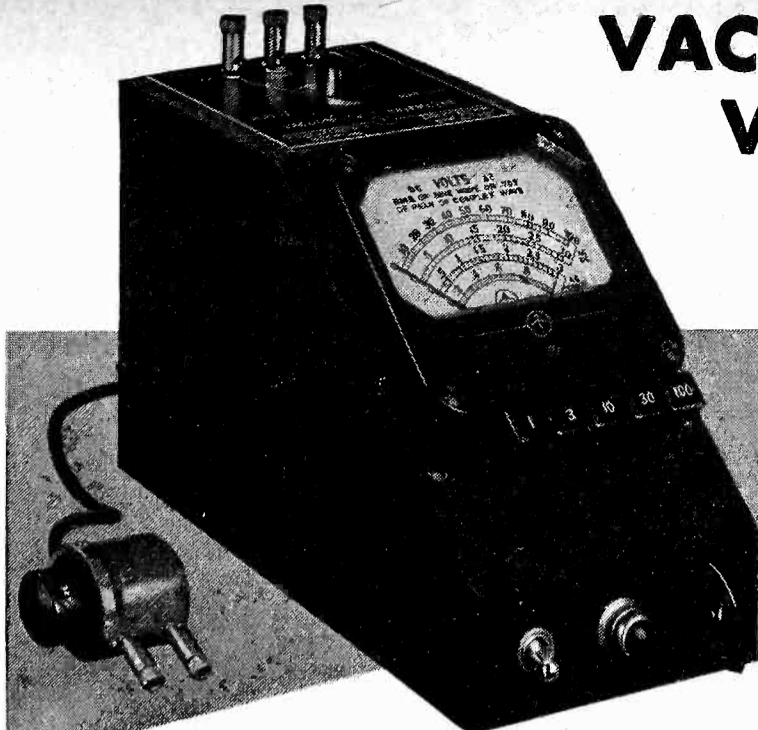

SPECIFICATIONS:

RANGE: Push button selection of five ranges—1, 3, 10, 30 and 100 volts a.c. or d.c.

ACCURACY: 2% of full scale. Useable from 50 cycles to 150 megacycles.

INDICATION: Linear for d.c. and calibrated to indicate r.m.s. values of a sine-wave or 71% of the peak value of a complex wave on a.c.

POWER SUPPLY: 115 volts, 40-60 cycles—no batteries.

DIMENSIONS: 4¾" wide, 6" high, and 8½" deep.

WEIGHT: Approximately six pounds. *Immediate Delivery*

MANUFACTURERS OF
 Standard Signal Generators
 Pulse Generators
 FM Signal Generators
 Square Wave Generators
 Vacuum Tube Voltmeters
 UHF Radio Noise & Field Strength Meters
 Capacity Bridges
 Megohm Meters
 Phase Sequence Indicators
 Television and FM Test Equipment

MEASUREMENTS CORPORATION

BOONTON



NEW JERSEY

Model 2450 ELECTRONIC TESTER

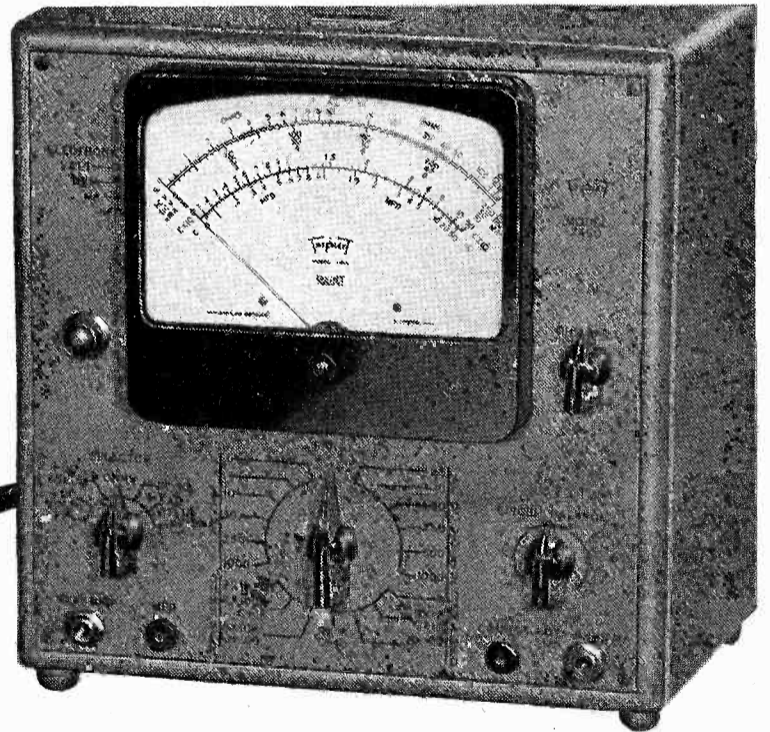

There's never been a tester like this!

Here's a tester with dual voltage regulation of the power supply DC output (positive and negative), with line variation from 90 to 130 Volts. That means calibration that stays "on the nose"! That means *broader service* from a tester that looks as good as the vastly improved service it provides. This model includes our Hi-Precision Resistor which outmodes older types. Detailed catalog sheets on request. Write today.

Triplet

ELECTRICAL INSTRUMENT CO. BLUFFTON, OHIO

BOOKS FOR THE ENGINEER

UNDERSTANDING MICROWAVES

(Chapter Heads)

The Ultra High Frequency Concept
Stationary Charge and its Field • Mag-
netostatics • Alternating Current and
Lumped Constants • Transmission Lines
Poynting's Vector and Maxwell's
Equations • Waveguides • Resonant
Cavities • Antennas • Microwave
Oscillators • Radar and Communica-
tion • Section Two is devoted to de-
scriptions of Microwave Terms, Ideas
and Theorems. Index.

400 PAGES

PRICE \$6.00

A-C CALCULATION CHARTS

Student engineers will find this book
invaluable. Simplifies and speeds
work. Covers all AC calculations
from 10 cycles to 1000 megacycles.

160 PAGES

PRICE \$7.50

JOHN F. RIDER, Publisher, Inc.

404 FOURTH AVENUE, NEW YORK 16, N. Y.
EXPORT DIV. ROCKE-INTERNATIONAL ELEC. CORP.
13 E. 40TH STREET, NEW YORK CITY CABLE:ARLAB

NEWS! YOUR 1947

RADIO ENGINEERING SHOW

to be at

GRAND CENTRAL PALACE

March 3-6

NOT at the 34th Street Armory. We
outgrew that place and were lucky
enough to get space at Grand Central
Palace . . . the biggest exhibition hall
in New York, for the biggest radio
engineering show in history!

Admission to Grand Central Palace
and all lectures free to members of The
Institute of Radio Engineers. \$3.00 ad-
mission for non-members.

Have you made your plans yet to
attend the show?

(Incidentally, better make hotel
reservations well in advance!)

Wm. C. Copp, Exhibits Manager

THE INSTITUTE OF RADIO ENGINEERS

1 E. 79TH ST., N. Y. 21 Circle 6-6357

that company. Dr. Yertzley, a graduate of
Cornell university, holds the degrees of
M. E. and Ph. D.

He is a specialist in insulation and his
former connections include Bell System,
where he was a product engineer, West-
ern Electric, Bendix Aviation Corp. (Pio-
neer-Eclipse Division), Weston Electric
Co. and E. I. DuPont de Nemours, where
he was in charge of research and develop-
ment.

B. V. K. French

★ Howard W. Sams & Co., Inc. announces
the appointment of Mr. B. V. K. French
as director of field relations.

Mr. French is a senior member of the
Institute of Radio Engineers and has



B. V. K. French

served as chairman of the Connecticut and
Indianapolis sections. He has been a fre-
quent contributor of technical articles to
publications in the radio engineering and
service fields.

Herbert C. Graves, Jr.

★ Herbert C. Graves, Jr., has been ap-
pointed chief engineer for Gibson Electric
Co., Pittsburgh, Pa., manufacturers of
electrical contacts.

Previous to joining Gibson Electric
Company, Mr. Graves was engineering
manager for I-T-E Circuit Breaker Com-
pany and, during the war, was in charge
of navy activities for that company.

Mr. Graves has been granted approxi-
mately twenty patents in the United States
and a considerably larger number of as-
sociated patents in foreign countries.



Herbert C. Graves, Jr.



Roy S. Laird

★ Roy S. Laird, vice president and sales
manager of Ohmite Manufacturing Co.,
Chicago, was recently elected chairman of
the Association of Electronic Parts and
Equipment Manufacturers, to succeed J. A.
Berman of Shure Bros.



CENTER-FREQUENCY

[from page 13]

quency is equal to the total number of
cycles produced while the oscillator is
low in frequency, then the average cen-
ter frequency of the transmitter will be
correct.

This system, used in Westinghouse
FM transmitters, has been explained in
detail by J. R. Boykin³. Each cycle of
beat frequency between the signal fre-
quency and the crystal reference fre-
quency is used to generate a pulse.
The pulses are separated, one circuit
receiving the pulses when the master
oscillator frequency is higher than ref-
erence, and the other circuit receiving
the pulses when the MO frequency is
lower than reference. A pulse-counting
circuit is utilized to develop a control
voltage for a reactance tube shunting
the MO.

A pair of voltages in phase quadra-
ture is obtained from the crystal refer-
ence frequency through RC networks.
These phase-shifted voltages are mixed
with the FM signal, and the output of
one mixer is used to trigger a multi-
vibrator. The multivibrator is differen-
tiated to pulses, which are superposed

“Help me
walk
again...”

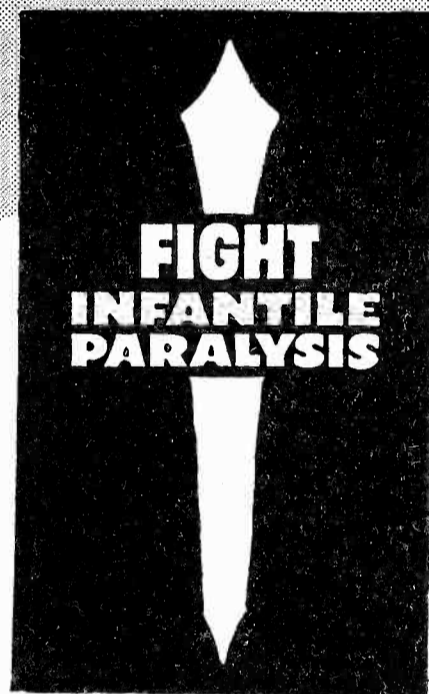

Join the
MARCH OF DIMES

January 15-30

THE NATIONAL FOUNDATION FOR INFANTILE PARALYSIS

FRANKLIN D. ROOSEVELT, Founder

HOPP Plastic RADIO DIALS

DIAL WINDOWS, NAME PLATES, GAUGES,
CALCULATORS, SCALES, CHARTS, ETC.

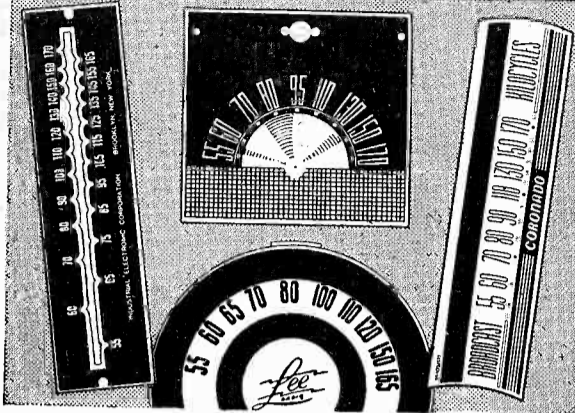

PLASTIC RADIO DIALS have endless possibilities in design, size, shape and color combination. Attractive and durable, our radio dials, windows and scales are preferred by many leading Radio manufacturers.

Not only for dials, but for numerous other electronic and electrical applications, Laminated Plastics are preferable.

Consult with our artists and engineers regarding applications for your particular purpose. Or . . . send us your blue prints or samples for quotation.

THE HOPP PRESS, INC.
460 W. 34th STREET, NEW YORK 1, N. Y.
ESTABLISHED 1893

WILLARD Type 20-2 2 Volt STORAGE BATTERY

EXACT REPLACEMENT FOR "GE"
MODEL #530 PORTABLE RADIOS
Also Suitable For Other Types

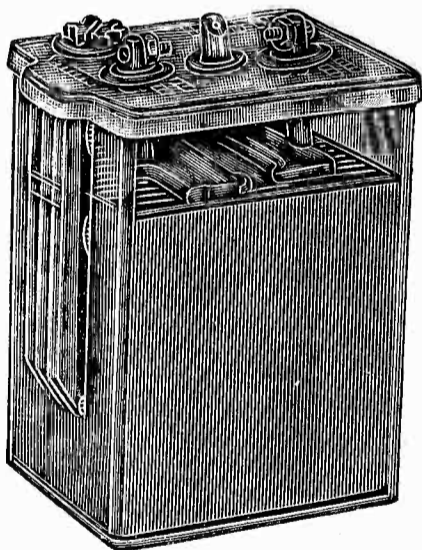

In an attractive Spill-Proof Clear Plastic Case. Rating 20 AH. Gangs nicely for other voltages in multiples of two volts. Has ball float charge indicator and handy screw type connections.

Shipped Dry. Uses regular battery electrolyte available everywhere. Size 3 3/4" x 3 1/2" x 5 1/2" high.

Every One BRAND NEW in individual cartons.

No. 5A142, At Our Crazy Low Price of \$3.95
(Remit with order and include postage.)



BURSTEIN-APPLEBEE CO.
1012-14 McGee Street
Kansas City 6, Mo.

upon the output of the second mixer. The pulses subtract from the sine wave when the signal frequency is higher than reference, and vice versa.

A pair of biased diodes serve as pulse discriminators; these deliver their outputs to two pulse counters used for biasing the reactance tube associated with the master oscillator.

One advantage of the circuit which Mr. Boykin notes in his article is that the tubes are used only as electronic switches, being driven from grid current to cut-off. For this reason, tube tolerances are unimportant, and in normal service a tube would be discarded long before emission failure.

References:

¹Honner and Trew, *A.W.A. Tech. Rev.*, v. 5, p. 287, 1941

²*Proc. I.R.E.*, p. 33, Jan., 1945

³RADIO, Feb. 1946, p. 20.

INVENTIONS

[from page 17]

as the energy seal, without recourse to mechanical contact. This property is a result of the very low input impedance offered by an open quarter-wave section, which makes the walls of the coaxial cable appear continuous electrically.

It is pointed out that while integral multiples of a quarter-wave section can also be used, the single quarter-wave section provides a better seal for a frequency band centered about $\lambda/4$.

The patent is assigned to the General Electric Co., Ltd., England.

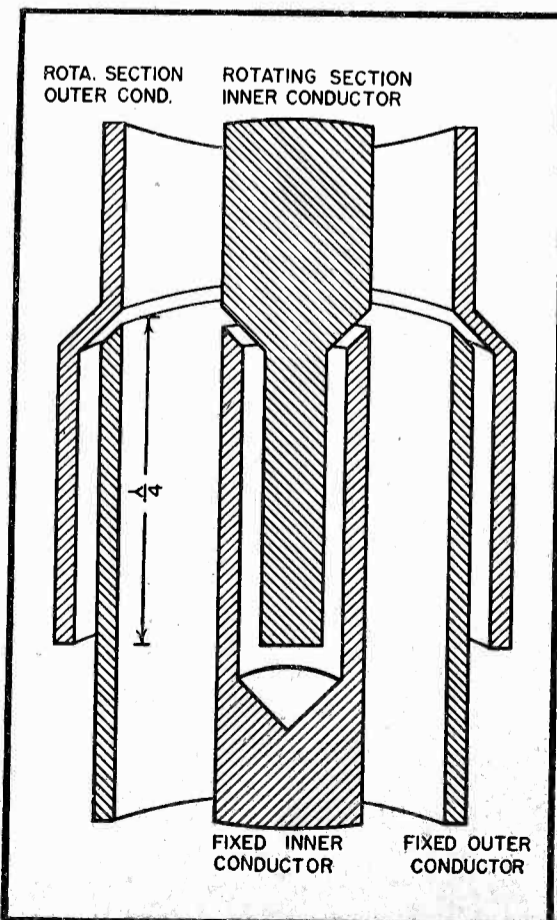

Patent No. 2,401,344

ADVERTISING INDEX

ADVERTISER	PAGE
American Phenolic Corp. Cover	4
Boonton Radio Corp.	27
Burstein-Applebee Co.	32
Capitol Radio Engineering Inst.	6
Concord Radio Corp.	28
Eitel-McCullough, Inc.	Cover 2
Federal Tel. & Radio Corp. Cover	3
Hopp Press, The	32
Institute of Radio Engineers, The	30
Jensen Manufacturing Co.	2
Kaar Engineering Co.	5
Measurements Corp.	27, 29
Mid-America Co.	25
Racon Electric Co., Inc.	8
Radio and Television Supply Co.	32
Radio Wire Television, Inc.	22
Rider, John F. Publisher, Inc.	30
Ruby Chemical Co.	32
Sigma Instruments, Inc.	7
Triplett Electrical Instr. Co.	29
United States Treasury	26
Wrigley Jr., Co., Wm.	23

Make Better Connections with Rubyfluid Flux

Rubyfluid Flux gives solder a stronger, more solid bite—and that makes better electrical connections. Rubyfluid wets out freely—is quick acting and easy to use—it's economical—it has no harmful or objectionable fumes.

See your jobber—and try Rubyfluid Flux today.

Paste and Liquid for general use and liquid for Stainless Steel.



RUBY CHEMICAL CO.
61 McDowell St.
Columbus 8, Ohio

Rubyfluid

In the Rocky Mountain Region it's
RADIO & TELEVISION SUPPLY CO.

ELECTRONIC EQUIPMENT
252 HOBSON AVENUE, PUEBLO, COLO.
P. O. Box #892

"If we don't have it, we'll get it—
or it can't be had! Phone 5729"



FEDERAL'S BALANCED HF CABLE

KT-51

HAS THE RIGHT TWIST

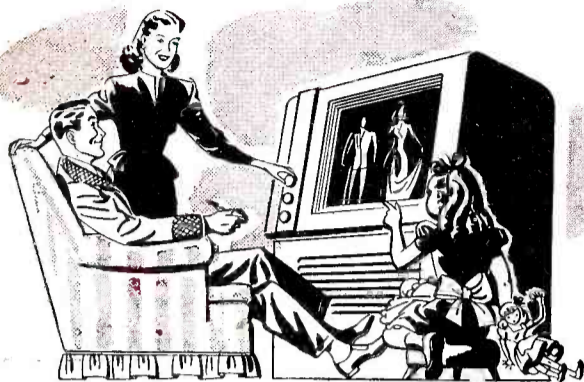

for Peak Performance of FM and Television Receivers

HERE'S A NEW HF cable that will keep your FM and Television receivers working at peak performance—free from locally-induced interference, even in the most adverse locations. Where the performance of such costly equipment is at stake, it will pay you to specify Federal's KT 51—the finest high frequency lead-in cable available. More costly—but worth more!

The *twisted*, dual-conductor cable cancels any noise or signals not stopped by the double *braided shields*... because it's electrically balanced and stays that way in service, in any position. It's a rugged cable, too—remarkably resistant to abrasion, acids, alkalis, oils and greases, as well as smoky atmospheres and weather.

Don't let the lead-in wire be the "weak link" in otherwise perfect equipment. Be sure it's KT 51—the HF cable with the "right twist" to assure interference-free operation. For complete details, write to Dept. D-643.

ELECTRICAL CHARACTERISTICS

Nominal Attenuation (db/100 ft.)	Maximum Capacity Unbalance	1%
Frequency	Nominal Characteristic Impedance (ohms)	95
10 mc	Nominal Capacitance per ft. (uuf)	16
30 mc	Volts (rms)	2000
100 mc		
300 mc		
400 mc		

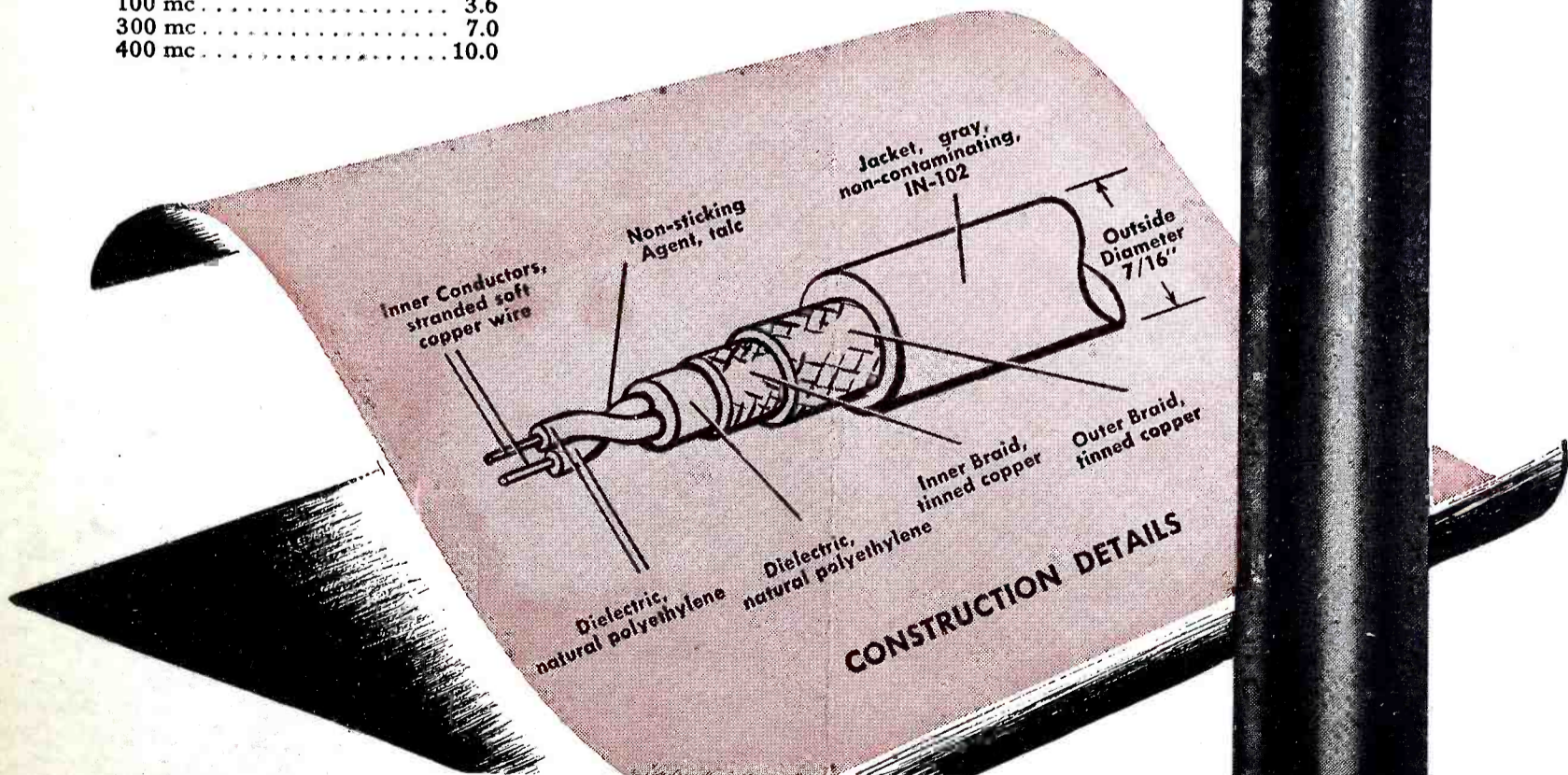

Federal Telephone and Radio Corporation

In Canada:—Federal Electric Manufacturing Company, Ltd., Montreal
Export Distributor—International Standard Electric Corporation, 67 Broad St., N. Y. C.



Newark 1,
New Jersey



Amphenol Components

GIRDLE THE GLOBE—

and the Frequency Spectrum, Too!

In the eyes of amateurs and professionals of every nation Amphenol components represent the last word in electrical and mechanical design and correct manufacture.

From high voltage, high-frequency uses in the temperamental top segments of the spectrum, down through the high-current, low-voltage industrial applications — there are Amphenol cables, connectors, plugs and fittings designed and built to hold to the irreducible minimum loss of power, potential or waveform.

For Radar, Television, F.M., Railroad, Broadcast and Industrial use; Amphenol components speak the universal language of scientific efficiency, and they are available in the most complete line available from any one source in the world today. Write today for prompt attention to your needs.

AMERICAN PHENOLIC CORPORATION • Chicago 50, Ill.
In Canada • Amphenol Limited • Toronto



AMPHENOL



COAXIAL CABLES AND CONNECTORS • INDUSTRIAL CONNECTORS, FITTINGS AND CONDUIT • ANTENNAS • RADIO COMPONENTS • PLASTICS FOR ELECTRONICS