

RADIO

ESTABLISHED 1917

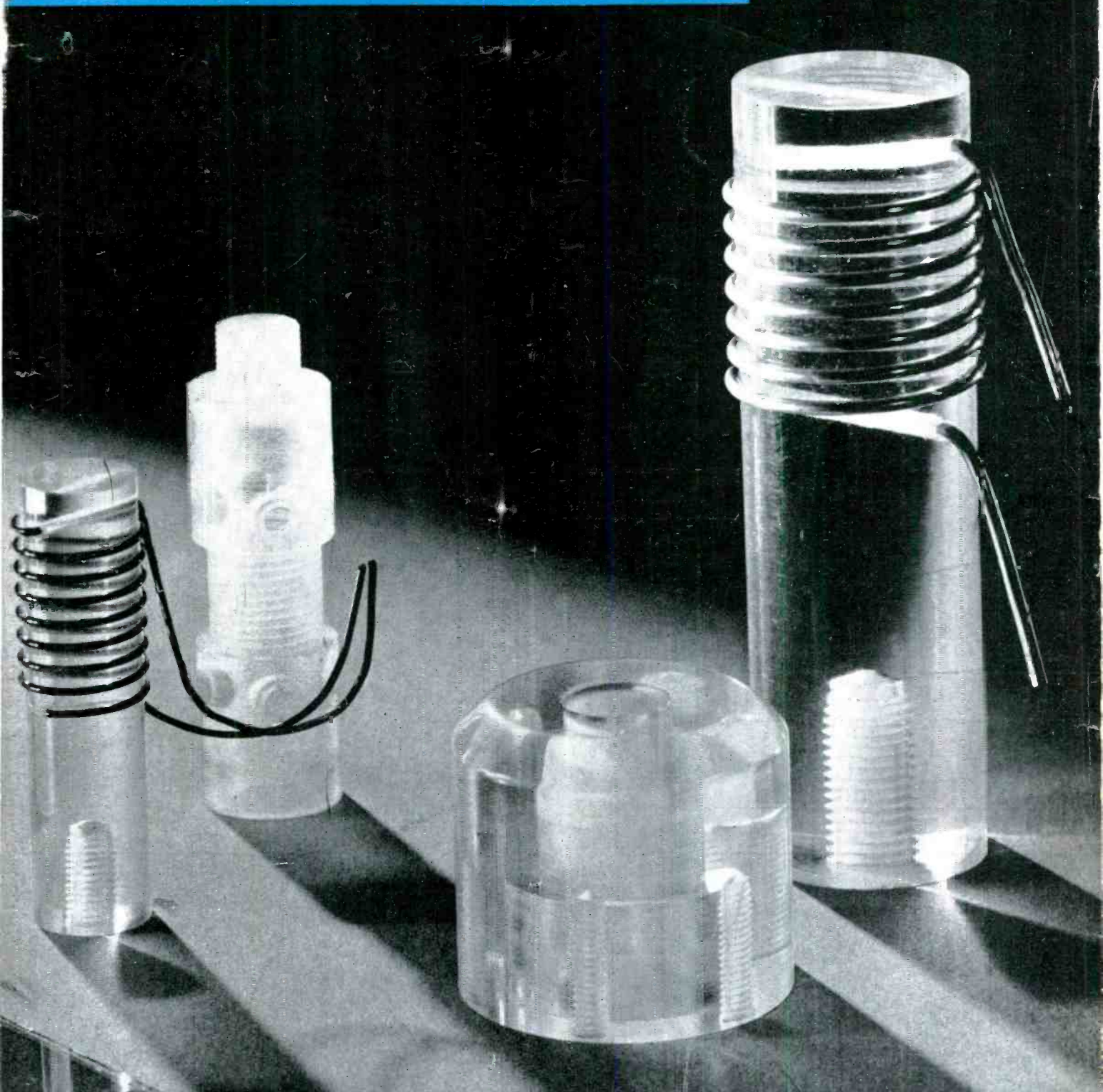

RADIO-ELECTRONIC

Design • Production • Operation

JULY, 1943

Designs for War... Hermetic Sealing

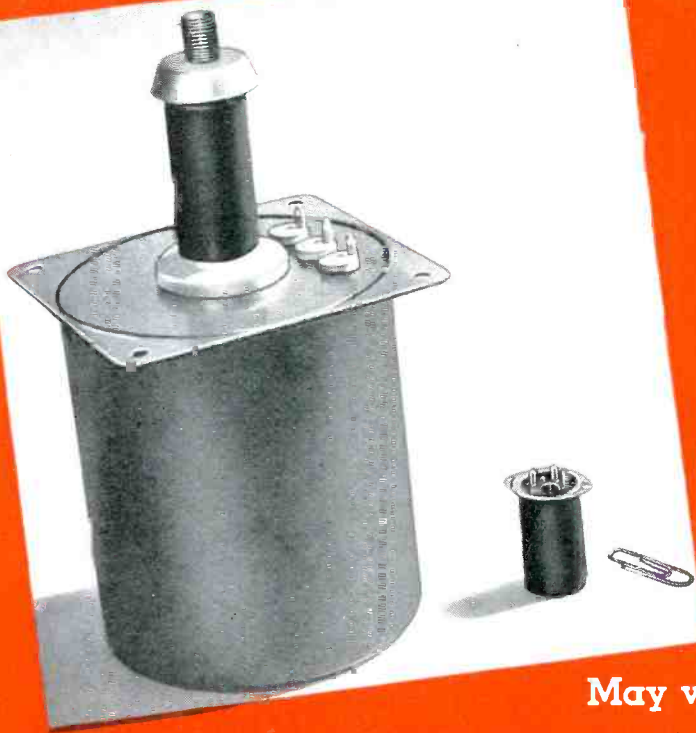

The hermetic sealing of transformers covers a wide range of problems, and an equally wide range of applications. The two units illustrated at the left, for example, represent a high voltage transformer for high altitude operation, and an audio unit weighing approximately one ounce.

There is more to hermetic sealing than meets the eye. The illustrations below show some of the factors contributing to the high quality of UTC hermetically sealed units.

May we design a war unit to your application?

For obvious reasons, the units illustrated are not actual war items.

Engineering . . . PRODUCT

Engineering starts with research, continues through the conference table, and then goes through the proving of electrical design, sealing methods, vibration test, etc.



ENGINEERING CONFERENCE



DESIGN PROVING . . . AUDIO



DESIGN PROVING . . . POWER

Engineering . . . PRODUCTION

The production of war units generally requires precise control. This requires the scientific choice of workers for specific operations . . . the use of modern methods throughout . . . and continuous control of quality and production flow.

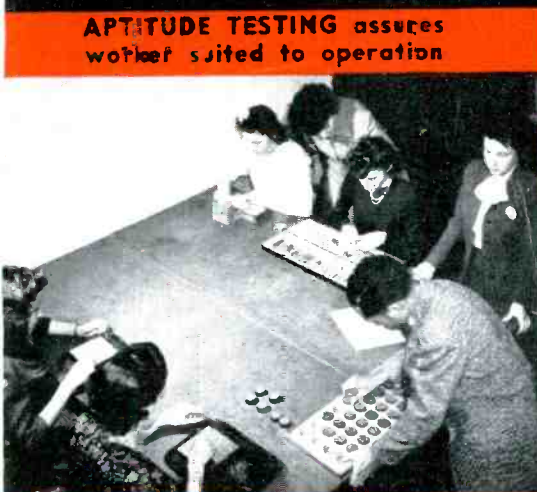

APTITUDE TESTING assures worker suited to operation

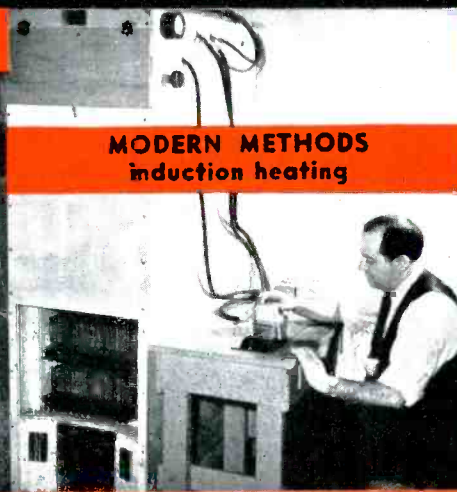

MODERN METHODS
induction heating

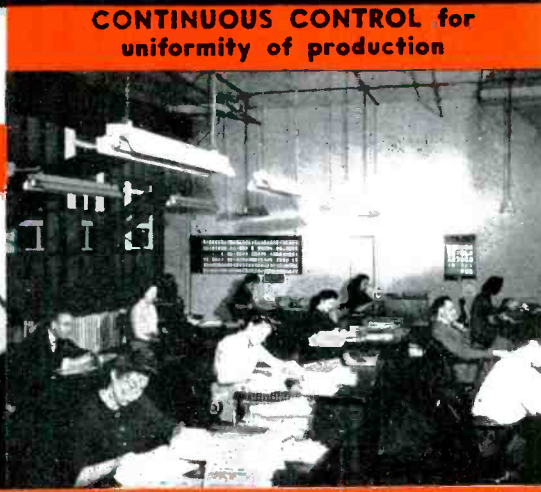

CONTINUOUS CONTROL for
uniformity of production

UNITED TRANSFORMER CO.

150 VARICK STREET



NEW YORK, N. Y.

EXPORT DIVISION: 100 VARICK STREET NEW YORK, N. Y. CABLES: "ARLAB"

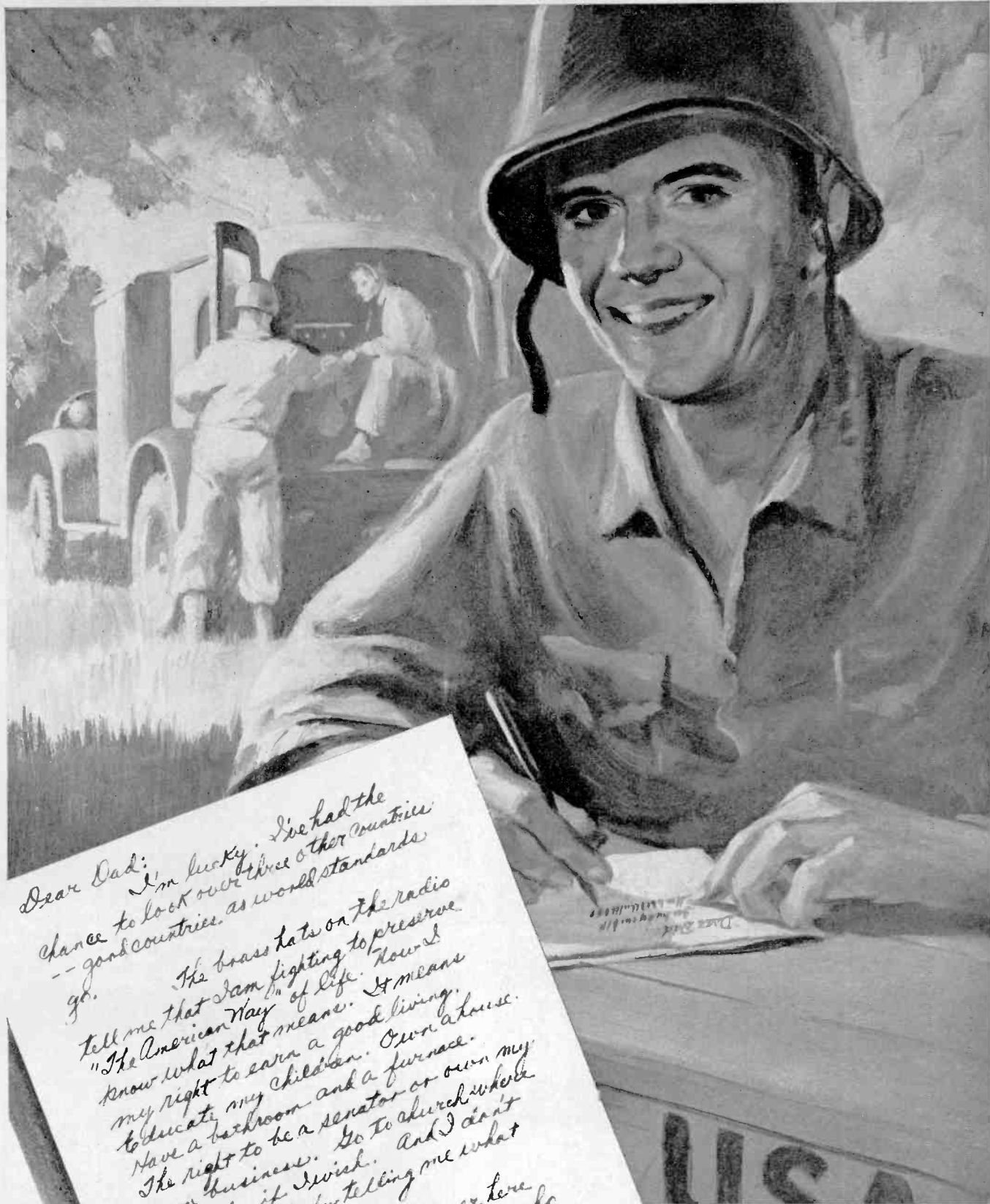

Dear Dad:
 I'm lucky. I've had the
 chance to look over three other countries
 -- good countries, as world standards
 go.

The brass hats on the radio
 tell me that I am fighting to preserve
 "The American Way" of life. Now I
 know what that means. It means
 my right to earn a good living,
 to educate my children. Own a house.
 Have a bathroom and a furnace.
 The right to be a senator or own my
 own business. Go to church while
 I wish, if I wish. And I don't
 want anybody telling me what
 I have to do.

While we're over here
 taking care of our enemies who
 think they know what's best for us...
 don't you men at home forget what
 we're fighting for.

Your Son

BUY
 MORE
 BONDS!



Hallicrafters

CHICAGO, U. S. A.





Winning

"THE BATTLE OF COMMUNICATIONS!"

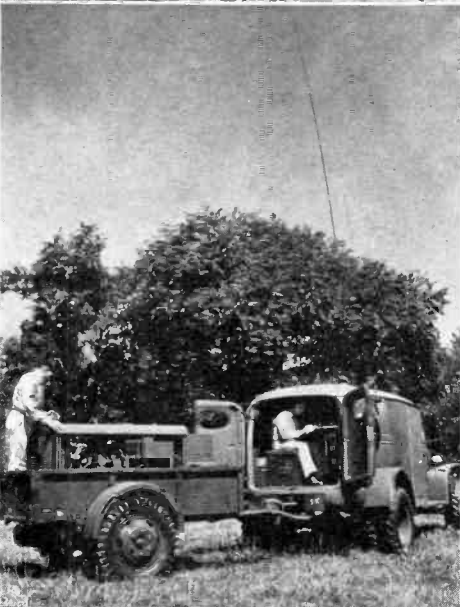

Mobile communications units assembled by Hallcrafters are helping to win the battle of communications on every fighting front. They are built to endure the rigors of modern warfare . . . The consistent performance of SCR-299 has been highly praised by leading members of our armed forces for its adaptability in meeting all the requirements of combat duty . . . A phrase best describing the SCR-299 was given when a leading military authority said, "It is to communications what the jeep is to transportation."

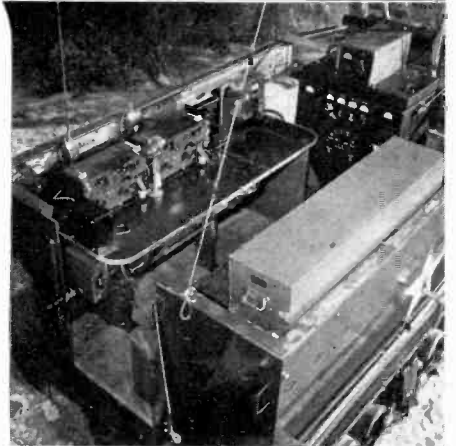

BUY MORE BONDS!

hallicrafters

CHICAGO, U. S. A.



THE WORLD'S LARGEST EXCLUSIVE MANUFACTURERS OF SHORT WAVE RADIO COMMUNICATIONS EQUIPMENT

RADIO

Published by RADIO MAGAZINES, INC.

Editor

M. L. MUHLEMAN

Business Staff

M. L. Muhleman, Publisher
and President

S. R. Cowan, Business Manager
and Treasurer

R. Weiss, Advertising Production

R. Alan, Circulation Manager

CORRESPONDENCE and ORDERS should be sent only to our New York office. MANUSCRIPTS, if unsolicited and unusable, will not be returned unless accompanied by a stamped, self-addressed envelope.

EXECUTIVE, editorial, and advertising offices of Radio Magazines, Inc., are located at 132 West 43rd Street, New York, 18, N. Y., to which address all correspondence, advertising copy and cuts should be directed.

SUBSCRIPTION RATES (in U. S. funds): Two years, \$5.00, or \$3.00 yearly in U.S.A. To Canada and all foreign countries, \$4.00 yearly. Twelve issues yearly; back issues are not included in subscriptions.

NOTE: Because of wartime censorship restrictions, we must reserve the right to withhold from foreign subscribers any issue the regular domestic edition of which is not approved by the authorities for export without changes. In such cases subscriptions will be extended so that each subscriber will eventually receive the number of issues to which he is entitled.

IF YOU MOVE, notify us in advance; we cannot replace copies sent to your old address. Notice must be received by the 20th of the month preceding the cover date of first issue to go to the new address.

JULY 1943

No. 282

Table of Contents

COVER

Insulators and coil forms of "Lucite" methyl methacrylate resin that are doing their bit in military high-frequency radio equipment. Photo courtesy duPont Co.

ARTICLES

Product Inspection— <i>F. R. Prentice</i>	17
Wide-Band Amplifier Design— <i>E. M. Noll</i>	22
Characteristics of Radio-Electronic Components, Part 2— <i>A. C. Matthews</i> ..	24
Radio Design Worksheet: No. 15—Antenna Current; Wave Approximation; Feeding Multiple Speakers	29
Q. & A. Study Guide: A. F. Amplification, Part 3— <i>C. Radius</i>	32
Calculation of Odd-Sized Resistors— <i>Dawkins Espy</i>	36
Radio Bibliography: 11—Direction Finding, Part 2— <i>F. X. Rettenmeyer</i> ..	38

MISCELLANEOUS

Technicana	6
Editorial	15
This Month	46
New Products	48
Advertising Index	62

RADIO (title registered U. S. Pat. Off.) is published monthly at 34 N. Crystal Street, East Stroudsburg, Pa., by Radio Magazines, Inc., Executive and Editorial Offices at 132 West 43d Street, New York 18, N. Y. Subscription rates—United States and Possessions, \$3.00 for 1 year, \$5.00 for 2 years; elsewhere \$4.00 per year. Single copies 35c. Printed in U.S.A. All rights reserved, entire contents Copyright 1943 by Radio Magazines, Inc. Entered as Second Class Matter October 31, 1942, at the Post Office at East Stroudsburg, Pa., under the Act of March 3, 1879.

SKILL

To Meet Your Specifications

PERFORMANCE is the real measure of success in winning the war, just as it will be in the post-war world. New and better ideas—production economies—speed—all depend upon inherent **skill and high precision** . . . For many years our flexible organization has taken pride in doing a good job for purchasers of small motors. And we can help in creating and designing, when such service is needed. Please make a note of Alliance and get in touch with us.

ALLIANCE DYNAMOTORS

Built with greatest precision and "know how" for **low ripple—high efficiency—low drain and a minimum of commutation transients**. High production here retains to the highest degree all the "criticals" which are so important in airborne power sources.

ALLIANCE D. C. MOTORS

Incorporate precision tolerances throughout. Light weight—high efficiency—compactness. An achievement in small size and in power-to-weight ratio. Careful attention has been given to distribution of losses as well as their reduction to a minimum.



Remember Alliance!
—YOUR ALLY IN WAR AS IN PEACE

ALLIANCE

MANUFACTURING CO.

ALLIANCE . OHIO

TECHNICANA

REGULATED A-C POWER SUPPLY

AN INTERESTING ARTICLE ON a constant-voltage source for laboratory and test instruments appears in the *Wireless World* for June 1943 under the title, "AC Voltage Stabilizer," by T. A. Ledward. The regulation is obtained by means of a saturable reactor in series with the line, the reactor being controlled by means of a power pentode which is so connected to the system that an increase in the line voltage makes the bias more negative, thus reducing the pentode plate current flowing through the d.c. windings of the reactor. This will, of course, increase the reactance of the unit and will tend to keep the output voltage constant.

The arrangement of the reactor is of special interest since the d.c. windings must be arranged so that no a.c. is induced in them. We quote: "A very effective arrangement is to connect two chokes in parallel, and provide separate windings for the d.c. The d.c. windings are then connected in series-opposition, and no a.c. voltage is applied to the d.c. circuit. This arrangement . . . is simplified in Fig. 1 by using a single winding for the d.c., embracing both cores. In this case one of the a.c. windings must be reversed.

"The single d.c. winding has the advantage that a large number of turns may be used without high values of a.c. voltage being induced in any part of

[Continued on page 8]

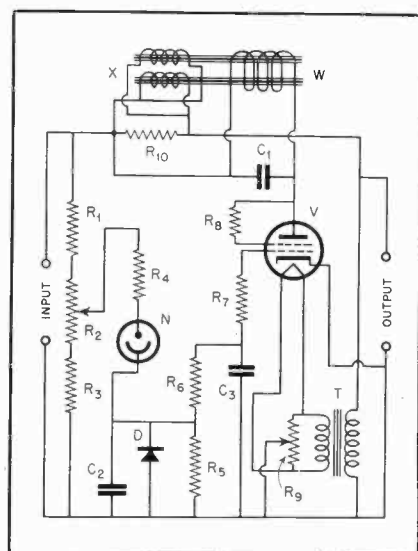
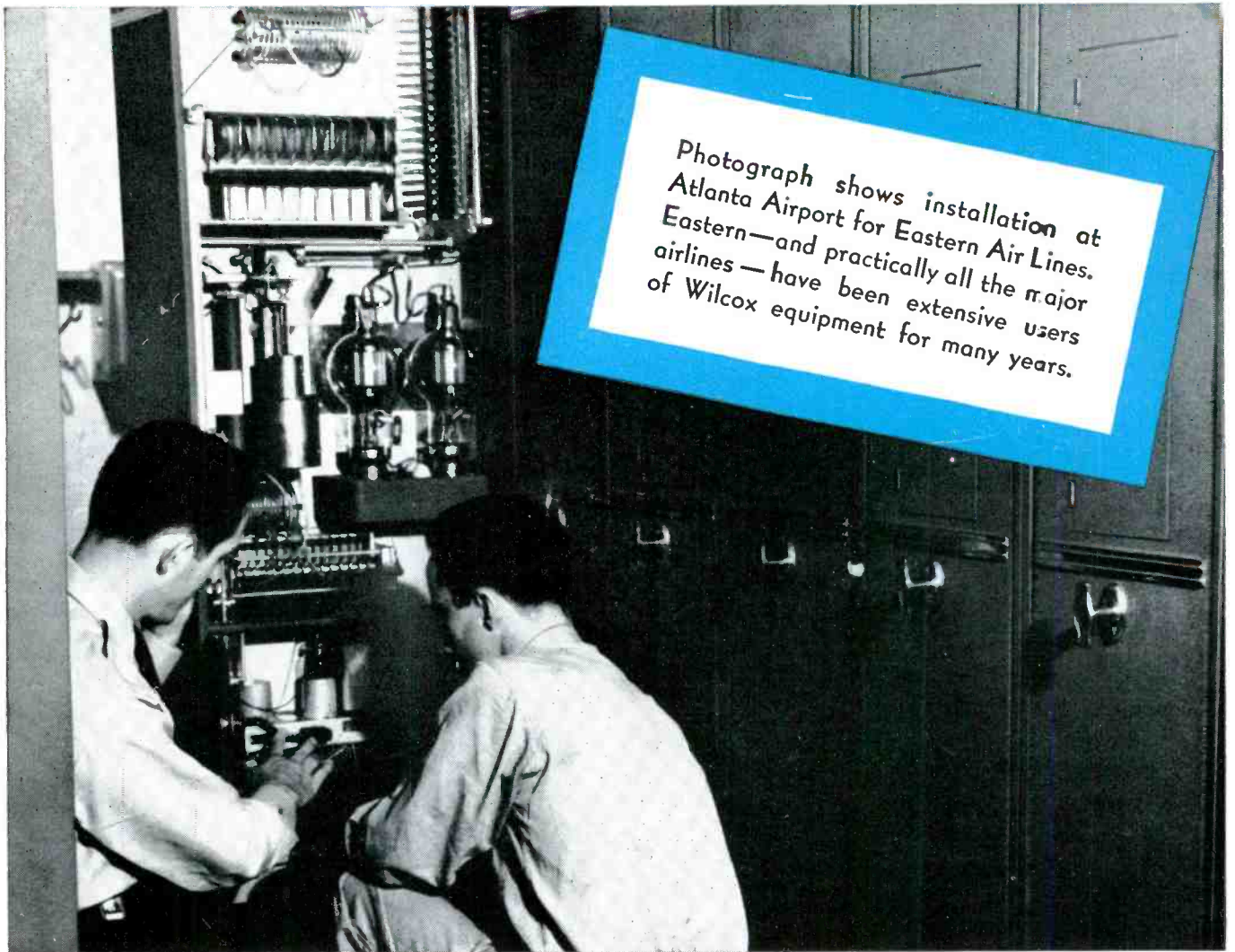

Fig. 1. Circuit of voltage stabilizer.

WILCOX EQUIPMENT

Proves Dependable for Eastern Air Lines



Photograph shows installation at Atlanta Airport for Eastern Air Lines. Eastern—and practically all the major airlines—have been extensive users of Wilcox equipment for many years.

Photo, Courtesy Eastern Air Lines

Communication Receivers
Aircraft Radio
Transmitting Equipment
Airline Radio Equipment

Today, the experience of years in manufacturing flight control radio equipment is turned to production for military needs. Tomorrow, this added experience with present developments will be reflected in greater radio advantages for a peacetime world.



WILCOX ELECTRIC COMPANY

Quality Manufacturing of Radio Equipment
14th & CHESTNUT KANSAS CITY, MO.

THERE MUST BE DEPENDABLE COMMUNICATIONS

RADIO

* JULY, 1943

[Continued from page 6]



EE8-A

THE EE8-A field telephone is one good reason why American-built communications equipment has a reputation for being the best there is. It is an *unclassified* (not secret) instrument, but we, whose prime war job is to build it, doubt that the enemy can match the EE8-A phone.

You see there *is* a secret to it—the secret of American know-how. For instance:

- How to turn out such delicate, and at the same time, rugged instruments by the tens of thousands, and still have each the equal or superior of a handmade product.
- How to devise instruments to give each unit a complete "laboratory" test, in a few seconds, right on the production line.
- How to make telephones that will operate equally well whether they serve in arctic cold or tropic moisture.

America has the answers. Major credit belongs to Signal Corps engineers, but *Connecticut* is proud to have had a part in making the EE8-A a weapon for helping our boys get the jump on the enemy wherever they find him.

In your postwar planning of products and factory method, you will need American know-how in the design, engineering and manufacture of precision electrical devices. We believe *Connecticut* can help you.

CONNECTICUT TELEPHONE & ELECTRIC DIVISION



MERIDEN, CONNECTICUT



For the second time within a year, the honor of the Army-Navy Production Award has been conferred upon the men and women of this Division.

© 1943 Great American Industries, Inc., Meriden, Conn.

the winding. Where separate d.c. windings are used, although there is no resultant a.c. when the two windings are connected in opposition, the induced voltages may be very high. The variation of reactance obtainable with either of these twin choke arrangements is much greater than that obtainable with a single choke." An illustration of the mechanical arrangement of the chokes is given in *Fig. 2*.

The operation of the unit is easily understandable by studying *Fig. 1*; we quote again some of the remarks regarding the control circuit. "Negative bias for the valve *V* is obtained by means of current through the neon tube *N*, the bias voltage being rectified and smoothed as shown. The anode current of *V* provides d.c. for the winding *W* on reactance *X*. The d.c. is smoothed by the condenser *C1*.

"The neon tube *N* is connected to a potential divider formed by the resistances *R1*, *R2* and *R3*. *R2* provides a fine adjustment of the neon tube voltage, and thus of the output volts. The resistance *R4* limits the control exercised by the neon tube. If the value of *R4* is too small, the neon control will be too great, and the output volts will fall appreciably as the supply volts rise; if *R4* is too high, the reverse will be the case.

"The potential divider is so proportioned that the neon tube just strikes when the supply voltage is a minimum."

In the example described, the output voltage varied less than 1/2 per cent when the input voltage changed from 205 to 245 volts.

[Continued on page 11]

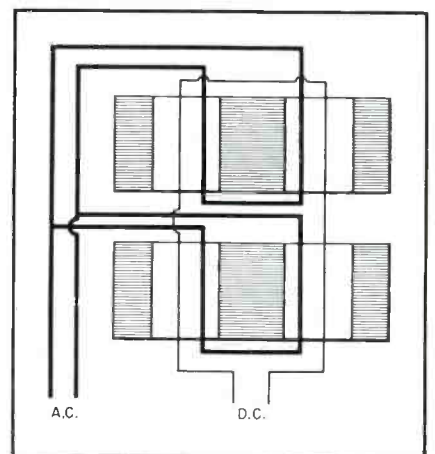

Fig. 2. Winding arrangement of choke.



TESTED ON AN ATOLL

ON a tiny strip of coral . . . an observation post pierces the dawn with cryptic messages that may spell the difference between victory and defeat. Duty on this speck on your map calls for iron men and dependable equipment.

Under the toughest of conditions . . . under the roughest of handling . . . far from sources of replacement . . . parts must work—for men's lives hang in the balance. Utah Parts are passing this final test on tiny atolls, in steaming jungles, on burning sands in all parts of the world—from pole to pole.

A shooting war is also a talking war. The weapons of communications must have the same dependability and non-failing action as weapons of destruction. These qualities are built into Utah Parts at the factory where

soldiers of production are working 100% for Victory. In Utah laboratories, engineers and technicians are working far into the night developing new answers to communication problems—making improvements on devices now in action.

But "tomorrow" all this activity, all this research, all this experience learned in the hard school of war, will be devoted to the pursuits of peace. Thanks to the things now going on at Utah—there will be greater convenience and enjoyment in American homes . . . greater efficiency in the nation's factories. UTAH RADIO PRODUCTS COMPANY, 846 Orleans Street, Chicago, Ill. Canadian Office: 560 King Street West, Toronto. In Argentine: UCOA Radio Products Co., SRL, Buenos Aires. Cable Address: UTARADIO, Chicago.

PARTS FOR RADIO, ELECTRICAL AND ELECTRONIC DEVICES, INCLUDING SPEAKERS, TRANSFORMERS, VIBRATORS, VITREOUS ENAMELED RESISTORS, WIREWOUND CONTROLS, PLUGS, JACKS, SWITCHES, ELECTRIC MOTORS



CRYSTALS IN THE MAKING

AS DIAGRAMMED BY CRYSTAL PRODUCTS

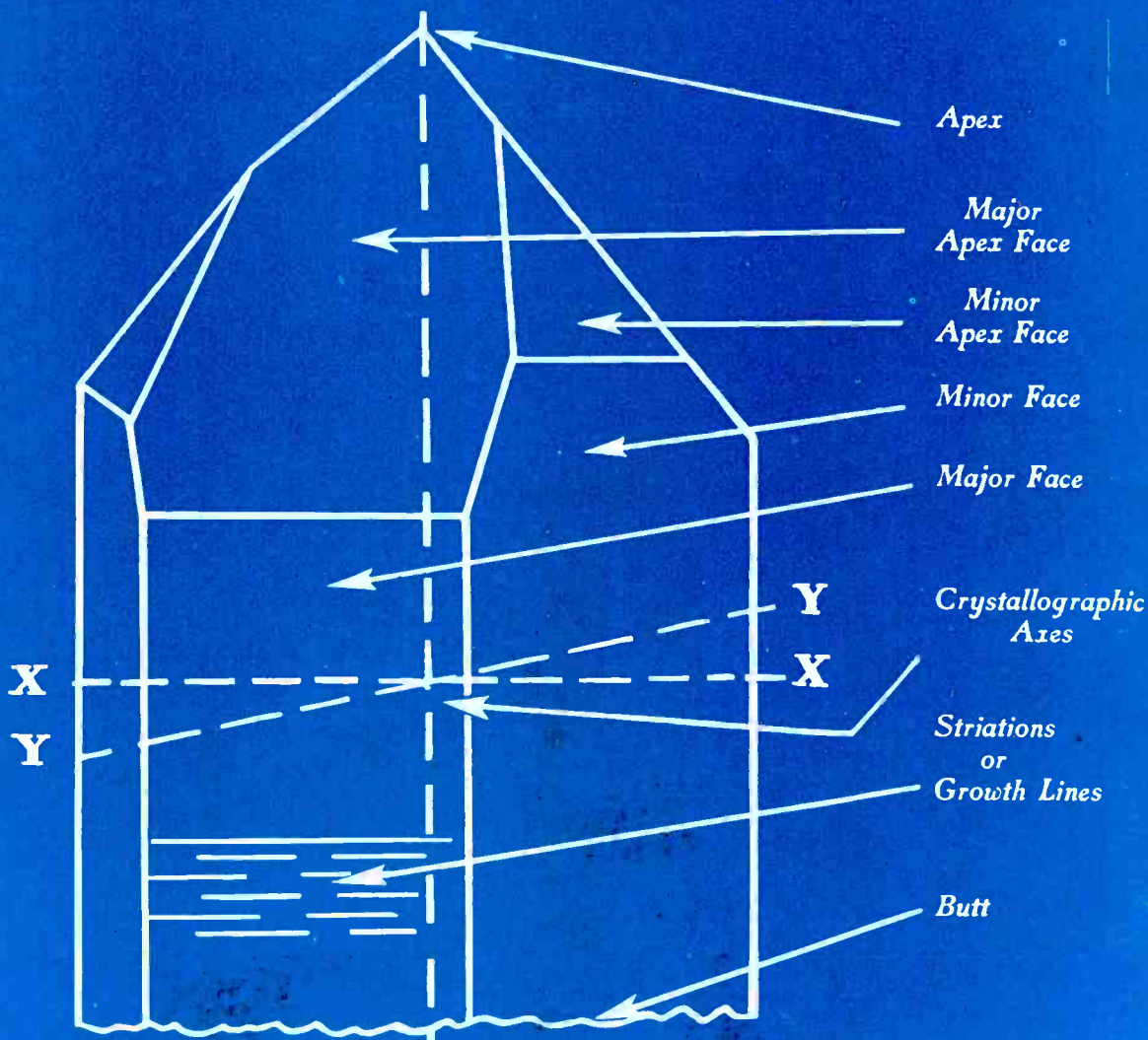

After being expertly inspected for impurities and the direction of cut determined . . . each of these painstaking operations must be absolutely accurate . . . the crystal is mounted for sawing. For precision crystals the mother is mounted with the optic axis running parallel to the plate and the electric axis perpendicular

to it. This operation can become exceedingly difficult with a lack of an apex and well-defined faces.

When neither faces nor apex are present, the axis must be located by another method before it can be mounted for cutting.

Precision cutting is an all important factor in the production of crystals for radio frequency control.

 *Crystal*

PRODUCTS COMPANY
1519 MCGEE STREET, KANSAS CITY, MO.

Producers of Approved Precision Crystals for Radio Frequency Control

[Continued from page 8]

TRANSDUCER

A CIRCUIT WHICH will convert changes in capacity into changes of a rectified current is described in an article entitled *An Electrical Transducer Circuit for Use With Capacity Pick-Up Devices*, by E. V. Potter, appearing in the *Review of Scientific Instruments* for May 1943.

The circuit, as shown in Fig. 1, consists of two oscillators working at the same radio frequency. The two oscillators are shielded and their only coupling is through the link circuit $L1-L2-V1-M1$. By virtue of this coupling the two oscillators are interlocked and will remain synchronized even if one of them is somewhat detuned. Now the important point is that while one circuit is detuned, the current in the meter $M1$ varies and thus provides a means of converting capacity changes to current changes.

The characteristics of the current variation plotted against capacity variation is in the form of a V , with the minimum value at the capacity value which makes the two oscillators operate at identical frequencies. One side of the V is practically a straight line and may have a slope of as much as 2 ma per $\mu\mu\text{f}$. Placing a load in the circuit—in series with the meter—has the effect of lowering the sensitivity. With a load of 10,000 ohms a sensitivity of 1.5 ma per $\mu\mu\text{f}$ was obtained. It is stated that the maximum frequency of variation in the capacity which can be used is 20 per cent of the oscillator frequency. Some of the advantages claimed for this transducer are: Flexi-

[Continued on page 12]

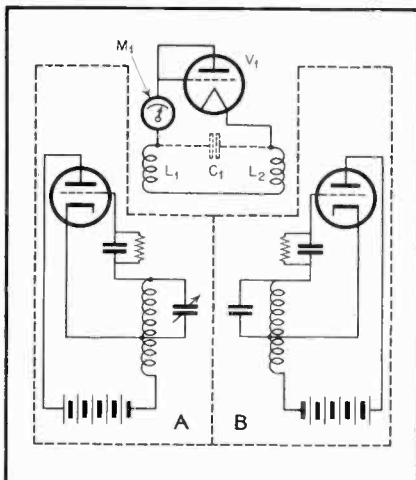
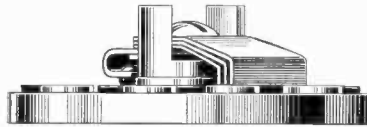

Fig. 1. Circuit of transducer.

"SHORTING" Switches



This is the shorting type. As the arm is rotated from one position to another the adjacent contact points are "shorted" (bridged).

or

"NON-SHORTING" Switches

This is the non-shorting type. As the arm is rotated from one position to another, the arm lifts up, and only one contact is touched at a time.

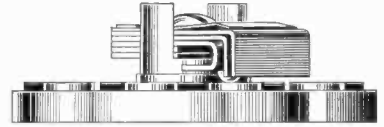

OTHER SHALLCROSS

Switches are designed for use in your particular field.

Let Shallcross answer your problems.

Address Dept. C. 28

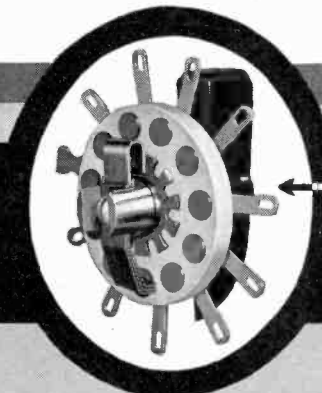

THE No. 4605

is one of many Shallcross Switches extensively used in instruments and in many other applications.

SHALLCROSS ROTARY SELECTOR SWITCHES USE SOLID SILVER CONTACTS, BECAUSE SOLID SILVER . . .

1. Has the highest conductivity of materials available.
2. Is superior to silver-plating which wears off, resulting in high resistance contacts.
3. Should it corrode the sulphide formed does not appreciably increase the contact resistance.

Creators and Makers of

Accurate Resistors—Switches—Special Equipment and Special Measuring Apparatus for Production and Routine Testing of Electrical Equipment on Military Aircraft . . . Ships . . . Vehicles . . . Armament . . . and Weapons



SHALLCROSS MFG. CO.

COLLINGDALE, PENNA.

[Continued from page 11]

bility in sensitivity and characteristics of current-capacity curves; simplicity in operation; substantially constant sensitivity over a range of frequencies from zero to several hundred kilocycles; low background-noise level; sensitivity that depends on absolute changes of capacity rather than on percentage changes; freedom from interference from local magnetic and electrostatic fields so long as their frequencies differ somewhat from the resonant frequency of the two oscillator circuits.

This apparatus may be used as a pick-up for the measurement of mechanical vibrations and has been used successfully as a microphone.

★

TUNED NULL DETECTOR

THE JUNE 1943 ISSUE of the *Bell Laboratories Record* contains an article on *A Tuned Null Detector*, by F. B. Andersen. The instrument described is of interest due to the novel arrangement of automatic sensitivity adjustment. This is an amplifier, intended as a detector for a.c. bridges, which is tunable and has a visual indicator—a meter—with an approximately logarithmic scale having a range of about 120 decibels.

The author obtains this long range by using *avc in cascade*, so to say. The amplifier comprises three double-tuned stages, each consisting of a pentode amplifier with its own *avc* system. The indicating meter shows the total plate current variation of all three of these stages. Mr. Andersen says: "The basic element of the volume control circuit is a pentode feedback amplifier with an input-output characteristic roughly as indicated in *Fig. 1*. For inputs less than 40 db below one milliwatt, the plate current remains essentially constant at its maximum value, but as the input increases above -40 dbm, the plate current decreases as shown, becoming essentially zero at 0 dbm. This characteristic is obtained by connecting a di-

[Continued on page 14]

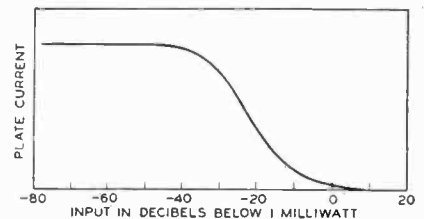
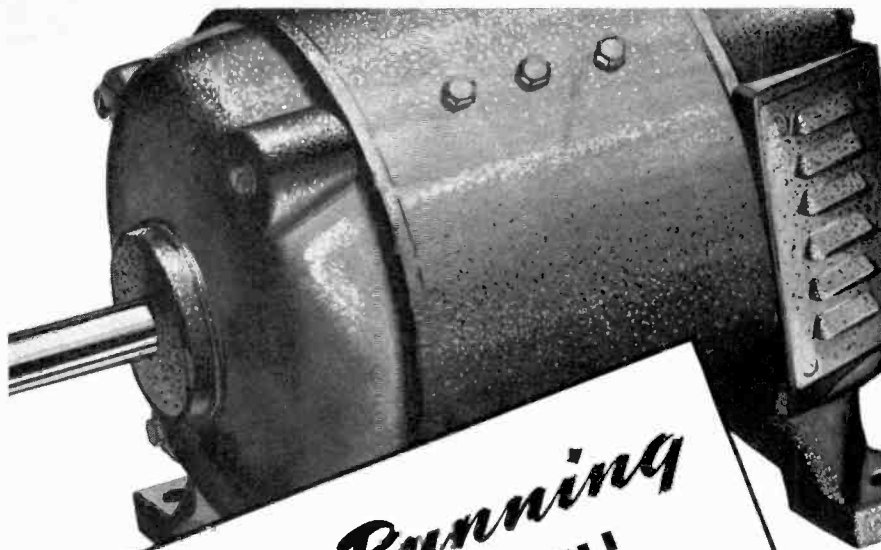

Fig. 1. Input-output characteristic.



**Keep 'Em Running
FOR THE DURATION!**

It is difficult to secure new Generating Sets or new Rotary Converters . . . Pioneer is devoting all of its resources toward winning the war . . . but we can, and will, help you keep your present equipment running for the duration. Send your service problems, by letter, to Pioneer's Customer Service Department.

DYNAMOTORS · CONVERTERS · GENERATORS · DC MOTORS · POWER PLANTS
GEN-E-MOTORS

PINCOR Products

PIONEER GEN-E-MOTOR
CHICAGO ILLINOIS · EXPORT ADDRESS: 25 WARREN STREET, NEW YORK CITY
CABLE ADDRESS: SIMONTRICE, NEW YORK CITY

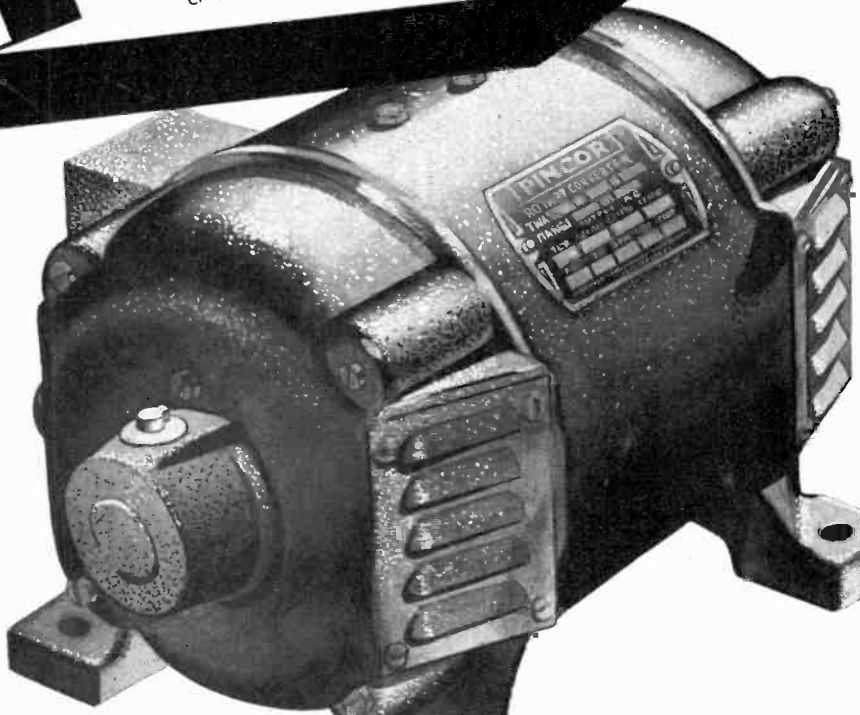



Only M. I. D. graduates need apply

● **M. I. D.**—Material Inspection Department — is the first of many watchdogs that guard Sylvania Radio Tube quality. Before acceptance for precision fabrication, molybdenum, nickel, mica, strip steel, glass, plastics — all materials delivered — must pass exacting tests and graduate from M. I. D.

Here a trained inspector subjects tungsten to a microscopic test. From her table, it will pass on to micrometer and tensile strength measurements, mechanical and other tests.

And, once accepted, all materials that go into Sylvania Radio Tubes undergo successive quality inspections through every step of manufacture. Thus, Sylvania's reputation for specialization in electronics is jealously guarded by hundreds of alert and painstaking inspectors on watch for the microscopic flaw.

That is why you can specify Sylvania Radio Tubes and Electronic Devices with confidence that the name they bear is a guarantee of quality.

**QUALITY
THAT SERVES
IN WAR**



SYLVANIA

ELECTRIC PRODUCTS INC.

Emporium, Pa.

INCANDESCENT LAMPS, FLUORESCENT LAMPS, FIXTURES AND ACCESSORIES, RADIO TUBES, CATHODE RAY TUBES, ELECTRONIC DEVICES

RADIO

★ JULY, 1943

13

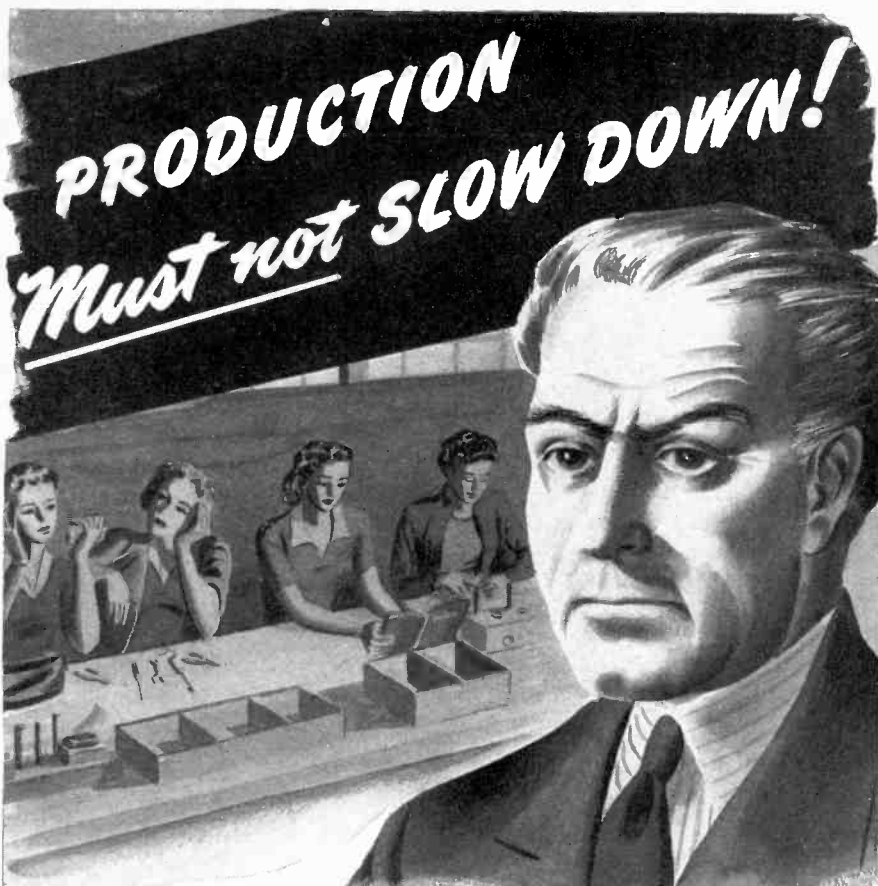

GET NEEDED RADIO PARTS Quickly!

Don't allow *your* production lines to slow down for lack of essential parts. Lafayette Radio Corp. is headquarters for all radio and electronic parts and equipment of every nationally known manufacturer in the field. Let Lafayette help you keep your production humming and save *your* time—one single order to Lafayette will insure *prompt* delivery on all hard-to-get parts and equipment your program may require.

Thousands of manufacturers, electronic engineers and private and military training program directors know Lafayette's reputation for complete stocks and extensive procurement facilities. We can fill *your* needs too—*quickly!*

Write today for Free 130 page Radio and Electronic Parts and Equipment Catalog—
Address Dept. 6F3



LAFAYETTE RADIO CORP.

★ 901 W. JACKSON BLVD. CHICAGO, ILLINOIS
★ 265 PEACHTREE STREET ATLANTA, GEORGIA

TECHNICANA

[Continued from page 12]

ode rectifier between the plate and grid in such a way that as the input increases above -40 dbm, a certain portion of the plate current, rectified by the diode, will increase the negative bias of the control grid and thus reduce the plate current. The grid-to-plate voltage gain in the region of 0 dbm input approaches unity, so that several stages may be cascaded for input ranges in excess of 40 db.

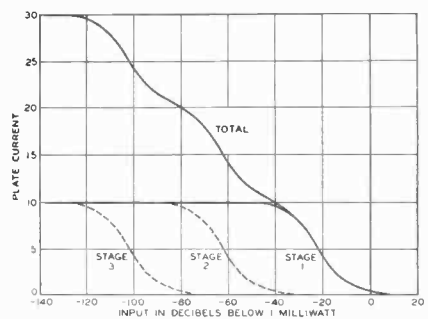

Fig. 2. Input-total output relation.

"In the new detector circuit, three such tubes are connected in cascade. Each has a gain of approximately 40 db, and thus the total gain for the circuit is 120 db, but because of the feedback arrangement, each tube will supply maximum plate current while its input is less than -40 dbm, and its plate current will decrease as its input increases from -40 to 0 dbm. The total output current is the sum of the plate currents of the three tubes, and thus is related to the input as shown in Fig. 2, which gives the relationship between the total output current and the input to the first tube for a detector consisting of three tubes."

★

STATIC NEUTRALIZER

THE GOODYEAR TIRE & RUBBER CO. have announced the development of a "radio static neutralizer," said to be capable of eliminating natural and man-made static in any type of radio receiving device.

Specific details are not available, but, broadly speaking, the neutralizer makes use of vacuum tubes in such a way that they are automatically adjusted to each signal level. A detection control circuit eliminates static which has a level greater than the incoming signal, even in cases where the static is so loud as to obliterate the incoming signal

[Continued on page 41]



SH-H-H-H! THE ENEMY IS LISTENING!

● Sailors at sea couldn't listen to their favorite radio programs until one of our foremost radio manufacturers was commissioned to build a special sea-going receiver. It was found that ordinary radios "rebroadcast" and tipped off the ship's location. And without any radio, morale suffered.

Now, it's different! Sailors around the world are listening to radio programs from home through this low-radiation receiving set. The speed with which it was produced and put in service is a tribute, in part,

to the *E·L* engineers asked to provide a suitable power supply. They did it—fast, and well.

This is just one of the many contributions to America's war effort which *E·L* research and specialized knowledge of vibrator power supplies and electronic circuits has made possible. You'll find *E·L* Vibrator Power Supplies on the job in all types of service, and on every front where the United Nations are fighting.

Wherever electric current must be changed, in voltage, frequency or type, *E·L* Vibrator Power Supplies and Converters offer a wide range of advantages, for peace, as well as for war.



Electronic

LABORATORIES, INC.

INDIANAPOLIS

E·L ELECTRICAL PRODUCTS—Vibrator Power Supplies for Communications . . . Lighting . . . Electric Motor Operation . . . Electric, Electronic and other Equipment . . . on Land, Sea or in the Air.



For Operating Radio Transmitters in Lifeboats—*E·L* Model S-1229-B Power Supply. Input Voltage, 12 Volts DC; Output Voltage, 500 Volts DC; Output Current, 175 MA; Dimensions, 7½" x 5½" x 6¼".

For Operating AC Radio Receivers from DC Current—*E·L* Model 262 Marine Power Supply. Input Voltage, 110 Volts DC; Output Voltage, 110 Volts AC; Output Power, 250 Volt-Amperes; Output Frequency, 60 Cycles; Dimensions, 10½" x 7¾" x 8¼".



WORKMANSHIP

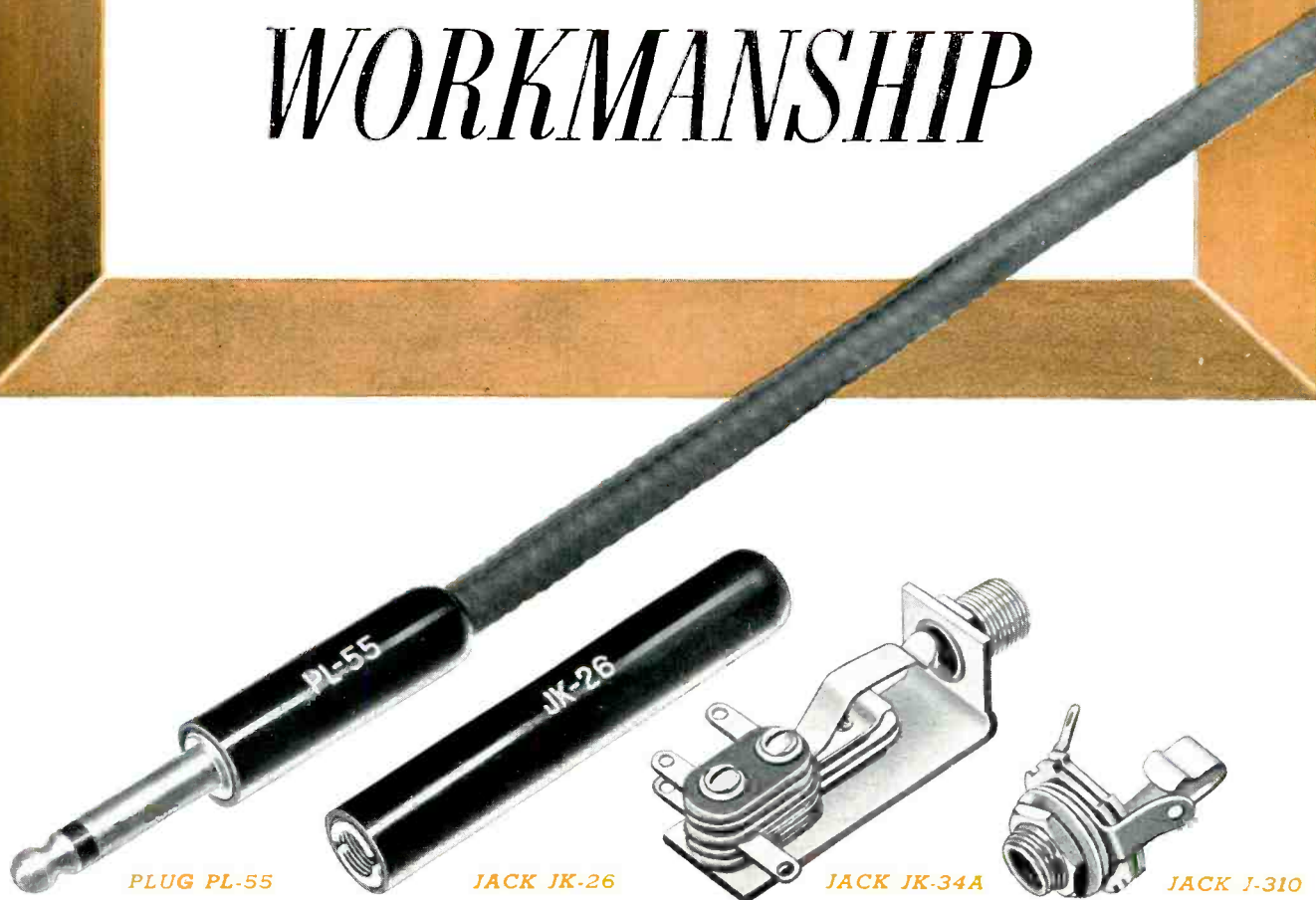

PLUG PL-55

JACK JK-26

JACK JK-34A

JACK J-310

For more than 46 years the products of the Chicago Telephone Supply Company have been the standard for high quality workmanship. From their inception in the engineering laboratories to the craftsmanship of the finished article, Chicago Telephone

Supply products are planned for maximum performance and trouble-free long life. If you are a manufacturer of electronic equipment—all of the engineering skill and great production facilities of Chicago Telephone Supply Company are at your service.

Plugs, Jacks, Switches, Variable Resistors

Telephone Generators and Ringers



Representatives
 R. W. Farris
 127 E. Thirty-first St.
 Kansas City, Mo.
 Phone: Logan 0234

 Frank A. Emmet Co.
 2837 W. Pico Blvd.
 Los Angeles, Calif.



Branch Offices
 S. J. Hutchinson, Jr.
 401 N. Broad St.
 Philadelphia, Pa.
 Phone: Walnut 5369

In Canada:
 C. C. Meredith & Co.
 Streetsville, Ontario

ELKHART • INDIANA

Manufacturers of Quality Electro-Mechanical Components Since 1896

EDITORIAL

PEACEWORK

★ It is now widely recognized that the development of an industrial program for the post-war period cannot be altogether put off until the war is won. As strong as the desire may be to throw everything into the war effort, it is essential that over-zealousness be tempered to meet the danger present in an unplanned future.

The picture of a huge accumulation of buying power stacked up against an equally huge replacement demand is bright only in the event that the demand is met by a reasonable supply within a reasonable length of time. If industries remain static during the reconversion periods, accumulated wealth may be drained off to meet primary living expenses. This would cause a downward spiral that would be difficult to brake.

A number of solutions to this problem have been proposed. The one most likely to succeed is the suggestion that employment be maintained close to the present level through a continuation of government purchases during the period of transition from wartime to peacetime production.

The problem of what to do with our excess production facilities is more acute. The production capacity now existing in all fields is so huge that it can be maintained only through the development of products that are both new and useful. After the last war, manufacturers produced articles that were not new and not useful, in an effort to maintain plant operation. The results were disastrous. Yet there are today many small manufacturers and a few large manufacturers who simply don't know where the products are coming from to replace the military equipment they now produce.

This problem is particularly acute in the radio-electronics field. For one thing, the number of manufacturers engaged in this field has increased tremendously, and a large percentage of them intend maintaining their foothold after the war is over. Coupled to this situation is the huge production capacity that has grown out of military requirements. As a result of these factors we are faced with the possibility of having after the war a radio-electronic industrial structure so highly competitive that it will defeat its own ends.

The solution to this problem is an open question. From five to ten years may pass before the market for specialized electronic equipment reaches sufficient proportions to sop up excess production facilities, for this business is definitely a long-range proposition. In the

meantime, therefore, it appears essential that the slack be taken up by the development of new and useful radio-electronic products suitable to mass production.

It goes without saying that many such products have already been developed, and many others are in the idea stage; but there is no indication that there are a sufficient number of new and useful articles in the bank to pay off directly after the war.

SPACE-CHARGE FM

★ Readers who found interest in the article by H. E. Ennes on space-charge frequency modulation, page 17, May issue, may wish to explore the subject further by referring to a series of patents granted to H. M. Bach, chief engineer of Premier Crystal Laboratories, Inc., New York City. *Patent No. 2,311,631*, filed August 22, 1940 and issued February 23, 1943, lists 18 claims covering a frequency-modulation oscillator. *Patent No. 2,274,648*, filed May 2, 1940 and issued March 3, 1942, covers a reactance-tube modulator. *Patent No. 2,262,380*, issued November, 1941. *Patent No. 2,313,911*, *Patent No. 2,270,243* and *Patent No. 2,274,184*, all disclose various usages of this space-charge variable reactance. An additional patent, to be issued this month, covers a system similar to that shown in *Fig. 3* of the article.

DISTRIBUTION COSTS

★ On the basis of two years of experimental study by the Radio Corporation of America, it was found that production costs were approaching the minimum, with distribution costs excessively high. The latter were always equal to, and in many instances greater than, the former.

As a result of this study, RCA has applied the fact-finding methods of science to the problems of distribution to the point where it is apparent that this new type of commercial research soon must be given importance equal to technical research as a necessary tool of American business.

According to David Sarnoff, one of the most interesting phases of studies made thus far concerns the exploration of new markets for both old and new products. An important element in this connection, he pointed out, is the swiftly accelerating trend in the radio industry to become, in addition to a supplier to the individual consumer, a supplier to industry itself of both communications and non-communications products.



STANDING BY...

*to give our boys on submarine duty the "alert"
warning . . . JENSEN marine speakers are
living up to their quality tradition of consistent
performance on missions that must not fail.*

Jensen
JENSEN RADIO MANUFACTURING CO.
6601 SO. LARAMIE AVE., CHICAGO



Workers at a General Electric plant start assembling Radar equipment for the U. S. Navy.

PRODUCT INSPECTION

F. R. PRENTICE

★ Product inspection to insure uniform quality has probably not received its share of attention until recently. During the past two years a number of excellent books have been published on inspection methods. Product inspection and product quality are matters which should logically concern the design engineer as well as the production superintendent. In short production runs and in job shop operation, inspection of each part is usually a matter of specification. When long production runs involving thousands of identical parts are made, statistical methods can and often do materially influence inspection practice.

Performance Tolerances

The first requirement of inspection is to insure that the product meets a specified performance. On a basis of essentiality a uniform product is equally important. This is of particular importance in mass production, since uniformity of components is one

of the prime conditions which form the very basis of the assembly-line method of manufacture.

To obtain uniformity of a product it is customary to set up definite boundary conditions within which the product must fall. Irrespective of the precision of the manufacturing process or the care taken with inspection, it is axiomatic that no two units of a

given product will be identical. Factors which contribute to this condition are psychological conditions of the manufacturing operators, operator fatigue, lighting, conditions of the air, temperature, machine wear, humidity, homogeneity of material, and many others. It is customary to accept certain random variations as inevitable, and to devote inspection effort toward the reduction of circumstances of a controllable nature which promote irregular, cyclic, or secular trends in the product. This calls for the tracing to its source of any phenomenon producing a definite trend. This calls for the recognition and segregation of natural random variations from variations due to assignable faults in materials and processes. It is here that statistical methods may be used to advantage in the interpretation of the data to separate natural and assignable trends and track the latter to their source for correction.

A product may be rated as satisfactory or unsatisfactory depending on

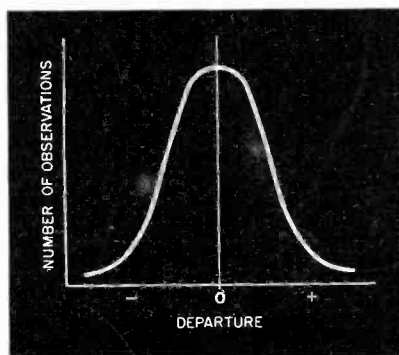

Fig. 1. Typical probability curve.

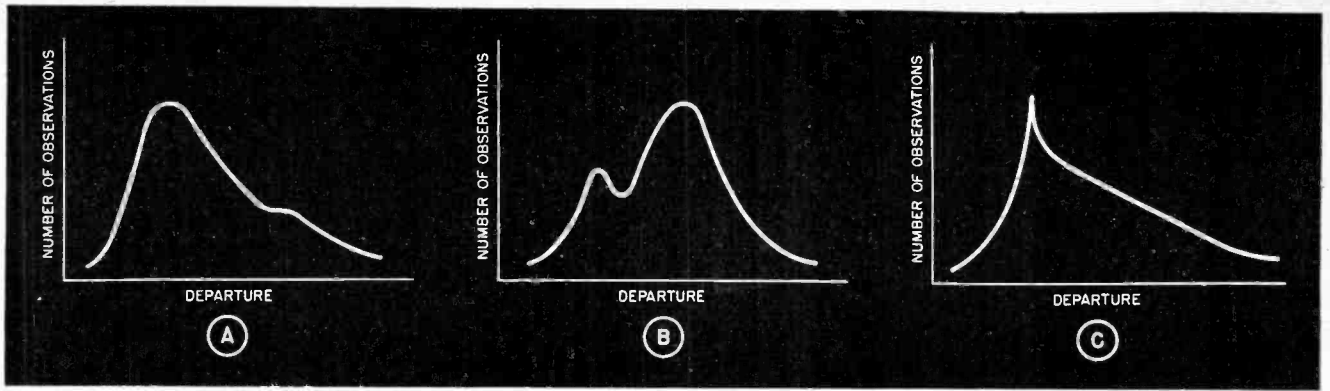

Fig. 2. Probability curves indicating random variations.

whether it falls within definite tolerances, or in terms of its variation from a desired characteristic, or both. The first is usually referred to as the method of attributes, and the second is generally termed the method of variables. Both methods may be applied to a single product or even to a single characteristic of a product. An example to illustrate these methods might be the measurement of the capacitance of a fixed capacitor. Thus the unit may be rated as satisfactory or unsatisfactory depending on whether its capacitance falls within specified limits, or its variation from the desired capacitance may be measured. In the former case the tested units might be collected into two groups and in the latter into several.

Sampling Inspection

Whether each unit of a product is to be tested or whether a few representative samples are to be tested depends upon economic considerations, the effect of testing on the desired characteristics of the product, the rigidity of the specification and many other factors. For example, spherical ball bearings are often tested for accuracy of contour and uniformity of material by dropping each of them on a flat surface from a given height and catching the acceptable balls in a small fixed aperture after they have bounced. Although each ball is tested, this is, in the rigorous sense, sampling inspection, since all points on the surface are not subject to test. Certain types of light bulbs intended to produce an intense light for one very short period of time for photographic purposes, are examples of a product whose later characteristics are influenced by testing. Sampling inspection of such products must be employed, since all bulbs inspected for electrical characteristics must be tested to destruction.

As previously pointed out, statistical methods can aid in differentiating between random trends in product and

assignable variations. Once the data is collected it can be arranged to study significant trends in order that controllable trends may be traced to their source and corrected. It is futile to attempt to correct random variations due to natural causes. Indeed, it will be shown that it is often possible to arrange the data as it is collected so that it may be analyzed as it is being collected rather than at some subsequent time. This is of great importance in processes involving chemical reactions and chemical concentrations, such as metal plating, etc.

Probability Curves

If any random phenomena of occurrence is plotted, with departure from some median value as a function of number of occurrences, the familiar probability curve results. Thus, let a coin be pitched under identical conditions at a mark, or let observations of Wheatstone bridge adjustment for a given set of conditions be made and the departures from an average value plotted against number of pitches or number of observations. The curve of Fig. 1 results, or one very nearly like it. If the observations are influenced by some extraneous phenomena such as interference, variation in the observer, etc., the probability curve departs from that of Fig. 1 which ac-

counts for random variations only. Thus a curve with multiple peaks or dissymmetry might result. Hence it would become evident that something was affecting the quality of the observation or the quality of the phenomena under observation. Such a set of curves is shown in Fig. 2.

The median value represented by the line O-O in Fig. 1 is generally called the most probable value. This might represent the intensity of light given off by the photographic light bulbs, the capacitance of the electrical capacitor, the inductance of a coil, or the reading of a Wheatstone bridge. Consider the following series of observations:

1, 2, 3, 4, 5, 5, 5, 5, 6, 6, 6,
7, 7, 8, 9, 10, 11

Let us attempt to establish the most probable value of the phenomena resulting in this set of observations. The arithmetic mean value is:

$$\frac{100}{17} = \frac{\text{Sum of observation values}}{\text{Number of observations}} = 5.9$$

The median value is the central observation, when all observations are arranged in order of magnitude. Therefore the median value is 6. The observation which occurs most frequently is usually called the mode. In this case the mode is 5.

If this set of observations is plotted as in Fig. 2, the median value would

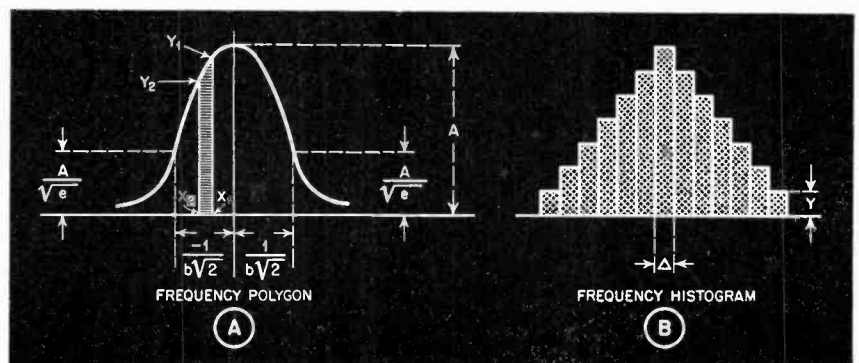

Fig. 3. Frequency polygon and frequency histogram.

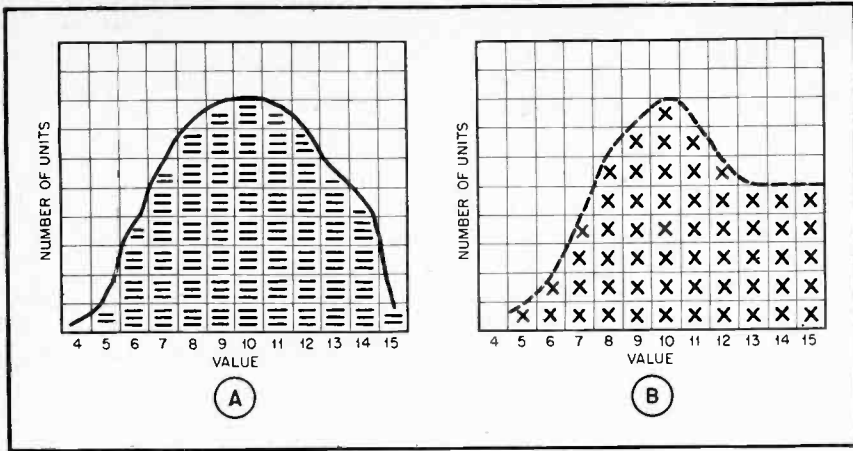

Fig. 4. If results are arranged in recording, they may be analyzed as they are recorded.

be that which would divide the area beneath the curve into two equal parts. The mode would obviously represent the peak of the curve. Such a series of computations might be made to establish the rating for a product, such as the capacitance of an electrical capacitor, the most probable value of a series of observations, etc.

Another commonly used vehicle for establishing the most probable value is the method of least squares. The most probable value as established by the method of least squares is that value for which the sum of the squares of the departure is a minimum. In the above case it would be the same value as the arithmetic mean. This will be discussed in more detail in connection with the derivation of the error equation.

The curve of Fig. 1 may be represented by:

$$Y = Ae - b^2x^2$$

This fundamental relation may be developed as follows:

Let q represent the unknown value of a large quantity and suppose a series of N measurements to be made upon it, where N is large. Assume the departures from the most probable value of q to be $X_1, X_2, X_3, \dots, X_N$. Obviously the probability of the occurrence of departure X is an inverse function of its magnitude. Let the probabilities of departures $X_1, X_2, X_3, \dots, X_N$ be $Y_1, Y_2, Y_3, \dots, Y_N$ respectively, i.e.;

$$\begin{aligned} Y_1 &= f(X_1) \\ Y_2 &= f(X_2) \\ Y_3 &= f(X_3) \\ &\dots \\ Y_N &= f(X_N) \end{aligned}$$

Since the value of the observed quantity q and the departure X are not known, we may assume tentative values of q and examine the resulting tentative departures, from which may be selected the most natural distribution which is in accordance with ex-

perience. It therefore remains to find that system of values for X which as a whole has the greatest probability. Whence:

$$Y = Y_1, Y_2, Y_3, \dots, Y_N = f(X_1), f(X_2), f(X_3), \dots, f(X_N)$$

In order that the system of X shall have the greatest probability, the value of q should be such that Y is a maximum. This condition is attained when $\delta Y / \delta q = 0$. Whence:

$$\frac{\delta Y}{\delta q} = \frac{Y}{f(X_1)} \cdot \frac{\delta f(X_1)}{\delta q} + \frac{Y}{f(X_2)} \cdot \frac{\delta f(X_2)}{\delta q} + \dots = 0$$

$$\frac{Y}{\delta q} \left[\frac{\delta f(X_1)}{f(X_1)} + \frac{\delta f(X_2)}{f(X_2)} + \frac{\delta f(X_3)}{f(X_3)} + \dots + \frac{\delta f(X_N)}{f(X_N)} \right] = 0$$

$$\frac{Y}{\delta q} [\delta \log f(X_1) + \delta \log f(X_2) + \dots + \delta \log f(X_N)] = 0$$

Replacing $\delta \log f(X)$ by $\phi(X) \delta X$ we have:

$$\phi(X_1) \frac{\delta X_1}{\delta q} + \phi(X_2) \frac{\delta X_2}{\delta q} + \phi(X_3) \frac{\delta X_3}{\delta q} + \dots + \phi(X_N) \frac{\delta X_N}{\delta q} = 0$$

If the results of the respective N measurements on q be designated by $S_1, S_2, S_3, \dots, S_N$, each having definite fixed and finite values, then the departures X are:

$$\begin{aligned} X_1 &= S_1 - q \\ X_2 &= S_2 - q \\ X_3 &= S_3 - q \\ &\dots \\ X_N &= S_N - q \end{aligned}$$

Whence:

$$\frac{\delta X_1}{\delta q} = \frac{\delta X_2}{\delta q} = \frac{\delta X_3}{\delta q} = \frac{\delta X_N}{\delta q} = -1$$

Or:

$$\phi(X_1) + \phi(X_2) + \phi(X_3) + \dots + \phi(X_N) = 0 \quad (1)$$

If the departure curve is symmetrical about the value of q , which is to say the number of positive departures equals the number of negative departures for an infinite number of observations, then the algebraic sum of all departures is zero. Whence:

$$X_1 + X_2 + X_3 + \dots + X_N = 0 \quad (2)$$

Equations (1) and (2) are satisfied if:

$$\begin{aligned} \phi(X_1) &= K X_1 \\ \phi(X_2) &= K X_2 \\ \phi(X_3) &= K X_3 \\ &\dots \\ \phi(X_N) &= K X_N \end{aligned}$$

where K is a constant.

As justification add a finite quantity α to any value of X and subtract the same quantity from any other value of X . Obviously this will not alter equations (1) and (2) since by hypothesis these conditions are simultaneous. Thus:

$$\phi(X_1) + \phi(X_2) = \phi(X_1 + \alpha) + \phi(X_2 - \alpha)$$

and:

$$[\phi(X_1 + \alpha) - \phi(X_1)] + [\phi(X_2 - \alpha) - \phi(X_2)] = 0$$

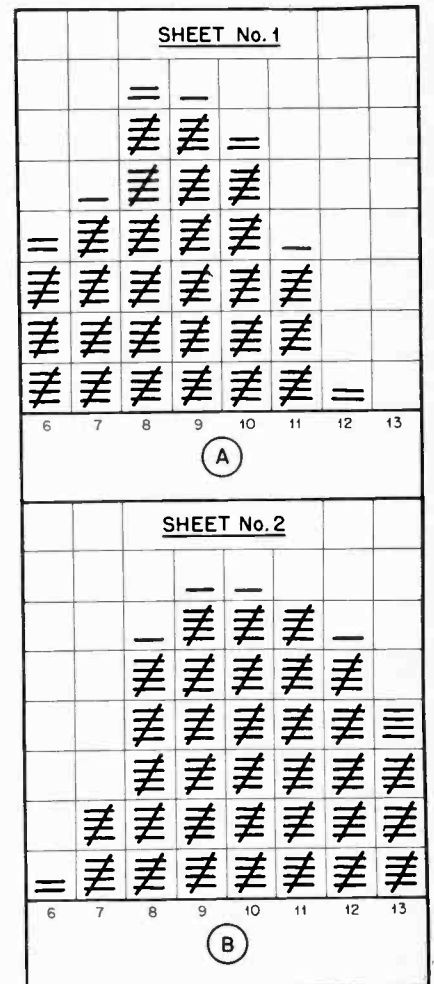

Fig. 5. Trends in product can be observed from a series of test data sheets.

Dividing by α :

$$\frac{\phi(X_1+\alpha)-\phi(X_1)}{\alpha} - \frac{\phi(X_2-\alpha)-\phi(X_2)}{-\alpha} = 0$$

As α approaches zero, this becomes as a limit:

$$\frac{\delta}{\delta X_1} \phi(X_1) - \frac{\delta}{\delta X_2} \phi(X_2) = 0$$

or in the general case:

$$\frac{\delta}{\delta X_N} \phi(X_N) = 0$$

From which it follows that since the X 's may be varied in any manner so that:

$$X_1+X_2+X_3+\dots+X_N=0$$

it holds that:

$$\frac{\delta}{\delta X} \phi(X) = K = \text{constant}$$

Integration yields:

$$\phi(X) = KX + A$$

But since:

$$X_1+X_2+X_3+\dots+X_N=0$$

and:

$$\phi(X_1)+\phi(X_2)+\phi(X_3)+\dots+\phi(X_N)=0$$

it follows that:

$$K(X_1+X_2+X_3+\dots+X_N)+NA=0$$

or:

$$\phi(X) = KX$$

But:

$$\phi(X) \delta X = \delta \log f(X) = \delta \log Y$$

Then:

$$\delta \log Y = KX \delta X$$

Integrating:

$$\log Y = \frac{1}{2} KX^2 + A$$

or:

$$Y = e^{\frac{K}{2} X^2 + A} \quad (3)$$

This is the error equation. We have assumed that the larger the departure, the less likely it is to occur, whence the larger is X , the smaller is Y . From which it follows that K is negative. Replacing $K^2/2$ by $-b^2$ and e^A by a constant A , equation (3) becomes:

$$Y = Ae - b^2 X^2 \quad (4)$$

The bilateral symmetry of function Y is obvious from the appearance of X in the second degree only. This indicates the equal possibility of positive and negative departures of the same magnitude. Therefore Y approaches zero as X increases, which indicates that large departures are correspondingly improbable.

The derivatives of Y are:

$$\frac{\delta Y}{\delta X} = -2Ab^2e - b^2 X^2$$

$$\frac{\delta^2 Y}{\delta X^2} = -2Ab^2e - b^2 X^2 [1 - 2b^2 X^2]$$

Since: $\delta Y/\delta X = 0$ and $\delta Y/\delta X$ is less than zero when $X = 0$, Y is maximum when $X = 0$. This is equivalent to saying that zero departure is most probable. The shape of the probability curve is therefore established by:

Peak of curve occurs at zero departure and equals A . And from:

$$1 - 2b^2 X^2 = 0$$

$$X = \pm \frac{1}{b\sqrt{2}}$$

which establishes the two points of inflection of the curve. The ordinate at each point of inflection is:

$$Y = \frac{A}{\sqrt{e}}$$

The quantity A obviously represents the probability of zero departure.

In the above derivation X has been treated as a continuous variable which might assume any value from zero to infinity. This assumes an infinitely small gradation of the measuring scale. Thus the probability of any particular departure out of the infinite number of possibilities would be infinitesimally small. It is thus apparent that the variable departure X instead of varying by infinitesimal increments δX does have finite discontinuities Δ , which represents the smallest unit or fraction of a unit in which



Huge Brazilian quartz crystal passes microscopic inspection at a Western Electric plant.

measured departures are expressed. This is expressed by Fig. 3-B, the width of the departure compartments being Δ and their ordinate Y . Thus:

$$\Sigma Y = 1$$

If a series of measurements are made upon a single attribute of a product each under identical boundary conditions, the result is a series of values each approximating the true value. However, no one of them is the true value and it therefore becomes a matter of judgement to select a value which will cause the departures to assume the most normal distribution. The symmetry of departures from the true value has been shown above to be symmetrical when the departures are due to chance (i.e., natural causes). This true value or most probable value is in general the arithmetic mean. This can be shown as follows:

Let the measured values be $S_1, S_2, S_3, \dots, S_N$ and their arithmetic mean be M , whence:

$$\begin{aligned} X_1 &= S_1 - M \\ X_2 &= S_2 - M \\ X_3 &= S_3 - M \\ &\dots \\ X_N &= S_N - M \end{aligned}$$

By summation:

$$\Sigma X = \Sigma M - NM = 0$$

This expresses the fact that the arithmetic mean of the results is the value with respect to which they are symmetrically disposed. That is, the sum of the departures are equal to zero. From which it follows that the arithmetic mean is the most probable value that can be assumed.

Method of Least Squares

This can likewise be shown by the

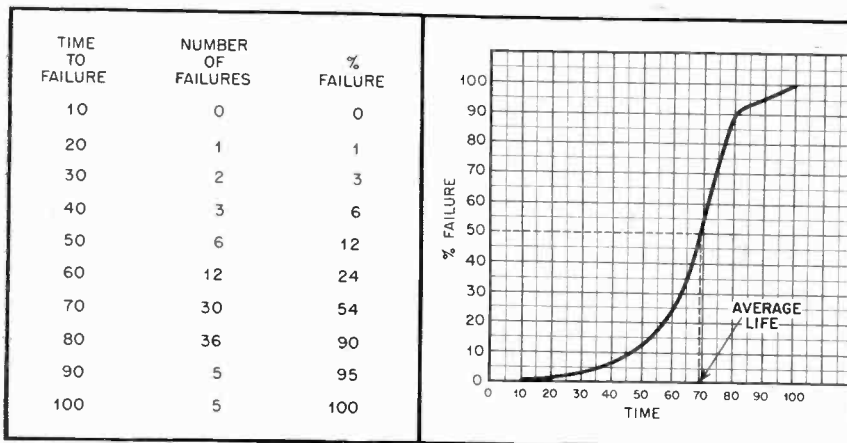

Fig. 6. Accumulative frequency distribution curve.

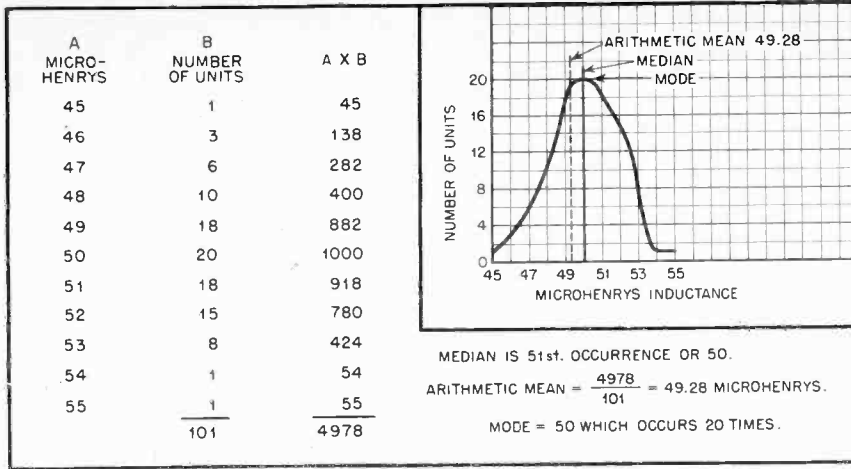

Fig. 7. Accumulative data on inductance of r-f coils.

method of least squares, as mentioned previously. The principle of least squares states that the most probable value of a measured quantity that can be deduced from a series of direct observations made under identical boundary conditions, is that for which the sums of the squares of the departures is a minimum. Again assume the observed departures to be $S_1, S_2, S_3, \dots, S_N$. Then:

$$\begin{aligned}
 Y_1 &= Ae^{-b^2x_1^2} \\
 Y_2 &= Ae^{-b^2x_2^2} \\
 Y_3 &= Ae^{-b^2x_3^2} \\
 &\dots \\
 Y_N &= Ae^{-b^2x_N^2}
 \end{aligned}$$

The probability of the occurrence of the assumed series of events is:

$$Y_1, Y_2, Y_3, \dots, Y_N = \frac{1}{A^N} e^{-b^2(x_1^2 + x_2^2 + x_3^2 + \dots + x_N^2)}$$

If $Y_1, Y_2, Y_3, \dots, Y_N$ is to be a maximum, then $X_1^2 + X_2^2 + X_3^2 + \dots + X_N^2$ must be a minimum. That is, M must be chosen so that $\sum X^2$ is a maximum in accordance with the principle just stated. Whence:

$$\sum X^2 = (S_1 - M)^2 + (S_2 - M)^2 + (S_3 - M)^2 + \dots + (S_N - M)^2 = \text{a minimum}$$

$$\frac{\delta}{\delta M} \sum X^2 = -2[(S_1 - M) + (S_2 - M) + (S_3 - M) + \dots + (S_N - M)] = 0$$

$$M = \frac{S_1 + S_2 + S_3 + \dots + S_N}{N}$$

which is the arithmetic mean of the observations.

Precision Index

Equation (4) was first derived by Gauss and is the fundamental formula around which most statistical theory has been built. The quantity b is usually called the precision index and has to do with the precision of observations or the difference between successive departures from the modal value of

the error curve. Thus, large values of b indicate high precision or small incremental departures which may be plotted as shown in Fig. 3-B. It may be shown that:

$$A = \frac{\Delta b}{\sqrt{\pi}}$$

Whence equation (4) reduces to:

$$Y = \frac{\Delta b}{\sqrt{\pi}} e^{-b^2x^2}$$

One of the most important problems in statistical theory is to find the probability that a given observation will fall between two limits X_1 and X_2 (see Fig. 3-A). This may be determined in terms of the precision index b , for the result desired is simply the sum of the probabilities of all observations between X_1 and X_2 which is:

$$Y = \frac{b}{\sqrt{\pi}} \int_{x_1}^{x_2} e^{-b^2x^2} \Delta = \frac{b}{\sqrt{\pi}} \int_{x_1}^{x_2} e^{-b^2x^2} \delta X$$

$$= \frac{b}{\sqrt{\pi}} \int_0^{x_2} e^{-b^2x^2} \delta X - \frac{b}{\sqrt{\pi}} \int_0^{x_1} e^{-b^2x^2} \delta X$$

This expression has been termed the probability integral. Tables of the value of this integral are given in numerous reference books on the subject of statistics.

Simultaneous Analysis

When controllable variations are reduced to a minimum only natural or non-assignable variations remain. Such natural variations obey the laws of chance. It is these variations which have been treated above and which are generally accepted as inevitable. Controllable variations cause results such as that shown in Fig. 2. It is possible and frequently desirable to record and arrange data simultaneously for rapid analysis. Thus if results are arranged in recording as shown in Fig. 4, they may be analyzed as they are recorded. Hence if departure is recorded on prepared sheets as shown, trends may readily be observed as the data is being taken and corrections applied promptly. For example, if the maximum capacitance of mica dielectric trimmer capacitors was being tested, one might suspect the thickness of mica dielectric as the assignable cause in Fig. 4-B. If this were corrected promptly, the next batch might yield the results of Fig. 4-A, showing a more normal distribution.

Daily, hourly, weekly or monthly trends in products sometimes can be quickly observed from a series of test data sheets such as that shown in Fig. 5. Here a trend can be observed toward higher values. Sometimes two sets of test results by two operators

[Continued on page 34]



Radio equipment destined for shipboard use is undergoing inspection at the RCA Victor Division plant.

WIDE-BAND AMPLIFIER DESIGN

E. M. NOLL

★ The wide-band amplifier evolved from the necessity of amplifying with uniform response, an extremely wide range of frequencies. The audio amplifier with a linear response from 30 to 8000 cycles is considered exceptional—a wide-band amplifier must have a linear range from 5 cycles to 2, and sometimes 5, megacycles. The same limitations and precautions considered in the design and construction of a high-fidelity resistance-coupled audio amplifier must be observed to a much greater extent in the design and construction of a wide-band amplifier.

Design Factors

The a.c. plate current produced by the applied signal in Fig. 2-A is found to be:

$$i_p = \frac{-\mu e_s}{R_p + \frac{R_L R_g}{R_L + R_g}} \quad (1)$$

In order to facilitate the use of this equation in pentode wide-band design we substitute $\mu = g_m R_p$ with the result that the equation becomes:

$$i_p = \frac{-g_m R_p e_s}{R_p + \frac{R_L R_g}{R_L + R_g}} \quad (2)$$

This amount of current flowing in the total output resistance determines the output voltage developed, or:

$$e_o = i_p R_T = \frac{-g_m e_s R_p R_T}{R_p + R_T} \quad (3)$$

where:
$$\frac{1}{R_T} = \frac{1}{R_L} + \frac{1}{R_g}$$

However, in wide-band applications a plate load resistor many times smaller than the plate resistance of the pentode used is required; thus the shunting effect of the plate resistance can be disregarded. What is more, in most cases the grid resistor is many times the value of the load resistor. Under the above conditions the equation is simplified and the output over the middle frequency ranges becomes:

$$e_o = -e_s g_m R_L \quad (4)$$

and the gain over the middle ranges is:

$$\text{Gain} = \frac{e_o}{e_s} = g_m R_L \quad (5)$$

assuming $R_g + R_p \gg R_L$

The equivalent circuit is shown in Fig. 2-A.

Equation (5) demonstrates very definitely the direct relation between mutual conductance (g_m) and gain in a wide-band amplifier. The g_m is considered the figure of merit for a pen-

figure of merit for a tube used in wide-band applications is:

$$M = \frac{g_m}{C_{IN} + C_{OUT}} \quad (6)$$

Over the middle range of frequencies the load presented to the output of the tube is resistive; however, at the higher frequencies it is necessary to consider the shunt capacities which consist of plate-cathode capacity, wiring capacities, and grid-cathode capacity of

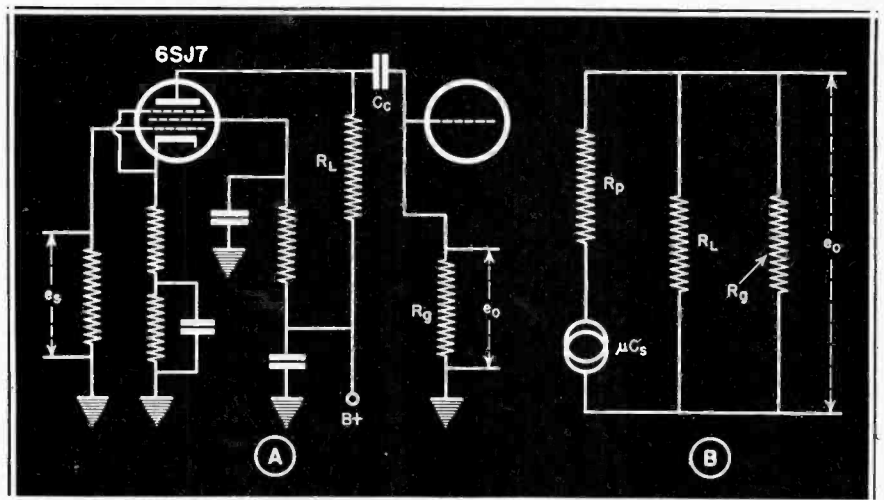

Fig. 1. Resistance-coupled wide-band amplifier and its equivalent circuit.

tode, or it demonstrates how effective the tube is in changing small voltage variations applied to its grid into plate-current variations of sufficient magnitude to develop a much larger voltage across the output. Again, by observing equation (5), it is seen that gain is directly proportional to the value of load resistor used. The value of load resistor depends upon the amount of distributed capacity in the circuit and the input and output interelectrode capacities. The larger these capacities become the lower it is necessary to drop the load resistor to obtain uniform response at the high frequencies. So the

following tube. The total shunting capacity is the sum of these three, or: $C_T = C_{wiring} + C_{IN} + C_{OUT}$. The equivalent circuit for the high frequency is shown in Fig. 2-B and the gain is:

$$\text{Gain} = \frac{g_m X_{CT} R_L}{\sqrt{(X_{CT})^2 + (R_L)^2}} \quad (7)$$

From the above equation it is evident that in order to prevent degeneration at the high frequencies we must operate with a low value of plate resistor in order to overcome the shunting reactance of the distributed capacities.

In the case of the low-frequency

CHARACTERISTICS OF

RADIO-ELECTRONIC COMPONENTS

A. C. MATTHEWS

PART 2—CAPACITORS

★ The most important characteristics of a capacitor under normal operating conditions are percent capacity change, Q and leakage resistance. These are in general dependent upon the grade of dielectric employed and to a smaller extent upon the treatment given the completed part.

Test Chamber

In order to determine the relative merits of a given capacitor design it is necessary to establish a testing procedure whereby the effects of temperature and humidity can be studied. A 1000-cycle bridge using a precision air condenser as a standard is required. The bridge should be supplied with a good amplifier so that an unbalance of 0.005% may be detectable. The bridge, together with a specially designed test chamber, as shown in *Fig. 3* is the only apparatus necessary for these studies. One side of the test chamber may be made of glass which has been drilled for banana type plugs. This wall may be removed to facilitate mounting of parts to be tested. The lower part of the unit contains heating

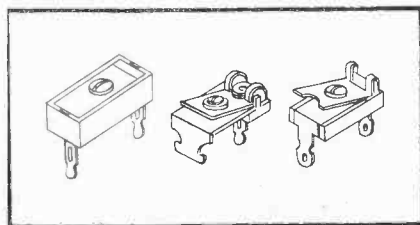

Fig. 4. Types of trimmer capacitors.

elements which are separated from the main compartment by a perforated metal partition. A small ventilating fan aids in circulating the air and prevents "hot spots" from forming.

A tray of dehydrated calcium chloride or silica gel in the main compartment aids in keeping the humidity at a minimum. The thermometer protruding from the side of the unit indicates the chamber temperature. Where it is necessary to make measurements at temperatures below ambient, a quantity of dry ice is placed in the lower section of the test chamber. A small vent hole is necessary to allow gas to escape.

Ordinarily tests are made at temperatures higher than ambient since this

more nearly simulates normal operation. The test chamber is located conveniently near the bridge and great care should be exercised in making the necessary connections between the bridge and the test chamber. An excellent method is to make the high potential lead longer than necessary and loop it from the bridge to the test connection.²

Temperature and Humidity Measurements

Having made the necessary connections the capacity is measured at room

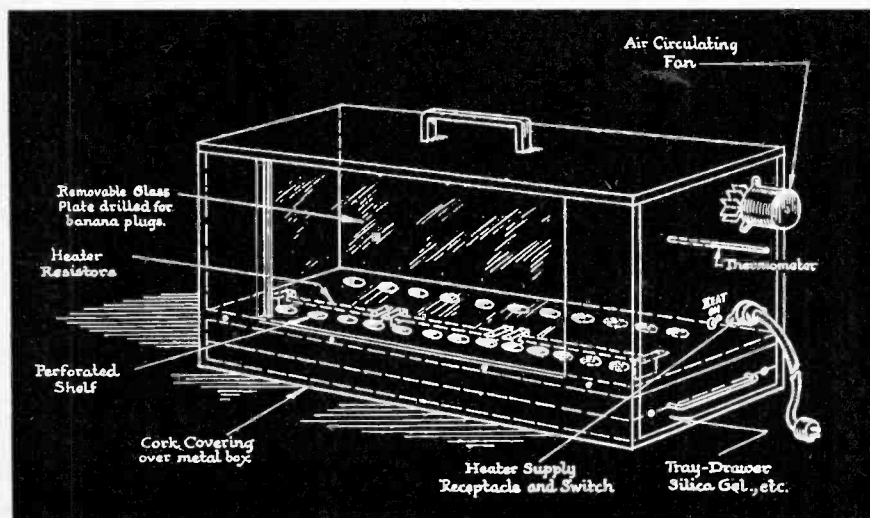

Fig. 3. Mechanical details of typical test chamber.

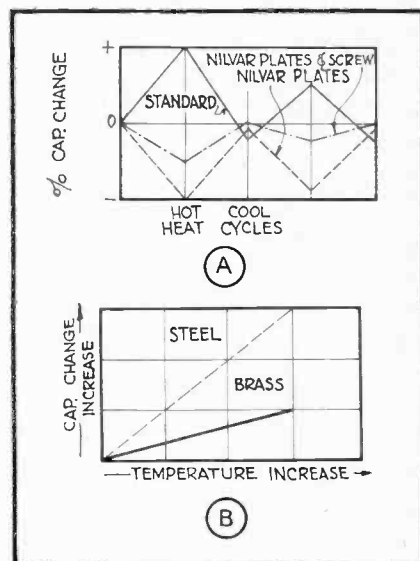

Fig. 5. Effects of temperature on compression-type trimmer capacitor.

temperature (25° C.). The chamber temperature is then raised to 65° C. by turning on the heaters. A thermostat set for this value will prevent overshooting and eliminate temperature variations due to changes in the heater supply voltages or normal conduction through the chamber walls. It should be noted that the chamber walls are

² General Radio Experimenter, January, 1938.

insulated with cork to minimize temperature changes. After maintaining 65° C. for two hours the capacity is again measured. This constitutes one heat cycle. Usually three complete cycles of heating and cooling will suffice to indicate the temperature coefficient and any permanent drift.

The same unit can be used for humidity checks by replacing the tray of calcium chloride with a saturated solution of ammonium-mono-phosphate crystals. The temperature should be maintained at 100° F. during all tests and the components being checked may either be left connected to the test wall or merely placed in the chamber at convenient points. In the latter case, care must be taken when removing parts for testing not to decrease the humidity. The better method is to have the parts securely soldered to the test plugs. Some difficulty may then be experienced due to condensation of water vapor between the test plugs. However, this can be remedied by connecting a potential between the plugs about an hour before making the humidity checks to allow the heat generated by the resistance of the water vapor to dry that section of wall being used. Obviously the potential must not be high enough to damage the part under test and should be removed before connecting the bridge.

Capacity measurements are first made under initial dry conditions, then the humidity is raised to 90-98% and the components remeasured at 24, 48 and 100 hours. "Q" or power factor measurements must be made outside the humidity chamber unless only a comparative curve is desired, since the test panel will seriously affect the results. However, if care is taken always to keep the measurement time for each unit as nearly the same as possible no serious error will result from removing the parts from the humidity chamber.

Mechanical Stability Test

Definite rules for inspecting trimmer condensers are difficult to specify;

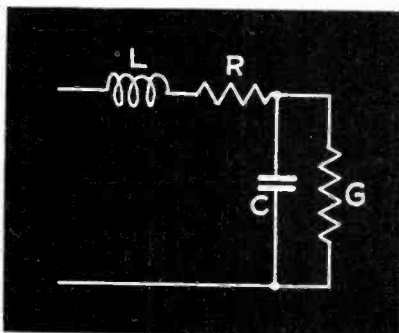

Fig. 7. Equivalent circuit of fixed capacitor.

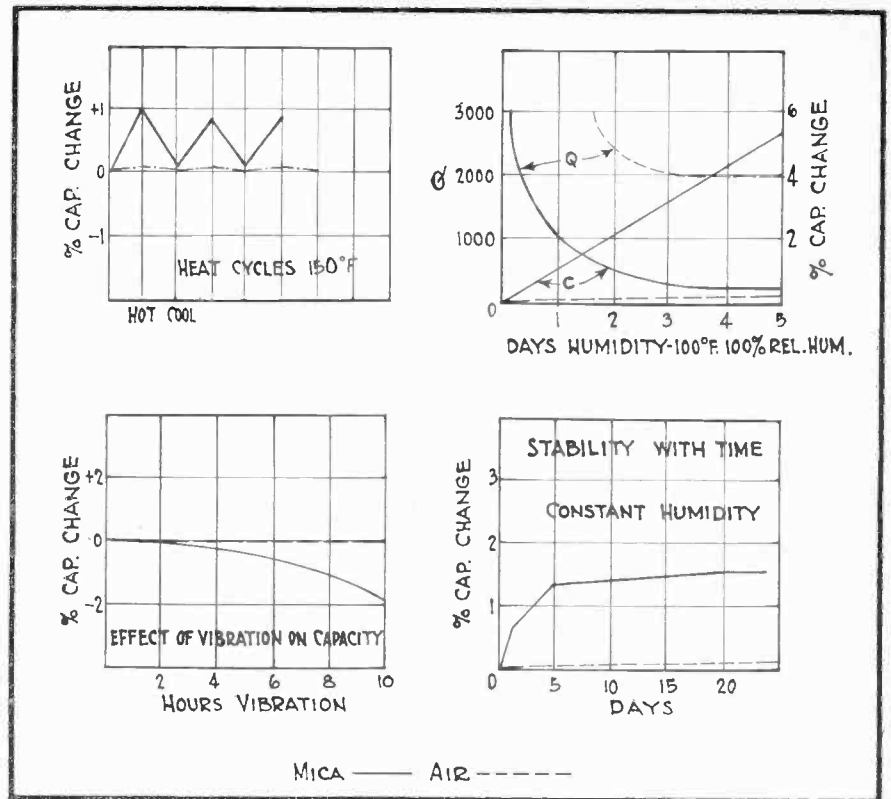

Fig. 6. Typical air vs. mica trimmer capacitor characteristics.

however, there are a few points that should be noted. The mountings should be so designed that movements of the mount will not cause mechanical shifting of the armature plates, mica films, adjusting screw or nut. The adjusting means should be firm and have no backlash throughout the entire operating range of the condenser. The capacity versus turn curve should be smooth and without any negative slopes within the capacity range of the condenser. The armature plates should be under tension throughout the full operating range to promote stability and freedom from microphonics.

The following procedure has proven to be very useful as an empirical test for microphonic tendencies. The percent instability is expressed as the percent capacity change in the test, and for similar types of condensers, direct comparisons of relative stability may be made from the test results. Electrostatic forces due to a d-c polarizing voltage result in changes in armature plate shape and spacing. The percent capacity change of the trimmer when the condenser is polarized with a 500-volt d-c potential is the percent instability by this method. Tests should be performed at a number of points throughout the capacity range of the condenser. This method should supplement mechanical vibration tests for an overall check on mechanical stability.

Trimmer Condensers of varying designs are available for use in trimming r-f and i-f stages, for oscillator padding and for general use as neutralizing and balancing condensers. Probably the most common type is the mica dielectric compression trimmer. The armature plates are separated by thin sheets of mica (0.0015"-0.003" thick) and held under tension by means of an adjusting screw. The mechanical design varies to a certain extent with the manufacturer and with the particular application. Typical designs are shown in Fig. 4.

Stability with temperature, humidity and life; low losses, smoothness of adjustment and accuracy of adjustment are the prerequisites of any trimmer condenser. To satisfy these requirements is very difficult. Such factors as the expansion of materials, plate tension and dielectric losses must be coordinated to produce a satisfactory design. An example of how the expansion of material with temperature affects the capacity of a compression-type trimmer condenser is shown in Fig. 5.

The capacity is seen to increase with temperature due to the increase of the plate area. This effect is offset somewhat by the elongation of the adjusting screw, which holds the plates together, but unfortunately the two opposite effects do not balance. There is, however, an optimum point of adjustment. Subsequent cycles show the same tend-

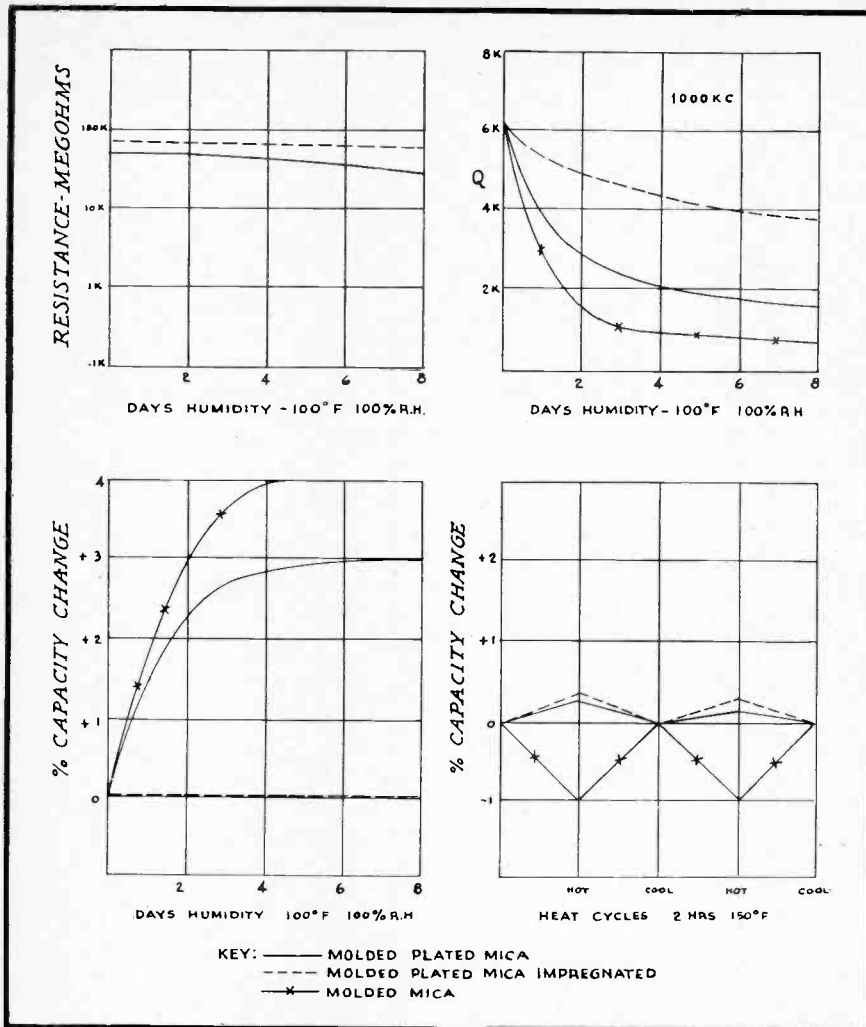

Fig. 8. Plated mica vs. mica film fixed capacitor characteristics.

ency to increase capacity with temperature, but to a smaller degree. This decreased capacity change is accompanied by a gradual shift in the cool or zero capacity point. Many manufacturers "age" or heat cycle their products to eliminate stresses set up in the materials during the process of manufacture, thus improving them in this respect.

Fig. 5-A shows the performance of a condenser constructed with a plate material which has a zero coefficient of expansion over the operating temperature range. Note how the capacity decreases with an increase in temperature. This is due to the elongation of the adjusting screw which allows the plates to separate more as the temperature is increased. Curve 5-C shows the same condenser with the adjusting screw made of non-expanding material, and it is noted that the capacity drift is negligible. These curves were taken under ideal conditions which very rarely exist in practice and are useful only in showing the effect of plate and adjusting screw material when subjected to heat. Curve 5-B

shows the relative difference in drift due to adjusting screws of different metals.

Unfortunately there is another type of drift which is not commonly considered when testing condensers. This is the drift in capacity after each mechanical adjustment of the trimmer to a new capacity value. The largest percentage of this "adjustment drift" takes place in the first few minutes after the adjustment is made. It is due to the relatively high coefficient of friction between the electrode plates and the mica films under tension, which requires an appreciable time for the spring action of the plates to bring them into their final positions. A graphite film treatment on the electrode plates will provide the necessary lubricant to greatly overcome this difficulty.

The dielectric between the plates is usually a high quality India mica which has been inspected for possible flaws, variations in thickness and losses. Great care is taken to remove all foreign matter such as grease and body salts by cleaning and degreasing operations on the mica. These precautions,

while important, do not eliminate all of the poor mica. A sheet of mica is composed of many very thin layers and it can absorb a considerable amount of moisture under conditions of high humidity. Since the dielectric constant of water is 85, while mica has a dielectric constant of approximately 5, it is readily seen that even a minute quantity of moisture will appreciably increase the capacity of the condenser. For this reason a humidity test should be made on all mica used in high quality trimmer condensers.

Finally the insulating material in the base of the condenser must be considered. Here we have both a mechanical and electrical problem. The coefficient of expansion and the dielectric loss should be small and the mechanical strength must be great. Some designs make use of metal instead of an insulating material as the base plate; an insulator is then placed under the head of the adjusting screw. The basic design problems, however, remain unchanged.

The air dielectric type, like the mica compression type trimmer, is manufactured in many varied designs. Probably the most popular, and rightly so, is the miniature tuning condenser type. In general its design closely resembles the regular air tuning condenser in that it has a set of fixed stator plates and a set of movable rotor plates. Usually both sets of plates are mounted on a ceramic base, the stator being soldered to eyelets fastened through the base, and the rotor being mounted with a single bearing which protrudes through the ceramic. A screw driver slot or hexagon head shaft usually serves as a means of adjustment.

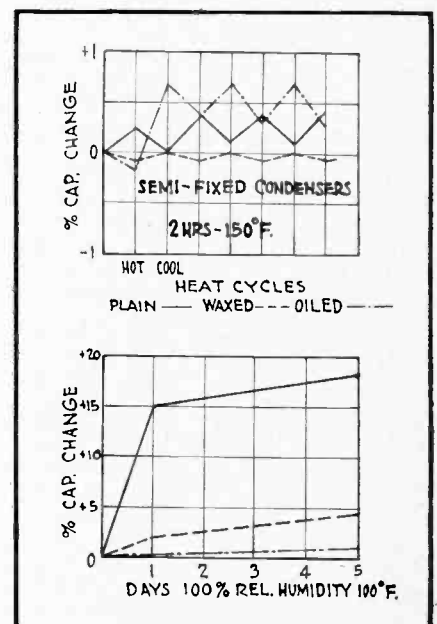

Fig. 9. Semi-fixed capacitor characteristics.

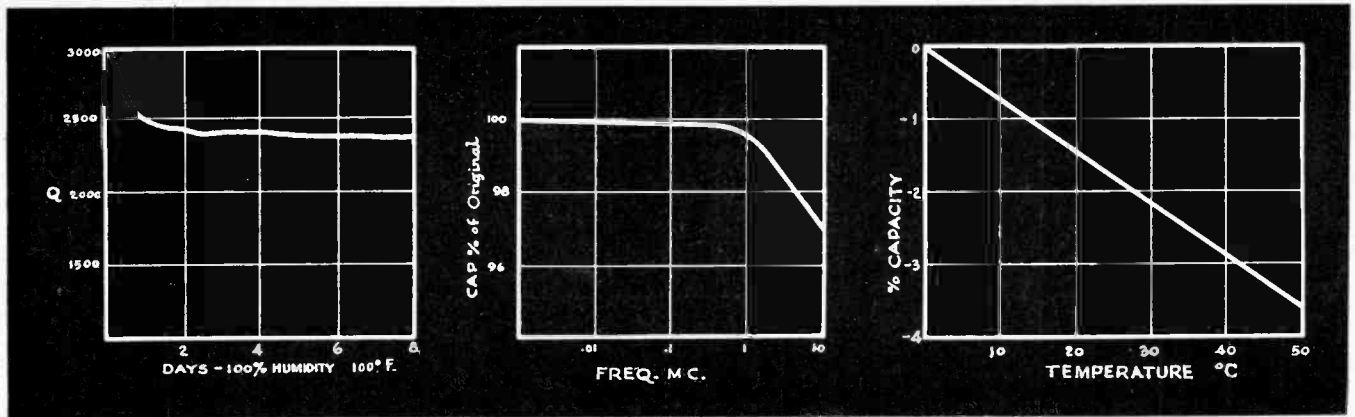

Fig. 10. Characteristic curves of Titanium Dioxide type of fixed capacitor.

Trimmers of this type possess unusually good characteristics. Stability under varying conditions of temperature and humidity is exceptionally good. When properly designed their ability to withstand mechanical shock make them especially desirable for use in high quality equipment subject to exceptionally hard usage or wherever a stable trimmer condenser is required.

Another air dielectric trimmer which deserves mention is the concentric plate type. It consists of a group of concentric cups in both rotor and stator which are intermeshed by means of an adjusting screw. It is not as stable mechanically as the miniature tuning condenser type, although electrically it has good characteristics, provided a high grade ceramic insulation is used throughout. A comparison of air versus mica dielectric trimmer condensers is shown in Fig. 6.

Fixed Mica Dielectric Condensers are usually protected by a molded insulating case, although some designs employ a metal cover. The molded types are available with bakelite, XM-262 (low loss bakelite) or polystyrene cases. The electrode plates are separated by sheets of mica and securely clamped at each end with wire leads which also serve as connections.

A fixed mica condenser may be represented by the equivalent circuit as shown in Fig. 7 where L represents the residual inductance of the condenser, R the effective series resistance, corresponding to losses in the metallic structure, G the effective parallel conductance corresponding to losses in the solid dielectric material, and C the true capacity. The true capacity C is practically constant for frequencies up to a transition region, where the dielectric constant of the insulating material decreases and the power factor peaks. The conductance G varies with frequency in a rather complicated manner. However at high frequencies where mica condensers are usually employed, the conductance in-

creases linearly with frequency. It behaves as a positive reactance in series with the negative reactance of the true capacity. The resistance R contributes a negligible loss at low frequencies. As the frequency increases however, R becomes comparable to the capacitive reactance and the power factor introduced by metallic losses becomes comparable to that introduced by dielectric losses.

Losses may be attributed mainly to two sources:

- (a) energy losses in the solid dielectric
- (b) energy losses in the metallic structure and leads.

Mica, while being a most efficient dielectric, is not impervious to moisture.

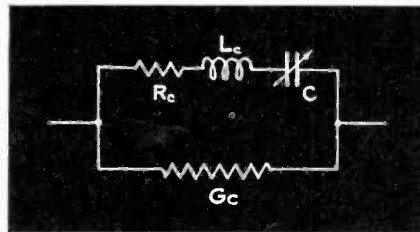

Fig. 11. Equivalent circuit of variable air capacitor.

A thin film of moisture even a molecule thick will increase its dielectric loss tremendously. Precautions must therefore be taken during the process of manufacture to keep the mica and the electrode plates free from moisture. Both the plates and the mica are kept on a hot plate during assembly. After the condenser is molded into its case they are usually further protected by giving the completed unit a flash dip of ceres or equivalent wax.

It is obvious that changes in pressure in a mica condenser will cause a change in capacity. In practice such a change in pressure occurs due to expansion or contraction of the materials with temperature. Unless the unit is very highly compressed all of the air cannot be ex-

cluded from the space between the conducting foils and mica. This results in a series of minute air pockets which remain throughout the assembly. Heating causes these pockets to expand, resulting in a negative temperature coefficient. However, since air is easily compressible, if the pressure on the unit is increased beyond a certain point a positive temperature coefficient may result. From these facts it is readily seen that the temperature coefficient may be either positive or negative depending upon the pressure applied during the molding process. This explains the difference between ordinary bakelite and XM-262. The XM-262 is normally molded at a lower pressure than ordinary bakelite.

Losses in the metallic structure are due to eddy currents in the conducting material, and to skin effect. These become appreciable as compared with the dielectric loss at high radio frequencies. The fact that the effective capacity increases with frequency also tends to make the series resistance of more importance.

Plated Mica Condensers are specified wherever good stability is required in a small capacity. Recognizing the limitations of the ordinary mica condenser under varying conditions of temperature and humidity, the plated mica type was developed. This type of condenser is extremely stable under the most adverse operating conditions. The conducting electrodes are "plated" on the mica film, thus insuring intimate contact at all times. Moisture between the dielectric and conducting electrodes is thereby eliminated, so the remaining humidity problem lies in preventing surface leakage. This is accomplished by wax impregnation and the use of a high grade ceramic base material.

Since the plates are in intimate contact with the mica, no air traps are formed, and since the coefficient of expansion of mica itself is about balanced by the changes in its dielectric constant, the condenser has an extremely

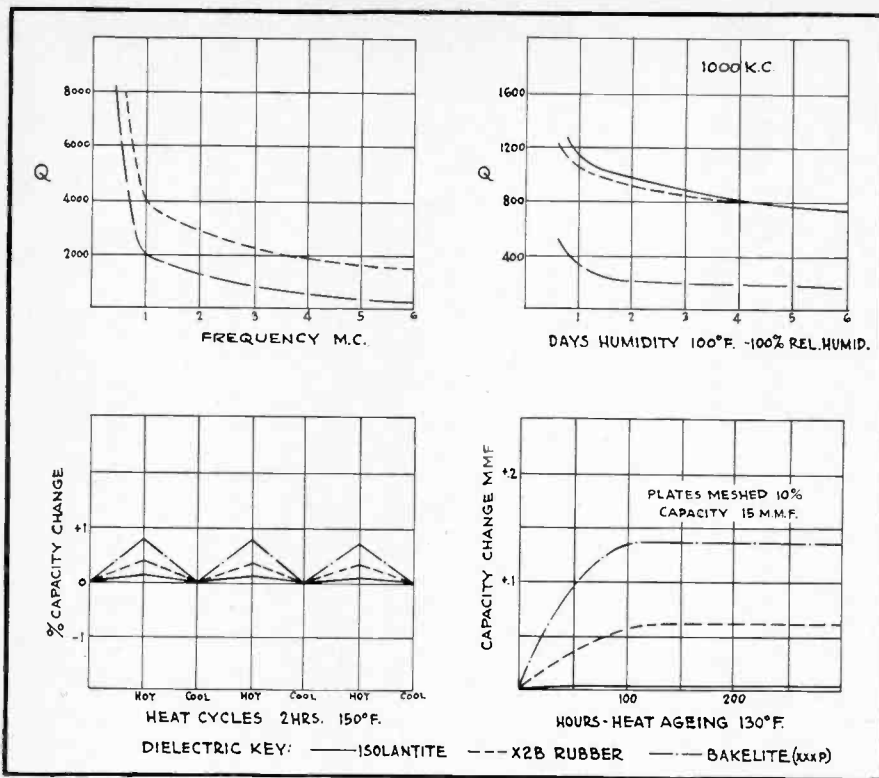

Fig. 12. Typical characteristics of a variable air capacitor.

low temperature coefficient of capacity. Several plated films may be connected in parallel to increase the capacity of the unit. Plated mica condensers are also available with molded cases. The molded type is somewhat less stable than that with a ceramic base; however, it is far superior to the ordinary molded mica type discussed previously.

Typical characteristics are shown in Fig. 8. These curves show that the unimpregnated condensers are superior to the impregnated condensers with regard to capacity stability versus temperature. On the other hand the impregnated condenser is more stable with respect to changes of humidity. The temperature coefficient is positive. Unimpregnated units show a slight increase in capacity with humidity; however, upon drying their capacity returns to normal. Comparisons between plated mica versus molded mica condensers are also shown in Fig. 8.

The Semi-fixed Mica Condenser is quite similar to the ordinary molded mica condenser in construction except that comparatively thick metal plates are used to clamp the mica films and conducting electrodes together instead of a molded case. An adjusting screw between the outside plates allows the pressure, and thus the capacity, to be set to a specified value. Capacities between 300 μf and 5000 μf are available.

Common impregnations are cerese wax or high quality acid-free oil. A wax impregnation prevents moisture from reaching the mica films, while an

oil impregnation thoroughly covers each insulating film, and, since the plates are under pressure, prevents moisture from entering between the conducting electrodes. This type of condenser is particularly stable under conditions of high humidity, as may be seen in Fig. 9.

The Titanium Dioxide Type of fixed condenser is characterized by its negative temperature coefficient. Titanium dioxide (TiO_2) has a dielectric constant of 85 and a temperature coefficient of -6.5×10^{-4} per degree centigrade temperature rise. This is equivalent to approximately 2 percent capacity change with a temperature rise from 30° to 60° C. Silver is coated on the TiO_2 surface and fired at a high temperature. Characteristic curves are shown in Fig. 10.

By combining the titanium dioxide with other ceramics any desired temperature coefficient may be obtained between $+1.2 \times 10^{-4}$ to -6.5×10^{-4} . The temperature coefficient of the dielectric employed is a function of the molecular structure of a material so it is reproducible under all normal conditions. With the silver plates in intimate contact with the surface of the

[Continued on page 53]

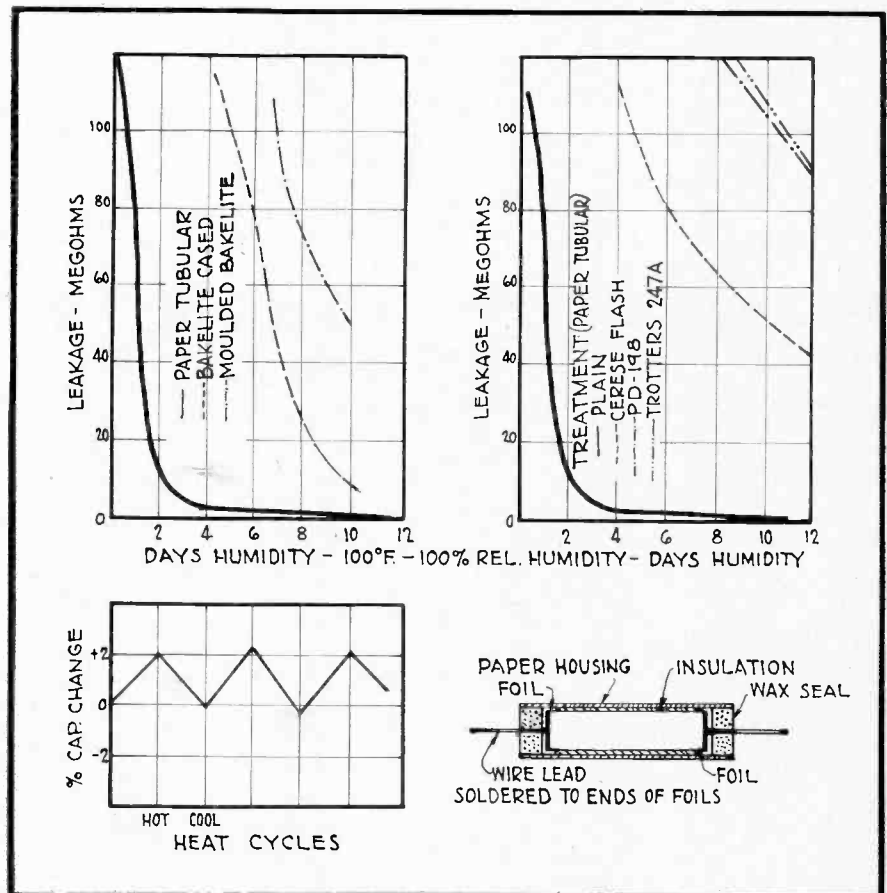

Fig. 13. Humidity characteristics of paper capacitors.

RADIO DESIGN WORKSHEET

NO. 15—ANTENNA CURRENT; WAVE APPROXIMATION; FEEDING SPEAKERS

ANTENNA CURRENT AND MODULATION RELATIONS

Problem: Antenna current increase is often used as a rough measurement of percentage modulation of an amplitude-modulated transmitter. Determine the relation between percentage increase in antenna current and modulation of a transmitter assuming transmission losses for carrier and two sidebands from tank circuit to antenna are equal, and antenna impedance is constant.

Solution: The common expression for an amplitude-modulated signal in terms of antenna current is:

$$I = A \cos \omega t (1 + K \cos pt)$$

where $\omega = 2\pi \times$ carrier frequency
 $p = 2\pi \times$ modulation frequency

$$I = A \cos \omega t (1 + K \cos pt) = A \cos \omega t + \frac{AK}{2} \cos(\omega - p)t + \frac{AK}{2} \cos(\omega + p)t$$

$$\text{RMS antenna current amplitude} = I = \sqrt{A^2 + A^2 K^2 / 4 + A^2 K^2 / 4} = A \sqrt{1 + K^2 / 2}$$

Assuming $A = 1$

Then: Percentage increase in antenna current is given by:

$$\sqrt{1 + K^2 / 2} \quad (1)$$

where $K =$ percent modulation.

From (1) we have:

K	$\sqrt{1+K^2/2}$	% increase ant. cur.
1.0	1.22	22%
.9	1.185	18.5%
.8	1.148	14.8%
.6	1.086	8.6%
.5	1.06	6.0%

From this a frequently used curve may be plotted to relate percent increase in antenna current and percent modulation. Such a curve is shown in Fig. 1.

WAVE APPROXIMATION BY MEANS OF FOURIER SERIES

Problem: To derive a trigonometric series which will approximate a square wave.

Solution: Let the square wave of Fig. 2 be approximated by a sine series.

In Fig. 2-A a simple sine wave ($E = A \sin \theta$) gives a poor approximation; a sine wave series with a third harmonic ($E = A \sin \theta + A/3 \sin 3\theta$) gives a somewhat better approximation, as in Fig. 2-B; and a sine wave series with a third and a fifth harmonic in addition to the fundamental a still better approximation, as in Fig. 2-C. The series for Fig. 2-C is:

$E = A \sin \theta + A/3 \sin 3\theta + A/5 \sin 5\theta$
 The proper coefficients for either a sine or cosine series may be obtained from

$$a_n = \frac{2}{\pi} \int_0^\pi \frac{f(\theta) - f(-\theta)}{2} \sin N\theta d\theta$$

where

$$\frac{f(\theta) - f(-\theta)}{2} =$$

$$a_1 \sin \theta + a_2 \sin 2\theta + a_3 \sin 3\theta + \dots$$

and:

$$b_n = \frac{2}{\pi} \int_0^\pi \frac{f(\theta) + f(-\theta)}{2} \cos N\theta d\theta$$

where:

$$\frac{f(\theta) + f(-\theta)}{2} = \frac{b_0}{2} + b_1 \cos \theta + b_2 \cos 2\theta + b_3 \cos 3\theta + \dots$$

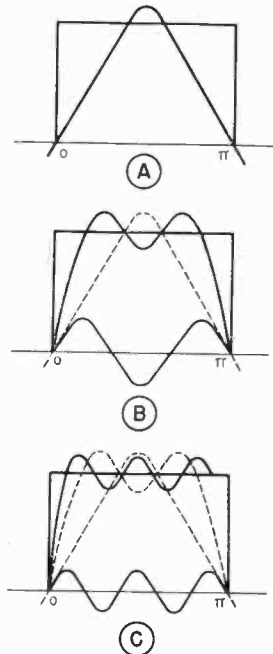

Fig. 2.

Some typical waves and their corresponding series are shown in Fig. 3. Derivations will not appear here because of space limitations, but will appear in a later Worksheet.

Any of the waveforms shown in Fig. 3 may be expressed as either a sine or a cosine series. For example, the equation for the second waveform shown in Fig. 3 may be expressed by the following cosine series:

$$E = \frac{A\pi^2}{16} - \frac{A}{2} \cos 2\theta - \frac{A}{18} \cos 6\theta - \frac{A}{50} \cos 10\theta$$

[Continued on page 30]

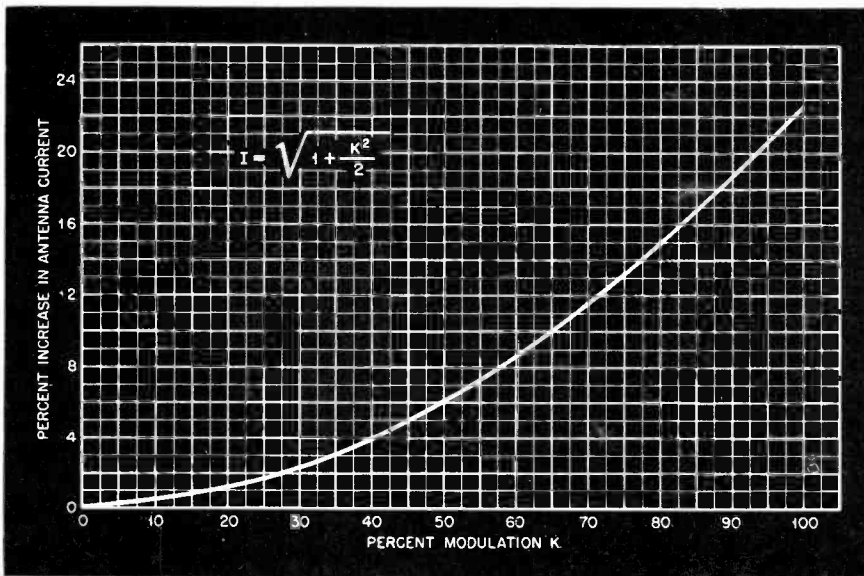

Fig. 1.

FEEDING MULTIPLE SPEAKERS

Problem: Derive a formula relating the number of loudspeakers or headphones that may be supplied at a given level from an amplifier of known power output.

Solution: A simpler formula will result if power level is expressed in decibels above some arbitrary level. The value commonly used as reference level is 0.01 watt. Thus, as in the accompanying table:

db level	watts	db level	watts
0	.010	18	.631
2	.016	20	1.000
4	.025	22	1.585
6	.030	24	2.512
8	.063	26	3.981
10	.100	28	6.310
12	.159	30	10.000
14	.251	32	15.850
16	.398	34	25.120

Now suppose an amplifier delivers 10 watts and we wish to supply as many loudspeakers as possible. If a given amplifier will deliver 1 watt (20 db) to a single loudspeaker, it will obviously deliver 0.5 watt to two loudspeakers or 0.25 watt to four loudspeakers. Thus, if the number of loudspeakers is doubled the power level to each is halved or reduced 3 db.

Let X = number of speakers to be energized.

Let A represent reduction in power level in db from amplifier output to speaker. Then the formula desired is:

$$X = 2^{A/3}$$

Thus assume we wish to supply as many loudspeakers as possible from [Continued on page 55]

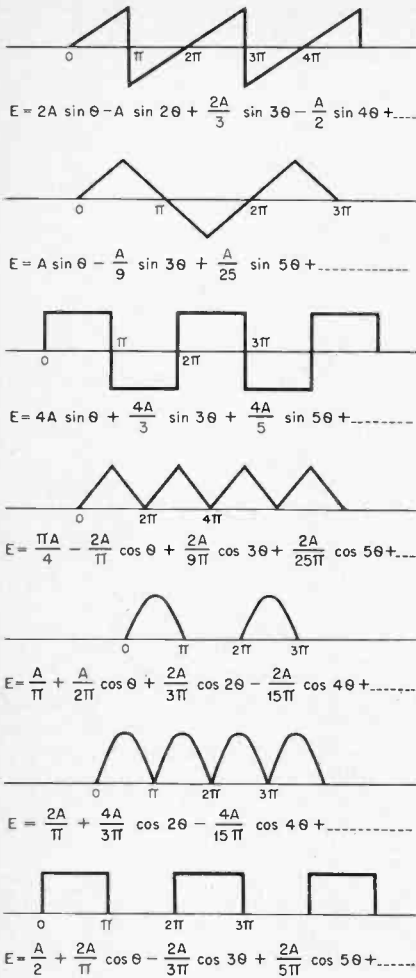

Fig. 3.

If the origin is shifted so that the minimum value is equal to zero but never negative, a constant equal to the peak amplitude of the wave must be added.

Similar series may likewise be derived for waves having periodicities of more than 2π or less than 2π . For example:



$$E = \frac{\pi A}{2} - \frac{4A}{\pi} \cos \theta - \frac{4A}{9\pi} \cos 3\theta + \frac{4A}{25\pi} \cos 5\theta + \dots$$

Likewise:

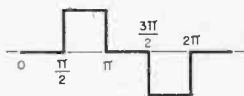

$$E = \frac{A\pi}{4} - A \cos \theta + \frac{A}{3} \cos 3\theta - \frac{A}{5} \cos 5\theta + \dots$$

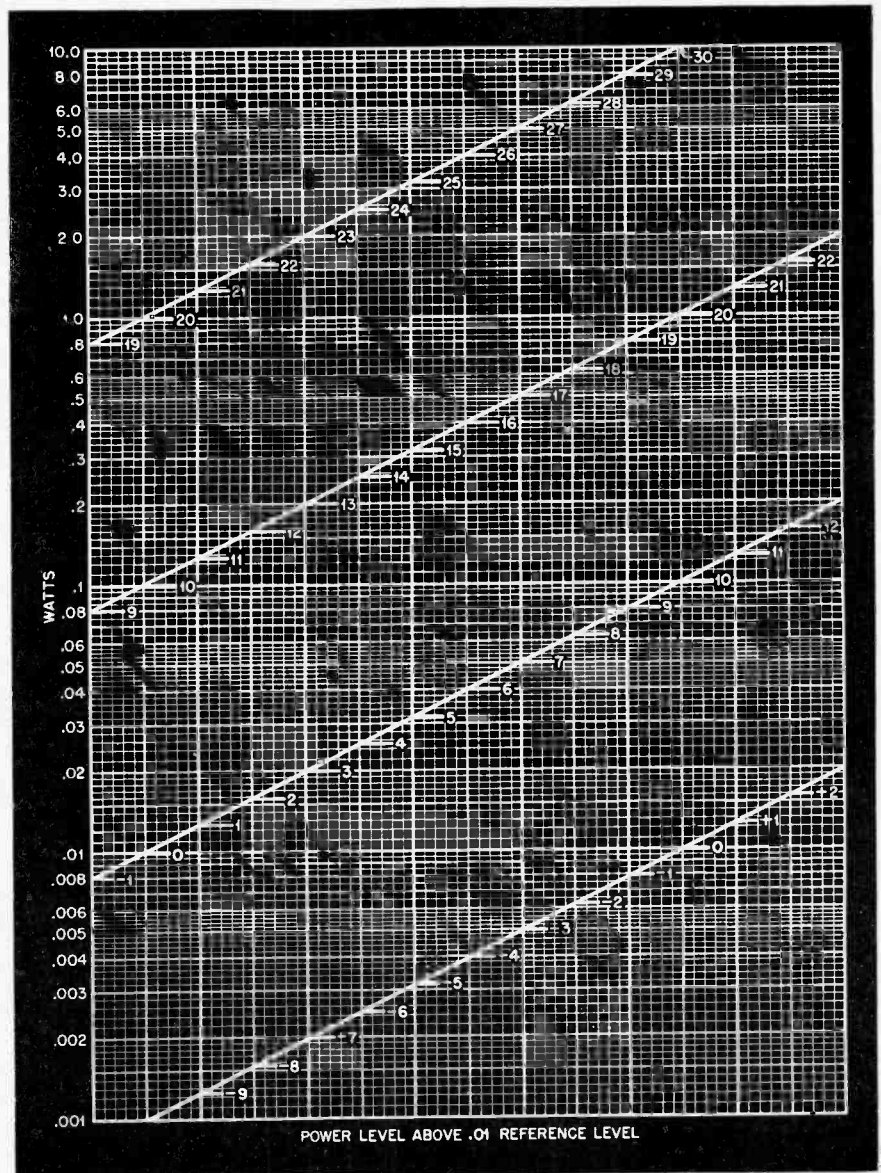

**"HOGARTH'S ECHOPHONE EC-1
SURE SOOTHES THE SAVAGE BREAST"**



Echophone Model EC-1

(Illustrated) a compact communications receiver with every necessary feature for good reception. Covers from 550 kc. to 30 mc. on three bands. Electrical bandspread on all bands. Six tubes. Self-contained speaker. 115-125 volts AC or DC.



ECHOPHONE RADIO CO., 201 EAST 26th ST., CHICAGO, ILLINOIS

Q. & A. STUDY GUIDE

C. RADIUS

A-F AMPLIFICATION—III

Transformer-Coupled Voltage Amplifiers

17. Draw a schematic diagram showing the method of transformer coupling between two triode vacuum tubes in an audio-frequency amplifier. (11-98)

18. Why is it preferable to isolate the direct current from the primary winding of an audio transformer working out of a single vacuum tube? (1V-33)

19. Draw a simple diagram of a single-stage triode pre-amplifier employing direct current isolation of the output transformer primary. (1V-34)

20. Why is an audio transformer

with an R-C filter. The capacitance should be such that there is no appreciable voltage drop across its reactance at the lowest frequency to be amplified. The resistance should be as high as possible, limited only by the power-supply voltage available and the desired plate potential.

The high-frequency response is usually peaked because the leakage inductance may resonate with the distributed capacitance. Improved frequency response can be obtained at the expense of overall gain by shunting the secondary with a high resistance. Fig. 3 illustrates the altered frequency re-

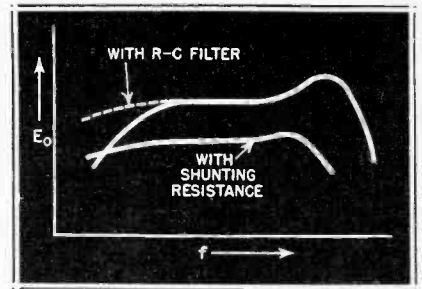

Fig. 3. Frequency response curves for transformer coupling.

from pentodes in resistance-capacitance coupling. As far as voltage amplifiers are concerned, transformers are used: (1) to couple low-impedance line, microphone, and pickup to grid; (2) to couple the output tube to the line; (3) to couple a single plate to push-pull grids.

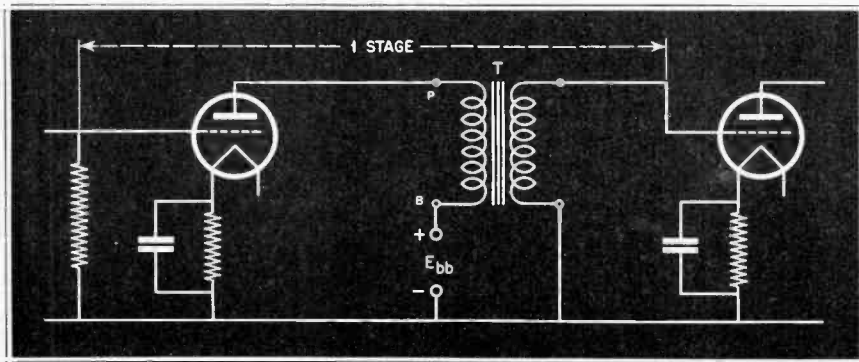

Fig. 1. Transformer-coupled triodes.

seldom employed as the output device to be used in the plate circuit of a tetrode audio-amplifier stage? (V-56)

21. What is the principle advantage of transformer coupling compared to resistance coupling as used in audio-frequency amplifiers? (V-52)

Fig. 1 illustrates how two triodes can be coupled together by an interstage transformer T . Since the primary impedance of the transformer should be several times greater than the plate impedance of the vacuum tube, it is not desirable to couple tetrodes or pentodes in this manner. For good frequency response the turns ratio must be held down to about 3:1. In general pentodes in resistance-capacitance coupling will deliver more gain with better over-all frequency and phase shift characteristics than triodes with transformer coupling.

It is possible to improve the low-frequency response of transformer-coupled amplifiers by providing a separate path for the d.c. plate current. Fig. 2 illustrates how this can be done

sponse curves.

Comparing low- μ triodes in resistance-capacitance coupling with the same tube in transformer coupling, the latter will deliver about 15 db more gain per stage. The amplification expressed in db is given by the formula $20 \log \mu n$, where n is the step-up turns ratio of the transformer. More gain per stage at lower cost can be obtained

Shielding

22. Why are electrostatic shields used between windings in coupling transformers? (1V-31)

A metallic electrostatic shield is usually employed between windings in coupling transformers to prevent electrostatically induced voltages from arising in one winding as a result of a voltage present on the other. The capacity between primary and secondary is reduced with some improvement in the high-frequency response. $T1$ of Fig. 2 indicates an electrostatic shield.

It is also desirable to enclose the transformer in a steel case to provide magnetic shielding which will reduce electromagnetic interference between the transformer and other circuit elements. [Continued on page 34]

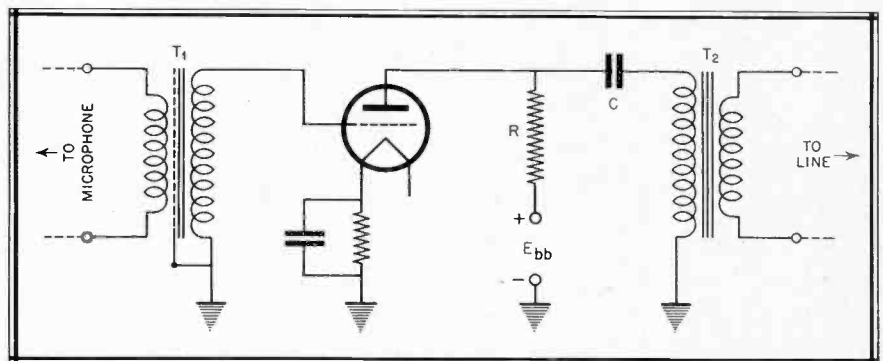
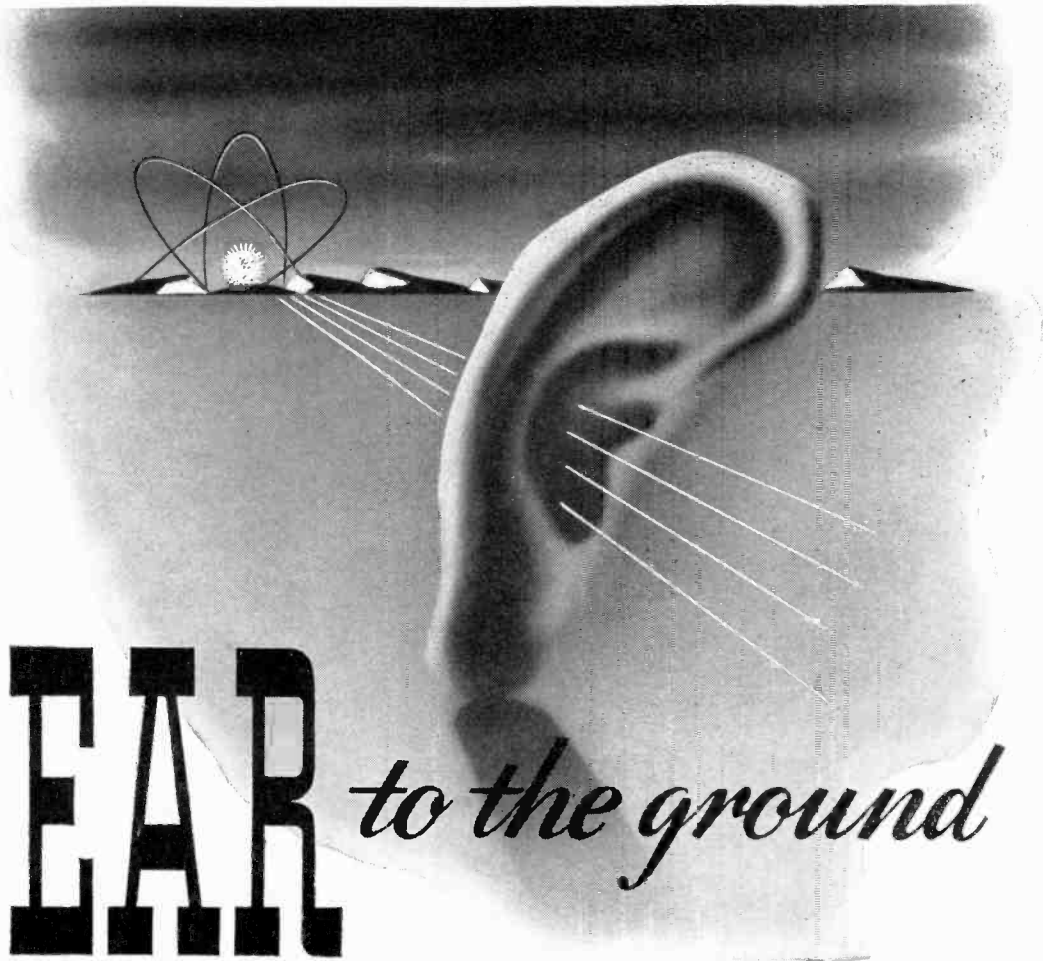

Fig. 2. Pre-amplifier with shunt-feed in the plate circuit.



EAR *to the ground*

Two kinds of news that does not reach the public prints is known to Stancor engineers: new applications of electric energy to war communications, and new ideas for using electronic devices in peace-time production. Both are secrets of victory, not to be told until the war is won.

While devoting major attention to war production, Stancor engineers keep their ear to the ground . . . alert for news of developments that will help you to meet the challenge of a new industrial era.

S T A N C O R

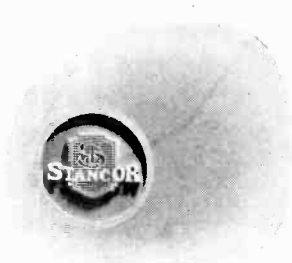

STANDARD TRANSFORMER CORPORATION - 1500 NORTH HALSTED STREET - CHICAGO

Grid Bias Considerations

23. Explain how you would determine the value of the cathode-bias resistance necessary to provide correct grid bias for any particular amplifier. (II-180)

24. Why is correct grid bias important in an audio-frequency amplifier? (V-158)

25. What will be the effect of incorrect grid bias in a Class A audio amplifier? (II-168)

26. What is the purpose of bypass condensers connected across audio-frequency amplifier cathode-bias resistors? (III-160)

Starting with a known plate supply voltage, the value (inclination) of the load line is determined on the basis of a compromise between gain and linearity of the dynamic characteristic. This was pointed out in the discussion of questions 7 (II-129) and 8 (III-167). Once the load line is located, a dynamic characteristic can be drawn and its most linear (straight line) portion marked off. The midpoint of this section will usually determine the bias voltage. See Fig. 4. This voltage E_c divided by the zero-signal plate current I_{b0} will give the value of the bias resistor R_c for triodes. In the case of tetrodes and pentodes it is necessary to use the cathode current which is a sum of the plate current and screen current.

Unless the bias voltage is properly adjusted there may be serious loss in fidelity of reproduction. Frequencies not present in the signal input appear in the output. If the bias voltage is improperly adjusted at too small a value, the zero-signal plate current may be too large with the result that the safe plate dissipation may be exceeded.

Both the direct current component I_{b0} and the alternating component i_p of the plate current flow in the cathode circuit. If $(I_{b0} + i_p)$ were permitted to flow through the cathode-bias resistor, the bias voltage would change and

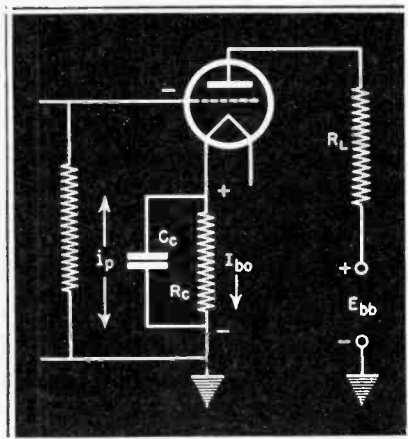
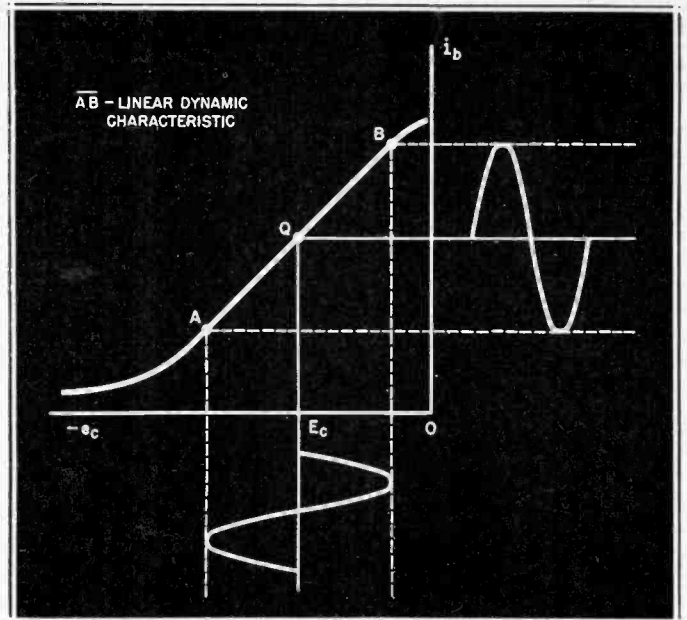

Fig. 5. Triode amplifier showing cathode-resistor method of obtaining grid bias.

Fig. 4. Midpoint of linear portion of curve is used to determine bias.



the magnitude of the change would depend on the amplitude of the signal voltage. Since the cathode resistor is also a part of the input or grid-cathode circuit, the voltage component $i_p R_c$, which is 180 degrees out of phase with the signal, would combine with the latter and cause an effective reduction in the output. In order to prevent both

of these conditions, it is necessary to provide a separate low impedance path for the a.c. component of the plate current. This is done by placing an electrolytic condenser across the cathode resistor. The bypass condenser C_c must have as low a reactance as possible in comparison to the resistor R_c for the frequencies to be amplified.

PRODUCT INSPECTION

[Continued from page 21]

testing the same product simultaneously will indicate differences in operators or in their equipment. Occasionally such variations are cyclic and can be assigned to operator fatigue, power-supply changes or humidity variations. The value of tabulating test results as they are taken can thus be observed in making it possible not only to observe the results of corrections in process but also defects or need of calibration in test equipment or faulty operators at a glance.

Accumulative Distribution Curve

The accumulative frequency distribution curve is another instrument of considerable value. Such a curve is shown in Fig. 6. This curve is often used to determine the life of a product. Average life is usually taken as time required for 50 percent failures. Thus accumulative curves compared at intervals on life tests of samples picked at random from a product indicates increasing or decreasing quality of product. Daily or weekly checks of product are often taken in actual manufacturing operations to determine product quality trends.

It is often necessary in manufactur-

ing operation to establish a rated value of an attribute of a product. This might be the inductance of an r-f coil. Let the result of the measurements on 101 coils be as shown in Fig. 7. We find that the frequency polygon is not symmetrical. The arithmetic mean is 49.2, close but not coincident with the median or modal values. Had the curve been symmetrical all three values would be coincident, and we would be justified in assuming that the departures were due to random or non-assignable causes. For a symmetrical curve the arithmetic mean is the most probable value, but in cases of this sort in which manufacturing irregularities play an important part, the mode would normally be chosen as the most probable value since it occurs most frequently. The more unsymmetrical the curve, the further the mean, modal and median values can be expected to depart from equality. In such cases usually the modal value is used as most probable value, although in certain cases of extreme irregularity the median value might be used. Of course, in cases in which the frequency polygon is very unsymmetrical, manufacturing process might well be investigated to obtain better product uniformity before determination of a most probable value.

$$V = V_0 [H(t) - H(t - \tau)]$$



...AND V_0 IS ANYTHING UPWARDS OF 1 Kv.!

If you're dealing with voltages of a type indicated by the above formula—well, we don't have to tell you that the job of finding suitable components is a tough one, especially if these V 's are working into low Z 's.

Obviously then, we don't pretend that transient voltages of this order haven't been a contributing factor to premature gray hairs for Sprague engineers charged with developing condensers and Koolohm Resistors to meet these difficult specifications. They have—and some problems re-

main to be solved. We're working on them now!

On the other hand, more often than not, eminently suitable components have been forthcoming. A typical illustration is the Sprague Type PX-25 "VITAMIN Q" Paper Capacitor that reads "off scale" on megohm bridges at more than 200,000 megohms.

Let us know just what your problems are, and how the capacitors are to be used. We'll make our recommendations accordingly—telling you frankly and honestly just what you can expect.

SPRAGUE

SPECIALTIES COMPANY

NORTH ADAMS, MASS.

SUB-CONTRACTORS, ATTENTION!

Sprague Specialties Company will be glad to hear from reliable firms having screw machine and metal stamping facilities available for sub-contract work on high-priority orders; also from concerns equipped to make up jigs and fixtures, and having female help available.

F. W. McNAMARA, Purchasing Agent
Telephone: NORTH ADAMS (MASS.) 804

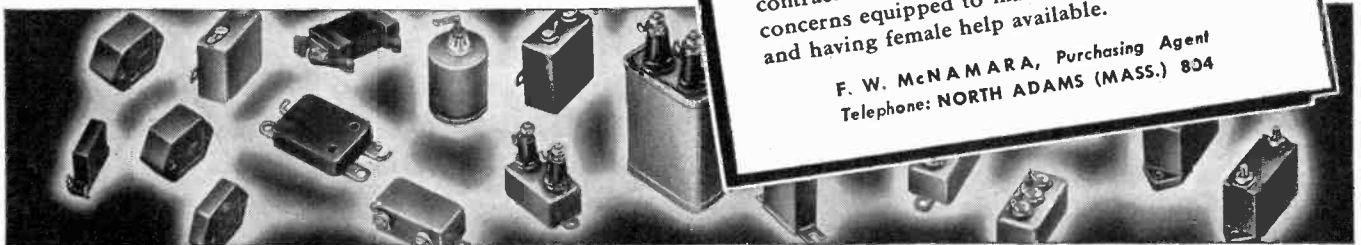

MANUFACTURERS OF A COMPLETE LINE OF RADIO and INDUSTRIAL CAPACITORS and KOOLOHM RESISTORS

CALCULATION OF ODD-SIZED RESISTANCES

DAWKINS ESPY*

★ Frequently it is necessary to have an accurate resistor of a non-standard value. There is a very simple way of obtaining the size of the required parallel resistors which give the desired resistance. The method is best illustrated by an example.

Let 850 ohms be the required resistance, R . Select a resistor, R_1 , of the next larger stock size, 1000 ohms. Measure the exact value of this resistor. It is found to be 1020 ohms. By the following formula determine the size of the resistor, R_2 , which should be put in parallel with the 1020-ohm resistor in order that the result be 850 ohms.

$$R_2 = \frac{R_1 \times R}{R_1 - R} = \frac{1020 \times 850}{1020 - 850} = 5100 \text{ ohms}$$

A standard 5000-ohm resistor is chosen. The first 5000-ohm resistor checked actually measures 4900 ohms. The result of this resistor in parallel with the 1020-ohm resistor is given by

$$R = \frac{R_1 \times R_2}{R_1 + R_2} = \frac{1020 \times 4900}{1020 + 4900} = 844 \text{ ohms}$$

This represents an error of

$$\frac{850 - 844}{850} = \frac{6}{850} = .007 = .7\%$$

Naturally a large error in R_2 causes a smaller error in R , depending on the ratio of R_2 to R . The accompanying graph gives curves of the error in R caused by a given error in R_2 as a function of the ratio R_2/R . In the example just worked out R_2/R is 5100

$\frac{5100}{850} \cong 6$. From the graph, an error of

$$\frac{5100 - 4900}{5100} = \frac{200}{5000} \cong 4\% \text{ in } R_2$$

*Radio Engineer, Columbia University Division of War Research, New London, Connecticut.

ERROR IN R Vs. ERROR IN R_2 FOR RATIOS OF R_2/R

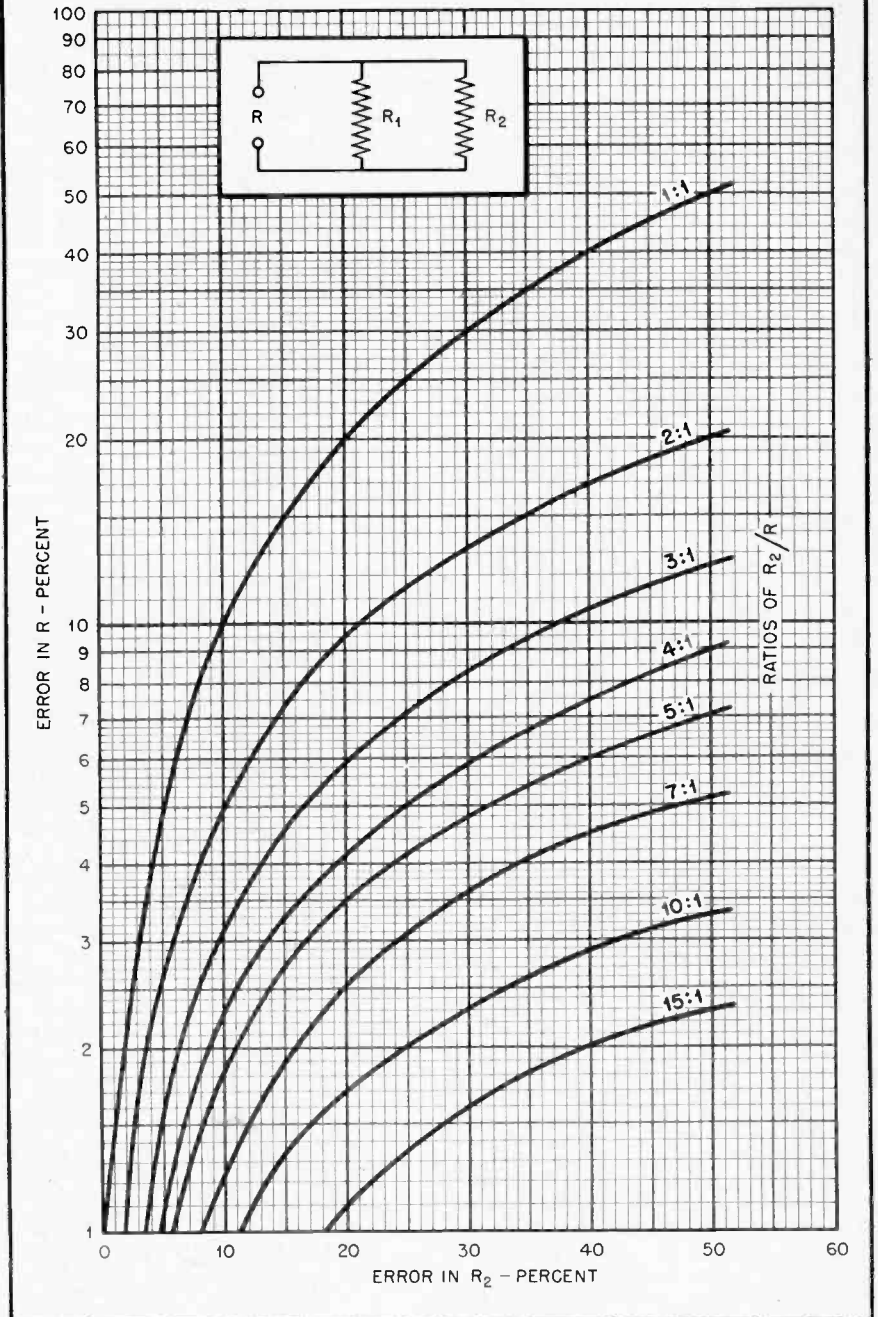

causes an error of less than 1% in R and is therefore negligible. If the nearest resistor for R_2 had been 20% off then there would have been an error of 3% in R .

In general, when the ratio of R_2 to R is 5 to 1 or greater, a standard accuracy of $\pm 10\%$ in R_2 can be tolerated.

Some values of R will not be so easy to achieve with standard resistors because the calculated size of R_2 will fall midway between two stock values, and the error which the use of one of these for R_2 would cause in R is too great. In such cases, it is better to choose one

of the available stock values for R_2 and calculate a new value for R_1 by the formula

$$R_1 = \frac{R_2 \times R}{R_2 - R}$$

This process should be repeated back and forth until the available resistances will allow a combination of R_1 and R_2 that will give a sufficiently accurate value of R .

Thus, although this method does not give a direct and positive solution to the problem in all cases, it always leads in the right direction and in many cases to an immediate answer.

Too Bad He Didn't Have RACONS

When airplanes were pioneered, and later being used in World War I, many pilots lost their lives. They had bad communications methods, couldn't land at night or "blind". In those days RACON was pioneering too—making loudspeakers. RACONS and planes have improved in twenty years. Now-a-days many types of RACON speakers and driving units are "flying high" aboard bombers, blimps, transports and naval vessels. They save lives. They were selected because they are most dependable and efficient.

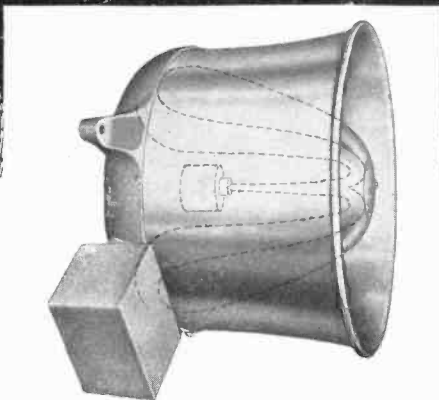
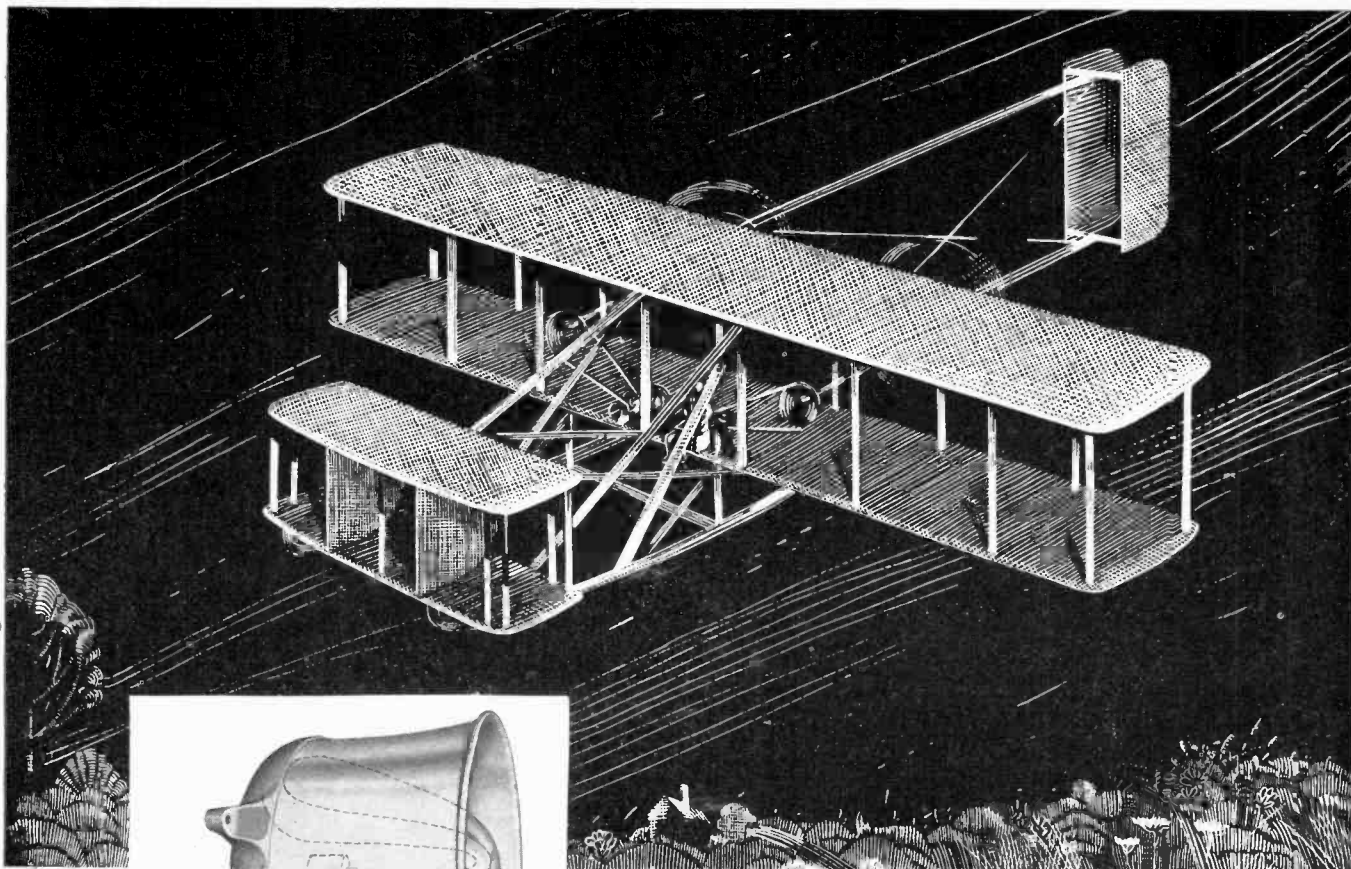

You can obtain RACONS for every conceivable type of public-address or paging installation for industrial war plants, shipyards, training bases, etc. Write for complete details.

RACON ELECTRIC CO., 52 East 19th St., New York, N. Y.

RACON

Shown here is the RACON MARINE HORN Speaker used on many bombers and navy vessels. Approved by the U. S. Coast Guard, formerly the Bur. of Marine Inspection, Dept. of Commerce. Several sizes available. Stormproofed, of the reentrant type, suitable for indoor or outdoor use—may be used as both speaker and microphone.

RADIO BIBLIOGRAPHY

F. X. RETTENMEYER

RCA Victor Division
Radio Corporation of America

11—DIRECTION FINDING, PART 2

- Radio Acoustic Position Finding in Hydrography—J. H. Service—*A.I.E.E.*, Vol. 48, Jan. 1929, p. 198.
- Radio Direction-Finding by Transmission and Reception—R. L. Smith-Rose—*Proceedings IRE*, Vol. 17, March 1929, p. 425.
- The Reversibility of Radio Direction-Finding and Local Error at Rotating-Loop Beacons—R. L. Smith-Rose—*Journal IEE*, Vol. 67, Jan. 1929, p. 149.
- Portable Direction Finder—R. L. Smith-Rose & E. L. Hatcher—*Wireless World*, Vol. 24, June 12, 1929, p. 614.
- Ummittelbare Steuerung der Luft durch Elektrische Schwingungen, *E.T.Z.*, Vol. 50, Oct. 17, 1929, p. 1526.
- Directional Wireless and Marine Navigation—R. L. Smith-Rose—*Elec. Rev.*, London, Vol. 103, July 6, 1928, p. 43.
- Directional Wireless and Marine Navigation; the Rotating Loop Beacon—R. L. Smith-Rose—*Nature*, Vol. 121, May 12, 1928, p. 745.
- Radio Direction Finder—R. L. Smith-Rose—*Wireless World*, Vol. 23, Aug. 29, 1928, p. 246.
- Some Experiments on the Application of the Rotating-Beacon Transmitter to Marine Navigation—R. L. Smith-Rose—*Exp. Wireless*, Vol. 5, Feb. 1928, p. 88.
- A Theoretical Discussion of Various Possible Aerial Arrangements for Rotating-Beacon Transmitters—R. L. Smith-Rose—*Exp. Wireless*, Vol. 5, Feb. 1928, p. 90.
- Vessels Equipped with a Radio Compass, *Radio Service Bulletin*, Jan. 31, 1928, p. 6.
- New System of Radio Direction-Finding, *Telegraph and Teleph. Age*, April 16, 1928, p. 176.
- Opening of Portpatrick (Scotland) Station for Radio-Compass Service, *U. S. Navy Bureau, Radio Service Bull.*, Oct. 31, 1928, p. 17.
- Radio Helps in the Coast Survey—D. L. Parkhurst—*Radio Broadcast*, Vol. 13, Oct. 1928, p. 374.
- Radio-Compass Service Established at Indian Stations, *U. S. Navy Bureau, Radio Service Bull.*, Jan. 31, 1928, p. 7.
- Radio Direction Finding: New system, *Elec. Review*, Lond., Vol. 102, Mar. 16, 1928, p. 468.
- The Rotating Loop Wireless Beacon. The Sixth Special Report of the Radio Research Board—R. L. Smith-Rose & S. R. Chapman—*Nature*, Vol. 121, June 23, 1928, p. 1000.
- Sur un Procédé de Visée Radioélectrique Applicable à la Géodésie—P. Schwartz—*Comptes Rendus*, Vol. 186, Jan. 9, 1928, p. 73.
- Radio Acoustic Position Finding in Hydrography—J. H. Service—*Journal AIEE*, Vol. 47, Sept. 1928, p. 670.
- The Transmission of Sound Through Sea Water—J. H. Service—*Franklin Inst. Jour.*, Vol. 206, Dec. 1928, p. 779.
- Rotating-Loop Radio Transmitters and Their Application to Direction-Finding and Navigation—T. H. Gill & N. F. S. Hecht—*IEE, Wireless Section Proc.*, Vol. 3, June 1928, p. 69.
- Goniometre Enregistreur a frappes, *Revue d'Optique*, Vol. 7, Aug. 1928, p. 314.
- Government Vessels Equipped with Radio Compass, *U. S. Nav. Bureau, Radio Service, Bull.*, Nov. 30, 1928, p. 17.
- Sur une Carte Conforme Utilisable Comme Carte Orthodromique pour les Grands Itinéraires—L. Kahn—*Comptes Rendus*, Vol. 186, Feb. 20, 1928, p. 4961.
- Robbing Fog of Its Perils—N. C. McLoud—*Pop. Sci.*, Vol. 112, Mar. 1928, p. 47.
- New System for Determining Ship's Position, *Radio*, Vol. 10, Nov. 1928, p. 22.
- New Direction Finder Aids Plane's Safety, *Radio World*, Vol. 12, April 14, 1928, p. 12.
- Direction Finding in Navigation, *Nature*, Vol. 121, Feb. 4, 1928, p. 189.
- Über Fehlweisungen der Fjunkpeilung in Abhängigkeit von der Wetterlage—P. Duckert—*Zeit. f. Tech. Physik*, Vol. 9, Dec. 1928, p. 466.
- Über die von Leiterbeholden in der Umgebung eines Funkpeilers Rückgestrahlten Störfelder und die Verfahren zu ihrer Kompensierung—F. A. Fisher—*E. T. Z.*, Vol. 49, July 12, 1928, p. 1043.
- Le Chemin du Rayon Electromagnetique—L. de la Forge—*QST Francais*, Vol. 9, Sept. 1928, p. 9.
- Le Radiocompas et la Navigation Aerienne—P. Franck—*L'Onde Electrique*, Vol. 7, Mar. 1928, p. 109.
- Construction Rapide, sur la carte, des Lignes de Relevements Constants pour Utiliser les Relevements Radiogoniometriques pris du bord—D. Gernez—*Comptes Rendus*, Vol. 186, May 7, 1928, p. 1278.
- Sur un Nouveau Dispositif d'Alignement par Emissions Hertiennes—J. Aircardi—*Comptes Rendus*, Vol. 186, Jan. 30, 1928, p. 305.
- Radio Direction Finding Stations—Canada—*Elec. Review*, Lond., Vol. 102, April 13, 1928, p. 305.
- Compass Service Established for Vessels Approaching Dairen Ko, Kwantung Peninsula, China, *U. S. Nav. Bureau, Radio Service Bull.*, Jan. 31, 1928, p. 8.
- Deviation of Wireless Waves at a Coastal Boundary, *Nature*, Vol. 121, Jan. 7, 1928, p. 35.
- Direction Finding for Planes, *Science & Invention*, Vol. 16, Sept. 1928, p. 431.
- Theory Discussing Various Possible Aerial Arrangements for Rotating Beacon Transmitters—R. L. Smith-Rose—*Journal IEE*, Vol. 66, 1928, p. 270.
- Untersuchung der Leitkabelmethode zur Flugzeugpeilung—H. Fasshender & G. Kurlbaum—*E.V.L.*, 1928.
- True Altitude Meters—L. A. Hyland—*Aviation*, N. Y., Vol. 25, No. 18, 1928, p. 1322.
- The Attenuation of Wireless Waves over Land—Barfield—*Journal IEE*, Feb. 1928.
- Electrical Prospecting—Jakosky—*Proceedings IRE*, Oct. 1928.
- Appareils Indicateurs Donnant par Lecture Directe la Direction d'une Onde—H. Buisignies—*L'Onde Electrique*, Vol. 6, 1927, p. 277.
- The Index of Refraction of Water for Short Continuous Waves—McCarty & Jones—*Physical Review*, Vol. 29, 1927, p. 880.
- Short Wave Wireless Telegraphy—Eckersley—*Journal IEE*, June 1927.
- Cause et Elimination des Erreurs de Nuit en Radiogoniometrie—P. Abadie—*Rev. Scientifique*, Vol. 65, April 9, 1927, p. 210.
- Radio in the Army; With Special Reference to Developments Initiated by the World War—J. A. Ballard—*Radio*, Vol. 9, Jan. 1927, p. 18.
- Big American Ship to be Guided by Radio, *Telegraph and Teleph. Age*, Sept. 1, 1927, p. 386.
- Guiding the Battle Fleet by "Multiplex" Radio Signaling—H. F. Brackel—*Radio News*, Vol. 8, June 1927, p. 1420.
- Appareils Indicateurs Donnant par Lecture Directe la Direction d'une Onde—H. Buisignies—*L'Onde Electrique*, Vol. 6, June 1927, p. 277.
- La Radiophone et les Phenomenes de Propagation—Cartier—*QST Francais*, Vol. 8, Nov. 1927, p. 3.
- Compt Demonstrates Finder—*Radio World*, Vol. 12, Dec. 3, 1927, p. 16.
- Applications of Radio in Air Navigation—J. H. Dellinger—*Mechanical Eng.*, Vol. 49, Jan. 1927, p. 29.
- Direction Finder Fits Loop Receiver, *Radio News*, Vol. 8, Mar. 1927, p. 1102.
- Direction Finders, *Elec. Review*, Lond., Vol. 101, Sept. 2, 1927, p. 388.
- Radio Among the Airways—O. E. Dunlap—*Scientific American*, Vol. 83, Jan. 1927, p. 32.
- Rahmen- und Goniometerpeilanordnungen—A. Esau—*Jahrb. Draht. Telegr. u. Teleph.*, Vol. 29, June 1927, p. 180.
- Die Vergrößerung des Empfangsbereiches bei Doppelrahmen und Doppelcardienanordnungen durch Goniometer—A. Esau—*Jahrb. Draht. Telegr. u. Teleph.*, Vol. 30, Nov. 1927, p. 141.

[Continued on page 40]

HIGH FREQUENCY
VACUUM TUBES

RECTIFIERS

ELECTRODE

PRODUCT

ELECTRODE

ELECTRONIC BRIEFS: Electrostatic Heating

High frequency electrostatic heating is simply the use of electricity to create friction between the molecules of a substance. The generation of heat in non-metallic substances by molecular friction is accomplished by the application of high frequency current, which is converted from a standard power supply. The equipment used employs the basic electronic circuit used in radio transmitters. The output of the power amplifier is connected direct to the material to be heated exactly as the antenna put of a transmitter is sufficient to cause and ground. The energy is connected to distort the molecules within the material to distort and rub against one another very rapidly. The friction thus caused creates heat within the material.

As with all things in the field of electronics, Electrostatic heating is wholly dependent upon the vacuum tubes employed. Eimac tubes are first choice of the world's leading engineers, first in the key sockets of the important new developments in electronics. You'll get long life, dependability and superior performance with Eimac tubes in the key sockets. Today Eimac tubes are proving their superiority in the most gruelling test — WAR.

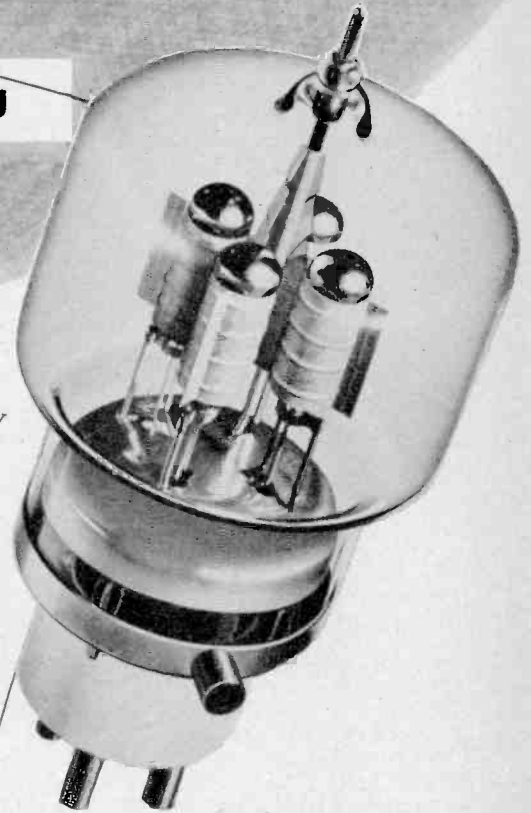

EITEL-McCULLOUGH, INC.

SAN BRUNO, CALIFORNIA

Export Agents: FRAZAR & HANSEN,
301 Clay St., San Francisco, California, U.S.A.

Follow the leaders to

Eimac
REG. U.S. PAT. OFF.
TUBES



Army-Navy "E" flag awarded for high achievement in the production of war material.

- Kurzwellenpeilversuche mit Rahmen und Hilfsantenne auf Grosse Entfernungen Über See—F. A. Fischer—*Jahrb. Draht. Teleg. u. Teleph.*, Vol. 30, Dec. 1927, p. 188.
- Über das Peilen von Drehfeldern mit Rahmen und Hilfsantenne—G. A. Fischer—*Jahrb. Draht. Teleg. u. Teleph.*, Vol. 30, July 1927, p. 23.
- Le Chemin du Rayon Electromagnetique—L. de la Forge—*QST Francais*, Vol. 8, Nov.-Dec. 1927, p. 23.
- Radiogoniometrie Meteorologique—L. de la Forge—*QST Francais*, Vol. 8, Mar. 1927, p. 56.
- La Traversee Aerienne de l'atlantique et la T.S.F.—L. de la Forge—*QST Francais*, Vol. 8, Nov. 1927, p. 63.
- Über Ein Neues Photogoniometer — E. Herlinger—*Zeit f. Kristallographie*, Vol. 66, Dec. 1927, p. 282.
- Direction Finders for Mail Planes—D. R. Lane—*Radio*, Vol. 9, June 1927, p. 8.
- A Visual Radio Compass—A. Maclean—*Radio*, Vol. 9, Aug. 1927, p. 10.
- Les Radiogoniometres et Leurs Applications—G. Malgorn—*Rev. Gen. de l'Electricite*, Vol. 21, Feb. 26, 1927, p. 72D.
- Les Voes sur la Mer. Les Radiophares—H. le Marquand—*QST Francais*, Vol. 8, Feb. 1927, p. 47.
- La Propagation des Ondes Electromagnetiques. Application des Idees Actuelles sur la Propagation a l'Emploi des Ondes Courtes, a la Meterologie, a la Goniometrie—Metz—*Rev. Gen. des Sci.*, Vol. 38, Jan. 15, 1927, p. 5.
- Untersuchungen über die Peilbarkeit kurzer Wellen bei Tag und Nach. Rahmenpeiler mit Hilfsantenne—F. Michelsen—*Jahrb. Draht. Teleg. u. Teleph.*, Vol. 30, Dec. 1927, p. 183.
- Die Ermittlung Wahrer Funkstrahlrichtungen auf Landpeilstationen—E. Nitzsche—*Jahrb. Draht. Tel. u. Tel.*, Vol. 4, Nov. 1927, p. 699.
- Radio Aids to Navigation, *Science*, Vol. 66, July 1, 1927.
- Radio Direction Finding, *Engineering*, Vol. 124, Nov. 4, 1927, p. 587.
- Radio Direction-Finding, *Nature*, Vol. 120, Dec. 3, 1927, p. 818.
- Radio "Eyes" for Ships in Fog, *Popular Science*, Vol. 110, April 1927, p. 53.
- Radio in the Whaling Industry, *Nature*, Vol. 119, Feb. 12, 1927, p. 255.
- Radio Paths for Ocean Liners, *Lit. Digest*, Vol. 94, Sept. 3, 1927, p. 53.
- The Radio Plane Locator: Stations Equipped with Radio Compass Can Find Exact Position of Airplane, *Sci. and Inv.*, Vol. 15, Aug. 1927, p. 1401.
- Radio Aids to Navigation—W. C. Rados—*Radio News*, Vol. 8, May 1927, p. 1316.
- Simplified Direction Finding, *Wireless World*, Vol. 20, April 1, 1927, p. 423.
- A Small Portable Radio Compass, *Pop. Radio*, Vol. 11, Mar. 1927, p. 272.
- Directional Wireless as an Aid to Navigation—R. L. Smith-Rose—*Nature*, Vol. 120, Nov. 26, 1927, p. 774.
- A Sensitive Long-wave Radio Direction Finder—R. L. Smith-Rose—*Jour. Sci. Instruments*, Vol. 4, May 1927, p. 252.
- Directional Properties of Receiving Aerials—R. L. Smith-Rose & R. H. Barfield—*Experimental Wireless*, Vol. 2, June 1925, p. 575.
- Time Signals Safeguard Lives of Those at Sea, *Radio World*, Vol. 11, May 14, 1927, p. 17.
- Vessels Equipped with a Radio Compass, *U. S. Nav. Bureau, Radio Service Bull.*, Dec. 31, 1927, p. 5.
- Vessels Equipped with a Radio Compass, *U. S. Nav. Bureau, Radio Service Bull.*, Oct. 31, 1927, p. 10.
- Vessels Equipped with a Radio Compass, *U. S. Nav. Bureau, Radio Service Bull.*, Sept. 30, 1927, p. 8.
- Vessels Equipped with a Radio Compass, *U. S. Nav. Bureau, Radio Service Bull.*, Feb. 29, 1928, p. 7.
- Vessels Equipped with a Radio Compass, *U. S. Nav. Bureau, Radio Service Bull.*, June 3, 1927, p. 16.
- Vessels Equipped with a Radio Compass, *U. S. Nav. Bureau, Radio Service Bull.*, May 31, 1927, p. 15.
- Radiogoniometrie et Aviation—J. Vivie—*QST Francais*, Vol. 8, May 1927, p. 77.
- Wireless Direction Finding Equipment, *Engineering*, Vol. 123, Feb. 4, 1927, p. 131.
- An Instantaneous Direct Reading Radiogoniometer—R. A. Watt & I. F. Herd—*Experimental Wireless*, Vol. 3, April 1926, p. 239.
- A Wireless Beam for Ships, *Elec. Review*, Vol. 99, Sept. 17, 1926, p. 459.
- The Stationary and Rotating Equisignal Beacon—W. H. Murphy & L. M. Wolfe—*S. A. E. Jour.*, Vol. 19, Sept. 1926, p. 209.
- Progress with Radio Direction Finder, *Pop. Radio*, Vol. 10, Oct. 1926, p. 590.
- The Cause and Elimination of Night Errors in Radio Direction-Finding—R. L. Smith-Rose & R. H. Barfield—*Journal IEE*, Vol. 64, Aug. 1926, p. 831.
- A Direct-Reading Radio Compass—W. A. Steel—*Science Abstracts*, Section B, Vol. 29, Nov. 25, 1926, p. 536.
- A Unicontrol High Frequency Radio Direction Finder, *Journal AIEE*, Vol. 45, Aug. 1926, p. 728.
- A New Radiogoniometer—R. A. Watson & J. F. Herd—*Electrician*, Vol. 97, Dec. 11, 1926, p. 763.
- An Instantaneous Direct Reading Radiogoniometer—R. A. Watson & H. A. Watt—*Journal IEE*, Vol. 64, May 1926, p. 611.
- Note sur le Calcul de la Courbe de Deviation d'un Radiogoniometre de Bord sur les Navires de commerce—M. Gouinet—*L'Onde Electrique*, Vol. 5, Oct. 1925, p. 553.
- Experiments on the Variation of the Angles of Crystals During Growth—E. S. Hedges—*Jour. Chem. Soc.*, Lond., April 1926, p. 791.
- Theory and Action of the Goniometer—A. Herzog—*Science Abstracts*, Section B, Vol. 29, Nov. 25, 1926, p. 536.
- Zur Theories und Wirkungsweise des Goniometers—A. Herzog—*Jahrb. Draht. Teleg. u. Teleph.*, Vol. 27, No. 6, June 1926, p. 172.
- An Instantaneous Direct-Reading Goniometer, *Wireless World*, Vol. 18, Mar. 10, 1926, p. 367.
- Procede et Appareil pour Calculer Rapidement le Point en Radiogoniometrie—C. Ledoux—*Comptes Rendus*, Vol. 183, Nov. 29, 1926, p. 1029.
- A Loop Antenna Direction Finder, *Scientific Amer.*, Vol. 82, Dec. 1926, p. 459.
- Marine Direction Finding—L. Bainbridge-Bell—*Electrician*, Vol. 97, June 1926, p. 125.
- Das Weissenbergsche Rontgengoniometer—J. Bohm—*Zeit f. Physik*, Vol. 39, Oct. 26, 1926, p. 557.
- Radiogoniome tres et radiophares a maximum accentue—L. Bouthillon—*Comptes Rendus*, Vol. 183, Nov. 22, 1926, p. 955.
- The Cause and Elimination of Night Errors in Radio Direction Finding, *Experimental Wireless*, Vol. 3, June 1926, p. 367.
- A Direct Reading Radiogoniometer; the Directional Indication of Wireless Signals by Cathode Rays, *Elec. Review*, Vol. 98, Mar. 26, 1926, p. 515.
- A Unicontrol High-Frequency Radio Direction Finder—F. W. Dummore—*Sci. Papers of the Bureau of Standards*, No. 525, April 16, 1926, p. 25.
- A Suggestion for Experiments on Apparent Radio Direction Variations—L. W. Austin—*Proceedings IRE*, Feb. 1925, p. 3.
- The Marconi Marine Radio Direction Finder—H. de a Donisthorpe—*Proceedings IRE*, Feb. 1925, p. 29.
- A New Directional Receiving System—H. T. Friis—*Proceedings IRE*, Dec. 1925, p. 685.
- Bedendistanzmessung vom luftschiff Mittels Kapazitatamethode — H. Lowy — *Physik. Z.*, Vol. 26, No. 18, 1925, p. 646.
- Apparatus for the Mercantile Marine, *Electrician*, Vol. 45, Nov. 13, 1925, p. 560.
- Automatic Announcer, *Scientific Amer.*, Vol. 138, May 1925, p. 456.
- Beam Direction Finding, *Electrician*, Vol. 95, Sept. 11, 1925, p. 296.
- Sur la selection acoustique en Radiogoniometrie—A. Blondel—*Comptes Rendus*, Vol. 180, Mar. 30, 1925, p. 1000.
- A Goniometer Attachment for the X-ray Spectrometer—H. C. Dews—*Jour. Sci. Instruments*, Vol. 2, Feb. 1925, p. 173.
- Applications de la Radiogoniometrie a la Navigation Aerienne—P. Franck—*Ann. de Postes*, Vol. 14, June 1925, p. 529.
- Die Azimutgleiche und Ihre Verwertung bei der Funkortung—W. Immler—*Jahrb. Draht. Teleg. u. Teleph.*, Vol. 26, 1925, p. 73.
- Nouveaux Radiogoniometres, *Radio Electricite*, Vol. 6, April 10, 1925, p. 129.
- Radio Acoustic Range Finder—C. A. Oldroyd—*Science and Invent.*, Vol. 13, Nov. 1925, p. 614.
- The Direction-Finding Equipment at Niton and Cullercoats—J. H. Reyner—*Journal IEE*, Vol. 27, Nov. 1925, p. 1138.
- Coastal Errors in Direction Finding—R. L. Smith-Rose—*Nature*, Vol. 116, Sept. 19, 1925, p. 426.
- The Effect of Wave Damping in Radio Direction Finding—R. L. Smith-Rose—*Journal IEE*, Vol. 63, Sept. 1925, p. 923.
- Modern Marine Wireless Equipment—R. Twelvetrees—*Electrician*, Vol. 95, July 10, 1925, p. 35.
- Ortsbestimmung durch Funkpeilungen—A. Wedenmeyer—*Jahrb. Draht. Teleg. u. Teleph.*, Vol. 25, 1925, p. 150.
- Directive Radio Telegraphy and Telephony—R. L. Smith-Rose—*Experimental Wireless*, Vol. 1, Jan. 1924, p. 192.
- Some Radio Direction-Finding Observations on Ship and Shore Transmitting Stations

[Continued on page 42]



*W*ith the fate of a quarter-million-dollar airplane...and the precious lives of its crew...so dependent upon the performance of the Communications system, even so seemingly simple a part as a transformer becomes vitally important. **Its value is not measured in dollars and cents, but in the service it performs.**

ROLA, now streamlined for war work, is producing transformers, head sets, choke coils and other communications equipment for Army and Navy aircraft in unprecedented volume—built to standards of perfection never before

attempted “commercially.” This has meant a transition in processes, in equipment, in testing and inspection, but thanks to the experience gained from twenty years of leadership in the radio field, the task has been accomplished, speedily and effectively.



We can do still more:

Today, Rola's greatly expanded facilities are dedicated completely to making materials of war. If transformers... or related electronic items... are a part of the product you make, we're sure it would be to your advantage to discuss your requirements and your problems with us. The Rola Company, Inc., 2530 Superior Avenue, Cleveland, Ohio.

★ **ROLA** ★

MAKERS OF THE FINEST IN SOUND REPRODUCING AND ELECTRONIC EQUIPMENT

RADIO

★ JULY, 1943

41

- tions—R. L. Smith-Rose—*Journal IEE*, Vol. 62, Aug. 1924, p. 701.
- Radio Acoustic Method of Position Finding in Hydrographic Surveys, by N. H. Heck, E. A. Eckhardt, and M. Keiser. U. S. Coast and Geodetic Survey.
- A Directive Type of Radio Beacon and Its Application to Navigation, by F. H. Engel and F. W. Dummore. U. S. Bureau of Standards.
- Wireless Position Finding: Frame Aerial Ship Equipment, *Wireless World*, Vol. 14, Aug. 20, 1924, p. 587.
- Relevements Radiogoniometriques a Changhai—Gherzi—*L'Onde Electrique*, Vol. 3, Nov. 1924, p. 442.
- An Experimental Direction Finding Station—R. Keen—*Wireless World*, Vol. 14, April 2, 1924, p. 9.
- Direction Finding for the Amateur—W. Kelk—*Radio*, Vol. 6, July 1924, p. 31.
- Etude d'un cas Particulier d'effet antenne sur un Cadre de radiogoniometre—M. B. Lyot—*L'Onde Electrique*, Vol. 3, Nov. 1924, p. 530.
- La Radiogoniometrie a Bord des Navires Metalliques—M. Mesny—*Soc. Francaise, Elect. Bull.*, Vol. 4, Aug. 1924, p. 833.
- Radio Fog Signals for the Protection of Navigation. Recent Progress—G. R. Putnam—*Nat. Acad. Sci. Proc.*, Vol. 10, June 1924, p. 211.
- La Radiogoniometrie a Bord des Navires, *Radio Electricite*, Vol. 5, Jan. 10, 1924, p. 15.
- Development of the Billini-Tosi System of Direction-Finding in the British Mercantile Marine—J. A. Slec—*Journal IEE*, Vol. 62, June 1924, p. 543.
- Un Nouveau Radiogoniometre Avec Levee du Doute—E. Bellini—*L'Onde Electrique*, Vol. 3, May 1924, p. 233.
- Direction-Finding Wireless, *Engineering*, Vol. 118, Dec. 26, 1924, p. 866.
- The Marconi Marine Radio Direction Finder—H. de A. Donisthorpe—*I.R.E. Advance Paper*, Oct. 1924.
- Radio Beacons, Non-Directive and Directive—V. W. Dummore—*Radio News*, Vol. 5, May 1924, p. 1554.
- The Dielectric Properties of Water for Continuous Waves—G. C. Southworth—*Phys. Rev.*, Vol. 23, 1924, p. 631.
- Ballonversuche über die Abhängigkeit der Antennkapazität von der Bodendistanz—E. Alberti, W. Klemperer, & H. Lowy—*Physik. Z.*, Vol. 26, No. 18, 1923, p. 644.
- A Study of Polarization Capacity and Resistance at Radio Frequencies—C. B. Jolliffe—*Phys. Rev.*, 1923, Vol. XXII, p. 293.
- A Discussion of the Practical Systems of Direction-Finding by Reception, by R. L. Smith-Rose and R. H. Barfield. Great Britain. Scientific and Industrial Research Department.
- Über die Gründe der Missweisungen beim Richtungsempfang—T. Heiligtag—*Jahrb. Draht. Teleg. u. Teleph.*, Vol. 21, Feb. 1923, p. 77.
- Wireless Direction-Finding in Steel Ships—C. E. Horton—*Journal IEE*, Vol. 61, Sept. 1923, p. 1049.
- Latest Aid to Fog-Bound Ships, *Wireless Rev.*, Vol. 2, Jan. 19, 1924, p. 203.
- Rayonnement d'un Cadre—M. R. Mesny—*L'Onde Electrique*, Vol. 2, Oct. 1923, p. 572.
- Compensation des Cadres Radiogoniometriques—R. Mesny—*Rev. Gen. Elect.*, Vol. 13, May 12, 1923, p. 773.
- Transmission dans l'air par induction (T.P.A.) Systeme Perot-Lyot—A. Perot—*L'Onde Electrique*, Vol. 2, April 1923, p. 193.
- Radio Direction Finding, *Elec. Reviews*, London, Vol. 93, Sept. 14, 1923, p. 387.
- Radio Direction Finding by Reception, *Nature*, Vol. 112, Nov. 10, 1923, p. 690.
- Les Radiogoniometres a Cadres Perpendiculaires, *Radio Electricite*, Vol. 4, July 15, 1923, p. 268.
- Radiotelegrafia Directa con Ondas Cortas, una Nueva Ayuda Para la Navegacion, *Boletin de la Asociacion Argentina de Electro.*, Vol. 9, Sept.-Oct. 1923, p. 161.
- Radio-telegraphic Direction Finding by Reception, *Engineering*, Vol. 116, Sept. 7, 1923, p. 305.
- The Effect of Local Conditions on Radio Direction-Finding Installations—R. L. Smith-Rose—*Journal IEE*, Vol. 61, Jan. 1923, p. 179.
- Directional Observations of Atmospheric—1916-1920—R. A. Watt—*Phil. Mag.*, Vol. 45, May 1923, p. 1010.
- A Radio-Acoustic Method of Locating Positions at Sea—A. B. Wood & H. E. Browne—*Physical Society*, London, Vol. 35, April 1923, p. 183.
- Radio Direction-Finding, *Electrical World*, Vol. 91, Nov. 17, 1922, p. 750.
- Radio Thread Will Guide Future Ships of the Air, *Teleg. and Teleph. Age*, Vol. 40, April 1, 1922, p. 153.
- The Effect of Local Conditions on Radio Direction Finding Installations—R. L. Smith-Rose & R. H. Barfield—*Electrician*, Vol. 89, Dec. 8, 1922, p. 654.
- The Effect of Underground Metal Work on Radio Direction Finders—R. L. Smith-Rose & R. H. Barfield—*Wireless World*, Vol. 11, Nov. 4, 1922, p. 165.
- The Radio Direction Finder and Its Application to Navigation, by F. A. Kolster and F. W. Dummore, U. S. Bureau of Standards Scientific Paper 428, Jan. 16, 1922.
- The Use of Radiogoniometry in Navigation, *Radio-Electricite*, Vol. 3, June 1922, p. 249.
- Controlling Aeroplanes in Fog, *Engineering*, Vol. 133, Feb. 3, 1922, p. 125.
- Directional Transmission of Electromagnetic Waves for Navigational Purposes—J. Erskine-Murray & J. Robinson—*Electrician*, Vol. 88, Mar. 17, 1922, p. 315.
- The Use of Radiogoniometers in Fog—R. Henin—*Radio-Electricite*, Vol. 3, June 1922, p. 250.
- The Indication of the Position of Ships at Sea by Combined Use of Radio and Submarine Sound Waves—P. Marti—*L'Onde Electrique*, Vol. 1, Aug. 1922, p. 444.
- The Radiogoniometer—Mesny—*Ann. de Postes, T. and T.*, Vol. 11, Nov.-Dec. 1922, p. 1240.
- The Direction and Intensity of Waves from European Stations—G. W. Pickard—*Proceedings IRE*, Vol. 10, June 1922, p. 161.
- The Effect of the Heaviside Layer on the Apparent Direction of Electromagnetic Waves, *Radio Review*, Vol. II, No. 5, May 1921, p. 231.
- The Heart-Shaped Polar Diagram and Its Behavior Under Night Variations—G. M. Wright & S. B. Smith—*Radio Review*, Vol. II, No. 8, Aug. 1921, p. 394.
- Piloting Vessels by Electrically Energized Cables—A. Crossley—*Proceedings IRE*, Aug. 1921, p. 273.
- The Use of Radiogoniometers in Navigation—J. Bion—*Radio-Electricite*, Vol. 2, Nov. 1921, p. 218.
- The Solution of the Problem of Guiding Aerial Craft Invisibly Through Fog or Night—W. Loth—*Comptes Rendus*, Vol. 173, Dec. 5, 1921, p. 1152.
- An Electrical Signaling Method for Guiding Aerial and Marine Craft—R. H. Marriott—*Proceedings IRE*, Oct. 1920, p. 345.
- Theory and Practical Attainments in the Design and Use of Radio Direction Finding Apparatus Using Closed Coil Antennas—A. S. Blatterman—*Franklin Inst. Journal*, Vol. 190, Sept. 1920, p. 421.
- The Diffraction of the Field by a Cylinder and Its Effect on Directive Reception on Board a Ship—R. Mesny—*Radio Review*, Vol. 1, Sept. 1920, p. 591.

WIDE-BAND AMPLIFIER DESIGN

[Continued from page 23]

high- and low-frequency compensating circuits to obtain a linear response with a reasonable amount of gain.

In the case of high-frequency compensation we use a peaking circuit which, in its simplest form, is an inductance in series with R_L , and the value so chosen as to present a constant impedance to the output of the tube over a wide range of frequencies. The upper frequency limit is determined by R_L , the shunt reactance, and the inductance of the peaking coil.

In the case of low-frequency compensation we utilize a plate-circuit filter which has the same time constant as the grid or cathode circuit, which equalizes the time delay, and a series decoupling resistor which maintains the low-frequency response within reason. In Fig. 3 is shown a single compensated stage.

The succeeding article will cover the theory, mathematics, and practical application of compensated wide-band amplifiers.

for **Permanent resistance**
today and tomorrow...

OHMITE
Resistance Units



Many factors contribute to the permanent performance of Ohmite Units—factors of design and construction that enable them to meet every condition of service . . . to withstand shock, vibration, heat and humidity . . . and keep going. These characteristics make Ohmite Rheostats, Resistors, Chokes and Tap Switches especially well fit for today's critical wartime needs.

What's more . . . Ohmite leadership in developing an extensive range of types and sizes has made it possible to serve innumerable applications. All this, of course, makes them readily applicable for the new peacetime products of tomorrow. Ohmite Engineers are glad to assist on any problem for today . . . or tomorrow. Write on company letterhead for helpful Industrial Catalog and Engineering Manual No. 40.

Send for Handy Ohmite Ohm's Law Calculator. *Thousands of these Ohmite Calculators are in practical use today. Figures ohms, watts, volts, amperes—quickly, easily. Solves any Ohm's Law problem with one setting of the slide. All values are direct reading. Send only 10c in coin to cover handling and mailing. (Also available in quantities.)*



OHMITE MANUFACTURING COMPANY
 4866 FLOURNOY STREET, CHICAGO, U. S. A.

RADIO

* JULY, 1943

[Continued from page 14]

entirely under ordinary circumstances.

In addition, the neutralizer also gets rid of static that is on the same frequency as the incoming signal. This is done by means of a circuit which uses the static voltage to build up an opposing voltage of equal magnitude.

In one test, a 25,000-volt spark from the ignition system of an engine was projected directly into a receiving antenna. The neutralizer eliminated this so effectively that it was possible to tune in a short-wave radio program from Europe.

Despite its great effectiveness, the device is simple, compact, and rugged. It can readily be built into any radio receiver.

★

DEFLECTION MODULATION

AN ENTIRELY NEW type of tube for the generation of sweep voltages directly from a signal, is the *Signal Converter*, described in an article by that name by P. Nagy and M. J. Goddard in the *Wireless Engineer* for June 1943. In the conventional sweep circuit, a condenser is charged through a constant-current device, such as a pentode and then discharged by means of a gaseous tube. As a rule, two tubes are required, conducting current in opposite directions from the standpoint of the condenser. The new tube is capable of combining both actions within itself and to provide more accurate synchronization besides.

The signal converter tube is designed to convert a signal into its own time base. It is essentially a small cathode-

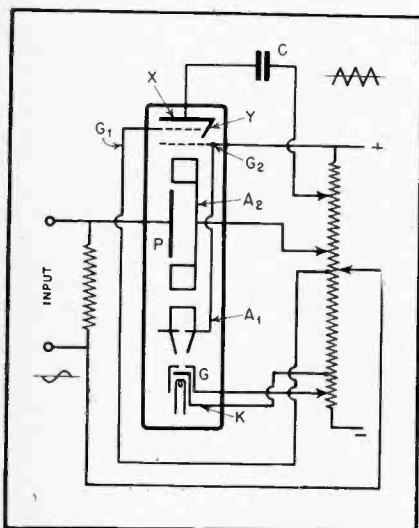

Fig. 1. Signal converter tube.

ray tube with one deflecting plate, P , (See Fig. 1) which can move the electron beam across the target X - Y . The beam is focussed in one dimension only, becoming a slit which can have various lengths, thus making different beam currents possible. The target is divided into two parts, X and Y ; both of them being arranged so as to provide secondary emission. However, the part X is protected by the suppressor grid $G1$ which repels all secondary electrons back to the target. Consequently, so long as the beam is directed to the part X , the current is in the usual direction of a tube and charges the condenser so as to make the target negative. When the beam remains sufficiently long on part X of the target, the condenser voltage rises and the target becomes more negative until a point of equilibrium is reached.

When the beam is shifted by means of a deflection potential on the plate P , so that the beam falls on part Y of the target, the suppressor is not effective. Due to secondary emission, more electrons will leave the target than arrive, thereby discharging the condenser or charging it positive. The secondary electrons are attracted by the screen grid $G2$. When the spot remains on part Y long enough, the target voltage becomes more positive until it nearly reaches the potential of the screen grid. A point of equilibrium is then reached where the electrons arriving are as numerous as the electrons leaving the target.

It is thus seen that by shifting the beam at the proper moment, the tube can be made to charge and discharge the condenser C alternately, forming the required saw-tooth wave. The discharge current is much greater than the charge current, because the ratio of secondary to primary electrons can be made high. This insures a rapid fly-back period.

The signal to be observed on the cathode-ray screen is applied to the deflecting plates, P , of the signal converter and made to move the beam between X and Y . Thus the necessary synchronization is automatically obtained.

The form of signal converter described above is but one of many possibilities. The authors also show a circuit where the signal converter produces one sweep for every three or four cycles of the signal. This is done by feeding some of the voltage from the target back to a deflecting plate.

★

D-C GALVANOMETER IN A-C BRIDGE

HOW ONE MAY USE a d.c. galvanometer as a null detector in an a.c. impedance bridge is described in an article entitled *Impedance Bridge with D.c. Gal-*

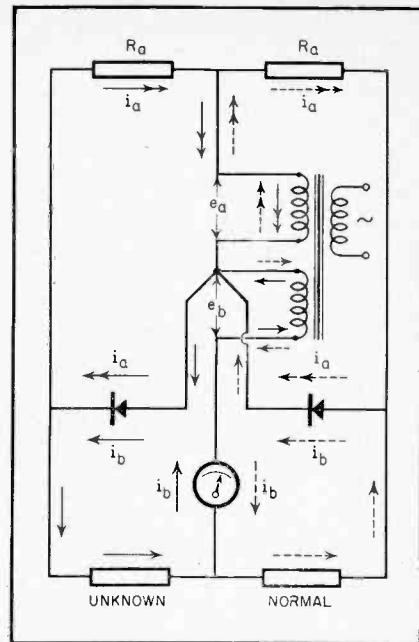

Fig. 2. Impedance bridge circuit.

vanometer, by E. Mittelman, appearing in *Instruments* for April 1943.

The circuit is shown in Fig. 2; the bridge proper consists of the two impedances marked *normal* and *unknown* and the two selenium or copper-oxide rectifiers. The power to the bridge is the voltage e_b derived from the secondary of a power transformer in series with the d.c. galvanometer. The currents due to this voltage e_b are marked i_b , and arrows in the diagram show how the current passing through the galvanometer during the first half cycle is that passing through one rectifier and the standard impedance, and that during the next half cycle the current passing through the unknown impedance and the other rectifier. When these two currents are equal, the galvanometer will not deviate from its normal position. When the two impedances are not equal, the current in one direction is greater than that in the other direction and the needle will deviate. The detector will indicate just as in a Wheatstone bridge whether the unknown is too high or too low.

In order to get the greatest sensitivity, it is desirable to operate the rectifiers at the point of greatest slope of their characteristics. For this purpose an auxiliary voltage, e_a , is required.

"This auxiliary voltage must not affect the current through the indicating instrument. The auxiliary voltage e_a is obtained from a second winding of the same number of turns as the other secondary but in opposite direction. When the windings e_b and e_a are carefully balanced (equal and opposite in phase), no potential difference will exist between the outer terminals of the two

[Continued on page 50]

Like a phone in your car?



After the war...



... the two-way radiotelephone will be employed by American industry as a convenience, a safeguard and a business requirement. This modern method of communication has many proven applications in the following fields:

Aviation	Railroading
Marine	Public Utilities
Police Patrol	Fire Fighting
Trucking	Engineering
	Mining

If you think you may be able to employ two-way radiotelephone communication in your field, we would be pleased to discuss your problem without cost or obligation. We have nothing to sell since our entire output has been placed at the disposal of the United Nations all over the world!

Requests for information and literature from responsible parties may be addressed to Jefferson-Travis Radio Manufacturing Corporation, 380 Second Avenue, New York.

THE development and production of two-way radiotelephone equipment for military purposes is convincing evidence that you will employ this unique form of communication in many undreamed-of ways after the war. Long before Pearl Harbor, Jefferson-Travis was making superior two-way radiotelephone equipment for ship-to-shore and plane-to-ground communication. With Victory, it will again be used for these and a great many other peacetime purposes by all nations in Tomorrow's World!



JEFFERSON-TRAVIS

RADIOTELEPHONE EQUIPMENT

NEW YORK • WASHINGTON • BOSTON

THIS MONTH

BENDIX STREAMLINED

The streamlining of Bendix Aviation, Ltd., of North Hollywood, Calif., has been announced by Palmer Nicholls, president, who declared the action was taken in the interests of greater war-time efficiency.

Named responsible for management of Bendix operations was Mel Burns, vice-president, who has been associated with Nicholls in various enterprises over the past 14 years.

Bert Hemingway moves up from manager of radio sales to staff executive along with J. R. Haney, who has been acting in such a capacity.

Sales of both radio-electrical equipment and hydraulics are consolidated under R. C. Fuller, who previously had been in charge of the hydraulic line.

Nicholls recently was elevated from vice-president to president of the company and made a member of the administration committee of the parent concern, Bendix Aviation Corporation.

★ PIONEER CAMPAIGN TO REDUCE ABSENTEEISM

In a public rally held at the Chicago plant of Pioneer Gen-E-Motor the 1500 employees pledged their allegiance to a "Stay In The Safety Zone" cam-

paign to stop absenteeism and also reduce accidents.

The "Stay In The Safety Zone" campaign is planned to reduce absenteeism over fifty percent within the next 12 months and to inspire other industries to adopt this, or a similar plan, with a like goal in view.

Statistics revealed at the Pioneer employees rally show that during the year of 1942 the man-day loss because of illness and accidents apart from the workers occupation reached the astounding total of two billion, two hundred and fifty million (2,250,000,000) man-days.

The "Safety Zone" campaign was presented by David Bright, president of Pioneer Gen-E-Motor. Invited guests included Governor Dwight H. Green of Illinois; Colonel Paul G. Armstrong, Illinois Selective Service Director; Nathaniel Leverone, State Salvage Director; Major General Henry S. Aurand, Commanding Officer of the 6th Service Command; Admiral John Downes, Commandant of the 9th Naval District; Wilfred Hansford Gallienne, British Consul in Chicago; Dr. Philip L. Seman, Chairman, Chicago Recreation Commission; State Legion Comdr. Francis Phelan, and many high ranking Army and Navy officials.



Admiral Charlton and David Bright.

The Pioneer Gen-E-Motor "Safe Zone" committee includes T. S. Morrison, chairman; Pauline Cooper, R.N., secretary, and Al Bartz, James Carr, E. J. Decker, Ephraim Kaplan, Mary Kovac, Ina La Miaux, Arthur Manson, Chester Neuman, Rose Piekietko, Francis Schwartz, Marie Surman, Elmer Thornton, Morris Wadro, and John Zienty.

★ FCC MANPOWER SURVEY

As part of its program to ease the present shortage of skilled technicians in the communications industry, the Federal Communications Commission has mailed to the War Manpower Commission and interested groups in the industry the first series of names of first and second-class radio-telephone licensees who have reported themselves available for immediate employment in essential communications jobs. The list was prepared from responses to the Commission's postcard survey of a sample of 1000 of the nation's 20,000 licensed radiotelephone operators in these classifications.

To date over 550 holders of first- and second-class radiotelephone licenses have answered the FCC's query. Information obtained from the questionnaire related to the licensee's present employment, his draft status, whether or not he was using his license in his present job, and his availability for either full or part-time employment in the communications field.

The Commission, of course, does not

[Continued on page 60]



THE GIBSON GIRL—so named because of its shape—is a virtually foolproof, precision emergency radio transmitter which automatically sends out SOS signals. Developed by Bendix, it is used by army flying crews on ocean-going missions.

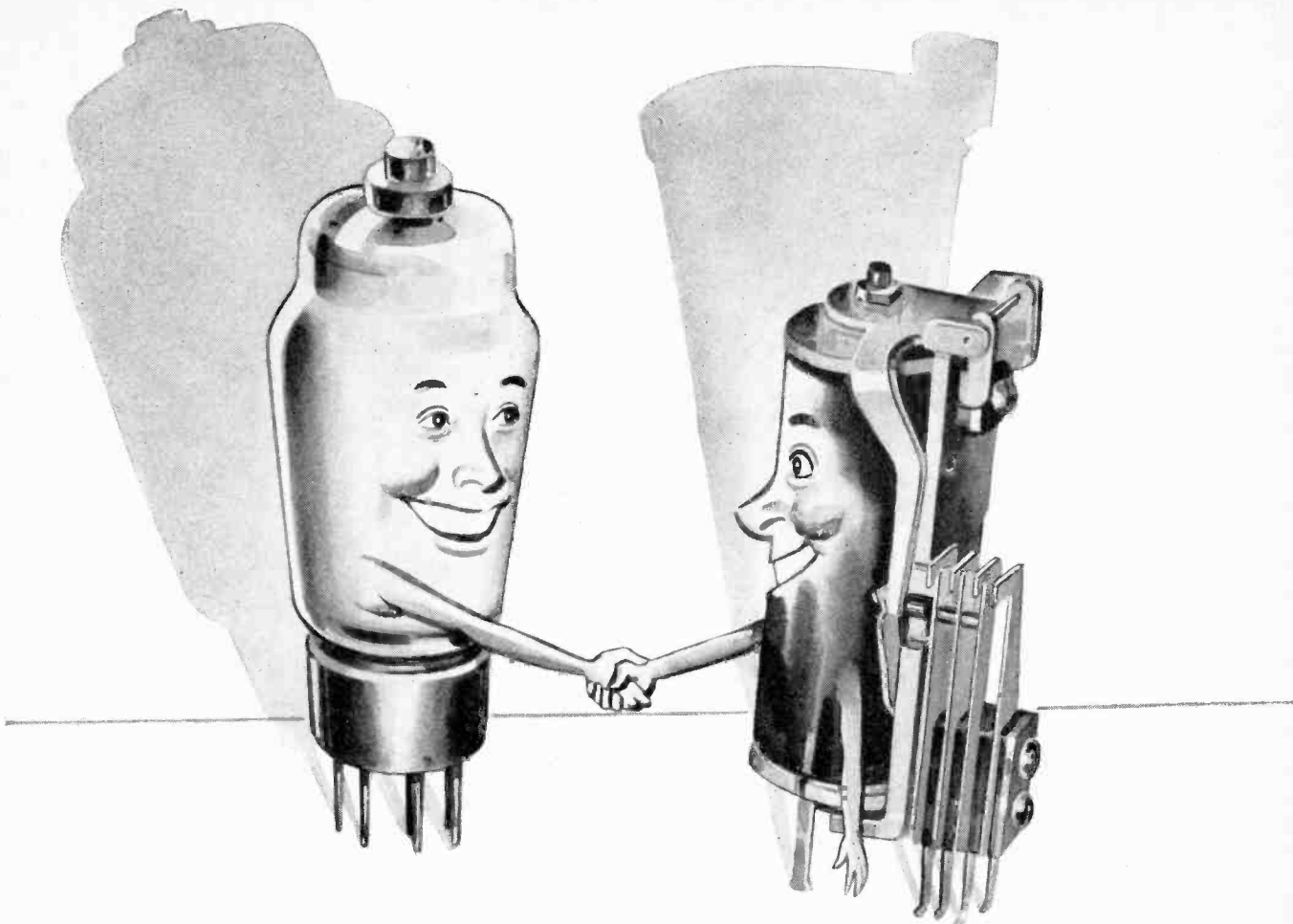

LET'S POOL OUR KNOWLEDGE

WORKING with electronic engineers in scores of industries has taught us a lot about electronic science—what it is doing to increase the effectiveness of our tools of war—how it is speeding up war production—about the miracles it promises for our postwar world.

We have learned, for example, how much this “new-old” science depends on the right electrical controls—the important part that relays, stepping switches, solenoids and other control devices play in putting electrons to work.

And that's *our* strong point. We know electrical control because that has been our sole business for over fifty years. So why not pool our resources? Let's apply *our* experience in electrical control to *your* problems in making electronic developments do a better job at lower cost.

First step in this direction is to make sure you have the Automatic Electric catalog of control apparatus.

Then, if you need help on any specific electronic problem, call in our field engineer. Behind him are Automatic Electric's fifty years of experience in control engineering. His recommendations may save you time and money.



AUTOMATIC ELECTRIC SALES CORPORATION
 1033 W. VAN BUREN ST. CHICAGO
 In Canada: Canadian Telephones & Supplies Limited, Toronto

Relays

AND OTHER CONTROL DEVICES

by AUTOMATIC ELECTRIC

MUSCLES FOR  THE MIRACLES OF ELECTRONICS

RADIO ★ JULY, 1943

NEW PRODUCTS

OHMITE SLIDE-WIRE RHEOSTAT

Designed especially for low resistance low wattage applications, this Ohmite rheostat-potentiometer has found several applications in the instrument field. A length of resistance wire is stretched tightly around the outside of a cylindrical core which is bonded to a ceramic base. The wire is firmly anchored to two terminals. Contact to the wire is made by a phosphor-bronze spring arm which is connected to a third terminal. The provision of three terminals allows the unit to be used as a potentiometer or voltage divider. The maximum resistance which can be supplied on this unit is approximately 1 ohm while the minimum total resistance can be made approximately

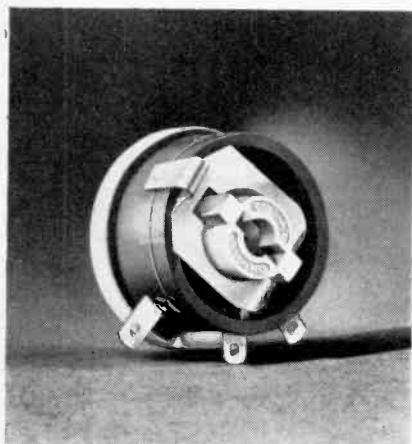

0.1 ohm. Since the contact arm travels along the wire from end to end, the resistance variation is stepless. Shafts for knob control or for screw driver control can be supplied. These units are made to order to suit the particular application by the Ohmite Manufacturing Company, 4835 West Flournoy Street, Chicago 44, Illinois.

★

AIRCRAFT RADIO RELAY

A general purpose radio relay, the series 345 designed by Guardian Electric for use in aircraft, is available in contact combinations from single pole, single throw, up to three pole double throw. This feature combined with the large coil winding area makes the series 345 a highly efficient relay in compact space. Dimensions are $2\frac{3}{8}$ " x $2\frac{1}{32}$ " x $1\frac{11}{16}$ ". Contacts, rated 12 amps. at 24 volts d.c., are arranged to

resist over 10 G. acceleration and vibration in all positions.

Coil resistances range from .01 ohm to 15,000 ohms in a varnish impregnated and baked coil. Standard volt-

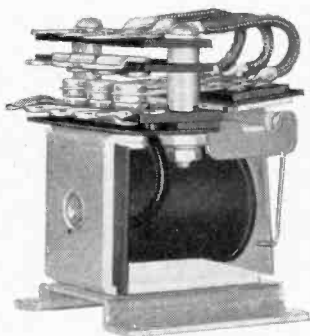

ages are 16 to 32, however, other values are available. Bearing is pin type, of hardened, non-magnetic, stainless steel and staked to the armature hinge. Armature return spring is torsion type to maintain an even spring pressure.

Relay parts are plated to resist deterioration under conditions of high humidity. Circular 345 with full details, is available from the manufacturer, Guardian Electric, Dept. 345, 1605 W. Walnut Street, Chicago, Ill.

★

SLOTTED-TERMINAL RESISTORS

These slotted-terminal, high-accuracy In-Res-Co resistors were expressly designed to meet the complex and intricate integrating requirements of precision apparatus and equipment.

Where available area is at a minimum, and the weight factor vitally important, Type P-2 and P-4 wire-wound resistors have the added advantages of being minute in size and inconsequential in weight.

Type P-2 has one-half watt rating with a maximum resistance of 500,000 ohms. It measures only $\frac{9}{16}$ " long

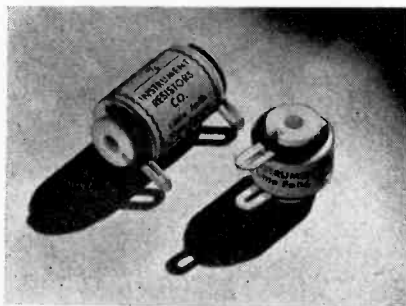

with a diameter of $\frac{9}{16}$ ". Type P-4, with a one-watt rating, has a maximum resistance of one megohm. Measurements are 1" long and $\frac{9}{16}$ " in diameter.

Terminals on both types are .025 hot tinned copper, slotted to take stranded or solid wire. Mounting is permitted by No. 6 holes through centers of bobbins.

Products of Instrument Resistors Company, Little Falls, New Jersey.

★

NEW AIR DRYING DEVICE

Here is a simple, quick, easily operated way to obtain dry air. It consists of a hand-operated air pump combined with a chemical drying tube. The drying agent is in a transparent container mounted concentric with the pump barrel. The drying agent contains a color index which is blue when the chemical is active, and turns pink when it becomes saturated. The drying chemical



may be replaced when saturated, or may be removed from the tube and re-activated by heating in an open pan.

This device, first developed for use with coaxial cables in radio transmitting stations, is equally applicable to many other uses. The manufacturer is Victor J. Andrew Co., 363 E. 75th St., Chicago, Ill.

★

PLANT-BROADCASTING UNIT

A simplified low-cost unit for voice-paging and music broadcasting in war production plants is announced by the

[Continued on page 56]



**POWER LINES
DOWN!**

IRC RESISTORS Send the Signal

When trouble develops on a high voltage power line, time is of greatest essence. For in our fast-moving electro-mechanical age, minutes quickly translate themselves into countless man-hours. Communications go "dead" . . . lights snuff out . . . vital production grinds to a sudden halt . . . and it's "taps" for a busy world.

Another IRC Contribution

Until comparatively few years ago, when power transmission interruptions occurred, it often required hours to locate the trouble. Today, thanks in part to the contribution of IRC research engineers, the point of disruption in any electrical circuit—whether power or communications—can readily be spotted in a matter of moments.

Specially designed, IRC high voltage power resistors dependably dissipate the heavy loads and deliver the voltage required to operate trouble-signalling mechanisms. On receipt of signal, other instruments in which resistors play an important role accurately locate the point of disturbance within a few feet.

Here at IRC we welcome—and usually solve—unusual problems in the field of resistance devices.

And because IRC makes more types of resistance units, in more shapes, for more applications than any other manufacturer in the world, many leading engineers make it a point to seek our unbiased counsel. There is no obligation, of course.



INTERNATIONAL RESISTANCE COMPANY

411 N. BROAD STREET • PHILADELPHIA

RADIO

* JULY, 1943

TECHNICANA

[Continued from page 41]

windings. Hence, no additional current will flow through the galvanometer. In other words, the galvanometer remains unaffected by the presence of the voltage e_a as far as the balance is concerned. The additional voltage e_a will drive a current i_a through the rectifier the magnitude of which is determined by the values of the auxiliary resistances, R_a . The double arrows in full and dashed lines corre-

spond to a gain in the first and second half-period, respectively. The value of i_a is suitably chosen to correspond to the maximum slope of the rectifier."

★

SOLDERING IRON-POT

THE USE OF STANDARD soldering irons especially adapted as small soldering pots has facilitated the production of small instrument-type motors in one of General Electric's Works. Because they present only a very small area for oxidation, the irons are saving materials.

The improvised solder pot, which

was developed by R. H. Bainbridge, a foreman, is easily built. A standard medium-size soldering iron tip is faced off flat and drilled with a 1/4-inch diameter hole, 3/4-inch deep. This tip is reassembled to the soldering iron. The iron is then mounted vertically in a hole in the bench so that the tip projects about two inches above the top. The mounting is made permanent by the use of a standard pipe nipple locked from the top with an electrician's conduit bushing and from the bottom with an electrician's lock nut. The iron is held in the bushing by three setscrews which clamp the body of the iron proper.

Only the insulation contained in the iron itself is required for efficient operation. A perforated sheet-metal

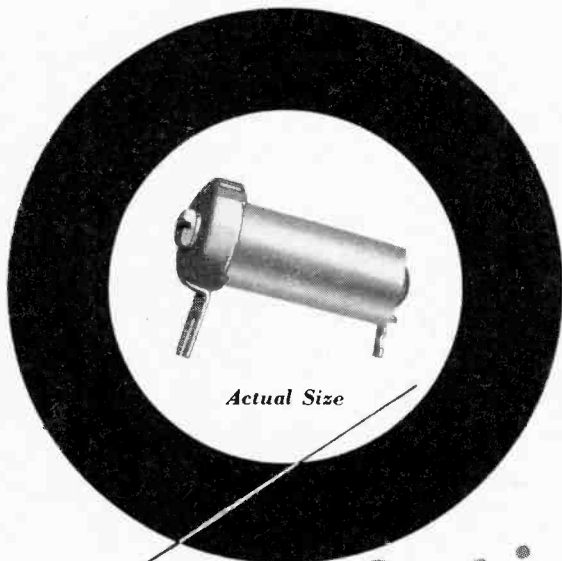

Actual Size

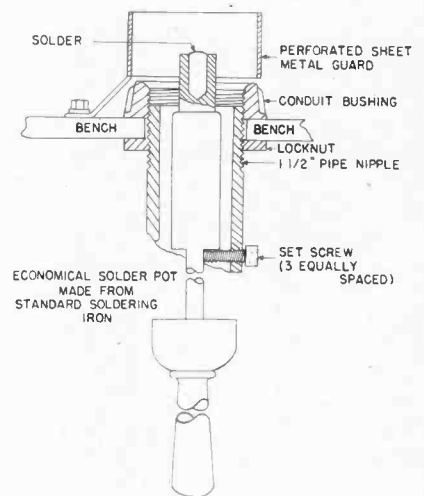

ECONOMICAL SOLDER POT MADE FROM STANDARD SOLDERING IRON

guard which encircles the exposed tip permits free circulation of air about the tip, eliminating the possibility of overheating the solder, and at the same time assures complete operational safety by guarding against accidental contact with the heated tip.

★

"OPTI-ONICS"

"OUT OF THE GREATLY accelerated technical and research developments of this war period is coming a new science," said Mr. J. H. McNabb, President of Bell & Howell Company, in a recent interview. "This science of Opti-onics is not optics; it isn't electronics, but it is a combination of both, combined with precision mechanical design. Actually, in the physical world, we reach a point where ultra-high frequency radio waves take on many of the characteristics of light rays. We have learned that optical science can bring much to the development of electronics. Likewise, electronics enhances and supplements the work of optical science.

"It would be inaccurate to describe the work this company is doing in this

[Continued on page 53]

IMPROVED... Low Loss Align-Aire Trimmer!

CAPACITY RANGE: 2.5 TO 16 MMF

Meissner improved, low loss, low drift, Align-Aire Trimmers are ideally suited for operation under high humidity...and in critical R.F. circuits...3200 degrees rotation...less than 1 mmf per 180 degrees!

Dissipation factor at 1000 kc: .064%...Q-1570...dissipation factor at 40 mc: 3.7%...insulation resistance: greater than 1500 megohms...breakdown over 350 volts, 60 cycles...700 volt AC breakdown available on special order. Meissner Align-Aires are encased in the newly developed Type 16444 Bakelite...compact in size: 7/16" in diameter by 1 1/8" long. Samples sent upon request.



"PRECISION-BUILT ELECTRONIC PRODUCTS"





PARTS

by Centralab

Steatite Insulators • Ceramic Trimmers
High Frequency Circuit Switches
Sound Projection Controls
Wire Wound Controls
Ceramic Capacitors

Centralab

Division of GLOBE-UNION INC., Milwaukee

RADIO

Group Subscribers Can Save ^{UP} _{TO} 50%

In response to a great demand for a reduced
Group Subscription Rate*



★ Many "RADIO" Magazine subscribers tell us "Your magazine is so good that my associates monopolize my copy every month. Why don't you offer these men a special inducement so each can obtain his own personal copy every month."

Regular RADIO Subscription rates are \$3.00—1 year . . . \$5.00—2 years in U.S.A. \$4.00 per year in Foreign countries.

★ Men in the Armed Service may still subscribe for 1 year at \$1.50.

*Special reduced group rates apply to U.S.A. Subscription orders only.

TEAR OUT—MAIL TODAY

RADIO MAGAZINES, INC.
132 W. 43rd St., New York, 18, N. Y.

Kindly enter the following subscriptions, for which remittance is attached.

- One 1-year subscription . . . \$3.00
- Two 1-year subscriptions . . . \$5.00
- Three 1-year subscriptions . . . \$6.00
- Four 1-year subscriptions . . . \$7.00
- Five 1-year subscriptions . . . \$8.00

Groups of 6 or more subscriptions will be accepted at the rate of \$1.50 each.

PLEASE PRINT

Name	Company
Address	
Position	Company
Name	Company
Address	
Position	Company
Name	Company
Address	
Position	Company
Name	Company
Address	
Position	Company

NOTE: If you do not wish to tear out this order blank, print or type the information on a single sheet of paper and send with remittance.

overlapping region as either electronics or optics. Hence, the new term, Opti-onics.

Mr. McNabb predicted unique but highly practical devices for entertainment and service for the postwar world to arise from the field of Opti-onics. "Today, Opti-onics is a weapon but tomorrow it will be a servant which will work, protect, educate, and entertain," said Mr. McNabb. "When the day comes on which we can make known and apply to general use the things we are now doing, in making equipment for our armed forces, we can make products which will open new markets and afford new fields of employment. I do not wish to seem over-enthusiastic," said the executive, "but some of the things we have learned in Opti-onics are almost startling in their implications and in further development made possible."

RADIO-ELECTRONIC COMPONENTS

[Continued from page 28]

dielectric there is no possibility of any air space or wax filled pockets between the two. For this reason the capacity is inherently stable. A change of less than 0.25% will be found after cycling for 200 hours between the temperatures of 250° F. and -40° F.

Variable Air Condensers are employed to adjust the resonant frequency of tuned circuits when a continuously variable capacity is required. They usually consist of two interleaving sets of metal plates, one capable of being rotated (rotor) and the other being fixed (stator). The principal dielectric is air. The supporting frame is usually connected to the rotor although in some instances it is insulated from both sets of plates. Several plate shapes are available, such as straight line capacity, straight line wavelength, straight line frequency and modifications thereof.

The equivalent circuit of a variable air condenser is shown in Fig. 11, where R_e represents the losses in the metallic portion of the condenser; G represents the solid dielectric losses; and L represents the magnetic flux set up by the conduction currents in the metal portion. The static capacity of the condenser is represented by C . R , G and L remain approximately constant with dial setting. L remains constant with frequency, while G increases approximately as the square root of the frequency. Obviously R , G and L should be minimized. Brass wipers are usually provided on the shaft for each section of the rotor to minimize the variation of metallic resistance through the bearing surfaces. This also reduces the residual inductance by pro-

viding a multiple current feed system. The solid dielectric should be located out of the electrostatic field as far as possible and should be mechanically stable and as low loss electrically as possible.

Typical characteristic curves under varying conditions of temperature and humidity are shown in Fig. 12. The most important of these are percent capacity change, Q and leakage. In general they depend upon the grade of dielectric employed. Note the small capacity change with temperature, and the large loss in Q with humidity for the different insulators. This indicates

that humidity characteristics are by far the more important in this case. (With the exception of the ceramic insulation all cost approximately the same).

Even though direct absorption of moisture in the insulation is negligible, the formation of a film on the surface lowers the insulation resistance and when subjected to a.c., introduces a material loss. Surface characteristics such as roughness or pores at molecular dimensions are important factors. An insulation which water does not wet such as glazed ceramic or XM-262 is usually only slightly affected by surface moisture because the water col-

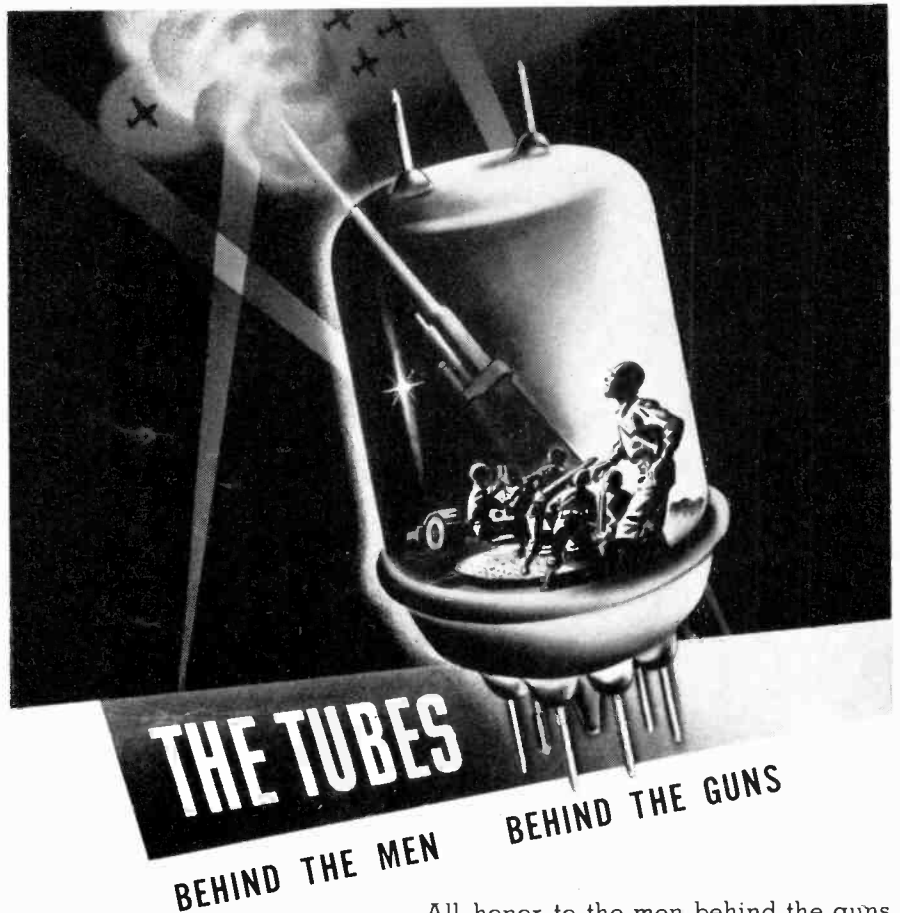

All honor to the men behind the guns
 Ken-Rad salutes them heroes they Not only
 salutes with words but with electronic tubes that sight time and fire
 the guns that detect enemy nearness *in advance of sight or sound*
 Electronic engineers knew before anyone else that the blitz on
 Britain was thwarted by the locators which gave the ground defenses
 time for repulsing action And we know that Electronics will be the
 servant of men of good will for whom Ken-Rad now is working at war!

TRANSMITTING TUBES
 CATHODE RAY TUBES
 SPECIAL PURPOSE TUBES
 METAL AND UHF TUBES

KEN-RAD

OWENSBORO KENTUCKY U S A



*Radio's outstanding practical text...
...for war-training and regular purposes*

RADIO Handbook

NINTH EDITION

NEW REVISED NINTH EDITION

Revisions in this edition adapt it even better than ever before for war-training and general use; contains added and simplified theory in the simplest possible language; added test equipment which can be home- or field-constructed; and a review of mathematics for solving simple radio problems.

More than 600 pages; durably clothbound; goldstamped. Get it from your favorite dealer, or direct from us, postpaid; please add any applicable taxes.

\$2.00 in continental U. S. A.

Elsewhere, \$2.25

Published by

Editors and Engineers, 1422 North Highland Avenue, Los Angeles 28, Calif.

To the trade: Radio parts stores, schools, and governmental units may order direct from us; all other trade outlets should order through the nearest branch of the American News Co., Inc.

lects in drops and does not cover the whole surface.

Tubular Fixed Condensers consist of two or more long strips of metal foil separated by thin waxed paper or the equivalent. These parts are rolled into a compact cylindrical form and enclosed in a suitable case of bakelite, cardboard or metal. The dielectric material is sometimes impregnated in oil instead of wax, thus increasing the breakdown point. The unit is carefully sealed with a high melting point wax. Further protection from humidity is obtained by giving the completed unit a flash dip in cerese or equivalent wax.

Paper is generally used as the dielectric although it does contribute appreciably to the losses due to dielectric hysteresis when subjected to alternating currents. The losses appear in the form of heat and cause the power factor to increase which in turn further increases the losses, so the effect is cumulative. The dielectric strength of the insulation decreases with temperature so the condenser may break down under lower voltages in continuous service than when operated intermittently, since it has a chance to cool between operating periods.

Most fixed paper condensers are wound non-inductively; that is, the

connecting leads are soldered to the entire edge of the foil instead of at one end only. Such construction is to be preferred for high-frequency work since the bypass action of the condenser is maintained at higher frequencies. A typical construction is shown in Fig. 13.

FEEDING SPEAKERS

[Continued from page 30]

an amplifier delivering 10 watts, (20 db) and the required level at each speaker is 0.63 watt (18 db). Then:

$$A = 20 - 18 = 12 \text{ db}$$

and: $X = 2^{A/3} = 2^4 = 16 \text{ speakers}$

To check, the total power delivered to 16 loudspeakers is:

$$16 \times 0.63 = 10 \text{ watts} = \text{amplifier output}$$

Thus $X = 2^{A/3}$ is the formula desired.

The table given on page 30 may be plotted on linear logarithmic paper to form a convenient reference chart, such as the one on this page. From this chart power values in terms of db above or below a reference level of 0.01 watt may be quickly found. Similar charts can be readily computed for any desired reference level.

Basic Facts on Electricity Needed to UNDERSTAND ELECTRONICS!

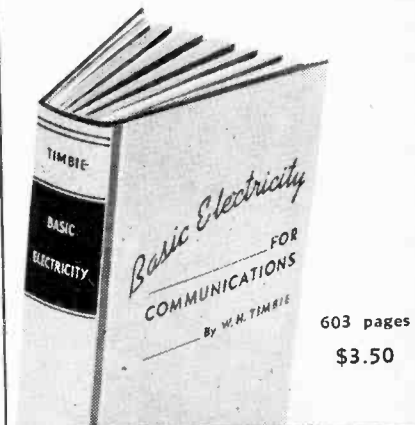

603 pages
\$3.50

BASIC ELECTRICITY
for
COMMUNICATIONS
by
W. H. TIMBIE

A clear, concise, practical book for those who want to prepare themselves now for the rapidly growing fields of Communications and Industrial Electronics.

Only those facts and principles every communications or electronics worker needs to know—and know well, are presented. Actual job problems are used throughout to show, step by step, how to solve electrical and communications problems that arise in practice.

This book gives you a comprehensive picture of the fundamental laws and principles governing communications practice. You will know the instruments and apparatus used—what they look like—how they work. You will know the symbols and language of the trade, and learn to figure quickly daily problems. This book will give you a foundation that will serve you well at all times and prepare you for advanced work in the field.

-----On Approval Coupon-----

JOHN WILEY & SONS, Inc.
440 Fourth Avenue, New York 16, N.Y.

Please send me a copy of Timbie's BASIC ELECTRICITY FOR COMMUNICATIONS on ten days' approval. At the end of that time, if I decide to keep the book, I will remit \$3.50 plus postage; otherwise I will return the book postpaid.

Name

Address

City and State

Employed by

11-7-43

GENERAL INDUSTRIES

Small-Power Motors and Electronic Devices



Now Being Produced for Victory—and

★ When peace comes, General Industries is prepared to contribute outstandingly to the electronics industry in the post-war world. For thirty years G. I. has led in building small-power motors for a wide range of applications. Today these, together with elec-

tronic devices, are being produced entirely for war needs. Manufacturers working for Victory will profit by consulting with G. I. engineers on small-power motors, electronic and other precision-made devices.

THE GENERAL INDUSTRIES CO. ELYRIA, OHIO

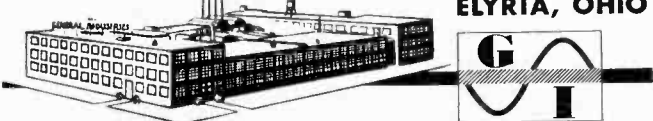

Talk to any Point in your Plant ... IN A SPLIT-SECOND!

SAVE MAN HOURS ... SAVE STEPS ... SAVE MONEY

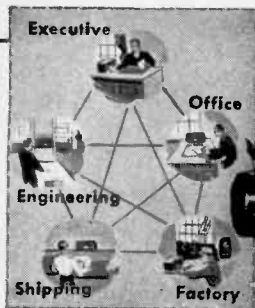

ALLIED INTERCOMMUNICATION SYSTEMS

Speed communication between departments... remove traffic from your switchboard! The new 10-Station "SUPER-CHIEF" illustrated handles up to 5 separate 2-way conversations. New features include: Private Multi-Station Conference—Call Waiting and Busy Signal Lights—No Eavesdropping—Privacy Earphone—High Power. Available with any number of stations.

★ Other versatile low-cost Allied Intercom Systems for War and Industry. Easily installed and operated. Our veteran staff can help you. Send for literature and full details.

Write, wire or phone Haymarket 6800.

ALLIED RADIO CORP.

833 W. Jackson Blvd., Dept. 14-G-3, Chicago

ALLIED RADIO ★
EVERYTHING IN ELECTRONICS AND RADIO

COMPLETE CENTRALIZED SERVICE On Electronic and Radio Needs

Simplify your procurement... speed delivery... get everything in Electronics and Radio from this one dependable, central source. Over 10,000 electronic parts... all famous brands... for the Armed Forces and for Industry.



FREE!

NEW
Most Complete
Up-to-Date 1943
BUYING
GUIDE

NEW PRODUCTS

[Continued from page 48]

Operadio Manufacturing Company, St. Charles, Illinois.

Standardized and "packaged" to include in a single unit the most popular features of more elaborate installations, the "Plant Broadcaster" operates 20 to 40 loudspeakers and covers an area of up to 100,000 square feet. The cabinet requires only 22 inches of floor space and comes ready to "plug in."

The new standardized broadcasting unit is highly versatile. In addition to broadcasting music to maintain or increase production with fewer workers or untrained personnel, it can be used to provide plant-protection alarm and air-raid warning. It enables management to talk directly to employees and to furnish them with news broadcasts, nutritional and safety information, War Bond programs, inspirational material and the like.

★ PHOTOCOPY MACHINE

The fool-proof new Apeco Photocopy Machine comes to the rescue of harassed management, quickly reproducing government reports, statistics, duplicates of orders, extra copies of blueprints and tracings, etc. No skill is required to produce perfect photocopies of anything printed, written, typed, drawn or photographed, and any new, inexperienced boy or girl can take over the job with a few simple instructions.

The new Apeco Photocopy Machine has almost no working parts and presents practically no repair or maintenance problems. It is so small it can be set up on any desk or table, anywhere in the plant or office, and no darkroom is needed. The machine makes same-size copies of anything up to 18 x 22 inches.

Additional information on the photocopy machine may be obtained from the manufacturer: American Photocopy Equipment Company, 2849 N. Clark St., Dept. 146, Chicago, Ill.

★ MICA CAPACITOR ALTERNATES

Ultra-small oil-impregnated oil-filled capacitors for use in assemblies where both space and weight are at absolute minimum, are now announced by Aerovox Corporation, New Bedford, Mass. Originally designed as metal-cased alternates for mica capacitors, these Type 38 oil tubulars are now being used for newly-designed equipment.

Despite extreme compactness, Type 38 units meet many of the exacting conditions to which the replaced mica

ACCURATE



Accuracy and dependability are built into every Bliley Crystal Unit. Specify BLILEY for assured performance.
BLILEY ELECTRIC COMPANY
ERIE, PENNSYLVANIA

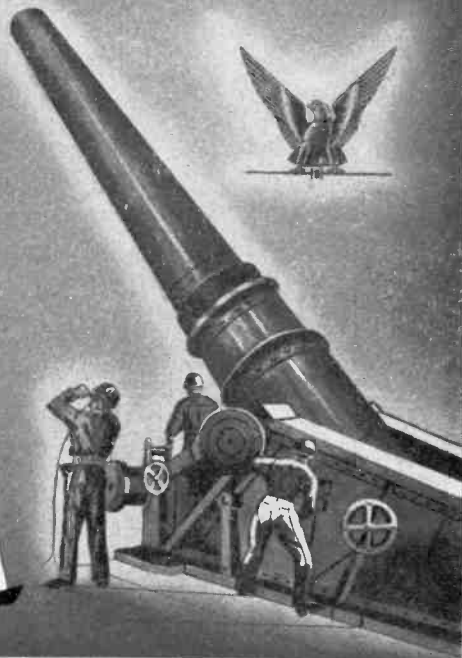

Bliley Crystals

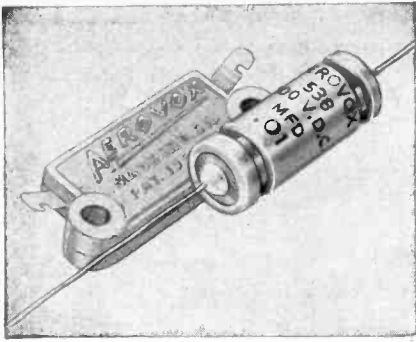

ANDREW COAXIAL ANTENNA

Suitable for fixed station use and pretuned at the factory to the desired operating frequency, the Andrew type 899 vertical coaxial antenna provides an efficient, easy-to-install, and inexpensive half-wave radiator in the frequency range from 30 to 200 mc. Careful engineering has utilized to the utmost the well-known advantages of the coaxial antenna over other types of vertical half-wave antennas.

The upper half of the antenna is a whip of conventional design. The lower half, or skirt, is a 2½" tube. The entire assembly is rigidly supported by a 1 5/16" support pipe 12' long, which is attached to a mast with a clamp that is provided. Overall length including support pipe is about 20' and the weight is 48 pounds.

No impedance matching devices are required. The whip and skirt are cut to length at the factory for the exact operating frequency, thus insuring maximum operating efficiency. The unit is designed to be fed from a 70-ohm coaxial transmission line. Fourteen feet of 7/8" coaxial cable are provided with the antenna. Made by Victor J. Andrew Company, 363 E. 75th St., Chicago, Ill.

capacitors are normally subjected. They are conservatively designed with no skimping of insulation or oil-fill despite their size. They meet all standard specifications for paper dielectric capacitors used as mica alternates. Metal case is capped by Aerovox double-rubber-bakelite with both terminal insulator assembly, and units are available with both terminals insulated or with one terminal grounded to the case. Pigtail terminals. Normally supplied without outer sleeve but can be had with insulating jacket adding 1/16" to diameter and length. 1 and 1-3/16" long, 5/16 and 7/16" diameters. Castor (Hyvol) or mineral oil impregnant and fill. 300 to 800 v. d.c.w. Capacitances from .001 to .01 mfd.

★

★

BUD CONDENSERS

are doing their part for **VICTORY**

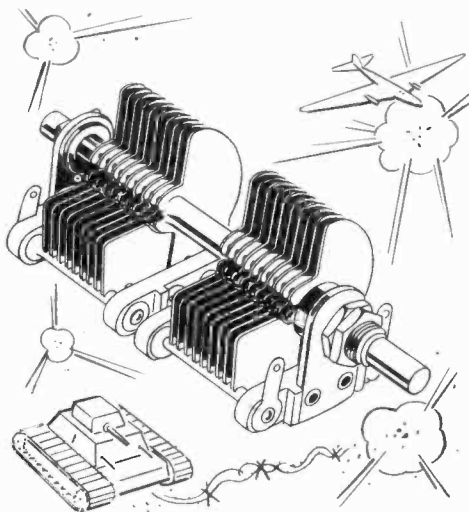

In the middle of the fight, on battlefronts all over the world, American radio equipment is doing its part nobly. Speedy communications are helping us carry the battle to the enemy today. And there, where dependability is most vital, BUD condensers and other BUD precision radio parts are proving their real worth under fire.



BUD RADIO, INC.
CLEVELAND, OHIO

RADIO

★ JULY, 1943

Electronic TRANSFORMERS

Acme electronic transformers are made-to-measure, for each application. That's why independent, unbiased tests give Acme first choice in performance. Acme engineers combine exact electrical specifications with mechanical limitations into precision-made transformers that provide for maximum performance of the electronic device.

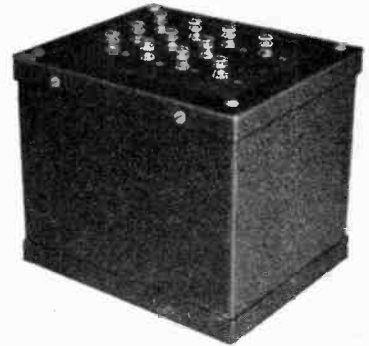

POWER OR FILAMENT TRANSFORMERS

Acme case designs require minimum mounting area. May be mounted on bottom, or suspended from top or side. Produced to specifications in sizes from 50 VA to 500 VA.

FILAMENT TRANSFORMERS

Type T-7025 Acme Filament Transformer for 2-866 Rectifier Tubes. Requires minimum mounting space; mounting centers for 2 5/8" VA, only 3 3/4" x 3 1/2" height. Precision-made to specifications in production quantities in ratings from 25 VA to 1 1/2 KVA.

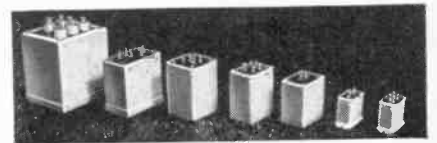

MINIMUM WEIGHT AIR-BORNE TRANSFORMERS

Acme compound-filled, sealed case Audio, Driver, Interstage transformers, Reactors and Microphone input transformers are built to withstand and satisfactorily perform under extreme temperature variations. Bulletin 159 tells why. Write for your copy today.

THE ACME ELECTRIC & MFG. CO.
55 WATER ST. CUBA, N. Y.

Acme Electric
TRANSFORMERS

SOLVE YOUR "SHORT RUN" DIE PROBLEMS

with **DI-ACRO** PRECISION MACHINES
(DIE - A C K - R O W)

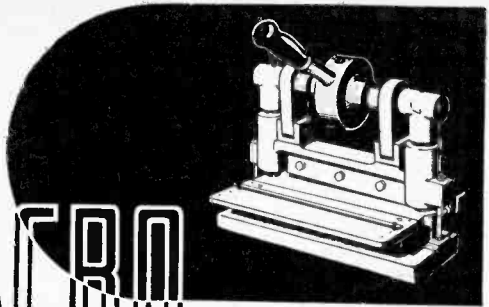

SEND FOR CATALOG "Metal Duplicating without Dies"

It's an eye-opener on what you can do without dies, shows typical parts, and gives sizes and capacities of all models of Di-Acro Shears, Brakes, Benders.



"Extra Special Rush! Speed it up! When can you deliver?" Maybe you don't have to wait — Wait — WAIT — for dies! Try "DIE-LESS DUPLICATING" with Di-Acro Shears, Brakes, Benders. These are *precision* machines — all duplicated work is accurate to .001". You'll get a new slant on "short-run" production problems from the great variety of parts which can be produced by Di-Acro Machines. Thousands of them are in use saving Man Hours and Critical Materials.

BENDERS

Di-Acro Bender bends angle, channel, rod, tubing, wire, moulding, strip stock, etc. Capacity — Bender No. 1 — $\frac{1}{4}$ " round cold rolled steel bar. Bender No. 2 — $\frac{1}{2}$ " cold rolled steel bar.

BRAKES

Di-Acro Brake forms non-stock angles, channels or "Vees". Right or left hand operation. Folding width — Brake No. 1 — 6". Brake No. 2 — 12". Brake No. 3 — 18".

SHEARS

(Illustrated)
Di-Acro Shear squares and sizes material, cuts strips, makes slits or notches, trims duplicated stampings. Shearing width — Shear No. 1 — 6". Shear No. 2 — 9". Shear No. 3 — 12".

O'NEIL-IRWIN  **MFG. CO.** 346 8th Avenue So., Minneapolis 15, Minn.

CRYSTALS BY



Ample production facilities available for lots or individual crystal orders—Priorities, of course.

Buy More Bonds!

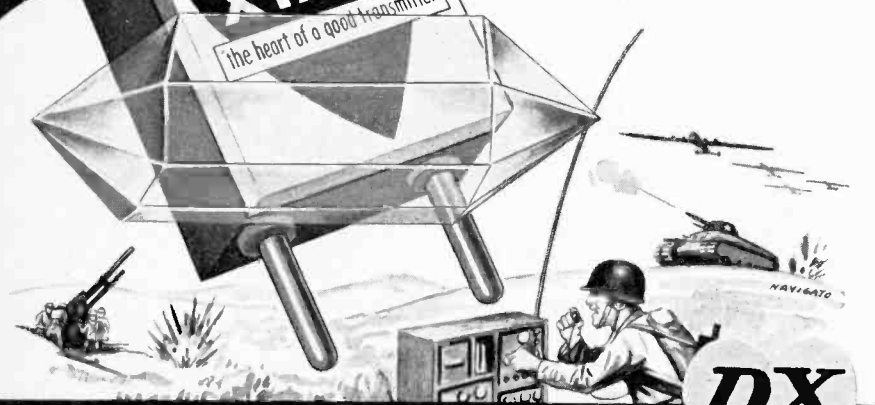

DX CRYSTAL CO.
GENERAL OFFICES: 1841 W. CARROLL AVE., CHICAGO, ILL., U.S.A.
DX XTALS
"the heart of a good transmitter"
TRADE MARK

GENERAL ELECTRIC LIMIT SWITCH

A new lightweight, dust-tight limit switch specially designed for aircraft applications where space is limited, has been announced by the General Electric Company. This small switch has a contact mechanism of the snap-action, double-break type which gives it a high current rating and makes it desirable for applications where severe vibration conditions are encountered.

Designed for use in a wide range of ambient temperature—from 95 C to minus 40 C—the switch is corrosion-proof, meeting 200-hour salt water tests as stipulated by various government agencies, and is suitable for use at altitudes from sea level to 40,000 feet.



GE Limit Switch

The new switch is a spring-return, plunger-operated type with a $\frac{7}{32}$ " overtravel. It can be mounted either on the cover side or on the opposite side, thus facilitating the operation of the plunger from either the right or the left.

The switch is available in three different contact arrangements — single-circuit, normally open; single-circuit, normally closed; and two-circuit, normally open and normally closed. It is also furnished with either die-cast zinc or die-cast aluminum housings and with either solder lug connections or, in the single-circuit forms, with an AN connector insert built in the AN threaded nipple of the housings. In addition, the switch is available with a rubber boot mounted over the plunger-operating mechanism for use in locations where mud and sand are encountered.



ANTI-CORROSION PAPER

A new greaseproof, noncorrosive paper has been announced by Sherman Paper Products, to protect highly finished metal parts against corrosion. Called V-26, this protective wrapping paper is described as a new development in the packing of war materials, which eliminates multiple wrapping operations at point of use, thereby permitting substantial savings in time.

Multiple wrapping operations are eliminated by combining two protective laminations in one paper. The inner ply provides a greaseproof barrier for the retention of corrosion-preventives used on metal products, while a strong outer ply protects the greaseproof membrane against damage in transit. Both inner and outer laminations are non-corrosive, consisting of neutral kraft, colored red in accordance with government specifications for Grade A noncorrosive papers. Both are creped for greater flexibility in wrapping, with a dead-limp folding quality. The new line is available either with an outer film of wax that provides a self-sealing surface, or uncoated where the self-tack quality is not needed.

Samples and literature showing new speed-packing methods may be obtained from the Sherman Paper Products Corporation, Newton Upper Falls, Massachusetts.

★
NEW R.C.P. 3" OSCILLOSCOPE

The Radio City Products Co., Inc. announce the design of Model 553, 3" Cathode-Ray Oscilloscope. This instrument fills the need for an extended frequency 3" oscilloscope with greater sensitivity.

Its compactness, limited weight, and



sturdy construction makes it a desirable portable field instrument. The power consumption is made low enough for field work. All controls and terminals are located on the front panel. Switching arrangement permits applying input either directly to deflection plates or to input of the amplifier. Position and stable locking of the image can be obtained with either the vertical signal or any external signal.

★

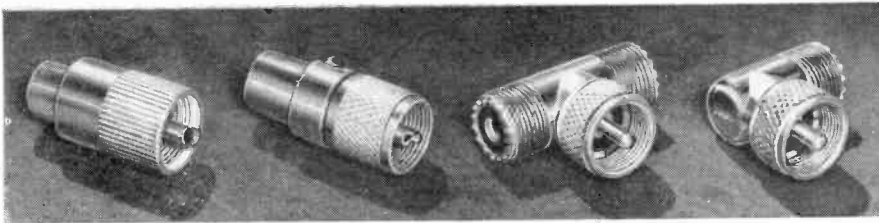

**Busy Making
"CONNECTIONS"**

★ The operator at the switchboard is no busier making connections than is The Astatic Corporation in the volume production of many types of Army and Navy approved Constant Impedance

High Frequency Connectors, Co-axial Cable Connectors and Multi-contact Plugs and Sockets for wartime radar and radio equipment. While Astatic production facilities are devoted in large part to the manufacturing of these important products, a limited number of Microphones and Phonograph Pickups, for which Astatic is so widely known, are still being made for government use and industries with high priority ratings.



BUY WAR BONDS!

ASTATIC

IN CANADA:
CANADIAN ASTATIC, LTD.
TORONTO, ONTARIO

THE ASTATIC CORPORATION
YOUNGSTOWN, OHIO

RADIO

★ JULY, 1943

**General
Production
Manager**

WANTED

Preferably with experience in electronics—must possess solid background of achievement in organizing and conducting development and manufacturing enterprises. This represents a broad-gauge current and postwar opportunity of the highest calibre. Company has plants, including vacuum tube division, and substantial electronic contracts. Letter applications in detail are requested and will be held in strictest confidence. Persons in war work or essential activity not considered without statement of availability.

Box No. 672

PLUGS JACKS

U. S. ARMY
SIGNAL CORPS
U. S. NAVY
APPROVED



NAF-1136-1
PL-68, PL-54
PL-55, JK-26
JK-48, PL-291
NAF-212938-1

Prompt Deliveries

UNIVERSAL MICROPHONE CO., LTD.
424 WARREN LANE
INGLEWOOD, CALIFORNIA

Subscribers— ARE YOU MOVING?



Due to the shortage of manpower, more time is required for the handling of changes of address and the making of new stencils. If you change residence, please make every effort to provide us with your new address from two to three weeks before you move. The Post Office Department does not forward magazines mailed to a wrong address unless you pay additional postage; and we cannot duplicate copies mailed to old addresses. Your cooperation will be appreciated.

Subscription Department

RADIO MAGAZINES, INC.,
132 W. 43rd St., New York 18, N. Y.

tribute their time, energy and talent to the war effort. At the present time, there are in the War Emergency Radio Service 192 Civilian Defense, eight State Guard, and two Civil Air Patrol station licenses, as well as many more licensed operators. Each station licensee may use from two to 100 or more radio station units, whose operation is coordinated to form a comprehensive local communications system.



OHMITE WALL CHARTS

To aid teachers, students, technicians and engineers in war training and industry, the Ohmite Manufacturing Company of Chicago, have produced their *Ohm's Law Chart* and *Parallel Resistor Chart* in 26" x 36" wall size ready for hanging.

The *Ohm's Law Chart* is used for graphical determination of wattage,

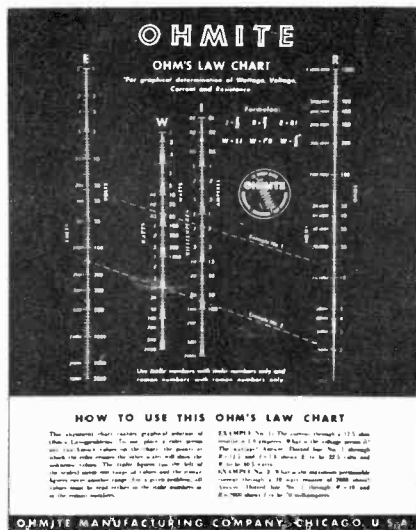

voltage, current and resistance. The *Parallel Resistor Chart* is used for graphical determination of the resistance of resistors in parallel. Explanatory examples are given on the face of each chart.

The two Wall Charts are available without charge to Schools, Training Centers, Engineers, Procurement Officers and Plant Executives who write for it on official stationery or company letterhead, to Ohmite Manufacturing Company, 4835 Flournoy Street, Chicago, 44, Illinois.



APCO NATIONAL CONFERENCE

At a meeting of the Executive Committee of the Associated Police Communication Officers (APCO) held in Decatur, Illinois, on June 3, it was decided to hold their 1943 National Conference at Madison, Wisconsin, on August 31, September 1, and September 2.

As it was not possible to hold the

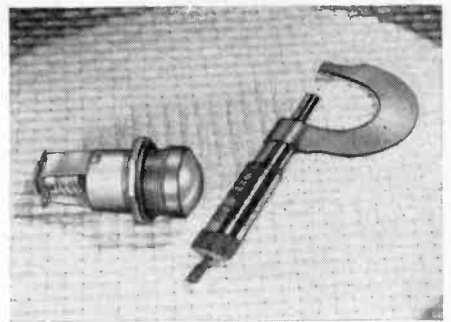

BUILT WITH WATCH-LIKE PRECISION

SKILFUL creative engineering and fine materials are factors, but even more important is the extreme precision with which DRAKE Pilot Light Assemblies are made. Their long life and dependable performance reflect the infinite tolerances employed. Speedy deliveries are the result of large capacity, high-speed methods and machinery. Specify Drake assemblies.



★
Do you need
our catalog?
★

PILOT LIGHT
ASSEMBLIES

DRAKE MANUFACTURING CO.
1713 W. HUBBARD ST. • CHICAGO, U. S. A.

... Here's How You Can Qualify for a BETTER RADIO JOB!

• • • CREI technical training is preparing others for good-paying radio jobs—WHY NOT YOU?

Are you finding yourself in a routine job—a job that any other man can handle just as well as you? Today, radio JOBS are many—but radio CAREERS are few! Now is the opportune time for you to equip yourself with the necessary technical training to qualify for an important engineering position with a sound future.

NOW when industry needs men, is the time for you to investigate radio career training. Your radio experience backed by modern CREI technical training will equip you to share in the good-paying jobs that await trained men . . . and to make good in the important positions that lead to security and happiness!

Write for Details

About CREI Home Study Courses

If you are a professional radioman and want to make more money—let us prove to you we have something you need to qualify for the BETTER career-job opportunities that can be yours. To help us intelligently answer your inquiry—PLEASE STATE BRIEFLY YOUR EDUCATION, RADIO EXPERIENCE AND PRESENT POSITION.



Free Booklet Sent

CAPITOL RADIO
ENGINEERING INSTITUTE

Dept. RA-7, 3224-16th St., N. W., Washington, 10, D. C.

Covington LAPIDARY EQUIPMENT

FOR QUARTZ CRYSTAL PRODUCTION

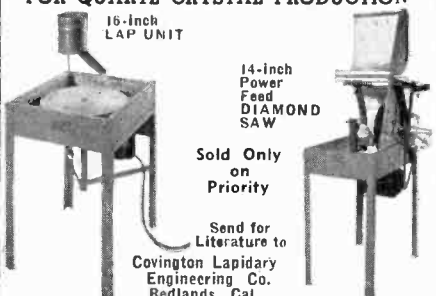

16-Inch LAP UNIT

14-Inch Power Feed DIAMOND SAW

Sold Only on Priority

Send for Literature to
Covington Lapidary Engineering Co.
Redlands, Cal.

BUY BONDS

RADIO AND ELECTRONIC DEVICES



BURSTEIN-APPLEBEE CO.
1012-14 McGee St. Kansas City, Mo.

TRIPLITT *Combat Line* TESTERS



TRIPLITT MODEL 625 T PORTABLE TESTER

A long scale 4.58 highly sensitive, compact, easily portable Tester.
12 A.C.-D.C. Voltage Ranges to 5,000 Volts.
Six Direct Current Ranges including microamperes, milliamperes and amperes.
3 Resistance Ranges to 4 megohms.
Bakelite Case 6"x5½"x2½".

TRIPLITT

Although some older designs are no longer obtainable, several alternate models are available to you under Government requirements.
TRIPLITT ELECTRICAL INSTRUMENT CO., BLUFFTON, OHIO

Convention in Buffalo as originally scheduled, Madison was chosen because it is centrally located and yet far enough north to assure reasonably cool weather. Also, Madison is the seat of several large military radio training schools.

Holding a conference this year was considered extremely important because of the many problems brought on by the war. Discussions on war-time operations, WERS, OCD, priorities, etc. will occupy most of the time.

Ray Groenier, Chief Radio Engineer of the Madison Police Department is Conference Chairman, and is now busy arranging the program. He assures visiting delegates that even though the business sessions will be longer than usual, there will still be some time available for entertainment.

★

"THE REPRESENTATIVES" MEETING

The June meeting of the Mid-Lantic Chapter of "The Representatives" was held June 1st at the Engineer's Club, 1317 Spruce St., Philadelphia. Formerly "The Representatives" met each month at the Essex Hotel, but through an arrangement made by one of its members, Martin Friedman, the Engineer's Club has been selected as the regular meeting place.

The following new members have been added to the Mid-Lantic Chapter: Charles Fryburg, 402 Cherry St., Phila.; I. R. Blair, 1418 Walnut St., Phila.; Robert Williams, Lincoln-Liberty Bld., Phila.

★

SYLVANIA ANNOUNCES NEW INTERNATIONAL DIVISION

As the first step toward preparation for increased world-wide operation, Sylvania Electric Products Inc., announces the formation of an International Division with Walter A. Coogan as Director. As part of its expanded activities, the International Division will include the operations formerly carried on by the Foreign Sales Department.

With a substantial increase in personnel, a much wider scope of operation is planned. To facilitate the movement of Sylvania Products to all parts of the world, the International Division will provide engineering counsel, prompt delivery, more frequent and personal contact with the market in each country.

In addition to being prepared for an increased demand for Sylvania incandescent lamps, fluorescent lamps and fixtures, radio and electronic tubes, the new International Division will be geared to the coming age of electronics. There will be new Sylvania products, many of which are at this time carefully guarded secrets.

S. I. COLE JOINS R.M.A. EXECUTIVE COMMITTEE

S. I. Cole, president of Aerovox Corporation, was elected a member of the Executive Committee of the Radio Manufacturer's Association at its annual convention held in Chicago.

With a radio manufacturing and merchandising background dating back to the earliest days of broadcasting and preceded by extensive production and sales activities in other fields, Mr. Cole brings a wealth of experience to the executive branch of the R.M.A.

ADVERTISING INDEX

Acme Electric & Mfg. Co.	57
Alliance Mfg. Co.	6
Allied Radio Corp.	56
American Automatic Elec. Sales Co.	47
Astatic Corp., The	59
Bliley Electric Co.	56
Bud Radio, Inc.	57
Burstein-Applebee Co.	62
Capitol Radio Eng. Inst.	61
Centralab	51
Chicago Telephone Supply Co.	14-B
Connecticut Tel. & Elec. Div.	8
Covington Lapidary Eng. Co.	62
Crystal Products Co.	10
Drake Manufacturing Co.	61
DX Crystal Co.	58
Echophone Radio Co.	31
Editors & Engineers	54
Eitel-McCullough, Inc.	39
Electronic Laboratories, Inc.	14-A
General Industries Co., The	55
Hallcrafters Co., The	3, 4
Hytron Corporation	Cover 3
International Resistance Co.	49
Jefferson-Travis Radio Corp.	45
Jensen Radio Mfg. Co.	16
Ken-Rad Tube & Lamp Corp.	53
Lafayette Radio Corp.	14
Meck Industries, John	Cover 4
Meissner Mfg. Co.	50
Muter Co., The	60
Ohmite Mfg. Co.	43
O'Neil-Irwin Mfg. Co.	58
Pioneer Gen-E-Motor	12
Racon Electric Co.	37
Rola Co., Inc.	41
Shallcross Mfg. Co.	11
Sprague Specialties Co.	35
Standard Transformer Corp.	33
Sylvania Electric Products, Inc.	13
Triplitt Elec. Inst. Co.	62
United Transformer Co.	Cover 2
Universal Microphone Co.	61
Utah Radio Products Co.	9
Wilcox Electric Co., Inc.	7
Wiley & Sons, John	55

REPRINTED TO SHOW REVISED PRICES

SELECT
for
SERVICE



NEW HYTRON TUBES

Type	Description	Price
836	Half-wave, high-vacuum rectifier.....	\$11.50
837	12-watt, r.f. pentode.....	2.80
954	Acorn triode.....	4.50
955	Remote cut-off, acorn pentode.....	2.75
956	Half-wave, high-vacuum rectifier.....	4.50
1616	25-watt, r.f. tetrode (12-v. heater)....	5.75
1625	5-watt, triode oscillator.....	3.50
1626	3.5-watt, u-h-f triode.....	2.25
E1148	Gaseous voltage regulator.....	1.25
YR105-30	Gaseous voltage regulator.....	1.25
YR150-30	Gaseous voltage regulator.....	1.25

Type	Description	Price
2C25	15-watt, medium- μ triode.....	\$3.00
2C45	7.5-watt, triode (modulator).....	2.50
10Y	15-watt, general-purpose triode.....	2.50
801A/801	20-watt, general-purpose triode.....	2.50
HY61/807	25-watt, r.f. beam tetrode.....	2.25
841	15-watt, high- μ triode.....	1.50
864	Non-microphonic voltage-amp. triode... 1.50	1.50
HY24	2-watt, power triode.....	1.00
HY31Z	30-watt, high- μ twin triode.....	3.95
HY65	15-watt, r.f. beam tetrode.....	3.95
HY69	40-watt, u-h-f triode.....	2.25
HY75	15-watt, r.f. beam tetrode.....	2.25
HY1148	(2C24) 1.8-watt, u-h-f triode.....	2.25
HY615	3.5-watt, u-h-f triode.....	2.25

*This is not a complete list. Wattage ratings indicate
instant-heating filament. maximum plate dissipation.
For complete characteristics consult Government
specifications.

On this list of tubes which have recently joined the growing legions of Hytron types already marching on to Victory, you may find just the ones you want for your War equipments. Whether you choose the tiny "acorns" or the husky 1616 rectifier, you will discover the same high quality and design refinements which have made other Hytron tubes famous. If you place your orders well in advance, you will also be pleased by Hytron's on-schedule deliveries. Not too infrequently, deliveries are made from stock.

HYTRON CORPORATION
SALEM AND NEWBURYPORT, MASS.
Since 1921 Manufacturers of Radio Tubes



CRYSTALS

Keep this in mind

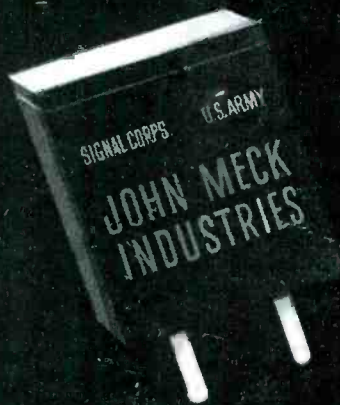

EVERY TYPE OF CRYSTAL

is now available in quantity. These are in excess of the needs of war.

ANY TYPE OF CUT OR FREQUENCY

is now possible thru the advances made in manufacturing techniques and facilities.

YOUR NEEDS—LARGE OR SMALL

will get immediate action in our Special Crystal Service Division.

PHONE PLYMOUTH (INDIANA) 33

JOHN MECK INDUSTRIES
PLYMOUTH, INDIANA

