

RADIO

ESTABLISHED 1917

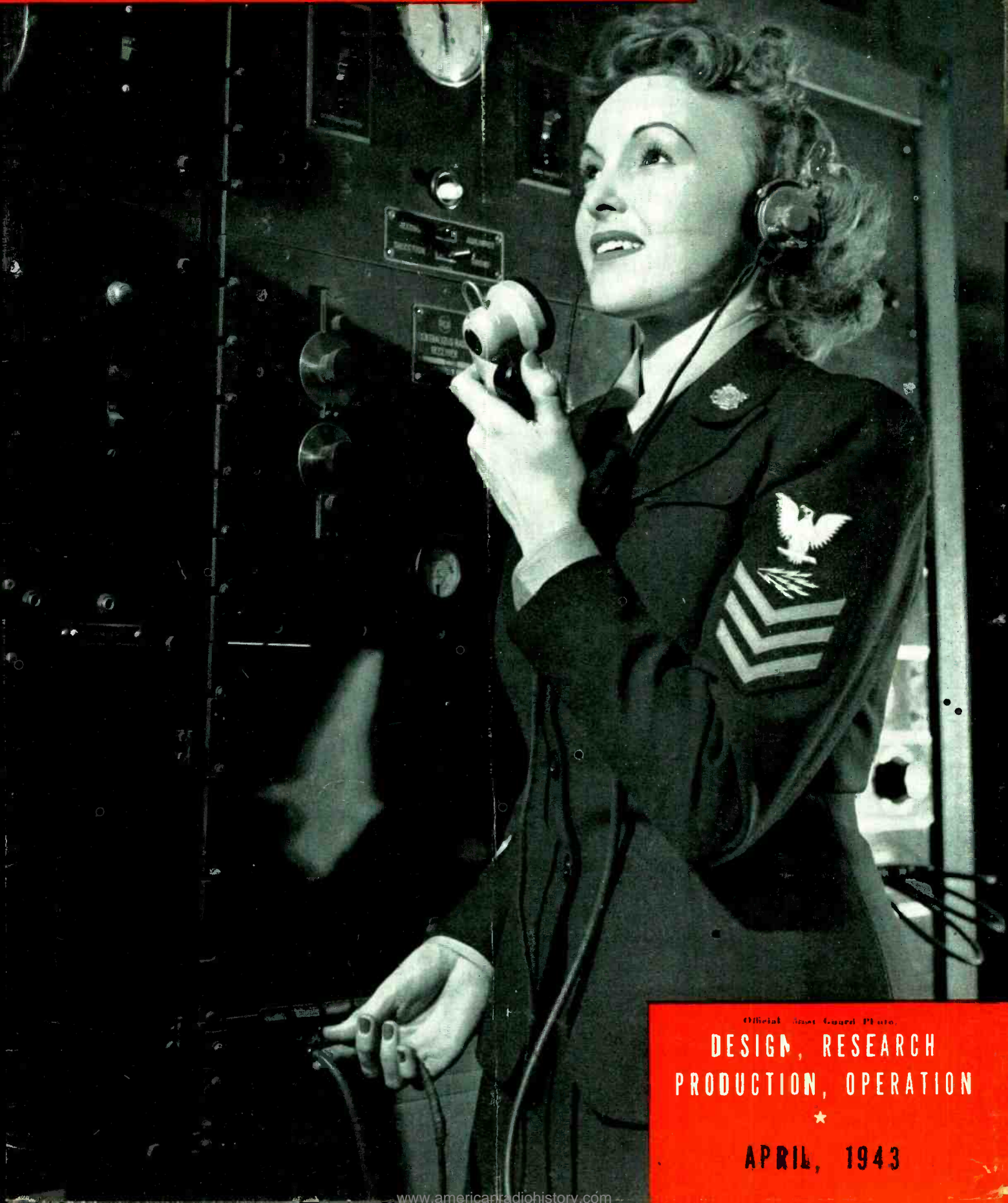

Official Army-Covered Photo

DESIGN, RESEARCH
PRODUCTION, OPERATION



APRIL, 1943

Waste is as damnable as sabotage

Electrical and mechanical design are the foundation of our military production. Small individual savings, when multiplied in mass production, add up to large savings in critical materials and labor time. Here are some examples from our organization:

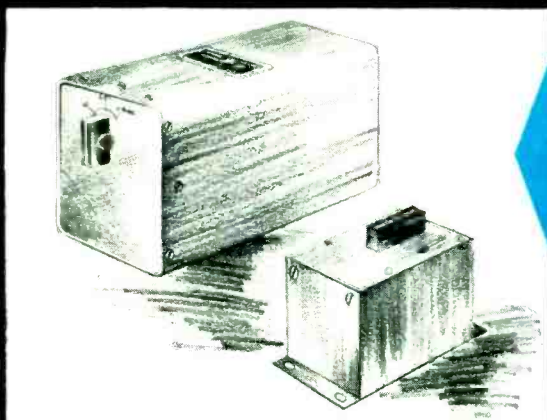

Cumulative electrical and mechanical redesign reduced the quantity of critical materials in this unit 60%, reduced total size and weight in direct proportion.

Through proper mechanical redesign, the weight and volume of this unit were halved, yet the same mounting centers were maintained for field replacements.

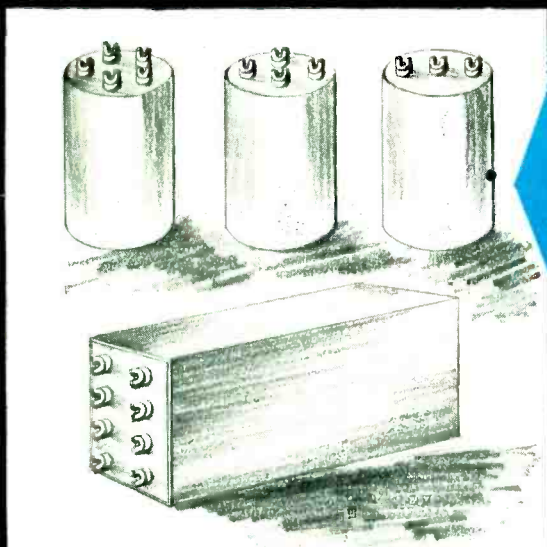
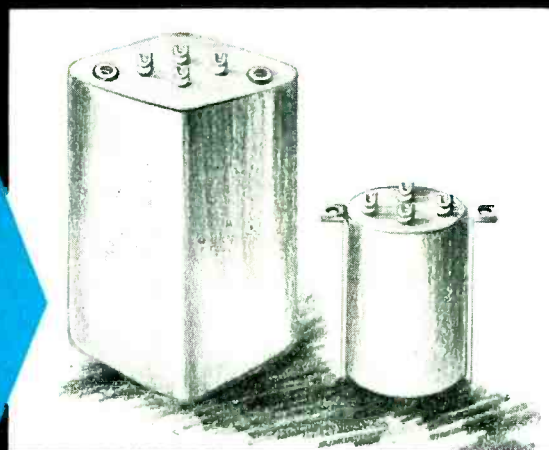

This application employed three of our Ouncer units. By combining the three in one case, we eliminated two aluminum housings, four terminals, two terminal strips, etc.

Electrical redesign reduced the amount of nickel iron alloy used in this filter by 50% . . . the mechanical redesign eliminated a dozen brass brackets and screws and cut installation time one-half hour.

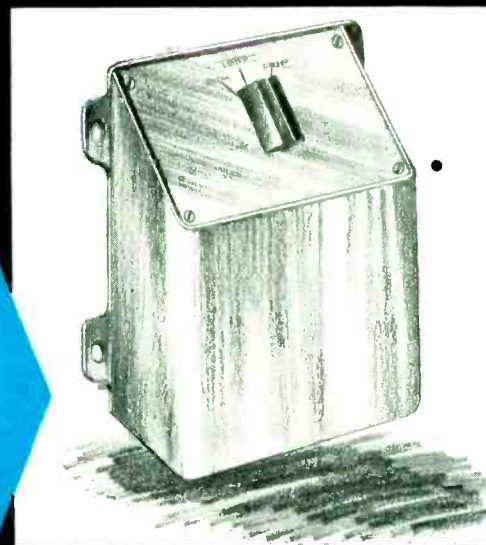

UNITED TRANSFORMER CO.

150 VARICK STREET



NEW YORK, N. Y.

THE MEN WHO LICKED THE JAPS IN NEW GUINEA!

... and they do an excellent job of it, too, against almost insurmountable obstacles. When there is a chance for a few moments off duty, a Hallicrafters short wave radio is the means of hearing voices from "back home" and a very welcome sound indeed. This is only one of the many wartime uses of Hallicrafters short wave radio communications equipment.

hallicrafters

CHICAGO, U.S.A

Hallicrafters Model S-29 (illustrated). A completely self-contained portable short wave communications receiver.

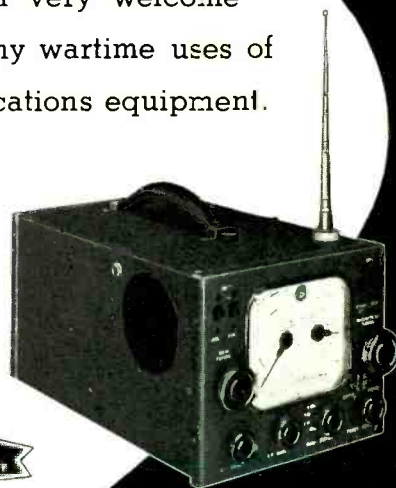



A FIRST IN FM!

Hallicrafters are pioneers in FM! Producers of the first general coverage U. H. F. communications receiver to incorporate both FM and AM. Time and research have added much to the performance capabilities of Hallicrafters FM-AM communications receivers... wartime experience is adding invaluable engineering advantages... all of which will be available to you in your peacetime Hallicrafters communications receiver.

hallicrafters
CHICAGO, U.S.A.



World's Largest Exclusive
Manufacturer of Short Wave
Radio Communications
Equipment



RADIO

Published by RADIO MAGAZINES, INC.

Editor

M. L. MUHLEMAN

Business Staff

Lee Robinson, Publisher
and President

S. R. Cowan, Business Manager
and Treasurer

M. L. Muhleman, Vice President
and Editor

R. Alan, Circulation Manager

CORRESPONDENCE and ORDERS should be sent only to our New York office. MANUSCRIPTS, if unsolicited and unusable, will not be returned unless accompanied by a stamped, self-addressed envelope.

EXECUTIVE, editorial, and advertising offices of Radio Magazines, Inc., are located at 132 West 43rd Street, New York, N. Y., to which address all correspondence, advertising copy and cuts should be directed.

SUBSCRIPTION RATES (in U. S. funds): Two years, \$5.00, or \$3.00 yearly in U.S.A. To Canada and all foreign countries, \$4.00 yearly. Twelve issues yearly; back issues are not included in subscriptions.

NOTE: Because of wartime censorship restrictions, we must reserve the right to withhold from foreign subscribers any issue the regular domestic edition of which is not approved by the authorities for export without changes. In such cases subscriptions will be extended so that each subscriber will eventually receive the number of issues to which he is entitled.

IF YOU MOVE, notify us in advance; we cannot replace copies sent to your old address. Notice must be received by the 20th of the month preceding the cover date of first issue to go to the new address.

APRIL 1943

No. 279

Table of Contents

COVER

A "Radioman-SPAR" on the job in the U.S. Coast Guard. A recruiting campaign is now under way in this important service. Official Coast Guard Picture by Henry F. Kroeger, Jr., Chicago Public Relations Office.

ARTICLES

Q Measurements at U.H.F.— <i>S. Young White</i>	15
Mismatching in Coaxial Lines— <i>V. J. Young</i>	17
Phase and Frequency Modulation, Part 3— <i>W. P. Bollinger</i>	20
Radio Design Worksheet: No. 1—Bridge-Circuit Current; Multiple Angles; Calculating Phase Difference	23
Use of Transmission Line in Determining Antenna Characteristics— <i>Oscar E. Carlson</i>	26
Radio Bibliography: 9—Propagation— <i>F. X. Rettenmeyer</i>	35

MISCELLANEOUS

Techniciana	6
Editorial	13
This Month	42
New Products	44
Advertising Index	58

RADIO (title registered U.S. Pat. Off.) is published monthly at 34 N. Crystal Street, East Stroudsburg, Pa., by Radio Magazines, Inc., Executive and Editorial Offices at 132 West 43d Street, New York, N. Y. Subscription rates—United States and Possessions, \$3.00 for 1 year, \$5.00 for 2 years; elsewhere \$4.00 per year. Single copies 35c. Printed in U.S.A. All rights reserved, entire contents Copyright 1943 by Radio Magazines, Inc. Entered as Second Class Matter October 31, 1942, at the Post Office at East Stroudsburg, Pa., under the Act of March 3, 1879.

RADIO

★ APRIL, 1943

5

Clearer Transmission

Simplify sound pickup problems in studio and remote broadcasting with the Shure Broadcast Super-Cardioid Microphone. Its pickup pattern rejects 73% of all reverberation and random noise energy. It is highly immune to mechanical vibration and wind noises. These features insure clear penetrating signals. Use a Shure Super-Cardioid for better performance.



SHURE REACTANCE SLIDE RULE

Offers quick, easy solutions of problems in resonant frequency and in circuits involving inductances and condensers. Covers frequency range from 5 c.p.s. to 10,000 MC. Send 10c in coin or stamps to cover handling.

SHURE BROTHERS, Dept. 174U 225 W. Huron St., Chicago
Designers and Manufacturers of Microphones and Acoustic Devices

TECHNICANA

COAXIAL VS. WAVEGUIDE

IN A PAPER RECENTLY presented by Dr. G. C. Southworth, and reviewed in the March issue of the *Bell Laboratories Record*, some interesting comparisons were made between the coaxial cable and the waveguide at various frequencies.

Compared from the standpoint of attenuation losses, it is pointed out, the coaxial is better at the lower frequencies; but in the microwave region, which has assumed great importance, the waveguide has decided advantages. However, below a certain frequency—about 3×10^9 for the waveguide—the waveguide cuts off abruptly, as shown in the accompanying illustration.

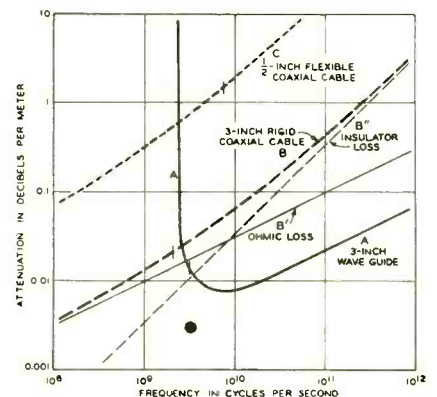

The illustration gives comparison of attenuations of a 1/2-inch coaxial, a 3-inch coaxial, and a 3-inch waveguide. Curves B' and B'' show respectively the loss due to resistance alone, and to dielectric alone, for the 3-inch coaxial.

"SPIRAL-4"

ONE OF THE MOST effective aids in modern warfare is rapid and dependable communications. The success of an engagement may depend on establishing lines to advanced positions in minimum time. To aid the Signal Corps in such work, the Western Electric Company and Bell Telephone Laboratories have recently made available a new communications system known as "Spiral-4."

The basic idea behind Spiral-4 is borrowed from carrier telephony. The system provides three telephone and four telegraph circuits over a single rubber-covered cable about the thick-

[Continued on page 8]

CRYSTALS



"SHORT ORDERS" IN A HURRY

If it's a "Rush" phone us, and your order for special crystals will go into work immediately under a competent crystal engineer personally charged with the responsibility for your project.

Our full facilities, including latest electrical and optical equipment, X-ray orientation, etc.—are at your service. John Meck Crystals are "Good Will Ambassadors of the Future" to acquaint you with our Family of Activities in the field of Sound and its Projection. That's why "Short Orders in a Hurry" are we come.

Phone **CRYSTAL SERVICE DIVISION**
PLYMOUTH THREE THREE



JOHN MECK INDUSTRIES
PLYMOUTH, INDIANA 



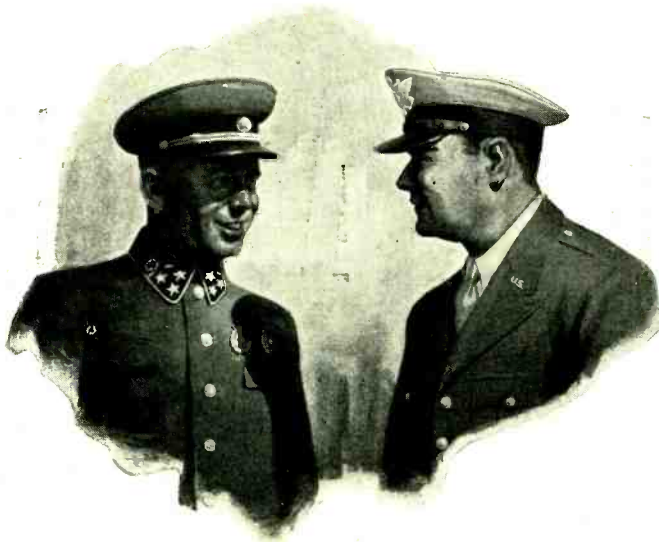

ОНИ ХОРОШИ ОНИ ЗАМЕЧАТЕЛЬНЫ

Don't speak Russian? Then let us translate the words of a Russian General to an American War Correspondent:

**"THEY'RE GOOD . . .
THEY'RE EXCELLENT!"**

You see, the Correspondent had just remarked upon the number of "Connecticut" field telephones in use by the famed Cossack Cavalry. . . . Like many an American industry, our reputation for know-how rests today on the performance of our products in the service of the United Nations, all around the world. . . . When we can again freely solicit your patronage, there will be no testimonial to which we shall point with greater pride than the commendation of the fighting Russians.

CONNECTICUT TELEPHONE & ELECTRIC DIVISION



MERIDEN, CONNECTICUT



© 1913 Great American Industries, Inc., Meriden, Conn.

8

TECHNICANA

[Continued from page 6]

ness of a fat lead pencil. The cable contains four spiralling wires. Hence, the name. It is made in quarter-mile lengths, the ends of which are fitted with weather-proof connectors. Each length may be snapped to a companion section as rapidly as the cable can be payed off a moving Army truck. With intermediate amplifiers spaced along the way to compensate for loss in the strength of the current, distances up to 150 miles may be so spanned.

★

INVISIBLE "RAINCOAT"

AN INVISIBLE "RAINCOAT" which can be formed on cloth, paper and many other materials by exposing them to chemical vapors from a new compound, thereby making them water-repellent, has been developed in General Electric's Research Laboratory at Schenectady, N. Y., by Dr. Winton I. Patnode who is studying many possible uses of this new method of water-proofing.

Called Dri-Film by the G. E. Electronics Department which will market the new compound, one of its most important uses so far is the treatment of ceramic insulators for radio equipment being made for the armed forces of the United States. It is about nine times more effective than the wax used at present as a water repellent, and its results are permanent.

Dri-Film is a clear liquid composed of various chemicals which vaporize at a temperature below 100 C. Articles to be treated are exposed, in a closed cabinet, to the vapors for a few minutes. Then they are taken out and, if neces-

[Continued on page 10]



"Dri-Film" treated paper sheds water like duck. Its results are permanent.

APRIL, 1943 ★

RADIO



AVAILABLE for prompt shipment

FULLY PROVED and tested to meet exacting specifications on land, at sea, and in the air

HANDLE TODAY'S CAPACITOR JOBS with SPRAGUE ELECTROLYTICS

Frankly, we're looking for the people, military or civilian, who "don't like electrolytics". We keep hearing about them, but never quite catch up with them. When we do, we're not going to argue. We simply want to find out what performance they need, then give it to them—in electrolytic capacitors that can be delivered almost in the time it takes to arrange priorities on certain other types.

Actually, Electrolytics have far more than small size and light weight to recommend them. They meet all specifications: salt-air, reduced pressure, reduced and elevated temperatures, transients, reversed voltage,

r.f. impedance, and many more. They fly. They swim. They even sit unused for months and are still ready to go at the flick of a switch. They can be sealed as well as any condenser type—and they're adaptable to many designs and combinations, from the popular octal base types shown here right along the line so whatever may be required.

SPRAGUE SPECIALTIES COMPANY
North Adams, Mass.

GET THE PROOF!—Put your capacitor problem up to Sprague engineers. Let them prove that Sprague Electrolytics will do your job—and do it right.

SPRAGUE ELECTROLYTICS for PORTABLE EQUIPMENT!

• To those who question the use of electrolytics in portable equipment, we suggest: Find the smallest capacity of paper condenser (even if it is as big as a house) that will do your low frequency filtering job. Then tell us the low frequency you are trying to get rid of (20 to 120 cycles), and the voltage ranges... then...

You'll be unable to detect any difference in performance between this paper condenser and the Sprague Electrolytic we'll recommend. The only difference will be in the greatly reduced size and weight of the electrolytic!

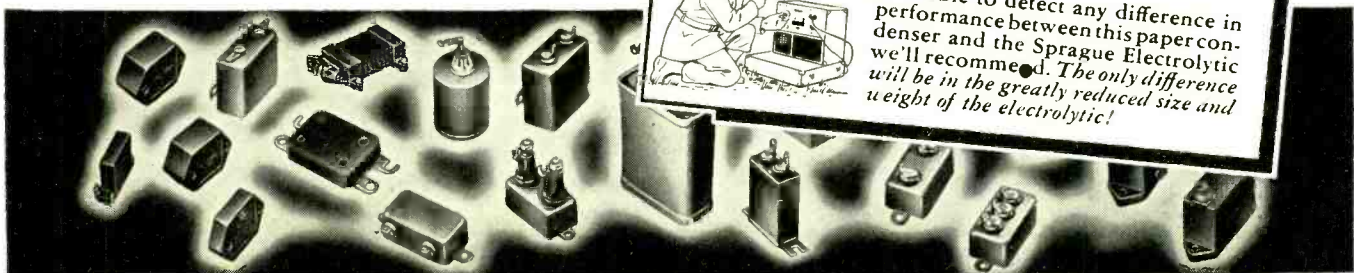

MANUFACTURERS OF A COMPLETE LINE OF RADIO AND INDUSTRIAL CAPACITORS AND KOOLOHM RESISTORS

[Continued from page 8]



"TELL 'EM WE COULDN'T DO WITHOUT THE PARTS THEY'RE GIVING UP"

"Yeah, the folks back home are helping us plenty by giving up those radio and communication parts. See—over those hills! There's a bridge there. We just bombed bell out of it—cutting off an enemy tank column. With inadequate communications, we couldn't have done it!"

COMMUNICATIONS are vital in this war of rapid movement—where success demands "co-ordination" of widely dispersed units.

When a swift PT boat gets its radio orders to torpedo an enemy transport . . . when a bomber drops its eggs over a submarine base . . . when an allied tank column, keeping in contact by radio, speeds over Sahara's sands . . . Utah Parts are playing their role in this war of communications.

Soldiers of production build dependability into those parts at the Utah factory. Utah engineers plan it in the laboratories . . . as they pore over blueprints far into the night.

Constantly, research is going on at Utah . . . new and better methods of production are being developed . . . to help keep the ears of the armed forces open. Tomorrow—when peace comes—this research and experience will be reflected in the many civilian products being planned at the Utah Laboratories. Utah Radio Products Company, 846 Orleans Street, Chicago, Ill. Canadian Office: 560 King Street West, Toronto. In Argentine: UCOA Radio Products Co., SRL, Buenos Aires. Cable Address: UTARADIO, Chicago.



PARTS FOR RADIO, ELECTRICAL AND ELECTRONIC DEVICES, INCLUDING SPEAKERS, TRANSFORMERS, VIBRATORS, UTAH-CARTER PARTS, ELECTRIC MOTORS

sary, are exposed to ammonia vapor. This is to neutralize corrosive acids which may collect during treatment.

Dr. Patnode is not able to explain exactly what happens in the process, but the result is that an extremely thin film is formed on the surface. This "raincoat" is so thin that its structure cannot be determined by chemical analysis. It cannot be seen under a high-powered microscope. But, whatever its nature, it prevents water from spreading to form a continuous film. If moisture does collect, it is in the form of small isolated drops.

G. E. Research Laboratory tests show the wide difference in the water-repellent characteristics of ceramic surfaces when glazed or treated with wax, and with the new compound. These tests were made under conditions of temperature and humidity similar to those met by military forces in service from the arctic to the tropics. Tests of surface resistivity were made on a number of closely controlled specimens which had been subjected to the condition of 100 per cent relative humidity at 25 C. with the ceramic parts precooled below the dew point. A value of 100 was arbitrarily assigned to the surface resistivity of unglazed ceramics that had been treated with wax. On the same basis of evaluation, parts treated with Dri-Film were found to have a surface resistivity of 870.

★

THERMAL RADIO SLAYS BUGS

AS RECORDED IN *The Ohmite News*, a new and very valuable use for high-frequency heating may result from research now being conducted for the purpose of preventing a \$250,000,000 yearly stored grain loss due to insects. In the experiment the grain was passed between two electrodes and subjected to an electrostatic field of 3.5 megacycles. In 50 seconds the temperature of the grain was raised to 130°F. and all four life stages of the insects were killed.

★

RADIONICS/ELECTRONICS

AMERICAN NEWSPAPER AND magazine editors by a ratio of better than nine to one, and scientists by more than two to one, prefer "radionics" to "electronics" as a name for the industry which has grown from the radio tube, according

[Continued on page 53]

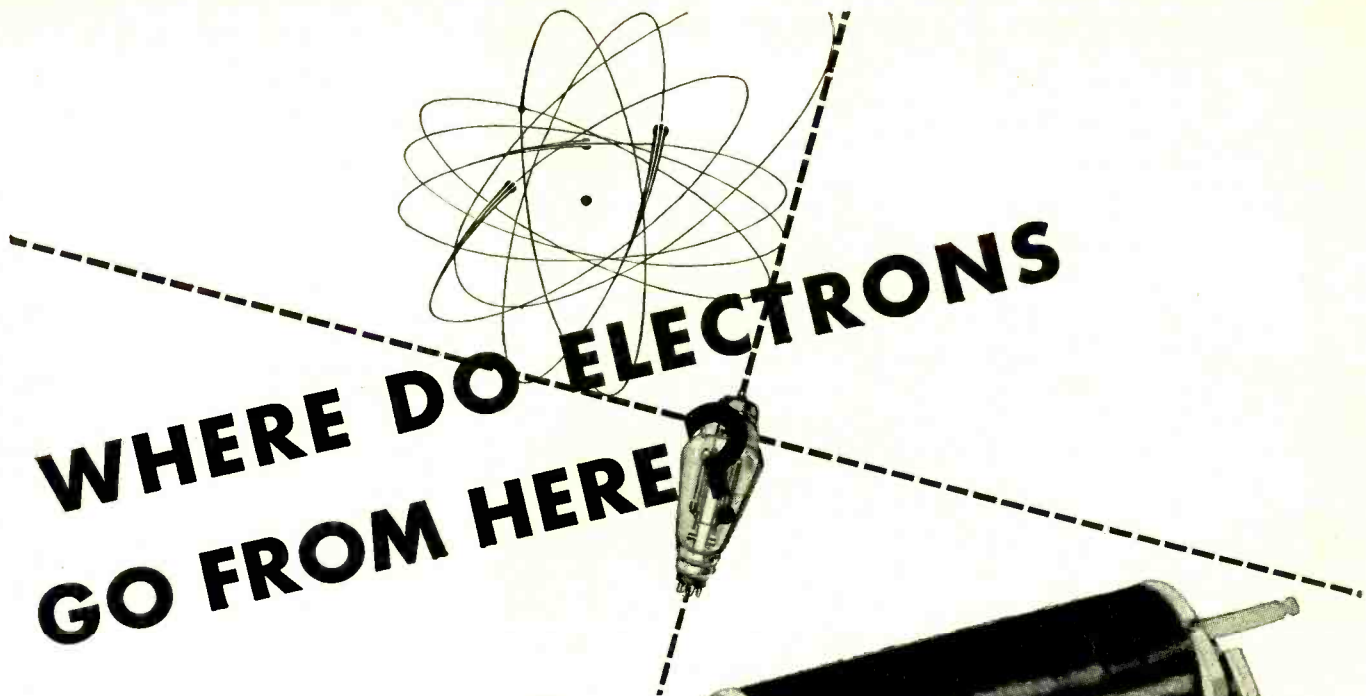

WHERE DO ELECTRONS GO FROM HERE

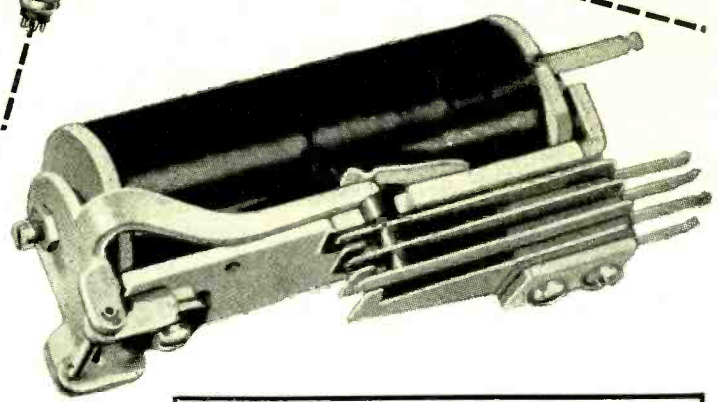

THE ERA of electronic experiment is fast giving way to the era of practical use. Already the electronic tube is doing indispensable work on the fighting fronts. At home, it is improving the tools of production, standing guard over product quality, speeding up industrial operations, and in a hundred other ways aiding in the making of more and better fighting equipment.

But between the electron tube and the "work to be done" there is a gap to be bridged. The tiny electronic currents must be captured, controlled, and put to useful work. Here is where Automatic Electric relays and stepping switches do their part—completing the link between tube and tool. That's why they're being called the "muscles for the miracle of electronics."

Today, Automatic Electric field engineers are working with the makers of electronic devices in many fields—offering time-saving suggestions for the selection of the right apparatus for each job, and the benefit of the technique which comes from fifty years of experience in remote control applications.

If you have a control problem—electronic or electrical—be sure to get the Automatic Electric catalog of control apparatus. Then, if you would like competent help in selecting the exact combination for your needs, call in our field engineer. His long experience will save you time and money.

AMERICAN AUTOMATIC ELECTRIC SALES COMPANY
1033 West Van Buren Street, Chicago, Ill.

Relays
AND OTHER CONTROL DEVICES
by **AUTOMATIC ELECTRIC**

Automatic Electric control devices are working with electronic tubes in these typical applications:

<p>Quality control—automatic inspection and sorting operations</p>	<p>Detecting and indicating—checking operations and revealing unstandard conditions</p>
<p>Automatic or directed selection of mechanical or electrical operations</p>	<p>Selection and switching of signaling and communication channels</p>
<p>Counting and totalizing of mechanical or electrical operations</p>	<p>Time, temperature and sequence control of industrial processes.</p>

The Automatic Electric catalog of control apparatus is the most complete reference book on the subject ever published. Write for your copy.

MUSCLES  FOR THE MIRACLES OF ELECTRONICS

RADIO

★ APRIL, 1943

11

Better SPEECH REPRODUCTION FROM THE SKYWAYS!

*No matter what the operating conditions . . .
JENSEN speech reproducers bring in those
important orders. PAN AMERICAN AIRWAYS SYSTEM
installed JENSEN speech reproducers at their
bases for ship to ground communications
because they know quality is an essential
and reliability a must.*

Jensen RADIO MANUFACTURING COMPANY

6601 SOUTH LARAMIE AVENUE
CHICAGO, U. S. A.



OAKS FROM ACORNS

★ The pace of progress in the design of standard u-h-f circuits having tunable elements has been materially reduced with an increase in frequency and the resultant decrease in the physical dimensions of the circuit elements involved. Though it is no engineering feat to design, say, an oscillator circuit of this type that will operate in the 100-megacycle region, it is quite a different matter to build into it a stability and accuracy equal to or better than that of a crystal-controlled unit. This is where the average engineer find himself up against a stone wall.

That circuits of this nature suitable for mass production can be built, has been demonstrated to us by S. Young White, who has devoted some years to research in this field. Working around the acorn tube, which is particularly adaptable to such circuits, he has developed tunable units as steady as an oak and with a precision unusual at such high frequencies.

Mr. White's experience in u-h-f design has brought forth some interesting conclusions. For one thing, it would seem that the application of engineering prediction in design work at these high frequencies serves only to lead the engineer into blind alleys, and there remains the necessity of throwing overboard the engineering axioms of the past and making entirely new approaches to the problems involved. And, where no engineering groundwork exists upon which to proceed, the engineer is forced to revert to the trial and error method of research.

It would also seem that the radio engineer seriously involved in the design of u-h-f equipment for frequencies of 100 megacycles and above, must learn a new trade. Physical dimensions of circuit elements become so minute and yet play such an important role in the determination of electrical characteristics, that the designer requires the knowledge of an expert machinist if he is to make any substantial progress. In the development of such equipment, wherein many circuit elements are purely imaginary and precision must fall in the realm of physical structure, a high degree of mechanical ingenuity is a prime requisite.

Moreover, since tunable circuits designed for operation at such high frequencies must be developed as an entity, it would seem that engineering collaboration must also be dispensed with, and the work placed into the hands of one man. The usual procedure of calling in the tube engineer, the coil engineer and the condenser engineer does not appear to be an appropriate approach to the subject, for the circuit elements at these high frequencies become inseparable and cannot be designed apart from the other elements. In this realm of design, more than one cook is apt to spoil the broth.

The fact that tunable circuits for operation in the 100-megacycle region can be designed to have an exceptionally high degree of stability and accuracy is interesting, and would suggest that they can be built for much higher frequencies; but what is particularly encouraging is the fact that these units can be produced in large quantities and at comparatively low cost. This fact alone will have a definite effect on post-war markets.

FINE WIRE DELIVERIES

★ Manufacturers of resistors and fine wire, used in military radio, have been urged to place orders quickly for fine wire in a recent letter by S. K. Wolf, Chief of the Resources Branch of the Radio Division, War Production Board.

Mr. Wolf pointed out that while orders for many sizes of fine wire are being delayed, the wire producers are working below capacity. He stated that facilities for producing some sizes have not been completed so that complaints of slow deliveries may be justified. He urged those who are experiencing difficulty in the delivery of fine wire .002 or smaller to seek the direct assistance of the Resources Branch. Report for each order the name of the supplier, purchase order number, size, quantity, description, delivery date promised and date required.

SCORPION

★ A favorite story of Parlor Pinks is the one about the storage-battery patent that was shelved because the battery itself was so revolutionary that it would have put the big battery companies out of business. More convincing, though not necessarily more logical, is the one about the oil companies discouraging the development of Diesel engines for autos because their use would leave said oil companies with a host of useless cracking plants on their hands.

But tales of this sort do serve to demonstrate the impact of technological advancement on the *status quo*. A new invention can displace an entire industry; an advancement in one field provides the mechanism for the invasion of another field; and above it all, workers are displaced and must learn new trades.

A curious sidelight, and one which we believe has no parallel, is the case of an industry that, through its own efforts can jeopardize its own interests. For there remains a strong possibility that, should home recording be advanced to the point where it can compete in quality, convenience and processing cost with factory-produced phonograph records, then the industry to which both are accountable will have, like the scorpion, stung itself with its own tail.—M. L. M.

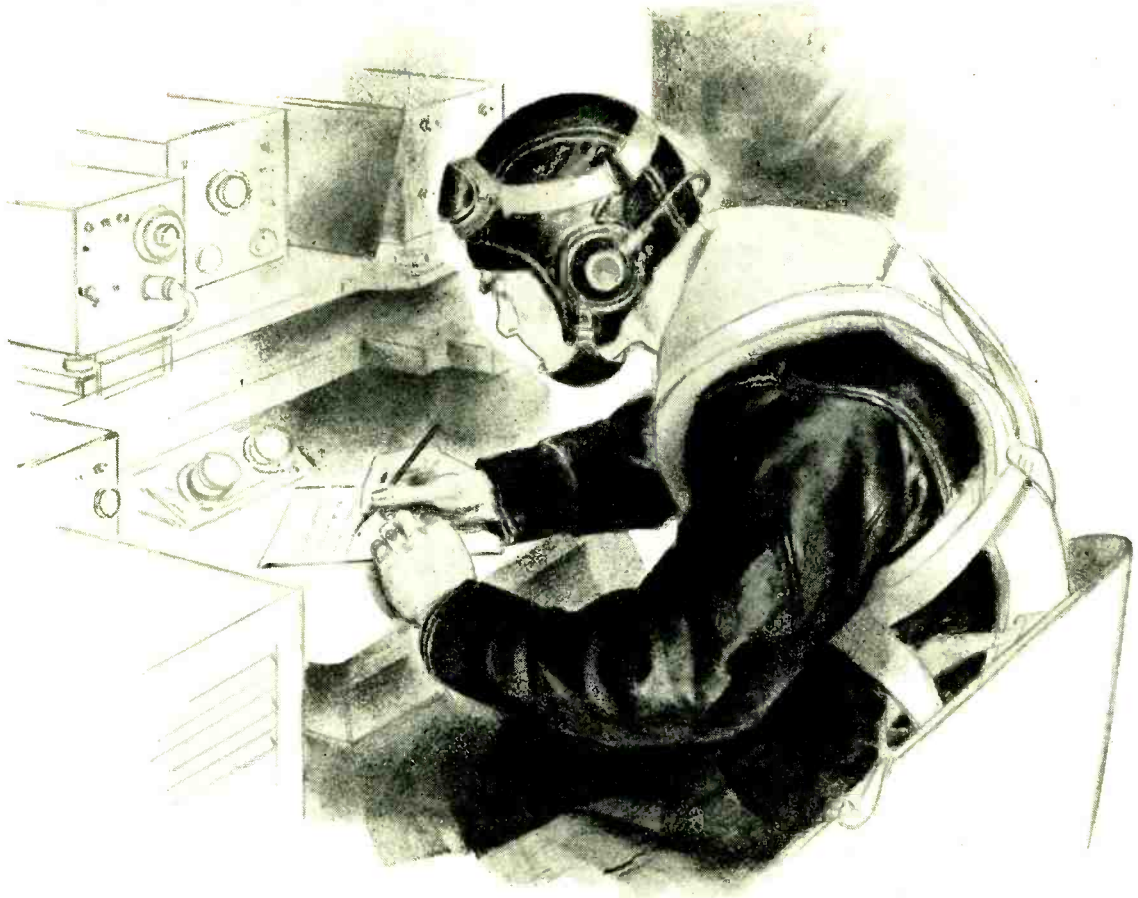

“Survivors sighted . . . proceed to rescue”

Through the blue comes the message that tells men in the air what to do . . . where to go. These messages must not, *cannot*, fail, for the whole operation of our Army and Navy Air Forces depends upon the vital artery, Communications.

Streamlined for this most exacting job, ROLA is devoting all of its facilities and its energies to the production of wartime electronic equipment — transformers, headsets, choke coils, and related devices. And, thanks to its long experience in this field, ROLA has been able to develop machines and methods to speed

production, prevent spoilage and improve performance . . . all to the end of better communications for our fighters in the air.

Today, all these developments belong to the War Effort. Later, we are confident, they will be of great significance in the field of peacetime Electronics.

Rola has done an outstanding job, both as prime contractor, and as subcontractor for other manufacturers and it can further utilize its expanded plant equipment, its increased knowledge and skill, in the War Effort. If you have a subcontracting problem, we suggest you write us, or ask our representative to call. THE ROLA COMPANY, INC., 2530 Superior Avenue, Cleveland, Ohio.

★ ROLA ★

MAKERS OF THE FINEST IN SOUND REPRODUCING AND ELECTRONIC EQUIPMENT

Q MEASUREMENTS AT U. H. F.

S. YOUNG WHITE

Consulting Engineer

★ The measurement of circuit losses is a basic one. In the post-war period the u-h-f communication bands between 50 and 500 megacycles will undoubtedly come into wide use, and the engineer must be prepared for accurate measurement in this region.

applied to a vacuum-tube voltmeter circuit including the meter *M2*, calibrated directly in *Q*. In operation, the oscillator is adjusted to the desired frequency, the current through *R1* is determined, the coil under test is brought to resonance with the oscillator fre-

quency, as indicated by a maximum reading of meter *M2*, and the *Q* directly read from the meter scale.

In the case of a routine *Q* measurement on a broadcast-band coil, this type of *Q* meter is extremely reliable and accurate. Since the coil will contain many feet of wire, extension leads several inches long will have negligible effect on the accuracy of the *Q* reading. The inductance of the coil will be several hundred microhenries, and the r-f resistance somewhere in the neighborhood of 3000 milliohms. The measurement frequency may be something like 1 mc, and the *Q* of the coil 100 or so.

Under these circumstances the 50-milliohm value of the series resistor *R1* is inconsequential in relation to the 3000-milliohm coil value. Moreover, at the low frequency of 1 megacycle, the vacuum-tube voltmeter operates well with almost no circuit loading; and the

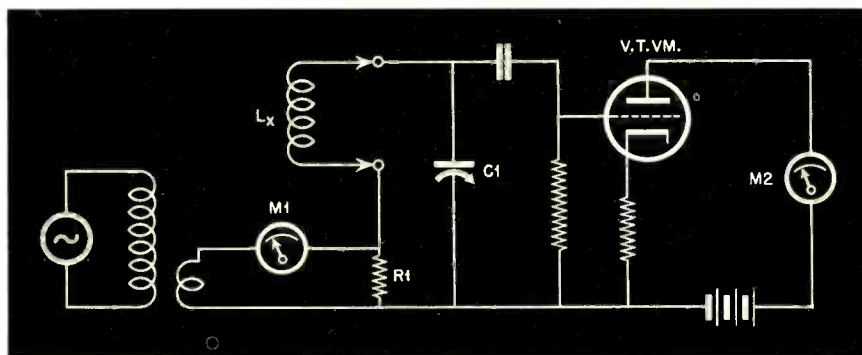

Fig. 1. Representative *Q*-meter circuit.

There are a number of methods of *Q* determination in use at the lower radio frequencies that offer difficulties if directly applied to u-h-f circuits. Other methods must be devised. The purpose of this article is to present a simplified approach to the problem, together with a few remarks relating to the problems involved in attempting to extend the range of operation of the standard *Q* meter into the u-h-f region.

Standard *Q* Meter

A representative *Q*-meter circuit is shown in Fig. 1. The calibrated oscillator drives a circuit containing the coil under test. L_x , in series with which is the resistor *R1*, having a value in the neighborhood of 0.050 ohm. The coil is tuned to the frequency of the oscillator by means of condenser *C1*, and the current through *R1* is measured by meter *M1*. By virtue of the resonant action of the circuit, the known voltage that appears across *R1* is increased by a factor directly proportional to circuit *Q*. The voltage so developed is

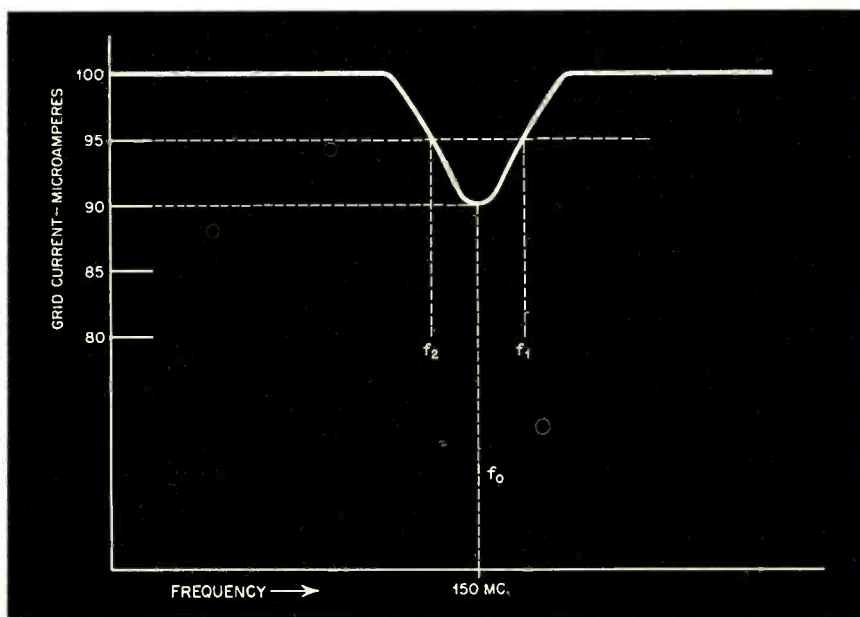

Fig. 2. Illustrating grid-dip method of determining *Q* and resonant frequency.

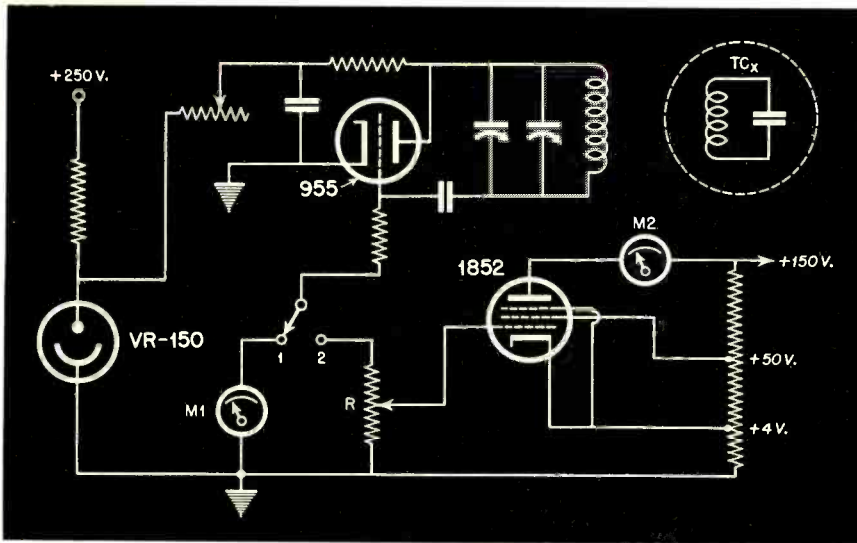

Fig. 3. Absorption-type Q-measuring circuit composed of oscillator and d-c amplifier.

length of the wiring inside the meter is likewise swamped by the (comparatively) large r-f resistance of the coil. Lastly, the resistor $R1$ can be readily designed to offer almost pure resistance at the low radio frequencies involved.

Now let us consider a Q measurement at 150 mc rather than 1 mc. Assume the coil to be something on the order of 3 turns of No. 14 copper wire with an inside diameter of about $\frac{3}{8}$ " and about the same length. Its d-c resistance will be approximately one milliohm, but its r-f resistance at 150 mc will be 40 milliohms or less.

The situation is now altogether different. The meter $M1$ will have some effect on the circuit; the value of $R1$ will be too large in relation to 40 milliohms to provide an accurate reading; and the vacuum-tube voltmeter will present a heavy load at 150 mc. The value of $R1$ will therefore have to be reduced to about 1 milliohm, and maintained as a pure resistance, and because of its low value it will be necessary to pass several amperes through it in order to obtain a reasonable voltage drop as a provision for usable readings on $M2$ in the vacuum-tube voltmeter circuit. Since the vacuum-tube voltmeter presents a heavy load at such frequencies, it introduces considerable loss into a high-Q circuit, with the result that the Q is seriously lowered. Though it is possible to compute a correction factor, calculations at these frequencies are, on the whole, unreliable.

The situation is further deteriorated by the fact that the 150-mc coil contains, altogether, only several inches of wire. Hence, the internal wiring of the Q meter becomes a large part of the total inductance under measurement. Moreover, there is so little wire constituting the coil proper that it is im-

possible to add lead lengths for the purpose of connecting it to the Q-meter binding posts, without adding to the inductance of the coil and its losses. If an attempt is made to connect the coil directly to the binding posts, and thus bring it close to these points, the eddy currents set up in the binding posts will seriously increase the coil losses, and serve also to change its inductance. This latter difficulty cannot be remedied by using less massive binding posts, for large contact areas are

required to keep the contact resistance well below one milliohm; otherwise the additional resistance of these two joints in series with the coil, will cause a false reading.

Some of the foregoing difficulties can be overcome by proper design, but a few of the drawbacks are inescapable. It is preferable to attack the complete problem from a different angle.

Grid-Dip Method

It is common knowledge that when a tuned circuit is coupled to an oscillator, some power will be drawn from the oscillator at the resonant frequency of the tuned circuit. If, as in Fig. 2, we plot the grid current of the oscillator in the vicinity of the resonant frequency of the tuned circuit under test,

we bring up the familiar grid-dip method of determining the frequency of a tuned circuit. The dip can be made more or less pronounced by altering the degree of coupling between the oscillator and the tuned circuit. And, in following this procedure, we have also plotted the resonance curve of the circuit under investigation, which is a function of the Q of the circuit.

The advantages are obvious: Since both the resonant frequency and the Q of the tuned circuit under test can be measured by merely coupling the unit to an oscillator, the inherent drawbacks of the standard-type Q meter at ultra-high frequencies are altogether eliminated. Moreover, the Q of the tuned circuit may be accurately measured as a unit, apart from other circuit elements, and re-measured again as circuit elements are added to form an operative assembly.

Practical Example

The generalized circuit of the absorption-type Q meter is shown in Fig. 3. The tuned circuit TC_x represents the unit under test. Assuming the Q-meter oscillator to be accurately calibrated, we can determine the Q of TC_x and also its resonant frequency, first entirely disassociated from other circuit elements and subsequently with the addition of circuit elements.

A representative test carried out by the author involved the use of TC_x as

CHANGES IN Q AND F BY ADDITION OF COMPONENTS

Condition	Q	Frequency
Unit in air	690	142,360
Unit in set	425	143,800
Socket added	420	143,200
Grid leak added	365	143,100
Tube added (dead)	350	139,780
Coupled to mixer	335	139,520
Oscillating	—	139,503

the tuned circuit in the oscillator of a u-h-f superheterodyne, employing a 955 acorn as the oscillator tube. Measurement of the tuned circuit in air indicated a Q of 690 and a resonant frequency of 142,360 kc. Progressive measurements, with circuit elements added, provided a complete and very informative set of figures showing the effect of each change. This data is given in the accompanying table as a matter of interest.

Data of this nature is of value to the design engineer in a number of ways, as, for instance, in determining the stability of an oscillator under voltage, temperature and humidity changes. In the case cited, examination of the table shows that the frequency rises 1440 kc

[Continued on page 46]

MISMATCHING IN COAXIAL LINES

V. J. YOUNG

★ In the transmission of very high frequency electrical energy through metallic conductors, we are concerned with three distinct types of losses. They are, (1) radiation, (2) a heating of the conductor due to its finite resistance through which currents flow, and (3) a loss due to mismatching of the line either at the source or at the load. The third type is perhaps the hardest to understand and if the line is not perfectly uniform along its length, additional mismatching may occur in the line itself.

If we wish to connect an electric toaster or a vacuum cleaner to a 60-cycle, 110-volt line, we use what we

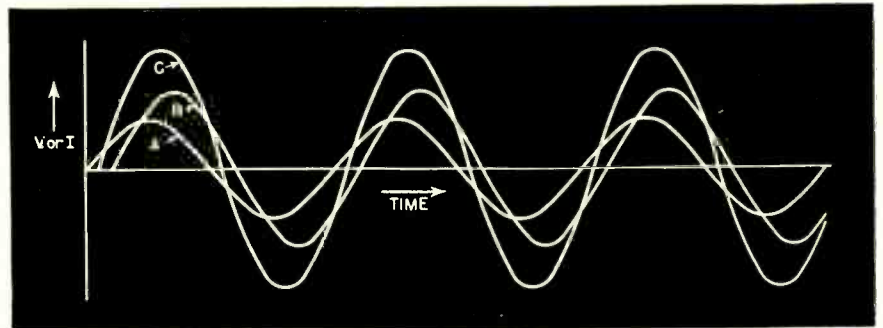

Fig. 3. Addition of sine waves. The sum of any two out-of-phase waves of the same frequency is in general another sine wave of intermediate phase. The point here is that any current or voltage which can be represented by C, can equally well be thought of as being two currents or voltages represented by A and B. Sine wave A plus sine wave B equals sine wave C.

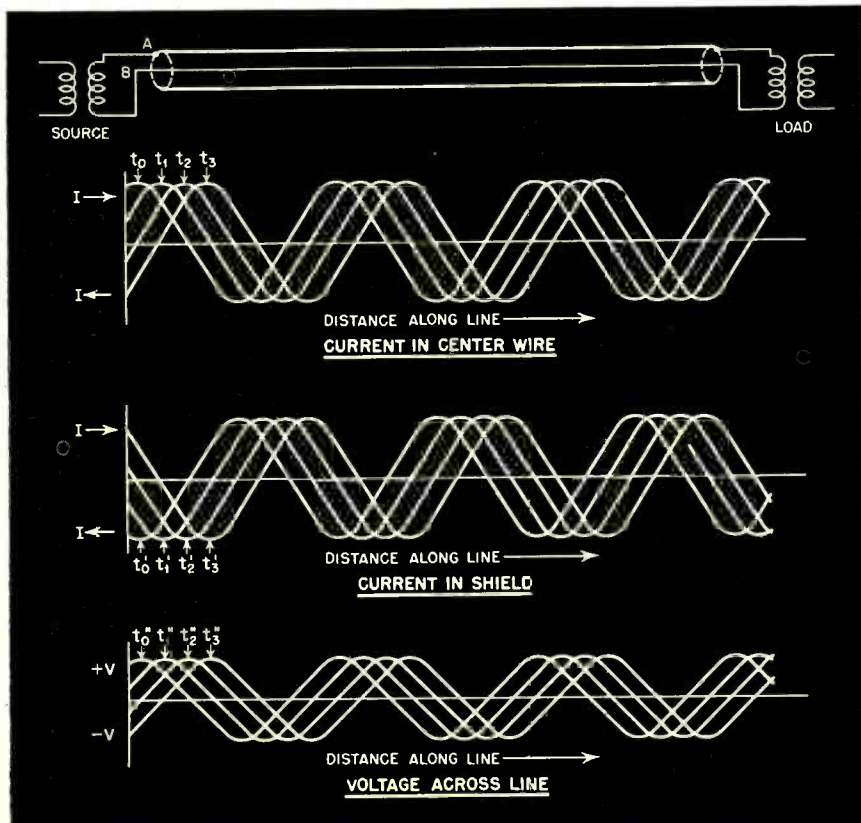

Fig. 1. Currents and voltages in a matched coaxial line for a sine-wave input.

may call a constant-voltage line. We do not concern ourselves about the characteristic impedance of the connecting cord. The speed of the current is so great that in the 120th of a second necessary for the polarity to reverse, the charge can travel an enormous distance as compared to the length of the cord. Every point on each conductor is at the same potential at any instant. The currents in the lines are always equal and opposite. If the two wires are close together, practically no net magnetic field ever surrounds the pair. The capacity between the leads is small enough to exert very little influence at such low frequencies.

With coaxial line used for a high enough frequency so that the line is more than a wavelength long, the situation is quite different. We then usually talk about the characteristic impedance of the line and say that we should match both the source and the load to that impedance. In principle we can see how to do this directly by using, for example, transformers both at the load and source ends. If, then, the transformers are perfectly adjustable and we can fix them so that a maximum of power is drawn from the source through one transformer

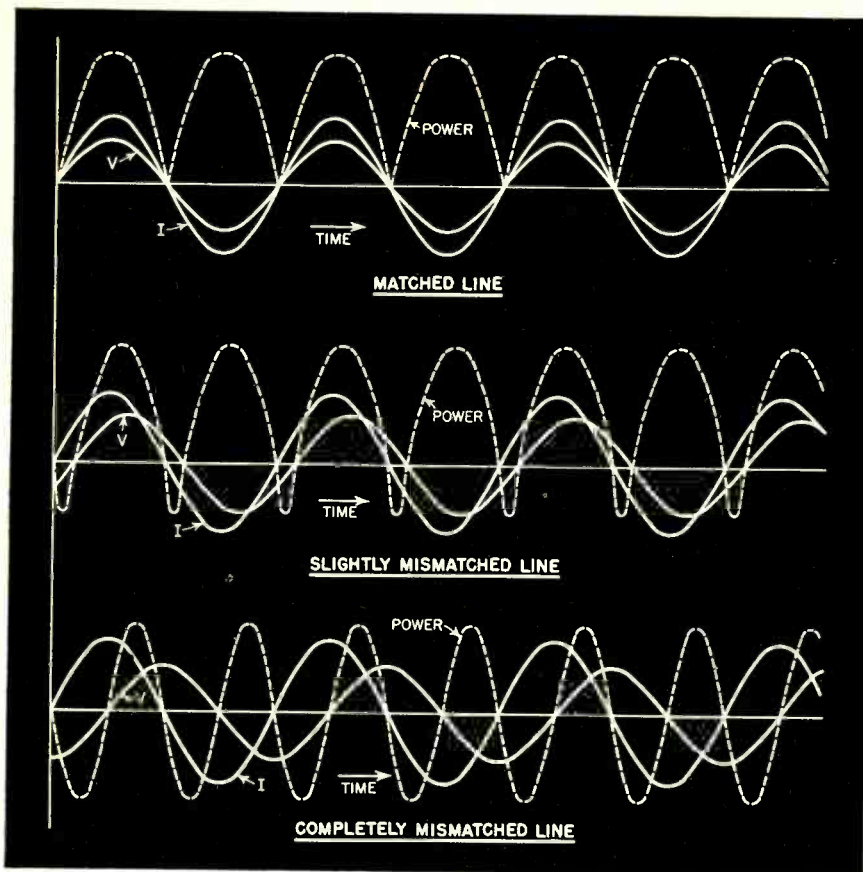

Fig. 2. Power fed from a coaxial line into a load. Voltage and current at the load are plotted as a function of time. Their product represents power.

into the line and made available out of the other transformer, then we have obtained perfect matching to the line, the source, and the load. If, with this arrangement, the line is broken at any point, the measured impedance will be the characteristic impedance and will be found to be the same in either direction. This seems reasonable since we know that maximum electrical energy is always fed from one device to another when the impedances are equal.

Current Propagation

In Fig. 1 is shown plots of current in the shield and center wire and the voltage across the coaxial line as a function of distance along the line. The curves marked with zero subscripts represent the situation at some arbitrary time at which we make our first plots. The subscripts 1, 2, 3, then represent a perfectly matched line at respectively very short times later. The two current curves have been plotted out of phase since it is in general apparent that A will receive a positive charge from the source transformer when B receives a negative charge, and vice versa. The current will vary with time and reverse polarity $2f$ times per second. Thus, if at some instant we focus our attention on a point on the wire, the direction and magnitude of the current changes with time. On the other hand if we focus our atten-

tion on a given current flow, we will find our eyes moving along the line from left to right. This is true of both the center conductor and the shield. The current wave moves down both wires from the source to the load. By looking at the curves in Fig. 1 in the order t_0, t_1, t_2 , etc., the propagation of the current wave can be visualized.

Similarly voltage waves are impressed on the line. A given voltage is at a certain instant applied to the line at the source. Successive sections of the line in turn come to this voltage only to continue on to the next voltage dictated by the source.

Phase Relations

We next ask about the phase of these three sinusoidal waves which we visualize as traveling along the line. In doing so we must note that in drawing these curves of Fig. 1, we really have in mind only one possible mode of propagation. If we were to consider higher modes at this point we would need to draw the curves quite differently. Fortunately for the simplicity of this discussion, it turns out that only this principal mode is of any importance when the diameter of the coaxial shield is sensibly smaller than a wavelength. Such a diameter is a convenient one for most applications.

The current waves must remain just 180 degrees out of phase. If they

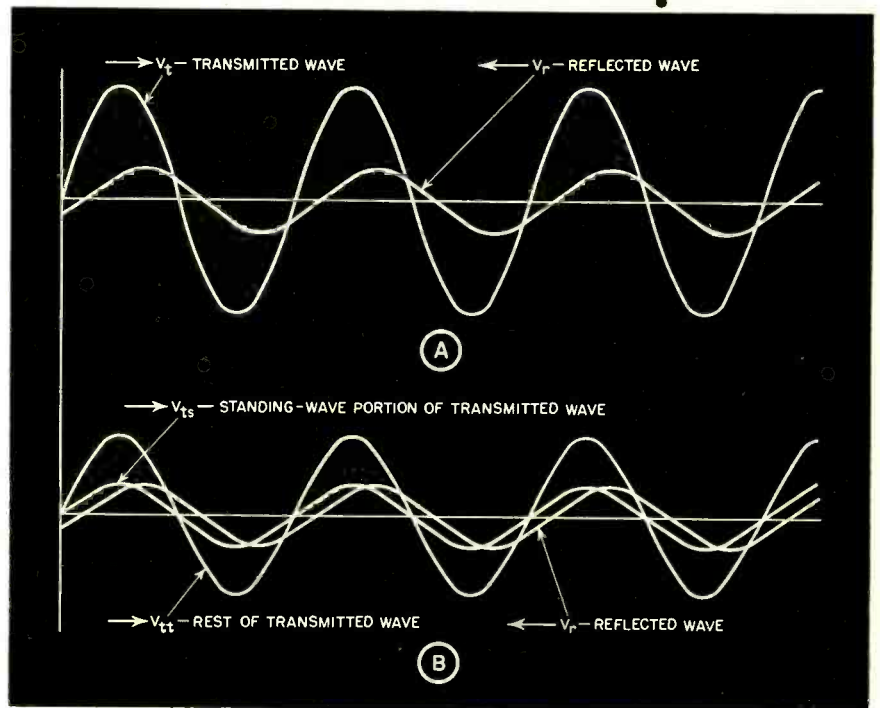

Fig. 4. "A" shows the voltage waves in a mismatched line. V_t is associated with the flow of energy to the load while V_r represents energy reflected back from the load to the source. In "B" the same line condition is represented. Here V_t has been replaced by V_{ts} and V_{tt} whose sum is always equal to V_t . V_{tt} represents net flow of energy to the load.

were otherwise, then at some time in the cycle current would be flowing into the load on both the center conductor and the shield. This in turn would require, during that interval, a charging up of the load with respect to the source and hence assumes an external capacity coupling of the load and source. This, of course, does not exist.

The two other possibilities for change in the curves of Fig. 1 with a specified frequency and input amplitude are a change of phase between voltage and current, and a progressive loss of amplitude of the waves as they move along the wire. These turn out to respectively represent mismatch and dissipative loss in the line.

Effect of Mismatch

To demonstrate the effect of mismatch let us look at Fig. 2. Here the voltage and current curves are drawn as they appear across the load as a function of time for one matched and

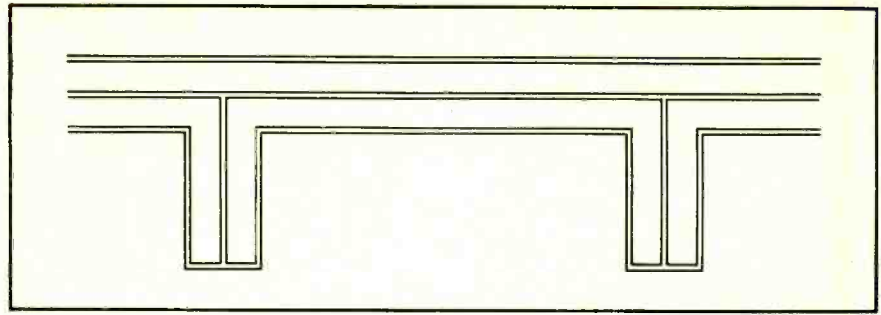

Fig. 6. A stub-supported concentric line. The stub supports are examples of perfectly mismatched lines. When properly adjusted they can be made to have practically no effect on a given frequency in the main line.

two mismatched cases. Also drawn in each case is a third curve representing their product. Since we know that the instantaneous product of voltage and current is the instantaneous power, this third curve represents power. The positive lobes represent energy brought to the load while the negative lobes represent energy fed from the load back to the source. Thus, the useful

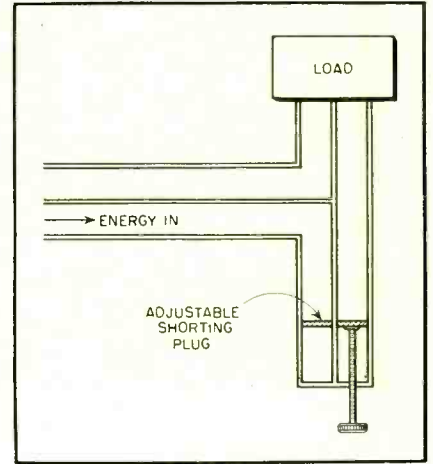

Fig. 7. In some cases it is possible to match a load to a coaxial line by the use of a matching stub. The stub is terminated as a perfect mismatch and is adjusted in length so that its reflected wave cancels the reflection from the load.

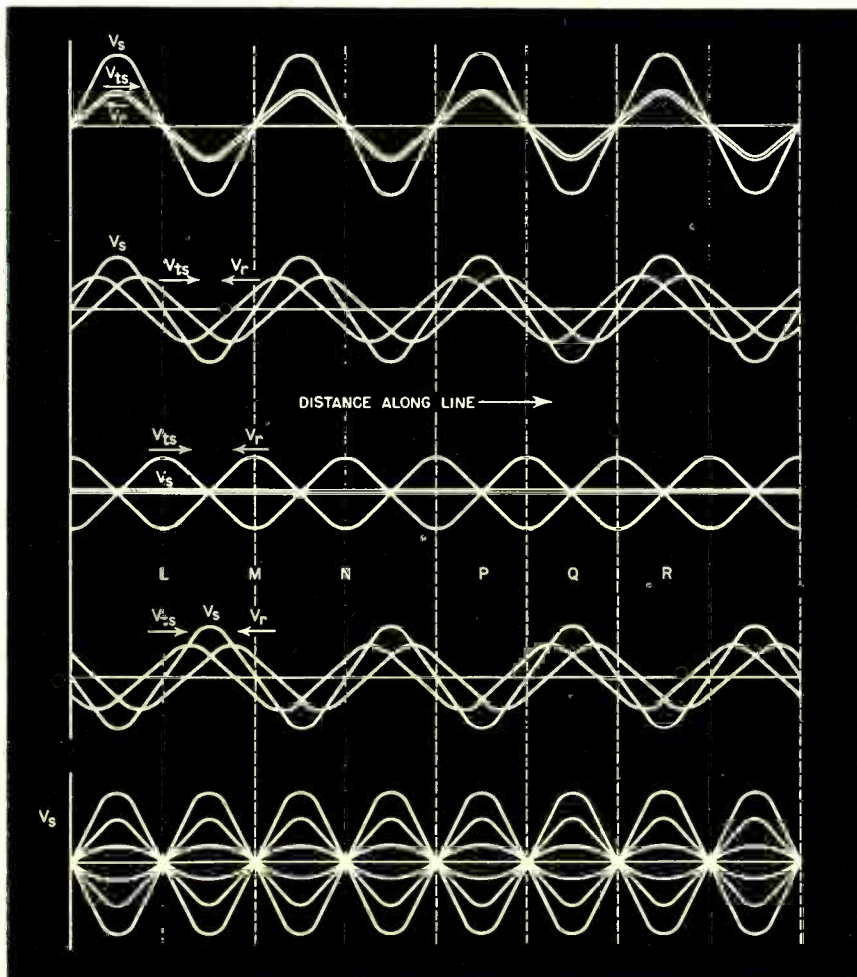

Fig. 5. The first four sketches represent "snapshots" of V_{ts} and V_r as they travel past each other. In the top line the two waves happen to be just in phase. In the second line V_{ts} has moved to the right and V_r to the left. In the third line these motions have progressed further so that the two waves are just out of phase. In the fourth line still greater progression is indicated. V_s is, in each case, the sum of V_{ts} and V_r and, of course, represents the voltage actually on the line by reason of these two waves. In the bottom line these sums have been redrawn on a single base line to show how voltage varies with time.

power for the load is the average difference between these two. This type of power loss is said to be non-dissipative, since the energy lost is not used up in heat but rather is fed back into the source. Inspection shows us that this loss becomes less and less as the phase angle between voltage and current becomes nearer to zero. Hence, a perfectly matched system is one in which there is no phase difference. The greater the mismatch the greater the phase angle.

Unfortunately this physical picture of what happens with a mismatched line is not one that makes for easy measurement. We cannot in general easily measure the amount of power traveling in each direction. As it happens, it is much easier to make measurements on the voltage wave, as will be explained later on. To understand how we should interpret this we must look further at our method of representing the voltage across the line.

In Fig. 1 we have shown the voltage as a sinusoidal wave traveling from the source to the load. In the mismatched case, since energy is flow-

[Continued on page 50]

PHASE AND FREQUENCY MODULATION

W. P. BOLLINGER

RCA Victor Division
Radio Corporation of America

PART 3

★ Generators of frequency-modulated signals which are in general use fall in one class. The fundamental circuit arrangement is a self-excited oscillator whose frequency is shifted in accordance with the modulation by varying either the inductance or capacitance in the frequency determining circuit. One method of accomplishing this is to have the vibrating diaphragm or other sound pick-up mechanism operate directly on the tuning capacity to vary it in accordance with the modulating sound and hence modulate the frequency of the self-excited oscillator. Practical applications of this method may be made by using an ordinary condenser microphone as all or a portion of the tuning capacity in the self-excited oscillator. Similar applications have been made in phonograph pickups.

The use of mechanical methods of varying capacity or inductance have many disadvantages from the standpoint of broadcast applications. The principal one is, of course, that each sound pick-up device must have its own

oscillator and since this oscillator determines the frequency of the frequency modulation station, prohibitive considerations would have to be given to each sound pick-up device associated with the transmitter.

Reactance-Tube Modulator

The solution to this problem lies in the use of a circuit commonly called the reactance tube. The fundamental circuit of the reactance tube is shown in Fig. 16-A. The generator E represents the voltage across which the circuit is to represent a reactance. This voltage is fed both to the plate of the tube and to the grid through the combination of C and R . The value of C is chosen such that at the frequency of E , its reactance is much greater than the resistance of R . Therefore, the voltage applied to the grid leads that applied to the plate by about 90° . Since the plate current is nearly proportional to the grid voltage, a large component of the plate current leads the plate voltage by 90° . The tube then represents a capacity whose value may be varied by varying the effect the grid

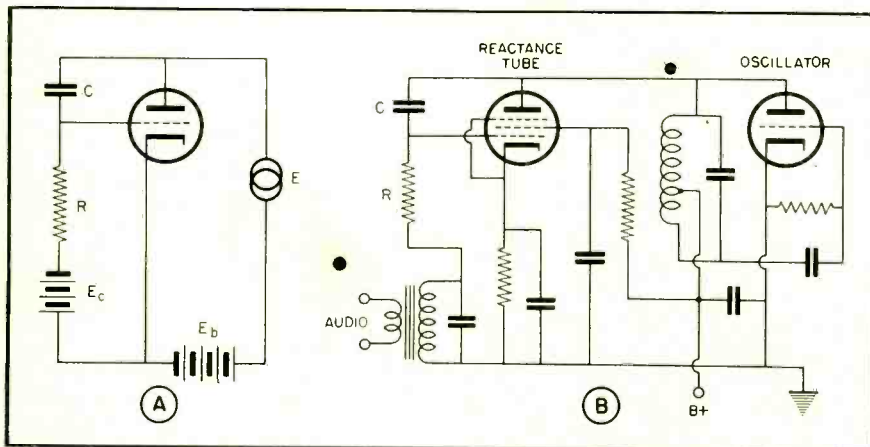

Fig. 16. Explanatory and typical circuit of reactance-tube frequency modulation generator.

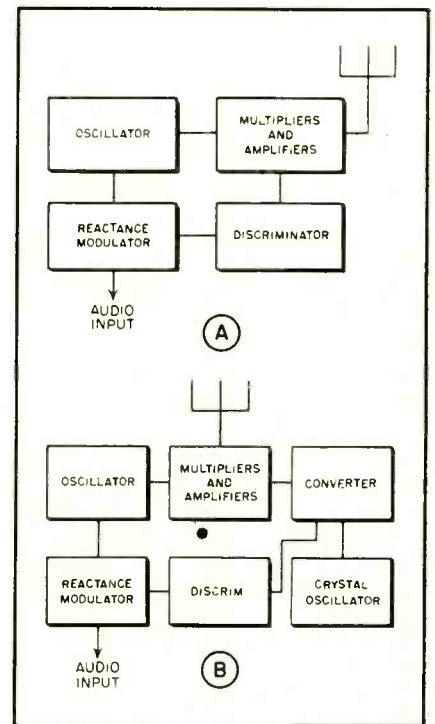

Fig. 17. Two methods of stabilizing the mid frequency of a reactance-tube modulator.

has on the plate current, that is, by varying the transconductance. The transconductance of a tube is dependent on the grid bias, so in Fig. 16-A the capacitive reactance of the circuit may be varied by varying the value of E_c . If then, as in Fig. 16-B, the modulating voltage is placed in series with the grid return of the reactance tube, and if this reactance tube is placed across the tuned circuit of a self-excited oscillator, a practical frequency modulation generator will be produced. If desired, the modulating voltage may be introduced into a second control grid using a tube similar to a 6SA7 as the reactance tube. Other modifications are possible; for example, the

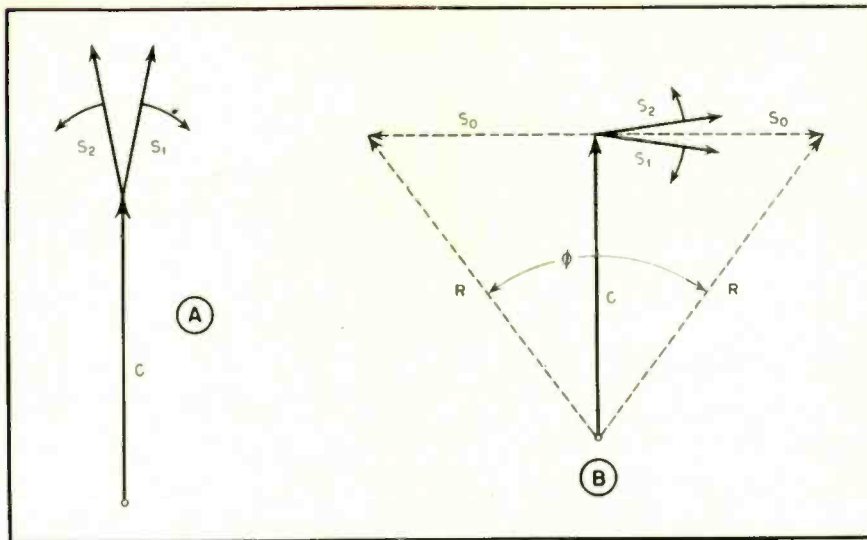

Fig. 18. Vector representation of method of phase modulation.

modulated signal. The vector C represents the carrier while the vectors S_1 and S_2 represent the two sidebands. Since the sidebands lie on either side of the carrier, they must be rotating with respect to the carrier, one in one direction and the other in the opposite direction, as indicated in the figure. Since the sideband vectors pass each other when they are in line with the carrier vector, the horizontal components of the sideband vectors cancel each other leaving for the sum of all the vectors only a vertical vector of oscillating magnitude.

Let us now consider the results if the sideband vectors are shifted 90° with respect to the carrier so that they now pass each other at the 90° position instead of in line with the carrier vec-

phase-shifting capacitor, C , may be replaced by an inductance of equal reactance, in which case the tube will present an inductive rather than capacitive lead.

Stabilization Systems

As would be expected, the principal disadvantage of the reactance tube modulating a self-excited oscillator is that the center frequency of the frequency-modulated transmitter is dependent on the stability of a self-excited oscillator. Although this is a serious drawback, many methods have been devised for causing the overall circuit to be self-correcting for changes in the oscillator frequency.

One method of correction, shown in block form in Fig. 17-A, is to feed the output of the frequency-modulated transmitter to a discriminator whose output is filtered to exclude the audio components. From this circuit, then, there is obtained a d.c. voltage whose magnitude and polarity represents the magnitude and direction in which the mid-frequency of the frequency-modulated transmitter differs from the center frequency of the discriminator. If then, this voltage is fed with the proper polarity to the control circuits of the reactance tube, the mid-frequency of the oscillator will be shifted in the direction toward the tuned frequency of the discriminator. Any external influence which then tends to change the frequency of the oscillator will be counteracted by a control voltage from the discriminator which, when applied to the reactance tube, tends to bring the frequency back to its original value.

The efficiency of the circuit can be greatly increased by the introduction of a frequency converter before the discriminator, as shown in Fig. 17-B. This converter lowers the mid-frequency of the frequency-modulated

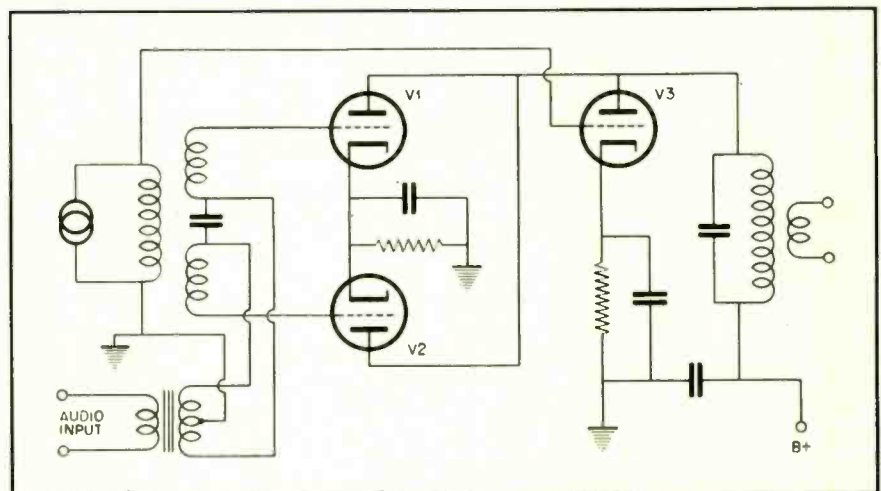

Fig. 19. Balanced reactance-tube phase-modulation generator.

signal while maintaining the same deviation. Hence, any small change of mid-frequency is greatly magnified in percentage by the converter making for a more stable circuit. The lower the mid-frequency output from the converter, the more nearly the mid-frequency of the frequency-modulated oscillator is dependent on the frequency of the crystal oscillator driving the converter. Hence, the crystal oscillator frequency is usually very near the mid-frequency of the output of the transmitter, making for a highly stable circuit.

Phase-Shift Methods

Phase-modulated signals can be produced in a great many ways, many of which are suitable for the phase-modulated transmitter. One of the early systems, which gained use in what are now the commercial frequency modulation stations, employs a rather complicated circuit whose method of operation can be explained by reference to Fig. 18-A. In this figure is shown a vector representation of an amplitude-

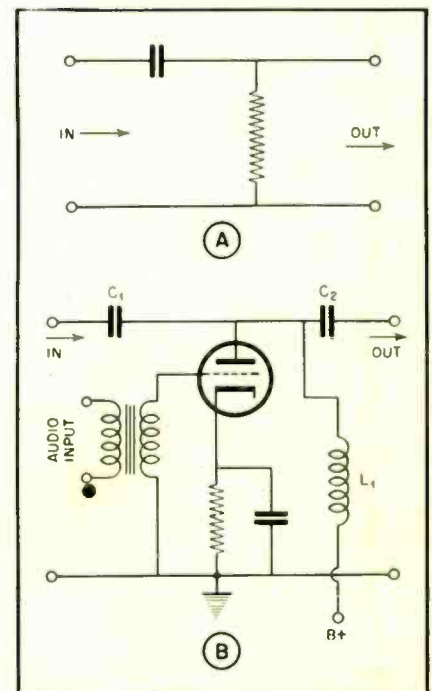

Fig. 20. Two R-C circuits for obtaining phase shift.

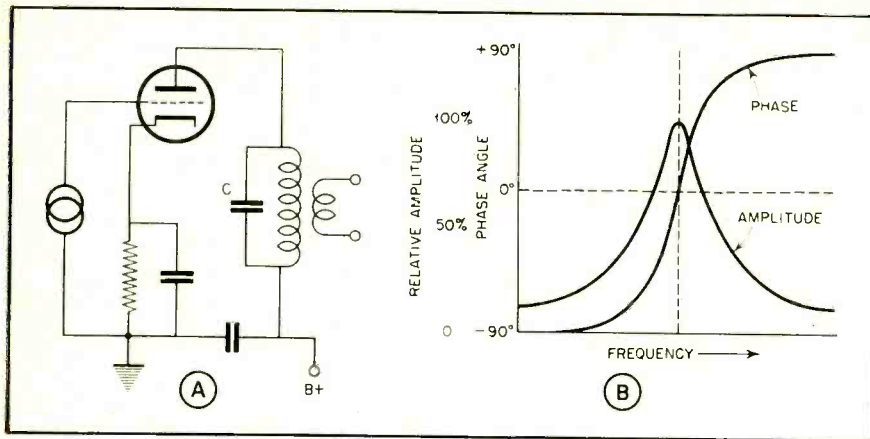

Fig. 21. A tuned phase-shift circuit, and its characteristics.

tor as shown in Fig. 18-B. The vertical components of the sideband vectors now cancel each other, leaving only a horizontal vector of varying magnitude and direction, as indicated by S_0 . If this resultant is added to the carrier vector the new resultant, R , will be a vector which oscillates back and forth through an angle ϕ and hence represents a phase-modulated signal so long as the angle ϕ is small. If ϕ becomes too large, it is no longer proportional to the amplitude of the sideband components and hence distortion will result.

Phase-Modulation Generator

It is then possible to produce a phase-modulated signal by separating the sidebands from an amplitude-modulated signal, shifting either the sidebands or the carrier by 90° , and recombining the two again. This can be accomplished as shown in the diagram of Fig. 19. A signal, such as from a crystal oscillator, is fed to two channels, one a 90° phase-shift circuit and the other a balanced modulator. This balanced modulator when fed the r-f signal and the modulating signal produces only the sidebands, the carrier being eliminated by virtue of a balancing action. The sidebands and the 90° shifted carrier are then recombined in a mixer, the output being a phase-modulated signal. In the circuit shown, $V1$ and $V2$ comprise the balanced modulator, while $V3$ is the mixer.

R-C Circuits

Since phase-modulation generators have a distinct advantage in that the mid-frequency may be obtained directly from a crystal oscillator, they have found wide application. Hence, simpler circuits than the one described above have been devised.

One form of phase shifter is shown in Fig. 20-A. In the range where the reactance of the capacitor is equal to

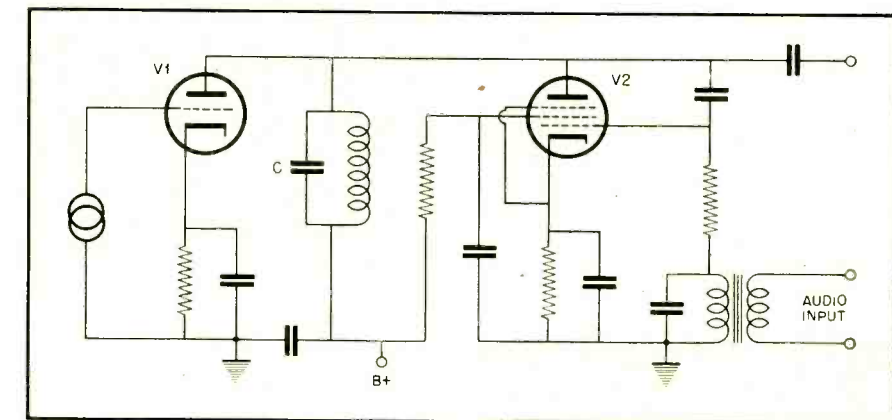

Fig. 22. Tuned circuit phase modulator in which reactance-tube provides variation in capacity.

the resistance, fairly large changes in phase shift can be obtained by varying either component. If, then, the value of, say, the resistance, were varied in accordance with the modulation signal, a phase-modulated output would be obtained. The value of the resistance can be varied by substituting for it the plate resistance of a vacuum tube and varying this plate resistance by controlling the bias.

Such circuit is shown in Fig. 20-B. The capacitor $C1$ and the plate resistance of the tube form the phase-shifting circuit while $V2$ and $L1$ comprise the output coupling. The chief disadvantages of this circuit are that only small phase deviations may be obtained without distortion, and that the output amplitude varies considerably with phase shift.

Tuned Phase Shifter

Some of the disadvantages of the simple R-C phase-shift circuit can be eliminated by the use of an L-C resonant circuit, as in Fig. 21-A. If the value of the capacity, C is varied, the output voltage will vary in phase and amplitude, as shown in Fig. 21-B. At

about the resonant frequency of the tuned circuit the phase shift is fairly linear and considerable deviation can be obtained before distortion is introduced. However, as indicated, the amplitude varies considerably over this range and provisions must be made for eliminating this variation. The variation in capacity can be obtained by use of the reactance tube previously discussed and connected as shown in Fig. 22. The main tuning capacity is C while the small variation in capacity is provided by the reactance tube, $V2$.

In Fig. 23-A is shown still another circuit which has several advantages over the others described. If L-C form a tuned circuit which is resonant at $\sqrt{2}$

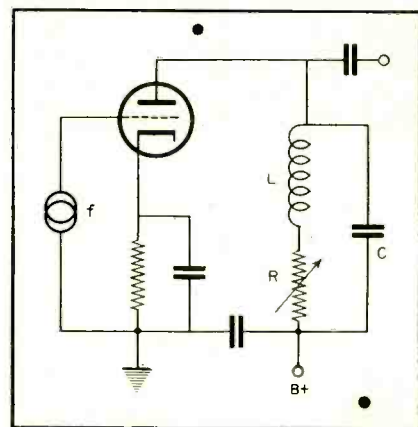

Fig. 23A. Improved reactance-tube phase-shift circuit.

times, the frequency of the signal voltage, some interesting effects are obtained. The most important of these is, that regardless of the value of R the impedance of the combination of R and L in parallel with C is a constant. The output voltage is then also a constant value regardless of R , but as R is varied, the phase varies, as shown in Fig. 23-B. Then, by substituting for R

[Continued on page 40]

RADIO DESIGN WORKSHEET

NO. 12—BRIDGE-CIRCUIT CURRENT; MULTIPLE ANGLES; CALCULATING PHASE DIFFERENCE

BRIDGE-CIRCUIT CURRENT

Problem: In the bridge circuit of Fig. 1, assume there is mutual inductance between the two coils such that a-b-n-m is series aiding, and that each arm b-n-m and b-a-m is resonant at the frequency of E . Find the current through the load (indicator mesh).

Solution:

If each arm is resonant, then:

$$Z_L = \omega(L+M), Z_C = 1/\omega C$$

where: M is mutual inductance between arm ab and arm mn .

Also: $\omega(L+M) = 1/\omega C$
Or $\omega^2(L+M)C = 1$

By Thevenin's Theorem* we have:

Impedance looking back into network with E short-circuited is:

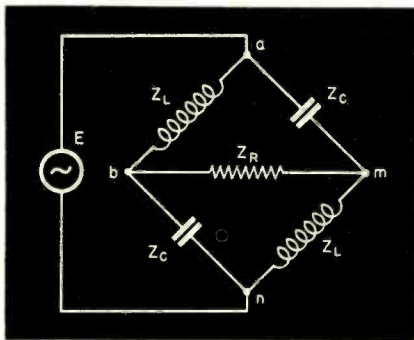

Fig. 1. A bridge circuit in which it is assumed that there is mutual inductance between the two coils.

$$Z = \frac{2Z_L Z_C}{Z_L + Z_C} \quad (\text{see Fig. 2})$$

$$E' = \left\{ \frac{Z_L}{Z_L + Z_C} - \frac{Z_C}{Z_L + Z_C} \right\} E$$

$$= \frac{Z_L - Z_C}{Z_L + Z_C} E \quad (\text{see Fig. 3})$$

where: E' is the open-circuit voltage across terminals mn with Z_R disconnected.

$$I_R = \frac{E'}{Z + Z_R} = \frac{E' (Z_L - Z_C)}{(Z_L + Z_C)(Z_L + Z_C + 2Z_L Z_C + Z_R(Z_L + Z_C))}$$

* Thevenin's Theorem, page 23, October, 1942.

But $Z_L = -Z_C$, whence $Z_L + Z_C = 0$
Then $I_R = \frac{Z_L - Z_C}{2Z_L Z_C} E = \frac{2Z_C E}{2Z_C^2} = \frac{E}{Z_C} = \frac{E}{Z_L}$
But $Z_L = \omega(L+M) = 1/\omega C$

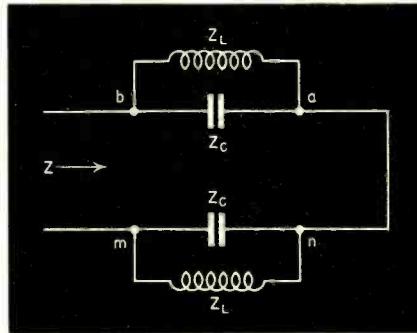

Fig. 2. Expression of the circuit shown in Fig. 1, with impedance looking back into the network with E short-circuited.

Whence:

$$I_R = \frac{E}{Z_L} = \frac{E}{\omega(L+M)} = E\omega C \quad (1)$$

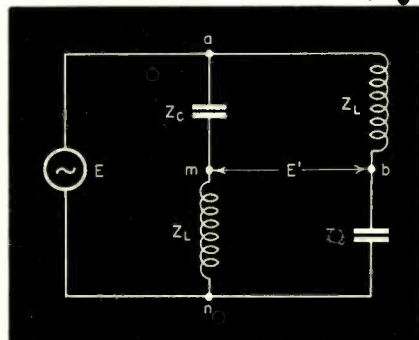

Fig. 3. Another expression of the bridge circuit of Fig. 1, wherein E' is the open-circuit voltage across terminals mn with Z_R disconnected.

omitting signs for imaginary quantities.

From (1) we find that the I_R , the current through the load or indicator is independent of the magnitude of phase of Z_R . Whence we have a con-

stant current circuit in which the current through the load is dependent only on the applied voltage and on the reactive arms of the bridge.

★

EXPRESSION FOR $\cos^N \theta$

Problem: Derive an expression for $\cos^N \theta$ in terms of multiple angles, that is harmonics of θ .

Solution: From Euler's Theorem we have:

$$\cos \theta = \frac{e^{j\theta} + e^{-j\theta}}{2} = \frac{1}{2} [e^{j\theta} + e^{-j\theta}]$$

where $j = \sqrt{-1}$

and $e = 2.7183$ which is the base of Napierian logarithms.

Whence:

$$\cos^N \theta = \frac{1}{2^N} [e^{j\theta} + e^{-j\theta}]^N$$

Expanding by the binomial theorem we have:

$$\cos^N \theta = \frac{1}{2^N} [e^{Nj\theta} + N e^{(N-2)j\theta} + \frac{N(N-1)}{2} e^{(N-4)j\theta} + \frac{N(N-1)(N-2)}{3 \times 2} e^{(N-6)j\theta} + \dots + e^{-Nj\theta}] \quad (1)$$

If $N = 2$ we have:

$$\cos^2 \theta = \frac{1}{4} [e^{2j\theta} + 2e^0 + e^{-2j\theta}]$$

But $e^0 = 1$

$$\therefore \cos^2 \theta = \frac{1}{2} \left[\frac{e^{2j\theta} + e^{-2j\theta}}{2} + 1 \right]$$

$$= \frac{1}{2} \cos 2\theta + \frac{1}{2}$$

And if $N = 3$ we have:

$$\cos^3 \theta = \frac{1}{8} [e^{3j\theta} + 3e^{j\theta} + 3e^{-j\theta} + e^{-3j\theta}]$$

$$= \frac{1}{4} \left[\frac{e^{3j\theta} + e^{-3j\theta}}{2} + 3 \left(\frac{e^{j\theta} + e^{-j\theta}}{2} \right) \right]$$

$$= \frac{1}{4} \cos 3\theta + \frac{3}{4} \cos \theta$$

Likewise, if $N = 4$ we have:

$$\cos^4 \theta = \frac{1}{16} [e^{4j\theta} + 4e^{2j\theta} + 6e^0 + 4e^{-2j\theta} + e^{-4j\theta}]$$

$$= \frac{1}{8} \left[\frac{e^{4j\theta} + e^{-4j\theta}}{2} + 4 \left(\frac{e^{2j\theta} + e^{-2j\theta}}{2} \right) + 6 \right]$$

$$= \frac{1}{8} \cos 4\theta + \frac{4}{8} \cos 2\theta + \frac{6}{8}$$

Thus, by substituting in (1) which is
[Continued on page 24]

the desired expression, we find:

$$\begin{aligned} \cos^2 \theta &= \frac{1}{2} \cos 2\theta + \frac{1}{2} \\ \cos^3 \theta &= \frac{1}{4} \cos 3\theta + \frac{3}{4} \cos \theta \\ \cos^4 \theta &= \frac{1}{8} \cos 4\theta + \frac{4}{8} \cos 2\theta + \frac{6}{8} \\ \cos^5 \theta &= \frac{1}{16} \cos 5\theta + \frac{5}{16} \cos 3\theta + \frac{10}{16} \cos \theta \\ \cos^6 \theta &= \frac{1}{32} \cos 6\theta + \frac{6}{32} \cos 4\theta + \frac{15}{32} \cos 2\theta + \frac{20}{32} \\ \cos^7 \theta &= \frac{1}{64} \cos 7\theta + \frac{7}{64} \cos 5\theta + \frac{21}{64} \cos 3\theta + \frac{35}{64} \cos \theta \\ \cos^8 \theta &= \frac{1}{128} \cos 8\theta + \frac{8}{128} \cos 6\theta + \frac{32}{128} \cos 4\theta + \frac{70}{128} \cos 2\theta + \frac{70}{128} \\ \cos^9 \theta &= \frac{1}{256} \cos 9\theta + \frac{9}{256} \cos 7\theta + \frac{36}{256} \cos 5\theta + \frac{84}{256} \cos 3\theta + \frac{126}{256} \cos \theta \\ \cos^{10} \theta &= \frac{1}{512} \cos 10\theta + \frac{10}{512} \cos 8\theta + \frac{45}{512} \cos 6\theta + \frac{120}{512} \cos 4\theta + \frac{210}{512} \cos 2\theta + \frac{126}{512} \end{aligned}$$

In similar fashion, it may be shown that:

$$\begin{aligned} \cos 3\theta &= 4 \cos^3 \theta - 3 \cos \theta \\ \cos 4\theta &= 8 \cos^4 \theta - 8 \cos^2 \theta + 1 \end{aligned}$$

$$\begin{aligned} \cos 5\theta &= 5 \cos^5 \theta - 20 \cos^3 \theta + 16 \cos \theta \\ \cos 6\theta &= 32 \cos^6 \theta - 48 \cos^4 \theta + 18 \cos^2 \theta - 1 \\ \cos 7\theta &= 64 \cos^7 \theta - 112 \cos^5 \theta + 56 \cos^3 \theta - 7 \cos \theta \\ \cos 8\theta &= 128 \cos^8 \theta - 256 \cos^6 \theta + 160 \cos^4 \theta - 32 \cos^2 \theta + 1 \\ \cos 9\theta &= 256 \cos^9 \theta - 576 \cos^7 \theta + 432 \cos^5 \theta - 120 \cos^3 \theta + 9 \cos \theta \end{aligned}$$

CALCULATING PHASE DIFFERENCE

Problem: Phase differences can be measured in a number of different ways, one of which is to compare the magnitudes of the sum and difference of two vector quantities. Before the cathode-ray oscilloscope came into general usage, the circuit shown in Fig. 1 was sometimes used for this purpose.

Establish the relation between the sum and difference currents out of the network and attenuator which permits calculation of phase difference.

Solution: Let it be required to determine the phase shift in the unknown network, i.e., between input and output currents. Let the output current of the network be a . Let the output current of the attenuator be b . Let switch 1 either properly terminate the unknown network or connect it to one primary of transformer T , through the reversing switch 2. Let switch 3 perform a similar function for Attenuator 1 without the reversing feature. The two primary windings of T are assumed to be balanced and identical. Current b can be assumed to be in phase with the input current of the unknown network.

If I_1 is the vector sum of a and b

and I_2 their vector difference, then:

$$\begin{aligned} I_1^2 &= a^2 + b^2 + 2ab \cos \theta \\ I_2^2 &= a^2 + b^2 - 2ab \cos \theta \end{aligned}$$

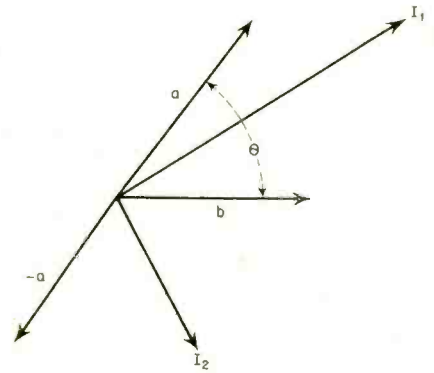

Let $a = K_1 b$.

Then:

$$\begin{aligned} I_1^2 &= b^2 (K_1^2 + 1 + 2K_1 \cos \theta) \\ I_2^2 &= b^2 (K_1^2 + 1 - 2K_1 \cos \theta) \end{aligned}$$

Further let $I_1 = K_2 I_2$.

Then:

$$\begin{aligned} K_2^2 &= \frac{I_1^2}{I_2^2} = \frac{K_1^2 + 1 + 2K_1 \cos \theta}{K_1^2 + 1 - 2K_1 \cos \theta} \\ \cos \theta &= \frac{2K_1 (K_2^2 - 1)}{2K_1 (K_2^2 + 1)} \end{aligned}$$

If the network attenuates rather than amplifies, then a and b can be adjusted to equality.

If $a = b$, then $K_1 = 1$

$$K_2^2 - 1$$

and $\cos \theta = \frac{K_2^2 - 1}{K_2^2 + 1}$ which is the relation desired.

In this connection it is interesting to note that the phase difference between the vector sum and vector difference of two equal vectors is $\pi/2$.

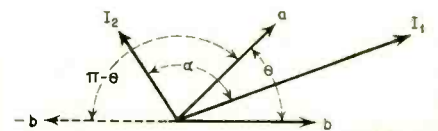

α is angular difference between sum and difference vectors I_1 and I_2 .

θ is the angular difference between equal vectors a and b . Obviously I_1 bisects θ and I_2 bisects $(\pi - \theta)$.

Then:

$$\alpha + \frac{(\pi - \theta)}{2} + \frac{\theta}{2} = \pi$$

$$\begin{aligned} \text{or: } 2\alpha + \pi - \theta + \theta &= 2\pi \\ 2\alpha &= \pi \\ \alpha &= \pi/2 \end{aligned}$$

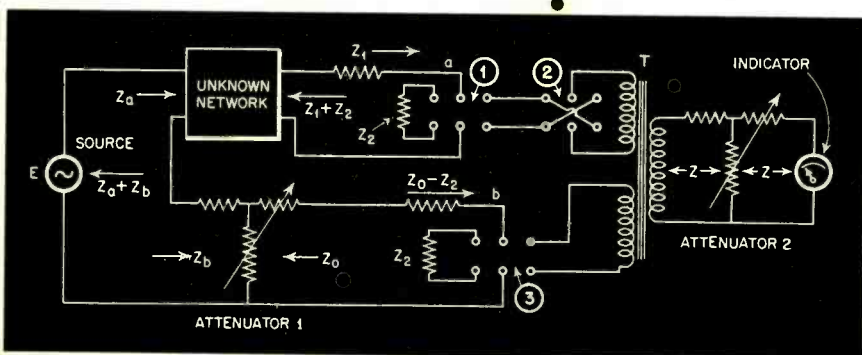
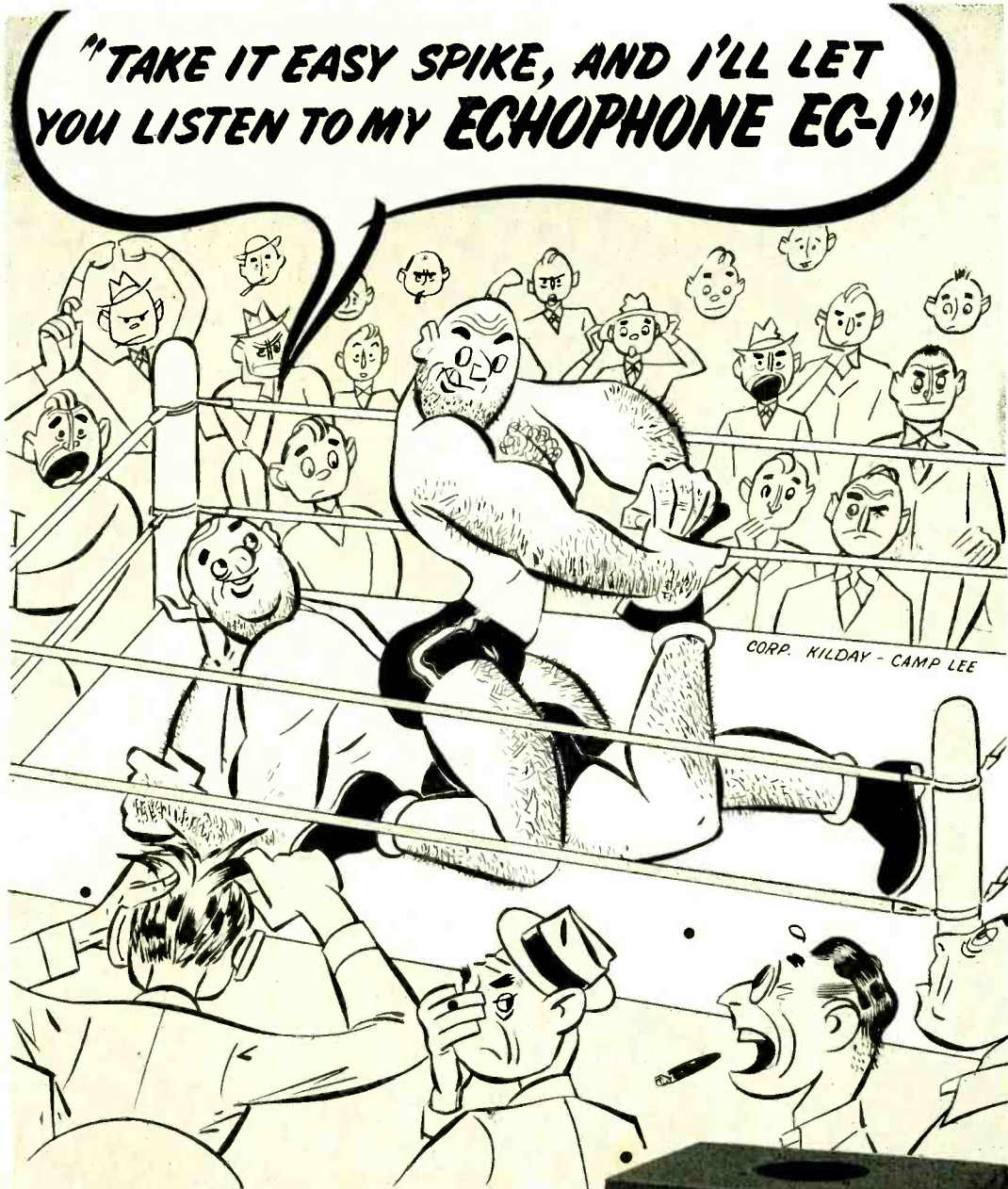

Fig. 1. Circuit by means of which phase differences can be measured. Manner of operation and calculations are explained in the accompanying text.



Echophone Model EC-1

(Illustrated) a compact communications receiver with every necessary feature for good reception. Covers from 550 kc. to 30 mc. on three bands. Electrical bandspread on all bands. Six tubes. Self-contained speaker. Operates on 115-125 volts AC or DC.



ECHOPHONE RADIO CO., 201 EAST 26th ST., CHICAGO, ILLINOIS

Use of Transmission Line in Determining

ANTENNA CHARACTERISTICS

OSCAR E. CARLSON

★ In the practical design and subsequent test and adjustment of u-h-f antennas of either the simple dipole or the more complex multi-element array type, it becomes necessary to adjust the antenna so that at the desired operating frequency the antenna will appear as an essentially pure resistance designed either for loading a transmitter or for feeding received energy into a receiver. Each antenna is designed to have some specific impedance value at its resonant frequency. The antenna will usually be fed by a coaxial-type transmission line having a characteristic impedance equal to the antenna impedance at resonance.

In some instances the antenna may be designed to have an impedance either lower or higher than that of the transmission line which is to feed it. In such cases a matching arrangement is usually built into the antenna assembly and must also be pre-adjusted by the manufacturer or designer.

It lies in inherently good manufacturing design and procedure to adjust all such antennas to the proper points as determined by customer's specifications concerning frequency, bandwidth, and the characteristic impedance of the transmission line to which the antenna will be coupled.

It is the purpose of this article to clarify the methods used to accomplish the proper adjustments of u-h-f

antennas. The data is applicable to antennas for television, frequency modulation, and straight communications.

Before going into the actual use of a transmission line in determining antenna characteristics we will deal briefly with some transmission-line and antenna theory which will aid in the clarification of the method to be used.

Transmission Lines

In any uniformly constant transmission line there are line constants such as resistance, capacitance and inductance, and all are uniformly distributed, as shown in *Fig. 1*. The transmission line will therefore offer a certain wave resistance which we term the "surge impedance" or "characteristic impedance" of the line. The characteristic impedance is expressed as Z_o and can, in most high-frequency cases, be considered as a pure resistance.

$$Z_o = \sqrt{\frac{R + j\omega L}{G + j\omega C}} \text{ ohms}$$

where: R is resistance per unit length.
 ωL is inductive reactance per unit length.

G is leakage conductance per unit length, expressed in mhos.

ωC is capacitive susceptance in mhos per unit length.

This becomes $Z_o = \sqrt{L/C}$ ohms, since R and G may be neglected for practical lengths of line.

With an r-f input into a transmission

line having a certain characteristic impedance, no standing waves are on the transmission line when the line is terminated with a resistance equal to the characteristic impedance of that line. This is due to the fact that with such a termination no wave reflection results back along the line from the load.

Since the line is to be used to feed energy from a transmitter to an antenna, or from antenna to receiver, maximum power will be transferred when $Z_o = Z_a$. While the amount of unbalance as indicated by voltage maximum to voltage minimum on the transmission line represents some power lost, that is not the most important factor if the line is short. However, such standing waves cause considerable difficulty in tuning the transmitter since under such conditions the transmitter is feeding into a reactive load.

The transmission-line impedance of a coaxial line is given by the formula:*

$$Z_o = 138 \log_{10} \frac{D_o}{D_i}$$

where D_o is inner diameter of outer conductor.

D_i is outer diameter of inner conductor.

Antennas

Dipoles of very small diameter have more inductance and less capacitance per unit length than larger diameter dipoles, and therefore have larger Q ratios and greater impedance variation over a given range of frequencies. In short, the reactance of small diameter dipoles is greater than that of larger diameter dipoles, and inductive.

The resistive component of the impedance of a half-wave dipole is approximately 73 ohms, but the dipole also has 42 ohms of reactance so that

* For further discussion, see "Transmission Lines as Circuit Elements," RADIO, March, 1943, page 24.

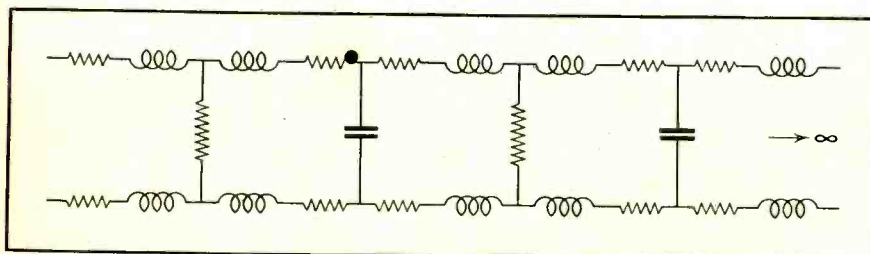

Fig. 1. Line constants of a transmission line.



F.M. Emergency Communications

by *Motorola*

RADIO ENGINEERING FOR TODAY
that means a lot for Tomorrow

Pioneers in the development of Portable and Mobile F-M and A-M Radiotelephone Equipment, Motorola engineers are today applying their accumulated skills and scientific knowledge to solving problems which confront our country, its states, counties, cities and towns. Housed in a new Engineering Building, with

expanded facilities for research and engineering, the Motorola capacity for vital service is greater than ever. Electronic knowledge thus gained will one day soon be applied to the normal peacetime demands of a nation eager for better things in all phases of its living.



THE ARMY-NAVY "E"—Awarded for excellence in the production of Communications Equipment for America's Armed Forces

Motorola Radio Communication Systems
Designed and Engineered to Fit Special Needs
GALVIN MFG. CORPORATION • CHICAGO

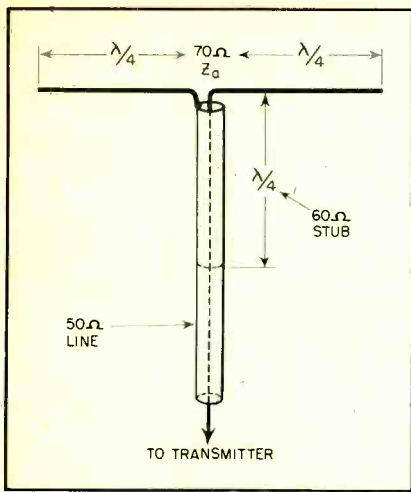

Fig. 2. Dipole antenna, transmission line, and matching stub.

its actual impedance is 84 ohms. But the impedance of the dipole at resonance is purely resistive since it acts as a series-resonant circuit. The impedance at resonance is resistive and is approximately 68 ohms. At resonance the dipoles should be 95% of the length of a computed half wave since the velocity of the wave current within the dipoles is less than that in free space, which velocity is used to compute a half wavelength.

Antenna combinations of other than the half-wave dipole type may be designed with various values of impedance at resonance. Some commercial u-h-f antennas have impedances as low as 20 ohms. Others may be considerably higher.

To match such antennas, or antenna elements of complicated arrays, to a transmission line having a characteristic impedance other than that of the antenna impedance requires a form of matching transformer. A quarter-wave transmission line matching stub may be made a part of the transmission line between the antenna elements to be matched and the feeder transmission line. This section should be

of a characteristic impedance determined as follows:

$$Z_o = \sqrt{Z_{in} Z_a}$$

where Z_{in} is the transmission-line impedance.

Z_a is the antenna impedance.

Z_o is the matching-section impedance.

Such an arrangement would be as shown in Fig. 2. To match a 50-ohm line to a 70-ohm antenna would then

the direction of current flow in the radiating elements, and a dipole radiates or receives energy—depending upon whether it is a transmitting or receiving antenna—in a direction broadside to the antenna.

The simplest uni-directional antenna is a half-wave dipole with another half-wave dipole mounted an approximate quarter wave behind it in the same plane but not fed by a transmission line. This arrangement is

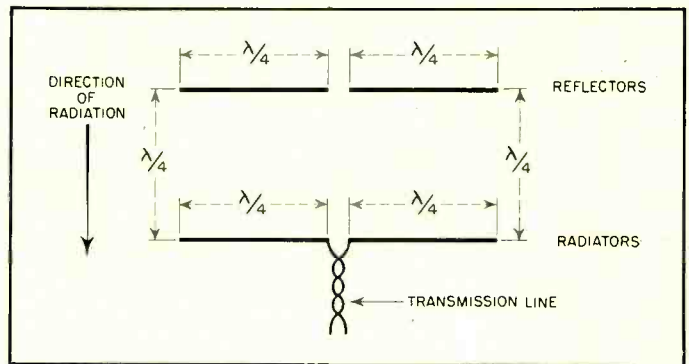

Fig. 3. Half-wave dipole antenna made uni-directional by addition of a reflector.

require a matching stub having a characteristic impedance of about 60 ohms.

For satisfactory operation on ultra-high frequencies, an antenna should offer a termination to a transmission line that does not change rapidly with frequency variations on either side of the operating frequency. To ascertain this frequency characteristic, the ratio of maximum to minimum voltage on the transmission line is measured for a number of frequencies on either side of the operating frequency. A ratio of unity is a perfect match. A ratio of 1/666, or 1.5, at the end frequencies and 1.25 at center frequency may be considered in most cases as a satisfactory match.

The aforementioned data holds for directional arrays as well as for simple dipoles. Directional antennas depend on the fact that radio waves are transverse; that is, the electric force of a radio wave is exerted perpendicular to

shown in Fig. 3. The two sets of elements shown are "mutually" coupled just as the primary and secondary of a transformer. The reflector may then be considered as a "self-generating" antenna. By the time the radiation from the reflector reaches the radiator dipole it is exactly in phase with the resonance current of the forward dipole and an increased current flows in the forward, or radiator, elements, and consequently an increased forward radiation results.

Since the radiator current lags the inherent reflector current by 90 time degrees, or a quarter wavelength, the induced reflector current is in phase opposition with respect to inherent reflector current and, therefore, tends to cancel the inherent reflector current. The reflector therefore blocks radiation in a direction away from the radiator and adds to the radiation in the direction of the radiator elements.

Directional Arrays

There are many types of directional arrays which it is not within the scope of this article to cover. It will suffice, now that some of the fundamentals have been detailed, to state that in most directional arrays there are chiefly two types. One type has all the elements fed in phase and with equal currents. The other feeds all the elements in phase but provides unequal current distribution to the various elements. Thus, by feeding less current to the side elements of an array, the forward radiation is greatly accentuated in a narrow beam. This unequal current distribution is accom-

[Continued on page 32]

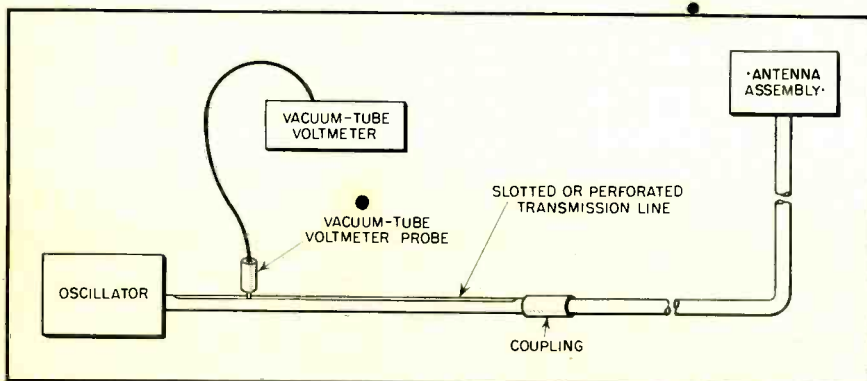
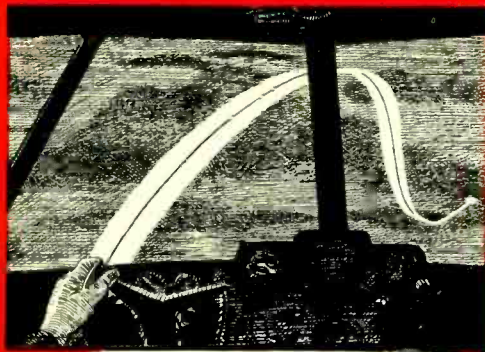

Fig. 4. Antenna test setup, using oscillator and vacuum-tube voltmeter, for determining antenna characteristics.



elec



Eimac ENGINEERING

The cornerstone in Eimac's existence has been their advanced electronic engineering. The development of the gas-free tube, pioneering in the use of new materials, radical changes in existing tube design... all these things are the results of their research. During today's accelerated business situation Eimac engineers have developed and put to work many outstanding innovations. Number one on this list is the actual achievement of mass production of a product that heretofore was hand-made in a scientific laboratory. Today the most interesting of the other developments must be kept secret but the heads-up engineering is going forward apace. The services of this organization are available only for war problems now but will be offered to industry at large when peace comes. If you have a problem, the solution to which might involve vacuum tubes, write direct to factory.

EITEL - McCULLOUGH, INC. • SAN BRUNO, CALIFORNIA

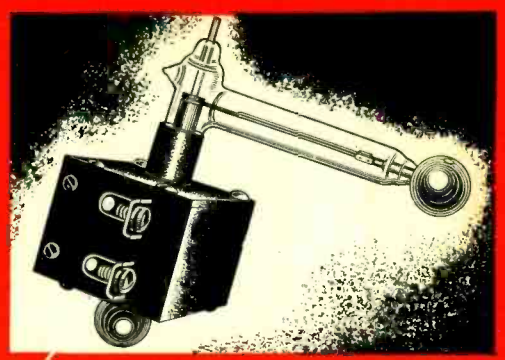
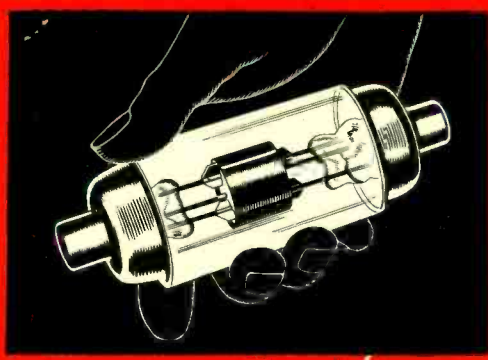

tronic telesis*

* Progress conciously planned and produced by intelligently directed effort.

— Century Dictionary and Cyclopedia

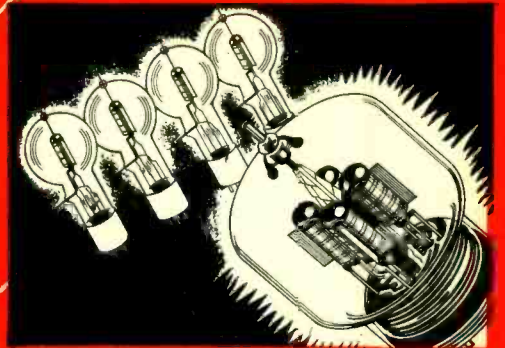

● **Eimac Tubes in the Ground Stations of the Major Airlines.** The economy, stamina and superior performance capabilities of Eimac tubes helped make the operation of complex multi-frequency transmitters practical for aircraft ground stations. Eimac 450T tubes are in use by practically every major airline today.

● **Eimac Tubes in Instrument Landing Equipment.** Airline pilots no longer need fly "by the seat of their pants" for blind landing equipment is in regular service. There are several of these systems in existence which use Eimac tubes.

● **Eimac Tubes and Frequency Modulation.** Close cooperation between Eimac and the leading engineers throughout the world has made Eimac first choice in the important new development in radio. FM and Eimac tubes have been close companions from the very start of Major Armstrong's experiments.

● **Eimac Tubes in Police Radio Communications.** Where dependability, stamina and superior performance are extremely vital you'll find Eimac tubes every time. Police radio engineers from Connecticut to California are loud in their praise of the service of Eimac tubes.

● **Eimac Engineered the Vacuum Condenser.** Small, compact tank circuits, made possible with the Eimac vacuum condensers helped increase the efficiency of many types of radio transmitters. Since plate spacing is determined by mechanical rather than voltage limitations, actual plate area is reduced to the very minimum.

● **Eimac Developed the Vacuum Relay.** Over two years ago Eimac developed this single pole double throw vacuum relay. It handles 20,000 volts of RF potential without internal breakdown. Air pressure and humidity have no effect on it. Actually flashover will occur across outside terminals first even though contact spacing is but .015". A tribute to Eimac engineering.

● **Eimac Developed the Multi-Unit Tube.** Triode units so nearly perfect that two or more can be placed in a single envelope. Power capabilities are determined by multiplying the capabilities of the single triode unit by the number of units employed in the tube. A revolutionary vacuum tube typical of Eimac's engineering leadership.

● **Power Transmission with Vacuum Tubes?** In the days to come many new uses for Eimac tubes will be announced. The use of vacuum tubes for power transmission may be one of them. Of one thing you can be sure, Eimac engineering and development will be in the forefront.

● **Eimac Tubes have gone to War.** With almost machine gun rapidity, Eimac tubes have been adopted by one after another of the peacetime services. Naturally Eimac was among the first to be drafted into war. The important job they are accomplishing today must remain secret for the duration. When the shooting is over, you'll find out why the armed services turned to Eimac so quickly.

● **Coveted Army-Navy "E" award for high achievement in production for war.**

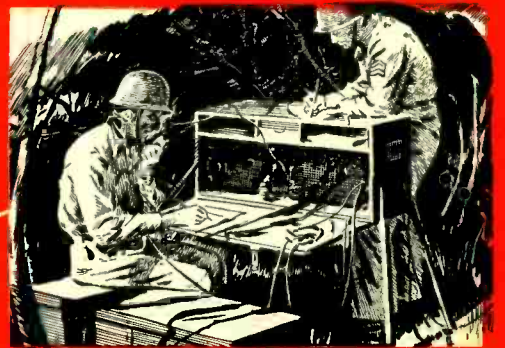
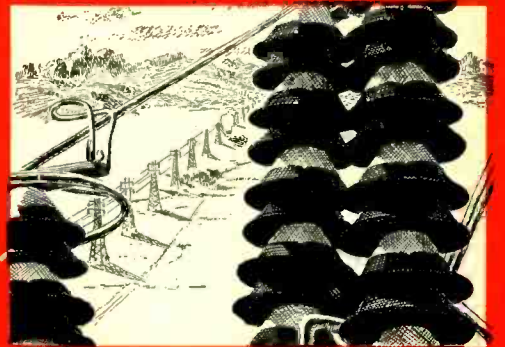

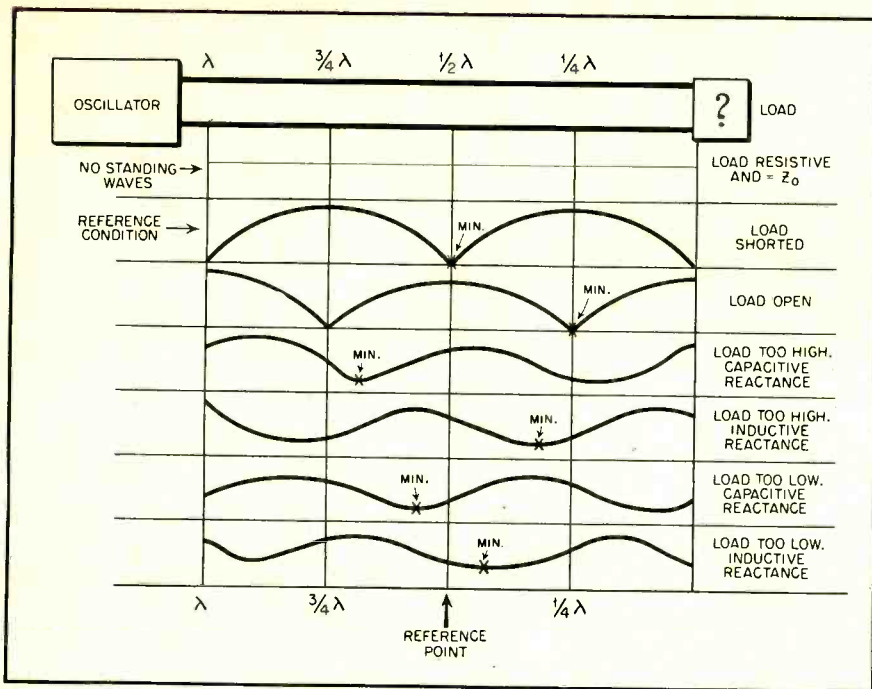

Fig. 5. Standing waves on a transmission line under various load conditions.

plished by using different impedance transmission lines to tie the outer elements to the center elements. By feeding the outer elements through a higher impedance line than the center elements and combining the various impedance lines to one tie point terminating in a line having the characteristic impedance of the line that is to be used from the transmitter, the desired unequal current distribution will result, since in all cases $I = E/Z$.

Determining Antenna Characteristics

We have seen that it is necessary to match the antenna impedance to the transmission-line impedance. With the best of design and closest of manufacturing tolerances, it is nearly impossible to build an antenna that we can state has some definite impedance which is purely resistive at a desired frequency.

Before attempting to match the impedances we must determine two things; the amount of mismatch, ratio of voltage maximum to voltage minimum and the location of the voltage minimum point nearest the load, or antenna. To accomplish this we need a section of transmission line that has the same characteristic impedance as the line that the antenna is intended to be used with. This section of test line should be at least a wavelength long and must be either slotted to allow the insertion and moving along the line of a vacuum-tube voltmeter probe, or should have small holes drilled in it at one- or two-inch intervals so the probe voltmeter can be inserted to measure the r-f voltage at various points on the line.

This section of line is coupled to the antenna to be tested either directly or in conjunction with another section of the same size line, as shown in Fig. 4. A low-power oscillator covering the frequency that the antenna is intended to operate on is needed, as is a good wavemeter covering the frequency range in question.

With the antenna and equipment set up as in Fig. 4 the standing wave ratio may be readily checked. Tune the oscillator to the operating frequency that the antenna is designed for and slide the vacuum-tube voltmeter probe along the slot in the transmission line. Also measure the standing wave ratio at the end frequencies of the desired antenna band.

If the standing wave ratio shows a decided mismatch, as indicated by large ratio of voltage maximum to voltage minimum, place a short circuit across the transmission line feeding the antenna at the point where the antenna assembly joins the transmission line. Then find the first voltage minimum—zero voltage in this case—nearest the loaded end of the slotted line. Mark this point, as it is the reference for later computations. Remove the short circuit, and with the voltmeter probe locate the new voltage minimum position nearest the load end of the slotted line. Fig. 5 shows various conditions of voltage ratios on the line for different appearing loads.

From the above it will be seen that if the voltage decreases as the probe is moved past the reference point toward the load, the load appears inductive. If the voltage minimum with the load occurs within one eighth wave-

length of the reference point, the load impedance is too low. This means that the load impedance is lower than the characteristic impedance of the line. If the voltage increases as the probe is moved toward the load at the reference point, then the load appears capacitive.

When we have established the character of the load, or antenna, we can apply corrective measures to counteract the impedances that the antenna has assumed. Let us say that tests show the antenna impedance to be too low, and capacitive. It would then be a simple matter to increase the spacing of the parallel lines on the antenna, if it were so constructed. We could also alter the impedance of the matching stub.

Besides the series arrangement for matching, as shown in Fig. 2, shunt arrangements are used. A line with some given characteristic impedance Z_0 and admittance Y_0 may be terminated by an antenna having some other admittance than Y_0 . To prevent standing waves on the transmission feed line to such an antenna we can insert a shunt somewhere along the line where the conductance G of the

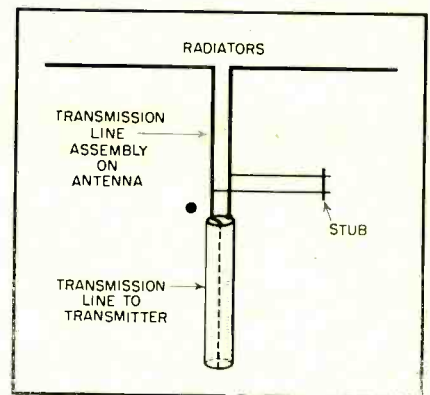
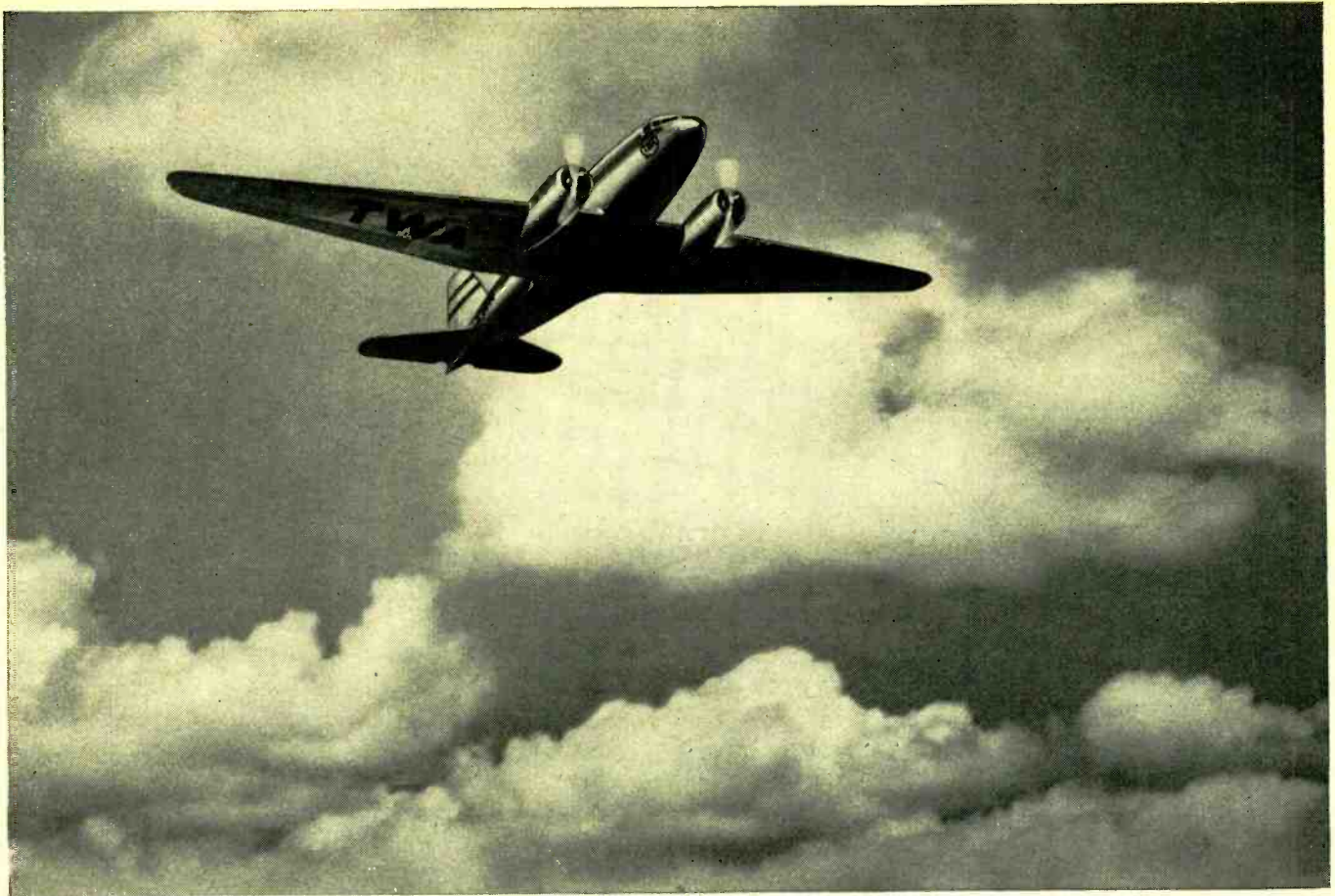

Fig. 6. Dipole antenna with shunt arrangement for matching, using a shorted matching stub.

line equals the characteristic admittance Y_0 . This shunt is composed of a shorted line whose shorting point is variable so that it may be adjusted to have a susceptance B equal and opposite to the susceptance of the line at that point. The resulting admittance of the total arrangement is then the characteristic admittance, so that a match is obtained. Fig. 6 shows such an arrangement. This stub would then be tuned so that no standing waves resulted on the test transmission line. For such an arrangement the stub and necessary length of line would usually be built into the antenna assembly as an integral part of the antenna.

[Continued on page 46]



Photograph, courtesy Transcontinental and Western Air, Inc.

THERE MUST BE DEPENDABLE COMMUNICATIONS

The reliability of Wilcox communications and other radio equipment has made them invaluable servants of leading commercial airlines.

Now, the entire output of Wilcox factories is going to wartime uses, and the experience gained during

peacetime is standing in good stead for military operations.

Thus, Wilcox is keeping pace with the miracles of flight...and, after Victory, new Wilcox developments will be available for the better-to-live-in, sane, sensible world ahead.

Communication Receivers
Aircraft Radio



Airline Radio Equipment
Transmitting Equipment

WILCOX ELECTRIC COMPANY

Quality Manufacturing of Radio Equipment

14TH & CHESTNUT

KANSAS CITY, MISSOURI

RADIO

* APRIL, 1943

33



828

BEAM POWER
AMPLIFIER

\$17⁵⁰

Now...

MANY ADDITIONAL HOURS OF LIFE

BECAUSE OF EXCLUSIVE RCA DESIGN IMPROVEMENTS

RCA engineering scores again—this time with manufacturing improvements which make it possible for the famous RCA-828 Beam Power Amplifier to deliver its 150 watts* with only 2.1 watts of driving power many hours longer than heretofore.

Chief among the improvements has been the incorporation of the RCA zirconium-coated molybdenum anode in this popular tube. Actual service tests over a long period have proved that this construction change increases the life of the tube several fold!

Ordinarily, such a change might well warrant a substantial boost in the performance ratings of a tube—but not under war conditions. Longer and still longer tube life now looms far more essential than high “peak” performance. Thus, always conservatively rated in line with RCA practice, the RCA-828 now comes to you with a safety factor several times greater than ever before—just as similar improvements in other RCA Transmitting Tube types have been reflected, not in spectacular rating increases, but in terms of making the tubes perform better and lasting longer at the ratings at which you are already accustomed to using them.

RADIO CORPORATION OF AMERICA
RCA Victor Division, Camden, N. J.

RATINGS

FILAMENT VOLTAGE, 10 VOLTS	SCREEN VOLTAGE, 400 VOLTS, MAX.*
FILAMENT CURRENT, 3.25 AMPERES	PLATE DISSIPATION, 70 WATTS,
PLATE VOLTAGE, 1250 VOLTS, MAX.*	MAX.*

*ECS rating for class C telegraph service.

HOW TO MAKE YOUR TUBES LAST LONGER

This valuable booklet, based on RCA Transmitting Tube advertising of the past year, contains dozens of helpful tips on getting maximum life from your old tubes. Get your copy today . . . free. Address: Radio Corporation of America, Commercial Engineering Section, Harrison, N. J.



RCA TRANSMITTING TUBES
PROVED IN COMMUNICATION'S MOST EXACTING APPLICATIONS

RADIO BIBLIOGRAPHY

F. X. RETTENMEYER

RCA Victor Division
Radio Corporation of America

9—PROPAGATION

- Impedance Calculation for Eccentric Lines—G. H. Brown—*Electronics*, Vol. 15, No. 2, Feb. 1942, p. 49.
- Characteristic Impedance of Eccentric Lines—W. Barclay & K. Spangenberg—*Electronics*, Vol. 15, No. 2, Feb. 1942, p. 50.
- Five-Meter Wave Paths—W. Wilson—*QST*, Vol. XXV, Aug. 1941, p. 23; *QST*, Vol. XXV, Sept. 1941, p. 23.
- Predictions of Useful Distances for Amateur Radio Communications—*QST*, Vol. XXV, Jan. 1941, p. 32; Vol. XXV, April 1941, p. 46; Vol. XXV, July 1941, p. 24; Vol. XXV, Oct. 1941, p. 41.
- Development of the Rumanian Telephone System: 1930-1940—L. B. Tucker—*Electrical Communication*, Vol. 19, No. 3, 1941, p. 71.
- Hyper-frequency Waves and Their Practical Use—L. Brillouin—*Electrical Communication*, Vol. 19, No. 4, 1941, p. 118.
- The Mackay Radio and Telegraph Company Communication System—M. H. Anderson—*Electrical Communication*, Vol. 19, No. 4, 1941, p. 81.
- Propagation of Radio Waves Around the Earth—T. L. Eckersley—*Nature*, Vol. 148, Sept. 27, 1941, p. 364.
- The Effect of the Earth's Curvature on Ground-Wave Propagation—*Wireless Engineer*, Vol. XVIII, No. 217, Oct. 1941, p. 393.
- A Reflection Method of Measuring Optical and Electrical Constants at Ultra-High Radio Frequencies—L. S. Palmer & G. R. Forrester—*Proceedings Phys. Soc.*, Vol. 53, Part 4, July 1941, p. 479.
- Penetration of Thin Ionospheric Layers—A. C. Deb—*Indian Journal of Physics*, Vol. 15, Part 6, Dec. 1940, p. 451.
- The Solar Radiation Constant and the Active Region of the Sun—F. Sanford—*Science*, Vol. 94, July 4, 1941, p. 18.
- The Ionosphere—K. K. Darrow—*Electrical Engineering*, July 1940, p. 270.
- The Velocity of Propagation of Electrical Disturbances—S. Ramo—*Communications*, Vol. 20, No. 3, March 1940, p. 9.
- Ground Wave Propagation Characteristics—C. E. Smith—*Communications*, Vol. 20, No. 4, April 1940, p. 7.
- Travelling Waves in Electron Beams—S. Ramo—*Communications*, Vol. 20, No. 11, Nov. 1940, p. 5.
- High Frequency Propagation Characteristics—F. Hamburger, M. Jones & C. V. Larrick—*Proceedings IRE*, Vol. 28, No. 4, April 1940, p. 175.
- Damped Electromagnetic Waves in Hollow Pipes—W. W. Mellok—*Proceedings IRE*, Vol. 28, No. 4, April 1940, p. 179.
- A General Reciprocity Theorem for Transmission Lines at UHF—R. King—*Proceedings IRE*, Vol. 28, No. 5, May 1940, p. 223.
- Field Strength Survey 52.75 mc from Empire State Building—G. S. Wickizer—*Proceedings IRE*, Vol. 28, No. 7, July 1940, p. 291.
- The Troposphere & Radio Waves—R. C. Colwell—*Proceedings IRE*, Vol. 28, No. 7, July 1940, p. 299.
- Ultra Short Wave Transmission Over a 39-mile Optical Path—C. B. Englund, A. B. Crawford & W. W. Mumford—*Proceedings IRE*, Vol. 28, No. 8, Aug. 1940, p. 360.
- A Useful Network Theorem—J. Millman—*Proceedings IRE*, Vol. 28, No. 9, Sept. 1940, p. 413.
- A Radio Transmission Anomaly; Co-operative Observations Between U. S. & Argentine—J. H. Dellinger & A. T. Cosentino—*Proceedings IRE*, Vol. 28, No. 10, Oct. 1940, p. 431.
- The Generation of Spurious Signals by Non-Linearity of the Transmission Path—A. V. Eastman & L. C. F. Hosh—*Proceedings IRE*, Vol. 28, No. 10, Oct. 1940, p. 438.
- Experiments on Propagation of Ultra Short Radio Waves—A. H. Waywick—*Proceedings IRE*, Vol. 28, No. 10, Oct. 1940, p. 468.
- Notes on the Relation Between Solar Emission and Terrestrial Disturbances—C. N. Andersen—*Proceedings IRE*, Vol. 28, No. 11, Nov. 1940, p. 503.
- Transient Response of Single Sideband Systems—H. E. Kullen & R. E. Spencer—*Proceedings IRE*, Vol. 28, No. 12, Dec. 1940, p. 557.
- Horizontal and Vertical Polarization, Mobile Field Strength of 49.5, 83.5, and 142 mc from Empire State Building—G. S. Wickizer—*RCA Review*, Vol. IV, April 1940, p. 397.
- Application of Abelian Finite Group Theory to Electromagnetic Refraction—R. A. Whiteman—*RCA Review*, Vol. IV, Jan. 1940, p. 372.
- Design Factors Influencing the Economical Size and Spacing of Multi-Channel Telephone Repeaters—K. G. Hodgson & A. A. Roche—*Electrical Communication*, Vol. 19, No. 2, 1940, p. 100.
- The Effect of Non-Linear Distortion in Multi-Channel Amplifiers—B. B. Jacobsen—*Electrical Communication*, Vol. 19, No. 1, 1940, p. 29.
- Distance vs. Angle of Radiation—Rockey—*QST*, Vol. XXIV, Oct. 1940, p. 68.
- The Ionosphere and Radio Transmission—*QST*, Vol. XXIV, March 1940, p. 32.
- Predictions of Useful Distances for Amateur Communication—Smith & Kirby—*QST*, Vol. XXIV, Sept. 1940, p. 26; Vol. XXIV, Oct. 1940, p. 52.
- The Propagation of Electromagnetic Rays in the Ionized Medium and the Calculation of the True Heights of the Ionized Layers of the Atmosphere—C. Rydbeck—*Phil. Mag.*, Vol. 30, No. 201, Oct. 1940, p. 282.
- Early Morning Variations of Ionization and the True Height of Region F of the Ionosphere—S. P. Ghosh—*Indian Journal of Physics*, April 1940, Vol. 14, No. 2, p. 101.
- Reflection at Absorbing Media—H. Littmann—*Ann. der. Physik*, Vol. 38, Ser. 5, No. 2, 1940, p. 139.
- The Transmission of Infra-Red Light by Fog—J. A. Sanderson—*Journal Opt. Soc. Amer.*, Vol. 30, No. 9, Sept. 1940, p. 405.
- The Concentric Line as a Resonator—F. Borgnis—*Hochf. u. Elek. Akus.*, Vol. 56, No. 2, Aug. 1940, p. 47.
- Analysis of the Ionosphere (Editorial), *Wireless Engineer*, Vol. XVIII, No. 209, Feb. 1941, p. 43.
- Cables for Hyper Frequencies—E. Soleri—*L'Elettrotecnica*, Vol. 27, No. 19, 1940, p. 446.
- Region Formation in the Ionosphere According to Attachment Theory—M. V. Wilkes—*Proceedings Cambridge Philosophical Soc.*, Vol. 36, No. 4, 1940, p. 479.
- Physics and Technique of the Hollow Spaced Conductor (Wave Guide)—O. Schreiber—*ETZ*, Vol. 61, No. 33, Aug. 15, 1940, p. 749.
- The Troposphere and Radio Waves—R. C. Colwell—*Proceedings IRE*, Vol. 28, No. 7, July 1940, p. 299.
- The Transmission of Ultra Short Waves Through Ionospheric Action—E. Fendler—*Hochf. u. Elek. Akus.*, Vol. 56, No. 2, Aug. 1940, p. 41.
- A Note on the Origin of the D Layer—S. Deb—*Indian Journal of Physics*, Vol. 14, No. 2, April 1940, p. 89.
- Radio Fade-Outs and Their Origin—J. M. Bhar—*Science and Culture* (Calcutta), Vol. 6, No. 3, Sept. 1940, p. 150.
- Physical and Astronomical Information Concerning Particles of the Order of Magnitude of the Wavelength of Light—F. Ehrenhaft—*Journal Franklin Institute*, Vol. 230, No. 3, Sept. 1940, p. 381.
- Solar Radiation and Geomagnetism—J. Bartels—*Terr. Mag. and Atoms. Elcc.*, Vol. 45, No. 3, Sept. 1940, p. 339.
- Periodicities in Solar Variation Reflected in the Weather—E. G. Abbot—*Nature*, Vol. 146, Oct. 26, 1940, p. 564.
- The Theory of the First Phase of a Geomagnetic Storm—S. Chapman & V. C. A. Farrow—*Science and Culture* (Calcutta), Vol. 6, No. 2, Aug. 1940, p. 70.
- Magnetic Storms—S. H. Mitra—*Terr.*

Mag. and Atoms. Elec., Vol. 45, No. 3, Sept. 1940, p. 245.

The Active Region of the Sun's Surface—F. Sanford—*Science*, Vol. 29, Oct. 4, 1940, p. 309.

Trends of Characteristics of the Ionosphere for Half a Sunspot Cycle—N. Smith, T. R. Killiland & S. S. Kirby—*Jour. Res. Nat. Bur. Stand.*, Vol. 21, Dec. 1938, p. 835.

Relation Between Actual and Virtual Ionospheric Height—H. B. Booker & S. L. Seaton—*Physical Review*, Vol. 57, Jan. 15, 1940, p. 87.

Transatlantic Reception of London Television Signals—D. R. Goddard—*Proceedings IRE*, Vol. 27, Nov. 1939, p. 692.

Noise Measurements in the Television Bands—J. Minter—*Electronics*, Vol. 12, Dec. 1939, p. 21.

Ultra-High Frequency Propagation Formulas—H. O. Peterson—*RCA Review*, Vol. IV, Oct. 1939, p. 162.

Notes on the Random Fading of 50-megacycle Signals Over Nonoptical Paths—K. G. MacLean & G. S. Wickizer—*Proceedings IRE*, Vol. 27, No. 8, Aug. 1939, p. 501.

Resonant Impedance of Transmission Lines—L. S. Nergaard & B. Salzberg—*Proceedings IRE*, Vol. 27, No. 8, Aug. 1939, p. 579.

The Heights of the Reflecting Regions in the Troposphere—A. W. Friend & R. C. Colwell—*Proceedings IRE*, Vol. 27, No. 10, Oct. 1939, p. 626.

Deviations of Short Radio Waves from the London-New York Great Circle Path—C. B. Feldman—*Proceedings IRE*, Vol. 27, No. 10, Oct. 1939, p. 635.

Report of Commission II, Radio Wave Propagation—J. H. Dellinger—*Proceedings IRE*, Vol. 27, No. 10, Oct. 1939, p. 645.

Asymmetric-Sideband Broadcasting—N. Koomans—*Proceedings IRE*, Vol. 27, No. 11, Nov. 1939, p. 687.

The Solar Cycle and the F₂ Region of the Ionosphere—W. M. Goodall—*Proceedings IRE*, Vol. 27, No. 11, Nov. 1939, p. 701.

The Application of Low-Frequency Circuit Analysis to the Problem of Distributed Coupling in Ultra-High Frequency Circuits—R. King—*Proceedings IRE*, Vol. 27, No. 11, Nov. 1939, p. 715.

The Scattering of Radio Waves in the Lower and Middle Atmosphere—J. H. Piddington—*Proceedings IRE*, Vol. 27, No. 12, Dec. 1939, p. 753.

The Electronic-Wave Theory of Velocity-Modulation Tubes—S. Ramo—*Proceedings IRE*, Vol. 27, No. 12, Dec. 1939, p. 757.

Atmospherics in Radio Broadcast Reception at Calcutta—P. B. Ghosh, S. P. Chakravarti & H. Ghosh—*Proceedings IRE*, Vol. 27, No. 12, Dec. 1939, p. 780.

Observations on Sky-Wave Transmission on Frequencies Above 50 Megacycles—D. R. Goddard—*Proceedings IRE*, Vol. 27, No. 1, Jan. 1939, p. 12.

A Study of Ultra-High-Frequency Wide-Band Propagation Characteristics—R. S. George—*Proceedings IRE*, Vol. 27, No. 1, Jan. 1939, p. 28.

56-Megacycle Reception via Sporadic E-Layer Reflections—E. H. Conklin—*Proceedings IRE*, Vol. 27, No. 1, Jan. 1939, p. 36.

Transmission Lines with Exponential Taper—H. A. Wheeler—*Proceedings IRE*, Vol. 27, No. 1, Jan. 1939, p. 65.

Nonexistence of Continuous Intense Ionization in the Troposphere and Lower Stratosphere—O. H. Gish & H. G. Booker—*Proceedings IRE*, Vol. 27, No. 2, Feb. 1939, p. 117.

The Relation of Radio Sky-Wave Transmission to Ionosphere Measurements—N. Smith—*Proceedings IRE*, Vol. 27, No. 5, May 1939, p. 332.

The Interpretation of Amplitude and Phase Distortion in Terms of Paired Echoes—H. A. Wheeler—*Proceedings IRE*, Vol. 27, No. 6, June 1939, p. 384.

Scattered Reflections in the Ionosphere—B. Beckmann, M. Menzel & F. Vilbig—*Teleg. Fern- und Funk-Tech.*, Vol. 28, April 1939, p. 130.

The Polarization Condition of Radio Waves by Reflection on Layers Which are Formed by Magnetic Storms and Northern Lights—L. Harang & W. Stoffregen—*Hochfrequenztech und Elektroakustik*, Vol. 53, June 1939, p. 181.

Ionospheric Effects Associated with Magnetic Disturbances—L. V. Berkner, H. W. Wells & S. L. Seaton—*Terr. Mag.*, Vol. 44, Sept. 1939, p. 283.

Incident Angle of Short Waves and High-Frequency Noise (Resembling Grinders) During Dellinger Effect—N. Nakagami & K. Miya—*Elec. Journal (Tokyo)*, Vol. 3, Sept. 1939, p. 216.

Atmospheric Disturbances—O. Morgenroth—*Funktech. Monatshefte*, No. 3, March 1939, p. 70.

On the Influence of the Troposphere on Ultra-Short-Wave Propagation—W. Scholz & L. Egersdorfer—*Teleg. Fern- und Funk-Tech.*, Vol. 28, March 1939, p. 77.

The Origin of Radio-Wave Reflections in the Troposphere—J. H. Piddington—*Proc. Phys. Soc. (London)*, Vol. 51, Jan. 1939, p. 126; Vol. 51, May 1939, p. 547.

A Representation of the Sunspot Cycle—C. H. Anderson—*Bell System Tech. Jour.*, Vol. 18, April 1939, p. 292.

Report of Commission II, Radio Wave Propagation, International Scientific Radio Union—J. H. Dellinger—*Proceedings IRE*, Vol. 27, Oct. 1939, p. 645.

Ionospheric Observations—I. Ranzi—*La Ricerca Sci.*, Vol. 10, Jan.-Feb. 1939, p. 32.

Annual Variation of the Critical Frequencies of the Ionized Layers at Tromsø During 1938—L. Harang—*Terr. Mag.*, Vol. 44, March 1939, p. 15.

Midday F₂ Region Critical Frequencies for Deal, N. J.—W. M. Goodall—*Terr. Mag.*, Vol. 44, June 1939, p. 212.

Simultaneous Ionosphere Observations at Washington, D. C., and Deal, N. J.—J. P. Schafer—*Terr. Mag.*, Vol. 44, June 1939, p. 205.

Scattering of Radio Waves in the Ionosphere—T. L. Eckersley—*Nature*, Vol. 142, Jan. 16, 1939, p. 33.

Theoretical Ionization Curves for the E Region—M. V. Wilkes—*Proc. Phys. Soc. (London)*, Vol. 51, Jan. 1939, p. 138.

Application of Graphs of Maximum Usable Frequency to Communication Problems—N. Smith, S. S. Kirby & T. R. Killiland—*Jour. Res. Nat. Bur. Stand.*, Vol. 22, Jan. 1939, p. 81.

The Prediction of Ionosphere Character-

istics and Maximum Usable Frequencies—N. Smith & A. S. Taylor—*Presented IRE-URSI Meeting, Washington, D. C.*, April 29, 1939.

The Solar Cycle and the F₂ Region of the Ionosphere—W. M. Goodall—*Proceedings IRE*, Vol. 27, Nov. 1939, p. 701.

Limiting Waves and the Ionosphere: III—O. Burkard—*Hochfrequenz und Elektroakustik*, Vol. 52, Oct. 1938, p. 142.

The Exponential Transmission Line—C. R. Burrows—*Bell System Tech. Jour.*, Vol. XVII, Oct. 1938, p. 555.

The Relation Between Radio-Transmission Path and Magnetic-Storm Effects—G. W. Kenrick, A. M. Braaten & J. General—*Proceedings IRE*, Vol. 26, No. 7, July 1938, p. 831.

Abnormal Ionization in the E Region of the Ionosphere—J. A. Pierce—*Proceedings IRE*, Vol. 26, No. 7, July 1938, p. 892.

Asymmetric Side-Band Broadcasting—P. P. Eckersley—*Proceedings IRE*, Vol. 26, No. 9, Sept. 1938, p. 1041.

Report of Committee on Radio Wave Propagation—*Proceedings IRE*, Vol. 26, No. 10, Oct. 1938, p. 1193.

A Method for the Investigation of Upper-Air Phenomena and Its Application to Radio Meteorography—H. Diamond, W. S. Hinman, Jr., & F. W. Dunmore—*Proceedings IRE*, Vol. 26, No. 10, Oct. 1938, p. 1235.

Practical Application of an Ultra-High-Frequency Radio-Relay Circuit—J. E. Smith, F. H. Kroger & R. W. George—*Proceedings IRE*, Vol. 26, No. 11, Nov. 1938, p. 1311.

On the Long-Period Variations in the F₂ Region of the Ionosphere—K. Tani, Y. Ito & H. Sinkawa—*Proceedings IRE*, Vol. 26, No. 11, Nov. 1938, p. 1340.

Maximum Usable Frequencies for Radio Sky-Wave Transmission, 1933-1937—T. R. Gilliland, S. S. Kirby, N. Smith & S. E. Reymer—*Proceedings IRE*, Vol. 26, No. 11, Nov. 1938, p. 1347.

A Short-Wave Single Side-Band Radiotelephone System—A. A. Oswald—*Proceedings IRE*, Vol. 26, No. 12, Dec. 1938, p. 1431.

A Single Side-Band Receiver for Short-Wave Telephone Service—A. A. Roetken—*Proceedings IRE*, Vol. 26, No. 12, Dec. 1938, p. 1455.

The Ultra-Short-Wave Guide-Ray Beacon and Its Application—K. Grammer & W. Hahnemann—*Proceedings IRE*, Vol. 26, No. 1, Jan. 1938, p. 17.

Precise Measurements of Electromagnetic Fields—H. G. Smith—*Proceedings IRE*, Vol. 26, No. 1, Jan. 1938, p. 276.

Single Side-Band Telephony Applied to the Radio Link Between the Netherlands and the Netherlands East Indies—N. Koomans—*Proceedings IRE*, Vol. 26, No. 2, Feb. 1938, p. 182.

Hertz, the Discoverer of Electric Waves—J. Blanchard—*Proceedings IRE*, Vol. 26, No. 5, May 1938, p. 505.

Stability of Two-Meter Waves—C. R. Burrows, A. Decino & L. E. Hunt—*Proceedings IRE*, Vol. 26, No. 5, May 1938, p. 516.

The Impedance Concept and Its Application to Problems of Reflection, Refraction, Shielding and Power Absorption—S. A. Schekunoff—*Bell System Tech. Jour.*, Vol. XVII, Jan. 1938, p. 17.

- A Carrier-Telephone System for Toll Cables—C. W. Green & E. I. Green—*Bell System Tech. Jour.*, Vol. XVII, Jan. 1938, p. 80.
- Cable Carrier Telephone Terminals—R. W. Chestnut, L. M. Ilgenfritz & A. Kenner—*Bell System Tech. Jour.*, Vol. XVII, Jan. 1938, p. 106.
- A New Single Channel Carrier Telephone System—H. J. Fisher, R. H. Mills & M. L. Almquist—*Bell System Tech. Jour.*, Vol. XVII, Jan. 1938, p. 162.
- Studies of Telephone Line Wire Spacing Problems—J. A. Carr & F. V. Haskell—*Bell System Tech. Jour.*, Vol. XVII, April 1938, p. 195.
- The Occurrence and Effect of Lockout Occasioned by Two Echo Suppressors—A. W. Horton, Jr.—*Bell System Tech. Jour.*, Vol. XVII, April 1938, p. 258.
- Characteristic Time Intervals in Telephonic Conversation—O. J. Murphy & A. C. Norwine—*Bell System Tech. Jour.*, Vol. XVII, April 1938, p. 281.
- Radioactivity—Artificial and Natural—K. K. Darrow—*Bell System Tech. Jour.*, Vol. XVII, April 1938, p. 292.
- The Discovery of Electron Waves—C. J. Davisson—*Bell System Tech. Jour.*, Vol. XVII, July 1938, p. 475.
- Ultra-Short-Wave Transmission and Atmospheric Irregularities—C. R. Englund, A. B. Crawford & N. W. Mumford—*Bell System Tech. Jour.*, Vol. XVII, Oct. 1938, p. 489.
- Tropospheric Reflections of Radio Waves—R. C. Colwell & A. W. Friend—*U. R. S. I. Proc. of 1938 General Assembly*, Vol. 5, 1938, p. 146.
- Scattered Reflections of Radio Waves from Height of More Than 1,000 km—Harang & Stoffregen—*Nature*, Vol. 142, Nov. 5, 1938, p. 832.
- Marconi-TCM High-Frequency Cables—E. W. Smith & R. F. O'Neill—*Marconi Review*, July-Sept. 1938, p. 32.
- Theoretical Relationships of Dielectric Guides (Cylindrical) and Coaxial Cables—A. G. Claver—*Electrical Communication*, Vol. 17, Jan. 1939, p. 276.
- Electrical Properties of Aerials for Medium and Long Wave Broadcasting—W. L. McPherson—*Electrical Communication*, Vol. 17, July 1938, p. 44.
- Notes on the Effect of Irregularities in Coaxial Cables on Television Transmission—P. Gloess & J. Saphres—*Electrical Communication*, Vol. 17, Oct. 1938, p. 188.
- Characteristics of Amplitude Modulated Waves—R. M. Morris—*RCA Review*, Vol. 1, April 1937, p. 26.
- Some Notes on Ultra-High Frequency Propagation—H. H. Beverage—*RCA Review*, Vol. 1, Jan. 1937, p. 76.
- Sudden Disturbances of the Ionosphere—J. M. Dellinger—*Proceedings IRE*, Vol. 25, No. 10, Oct. 1937, p. 1253.
- On the Ionization of the F₂ Region—W. M. Goodall—*Proceedings IRE*, Vol. 25, No. 11, Nov. 1937, p. 1414.
- Electromagnetic Wave Fields Near the Earth's Surface—C. R. Mingins—*Proceedings IRE*, Vol. 25, No. 11, Nov. 1937, p. 1419.
- Transmission Theory of Plane Electromagnetic Waves—S. A. Schelkunoff—*Proceedings IRE*, Vol. 25, No. 11, Nov. 1937, p. 1457.
- Characteristics of the Ionosphere at Washington, D. C., September 1937—T. R. Gilliland, S. S. Kirby, N. Smith & S. E. Reymor—*Proceedings IRE*, Vol. 25, No. 11, Nov. 1937, p. 1493.
- Minimum Noise Levels Obtained on Short-Wave Radio Receiving Systems—K. G. Jansky—*Proceedings IRE*, Vol. 25, No. 12, Dec. 1937, p. 1517.
- Measuring the Reflecting Regions in the Troposphere—A. W. Friend & R. C. Colwell—*Proceedings IRE*, Vol. 25, No. 12, Dec. 1937, p. 1531.
- Partial Suppression of One Side Band in Television Reception—W. J. Poch & D. W. Epstein—*Proceedings IRE*, Vol. 25, No. 1, Jan. 1937, p. 15.
- Ultra-High-Frequency Wave Propagation Over Plane Earth and Fresh Water—R. C. Colwell & A. W. Friend—*Proceedings IRE*, Vol. 25, No. 1, Jan. 1937, p. 32.
- Comparison of Data on the Ionosphere, Sunspots, and Terrestrial Magnetism—E. B. Judson—*Proceedings IRE*, Vol. 25, No. 1, Jan. 1937, p. 38.
- Simultaneous Radio Range and Telephone Transmission—W. E. Jackson & D. M. Stuart—*Proceedings IRE*, Vol. 25, No. 3, March 1937, p. 314.
- Ultra-Short-Wave Propagation Along the Curved Earth's Surface—P. von Handel & W. Pfister—*Proceedings IRE*, Vol. 25, No. 3, March 1937, p. 346.
- Characteristics of American Broadcast Receivers as Related to the Power and Frequency of Transmitters—A. Van Dyck & D. E. Foster—*Proceedings IRE*, Vol. 25, No. 4, April 1937, p. 387.
- The Surface Wave in Radio Propagation Over Plane Earth—C. R. Burrows—*Proceedings IRE*, Vol. 25, No. 2, Feb. 1937, p. 219.
- Some Fundamental Experiments with Wave Guides—G. C. Southworth—*Proceedings IRE*, Vol. 25, No. 7, July 1937, p. 807.
- Characteristics of the Ionosphere and Their Application to Radio Transmission—T. R. Gilliland, S. S. Kirby, N. Smith & S. E. Reymor—*Proceedings IRE*, Vol. 25, No. 7, July 1937, p. 233.
- The Propagation of Radio Waves Over the Surface of the Earth and in the Upper Atmosphere—K. A. Norton—*Proceedings IRE*, Vol. 25, No. 9, Sept. 1937, p. 1203.
- The Origin and Development of Radiotelephony—L. Espenschied—*Proceedings IRE*, Vol. 25, No. 9, Sept. 1937, p. 1101.
- Transoceanic Radiotelephone Development—R. Bown—*Proceedings IRE*, Vol. 25, No. 9, Sept. 1937, p. 1124.
- Irregularities in Broad-Band Wire Transmission Circuits—P. Mertz & K. W. Pflieger—*Bell System Tech. Jour.*, Vol. XVI, Oct. 1937, p. 541.
- The Physical Reality of Zenneck's Surface Wave—W. H. Wise—*Bell System Tech. Jour.*, Vol. XVI, Jan. 1937, p. 35.
- A Million-Cycle Telephone System—M. E. Strieby—*Bell System Tech. Jour.*, Vol. XVI, Jan. 1937, p. 1.
- Radio Propagation Over Plane Earth; Field Strength Curves—C. R. Burrows—*Bell System Tech. Jour.*, Vol. XVI, Jan. 1937, p. 45.
- The Inductive Coordination of Common-Neutral Power Distribution Systems and Telephone Circuits—J. O'R. Coleman & R. F. Davis—*Bell System Tech. Jour.*, Vol. XVI, Jan. 1937, p. 76.
- Crosstalk Between Coaxial Transmission Lines—S. A. Schelkunoff & T. M. Odarenko—*Bell System Tech. Jour.*, Vol. XVI, April 1937, p. 144.
- The Calculation of Input or Sending End Impedance of Feeders and Cables Terminated by Complex Loads—*Marconi Review*, Sept. 12, 1937, p. 21.
- Micro-Waves in NBC Remote Pick-ups—R. M. Morris—*RCA Review*, Vol. I, July 1936, p. 41.
- Optical Paths of Limiting Transmissions at Ultra High Frequencies—R. D. Rettenmeyer—*Communication & Broad. Eng.*, Vol. 3, No. 4, April 1936, p. 11.
- High-Frequency Wave Guides—G. E. Southworth—*Communication & Broad. Eng.*, Vol. 3, No. 6, June 1936, p. 16.
- Transmission-Line Calculations—J. G. Sperl—*Communication & Broad. Eng.*, Vol. 3, No. 6, June 1936, p. 18.
- Terminating R-F Lines—J. L. Potter—*Communication & Broad. Eng.*, Vol. 3, No. 12, Dec. 1936, p. 5.
- Long-Wave Radio Transmission Phenomena Associated with a Cessation of the Sun's Rays—A. Bailey & A. E. Harper—*Bell System Tech. Jour.*, Vol. XV, Jan. 1936, p. 1.
- Technical Digest: On the Correlation of Radio Transmission with Solar Phenomena—A. M. Skellett—*Bell System Tech. Jour.*, Vol. XV, Jan. 1936, p. 157.
- Technical Digest: Eclipse Effects in the Ionosphere—J. P. Schafer & W. M. Goodall—*Bell System Tech. Jour.*, Vol. XV, Jan. 1936, p. 162.
- Technical Digest: Earth Resistivity and Geological Structure—R. H. Card—*Bell System Tech. Jour.*, Vol. XV, Jan. 1936, p. 167.
- The Reliability of Short-Wave Radio Telephone Circuits—R. K. Potter & A. C. Peterson, Jr.—*Bell System Tech. Jour.*, Vol. XV, April 1936, p. 181.
- Hyper-Frequency Wave Guides; General Considerations and Experimental Results—G. C. Southworth—*Bell System Tech. Jour.*, Vol. XV, April 1936, p. 284.
- Hyper-Frequency Wave Guides; Mathematical Theory—J. R. Carson, S. P. Mead & S. A. Schelkunoff—*Bell System Tech. Jour.*, Vol. XV, April 1936, p. 310.
- Optical Paths for Transmission at Ultra-High Frequencies—R. D. Rettenmeyer—*Radio Engineering*, Vol. XVI, No. 9, Sept. 1936, p. 16.
- R.F. Transition Losses—H. A. Wheeler—*Electronics*, Jan. 1936, p. 26.
- The Ionizing Effect of Meteors—A. M. Skellett—*Proceedings IRE*, Feb. 1935, p. 132.
- The Characteristics of Down Coming Radio Waves—D. F. Martyn & A. L. Green—*Proceedings Royal Soc.*, Vol. 148, No. 863, Jan. 1935, p. 104.
- The Interaction of Radio Waves—V. A. Bailey & D. F. Martyn—*Wireless Engineer*, Vol. XII, No. 138, March 1935, p. 122.
- Eclipse Effects in the Ionosphere—J. L. Schafer & W. M. Goodall—*Proceedings IRE*, Vol. 23, No. 11, March 1935, p. 1356; *Science*, Nov. 11, 1932; *Proc. Fifth Pacific Science Congress*, Vol. 3, 1934, p. 2171; *Nature*, Sept. 30, 1933; *Bell Lab. Record*, March 1935.

RADIO BIBLIOGRAPHY

- Common-Frequency Broadcasting—*Radio Engineering*, Vol. XIV, No. 1, Jan. 1934, p. 21.
- Direction of Arrival of Waves—C. B. Feldman—*Radio Engineering*, Vol. XIV, No. 5, May 1934, p. 14.
- Shared Channel Broadcasting—C. B. Aiken—*Radio Engineering*, Vol. XIV, No. 6, June 1934, p. 7.
- Directional Broadcasting—R. M. Wilmotte—*Radio Engineering*, Vol. XIV, No. 6, June 1934, p. 12.
- Coaxial Communication Transmission Lines—S. A. Schelkunoff—*Electrical Engineer*, Vol. 53, No. 12, Dec. 1934, p. 1592.
- The Diurnal Variation of Intensity of Wireless Waves Reflected from the Ionosphere—G. W. G. White—*Proc. Physical Soc.*, Vol. 46, Part 1, No. 252, Jan. 1934, p. 91.
- Studies of Ionosphere and Their Application to Radio Transmission—S. S. Kirby, L. V. Berkner & D. M. Stewart—*U. S. Bureau of Standards Jour. of Res.*, Vol. 12, No. 1, Jan. 1934.
- Some Automatic Records of Wireless Waves Reflected from the Ionosphere—J. A. Ratcliffe & E. L. C. White—*Proc. Physical Society*, Vol. 46, Part 1, No. 252, Jan. 1934, p. 107.
- Resonant Series in Radio Charts—F. E. Terman—*Electrical Engineering*, July 1934, p. 1046.
- The Influence of Electromagnetic Waves on the Ionosphere—V. A. Bailey—*Phil. Magazine*, Vol. 18, No. 118, Aug. 1934, p. 369.
- Radio Wave Propagation—E. C. S. Megan—*Wireless Engineer*, Vol. XI, No. 134, Nov. 1934, p. 583.
- The Suppression of Transmitter Horns—C. G. Dietsch—*Electronics*, June 1933, p. 167.
- The Electric Properties of Soil for Alternating Currents at Radio Frequencies—R. L. Smith-Rose—*Proceedings Royal Society*, May 1933, Vol. 140, No. A, Aug. 1941, p. 359.
- Studies in Radio Transmission—T. L. Eckersley—*Journal IEE*, Vol. 71, No. 429, Sept. 1932, p. 405.
- Transmission Lines for Short-Wave Radio System—E. J. Sterba & C. B. Feldman—*Proceedings IRE*, Vol. 20, July 1932, p. 1163.
- Transmission Line Feed for Short-Wave Antennas—T. McLean—*QST*, Oct. 1932, p. 25.
- Radio Transmission Problems Treated by Phase Integral Method—T. L. Eckersley—*Proceedings Royal Society*, Series A, Vol. 136, No. 830, June 1932, p. 499.
- The Time Factor in Telephone Transmission—C. B. Blackwell—*Bell System Tech. Jour.*, Vol. XI, Jan. 1932, p. 53.
- The Conception and Demonstration of Electron Waves—C. J. Davison—*Bell System Tech. Jour.*, Vol. XI, Oct. 1932, p. 546.
- New Methods of Frequency Control Employing Long Lines—Conklin, Finch & Hansell—*Proceedings IRE*, Vol. 9, Nov. 1931, p. 1918.
- The Spread Sideband System on Short-Wave Telephone Links—L. T. Hinton—*Electrical Communication*, Vol. 10, Oct. 1931, p. 60.
- Micro-Ray Radio—*Electrical Communication*, Vol. 10, July 1931, p. 20.
- The Single Sideband System Applied to Short Wavelengths—A. H. Reeves—*Electrical Communication*, Vol. 10, July 1931, p. 3.
- The Propagation of Short Radio Waves Over the North Atlantic—C. R. Burrows—*Proceedings IRE*, Vol. 19, No. 9, Sept. 1931, p. 1634.
- Long-distance Transmission of Static Impulses—S. W. Dean—*Proceedings IRE*, Vol. 19, No. 9, Sept. 1931, p. 1660.
- The Relation Connecting Skip Distance, Wavelength, and the Constants of Ionized Layers—N. H. Edes—*Proceedings IRE*, Vol. 19, No. 9, Sept. 1931, p. 1663.
- A Correlation of Long-Wave Radio Field Intensity with the Passage of Storms—I. J. Wymore-Shield—*Proceedings IRE*, Vol. 19, No. 9, Sept. 1931, p. 1675.
- Communication with Quasi-Optical Waves—C. Karplus—*Proceedings IRE*, Vol. 19, No. 10, Oct. 1931, p. 1715.
- Long-Wave Radio Receiving Measurements at the Bureau of Standards in 1930—L. W. Austin—*Proceedings IRE*, Vol. 19, No. 10, Oct. 1931, p. 1766.
- Some Observations of the Behavior of Earth Currents and Their Correlation with Magnetic Disturbances and Radio Transmission—I. S. Bemis—*Proceedings IRE*, Vol. 19, No. 11, Nov. 1931, p. 1931.
- Formation of Standing Waves on Lecher Wires—A. Mohammed & S. R. Kantebet—*Proceedings IRE*, Vol. 19, No. 11, Nov. 1931, p. 1983.
- Polarization Phenomena of Low-frequency Waves—S. Namba—*Proceedings IRE*, Vol. 19, No. 11, Nov. 1931, p. 1988.
- Polarization of High-frequency Waves and Their Direction Finding—S. Namba, I. Iso & S. Ueno—*Proceedings IRE*, Vol. 19, No. 11, Nov. 1931, p. 2000.
- Effects of Sun Spots and Terrestrial Magnetism of Long-Distance Reception of Low-frequency Waves—S. Yokoyama & T. Nakai—*Proceedings IRE*, Vol. 19, No. 5, May 1931, p. 882.
- Reflection of Electromagnetic Waves at Ionized Media with Variable Conductivity and Dielectric Constant—C. J. Elias—*Proceedings IRE*, Vol. 19, No. 5, May 1931, p. 891.
- The Multiple Refraction and Reflection of Short Waves—N. H. Edes—*Proceedings IRE*, Vol. 19, No. 6, June 1931, p. 1024.
- Bibliography on Radio Wave Phenomena and Measurement of Radio Field Intensity—Bureau of Standards, *Proceedings IRE*, Vol. 19, No. 6, June 1931, p. 1034.
- Notes on Radio Transmission—C. N. Anderson—*Proceedings IRE*, Vol. 19, No. 7, July 1931, p. 1150.
- A Note on the Relation of Meteor Showers and Radio Reception—G. W. Pickard—*Proceedings IRE*, Vol. 19, No. 7, July 1931, p. 1166.
- Application of Frequencies Above 30,000 Kilocycles to Communication Problems—H. H. Beverage, H. O. Peterson & C. W. Hansell—*Proceedings IRE*, Vol. 19, No. 8, Aug. 1931, p. 1311.
- Radio Transmission Studies of the Upper Atmosphere—J. P. Schafer & W. M. Goodall—*Proceedings IRE*, Vol. 19, No. 8, Aug. 1931, p. 1434.
- Investigation of the Attenuation of Electromagnetic Waves and the Distances Reached by Radio Stations in the Wave Bands from 200 to 2000 Meters—H. Fassbender, F. Eisner & G. Kurlbaum—*Proceedings IRE*, Vol. 19, No. 8, Aug. 1931, p. 1446.
- A Method of Representing Radiowave Propagation Conditions—L. W. Austin—*Proceedings IRE*, Vol. 19, No. 9, Sept. 1931, p. 1615.
- Note on Skip Distance Effects on Superfrequencies—*Proceedings IRE*, Vol. 19, No. 1, Jan. 1931, p. 103.
- Kennelly-Heaviside Layer Studies—P. A. DeMars, T. R. Gilliland & G. W. Kenrick—*Proceedings IRE*, Vol. 19, No. 1, Jan. 1931, p. 106.
- Kennelly-Heaviside Layer Height Observations for 4045 kc and 8650 kc—T. R. Gilliland—*Proceedings IRE*, Vol. 19, No. 1, Jan. 1931, p. 114.
- On the Simultaneous Operation of Different Broadcast Stations on the Same Channel—P. P. Eckersley—*Proceedings IRE*, Vol. 19, No. 2, Feb. 1931, p. 175.
- Note on High Frequency Transmission During the Summer of 1930—G. W. Kenrick, A. H. Taylor & L. C. Young—*Proceedings IRE*, Vol. 19, No. 2, Feb. 1931, p. 252.
- Overseas Radio Extensions to Wire Telephone Networks—L. Espenscheid & W. Wilson—*Proceedings IRE*, Vol. 19, No. 2, Feb. 1931, p. 282.
- Sinusoidal Currents in Linearly Tapered Loaded Transmission Lines—J. W. Arnold & P. F. Bechberger—*Proceedings IRE*, Vol. 19, No. 2, Feb. 1931, p. 304.
- Note on the Fifteen-Month Period of Solar Activity, Terrestrial Magnetism and Radio Reception—G. W. Pickard—*Proceedings IRE*, Vol. 19, No. 3, March 1931, p. 353.
- Some Details Relating to the Propagation of Very Short Waves—R. Jouaust—*Proceedings IRE*, Vol. 19, No. 3, March 1931, p. 479.
- Diversity Receiving System of RCA Communications, Inc., for Radio Telegraphy—H. H. Beverage & H. O. Peterson—*Proceedings IRE*, Vol. 19, No. 4, April 1931, p. 531.
- Design Tests for Amplifiers & Receivers—S. Harris—*Radio Engineering*, March 1931, p. 25.
- Outline of Notes on Telephone Transmission Theory—K. Palmer—*P. O. E. E. Journal*, April 1931, p. 79; Jan. 1931, p. 309.
- Propagation of Radio Waves in Ionized Atmosphere—C. E. Burnett—*Proc. Cambridge Phil. Soc.*, Oct. 1931, p. 578.
- Electric Circuit Analysis—Multi—(Book)*, John Wiley & Sons, 1930.
- The Theory of Electric Lines and Filters—A. A. Bartlett—(Book)*, John Wiley & Sons, 1930.
- Some Problems in S.W. Telephone Transmission—J. C. Schelling—*Proceedings IRE*, June 1930.
- Volume Control in Broadcasting—H. A. Harrison—*Radio Broadcast*, March 1930, p. 260.
- Importance of the Impedance Relation—C. T. Burke—*Radio Broadcast*, March 1929.
- French System of Directional Aerials—Chereaux—*Experimental Wireless*, May 1929.
- Picture Transmission in England—L. A. O'Brien—*Bell Lab. Record*, Vol. VII, No. 10, June 1929, p. 385.
- Story of the Short-Wave Transoceanic Telephone—A. A. Oswald—*Bell Lab.*

- Record*, Vol. VII, No. 12, Aug. 1929, p. 481.
- Ground Return Impedance of Underground Wire with Earth Return—J. R. Carson—*Bell System Tech. Jour.*, Vol. VIII, 1929, p. 94.
- Test for Polarization of Electron Waves by Reflection—C. J. Davisson & L. H. Germer—*Bell System Tech. Jour.*, Vol. VIII, 1929, p. 466.
- Determining Short Wave Paths—H. T. Friis—*Bell Lab. Record*, Vol. VI, No. 5, July 1928, p. 359.
- Ionized Regions in the Atmosphere—R. A. Heising—*Bell Lab. Record*, Vol. V, No. 6, Feb. 1928, p. 173.
- Carrier Systems on Long Distance Lines—H. A. Affel, C. S. Demarest & C. W. Green—*Bell System Tech. Jour.*, Vol. VII, 1928, p. 564.
- Present Status of Wire Transmission Theory and Some of Its Outstanding Problems—J. R. Carson—*Bell System Tech. Jour.*, Vol. VII, 1928, p. 268.
- Rigorous and Approximate Theories of Electrical Transmission Along Wires—J. R. Carson—*Bell System Tech. Jour.*, Vol. VII, 1928, p. 11.
- Transmission of Information—R. V. L. Hartley—*Bell System Tech. Jour.*, Vol. VII, 1928, p. 535.
- Skip Distance and Range Table—J. E. Young—*Radio Broadcast*, July 1927.
- Echo Elimination in Trans-Atlantic Service—G. C. Crawford—*Bell Lab. Record*, Vol. V, No. 3, Nov. 1927, p. 80.
- Long Waves or Short—J. C. Schelling—*Bell Lab. Record*, Vol. IV, No. 4, June 1927, p. 349.
- Trans-Atlantic Radio Telephony—R. Bown—*Bell System Tech. Jour.*, Vol. VI, 1927, p. 248.
- Radio Broadcast Coverage of City Areas—L. Espenschied—*Bell System Tech. Jour.*, Vol. VI, 1927, p. 117.
- Electromagnetic Theory and the Foundations of Electric Circuit Theory—J. R. Carson—*Bell System Tech. Jour.*, Vol. VI, 1927, p. 1.
- Propagation of Periodic Currents Over a System of Parallel Wires—R. S. Hoyt & J. R. Carson—*Bell System Tech. Jour.*, Vol. VI, 1927, p. 495.
- Determination of Electrical Characteristics of Loaded Submarine Telegraph Cables—J. J. Gilbert—*Bell System Tech. Jour.*, Vol. VI, 1927, p. 38.
- Development and Application of Loading for Telephone Circuits—T. Shaw & W. Fondiller—*Bell System Tech. Jour.*, April 1926, p. 221.
- Transmission Limits of Telephone Lines—R. V. L. Hartley—*Bell Lab. Record*, Vol. I, No. 6, Feb. 1926, p. 225.
- Hawaiian Radio Survey—F. M. Ryan—*Bell Lab. Record*, Vol. II, No. 6, Aug. 1926, p. 228.
- The Polarization of Radio Waves—G. W. Pickard—*Proceedings IRE*, April 1926, p. 205.
- Preliminary Note on Proposed Changes in the Constants of the Austin-Cohen Transmission Formula—L. W. Austin—*Proceedings IRE*, June 1926, p. 377.
- Discussion on "Polarization of Radio Waves" by G. W. Pickard—E. F. W. Alexanderson—*Proceedings IRE*, June 1926, p. 391.
- Relation Between the Height of the Kennelly-Heaviside Layer and High Frequency Radio Transmission Phenomena—A. H. Taylor—*Proceedings IRE*, Aug. 1926, p. 521.
- Some Measurements of Short-Wave Transmission—R. A. Heising, J. C. Schelling & G. C. Southworth—*Proceedings IRE*, Oct. 1936, p. 613.
- Long Distance Radio Receiving Measurements and Atmospheric Disturbances at the Bureau of Standards in 1925—L. W. Austin—*Proceedings IRE*, Oct. 1926, p. 663.
- Trans-Atlantic Radio Telephone Transmission—L. Espenschied, C. N. Anderson & A. Bailey—*Proceedings IRE*, Feb. 1926, p. 7.
- Some Studies in Radio Broadcast Transmission—R. Bown, D. K. Martin & R. K. Potter—*Proceedings IRE*, Feb. 1926, p. 57.
- Transmission and Reception of Photoradiograms—R. H. Ranger—*Proceedings IRE*, April 1926, p. 161.
- Recent Advances in Marine Radio Communication—T. M. Stevens—*Proceedings IRE*, April 1926, p. 197.
- Wave Propagation Over Parallel Tubular Conductors—S. P. Mead—*Bell System Tech. Jour.*, April 1925, p. 327.
- Recent Investigations on the Propagation of Electromagnetic Waves—M. Batemier—*Proceedings IRE*, Feb. 1925, p. 5.
- Some Trans-Pacific Radio Field Intensity Measurements—L. W. Austin—*Proceedings IRE*, April 1925, p. 151.
- Long Distance Radio Receiving Measurements in 1924—L. W. Austin—*Proceedings IRE*, June 1925, p. 283.
- Production of Single Sideband for Trans-Atlantic Radio Telephony—R. A. Heising—*Proceedings IRE*, June 1925, p. 291.
- A New Phenomenon in Sunset Radio Direction Variations—L. W. Austin—*Proceedings IRE*, Aug. 1925, p. 409.
- The Effect of the Solar Eclipse of January 24, 1925, on Radio Reception—G. W. Pickard—*Proceedings IRE*, Oct. 1925, p. 539.
- An Investigation of Transmission on the Higher Radio Frequencies—A. H. Taylor—*Proceedings IRE*, Dec. 1925, p. 677.
- Distribution of Radio Waves from Broadcasting Stations Over City Districts—R. Bown & G. D. Gillett—*Proceedings IRE*, Aug. 1924, p. 395.
- Building Up of Sinusoidal Currents in Long Periodically Loaded Lines—J. R. Carson—*Bell System Tech. Jour.*, Vol. III, No. 4, 1924, p. 558.
- Short Period Variations in Radio Reception—G. W. Pickard—*Proceedings IRE*, April 1924, p. 159.
- On Propagation Phenomena and Disturbances of Reception in Radio Telegraphy—F. Kiebitz—*Proceedings IRE*, June 1924, p. 233.
- Long Distance Radio Receiving Measurements at the Bureau of Standards in 1923—L. W. Austin—*Proceedings IRE*, Aug. 1924, p. 389.
- Relations of Carrier and Side-Bands in Radio Transmission—R. V. L. Hartley—*Proceedings IRE*, Feb. 1923, p. 34.
- Radio Transmission Measurements—R. Bown, C. R. Englund & H. T. Friis—*Proceedings IRE*, April 1923, p. 115.
- Receiving Measurements and Atmospheric Disturbances at the United States Naval Radio Research Laboratory, Bureau of Standards, Washington, January and February, 1923—L. W. Austin—*Proceedings IRE*, June 1923, p. 186.
- Receiving Measurements and Atmospheric Disturbances at the Bureau of Standards, Washington, D. C., May and June, 1923—L. W. Austin—*Proceedings IRE*, Dec. 1923, p. 579.
- Radio Transmission Measurements on Long Wave Lengths—H. H. Beverage & H. O. Peterson—*Proceedings IRE*, Dec. 1923, p. 661.
- Receiving Measurements and Atmospheric Disturbances at the Naval Base Radio Research Laboratory, Bureau of Standards, March and April, 1922—L. W. Austin—*Proceedings IRE*, Aug. 1922, p. 239.
- Receiving Measurements and Atmospheric Disturbances at the United States Naval Radio Research Laboratory, Bureau of Standards, Washington, D. C., May and June, 1922—L. W. Austin—*Proceedings IRE*, Oct. 1922, p. 315.
- Applications to Radio of Wire Transmission Engineering—L. Espenschied—*Proceedings IRE*, Oct. 1922, p. 344.
- The Monthly Averages of Signal Strength of Nauen in Washington, 1915-1921, and the Monthly Averages of Atmospheric Disturbances in Washington, 1918-1921—L. W. Austin—*Proceedings IRE*, June 1922, p. 153.
- The Direction and Intensity of Waves from European Stations—G. W. Pickard—*Proceedings IRE*, June 1922, p. 176.
- Radio Telegraphy—G. Marconi—*Proceedings IRE*, Aug. 1922, p. 215.
- Carrier Current Telephony and Telegraphy—E. H. Colpitts & O. B. Blackwell—*Trans. A.I.E.E.*, Vol. 40, 1921, p. 205.
- Simultaneous Transmission and Reception in Radio Telegraphy—N. Marumo—*Proceedings IRE*, June 1920, p. 199.
- Trans-Oceanic Radio Communication—E. F. W. Alexanderson—*Proceedings IRE*, Aug. 1920, p. 263.
- Measurement of the Electric and Magnetic Fields Received During Trans-oceanic Radio Transmission—G. Vallauri—*Proceedings IRE*, Aug. 1920, p. 286.
- Radio Direction Changes and Variations of Audibility—C. Kinsley—*Proceedings IRE*, Aug. 1920, p. 299.
- Static Elimination by Directional Reception—G. W. Pickard—*Proceedings IRE*, Oct. 1920, p. 358.
- Multiplex Radio Telegraphy and Telephony—F. M. Ryan, J. R. Tolmie & R. O. Bach—*Proceedings IRE*, Dec. 1920, p. 451.
- Short Wave Reception and Transmission on Ground Wire (Subterranean and Submarine)—A. H. Taylor—*Proceedings IRE*, Aug. 1919, p. 337.
- Simultaneous Sending and Receiving—E. F. W. Alexanderson—*Proceedings IRE*, Aug. 1919, p. 363.
- Radio Telegraphy in Competition with Wire Telegraphy in Overland Work—R. B. Black—*Proceedings IRE*, Aug. 1919, p. 391.
- Reception Through Static and Interference—R. A. Weagant—*Proceedings IRE*, June 1919, p. 207.
- Radio Communication with Moving Trains—F. H. Milener—*Proceedings IRE*, Aug. 1918, p. 185.
- On the Interpretation of Early Transmission Experiments by Commandant Tissot and Their Application to the Verification

RADIO BIBLIOGRAPHY

of a Fundamental Formula in Radio Transmission—L. Bouthillon—*Proceedings IRE*, Aug. 1918, p. 221.

Further Discussion on "The Interpretation of Early Transmission Experiments by Commandant Tissot and Their Application to the Verification of a Fundamental Formula in Radio Transmission"—L. Bouthillon—*Proceedings IRE*, Oct. 1918, p. 285.

Sustained Wave Transmission Chart—T. M. Libby—*Proceedings IRE*, Feb. 1916, p. 25.

Note on "The Measurement of Radio-telegraphic Signals with the Oscillating Audion"—L. W. Austin—*Proceedings IRE*, Oct. 1917, p. 327.

Some Experiments with Long Electrical Conductors—J. H. Morecroft—*Proceedings IRE*, Dec. 1917, p. 327.

The Mechanism of Radiation and Propagation in Radio Communication—F. Lowenstein—*Proceedings IRE*, June 1916, p. 271.

Sustained Wave Receiving Data—L. F. Fuller—*Proceedings IRE*, June 1916, p. 305.

Further Discussion on "Experiments at the U. S. Naval Radio Station, Darien, Canal Zone"—L. W. Austin (August, 1916) viz: "On Telephonic Measurements in a Radio Receiver"—J. Zenneck—*Proceedings IRE*, Aug. 1916, p. 363.

The Heaviside Layer—E. M. Marchant—*Proceedings IRE*, Dec. 1916, p. 511.

The Impedances, Angular Velocities, and Frequencies of Oscillating Current Circuits—A. E. Kennelly—*Proceedings IRE*, Feb. 1916, p. 47.

Variations in Nocturnal Transmission—*Proceedings IRE*, April 1916, p. 131.

Radio in Alaska—A. H. Ginman—*Proceedings IRE*, June 1916, p. 221.

Experiments at the U. S. Naval Radio Station, Darien, Canal Zone—L. W. Austin—*Proceedings IRE*, June 1916, p. 251.

Seasonal Variation in the Strength of Radio-Telegraphic Signals—L. W. Austin—*Proceedings IRE*, June 1915, p. 103.

Long Range Reception with Combined Crystal Detector and Audion Amplifier—H. Pratt—*Proceedings IRE*, June 1915, p. 173.

A Derivation of the Bjerknes Logarithmic Decrement Formula—L. Cohen—*Proceedings IRE*, Sept. 1915, p. 295.

Radio Range Variation—R. H. Marriott—*Proceedings IRE*, Jan. 1914, p. 37.

The Goldschmidt System of Radio Telegraphy—E. E. Mayer—*Proceedings IRE*, Jan. 1914, p. 69.

The Resistance of the Speaker and Its Effect on the Oscillations of Electrical Oscillators—J. S. Stone—*Proceedings IRE*, Dec. 1914, p. 307.

The Daylight Effect in Radio Telegraphy—A. E. Kennelly—*Proceedings IRE*, July 1913, p. 39.

The Multitone System—H. Rein—*Proceedings IRE*, Dec. 1913, p. 5.

Commercial Loading of Telephone Circuits in the Bell System—B. Gherardi—*Trans. A.I.E.E.*, Vol. 30, 1911, p. 1743.

On Loaded Lines in Telephone Transmission—G. A. Campbell—*Phil. Mag.*, March 1903, p. 313.

Wave Transmission Over Non-uniform Cables and Long Distance Air Lines—M. I. Pupin—*Trans. A.I.E.E.*, Vol. 17, 1900, p. 445.

Propagation of Long Electrical Waves—M. I. Pupin—*Trans. A.I.E.E.*, Vol. 16, 1899, p. 93.

Single Wire Transmission Lines for Short-wave Antennas—W. L. Everett & J. F. Byrene—*Bulletin No. 52, Engineering Experiment Station, Ohio State University.*

Transmission Circuits for Telephonic Communication—K. S. Johnson—(Book), D. Van Nostrand Co., p. 147.

Averages of Critical Frequencies and Virtual Heights of the Ionosphere, Observed by the National Bureau of Standards at Washington, D. C. *Published Quarterly in Terr. Mag.*

The Ionosphere at Huancayo, Peru—H. W. Wells & H. E. Staton—*Published Quarterly in Terr. Mag.*

The Ionosphere at Waterloo, Western Australia—W. C. Parkinson & L. S. Prior—*Published Quarterly in Terr. Mag.*

FREQUENCY MODULATION

[Continued from page 22]

the plate resistance of a vacuum tube, as in Fig. 24, phase modulation can be produced.

From first observation of Fig. 23-B, it would seem that considerable distortion would be produced by this circuit, due to the non-linearity of the phase-shift curve. However, the plate resistance vs. grid voltage of the modulating tube also has a similar characteristic which can be made to cancel the phase-shift characteristic over a considerable portion of the curve. Maximum cancellation can be obtained by adjusting the bias of the resistance modulator tube for lowest distortion. In Fig. 24, $L1$ and $C1$ form the tuned circuit resonant at $\sqrt{2}$ times f , the input frequency, while $L2$ is a decoupling choke.

Phase-modulation generators have as their principal disadvantage over frequency-modulation generators the fact that only small deviations in phase, and consequently small deviations in frequency, can be produced before considerable distortion is introduced. This means that in order to obtain adequate deviation the phase-modulation generator must be operated at a rela-

tively low frequency in order that after multiplication to the operating frequency the deviation is of a suitable value.

Although the phase-modulation generators produce an entirely different type of signal than the frequency-modulation generators, they can be used interchangeably by proper treatment of the audio circuits. For example, commercial frequency-modula-

tion broadcast stations produce frequency modulation up to about 1600 cycles and phase modulation for the higher modulation frequencies. If, then, we have a frequency-modulation generator, we must make the audio response flat up to about 1600 cycles and then increase 6 decibels per octave throughout the remainder of the audio spectrum, producing phase modulation

[Continued on page 52]

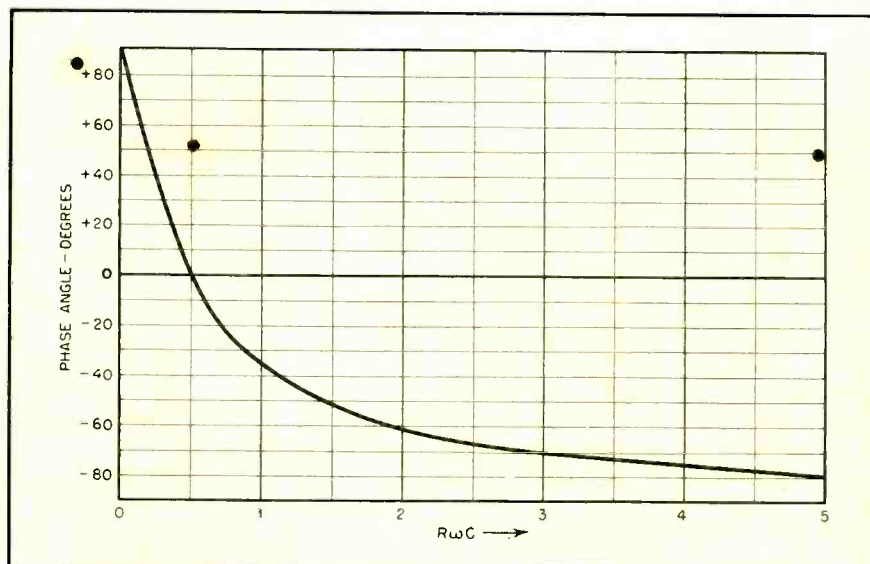
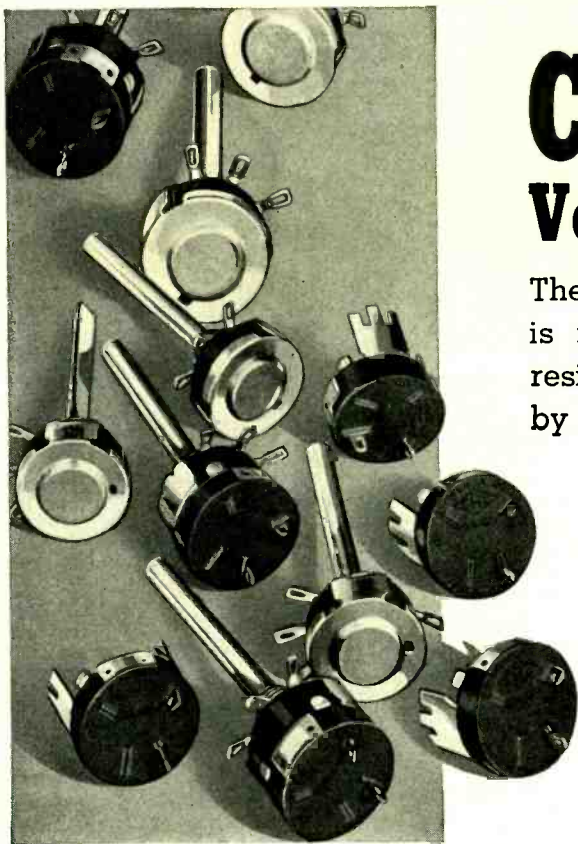

Fig. 23-B. Phase characteristics of method diagramed in Fig. 23-A.



Centralab's Volume Control Tapers

The resistance curve of a volume control is more important than the maximum resistance. Curves 1, 2 and 4 are drawn by measuring the resistance between the Right Terminal and the Variable Terminal and plotting values corresponding to different shaft positions. Curves S, 3 and 6 show the resistance between Left Terminal and Variable Terminal for different shaft positions. The chart reproduced here indicates the percent resistance change with rotation.

CURVE 1. Linear taper. Has uniform resistance change from either end. Used as a voltage divider, will dissipate 1 Watt through total resistance, $\frac{1}{2}$ Watt through half the total resistance, etc.

CURVE 2. Right hand log taper used as "C" bias rheostat or in cases where only right and center terminals are used.

CURVE 3. Tapered at both ends. Used where a very slow resistance change from minimum volume end with smooth change from right end is required. Used as an antenna shunt and "C" bias of 1 or 2 tubes without bleeder current.

CURVE 4. Slow resistance change from maximum volume with a short taper from the left end for antenna shunt. With the same overall resistance as Curve 3, Curve 4 will carry much more current in the "C" bias circuit because of the more gradual resistance change from the right terminal end. Use where "C" bias change gives the principle volume control effect.

CURVE 6. A log curve with slow resistance change from the left end. Use as a straight antenna shunt without "C" bias connection; in audio grid or as a tone control.

S CURVE A linear taper with uniform resistance change from either end but tapered at both ends. Will dissipate slightly less current than Curve 1.

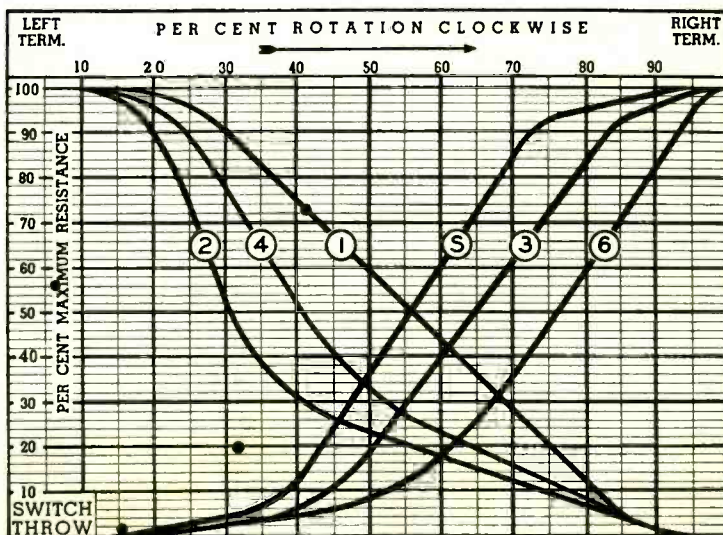

Always Specify Centralab

Centralab

Division of Globe-Union Inc., Milwaukee, Wisconsin

THIS MONTH

ZIEGLER APPOINTED W.P.B. ADVISOR

John M. Ziegler, Crystal Products Company, Kansas City, Missouri, has been appointed to the National Quartz Crystal Industries Advisory Committee. Mr. Ziegler has, for some time,



been a member of the Crystal Standardization Committee. A pioneer in the crystal field and a former member of the RCA Research Laboratories for crystals, Mr. Ziegler taught the first Piezo Electrical Application Courses through the Government Engineering Science, Management, War Training Program sponsored by the University of Kansas.

RMA TRANSMITTER ORGANIZATION

Further organization of the RMA

Transmitter Division, of which Mr. G. W. Henyan of Schenectady is chairman, has been effected. Five product sections of the Division are being organized and activities planned to include RMA members manufacturing transmitting and related products.

Following are product sections which have been organized with their respective chairman: Broadcast Transmitters—Mr. C. W. Miller, Baltimore, Md.; Emergency Service Communication Equipment—Mr. F. A. Gunther, Long Island City; Aircraft and Marine Equipment—Mr. J. W. Hammond, Baltimore, Md.; and Piezo-electric Quartz Crystals—Mr. G. E. Wright, Erie, Pa. Organization of a fifth product section of radio transmitter tubes, with the chairman to be named later, also has been arranged.

ELECTRONICS MANPOWER COMMITTEE

An "Electronics Manpower Advisory Committee," with representatives of management and labor, has been organized to operate under WPB Radio and Radar Division, ANEPA, and the Navy Radio Division of the Bureau of Ships. It will study and make recommendations regarding all manpower problems of electronics manufacturers in war production, and has formed a "task" committee for vital studies.

"OLD COW HANDS" IN ARIZONA

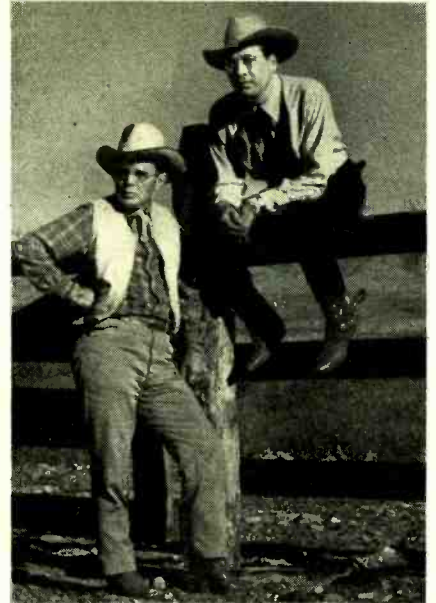

The "old cow hand" on the left is Thomas A. White, Vice President and Sales Manager of Jensen Manufacturing Co., Chicago; the one riding the fence is president of the Chicago advertising agency bearing his name. Both fellows are Arizona ranch veterans having spent their vacations there for several years.

Members of the committee representing management are: L. B. Morris, RCA Manufacturing Company, Inc., Chairman; J. D. Washburn, Sprague Specialties Co., North Adams, Mass., and W. K. Wiggins, Western Electric Co., Chicago, Ill.

Members representing labor are: Harold Sharpe and James J. Conroy, United Electric, Radio and Machine Workers of America, C.I.O., and Lawson B. Wimberly, International Brotherhood of Electrical Workers, A.F.L.

POST-WAR PRIORITY PLAN FOR RCA THEATER PRODUCTS

The first plan within the industry designed to meet the post-war demand for theater and sound projection equipment was announced recently by RCA.

Known as the "Purchase Priority Plan," it offers to forward-looking exhibitors the opportunity to apply now for post-war deliveries of RCA sound and other theater equipment the manufacture of which has been halted by the war.

In brief, the plan provides, first, a preferred position for a theater owner

[Continued on page 54]

RUSSELL AND WIOT JOIN HALLICRAFTERS



R. W. Durst (left), partner in Hallicrafters Co., has announced the appointment of R. L. Russell (center) as administrative assistant, and Cletus Wiot (right) as manager of Government Contract Section.

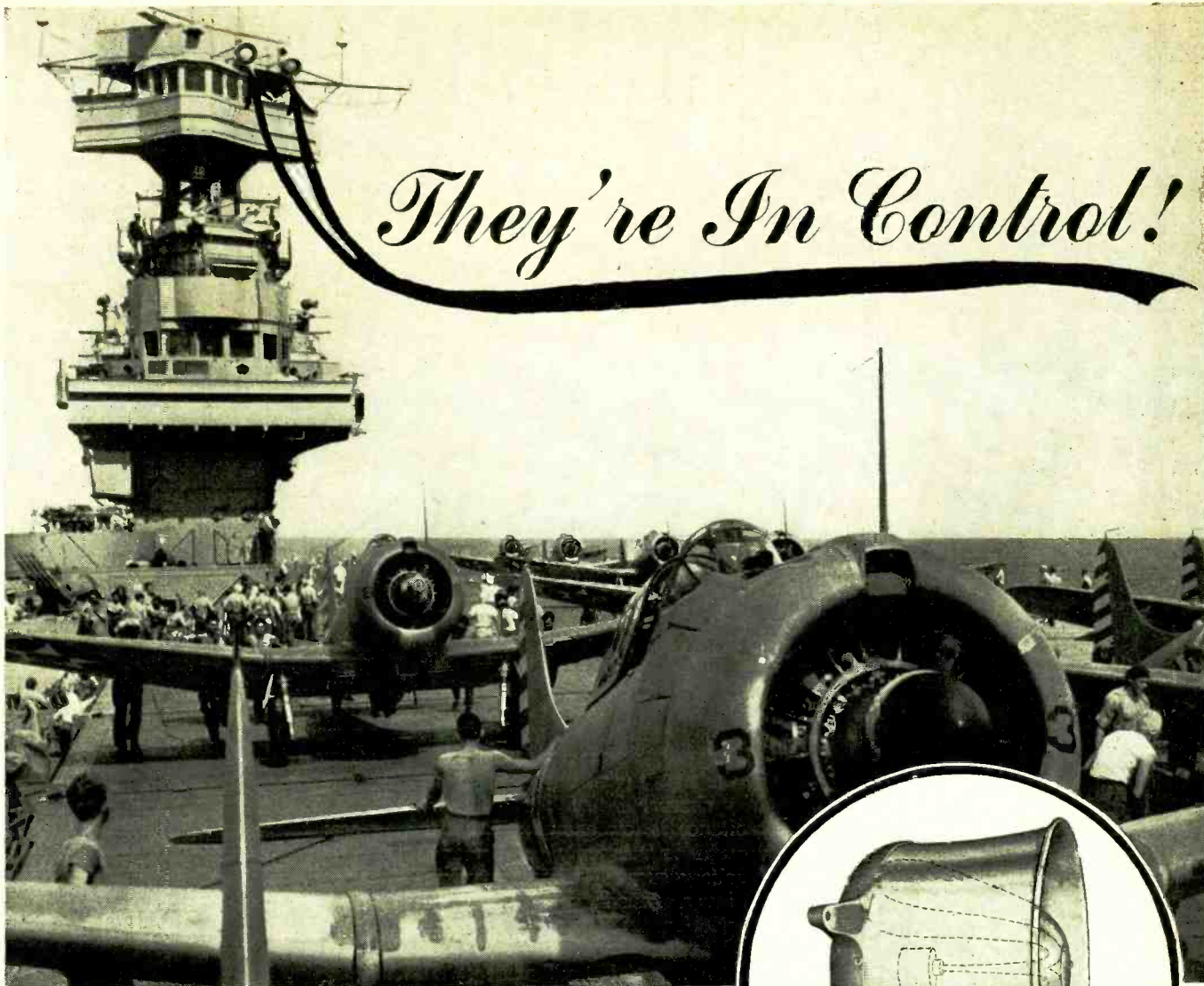

They're In Control!

Official U. S. Navy Photo

When our Battle Force has an important job to do, out go the "Flat-tops". Aboard these carriers RACON Speakers carry commands to the entire crew. RACONS are on the "island" which is the battle control center—and all through the ship's innards. For big jobs, where thousands of lives are at stake—upon which even Victory itself might depend—our Navy relies on aircraft carriers and RACONS. Both are efficient and dependable.

The entire war is not carried on at sea, nor are RACONS to be found only on carriers. RACONS are used on all types of Navy, Coast Guard and Maritime Commission ships—also by the Air Force and Army, in War Plants and Training Bases.

Wherever there is need for dependable public address and sound distribution systems RACONS are in the forefront. There is a RACON for every conceivable application. Our production facilities can meet your requirements. Write to us today. Ask for our latest, free catalog.

RACON ELECTRIC CO., 52 East 19th St., New York, N. Y.

RACON

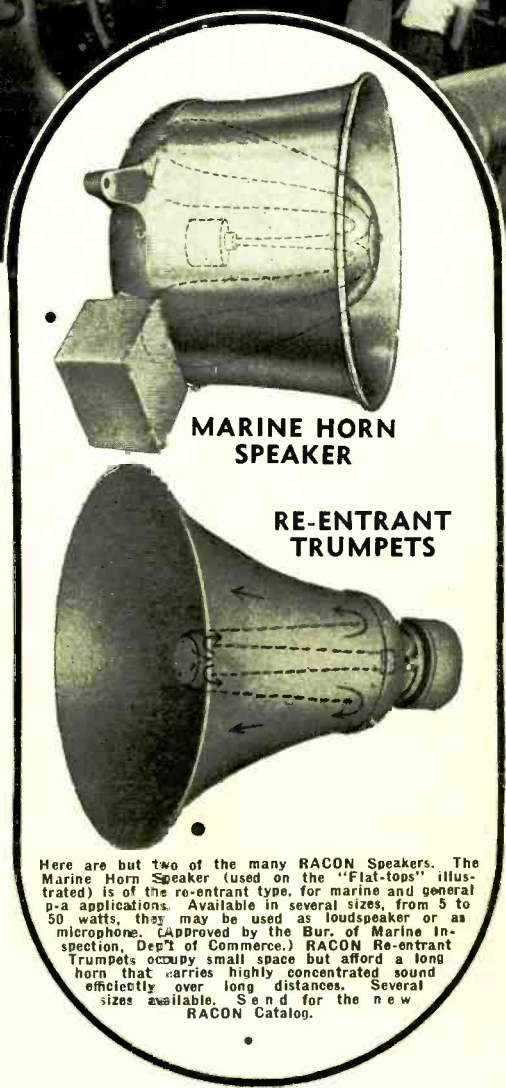

Here are but two of the many RACON Speakers. The Marine Horn Speaker (used on the "Flat-tops" illustrated) is of the re-entrant type, for marine and general p-a applications. Available in several sizes, from 5 to 50 watts, they may be used as loudspeaker or as microphone. (Approved by the Bur. of Marine Inspection, Dep't of Commerce.) RACON Re-entrant Trumpets occupy small space but afford a long horn that carries highly concentrated sound efficiently over long distances. Several sizes available. Send for the new RACON Catalog.

NEW PRODUCTS

"PLUG-IN" TYPE DRY ELECTROLYTICS

The Sprague "Plug-In" type of Dry Electrolytic Condenser is recommended for the elimination of low frequency ripple (2—100 cycles). This modern type of condenser can be sealed as well as any condenser. It can be easily mounted or removed. It is regarded as so reliable—able to take abuse and deliver long life, that the manufacturer considers it entirely practical to solder or weld it into units.

Its basic qualities of small size and light weight are further enhanced by the fact that they perform uniformly up to the very last volt on the rating, and will take repeated surges even higher. Underloads likewise are no problem.

Special emphasis is placed on the ability of these "Plug-In" type dry electrolytic condensers to operate efficiently under the most adverse tem-

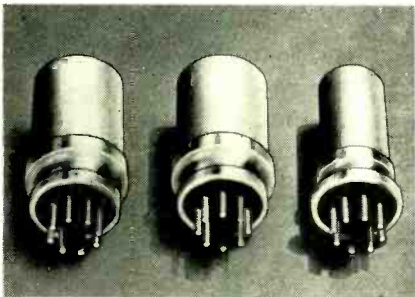

perature and climatic conditions, whether at extremely high or at normal levels.

★

LIGHTWEIGHT THYRATRON TUBE

Designed for applications where weight and space must be considered, a new thyratron tube with both a control and a shield grid for control applications, has been announced by the tube division of the General Electric Electronics Dept., at Schenectady, N. Y. Designated as the GL-502, the new tube is a little over two and one-half inches long, weighs about two ounces, is inert-gas-filled and of all-metal construction. Applications for the new tube will be found in industrial welding and any general control equipment.

The control characteristic is practically independent of ambient temperature over a wide range. Since the grid



current is low enough to permit the use of a high resistance in the grid circuit, the new thyratron has high sensitivity characteristics. The grid-anode capacitance is low enough so that the new tube is relatively unaffected by line-voltage surges. It has a maximum peak inverse anode voltage rating of 1300 volts, instantaneous current rating of 500 milliamperes, and an average current rating of 100 milliamperes. The cathode is quick heating and is rated at 6.3 volts, 0.6 ampere.

★

SHUTTER-TYPE PILOT LIGHT

The Gothard Manufacturing Company, 1300 N. Ninth Street, Springfield, Illinois is now manufacturing a new Shutter Type Pilot Light which is particularly suited to aircraft, marine, signal and similar applications where various intensities of light are desired under constantly changing conditions. These new pilot lights permit a gradation of light from bright, through intermediate glows, to total dark with 90° rotation of the Shutters. Known as the Gothard Model 430 (with faceted

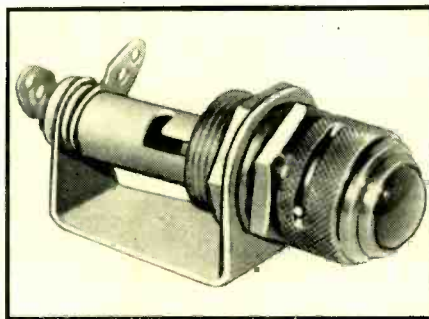

jewel) and Model 431 (with plain jewel) these lights are available with Red, Green, Amber, Blue or Opal lens—also with polarized lens.

Complete information, prices, etc., are given in the recently published Gothard catalog, which also covers other styles and models available for immediate shipment. A copy of the Gothard catalog may be obtained, without obligation by writing direct to the manufacturer.

★

SHALLCROSS MEGOHM DECADE BOX

The Shallcross No. 915-A Megohm Decade Box consists of ten 1.0 megohm resistors, connected in series, mounted on steatite insulators. These accurate resistors are thoroughly impregnated so that the calibration is not affected by high humidity. Each resistor is capable of dissipating two watts; however, in work requiring closer tolerance the dissipation should be held to one watt per unit. The re-



sistors have a standard accuracy of $\pm 0.05\%$ at 74°F.

This No. 915-A Megohm Decade Box is housed in a metal box, may be furnished completely shielded. The unit may be immersed in an oil bath, for work demanding extreme accuracies, increased dissipation or both. A maximum of 10,000 volts may be applied across the binding posts.

Standard 2 and 4 dial resistance boxes may now be secured with all of the advantages of this new instrument.

★

WANTED

TECHNICAL SPECIALISTS

MEN & WOMEN

The COLONIAL RADIO CORPORATION needs immediately, for WAR RADIO WORK, the following technically trained personnel:

RADIO ENGINEERS
PHYSICISTS — RADIO
VACUUM-TUBE ENGINEER
CALIBRATION TECHNICIAN
MECHANICAL ENGINEERS
ELECTRO-MECHANICAL ENGINEERS
MECHANICAL DRAFTSMEN
TOOL DESIGNERS
ENGINEERING SPECIFICATION WRITERS
FIELD ENGINEERS — RADIO
FIELD INSPECTORS — RADIO
MODEL MAKERS
TECHNICAL ASSISTANTS — RADIO

These are NOT temporary positions. Satisfactory employees may expect PERMANENT employment. Qualified applicants, NOT NOW IN WAR WORK, should write, giving full history of education, experience, and salary desired.



COLONIAL
RADIO CORPORATION

254 RANO ST.
BUFFALO, N. Y.





Much is rumored of the wonders of military radio and electronic devices presently in use on land and sea. Brief bits of description of the accomplishments of these secret weapons and the possibilities of their further application stimulate the imagination and inspire confidence in early victory in technician and layman alike.

JOHNSON "Viking" parts are finding preference in everything from the government trainee's transmitter kit to the most secret electronic weapon. Whether it be a socket, insulator, plug, jack, inductor, condenser or similar item it is chosen by men who know radio and men who know radio know JOHNSON parts. The "VIKING" trademark is becoming synonymous with quality and advance design to thousands of newcomers as it has been for some time to the veterans. The engineer and newcomer alike will look to JOHNSON for release of wartime developments and for leadership in new products in a new world of peace and freedom. They won't be disappointed.

Many parts can now be delivered more quickly than before. If it will help win the war please forward your inquiry. Catalog 967K available on request.



JOHNSON

a famous name in Radio

E. F. JOHNSON COMPANY
WASECA, MINNESOTA

ANTENNA CHARACTERISTICS

[Continued from page 32]

Although the foregoing treatment is by no means a complete procedure for adjusting various antennas to proper matching with their transmission lines, it is hoped that the conclusions to be drawn from this data will be of assistance in diagnosing and correcting antenna to transmission line mismatches.

For those readers who wish to pursue the subject further, the following bibliography will be found of great help.

BIBLIOGRAPHY

BOOKS

Frequency Modulation—Hund—Chapter 5.
High-Frequency Measurements—Hund—Chapter 15.
Radio Fundamentals—Ballou—Chapter 5.
Microwave Transmission—Slater—Chapter 1.

PERIODICALS

Antennas and Radiation (Bibliography)—Rettenmeyer—*Radio*, February & March, 1943.

An Ultra-High-Frequency Antenna of Simple Construction—Brown & Epstein—*Communications*, July 1940.

Dipoles and Reflectors; a Short Review—Goldman—*Electronics*, May 1940.
Measurements in the U. H. F. Spectrum—Lewis—*Electronics*, April 1942.

Q MEASUREMENTS

[Continued from page 16]

when the tuned circuit is mounted in the set. This is due to the presence of metal adjacent to the coil; hence we can estimate that when the set is given a temperature run, a certain degree of drift will be caused by a change in the physical dimensions of the metal, and also due to a variation of its surface resistance. This measurement would obviously be impossible with a standard Q meter, since leads from the Q meter to the tuned circuit in the set would render the readings meaningless.

The final reading in the table is interesting as a demonstration of the close agreement between the frequency as measured by careful use of the absorption-type Q meter, and the actual oscillating frequency. It serves to prove that the oscillator tube generates almost no reactive component the magnitude of which would depend on plate voltage. The measurements therefore predict a voltage-stable oscillator.

A complete investigation of this system was made by the writer about five years ago, when faced with the problem of designing tunable receivers and transmitters of crystal accuracy in the u-h-f region. A stable and well-calibrated oscillator was first built. A

standard circuit was then constructed from a 3-turn coil wound on a grooved ceramic form $\frac{3}{8}$ " in diameter, with a special ceramic condenser built in as an integral part of the tuned circuit.

The plate voltage of the calibrated oscillator was then made variable so as to adjust the grid current to an even value of 100 microamperes. The tuned circuit was then coupled in sufficiently to drive the grid current down varying amounts to check the effect of coupling coefficients on the accuracy of measurement. Coupling at this high Q value was found not to be very critical, and in all subsequent work a reduction of grid current of 10 percent, or down to 90 microamperes, was used as a standard. The type of coupling was then varied from pure capacitive to pure inductive, with no difference noted. When the unknown circuit is brought close to the oscillator coil, both forms of coupling are present if no screens are used, and this proved quite satisfactory.

In other Q measurements based on taking points on the resonant curve, the 45-degree phase angle points were taken 0.707 down from the peak. The Q is then obtained by taking the frequency difference between these points (Fig. 2) and dividing the resonant frequency by this difference; that is $Q = f_0 / f_2 - f_1$. As a point of practical utility in using this system almost daily, the points were actually taken half-way down the resonance curve, where it is steeper. The calculation is then made as though the 0.707 points were used and the resultant value divided by 0.59 to give the correction for this condition.

The Q of the standard circuit was measured in this manner. The condenser was ground down so that its capacity provided a frequency of exactly 150,000 kc. It was then coupled into the oscillator to drive down the grid current from 100 μ a to 90 μ a; the oscillator then detuned until the grid current rose to 95 μ a. The frequency was 150,185 kc. The oscillator was then tuned to the other side of resonance until the grid current was again 95 μ a, and the frequency was 149,815 kc. Then by dividing the resonant frequency of 150,000 kc by the difference frequency of 370 kc the answer 405 was obtained. But, since these points are the half-way-down points, the figure 405 was divided by the correction factor of 0.59, giving as an answer the true Q of 687.

Check on Results

The thought naturally arises as to how it may be proven that the Q of the circuit in the example given, is just below 700. The requirement of cross checking a new measurement in such a relatively undisciplined field is

SHALLCROSS ROTARY TAP SWITCHES USE SOLID SILVER CONTACTS, BECAUSE SOLID SILVER...

1. Has the highest conductivity of materials available.
2. Is superior to silver-plating which wears off, resulting in high resistance contacts.
3. Should it corrode the sulphide formed does not appreciably increase the contact resistance.

Let Shallcross answer your switch problems
Address Dept. C 28

WHY "SHORTING" AND "NON-SHORTING" SWITCHES?

This is the shorting type. As the arm is rotated from one position to another the adjacent contact points are "shorted" (=ridged).

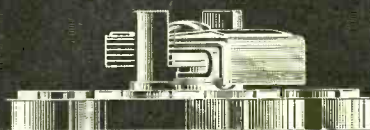

This is the non-shorting type. As the arm is rotated from one position to another, the arm lifts up, and only one contact is touched at a time.

Creators and Makers of

ACCURATE RESISTORS—SWITCHES—SPECIAL EQUIPMENT AND
SPECIAL MEASURING APPARATUS FOR PRODUCTION AND
ROUTINE TESTING OF ELECTRICAL EQUIPMENT ON MILITARY AIR-
CRAFT... SHIPS... VEHICLES... ARMAMENT... AND WEAPONS



SHALLCROSS MFG. CO.
COLLINGDALE, PENNA.

necessary. Several methods were tried, but promoted such difficulties as to inspire no confidence, until the following procedure was tried.

A parallel tuned circuit has a dynamic impedance which is the impedance of either the inductive leg or capacitive leg times the Q . In the u-h-f region, a coil is too small to permit an accurate measurement of its inductance, but the capacitor placed across the coil can be accurately measured.

As an example, assume a practical case where the value of the shunt capacitor is $19 \mu\mu\text{f}$ and the distributed

capacity $1 \mu\mu\text{f}$ —a total of $20 \mu\mu\text{f}$. A capacitance of $1 \mu\mu\text{f}$ at 150 mc has an impedance of 1061 ohms, and if this value is divided by the total capacity of $20 \mu\mu\text{f}$, the capacity leg is found to have an impedance of 53 ohms. Multiplying this by the Q value of 687 turns up a dynamic impedance of 36,400 ohms in round figures.

If, now, a pure resistance of 36,400 ohms is placed across the tuned circuit, the circuit losses will be doubled and the Q halved. This was done, and another measurement indicated a Q of 348, just slightly more than half the

original Q of 687—a very close agreement. By successive steps the resistance was lowered to provide Q values of one-third, one-quarter, etc., and at each step a close agreement was obtained.

The pure resistance was obtained by rebuilding an IRC resistor of the type made by depositing colloidal carbon on a glass thread, inserted in a ceramic tube or sleeve, with large cast-metal ends. A resistor of this type, and having a value of 25,000 ohms, was taken apart by melting off the cast-metal ends and removing the resistance element proper. Connections were made to this element by tightly winding about seven turns of No. 32 wire around each end, and soldering the turns completely, to form sleeves. The loose ends of wire were snipped off, and the sleeves soldered directly across the circuit. Previous to this, however, the resistor was placed across a bridge and enough carbon scraped off to bring its value up to exactly 36,400 ohms.

The addition of this resistor to the tuned circuit lowered the frequency by about 55 kc at 150,000 kc, a definite indication that the element was a very close approach to a pure resistance.

Circuit Details

A few points with regard to the design of the Q -meter circuit shown in Fig. 3 are worth consideration. If the oscillator is condenser tuned, it is preferable to incorporate a vernier condenser for the purpose of precise measurement. It is also desirable to employ a voltage-regulated power supply, a VR-150 tube being quite satisfactory for this purpose. A switch is shown in the grid circuit of the oscillator tube. The grid-current meter $M1$ in position 1 of the switch is necessarily an expensive unit, with a well open scale, as high accuracy is required in the 90- to 100- μa region for precisely spotting the halfway point.

Since meters of this type are difficult if not impossible to obtain these days, an alternative arrangement is incorporated, with the switch in position 2. As we are dealing with changes in current rather than absolute values, it is quite feasible to employ a d-c amplifier used in conjunction with an inexpensive, 1-mil meter, $M2$. The amplifier tube may be an 1852 run off a rather heavy bleeder, and from the same voltage-regulator tube used in conjunction with the oscillator. The cathode is biased up on the bleeder by about 4 volts, and the tap on the grid-leak extension resistor R adjusted to provide a reasonable meter reading. If a 1-mil meter is used, the 1852 screen voltage must be pulled down to about 50 volts. This meter, of course, will be driven up as the circuit under test is brought close to the oscillator.



**FOR
ACCURATE
CALIBRATION**

Use a Meissner Signal Calibrator . . . the precision frequency standard

THE ANSWER to calibrator checking of products used in the war effort. Provides accurate signals from 10 kc. to 60 mc. for accurately checking calibration. Produces modulated and unmodulated signals every 10, 50 and 100 kc. Vernier control for adjusting to zero beat against WWV or other primary standard. Special Meissner Signal Calibrators can be ordered to provide 100 kc. and 1000 kc. output.

The Signal Calibrator is invaluable as a secondary frequency standard for Crystal Manufacturers, Radio Laboratories and Government Inspectors.

Entire unit, including 110 volt AC power supply, housed in 8"x8"x12" cabinet. Shipped complete with tubes. Net price \$46.00.

See your Meissner distributor, or write for complete catalog



Meissner

MT. CARMEL, ILLINOIS

"PRECISION-BUILT PRODUCTS"

The measurement technique involves four steps. Since the oscillator grid current will vary somewhat through the range of tuning, it is necessary to first couple the unknown circuit quite closely to the oscillator coil, and locate the point at which there is a marked dip in grid current; or, if the d-c amplifier is used, when there is a marked rise in the reading of meter M2. The tuned circuit under test should then be gradually withdrawn while the oscillator is slightly retuned, and this continued until only a slight dip in grid current is registered. The resonant frequency of the circuit under test has then been ascertained.

The circuit under test is then removed, and the oscillator plate voltage adjusted to provide, for the sake of convenience, some even value of meter reading. The tuned circuit is then re-introduced and the coupling altered until the meter reading is changed the desired amount; then the oscillator is detuned to one side of the resonant frequency of the circuit under test by an amount that halves the meter reading. Proceed from here as previously described.

It will be found that at low values of Q, of the order of 50 or so, it will be necessary to couple in the test circuit so tightly as to affect the average grid-current for a considerable distance either side of resonance, and this must be allowed for. By taking a number of points besides those at halfway, it is possible to work out a correction factor, since this effect is a function of the oscillator Q and L-C ratio.

Typical Q Measurements

Some typical Q measurements at 150 mc might be of interest. A 3-inch diameter loop of $\frac{1}{4}$ " copper tubing on a well-constructed 50- μmf variable condenser gives a Q of 675. A 2-inch concentric line was found to have a Q of 1700. A 3-turn coil of No. 14 copper wire with a $\frac{3}{8}$ " inside diameter and a Centralab ceramic condenser connected across it, had a Q of 700. If a hydrogen-iron core is inserted in the coil, the Q falls to 28; whereas a properly designed ferrous-oxide iron core provided a Q of 400 or so, depending upon particle size, insulation, etc. A parallel-line copper rod or tube a quarter wave long, turned out to have a Q of a little over 1000.

In taking some of these measurements, a curious condition was discovered. If a solid metallic core is inserted in the coil for the purpose of tuning, the Q was found to be the same for all non-magnetic metals, regardless of their type. The losses in the best soft-annealed silver core gave a Q of 90 when fully inserted in the coil, but so did brass, aluminum, zinc, or any

For Finer Co-ordination...remember

ONLY

WINCO

GIVES YOU

ALTI-TEMP

The dynamotor specially designed to insure maximum efficiency at all operating altitudes and temperatures.



Quality Built WINCO DYNAMOTORS Insure

- ★ COMPLETE DEPENDABILITY
- ★ PERFECT BALANCE
- ★ MINIMUM A. C. RIPPLE
- ★ LOW VOLTAGE REGULATION
- ★ COMPACTNESS and LIGHT WEIGHT

... And, whatever your power problem, Winco Engineers will be glad to help you solve it. This service is free and without obligation. Why not consult us?

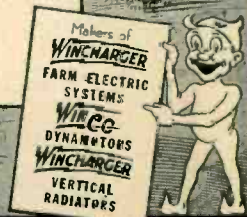

WINCO

DYNAMOTORS
WINCHARGER CORPORATION - SIOUX CITY, IOWA



THE ERWOOD COMPANY

WITHIN our book of experience are contained the results of over twenty years in the electronics field. Today we are engaged entirely in the war . . . tomorrow we hope to devote that experience to the handling of your difficult electronics needs.

223 W. ERIE ST., CHICAGO

On the Sea...
PINCOR Products
Keep 'Em Winning!

DYNAMOTORS * CONVERTERS * GENERATORS * D.C. MOTORS * POWER PLANTS * GEN-E-MOTORS
PIONEER GEN-E-MOTOR
 CHICAGO, ILLINOIS
 EXPORT ADDRESS: 21 WARREN STREET, N. Y., N. Y. . . . CABLE: SIMONTRICE, NEW YORK

usual metal tried. Nickel bearing alloys were much worse, of course.

This effect is still being analyzed, but as a guess it could be assumed that the short-circuited ring formed in the core face has a depth of between one and two ten-thousandths of an inch for high conductivity metals at these frequencies; but we know that the penetration of the current is deeper as the resistance of the metal increases, so apparently the increased cross section of the ring due to deeper penetration maintains the resistance at the same value for all non-magnetic metals.

Incidentally, a dried raisin inserted in a coil at these frequencies will lower the frequency about 150 kc, proving that the raisin contains iron . . . which should make the California raisin growers happy!

The system described is believed to be quite reliable, as the results have been consistent over a long period of research. A bit of practice is required before the system can be handled smoothly, but that is true of any system providing precise measurement.

It has the disadvantage over the standard type of Q meter in that direct readings cannot be obtained, but the added advantages to be derived from the meter over-ride this one drawback.

COAXIAL LINES

[Continued from page 19]

ing in both directions we must have two of these traveling waves, one moving toward the load and the other toward the source. We will then find that the wave moving toward the load is in phase with a current, while the wave traveling back to the source is out of phase with its accompanying current wave. This allows one wave to carry power in one direction and the other in the opposite direction.

This concept of voltage and current waves moving in opposite directions is not inconsistent with the mismatched cases shown in Fig. 2, since there we have plotted what would be the sum of the two traveling waves as a function of time when measured at the load. Each represents a sinusoidal variation with time and it is well known that the sum of any two sine waves of the same frequency is another sine wave regardless of phase angle relation.¹ Fig. 3 shows how the voltage curve of Fig. 2 may actually be made up of two sinusoidal voltage curves.

¹ $A \sin \omega t + B \sin(\omega t + \alpha) = C \sin(\omega t + \beta)$;

where $C = \sqrt{A^2 + 2AB \cos \alpha + B^2}$
 and $\beta = \sin^{-1}(B/C \sin \alpha)$.

Voltage Distribution

In Fig. 4A the two voltage waves traveling in opposite directions are shown. V_t is the transmitted wave and V_r is the wave reflected from the load. If we now think of the transmitted voltage wave as made up of two in-phase waves, V_{ts} and V_{tr} (whose sum is V_t) where V_{ts} has the same amplitude as V_r , we are in a position to see what the actual voltage distribution along the line is like for a mismatched case. In Fig. 4-B, are shown the three waves whose sum represents the actual voltage on the line.

In Fig. 5 we have paired V_{ts} and V_r of our now three traveling voltage waves and show their sum for successive times t_0 , t_1 , and t_2 . The sum, which we have called V_s , is a so-called standing wave and is one which generates no voltage at all along the line at points such as L , M , N , etc. At intermediate points an alternating voltage is obtained which is a maximum at points such as P , Q , R , etc.

In an actual mismatched line if we measure the voltage at points such as L , M , N , etc., of Fig. 5, we will find some voltage other than zero because of the traveling voltage wave V_{tr} . This will be zero only if the reflected wave is equal to the transmitted wave. Perhaps such a case would be called a perfect mismatch. It would occur if the load end of the line were open or shortened. In general, however, as we measure voltage along a line we do find maximum r.m.s. voltages at points like P , Q , R , and minimum voltage at points like L , M , N . The ratio of these voltages is known as the voltage standing-wave ratio. When it is unity, there is no standing wave, hence no reflected wave, and therefore a perfect match with a maximum of power available at the load. The larger the ratio, the worse the mismatch and the less power is available at the load.

The voltage standing-wave ratio is conveniently measured by making a slot lengthwise in the shield of the coaxial cable. A very small probe connected through a rectifier to a voltmeter is then inserted into the slot and moved along. Unless the s.w.r. is unity, two points of respectively maximum and minimum reading will be found a quarter wavelength apart. The ratio of these two readings is the s.w.r. and its departure from unity is a measure of the mismatch in the system on the load side of the point where the measurement is made.

Stub Support

Strangely enough, the mismatched cases are in some places of great practical importance. For example, when air is used around the center conduc-

tor as a dielectric some method of support must be found. The so-called stub support method represented in Fig. 6 is one possibility of practical importance. To understand its operation let us examine what happens in lines one-half wavelength and one-quarter wavelength long which are shorted at the far end. The incident and reflected waves are equal in magnitude since we have perfect mismatching. No voltage can ever appear at the shorted end so one node of our standing wave must be there. In the half-wavelength line there must be another node at the source end. Such a

line can thus have no voltage impressed across its open end. With a quarter-wavelength line the situation is quite different. The unshorted end is then a point which will accept any voltage impressed on it but absorb no power. Thus the stubs built out from the side of a coaxial cable can, if they are the right length, give a support for the center conductor without affecting the action of the line at all. A given quarter-wave stub will, of course, be appropriate only for certain frequencies.

At times the deliberate introduction of mismatch in a stub line can be used



Instant communication — fighter planes
with bombers — cruisers with their
convoy — tanks with infantry And in the
midst of it all — Radio Tubes — the heart
of communication Yes Ken-Rads are
helping to decide the destiny of democ-
racy in a big way Your dealer may
not have a plentiful supply of Ken-Rad
tubes now But our fighting forces
have — and after victory every one will

KEN-RAD

RADIO TUBES • INCANDESCENT LAMPS • TRANSMITTING TUBES

OWENSBORO • KENTUCKY

GENERAL INDUSTRIES

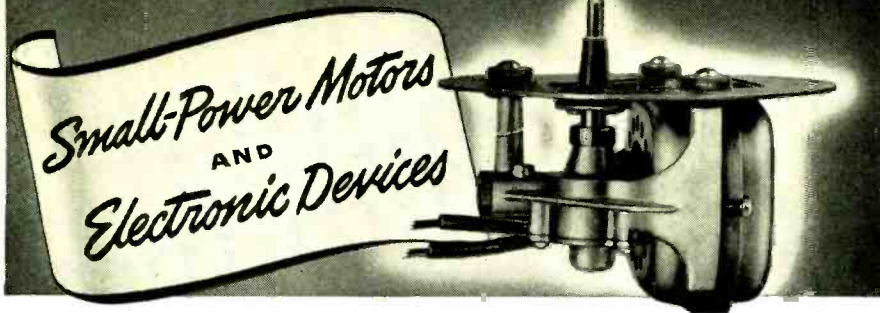

Engineered Right—Built Right for Wartime Needs

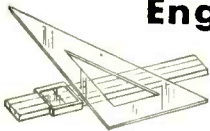

The engineering ability and careful construction that advanced G. I. motors to foremost place in domestic and commercial fields are now available to manufacturers producing for Victory. General Industries' facilities are devoted not only to building motors but also to a wide range of electronic devices that find application in the war effort. Do not hesitate to ask for the cooperation of G. I. engineers.

THE GENERAL INDUSTRIES CO.
ELYRIA, OHIO

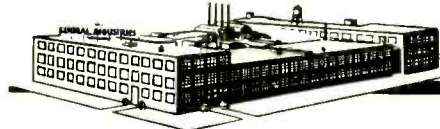

to correct inherent mismatch between the main line and the load. In a sense it thus acts like a transformer. In Fig. 7 is shown how a stub of adjustable length might in certain cases be used to match a load to a given line. Let us assume for example that with the stub eliminated a s.w.r. of 5 is obtained in the main line. This means that the incident voltage wave to the load is only $1/5$ larger than the reflected wave. Now suppose we adjust the shorted stub line somewhere over a half wavelength range but in general not precisely at a quarter or half wavelength. It will then accept a voltage wave and return it after reflection in some changed phase. With proper adjustment this returned wave may be just out of phase with the reflected wave from the load. The resulting cancellation of the load reflection will lower the s.w.r. in the main line and thus improve the match.

FREQUENCY MODULATION

[Continued from page 40]

at the higher frequencies. Conversely, if we have a phase-modulation generator, the audio characteristic must drop off 6 decibels per octave up to about 1600 cycles, being flat from there on, thus causing frequency modulation to be produced at the lower audio frequencies.

R-F Amplifiers

The r-f amplifiers which follow a frequency-modulation generator may, unlike amplitude modulation, be of the Class C variety. This is made possible by the fact that no amplitude variations are present in a frequency-modulated signal. In fact, it is desirable that

The NERVES of WAR

COMMUNICATIONS are the nerve-center of modern warfare. Where the battle is hottest today, there our radio broadcasting and receiving equipment is leading the way to Victory. And there, on America's far flung battle fronts, you'll find BUD Products — and in them just one of the reasons our Nerves of War are so steady today.



BUD RADIO, Inc.
CLEVELAND, OHIO

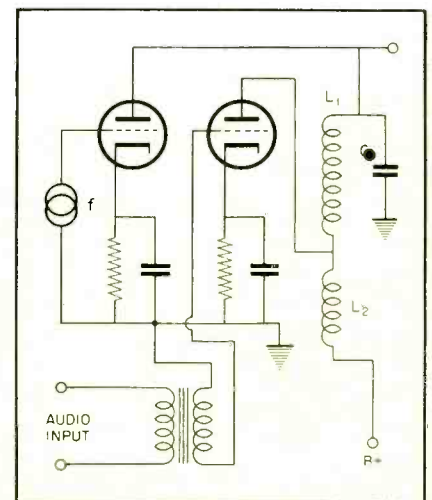

Fig. 24. The circuit of Fig. 23-A with plate resistance of a tube in place of resistance R.

the amplifiers be of the Class C type, since they will then act as limiters, and remove undesirable amplitude-modulation components which may have been produced.

The bandwidth of amplifiers following the frequency-modulation generator must be given special consideration, especially when large deviations are employed. The situation is not, however, as critical as in the case of i-f amplifiers for the receivers, since the operating frequency for the transmitter amplifiers is usually considerably higher.

(Conclusion)

TECHNICANA

[Continued from page 10]

to sample surveys conducted by Commander E. F. McDonald, Jr., president of Zenith Radio Corporation.

Commander McDonald wrote to the editors of a number of publications, large and small, in all parts of the country, pointing to the confusion that has risen from the use of two terms to mean exactly the same thing, namely the application of vacuum tubes in electrical circuits, not only for broadcasting and communications, but in television, radar, rectifiers, phonographs,

hearing aids, welding machines, smoke detectors, and other devices comprising this entire field. He outlined the derivation of the two terms, and asked for opinions. Then he wrote to a number of physicists, college professors of physics, and deans of engineering schools, asking them the same question.

Replies came from 68 editors and 202 scientists. Of the editors, 56 preferred radionics, six were neutral, and six thought electronics the better word. Scientific opinion was not quite so one-sided: 131 preferred radionics, 57 electronics, and 14 were neutral.

In general those who preferred electronics did so because they were more familiar with the word, because they felt that radionics might be restricted to radio alone, or because the functioning of a tube is dependent on control of electrons. The opposing majority favored radionics because they believed it would be more readily understood by the public, because of its precision and accurate connotation, and because it is a normal and logical growth of language.

"Radionics is exact in its meaning," wrote one editor, "while electronics suggests electrons, with which the public commonly associates the fundamentals of matter and of atom smashing."

RUGGED

Accuracy and dependability are built into every Bliley Crystal Unit. Specify **BLILEY** for assured performance.

BLILEY ELECTRIC COMPANY
ERIC, PENNSYLVANIA

Bliley Crystals

No Time for Minor League Stuff Today

Our force, the largest in our history is hitting the production ball at a .400 clip for Uncle Sam and our Allies, and every person in our employ is a "Minute Man" in buying bonds.

Yes, sir—we are in the "Big League" and we will continue lining them out until the scrap is over.

HENRY FORSTER
President

RADIO SPEAKERS
INCORPORATED

221 East Cullerton St.
Chicago, Illinois

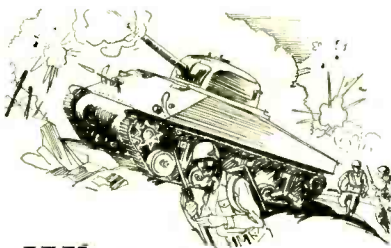
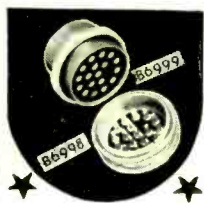
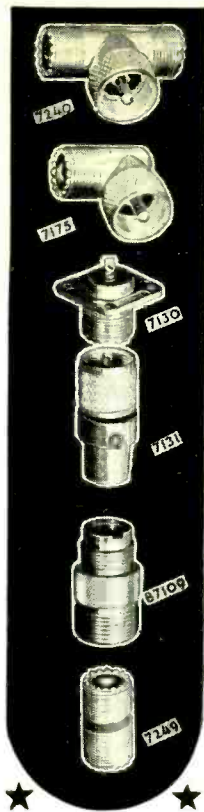

When Every SECOND Counts

★ Astatic Multi-contact Plugs and Sockets and Co-axial Cable Connectors not only speed up the operation of connecting and disconnecting electrical circuits for military radio equipment but what is more important, they guarantee positive circuit contacts for uninterrupted radio communications. Government approved, Astatic Plugs, Sockets and Connectors are highly praised by radio manufacturers for uniform quality and expert workmanship.

ASTATIC

IN CANADA:
CANADIAN ASTATIC, LTD.
TORONTO, ONTARIO

THE ASTATIC CORPORATION
YOUNGSTOWN, OHIO



COAXIAL CABLES

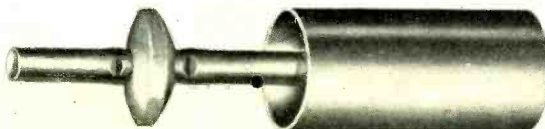

... for Radio Transmission Lines

The VICTOR J. ANDREW CO., pioneer manufacturer of coaxial cables, is now in a position to take additional orders, in any quantity, for all sizes of ceramic insulated coaxial cables and accessories. The Andrew Co. engineering staff, specialists in all applications of coaxial cables and accessories, will be pleased to make recommendations to meet your particular requirements.

"Attention!"

If coaxial cables are your problem... write for new catalog showing complete line of coaxial cables and accessories.

VICTOR J. ANDREW CO.

363 East 75th Street, CHICAGO, ILLINOIS

ANTENNA EQUIPMENT

A noted scientist wrote, "We do not say electron-tube usually, but only radio-tube. The scientist can associate with radionics all that he finds in the words 'electronics,' whereas 'radionics' will give to the people some idea of what is meant when they read or hear that name."

Another said: "I have spoken to several professors of languages and chemistry. The general opinion is that 'electronics' is well suited as a generic term, especially in advanced studies in chemistry and physics. However, they all agree that radionics is a more specific word to express clearly the exact meaning for the various applications of electron emission. The students of my advanced course in electricity favor the use of the word radionics in identifying the science of vacuum tubes and their circuit applications."

Other comments included:

"Radionics is definitely descriptive of the action, the meaning of which the terms should convey, and for that reason above any other scientists should be inclined to adopt it."

"I have long felt that the term electronics is used in too general a connotation. Radionics appeals to me because it is so much more specific."

"The fields which make use of electrons in vacuum tubes belong to a restricted division of the large subject of electron activity, but it is a wide field and rapidly growing, and it certainly deserves a special name. Hence, I for one would favor the description, radionics."

"Certainly, radionics is a much better word than electronics. The word electronics is a misnomer, while radionics is definite and exact."

THIS MONTH

[Continued from page 42]

on the "priority purchase" list; and second, a method of building up an interest-bearing cash reserve for the theater owner to apply against his post-war purchases.

CLAROSTAT OPENS SECOND PLANT

As a further contribution to the war production effort and especially with an eye to that six-months' star for its Army-Navy "E", Clarostat Mfg. Co., Inc., Brooklyn, N. Y., announces the opening of its second plant in the same city.

Clarostat Plant 2 provides greater production floor space than that of the original plant, and will be devoted exclusively to assemblies, while the original plant will be devoted to fabrication of parts, windings, engineering and general offices.

ARMY-NAVY "E" TO SOLAR

The Solar Manufacturing Corporation, Bayonne, N. J., has been awarded the Army-Navy "E" for its contribution to excellence in the production of war equipment.

The presentation of the award was held early in April at which time prominent Army, Navy, State and civic officials joined with the management and several thousand employees in appropriate ceremonies.



AEROVOX OPENS SECOND PLANT

Again stepping up its production capacity to meet the enormous war requirements for mica capacitors, Aerovox Corporation of New Bedford, Mass., announces the opening of a plant in Taunton. This second plant, with some 60,000 square feet of production space will be devoted exclusively to mica capacitors. The enlarged mica production facilities will virtually double the Aerovox mica output which has been running well into the hundreds of thousands of units weekly.



"E" AWARD TO THERMADOR

Thermador Electrical Manufacturing Company of Los Angeles was recently awarded the coveted Army-Navy "E" Flag, in impressive ceremonies conducted at the plant.

Officiating were ranking officers of the Army and Navy and executives of the company. Chief Bandmaster Rudy Vallee led the Coast Guard Band at the raising of the American flag by the Navy Color Guard.



GARNER OPENS NEW PLANT

Fred E. Garner Company of Chicago announces the opening of Plant No. 2 at 1100 West Washington Street, Chicago. This new plant will be devoted to manufacturing Frequency Meters, Test Equipment, Radio Telephones, Direction Finders, Silent and Sound Picture Projectors, and other Radionic Devices.

The engineering staff will be located at the new plant at 1100 West Washington Street—the general offices will remain at 43 E. Ohio Street, Chicago.



NEW KEN-RAD PLANTS UNDER WAY

Authorization of a contract with Ken-Rad Tube & Lamp Corporation, Owensboro, Ky., by the Defense Plant Corporation, Washington, for plant facilities in Indiana and Kentucky to cost \$1,300,000 has been announced by Roy Burlew, Ken-Rad's president. This appropriation is allocated to the construction of a branch plant in Tell City, Indiana, and the installation of new equipment in the company's Owensboro plants. Construction and

**WE TOO, FIGHT
... FOR PEACE!**



Lafayette is doing its part to win the war...and the peace that must surely follow. We play the important part of speeding the war effort by supplying emergency requirements of radio, sound and electronic parts to all branches of the armed forces as well as to manufacturers and sub-contractors. Lafayette is in there fighting to save you time by supplying all of your needs in one order—*quickly!*

Now it is no longer necessary to comb the field to find the various parts you need. Due to Lafayette's extensive buying facilities and large, diversified stocks, one order (no matter how large or how small) will bring quick deliveries on *all* of your requirements.

Free catalog—Radio, Sound and Electronic Parts—Dept. 4F3



"Quick Deliveries on Radio, Sound and Electronic Parts"



**SHE'S
FIGHTING
TOO!**

Making Parts Without Dies

No delay waiting for dies—parts ready quicker—deliveries speeded up—all to bring the Victory sooner! Women are rapidly taking a major place on the industrial front. DI-ACRO Precision Machines—Shears, Brakes, Benders—are ideally suited for use by women in making duplicated parts accurate to .001" — DIE-LESS DUPLICATING. Thousands of DI-ACRO Machines are now in use in War plants.

Send for Catalog

"METAL DUPLICATING WITHOUT DIES"
It's an eye-opener on what you can do without dies, shows typical parts, and gives sizes and capacities of all models of Di-Acro Shears, Brakes, Benders.



BRAKES

(Illustrated)

Di-Acro Brake forms non-stock angles, channels or "Vees". Right or left hand operation. Folding width—Brake No. 1—6". Brake width—2—12". Brake No. 3—18".

BENDERS

Di-Acro Bender bends angle, channel, rod, tubing, wire, moulding, strip stock, etc. Capacity—Bender No. 1— $\frac{3}{4}$ " round cold rolled steel bar. Bender No. 2— $\frac{1}{2}$ " cold rolled steel bar.

SHEARS

Di-Acro Shear squares and sizes material, cuts strips, makes slits or notches, trims duplicated stampings. Shearing width—Shear No. 1—6". Shear No. 2—9". Shear No. 3—12".



346 8th Avenue So., Minneapolis, Minn.

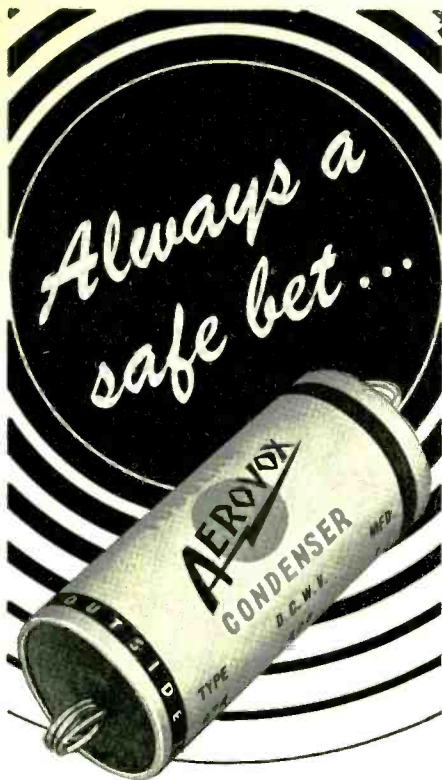

● Yes indeed, Aerovox paper tubulars Type '84 are thoroughly dependable. Millions of them are in daily use, establishing enviable service records. The non-inductive section is sealed in wax-impregnated paper tube with extra-generous wax-filled ends. Varnished colorful jacket labels make them look as good as they really are. Maximum protection against moisture. Adequate selection of voltages and capacitances.

TUBULAR PAPER CONDENSERS

Type 484—400 v. D.C.W.
.01 to 1.0 mfd.

Type 684—600 v. D.C.W.
.001 to .5 mfd.

Type 1084—1000 v. D.C.W.
.001 to .1 mfd.

Type 1684—1600 v. D.C.W.
.004 to .05 mfd.

● *See Our Jobber...*

Consult him regarding your wartime servicing or other capacitance requirements. Ask for copy of latest "Victory" catalog. Or write us direct.

AEROVOX CORPORATION

NEW BEDFORD, MASS., U. S. A.

In Canada: AEROVOX CANADA LTD., Hamilton, Ont.

EXPORT: 100 Varick St., N. Y., Cable 'ARLAB'

installation work will begin soon. The Tell City plant is expected to employ 1,500 persons.

The Defense Plant Corporation's authorization follows closely upon a government appropriation of \$915,000 for the Bowling Green, Ky., branch plant of the Ken-Rad Company, for which materials for construction are now being shipped. The Bowling Green plant will manufacture "radio and secret ordnance equipment for the armed forces" and the Tell City plant will manufacture materials for the Army Signal Corps.

★

VIC MUCHER W.P.B. RESISTOR CONSULTANT

Clarostat's Vic Mucher has been appointed a consultant to the Radio and Radar Division of W.P.B. on the dollar-a-year basis. He is subject to



call at any time and as a matter of fact spends several days in Washington each month. If there's one thing Vic knows it's resistors, for he's been brought up in a family that has specialized in this field for the past 22 years. Vic also brings to W.P.B. a keen knowledge of the radio parts industry generally, as well as a host of contacts.

★

EMBY CHANGES NAME

Emby Products Company, Inc., announces a change in name to Selenium Corporation of America, for the purpose of indicating the increased scope of manufacturing activities. Located at 1800-1804 West Pico Boulevard, Los Angeles, the Company manufactures Emby Instrument and Relay Rectifiers, Emby Photo-Electric Cells and other related scientific products.

DEPENDABLE MUTER PRODUCTS ★ DEPENDABLE MUTER PRODUCTS

DEPENDABLE **MUTER** PRODUCTS

Manufacturers of Component parts for the Radio, Electronic and Communications Industries

THE MUTER CO.
1255 South Michigan Avenue
Chicago, U. S. A.

MUTER PRODUCTS ★ DEPENDABLE



Bob Henry, distributor of communications receivers, has been appointed to the Radio Procurement Division of Bureau of Ships, U. S. Navy. Bob is shown during a recent visit to the Hallicrafters plant, having a talk with W. J. "Bill" Halligan.

G. E. APPOINTS ELECTRONICS SPECIALISTS

To help industry with electronic application problems, eighteen General Electric industrial electronic specialists in G-E offices throughout the country have been appointed, according to an announcement by J. E. N. Hume, Commercial Vice President of the General Electric Company. These specialists will be responsible for all industrial electronic applications in their territories.

The new General Electric industrial electronic specialists include: I. C. Diefenderfer and D. C. Hierath, New York City; J. F. Getz, Philadelphia; A. J. Moore, Boston; W. B. Frackelton, Chicago; L. E. Donahue, Los An-

geles; J. A. Setter, Denver; I. F. Conrad, St. Louis; A. D. Boardman, San Francisco; L. B. Parsell, Detroit; L. R. Elder, Portland, Oregon; Frank C. Neal, Jr., Dallas; R. H. Jackson, Atlanta; K. H. Keller, Cleveland; R. C. Norris, Cincinnati; A. M. Dawson, Pittsburgh; B. Cogswell, Buffalo; L. F. Stone, Newark.



LAIRD NAMED OHMITE VICE-PRESIDENT

Roy S. Laird, Sales Manager of the Ohmite Manufacturing Company, Chicago, has been named Vice-President of the company. Laird will continue in charge of sales and will maintain as close contact as possible with Ohmite



The bomber must be built and the crew must be trained.

In war plants and in training stations throughout America, BOGEN CENTRALIZED SOUND SYSTEMS are helping to build the ships and train the men — expediting production, locating vital men instantly, issuing orders and automatic signals and alarms.

May we tell you how?

DAVID BOGEN CO., INC.
663 BROADWAY,
NEW YORK CITY



**WANTED !!!!!
PARTS TO MAKE**



One of our clients strategically located in the middle west, with excellent shipping facilities, has a plant now exclusively in war work operating at only 50% of capacity. They are equipped to make electronic or radio parts, or any similar units. Their ability and references are unquestionably of the highest calibre. If you are in need of their manufacturing services, your inquiry will receive prompt attention.

Address

BURTON BROWNE
ADVERTISING
150 EAST SUPERIOR STREET
CHICAGO · DEL. 3800

VOKAR

**CURRENTLY
PRODUCING**

JK26 JK48 JACKS
FT243 CRYSTAL HOLDERS



Radio and Electrical
Assemblies



**WRITE FOR
INFORMATION**



**ELECTRONIC PRODUCTS
MFG. CORP.**

7300 Huron River Drive
DEXTER, MICHIGAN

Covington LAPIDARY EQUIPMENT
FOR QUARTZ CRYSTAL PRODUCTION

16-inch LAP UNIT

14-inch Power Feed DIAMOND SAW

Used by U.S. Gov't.

Send for Literature to
 Covington Lapidary Engineering Co.
 Redlands, Cal.

RADIO AND ELECTRONIC DEVICES

BURSTEIN-APPLEBEE CO.
 1012-14 McGee St. Kansas City, Mo.

BUY BONDS

TRIPLETT
Combat Line
INSTRUMENTS

TRIPLETT MODEL 626
 with long 5.60" scale

This illustration is 1/2 actual size. Note long scale and minimum panel space required.

TRIPLETT

A WORD ABOUT DELIVERIES
 Naturally deliveries are subject to necessary priority regulations. We urge prompt filing of orders for delivery as expeditiously as may be consistent with America's War effort.
 TRIPLETT ELECTRICAL INSTRUMENT CO., BLUFFTON, O.

customers in order to serve them well. The company today is engaged in producing Rheostats, Resistors, Chokes, Tap Switches, and Attenuators for war equipment and for industry. Every effort is being made to meet the tremendously increased demands for Ohm-ite products.

★

EVANS NAMED GENERAL MANAGER OF TURNER

Renald P. Evans of Cedar Rapids, Iowa, has just recently been elected a partner and made General Manager of the Turner Company of Cedar Rapids, pioneer manufacturers of microphones and electronic equipment.



Prior to assuming duties as General Manager, Mr. Evans had been associated in other businesses for the past eight years with David Turner, founder and senior partner of the Turner Company, and John B. Turner, II, also a partner of the company. Before that time, he was engaged in sales and service work of electronic equipment. This background, plus some legal and specialized business training, will enable Mr. Evans to do a thorough management job with the Turner Company.

INSTRUMENTS WANTED

The Signal Corps, Aircraft Radio Laboratory, Wright Field, Dayton, Ohio, and associated critical war industries, have need of meters and test equipment for use in training programs.

Write stating type, condition of equipment, and price desired to

Director, Aircraft Radio Laboratory,

WRIGHT FIELD . . . DAYTON, OHIO

CORRECTION

In the article "Transmission Lines As Circuit Elements," pages 24-25, March issue, the dimension "D" in Fig. 6 should be 1/4" rather than 1/8", to agree with the text and problem therein.

★

GUARDIAN SIGNAL CORPS RELAYS

Guardian Electric, 1615 West Walnut St., Chicago, Ill., have issued a special catalog sheet on three types of relays made to Signal Corps specifications, but having other wide applications; and their type 195 Midget Relay for such applications where space is a vital factor. Copies available from manufacturer.

ADVERTISING INDEX

Aerovox Corporation	56
American Automatic Electric Sales Co.	11
Andrew Co., Victor J.	54
Asiatic Corp., The	54
Bliley Electric Co.	53
Bogen Co., Inc., David	57
Browne Advertising, Burton	57
Bud Radio, Inc.	52
Burstein-Applebee Co.	58
Centralab	41
Colonial Radio Corp.	45
Connecticut Tel. & Elec. Div.	8
Covington Lapidary Eng. Co.	58
Crystal Products Co.	Cover 3
Echophone Radio Co.	25
Eitel-McCullough, Inc.	30, 31
Electronic Products Mfg. Corp.	57
Erwood Company, The	50
Galvin Mfg. Co.	27
General Industries Co., The	52
Hallicrafters Co., The	3, 4
Hytron Corp.	Cover 4
Jensen Radio Mfg. Co.	12
Johnson Co., E. F.	46
Ken-Rad Tube & Lamp Corp.	51
Lafayette Radio Corp.	55
Meck Industries, John	7
Meissner Mfg. Co.	48
Muter Co., The	56
National Union Radio Corp.	29
O'Neil-Irwin Mfg. Co.	55
Pioneer Gen-E-Motor	50
Racon Electric Co.	43
Radio Speakers, Inc.	53
RCA Mfg. Co., Inc.	34
Rola Co., Inc.	14
Shallcross Mfg. Co.	47
Shure Brothers	6
Sprague Specialties Co.	9
Triplett Elec. Inst. Co.	58
United Transformer Co.	Cover 2
Utah Radio Products Co.	10
Wilcox Electric Co., Inc.	33
Wincharger Corporation	49
Wright Field, Radio Lab.	58

QUARTZ MOTHER

THE PREPARATION OF PRECISION
CRYSTALS FOR RADIO FRE-
QUENCY CONTROL...
AS MADE BY
CRYSTAL PRODUCTS

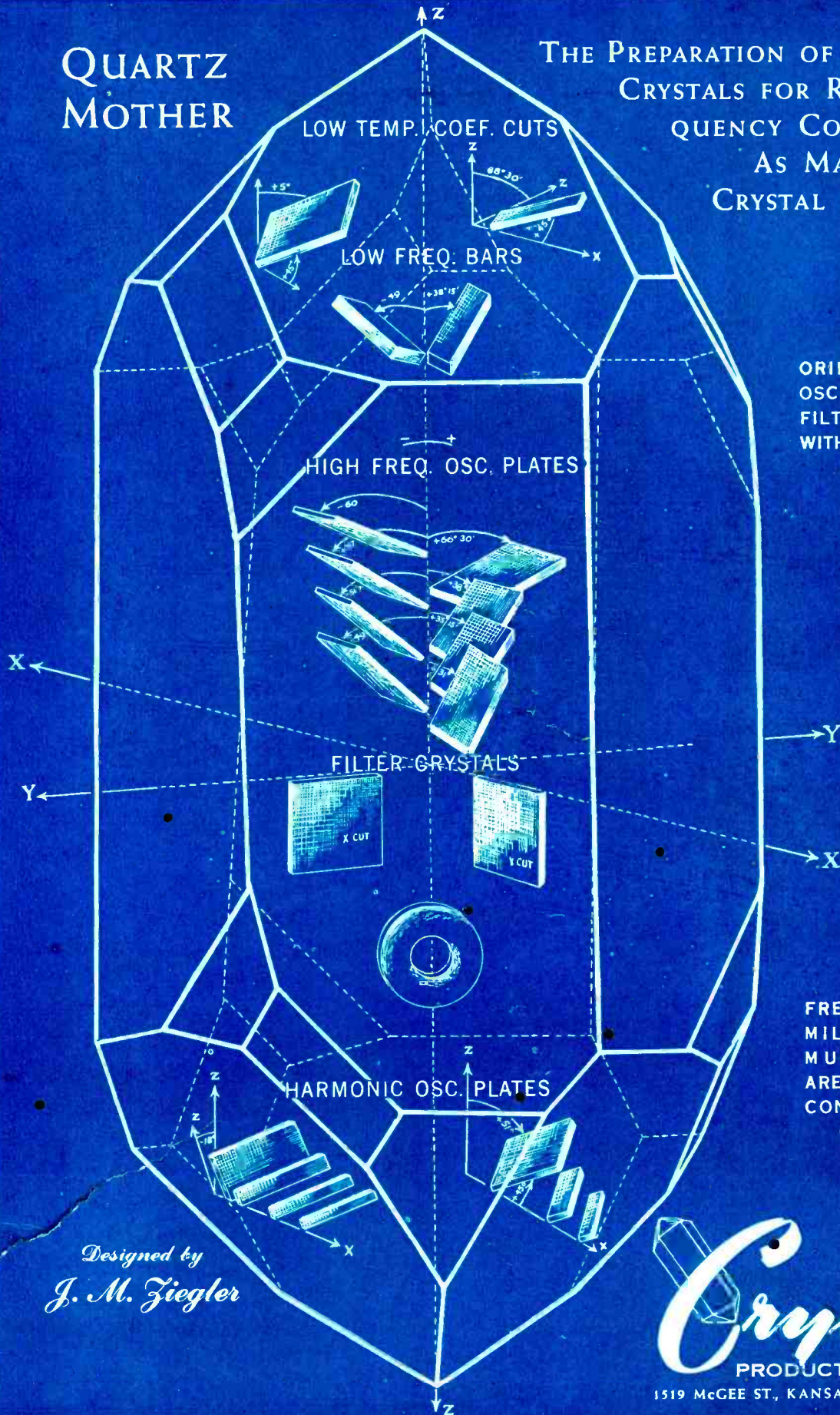

ORIENTATION OF
OSCILLATOR AND
FILTER CRYSTALS
WITH RESPECT TO
MOTHER

FREQUENCIES IN
MILITARY COM-
MUNICATIONS
ARE ACCURATELY
CONTROLLED BY
CRYSTALS

*Designed by
J. M. Ziegler*

Crystal
PRODUCTS COMPANY

1519 MCGEE ST., KANSAS CITY, MISSOURI

Producers of Approved Precision Crystals for Radio Frequency Control

SELECT

for

SERVICE



NEW HYTRON TUBES



Type	Description	Price
836	Half-wave, high-vacuum rectifier.....	\$11.50
837	12-watt, r.f. pentode.....	7.50
954	Sharp cut-off, acorn pentode.....	5.00
955	Acorn triode.....	3.00
956	Remote cut-off, acorn pentode.....	5.00
1616	Half-wave, high-vacuum rectifier.....	5.75
1625	25-watt, r.f. tetrode (12-v. heater).....	3.50
1626	5-watt, triode oscillator.....	2.50
E1148	3.5-watt, u-h-f triode.....	2.25
VR105-30	Gaseous voltage regulator.....	1.25
VR150-30	Gaseous voltage regulator.....	1.25

OTHER POPULAR HYTRON TUBES*		
Type	Description	Price
2C25	15-watt, medium-mu triode.....	\$3.00
2C45	7.5-watt, triode (modulator).....	2.50
10Y	15-watt, general-purpose triode.....	1.50
801A/801	20-watt, general-purpose triode.....	2.50
HY61/807	25-watt, r.f. beam tetrode.....	3.50
841	15-watt, high-mu triode.....	2.25
864	Non-microphonic voltage-amp. triode.....	1.00
HY24	2-watt, power triode.....	1.50
HY31Z	30-watt, high-mu twin triode.....	3.50
HY65	15-watt, r.f. beam tetrode.....	3.00
HY69	40-watt, r.f. beam tetrode.....	3.95
HY75	15-watt, u-h-f triode.....	3.95
HY114B	(2C24) 1.8-watt, u-h-f triode.....	2.25
HY615	3.5-watt, u-h-f triode.....	2.25

*This is not a complete list. Wattage ratings indicate
 ‡Instant-heating filament. maximum plate dissipation.
 †For complete characteristics consult Government specifications.

On this list of tubes which have recently joined the growing legions of Hytron types already marching on to Victory, you may find just the ones you want for your War equipments. Whether you choose the tiny "acorns" or the husky 1616 rectifier, you will discover the same high quality and design refinements which have made other Hytron tubes famous. If you place your orders well in advance, you will also be pleased by Hytron's on-schedule deliveries. Not too infrequently, deliveries are made from stock.

HYTRON CORPORATION
 SALEM AND NEWBURYPORT • MASS.
 Since 1921 Manufacturers of Radio Tubes

