

RADIO

ESTABLISHED 1917



THIS MONTH

- 30-WATT AIRPLANE TRANSMITTER
- SIMPLIFIED ELECTRONIC BUG KEY
- SOUND RECORDING DEPARTMENT
- POLICE MOTORCYCLE TRANSMITTER
- INDEX TO 1941 ISSUE OF RADIO

Technical Radio
and Electronics



January 1942

NUMBER 265

36c IN U.S.A.

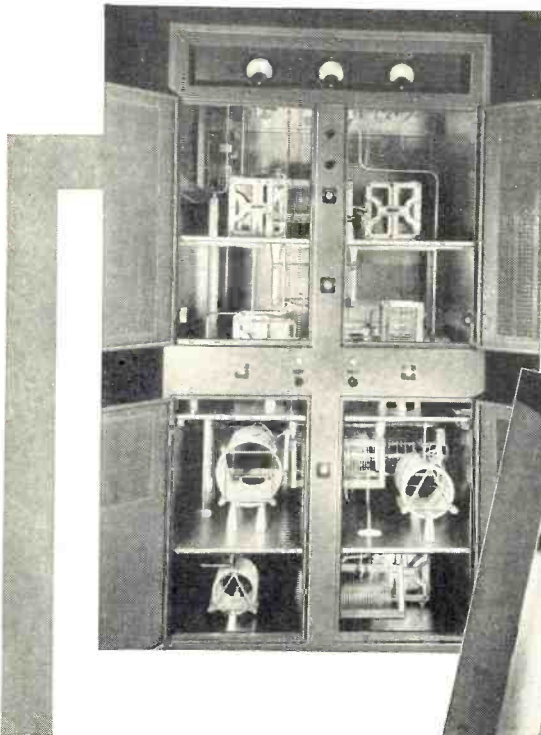

Phasing Unit built to order for WTMJ, Milwaukee, Wisconsin. Dozens of similar units have been supplied by Johnson to other stations recently.

Antenna Coupling Unit for WTMJ. One such unit is required for each tower.

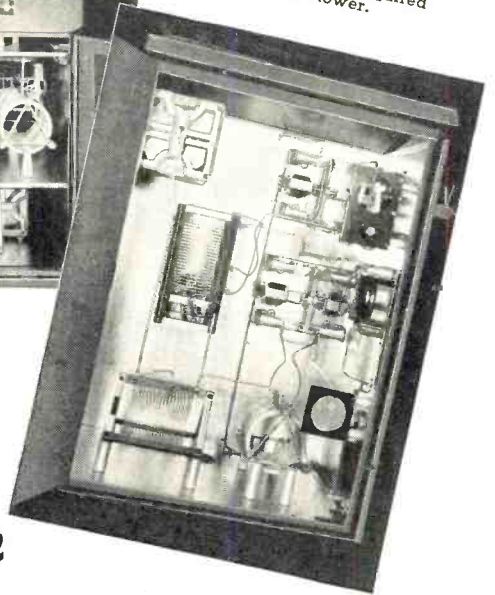

PRECISION ENGINEERING

at your service

Directional patterns of modern broadcast stations are determined by the phase relationship of the energy radiated and the placement of each tower in the system. To control the phase and power relationship a Phasing Unit is employed. A separate coupling unit for each tower is necessary to properly match the impedance of the tower to the transmission line. For years Johnson Engineers have specialized in designing and building such equipment.

ASK FOR CATALOG
967 K



E. F. JOHNSON CO

WASECA, MINNESOTA

EXPORT: 25 WARREN ST., NEW YORK, N. Y.

"MANUFACTURERS OF RADIO TRANSMITTING EQUIPMENT"



Here's to a Good Old Fashioned Christmas!

We wish we could give you the DX we used to enjoy not so long ago when, on clear starlit nights, stations thousands of miles away could be copied across the room.

We hope it won't be long 'til we will be back together again—one happy family able to send heartfelt Christmas greetings by radio around the world.

the **Hallicrafters** co.
Chicago, Illinois

RADIO

Handbook
EIGHTH EDITION

RADIO
Handbook
EIGHTH EDITION

TOPS!

The Eighth Edition of the famous "RADIO" HANDBOOK—thoroughly revised and brought up-to-the-minute for you is now available at all regular outlets.

This book belongs on your reference table or work bench—carefully arranged for easy quick reference—opens flat to any page. The data sections have been brought right up to date of publication. There are well over 600 illustrations. New equipment for you to work on described concisely, yet accurately.

- There are chapters on: Introduction to amateur radio; basic theory; vacuum tube theory; receiver theory; tube characteristics; receiver and transmitter construction; transmitter theory; radiotelephone theory; FM; transmitter design; amplifiers; speech and modulation equipment; power supplies; UHF communication — theory, receivers, transmitters, antennas; test and measuring equipment; antennas; workshop practice; engineering mathematics and calculations for radiomen. Thoroughly indexed. ●

All this within two covers—written so you can understand it—is the reason for the amazing growth in demand among radiomen for the "RADIO" HANDBOOK. Get your copy right away. See your favorite radio parts dealer—he'll have them. If you prefer, you can order your copy direct from us for immediate shipment.

\$1.75 in Continental U.S.A. (Prepaid) Elsewhere **\$2.00**

THE EDITORS OF RADIO *technical publishers*
CORPORATE NAME: EDITORS AND ENGINEERS, LTD. 1300 KENWOOD ROAD, SANTA BARBARA, CALIFORNIA

Past

Present

and

Prophetic

Help, Police!

Last month in this department was a squib to the effect that if the response was favorable, a "Police Department" would be included as a more or less regular feature. Well, we got lots of favorable response but few contributions. So now that we can go on record as being very much in the market for hints, kinks, pictures, and articles having to do with police radio, perhaps the brethren will be prompted to do a little submitting. We hope.

Patriotic Ventilation

If some of the apparatus that comes out of our lab should sport chassis and panels with various assorted holes which do not appear necessary to the proper functioning of the device, it is only because of our policy of patriotic frugality. And besides, we aren't sure we can replace our present stock of chassis and cabinets when they are gone.

The Pace That Kills . . . Tubes

You fellers who have been inflicting 600 volts on a 6L6 doubler or sucking 600 ma. out of a pair of 866's saddled with a condenser input filter had better ease off a bit. The number of tubes of these two types reposing on dealers' shelves seems to be alarmingly small, and other types may become scarce in a very short time. We know of one amateur who had to try a half dozen supply houses before he could locate a 100-TH, and it was the last one they had. It is a cinch that the Army and Navy come first, and if there are not enough tubes to go around, the amateurs are going to be the ones who have to get along the best they can.

Many amateurs long have had their own little system of I.C.A.S. ratings. "You just multiply all the ratings by 2 except the filament voltage." *Them days are gone forever, brother.* Each tube in the rig should be treated as though it is the only one of its type in existence. But this does *not* necessarily mean

running the tubes at half rated power.

Strange as it may seem, certain tubes (particularly those having tantalum plates) will last as long or *even longer* when run at *rated* input than when run at greatly reduced power.

The important thing is not to *overload* the tubes, and to *keep the filament voltage on the button.*

If possible, we are going to find out which tube types are least likely to become scarce, and to favor these tubes when designing equipment to be shown in the magazine. If, in future issues, certain tube types are conspicuous by their absence, please remember that it does not necessarily mean that we do not favor them. It may mean that the Army or Navy is taking so many that they are scarce or unobtainable on the open market.

Sound Off

The manufacturers of sound recording and playback equipment are feeling the squeeze of National Defense, and unless well stocked with government orders, are not generally optimistic about the immediate future. Many of these fellows are in no mood to spend money on advertising, what with things looking as they do.

This explains the demise of our one-shot magazine "Sound." The expected volume of advertising did not materialize, which is understandable. And it is impossible to get out a magazine of this type without a fair amount of advertising.

However, reader acceptance was very good. And our circulation department pointed out to us the interesting and significant coincidence that many subscriptions for Sound came from RADIO subscribers.

This evidence of widespread interest in recording and sound equipment and technique on the part of our readers has caused us to take our cue and inaugurate in this issue of RADIO a department devoted to this field. Let us know how you like it and what you would like to see in it.

Y.L.'s, Ex- and Current

The y.l.'s are with us again, bless 'em. Please don't ask why we run such stuff in a technical magazine. All we know is that most of our readers seem to like it, and few actually object to it. Provided, of course, that we don't run it too often.

Easily Fixed

The printer was in such a hurry to get shipments of the 1942 HANDBOOK under way that some of the books were packed for shipment before the cover ink was thoroughly dry. If the cover on your copy should show a slight smear, it can be removed with a soft rubber eraser or piece of art gum.

RADIO

the worldwide authority . . .

Published by
EDITORS and
ENGINEERS, Ltd.

Home offices: 1300 Kenwood Road, Santa Barbara, California

Telephone: Santa Barbara 4242
Bell System teletype: S BAR 7390
Cables: EDITORSLTD SANTABARBARACALIF

January • 1942

The publishers assume no responsibility for statements made herein by contributors and correspondents nor does publication indicate approval

No. 265

Table of Contents

ARTICLES

A 30-Watt Airplane Transmitter— <i>J. H. Rothman, W6KFQ</i>	9
A Junior Electronic Key— <i>J. W. Stuerhoff, W6UMZ</i>	13
Flexibility in a De Luxe Audio Amplifier— <i>J. E. Striker, W6MOV-W6OPG</i>	17
A Medium-Power C.W. Portable— <i>Lewis Mims, W5BZT</i>	20
An Experimental 56 Mc. R. F. Amplifier— <i>W. E. McNatt, W9NFK</i>	24
Radio's 1942 YL Section Featuring YLRL— <i>Anita Calcagni Bien, W8TAY</i>	29

MISCELLANEOUS FEATURES

Past, Present and Prophetic	6	Advertising Index	89
Crossword Puzzle	75	Buyer's Guide	90
Marketplace	87	Index to RADIO for 1941	91

DEPARTMENTS

Police Department: A 6-Watt Motorcycle Transmitter— <i>H. W. Brittain, W6OQX</i>	36	Yarn of the Month	57
Sound Department: High Quality Lateral Disc Recording— <i>H. P. Meisinger</i>	40	With the Experimenter: Self-Contained Keying Monitor for Communications Receiver	70
The Amateur Newcomer: A 25-Watt C.W. Transmitter— <i>W. W. Smith, W6BCX</i>	45	What's New in Radio	72
U.H.F.	49	Postscripts and Announcements	74
		The Open Forum	74
		New Books and Catalogues	76

CORRESPONDENCE and ORDERS should be sent only to our home offices. MANUSCRIPTS, if unsolicited and unaccompanied, will be destroyed unless accompanied by a stamped, self-addressed envelope.

ADVERTISING copy and cuts (fully mounted and mortised) should be sent to "Radio," Production Office, 417 S. Dearborn St., Chicago; send duplicate copy and insertion order to Santa Barbara, as no advertisement will run until home office telegraphs its approval thereat.

SUBSCRIPTION RATES (in U. S. funds): Two years, \$4.50, or \$2.50 yearly in U.S.A. (plus tax in Illinois). To Canada (inclusive of current taxes), Pan-American countries, and Spain, \$0.50 per year additional. Elsewhere, \$1.00 per year additional. Ten issues yearly; back issues are not included in subscriptions.

IF YOU MOVE, notify us in advance; we cannot replace copies sent to your old address. Notice must be received by the 15th of the month preceding the cover date of first issue to go to the new address.

PUBLISHED monthly except August and September (and COPYRIGHTED, 1941 by Editors and Engineers, Ltd., 1300 Kenwood Road, Santa Barbara, Calif. ENTERED as second-class matter Sept. 26, 1934 at Santa Barbara, Calif., under the Act of March 3, 1879. Additional entry of Mar. 26, 1934, Ill. All rights reserved. TITLE REGISTERED in U. S. Patent Office. PRINTED in U. S. A.

The Editors of "Radio"

EDITOR

R. L. DAWLEY, W4DHG

ASSOCIATE EDITORS

W. W. SMITH, W6BCX

K. V. R. LANSINGH, W6QX

J. E. BEARDSLEY, W8UYA/6

Contributing Editors

H. BECKER, W4QD

J. CONKLIN, W9SLG/3

Editorial and Technical Assistants

J. H. ROTHMAN, W6KFO

B. A. ONTIVEROS, W6FF

Published by Editors and Engineers, Ltd.

K. V. R. Lansingh, Publisher

A. McMillan, Treasurer

J. A. Thompson

J. E. Beardsley

Editorial Director, W. W. Smith

Circulation Manager, A. M. Wilson

Advertising and Sales Promotion Manager

Production Managers W. Wadsworth



The new 10,000-watt transmitter of W71NY, frequency modulation station of WOR, New York, which was dedicated on Sunday, Nov. 30th. The transmitting plant is located at 444 Madison Ave., New York City.

Front view of the transmitter with the dust cover in place. Two of the automobile-type connectors shown on the chassis have been changed over to multiple-circuit connectors since the photograph was taken. Complete details are given in the text. The coiled piece of braid serves as the grounding strap for the transmitter.



A 30-Watt AIRPLANE TRANSMITTER

By K. H. ROTHMAN,* W6KFQ

A practical transmitter for use on civilian airplanes. The unit is so designed that it can be used as a yacht transmitter with but a small alteration in design.

The recent increase in airport traffic has made it almost a necessity that the civilian flier have radio facilities in his airplane. In fact it has become practically impossible to land at some of the larger fields without two-way radio communication. Hence, this transmitter was designed for the civilian flier who is an amateur or knows an amateur who can obtain the components and undertake the construction of the unit.

Originally it was our desire in building this transmitter to construct a very light and compact rig with about 10 watts output. But we had a lot of parts on hand—and in these days one uses those parts he has on hand. Hence, the design of the transmitter was more or less set by the available stock of components.

Among these available components was a 500-volt 300-ma. genemotor with a 12-volt primary. Naturally it would be a waste to use this medium-power generator on a 10-watt rig. So it was decided that the final amplifier stage should be capable of handling 40 to 50 watts input. An 807 was finally decided upon for the final amplifier, with a pair of 6L6's class AB as the modulator.

Since the transmitter runs from a 12-volt d.c. supply, it is necessary to series-parallel the filaments of the tubes. The small side drawing on the main diagram shows how the heaters of the five tubes are connected. Since the drain of the two paralleled 6L6's is 1.8 amperes, the drain of the two tubes (crystal oscillator and speech amplifier) in parallel with the 807 heater (0.9 ampere) must draw 0.9 ampere. A pair of 6V6's with their 0.45-ampere heaters answer this requirement.

*Laboratorian, RADIO

diagram is very active; in fact, it starts oscillating just about as soon as the genemotor starts rolling, and continues until the genemotor has coasted to a complete stop. The actual operating voltage of the 6V6 in the transmitter is 225 volts; the screen is fed by means of a 100,000-ohm dropping resistor. Ample excitation for full output from the 807 is obtained with these operating conditions.

The 807 Modulated Amplifier

From all indications, the optional unscheduled aircraft frequency of 6210 kc., which is in harmonic relation to 3105, is to be disposed of for this use. Hence, there is no need for any provision for doubling in the 807. Thus the grid leak for the 807 is made comparatively low, 20,000 ohms, so that full output may be obtained with a small amount of excitation voltage. The tube actually runs with about

5 ma. of grid current, giving 100 volts of bias which is ample for this mode of operation.

The screen dropping resistor to the 807 was also made comparatively small after trying a number of different values. This resistor was varied until a value was found which would give less than the maximum rated 300 screen volts under load, and which would still allow the plate current to go above 100 ma. when the plate circuit was detuned. A 15,000-ohm resistor was found to give optimum operation. With these resistor values the 807 can be loaded to the full desired 100 ma. of plate current.

Since the 807 plate circuit is single ended, and since it is to be loaded comparatively heavily, it was necessary to use a comparatively high-C plate tank circuit. A 50-watt manufactured-type 80-meter coil was used with all but 20 turns removed. This circuit is tuned by means of two 100- μ fd. condensers

Top view of the transmitter with the dust cover removed. The modulator section is lined up along the rear of the chassis, the power supply filter choke is in the center, and the r.f. section is in the front. Note the cut-down 80-meter tank coil with the antenna coupling turns on one end. In case there is any tendency toward howling in the audio system it may be necessary to reverse the secondary leads to the microphone transformer which is mounted on the end of the chassis to the right of the 6V6 audio stage.

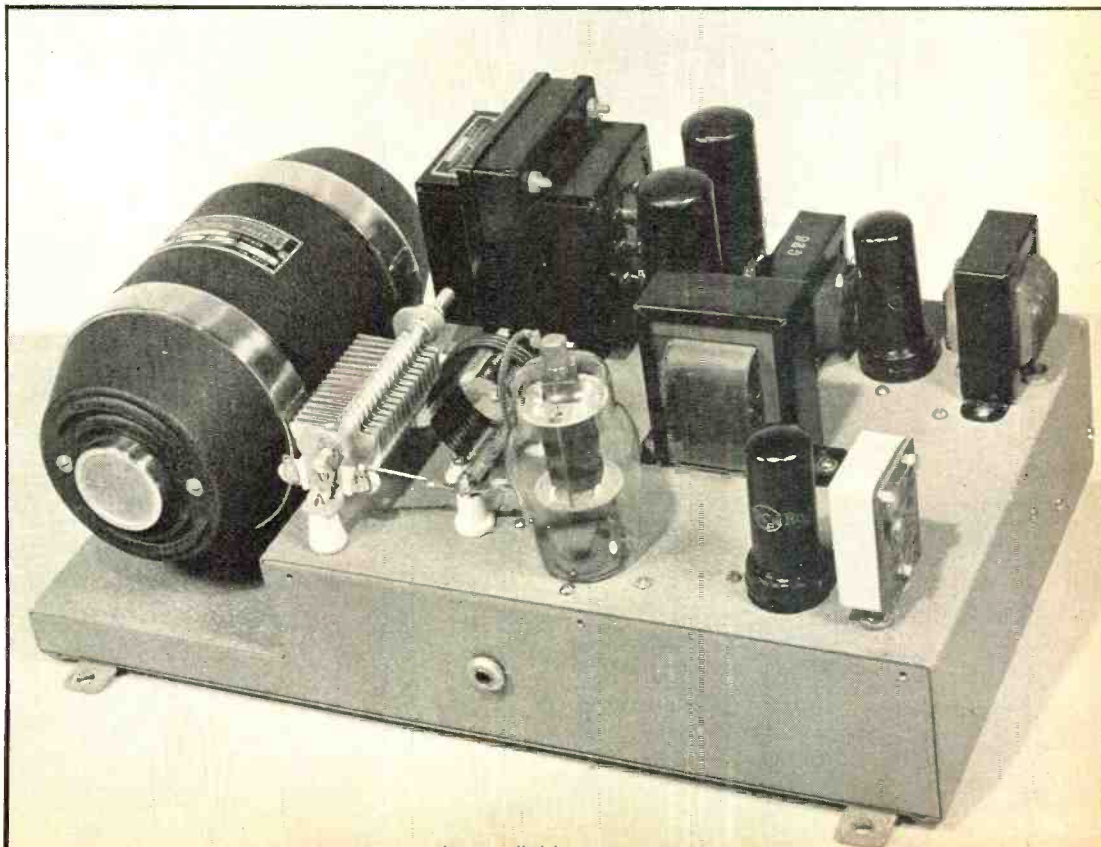

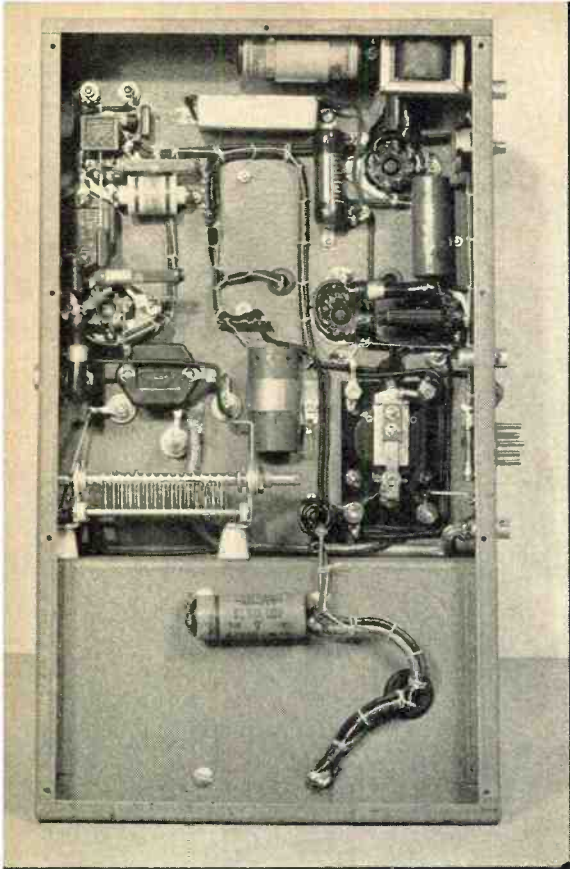

Underchassis photograph of the airplane transmitter, with the bottom cover removed. The small choke in the upper right hand corner is the microphone filter inductance.

in parallel. The condenser under the chassis acts merely as a padding condenser and is set full in; tuning is accomplished by means of the 100- μmfd . condenser above the chassis. This latter condenser also tunes nearly clear in, giving a substantial tuning capacity of about 190 μmfd . Both of the plate tank condensers are double spaced to prevent any possible arcing at high altitudes.

The link coil which feeds the antenna consists of four turns wound on the cold end of the amplifier tank coil. This coil feeds a piece of concentric line about 15 feet long, going from the transmitter behind the rear seat to the antenna reel which is hand driven by the pilot.

The Microphone Circuit

Although the microphone circuit is comparatively simple, there are a few difficulties which were encountered and which will be pointed out. The mike itself is plugged into the dash through a three-way plug and jack. This jack feeds a three-conductor cable—two wires and the shield—which runs back to the transmitter. The grounded shield is used for the return from the push-to-talk switch on the microphone which operates the main relay of the transmitter. This shield is grounded both at the dash and at the transmitter end. The other two wires are used *only* for the mike cir-

cuit, and the grounded wire is returned at only one point. In this case the ground was made at the dash since the microphone jack was not of the insulated type. Note that it is also necessary to ground the microphone filter condenser C_{10} *only* at this one point. Before the microphone circuit was altered to use a single ground there was a fair amount of hash getting into the microphone circuit from the generator due to the common ground.

A very small 40-ma. filter choke of 150 ohms resistance is used to filter the voltage going to the microphone circuit. This small choke serves a dual purpose of filtering the voltage fed to the mike and of dropping this voltage to the proper value.

It was found necessary to install a volume control on the secondary of the microphone transformer, both to keep from overmodulating the transmitter and to keep motor noise down. One *should* talk directly into the mike in a natural voice. However, the average pilot has a tendency to yell into the mike so that he can hear his own voice above the engine noise. Since this cannot be helped it will be necessary to turn the volume control down a considerable amount from the setting which has been found optimum on the ground test. The proper setting can best be determined when the plane is actually in the air under normal operating conditions.

Just as a little side hint (from practical experience) make sure that the mike can withstand being shouted into before blaming any tendency toward poor quality on the audio system. In this case trouble was had with one microphone which would sound fine on the bench and on the ground test but which would mush up when the plane was in the air and the pilot was driving the mike too hard. Replacement of the microphone eliminated the trouble completely.

Speech and Modulator

The speech amplifier tube is a 6V6, triode connected. This method of connection, rather than pentode, was used because the tube will make a better driver for the 6L6's, and because the additional gain of a tetrode amplifier is not needed. The push-pull input transformer from the 6V6 to the 6L6's is a conventional class AB transformer capable of handling the plate current of the 6V6. One thing slightly different about the 6L6 plate circuit is the use of a .005- μfd . condenser from plate to plate.

[Continued on Page 84]

A Junior

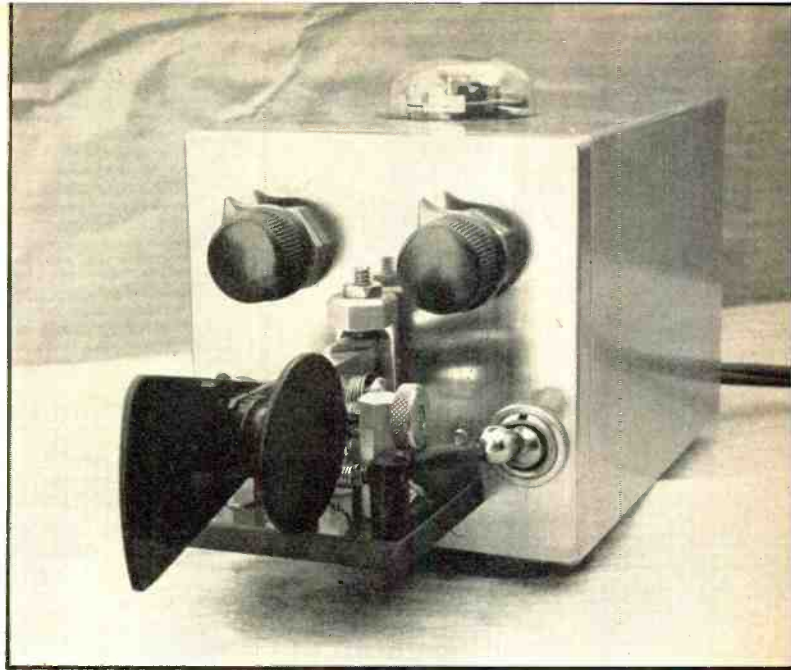

ELECTRONIC KEY

By J. W. STUERHOFF,* W6UMZ

Electronic keys have been described for construction in several articles during the last two years. Most of them were complicated and expensive. They were usually made up of two units with connecting cables lying all around. It was difficult to decide whether their good points outweighed their bad ones, so plans were made to overcome as many of the bad features as possible. The unit to be described is the result.

It is completely self contained and very little larger than a standard bug, which makes it easily portable. The circuit is very simple, no unnecessary parts being used. It can be built for from five to seven dollars, or much less if your junk box is up to standard.

Construction of the unit is not difficult; the model shown having been built completely with hand tools of the variety found in any home workshop. In fact, with the exception of the socket punch (borrowed) any of them can be found in the five and dime store. These

along with a reasonable amount of patience are all that is necessary.

Upon studying the circuit diagram of figure 1, you will recognize it as a close relative of one published in RADIO several months ago. To the author of this original circuit belongs most of the credit for the present one.

The parts used are all standard and are identified in the parts list. The 117L7GT was again called on to do double duty and performs its job very well. The audio transformer happened to be on hand and was the only one tried, although there is no reason why any other brand will not work as well. With other transformers the value of R_2 may have to be changed or possibly a condenser used instead. This resistor was the only tricky part of the circuit. With the wrong value here the first dash always turned out to be a dot. Also, the size of this transformer is one of the reasons for the small size of the complete unit. The relay used was chosen for its price and works as well as many of the more expensive types tried previously. Its size is also

*4243 Monterey Blvd., Oakland, Calif.

in favor of compactness. The resistors, switches, and condenser make up the balance of the circuit parts. The hand keying unit is homemade and is the most time-consuming part of the entire job.

Right now is a good time to plug in the soldering iron and while it heats dig the above-mentioned parts out of the junk box and haywire them together for a trial. It will only take a short time and resistor values can be easily tried and changed this way. A single-pole-double-throw knife switch will substitute for the key action, or you can just touch the wires together for the trial. Remember R_6 .

If you care to experiment further it may be possible to use a variable resistor for R_1 and fixed resistors in place of R_2 and R_3 . R_1 would then be speed control for both dots and dashes, eliminating one control. If you try this the cathode connection, no. 8, will go to R_1 only. The other end of R_1 will go to R_2 and R_3 , the balance of the circuit remaining as is. There is a distinct advantage in having separate control of dots and dashes so this has not been tried here.

Material

Material necessary for the chassis and cabinet are: A front plate of brass 1/4 inch thick and 3 inches square. Your local brass company will cut this from a piece of 1/4-inch by 3-inch bar right to size for the asking and all you will have to do is touch it up with a file.

The shelf is sheet brass or steel 1/16 inch thick, 2-13/16 inches wide and 4-1/4 inches long. The front end of it is narrowed down to 1-5/8 inches, cutting an equal amount from each side. This cut should go 3/4 inch into the length of the shelf and is made to make room for the two toggle switches. A piece of brass or iron bar 1/4 inch by 1/2 inch and 1-5/8 inches long is used to hold the shelf and cabinet to the front plate. The cabinet is a piece of aluminum or brass tubing 3 inches square and 4-1/4 inches long, with 1/16-inch wall. It butts up against the back of the front plate, not around it. This tubing sells for about 10 cents an inch or 45 cents for this piece. If you prefer you can bend your cabinet out of sheet stock, keeping the seam at the bottom. The key base is of bakelite 3/16 or 1/4 inch thick and about 2 inches square.

Assembly

Assembling the chassis and cabinet first will help in arranging other parts later. To start, fasten the 1-5/8-inch end of the shelf to one of the narrow edges of the 1-5/8 inch bar. A 6-32 machine screw tapped into the bar close to each end will do this. Tap these holes all the way through the bar and fasten the shelf on with 1/4-inch machine screws. The bottom end of these holes will take the screws that hold the cabinet on. Now fasten the front wide side of the bar to the back of the front plate. It fastens so the lower edge of the bar is 1/16 inch from the bottom of the front plate and

Interior view of the electrical portion of the electronic bug. Note the body of the housing in the background; it is made of 3-inch square brass or aluminum tubing.

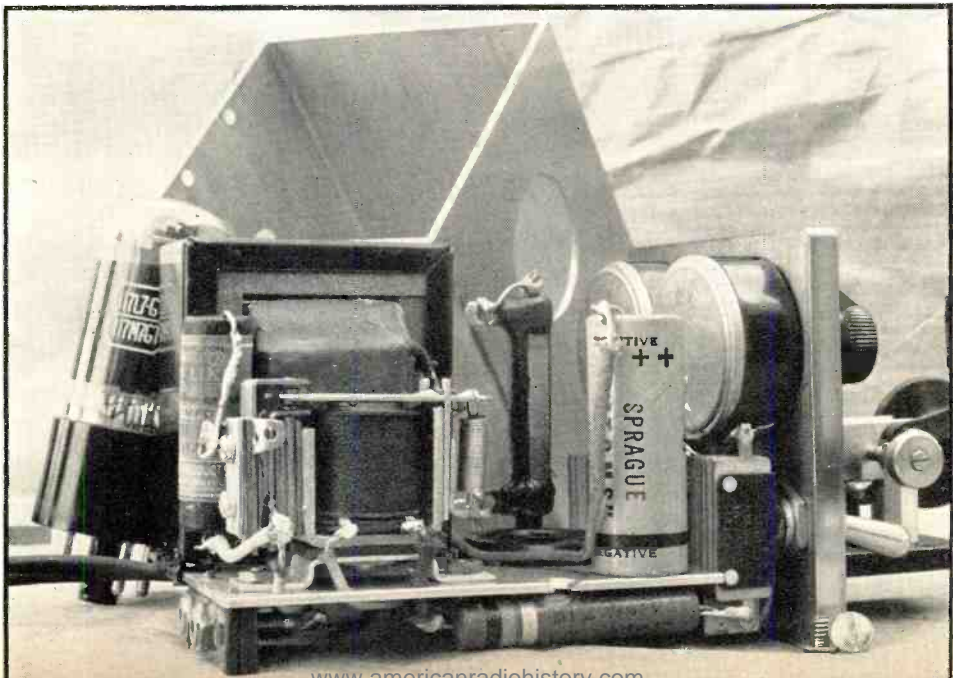

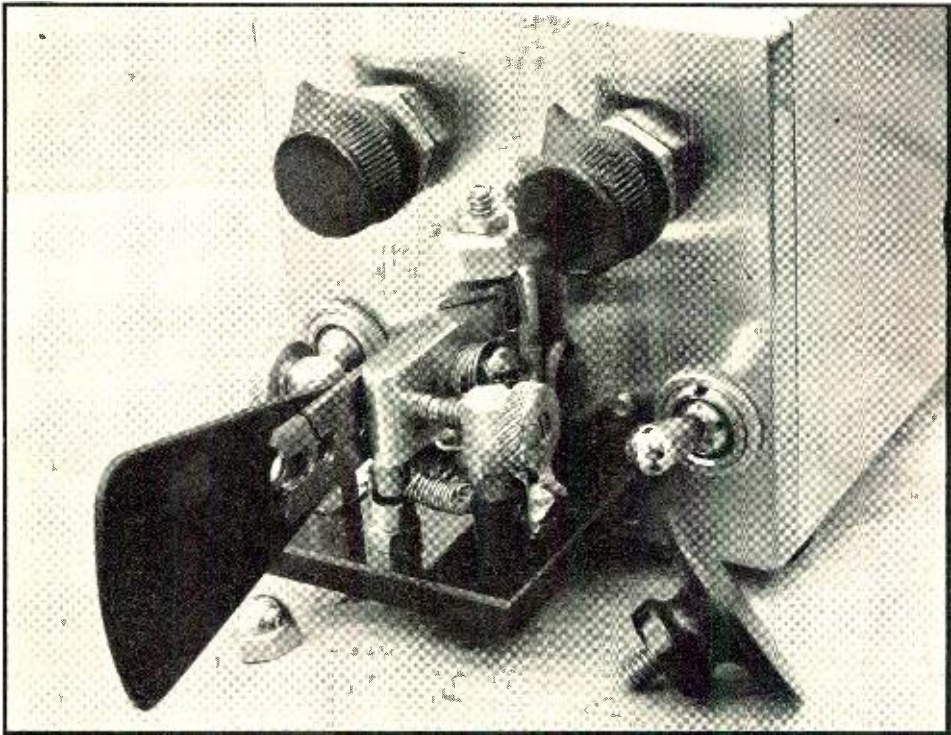

Detail view of the "bug" portion of the electronic key.

centers with the sides. The shelf will now be $9/16$ inch from the bottom of the front plate. This is a good time to mention that everything fastening to the front plate should be kept $1/16$ inch in from the edge all the way around so the cabinet will go on.

Now slip the cabinet on over the shelf until it butts up against the front plate and mark it for the holes in the bottom of the shelf bar. One-quarter inch screws placed through these holes into the bar will hold it firmly. Now disassemble and punch the hole in the shelf for the tube socket. Its center is $1-3/8$ inches from the front edge of the shelf and on the center line. This distance will leave room for the resistors on the front plate ahead of the tube and the transformer and relay behind it. In the top of the cabinet directly over this socket hole punch and ream a hole big enough for the tube to slip through, base and all, as the tube goes in after the cabinet is on. In the bottom of the cabinet drill about a $5/16$ -inch hole directly under the center of the socket. This is to insert a pencil through to push the tube out of its socket when necessary.

The tube socket can now be inserted in the shelf and the transformer and relay mounted.

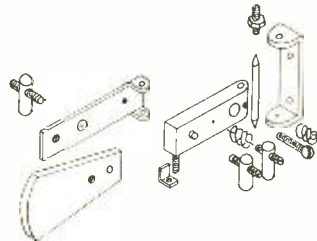

Exploded view of the mechanics of the "bug" portion of the electronic key.

They go together across the back end of the shelf. You may have to trim their mounting feet in order to get them close enough to the socket so they won't stick out over the rear of the shelf. The bleeder resistor mounts on one side of the tube and the filter condenser on the other, both standing on end. One end of these can be wired right to the shelf as it is the common ground. The resistors under the shelf are all supported by the wiring and can be put in while doing that. Referring to the photographs will help in all this assembly,

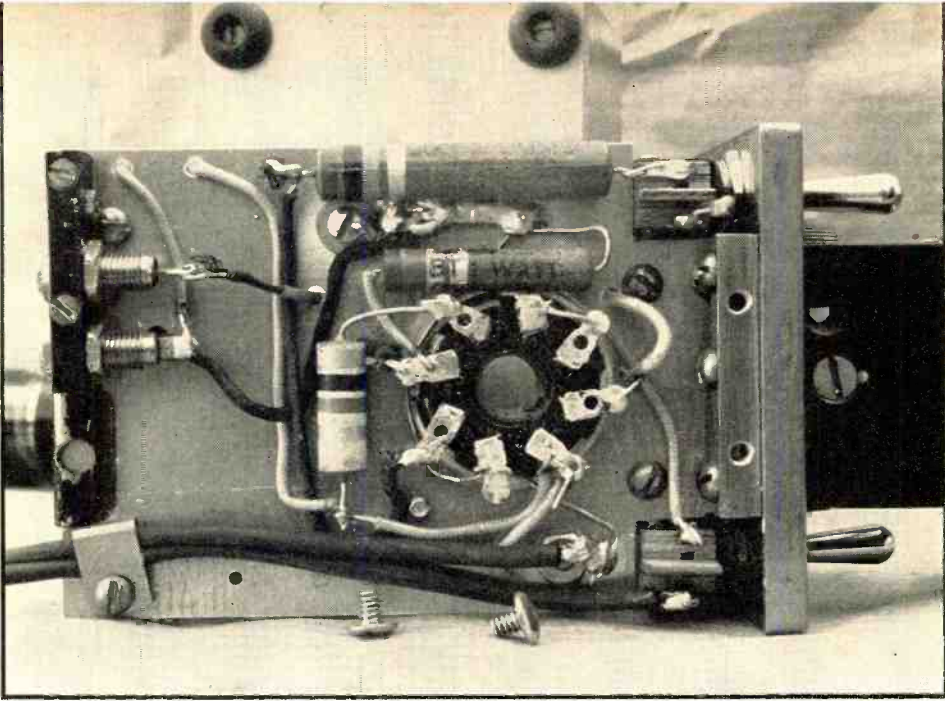

Underchassis view of the "bug". Certainly nothing complicated here.

as different makes of equipment may mount differently.

On the front plate mount R_2 and R_3 in the two upper corners, keeping them 1/16 inch from the edge. R_1 mounts close to their terminals and is supported by wiring. Mount the

two switches in the two lower corners of this plate, also observing the same 1/16 inch caution. From the front R_2 and S_1 go on the left side of the plate. The bakelite key base is fastened to the front plate with two flat-head 6-32 screws. The bottom of it is about 3/8 inch from the bottom of the plate which puts the flat-head screws under the shelf bar, through the front plate and tapped into the bakelite.

After the key assembly is finished the front plate can be wired as a unit. There will be four wires leaving it. One is from S_2 to socket prong no. 7, another from S_2 to the line plug. One from S_1 to R_4 (see bottom view for these three) and the last from R_1 to socket prong no. 8, the cathode.

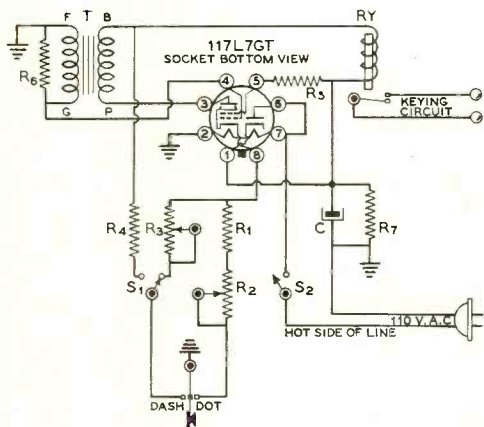

Wiring diagram of the Junior Electronic Key.

- | | |
|-----------------------------------|--|
| C—16- μ fd. 200-volt elec. | S_1 —S.p.d.t. toggle, automatic or manual dash sw. |
| R_1 —500 ohms, 1 watt | S_2 —S.p.s.t. toggle, a.c. on-off switch |
| R_2 —10,000-ohm wire-wound pot. | T—3.26:1 audio transformer |
| R_3 —3000-ohm wire-wound pot. | RY—2500-ohm midget relay |
| R_4 —20,000 ohms, 2 watts | |
| R_5 —50,000 ohms, 1 watt | |
| R_6 —250,000 ohms, 1 watt | |
| R_7 —7500 ohms, 10 watts | |

Construction

No attempt will be made to describe construction of the key unit, as pictures serve better than many words. The close-up photo of the key and the sketch in figure 2 will help here. Start by making the dot arm first and fit everything to it. It is about 1/4 inch by 1/2 inch and 1-1/2 inches long. The dash bar and mounting bracket are 1/16- by 1/2-inch brass strip. The posts are 1/4-inch round or hex brass rod. The shaft is made of the shank of the drill which drilled the holes it fits into. These latter parts can be made by putting your hand drill in the vice in a horizontal position, putting the round rod or shank in the drill chuck and turning them down with files or drilling into the end of them, holding the drill with pliers, sort of lathe fashion.

[Continued on Page 86]

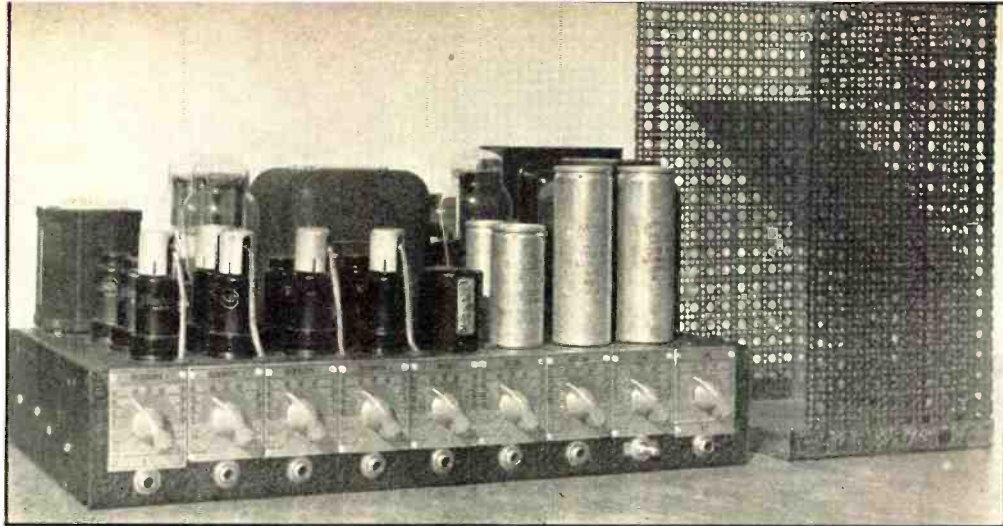

From left to right are the four microphone gain controls with the respective microphone jacks directly below. The A.C. switch is on the extreme left-hand control. The fifth and sixth controls are for the phonograph inputs with the input jacks directly below. The seventh control is the expansion-a.v.c., directly underneath it is the s.b. microphone input. The eighth and ninth controls are bass and treble boost respectively. A convenience jack for the key is underneath the treble boost control and the expansion-a.v.c. switch is below the bass boost control.

Flexible

DE LUXE AUDIO AMPLIFIER

By J. E. STRIKER,* W6MOV-W6OPG

With excellent quality in recording and reproduction, flexibility in output and input impedances, a.v.c. and expansion features, there is little left to be desired in an amplifier of this wattage.

In the last few years the phonograph record has again played a major part as a form of entertainment for music lovers and jitter-bugs alike. By the same token, a number of 'phone amateurs have purchased a phonograph pick-up and have used the speech amplifier as a record player. Some have gone even farther and, adding another microphone channel, have gone into the public address business on a small scale as a side line.

The difficulty encountered by most of us is that the average audio system lacks one feature or another that makes it impractical for all applications. In the amplifier to be described an attempt has been made to incorporate the desirable features of many ampli-

fiers into one *all-purpose* piece of equipment.

An ordinary amplifier suitable for the average amateur lacks the fidelity to meet the requirements of most public address jobs. In many cases the commercially built amplifier, even though it has excellent quality, lacks desirable features for amateur or communication purposes, besides being somewhat expensive. Even the most popular makes sometimes have insufficient shielding to prevent r.f. feedback, especially on high frequencies.

After much head scratching and thumbing through catalogs the circuit as set forth in one of the popular amplifier guides was decided upon as a foundation for an all-purpose amplifier. But every handbook and magazine article on the subject showed various and sundry values for the components of a resistance-

*1655 Everett Ave., San Jose, Calif.

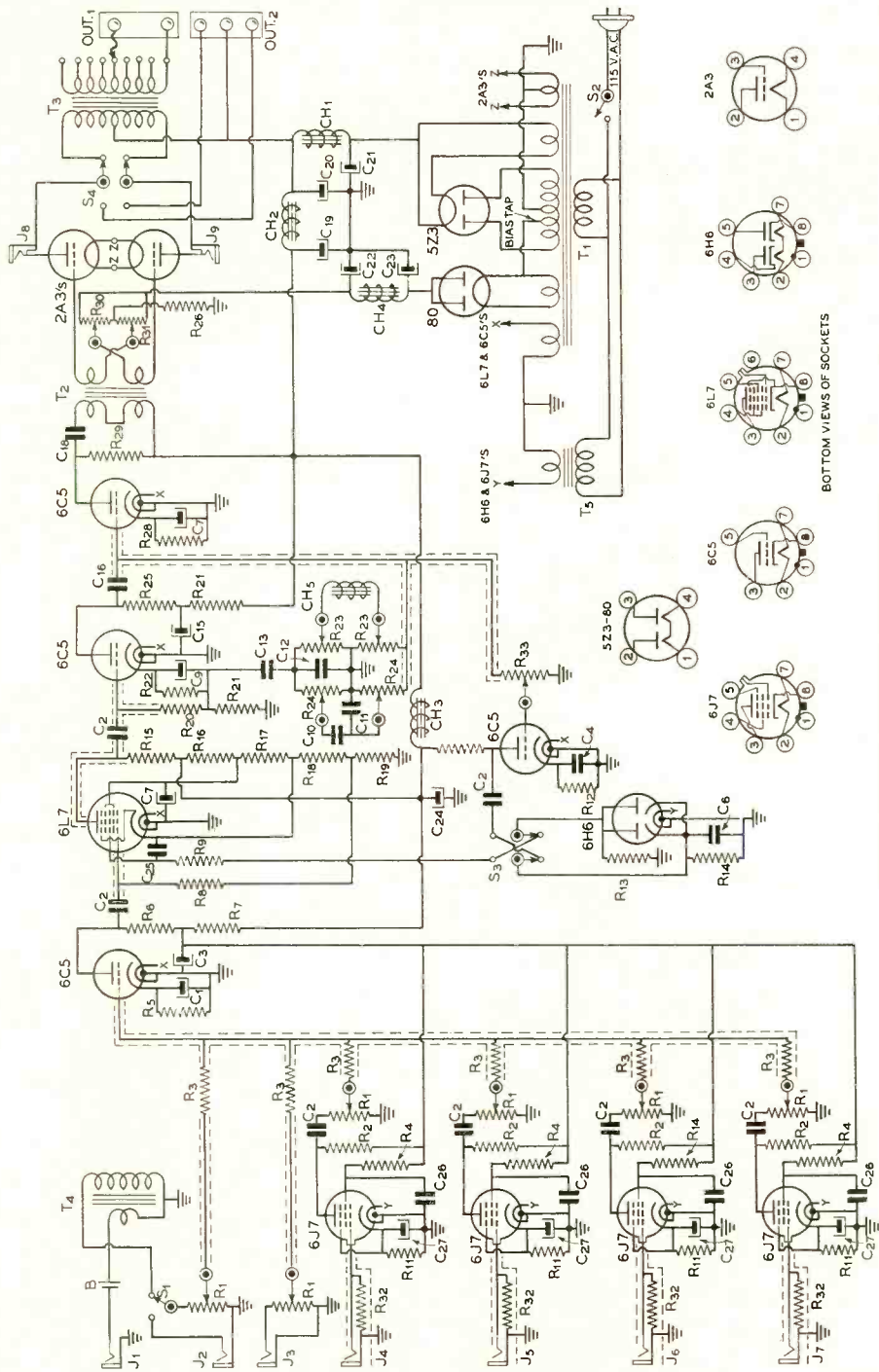

Wiring diagram of deluxe audio amplifier.

Underchassis view showing the placement of parts, methods of shielding the microphone input channels, and the manner in which the meter jacks and bias potentiometers are mounted.

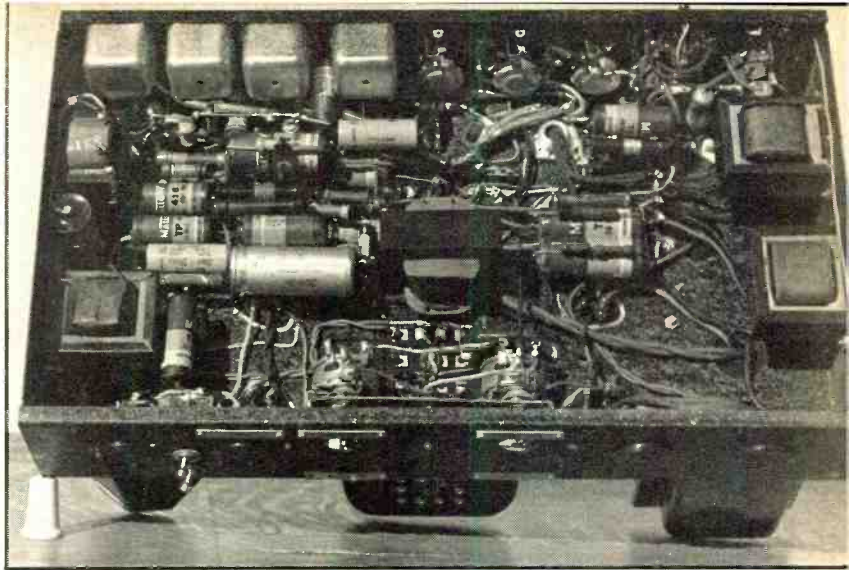

coupled high-gain amplifier. As a consequence, it was decided to use the values as given in a table from a manual put out by one of the leading tube manufacturers. In this manner an amplifier evolved that was completely bug-proof.

Microphone and Phono Channels

The microphone channels are conventional in every respect and need little explanation. Proper shielding is always a wise practice, of course. To isolate each channel completely a 500,000-ohm, 1/4-watt resistor is placed in series with each lead. An exceptionally small

size in this wattage is now being manufactured and these small resistors greatly simplify shielding. A piece of spaghetti can be placed over the resistor and the resistor completely shielded by slipping a small section of braided shielding over the spaghetti and soldering the shielding at each end to the shielded hook-up wire.

Almost everyone uses a crystal microphone but accidents can and do happen to them. So an ace-in-the-hole in the form of a single-tube microphone channel has been included. This additional channel comes in handy at times and costs but a few cents more to incorporate into the circuit. A s.p.d.t. switch (S_1) is placed so that one of the phonograph channels may be switched to accommodate the single-button microphone. F-1 Western Electric telephone transmitters are usually available and make excellent voice frequency microphones.

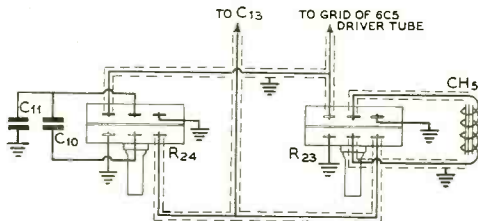

Physical connections for the dual tone control potentiometers R_{23} and R_{24} .

Expansion A.V.C., and Boost Circuits

The expansion circuit, so desirable for phonograph reproduction, is so arranged that by reversing the d.p.d.t. switch (S_2) the action

[Continued on Page 72]

- R_1 —1 meg vol. control
- R_2 —500,000 ohms, 1 watt
- R_3 —500,000 ohms, 1/4 watt
- R_4 —3 meg., 1 watt
- R_5 —2,000 ohms, 1 watt
- R_6, R_7, R_{21}, R_{25} —20,000 ohms, 1 watt
- R_8 —1 meg., 1/2 watt
- R_9 —500,000 ohms, 1/2 watt
- R_{10}, R_{13} —100,000 ohms, 1 watt
- R_{11} —3,000 ohms, 1 watt
- R_{12} —10,000 ohms, 1 watt
- R_{14} —100,000 ohms, 1/2 watt
- R_{14}, R_{30} —250,000 ohms, 1/2 watt
- R_{16}, R_{17} —10,000 ohms, 10 watts

- R_{15} —800 ohms, 1 watt
- R_{19} —200 ohms, 1 watt
- R_{22}, R_{28} —1,000 ohms, 1 watt
- R_{23}, R_{24} —Dual tone control
- R_{26} —3,500 ohms, 10 watts
- R_{27}, R_{29} —50,000 ohms, 1 watt
- R_{30}, R_{31} —3,000-ohm wire wound pot.
- R_{32} —5 meg., 1/4 watt
- R_{33} —1 meg, pot.
- C_1, C_9, C_{17}, C_{27} —10- μ fd. 25-volt elect.
- C_3, C_5, C_8, C_{10} —1- μ fd. 400-volt paper

- $C_2, C_7, C_{15}, C_{19}, C_{20}, C_{23}, C_{24}$ —8- μ fd. 450-volt elect.
- C_4, C_6, C_{13}, C_{25} —5- μ fd. 400-volt paper
- C_{10}, C_{11} —0.3- μ fd. 400-volt paper
- C_{12} —0.02- μ fd. 400-volt paper
- C_{18} —0.25- μ fd. 400-volt paper
- C_{20} —8- μ fd. 450-volt elect.
- C_{21} —8- μ fd. 600-volt elect.
- C_{26} —0.02- μ fd. 400-volt paper
- CH_1 —5-20 hy. 150 ma.
- CH_2 —42 hy. 15 ma.

- CH_3 —300 hy. 5 ma.
- CH_4 —22 hy. 35 ma.
- CH_5 —Tone control-hum bucking type
- T_1 —330 v.a.c. 145 ma., 77 v. bias tap, 5 v. 3 a., 5 v. 2 a., 6.3 v. 2 a., 2.5 v. 5 a.
- T_2 —Single plate to p.p. grids, split secondary
- T_3 —3,000-ohm pri. 2-3-4-6-8-16-125-250-500-ohm sec.
- T_4 —S.b. mike to grid
- T_5 —6.3 volts 2 amp.
- S_1 —S.p.d.t. toggle
- S_2 —S.p.s.t. on vol. control
- S_3, S_4 —D.p.d.t. toggle

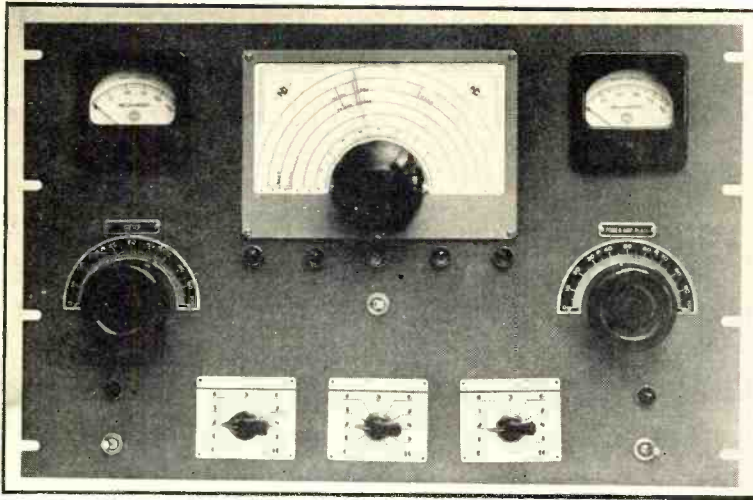

Front panel view of the 100 watt c.w. transmitter. To permit mounting of the v.f.o. tuning dial in the center of the panel in the interests of symmetry, the shaft of the v.f.o. condenser is driven by means of flexible cable and a system of pulleys.

A Medium-Power C.W. PORTABLE

By LEWIS MIMS,* W5BZT

Anyone who has a job which requires him to move more than once a year is sure to find that it is impractical to possess heavy or bulky radio equipment. The transmitter described in this article was constructed with four thoughts in mind: compactness, flexibility, a worthwhile amount of power output, and provision for use as an exciter in some future transmitter.

General Description

The r.f. portion of the transmitter winds up with an 809 amplifier, running at the I.C.A.S. rated maximum c.w. voltage of 1000. (If desired, an 812 may be substituted. This will permit running a little more plate current than can be run to the 809 with safety.) To permit oscillator keying, the 809 (or 812) is supplied with 75 volts of fixed bias from a voltage regulated bias pack. The rest of the bias is furnished by a grid leak. This makes a good combination, as the fixed bias is sufficient to cut the plate current off cleanly, and the grid

leak makes the 809 insensitive to small changes in excitation.

The 809 is driven by an 807 running at 500 volts. For crystal operation the 807 is used as a triode oscillator. For v.f.o. operation the 807 is driven as an amplifier by a self-contained v.f.o.

As shown in the diagram, the triode cathode coil (which is shorted out automatically when the switch is thrown to "v.f.o.") is tapped and connected for use with two 40-meter and two 80-meter crystals. Any combination of 40 and 80 meter crystals may be used if the connections are made to S_1 to correspond to the crystals. The important thing to remember is that with 80-meter crystals the arm goes to the top of L_1 , while for 40-meter crystals it goes to the tap.

The v.f.o. portion consists of a 6K7 electron coupled oscillator and a 25L6 buffer, connected in the standard "a.c.-d.c." arrangement in order to save a power transformer. This makes it necessary to insert the a.c. plug a specific way in order to prevent the transmitter chassis and panel from being "hot" with a.c.

*Care Shell Oil Co., Inc., Geophysical Dept., Box 1212, Breckenridge, Texas.

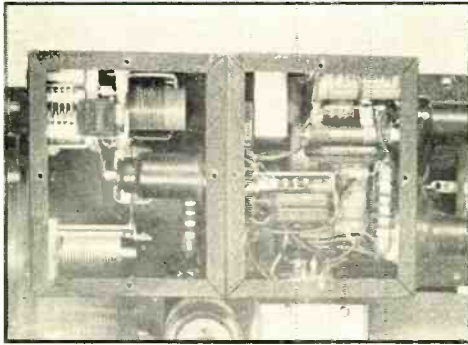

In this view the lids have been removed from the two small boxes housing the v.f.o. portion, to show the interior construction.

In operation, the cathode resistor to the 25L6 is adjusted until the plate current is the same with the key up or down. When this condition is obtained, the plate voltage to the 6K7 oscillator will not vary with keying. This makes a voltage regulator unnecessary, provided that the line voltage is reasonably steady.

Cathode oscillator keying is employed. With switch S_2 closed, the 6K7 is keyed, along with the 807 amplifier. With S_2 open, the oscillator is dead, and it will not be affected by keying of the 807. When the 807 is used as an oscillator, S_4 should be open; when the 807 is used as an amplifier, S_4 should be closed.

Meter switching permits a single 0-100 ma. milliammeter to be used for reading plate current to the 25L6 (necessary in adjusting R_1 properly), plate current to the 807, and grid

current to the 809. A 0-200 milliammeter permanently wired in the plate circuit of the 809 is used to read plate current to that stage.

A "dual" power supply using three 5Z3's in a bridge arrangement delivers 1000 volts for the final amplifier and 500 volts for the buffer. This provides an economical means of obtaining plate voltage with a minimum of transformers. And as no mercury vapor rectifiers are used there is no "hash" in the receiver on standby when working break-in.

Construction

The transmitter is constructed on a 17" x 13" x 3" chassis and 12 $\frac{1}{4}$ " x 19" panel. The v.f.o. portion is mounted on a platform over the plate transformer, filament transformer, and power choke, the reason being to get the v.f.o. away from the r.f. field of the final coil and from the heat of the rectifier tubes. Directly in the center of the chassis is the 807 combination crystal oscillator and buffer tube. The 807 plate coil is mounted on a small platform over its associated variable condenser. Directly under the v.f.o. plate coil is the grid coil of the 807, which plugs in a socket in the chassis but cannot be seen in the photo. To the right rear of the chassis are the three 5Z3's. Just to the rear of the final tuning condenser can be seen the 80 and VR-75.

In order to have a balanced front panel it was necessary to use a cable and pulley arrangement between the condensers and dials on both the e.c.o. and crystal oscillator-buffer. The pulleys were made from some old bakelite dials which were turned down on a lathe. Heavy fish cord was first used for the cable

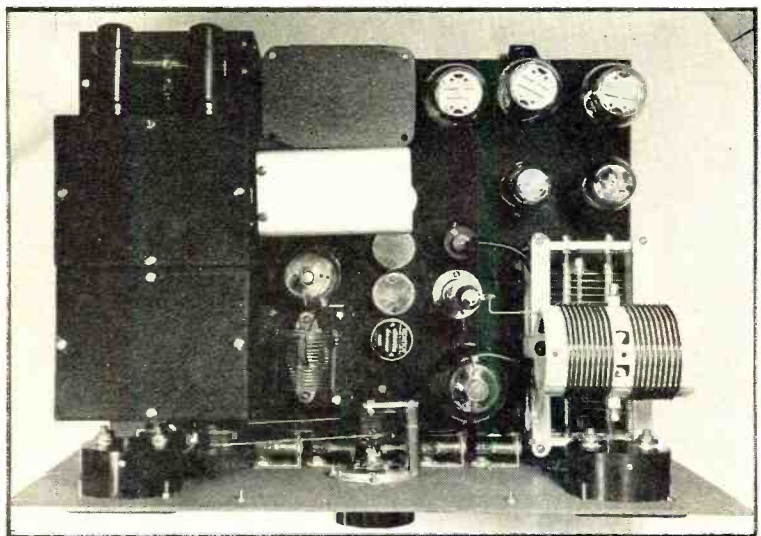

Top view, showing interior construction. The v.f.o. portion is housed in the two shield compartments to the left. The drive pulley for the main tuning dial is visible in this view.

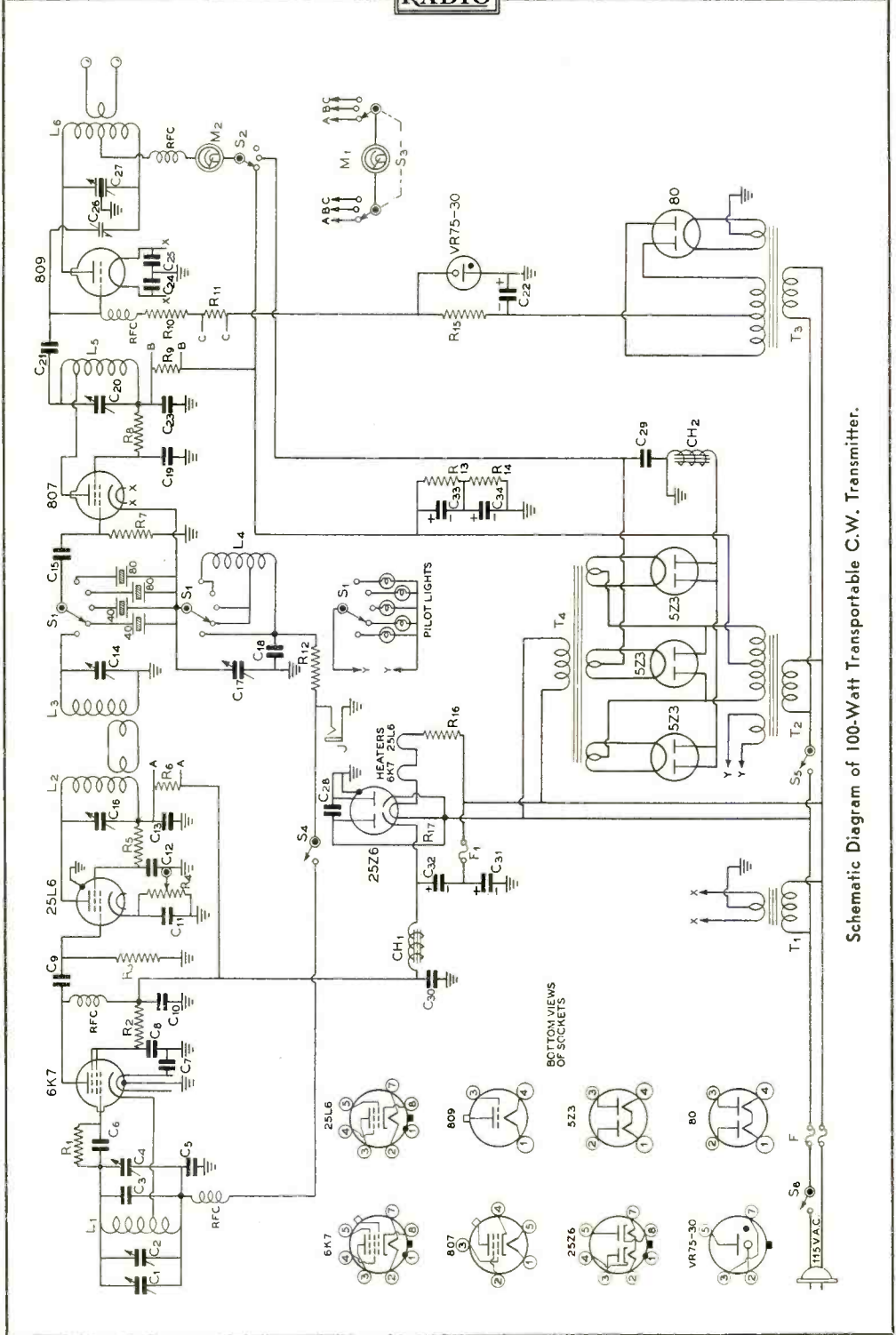

Schematic Diagram of 100-Watt Transportable C.W. Transmitter.

Under chassis view, showing layout of parts. The small split-stator condenser to left center on the front panel is used as a single section condenser. It was used simply because it happened to be available.

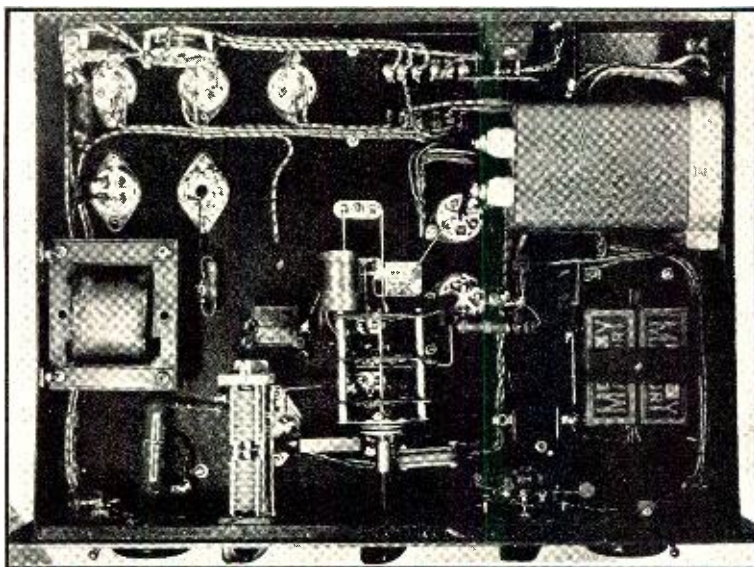

but it was affected too much by atmospheric conditions. Regular dial cable (wire type) was used with success. There is no noticeable backlash in the drive arrangement.

The Electron Coupled Oscillator

The e.c.o. was constructed in two metal boxes 3" x 5" x 4" which were bolted together.

The entire unit is mounted on rubber bushings supporting it from the platform.

In the front box is located the 6K7 (in a horizontal position) with the grid coils and condensers. The grid coil and trimmer condensers are made up from a National fixed tuned tank unit and the tank is very stable.

[Continued on Page 78]

C₁—50- μ fd. midget variable condenser (adjustable "band set")
 C₂—Centralab 6-30- μ fd. adjustable negative coefficient capacitor
 C₃—350- μ fd. zero coefficient capacitor
 C₄—100- μ fd. midget variable condenser, two bearing type (main tuning)
 C₅—0.1- μ fd. fixed mica
 C₆—100- μ fd. midget mica
 C₇—0.1- μ fd. paper tubular (right at tube socket)
 C₈—0.002- μ fd. mica
 C₉—250- μ fd. mica
 C₁₀—0.1- μ fd. tubular paper
 C₁₁—0.1- μ fd. tubular paper
 C₁₂—0.002- μ fd. mica
 C₁₃—0.1- μ fd. paper tubular
 C₁₄—3-30- μ fd. compression trimmer
 C₁₅—0.001- μ fd. mica
 C₁₆—3-30- μ fd. compression trimmer
 C₁₇—100- μ fd. midget variable

C₁₈—0.1- μ fd. paper tubular
 C₁₉—0.002- μ fd. mica
 C₂₀—50- μ fd. midget variable, .025 in. spacing or greater
 C₂₁—0.01- μ fd. mica
 C₂₂—8- μ fd. electrolytic 450 v.
 C₂₃—0.02- μ fd. mica
 C₂₄, C₂₅—0.02- μ fd. midget mica
 C₂₆—7.5- μ fd. neutralizing condenser, 4500 v. spacing
 C₂₇—50 μ fd. per section, 3500-volt spacing or greater
 C₂₈—0.1- μ fd. paper tubular
 C₂₉—2- μ fd. 1500 or 2000 v. (working) oil-filled condenser
 C₃₀—8- μ fd. electrolytic, 450 v.
 C₃₁, C₃₂—40- μ fd. electrolytics, 150 v.
 C₃₃, C₃₄—8- μ fd. electrolytics, 450 v.
 R₁—150,000 ohms, 1/2 watt
 R₂—25,000 ohms, 1/2 watt
 R₃—250,000 ohms, 1/2 watt

R₄—500-ohm wire-wound pot.
 R₅—50,000 ohms, 1 watt
 R₆—50 ohms, 1 watt
 R₇—50,000 ohms, 1 watt
 R₈—20,000 ohms, 10 watts
 R₉—50 ohms, 1 watt
 R₁₀—2500 ohms, 10 watts
 R₁₁—50 ohms, 1 watt
 R₁₂—600 ohms, 10 watts
 R₁₃, R₁₄—50,000 ohms, 2 watts
 R₁₅—50,000 ohms, 2 watts
 R₁₆—200 ohms, 10 watts
 T₁—6.3 volt 4 amp. fil. trans. (6.3 v. winding on T₈ may be used if it will handle 2.5 amp. for 809 fil.)
 T₂—600 v. r.m.s. each side c.t., 250 ma.
 T₃—250 to 300 v. each side c.t., 40 ma., with 5 v. winding
 T₄—Rectifier fil. transformer to handle three 5Z3's, each winding 5 v. at 3 amp. or more, high voltage insulation
 J—Keying jack (either open or closed circuit, depending upon preference)

CH₁—10 to 30 hy. choke, 50 ma.
 CH₂—5-20 hy. swinging choke, 250 ma.
 L₁—15 turns no. 22 enam. on 1 in. dia. form, spaced to 1 inch. Cathode tap 6 turns from coil end.
 L₂, L₃—17 turns no. 20 enam. on 1/2 in. dia. form, spaced to 1/2 inch. Link 3 turns on each coil, wound around coil end.
 L₄—16 turns no. 20 enam., close-wound on 1 inch form, tapped 7 turns from bottom.
 L₅—Manufactured plug-in coils, 25-watt type (see text for data on tap)
 L₆—Manufactured plug-in coils, 100-watt type, with variable link
 M₁—0-100 ma. d.c.
 M₂—0-200 ma. d.c.
 S₁—3-gang 5-pos. selector switch
 S₂—1-pole 3-throw selector switch, ceramic insulation
 S₃—2-pole 3-throw selector switch

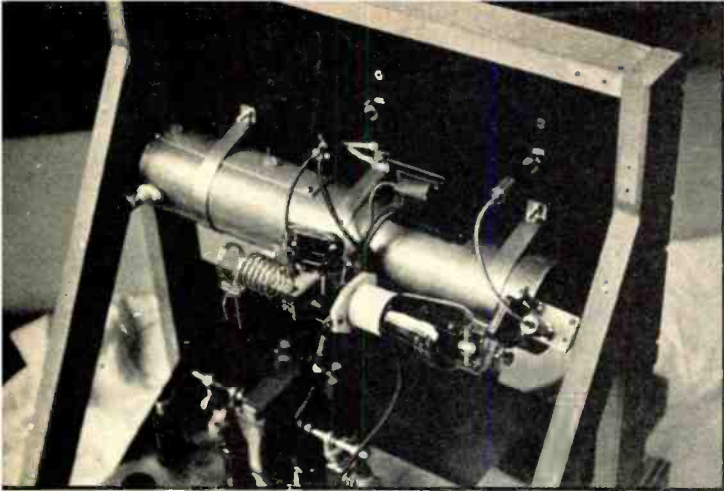

Rear view of the final version of the amplifier. Excitation is coupled into the grid circuit via the small link loop to the left of the grid coil.

An Experimental

56-Mc. R. F. Amplifier

By W. E. McNATT,* W9NFK

Articles describing the use of concentric lines as oscillator grid-circuit elements have been numerous. This article describes the application of a concentric line in the plate tank circuit of an r.f. amplifier.

About two years ago, when E. H. Conklin began his "drive" in these pages¹ for bigger and better concentric lines (and more of them) in u.h.f. equipment, the writer became interested in the possibilities of such lines as plate circuit elements in r.f. amplifiers for u.h.f. At that time the OPM and its copper "shortage" were totally unknown, and it was a simple matter to obtain two lengths of copper pipe for construction of the line.

In order to become acquainted with the peculiarities of concentric lines, the original line was first used in the grid circuit of a 56-Mc. oscillator. As shown in figure 1, the line was 25 inches long, the inner diameter of the outer conductor being 2.84 inches, and the outer diameter of the inner conductor, 0.75 inch. The impedance, Z_0 , of this line is approximately 79 ohms. Subsequent experiments with the oscillator circuit having satisfied our curiosity concerning several features of concentric lines, it was decided to go ahead with experiments on r.f. amplifiers with the line being used in place of the conventional coil-condenser combination.

*4805 North Moody Avenue, Chicago, Illinois.

Circuits

Figure 2 shows the conventional, single ended r.f. amplifier circuit using a triode. The "concentric line" equivalent of this circuit is shown in figure 2A, and uses a neutralizing circuit which, though not new, is seldom employed in amateur practice.

While the circuit of figure 2A was made to perform, it was found to be quite "tricky" in neutralizing and generally not up to the standards which had been expected of it. Therefore, elimination of the neutralizing problem was the next step and was accomplished by substituting an HY-69, beam-type tetrode which requires no neutralization.

The next trial circuit is shown in figure 3, with its more familiar equivalent appearing in Figure 3A. Because the inner and outer conductors are connected together at the shorted

¹E. H. Conklin, "Transmission Lines as Circuit Elements," RADIO, April and May, 1939. Conklin, "Superhet Tracking at Ultra-High Frequencies," RADIO, February, 1940. Conklin, "U.H.F. Circuit Delevopment," RADIO, March, 1940.

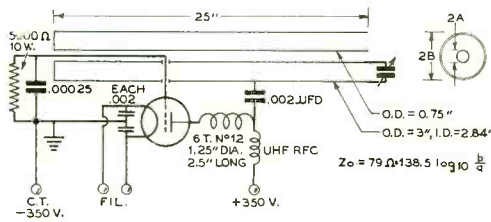

FIGURE 1

end of the line, the outside pipe is "hot" to ground and care should be taken to avoid jolts of volts. As a circuit, however, it was found quite superior to that in which a triode was used.

With excitation applied from a self-excited 56-Mc. oscillator (about 10 feet away, to avoid feedback and stray coupling) the circuit of figure 3 responded to tuning and loading as does its equivalent when used on the lower frequency bands. With excitation removed, however, it was found that the amplifier acts as a tuned-grid tuned-plate oscillator with a respectable amount of power output.

Stray r.f. (when the circuit is acting as an amplifier) was—surprisingly enough—found only at the filament leads, and was eliminated by placing r.f. chokes in the filament leads. (In some cases, it may be found necessary to add filament by-pass condensers as well.)

Inasmuch as this setup made it all too easy to tangle with high voltage, the next problem was to ground the line, and yet preserve the performance standard which had, surprisingly

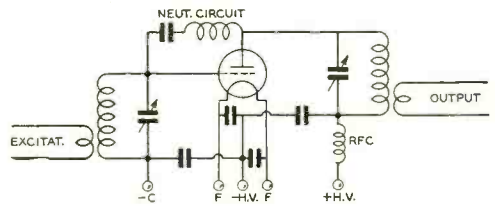

FIGURE 2

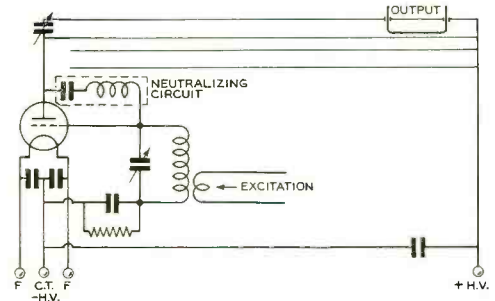

FIGURE 2A

enough, been so easily attained. One possibility is shown in figure 4, in which the shorted end of the line is converted to a by-pass condenser. A suggested mechanical arrangement is illustrated by figure 4A. The mechanical work involved immediately classified the idea as a "last chance" proposition, and it was decided to try an old friend, parallel feed.

The parallel-feed arrangement, and its conventional equivalent are shown in figures 5 and

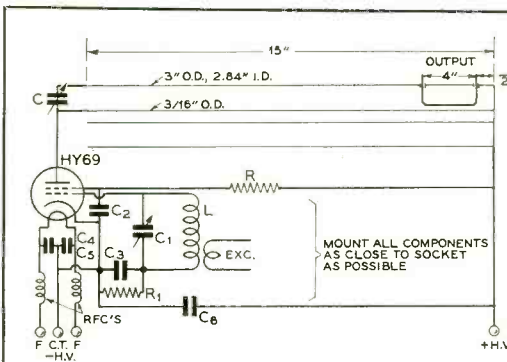

FIGURE 3

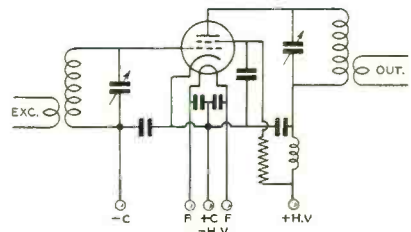

FIGURE 3A

Wiring diagram of the "hot line" HY-69 amplifier.

- C—35- μ fd. variable, double spaced
- C₁—15- μ fd. variable
- C₂—0.02- μ fd. mica
- C₃—0.001- μ fd. mica

- C₄, C₅, C₆—0.02- μ fd. mica
- R—100,000 ohms, 10-watt wirewound

- R₁—50,000 ohms, 10-watt wirewound
- L—7 to 10 turns no. 12 enam., 1" dia., 2 1/4" long

- RFC—10 turns no. 14 enam., 1/4" dia. close-wound

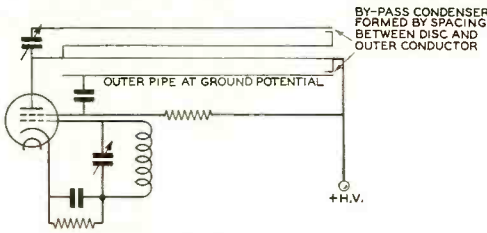

FIGURE 4

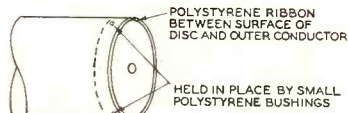

FIGURE 4A

5A. This provides full grounding of the line and greatly minimizes the shock hazard. It has the disadvantages of requiring additional by-pass condensers, and a somewhat crowded arrangement of components at the tuned end of the line. Yet, after the change-over to parallel feed had been made and new tests made, the results indicated no appreciable difference in performance. The circuit accepted excitation, tuned sharply in the plate circuit, and generally performed excellently. Stray r.f. was sought for, and found absent. Here, we decided, was the answer: satisfactory performance, minimum shock hazard and circuit simplicity.

Construction

As earlier stated, the original line was 25 inches long, and made of two pieces of copper pipe. The outer pipe diameters are, 3 inches o.d., and 2.844 inches i.d. The diameter of the inner conductor is 0.75 inch. This combination produces a line ratio (b/a) of 3.78, and impedance, Z_0 , of about 79 ohms (see reference 2).

So, after the initial experiments and tests

$$^2Z_0 = 138 \log_{10} b/a$$

had been made, the line for the final version was changed over for amplifier duty. First, the length was reduced to 15 inches (requiring more capacity in the plate tuning condenser), so as to fit lengthwise on a standard 19-inch panel—a rack-mounted unit being our ultimate objective. The inner diameter of the outer conductor remains the same, 2.844 inches. The outer diameter of the inner conductor, however, should be such as to produce b/a equal to 14.3. ("Transmission Lines as Circuit Elements"—Conklin, RADIO, May, 1939, page 45). Or, the required diameter = 0.198 inches. The nearest B&S gauge number for this is no. 4, which has a diameter of 0.204 inches. In our case, 3/16-inch tubing is the compromise.

As shown in figure 6, one end of the tubing is sweat-soldered directly over a 1/8-inch diameter hole in the center of a 3-inch diameter disc. Next, a spacer of Lucite is shaped so as to hold the inner conductor on center at the open end of the line. Other than following the idea of figure 6A, there are no particular precautions to be taken in shaping the spacer. Lucite works readily, but should not be permitted to get too warm while sawing or drilling.

A slot 1 inch wide by 6 inches long was cut

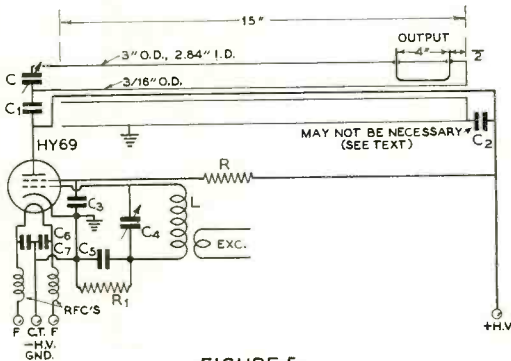

FIGURE 5

Wiring diagram of the circuit decided upon as the best version. C_1 and C_2 —.005- μ fd. mica. All other components same as in figure 3.

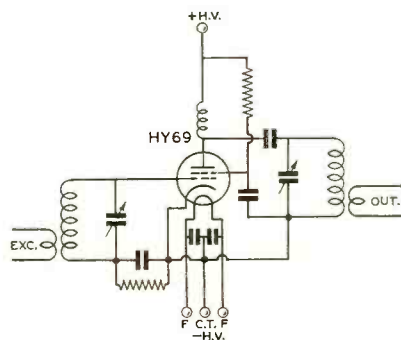

FIGURE 5A

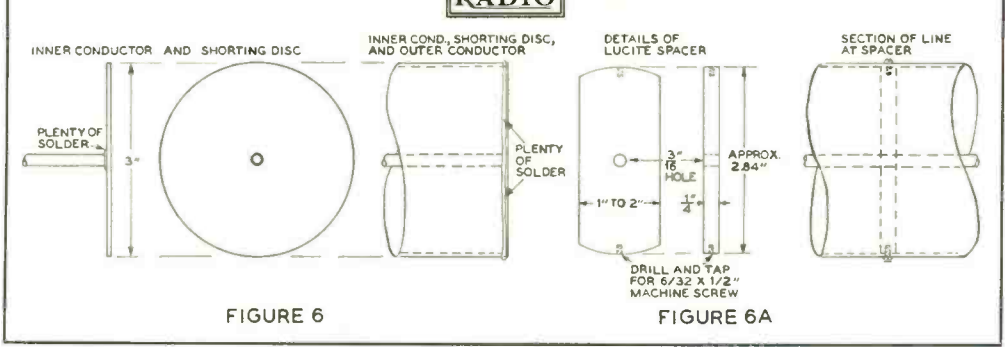
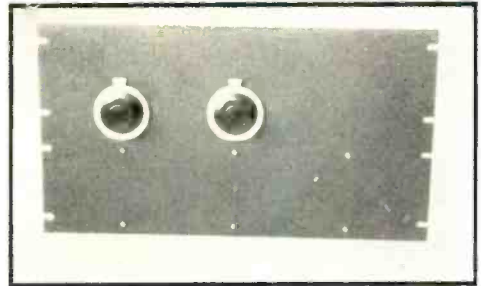

FIGURE 6

FIGURE 6A

at one end of the outer conductor. This opening is to accommodate the output coupling assembly which consists simply of a strip of copper plate drilled and fitted with two National polystyrene feed-through bushings which are 4 inches apart, on centers. A piece of no. 12 or no. 14 copper wire is then soldered across the two terminals which are to be inside the line. (See figure 7 and 7a.) After completion of the unit, different dimensions of the pickup loop may be tried in order to obtain maximum output. Mounting holes for the output coupling assembly are drilled in the outer pipe.

Now, after all drilling, cutting and burr-removing have been taken care of, the parts of the line are ready for assembly. The inner conductor and shorting disc are brought into position and two or three "tacks" made with a heavy soldering iron, or small soldering blow-torch. Then—if a vise is available—the shorted end of the line should be clamped so as to hold the disc and pipe together while the finishing job of soldering is done. This job can be done without a vise, but it's not likely to be as easy. Suggested best way is to place the pipe so that the shorted end is "up," brace it with a couple of boxes, and solder carefully, a little at a time. The disc, before being soldered at a few points, has a disconcerting habit of slipping out of position at the lightest touch. If possible, the two pieces should be sweated together, using plenty of solder. The excess solder can be filed off, and the joint sandpapered down to a nice finish.



A millimeter, mounted on the right hand side of the panel, would have greatly improved the appearance of the front view of the amplifier. The six screws hold the line securely to the panel by means of three strips of thin sheet metal.

Next, the spacer should be inserted into the line and drawn into position by two 6-32 machine screws.

Following this step, the entire outer surface of the assembly should be cleaned up, polished, and given a coat or two of clear lacquer to preserve that attractive brightwork appearance. (The author slipped up on this point, as is evident from the photographs.)

The remainder of the assembly work on the amplifier proper consists of mounting the tube socket by an angle bracket at a point on the outer pipe so that the plate cap of the tube is about flush with the end of the concentric

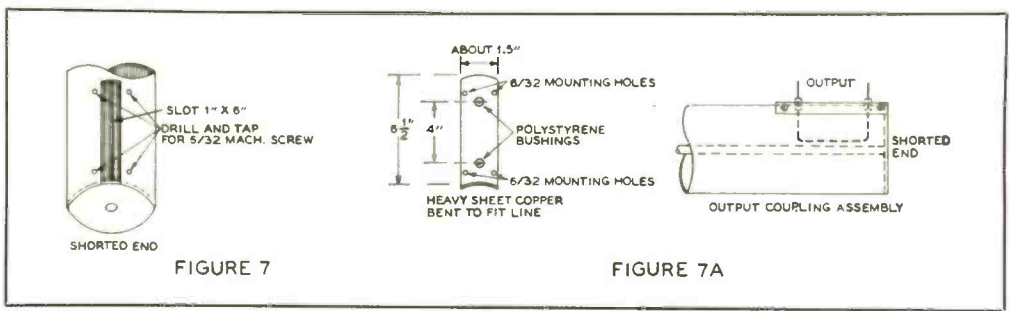
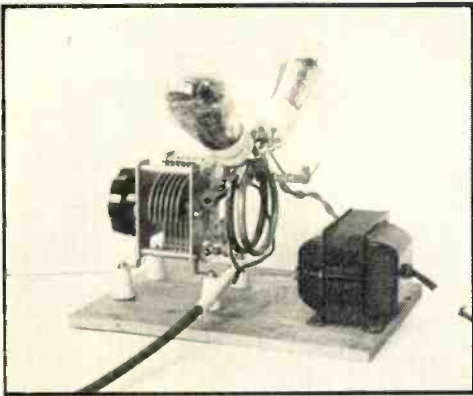

FIGURE 7

FIGURE 7A



56-Mc. push-pull oscillator used for tests on the amplifier.

line, at its open end. Next, the screen voltage dropping resistor and by-pass condenser, control-grid bias resistor and by-pass condenser are all connected to their appropriate socket connections. The grid tuning condenser supports the grid coil, which is soldered directly to the condenser terminals at its knob-end. A small mounting bracket (Cardwell) is then used to mount the coil and condenser on the tube socket.

While the photographs show the filament transformer mounted on the concentric line, the transformer was later removed because of the suspicion that its 120-cycle mechanical vibration (while ever so slight) might somehow affect the performance of the amplifier. We don't know for sure that this would, or might be the case, but felt it best to not overlook any sources of possible trouble.

The plate tuning condenser is mounted at the open end of the line by soldering the rotor lead to the outer pipe, and one stator lead to the inner conductor. Heavy soldering makes a quite rigid mounting, although this undoubtedly could be improved by using a strip of sheet metal as a support at the panel end of the condenser to the outer pipe. One end of the plate blocking condenser is connected to the tuning condenser by a piece of flexible shield braid. Another short piece of braid connects the blocking condenser to the tube plate clip. The high voltage lead to the tube also connects to the tube clip after being brought from the shorted end of the line to the open end through the inside of the inner conductor. (See diagrams.)

At the shorted end of the line a small stand-off insulator serves as a terminal for the positive high voltage connection. The plate by-pass condenser, seen at the shorted end of

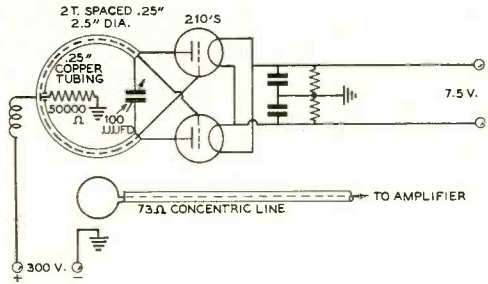

Simple push-pull oscillator using a pair of 210's used as a source of excitation for the tests on the various amplifier circuits.

the line, may not be necessary if sufficient capacity is produced by the plate lead to the tube and the inner conductor of the line.

Panel Mounting

Mounting the entire amplifier assembly on a panel will enhance its appearance no end, and the work involved is not complicated.

The rear-view photo of the amplifier illustrates the mounting used by the writer. The panel is a standard 19" x 20½" x ⅛" steel panel. Holes are drilled, as shown, to pass six 8-32 screws which serve to tighten the three straps of electraloy which, in turn, securely hold the amplifier against the panel.

Drilling centers for the dial shaft panel-bushings are spotted by fastening the flexible shafts to both variable condensers and "exploring" behind the panel for the positions which appear to permit mechanically-smooth condenser operation. As noted from the photographs, it is possible to do this satisfactorily by a combination of different lengths of flexible shaft and rigid, bakelite shafting.

If available, a 0-150 millimeter may be mounted in the panel at the right hand side, and thus balance the appearance of the unit, as well as provide a useful electrical feature.

[Continued on Page 76]

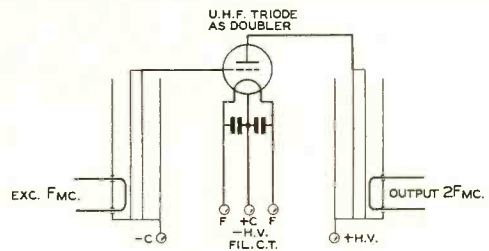

FIGURE 8

RADIO'S 1942

YL SECTION

FEATURING YLRL

By ANITA CALCAGNI BIEN,* W8TAY

"The Colonel's Lady and Judy O'Grady" visit daily through modern short wave equipment in their homes. A large percentage of these YL operators are members of the Young Ladies' Radio League. This grand international group of YL ops is unique. Despite world conflicts, several continents are represented. Women of leisure? No Sir! But many run kws. although more combat QRM and QRN with low powered rigs and inexpensive receivers. A kaleidoscopic view re-

veals members' occupations as: clerks, teletype operators, salesgirls, teachers, (even a Braille teacher), farm manager, nurses, doctor, lawyer, nun, concert musicians, secretaries, housewives, and a factory radio technician—truly a heterogeneous group but all with one idea—*Amateur Radio*.

Life on the ether waves is a long way removed from the early days when one could count the YL ops using the fingers of one hand. You'll find Miss "Busypaw" on any of the c.w. bands and her "sister ham" operating the phone bands. Call it a miracle of labor and

*13 Wiltshire Rd., Rte. 3, Chagrin Falls, O.



Upper left—W8UCY/9, Carol Conrad, now studying nursing in Chicago. Upper right—W8UHB, "Blondie" Trebendis, N. Braddock, Pa. Lower left—WILGZ, Marion E. Field, Johnson, Vt. Lower right—W9JWL, "Gertie" Culver, New Haven, Ind.





W9BEY, Mae Hirt, Deerbrook, Wisc.

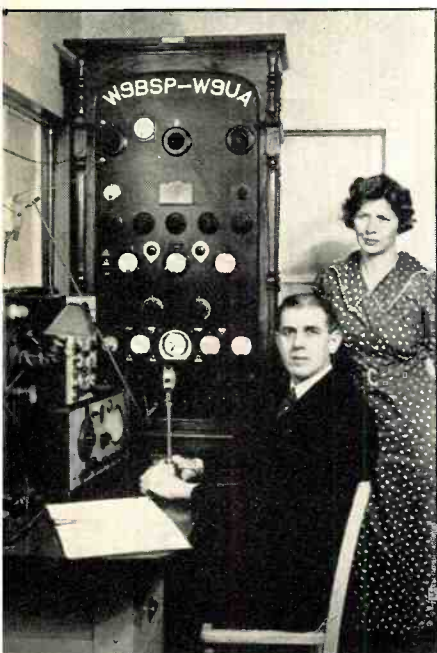

W9UA, Lorretta Ensor, Olathe, Kansas. Lorretta's brother, Marshall, won the Paley Award this year for outstanding work in teaching code via the ham bands under his call W9BSP.



WIMDV, Louise Bruya, Waltham, Mass.



Left—W9PFO, Marie Van Aller, St. Louis, Mo.

Right—W9HIG, "Jerry" Burgett, Flaxton, N. D., collects autographs as well as QSL cards.



W6TCH, Marty Miller, Long Beach, Calif., is a Captain in The Women's Ambulance and Defense Corps of America.

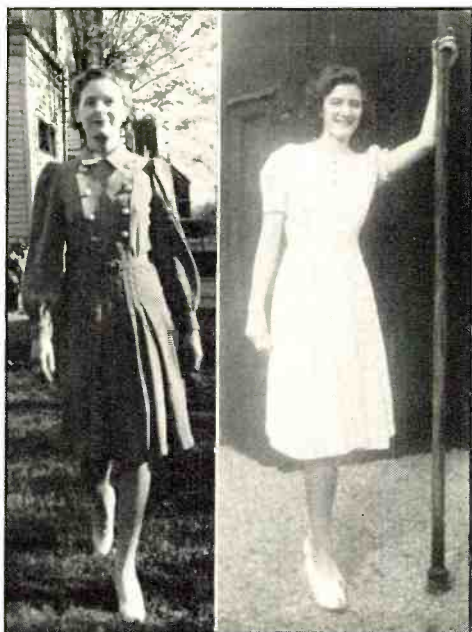

Left—W8ODI, Ruth Beckwith, Cleveland, Ohio.
Right—W2MWY, E. (Ellie) A. McGovern, N.Y. City.



W4HTT, Ann Fox, Greenville, S. C.

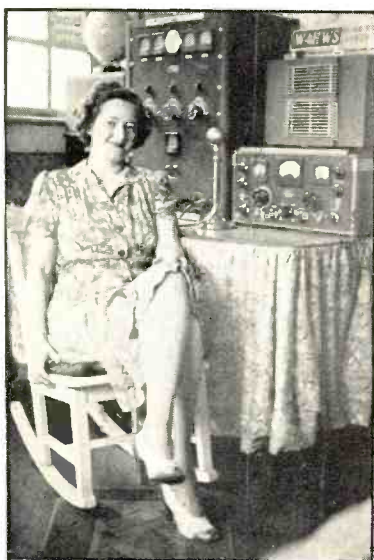

Above—W4HWS, Bessie (but known as "Jerry") Cunningham, Atlanta, Ga.
Right—W9GOJ, Alice-May Stewart, St. Louis, Mo. Taken at first YLRL Field Meet, Alton, Ill.



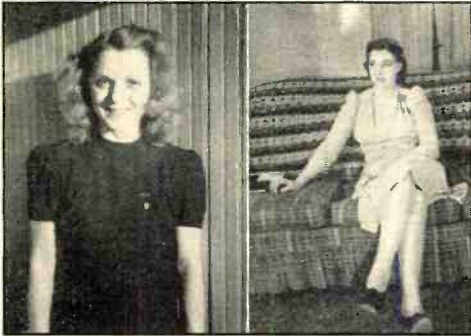

Left—W9JTX, Louise Baker, E. St. Louis, Ill.
Right—W8SPU, Helen Smith, Sycamore, Ohio

love but emerging she is indeed, particularly due to the concerted efforts of the YLRL members. The metamorphosis is a welcome change and their debut into a world of hidden mysteries feazes the girls no more than the OM. They claim no superior virtues but it can be said that the more proficient have galvanized the attention of more than one male op who happened to take note. There are W3BAK (Jean Hudson), W3AKB (Frances Rice) and many others who can copy 40 w.p.m. and over, yet they always lend encouragement to the greenest "lid" and are willing to match their speed if necessary. As many of these girls are married, they prefer to "rock the cradle" than "rule the world." Nor do the single girls ask special privileges. They prefer to be the OM's complement, and preferably his mate, in this radio game, than his competitor but will give him a run for his money in any contest. Besides the nets on all bands, *YL HARMONICS*, their monthly paper, which is edited and published by W9DBD, Secretary, keeps the girls united. No small feat is accomplished by the 160 phone NCS, W9EFW of Ft. Wayne, Indiana, whose roll call is answered by about 30 girls. W7HHH, W7HIQ, W6SPX, W6SGD, W5HEK, W8UDA, W9JMI, W1MRC and others in the YLRL net, which meets every Thursday A.M., indicate points East, West, North and South all eager to meet the rest of

the gang. "W-YL-AS" (Worked YL All States) is another objective. They are grateful to the boys who have sacrificed 1970 kc. that one day of the week. Few operate that spot other mornings in fairness to the boys. W9ZWL and W6RJV are a few of the other Net Control Stations.

The plucky Greater St. Louis girls held their first "All YL Field Meet" last summer at Alton, Ill. Bolstered by the fine operating of W9ILH, they remained at their posts throughout a cold night with ear phones serving as ear muffs. W9JTX climbed trees to hang up the antennas. About the time a good signal would be heard, someone testing would "V" all over him, they said. Nine of the 11 members of the *YL Club of Greater St. Louis* participated. On Sunday, when the contest heat was at its height, W9WQY brought them a gallon of ice cream donated by W9UAK. (Again the boys exhibit their gallantry.)

W1MDV has neighbors who have one of those "things" for a receiver and get her R12. The payoff is that they'd rather listen to her



K4FOW, Jenny Ramirez, Santurce, Puerto Rico. "The Funny Old Woman" in the island of enchantment.

Left—W2MIY, Dorothy Knapp, Albany, N. Y., now in Washington, D. C. Middle—W8UDA, Dot Willett, Flint, Michigan, has two low-power rigs with which she does remarkable work on the ham bands. Right—W9ZQI, Erma Graver, Anamosa, Iowa.





Left—W1MXH, Marion L. Kissick, Westerly, R. I. Middle—W8KYR, Clara Reger, Buffalo, N. Y. Also has Army call WLNU, 8th District Chairman, YLRL, AARS since May, 1939. Alternate SNCS, NCS for WNY net. Right—W4GUZ, Dean Lovely, Egan, Tenn.

QSO's than the BC set and walked in on her one day to ask her if she'd mind their listening or would she prefer that they turn her off when she comes on the air. (?)

W9EZX, OM of W9PFO—Marie Van Aller—interested her in hamming. The OM influence was prevalent in most of the hamette cases.

"Our Wonderful Queen" (W9OWQ), and "Grand Queen Transmitting" (W1GQT) are but a few of the "Queens" in the YLRL. An excellent slogan is that of W8UHB, "U BE CAREFUL." "United American" stamps the signal of W9UA. Loretta Ensor has been the co-worker and helper of her brother W9BSP in his daily code lessons for many years. For this reason, she too was feted when he won the 1940 Paley Award. They've turned out many hams, commercial operators and service men.

In sixteen months W4GUZ has worked almost all states and has successfully carried on over 4000 QSO's. She says she still gets a thrill out of every new contact.

W4HTT, one of the newer hams, is getting a rig ready for 10 meters but at present is heard on 2040 and 1875 kc. She was the first South Carolina member, making her a welcome addition. (Does anyone know a YL op in Utah?)

Because W1HBR kidded her, W1MZH "upped" and showed him. The spirit of radio

hovers over her shack in Massachusetts to the point that her call letters are appliqued on her bedspread and drapes.

From the "Center of the 10,000 Lake Region" in Minnesota radiates the 350-watt signal of W9JMI. A three element rotary and a Collins 30J are used.

Vocalizing on 75 phone will be found W8SPU when she finds time aside from being a busy doctor's wife and homemaker.

When there's a moment's spare time for W2NIN (Never In Nights), she occupies herself usually with 40 c.w. Teacher, X-ray technician and registered nurse, she wonders how many other licensed YL's are similarly employed.

When attending school in New York in 1941, K4FOW got a taste of Yankee hospitality. The only unfavorable visitor was the weather, which found Jenny sighing: "Where, oh where is my good ol' Puerto Rico sunshine?"

Government work in Washington, D.C., has snatched W2MIY of Albany, N.Y. Was State Radio Aide of Eastern N.Y. and Asst. E.C., as well as one of the increasing number of YL's to hold an army call in the AARS. (W1NG)

Bowling and gardening cut in a bit on the radio program of W9ZQL, one of Iowa's Class A ops who operates both phone and c.w.

Grey-eyed "Jerry" Burgett of Flaxton, N.D., W9HIG, is one of the League's youngest members but patience, perseverance and persuasion

Left—W6QOG, Helen Leonard, Los Angeles, Calif., who is better known under her OM's call of W6 Man Bites Dog. Right—W2NIN, Violet Hayden, New York City.

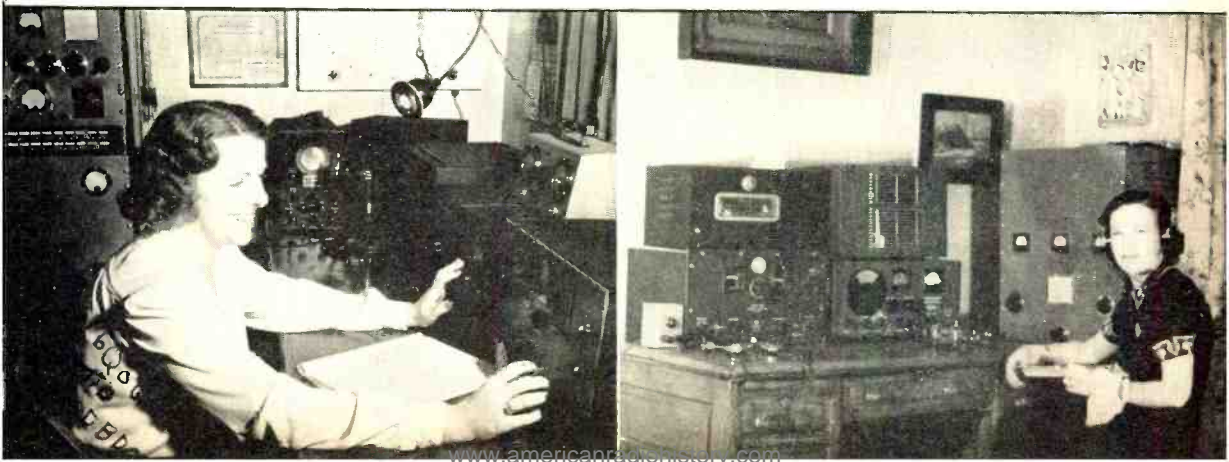



W9NLW, Jean Walden, Urbana, Ill.

known to stay up half the night to oblige. "Sugar and Spice, etc.," makes one think of (Ur Heavenly Babe) W8UHB, "Blondie" who is fond of sports. Prefers brass pounding. Needs one state for 40 meter WAS. N. Braddock, Pa., boasted some rare Gladioli blooms this year due to her efforts in nursing and caring for 800 bulbs.

• • •

U.H.F. Bypasses

Bypassing at frequencies above 100 Mc. often proves to be a serious problem. Midget mica condensers of the bakelite case type usually have small, tinned leads, and such condensers are none too good at these frequencies. Also, the shortest possible leads are bound to have appreciable inductance at such high frequencies, thus preventing a low impedance path back to cathode or ground.

A simple solution is to use a small ceramic trimmer of the compression type. Not only do these capacitors have lower losses than the bakelite type at very high frequencies, but they can be tuned so as to provide series resonance. At series resonance the inductance of the connecting leads is nullified by the reactance of the condenser.

The trimmer is connected so as to provide the shortest possible lead length, and then adjusted until bypassing action is best. The adjusting tool should be of the insulated type, as a screwdriver touched to one side of the trimmer will disturb the resonant frequency.

A 50- μ fd. trimmer ordinarily will resonate with lead lengths commonly employed in u.h.f. circuits at frequencies between 100 and 250 Mc.

are helping her fill her log books when maybe she should be working on her algebra.

Second Class Radiotelephone licenses are held by several of the girls not content with their Class A. One of these licenses is W9NLW, pretty college girl of Illinois.

Since W3CDQ represents democratic Washington, D.C., W7EXY doesn't let you forget Republic, Washington.

Clerk of Superior Court in Prescott, Arizona, W6SGD's relaxing moments are spent rag-chewing 50 per cent and DX'ing the other 50 per cent. That one of the girls in the club might get a sorely needed W6, she's been

Left to right—W9EFW, Esther Davis, Fort Wayne, Ind., NCS of 160 net. W9JMI, Clara Fehr, Willmar, Minn. W7EXY, Gretchen Walden, Republic, Wash. W9HIG, "Jerry" Burgett, Flaxton, N. D., again, this time she hasn't got her back turned.



• • Maybe mice should be listed as one of the causes of transmitter failures, as needless to say, this one failed! • •

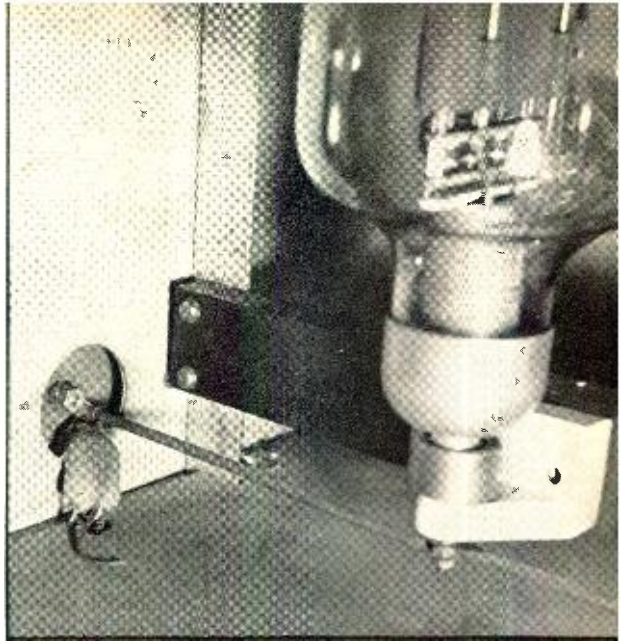

DEPARTMENTS

- **Police Department**
- **Sound Department**
- **The Amateur Newcomer**
- **U. H. F.**
- **Yarn of the Month**
- **With the Experimenter**
- **Postscripts and Announcements**
- **The Open Forum**
- **What's New In Radio**
- **New Books and Catalogues**

POLICE DEPARTMENT ♦ ♦ ♦

MOTORCYCLE POLICE TRANSMITTER

By H. W. BRITTAIN,* W6OQX

A motorcycle transmitter for police service must meet rather rigid standards both in regard to mechanical stability and electrical efficiency. The ingenious design of this transmitter (made possible by the new instant-heating HY65's) is the result of several years' experience in the construction and operation of both automobile and motorcycle mobile u.h.f. police transmitters.

When contemplating the design of a police radio transmitter for a motorcycle one of the

*Radio Supervisor, City of Santa Barbara, California.

major items to be considered is economy of battery power. About 10 amperes is the limit that can be drawn from one of these small batteries if it is to maintain its long life. Up

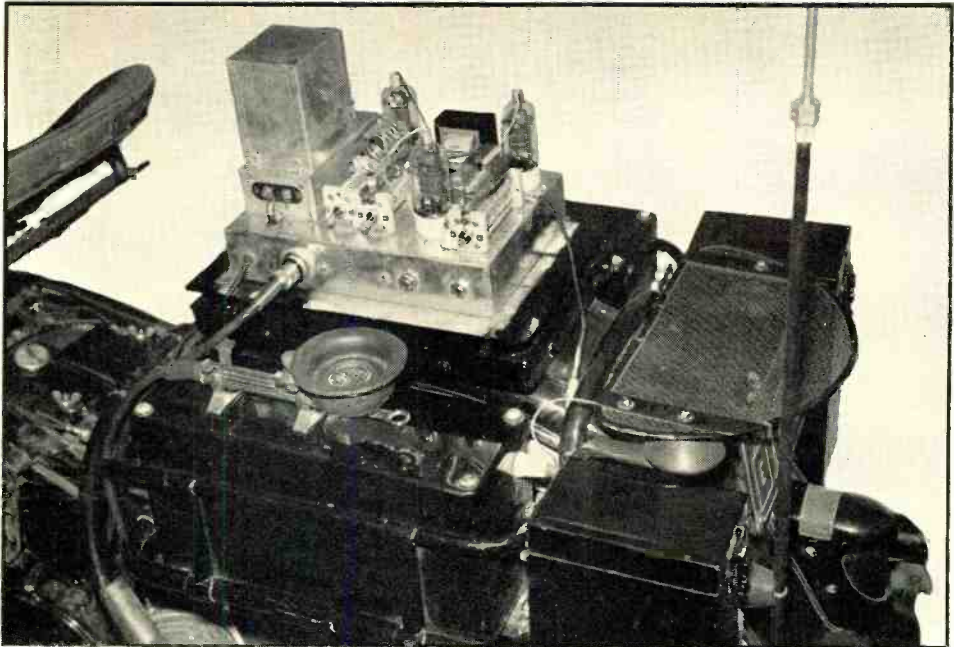

Looking down upon the installation of the transmitter over the rear wheel of the motorcycle. The dust cover for the unit has been removed for this photograph. Note the method in which the vertical antenna is mounted on the small box at the side of the motor. The tuned circuit C₄-L₅, which couples the end of the transmission line into the short antenna, is located in this box—along with the officer's ticket book, etc. The semicircular piece of screen mounted upon insulators at the rear of the motor is the receiving antenna for the low-frequency receiver.

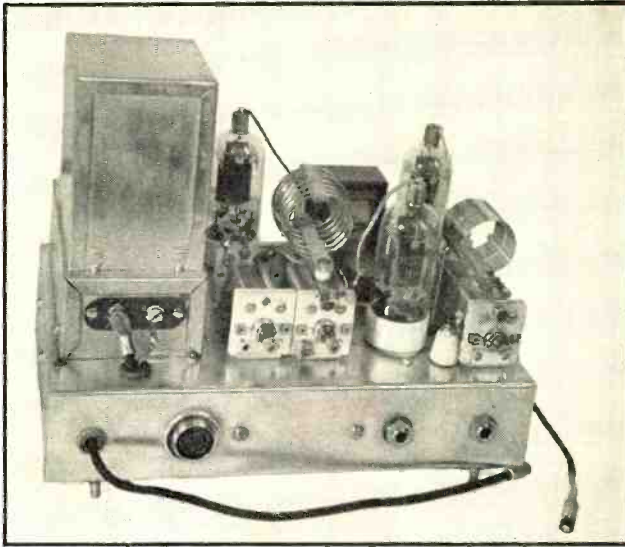

Closeup view of the transmitter itself with the shielding dust cover removed.

to 15 amperes can be drawn for short periods of time, but it has been found the life of a battery will be shortened even at this intermittent drain. Most motorcycle batteries are rated at 30 to 40 ampere hours, usually at 30 hours.

The generators used on motors are of necessity small and charge a maximum of 5 amperes. In most cases this just about compensates for ignition, light, and receiver consumption. Sometimes the generator can be set up to charge more. But a charging rate above 5 amperes is dangerous for the small generator on the motor. Large transmitters have been tried on motorcycles but were not satisfactory for the simple reason that the battery had to be changed about twice a week. The old law that transmitter power must be quadrupled to give twice the received signal strength still holds true. So the few watts gained by pulling a heavy battery load is of no practical benefit in covering longer distances by radio.

The second important factor is weight and the distribution of weight on the motorcycle. Too much weight too high up on the motor

will cause it to become top heavy. If a motor is used by traffic officers it must not have so much weight that it becomes less maneuverable than it was before the radio transmitter was installed. Motorcycles are called upon to travel at high speeds at times and if their versatility is impaired in this respect it is questionable whether a transmitter would be a benefit or a hindrance. Therefore the weight

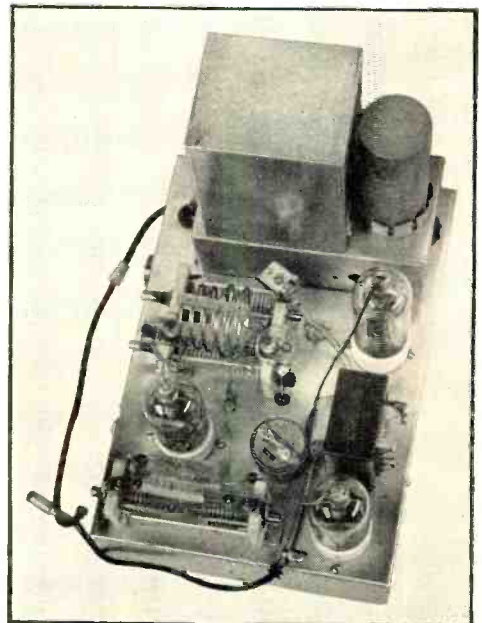

Top view of the transmitter. The small mica trimmer mounted on top of the antenna circuit tuning condenser was used only for tuning the transmitter into a lamp-bulb dummy load and is not used in the transmitter as it is installed on the motor cycle.

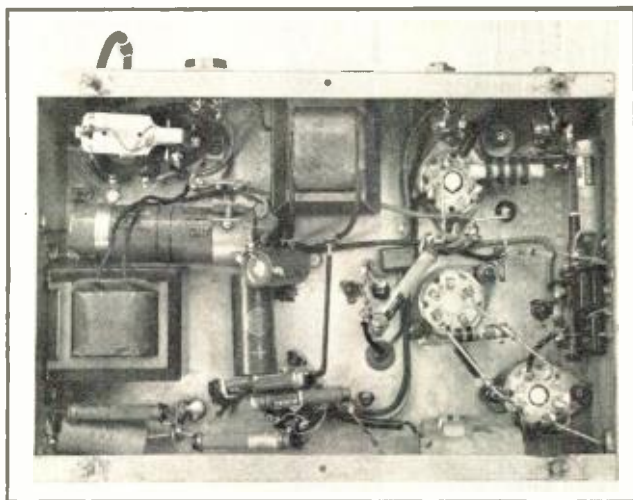

Underchassis view of the transmitter. The two filament chokes for the triode oscillator can be seen in the lower right hand corner of the chassis.

types, it is lighter in weight, it is instant starting (no waiting for rectifier tubes to warm up), and the overall efficiency is better. Also, a vibrapack can usually be serviced at home, whereas a genemotor nearly always has to be sent to a shop especially equipped to repair it. Most failures in vibrapacks fall in this order: vibrator, buffer condenser, filter condensers, and power transformers. Any one of these components can be replaced with a minimum of time lost and at little expense.

The Exciter

The first thing to be considered in the actual planning and construction of a transmitter is the type of oscillator to be employed. Bear-

ing in mind that each tube must perform as many functions as possible, the triode seems to be the answer. Several trial setups were tested. The first idea was to quadruple in the oscillator. This, however, gave insufficient drive and was given up. The second idea was to double in the oscillator and also in the final amplifier. With such small tubes it hardly seems possible that a doubler-final amplifier would give enough output, but a trial of this arrangement proved entirely successful.

An HY65 tube was chosen for the oscillator because of its small size and the quick-heating capabilities of its filament. Several filament chokes were hand wound to make the oscillator function as a triode but each one had

[Continued on Page 79]

Side view of the transmitter installation with the dust cover in place. Note the rubber shock mounts which support the transmitter.

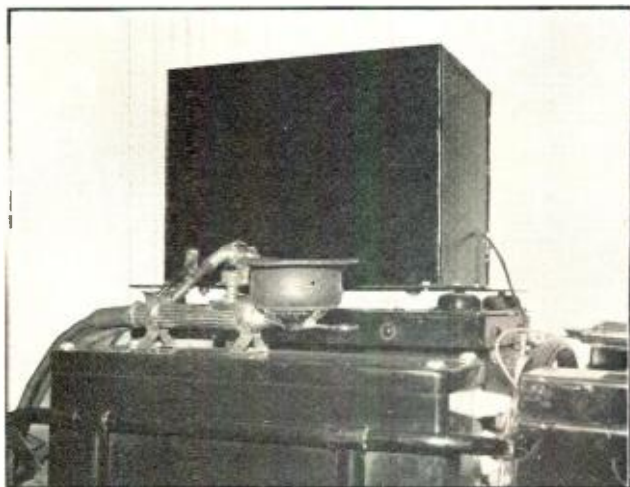

Sound

RECORDING AND REPRODUCTION

Rudy Vallee sings and ad libs for Al Pearce at a party held at the famous "Fun House" at Venice, California, where guests were called upon to offer greetings and comment for the benefit of the Presto portable recorder.



High Quality

LATERAL DISC RECORDING

By H. P. MEISINGER*

There are two general methods of lateral recording, namely *embossing* and *engraving*. In embossing we usually have a diamond stylus with a ball point. The stylus operates at an angle and presses upon the disc with uniform pressure, depressing the disc material without actually cutting it.

In engraving the stylus is sharp, and is in a vertical or nearly vertical position. In engraving we actually cut a thread or chip from the disc. Engraving is the type of recording that we are going to consider here.

Discs

At present either metal, fibre composition, or glass is used for the base of the disc. There are many coating formulas used by the various companies, most of which are similar and most of which are kept secret. There is material to give the coating body, a plasticizer, and a solvent. The incorrectly named "acetate" disc is usually a mixture of either nitro cellulose, acetyl cellulose, or ethyl cellulose and oils, resins, lacquers, and glycerine. The solvent is added so that we can apply the coating to the base. The plasticizer is really a softening material. The chemist, or formulator as he is called, combines these ingredients to meet certain requirements of frequency response, noise level, and record life.

Up to certain limits adding plasticizer will give us a quieter cut due to the fact that we have a softer coating. However, the record life decreases very rapidly with softening. A change of a few per cent in the plasticizer may change the durability from twenty five to two hundred and fifty playings for a rise in noise level of two db. Hardening the coating will, in general, increase the high-frequency response. Incidentally, hardness does not refer

to hardness as felt by the fingers or fingernails, but to *cutting* hardness.

A common defect of cheaper discs takes place when the solvent is not completely dried out. The manufacturer will sell these discs and they will appear to be fresh and to take a quiet cut; however, they will dry out after cutting and develop distortion. Most of these discs do not dry out in the cans in which they are shipped but they do dry out in open air if left out for any length of time, making it hard to get a good cut. A really good disc will not dry out at all.

At the outside of a sixteen-inch disc even the cheaper ones have good frequency response. It is at the center that disc quality begins to show up. This is easy to understand, as the wavelength at the center is not as great as at the outside and the cheaper materials break down when the slope becomes so great. (At a given distance from the center of the disc the wavelength of the groove is inversely proportional to the frequency.) At $33\frac{1}{3}$ r.p.m. a diameter of about eight inches seems to be the limit for good quality.

Of course a softer coating is easier to use, for it can be cut with a comparatively dull stylus (giving a quiet cut) and will not be too critical as to cutting angle. A hard disc will not give a clean, quiet cut unless a sharp stylus and the exact proper cutting angle are used. A harder disc is worthwhile if we want better frequency response, but if we are interested primarily in low noise level the softer material has its advantages. Another difficulty frequently encountered in low grade discs takes place when the coating, instead of cutting clean, tends to be pushed aside by the stylus. The material that is pushed aside will tend to return to normal in a few seconds and develop distortion. One little-known cause of distortion takes place when the formulator

*Washington, D. C.

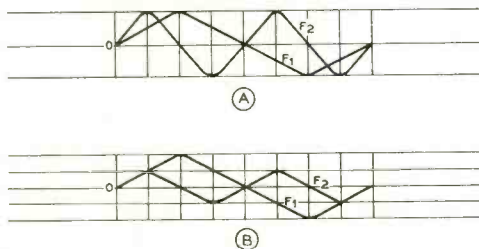

Figure 1. At A are shown the grooves cut by a crystal head at two different frequencies, one twice the other, when fed at constant voltage. At B is shown what happens when a magnetic head is used. In the first instance the amplitude of the lateral displacement is constant; in the second the velocity is constant.

makes the thread "throw" toward the center by making a coating which dries under tension. The thread shortens immediately after being cut and jumps toward the center. Although this simplifies cutting it will cause serious distortion, because just as the thread shortens, the groove wall deforms. It might be well to stay away from thread-throwing discs for best results. A good suction pump or a brush skillfully handled will pay in results secured.

Cutting Heads

A few remarks about some of the available cutting heads seem in order. When a high quality head leaves the factory the frequency response is measured within 2 db from 50 to 10,000 cycles. Heads are matched against each other for equal sensitivity within two db at one thousand cycles. These measurements are made at 72 degrees Fahrenheit. Variations in temperature from 65 to 80 degrees will produce a change in frequency response of as much as 3 db on even the best heads.

A good cutter should fully modulate a groove with one watt input. When making frequency response measurements no more than one watt should be fed into the coils or else they will heat up and this may affect the damping. Also, the coils should be connected in series in such a way as to cancel out the even harmonics, thus cutting down on harmonic distortion.

There are two general types of cutting head, the crystal and the electro-magnetic. It may be well to point out that the crystal head has an inherent constant amplitude characteristic. This is true because the lateral distance of crystal stylus displacement is proportional to the amplitude and not to the frequency, dis-

regarding mechanical resonance. Also, the slope of the cut becomes greater as we go up in frequency on a crystal head. (The maximum slope of the wave is directly proportional to the frequency.)

Velocity, stylus travel, and slope are all related to one another. One is the cause and the other the effect. The electro-magnetic head has a characteristic of constant velocity. The amplitude on an electro-magnetic is inversely proportional to the frequency over the normal range. In other words, going down one octave, or cutting the frequency in half, will double the amplitude.

In figure 1A we see two signals working through a constant amplitude head. F_2 is twice the frequency of F_1 . In figure 1B we have the same two signals on a constant velocity head. The proportions of the two curves hold true for higher frequencies.

There is a range of eight and one-third octaves from thirty to ten thousand cycles. This should make it apparent that with a crystal head the higher frequencies will produce a slope which will be so great that the pickup will not follow the groove, as some of the grooves will cross the mean at almost right angles. Also, on the cheaper discs the "acetate" may break down. There are not many styli which can cut such steep angles.

It should be equally apparent that with an electro-magnetic head we are going to over-cut on the lower frequencies. Of course, to keep from over-cutting we can just decrease the level of sound that we put on the disc. However, this plays havoc with our signal-to-noise ratio.

To simplify the matter, we can design a head which has a cross-over frequency of, say, 500 cycles. In other words, below 500 cycles it is constant amplitude and above it is constant velocity.

We could design a head and put in a filter to gradually lower the amplitude below 500 cycles. But it is easier to take advantage of the natural mismatch that takes place between

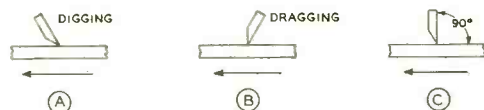

Figure 2. Illustrating incorrect and correct cutting angle. The digging stylus at A will cause a bouncing head. The dragging stylus at B will cause whistling or squeaking. The stylus at C, within 3 degrees of 90 degrees, will give a quiet, shiny cut.

the head and the amplifier at the low frequency end. For example: A head has an impedance of 15 ohms and it is working out of a "15 ohm" winding. The cutting head impedance is 15 ohms at only one frequency. This can be made the "cross-over" frequency. The impedance rises as the frequency rises and drops as the frequency is lowered. The cutter head impedance may drop as low as one ohm. The loss at one ohm will be about 15 db. By putting a 10-ohm resistor in series with the head we can increase the loss another couple of db and keep a more constant load impedance on the amplifier at all frequencies.

The linear velocity of the pickup in the groove is proportional to the distance from the center of the disc to the groove in which the pickup is resting. This will cause the slope to become greater as we go toward the center. Hence, we lose highs toward the center, as the playback needle cannot follow accurately. To make up for this loss of highs we insert a filter in the amplifier so that the output will have a rising character for the highs, and as we cut closer to center we increase the highs gradually, thereby giving more nearly flat response on the playback. At the present time, practice calls for recording at from 88 to 136 lines per inch. By using the lower figure we can put more level on a record without overcutting. The higher figure enables us to keep farther away from the center of the disc, cutting down on the necessity for equalization (assuming a given playing time).

Orthacoustic Recording

"Surface noise" in records is caused by either dirt or dust in the grooves. This noise is worst above 4000 cycles. Also, there is a low frequency rumble which is brought about in recording by the machine and drive mechanism. The portion of the spectrum between two hundred and one thousand cycles contains most of the energy of the average sound wave and very little rumble and surface noise. Now let us boost the highs and the lows about 10 db. With the possible exception of an organ, we can do this without overcutting. If we play the disc back with a filter which is the complement or "inverse" of the recording filter we can cut the scratch and rumble and still have flat response. This is generally called a system of pre-emphasis and de-emphasis or complementary compensation.

Cutting Styli

The cutting stylus is probably the most important part of the equipment, and for the best results there can be no compromise with

quality. This means using a sapphire stylus. Steel and most alloys usually have a certain amount of "give" while cutting. This limits their ability to record the higher frequencies.

Although the diamond is harder than the sapphire it is too difficult to grind. The sapphire readily adapts itself to specification grinding and is very hard.

When ordering a sapphire it should be specified on what type of disc it is to be used. When the sapphire is not in the cutting head it should be put in a container that will protect the whole length of it. One may think that he is not damaging the stylus when scratching the side of the sapphire as long as he does not touch the point, but some time when the sapphire goes up for resharpening, the scratch, which was half way up the side, is now at the point and must be ground away. This kind of scratch causes a great deal of waste.

A sapphire that has been dulled from use, or even one that has been dulled by cutting through to aluminum, can be resharpened without breaking down the edge. However, if there is a chip or break in the edge, new edges must be ground. As long as the edges do not have to be broken down for resharpening the stylus should take about 20 resharpenings. If the edge does have to be broken down the number of resharpenings will be reduced to five or six. The sapphire is mounted in either a dural or brass shank, as these materials do not have much "give" and hence will not lose any highs.

The sapphire usually can be resharpened until part of the shank is actually ground away. When the sapphire is inserted in the shank it usually is turned off about three degrees to throw the thread toward the center.

Mechanical

The actual maintenance and operating of a recording machine is undoubtedly the hardest to write about or to learn by reading. The best thing that can be said is to "learn by doing." The two important parts of the machine are the drive mechanism and feed mechanism. In conjunction with the feed device we have a system of varying the depth of cut.

There is the advance ball system in which a rounded ball or shoe rides next to the head on the uncut portion of the disc. The arm that carries the ball is adjustable and hence the depth can be varied. This system is very good to get a constant depth, i.e., equal groove width. Also, there is the more popular system of having a spring attached to the head. This spring adjustment sometimes is operated in conjunction with either a glycerine or gelatine

compound damper to keep the depth more constant.

On some machines there is also a method of varying the cutting angle while cutting. The actual feed system will depend on the manufacturer. On most machines, in order to change the pitch it will be necessary to change feed screws. This is not a great disadvantage, as speed here is not essential. On other more expensive machines the speed can be changed by either a gear or a movable belt. The worst thing that can happen is to get a feed-screw that is not perfectly turned. This may cause an effect known as "twinning" which will cause an uneven spacing of the grooves. This will cause possible cross-overs where the grooves are thin.

The second and more important point is the drive mechanism. There are two methods of

drive. The rim drive, in which a rubber roller drives against the rim of the turntable, is one type. The change of speed is usually accomplished by changing the diameter of the motor drive shaft. One very important point to remember is to release pressure on the rubber roller when not using the machine, as a "flat" may develop, causing a "wow."

The second method is the center drive system. Here a set of gears and a "mechanical filter" is used, or a belt-drive can be used. In order to get the proper speed reduction with the belt-drive system, two belts in series are used. There is no excuse for having any variation in speed at all, nor is there any excuse for having even a small amount of motor vibration. Speed variation will show up as a "wow." Vibration will show up as hum on the finished disc.

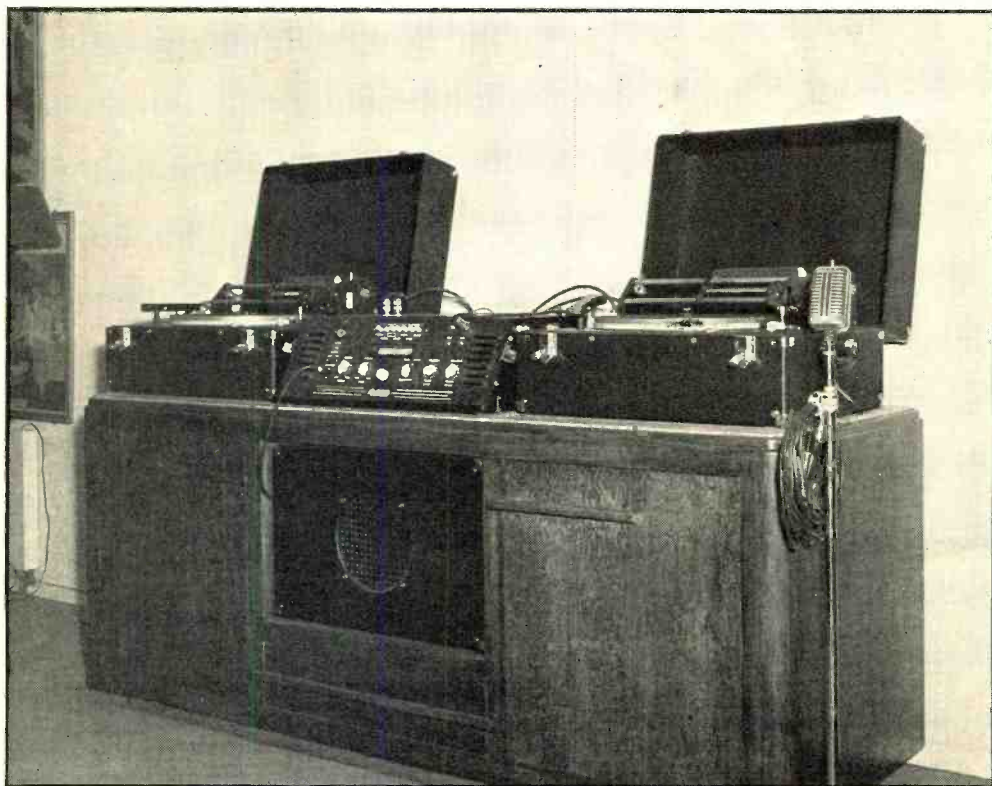

The above installation, consisting of a dual turntable Radiotone portable recorder and a semi-portable cabinet-console, is used by Orson Welles to record advance rehearsals, both for radio productions and movie productions. This permits more careful analysis and the catching of flaws that would be difficult to detect without the recorder. The equipment also is used for auditioning radio talent, saving artists many a tedious wait, and permitting the producer to hear the artist at his convenience.

A 25-WATT C.W. TRANSMITTER

A simple yet efficient c.w. transmitter that is inexpensive to build and easy to get going.

By W. W. SMITH, W6BCX

The newcomer who is contemplating his first rig should find the transmitter to be described just what the doctor ordered for c.w. operation. It offers a high ratio of "watts per dollar" and is not in any way tricky to build or get going, the latter in spite of the fact that it incorporates a couple of interesting innovations.

A straightforward tetrode crystal oscillator, lightly loaded for sure fire operation and clean keying even with sluggish crystals, drives a neutralized 6L6 amplifier either straight through or as a frequency doubler. This permits two band operation with each crystal. Either 40, 80, or 160 meter crystals may be used, permitting operation on 20, 40, 80, or 160 meter c.w. Parasitic suppressors are used in the 6L6 stage and it has no tendency to self oscillate at any frequency, when correctly neutralized.

Oscillator keying is employed to permit break-in operation. To slow down the decay of oscillations a bit, and minimize keying thumps, the cathode bypass condenser is made somewhat larger than usual. The natural inertia or "Q" of the crystal tends to soften the "make," and the condenser C_c tends to soften the "break" by slowing down the cessation of plate current. An .01- μ f. r.f. bypass right at the key terminals will prevent key sparking from producing clicks in nearby receivers, and the keying will be free from serious thumps even though the usual "click filter" has been omitted. An 0.1- μ f. condenser in series with

a 50-ohm carbon resistor placed across the key terminals sometimes will be found necessary in place of the .01 μ f. condenser, but not in every case.

In order to provide a good L/C ratio in the amplifier tank on all bands, separate coils are used. In other words, each band has its own amplifier coil, in spite of the fact that with the tuning condenser specified it is possible to hit two bands with one coil.

To eliminate the possibility of confusion caused by the fact that some of the coils will resonate at two spots, a paper scale is made for the pointer type knob on the amplifier tuning condenser and stuck to the front of the chassis with rubber cement. It is hand lettered with "20", "40," "80," and "160" to show the approximate position of the pointer for each band, after these have been found by experiment. Then, when changing coils for another band, one is not likely to wind up on one band while thinking he is on the next higher or lower frequency band.

To prevent inductive coupling between the oscillator and amplifier tank circuits, the coil sockets are well spaced and the oscillator coils are wound on small-diameter forms to reduce the inductive field.

Perfect neutralization on each band, without need for readjustment when changing bands, is assured by the use of an individual neutralizing condenser for each band. A small mica trimmer condenser of the compression type is stuck down inside each amplifier coil

form and adjusted for exact neutralization for that band. As these condensers are inexpensive, this provides a practical method of avoiding the common difficulty of obtaining neutralization with a single-ended stage which will hold for all bands. The neutralization procedure will be covered later.

To prevent the amplifier stage from drawing excessive plate current when the key is open and the amplifier is not receiving excitation, a system of screen ballast is provided. This does away with the need for fixed bias. When the 6L6 amplifier is being excited, the bias developed across the grid leak is applied also to the 6V6-GT ballast tube, cutting off the space current and making it inoperative. When excitation is removed from the 6L6, the d.c. bias also is removed from the ballast tube, and its d.c. plate resistance drops to a low value. This increases the current drawn through the 6L6 screen dropping resistor R_s , causing the screen voltage on the 6L6 to drop to a very low value. Under these conditions the 6L6 draws only moderate plate current even though it has no bias. A more detailed discussion of this system was described in this magazine,* and the reader is referred to this article if more information is desired.

*Smith, "A Substitute for Safety Bias When Using Screen Grid Tubes," RADIO, December, 1941.

Because meters are expensive and rapidly are becoming scarce, a 6.3-volt 150-ma. dial lamp is used as a plate current indicator for the amplifier. This bulb is mounted in a rubber grommet of such a size that it is held snugly in place. No plate current indicator is required for the oscillator, as this stage simply is tuned for good output with clean keying. Under no conditions of tuning will the oscillator plate current become excessive.

To prevent the oscillator screen voltage from rising to the full d.c. plate voltage when the key is up, thus endangering the crystal and producing a tendency towards chirp because of the d.c. charge on the screen bypass condenser, a potentiometer arrangement is used rather than a straight dropping resistor.

The antenna coupling method used is flexible and permits any desired degree of coupling without adding an excessive amount of leakage reactions. It may be used to feed an untuned line, or, by the addition of a series condenser, may be used to feed a tuned antenna such as a zepp, Marconi, etc.

Antenna coils of 1, 2, 4, and 8 turns are "scramble" wound out of pushback hookup wire and terminated with banana plugs as shown in the illustration. The multi-turn coils are held together by tying them with heavy thread. The coupling coils are made 2 inches in diameter so as to fit loosely but not too

This 25-watt c.w. transmitter has been designed with the primary thought in mind to make it as inexpensive, foolproof, and easy to construct as possible. Observe that a composition chassis has been used in place of a metal one, and that no milliammeter is included.

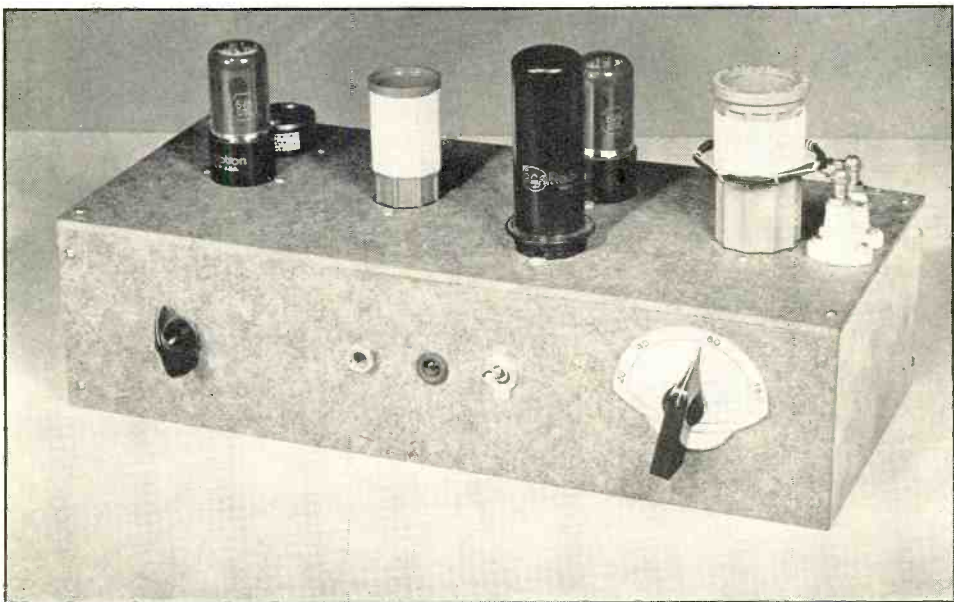

loosely over the 1½-inch coil forms, and fine adjustment is obtained by varying the position of the link with respect to the coil. If more or less coupling is required than can be obtained by bending the link up or down, a link with more or fewer turns is substituted. Two jack-type standoff insulators are mounted close together right beside the coil socket to accommodate the plug-in links.

The chassis upon which the transmitter is built is constructed of white pine and Masonite Presdwood, fastened together by means of wood screws and glue. The Presdwood, the thin "tempered" variety measuring just slightly over ⅛ inch in thickness, is used for top and front, with the pine making up the back and sides.

Two pieces of Presdwood are required, one measuring 14½ by 6½ inches, and the other 14½ by 3½ inches. Three pieces of surfaced white pine are required, one measuring 13¼ by 3½ inches and two measuring 6⅜ by 3½ inches. The pine (surfaced both sides) measures approximately ⅝ inch in thickness.

Fahnestock connectors are fastened to the back of the chassis by means of bolts which go all the way through the wood. An extra pair is provided (not shown in the diagram) which go nowhere except to a toggle switch on

the front panel. This permits the power supply to be turned on and off from the front of the transmitter panel. While not really necessary, it is a handy feature, and can be included or left out at the option of the constructor.

The rotor of the oscillator tuning condenser is "hot" with d.c. plate voltage, and the rotor of the amplifier tuning condenser is "hot" with both d.c. plate voltage and r.f. However, as the Presdwood is a good insulator (both d.c. and r.f.) the condensers are bolted directly to the front panel. Knobs or pointers should be chosen of the type which have a set screw which is comfortably countersunk. This prevents the possibility of the operator's getting "bit" from the set screw.

The power supply is conventional, using the minimum amount of filter which will provide a satisfactory note. Because of the high value of input capacity and the low resistance of the specified rectifier tube, the regulation of the power supply is quite good even though it isn't of the "choke input" type.

Adjustments

The 160-, 80-, and 40-meter amplifier coils contain their own mica trimmer. The ampli-

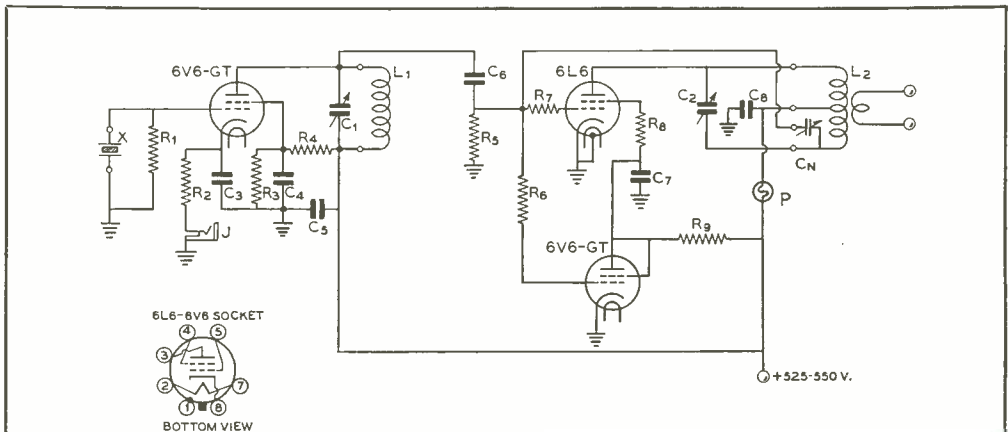
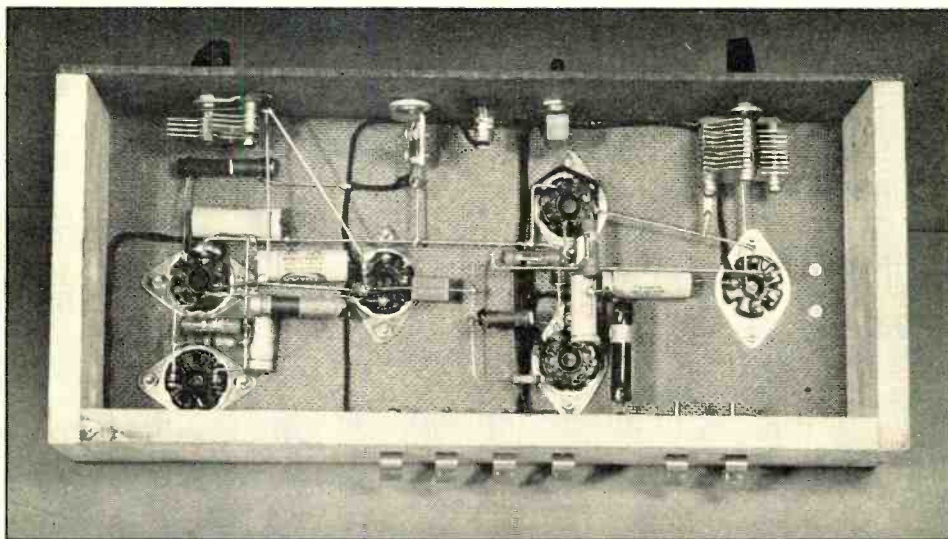

Figure 1

Schematic Diagram of 25-Watt C.W. Transmitter.

- | | | | |
|---|---|---|---|
| R ₁ —50,000 ohms, ½ watt | R ₇ —50 ohms, ½ watt | C ₄ —0.1-μfd. tubular condenser, 400 v. | compression trimmer, adjusting screw removed, inside 40-, 80-, and 160-meter coil forms |
| R ₂ —500 ohms, ½ watt | R ₈ —50 ohms, ½ watt | C ₅ —0.1-μfd. tubular condenser, 400 v. | |
| R ₃ —15,000 ohms, 1 watt | R ₉ —25,000 ohms, 20 watts | C ₆ —40-μfd. midget mica condenser | J—Keying jack, closed circuit type |
| R ₄ —50,000 ohms, 3 watts (two 100,000-ohm ½-watt resistors in parallel) | C ₁ —50-μfd. inexpensive midget condenser | C ₇ , C ₈ —0.1-μfd. tubular condenser, 400 v. | |
| R ₅ —250,000 ohms, ½ watt | C ₂ —140-μfd. inexpensive midget condenser, at least .025" spacing | CN—3-30 μfd. mica | P—6.3-volt 150-ma. dial light (these are identified by brown bead) |
| R ₆ —500,000 ohms, ½ watt | C ₃ —0.1-μfd. tubular condenser, 400 v. | | |



Under chassis view. Because of the good insulating properties of the Presdwood panel, the tuning condensers are bolted directly to the panel. The small dial light in the exact center of the front panel is used as a plate current indicator.

fier is never used on 20 meters except as a doubler (the oscillator is not designed for use with 20-meter crystals) and therefore the 20-meter coil does not require a neutralizing capacitor. The adjusting screw is removed from the capacitor on each of the lower frequency amplifier coils, and adjustments are made simply by bending the removable plate closer to or farther from the stationary one. A six-inch rod of insulating material such as glass, lucite, or even dry wood will enable one

to vary the capacity while the plate voltage is applied.

Insert the key and the two 40-meter coils. Turn the amplifier plate condenser so that it is about $\frac{1}{3}$ meshed. Turn on the power supply plate voltage (remembering that it takes

[Continued on Page 88]

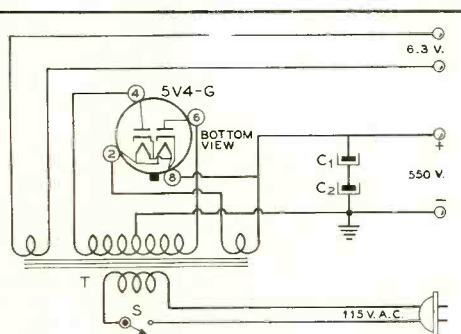

Figure 2

Schematic of 135 Ma. 525-Volt Power Pack for 25-Watt C.W. Rig

T—800 v. c.t., 150 ma. or more, with 5 v. and 6.3 v. fil. windings

C₁, C₂—16 μ f. 350 volt electrolytics. Should be of same make, capacity, and voltage rating.

COIL TABLE

Oscillator

($\frac{1}{4}$ inch dia. forms)

160 M.—50 turns of no. 26 enamelled, close-wound

80 M.—30 turns of no. 22 d.c.c. close-wound

40 M.—12 turns of no. 22 d.c.c. spaced to $\frac{1}{4}$ inch

Amplifier

($\frac{1}{2}$ inch dia. forms)

160 M.—54 turns no. 22 d.c.c. close-wound

80 M.—26 turns no. 22 d.c.c. close-wound

40 M.—22 turns no. 22 d.c.c. spaced to $\frac{1}{2}$ inches

20 M.—12 turns no. 22 d.c.c. spaced to 1 inch

For data on coupling link, see text.



By JOSEPHINE CONKLIN,* W9SLG/3

January, 1942! Doesn't that date just ooze with the idea of "time marches on"? If we continue to enjoy ten meter summer short skip and five meter dx this year, it will run to some eight years of the sunspot cycle. Five years used to qualify anyone as an old-timer, so it is to be assumed that the ultra-high frequencies have been open for the whole amateur life of many present hams.

It was about seven years ago that the late Ross Hull sensationally opened things up for five meter work on the order of 100 miles without use of mountain-top locations, by the simple expedient of using an eight element beam on some fair u.h.f. equipment, not outstandingly efficient from present standards. Since those days, the east became noted for five meter dx over distances above a hundred miles and, some two years ago, similar dx work became more common in the middle west.

Since we moved to Washington where frequent ragchews with the eastern gang have been possible, it is apparent that this eastern dx is not such a consistent thing as most of us had imagined. Only a small percentage of the fellows on the ultra-highs are pushing out their signals to extremes for ground wave dx without the help of low atmosphere bending. Most of the fellows have antennas, receivers and transmitters which do not compare favorably with those used by Ross Hull in his Hartford-to-Boston work long ago. Those in the middle west who get out beyond a hundred miles are more often using rather good beams and equipment, with the result that the work is noticeably more consistent than it is in the east. Much work like that of W9YKX-NFM across Iowa, 235 miles, has gone on each week for nearly a year without appreciable interruptions. There is also a greater use of keyed carriers in the middle west work, which is a great help in making regular contacts at

*300 Wilson Lane, Bethesda, Maryland.

long distances when no low atmosphere bending assistance is present.

Now that priority troubles have overtaken amateur radio—except where supply houses, Sears and Ward, still have a stock (including copper pipe)—let's get out the wood-working tools, improve the antenna situation, and put our ingenuity to work fixing up our rigs.

Skip Antennas

During the 1941 summer five meter dx, many ideas on which antenna is best have come into the minds of the gang. Let's review some of these reports.

In June, W5AJG wrote as follows:

"Have been having a good time running two transmitters lately. One is 30 watts on 56.6 with a low (30 foot high) beam antenna and the other is the 300 watt rig with a 70 foot high beam. And am I learning things. At times and for certain critical skip distances the low beam will whip the socks off the high beam both on transmitting and receiving. Power seems to have little effect except upon opening and closing of the band, when it seems to get out slightly better. Boy, that antenna height surely does have the effect, though. I used to have trouble working the close in W9's last year and the year before, and swore I would try a lower beam for meanness, so I put her up this year and it works swell."

On August 11, Leroy added these comments:

"A very peculiar condition has existed during the last month or so. The beam has to be on anyone to work them. I do not get the same result as W6OVK wherein his beam doesn't make too much difference this year. I lost several QSO's before I got wise to the fact. Especially the last month of openings. Also, I have found that my low beam (working two transmitters at the same time on two antennas as reported to you previously) whips the socks off of my high beam many times. All stuff to the west is raised and received better off the low beam."

Turning to the reports of Jim Brannin, W6OVK, it is noted that on July 3 he said, "I am trying out an extended double zepp vertical. So far, I cannot tell any difference on normal one hop signals but the four element is 1 to 1½ R's better on the W8's." On July 9 he adds, "The vertical e.d.z. did not do nearly as well as the four element horizontal, although once or twice it did a fair job for very short periods. It seemed best on W8CIR for a few minutes." The next day the e.d.z. worked well on W9YKX and W7FDJ but poor on others. On July 22 the vertical e.d.z. was very poor. He sums up the summer antenna comparisons as follows:

"W6PGO and I have made some tests on antennas. PGO while using an e.d.z. vertical heard 7 out of 9 stations that I heard on my beam on July 8. On July 22 he used a half wave vertical (exactly the same antenna that we both used last year) and heard only 3 out of 14 stations that W6QAP SLO and I worked. During some skip to Texas and Oklahoma last winter, I tried a half wave vertical, delta matched, against my beam and found that the signal had to be 4 to 5 R's above the noise on the beam (3 elements at that time) before they could be heard at all with the b.f.o. on and using the vertical half wave.

"Summing it all up, the half wave vertical is just out of the picture and I'm sure that is one reason we did not work the dx here last summer that we have worked this summer with higher gain antennas. The e.d.z. is certainly far better than the half wave, and approaches the 4 element in gain on skip signals at certain times. I believe that conditions have been somewhat better for us here in Tucson this season; however, I believe the main factor is the antennas being used here this season which have enabled us to make 60 or 70 percent more contacts than we would have made on those vertical half waves.

"My e.d.z. vertical compared fairly well this summer with the four element except when double hop was coming through. Only once did it approach the beam and that was on W8CIR, when it did well on two occasions.

"Lots of fellows remark that anything works when the band is really open. This is true to a certain extent. I've heard several fellows R7 to 8 with no antenna on the converter but that doesn't prove that 'anything will work' when it comes to double hop and to the extended single hop stuff that is not R9 double plus with a good beam. In order to scoop up some of that noise level dx, you gotta have something with good gain."

On June 1, W8CIR shifted some antennas, about which Joe Addison, W9PKD, makes these comments:

"W8CIR changed from horizontal to vertical several times against my 3 element 1/4 wave spaced horizontal and he was 12 db stronger on the horizontal than on the vertical."

The classic story on skip antennas is that polarization as such makes no difference except in local noise, and that the high antennas used—in terms of wavelengths—cause nulls to appear at certain angles, depending on the height and polarization, which makes for very marked differences between antennas on a given signal. The ideal situation still seems to be a fairly low antenna at the peak of a gradual slope—possibly about three degrees—

that will give good response between zero and 20 degrees above the horizon.

New Tubes

A G2 is—or was—visiting at the house. Every time that Bill—who is now W3JUX instead of W9BNX—gets together with the G2, they discuss how to squeeze more Sporadic-E layer dx contacts out of the band and how to push signals across the Atlantic. Summer ten meter Sporadic-E layer skip has already been heard in England nearly every year—a little more punch may do it on five meters even without waiting for the next sunspot cycle to bring about peak conditions for winter F layer skip. The boys are getting down to design details now, but the rate of technical improvement is such that their ideas are constantly changing. They carry around little tubes that do tricks that even they would not have believed two years ago. Some of these cannot be told yet, but some can.

The November issue of the *IRE Proceedings* carries an article about "The orbital-beam secondary-electron multiplier for u.h.f. amplification." This tube looks like a 955 acorn except for about twelve radial pins coming out of it instead of five. A cathode, grid and screen structure in it is like that in the 954, but this structure is mounted along one side of what looks like a thimble. On the other side of the thimble is a hole, inside of which is the plate. Outside of the hole is a metal sheet or target. Electrons leaving the cathode are made to travel around the thimble until they hit the sheet, knocking a lot of electrons out of it by secondary emission, which go through the hole and are collected by the plate.

This tube is operated normally, with no external magnetic field. Input is fed into a concentric line grid circuit, and the output is taken from the concentric line plate circuit, just as described in this magazine and in the *RADIO HANDBOOK*. Measurements on a developmental tube used in a resistance-broadened television circuit indicated a voltage gain of seven times with a 6 megacycle band width on 500 megacycles. A data sheet promised a gain of about 115 at 100 megacycles, compared with just about nothing or an actual loss on most ham r.f. stages. A good 954 concentric line r.f. stage might hit something like a stage gain of 16 at 112 megacycles, so the new tube represents a real improvement that will knock the old signal-to-set-noise ratio into a cocked hat, iron derby, or something. It is believed that production tubes with a reasonable life are not available to amateurs as yet, but they may be coming along soon.

Another paper in the same issue discusses

the behavior of electrostatic electron multipliers as a function of frequency. These tubes have been studied as high as 500 megacycles but the upper limit of present models appears to be of the order of a few thousand megacycles.

Nor are these by any means all of the possibilities which can be applied to amateur u.h.f. work. Our suggestion to all of our readers is to turn back the pages of this magazine and the handbook and read up on transmission lines as circuit elements. After that, build up improved equipment for everything above 56 megacycles using acorn tubes, the 9000 series, and also the new Sylvania 1201-1204-1282 which have standard locked-in bases but good u.h.f. characteristics. A few pieces of metal and a good tube make up the major items in efficient u.h.f. receiver construction. If you can not get copper, remember that there is lots of silver around with which to plate other metals.

Skip DX

This is written before any reports of a possible recurrence of the December openings have reached us. However, the band opened for Sporadic-E layer dx on October 20, 22 and November 1.

Bill Copeland, W9YKX, says that the boys on the east coast were rolling in like nobody's affair for a short period on October 20. He worked W1DLY and W2BYM.

Bill told Mel, W2BYM, that this was the first real dx opening of this type for him since their contact on August 18. BYM raised W9FFV and W9DYH in St. Paul, Minnesota, for a new state—adding contacts with W4FBH W9NFM YKX.

W1LSN came on late to hear only W4FBH. W9RFT in Waterloo, Iowa, heard W2BYM with a very strong signal, and some other carriers that were not identified. He may have been a little too close to the east coast to hear many others.

Two days later, on October 22, W2BYM did it again by working W4FBH DXP and hearing W4EQM.

The u.h.f. field day brought out some aurora dx on Saturday and real skip on Sunday. On November 1, W2BYM enjoyed a short but snappy opening in which he worked W9OFL ZHB KZD RGH LF HSD. He dropped a message into W9ZHB thirty minutes after it was filed at W1HDQ.

W3AWM in Washington heard W9HAQ and W9ZHB working W3IIS and W2BYM. W3CUD worked W9HSB and heard W9KZP LF. W6OVK observed all of the signs of an opening on November 2 but it was all in vain.

Anyhow, with W5AJG busy and W5VV in Washington, it will be harder for Jim to scare up contacts.

W1LSN found the band open for skip dx last summer on May 19; June 4, 5, 23, 28, 29; July 24, 29; August 9, 11; and for aurora dx on July 5, 6; August 6, 18; September 11. Jerry is in Exeter, New Hampshire, where he has provided a new state for many of the boys near and far. Running down his log of open days, the following calls appear as heard or worked: W9UWL; W6OVK W8RFW KKE W9ZQC HAQ OFL LMX AKF LLM NFM ARN GHW BDL NYV; W4DRZ FBH; W8QYD NSS QQP W9NFM WWH ARN RRX; W8KQC TIU W9IOD BWJ; W9BDL; W2HGU W3CUD HDJ W8QXU; W2BYM; W4FBH W9NYV LMX IOD LF RRX; W2AMJ; W4FBH EQM; W3HWN W8CIR; W4FBH.

W2LAL used 57.324 kilocycles to good advantage during the summer. He hooked some aurora dx on July 6 and skip on May 10; June 5, 9, 23, 28; July 7, 14, 29; August 2. Running through his log, we note these calls: W5BDB DXW; W9USI IFB ZHB NFM; W4DRZ FPM W9GHW; W4FKN DRZ FBH W5DXB DXW HTZ AJG (and not a W5 could hear him); W5HYT W9STX ZHB RRX YLX YKX GRH OLY; W8CIR; W4FBH DYH; W9YKX; W4FBH; W4DXP AUU FLH HHW W5AAN AXA(?).

October 31 Aurora DX

The boys seem to have been on the lookout for more aurora dx, for there were more reports about October 31 received by this column than on skip dx.

In an hour and a half following 7 p.m., Eastern time, W8FGV in Barberton, Ohio, worked W3HDJ W8RNP NYD W9ARN AKE and heard W1HDQ LLL LSN W3AXU BKD CUD W8FDA JLQ KWL CIR QQP W9ZHB GFT. Frank left the house at 8:30 but found the band still open when he came home at 1:30 a.m.

W9CJS in Bryant, South Dakota, says that Curly of W9ZQC NLR is home from the Army and got in on the October 31 aurora, working W9HAQ and hearing W9NFM RFT.

In Lakehurst, New Jersey, W2BYM worked W8QQP NYD FDA. W9NFM came on and smothered W9NYD with an RST599 signal. Other than that, the aurora signals were way down in comparison with previous openings of this type.

Harry, W3CUD, was really around his rig on this week-end. He worked W8FDA CIR W9NFM AKF and heard W1LLL AEP W8NYD FGV W9ZHB IDJ on the so-called

aurora dx which may have been mixed with a little Sporadic-E skip on the better signals from Iowa and thereabouts. Perhaps W2BYM, W3CUD and others checked the beam direction on these long signals and can comment on the matter.

W8KWL in Morgantown, West Virginia, gives the aurora dx date as October 30 but the calls look like the above reports for the following day. He worked W8JLQ W9IOD NFM and heard W1LLL W2BYM W8CIR FGV RUE TDJ W9ZHB IOD NFM. On an earlier day of aurora dx, September 18-19, W8KWL worked W2BYM ILK W8KKD NSS KQC W9ZHB IOD and heard W1NF W2BYM ILK W3HDV AXU W8BKI RUE CLS CIR KKD QQP NSS KOC BPQ KQC OKC KDR QQS NYD FGV W9RHB ZHB AQQ.

Calls heard and worked by W1LSN last summer on aurora include these: July 5, W2HGU W3CUD HDJ W8QXU; July 6, W2BYM; August 6, W2AMJ; August 18, W3HWN W8CIR.

Ground Wave Work

Here it is winter, and most of the news has been of dx work by skip or aurora. The usual seasonal reduction in low atmosphere bending in the east has been noticed but long ground wave work still goes on.

W9YKX in western Iowa is making most of his contacts with W9NFM in eastern Iowa. NFM has pushed his beam up to 70 feet and his phone comes in nicely at YKX at times. This statement implies that one of the basic reasons for the Iowa dx is the use of a keyed carrier—something that the easterners have largely neglected, judging from the word reaching this column. Another contact made by YKX is W9RFT in Waterloo, Iowa.

W9YKX called on W9NFM on a week-end in October and was later joined by W9HAQ and some of the Illinois boys in Davenport for a good five meter ragchew.

Robbie, W4EDD/3, is moving 10, 5, and 2½ low power rigs to Washington where he is looking for a house. The bug is biting him hard again and he cannot wait until he gets on the air.

W5AJG says that the ground wave boys are slowly coming back on. Leroy has been working Merlin, W5HTZ, 165 miles away up in Cromwell, Oklahoma. Contacts have been daily for some ten days. W5ATH EYZ are back on in Fort Worth.

Last July 16, W1LSN in New Hampshire worked W3AC/3 for a nice long haul.

W6OVK and W6QLZ still make regular 107 mile contacts over the mountains, finishing a

The Saga of Five Meters

Our story which we will relate
Of facts and things right up to date
Concerning hams who once of yore
Did work on five by many a score.

They loved to tune and listen 'round
The band on which signals abound.
And laugh and joke and talk and chew
And even play some records too.

Then came one day an awful jolt
Which caused so many to revolt.
"We'll not go crystal," so they said
And so at once the band went dead.

Except a few old faithfuls who
Went at it with a different view.
"We'll try it out—give it our best,
And give this band a real fair test.
Why should we leave our favorite bands?
"Twill not lick us for we are hams."

So on they march and start to make
Real progress toward the goal at stake.
Where once a signal went a mile
Results like that now bring a smile.

Dx in days of used to be
Is now a common thing to see.
Converters which are now the style
Make listening on the band worthwhile.

Excessive hiss is now absurd
Reradiation just is not heard.
Antennas too, improved in style,
Bring signals in from miles and miles.

We hear remarks and things are said
About the band they all think dead:
" 'Twas fun those days," you'll hear them
say,
"Too bad it's not like that today."

But wait, good friends, it's not like that.
Don't let old five take such a bat;
It's better now than e'er before.
Let us step up and take the floor.

Just 'cause it's crystal now you go,
It doesn't take up all your dough.
Just double down from ten you know
And just watch where those signals go.

It's up to you and up to me
To make it like it used to be.
Enough of this, let's look alive
And greet each other down on five.

—W1LSN

year of daily tests without failure although only c.w. got through at times. They are more enthused now about the fact that they have been able finally to do it on 112 megacycles with vertical polarization. Only horizontal antennas had been successful in the past. W9RFT in Waterloo, Iowa, moved to five meters in October and picked up ground wave contacts with W9ARN HAQ SBU YKX NFM ZHB. He holds nightly schedules with W9ZHB at a distance of 174 miles using 57,192 kilocycles phone and code. For his first month on the band, he is doing right well, but he can still try for Minneapolis-St. Paul. Vernon talked about five meters for a year and a half, and finally kept his promise to W9YKX NFM by getting on the band.

In Morgantown, West Virginia, W8KWL came back on the air in July after a lapse of six months. His ground wave contacts are mostly with W8RUE CLS AOC CIR whom he can work almost any time that they turn their beams toward him.

Miscellany

George Ashton, W9PNV, called on an old friend recently. He is Harry Lang, VE3ADO. George asked VE3ADO and VE3EYY what takes the place of ham radio and just got the old stary glare. Like a certain G2 we know whose greatest urge to get on with the war is based on getting back on ten meters to call "test."

Speaking of G's, the government over there seems to be a bit sorry that there are not more hams who can turn to on various types of radio work. This may be a great thing for amateur radio after the fuss is all over. But the rules seem to have both good and bad points. It took a long while in Britain to get a u.h.f. permit whereas the tendency here was to let the least technical boys go on the air with "bobulated oscillators." But the one year period of operation on a dummy antenna before getting a transmitting license in Britain was conducive to learning something about the subject. When the inspector glanced through the embryo ham's notes, he might point to one and ask, "And what did you learn from this experiment?" This kind of a background may lead to a more intelligent approach to the subject of "what goes on inside" than a policy of accepting a memorized examination that is lost to the applicant shortly afterwards. He is likely to do things later "B.S. and B.I." as the G's say, meaning by brute strength and bloody ignorance.

While on the subject, another Royal Air Force saying seems to be "N.B.F." meaning

that someone is no ball of fire—or just slow and stupid.

One ball of fire over there seems to be Johnny Hunter, G2ZQ, who has been reported in the *T & R Bulletin* to have been promoted to Squadron Leader, the equivalent to our Army Major or Navy Lieutenant-Commander.

VE3ADO says that Arnold Ely, W8IPD, in Niagara Falls, has been married. That may explain why the old post officer has not been on the five meter band, but we allow him only the usual six months for his honeymoon after which his return to the fold will be in order.

Leroy May, W5AJG, has been busy with some remote pickups but never fear, he will be back on the air before you know that the band has been open again.

W8GZP/3 has moved to Washington to be an instrument maker in the Navy Yard. He is thinking of the ultra-highs as a place to play around, finding photography a dull substitute for ham radio. For the information of others like him, the Washington Radio Club meets twice a month on Saturday (drat them!) in the rooms of the Capitol Radio Institute.

Incidentally, the club had about 75 including a large u.h.f. delegation at a dinner on Saturday (drat them again!), November 15. We thought of going over there at 2 a.m. but it seemed to be too late. Some of the boys left at ten p.m., but others like Vince Dawson, W9ZJB/W3JLS stayed on until six a.m. There were to be station visits afterwards, but no news of them leaked out.

When W9UZX lived in Wichita, Kansas, in August, he worked W6OVK SLO W7ACD. Now he has taken up residence in Rushville, Missouri, where W9YKX and the other Iowa boys will be out after a contact with him.

W9RFT in Waterloo, Iowa, started out on five with 180 watts on a single HK54 in the final. It works into a horizontal three element rotary beam 56 feet high. His receiver is a DM36 in front of an SX25. Other activity around him includes W9WIP who has been using a ten meter beam but plans to put up a three element "ZHB Special" soon. Also, W9OJD near Mt. Auburn, Iowa, is coming on the band soon.

In Morgantown, West Virginia, W8KWL uses a 6L6, 807, and 200 watts into push-pull T40's. The beam is a four element horizontal. The receiver uses two 1852's and a 6C5 into a Howard. Another West Virginia station is W8KWI in Clarksburg who has 125 watts into his final.

Vince Dawson called on W3HXI in Takoma Park, Maryland. HXI uses a pair of 6L6's that push up to W1HDQ now and then.

The receiver is an 1852 mixer into a small broadcast receiver.

The Monday noon luncheons at Harding's

restaurant at the Fair Store in Chicago have been resumed, according to W9PNV.

W9LLM in Illinois worked all districts using a 35T final with 35 watts input. His receiver is a DM36 into an HRO.

There are two research problems awaiting someone who has the time to work on them. One is a study of aurora dx in relation to magnetic and ionosphere storm; the other is a study of seasonal skip dx to see just how much of a December peak there is from year to year. A good deal of the information necessary for the study is available in the *IRE Proceedings* and *RADIO*.

Above 112 Megacycles

As to dx, W2OEN in New Jersey has started to get out. On September 20, Dave raised W2HZR/8 at Beach Lake, Pennsylvania, 100 miles away. Two days later he got W1LZB at Boston which he figures at 218 miles, and again at Kingston, Mass., a little closer. He also worked W2LH at Middletown, New York, over 100 miles. Many W1 contacts have been made including W1HDQ, using only a five watt carrier. But he has a 16 element vertical rotary beam consisting of four double extended zepps in phase backed by eight $\frac{5}{8}$ wave parasitic reflectors.

Perry Ferrell in Pleasantville, New Jersey, is still copying 112 megacycle signals. On September 22 he logged W2TY NKO BYM OCP EZE NHE RZ LXO W3BZJ IBH and others, but he seems to have missed the Boston signals that were rolling into the state a little farther north that night.

W3CGV in Wilmington heard W2TY LMS on September 22 and W2LCO OCP LZY NKQ W3AYG on October 2. He says that 100 miles is easy to W3HOH. He also mentions hearing W3IOF in Camden and W2JSJ MIV in Brooklyn.

W9LLM in Downers Grove, Illinois, has been heard by W8AKR, 125 miles away. W9PNV says that W9RLA of Chicago has been heard in Kalamazoo, Michigan, at 120 miles. PNV as well as LLM was reported by W8AKR in Breadsville, Michigan, which is 110 miles for PNV. PNV worked W9AVE who was using the Coast Guard tower at Michigan City, Indiana, 55 miles away—with the help of temperature inversion. The Chicago gang is still a little behind on two-way 112 megacycle dx.

W6OVK-W6QLZ Review

Contacts above 100 miles are now being made on 112 megacycles by several more of the Arizona gang, especially on recent field

56 Mc. DX HONOR ROLL

Call	D	S	Call	D	S
W5AJG	9	38	W4FLH	7	18
W5HTZ	9	29	W5CSU	7	
W8CIR	9	35	W5EHM	7	
W8RKE	9		W6OVK	7	23
W9AHZ	9	16	W8CVQ	7	
W9AKF	9		W8OKC	7	12
W9AQQ	9	25	W8PK	7	9
W9CBJ	9	31	W8RUE	7	21
W9CLH	9	23	W9BJV	7	15
W9GHW	9		W9GGH	7	
W9CJS	9	22	W9IQZ	7	14
W9LLM	9	17	W9PKD	7	13
W9NYV	9		W9SQE	7	22
W9PK	9	25	W9WWH	7	26
W9QCY	9	25	W9ZUL	7	18
W9USH	9	18			
W9USI	9	24	W1LLL	6	24
W9WAL	9		W1LSN	6	18
W9YKX	9	30	W1CLH	6	13
W9ZHB	9	43	W1JFF	6	11
W9ZJB	9	31	W1KHL	6	11
W9ZQC	9	26	W1JJR	6	17
			W2KLZ	6	
W1DEI	8	20	W2LAH	6	
W1EYM	8	20	W5VV	6	18
W1HDQ	8	31	W8LKD	6	11
W1SI	8		W8NKG	6	16
W2BYM	8	30	W8OJF	6	
W2GHV	8	24	W8PKJ	6	12
W3AIR	8	24	W9NY	6	13
W3BZJ	8	27	W9CJS	6	
W3RL	8	29			
W5AFX	8		W1GJZ	5	15
W5DXW	8	21	W1HXE	5	18
W6QLZ	8	23	W1JMT	5	9
W8JLQ	8		W1JNX	5	12
W8QDU	8	25	W1JRY	5	
W8QQS	8	17	W1LFI	5	
W8VO	8		W2LAL	5	11
W9ARN	8	17	W3CGV	5	10
W9EET	8	15	W3EIS	5	11
W9VHG	8		W3GLV	5	
W9VWU	8	16	W3HJT	5	
			W4EQM	5	8
W2AMJ	7	22	W6DNS	5	
W2JCY	7		W6KTJ	5	
W2MO	7	25	W6QAP	5	14
W3VYF	7	22	W6SLO	5	19
W3EZM	7	24	W8EGQ	5	10
W3HJO	7		W8KWL	5	13
W3HOH	7	17	W8NOR	5	16
W4DRZ	7	22	W8OPO	5	8
W4EDD	7		W8RVT	5	7
W4FBH	7	17	W8TGJ	5	9
W4FKN	7	16	W9UOG	5	8

Note: D—Districts; S—States.

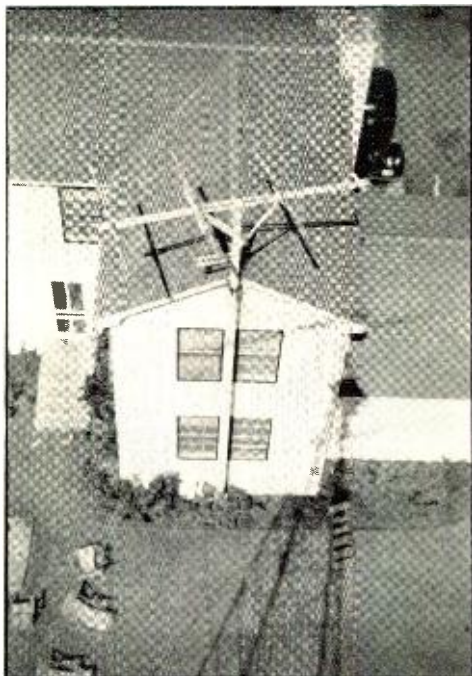

Looking down on the "little friend" at W5AJG from atop the "big friend."

days. Jim, W6OVK, passes this dope on to us in several letters:

"On November 2, I heard W9KMB/6 while he was on Signal Peak near Globe, a distance of 80 miles. W9KMB heard me one time during the afternoon but I had to QET at 4 p.m. so did not get to contact him. He came through nicely here at my home station while he was working W6QLZ and W6PCB. The Rincon mountains stick right up in my face in the direction of Globe and this cuts down our signals considerably in spite of W9KMB's high altitude on Signal Peak, which was 8000 feet. The Rincos reach 9000 feet at some points, and are around 4500 to 5000 feet and only eight miles from my shack in that direction. W9PCB with W6SLO's help went to Mount Lemon, 30 miles from Tucson, and was R9 plus here in Tucson. . . .

"Clyde is coming through nicely here on 112 again with signals reaching R8 to R9 on some evenings. I am about to try my new 112 megacycle preselector using a 9003, which may improve W6QLZ's signal. I also have 9000 series tubes in a 224 megacycle superhet converter working into a 56 megacycle superregen detector, which has been tested on W6SLO's 1¼ meter transmitter. . . .

"W6QLZ and I are just rounding out our first year of daily tests on five meters, with several months of 112 megacycle tests thrown in. We made our first contact on five meters on November 11, 1940. Since then we have contacted daily with the exception of a few days during this period when one or the other could not be on the air. These have been few and we have never found a day that signals could not be put across this path, although there have been a few occasions when we had to postpone the schedule for half an hour or so due to local thunderstorms and heavy lightning nearby. From all indications, 2½ meters is an every day, any time affair although our antennas on five have much the advantage in height, and have more power in them too. . . .

"Our tests show very definitely that signals are far the best from September to April, and drop off to very low levels through the summer months (the reverse of Ross Hull's data), forcing us to c.w. on several occasions. Practically no inversion of any consequence is noted here in the desert during the summer months. In winter, it is much the best with Clyde Hitting the peg on the meter at 18 db over R9 lots of days and seldom failing to hit R9 every day."

"Well, we finally made the grade on 2½ from Phoenix to Tucson with vertical antennas! After a number of tests with QLZ using 6 and 8 element Yagi's and a half wave, Clyde finally got a signal through using a new coaxial vertical. He worked both W6SLO and myself with this antenna, crossband from five. W6SLO and I both use extended double zepp verticals here for vertical polarization. I have tried to hear Clyde on this same antenna with no success until he put up the coaxial. So it looks like he has a pretty good one for 2½ now; two other coaxials failed to make the grade on previous tests."

Clyde Criswell, W6QLZ, comments in regard to the photo of his portable mobile rig:

"The photo shows my portable mobile rig using HY615's with 15 watts input, modulated by 6L6-G-6C5. The receiver, on the right, uses 956-955-6C5-6K6-GT. The HY615's have 6 turns 1½ inches in diameter on 2½, and three turns on a one-inch diameter for 1¼. Rods are used on 400 megacycles. The coaxial pictured is a collapsible job built for mobile work with demountable radials mouted under the three-inch copper skirt. Tests made with W9KMB/6 over a 125 mile path show the coaxial to be as good in all directions as the three element ¼ wavelength spaced vertical was in one direction. The radials are 3/16-inch rods welded to a hose clamp."

Clyde says that others who use coaxial lines

on superregen receivers may be having trouble getting proper antenna matching and coupling. Those who connect the antenna through a variable condenser to the grid coil are hardly getting the best results. Clyde hooks another variable condenser between the antenna and ground. This in effect places two condensers from grid to ground with the transmission line inner conductor hooked on between. The result is that the ratio of the capacities determines the antenna matching to the tuned circuit, while the amount of capacity tunes the circuit. He was able to get additional control over the coupling by using a two turn link, coupled to the coil, and inserted between feeder and the grounded variable condenser. Whether all this is any better than a variable antenna coupling coil and a separate tuning condenser, we cannot say.

2 1/2 METER HONOR ROLL

ELEVATED LOCATIONS

Stations	Miles
W2MPY/1-W1JFF	325
W2MPY/1-W1BHL	295
W6KIN/6-W6BJI/6 (airplane)	255
W6QZA-MKS	215
W6BKZ-QZA	209
W6QZA-OIN	201
W6BCX-OIN	201
W3BZJ-W1HDQ (crossband)	200
W6FVK-BIP	190
W6LSC-NNN	190
W6OXQ-NNN	190
W1JYI/6-W6NNN	190
W3HOH-W1HDQ	175
W6NJJ-NJW	175

HOME LOCATIONS

Stations	Miles
W2BYM-W1LZB	230
W2FJQ-W1LZB	220
W2OEN-W1LZB	218
W1MON-W2LAU	203
W1LZB-W2ADW	200
W1LZB-W2NCG	200
W6ECP-W6NNN	190
W6NNN-W6OIN	185
W8CVQ-QDU (crossband)	130
W3BZJ-W1MRF	130
W6QLZ-OVK (crossband)	107
W1IJ-W2LAU	105
W3BZJ-W1LAS	105
W2OEN-W2LH	100
W2OEN-W2HZR/8	100

1 1/4 METER HONOR ROLL

ELEVATED LOCATIONS

Stations	Miles
W6IOJ-LFN	135
W1AJJ-COO (crossband)	93

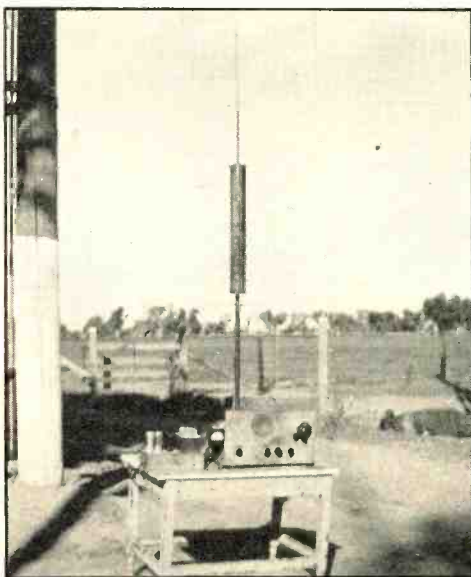

W6QLZ's u.h.f. portable-mobile job—complete with coaxial radiator. See text for complete details.

Rigs and Stuff

Due to less frequent low atmosphere bending, 112 megacycle activity has dropped off, according to W2BYM. Mel has put up an 8 element beam and has increased power, hoping to get even more dx than his contacts with W1LZB at Boston. He says that something is screwy about the distance covered in his contact with the latter, as reported in November. He figures it at 230 miles on a Regional Aeronautical Chart. If the fault cannot be blamed on the printer, it must be that our state maps were in the children's room and the distance could not be checked.

W2OEN in Middletown, New Jersey, is now using a.m. and f.m., the latter working well into f.m. converters. Dave has revised his acorn concentric line superregen, using the French 75 shell casing. Oscillation is obtained by means of a small coil in the detector cathode lead. The grid condenser is 50 μ fd., the grid leak 10 to 20 megohms, the plate by-pass condenser .002. The plate voltage is varied with a potentiometer.

On 224 megacycles, W3CUD and W3GOI could not hear each other until they put a set in a car and led the signal across. CUD has about 150 watts on HK54's working into a horizontal four element antenna 40 feet high.

[Continued on Page 82]

YARN of the MONTH

OIL IS WELL, IV

Los Angeles, Calif.
June 11, 1941.

Dear Bill:

It is awfully quiet here, and there's nothing for a widow lady to do but write to her husband's buddy. My own people are pretty well scattered, so I guess you're elected.

What can a poor sailor do on a night like this? Just as Cy and I were getting all set after our honeymoon, we decided that we would be happier if I didn't work. He got his old job back, and I tore up my contract with the Golio-Mammoth Pictures and settled down to being a housewife. After about a month as a commercial radio op, he got tired of it, and went to work as a technician for RADIO in their experimental lab. Boy, did he have fun. He put all the wrong gadgets together and for some reason or other, they seemed to work. He spent all day in the lab and all night writing articles. They tell me you don't have to be crazy, but it helps, which is apparently why my husband is going to be a success in radio.

Anyhow, I did get to watch him reading the newspaper every morning over the breakfast table. That was last month. The big catastrophe struck me with unbelievable force. I was taken by surprise. Much to my amazement, I found after marrying the lug that he was a graduate engineer! While I was staggering around under this blow, but still feeling happy that the old soak was a married man now and probably wouldn't be drafted, I saw the second strike go whizzing past the plate. There I stood with my face hanging out. Literally, I was standing on the front stoop in a housecoat, looking at the letter the postman had just left. Of all things, it was addressed to "Cy Jones, 2nd Lieut., Signal Corps!" A fourth columnist in my own house. A military man in my bedroom! So help me, Bill, the next time I get married I'm going to have

the FBI investigate the lug before I say "I do." My sweet little boy a professional shooter-upper. At that moment, you could have burnt me to a crisp with a 22nd harmonic. My heart was motor-boating like a 47 with an open grid lead. I knew of course that it couldn't be my little lamby pie, but it was a shock.

Well, when Cy got home, I waited until he had finished supper, and very hopefully said, "Honey, there's a letter out there addressed to a man with your name, but I know it isn't you."

"Lemme see it," he sez, in his best English. "Get it yourself. It's on the hall table." Not being married, you can't appreciate this. Of course, the above went on for some time, until I finally weakened and got it for him. "Ye gods," he bellowed. "I've been waiting for this for months."

In the wash, it all comes out as follows. One of his weaknesses in college was ROTC. He just couldn't leave it alone. So, comes graduation day and he not only gets a sheepskin from the school, but he acquires a nice commission from the Great White Father in Washington.

After reading the letter, I felt better. It was just a routine request for information on home address, wife's name, etc. I went to bed happy in my knowledge (woman's intuition) that I still had a husband.

To slice a long tale down to wagging size, the first letter was followed by another one. The War Department apparently had not heard of the opinion of my woman's intuition, so they ordered the poor lug to active duty. We started packing on the spot, as he had to leave the next morning for some hole in the swamps of Louisiana. Strike three! I'm out (a husband).

That was a week ago. Since then very little has happened. It sure is quiet around here

without that noisy man bellowing for his dinner. I go up and pound brass once in awhile, but most of the people he works are used to his 30 wpm on the bug, and don't recognize my beat-out 8 per.

That's all for now. Drop me a line one of these weeks, for I'm sure he won't write. A college grad and a commissioned officer—phooey! Why didn't I marry somebody like you with flat feet (?) and no brains?

Love, Margarita.

Camp Whittle, La.
June 12, 1941.

Dear Bill:

OH BOY! Do I have fun. Of course, it is kind of inconvenient, not being home anymore, but I'm in the Army now. This maneuver business is great stuff. I've been taking a two weeks refresher course before going out in the field. Some sergeant gets up and lectures on sources of supply, and then we have a discussion of tactics or almost anything else for a couple of hours, and then we go over to the officer's club for a brew. It's really quite pleasant.

Of course, I'm a married man now, but there is a certain blonde who is a charter member of the Little Beaver Club (eligible daughters of officers on the post), and the bachelors have made me an honorary member of the Beaver Trappers. It looks like I might have a little fun if I use my head. Boy, she's a honey! After all, you can't pass up naturally colored and curled hair of that flavor, especially if it looks interested and has a voice that would knock anybody's heart out of oscillation. I finally made a date with her, and I'm going to have to scram. I'll write more later.

73, Cy.

Camp Whittle, La.
June 12, 1941.

Margarita Darling:

I only have a moment between supper and night classes, so I'll try to squeeze out a short letter. After I get home I'll have a lot of studying to do.

I sure do miss you. The food here is terrible, and it is rather rough living in one room again. There isn't any other place to go, so we scarcely get out. Of course, we don't have time to go anyplace anyhow, so it doesn't make much difference. Write soon, and I'll try to write more frequently.

88's Cy.

Los Angeles, Calif.
June 26, 1941.

Dear Cy:

I didn't like your letter a bit. There is no reason why my little lamb should be so lone-

some, so guess what? I'm going to pack up tomorrow and drive down there. It won't cost us much, because I've put all of our things in storage, and given up the apartment. I can drive down there for about \$80, and can live in a tourist camp near the post. Then you can come home every night to study, even if you will have to go back to the post to sleep. Won't that be just swell!

I sure feel funny chasing a man around like this, but I guess it's alright now that I'm your wife.

Say, I got a telegram from Bill a couple of days ago and I don't understand it. I guess he must have been drunk again, for it didn't make sense. It read, "GO TO CY IMMEDIATELY STOP HE NEEDS INVESTIGATION STOP." He must have meant "attention" instead of "investigation."

Well, dear, I have a lot of packing to do, so I'll close. Oh, yes. I almost forgot. The storage company said that they couldn't store your rig and the receiver and guarantee that it would be in the same shape when we took it out of storage as when we put it in, so I sold the whole business. I got a swell price for it. That old kilowatt rig that was so dusty went for \$30, and I got \$10 for that beat-up receiver of yours. I sold a bunch of old tubes for 50c each. I don't know what they were. Seems like they had "852" or something stamped on them. Anyhow, the whole business brought about \$50, so I bought a new dress and some seat covers for the car. Don't you think that was just ducky of me to get such good prices for the stuff? The fellow that bought it said it would have been a bargain at twice the price. I don't get it!

That's all for now, dear. I'll see you in three days.

Lots of love for my lamby pie,
Margarita.

Camp Whittle, La.
June 26, 1941.

Dear Bill:

What goes on? Do you remember back in 1939 you and Wilma got a blind date for me? He was a radio operator going down to South or Central America, and we were seeing him off. Was his name Cy Jones? I could swear that was his name. And didn't he marry Margarita Alvarez, movie actress daughter of Don Jose Alvarez, president of the Northern Republic? You remember, she made the front pages when she tore up her contract and decided to be a housewife. Well, doggonit, there's a shavetail here by that name and I could swear that that is who he is, but he says he's single. I guess I'm just imagining things, because he doesn't remember ever meeting me here. The first time I saw him I went up to him and said, "Hey, haven't I met you before?"



Vacuum Tube PERFORMANCE begins on Eimac's own MACHINES

Eimac tubes are different. Different in their outstandingly superior performance capabilities... the shapes of the bulbs... the rugged design and the materials used. They are the only tubes on the market which are unconditionally guaranteed against premature failures which result from gas released internally.

So exacting are the production requirements for Eimac tubes that the tools are specially made in the Eimac factory. The glass lathes... the vacuum pumps... there's many a 'gadget' so unusual that procurement from a conventional tool maker is impossible.

Follow the leaders to

Eimac
TUBES

Eitel-McCullough, Inc.
San Bruno, Calif.

EIMAC REPRESENTATIVES

California, Nevada
FERB BECKER, 1530 W.
104th St., Los Angeles, Cal.

N. Y., N. J., Penn., Md., Del.,
Dist. of Col., Maine, N. H.,
R. I., Conn., Mass.

ADOLPH SCHWARTZ, 262
Crayson Place, Teaneck, New
Jersey.

Wash., Ore., Idaho, Mont.
GENERAL SALES CO.,
Verner O. Jensen, 2605-07
Second Ave., Seattle, Wash.

Colo., Wyo., New Mexico,
Arizona, Utah
RICHARD A. HYDE, 4253
Quitman St., Denver, Colo.

Chicago, Illinois, Wisconsin
G. G. RYAN, 549 W.
Washington Blvd., Chicago,
Ill.

N. Caro., S. Caro., Georgia,
Tenn., Flor., Ala., Miss.
JAMES MILLAR, 316 Ninth
St. N. E., Atlanta, Georgia.

Texas, La., Okla., Ark.
J. EARL SMITH, 2821 Live
Oak St., Dallas, Texas.

Ohio, Mich., Ky., Ind., Minn.,
Mo., Kan., Neb., Iowa
PEEL SALES ENGINEER-
ING CO., E. R. Peel, 154
E. Erie St., Chicago, Ill.

Export Agents: Frozar & Co., Ltd., 301 Clay Street, San Francisco

He said, "I don't think so, darling, but there's no time like the present." Since then, I've tried several times to see if he didn't remember me, but he apparently doesn't. I asked him if he didn't remember that night we spent together in New Orleans, and he said he didn't. He said maybe if we could go over the territory some night his memory would come back. He sure is putting on the old pressure. I hope he doesn't get any funny ideas. He really couldn't though, because I never say anything that would lead a man on.

Wilma wrote to me that you had finally popped the question. Congrats. It's about time.

Well, I gotta go 'cause I've gotta date with the man of mystery.

Your prospective sis-in-law,

Jane.

Miss Jane Horton
% Colonel Harold Horton
Camp Whittle, La.

CY JONES IS SAME MAN COMMA
IS MARRIED COMMA AND IS BIG
BAD WOLF ON VACATION STOP
REPEAT STOP WHATEVER YOURE
DOING STOP

(delivered June 28) signed BILL

Camp Whittle, La.
June 29, 1941.

Dear Bill:

If a man ever needed a friend, it is I. And you pull a double cross on me. Why didn't you tell me sooner that Jane was Wilma's kid sister that I dated in 1939 just before I left for the Northern Republic? I don't mind your tipping her off, or sending my wife that dirty wire, but why didn't you send me one too? Oh boy, what a night!

Far be it from me not to let an ex-friend in on my misfortunes, for I suppose when I am old and decrepit, I'll tell my grandchildren about it and laugh. But, boy, I'm not just beating my gums together when I say that it aint no laughing matter now. She's even locked me out of the doghouse!

The night you sent your wire to Jane, I had a date with her. We left the post about nine and went to a show. After that, I tried to take her out riding, but she said she wanted to dance for awhile. It wasn't late yet, so I thought that was ok. We went to a nice little place just outside of town, got a booth, a bottle, and tripped our dogs in the light fantastic. About two hours later, when I was beginning to feel pleasantly happy, the little louse asked me to tell her all about myself. I told her about the Central American business

and she said it must be fun going away like that. She asked me if I had been given a send-off by my friends.

I said I had had a little party, but hadn't had much fun. Then I told her about the brawl you and Wilma hatched up for me, and went to great pains to tell her what a frowsy little sap Wilma's sister was. She seemed very interested, and had me go over it several times. Then I told her about the ride Maria, Margarita's sister, had given me on the trip down to San Baloney. After finishing this, she said, "Oh, so you always chase innocent little blondes?" I should have taken warning, but I was just happy enough not to be my usual suspicious self.

After going through the story of meeting Margarita, the revolution, and the rest of the screwy business down there, Jane stopped drinking, and acquired a definite hard, fishy, look. Poor, trusting me, I didn't suspect a thing. Jane asked me to go through the story of my send-off from New Orleans again. I really made it good the second time through. I told her about the pigtailed brat your gal calls a sister, and the moldy bread-pudding she served us when we got back from the fireman's dance.

"Gee, that's funny," she said when I had finished. "You know what?" she asked, sticking her most luscious little lips right up near mine. I thought, "Oh boy, here we go." What a let down.

"You know what?" she repeated. "I'm Wilma's sister, and that bread pudding was pretty good, and I wasn't a pigtailed brat." Boy, you could have stopped me at three words per minute. Here I'd been—well, you know what, and the gal knew me. I began to see through her constant effort to establish an old acquaintance. And I thought she had been trying to tantalize me. You'd think that would be enough, but it was only the beginning.

While I was staggering into a quick drink, another familiar face, draped on a tall, handsome man, walked into my befuddled view. He had just gotten up from the booth next to mine. I couldn't quite place him.

"I believe we've met before," he says. "I'm Pepe Cardenez and my wife introduced you to me on the dock at San Baloney." I thought I was drunk, but I knew I wasn't that far gone. What have I done to deserve this? It was almost like old home week.

While I digested this newcomer, a luscious blonde ambled into view. She had a page boy bob which swirled out like a dancer's skirt when she moved her head. Her eyes sparkled like sunlight on a new insulator. She floated over to Pepe, stuck her arm through his, and spoke to Jane.

"And I'm the blonde he chased on the boat,"

24 hour SERVICE!

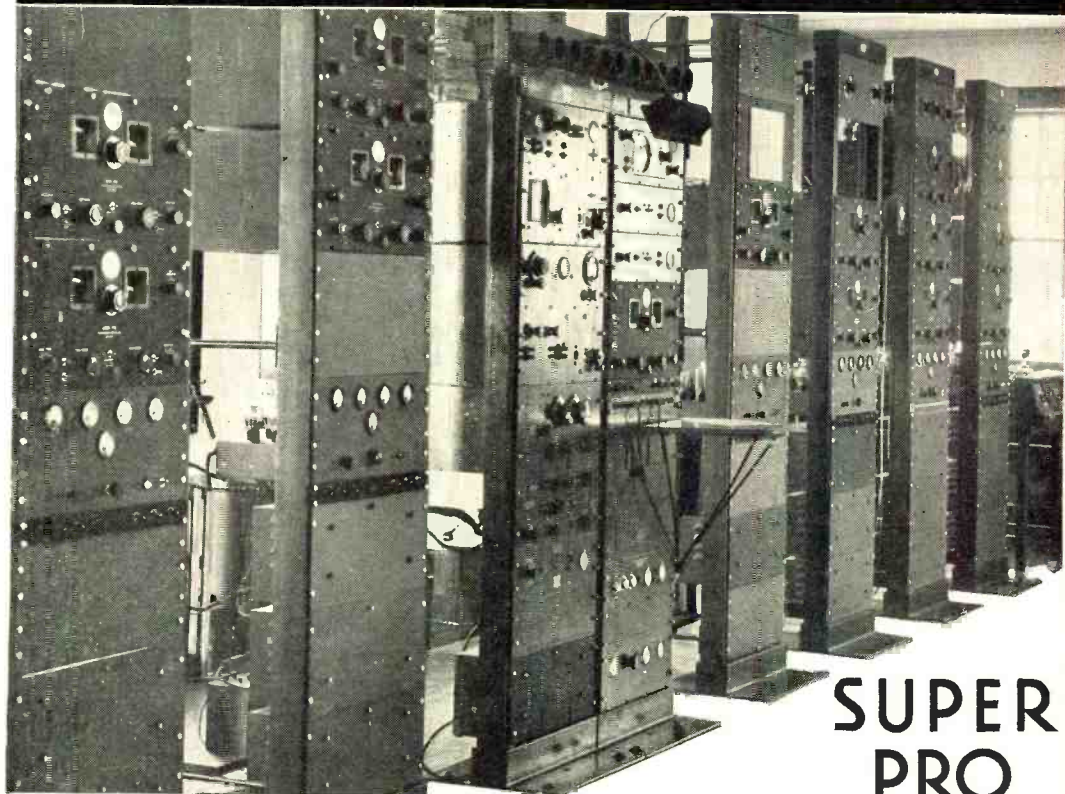

SUPER PRO

EVERY hour of the day and night, in all parts of the world, news pours through Super-Pro receivers at hundreds of words a minute. Many of these press receivers have been in service for 5 and 6 years, and are still giving trouble free performance. The new series 200 Super-Pro has all the outstanding features of the older models plus a number of improvements. Today, no matter what the requirement, you'll find the Super-Pro has

everything necessary to do a good job over a long period of time.

SEND FOR FREE BOOKLET!

HAMMARLUND MFG. CO., INC. R-12
424 W. 33 Street, New York City

Please send "Super-Pro" booklet

Name

Address

City..... State.....



HAMMARLUND MFG. CO., INC.
424-438 WEST 33rd ST., NEW YORK



CANADIAN OFFICE: 41 WEST AVE. NO., HAMILTON, ONTARIO

she says, just by way of opening conversation. "Hello, Cy, are you doing any good?"

The end of the world was here. Any more would be anti-climax. At least, that is what I thought then. The turn of events slowed just long enough for me to recover my eyesight and sense of hearing to amble on to the grand finale.

"While we're all here," said a voice that has been very familiar these past months, "I might as well introduce myself to you, Jane. I'm Margarita, the movie actress this wolf married." Words failed me. My last recollection was a hurried grasp for the bottle, a mighty swig, and blessed darkness.

When I came to this morning, Margarita (between unsweet words not of love) informed me that she drove all day and all night to get here and found me out. Her sister, Maria, is up here with her husband, Pepe, who is a military observer. So help me never another blonde. Twice is enough.

Oh, yes. Before I forget it, the reason I wrote you is this. Can you let me have \$150 for a couple of months? I've got to buy a long overcoat, white gloves, some leather goods, woolen undies, and a lot of other essentials for field duty. I'll be able to pay it back to you soon.

My head is beginning to pound brass again, and I have a spurious oscillation in my stomach, so I'd better sign off.

C u agn sn,

Cy.

Denver, Colo.
July 8, 1941

Dear Cy:

You poor sap. Don't you know by now that you haven't enough brains to get by with anything? I'll admit Wilma's sister has changed a bit in the past couple of years. Incidentally, as you now know, I'm engaged to be married to your CO's daughter.

Speaking of which, you know I have always been a friend who came through in any emergency. But when you put the bee on a bloke about to be married to a colonel's daughter, who expects to be supported in the style in which her father is not financially capable of letting her become accustomed, it is just no go. Anything else, old pal, but no money. If I can put in a good word with Jane, or maybe advise Margarita not to take you too seriously and let you out of the corral again, I'll do it. But I couldn't buy half an inch of second-hand solder right now.

I think your experience is very funny. I only wish that red-head in St. Paul could have been there to make the party complete.

If there is anything you want me to do, just ask and it shall be yours.

Faithfully yours,

Your old friend, Bill.

Signal Platoon Hq.
July 19, 1941.

Dear Old Pal:

Say, old chappy, old friend, my buddy. Thank you so much for your kind letter of the 8th. You don't know how glad I was to get your condolences and splendid assistance. I took your letter right over to the credit manager and offered it as my payment on the uniforms, but he wasn't much impressed.

Just after I wrote my last letter, I got sent out in the field on maneuvers. Boy, that two weeks refresher course was propaganda. I only work about 26 hours per day now, and we get every sixth Sunday in each month for rest and relaxation. I believe I'll put in a transfer to England for a little quiet. Boy, when this man's army maneuvers, the earth shakes, the trees bow down, and the natives retire to their cyclone cellars.

Oh, well. It has given Margarita a chance to cool off. I haven't seen her since the morning after that awful night. She is coming down here this afternoon and I am going to take her riding in a jeep. We are about 16 miles back of the front lines, and there isn't much danger of getting into trouble for I am in such an awful hole in the swamp that no brass hat would dare come very close. She's coming down on the bus and will spend all afternoon with me. I hope I can get her to forget the little incidents of two weeks ago.

73

Cy.

Camp 643
July 21, 1941.

Bill:

Ye Gods and Little Catfish! Have you heard from Margarita? If you think I was in the doghouse on the last little episode, where am I now? If there was ever a shavetail in trouble, and I mean bad trouble, I guess I qualify. If you hear from her, write me a letter immediately. No, you'd better send me a telegram.

Roughly, for I haven't the command of the language to describe it accurately, this is what happened.

Margarita got here OK on the bus, and we had supper at the mess tent. Everything was going along fine. She had apparently forgotten about the little episode with Jane. After supper, we climbed aboard a jeep and took off for the wide open spaces. No fooling, bud, there isn't any place one of those little buggies won't go. We climbed over hills, down stream beds, and generally had a swell time. Boy, if I could have had one of those things in high school, I really could have rated the fems. This pleasant gamboling about the woods went on for two hours, and we finally decided to head back for camp so that Mar-

NEW Quick-Reference Catalog 18 on Rheostats • Resistors • Tap Switches

FREE

Especially useful today! Gives complete up-to-date information on the wide range of Ohmite stock resistors, rheostats, chokes and switches used in all types of applications—Lists over a thousand stock items, including new developments—Gives descriptions, ratings and prices—Helps you select the right units for each job, easily, quickly. Get your copy of this handy new Catalog 18 now! It's FREE.

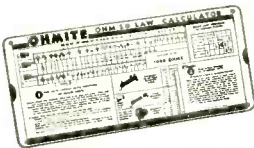

Handy, Useful Ohm's Law Calculator

Figures ohms, watts, volts, amperes — quickly, easily. Solves any Ohm's Law Problem with one setting of the slide. All values are direct reading. Does not require any slide rule knowledge. Size 4 3/4" x 9". Yours for only 10c to cover handling cost.

OHMITE

RHEOSTATS • RESISTORS • TAP SWITCHES • CHOKES • ATTENUATORS

Be Right with
OHMITE

For Radio, Television, Sound, Electronic and Industrial Uses
CATALOG NUMBER 18

	Page		Page
RHEOSTATS, Models H and J, Vitreous Enamelled	2	FILAMENT DROPPING RESISTORS	11
RHEOSTATS, Models K, L, N, R, and C, P, T, U, Vitreous Enamelled	3	CENTER-TAPPED RESISTORS	11
"DIVIDOHM" ADJUSTABLE RESISTORS	4	TAP SWITCHES, Open-Type, All-Ceramic	11
16, 25, 50 and 75 Watt Ratings, Vitreous Enamelled	4	TAP SWITCHES, Power Type, All-Ceramic	12
"DIVIDOHM" ADJUSTABLE RESISTORS	5	Models 111 and 212	12
100, 160 and 200 Watt Ratings, Vitreous Enamelled	5	TAP SWITCHES, Power Type, All-Ceramic	13
25, 50, and 100 Watt Ratings	6	Models 312, 412 and 508	13
FIXED RESISTORS, Vitreous Enamelled	6	BAND CHANGE SWITCH BC-3	13
160 and 200 Watt Ratings	7	CHOKES, Radio Frequency Plate	13
"BROWN DEVIL" RESISTORS, Vitreous Enamelled	7	CHOKES, Power Line	14
"WIREWATT" RESISTORS	7	ATTENUATORS, High Wattage T and L-Pads	14
NON-INDUCTIVE DUMMY ANTENNA RESISTORS	8	PARASITIC SUPPRESSOR	14
Hermetically Sealed in Glass	8	SOLDERING IRON CONTROL RHEOSTATS	15
NON-INDUCTIVE RESISTORS, Vitreous Enamelled	9	"DETERMOMH" RESISTANCE BOXES	15
"MULTIVOLT" TAPPED RESISTORS	9	DIALS AND KNOBS	15
Vitreous Enamelled	9	LINK CONTROL	15
"RITEOHM" PRECISION RESISTORS	10	MODEL TR	16
		OHMITE CO.	

© 1942 NOVEMBER 1941

All of the Items listed in this catalog are carried in stock. They are as noted and are subject to the usual trade discounts. Prices may vary.

OHMITE MANUFACTURING COMPANY
4835 West Flournoy St., Chicago, U. S. A.

Send Free Catalog 18.
 10c enclosed — Send Ohm's Law Calculator.

Name _____
Address _____
City _____ State _____
Radio—Jan. '42.

Mail this
Coupon Now! →

Be Right with **OHMITE** RHEOSTATS • RESISTORS • TAP SWITCHES

garita could catch her bus back to Camp Whittle. I drove out of the woods onto a country road and opened her up. About a mile after we got out of the forest, we went over a wooden bridge, and that is where the fun really began.

One of the boards which served as surfacing for said country bridge had been nailed on from the bottom. This is good construction, I suppose, and is probably recommended in some county highway road manual. The only difficulty is that when the aforementioned board rots away, it leaves an obstacle which not even a jeep can surmount. The nail went through the tire as we approached, and retracted as we passed by. The air in the tire rushed out with a sound like a dying duck, and there we were, miles from no place with a flat.

The first realization of our situation was a shock. Then I laughed it off. These gadgets have a spare tire and a tool box which includes everything. I explained this to Margarita, and got her back in a good mood. But this was only the lull before the storm. Some dim-witted idiot had removed the tool box. I tried loosening the wheel bolts by hand, but of course that was hopeless. Just as we were about to give up, we heard a noise that could be made only by a farmer's jallopy laboring down the road.

When the old crate got up to us, an elderly gentleman looked down from way up there and said, "Having trouble, son?"

"I sure am," I replied. "Do you have a set of tire changing tools I could borrow?" I asked.

"I don't know about borrowing them," he answered, "but I might rent them to you."

"Well, fine," I said, reaching in my pocket for the where-withall. I reached in one pocket. I reached in the other side pocket. I tried the watch pocket and the rear pockets. The two shirt pockets yielded the same. Boy, what a kettle of fish. Out here, we never find a place to buy anything and we consequently don't carry any money. If we do buy anything, it is on an Army post, and an officer's credit is good. The old codger said my credit wasn't worth a nickel with him and to fork up or shut up.

About the time when I had given up hope, the darned old robber spotted Margarita's wedding ring. He made an offer, ten bucks plus the tools. I looked at the sun. It was setting. I was thirty miles from camp. I had a night march starting at 8:30. I had a tire to change. I looked at my watch. It was 7:40. I looked at Margarita.

Tell me, chum, did you ever look into the wrong end of a loaded 75? Did you ever get hold of a tank coil in a kilowatt final, get a good grip on it, I mean, and realize that plate

voltage was still on? Did you ever look at your wife and tell her to sell her wedding ring for ten bucks and a handful of assorted wrenches? Boy, I'll take the 75 and the plate voltage both before I'll ever again try the latter.

Neither one of us opened our mouths, but the answer was "NO."

The sun had set. I looked at my watch. It was 7:42. Golly, what a long two minutes. I looked at the road, and saw it wasn't good. I thought of the night march, with me AWOL, including one each G.I. jeep. And finally I thought of the bus that left at 8:20. My heart did four slow-rolls, stalled, and went into an inverted spin. My ghastly big mouth dropped open. I presume my eyes rolled a bit.

Margarita knows me well. She has lived with me. She saw the symptoms, read my mind, and whispered, "The bus."

I worked feverishly as the old pirate's rattletrap wheezed away. Margarita sniffed a couple of times. The spare came loose and was placed on the hub. I spun the bolts home. We were bathed in light. The ground shook and the first unit of a convoy rambled around the bend. Margarita stood by the side of the jeep, and I sat ready to start the motor as soon as the convoy passed. My clock pounded out the seconds over the roar of the motors. Margarita started to climb in and I stopped her as non-military personnel are not permitted in government vehicles. The last truck roared by, I started the motor, a staff car eased past, hesitated, and stopped. Colonel Horton got out.

"Having trouble, Jones?" he bellowed. (If you marry that old buzzard's daughter, you're crazy. He'll shout you out of existence.)

"I just repaired a flat tire, sir," I answered. "I've been out on a little reconnaissance trip in preparation for tonight's work."

"She looks pretty good to me," he says, looking Margarita over. "I understood you preferred blondes." I wasn't quite sure what that glint in his eye meant. "Well, hop aboard, and we'll follow you into camp to see that you don't get any more flat tires."

I believe in talking right back to these old martinets. I said, "Yes, sir," and started my engine. I drove off, leaving my wife standing by a country bridge (with a nail in it), 30 miles from nowhere, in the swamps of Louisiana, and in the middle of the night. The colonel's car followed for awhile, but couldn't keep up with me.

Boy, I'm about nuts. Please wire me if you hear anything from the gal. She's pretty capable, but that is a tough spot for anybody to be left in. I hope she can take care of herself ok. I'm a hundred miles from the spot now.

Cy.

The Year's Best Sellers!

TAYLOR TUBES



T40 and TZ40
\$3.50

866/866A
\$1.50



Wishing all the gang

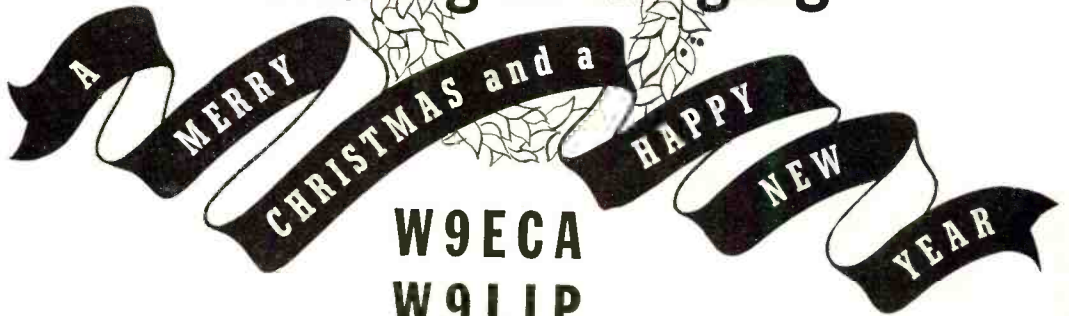

W9ECA
W9LIP

MORE WATTS PER DOLLAR

Taylor HEAVY **CUSTOM BUILT** DUTY Tubes

TAYLOR TUBES, INC., 2341 WABANSIA AVE., CHICAGO, ILLINOIS

New Orleans, La.
August 12, 1941.

Bill Ol' Soak:

Imagine my being here. Gee, am I having fun. I'll bet Cy is having cat fits worrying about me. Well, it serves him right for all the crazy things he's done.

Someday when I get time I'll tell you all about the awful afternoon I spent with him. He took me out on some kind of a machine called a "jeep," and nearly shook me to pieces. Instead of whispering sweet nothings in my ear, that darned old engineer spent the entire afternoon telling me about compression ratios, speeds, four wheel drive, gun mounts, etc. When we started home, we got a flat. The dirty bum sold my wedding ring to an old billy-goat to get some tools with which to change the tire, and then drove off leaving me standing there. Wait 'til I get hold of him! It was all because of some silly regulation that civilians can't ride in Army vehicles. I guess the first two hours we spent in the darned thing don't count because nobody saw us.

There I was, in the middle of Louisiana without a cent to my name. I didn't even have any identification because it was all in my purse, which we left back at the camp. The bridge was handy, so I went to the rail and sat down to think. While I was thinking, I saw the headlights of a car coming down the road. It was a jeep (you could tell by the way it bounced around) and I was sure it was Cy coming back to pick me up. But you can't tell the driver by looking at his headlights.

I thought I'd have some fun, being certain it was my husband, so I pulled my skirt up over my knees and draped my thumb in the breeze. The jeep skidded to a halt next to me, and a very masculine voice said, "Well, look who's here!" In brief, it wasn't Cy's voice.

A captain got out and asked, "What's the matter, gal, did some soldier leave you stranded out here?"

I couldn't have phrased it better myself. "Boy, you said it," I replied.

After asking me what outfit the soldier was in, what kind of work he did, and how long I had spent with him, he told me to get in the back seat of the jeep. "I think we can use you," he said.

I was already in the car, but I didn't like the way he made that last remark. "No you don't," sez me, climbing out with all the speed of a mountain goat leaping from one crag to another. "I'm married, and my husband doesn't approve of such things."

"That's a nice looking wedding-ring you don't have," said the captain, "and your story doesn't tie together very well. Married

women don't go out dating strange soldiers. Anyway, your story sounds fishy and we're taking you back as a prisoner of war."

I wasn't within walking distance of any place, and here was a nice (?) man offering me free transportation. On top of that, he seemed to want to use force if I resisted. He had a tough looking driver with him, so I decided that I'd better go along. They really do take this maneuver business seriously. Since the captain sat in the front seat with the driver and left me alone, I decided my position wasn't too precarious.

When we had driven perhaps forty miles, we passed near some sort of an outpost and the driver honked his horn twice and gunned his engine. The sentries waved us on. "Lucky we found out their countersign, sir," said the driver. A few minutes later, we were stopped by another bunch of sentries. They passed us on and we drove into a tent area.

It took only a minute to get through the company street, stop in front of an administrative tent, dismount, and walk in. I don't try to duplicate the conversation that followed, for it was a little too ripe for repetition, even to you. They sure said some nasty things about me, but you really couldn't blame them. By that time I realized that I was in the enemy camp, and I wouldn't have shown my credentials even had I had them. They were taking this business entirely too seriously. I guess I got pretty mad, because I broke out in Spanish a couple of times. After all, that is the language I first learned, and sometimes when I get excited, it just pops out. ¿Verdad?

Well, this letter is getting too long, and I'm sure you are bored. There is an Air Corps unit from Cy's side which had to be stationed in enemy territory because no other field was available. The officers of this unit are taking Spanish, and the colonel decided that I ought to get a job as an instructress, and, incidentally, find out their plan of action. Of course, this Air Corps is on Cy's side, so I am not giving the Old Man any more information than I have to. I really couldn't think of anything better to do, though, and it is fun. I have to watch my step. The only way I can get this letter mailed is to give it to the laundry man and ask him to mail it. Having only two slack suits (the one I was wearing and one I bought out of my wages as an instructress), the laundry man is a frequent visitor.

One of the pilots, Hal somebody or other, is really giving me a run for my money. He's taking me out to dinner tonight. That sure helps the budget. I'll write more in a few weeks. Maneuvers are over then, and I can probably find that nit-wit husband of mine. I'll teach him to sell my wedding ring!

Love and kisses,

Margarita.

September 1, 1941
Miami, Fla.

Dear Bill:

We're having a marvelous time, and we're glad that ugly puss of yours is not around to spoil things. Nothing like a "best friend" to tell a guy that he has halitosis, athlete's foot, and that his wife is running around with a bunch of pilots. It surely is nice to have someone around to keep one from worrying, especially when on maneuvers, with no possibility of getting the situation corrected.

It was most kind of you to send me that first wire. "MARGARITA SAFE IN THE HANDS OF THE ENEMY," it said. Now what kind of talk is that? You should be a foreign correspondent, with your flare for inaccuracy and incompleteness. That was a nice snappy comeback to my query as to where she was, too. "SHHHHHH STOP MILITARY SECRET." And to think you got an "A" in engineering letter writing. Fortunately for my nervous system, I attributed both of these telegrams to your usual drunken stupor, fortified by the stupid sense of humor that makes you play April Fool's jokes.

If you are sober enough to recall, I then wrote you a letter asking for further information. To this honest attempt to find the light of my life I get for an answer, "THE AIR CORPS HAS THE SITUATION WELL IN HAND." That was nearly the straw that broke the camel's back. The real blow came a half hour after I received the telegram. Do you remember Hal Saunders? He was that campus cutey catcher that practically wore out the steps of the Women's Residence Hall. Well, he's a pilot now, and flew in here the morning I got your telegram. I told him my trouble, and he offered his condolences. I got your telegram just before going off duty, and when I showed it to him he decided that we ought to go out and get drunk and forget the whole thing. I thought it was a good idea. We went to work on the project, and he started telling me about a hot little number he had just cornered. He described the situation and the gal in great detail. Just as I lost interest, he showed me her picture. So help me, my wife!

That surely was a bad start, but the situation looked up. I'll let Margarita tell you the rest of the story.

Cy.

Slug:

Cy seems to think I did something wonderful, but it was really nothing at all. I just carried on in the style I learned in college.

I had to go back to the colonel's office every evening and make a report to his adjutant. His adjutant was a rather snappy (self-styled) captain, who, like all adjutants, thought he

was the CO. After a few visits, he ordered me to go out to dinner with him. I took him for a jolly ride, to the tune of a nice steak, and no soap.

About a week ago, I went in to report, and the colonel and his entire staff were in conference. I got the old gray-matter working and decided something big must be afoot. It looked like I might do Cy some good if I could find out what it was, and get him the information. I didn't know then how I could do it, but it worked out later.

The adjutant played right into my hands. The headquarters was set up on some leased private property, including a lake. Several canoes were available, all having been confiscated for use by the officers. The captain told me when I reported that he had been working hard all day and that we were going for a little canoe ride on the lake. I knew that he would know the whole plan, but I was a little worried about how far I would have to go to get it out of him.

About 10:30, the moon went behind a bank of clouds, and a lone canoe pushed off from shore. Included in said canoe were one very scared recent bride, as well as a wolf in khaki (not a bridegroom). He was very polite about the whole business. We had been out fully fifteen seconds when he suggested that we paddle across the lake to some unoccupied cabins on the far side. To stall for time, I suggested that we just drift across. Most of the lakes in Louisiana aren't really lakes, but are wide spots in sluggish streams. This particular one was so situated that the slight current would drift us across in about an hour. He settled down next to me, and said that would be fine.

Man is vain, and woman is a rat. It took about a minute to get him talking about himself. I told him it must be wonderful knowing all of the things the colonel was going to do before they got started. It wasn't long until he was telling me all about the maneuver, and especially about the blitz which was going to end it. Boy, oh boy! I thought I might get a little useful information, and I suddenly found that I had the key to the entire enemy campaign. By that time we were out in the middle, still drifting.

I didn't want to ask too many questions, and I knew I had enough information to stymie their blitz, so I shifted the subject. I asked the old buzzard about his boyhood. It seems that about all he ever did was sing in the glee club. It was while he was telling me about his part as a gondolier in the high school operetta that the brainstorm smacked me.

"Captain," I said in my most Hollywoodish voice, "we're going to have such a perfect

[Continued on Page 85]



They keep right on rolling off the lines . . . the Radiohms, Resistors, Capacitors and Switches under the eagle-eye of Old Man Centralab.

The present emergency has neither stopped (nor slowed) the steady flow of deliveries nor has it impaired the priceless perfection that has made the name CENTRALAB a synonym for Quality.

Constant research in our laboratories by Centralab engineers, chemists and metallurgists assure you that the resources of Centralab are "forever yours".

Keep on using CENTRALAB parts for every replacement job . . . now as in the past.

CENTRALAB • Div. of Globe-Union, Inc., Milwaukee, Wis.

Centralab

With the Experimenter

SELF-CONTAINED KEYING MONITOR FOR COMMUNICATIONS RECEIVERS

One of the most popular keying monitors that has appeared is that described in the November, 1940, issue of RADIO. This monitor consists of an audio oscillator which utilizes rectified and filtered r.f. carrier as plate voltage.

A modification of this arrangement, due to W6HBD, is shown in the accompanying diagram. It works on the same principle, but makes use of the receiver loudspeaker, thus making a separate loudspeaker unnecessary. To avoid the using of a transformer in the oscillator circuit, a dual triode is used in a multi-vibrator oscillator.

Almost any medium μ dual triode may be used as the oscillator, and any heater type triode or diode may be used as the carrier rectifier. If the receiver power transformer is used to supply the heater voltage, it is recom-

mended that a 0.3 amp. dual triode and 0.15 amp. rectifier be used in order to minimize the extra heater drain on the power transformer.

As the required components take up but little space, the whole works will fit inside the receiver cabinet with no difficulty. The link to the r.f. pickup coil will be the only external connection.

The diagram assumes that the receiver employs a single pentode or beam tube in the audio output stage, as this is common with the majority of communications receivers. The potentiometer R_7 adjusts the volume of the keying tone in the speaker without affecting the receiver volume. Resistor R_6 and condenser C_4 tend to remove some of the higher order harmonics in the output of the tone oscillator and make the note more smooth and pleasant to copy. The pitch of the note may be made lower or higher if desired, simply by increasing or decreasing the size of C_5 or C_6 or both.

When receiving weak signals it may be found desirable to throw the receiver communication switch or reduce the receiver volume when keying, in order to prevent objectionable key clicks. When receiving a loud c.w. signal this will not be found necessary, and break-in is possible without objectionable clicks or thumps.

An attempt to provide a blocking circuit to kill the receiver and actuate it by another carrier rectifier to permit clickless break-in under all conditions did not prove successful. The blocking circuit, when adjusted to work fast enough to do any good, produced thumps which were just as objectionable as transmitter key clicks or thumps caused by receiver overloading.

If the communications switch (send-receive switch) on the receiver breaks the B negative or otherwise makes the last audio stage inoperative, it will be necessary to change the circuit so that it kills the first a.f. stage or one of the i.f. stages so that the monitor circuit will still work when the switch is thrown to "quiet" or "send."

A twisted pair consisting of lamp cord can be run from the carrier rectifier to the output tank of the transmitter. With R_7 turned full on, adjust the coupling until the volume is a little louder than desired. The volume then is adjusted at the receiver by means of R_7 to any desired level.

The presence of the resistor R_1 will cause a slight reduction in receiver gain, but as most receivers have more a.f. gain than is needed, this is not a serious consideration.

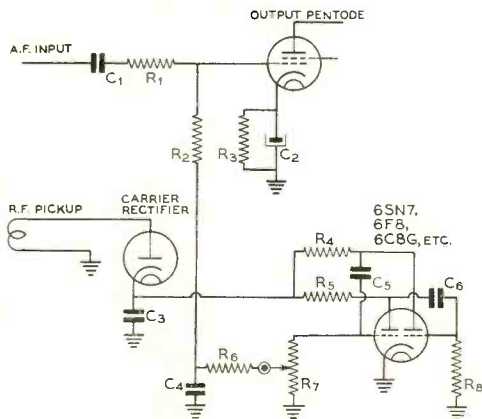

Receiver Keying Monitor

R_1 —500,000 ohms, 1/2 watt	C_1 —Regular coupling condenser (.01 μ f. or more)
R_2 —500,000 ohms, 1/2 watt	C_2 —Regular cathode bypass
R_3 —Regular cathode resistor	C_3 —.05 μ f. tubular, 400 v.
R_4, R_5 —25,000 ohms, 1 watt	C_4 —.002 μ f. mica
R_6 —100,000 ohms, 1/2 watt	C_5, C_6 —about .003 μ f. mica (smaller capacity will give higher pitch)
R_7 —50,000 ohms pot., a.f. taper	
R_8 —50,000 ohms, 1/2 watt	

"It's Overloading That Ends The Life Of Most Amateur Parts"

K. B. WARNER'S EDITORIAL IN QST FOR DECEMBER, 1941



Hytron's engineers verified the soundness of this statement years ago. When intermittent ratings were popularized, Hytron stood alone as an advocate of continuous-service ratings exclusively. Although the conservative continuous-duty ratings of its tubes did not have the spectacular appeal of others' ratings, Hytron has remained firm in pleading for ratings which it considered to be in the best interests of the amateur.

Mr. K. B. Warner's plea for tube conservation, we believe, is particularly apt in this time of National Emergency. At our own expense, and to give additional prominence to these timely words of wisdom, we quote Mr. Warner:

"It's overloading that ends the life of most amateur parts. Conversely, underloading vastly extends their lives—indefinitely. There is no blinking the fact that it's going to be hard, if not downright impossible, to get some components. When they go *blooie* under our customary overloads, there may be no replacement. We therefore propose that all amateurs who value their place on the air immediately reduce power, say to three-quarters or half of what they are using now. We don't believe there would be any detectable difference in signal strengths and we know that gear would last much longer—particularly tubes, and especially rectifiers.

"If you'll cut down on that plate voltage that now rips hunks out of filaments and electroplates it onto grids, you'll be just as happy and you'll stay on the air a whole lot longer. Tubes deserve particularly loving care. Keep your filament voltages exactly right. Warm up *plenty*. Avoid frequent cooling and reheating of filaments; if you're going to use the transmitter again within two hours it will be cheaper in the long run to leave the filaments on. Treat each item in your station as if you never expected to see another like it. You'll be glad you did."



ADVERTISEMENT

What's New

IN RADIO

JIGGERS

A new product, Jiggers, should have instant appeal to all electricians, electrical service and maintenance men, contractors and manufacturers of electrical products. Each Jigger is a small, self-contained soldering unit that contains just the correct amount of 50-50 solder and flux hermetically sealed within a water-proof heat-generating outer shell. To obtain a strong, perfectly soldered electrical connection, it is only necessary to push the wire splice into a Jigger and touch a lighted match to the Jigger as shown. The Jigger shell ignites and produces the proper temperature to flow the solder into the splice. The burnt shell is then dropped off and a smooth, perfectly soldered splice is revealed. Simple, fast, clean, without waiting for the soldering iron or torch to heat.

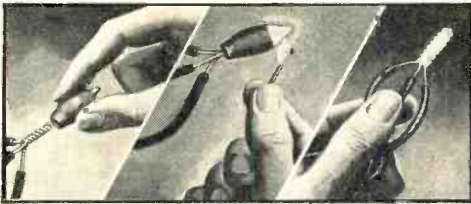

To demonstrate how practical, simple, and easy "Jiggers" make the soldering job, the manufacturer is offering free samples. Simply write Jiggers, Inc., 215 W. Illinois St., Chicago.

SEALED VOLTMETER MULTIPLIERS

Two types of sealed precision voltmeter multiplier resistors introduced by International Resistance Co., 401 N. Broad St., Philadelphia, Pa., are specifically designed for dependable performance under severely humid conditions, such as those encountered in marine service. Hermetically sealed and encased in a glazed ceramic tube, these multipliers are absolutely watertight, being unaffected by the famous salt immersion test. In addition, they are exceptionally rugged, meet all dimensional requirements of existing government specifications, and are fully approved.

Multiplier Type MFA is 8-13/16 inches long and is available in resistance ranges of 3.5, 4, 4.5, and 5 megohms with corresponding voltage ratings of 3.5, 4, 4.5, and 5 kilovolts, respectively. Type MFB is 4-5/16 inches long, and is available in ranges of 1, 1.5, 2, 2.5, and

3 megohms, with voltages of 1, 1.5, 2, 2.5, and 3 kilovolts, respectively.



They consist of a number of IRC Precision wire-wound resistors suitably mounted and inter-connected, and encased in a glazed ceramic tube. Monel ferrule terminals are hermetically sealed.

De Luxe Audio Amplifier

[Continued from Page 19]

is reversed and an a.v.c. action is obtained. Modulation peaks can be clipped considerably and the average modulation percentage increased without undesirable and illegal over-modulation. In either a.v.c. or expansion a small amount of audio is obtained from the grid of the 6C5 driver tube, amplified through another 6C5, and rectified through the 6H6. S_3 in one position places an increased negative potential on the suppressor grid of the 6L7 with an increased signal, thus producing the a.v.c. action. With S_3 reversed an increased positive potential is placed upon the suppressor grid and expansion takes place. A simplified explanation of expansion is that the loud signals become louder and the soft signals become softer. A considerable increase in naturalness is obtained in this manner when the amplifier is used to play back recordings. The potentiometer R_{33} in the grid circuit of the 6C5 amplifier tube controls the effectiveness of both of these features.

The bass and treble boost is a desirable feature in any amplifier and actually converts a high-fidelity amplifier into a *speech* amplifier with no more trouble than that required to turn the respective knobs. In most instances the lower frequencies are not needed for communication work. With the flexibility of bass and treble boost any pitch may be obtained

[Continued on Page 83]



You Can't Beat
"Personal Service"

Everytime I get a repeat order with an added note of thanks for my "personal service" I know I am accomplishing my ambition to give every order, not only my personal attention but to see you are getting the best value for your money.

I can give you the lowest financing costs on any communications receiver because I personally finance my own low cost time payments, easy 6% terms, and I eliminate the "red tape."

You get prompt shipments from the world's largest stock of all makes and models of amateur communications receivers.

You can't lose with my 10 day free trial, low cost finance plan and the best trade-in value for your old communications receiver.

Drop me a line here at Butler—I'll see that you are 100% satisfied, and I will save you money!



If you live in the western states, write my brother
Ted Henry

HENRY RADIO SHOP
2335 Westwood Blvd., W. Los Angeles, Calif.



HENRY RADIO SHOP

WORLD'S LARGEST DISTRIBUTOR OF AMATEUR RECEIVERS

POSTSCRIPTS...

and Announcements

FCC To Appoint Radio Monitoring Officers

Within the past year there has been considerable expansion of the radio monitoring activities of the Federal Communications Commission. Even further expansion is anticipated in connection with national defense. To secure qualified people to do this work, the U. S. Civil Commission has just announced an examination under the title "Radio Monitoring Officer." The positions pay \$2,600 and \$3,200 a year.

No written test will be given for these positions. To qualify for the full-grade position (\$3,200 a year), applicants must have at least 2 years of responsible supervisory experience in installation, testing, inspection, laboratory development, or responsible maintenance of commercial or Government radio transmitters. In addition, they must have either similar experience, not necessarily supervisory, or have completed appropriate college or technical study. Applicants for the assistant grade (\$2,600 a year), may qualify on appropriate study or experience such as that of studio engineer supervising high-fidelity recording of aural programs and their reproduction.

Applications may be filed with the U. S. Civil Service Commission, Washington, D. C., until June 30, 1942. However, interested persons are urged to secure a copy of the announcement and application forms at once from the Commission's representative at any first- or second-class post office or from the Commission's central office in Washington, D. C.

Civil-Service Examination for High-Speed Radio Equipment Operators Amended

There is a continuing and urgent need for High-Speed Radio Equipment Operators in the Signal Service of the War Department. Over 200 positions paying \$1,620 a year are now open at various Army posts throughout the United States and its Territories. In an effort to secure men for these positions, the experience and operating requirements of the *Junior Communications Operator, High-Speed Equipment examination* (Announcement No. 20) issued by the Civil Service Commission, January 20, 1941, have been amended to read as

follows:

"Experience.—Applicants must have had at least 1 year of experience as a radiotelegraph operator in commercial or government communications system, which must have included at least 3 months' experience in the operation of high-speed radio communication equipment.

"Operating Requirements.—

(a) Reading and transcribing to typewriter siphon recorder tape in continental Morse code at a sustained speed of 40 words per minute.

(b) Operating transmitting perforator at a speed of 40 words per minute.

(c) Copying audio English to typewriter at a speed of 30 words per minute and audio code groups at a speed of 20 words per minute.

(d) All applicants must produce evidence on forms to be provided by the Commission for this purpose that they are qualified touch typists capable of a sustained speed of 50 words per minute.

"Substitution.—Training in radio operation at a service school may be substituted month for month for the required radio operator experience except that in any case applicants must have had the 3 months' experience in the operation of high-speed radio communication equipment as described in (a), (b), (c), and (d)."

Further information regarding the examination is contained in Announcement No. 20, available at any first- or second-class post office or the Civil Service Commission in Washington, D. C. Proper application forms Nos. 6 and 4006-ABCD, and Supplemental Form 3629 may also be obtained from these offices.

Transceiver Diagram Error

In the wiring diagram of the 112-Mc. battery transceiver appearing in the December issue the ground erroneously was left off the rotor arm of the center section of the send-receiver switch S_2 .

The Open Forum

Napa, Calif.

Sirs:

Can you think of any good reason why the 20-meter phone band should be held exclusively for Class A operators, or, what has that particular band got that the other bands haven't?

There was a time when it was an inducement to go to the trouble and work for a Class A ticket, in order to have a 20-meter phone. Times have changed; with progress in u.h.f. equipment, and 2½-, 5- and 10-meter phones everywhere, the game isn't worth the candle.

My proposition is, the 20-meter phone band should be opened to Class B operators. What do you think about it?

H. A. HARROLD, W6CZN.

January Crossword Puzzle

This month's crossword puzzle was sent in by Richard L. Bridges, W6PMU. Watch for the answers next month.

DOWN

1. The negative pole (abbr.).
2. Universal type tube socket employing a keyway.
3. Coil cement.
4. Initial letters of 6-down, 12-across, and 34-across given in the order in which the words were brought into existence.
6. You use your eyes as well as your ears with this.
7. To properly adjust the tuned stages of a receiver.
8. The following letters in the order given: symbols for (a) number of turns, (b) voltage, (c) density, (d) area.
9. Proper kind of current for electroplating.
11. Unsatisfactory (abbr.).
15. Device for transforming electrical impulses into sound waves.
18. Stabilized type of oscillator.
21. This condenser is ... at 1000 volts.
22. End of message.
24. What you lift when the bus stops.
26. Tuned secondary (abbr.).
27. We get a combination of this and amplitude modulation when the plate voltage of a self-excited os-

- cillator is varied.
29. Astounding resemblance to 21-across.
 30. "Yes." XE-style.
 32. Astounding resemblance to 32-across.
 33. From (c.w. abbreviation).

ACROSS

1. System of dots and dashes used extensively.
5. Portable unit for suspension of a microphone.
10. Type of tube designed for minimum loss at ultra-high frequencies.
12. Science upon which radio is based (abbr.).
13. Self-excited oscillator employing variable capacitance in both grid and plate circuits.
15. Society of Automotive Engineers (abbr.).
16. Probable exclamation of British amateur upon erratic operation of his rig.
19. Voltage node (abbr.).
20. Laughter (a la ham).
21. Intensely radioactive element (symbol).
23. You'll think you have a cold when you say this.
25. Transformer connection used in three-phase operation.
27. Ability to send with telegraph key.
28. Greek god who supports y! interest.
31. Washday (abbr.).
32. Every magazine has one of these.
34. If you aren't thinking about this now, your mind's wandering.
35. Point at which there is no flow of current or at which there is no voltage.

1	2	3	4		5	6	7	8	9
10				11		12			
	13					14			
15						16			
17			18			19			
					20			21	22
23		24				25	26		
					27				
28	29		30		31			32	33
34						35			

NEW BOOKS and catalogs

Radio Service Publications

Supreme Publications, 328 South Jefferson Street, Chicago, Illinois, announces the release of two new books which will be of interest to radio servicemen.

The first is "Most-Often-Needed Service Notes on Record Players, Recorders, Automatic Changers, and Wireless Units." This book furnishes the answer to the serviceman's needs in rapidly growing record equipment field. Size, 8½ by 11 inches, 128 pages, illustrated. Price, \$1.50.

The second publication is "Radio Servicing Course Book." A general reference book of servicing designed for home instruction or for use as a source for study of new servicing methods. Size 8½ by 11 inches, 216 pages, illustrated. Price, \$2.50.

New Mallory Radio Service Encyclopedia

The fourth edition Mallory Radio Service Encyclopedia is now being distributed to servicemen and dealers throughout the country.

The new book is considerably larger than the former editions and lists recommended replacements by model number for over 20,000 radio receivers. Original part number listings for condensers, controls and vibrators is one of the new features. The fourth M.Y.E. also lists the complete tube complement and number of tubes for each model. I.f. peaks are also noted if the receiver is a superheterodyne. Reference to Rider's Manuals is given for each model so that the serviceman can see the complete set schematic, if necessary.

The present size of the M.Y.E. prohibits the inclusion of technical information which will be published, as in the past, in separate supplemental form. The book may be obtained from any Mallory distributor at \$.95 per copy net.

An Experimental 56 Mc. R.F. Amplifier

[Continued from Page 28]

Or, the extra space behind the right hand portion of the panel can be used for the mounting of an antenna coupling system.

Operation

Tuning up of the unit will be found identical to the procedure for lower-frequency units. Very little excitation (about 3 watts) is required. It will be found that excessive drive will cause a considerable drop in power out-

put. Conversely, too little excitation will not permit optimum performance.

Excitation coupling to the grid circuit should be as "loose" as possible, and yet provide sufficient excitation. Input tuning under this condition will be very sharp, and the first tuning should be done very slowly. Resonance in the grid circuit will be indicated by an increase in the plate current of the exciter output stage.

Having obtained excitation, plate voltage of about 150 or 200 v.d.c. (for initial tune up) should be applied, and the plate tuning condenser tuned for resonance. This tuning will also be quite sharp. Resonance, as in conventional amplifier tuning, will be indicated by minimum plate current. Maximum r.f. output will be indicated by the old standby of holding a small neon bulb near the plate cap of the tube. Incidentally, don't be chagrined if your neon bulb does not indicate r.f. at the antenna output terminals, alone. There's no resonant circuit there, and, consequently, no voltage peak to start the neon bulb.

If all has gone well up to this point in tuning up, the maximum plate voltage of 600 volts may be applied. Touch up the grid circuit tuning for maximum plate current, and retune the plate condenser for maximum r.f. output and minimum plate current. The plate current at this point should be about 15 ma. (Full load plate current for the HY-69 is 100 ma.)

If, for curiosity's sake, you want to try the amplifier as a t.p.t.g. oscillator, shut off the exciter and tune both grid and plate condensers for maximum brilliance of a neon bulb held to the plate cap of the tube. In the author's amplifier, best self-excited operation occurred at a frequency of about 63 Mc., or about 7 Mc. higher than the tuneup frequency (56 Mc.) of the unit as an r.f. amplifier. The note of the signal was lousy. When the unit was operating strictly as an r.f. amplifier, however, no spurious self-excited output could be detected in a receiver tuned across 52 Mc. to 66 Mc. If unwanted oscillations are present when straight amplifier performance is being tested, use of external bias should clear up matters. If not, try different values of C_1 and C_2 , figure 5. Straight amplifier r.f. output produces a principally-red glow in a neon bulb, whereas a decidedly purplish-blue glow indicates self-excited or parasitic oscillations.

Next?

In view of the encouraging results obtained on 56 Mc. with the described unit, the next exploration will be made on 224 and 448 Mc. In these trials, it is intended to try a 100 per cent concentric line circuit similar to that shown in figure 8. What success we'll have is yet to be determined. But, finding out should be an interesting process.

5

BIG ISSUES FOR

\$1



INTRODUCTORY OFFER

For all new subscribers or those who have not been on our subscription lists during the past year, we make this special introductory offer of five big issues of RADIO for only one dollar! This rate good in U.S.A. only (elsewhere, four issues).

RADIO is known the world over as the authority of practical and technical radio. Every issue is packed with easy-to-understand and profusely illustrated text written by our own editors—and as RADIO pays for technical and constructional material, we publish the “cream of the crop” from outside authors.

Take advantage of this introductory offer—subscribe today!

\$2⁵⁰ yearly (in U.S.A.) Two years **\$4⁵⁰**

To Canada (inclusive of current taxes), Newfoundland, Pan-American countries, and Spain, add 50c per year. Elsewhere add \$1 per year. California and Illinois customers: please add 2% sales tax.

THE EDITORS OF

RADIO

CORPORATE NAME: EDITORS AND ENGINEERS, LTD.

technical  *publishers*

1300 KENWOOD ROAD, SANTA BARBARA, CALIFORNIA

Medium-Power C. W. Portable

[Continued from Page 23]

The power supply parts are located in the rear box along with the necessary condensers and resistors for the 25L6. The 25Z6 and 25L6 are mounted on the back side, directly over the filament voltage dropping resistor. On the right side is the 25L6 plate coil.

The r.f. choke between the e.c.o. cathode and key is used to help prevent any coupling between the e.c.o. and 807, as both cathodes are connected together. The e.c.o. is link coupled to a tank circuit in the grid of the 807.

One bank of a three-gang rotary switch in the 807 grid circuit switches in either 80 or 40 meter crystals or a grid coil which is link coupled to the e.c.o. Extreme care should be used in mounting this switch as all leads should be as short as possible.

The second bank of the switch connects the cathode to the proper tap on the cathode coil L₄ (which is tapped for either 80 or 40 meters) or shorts out L₄-C₁ for e.c.o. operation.

The third bank switches the pilot lights on the panel. Four green lights are used for the crystals and a red light is used for the e.c.o.

The grid drive to the 809 for each band is initially adjusted to give normal rated grid current by adjusting the tap on L₅. First, try tying the plate right to the end of the coil and tune the 807 to resonance. If the 809 grid current is low, tap the 807 plate down on the coil until the grid current is normal. If the grid current is high, tap the *grid* down on the coil until the grid current is normal.

As no link is used on L₅, one of the two socket terminals for the link of the manufactured type coils is used to take care of the tap. This permits the grid to be tapped down on one band and the plate tapped down on another band, should this prove desirable in obtaining uniform excitation to the 809.

• • •

Finishing up the year in which W6BCX, W6CEM, W6DHG, and W6QX of RADIO'S staff became proud papas, W6FFF was recently presented with a son while W6EQS presided as doctor with Mrs. W6KCG as nurse.

YOUR REFERENCE BOOK BUYING GUIDE AND MASTER FILE

Gives This Important Data

Contained within the hard covers of this 800-page MASTER BOOK are the listings of the products of 90% of all Radio Parts and Equipment Manufacturers in the industry. In it you will find many thousands of items, such as electronic devices, transmitting and receiving sets, public address equipment, speakers, tubes, antennas, transformers, condensers, replacement parts, meters, laboratory test equipment, relays, plugs, coils, wire, and numerous other radio components. Thousands of clear illustrations with descriptions and specifications. Yes, this is your "MUST HAVE BOOK."

Saves Time—Saves Money

WHERE, WHAT AND HOW MUCH: Such information is instantly at your fingertips. This valuable RADIO MASTER eliminates the maintenance of bulky files. It is completely indexed for speedy reference.

If you buy, sell or specify, you will find the RADIO MASTER an indispensable and handy book to have around at all times.

NINTH EDITION IT'S A MASTERPIECE

Took 6 years and thousands of dollars to develop to its present size—yet it costs you only **\$2.50**

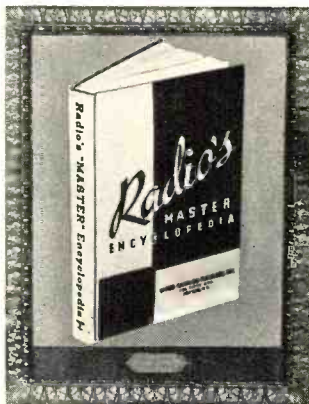

MONEY BACK GUARANTEE

Order your copy today—look it over. You will find it to be an excellent investment; if not, return it to us in five days for full refund. We prepay transportation charges if remittance accompanies order.

THE ONLY OFFICIAL RADIO & EQUIPMENT MASTER CATALOG

Compiled in co-operation with and approved by the Radio Manufacturers Group as the industry's official source book.

Who Uses It?

- Broadcasting Stations
- Department Stores
- Electrical Engineers
- Exporters
- Foreign Governments
- Industrial Plants
- Mail Order Houses
- Mechanical Engineers
- Newspaper Publishers
- Police Departments
- Purchasing Agents
- Radio Distributors
- Radio Service Organizations
- Radio Salesmen and Buyers
- Radio Parts Manufacturers
- Radio Set Manufacturers
- Radio Sales Agents
- Students and Experimenters
- Technical Libraries
- Telephone Companies
- Telegraph Companies
- Universities & Schools
- U.S. Military, Naval and Aircraft Depts.

UNITED CATALOG PUBLISHERS, Inc.
106-110 LAFAYETTE STREET, NEW YORK, N. Y., U.S.A.

Police Department

[Continued from Page 39]

something lacking. They were either too large or too hard to mount or did not give the desired results. In desperation a pair of Meissner filament chokes were used exactly as they came from the factory and they worked like a charm. They were well insulated and could be mounted directly against the chassis with one bolt and two tie-downs.

Several size condensers were tried across the filament coils. A 100- μ fd. condenser seemed to give maximum output to the grid of the amplifier doubler. The screen of the oscillator was run a trifle high (about 225 volts) to give slightly more grid drive. On the first few trials the modulation was downward. But by increasing the screen voltage slightly on the oscillator and getting about one-half milliampere more grid current on the final amplifier this was eliminated.

The oscillator plate coil is a Barker and Williamson MCL with two turns removed from each end. The condenser tuning this coil was a dual 35- μ fd. split stator with the rotor floating. This circuit should be tuned to the second harmonic of the crystal. Care should be taken to check the frequency with a wavemeter, because it is possible to tune this circuit to the fundamental frequency which is very hard on a crystal. The particular tuning condenser used tuned nearly all the way out. All tuning condensers used in the set itself had shaft bearings at each end to keep down vibration.

The oscillator plate coil was removed from the base and mounted on a strip of lucite which was long enough to mount on top of the tuning condenser. The coupling condenser to the grid of the final was connected to the end of the coil opposite from the oscillator tube to give as much balance as possible to the circuit. A 40- μ fd. condenser is used to couple the oscillator to the amplifier grid. Anything larger causes too much capacity across the oscillator coil necessitating the removal of more turns. A Bliley MO-2 crystal was used. It might be well to mention here that a third-harmonic crystal will not work in this circuit. Crystal slivers or even crystal dust is the usual result of plugging a third-harmonic crystal into a tritet circuit.

The Modulated Amplifier

An HY65 tube was used in the final amplifier-doubler for the same reasons that one was chosen as an oscillator. It has quick heating filament and is small in size. Also, the power handling capabilities of this tube are

BLILEY



Active ————||———

Rugged ————||———

Accurate ————||———

Dependable ————||———

Ask any experienced amateur
— then contact your distributor
and find out for yourself.

CRYSTALS

more than it would ever be called upon to deliver. Since it was used as a doubler no provision was made to shield or neutralize it.

Several values of grid resistor were tried. Finally a potentiometer was used to ascertain at what exact value of grid leak the most output occurred. On the three tubes tried about 65,000 ohms gave the most output.

The screen voltage was secured from the modulated plate supply through a series screen dropping resistor. Several values of screen dropping resistor were tried. A 15,000-ohm resistor which gave about 200 to 225 volts was optimum. If too much screen voltage is used (to make the tube draw more plate power) the stage would modulate downward.

Three hundred volts was about all the voltage procurable from a vibrapack, so no other value of plate supply voltage was tried. A 15-watt bulb was used as a load for the initial tests. At first the amplifier could not be loaded to much over 20 ma. But after getting a little more grid drive and increasing the grid resistor it could be loaded to 10 watts input and still modulate upward. The output has not been measured accurately but it appeared to be 5 to 6 watts. A Bud 50- μ fd. tuning condenser and a Bud OEL coil were used in the plate tank circuit. The coil was removed from

the base and mounted on the tuning condenser, as plug-in coils do not lend themselves very well to this type of construction.

The Modulation System

The same type tube was used for the modulator as for the oscillator and amplifier. The audio capabilities of an HY65 are just about the same as a 6V6G. The modulator was driven directly from a single-button carbon microphone. No special effort was made to use a high-gain mike transformer since the power sensitivity of this tube is very good. Plenty of modulation was secured with 3 volts on the microphone taken from a voltage divider across the A battery. The microphone voltage was taken off at the center tap of a pair of 100-ohm 2-watt resistors, and a 250- μ fd. 6-volt condenser was run from the microphone voltage tap to ground. This gave absolutely pure d.c.

The bias for the modulator was taken from the voltage drop in the grid resistor of the final amplifier. There was some doubt as to whether this would work reliably but it has been in use for some time and no trouble has developed from this cause. The amplifier grid resistor was divided into two parts: 50,000

PERFORMANCE PREDICATED UPON PERFECTION

The operating efficiency or value of any product depends upon the care and precision with which it is made. Astatic Microphones, Pickups, Cartridges and Recording Heads render long and satisfactory service because their performance is predicated or based upon as nearly perfect construction as is humanly possible. In all operations, for example, assembling trunnion rubbers to chucks of phonograph pickup cartridges, shown in the accompanying illustration, special care is exercised to produce a quality product. The dependability of Astatic Crystal Products and parts as evidenced by their universal use by a majority of manufacturers as well as amateurs, assures you the highest measure of service and satisfaction.

*See your Radio Parts Jobber
or write for Catalog.*



ASTATIC

THE ASTATIC CORPORATION

YOUNGSTOWN, OHIO

Licensed Under Brush
Development Co. Patents

In Canada:
Canadian Astatic Ltd.
Toronto, Ontario

ohms and 15,000 ohms. The 15,000-ohm resistor was put in the ground side. This gave about 20 volts which was the correct amount of bias for good speech quality from the HY65 modulator. A small push-pull pentode output transformer was used as a modulation transformer. The B plus is fed to the center tap of the primary, the modulator tube is connected to one side, and the modulated amplifier is connected to the other. The secondary winding of the transformer was not used.

Antenna Installation

In the first trials the antenna was left a full quarter wave long. But on the motorcycle this antenna looked too high and also whipped around quite badly in the wind. After using it one quarter wave long for several days an attempt was made to shorten it without cutting down the efficiency. At first the antenna was shortened to above five feet. But with the loading method used it would not draw power. A temporary coil was wound to top load it. This worked very well but so far no suitable mechanical means has been found to top load such an antenna. If the top part of the antenna could be wound into the shape of a coil it would still be short in physical length but would be one quarter wave long electrically. After trying several methods of base loading the one shown in the wiring diagram was used. It gave results not quite comparable to the full quarter wave antenna but good enough to give good coverage anywhere in the city.

Transmitter Installation

The cover was not fastened to the transmitter but to the shock mounted base to which the transmitter was fastened. It did not need ventilation holes of any kind, since the transmitter was on only for short periods of time. Too, it was amazing how much dirt and dust accumulated in a transmitter if the cover was not dust proof. There were no connections on the transmitter itself except those for the microphone. The A hot wire was soldered in place and brought out through a rubber grommet using a receiver type fuse. The antenna lead was also brought out through a rubber grommet to keep it from chafing. All leads should be of some sort of flexible wire, as the transmitter vibrates and moves about on the rubber mounts quite vigorously when the motor is under way.

One word of caution—remove the modulator tube before tuning up the r.f. section.

• • •

Super-Something Department — Frederick Best is the op at W1BIG.

Here's the "HOW" Book on Noise Reduction . . .

Reduce extraneous noises—eliminate them at their sources with the help of this valuable book.



When noise elimination is not practicable, one of the several noise limiting and noise balancing circuits described will often mean the difference between a clear and an unintelligible signal.

All operations are described completely, in theory, construction details, and application methods.

At your favorite radio dealer, or direct from us postpaid.

35c in U. S. A.

Elsewhere, 40c

THE EDITORS OF **RADIO** 1300 Kenwood Road, Santa Barbara CALIFORNIA



“Approved”

Consider the term “Approved” as applied to a radio part. It means:

- The product has been time-tested and proved satisfactory.
- The product has been accepted by design, production, and inspection engineers.
- The product is uniform . . . made to close production-tolerances.
- The product is honestly priced, leading to its universal acceptance.
- The sponsor of the product has a fair and equitable sales-policy, recognized by the industry.

That the term “Approved” has been earned by Mallory products, is evident by the long list of users, a veritable Who’s Who of the radio industry. Since it costs no more to have industry’s stamp of approval on the parts you use, always specify Mallory “Approved” Precision Products.

P. R. MALLORY & CO., Inc.
INDIANAPOLIS INDIANA
Cable Address—PELMALLO



RADIO

U.H.F.

[Continued from Page 56]

The Defense Guard boys were defending W5AJG with transceivers recently, thus encouraging Leroy to dig out his 30 watt line-controlled oscillator. The Fort Worth boys are also ready to go on. Now Leroy is putting in an 815 crystal controlled final. He had saved the pipes of the 2½ meter converter that he had started, although his wife, W5JKM, wanted to give away the aluminum. He says that they can have his 40, 80, 160 meter rigs, his antenna and even the Ford, but not his 2.5 meter pipes!

W6CLV at Salinas, California, is still at it using an Abbott DK-3 with special provision for tone modulation. He has converted W6BP to 112 megacycles. Vacation brought Lloyd many L.A. contacts and he still has week-end contacts in S.F. W6RBQ has a high power mobile rig. W6CIS has revamped his mobile transceiver. The DK-3 rig at CLV gets good reports up to 35 to 40 miles, netting CLV a contact with W6GDF in San Mateo.

W9PNV contacted his 150th station on 112 megacycles when he worked W9OPU.

THE 28 Mc. BAND IN BRITAIN

By NELLY CORRY, G2YL

In pre-war years the winter “DX Season” was in full swing by the end of September, and even in 1940 U.S.A. amateurs were audible daily after the 15th, but this year there has been a marked deterioration of conditions, and at the time of writing no reports of W signals have come to hand. Probably the recent severe magnetic disturbances, plus a reduction of U.S.A. activity partly account for this state of affairs, but undoubtedly the major cause is the approach of sunspot minimum.

It is interesting to note in this connection that South America, the source of the first DX to be worked from this country when the band reopened in 1935 after sunspot minimum, produced, with one exception, the only amateur signals reported during September 1941.

BRS3003 heard three Brazilian amateurs, viz: PY1FN on September 7, 13 and 22. PY2QK on September 7 and 21, and PY2EJ on September 7, and in addition unidentified South American ‘phones were logged on September 8, 10, and 23. All these signals were heard between 18:00 and 20:30 G.m.t. and PY2QK was audible for over an hour on September 21.

LQB4/LSA2 on 27.5 Mc. was logged by G4MR on 12 days, by BR3003 on 11 days, and by 2FWA on 8 days, but was inaudible on 10 days between September 1 and 24.

Other commercial harmonics from the Western Hemisphere were HHA 33.2 Mc., HRX7 27.7 Mc., and WQA/WQA2 31.5 Mc., heard by G4MR on September 23, and LSM2 29 Mc., and LUJ 29.6 Mc., heard by BRS3003 on September 22 and 10 respectively.

Stop Press—A late report received from BRS3893 shows reception of W1AK, W3AFG, W4HBQ, W4HJB and W6LG on September 7, 20:45-21:05 G.m.t., and of W2GW at 17:15 on September 13. Other amateur signals were logged as follows: PY1FN, PY1FX (?), and K4USA (?) on September 7, PY1FN on September 10, CE1AT on September 13, EA4AL and PY4JT on September 21, and PY1FN and PY2QK on September 28.

De Luxe Audio Amplifier

[Continued from Page 72]

Output Circuit and Adjustment

The output transformer chosen will match any common voice coil impedance. Also, 125-, 250-, and 500-ohm line outputs are provided making it possible to connect 1, 2, or 4 500-ohm lines in parallel. In the event that the input class B transformer is of the type without a low impedance primary, a d.p.d.t. switch (S₁) is provided to connect the plates of the 2A3's directly to the grid input transformer. The plate-to-plate impedance of the 2A3's as they are being operated in this amplifier is 3,000 ohms. Considerable mismatch can be tolerated in the input class B transformer where the class B stage is not larger than that required to 100 percent modulate 600 to 700 watts.

The equalizing potentiometers (R₃₀ and R₃₁) are adjusted until the plate current in each output tube is the same (40 ma.). This adjustment need not be made again unless it becomes necessary to replace one or both of the 2A3 output tubes. The meter jacks are mounted about an inch from the lip of the chassis so that there is no danger of accidental shock. Also, the equalizing potentiometers are mounted so that it is necessary to make the adjustment with a screw-driver through a hole provided. This prevents prying fingers from upsetting the bias adjustments.

Very little amplification is obtained through the 6L7 a.v.c.-expansion tube and likewise through the 6C5 tone control tube. However, when using the unit as a speech amplifier for transmitting, 100 percent modulation is obtained when speaking just above a whisper about 18 inches away from the crystal microphone with the gain control full-on. Even with this extreme amount of voltage gain no r.f. feedback was present on any operating frequency.

The "Open Sesame" to Ham Radio . . .

This handy little book will open to you the doors of the radio amateurs' world.

In thoro, easy-to-read fashion, the book explains the fundamental theory behind radio—tells how to study the code—what laws and regulations you must know.

The Editors' notes explain the new type F.C.C. examination questions—and give typical questions and answers to guide you in your studies. Then, when you've passed the examination, you'll want to build your equipment and get on the air. Simple, yet practical beginners' equipment is described. You can build it yourself.

The book explains the correct operating technique and regular procedures followed by thousands of amateurs.

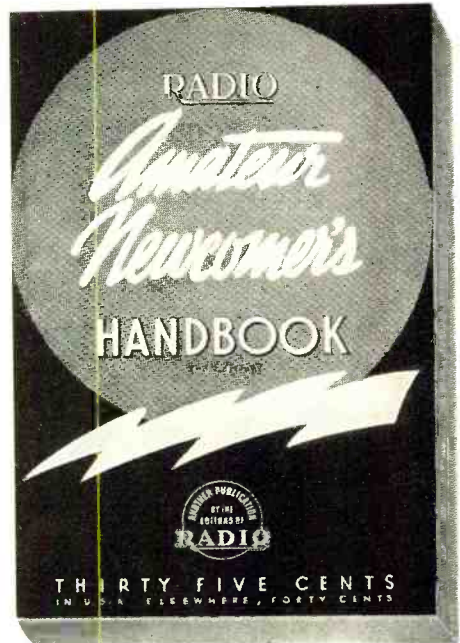

Order your copy today—from your favorite radio dealer, or direct from us, postpaid.

35c in U. S. A.

Elsewhere, 40c

THE EDITORS OF
RADIO 1300 Kenwood Road, Santa Barbara
CALIFORNIA

30-Watt Airplane Transmitter

[Continued from Page 12]

This condenser acts so as to keep the peak plate-to-plate voltage on the 6L6's down on the higher frequencies where the leakage reactance of the modulation transformer is high enough to allow the voltage to soar. Also, it will be noticed that a cathode by-pass condenser is used on the 6L6's. Before this condenser was used the waveform output of the modulator began to depart from a sine wave

at about 75 per cent modulation. With this condenser in the circuit the waveform is excellent to about 90 per cent modulation.

The resistor R_4 is a 5000-ohm 25-watt unit, by-passed with an 8- μ fd. electrolytic, which serves to drop the 450-volt supply to about 225 volts for the 6L6 screens, the plate of the crystal stage, and the speech amplifier.

Power Supply

All power from the 12-volt battery in the airplane is taken from the ammeter which is on the controlled side of the master switch of the plane. This was done for safety's sake; and for additional protection the transmitter is fused in itself. The filaments of the transmitter are turned on by a toggle switch on the dash, located just above the microphone jack. The voltage to the primary of the genemotor is controlled by a relay in the transmitter, and the action of this relay is controlled by the switch mounted on the microphone.

The hot lead is fed to the primary of the generator through a conventional hash choke. A 0.5- μ fd. condenser across the genemotor primary then completely eliminates any hash radiation from the primary circuit. The single choke and electrolytic condenser in the high voltage circuit serve to eliminate all ripple and hash from that source. In one sense the filter choke that has been employed for this filter circuit is too small for the job, since it is rated at only 150 ma. while the transmitter pulls about 210 ma. without modulation and kicks up somewhat with modulation. But a choke that would be rated for continuous service at this current drain would be far too large and heavy. So it was decided to use a smaller choke, since the transmitter is only used for very small periods at a time.

Tuning Up

When the transmitter has been tested on the bench and then installed in the plane, it should first be checked on the ground when operated from the battery in the airplane. If this first check has proved satisfactory, the cover of the transmitter should be removed and the set screw of the tuning condenser loosened. Then, with the airplane in the air the antenna should be reeled out to the point which will give somewhat less than a quarter wave at 3105 kc. (The number of turns of the reel for this antenna length should first be determined with the plane on the ground.) The transmitter is turned on, the plate circuit of the 807 is dipped, and the plate current noted. Then reel in the antenna about two turns and take another reading. (It probably will not be necessary to re-dip the amplifier after the first re-adjustment.) If the meter

[Continued on Page 86]

Now—a really high-powered—

RADIO ENGINEERING LIBRARY



NOTE:

The Library comprises a selection of books culled from leading McGraw-Hill publications in the radio field.

- especially selected by radio specialists of McGraw-Hill publications
- to give most complete, dependable coverage of facts needed by all whose fields are grounded on radio fundamentals
- available at a special price and terms

These books cover circuit phenomena, tube theory, networks, measurements, and other subjects—give specialized treatments of all fields of practical design and application. They are books of recognized position in the literature—books you will refer to and be referred to often. If you are a practical designer, researcher or engineer in any field based on radio, you want these books for the help they give in hundreds of problems throughout the whole field of radio engineering.

5 volumes, 3319 pages, 2289 illustrations

1. Eastman's FUNDAMENTALS OF VACUUM TUBES
2. Terman's RADIO ENGINEERING
3. Everitt's COMMUNICATION ENGINEERING
4. Hund's HIGH FREQUENCY MEASUREMENTS
5. Henney's RADIO ENGINEERING HANDBOOK

10 days' examination. Easy terms. Special price under this offer less than books bought separately. Add these standard works to your library now; pay small monthly installments, while you use the books.

SEND THIS ON-APPROVAL COUPON.

McGraw-Hill Book Co., 330 W. 42nd Street, N.Y. C.

Send me Radio Engineering Library, 5 vols., for 10 days' examination on approval. In 10 days I will send \$3.00, plus few cents postage, and \$3.00 monthly till \$24.00 is paid, or return books postpaid. (We pay postage on orders accompanied by remittance of first installment.)

Name

Address

City and State

Position

Company

R-1-42

(Books sent on approval in U. S. and Canada only.)

Yarn of the Month

[Continued from Page 68]

night, I wonder if you'd do me a favor first."

His eyes lit up, and he said he'd do anything for an agreeable girl like his little Margarita. I told him I'd always wondered how it felt to be a girl being sung to by a handsome gondolier. He said he surely would oblige, and that that wasn't all he was going to do for me that night.

I'm getting too much into detail. It was really fun, as he hadn't tried to sing for years, and his control showed it. Just as he was breaking buttons off of his shirt trying to hit a high one, I rolled the canoe from side to side. I was lying down in it, and it didn't bother me. He attempted a poorly executed jack-knife, and splashed in face first. He came to the surface, standing in the muddy bottom, with his head and neck just out of the water. "Good-bye, darling," I said sweetly. "The cabins are still on the other side."

Up to this point, I hadn't formed any definite plan. I paddled in to the headquarters, and was just on the point of sneaking past and trying to get to a civilian telegraph office when a better idea struck me. The administrative radio office was the only office illuminated, and I remembered that they only had one operator on duty at night. Cy had shown me all of their equipment, and I knew roughly how to tune it.

When I came to the door, the operator was definitely startled, and when he heard the Captain's faint cry for help, he nearly fainted. While trying to get from the canoe to the dock, I had fallen in, and looked slightly bedraggled as a result. "The captain," I gasped. "He's drowning. Go get him out." With this melodramatic entry, I stumbled across the doorsteps, and put on a good faint. The poor lug threw half a bucket of cold water on me and ran for the dock, shouting apologies for leaving so abruptly. Nothing could have been nicer.

I kicked the rig over on one of Cy's standard frequencies and cut out one of my best QRR's. Most of the Army operators have had a ham rig at some time or other, and I got a reply in nothing flat. By that time the op had gotten out to the captain, so I locked the door, and settled down for a little traffic. Boy, when I got through, it was really getting rough outside. Just as I signed off, the provost marshal said, "Open this door, or I'll shoot." Having been warned more than the required three times, and having seen a horse get his head blown half off by a .45, I did the only thing left to do and surrendered gracefully. That is, I surrendered as gracefully as one can with a cheap pair of slacks, shrunk skin tight by a recent ducking.

The two nights in the guard house, my eventual release when the enemy were completely licked, and the slightly slap-happy reunion with my nit-wit husband will have to be told in person. Cy's CO, your future father-in-law, pulled a few strings, and now we are on the commanding general's staff. Of course, our next maneuver is in Florida, so we got a little leave and are having a swell time.

Wish you were here to enjoy the swimming, fishing, etc.

Love,

Margarita.

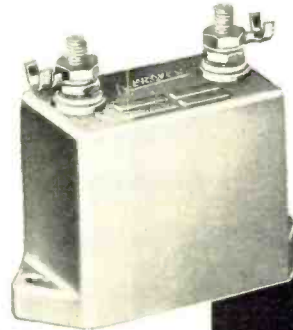

Heavy-duty
MICAS

Porcelain-case micas in 200, 3500, 5000, 7000, 10,000 and 12,500 v. test ratings.

Standard capacities of .003 to .1 mfd. depending on voltage.

Bakelite-case micas in 250 to 6000 v. test. Widest range of capacities. Ask jobber to show you the listings.

These units are typical of the extensive Aerovox line of transmitting capacitors which also offers stack-mounting micas, cast-aluminum-case micas, sulphur-filled ultra-high-frequency micas, plug-in electrolytics and paper capacitors, oil-filled "bathtubs", high-voltage oil capacitors, etc., etc.

● As still another contribution to better "ham" radio, Aerovox offers you superior mica transmitting capacitors in both porcelain-case and bakelite-case types. The latter, until now made to order for commercial-equipment builders, are now standard items available to you.

The Aerovox Transmitting Capacitor Line, *not listed* in our general catalog, provides a wide choice of extra-heavy-duty types that will give your "rig" the truly professional touch and efficiency.

Ask Our Jobber . . .

He'll gladly go over the transmitting capacitor data with you and help you select those units you need. Consult him about your capacitance requirements.



A Junior Electronic Key

[Continued from Page 16]

Many useful parts can be made in this way.

The contact points are Speedex 1/8-inch. Two of them come threaded screw feed and two in the form of rivets. These are mounted by drilling holes in the dot and dash bars to fit the contact shank (about 1/16-inch) and then drilling the back of these holes out with a 3/16-inch drill until the shank sticks through for riveting. The hinge bracket for the key mounts directly on the front plate as this grounds it. The contact posts and dot lever stop mount on the bakelite base. This entire unit was copied closely from a standard bug, so as to have that "feel" if possible.

With the finish of the front plate, fasten the shelf on, do remaining wiring, slip on cabinet, insert tube, and you are ready to go.

Operation

With S₁ on the mechanical dash side the unit performs just like a standard bug and at much less cost. Switched to the automatic side it will do things no bug can—make even rhythmic dashes. A short period of practice will give you the hang of it. The main thing is to learn to "let go" at the right instant, that is during the space between two dots or two dashes.

A 30-Watt Airplane Transmitter

[Continued from Page 84]

reads more, keep rolling in turns, a few at a time, until the point of maximum loading is found. If, when this point has been found, the current is greater than 100 ma., take off one turn from the link and repeat the process. If, on the other hand, the current decreases when the first two turns are wound in, let the wire out further and follow process given above.

When the adjustment process has been completed the power input should be about 45 watts, 450 volts at 100 ma. The power output will be a conservative 30 watts. The plate supply voltage is only 450 volts instead of the 500 at which the generator is rated, since there is a small drop in the filter choke in the high-voltage circuit, and there is an additional small drop in the 12-volt line from the front of the plane back to the transmitter.

Construction

The transmitter was built up on a specially designed chassis which was constructed by R. H. Lynch of Los Angeles. The chassis measures 16" by 19" over all. The top portion is 11" by 9" and its over-all height is 7". The chassis portion is 1" high for the genemotor section and 3" high for the portion that supports the rig. The total weight of the transmitter, exclusive of cables and microphone, is 36½ lbs.

Two of the connector sockets on the back of the chassis have been changed since the photographs were taken. The microphone socket under the microphone transformer was changed to a three-wire outlet to make possible the special mike return circuit shown in the circuit diagram. The other socket was changed to the two-prong type; the leads from this outlet go to the muting relay in the receiver. The wires to this relay are connected across the primary of the main power control relay for the transmitter. At first one side of the receiver muting relay was grounded. But this didn't work correctly since the receiver relay would stay operated until the genemotor came to a complete stop. Hence the change in connections noted above.

Possible Alterations

There is some talk of assigning a new frequency for civilian aircraft on 3117.5 kc., to relieve some of the congestion on 3105. In the event of this change it will be possible to install a relay and another crystal in the transmitter to change between the two frequencies. However, it will not be

[Continued on Page 88]

MAILING LISTS

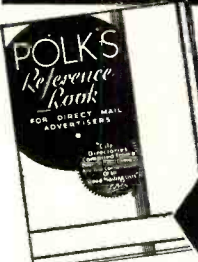

GET OUR FREE
REFERENCE
BOOK and
MAILING
LIST CATALOG
FREE

Gives counts and prices on accurate guaranteed mailing lists of all classes of business enterprises in the U. S. Wholesalers—Retailers—Manufacturers by classification and state. Also hundreds of selections of individuals such as professional men, auto owners, income lists, etc.

Write today for your copy

R. L. POLK & CO.

Polk Bldg.—Detroit, Mich.
Branches in Principal Cities
World's Largest City Directory Publishers
Mailing List Compilers. Business Statistics. Producers of Direct Mail Advertising.

The Marketplace

Classified Advertising

(a) Commercial rate 10c per word, cash with order; minimum, \$1.00. Capitals: 13c per word. For consecutive advertising, 15% discount for 3d, 4th, and 5th insertions; 25% thereafter. Break in continuity restores full rate. Copy may be changed as often as desired.

(b) Non-commercial rate: 5c per word, cash with order; minimum, 50c. Available only to licensed amateurs not trading for profit; our judgment as to character of advertisement must be accepted as final.

(c) Closing date (for classified forms only): 25th of month; e.g., forms for March issue, published in February, close January 25th.

(d) No display permitted except capitals.

(e) Used, reclaimed, defective, surplus, and like material must be so described.

(f) Ads not relating to radio or radiomen are acceptable but will be grouped separately.

(g) No commissions nor further discounts allowed. No proofs, free copies, nor reprints sent.

(h) Send all Marketplace ads direct to Santa Barbara accompanied by remittance in full.

WANTED—October 1936 issue Proc. I.R.E. and issues prior to 1931. Cash or swap radio gear. Radio, 1300 Kenwood Rd., Santa Barbara.

LEO, W9GFQ—Offers the hams more and better deals always. Lowest terms without red tape on all new and used equipment. Free trial, personalized service. Write for big free ham bargain catalog and used receiver list. Wholesale Radio Laboratories, Council Bluffs, Iowa.

NEW TRANSMITTING KITS—All phone and CW from 15 watts through 150 watts. Also new ECO unit for \$39.50. New 40 meter phone transmitters reasonable. Also plenty of 40 meter crystals. Write for details today. Leo, W9GFQ.

ORDER FROM BOB HENRY, W9ARA, for immediate delivery and best deal on all amateur receivers, transmitters, kits, parts. Bob offers you largest trade-in; best terms (financed by Bob at lowest cost with no red tape); lowest prices; ten day trial; personal cooperation to see you are 100% satisfied. Write, telegraph, telephone Bob for anything. Bob stocks hundreds of amateur receivers of all makes and models for positively immediate delivery. Henry Radio Shop, Butler, Missouri.

RECONDITIONED guaranteed amateur receivers and transmitters. All makes and models cheap. Free trial. Terms. List free. Code machines rented. W9ARA, Butler, Missouri.

HENRY RADIO SHOP has branch store 2335 Westwood Blvd., West Los Angeles, California, operated by Bob's brother, Ted Henry. Western Amateurs get acquainted with Ted.

HEARING aid in kit form. Write—Microtube Labs., 2414 Lawrence Avenue, Chicago.

CHASSIS. Panels. Racks. Portable steel cases. Defense orders first. Lynch 970 Camulos, Los Angeles, Calif.

OSL's. SWL's—Free Samples. Theodore Porcher, 7708 Navahoe, Philadelphia, Pa.

WANTED—R.C.A. Model 254 A.F. Oscillator. Will pay \$20.00 to \$25.00 depending on condition, or swap amateur equipment. Colin A. Campbell, 1101 E. Caldwell, Compton, California. Phone Newark 1-4936.

FOR SALE—Slightly used complete radio telephone and telegraph rig, complete with SX25 receiver, Shure crystal mike, crystal control with HK354T tube in the final. Transmitter mounted in standard 5-foot rack. Price complete with tube and crystal \$350. Will sell only as a unit f.o.b. Berkeley. J. Craviotto, 2119 University Ave., Berkeley, Calif.

WANTED—Old spark equipment such as transformers, quenched gaps, mica condensers, etc.; also good receiver, DB-20, mercury arc, synchronous and dry disc type rectifiers. W5KD, 215 N. W. 19th Street, Oklahoma City, Oklahoma.

FOR SALE—Stancor 110-CM transmitter, practically new, complete with 160 m. crystal, 160 and 80 m. coils, tubes. First 60 bucks takes it. J. E. Beardsey, % Radio, 1300 Kenwood Rd., Santa Barbara, Calif.

WILL TRADE—AC light plant for oscilloscope with 3" screen suitable for checking 60 cycle wave form. Katolight, Mankato, Minn.



RADIO
CATALOG NO. 53
164 PAGES
SETS-PARTS
SUPPLIES
FLUORESCENT
Burstein Applebee Co.

BIG FREE CATALOG

EVERYTHING IN RADIO

Sets, parts, supplies, public address systems, amateur equipment, testers, kits and fluorescent lighting at lowest prices. Huge stocks, bought months ago... ready for shipment the same day your order is received. The Defense Program is making big demands on our industry but because of our advance buying we are able to fill your orders promptly and efficiently.

PACKED WITH VALUES!

BURSTEIN-APPLEBEE COMPANY
1012-14 MCGEE STREET, KANSAS CITY, MO.

A 30-Watt Airplane Transmitter

[Continued from Page 86]

necessary to change the tuning of the transmitter when shifting from one frequency to the other if the final amplifier plate circuit is tuned about half way between. And since the two frequencies are only 12.5 kc. apart, one setting of the antenna reel will serve for both frequencies.

The transmitter design as it stands makes an excellent basic unit for ship-to-ship and ship-to-shore radio telephone operation from private yachts. The tank coil will have to be slightly larger for the lower frequencies of this band, and it would be desirable to incorporate about three crystals with a switching mechanism to select the different channels.

Then the antenna tuning system should be changed over for matching the impedance of the short radiator usually used. Aside from these changes, the only other important one would be that of changing the filament wiring and the genemotor over to the supply voltage of the boat.

The Amateur Newcomer

[Continued from Page 48]

about 20 seconds for the rectifier cathode to heat up). With the aid of a flashlight bulb and a two-turn loop, determine whether or not the amplifier is oscillating. Then adjust the neutralizing condenser by means of the insulated rod until the amplifier will not oscillate at any setting of the *oscillator* condenser. The amplifier then is satisfactorily neutralized. This is done with the key up.

Repeat with the 80-meter coils, except that the amplifier plate condenser should be adjusted until it is about $\frac{2}{3}$ meshed. Then repeat with the 160-meter coils and the amplifier plate condenser about $\frac{7}{8}$ meshed.

This neutralizing procedure is based on the fact that unless the 6L6 is accurately neutralized, it will self-oscillate when excitation is removed, assuming of course that both the oscillator and amplifier tank circuits are tuned approximately to the same frequency.

After the neutralizing procedure is completed, the antenna may be coupled and the rig is ready to go on the air. With the flashlight indicator loop coupled just close enough to the oscillator tank to give a visible indication, adjust the oscillator tuning condenser (key down) until the bulb is brightest. Then back off the condenser just a little towards the low capacity side, to assure clean keying.

The antenna coupling is increased a little at a time until the bulb which is used as a plate current indicator gets *just slightly* dimmer when the amplifier tuning condenser is tuned to resonance. With light loading or no loading on the amplifier, the plate current indicator bulb will go clear out when the amplifier tuning condenser is adjusted for resonance, but as the loading (coupling) is increased, the "dip" will become less and less. Maximum power will be delivered to the antenna when just a slight "dip" is observed at resonance. The condenser always should be tuned to the middle of the "dip" (minimum plate current) regardless of the amount of loading employed.

If the amplifier is properly neutralized and is free from self-oscillation, it will not be necessary to turn off the power supply on "stand-by." When the key is up, the transmitter will be dead. However, when changing coils, the



EXPERIMENTAL RADIO

4th Edition. 186 Experiments

By R. R. Ramsey, Prof. of Physics, Ind. Univ. The experimenter's manual: Measurements. Tests. Calibrations, with ordinary radio and physical apparatus. "Measure and know."

FUNDAMENTALS OF RADIO

2nd Edition (426 pages, 430 figures).

Modern radio explained with a minimum of mathematics. "You find it in Ramsey's." Experimental. \$2.75. Fundamentals. \$3.50 postpaid.

RAMSEY PUBLISHING CO.

Bloomington

Indiana



**Buy a Fresh
Copy Today
of the
RADIO
AMATEUR
CALL BOOK**

ISSUED QUARTERLY

March . June . September . and
December

Annual Subscriptions \$4.00

Single Copies \$1.25

**Bold Face Listing of your QRA \$1.00
for a year. Three years \$2.00**

RADIO AMATEUR CALL BOOK

608 South Dearborn St.
Chicago, Illinois, U. S. A.

power supply should be turned off. Not only would there be danger of shock to the operator if he attempted to change coils with the plate voltage on, but the amplifier tube would be supplied with screen voltage but no plate voltage so long as there was no coil in the coil socket. Pentodes and beam tubes can be permanently damaged by removing plate voltage while screen voltage still is applied, as this will cause the screen to draw excessive current and overheat.

It should be noted that the screen dropping resistor for the 6L6 is somewhat huskier than

ordinarily is specified. This is made necessary by the current drawn by the ballast tube when the key is up.

Advertising Index

• • •

Aerovox Corp.	85
Astatic Corp., The	80
Bliley Electric Co.	79
Bud Radio, Inc.	67
Burstein-Applebee Co.	87
Centralab	69
Eitel-McCullough, Inc.	59
Hallicrafters Co., The	3
Hammarlund Manufacturing Co., Inc.	61
Henry Radio Shop	73
Hytronic Laboratories	71, IV Cover
Johnson Co., E. F.	II Cover
Mallory & Co., Inc., P. R.	82
McGraw-Hill Book Co.	84
National Co.	III Cover
Ohmite Manufacturing Co.	63
Polk & Co., R. L.	86
RADIO	77
RADIO—Amateur Newcomer's Handbook	83
RADIO—Binders	90
RADIO—Handbook	4, 5
RADIO—Noise Reduction Handbook	81
RADIO—Publications	89
Radio Amateur Call Book	88
Ramsey Publishing Co.	88
Solar Manufacturing Corp.	89
Taylor Tubes, Inc.	65
United Catalog Publishers, Inc.	78

New... Handy



Write for Catalog

UNIVERSAL REPLACEMENT Capacitors

SOLAR MFG. CORP., Bayonne, N. J.

Kindly send me the items listed below for which I enclose \$..... in payment.

- "Radio" (five issues)
- "Radio" (one year)
- "Radio" (two years)
- "Radio" (three years)
- "Radio" Handbook
- "Radio" Amateur Newcomer's Handbook
- "Radio" Noise Reduction Handbook
- "Radio" Binder
- W.A.Z. Map (6 great circle maps)

Name

Call

Address

Note: All shipments are prepaid by us. Current editions are always supplied unless previous or future editions are requested in the original order. California and Illinois customers: please add sales tax.

THE EDITORS OF **RADIO** 1300 Kenwood Road, Santa Barbara CALIFORNIA

• 89 •

Amateur Newcomer

Away With Haywire—Conklin	Feb., 63
Banana Boat on Lake Erie—Sadoski	July, 66
Keying the V.F.O.—Smith	April, 62
Meter Switching for Transmitters—Griggs	Oct., 60
Multi-Band Antenna—Johnson	June, 64
Pocket Transceiver for 112 Mc.—McEntee	Jan., 118
Simple R.F. Power Measuring Device—McNatt	May, 61
Simple Superheterodyne	Dec., 55
Simplicity in the Speech Amplifier—Dawley	Nov., 52
112-Mc. Bandsread Wavemeter—Broderson	Mar., 57

Amateur Stations

(Station Photographs)

KD4GYM—Swan Island	July, 9
K7BC—Sitka, Alaska	July, 47

OQ5ZZ—Gatti Expedition—Hall	June, 21
W2MYH—Summit, New Jersey	April, 61
W2OEC—Fort Monmouth, New Jersey	Dec., 94
W3KJ—Springfield, Pennsylvania	July, 57
W4FUM—Montgomery, Alabama	Mar., 54
W5EGJ—Perryton, Texas	Feb., 53
W5HLG—Amarillo, Texas	July, 56
W5IRO—Hodge, Louisiana	July, 56
W6PKK—Hollywood, California	May, 55
W6PMB—Los Angeles, California	Mar., 54
W6POZ—Hermosa Beach, California	May, 54
W6RBQ—San Francisco, California	Mar., 54
W6TOM—Los Angeles, California	July, 55
W7FTO—Coram, Montana	May, 55
W9BDO—Seneca, Nebraska	July, 57
W9CVU—Cedar Rapids, Iowa	Feb., 53
W9DIB—Mitchellville, Iowa	July, 56
W9LXC—Sheboygan, Wisconsin	April, 60
W9OQB—Decatur, Illinois	July, 55
W9QCY—Fort Wayne, Indiana	Mar., 61

• 91 •

Buyer's Guide

Where to Buy It

ROTHMAN AIRPLANE TRANSMITTER

Page 11

C₁, C₂—Bud 941
 C₁₀—Cornell-Dubilier BR-502
 C₁₃—Cornell-Dubilier BR-252-A
 C₁₇—Cornell-Dubilier BR-4015
 C₁₈—Cornell-Dubilier BR-845
 C₁₉—Cornell-Dubilier DT-4P5
 C₁₆—Cornell-Dubilier BR-850
 R₁—Centralab 714
 R₂, R₃—Centralab 516
 R₄, R₆, R₇—Ohmite "Brown Devil"
 R₅—Ohmite 0382 or 0212
 T₁—Thordarson T-86A02
 T₂—Thordarson T-17D01
 T₃—Thordarson T-19M14
 CH₁—Thordarson T-13C30
 CH₂—Thordarson T-13C27
 RFC—Hammarlund CH 8

T₁—Thordarson T-57S01
 T₂—Thordarson T-86A02
 RFC—Meissner 19-4215 chokes
 HY-65's—Hytron
 Vibrator pack—Mallory VP-552
 Crystal—Bliley MO-2

SMITH 25-WATT TRANSMITTER

Page 45

R.F. Section

R₁, R₆, R₇, R₈—Centralab 710
 R₂, R₄, R₅—Centralab 516
 R₃—Centralab 714
 R₉—Ohmite "Brown Devil" 20 W.
 C₁—Hammarlund SM-50
 C₂—Hammarlund SM-140

W9RIL—St. Cloud, Minnesota..... July, 57
 W9TJ—Mt. Carmel, Illinois..... May, 53
 W9WZO—Naperville, Illinois..... Feb., 53
 W9ZJB—Kansas City, Missouri..... May, 60

Antennas, Feeders and Masts

(see also: *Ultra-High Frequencies*)

Aircraft Beam Operation and Uses—
Finger..... May, 37
 Broadside Close-Spaced Arrays—
Espy..... Feb., 35
 Cathode-Ray Indicator for the Rotary
 Beam—*MacAllister*..... July, 30
 Calculating Distance and Direction—
Conklin..... Mar., 46
 Converting the Ten-Meter Rotary to
 Twenty—*Valentine*..... July, 39
 Compact 160-Meter Antenna—
Rimathe..... April, 98
 Counterweighted Antenna Tower—
Fraser..... Nov., 44
 Distance Ranges of Radio Waves..... May, 46
 End Loading the 3-Element Beam—
Bourret..... Mar., 43
 Five and Ten Meter Skip—*Conklin*..... Feb., 40
 Ideas on Feeder Spreaders—*Dowding*..... May, 44
 Inexpensive Beam Rotator—*Edmond-*
son..... April, 42
 Mercury as an Antenna—*Peterson*..... May, 31
 Multi-Band Antenna—*Johnson*..... June, 64
 New Ideas in Rotatable Beam Con-
 struction—*Ludgate*..... June, 49
 Self-Synchronous Direction Indicator
 —*Everest*..... Oct., 23
 Terminating Antenna Feeders—*Mc-*
Natt..... Feb., 27
 Tuning Short Radiators on Low Fre-
 quencies—*Stanley*..... Nov., 24
 U.H.F. Transmission Line—*Dumas*..... Nov., 92
 Versatile Vertical—*Grening*..... Jan., 55
 Vertical Concentric Fed Doublet—
Kiernan..... June, 16
 Wide-Band Antenna for 10 Meters—
Barilow..... May, 62
 12-Element Rotary for 56 Mc.—*Cope-*
land..... Oct., 34

Book Reviews and Catalogs

Aerosphere, 1941—*Angle*..... Oct., 72
 Amateur Radio—*Harper's*..... Nov., 6
 Antenna Manual—*Premax*..... July, 80
 ASTM Standards on Electrical Insu-
 lating Materials..... Feb., 72
 Capacitor Manual—*Cornell-Dubilier*..... June, 68
 Catalog—*Allied*..... July, 80; Nov., 74
 Catalog—*Amplifier Co. of America*..... April, 88
 Catalog—*Bud*..... Oct., 72
 Catalog—*Cornell-Dubilier*..... Feb., 72
 Catalog—*DeJur-Amsco*..... June, 68

Catalog—*Hallicrafters*..... Dec., 85
 Catalog—*Howard*..... April, 88
 Catalog—*Miller*..... Oct., 72
 Catalog—*Sprague*..... Oct., 72
 Catalog—*United Radio Supply*..... June, 68
 Catalog of Replacements—*Thordar-*
son..... Dec., 88
 How to Choose a Slide Rule—*Herold*..... Feb., 95
 How to Make Good Recordings—
Audio Devices, Inc...... April, 88
 Laboratory Instruction Manual—*Ra-*
diolab Pub. Co...... May, 96
 Log Book—*RCA*..... June, 68
 Most Popular 1940 Radio Diagrams
 —*Beitman*..... Feb., 72
 Mycalex Booklet—*G.E.*..... Nov., 74
 Name Plate Bulletin—*Crowe*..... June, 90
 Phototube Application—*RCA*..... June, 68
 Radio Engineering Handbook—*Hen-*
ney..... Oct., 72
 Receiving Tube Characteristics—
RCA..... Mar., 81
 Receiver Booklet—*Hallicrafters*..... May, 96
 The Meter at Work—*Rider*..... Feb., 72
 Transmitting and Special Purpose
 Tube Booklet—*RCA*..... June, 68
 Transmitting Tubes—*RCA*..... Oct., 72
 Tube Pamphlet—*G.E.*..... June, 90
 Vacuum Tube Voltmeters—*Rider*..... May, 96

Conventions and Hamfests

Boston Hamfest..... Oct., 70
 Chicago Luncheon Club..... Feb., 72
 Houston Convention..... Oct., 70
 Minnesota Convention..... Nov., 86
 Pacific Division Convention..... Nov., 94
 Pittsburgh Area Hamfest..... Feb., 72
 Rochester Hamfest..... Feb., 72
 U.H.F. Meeting..... Jan., 117

Diathermy

F.C.C. on Diathermy..... Mar., 6
 Modernized Portable Diathermy—
Raguse and Denney..... Mar., 20

DX

Five-Meter Summer DX—*Dawson*..... Oct., 47
 160-Meter DX with 3 Watts—*Sasser*..... Mar., 98
 WAAP—Prefixes and Rules.....
 Jan., 113; May, 50; June, 58
 WAZ Honor Roll..... Jan., 112; Feb., 50
 56 Mc. DX Honor Roll.....
 Jan., 123; Feb., 59;
 Mar., 62; April, 56; May, 58;
 June, 61; July, 75; Nov., 58; Dec., 48
 2 1/2 Meter DX Honor Roll.....
 Jan., 124; Feb., 61; Mar., 63;
 April 58; May, 59; June, 62;
 July, 86; Oct., 92; Nov., 59; Dec., 54

X-DX—*Becker*
Jan., 113; Feb., 51; Mar., 52;
 April, 52; May 50; June, 58; July, 46

Emergency and Relief Work

112 Mc. Net Aids Red Cross..... April, 59

Federal Communications Commission

Aircraft Frequency Changes.....Oct., 96
 Band Shrinkage.....Dec., 88
 Changes in Amateur Frequency Allo-
 cations.....Oct., 6
 Distinctive Calls for F.M.....Jan., 159
 FCC on Diathermy.....Mar., 6
 FCC Ruling on "Loaned" Equipment.....July, 77
 F.M. on Ten.....July, 6
 From the Mail Bag of the FCC.....Oct., 98
 Good Omen for Amateur Station
 Owners.....Dec., 94
 New International Broadcast Station.....Dec., 72
 Progress of NBC Commercial Tele-
 vision.....Oct., 70
 Ship Radiotelegraph Operator Re-
 quirements Modified.....Oct., 96
 Withdrawal of Frequencies from
 Amateur Service.....Nov., 70

Fiction and Verse

A Story from India—*The Old Timer*.....June, 66
 Automatic C.W. Meter—*Caswell*.....May, 65
 A Word to the Wives—*Leibens-
 perger*.....April, 66
 Banana Boat on Lake Erie—*Sadoski*.....July, 66
 Cousin Zeb's Grebe—*Jackson*.....Dec., 64
 CQ CQ CQ—*W7FPP*.....Oct., 96
 Encounter at Sea—*The Old Timer*.....Nov., 61
 Green Cheese in the Summer—
Sadoski.....Oct., 64
 Ham's Wife—*Vining*.....July, 60
 McPoostoe—the Cat—*W7FPP*.....Dec., 94
 Ode to Ye Never-Known—*W3EYY*.....Mar., 93
 Oil is Well, 111—*Stafford*.....Jan., 129
 Practical Dialogue Meter—*Caswell*.....Feb., 67
 PSE QSP—*The Old Timer*.....Mar., 68
 Set-Builders' Nightmare.....Dec., 78
 The Answer to that Pink Ticket—
Wormwood.....Jan., 139
 The New Spring Outfit—*Lingan*.....June, 92
 Wandering Willie.....Dec., 89
 56-Mc. "Potgut" Oscillator—*May*.....Nov., 48

Five Meters

(see: *Portable-Mobile and Ultra-High
 Frequencies*)

Frequency Modulation

Control of F.M. Receiver Readability
 —*Ferrell*.....July, 76

Distinctive Calls for F.M.....Jan., 159
 F.M. for Ten—*Norton*.....Oct., 14
 F.M. on Ten.....July, 6
 F.M. Receiver for Less than Fifteen
 Dollars—*Brooks*.....Feb., 54
 Improved Design Frequency Modula-
 tor—*Falor*.....June, 24
 NBC Frequency Modulation Field
 Test—*Guy and Morris*.....Jan., 12
 Ten to 2.5 Meter F.M. and A.M.
 Superhet—*Brown*.....Dec., 36
 Why Not Narrow-Band F.M.?—
Norton.....Jan., 88
 8-Tube Converter for F.M. Reception
 —*Thompson*.....Mar., 9

Hints

Adjusting the Superregenerative Re-
 ceiver—*Fleming*.....Dec., 30
 Bandsread—*Norton*.....April, 20
 Calibrating Ohmmeters with a Slide
 Rule—*Sadoski*.....May, 63
 Cleaning Rust From Tools.....June, 80
 Control of F.M. Receiver Readability
 —*Ferrell*.....July, 76
 Equipping the Amateur's Workshop
 —*Caird*.....Jan., 75
 Filament and Plate Control for Mer-
 cury Vapor Rectifiers—*Hall*.....Jan., 126
 Helpful Hints.....April, 50
 Homemade Rotatable-Link Induc-
 tances—*Elsen*.....Jan., 127
 I.C.W. with a Transceiver—*Crabill*.....May, 63
 Ideas on Feeder Spreaders—*Dowding*.....May, 44
 Inexpensive, Stabilized Oscillator—
Falor.....Feb., 56
 More A.F. Gain.....Feb., 88
 Police Radio Kinks.....Nov., 37
 Reduction of Drift in V.F.O.'s—
Dixon.....July, 58
 Sound Kinks—*Blair*.....Mar., 64
 Stabilization of Grid Bias—*Shaw*.....July, 58
 Terminating Antenna Feeders—*Mc-
 Natt*.....Feb., 27
 Transceiver Data for the Newcomer
 —*Broderson*.....Dec., 60
 When You Solder.....May, 72

Keying

(see also: *Transmitting*)

A.C. Operated Code Practice Oscilla-
 tor—*Williams*.....May, 62
 Are You Using a Keying Monitor—
Swan.....June, 52
 Banana Boat on Lake Erie—*Sadoski*.....July, 66
 Combination Keying Monitor and
 Break-In Control Unit—*Read*.....June, 55

I.C.W. With A Transceiver— <i>Crabill</i>	May, 63
Inexpensive Electronic Bug— <i>Clark</i>	Oct., 36
Keying the V.F.O. Without Clicks, Chirps or Tails— <i>Smith</i>	April, 62
"TRMA" Helpful Hints for Code Learners— <i>Parker</i>	Dec., 42
Versatile Electronic Key— <i>Gunkle</i>	April, 40

Meters and Measurements

Calibrating Ohmmeters With A Slide Rule— <i>Sadoski</i>	May, 63
Cathode-Ray Indicator for the Ro- tary Beam— <i>MacAllister</i>	July, 30
Determining R.F. Power Output— <i>McNatt</i>	Jan., 93
Directly Calibrated Audio Oscillator — <i>Davis</i>	July, 40
Electronic Ohmmeter— <i>Donaghue</i>	Jan., 127
Grid Dip Oscillator for Amateur Use — <i>Bernard</i>	Oct., 42
High-Sensitivity Vacuum-Tube Volt- meter— <i>Ryder</i>	Oct., 26
Instant Action Negative Peak Over- Modulation Indicator— <i>Harrell</i>	Mar., 65
Meter-Switching for Transmitters— <i>Griggs</i>	Oct., 60
Parallel T for Amateur Use— <i>Sheaffer</i>	Nov., 12
Practical Sine-Wave Generator— <i>MacAllister</i>	April, 14
Probe Type Rectifier for the D.C. Voltmeter— <i>McLaren</i>	Nov., 40
Regulated A.C.-D.C. Vacuum-Tube Voltmeter.....	Feb., 32
Self-Synchronous Direction Indicator for Rotary Beam Antennas— <i>Everest</i>	Oct., 23
Simple R.F. Power Measuring Device — <i>McNatt</i>	May, 61
Simple 400-Cycle Audio Oscillator— <i>Bown</i>	July, 59
The "Gimmick"—A Transmitter Tester— <i>Statt and Beebe</i>	Dec., 22
Vacuum-Tube Voltmeters— <i>Moody</i>	May, 34
Wide-Range U.H.F. Wavemeter— <i>Rehm</i>	April, 30

Miscellaneous

Aids in Filter Designing— <i>Aerovox</i> <i>Corp.</i>	Mar., 38
Aircraft Beam, Its Operation and Uses— <i>Finger</i>	May, 37
Army Amateur Radio System.....	April, 37
Aurora U.H.F. Propagation— <i>Ferrell</i>	Feb., 20
Baffling the Loudspeaker— <i>Gilbert</i>	Dec., 32
Bandspread— <i>Norton</i>	April, 20
Becoming An Amateur— <i>Bradley</i>	Dec., 40
Calculating Distance and Direction— <i>Conklin</i>	Mar., 36

Coincidence of U.H.F. Fading— <i>Fer- rell</i>	April, 9
Custom Equalizer for any Phono- graph— <i>Smith</i>	Nov., 21
Design and Operating Data for Con- denser Input Filters— <i>Lampson</i>	Nov., 35
Distance Ranges of Radio Waves.....	May, 46
Effect of Temperature on the Fre- quency of a Self-Excited, High- Frequency Oscillator.....	Jan., 103
Elements of Home Recording.....	Jan., 81
Equipping the Amateur's Workshop — <i>Caird</i>	Jan., 75
Five-Meter Summer DX— <i>Dawson</i>	Oct., 47
Flux Density and Its Effect Upon Transformer Performance— <i>Gross</i>	Mar., 36
Great Circle Calculations— <i>Gadua</i>	Dec., 21
Hams and the Army— <i>Phillips</i>	May, 22
Inexpensive Wooden Relay Rack— <i>Smith</i>	May, 28
Injection Molding of Mycalex.....	July, 88
Japanese Radio Code— <i>Lee</i>	May, 42
Low Pass Filter for Radio or Phono Use— <i>Kosolapoff</i>	June, 35
Lucite vs. Polystyrene.....	Dec., 63
NBC Frequency Modulation Field Test— <i>Guy and Morris</i>	Jan., 12
Oscillator Operation— <i>Freeman</i>	Mar., 24
Perfect-Balance Self-Balancing Phase Inverter— <i>Wallman</i>	Oct., 46
Recording Theory and Practice— <i>Espy</i>	Jan., 68
Splatter Filter Notes.....	Jan., 31
Story of KD4GYM— <i>Paull</i>	July, 9
Story of OQ5ZZ— <i>Hall</i>	June, 21
Sunspots and Radio— <i>Conklin</i>	July, 20
Synchronize Your Skeds With Arling- ton Time— <i>Poole</i>	Dec., 15
"Tallyho, Two-and-A-Half" — <i>Wil- burn</i>	April, 44
Transmitter Interference Elimination — <i>Lawrence</i>	Nov., 30
Trailers for Amateur Emergency Work— <i>Warner</i>	June, 30
Triode Connected 6V6's and 6L6's.....	Dec., 78
Using the Barometer— <i>Hall</i>	April, 39
Why Every Amateur Should Be A Member of A.R.R.L.— <i>Warner</i>	July, 43
Would You Pass?— <i>Kitchin</i>	Dec., 39
28-Mc. Band in Britain.....	Feb., 93
112 Mc. Net Aids Red Cross at Presi- dential Inauguration— <i>Reed</i>	April, 59

Mobile, Portable and Emergency

(see also: *Radiotelephony, Receiving
Transmitting, U.H.F.*)

Another Version of Portable Emer- gency Equipment— <i>Strock</i>	Dec., 8
---	---------

Compact Portable Transmitter— <i>Van Rensselaer</i>	June, 26
Dual-Service Transceiver— <i>Lewis</i>	Nov., 42
Emergency-Service Portable Station— <i>Hlywa</i>	Nov., 16
Filament Tube Airplane Transmitter— <i>Roibman and Dawley</i>	May, 18
Just Another Portable Mobile— <i>May</i>	July, 13
Mobile Transmitter with Instant-Heating Tubes— <i>Newnan</i>	April, 26
Pocket Transceiver for 112 Mc.— <i>McEntee</i>	Jan., 118
Portable Emergency Transmitter for Home or Field Use— <i>Taylor</i>	Nov., 32
Portable or Mobile Bandswitching Transmitter— <i>Bloom</i>	May, 12
Self-Contained, Battery Powered 2.5 Meter Transceiver— <i>Smith</i>	Dec., 26
Trailers for Amateur Emergency Work— <i>Warner</i>	June, 30
U.H.F. Direction Finder and Transceiver— <i>McHolland</i>	May, 26

New Apparatus

Aircraft Radiophone— <i>Electronic Specialty</i>	Feb., 70
B.C. Signal Generator— <i>Allied</i>	May, 86
Blackout-Panel Oscillograph— <i>Dumont</i>	Dec., 66
Cardioid Microphone— <i>Turner</i>	July, 87
Centralized Sound System— <i>Hallcrafters</i>	Oct., 68
Code Practice Oscillators— <i>Bud</i>	Jan., 134
Code Practice Oscillator— <i>Airadio</i>	July, 82
Converter— <i>Eicor</i>	July, 88
Decade Inductance— <i>N.Y. Trans-former</i>	Oct., 66
Dispatcher's Mike— <i>Universal</i>	Jan., 134
EC-2 Receiver— <i>Echophone</i>	Oct., 76
EC-3 Receiver— <i>Echophone</i>	July, 87
Elim-O-Stat— <i>Solar</i>	Nov., 68
Filament Transformer— <i>Thordarson</i>	Oct., 68
FM/AM Tuner— <i>Hallcrafters</i>	Mar., 90
General Electric 866A/866	Feb., 70
Generator Field Rheostats— <i>Ohmite</i>	Mar., 90
Hand Drill— <i>Paramount</i>	Feb., 88
Live-Bracket and Dead-Bracket type Resistors— <i>Ohmite</i>	July, 74
Low-Power Sound Amplifier— <i>Lafayette</i>	Mar., 91
Magnetic Pickup— <i>Turner</i>	Jan., 134
Marine Radio Equipment— <i>Federal</i>	Dec., 68
Mercury Switch— <i>Littlefuse</i>	April, 72
Microtubes— <i>Microtube Labs.</i>	April, 72
Midget Insulated Resistors— <i>Aerovox</i>	Oct., 66
Mobile P.A. Amplifier— <i>Thordarson</i>	May, 64
Plug-In Electrolytics— <i>Solar</i>	Jan., 134
Portable Aviation Radio Receiver— <i>RCA</i>	July, 74
Polystyrene Spacer— <i>Ampbenol</i>	May, 86
Preferred Tube Replacement— <i>RCA</i>	April, 72
Push-Pull Vibrators— <i>Turner</i>	Mar., 91
QSO-Index File— <i>Bud</i>	May, 64
Radio Compass and Receiver— <i>Hallcrafters</i>	April, 72
Radio Flight Instruction Equipment— <i>Electronic Specialty</i>	Feb., 70
Radio Training Course Kit— <i>Allied</i>	July, 87
RCA Tubes	April, 72, 76; May, 64
Recorder— <i>Presto</i>	April, 72
Record QSL's— <i>National Recording Supply</i>	April, 72
Relay— <i>Ward-Leonard</i>	Nov., 68
Semi-Communications Receiver— <i>Echophone</i>	Jan., 155
"Skyrider 32"— <i>Hallcrafters</i>	Oct., 66
Speaker Baffle— <i>RCA</i>	Nov., 68
"Speech Master" Reproducer— <i>Jensen</i>	Oct., 68
Stellite and Sapphire Recording Needles— <i>Audio Devices</i>	Feb., 87
Sum-Up Slide Rule— <i>Sum-Up Slide Rule Co.</i>	Dec., 66
Tapped Resistors— <i>Sprague</i>	Oct., 76
Temperature Compensating Capacitors— <i>Aerovox</i>	Dec., 68
Test Equipment— <i>RCA</i>	Jan., 134
Time Delay Switch— <i>Betts and Betts</i>	May, 86
Transformer— <i>Kenyon</i>	Dec., 66
Transmitter Kits— <i>Thordarson</i>	Jan., 155
Transparent Acetate Tube— <i>Precision</i>	May, 64
Vernier Dial— <i>Bud</i>	Oct., 66
Vibrator Power Supply— <i>Electro Products</i>	Dec., 66
Waterproof Speakers— <i>Cinaudgraph</i>	Oct., 66
2.5 Meter R.F. Plate Choke— <i>Ohmite</i>	Oct., 76
10-Channel Marine Radiophone— <i>Hallcrafters</i>	Feb., 87
110-Volt A.C. Light and Power Plants— <i>Kato</i>	Oct., 76

Open Forum

Communication With Central and South America— <i>W3AG</i>	Oct., 80
DX and the Good Old Days— <i>W6OVK</i>	Dec., 63
"Fritz the Radio Spy"— <i>W9QHZ</i>	June, 70
Letters from England— <i>G6DH, G8QH and Cosb.</i>	April, 78
New York Five-Meter Activity— <i>W2LAL</i>	Jan., 146
OMRC Additions— <i>W1JIS</i>	July, 76
QRN and Loops— <i>W6CAN</i>	Dec., 63
RADIO in Retrospect— <i>W2LIW</i>	June, 70

Postscripts

OM's Club Additions	Jan., 117; Nov., 86
Radio Interference Conference	May, 94

Rules Waived for Radio Operators...Jan., 117
 Withdrawal of Frequencies from
 Amateur Service.....Nov., 70

Radiotelephony

(see also: *Transmitting, U.H.F., and Meters and Measurements*)

Aids in Filter Designing—*Aerovox*...Mar., 38
 A Kilowatt Gets Ready for Active
 Service—*Christensen*June, 36
 Another Version of Portable Emer-
 gency Equipment—*Strock*Dec., 8
 Bandswitching 100-Watt Transmitter
 —*Adams and Smith*.....Jan., 60
 Compact Portable Transmitter—*Van-*
RensselaerJune, 26
 Compression Amplifier for Communi-
 cations Work—*Smith*Mar., 16
 Directly Calibrated Audio Oscillator
 —*Davis*July, 40
 Dual-Service Transceiver—*Levis*.....Nov., 42
 Emergency-Service Portable Station—
HlywaNov., 16
 Filament Tube Airplane Transmitter
 —*Rothman and Dawley*.....May, 18
 F.M. for Ten—*Norton*.....Oct., 14
 Improved Design Frequency Modula-
 tor—*Falor*June, 24
 Intercommunication Circuits for Po-
 lice Radio Systems—*Ives*.....July, 34
 Just Another Portable Mobile—*May*.....July, 13
 Low Pass Filter for Radio or Phone
 Use—*Kosolapoff*June, 35
 Low-Powered Police Transmitter—
ShannonJuly, 26
 Midget Modulator—*Patterson*.....April, 49
 Mobile Transmitter With Instant
 Heating Tubes—*Newnan*.....April, 26
 Negative Peak Over-Modulation Ind-
 icator—*Harrell*Mar., 65
 One-Kilowatt Police Transmitter—
BrittainJan., 99
 Peaked Audio Amplifier—*Smith*.....Feb., 23
 Phone-C.W. Transmitter with In-
 verted Oscillator—*Reed*.....Jan., 83
 Pocket Transceiver for 112 Mc.—
McEnteeJan., 118
 Portable Emergency Transmitter for
 Home or Field Use—*Taylor*.....Nov., 32
 Portable or Mobile Bandswitching
 Transmitter—*Bloom*May, 12
 Practical Sine-Wave Generator—
MacAllisterApril, 14
 Simple A.F. Peak Limiter for the
 Phone Transmitter—*Smith*.....June, 46
 Simple 400-Cycle Audio Oscillator—
BowenJuly, 59
 Simplicity in the Speech Amplifier—
DawleyNov., 52

Sounds Kinks—*Blair*Mar., 64
 The "Gimmick"—A Transmitter
 Tester—*Statt*Dec., 22
 25 Watts on 56 Mc.—*Dawson*.....Mar., 33
 40- or 200-Watt Phone-C.W. Trans-
 mitter for 10-160 Meter Opera-
 tion—*Smith*Jan., 37
 500-Watt Commercial Transmitter—
MoynabanFeb., 11

Receiving

(see also: *Frequency Modulation, Ultra-High Frequencies*)

Accessory Variable-Selectivity Crystal
 Filter—*Norton*May, 8
 Adjusting the Superregenerative Re-
 ceiver—*Fleming*Dec., 30
 Bandsread—*Norton*April, 20
 "Bare Essentials" Superhet Receiver
 —*Taylor*Mar., 48
 Coaxial-Tuned Converter—*Copeland*..June, 17
 Control of F.M. Receiver Readability
 —*Ferrell*July, 76
 Emergency Service Portable Station—
HlywaNov., 16
 Five- and Ten-Meter Converter—
TaylorOct., 31
 F.M. Receiver for Less Than Fifteen
 Dollars—*Brooks*Feb., 54
 High Fidelity Receiver for Local
 Broadcast Reception—*Smith*.....April, 46
 Simple SuperhetrodyneDec., 55
 Superregenerators—*Conklin*Jan., 32
 Ten to 2.5 Meter F.M. and A.M.
 Superhet—*Brown*Dec., 36
 Transceiver Data for the Newcomer
 —*Broderson*Dec., 60
 Two-Frequency Police Receiver—
BrittainDec., 44
 8-Tube Converter for F.M. Reception
 —*Thompson*Mar., 9
 56-Mc. Preselection for Weak-Signal
 DX—*May*April, 16
 400-Megacycle Receiver—*Reed*.....Mar., 27

Transmitting

(see also: *Radiotelephony, Tubes, Ultra-High Frequencies, and Frequency Modulation*)

A.C. and Vibrator Power Supply—
GunkleJuly, 33
 Another Final—*Link*Nov., 64
 Another Version of Portable Emer-
 gency Equipment—*Strock*Dec., 8
 Bandswitching 100-Watt Transmitter
 —*Adams and Smith*.....Jan., 60
 Compact Portable Transmitter—*Van-*
RensselaerJune, 26
 Deluxe Multi-Band V.F.O. Exciter—
PierceOct., 9

- Design and Operating Data for Condenser Input Filters—*Lampson*.....Nov., 35
- Determining R.F. Power Output—*McNatt*Jan., 93
- Dual-Service Transceiver—*Levis*.....Nov., 42
- Effect of Temperature on the Frequency of a Self-Excited, High Frequency Oscillator.....Jan., 103
- Emergency-Service Portable Station—*Hlywa*Nov., 16
- Filament and Plate Control for Mercury Vapor Rectifiers—*Hall*.....Jan., 126
- Filament Tube Airplane Transmitter—*Rothman and Dawley*.....May, 18
- F.M. for Ten—*Norton*.....Oct., 14
- General Purpose Variable Frequency Oscillator—*Bernard*May, 23
- Improved Design Frequency Modulator—*Falor*June, 24
- Inexpensive 112 Mc. M.O.P.A.—*Falor*.....Jan., 98
- Just Another Portable Mobile—*May*.....July, 13
- Kilowatt Gets Ready for Active Service—*Christensen*June, 36
- Low-Powered Police Transmitter—*Shannon*July, 26
- Medium-Powered C.W. Transmitter—*Norton*June, 9
- Medium-Power Transmitter for 28 Mc.—*Rothman*Feb., 38
- Meter Switching for Transmitters—*Griggs*Oct., 60
- Mobile Transmitter with Instant Heating Tubes—*Newnan*.....April, 26
- One-Kilowatt Police Transmitter—*Brittain*Jan., 99
- Phone-C.W. R.F. Unit for 7, 14, and 28 Mc.—*Haberlitz and Rothman*.....Mar., 30
- Phone-C.W. Transmitter with Inverted Oscillator—*Reed*Jan., 83
- Pocket Transceiver for 112 Mc.—*McEntee*Jan., 118
- Portable Emergency Transmitter for Home or Field Use—*Taylor*.....Nov., 32
- Portable or Mobile Bandswitching Transmitter—*Bloom*May, 12
- Push-Pull Beam Tetrode Amplifier—*Rothman*Dec., 18
- Reduction of Drift in V.F.O.'s—*Dixon*July, 58
- R.F. Power Measuring Device—*McNatt*May, 61
- Rotatable-Link Inductances—*Elsen*.....Jan., 127
- Safety Switch for V.F.O. Operation—*McNatt*Jan., 46
- Self-Contained, Battery-Powered 2.5 Meter Transceiver—*Smith*Dec., 26
- Series Tank Frequency-Multiplier Circuits—*Munzig*Nov., 49
- Simple A.F. Peak Limiter for the Phone Transmitter—*Smith*.....June, 46
- Simplified Transmitter Control—*Whitehorn*Nov., 46
- Splatter Filter Notes.....Jan., 31
- Stabilization of Grid Bias—*Shaw*.....July, 58
- Substitute for Safety Bias When Using Screen Grid Tubes—*Smith*.....Dec., 13
- Sweepstakes Exciter—*Onnigian*.....Nov., 26
- Terminating Antenna Feeders—*McNatt*Feb., 27
- Three-Phase Power from Single-Phase Supply—*Jennings*.....Jan., 108
- Transmitter Interference Elimination—*Lawrence*Nov., 30
- Triodes as Class C Amplifiers—*Naslund*Jan., 49
- V.F.O. Design Considerations—*Smith*Oct., 39
- ¼ Cubic Foot-¼ Kilowatt—*Burgess*.....July, 22
- 56-Mc. Exciter or Transmitter—*Fabian*March, 64
- 25 Watts on 56 Mc.—*Dawson*.....March, 33
- 40- or 200-Watt Phone-C.W. Transmitter for 10-160 Meter Operation—*Smith*Jan., 37
- 100-Watt Semi-Bandswitching Transmitter or Exciter—*Caswell*.....April, 33
- 100-Watt Triode Transmitter-Exciter—*Dawley*Feb., 16
- 300-Watt R.F. Section for V.F.O. Operation—*Rothman*Nov., 8
- 500-Watt Commercial Transmitter—*Moynahan*Feb., 11

Tubes

- 3S4 Battery-Receiver Pentode.....Feb., 73
- 5Y3-GT/5Y3 Full-Wave Rectifier.....July, 42
- 6SF7 I.F. Amplifier-Detector.....May, 64
- 6SG7 R.F. Pentode.....April, 72
- 6SN7 Twin Triode.....May, 64
- 6SS7 R.F. Pentode.....July, 42
- 12H6.....July, 42
- 12SF7 I.F. Amplifier-Detector.....May, 64
- 12SG7 R.F. Pentode.....April, 72
- 12SL7-GT High-Mu Twin Triode.....July, 42
- 12SN7-GT Twin-Triode Amplifier.....July, 42
- 117P7-GT Rectifier-Beam Power Amplifier.....July, 42
- 815 Dual Beam Tetrode.....Feb., 45
- 816 Mercury-Vapor Rectifier.....July, 42
- 826 U.H.F. Triode.....Feb., 47
- 866A/866 Mercury Vapor Rectifier.....Feb., 48
- 930 Gas Phototube.....April, 77
- 931 Phototube.....July, 92
- 1625 Beam Power Amplifier.....Feb., 48
- 1626 12.6-Volt 5-Watt Triode.....Feb., 75
- 1629 Electron Ray.....April, 77
- 8000 Transmitting Triode.....April, 77
- 8001 Transmitting Beam Tetrode.....July, 92
- 8005 Transmitting Triode.....July, 79
- 9001 Detector Amplifier Pentode.....Oct., 74
- 9002 Detector Amplifier Triode.....Oct., 74

- 9003 Super-Control Amplifier Pentode Oct., 77
 HY65 R.F. Beam Tetrode..... July, 94
 HY67 R.F. Beam Tetrode..... July, 94
 HY245 Filament Type Pentode..... Oct., 78
 HY255X Filament Type Pentode..... Oct., 78
 Z-225 Mercury Vapor Rectifier..... July, 94
 Microtubes April, 72
 Phototube Application—*RCA*..... March, 81
 Preferred Replacement Types—*RCA* April, 77
 Receiving Tube Characteristics—*RCA* March, 81
 Transmitting and Special Tube Booklet—*RCA* June, 68
 Transmitting Tubes—*RCA*..... Oct., 72
 Triode Connected 6V6's and 6L6's..... Dec., 78
 Triodes as Class C Amplifiers—*Naslund* Jan., 49
 Tube Pamphlet—*G.E.*..... June, 90
- Ultra-High Frequencies**
- (see also: *Antennas, Radiotelephony, Receiving, Transmitting, Tubes, Frequency Modulation*)
- Adjusting the Superregenerative Receiver—*Fleming* Dec., 30
 Aurora U.H.F. Propagation—*Ferrell*..... Feb., 20
 Broadside Close-Spaced Arrays—*Espy* Feb., 35
 Calculating Distance and Direction—*Conklin* March, 46
 Coaxial-Tuned Converter—*Copeland*..... June, 17
 Coincidence of U.H.F. Fading—*Ferrell* April, 9
 Control of F.M. Receiver Readability—*Ferrell* July, 76
 Converting the Ten-Meter Rotary to Twenty—*Valentine* July, 39
 Distance Ranges of Radio Waves..... May, 46
 Dual-Service Transceiver—*Levis*..... Nov., 42
 Filament Tube Airplane Transmitter—*Rothman and Dawley*..... May, 18
 Five- and Ten-Meter Converter—*Taylor* Oct., 31
 Five- and Ten-Meter Skip—*Conklin*..... Feb., 40
 Five-Meter Summer DX—*Dawson*..... Oct., 47
 F.M. for Ten—*Norton*..... Oct., 14
 F.M. Receiver for Less than Fifteen Dollars—*Brooks* Feb., 54
 I.C.W. with a Transceiver—*Crabill*..... May, 63
 Improved Design Frequency Modulator—*Falor* June, 24
 Inexpensive Beam Rotator—*Edmondson* April, 42
 Inexpensive, Stabilized Oscillator—*Falor* Feb., 56
 Inexpensive 112 Mc. M.O.P.A.—*Falor* Jan., 98
 Just Another Portable Mobile—May..... July, 13
 Medium Power 28-Mc. Transmitter—*Rothman* Feb., 38
 Mobile Transmitter with Instant Heating Tubes—*Newman*..... April, 26
 NBC Frequency-Modulation Field Test—*Guy and Morris*..... Jan., 12
 New Ideas in Rotatable Beam Construction—*Ludgate* June, 49
 Pocket Transceiver for 112 Mc.—*McEntee* Jan., 118
 Self-Contained, Battery-Powered 2.5 Meter Transceiver—*Smith*..... Dec., 26
 Sunspots and Radio—*Conklin*..... July, 20
 Superregenerators—*Conklin* Jan., 32
 "Tallyho, Two-and-a-Half"—*Wilburn* April, 44
 Ten to 2.5 Meter F.M. and A.M. Superhet—*Brown* Dec., 36
 Transceiver Data for the Newcomer—*Broderson* Dec., 60
 Two-Frequency Police Receiver—*Brittain* Dec., 44
 Two-Frequency Stub Matching..... July, 36
 U.H.F. Transmission Line—*Dumas*..... Nov., 92
 Vertical Concentric-Fed Doublet—*Kiernan* June, 16
 Wide-Band Antenna for 10 Meters—*Barlow* May, 62
 Wide Range U.H.F. Wavemeter—*Rehm* April, 30
 Why Not Narrow-Band F.M. for General Amateur Use?—*Norton*..... Jan., 88
 8-Tube Converter for F.M. Reception—*Thompson* March, 9
 12-Element Rotary for 56 Mc.—*Copeland* Oct., 34
 25 Watts on 56 Mc.—*Dawson*..... March, 33
 28-Mc. Band in Britain..... Feb., 93
 56-Mc. Exciter or Transmitter—*Fabian* March, 64
 56-Mc. Preselection for Weak-Signal DX—*May* April, 16
 112-Mc. Net Aids Red Cross—*Reed*..... April, 16
 112-Mc. Bandspread Wavemeter—*Broderson* March, 57
 400-Megacycle Receiver—*Reed*..... March, 27
- Variable Frequency Oscillators-Exciters**
- (see also: *Transmitting*)
- De luxe Multi-Band V.F.O. Exciter—*Pierce* Oct., 9
 General Purpose V.F.O.—*Bernard*..... May, 23
 Keying the V.F.O. without Clicks, Chirps, or Tails—*Smith*..... April, 62
 Reduction of Drift in V.F.O.'s—*Dixon* July, 58
 Safety Switch for V.F.O. Operation—*McNatt* Jan., 46
 Sweepstakes Exciter—*Onnigian*..... Nov., 26
 V.F.O. Design Consideration—*Smith*..... Oct., 39

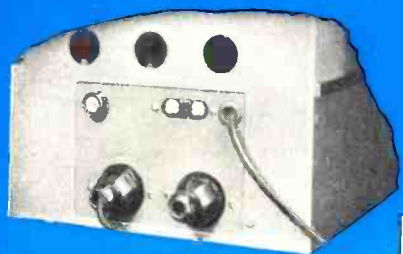

**PORTABLE OR
AC OPERATION**

**TEN
COIL
RANGES**

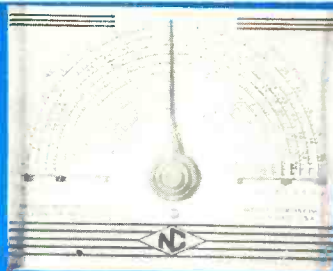

**MOVABLE COIL
TUNING SYSTEM**

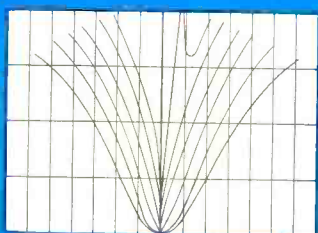

**WIDE RANGE
CRYSTAL FILTER**



The NC-200 has

TEN COIL RANGES

The NC-200 has ten calibrated coil ranges. Six of these ranges provide continuous coverage from 490 KC to 30 MC. The remaining four ranges cover the 10, 20, 40, and 80 meter bands, each band being spread over the major portion of the dial scale.

WIDE RANGE CRYSTAL FILTER

An improved wide range crystal filter is used in the NC-200. Selectivity is adjustable in six steps corresponding to bandwidths from 200 to 7600 cycles. The phasing circuit provides rejection ratios as high as 10000 to 1 when the interfering signal is only a few hundred cycles from the desired signal.

MOVABLE COIL TUNING SYSTEM

RF and oscillator coils, together with their associated padding condensers, are completely enclosed in separate pockets in a heavy cast aluminum shield. This shield moves bodily on a track, bringing the desired coils into operating position directly below the tubes and condenser, and taking the unused coils out of the way.

PORTABLE OR AC OPERATION

Typical of the refinement of detail in the NC-200 is the provision for operating standard AC models on batteries for emergency or portable use. All that is necessary is to plug in a battery cable in place of the dummy plug supplied with the receiver. This makes all necessary connections, and leaves the speaker and standby switch in operation. The B-supply filter is left in the circuit to assist in filtering vibrator and dynamotor B-power units.

*—and low
price!*

Best of all, the NC-200 sells for a very low price in spite of its many exclusive features. Without speaker the net price is only

\$159.50

At your dealer's!

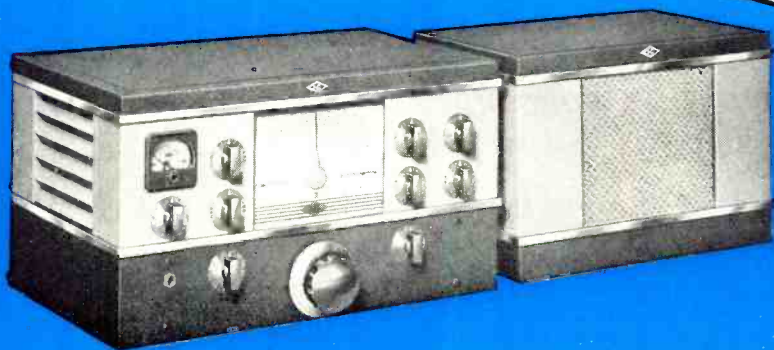

**NATIONAL
COMPANY
MALDEN, MASS.**

New Plant Triples Capacity

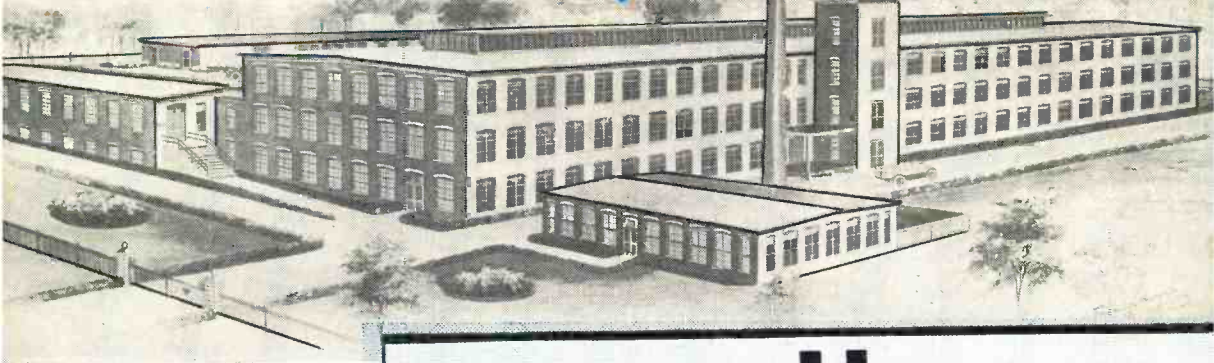

Hytron's newly acquired "Sunshine Plant" at Newburyport, Massachusetts

ALREADY an important part of the Arsenal of Democracy, Hytron anticipates the increasingly greater role which it must play in National Defense, by acquisition of the splendid new plant shown above.

The TRIPLED SPACE thus gained will enable Hytron to manufacture more and more tubes to supply the Government's rapidly mounting demands, also those of our own customers. Armed Forces to Amateurs . . . Hytron now can take care of ALL!

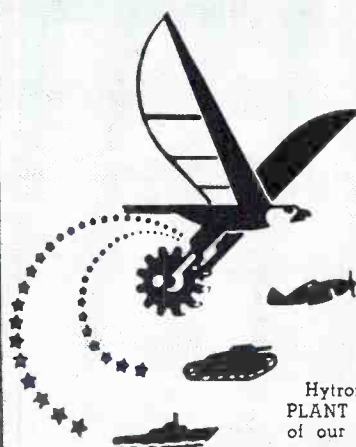

HYTRON PART OF THE ARSENAL OF DEMOCRACY

Hytron is authorized to display this official DEFENSE PLANT IDENTIFICATION, signifying that more than 50% of our production is devoted to the needs of defense.

Measured in radio tubes, this figure represents more than a casual devotion to Defense. Important, indeed, are the tasks which Hytron tubes will perform during long, routine hours and in sudden, crucial moments.

To loyal Hytron users—to all who know of the many basic improvements developed here—it will be no surprise to find these better tubes taking key positions in the vast military mosaic of America and Britain. What should be emphasized now is:—Defense is getting

what it needs from Hytron, with no serious effect upon our ability to supply the radio industry, nor any slightest relaxation in quality.

The needs of our regular customers, increasing heavily, have put Hytron capacity to a double test. That additional trial is also being met—in a plant whose flexibility astonishes even ourselves—by a master-combination of men, women and machines that seems ever capable of doing more and more!

Outstanding in the manufacture of unique tubes for highly specialized U.H.F. and Portable-Mobile equipment, Hytron stands ready to meet the unprecedented demand for such tubes by Government and Civilian Defense services. Power-conserving, instant-heating Hytron tubes of many types are ready to take over their important jobs in the defense communication nets being rushed to completion on the high and ultra-frequencies.

Not content with record-making tubes like the HY75, HY615 and HY69, Hytron has already added several new types, such as the HY65. This exceptional newcomer is used throughout in the 100 transmitters made by Cover Dual Signal Systems, Inc. for the radio intercommunication net of the huge Ravenna, Ohio, ordnance plant. No resting on oars here! Hytron keeps on developing "only-one-like-it" tubes . . . to serve YOU better and maintain Hytron leadership.



HYTRONIC LABORATORIES

23 New Darby St., Salem, Mass.

MANUFACTURERS OF RADIO TUBES SINCE 1921

A DIVISION OF
HYTRON CORP.