

# RADIO

ESTABLISHED 1917

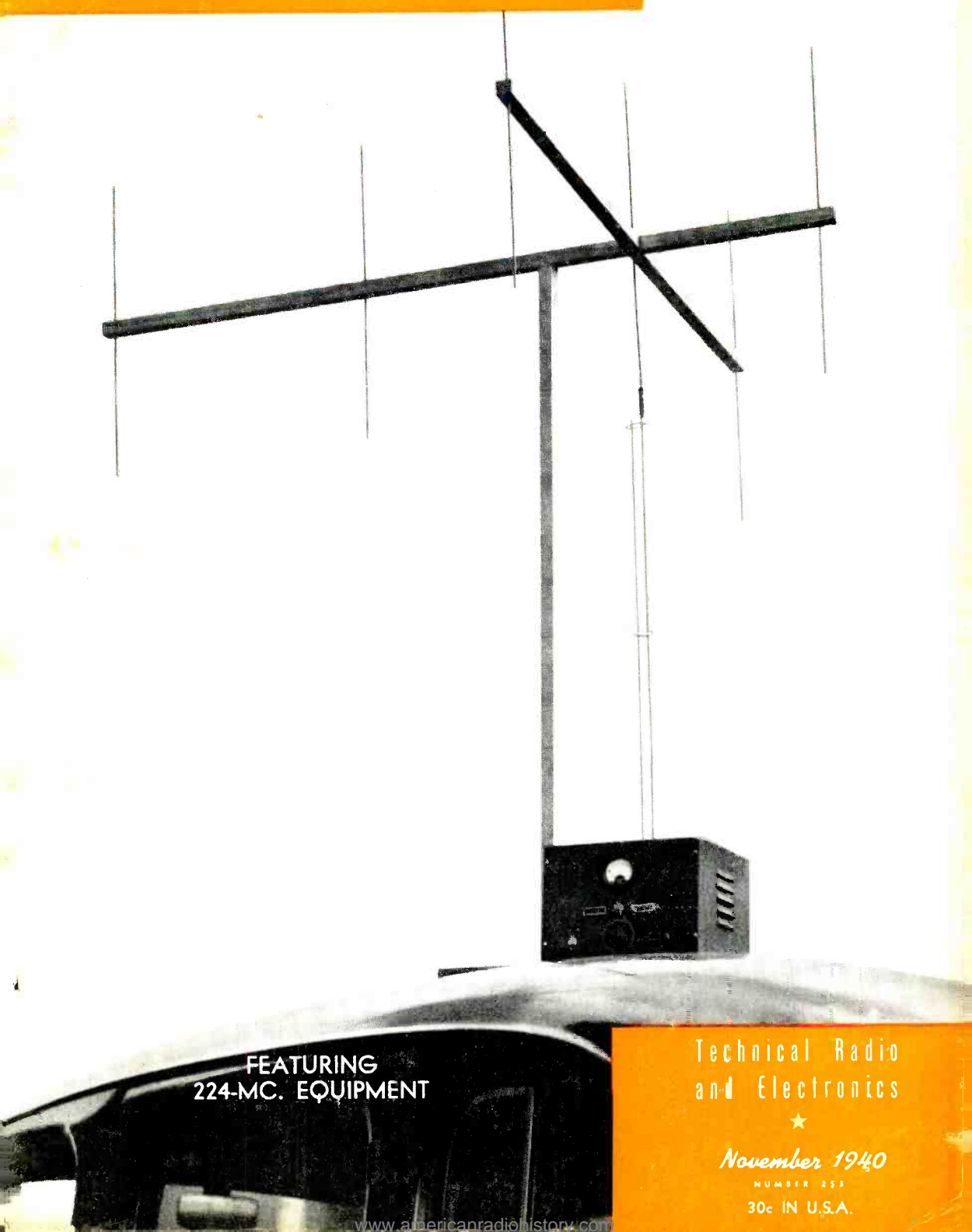

FEATURING  
224-MC. EQUIPMENT

Technical Radio  
and Electronics



*November 1940*

NUMBER 253

30c IN U.S.A.

# TW-75 WINS PRAISE!

## Easy to Drive to 650 Watts Phone Input Writes W7GGG



DAM S ZUCKERMAN, M.D., F.A.S.C.P.  
CLINICAL PATHOLOGIST  
WYAND BUILDING, WILMINGTON, N.D.

April 22, 1940

Mr. Frank Hoyle,  
Taylor Tubes, Inc.,  
Chicago, Illinois

My dear Frank:

The TW-75's are in the rig and working fine. I've had several of the fellows on the air ask me just how difficult it is to excite these new tubes. So here's the dope -- I am putting from 500 to 650 watts of ten or twenty meter phone RF on the air with a pair of TW-75's driven by one 807 acting as either a straight driver or as a doubler-driver. To use one of Herb Becker's X-80's to drive the 807. A three stage 600 watt phone rig. You know how we sound on 75 and I think it's probably a lot better on 20.

I hope to see you on the air soon. Until then, best 73's to you and the gang.

Cordially yours,  
*D.S.Z.*

W7GGG

To say we are greatly pleased with the information given in W7GGG's letter is putting it mildly. Of course we are pretty well sold on the TW-75's ourselves, but we are just amateurs enough to always get a kick out of it when the hams tell us they like our tubes.

VIEW OF CHASSIS WITH TW-75'S  
As Described in Taylor Manual—Page 47.

## TW-75 RATINGS

The TW-75 is a Thin Wall Carbon Anode tube with a 75 watt plate dissipation. It can be operated at full ratings up to frequencies as high as 60 MC. Reports have been received of very satisfactory operation at 112 MC. It has a Safety Factor of 525 watts and will stand temporary overloads up to 800%.

Filament Volts ..... 7.5  
Filament Amps. .... 4.15  
D.C. Plate Volts ..... 2,000  
D.C. Plate Current MA. .... 175

**\$8<sup>00</sup>**

"More Watts Per Dollar"

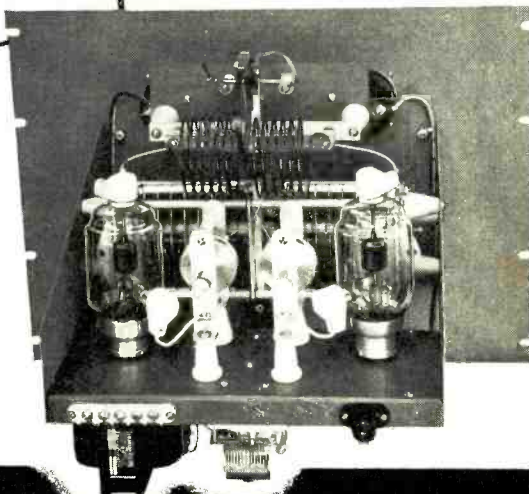

**Taylor** HEAVY **CUSTOM BUILT** DUTY **Tubes**

TAYLOR TUBES, INC., 2341 WABANSIA AVE., CHICAGO, ILL.

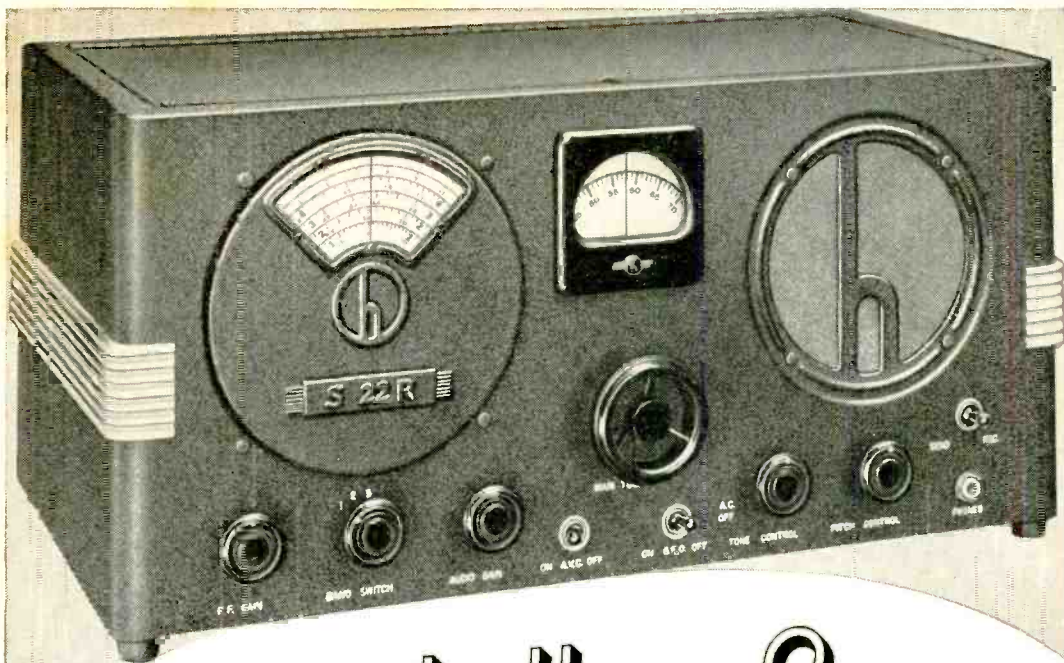

a new hallicrafters  
 WITH 1941 IMPROVED FEATURES  
**The SKYRIDER MARINE**  
 (MODEL S-22R)

**THIS** communications model is truly an all purpose receiver: Covers Weather and Time Signals (NAA). Beacons and Aircraft Weather. Commercial wave lengths—Ship-to-Shore, Ship-to-Ship, (calling and working on the same band.) The Broadcast band. The Amateur Bands (160 to 20 meters inclusive.) Police. High Frequency Ship-to-Shore, Aircraft, Press and Government channels. Plus the International Short Wave channels. 4 Bands. Frequency range from 16.5 to 2730 meters

**IMPROVED FEATURES**—Two stages of IF—Greater sensitivity and selectivity. Permeability tuned IF transformers assure permanency of tuning.

Specially treated variable mica condensers will maintain adjustment under all atmospheric changes.

Directly calibrated main tuning dial.

Permeability-tuned beat oscillator with control to change BFO setting.

All steel parts and chassis heavily copper plated and nickelled.

(18 mc. to 110 kc.). 110 volt AC/DC operation.

Easy logging is provided by mechanical bandspread with separate dial. The directly calibrated main tuning dial eliminates the use of confusing charts and tables. The improved image rejection at the higher frequencies is achieved through the use of a 1600 kc. IF amplifier. Tuning permanency is assured through permeability tuned IF transformers. The 1941 Sky Rider Marine (Model S-22R) will give the maximum in utility and dependability.

Highly efficient mechanical bandspread with separate dial provides easy logging.

Frequency range 16.5 to 2730 meters (18 mc. to 110 kc.). Band 1—110-410 kc. . . . Band 2—400-1500 kc. . . . Band 3—1.7-5.9 mc. . . . Band 4—5.3-18 mc. 8 Tubes, cabinet dimensions 18½" x 9½" x 8½".

The Sky Rider Marine (Model S-22R) complete with tubes and speaker, \$64.50 net.

the hallicrafters inc.  
 CHICAGO, U. S. A.

USED BY 33 GOVERNMENTS • SOLD IN 89 COUNTRIES

# 2 *in* ONE



THE RME-99

## *professional and amateur* COMMUNICATIONS RECEIVER

When you buy your new RME-99, precision-built communications receiver, you really are getting *TWO* receivers for the price of *ONE*! For the "99" may be used with equally high efficiency as a commercial instrument or as a fine amateur band receiver.

Its *LABORATORY TYPE* construction classifies it as a *DOUBLE-DUTY* unit of positive characteristics. For example the *RME* method of assembly and test is of the *INDIVIDUAL* type. That is, each receiver is built as an *INDIVIDUAL UNIT* to conform to a strict set of *LABORATORY* standards. This system of construction assures *UNIFORMNESS* in all *RME* receivers.

In addition, *RME* communications instruments are designed so that they may be *ALTERED* slightly to specifications with a minimum of *EXPENSE* or *TIME LOST* to the purchaser. Certain variations of this fine receiver are available for specific industrial applications.

Finally, each "99" is equipped with all *STANDARD FEATURES* of the modern communications receiver such as *FULL-RANGE TUNING* of 550 to 33,000 kilocycles, *CALIBRATED BANDSPREAD* dial for amateur use, *NOISE LIMITER*, *VOLTAGE REGULATOR*, *5 POSITION* crystal filter, and *CALIBRATED R-DB METER*, *PLUS*, such outstanding *NECESSARY EXTRAS* as, a *CAST ALUMINUM CHASSIS* frame, *GROUNDING CATHODE* type oscillator, *LOKTAL* tubes, and velvet smooth *PLANETARY DIAL MECHANISM*.

Whether you are an amateur station owner, or whether you are chief engineer of a powerful commercial transmitter, investigate the *DUAL POSSIBILITIES* of the New RME-99. We have a copy of technical specifications waiting your request . . . why not write today?

*Net price of the RME-99 complete with speaker and tubes  
ready for operation is \$139.20*

**RADIO MFG. ENGINEERS, INC.**  
111 HARRISON STREET PEORIA, ILLINOIS

# RADIO

the worldwide authority . . .

Published by  
RADIO, Limited

Home offices: 1300 Kenwood Road, Santa Barbara, California

Telephone: Santa Barbara 4242  
Bell System teletype: S BAR 7390  
Cables: RADIO LTD SANTABARBARACALIF

November • 1940

The publishers assume no responsibility for statements made herein by contributors and correspondents, nor does publication indicate approval

No. 253

## Table of Contents

### ARTICLES

A 5- to 40-Meter R.F. Unit Featuring High Efficiency and Quick Band Change— <i>H. V. Sherrod, Jr., W5ZG</i>	10
A Simple and Effective Superregenerative Receiver for 224 Mc.	14
A Highly Efficient 224 Mc. Transmitter— <i>Arthur Cann, W1AJJ</i> and <i>Vinton K. Ulrich</i>	16
Improved Performance from the Regenerative I. F. Amplifier— <i>Ivan Eby, W6MHF</i>	21
A Bandswitching Grid-Modulated Transmitter— <i>J. T. Goode, W6LVT</i>	22
A Noise-Free Antenna— <i>Dawkins Espy, W5CXH/6</i>	26
A Novel and Versatile Keying Monitor—	28
Two A.C.-D.C. Transmitters— <i>William D. Hayes, W6MNU</i>	30
A DeLuxe A.C. Operated Ohmmeter— <i>Carl J. Swenson, W9RFV</i>	34
An Electrically Rotatable 112-Mc. Array	38
Two-Way Television—with Voice	39
An Interesting Discovery Regarding Tube Life New Tubes	40 41

### MISCELLANEOUS FEATURES

Past, Present and Prophetic	9	Advertising Index	95
Radio Soldering Technique	62	F.C.C. Notes	96
QRX	92	Buyer's Guide	97
The Marketplace	98		

### DEPARTMENTS

X-DX	45	The Amateur Newcomer	58
U. H. F.	50	Postscripts and Announcements	61
With the Experimenter	56	Yarn of the Month	64
A Complete 112 Mc. Crystal Transmitter— <i>Gilbert de la Laing, W6BJI</i>		What's New in Radio	66
A Simple Coil Winding Scheme— <i>Lt. Comdr. J. H. Ellison, W3AOI</i>		New Books and Catalogues	68
A Simple Two Band Antenna Filament Voltage vs. Hum			

CORRESPONDENCE AND ORDERS should be sent only to our home offices. MANUSCRIPTS, if unsolicited and unusable, will be destroyed unless accompanied by a stamped, self-addressed envelope.

ADVERTISING copy indicata (fully mounted and matted) should be sent to Radio, Ltd., 117 S. Dearborn St., Chicago, where "Radio" is printed; send duplicate copy and insertion order to Santa Barbara, as an advertisement will run until home office telegraphs its approval thereof.

SUBSCRIPTION RATES (in U. S. funds): Two years, \$4.00, or \$2.50 yearly in U.S.A. and contiguous countries (plus tax in California and Illinois). To Pan-American countries and Spain, \$0.50 per year additional. Elsewhere, \$1.00 per year additional. Ten issues yearly, special issues included only with subscriptions of one-half year or more. Back issues are not included in subscriptions.

IF YOU MOVE, notify us in advance; we cannot replace copies sent to your old address. Notice must be received by the 5th of the month preceding the cover date of first issue to go to the new address.

PUBLISHED monthly except August and September by Radio, Ltd., 1300 Kenwood Road, Santa Barbara, Calif. ENTERED as second-class matter Sept. 26, 1934 at Santa Barbara, Calif., under the Act of March 3, 1879. Additional entry at St. Morris, Ill. COPYRIGHTED. All rights reserved. TITLE REGISTERED in U. S. Patent Office. PRINTED in U.S.A. by the Kobil Brothers Company, Inc. Rights, Inc.

## The Editors of "Radio"

EDITORIAL DIRECTOR  
**W. W. SMITH**  
W5BCX

EDITOR  
**R. L. DAWLEY**  
W6DHG

ASSOCIATE EDITORS  
**R. L. NORTON, W6CEM**  
**K. V. R. LANSINGH, W6QX**  
**E. H. CONKLIN, W9BNX (CHICAGO)**

CONTRIBUTING EDITOR  
**H. BECKER, W6QD**

EDITORIAL AND TECHNICAL ASSISTANTS  
**J. H. ROTHMAN, W6KFO**  
**B. A. ONTIVEROS, W6FFF**

Business Staff  
**K. V. R. LANSINGH, Publisher**  
**A. McMULLEN, Managing Editor**  
**H. SNETSINGER, Circ. and Adv. Mgr.**  
**W. E. McNATT, Jr., Production Mgr.**

# 1941 "RADIO" HANDBOOK

## *Clothbound and Goldstamped*

Indisputably the outstanding annual text of practical and technical radio, the big 1941 "Radio" Handbook is *available now!* No other radio book contains so much previously unpublished and easy-to-understand material between two covers. No other radio book contains over 600 profusely illustrated pages, bound in cloth and stamped in gold. No other radio book offers you so much for its price.

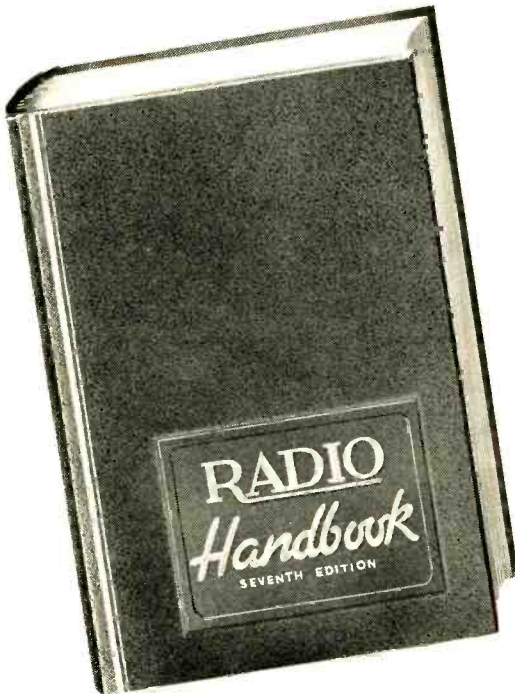

### ORDER YOUR COPY TODAY

This is the first time we have published a clothbound, goldstamped edition of this famous book! We offer it to you at a popular price—only ten cents more than previous paper bound editions. Be sure to *order your copy today* prepaid direct from us, or at your favorite radio parts store or newsstand.

Copies of the previous paper bound edition have been exhausted for several months. 20,000 of them were sold during the first six months of

the sale period. To avoid disappointment and to avoid waiting for the second printing, we urge you to *order now*.

**\$1.60** in Continental  
U. S. A.

(prepaid)

Elsewhere **\$1.85**

(On mail orders, Illinois and California customers please add 3% sales tax)

THE EDITORS OF  
**RADIO** *technical publishers*

1300 Kenwood Road, Santa Barbara  
CALIFORNIA

IS NOW AVAILABLE!!!

*With Over 600 Big Pages*

**Easy-to-Understand Chapters On:**

*Introduction to Amateur Radio; Introductory Electricity and Fundamental Radio Theory; Vacuum Tube Theory; Radio Receiver Theory; Radio Receiver Tube Characteristics; Radio Receiver Construction; Transmitter Theory; Radiotelephony Theory; Frequency Modulation; Transmitter Tubes; Transmitter Design; Exciters and Low Powered Transmitters; Medium and High Powered Amplifiers; Speech and Modulation Equipment; Power Supplies; Transmitter Construction; U. H. F. Communication; U. H. F. Receivers; U. H. F. Transmitters; Antennas; U. H. F. Antennas; Test and Measuring Equipment; Workshop Practice; Broadcast Interference; Radio Therapy; Radio Mathematics, and Calculations, etc.*



**ORDER YOUR COPY TODAY**

*Prepaid, Direct From Us—Or At Your Favorite Dealer*

THE EDITORS OF  
**RADIO**

*technical publishers*

1300 Kenwood Road, Santa Barbara  
CALIFORNIA

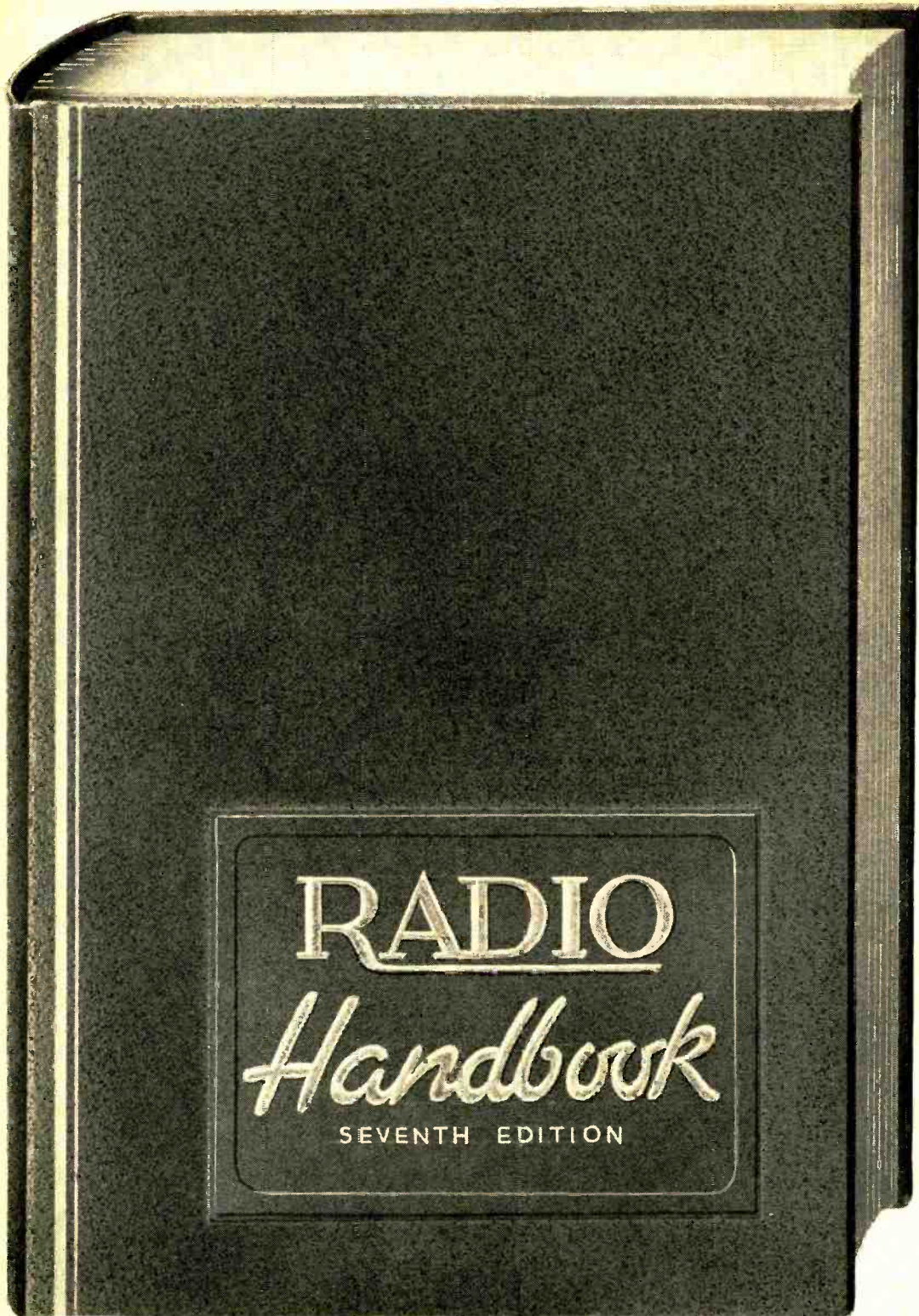

\$1.60 in Continental U. S. A. From Your Favorite Dealer or Postpaid Elsewhere \$1.85  
From the Editors of Radio, Santa Barbara, Calif.

• 8 •



---

---

**Past** •  
**Present**  
**and**  
• **Prophetic**

---

---

### Record Rigs

Thus far we've done pretty well in keeping track of the 112 Mc. record-holders' equipment—or at least one end of it. We have had a detailed description of the rig used by W6BCX, who, with W6QZA and W6ION, was co-holder at 201 miles. And then there was the rig used by W6QZA who, besides being co-holder on the above record also holds the present ground-station record, with W6MKS, at 216 miles. This month we round out the roster of record holders by presenting the article on page 56, which describes the transmitter of W6BJI, who holds one half of the present "open" record by virtue of a 255-mile contact with W6KIN while BJI was flying at an altitude of nearly 10,000 feet over California's San Joaquin Valley.

### Fundamentals

In the Newcomer Department this month you will find an article on electric wave filters. Of course it is quite impossible to cover filter theory in all its ramifications in a single article, but the newcomer should find the information contained therein of considerable help in gaining an insight into filter operation. For the old timer, the article should prove helpful in brushing up on fundamental filter theory.

Which brings us to the fact that we are hoping to be able to run articles of this type regularly in the future. These will cover various phases of basic and advanced theory—material similar to that covered in handbooks, but of which handbook space limitations do not allow as thorough an explanation as some might like. There are a multitude of subjects suitable for these articles, of course, but we are interested in knowing what you would like to see better explained. Drop us a card expressing your preference.

### Improved Audio Oscillator

Ever since Editor Dawley presented his wide-range audio oscillator to a waiting world last July there has been a constant stream of correspondence through this office concerning

the unit. Apparently there are quite a number of experimenters who, like ourselves, think the beat oscillator method of generating sine-wave audio is a little more involved than would seem necessary. Most of the correspondence has centered around means of improving the low-frequency operation of the oscillator, and, while the solution has been apparent for some time, it is only now that time has permitted making the necessary changes. The haywire models of the new oscillator show good wave form down to somewhat below 20 cycles, without impairing the previous excellent high-frequency operation. A complete description of the improved unit is tentatively scheduled for next month.

### Termite

It happened several months ago but we're still laughing. The local radio club was hold-

ing one of its periodical elections of officers. There in the rear row among the spit-ball throwers and the chair pullers sat RADIO'S custodian of the T-squares, triangles and India ink, Bernie Ontiveros. All went well until Ontiveros suddenly discovered that he had been elected to the Executive Committee of the club, which happens to be an A.R.R.L. affiliate. Here you have the spectacle—sorry spectacle, some might say—of a member of RADIO'S staff boring from within, termite like, to destroy the whole affiliated club program—or at least he will, as soon as he discovers the secret of staying awake at Committee meetings.

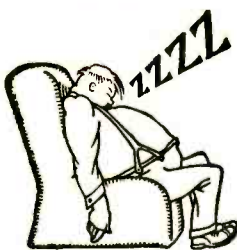

### "Sorry, Doc"

W7HJE has called to our attention the fact that Seattle has passed an ordinance making it illegal to run a diathermy or other device if it interferes with reception of their u.h.f. police broadcasts. Offending machines must be remodeled or discarded. It's too bad that they couldn't reword the ordinance to include interference to radio amateurs. "I'm sorry, Doc, but your machine is smearing KC4USA. You'll have to junk it or go crystal control."

Unfortunately crystal control would complicate a diathermy machine considerably and run up the cost quite a bit. But perhaps a high-Q (concentric pipe?) grid tank and some filter on the plate supply would do a lot toward cleaning up the existing T-1 QRM gen-

[Continued on Page 94]

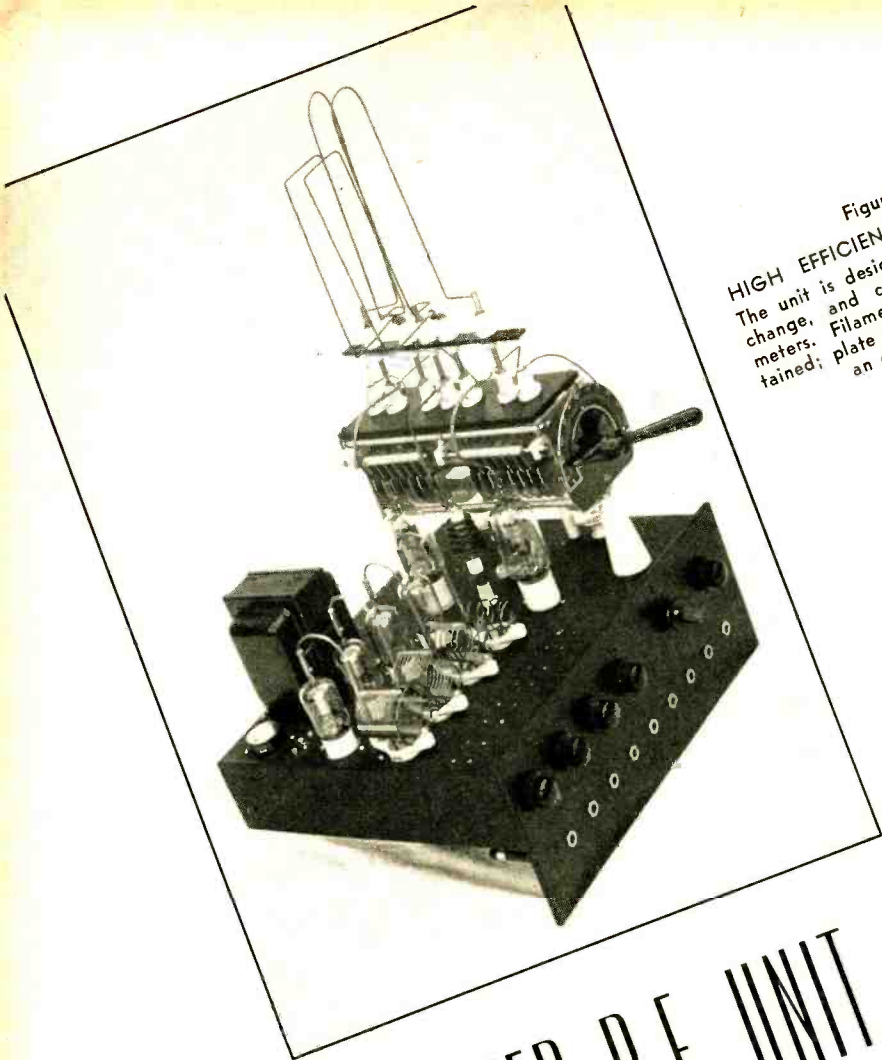

Figure 1.  
**HIGH EFFICIENCY TRANSMITTER**  
The unit is designed for rapid band change, and covers from 5 to 40 meters. Filament supply is self contained; plate voltage is furnished by an external supply.

# A 5- TO 40-METER R.F. UNIT ... featuring

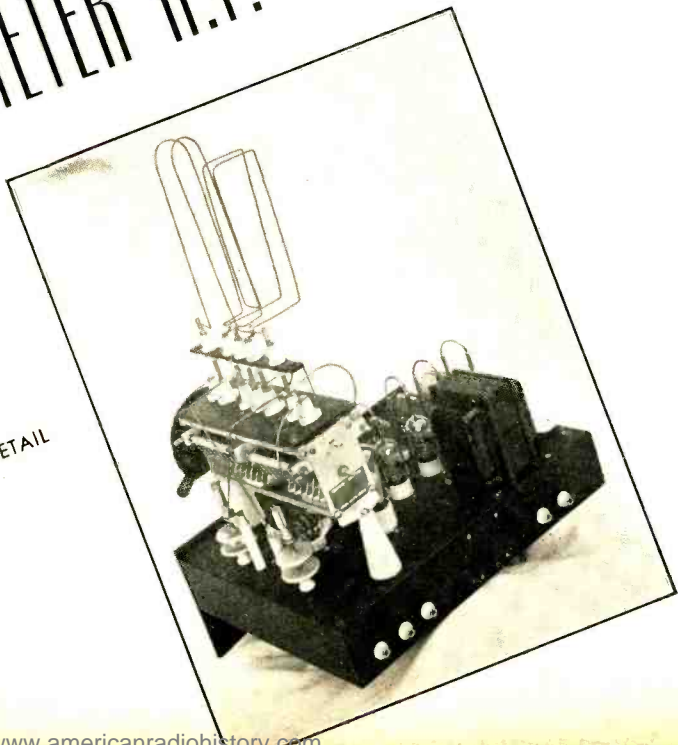

Figure 2.  
REAR VIEW OF CHASSIS, SHOWING DETAIL

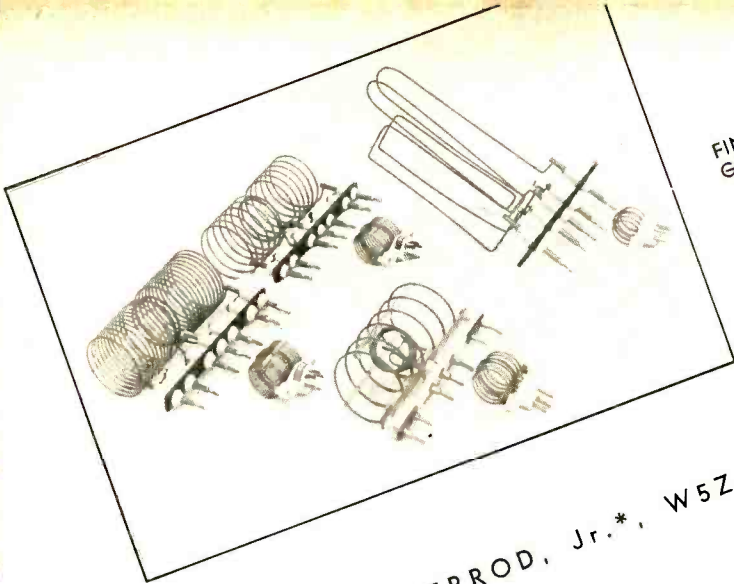

Figure 3.  
FINAL STAGE PLATE AND  
GRID COILS FOR 7, 14, 28  
AND 56 MC

By H. C. SHERROD, Jr.\*, W5ZG

# High Efficiency and Quick Band Change

At the 1938 annual convention of the West Gulf Division of the A.R.R.L., the writer had the privilege of witnessing a demonstration by Messrs. Eitel and McCullough of a particularly efficient and economical high frequency transmitter. In this transmitter, the final amplifier was driven by power doublers or, for fundamental operation, by the crystal oscillator itself. Those who attended this meeting will remember the impressive demonstration. No originality is claimed by the writer for the accompanying version, as the design is basically the same as that of the unit demonstrated by Eitel and McCullough.

\*4715 Crockett Blvd., Galveston, Texas.

Because the circuit arrangement is entirely orthodox, little description is necessary. The schematic diagram tells the whole story of the circuit, and mechanical details are clearly illustrated by the accompanying photographs. As will be seen upon inspection, the unit consists of an HK-24 crystal oscillator followed by three capacitively coupled HK-24 doublers. The third doubler as well as its two predecessor and the oscillator carry individual link coils on their respective tanks.

By means of the bandswitch the link line from the grid of the final amplifier is switched to the link coil of the stage doubling to the band desired. Simultaneously, the filaments

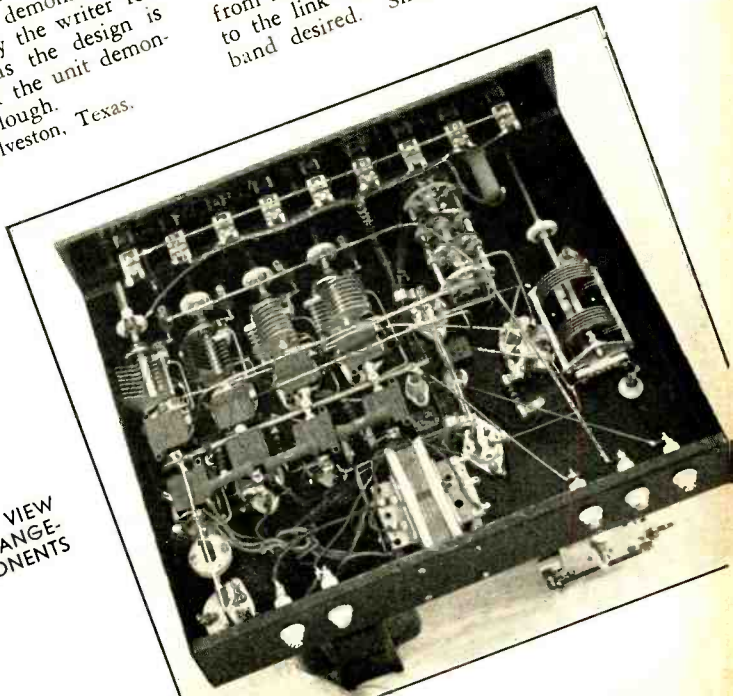

Figure 4.  
UNDER CHASSIS VIEW  
SHOWING ARRANGEMENT  
OF COMPONENTS

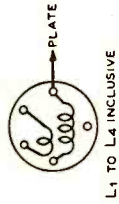
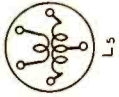
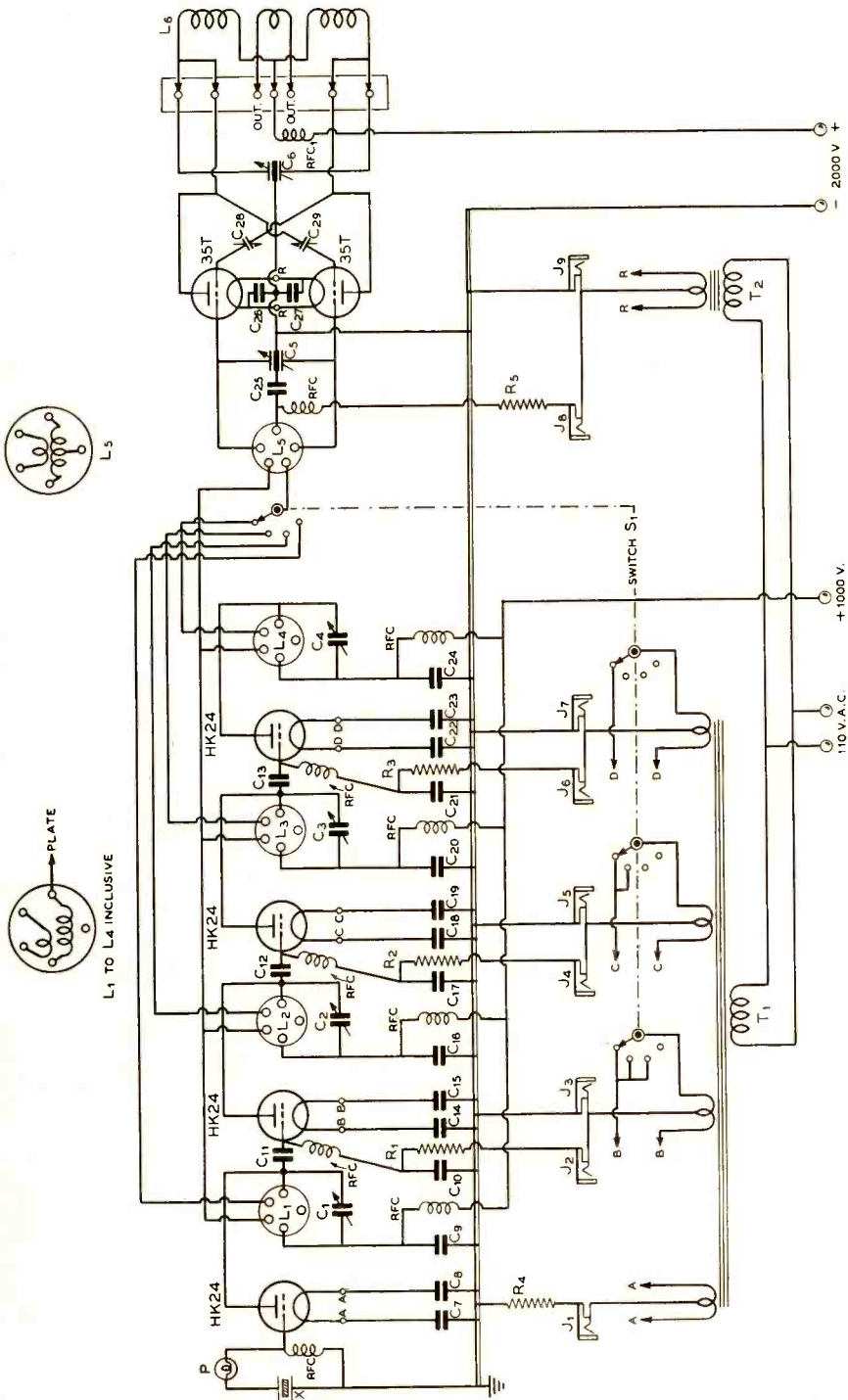

Figure 5.  
THE GENERAL WIRING DIAGRAM

### COMPONENTS FOR WIRING DIAGRAM OF FIGURE 3.

$C_{11}, C_{21}, C_{31}, C_4$ —50- $\mu$ fd. mica	$C_{26}$ —0.025- $\mu$ fd. mica
midget variable, .060" spacing	$C_{261}, C_{262}, C_{263}$ —0.01- $\mu$ fd. mica
$C_5$ —100- $\mu$ fd. per section, .026" spacing	$C_{281}, C_{282}$ —Neutralizing condenser
$C_6$ —150- $\mu$ fd. per section, .125" spacing	$R_{11}, R_{21}, R_3$ —15,000 ohms, 10 watts
$C_7, C_{81}, C_9$ —0.2- $\mu$ fd. mica	$R_4$ —750 ohms, 10 watts
$C_{10}$ —0.1- $\mu$ fd. mica	$R_5$ —2750 ohms, 20 watts
$C_{11}$ —0.01- $\mu$ fd. 2500-volt mica	$S_1$ —4-pole, 4-position isolantite selector switch
$C_{12}$ —0.005- $\mu$ fd. 2500-volt mica	RFC—2½ mhy., 125 ma.
$C_{13}$ —0.0025- $\mu$ fd. 2500-volt mica	RFC <sub>2</sub> —2½ mhy., 1 amp.
$C_{14}, C_{15}$ —0.1- $\mu$ fd. mica	$J_1, J_2, J_3, J_4, J_5, J_6, J_7, J_8$
$C_{16}$ —0.1- $\mu$ fd. 2500-volt mica	$J_9$ —Closed-circuit jacks
$C_{17}, C_{18}, C_{19}$ —0.05- $\mu$ fd. mica	$T_1$ —Rewound 100-watt transformer, four 6.3 v., 3 a. windings
$C_{20}$ —0.05- $\mu$ fd. 2500-volt mica	$T_2$ —5 v., 8 a., c.t.
$C_{21}, C_{22}, C_{23}$ —0.02- $\mu$ fd. mica	X—40-meter crystal
	P—150-ma. pilot light
	Coils—See text

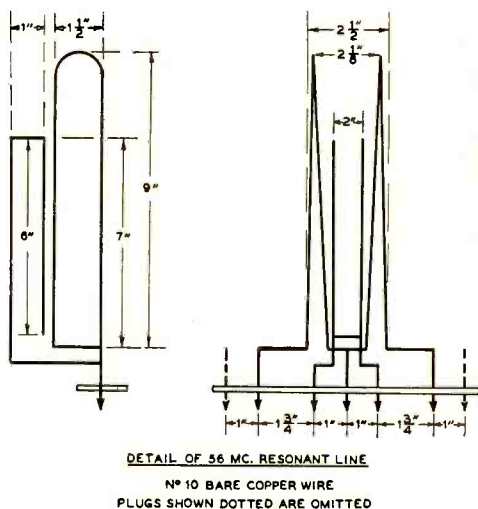

FIGURE 5A.

of all doubler stages ahead of the one driving the final amplifier are turned off.

For fundamental operation the crystal oscillator alone is used to drive the final amplifier.

Jacks are provided for metering both grid and plate current in all stages with the exception of the grid circuit of the crystal oscillator. These jacks are connected in the low potential side of the plate supply circuit for safety's sake and are numbered as they appear from left to right in the illustration of the front panel.

The rear view of the unit shows that both the a.c. and the high voltage d.c. terminals are made to jack type standoff insulators. With "drawer type" construction, such a method of making power connections greatly facilitates removal of this unit from its mounting frame.

In the bottom view of the unit, it will be noted that no r.f. ground connections are made to the chassis proper. These connections are made to an "r.f. ground bus" which consists of a piece of ¼-inch copper tubing. All bypass condensers for each stage are grounded to this bus at the same point, in order to eliminate circulating currents.

As will be seen from the illustrations and the schematic diagram, a resonant line is used and the tank tuning condenser omitted entirely for 56Mc. Tuning of the resonant line is accomplished by varying the spacing between adjacent halves of the line. While this line may appear considerably shorter than would be expected, final judgment should be reserved until full consideration is given to the loading effect of the necessary neutralizing capacity.

The positions of the exciter tubes and coils are shown in figure 1. The coils for the exciter portion of this unit are Bud OEL. These coils come supplied with a two or three turn link coil whose coupling is permanently fixed. To secure proper operation, all of these link coils were reduced to one turn and the mounting so arranged that a variation in coupling was possible. This will be shown by a close inspection of figure 1. When the oscillator and succeeding doubler stages have been properly tuned and the coupling of the various links properly adjusted, any change of tuning when changing bands on the exciter portion is entirely unnecessary. The final stage is changed from band to band by the orthodox method of changing plug-in coils. The band changing process on the entire unit is quite simple: 1. Insert the proper coils in the grid and plate of the final. 2. Throw the band-switch to the desired band. 3. Tune the plate and grid circuits of the final stage to resonance.

The 40, 20, and 10 meter final amplifier plate tank coils are all 3 inches in diameter and spaced to 7½ inches. The 40 meter coil consists of 24 turns, the 20 meter coil 12 turns, and the 10 meter coil 6 turns.

The construction detail on the linear tank for 5 meter operation is given in the schematic diagram, figure 3A.

The method of connection of the grid current jacks permits direct reading of plate current in the cathode jacks. The cathode jacks

[Continued on Page 77]

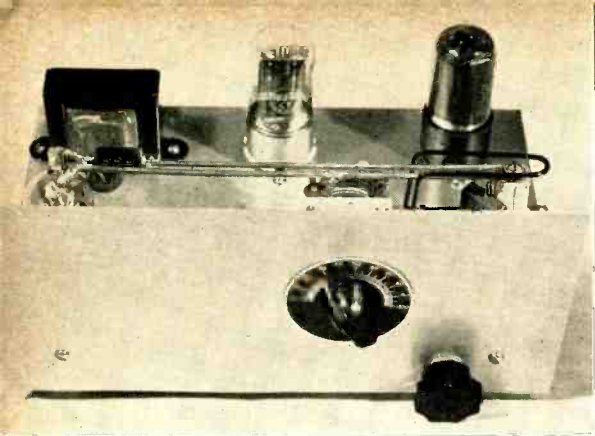

Figure 1.  
224-MC. SUPERREGENERATIVE RECEIVER

An HY-615 triode oscillator and linear tank circuit provide high sensitivity.

*A Simple and*

# SUPERREGENERATIVE

A few short years ago amateurs who engaged in u.h.f. experimenting would tell you, "56 Mc. is duck soup; anything will work on five. But 112 Mc. that is something else again. You have to use the right oscillator tube and part your hair just right."

Now that 112 Mc. no longer appears to scare anyone, 224 Mc. is looked upon as the band that requires especial care and equipment that is "just so." The 224 Mc. receiver to be described should dispel any such idea. It is no more difficult of construction or critical in operation than the various 112 Mc. receivers and transceivers that have been described recently in this magazine. The receiver makes an ideal companion unit for the 224 Mc. trans-

mitter described elsewhere in this issue. For portable operation the receiver can be powered by a 200 volt vibrapack; or, if desired, the receiver may be supplied through a dropping resistor from the same dynamotor or vibrapack that feeds the transmitter, assuming that the transmitter supply delivers more than 250 volts at the current drawn by the receiver.

The receiver is constructed on a 5½ by 11 inch chassis, 1½ inches high, which supports a 5 by 9 inch front panel. The HY-615 oscillator tube is placed at one end of the chassis as illustrated in order to permit horizontal mounting of the linear tank circuit. This tank circuit consists of a length of no. 10 bare copper wire, bent back on itself so that the

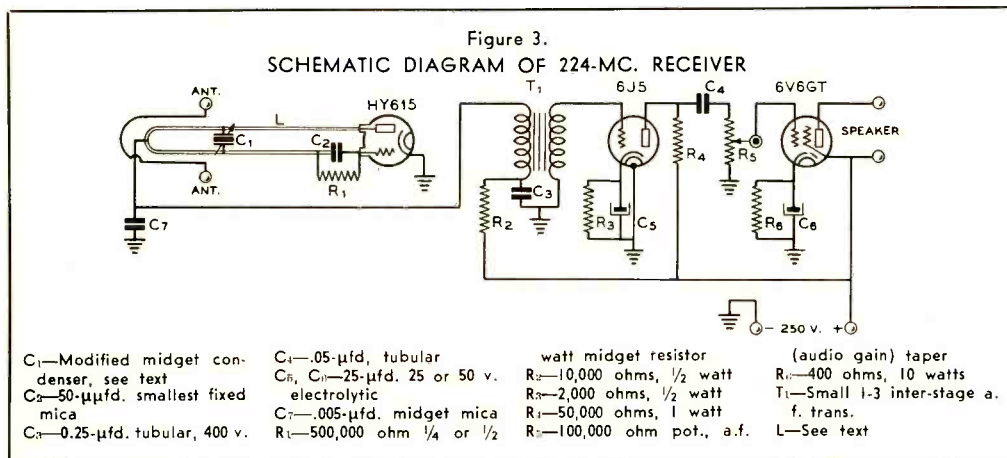
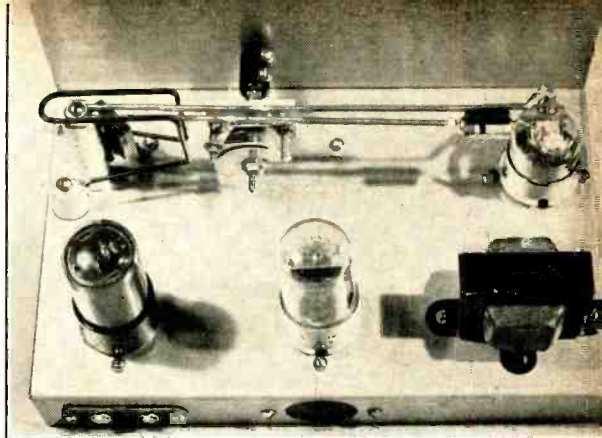

Figure 2.  
ILLUSTRATING MECHANICAL  
CONSTRUCTION OF 224-MC.  
RECEIVER.

Note particularly the modified  
tuning condenser and the arrange-  
ment of the linear tank and the  
antenna coupling "hairpin loop."



*Effective*

# RECEIVER *for* 224 MC.

A receiver combining moderate cost and simplicity of construction  
with excellent performance.

spacing of the two wires is approximately equal to the wire diameter. The grid wire is cut off shorter than the plate wire, in order to allow the insertion of the small grid condenser and grid leak. The overall length of the tank, from the center of the tube caps to the center of the bolt in the standoff insulator which supports the closed end of the "U" and acts as the plate voltage connection is  $7\frac{3}{8}$  inches. This pillar type standoff insulator is 2 inches high.

Tuning is by means of an improvised split-stator type condenser, the rotor of which is left "floating." A Cardwell ZR-35-AS "Trim Air" is operated upon as follows. Disassemble the condenser so that all rotor and stator plates are removed. Discard all except four rotor and two stator plates. The four remaining rotor plates are not altered, but the two stator plates are trimmed with a pair of heavy shears so that each plate is supported by only

[Continued on Page 74]

Figure 4.  
UNDER-CHASSIS VIEW OF 224-  
MC. RECEIVER.

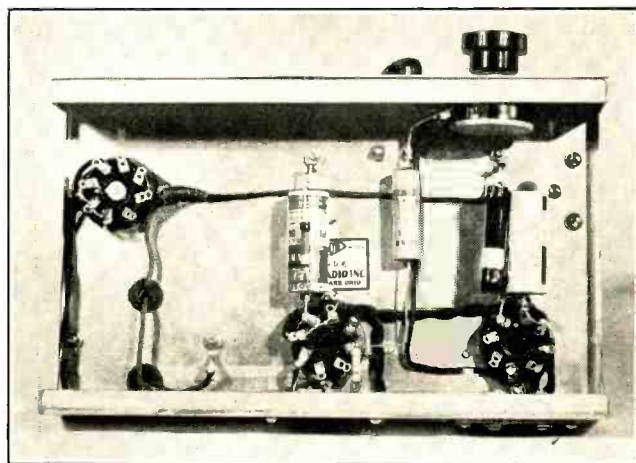

# *A Highly Efficient*

## 224 Mc. TRANSMITTER

By ARTHUR CANN†, W1AJJ and VINTON K. ULRICH\*

Through the use of an efficient oscillator and directional antenna, a power input of 24 watts gives results ordinarily requiring several hundred watts input.

While it is customary to rate amateur transmitters on the basis of plate power input, this parameter is both meaningless and misleading when applied to ultra-high-frequency transmitters, since their efficiency varies over wide limits, depending upon the circuit and tubes employed.

The transmitter to be described has a power input rating of 20 to 25 watts and a power output of 10 to 12 watts. In the circuit employed, the HY75 tube operates at an efficiency of 50% or slightly better. Incidentally, the power output of this transmitter on  $1\frac{1}{4}$  meters is equal to that of many transmitters having plate inputs from 2 to 5 times as great. To put it another way, the efficiency of the HY75 tube is 2 to 5 times greater than that of many tubes commonly employed by amateurs for a  $1\frac{1}{4}$  meter transmitter.

The advantage of the higher efficiency obtainable from the HY75 is most important when one considers that the transmitter will be operated generally as a portable or mobile unit powered by a battery. If one tube is 2 to 5 times more efficient than another delivering the same power output, it naturally follows that the plate supply battery drain will be only  $\frac{1}{2}$  to  $\frac{1}{5}$  as great. Likewise, the power output from the modulator need only be  $\frac{1}{2}$  to  $\frac{1}{5}$  as great.

It is, therefore, apparent that the choice of an ultra-high-frequency tube is particularly important when mobile operation is contemplated, for it is, after all, power output into the antenna which determines the strength of a signal rather than the plate power input to the tube.

The  $1\frac{1}{4}$  meter transmitter used at W1AJJ is of the self-excited oscillator type and plate modulated. This design was employed because of its simplicity and compact arrangement.

† 47 Lawrence St., Danvers, Mass.

\* 224 Lafayette St., Salem, Mass.



Figure 1.  
THE COMPLETE  $1\frac{1}{4}$  METER  
TRANSMITTER WITH ASSOCI-  
ATED POWER SUPPLY AND  
CABLES.



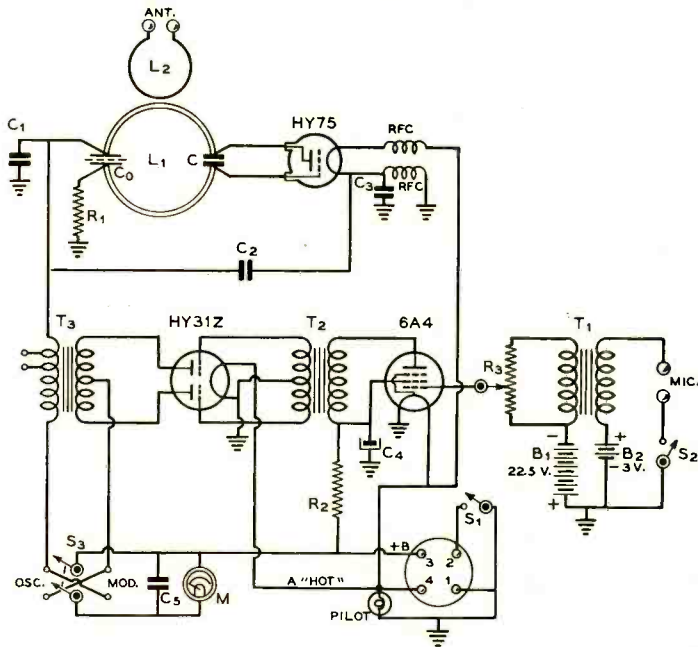

Figure 2.  
SCHEMATIC DIAGRAM OF R.F. SECTION AND MODULATOR.

C—Copper plates size of a penny spaced approx. 3/64". See figure 4.  
 C<sub>0</sub>—Mica by-pass condenser, built in. See figure 4.  
 C<sub>1</sub>—.002 μfd. midget mica, 600 volts  
 C<sub>2</sub>—.005 μfd. midget mica, 600 volts

C<sub>3</sub>—.001 μfd. midget mica, 600 volts  
 C<sub>4</sub>—8 μfd. electrolytic  
 C<sub>5</sub>—.005 μfd. midget mica, 600 volts  
 R<sub>1</sub>—10,000 ohms, 2 watts  
 R<sub>2</sub>—10,000 ohms, 10 watts  
 R<sub>3</sub>—250,000 ohm pot., a. f. taper

RFC—21 turns no. 16, 3/8" dia. spaced 1 3/4"  
 L<sub>1</sub>—Tank coil. See figure 4.  
 L<sub>2</sub>—Antenna coupling coil, 1 turn.  
 S<sub>1</sub>—S. p. s. t. switch  
 S<sub>2</sub>—Mike switch (incorporated in mike specified in Buyer's Guide)

S<sub>3</sub>—D. p. d. t. switch  
 M—0-100 ma. d. c.  
 T<sub>1</sub>—500 or 100 ohms to grid, depending upon impedance of microphone used.  
 T<sub>2</sub>—Driver transformer, 2/1 step down pri. to 1/2 sec.  
 T<sub>3</sub>—Output transformer, 10,000 ohm pri., 8000 ohm sec.

Since the transmitter was to be used chiefly for portable and mobile installations, it was deemed advisable that instant-heating type tubes be used throughout so that there would be no battery drain during stand-by periods. Accordingly, a HY31Z, zero-bias twin-triode tube made an ideal modulator because it has an instant-heating thoriated-tungsten filament. In order to simplify the driver stage, a 6A4 tube was chosen. This tube has a filament which heats very rapidly and has a further advantage in that the tube has sufficient power sensitivity to operate directly from a carbon microphone. The radio frequency and modulator portions of the transmitter are comprised of only these three tubes. The complete transmitter with power supply, cables, and microphone is shown in figure 1.

The transmitter is designed to operate from a 6 volt d.c. source, which may be either a

separate storage battery or the electrical system of any automobile. It can be adapted to a.c. operation by returning the center tap of the filaments instead of the negative side to ground.

A dynamotor incorporating both a filter and relay is employed, thus eliminating the need for filtering in the transmitter. This is shown in figure 3.

The use of a starting relay simplifies the operation of the transmitter, as it turns on the filaments of the transmitter simultaneously with the plate supply.

### The Oscillator Circuit

A modified Hartley circuit as shown in figure 2 is employed. Other circuit arrangements such as a linear tank with parallel bars or a concentric line can be used with the HY75 at the expense of compactness but with

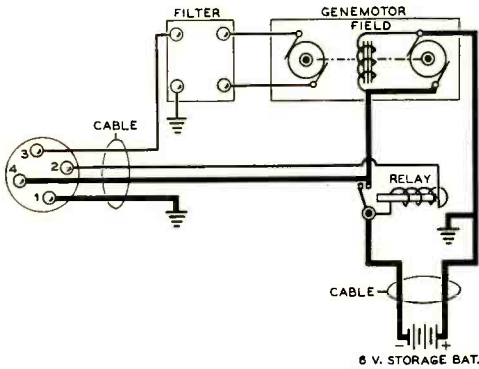

Figure 3.  
SCHEMATIC OF POWER SUPPLY SHOWING CABLES EMPLOYED.

Heavy lines are cables carrying high current. The filter and relay are self-contained in the particular dynamotor used. The dynamotor is rated at 400 volts at 135 ma.

slightly higher operating efficiency. By changing the tank circuit, operation on  $2\frac{1}{2}$  meters is possible.

In order to reduce the length of leads from the tank circuit to the twin top cap of the oscillator tube, series feed to both the grid and plate circuits has been used. To isolate the d.c. plate voltage from the grid circuit, a by-pass condenser is built into the center of the tank coil. The construction of this tank coil is shown in figure 4. From one side of this by-pass condenser, the B plus voltage is applied, and from the other side the grid return to ground via a grid leak is made. Details of the tank circuit will be found in figure 4. The copper disks used for tuning are the size of a penny and are soldered or brazed to the copper tubing. An optional arrangement is to eliminate this capacitance and run the tank circuit directly to the twin top caps of the tube using a slightly larger diameter coil (approx.  $1\frac{3}{4}$ - $1\frac{7}{8}$  inside dia. for  $1\frac{1}{4}$  meters).

The disadvantage of eliminating the condenser is that tuning is possible only by changing the diameter of the turn, and frequency changes are impractical.

The tank circuit is mounted on a jack type feed-through insulator so as to facilitate interchanging the  $1\frac{1}{4}$  meter tank for a  $2\frac{1}{2}$  meter tank. Also, the lower end of the grid resistor grounds to the chassis through a plug-in jack arrangement. Figures 5 and 6 showing the topside arrangement of parts clearly illustrate the constructional features.

Filament chokes were found desirable in order to keep the r.f. energy in the radio fre-

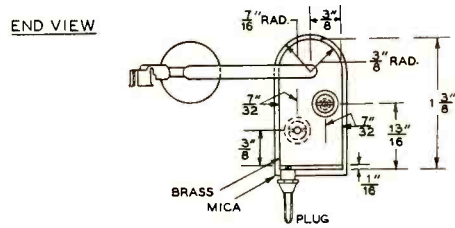

FOR  $1\frac{1}{4}$  METERS—L =  $1\frac{3}{16}$ " APPROX. INSIDE DIA.,  $\frac{3}{16}$ " COPPER TUBING  
C =  $\frac{3}{8}$ " DIA. OF DISCS,  $\frac{1}{16}$ " COPPER

FOR  $2\frac{1}{2}$  METERS—L =  $1\frac{7}{8}$ " APPROX. INSIDE DIA.,  $\frac{3}{16}$ " COPPER TUBING  
C =  $1"$  DIA. OF DISCS,  $\frac{1}{16}$ " COPPER

SPACING BETWEEN DISCS IN EACH CASE IS  $\frac{3}{64}$ " APPROX.

Figure 4.  
DETAIL DRAWING OF  $1\frac{1}{4}$  AND  $2\frac{1}{2}$  METER TANK CIRCUITS.

The only critical dimensions are the diameter of the coil and the diameter of the copper disks. Clips to plate and grid caps are soldered to the tank circuit with flexible copper ribbon and connection is made after transmitter is assembled.

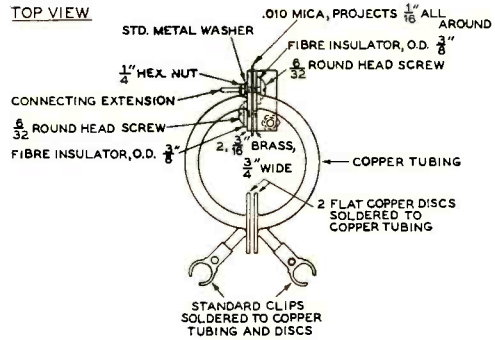

quency circuit. In some lay-outs, it may turn out that the filament chokes are not necessary. These chokes on the bottom side of the chassis are shown in figure 7.

The use of by-pass condensers and their positions must be found by experimentation. This is most easily accomplished by getting the transmitter into operation and then holding a by-pass condenser between points which might require a by-pass. The ground side of the condenser should be moved about and it will be generally found that when the by-pass condenser is grounded in one place an improvement will be found, while if grounded in another place, its use will be detrimental.

In the circuit shown in figure 2, a by-pass is connected from the plate lead to one filament lead and this same filament lead is by-

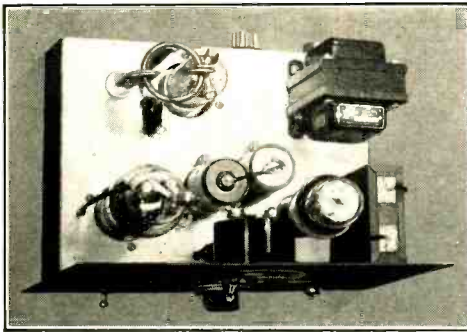

Figure 5.  
TOP VIEW OF TRANSMITTER SHOWING  
LAYOUT OF PARTS.

passed to ground. The other filament connection is allowed to float.

Two transmitters were built, incorporating identical design features, yet it was found that the by-passing requirements were not identical. While not shown in the wiring diagram, the other transmitter required a by-pass across the grid resistor. The position of the ground of this by-pass condenser was particularly critical and the best position resulted in by-pass condenser leads totaling approximately 4 inches. While it is generally desirable to make all ground connections to a single point and keep by-pass leads at a minimum length, such was not the case in this particular instance. There are, without question, numerous r.f. standing waves on the chassis and condenser lead wires, and it is essential that some experimenting be done with the length and position of the by-pass condenser leads in order to obtain minimum unloaded plate current.

It will be found upon a little experimentation that while by-passes in two different positions when used separately improved performance; when two of them are used together the reverse may be true. Accordingly, each by-pass should be added separately and then a check made to see what the effect of additional by-passing is.

While such may seem complicated, it is really very simple when an accurate check is kept on the plate current value for various conditions.

When the plate current at no load is approximately 30 to 45 ma. with 450 volts on the plate, the by-passing job can be considered adequate. A by-pass condenser is used directly across the meter terminals to protect the movement.

### The Class B Modulator

The modulator and speech amplifier are conventional in design; and since the HY31Z



Figure 6.  
REAR VIEW, GIVING DETAILS OF TANK  
CIRCUIT.

has a power output capability considerably in excess of that required to 100% modulate the oscillator, the matching of the modulator to the secondary r.f. load is not critical. The particular modulation transformer employed has a rated primary impedance of 10,000 ohms, and the 8,000 ohm portion of the secondary is employed. As the HY31Z tube is zero-bias in operation, the modulator is greatly simplified.

Gain is controlled by a 250,000 ohm volume control connected across the secondary of the microphone transformer. Bias for the 6A4 is derived from a small 22½ volt hearing aid battery.

While with this type of rig microphone current generally is obtained from the 6 volt circuit, two flash-light cells in series have been used here. If the 6-volt system is employed for the microphone, it is necessary to use a dropping resistor so as to reduce the voltage to the microphone to a safe value and, in addition, a condenser on the order of 50  $\mu$ fd. must be used to by-pass this resistor so as to avoid low frequency loss. The two flashlight cells and condenser clamps employed cost less than the necessary resistors to say nothing of the by-pass condensers. In normal use the batteries will last several months.

### Meter Switching

In order to insure proper operation of the transmitter, a 100 ma. plate current meter was incorporated. A double-pole, double-throw switch is used to throw the meter from the oscillator to the modulator or vice versa. When transmitting it is desirable to read the modulator current; in this way, with a little bit of experience, a fair indication of modulation percentage can be obtained.

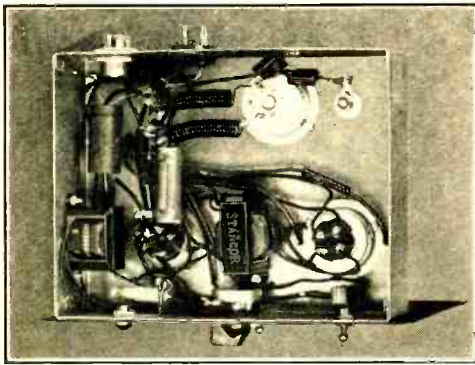

Figure 7.  
BOTTOM VIEW OF CHASSIS.

A metal cabinet with a 2" x 9" x 7" chassis was found to be ideal. As the overall height of the cabinet is somewhat limited, it was found desirable to use a sub-chassis socket which permits dropping the HY31Z tube approximately an inch below the chassis. In the case of the oscillator tube, this same sub-chassis socket mounting was employed so as to reduce the height of the tank circuit above the chassis and thus make it possible to use a standard size ceramic feed through insulator. The use of this mounting also places the r.f. chokes in the filament line about an inch away from the chassis, which has been found desirable. When the chokes are mounted too near the chassis the capacity to ground is increased and they seem to be less effective.

### Power Supply

The 400-volt, 135 ma. genemotor employed has a heavy-duty starting relay, the circuit for which is controlled by a switch on the transmitter panel. This switch closes the circuit of the relay to ground. Accordingly, its use necessitates only one additional wire in the cable to the transmitter, making a total of four.

The power cable from the transmitter to the genemotor has two no. 12 ignition type wires for the filament and two no. 18 for the B+ and relay circuits. The heavy filament lead wires are essential so as to maintain adequate filament voltage at the tube sockets.

Connections from the genemotor to a battery (the automotive ignition system) are made through two 7 ft. heavy-duty cables, having a wire (stranded) diameter of approximately 1/4 inch. 150 ampere lugs are employed at one end to make connection to the cylinder block and high side of the auto starting switch. In the newer model cars, this binding post will be found on the top of the starting motor. These two positions have been found to be most con-

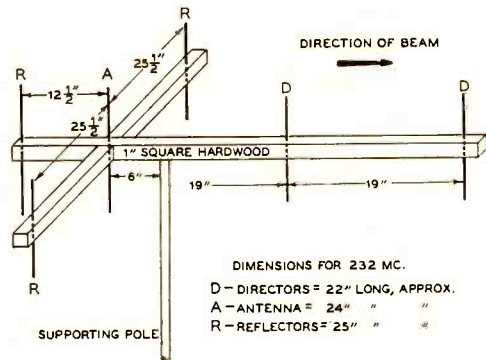

Figure 8.  
CONSTRUCTION DETAILS FOR THE DI-  
RECTIONAL ARRAY

A picture of the array in use atop a car is shown on the cover.

venient for attaching the cables to the automotive power system. Actual cable lengths will vary depending upon the installation. Seven feet for each will be found to be a convenient length, particularly if the unit is not to be installed permanently in the car. It may be used with several different autos.

### Directional Antenna

The antenna employed is a Yagi directional array that is approximately an electrical equivalent to a parabolic reflector. This antenna is shown in figure 8 and on the cover. It is made up from two wood cross-pieces and the directors and reflectors as well as the main radiating elements are mounted on the wooden cross. The radiating element, which is a half-wave and located mid-way between the two side reflectors, is fed by a Zepp feeder which is cut to resonance. The feeders used at W1AJJ measure 32" long.

A pole located at the center of gravity of the antenna array supports the whole set-up. This pole is fastened to a base on which the transmitter or receiver is supported. In actual operation the base of the antenna and the transmitter are turned as a unit. So as to gain maximum height, this array is generally placed in the top of an automobile as pictured. A small marine-type pocket compass with a floating dial is attached and used for determining the directions.

For receiving, an identical array is employed and it is placed 10 or 12 ft. away from the transmitting antenna so as to avoid interacting effect. When properly proportioned, these antennas give a theoretical power ratio of approximately 8 times (9 db) and if used at

[Continued on Page 82]

# Improved Performance from the Regenerative I. F. Amplifier

By IVAN EBY\*, W6MHF

Many who have tried regeneration in an i.f. stage in their receivers have discarded it in favor of a crystal filter. I did the same thing after first trying it. A crystal filter provides rejection ordinarily not brought forth in a regenerative i.f. amplifier. However, in the circuit described, the rejection of a crystal filter can be approached closely and a high gain maintained in the stage. The gain feature is one that the crystal cannot boast. Most crystal filters have considerable loss.

If properly shielded and designed, a regenerative i.f. stage will be easy to adjust and will bring those weak signals out of the QRM practically as well as a crystal filter.

The circuit in figure 1A was the first tried. This circuit, as well as that in figure 1B, provides good single-signal; but in either circuit there is no rejection on the undesired side of the signal. There is a gain equivalent to about 3 R points on the desired side of the signal but the other side of the signal remains the same. This lesser signal may be loud enough on some stations to be R9. Also, the circuit of figure 1A is not sufficiently stable with respect to input signal. A critical adjustment in a receiver is the reason for many a regenerative stage being discarded.

In the circuit in figure 1B the regeneration control affected the pitch of the signal so that it was hard to adjust the set quickly. In both of these circuits it was found impractical to use iron-core transformers or to use more than one i.f. stage. Any attempt to secure gain over a given level was stifled by the fact that the regenerative i.f. control had to be reduced beyond the effective point. Much experimenting was done in an attempt to obtain stable operation from these circuits but without success. It was a long time before any new ideas sprung forth but we tried everything from a tapped connection for the cathode to a tickler winding in the plate circuit.

The circuit in figure 1C was one circuit that didn't look particularly promising. It was tried, however, and surprisingly enough it

performed to perfection. It is the same circuit used in the Super Gainer second detector. In the experimental state the whole

[Continued on Page 76]

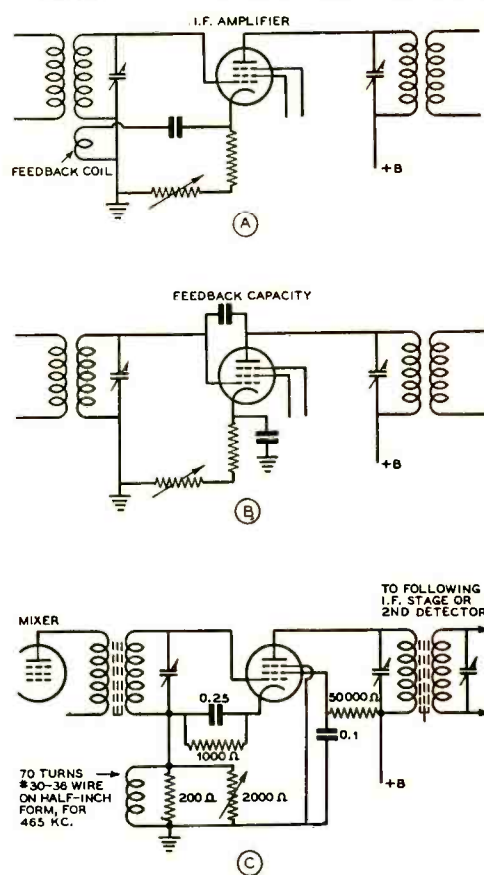

Figure 1.

## REGENERATIVE I.F. CIRCUITS.

The circuit illustrated at C was found to be much superior in operation to any other type.

\*336 Worcester Ave., San Francisco, Calif.

# A BANDSWITCHING GRID

By J. T. GOODE\*, W6LVT

The design of the transmitter to be described in this article was centered around two main considerations—compactness, and medium power output on all bands. All types of modulation were considered, with the final decision in favor of grid modulation. Plate modulation would mean added weight and bulk, as well as additional drive for the final amplifier. Cathode modulation had but one

somewhat inefficient, though effective, method of exciter bandswitching may be employed. Even under these conditions of exciter switching, a reserve of excitation power is available on all bands. The final amplifier could not have been made bandswitching without a considerable enlargement of the transmitter to allow for isolation of the individual tank circuits. Hence, plug-in-coils are used in the final amplifier, with separate plugs for the coil, the neutralizing link, and the antenna link.

## The Exciter

The exciter of the transmitter consists of a 6L6 regenerative oscillator and an 807 buffer-



Front panel view of the r.f. section of the transmitter. The complete grid-modulated rig, exclusive of power supplies, mounts behind this panel.

drawback, this being the necessity for an additional chassis for the amplifier-modulator and its power supply.

The final transmitter, as described herein, is capable of more than one watt output per dollar, can be 100 per cent modulated, is bandswitching from 160 through 20 meters, with 10-meter operation through the use of plug-in coils, and it normally runs 600 watts input on all bands.

## Bandswitching

Bandswitching exciter stages are comparatively easy to design for grid-modulated amplifiers. Since the final amplifier requires only about 6 ma. of grid current on all bands, a

doubler. Regeneration is obtained by means of an r.f. choke in the cathode circuit of the oscillator. The plate circuit of the oscillator is shunt fed with an r.f. choke. A cathode resistor is used in the 807 buffer to limit plate current during the tuning operation. The coupling condenser between the 807 and the final grids is a variable condenser. Excitation to the final is varied by this condenser. Grid resistors of 50 ohms are placed in each grid lead of the final amplifier. These are parasitic-suppressor resistors. The plate circuit of the final amplifier is shunt fed to remove the plate voltage from this tank coil. Neutralization is obtained by a one-turn link around the 807 tank coil which is loosely coupled to the grounded end of the final amplifier tank coil. Filament by-pass condensers are placed at the tube sockets.

## The 6V6 Modulator

The modulator stage consists of a single 6V6. The grid of this tube may be fed either

\*2422 E. 6th St., Long Beach, California

# MODULATED TRANSMITTER

Two 100TH'S are operated in parallel as the final amplifier.

from a 500-ohm line-to-grid transformer or by capacity coupling from a speech amplifier. The modulation transformer has a one-to-one ratio, the secondary being shunted by a loading resistor.

When a single or double button mike is used, a one-stage pre-amplifier using a 6J5 will

condensers. The bleeder is 5000 ohms and loads the power supply for improved regulation. Bias for the final is regulated by a tap on this bleeder resistor.

The final amplifier uses a dual-purpose, one-kilowatt power transformer. Using a transformer of this type cuts down space and

---

Top and under-chassis views of the r.f. and modulator section of the 600-watt input grid-modulated transmitter.

---

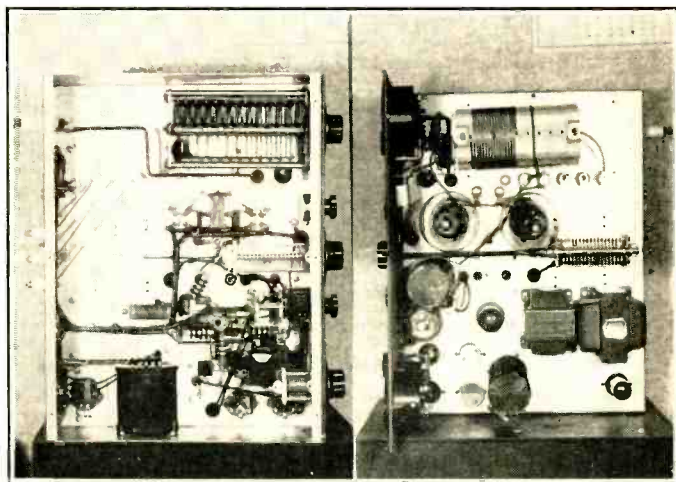

be sufficient to drive the 6V6 modulator. If a dynamic or crystal mike is used, a two-stage pre-amplifier will be necessary, such as a 6J7 driving a 6J5. The 500-ohm line transformer may be eliminated if the pre-amplifier is located near the transmitter, and in this case a regular resistance coupled amplifier circuit may be used.

## Power Supplies

The bias supply consists of a midget power transformer with a five-volt winding for rectifier filament and a 6.3-volt winding capable of 3 amps. The filter for this supply uses a 30-henry choke and two 8- $\mu$ fd. electrolytic

weight. The secondary of this transformer is wound for 550 volts and 500 ma. each side of center tap for the low voltage rectifier, and 300 ma. for the high voltage winding of 2000 volts each side of the low voltage one. This gives a total of 2550 volts each side of center tap for the high voltage winding. The filter for the low voltage supply uses a 2 mfd. 1000-volt input condenser, a 15-henry 200-ma. choke, and a 4- $\mu$ fd, 600-volt output condenser. The tap on the bleeder for this supply furnishes 300 volts for the oscillator and modulator stages. The 600-volt output of this supply goes to the plate circuit of the 807 buffer-doubler stage.

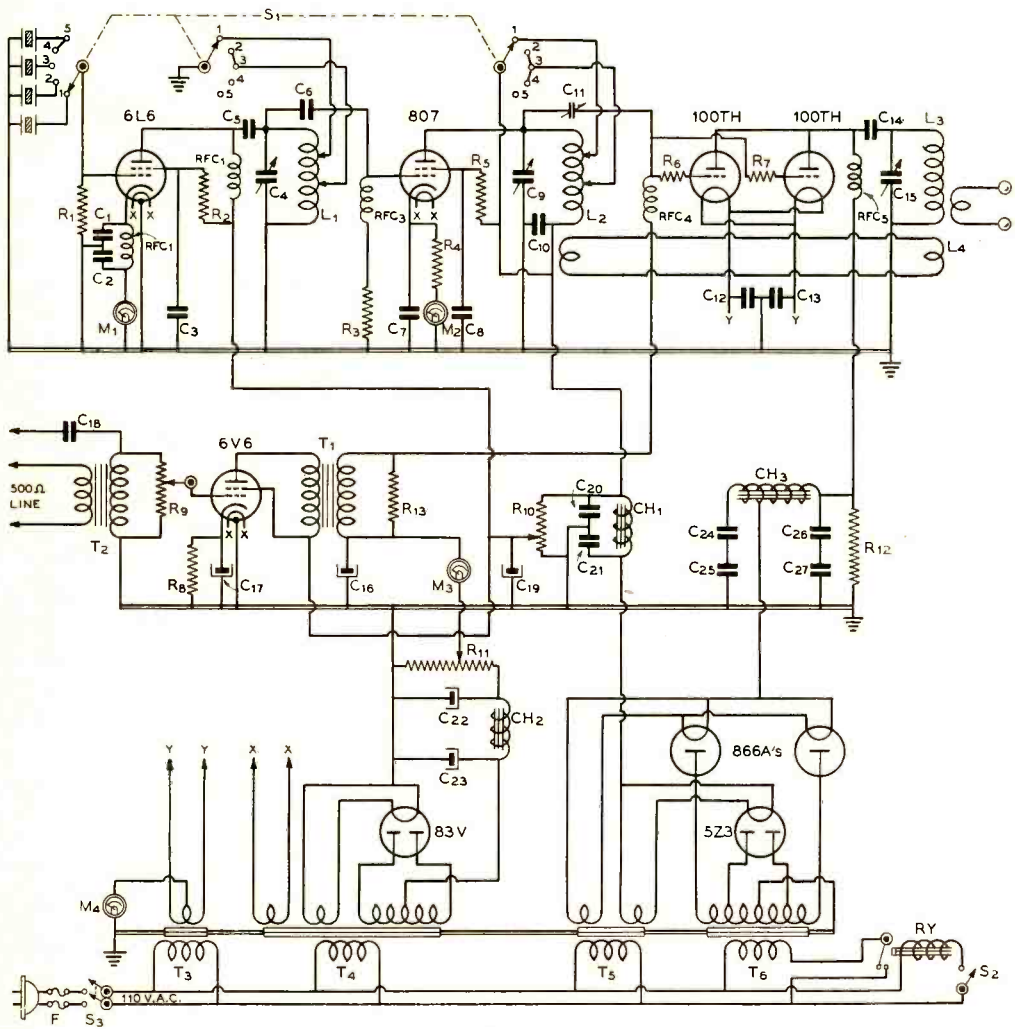

WIRING DIAGRAM OF THE GRID-MODULATED PHONE.

C<sub>1</sub>—0.0025- $\mu$ fd. mica  
 C<sub>2</sub>, C<sub>3</sub>—0.02- $\mu$ fd. mica  
 C<sub>4</sub>—100- $\mu$ fd. midget variable  
 C<sub>5</sub>—0.02- $\mu$ fd. mica  
 C<sub>6</sub>—0.001- $\mu$ fd. mica  
 C<sub>7</sub>, C<sub>8</sub>—0.02- $\mu$ fd. mica  
 C<sub>9</sub>—100- $\mu$ fd. double-spaced midget variable  
 C<sub>10</sub>—0.02- $\mu$ fd. mica  
 C<sub>11</sub>—100- $\mu$ fd. double-spaced midget variable  
 C<sub>12</sub>, C<sub>13</sub>—0.02- $\mu$ fd. mica  
 C<sub>14</sub>—0.02- $\mu$ fd. 5000-volt mica  
 C<sub>15</sub>—100- $\mu$ fd. variable, .17" spacing  
 C<sub>16</sub>—0.5- $\mu$ fd. 600-volt tubular

C<sub>17</sub>—10- $\mu$ fd. 50-volt electrolytic  
 C<sub>18</sub>—0.01- $\mu$ fd. 600-volt tubular  
 C<sub>19</sub>—8- $\mu$ fd. 450-volt electrolytic  
 C<sub>20</sub>—4- $\mu$ fd. 600-volt paper dielectric  
 C<sub>21</sub>—4- $\mu$ fd. 1000-volt paper dielectric  
 C<sub>22</sub>, C<sub>23</sub>—8- $\mu$ fd. 450-volt tubular  
 C<sub>24</sub>, C<sub>25</sub>, C<sub>26</sub>, C<sub>27</sub>—2- $\mu$ fd. 2500-volt, oil filled  
 R<sub>1</sub>—50,000 ohms, 1 watt  
 R<sub>2</sub>—10,000 ohms, 10 watts  
 R<sub>3</sub>—50,000 ohms, 1 watt  
 R<sub>4</sub>—300 ohms, 10 watts

R<sub>5</sub>—20,000 ohms, 10 watts  
 R<sub>6</sub>, R<sub>7</sub>—50,000 ohms, 10 watts  
 R<sub>8</sub>—400 ohms, 1 watt  
 R<sub>9</sub>—500,000-ohm potentiometer  
 R<sub>10</sub>—25,000 ohms, 100 watts, with slider  
 R<sub>11</sub>—5,000 ohms, 75 watts, with slider  
 R<sub>12</sub>—100,000 ohms, 100 watts  
 R<sub>13</sub>—10,000 ohms, 10 watts  
 RFC<sub>1</sub>, RFC<sub>2</sub>, RFC<sub>3</sub>—2 $\frac{1}{2}$ mhy., 125 ma.  
 M<sub>1</sub>, M<sub>2</sub>—0-100 ma.  
 M<sub>3</sub>—0-50 ma.  
 M<sub>4</sub>—0-500 ma.  
 T<sub>1</sub>—Driver trans. 1-to-1 ratio  
 T<sub>2</sub>—500-ohm-line-to-grid trans.

T<sub>3</sub>—5 v., 15 a.  
 T<sub>4</sub>—Receiver replacement type power transformer  
 T<sub>5</sub>—5 v., 3 a.; 2.5 v., 10 a.  
 T<sub>6</sub>—5,000 v., c. t., 300 ma.; tapped at 500 v. each side of center  
 CH<sub>1</sub>—15 hy., 200 ma.  
 CH<sub>2</sub>—30 hy., 75 ma.  
 CH<sub>3</sub>—15 hy., 250 ma., tapped 10% from one end  
 RY—S. p. s. t. 110-volt a. c. relay  
 S<sub>1</sub>—3-section, 5-position ceramic tap switch  
 S<sub>2</sub>—S. p. s. t.  
 S<sub>3</sub>—D. p. s. t.  
 L<sub>1</sub>, L<sub>2</sub>, L<sub>3</sub>, L<sub>4</sub>—See text



The filter of the high-voltage power supply takes advantage of the voltage step-up action of a tapped choke. The filter condensers are of the 2- $\mu$ fd, 2500-volt type wired in series. This gives 1- $\mu$ fd. capacity with ample safety factor. With 2500 volts on the plates of the rectifier tubes and this type of filter, the d.c. output voltage will be approximately 3200 volts. To obtain this voltage with choke input, the power transformer winding would have to supply approximately 3700 volts each side of center tap. Transformers of this type are usually expensive and quite large. Also it would be necessary to use rectifier tubes with a higher inverse peak voltage rating, or to use a bridge rectifier. The bleeder for this supply simply bleeds the filter condensers after the power supply is turned off. This bleeder might be a life-saver, so spend an extra dollar and get it even though the transmitter will operate perfectly without it.

### The Band Switching System

The band switch consists of a 3-pole, 5-point isolantite type. One section of this switch changes crystals, another section changes oscillator coil taps, and the remaining section changes buffer-doubler taps.

The operation of this switching arrangement is comparatively simple. First, number your switch contacts from 1 to 5; next, number your crystal sockets from 1 to 4. The switching arrangement in the diagram is wired for one frequency on 160 meters, three frequencies on 75 meters, and one frequency on 20 meters. To obtain this setup, one 160-meter crystal that will double into 75 meters is placed in no. 4 crystal socket. Seventy-five meter crystals are placed in no.'s 2 and 3 sockets, and a 40-meter crystal that will double to 20 meters is placed in no. 1 crystal socket.

160-meter commercial air-wound coils are used in the plate circuit of the oscillator and buffer doubler. Taps on these coils are made by soldering small lengths of no. 16 tinned-copper wire every few turns down the coils. Wires from the switch decks, with alligator clips on the ends, are used to clip onto various taps of the coils.

With the bandswitch in the no. 5 position, the 160-meter crystal is in the circuit and no turns are shorted out in either coil. This gives the correct coil setup for 160-meter operation.

When the band-switch is placed in the no. 4 position, the 160-meter crystal is still used; no turns are shorted out of the oscillator coil, but approximately half of the turns are shorted out of the doubler coil. This setup gives 75-meter operation by means of doubling.

With the bandswitch in the no. 3 position,

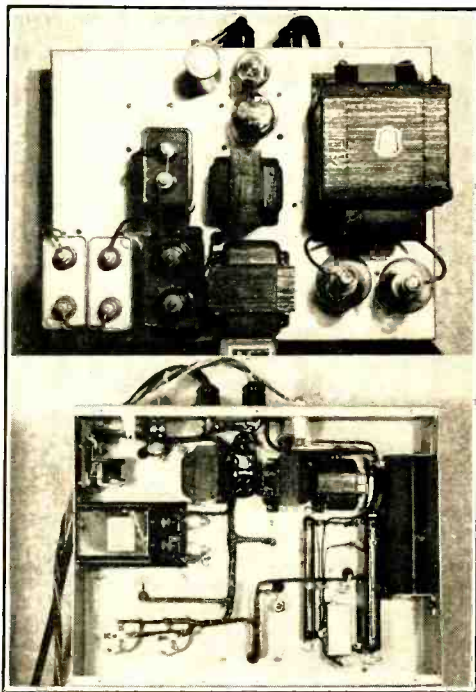

Top and under-chassis views of the power supply deck of the transmitter.

a 75-meter crystal is placed in the circuit and approximately half of the turns are shorted out of the oscillator-plate coil, and the same tap is used in the buffer-doubler coil by shorting contacts on that portion of the bandswitch. This gives 75-meter operation with a 75-meter crystal. When the bandswitch is placed in the no. 2 position, another 75-meter crystal is placed in the circuit; but taps remain the same as with no. 3 position, giving another frequency on 75 meters, operation being the same as the no. 3 position.

When the bandswitch is placed in the no. 1 position, a 40-meter crystal that will double to 20 meters is placed in the circuit and additional turns are shorted out of the oscillator coil, placing the oscillator on 40 meters. Sufficient turns are shorted out of the doubler-plate coil to place this plate circuit on 20 meters.

When going from one band to another, it will be necessary to vary the plate-tank condensers as well as the grid-coupling condenser to the final amplifier. All of these condensers are controlled from the front panel by means of dials. After logging the settings of these dials for each band, it is possible to go from one band to another in less than 30 seconds.

[Continued on Page 79]

# A NOISE-FREE ANTENNA

By DAWKINS ESPY\*, W5CXH/6

The chief limitation in receiving weak signals in most locations is the local noise level. Receiver engineers have made great strides in increasing the inherent signal-to-noise ratio of current sets. But, obviously, if one can reduce the noise introduced into the first stage of the receiver, the improvement will be even more pronounced. And too, there are those of us who have not been able to afford a late model with all the modern noise reduction gadgets.

Quite often it is possible to trace the cause of the noise to a particular source—a neon sign, a diathermy machine, a noisy pole transformer, or, even more bothersome, a noisy ham neighbor. The antenna described here is useful if the noise can be considered as coming from a definite direction.

## Theory

In figure 1, A represents the source of the desired signal, B represents the undesired electrical disturbance, and R represents the receiving point. We must necessarily find some way in which to increase the ratio of A to B. Naturally this would be most satisfactorily done if we could not only decrease the intensity of B but increase that of A. Now that a clear conception of the problem involved is had, let us look to a solution.

Consider two vertical half-wave dipoles in phase, oriented approximately so that their plane is at right angles with the desired sig-

\*1933 N. Wilcox Ave., Hollywood, Cal.

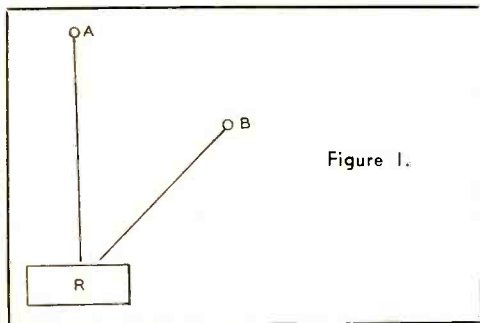

Figure 1.

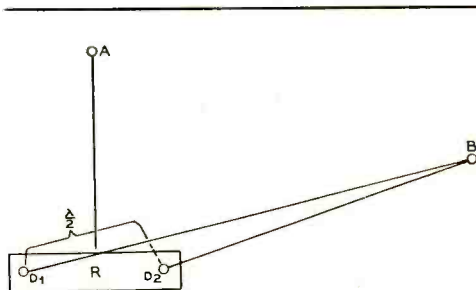

Figure 2.

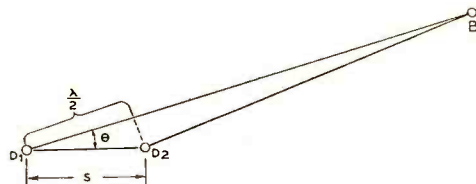

Figure 3.

nal. If their spacing is somewhere in the neighborhood of a half-wave, the broadside gain will be about 3 db. If, by proper orientation and spacing of the two dipoles, we could cause the voltage from the undesired source to be out of phase in the two parts of the antenna the problem would be solved. This can be accomplished by making the difference in path between the two dipoles and the undesired source equal to one half wave and thus cause a complete reversal of phase in the voltage introduced into the two parts of the antenna. This is shown in figure 2.

## Method of Calculation

If the noise source B is very far away (more than 20 wavelengths), then the lines  $D_1B$  and  $D_2B$  may be considered parallel. Let us further assume that we will fix the orientation by causing the plane  $D_1D_2$  to be perpendicular to the line connecting A to the antenna. That leaves the spacing between the dipoles to be varied.

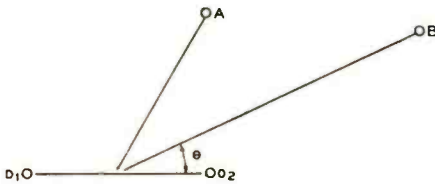

Figure 4.

The proper separation, S, expressed in feet, of D<sub>1</sub> and D<sub>2</sub> is given by the formula:

$$S = \frac{468}{F \cdot \text{Cosine } \theta} \left( = \frac{\lambda/2}{\cos \theta} \right) \quad (1)$$

where F is the frequency in megacycles, and  $\theta$  is the angle between the plane of D<sub>1</sub>D<sub>2</sub> and the interference source B as shown in figure 3. Values for the cosine are given in the table.

It is recommended that if it appears that the angle  $\theta$  will exceed about 50° that the antennas be oriented such that A is moved toward B from the peak of the lobe, for as shown in figure 4, the antenna gain for A will not be seriously affected by this change but it will make possible a reduction in the

$\theta$	Cos $\theta$
0°	1.000
2.5°	0.999
5.0°	0.996
7.5°	0.991
10.0°	0.985
12.5°	0.973
15.0°	0.966
17.5°	0.954
20.0°	0.940
22.5°	0.924
25.0°	0.906
27.5°	0.887
30.0°	0.866
32.5°	0.843
35.0°	0.819
37.5°	0.793
40.0°	0.766
42.5°	0.737
45.0°	0.707
47.5°	0.676
50.0°	0.643
52.5°	0.609
55.0°	0.574
57.5°	0.537
60.0°	0.500

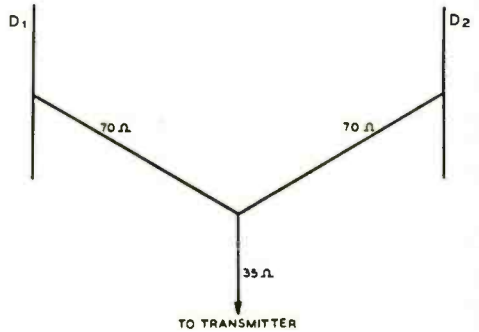

Figure 5.

distance S. In these calculations it is not necessary to know the distance to the noise source.

If, for example, one wished to design an antenna of this sort for a frequency of 28,600 kc. with the direction of A perpendicular to the plane D<sub>1</sub>D<sub>2</sub> and with an angle of  $\theta=30^\circ$ , one would get, by substitution into formula (1), a value of S equal to 19.7 feet. Substitution into the conventional frequency formula yields an element length of 17.05 feet for the dipoles.

### Feeding

Feeding the two dipoles in phase is accomplished in the usual way, that is, by paralleling two concentric cables which feed the dipoles in phase and doing this so that the juncture, Q, as shown in figure 5, is equidistant from both elements. The impedance of the line between the juncture and the transmitter must of course be one-half the impedance of the lines between the juncture and the dipoles.

[Continued on Page 78]

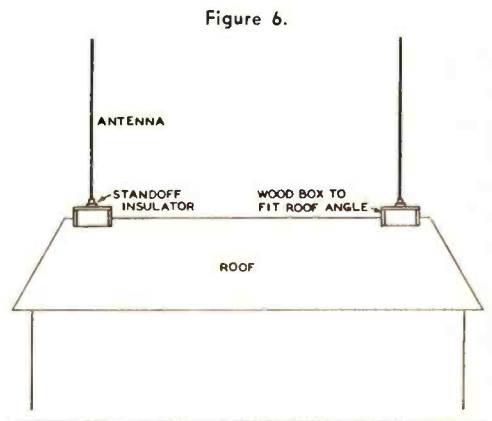

Figure 6.

# A Novel and Versatile KEYING MONITOR

An inexpensive and simple instrument which can be used as a test speaker, keying monitor, or code practice oscillator.

In the good old days of i.c.w., keying monitors were something of a superfluity. It didn't make much difference about the note anyhow, and as for something to "make the letters by," the receiver could be opened up just one notch and there was a nice whine to key by, no matter where the receiver happened to be tuned.

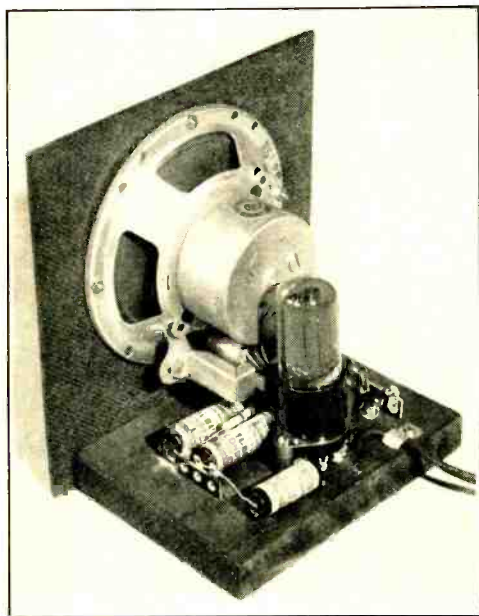

Figure 1.  
KEYING MONITOR AND CODE  
PRACTICE OSCILLATOR.

This versatile unit may be used as a c.w. monitor, an audio "howler" for code practice, or as a test speaker requiring no field supply.

But nowadays life is not so simple. A buzzer can be used as a keying aid, but buzzers have a habit of changing tone erratically after they have been in use a while. And a buzzer won't give any warning when all is not well with the transmitted signal.

A c.w. monitor of the heterodyne type, one that doesn't block when tuned through zero beat, will serve the purpose nicely; but such an instrument represents a bit more money than many amateurs are willing to spend.

The novel keying monitor illustrated in figures 1 and 2 not only gives a check on any ripple or chirp in the note, but can be used as a test speaker or as a code practice "howler." It is considerably simpler and cheaper to construct than a heterodyne keying monitor, and has the advantage that when a v.f.o. is used for frequency control of the transmitter, it is not necessary to retune the monitor each time the transmitter frequency is shifted a few kilocycles.

Any ripple or keying chirp present in the carrier in sufficient degree as to be objectionable is readily apparent on the monitor. It also may be used as a code practice oscillator. The speaker itself, requiring no external field supply, will come in handy around the test bench for use as a test speaker. To give the device this wide utility, several connections are brought out to terminals.

The speaker is a 5 inch p.m. dynamic type complete with midget push pull output transformer. The output transformer acts as the oscillation transformer for the tetrode section of the 117L7GT, which is used as a conventional Hartley oscillator. For plate voltage, some r.f. carrier voltage is picked up from the final amplifier plate coil by a few turns of heavily insulated wire and fed to the mon-

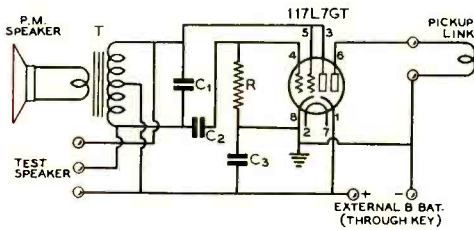

Figure 2.  
WIRING DIAGRAM OF VERSATILE  
KEYING MONITOR.

The line voltage is applied directly to the heater of the 117L7GT, prongs 2 and 7 on the octal socket.

- |   |   |
|---|---|
| T—Midget push-pull<br>output transformer<br>(on speaker)      | higher pitched note)                    |
| C <sub>1</sub> —0.1- $\mu$ fd. (smaller<br>capacity will give | C <sub>2</sub> —0.05- $\mu$ fd. tubular |
|   | C <sub>3</sub> —0.1- $\mu$ fd. tubular  |
|   | R—100,000 ohms,<br>1/2 watt             |

itor by means of a twisted pair or coaxial line. This carrier is rectified by the rectifier section of the 117L7GT and utilized as plate voltage. The plate by-pass condenser C<sub>3</sub> filters the rectified carrier into pure d.c. if the carrier itself is free from ripple. However, the time constant of this condenser is small enough that any ripple in the carrier will show up as modulation of the signal generated by the keying monitor. Likewise any keying lag will be apparent, because the strength of the monitor signal is determined by the strength of the carrier.

The amount of r.f. picked up by the pickup coil is adjusted until the monitor signal is of the desired volume. The r.f. power required is quite small, less than a watt for full room volume. For keying monitor use the terminals marked "external B bat." should be shorted.

For use as a code practice oscillator, a small B or C battery is connected in series with a key and hooked to the terminals indicated. A 22½ volt battery will give good room volume, and a fair signal is obtained with as little as 4½ volts. The current drain is low and the battery will have long life.

The tone or pitch of the oscillator can be varied by changing the value of C<sub>1</sub>. A smaller capacity will give a higher pitched note, and vice versa. If the condenser is made too large, however, the tube will no longer oscillate.

A "loose" speaker requiring no field supply is often useful for test purposes. By bringing out leads from the three primary wires to terminals as shown in the diagram, the speaker may be used for such purposes. For such work, the heater of the 117L7GT is not lighted.

When used as a test speaker the highs will be somewhat attenuated in the manner of "tone control" because of the effect of the shunt condenser C<sub>1</sub>. If suppression of the extremely high voice frequencies is undesirable, provision for opening one lead to C<sub>1</sub> can be made.

If the speaker transformer is of the variable ratio type, the voice coil tap should be chosen to give 14,000 ohms across the full primary, though this adjustment is not especially critical. More volume can be obtained for a given plate voltage by adjusting the voice coil tap for a lower primary impedance, but if this is carried too far the tube will not oscillate at low plate voltage. To give a true replica of the monitored signal, the monitor should be capable of oscillating on as little as 3 volts.

The unit is constructed on a small wooden baseboard and a Masonite front panel. The unit may be enclosed in a small cabinet or wooden box if desired.

The amount of coupling between the transmitter tank coil and the keying monitor pickup link will depend upon the transmitter power and the volume desired. For a medium power transmitter, the pick up loop need only be brought near the final tank coil.

To get an idea of what sort of change to expect in the note should there be excessive ripple, it is advised that the user remove filter from the final amplifier power supply until appreciable ripple is present (while testing on a dummy antenna) and then listen carefully to the character of the note. There will be a distinct 120 cycle modulation superimposed on the higher pitched signal which is easily recognizable once one is familiar with it.

A minor advantage of this monitor over the widely used heterodyne type, but one worth mentioning, is the pleasant timbre of the note. Due to the harmonics present, the note is musical in character and does not tire the ears as does a pure or nearly pure sine tone.

See Buyer's Guide, page 97, for parts list.

### Radioddities

Radio communication with police cars was being carried on in Detroit in 1920. In 1922, the Detroit Police department received the call letters KOP.

Everyday ads just naturally invite us to pull out the radio boners they display. Among the late ones are a billboard gas ad displaying comparatively new dome-type tubes in a 1923 model home-made receiver. Another whopper, in a spaghetti ad, has a velocity mike doing some loud speaking.

# TWO A.C.-D.C. TRANSMITTERS

By WILLIAM D. HAYES\*, W6MNU

## 1. A Flea-Power Rig for Local Contacts

A section of the Communications Act says in effect that, except in the case of signals relating to vessels in distress, all radio stations shall use the minimum amount of power necessary to carry out the desired communication. To interpret such a requirement literally would be ridiculous. In the case of a 500-watt transmitter, for example, it would mean that the power input should be adjustable in fairly small steps from the full 500 watts down to one or two watts.

The difficulties which would be encountered with such a set-up are too numerous to mention. Adjustment of r.f. excitation and antenna coupling are two of the more obvious headaches. A moment's thought will reveal a dozen or so more. To comply with such a requirement would probably double the cost of a given transmitter and would increase the operating complexity tenfold. Every time a new station was contacted the power would have to be adjusted to the point where the signals could be copied solid but were no

louder than necessary. Obviously, no such interpretation is intended.

However, the purpose behind the law is a good one, in spite of the fact that it is disregarded even more than a fifteen mile per hour speed limit. It is supposed to prevent the needless QRM which results when a station uses fifty, or a hundred, or two hundred times as much power as is needed for a given contact. Such a situation frequently arises when a station running several hundred watts contacts another station a few miles away. I have even heard 400 watts used to work a distance of two blocks! The unnecessary QRM which arises from such practices is annoying, to put it mildly, and adds nothing to the popularity of the station so operating. Some of the brethren get so in the habit of running half a kilowatt or more that they feel it beneath their dignity to go on the air with anything less than a hundred watts, even for conversing with their next-door neighbor whose antenna parallels their own.

\*429 Perkins Street, Oakland, California

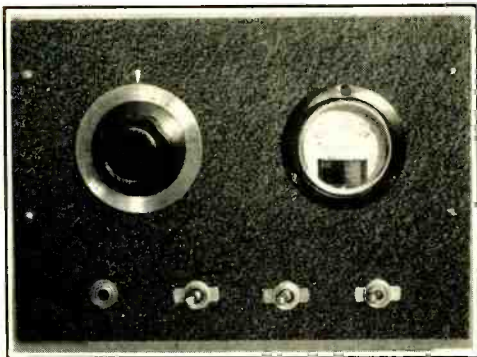

Front view of the four-watt a.c.-d.c. c.w. transmitter.

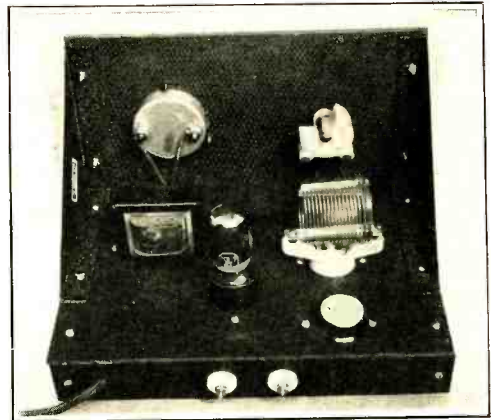

Rear view of the a.c.-d.c. c.w. transmitter which uses a 70L7-GT as the rectifier and as a beam-tetrode crystal oscillator.

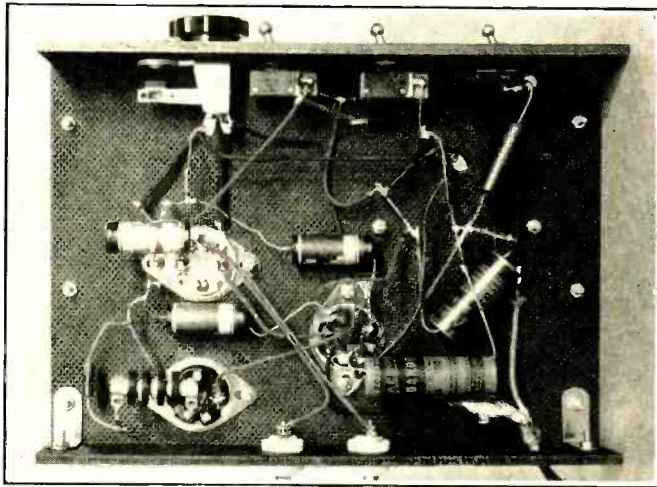

Underchassis view of the 4-watt a.c.-d.c. c.w. transmitter.

Wouldn't it make the ham bands more livable if flea-power rigs were always used for local contacts where only flea-power is necessary? All of which brings us to the point of this article, and to an inexpensive, flea-power (a strong flea), c.w. transmitter.

Circuit

A 70L7-GT is used in a conventional crystal oscillator circuit and also as a half-wave rectifier. This tube, which consists of a beam-power tetrode and a diode in one envelope, requires a heater current of only 0.15 ampere, which means that the power drawn from the line is only about half what it would be if the older type 0.3 ampere tubes were used. The 70L7-GT dissipates almost twice as much power in its heater as does a 6L6G which is encased in a much larger envelope. As would be expected, the bulb gets quite hot during operation even with the plate circuits open, and the tube should be located so as to provide for adequate ventilation.

The half-wave rectifier circuit permits the unit to be used on either a.c. or d.c., and the high capacity input filter condenser maintains the plate voltage of the oscillator at about 100 volts with four watts input. This amount of power may seem insignificant to the gentlemen accustomed to 500 watts or more, but it has proven ample for 95% of all local or near local contacts on forty and eighty meter c.w.

The d.c. milliammeter in the plate circuit of the oscillator should read about 40 ma. with the oscillator loaded, and at the request of the Society for the Prevention of Cruelty to Meters, a toggle switch is provided for shorting out the meter while keying.

The tank circuit is made up of a small air-wound plug-in-coil and a receiving type midget variable condenser. The antenna tank is not included on the chassis proper since its design will depend entirely on the type of antenna available. Instead, the r.f. output from the link

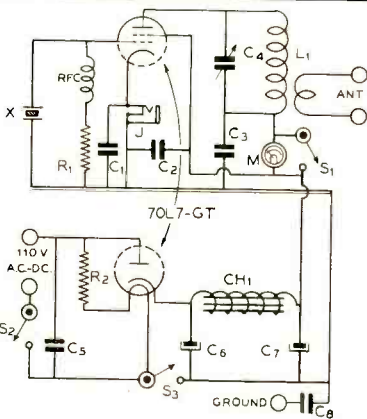

Wiring diagram of the 70L7-GT a.c.-d.c. transmitter

- C<sub>1</sub>, C<sub>2</sub>, C<sub>3</sub>—0.01-μfd. 600-volt tubular
- C<sub>4</sub>—100-μfd. midget variable
- C<sub>5</sub>—0.01-μfd. 600-volt tubular
- C<sub>6</sub>—24-μfd. 150-volt electrolytic
- C<sub>7</sub>—12-μfd. 150-volt electrolytic
- C<sub>8</sub>—0.01-μfd. 600-volt tubular
- R<sub>1</sub>—25,000 ohms, 1/2 watt
- R<sub>2</sub>—290-ohm line cord resistor
- RFC—2 1/2-mh. 125-ma. r.f. choke
- L<sub>1</sub>—Manufactured air-wound plug-in coil with end link
- CH<sub>1</sub>—30-hy. 50-ma. filter choke
- J—Keying jack
- X—Crystal for band of operation
- M—0-100 inexpensive ma. meter
- S<sub>1</sub>, S<sub>2</sub>, S<sub>3</sub>—S. p. s. t. toggle switches

is brought out to two small feed-through insulators at the rear of the chassis.

And here's a paragraph in itself: Do not ground the "B" negative.

### Construction

In the interests of quick and easy construction, the rig is built on Macolite, a very inexpensive material that is a real pleasure to work with. The panel is finished in black crackle and is attached to the chassis with a pair of steel angle brackets. Measurements are as follows: panel 7" x 10"; chassis 7" x 10" x 1½". Across the bottom of the panel from left to right are the keying jack, meter shorting switch, stand-by switch, and line switch.

The size of the unit could be very much reduced if compactness were desired, but there's no sense in crowding things without a good reason. With plenty of room for everything, mounting and wiring the parts is an extremely simple job.

### Operation

As in tuning any crystal oscillator, the tank condenser should be tuned to resonance as indicated by minimum plate current, and then rotated about one degree in the minimum capacity direction. If this is done, there will be no tendency to chirp, the rig will key properly, and the note will be T9X.

### Conclusion

A small rig of this sort consistently used for local contacts will spare your neighbor hams the merciless QRM of your California kilowatt, or whatever kind or fraction of a kilowatt you happen to be running, and the long-suffering BCL's will appreciate the temporary cessation of "that machine gun noise." Then, as you walk down the street, your neighbors, both ham and BCL, will give you soulful glances instead of the usual dirty looks, and after you have passed they'll murmur reverently, "There goes the man who uses four watts for local contacts."

## 2. An A.C.-D.C. Transmitter for 160-Meter Phone

The recently introduced series of receiving tubes employing relatively high voltage heaters permits the construction of a.c.-d.c. apparatus having economy and convenience hitherto impossible. These tubes require a heater current of only 0.15 ampere as compared with 0.3 ampere drawn by the older types. This means that the power drawn from the line is correspondingly less, and because of the higher voltage drop in the heaters, the usual line cord resistor or ballast tube can frequently be entirely eliminated. In the case of the little rig described in this article, three 35-volt tubes and a 12-volt tube are employed with their heaters in series, so that the total heater voltage is 117. Hence no dropping resistor is required.

### R.F.

A 12J5-GT is used in a Pierce crystal oscillator circuit which serves to simplify things considerably by eliminating tuning in the oscillator stage. The output of the 12J5-GT is small, but the excitation requirements of the 35L6-GT are even smaller, so all's well. An air-wound plug-in coil with an end link is used in the final tank circuit, and its output is fed to

two small feed-through insulators at the rear of the chassis. The antenna tank is not included on the chassis proper since its design will depend entirely on the type of antenna available.

The current to the final (plate plus screen) should be about 30 ma. with the antenna connected and in resonance, which corresponds to

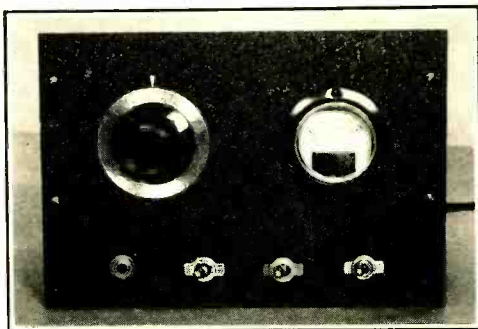

Front panel view of the 3-watt a.c.-d.c. 160-meter phone transmitter.



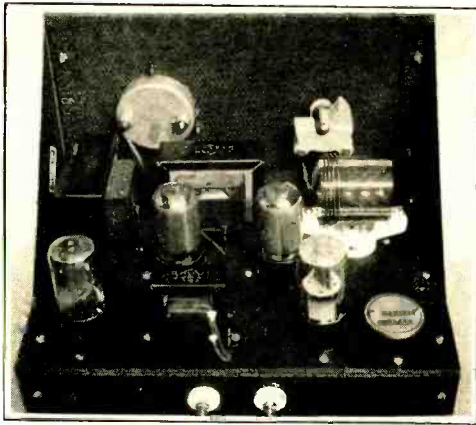

Looking down on the chassis of the a.c.-d.c. 160-meter phone.

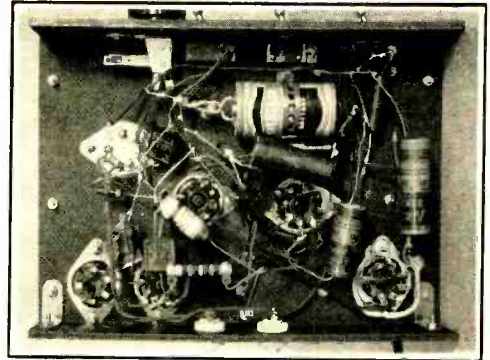

Underchassis view showing wiring and the location of the flashlight cell which supplies microphone current.

an input of about three watts and an impedance of 3300 ohms. Neutralization was found to be unnecessary on the 160-meter band because the reactance of the very small grid-plate capacity is high.

**Modulator**

The modulator also consists of a 35L6-GT, which is choke coupled to the final. The load impedance required by the modulator under the given conditions is in the neighborhood of 2500 ohms. This is sufficiently close to the 3300 ohms provided by the final so that no impedance matching network is needed.

A jack is included for a single button microphone, and the 1.5-volt mike battery is mounted underneath the chassis. Care should be taken during wiring to leave the battery in the clear, so that it can be easily replaced

when exhausted. The switch  $S_1$ , is provided for opening the mike circuit without the bother of pulling out the microphone plug. Condenser  $C_6$  grounds the grid of the modulator as far as r.f. is concerned, and since there is no power transformer, the hum pick-up in the mike transformer is nil despite the lack of shielding. As a matter of fact this freedom from hum is one of the biggest advantages of a.c.-d.c. construction when a mike transformer is to be mounted within a few inches of the power supply. The microphone used with the rig is a Universal Model "W" which, with close talking, drives the 35L6-GT to full

[Continued on Page 82]

Wiring diagram of the a.c.-d.c. 160-meter phone transmitter.

- $C_1$ —.00005- $\mu$ fd. midget mica
- $C_2$ —.01- $\mu$ fd. 600-volt tubular
- $C_3$ —.00025- $\mu$ fd. mica
- $C_4$ —.005- $\mu$ fd. mica
- $C_5$ —100- $\mu$ fd. midget variable
- $C_6$ —.001- $\mu$ fd. mica
- $C_7$ —25- $\mu$ fd. 25-volt elect.
- $C_8$ —.01- $\mu$ fd. 600-volt tubular
- $C_9$ —24- $\mu$ fd. 150-volt elect.
- $C_{10}$ —12- $\mu$ fd. 150-volt elect.
- $C_{11}$ —.01- $\mu$ fd. 600-volt tubular
- $R_1$ —25,000 ohms, 1/2 watt
- $R_2$ —75,000 ohms, 1/2 watt
- $R_3$ —175 ohms, 1/2 watt
- RFC—2 1/2-mh. 125-ma. r.f. choke
- $L_1$ —Air-wound end-link 160-meter plug-in coil
- $T_1$ —Single-button mike trans.
- $CH_1$ ,  $CH_2$ —30-hy. 74-ma. chokes
- J—Microphone jack
- B—1 1/2-volt flashlight cell
- X—1800-2050 kc. crystal
- M—0-100 inexpensive d.c. ma. meter
- $S_1$ ,  $S_2$ ,  $S_3$ —S. p. s. f. toggle switch

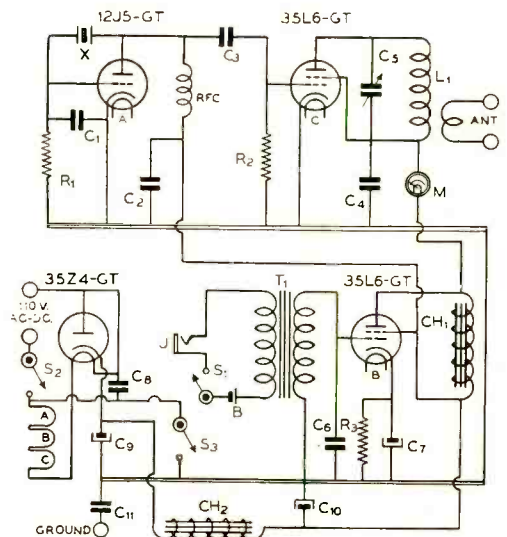

# A DeLuxe

# A. C. OPERATED OHMMETER

By CARL J. SWENSON\*, W9RFV

It has been this writer's experience that when the ohmmeter is needed badly, the battery in it is usually so low that it cannot be adjusted to zero. To overcome this undesirable feature of ordinary ohmmeters, and to extend the ranges available, the a.c. operated meter described was designed and constructed.

## Ranges

The following features were thought to be highly desirable:

1. The indicating meter used must be of standard range and must be obtainable at a reasonable cost.
2. A standard ohmmeter scale with a center-of-scale marking of 4500 ohms should be used.
3. Only one ohms scale to be used for all ranges.

4. The low range should be of such a magnitude that resistances of the order of a few ohms can be easily measured.

5. It must be operated directly from the 110 volt 60 cycle line.

The indicator used can be any 0-1 milliammeter of 50 ohms resistance or less. A method of measuring its resistance is described. All ohm ranges are read on the same scale which is marked 100,000 ohms at the extreme left of the scale and 4500 ohms at the center of the scale. The six ranges of this ohmmeter are 100, 1000, 10,000, 100,000, 1 megohm, and 10 megohms full scale, which correspond to 4.5, 45, 450, 4500, 45,000, and 450,000 ohms at the center of the scale.

With the low range it is very easy to check filament windings, voice coils, and even solder joints while the high range will be useful for testing leakage of condensers, a.v.c. circuits, etc. Voltage ranges of 50, 250, and 1000 are also included.

\*3937 Wayne Ave., Chicago, Ill.

Figure 1. Front panel view of the deluxe a.c.-operated ohmmeter.

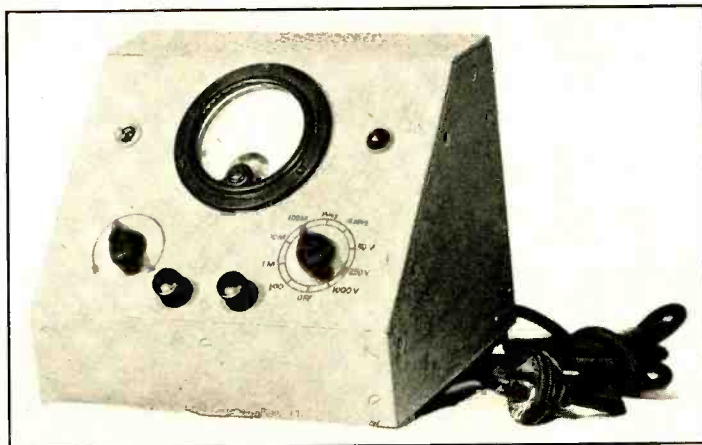

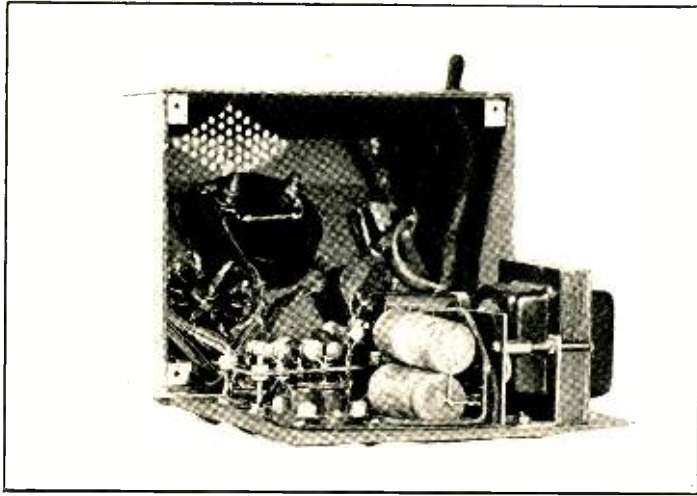

Figure 2. Rear view of the ohmmeter with the cabinet tipped back from the chassis. The rectifier tube has been removed from the socket to show the method of mounting the resistors upon a resistor tie plate. The two tubular condensers to the left of the power transformer are the filter condensers for the unit.

**Construction**

The case for this instrument is constructed from 1/8-inch tempered Presdwood and need not cost more than 50 cents at the most. The construction is clearly shown by the photographs, figures 1 and 2, and the drawing, figure 4. The positions for the angles used to hold the case together are not shown since few constructors would have the same sizes. The angles for the four bottom corners are constructed as shown in figure 4 and the entire case is fastened together with 3/8-inch 6-32 flat-head machine screws which are counter-sunk flush with the panels.

After the case is assembled and drilled for the parts on hand, it may be given a coat of grey wrinkle varnish which will enhance its

appearance. Instead of using a dial plate, the switch markings are drawn directly on the front panel with black India ink after, of course, the varnish has dried thoroughly. Most of the parts are mounted on a 5 3/4 by 7 3/4-inch sheet of the same material which slips inside the bottom of the case and which is held in place with four 6-32 machine screws through the bottom angles which also hold the rubber feet in place. The resistors are mounted on a small sheet of 1/16-inch bakelite and the placement of the other parts is easily seen from the photographs. Many of the resistors can be salvaged from the "junk box" but they should be in good condition. Many of these values can be obtained by paralleling two resistors.

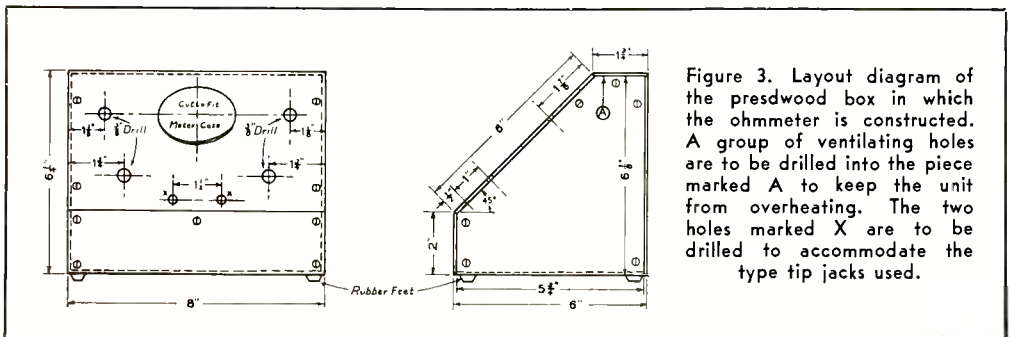

Figure 3. Layout diagram of the presdwood box in which the ohmmeter is constructed. A group of ventilating holes are to be drilled into the piece marked A to keep the unit from overheating. The two holes marked X are to be drilled to accommodate the type tip jacks used.

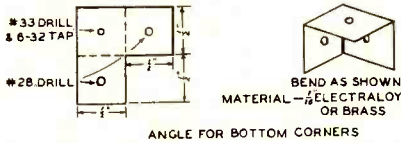

Figure 4. Detail drawing of the small metal angles which are to be made for the bottom corners. They can be seen in the photograph of figure 2.

### Calibration

The first step in the calibration if the meter resistance is not known is to hook it up in a circuit as shown in figure 6. The variable resistance is adjusted until the meter indicates exactly 1 milliamper. The rheostat is left at this position and an accurate resistance of 50 or 100 ohms is connected across the meter terminals. The meter reading will drop when this is done.

The graph of figure 7 should then be consulted and from the meter reading the value of its resistance can be read from the curve. If a 100-ohm resistance is used curve A should be used. If a 50 ohm resistance is used curve

B should be used. If a resistance value of less than 50 ohms is obtained, a resistance must be added in series with the meter to bring its resistance up to 50 ohms. The only precaution it is necessary to observe is that the meter must be adjusted to full scale or 1 milliamper with the shunt resistance removed.

After the meter has been adjusted to 50 ohms resistance the adjustable resistance  $R_{15}$  should be adjusted approximately with another ohmmeter. Starting at point A on the diagram of figure 5, the first slider should be set at approximately 3600 ohms which is then connection B. Slider C should then be set so that the resistance between A and C is 25,000 ohms. Resistance  $R_8$  should be adjusted to about 8600 ohms. If a 10,000 or 15,000 ohm wire-wound potentiometer is on hand it can be used for  $R_8$ .

Now the parts may be wired, locating the rectifier tube and adjustable resistance so that they do not heat the meter or other resistors. If the transformer used has a higher voltage than the one shown, the tap C should be set at 30,000 ohms for a preliminary check.

The range selector switch should now be set at the 100-ohm range. The line switch should be left in the off position except when an actual test is being made. It may be found

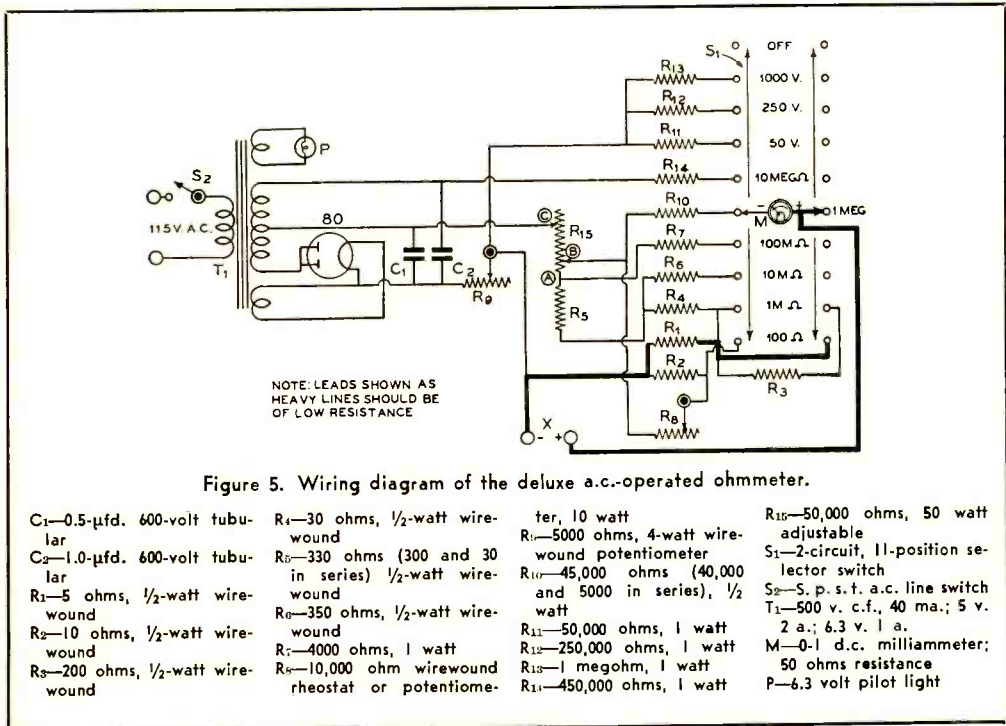

Figure 5. Wiring diagram of the deluxe a.c.-operated ohmmeter.

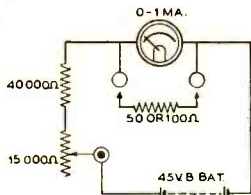

Figure 6. Circuit for determining the d.c. resistance of the meter. See text for details of the method.

that the meter reads even though the binding posts or jacks are not connected. This reading may be in either direction; that is, it may be either above or below the zero milliampere mark on the scale. Resistance  $R_s$  should now be adjusted until no reading is obtained.

The binding posts may now be shorted together with a short piece of wire and the reading noted. The zero adjuster rheostat  $R_a$  should be set at mid-scale during this test. If the pointer does not deflect to zero ohms the tap C should be moved toward A a small amount or if it deflects too far beyond zero ohms it should be moved away from A.

The selector switch should now be set at the 1 megohm position and the binding posts again shorted. (Ranges should never be changed when the binding posts are shorted as this may damage the instrument.) If the pointer does not deflect to zero ohms the tap B should be moved away from A or if it deflects beyond zero it should be moved toward A.

If the resistors are of the values specified the 1M, 10M, and 100M ranges should indicate zero ohms also with perhaps a difference of three or four scale divisions between them. The zero adjuster rheostat is for the purpose of adjusting this difference.

The selector switch should now be set at the 10 megohm range. The binding posts should be momentarily shorted together and the deflection noted. If the transformer voltage is higher than that specified and if the pointer deflects too far the condenser  $C_2$  should be made approximately  $\frac{1}{2}$   $\mu$ fd. or in an extreme case  $\frac{1}{4}$   $\mu$ fd. If, however, the pointer does not deflect to zero ohms,  $C_2$  should be made larger. Condensers  $C_1$  and  $C_2$  should be paper condensers and not electrolytics.

When this range has been properly adjusted, with the zero adjuster rheostat still set at midscale, the 100-ohm range should be again checked to see if its reading with no connection between the binding posts is still zero milliamperes. If not it should be set at zero by means of  $R_s$ . The circuit on the 100-ohm range is a modified form of Wheatstone bridge and by adjusting  $R_s$  the bridge is brought in

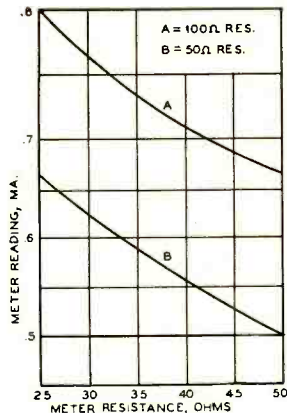

Figure 7. Chart for determining meter d.c. resistance from the change in indication when the circuit of figure 6 is used.

balance. The 100-ohm range should now be tested at zero ohms and if its reading is different from when it was first adjusted, slider C on  $R_s$  should be adjusted until all ranges are close to zero. From then on each individual range can be adjusted to zero with the zero adjuster. The preceding adjustments may seem complicated but they are in reality very simple.

### Design

The 100-ohm range of the meter operates as a Wheatstone bridge with the meter as a galvanometer and the unknown resistance shunted across one leg of the bridge. With this system it is possible to get by with a current drain of only 15 milliamperes for this range. If an ordinary series type ohmmeter of this range were made using a 4.5 volt battery it would require a current drain of 1 ampere which is excessively large and which can easily damage a low wattage resistance of low ohmage. The maximum voltage applied to the unknown resistance is only 50 or 60 millivolts on the 100-ohm range of this tester. The other ranges merely consist of fixed series resistances with a variable voltage supply to compensate for line voltage variations. The 10-megohm range operates at a potential of 450 volts which can cause a shock if the leads are touched but this is not dangerous since the current cannot exceed 1 milliampere. The filter system may seem inadequate but it is sufficient for its purpose.

### Very Much Alive

The common practice of using "dead" socket pins as tie points for resistors, etc. is not to be recommended with the new loctal type tubes. Certain of these tubes use a "dead" pin as additional support for one of the elements.

# An Electrically Rotatable

## 112-MC. ARRAY

The idea of rotating the directivity of an array around the compass without actually swinging the array itself is not new<sup>1</sup>, but the arrangement to be described possesses certain advantages over those previously described, particularly from the standpoint of simplicity.

A single section vertically polarized close spaced two element array of the driven type makes an excellent 112-Mc. radiator, because of its low vertical angle of radiation and because of the substantial amount of horizontal directivity. The low vertical angle is due to the fact that the antenna is inherently balanced, and there is no resultant current in the feed line that is out of phase with the antenna radiation as is the case with the vertical J and similar vertical antenna systems.

The "nose" of the beam is sufficiently broad to cover an arc of approximately 60 degrees

before there is noticeable loss in signal strength, but the radiation drops off rapidly beyond 30 degrees to either side of the direction in which the array is aimed. This means that three, but not less than three, such antennas could be used to cover the entire compass, because the array is bi-directional.

The simplest and cheapest way to erect three such arrays is to combine them in the form of the arrangement of figure 1. If desired, it may be entirely a "plumbing job," the mast, supporting members, and radiators themselves all being of pipe. Because each radiator and its corresponding support member and feed wire are equally spaced from the others, any two radiators may be used with the assurance that the remaining radiator and feed wire are completely "dead" and have no effect upon the radiation pattern of the two radiators in use.

The radiating elements should preferably be of  $\frac{1}{2}$  or  $\frac{3}{4}$ -inch copper pipe, though galvanized conduit or pipe will serve practically as well. The vertical support pipe should be heavy enough that the antenna will not whip about too much in a heavy wind. The support pipe may be guyed at a point 2 feet or more below the bottom of the radiator elements.

The feed wires, which may be of either no. 14 or no. 16, are tapped approximately 6 inches from the center of each radiator. The best point of attachment will have to be determined experimentally. The feed wires are slid up and down the radiators together until the standing wave ratio on the line is mini-

[Continued on Page 78]

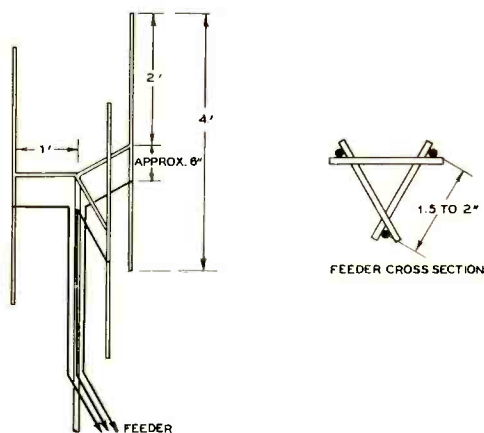

Figure 1.  
112 MC. SIX-DIRECTIONAL BEAM  
ANTENNA.

Simply by throwing a switch at the operating position, the pattern of this array may be altered to cover all points on the compass. It is a low-angle radiator and gives considerable gain. Three bidirectional patterns are available.

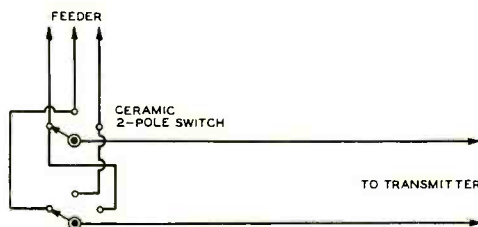

Figure 2.  
SWITCH CONNECTIONS FOR 3 WIRE  
LINE.

# TWO-WAY TELEVISION

## • *With Voice*

Two-way television was demonstrated for the first time by amateur radio men of the W2USA Radio Club, between their station in New York City and their glass-enclosed booth in the Communication Building at the World's Fair, New York. People visiting the Fair can see and hear those on the New York end of

---

An example of the quality of the television image received over the amateur television system. This photograph of Lola Lane was sent over the eight-mile path between the transmitter in New York and the receiving equipment at the World's Fair, where the fluorescent screen of the receiver was photographed.

---



the circuit and vice-versa. The glass booth, which is also provided with loudspeakers, enables quite a group to see and hear the demonstration. The television pick-up camera to the left is being operated by Bill Meissner, W2HYJ. The voice sending and receiving equipment is shown in the center, with Arthur H. Lynch, W2DKJ, managing director of the W2USA Club, talking to Fred Cusick, W2HID, who is at the other end of the eight-mile radio path, but who is seen in the television receiver at the right. The purpose of

the demonstration is to acquaint as many people as possible with the possibilities of home-made amateur television equipment.

The accompanying picture of Lola Lane, star of "Girls on the Road," was photographed at the Fair end of the circuit as it was televised in New York. Photos are used for the preliminary testing of the equipment. Individuals as well as scenes of the surrounding territory may then be sent out. Definition of the images on the receiver screen is much better than these pictures indicate.

A. H. Lynch, W2DKJ, at the operating position of the W2USA amateur television demonstration at the World's Fair in New York. W2HYJ is operating the television pickup camera, and the incoming signal is viewed on the screen of the television receiver to the right and above Mr. Lynch.



# An Interesting Discovery Regarding

## T U B E   L I F E

The Bell Telephone Laboratories report a discovery\* which, if applicable to receiving and transmitting tubes as well as to the repeater tubes on which checks were made, should be of vital interest to every amateur, and of particular interest to the amateur who is considering the purchase of that pig-in-a-poke, a "slightly" used transmitting tube.

Checks on life test records of various repeater tubes, operating under unvarying conditions, showed that invariably the rate of failure in a group of tubes when expressed in per cent of the tubes remaining tends to become constant—just as though the tubes failed in random fashion. The same results were obtained in every case where sufficient data was kept on field trials. There is every reason to believe that the same law of probability will apply to receiving tubes and possibly to transmitting tubes, even when being punished in an amateur transmitter.

This means that a used tube, *still in perfectly good condition*, has a further life expectancy just as great as that of a brand new tube of the same type. At first glance this seems hard to believe, but after a little thought on the subject it is not so hard to accept. The reason is that the life of individual tubes in a large group will be found to vary widely from the average life or "life expectancy." Some will last only a few hours, some a few hundred, some a few thousand, and some many thousands of hours. If the average life for the group is say, 3000 hours, it will be found that at the end of 3000 hours only 37 per cent of the group are still in service. The extra long life of the tubes which exceed the average life makes up for those that fail before 3000 hours.

It is interesting to note that the practice of replacing all tubes periodically, whether it is done because uninterrupted service is of prime importance or because "the tubes are old and they would soon start going out one at a time as their life expectancy is reached," is pure folly. The short lived tubes already having

given up the ghost, the tubes remaining in service, even though they may have exceeded the average life expectancy, are likely to last as long as brand new tubes.

Most every amateur knows of a case where a brand new transmitting tube, of reputable manufacture, failed after a very short period of service during which the tube was not abused. This should be no reflection upon the manufacturer or his product. The tube may have a life expectancy (average for a large group) of possibly 5000 hours when run at normal ratings. Even so, an occasional one is bound to fold up after a few dozen hours, which will be compensated by an occasional one lasting 25,000 hours or even more. Theoretically all tubes of a certain type *should* have a definite life span, at the end of which all of them elevate their toes skyward simultaneously. But such is not the case in practice. Manufacturers are doing their best to get at the root of the non-uniformity, but don't seem to be able to do so. They can improve and extend the average life of a certain type of tube, but still some will last 10 times as long as others in the same service.

Of course the survival law falls down when carried to extreme. It is true that according to this law of survival, in which a certain fixed percentage of surviving tubes fail every given number of hours, sooner or later a tube would be found which would last indefinitely. Of course no tube can last forever, but it would be reasonable to believe that if a tube somehow did manage to survive say 200,000 hours, it would have just as good a chance of lasting another 1000 hours as would a new tube. This assumes, of course, a new tube which was made at the same time and on the same equipment. It would be highly probable that after 200,000 hours a manufacturer would have improved his manufacturing technique and would be turning out improved versions with a greater life expectancy.

If this law of survival applies even approximately to transmitting tubes, and there appears to be no reason why it shouldn't, used tubes should be worth a lot more than they are. This takes for granted that the tube still

[Continued on Page 74]

\*See D. K. Gannett, "Determination of the Average Life of Vacuum Tubes," *Bell Laboratories Record*, August, 1940.



# NEW TUBES

Among the new tubes recently released are the HY-31Z, manufactured by the Hytron Corporation, and the 1847, 117N7-GT, 827-R, 889-R, VR75-30, 825, SW4-GT, 833-A, 1627, 8003, 6AD7-G and 12A6, all manufactured by RCA.

The HY-31Z is an instant-heating twin-triode designed specifically for use as a class B modulator for the type HY-69 beam tetrode. The HY-31Z is also suitable for use as a class C r.f. amplifier or oscillator. Characteristics and typical operating data are as follows:

Filament voltage (a.c. or d.c.)...5.7 to 6.6 volts  
 Filament current.....2.5 amperes  
 Mutual conductance (per section) 1800  $\mu$ mhos  
 Average amplification factor.....45  
 Plate leads.....metal top caps  
 Base ..... 4-pin ceramic  
 Grid-to-plate capacitance .....5.0  $\mu$ fd.  
 Grid-to-filament capacitance .....5.0  $\mu$ fd.  
 Plate-to-filament capacitance .....1.9  $\mu$ fd.

Typical Operation, CCS Ratings Class B Audio Amplifier or Modulator				
D.C. plate voltage	300	400	400	500 volts
D.C. grid voltage	0	0	0	0 volts
Peak a.f. grid-to-grid voltage	104	140	98	131 volts
Zero-sig. d.c. plate current	20	26	26	36 ma.
Max.-sig. d.c. plate current	100	150	100	150 ma.
Max.-sig d.c. grid current	20	28	16	30 ma.
Load res. (per section)	1250	1250	1750	1750 ohms
Plate-to-plate effective load	5000	5000	7000	7000 ohms
Max.-sig. grid driving power	1.4	2.0	1.2	1.8 watts
Max.-sig. power output	18	40	24	51 watts

Plate-Modulated R.F. Amplifier (Values are per section)	
D.C. plate voltage.....	400 max volts
D.C. plate current.....	75 max. ma.
D.C. grid voltage.....	-100 max. volts
D.C. grid current.....	15 max. ma.
D.C. plate input.....	30 max. watts
Plate dissipation.....	10 max. watts

## Class C Telegraphy R.F. Amplifier (Values are per section)

D.C. plate voltage.....	500 max. volts
D.C. plate current.....	75 max. ma.
D.C. grid voltage.....	-150 max volts
D.C. grid current.....	15 max. ma.
D.C. plate input.....	37.5 max. watts
Plate dissipation.....	15 max. watts

## 1847

The 1847 is a two-inch, electrostatic-deflection iconoscope designed particularly to serve as a pick-up tube in amateur television transmitters. The new tube provides a 120-line picture suitable for transmission in the 112- or 224-Mc bands. The maximum voltage required for the 1847 is 600 volts, which allows inexpensive power-supply components to be used. Since the mosaic is less than 2 inches in diameter, an inexpensive short-focal-length lens can be used in the pick-up unit.

### Typical Operation

Heater voltage.....	6.3 volts
Anode no. 2 and col. voltage.....	600 volts
Anode no. 1 voltage.....	150 approx. volts
Grid no. 1 cut-off voltage.....	120 approx. volts
Peak-to-peak vertical def. voltage.....	225 volts
Peak-to-peak horizontal def. voltage.....	225 volts

## 827-R

The 827-R is an air-cooled radiator type of u.h.f. transmitting beam-power amplifier. In class C telegraphy service, the maximum plate dissipation rating is 800 watts. The 827-R is particularly well suited for use in f.m. and television transmitters. Unique features of the new tube include the use multiple-ribbon filament leads, two multiple-ribbon grid leads to minimize the effects of lead inductance, and an entrant metal header. The header serves both as a screen terminal and as a portion of the shielding between the input and output circuits. When proper precautions are taken in regard to isolating the input and output circuits, it is not necessary to neutralize the 827-R except at the very high frequencies. The following ratings apply at frequencies up to 110 Mc.:

Typical Operation, CCS Ratings  
Plate-Modulated Class C R.F. Amplifier

D.C. plate voltage.....	2500	3000 volts
D.C. screen voltage.....	700	750 volts
D.C. grid voltage.....	-350	-325 volts
D.C. plate current.....	400	400 ma.
D.C. screen current.....	140	125 ma.
D.C. grid current (approx)	125	125 ma.
Driving power (approx)...	72	68 watts
Power output (approx)....	670	825 watts

Class C Telegraphy R.F. Amplifier

D.C. plate voltage.....	3000	3500 volts
D.C. screen voltage.....	900	700 volts
D.C. grid voltage.....	-350	-300 volts
D.C. plate current.....	500	428 ma.
D.C. screen current.....	165	185 ma.
D.C. grid current (approx)	125	100 ma.
Driving power (approx)...	66	50 watts
Power output (approx)....	1000	1050 watts

### 889-R

Type 889-R is an air-cooled radiator type triode with a plate dissipation rating of three to five kw., depending upon the type of service in which the tube is used. The tube is intended for use with full input at frequencies up to 25 Mc. At reduced input, operation is permissible up to 100 Mc.

### 825

The 825 is a new type of multi-electrode tube in which the electron-stream is inductively coupled to the output circuit. The tube is designed to be used as a r.f. amplifier, oscillator, or frequency multiplier at frequencies above 300 Mc. A photograph of the 825 is shown on this page. In use, a toroidal-shaped resonator circuit is placed over the smaller end of the tube. Electrons passing to the collector element, which may be seen at one end of the small portion of the tube, impart energy to the external tank circuit. The electrons flowing through the tube are focused into a beam by means of a permanent or electro-magnet. The 825 is capable of a power output of 35 watts.

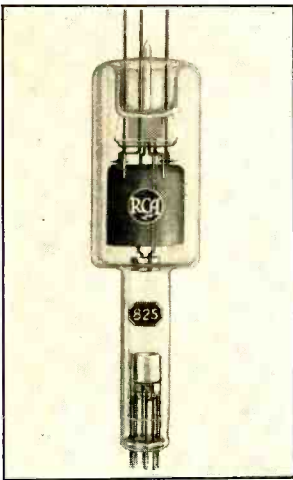

### 833-A

The 833-A is an improved version of the well-known 833 triode. The improved construction of the new tube allows it to be run at higher output with forced-air cooling. The 833-A has a maximum ICAS plate dissipation rating of 450 watts. Typical ICAS operating conditions with forced-air cooling are as follows:

Class B Audio Amplifier

D.C. plate voltage.....	4000 volts
D.C. grid voltage.....	-100 volts
Peak a.f. grid-to-grid voltage.....	510 volts
Zero-sig. d.c. plate current.....	100 ma.
Max.-sig. d.c. plate current.....	900 ma.
Load resistance (per tube).....	2750 ohms
Plate-to-plate load resistance.....	11,000 ohms
Max.-sig. driving power (approx).....	38 watts
Max.-sig. power output (approx).....	2700 watts

Class C Telegraphy R.F. Amplifier

D.C. plate voltage.....	4000 volts
D.C. grid voltage.....	-225 volts
D.C. plate current.....	500 ma.
D.C. grid current (approx).....	95 ma.
Driving power (approx).....	35 watts
Power output (approx).....	1600 watts

The 833-A is directly interchangeable with the 833 in circuits designed for the latter tube.

### 1627

Except for the filament, which is intended to operate at 5 volts, 9 amperes, the 1627 is identical with the type 810 transmitting triode.

### 8003

The 8003 is a transmitting triode suitable for use as a power amplifier, modulator or oscillator. The plate dissipation rating is 100 watts. The tube is designed particularly for use in self-rectifying diathermy oscillators. In this type of circuit a useful power output of 375 watts may be obtained from a pair of 8003's. Maximum ratings apply at frequencies up to 30 Mc., but the tube may be used at frequencies as high as 50 Mc. at reduced plate voltage and input.

### 117N7-GT

The 117N7-GT is intended for use as a half-wave rectifier and beam-power audio amplifier in portable battery-a.c.-d.c. receivers. The maximum rectifier-section output current is 75 ma. At 100 volts on the plate and screen, the audio amplifier section of the 117N7-GT will deliver 1.2 watts of audio at 6 per cent total harmonic distortion. The heater is designed for connection directly across the 117-volt supply line.

[Continued on Page 76]

● The 1922 photo QSL card of 6ZAC, Cliff Dow, Wailuku. It was about this time that Cliff started operating from Hawaii using a pair of 50 watters in his rig. He had the whole mainland gang clamoring for contacts, but only a few of the sparks got through. He made the fellows realize that it was the very beginning of the end for spark.

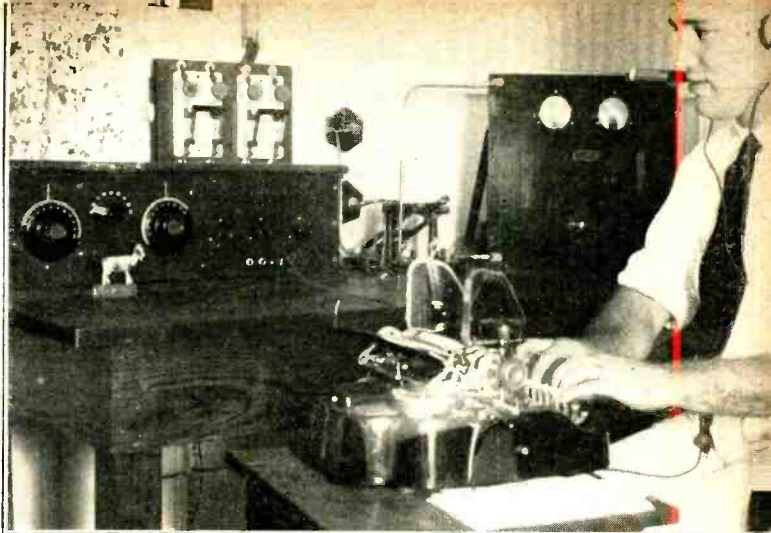

# DEPARTMENTS

---

---

- **X-DX**
- **U. H. F.**
- **With the Experimenter**
- **The Amateur Newcomer**
- **Postscripts and Announcements**
- **Yarn of the Month**
- **What's New in Radio**
- **New Books and Catalogs**



# X-DX AND OVERSEAS NEWS

By Herb Becker, W6QD

Send all contributions to Radio, attention DX Editor,  
1300 Kenwood Road, Santa Barbara, Calif.

"W8CRA, W6GRX, G5BD and VS1AJ had a lot of fun a couple of weeks ago in a 4-way QSO. It was solid all around. Did you know that G5BD has worked W6GRX exactly 101 times? ZS2A is just about ready to come back on the air with a few watts. OK2AK is going in for a little power, having just purchased a 354.

"Flash! W6GRL has just made WAC in 55 minutes. On September 22nd Doc hooked the following stations, J4CR, KA1JC, ZT5R, VK6FO, W6QD, LU4DQ and G6MK. Brother that's stepin' on it.

"W8CRA has worked 1368 different DX stations, the latest being YM4DSG and VR4BA, and the latter was using only .7 of a watt. F8EO and his sidekick F8EX are the two most consistent F stations on the air. Both use 203A's in the final. W6GRL just hooked his 88th country in getting YS1FM, and W6DLN outsmarts the gang in sneaking a contact with F7CFV in New Caledonia.

"ON4CSL has just invested in a new FB7A receiver. W9KG did a QSY to 14 Mc. to grab off VQ8AF, and W9ARL nabs VU2CQ. W8DOD worked ZL2GN on 80 meters and W8BTI hooked PK1WK for No. 93. W6CNX and W6AUX have combined, and have a nice Rhombic headed for Europe. They work about 15 Europeans every morning on 20. W6QD working plenty of 9's.

"W3AYS heard ET1TT calling CQ USA. AYS hooked VQ3MSN as well as some South African station. K6CGK says some of the best dx in his neck of the woods include VQ2WAB, VQ8AB, FB8AA, FB8AD, ZE1JU, ZE1JY, VU2CQ, YJ1RV, CR7AU, CR7AC, CR7MB, CR7GC. On 7 Mc. the best are about 20 ZS, ZT and ZU. W2BJ says FT4AF puts in a good signal and that EA3AN wants W6 and W7 QSO's. W7AMX works Europeans every day on 20 and at night on 40. W6CXW adds a few good ones PZ1AA, VQ4SNB, ON4CSL, FB8AB, FO8AA, YM4ZAA.

"W8ZY hooked up with VU7FY for his 35th zone and 96th country while W8DVS worked K7UA for his 88th. W9KA landed KA1MD on 40 which is nice work from Chicago. VK3EG won the VK-ZL contest for their neck of the woods. F8EO says W6KRI and W6CNX are the most consistent on 40 meters. W6CUH has just finished a new quick change rig using three 150T's in the final, doubling to 14 Mc. which facilitates QSY. W8CRA's poles took the count in the last storm and now he uses his maw's clothesline. W8BCT nabbed PK1BO who was on 7130 kc. W6QD decides to work W9's in the dx contest."

If you don't believe any of the above, you can find all this and more too, back in the 1935-36 issues of RADIO, from October to March inclusive. Remember when? No, I'm not completely off my nut but I'll bet 10 to 1 you are, after reading

through that stuff. Ah me . . . just sit back and guzzle a coke . . . things 'aint' like they usta be.

The proprietor of this department is now milling out the column for the sixth year, but the material is surely thinning out. We'll try to ramble along, however, giving what info we can pick up, as well as running a few photos of the gang around the country. A dx man is *still* a dx man regardless of how little (if any) he is working today. The proof of this is brought out when you get a gang together. They all begin by saying . . . "Remember so and so, well I just received his card the other day." From then on they're off to the races. At the recent convention out here we held many impromptu bull sessions, and they all turned toward dx . . . and how it "usta was."

## WAAP

In last month's column announcement was made of a new award, WAAP, Worked All American Possessions. In view of the fact that there is strong possibility of other islands popping up with American calls, a question is bound to arise as to whether or not these must be worked, also. Until such a time as we can definitely determine what other possessions are going to show up, we will let the 15 named last month stand for WAAP.

One of these I have in mind is KD4GYM on Swan Island. This is supposed to be located between Cuba and Honduras. He operates phone on 14240 kc. and the rig runs about 100 watts input. W6TT of Oakland was the first West Coast contact for him although many other boys



Major E. H. Armstrong, taken at the Pacific Coast Convention.

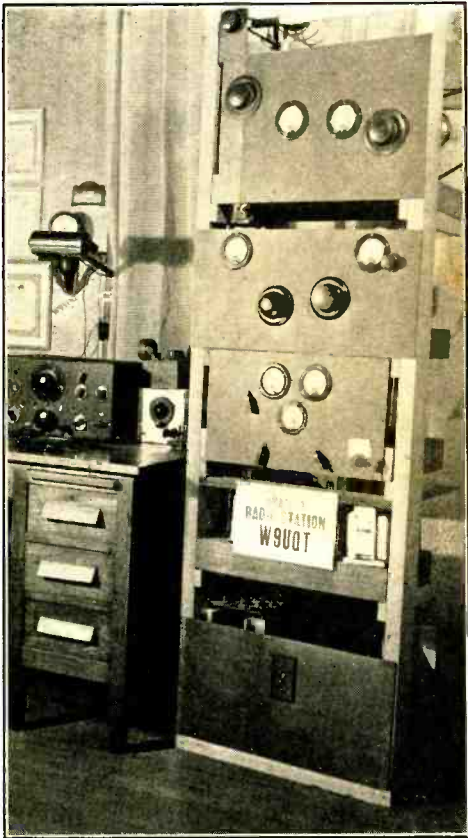

W9UQT, owned by "Doc" Matthews. The rig ends up in a pair of HF-300's.



KB6CBN, Guam, owned and operated by Roy Henning.

received cards from U9ML, CR6AF, J9CA, VS1AP, VQ8AS, TG9AA, PK6XX and PK5JT. This gave Homer 39 zones and 131 countries, which no doubt will stand for some time now. Homer has been fooling around with a new Chris-Craft this summer and by the time you read this he will be hard at work (?) at the West Va. Univ. again. W6SUD received a letter from PK1FK stating he was one of the youngest hams in the D.E.I., being 18 years of age. Before they were closed down he ran 60 watts on phone and 80 on c.w. although he claims his code speed was not too good. PK1FK says the dx gang in Bandoeng consists of PK1TM, PK1XZ, PK1VM, PK1OG and PK1FK. He needs cards from W6HCE, W6EFC, W5AKZ, W5GGX, W9BBS, and W9FCJ.

KB6CBN, Roy Henning shoots a few highlights of the situation in Guam. In the first place his rig consists of a 75T in the final running around 250 watts on c.w. and 50 watts phone, with cathode modulation. Frequencies most used are 14246 and 14178 while c.w. frequencies are 14365 and 14008. Approximately 80% of Roy's time is on phone. The receiver is an HRO and the antenna is two half-waves in phase. Roy says that now that the Pacific islands are about all that's left out of USA to work he finds himself at a sort of a "premium." One CQ keeps him busy the whole evening.

Quoting a portion of Roy's letter directly, "I have been located on Guam since February and have been operating the rig daily. My hobby has sure made my time pass very pleasantly. In these past six months I have received more pleasure from amateur radio than at any time in the ten years that I have had my license. It is interesting to hear the average operator's opinion of Guam. They picture it as a barren coral reef—nothing could be further from the truth. It is a beautiful island. Incidentally I had better like it because my tour of duty here is two years. Hi. All QSL cards will be answered although the mail service to Guam is very irregular and slow."

around the country have worked him too. One time to find KD4GYM is around 7:30 p.m. p.s.t. but no doubt he is on in the a.m. also.

Following is a list of the prefixes from which confirmations will be required, also a set of simple rules to follow: K4, KB4, KC4, K5, K6, KB6, KC6, KD6, KE6, KF6, KG6, KH6, K7, KA and W.

1. 15 confirmations must be submitted which will entitle the operator to a WAAP certificate. A list will be published in RADIO showing the order in which they have been awarded.

2. Either phone or c.w. may be used, or both.

3. Confirmations may consist of QSL cards, letters, or lists sent in by the station to RADIO. Other forms of confirmation will be acted upon by the committee.

4. All confirmations should be sent via registered mail direct to The Editors of RADIO, 1300 Kenwood Rd., Santa Barbara, California. A self-addressed envelope should be included with sufficient postage to cover the return of your confirmations.

W9GKS is still in there punching, having just worked KC4USA on 20 phone. W8PQQ recently

W6HJT, "Cam" Pierce, and  
W6GRL, "Doc" Stuart.



W6PMB passes along some information that KC4USB is now operating 10-meter phone. Elmer at the East Base was using a frequency approximately 28540 kc. The time of this QSO was 9:22 a.m. p.s.t. Elmer also mentioned that Earl was on at an outpost station and to keep an ear open for him. PMB reports too, that KF6JEG is on 28600 operating portable from KG6 on Jarvis. Time, about 4:00 p.m. p.s.t.

W6MUS is attending an engineering college in Oakland, so is a long way from his rig in San Diego. W4DHz, Dave Evans, is now W6SZQ, and rumor has it he will really get on the air again. Wallie Jones, W9EQG is now a "native son" having acquired W6SZY. Wallie lives not far from my "jcnt" and has harnessed up his 150T for 20 and 40 c.w. The W6's lost one, W6EVL, who is now back at RCA somewhere and is signing W3INE. W9ELX worked KG6MV for a new one, and W6SN hooked KC4USB for Nr. 100.

From the VK magazine, *Amateur Radio Digest*, we find a few items written by VK4ZU. Quoting him, "We are thinking of offering a prize to the sender of the best suggestion as to what Frank, VK4JU, does with his spare time now. . . . and we see so little of George, VK4JP, now we are wondering if he uses his rotary to hang his wash on. VK4AW is still punching the key as he belongs to the R.A.A.F. in VK, as do 4OK, 4AH and 4KK."

Brasspounders will remember VK2PX, he has joined up with the A.I.F. and is in the Special Wireless Section. That ol' dixer, Snow Campbell, VK3MR, is now in the R.A.A.F. and finds that great concentration is required when signing VMR, so as to not unconsciously sign VK3MR. That guy Eric Trebilcock who is the world's most outstanding SWL and known by everyone as BERS-195, is now at Aeradio Station, Liverpool, NSW. Eric just received his first ticket with the call VK5TK, a month before the VK's were closed down.

From the ZL magazine, *Break-In*, I see where Alan Boyle, ZL2VM, is now working in a BC station in Sydney, Australia. Alan says the VK sunshine is swell as are the yf's. VK2DA met him at the wharf and drove him around town for a while showing him the sights.

The following is snatched intact from the same mag. "In a splendid story of the fascinations of amateur radio appearing in a non-radio magazine, the editor (not the author) captions one of the illustrations: 'The antenna towers for the station are suspended 110 feet above the ground.' (Quite an idea if you can work it)." Some of the ZL's serving in the N.Z. Expeditionary Force include 1HF, 4DQ, 4GM, 1AD, 2PW, and 2UK. In the Royal N.Z. Air Force we find 1FN, 2QF, 2ID, 2QU, 2GQ, 2MO, 2PA, 1MP, 1LU, 4FB and 4FW. The Royal Navy has 1JW and 1GQ.

In snooping around a bit I find that W5CXH,

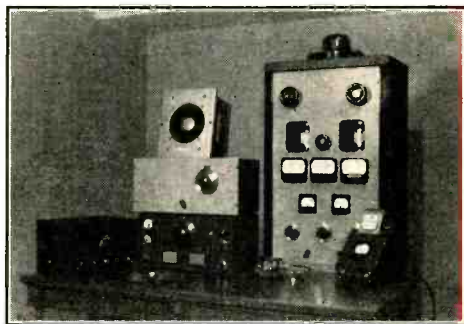

The operating position at W6ONQ, the station of Johnny Woerner, Oakland, Calif.



W2CMY, owned by Hugo Bondy. The tube lineup is a 6V6 crystal oscillator with eight 7-Mc. crystals, a pair of 802's in the buffer, and a pair of 860's in the final with a kilowatt to them.

who won the 1939 Maxim Trophy, is now with FKI which is a 50,000 watter. W6SA has been building on a new rig for some months now, and has just finished wiring the power supply. The filter section is next, but because of the lack of time, some of us believe he will skip this unit and jump to the final. His xyl, W6FU, is still holding down her own on 10 phone, using the Bi-Push. W6UF and W6CHE, of Eimac, ride to work on their "bikes" every day . . . weather permitting. (We'll get a picture of this one of these days.) W9RBI is still running his 180 watts and just to show the boys he is versatile, he was banging away on c.w. again the other p.m. His friend W9DIR had just left his shack with his yl, a few minutes before

our QSO. Looks like that's one reason why DIR isn't more active now. K6CGK is not in Honolulu any more . . . he is at a school on one of the other islands.

#### ON4HS in England

In another letter from Harold Simmons, ON4HS, he wants the word passed around that he is getting along fine. He says when he came to England during the last of June he managed to bring his receiver and listens quite often to the gang around USA. I am listing Harold's address so that you might drop him a line occasionally. Here 'tis: Harold Simmons, "Dunara," Bridgeway, Selsey, England.

Bud Keller, W6QAP, is again back in Tucson going to the Univ. of Ariz. He has stowed his ham gear away at W6CVW's so as not to be a temptation. Recent out-of-towners around here are W8KVD, W9FYY and W7AMQ. W8CRA was overheard the other day telling someone that he was having trouble with one of his neighbors. Wonder if it was BCL trouble or just plain trouble. W2BMX is off to some sort of a job, I think with the FCC in Detroit, and W8OSL is now in the Army. W7DBR is signing portable KF6 and is located on Canton Island. W6ONQ is now with Eimac. Between this job and his lovelife he should have less time on the air . . . but he probably won't.

Lindy, W2BHW, works out of town a bit, but sometimes during weekends we can hear him pounding a little brass. Think yl's are keeping him busy, too. Boy, these dames, can they make a guy forget? Oh yes, ask W1JPE about that angle. W2GTZ still knows the code, that is, if the other p.m. was any criterion. . . . and ol' W1AQT is active. Doc Westervelt, K6QYI really punches in a good signal, and some east coasters tell me he is one of the best from K6. Doc is still using a Bi-Push driving a pair of 35T's. From out of nowhere, W9UQT sprang up the other day and was punching out a few QSO's. Sooner or later we'll get all these 9's lined up.

If you think I can't work 'em just take a peek at my latest . . . W9ZVN, W9TXS and W9SWV. And they would have made such fine dx men, too. W9HLF had quite a time getting on 40 meters, but he finally made it by hanging a couple of wires from his 20-meter rotary center structure, giving him an antenna for 7 Mc. He says he hasn't worked AC4YN lately.

#### Let's Build a 200-meter Spark Station

This may be the wrong time to rebuild, but there are so many doing it that I thought I didn't want to be left out in the cold. The first question which came to my mind was, "Just what will I use in my new station?" Seemingly everything had been tried by the other fellows, and ever on the alert (?) for something sensational and different, I finally hit upon an idea. I thought to myself, "Boy, this will slay 'em, I'll go on spark." (And if I don't watch it'll slay me too).

Well, I may as well start with the receiver. By looking at the photo of the operating position you will see I chose to build a detector and two-step.



" . . . we should make our OT's with a ratio of 4 to 1. By that I mean one large turn in the primary and four turns in the secondary. This should give the best transfer on 200 meters."

Inasmuch as you can't beat the Audiotron for a detector, it was selected to do the job. There are two reasons for using the Audiotron . . . and both of them are filaments. In other words there are three filament leads and when one leg konks out you just hook onto the other one. You can see this detector tube hanging on the outside of the cabinet. On the plate of this tube I put between 45 and 55 volts from B batts. This is just right for allowing the proper amount of regeneration.

The tuning is accomplished with two variometers and a vario-coupler. It was ticklish getting just the right amount of no. 24 d.c.c. wire to stick on my variometer forms, but after several attempts it stuck. The vario-coupler was copied after some of the manufactured types, and you can see the three switches and their taps on the upper part of the right hand cabinet. Between the two cabinets the little box contains a 43-plate variable condenser which is used in the aerial—it can be switched from series to shunt.

I forgot to mention about the two-step audio amplifier. The tubes used are those VT-2's which are harder than the audiotrons thereby making good amplifiers, although the drain on the storage battery is quite heavy. When you sock about 135 volts of B batts on 'em they really go to town. With a receiving setup like this I can often hear signals from northern California on the loud speaker, for a distance of two blocks. (So could the neighbors.) Signals are always very QSA from the following: 6EX, 6AO, 6EJ, 6AK, 6FH, 6VK, and 6JN. 6EX has the best sounding rotary gap, and with the peculiar twang to his note, it gets through the 200-meter static best.

Now for the transmitter. The picture will show the Bendix rotary spark gap on the table. To the right you can see the one-half kw. Acme transformer. I made my own condenser which is contained in a chunk of a 5-gallon oil can. This is just above the transformer. The condenser consists of

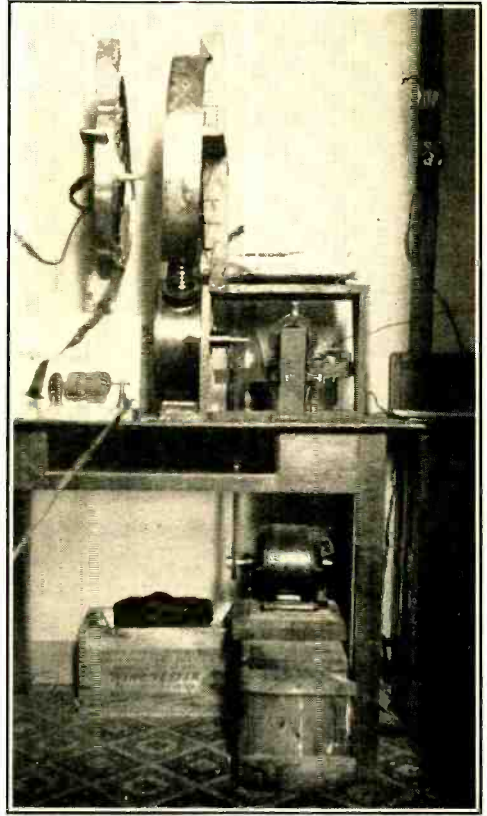

about two dozen 8 x 10 photographic plates. Naturally we use these because of their high dielectric qualities. I always hate to clean the emulsion off from the plates . . . it's a heck of a job. Between the plates I use brass foil picked up at the hardware store. My first condenser used the tin foil from cigarettes but it was too crinkly and the condenser broke down too often. A good grade of transformer

[Continued on Page 83]

"Inasmuch as you can't beat the Audiotron for a detector, it was selected to do the job."

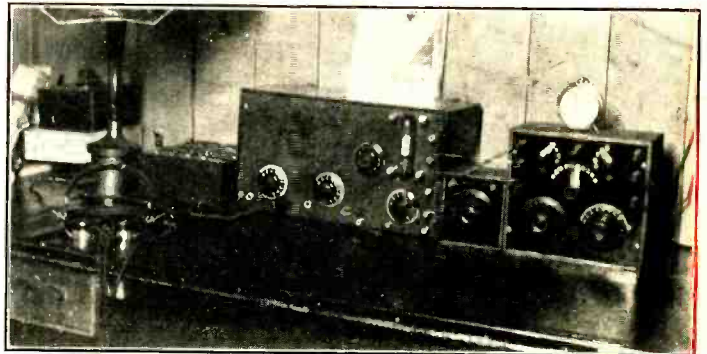



BY E. H. CONKLIN\*, W9BNX

During the last five years, particularly, a great deal of thought has been expended—and profitably, too—on ultra-high frequency propagation and equipment. Commercial organizations and amateurs have been doing very good work. One of the difficulties in reporting developments is the rapidity with which they come, and the time it requires for amateurs to assimilate them.

In talking with a number of operators active on the ultra-highs, it is noted that there is by no means a complete acceptance of the value of improvements that have been given rather complete trials by others. Reference is not made to expensive equipment but to the more simple improvements that may cost only a dollar or two. It seems to take years before a new idea takes hold. If a laboratory develops something, it may even be years before an amateur application of it is placed before us. In an attempt to cut down this time lag and stimulate experiment and thought among amateurs, it has been the policy of this column these last five years and more—not necessarily the policy of the magazine—to mention ideas when the development may be in its early stages. Sometimes, things may be said that turn out to be incorrect upon further investigation, in which case there is no objection to saying so. But on the whole, even many of the radical-sounding statements have proved to be correct, justifying the policy—so long as our minds are kept open to the facts and not biased by our pet theories.

### Noise Above 112 Megacycles

Recently, statements have appeared in amateur journals to the effect that there is less auto ignition and other noises at increasingly high frequencies and that  $2\frac{1}{2}$ , and  $1\frac{1}{4}$  meters especially, are free of this trouble. Yet on testing a six stage t.r.f. receiver at W9GFZ on 160 megacycles (see RADIO for January, 1939, page 17), having a sensitivity

\*Associate Editor, RADIO, 512 No. Main Street, Wheaton, Ill.

of about ten microvolts as recently measured, it was found that autos passing the small angle not shielded by the antenna drum and reflector put the receiver out of commission unless a silencer was used. After that experience, this column made the radical proposal that if a receiver on  $2\frac{1}{2}$  or  $1\frac{1}{4}$  does not pick up auto ignition, it is unworthy of the name and should be rebuilt or thrown out. That idea did not take hold, and eminent amateurs have continued to work on the theory that the higher frequencies removed ignition troubles.

What was wrong? Are automobiles different in Wheaton? That was a bothersome problem until reasonably accurate field strength measuring apparatus was developed and a paper by R. W. George was presented to the U.R.S.I. meeting in Washington this year. Actual noise measurements proved that automobile-ignition interference is present with about the same field strength on all frequencies between 40 and 450 megacycles (beyond our  $\frac{3}{4}$  meter band). There is, however, one advantage on the higher range, even though the interfering energy received with antennas of the same effective height and directivity will be constant with frequency. It is that the antenna directivity (power gain) for a given aperture area (actual size of the array) increases in proportion to the square of the frequency; hence, a large reduction of received interference is had at the higher frequencies if the interference is not generated directly in front of the beam receiving antenna, by devoting the same space to a more complicated antenna array (see page 34, *RCA Review*, July, 1940).

### Receiver Sensitivity

A few years ago, many advocates of the superregenerative receiver were firm in their conviction that it can be made more sensitive than any other type. It is possible to admit that it can give more gain per stage, but that is not to say that it will pull in the weakest signal, even when it is adjusted to the absolute minimum of hiss and maximum signal. An analysis of the causes of hiss may lead to some interesting conclusions.

A receiving tube coupled to a tuned input circuit inherently has noise in its output which will be heard if amplified sufficiently. Closer scrutiny of this fact is illuminating. On page 355 of RCA's book on *Radio at U.H.F.*, appears this statement:

"The importance of obtaining maximum voltage gain to the grid of the first tube in ultra-high-frequency receivers should be especially stressed because it has a direct bearing on the ratio of signal to internal receiver noise at low signal levels. At lower frequencies the impedance in the grid circuit of the first tube

is usually so high that thermal-agitation hiss, amplified through the first tube, exceeds the random hiss of the space current in its plate circuit. But in most u.h.f. receivers, particularly for television, the first-tube grid-circuit impedance is so low that the space-current hiss predominates. This means that all gain in signal voltage up to the plate circuit of the first tube gives a nearly proportionate improvement in signal-to-hiss ratio. The first-tube grid circuit should, therefore, have an impedance limited only by tube-input and line-termination losses and should have a high *L/C* ratio. This means that the conventional variable-capacitor tuners used at lower frequencies may advantageously be replaced at ultra-high frequencies by inductance tuners having much higher reactance."

The coil generally used in u.h.f. receivers has distributed capacity which reduces the amount of inductance that can be used. This accounts for the numerous items in this column and elsewhere in the magazine and RADIO HANDBOOK during the last three years urging the use of parallel rods or coaxial lines as resonant circuits. The almost complete use lately of such distributed-constant circuits in commercial practice tends to justify the space devoted to the matter.

Returning to the subject of receiver hiss, recent studies indicate that impulse noise varies directly with band width of the receiver and fluctuation or smooth noise varies directly with the square root of the band width. Tests on an RCA 100-megacycle circuit using directive antennas showed the audible noise generally to be of the fluctuation type except during occasional intervals of diathermy or motor ignition interference, at which time the impulse type predominated. In a superheterodyne receiving arrangement, the noise in the circuit for a wide bandpass of 14 kilocycles and a narrow bandpass of 100 cycles was compared. The results agreed closely to an 11.83-to-1 (21.5 decibel) increase in the wide band channel, as calculated for fluctuation noise. During the occasional intervals when impulse noise predominated, such as when diathermy or motor ignition noise was picked up, the wide band channel sometimes was rendered useless although the normal operation of the narrow band channels was not disturbed (page 241, *Radio at U.H.F.*)

In view of the fact that the i.f. amplifier in a superheterodyne receiver determines the width of the band passed, and can be made very sharp, it follows that the ratio of signal to internal receiver (and outside) noise can be much better in it than in a superregen, provided that the desired signal itself is not too broad. Modulated oscillators, however, need not be extremely broad, and should not require

56 Mc. DX  
HONOR ROLL

Call	D	S	Call	D	S
W9ZJB	9	27	W1LLL	6	18
W9USI	9	23	W2KLZ	6	
W9USH	9	18	W2LAH	6	
W9AHZ	9	16	W5VV	6	18
W5AJG	9	34	W8LKD	6	11
WIDEI	8	20	W8NKJ	6	16
W1EYM	8	20	W8OJF	6	
W1HDQ	8	26	W9NY	6	13
W2GHV	8	24	W1GJZ	5	15
W3AIR	8	24	W1HXE	5	18
W3BZJ	8	27	W1JMT	5	9
W3RL	8	29	W1JNX	5	12
W6QLZ	8	20	W1JRY	5	
W8CIR	8	32	W1LFI	5	
W8JLQ	8		W2LAL	5	11
W8QDU	8	25	W3CGV	5	10
W8QQS	8	17	W3EIS	5	11
W8VO	8		W3GLV	5	
W9ARN	8	17	W3HJT	5	
W9CBJ	8		W4EQM	5	8
W9CLH	8		W6DNS	5	
W9EET	8	15	W6KTJ	5	
W9VHG	8		W6OVK	5	10
W9ZHB	8	29	W8EGQ	5	10
W2AMJ	7	22	W8NOR	5	16
W2JCY	7		W8OPO	5	8
W2MO	7	25	W8RVT	5	7
W3BYF	7	22	W8TGJ	5	9
W3EZM	7	24	W9UOG	5	8
W3HJO	7		W9WWH	5	
W3HOH	7	17	VE3ADO	4	
W4DRZ	7	22	W1LKM	4	6
W4EDD	7		W1LPF	4	16
W4FBH	7	17	W3FPL	4	8
W4FLH	7	18	W4FKN	4	7
W5CSU	7		W6IOJ	4	4
W5EHM	7		W7GBI	4	6
W8CVQ	7		W8AGU	4	8
W8PK	7	9	W8NOB	4	
W8RUE	7	17	W8NYD	4	
W9BJV	7	12	W8OKC	4	10
W9GGH	7		W8TIU	4	8
W9QCY	7	15	W1KHL	3	
W9IZQ	7	14	W6AVR	3	4
W9SQE	7	22	W6OIN	3	3
W9WAL	7		W6PGO	3	6
W9YKX	7	12	W6SLO	3	3
W9ZUL	7	18	W7FDJ	3	3
W1CLH	6	13	W8OEP	3	6
W1JFF	6	11	W9WYX	3	3
W1JJR	6	17			

Note: D—Districts; S—States.

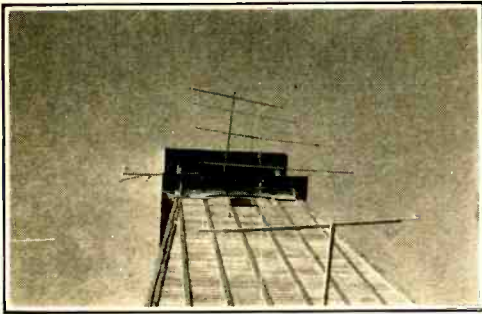

Looking up at the tower which supports the array in use at WIHDQ

the broadness of an overmodulated superregen receiver for satisfactory reception. It follows, therefore, that the superhet can be built for a better signal-to-noise ratio than the superregen, though there are times when the superregen is quite useful.

Nevertheless, the superregen itself can be improved by using an r.f. stage and high *Q* circuits not heavily loaded by the tube (and good tubes such as the RCA acorns or the HY615 really should be used). This is entirely aside from the problem of getting optimum antenna coupling and adjusting the oscillation, quench

frequency and quench injection for the best signal-to-rush ratio in the receiver.

From the same source quoted earlier:

Perhaps just as important as high grid-circuit impedance for maximum signal-to-hiss ratio are the characteristics of the first tube in the receiver. The best first tube is not necessarily the tube capable of giving the greatest voltage gain, but rather the tube with the best gain per milliampere of space current.

The signal-to-hiss ratio for any type of tube is usually better when the tube is operated as an amplifier rather than as a frequency converter. Also, a radio-frequency amplifier stage reduces oscillator radiation considerably by keeping the oscillator energy from being fed back into the receiving antenna.

Oscillator radiation from u.h.f. receivers without r.f. stages is more serious than that from conventional low-frequency receivers because of the converter arrangement used to obtain the best possible signal-to-hiss ratio. At lower frequencies it is customary to apply oscillator and signal voltages to different converter grids which are usually shielded from each other so that oscillator energy cannot get to the antenna by way of the signal grid circuit. But for u.h.f. receivers where converter efficiency is at a premium, better performance can be obtained by applying both oscillator and signal voltages to the same grid.

2 1/2 METER HONOR ROLL

ELEVATED LOCATIONS

Stations	Miles
W6KIN/6-W6BJI/6 (airplane)	255
W6QZA-MKS	215
W6BKZ-QZA	209
W6BCX-OIN	201
W6QZA-OIN	201
W9WYX-VTK	160
W6KIN/6-W6OMC/6	140
W6IOJ-OIN	120
W1HDQ-W2JND	105

HOME LOCATIONS

Stations	Miles
W1HBD-W1XW (1935)	90
W1SS-BBM	74
W8CVQ-W8?	48
W1LEA-BHL	45
W2MLO-HNY	40
W3CGU-W2HGU	40

1 1/4 METER HONOR ROLL

ELEVATED LOCATION

Station	Miles
W6IOJ-LFN	135

Cathode Injection

Cathode injection, which has been frowned upon in this column and elsewhere because it may result in a long cathode lead common to the grid and plate returns, resulting in increased apparent transit-time loading of the tuned grid tank by the tube, is a form of grid injection. It again becomes satisfactory when the frequency is high and it is possible to tap the mixer cathode only a quarter inch or so up the oscillator resonant line, requiring only a very small increase in the length of the cathode lead.

With grid or cathode injection, a 955 acorn triode can be used as a mixer. The type is so used in the 500 megacycle television relay system installed by R.C.A. On 100 megacycles, however, the tendency is to use a 954 pentode.

Harmonic Injection

In earlier days of superhets when tubes were not what they are now, some use was made of "second harmonic injection" of oscillator voltage into the mixer. Seeley and Anderson in an article in the *R.C.A. Review*, on u.h.f. oscillator stability, again propose the operation of the oscillator at a submultiple of the normal

oscillator frequency in order to make possible the use of more than twice the oscillator tuning capacity, to wash out the effect of the tube variables on the oscillator frequency. This increases the number of images but a single r.f. stage has been ample to reject them.

It appears that conversion gain does not necessarily suffer by virtue of the operation of the oscillator at half frequency. Measurements indicated that if *adequate* injection voltage is applied at half frequency, the conversion conductance of pentagrid converters is nearly equal to that obtained with normal operation. Pulling and oscillator radiation are reduced or eliminated. In one rig, the authors used an oscillator at  $\frac{1}{4}$  normal frequency, inductively coupled to the converter tube with tuned circuits passing the oscillator's second harmonic and adjusted to act as a band-pass filter that did not have to be readjusted over the limited oscillator range necessary to cover a band. The band pass eliminated the fundamental of the oscillator, passing injection voltage that was at half the normal frequency.

### Plated Invar Wire Coils

The suggestion was also made that drift compensation with a negative coefficient condenser (tapped across part of the coil for close adjustment) is all right so far as it goes, but a stable oscillator should use a coil wound with copper plated *invar* or *nilvar* wire on a ceramic form, so that the inductance is substantially constant with changing temperature. A few telephone calls in Chicago revealed that this special wire, with a zero temperature coefficient, is not regularly stocked but is drawn to order by Driver, Harris & Co., Harrison, N.J., at a minimum charge of \$5.00 for which one can get two to four pounds of the stuff depending on the wire size. It must then be copper plated. Some radio supply house may gamble a few dollars and carry it in stock for those who are building a stable e.c.o. or other oscillator.

In a push-button tuned oscillator, Seeley and Anderson used a 6SJ7 pentode in a tri-tet e.c.o. doubler circuit, with the cathode above ground. It was stated that tapping the grid down on the coil, or using a low  $L/C$  ratio, improved stability about equally. There were two effects of the tube on the tuned circuit, one resulting from changes in grid-cathode capacity, the other from cathode-heater capacity. Adjustment of the cathode tap for minimum frequency shift with plate voltage variations is unnecessary with regulated power supplies, so the tap can be adjusted to compensate for the other factors.

It was pointed out that a tube type showing



On the left, Frank Lester, W2AMJ; on the right, Bob Elmer, W3BZJ.

the least capacity change during warm-up is likely to be least susceptible to changes in heater voltage, so the grid-cathode capacity variation is likely to have a greater effect on frequency than the cathode-heater variation. In this case, the stability with plate voltage variation was best with the cathode tapped *five* turns up from ground on a *seven* turn coil—unusually high. This increases the effect of cathode-heater capacity, which might be reduced with heater chokes or winding a heater wire along or inside of the grid inductance, up to the heater tap. The latter has also reduced a.c. hum modulation in many oscillators, due to obtaining the same r.f. potential on the heater and cathode.

The Seeley-Anderson oscillator was compensated far enough so that temperature-controlled crystals or WWV transmissions had to be used for a comparison, ordinary laboratory crystal oscillators often being insufficiently stable.

### Stabilizing Transmitters

Quite a number of u.h.f. modulated oscillators have been seen which do not take full advantage of simple means of stabilizing them. In some cases, for instance, the largest diameter pipes in the rig (or the only ones in some cases) were not put in the grid circuit, lightly

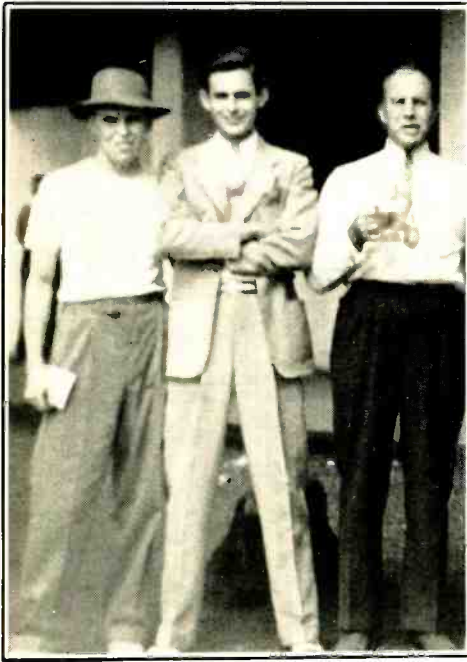

Reading from left to right, W3BYF,  
W3HWN, and WIKTF.

loaded, for increased stability. The grids should be tapped as far down on the grid line as possible in order to reduce the effects of the tubes on the frequency controlling line. Neutralizing condensers can be added, to be used as regeneration controls, on one side or the other of actual neutralization; by this means, the disturbing effects of feedback on the frequency-controlling line can be reduced to a minimum. Note that a neutralizing circuit permits the use of parallel rods in a single tube oscillator.

In an article in the *Proceedings IRE* for April, 1936, reprinted in the R.C.A. book on u.h.f., there is the following suggestion:

In general, line controlled oscillators require the same precautions for obtaining a pure continuous wave output as are required for crystal oscillators. Ripples in the direct power voltages and alternating cathode heating current all tend to produce undesired amplitude, phase and frequency modulations of the output. Because of the line these undesired modulations will be far less than they would be in a simple oscillator but they will always be present.

The most obvious means for reducing these modulations are to use very smooth direct voltages and direct-current cathode heating. Both of these expedients are undesirable from the standpoint of cost, simplicity, and reliabil-

ity but may be necessary in some cases. In other cases, satisfactory results may be obtained while using alternating current cathode heating and impure direct-current anode supply by taking a few simple precautions.

Amplitude modulations introduced in all but the last stage, may be kept small by using sufficient excitation in the later stages to produce limiting . . .

Elimination of undesired phase and frequency modulations requires holding constant tube impedances and the use of circuits tending to minimize the effect of changing impedances upon the tuning of the circuits. Small grid current and the use of grid leak and cathode return resistor biasing, particularly in the oscillator and next succeeding amplifier, assist materially in holding constant effective grid impedances, provided the resistances have sufficiently small parallel dielectric capacity to prevent appreciable phase lag in bias variation in response to radio-frequency amplitude variations. Also the effective series radio-frequency reactance from the anodes of one stage to the grids of a succeeding stage must be made a minimum. Leads from the output circuit of one stage to the input circuit or grids of a succeeding stage should be large and extremely short or else equal to a half wave or multiples of a half wave long. Leads which are near a quarter wave or (odd) multiples of a quarter wave in length should be carefully avoided.

It is interesting to note that any phase or frequency modulation noise introduced in an early stage of a transmitter will be increased in proportion to the amount of frequency multiplication used after that stage. A crystal controlled transmitter having an output of 100,000 kilocycles would probably start out with an oscillator frequency of about 3125 kilocycles. One degree of phase modulation in the output of the crystal oscillator would then appear as thirty-two degrees in the output of the transmitter and produce side frequency energy equivalent to that obtained with about sixty per cent amplitude modulation. With line control the oscillator may be operated at the output frequency so that one degree of phase modulation in the oscillator will appear as one degree in the transmitter output.

Several years ago, Lindenblad suggested compound modulation (grid and plate) as a means of reducing frequency shift during modulation. This indicates that cathode modulation, divided properly between the grid and plate, may be a step in the right direction. Greater use of m.o.p.a. circuits should be encouraged, but the gang may not take kindly to the suggestion for use above 112 megacycles.

### DX at U.H.F.

How far can you work on  $2\frac{1}{2}$ ? On  $1\frac{1}{4}$ ? On  $\frac{3}{4}$  meter? Only a year ago, amateurs considered these bands as purely local, but the last summer has brought some very good results above 100 miles on  $1\frac{1}{4}$  and even 255 miles on  $2\frac{1}{2}$  from favorable elevations. The difficulty now is more often in the receiver or antenna than anywhere else.

Several years ago, the Bell Labs were making continuous signal strength records at 70 miles, down to 1.6 meters. More than five years ago, R.C.A. started some work on 462 megacycles (below  $\frac{3}{4}$  meters) with six watts, working 14 miles. With 15 watts on 432, signals were not even fading on a car receiver 30 miles away, well below the line of sight. When 100 watts on 411 megacycles became available, it was noted that there was little fading at 65 miles over water, but bad fading when the test was made at ground level 113 miles away. Horizontally polarized waves were considerably superior to vertical polarization at least on this circuit. An airplane picked up the signals out to 172 miles from an altitude of 7500 feet. On 406 megacycles, signals were received at 112 miles, between Long Island and New Jersey, the ends being 250 and 400 feet above sea level.

Part of this work was done with horizontal V antennas 70 and 100 wavelengths long. The proper angle for the 100 wave job is 9.8 degrees. When a V is 50 to 100 waves long, little energy reaches the end of the wire so the antenna becomes unidirectional and aperiodic—making reflector systems, termination, and tuning arrangements unnecessary. One of these beams should have been five miles wide at a distance of 56 miles, but it was only 2 miles wide. The power gain over a doublet was more than 100.

In 1934, using a 4 foot parabolic reflector, magnetron oscillator, and iron pyrites crystal detector on 9 centimeters (3000 megacycles) with less than a watt of power, signals were good enough at 16 miles to suggest that they could have been heard out to 40 miles.

More recently, 500 megacycle television links have been established over a 30 mile distance with little fading. Fading was reduced by putting the antennas high enough above ground to make the direct and reflected paths differ by  $1/6$  wavelength (120 degrees), requiring towers 100 feet high or more. Antennas were four folded doublets located along the vertical focal axis of parabolic reflectors.

### 56 MEGACYCLES

In Kansas City, an idea was discussed with W9ZJB who is very interested in finding out

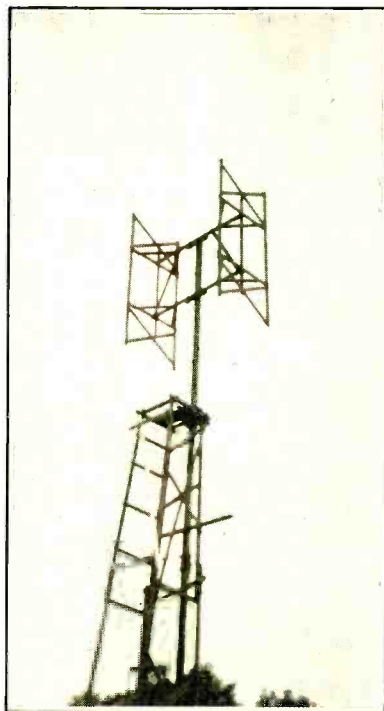

Four half waves in phase with reflectors as used by W1GJZ

who is working on 56 megacycles or higher frequencies within several hundred miles of him. The idea is to ask for volunteers who will make a definite drive for such information covering part or all of one state. The information could be spread via letters and through the magazines. Maps can be published occasionally to show all interested stations within possible ground-wave distance. For instance, W9EET and W9ZJB might cover eastern and western Missouri, W9HAQ and W9YKX might do the same in Iowa (what happened to W9OLY, formerly in Des Moines?) and so on. In this way, organized groups on the ultra-highs would be possible. What do you say, gang? Who volunteers for the job in each state?

Ernie Grant, W1GJZ, sends in a picture of his eight element beam, using four half waves in phase, in the H arrangement, backed by four more as a reflector. The beam is 40 feet high at its center. Up to August he had worked 130 stations in 15 states. The best ground-wave dx this year was W3GGR/3 in Maryland, 275 miles. The beam must get them, for on August 16 he worked W1MEP/1 in Vermont who was 145 miles away and using only two watts input.

[Continued on Page 85]

# With the Experimenter

## A COMPLETE 112-MC. CRYSTAL TRANSMITTER

By Gilbert de la Laing,\* W6BJI

The transmitter shown in the photograph is the one which recently was able to establish the new 112-Mc. record by working 225 miles to W6KIN/6. The transmitter was installed in a Stinson monoplane with power supplied from a vibrator supply. W6KIN/6 was operating portable on Mt. St. Helena and the longest contact was made when the plane carrying W6BJI/6 was in the vicinity of Tulare, California. To quote from the information given by Mr. de la Laing concerning the transmitter:

The transmitter is quite orthodox in every respect as far as circuit is concerned. A 7-Mc. crystal is used with a 6V6-GT in a tritet circuit with the output on 14 Mc. Link coupling is used to the next 6V6-GT doubler and a self-resonant grid coil is used to cut down on the number of tuning condensers. The 28-Mc. output from this stage is again doubled with a similar set-up, and although a 6L6-G happened to be in the socket when the photograph was taken, a 6V6-GT works every bit as well and is usually used. The output circuit of the 56-Mc. doubler is series tuned in the interests of higher efficiency; series tuning was found to give considerably greater output. The grid coil for the HK-24 again is self-resonant, but unlike the other stages it is

\*1934 Sonoma Avenue, Santa Rosa, California.

coupled quite closely to the 56-Mc. doubler tank.

Although the photograph does not reveal the fact, all the plate coils (oscillator and two doublers) are mounted on the far outside of the copper super-chassis with through-point bushings. The coils are exposed so that the antenna may be coupled to any of them for operation on the 28-, 56-, or 112-Mc. bands, since the modulator may be coupled to the final or to either of the two preceding doublers.

It must be confessed that the transmitter started out to be merely good for five meters, but the rest of the parts, HK-24 and all, were bolted on later as accessories are attached to an automobile. The performance of the transmitter on 2½, however, has been more than gratifying. A few tricks were tried later on in an effort to reduce the number of stages (quadrupling, regeneration in doubler cathodes, and reduced by-passing), but all were discarded in favor of the present conventional circuit.

The semi-concentric output circuit is made of copper with copper tubing as the inner conductor. Its construction can be seen fairly clearly in the photograph. This line seems to work very well and no trouble was had in getting it to tune. The plate voltage to the HK-24 comes through the copper tubing via a well insulated wire, which allows the whole line to be grounded. The shorting strip must be adjusted to within 1/16 inch to obtain

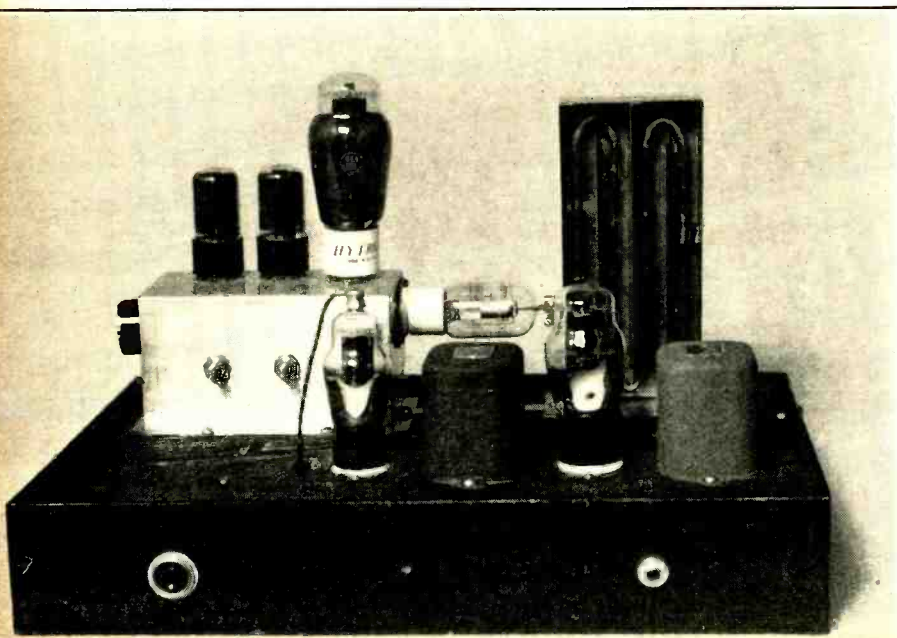

The exciter portion of the 2½-meter transmitter is located in the small copper box atop the chassis. The exciter starts out with a 7-Mc. crystal in a tritet, from whence the frequency is doubled down to 56 Mc. to excite the grid of the HK-24. The 24 then doubles to 112 Mc. with the folded semi-concentric line in the plate circuit. An 89 into a 6A6 comprises the speech and modulator of the final stage.



exact resonance when the stage is unloaded. With the antenna coupled, tuning is a bit more broad, of course, but the tolerance is still very low.

Rough lamp bulb estimates seem to indicate that the plate circuit efficiency of the 24, doubling and with this line, is 65 per cent provided grid drive is sufficient. This seems to be rather good for 112 Mc. By sliding the shorting strip down to resonate at 224 Mc., about 1 watt of output can be obtained.

The audio portion of the transmitter was built strictly for utility. A WE single-button microphone is fed through a high-ratio single-button mike transformer into the grid of a triode connected 89. The 89 acts as speech amplifier and driver for the 6A6 class B modulator.

## A SIMPLE COIL WINDING SCHEME

By Lt. Comdr. J. H. Ellison,\* W3A01

The following method of winding and securing windings on celluloid forms has been used by the writer for some time. However, I believe that it has never been described for the benefit of all and sundry exponents of "roll your own." The method is superior to the "split-cylinder" form and requires no special tools or gadgets, hence it has a general appeal believed worth describing.

The chief difficulty in winding coils on celluloid is that of removing the form after the windings are tightly laid and cemented to the celluloid. By the method described below any sort of form available may be used; for example, wood dowel, wood rod, pipe, cardboard cores from paper towels or the homely "music roll," or cardboard mailing tubes will be suitable.

The "modus operandi" is as follows: wind on the form a layer of close-wound fine twine about the size of no. 16 or 18 wire and as long as the celluloid form. Both ends of the twine should be temporarily secured to the form. Over the twine layer wrap the celluloid and cement the lap with coil dope, Duco cement or the wife's nail polish. The celluloid layer should be securely wrapped and held to allow the cement to set. This wrapping is very conveniently done with 1/2" wide cloth tape or seam binding. (Refer to xyl for this item.)

Then wind on the desired wire, pulling it as tight as possible while winding. For the first coat of cement for the windings, straight ace-

tone or cellulose acetate dope is to be preferred since these use solvents which slightly soften the celluloid, allowing the wire to sink in or become imbedded. The final coat can be cellulose acetate dope or Victron dope similar to Amphenol coil dope.

To get the coil off the form, loosen one end of the twine and pull it out of the end between the coil and form. It will peel out a turn at a time as slick as you please. Repeat at will.

## A SIMPLE TWO BAND ANTENNA

The antenna illustrated in the accompanying diagram works at high efficiency on two adjacent amateur bands. The specifications given are for a 20-40 meter antenna, but dimensions for a 10-20 or 40-80 meter antenna can be obtained simply by dividing or multiplying the dimensions given by 2.

The antenna is essentially a 40-meter multi-wire doublet, but the "unfed" radiator is split

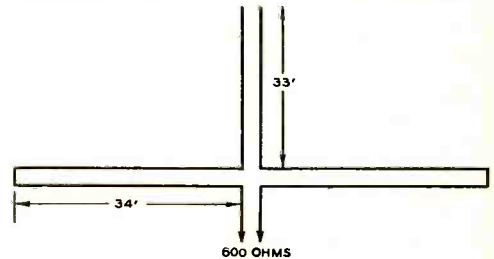

Figure 1.

### 20-40 METER ANTENNA.

No switching is required to use this antenna on two bands. The standing wave ratio will be low (2:1 or less) on both bands. Dimensions given are for operation on the 20 and 40 meter bands. The antenna has high radiation resistance and need not be cut for any particular part of the band.

at the center and a quarter-wave open stub is inserted. This quarter-wave open tube acts as a shorting bar, and has no effect upon the operation of the antenna. On 20 meters, the antenna is essentially two half waves in phase, commonly called a "double zepp." The stub is a half wave long on 20 meters, and being open, does not act as a shorting bar, but rather as an infinitely high impedance or open circuit.

The mismatch is just under 2/1 on both bands, and therefore a standing wave ratio of this order can be expected on both bands.

[Continued on Page 81]

\*Navy Department, Washington, D.C.

# The Amateur Newcomer

## A - B - C of ELECTRIC WAVE FILTERS

This article eliminates some of the mystery that has always been associated with filters for separating electric currents of different frequencies.

The theory of the electric wave filter seems to be one subject on which there is no elementary literature. The reason is probably that, unlike most electrical apparatus, the filter grew from the top down, i.e., its theory was not deduced from its operation, but it was evolved in accordance with rigorous mathematical computations. Then, too, filters have been used almost wholly in telephone practice, and terminology quite unfamiliar not only to the amateur, but to many qualified engineers as well, has joined forces with the awe-inspiring mathematics to keep the casual reader at a distance.

There are three things that amateurs should know about filters—what they do, how they do it and how they are made. We will touch upon these questions lightly and in order.

Suppose we have a line which carries current at many frequencies. We wish to deliver certain of these frequencies to a second line, at the same time excluding certain others. Between the two lines and connecting them we insert a filter. A filter is simply a combination of impedances, and, like any impedance, it offers opposition to the flow of current, and the amount of opposition it offers depends upon the frequency. Where the difference comes in is that the current of those frequencies which the filter is to exclude starts through the filter just as it would through any other impedance, but it is side-tracked, or short-circuited, on its way through, so that little if any of it ever reaches the second line. This disappearance of *current* as well as *voltage* is what is known as "attenuation," and cuts down the power passed through much faster than would any mere interposition of impedance.

The properties of filters that give them their especial value are: (1) Within certain

frequency ranges (known as "pass-bands") power is transmitted without attenuation. (2) As the frequency changes, attenuation begins at certain definite "cut-off" points, and rises rapidly to high values. (3) Filters may be designed with as many pass-bands as required and the cut-off points may be established wherever required. (4) Adding a second filter section *multiplies* its effect. That is, if one section of a filter attenuates the power transmitted at a given frequency to one one-hundredth of its former value, a second section will cut the total transmitted power to  $(1/100)^2$  or one ten-thousandth.

Perhaps the easiest way to comprehend the action of a filter is to consider its make-up with reference to one of its "stop-bands".

For any given frequency there is a circuit element which has infinite impedance. For zero frequency—direct current—this element is a condenser. For infinite frequency it is an inductance. For any intermediate frequency, it is an inductance and a condenser in parallel—"a parallel resonant circuit."

Corresponding with this element of infinite impedance is an "inverse circuit" which has zero impedance. This is an inductance for d.c., a condenser for infinite frequencies, and a series resonant circuit—condenser and inductance in series—for intermediate frequencies.

Now to build up our filter. We take a stop element, which is a parallel resonant circuit tuned to a frequency in the middle of our attenuating band, and place it in series with the line. Then across the line, at either end of the stop element, we place the inverse circuit which shorts out the frequency which has already been blocked.

The cut-off points are determined by the quantities chosen to make up the "stop" and

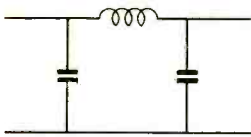

FIGURE 1  
LOW PASS, PI TYPE

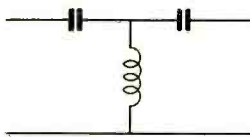

FIGURE 2  
HIGH PASS, T TYPE

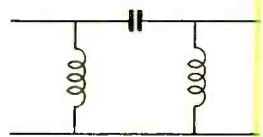

FIGURE 3  
HIGH PASS, PI TYPE

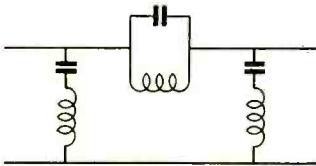

FIGURE 4  
HIGH AND LOW PASS

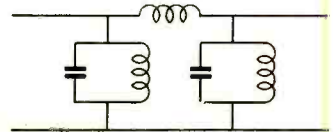

FIGURE 5  
BAND PASS

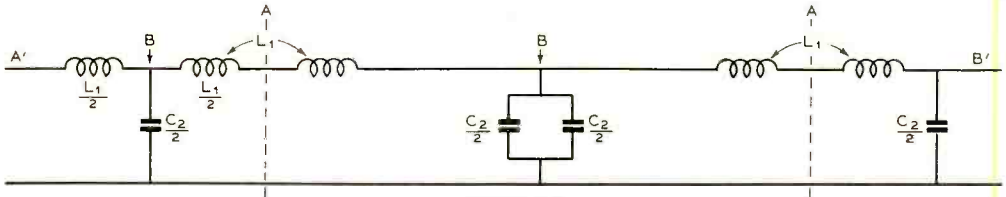

FIGURE 6  
2 1/2 SECTION FILTER, T TYPE LEFT TO RIGHT, PI TYPE RIGHT TO LEFT

"pass" elements. Thus figure 1 shows a "low pass" filter. This has an inductance coil as the series member and condensers as the shunt member. Such a filter will allow direct current to pass and will attenuate high frequencies, but just where the dividing line comes depends on the capacity of the condensers and the inductance of the coils. The resistance of the load enters into the computation, so it is not possible to give exact data from the filter constants alone, but as a general indication we may say that .002  $\mu$ fd. condensers and a 250-turn 2 in. diameter coil would pass all audio-frequencies and attenuate all radio frequencies; 1  $\mu$ fd. condenser and a 1-henry choke would cut off at about 225 cycles, all except the lowest audio frequencies; while 5  $\mu$ fd. and 5-henry choke would attenuate everything above 45 cycles.

By transposing the inductances and capacities we transpose the attenuating and pass-bands, so far as their general position is concerned, although the cut-off points will usually be somewhat changed. The low pass filter of figure 1 thus becomes a high-class filter of the T-type if the elements are arranged as in figure 2. Figure 3 gives another arrangement for a high-pass filter, known as the  $\pi$  type.

As far as effect is concerned, these arrangements are equivalent.

Figure 4 shows a high and low-pass filter. The series resonant circuits serve to short the frequencies in the attenuating band, which are also blocked by the parallel resonant circuit. The mid point of the attenuating band is, of course, fixed by the resonant period of the component circuits. Small capacity and large inductance in the blocking circuit, combined with large capacities and small inductance in the pass circuits, will give a narrow attenuating band. If the relative magnitudes of the elements are reversed, the attenuating band will be a wide one.

A band-pass filter is shown in figure 5. Here two blocking elements are used *in series*—a condenser for the low frequencies and an inductance for the high, and two pass elements *in parallel* give the short circuiting elements.

Figure 5 also gives a hint of another way to design a filter, which is by a consideration of the pass-bands instead of the attenuating bands. Thus the two blocking elements in this figure taken together form a series resonant circuit, with the resonant point in the

center of the pass band. Similarly the two shorting elements together form a blocking element for an intermediate frequency—again about the center of the pass band. The same thing is true of the other types shown. In some of the more complex types of filter the two methods of design may not lead to identical physical structures, but they will give identical characteristics.

It will be observed that, so far, resistance has been neglected. This is not because it has no effect, but because in a really efficient filter it must be reduced to a point where it is negligible. Its chief effects are to introduce attenuation into the pass bands, and to make the cutoff points less definite. It also serves to make the attenuation at the frequency of "infinite attenuation" something less than "infinite," but this effect is seldom noticeable.

It is evident that the types of filters shown by no means constitute the entire list of possible filters. Almost any combination of series and shunt impedances will act as a filter, and most such combinations are used for the purpose, in order to get desired combinations of cutoff, impedance and frequency of maximum attenuation. The forms shown, however, are the basic ones from which to derive the more complex types.

Before going on to the subject of design, there are a few minor matters that should be cleared up, as to types of filter, definition of a "section," and choice of type for a particular use. Figure 6 shows a typical low-pass filter of  $2\frac{1}{2}$  sections. We may read from left to right and consider the sections as extending between the lines AA in which case we have a T type filter, or we may read from right to left and consider the sections as extending between the arrows BB, which gives a  $\pi$  type filter. The half sections of which the two types are formed are identical, the difference being only the order in which they are arranged. They are equally efficient and for many purposes there is no choice between them. If the source of current supply is of constant potential, however, a resonant series circuit directly across the line may well draw a destructive current, as it is practically a dead short across the line. The actual current of attenuating frequency will be less if the series member is inserted before the shunt member, and hence the T type is preferable.

The T section filter is said to be terminated in mid-series; the  $\pi$  section in mid shunt. Accordingly the impedance of the end member of a T-type filter is only  $\frac{1}{2}$  of the impedance of the section as used in computation. The  $\pi$  type filter is terminated in mid shunt, and the

admittance of the shunt member is  $\frac{1}{2}$  the admittance of the section (admittance is the reciprocal of impedance). This means that the impedance of each of these shunt members is double that of the section. Going back to figure 6, it will be seen that just as the inductance at A is formed by two coils like that of A' *in series*, so the condenser at B is really formed of two like that at B' *in parallel*. All this may be stated as follows: In a T filter the impedance is divided and half is placed on either side of the shunt member. In a  $\pi$  type, the admittance is divided and half is placed on either side of the series member.

Most authors on the subject of filters emphasize the importance of the resistance of the load. This is entirely justified from the telephone engineer's point of view, as he must balance the filter against the line in order to avoid reflections and "echoes" which not only disturb transmission but waste power and attenuate where no attenuation is wanted. A filter balanced against its output impedance is also desirable in that it avoids excessive current or potential rises due to resonance (which might prove troublesome).

For the uses of the radio amateur, however, the exact cut-off point is seldom a matter of importance. As long as the objectionable frequencies are cut out, the exact cut-off means very little and even fairly wide departure from the theoretically correct resistance will still give good results.

Therefore, in designing his filter, the amateur will estimate the resistance of his load, but if he misses it by 50% the effect upon the filtering will not be noticeable. Therefore, we will ignore the attenuating effect of reflections, and say that our cut-off points come where  $Z_1 = -4Z_2$ . Here  $Z_1$  is the total series impedance per section, and  $Z_2$  is the total shunt impedance per section. Do not use the half quantities at the end of a section in this formula. The minus sign indicates that if the series reactance is inductive the shunt reactance must be capacitive, and vice versa.

The impedance of a condenser is  $\frac{1}{2} \pi f C$ , where  $\pi = 3.1416$ ,  $f$  = frequency in cycles and  $C$  = capacitance in farads. That of an inductance is  $2\pi f L$ , when  $L$  is the inductance in henries. In a low-pass filter the inductance  $L_1$  is the series member and the capacitance  $C_2$  the shunt. By substituting these values in the equation  $Z_1 = -4Z_2$  we obtain  $2\pi f L_1 = 4/2\pi f C_2$ , whence  $f = 1/\pi \sqrt{C_2 L_1}$ , which is the cut-off point for the low-pass filter. Likewise, for the high-pass filter the capacitance  $C_1$  is the series element and the inductance  $L_2$  is the shunt element. Therefore  $1/2\pi f C_1 =$

[Continued on Page 80]

# POSTSCRIPTS...

*and Announcements*

## 160-Meter Shift Becomes Effective Nov. 1

Following negotiations between the Commission, the amateurs, and representatives of the International Association of Chiefs of Police (IACP) and the Association of Police Communication Officers (APCO), it was arranged for the amateurs to relinquish the frequencies between 1715 and 1750 kilocycles and to accept the frequencies between 2000 and 2050 in exchange. Likewise, the police relinquish the zone police frequencies in the 2000 to 2050 band and in exchange receive frequencies between 1715 and 1750 kilocycles. The new amateur frequencies between 2000 and 2050 are open to class B radiophone operation as are the frequencies between 1800 and 2000 kilocycles.

Thus the new 160-meter band is divided as follows: 1750 to 1800, c.w.; 1800 to 2050, class B radiotelephone operation. The change becomes effective on November 1, 1940.

## Certain Amateur Stations to be Permitted to Communicate with W10XDA and WHFZ

Commission Orders Numbers 72, 72A, 72B, 72C, 72D, and 72E have been amended for a period of three months from August 20, 1940 (until November 20, 1940) to permit stations W 2 U S A, W 2 A V O, W 2 A P T, W 1 A W, W 3 H Z H, and W 8 P H to communicate with the ship station WHFZ and the experimental station W10XDA on board the *Effie M. Morrissey*. These stations only were granted authority to communicate with the *Morrissey*. The special amendment to the rules and regulations of the Commission was made at the request of Alan R. Eurich, radio officer aboard the ship.

## Chicago Area Radio Club Council Fall Dance

The Chicago Area Radio Club Council will hold their Fall Dance on Saturday, October 26, 1940, in the Bal Tabarin Room of the Hotel Sherman in Chicago. Tickets are 75c plus 8c tax, and include dancing to a well known orchestra, several top notch vaudeville acts, and a good time for all. Joint sponsorship of the dance is shared between the Halli-

crafters, Inc., Chicago, and the Council, which represents 12 of the active clubs in the Chicago area.

## Oops!

In several hundred copies of our October issue the coil table for the Rehm Preselector-Converter, page 30, somehow was placed on page 38. . . . where it most definitely did not belong.

## New FCC Publications For Sale

The Government Printing Office now has for sale at a cost of 15 cents per copy, a Study Guide and Reference Material for Commercial Radio Operator Examinations, including Questions on Basic Law (Element I), Basic Theory and Practice (Element II), Radio telephone (Element III), Advanced Radiotelephone (Element IV), Radiotelegraph (Element V), Advanced Radiotelegraph (Element VI), General Radio Regulations (Cairo Revision, 1938), and Extracts from the Commission's Rules and Regulations—Practice and Procedure.

Printed copies of the Commission's Rules in pamphlet form are also on sale at the Government Printing Office. The following parts have been issued:

Part No.	Title	Price
*1	Rules of Practice and Procedure	10 Cents
3	Rules Governing Standard Broadcast Stations	5 Cents
4	Rules Governing Broadcast Services (other than standard broadcast), including Relay, International, Visual, Television, Facsimile, High Frequency, Non-commercial Educational and Developmental Broadcast stations.	10 Cents
6	Rules Governing Fixed Public Radio Services, including Fixed Public Press, Agriculture, Point-to-Point telegraph, Point-to-Point Telephone, Radiotelegraph and Radio-telephone Services.	5 Cents
7	Rules Governing Coastal and Marine Relay Services.	5 Cents
9	Rules and Regulations Governing Aviation Services, including Aircraft Stations, Aeronautical and Aeronautical Fixed Stations, Airport Control, Flying School, Instrument Landing Stations, and Public Aviation Service.	5 Cents
10	Rules Governing Emergency Radio Services, including Mu-	5 Cents

[Continued on Page 88]

# Radio

## SOLDERING TECHNIQUE

While most any radio man considers his soldering beyond reproach, it is surprising how many of the soldering "experts" who consider themselves so highly proficient that they feel qualified to give advice actually have a lot to learn themselves. No matter how good you consider yourself, it is quite likely that your soldering technique can stand improvement.

The first requisite for a good soldering job is a good iron. No matter how much you know about soldering you cannot do a really good job when handicapped with poor tools.

Rosin core solder, the most commonly employed solder in radio work, is awkward to work with if the iron is *too hot*. Many warnings have been voiced about using a soldering iron that is not sufficiently hot, and the "rosin joint" that may result. However, an excessively hot iron is more common than one that is too cold for good work. Rosin ceases to act as a flux when the temperature is raised much above that at which ordinary radio solder melts.

This fact may be readily observed the next time your iron needs tinning. If the iron reaches a high temperature, it will be impossible to tin it with rosin core solder no matter how brightly it is filed. Paste, salamoniac, or acid will be required for a good tinning job. However, if the iron is filed bright and the rosin core solder is rubbed on the point when the tip is just barely warm enough to melt the rosin core solder, a beautiful tinning job can be accomplished.

If the iron is allowed to run quite hot, it will be found that retinning is required much oftener than if the iron is operated at a temperature just sufficiently high to do a good job.

Many so called "radio" irons are of about 60 watts, and at normal line voltage run almost red hot. While a little more awkward to handle, a 100 or even a 150 watt iron, with the line voltage reduced slightly, is much better for the job. The iron should have sufficient mass or radiating flanges that when several joints are soldered in succession, it will not become too cold. When the iron is run just suf-

ficiently hot to do a good job, some "reserve" is required in order to prevent its becoming too cold. In other words, a large iron running at medium heat is better than a small iron running much hotter.

Assuming a 100 or 150 watt iron with a "radio" type tip, the problem is to reduce its temperature to the desired value. This can be done by placing an inexpensive heater element of approximately 500 watts in series with the iron. Various resistance values should be tried until one is found that permits the iron to run *just slightly* hotter than is desired. By means of a stand or rest which has high conductivity and high radiation, the iron is then maintained at the desired temperature, whether in use or not.

This rest may be made from a piece of sheet aluminum or from an aluminum auto piston. The sheet is bent so as to form a rest which makes contact with the iron for at least 2 inches of its length. The piston is operated upon with a hack saw, the top being sawed off at the wrist pin hole to leave a semi-circular channel "bed" for the iron.

If desired, a shorting switch may be placed across the series resistor, so that when it becomes necessary to solder something heavy such as a piece of chassis, more heat will be available.

Several gravity-switch type stands, which maintain the iron at an even temperature, are manufactured. However, unless one does lots of soldering, the cost (about \$4.00) is hardly justified. It would be better to put the extra money in a better iron.

With a good iron, maintained at the correct temperature, a good joint is an easy job. Simply make sure that the wires to be joined make a good mechanical connection before solder is applied; also that the joint is clean and bright. Heat the joint for a moment with the iron, from below if possible, and then apply rosin core solder to the joint—not the iron. Hold the iron against the joint until the solder flows freely into the joint. A good connection, perfect mechanically and electrically, should result.

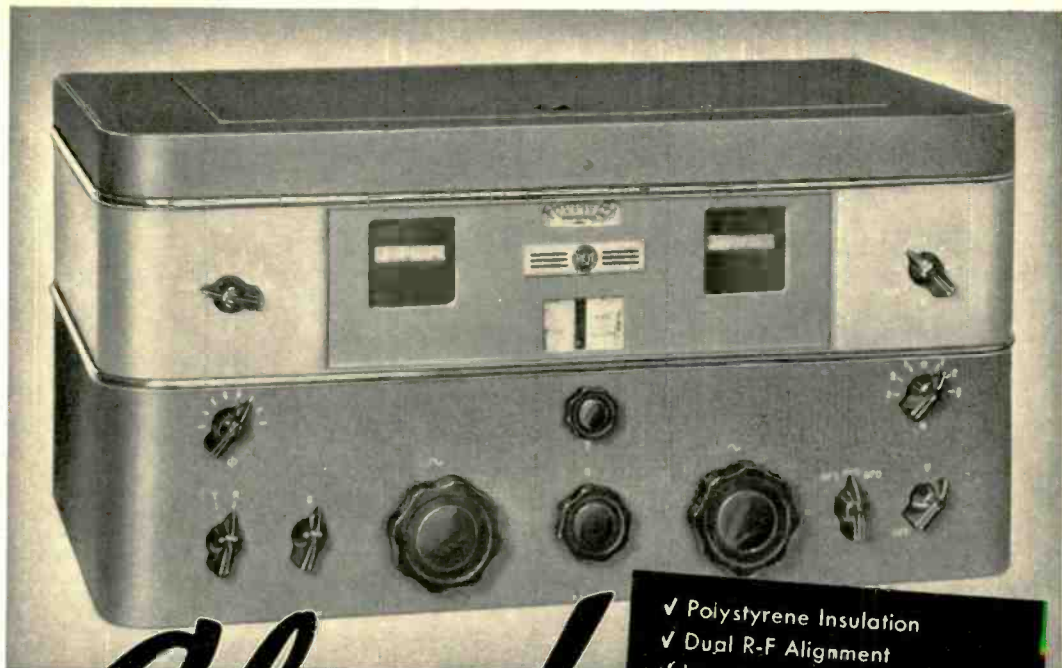

# Check

The AR-77 is one of the most stable, most sensitive receivers of its type ever built. It has more features for the money. It has finer performance as gauged by any test you care to name. Before getting that new receiver for your shack, we suggest that you check the AR-77, feature for feature, point for point, against any other outfit on the market at anywhere near the price. You be the judge!

**Amateur's Net Price \$139.50 f.o.b. factory**  
 MI-8303 Table Speaker in matched cabinet, \$8.00 extra

- ✓ Polystyrene Insulation
- ✓ Dual R-F Alignment
- ✓ Low Circuit Noise
- ✓ Negative Feedback
- ✓ Stay-Put Tuning
- ✓ Uni-view Dials
- ✓ Accurate Signal Re-set
- ✓ Calibrated Bandsread
- ✓ Variable Selectivity
- ✓ Crystal Filter
- ✓ Diversity Reception
- ✓ 60 to 5000 cycles  $\pm$  4 d. b. A-F range
- ✓ Voltage Regulation
- ✓ Break-in Operation
- ✓ Exceptionally High Image Rejection
- ✓ Improved Noise Limiter
- ✓ 540 to 31,000 KC Range
- ✓ Magnetite Core I-F Transformer
- ✓ High-Gain Pre-Selector Stage
- ✓ Temperature Compensation for Frequency Drift
- ✓ Single-ended Tubes
- ✓ Carrier Level Meter
- ✓ Antenna Trimmer



## AR-77 COMMUNICATION RECEIVER



RCA MANUFACTURING COMPANY, INC., Amateur Division, CAMDEN, N.J. • A Service of the Radio Corporation of America

# YARN *of the* MONTH

## FIFTY WATTS—PORTABLE

Tinkling glassware and the slosh of water as the maestro patiently cleaned and polished his back-bar appurtenances, punctuated the rhythmic drone of the electric fans. Desultory conversation lagged and finally spurted only at intervals.

The Lid at the far end of the table suddenly suffered the need of being heard and blatantly voiced his disgust, "No wonder we can't round up the gang in summer. They're all out with the yl's. There's no romance in ham radio."

We knew at once that such remarks would arouse AKX, whose entire universe revolved about his hobby. Said the o.t., "None of you fellows are more anxious to get a good turnout for club nite than I am, but you can't blame amateur radio because the boys lose interest in summer—and what's more, don't ever say there's no romance in ham radio."

Sensing a story in the brew, and to relieve the monotonous silence, I threw the switch with, "What experience have you had with romance, Al?"

In a manner deprecating the disbelief which he detected in my question, he directed his next remark toward me. "If you fellows feel like listening, I'll tell you about a little romance born of ham radio."

"The light is green," I replied. "Go ahead."

"It so happened," the o.t. began, "that my college career had entered the last round just about the time talk was circulating that the code speed required for a ham ticket was going to be raised from ten to thirteen words per minute. Plink Anderson, a sophomore from my town, who had the next room to mine at the House, had been practicing code for a few weeks. Whenever I found a spare moment, I took my bug into his room, threw his book-worm room-mate in with mine, hooked up to his oscillator and then proceeded to make his ears flop. Sometimes he'd yell QRS so loud he could be heard down to the first floor reception room.

He progressed however, and finally went up

to St. Paul, took the examination and came back to school happy as a kid.

His ticket arrived about three weeks before school closed for the summer, and from then on I was in hot water. I was cramming for finals, with a make-up in Botany that had me worried. It seemed as though everytime I turned a page, this Virgin Lid would rush into the room with a big piece of Bristol board, lay it on top of my opened textbook, point to a group of hieroglyphics and blurt something like, "Would you use link or capacity coupling here, Al?" Or, "Al, do you think a single 56 will give me enough gain?"

The morning of the Botany exam I was so balled up I almost put down Ham Radio as the alternate host for Pine Blister Rust.

Commencement week I didn't see anything of Plink, but I had been home only a short time when he put in his appearance. He drove into the yard in his collegiate jalopy and looked up in awe at my two eighty footers. When I came out of the house he was still standing there, shading his eyes with his hand and studying the feeder system.

He came toward me with a grin on his face, shook my hand and said, "Gosh, I'm glad to see you Al; I brought my rig over to show it to you." And fellows, he had the sweetest looking fifty watt job I ever saw. It was neat and trim, very compact and perfectly arranged.

"Plink," I said, "That's a honey and small enough to use for a portable."

He looked at me, hesitated a moment, then finally took the hurdle, "That's just what I wanted to see you about, Al—I've taken a job with a Federal Barberry Eradication project, working thru Nebraska and Kansas, and I thought if you were going to stay home this summer you could keep skeds with me. Whenever I'm located in a spot that has power and a place to hang a skywire I'll give you a buzz. You see, I've given up going back to school,

[Continued on Page 70]

By HANS H. HAUGARD, W8QWN



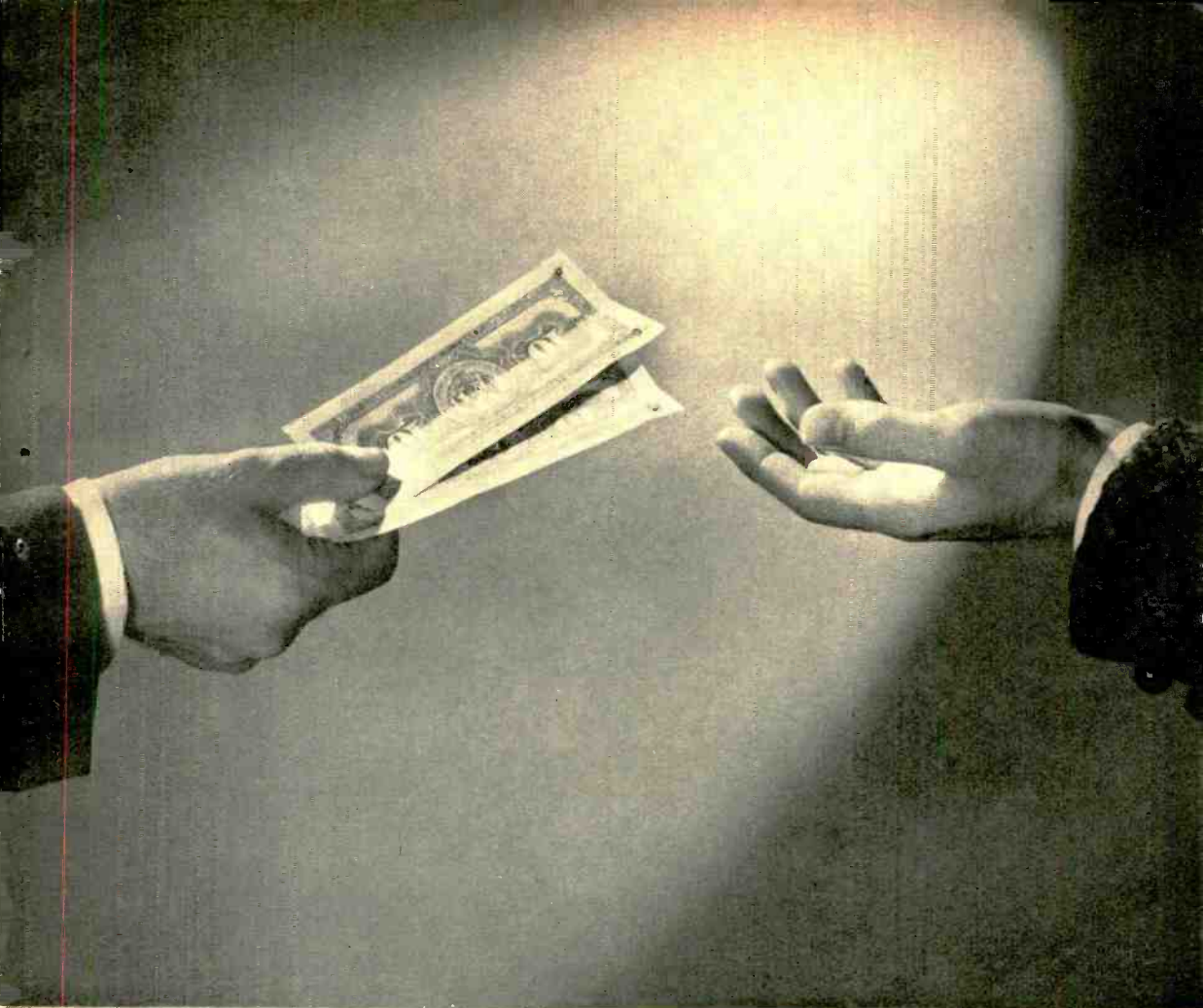

## We Pay:

Because we pay for accepted technical and constructional material, publications by the Editors of "Radio" contain the "cream of the crop" from outside authors.

THE EDITORS OF **RADIO**  
CORPORATE NAME, EDITORS AND ENGINEERS, LTD.

*technical*  *publishers*

1300 KENWOOD ROAD, SANTA BARBARA, CALIFORNIA

What's New . . . .

## IN RADIO

### NEW SOLAR CAPACITOR EXAM-ETER

The latest addition to the line of Solar Capacitor Analyzers combines in one instrument simple methods of making all the measurements necessary to determine quickly the condition of any condenser or resistor ordinarily used in any radio receiver. It has a provision for making quick check tests for shorts, opens, high r.f. impedance, and intermittent units. In addition it is capable of making quantitative measurements of capacity from 0.00001  $\mu$ fd. to 2000  $\mu$ fd., and of resistance from 50 ohms to 10,000 megohms. These quantitative measurements are made with a bridge having a meter to indicate the null point. In addition the unit can make quantitative measurements of leakage, insulation resistance, and power factor. Supplementary features of the instrument include a variable d.c. voltage supply up to 550 volts d.c., a d.c. vacuum-tube voltmeter with scales in three ranges up to 600 volts d.c., an a.c. vacuum-tube voltmeter with a range up to 30 volts a.c., and in addition the instrument can be used as a continuity checker in all types of routine measurements.

The unit is quite small, measuring only  $8\frac{1}{2} \times 11\frac{1}{2} \times 5\frac{1}{2}$  inches high, and the price is surprisingly low considering the capabilities of the instrument. A circular describing the model CE Capacitor Exam-eter may be obtained from your distributor or direct from the manufacturer, Solar Manufacturing Corp., Bayonne, N.J.

### MOVIE SOUND SYNCHRONIZER

Presto Recording Corporation, 242 West 55th Street, New York, N.Y., has announced a versatile synchronized sound recording and reproducing attachment which makes possible the recording and playback of synchronized sound with any conventional 8 or 16 millimeter silent-type motion picture equipment. The system comprises a conventional sound-on-disc recorder with a set of three synchronizing attachments. The controlling attachment is connected to the turntable shaft and contains a multi-segment commutator which acts as the control unit. This is connected by cables to a synchronized camera drive

motor which attaches to the silent motion picture camera when recording, and which is connected to another synchronizing unit which is attached to the projector when the films are to be shown.

The three synchronizing units are quite small, and standardized fittings are being made for attachment of the units to Ampro projectors, Bell & Howell 8mm and 16mm cameras and projectors, Bolex cameras, Keystone 8mm camera and projector, and the Victor 16mm camera and projector. Units can be supplied for other makes on special order. Complete information on the Synchrosound units, in the form of a free booklet, can be obtained upon request from the Presto Recording Corporation.

### AIRCRAFT MICROPHONE

Universal Microphone Co., Inglewood, Cal., in October started to distribute its newly manufactured aircraft model microphone which, though primarily for aircraft and marine installations, is also adaptable for mobile transmitters. The unit is single button carbon in bakelite case with moisture proof cord and plugs.

Motor noises are damped out by special anti-noise construction. Button impedance is 200 ohms and output of approximately 30 volts r.m.s. is obtained across the microphone transformer secondary.

### 3-AG FUSES 0 TO 8 AMPS.

Littelfuse Incorporated are now manufacturing Underwriters approved 3-AG glass enclosed fuses in ratings up to 8 amperes for 250 volt AC or DC service or less. This is the first time any manufacturer has had the Underwriters' Laboratories approval on 3-AG fuses ( $1\frac{1}{4}'' \times \frac{1}{4}''$  dia.) in current ratings over 3 amperes.

### NEW SPEAKER AVAILABLE

A new  $15\frac{1}{4}$ -inch high-fidelity loudspeaker mechanism, available either separately or with wall housing or console cabinet, has been announced by the Commercial Sound Division of the RCA Manufacturing Company. It is

[Continued on Page 90]

**150 WATTS OUTPUT  
WITH A SINGLE 35T**

**WINS DX CENTURY CLUB  
MEMBERSHIP FOR**

**ED HOPPER  
AMATEUR STATION**

**W2GT**

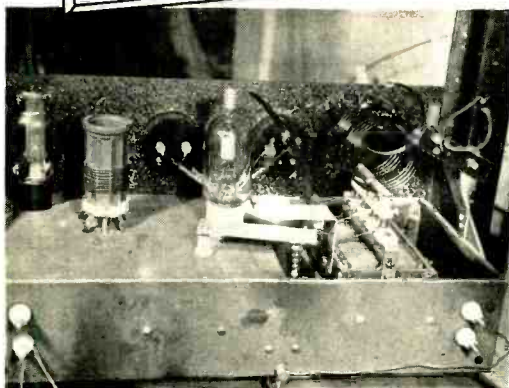

*Above is the complete station W2GT. At left is a close up of the lone Eimac 35T that was responsible for 150 Countries contacted and confirmed.*

Ed's success should be an inspiration to the amateur who operates a low power station—certainly it's a definite indication of what you can expect with an Eimac tube in your "rig." Ed says: "Choosing Eimac tubes was not accidental but, based upon the experiences of many friends who found, as I have found, that Eimac tubes give long life, dependability, stability, are easy to neutralize and easy to drive."

**EIMAC REPRESENTATIVES**

California, Nevada  
HERB BECKER, 1530 W.  
104th St., Los Angeles, Cal.  
Wash., Ore., Idaho, Mont.  
GENERAL SALES CO.,  
Verner O. Jensen, 2605-07  
Second Ave., Seattle, Wash.  
Colo., Wyo., New Mexico,  
Arizona, Utah  
RICHARD A. HYDE,  
4253 Quitman St., Denver,  
Colo.

N. Caro., S. Caro., Georgia,  
Tenn., Flor., Ala., Miss.  
JAMES MILLAR, 316  
Ninth St. N. E., Atlanta,  
Georgia  
N. Y., N. J., Penn., Md., Del.,  
Dist. of Col., Moine, N. H.,  
R. I., Conn., Mass.  
ADOLPH SCHWARTZ,  
11726 Elm Ave., Flushing,  
New York

Texas, La., Okla., Ark.  
J. EARL SMITH, 2821  
Live Oak St., Dallas, Texas  
Chicago, Illinois, Wisconsin  
G. G. RYAN, 549 W.  
Washington Blvd., Chicago,  
Ill.  
Ohio, Mich., Ky., Ind., Minn.,  
Mo., Kan., Neb., Iowa  
PEEL SALES ENGINEERING CO., E. R. Peel  
154 E. Erie St., Chicago, Ill.



**35T**

**Eimac  
TUBES**

Eitel-McCullough, Inc.  
San Bruno, California

# NEW BOOKS

## and trade literature

RADIO OPERATING QUESTIONS AND ANSWERS, by Nilson and Hornung, seventh edition. Published by McGraw-Hill Book Co., Inc., 330 W. 42 St., N. Y. 415 pages. 5 by 7½ inches, 87 illustrations, cloth bound. Price \$2.50 in U.S.A.

This, the new seventh edition of Nilson and Hornung's well known book, gives an answer to every question in the FCC *Study Guide and Reference Material for Commercial Radio Operator License Examinations*. The six elements for which questions are given in the study guide are: 1. Questions on basic law, 2. Basic theory and practice, 3. Radio telephony, 4. Advanced radiotelephony, 5. Radiotelegraphy, 6. Advanced radio telegraphy. Complete answers for all the questions for all six elements are given in the text. Considered from another standpoint, the book contains a wealth of concise information on radio communication—theory, apparatus, circuits, and laws and regulations—which will be found valuable for other uses than as an assistance to preparation for the FCC Commercial License examinations.

### New Shure Catalog Released

A new 12-page Shure Catalog No. 153 covering the complete Shure Line is ready for the trade. This enlarged catalog includes the new items for 1941 such as the "Stratoliner" microphones, magnetic recording head, etc. It is attractively illustrated and provides much helpful information.

A copy of this new Catalog may be obtained by writing to Shure Brothers, 225 W. Huron Street, Chicago, Illinois.

### Radio Dictionary

Allied Radio Corporation, Chicago, has just released A Dictionary of Radio Terms. This booklet contains simple, easy-to-understand definitions of approximately 800 radio terms and abbreviations most likely to be encountered in magazine articles, books and lectures on radio and its allied fields of electronics, television and facsimile broadcasting. Schematic symbols, tips on reading circuit diagrams, instructions for using the R.M.A. Color Code, historic data and other useful historical radio information are included in this book. The dictionary is fully illustrated throughout.

This new 36-page Radio Dictionary comes in a handy 6" x 9" size and has an attractively designed cover in grey and maroon. A copy may be had by sending 10c, to cover the cost of preparation and mailing, to Allied Radio Corporation, 833 West Jackson Boulevard, Chicago, Illinois.

### New Transmitter Guide

A new edition of the very popular transmitter Guide has just been released by the Thordarson

Electric Mfg. Co. A wide selection of transmitters is presented, ranging from 20 to 1000 watts, in addition to a portable and emergency unit and two band-switch exciter units.

Complete building and operating instructions are furnished, including over 100 illustrations to help build high quality transmitters of modern design. This new guide contains many new circuits and ideas on ham transmitter equipment and technical articles covering class B output calculations, driver transformer ratios, matching class C loads to modulators and other information of vital importance to the amateur.

Available at 15 cents postpaid from the Thordarson Electric Mfg. Co., 500 W. Huron St., Chicago, or from your local radio parts distributor.

### Lafayette 1941 Master Catalog Off the Presses

Lafayette Radio Corporation (formerly Wholesale Radio Service Co., Inc.) now have their "Master" catalog for 1941, Number 82, ready for distribution. Its 196 pages show items to meet every possible radio requirement. This new catalog with its four-color covers features 32 pages of the latest Lafayette radios and radio-phonograph combinations, in addition to several new types of its famous "Radiocorder" home recorder. 32 pages are devoted to Lafayette's new line of public-address equipment; 96 pages are given over to every possible type of radio equipment, parts and tools for the serviceman, experimenter and set builder. 13 pages of test instruments for all purposes are included. The "Ham," F.M. and television fan will find over 25 pages devoted to the latest equipment for short wave and u.h.f. work. 3 pages list the latest type of fluorescent lighting fixtures for home and industrial purposes.

A postcard addressed to the above company at 100 Sixth Avenue, New York City, will bring this catalog to any of our readers, without charge, or a copy may be obtained by a personal call at this or at any of the following branch stores: 265 Peachtree Street, Atlanta, Ga.; 110 Federal Street, Boston, Mass.; 901 W. Jackson Blvd., Chicago, Ill.; 542 E. Fordham Rd., Bronx, N. Y.; 90-08 166th Street, Jamaica, L. I.; and 24 Central Ave., Newark, N. J.

### New Amphenol Catalog

An interesting new 40-page Blue Book Catalog No. 62 for the Radio, Electrical and Aircraft industries has just been released by American Phenolic Corporation, 1250 Van Buren St., Chicago, Illinois. In addition to a complete listing of this company's many products such as sockets, plugs

[Continued on Page 90]

# BUD PRODUCTS

*Scientifically Designed . . .*



*For  
Exacting Amateurs*

Exacting amateurs recommend BUD products. They say that the high quality and careful design built into every BUD item enables them to construct better performing and better looking equipment. They know, too, that whatever their requirements may be—a tiny condenser or a big six foot cabinet—there is a BUD part perfectly suited to their application.

Write for your copy of the latest BUD catalog. It gives complete information on all BUD products.

**BUD RADIO, INC.**  
Cleveland, Ohio

because it's too big a sacrifice for the folks and I can't make enough myself to cover expenses. Anyway, my ambition has always been to take over that little farm of Dad's on the edge of town and make it pay. I'd like a degree all right before I go dirt farming, but I guess I'll have to do without it."

He was so darn sincere, I couldn't refuse. I didn't even have the heart to dampen his spirit by making cracks about long hauls on 160 through summer static. Ten was out for that distance and his class B ticket wouldn't permit a try on 80 meter phone. He almost cried when I suggested 40 meter c.w.; so the sked was finally made up for 160 meter phone: 1900 kc. to be exact.

He thanked me, said he'd make it up to me somehow, and rattled away in his chariot.

Our first contact was from a small town in northern Nebraska. I don't remember now whether it was O'Neill or Atkinson—anyway he told me something about the work the crew was doing and said he found it interesting. Apparently they didn't stay long in any one location, moving to areas previously mapped out for them. We gabbed quite a while that first night. I gave him an S7 to 8 and he logged me S9 plus.

The next scheduled contact didn't materialize. I called and stood by and listened and called until I began to feel foolish; so gave it up.

A few days later Plink sent me a letter, explaining why he wasn't on the air. He wrote that the crew was stopping in a small town and had taken quarters in the only Hotel. Plink had incurred the proprietor's displeasure while trying to hang his temporary antenna, and to top it all off, had somehow blundered into a short and blown the fuses.

We managed to QSO a few more times with conditions fair to poor, and with Plink gradually getting closer to the Kansas line and farther from home. There was an interval of about two weeks that QRN was so bad I didn't try to get through and I knew Plink couldn't—not with fifty watts and a makeshift skywire.

Came a night when I was late getting home for the schedule, and I no sooner flipped the plate switch on the receiver, than the speaker began to articulate. A very crisp but pleasant female voice was calling me on 1900 kc., and putting an S9 signal thru the static. She signed and I gave her a call. Boy Oh Boy, she came back to me and told me plenty about fellows who make a sked and then show up late. Finally she passed along her handle, Myrna. Pretty, I thought. Said she was standing by for Plink, who was now located at Wellington, south of Wichita, her QTH. I could hear Plink's carrier when he came on but the modulation was unintelligible. We carried on for a while, she repeating Plink's transmissions. Plink signed off, and I had a good gab-

fest with the Wichita y.l. Her conversation was interesting, but I didn't get much personal information. Of course, that was my first phone QSO with a y.l. op; so I was a bit stumped. If we had been using c.w. it would have been much easier. I was sure I hadn't heard her before on 160; but she insisted she had been very active, and the tube lineup she gave me had the smell of a high priced commercial job advertised sometime previous in RADIO. Of course 80 meters is usually my playground; so it would have been easy enough to pass up her sigs the few times I had worked 160.

We arranged a sked for a few nights later. That night I was Johnny-on-the-spot, so no harsh comments would be forthcoming. During the QSO Myrna told me that she usually folded up in summer, but that her sister, Dale, had asked her to act as relay station for Plink. Dale had met Plink in the small town bank where she worked one time when he was in to cash his pay check. Myrna further told me that they were pretty sweet on each other and that it was fast developing into something permanent. She then asked me all about Plink: his home life, his folks,—in fact, I don't think she left out anything. I answered her questions as best I could, getting a little peeved that Plink should get so much attention and me having to act as a mere information booth. All the time I was hoping that our hero was at the movies, or at least somewhere remote from his receiver.

After a few more contacts, Myrna and I became quite chummy, as Hams are prone to after having worked each other a few times. One night she waxed more confidential than usual and told me that Dale and Plink had decided to go farming. They were going to work for a year, pool their savings and then get married. Thus they figured they'd have enough to acquire sufficient stock and equipment to get started on their farming venture. She further confided to me that the arrangement to work for a year before their marriage was Dale's idea, in order to make sure that her easy going Plink really had the stuff to stick.

Summer passed all too quickly and Fall found me working for the county as Farm Agent. Plink's job with the Barberry Crew had run out with the coming of cold weather, but he had made connections with a Livestock Commission Firm in Sioux City. The day he landed in Sioux City he began looking around for a boarding house that had possibilities for hanging a good antenna, and found one.

From then on 1900 kc. was a stumbling block for plenty of W9's. Defying all the ethics and forgetting the courtesy of the fraternity, we clamped on that frequency for hours on end.

Things went on like this throughout the

# AXIAL LEAD

# RESISTORS

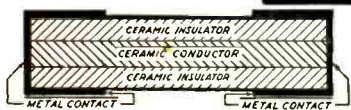

Magnified cross section showing the important and exclusive Centralab features:

Note center core of resistance material surrounded by a dense shock-proof ceramic providing strength and protection against humidity.

Both core and jacket are fired together at 2500 degrees F. into a solid unit . . . hard and durable as stone.

Pure copper covers the resistor ends for contact.



## AXIAL LEAD RESISTORS

Completely insulated

Designed to fit into limited space without danger of shorting to the chassis or other parts. Same resistor bodies are used as in Radial Lead units, millions of which are now in use . . . only difference is in method of making end contact. End leads brought through bakelite insulation. Will withstand five times rated load without permanent change.

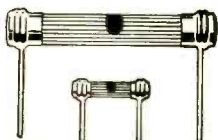

**RADIAL LEAD RESISTORS**  
90% Insulated

The ceramic body of all Centralab resistors is in itself an insulator of the highest quality. Only the radial leads where attached to the body are un-insulated. Electrical characteristics of the Axial and Radial lead types are identical.



Old Man Centralab continues to score a bulls eye with the millions of Fixed Resistors that are doing duty in new and replacement jobs the country over. Manufacturers, experimenters, hams and service men continue to believe (and justly so) that Centralab's unique method of uniting the resistance material with the ceramic body makes for a resistor of unusual strength and efficiency under any and all conditions. Available in either Radial or Axial Lead . . . color coded (R.M.A.) in convenient sizes and ratings.

Always insist on CENTRALAB.

CENTRALAB: Division of Globe Union Inc., Milwaukee, Wis.

by

# Centralab

winter and spring and into the following harvest. Plink lived on a very strict budget coming home just once, and that at Christmas time. Dale came up to Sioux City to see him once in the spring, the only time they had seen each other since Plink had left the Barberry crew.

Duck season opened late that year and I managed to strike everything off the calendar in order to get in on the inauguration. Lady Luck was good to me and I was at home shortly after noon with the limit.

There was a car in the yard with Iowa plates when I drove in; so I guessed the owner to be Plink. It was. He'd been waiting nervously since noon and was very fidgety; so much so that I had to question him repeatedly in order to understand just what he was trying to put across.

To sum up his conversation briefly, the big day was about to dawn. The Dale & Plink company had gathered sufficient collateral to start farming and the wedding was to take place the following day. Dale and Myrna would be in Sioux Falls in the morning. Plink and I were to meet the girls at a Hotel, drive up to Benny Michelson the County Clerk, get the license, then dash over to the parsonage and get the knot tied. No frills and no extra expense.

I agreed, even though I had just taken a day off to shoot ducks. I couldn't very well refuse, and then too, I wanted to see Myrna. I had talked with her for over a year but had never seen her.

We left shortly after breakfast in my car. It was new and Plink's had reached a stage in which it would depreciate but little from then on. Plink hardly spoke the whole thirty miles, and I had hardly parked the car before he had the door opened and was out on the sidewalk telling me to hurry. His nervousness had become infectious by this time and for some unknown reason I felt weak myself.

We walked through the lobby of the hotel and up to the desk, both of us trying to appear nonchalant. The girls had registered the night before; so the clerk very politely suggested we use the desk telephone to speak to them. Plink did the talking, hung up abruptly and said that they would be right down.

The few minutes we waited seemed interminable. Finally the elevator opened and two very well groomed young women stepped out. Plink dashed over to the shortest one and they embraced, oblivious to everyone else. I felt foolish and conspicuous, but was finally relieved and pleased when the introductions were over. Both women were very attractive, and I became conscious of a feeling of importance myself, just being included in the little group.

Then the Bell-hop brought their baggage out of the elevator, and I recognize luggage when

I see it. Believe me this heap of leather was tops. Airplane style luggage wasn't the rage then. This was the real McCoy, and it didn't look as though it belonged to a woikin goil.

Dale turned to the clerk at the desk and told him to have the car sent down. I picked up two bags, Plink picked up another two, and the Bell-hop a raft of hat boxes. We reached the street just as a mechanic pulled up to the curb in a swanky convertible. Dale gave him the pasteboard and his tip, and dismissed him, while I packed the luggage under the rear deck.

I didn't know what to say, and Plink looked like he'd had a stroke and couldn't talk. While he was still in a daze, Dale wiggled him under the wheel and climbed in beside him. I mumbled something to Myrna about riding with me and we started up the street toward my car.

As we pulled out into the traffic, I remembered the tube line-up Myrna had given me during our first QSO, and that made me feel a little more sure of myself, so I came right out flat footed and wanted the dope.

Poor Plink thought he was going to marry a working girl and this same girl shows up with a three thousand dollar automobile. It certainly had me buffalo-ed, say nothing about the way it had affected Plink.

Myrna was very brief but frank about the whole affair. It seems that their Mother had died while the girls were very young, leaving them in the care of a devoted Father with plenty of money to lavish on his children. Mr. Huntington however was a very practical man and having no sons, insisted that his daughters prepare themselves for a life of usefulness, particularly in his field of business. As a result, both girls were given a business education, coupled with practical duties in the Pater's banks, of which I gathered, there were quite a number scattered throughout the State of Kansas. The Father had succumbed in a plane crash on a trip to the west coast, leaving Myrna in command. She had immediately removed Dale from her debutante clique and put her to work in the small town bank where Plink had met her. Obviously both girls were besieged by an army of stuffed shirts; so when Dale first wrote that she had become interested in a Ham Radio Operator, Myrna was a bit skeptical. She consented to act as relay station for us, not only because of her interest in Amateur Radio, but also to keep tabs on the affair between Plink and Dale. By now she was thoroughly satisfied that the match was a good one, and she was very happy about the whole thing.

Everything came off on schedule, with Plink so confused he could hardly answer questions intelligently. However, things are now hunky-dory. Plink and Dale live near the edge of town on a magnificent farm, and Plink is what



For top performance on all bands, buy me - Hallicrafters' latest and finest - the SX-28. Terms \$12.50 a month. Write to W9ARA for information on me or any receiver.



For top performance at medium cost, buy me, the SX-25. Terms only \$7.00 a month. W9ARA gives you the best trade for your old set on any new one. Write him!



I'm S19R and a lot of radio for \$29.50. Terms, \$2.08 a month. Bob finances all terms himself, so you buy with less cost - no red tape - quicker delivery. Write Bob for details.



S-29 9-tube portable - that's me! - operating from 110V AC-DC or self-contained batteries. I tune 9-500 meters. Send \$5.00 deposit + I'm shipped on Free Trial Plan.

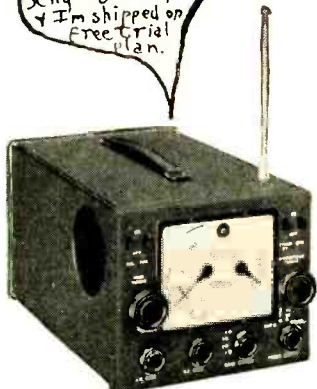

I'm SX-24, the 9-tube with electrical bandspread and frequency meter tuning from 43.5 to 54 MC, costing only \$69.50. Try me or any other set on Bob's free trial plan.



I'm the 9-tube S20R, giving top performance at \$49.50. When ordering me or any other set state whether you prefer shipment from W9ARA's world's largest stock or from factory.



I sell all makes and models of receivers, xmtrs, parts. I want to help you get the best apparatus for your use and to see that you are 100% satisfied. I guarantee you can't buy for less or on better terms elsewhere. Write and tell me what you want and how you want everything handled. Bob Henry W9ARA

# HENRY RADIO SHOP

BUTLER, MISSOURI

he always wanted to be: a gentleman farmer. The business is raising pure bred Shorthorns, and the side-line is evidenced by two huge towers, one balancing a rotary beam on its top.

That's my story boys, and it proves that there's still romance in Ham Radio.

Al drained his glass and arose to go. The Lid who had started the ball rolling, came over to our end of the table, put his hand on Al's shoulder and apologized, "Take it all back Al, —I'm going home and look over the band."

That broke up the gathering, and I walked with Al to his car. Suddenly something between my ears clicked, and I just had to satisfy my curiosity. So I piped, "Al, don't you call the x.y.l. Myrna?"

"Yeah," he drawled, as he opened the car door, "Plink Anderson is my wife's brother-in-law."

### A Simple and Effective Superregenerative Receiver for 224 Mc.

[Continued from Page 15]

one of the two stud bolts which originally supported all stator plates. The condenser then is assembled, making use of the original spacing washers, so that the two stator plates are 5/16 inch apart, one plate being supported by one stud bolt and the other plate being supported by the other stud bolt. The four rotor plates are then attached, spaced so that each stator plate is enveloped by two rotor plates with the original spacing of .03 inch between adjacent rotor and stator plates. Inspection of figure 2 shows how the condenser looks when reassembled.

Connection from each stator to the parallel wires is made by means of two 7/8 inch solder lugs, the lugs being bent in towards each other as illustrated in order to permit connection at approximately the same point on each tank wire with respect to the closed end of the tank. The tuning condenser is mounted inverted by means of a Trim Air bracket so that the lugs attach to the tank wires 2 3/4 inches up from the bolt through the bottom of the "U." The condenser is driven by means of an insulated shaft extension.

The antenna coupling loop is made of no. 12 enameled wire, bent as shown in figures 1 and 2, and varied with respect to the tank wires in order to vary the coupling.

Condenser C<sub>1</sub> should be grounded directly to the chassis with the shortest possible lead.

The receiver runs at full plate voltage at all times, the antenna coupling being adjusted to the closest value which will still permit super-regeneration.

When the receiver is initially put into oper-

ation, the frequency range should be checked on Lecher wires. If slightly off, the frequency range can be altered sufficiently by varying the spacing between the two tank wires: spreading the wires slightly *lowers* the frequency. If the frequency is very far off, it will be necessary to alter the length of the tank wires slightly as required to enable the tuning condenser to cover the band.

While the receiver will work well with most any antenna system, it is to be expected that best results will be obtained with an efficient feed system and a directive array. Because of the comparatively short length of dipole elements at 224 Mc., a high gain array can be constructed cheaply, easily, and in small space. Particular care should be paid to the feed line; a two wire line with good insulation (preferably polystyrene) and spaced not over 1 1/2 inches is recommended.

An interesting fact will be observed when the receiver has been in operation for a while: Local station, in line of sight or nearly so, will be slightly louder on 1 1/4 meters than on 2 1/2 meters. As for distances over 100 miles, that still remains to be seen. It appears at present as though 1 1/4 may prove to be virtually as good for u.h.f. dx as is 2 1/2 meters.

See Buyer's Guide, page 97, for parts list.

### An Interesting Discovery Regarding Tube Life

[Continued from Page 40]

checks up to the standards of a new tube, and that it has not been rejuvenated in order to make it look good. If you know of a broadcast or police station who is in the habit of replacing tubes after so many hours, just on general principles, and you can pick up a 203-A, 211, 242-A, etc., for a couple of dollars, it would be foolish to pass up such a bet if the tubes were known to be in first class condition when removed from the transmitter. On the other hand, it would be unwise to purchase a used tube even if only a month or two old if offered for sale by a person known to be unscrupulous enough to "hop up" an ailing tube in order to sell it, because there is no assurance that the tube did not begin to go sour after a few dozen hours use, even though not abused.

Oddly, while this peculiar law of survival applies to tubes with oxide coated and thoriated tungsten emitters, it does not apply to pure tungsten filaments. The life of a tube with a pure tungsten filament can be predicted quite accurately. However, it is unlikely that any amateur is going to be interested in picking up any second hand water cooled tubes.

# 5

# BIG ISSUES FOR

# \$1



For all new subscribers or those who have not been on our subscription lists during the past year, we make this introductory offer of *five big issues of RADIO for only one dollar!* By acting now, the big January Yearbook Issue will be included on your subscription. This rate is good in U.S.A. only (elsewhere, half the one-year rates quoted below).

Here's the magazine that's known the world over as the authority of practical and technical radio. Every issue is packed with easy-to-understand and profusely illustrated text written by our own editors—and as RADIO pays for technical and constructional material, we publish the “cream of the crop” from outside authors.

Take advantage of this introductory offer by acting now. We'll send you the *next five issues of RADIO* for only one dollar!

**\$2.50** yearly

(U. S. A.)

Two years **\$4.50**

To Canada (inclusive of current taxes), Newfoundland, Pan-American countries, and Spain, add 50c per year. Elsewhere add \$1. per year. California and Illinois customers: please add sales tax.

THE EDITORS OF  
**RADIO** *technical publishers*

1300 Kenwood Road, Santa Barbara  
CALIFORNIA

## Improved Performance from the Regenerative I. F. Amplifier

[Continued from Page 21]

affair was unshielded and the regeneration control was boosted to the limit. Under these conditions the full capability of the single-signal feature was realized, with a rejection on the undesired side of the signal of about the same as the gain on the desired side.

All of these circuits were tried with both air-core and iron-core transformers and the latter circuit (figure 1C) was the only one wherein the good selectivity and gain of the iron-core unit was obvious. The second detector had to be changed immediately, however, because it was of the plate type and it blocked up on loud signals. In the present set a diode type rectifier is used. An infinite impedance type detector could be used if desired. The screen voltage of the i.f. tube should be maintained constant; a divider arrangement is suggested.

When aligning the set the usual modulated oscillator may be used on all circuits except the input i.f. transformer. The same method used to line up a Super Gainer should be used, i.e., the regeneration should be boosted to a point just before the stage oscillates and the secondary trimmer adjusted with the help of the mod. osc. after the succeeding stages have been aligned. Then the primary of the input transformer is adjusted, with the oscillator off, until the i.f. stage drops out of oscillation. The i.f. gain is run up again and the procedure repeated. The reason for this method of alignment is due to the detuning effect of the cathode coil on the secondary of the transformer. The b.f.o. is adjusted to whichever side of the signal is desired and to the frequency pitch desired. Usually a 1000 cycle note is best for reading weak signals.

Shielding is a good measure towards stability, and the cathode coil should be mounted close to the socket and i.f. transformer. The lead to the regeneration control on the panel should be shielded and a ground wire brought from the cathode coil to the control. The cathode coil itself need not be shielded unless desired, although any means to keep the regeneration solely in the grid-cathode circuits is a means toward better rejection. A good tube is necessary for stable operation and it must be shielded. With this circuit, full gain may be applied to all the stages of the receiver without affecting the i.f. operation. This is an advantage over any of the other circuits tried as in most of them the r.f. gain had to be backed down to get good i.f. gain with stability.

Good signal-to-noise ratio is outstanding even at the threshold point of regeneration. Phone signals are so sharp that the control

must be backed down for good readability, just as with a crystal filter. The twenty meter band is really a pleasure to tune with the i.f. control turned up. If more than one i.f. stage is desired, they may be added without disturbing the operation of the regenerative stage. But they must be added *after* the regenerative one.

The set in which this i.f. circuit is now being used has a regenerative r.f. stage and three i.f. stages, with three iron-core units. The whole thing is stable as a rock with all controls cranked up to the limit. The S.S. quality is comparable to crystal filter and a signal barely audible with the i.f. gain down can be brought in R7 or better in the maximum position. The change is simple to make in any super. No means have been devised for a.v.c. connection, but this can usually be omitted from one stage. I never use a.v.c. except on a loud wavering signal, anyway, and enough a.v.c. action can be had with control of an r.f. tube and one i.f. stage.

Smooth control is accomplished with a rheostat of 2000 ohms and a shunt of about 200 ohms. Both resistors are non-inductive. The cathode coil for 456-465 kc. i.f. may be constructed by winding about 70 turns of no. 30-36 wire on a 1" stand-off insulator upon which has first been wound a layer of tape to prevent slipping of the wire. The unit may then be mounted with a screw through one of the three holes. The shield, if used, may be mounted on the insulator by one of the remaining holes. The stage should oscillate with the control nearly wide open, and the cathode coil should be altered if necessary in order to produce this condition. A crisp, bell-like sound is indication of proper operation.

---

### New Tubes

[Continued from Page 42]

---

#### VR75-30

As the type designation indicates, the VR75-30 is a 75-volt, cold-cathode, glow-discharge tube intended for use as a voltage regulator. Minimum starting voltage is 105 volts, while the maximum and minimum operating currents are 30 and 5 milliamperes, respectively.

#### 5W4-GT

The 5W4-GT is the "GT" version of the 5W4 full-wave, high-vacuum rectifier. The maximum r.m.s. voltage per plate is 350 volts with condenser input, and 500 volts with choke input. In both types of service the maximum d.c. output current is 100 milliamperes. The

## RADIO

principal difference between this tube and other 5-volt-filament rectifiers is the relative low permissible output current and the corresponding low (1.5 amperes) filament current requirement.

### 6AD7-G

Something new in the way of audio output tubes is presented in the 6AD7-G. This tube combines an audio output pentode and a small triode in the same envelope. The pentode unit, which corresponds with the 6F6, may be used as a single-ended audio amplifier, with the triode ahead of it as a voltage amplifier. However, the new tube is intended primarily to operate with a 6F6 as a push-pull output stage, with the triode unit serving as a phase inverter. In this latter type of service the 6F6 and 6AD7-G combination is capable of an audio output of 9 watts at 375 plate volts, with 2 per cent total harmonic distortion.

### 12A6

The 12A6 is a metal-envelope beam-power amplifier with a 12.6-volt, 0.15-ampere heater for use as an audio output stage in a.c.-d.c. receivers. With 250 volts on the plate and screen, the 12A6 will deliver an audio output of 2.5 watts, with 10 per cent total harmonic distortion.

### A 5- to 40-Meter R. F. Unit

[Continued from Page 13]

measure plate current only; they do not read the combined plate and grid current as is the case when the grid return is made to ground instead of to the hot side of the cathode jack.

As a guide to aid in the initial tune up, the following typical current values are given. They are indicative of normal operation. This assumes a plate voltage of 1000 on the HK-24's and 2000 on the 35-T's.

The oscillator draws about 60 ma. when driving the final amplifier, and about 40 ma. when driving the succeeding doubler.

The doublers draw from 60 to 65 ma. each regardless of whether they are driving the final amplifier or a succeeding doubler. The first and doubler grid current will run close to 20 ma. and the third doubler 18 ma.

The final amplifier grid current normally runs about 55 ma. on 7 Mc., 72 ma. on 14 Mc., 65 ma. on 28 Mc., and 40 ma. on 56 Mc. The amplifier is loaded to 175 ma. on all four bands.

See Buyer's Guide, page 97, for parts list.

Keydash is W3HTB's last name.

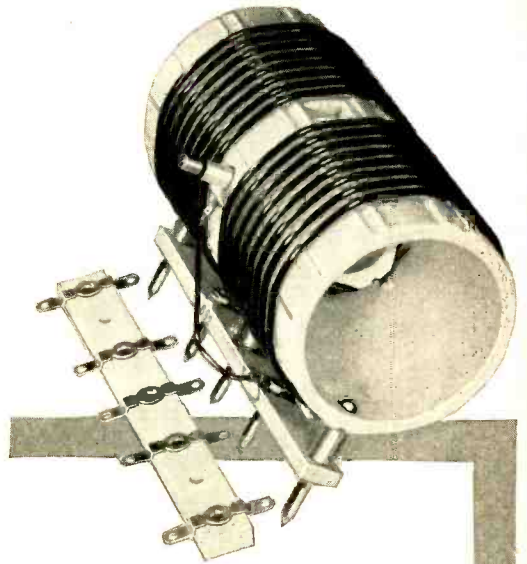

# JOHNSON

*has the answers*



**EFFICIENT DESIGN  
STURDY CONSTRUCTION**

For permanent installations, **Broadcast Stations, Airlines, Police Stations,** and other **Commercial Services** prefer JOHNSON.

Built for applications requiring high efficiency, correct electrical design, frequency stability and long life—these Hi-Q inductors cost no more because of JOHNSON'S quantity production for manufacturers using these inductors.

Investigate their many advantages. Ask your jobber for the **New Catalog 966K.**



**E. F. JOHNSON CO**

WASECA, MINNESOTA

EXPORT: 25 WARREN ST., NEW YORK, N. Y.

"MANUFACTURERS OF RADIO TRANSMITTING EQUIPMENT"

An Electrically Rotatable 112-Mc. Array

[Continued from Page 38]

mum. With proper adjustment the line will be found to be nearly "flat."

The three wire feeder is constructed of small strips of Lucite, as shown in the insert of figure 1. It will be found easier to keep the wires separated if the spacing is made 2 inches, but spacing greater than this should be avoided in order to keep down radiation from the line.

Either of two methods may be used for bringing the feed line down the pole. The line should not leave the pole at an angle until it is at least 1 foot below the bottom of the

radiator elements. The line may be brought down the support pipe a couple of inches to one side, being twisted slightly as it is brought down so that the same feed wire is not closest to the support pipe for the entire length. The alternative method is to space the three wires equally around the support pipe by means of 1-inch ceramic or polystyrene stand off insulators mounted on the pipe. The wires are brought down the pipe in this manner for the specified distance, then terminated and connected to the three wire feeder described.

The direction switch, figure 2, is a single gang, 2 pole selector switch having ceramic insulation, such as the Centralab no. 2505. The line from the switch to the transmitter should have the same spacing as the 3-wire line, or about 2 inches.

A Noise-Free Antenna

[Continued from Page 27]

This is shown in figure 5, and is accomplished with one 35 and two 70 ohm lines. Open lines with delta matches could be used instead if the particular construction will permit.

Construction

A small platform on the eave of the roof is a convenient support for the elements. A typical arrangement of such a platform is shown in figure 6.

Further Possibilities

Further improvement of the results obtained with the antenna can be had if it is used in conjunction with the noise antenna described in the RADIO HANDBOOK; in this set up an antenna is constructed so that it will pick up the most noise and the least signal possible. Then this noise voltage is introduced into the antenna circuit of the receiver through a phasing system so that it is out phase with the noise in the signal antenna, thus tending to cancel all the noise in the signal antenna.

Results

One of these antennas, with a pair of reflectors, was used at the California Institute of Technology with notable success in eliminating interference from the one million volt generator used in high voltage experiments. The generator was only about 2000 feet from the antenna. The frequency used was in the neighborhood of 40 Mc.

A real "birdie" is heard from W8SEM—a canary singing in the background.



FOUR-LEAD  
Dual  
DANDEES

Entirely separate sections. Two positive and two negative leads.

Identified as PRS-B series, as distinguished from PRS-A duals with concentrically-wound sections and three leads (common negative).

Can be used in separate circuits, or in common negative or common positive circuits.

All popular capacities—8-8 to 20-20, 25 up to 450 v. D. C.W.

We believe the dimensions of these units to be the smallest of any corresponding dual mid-gets.

With these latest Four-Lead Dual Dandees, still more uses are found for ultra-compact electrolytics. Two *entirely separate sections* permit use in two entirely isolated circuits, or in common negative or common positive circuits, or even connected in parallel or series for different capacity or voltage values.

For your compact assemblies, such as portable transmitters, receivers, trans-receivers, and even for your regular station equipment, you'll find these Dual Dandees mighty handy — and quite inexpensive.

Ask for CATALOG . . . Latest Aerovox Catalog contains complete listings. Ask jobber for copy—or write us direct.



**A Bandswitching Grid-Modulated Transmitter**

[Continued from page 25]

With this type of band-switching, operation on all bands is possible by increasing the number of leads from the switch decks to the coils, and by tapping the correct turns on the coils for the frequencies desired. Use the cut-and-try method for finding the proper taps for various frequencies. Simply tap the coils so that each plate circuit tunes to resonance on the desired frequencies. This is in no way difficult and may be done in a very few minutes.

**28-Mc. Operation**

The oscillator and buffer-doubler coils are of the plug-in type, and for 10-meter operation these coils are removed and replaced with regular 10-meter coils. The previously discussed type of band switching is not practical for 10-meter operation, but perfectly permissible on frequencies up to 15 megacycles. There is ample excitation for the final up to 15 megacycles.

**The Paralleled 100TH Final**

The tubes in the final amplifier are paralleled using shunt feed in their plate circuit. The tank coils are wound on ribbed isolantite forms. Solid coil forms permit permanent adjustment of the neutralizing link and antenna link. After these links are once set, they may be secured and no further adjustment will be necessary. While winding the final tank coils for 160 and 75-meter operation, cut down turns until the coils resonate with the final tuning condenser practically closed. Wind higher frequency coils so that the final tuning condenser hits resonance near minimum capacity.

**Tuning Procedure**

Place the bandswitch in the correct position for the frequency desired. Remove the 866 plate caps. This will cut the high-voltage power supply. Adjust the bias supply for 200 volts. Adjust the low-voltage supply for 300 volts on the oscillator and modulator stages. Turn on the power and tune the oscillator tank condenser for minimum current reading of the oscillator plate milliammeter. Tune the buffer-doubler stage for minimum current, reading the meter in that stage. Adjust the coupling condenser to the final grid for 15 or 20 grid ma. of grid current. Tune the final plate circuit through resonance and note any change in grid current. Next adjust the neutralizing link on the final tank coil. When this link is once adjusted, there should be no change in grid current as the final tank circuit is tuned through resonance.

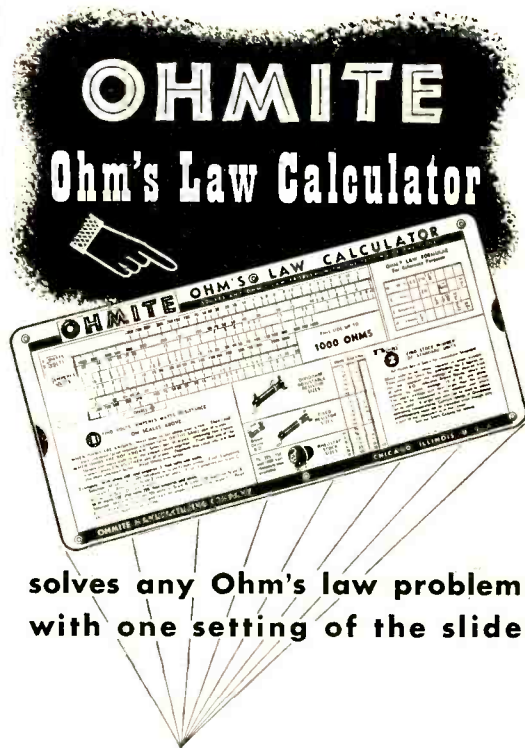

**solves any Ohm's law problem with one setting of the slide**

**IT'S NEW**

**SIMPLE EASY**

**and Complete**

Here's the handiest Ohm's Law Calculator you've ever seen! Specially designed for you by Ohmite Engineers. Gives the answer to any Ohm's Law problem in a jiffy, with one setting of the slide. No decimal points to worry about because all values are direct reading. Simple as can be. Does not require any knowledge of a slide rule to operate. Nothing else like it. Smaller than any such calculator ever available. Size 4 1/8" x 9". Covers the range from .1 ohm to 10 megohms, also the range of currents, wattages and voltages commonly used in radio and commercial work. A setting of the slide also tells the stock number of resistor or rheostat you may need. Available to you for only 10c to cover handling cost. At your Jobber, or send 10c in coin now.

**OHMITE MANUFACTURING CO.**  
 4867 Flournoy St., Chicago, U. S. A.

10c in Coin enclosed. Send Ohm's Law Calculator.

Name .....

Address .....

City ..... State .....

*Radio-Nov.*



The transmitter is now ready to operate. Connect the 866 plate caps and antenna. Turn on the plate power and load the final to 220 ma. of plate current with 6 ma. grid drive. The ideal adjustment for grid modulation is to use as much grid current as possible and as light an antenna coupling as possible, still obtaining upward modulation. By experimenting with grid bias, grid current, and final amplifier plate loading, maximum efficiency will be obtained. When a grid-modulated amplifier is tuned by this method, the efficiency will run between 40% and 50%.

Repeat the previous tuning procedure for each band. After adjustments have been made, log all dial settings. When changing from one band to another, set the exciter stages to the logged dial settings and follow the same procedure of tuning the final amplifier.

This transmitter may be cathode modulated, if desired, by employing any of the approved methods of cathode modulation.

**Construction Notes**

A careful study of the pictures should be made to determine the location of parts. It is very important to locate properly the component parts of a high-power portable transmitter. The two chassis are 13" by 17" and 4" deep. A deep chassis allows sub-chassis mounting of many parts, resulting in more compact construction. Great care should be taken to use properly insulated wire for all high voltages, and sufficiently heavy wire for circuits carrying large current. The use of isolantite sockets and isolantite-insulated variable condensers is recommended throughout.

See Buyer's Guide, page 97, for parts list.

**The Amateur Newcomer**

[Continued from Page 60]

$4 (2\pi/L_2)$  and  $f=1/4\pi\sqrt{C_1 L_2}$ . The subscript 1 always indicates a series element and 2 a shunt element.

The type of filter used for "smoothing out" rectified a.c. is almost always of the simple low-pass type. The fundamental of rectified a.c. (60 cycles) has a frequency of  $2 \times 60$  or 120 cycles. Near to its cut-off point a low-pass filter attenuates very little, the attenuation rising toward infinity as the frequency increases. It might, therefore, seem more logical to use a high and low-pass filter, giving infinite attenuation at 120 cycles, and a very sharp rise of attenuation from cut-off. The reason for not doing this is that the wave form of a rectified sinusoidal current is *not* sinusoidal, but is made up of an infinite number of sinusoidal components. Moreover, it is the higher ones which are most likely to get through the loud speaker.

The low-pass filter is increasingly effective as the frequency rises, and therefore a filter of this class which eliminates the fundamental passably well will block off the higher frequencies even better. It has been termed the "brute force" filter, but there are occasions where "brute force" is justifiable. Better than this, however, is to combine a section designed specifically to give maximum attenuation at 120 cycles with a low-pass section. In this way a high degree of attenuation may be obtained at all frequencies.

The City of New York operated a police radio station as early as June 1916. This stations is still in operation.

**MY NEW JOB WAS MY OLD HOBBY**

SAY, JIM, WHY DON'T YOU DO SOMETHING MORE THAN JUST PLAY WITH RADIO?

WHAT CHANCE HAS A "HAM" GOT, BILL?

**A True Experience**

WHY YOU'VE GOT EVERY REASON TO CAPITALIZE ON YOUR AMATEUR EXPERIENCE. CREI HOME STUDY COURSES PROVIDE THE TECHNICAL TRAINING - YOUR "HAMMING" SUPPLIES THE PRACTICAL EXPERIENCE

**LATER -**

HI BILL, CONGRATULATE ME! JUST GOT THAT CONTROL ROOM JOB AT THE NEW STATION. MY CREI TRAINING CLINCHED IT - THANKS FOR THE ADVICE - I TURNED MY HOBBY INTO A CAREER!

**MR. E. H. RIETZKE SAYS :**  
**MEN - WRITE ME TODAY FOR DETAILS AND FREE ILLUSTRATED BOOKLET**

**CAPITOL RADIO**  
 ENGINEERING INSTITUTE  
 3224 16th Street, N. W.  
 DEPT. RO-11 WASHINGTON, D. C.



**With the Experimenter**

[Continued from Page 57]

This assumes a line having a surge impedance close to 600 ohms.

If the slight amount of reactance that may appear should be found objectionable, it can be virtually eliminated on both bands simply by lengthening or shortening the feed line a small amount at a time.

The stub may be of the same wire size and spacing as the transmission line. It should preferably leave the antenna at a right angle, being pulled away from the radiator in the opposite direction of the transmission line. This will prevent the stub from swinging.

The spacing between the radiating elements is not critical, and need not be exactly the same throughout the length of the radiating elements. Spacing up to 1 foot for 10-20 meters or 2 feet for 20-40 meters will be satisfactory. If the spacing at the free end of each radiator is greater than a few inches, the corresponding amount should be subtracted from the length of the radiators. For instance, if the spacing is made 2 feet in the antenna illustrated in figure 1, each wire of each element should be shortened by 1 foot, thus making up the 2 feet. In this case each radiating element would be 33 feet instead of 34 feet, the overall length of each folded radiator wire being approximately 68 feet in either case.

When using the antenna on the lower frequency band, care must be taken to avoid the radiation of a second harmonic.

**FILAMENT VOLTAGE vs. HUM**

There is a general opinion that an accurately center tapped filament transformer will remove every last vestige of hum caused by a.c. filament supply of directly heated type tubes. This is true with a push pull audio amplifier; in fact there will be no hum trouble in most cases even if the filament return is made to one leg of the filaments. With single ended a.f. stages and all types of r.f. amplifiers not incorporating inverse feedback this is not true. While a center tap return will minimize the hum, it cannot be eliminated.

The amount of hum generated in such cases is a function of the filament supply voltage. Thus, where very low hum level is required when filament type tubes are used, the hum can be kept at a minimum by choosing tubes whose filaments draw high current at low voltage rather than low current at higher voltage. For instance, when very low hum level is required in a class C amplifier with a.c. filament supply, a tube such as the 152-T (which may be operated on either 5 or 10 volt supply) should be supplied from a 5 volt transformer.

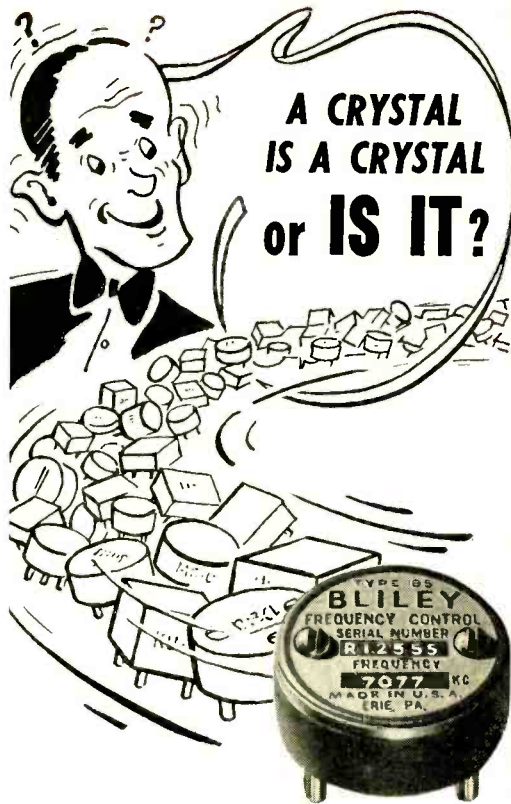

Quartz crystals are manufactured from quartz. Yes, and all finished quartz crystals look just about alike. Does that mean one crystal is necessarily as good as another? No Sir! It takes more than raw material or appearances to bring out true performance—and performance is what counts!

Under visual examination, it would be difficult, if not impossible, to detect the difference between a good and a questionable crystal. Yet, behind the properly made crystal lie many precision operations, thorough checking at every processing step, immediate rejection of questionable material, and the skill of trained craftsmen guided in their work by effective engineering. How else could any precision-made product be produced?

In the manufacture of each Bliley Crystal, nothing is taken for granted. Engineering, individual skill and the application of adequate equipment are all combined to produce not a better, but the best possible, final product. Sure, there is a difference in crystals—install a Bliley Crystal Unit in your transmitter and find out for yourself.

**BLILEY ELECTRIC CO.**  
UNION STATION BUILDING ERIE, PA.

## A Highly Efficient 224 Mc. Transmitter

[Continued from Page 20]

both the receiving and transmitting positions, an effective power gain of 64 is possible.

The beauty of this 1¼ meter set-up is that the equipment is extremely simple and compact in every respect. The antennas measure approximately 4 ft. across and by designing them so that the elements can be removed, transportation is extremely simple. If desired, a single array can be used for both receiving

and transmitting by the incorporation of a small, ceramic insulated d.p.d.t. switch in the feed line. However, slightly greater efficiency will be obtained with separate arrays, as there will be some loss if feeder switching is used.

Receivers used at W1AJJ have included the National 1-10 employing an r.f. stage and a super-regenerative detector, and a simple band-spread super-regenerative type employing the Hytron HY615. The chief advantage of the National 1-10 on 1¼ meters is that there is no radiation from the unit when receiving. The radiation of a regular super-regenerative receiver may be objectional when there is more than one station in the locality receiving the signal.

Proof of the simplicity and reliability of this transmitter is found in the fact that one of the two units constructed has been loaned to several different amateurs for field work and no difficulties have been encountered. Naturally, it is necessary to take into account the polarity of the motor generator and avoid shorts between the cabinet of the transmitter and the auto body should they not be at the same d.c. potential. Quality of transmission is unusually good and the transmitter gets out very well even with a simple half-wave radiator. With such an antenna a distance of 90 miles was worked on 1¼ meters.

See Buyer's Guide, page 97, for parts list.

## Getting Your RADIO OPERATOR'S LICENSE made easier—

if you prepare for exams  
this direct, tested way

Check your training and knowledge and focus on the key points of theory and practice as covered in new Government license requirements, in the quickest, easiest way with this new book.

**JUST OUT  
NEW 7th EDITION**

Nilson and Hornung's

### **RADIO OPERATING QUESTIONS and ANSWERS**

415 pages, 5 x 7½, 87 illustrations, \$2.50

This book gives an answer to every question in the FCC Study Guide and Reference Material for Commercial Radio Operator License Examinations. Here is a wealth of concise information on radio communication—theory, apparatus, circuits, laws and regulations, etc.—classified exactly as in the six elements on which all professional radio operator license examinations now are based:

1. Questions on Basic Law
2. Basic Theory and Practice
3. Radiotelephony
4. Advanced Radiotelephony
5. Radiotelegraphy
6. Advanced Radiotelegraphy

Appendix of operating abbreviations, rules governing commercial operators, and radio laws.

### THOUSANDS OF MEN

have used previous editions with success. More than ever this new edition helps you get a quick command of all the information needed to pass tests.

**SEE IT 10 DAYS—SEND THIS COUPON**

McGraw-Hill Book Co., Inc., 330 W. 42 St., N.Y.

Send me Nilson and Hornung—Radio Operating Questions and Answers for 10 days' examination. In 10 days I will send \$2.50 plus few cents postage or return it postpaid. (We pay postage if remittance accompanies order.)

Name .....

Address .....

City and State .....

Position .....

Company ..... R 11-40

(Books sent on approval in U.S. and Canada only.)

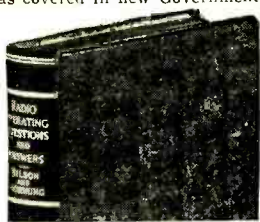

## Two A.C.-D.C. Transmitters

[Continued from Page 33]

output (1.5 watts). A Western Electric F microphone will give equal results. Quality reports have been very gratifying, and the monitor agrees. The output of the mighty transmitter is as clean as a whistle.

### Power Supply

The half-wave rectifier is a 35Z4-GT, and the a.c.-d.c. circuit in which it is used is standard; as in all such circuits, the "B" negative is allergic to ground. A fairly high capacity input filter condenser is advisable for maintaining maximum output voltage. The filter choke and modulation choke are strangely similar.

### Construction

The transmitter is constructed on Macolite which is not only very inexpensive but also extremely easy to work with. The panel measures 7" x 10", and the chassis is 7" x 10" x 1½". The panel is finished in black crackle as are the steel brackets with which it is attached to the chassis. Across the bottom of the panel from left to right

are the mike jack, mike switch, stand-by switch, and line switch.

### Operation

I hesitate to get involved in a detailed discussion of the operation of this complex rig, so you can just use your imagination. It is sufficient to say that with proper loading the final ma. should minimize at about 30, and should not vary with modulation.

A small rig of this sort, when used with a good antenna, provides ample power for local ragchews without causing unnecessary interference. It's easy to build, inexpensive, and foolproof in the fullest sense of the word.

See Buyer's Guide, page 97, for parts list.

### X-DX

[Continued from Page 49]

oil is used for the insulation.

The motor to drive the gap is a one-eighth H.P. at about 2800 r.p.m. which gives a good note. The O.T., or oscillation transformer, is made of copper ribbon. Some of us always have a peculiar idea that we should make our OT's with the ratio of 4 to 1. By that I mean use one large turn in the primary and 4 turns in the secondary. This should give the best transfer on 200 meters. Coupling is usually about 6 to 8 inches which gives a fairly sharp signal. The straight gap to the left of the rotary is in the ground lead thus allowing a single wire to tap on the aerial for the receiver, without going through the OT to ground.

The aerial is a "T." It consists of six wires spaced evenly on 16-foot spreaders, the aerial being 50 feet long and 60 feet high. The lead-in is of the cage type, all six wires forming a 4-inch cage all the way into the secondary of the OT. The ground system is made up of about ten old hot water boilers gathered from far and wide. They are buried in a 40-foot circle with a heavy lead from each going to a center terminal and from there to the other side of the OT. This gives me quite an efficient spark station. Once in a while we can get through to the 7's but it is usually in the winter when the static isn't so bad. I like to sign off from a station and send the "SK" with my rotary's motor slowing down, as this gives a distinctive flavor. (This flavor turns to "odor" in case the condenser breaks down.)

All in all I get out pretty well, and it's fun listening to the gang, most of which have the "banana boat swing" or "Lake Erie swing." There is just one drawback. I haven't been able to work any W9's. After all this work it looks as though I would be forced to go back to c.w., and that's pretty hard to take because I felt as though I was progressing all the time.

Now then proper credit should be given to the fellows who actually owned the stations pictured. The receiving setup belonged to Harold Steen, W6FH, Sacramento, while the transmitter belonged

## Avoid a run-down battery with a **MALLORY** BATTERY CHARGER

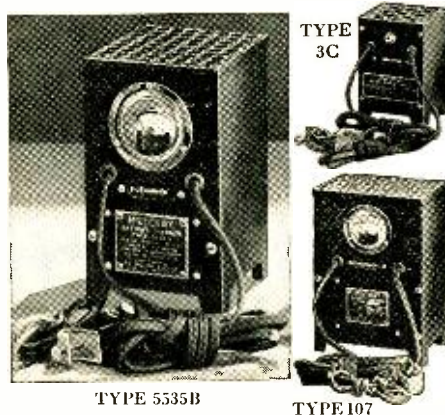

TYPE 5535B

TYPE 107

In your rig, automobile, plane, boat or laboratory apparatus, a fully charged storage battery is your best insurance against shutdowns, delays and loss of service. Battery charging is easy and inexpensive with a Mallory Battery Charger. There is no need to disconnect or remove the battery—just plug the Mallory Battery Charger into the easily installed special receptacle.

Mallory Battery Chargers are available in three standard types:

Type	Maximum Charging Rate	Tapered Charging Rate
3C	4 amperes	2 amperes
5535B	6 amperes	4 amperes
107	10 amperes	7 amperes

Mallory Battery Chargers are protected by built-in thermal circuit breakers—there are no fuses to blow. The Chargers are designed for use with a 3-cell lead-acid battery, but can be used with lower voltage batteries by simply inserting resistance in the DC circuit. Airplane and similar 12-volt storage batteries can be serviced by using two chargers with DC outputs connected in series.

The heart of a Mallory Battery Charger is the rugged Mallory Magnesium Copper Sulphide Dry Disc Rectifier, operated with a transformer having a separate, insulated secondary. There is no danger of shock, as might occur if an auto transformer were used. Trouble-free service is yours by using a Mallory Battery Charger. See these units at your dealer or write for a descriptive folder.

**P. R. MALLORY & CO., Inc.**  
INDIANAPOLIS      INDIANA  
Cable Address — Peimallo



to our old friend Les Pickers, 6AJH and 6ZH, who has now passed on. Let's start a "Spark Forever" club!!

Before it slips my mind again we should record in big black type the fact that W5BB marched out of bachelorhood last June. Haven't heard much from Tom since then but we are taking it for granted that he still can get on the air once in a while. If there is anyone knowing anything to the contrary, they may signify by the usual sign. W6NNR and W6MLG think we should count Catalina Island in on the WAAP. W6EXQ, a former dx man, although married, is now a 10-meter phone recruit.

W7GGG is giving 40 the works these nights although Doc claims to be so busy he seldom has time to punch the ol' brass anymore. Just listen to him almost any p.m. Another one who breaks loose on 40 nearly every night is W8OFN . . . also another Doc. It just occurred to me that W6ONQ was building a speech amplifier the last time I was in Oakland. At that time I thought he must be building it for someone else, but the vacant spot on the low end of 40 the past week tells me a double-cross is in effect and no doubt he is wafting his voice around the 20-meter phone band. And for 1400th time the guy that signs "W600" (W six-zero-zero) is not a BL, it is none other than W6TT signing his call as he should. I think that's one reason why Elvin uses phone more now . . . it's easier to identify himself.

**W9LEA-K7HCX TAKEN BY SUDDEN DEATH**

Whitney Lewis, W9LEA and ex-K7HCX was taken by death very suddenly Monday, September 30th. As far as anyone knew he had been in good health, and this news was a furious blow to those who knew him. Death was caused by a heart attack. Early in the afternoon Whit had a long QSO with his old school day pal, Ed Gilbert, W6GAT, and was as full of life as ever. I might mention that Whit, Ed and I were kids together. We went through the lower grades, obtained our first ham licenses at the same sitting, and if the truth must be known, we all used to "swipe" apricots from the same orchard, to say nothing of "finding" an occasional 2 x 4 to be used as an "aerial" pole.

Whit's first call in the spark days was 6AQV. His very first transmitter consisted of a buzzer whose contacts gave a good husky arc. With this "rig" he worked around the southwest part of Los Angeles. From this he graduated to the Ford spark coil and from here to a one kw. rock crusher type of rotary gap transmitter. After this period he lost interest for a few years. When Whit came back on the air he was issued the call, W6JYF, and was located at Manhattan Beach.

He was employed by the U. S. Postal Department and a few years ago was transferred to Fairbanks, Alaska. It was here under his new call of K7HCX that Whit made many friends throughout the world. Ham radio had a warm spot in the hearts of the Lewis family because it enabled them to keep in touch with their relatives and friends in Los Angeles through schedules with W6GAT. From Fairbanks Whit was transferred to Lake Andes, South Dakota, where he received his last call, W9LEA. From here he continued to make friends throughout the country with his personal type of QSO's. After Whit's QSO with W6GAT on September 30th, he contacted other stations around USA. Late in the afternoon the fire siren blew, and being a member of the volunteer fire department in this small town, he left to do his part. The fire wasn't much hut after it had been brought under control Whit asked a co-worker if he would take him home as he had a terrific pain in his chest. A doctor was called and respiration administered. He responded long enough to chat with his family for a few minutes, and then slipped away. Whit had made his last entry in his Log. I know the many friends he has made as W9LEA, K7HCX and W6JYF will join us in extending our sincere condolences to his family.

W6CUH Works a "9"!

W6CUH was over the other night. After chewing the rag about one thing then another, he

**M I C R O M E T E R  
F R E Q U E N C Y M E T E R**

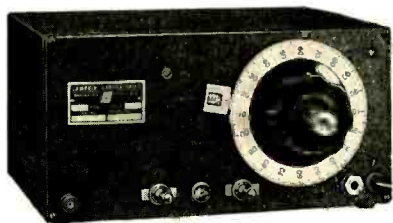

**. . . for police, relay-broadcast, aviation stations—a precision, heterodyne-type, band-spread instrument for checking any number of transmitters, 1.5 to 56 megacycles.**

- ACCURATE: better than 0.01%.
- CONVENIENT: calibrations show directly per cent deviation from assignment.
- ECONOMICAL: Type 103, maintained against WWV, \$90.00, net. Type 105, including quartz-crystal calibrator, \$135.00, net.

—Write for details—

**LAMPKIN LABORATORIES**

— Bradenton, Fla. —



**TURNER**

*Microphones*

Write for free new literature to

**The TURNER CO. Cedar Rapids, Iowa**

Crystals licensed under patents Brush Development Co.

said he would like to work a W9. Knowing that CUH hadn't been on the air for a couple of years we wanted to know, first, if he knew the code. He assured us that he did and after finding that he still knew what "A" was, we let him bang away. Yes, he worked a 9.

This just about winds up our session for November, but I would like to stress the point for you fellows to shoot us in any photo you may think would be of general reader interest. This column will continue to carry information about the x-dx men as long as there is anything to run.

Here is an idea that we may all enjoy. If any of you fellows have some pet idea of yours that you use around the shack, that would not be classified as a full length article, we would like to hear about them. It would more or less be considered under the heading of "A Short Cut to do This and That" or "A Good Way to Accomplish This or That," etc. I would not want to see just brainstorm, but rather tried and proven gadgets. Look around will you, gang, and see what you can dig up; the space is yours. I'll see you in December. P.S. W6CUH took care of my W9 quota.

U. H. F.

[Continued from Page 55]

Either W8CIR's portable rig is exceptional or the Maine stations lack oomph, for W1HDQ did not snag that state until the other Ed went to Maine on a vacation. HDQ has been kept plenty busy trying to be on 56, 112 and 224 megacycles, several evenings a week, in addition to work on the massed marathon reports. He has been getting good results on the rhombic and Vee beams for skip dx, the rhombic for W4-5 and the Vee for W9 and, of course, W6QLZ. Ed thinks that there is some discrimination in polarization even on skip, H to H and V to V being best. It will take a careful study of numerous reports to work this out, probably in view of variations in the gain of comparison antennas and their complex vertical patterns when several wavelengths high. There will be sharp differences in the relative signal strength from two antennas, sometimes favoring one and sometimes the other, in addition to whatever polarization effect is present. He notes that the rhombic gives particularly splendid performance on horizontally polarized transmission along its line of directivity.

A new antenna at W1HDQ is 8 vertical half waves, made up of four elements stacked vertically with a similar string a half wave away, center fed. This is something like a four section W8JK vertical but is directive broadside. The W8JK arrangement was fairly satisfactory at W9CLH when hung high. Both of these have fairly broad horizontal directivity but make the most of the signals, which are at low

# ATTENTION C W MEN!



THE  
NEW

## UNI-SIGNAL SELECTOR

**PROVIDES 100% READABILITY**

A combination electrical, mechanical and acoustical filter, this amazing device takes up where crystal selectivity leaves off—25-cycle band width gives super-selectivity to any receiver.

Connected in place of a regular speaker, it eliminates the interference but does not reduce the signal! Tube Hiss is completely gone—QRN, no longer troublesome! QRM is practically obsolete. Cuts right through those South American phones.

Can not be used on phone reception—cut over switch on Selector connects standard speaker for phone. With Selector "ON" you never know the phones are on the air! Peaked at 1000 cycles, all signals come in with the same clear, ringing tone. Absence of interference and back-ground noises makes the weakest signal quite readable.

Get yours now and begin at once to enjoy real CW reception! Once this good news gets around every CW Ham will have one. See your Meissner Parts Jobber TODAY!!

GET YOUR NAME IN NOW

Exclusive Amateur Catalog, listing only real Ham Products, now being prepared. Send your name in early for one of the first copies of this big book. Absolutely FREE. A post card will do.

DEPT. A-11

**Meissner** MT. CARMEL, ILLINOIS  
A FAMOUS NAME FOR TWO DECADES

vertical angles at this frequency. The gain compared with a double zepp is 4 to 12 db on receiving, getting 2 to 4 R better reports on transmitting. Who says that theory won't work? It is 40 feet off ground at the bottom, 75 at the top, and costs about \$2.00. But it takes plenty of tower.

Finally, W1LIG received a confirmation of his reception of the five-meter harmonic of W6NNR's twenty-meter phone on September 24, 1937.

W1LPF in Lowell, Mass., has worked six states in four districts this summer with a 6J5G ten-meter crystal, 6L6G doubler and 60 watts on a pair of 6L6's in the final. The receiver uses an 1852-6K8 converter.

Down the coast in Wilmington, Delaware, W3CGV says that Vince Dawson, W9ZJB, will set up there with 400 watts when he moves in October. Perhaps Vince is going after the ground wave stuff that he missed so much in Kansas City. CGV has ten states in five districts worked on 20 watts phone or 40 watts on c.w. on 57,408 kilocycles. He believes that he is the only active station on the band in Delaware. (Later—Pauline says that Vince got another job so will stay in Kansas City.)

Kenneth Kingsbury, W3HOH, was away when W6QLZ came through so is still stuck at

7 districts and 17 states. He is up to 200 stations worked this year, a good share of them on ground wave.

August averaged poor but with a few good days at W6QLZ. On the first he worked W5EHM EEX; and EHM again on the 8th. On either the 12th or 13th, he heard W7FDJ and W9ZJB. On the 19th he raised W9ZJB AHZ EET and exchanged calls with W9GHW (all in Missouri, but both ends of the state) without contacting. Clyde says that on ten it is now possible to work anybody in Arizona south of Phoenix, up to 200 miles, but he cannot hear anyone north. He hooks W6OVK at 125 miles on 29 megacycle c.w. but even with an R7 carrier the modulation does not get through. W6PBD and W6SAV in Douglas and Bisbee, 200 miles away, sometimes are up to R9.

From Fort Wayne, W9QCY sends in a complete five-meter log for May 2, 13, 21, 26; June 4, 13, 24, 27; July 2, 3, 11, 23 and 30. Calls heard or worked include W1KXK BHJ W3HDJ W4EDD FLH W5AJG EHM VV ATW DXB W9ZJB QCL UJE AHZ CLN VWU ZQF BJV.

The five-meter band in England was not dead in May and June. Some Italian and other signals came through on a number of days, according to the few listeners with time to devote to the otherwise dead band. G8OS heard some television with slow fading on 100 megacycles for nine minutes on June 23, apparently being shut off abruptly. The August issue of the *T&R Bulletin* was published in London on schedule, believe it or not. 2DYN in England heard good ten-meter signals on July 18, 19 and 21. Five eastern districts plus W5BEK and W9CJW came through on the 18th. KCAUSA at Antarctica and W1FH were heard working each other. Five and ten meter Italian signals also came through on short skip.

## THE "RADIO" NOISE REDUCTION HANDBOOK

Tells in simple language, how to eliminate or greatly reduce every form of radio noise with the exception of natural static.



Use of the systems described will frequently mean the difference between an unintelligible signal and one which can be read with ease. Emphasis is laid on elimination of noise at its source. When this is impractical, a highly effective modification of the noise balancing method, which brings equally good results, is explained. A complete

description, theoretical and constructional, of the application of this method is included.

35c in U.S.A. Elsewhere, 40c

THE EDITORS OF **RADIO** 1300 Kenwood Road, Santa Barbara CALIFORNIA

## EVERYTHING IN RADIO FOR ALL YOUR NEEDS



This one big book serves your entire requirements. It includes sets, parts and supplies, public address systems, amateur equipment, testers, kits and fluorescent lighting... the nationally known favorites at lowest possible prices. Our prompt, efficient service will please you. Write today and get your copy of this...

**BIG FREE CATALOG**

**BURSTEIN-APPLEBEE COMPANY**  
1012-14 MCGEE STREET, KANSAS CITY, MO.

ABOVE 112 MEGACYCLES

W1HDQ got through to W3BZJ, 200 miles away, on 112 Mc. in a cross-band contact but could not make it two-way on the same band. Ed used an F.M. receiver so he may have used an F.M. transmitter. BZJ is reported to have a Hallicrafter F.M. job. HDQ's new antenna is a stacked broadside that looks like one H above another, center fed. This is a bidirectional array requiring only 90 degrees rotation for full coverage. It is inside of his tower, the similar one for five meters being outside.

From Franklin Square, Long Island, W2KYT has worked five states in three districts on 2½ but has left the band because of b.c.l. interference and other reasons. He says that some stations seem to dominate the band, plus added interference from broad low power rigs with a \$2 investment. Since 56 Mc. went stabilized, no reports of b.c.l. interference have come in to this column except for cheap (?) receivers without an r.f. stage, so the answer to that problem on 2½ may be an m.o.p.a with a good coaxial-line-controlled oscillator, or crystal control, plus a well-matched feeder to an antenna up out of harm's way. Has anyone had any experience along this line? When a band is nearly as wide as from long waves down to forty meters, it should not be hard to squeeze the low power boys into it with a two-bit investment in pipe to cut down frequency modulation. KYT says that W1HDQ LAS MRF W2LAU W3BZJ are quite active and interested in developing the band.

W3HOH lacks a good receiver, he says, but has raised four states in three districts, best dx being about 55 to 60 miles!

W6BJI uses a 6V6GT crystal on 40, 6V6G, 6L6GX, and HK24 doubling to 2½ with a folded coaxial line in the plate circuit to give five watts output from nine input. He says that he is a firm disciple who thinks that lines are the ultimate for resonant circuits at u.h.f. His receiver is soon to get a line in it but is now using a 6J5GT with separate quench. Anyhow, he worked W6KIN in an airplane 255 miles away and 9700 feet up, to establish a new 2½-meter elevated location record.

Stations in Santa Rosa, California, include W6KIN ADM MGL BJI. On August 4, W6KIN on Mt. St. Helena worked W6OMC on Mt. Elizabeth in the Sierra Nevadas, for a 140 mile contact.

W6QLZ is using a 955-6C5G converter on 2½ but wishes for a good but not too expensive manufactured product. He will be on 112.1 with 80 to 90 watts during the winter; things are dead until the college gang starts up. The state police are putting a relay transmitter on 116.15 on a mountain peak to relay 35.7 car signals over the hump. Extensive tests by W6GZU, chief engineer, showed the

# "MARVELOUS, ME EYE!" SAID PROFESSOR OSWALD SQUEEGEE



PROFESSOR OSWALD Z. SQUEEGEE, Ph.D., ABC, PDQ., etc., turned an austere eye on the eager, up-turned faces of his class in industrial engineering. Then, in the simple dignity becoming to a great man (which everyone, including himself, admitted he was) the Professor spoke:

"Listen, you dimwits," he thundered. "If there's one thing I want to pound through your thick skulls, it's simply this: The easiest

way of doing any job is generally the complicated way. The hardest way is to keep plugging along until you've developed the simple way. That takes time. It takes patience and—ahem!—it takes brains."

Here the Professor paused, reached for the glass of water on his desk, got the ink by mistake, and sipped it calmly. Then he cleared his throat and continued:

"Some of the world's greatest inventions have been so simple that everyone wondered why Noah hadn't thought of them while he was sitting in the Ark.

"What, for instance, was more logical than putting an eraser on the end of a pencil? What was more logical than the safety razor? What was more logical than, instead of making nuts to fit the wrench, to make the monkey fit the nuts. I mean—ahem—the monkey wrench."

Fishing through the pile of notebooks, overshoes and chewing gum wrappers on his desk, Professor Squeeggee found a Sprague Koolohm Resistor and held it up.

"Now here is a practical example of simplified improvement," he bellowed. "One of you clucks brought this resistor in and told me how marvelous it was.

"Marvelous, me eye! The only thing marvelous is that some resistor manufacturer didn't do it sooner—that it took a condenser manufacturer to figure out how much simpler it would be to insulate the wire itself, instead of trying to insulate the resistor after it is wound without shorting a lot of turns, or without having a coating that will crack, chip or maybe even peel like a banana. Now hand me that crowbar and cold chisel and I'll show you something real."

After 15 minutes' hard work and 3 skinned knuckles, the Professor pried the outer ceramic shell off the Koolohm.

"There it is," he beamed, "a practical example of a little simple simplification that meant a whale of a big improvement. Larger wire. No danger of shorted turns. More resistance in less space. So moisture-proof a duck's back would turn green with envy. So well designed it runs cooler than any other resistor of equal size and rating. The only resistor with an automatic overload indicator and the first . . ."

Just then the 'phone rang. It was the Professor's wife telling him he was already three hours late for lunch. Without even waiting to bid his class goodbye, he laid a handkerchief carefully on his head, crammed his hat into a pocket, shut the door and walked calmly out through the open window.

## SPRAGUE PRODUCTS COMPANY North Adams, Mass.

P.S.—See Koolohms at our Sprague jobber's. Free catalog on request.

extended double zepp vertical to be superior for getting over mountains, so Clyde is also putting one up.

The gang in the southern and western suburbs of Chicago are becoming very active. They plan to have one or more forums for 2½-meter hams, devoted largely to transmitter, receiver and antenna construction and improvements. It may be November before the first meeting some place in Chicago, is held. Anyone who is interested enough to attend a meeting or two should write to W9AVE and encourage him to go ahead with the project.

W9PNV in Riverside has worked W9EDG in north Evanston. George had 29 contacts in two weeks, good considering his location and the activity locally. He threw up a six element beam that rotates on his 20-meter job, being one of these Sterba folded ice-melting affairs that is like W1HDQ's except that the top and bottom quarter waves are folded together so that it becomes a continuous wire, opened at a bottom corner where it seems to match a 600-ohm line. The frame is a 13 foot vertical 2x1, with five-foot crosspieces at top and bottom from the ends of which the wires are suspended.

W9AOB of Stancor lives in Harvey, Illinois. He has one of the HY75 transceivers described

in RADIO last spring, with which he operates portable mobile out to 15 miles or so, getting into Chicago's south side. He found that a ground plane vertical antenna 20 feet high would make it, while four half waves in an H and a dipole centered ten feet off ground were good only for about five miles.

W2BZB writes that he has worked five states in four districts on 2½ but says that he has not raised any outstanding dx lately.

### 400 MEGACYCLES

In a recent note from W6IOJ (dated September 24, 1940) John states that he and W6MYJ succeeded in making an 11-mile contact on 400 Mc. after a series of preliminary tests. They also expect to lengthen the distance by a considerable margin in the near future. Both W6IOJ and W6MYJ were using WE 316-A tubes as oscillators in the transmitters, and both were using a 955 acorn in the receiver. W6MYJ was using 30 watts input at a fixed location at his home and W6IOJ was using 5 watts input to the transmitter which was mobile in his automobile. Both were using simple half-wave doubles as antennas.

### SORRY, W6MKS

We regret that due to a misunderstanding an error appeared in the October UHF Honor Roll. W6QZA and W6OIN were reported as having contacted at 215 miles. It should have read "W6QZA and W6MKS." The record is the more laudable because W6MKS was operating from his home station.

W6QZA, who has been the northern end of many 200 mile 112 Mc. contacts, is threatening to get on 224 Mc. If he does, maybe there will be some new records for 224 Mc. Or does it take Summer temperature inversion?

### Postscripts and Announcements

[Continued from Page 61]

municipal, State, Interzone and Zone Police, Marine Fire, Special Emergency and Forestry Stations.

- 11 Rules Governing Miscellaneous Radio Services, including Geological Stations, Special Press Service (Mobile Press Stations), Relay Press Stations, Intermittent Service (Motion Picture Stations). 5 Cents
- \*12 Rules Governing Amateur Radio Operators and Stations 5 Cents

## "RADIO" AMATEUR NEWCOMER'S HANDBOOK

Really two complete books under one cover, the big "Radio" Amateur Newcomer's Handbook contains everything needed to obtain a license and get on the air!



Easy - to - understand data on elementary radio theory (simplified), radio laws and regulations; how to learn the code; how to pass the amateur examination (including Editor's notes on new F.C.C. examination questions); detailed construction data

on simple receivers; a low-powered c.w. transmitter; and a beginner's phone transmitter.

Order from your favorite radio dealer, newsstand, or direct from us postpaid.

**35c in U.S.A., Elsewhere 40c**

THE EDITORS OF **RADIO** 1300 Kenwood Road, Santa Barbara CALIFORNIA



- \*13 Rules Governing Commercial Radio Operators. 5 Cents
- 14 Rules Governing Radio Stations in Alaska (other than amateur and broadcast), including Fixed Public Service, Public Coastal Service, Ship Service and Aviation Service. 5 Cents
- 41 Rules Governing Telegraph and Telephone Franks 5 Cents
- 42 Rules Governing the Destruction of Records of Telecommunication Carriers. 10 Cents
- 43 Rules Governing the Filing of Information, contracts, periodic reports, etc., of telecommunication carriers. 5 Cents
- 61 Tariffs—Rules Governing the Construction, Filing and Posting of Schedules of Charges for Interstate and Foreign Communication Service. 10 Cents

The following parts are in process of being printed and will be issued in due course:

- \*General Rules and Regulations (Part 2)

- \*Experimental Service Rules..... (Part 5)
- Ship Service Rules..... (Part 8)
- \*Miscellaneous Rules and Regulations .....(Part 71)

\*Most likely to interest RADIO readers.

**MEN WANTED**

Young men, 17 to 35, who are interested in radio and signaling are now offered one year's active duty with pay in the United States Naval Reserve.

Successful applicants for classification V-3 will be assigned for a period of four months to a communications school at the new million dollar Naval and Marine Corps Reserve Armory in Chavez Ravine in Los Angeles.

They will then be sent out to the fleet or to Naval shore stations as petty officers with the rating of Radioman or Signalman third class, for a period of eight months, completing a total of one year's active service. They will complete the balance of 4 years' service in Reserve or as an Inactive Reservist.

When recruits report for duty at the local school they will receive a full outfit of clothing. Food and quarters will be furnished at the armory and they will receive pay in accordance with their proficiency in radio work at the time of enlistment. Men holding commercial radio telegraph

# Have You Seen the New INCA TRANSFORMER CATALOG?



New type format of Bulletin L-45 permits much more space for descriptive material, charts, tables and diagrams. Lists the sensational new "TI-get" series of midget high fidelity transformers as well as standard transformers for Amateurs, Radio Broadcast, Sound Equipment, Television, and Replacement. All Inca transformers are treated by the exclusive "Climatite" system\* which has proven its worth in the most humid regions of the globe. *ONLY Inca transformers have Climatite\* treatment.*

\*Reg. U. S. Pat. Off.

*Get bulletin L-45 from your jobber or from*

## THE PHELPS DODGE COPPER PRODUCTS CORPORATION

INCA MANUFACTURING DIVISION—DEPARTMENT R

2375 East 27th Street

Los Angeles, California

or amateur radio operator licenses will be enlisted at a higher rate of pay. However, neither a license or familiarity with radio work is necessary for acceptance.

Frequent liberty will be granted the Reservists while enrolled in the school. Due to the increased needs of the service, there is a splendid opportunity for qualified radiomen and signalmen in the Navy at the present time and the Naval Reserve will furnish the Navy with them. The individual will have the opportunity of preparing himself for employment in the communication industries upon his return to civilian life after

completion of his year's active duty.

Application should be made immediately to Naval Reserve Headquarters at 1965 So. Los Angeles Street, Los Angeles, between the hours of 9 and 4.

**What's New in Radio**

[Continued from Page 66]

## Recording Blanks



Professional coated blanks, an entirely new semi-plastic material: Uni-Cord non-inflammable acetate coated cardboard blanks; constant velocity record for testing sound channels, calibrating pickups, checking turntables, etc.; stroboscopes, needles and styl. Universal also mfg. complete recording parts, complete machines and the Recorder Kit.

**UNIVERSAL MICROPHONE CO., Ltd.**  
Inglewood, Calif., U. S. A.

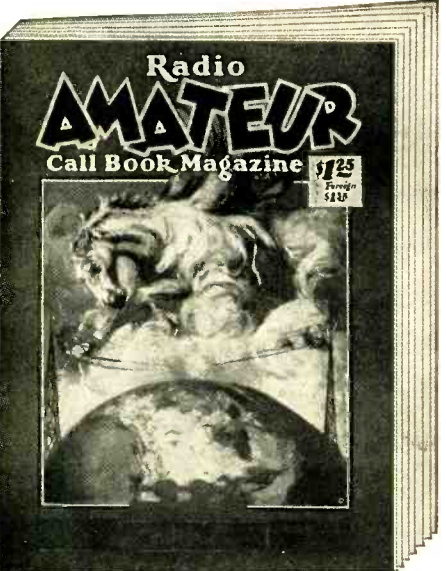

**Radio AMATEUR Call Book Magazine** #725  
Price \$1.25

**MARCH . . . JUNE . . . SEPTEMBER and DECEMBER**

Annual subscription \$4.00      Single copies \$1.25

**RADIO AMATEUR CALL BOOK, Inc.**  
608 S. Dearborn St.      Chicago, Ill., U. S. A.

designed for use wherever excellent tone quality and fidelity are required.

Also announced was a new type of baffle designed for mounting four 7-inch "accordion edge" high-fidelity RCA loudspeakers in both the new cabinets.

The 15¼-inch permanent magnet loudspeaker handles 15 watts of power, excellent for reproducing phonograph recordings or other sound under conditions of high noise level. The voice coil (impedance 8 ohms) is completely dust proof. It is designated as model MI-6237.

The console cabinet designed for the new mechanism is a brilliantly finished walnut unit built to give correct acoustic response. An acoustic phase inverter circuit is built into the cabinet to extend low frequency response. Model MI-6222, the cabinet stands 32" high, 24" wide and 14" deep.

The wall housing for the new speaker is of heavy veneer, finished in umber grey or, for installations where it is desirable to paint it to match its surroundings, in a neutral color. It measures 28" high, 19" wide and 13" deep, and is designed to give proper acoustic response. It is designated as Model MI-6223.

The new baffle (MI-6224) is cut to mount four RCA 7-inch "accordion edge" loudspeakers (MI-6234) in either the console cabinet or the wall housing mentioned above. Four matching transformers are supplied with and mounted on the baffle.

**HALLICRAFTERS AMATEUR TRANSMITTER**

Hallicrafters, in their new HT-9 amateur transmitter provide an example of highly refined design and sturdy construction combined with price economy made possible by the growing demand for ready-built transmitting equipment.

Five hand-switched channels are provided for operation on any frequency in any bands between 1.7 and 30 megacycles. These channels are set up by means of plug-in coil units, each of which contains its own tuning capacity and is pre-tuned to the desired frequency on installation.

Rated carrier power is 100 watts on c.w., 75 watts fully modulated on phone. The r.f. line-up consists of a 6F6 oscillator, 6L6 doubler and 814 power amplifier with automatic provision for using the 6L6 as oscillator when working straight through on the crystal frequency. The audio end employs a 6J7 input amplifier, 6J5 voltage ampli-

fier and push-pull parallel 6L6's coupled to the 814 through a special 3-winding transformer for properly proportioned simultaneous modulation of screen and plate. Four built-in power supplies provide separate supply sources for the r.f. exciter, r.f. final, audio voltage amplifiers and 6L6 screens, and plates of the 6L6 modulators.

Three meters provide a continuous check on all circuits. Because all exciter circuits are pre-tuned, the only tuning control on the front panel is that for the r.f. final tank. Other controls are the audio gain and switches for stand-by, plate power, filament power, band-changing, meter shift and C.W.-phone. The HT-9 is completely self-contained in a 28" x 18½" x 11½" steel cabinet with interlock safety switch on cover. Neatly screened openings in ends and covers provide ample ventilation.

[Continued on page 94]

### New Books

[Continued from Page 68]

and connectors, coaxial cable and connectors, insulators and insulating materials, this new catalog also contains a great deal of information on properties of insulating materials, fabricating methods, etc.

**RADIO AS A CAREER**, by Julius L. Hornung. Published by Funk & Wagnalls Company, New York, N.Y. 212 pages, 7½" by 5", price, \$1.50 in U.S.A.

This book is primarily written for the layman or beginning amateur who might be considering the field of radio as his career. The author conducts the reader through the various branches of the industry and describes the work of the radio operator—the ship or broadcast man, outlines the preparation necessary for the position of either, the duties of the operator, advancement in the field, the salaries offered, and the future of radio operating in general. He gives the same type of information for the radio serviceman, his place in the field, training for the position, etc.

The author also presents an outline of the various work available in radio engineering with details about the type of engineering courses offered in schools and colleges and stresses the necessity of basic training and study for the prospective engineer before he enters college. There is a brief historical review of radio itself, giving the important advances in the industry during the past twenty-five years. One of the most important sections of the book discusses the amateur operator and his contribution to the development

of radio. Mr. Hornung lays emphasis upon the importance of beginning as an amateur as an opening wedge into the field.

A new 64-page catalog of sound systems was recently issued by Montgomery Ward & Co. It illustrates and describes a complete new line of amplifiers for every purpose. It shows how to select a sound system for any hall or installation; what type speakers and how many; what microphone for the particular purpose; how much power needed in the amplifier, etc. A new copy can be obtained by writing Montgomery Ward & Co., Chicago.

### CATHODE-RAY TUBE CHARACTERISTIC BULLETINS

New technical bulletins covering 3-inch and 5-inch teletrons or Du Mont cathode-ray tubes for oscillograph applications, are available to anyone addressing Allen B. Du Mont Labs., Inc., 2 Main Avenue, Passaic, N. J.

These bulletins cover the various characteristics of teletrons in considerable detail, together with installation notes, typical power supply, positioning circuit, base connections and dimensions of each tube, which data will prove indispensable to users of such equipment.

W6QX's laundry-mark is W6QX.

# FREE

## 196 PAGE RADIO CATALOG



You never saw such values as Lafayette offers in this new 1941 radio amateur catalog. It's got all the latest nationally advertised ham equipment. Plus many items now out of manufacture. Money-saving prices, and everything guaranteed. A "ham" holiday between covers! If you don't know Lafayette value-giving, Lafayette selection and service, send for this big **FREE** Buying Guide today. If you *do* know, then no one has to urge you to tear out and mail the coupon at once.

Lafayette  
Radio



NEW YORK, N. Y.  
100 Sixth Ave.  
CHICAGO ILL.  
901 W. Jackson Blvd.  
ATLANTA, GA.  
265 Peachtree Street  
BOSTON, MASS.  
BROOK, N. Y.  
NEWARK, N. J.  
JAMAICA, L. I.

■ LAFAYETTE RADIO CORP.  
■ Dept. 6L—100 Sixth Ave., New York, N. Y.  
■ Rush FREE 1941 Catalog No. 82.

WORLD'S  
FINEST  
RADIO  
CATALOG  
FREE

NAME \_\_\_\_\_

ADDRESS \_\_\_\_\_

CITY \_\_\_\_\_ STATE \_\_\_\_\_

QUALITY ABOVE ALL

# SOLAR

CAPACITORS

Write for Catalog  
SOLAR MFG. CORP.  
BAYONNE, N. J.

# Q R X

By STUART D. COWAN, Jr., W2DQT

It was hot last night. After supper I glanced at the evening paper and then went upstairs and sat down in front of the radio table. The family had gone to the movies and I was left alone. The white faces of the still meters stared out of the black panels . . . it was funny, but I didn't feel like turning on the rig.

I decided to clean out my desk drawers. In the bottom of one of the drawers I came on a batch of crumpled papers with my scrawl on them—old sheets I had used to mark call-letters, dial settings, and QSO remarks on when the DX was still rolling in. With difficulty I extracted every last one of them from the drawer, and tilted the desk lamp so as to better read the faded writing.

August 6: YM4AA . . . "Ga om tks for call

—ur sigs weak today rst 349 . . ." Further down the page, in big block letters, was printed OE7EJ, and notes from the QSO . . . "Sure will QSL dr om!" I remembered that card from OE7EJ, the one with his picture on the back. He was a handsome, blond-haired lad about twenty-four years old with a faint smile etched in his finely chiseled face. That was in 1936 that I worked him.

August 16: 6:05 P.M. F3AM, written in a scrawly hand, and right underneath, "QRM from W9— washed him out!" Beneath this was some kind of an illegible diagram for a new antenna—that was never put up! I remember the QRM that day, too. Fifteen minutes later I worked ON4VW, and this QSO was evidently satisfactory.

August 24: FT4AE, along side of which was written, "New country for me!" Then some writing I couldn't read, and, 5:09 P.M. F3DR . . . "Ge mon ami mci pr votre . . . rst 569 ici Toulons." Under that was written: Nice chap, sked next week, look him up when go abroad!

September 4: URAK9 . . . wonder where he was, anyway . . . wouldn't QSL! And a few lines later came this fabulous entry: T4TWO . . . "ship off French Equatorial Africa!" What an imagination he must have . . . probably on the banks of the Wabash! And it was a long while before I caught on to that call!

That was the time ZZ2X was active. I missed him on the 10th—called him five times, too! Heard him tell someone he was a Greek

## MAILING LISTS

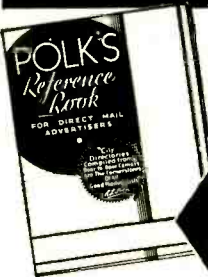

GET OUR FREE  
REFERENCE  
BOOK and  
MAILING  
LIST CATALOG

FREE

Gives counts and prices on accurate guaranteed mailing lists of all classes of business enterprises in the U. S. Wholesalers—Retailers—Manufacturers by classification and state. Also hundreds of selections of individuals such as professional men, auto owners, income lists, etc.

Write today for your copy

## R. L. POLK & CO.

Polk Bldg.—Detroit, Mich.  
Branches in Principal Cities

World's Largest City Directory Publishers  
Mailing List Compilers. Business Statistics. Producers of Direct Mail Advertising.

**NEW!**



### STACO

#### R. F. RELAYS

- 4 Ampere Contacts
- Larger Contact Spacing
- Shorter R.F. Path
- Triple-X Insulation
- Ball Bearing Pivot
- No AC Chatter
- Mycalex Units (Available)

Type RBA-1, SPST (double-break) 110 V, AC	<b>\$1.65</b> net
Type RBD-1, SPST (double-break) 6 V, DC	<b>\$1.95</b> net
Type RBA-2, DPST (single-break) 110 V, AC	<b>\$1.95</b> net
Type RBD-2, DPST (single-break) 6 V, DC	<b>\$1.95</b> net

See your jobber or write for complete STACO data.

**STANDARD ELECTRICAL PRODUCTS COMPANY**  
319 Sibley Street St. Paul, Minnesota

## RADIO

ship off the Azores. But a few days later came the biggest disappointment . . . Carefully printed in big letters was VS6AR! And part of what he said . . . "Using a V-beam on you that is why so loud . . . QTH Hong Kong . . ." Yea, but it was funny he asked how the Brooklyn Dodgers were doing!

OH3NP on Sept. 12th . . . "Pse QSL via S.R.A.L.—mani tks fb QSO hope meet you agn sn—73." Good operators those fellows. Say, here's something . . . a picture of ON4SG standing beside his rig—wonder where he got those giant meters? Boy, they're really something!

On the 28th EI4J gave me a long message for a radio pal of his—never saw so many Irish names in my life!

October 8: 4:46 P.M. D4PCU . . . "Ur rst 449 hr om . . . gld c u agn." Oh, here's his card—Leipzig, the City of Music, birthplace of Johann Sebastian Bach, 1723-1750 . . . the city of music. Under it was GM5YN's QSL—"Greetings from the land of whiskey and heather!"

That year when Christmas came, our greetings to foreign lands echoed back and forth on a frosty morning. Snow weighted down the tall pine trees, and the skating was good.

Winter melted into raw February, and DX wasn't so good. Windy March was a bad month for rotary beams, but that soon gave way to summer's heat.

On the last page was an entry: G2IM 6:35 P.M. . . . "Ur sigs pounding in here rst 589 at London tonight . . . wx cool and cloudy . . . input 25 watts . . . must run now 73 es Cheerio!" And on his QSL card the motto: "Always trying . . ."

Now they are gone—every one of them. What are they doing? Where are they? What will result from the death-rumblings of this changing world?

Perhaps some of us—on a silent, lonely night when the tubes in our transmitters are dark and our receivers silent—will find ourselves looking through old QSO notes and *their* cards. Perhaps we will bow our heads a moment for our brothers over the sea engaged in a life and death struggle, for they are the young, the strong, and the courageous.

Perhaps we shall say a prayer for peace and for friendship, for *all* of them in the war-ridden world where they are living and dying. And let us work to keep horrible, devastating, useless war forever from the shores of *our* hemisphere.

### Swap

On the same day that W8QBO moved, W8IQS moved into the house that W8QBO vacated and W8LKJ moved into the one which W8IQS vacated. Two existing antennas merely changed calls!

## Changes of Address

To become effective with  
**The Next Issue**  
must be RECEIVED at SANTA BARBARA  
by the 5th of this month

Address labels are shipped to our mailers on that date. Remember: under U.S. postal laws, magazines sent to an old address are junked unless forwarding postage has been left in advance with the postmaster; unlike letters and cards, magazines are not forwarded either free or collect (except to addresses in the same city).

Circulation Department

THE EDITORS OF **RADIO** 1300 Kenwood Road, Santa Barbara  
CALIFORNIA

Kindly send me the items listed below for which I enclose \$..... in payment.

- "Radio" (five issues)
- "Radio" (one year)
- "Radio" (two years)
- "Radio" (three years)
- "Radio" Handbook
- "Radio" Amateur Newcomer's Handbook
- "Radio" Noise Reduction Handbook
- "Radio" Binder
- W.A.Z. Map (6 great circle maps)

Name .....

Call .....

Address .....

Note: All shipments are prepaid by us. Current editions are always supplied unless previous or future editions are requested in the original order. California and Illinois customers: please add sales tax.

**Past Present and Prophetic**

[Continued from Page 9]

erators. Fixed-frequency operation of the diathermy outfit would require a change in the output circuit in most cases, since with most machines the amount of output is controlled by tuning the oscillator toward or away from the resonant frequency of the applicator pads and their connecting leads.

**Splatter Palaver**

We are pleased to note with satisfaction (to borrow an expression from one of our contented readers) that as we go to press one<sup>1</sup> manufacturer has brought out a line of chokes suitable for use in Smith's splatter squasher, and that another<sup>2</sup> is offering both chokes and special filament transformers. The immediate popularity of this device appears to indicate that a "splatter squasher" will soon be considered just as much a necessary part of a phone transmitter as is the power supply. If you are a phone man and missed the description of this amazing little gadget in the October issue, we suggest you hustle up one and cast an eye on page 16.

<sup>1</sup>Thordarson Electric Mfg. Co.

<sup>2</sup>Precision Transformer Co.

Cornell University has linked electrical brain waves directly to human intelligence.

**What's New in Radio**

[Continued from page 91]

**BROWNING 5-10 METER CONVERTER**

The Browning Laboratories, Winchester, Mass., have announced an extremely compact 5-10 meter converter for receiving two bands of frequencies, when used in conjunction with any mobile, home, or aviation receiver.

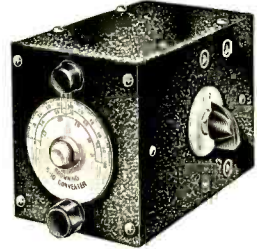

The receiver to which the converter is attached acts as an i.f. amplifier as well as supplying plate and filament voltage for the 6K8 tube used in the converter. Four separate low-loss tuned circuits are employed resulting in exceptional performance. Isolantite insulation is employed on all tuning and trimmer condensers. The BL-510 is described in detail in bulletin 106 available from jobbers or directly from the Browning Laboratories.

**ELECTROPLATING KIT**

Rapid Electroplating Process, Inc., 1414 South Wabash Avenue, Chicago, Illinois, has developed a special brush method of electroplating common or precious metals upon any metallic base. Of particular interest to amateurs, broadcasters, and equipment designers is the fact that an inexpensive kit is available which will enable the user to electroplate with silver any surfaces where high conductivity is of greatest importance. Switch contacts, plugs and jacks, high-frequency coils, and many other surfaces may be inexpensively electroplated to improve conductivity, increase Q, and reduce contact resistance. Complete information upon the process and the kits may be obtained from the manufacturer.

**FCC Defines . . . .**

**Ownership of Premises**

In a recent F.C.C. release the information is given that the premises upon which an amateur radio station is placed must be *fully* under the control of a citizen. Joint ownership of premises between an alien and the person who is applying for the station license makes it contrary to regulations for a station license to be assigned.

The call letters assigned to the private plane of James Stewart, movie actor, are KHJIM.

**Complete RADIO COURSE \$1.95**

Exact reprint of \$39.00 Radio Tech. Institute course. All lessons, supplementary material, review questions combined in a single large book (8 1/2" x 11") published 1940. Amazing bargain in radio training. Limited quantity at special \$1.95 price. Money-back guaranteed. Send only \$1.95 as full payment for complete course or write for circular.

**SUPREME PUBLICATIONS, 3727 W. 13th St., Chicago, Ill.**

**POSTPAID**

SEND POSTAGE STAMP FOR

**CATALOG**

**BOOKS, MAGAZINES  
MAPS, BINDERS**

---

**THE EDITORS OF RADIO** 1300 Kenwood Road, Santa Barbara CALIFORNIA

## Advertising Index

Aerovox Corporation.....	78	RADIO .....	75
Biley Electric Company.....	81	RADIO <i>Amateur Newcomer's Handbook</i> ....	88
Bud Radio, Inc.....	69	RADIO Binder.....	96
Burstein-Applebee Company.....	86	RADIO Catalog.....	94
Capitol Radio Engineering Institute.....	80	RADIO HANDBOOK.....	6, 7, 8
Centralab .....	71	RADIO <i>Noise Reduction Handbook</i> .....	86
Eitel-McCullough, Inc.....	67	Radio Publications.....	93
Hallicrafters, Inc., The.....	3	RADIO <i>WAZ Map</i> .....	96
Henry Radio Shop.....	73	Radio Amateur Call Book, Inc.....	90
Hytronic Laboratories.....	Cover III	RCA Manufacturing Co., Inc.....	63, Cover IV
Johnson Co., E. F.....	77	Radio Mfg. Engineers, Inc.....	4
Lafayette Radio Corp.....	91	Solar Manufacturing Corporation.....	91
Lampkin Laboratories.....	84	Sprague Products Company.....	87
Mallory & Company, P. R.....	83	Standard Electrical Products Co.....	92
McGraw-Hill Book Co., Inc.....	82	Supreme Publications.....	94
Meissner Manufacturing Co.....	85	Taylor Tubes, Inc.....	Cover II
Ohmite Manufacturing Co.....	79	Turner Co., The.....	84
Phelps-Dodge Copper Products Corp.....	89	United Catalog Publishers, Inc.....	95
Polk & Co., R. L.....	92	Universal Microphone Company, Ltd.....	90

*New Edition*

## It's A Masterpiece

Took 5 years and thousands of dollars to develop to its present size—yet it costs you only \$2.50

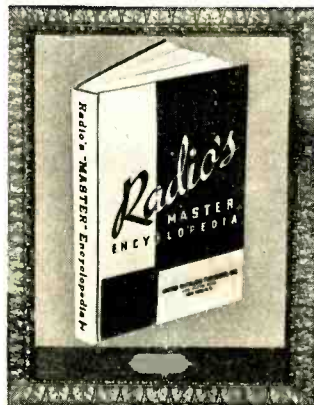

- Bound in one large volume
- Replaces bulky files
- Completely indexed
- Saves Time and Money

- Indispensable for every-day reference
- Approved and with the cooperation of the Radio Manuf. Group

Contained within the hard covers of this 750 page book are the listings of many thousands of items from transmitting sets to coils and plugs. Beautifully illustrated with complete specification and prices. The RADIO'S MASTER ENCYCLOPEDIA is a "must" book for all those who buy, sell or specify radio parts and

accessories. Price is \$2.50 in U.S.A., elsewhere \$3.00. Remittance with order saves you transportation charges.

Order your copy TODAY and start the latest edition of RADIO'S MASTER ENCYCLOPEDIA on its way. Do it NOW.

**UNITED CATALOG PUBLISHERS, Inc., 230 Fifth Ave., New York, N. Y.**

# RADIO BINDER

Keep your copies of RADIO and your big "Radio" Handbook in this handsome binder!

Holds a full year's copies of RADIO and the "Radio" Handbook, in addition to one smaller book by the Editors of RADIO. Each book or magazine may be inserted or removed at will and the sturdy, red imitation leather binding which is embossed in gold, will last a lifetime!

**1.50** in Continental U. S. A. Elsewhere, **1.75**

THE EDITORS OF **RADIO** 1300 Kenwood Road, Santa Barbara CALIFORNIA

# NEW W.A.Z. MAP

The "DX" map by the Editors of "Radio" consists of the W.A.Z. (worked all zones) map which shows in detail the forty DX zones of the world under the W.A.Z. plan. This has become by far the most popular plan in use today for measurement of amateur radio DX achievement.

An additional feature of this new, up-to-date edition is the inclusion of six great-circle maps which enable anyone, without calculations, to determine directly the great-circle direction and distance to any point in the world from the base city for the map in use!

**POSTPAID 35c ANYWHERE**

Seven international postal reply coupons accepted as 35c

THE EDITORS OF **RADIO** 1300 Kenwood Road, Santa Barbara CALIFORNIA

## *F. C. C. Notes . . . .*

### New Television Station for Manhattan

The Federal Communications Commission has affirmed its June 18 tentative grant of a construction permit to Bamberger Broadcasting Service, Inc., for a new television station in New York City to use channel No. 6 (96,000-102,000 kilocycles) with 1 kilowatt aural and visual power, A3 and A5 emission.

Confirmation was made upon showing that, in fostering television development, the applicant will test vertical and horizontal antenna systems, experiment with FM (frequency modulation) sound carrier, and make comparisons of pictures using from 441 to 729 lines and 15 to 30 frames.

### Color Television

The latest development in the radio art seems to be the practical solution of the problem of television with color. A demonstration of a simple system of sending and receiving television images in full color was given for Chairman Fly of the FCC in New York on August 29th. The system has been developed by CBS through the efforts of its well known television engineer, Dr. Peter C. Goldmark.

### B. C. Frequency Reallocation

The FCC has announced that March 29, 1941 will be the date for putting into effect the reallocation of frequencies in the broadcast band in accord with the provisions of the North American Regional Broadcasting Agreement. The result of this change will be that the majority of the broadcast stations now operating on frequencies above 730 kc. will be moved from 10 to 30 kilocycles higher in frequency. The demand for crystals in the next few months should keep the crystal manufacturers plenty busy—or maybe the demands of the stations on the in-between frequencies can be met by exchanges of crystals and spare oscillator units to limit the number of completely new units that will be required.

. . .

**Well!**

In 1923 superregenerative receivers were widely publicized as one-tubers capable of extraordinary dx and loudspeaker operation with a table-top loop antenna.



# Buyer's Guide

## Where to Buy It

### PARTS REQUIRED FOR BUILDING EQUIPMENT SHOWN IN THIS ISSUE

The parts listed are the components of the models built by the author or by "Radio's" Laboratory staff. Other parts of equal merit and equivalent electrical characteristics usually may be substituted without materially affecting the performance of the unit.

#### SHERROD TRANSMITTER

Page 10

C<sub>1</sub>, C<sub>2</sub>, C<sub>3</sub>, C<sub>4</sub>—Bud 898  
C<sub>5</sub>—Johnson 150DD45  
C<sub>7</sub>, C<sub>8</sub>, C<sub>9</sub>, C<sub>10</sub>, C<sub>11</sub>, C<sub>15</sub>, C<sub>17</sub>, C<sub>18</sub>, C<sub>19</sub>, C<sub>21</sub>, C<sub>22</sub>, C<sub>23</sub>  
C<sub>25</sub>, C<sub>26</sub>, C<sub>27</sub>—Aerovox 1450  
C<sub>11</sub>, C<sub>12</sub>, C<sub>13</sub>, C<sub>16</sub>, C<sub>20</sub>, C<sub>25</sub>—Aerovox 1456  
S<sub>1</sub>—Centralab 2545  
RFC—Bud 920  
RFC<sub>1</sub>—Bud 568  
J<sub>1</sub> to J<sub>9</sub>, inclusive—Mallory-Yaxley A-2  
X—Bliley BC3  
Flexible shaft couplings—Cardwell A  
Thru-Panel insulators—Johnson 42 and 42J  
Stand-off insulators—Johnson 22  
Jack-top stand-off insulators—Johnson 22J  
L<sub>1</sub> to L<sub>4</sub>, inclusive—Bud-OEL series  
L<sub>5</sub>—Bud OCL series  
Cone insulators—Johnson 604  
24's—Heintz and Kaufman  
35T's—Eitel-McCullough

#### SUPERREGENERATIVE 224 MC. RECEIVER

Page 14

C<sub>1</sub>—Modified Cardwell Trim-Air  
C<sub>2</sub>—Aerovox 1468  
C<sub>3</sub>, C<sub>4</sub>—Aerovox type 84  
C<sub>5</sub>, C<sub>6</sub>—Aerovox type PRS  
C<sub>7</sub>—Aerovox 1467  
R<sub>1</sub>, R<sub>2</sub>, R<sub>3</sub>—Centralab 710  
R<sub>4</sub>—Centralab 714  
R<sub>5</sub>—Centralab 72-122  
R<sub>6</sub>—Ohmite "Brown Devil"  
T<sub>1</sub>—Thordarson T-13A35  
HY615 and 6J5GT Hytron  
6F6—RCA

#### CANN-ULRICH 1 1/4 TRANSMITTER

Page 16

C<sub>1</sub>, C<sub>2</sub>, C<sub>3</sub>, C<sub>4</sub>—Sprague IFM  
C<sub>4</sub>—Sprague UT8  
T<sub>1</sub>—Stancor A4706  
T<sub>2</sub>—Stancor A4723  
T<sub>3</sub>—Stancor A3845 or A3891  
S<sub>1</sub>—Bud SW1003  
S<sub>2</sub>—Bud SW1009  
R<sub>1</sub>—Centralab 516

R<sub>2</sub>—Ohmite Brown Devil  
R<sub>3</sub>—Yaxley type M  
Cabinet—Bud 999  
Chassis—Bud CB1192  
Pilot light—Bud JLI694F  
Tubes—All Hytron  
Dynamotor—Carter LAR-413

#### GOODE GRID-MODULATED TRANSMITTER

Page 22

C<sub>1</sub>, C<sub>2</sub>, C<sub>3</sub>, C<sub>7</sub>, C<sub>8</sub>—Aerovox 1467  
C<sub>1</sub>—Hammarlund MC-100-SX  
C<sub>5</sub>, C<sub>6</sub>, C<sub>10</sub>, C<sub>12</sub>, C<sub>13</sub>—Aerovox 1450  
C<sub>9</sub>, C<sub>11</sub>—Hammarlund MC-100-SX  
C<sub>14</sub>—Aerovox 1652  
C<sub>16</sub>—Cardwell XG-110-XS  
C<sub>16</sub>, C<sub>18</sub>—Aerovox 684  
C<sub>17</sub>—Aerovox PRS50  
C<sub>19</sub>, C<sub>22</sub>, C<sub>23</sub>—Aerovox PRS450  
C<sub>20</sub>, C<sub>21</sub>, C<sub>24</sub>, C<sub>25</sub>, C<sub>26</sub>, C<sub>27</sub>—G. E. Pyranol  
R<sub>1</sub>, R<sub>2</sub>, R<sub>3</sub>, R<sub>7</sub>, R<sub>8</sub>—Centralab 514  
R<sub>2</sub>, R<sub>4</sub>, R<sub>5</sub>, R<sub>13</sub>—Ohmite Brown Devil  
R<sub>9</sub>—Centralab 72-105  
R<sub>10</sub>—Ohmite 0968  
R<sub>11</sub>—Ohmite 0783  
R<sub>12</sub>—Ohmite 0625  
S<sub>1</sub>—Centralab 2521  
Feed-through insulators—Johnson 44 and 42  
RFC<sub>1</sub>, RFC<sub>2</sub>, RFC<sub>3</sub>—Bud 920  
RFC<sub>4</sub>—Bud 568  
Crystals—Bliley BC3 and B5  
6L6, 807, 6V6, 83V and 866-A's—RCA  
100-TH's—Eimac  
866's—General Electric  
RY—Staco RBA-1

#### VERSATILE KEYING MONITOR

Page 28

Speaker—Wright Decoster N5LBU with trans.  
C<sub>1</sub>, C<sub>2</sub>, C<sub>3</sub>—Sprague TC  
R—Centralab 710

#### HAYES A.C.-D.C. TRANSMITTERS

70L7-GT C.W. Rig

Page 30

C<sub>1</sub>, C<sub>2</sub>, C<sub>3</sub>, C<sub>4</sub>—Sprague TC-11  
C<sub>1</sub>—Hammarlund SM-100  
C<sub>6</sub>—Aerovox PRS150-24  
C<sub>7</sub>—Aerovox PRS150-12

[Continued on Page 98]

# The Marketplace

## Classified Advertising

(a) Commercial rate 10c per word, cash with order; minimum, \$1.00. Capitals: 13c per word. For consecutive advertising, 15% discount for 3d, 4th, and 5th insertions; 25% thereafter. Break in continuity restores full rate. Copy may be changed as often as desired.

(b) Non-commercial rate: 5c per word, cash with order; minimum, 50c. Available only to licensed amateurs not trading for profit; our judgment as to character of advertisement must be accepted as final.

(c) Closing date (for classified forms only): 25th of month; e.g., forms for March issue, published in February, close January 25th.

(d) No display permitted except capitals.

(e) Used, reclaimed, defective, surplus, and like material must be so described.

(f) Ads not relating to radio or radiomen are acceptable but will be grouped separately.

(g) No commissions nor further discounts allowed. No proofs, free copies, nor reprints sent.

(h) Send all Marketplace ads direct to Santa Barbara accompanied by remittance in full payable to the order of Radio, Ltd.

**CUSTOM**—built factory job. 200 watt 5 bands phone or c. w. 36 inches completely inclosed. Relay controlled 616-807-TZ40s—class B TZ20s \$150.00 W5EPB.

**WRITE**—Bob, W9ARA, for the best deal on all amateur receivers, transmitters, kits, parts. You get best terms (financed by myself); best trade-in; personal cooperation; lowest prices. Prompt delivery of the new NC-200 and all other newest 1941 receivers. New Howard 460s with crystals \$59.95, SX-23s \$79.50. Write. Bob Henry, W9ARA, Butler, Missouri.

**RECONDITIONED**—guaranteed amateur receivers and transmitters at lowest prices. All makes and models cheap. Ten day free trial. Terms. Write for free list. W9ARA, Butler, Missouri.

**SEVERAL**—guaranteed reconditioned 350 watt JRA3 110-v. A.C. light plants at \$45.00. Ideal for amateurs. Write Katolight Company, Inc., Mankato, Minnesota.

**CHASSIS**—panels, portable cabinets, racks, specials. R. H. Lynch. 970 Camulos St., Los Angeles, California.

**BUY**—direct for less. Complete line for amateurs. Universal 125 watt class "B" output \$10.00 postpaid. Write for list. PRECISION TRANSFORMER COMPANY, Muskegon, Michigan.

**QSL'S**—and Ham Stationery . . . W8JOT. Box 101, Rochester, N.Y.

**CRYSTALS**—in plug-in heat dissipating holders. Guaranteed good oscillators. 160M-80M AT \$1.25. 40X \$1.65. 80M vari-frequency (5 Kilocycles Variance) complete \$2.95. State frequency desired. C.O.D.'s accepted. Pacific Crystals, 1042 S. Hicks, Los Angeles, California.

**"QSL'S"**—Samples. W9RUJ, Auburn, Nebraska.

**QSL'S??—SWL'S??—Ham Christmas Cards??—Samples??** W8DED. Holland, Michigan. (Bibley Crystal Sales).

**COMMERCIAL**—radio operators examination questions and answers. Two dollars per element. G. C. Waller, W5ATV, 6540 E. Washington Blvd., Tulsa, Oklahoma.

**WANTED**—Used Ham Transmitter. Serviceman's test equipment, manuals. Write W9ACT, 517 West 20th St., Sioux Falls, South Dakota.

**TRADE METERS**—Analyzers. Checkers. Parts. Roe, 6144 South Park, Chicago, Illinois.

**SELLING**—Low power transmitter, relay rack, K.W. power supply, and high voltage variable condensers. W6OFQ, San Mateo, California.

### Buyer's Guide

[Continued from page 97]

R<sub>1</sub>—IRC BT-1/2  
R<sub>2</sub>—Ohmite Cordohm  
L<sub>1</sub>—Bud OEL coils  
CH<sub>1</sub>—Stancor C-1003  
X—Bibley crystal for band in use  
S<sub>1</sub>, S<sub>2</sub>, S<sub>3</sub>—Arrow H&H

Four-Tube 160-Meter Phone

Page 16

C<sub>1</sub>, C<sub>3</sub>, C<sub>4</sub>, C<sub>5</sub>—Aerovox 1467  
C<sub>2</sub>, C<sub>6</sub>—Sprague TC-11  
C<sub>7</sub>—Hammarlund SM-100  
C<sub>8</sub>—Sprague "Atom"  
C<sub>9</sub>—Aerovox PRS150-24  
C<sub>10</sub>—Aerovox PRS150-12  
R<sub>1</sub>, R<sub>4</sub>, R<sub>5</sub>—IRC BT-1/2  
L<sub>1</sub>—Bud OEL-160  
CH<sub>1</sub>, CH<sub>2</sub>—Stancor C-1002  
T—Stancor A-4707  
X—Bibley 160-meter LD-2  
35L6-GT, 12J5-GT, 35Z4-GT—RCA

# The NEW RADIO HANDBOOK

(SEVENTH EDITION)

608 PAGES

CLOTH-BOUND—GOLD STAMPED

\$1.60

ORDER NOW—SEE PAGES 6 and 7.

# A new Record FOR 1/4 METER OPERATION!

Any amateur will tell you that UHF operation is the real test of quality and performance of a radio tube and that 1 1/4 meters provides the stiffest test of all. So when HYTRON HY615 tubes helped to establish a new world's record for 1 1/4 meter operation (on Aug. 18, 1940, by W610J and W6LFN) it only proved our contention that Hytron tubes are "for those who want the best."

Hytron UHF tubes have been the choice of amateurs and engineers since their introduction two years ago. Their greater efficiency means lower power drain, less expensive modulators and power supplies for the same power output as other larger tubes. No wonder more Hytron UHF transmitting tubes are in use by amateurs than any other brand!

## ALL HYTRON TUBES ARE QUALITY TUBES

With Ratings That Are For Continuous-Service Operation

Other outstanding Hytron transmitting tubes are the instant-heating RF beam-power tetrode and the twin triode modulator. These tubes are now first choice for portable and mobile rigs. Thousands of them sold in the past year attest to their superiority.



### HY69 R.F. BEAM

**\$3.50 net**

40-watt plate dissipation allows 50% more output on 'phone than equivalent cathode-type HY61/807. Equally as efficient when used in AC-operated transmitters as a buffer or final amplifier.

### HY31Z MODULATOR

**\$3.50 net**

A zero-bias twin triode designed primarily for Class B modulator applications. An ideal companion to the HY69 and HY75 tubes.



Hytron transmitting tubes licensed by Radio Corp. of America for your protection.

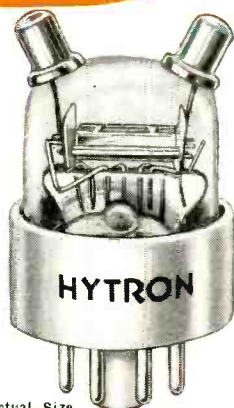

Actual Size  
**HY615, HY114 \$2.00 net**

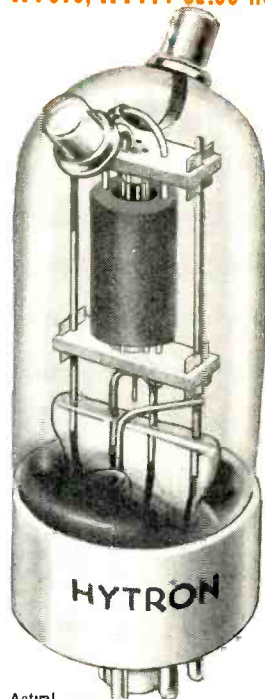

Actual Size  
**HY75 \$3.75 net**

# HYTRONIC LABS.

23 New Darby St., Salem, Mass.



A DIVISION OF  
**HYTRON CORP.**

Manufacturers of Radio Tubes Since 1921

# This ONE TUBE covers them all!

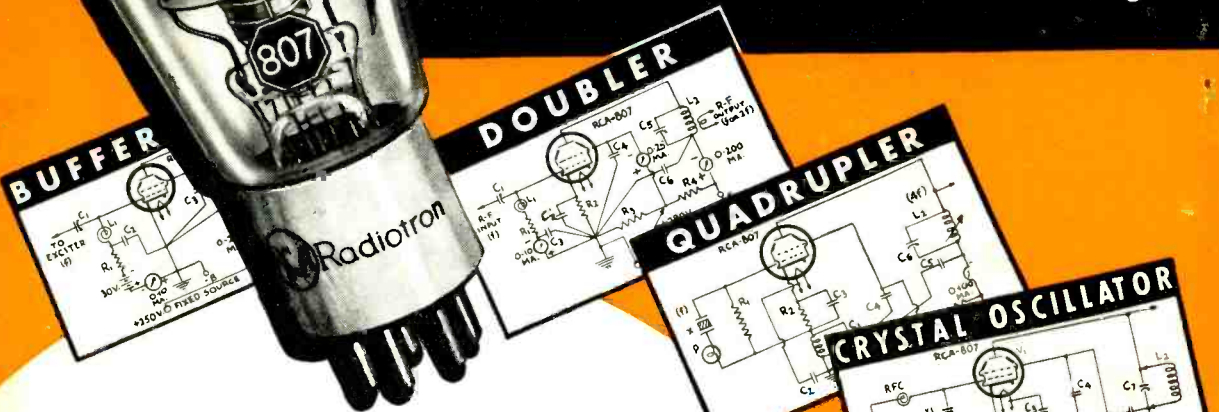

## RCA-807 "Little Magician" of Beam Power Amplifiers

No matter what rig you build, no matter how often you change it, there's always a place for the versatile little RCA-807. From crystal oscillator to doubler, quadrupler, buffer, Class C r-f amplifier, grid-modulated r-f amplifier, or modulator, you can shift this "little magician" of beam power tubes and, each time, be assured of performance hard to beat. The RCA-807 is, without doubt, the handiest tube in any amateur shack—and one that will prove particularly valuable to the beginner. It is really "half a dozen tubes in one"!

Maximum ICAS (Intermittent Commercial and Amateur Service) Ratings for the RCA-807 in Class C c-w service are: plate voltage, 750 V.; plate input, 75 W.; plate dissipation, 30 W. *Amateur net price, \$3.50.*

### DON'T MISS IT!—the RCA HAM GUIDE

Forty-eight pages filled with timely technical information for radio amateurs on transmitter construction, transmitting-tube circuits and tube data. Easy-to-build rigs designed from "mike to tank"; latest in cathode modulation; "hor" plate modulated and c-w rigs; straight-forward single-stage circuits; up-to-the-minute data on tubes like the 802, 806, 807, 808, 809, 810, 811, 812, 828, etc. Richly illustrated, it is a radio transmitter book you will want in your shack. A boon to the new-comer; indispensable to the old-timer. Available through RCA Power Tube Distributors, or send 15c direct to the Commercial Engineering Section, RCA Manufacturing Co., Inc., Harrison, N. J. Ask for the new RCA Ham Guide.

**HAM TIPS FREE!**—A helpful little news publication brimful of worthwhile information for amateurs—free—from all RCA Power Tube Distributors. Don't fail to get it regularly!



# Radio Tubes

RCA MANUFACTURING CO., INC.  
CAMDEN, N. J.  
A Service of The Radio Corporation of America

FIRST IN METAL—FOREMOST IN GLASS—FINEST IN PERFORMANCE

[www.americanradiohistory.com](http://www.americanradiohistory.com)