

OHM'S LAW

$$E = I \times R$$

$$R = \frac{E}{I}$$

$$I = \frac{E}{R}$$

CONDENSERS IN SERIES

$$C_{TOTAL} = \frac{C_1 \times C_2}{C_1 + C_2}$$

RESISTANCES IN PARALLEL

$$R_{TOTAL} = \frac{R_1 \times R_2}{R_1 + R_2}$$

25c [ 30c in Canada ]

SEPTEMBER, 1935

\$3.00 PER YEAR BY SUBSCRIPTION

# RADIO

ESTABLISHED 1917

## SHORT-WAVE AND EXPERIMENTAL

BOTTOM VIEWS OF SOCKETS

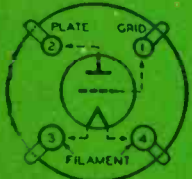

4-PRONG SOCKET  
50-201-A, 43, 210, 30, 31, ETC.

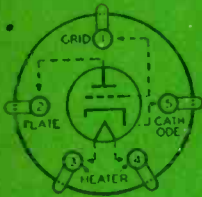

5-PRONG SOCKET  
56-46-47-76-27-37  
(Cathode is Screen Connection for '47)

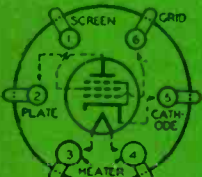

6-PRONG SOCKET  
2A5-41-42-43

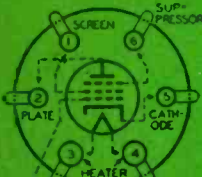

GRID-METAL TOP CAP  
6-PRONG SOCKET  
57-58-606-606-77-78

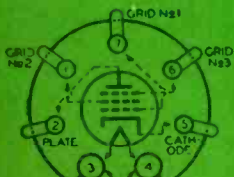

7-PRONG SOCKET 59

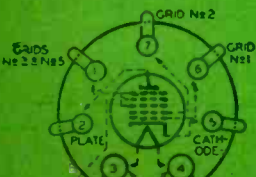

GRID No 4 - METAL TOP CAP  
7-PRONG SOCKET  
2A7-6A7

- IN THIS ISSUE -

### ★ 3-Tube Amateur Superheterodyne

### Controlled Carrier Unit for Small Phones

### How to Build Over-Modulation Indicators

### Better Phones for 160 Meters

### Data on Class C Amplifiers



A Variactor Controlled Carrier Unit for Small Transmitters. This compact, inexpensive unit can be added to any phone transmitter with a minimum of effort. By its use the power output is increased and heterodyne interference is reduced. Completely described in this issue.

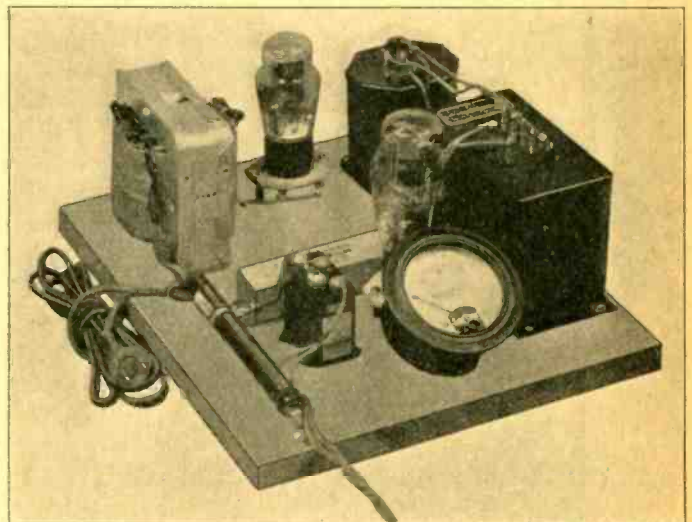

FEATURE ARTICLES BY ...

- |                  |   |                   |   |                |
|------------------|---|-------------------|---|----------------|
| FRANK C. JONES   | - | D. B. McGOWN      | - | COL. C. FOSTER |
| J. N. A. HAWKINS | - | FRANCIS CHURCHILL | - | HENRY WILLIAMS |

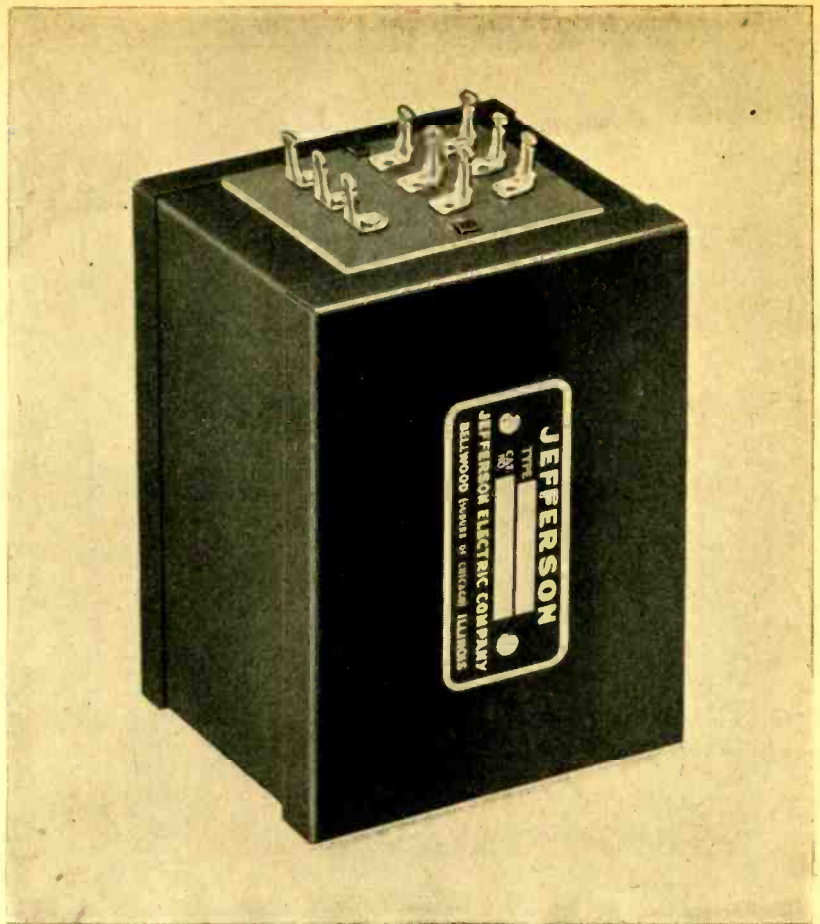

Cat. No. 467-421.  
Sealed in rectangular case. Convenient chassis mounting and wiring. Size 2 3/4" x 2 3/8" x 4 1/4" high. Wt. 2 1/2 lbs. List price \$8.00.

# A Humless

## Jefferson Microphone and Coupling Transformer

WHAT do we mean by "HUMLESS"? Just this—the JEFFERSON Catalog No. 467-421 Microphone Transformer is designed on a new and improved principle. It has balanced windings assembled on an alloy core (hydrogen annealed high permeability nickel alloy). In spite of heavy shielding, the ordinary microphone transformer will pick up hum which is then amplified through the whole audio sys-

tem. In this new Jefferson Transformer, all hum is balanced out and cancelled—cannot reach the speaker. This transformer can be mounted on the chassis of a high gain amplifier without hum pickup. The windings are also provided with taps to match 50, 100, 200 or 500 ohm lines to single or push-pull grids.

In performance, in convenience, in quality it is what you have been looking for.

### A MICROPHONE TRANSFORMER FOR EVERY NEED

Catalog Number	For Coupling	Size	Wt. Lbs.	Price
467-439	Telephone Mike (75 Ohms) to Grid	2 x 3 1/4 x 1 7/8	1	\$1.30
467-413	Single Button (200 Ohms) to Grid	2 x 3 1/4 x 1 7/8	1	1.30
467-429	Velocity (Ribbon) to 50/200 Ohms	1 5/8 x 3 x 1 5/8	3/4	1.40
467-414	Double Button (200-0-200) to Grid	2 x 3 1/4 x 1 7/8	1	1.40
467-261	Single Button (200 Ohms) to Grid	2 1/4 x 2 7/8 x 2 7/8	1	1.90
467-263	Double Button (200-0-200) to Grid	2 1/2 x 2 7/8 x 2 7/8	1 1/4	2.00
467-430	Double Button to Line 50/200/500 Ohms	2 1/2 x 2 7/8 x 2 7/8	1 1/4	2.65
467-431	Velocity (Ribbon) to 50/200 Ohms	2 1/2 x 2 7/8 x 2 7/8	1 1/4	2.50
467-432	Double Button to Line 50/200/500 Ohms	3 1/4 x 2 1/4 x 3 1/4	2 1/2	4.00
467-262	Double Button (200-0-200) to Grid	3 1/4 x 2 1/4 x 3 1/4	2 1/2	3.75
467-421	Double Button (200-0-200) to Grid	2 3/4 x 2 3/8 x 4 1/4	2 1/2	8.00

Write Your  
Wholesaler Today  
for Jefferson Radio  
Catalog

JEFFERSON ELECTRIC COMPANY, Bellwood (Suburb of Chicago), Illinois  
Canadian Factory: 535 College Street, Toronto

# JEFFERSON T *Radio* Transformers

# Now *You* can build this

PROFESSIONAL COMMUNICATION 10-TUBE



## SUPERHET

and save over

# 50%

No longer need you yearn in vain for that expensive communication receiver. Here's one that you can build at home, for less than half the cost of a factory-built set. You can buy the standard parts just as you can afford, or complete the job all at once if you wish.

This new "RADIO"-SILVER 9 to 200 meter professional superhet was designed by the Technical Staff of "RADIO" Magazine in collaboration with McMurdo Silver and fifteen of America's biggest part makers. And it comes to you on this money saving plan through the cooperation of these well known manufacturers of high grade radio equipment.

## 9 to 200 Meter "RADIO"-SILVER HIGH-FREQUENCY SUPERHETERODYNE

**LOOK**  
*what you get in this fine*  
**PROFESSIONAL SUPERHET!**

- Ten Raytheon Tubes.
- Two Tuned R. F. Stages on all four bands.
- Four Low-C Tuning Bands, 1500 to 33,000 kc. (9 to 200 meters).
- Ample and Accurately Relogging Crowe Band Spread Tuning anywhere in its range.
- Bliley Crystal Filter For Single Signal that doesn't cut down volume.
- All Chitran A. C. Operated—one unit—without hum.
- 8-inch Jensen Concert Speaker—and head phone jack.
- Polished Chromium Welded chassis.
- Air Tuned Polyiron I. F.—3 pi coils and big, no-loss copper shields.
- Separate R. F. Coils positively switched for each band—all Hammarlund Air Trimmed, not unstable compression mica.
- Sensitivity 1 Microvolt absolute and better.
- Selectivity just what you want—variable 50 cycle to 10 kc.
- Amplified Automatic Volume Control.
- No Inherent Circuit or Tube Noise—lets you copy signals now lost in the noise of the best competitive sets.
- Wired With Made-up Colored Coded Cable—requires no circuit tracing, or even a diagram.

**SEND TODAY for**  
**"HOW TO BUILD IT"**  
**Book—Buy parts from your local jobber**

This is not the usual makeshift "build-it-at-home" kit, but a precision job engineered for laboratory building. Yet it's so skillfully designed that any amateur at all can assemble it at home with pliers, screw driver and soldering iron. It's so thoroughly worked out that ordinarily critical alignment and testing is almost child's play. It requires no expensive test equipment—only what's right in it!

**Start for as little as \$7.30**  
**Buy the parts as you build!**

For only 10c (stamps or coin) we will send you the 32-page "How To Build It" book which tells the whole story of this latest and "hottest" high-frequency receiver. It is really an education in high frequency superhets—profusely illustrated with photographs of every assembly and wiring step, diagrams, performance curves, and testing and alignment procedure so simple that any amateur can build and align it in an evening.

Now is the time to get set for the good DX season. Start building this real receiver, that costs you less than half the price of equally good factory built sets. It can be yours for the bare cost of easily obtainable parts and a few hours fun of building it.

You can start for as little as \$7.30 and buy needed parts from your local jobber as you build. You've probably got many of its parts right now!

### SPONSORED BY

- Bliley Piezo Electric Co., Crowe Name Plate and Mfg. Co., Hammarlund Mfg. Co., Chicago Transformer Corp., Yaxley Division of P. R. Mallory Co., Jensen Radio Mfg. Co., Sprague Products Co., Continental Carbon Co., Ohmite Mfg. Co., Readrite Meter Works, Raytheon Production Corp., Alladin Radio Industries, Inc., Steel Box & Display Co., Filtermatic Mfg. Co., McMurdo Silver Corp.



**MAIL COUPON**  
**WITH 10c**  
 in stamps or coin for  
 32-page Book  
**"HOW TO BUILD IT"**

R-S MERCHANDISING COMMITTEE  
 1701 Roscoe St., Chicago, Ill., U. S. A.

Enclosed find 10c (stamps or coin) for which send me at once 32-page "HOW TO BUILD IT" Book with all details of new 10-Tube Professional Superhet.

Name \_\_\_\_\_  
 Address \_\_\_\_\_  
 City \_\_\_\_\_ State \_\_\_\_\_

**R-S MERCHANDISING COMMITTEE**  
 1701 Roscoe Street Chicago, Illinois, U. S. A.

# Would You Like to See

- The Modern Wonders of Electrical Science and Invention Unfold Before Your Eyes?
- The Modern Miracles of Radio and Electricity Demonstrated in Terms of "The Man in the Street?"
- The Mystery of the Ultra-Short Waves—the Cathode Rays—Electronic Super-Amplification—the electric Brain that thinks like a man.
- The Electric Eye that does such amazing things as The Servant of Man?
- A hundred and one inventions and developments brought forth by the genius of the Giants of Invention and Research.

The Radio Knife

The Electric Tongue

The Talking Book

How Science Locates Underground Treasure

The Ship's Eye that Sees Through the Fog

The New Electronic Musical Instruments

- The New Art of Electron Control from the World of Radio that is today revolutionizing our daily lives, science, industry, technology, chemistry, surgery, therapeutics, metallurgy, mining, music.

Would you like to see these amazing inventions and developments—see them and *hear* them explained?

## Then Come and See Them Demonstrated

IN THE

## Hall of Science

Under the Direction of Dr. Orestes H. Caldwell, Noted Authority in the field of Science and Radio, at the

# NATIONAL ELECTRICAL AND RADIO EXPOSITION

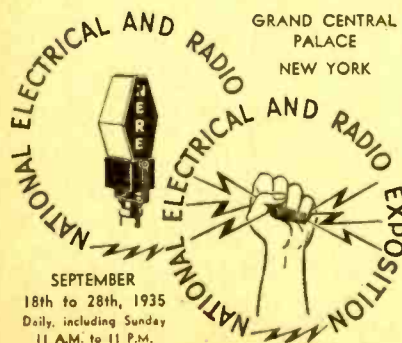

GRAND CENTRAL  
PALACE  
NEW YORK

GRAND CENTRAL PALACE, NEW YORK  
Lexington Avenue between 46th and 47th Streets

General Admission 25c

A Review of Progress—all that electrical science and industry have to offer in the fields of Lighting, Heating, Refrigeration, Air Conditioning, Oil Burners and Domestic and Industrial Appliances.

September 18th to 28th incl.

Daily including Sunday—11 A.M. to 11 P.M.

BRANCH OFFICES:  
New York City,  
253 W. 128th St.  
Tel. MOnument 2-2812  
Boston,  
J. H. Condon,  
6 Marlboro St.  
Chicago,  
C. W. Nelson,  
3618 North Bernard St.  
Los Angeles, Calif.,  
1455 Glenville Drive,  
Tel. CRestview 4017

# RADIO

ESTABLISHED 1917

Reg. U. S. Pat. Off.

A NATIONAL MAGAZINE - PUBLISHED MONTHLY

Publication Offices—Pacific Building, San Francisco, California

H. W. Dickow, Publisher.

D. B. McGown, Technical Editor.  
Clair Foster, Amateur Activity Editor.

Frank C. Jones, Engineering Editor.  
C. C. Anderson, Engineering Draftsman.

25c per copy, \$3.00 per year by subscription in the U. S. \$4.00 elsewhere  
Send subscriptions to the San Francisco office. Entered as second class matter at the Post Office at San Francisco, California, under the Act of March 3rd, 1879.

Vol. 17

SEPTEMBER, 1935

No. 9

## Radiotorial Comment

### A "Scoop"!

One of the pleasures we get out of life is to sit-in on a confab with a bunch of our brother hams. About a year ago we were chin-wagging with some of the fellows at the radio club. "Why don't somebody show us how to build a very small, inexpensive superheterodyne for amateurs . . . one that can be built for about fifteen dollars . . . one that fills the gap between the blooming blooper and the full-grown superhet?" The question came from an amateur of limited means, one who simply could not afford an expensive receiver. Yet his three-tube tuned RF set wasn't doing its stuff in the congested area where he resided.

Frank C. Jones was there when the question was asked. A few weeks ago he asked the editor if he recalled the incident. Indeed, he did! A \$15.00 version of an amateur superhet had been built and rebuilt many times by Mr. Jones in recent months . . . yet none of the finished models met with his approval. Along came the iron-core IF transformer, first shown to the amateurs in the Jones "222" receiver, some months ago. Using this new transformer as the heart of a \$15.00 receiver, Mr. Jones succeeded in developing a 3-tube super which may spell the doom of the lesser-efficient RF receiver for amateur operation. The inexpensive ham super has arrived. It is fully described in this issue of "RADIO". It uses only three tubes, one iron-core I.F. transformer . . . is easy to build and works so good that its performance has already surprised a group of critical amateurs who have tested the set. Here is an opportunity for almost every amateur to build himself a modern receiver. It is one of Mr. Jones' most useful contributions. Its popularity will be infinitely greater than his "All-Band 53 Exciter Unit."

### Conflicting Reports on Roberts

ARRL director Ed. Roberts addressed the Aurora, Illinois, Convention on August 4. Two of "RADIO's" reporters sent conflicting versions of the speech, simply because it was not quite clear to them what Director Roberts' ultimate stand would be. Thus it seems that the address was not accepted in a similar vein by all who were at the convention.

Consequently "RADIO" can give you only a short summary of what transpired; we do not yet know where Roberts stands, and it is evident, from a reading of the reports which have reached the editorial desk, that the amateurs don't know much more about it than we do.

Roberts opened his address, one report reads, by criticising the conventioners for inadvertently forgetting to display the ARRL emblem. However, it was assumed by all present that the affair was conducted under the auspices of ARRL. Colonel Foster and Sumner B. Young were complimented for their criticisms of League policies. Roberts brought out the fact that neither the Colonel nor Mr. Young were mercenary, because both are known to be financially independent. Neither of these men is gunning for Warner's job it has taken some of the amateurs a long time to find out that neither the Colonel nor Mr. Young are surplus snatchers. Roberts then discussed the Warner affair. And here the reports differ. One report states that Roberts will vote to fire Warner, the other says a remark was made that Warner is the best man for the job and should not be replaced. Because of Roberts' refusal to correspond with the editor of this magazine, it is impossible for us to tell you just how Roberts stands.

All that remains is to ask you to QRX until the ARRL investigating committee reports. In the meantime, the editor is mixing a huge pot of whitewash with one hand, and picking a beautiful bouquet of roses with the other, ready to proffer either hand as soon as the committee reports. May the whitewash remain in the pot—may the roses adorn the lapels of the coats of the investigating committeemen. As the old sea-going salt would say, "Ya never can tell which way the wind will blow."

### Questions and Answers

Over a period of less than 30 days more than 200 technical questions were received by the publishers of this magazine. To answer all of these questions will require more than two weeks' work on the part of the technical editors. Some of the questions call for an elaborate circuit diagram with constants and coil-winding data for all of the amateur bands. It is a physical impossibility for the technical staff to answer all of these questions. More than half the questions are in the form of a complaint that a certain receiver or transmitter had been built, "exactly as specified—but with a few dozen exceptions", because use was made of old equipment which was on hand. Parts layouts sent to the technical editors call for suggestions on how to rebuild a receiver or transmitter using entirely different components than those specified in the original editorial manuscript. No attempt is made to answer these questions because it is not often possible to get the same results from a receiver or transmitter in which so many changes are to be made. On the other hand,

the editor has a large file of glowing testimonials from readers who have acclaimed the merits of the equipment described in these pages, simply because the reader built the equipment exactly as specified. Many superheterodynes have been built . . . some of them twice as large as the original model shown in these pages. Leads are twice as long. Coil forms and condensers of a different size are used . . . and along comes a complaint from the reader that his receiver does not work.

Those who ask for technical advice are reminded that our staff is small. Three technical men do most of the work. Almost any next-door amateur can answer many of the questions which are received by our technical staff. Ask your friends for advice . . . if they can't help you, then write us. Indeed, we are here to serve you. But the avalanche of questions which has been received within the past 30 days is amazing. Many have offered to pay liberally for the service. But we can't accept your money. All we ask of you is to have mercy on us.

So let us be fair with each other. If you do not build the equipment in conformity with the editorial instructions, there isn't much we can do to help you make it work. Condensers, coils, resistors, chokes, chassis layouts, etc., are carefully chosen before a receiver is built. Many complaints have been received in regard to the very poor quality of some brands of resistors and condensers which are found on the market. Often a receiver or transmitter will not operate properly because the resistor was either open-circuited before it was installed into the set, or because it had a widely different value from that shown on the label. Of a dozen resistors recently tested in our laboratory, three had an "open", two had only half the resistance they were supposed to have had. Of the seven remaining, only one checked within 10% of its rating. Thus the set builder is cautioned to buy GOOD resistors and GOOD condensers. There is no economy in buying cheap products of this kind. A good resistor costs only a few pennies more than some of the very inferior brands which are offered. Ask the dealer to check the resistor for an open circuit. He can do it in a jiffy on his test set . . . and many a ham heartbreak can thus be avoided.

Imagine what is going to happen when a poor resistor or fixed condenser finds its way into your set! Make your own coil forms, if you so desire . . . build your own variable condensers . . . but when it comes to buying a small resistor or fixed condenser BUY THE BEST. There are a number of volume controls on the market which are exceptionally noisy. Pay ten cents more and get a noiseless volume control. It pays!

# The Barkhausen Oscillator

By F. B. LLEWELLYN  
Radio Research, Bell Telephone Laboratories

THE Barkhausen oscillator for ultra-high frequencies has been the subject of many complicated analyses. As with other developments, the history of its theory has gone through three stages; starting with a simple but incomplete concept, advancing through a more and more involved

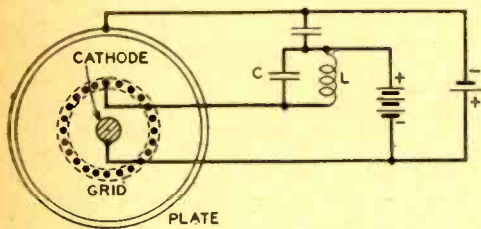

FIG. 1—This general arrangement of tube elements and circuit is used in the production of Barkhausen oscillations.

mathematical analysis, and finally yielding the important properties in simple enough form to be stated in everyday language.

The elementary concept upon which the explanation of the Barkhausen oscillator was originally based was that of an electron or group of electrons which danced back and forth through the opening, in a positively polarized grid. Among other things this concept did not show why the number of electrons going in opposite directions through the grid was not always the same. The mathematics which followed led in many cases into strange paths, but finally was placed on a sound basis. When this had been done it was found that the explanation could be made in a perfectly straight-forward way, and that the original concept of the dancing electron contained only enough truth to delay and complicate the process of arriving at the correct answer.

Physically the Barkhausen oscillator consists of a filamentary cathode surrounded by a cylindrical grid and plate, as shown in Fig. 1. The grid is operated at a positive potential, the plate is biased to a slightly negative potential, and a tuned circuit LC is usually connected between them.

Electrons starting out from the cathode are attracted by the positive grid, and move with increasing velocity in that direction. Many of the electrons hit the grid, and become of no further concern. Many others, however, pass between the grid wires without hitting them and move toward the plate with decreasing velocity, coming to rest just before reaching the negative plate and then starting back toward the grid again. As before, a given electron may hit the grid or

may miss it again and continue on toward the cathode, when the cycle is repeated.

If the tube were not oscillating, the story would now be complete. A convenient way of seeing what causes the oscillations in the

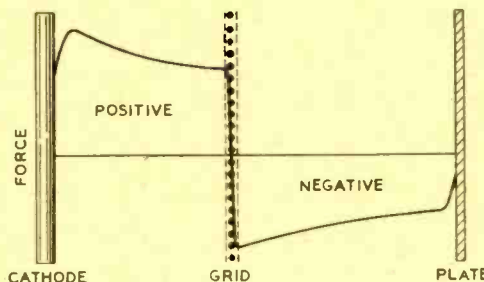

FIG. 2—When a constant potential is applied to the grid of a vacuum tube constructed as shown in Fig. 1, the force exerted on the electron at various points in its trip across the tube is as shown by the curve. The work done on the electron is therefore measured by the area under the curve.

tube is to investigate what happens when a transient oscillation is produced in the LC circuit by some external means. If the forces produced on the moving electrons by

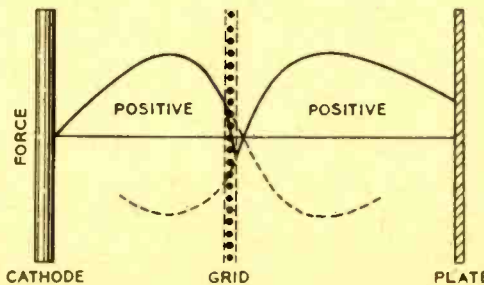

FIG. 3—Because the work done on an electron of the useless type by an alternating force is positive, the electron abstracts energy from the alternating-current transient.

this transient deliver energy to the electrons, the transient will die out; but if the electrons, having acquired kinetic energy from the grid battery, can oppose the forces set up by the transient and thus deliver energy to the circuit, the transient will persist or build up as a continuous oscillation instead of dying out.

In the absence of the transient, an electron starting from the filament moves in the direction of the force from the positive grid, and so draws energy from the grid battery. After passing through the grid wires, the electron moves against the force from the grid, thus returning energy to the grid battery. When it comes to rest in the grid-plate space, the entire amount of energy picked up in the cathode-grid space has been restored to the

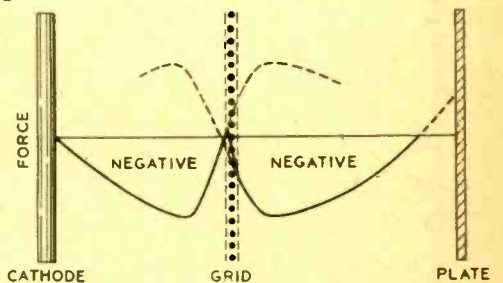

FIG. 4—With an alternating force, an electron of the useful type delivers energy to the transient, at the expense of the battery producing the constant force.

battery. During the return trip, the same sequence again occurs: the energy which was abstracted in moving toward the grid is restored in moving away from it. The net result is that energy is neither absorbed from nor delivered to the external circuit and batteries by such an electron. This fact is made graphically evident in Fig. 2, where the force from the batteries which acts on the electron is plotted as ordinate while the distance the electron has moved from the cathode is taken as abscissa. The area under the curve consequently measures the work done on the electron during its trip across the

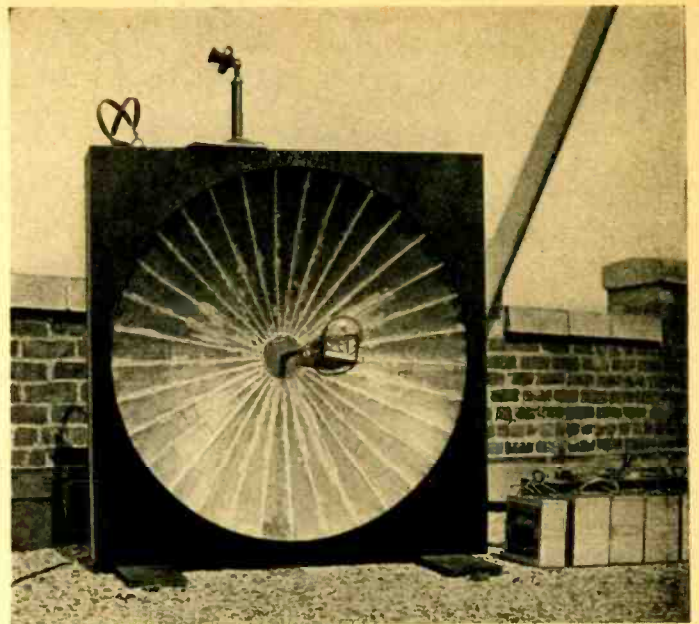

FIG. 6—Experiments were also performed in which a transmitter, incorporating a Barkhausen oscillator and associated with a parabolic reflector, transmitted 28-centimeter waves from the roof of the Graybar-Varick Building to the New York Telephone Company's Building at 140 West St.

tube: the positive work done between cathode and grid is just equal to the negative work done between the grid and the plate.

When the transient is introduced into the LC circuit, conditions are considerably changed. Superposed on the force diagrammed in Fig. 2 is the force set up by the alternating grid potential. Since the latter force alternates, the resultant forces acting on electrons which start out from the cathode at different times in the alternating-current cycle will be quite different. For purposes of illustration, it is sufficient to trace the history of two electrons only. One of these starts out just at the time when the alternating force begins acting in the same direction as the constant force of Fig. 2. The other starts out a half cycle later, when the alternating force begins to oppose the constant force.

In the first case, the alternating force increases in intensity as the electron moves along, then decreases to zero, then reverses and opposes the motion, and finally completes the cycle by becoming positive again. If the electron passes through the grid mesh just before the alternating force returns to its first zero value, the action of the force upon it is as shown in Fig. 3. At the instant the electron passes through the grid, of course, the direction of the force acting on the electron reverses, not because of any abrupt change in the grid potential, but because the grid is now located behind the electron instead of ahead of it. As the electron moves on toward the plate, however, the alternating force decreases to zero and then reverses. Thus during both halves of the cycle the force acts in the same direction as the electron is moving, and delivers energy to it, as can be checked by reference to the area under the curve in Fig. 3. In other words, the transient in the external circuit has done work on this particular electron, and the electron, by taking energy away from the circuit, has produced a tendency for the transient to die out.

There is nothing in this behavior that gives encouragement to the maintenance of oscillations. The only consolation comes from noting that the electron is moving faster when it approaches the plate than it would if no alternating forces had acted on it, and consequently it will hit the plate even though the latter be at a slightly negative potential. Thus this useless, and in fact harmful, electron is at least prevented from doing still further harm by being removed through the plate from the scene of action.

Fortunately the other electron, that leaves a half cycle later than the worthless one just dismissed, is more useful. From the very start the alternating force opposes the motion of the new electron, but cannot stop it because the alternating force is never larger than the constant force of Fig. 2. The electron is therefore doing work against the alternating force, delivering energy to the transient in the external circuit. As the electron progresses, the phase of the force changes as shown in Fig. 4. Unlike Fig. 3, the reversal in direction occurs before the electron has reached the grid, because the force opposing the motion has decreased the speed. When passage through the grid mesh again reverses the direction of the force, the agreeable electron continues to deliver energy to the circuit transient, as it approaches the plate. Having lost much of its velocity in transferring its energy to the circuit, the electron comes to rest before hitting the plate, and then, urged by the constant force of Fig. 2, starts on its return journey toward the grid. At about the same time, the phase of the alternating force again reverses and again opposes the motion, so that the hapless electron must give up still more of its energy to the growing transient.

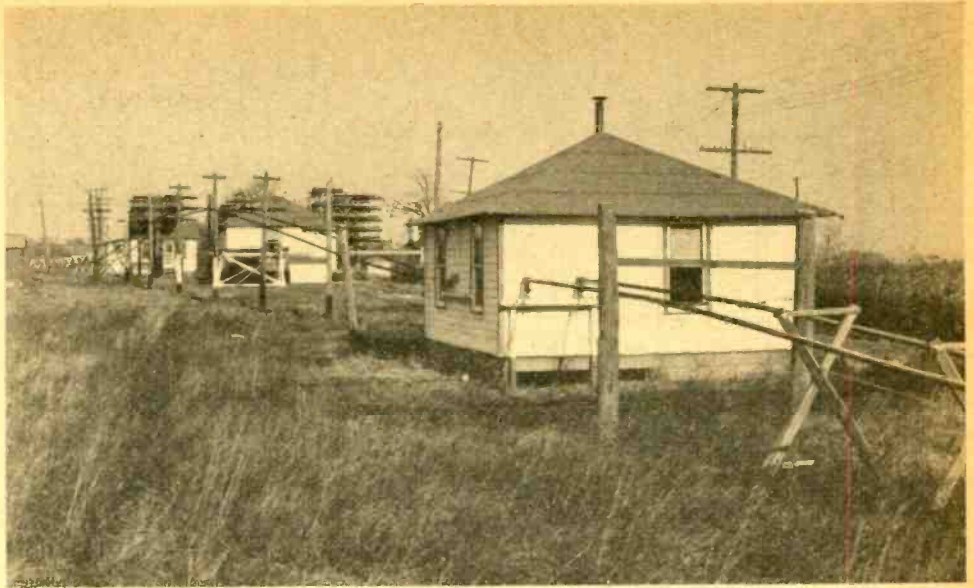

Experimental installation of large coaxial conductor lines near Phoenixville, Pennsylvania.

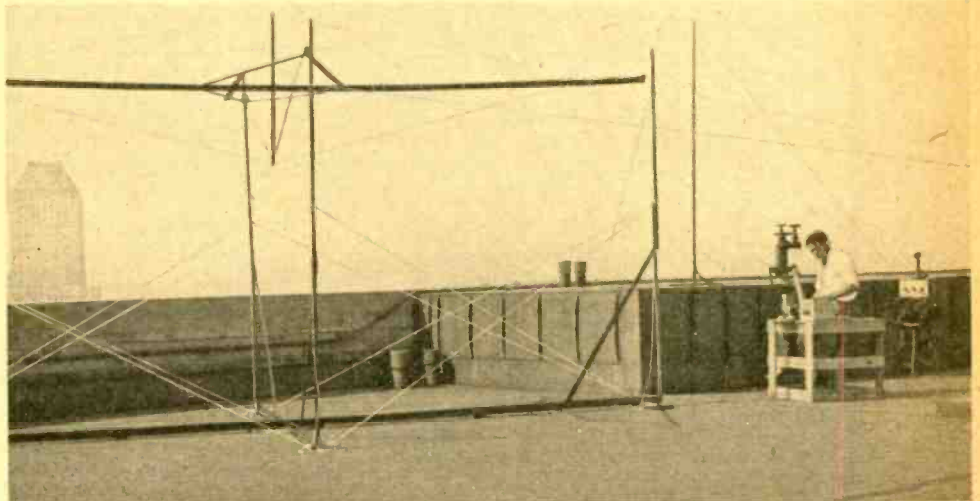

FIG. 5—During certain experiments on ultra-short-wave transmission, a receiving layout was placed on the roof of the New Jersey Telephone Company's headquarters building in Newark, to receive 60 centimeter waves transmitted from Barkhausen oscillators located in New York.

Another passage through the grid follows, accompanied by another reversal in the phase of the alternating force, and the tormented electron must again yield energy acquired from the constant force to the hungry transient. The energy loss brings the electron to a halt before it reaches the cathode, the phases again reverse, and the cycle starts over again.

In its round trip, the useful electron of Fig. 4 supplies to the transient nearly twice as much energy as the useless one of Fig. 3 abstracted in its one-way trip. Moreover, the useful electron reaches the cathode again at just the right time to join with other electrons of the useful type and augment their relative number. The action is consequently progressive, building up more and more useful electrons.

In practice, operating conditions modify somewhat the mechanism described. For example, space charge near the cathode produces more harmful electrons than useful ones and is to be avoided. Space charge near the plate causes a shift between the phase of the grid voltage and the force acting on the electrons, which in general tends to raise the frequency of oscillation. On the other hand, space charge in general makes the electrons move slower. Since the slower

motion tends to decrease the frequency, the net result of space charge near the plate is only a small decrease in frequency. The tuning of the external circuit can also modify the frequency by about 30 per cent, but for fixed values of plate, grid, and filament battery voltage, there is a particular tuning adjustment which gives maximum output.

There is a simple approximate expression for determining the proper grid voltage and size of vacuum tube to produce oscillations of a given wavelength. For example, a tube with a plate diameter of one centimeter, and with 100 volts applied to the grid, will produce oscillations with a wavelength somewhat between 100 and 50 centimeters, corresponding to a frequency between 300 and 600 megacycles, depending on the circuit adjustments.

It is interesting to note that the same kind of analysis here used to illustrate the workings of the Barkhausen oscillator can be applied to the well-known feedback oscillators operating with negative grid and positive plate, and shows that the two are not very different from each other after all. The Barkhausen oscillator will probably prove very useful in the fields of ultra-short-wave transmission, which are rapidly coming into commercial application.

# The "Super-Gainer"

A 3-Tube Superheterodyne With Regenerative First and Second Detectors. It Uses No I.F. Stage. Is Selective and Sensitive. The Answer to a Problem Which Has Long Confronted the Experimenter of Limited Means. A Useful Contribution to the Art.

By the Technical Staff of "RADIO"

● This 3-tube superheterodyne was developed to meet the demand for a simple CW or phone receiver which would be more selective than an ordinary T.R.F. regenerative set. The latter will not cut through strong local interference in metropolitan areas where this defect is very objectionable. A strong local signal will not block-up this new receiver.

This 3-tube superheterodyne circuit offers the best possibilities for selectivity. Most

order to prevent tuning interlock or reaction between the first detector and oscillator. The front-end of this receiver is quite similar to the "222" previously described in these pages, except that a 76 instead of a 6C6 oscillator was used.

The second detector is the heart of this new receiver. A 79 twin triode tube is used as a regenerative second detector, beat-frequency oscillator, and as an additional stage of audio amplification. Regeneration in the

trouble is had from detuning effect on CW for various settings of the regeneration or oscillation control. To complete the oscillator circuit, the plate is grounded through a .002 mfd. condenser since the cathode is floating for RF, or rather IF. Low values of resistors are used in the audio amplifier in order to prevent motor-boating and too much audio gain. Too much gain will produce a strong hum level in the telephone receivers which cannot be entirely balanced out, even

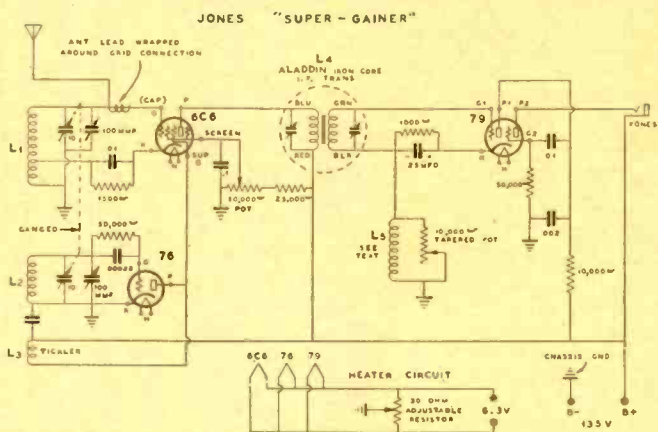
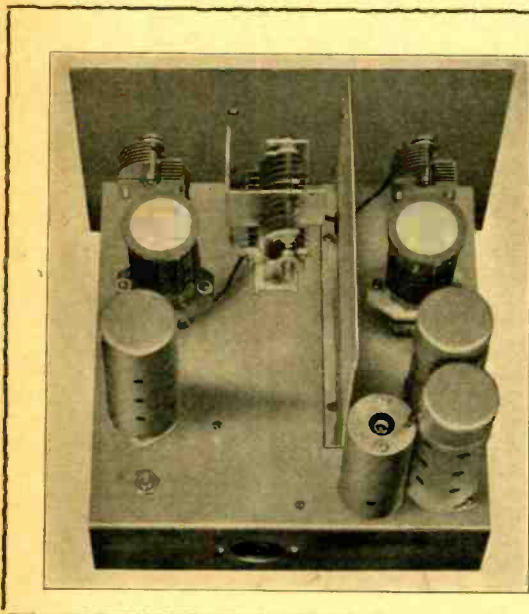

Above: Complete circuit diagram of the "Super Gainer". L1 is the detector coil; L2 oscillator coil; L3 tickler coil; L4 iron-core I.F. transformer; L5 BCL type coil. See text for coil winding data.

Left: Rear view of the receiver, showing location of shield partition between detector and oscillator coils, also shield plate between sections of the two-gang band-spread tuning condenser. These shields are of utmost importance.

short-wave superhets use from 6 to 10 tubes and they are rather complicated to build and line-up. By the use of regeneration at two frequencies, three tubes do the work of six, in the unique circuit here shown. The use of a 6C6 regenerative first detector enables reception of weak signals and good signal to noise ratio, especially on 10 or 20 meters. Because regeneration is used, a separate 76 tube oscillator is necessary in

second detector, even when oscillating for CW reception, eliminates the need of an IF stage. By the same token, a separate B.F.O. tube is eliminated. The second triode is used only as a stage of resistance-coupled IF.

Transformer coupling was tried, but trouble arose from audio feedback and too much audio gain when using a high mu tube such as a 79. The 79 is a small tube and it will fit inside of a standard tube shield. All tubes are shielded.

Cathode regeneration is used in the first section of the 79 tube because it simplifies the problem of obtaining feed-back to the grid coil and also provides a stable oscillator circuit. The cathode resistor is by-passed with a 25 mfd. electrolytic condenser in order to prevent audio feed-back due to common coupling between the detector and audio amplifier of the 79. The cathode coil consists of an old BCL receiver coil of about 100 turns of No. 30 wire on a 1/4-in. diameter form. This coil value is not critical; several BCL coils were tried and all gave satisfactory results.

Control of regeneration is by means of a tapered 10,000 ohm variable resistor shunted across this BCL cathode coil. This cathode coil is not directly a part of the 456 KC tuned circuit and therefore practically no

with a variable center-tapped heater shunt resistor. The latter is very useful if the heaters are operated on AC and the hum can be reduced 50 per cent by proper adjustment of this variable resistor. The 79 tube seems to be more subject to hum pick-up from its heater circuit than some of the other type tubes.

A single Alladin iron-core IF transformer (465 KC) provides sufficient selectivity for this receiver. This unit has a screw adjustment on the side of the shield can which varies the coupling between the two tuned coils. When regeneration is used in the second detector, very loose coupling between the tuned circuits is necessary. For this reason only such types of IF transformers should be used which will allow adjustment of coupling. Too close coupling will prevent oscillation at the resonant frequency of the IF unit. This adjustment of coupling should be made by trial when the receiver is in operation. The correct value is that which will allow oscillation with the cathode control fairly well advanced when the primary is tuned through resonance with the secondary. The 79 should go into oscillation with a fairly smooth action, just like any ordinary regenerative detector.

The values of resistors shown are satisfactory for B voltages of from 90 to 180 volts, 90 volts gives less gain, and a good average value is 135 volts of B battery. If

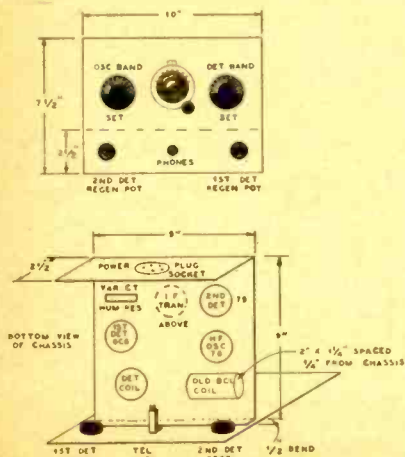

Front panel view and under-chassis layout.



an AC power supply is used it should be very well filtered, about three sections of filter being generally sufficient, and by-passed with at least 8 mfd. across the output. If over 180 volts is used, a lower value of cathode resistor is necessary to prevent motor-boating. With 250 volts supply, as low as 350 ohms is necessary in the second detector cathode. If much over 135 volts plate supply is used, it is also necessary to drop the plate voltage on the 76 oscillator and the plate return circuit must be by-passed with an additional .01 mfd. condenser. For example, at 200 volts supply, a 25,000 ohm 1 watt resistor is needed in series with the +B lead from the oscillator coil after being by-passed both sides to ground. At 250 volts supply, a 50,000 ohm 1 watt resistor is approximately correct.

If an AC power supply is used, the simplest method is to use a voltage divider in order to obtain about 135 volts; then by-pass this voltage supply with an 8 mfd. condenser. The receiver can also be used with a set of three 45 volt B batteries in series because the current drain is quite low. Either a filament transformer or a 6 volt storage battery can be used for filament supply.

The high-frequency oscillator and detector coils are of the 1/2-in. diameter plug-in type, with a 4-prong ribbed coil form for the oscillator and a 5-prong form for the detector. Using coils with unlike number of prongs insures plugging the right coil into the right socket. The coil sockets should be isolantite. The coil data are given in the table of coils.

The main tuning is accomplished by means of a Hammarlund two-gang double-spaced condenser, originally having 35 mmfd. max. capacity per section. To prevent interlock effect on 20 meters, an aluminum shield is placed around the oscillator section of the condenser. By pulling out one stator plate from each of the inside ends of the stators, space is made available for the grounded shield and better band-spread tuning is also obtained. The oscillator section of the condenser also has its front rotor plate removed; thus this section has 7 dielectric air spaces between rotor and stator, while the detector has 8 spaces. This greater capacity on the detector allows a better degree of tracking for any particular setting of the two 100 mmfd. band-setter condensers. The detector band-setter condenser should always be adjusted for maximum signal or noise pick-up when advancing the first detector regeneration control, i.e., increasing the screen-grid voltage. The cathode tap on the first detector coil allows regeneration at the signal frequency; variation of screen-grid voltage provides a convenient adjustment of regenera-

tion. The tube should never be permitted to actually oscillate, otherwise it will usually bring in undesired stations which differ in frequency from the desired station by the value of IF used.

Bias detection is used because it does not cause as much loading effect on the tuned circuit as when grid-leak detection is used. This method, plus regeneration, reduces the image interference to at least 50 DB down.

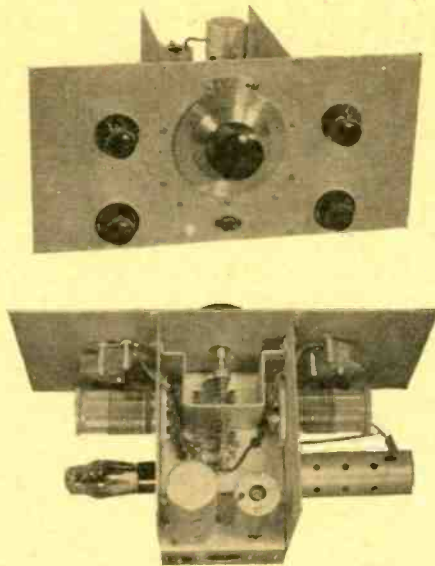

A de luxe chassis assembly for the "Super Gainer" with 76 tube shield removed. The tubes and coils are mounted horizontally. The front panel is a piece of No. 12 gauge aluminum, 7" x 14". The shield partition pieces are 7" high and 6 3/4" deep, with a 1/2" bend for fastening to the front panel. The deck on which the 79 tube, I.F. transformer and main band-spread tuning condenser is mounted is 4 1/2" x 6 3/4" with a 2" U-bend. All tubes must be shielded.

The suppressor grid is connected directly to the plate of the 76 oscillator and provides ample oscillator voltage coupling to the first detector for proper mixing to the IF "amplifier" frequency. The amplifier in this case is the regenerative second detector.

One thing to remember in connection with any superheterodyne is the importance of obtaining proper HF oscillator voltage into the first detector. Too little voltage results in loss of sensitivity, too much voltage due to too many tickler turns or too high plate voltage on the 76 will reduce sensitivity and selectivity, as well as sometimes producing extra heterodyne whistles and other unde-

sirable characteristics. This form of suppressor grid coupling does not require as strong an oscillator as is needed for most other mixer circuits.

A shield is placed between the oscillator and first detector portions of the receiver in order to prevent undesired coupling. The receiver should be placed in a metal cabinet if more complete shielding is desired. The IF transformer and 79 tube can be placed in some other part of chassis than that shown in the picture if a smaller chassis is deemed necessary. The one here shown originally had an extra IF transformer and also an audio transformer mounted on it, but tests proved that these are unnecessary.

The antenna is capacitively coupled to the grid of the 6C6 by twisting a few turns of the antenna lead around the grid lead of the first detector. If a doublet antenna is used on any band, inductive coupling can be used in the form of a grounded center-tapped coil of about 5 turns, slipped down over the plug-in coil form and allowed to rest on the coil socket base. It is necessary to have a rough adjustment of antenna coupling in order to always be able to obtain regeneration up to the point of oscillation in the first detector. Too much antenna coupling, when using a resonant antenna, will prevent sufficient regeneration.

A ground connection should be used to reduce hum in the headset. A long antenna or a resonant antenna should be used when possible.

With some coils, the oscillator band-setter condenser will have two points at which any given signal will be heard. The point on the high side, that which is the 456 KC side of the signal, should always be used. This point is on the side of less capacity setting. The coil turns can be so spaced, for each band, that good tracking will be obtained on the main tuning condenser without having to continually reset the detector band-setter condenser.

With the coils listed in the table, the 80 meter band-setter condenser in the receiver shown is set at 33° on the oscillator and 40° on the detector. On 40 meters the oscillator is set at 87° and the detector at 97°. On 20 meters the oscillator is set at about 67° and the detector at 80°. Different lengths of leads or slight differences in coil winding will, of course, result in different readings on the band-setter dials.

Number 12 gauge aluminum is used for the chassis and the front panel. The band-setter condensers can be mounted directly on the front panel, but the main tuning condensers should be mounted on a separate bracket. The telephone jack must be insulated from the front panel by means of fibre collars or washers in order to prevent short-circuiting the B supply. A tube socket is used for connection of power supply leads. Either an AC power pack or a set of batteries can be used by connecting them to the proper plug and cable.

The procedure in testing this set is fairly simple. The second detector should oscillate when its regeneration control is adjusted. The IF transformer tuning can then be adjusted to resonance with the secondary by noting the spot at which it tends to pull this detector out of oscillation. The IF transformer may require less coupling between coils than the adjustment originally made by the manufacturer. To loosen the coupling between the coils in the IF transformer, two holes should be cut in the chassis under the IF coil at the points where the set screws can be reached with a screwdriver. The actual coupling adjustment on the iron-core IF units is on the side of the transformer can, but the set screws (inside the can)

(Continued on page 34)

"SUPER GAINER" COIL DATA—All Coils Wound on 1/2-in. Diameter Forms.

Wavelength	L <sub>1</sub>	L <sub>2</sub>	L <sub>3</sub>
160 Meters	1 3/4-in. winding space of No. 24 E. tapped at 1/2 turns. Close-wound.	1 1/4-in. winding space of No. 24 E. Close-wound. Grid on top end.	12 turns No. 24 E. Close-wound 1/8-in. from L <sub>2</sub> . Wind in same direction as L <sub>2</sub> with plate on far end.
80 Meters	40 turns No. 20 DSC spaced to cover 1 3/4-in. Tap at 3/4 turn.	33 turns No. 20 DSC paced to cover 1 3/4-in.	8 turns No. 24 E. Close-wound 1/8-in. from L <sub>1</sub> .
40 Meters	12 turns No. 20 DSC spaced to cover 1 1/2-in. Tap at 1/2 turn.	11 turns No. 20 DSC paced to cover 1 1/4-in.	5 turns No. 24 E. spaced 1/4-in. from L <sub>2</sub> .
20 Meters	5 turns No. 20 DSC spaced to cover 3/8-in. Tap at 1/3 turn.	5 turns No. 20 DSC spaced to cover 3/8-in.	3 turns No. 20 DSC spaced 1/4-in. from L <sub>2</sub> .
10 Meters	3 1/2 turns No. 20 DSC spaced to cover 1-in. Tap at 1/2 turn.	3 1/2 turns No. 20 DSC spaced to cover 1-in.	2 1/2 turns No. 20 DSC 1/4-in. from L <sub>2</sub> and 1/8-in. between turns.

# A New Vacuum Tube For Ultra-High Frequencies

By C. E. FAY

Vacuum Tube Development, Bell Telephone Laboratories

**I**N THE past few years, considerable attention has been devoted to the development of radio communication at the ultra-high frequencies. As the available channels in the lower frequencies range become assigned, this high-frequency portion of the radio spectrum, including frequencies higher than 30 megacycles, offers an abundant supply of additional channels. Developments have not progressed sufficiently, however, to give knowledge of the full possibilities of these higher frequencies. To be able to carry on studies of communication systems that may employ them, it has been necessary to develop vacuum tubes that will oscillate and amplify in this ultra-high frequency region.

Difficulties have been encountered in operating the conventional vacuum tubes at these higher frequencies. One of these is a reduction in efficiency as the operating frequency is increased. For ordinary tubes, the efficiency does not decrease to any great extent for frequencies below 15 megacycles. At frequencies somewhat above 30 megacycles, however, it begins to fall off rapidly

until a point is finally reached where the maximum allowable energy must be dissipated in the tube elements to produce any detectable output power. This is known as the frequency limit of the tube.

One of the causes of this decrease in efficiency with increasing frequency is that the charging currents to the inter-electrode capacitances increase in proportion to the frequency. Since these charging currents must flow through the tube leads, which are not ordinarily designed to carry heavy currents, a considerable energy loss results, which decreases the useful output. These capacitances and charging currents are indicated by the dotted lines of Fig. 1.

Besides its reduction caused by excessive charging current, the efficiency of a vacuum tube falls off very rapidly as the time of a period of oscillation approaches the time required for electrons to travel from the cathode to the anode. Reduction in efficiency due to this effect begins to be noticeable for most tubes at frequencies between 30 and 60 megacycles. Its most obvious cause is a lagging in phase of the plate cur-

rent with respect to the plate voltage, although other and more involved effects are present.

Still another difficulty in the operation of the ordinary tubes at very high frequencies is the magnitudes of the inductances and capacitances within the tube relative to the external tuning reactances. The capacitances and inductances within the tube itself are fixed in magnitude, but at ordinary frequencies are very small compared to the external reactances, such as  $L_o$  and  $C_o$  of Fig. 1. To tune the circuit to a higher operating frequency, however,  $L_o$  and  $C_o$  must be made smaller, and a frequency is ultimately reached at which they become small compared to the inductances and capacitances of the tube. In extreme cases the tube reactances themselves control the oscillating frequency.

To avoid these difficulties that arise when ordinary tubes are operated at ultra-high frequencies, a tube has been recently developed in which these frequency limitations have been eliminated to such an extent that the tube is suitable for operation in the range from 30 to 300 megacycles. This tube,

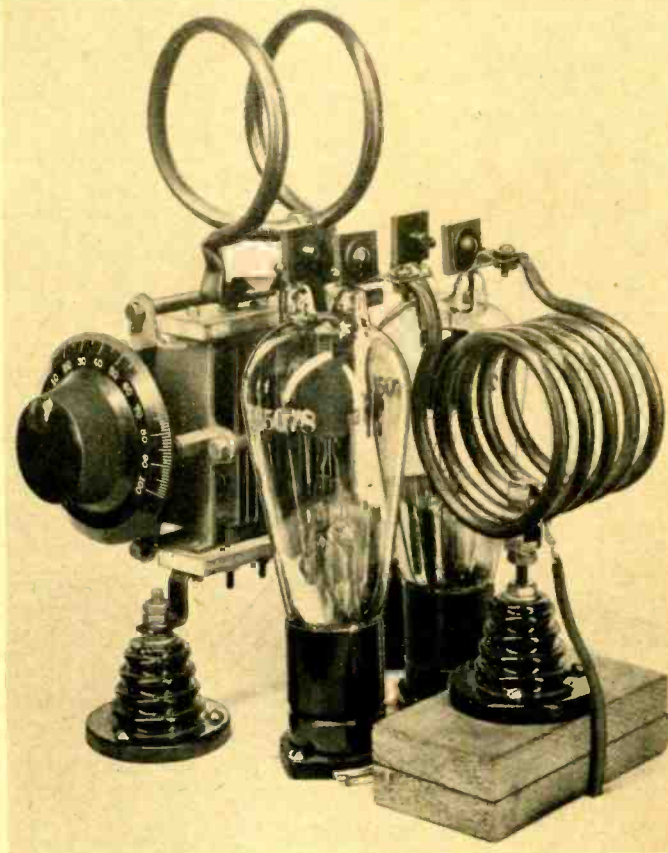
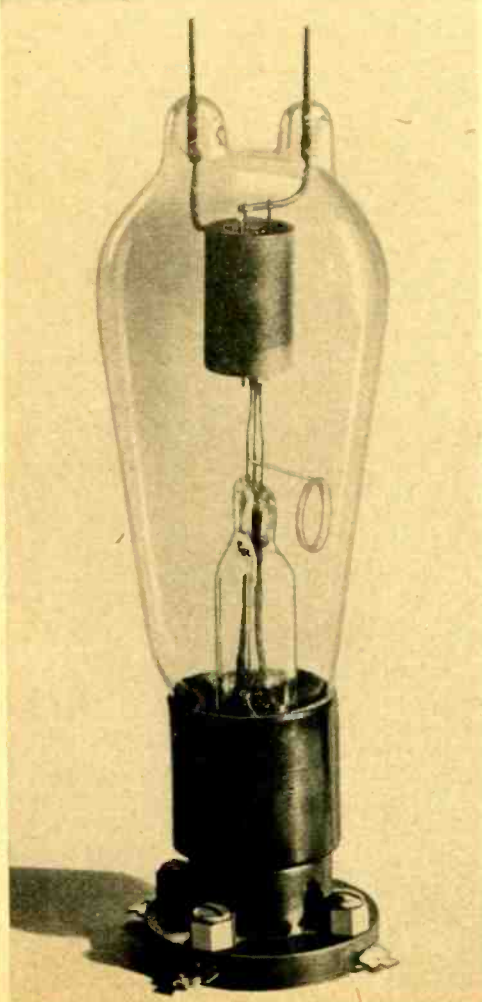

Left: FIG. 2—The Western Electric 304A vacuum-tube, designed for frequencies from 30 to 300 megacycles.

Above: A pair of W.E. 304As in push-pull in an ultra-high frequency transmitter.

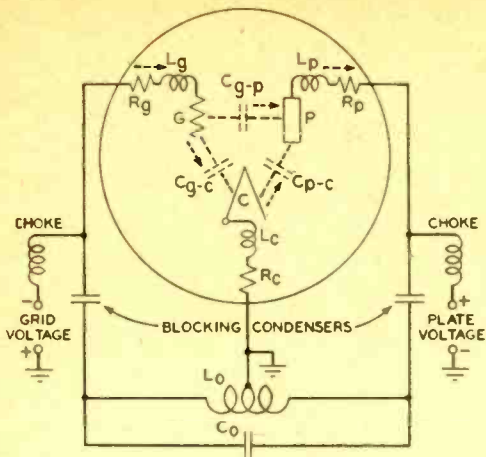

(Above)—FIG. 1—Diagrammatic arrangement of vacuum tube showing external and internal reactance.

(Right)—FIG. 3—Output and efficiency characteristics of 304 A tube at various plate potentials.

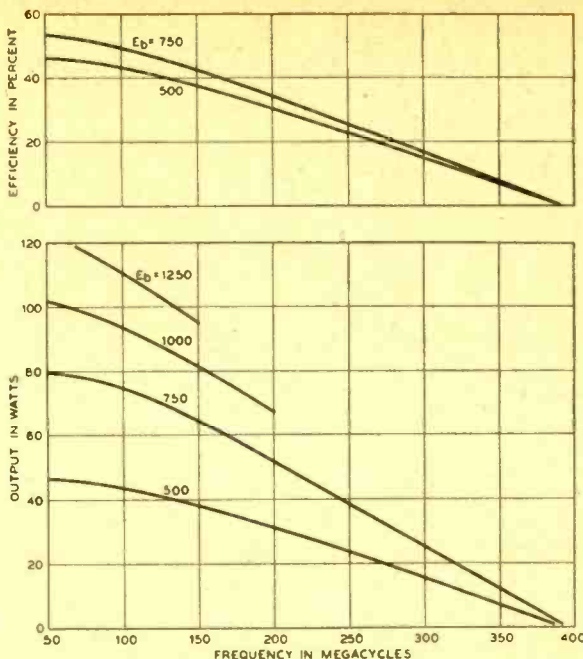

known as the Western Electric 304A, and shown in Fig. 2, is a low power triode suitable either as an oscillator or an amplifier. Its characteristics and ratings are given in the tabulation of Fig. 4. At frequencies up to 100 megacycles it may be operated at full rating, but with higher frequencies the output is gradually reduced. The power output and efficiency of this tube in the range from 50 to 400 megacycles is shown by the characteristic curves plotted in Fig. 3.

Several modifications have been incorporated in this new tube to make it suitable for operation at the higher frequencies. Dissipation of energy in the leads due to excessive charging current is avoided both by decreasing the inter-electrode capacitances and by decreasing the resistance of the leads. The grid and plate electrodes are supported by short heavy wires which pass through the top of the hard glass envelope. These serve both as supports and lead-in wires, and provide a construction giving the low inductance and resistance essential to the

operation of the tube at ultra-high frequencies. This construction has the further advantage of eliminating any solid dielectric other than the glass envelope. In a high-frequency field, solid dielectric absorbs energy and may break down, so that its elimination is desirable.

Besides these modifications, the charging currents themselves have been made very small by employing smaller electrodes. In general, the size of the anode is determined by the amount of heat that must be radiated, which for any given material is a function both of its operating temperature and its radiating area. By employing graphite for the anode, which is a much better radiator than molybdenum, the material commonly employed as an anode material, it has been possible to radiate the desired amount of heat with a smaller plate. The plate is cylindrical in shape, and thus a smaller surface area makes possible a smaller diameter. The smaller diameter, in turn, results in a shorter electron transit time, and thus increases the frequency at which the phase

lag of the current with respect to the voltage becomes appreciable.

With these many advantages the new tube is proving highly satisfactory for a variety of ultra-short wave circuits. A typical application is the push-pull oscillator operating at 60 megacycles shown in the illustration on the facing page.

FIG. 4—Characteristics and ratings of the 304A tube

Filament Voltage	7.5 Volts
Filament Current	3.25 Amperes
Max. DC Plate Voltage—Unmodulated	1250 Volts
Max. DC Plate Voltage—Modulated	1000 Volts
Max. DC Plate Current	0.10 Ampere
Max. Continuous Plate Dissipation	50 Watts
Max. RF Grid Current	5 Amperes
Max. DC Grid Current	0.020 Amperes
At a Plate Voltage of 1000 Volts DC and Plate Current of 0.050 Amperes;	
Amplification Factor	11
Transconductance	2300 Micromhos
Plate Resistance	4800 Ohms
Inter-electrode Capacities	
Grid to Plate	2.5 Micro-microfarads
Grid to Filament	2.0 Micro-microfarads
Plate to Filament	0.7 Micro-microfarads

## Group Hearing Installations Help for Service Men

One division of the Public Address field that is becoming increasingly important is that of the installation of Group Hearing Aids in theatres and churches for use by the hard of hearing. Individuals with a hearing impairment are anxious to be able to use such a service of this type and are pleading that their church, theatre and schools provide some means of permitting them to hear. Parent-Teacher associations and Kiwanis groups throughout the land are beginning to become interested in the young child who is hard of hearing and thus, is deprived of obtaining the utmost from his education, resulting in at least one state furnishing a group hearing aid in its public schools wherever needed by hard of hearing children. In short, the field is extremely broad and of great practical value as well as a good financial proposition to the service men.

Because of the fact that the majority of the Group Hearing Aid Installations are of necessity small, requiring but a limited number of earphones, they will be made by the local radio service man.

Essentially, a Group Hearing Aid consists of a microphone, amplifier, outlet boxes,

individual volume controls and the ear-phones. Because of the numerous parts that must all work together, it is desirable to purchase all of the equipment from a manufacturer as a group. This can now be done at a price less than the various components of equal quality could be purchased individually and with the added advantage that it is tested and guaranteed by one organization. An installation of from 6 to 10 phones can be installed, if so purchased, within a few hours.

Inasmuch as the public comes in contact with the earphones, the entire installation is judged by their quality and comfort; therefore, great care should be used in the selection of this particular unit. In particular the phones should all be light in weight, the flat disc type, are generally preferred, which in addition to their inherent lightness, are extremely comfortable, especially in the case of a theatre, where they are often worn several hours at a time. The phone should also be capable of reproducing sound at high levels without abnormal distortion. Combined with the foregoing requisites, the phones should be very durable and able to

stand considerable rough treatment without unusual injury, particularly the cordage used on the phones should be the best available as this is the largest source of wear. In general, the phones should be of a type especially adapted for this type of service. Earphones with headbands are usually preferred for theatres while churches use the lorgnette handle type.

Outlet boxes serving the double duty of furnishing a mounting for the phone jack and also housing the volume control, are proving to be the most economical due to their great durability and general all-around service ability. Volume controls selected, should be of such value as to operate properly with the phones used, resulting in potentiometers having a value of approximately 10-20 times the direct current resistance of the phones. Another advantage with the volume control located in the outlet box, is the much better regulation of the line that may be attained with this system as compared with having the volume located in the cord of the phone, which is used especially where portability of the installation is desired.

(Continued on page 37)

# Push-Pull-Parallel Operation of Final Amplifier for Grid-Modulated Phone - - -

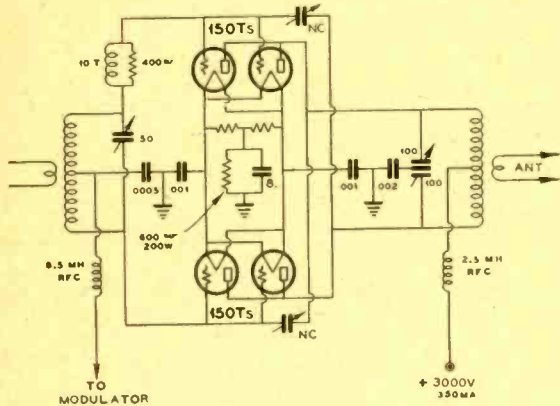

Circuit Diagram of the Push-Pull-Parallel Final Amplifier. Only one grid choke is required, as shown.

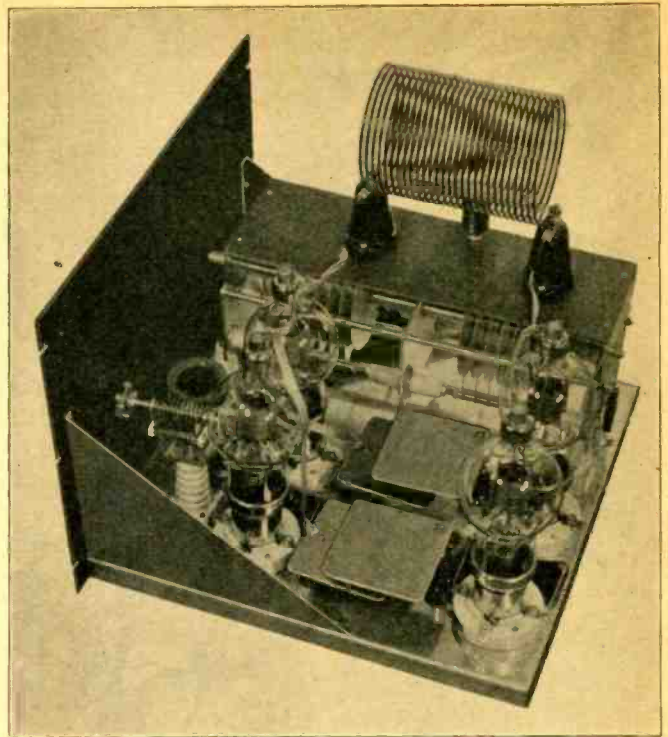

By adding two 150Ts to the final amplifier of the grid-modulated transmitter described in July "RADIO", the output power is increased to 40 watts. The illustration above shows the complete push-pull-parallel amplifier, ready for mounting in the relay rack. The neutralizing condensers are made from pieces of heavy aluminum, supported on stand-off insulators. The edges are rounded, and the surfaces of all plates are given a high polish.

● An economical solution to a high power phone is to use push-pull parallel connection of tubes, as shown, with four type 150T tubes. The RF amplifier is driven by a pair of 2A3s and modulated by means of a pair of 45 tubes. This unit was built to fit into the relay rack which originally used two 150T tubes in parallel, as described in July

"RADIO". The carrier power output is approximately 400 watts.

Trouble was evidenced in the form of a 4-meter parasitic oscillation when this amplifier was first tested with a 3,000 volt power supply. A small RF choke of about 10 turns of No. 14 wire on a half-inch diameter, shunted by a 400 ohm carbon resistor, stopped this effect entirely. Due to the placement of parts, one grid lead was longer than

the other, so the choke was put into the short lead.

Cut-off bias is supplied by means of a C bias power pack, and cathode automatic cut-off bias furnished by means of a 600 ohm 200 watt resistor in the center-tap lead to the filaments. Since this unit is to be used exclusively for phone operation, only a small RF driver is necessary, one which will supply about 15 to 20 watts for grid excitation.

## Amateurs to Be Hamfested by Oakland, Calif., Radio Club

● The Oakland Radio Club will be host to the largest gathering of radio amateurs ever to assemble in Northern California when the annual tri-section hamfest is staged on September 28th. Hundreds of dollars worth of prizes will be awarded. These prizes were purchased from manufacturers and dealers from the proceeds derived from the sale of display advertising space in the official hamfest program.

A number of prominent amateurs will address the hamfests. An excellent dinner will be served. The price of the tickets is \$1.00, everything included. There will be no "extras," there will be no raffles.

Ways and means of reorganizing the northern Pacific division will be discussed. Now that the southern sector of the state is to have a new division of its own, it becomes necessary to bring about a number of important changes in the administrative affairs of the northern division. The affair will be staged in the Aahmes Temple Building, 13th and Harrison Sts., Oakland, California. The time: 7 P. M. Reservations are now being accepted by Mr. Charles Ziegler, 1322 60th Avenue, Oakland. Those who purchase tickets on or before September 25th will participate in a special prize-drawing.

## "THEY'LL DO IT EVERY TIME"



—Courtesy of Jimmy Hatlo.

# Economical High-Power Transmitting Condensers

By FRANCIS CHURCHILL

● The condensers here shown were built for use in high power transmitters. The smaller one has a capacity of a little over 10 mmfd. and is suitable for neutralizing or regeneration. The larger one is of the split-stator type, having about 45 mmfd. capacity per section, and can be used as a tank condenser for the final stage of a transmitter with an input of at least a kilowatt.

The formula used is  $C = \frac{.225A}{d}$ , where A

is the area in square inches of the interleaved plates multiplied by the number of air spaces; (for example, four plates give three air spaces); d is the distance between adjacent plates in inches and C is the capacity in micro-microfarads.

The total cost of the parts for building these condensers will not run over two or three dollars and the construction is quite simple. The moving plates are raised or lowered by means of a piece of dial silk-oiled string, winding over a 1/4-in. brass rod which is rotated by means of a knob. The brass rod is held in place by means of a pair of small aluminum brackets. A long machine screw is run through these brackets, parallel to the rod. The latter provides an adjustable tension or push of the two end mounting plates against the end bearings on the brass rod. These end bearings can be a pair of washers between the two knobs, one on each end of the brass rod.

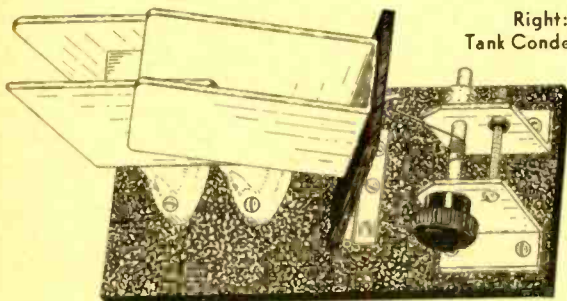

Pictorial and Plan Views of the home-made high-power transmitting condenser.

Left: Neutralizing Condenser.

Right: Tank Condenser.

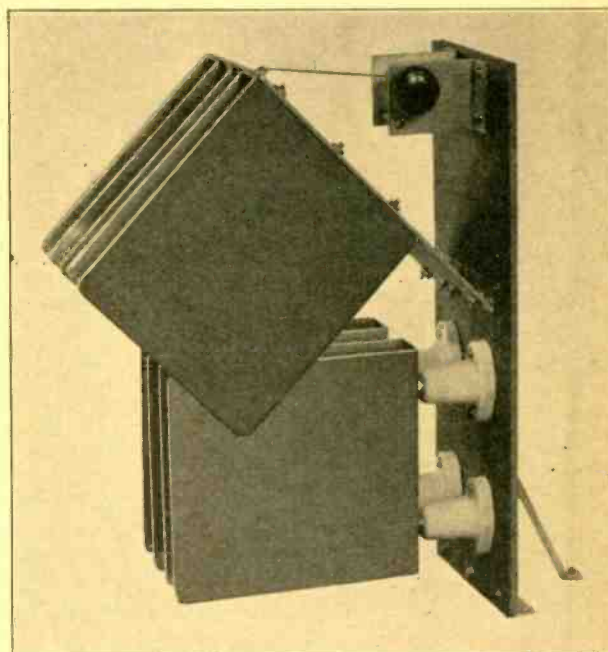

The rotor plates are mounted with flat-head machine screws to a back plate which is hinged to the main vertical mounting panel. The weight of the No. 14 gauge aluminum plates holds them in place and consequently no spring is necessary to pull against the "fish line." The back plate on the split-stator condenser is a piece of 12 ga. aluminum, 7 1/2-in. x 4-in., with a pair of hinges at one end. The vertical mounting strip is a piece of 4 1/2-in. x 12-in. x 1/8-in. tempered Masonite or Cleotex board. Bakelite or 1/2-in. wood will give even better rigidity.

The smaller condenser uses a hard rubber panel as a rotor mounting strip in order to provide insulation. This strip is 5-in. x 2-in. x 1/8-in., and the vertical mounting board is a piece of Celotex 7 1/2-in. x 3-in. x 1/8-in. The vertical mounting boards have right angle feet and an additional angle strip so as to mount easily on a breadboard transmitter. The vertical boards hold the 1 1/2-in. porcelain stand-off insulators for stator mounting. Two of these insulators are used for each of the "U" shaped stator sections.

## Acorn Tube Isolantite Socket Released By Hammarlund

Another exclusive unit has just been developed in the laboratories of the Hammarlund Manufacturing Company. It is a special extruded Isolantite socket for the new ultra-high frequency acorn type tubes, types 954 and 955. This socket, only 1 1/8-in. in diameter, has five double grip prongs of tinned phosphor bronze. These are not only eyeleted to the base, but also lipped. This guarantees perfect contact, for the prongs can not move—cannot shift—a feature found only in Hammarlund sockets.



Another important feature is the alignment plug, which assures proper insertion of the tube. The top, sides and the alignment plug are all glazed for highest surface resistivity. The opposite side of the socket is flush, with all terminals recessed, permitting flat mounting to a metal shelding to prevent interstage coupling. Two mounting holes are provided. The entire exact structure and design insures constant maximum efficiency.

piece of 8-in. x 2 1/2-in. aluminum to give plates 3 1/2-in. x 2 1/2-in. with a 1-in. end portion. The sections overlap an area 3-in. by 2 1/2-in. If more capacity is desirable, larger plates can be used.

Be sure to use hinges which have very little, if any, back-play. They should swing freely when oiled. The string for the rotor adjustment should be of the type used on drum dials, available at most radio stores for service purposes. This string has practically no stretch and the weight pulling on it will not tend to change the capacity of the condenser after it has been adjusted for resonance in a tank circuit. The friction on the adjusting knob-shaft should be such that the knob will not turn too easily. The vertical mounting arrangement takes up minimum breadboard space in the transmitter and allows the use of very short leads.

## Neutralization Kink

● In transmitter amplifiers where tubes are used singly or in parallel, it is sometimes necessary to use filament by-pass condensers in order to obtain complete neutralization and maximum DC grid current. Values of from .01 to .001 mfd. are satisfactory. These condensers should be connected from each side of the filament to the ground bus connection of the stage in which the condensers are used. Some types of filament center-tap resistors are inductively wound and thus they offer considerable RF impedance, which provides a common coupling between the plate and grid circuits. In one particular instance, a 211 stage would not neutralize completely, and the grid current was less than 25 MA. By-passing the filament leads increased the grid current to over 40 MA and the stage was readily neutralized.

## NEXT MONTH . . .

"The 20-Meter Problem," a comprehensive discussion by the technical staff of "RADIO." Don't miss this special feature.

# The W. E. 211-D in a Grid-Modulated Phone

## An Economical, High-Quality Transmitter

By HENRY WILLIAMS

• The Western Electric 211D tube is widely used by amateurs because of its low price and high output. Two of these tubes in class C, with from 900 to 1000 volts on the plates, will give up to 200 watts output on CW. For use in class B, two 211Ds will give approximately 100 watts of audio output with 1000 volts on the plates. In proportion to their filament emission, these tubes have high plate loss capability and therefore they are especially suitable for use in low-cost grid-bias modulated phones.

The phone transmitter here shown gives approximately 60 watts of carrier output at the voltages indicated. Its simplicity is a noteworthy feature and relatively few parts are required. It gives good results on 160 or 80 meters. A 160 meter crystal in the Jones Exciter circuit enables the transmitter to be used on either 160 or 80 meters by changing the coupling loop to either exciter coil, as the circuit diagram shows. Obviously, the grid and plate coils in the final amplifier must also be changed when changing from 160 to 80, or vice versa. The coil winding data is the same as that shown for other 160 or 80 meter transmitters previously described in these pages.

Two separate speech channels are shown, one for use with a crystal mike, the other for use with a double-button carbon mike, to suit the taste of the individual constructor. The 1-to-1 output transformer can either be a class B input transformer, or one of the old-time 112A tube-to-magnetic speaker output transformers.

The grid current on the 211E tubes, unmodulated, should be not more than 2 or 3 MA. Under modulation, this grid current may run as high as 10 MA. For best quality of speech the grid current should never be more than 5 MA. The plate current should remain constant when modulating and the antenna current should increase upward when the mike is spoken into, as is the case when plate modulation is used.

The antenna coupling must be tight enough so that the plate current will be 160 MA when 1,100 volts plate supply is used. This coupling is obtained by varying the two plate tuning condensers and also by varying the number of turns on the plate coil until 160 MA of plate current is drawn. Increasing the capacity of the 350 uufd. condenser reduces the antenna coupling. After each ad-

justment of the antenna condenser, tank circuit resonance must be restored by varying the 100 uuf. main tank tuning condenser. The antenna can be a single wire of any length, as high and as long as possible.

transformer must be used for the 211D tubes. The plate supply for the speech channel is also applied to the exciter unit. A single-section filter is usually sufficient, because the speech amplifier uses an additional section of resistance filter. The power supply for the 211D tubes can be obtained from a rectifier system using three type 83 tubes in a bridge circuit. This system requires a

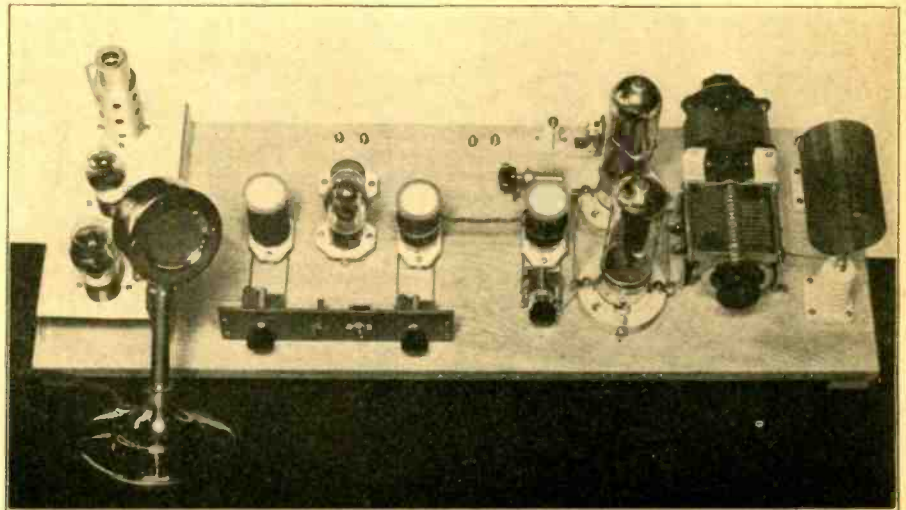

Breadboard mounting for speech channel, Jones Exciter and parallel-connected W. E. 211D tubes.

The 2A6 (or 75) tube in the speech channel should be shielded, and the diode plates of this tube should be connected to the cathode. One filament transformer is all that is required for the tubes in the speech channel as well as for the tube in the exciter unit. A separate 10 volt, 3 ampere filament

transformer with three separate 5 volt windings, insulated to withstand the full plate voltage. The power transformer should deliver 1000 volts RMS at 250 MA because condenser input to the filter is necessary in order to obtain 1100 volts at the output terminals of the rectifier.



Close-up of the Final Amplifier showing the W. E. 211D tubes and the Jones Simplified Antenna Coupler.

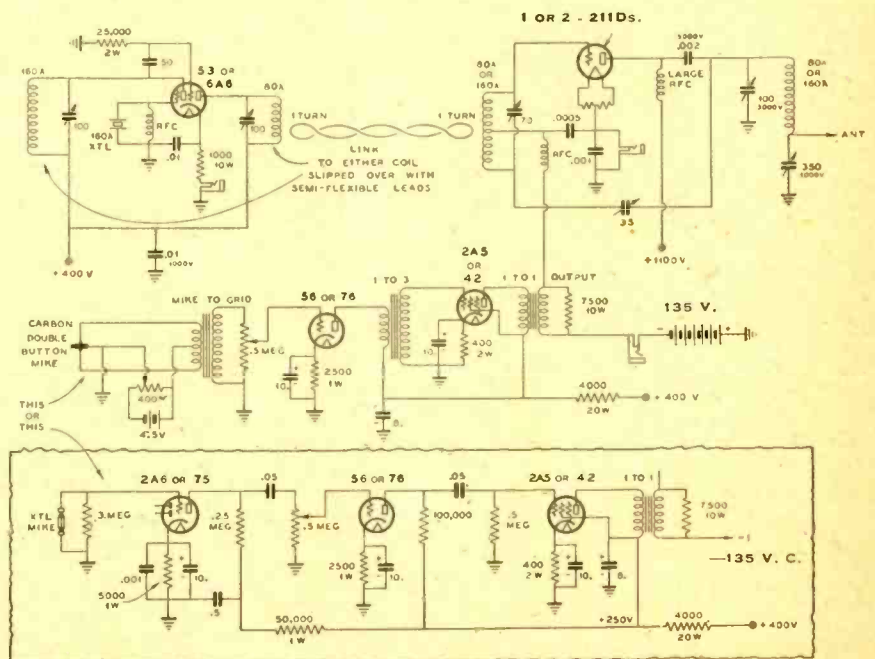

Complete Circuit Diagram of Grid-Modulated Phone and two methods of modulating it. Either of the speech channels shown will give entirely satisfactory results.

# A Variactor Controlled Carrier Unit for Small Transmitters

Easy to Build . . . Can Be Quickly Installed

By FRANK C. JONES

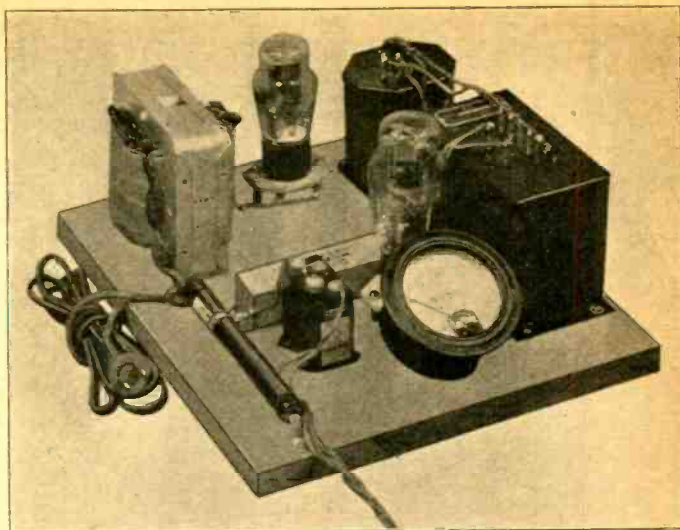

UTC Variactor Components in a simple, inexpensive controlled carrier unit which can be used with nearly any moderate power phone transmitter.

● This unit can be used with nearly any moderate or low power phone transmitter in order to provide controlled carrier transmission. The latter has the advantage of reducing heterodyne interference and providing a method for practical reduction of power for local communication without using low percentage modulation. A controlled carrier Class C modulated amplifier can be used to drive a high power RF linear stage at relatively high efficiency, resulting in high power phone operation at low cost.

The unit here described can be used with any form of plate modulator, class A, AB or B, without disturbing its operation. The only requirement is that the plate voltage supply to the modulated class C stage must be on a separate power transformer and filter supply, in order to use control of the voltage on the 110 volt primary winding for controlling the carrier power. In this form of control, the audio syllabic modulation is used to control the actual "line voltage" into the class C stage which, of course, varies the carrier power. The particular unit here shown uses UTC CV-1 and AV-1 units which will control power of from 25 to 50 watts input to the class C stage. For 50 to 100 watt input, the CV-2 and AV-2 units must be used. When units larger than the type CV-2 are used, more 2A3 tubes must be paralleled, and a heavier duty power supply for these 2A3 tubes must also be used.

Normally these units are made for operation with class B modulators which have not over 5 or 10 MA "resting" plate current when the microphone is idle. A great many modulators use class A or AB (A prime), or even class B tubes, in which the plate current is high at all times. The circuit here shown provides a simple means for providing controlled carrier in such cases. The investment is not great, and controlled carrier can be used without making drastic changes in any particular station.

The circuit consists of a 2A3 tube biased to cut-off, acting as a V.T. voltmeter for large changes of plate current when audio voltage is impressed across its input. A power supply with poor regulation should be used for the 2A3 if linear operation is desired. With the power supply shown, a type 80 rectifier with a 20-watt 150 ohm series resistor provides sufficiently poor regulation. This may sound peculiar to the reader, but the point is that it is desirable that the 2A3 plate current through the CV-1 variactor shall vary directly as the ratio of input AF voltage from the modulator. A VT voltmeter follows a "square law" action; consequently a doubling of the input voltage would give four times as much plate current, unless the plate voltage drops enough to only

give approximately twice as much plate current.

Because only the DC current through the variactor DC winding is important in controlling the saturation of iron in this variactor, it should not be necessary to worry about filtering the output of the 80 rectifier. An 8 or 16 mfd. condenser across the output of the 2A3 provides a path for the AF from plate to filament, thus permitting the 2A3 tube to act as a good rectifier or detector for

input to the 2A3 to the proper value for carrier control.

C bias should be of value that will bring the plate current of the 2A3 to between zero and ten milliamperes with no input. 90 volts C bias proved satisfactory with the power unit here described. It delivered a little over 300 volts at no load. Higher plate current, with no input, will give less carrier control, which might be desirable practice in some cases. A 0-200 MA DC meter

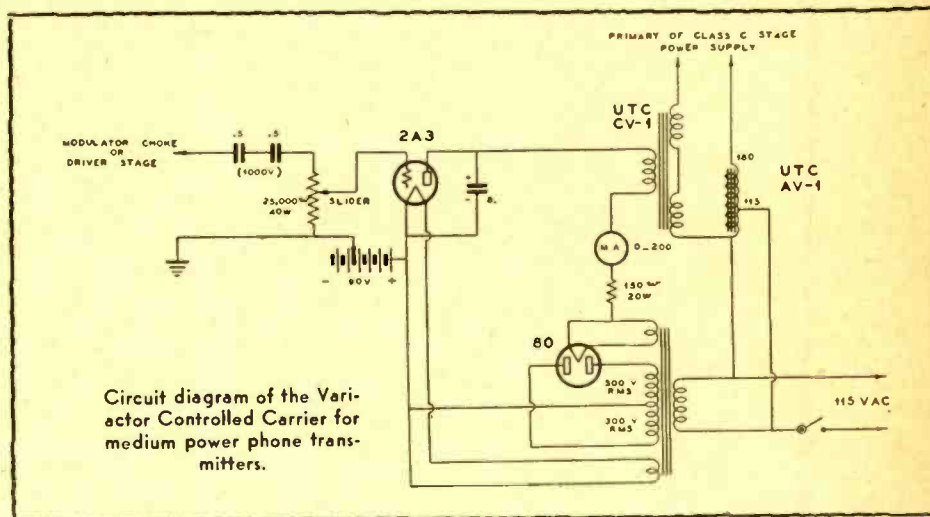

the syllabic modulation. Without this condenser, very little plate current change will take place when AF voltage is applied to the input.

The input, as shown, consists of two of the new "midget" 1/2 mfd. oil-filled 1000 volt condensers, in series with a 25,000 ohm 40 watt voltage divider. This provides a simple method for connection across any modulator output without excessive loading, and further provides a suitable means of setting the actual AF voltage to the desired value which is to be supplied to the grid. Semi-adjustment of the resistor slider should be sufficient for ordinary installations. A small 50,000 ohm potentiometer volume control could be used if this unit is connected across the modulator's driver stage. A small resistor would burn out if connected across a 20 or 30 watt modulator. An audio transformer input could be used in place of the resistor and condensers, if the unit is connected across a speech stage ahead of the modulator. An ordinary 1/2 megohm volume control could then be used to set the audio

in the plate circuit provides a convenient means of adjustment of all voltages.

With 24 volts of AF across the grid of the 2A3, a plate current of 50 MA was obtained through the variactor winding. 37 volts gave about 100 MA and 60 volts gave about 150 MA, which is ample for complete control of the variactor winding. The higher values of direct current saturate the variactor core, and consequently its impedance to the 60 cycle alternating current power is lowered, with the result that more power input is supplied to the class C stage power supply. The auto transformer AV-1 simply steps-up the voltage to 115 at full modulation across the class C stage power supply. The variactor drops the line voltage, even at saturation, and for this reason this auto-transformer is needed.

A pair of 46 tubes was tried in place of the 2A3, but the required input was found to be much greater. It required 110 volts at quite a bit of power input to obtain 140 MA plate current, since the 46 tubes were

(Continued on page 34)

# Introducing the "Radio"-Silver Super

A Professional Amateur Superheterodyne With High-Gain Air-Tuned Iron-Core I.F. Transformers, a Better Crystal Filter, and a Host of Advanced Features.

By McMURDO SILVER and FRANK C. JONES

● In looking over high frequency receivers available to the amateur, superheterodynes, of course, predominate today due to their high selectivity, especially with crystal filter, and their ease and dependability of operation. Looking a bit farther, one finds them mostly all alike, using but one r.f. stage if any, and the usual and typical crystal filters in a conventional one or two stage i.f. amplifier. Obviously more can be, and is, desired, for the past year has witnessed a rapid increasing appreciation of the image selectivity and noise elimination benefits of not one, but of two r.f. stages, of a quiet low gain i.f. amplifier and stable air tuned and temperature isolated circuits throughout.

The writers got together in a vein of dissatisfaction and criticism and decided to do something constructive about it for amateurs in general, instead of simply bewailing an unsatisfactory condition which made improvement possible only to those of us who are possessed of a couple of hundred dollars to buy a new receiver with.

The result is the receiver illustrated herewith, and described in this and future articles—an amateur, not a revamped broadcast receiver, designed by amateurs for amateurs and to fit amateur pocketbooks, and usually to fit an amateur junk box assortment of standard parts.

One of the first premises established was that any receiver good enough for serious amateur use should be well enough and clearly enough designed for amateur construction, not just for laboratory building and testing, since all complications allowing of only such treatment would automatically spell expense.

The only remaining considerations were that the ideal receiver must have "everything" and cost nothing. On these points the designers fell down—it has almost everything any amateur could desire, but it costs something more than nothing.

Taking the worst first, all parts (assuming the impossible condition of more in the junk box!) cost about \$87.00, which includes tubes, crystal filter and loud speaker. Now let's see what it has.

For the engineering minded, this is easily stated by saying that its four low-C 200 mmf. tuning bands cover 1700 to 33,000 kc. which includes the 160, 80, 40, 20 and 10 meter amateur and all short waves broadcast bands, its sensitivity is below a microvolt all over this range, its inherent noise never exceeds 10 milliwatts at maximum sensitivity, its selectivity is variable from 50 cycles 10,000 times down to 10 kc., its fidelity is controllable from flat to 4 db. from 30 to 4000 cycles, to "peaked audio" for C.W. reception, its undistorted power output 3.0 watts, rising to a maximum of about 4.0 watts.

After digesting the really ideal performance described above, let's take a look at its other features as briefly as possible.

**CIRCUIT:** Superheterodyne, with two 6D6 tuned r.f. stages on all four bands, suppressor grid injected 6D6 s.g. first detector 76 electron coupled H.F. oscillator, one 6D6 i.f. stage, high gain 6C6 tetrode second detector, 6B7 amplified A.V.C. optimum inductively coupled variable pitch 76 beat oscillator, 42 output pentode and 5Z3 rectifier.

**BAND CHANGE:** Individual coils for each band, picked up by dependable Yaxley eight-

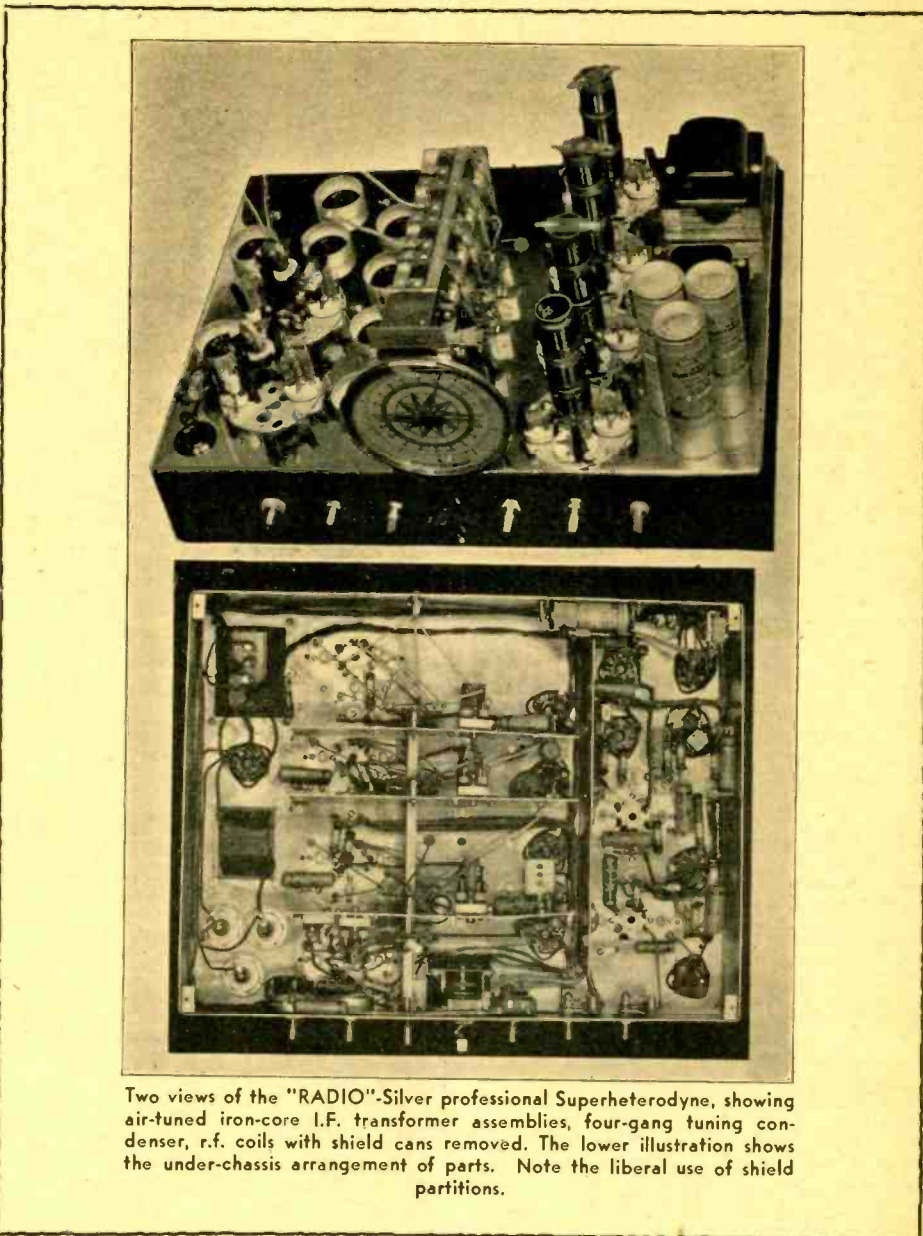

Two views of the "RADIO"-Silver professional Superheterodyne, showing air-tuned iron-core I.F. transformer assemblies, four-gang tuning condenser, r.f. coils with shield cans removed. The lower illustration shows the under-chassis arrangement of parts. Note the liberal use of shield partitions.

gang wave change switch just like you find in all good broadcast receivers.

**FREQUENCY STABILITY:** Individually shielded coils, all circuits Hammarlund air dielectric, not compression mica, tuned and trimmed, plenty of ventilation, and temperature isolation make for the ability to stay "zero beat" on a good 20 meter signals for hours.

**I.F. AMPLIFIER:** Set at 25 microvolts absolute sensitivity to place the limit of inherent noise at thermal agitation in the antenna circuit where it belongs, not as usual at the first detector so as to lose weak signals in set noise. Two Aladdin polyiron 465 kc. i.f. transformers, air tuned, and variable as to selectivity to suit your taste. Crystal i.f. transformer dual tuned.

**SELECTIVITY:** Variable—so you can adjust it with two knobs from 150 cycles wide

to 10 kc.—or a socket wrench pushed through two i.f. can holes lets you vary the i.f. transformer coupling and selectivity even further.

**CRYSTAL FILTER:** Of course, but one that makes the usual garden variety look sick by comparison. As much, and usually more sock in series circuit as when cut out, and in parallel, the ability to drop an unwanted heterodyne right down the drain. Both i.f. stages are dual tuned, and the crystal filter stage is completely eliminated.

**BAND SPREAD:** One tuning dial, accurately calibrated (yes, you can so align it without any extra test equipment) with geared, no slip, band spread pointer on 200 division, 360 degree inside scale which accurately and positively relogs. Fast and slow (and how you need slow with this crystal circuit) tuning ratios, 23:1 and 130:1. Band spread, 900 degrees on 160 meters, 620 de-



greens on 80 meters, 216 on 40, 153 on 20, and 486 degrees on 10 meters. Effective feet, not inches, of dial space on the amateur bands, since 360 degrees of band spread equals about one foot of dial space. Five full turns of slow knob for 360 degree band spread pointer rotation.

A.V.C. of course, but amplified so it really does a job on weak signals, and speeded up so it does likewise on C.W. But if you're of the old school, a switch cuts it out for C.W., and in for phone.

**CONTROLS:** Enough and no more. Not usual blind knobs, but every one labeled as to what it does, and calibrated so you can tell that QSO just how much better he comes in tonight than he did with the old rig last night.

**R-METER:** A sensitivity meter that lets you actually measure signals as weak as 5-0 microvolts absolute—and that's not an R9 signal, it's about R2-R3.

**CONSTRUCTION:** Finish is polished chromium, like the finest custom built jobs, yet doesn't cost like gold, only a little more than black enamel. But, does it trim up the shack! Assembly is a pipe, for all low frequency wiring comes all laced up in a color coded cable—only the few "hot" bus-bars have to be cut and fitted.

**ALIGNMENT:** The sensitivity meter is the output meter in aligning, the crystal in a temporary circuit using no extra parts except that odd '99 or 30 tube, its socket and a couple of flashlite batteries does the i.f. job, while signals do the whole r.f. job. Hammarlund's air trimmers make all this a pleasure, not the usual uncertain God-knows-when headache.

If you read this far, we'll sign off until next issue leaving you the circuit to study, Mac Silver's article elsewhere in this issue on how to make crystal filter circuits really perk, and a couple more thoughts.

In the photo, the knobs left to right are crystal phasing and parallel switch, beat oscillator pitch and on-off switch, audio volume control, A.V.C. on-off switch, five position (one dead for "send") wave change switch, tone control and sensitivity or manual volume control. The dial is shown 0-100—actually its outside carries four calibrated bands and the inside 0-200 division, full circle band spread pointer scale. The "dog house" behind the dial houses the four-gang low minimum capacity 200 mmf. tuning condenser rubber mounted to kill microphonism (as is the whole chassis) at its right are the big copper shields housing the 1st r.f., 2nd r.f. first detector and oscillator coils and trimmers for three bands—the high frequency (16 to 33 megacycle) band being below the gang condenser. To the right, back to front, is power transformer, 5Z3 rectifier, filter choke and three wet electrolytics—two self-regulating to save wear and tear on other circuits parts, though all are safely rated and . . . but look at the parts list and see for yourself.

The row of four tubes left of the "dog house" on back to front, 6D6 first r.f., 6D6 second r.f., 6D6 suppressor injected first detector (like the metal 6L7, but save us from metal tubes until the B.C.L. boys have taken their beatings) and 76 electron coupled (yes, connected only to 6D6 suppressor grid) H.F. oscillator. Left front to rear are first Aladdin iron core i.f. transformer, Bliley crystal, 6D6 i.f. tube, second polyiron i.f. transformer, 6C6 second detector, 76 beat oscillator (not electron coupled-harmonics not wanted) 6B7 amplified A.V.C. and 42 output pentode, phone jack and speaker plug on left rear. Speaker new Jensen C8X, 8" (bigger and better can be had if you prefer).

Net result, even if you don't agree, is a honey of an amateur receiver, and nice and

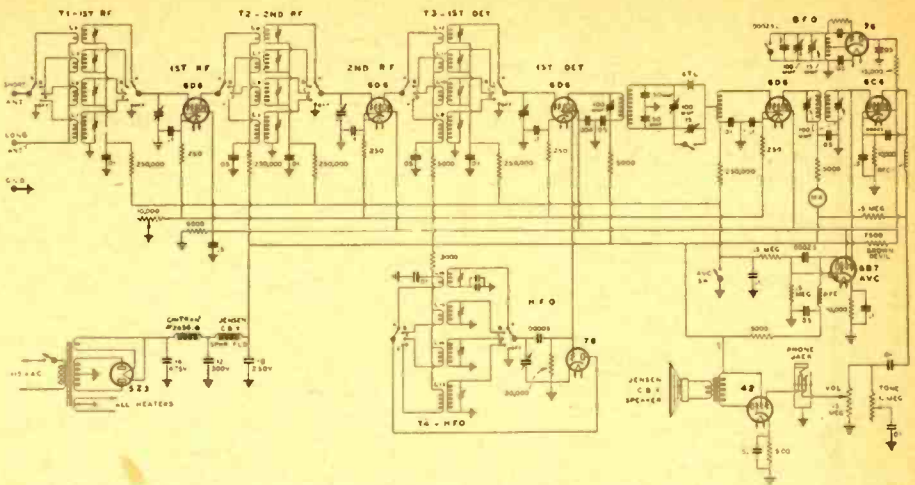

Complete circuit diagram of the "RADIO"-Silver professional superheterodyne. The output choke in the crystal filter is a resonant tapped choke.

pretty in black enamel panel and polished chromium. If you like more chromium, a dust cover can be had to hide the works, dropping over everything but panel. But it is not needed—turn on the KW and you'll see how well it's shielded.

### Colonel Foster on Vacation

Enjoying his annual vacation at his summer home on Vancouver Island, Colonel Foster will contribute no monthly political department to the pages of this magazine until he again returns home.

Informed of the Roberts address to the Aurora Convention, the Colonel replies with the following remarks:

You will recall my saying several times that Roberts' flop from his former attitude towards Warner was altogether too sudden for me to credit until I had seen it backed up by performance. I have a stack of the campaign literature he issued three years ago when he tried to take the directorship from Windom, and I have several copies of his own paper, "The Sky Wire," written since he became director. His remarks were all fulsome, sometimes nauseous, in praise of Warner. I see nothing inappropriate in a man's suddenly changing his position. The ability instantly to reverse one's views is an essential accompaniment of the function of judgment. But I wish to be sure that that man's views have changed from con-

viction and not as a matter of policy or expediency.

It is reported that at the Fox River convention Mr. Roberts was asked why Warner did not answer his critics. That is a natural question, for when a man makes no attempt to refute serious charges there is always the justified inference that he cannot answer them. Roberts' reported reply, "Warner does not fight back; he keeps out of disputes; he is not disturbed by criticism," is certainly the weak defense of a weak man. Why doesn't Roberts himself refute the charges if he is convinced that they are untrue!

Mr. Roberts is reported to have said that the present effort to reform the administration of the ARRL is merely a private feud between Warner and Foster and to have likened it to the mimic squabble between Walter Winchell and Ben Bernie. Well, if Roberts really believes this then he is lacking in the discernment that is expected in a man of his years. But perhaps he was only wise-cracking to get a laugh out of the gallery. Winchell and Bernie are the only men who could take exception to the comparison. As an entertainer Warner is about as funny as a crutch and in such a role I'm no better, myself.

No, let us wait until Mr. Roberts gets through flopping from one side to the other and see what he DOES rather than take any present interest in what he SAYS.

CLAIR FOSTER, W6HM.

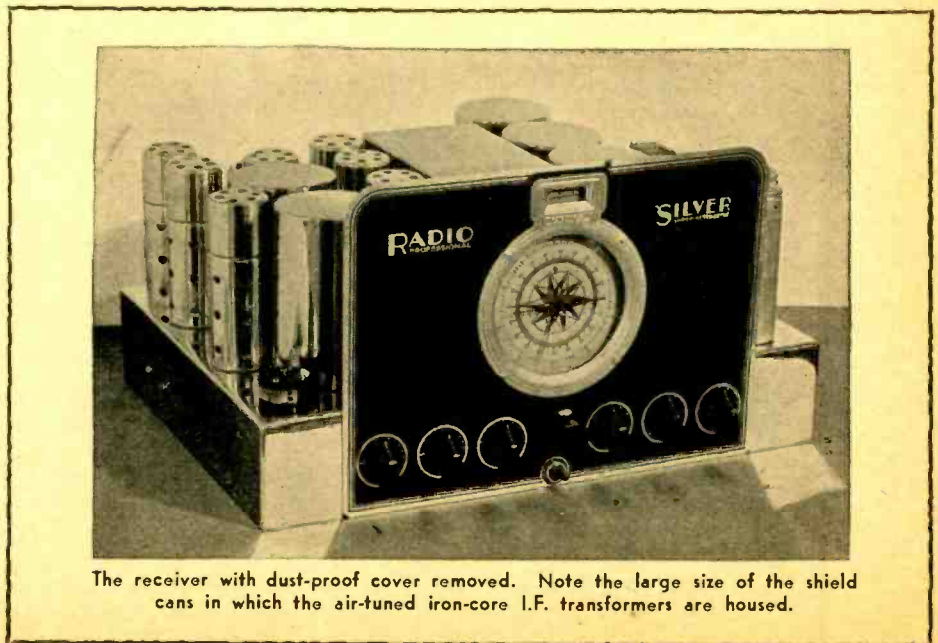

The receiver with dust-proof cover removed. Note the large size of the shield cans in which the air-tuned iron-core I.F. transformers are housed.

# More Data on the 53 Exciter

## —and Details for Building a One-Tube Push-Pull Transmitter

• The 53 twin triode 2.5 volt heater tube, or the 6A6 tube with 6.3 volt heater, have proved ideal for use in good crystal oscillator and doubler circuits for amateur transmitters. The circuit diagram shows an experimental hook-up for testing this oscillator circuit at various plate voltages and circuit constants. One triode of the 53 tube acts as a very effective crystal oscillator because of its high amplification constant and low inter-electrode capacity. The other section of the tube is a good doubler because of its high amplification constant. The doubler section can be used as a quadrupler by using a little regeneration in the form of a 15 mmfd. variable condenser connected from grid to plate coil with the plus B connection at the coil center-tap of the frequency multiplier. For general use the type of circuit here shown is most practical. The output load can be either capacitively or link coupled to a 45, 2A3 or type 10 tube stage.

CRYSTAL OSCILLATOR - DOUBLER

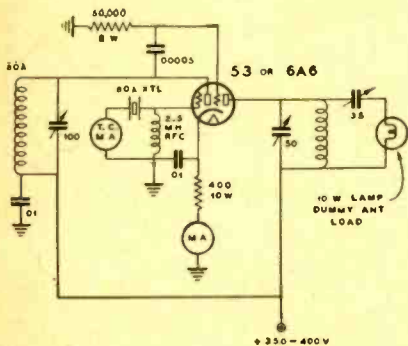

Circuit used for making the tests.

More power can be obtained from this circuit than from a Tritet or pentode crystal oscillator-doubler at anywhere near the same plate voltage. It is a very reliable oscillator, and while it is not as easy on the quartz crystal as is a pentode tube, it is generally easier on the crystal than a Tritet oscillator. Its main disadvantage is that the 53 tube tends to run wild at high plate voltage unless the plate current is kept below 80 MA.

Seventy-five MA at 400 volts means 30 watts input and thus an output of 8 to 10 watts can be secured on the second harmonic. The output of a Tritet oscillator is usually somewhere between 1 to 3 watts on the second harmonic at 400 volts plate voltage. This is because the plate current of the tube in the Tritet is usually less than half of that for a 53 tube.

The original circuit of the 53 exciter shows the use of a cathode resistor of 400 ohms and a 15,000 ohm doubler grid-leak. Other values of resistors as high as 1,000 ohms and 25,000 ohms have later been shown, together with various values of doubler grid coupling condenser capacities. Usually these higher values were used in order to limit the 53 cathode or total plate current to not over 75 MA in the particular transmitter described. Sometimes steel panels or other shielding such as used in relay rack construction introduces some loss in efficiency when compared with a breadboard layout.

The constants here shown are generally satisfactory and they are the result of a great many 53 exciter unit tests made with various sets. The cathode resistor is 400 ohms, 10 watt type. The doubler grid-leak is a 50,000 ohm 2 watt resistor because this higher value

does not appreciably affect the maximum output obtainable, but it does eliminate the need of an RF choke in series with it, such as is needed when a 15,000 ohm grid-leak is used. A .00005 mfd. (50 mmf.) mica fixed condenser is suitable for use with any

values of grid resistors and other constants. Varying the value of the doubler grid-leak has very little effect, until values above 50,000 ohms are used. Either a 25,000 or 50,000 ohm resistor is satisfactory. Some readings are given in the following data:

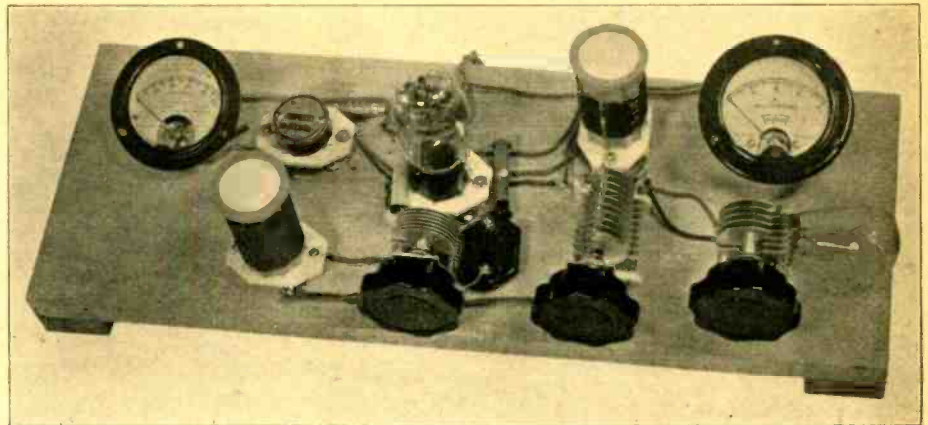

Equipment used for making the tests.

crystals from 160 down to 40 meters. A larger value can be used with a very slight increase in output, but at high plate voltages the cathode current is excessive.

No grid-leak should be used across the crystal section for the reason that the crystal RF current will then be excessive. The use of a grid-leak results in lower plate current, the tube runs easier, the output is about the same, but the crystal current is usually 50 to 100 per cent higher than with cathode bias. A 2.1 or 2 1/2 mh. RF choke across the crystal should always be used instead of a grid-leak, so as to provide a DC path for the grid return to ground.

The cathode resistor should be by-passed with at least .005 mfd. A .01 paper condenser does the job very nicely. The plate return circuit should have similar values. The values of the tuning condensers are not critical; low C for the doubler and moderate C for the crystal oscillator section is advisable. The latter can be either a 50 or 100 mmf. midget condenser, and the doubler tuning condenser can also be a 50 mmf. single-spaced condenser.

The oscillator section should have its tank condenser tuned toward the maximum capacity setting at which oscillation holds on. This point is at maximum output of the doubler section and the cathode current is usually about 20 per cent less at this point than at the mid-point of oscillation range on the oscillator tuning condenser. The doubler tuning condenser is always adjusted for maximum output and greatest dip in cathode current. Even under load this dip should be 10 to 15 MA.

The plate voltage can be anywhere from 300 to 400 volts, depending upon the output desired and upon the allowable limit of crystal heating. If a 40 meter crystal is used, the 53 tube should be operated at not more than 350 plate volts, unless a special power-cut crystal is used. Voltages up to 500 can be used, provided the cathode current is held to less than 75 MA for 80 and 160 meter crystals, but 500 volts is higher than can be recommended for general use.

A 10 watt lamp can be used as a capacitively coupled dummy antenna for testing, and the output can then be judged for vari-

Xtal Frequency (KC)	Plate Voltage	Cathode Current (MA)	Xtal Current (MA)	Approx. Doubler output in Watts
1762	380	50	20	5-6
1762	500	65	28	9
1969	380	50	23	5-6
1969	500	60	28	9
3600	380	60	46	5-6
3600	500	75	55	10
3671	380	55	44	5-6
3671	500	70	52	10
3815	380	60	46	5-6
3815	500	75	55	10
7058	380	57	89	5
7058	500	70	109	7-8

When the 53 tube is used as a triode crystal oscillator with grids and plates parallelled, the crystal RF current is higher than in the system here shown, and the output is comparable to the doubler output, consequently this method of connection is not very satisfactory.

Using the 53 as a push-pull crystal oscillator, the output is approximately 10 watts with 380 volts plate supply. The crystal current is lower, being 11 MA for a 1969 KC xtal, 40 MA for 3600 KC, and 65 MA for 7058 KC. The cathode current is about the same as when the tube is used as a crystal oscillator and doubler. In push-pull, the output is on the frequency of the crystal used. This push-pull 53 arrangement makes a good one-tube transmitter. The crystal current is twice as high with grid-leak bias as with cathode resistor bias at the same output and plate voltage for push-pull connection. Values of cathode resistor greater than 400 ohms will increase the crystal current and drop the output slightly. Lower values give less crystal current but excessive cathode current, and zero cathode resistor gives unstable oscillation with respect to keying.

The system developed by Lampkin\* (using a 53 with three tank coils on 80, 40 and 20 meters) was also tried. It works very nicely, but it gives less power than can be obtained which the tube is used as a straight-forward

\* August "RADIO".

doubler. The output on 20 and 40 meters ran about 3 watts, and about 5 or 6 watts on 80 meters. At a plate voltage of 370 volts the crystal current was around 80 MA and the cathode current about 90 MA, which is excessive for the 53 tube. The crystal current was about 60 per cent higher than in the circuit shown. Without regeneration, the 20 meter output from a 3600 KC crystal was nearly 2 watts as a straight quadrupler and nearly 6 watts as a doubler. The Lampkin circuit has an advantage in that it gives a moderate amount of output on three bands without having to change coils, but this circuit should be used only with special cut, high current crystals.

The 53 tube circuit here shown is normally used without the RF meter and dummy antenna. A jack is used in place of the cathode milliammeter in order to allow either current measurement or cathode keying for CW transmission. Link coupling to a buffer stage is desirable, but capacity coupling can be used when low mu tubes, such as 45s or 2A3s, are being driven.

### A Transmitter for the Newcomer

★ The type 53 tube in a push-pull crystal oscillator circuit for a one-tube CW transmitter, as illustrated in the photograph above, is an ideal means for securing 10 watts of output. The 53 in a push-pull circuit gives more output than a single 47 tube in a crystal-oscillator circuit, and it can even deliver more output than two 47 tubes in push-pull.

This tube makes possible the construction of a most simple and efficient CW transmitter. The layout of the parts should be as shown in the pictorial diagram. The 53 tube socket, (7 prong) and the socket which holds the crystal are mounted close to each other. The double-spaced 35 mmf. (or 50 mmf.) midget variable condenser for plate tuning is placed between the tube and the plate coil. For 160 meter operation, a 140 mmf. condenser should be used. This condenser is mounted about 6 inches back from the front panel and a 1/4-inch round bakelite rod is used for an extension shaft to the tuning dial. The front panel is a piece of 12 or 14 gauge aluminum, 4-in. x 10-in. The baseboard is 11-in. x 15-in. x 3/4-in. A wooden cleat is screwed to the two ends of the baseboard so as to raise it off of the table, and also to permit mounting the bypass condensers and resistors under the baseboard. The filament and plate supply wires are also under the baseboard, out of sight. Thus the completed unit has a business-like appearance. The two RF chokes are mounted above the baseboard, close to the socket which holds the crystal. The telegraph key is plugged into the closed-circuit cathode jack.

The circuit diagram shows two methods of antenna connection. The link coupling loop is placed around the center of the plate coil, as the picture shows. The 0-200 (or 0-100) MA DC milliammeter, and the plate tuning condenser dial, are both mounted on the front panel.

The plate coil for 80 meter operation has 37 turns of No. 14 enameled wire, space wound over a winding space of 4 1/4-in. The coil is 2 3/4-in. in diameter. A tap is taken at the center of the coil for the plus B connection.

It may sometimes be advisable to use a plate tuning condenser with a higher capacity than 35 mmf. for tuning an 80 meter plate coil, if the plate coil is not wound to exact specifications. A single-spaced 100 mmf. midget variable condenser can also be used for 80 meter operation if the plate supply is less than 400 volts. For 40 meter operation, a 35 mmf. double-spaced midget vari-

# One-Tube Push-Pull Transmitter

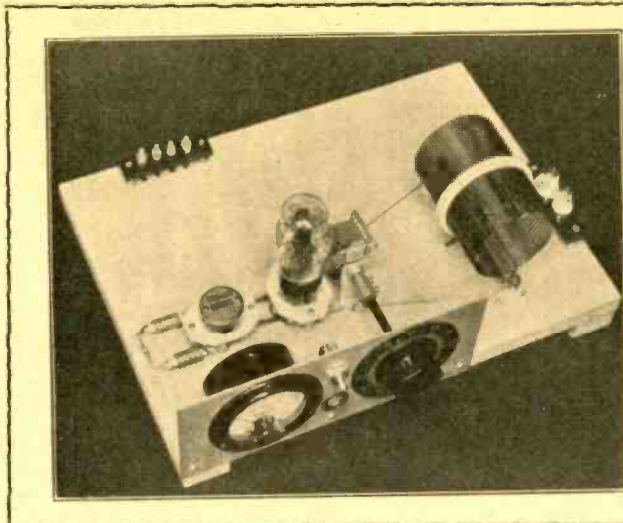

A breadboard one-tube push-pull transmitter, with crystal control. This is an ideal beginners' transmitter. It can later be used to drive a higher power amplifier stage. Consistent RB reports were received from amateurs 500 miles away when this transmitter was tested in the laboratory.

★ Circuit diagram of the one-tube push-pull transmitter, showing power supply and methods of coupling the transmitter to two types of antennas. L2 is a 2-turn coupling loop, wound around the center of plate coil L1. L3 is a loop with from 4 to 6 turns, wound around the antenna coil L4. L4 has the same number of turns as L1.

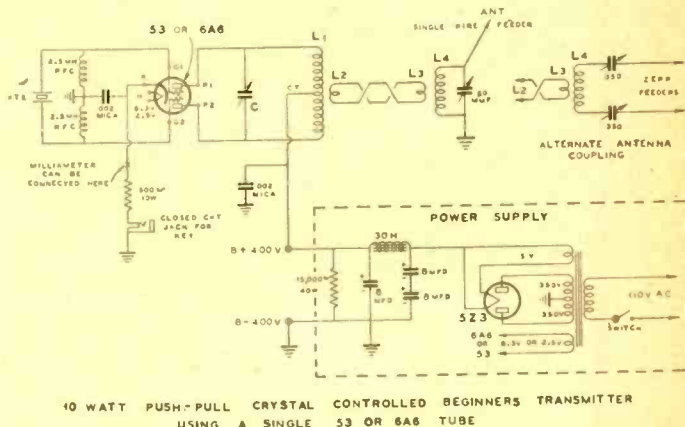

10 WATT PUSH-PULL CRYSTAL CONTROLLED BEGINNERS TRANSMITTER USING A SINGLE 53 OR 6A6 TUBE

able is entirely satisfactory. The plate coil for 40 meter operation should have 22 turns of No. 14 enameled wire, spaced over a winding space of five inches, 2 3/4 inches in diameter.

The two connecting leads from the plate coil to the plate condenser should be of the same length.

This single-tube push-pull transmitter will give surprisingly good results. With only 400 or 450 volts plate supply, the output is slightly more than 10 watts.

### Farnsworth Predicts Amateur Television Circuits Will Be Ready Soon

★ "The amateur will be pushed forward, rather than out, by television. The radio amateur has been a pioneer, in the highest sense of the word, exploring new fields that have later been taken up by others, and like a true pioneer he has pushed forward always exploring new fields," said Philo T. Farnsworth, vice-president of Farnsworth Television Incorporated, and inventor of the devices used by his company, in an exclusive interview with "The Sun" (New York).

Mr. Farnsworth had been asked what part the amateur might expect in the development of television. Some have taken the attitude that television should first be absolutely perfected in the laboratory before being released to the public, thus eliminating the amateur completely. This, however, is not Mr. Farnsworth's attitude toward the problem.

"As soon as technical information can be released," continued Mr. Farnsworth, "amateurs will have an opportunity to make re-



400 volt plate supply for beginners' transmitter.

ceivers." He stated that this information would be available to the amateurs in the near future, and that before very long component parts would be procurable at prices that would not be prohibitive.

"Amateurs have actually been responsible for exploring the short wave bands required for high definition television," continued Mr. Farnsworth, "and as a partial compensation for this I feel that they should at least have opportunity to participate in the development of television, and if this opportunity is given amateurs I feel that they will contribute substantially toward television."

Mr. Farnsworth pointed out that television will open a tremendous field for engineers and technicians, and he predicts that not a few of these television engineers will come from the ranks of the amateurs. Two-thirds of the men forming the highly technical staff of the Farnsworth laboratories were at one time amateurs.

# A Method of Improving "Single-Signal" Crystal Filter Performance

By McMURDO SILVER

• In James J. Lamb's original revelation of the inherent possibilities of audio image rejection and improved selectivity possible through the use of a quartz crystal resonator in the intermediate frequency amplifier of a superheterodyne, attention was called to the bridge circuit in which the crystal should be employed with a variable capacitance in the adjacent bridge "arm" to balance out the disadvantageous effects of crystal holder and associated wiring capacity.

Since then any amateur superheterodyne laying claims to modernity has employed James J. Lamb's "single signal" crystal filter in about its original form.

In recent investigations of crystal filter performance, a simple method was discovered by which almost any one can

- (a) obtain maximum image reactivity and selectivity;
- (b) avoid loss of volume when using the crystal resonator in its most selective series connection and
- (c) obtain the benefit of full crystal reactivity of an unmounted interfering carrier.

Remembering that for practical receiver purposes, a crystal filter has substantially infinite reactivity for any but its resonant frequency (see Fig. 3 for example of good Bliley 465 kc. crystal selectivity), and negligible reactivity at resonance, let us consider a simple resistance bridge circuit of Fig. 1 and the variation thereof in which a crystal filter may be employed.

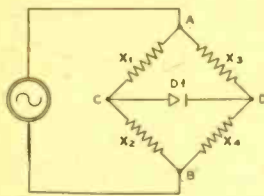

FIG. 1

In Fig. 1 signal or measuring voltage is fed to the bridge at points A and B, when arms  $X_1 = X_2$  and  $X_3 = X_4$ , balance is obtained and no signal can be detected at the measuring device D1 connected to points C and D. This is elementary electricity. In Fig. 2, with the same symbols employed, X1 and X2 represent parts of an i.f. transformer secondary or other circuit feeding the balanced detecting device, in this case the following amplifier tube D1. When the phasing condenser X4 is adjusted so that in this bridge circuit the crystal capacity at X3 is balanced out, D1 receives no signal.

This is true except at crystal resonance, when the impedance of X3 falls quite low, unbalance occurs, and D1 receives a signal.

If these theoretical assumptions are satisfied in practice, the above described results will follow, and the selectivity of the crystal

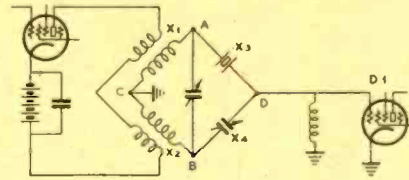

FIG. 2

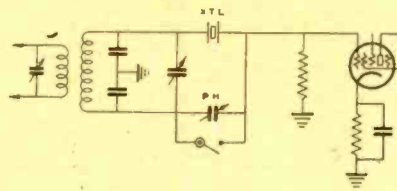

FIG. 2A— ACTUAL USEFUL CIRCUIT

filter will be so great that the 2000 cycle difference between a wanted heterodyne beat note and the second unneeded duplicate thereof observed in heterodyne reception may be on the order of 10,000 times or more—obviously quite desirable. By careful adjustment, this discrimination may be made extremely high. The method of obtaining this discrimination lies in adjustment, assuming a normally good receiver crystal circuit to begin with.

The process involved is to align the i.f. amplifier to the crystal frequency by using the crystal temporarily in a local alignment oscillator circuit outside the receiver. This done, the crystal is replaced in the receiver in series circuit, and a loud test signal tuned in to desired beat note pitch of about 1000 cycles. If the condenser tuning the i.f. transformer secondary is then carefully adjusted in conjunction with simultaneous adjustment of the phasing or balancing condenser X4, the bridge circuit can be so completely balanced that the test signal will disappear completely.

This balance obtained, the other heterodyne note for the same signal should be tuned in with the r.f. and h.f. oscillator circuits only, and all remaining i.f. trimmers adjusted for maximum signals. This done, the i.f. am-

plifier is aligned as it should be, exactly to the frequency of its crystal, not a few kc. off. The net result is usually a surprising gain in sensitivity or volume, as the adjustment method can easily be applied to any existing "single signal" receiver. Once done, however, the crystal should not be removed, or its holder reversed in its socket, or deleterious unbalance will result.

Most of us have found the parallel crystal connection of little practical value. If we examine a selectivity curve measured for this condition when alignment as described above has been effected, we will find the typical curve of Fig. 4. Here the high impedance of the crystal off resonance is not affecting the i.f. circuit which it parallels. At resonance, its impedance falling quite low, we find the dip seen in Fig. 4. This dip can apparently be quite useful in eliminating an undesired heterodyning carrier quite close indeed to a desired signal. It is quite useful in phone and C.W. reception, if the alignment proceedings described above have been followed out carefully for the unwanted carrier can be dropped into this dip, and presto, it is gone—while the desired signal remains.

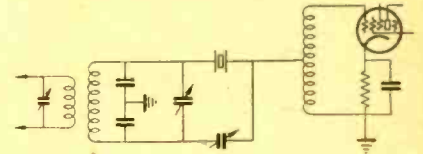

FIG. 5

Consideration of almost every amateur superheterodyne employing crystal filter in the light of the bridge circuits of Figs. 1, 2 and 3 indicates that a substantially 2:1 voltage loss results when the series crystal filter is used, or when it is switched out of circuit.

Various attempts at tuned circuits following the crystal and relatively complicated transformer systems for voltage step-up and impedance matching have been advocated and used in some cases. The simple and direct answer is the use of an auto-transformer which is semi-resonant by virtue of its own inductance and circuit capacity, as shown in Fig. 3. Actually this auto-transformer takes the form of a tapped r.f. choke. This choke is ordinarily used in crystal filter circuits, but by increasing its inductance so that it resonates relatively broadly at the crystal frequency, and by tapping the crystal circuit into the choke better than half way down from the grid, the 2:1 voltage loss in the crystal bridge circuit can be more than made up, and obviously a more satisfactory impedance match will be had since the crystal circuit works into a more rational impedance than the ordinarily quite high impedance tube grid circuit.

This little trick, which makes use of a McMurdo Silver type 17G auto-transformer, can be applied to practically any single signal superhet utilizing an i.f. of between 450 and 525 kc., and coupled with realignment in accordance with the suggested procedure will make a new set out of many of the one-lung SS supers now in use.

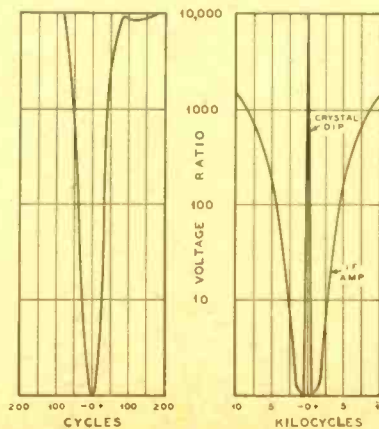

FIG. 3

FIG. 4

# An Over-Modulation Indicator

-To Help You Comply With the New FCC Regulations

● The linear rectifier here shown is useful for determining the limit of modulation to which a phone transmitter can be operated. The new FCC regulation requires every phone station to have a means for determining the limit of modulation. Thus an overmodulation indicator must be constantly used when the phone transmitter is in operation.

A well-designed and adjusted phone will allow up to 100% modulation, but many amateur phones overmodulate before reaching 100%. Overmodulation sends out spurious sidebands and causes voice splatter into other parts of the amateur bands. This causes needless and illegal interference with other stations. A phone transmitter should not overmodulate, nor should a CW transmitter radiate bad key clicks.

The linear rectifier here shown can be used to indicate even the slightest amount of carrier shift, which means overmodulation. This instrument is easy to adjust; it uses a small variable condenser for adjustment of the meter deflection without juggling the coupling to an antenna wire or coil. The 50 mmfd. fixed condenser and 100 mmfd. variable condenser form a variable attenuator for RF voltage. Capacity coupling is used to the antenna lead by simply running the lead from this unit close to the antenna lead-in or feeder. This is easier to do than trying to hang a coil in the air in such a position that it will have a critical value of coupling to the final amplifier tank coil.

Any type of tube can be used, connected as a diode. A 76 was chosen for use in the indicator here shown. The heater is connected to the receiver power pack. A type 30 tube can be used with a single 1½ volt dry cell as filament supply. The RF choke is a pie-wound 2½ mh. choke, connected as shown through a telephone jack in order to allow monitoring the modulated signal. This instrument makes a very good monitor for phone or CW signals. For monitoring CW signals it will show-up key clicks in the headphones, and the meter reading can be used to show relative radiation.

The indicator is built into a 4-in. x 12-in. x 14 ga. aluminum strip, bent as shown in

By D. B. McGOWN



A piece of No. 12 gauge aluminum is bent in one piece to provide a mounting stand for the Overmodulation Indicator.

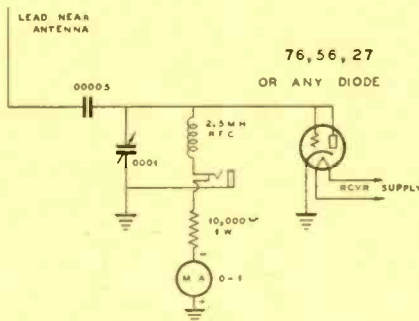

Circuit diagram of the Overmodulation Indicator.

the photograph. This mounting arrangement enables the unit to be placed directly in front of the operator so that he can be constantly on the look-out for overmodulation. The needle on the meter should remain stationary at some fixed reading on the scale, such as the half or two-thirds scale position.

The overmodulation indicator and phone monitor here shown can be mounted on a 3½-in. x 19-in. relay rack panel. It makes a necessary and simple addition to the phone station. When coupled to the antenna lead, it also provides a good indication of the relative power going into the antenna system at all times.

This form of overmodulation indicator can not be used with controlled carrier modulation transmitters. For such transmitters a 45 or 80 tube, or an 879 should be connected-up as a negative peak indicator and the transmitter monitored by a selective superheterodyne receiver with crystal filter, in order to test for voice splatter outside the channel in use. This tube acts as a half-wave rectifier with its plate connected to the filament center-tap of the modulated class C stage and its filament connected through a 0-5 or 0-10 MA DC meter and a 10,000 ohm resistor to the plate RF return circuit of the class C stage before it reaches the plate modulator. This method shows overmodulation on negative peaks, but not on positive peaks.

A cathode-ray tube oscilloscope is the best indicator for overmodulation. The trapezoidal figures readily show distortion and modulation capability even more clearly than the sine wave figures. The trapezoidal figure requires only a simple form of oscilloscope.

The simple antenna field strength meter described in the June, 1935, issue of "RADIO" can be used as an overmodulation indicator. It can be made more linear by plugging a 5,000 or 10,000 ohm 1 watt resistor into the headset jack. Another form of linear detector is a tube with a high cathode bias resistor and high plate voltage, such as used in most superheterodyne second detectors. A 0-1 MA DC meter can be connected in series with the cathode resistor.

## 5 Meter Band Opens

● On the evening of August 10, 1935, W2MO of Livingston, N. J., while operating portable with his 5 meter equipment in his automobile at Garret Mountain, a mere hill of 650 feet above sea level, in the city of Paterson, N. J., was successful in working not only a first district station but literally "THE" first district. At about 8:30 P.M. daylight time he swung his automobile in such a direction as to have the eight element antenna on the car concentrate toward the Boston area, and from that time until 1:00 A.M. one first district station after another was worked.

During this period 32 different first district stations were worked and identified with five or six more worked but not identified on account of local QRM covering the station. The location of the portable equipment is in the heart of the New York QRM, and it was through this that the first district stations had to be contacted. The number of distant contacts on five meters in such a short period of time is probably without precedent, and the total of the miles worked during the contacts is probably also a record.

The W2MO equipment has been operated portable for the past four summers, during which time a total of 535 different stations have been worked, with the total number of contacts well above 4000. The equipment is carried in a touring sedan, and includes both power supply and directive antenna. The transmitter employs a pair of 801s with 50 to 80 watts input, modulated with 46s class B, 46 driver, 56 first audio. Two power packs using 82s supply the plate power. Primary power comes from a portable gas engine generator providing 300 watts, 60 cycle AC. The antenna can be varied from a single half wave element to

an array of 8 half wave elements, the array giving a power gain of approximately 17 times as compared to the single half wave element. The complete beam mounts on four bamboo poles, two attached to the rear bumper, and two to the two spare wheels in the front fender wells. The car must, of course, be placed broadside to the desired direction of transmission as the distance between the opposite sides of the car is just about one-quarter wavelength, whereas the front to back distance between poles is nearly three-quarters wavelength, just about optimum for such an antenna. Each pole carries two elements, one phased above the other.

The first district stations worked were in Connecticut, Massachusetts and Rhode Island, and included DEK, IYS, GDJ, EZL, BSL, HHU, DPW, AZX, DBE, HBD, ZE, AOZ, CDR, ZJ, DQ, QP, DDM, DEL, HVP, HMA, AGR, GMT, HWC, IWG, NF, FJN, CKV, HOB, HSP, HXY, AIY, HDQ.

## BOOK REVIEW

### "Practical Radio Communication"

By A. R. Nilson and J. L. Hornung

● As its name implies, this is essentially a text book for radio operators and radio servicemen or technicians. Very little mathematics is used, the text being written more in the form of an encyclopedia on all subjects pertaining to radio reception and transmission. It is up to date; it covers marine radio, broadcasting, aviation radio, ultra-short wave theory and equipment, as well as operation. Much space is devoted to charts and tables. This book sells for \$5.00 and is published by the McGraw-Hill Book Company.

## TUBE - ITUS

When I was young and full of hope,

The diode tube was all the dope.

Then came the triode and high-mu,

The latest thing, I'm telling you.

Next came the tetrode with its screen,

And then the pentode hit the scene.

We thought they surely were the last,

But from then on things happened fast.

Duo-diode, Pentode-triode,

Pentagrid converter;

Duplex-diode, detector triode,

Pentagrid inverter

New tubes arrived by every train,

'Twas at this point I showed the strain,

Now I am old beyond my years,

I've got gray hairs above my ears,

And to this world I tell my wrongs,

Why do tubes have so many prongs?

—I. M. NERTS.

(Editor's Note:)

The author of this bit of verse

Is in a padded cell.

The metal tubes have made him worse,

He isn't doing well.

—"The Radio Technician."

# Tank Circuits

## How to Determine the Proper Ratio of Inductance and Capacity for Minimum Losses and Maximum Efficiency

By J. N. A. HAWKINS\*

• The plate tank circuit of any transmitting radio frequency amplifier consists of a parallel resonant tuned circuit. This circuit must have a low DC resistance and a relatively high AC resistance (impedance) measured across the circuit. The shunt impedance of any resonant tank circuit is the resultant of two factors; (1) the inherent resistance of the tank circuit itself, and (2), the reflected resistance caused by coupling a load, such as an antenna, to the tank circuit. The output power dissipated in the inherent resistance of the tank itself is entirely lost, so that for high output and efficiency it is desirable to make the tank losses as low as possible. The test for any tank circuit is to disconnect the load (antenna, etc.) and measure the DC plate current at normal plate voltage, bias, excitation, etc. This unloaded plate current should be less than 10% of the normal loaded DC plate current.

Theoretically, a parallel tuned tank circuit should represent an infinite impedance with no load coupled to it. If this were true in practice, the minimum unloaded plate current would fall to zero. However, the inherent resistance of the tuned tank prevents the shunt impedance from rising to infinity (unloaded). A representative 4 MC tank circuit using 100 uufds of tuning capacity had a shunt impedance of 40,000 ohms, unloaded. This particular tank, when properly loaded, reflected a 4000 ohm load for its associated amplifier tube. The reactances of the coil and condenser are equal as the circuit is tuned to resonance, and the value of the reactance of each is 400 ohms. Because the Q, or factor of merit of a tuned circuit, is the ratio of resistance to reactance, it is seen that the aforementioned circuit has a Q of 10 loaded, and 100 unloaded.

The Q of a transmitting tank circuit is of importance only when determining the optimum ratio of L to C for a given frequency and load resistance. The problem of determining the proper ratio of L to C in an amateur CW transmitter can be simplified by the following rule-of-thumb:

Make the L as large as possible and the C as small as possible, up to the point where maximum antenna current and minimum DC plate current do not occur at the same point on the tank tuning condenser. When this occurs, it is an indication that the Q, or ratio of resistance to reactance of the tuned tank circuit, is too low. More C and less L will therefore be necessary in order to increase the "flywheel effect" of the tank, which is related to its Q. It is impossible to obtain high plate efficiency and power output unless a rather low C, high Q tank circuit is used. For phone use, considerations of linearity require that more C be used than for an equivalent CW amplifier, but there is no set rule which determines how much more C is desirable. Authorities seem to agree that about twice as much C should be used for phone as for a similar CW amplifier. For use in the plate tank of a self-excited oscillator the C should be about three times as much as that which is desirable for a given CW amplifier. Comparatively, the minimum Q of a single-ended amplifier should be about 5 for CW, 10 for phone, and about 15 for a self-excited oscillator.

A lower value of Q is permissible in the

push-pull amplifier; a minimum Q of 3 for CW, 6 for phone, and 9 for self-excited oscillators is satisfactory.

The table shows approximations of the optimum tank capacity to be used in a single-

### High-Lights

In order to avoid tank circuit losses and in order to obtain the highest circuit efficiency, it is desirable to consider the tank circuit problem in some detail. The LC ratio is a very important consideration, and for maximum efficiency it should be neither too low nor too high.

The two tests for the operation of a tank circuit are—

1. The unloaded plate current should be as low as possible and always less than 10% of the normal operating plate current.
2. Maximum RF output current and minimum plate current should always occur at the same point when the tank condenser is tuned.

ended CW amplifier (Q of 5) at different plate voltages, powers and frequencies. For phone use, multiply the indicated C by two; for self-excited use, multiply the indicated C by three. Variations of 20% from the indicated values of capacity will not materially affect the operation of the amplifier. Larger capacities will increase the Q somewhat, but with an increase in the tank losses due to the increased circulating tank current, which reduces power output and efficiency. The use of less C than that shown will reduce the Q and may again reduce the efficiency and power output if minimum plate current does not coincide with maximum output current. The capacities shown are those which should actually be used, not just the maximum capacity of the tuning condenser.

The table should take care of most of the common combinations encountered in practice. However, for widely different frequencies or power inputs the following formula will enable the approximate tank capacity to be determined directly. It should be noted that the following formula applies to a single-ended grid neutralized (unsplit tank) amplifier for CW use (Q of 5). For phone use (Q of 10) multiply the indicated capacity by two.

If a split tank is to be used divide the indicated capacity by four.

$$C = \frac{2,600,000}{fR_B}$$

Where C equals tank capacity in micromicrofarads (uufds.). f equals frequency in MEGACYCLES.  $R_B$  equals DC resistance, in ohms, of the plate to filament path of the amplifier. In other words, DC plate voltage divided by DC plate current, in amperes.

It will be seen that there will be relatively little difference between the cost of the tank condenser used with either grid neutralization or plate neutralization. When grid neutralization is used, the plate tank capacity must be four times as large as the capacity necessary for use in a plate neutralized amplifier. However, the condensers in the plate neu-

tralized tank circuit will have twice the peak RF voltage across them; consequently they must have twice as much plate spacing as the condensers which are used in grid neutralized amplifiers.

### Tank Coils

Research with various types of tank coils definitely indicates that a tank coil wound with copper wire (size No. 10 to No. 14, depending on power used) and supported by three or four narrow strips of thick celluloid fixed to the coil turns with collodion, or its equivalent, has the lowest inherent losses. When properly built, this type of coil is quite rigid mechanically. Furthermore, it has the absolute minimum of dielectric in the field of the coil. The length of the coil should be about one-and-one-half times its diameter, and turns should be spaced at least three times the diameter of the wire. The coil should be mounted about one diameter away from its associated tuning condenser and at least three diameters away from metal chassis, panels, braces and other large metal objects. It is desirable to link couple the plate tank to a separate antenna tank in order to keep any transmission line radiation away from the final amplifier, where it might upset neutralization or cause unbalance, particularly in a push-pull stage.

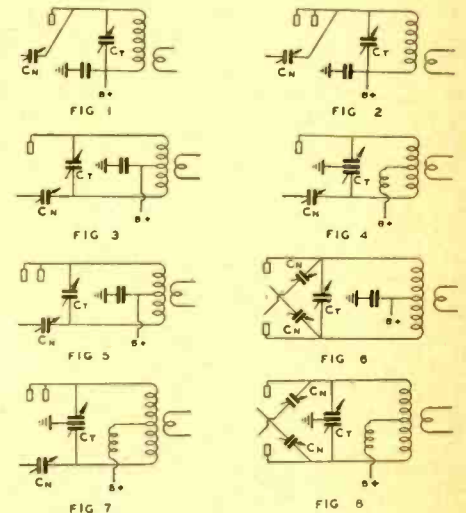

### Characteristics of Various Plate Tank Circuits

Eight different circuit arrangements can be used for the plate tank of a radio-frequency amplifier. However, there are really only two fundamental circuits; the split plate tank used with plate neutralization, shown in Figs. 3, 4, 5 and 7, and the unsplit plate tank used with grid neutralization, shown in Figs. 1 and 2. Of course, the push-pull circuits shown in Figs. 6 and 8 also use a split plate tank as well as a split grid tank, because the neutralization of a push-pull stage may be considered to be both grid and plate neutralization.

From the standpoint of the optimum ratio between inductance and capacity in the plate tank circuit of a RF amplifier the circuit arrangement affects the required tuning capacity for a given tube, plate voltage, power output and frequency.

For a given set of conditions, the impedance in ohms, measured across the ends of a split tank coil, will be exactly four times the impedance across an unsplit plate tank coil. For example: a 150T in a single-ended amplifier working at 3000 volts plate voltage and 150 milliamperes (450 watts input), happens to work best into a plate load resistance of 5000 ohms. The actual value of the load impedance is unimportant because no amateur takes the trouble to actually measure load impedances. In this case, however, the known optimum load impedance helps to illustrate a very important point. In the grid neutralized tank circuit shown in Fig. 1 the plate circuit of the amplifier tube is connected across the entire circuit so that the required 5000 ohms of reflected load impedance appears across the entire tank circuit.

When the same amplifier is changed to plate neutralization with either the split coil circuit shown in Fig. 3, or the split stator condenser circuit shown in Fig. 4, the plate circuit of the tube is then tapped across only half of the tank circuit. Thus the impedance measured across either half of the plate tank circuit must be 5000 ohms in order that the tube will operate under exactly the same conditions as in the grid neutralized circuit. It might seem, at first glance, that if the impedance across half of the tank is 5000 ohms, the impedance across the entire tank should be twice 5000, or 10,000 ohms. However, it will be seen that this is an autotransformer arrangement, and the impedances across part or all of an inductance vary as the square of the turns ratio. Because there are twice as many turns across the entire tank coil as there are across either half, the impedance across the entire tank coil must be two squared, or four times the impedance that one-half of the tank reflects back into the tube. Thus the total impedance across the entire split tank is 20,000 ohms. For a given power, tube and plate voltage, there is twice the peak RF voltage across the split plate tank as there is across the unsplit tank. This means that a longer RF arc can probably be drawn from the split tank than from the unsplit tank, but the arc would not be as "fat." The power would be the same in either case. This higher RF voltage means that dielectric losses in the plate tank circuit are four times as high in the split circuit as in the unsplit arrangement, but because the circulating RF current is twice as high in the unsplit tank the resistance losses in that circuit are four times as large. Modern tank circuit design has brought both resistance and dielectric losses down to a very low value, but because dielectric and corona losses due to high RF voltage are only bothersome with high power tubes operating above 4000 volts plate voltage, the split plate tank is probably desirable in high efficiency amplifiers where high power gain is more desirable than ultra-high plate efficiency, the lower grid circuit losses found in the grid neutralized tank arrangement make it about six of one, and half dozen of the other.

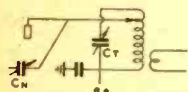

FIG 1A

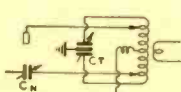

FIG 4A

In a single-ended grid neutralized high efficiency amplifier operating at less than 4000 volts DC plate voltage, the circulating current losses can be minimized by tapping the plate down on the plate coil in order to reduce the amount of C which is necessary for a given Q (see Fig. 1A). This is usually more desirable than using plate neutralization; furthermore it allows the use of a single-section condenser.

Table showing proper value of tuning capacity to use for a Circuit Q of 5 at the frequencies, plate voltages and plate currents indicated.

DC Plate Voltage E <sub>B</sub>	DC Plate Current I <sub>P</sub>	Plate Tank Capacity C <sub>A</sub>	Plate Tank Capacity C <sub>B</sub>	Frequency	DC Plate Voltage E <sub>B</sub>	DC Plate Current I <sub>P</sub>	Plate Tank Capacity C <sub>A</sub>	Plate Tank Capacity C <sub>B</sub>
375 V	.025 A	100	25	1750 KC	1500V	.100A	100 $\mu$ fd	25 $\mu$ fd
375	.050	200	50		1500	.200	200	50
375	.100	400	100		1500	.400	400	100
750	.050	100	25		3000	.100	50	12.5
750	.100	200	50	3000	.200	100	25	3500 KC
750	.200	400	100	3000	.400	200	50	
375	.025	50	12.5	1500	.100	50	12.5	
375	.050	100	25	1500	.200	100	25	
375	.100	200	50	1500	.400	200	50	7000 KC
750	.050	50	12.5	3000	.100	25	6.25	
750	.100	100	25	3000	.200	50	12.5	
750	.200	200	50	3000	.400	100	25	
375	.025	25	6.25	14,000 KC	1500	.100	25	6.25
375	.050	50	12.5		1500	.200	50	12.5
375	.100	100	25		1500	.400	100	25
750	.050	25	6.25		3000	.100	12.5	3.12
750	.100	50	12.5	3000	.200	25	6.25	28,000 KC
750	.200	100	25	3000	.400	50	12.5	
375	.025	6.25	1.56	1500	.100	6.25	1.56	
375	.050	12.5	3.12	1500	.200	12.5	3.12	
375	.100	25	6.25	1500	.400	25	6.25	3000
750	.050	6.25	1.56	3000	.100	3.12	.78	
750	.100	12.5	3.12	3000	.200	6.25	1.56	
750	.200	25	6.25	3000	.400	12.5	3.12	

\*C<sub>A</sub> is the plate tank capacity to be used with all single-ended amplifiers when grid neutralization is used. This value is correct for a single tube (or tubes) in parallel, as long as the total DC plate current is as shown above.

†C<sub>B</sub> is the total plate tank capacity to be used with all single-ended amplifiers which use plate neutralization. If a split-stator tank condenser is used, the capacity per section should be twice C<sub>B</sub> in order that the total capacity will equal C<sub>B</sub>.

‡If push-pull is used, a minimum circuit Q of 3 is permissible for CW use. Thus only 60% of the capacities shown in the column headed C<sub>B</sub> should be used in a push-pull amplifier. As with the single-ended amplifier, multiply the indicated capacity by 2 for phone, and by 3 for a self-excited oscillator.

The point of difference between the split and the unsplit plate tank circuits lies in the fact that, for a given tube and operating conditions, the unsplit tank circuit requires exactly four times as much capacity shunted across the plate tank coil in order to maintain a constant Q of the circuit. For a given Q and frequency the required tuning capacity varies inversely with the impedance of the tank circuit. Quadruple the impedance by splitting the plate tank, and only one-fourth of the tuning capacity is necessary to maintain a constant Q. However, the condenser cost is almost the same for either tank circuit because the smaller condenser required for the split tank must have twice the voltage rating of the condenser used in the unsplit tank. As an example, consider the split-stator condenser shown with the two sections in series in the split tank circuit shown in Fig. 4. If the two sections are paralleled, the total capacity will be quadrupled and the voltage rating will be cut in half. This same condenser would now be of the correct size to operate in the unsplit circuit shown in Fig. 1.

There is practically no difference in the overall cost of operation of a split plate tank which uses a split coil and the tank which uses a split condenser (split-stator). The split-stator condenser is usually more desirable when using a tube with low interelectrode capacities. It also has advantages at frequencies below about 5 MC with the medium and high C tubes. However, at the higher frequencies where the tuning capacity each side of the split-stator condenser becomes quite small, the unbalancing effect of the plate to ground capacity of the high C tubes makes the stage difficult to neutralize. Thus above about 5 MC it is usually better practice to split the coil with a bypass to ground at the electrical center when using high C tubes.

### Tapping the Plate Lead Down on the Plate Tank

When an amplifier is found to have too low a Q, so that the tank tuning is decidedly "sloppy" and maximum antenna current does not coincide with minimum plate current, the situation can be remedied by tapping the plate of the tube down on the plate coil, as shown in Fig. 1A. This has the same effect on the circuit as increasing the C and reducing the L. The circuit Q is increased because the impedance across the entire tank is greater than the impedance reflected into the tube due to the impedance step-up. If the plate tap is half way up the tank coil and if the optimum tube load is 5000 ohms, the impedance across the entire tank would be 20,000 ohms and the circuit capacity for a given Q would then be one-fourth of that necessary in the circuit of Fig. 1, or the same capacity as the split plate circuit of Fig. 4. The RF voltage is stepped up directly with the turns ratio; it would be doubled when the impedance is stepped up by a factor of four. In most cases, the plate does not have to be tapped down more than a few turns, unless the tuning capacity is 'way off. When the turns ratio between the entire coil and that part of the coil below the plate tap (Fig. 1A) is 1.4 to 1, the circuit Q is exactly doubled as compared with the circuit of Fig. 1, for a given tuning capacity. The only change in adjustment when the circuit of Fig. 1 is changed to the circuit of Fig. 1A is that the antenna coupling must be loosened as the plate tap is moved down, in order to hold the plate input constant. (In other words, to reflect the same load impedance into the tube).

Tapping down on the plate coil is highly recommended for use with the low voltage tubes, especially when operating on the lower frequencies. It enables a high circuit Q to be obtained without the use of high C, and materially reduces the inherent tank losses

(Continued on page 24)

due to circulating current. When the plate is tapped on the coil exactly half-way up the coil, the circulating current is cut in half (for constant Q). Resistance losses in the tank vary as the SQUARE of the current; therefore it is seen that the losses are reduced to one-fourth of what they would be when the plate is connected directly to the "Hot" end of the tank. At more than 4000 volts plate voltage, corona and dielectric losses, which increase as the square of the RF plate voltage, become increasingly important; then the increase in voltage losses practically offsets the decrease in circulating current losses.

Tapping down on the plate coil is highly desirable in a multi-band transmitter because it allows a low capacity tuning condenser to give equal Q on all frequencies. For example, suppose a grid neutralized amplifier is to be used on 20, 40 and 80 meters. The tank condenser should be chosen for the highest frequency to be used—in this case 20 meters. On 20, therefore, the plate would tap directly on the hot end of the coil. At 40 meters the same capacity would give the same Q if the plate lead is tapped 71% up from the bottom, or "Cold" end of the tank. On 80 meters the plate would be tapped exactly half-way up the coil, in order to preserve the same value of circuit Q. Of course, the tank coils should be built so that resonance occurs at approximately the same point on the tuning condenser.

Only in very few cases will it be found necessary to raise the Q of a split plate tank, because a split plate tank is already a high impedance circuit. However, if and when this practice becomes necessary, the circuit shown in Fig. 4A is the correct method to use. It is very important that the neutralizing condenser be tapped toward the center exactly as much as the plate is tapped in, otherwise it will be impossible to get perfect neutralization.

### Parallel and Push-Pull Operation

The circuit in Fig. 2 is exactly the same as that in Fig. 1, with the exception that the two tubes are in parallel in Fig. 2. If the two tubes when used in parallel together draw the same plate current under the same conditions of operation as the one used in Fig. 1, then the load impedance across the two tank circuits will be equal, and the same tuning capacity will give the same circuit Q. Now suppose that a second tube is added to an already existing amplifier in order to double the output. The bias should remain unchanged, of course, even though the DC grid current will double. The neutralizing capacity must be doubled, and the antenna coupling must also be doubled in order to make the amplifier draw twice the plate current it did before. It is assumed that the two tubes in parallel will operate under identical conditions as the single tube previously did, and the total power input and output will be exactly doubled. It will be found that the tank tuning capacity must be doubled in order to preserve the same circuit Q. An example will clarify the situation. Assume that a second tube has been added to the amplifier described above, operated at 3000 volts and 150 MA. The tube load impedance was 5000 ohms for the one tube. Using two tubes in parallel is exactly the same as using one larger tube with exactly half the plate resistance of each. For the same plate efficiency the plate load impedance must have the same ratio to the tube resistance; thus if one tube works into 5000 ohms then two in parallel will work into 2500 ohms. The RF voltage across the entire tank will be exactly the same for either a single tube or for two in parallel, but a given RF voltage across 2500 ohms represents twice the power as the same voltage across 5000 ohms repre-

sents, because the current has doubled (by Ohm's law). Suppose that a circuit Q of 5 is desirable. This means that the reactance of the tuning condenser must be the load impedance divided by the Q of 5. In the single tube amplifier the condenser reactance would be 5000/5, or 1000 ohms. In the two tube amplifier with twice the power output the condenser reactance would be 2500/5, or 500 ohms. The reactance of a condenser varies inversely with the capacity; thus half the reactance is twice the capacity. The circuit is always operated at resonance and therefore the coil reactance must be exactly equal to condenser reactance. Therefore the entire discussion could have referred to coil inductance, rather than tuning condenser capacity. The capacity of a tuning condenser is usually known. If it is operated nearly all the way in (recommended point) it is easy to estimate fairly accurately the circuit capacitance. Few amateurs take the trouble to measure or estimate the inductance of tank coils. They usually guess at the proper size of coil to use, and then add or prune turns until resonance is found.

Now consider the split tank circuits using paralleled tubes, as shown in Figs. 5 and 7. Again it is found that the impedance across the split circuit is four times that across the unsplit circuit of Fig. 2 (2500 ohms each side of center, 10,000 ohms across the entire tank). Thus only one-fourth as much tuning capacity is necessary for a given Q. It logically follows that the addition of a second tube to the unsplit tank as in Fig. 2 resulted in doubling the capacity required when only one tube was used as in Fig. 1; adding the second tube to the split circuits of Figs. 3 and 4 to get the arrangement of Figs. 5 and 7 also doubled the required capacity. Thus it is seen that the required tuning capacity goes up directly with the power in a circuit using a given tube and plate voltage. More strictly, it should be remembered that the capacity goes up as the load impedance goes down.

### Push-Pull

Push-pull circuits are shown in Figs. 6 and 8. All push-pull circuits use split plate tanks and therefore there are no unsplit tanks to consider. There is no unbalance of the splitting due to plate-to-ground capacities and the split-stator condenser arrangement shown in Fig. 8 is preferable at all frequencies, and with all tubes used in push-pull. The total plate tuning capacity is the same in either circuit. Push-pull cannot be analyzed in the same way as a single-ended split tank circuit because the tubes do not draw plate current at the same time. The point involved is that each tube in the push-pull circuit works into the entire tank, instead of into the impedance across each half.

The load impedance across the entire tank is only twice the reflected load on each tube instead of four times the load on each tube, as might seem to be the case. Thus if each tube works into 5000 ohms, the plate-to-plate load is 10,000 ohms, which is the same load as for the circuit in Fig. 7 where two tubes in parallel are worked into a split tank. The power is the same in both cases, and the peak RF voltage across the tank is the same, therefore the impedance across the tank must be the same. Because the impedance is the same, it follows that the same value of tank tuning capacity in the push-pull circuit will give the same circuit Q. Regardless of the fact that the paralleled tube capacities tend to unbalance the split-stator circuit shown in Fig. 7, the push-pull circuit shown in Fig. 8 is very similar insofar as voltages, currents, capacities and inductances are concerned. It will also be seen that the push-pull circuit in Fig. 8 has twice the power output and half the load impedance as the single-ended split-

stator circuit shown in Fig. 4 (10,000 ohms as against 20,000 for Fig. 4) so that twice the tuning capacity is necessary to preserve the Q, as in Fig. 4.

With reference to Fig. 8 it is seen that if two tubes are used which together draw the same plate current as the one tube used in the circuit of Fig. 4 (assuming identical operating parameters), the load impedance across the entire circuit is the same in both cases, and the required condenser capacities would therefore be the same.

The push-pull circuit makes possible the use of a lower value of Q for the same circuit merit; the Q of a push-pull circuit need only be approximately 60% of the Q of an equivalent single-ended amplifier. The purpose of Q in any tank circuit is to preserve the waveform of the alternating tank current. For proper and efficient tube operation it is essential that the waveform be as close to a sine wave as possible. One way to define how much any given complex waveform departs from the ideal sine wave is to specify the amplitude of the various harmonic frequencies present, because any waveform, no matter how complex, can be resolved into a fundamental frequency plus integral harmonics.

Thus the particular advantage of the push-pull circuit is that it produces very few even harmonics and thus preserves the shape of the wave better than a single-ended circuit of the same Q. For a given amount of harmonic wave distortion, therefore, less circuit Q is required in the push-pull amplifier.

The presence of harmonics in the distorted wave output of a low Q amplifier is precisely the reason why a high C (meaning high Q) tank circuit minimizes the radiation of undesirable radio-frequency harmonics.

Harmonic distortion of the alternating wave in the plate tank also explains why a self-excited oscillator requires a high Q tank circuit for high-frequency stability. All oscillators receive their grid excitation from the plate circuit. If the AC which is fed back to the grid is full of harmonics, a very small change in load or electrode voltages will have sufficient effect on the harmonic content of the feedback voltage to create a disproportionate change in the frequency of oscillation. Thus a very high Q tank circuit must be used in a self-excited oscillator in order to keep the harmonics out of the grid excitation voltage which fed back from the plate circuit.

The statement that the plate-to-plate load impedance of the push-pull circuits is twice the reflected load on each tube applies only to tuned tank circuits where considerable circulating current flows. In class B audio circuits which are never tuned, the plate-to-plate load impedance is four times the load on one tube.

### Tank Circuit Relationships

The impedance across any tuned circuit is related to the series resistance of the tank. The higher the series resistance, the lower the shunt resistance. (Resistance and impedance are identical at resonance.) The shunt resistance is always Q squared, times the series resistance.

The reactance of either the coil or condenser of any resonant circuit is always equal to Q times the series resistance, or the shunt resistance divided by the Q. Thus a tank loaded so that it has a shunt resistance of 5000 ohms at resonance would be said to have a series resistance of 50 ohms if the LC ratio were such that the circuit Q were 10. In order to have a Q of 10, the coil and condenser reactance would have to be Q times the series resistance, or 10 times 50, or 500 ohms. The reactance is also shunt resistance divided by Q, or 5000/10=500. The capacity required to equal a 500 ohm reactance can be

(continued on page 31)



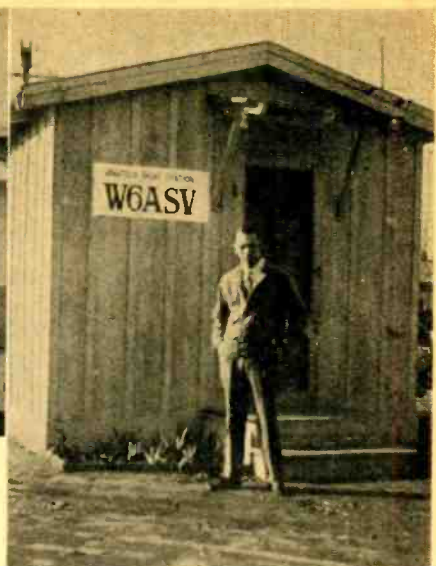
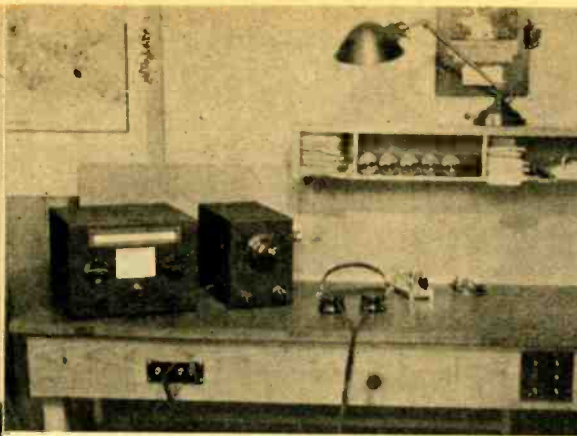
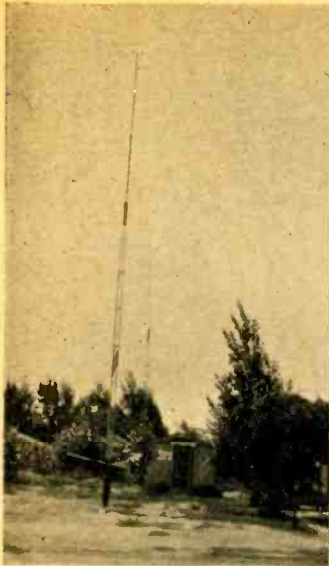

# W6ASV

Orvall Woods, Tulare, California

By C. C. ANDERSON

● W6ASV, built by Orval Woods, is housed in a 10x12 foot shack adjacent to his home at 417 South E Street, Tulare, Calif. ASV was a ham in the days before the war; soon after he was assigned the call 6ASV and has been on the air ever since.

The first rig was a UV202 at eleven bux, plus the rest of the parts necessary to make it perk on 200 meters. Since then the station has kept in step with all the changes up to the 6CUH style, from which the present transmitter was evolved, about three years ago, and since then it has not been changed. It consists of the conventional 47 osc, 210 buffer-doubler, 242 buffer and an 860 final. While the 860 is not always the final, it is used that way most of the time on both 20 and 40 meters, although when more power is found to be necessary, an 852 PP final is hooked up on 40 meters.

The 210 is keyed by a tube-keying method, and it has positively eliminated all traces of key clicks and back wave. The ordinary BC set can be played in the shack less than six feet away from the transmitter without the slightest bit of interference to the program.

The 860 is inductively coupled to the 242 buffer, and normally runs at 700 watts input, while operating as the final on 20 meters. When this 860 stage is used as a buffer for the PP 852 1000 watt final, it is link coupled to this stage, and runs at about 500 watts, providing ample excitation.

The complete RF portion of the transmitter is breadboard, nine feet long, with the necessary power supplies directly under the table, protected by a grounded screen. This screen helps keep the cats, dogs and rats from putting the station off the air.

While the 860 seems to be in disfavor among the general run of hams, W6ASV finds that it is really a good tube, giving plenty of power without being overloaded. The 860 stage is far simpler to tune than the usual neutralized type. All that is necessary to put this stage in operation is to take off the plate voltage, tune the grid tank to resonance with the exciting stage, resonance being indicated by peak grid mils. Then tune the plate tank to resonance, which is indicated by a slight kick on the grid meter. Finally the plate voltage is applied. For 20 meter work, the single wire fed antenna is clipped on the tank at a point which does not overload the tube.

The seldom-used PP 852 final is link coupled by the Jones method. A Dwyer 100 mmfd. split-stator condenser, 6000 volt rating, tunes the grid tank without breakdown, but

(Continued on page 28)

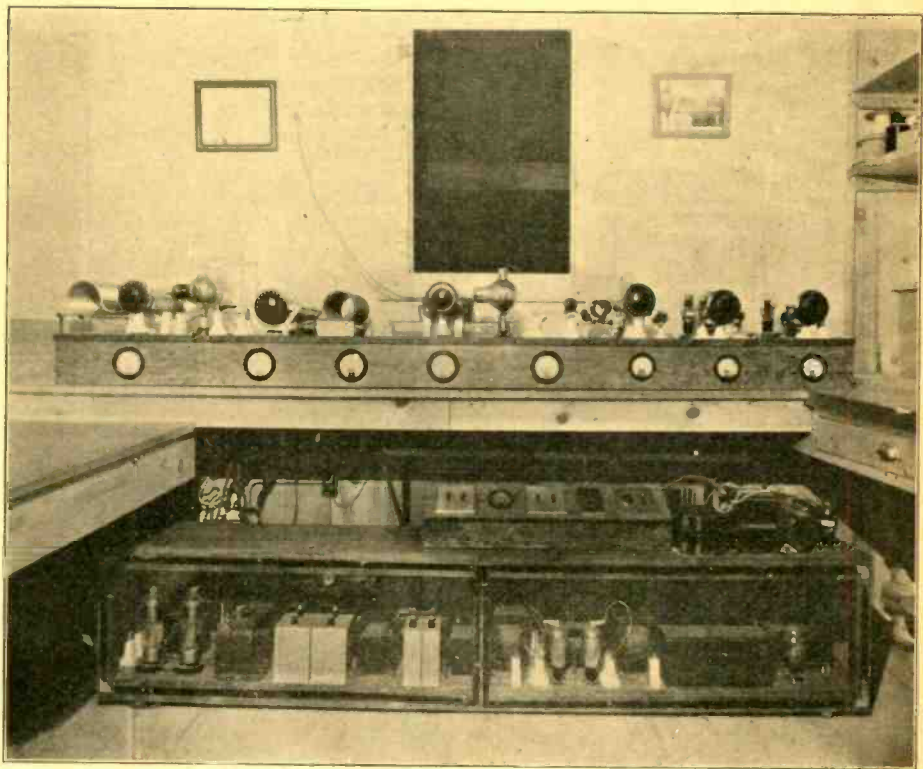

The 1 KW transmitter and power supply at W6ASV.

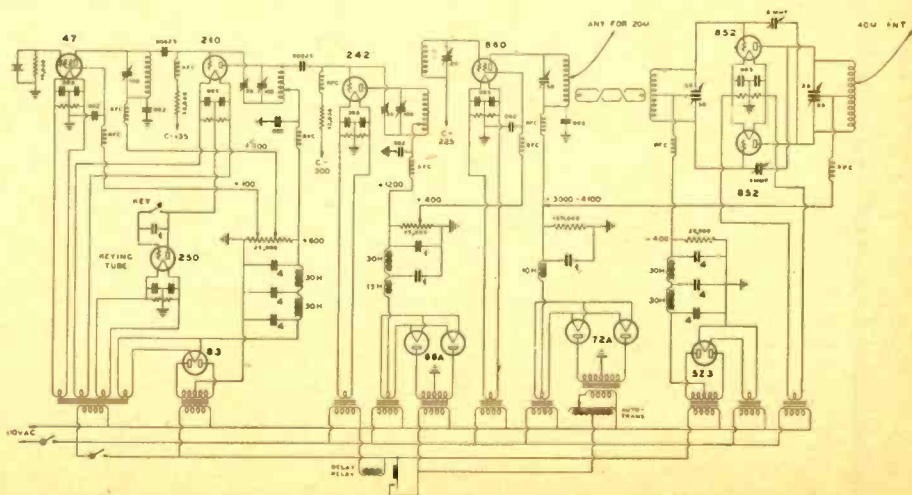

Complete circuit diagram of W6ASV's transmitter.

## Single-Signal Effect Without Use of a Crystal

● A short-wave superheterodyne receiver can be re-arranged in such a manner that regeneration can be added to the IF amplifier by the use of a small BCL coil and a variable resistor in the IF circuit. The addition of this regenerative circuit, if sufficient regeneration is used, will give the receiver a single-signal effect which approaches that of a quartz crystal filter.

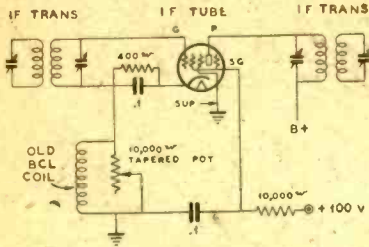

The arrangement is shown in the circuit diagram. It requires a minimum of effort to install. A secondary RF coil taken from an old BCL receiver is used for cathode regeneration, controlled by a tapered 10,000 ohm potentiometer or volume control. The isolating resistor and by-pass condenser in the screen-grid circuit are not always required. The suppressor of the IF tube should be grounded so as to enable it to act as an RF shield within the tube. If oscillation is too strong, some turns should be removed from the BCL cathode coil. This system does not require a coil coupled inductively to the IF transformer winding. The cathode coil can be made by winging 100 turns of No. 32 enameled wire on a 1 1/4 in. diameter form.

## The New 6A3 Low Mu Triode

● This tube has recently been announced by Sylvania, Philco and other independents and is a first cousin to the 2A3, although the mechanical construction is quite different. It really consists of two low mu triodes in one envelope, internally connected in parallel in order to reduce the plate resistance. In fact, many of the newer 2A3s are also using the same construction. The 6A3 is a fine tube for use as an audio driver for a class B or class AB stage, and a pair of 6A3s are good for about 18 watts of high-quality audio at 325 volts plate supply. The tube also operates well as a buffer at 7 MC and below and it can be used on 14 or 28 MC, with proper care. The interelectrode capacities are not particularly low, but the tube acts almost as a 45, 46 or 2A3 at radio frequencies.

## The RK34

● The RK34 (Raytheon) is well suited for use below 5 meters, although at five meters and above there is very little difference between the RK34 and the 6A6, which is practically identical to the RK34 except for the fact that the plate leads on the RK34 are brought out of the top of the envelope. This tube is the answer to the 2 1/2 meter problem.

## The 5Z4, a Full-Wave High-Voltage Rectifier

● This tube is practically the equivalent of the 80. The 6A8 Pentagrid converter is very similar to the 6A7. The 6L7 Pentagrid mixer amplifier is designed for use as a first detector in circuits using a separate high frequency oscillator. It has very good shielding between oscillator and signal circuits.

The 6J7 is similar to the 6C6 (7) although the input and output capacitances are somewhat higher.

The 6K7 is a remote cut-off pentode similar



# HAM HINTS

— By JAYENAY —

to the 6D6 (58) and also has higher input and output capacitances.

The 6H6 is a twin diode detector with two separate diode plates and cathodes.

The 6F6 is a power pentode quite similar to the 42.

The 6F5 is a high mu triode with a mu of 100 and is similar to the triode portion of a 75.

The 6C5 is a general purpose triode similar to the 76, although electrically its characteristics more closely resemble a triode-connected 6C6. Its mu is 20 and plate resistance 10,000 ohms making it suitable for use in transformer coupled audio circuits.

The all metal tubes seem to be most advantageous in speech amplifiers because the improved shielding will undoubtedly reduce RF feedback from the transmitter.

## Automatic Break In

● It is customary to use a back contact on a relay in order to automatically cut off the receiver while transmitting. This back contact usually causes a bad click in the phones or loud speaker. The circuit here shown uses 100 volts of negative bias from a grid leak somewhere in the transmitter in order to

lock-up the AVC system in the receiver. The slight lag introduced by the filtering action of the .01 condenser and the .1 megohm isolating resistor eliminates the clicks and prevents the transmitter from loading the AVC circuit of the receiver.

The circuit operates whenever a stage in the transmitter receives enough RF grid excitation to make it draw grid current. The resulting negative bias is applied to the grids of the receiver tubes and prevents them from amplifying. In a receiver in which no AVC is used, the high negative bias can be used to block-out a resistance-coupled audio stage, or even a transformer-coupled stage, if the DC grid return to ground is made through the transmitter grid leak and then bypassed with about 1 microfarad in order to complete the audio circuit back to ground. A convenient way to introduce the blocking bias into the receiver is to use a closed circuit jack mounted at the rear of the receiver in the circuit in which the blocking bias is to be applied. If it is desired to move the receiver to another location, or trouble-shoot it, the set will operate in perfectly normal manner by merely taking the plug out of the jack.

## Brief Comments on the Metal Tubes

● The new metal tubes are undoubtedly here to stay. Regardless of whether or not they are actually better than the glass tubes, there is no doubt that they will be constantly refined and improved. Ultimately they will be standardized throughout the entire radio industry (for use in receiving sets). At the present time there is no evidence to indicate that metal tubes will be made sufficiently gas-free for high voltage operation in transmitters.

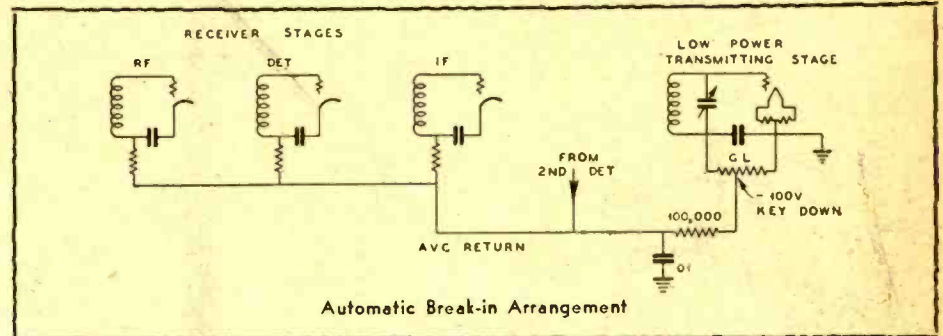

## Characteristic Chart for Metal Tubes

TYPE	Use	Base	Dimensions Lgth. Dia.	FILAMENT RATING Volts Amps.	Plate Volts	Negative Grid Volts	Screen Volts	Phase Current ma.	Screen Current ma.	Plate Resistance Ohms	Mutual Inductance Microhenries	Amplifier Factor	Load Resistance Ohms	Milliwatt Output	Other Output	Other Type
5Z4	F. W. Rectifier	5-L	5 1/2" 1 1/2"	5.0 2.0	400	RMS-Volts/Plate	125									80
6A8	Converter	8-A	3 1/2" 1 1/2"	6.3 0.3	250	3.0	100	3.0	3.5	500,000	1000					6A7
6C5	Amplifier	6-Q	2 3/4" 1 1/2"	6.3 0.3	250	8.0	8.0			10,000	2,000	20				76
6D5	Power Amplifier	6-Q	3 1/2" 1 1/2"	6.3 0.7	275	40.0	31.0			2,200	2,100	4.7	7,200	1,400		45
6F5	Amplifier	5-M	3 1/2" 1 1/2"	6.3 0.3	250	2.0	0.9			66,000	1,500	100				
6F6	Power Amplifier	7-S	3 1/2" 1 1/2"	6.3 0.7	250 250	16.5 20.0	250 31.0	34.0	6.5	80,000 2,000	2,500 2,700	200	7,000 4,000	2,000 800		42
6H6	Rectifier	7-Q	1 1/2" 1 1/2"	6.3 0.3	100	RMS-Volts/Plate	2.0	Maximum								
6J7	Detector, Amplifier	7-R	3 1/2" 1 1/2"	6.3 0.3	250	3.0	100	2.0	0.5	1,500,000	1,225	1,500				77
6K7	Amplifier	7-R	3 1/2" 1 1/2"	6.3 0.3	250	3.0	100	7.0	1.7	800,000	1,450	1,100				78
6L7	Mixer	7-T	3 1/2" 1 1/2"	6.3 0.3	250	6.0	150	3.5	8.0	2,000,000	1325					None

\*Conversion Conductance. When used together they become equivalent to the 75. †Triode operation.

## Bottom View of Bases



SYMBOLS—H-Heater; P-Plate; C-Cathode; S-Metal Shell; G-Control Grid; Gs-Screen; Ga-Anode Grid; Gc-Oscillator Grid; Gm-Modulator Grid; Su-Suppressor Grid; □ Top Cap; —> Locating Pin.

Courtesy of Hygrade-Sylvania Corp.

# EIMAC Tubes—More Power, Longer Life

## The Collins 202A Transmitter

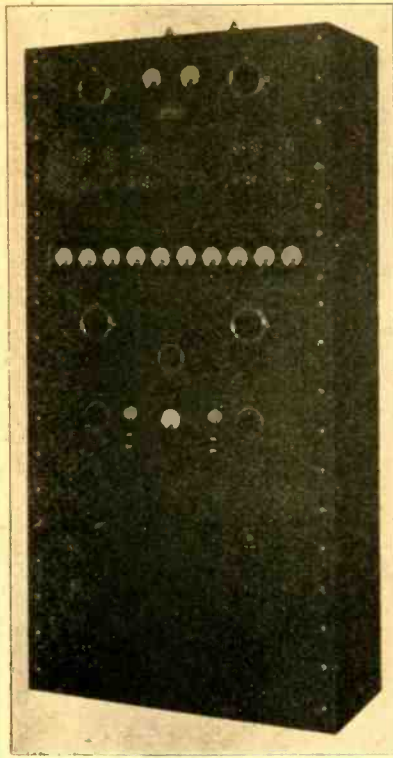

1 KW input—700 watts of carrier output—high level modulation.

The new Collins 202A represents the last word in high powered amateur transmitters. It employs two 150Ts in the final class C amplifier, two more as class B modulators and a fifth 150T as radio frequency driver.

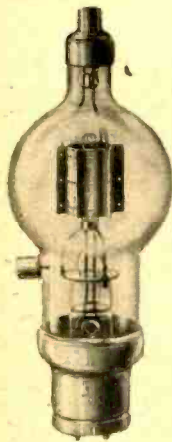

**150T**—Price \$24.50 Net  
150 watts of available plate dissipation. 50 watts of filament heating power. Only 3.5 wufds. plate-to-grid capacitance.  
Filament 5 V. at 10 A.; rated plate loss 150 W. Amp. factor 14. max. plate current 200 MA. C<sub>gp</sub> 3.5 wufds. C<sub>gf</sub> 3.0 wufds. C<sub>pf</sub> 5 wufds. Base 50 watt. Max. height 10 inches. Max. diameter 3 3/4 inches.

Plate Voltage	Class C Output RF One Tube	Class B Output Two Tubes
1000 V.	150 W.	200 W.
1500 V.	225 W.	350 W.
2000 V.	300 W.	500 W.
2500 V.	375 W.	625 W.
3000 V.	450 W.	700 W.

No. 6  
of a  
Series  
of 12

## Your Problems—and Their Solution Class B Audio Amplification

**C**LASS B audio amplification is widely used because it enables high audio power output to be obtained from relatively small tubes. However, in order to obtain good audio fidelity from a class B amplifier it is necessary to observe certain characteristics of class B operation.

### THE GRID CIRCUIT

As the grids of a class B audio amplifier must be driven beyond zero bias into the positive region, the audio driver amplifier must supply POWER to the class B grid circuit. The audio driver circuit requires careful design and construction because the power which it must supply is not being dissipated in a constant load, but in a load whose resistance varies widely over each audio cycle. In the negative region the input resistance of a vacuum tube is practically infinite. However, as the grid is driven more and more positive, the increase in grid current causes the input resistance to drop to a very low value; 2300 ohms, for example in a 150T operating in a 500 watt class B audio amplifier with 2000 volts plate supply.

The audio driver stage, like any vacuum tube amplifier, delivers power most effectively to a fixed load resistance, and if the load resistance varies, as it does on a class B driver, a considerable reserve of grid driving power must be provided to minimize waveform distortion.

In some cases it is necessary to provide parasitic filters in the class B grid circuit due to the fact that excessive secondary emission from the grid in certain types of tubes causes a negative resistance kink in the grid characteristic. It should be noted that while some secondary emission is desirable to reduce the required grid driving power, it should not be great enough to make the grid resistance negative over any part of the operating characteristic because this makes the amplifier unstable and impairs the quality. The EIMAC 150T is free from negative resistance kinks in the grid current characteristic under normal operation. This materially simplifies the problem of getting large amounts of high quality audio power at relatively low cost.

### CLASS B BIAS SUPPLIES

Due to the fact that the grid current drawn by a class B audio amplifier varies widely with the amplitude of the audio signal, the negative bias supply must have very good voltage regulation. Cathode bias and grid leak bias cannot be used on a class B audio amplifier. B batteries are generally quite satisfactory, as long as they are in good condition, and an AC operated rectifier and filter can be used, provided care is taken to make the bias supply output voltage independent of the load current (more strictly charging current) drawn by the grids. This can be done by using low resistance transformers and filter chokes in the bias supply. A low resistance bleeder should be used, the bleeder current being about four times the maximum grid current. All series resistance should be avoided, either in the primary or secondary circuit of the bias supply, as it impairs the voltage regulation. It might be noted that it is harder to get good regulation in a bias supply for the higher mu tubes than when medium mu tubes are used. A higher voltage bias supply is necessary for the medium mu tubes but the maximum DC grid current is usually a great deal lower, so that satisfactory voltage regulation is easier to obtain. The lower grid current in the medium mu tubes, such as the EIMAC 50T and 150T, also reduces the size and cost of the class B input transformer.

### OUTPUT TRANSFORMERS

In order to get good fidelity it is necessary to use a properly designed class B output transformer. Several transformer manufacturers have recently brought out new lines of class B transformers which are a great deal better than those which were standard a few years ago.

Note that a pair of EIMAC 150Ts, operating within ratings, will deliver 500 watts of audio power with only 2000 volts plate supply. Under these conditions the plate to plate load resistance should be 10,000 ohms.

The limiting factor in the operation of many class B amplifiers is the filament emission of the tubes used. Audio distortion can be quite bad if the tubes are driven into the region where saturation, or diode bend effects are noticeable. The 50 watts of efficient Thoriated Tungsten filament used in the 150T provides a large reserve of electron emission which minimizes the possibility of this type of distortion affecting amplifiers using these tubes.

**EITEL-McCULLOUGH, INC. SAN BRUNO CALIFORNIA, U. S. A.**

Albany, N. Y. Uncle Dave	Midwest Radio Mart, Newark Electric Co.	Grand Rapids, Mich. Radio Distributing Co.	Los Angeles, Cal. Radio Supply Co. Radio Television.	Peoria, Illinois. Radio Mfg. Engrs.	San Diego, Calif. Coast Electric Co.
Atlanta, Georgia. Wholesale Radio.	Dayton, Ohio Standard Radio Parts	Honolulu, T. H. Honolulu Furniture Co.	Milwaukee, Wis. Radio Parts Co.	Philadelphia, Pa. Radio Electric Svc.	San Francisco, Cal. Offenbach Electric.
Baltimore, Maryland Radio Electric Svc.	Des Moines, Iowa Iowa Radio Corp.	Indianapolis, Ind. Stanley Jewelry Co.	Newark, New Jersey. Wholesale Radio Svc.	Herbach & Rademan Pittsburgh, Penna.	Seattle, Washington Seattle Radio Supply.
Boston, Masa. H. Jappe Co. The Radio Shack.	Detroit, Mich. Radio Specialties Co.	Jacksonville, Fla. Glover-Weiss Co.	New Orleans, La. Shuler Supply Co.	Cameradio Co. Portland, Oregon.	Spokane, Washington. Spokane Radio Co.
Buffalo, N. Y. Dymac Radio	Denver, Colorado. Interstate Radio	Kansas City, Mo. Radio Laboratories	New York City. Gross Radio, Inc. Wholesale Radio Svc.	Providence, R. I. W. H. Edwards & Co.	Texarkana, Ark. Mim's Radio
Butler, Missouri. Henry Radio Shop.	Fayetteville, N. C. Hunter Brothers.	LaCrosse, Wisconsin. SOS Radio Supply.	Oakland, California. Electric Supply Co. E. C. Wenger Co.	Reading, Pa. George D. Barbey Co.	Toronto, Ont. Canadian Tire Corp.
Chicago, Illinois. Allied Radio Corp. Chirad	Forest City, N. C. Empire Radio Service	Lancaster, Pa. Conestoga Elec. Co.	Oklahoma City, Okla. Southern Sales Co.	St. Louis, Mo. Walt. Ashe Radio Co.	Tulsa, Oklahoma. Radio, Inc.
	Fresno, California. Ports Mfg. Co.	Little Rock, Ark. Vinson Radio Co.		St. Paul, Minnesota. Lew Bonn Company.	Wheeling, W. Va. Cameradio Co.

# The BOOK

# You Need!



Tells how to build a Real High Power Transmitter  
—Step by Easy Step  
—In *Progressive Usable Units!*

You've always dreamed of going on the air with a real high power job... seen yourself as the boss of an outfit to be proud of... Well, here's your chance to get that way by easy steps... each one a real economical addition... each one usable and practical! This sensational new book tells you just how... outlines each progressive step in simple, easily-followed fashion. Get it right NOW!

## Get It HERE!

You can get a copy of the "Progressive" Transmitter Guide at almost any live radio jobber's, at better newsstands, or write for the name of nearest distributor to Amateur Press, 1300 W. Harrison St., Chicago, Ill.; General Transformer Corp., 500 S. Throop St., Chicago, Ill.; The National Co., 61 Sherman St., Malden, Mass.; The Aerovox Corp., 70 Washington, Brooklyn, N. Y.; Guardian Elect. Mfg. Co., 1528 W. Adams St., Chicago, Ill.; Beede Instrument Co., Penacook, N. H.; Crowe Nameplate & Mfg. Co., 1749 Grace St., Chicago, Ill.; or Bliley Electric Company, Erie, Penna.

Once you've looked over this book you'll admit that it's the biggest two-bits' worth ever offered the ham who wants to keep abreast with what's going on in the world. Chock full of helpful hints, the real low-down on high power transmission—and how to get it. Photographic illustrations of every unit, and practical circuit diagrams for every hook-up—eleven of 'em that show you each progressive step, and all its whys and wherefores. Best of all, the diagrams are not "trick" circuits rigged up to sell you new tubes or fancy folderols... instead, they are the best, most practical and time-tried circuits that have proved to be real performers, and designed to get you on the air quick. Your Uncle Dudley, who puts up the old mazuma, will approve of this, for it doesn't put the big drain on his check-book all in a heap, but spreads it out so that it can be taken care of from time to time as the funds increase. Don't hesitate a minute—get this big, interesting, practical book—and get yourself on the air in the Hi-Power Class quickest and best!

## It's Ready NOW

## Tank Circuits

(Continued from page 24)

easily calculated if the operating frequency is known by the following formula:

$$X_C = \frac{1,000,000}{2\pi fC}$$

Where  $X_C$  equals reactance in ohms,  $f$  is the frequency in cycles per second,  $C$  is the capacity in microfarads.

## Antenna Tank Circuits

The use of link coupling between the plate tank of the final amplifier and a separate tuned antenna tank circuit to which the antenna or feeders are coupled is widely used. This type of coupling reduces harmonic radiation, preserves better balance on a push-pull stage, prevents the feeder radiation from upsetting the stability of the various amplifiers in the transmitter, and tends to improve the effective Q of the plate tank circuit of the final amplifier.

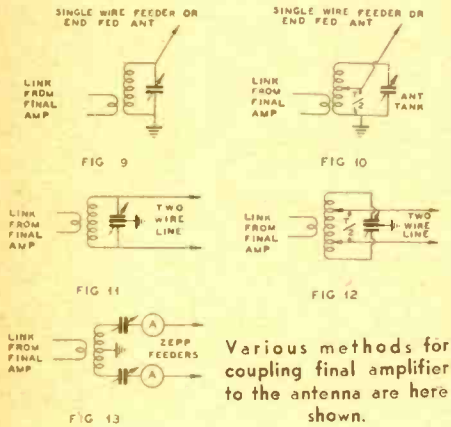

The higher the Q of the antenna tank the more the harmonic radiation will be reduced. The Q of the antenna tank should not be less than 3, and should preferably be above 5.

The Q of the antenna tank is calculated or estimated in exactly the same manner as that of the plate tank. Estimate the shunt impedance across the entire tank and divide by the Q in order to get the necessary condenser reactance. Then, from the frequency the capacity of the condenser can be determined.

The simplest antenna tank arrangement is shown in Fig. 9. If the tank is feeding an off-center-fed Hertz antenna the shunt impedance across the tank will be the same as the characteristic impedance of the feeder, which is in the neighborhood of 600 ohms. Thus to get a Q of five the condenser reactance at the operating frequency would be 120 ohms. At 7000 KC this would require a condenser capacity of 190 uufds. At 3500 KC, twice this capacity would be necessary. These values of capacity are larger than can be conveniently handled and therefore the arrangement shown in Fig. 10 cuts down the required capacity to one-fourth, although the RF voltage (for any given power output) is doubled; consequently twice the spacing must be provided. The feeder is tapped across one-half of the total turns, making the impedance across the entire tank four times the impedance from feeder to ground, or 2400 ohms across the tank for a 600 ohm feeder. The condenser reactance for a Q of 5 is 480 ohms; therefore only 48 uufds of capacity is necessary at 7 MC. The capacity is independent of the power output of the transmitter, which is a point of difference between the antenna tank and a plate tank, because the power output of a transmitting tube is very closely tied-up with the reflected load impedance into which the tube works. Therefore a 1 KW transmitter would require no more capacity in a given antenna tank than a 5 watt

transmitter, but the voltage spacing would have to be much greater. The effective RF voltage across any tuned circuit is always equal to the square-root of the product of the power in watts, times the shunt impedance, in ohms.

$$E = \sqrt{PZ}$$

Where  $E$ =Volts,  $P$ =Watts,  $Z$ =Ohms.

Thus 1 KW of power across a 600 ohm feeder represents an effective voltage of 775 volts. The voltage across 2400 ohms for the same power is twice this value, or 1550 volts. The peak voltage can be about twice the effective voltage, particularly if harmonics are present or if the carrier output is voice modulated, and thus the antenna tank tuning condenser should be rated at from two to three times the peak voltage which is present.

If it is desired to use a still smaller condenser to tune the antenna tank, the feeder can be clipped farther down the tank coil. This steps-up the impedance across the entire tank circuit, according to the law of impedance transformation, wherein the impedance ratio is equal to the square of the turns ratio.

If an end-fed antenna is clipped directly to the antenna tank coil, it will usually be found desirable not to tap the antenna down on the coil, but to use the circuit of Fig. 9 instead. This is advisable because the end of any Hertz antenna represents a fairly high impedance, which is just another way of saying that the end of a Hertz antenna must be fed with voltage. Of course, any antenna must be fed with voltage, and current too, but a voltage fed antenna is the name used to describe an antenna which is fed with high voltage and low current at a high impedance point. Figs. 11 and 12 show split antenna tanks for feeding two wire non resonant transmission lines. Fig. 13 shows how a Zepp antenna can be fed by means of a link from the final amplifier.

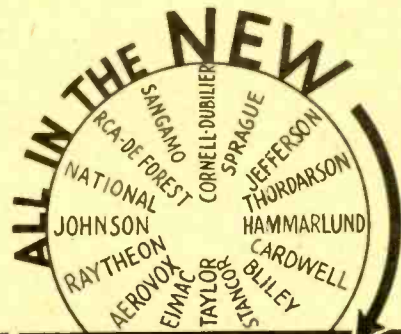

## 1935 SPRING & SUMMER ALLIED CATALOG

You will find complete answers to all of your Short Wave Transmitting and Receiving needs in this new Catalog, devoted 100% to Radio. Prices are LOWER than ever before—it will pay you to consult this book before you do your radio buying. Every leading standard Short Wave line is listed—outstanding new gear is fully described. Use the ALLIED Catalog and take advantage of our personal service. Let us help you with quotations for building any type of circuit—let our competent engineers and Amateurs in on your problems. We can always serve you better at ALLIED.

## ALLIED RADIO

ALLIED RADIO CORP.  
833 W. Jackson Blvd.,  
Chicago, Dept. J.  
Send me your FREE 1935 Spring and Summer Catalog.

Name \_\_\_\_\_  
Address \_\_\_\_\_

## COMPLETE DESIGNS of 20 TRANSMITTERS

12 tested transmitter R. F. section designs! 8 modulator and speech amplifier designs!

Outputs ranging from a little fellow on which the O.W. can learn, to big ones comparing in every way with the best broadcaster.

Circuit, and complete parts specifications of transformers, inductances, and all other component parts.

One of the most complete and thorough handbooks on transmitter design ever printed!

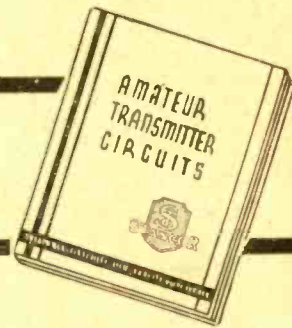

## FREE! VALUABLE REFERENCE BOOK

This advertisement and 12c IN STAMPS, to cover mailing expenses, will bring your FREE copy of this valuable Reference Book. There is no obligation.

## STANDARD TRANSFORMER CORP.



855 Blackhawk Street Chicago Ill.



## TRIMM FEATHERWEIGHT HEADSETS

BUILT FOR EXPERTS BY EXPERTS  
A Type for Every Need

NOW—  
A REAL SPONGE-RUBBER EARCUSHION  
A TYPE TO FIT ALL  
Lightweight - Standard Phones

TRIMM  
RADIO MFG. CO.  
1528 Armitage Ave., Chicago, Ill.



When writing to Advertisers, kindly tell them you saw their announcement in "RADIO".

# THE RADIO RECEPTOR MOVING COIL MICROPHONE

(DYNAMIC)

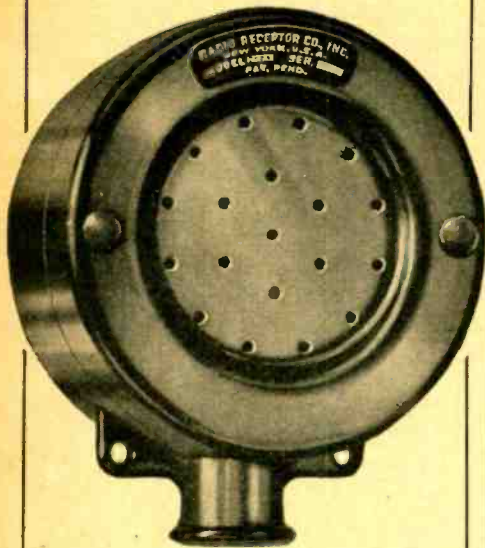

MODEL 6-A for Broadcasting Stations and Sound Recording.

MODEL 6-B is the most sensitive, self-generating microphone yet devised for general use; with the use of our special transformer, no amplification is required on present day standard amplifiers.

MODEL 6-C for Hams, and inexpensively priced Public Address System; requires less preamplification—hence, less noise, and more signal.

These microphones have undergone two years of grilling service in all climates before being offered to the trade.

List Price **\$33.00** and up

### Pacific Coast Representatives

NORTHERN CALIFORNIA  
KJAER EQUIPMENT CO., 557 Market St., San Francisco

SOUTHERN CALIFORNIA  
FRANK A. EMMETT CO., 1341 So. Hope St., Los Angeles

WASHINGTON AND OREGON Representatives:  
JAS. J. BACKER CO., 109 Bell St., Seattle, Wash.

### Radio Receptor Co., Inc.

110 SEVENTH AVE. NEW YORK, N. Y.  
Established 1922

## new! KELLOGG TRANSCEIVER HANDSET



A better all-around Transceiver Handset! Highly efficient single-button Kellogg microphone, super-sensitive Kellogg receiver. Easy to hold. Fits the face. ● Microphone has greater sensitivity and "flatter" response curve than the usual "mike" of this type. Precision built, as are all Kellogg products. Gold plated diaphragm. Especially processed carbon. ● Receiver is the product of 35 years experience building telephone apparatus. Bi-polar magnet of cobalt steel. Cadmium plated diaphragm. Small, compact, easy on the ear. ● Simply and ruggedly constructed and light weight. Cast aluminum triangular handle. Baked black enamel finish.

1sh. Has 6-foot, 4-conductor, 18-strand tinsel cord of telephone quality. ● You will be proud to own this unit. Better yet, it's not expensive. Code No. 38-A, 70 ohm receiver, list price \$10.00. Code No. 38-B, 2000 ohm receiver, list price \$11.

**KELLOGG SWITCHBOARD & SUPPLY CO.**  
1070 W. Adams St. CHICAGO, ILLINOIS

## Lafayette "PRO 9" AMATEUR RECEIVER



BUILD IT AND ENJOY REAL RESULTS ON ALL HAM BANDS

Here is the last word in modern amateur all-wave receiver Kits! It incorporates a factory assembled coil-switching unit so that only a few simple connections are needed to wire this unit into the completed receiver. Features 1 R.F. stage on all bands; Beat Frequency OSCILLATOR for C.W.; AVC or manual control; Demountable power speaker unit, etc. No. PXY-22069—complete kit of parts including speaker and panel, complete instruction booklet, but less tubes and cabinet **\$36.75**

If wanted completely wired **\$7.50 extra**  
Cabinet **\$7.50 extra**

## 5 METER Super Het

Here is a Super-het for 5 M. reception that is almost as simple as a straight super-regenerative receiver, but it will prove far superior as regards sensitivity, selectivity and noise level.

The absence of super-regenerative "Rush" is an outstanding characteristic. Any Ham can build it. No. PXR-22098—complete kit of parts including cabinet, panel and special copper plated chassis, complete instruction booklet, but less power supply, tubes and **\$16.75**

If wanted wired **\$3.25 extra**



## WHOLESALE RADIO SERVICE CO.

Main Office and Warehouse  
100 SIXTH AVENUE - NEW YORK, N.Y.

BRONX, N.Y. 642 E. Fordham Rd. ATLANTA, GA. 430 W. Peachtree St. N.W. NEWARK, N.J. 219 Central Ave.

### WHOLESALE RADIO SERVICE CO.

100 Sixth Ave., Dept. P-86, New York, New York

- Send me more data on the "PRO-9"
- Send me more data on the "5 M. Super-het"
- Send me FREE Ham Catalog #58-A

Name .....  
Address .....  
City ..... State .....

## If you need any of the following Items buy them from W8DED

Who Has Been an Active Ham for Over Ten Years

QSL CARDS "W8DED PRINT" World's finest! Stamp for samples and prices. CALLBOOKS (W9FO) with all U. S. & Foreign QRA's! Latest, \$1.25. QST SUBSCRIPTIONS (new and renewals) send yours through W8DED. \$2.50 year. RADIO magazine SUBSCRIPTIONS (write for big money saving offer from W8DED). HANDBOOKS (RADIO or ARRL) you need them both. \$1 each. Both \$1.75. BLILEY EXTALS!! (within 5 kc. or almost exact if you QRX) WITH HOLDER \$3.95. LIFETIME MIKES!! (Finest for the price—write for free catalog from W8DED). Send this ad along with your order and get a 7x11 station card FREE! Your call in red type.

Mail All Orders Direct to Rus Sakers, W8DED  
53 EAST 7th ST., HOLLAND, MICH.



## GET MORE DX

## The New MILLER PRESELECTOR

Here is a simple, inexpensive and really practical Preselector. It will give you more distance and sensitivity with lower noise and absolutely no images. The coils cover full range from 12 to 200 meters. Additional features include built-in power supply, two stages of tuned R.F., efficient output circuit and single wire or doublet antenna.

"Build it Yourself," in Kit Form, No. 302 Coil Kit **\$4.80**

Or if you prefer to buy your equipment, "tailor made" here is a real opportunity. Complete with tubes and metal cabinet **\$24.00**

At Your Dealer or Write

**J. W. MILLER CO.**  
5917 SOUTH MAIN STREET  
LOS ANGELES, CAL.

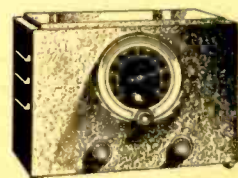

## CLASSIFIED ADS

Rates—10c Per Word

\$115.00 takes brand new NATIONAL HRO, NATIONAL power pack and RCA tubes, all complete, original cases. Also one new RCA 851 tube, \$50.00. McMurdo Silver Corporation, 3354 North Paulina St., Chicago, Ill.

If you are a member of a radio club, your secretary can secure low subscription prices to "RADIO" for you. Ask him to write at once for club rates. "RADIO", San Francisco.

WANTED . . . back copies of RADIO, April, 1934 and September, 1934 issues. If in perfect condition will pay 50c per copy. "RADIO", San Francisco.

## MILLIONS IN USE

- Two Year Guarantee
- Low Power Factor
- Long Life
- Self Healing
- Efficient and Compact
- Patented and Patents Pending



The superior quality and performance of millions of Duco Condensers are recognized all over the world.

NOW GUARANTEED FOR 2 YEARS

Manufactured by

**DUMONT ELECTRIC COMPANY, Inc.**

514 Broadway New York, N. Y.

Write for free Catalogs, Sales and Jobber Territory



## Announces New METAL TUBE TESTING ADAPTERS

- 8 PRONG MOULDED BAKELITE SOCKETS
- 8 PRONG ANALYZER PLUGS
- 1 3/4", 2 3/4" 4" TRANSMITTER DIALS
- 5 PRONG SOCKET FOR 803 TUBE
- TRANSMITTER ISOTEX TANK FORMS
- METAL CABINETS

**BUD RADIO, INC. CLEVELAND, OHIO**

Please send me your NEW 1936 Catalog FREE which describes your complete line of parts.

NAME \_\_\_\_\_  
ADDRESS \_\_\_\_\_  
CITY \_\_\_\_\_

R935

## LITTELFUSES

Instrument LITTELFUSES, for Meters, 1/200 amp. up—Hi-Volt Fuses for Transmitters, etc., 1,000, 5,000 and 10,000 volt ranges, 1/16 amp. up. All needed by radio men and save valuable equipment. Neon Voltage Fuses & Indicators (Tattalites), 100, 250, 500, 1,000 & 2,000 volt ratings—100 uses—A new test instrument. FREE Catalog on all Littelfuse Products—Aircraft Fuses, Auto Fuses, Mountings, etc. Write

LITTELFUSE LABS

4236 Lincoln Avenue Chicago, Ill.

\$1 brings you the next four issues of "RADIO"—Subscribe NOW.

# Announcing the New SILVER 5D

## COMMERCIAL SHORT WAVE SUPERHET



• We are glad to be able to offer to amateur radio every single valuable new engineering feature known today in the 5D receiver which can be had fully assembled and tested, or as a kit for home assembly.

In no way, however, is the 5D a "kit"—it is a strictly professional communication receiver so thoroughly designed and perfected that it may be assembled and tested by amateurs from standard high quality parts. By virtue of such design by McMurdo Silver, Frank Jones and fourteen co-operating manufacturers, it gives you all—and more—than other sets at twice its price.

Available from your jobber, the fully laboratory-assembled and tested 5D, complete with ten Raytheon tubes, Bliley crystal and Jensen loud speaker, RCA and Hazeltine licensed, is priced at \$114.00 net to amateurs. The complete Silver kit, with all above accessories and complete instructions, RCA and Hazeltine licensed, is priced at \$94.19 net to amateurs.

Better get a demonstration from your jobber.

### PROGRESSIVE JONES-SILVER TRANSMITTERS

Whether you want 25 watts, 50 watts, 150, 250 or 500 r.f. watts, C.W. or phone, the new Silver progressive transmitters designed



around the Jones harmonic exciter are the berries to build—or to rebuild your present rig up into—for nothing is wasted as power is increased. The illustration shows 500 watts of r.f., with exciter, modulator and power supplies in a 36" rack, yet not a bit crowded. You can build 50 watts of it for less than \$60.00, including modulator and power supply, or the whole 500 watts for under \$200.00. Data is yours for the coupon.

### TWO NEW ITEMS 500 Ma. 1 KW. R.F. Choke

Having found no available r.f. choke that would carry 500 ma. continuously at 2000 volts or more for 10 to 160 meter amateur bands, we now introduce the 17E choke, which will do just this. Wound on Steatite with silk-enamel wire, its insulation is adequate, and "sucking" (pies pulling together under load) has been eliminated, as well as distributed capacity held down by very wide spacing between pies. With inductance 2.5 m.h., distributed capacity below 2 mmf. and d.c. resistance under 8 ohms, the 17E is provided with two terminal lugs and one mounting screw at a net price to amateurs of 96c.

### 18A Socket for RK28-RCA803

Needing sockets for the new large five-pin bases, we have had to make them. The 18A socket is of Steatite, 2 1/2" in diameter, with large steel reinforced springs. It does the job very nicely, and nets to amateurs at only 96c, for delivery right now.

## McMURDO SILVER CORPORATION

3362 N. Paulina St. Chicago, U. S. A.

### DIP or BRUSH R.F. COMPONENTS with Q-MAX No. 3

The only Victrol base R.F. Coating. Do not destroy the efficiency of your apparatus by the use of ordinary lacquers never intended for high frequency service. USE Q-MAX No. 3. \$25 per can at your dealer's store.

Communication Products, Inc. 245 Custer Avenue Jersey City, N. J.

### These Features Tell the 5D Story:

- No plug in coils — efficient band switching and send-receive switch.
- Two tuned r.f. stages on all four bands.
- Low C tuned circuits — all circuits air trimmed and tuned.
- Bliley crystal filter for single signal C.W. and super-selective phone reception without loss of volume.
- Accurately relogging band spread anywhere in its tuning range—hundreds of degrees for each amateur band.
- Covers all five amateur 10, 20, 40, 80 and 160 meter and all S.W. broadcast bands—9 to 175 meters.
- Almost no inherent noise — the quietest yet most sensitive set you've ever operated.
- Sensitivity better than 1 microvolt at all points of all bands.
- Selectivity, just what you want, variable iron-core and air-tuned i.f. transformers.
- Tone what you want—from single signal "peaked audio" to fine broadcast quality.
- Ten new Raytheon 6.3 volt tubes—2 6D6 t.r.f. stages, 6D6 S.G. first detector, 41 electron coupled H.F. oscillator, 6D6 high gain, high Q i.f. stage, 6B7 amplified A.V.C., 76 beat oscillator and 6C6 high gain tetrode second detector. 42 output and 5Z3 rectifier. Ten tubes with 12 tube functions!
- "R" or sensitivity meter.
- All AC operated in one unit with no hum.
- 8" matched Jensen dynamic speaker.
- Polished chromium finish on heavy welded steel chassis fully shielded and temperature isolated for 100% frequency stability.
- Easy to assemble and wire—complete coded wiring cable furnished, with 32 pages of instructions, circuits and lots of detailed wiring and assembly photos.

### MAIL COUPON TODAY!

McMurdo Silver Corporation  
3362 N. Paulina Street  
Chicago, Illinois  
..... Enclosed 10c for 32 page "How to Build It" Book on "RADIO" SILVER 5D  
..... Enclosed 10c for "How to Build It" Book on Jones-Silver Transmitter.  
..... Send free circulars.  
Name \_\_\_\_\_  
Address \_\_\_\_\_  
City \_\_\_\_\_ State \_\_\_\_\_ 9RM

### SPECIAL GROUP SUBSCRIPTION RATES TO RADIO CLUBS

Generous discounts on subscriptions if 5 or more members subscribe at one time. Radio club secretaries are invited to write for special proposition. "RADIO", Pacific Bldg., San Francisco, Calif.

PROMPT DELIVERY ON THE NEW

# RADIO-SILVER RECEIVER

Down Payment \$45.00 - Monthly Payments \$16.00

We Are Also Making Immediate Delivery on

NATIONAL HRO - BRETING 12 - RCA-ACR 136

RME 9D - HALLICRAFTERS - TOBE

DOWN PAYMENTS START AT \$16.50

Balance on Easy Monthly Payments

SPECIAL TERMS ON NEW TRANSMITTERS

Hammarlund Super Pro and PR-16 scheduled for October

## DELAWARE RADIO SALES COMPANY

405 DELAWARE AVE.

WILMINGTON, DELAWARE

Attention: Willard S. Wilson, W3DQ

Established 1920

### The "Super-Gainer"

(Continued from page 9)

usually have to be loosened in order to allow variation of coupling.

After the second detector is operating properly, the 76 oscillator and detector can be aligned on some strong signal, or a calibrated modulated oscillator can be used. The latter is by far the easiest and best method, because the coils and condensers can then be made to track across any amateur band and the bands can be easily located. The first detector regeneration control should never be advanced to the point of actual oscillation. The antenna coupling can be adjusted so that it will allow the first detector to actually oscillate. All of these tests can be made by listening with a headset plugged into the telephone jack. The audio volume is not sufficient for operating a loudspeaker.

Lack of oscillation in the 76 tube can be traced to too little or too much tickler winding, insufficient plate voltage, defective by-pass condenser or, in most cases, a weak 76 tube. Failure to secure regeneration in the first detector is usually caused by too much antenna coupling, or high losses in the detector coil, or incorrect voltages. The cathode tap can be varied in either direction on the winding so as to obtain good regeneration over the complete range of the band-setter condenser.

Motorboating or oscillation with a loud "plunk" in the 79 tube can usually be traced to lack of sufficient by-pass across the B supply, or too-high values of resistors in the cathode, plate or grid circuits. Sometimes the 25 mfd. electrolytic condenser must be by-passed with a .01 mfd. paper condenser. If any feed-back is obtained at IF frequency, the phone jack can be by-passed with a .005 mfd. condenser. All resistors can be of the 1 watt size. The 79 tube should have its top grid connected to the IF transformer. The 79 socket should be mounted in such a manner that the audio plate and grid prongs are to the left side of the heater prongs, with the plate next to the heater. The detector plate is next to the heaters on the right side, and the cathode is between the detector plate and the audio grid prongs. The wiring leads should be as short as possible.

### Variactor Controlled Carrier Unit

(Continued from page 15)

at zero bias as in class B operation, and therefore drew grid current. The action seemed to be fairly linear but required much more driving power than the 2A3 which does not draw any grid current. Two small 45 volt B battery blocks are needed to act as a C battery when the 2A3 is used. There is no current drain or charging current through the C batteries, with the result that they will operate over a very long period of time.

### Electrad Offers New Volume Control Guide and 1936 Catalog Resistors

Electrad, Inc., New York resistor specialists, offers a new 100-page Volume Control Guide free to bonafide radio and electrical service men, who will mail in the flap (showing specifications) from one of this company's new-type Carbon Volume Control cartons, together with their business letterhead or business card.

This guide lists alphabetically all radio receivers, model numbers, makers' names, catalog numbers of proper Electrad replacement controls, resistance values and list prices. Such information should be of much practical, time-saving value to busy service men.

The new 1936 Electrad General Catalog of resistors for all purposes is now off the press, and a copy will be mailed free to anyone who will write for it to Electrad, Inc., 175 Varick Street, New York City.

\$1 Brings You the Next 4 Issues of "RADIO"

## CROWE

RADIO COMPONENTS

DIALS, KNOBS and SWITCH PLATES for TRANSMITTERS, SOUND EQUIPMENT, OSCILLATORS, Etc.

CARRIED IN STOCK BY LEADING JOBBERS AND DEALERS.



Chrome and black Gain plates in several styles and readings.

Die-cut instrument dials. Professional appearance and extreme accuracy.

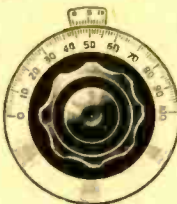

Black Bakelite knobs in matching sets. Bar Knobs - Switch Knobs - Skirt Knobs



Aluminum and black Switch Plates, Gain Plates, Volume and Selector Plates.

Write for Bulletin No. 70 for complete details.

Established 1899

## CROWE NAME PLATE AND MANUFACTURING CO.

1755 GRACE STREET

CHICAGO, ILLINOIS

Cable Address: Crowname, Chicago



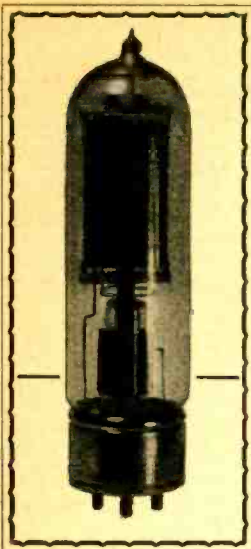

# This Is the Tube That They're All Talking About!

## Those FB *Western Electric* 211-D FIFTY WATTERS

The greatest, most sensational, value in Xmitting tubes ever offered!! Every tube is a GENUINE Western Electric! Every tube is BRAND NEW and in its original carton! Every tube is UNCONDITIONALLY GUARANTEED FOR THIRTY DAYS! (Free replacement for any reason whatsoever except broken glass or burnt out filament.)

ORDER YOURS TODAY! No risk. We have safely shipped over four thousand tubes to all parts of the world! Just send a check, money order, or cash (registered mail) for as many tubes as you wish. Include enough for postage. (Shipping weight is 3 lbs. each. Postage to the West Coast would be only 37c plus 5c for insurance against loss or damage.) Or, if you prefer, send a 20% deposit and we will ship C.O.D. Within 5 hours our shipment is on its way to you!

REGULAR SELLING PRICE - \$17.50  
HARRISON'S SPECIAL PRICE - only **\$4.90**

Your money cheerfully returned if you do not agree with us that they are worth many times this price or if you are not completely satisfied with your purchase!

IT PAYS TO BUY FROM HARRISON BY MAIL!!

### CLASS B POWER XFORMER

A heavy duty transformer for use wherever high current is required. Delivers 425 volts out of filter at 250 MA load! Has a 5 volt 3 amp winding for 83 or 5Z3 and three 6 amp, 2½ volt windings. Good regulation. Two with high voltage in series will give DC output of 850 volts at 250 MA! Metal shielding. May be mounted sub-panel or above board. Color coded leads. Net weight 8½ lbs. Brand new and guaranteed. SPECIAL—\$2.10 each. TWO for \$3.90.

### CLASS B CHOKE

Filter Choke. 6 Henry, 250 MA. 60 ohm DC resistance. Compact. Two hole mount. Connect two in series for 12 Henry. Good value. Actual weight—2 lbs. SPECIAL—75c each. (With airgap removed is a swinging input choke. 4 to 18 henry.)

### 240 WATT POWER PACK

Delivers 600 volts DC at 150 Ma. (570 at 200 MA.) Separate filament xformer delivers 7½ CT, 7½ CT, and 2½ at 12 Amp. for MOPA, Modulators, etc. . . . Large double choke and 9Mfd. Condenser Block insures perfect filtering! All completely assembled and wired in metal case 10" x 10" x 10"! Manufactured by Majestic for High Power job. Actual weight 46 lbs.! Every one New and Perfect. \$5.90. (With two 81 rectifier tubes—\$7.40.)

### Flechtheim Condensers

Special offering from regular stock. New. Guaranteed. 1000 Volts DC Working. Latest type HSM. Metal cased with insulated terminals.

1 Mfd (list \$2.25)—68c  
2 Mfd (list \$3.50)—\$1.05

SPECIAL COMBINATION  
Two 2 Mfd. and Two 1 Mfd. Units **\$2.80**

### Carbon Plate **\$8.45**

203-A  
A real good tube that can take it!! Fully guaranteed. General Radio Type 247 Variable condenser .00025 Mfd. 500 Volt rating—Regular Selling Price \$3. SPECIAL—**.68**

Thordarson 8 Henry  
400 MA Power Choke  
Neatly metal cased. FB for input choke. 3000 Volt insulation **\$1.35**

## HARRISON RADIO COMPANY

142 Liberty St., Dept P-9  
NEW YORK CITY

IMMEDIATE SHIPMENT OF ANY HAM APPARATUS! WHAT DO YOU NEED, OM?

### THE RADIO HANDBOOK

FOR AMATEURS AND EXPERIMENTERS



This Handbook by "RADIO" is Your Guide to Better Radio

It begins at the beginning, tells you how to master the code by means of the SOUND system. Tells how to build any kind of an amateur or short-wave receiver, from a 1 tube to a 12 tube de luxe crystal filter superheterodyne. Tells how to build any kind of a c.w. or phone transmitter, from the beginner's one tube to the big 1 KW job. Tells how to build a dozen kinds of ultra-high frequency transmitters, receivers, transceivers. Many charts, tables, formulae. New tube characteristics. Data on metal tubes. Laboratory test equipment. 300 pages.

## YOUR NEW AUTHORITY

The Handbook by "RADIO" 300 PAGES

Largest, Newest, Most Complete Book of Its Kind

AMATEURS everywhere are talking about the great, new Handbook by "RADIO". They are discussing it on the air, at club meetings, in radio stores. Something different . . . something NEW . . . something modern! "It's the last word," they say. The new high-power pentode transmitters are shown . . . the new theory on radio and electricity is creating wide comment . . . the complete chapters on antennas, radiotelephony, modern c.w. transmitters, ultra-high frequency equipment, etc., have brought an avalanche of commendation. Several hundred dealers have this book on sale. If your dealer cannot supply you, order direct from the publisher.

Immediate Deliveries  
SEND YOUR ORDER TODAY!

**\$1.00** PER COPY  
POSTPAID

RADIO

Pacific Building - San Francisco, Calif.

## ASTATIC

Crystal Microphones and Pickups

### A SENSATIONAL NEW MICROPHONE!



Astatic announces another triumph! A startling new conception in crystal microphone design—THE HIGH FIDELITY K-2, non-directional microphone embodying a distinctly new principle in microphone construction. The frequency response is substantially flat from 30 to 6000 cps with a rising characteristic to 10,000 cps. Output level approximately —75 db. Can be operated close to reproducer without feedback. Especially recommended for broadcast studios and high fidelity P. A. systems. (And it's guaranteed.)

SEE YOUR JOBBER TODAY!

Licensed under Brush Development Co., patents

### S-TYPE PICKUP

A light weight pickup noted for its exceptional quality in the reproduction of commercial recordings. Broadcast quality.



ASTATIC MICROPHONE LABORATORY, Inc. YOUNGSTOWN, O.  
Pioneer Manufacturers of Quality Crystal Products

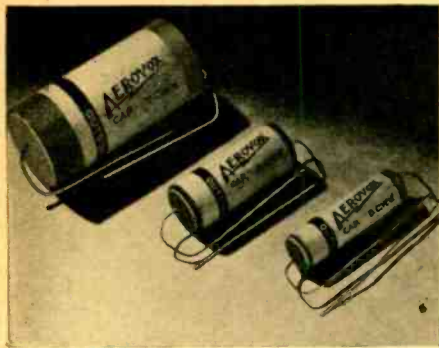

## CARTRIDGE CONDENSERS

... Triple-Sealed!

With the return of the radio industry to full-sized sets, superior performance, lasting satisfaction, AEROVOX re-introduces the triple-sealed cartridge condenser. Here is genuine quality at new low prices . . . skilled engineering for an economical result . . . featuring:

- 1 Non-inductively wound section of selected paper and foil, wax-coated.
- 2 Sturdy wax-impregnated tubing with imbedded aluminum foil.
- 3 Liberal wax-sealed ends in place of usual unsealed spun-over ends.

Result: Far greater freedom from humidity . . . 4½ times longer life than conventional unsealed tubulars. In single and dual sections . . . wide range of capacities . . . 200, 400, 600, 1000 volt ratings. And they cost no more!

**DATA** New 1935 catalog is yours for the asking. Also sample copy of monthly Research Worker. Meanwhile, see your local supply house about the AEROVOX line of condensers and resistors.

# AEROVOX

CORPORATION

84 Washington St.

Brooklyn, N. Y.

## CANNON-BALL HEADSETS

Made by America's oldest manufacturer of headsets

Heavy bar magnets, double pole, aluminum cases, D. C. resistances of 2000, 3000 and 5000 ohms. Sturdy construction, sensitive and faithful in reproduction.

Sold everywhere in America

C. F. CANNON CO.  
SPRINGWATER, N. Y.

### RADIO CLUBS!

Write for Special Group Subscription Rates for "RADIO"



Osockme, Japan.  
July 13, 1935.

Very truly yours the Editor  
of "RADIO". Kind Sir Ed.:

It do not make sense to Scratchi at all, Hon. Ed., either in this world or in such other place where all radio store dealers go when such make decease, how such dealer persons can make advertising extravagances of 40%, 50%, 60% and up discounts on radio ham parts when nothing are given for such discounts which mean anything or less. You take for examples such announcements that 100 feet of Ant Enna wire can be purchased from dealer at 50% discount prices. Scratchi figger it all out by himself. I lay trap for nipping such scheme in neck. I write to dealer and I send order with writings. It read as following:

Dear Gyp. (:): You wish to ensnare me with 50% discount bait. I bite. I want you make ship to me at once, 100 feet of Ant Enna wire. But before you make ship, you first listen to my instruction. 50% off of 100 feet are 50 feet. Yes? Please do not say no, for correct answer are YES! You give me 50% discount on 100 feet. I make you proposition. You make no charge for the 50% discount. You therefore send me 50 feet of wire free and I let you keep other 50% all for yourself, without cost to you. If it are true that you really give 50% off, then make proof you speak with truth. I wish to see what such 50% actually make look like in physical assets. If you give 50% off, and if there were really such a thing as 50% to add on to something, I wish to see what that 50% were, and because you give such 50% away with your compliment, please make proof to me by sending me my 50% feet of wire without cost and I will gladly make acceptance of such with due haste. And I thank you. Signed Scratchi, Unquotes. Stop.

Now, Hon. Editor, I are fair with such dealer. I make turntables on him, I let him keep his 50% and all I ask is that he give to me the other 50% which he give away so freely, but instead of only giving such on paper scraps, I wish see tangible evidence that such myth have once make existence.

I make haste-post down street few weeks ago and I pass in front of rear store entrance. There hang huge sign. It scream out at me—50% off. 50% off. 50% off. I stop. Dealer shake wicked finger at me and say come inside and see what we give you . . . 50% off. I ask him to show me where the 50% are. He hand me coil of wire and he say 50% off. Allright I say. I take the 50% you give away free and you keep rest with my compliments. I also wish to be so kind to you as you are to Scratchi, I say. It are not fair that you give everything and I give nothing. Whereupon he pick up large glass insulator and make lasting Impression on top of my head.

I come home scared stiff and my wife she say to me I look like holey ghost. I tell her I have just receive liberal education in how amateur discount are figured by store dealers. She say, "Scratchi, it sure sunk into your head, did it not?" I say to her it were the glass insulator and not the discount which sink into my head.

I are now sitting in upright position in soft arm chair and I make comfort myself with new animal pet which wander into ham shack few nights ago. I look at such animal and I quickly name it "Tank Coil". It were a cat which have become so skinny from lacks of food that rib bones stick out and such can be counted just like turns on copper tubing tank coil. So I make appropriate name for cat. I am sure, Hon. Ed., that such cat come straight and direct from 50% discount radio store. Maybe big-hearted store owner give his cat 50% off on food, yes? And mayhap 50% more off for cash, with result that cat get nothing at all.

I wish for you to make publish correct discount tables in Hon. RADIO sheet, showing proof how ham are given 50% discount when such thing never make existence in first place, and what are reason for giving ham something which never have been there to give. You xplain, Hon. Ed? Or do you also make think like I do, that something make smell rotten in Shanghai? I stop now, Hon. Ed, but you somehow go on forever.

and ever yours,  
Hashafisti Scratchi.

# NEW!

## Now Ready the 1936 ALLIED CATALOG

**New!**

RCA V-Cut Quartz Crystals in pressure-airgap ceramic holder. Complete listing in the new ALLIED Catalog. Supplied in the 3.5 to 4.0 m.c. band.

**New!**

The entire line of new Thordarson Transmitting Transformers—you'll find them all in the 1936 ALLIED Radio Catalog.

**New!**

The new RCA 838 and 803 Transmuting tubes, also — they're in the complete new Amateur section of the 1936 ALLIED Catalog.

**New!**

The Ohmite Band-Switch for instant QSY. Here's another example of the newness, the "up-to-dateness" of the 1936 ALLIED Catalog.

### ALLIED RADIO CORPORATION

833 W. JACKSON BLVD., CHICAGO, ILL.

## Radio Amateur Call Book

The only radio callbook published that lists all radio amateur stations throughout the entire World.

Also a complete list of high frequency commercial stations, International abbreviations and amateur prefixes, "Q, R, & T," systems for reporting signals, new US inspection districts and high frequency time, press and weather schedules.

Each copy contains a double post card addressed to the CALLBOOK for use in reporting your new QRA. We are extremely anxious to publish a callbook that will be 100% correct and want you to help us by checking your QRA at once in the latest edition and advise us of any errors.

**PUBLISHED QUARTERLY MARCH, JUNE, SEPTEMBER AND DECEMBER**

Single Copies \$1.25  
Annual Subscription USA, \$4.00

Order your copy today from your local radio jobber or direct from:

### Radio Amateur Call Book, Inc.

600 South Dearborn St. Chicago, Ill.

## ANYTHING IN AMATEUR RADIO FOR IMMEDIATE DELIVERY—

Aerovox, American Microphone, Barr, Birnbach, Bliley, Cardwell, Eimac, Electrad, Haigis, Hallicrafter, Hammarlund, Heintz & Kaufman, Johnson, Kenyon, RCA, deForest, Patterson, Raytheon, Sangamo, Shure, Signal, Thordarson, United Transformer, Universal, Vibroplex, Ward Leonard, Westinghouse, Yaxley.

FAMOUS GROSS LINE  
CW-TELEPHONE TRANSMITTERS  
(Write for descriptive literature)

The Leading Amateur Short  
Wave Receivers in Stock:

HALLICRAFTER  
HAMMARLUND  
PATTERSON

RME-9  
RCA

We Carry the Latest in  
5 METER EQUIPMENT

### GROSS RADIO, INC.

51 VESEY STREET, NEW YORK CITY  
Cable Address: Grossinc.

## BUILD This Great PROFESSIONAL RECEIVER.

AMATEURS  
S.W. LISTENERS!  
SAVE over  
**50%**

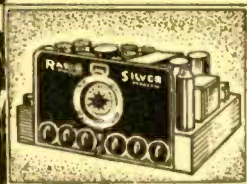

9 TO 200 METER  
H. F. SUPERHET

The new RADIO-SILVER 10 Tube Communications Superhet Kit, Designed by the Technical Staff of "RADIO", together with McMurdo Silver and 15 leading radio parts makers. A precision job for laboratory building. You wire with made-up colored cable. Start for as little as \$7.30—buy the parts as you build. Features air-tuned Polyiron I.F.'s; separate R.F. coils for each band, air-trimmed; 1 MV absolute sensitivity; crystal filter; bandsread tuning; 4 bands—2 tuned RF stages on each, etc.—all for less than half the cost of a factory-built set.



Send for FREE 6-page circular describing the new RADIO-SILVER Superhet. For 32-page "How-to-build-it" book, including diagrams, etc., send 10c.

## ALLIED RADIO

ALLIED RADIO CORPORATION  
833 Jackson Blvd., Chicago., Dept. J.  
 Send me FREE Radio-Silver Kit circular.  
 Find 10c enclosed for "How-to-build-it" book.

Name.....  
Address.....

\$1 brings you the next four issues of "RADIO"—Subscribe NOW.

## Group Hearing Aids

(Continued from page 11)

The amplifier should be of a high quality and as free of hum as possible as this becomes quite noticeable in earphones. It should have sufficient gain to raise the volume from the input level to a sufficient level for the needs of the hard of hearing; the power output need not be excessive yet sufficient to drive, in addition to a number of earphones, several bone conduction receivers and a small speaker which is frequently located in a side room for overflow meetings in the case of a church. The output transformer should have several taps thus permitting considerable flexibility in the impedance of the load into which it feeds, allowing additions to be made without any changes in the amplifier.

In the case of microphone pick-ups which are most frequently used, any of several of the higher grade microphones now offered at reasonable prices should be used. Each type has its particular advantages, velocity types because of their directional qualities; crystal types because of their high quality at low cost and non-directional properties, etc. Generally, types that do not require a source of power are to be preferred because of the greater ease of installation; nevertheless, each installation presents its own individual problems in microphone selection and placement.

In addition to the knowledge of the equipment used, securing group hearing aid installations require a realization of the problems of the hard of hearing. In each community there is a considerable field to be worked upon and the service man who early recognizes this fact, will be the dominating factor in his community along this line.

## A Banehawk—At Last!

After repeatedly promising our readers additional data on the Banehawk receiver, and after repeatedly failing to publish this data because the "promised circuit" had to be vamped and revamped so many times, the technical editors hope to have the information ready for the next issue of the magazine. The mechanical details remain unchanged and the same parts are used. The improvements are in the circuit only.

### AMPERITE

## HIGH LEVEL VELOCITY

(HIGH IMPEDANCE-2000 OHMS)

**OPERATES WITHOUT PRE-AMP**

THIS MICROPHONE IS HIGH ENOUGH IN IMPEDANCE TO OPERATE DIRECTLY INTO GRID . . . BUT NOT HIGH ENOUGH (ONLY 2000 OHMS) TO INTRODUCE SERIOUS LOSSES IN LINE UP TO 200.

Requires no pre-amp when used with regular high gain amplifier (100 DB) Replaces condenser and crystal microphones—NO CHANGES or additions necessary! ELIMINATES INPUT TRANSFORMER and its losses . . . Therefore requires 12 db. less overall amplification. . . Eliminates inductive hum. NO FEEDBACK.

**LIFELIKE BRILLIANCE**

The High Level Velocity reproduces both speech and music with their original brilliance. Also excellent on close talking.

MODEL RB-H for speech and music LIST \$42.00 with coupling  
RS-H for speech. can also be used for music. LIST \$32.00 with coupling

**ELIMINATES HUM TROUBLE**



Write For Bulletin HL  
561 BROADWAY NEW YORK

**AMPERITE Company**  
**AMPERITE** POINT Velocity MICROPHONE

## New



### ELECTRAD VOLUME CONTROL

## Has Quiet, Smooth CARBON RESISTANCE

ENGINEERED by resistor specialists who have concentrated on volume control problems since the beginning of broadcasting, this new Electrad unit gives sensational performance.

Individually tested at the factory for noise, the longer you use it the smoother it operates. Molded Bakelite case, when mounted, extends only 1/2 inch back-panel. New-type power switch (approved by underwriters) may be instantly attached or removed by a single screw. Long, easy-to-cut aluminum shaft. All standard and special values.



Carbon resistance element fused to flat outer rim of Bakelite ring, over which a special-alloy floating contact shoe gently glides.

Mail Coupon for FREE Descriptive Folder and 1936 General Catalog.

14 Varick St., New York, N.Y.

## ELECTRAD

1936 CATALOG

**ELECTRAD, Inc.**  
175 Varick St.,  
New York, N. Y.

Please send new Resistor Catalog  
Check here for folder on new  
**QUIET Volume Control.**

Name.....  
Address.....

PR-9

## HI-POWER for SOUND EQUIPMENT



The Carter Genemotor supplies the most Reliable and Economical "B" power for Class A or B Amplifiers from a 6 or 12 volt battery. Output up to 600 volts. Sturdy — Compact — Quiet in operation — Requires no oiling — Guaranteed. Write for Bulletin showing complete line of Genemotors for every purpose or specify your requirements.

**CARTER MOTOR CO.**  
365 W. Superior St. Chicago

Radio Dealers and Jobbers who desire to advertise in these columns are invited to write for rates.

# RADIO BUYERS' GUIDE

A Monthly Listing of Reliable Radio Dealers and Jobbers who solicit the patronage of our readers. Buy from your nearest Dealer or Distributor. He is dependable and reliable.

CHICAGO, ILLINOIS

## Chicago Radio Apparatus Company, Inc.

415 South Dearborn Street  
Harrison 2276

Dependable Radio Equipment

Established 1921

Bulletins on request.  
Everything for the amateur.  
Get our very low prices.

CHICAGO, ILLINOIS

## MID-WEST RADIO MART

520 South State Street

CHICAGO

Write for Special Catalog—Free

SCHENECTADY, NEW YORK

## ATLANTIC RADIO SUPPLY CO.

712 Broadway

Complete Equipment Stocked for  
Service men—Amateurs—Experimenters

Let us quote you

OAKLAND, CALIFORNIA

## RADIO SUPPLY CO.

2085 BROADWAY.

Hammarlund, Yaxley, Carter, National, Johnson, IRC, Cardwell, Miller, Morrill, Flechteim, Triplett, Haigis Transceivers  
W6GFY

ST. PAUL, MINNESOTA

## LEW BONN COMPANY

2484 University Avenue

Rex L. Munger, W9LIP, Sales Engineer

Radio Wholesaler

Complete Stock

NEW YORK, N. Y.



Complete Stock of Amateur Radio Supplies  
at Wholesale Discounts

LOS ANGELES, CALIFORNIA

## RADIO SUPPLY CO.

912 SO. BROADWAY

The Amateurs'  
HEADQUARTERS of the WEST

All Nationally Advertised Parts for  
Receiving and Transmitting carried  
in stock at all times.

9 Licensed Amateurs on Our Staff

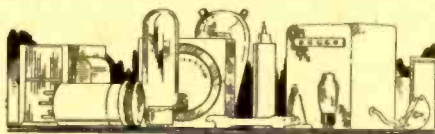

## NEW PRODUCTS

### IRC Announces New Insulated Metalized Resistors

Unique Development Represents an Important Departure in the Art of Resistance Manufacture

● Unique modern resistors specifically designed for exacting radio requirements of the present day and known as IRC type "B" Metalized Resistors have just been announced by the International Resistance Company.

Retaining all advantages of the familiar Type "F" Metalized Resistors, these new units have complete high voltage insulation protection and

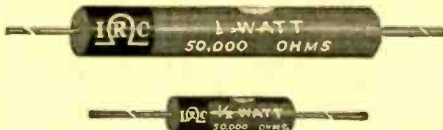

are constructed without metal ends. They can contact other parts without danger of shorting. Utilizing an improved Metalized resistance element, they have an extremely low noise level and represent a distinct improvement in essential resistor characteristics such as accuracy, permanency of resistance value and durability under all operating conditions.

In the New Type "B" Insulated Resistors a sturdy casing of insulating compound is moulded completely around the Metalized resistance element, sealing it against moisture and protecting it from shorting on other parts. Like Bakelite, this insulating material will not crack or deteriorate. Permanent contact between element and wire leads is obtained by a special bonding process which, after the insulation is moulded solidly around the assembly, cannot break or develop poor contact. Noise level is unusually low, making these new resistors ideally suited for amplifier circuits and for critical television requirements.

IRC Insulated Resistors are both color coded and individually marked with resistance value and wattage rating. Identification is quick and easy. They are available in 1/2-watt and 1-watt ratings which will suffice for practically every installation however crowded it may be. Not only is the 1/2-watt (type B-1/2) resistor as small as the usual 1/4-watt resistor but it may be used universally for any rating up to and including 1/2-watt with greater efficiency and a higher factor of safety.

Flexible wire leads extend straight out from the ends giving a more effective lead length and avoiding danger of breakage when installing. They are tinned for easy soldering.

The 1-watt (Type B-1) IRC Insulated Resistor is made in all ranges from 300 ohms to 10 megohms. The 1/2-watt unit (Type B-1/2) is made in all ranges from 100 ohms to 5.0 megohms.

For almost a year prior to this introduction to the radio service and amateur trades, these new resistors have been supplied to leading radio manufacturers who, up to the present time, have taken the entire output. Greatly increased manufacturing facilities now enable IRC to supply the new units through jobbing channels.

A new catalog containing full details will be sent, on request to International Resistance Co., 2100 Arch St., Philadelphia, Pa.

"The 'Radio' Handbook"  
Is Sold by All Dealers Whose  
Advertisements Are on This Page

Send Your Order Direct to Them

CHICAGO, ILLINOIS

## Chicago Radio Apparatus Company, Inc.

415 South Dearborn Street  
Harrison 2276

Dependable Radio Equipment

Established 1921

Bulletins on request.  
Everything for the amateur.  
Get our very low prices.

SAN FRANCISCO, CALIFORNIA



1452 Market Street.

"The House of a Million Radio Parts"

Hammarlund and National sets and parts.

RCA and EIMAC Tubes.

Arcturus Receiving Tubes.

Trimm Phones, all types.

Johnson Antenna Feeders, Insulators,  
Transposition Blocks.

FRESNO, CALIFORNIA

## PORTS MANUFACTURING CO.

3265 E. Belmont Ave. Radio W6AVV  
National FB7-SW3 and Parts; Hammarlund,  
Cardwell, Biley Crystals; Johnson Insulators.  
Distributors RCA-DeForest Transmitting Tubes  
Established 1914 Send for Wholesale Catalog

BUTLER, MISSOURI

## HENRY RADIO SHOP

Complete stock of RCA, Collins, Patterson, National, Hammarlund, Silver, RME9D, Super-Skyrider, Peake, Mac-Keys, Eimac, Taylor, Thordarson, Cornell-Dubiliar, Cardwell, Dwyer, Triplett, Weston, Turner, Astatic, Trimm, Johnson, Biley, and others at lowest wholesale prices. Your used apparatus accepted in trade, too. Write for any information.

Robt. Henry, W9ARA, Owner. 211-15 N. Main St.

OAKLAND, CALIFORNIA

## ELECTRIC SUPPLY CO.

12th and Fallon Sts.—"Down by the Lake"

Our New Catalog contains valuable information  
for Dealers, Servicemen and Amateurs. FREE.

Amperex Transmitting and  
Special Purpose Tubes

Raytheon 4-Pillar Tubes Factory Sealed Cartons

DISCOUNT 40% on most all lines

W6AZG  
W6DTM

Located in  
our store

W6IDB  
W6KGE

CHICAGO, ILLINOIS

## Newark Electric Company

226 W. Madison St.  
Chicago

All Kinds of Equipment for  
Service Men - Amateurs - Experimenters  
Write for free catalog

# This late Summer...

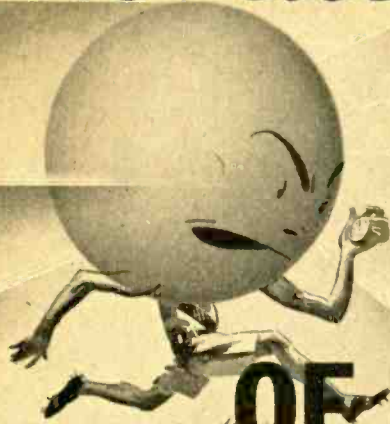

## WILL GIVE YOU EXTRA MONTHS OF PEAK BUSINESS

A late cool spring. People put off buying their electric refrigerators. But—it is followed by a late hot summer—a summer that will go far into fall. Like an explosion, so swiftly came the peak season—

so swiftly has come an unprecedented demand for Shelvador. For Crosley dealers a bumper crop of business . . . a longer harvest season, lasting far, far into the fall months.

### Thousands of women have their minds made up to buy an electric refrigerator this summer . . .



**TABLE SHELVADOR**  
2 models priced from \$79.50 to \$94.50. Semi-hermetic rotary compressor.

**SHELVADOR**  
5 models from \$99.50 to \$169.50. Sizes from 4.3 cu. ft. (net) to 7.08 cu. ft. Interior light. Flat bar shelves. Ventilated front.

**TRI-SHELVADOR**  
3 models from \$139.50 for 4.3 cu. ft. size to \$189.50 for 7.08 cu. ft. size. Same features as Shelvador, and in addition—Shelvatray, Shelvabasket, Storabin, self-closing ice-tray chamber door.

PRICES INCLUDE DELIVERY . . . INSTALLATION . . .  
ONE YEAR FREE SERVICE

Seldom, if ever, has an equal opportunity presented itself to Crosley dealers. A season that didn't grow up like Topsy; but one that came along with the impact of a freight train. One day—and it was cool, late, spring—people holding off buying their Shelvador Electric Refrigerators as they held off buying their hot-weather clothes. The next day—and a sweltering sun beat upon a people who wanted ice cubes and palm beach suits right now.

Then the surge to buy. Not just an urge—but a surge. The housewives who had been looking at and asking about Shelvador and admiring its smartness and many features, now DEMAND the Shelvador.

And the season has barely started. The calendar will say late fall while the thermometer will still say sweltering summer—and it's the thermometer, not the calendar, that puts people in the buying mood. You can't kid the thermometer.

The field is white and ready. The harvest is rich—and it's just started. Cut YOUR swath in this field. The sooner you start, the more you profit. Your Crosley distributor has the answer. It's SHELVADOR. Get in touch with him.

### THE CROSLEY RADIO CORPORATION - CINCINNATI

POWEL CROSLEY, Jr., Pres.

(Pioneer Manufacturers of Radio Receiving Sets)

Home of "the Nation's Station"—WLW—500,000 watts—

most powerful in the world—70 on your dial

# CROSLEY SHELVADOR



## Variactor Controlled Carrier Modulation

### Acclaimed the Greatest Forward Step in Radiotelephony

Phone Men who have switched over to Variactor Controlled Carrier Modulation agree it is the most economical and practical, least critical and simplest of any system of Controlled Carrier Modulation in use.

• • •

#### THE UTC SYSTEM OF VARIACTOR CONTROLLED CARRIER MODULATION:

- ★ Increases DX coverage many times over.
- ★ Allows power consumption savings of 50% or over.
- ★ Almost doubles Class C tube ratings and will double to quadruple Class B Linear Tube ratings.
- ★ Reduces interference between stations tremendously.
- ★ Increases tube life and power efficiency. Using the UTC Variactor CCM System the changeover from standard carrier to controlled carrier can be accomplished in less than an hour.

The Essential Variactor Unit Required for Controlled Carrier Modulation is now available in Six Types to take care of Transmitters from 25 to 800 Watts Output.

#### CV VARIACTORS FOR CONTROLLED CARRIER CLASS C

	List Price	Net to Hams
CV-1 25 to 50 watts maximum input controlled class C	\$ 7.50	\$ 4.50
CV-2 50 to 100 watts maximum input controlled class C	10.00	6.00
CV-3 100 to 170 watts maximum input controlled class C	15.00	9.00
CV-4 170 to 300 watts maximum input controlled class C	20.00	12.00
CV-5 300 to 500 watts maximum input controlled class C	25.00	15.00
CV-6 500 to 800 watts maximum input controlled class C	33.00	19.80

#### AV AUTOTRANSFORMERS FOR CV VARIACTORS 115/170 VOLTS AC

	List	Net
AV-1 for use with CV-1	\$ 5.00	\$ 3.00
AV-2 for use with CV-2	6.00	3.60
AV-3 for use with CV-3	7.00	4.20
AV-4 for use with CV-4	9.00	5.40
AV-5 for use with CV-5	12.00	7.20
AV-6 for use with CV-6	15.00	9.00

CV VARIACTORS are suitable for obtaining controlled carrier on any transmitter using high level plate modulation. For existing equipment the corresponding AV autotransformer must be used with the CV VARIACTOR.

## High Power Class B Audio Transformers For the New RCA 838 and EIMAC 150T Tubes

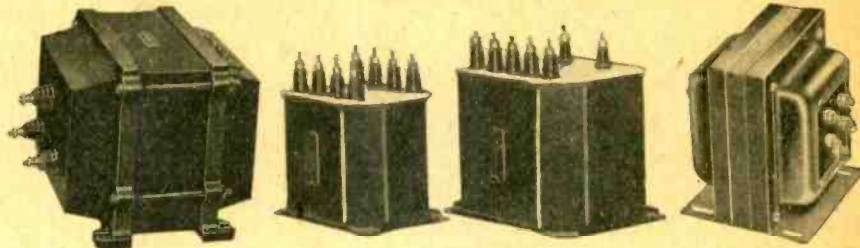

150T Output

838-203 Outputs

838-150T Filament Transformers

PA-601 Primary arranged to match 838 or 203A Class B plates to 6500, 5000 or 3500 ohm RF load	\$32.50
PA-438 Primary arranged to match push pull parallel 838 or 203A Class B plates to 6000, 4000 or 3000 ohm RF load	50.00
PA-489 Primary arranged to match 204A or 849 class B plates to 6500, 5000, or 3500 ohm RF load. Secondary will handle up to 750 watts AF	125.00
PA-150T Primary arranged for 12,500, 15,000, 18,000 ohm plate to plate loads to match 150 T's in A prime or class B at various plate voltages. Secondary arranged for 6250, 5000, and 3500 ohm RF loads. Will handle up to 750 watts AF	125.00
PA-238 Primary arranged for push pull parallel 2A3's, WE300A's, 250's to push pull parallel 838 or 203A Class B grids	12.50
PA-239 Primary arranged for push pull parallel 2A3, 300A, 250, push pull 211 or 845 plates to class B 204 or 849 grids	12.50
PA-501T Primary arranged for push pull parallel 2A3, 300A, 250, push pull 50T, 211 or 845 plates to class B 150T grids	12.50

## FILAMENT TRANSFORMERS FOR 838, 203A, 211, 845, 50T, 150T, 204A, 849, 2A3, 300A Type Tubes

CS-401 2½ V.C.T. 20 A; 5 V.C.T. 3A; 7½ V.C.T. 6½ A. 2500 V. insulation CD mtg.	\$8.50
CS-402 10 V.C.T. 6½ A; 10 V.C.T. 6½ A; 7½ V.C.T. 2½ A; 2½ V.C.T. 5 A; 2500 V. insulation. CD mtg.	11.50
CS-403 11 V.C.T. tapped at 12 and 14 volts at 10A. 5000 V. insulation. CD mtg.	8.00
CS-404 2½ V.C.T. 12 A; 5000 V. insulation; 10 V.C.T. 6½ A. CD mtg.	8.50
CS-405 5 V.C.T. 20 A; 7000 V. insulation. CD mtg.	7.50
CS-406 5 V.C.T. 20 A; 10,000 V. insulation. CD mtg.	10.00



#### THE CK-7 PREAMPLIFIER KIT

has been designed specifically for use with the new metal tubes. While the circuit is equally well suited for glass tubes, the low microphonic effects and excellent shielding of the metal tubes make them exceptionally well suited for operation at the low levels encountered in preamplifier work. A specially designed rectifier circuit and careful placement of component parts is responsible for the extremely low hum and noise level in the CK-7 preamplifier. Three identical tubes are used, one being connected up as a rectifier; so that no fear need be had regarding misplacement of tubes in the uniform 8 prong sockets. The preamplifier has a gain of 55 DB.

Overall Amplifier Dimensions—8½x7x4½.

#### Transformer Components for CK-7 Kit

	List Price
CS-5 Broadcast line or 2 button mike to single 6C5 or 6C6 grid	\$2.50
CS-1 Single 6C5 or 6C6 plate to single 6C5 or 6C6 grid	2.35
CS-26 Single 6C5 or 6C6 (triode) plate to 500 or 200 ohm line	3.00
CS-46 Filament and voltage supply unit for CK-7 kit	2.25
CS-37 2 Filter chokes for CK-7 kit each \$2.00	4.00
Chassis for CK-7 kit	1.90
CK-7 Transformer kit including chassis	16.00
CK-7 Accessory kit—includes all necessary resistors, condensers, sockets, AC. cord and plug, hardware—ready to wire	6.00

UTC products may be purchased from authorized distributors at 40% discounts from list prices shown.

# UNITED TRANSFORMER CORP.

72-78 SPRING STREET

Export Division, 15 Laight St., New York, N. Y.

NEW YORK, N. Y.

Exclusive UTC distributors carrying a complete stock of UTC products.	
Goldhamer's, Inc.	610 Huron Road, Cleveland, Ohio
Wholesale Radio Service Co., Inc.	100 Sixth Ave., New York, N. Y.
Wholesale Radio Service Co., Inc.	219 Central Ave., Newark, N. J.
Wholesale Radio Service, Inc.	430 W. Peachtree St. N. W., Atlanta, Ga.
Sun Radio	327 Fulton Street, New York, N. Y.
Gross Radio, Inc.	51 Vesey Street, New York City
Leeds	45 Vesey Street, New York City
William Gram	1444 Sheridan St., Lansing, Mich.
Mohawk Electric Co.	1335 State St., Schenectady, N. Y.
Walter Ashe	1100 Pine St., St. Louis, Mo.
Radio Shack	46 Brattle St., Boston, Mass.
Harvey's Radio	105 W. 43rd St., New York, N. Y.
United Radio Service	616 Main St., New Britain, Conn.
Nutter & Cross	900 Milk St., Boston, Mass.
Haty & Young	203 Ann St., Hartford, Conn.
Marine Radio Co.	124-13 101st Avenue, Richmond Hill, N. Y.
Hall's	35 So. Cameron, Harrisburgh, Penna.
Herbach & Rademan	438 Market St., Philadelphia, Penna.
Cameradio Company	603 Grant Street, Pittsburgh, Pa.
W. H. Edwards & Co.	32 Bway, Providence, R. I.
Seattle Radio Supply, Inc.	2319 Second Ave., Seattle, Wash.
Portland Radio Supply Co.	1300 W. Burnside, Portland, Ore.
Spokane Radio Co., Inc.	611 First Ave., Spokane, Wash.
San Francisco Radio Exchange	1284 Market St., San Francisco, Calif.
SOUTHERN CALIFORNIA	
Pacific Radio Exchange Inc.	729 S. Main St., Los Angeles
Radio Supply Co.	912-14 S. Broadway, Los Angeles
Coast Electric Co.	744 G. St., San Diego
Prest & Dean Radio Co.	400 American Avenue, Long Beach
Radio Television Supply Co.	1701 S. Grand Ave., Los Angeles, Calif.
Radio Specialties Co.	1516 West 8th St., Los Angeles, Calif.