

OCTOBER, 1929

RADIO

REG. U.S. PAT. OFF.

25 CENTS



THE JENSEN IMPERIAL

... a
*magnificent
reproducer
with the*

ELECTRO-DYNAMIC
AUDITORIUM

or

CONCERT
UNIT

Perfected by
PETER L. JENSEN



Prices, with Auditorium AC Unit, \$100.00
(less tube); with DC Unit, \$90.00; with
Concert AC Unit, \$80.00; DC Unit, \$72.50.



MUSIC and radio lov-
ing America will demand
this perfected repro-
ducer capable of concert
hall volume from push-
pull amplifiers of the
250 type, but retaining
full brilliance at softest
living room volume . . .
Used with any type of
receiver the superiority
is the same. Models are
available for either
110-volt A. C. or D. C.



JENSEN RADIO MFG. CO.
6601 S. Laramie Ave. 212 Ninth Street
Chicago, Ill. Oakland, Calif.
Licensed Under Lektophone Patents

A NEW SCREEN GRID RECEIVER

Engineered to a new
Height of Perfection

Here is a new receiver featuring a Screen Grid circuit—
245 push-pull power audio
—power detector—8 tubes
—with A-C. All electric
humless operation. A
tuned detector stage
imparts unusual power to
the receiver. Ultra selective—sturdy construction
—R C A licensed.



FREE RADIO CATALOG

Send for this new, big catalog—196 pages full of the very latest in radio, such as this new Screen Grid Chassis, as well as many other special features. All priced to you at wholesale—offering remarkable values on everything in radio.

Our recent purchases totaling over one million (\$1,000,000) dollars in standard radio receiving sets coupled with our tremendous stock of standard accessories, parts and kits has enabled us to make startling price reductions. Write today for the complete story as given in this large 196-page catalog of radio bargains.

EVERYTHING IN RADIO AT UNHEARD OF PRICES

New Screen Grid A. C. Humless All-Electric sets—standard A-C sets as well as battery operated receivers in an attractive array of consoles ranging from small table model types to gorgeous pieces of radio furniture. They represent the finest offerings of the season. The price range is especially attractive presenting unusual values as low as \$15.95.

Get this Allied catalog. Buy low so you can make more profit. Deal with an organization of experts who are trained to render real service in radio.



\$**15.95**

A
Reliable,
High-grade
Radio House

ALLIED RADIO CORPORATION

711 W. Lake Street Dept. E-1 Chicago

Backed by
Resources
totaling over
\$3,000,000

UNIFORMITY

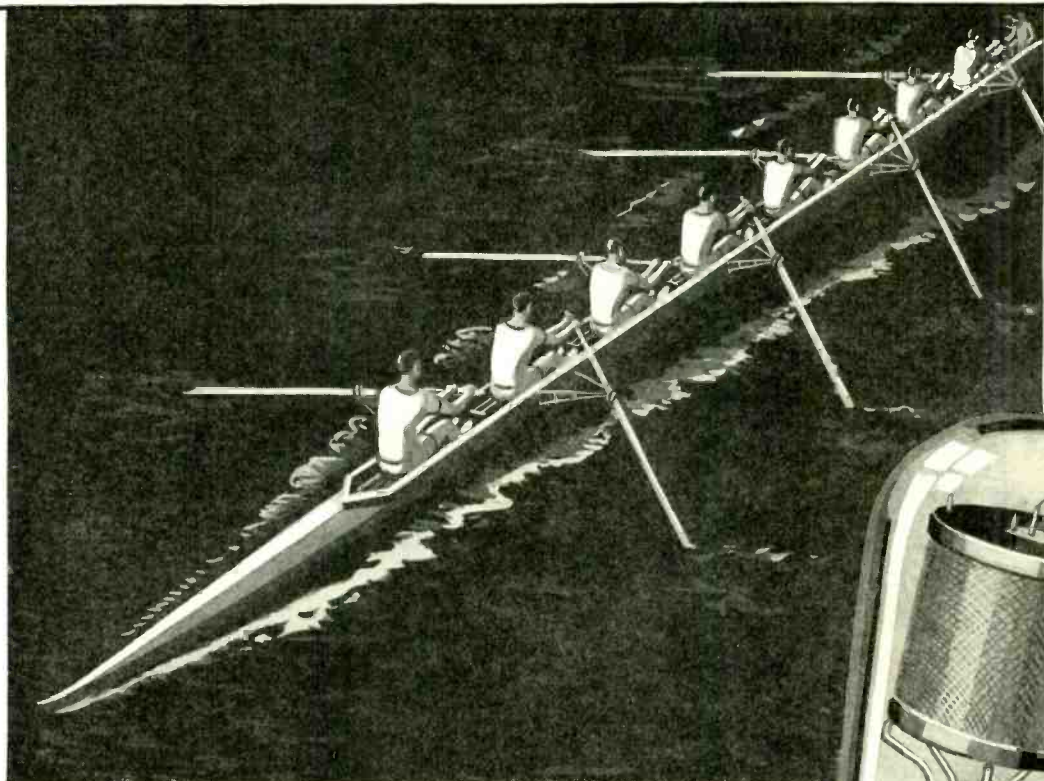

WHETHER in cartons or carloads, you will find TRIAD quality absolutely uniform! UNIFORM because the complete materials for TRIAD Tubes (except glass and base) are made right in the TRIAD plant; UNIFORM because the manufacturing process, from first to last, is personally supervised by world-famous radio engineers; UNIFORM because TRIAD Tubes are subjected to nine exhaustive tests for vital characteristics before ever reaching the packing department—and even there they are sorted for uniformity and *again* inspected before shipment! Even the testing machines themselves are made by the TRIAD Company, and are built to the U. S. Bureau of Standard Specifications. TRIAD Tubes are “honor-built” — throughout! That is why TRIAD *alone* can *insure* every tube for six months’ perfect service—and it is exactly the reason why *you* can win (as thousands of other dealers are now doing) far greater tube sales and profits with TRIAD than you have ever enjoyed before!

Call your jobber or write us direct for complete TRIAD dealer information.

TRIAD MFG. CO., Inc., PAWTUCKET, R. I.

West Coast Factory Representatives

W. J. NOEL
508 Eddy Street
SAN FRANCISCO, CALIF.

R. C. JAMES
Pioneer Building
SEATTLE, WASH.

TRIAD
INSURED
RADIO TUBES

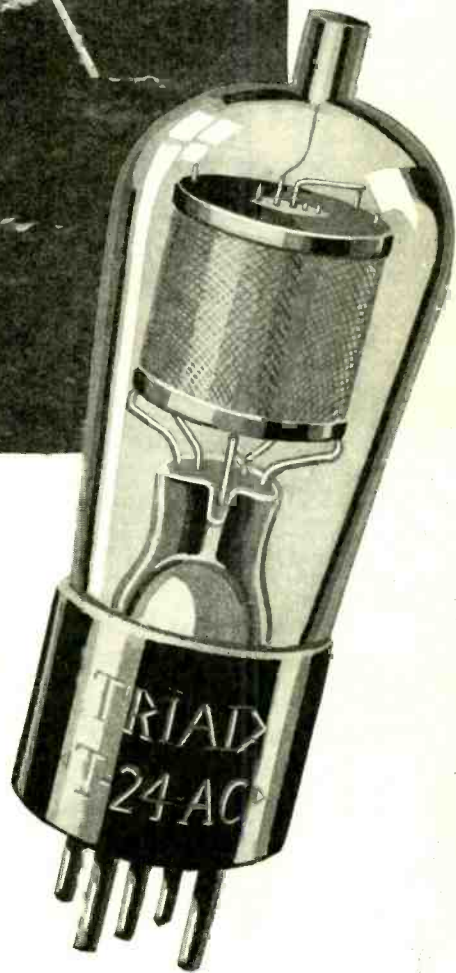

Above is shown TRIAD
T-24—Screen Grid Tube
for A-C use

▼
Tune in on the “Triadors”—every Friday evening 8 to 8:30 Eastern Daylight Time—on WJZ and associated NBC Stations.

SHORTWAVES

The World at Your Fingertips With a **Baird** Shortwave Converter

This converter, together with all other apparatus shown on this page, is the development of years of intensive experimental work by our chief engineer, Hollis Semple Baird, R.Sc., Fellow of the Television Society of Great Britain, Member of the Television Society of America and Associate Member of the I. R. E. In offering our new models and additions to the public we honestly believe that we have done everything humanly possible to build the finest and most efficient apparatus ever offered. Get the thrill of tuning in foreign stations in the daytime. We have authentic and verified reports of customers who tune in G5SW, Chelmsford, England, PCJ, Holland, etc., with consistent loud speaker volume. (These letters are on file for public inspection at any time.) To operate simply remove the detector tube from your receiver, plug the converter in its place, put a detector tube in the converter, connect your aerial to the converter and you are ready to tune in by simply operating the dial on the receiver and **Baird** not tuning your receiver at all. The **Baird** shortwave converter is an improvement in many ways over any other converter which has so far been offered to the public. Some **Baird** of its advantages are: .00015 SLP special variable tuning condenser, which spreads your signals over the whole dial range. **Baird** special antenna tuning condenser allows for efficient use with any type of aerial. Special volume control to prevent the usual awful squealings when tuning in a station. Cushion socket to eliminate microphone troubles. A four-foot flexible lead for the plug in allowing ample working space. By special patent applied for method A. C. hum is entirely eliminated from A. C. models. Compact size being only 9 1/2" x 5 1/2" x 4". 100 to 1 ratio vernier dial. Equipped with complete set of 4 OCTOCOILS, the finest and most efficient coils on the market, with a wavelength range of 16 to 225 meters.



Judge Fabyan of Brighton, Mass., logs G5SW and KGO practically every night. John Tee of Denver listens to Europe and South America. Ronald W. Brown of Stoneham, Mass., gets Australia occasionally. We do not guarantee that you will get consistent reception over five or ten thousand miles, but we do claim that with patience and careful tuning greater **Baird** distances can be obtained with the shortwave converter than ever can be had with the ordinary broadcast receiver. If you have not the patience to tune carefully, systematically and patiently, do not buy this converter, as you will be disappointed. An 8-page instruction booklet, together with the latest revised list of shortwave stations all over the world, furnished with each converter.



The No. 1-T Kit is a complete assembly of parts for the construction of a one-tube shortwave receiver. Can be assembled in 30 minutes. The chassis is all aluminum and the finest parts obtainable are included in this assembly. One complete set of 4 OCTOCOILS furnished with each kit.

Baird
Shortwave Converter
Complete with Four OCTOCOILS \$25.
Wavelength Range 16 to 225 Meters

OCTOCOILS



16 to 30 Meters
29 to 58 Meters
54 to 110 Meters
103 to 225 Meters

gladly refund your money. Packed in individual boxes of the same color as the OCTOCOILS with wavelengths printed on each box. The entire set is in a special attractive container. Broadcast coil also furnished, list price \$1.25 each. These coils will also cover the 10 to 80-meter amateur bands if used with our special No. 5 condenser, list price \$1.25.

Set of Four OCTOCOILS Wavelength Range 16 to 225 Meters \$5 Per Set of Four

For those who desire the ultimate in a shortwave receiver we offer our No. 20 Super, which is composed of one stage of screen grid tuned radio frequency with power amplification for either battery or A. C. operation. This is a complete unit in itself, is built into a beautiful metal cabinet finished in green and gold and is equipped with National illuminated vernier drum dial. Not only will this receiver work on the aerial which you now are using for your broadcast set, but it will work at the same time on the same aerial without any interference. This is a single-dial control receiver and uses the screen grid tuned antenna circuit, which is accepted by leading engineers as the method of giving the greatest possible amplification of a signal. For those who want loud speaker reception on shortwave signals with wonderful quality and simple tuning, we sincerely recommend the **Baird** No. 20 Super Shortwave Receiver.

Baird Super Shortwave Receiver Battery Model, Less Equipment \$88.
Baird Super Shortwave Receiver A. C. Model, Less Tubes \$135.

TELEVISION Wavelength Range 16 to 550 Meters
WATCH FOR OUR ANNOUNCEMENT IN A FORTHCOMING ISSUE OF OUR NEW TELEVISION RECEIVER—THE ONLY COMMERCIAL PRACTICAL UNIVERSAL TELEVISION RECEIVER EVER OFFERED THE PUBLIC. For further information, write.

Mfd. by **SHORTWAVE & TELEVISION LAB., Inc.**
18,000 Sq. Feet Devoted to the Manufacture of Shortwave and Television Apparatus
70 Brookline Avenue, Dept. 11
Boston, Massachusetts

OCTOCOILS are unquestionably the finest, most rugged and most efficient shortwave coils ever designed and have been built to a standard of efficiency and appearance seldom if ever attained in commercial production. The actual size of these coils is 3 3/8" high and 1 1/2" in diameter. With OCTOCOILS and the proper receiver or converter, distance means nothing in tuning your stations. Everything worth while has been logged, even **Bird** in the Antarctic (from Schenectady, New York). We furnish diagrams gratis for one-tube shortwave receiver and converter and two-tube shortwave receiver and converter with screen grid radio frequency, simply for the asking. The circuit is ideally simple for the fan who wishes to build his own shortwave receiver or converter. Within an hour he can be ready to tune in anything anywhere. OCTOCOILS are made in four distinctive colors, green, brown, blue and red, on genuine bakelite moulded forms and wound with Nos. 12, 14, 16 and 25 enameled wire. Will plug into the ordinary tube socket and has a rugged rim to grasp coils so that they will not break. If you are not satisfied with their appearance and performance, we will refund your money.



The No. 2-T Kit is a tuned antenna circuit, making it extremely desirable and simple to operate, it being only single-dial control. Will tune unbelievable distances and pull in stations one can never hope to get with the regular broadcast receiver. Remember that the stations you can get actually give you the same quality and type of entertainment as you can get on the long waves, with the difference that you might be listening to England or Holland or even further. This kit is composed of an all-metal chassis and panel and all the component parts are of the highest quality and fully guaranteed against defects. Simple to construct and can be built in one hour. Two complete sets of ten OCTOCOILS furnished with each kit.

Baird Shortwave Kit No. 2-T. Complete with 10 Coils, 3950 16 to 550 Meters.....

Baird International Shortwave Kit No. 4-T



The BT-15 SLP Tuning Condenser is the bath-tub type, rigidly built and especially adapted and constructed for shortwave work.

BT-15—.00015 SLP Variable Tuning Condenser.. 275

The **Baird** International No. 4-T Kit is composed of a detector, one stage of tuned screen grid radio frequency and two stages of audio amplification, using either 112 or 171 in the last stage. Will operate satisfactorily with loud speaker volume on practically any signal that can be pulled in. Get the thrill of hearing the chimes of Big Ben in your home every evening. All necessary parts for complete construction are included in this kit. Can be built in less than two hours. This kit is of all-metal construction. Two complete sets of ten OCTOCOILS furnished with each kit.

Baird International Shortwave Kit No. 4-T. Complete with 10 OCTOCOILS, 16 to 5950 550 Meters.....

Shortwave & Television Laboratory, Inc.
70 Brookline Ave., Dept. R-11, Boston, Mass.

Please send me

for which I enclose \$.....

as 25% deposit or \$..... which is in full payment for merchandise selected.

Name.....

St. & No..... City..... State.....

TELEVISION

Tell them you saw it in RADIO

Why the New Browning-Drake Is a Good "Buy" for You

HERE is a set which enables you to offer your customers considerably more "radio" than they can buy at anywhere near the price—a set which provides a degree of selectivity, distance-getting and tone-quality unsurpassed by receivers costing fifty per cent more.

In addition, Browning-Drake cabinets are so attractive in design and so well built and finished that they will instantly appeal to your feminine trade—our small cabinet models (56 and 66) particularly will find enthusiastic acceptance.

Browning-Drake construction, backed by a reputation for quality second to none, assures you of freedom from excessive servicing which eats into profits.

Eight models, table and console, heater and screen-grid types.

Send for information and territories still open

BROWNING-DRAKE CORP.
224 Calvary Street Waltham, Mass.
Builders of quality radio for five years

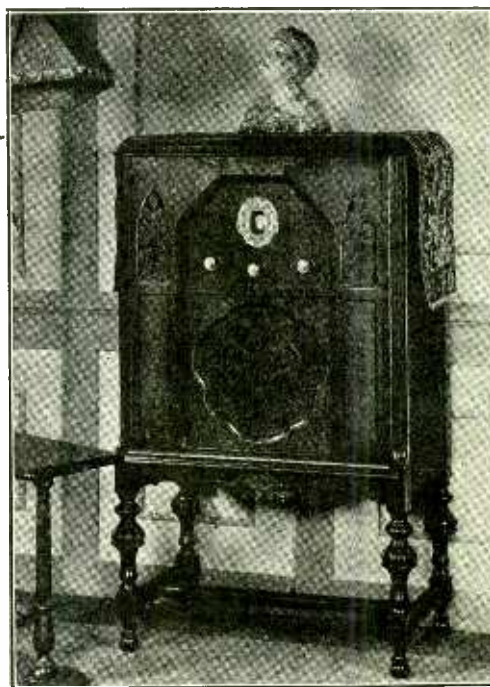

Model 56—(Screen-Grid) Small Console — (38x26x14), less tubes.....\$154.50
Model 66—(Heater type), Small Console — (38x26x14) less tubes.....\$149.50
Same prices East and West of Rockies

Model 53
Table Model, Screen-Grid Type, list, less tubes\$102.50

Model 63
Table Model, Heater Type, list, less tubes \$98.00

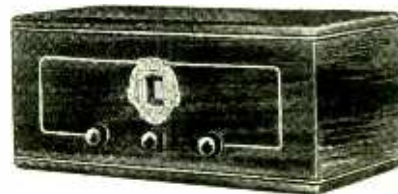

Prices slightly higher West of Rockies

1. Semi-automatic tuning, both kilocycles and call letters on dial.
2. Five tuned circuits—nine tubes.
3. Tuned antenna.
4. Push-pull audio (245 power tubes).
5. Power detection (plate rectification) optional.
6. Hum eliminator.
7. Band-pass filter effect (10) KC selectivity.
8. Mershon trouble-proof condenser.
9. Voltage regulation adjustment.
10. Power unit integral part of chassis.
11. Large size dynamic speaker.
12. Phonograph, short-wave and television connections.
13. Selected walnut and American gum wood cabinet.
14. Hand-ruhhed satin Duco finish.

Browning-Drake

RADIO

Nearly 1,500,000 People Are Using Browning-Drake Sets

Tell them you saw it in RADIO

Additional Profits

Have every set sent out on demonstration functioning at maximum efficiency.

Keep all sets sold in continuous efficient operation at negligible cost.

Know that the tubes you sell or install are right by testing them under actual operating conditions. Defective tubes cause a large percentage of radio troubles.

Make real profits in servicing by saving time and increasing efficiency.

Eliminate expensive and annoying returns to distributor or factory by making all adjustments or repairs in the owner's home accurately and quickly.

Build "good will" thru the enthusiastic satisfaction

of your patrons—an ever growing asset to your business.

All of this can be accomplished *only* by the use of the SUPREME DIAGNOMETER—the *only* service instrument that insures *thorough, scientific service work*.

If you don't buy a SUPREME you pay for it anyway many times over in wasted time and inefficiency. If you buy a SUPREME you pay for it but once and it becomes a permanent asset for your business, earning dividends daily in actual cash and customer good will.

Don't deprive yourself of these additional profits by delay.

The Only Complete Portable Radio Testing Laboratory

Thorough and Complete, yet surprisingly simple. The SUPREME RADIO MANUAL gives full instruction and much valuable radio information.

No other radio testing device can anywhere near approach the range, completeness and flexibility of the SUPREME DIAGNOMETER. A test will show you. Send for ours which is confidently called "A Test that Challenges Attention." Some of the outstanding features of the SUPREME are:

All tubes tested under actual operating conditions. Provides the only tube test of dependable value.

Screen grid socket analysis without oscillation.

750 Volt 4 scale A.C. and D.C. meters, 3 scale milliammeter.

Self-contained power plant.

Modulated radiator for testing, synchronizing, neutralizing.

External connections to all apparatus.

Tests both plates '80 type rectifiers.

All continuity tests without batteries.

Universal analyzer plugs.

Handy carrying case providing compartments and space for all tools and spare tubes.



"Set Testers" prove only 29% to 40% efficient in comparison with the SUPREME DIAGNOMETER

Supreme Service League

To Radio Owners: Look for this emblem in your radio shop, on the lapel button or card of your service man. It is your guarantee of dependable radio service. Cash in on the prestige the SUPREME SERVICE LEAGUE is building.

Order NOW

Present production permits immediate deliveries but the momentum of sales is such that buyers are cautioned to place their orders now.

Reservations will be made against all orders placed for future delivery on specified dates. Make use of this plan to avoid disappointments.



*(Most good distributors carry the SUPREME DIAGNOMETER in stock. *yours cannot supply you, send order direct on form to the right.)*

SUPREME

Radio Diagnometer

Makes every ^{conceivable} test on any Radio Set-

---and a request for complete specifications will reveal numerous other superiorities.

Supreme Instruments Corp.
341 Supreme Bldg.
Greenwood, Miss.

Please ship SUPREME DIAGNOMETER Model 400-B on basis checked below.

- Net cash \$139.50.
 Time payment plan—\$33.50 cash and 8 monthly payments of \$15.00 each.

All prices are F.O.B. Greenwood, Miss. No dealer's discount.

Date shipment desired.

Signed.

Firm Name.

.....

Street Address.

.....

City.

State.

Please give three or more bank or trade references and names of distributors from whom most purchases are made.

TRIPLE SCREEN-GRID

AMRAD



The ARIA

What tremendous value is represented in this leading model of the Amrad Bel Canto Series!

Within the exquisitely beautiful, tastefully proportioned console cabinet, richly veneered in butt walnut and African walnut, is the Amrad standard Screen-Grid Chassis, using eight tubes, including THREE Screen-Grid tubes and two 245 tubes in push-pull.

The interior panel is handsomely designed in Gothic inspiration—with illuminated dial calibrated in both meters and kilocycles. Has phonograph pickup attachment, built-in antenna, Mershon condenser and full nine-inch electric power speaker mounted on a baffle board.

Price at \$198
(Less Tubes)

Prices slightly higher West of the Rockies

A HAIR-RAISING FIVE HUNDRED PER CENT increase in business in 1929 over 1928 makes us stop to think — and check up.

Why is Amrad selling FIVE TIMES as many sets in 1929 as in the preceding year? It isn't enough just to say the retail dealers are moving the goods. We know that. But WHY? Possibly the answer lies in the critical analysis of all radio lines in comparison to Amrad which shows that the Amrad triple screen-grid chassis is unexcelled in sensitivity, selectivity or ease of operation; that Amrad has a chassis of extremely heavy, foolproof construction; that reports of trouble of any kind are practically non-existent; that Amrad cabinets constitute indisputably the finest furniture in the industry—and that due to a magnificent audio system, the world's best electric power speakers, and special adjustments, Amrad has the finest tone in radio!

The Amrad franchise is valuable—let us send you the name of your nearest Amrad distributor—he can prove it.

THE AMRAD CORPORATION
Medford Hillside, Mass.

J. E. HAHN
President

POWEL CROSLY, JR.
Chairman of the Board

The **FINEST TONE** in RADIO..



Tell them you saw it in RADIO

indisputable

EVIDENCE

THE demand for radio receivers equipped with Jensen Electro-Dynamic Speakers confirms the judgment of America's leading set manufacturers who early in 1929 proved to their satisfaction the superiority of the new Jensen Concert Speaker. These manufacturers' sets are known today as the industry's "best sellers". This new Jensen Concert Speaker with ten inch cone and many other exclusive features has been specifically designed to meet the individual requirements of these manufacturers who know the value of offering to their trade the finest possible tone quality. Each of them found this new reproducer to interpret into sound more faithfully and brilliantly the energy delivered by their receiver. ¶ Jensen Electro-Dynamic Speakers are offered in three models, with eight, ten and twelve inch cones, each size available for operation with either 110 volt AC or 110 or 220 volt DC current. Jensen Concert and Auditorium models are also available in the Imperial Cabinet, America's finest and most beautiful reproducer. Radio dealers are finding a ready market and attractive profits with Jensen Dynamic Speakers either sold separately or installed in radio furniture.

*Licensed under
Lektophone
Patents*



Jensen
ELECTRO-DYNAMIC SPEAKERS

JENSEN RADIO MANUFACTURING COMPANY
6601 South Laramie Avenue, Chicago, Illinois
212 Ninth Street, Oakland, California



NEW
EVEREADY
RAYTHEON
4-PILLAR
TUBES



Trade-marks

This marvelous and exclusive improvement in radio tubes means a new standard of tube performance.



PUT a new Eveready Raytheon Tube in each socket of your own receiver . . . and note the tremendous improvement in reception. These fine tubes come to you, and go to the receivers of your customers, in the same perfect condition as when they leave our laboratory test room.

To see the reason, examine an Eveready Raytheon Tube. See the solid, four-cornered glass stem at the base of the elements. Note the four rigid pillars which pass through the stem and support the elements. Observe how this 4-Pillar construction is further anchored at the top by a stiff mica plate.

Now you can understand what makes Eveready Raytheon Tubes so much stronger . . . why the super-precision with which they are built cannot be changed or destroyed by the jolts and jars of shipment and handling which every tube receives. The elements in an Eveready Raytheon are accurately spaced when the tube is made, to assure maximum performance. These tubes always reach you with their elements undistorted . . . ready to give laboratory reception.

With no other tube can you have all the advantages of Eveready Raytheon's patented 4-Pillar construction. People everywhere, using these tubes in their own receivers, report increased distance, greater power and better tone. In addition, the A.C. heater tubes are quick acting.

NATIONAL CARBON COMPANY, INC.

General Offices: New York, N. Y.

Branches: Chicago Kansas City
New York San Francisco

Unit of Union Carbide  and Carbon Corporation

LEUTZ

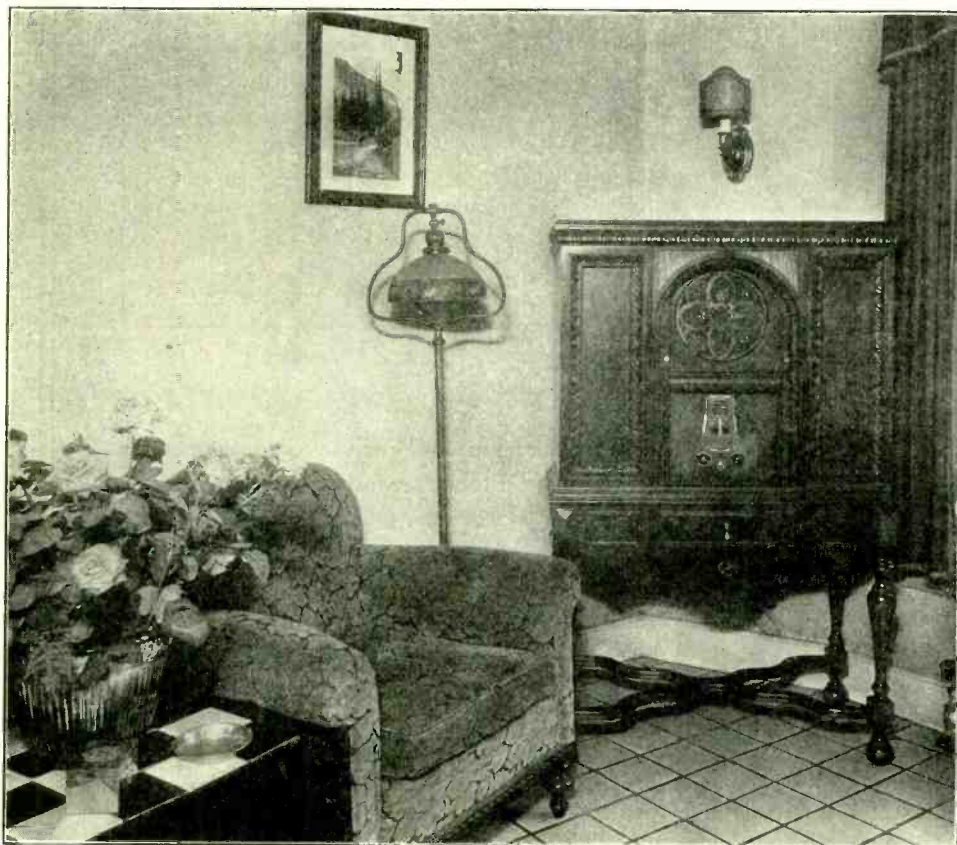

Above: Leutz "Seven Seas" Radio Phonograph Combination

Write, Wire or Cable Today

C. R. LEUTZ, Inc.

ALTOONA, PA., U. S. A.

Cables Experinfo, Altoona, Pa.

WEST COAST
B. J. HOWDERSHELL
Detwiler Building
412 West Sixth St.
LOS ANGELES, CALIF.

NEW YORK
Suite 628
112 West 42nd St.
NEW YORK CITY

FRANCE
BALDWIN M. BALDWIN
1 Boulevard Haussmann
PARIS, FRANCE
Cables Experinfo Paris



Close-up of Phonograph

Three Screen-
Grid Tubes
12-in. Dynamic
Speaker
Electric
Phonograph
Adjustable
Selectivity
Push-Pull 2-250
Tubes
Single (Split)
Dial
Panel Illumination
Unit Construction
**All
LEUTZ
QUALITY**

SEVEN SEAS

Tell them you saw it in RADIO

THE WARE ELECTRIC COMBINES

THE SELLING POINTS

· · · OF MANY

FINE SETS · · ·



MANY radios base their claims upon one or two special advertised features. Not so with the WARE. This set has *all* the good features of modern radio! Screen-grid and power output tubes. Dynamic speaker. One-dial control. Great selectivity. Super-sensitivity. And Vreeland Band Selector Tuning, used only in the WARE . . . the tuning unit that brings in *all* the sound frequencies broadcast.

The WARE Electric is a great radio . . . a tribute to the genius of Paul Ware. Truthfully it can be said, "This set sells . . . and stays sold." Such a set merits your careful consideration. Ware Manufacturing Corporation, 480 Lexington Avenue, New York, N. Y.

By PAUL WARE: With Vreeland Band Selector Tuning, Screen-Grid and 245 Output Tubes, Built-in Dynamic Speaker, Custom Cabinets if desired.

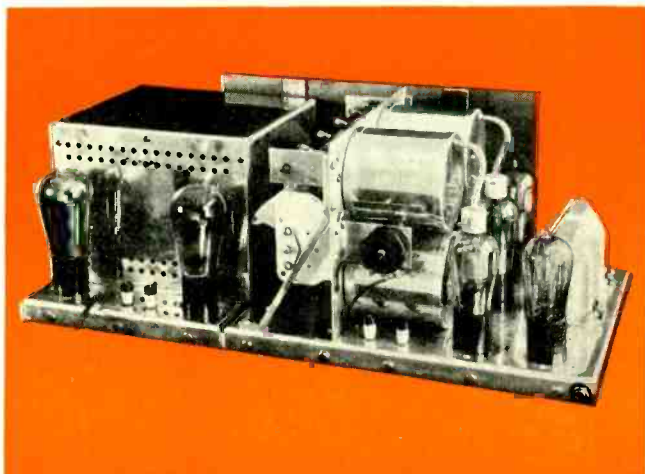

WARE
Electric
RADIO

Tell them you saw it in RADIO

COMMAND

the ENTIRE WORLD
with Pilot's Double Duty
SUPER-WASP



CUSTOM SET-BUILDER'S PRICE

A combination short wave and broadcast receiver covering all wave lengths from 14 to 500 meters. Price of kit includes two sets of five interchangeable plug-in coils, full-sized blueprint, and complete assembly data.

\$29⁵⁰

Slightly higher west of the Rockies

Why miss half the joy of radio? The Pilot Double-Duty Super-Wasp, designed by Robert S. Kruse internationally famous short-wave authority, will give you radio's greatest thrill for a few dollars and a single evening's "work" with screwdriver and pliers. Uses only four tubes—including the super-sensitive screen grid! Enthusiastic radio fans report nightly reception of Chelmsford, (England), PCJ Eindhoven (Holland), Costa Rica, Central and South America, Canada, Cuba, South Africa and Australia! Exceptional results because exceptionally engineered, and priced right because produced in the world's largest radio parts plant! Hear the Super-Wasp at any authorized Pilot Agency.

PILOT Now Makes RADIO TUBES!

Pilotron tubes "Built for Professionals" are especially designed and constructed for the professional radio engineer, custom set-builder and amateur—an audience which is super critical—and has a right to be! Moreover Pilotron tubes are available many months before you can obtain them from the usual sources. This gives custom set-builders an opportunity to use new tubes long before they are available in manufactured receivers. You would think that because of this, Pilot tubes would cost more—but they don't! Pilot's self-contained manufacturing provides definitely superior tubes at the usual prices! Stocked by all Pilot authorized agencies.



BUILT for PROFESSIONALS

TRADE MARK



REGISTERED

DEALER'S OPPORTUNITY! The Pilot policy of encouraging individual experimentation and custom set-building is the greatest single factor in stabilizing and maintaining the parts and kit business. Technically qualified and financially responsible dealers are invited to write for details of our agency plan.

HOW TO KEEP STEP WITH NEW DEVELOPMENTS. Send 50c for four quarterly issues "Radio Design" and membership in the Radio International Guild, a world-wide organization of radio engineers, experimenters, and custom set-builders. Radio Design, Dept. Z, 103 Broadway, Brooklyn, N. Y.

PILOT RADIO & TUBE CORP.
WORLD'S LARGEST RADIO PARTS PLANT
323 BERRY STREET
BROOKLYN NEW YORK
U. S. A.

LEVI F. WARREN JUNIOR HIGH SCHOOL, WEST NEWTON, MASS., PAM EQUIPPED

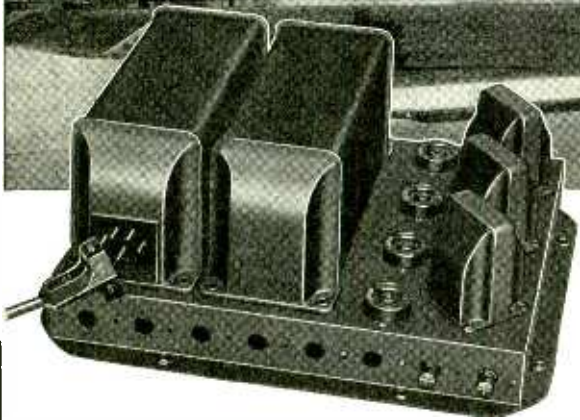

PAM 16

PAM

the new educator

WALTER DAMROSCH and other famous educators are instructing thousands of children in our schools through radio and PAM installations.

The voice of the educators or music received by radio or from phonograph record is amplified by PAMS for loudspeakers in classrooms and assembly halls.

The PAM equipment installed for educational purposes is admirably suited to

furnish music for class parties or other school social functions.

Many fine installations, such as that at the Levi F. Warren Junior High School, West Newton, Massachusetts, shown above, can be sold by wide awake radio dealers.

A new 16-page bulletin giving mechanical and electrical characteristics, representative installations and many new PAM amplifiers will be sent upon receipt of 10 cents in stamps to cover postage. When writing ask for bulletin No. R12.

Samson Electric Co.

MEMBER
RMA

Manufacturers Since 1882

PACIFIC COAST OFFICES:

Main Office:
Canton, Mass.

Factories: Canton and
Watertown, Mass.

327 Tilden Sales Bldg.
SAN FRANCISCO, CALIF.

324 North San Pedro Street
LOS ANGELES, CALIF.

2607-11 Second Avenue
SEATTLE, WASH.

637 East Broadway
PORTLAND, ORE.

Tell them you saw it in RADIO

THE IMPERIAL ENSEMBLE

A NEW SCREEN-GRID RECEIVER ..

COMBINING ALL THE 1930

ENGINEERING FEATURES

SOMETHING unique for the radio dealer. Something that will sell on sight—on a single demonstration—because it combines beauty with EVERY new engineering feature for 1930. Here is a receiver with four screen-grid tubes in the R-F component; two tubes in parallel in the first audio stage; two '45 tubes in push-pull in the second audio stage; ten tubes in all, including voltage regular tube and rectifier. Built into the beautiful Jensen Imperial Console cabinet with Jensen Concert Speaker.



REAR VIEW

Showing how the screen-grid component and the amplifier are built into the Jensen Imperial Console.

THE AMPLIFIER

With two heater tubes in parallel in the first audio stage the amplifier will not overload from the tremendous output of the

screen-grid power detector. The push-pull '45 second stage gives TONE QUALITY far in advance of any other type of amplifier.

THE SCREEN-GRID COMPONENT

Illuminated single dial control R-F component with individual stage shielding using bandpass selector, five gang tuning con-

denser, insuring the maximum in selectivity without impairment of tone quality.

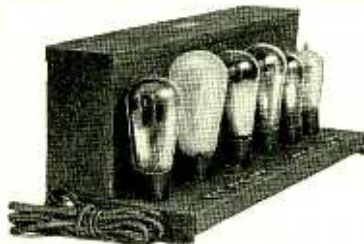

DELIVERIES
NOW BEING
MADE. NO
DELAYS.

Prompt Mail
Order Service

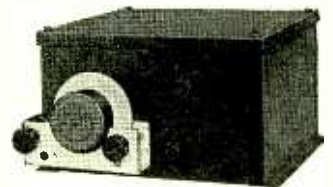

LIST PRICE \$160.00 LESS TUBES

DEALERS: WRITE AT ONCE FOR COMPLETE PAMPHLETS AND INFORMATION

THE ENTIRE SET—

1. Jensen Imperial Console Cabinet with Jensen Concert electro-dynamic speaker.
2. Remler Screen-Grid Radio Frequency Component.
3. Remler Audio Amplifier and A-C Power Supply.



PACIFIC RADIO SALES CO.

Webster Block Building

357 12th Street

Oakland, Calif.

The Coupon Brings the Whole Story . . .

PACIFIC RADIO SALES CO., R10
Webster Block Building,
357 12th Street,
Oakland, Calif.

Send me your complete pamphlets describing the IMPERIAL ENSEMBLE.

Name

Street and No.

City and State

THE OLDEST TUBE MANUFACTURER IN NEW ENGLAND



HYTRON
TUBES!

THE Hytron Tube Corporation of Salem, Mass., is the oldest manufacturer of radio tubes in New England. The prestige of Hytron's years of experience, plus unexcelled manufacturing and technical resources, is the best possible assurance to the purchaser that every Hytron Tube will fully equal his expectations for the purpose for which it was designed.

The Hytron Line gives the trade the utmost possibilities for profit. It comprises a tube for every purpose; guaranteed quality unsurpassed; the stability of an old established Company; attractive prices; big profit margin.

DISTRIBUTORS: Write for discounts and other information. Valuable territory still open. Hytron production assures a complete supply for your requirements.

*A Quality Hytron
for Every Radio
User*

HYTRON X-201-A
Detector Amplifier

HYTRON V-199
Detector Amplifier

HYTRON X-199
Detector Amplifier

HYTRON X-200-A
Detector

HYTRON X-120
Power Amplifier

HYTRON X-112-A
Power Amplifier

HYTRON X-171-A
Power Amplifier

HYTRON X-210
*Power Amplifier
Oscillator*

HYTRON Y-224
*Screen-Grid Radio
Frequency Amplifier*

HYTRON X-245
Power Amplifier

HYTRON X-250
Power Amplifier

HYTRON X-226
Amplifier

HYTRON X-227
Detector Amplifier

HYTRON X-280
Full-Wave Rectifier

HYTRON X-281
Half-Wave Rectifier

HYTRON  CORP.

KEELER, WHITE CO., Los Angeles—San Francisco—Seattle
SALEM, MASSACHUSETTS

Dealers *Listen!*

THE SET YOUR CUSTOMER WANTS - THE SET THAT MEANS QUICK SALES

Tom Thumb

SCREEN GRID PORTABLE RADIO

Speaks in the tone
of PROFITS



It Will Pay
You to
SEND
for
Dealer's
Proposition
Now!
Wire or Write

PROFITS because it's beautiful, light, shock-proof; unique among portables, and SCREEN-GRID. PROFITS because it's TRULY PORTABLE.

Dependability plus low price—that is why this FOUR-TUBE PORTABLE SET, requiring neither aerial nor ground, is winning dealers from coast to coast.

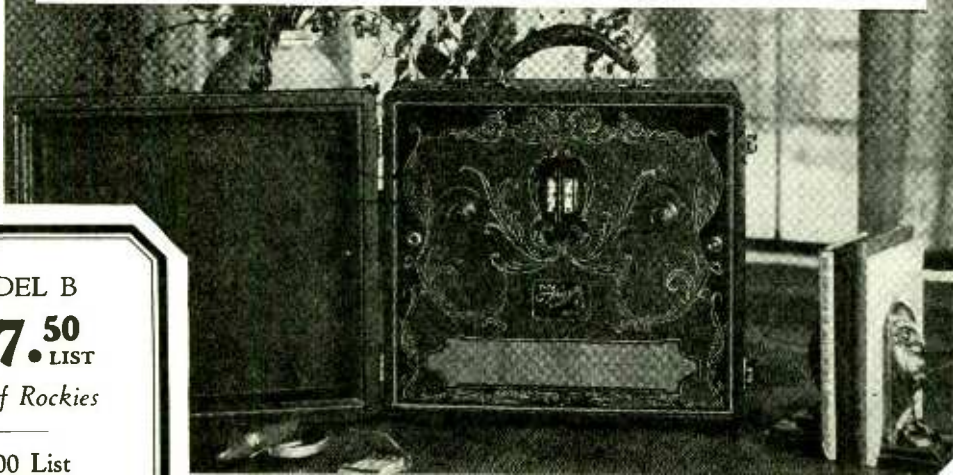

MODEL B

\$57.50 LIST

East of Rockies

\$60.00 List

West of Rockies

Less Tubes and
Batteries

ALL-ELECTRIC PORTABLES

Just Plug Into the Light Socket—and Tune In!

A-C PORTABLE ALL ELECTRIC, SCREEN GRID, 110 Volts, 60 Cycles, complete with special cone speaker in front cover—large output—QUALITY REPRODUCTION.

DE LUXE BATTERY MODEL, complete with special cone speaker in front cover and uses power tube. The prince of portables.

\$95.00 LIST

Less Tubes

\$65.00 LIST

Less Equipment

\$99.00

West of Rockies

\$67.50

West of Rockies

AUTOMATIC RADIO MANUFACTURING COMPANY, INC.

332 "A" STREET, BOSTON, MASS.

Northern California Distributors

OFFENBACH ELECTRIC CO., 1452 Market Street SAN FRANCISCO, CALIF.

THESE
NEW GILFILLAN MODELS

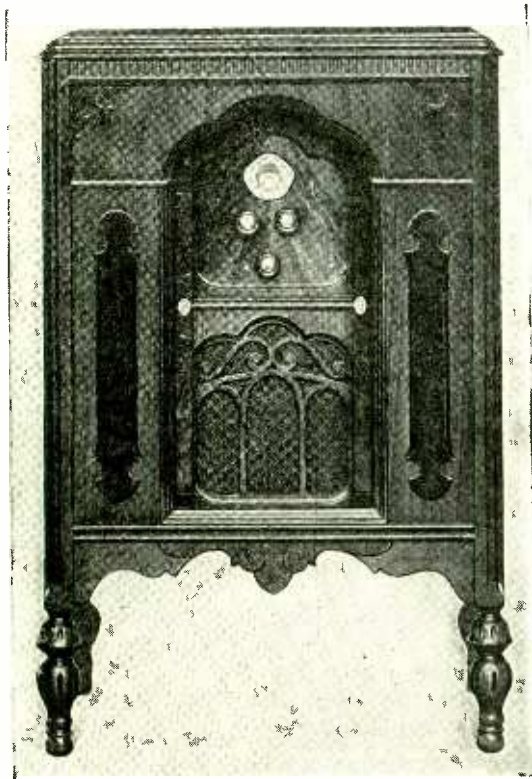

set higher standards
for **TONE** and
SELECTIVITY



Three new cabinet designs—Custom-made chassis—Silent operation—No A-C Hum—Sharpest selectivity with great distance-gaining power—New audio system and 4 stages of Radio Frequency Amplification—Screen-Grid and latest type Dynamic Speaker—Three attractive cabinet styles over compelling price range—complete with tubes and Dynamic Speaker

\$156.50

\$175.50

\$187.50

Tubes not included in above prices.

Gilfillan Radio

Manufactured under R. C. A., Latour and Hazeltine Patent License
in the Gilfillan Radio Factory — largest radio factory in the West.

GILFILLAN BROS., INC.

Main Office and Factory:

1815 VENICE BLVD., LOS ANGELES, CALIFORNIA

SAN FRANCISCO: 921 MISSION STREET

SEATTLE: 100 ELLIOTT AVE., WEST

- BUILT FOR WESTERN RECEPTION -

ON SEPTEMBER 3rd—IN A SINGLE DAY—405 RADIO
DEALERS AND SERVICE MEN SUBSCRIBED TO
“RADIO” FOR ONE YEAR. ON SEPTEMBER 12th—
IN A SINGLE DAY—417 RADIO DEALERS AND
SERVICE MEN SUBSCRIBED TO “RADIO” FOR ONE
YEAR. LOOKS AS IF ABOUT 4000 DEALERS WILL
SUBSCRIBE TO “RADIO” EACH MONTH HERE-
AFTER. SEE PAGES 57 TO 63 IN THIS ISSUE AND
YOU WILL KNOW THE REASON WHY.

**FOR 1930 “RADIO”
GUARANTEES THE
LARGEST NET PAID
CIRCULATION AMONG
RADIO DEALERS
AND SERVICE MEN . .**

*Wise Advertisers are now Contracting
for space*

Your Radio

can only be as good
as its Speaker

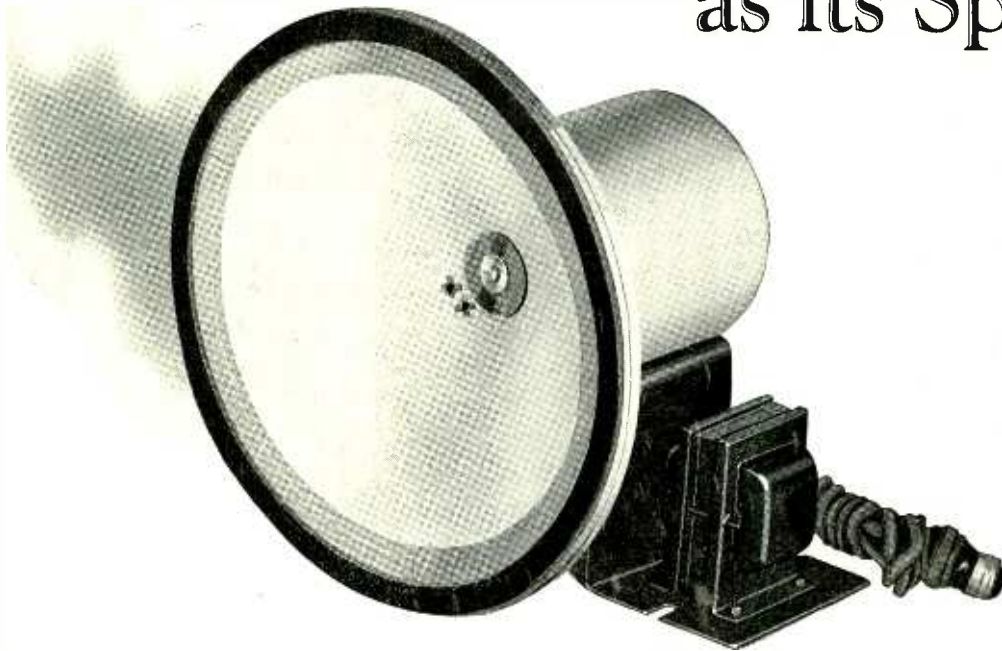

"The Speaker of the Year"

Wright-DeCoster Reproducer

Write Department "D"
for Descriptive Folder
of Chassis and Different
Cabinet Models

WRIGHT-DECOSTER, INC.
ST. PAUL, MINNESOTA

and Courier Radios

equipped with Kylectron

are breaking all sales records

Look at this set-up from the standpoint of a radio dealer. In the first place, here's everything the public wants and expects to get in a fine radio. Add to that a feature found on no other radio made today — Kylectron, the greatest and most sensational development since the first tube set.

But that's only *half* the story. We're not contented merely to make a fine product for you to sell. *We help you sell it!* We give you newspaper advertising *concentrated* in your territory. We give you the benefit of radio broadcasting by some of the most popular entertainers in the country. Smashing out-door displays are at your disposal to direct people to your store. Window displays, store displays, direct mail literature, standard and special selling helps of every

description are prepared for your use. We're leaving *nothing* undone that will help you to sell Peerless and Courier Radios equipped with Kylectron.

Now is it any wonder Kylectron is going over big? Is it any wonder dealers are breaking all sales records with Peerless and Courier Radios? You couldn't *want* any better proposition than is offered by the finest of radios — brand new, exclusive features — vigorous advertising — generous selling cooperation.

There isn't room here to give you *all* the details of our dealer proposition — our generous selling plan. Get in touch with your distributor or with us direct. But do it *now*. Don't let a few days delay cut you out of this valuable franchise. Write, wire or phone *today*.



The Courier Radio

Here's value that *shows*. Screen grid of course, three tubes; power detection; selectivity that delights the most critical — distance that will bring joy to the "DX fans" — tone that *everyone* will enjoy. Equipped with Kylectron. Certainly the radio "shopper" will never find another such value.

Peerless and Courier Radios are products of

**UNITED
REPRODUCERS CORPORATION**
Springfield, Ohio

Full license protection under RCA, Hazeltine and Meissner patents and applications

All Around the World!

ANTARCTICA

HOLLAND

JAVA

JAPAN

MELBOURNE

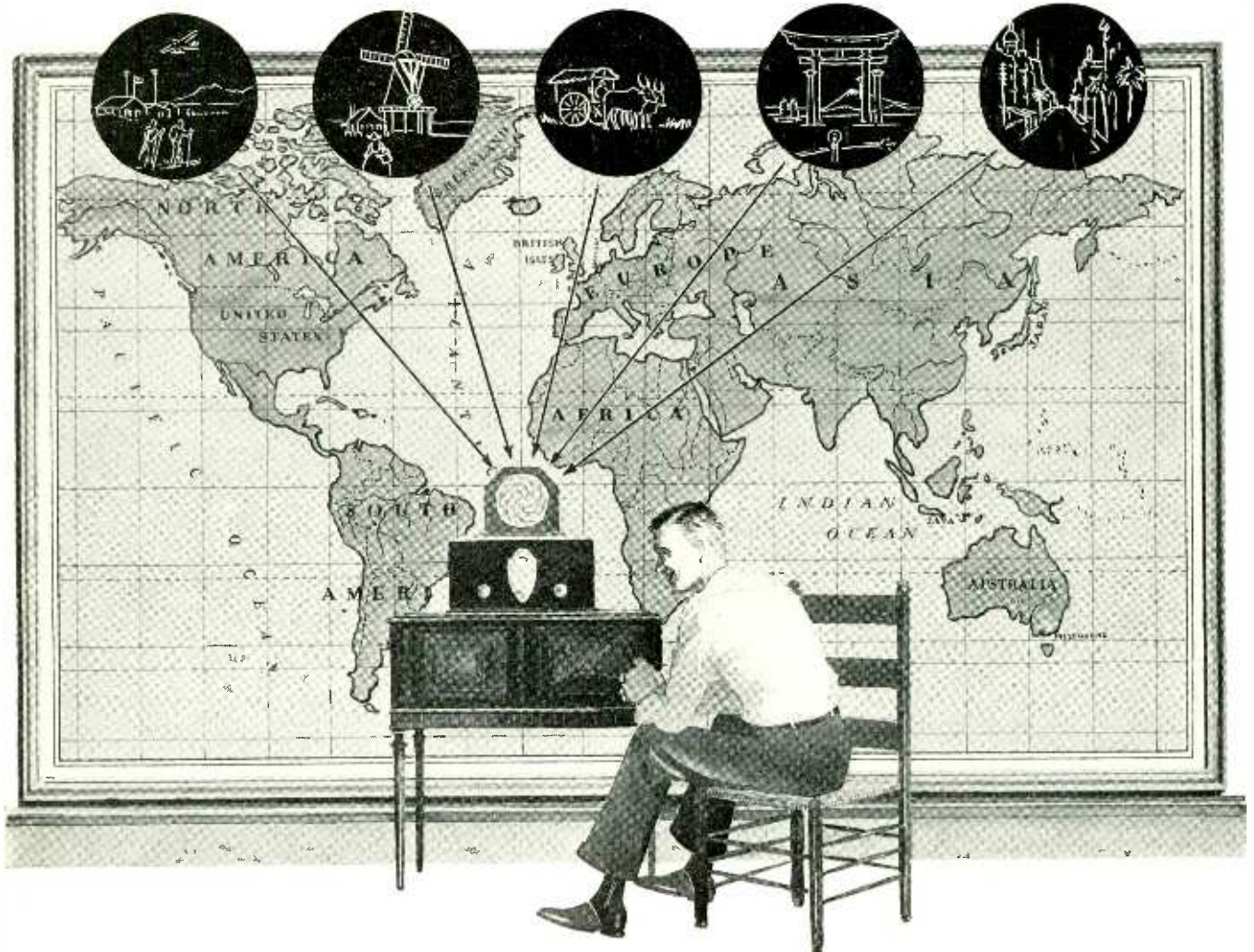

YOU can hear words and music from Java, Australia, England, France—from all around the world,—with the NATIONAL Screen-Grid SW-4 THRILL BOX.

Already many famous broadcasting stations abroad and in this country are putting their regular programs on the short waves, too. More and more stations are doing this. These broadcasts may be received anywhere else in the world, in cities, in the country, at the frozen poles, in the jungles and the deserts, with the NATIONAL THRILL BOX.

This simple Four-Tube Screen-Grid THRILL BOX is a trim, neat receiver with single dial tuning and smooth sensitivity-control. It is free from annoying radiation and the design eliminates "tuning holes," formerly a troublesome short-wave difficulty. The special audio system with 171-A Power Tube gives excellent loudspeaker operation, and the plate

supply may be taken from the lighting circuit, through the NATIONAL Velvet-B,—a feature not usually found in short-wave receivers. The interchangeable tuning transformers are kept in special storage sockets *inside* the cabinet, protected from dust and damage, and always ready for use.

The cabinet itself is more than just a box. It is of simple and very attractive design and finish, which harmonizes with the most tasteful surroundings.

Write us for full information and prices today.

NATIONAL COMPANY, INC.
ENGINEERS & MANUFACTURERS
61 SHERMAN ST., MALDEN, MASS.

Est. 1914 . . . W. A. Ready, Pres.



NATIONAL THRILL BOX

SCREEN-GRID SW-4

An 'A' To Meet The Trade's Demands



\$24.75

AN "A" Power Unit to meet this season's trade demands required a radical departure in construction.

The unit had to be exceptionally good and so designed that it could be produced economically.

The new Tobe "A" Power is de-

signed to meet these requirements. Our greatly increased production facilities make it possible for us to construct this unit at an unheard-of low price, extend the customary trade discounts and leave a legitimate margin of profit for the manufacturer.



Tobe's 14 Points

1. Dry rectifier (steady and quiet).
2. Variable transformer.
3. High inductance chokes.
4. Three Tobe "A" Condensers, 12,000 mfd.
5. Dial for regulating voltage.
6. Receptacle for "B" Supply.
7. Pendant switch controlling "A" and "B" Supply.
8. Most compact of all "A" units.
9. Simplified construction, will not get out of order.
10. Absolute elimination of hum or crackling.
11. Rigid construction, will withstand shipping.
12. Constructed with louvres, will not heat up.
13. Priced for quick turn-over.
14. Dull black finish on heavy metal, a beautiful unit.

Order your sample today, remove the cover and see a marked advance in "A" Eliminator construction.

Tobe Deutschmann Corporation

CANTON, MASS.

Tell them you saw it in RADIO



The New Pacent Combination Switch and Volume Control.
Patent applied for

Pacent new vitally improvements in

— Switch instantly from record to radio without changing a single thing

Pacent presents a revolutionary new switch for use with the Super Phonovox which greatly simplifies the operation of this famous pick-up. With it you can switch *instantly* from radio to records without removing a tube or changing a single thing. This marvelous device, moreover, is also a volume control as shown in the above illustration. When the arrow is in a downward position, the phonograph connection is off and the radio is ready to operate. When the arrow is turned upward—clockwise—the phonograph is connected at the *first movement* and its volume increased as the arrow is further turned.

THIS ADVANCED NEW SWITCH IS SUPPLIED WITHOUT EXTRA COST WITH THE SUPER PHONOVOX.

PACENT *Super Phonovox*

*announces two
important
pick-up operation*

**New Phonotrol Adapter Created
for Screen Grid Tubes**

The new Screen Grid radio sets, to get satisfactory tone quality and volume, from phonograph pick-up, require an adapter of a different type. The Phonotrol Adapter, by an entirely new method, enables the Super Phonovox to operate perfectly with screen grid tubes in sets such as Atwater Kent 55, 60 and 61, Crosley 41-S, 42-S and 82-S, and others. Simply remove the detector tube, insert the Adapter and replace the tube—a matter of a few seconds. And you need not touch it again.

Both the new Phonotrol Adapter for screen grid tubes and the regular adapter for other sets are supplied with the Super Phonovox at no extra cost.

Jobbers and Dealers—These important improvements will produce increased sales of the Super Phonovox. Order an adequate stock now and get your share of the greater profits.

**PACENT
SUPER PHONOVOX**

There is no finer pick-up to be had at any price. Has *English 36% Cobalt Magnets* — the most sensitive available. Balanced tone arm provides correct needle pressure. The Super Phonovox is famous for its marvelous tone and it is the fastest selling pick-up on the market.

**List Price
\$ 15.00**

Prices slightly higher west of the Rockies

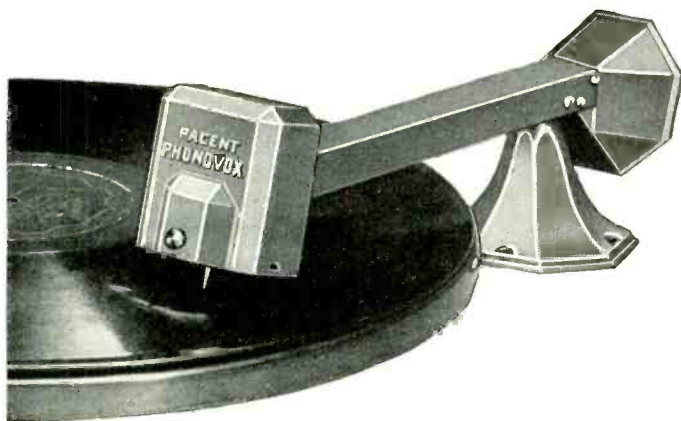

PACENT ELECTRIC CO., INC., 91 Seventh Ave., New York

Pioneers in Radio and Electric Reproduction for Over 20 Years

*Manufacturing Licensee for Great Britain and Ireland: Irganic Electric Co., Ltd., Bedford, England
Licensee for Canada: White Radio Limited, Hamilton, Ont.*



The New Phonotrol Adapter for use with Screen Grid Sets. Actual size. Patent applied for.

A New Opportunity for Profit!

IN the month of June, this year, the Capehart Corporation opened a great new factory at Fort Wayne, Indiana. Just 17 months before, the business started from a mere idea in a shack at Huntington.

Phenomenal growth based on immediate and widespread public response. Those who have been identified with the Capehart during this period have made big money. And still the business is in its infancy. Merely the surface of the market has been tapped. The opportunities for real big profits are still ahead. The business has grown so fast that many valuable territories still remain untouched.

The Capehart Organization is building its dealer organization carefully. It has a valuable franchise to award—one that is worth big money. It presents a *new opportunity for profit* to established responsible dealers who have the energy and ability to develop its tremendous possibilities.

The Musical Marvel of the Age

The Capehart Orchestrope actually *solves the problem of music* for hotels, restaurants, refreshment parlors, roadhouses — in fact any place of amusement or recreation that caters to the public in any way. The Capehart brings all the advantages and profit of music to establishments which never could afford it before.

The great sale and tremendous enthusiasm which has greeted the Capehart is proof that the business establishments of the country have been waiting for just such an instrument.

Mail Coupon for Details

If you are interested in a new activity which will not interfere with your present business—one that is bringing a profit of \$2,000 to \$5,000 a month to others, one that will take out the gaps in your yearly sales curve, *one that has so large a dollar margin in every sale that it pays you well for every effort*—send the coupon at once for full details. Those who become identified with the Capehart organization now are getting in on the ground floor, with all that such an opportunity offers. Don't wait until the ground floor is taken. Please write us at once.

THE CAPE HART
Orchestrope

THE CAPEHART CORPORATION
Fort Wayne, Indiana

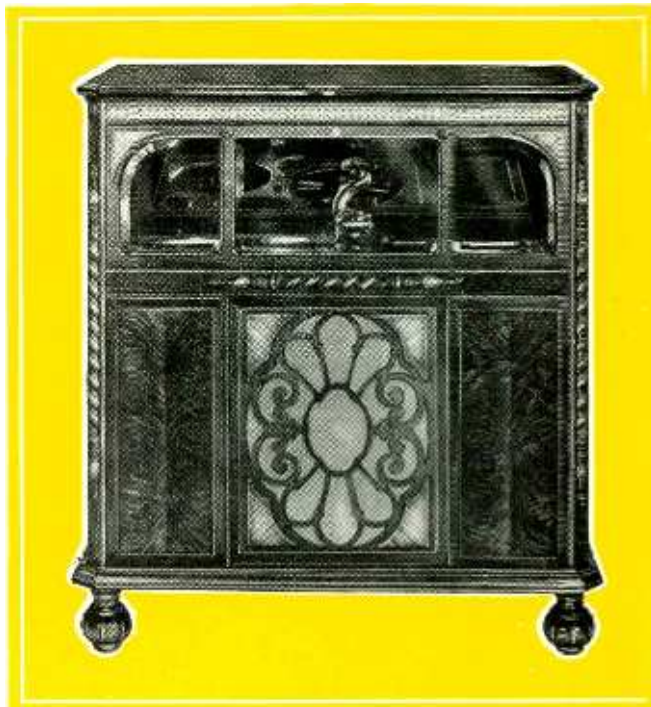

ARISTOCRAT MODEL
Exquisitely designed for use in the finest clubs and homes.



OUTDOOR MODEL
Specially built to meet great volume outdoor requirements. Fireproof and weatherproof.



AUDITORIUM MODEL
Recommended for public auditoriums, dancing academies, etc.

Plays 56 Selections

The Capehart Orchestrope offers the most complete line of automatic phonographs in the world. Each model plays 56 selections, 28 records on both sides, without repetition. They operate 24 hours a day, if desired, without even a moment's attention. The tone, brought through three stages of audio amplification and a dynamic speaker, is startlingly true to life. The volume is adjustable to any requirement. Supplied with or without coin-operating attachments. Also with as many as five auxiliariespeakers.

The Capehart Corporation
Dept. 3486, Ft. Wayne, Indiana

Please send me, without obligation, descriptions of all Capehart Orchestrope models and details of the Capehart Dealer's Franchise.

Name

Address

City

State

An Enlarged Service

"RADIO'S" Price and Data Sheet service is increased to 16 pages monthly. More than 40 manufacturers announced new models and price revisions in September. "RADIO" — alone — publishes this data in complete form.

KEEP POSTED ON ALL FACTORY DEVELOPMENTS

Prices of sets and accessories change constantly.

New models are announced regularly. Let us send this monthly Price and Data Service to you by mail for one year and let us send you a loose leaf binder for holding these sheets. You get this service and the loose leaf binder FREE of cost with a subscription to "RADIO" for one year, \$2.00

TURN TO PAGES 57 TO 63



"RADIO" needs many salesmen to sell this price and data service to dealers and jobbers. Would you like to work for "RADIO"—full or part time—and solicit orders from the trade on a very liberal commission basis?

HERE IS WHAT WE OFFER

A SUBSCRIPTION for one year to the monthly Price and Data Sheet Service, which we send by mail each month; a loose leaf binder for holding these sheets . . . AND a subscription to "RADIO" for one year . . . all for only \$2.00. No further payments of any kind to be made.

A good salesman can make \$100.00 weekly —taking orders for this service. It sells on sight. No radio dealer or jobber can profitably afford to be without it. Let us send you a supply of order blanks, sample data sheets and a loose leaf binder. Convince yourself that you can sell this service. Our commission to salesmen is mighty liberal. It will surprise you.

Write TODAY to

The Business Manager, "RADIO"
Pacific Building San Francisco, California

TONE QUALITY

An Outstanding Feature of All General Amplifiers



MODEL GA-15

A two-stage power amplifier employing one 227, two 245 power tubes in push-pull and one 280 rectifier. Will deliver approximately 4.5 watts of undistorted energy to the reproducer. Suitable for the home or other moderate sized installations.

Price (less tubes) \$85.00



MODEL GA-20

A three-stage power amplifier incorporating dual push-pull. The tubes required are one 227, two 226s, two 250 power tubes and two 281 rectifiers. Will deliver approximately 14 watts of undistorted energy to the reproducers. Suitable for apartment house, theatre or other service requiring extreme volume reserve.

Price (less tubes) \$225.00

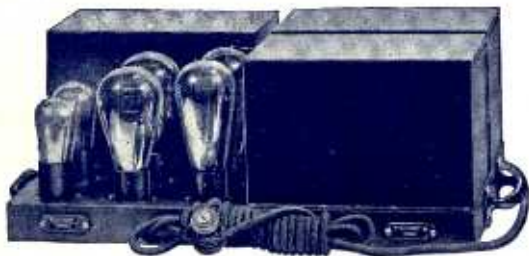

MODEL GA-30

A three-stage power amplifier employing two 227s, two 250 power tubes in push-pull and two 281 rectifiers. Will deliver approximately 12 watts of undistorted energy to the reproducers. As in all other General Amplifiers, no output device is required.

Price (less tubes) \$175.00

THE manufacturer and the purchaser of "Sound Projection" equipment realize the important relationship of the power amplifier to the satisfactory performance of the complete assembly. The rapidly increasing demand of the general public for finer tone quality necessitates improved design in all associated equipment. This demand has been successfully met in General Amplifiers.

Created by an engineering staff whose sole aim has been to give the public the best in power amplification. Built by men thoroughly experienced in their construction and operation. A product of merit is the result.

Sound engineering and inbuilt quality together with the incorporation of many distinctly unusual features have made possible this line of power amplifiers of unrivalled performance and tone quality. From the faintest whisper to tremendous volume absolute faithfulness in reproduction is maintained. Volume, tone fidelity, stability and service are assured with General Amplifiers.

Our engineering staff, specialists in the design and manufacture of power amplifiers to meet specific requirements, are always pleased to cooperate with you in your problems of audio amplification.

These and other models, not illustrated, are fully described in our Bulletin R3, which will be sent on request.

GENERAL AMPLIFIER COMPANY

27 Commercial Avenue, Cambridge, Mass.

MAKERS OF HIGH-GRADE POWER AMPLIFIERS

NEW

H·F·L·MASTERTONE

11 Tubes A·C· SCREEN-GRID Receiver

Humless, Noiseless, Efficient Operation. A receiver that Incorporates Every Advanced Engineering Practice, Magnificent Tone, Tremendous Power Volume.

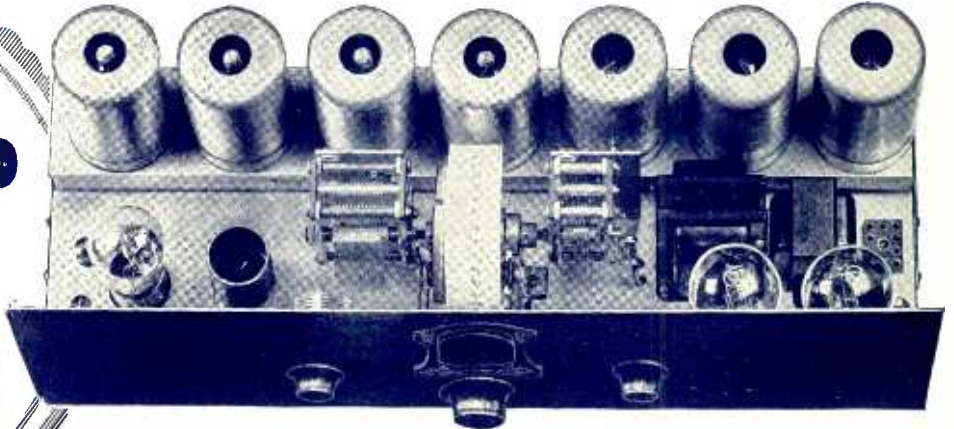

Completely Built, Wired and Assembled by H·F·L Engineers Shipped Ready to Operate

What Amazing Power

Amplification system built around the new AC Screen Grid tubes is especially adapted to intermediate frequency stages of superheterodyne receiver. No oscillation. Employs 5 screen grid tubes, the fifth being the detector, upon the plate of which is impressed 175 volts. This new system of power screen detection prevents overloading even at maximum volume.

Such Keen Sensitivity

Unlike any ever known, embracing every station, however weak or distant. Requires only wire screen or metal plate in cabinet for aerial to obtain coast to coast reception. Outside antenna may be used where louder signals or greater distances are desired.

Highly Developed Circuit

The intermediate employs four screen grid tubes with five tuned filter circuits, each one adjustable to peak of frequency to which they are tuned, assuring positive 10 kilocycle selectivity and defined clarity. The highly amplified signal is fed into the screen grid power detector, thence to the audio system. Most highly engineered receiver ever built.



Write Today for Proposition

Postal or letter brings Complete Description and Price

Greatest of all RECEIVERS!

11 tubes operating at peak efficiency (5-224, 3-227, 2-245, 1-280)

Single Dial Positive One Spot Tuning

Efficient, Humless AC Operation Uses 5 Screen Grid Tubes, 5 Tuned R. F. Circuits

Fits practically all models of Consoles. Panel 7x21 inches. Depth, Chassis 7 1/2 inches

High Power Screen Grid Detector, with 175 Volts Impressed on Plate Automatic Line Voltage Control Inbuilt Holds Voltage Against Fluctuation

100-Volt DC Dynamic Field Supply Incorporated

All Metal Chassis—Completely Shielded Units

3-Stage Phonographic Amplifier

Finest Quality, Precision Made Parts: Thordarson, Carter, Mershon, etc.

The New Audio System

Uniformity of amplification over entire musical scale is an outstanding achievement of Mastertone engineers. Absolutely free from hum. The first audio stage is followed by 245 tubes in push-pull arrangement. High plate voltage for these tubes is fed thru center tap push-pull impedance, permitting use of any type speaker. No actual B voltage feeds thru speaker. Operates with same efficiency with dynamic, magnetic or horn speakers.

Phonograph Reproductions and Other Mastertone Features

Plug-in jack for instant attachment of electric phonograph pick-up. Three stages of audio system employed for this purpose. Entire receiver sturdily constructed of heavy cadmium plated steel and copper. All stages and tubes are shielded. Condensers, coils and wiring completely enclosed. Front panel is 7 x 21 inches. Depth of chassis, 7 1/2 inches.

H-F-L Power Master

Designed to accommodate either AC or DC Dynamic. It is a specially developed unit of the Mastertone receiver built separately to simplify installation. Has large, oversized transformer. Filter system is equipped with a heavy choke and the new self healing type Mershon Condensers of 24 Microfarads capacity. Full wave type 280 rectifier tube. Automatic line ballast and regulator levels out all fluctuations in line voltage from 95 to 130 volts. Unit may be switched out if not desired.

A revolutionary achievement that sets up new standards of performance. After two years of painstaking research work and tests, the ultimate in receivers has been achieved—the H-F-L Mastertone—a receiver that awes and thrills with its great power, its sweetness of tone—each unit performing in its function with unflinching accuracy and precision.

Custom Built But Low in Price

Every Mastertone Receiver is built by hand in our own laboratories. This necessarily limits its production, yet the price is surprisingly low. Quality—not quantity—is our standard. We guarantee the Mastertone to be perfect in workmanship and materials, and to fulfill the claims we make for it. One demonstration will be proof conclusive that we have rightfully named it—MASTERTONE.

HIGH FREQUENCY LABORATORIES
28 North Sheldon St. Dept. 31, Chicago, Ill.

Cunningham

RADIO TUBES

Maintaining Volume
Sales and Fast
Territorial Service
on a Quality Product

M. F. BURNS
Vice-President and
General Sales Manager
Located at
New York, N. Y.



F. H. LARRABEE,
Assistant General Sales Manager
Located at
Chicago, Ill.

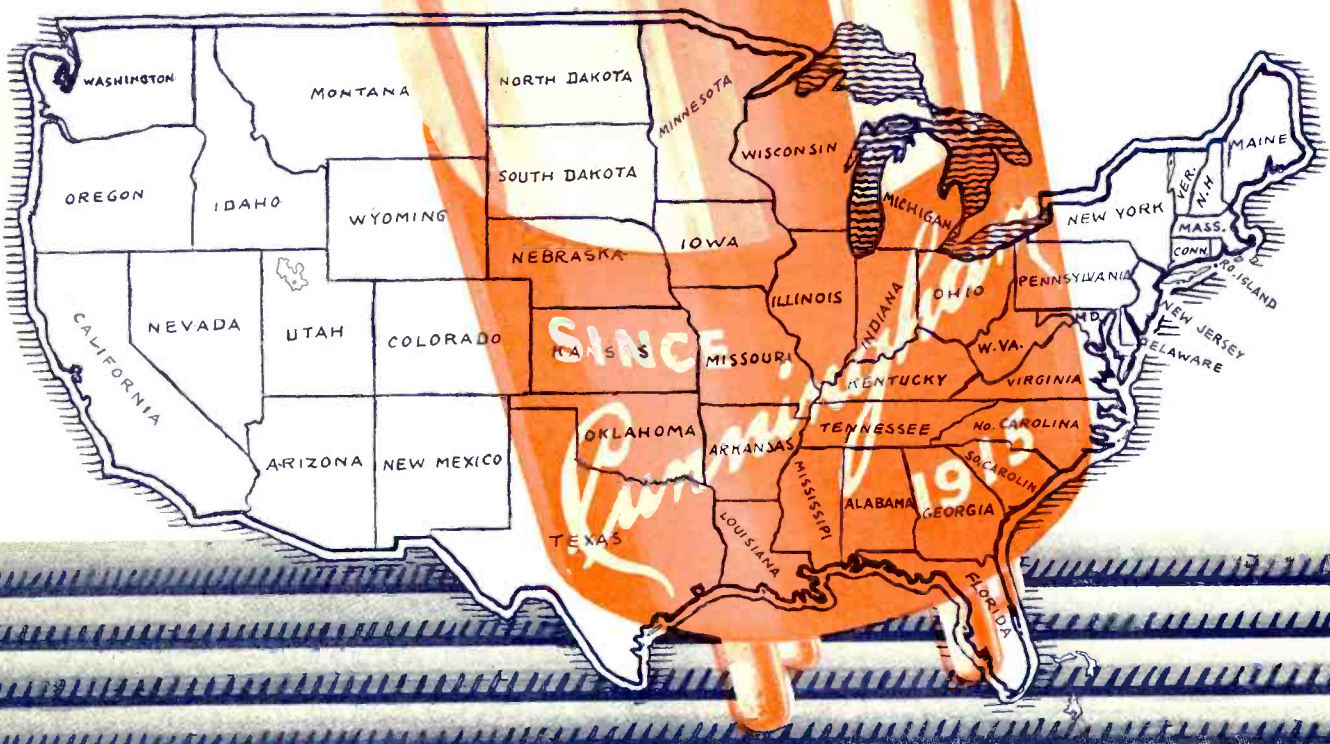



E. M. GREENHALGH
Superintendent
Newark Warehouse
Newark, N. J.



E. R. HAINES
Eastern District
Sales Manager
Located at
New York, N. Y.

Up-to-the-minute radio tube information and dealer helps are furnished the trade by Cunningham dealer-men who constantly and consistently cover this eastern territory. Under able direction from sales headquarters these men acquaint the trade with Cunningham service and they endeavor in every way to be a real help to each and every

dealer in helping to solve his particular sales problem. A close-up of the modern facilities; the fully equipped testing laboratory; the expert packing and shipping methods and the rapid replacement service is brought forcibly to the dealers' attention by these Cunningham good-will ambassadors.

What is true of the New York territory is also true of every one of the other four strategic points of Cunningham Tube Service located at Chicago, San Francisco, Dallas and Atlanta.

F. E. HARDING
District Sales Manager
Located at
Chicago, Ill.



CHICAGO

The Chicago sales territory covers the central states and is efficiently organized under able management. The spirit of Chicago's slogan "I will," is synonymous with the spirit of the Cunningham Chicago service. It's the "I will" of the Chicago sales team that counts for the remarkable score in recorded sales during this and past seasons. The co-operative effort on the part of Cunningham salesmen in helping dealers is keenly felt throughout the entire field.

H. A. EDWARDS
District Sales Manager
Located at
Minneapolis, Minn.



W. J. FLANNELLY
Supt. Chicago Warehouse
Chicago, Ill.

E. L. SUTTON
District Manager
Located at
San Francisco, Calif.



SAN FRANCISCO



The San Francisco territory comprises all of the Western slope and is in every essential the Cunningham sales headquarters for the Pacific Coast states.

Cunningham Tubes and the service back of the name is not an unknown quantity in these parts; San Francisco being the birthplace of E. T. Cunningham. It is fitting that the building pictured here bears four square sides correctly proportioned, which is symbolic of a service that has spread across the country and is known far and wide for its square dealing since 1915.



J. W. COCKE
District Manager
Located at
Dallas, Texas



DALLAS

Dallas, the hub of the Cunningham Southwest territory is manned by a forceful and energetic sales crew that reflects the dynamic personality of the district manager. In this active and thriving territory Cunningham tube sales have blazed a trail that is characteristic of their remarkable staying quality. People in this territory are keenly alive to a good thing when they see it and southwestern dealers lose no time in convincing their trade that Cunningham Tubes are the choice of millions.

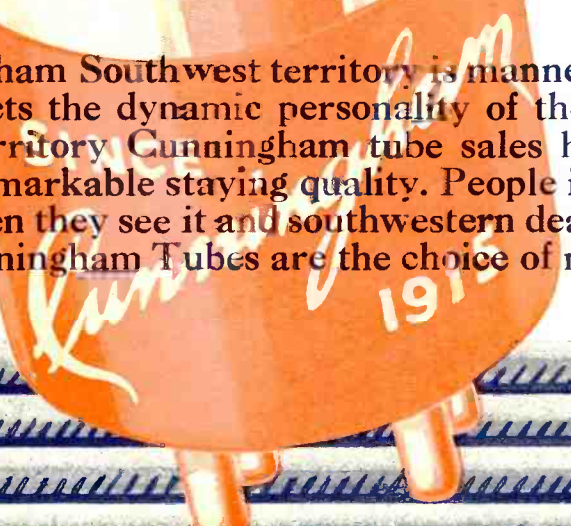



P. M. JEFFERYS
District Manager
Located at
Atlanta, Ga.



ATLANTA

The increasing population due to the industrial activities of this thriving community commands an important position in the sales set-up of Cunningham Radio Tubes. Keeping ahead on all essentials, the Cunningham Atlanta sales force is leading the way for many dealers to plan for quick sales by offering helpful merchandising suggestions and co-operating in sales helps pertinent to the Atlanta territory. Each territory in the Cunningham set-up is a sales unit in itself and yet benefits from the great fund of information gathered and distributed from headquarters.

The 5 Strategic Points of Cunningham Tube Service

Each one of the territorial sales points mentioned above bears record of sales strategy for Cunningham Radio Tubes. From these sales centers tube orders are filled, sales and merchandise material is furnished to the dealer. Each dealer is made to feel that Cunningham headquarters is near at hand.

Each sales center maintains a fully equipped testing laboratory; a live sales staff and modern facilities; expert packing and shipping department and a rapid replacement service—all for the trade's convenience.

E. T. CUNNINGHAM INC.

NEW YORK — CHICAGO — SAN FRANCISCO — DALLAS — ATLANTA

Manufactured and sold under rights, patents and inventions owned and/or controlled by Radio Corporation of America

Men Who COMPARE Voltage Controls Choose ELECTRADS

Licensed by
Technidyne
Corporation
U. S. Pats.
1034103-04
& Pats. Pend

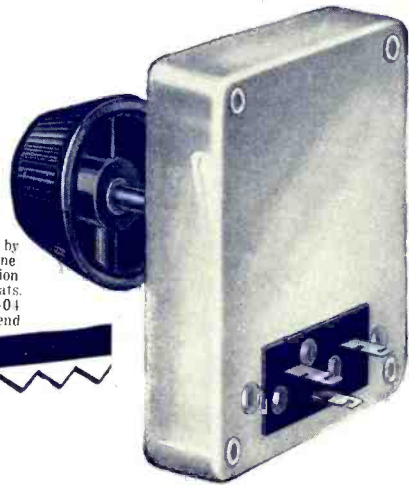

ELECTRAD Super- TONATROL

A long-lasting volume control for use with the heavy currents of modern receiver design. Will easily dissipate 5 watts without varying in resistance.

New type resistance element is fused to the surface of an enameled metal plate. Practically all-metal construction promotes rapid heat dissipation.



Pure silver floating contact of new design provides a remarkably smooth action which improves with use owing to a microscopic deposit of silver on the resistance element. Firmly riveted metal cover. Bakelite insulation.

7 types for every volume control purpose, including electrical phonograph pickups. List Prices, \$2.40 to \$3.50.

Western Representatives
UNIVERSAL AGENCIES
905 Mission Street
San Francisco, Calif.

RADIO engineers, manufacturers and custom-set builders **KNOW** that the effective performance of *their* product depends upon the reliability of the parts they use. They *compare* before making their selection. Quality performance—longer life—most advanced design and construction—all go to make **ELECTRAD** the first choice of men who **KNOW** resistances and voltage controls.

Yet, scientifically controlled mass production enables **ELECTRAD** products to be sold at prices which appeal to the pocket-book.

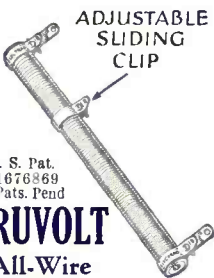

TRUVOLT All-Wire Resistances

The ideal resistance for eliminators and power packs owing to its constant value and long life. Patented winding—directly air-cooled. Nichrome resistance wire is wound around an asbestos covered copper core—then around a grooved fire-clay tube. Accurately rated. Exclusive sliding clip for quick adjustments.

TRUVOLT VARIABLES have same distinctive construction plus knob adjustment. Last longer owing to endwise travel of contact over wire. Greatly simplify eliminator design. 22 stock sizes—List price, \$2.50 each.

ROYALTY Variable High Resistances

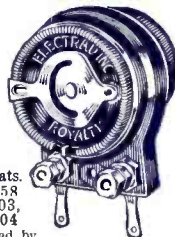

U. S. Pats.
1593658
1034103
1034104

Licensed by
Technidyne Corp.

Widely used for voltage controls in circuits where low self-inductance is desirable. Due to its unique construction the resistance element is not impaired through mechanical operation, therefore, long-lasting. **F i n e s t** insulating materials and careful workmanship. Entire resistance range covered with one turn of the knob—the same resistance being always obtained at the same setting. Eleven types. Potentiometer — \$2.00. Other types—\$1.50.

U. S. Pats.
5-2-16
7-27-26
& Pats. Pend

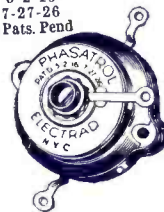

PHASATROL The Universal R. F. Balancer

A simple, yet effective means of balancing and controlling radio frequency oscillations. Can be quickly installed in any receiver using R. F. Amplification — tuned or untuned. Will completely eliminate all oscillation and R. F. distortion. Can be mounted anywhere and is exceptionally good looking. Installation instructions in each package. List price \$2.00 each.

ELECTRAD manufactures a complete line of resistance units and voltage controls for all radio and power supply requirements, including Television.

ELECTRAD INC.

ELECTRAD, INC., Dept. PR10, 175 Varick Street, New York, N. Y.
Please send complete information on products checked
 Super-**TONATROL** **ROYALTY** **PHASATROL**
 TRUVOLTS All Products
Name _____
Address _____

RADIO

for the profession

VOL. XI

OCTOBER, 1929

No. 10

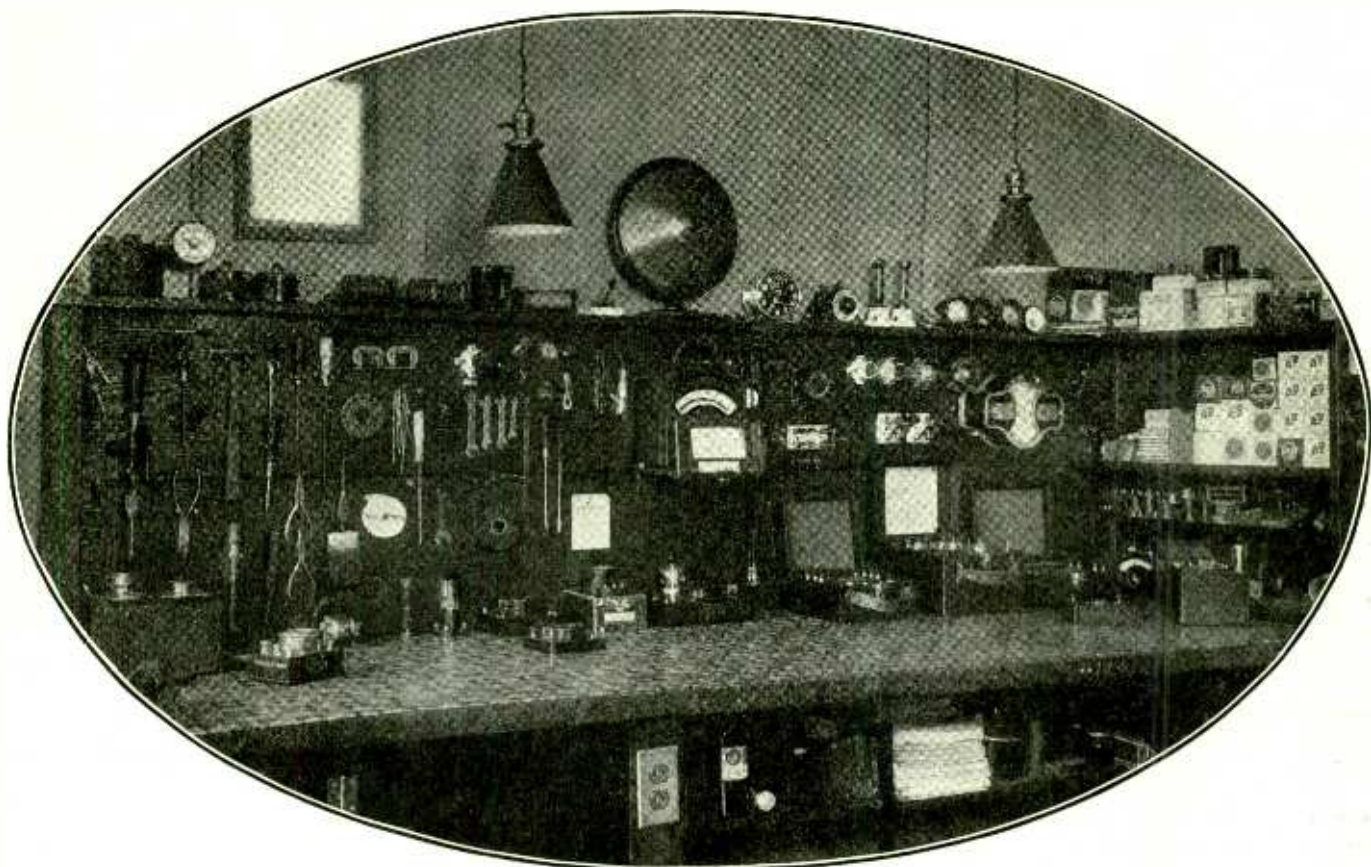

Fig. 1. A Convenient Shop Bench with Test Board

Winning the *Customer* by Efficient *Service* Methods

THE service man, if he is to be successful in his work and make friends for his employer, must be trained in his business. The day of "pick-'em-up-over-night" service men is over. No matter how high class a repair shop may be, the reliability of that shop rests on the efficiency of the service men it employs.

When such a shop is properly equipped and running it takes at least two men, one for outside work and the other an "inside" man, to do the repairing of sets after the outside man has brought them in. A single job usually consists of the following:

By D. A. BROWN

1. Phone call asking for service.
2. Service man makes out ticket and starts on call.
3. Service man arrives at house and checks antenna, ground and lightning arrester.
4. Checks wiring of set and batteries.
5. Makes a routine check of plate voltage, grid voltage, plate current, and filament voltage in their respective order. If they are O.K. he then tests the set and equipment in operation for volume, clarity and selectivity. After the set

checks O.K. the customer signs the ticket, stating that the service is satisfactory and complete. This frees the service man from any trouble that may arise in the set from other causes.

On the other hand, if the trouble cannot be repaired at the customer's house, it is brought into the shop and turned over to the "inside" man with the action of the set explained on a tag. After he has made the repairs it is again turned over to the outside man who completes the job.

Extensive repairs made at the house are not in line with good practice, as the sight of the dismantled set has a bad

effect on the customer and may cause dissatisfaction later. When a set is brought in it is put on the test bench and the same routine of testing used.

WHILE individual cases may arise calling only for common sense in the handling, the following troubles may be considered general.

1. *No plate voltage:* dead B batteries, defective power unit, open audio transformer winding, shorted condenser, or bad rectifier tube.

2. *No filament voltage:* power off, dead A battery, bad power unit, open rheostat, or corroded battery terminals.

3. *High plate current:* C battery reversed, or wrong connections on the B batteries.

4. *No grid voltage:* dead C battery, burned out or open audio transformer, open circuit in wiring.

The equipment for testing is purely a matter of personal taste. A lot of instruments make a good impression on the customer, yet is not necessary if such apparatus is well chosen. A small tool box or kit containing a number of carefully selected tools should be carried by the outside man. Usually two styles of long-nose pliers, a knife to scrape wire, long and short screwdrivers, and one especially with a bit about 1/8-inch wide to use on small set screws, a pair of tweezers, and two or three octagonal wrenches will be enough. A screwdriver made of fibre rod is used to neutralize sets and one of the regular screwdrivers is magnetized by pulling it across the ends of a good magnet. For testing purposes the set tester should carry a good set and tube checker, of which there are many on the market.

Some service men carry a lot of tubes for replacements, but in the case of the writer the right one was never in the kit, being used somewhere else and never replaced. So the practice was discontinued unless the call was some distance from the shop, when a complete replacement kit of tubes, transformers and supply parts was carried along.

IN THE shop the bench should be fairly well equipped both in tools and testing apparatus. It should be placed where there is plenty of daylight, both from a cost standpoint and for ease on the repair man's eyes.

The general wiring diagram of a satisfactory test board is shown in Fig. 2. The d-c meter in the center of the picture on the first page reads 0-1.5, 0-15, and 0-150 volts for continuity testing. The lamp banks to the right are used to test power units and to judge the approximate load of units under test. A source of 500 and 750 volts a-c is furnished by a step-up transformer under the bench. This is used to check condenser capacities and aid the repair man in testing condensers under actual operating conditions. A milliammeter equipped with flexible leads is used to cut in on the plate supply of a set under test to determine the current drain. The other instruments are to accurately measure a-c voltage and current loads of sets.

Instruments on the bench proper are of the portable type and include: r-f and a-f oscillator, set checker, combination volt-ammeter reading full scale 0-.5, 0-5, 0-50, 0-500, 0-1000 volts and 0-50, 0-500 and 0-5000 ma. The left side of the board holds the tools, all of which are within easy reach of the repair man.

A loudspeaker mounted above the bench is used to test the sets for volume and a large r-f oscillator (not shown) is used to improve selectivity by tuning the oscillator to a frequency slightly below the frequency of the station to which the set is tuned, and by adjusting the set to tune through this interference.

Testing Methods

IT IS OUT of the question for the writer to discuss all of the tests possible with the equipment described, but the most important ones used in set repair will be described.

Test for plate voltage: Touch the

plate and filament with the leads of a voltmeter, as in Fig. 3. If the meter shows a reading the circuit is O. K., provided the power is turned on.

If all of the sockets show a reading except two or three, the trouble is



Fig. 3. Test for Plate Voltage

likely to be in the audio frequency end of the amplifier, the trouble being in an open transformer. The one that is defective may be traced by the wires leading from the socket in which there is no voltage reading. In the r-f stages preceding the detector tube, trouble is most likely to be in the volume control, condenser or open in the wiring. If no voltage reading is available at any of the sockets, look at the power unit. Tests on this part of the equipment follow later. If there is current at the power unit and none at the set, the trouble is in the cable connecting the two as this breaks with the constant moving around. This may be found by checking the voltages at both ends and

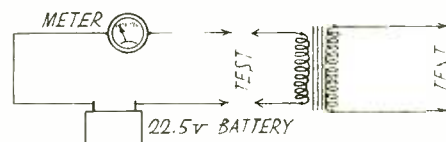

Fig. 4. Circuit for Testing Opens

then closing in to the place where the broken wire, or open circuit is located.

Open circuits may be tested with the circuit shown in Fig. 4, applying the test leads to each piece of the equipment, as shown in Fig. 5. Open circuits in transformers and coils may be located by placing a suitable meter in series with a 22.5 volt battery across the winding to be tested. If no reading is to be had the winding is open

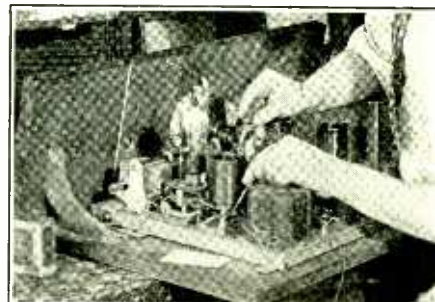

Fig. 5. Test for Open Circuit

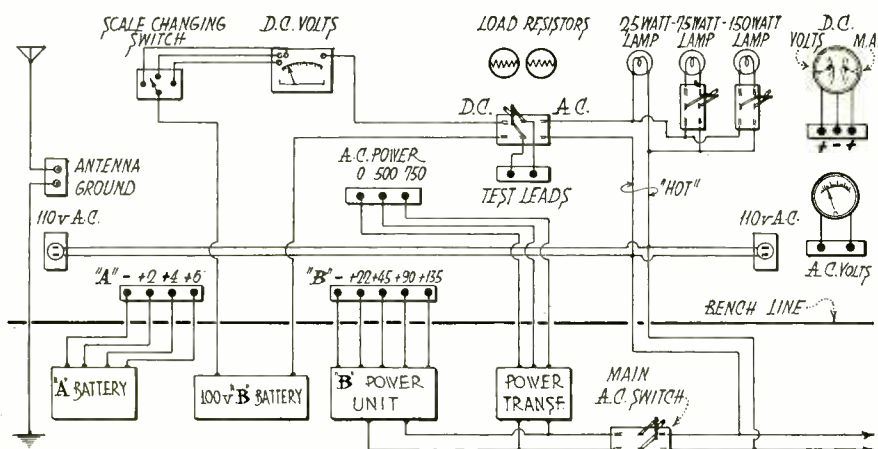

Fig. 2. Wiring Diagram of Test Board

and will have to be repaired or replaced. If a reading is to be had the winding is O. K., although this tells us nothing about a possible short circuit.

Short circuit tests depend upon the fact that any coil or part has resistance and should show a voltage drop unless there is a short. A lower reading will be had when testing through an unshorted coil than when the ends of the test leads are touched together. When the leads are touched together the full voltage of the battery is read, but when the coil under test is placed in the circuit the reading on the meter should be the battery voltage less the voltage drop in the coil. By this feature a voltmeter may be roughly calibrated in resistance by placing a resistance of known value in the circuit and calibrating the voltmeter accordingly for different resistances in the circuit.

Shorts in condensers may be tested by the same test as is used for open circuits. If the meter shows voltage the condenser is shorted and will have to be replaced. A condenser blocks d-c, allowing only a-c to pass. The best test for one that is thought defective is to apply a potential of 135 volts d-c to the condenser terminals, remove the wires, and after leaving it untouched for three minutes short the terminals with a short piece of wire. If there is a spark the condenser is O. K. Bad condensers are a possible cause of no plate voltage and will show up on test for zero plate and grid voltages.

Several good combinations of tube and set testers are on the market and it is an asset to the service man to have one in his equipment.

Fig. 6 is the circuit of the portable oscillator shown on the test bench. It provides signals to test sets during the

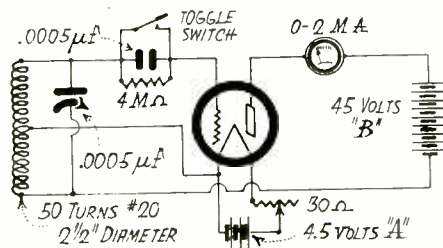

Fig. 6. Circuit of Portable Oscillator

hours when there is no broadcasting and also to align gang condensers.

Gang condenser alignment can be done either at the shop or on the job. The procedure is to loosen the lock-nuts holding the individual condenser units and, with the oscillator turned on, vary the condensers till the signal from the loudspeaker reaches maximum volume. At this point tighten the lock-nuts and reception will be much better. A slight error in one of the condenser units will cut the volume of the set tre-

mendously with a possibility of causing no reception.

If the oscillator is calibrated it may be used to check wavelengths and to calibrate receivers, which will enable the customer to find station frequencies more easily on the dial.

B eliminators are tested for shorted condensers by the following method.

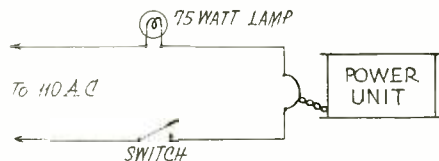

Fig. 7. Circuit for Testing Shorted Condensers and Transformers

Connect them to the power line in series with a 75 watt lamp, as shown in Fig. 7. If the lamp lights near its normal brilliancy there is a shorted condenser in the eliminator. By disconnecting the wires from the condenser bank, as shown in Fig. 8, the light will go out when the wire which is connected to the shorted condenser is re-



Fig. 8. Disconnecting Wires from Condenser Bank

moved. The condenser will have to be replaced.

Transformers are tested in the same circuit. A lamp of about the same wattage rating as the transformer under test, in the circuit will not light if the windings are O. K. If the lamp lights, part of the winding is shorted and repairs will have to be made.

IN testing the plate, grid and filament circuits of a-c sets the same procedure is followed, except that the filament is checked with an alternating current voltmeter.

Dynamic speaker rectifier units are tested by inserting an ammeter in series with the field coil. If the reading on the meter compares with the current rating on the speaker nameplate it is O. K. If it is too low in proportion to its rating it should be replaced. Speakers using low voltage rectification can be checked with an ammeter reading 0-2.5 amperes full scale and those using the higher voltages should be checked with a milliammeter reading 0-250 ma.

This covers about all of the general

testing, although the repair man will occasionally run up against odd jobs. The combination of the methods previously outlined will enable him to drive the trouble to a restricted area and with the individual testing of the components in that area he will soon have the set in repair.

A SIMPLE AUTOMATIC VOLUME CONTROL FOR REDUCING STATIC NOISES

By BORIS S. NAIMARK

VARIOUS systems for the automatic control of volume from a radio set have been found also to be effective in minimizing the annoyance of static crashes and bursts of sound when a fading station comes back. Such a control also reduces any other noise, like the howls from a radiating receiver, so that they are no louder than the incoming signal.

The basis of a simple and inexpensive volume control is a neon glow lamp,

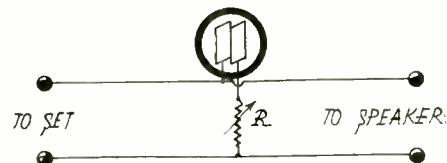

Fig. 1. Neon Tube Used as Static Minimizer

type T-14 rated at .1 watt and listed at 60 cents, and a variable resistor having a range of from about 10 to 10,000 ohms or more. This combination is connected across the leads from the receiver to the speaker as shown in Fig. 1.

The screw base should be cut from the lamp with a pair of tin snips so that the resistance compound within the base can be removed, care being taken not to break the delicate glass bulb or fragile lead-in wires. After soldering extension leads on to the lead-in wires and cutting off the bottom of the base which has been removed, this base is used as a mold for a new base made of melted paraffin, rosin or sealing wax, which will harden and protect the glass and lead-in wires.

The volume control on the set is adjusted so as to give the desired loudness of sound from the speaker and the variable resistor is adjusted so that the neon lamp does not glow at all or only at brief intervals. Any interference which has a greater intensity than that of the received signal will "spill" through the shunting neon tube.

Static is thus reduced to ineffective "plunks" and the howls of a regenerator to an inoffensive squeal. The neon lamp acts as a safety valve which does not permit the noise to rise above the sound level of the signal. The only indication of the presence of an excessive noise is the glow of the neon tube.

A MOBILE *Public Address* Plant

How an enterprising radio jobber is capitalizing public interest in a novel application of radio equipment.

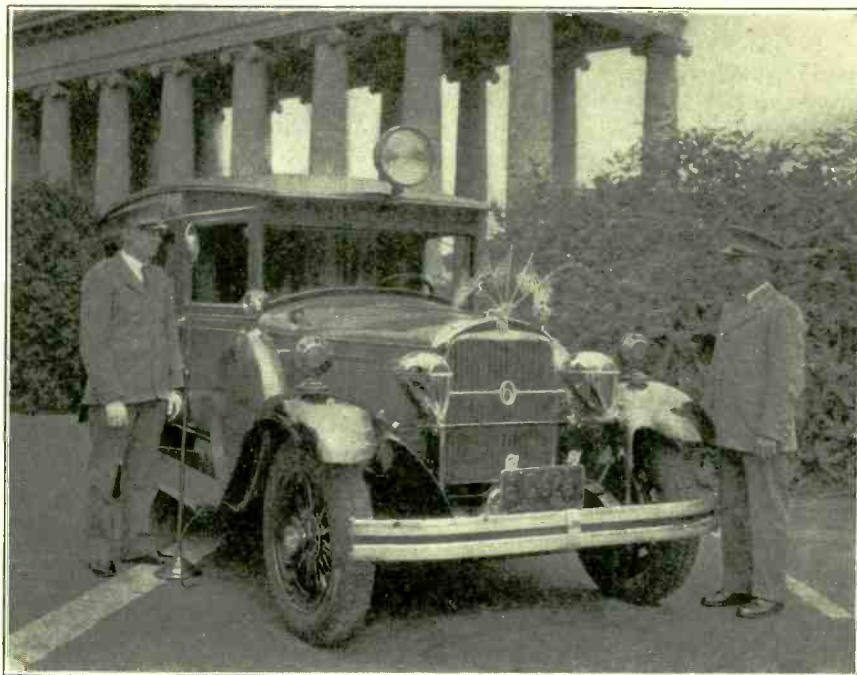

Automobile Which Carries Complete Public Address Equipment

Tis a far cry from the rig of the old-time itinerant patent medicine vendor, with his flaring gas lights and Indian assistant, to the scientifically designed and artistically constructed mobile public address plant here illustrated. Yet both represent an effective appeal to public attention. Furthermore, this outfit, as built by the Offen-

bach Electric Company of San Francisco, has many other novel uses such as assisting in the landing of airplanes after dark, fighting a fire, or entertaining an orphanage.

The equipment consists of a radio receiver, microphones, phonograph, and loudspeakers, together with a complete power plant and 500-watt floodlight, all

mounted in a custom-built automobile. Display signs may be placed in illuminated windows on each side of the body.

The power plant includes a 2 kw Kohler gasoline-driven electric generator and rotary converter which are mounted in the rear compartment. When the amplifier unit is turned on, the engine primes itself, kicks over, and



Amplifier in Forward Compartment

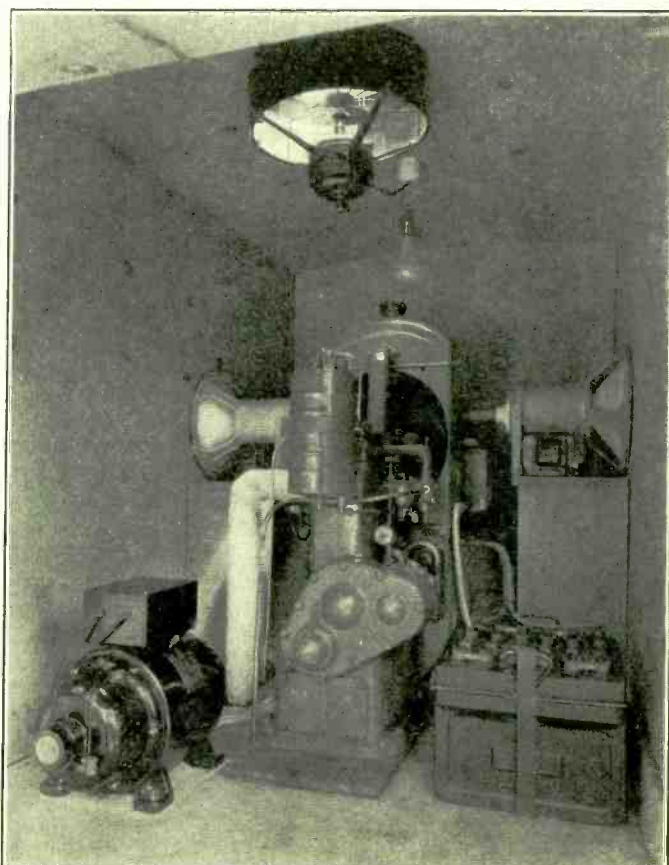

Power Plant in Rear Compartment

8,

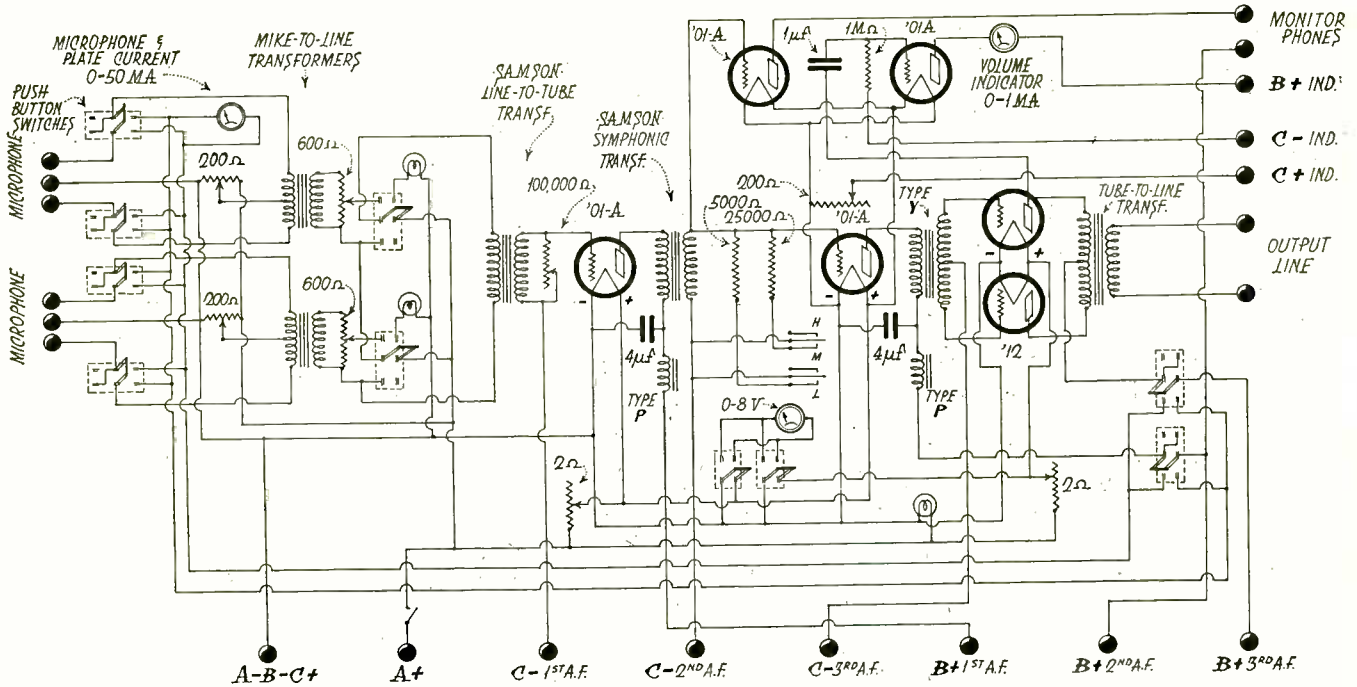

Fig. 1. Circuit Diagram of Mixer and Amplifier Unit

gets under way. The speed is automatically regulated, allowing no variation in the output voltage. Part of the 110 volt d-c output is used to operate the flood light, the window lights, the lights in the two compartments and the fans, the remainder being employed to turn over the rotary converter which supplies 110 volts a-c to the amplifiers, phonograph motor, radio receiver and the dynamic speakers. An Allis converter is used, having a capacity of 10 amperes at 110 volts a-c. An auxiliary terminal is provided so that if external a-c is available it will not be necessary to run the power plant. The compartment housing the power plant is thoroughly sound-proofed and insulated with Celotex, the sides and walls and bottom having a double layer. The Celotex is covered with a heavy velour.

The forward compartment, which is just to the rear of the driver's and technician's seat, houses the phonograph, a Bodine motor and turntable being used, a cabinet for records, the radio receiver and the amplifier rack with the complete amplifying equipment. This rack contains five shelves with three control panels. Samson amplifying equipment is used throughout, the bottom shelf holding a "MIK 1" microphone amplifier unit, the second a "PAM 5" two stage input amplifier and the top three holding three "PAM 25" single stage pushpull output amplifiers. The output of the six CeCo '50 tubes amounts to a total of 45 watts, enough to operate a battery of 6 Wright DeCoster electrodynamic speakers or 125 magnetic speakers.

The lower of the three control panels is the gain control and volume indicator panel. The meter on the left is the volume indicator; that on the right indicates the microphone current. There

are three control knobs, one for the microphone gain, one for the microphone current and the third for phonograph volume. The outstanding feature seems to be the simplicity of control.

The middle panel is the switchboard, and contains one row of toggle switches with their pilot lights and two rows of anti-capacity telephone switches. From left to right on the bottom row are: 1, the microphone amplifier a-c switch; 2 the PAM 5 switch; 3, 4, 5, the three PAM 25 switches; 6, the two side dynamics; 7, 8, 9, 10, controls for the external dynamics. An outlet box on the left side of the car houses four jacks for this purpose. The pilot light above each toggle switch is a 110 volt a-c globe, connected directly across the a-c input to the unit it serves. In order to eliminate inter-reflection each lamp has been enclosed in a bakelite tube.

In the second row of switches the three on the left connect the output of the PAM 5 to the input of the first, second and third PAM 25. The four on the right connect all speakers in parallel. The switch on the left extremity of the third row, when down, connects the phonograph to PAM 5. When up, it throws the output of MIK 1 into PAM 5. The output of the phonograph, of course, is not amplified before it goes into PAM 5. The second switch in this row connects the first microphone to the input of MIK 1.

Switch No. 3 on the left of the third row from the bottom connects the monitoring headphones to the output of MIK 1 when thrown in the up position. When thrown down it connects the monitor speaker to the output of PAM 5. The fourth switch from the left connects the second microphone to the input of MIK 1. Either microphone may be used or both may be used simul-

taneously. Switches 5, 6 and 7 connect various speakers in series so that by manipulating these and the four parallel switches below them, any series or parallel or series parallel combination of speakers desired may be obtained.

The top row of toggle switches controls the fans in the rear and forward compartments, the lamps in all sign windows and the compartment lights. Also the outside a-c, and three outside d-c connections. There are three meters in this panel, reading the a-c voltage, d-c voltage and total current drawn from the d-c supply.

The car is also supplied with a portable remote control amplifier, designed and built in the Offenbach shops. The circuit used in this mixer and amplifier is shown in Fig. 1. The output of this unit is fed into the microphone amplifier, MIK 1, in the main amplifier rack. The output of this rack is supplied to any or all of the Wright-DeCoster electrodynamic speakers carried. These may be used with extension leads up to a length of 1,000 feet so that if the car cannot be driven to the exact spot or if the entertainment is in an auditorium the equipment will still serve its purpose.

An interesting feature of this installation is that over 1200 feet of shielded Duplex No. 14 flexible wire are used in making the connections. Shielded wire was necessary in order to eliminate inter-circuit feedbacks.

Although the car has been completed but a short time it has been received by Mr. Offenbach's dealers and other concerns with more than anticipated enthusiasm. Both the city dealer and the dealer in outlying towns have found it to have great sales appeal, especially when they wish to stimulate the interest in a new model.

Trouble Shooting A Power Unit

Without Using a Cold Chisel and Blow Torch

By B. E. ESTES
Western College of Radio

How faults can be located by continuity tests with an ohmmeter; how to test and repair filter and bypass condensers, and how to take output readings.

FAULTS in *B* power units are ordinarily difficult to locate and repair because the complex wiring and parts are sealed in an insulating compound that can be removed only with the aid of a cold chisel and blow torch. Yet by means of the equipment here described it is possible to locate the exact position of the faults in the circuit without the necessity of opening the unit and to remedy the trouble without opening the entire unit, thus saving much time and expense in the diagnosis of the trouble.

The system consists essentially of a continuity test with a portable ohmmeter made from a milliammeter so as to have a range from 0 to 22,000 ohms. The ohmmeter may be mounted on a test panel which is equipped with meters for measuring the output of a power unit, the d-c voltage at the various taps, the a-c transformer voltages, and the capacities of the filter and bypass condensers. Or the ohmmeter may be mounted on a separate 7 by 6 in. panel. The procedure to be followed in making all of these tests is herein described in detail.

The ohmmeter not only indicates a

short or open, but gives direct readings so that the service man can tell whether he is reading a short through the 300 ohm resistance of a filter choke coil or the 3000 ohm resistance of some section of the voltage dividing system. A full description of its theory and calibration was given by Carl Joseph in the March, 1929, *RADIO* and will not be repeated here.

The instrument used in this particular case was constructed from a Jewell Pattern 54 0-20 milliammeter connected as in Fig. 1. A 22½ volt *C* battery with a 400 ohm rheostat in series with a 1000 ohm resistor is used to reduce the cur-

rent with the above voltage is from zero to 22,000 ohms. The test leads are about 18 in. long, one with a small battery clip and the other with an insulated screw driver, the blade of which has been ground to a sharp point so that it is possible to pierce the insulation of the wiring while making tests. An extra scale reading directly in ohms was pasted over the original scale of the meter. This scale is made from the meter's calibration curve by calculating the values in ohms for the different scale divisions of the milliammeter. After the calibration curve is finished, the new scale is calibrated in ohms, first in 2,000, then

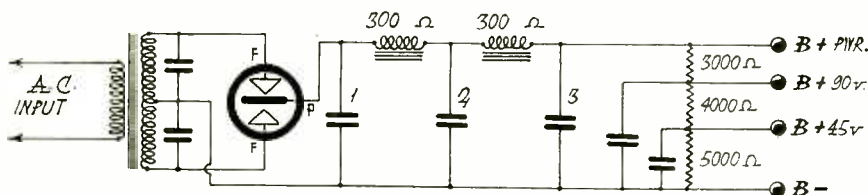
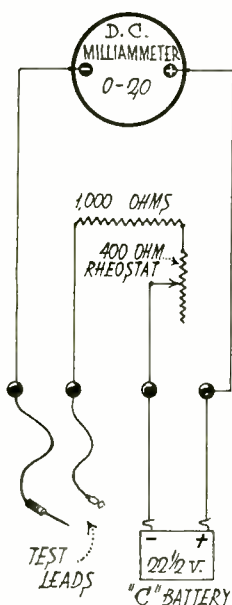

Fig. 2. Circuit of Typical Power Unit for Continuity Test

rent to 20 milliamperes. The 400 ohm rheostat allows the meter to be adjusted to full scale reading and compensates for any drop in voltage of the battery. The effective range of the ohm-

meter is from zero to 22,000 ohms. The test leads are about 18 in. long, one with a small battery clip and the other with an insulated screw driver, the blade of which has been ground to a sharp point so that it is possible to pierce the insulation of the wiring while making tests. An extra scale reading directly in ohms was pasted over the original scale of the meter. This scale is made from the meter's calibration curve by calculating the values in ohms for the different scale divisions of the milliammeter. After the calibration curve is finished, the new scale is calibrated in ohms, first in 2,000, then

OHMMETER CONNECTIONS



CALIBRATION CURVE

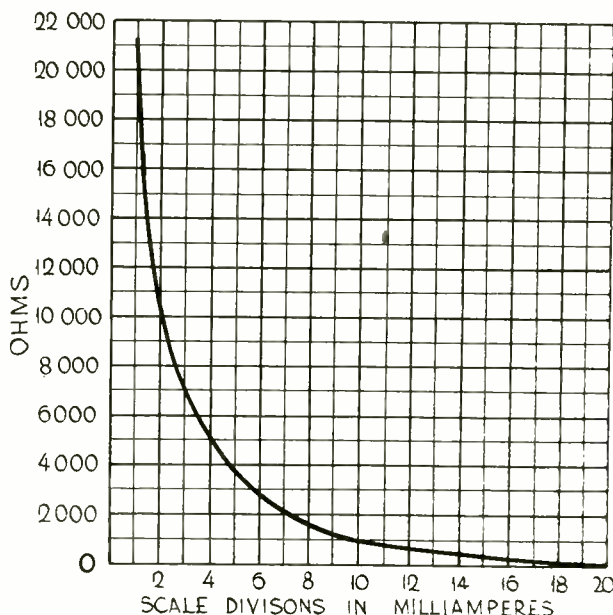

Fig. 1. Ohmmeter Connections and Calibration Curve

Continuity Tests

THE principle of these continuity tests can be understood by following the tests given in connection with the Raytheon *B* power unit shown in Fig. 2. After the circuit of a unit is thoroughly understood and a few tests have been made, the service man should be able to determine the fault in any unit within a few minute's time and without recourse to a continuity table.

The first step is to test the continuity of the voltage divider by clipping one lead of the ohmmeter to the *B* power terminal and testing to the *B* +90, +45 and *B* - terminals in turn by means of the test prod. The readings in ohms should be somewhere in the neighborhood of those shown in the diagram. In some units a loss resistor, such as is connected from *B* - to *B* 45 is not

used, in which case there will be no reading from *B* 45 to *B*—.

It will be noticed that the reading in ohms grows larger as the test prod is moved to the lower voltage taps. If the reading in ohms from the *B* power terminal to the *B* 45 or *B*— is less than that from *B* power to *B* 90, it is a sure indication of a shorted condenser somewhere in the circuit.

While the clip is still on *B* power, the test prod should be moved to the plate terminal of the rectifier tube socket so as to check the continuity of the filter choke coils. This reading will vary from 300 to 1000 ohms, depending upon the number of choke coils and their construction. Naturally, an open will show up as infinite resistance.

The clip is now moved to *B*— and tests made to *B* 45, *B* 90 and *B* power by means of the test prod. A reading of zero from *B*— to any of these terminals shows a shorted bypass condenser at that tap, or in the case of the *B* power tap, a shorted filter condenser. However, let us presume that when testing *B*— to *B* power we get a reading of approximately 300 ohms. That eliminates filter condenser No. 3, as it would indicate zero ohms if shorted, and as we have eliminated any possibility of the bypass condensers' being defective by our previous tests, the fault must be that either No. 2 or possibly No. 1 filter condenser is shorted and that the short is being read through the resistance of the filter choke coils. To check definitely, the test prod is moved to the plate terminal of the rectifier tube socket. If the ohmmeter now indicates zero ohms No. 1 condenser is shorted. If the reading were still around 300 ohms, No. 2 condenser would be the one that is shorted. Of course a choke coil which was shorted to the core might give a similar reading, but such trouble is very rare.

The next test is to check the buffer condensers connected across the high voltage secondaries of the power transformer. The clip is left connected to *B*— and the test prod is touched to one of the filament terminals of the rectifier tube socket. If the meter indicates infinite resistance, the secondary winding is open, if zero resistance the buffer condenser is shorted, and if in the neighborhood of 100 ohms, the circuit is correct, as the reading is through the resistance of the secondary winding. This test should be repeated by touching the test prod to the other filament terminal of the tube socket. The last test is the continuity of the primary winding of the power transformer, which can be made by testing across the lugs of the attachment plug on the cord of the *B* power unit.

After the fault has been located, the wiring to that particular part of the *B*

power unit can be traced and the trouble repaired without having to open up the entire unit or having to trace all of the wiring. When a filter or bypass condenser is shorted, it is quite often possible to cut the defective section loose from the circuit and to substitute sufficient capacity in the form of an external condenser, thus avoiding the discarding of the entire condenser block. This external condenser, if there is sufficient space, can be put inside the *B* power unit or can be left outside and the leads run to the correct point in the circuit.

If a number of *B* power units of similar design are to be tested a continuity chart can be made by taking from the manufacturers' service manual the value of the constants used in the unit and arranging them in a table of systematic tests such as outlined above. However, the most valuable asset in this work is the same as with any other part of the radio circuit, that is, a basic knowledge of the circuit used and of its constants.

Power Unit Test Panel

THE equipment for making the other tests on a plate supply unit includes three meters mounted on a test panel which is wired as shown in Fig. 3. A high resistance d-c voltmeter is connected to a four-point inductance switch

scale current of 6 ma, the resistance should be 50,000 ohms.

The milliammeter is a standard 0-300 ma instrument. It is connected in series with a compression type rheostat for measuring the current output of a power unit.

The a-c voltmeter has a range of 0-150, but may be used with multipliers to give maximum readings of 300 and 600 volts. On the fourth tap of the inductance switch the 150 volt scale is in series with the 110 volt a-c line so that the meter can be calibrated to read in mf when checking filter condensers.

The resistance used for the a-c voltmeter multiplier was a 25 watt Electrad Truvolt fixed resistor, which is provided with a sliding tap to adjust the value. The resistances required were 6100 ohms for the 300 volt scale and 18,300 ohms for the 600 volt scale. A 20,000 ohm resistor was used and taps placed at approximately 6000 and 18,000 ohms. Between each of these taps and the inductance switch is a 1,000 ohm resistor of the same type which is used to accurately adjust the meter to the correct scale reading. The scale is adjusted by first measuring the line voltage on the 150 volt scale. The switch is then set on the 300 volt scale and the resistor adjusted until the voltage indicated is exactly one-half of that

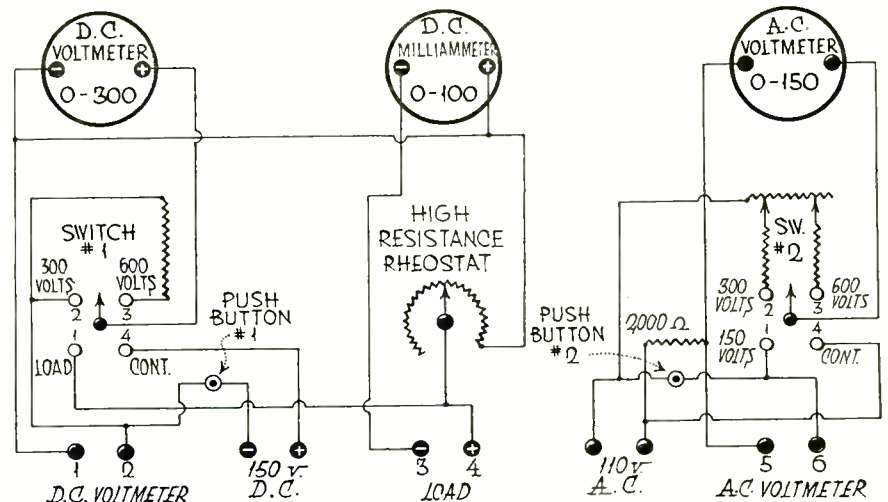

Fig. 3. Circuit Diagram of Test Panel for Power Units

so that it can be used as a voltmeter with a 300 or 600 volt scale, as a continuity tester for checking filter condensers, or to measure the voltage output of a unit under load. Heavy duty metallized resistors were used in making up the multiplier, their value being determined from $R = E \div I$, E being the desired voltage drop and I being the amount of current necessary to cause a full scale deflection of the voltmeter when it is connected in series with a low range milliammeter and a high voltage power unit whose voltage output can be controlled. For a voltage drop of $600 - 300 = 300$ and a full

indicated on the 150 volt scale. The switch is then set for the 600 volt scale and the resistance changed until the reading is one-quarter of that indicated on the 150 volt scale. The resistances of various a-c meters will vary, but the correct resistance for the multiplier can be found by taking the same value as the resistance of the meter for the 300 volt scale and three times the resistance of the meter for the 600 volt scale.

Output Tests

IN TESTING a *B* power unit for output, the *B*— and the *B* power terminals are connected to posts 3 and 4 (Continued on Page 72)

Get Onto Those Curves



A simplified explanation of how selectivity, sensitivity and fidelity curves are taken and what they tell about the performance of a receiver.



By P. S. LUCAS

AVOIDANCE of facts and figures which are presented in graphic form has become such a habit with the average radio man that he can dodge a set of curves just as quickly as Ty Cobb could steal a base. Curves, book-agents and charity solicitors are given the same welcome: "Back at midnight." The sad part of such side-stepping is that a curve, like Confucius' opinion of a good picture, will tell more in six square inches than will 10,000 words.

A curve is a path across a field of perpendicular lines. Any point on it intersects a horizontal and a vertical line, giving the value of the one with respect to the other. The curve itself tells nothing except the conditions under which the test was taken, e. g., the frequency. But it ties the horizontal and vertical scales together; points out an *unknown* place on one that corresponds to a *chosen* place on the other.

Of especial present interest are curves which tell about the performance of a factory-built radio receiver. RADIO has been publishing, and will continue to publish two or three sets of performance curves on as many different factory receivers each month. These curves are taken in RADIO's laboratory, under conditions that are alike for all sets. If they are filed by the dealer and service man they will increase in value, for by the end of a year the comparison to the ideal will be forgotten and a pretty fair average will have been established. Their greatest value lies in comparing them with each other and with the average; not with the ideal, for the latter is as far ahead of radio set design as it is ahead of automobile manufacture and cake-baking.

The practical value of performance curves for the dealer, salesman or service man is that they enable him to tell the inquirer just exactly what may be expected of that set in the way of selectivity, sensitivity and fidelity. Every experienced merchandiser knows that a reputation for accurate opinions will bring him more business than a dozen billboards and a silver balloon.

Selectivity Curves

THE selectivity curves in Fig. 1 were taken from a standard receiver which was set up in the laboratory and trimmed for satisfactory reception, just as if it were being installed in the home. Instead of connecting an aerial and ground, the output of a testing device was connected to its input. A vacuum tube voltmeter was connected to the output of the receiver and calibrated at one point to indicate 50 milliwatts (mw), and the receiver was tuned to 600 kc (500 meters). The oscillator in the test set, which was modulated to simulate the modern high class broadcast station, was adjusted to 600 kc also, and was set at 1 millivolt. Then the sensitivity control of the receiver was adjusted so that the output meter read the prescribed 50 mw, this being the standard established by the Radio Manufacturers' Association.

The frequency of the oscillator was then raised to 601 kc; the receiver being left untouched. Due to the fact that the two instruments were now out of tune, the output of the receiver dropped slightly. The input was increased until the output was back to 50 mw, a read-

ing of the input was taken and plotted on a line 1 kc to the left of the zero line.

Other points were taken at 2, 3, 5, 10, 15, 20, 25 and 30 kc above resonance then similar readings were taken below resonance. When points had been plotted up to 30 kc each side of the zero or resonance line with the receiver unchanged a line was drawn through the dots and the 600 kc curve in Fig. 1 took form.

The next step is to tune both the receiver and oscillator to 1,000 kc, set the sensitivity control of the receiver so that an input of 1 millivolt (mv) will produce an output of 50 milliwatts from the receiver and repeat the process of plotting. The curve for 1,400 kc is obtained in the same manner.

The 600 kc selectivity curve shows how much greater must be the field strength of an interfering station at some frequency off resonance to cause interference with the selected signal; or how much interference it will cause at any frequency off resonance. Suppose the interfering station is in the adjacent channel, 610 kc. Here the curve crosses the 10 kc positive line, i. e., 610 kc, on the horizontal line marked 36 mv, which means that the interfering station on 610 kc must have a field strength of 36 millivolts to cause 100 per cent interference, or to be heard with the same volume as the 600 kc station. Following the curve out still farther it will be noted that a station on 620 kc will require 270 millivolts field strength, or 270 times as much as is required by the chosen station.

This selectivity curve is unusually good; in fact it may be considered *too* good for reasons which will be taken up in their turn. The 1400 kc curve shows that the receiver is less sensitive and much broader at the higher frequencies. It will be noted that the curve passes the positive 10 kc line (1,410 kc) at 1.6 mv, meaning that when the receiver was tuned to 1,400 kc an interfering station on 1,140 kc would need a field strength of 1.6 millivolts to do the work that the 1,400 kc station could do with 1

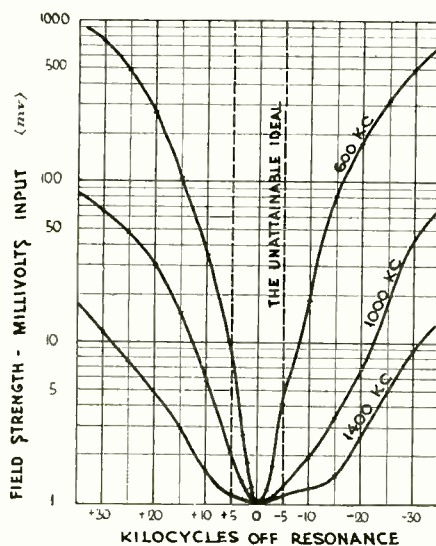

Fig. 1. Selectivity Curves Taken on a Standard Receiver at 600, 1,000 and 1,400 kc.

millivolt. The curve crosses the 20 kc line at 5.1 millivolts, so that the 1,420 kc interfering station would have to be five times as strong as the 1,400 kc station in order to have the same volume. A study of the 1,000 kc curve shows that it is intermediate between the 600 and 1,400 kc curves in broadness.

To give faithful reproduction of voice and music, radio apparatus should be able to pass with equal strength all frequencies between the lowest note of a sousaphone and the highest harmonic necessary to make up a full musical tone. Few broadcast stations are able to transmit frequencies much below 100 cycles per second, the notes we seem to hear below that figure being harmonics of the actual notes played by the bass instruments. Their upper limit is 5,000 cycles, being determined by the limitations of available broadcast equipment, receiving equipment, the absence of any real need for higher frequencies, and by legislation. Legislation has its say because the higher the audio frequencies the wider the required channel in the broadcast spectrum. That is to say if a carrier signal is modulated with a note of 5,000 cycles per second it will require a frequency band 10 kc wide; 5,000 cycles on each side of the carrier. To receive this signal the ideal receiver would amplify with equal gain all signals up to 5 kc each side of the zero line, cutting off abruptly at these points as shown by the dotted curve in Fig. 1. This is the ideal selectivity curve which may be considered the star to which the horse is hitched. It will never be attained, for it is perfection, and perfection in this old world is limited to advertising phrases.

A look at this ideal curve and another at the 600 kc curve in Fig. 1 make it clear what was meant by the inference that the latter was too sharp. This 600 kc curve intersects the positive 5 kc line at the 8.3 millivolt line, showing that 8.3 times as much voltage is required to reproduce a 5,000 cycle note as powerful as a 100 cycle note. In other words the high frequencies are reduced to one-eighth the voltage of the lows. This is called side-band cutting and is the result of carrying the quest for selectivity too far.

Sensitivity Curves

THE standard of sensitivity, as defined by the Institute of Radio Engineers and chosen by the Radio Manufacturers' Association, is the number of microvolts per meter ($\mu\text{V}/\text{m}$) required at the input of a receiver to produce an output of 50 milliwatts. The number of microvolts per meter means the field strength of the broadcast station at any particular location divided by the number of meters in the

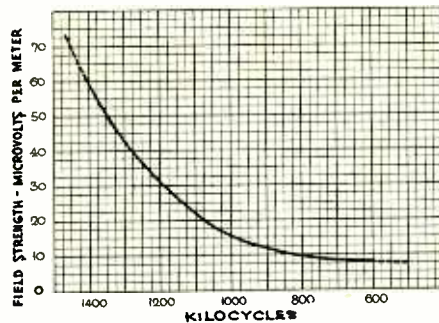

Fig. 2. Sensitivity Curve of the Same Receiver

height of the receiving antenna. To test for sensitivity, the receiver is set up with the same equipment and in the same manner as it was for the selectivity measurements, except for the fact that the sensitivity control was set at maximum. This measuring apparatus, which was described in the September issue of RADIO, contains a dummy antenna the characteristics of which are the same as an ordinary antenna 4 meters (13 feet) in height. Therefore all field strength measurements must be divided by 4.

In this case the receiver under test required a total field strength of 240 microvolts to produce the 50 mw output at 1,400 kc. Divided by 4 the sensitivity at this frequency is found to be 60 microvolts per meter ($\mu\text{V}/\text{m}$) and is plotted on the sensitivity curve in Fig. 2 where the 1,400 kc line intersects the 60 $\mu\text{V}/\text{m}$ line. Other points were made at each 100 kc and the curve was drawn.

To read the sensitivity curve is merely a matter of following the path of the curve to the desired vertical frequency line, then of following the intersected horizontal line to the left and reading the figure opposite it. The sensitivity curve of the ideal receiver will be almost horizontal, indicating that the sensitivity varies but slightly from one end of the dial to the other. The lower the values in the curve the greater is the sensitivity. Receivers have been built with 2 or 3 microvolts per meter sensitivity, although this degree of ex-

cellence has seldom if ever been attainable on a production basis. In truth, when reception is carried down below the 250 microvolt per meter level (depending upon the time and place), it is well down in the so-called "noise level," where static and kindred noises are present with greater field strength than the broadcast signal.

Fidelity Curves

FIDELITY curves are measured in audio frequency (cycles per second of the musical tone) and decibels (the unit of gain or loss). Because decibels are tainted with an odor of higher education is no reason why an ordinary human should be alarmed, for the use to which they will be put in this work is very simple and concrete.

A decibel (db) represents the minimum difference that the human ear can detect between two sounds. As an illustration, average conversation has 10,000 times the energy of the faintest audible sound, yet to the ear it is only 40 sound units louder. This conversation then indicates a gain or increase over the faint sound of 40 db. If an airplane motor, the purr of which is just perceptible to a distant listener, the sound energy is 1,000,000,000 times greater, yet to the person in the plane it sounds merely 100 sound units louder than to the distant listener. The gain is 100 db.

To be able to understand the fidelity curve it is not necessary to be able to work problems in logarithms. Suffice it to say that a decrease of 10 db between middle C and any other note does not make a great difference in the quality of tone reproduction. A loss of 20 db is more serious, while a 30 db loss indicates that the frequencies so reduced are pretty much out of the picture. The 1,000 kc curve in Fig. 3 is a sample of a fair fidelity curve. In this case the bass was slightly emphasized with respect to the middle frequencies and the high notes begin to drop off at about 1,000 cycles. At

(Continued on Page 74)

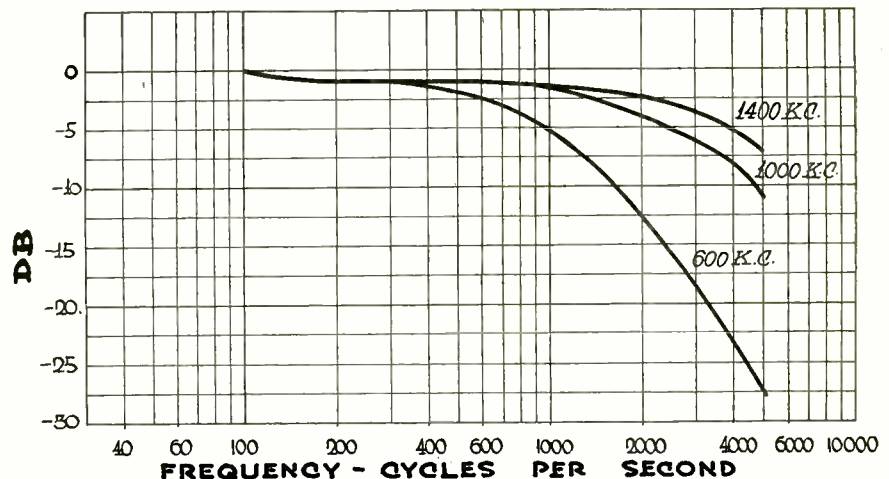

Fig. 3. Fidelity Curves on 600, 1000 and 1400 kc.

Translating Engineer *Language* Into *Customer* *Conversation*

How to tell a prospective buyer why
and to what degree a receiver is better
or worse than the average set.

By ARTHUR HOBART

STRANGE and terrifying indeed is the language whereby some radio men conceal their knowledge or their ignorance, as the case may be. Weird and baffling is it to the radio salesman who is trying to explain the merits of a receiver as indicated in its performance curves. Vainly does he consult a list of definitions, for not only does he find that the subject changes so often that it holds no interest nor sequence of thought, but also is expressed in words which themselves require a definition.

Yet it is possible to arrange and explain even such a formidable document as the I. R. E. "Definition of Terms Used in Radio Engineering," so that a salesman can readily learn to use them glibly and even translate them into a language which the customer in the store can understand.

For instance, start with the definition of a *cycle* as "one complete set of the recurrent values of a periodic phenomenon." Don't be discouraged by the big words, for a "periodic phenomenon" is only another name for the common house variety of alternating current (a-c) wherein the voltage rises from zero to a maximum positive value, then falls back to zero and continues to a maximum negative value. "Recurrent" isn't

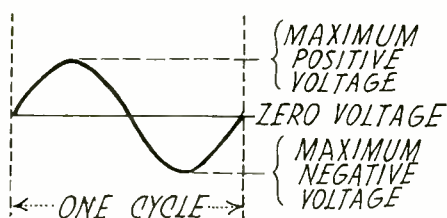

a new kind of electric current but means repeated. When a current is said to have a certain number of cycles, it means the number of "recurrent" cycles per second, this action repeating itself over and over again. Thus a 60-cycle current, such as is used for electric lighting, has 60 complete cycles per second.

But radio deals with electric currents which have thousands and millions of cycles per second. To avoid these unwieldy figures they are called *kilocycles* (kc) and *megacycles* (mc) respectively, *kilo* meaning 1000 and *mega* 1,000,000. Thus a kilocycle is a thousand cycles per second and a megacycle a million cycles per second.

AFTER studying this article a salesman should be able to explain to a customer what is meant when a typical modern receiver is said to have a selectivity sufficient to reduce an interfering signal on a channel adjacent to a desired signal of the same strength by 30 db., a sensitivity of 20 to 50 microvolts, and uniform fidelity from 50 to 4000 cycles.

The *frequency* of a current is "the number of cycles per second." Audible, or audio frequencies (a-f) lie between 16 and 15,000 cycles per second, this being the extreme response range of the normal human ear.

Radio frequencies (r-f) include all of the frequencies which are used for the transmission of radio signals through space. This range of frequencies is a continuous band from 10 to 60,000 kilocycles per second.

A *wavelength* is "the distance traveled

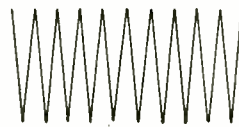

A CONTINUOUS WAVE



A DAMPED WAVE

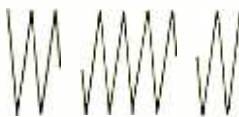

AN INTERRUPTED CONTINUOUS WAVE



A MODULATED WAVE

in one period or cycle by a periodic disturbance." This distance is usually measured in meters (1 meter=39.37 inches). As it is commonly used only in connection with radio frequencies which all travel at a speed of approximately 300,000,000 meters per second, and as it has introduced considerable confusion in the minds of radio listeners, this expression is gradually being replaced by its equivalent in kilocycles or megacycles.

Continuous waves (cw) are "alternating electric waves in space of constant amplitude and frequency," such as are emitted from a vacuum tube or arc transmitter. *Damped waves* are "electromagnetic waves proceeding in wave trains in each of which the amplitude of successive cycles progressively diminish," such as are transmitted from a spark.

Interrupted continuous waves (icw) are "waves obtained by interruption at audio frequency in a periodic manner of an otherwise continuous wave," this being accomplished with a chopper.

A *signal* is "the intelligence, message or effect conveyed in transmission." A signal wave is "a wave, the form of which conveys a signal." *Modulated waves* are "continuous waves of which the amplitude or frequency is repeatedly varied in accordance with a signal wave." *Key-modulated waves* are "continuous waves of which the amplitude or frequency is varied by the operation of a transmitting key in accordance with the characters of a communicating code."

The dots and dashes of the International Morse code are transmitted by damped waves, interrupted continuous waves, or key-modulated waves. Voice and music are transmitted as modulated waves whose modulations are produced by an audio frequency amplifier. "The component of a modulated wave which has the same frequency as the original unmodulated wave," i. e., a continuous wave is known as the *carrier wave*. The *carrier current* is "an alternating current which is modulated by a signal." The *carrier frequency* is "the frequency of a carrier wave or a carrier current."

Sidebands are "the bands of frequencies, one on either side of the carrier frequency, produced by the process of modulation." This is the method of transmission ordinarily used by broad-

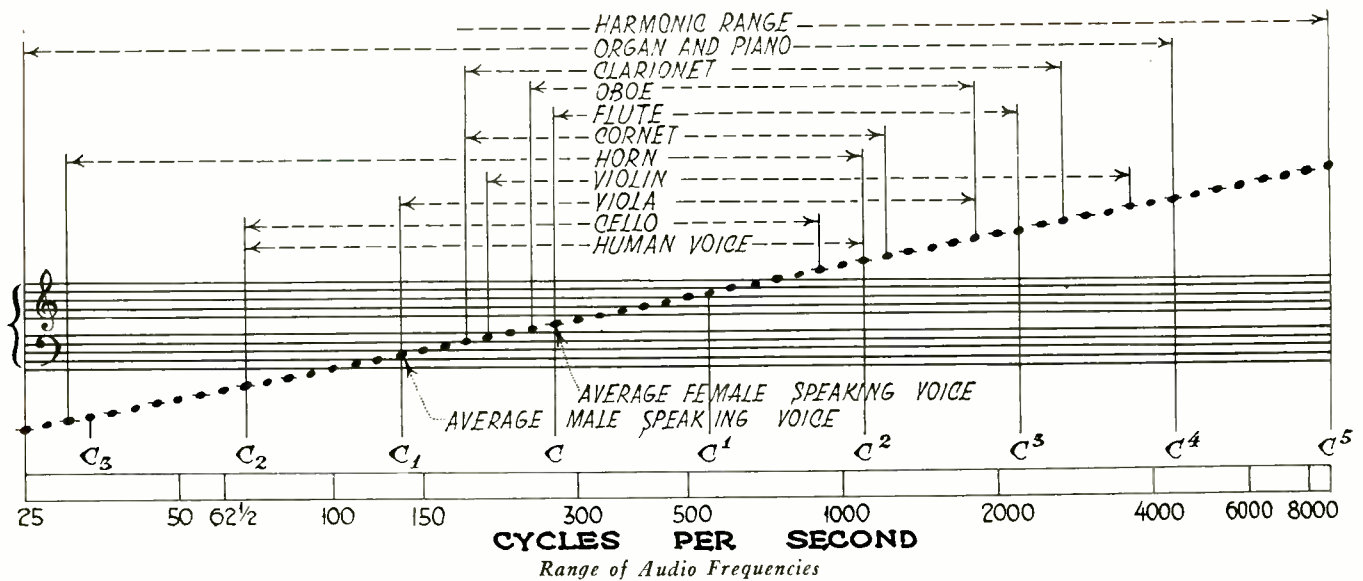

cast stations. Only one sideband is received, except in the older types of superheterodyne receivers where one station may be heard on two settings of the oscillator dial.

Single-side-band transmission is "that method of operation in which one side band is transmitted, and the other side band is suppressed. The carrier wave may either be transmitted or suppressed." In the case of *carrier suppression* the carrier frequency is supplied at the receiver. This method is used in transatlantic telephony.

A *radio receiver* is "a device for converting radio waves into perceptible signals." *Tuning* is "the adjustment of a circuit or system to secure optimum value of a desired current; commonly, the adjustment of a circuit or circuits to resonance," or condition of minimum opposition to the flow of the current of the desired frequency.

It is necessary to have a working knowledge of most of the foregoing definitions before trying to understand the three criteria of a radio receiver: selectivity, sensitivity and fidelity which are, respectively, the measure of a receiver's ability to cut out interference, to receive weak signals, and to give natural reproduction of speech and music. The explanation of the definitions as here given supplements a more detailed study of curves by P. S. Lucas in this issue.

SELECTIVITY is defined as "the degree to which a radio receiver is capable of differentiating between signals of different carrier frequencies." This is determined by tuning the radio receiver to carrier frequencies of 600, 1000 and 1400 kilocycles in succession and measuring the field intensity necessary to give .05 watt output for various carrier frequencies on each side of resonance. These values are plotted on a graph which shows the signal in-

tensity required to produce the standard output at each frequency.

A receiver is considered to be tolerably selective if the output power of the desired signal is 1,000 times greater than the output power from an unwanted signal of the same field intensity in an adjacent channel. As power varies with the square of the voltage, this means that an interfering signal 10 kc from resonance must have a field strength 31.6 times that of the resonant signal in order to produce the same volume of sound. ($\sqrt{1,000} = 31.6$). So if an examination of a selectivity curve shows that the line of the curve crosses the + or - 10 kc line at a point less than 31.6 times the ratio of the field intensity of the interfering signal to that of the resonant signal, it is better than tolerably selective.

While this "tolerance" is actually measured in terms of input field intensity or output power it is really determined in practice by the relative loudness of the two signals. But until recently there has been no generally accepted scale of loudness. Radio opera-

tors use a five-unit scale to express the strength of code signals where (1) is hardly perceptible, (2) is weak, (3) is fairly good, (4) is good, and (5) is very good, perfectly readable. Telephone engineers have adopted a more scientific scale which takes into consideration not only the electric field strength of the signal but also the response of the human ear.

The unit of the engineer's scale of loudness is called a decibel, just as the unit of the temperature scale is called a degree. Of the several thermometer scales which are in common use, the best is the Centigrade whose zero is the freezing point of water and whose 100 is the boiling point of water. In the old Fahrenheit scale the freezing point is 32 degrees and the boiling point 212 degrees. Naturally there are temperatures above and below zero in both scales.

In the loudness or decibel scale the zero point is a sound which is barely audible, just on the threshold of audibility, and the 100 decibel point marks the maximum sound intensity to which the ear can respond, the point where the human sense of sound passes to the sense of feeling. Between these two extremes it is found that the intensity of an average whisper is about 20 decibels, of quiet conversation about 40 decibels, of noise on a busy street about 60 decibels, and of the noise in an airplane about 95 decibels.

While all this is interesting, it becomes useful only when measurable in terms of the energy which produces the sound. So the engineers measure the amounts of power required to produce two different intensities of sound, find the logarithm of the ratio between them, multiply it by 10, and call the numerical result the number of decibels between the two sounds.

Although the decibel is thus seen to be an arbitrary unit, it fits very well

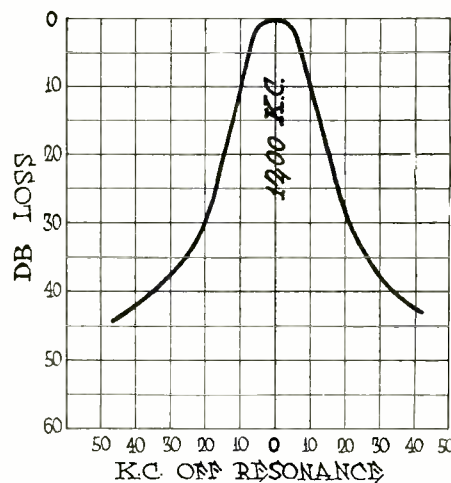

Typical Selectivity Curve in Terms of DB Loss.

into the scheme of natural things, since the ear hears logarithmically. A noise which sounds 20 decibels louder than another noise requires 100 times the energy to produce it. (Logarithm $100 = 2; 10 \times 2 = 20$.) A sound which is 30 decibels louder than another requires 1,000 times the energy. (Logarithm $1000 = 3; 10 \times 3 = 30$.)

Consequently, when a radio receiver is said to be tolerably selective if a signal of 10 kc off resonance requires 1,000 times the output power of a signal at resonance to be heard with the same volume of sound, there is a difference of 30 decibels between the two signals. But as it is customary to measure the input intensity of signals re-

quired to produce a standard power output and as signal intensities are measured in microvolts it is also necessary to express decibels in terms of voltage ratios instead of power ratios. As power varies as the square of the voltage, the voltage ratio is equal to the square root of the power ratio. So a voltage ratio of 31.6 also produces a difference of 30 decibels.

The relationship between decibels, power ratios and voltage ratios is graphically shown in the accompanying chart. The number of decibels from 0 to 20 corresponding to power ratios from 0-100 are shown by the slanting line and scale at the left of the chart. The number of decibels from 20 to 40

corresponding to power ratios from 100 to 10,000 are shown by the slanting line and scale at the right of the chart. The number of decibels from 0 to 40 corresponding to voltage ratios from 0 to 100 are shown by the central slanting line and the scale at the left. This chart is reversible so that it is also possible to find either the power ratio or the voltage ratio corresponding to a given number of decibels.

Most sets are inherently less selective at the high frequency end of the broadcast band than at the low frequency end. The sets tune more broadly on the short waves than on the long waves. In some of the later models the selectivity is more nearly equalized throughout the entire band.

SENSITIVITY is "the degree to which a radio receiver responds to signals of the frequency to which it is tuned." The passage of a radio wave across an antenna produces an electric field which is measured in microvolts per meter of antenna length. The sensitivity of a receiver is expressed in terms of the number of microvolts per meter required to produce a standard audio frequency power output of .05 watt under certain specified conditions. The lower the value of the field intensity required to produce the standard output, the more sensitive is the receiver. The average medium priced receiver requires a field intensity of from 20 to 50 microvolts per meter to give this standard output. In other words, it is said to have a sensitivity of from 20 to 50 microvolts.

All sets are more sensitive at high frequencies than at low unless special compensating means are adopted. Certain sets are at least fifteen times as sensitive at 1,500 kc as at 550 kc. In the better types of the more modern receivers the variation in overall sensitivity is less than three to one.

Since the general public is now more interested in good reception of local programs than in fishing for distant stations, the general tendency of manufacturers is to make receivers which have fidelity and distortionless volume rather than extreme sensitivity.

FIDELITY is "the degree to which a system, or a portion of a system, accurately reproduces at its output the signal which is impressed upon it." It represents the accuracy of tone reproduction. It is determined by tuning the receiver to each standard carrier frequency in succession, with the receiver in the same condition as in the sensitivity and selectivity tests and with constant standard radio field intensity, and then varying the modulation frequency from 40 to 10,000 cycles per second, taking measurements of relative output voltage at convenient modula-

(Continued on Page 72)

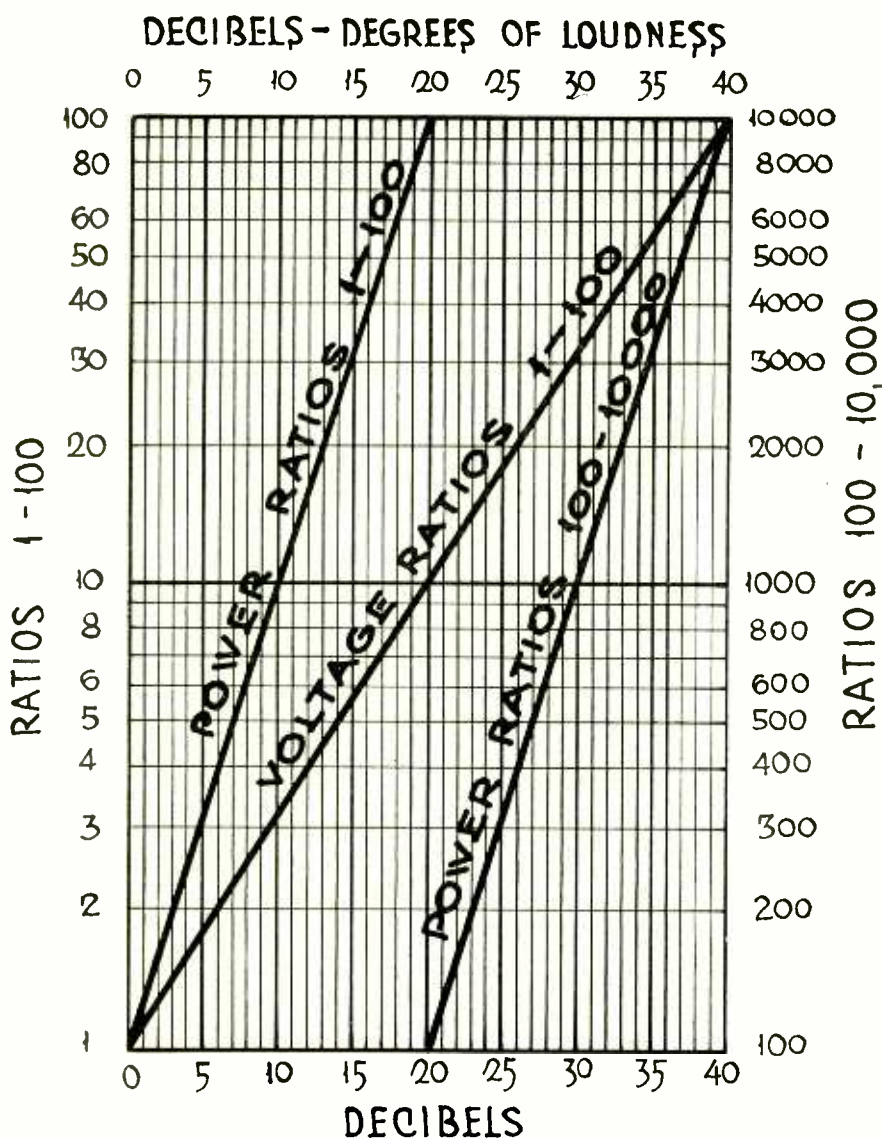

Chart for Converting Decibels to Ratios of Either Power or Voltage, and Conversely

Power ratios from 1:1 to 100:1 on left hand scale correspond to from 0 to 20 decibels; those from 100:1 to 10,000:1 on right hand scale correspond to from 20 to 40 decibels. To extend scales add 10 decibels each time that power ratio is multiplied by 10. Thus for a power ratio of 2:1 there are 3 decibels; of 20:1 there are 13 decibels; of 200:1 there are 23 decibels; of 2,000:1 there are 33 decibels; of 20,000:1 there are 43 decibels, etc.

Voltage ratios from 1:1 to 100:1 on left hand scale correspond to from 0 to 40 decibels; those from 100:1 to 10,000:1 on right hand scale correspond to from 40 to 80 decibels, that is, 20 decibels are added to the scale showing. To extend scales add 20 decibels each time that voltage ratio is multiplied by 10. Thus for a voltage ratio of 2:1 there are 6 decibels; of 20:1 there are 26 decibels; of 200:1 there are 46 decibels; of 2,000:1 there are 66 decibels.

Ability to Service *Electric Phonographs*

Opens Another Avenue for Profit

By CLINTON OSBORNE

THE alert radio fixer will not be insulted if a stupid owner of a phone-radio combination expects him to repair his or her phonograph motor or pickup as well as to replace the tubes. For, by being able to cope with such a situation, he will recognize an opportunity to expand his business without shifting from his beaten path. The results of a wider knowledge will be measured not only in dollars but in an increased prestige, with the accompanying expansion of his business.

The phonograph motor is a tricky little thing when it "goes democratic." However, in the great majority of cases it is merely in need of a cleaning and greasing job, which should always be the first treatment it should get. If the motor is stalled completely try twisting the shaft with the fingers. It should turn freely with a little pressure, its failure to do so indicating that the shaft is binding in the bearings or that something is blocking the movement of the armature. If the movement is free check for an open in the field of the motor or in the wiring circuit with the continuity tester.

If the torque is low; that is, if the motor does not pick up speed within two or three revolutions of the turntable, it is due either to excessive friction in the motor shaft or in the governor, or to shorted windings. Excessive friction in the motor shaft is usually caused by foreign particles in the bearing or by insufficient end play. In most cases it is impossible for the service man to get to the bearing so he should send the motor back to the factory. If the

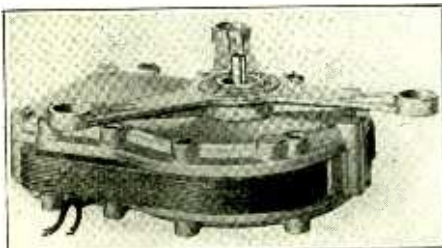

The Allen-Hough "Rotor," a synchronous motor without adjustments, advertised to revolve at 80 r. p. m. regardless of voltage fluctuation. It starts and stops with a push of the finger, no switch being provided.



The Gordon Induction Motor, which is suspended in sponge rubber. The guard around the governor is removable. The driving gear is at end of the motor opposite the governor.

armature is binding due to insufficient end play, which in ordinary circumstances should be about 1-32 inch, there is usually a thrust bearing adjusting screw held in place at the end of the shaft by means of a lock nut. This may be loosened just enough to allow more freedom to the armature with the subsequent higher torque. If the friction is located in the governor chamber, release the adjusting screw which holds the torque spring against the end of the shaft.

Shorts may occur in the field windings, the armature windings, or between commutator segments. To remedy the last mentioned, it is merely necessary to clear all conducting particles from between the segments and polish the commutator with very fine garnet paper or sand paper. The age-old caution against the use of emery cloth is hardly necessary as it is almost universal knowledge that emery is a conductor. A resistance test is necessary to locate the shorted field or armature winding, which emphasizes the fact that it is well to build a direct reading ohm-

FOR WHAT WOULD YOU LOOK:

- If a motor were stalled?
- If the *torque* were low?
- If the turntable were "hot"?
- If the speed were irregular?
- If the motor were noisy?
- If it should cause radio interference?
- If the volume should waver with each revolution?
- If needle scratch predominates?

meter into the testing equipment. If one of the field or armature coils indicates a lower resistance than the others it can be considered shorted and should be removed and replaced with a new one. A loud, uneven hum usually accompanies a shorted winding. When replacing field coils care should be taken first, that the new coil is identical to the old one (some motors have two different kinds of field coils), and second, that when the motor is reassembled the air gap is uniform on all sides of the armature.

If it is possible to receive a shock from the turntable or pickup check for grounded windings or a defective filter circuit. A 110 volt light with a pair of wires from the socket may be used for this test. A grounded armature will necessitate replacement. A ground in the brush box may be eliminated by a cleaning job, while a field coil may be insulated from the ground by the insertion of a piece of empire cloth or other insulation.

Fluctuations in motor speed are often due to improper operation of the governor. This is ordinarily equipped with a torque spring which is supposed to compensate for line voltage variations. The screw holding the torque spring should be backed out as far as possible and adjusted with the turntable in operation and the pickup in place on the record. If stability is not achieved with this adjustment the screws holding the governor housing may be loosened slightly to see if the trouble is caused by distortion of the governor housing due to faulty machining. If this proves to be the case the motor

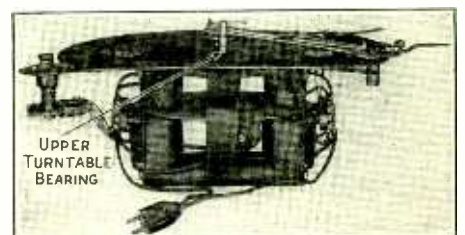

The Panatrope motor is of the induction disc type, having a closed core electromagnet or field coil on each side as shown. The governor is equipped with a bearing on each end.

should be returned to the factory for repairs. If the fluctuations in speed are incident to each revolution and they cannot be traced to the governor, check for opens in the armature with the continuity tester.

THERE are several causes for motor noise, the most frequent of which may usually be traced to a rattling governor. To stop this trouble put a little grease on the governor driving gear and worm and drop a little light oil on the felt brake shoe. If this is not effective try adjusting the torque spring. If the governor shaft is loose in its bearings it will be necessary to replace the governor assembly with a new one. An uneven hum through the cabinet or through the magnetic pickup may be caused by a turntable which doesn't run true. It is possible that turning the turntable to a different position on the shaft will correct this; although a replacement might be necessary. Be certain that there is no perceptible play in the bearing when the shaft is pressed from side to side with the fingers, as loose bearings will also cause a hum of this kind. Sometimes an eccentric air gap between armature and field will cause an uneven hum, and may be remedied by shifting the armature within the field, measuring the gap with a feeler gauge if one is obtainable.

As everyone familiar with electric motors knows, the usual causes of excessive sparking at the commutator are open armature coils, rough commutators and poorly seated or worn brushes. If the brushes are badly worn they should be changed; if not they may be resealed or tightened with a new set of springs. When installing a new set of brushes be sure that they are properly and thoroughly seated and that they have free movement in the brush boxes. It may be necessary to trim down the sides with a knife or file.

Most motors in phono-radio combinations are equipped with filters for suppressing radiation of spark discharge which is liable to be picked up by the radio set. This usually consists of a fixed condenser and a resistance of about 10,000 ohms. The condenser is connected between the power supply and the frame of the motor and the re-

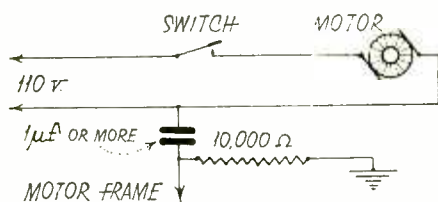
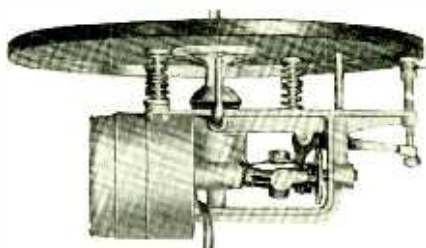

Fig. 1. Filter to Eliminate Sparking Interference in Radio Set

sistance between the motor frame and ground as shown in the drawing. The condenser is designed to absorb spark discharges from the commutator and



The Pacent, a single phase induction motor, having no brushes, commutator or armature windings; normal speed 1326 r. p. m. which is dropped to 78 by means of reduction gears.

may be of any handy size from 1 μ f up. The resistor is so placed to prevent the possibility of shocks from the turntable. It would be well to equip all motors with such a filter if not already equipped, and one should be carried by every service man in order that a demonstration might be given.

WITH the motor now operating in good shape listen carefully to the speaker to see if the pickup is working efficiently. If the music has the effect of an audible revolution counter, more business. The first thought that comes to mind is that the turntable is lifting and dropping with each revolution, and a look at it usually verifies this theory. However, many turn-

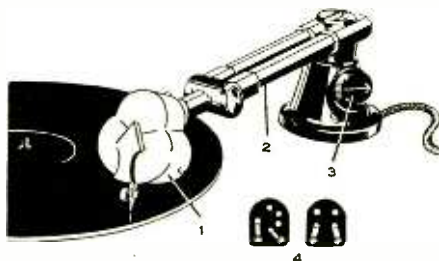

The Toman pickup is a new one on the market. It is equipped with two adapters for insertion into the detector socket. The volume control is mounted in the base.

tables do not run perfectly level, but rely upon the ease and freedom of movement of the pickup to offset this fault. If the volume drops with the low side of the turntable and raises when the high side passes under the needle the cause may usually be traced to one of three things.

First, the pressure of the needle on the record is not correct. It should be from 5 to 7 oz., depending upon the type of record played, and may be measured by a small letter scale, the tray of which is held at the level of the turntable. If this is found to be the case see that the bearings are free and well oiled. If there is a counterweight on the pickup readjust it for proper pressure. It may be that the cord inside the arm is too tight and binding the up and down movement of the arm.

Second, the armature, or small iron strip which vibrates between the two pole pieces of the pickup magnet may be jammed over against one pole. There are usually a couple of screws which

will release it if this is the case, and the adjustment of these will put the armature back in its place. It might be said that this is the most frequent cause of pickup trouble, and one which very few owners will be able to detect.

Third, the movement of the armature may be sluggish. If so, trace it down to the rubber buffer which protects the needle holder from the metal framework. If this has lost its elasticity it should be replaced with a similar piece of soft rubber.

A typical electromagnetic pickup consists of a U-shaped permanent magnet with soft iron pole pieces between which is centered a soft iron armature in which a phonograph needle is fitted. The armature is surrounded with a coil of fine copper wire in which electric oscillations are generated when the coil is moved by the needle so that it cuts the magnetic field between the pole pieces. These oscillations are amplified by vacuum tubes so as to give sufficient power to actuate a loudspeaker. The volume is varied by a variable resistance, which is shunted across the terminals of the moveable coil.

If the owner complains of excessive needle scratch look to the position of the pickup base. The arm should be at a tangent with the groove at the point the needle touches it. This, of course, is not possible for both the inside and outside grooves so a happy medium should be chosen. Care should also be taken to see that the axis of the needle, looking along the pickup arm, is perpendicular, for if it is tilted slightly to one side it will not only result in needle scratch but will wear down the lateral vibrations which have been cut into the grooves. The angle of the needle, looking at it from the side, should be about 60 degrees; otherwise it will cut deeply into the groove and the thicker shoulder will rub the sides of the groove. Try to impress the owner with the fact that a needle should be used but once.

If records are in such a condition that needle scratch is persistent, connect a filter across it as shown in the diagram. A choke of about 200 mh inductance having a little iron in its field and a .008 μ f condenser will have a broad filtering effect on frequencies

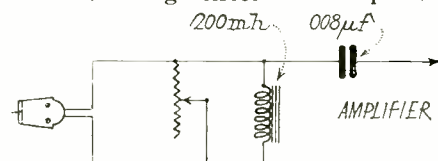

Fig. 2. Scratch Filter Designed to Cut Frequencies Above 5000 Cycles

above 5000 cycles. As the greater part of the needle scratch occurs at these high frequencies and as the musical tones above this figure will not be missed, this filter should be very effective.

Television In Natural Colors

A description and explanation of experiments in the Bell Laboratories which forecast the eventual accomplishment of this feat in practice.

By JOHN P. ARNOLD



Subject in Transmitting "Cage"

THE reproduction of television images at a receiving station in the natural colors of the original scene has been recently demonstrated in the laboratory. Strange as it may seem, this was accomplished without great difficulty and with only a few additions to apparatus originally employed for monochromatic television.

The method of effecting color television is readily understood by one who has some knowledge of the process of three-color printing, where the first step is to make three identical photographs of an object, each photograph having been taken through glass or gelatin light-filters which are stained to correspond with the three primary colors, blue-violet, green, and red. From the photographic negatives thus obtained three halftone plates are prepared. The printing inks then used are the complementary colors of the several filters; i. e., light yellow ink is used on the plate prepared from the photograph which was taken through the blue-violet filter, crimson on the green, and peacock blue on the red. Impressions are made on white paper by superimposing the plates exactly upon each other. The natural coloring of the original is thus obtained, because with these inks, as is also the case with the primary colors, all colors can be produced by suitable mixture. In this case, the effect of mixing is secured by photographing through the filters.

Such a printing process may be adapted to phototelegraphic or still picture communication systems without any fundamental changes. Photographs are made of the subject and the negative (or positive) transparencies employed in the usual way to modulate a beam of light and thus give rise to electrical

signals. From the photographic duplicates obtained at the receiving station the color plates are made. Therefore, the problem is not much more complicated than the transmission of monochrome or black-and-white records. This method has been successfully developed by the American Telephone and Telegraph Company over whose system, in the early part of 1927, color photographs were successfully transmitted from San Francisco to New York.

As far as basic principles are concerned color television is accomplished in the same manner, although photography does not enter into the problem. The idea of so doing is apparently not a new one. Anderson proposed such a system in about 1910. Baird in 1928 followed along the same lines, as did the engineers of the Bell System Laboratories in the last few months, but each have improved quite notably the methods of their predecessors.

Briefly, Baird employed the conventional Nipkow scanning disc and the glow discharge lamp. The scanning disc at the transmitting station had three sets of scanning apertures, each set being covered with light-filters—one red, the next green, and the third blue. At each revolution of the disc, the scene was scanned three times for each of the primary colors, thus corresponding to three photographs in the photo-engraving process described in the foregoing paragraphs.

To produce the three colors at the receiving station, two lamps were used, a neon lamp supplying the red, and a helium-mercury lamp the blue and green. A commutator evidently was used to shift the signals from one lamp to the other to correspond with the colors of the transmitting disc filters.

It is easy enough to give a glib description of such systems, but it is also well to look into some of the difficulties encountered when employing such methods. These are often passed over in discreet silence. For instance, it may be recalled for monochromatic television quite a large disc is necessary for detailed scanning, the ordinary disc being about 48 in. in diameter. Such a disc with three sets of spirals, so arranged as not to interfere with each other, begins to assume elephantine proportions.

The problem of the disc, however, is a minor difficulty compared to the limitations in color sensitivity of the light-sensitive cells available. The potassium-hydride photoelectric cell, which is universally used for television on account of its rapidity of response to changing light values, responds to blue-violet light quite well, but from green to the red it is practically unresponsive. Thus the problem is how to get effective signals through a red filter which will operate a cell.

This problem of rendering the correct tone value of colored objects has been met through the work of A. R. Olpin and G. R. Stilwell, of the Bell Telephone Laboratories, who have developed a sodium photoelectric cell which is sensitive to the entire spectrum from violet to red. Although full details of the method of preparing such cells is not yet forthcoming, it is said that the "active surface is sensitized by a complicated process using sulphur vapor and oxygen instead of by a glow discharge of hydrogen as with the former type of cell."

With this new type of cell and the original apparatus used in previous experimental work by these laboratories, the possibilities of color television were

recently demonstrated, particularly in the obvious improvement of the quality of reception, even though the scanning may be considered "coarse" when compared with the screens used for photo-engraving work.

It may be remembered that this system employs a novel method of scanning—usually called the "beam method"—which does not require that light-filters be used on the scanning disc, but three sets of signals must nevertheless be generated and three communication channels must also be employed. Here three sets of photoelectric cells are employed to collect the reflected light from the scene and the filters are placed directly in front of them.

The photoelectric cell container or transmitting "cage" is shown in Fig. 1. "In the new photo-cell cage twenty-four cells are employed, two with 'blue' filters, eight with 'green' filters, and four-

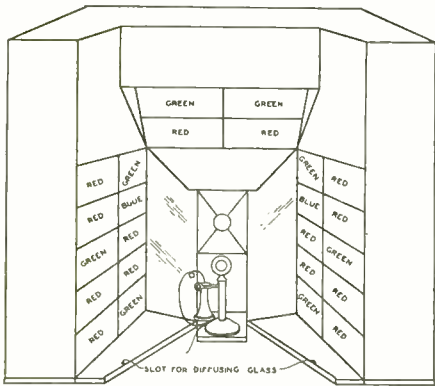

Fig. 1. Transmitting "Cage" Used in Experiments with Television in Natural Colors

teen with 'red' filters. These numbers are so chosen with respect to the relative sensitiveness of the cells to different colors that the photo-electric signals are of about equal value for the three colors. The cells are placed in three banks, one bank in front of and above the position of the scanned object, one bank diagonally to the right, and another bank diagonally to the left, so that the cells receive light from both sides of the object and above. In placing the cells they are so distributed by color as to give no prominence in any direction to any color. In addition, large sheets of rough pressed glass are set up in front of the cell-containers so that the light reflected from the object to the cells is well diffused.

"Thus far the television images have been received in a manner similar essentially to our method from monochromatic television. The surface of a disc similar to that used at the sending end is viewed, and the light from the receiving lamp is focused on the pupil of the observer's eye by suitable lenses. To combine the light of three lamps, they are placed at some distance behind the scanning disc and two semi-transparent mirrors are set up at right angles

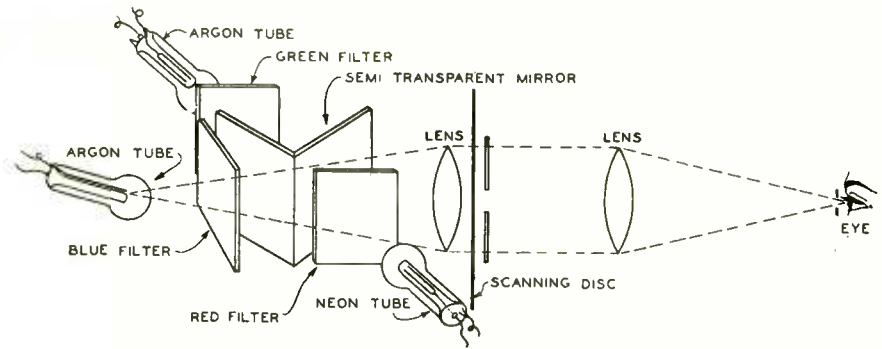

Fig. 2. Method of Viewing Received Image

to each other but each at 45 deg. to the line of sight. One lamp is then viewed directly through both mirrors and one lamp is seen by reflection from each, as illustrated in Fig. 2."

To obtain the three colors at the receiver three lamps were used. For the red, the usual neon-filled tube sufficed, but for the blue and green, two argon-filled lamps, one with a blue and the other with a green filter, were employed. The argon lamps were found to be less brilliant than the neon lamp and a special form of water-cooled lamp had to be designed to work at high current densities and special amplifiers were also required.

"The receiving apparatus at present consists of one of the 16 in. television discs used in our earlier experimental work. Behind it are the three special lamps and a lens system which focusses the light into a small aperture in front of the disc. The observer looking into this aperture receives through each hole of the disc as it passes by, the light from the three lamps—each controlled by its appropriate signal from the sending end. When the intensities of the

three images are properly adjusted he therefore sees an image in its true colors, and with the general appearance of a small colored motion picture."

SPECIAL CHANNEL AND NEW STANDARDS FOR TELEVISION

In the gradual development of television, still generally considered some time distant for commercial purposes except for experimenters, engineers of the Television Committee of the Radio Manufacturers Association, headed by D. E. Replogle of New York, are keeping pace with laboratory and experimental developments of television by flexible standardization. Changes in the first television standards, evolved by the RMA Committee at the first organized meeting of television engineers more than a year ago, are being studied as necessary. Another meeting of the Committee is planned this fall.

A separate air channel for a synchronizing signal for television experiments may be requested of the Federal Radio

(Continued on Page 74)

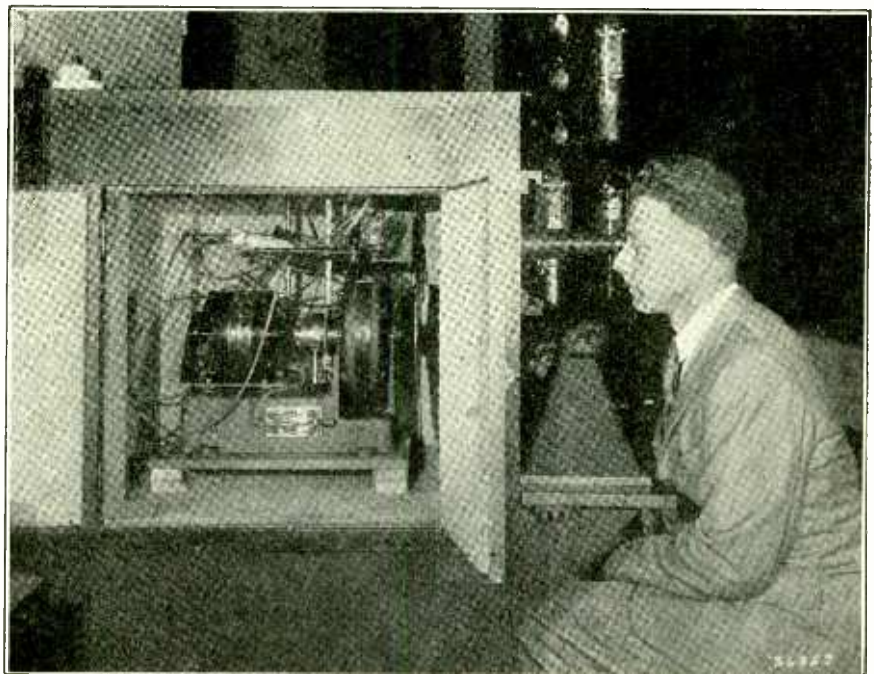

Side View of Receiving Equipment for Experiments with Television in Natural Colors

SM

Band-Selector Tuning 3 A.C. Screen-Grid Tubes Custom-Built, \$74.75!

Now—All-Electric Short-Wave Reception

The new S-M 735 Round-the-World Six brings every marvel of the low-wave bands within the perfect convenience of a. c. operation. A 224 screen-grid tube is connected so as to produce $2\frac{1}{2}$ times greater amplification than the '22; the a. f. amplifier (245 push-pull) is free from hum, even in distance reception. Four plug-in coils cover from 16.6 to 200 meters. Two extra coils (cost \$1.65) cover the broadcast band, with an altered connection built into the coil so as to greatly increase selectivity.

Yet the 735 is low-priced—\$64.90 net, wired complete with built-in

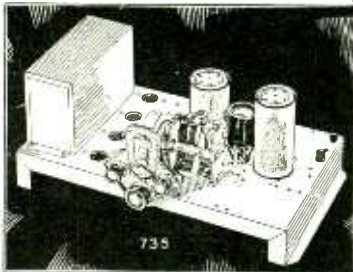

power unit; the component parts total \$44.90 net. Tubes required are: 1—'24, 2—'27, 2—'45, and 1—'80.

735DC, for battery use only, \$44.80 net less tubes and cabinet. Tubes required: 1—'22, and 4—'12A. Component parts total \$26.80 net.

Either set fits perfectly in any of the cabinets referred to at the right.

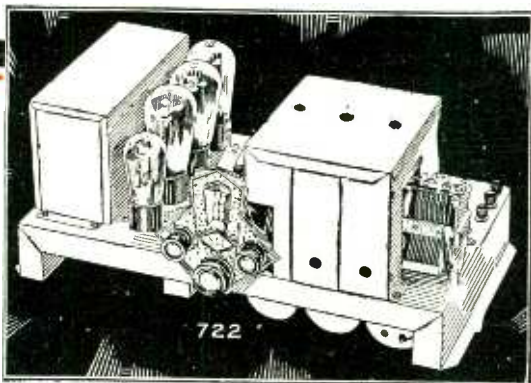

As trim and stylish-looking a one-dial set as was ever built to "sell on looks"—yet embodying such extreme performance as only Silver-Marshall can build into a set with three screen-grid tubes, band-selector tuning, and even screen-grid power detection—five times as efficient as '27 power detection. Four tuned circuits—highly shielded—an audio amplifier combining resistance coupling and 245 push-pull—complete built-in ABC power unit—chassis only $18\frac{3}{8}$ " by $9\frac{1}{2}$ "—all at the price of \$74.75 net, less tubes and cabinet, in the S-M 722 Band-Selector Seven. Tubes required: 3—'24, 1—'27, 2—'45, and 1—'80. Component parts total \$52.90 net. For use with any 90-120 volt d. c. electro-dynamic speaker.

Ideal for mounting in any of the cabinets mentioned below.

Up-To-The-Minute Cabinets

S-M 707 metal shielding table cabinet in beautiful crystalline brown and gold for 722 or 735, \$7.75 net.

Three beautiful console cabinets, adapted especially for mounting S-M 722, 735, or 712 with 677 by the I. A. Lund Corporation, are available from leading supply houses: see the new S-M Fall Catalog.

Surpassing the Famous Sargent-Rayment Seven

You know the Sargent-Rayment Seven—universally found to be the most sensitive broadcast receiver ever developed. Here, in the new 712 Tuner, is every feature of the 710 Sargent-Rayment—the five tuned circuits, the ultra-perfect shielding—the extra-fine r. f. coils—all built into an all-electric strictly single-dial tuner, with band selector tuning and power detection. Tubes required: 1—'27, 3—'24. Completely wired in satin-finish metal shielding cabinet, less tubes, \$64.90 net. Works into any audio amplifier.

Component parts, including shielding cabinet, total \$40.90. Fits beautifully (with controls central) in any cabinet with space $18\frac{1}{2}$ by $9\frac{1}{2}$ by $7\frac{1}{2}$ -inch high.



New 677 Amplifier

An ideal audio amplifier for the 712 is the new S-M 677. Fully equipped with the famous Clough system (in push-pull) the 677 takes radio or phonograph input; supplies all ABC power required for the 712 ($2\frac{1}{2}$ volts a. c., 180 volts B). Tubes required: 1—'27, 2—'45, 1—'80. Completely wired less tubes, \$58.50 net (or for 25 cycles \$72.50). Component parts total \$43.40.

Over 3000 Authorized S-M Service Stations are being operated; many are proving highly successful and profitable. The nearest one is ready to serve you if you want a custom-built set; write us for address if you do not know it. If you build professionally and do not have the S-M Service Station franchise—write us.

Complete circuit diagrams of the 722 and 735 were first published in the RADIOBUILDER for August. Valuable suggestions on building and servicing are to be found in every issue. Use the coupon

SILVER-MARSHALL, Inc.

6415 West 65th St., Chicago, U. S. A.

Silver-Marshall, Inc.
6415 West 65th Street, Chicago, U. S. A.

... Please send me, free, the new fall S-M Catalog; also sample copy of the Radiobuilder.

For enclosed in stamps, send me the following:

.... 50c Next 12 issues of The Radiobuilder

.... \$1.00 Next 25 issues of The Radiobuilder

S-M DATA SHEETS as follows, at 2c each:

- No. 3. 730, 731, 732 Short-Wave Sets
- No. 4. 255, 256, etc., Audio Transformers
- No. 5. 720 Screen Grid Six Receiver
- No. 6. 740 "Coast-to-Coast" Screen Grid Four
- No. 7. 675A BC High-Voltage Power Supply
- No. 8. 710 Sargent-Rayment Seven
- No. 9. 678 PD Phonograph-Radio Amplifier
- No. 12. 669 Power Unit
- No. 14. 722 Band-Selector Seven
- No. 15. 735 Round-the-World Six
- No. 16. 712 Tuner (Development from the Sargent-Rayment)
- No. 17. 677 Power Amplifier for use with 712

Name.....

Address.....

Tell them you saw it in RADIO

AGAIN

LINCOLN SETS THE PACE WITH THE

Lincoln

8-40

THE GREATEST ENGINEERED SCREEN GRID SUPER IN RADIO HISTORY

*800 Miles
Daylight
Mid-Summer
Reception*

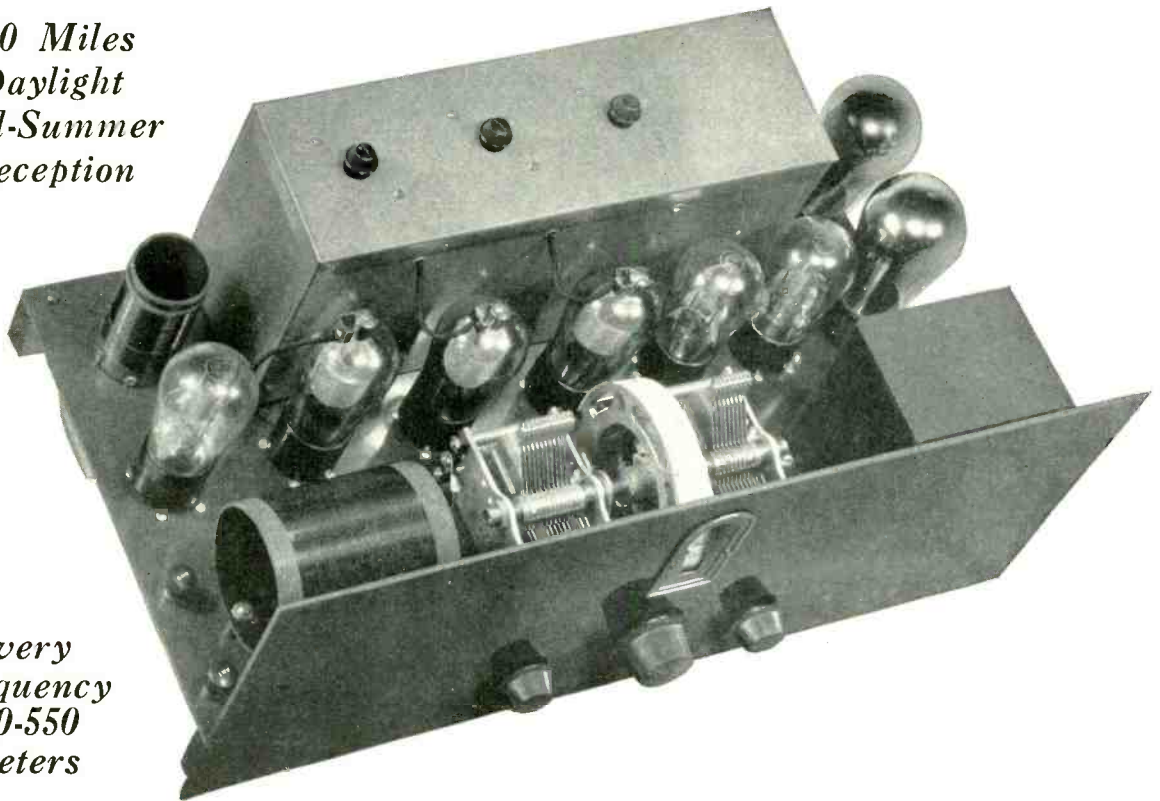

*Every
Frequency
180-550
Meters*

NO HIGH-PRICED POWER PACK REQUIRED—Operate this high-powered Super on a small "B" supply only—No other equipment necessary.

MARVELOUS TONE—Heavy register on low musical frequencies.

ONE SPOT—Absolutely no interference from a single harmonic.

A NEW I-F AMPLIFIER

Covering a period of six months of intensive study of high screen-grid amplification, Lincoln engineering has produced the highest gain I-F transformers known; with tremendous high gain perfectly controlled without oscillation at any amount of power.

One noted radio engineer states: "I have tested every make of modern intermediate transformer and could not believe my findings of the I-F transformers in the Lincoln 8-40 when my test showed over three times the gain over all other makes."

TUNABLE STAGES so operative that a slight movement of one control will tune out your local station, producing extreme selectivity which causes stations to actually explode in as dial passes frequency. **THIS MEANS RECEPTION YOU HAVE NEVER DREAMED OF.** There's a sound basic reason for every bit of the marvelous performance of the NEW LINCOLN 8-40. Its design is unique from antenna post to speaker. Every part is especially designed to co-ordinate in producing the tremendous amplification, perfect control and extreme selectivity available in this radically new receiver. For months, the Lincoln 8-40 has tuned in distant stations through the barrage of Chicago locals, all day long, through the hot summer months, right in our laboratory in a steel and concrete bank building located in the heart of Chicago, and brought them in with a heavy volume far above the static level of mid-summer.

SET BUILDERS AND DISTRIBUTORS—If you are not on our last season's list, write at once for complete information and special money-making program for authorized distributors.

Representatives—Australia, New Zealand, Union of South Africa:

JENTS, YORE & WHITEHOUSE
46-48-50 Haig Street Melbourne, Australia

Western Representatives:

LINCOLN RADIO SALES AGENCY
200 Davis Street San Francisco, Calif.

Write Today to Department R

LINCOLN RADIO CORPORATION

329 SOUTH WOOD ST. — CHICAGO - ILLINOIS.

As The Trade Thinketh..

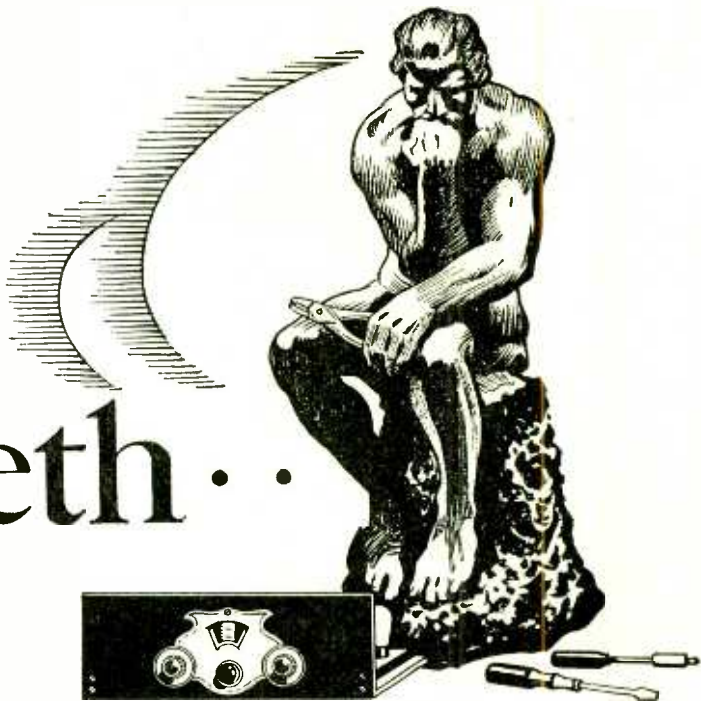

HARRY CHIRELSTEIN:

President, Sonatron Tube Company.

"Every advance which has been made in the set manufacturing branch of the radio industry can be directly traced to the development of some new type of radio tube."

JESS HAWLEY:

Vice-President, United Reproducers' Corp.

"The radio manufacturer who fails to maintain the best laboratory and research personnel which his resources will permit is going to fade from the radio industry picture."

M. D. HOOVEN, JR.:

Public Service Electric & Gas Company,
Newark, N. J.

"The elimination of radio interference is a problem of community coordination. To legislate against the occurrence of interference will accomplish as much and be as sensible as to legislate, for instance, against the occurrence of lightning."

ELLERY W. STONE:

President, Kolster Radio Corporation.

"The necessity for rising from the easy chair or couch where one is comfortably resting for the evening, to cross the room and tune in a different station in order to hear a favorite program, will soon be as out-of-date as cranking a car."

H. E. FENNER:

Chairman, RMA Service Section.

"I should like to see all manufacturers make certain information available to authorized radio wholesalers that have demonstrated their service ability, even though that particular wholesaler is not actually selling that manufacturer's product."

F. E. RISLEY:

Traffic Manager, Colin B. Kennedy Corp.

"Freight rates and classifications of all materials pertaining to radios are problems of special importance to manufacturers who are paying unduly high freight rates. About one-fourth of the materials used in the radio industry are rightly classified."

C. B. CLENDENEN:

Manager, Pacific Coast District National
Carbon Company.

"A radio receiver is like a three-legged stool, with the chassis, the loudspeaker and the cabinet forming the three supports. Unless the design of these three elements is harmonized, the results will be inferior. It is hopeless to expect the best tone quality from an assembly made of a high-quality chassis, an excellent loudspeaker and a cabinet which has not been treated acoustically to cooperate and harmonize with them."

DR. LEE DE FOREST:

Chief Consulting Engineer of the De
Forest Radio Company.

"No one appreciates the astounding progress of radio more than I do. For have I not seen this mass communication idea grow from my crude experiments of 1909 until the present national and international broadcasting system? Yet I venture to predict far greater progress during the next few years, due to our acceptance of organized research and engineering development as a means of guiding our radio future, rather than leaving it to chance invention and haphazard methods as in the past."

ALFRED H. GREBE:

Radio Manufacturer.

"The ideal radio receiver would provide (1) uniform amplification through both radio and audio stages; (2) uniform selectivity from one end of the dial to the other; (3) uniform input from the antenna to control selective sensitivity and limit atmospheric and other interferences; (4) high power and sharp tuning for distance reception, low power and broader tuning for local reception; (5) ideal sound reproduction ranging from 60 to 5000 cycles."

Radiotorial Comment

By the Editor

SCIENTISTS predict that radio reception will be poorer during October of this year than it has been since radio became the favorite indoor sport of millions of Americans. This dire prediction is based upon the expectation that there will be more dark spots on the sun than at any other time between 1923 and 1934. These spots are supposed to be the cause of magnetic disturbances which weaken radio signals. This should be a good healthy alibi when a new set fails to bring in a distant broadcast station.

Sun Spots and Radio Reception

HUGE sums have been spent by broadcast stations and their advertising clients in trying to determine what kind of a program is most acceptable to their listeners. While the prime purpose of these surveys is to increase the popularity of the broadcast station and to bring greater returns to the advertiser, they are also a guide as to the type of radio programs that will cause more of the American people to buy radio receivers. Consequently every man who sells radio sets is financially interested in the conclusions that are reached. For the sale of radio sets is fundamentally dependent upon the public's interest in what they can hear from the sets which are bought.

What Sells Radio?

The conclusions, in general, show that different people are interested in different types of programs. Some want classical music and some want jazz. Some like speeches and some do not. Some follow the reports of sports and some prefer church services. Everybody is interested in the news of some outstanding event like the arrival of the Graf Zeppelin or the results of a presidential election. But there are not enough major news items to attract universal interest every day in the year.

So it is evident, to paraphrase Lincoln, that you can please all of the people part of the time and part of the people all of the time, but you cannot please all of the people all of the time. Yet there is one acid

test that can be applied in determining the value of any program: It must be done well. A poor performance of any sort, no matter how popular the subject, creates the dissatisfaction that retards the sale of radio. A good performance of any kind, no matter how unpopular the instrumentality, arouses the enthusiasm that stimulates the sale of radio.

THE future of the business of conducting big radio shows for the general public is doubtful. Not that there is a lack of attendance, but that there is a question as to the value to the radio manufacturers and jobbers who bear most of the cost. The crowds go to the shows not to see radio receivers but to be entertained at low cost by the radio artists who appear in person through the courtesy of various broadcast stations. The galleries are filled with listeners and lookers while the booths are empty of prospective buyers or crowded with the overflow of eyes and ears which are focused on the stage.

Future of Public Radio Shows

Of course all this tends to popularize radio in general. But the expense of such advertising seems greater than is warranted by the direct returns, especially when compared with other more effective advertising mediums. Consequently many manufacturers and jobbers have announced that they will withdraw their support from next year's public shows, leaving the dealer to hold the bag for the show promoter's profits. The slump in the stock of big public shows will probably be gradual but none the less certain.

These comments do not apply to the strictly trade shows nor to the radio exhibits in county and state fairs. These have an educational and sales value and can be conducted at a fraction of the cost of a public show where the radio industry assumes all the cost of attractions which draw a non-buying crowd. But really the best public showing of radio appears to be in the dealers' salesrooms or the buyer's home where pleasure is business and business is pleasure.

VARIOUS radio engineers differ in their opinions as to whether grid or plate rectification is better for use in a power detector. One man finds that a grid-leak detector is more sensitive, less subject to overload,

Grid or Plate Detection?

and causes less distortion than a plate detector. Another finds that the impedance or transformer coupling required, because of the relatively great current used in a power detector with grid-leak, changes the permeability of the core and introduces distortion in the phase and amplitude of the audio-frequency currents.

A third engineer states that the second harmonic distortion introduced by a plate detector followed by a single audio stage is only a little greater than that occurring with a grid detector of small signals, while a fourth man claims that doubling the voltage to the grid of the plate detector multiplies the second harmonic by four, the third harmonic by eight and the fourth harmonic by sixteen. This fourth man also states that one stage of audio-frequency amplification requires five times as much voltage on the grid of a plate detector as is required when two audio stages are used, the fourth harmonic then increasing 625 times.

"Who shall decide, when doctors disagree?" Surely not the dealer who has to sell receivers which employ different kinds of detector and audio amplifiers. Nor even the service man who has to shoot trouble on them.

Yet it is these honest differences of opinion that make for progress. They must be substantiated or disproved by laboratory tests. Nor should such tests be colored by any desire to prove that a particular opinion is well founded. They should be made over a wide range of identical input signal voltages, radio frequencies, percentages of modulation, output impedances, and other variables that may influence the results.

Furthermore, it will probably be found that distortions which are evident in computations on paper are not apparent to the ear and that both types of detection cause some frequency discrimination and amplitude distortion. In its present stage of development, plate detection gives good fidelity but less gain. With grid-leak detection a happy medium between gain and fidelity depends upon the proper choice of grid-leaks and condensers.

FROM time to time it has been suggested that radio broadcasting is a public utility and as such should be subjected to more vigorous regulation than can be given by the Federal Radio Commission. This

Broadcasting Is Not a Public Utility

idea is fostered by the "public convenience and necessity" clause in the radio law and implies the forced acceptance of any program for which the prescribed rate has been paid, regardless of quality, human interest or entertainment.

In arguing against such an interpretation of the service performed by radio broadcasting, John W.

Van Allen, R. M. A. legal counsel, likens this new means of providing information and entertainment to a newspaper, magazine or theater. All of these businesses must exercise discrimination in the selection of what they judge will please the public. Unlike a railroad, telegraph or telephone company, they cannot accept any and all traffic which is offered.

Mr. Allen's point seems to be well taken and is likely to forestall stricter governmental regulation if the broadcasters scrupulously follow the present regulations and also refrain from imposing tiresome sales talks upon their listeners.

RADIO interference, like the poor, is always with us. Since the advent of the multi-tube a-c set it has been more ubiquitous than ever, unexpectedly occurring anywhere. Formerly it traveled mostly through space from atmospheric discharges, station heterodynes, regenerative sets and electrical sparks. But now it also comes

Finding the Unfindable

over the wires which supply power for the operation of the set. And it surely plays hob with reception when it comes, as every service man knows.

How to stop it is the biggest technical problem in radio today. This problem has two parts, one to find where it comes from and the other to prevent it from coming. It requires a detective to run it down and a straitjacket to confine it. A clever squad of sleuths go over the suspected district with surveying instruments for determining its direction and point of greatest intensity. Then when it is found, experiments are made with various electrical filter circuits until it is finally confined or killed. A radio trouble man is a combination of detective and jailer.

THE man who says that nine service men out of ten are crooks, is probably a man who does not pay them a living wage. Every man must eat. If his pay-check isn't big enough to cover the cost of the

Are Service Men Crooks?

bare necessities of life is he to be blamed if he practices a few tricks of the trade in order to knock down a few dollars?

Morally—yes, but practically—no. The real blame belongs to the boss who forces his men to adopt such tactics for self-preservation.

Every radio service man knows lots of ways to fool the boss. He can service sets on his own time, he can sell tubes for unnecessary replacements, or he can dispose of many radio accessories at a profit. But no self-respecting man does these things unless he thinks that the boss is cheating him.

There is much idle prattle about loyalty. But loyalty cannot be given unless there is a corresponding assurance of protection against needless unemployment, unfair treatment, and a starvation wage. This is not socialism but common business sense. So the next time that the boss has to fire a man because of dishonesty, he should ask himself the question if he has treated the man right.

Simplified Formulas for the Design of R-F Transformers

IN NEUTRALIZED AND SCREEN-GRID CIRCUITS

By D. L. BEDINGFIELD

Some valuable suggestions for the factory engineer and radio experimenter.

RADIO frequency transformers are among the most vital elements in the satisfactory performance of a receiver. Upon their theoretical design and practical construction largely depend the selectivity and sensitivity which is attainable. The complicated design formulas which are ordinarily available to the engineer can be simplified by ignoring several somewhat negligible factors and by confining the discussion to transformers which are used in a neutralized circuit, thus avoiding the tube's regenerative contribution. Practical experience shows that it is necessary to neutralize even the screen-grid tube in order to obviate oscillation.

The first factor in the problem is the minimization of the coils' r-f resistance. The approximate r-f resistance of inductance coils may be calculated from the formulas and charts presented by the writer in January 1929 RADIO. While this might appear to be a matter of only academic interest, it will be shown that a knowledge of the r-f resistance of a transformer secondary is of paramount importance in designing a primary to secure maximum amplification.

In fact, most of the losses usually associated with an r-f circuit can and should be considered solely from their effect in increasing the effective r-f resistance of the secondary. By this means the primary can be calculated so as to be the best for that particular secondary in the receiver. Obviously this might be quite different when the secondary is disassociated from other apparatus.

Thus a tube-socket will increase the effective secondary resistance by a small fraction of an ohm. A serious increase in resistance may be introduced by screening which is not carefully arranged so as to be outside the dense portion of the coils' magnetic field. Even a carefully arranged screen may introduce $\frac{1}{2}$ ohm increase in resistance. The losses due to a high-grade variable condenser are included in the author's estimates of percentage increase over calculated values for various types of windings listed in

January RADIO, since such a condenser was used in the measuring circuit.

In the formulas herein developed, the self and mutual capacity of windings will be neglected, since a consideration of them only serves to show the necessity of reducing them to truly negligible proportion. Furthermore, any error introduced by neglecting them is unimportant if certain of our suggestions are followed relative to reducing primary self-capacity and mutual capacity between primary and secondary.

Fig. 1 shows an r-f transformer circuit and its equivalent wherein a fictitious alternator develops a voltage $V = \mu v_g$, in series with a resistance ρ equal to the plate impedance of the tube under operating conditions. This combination feeds into a transformer comprising a primary which has an induc-

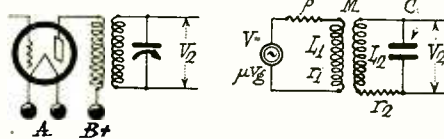

Fig. 1. R-F Transformer Circuit and Its Equivalent

tance L_1 and resistance r_1 coupled to a secondary of inductance L_2 and resistance r_2 tuned to resonance by a condenser C ; the mutual inductance between the two windings is represented by M , and is equal to $k\sqrt{L_1 L_2}$ where k is the coupling factor (of which more will be said later) between the two coils; both r_1 and r_2 can, where appropriate, safely be neglected in comparison with ρ .

It can readily be shown that at resonance the secondary current will be

$$i = \frac{\omega M C V}{k^2 L_1 + \rho r_2 C} \quad (1)$$

Then, since the voltage applied across grid and filament of the succeeding tube is that across C , it will, at resonance, be

$$V_2 = \frac{i}{\omega C} = \frac{M V}{k^2 L_1 + \rho r_2 C} \quad (2)$$

Putting successively, $M = k\sqrt{L_1 L_2}$

and $\sqrt{\frac{L_2}{L_1}} = t$, this becomes

$$V_2 = \frac{t k L_2 V}{k^2 L_2 + \rho r_2 C t^2} \cdot \frac{L_2 V}{\frac{k}{t} L_2 + \frac{t}{k} \rho r_2 C} \quad (3)$$

Then if $a = \frac{k}{t}$

$$V_2 = \frac{L_2 V}{a L_2 + \frac{\rho r_2 C}{a}} \quad (4)$$

By differentiation it will be found that V_2 is a maximum when the two terms in the denominator are equal, i. e., when

$$a L_2 = \frac{\rho r_2 C}{a} \quad \text{or } a = \sqrt{\frac{\rho r_2 C}{L_2}} \quad (5)$$

It is well known that at resonance the secondary winding comprises a dynamic resistance of value $R = L_2 / C r_2$ so that (5) can be written $a = \sqrt{\rho / R}$. (6)

Now $a = k/t$, and since in practice k , the coupling factor, is usually determined by the type of construction adopted and is therefore constant, we can put $t = k\sqrt{R/\rho}$ (7)

or $t(\text{opt}) = k\sqrt{\frac{L_2}{\rho r_2 C}}$ (8)

Normally L_2 consists of an inductance of fixed value, so that C is fixed by the frequency of the station to be received according to the formula

$$f = 10^6 / 2\pi\sqrt{L_2 C}$$

where L_2 and C are expressed in microhenries and microfarads respectively.

component coils of the completed transformer will have, it is possible to obtain the coupling factor k with sufficient accuracy to dispense with the need for any subsequent measurement. The assessment, by measurement, of the coupling factor k for a representative series of coils simulating the component coils of an r-f transformer is a study which might be commended to the notice of any experimenter with the necessary time and patience, the more so since no great degree of accuracy need be attempted.

Having ascertained the approximate coupling factor k , equation (8) can then be applied to find t . While t , when ascertained, can as a rough approximation be regarded as not varying greatly from the turns ratio, to attain any degree of precision it is necessary to correct this ratio (which, it will be remembered, is that of the square roots of the

factor for the primary was 16 and that for the secondary 4, then since $\sqrt{16}/\sqrt{4}=2$, the actual turns ratio of the transformer will be found by multiplying the ascertained value of t by 2, which gives a turns ratio of 8, or a primary winding of 10 turns. Similarly the transformer ratio should, strictly speaking, be greater or less than t according as the square root of the primary diameter is greater or less than that of the secondary diameter; in practice, however, the difference in diameter of the two windings is usually so small that no valuation in ratio need be made.

Notably in the case of the screened-grid tube, and also in cases where an exceedingly high degree of selectivity is required, it will not always be practical or convenient to use the optimum primary; in the case of the screened-grid tube in particular, difficulty is often encountered with double-hump resonance curves when the primary is made large enough to properly match the characteristics of the tube. In such cases it is advisable to work out from equation (3) a curve covering amplification with various values of t , the ratio between the square root of secondary and primary inductances. Such a curve will immediately show the point at which the reduction in amplification becomes so rapid as to render further reduction of the primary uneconomical.

For the sake of completeness, an example of the design of an optimum primary will be worked out. Assume a secondary design following the charts in the article previously referred to. A .00035 mf condenser will be used so that an inductance of 280 mh is suitable. Assume further that the winding will be of $2\frac{1}{2}$ in. in diameter and of equal length, and will be wound with wire of the optimum diameter, which reference to the chart shows to be approximately No. 24; 80 turns will be required. The transformer design will be based on an optimum performance at 640 kc (469 meters) so that the r-f resistance of the secondary to be used in our design will be the resistance at that frequency, or, from the chart 4.5 ohms. Allowing 1.5 ohms as the equivalent increase in secondary resistance due to coil former, condenser, tube socket, screening, etc., our total equivalent secondary resistance is 6 ohms. The particular tube in use has a working impedance of 9000 ohms and an amplification factor of 7. The total capacity required to tune to 640 kc with an inductance of 280 mh will be approximately .00022 mf from the formula $f=10^6/2\pi\sqrt{L_2 C}$.

We shall require to know in addition the approximate magnitude of the coupling factor k . Our primary, we will assume, is to be wound over the secondary on spacing strips $\frac{1}{8}$ in. thick covering 1.5 in. at the low-potential end of

the secondary; then mean primary diameter is approximately 2.65 in. and from (10) $k=\frac{2.5^2 \times 1.5}{2.65^2 \times 2.5}=0.534$. Since

the center of the primary winding is located $\frac{1}{2}$ in. from that of the secondary the coupling factor will be reduced by something between 5 and 10 per cent, so that we will assume k to be 0.5.

Then from (8) t (optimum)

$$=0.5\sqrt{\frac{280}{9000 \times 6 \times 0.00022}}$$

(since C and L_2 enter into this particular equation only as a ratio, it is permissible to express them in microfarads and microhenries rather than in farads and henries, but such a practice must be exercised with care, since in many equations it is not permissible)

or t (optimum) $=0.5\sqrt{23.57}=2.43$.

Then the ratio of the square roots of the inductances must be 2.43; but the shape factor S is 6.8 for the secondary and 10 for the primary. Thus the turns ratio will be $2.43\sqrt{10/6.8}=2.94$, subject to a correction factor corresponding to the square roots of primary and secondary diameters, which, since the primary diameter is greater than that of the secondary, results in an increase in the turns ratio to $2.65/2.5$ —approximately 3 to 1. Thus, since our secondary has 80 turns, our primary must have $80 \div 3=26$ turns. Under these circumstances, the amplification will be a maximum, and applying equation (9) this is found

$$\text{to be } \frac{7}{2\sqrt{9000 \times 0.00022 \times 6}} = \text{approximately } 17.$$

If it were wished to increase the turns ratio and thus the selectivity, this could be done and the amplification ascertained from (3) or (4); the writer must admit that he is not altogether in agreement with those who adopt this means of enhancing selectivity, preferring rather to increase the efficiency of the secondary and thus permit an increase in transformer ratio (and consequently selectivity) while still loading the tube to secure its optimum performance. A great deal has been accomplished in this connection by the use of secondaries wound with r-f cable or Litzendraht, with the added advantage of flattening the amplification-frequency curve; particulars of these results, however, will have to wait for a future article.

In any case, too great a degree of selectivity in any one stage has the undesirable effect of clipping side-bands; the proper method of securing extreme selectivity is by means of a plurality of tuned circuits not too sharply selective rather than by means of one or two circuits of extreme selectivity.

It is, of course, recognized that the

(Continued on Page 70)

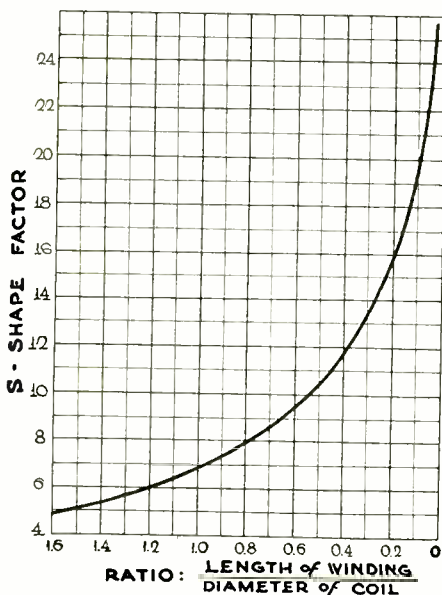

Fig. 5. Shape-Factor Curve

inductances of secondary and primary) both for the differing diameters of the two coils and for the differing shape factors; in the article previously referred to, the formula for the inductance (in microhenries) of a solenoid was given as $L=SN^2 D/1000$, where N =number of turns, D diameter in centimeters, and S a shape factor to be read from a chart suitably extended in Fig. 5 to cover the very short windings sometimes used for primaries.

To correct for the variation in shape factor, the shape factor must be ascertained from the chart for both primary and secondary; it will normally be found that the shape factor for the primary is greater than that for the secondary, and the turns ratio will be greater than t according to the ratio existing between the square roots of the two shape factors; thus, supposing a secondary winding of 80 turns, for which we had calculated $t=4$, while the shape

Inside FACTORY BUILT RECEIVERS...

By "RADIO" LABORATORY STAFF

MAJESTIC MODEL 90

THIS is a seven-tube receiver in which five type '27 tubes are used in the four r-f stages and detector and two '45 tubes in push-pull comprise the sole a-f stage. Short and long antenna posts are provided for local and distant reception. The antenna is connected to the grid of the first r-f tube through a tuned coil, the inductance of which is variable by means of a sliding metal cup which is fitted over it. This constitutes the antenna trimmer, or selectivity control. An r-f choke, shunted with a .001 μf condenser is connected across the antenna and ground connections and one of the units of the five-gang condenser is connected across both the tuned coil and the filter. The grid of the first tube returns to ground through the antenna

coil and the r-f choke, and is neutralized through a condenser and a section of the succeeding secondary inductance. The plate circuit is coupled inductively to the grid circuit of the second tube.

The first three cathodes are connected together and returned to ground through two variable resistors. The first is of 75,000 ohms and constitutes the volume control. The second is attached to the end of the gang condenser shaft and has a range of from 500 to 2,500 ohms. This resistor makes a slight change in the grid bias of the first three r-f tubes as the tuning dial is turned, tending to equalize the sensitivity of the receiver over the full scale. The effectiveness of this system is shown in the sensitivity curve in Fig. 4.

Two .5 μf condensers bypass the first three cathodes and the plates of the

first two tubes. Another .5 μf condenser bypasses the fourth r-f cathode while a fourth bypasses the plates of the third and fourth tubes. The cathode of the fourth r-f tube goes to ground through an 1,800 ohm resistor which supplies the grid with a negative bias of 9 volts.

The detector is truly a power detector. It operates on the plate rectification principle, with 270 volts on the plate and 30 volts on the grid. This grid bias is supplied from the drop through a 35,000 ohm resistor which separates the grid from the cathode. The latter is bypassed through a 1 μf condenser while the plate bypass condenser is of .004 μf capacity. An r-f choke in the plate circuit also helps keep the radio frequency out of the audio system.

The a-f stage is transformer coupled

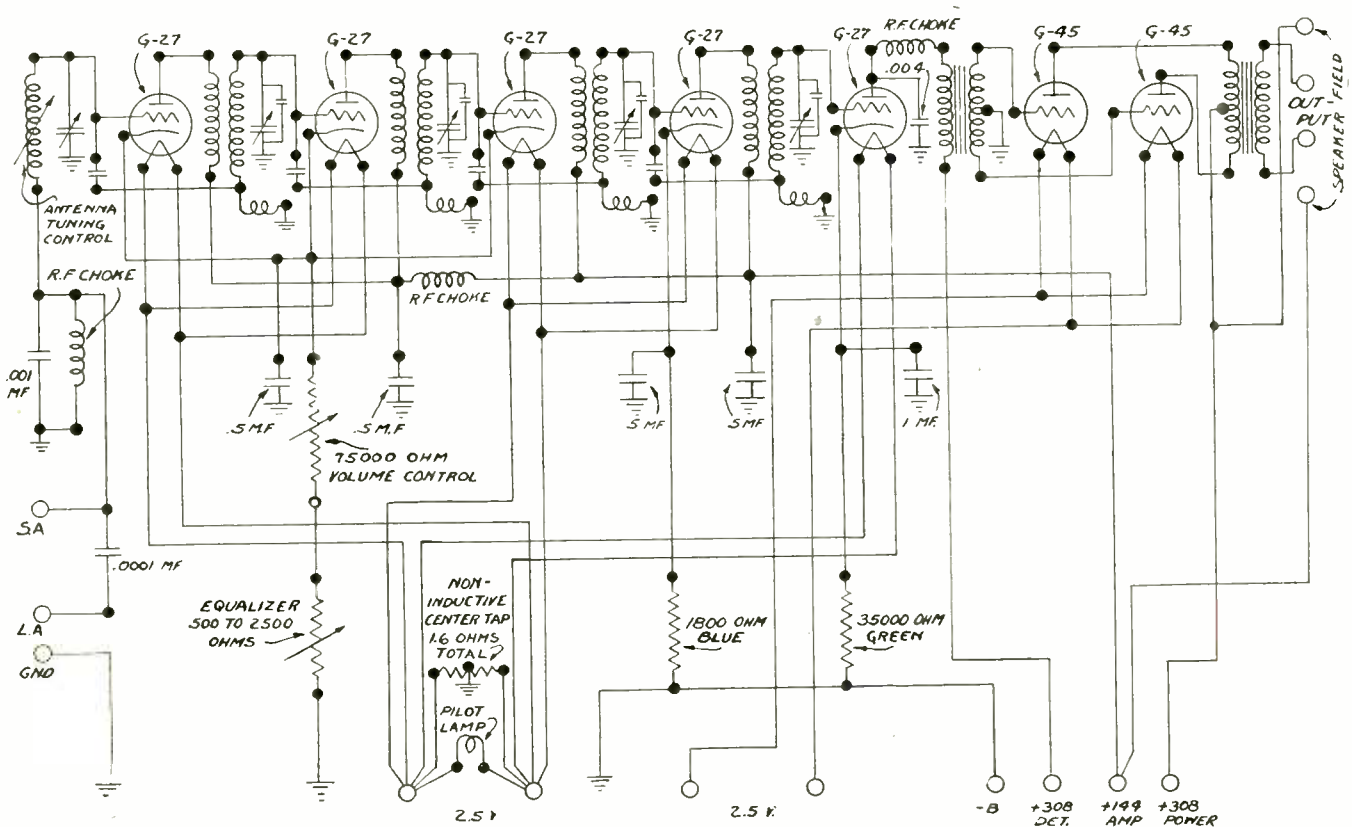

Fig. 1. Circuit Diagram of Majestic Model 90

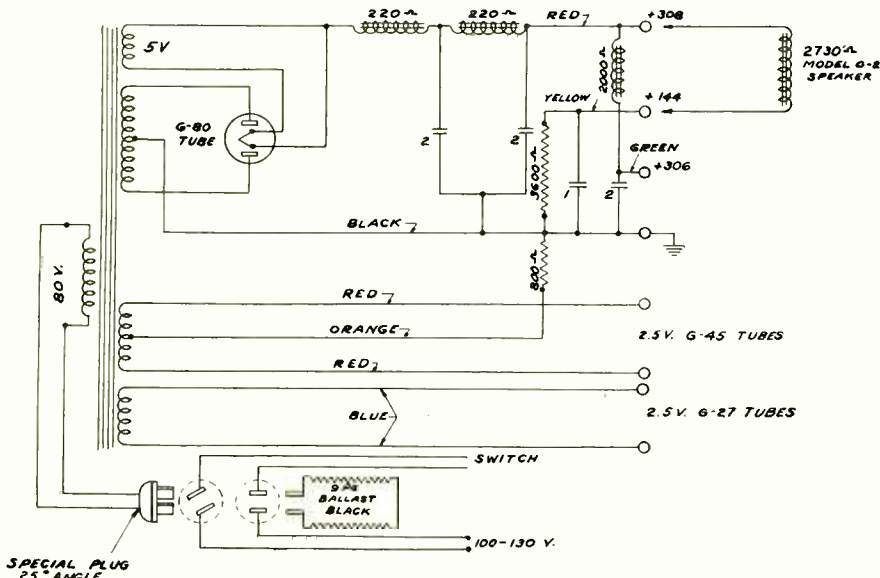

Fig. 2. Power Supply Circuit of Majestic Model 90

with 300 volts on the plate, 50 of which are dropped through an 800 ohm resistor in the power pack for use as the bias between the filament center tap and grids.

The power supply contains a single transformer with a ballast resistor in series with the a-c line and the primary. There are four secondaries: for the rectifier filament, high voltage, '27 filaments and '45 filaments. The high voltage is filtered through two chokes and two $2 \mu\text{f}$ condensers. The speaker field reduces the voltage from 308 to 144 volts for use on the plates of the r-f tubes. The detector voltage is taken from the 308 volt tap, passed through a third choke and bypassed through another $2 \mu\text{f}$ condenser. A 3,600 ohm resistor, shunted with a $1 \mu\text{f}$ condenser, is connected across the 144 volt tap and ground for purposes of stabilization.

The receiver assembly consists of three units: one containing the r-f

transformers, bypass condensers, sockets and chokes; one consisting of the tuning condenser gang, dial and equalizer; and the third housing the power apparatus. The efficiency of the receiver

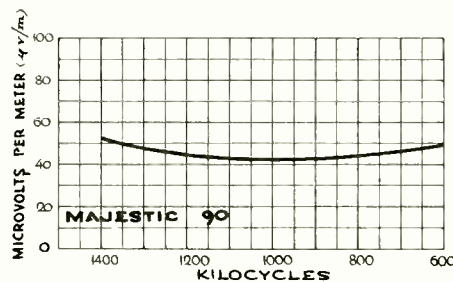

Fig. 4. Majestic 90 Sensitivity Curve

This sensitivity curve is unusually flat, showing a maximum variation of 11 microvolts per meter over the complete dial range. This is made possible by an automatic variation of the grid bias of the first three tubes. The curve shows the number of microvolts per meter of antenna height necessary in the field strength of a broadcast station to produce a 50 milliwatt output from the receiver.

has been measured in RADIO'S laboratory, a stock receiver having been used. The curves in Figs. 3, 4 and 5 give the dealer and service man a good idea of what may be expected of the Majestic 90 models when set up under average conditions.

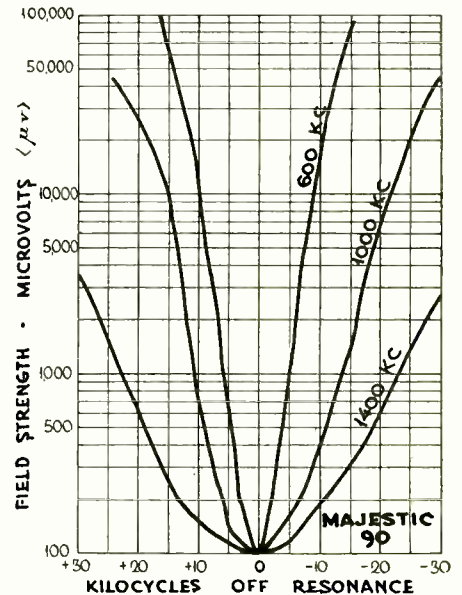

Fig. 3. Selectivity Curves of Majestic 90

Like most present day receivers, the Majestic 90 shows greater selectivity at the lower frequencies than at the high. The 600 kc curve shows that a station on 610 kc would have to have a field strength of 10,000 microvolts to deliver the same amount of power at the output of the receiver as the 600 kc station to which the receiver was tuned. At 1400 kc, however, only 150 microvolts are required by an interfering station 10 kc off resonance to equal the output of the station with the 100 microvolt field. If the interfering station were 30 kc away, on the positive side, it would require a field strength of 3500 microvolts to equal the 1400 kc station.

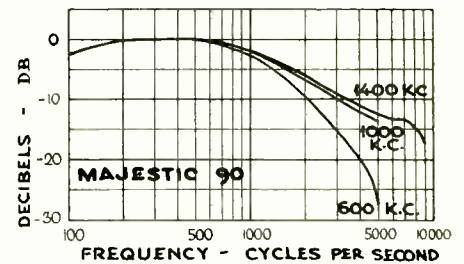
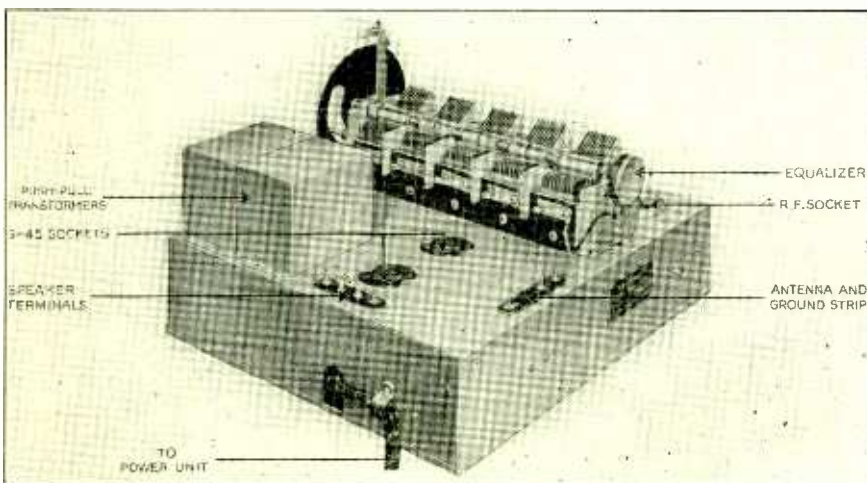

Fig. 5. Fidelity Curves of Majestic Model 90

These fidelity curves show a drop at both the low and high frequencies. The loss of $2\frac{1}{2}$ db at 100 cycles is not of importance, however, nor does the drop at the high frequency end of the scale take on serious proportions except in the case of the 600 kc curve. This one passes the 10 db mark at a point just above 2000 cycles, decreasing steadily until the notes and harmonics between 4000 and 5000 cycles are reproduced with less than one-twentieth the volume of the lower notes.



Chassis of Majestic 90

GILFILLAN MODEL 100

THIS receiver employs a rather unusual circuit, using '27 tubes in four tuned r-f stages, a '24 as a power detector, a '27 in the first a-f stage and a '45 power tube. The antenna is coupled to the first grid circuit in one of two ways: if a long antenna is to be used it is connected to a primary coil; if the antenna is short it is connected to a tap in the secondary coil. A specially designed variable resistor is connected across the primary to the cathodes of the four r-f tubes, the movable arm being grounded. This serves as the volume and sensitivity control, varying the strength of the incoming signal at the same time as it varies the grid bias on the r-f tubes. The resistance of this resistor is 15,000 ohms. A 450-ohm fixed resistor is in series with the volume control so that the r-f grids will never be operated without bias.

An 800-ohm resistor is included in each r-f grid lead for the purpose of suppressing oscillation, and a neutralizing condenser is connected between the primary circuit of each stage and that of the subsequent stage. The r-f cathode lead and the r-f plate lead are each bypassed to ground through a .5 μf condenser.

Power detection is used, the plate of the detector being supplied with the same voltage as that fed to the r-f and first a-f plates. The detector grid receives its bias from the drop through a 25,000-ohm resistor. The detector screen-grid is supplied from the r-f high voltage line also, a 500,000-ohm resistor dropping this voltage to the required amount. Both the screen-grid resistor and the cathode resistor are bypassed by .5 μf condensers.

The first a-f stage is resistance coupled and the second is resistance-impedance coupled. A .0001 μf condenser and an r-f choke serve as an r-f filter in the detector plate circuit. The plate resistor is of .25 megohm and is coupled to a .5 megohm grid resistor through a .1 μf condenser. The plate resistor in the second stage is of 20,000 ohms resistance and is coupled to the

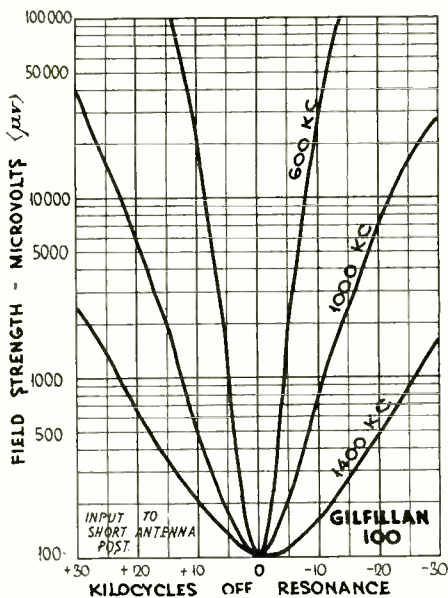

Fig. 2. Selectivity Curves of Gilfillan Receiver

These curves were taken with the receiver adjusted so that a field strength of 100 microvolts produced an output of 50 milliwatts. It will be seen in the 600 kc curve that at a point of 10 kc above resonance 20,000 microvolts were required from the testing equipment in order to give the 50 milliwatt output. The ratio of interference between a station at resonance and a station at 610 kc would therefore be 200:1. If it should be desired to know how much louder is the 600 kc station than the 610 kc station, the receiver being tuned to 600 kc and the field strengths of the two stations being equal, turn to Arthur Hobart's article in this issue and look up the number of decibels opposite the voltage ratio 200:1. The answer is 46 db; therefore the 600 kc station is 46 sound units louder than the 610 kc station.

When the receiver is tuned to 1,400 kc, however, it requires from the oscillator, at 1,140 kc, only 200 microvolts to produce the 50 mw output. This is just twice as much when the oscillator is 10 kc off resonance as when tuned to the same frequency as the receiver. At 1,430 kc 2500 microvolts are required.

grid impedance by another .1 μf condenser. The output of the '45 tube is fed direct into the speaker input transformer.

The power unit employs a transformer with a tapped primary, high-voltage secondary, a five-volt secondary for the '80 rectifier tube and a 2½-volt secondary for all other tubes. The filter

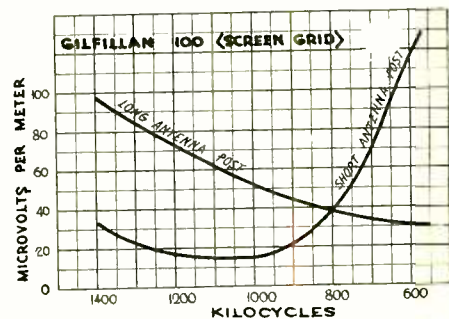

Fig. 3. Sensitivity Curves of Gilfillan Model 100

Here are two widely different sensitivity curves which should be of great value to the installer of a Gilfillan receiver. The dummy antenna used in the testing device was equivalent to four meters (13 ft.) in height. The curves show that the receiver is most sensitive at 1,000 and 1,400 kc when the antenna is connected to the short antenna post and that it is most sensitive at 600 kc when the long antenna post is used. If the set is to be installed near some high-powered stations on the low frequencies a sacrifice in sensitivity at 600 kc might be considered in favor of greater sensitivity in the higher frequencies.

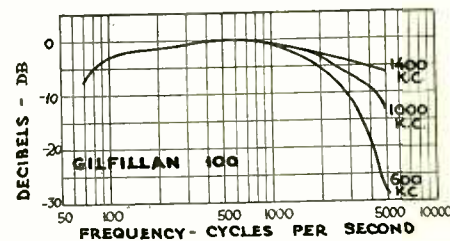

Fig. 4. Fidelity Curves of Gilfillan Receiver

This set of curves shows almost a straight line over a space of two octaves, from middle C (256 cycles) to C'' (1,024 cycles). The only fall that may give cause for concern is that of the 600 kc curve, which shows a loss of almost 30 db on the 5,000 cycle notes. This is due to sharp selectivity on 600 kc and seems to be a general characteristic of present day receivers.

includes two π sections and the field winding of the speaker. A 4,000-ohm stabilizing resistor is connected across the output. A 1,500-ohm resistor, shunted by a 1 μf condenser, provides the grid voltage for the '45 tube, this being the only tube in the circuit in which the grid circuit is returned to the filament center tap. The negative side of the power supply unit is grounded.

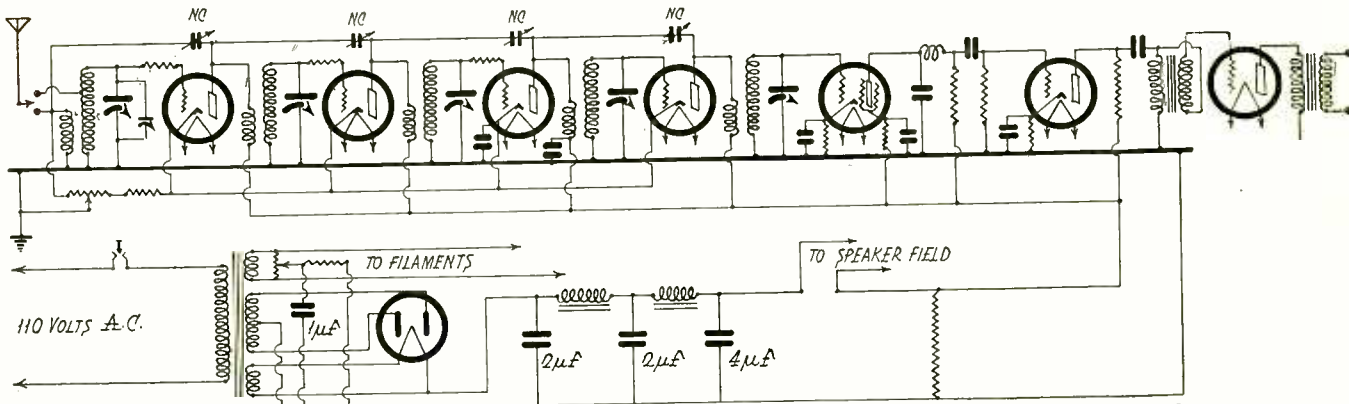

Fig. 1. Circuit Diagram of Gilfillan Model 100 Receiver

Ideas for the Bench Man

By WALTER DOYLE

How to make an audibility meter and a tester for short circuits in tubes, and why silicon steel is still used instead of permalloy in audio transformers.

Audibility Ratio Meter

AROUND the test and experimental bench it is often desirable to test the audibility of radio receivers under certain operating conditions, also for checking and matching tubes in receivers to determine which will produce the greater output. Many experimenters judge the increase in volume by sound of ear, but at the best, this method is very uncertain as the imagination can realize many things that are not so. With an audibility ratio meter any set may be checked for volume output against another. For comparing signal strength of different receivers, this is a distinct asset.

The parts used in the construction of the instrument are: two 5000 ohm potentiometers, four binding posts, one 4 x 4 x

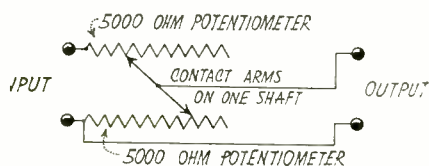

Fig. 1. Circuit for Audibility Ratio Meter

3/16-inch panel and a small cabinet to mount the completed instrument. These are connected as shown in Fig. 1, the two resistance units being connected with one common shaft, as shown in Fig. 2, which is brought through a hole in the panel and controlled by a dial on front. The scale of the dial can be calibrated in points of audibility or one can use the arbitrary reading of 0-100, or as many points as the individual builder desires.

The instrument is mounted in a small carrying case to permit taking on a

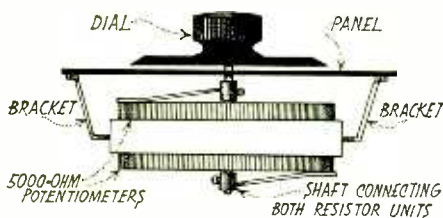

Fig. 2. Arrangement of Parts for Meter

trouble call where a set owner thinks his signal strength from a certain station is not on par with his next door neighbor.

By connecting the output of the receiver to the input of the audibility meter and a pair of headphones to output, then by varying the control knob, the signal can be reduced from maximum to a point where the signal is barely

audible and the dial reading noted. A similar procedure on a receiver at another location will ascertain whether or not the output signal strength is about the same, as it would be if the sound is barely audible in the headphones at the same dial setting.

This type of instrument can be used in many ways around the experimental bench and in field tests and is a great help in determining audibility ratios between units under such a test.

Testing Tubes for Short Circuits

TUBES can be easily tested for short circuits with a tester made from three flashlight cells, a tube socket and three flashlight bulbs. The parts are connected as shown in Fig. 3. It will quickly find short circuits between

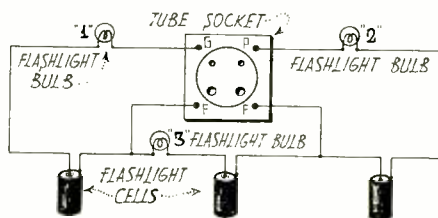

Fig. 3. Tube Tester for Short Circuits

grid-plate and grid-filament and open or burned out filament.

Upon inserting a tube in the socket, if lamp 3 burns, it shows the filament of the tube to be O.K. If not, the filament is probably burned out and no further tests are necessary. If lamp 3 burns, the other two should remain unlit if the tube is to be in perfect shape. Should lamp 1 light, the grid and the filament of the tube are touching and the best remedy is to discard the tube, as putting it in a receiver may cause serious damage. If lamp 2 burns, the grid and plate are touching in the tube and should be discarded.

Sometimes the short circuits causing lamps 2 and 1 to light can be remedied by gently tapping the tube in the palm of the hand when the elements may separate and clear the short, which will be evident should the lamp in the circuit under test fail to light.

This makes a small and convenient tester for tube shorts, as many of the commercial type of tube checkers have the grid and plate tied together for filament emission tests and there is no way to indicate the condition existing between the other elements.

Silicon vs. Nickel in Transformers

THE problem of designing audio transformers which will faithfully amplify 60 and even 30 cycles, corresponding to the tendency to thus extend the lower limit of broadcast transmitters and of loudspeakers, is primarily one of increasing the input inductance of the transformer, although an increase of the plate impedance of the tube is also effective. The inductance of the transformer depends upon the number of turns of wire on the coil, the size of the core, and the permeability of the core material. Adding primary turns causes a loss of high frequencies due to coil capacity, so high permeability nickel alloys are being used to an increasing extent. These alloys of nickel and iron have high permeability at low flux densities, the conditions encountered in audio transformer primaries.

However, these alloys have some disadvantages. The high permeability is maintained over a rather limited range of flux density, and falls off rapidly at higher or lower values. They saturate easily. This difficulty is becoming more important as the plate currents of the vacuum tubes are increased.

A more serious objection is that the transformer is permanently damaged by an increase in field strength, such as might result from accidental connection in a circuit without a C battery, or where a C battery is run down or where the plate current is abnormally high. Such temporary increase in flux through the core permanently changes the characteristics of the material.

On the other hand, silicon steel is not permanently affected by increases in flux. The frequency characteristic of the transformer is, of course, affected by core saturation while it exists, but the effect is not lasting. These considerations render the nickel alloy transformers particularly valuable for special laboratory work, or in commercial installations where care is taken to insure proper operation. All the electrical advantages of the nickel alloys may be obtained with silicon steel by adjustment of other factors in the design.

It has been found that when the lower end of the characteristic had been extended as desired, by changes in the coil and core, there was a tendency toward resonance at high frequencies as well as a falling off of amplification. These difficulties were overcome by changes in

(Continued on Page 76)

Radio Pickups

Items of trade interest from here, there, and everywhere, concentrated for the hurried reader.

Paul Ware, president of the Ware Manufacturing Corporation, is notifying other manufacturers as to their infringement on his patent wherein the use of selective shields in an r-f amplifier is claimed to prevent signal pick-up through other means than the antenna system, his purpose being to arrange for licenses.

The De Forest 422 d-c screen-grid audion is being made with a rugged oxide-coated filament so as to avoid microphonic trouble and to give long life. Its filament current is .132 amp. at 3.3 volts. Its plate takes 135 volts, its screen-grid 45 volts and its control grid —1.5 volts.

Cornell Electric Manufacturing Company, Long Island City, N. Y., are making a Cub condenser in capacities from .0001 to .006 mf for grid and bypass uses. It is a non-inductive three-paper condenser designed to withstand a flash of 1,500 volts d-c. It is self-mounting with terminal controls rigidly fastened to a vacuum-dial and impregnated mandrel.

The Radio Announcers School of America has been opened at Indianapolis to teach English, enunciation, radio theory, program instruction, radio advertising, and sales.

A new cabinet, model 75 Concert Grand, has been added to the Model 60 Lowboy and Model 95 Highboy for housing the Silver Radio eight-tube, screen-grid chassis and a 10-inch electro-dynamic speaker.

The Van Horne Tube Company has developed a 280 rectifier tube with metal plates instead of screen plates. It is designed to prevent burn-out from heavy overloads or fluctuating line voltage and is intended for use with sets having 2+5 tubes. For other types of power tubes it is better to use a 280 tube having screen plates as it is less gassy.

An analysis by W. P. Bear of the exhibits at the Pacific Radio Show in San Francisco shows that of the 214 radio sets exhibited, 86 per cent were consoles, 98 per cent operate from 110-volt a-c, 93 per cent use tuned r-f or neutrodyne circuits (40 per cent having screen-grid tubes) and 60 per cent use '45 type tubes in push-pull in the last audio stage, 20 per cent using a single power tube, and the balance other power tubes in push-pull. The number of tubes per set is increasing, averaging 3.8 in 1925, 5.66 in 1926, 6.26 in 1927, 6.54 in 1928, and 6.95 in 1929, including rectifier tubes. Sets having seven or eight tubes are in the majority, 32 per cent having seven and 32.8 per cent having eight tubes. Six-tube sets come next with 19.8 per cent. Prices of consoles without phonographs range from \$84.25 to \$595, averaging \$241, which is \$61 less than the average 1928 price and \$31 less than the average 1927 price. These figures represent the exhibits of forty-five manufacturers.

Fada engineers state that two stages of audio amplification are necessary with a power detector in order to avoid distortion from detector overload. The detector and first audio stage should be capable of overloading the power stage before either of them reaches the overload point.

De Forest engineers have changed the rating of the screen-grid audion from 75 to 90 volts for the a-c screen grid and from —1.5 to —3 volts for the control grid, with 2.5 volt filament supply and 180 volt plate supply. This change prevents the tendency of the last r-f stages to draw grid current which results in broad tuning and modulation of the carrier wave. Under the new rating the amplification constant, plate resistance, mutual conductance, plate current and control grid current are essentially the same as under the old rating.

Figures compiled for NEMA indicate that May, June and July sales of radio totaled \$91,000,000, and for the year from June 30, 1928, to June 30, 1929, \$510,000,000. This means the sale of more than 3,108,000 sets, of which 13 per cent were battery operated. The regional analysis included in the July 1 quarterly survey places Illinois first, New York second, and California third in volume of sales. Reports show sales by firms and individuals, giving their principal lines of business as that of poultry raiser, harness shop, funeral director, court reporter, baby chick hatchery, pool room, optometrist, insecticide dealer, patent medicine dealer, etc.

Victor Radio Corporation of Chicago announces a new screen-grid set in a table and in a console model as being ready for distribution.

The Zenith 50 screen-grid chassis for use in Models 52, 53, 54 and 55, uses eight tubes and rectifier, three '24 tubes in the r-f amplifier, three '27 tubes in the power detector and first stage push-pull a-f amplifier, and two '45 tubes in the last push-pull audio stage. All models except the 52 have automatic tuning with volume control, station silencer, and station indicator, all auto-

matic. The automatic tuner is at the right of the chassis, the right hand knob is for volume and "on-and-off" control and the left hand knob for vernier control. Model 55 is also equipped for remote control of automatic tuning and like Model 54 has a built-in antenna. All models are equipped with a 12 inch electrodynamic speaker and connection for phonograph pickup. The translucent dial for hand-tuning is calibrated in kilocycles and meters. The filter condensers are self-healing.

Bremer-Tully are using an automatic instrument for testing completed receivers for continuity of circuits and for breakdown and high resistance shorts. A radio set is placed in a fixture that makes all connections to the various circuits. When the operator presses a button a series of relays check the circuits, any fault being indicated by



Bremer-Tully Automatic Circuit Tester

lights on the instrument board. Thus light No. 1 indicates that something is wrong with the grid of the first a-f tube, light No. 13 shows trouble in the first '45 filament, or No. 19 tells of difficulty on the '80 plate. The device not only tests each individual circuit for continuity, but also applies a high potential between the various circuits. A complete and thorough test can be made in 15 seconds.

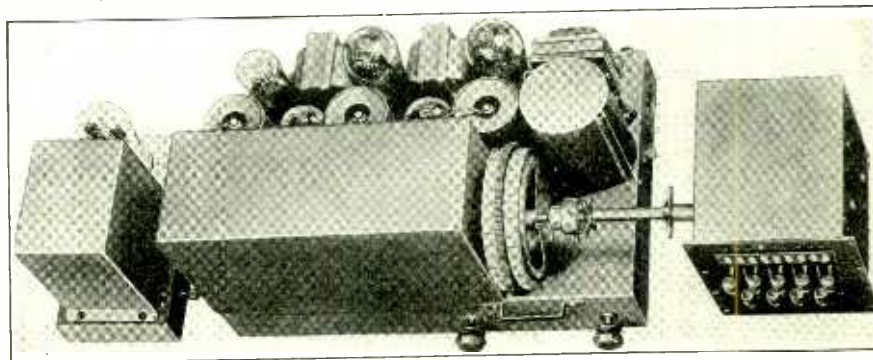

Zenith 50 Chassis with Automatic Tuner

A form of merchandising contract suggested by the Radio Retailers' Association of New York stipulates that the manufacturer shall provide the dealer with demonstrating equipment for which the dealer deposits 60 per cent of the list price. The dealer secures his future requirements with a similar deposit, due thirty days from delivery. The receivers remain the property of the manufacturer until sold, at which time the deposit is forfeited. By return of the merchandise to the manufacturer, the dealer is guaranteed full refund of his deposit. Thus the dealer is protected against overstocking, because the merchandise is fully returnable, and against price cutting since it sells at a uniform price through all competing outlets.

Sonora Phonograph Company has acquired the manufacturing facilities of the Federal Company, Buffalo, N. Y., which will be employed to produce Sonora sets housed in cabinets from the Sonora woodworking factory at Saginaw, Mich. All Sonora products are to be marketed through distributors exclusively. A competent staff of research and development engineers is to be maintained.

The feature of the new Grebe SK-4 is an equalized band-pass filter which consists of a variable condenser in the antenna circuit and two loosely coupled circuits preceding the first r-f amplifier. This tunes out all frequencies above or below a narrow band which is amplified and further filtered by three stages of screen-grid amplification. This is claimed to give equal selectivity and amplification of signals along the entire dial.

The Gulbransen Company of Chicago has arranged for a series of half-hour symphony orchestra concerts directed by Henry Hadley over the Columbia Broadcasting System, commencing Saturday night, October 8.

George A. Jacobs, founder and former president of the Dudlo Manufacturing Company, and his associates have organized the Inca Manufacturing Corporation at Fort Wayne, Indiana, to manufacture copper wire products for the electric, radio, automotive and kindred industries. Offices have been established and construction of a plant is under way on an eleven-acre factory site.

The R. M. A. Merchandising Committee plans to guard against over-production of radio products by recommending that manufacturers check their production schedules against present and prospective orders. Furthermore, the committee is securing and analyzing data on the distribution costs of all varieties of radio products in all localities.

The International Resistance Company states that the insensitive condition of an old radio set may often be traced to changed resistance values, usually upward rather than downward. Since the sensitivity of a radio circuit depends upon definite resistance values, it becomes evident that any serious change will materially affect the performance. The owner of an old set which is proving insufficiently sensitive will do well to obtain the resistance data from the manufacturer, and replace the old resistors with new metallized resistors of the proper resistance values. This will generally be found to restore the old radio set to the desired condition so far as sensitivity is concerned.

The American Bosch Magneto Corporation announces a complete line of Bosch radio tubes for d-c and a-c operation, including screen grid BX224 and amplifier BX245.

The Freed-Eisemann Radio Corporation has created the Joseph D. R. Freed Foundation in order to stimulate program artistry and to focus public attention on radio broadcasting. The method is to make annual awards for excellence as reported by non-partisan committees. The first award will be to the station which presents the outstanding program of the year; the second to the outstanding individual performer; the third to the outstanding program director; the fourth to the station which makes the greatest technical advance in handling programs; the fifth to the station whose programs best represent the educational value of radio in raising standards of morals, taste and manners, and the sixth to the advertiser who presents the finest advertising program.

The Daven Company of Newark, N. J., has purchased the physical assets of the Daven Corporation through receivership proceedings and announces that it will continue to manufacture and deliver Daven resistor specialties.

Roger M. Wise, for seven years chief engineer of E. T. Cunningham, Inc., now occupies a similar position with Sylvania Products Company, manufacturers of vacuum tubes, at Emporium, Pa.

The Crosley Radio Corporation announce production of the Monatrad, a six-tube set with a-c screen-grid tubes in the two r-f stages, heater type tubes in the power detector and first audio stages, and two '45 tubes in push-pull in the second audio stage, an '80 tube being used as a rectifier. This Crosley 30-S retails at the lowest price in history for an a-c screen-grid set. It is equipped with a triple range control device which is designed to give greater sensitivity on distant stations and better quality on near-by stations. It uses a completely shielded gang condenser with illuminated dial, a carbon-type volume control, and a Mershon condenser.

The report of the radio law committee of the American Bar Association recommends the repeal of that portion of the law which provides for equal distribution of radio facilities among the five zones into which the nation is divided. The report states that this provision of the Davis amendment "runs counter to well established engineering principles" and "in addition to the hardships which it brought about is distinctly wasteful and unsound."

The committee also advocates repeal of the "anti-monopoly" provisions of the law as they are "a constant menace to the foreign communications system of the United States." Senator Couzens' proposal of a Federal commission or communications is opposed on the ground that radio would thereby be thrown into a hodge-podge along with the control of cables, telegraph and power companies, and perhaps subordinated to them.

The Sylvania SX-280 rectifier tube may be operated with as much as 400 volts a-c on the plates, provided that the current drain does not exceed 110 milliamperes, thus giving considerably higher d-c voltages for operation of power tubes. If more than 110 ma is required it is best to limit the applied a-c to 350 volts per plate.

The new Brandes receiver is a seven-tube set with three tuned stages of r.f. amplification, detector and two audio stages; '27s are used in all but the last stage, in which two '45s are employed in push-pull. Types B-15 and B-16 are console models with built-in dynamic speakers. B-10 is a table model and is designed for either a dynamic or magnetic speaker.

NEW RADIO CATALOGS

Bud Radio, Inc., Cleveland, Ohio, are distributing an interesting pamphlet on wiring a home for radio by means of convenience outlets which are supplied with a standard switch box containing loom clamps. The outlets provide for aerial, ground, speaker, and current connections as well as remote volume control.

Master Engineering Company, Chicago, Ill., are distributing a leaflet on the Master Voltage Control, which is an a-c plug for use in a haseboard outlet whereby voltage ranges of 110-115, 115-120, 120-125 or 125 and over may be mechanically reduced to the standard voltage for which a set is designed.

Electrad, Inc., of New York City, have published an interesting pamphlet about the Super-Tonatrol, a volume control which will safely dissipate 5 watts with one-tenth or more of the resistance element in the circuit. Wiring diagrams and data are given on the use of seven types of this device in various methods of volume control, including antenna input, screen grid bias, plate voltage of '27 tube in r-f stage, grid bias, plate voltage shunt and grid voltage from a-f secondary.

"Polymet Radio Essentials" is the subject of a 12-page booklet from the Polymet Radio Mfg. Co. of New York City. It contains an illustrated price list of paper and mica condensers for all radio uses and of wire-wound tubular and strip resistors, rheostats and volume controls.

"Television, the Eye of Radio," is an attractively printed 32-page booklet from the Jenkins Television Corporation of Jersey City, N. J., describing the experiments and equipment used in reproducing shadowgraph moving pictures.

Alden Mfg. Co., Brockton, Mass., in a 16-page booklet entitled "Something That Is Low-Priced Is Actually Better," tells how Na-Ald sockets and adapters are made, illustrating and describing fifty different types.

Specifications of PAM amplifiers for various types of installations are contained in a recent bulletin from the Samson Electric Company of Canton, Mass. The mechanical and electrical characteristics of two and three-stage amplifiers using '10, '45 and '50 tubes and of several microphone amplifiers are shown, together with illustrations of representative installations.

Bulletin No. 62 from the Shallcross Mfg. Co. describes the Super Akra-Ohm, a non-inductive wire-wound resistor having low distributed capacity and temperature co-efficient. This unit is made in three types, which are calibrated to an accuracy of approximately 1, 1/2 and 3/4 per cent respectively for resistances from 5000 to 5,000,000 ohms. The units are designed to dissipate 1 watt.

TOBE Filterette

COPYRIGHT 1929 by Tobe Deutschmann Corporation. Excerpts may be used if credit is given.

VOL 1 NO. 6

OCTOBER, 1929

CANTON, MASS.

HIGHWAY COMMISSIONS REFUSING BLINKERS—WILL ACCEPT ONLY NON- INTERFERING TYPE

AN IMPORTANT disclosure to the effect that highway commissions throughout the country are universally refusing to accept any blinker which interferes with radio reception was recently made to the president of the Tobe Deutschmann Corporation by a representative of one of the largest flasher manufacturers in the United States.

"There is hardly a city or town in America today," explained the speaker, "whose street commissioners have not been hounded night and day by complaints from radio listeners whose reception was being spoiled by noises radiated from street blinkers. Evidently the word has gone around that this interference is wholly unnecessary, for harassed street commissioners are all insisting on non-interfering blinkers. Just try and sell an interference-radiating type of flasher signal today. They would throw you out bodily!"

While executives and engineers of the Tobe Deutschmann Corporation have long insisted that it was only a question of time before this situation would come about, they themselves expressed surprise at learning that such definite sentiment existed already. Much of this attitude they attribute to the enterprise of set manufacturers and dealers, who, with increased production, have been striving to place a radio set into every home in the country. The fact that they have been so successful, together with the excellence of the present day sets which they have been marketing, have combined to make a situation where we have now a larger number of listeners than ever before, all with sets that are delicate musical instruments in which the slightest flaw of reception is a

(Continued on Page 56)



George R. Walters, Static Nemesis

THE WORLD IS WATCHING HIM

Is interference legislation practicable? The Federal Radio Commission seems dubious. The N. E. M. A. urges manufacturer cooperation. A few power companies have intimated that the task is insuperable, and that legislation will cause more trouble than benefit.

The following quotation from *Radio Age* may throw some light upon the practical working out of this moot problem: "It is believed that this problem of interference is being handled better in Southern California than anywhere else in the United States."

George R. Walters, whose picture heads this column is the man responsible for this excellent work. And in response to the many who read of his success in the last issue of this magazine, we are glad to be able to publish his photograph.

INTERNATIONAL ASSOCIATION OF MUNICIPAL ELECTRICIANS CONVENES AT BOSTON

Radio Interference Exhibit Feature of Show

THE interest displayed by manufacturers in the Tobe exhibit of Radio Interference Prevention at the recent show, in the Hotel Statler, Boston, of the International Association of Municipal Electricians, promises to result in unanticipated benefit to radio fans throughout the country.

While the Tobe Deutschmann Corporation has long been in correspondence with manufacturers of devices such as were featured at the show—fire alarm systems, police alarm systems, traffic signal systems, street and municipal lighting plants, airport lighting systems and radio for municipal use—this was for many of these manufacturers the first opportunity of meeting Tobe representatives and discussing the problem of radio interference face to face.

As a result of the meeting several important facts came to light, among which perhaps the most important was that these manufacturers, practically to a man, are desirous of ridding their products of radio interference, provided the cost of filterizing is moderate. They were very much pleased to learn that radio interference, of which they had been receiving so many complaints, could be inexpensively eliminated from their apparatus.

As the most recent member to be elected to this body, TOBE, the "baby" of the show, had a very timely exhibit. In addition to the various types of filterettes on display, there was also a radio set in operation, which, picking up as it did interference from the various signs and signal apparatus arranged about the ballroom, showed more con-

(Continued on Page 56)

Small Motor *Interference*

Radio Interference Created by Fractional Horse Power A-C and D-C Motors

By W. K. FLEMING

Chief Engineer, Tobe Deutschmann Corporation

ONE of the most common and often overlooked types of radio interference is that caused by small motors. Contrary to general opinion, practically all types of motors are creators of radio interference. However, the worst offender in the small motor class is undoubtedly the series wound Universal type motor as shown in Fig. 1. This motor is largely used on professional and commercial devices, as well as on a great many types

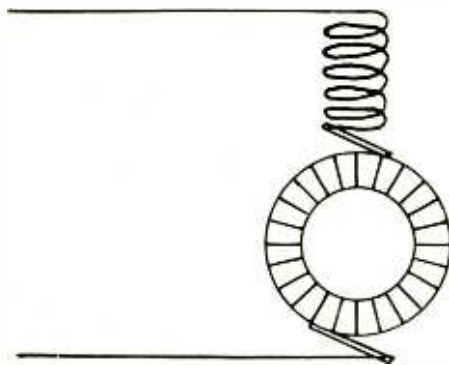

Fig. 1. Series-Wound Universal Motor

of household appliances. The interference, while severe, is, fortunately, not difficult to suppress.

The next worst offender in the small motor class is the repulsion starting induction running type of motor. Motors of this type may be divided into two classes; that in which all of the commutator bars are short-circuited when the motor is in running position, as shown in Fig. 2, and that in which the circuit across the brushes is opened

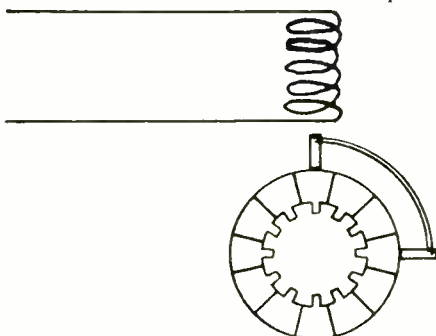

Fig. 2. Repulsion-Starting Induction-Running Motor. Commutator Bars Short-Circuited When Running

when the motor is in running position, as shown in Fig. 3.

It is generally thought that radio interference is created by either class of

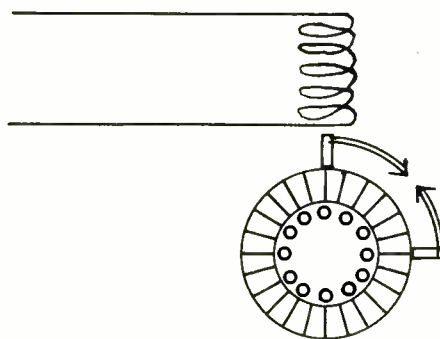

Fig. 3. Repulsion-Starting Induction-Running Motor. Brush Circuit Open When Running

repulsion - starting induction - operating motor only during the starting period; that is, while the motor is reaching its normal operating speed. Motors of the type shown in Fig. 2 are therefore seldom considered as creators of continuous radio interference. This, however, is true only as regards new motors. In practice, it has been found that after motors of this type have been in use for some time, due to the fact that the commutator short circuiting ring becomes oxidized or dirty and is thus prevented from completely short circuiting the commutator segments, they generally do become sources of continuous radio interference. Under these conditions, radio interference is caused by the continual arcing which occurs between the commutator short circuiting ring and the commutator.

Repulsion-starting induction-running motors of the class which open the circuit between the short circuiting brushes, as shown in Fig. 3, generally create interference only during the starting period, until the motor reaches its normal operating speed. However, this in itself is sometimes quite serious, as the motor is often used in circuits where it is being frequently started and stopped, thus causing an intermittent interference which is quite annoying.

Where several refrigerators or oil burners equipped with this type of motor happen to be located in the same apartment building or immediate neighborhood, sufficient disturbance may be created to classify this type of equipment as a source of serious radio interference.

In addition to this interference, it has been found that interference is frequently created by the action of the brushes on the commutator even after

the brush circuit is opened. However, the interference from this source is, in many cases, so slight as to be negligible.

The least offender among the commonly used types of small motor is probably the split phase induction motor, as shown in Fig. 4. This motor may use either the inductance resistance method of phase splitting or the condenser method. In either case, the interference created is due to the opening of the switch in the starting windings.

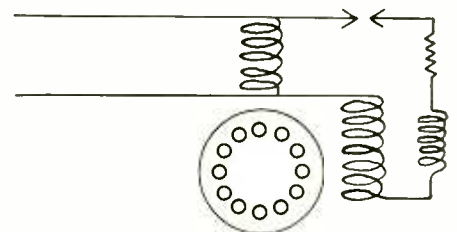

Fig. 4. Split Phase Induction Motor

This interference is, therefore, seldom severe enough to be objectionable. However, where several of these motors are operating in apartment houses or in the same vicinity, it is possible that the interference will be noticeable. We would not classify this motor, however, as a serious creator of radio interference.

In d-c districts, radio interference is created by all types of small motors. Fig. 5 gives the circuit of one of the most common types of d-c motors causing interference. The interference created by this type of motor is not so severe as that created by series wound motors; however, as it is continuous, it comes under the head of highly objectionable interference.

It may be said that while not all

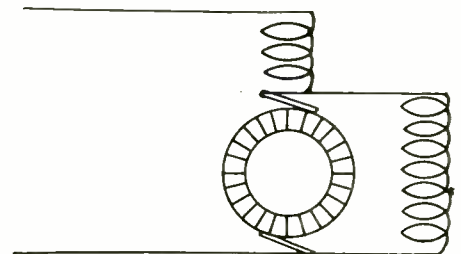

Fig. 5. Common Type of D-C Motor

types of induction motors cause serious radio interference, it might be well to consider them as offenders until they are proved not to be such. Series wound

motors, however, are consistent creators of radio interference. In view of these conditions, small motors of all description should be considered potential sources of radio interference, until proof to the contrary is obtained.

The general application of the small motors herein described is given below:

Application of Universal Motors

The appliances used in beauty parlors and barber shops are practically all equipped with these motors. Under this heading we have:

- Motor driven massage equipment
- Motor driven hair clippers
- Motor driven hair dryers
- Small electric fans

In modern offices many types of equipment are electrically driven:

- Calculating machines
- Addressing machines
- Stamping machines
- Dictaphones
- Adding machines

In optical and jewelry stores this motor is used to drive:

- Routing drills
- Small lathes
- Small drills
- Grinders

In the professional classification, series wound motors are used for operating all types of dental equipment:

- Dental grinders
- Dental lathes
- Dental engines
- Dental drills

In confectionery and drug stores and soda fountains, Universal motors are used for operating:

- Electric cash registers
- Juice extractors
- Drink mixers

In machine shops and garages, these motors are used to drive:

- Electrically driven gas torches
- Portable electric drills
- Grinding attachments

Under the class of household appliances using this motor, we have many devices already listed, with the addition of:

- Temperature regulators
- Vacuum cleaners
- Kitchen mixers
- Sewing machines
- Exhaust fans

In fact, this type of motor is so generally used that it would be impossible to give a complete description of its many applications.

Application of D-C Motors

As the application of D-C motors is practically the same as that given above for both the small series wound Universal motors and induction motors, it will not be necessary to enumerate the different applications where series wound and compound or shunt wound motors are used. In general, series wound or Universal type motors will be used on direct current in the same applications as those specified for alternating current. Compound wound direct current motors will be used in the same applications as those specified for induction motors. As all direct current motors are sources of interference, it is fortunate that direct current is generally used only in restricted areas in large cities.

Application of Induction Running Motors

Motors of either the repulsion starting induction running type as shown in Figs. 2 and 3, or split phase induction as shown in Fig. 4, are in general use on all types of apparatus for which a constant speed motor is required. The apparatus listed below will generally be equipped with one or the other of these two types:

- Soda fountain refrigerators
- Commercial refrigerators
- Household refrigerators
- Clothes washing machines
- Dish washing machines
- Oil burning furnaces
- Ironing machines
- Blowers
- Shop equipment
- Garage equipment
- Electric pianos
- Coffee grinders
- Flashing signs
- Meat grinders
- Meat slicing machines

Character of Interference

THE interference created by Universal or series wound motors is readily distinguishable from other types of radio interference, due to the fact that it is heard in the loud speaker as a characteristic high-pitched, buzzing sound, either steady or undulating in character, depending upon the type of work for which the motor is used.

For example, if it is used on a vacuum cleaner, the pitch of the interference will change whenever the cleaner is moved off the rug or lifted from the floor. This change in pitch is due to the change in speed of the motor which takes place under varying conditions of load.

In the case of dental equipment or sewing machine motors, which apparatus is frequently run at varying speeds as well as varying loads, it is relatively easy to detect the type of equipment which is creating the interference. Interference created by dental equipment may usually be readily identified by its characteristic high-pitched, intense note. That created by sewing machine motors may be identified by the progressive changes in pitch as the motor speed is varied.

In general, the interference characteristics of all types of apparatus employing series wound motors may readily be ascertained by a study of the conditions under which the apparatus operates.

The interference created by repulsion-starting, induction-running motors, as shown in Fig. 2, is readily distinguishable, due to the fact that it is heard in a loud speaker as a short buzz of increasing intensity and rising pitch, generally of about two to five seconds duration, followed in the case of old motors by a steady crackling noise while the motor is operating.

In the case of repulsion-starting, induction-running motors, as shown in Fig. 3, the characteristic of the interference is practically the same as that for the motor shown in Fig. 2, with

the exception that usually no interference is created after the first five seconds, during which time the motor is starting, unless the motor is overloaded.

In the case of an overloaded motor of either the type shown in Fig. 2 or 3, there will be a continuous, low-pitched, buzzing and crackling while the motor is operating. In general, all types of induction motors, employing commutators for starting purposes, are likely to cause some radio interference, and should therefore be checked carefully if interference is in evidence.

As the only interference likely to be created by a split phase motor is due to the opening of the automatic switch in the starting winding, this is generally heard as a single click similar to that heard when a snap switch is opened or closed.

In the case of direct current motors, as shown in Fig. 5, there will be a steady buzzing interspersed with a crackling noise during the entire operation of the motor.

To Suppress Interference

TO ELIMINATE or suppress the interference created by Universal or series wound motors used on either a-c or d-c, a simple capacitive type filter is generally found satisfactory. The best

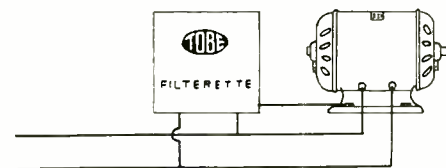

Fig. 6. Filterette Connection for Compound or Shunt-Wound Motor

type of filter to use is one that can be inserted directly in the line as close to the motor as possible, such as the \$3.50 Tobe Filterette Jr.

In the case of compound or shunt wound d-c motors, the filter should be attached in a similar manner to that shown in Fig. 6, a Tobe Filterette No. 10 listing at \$10. This same arrangement may be used with series wound motors. With some types of series wound motors which are operated at particularly high speeds, such as are used with dental equipment, it is generally necessary to use an inductive capacitive type filter, like the \$5 Tobe Filterette No. 1BPO or Senior, with the return wire from the filter connected to the frame of the motor.

To suppress the interference created by induction motors, it is generally necessary to use an inductive capacitive

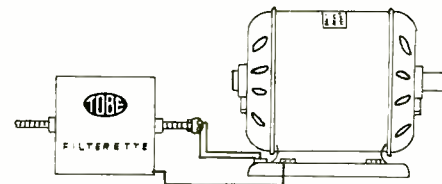
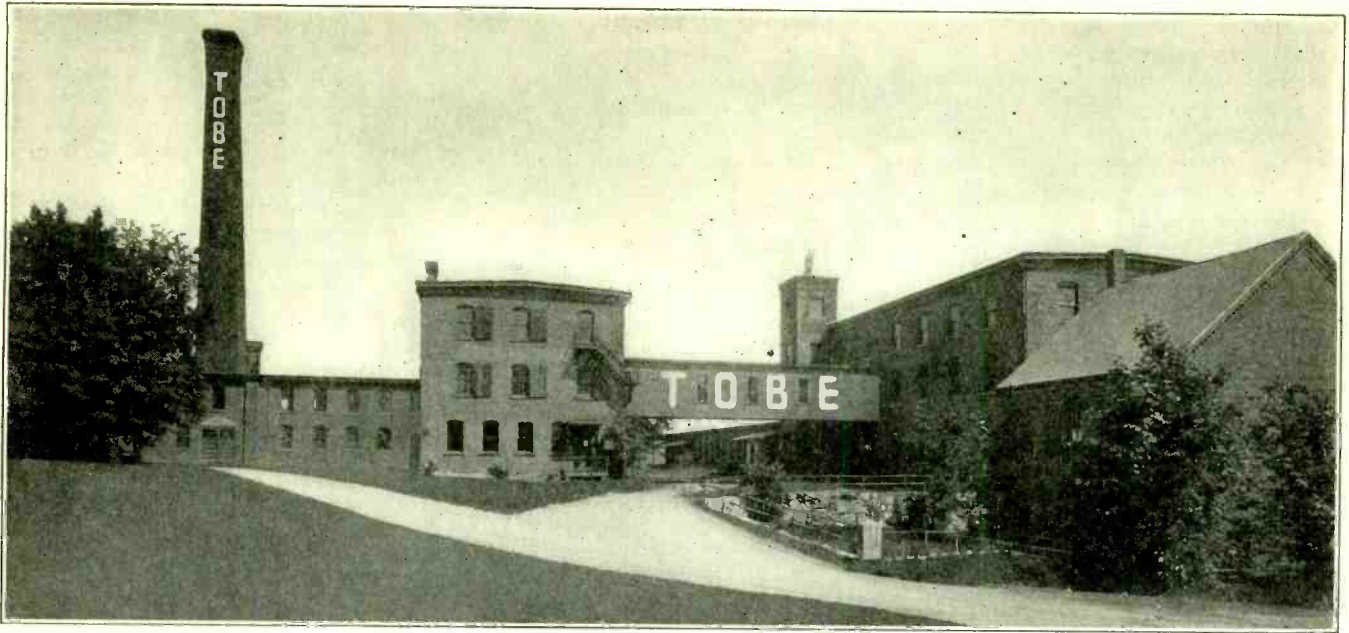

Fig. 7. Filterette Connection for Induction Motor



Where Filterettes Are Made

type filter (Tobe Filterette No. 110, \$15), as shown in Fig. 7, as the capacitive type filter is usually of practically no use with this type of motor.

In using an inductive type capacitive type filter, it is important that the filter be designed to handle the current drawn by the motor, as otherwise the filter may be destroyed after the motor has been operated for a short time.

Type of Filter to Use

THE application of filters to all appliances which are operated from lighting receptacles or sockets is a comparatively simple matter provided a properly constructed filter is used. It is important, however, that the filter used be of correct design and be approved by the underwriters; otherwise, a serious fire hazard may be created.

Where it is necessary to cut into the supply lines to install a filter, it is found more important that the unit be approved by the underwriters. In general, the unit should be constructed in a standard cutout box and protected by fuses, and, of course, connected in this circuit according to the standard electrical code.

In installing filters of either the plug-in type or line type, it is important that the return wire with which most filters are equipped be connected to the frame of the apparatus and to the circuit enclosing the supply wires in the most direct manner possible; otherwise, satisfactory suppression of interference may not be secured. The standard practice of grounding to water pipes is not applicable in attaching filters.

In providing motors with capacitive type filters, great care must be given the choice of the condensers employed, as experience has shown that specially designed condensers are required for filter work, particularly when the filters

are to be used in a-c circuits. The use of improperly designed condensers will result in the production of a filter which will not only be inefficient, but will also have a short life. As has been previously stated, the use of correctly designed inductances is also important. Only by giving sufficient attention to these factors may a filter be constructed which, while ensuring the suppression of interference without affecting the useful operation of the motor, will meet the Underwriters' approval and will conform to the National Electrical Code.

I. A. M. E. CONVENTION

(Continued from Page 53)

clusively than any amount of talking could have done, the need for filterettes.

On the third day the convention was addressed by Mr. C. W. Metcalf of the Tobe Deutschmann Corporation on the subject, "Suppression of Radio Interference Created by Traffic Control Apparatus." As a result of this talk, which was illustrated with specially prepared diagrams visible to all in the audience, the two engineers in charge of the Tobe exhibit, Mr. Haskins and Mr. Metcalf, were kept busy the fol-

lowing day answering questions on the application of filterettes to municipal electrical apparatus.

Most of the manufacturers admitted frankly that on account of the comparative novelty of this problem they had not had either occasion or opportunity to study its intricacies. Here they had a chance to stand before a radio set, watch the flashing of various blinkers, and hear the crashing in the speaker with each winking of the light. The absolute uselessness of a radio set under such circumstances could not have been more conclusively demonstrated. It was a simple matter, after that, to show how completely free from interference a filterized blinker could be.

NON-INTERFERING BLINKERS

(Continued from Page 53)

marked annoyance. The result was inevitable.

With the public already educated to the fact that radio interference from blinkers is preventable, it is certain that there will be, this winter, an increased sales resistance against all electrical apparatus which interfere with radio reception. The tremendous impetus which has been given radio sales through the general excellence of the new receivers as well as the activity resulting from the increased stabilization of the industry will find electrical manufacturers, next winter, with a public markedly hostile to any type of electrical apparatus whose operation mars the perfection of the new radio sets' reception.

And it follows likewise, that the public is going to display a preference for electrical appliances, which, through proper design and filtering, may be employed without fear of annoying hums, roars or crackles in the new receiver.

ACORDIAL invitation is extended to all our readers to visit the Tobe booth either at the Chicago Radio Show, October 25-26, the Radio World's Fair, Madison Square Garden, N. Y., September 23-28, or the Boston Radio Show, to witness demonstrations of the various filterettes.

We welcome inquiries regarding interference from any reader, whether dealer, service man or listener. Remember that we maintain a complete engineering service for the convenience of our readers, and we are glad to have you make use of it.

New Sets & Accessories Recently Announced. Changes in Models, Prices, Etc.

IN GENERAL

Dozens of new models were announced in September. Price reductions were made by a number of the large manufacturers. Many new additions were made to standard lines. The important developments of the month are chronicled on this page. The price sheets on the two following pages give all of the new prices of well-known sets. These prices are correct as of September 20.

Both Eastern and Western List Prices are shown but these are on separate pages.

This price sheet appears in each issue of "RADIO." See next month's issue for additional data.

List of Manufacturers

Whose prices are same both East and West

- MAJESTIC
- RCA
- GRAYBAR
- COLUMBIA
- BREMER-TULLY
- BRUNSWICK
- VICTOR
- EARL
- FREED
- BROWNING-DRAKE (Console models only)
- SONORA (All models except A-36 and A-44)
- One EVEREADY Model No. 31, Table, priced same East and West

BALDWIN

Nathaniel Baldwin, Inc., announces a SCREEN GRID Console. List price, \$198.00, less tubes. Uses 4 '24 tubes; 2 '45 tubes; 1 '80 rectifier. Screen-Grid detection. Baldwin electro-dynamic speaker. Also High Boy at \$219.00. Chassis separately. Prices on request.

RCA

RCA announces PHONO-RADIO COMBINATIONS. Radiola 47. Combination. Screen-Grid chassis. Same chassis as Model 44. Uses 5 tubes, including rectifier. Electro-dynamic speaker, electric phonograph motor and pick-up. List price, East and West, less tubes. \$274.50 With tubes \$293.00

RCA Model 67. PHONO-RADIO COMBINATION. Superheterodyne combined with phonograph. Eight tube receiver, not including rectifier. List price, both East and West, \$690.00 without tubes. \$733.00 with tubes. This new combination has a tone control to accentuate bass or high notes and a new method of volume regulation.

RCA Model 21—SCREEN-GRID battery type receiver. Table model. Using UX-222 tubes. UX-171-A power tube. \$69.50

RCA Model 22—Same chassis as Model 21 but in console. Uses Magnetic Speaker. \$135.00

RCA Model 62, PRICE REDUCTION. New price, less tubes. \$250.00 Former price, less tubes. \$350.00 A reduction of \$100.00

RCA Model 33AC PRICE REDUCTION. New price, (with legs) but without tubes. \$54.00 Former price, (with legs) without tubes. \$77.50

RCA Model 33DC PRICE REDUCTION. New price, (with legs) but without tubes. \$64.00 Former price (with legs) without tubes. \$87.50

RCA Model 60 PRICE REDUCTION. New price, less tubes. \$130.00 Former price, less tubes. \$147.00

RCA Model 18 Receiver Discontinued
RCA Model 62 Superheterodyne Discontinued

Sears Roebuck "Silvertone"

Sold to consumers. \$110.00 cash price. Complete with tubes, delivered and installed. Choice of 7 tube screen-grid set (including rectifier) or 8 tube neutrodyne (including rectifier), electro-dynamic speaker. Initial announcement made in "SATURDAY EVENING POST," issue of August 24.

APEX 1930 MODELS

New Super Screen-Grid Sets. New High Gain Neutrodyne.

Model 11—Super Screen-grid. 2 '24; 2 '27; 2 '45; 1 '80. Eastern list price. \$115.00 Western list price. \$124.50

Model 14—Super Screen-grid. Same chassis as Model 11. Eastern list price. \$140.00 Western list price. \$149.50

Model 24—Super Screen-grid. Chassis same as Model 11. Eastern list price. \$240.00 Western list price. \$249.50 This receiver has perfected remote control.

Model 115—Neutrodyne. 5 '27; 2 '45; 1 '80 tubes. Eastern list price. \$115.00 Western list price. \$124.50

Model 140—Neutrodyne. Chassis same as model 115. Eastern list price. \$140.00 Western list price. \$149.50

Model 160—Neutrodyne. 6 '27; 2 '45; 1 '80 tubes. Eastern list price. \$160.00 Western list price. \$169.50

APEX TABLE MODELS

Model 60—Neutrodyne. Same chassis as model 115. Eastern list price. \$60.00 Western list price. \$64.50

BATTERY OPERATED TABLE MODEL

Model 45—5 '01-A; 1 '71 tubes. Eastern list price. \$45.00 Western list price. \$49.50 (All prices are less tubes)

SPARTON "Equasonne"

New Model 931—Nine tubes, including rectifier. Deep black walnut console cabinet. Electro-dynamic speaker. Eastern list price, including tubes. \$179.50 Western list price, including tubes. \$189.50

Models 931 and 301 are now available in either D-C or A-C circuits without extra cost.

CROSLY

"MONOTRAD" Chassis with panel. Model 30-S (SCREEN-GRID). For installation into console cabinet. Book shelves, etc. Eastern list price, \$62.00, without tubes. Uses 2 '24 tubes; 1 '27 Power Detector; 1 '27 first audio; 2 '45 pushpull second audio; 1 '80 rectifier.

MONOTRAD, 33-S in Console, with Crosley Dynacoll Speaker. \$115.00

MANDEL Price Correction

SCREEN-GRID CHASSIS, list price \$115.00 and not \$110.00, as reported in these columns last month. This chassis uses 3 '24 tubes; 3 '27 tubes; 2 '45 tubes; 1 '80 rectifier.

MANDEL HEATER TYPE TUBE CHASSIS—List price, \$100.00. Uses 6 '27 tubes; 2 '45 tubes; 1 '80 rectifier. Operated from outside aerial and a ground. A new discount schedule on heater tube chassis is announced. These discounts are greater than those previously granted by the manufacturer.

FADA

FADA Model 22. Battery operated table model, 6-volt D-C. Eastern list price, less tubes. \$55.00 Western list price, less tubes. \$60.00

This model uses five 112-A tubes and one 171-A tube.

FADA Model 15-M. (Chassis only). This is a special chassis with electro-dynamic speaker for installation in consoles. SCREEN-GRID. This combination chassis and speaker is priced as follows:

Eastern list price, less tubes. \$115.00 Western list price, less tubes. \$120.00

Uses 4 '27 tubes; one '24 tube; 2 '45 tubes; one '80 rectifier.

FADA Model 15-MZ. Same as above but for 25-40 cycle operation. Same prices as Model 15-M.

FADA Model 18—110-volt D-C table model. 5 '12A and 2 '71 tubes. Eastern list price. \$120.00 Western list price. \$125.00

SENTINEL Screen-Grid

Two new models. Phono-radio No. 666-C combination, nine tubes, including rectifier. Eastern list, \$149.50. Western prices slightly higher.

Model 666 Console, Screen-Grid, 8 tubes and rectifier, 4 screen-grid tubes. Same chassis as in phono-combination. List price, 666 Console, \$99.50, East. Slightly higher in the West.

New Sets & Accessories Recently Announced. Changes in Models, Prices, Etc.

RCA Tube Prices Increased

Seven types of RADIOTRONS have been increased in price, effective early in September. Other tube manufacturers report that a corresponding increase in prices have been made.

Type of Tube	New List Price	Old List Price
WD-11	\$3.00	\$2.50
WX-12	3.00	2.50
UV-199	2.75	2.25
UX-199	2.50	2.00
UX-120	3.00	2.50
UX-200A	4.00	3.50
UX-240	3.00	2.00

Eveready Announces New Prices

National Carbon Company's line of screen-grid models is priced, at factory, as follows:

- 52—8 tubes, including rectifier. \$157.50
- 53—8 tubes, including rectifier. \$195.00
- 54—8 tubes, including rectifier. \$225.00

Western prices:
52, \$167.50 53, \$205.00 54, \$235.00

CECO

DISCONTINUES CERTAIN TYPES OF "D-C" TUBES

Types 199, Type G Hi-Mu—01B 1/4 amp. 210—have been discontinued by the CECO Manufacturing Co., to enable factory to concentrate entire production on other tubes.

VICTORY

GIANT SPEAKER PRICES ANNOUNCED

16-in. cone VICTORY GIANT electro-dynamic speaker, using '80 type rectifier tube for field current, list price. \$95.00 Known as Model AC80. Victory Model DC40, high resistance field electro-dynamic speaker. 8 1/2-in. cone, list price. \$22.50 (2500-ohm field.) Other type windings to specifications for manufacturers.

Model DC-63. Same as above but with 6000-ohm field. List price. \$23.50 Model AC-10 Concert. Same as above but with 110-v. A-C Elkon Dry rectifier. List price \$35.00

MAJESTIC

Effective September 17, MAJESTIC prices are same in West as in East. Model 91, both East and West. \$137.50 Model 92, both East and West. \$167.50 Model 92, combination, both East and West, prices are less tubes. \$265.00

Mr. R. J. Grigsby, President of Grigsby-Grunow, Inc., makers of MAJESTIC radio receivers, has written all Majestic jobbers, informing them that, contrary to rumors, there will be no new Majestic models announced during the year 1929. Distributors have been instructed to advise their dealers accordingly.

BROWNING-DRAKE

New Model 56, SCREEN-GRID, 9 tubes. Eastern list price. \$154.50 Western list price the same. Model 56 Heater Tube type, 9 tubes. Eastern list price. \$149.50 Western list price the same.

Table Model 53 Screen-Grid. Same chassis as 56. Eastern list price. \$102.50 Western list price \$109.50. Table Model 63, Heater Tube. Same chassis as 56. Eastern list price. \$98.00 Western list price \$105.00.

SILVER

SILVER—New "Intermediate Model." SCREEN GRID. Eastern list price, less tubes. \$185.00 Western list price, less tubes. \$195.00 This model uses the same chassis as SILVER Models 60 and 95.

SILVER—Special cabinet models for Pacific Coast distribution only. Cabinets supplied to the dealers by SILVER JOBBERS on the Pacific Coast. Same chassis used as in other SILVER models. SCREEN-GRID. There are three cabinet styles, known as follows:

"THE PRINCESS," Western list price, less tubes. \$170.50
"THE ARISTOCRAT," Western list price, less tubes. \$195.00
"THE DE LUXE," Western list price, less tubes. \$216.00

These special cabinets for Pacific Coast dealers are merely an addition to the standard line of SILVER receivers in cabinets as supplied by the factory.

MILES

GIANT AIR COLUMN SPEAKER—An electro-dynamic giant air column speaker for outdoor and theater use. A combination of speaker unit, special output transformer and horn.

M-3 1/2 COMBINATION. Has 3 1/2 ft. trumpet, unit and output transformer. List price. \$170.00 Net price. \$75.00

M-9 COMBINATION. Same as above but with 9 ft. theatrical horn. List price. \$230.00 Net price. \$103.50

M-12. Same as above with special 9-ft. coiled horn, 20x20x12-in. List price. \$185.00 Net price. \$83.25

M-10. Same abs above but with Giant 10-ft. horn. 40-in. bell. List price. \$275.00 Net price. \$123.75

MILES REPRODUCERS are designed to operate any output of from 10 to 30 watts undistorted power. Field supply 1.1 amps at 6 volts D-C. Can also be operated from A-C by means of rectifier. Manufactured by Miles Mfg. Corp., 31 West 21st St., New York City.

PREMIER

PRIVATE LABEL RADIO

Model 724. Screen-Grid. 4 '24; 2 '45; 1 '27 and 1 '80 tubes. Three stages screen-grid TRF. Resistance coupled first stage. Pushpull second stage. Prices on request.

TRADE-IN VALUES

A-C and D-C Sets

FORMULA FOR TRADE-IN ALLOWANCE Battery-Operated Set = 0. A-C Set, 1/2 [$\frac{\text{List Price}}{2}$ - list price of new tubes]

Every day in every way the trade-in value of a battery-operated set is getting lower and lower. One radio salvage concern offers to sell any battery-operated set in stock for one dollar. The San Francisco Radio Show was inaugurated with a huge bonfire of 2000 old sets, a few of the best being given away to the poor. A battery set will soon be as

obsolete as a horse and buggy. As the public is made to realize this fact the battery set will no longer be a feature in the trade-in problem. Battery operated sets will be purchased only by those who live in localities where no house lighting current is available.

In figuring the allowance for an A-C set,

it loses half its list price because it is second hand. From this fifty per cent deduct the cost of new tubes to replace the old ones. Divide this difference by two, the one-half being the trade-in value offered to the customer and the other half being the cost of selling and the profit on a possible sale to another buyer. This practice is safe.

EASTERN LIST PRICES OF HEATER & FILAMENT TUBE SETS

NOTE: RECTIFIER TUBES ARE NOT COUNTED IN LISTINGS BELOW.

MAKE	No. of Tubes	LIST PRICE	MAKE	No. of Tubes	LIST PRICE	MAKE	No. of Tubes	LIST PRICE	MAKE	No. of Tubes	LIST PRICE	MAKE	No. of Tubes	LIST PRICE
A-C DAYTON			BUSH & LANE			EARL Induct. Dyn.			FREED Electro. Dyn.			*RCA continued		
Batt. 98	7	79.00	20	7	125.00	121 Batt.	7	55.00	NR-79	7	169.00	18	6	95.00
AC-98	8	108.00	21	7	169.50	21 Tbl.	7	75.00	NR-95	7	225.00	60	8	130.00
AC-9960	8	148.50	30	7	169.50	21-DC	7	75.00	NR-95	8	235.00	64	8	550.00
AC-9970	8	165.00	32	7	179.50	21-25 cy.	7	80.00	NR-79	7	174.00	66	7	225.00
AC-9980	8	185.00	40	7	179.50	22	7	99.50						
AC-9990	8	188.00	50	7	197.50	22-DC	7	99.50				*SONORA		
AC-99100	8	234.00	60	7	199.50	22-25 cy.	7	104.50				A-30	7	190.00
*ACME			70	7	207.50	31	7	139.00	*GRAYBAR			A-32	7	250.00
77	6	115.00	90	7	217.50	31-DC	9	139.00	Same styles as			A-40	7	375.00
88	7	139.50	10-C	7	250.00	31-25 cy.	7	144.00	RCA. See RCA Radiola.			A-36	7	470.00
*ALL AMER "LYRIC"			11-C	7	290.00	Electro-Dyn.						A-44	7	695.00
93 LoBoy	9	145.00	12-C	7	297.50	32	7	169.00	*HOWARD			*STEWART WARNER		
94 LoBoy	9	145.00	COLUMBIA			32	9	169.00	Consult.	8	175.00	35-900	7	142.50
95 HiBoy	9	175.00	C-11	7	155.00	32-25 cy.	7	174.00	Shern.	8	235.00	58-900	7	165.50
*APEX			CONTINENTAL			41	8	225.00	Hplwt.	8	255.00	Ensemble	7	123.25
115-NU	7	115.00	"Star Raider"			41-25 cy.	8	235.00	LXVI	8	275.00	Table	7	89.75
140-NU	7	140.00	R-20	9	435.00	EDISON			Goth.	8	275.00	47-900	7	154.50
160-NU	8	160.00	R-25	9	475.00	R-1	6	260.00	HiBoy	8	199.50	SPARTON		
60 Table	7	60.00	R-30	9	525.00	R-2	6	225.00	*KENNEDY			49 Batt.	9	76.00
45 Battery	6	45.00	R-105	9	1,000.00	R-4	7	197.50	210	7	159.00	930	8	189.50
*AUDIOLA			*CROSLLEY			R-5	7	167.50	310	7	197.00	931	8	179.50
8430	7	95.00	31	6	52.00	Comb. C-1	7	1,100.00	MAJESTIC			301	9	274.50
BALKEIT			31 with Legs	6	57.50	Comb. C-2	6	395.00	91	7	137.50	110	9	315.00
"C"	8	175.00	41	7	70.00	Comb. C-4	7	295.00	92	7	167.50	Comb. 101	10	795.00
BRANDES			41 with Legs	7	75.00	*EVEREADY			181 Comb.	7	265.00	Tubes included in all Sparton models.		
B-10	6	85.00	41-A	7	70.00	31 Tbl.	7	115.00	*MANDEL			*STEINITE		
B-15	7	125.00	41-A with Legs	7	75.00	32	7	157.50	Chassis	8	100.00	40-C	7	135.00
B-16	7	165.00	42	7	99.50	42	7	195.00	*PHILCO			60	7	167.00
BREMER TULLY			82-H	7	125.00	43	7	195.00	LoBoy	7	129.50	Comb. 102	7	250.00
80	6	89.50	DAYFAN			34	7	225.00	HiBoy	7	149.50	*TEMPLE		
81	8	164.00	66	8	115.00	*FADA			DeLuxe HiBoy	7	205.00	8-60	8	149.00
82	8	195.00	67	7	45.00	Tbl.	7	99.50	*PREMIER-Chas. only			8-80	8	169.00
*BROWNING DRAKE			68	8	169.50	FREED Induct. Dyn.			601	6	45.00	Comb.	8	269.00
63 Table	9	98.00	69	8	225.00	55 Batt.	7	55.00	771-M	7	66.00	TRAVLER		
666 Console	9	149.50	72	8	175.00	56 Tbl.	7	75.00	745-D	7	70.00	Port.	5	65.00
BRUNSWICK			73	7	65.00	NR-55	7	99.50	845-D	8	74.00	DeLuxe Port.	5	75.00
14	7	148.00	EARL			NR-78	7	139.50	PT-771-M	7	74.00	Aristocrat Port.	5	100.00
21	7	174.00	21	7	92.75	NR-56 Tbl.	7	75.00	*RCA			VICTOR		
31 Phono. Comb.	7	272.00	22	7	117.25	NR-55	7	99.50	33-AC with Legs	6	54.00	R-32	8	155.00
			31	7	161.50	NR-78	9	139.00	33-DC-110-V with Legs	6	64.00	Comb.	8	275.00
			32	7	191.50	NR-78	7	144.00						
			41	8	250.00	NR-55	7	104.50						

*Denotes this manufacturer also builds screen-grid models.

WESTERN LIST PRICES OF HEATER & FILAMENT TUBE SETS

NOTE: RECTIFIER TUBES ARE NOT COUNTED IN LISTINGS BELOW.

MAKE	No. of Tubes	LIST PRICE	MAKE	No. of Tubes	LIST PRICE	MAKE	No. of Tubes	LIST PRICE	MAKE	No. of Tubes	LIST PRICE	MAKE	No. of Tubes	LIST PRICE
A-C DAYTON			*BROWNING DRAKE			EARL Induct. Dyn.			*GRAYBAR			*SONORA		
Batt. 98	7	Not car'd	63 Table	9	105.00	121 Batt.	7	55.00	Same styles as			A-30	7	190.00
AC-98	8	Not car'd	666 Console	9	149.50	21 Tbl.	7	75.00	RCA. See RCA Radiola.			A-32	7	250.00
AC-9960	8	154.40	BRUNSWICK			21-DC	7	75.00				A-40	7	375.00
AC-9970	8	175.00	14	7	148.00	21-25 cy.	7	80.00				A-36	7	480.00
AC-9980	8	192.50	21	7	174.00	22	7	99.50				A-44	7	705.00
AC-9990	8	197.50	31 Phono. Comb.	7	272.00	22-DC	7	99.50	*KENNEDY					
AC-99100	8	260.00	COLUMBIA			22-25 cy.	7	104.00	210	7	159.00	SPARTON		
*ACME			C-11	7	155.00	31	7	139.00	310	7	197.00	49 Batt.	9	Not set'd
77	6	115.00	CONTINENTAL			31-DC	9	139.00				930	8	189.50
88	7	139.50	"Star Raider"	(Add Freight)		31-25 cy.	7	144.00	MAJESTIC			931	8	189.50
ALL AMERICAN "LYRIC"			R-20	9	435.00	Electro-Dyn.			91	7	137.50	301	9	294.50
93 LoBoy	9	158.00	R-25	9	475.00	32	9	169.00	92	7	167.50	110	9	415.00
94 LoBoy	9	158.00	R-30	9	525.00	32-25 cy.	7	174.00	181 Comb.	7	265.00	Comb. 101	10	825.00
95 HiBoy	9	193.50	R-105	9	1,000.00	41	8	225.00	*MANDEL			Tubes included in all Sparton models.		
Phono. Comb.	9	235.00	*CROSLLEY			41-25 cy.	8	235.00	Chassis	8	100.00	*STEWART WARNER		
*APEX			31	6	57.00	EDISON			*PHILCO			35-900	7	147.00
115-NU	7	124.50	31 with Legs	6	62.50	R-1	6	260.00	LoBoy	7	139.50	58-900	7	170.50
140-NU	7	149.50	41	7	73.00	R-2	6	225.00	HiBoy	7	159.50	Ensemble	7	128.50
160-NU	8	169.50	41 with Legs	7	78.50	R-4	7	205.00	DeLuxe HiBoy	7	215.00	Table	7	92.25
60 Table	7	64.50	41-A	7	73.00	R-5	7	174.00	*PREMIER			47-900	7	159.25
45 Batt.	6	49.50	41-A with Legs	7	78.50	Comb. C-1	7	1,100.00	Chassis only.	(Add Freight)		*STEINITE		
*AUDIOLA			42	7	105.00	Comb. C-2	6	395.00	601	6	45.00	40-C	7	143.00
8430	7	95.00	42	7	130.00	Comb. C-4	7	305.00	771-M	7	66.00	60	7	175.00
			82-H	7	155.00	*EVEREADY			745-D	7	70.00	102 Comb.	7	268.00
BALKEIT			DAYFAN			31 Tbl.	7	115.00	845-D	8	74.00	*TEMPLE		
"C"	8	185.00	66	8	125.00	32	7	167.50	PT-771-M	7	74.00	8-60	8	159.00
BRANDES			67 with speaker and table	8	175.00	42	7	167.50	*RCA			8-80	8	179.00
B-10	6	88.50	68	7	175.00	43	7	205.00	33 with Legs	6	54.00	Comb.	8	289.00
B-15	7	133.25	69	8	235.00	34	7	205.00	33-DC-110-V with Legs	6	64.00	TRAVLER		
B-16	7	175.50	72	8	185.00	44	7	235.00	18	6	95.00	Port.	(Add Freight)	
BREMER TULLY			73	7	75.00	*FADA			60	8	130.00	DeLuxe Port.	5	75.00
80	6	89.50	EARL			Table	7	104.50	64	8	150.00	Aristocrat Port.	5	100.00
81	8	164.00	21	7	92.75	FREED Induct. Dyn.			66	7	225.00	VICTOR		
82	8	195.00	22	7	117.25	NR-55	7	99.50	*SENTINEL			R-32	8	155.00
			31	7	161.50	NR-78	7	145.00	See Screen Grid Data Sheets. Other sets discontinued.			Comb.	8	275.00
			32	7	191.50	*NR-79	7	172.50						
			41	8	250.00	*NR-95	8	225.00						
						*Latter two have electro. dyn. spkrs.								

*Denotes this manufacturer also builds screen-grid models.

EASTERN PRICES OF SCREEN-GRID SETS

NOTE: RECTIFIER TUBES ARE NOT COUNTED IN LISTINGS BELOW.

MAKE	No. of Tubes	LIST PRICE	MAKE	No. of Tubes	LIST PRICE	MAKE	No. of Tubes	LIST PRICE	MAKE	No. of Tubes	LIST PRICE	MAKE	No. of Tubes	LIST PRICE
*ACME 78 88-SG	6 7	130.50 77.00	ATWATER KENT 55-C, Chassis 55 Table 25 Cycle Chassis 25 Cycle Table 60 Chassis 60 Table Chass. DC, 61-C Table DC, 61 Batt. Chassis 67 Batt. Table 67	6 6 6 6 7 7 7 7 7	84.00 88.00 84.00 88.00 96.00 100.00 96.00 100.00 73.00 77.00	*CROSLEY 30-S Chassis 31-S 32-S 40-S 41-S 42-S 82-S	6 6 6 7 7 7 7	62.00 72.00 115.00 80.00 85.00 135.00 160.00	KOLSTER K-43 K-44 K-45	7 7 9	235.00 325.00 500.00	*STEWART WARNER Cabin't 35, M'd 900 Sher'tn 58, M'd 900 Consolette Ens'ble Table Model Model 47-900	7 7 7 7 7	142.50 165.50 123.25 89.75 154.50
*ALL AMERICAN LYRIC 94-SG 95-SG 96-SG 175-SG Comb	7 7 7 7	153.00 183.00 230.00 Next mo. Next mo.	AUTOMATIC TOM THUMB PORTABLES B DeLuxe DC AC	4 4 4 4	57.50 65.00 87.50 95.00	ERLA "TROPHY" 31 30 32 AR-3	7 7 7 7	150.00 169.50 145.00 134.50	PEERLESS 21 22 23 24 25 Comb.	9 9 9 9 9	195.00 245.00 245.00 375.00 600.00	*STEINITE 70 80	6 6	118.00 149.50
AMERICAN BOSCH 17 18 19 "L" "R" Table 48 Table 48-A "J"	6 6 6 6 6 6 6 6	230.00 240.00 280.00 230.00 280.00 119.50 168.50 240.00	BAIRD PORTARADIO Port. Port. Port.	4 4 4	60.00 87.50 97.50	EVEREADY 52 53 54	7 7 7	157.50 195.00 225.00	*PHILCO 65 LoBoy HiBoy HiBoy DeLuxe	5 5 5 5	99.50 119.50 139.50 205.00	*STERLING Troubador Serenader Imperial	7 7 7	129.50 149.50 187.50
AMRAD Aria Duet Symphony Serenata (Comb.)	7 7 7 7 7	198.00 295.00 245.00 245.00 495.00	BALDWIN Chassis Low Boy High Boy	6 6 6	On req't 198.00 219.00	*GRAYBAR Same prices and styles as RCA models.			*PREMIER 724	7	On Request	*STROMBERG CARLSON 641 25 cy. 641 642 25 cy. 642 846	5 5 5 5 7	155.00 155.00 247.50 247.50 347.50
*ANDREA FADA 15-M Chass. 15-MZ Chass. (25-40 cycle) 25 35 75 77 Comb.	7 7 7 6 6 7 7	115.00 115.00 165.00 245.00 360.00 675.00	*BROWNING DRAKE 56 53 Table	9 9	154.50 102.50	GREBE 21950-A 270-C 285-A Comb. 450	6 6 6 6	219.50 270.00 285.00 450.00	*RCA Radio Victor 44 46 21 Batt 22 Batt. Comb. 47 Comb. 67	4 4 5 5 4 8	110.00 179.00 69.50 135.00 275.00 690.00	*SENTINEL 444 666 Comb. 666-C	6 7 7	89.50 99.50 149.50
*APEX 11 14 24	6 6 6	115.00 140.00 240.00	COLONIAL Cavalier Picadilly Modern	7 7 7	235.00 235.00 270.00	GULBRANSEN 291 292	8 8	139.50 149.50	*SHAMROCK Console Chassis	7 7	139.50 On req't	*SONORA A-31 A-33 A-35	6 6 6	149.50 174.50 235.00
ARCO Chassis	8	75.00	COURIER 65 Table 651 652 653	7 7 7 7	85.00 140.00 165.00 165.00	*HOWARD Same prices as Filament tube sets. See other sheets.			SILVER 60 Intmd. 95	7 7 7	160.00 185.00 195.00	*TEMPLE 8-60 8-80 Comb.	8 8 8	149.00 189.00 289.00
*AUDIOLA Chassis	6	85.00				KELLOGG 523 524 525 Comb.	8 8 8	250.00 295.00 395.00	*WARE Table Cons. 10	5 5	195.00 280.00	*ZENITH 52 53 54 55 Comb.	8 8 8 8	175.00 275.00 395.00 700.00

*Denotes this manufacturer also builds non-screen-grid models.

WESTERN PRICES OF SCREEN-GRID SETS

NOTE: RECTIFIER TUBES ARE NOT COUNTED IN LISTINGS BELOW.

MAKE	No. of Tubes	LIST PRICE	MAKE	No. of Tubes	LIST PRICE	MAKE	No. of Tubes	LIST PRICE	MAKE	No. of Tubes	LIST PRICE	MAKE	No. of Tubes	LIST PRICE
*ACME 78 88-SG	6 7	130.50 Plus frt. 77.00	ARCO Chassis	8	75.00	ERLA "TROPHY" 31 30 32	7 7 7	158.50 179.50 152.50	PEERLESS 21 22 23 24 25 Comb.	9 9 9 9 9	207.00 260.00 260.00 400.00 635.00	STROMBERG CARLSON 641 25 cy. 641 642 25 cy. 642 846	5 5 5 5 7	165.00 165.00 272.50 272.50 377.50
*ALL AMER "LYRIC" 94-SG 95-SG 96-SG 175-SG Phono Comb.	7 7 7 7 7	166.00 201.50 198.00 243.00	AUDIOLA Chassis	6	85.00	EVEREADY 52 53 54	7 7 7	167.50 205.00 235.00	LEUTZ	7	410.00	*SENTINEL 444 666 Comb. 666-C	6 7 7	89.50 99.50 149.50 Plus frt.
American BOSCH 17 18 19 "L" "R" Table 48 Table 48-A "J"	6 6 6 6 6 6 6 6	237.00 248.00 290.00 238.00 290.00 122.50 172.50 248.00	AUTOMATIC TOM THUMB PORTABLES B DeLuxe DC AC	4 4 4 4	60.00 67.50 90.00 99.00	GILFILLAN Console Console Console	8 8 8	156.50 175.50 187.00	*MANDEL Screen-Grid-9 Chassis	8	115.00 Plus frt.	*SONORA A-31 A-33 A-35	6 6 6	154.50 179.50 240.00
AMRAD Aria Duet Symphony Serenata (Comb.)	7 7 7 7 7	213.00 310.00 260.00 510.00	BAIRD PORTARADIO Port. Port. Port.	4 4 4	Add Frt. 60.00 87.50 97.50	*GRAYBAR Same prices and styles as RCA models.			*PREMIER 724	7	On Request	*STERLING Troubador Serenader Imperial	7 7 7	139.50 165.00 201.00
*ANDREA-FADA 15-M Chassis 15-MZ (25-40 cy.) 25 35 75 77 Comb.	7 7 6 6 7 7	120.00 120.00 172.00 255.00 370.00 695.00	BALDWIN Chassis Low Boy Highboy	6 6 6	On req't 198.00 219.00	GREBE 21950-A 270-C 285-A Comb. 450	6 6 6 6	223.50 274.00 292.00 465.00	*SILVER 60 Intmd. 95	7 7 7	170.00 195.00 210.00	*STEINITE 70 80	6 6	125.00 157.50
*APEX 11 14 24	6 6 6	124.50 149.50 249.50	*BROWNING DRAKE 56 53 Table	9 9	154.50 109.50	GULBRANSEN 291 292	8 8	149.50 159.50	Special Cabinets for Coast only. "Princess" "Aristocrat" "De Luxe"	7 7 7	170.50 195.00 216.00	*TEMPLE 8-60 8-80 Comb.	8 8 8	159.00 179.00 289.00
ATWATER KENT 55-C, Chassis 55 Table 60 Chassis 60 Table Chass. DC, 61C Tbl DC, 61 Batt. Chass. 67 Batt. Tbl. 67	6 6 7 7 7 7 7 7	88.00 92.00 101.00 105.00 101.00 105.09 77.00 81.00	COLONIAL Cavalier Picadilly Modern	7 7 7	247.00 247.00 288.00	*HOWARD Same prices as filament tube sets. See other sheets.			*RCA Radio Victor 44 46 Batt 21 Batt 22 Comb. 47 Comb. 67	4 4 5 5 4 8	110.00 179.00 69.50 135.00 275.00 690.00	*WARE Table Cons. 10	5 5	210.00 295.00
			COURIER 65 Table 651 652 653	7 7 7 7	88.00 148.00 175.00 175.00	KELLOGG 523 524 Comb. 525	8 8 8	265.00 310.00 415.00	*ZENITH 52 53 54 55 Comb.	8 8 8 8	225.00 325.00 450.00 750.00			
			*CROSLEY 30-S Chassis 31-S 32-S 40-S 41-S 42-S	6 6 6 6 7 7	65.00 Price not yet an'ed 83.00 88.00 145.00 165.00	*KENNEDY 220 320	7 7	159.00 197.00	*STEWART WARNER Cabin't 35, M'd 900 Sher'tn 58, M'd 900 Consolette ens'ble Table Model Mod. 47-900	7 7 7 7 7	147.00 170.50 128.50 92.25 159.25			

*Denotes this manufacturer also builds non-screen-grid models.

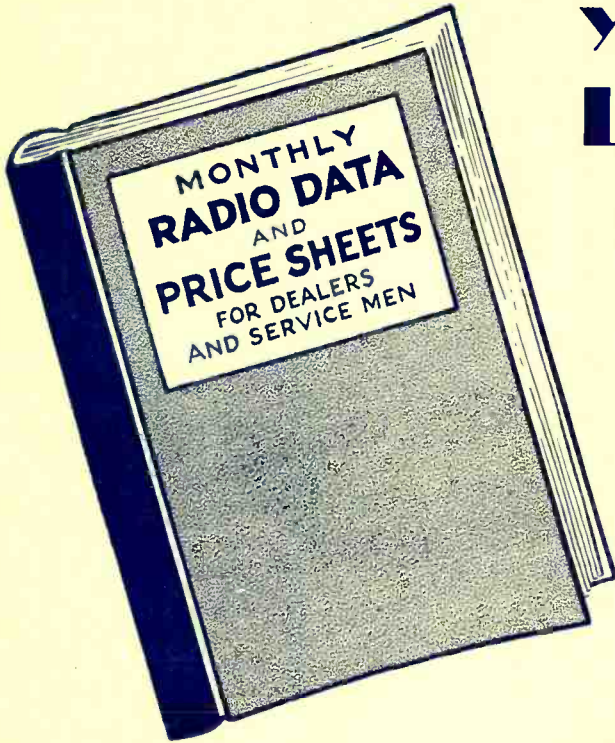

YOU GET THIS . . . LOOSE LEAF BINDER FREE

WITH YOUR
**SUBSCRIPTION
TO "RADIO"**

It Is Exactly the Correct Size
for Holding the MONTHLY
PRICE AND DATA SHEETS

NO STRINGS TO THIS OFFER

THERE will be no additional charges made during the year. "RADIO" guarantees that your payment of \$2.00 IS IN FULL.

The Binder is sent to you post-paid. The Monthly Data Sheets are also sent post-paid.

FOR only \$2.00 you get a one year subscription to "RADIO," in addition to a one year mail service to the Radio Price and Data Sheets. Furthermore, the loose leaf binder is sent to you FREE of all cost. There are positively no further payments of any kind to be made. \$2.00 covers the cost in full. The binder and the current set of 16 price and data sheets are mailed to you on the same day your subscription reaches us. Numerous data sheets not published in "RADIO" are sent to you by mail each month.

LET'S BE FRANK ABOUT THIS OFFER . . . AND TELL YOU THE REASON WHY

YOUR subscription to "RADIO," your subscription to the Price and Data Sheet Service and the Loose Leaf Binder costs us more than \$4.00. Yet, you get it for only \$2.00 for the reason that "RADIO" desires to increase its

paid-in-advance dealer circulation to more than 45,000 by December 31st. We get the circulation. You get double value for your money, plain as daylight. That's all there is to it.

192 PAGES OF DATA COME TO YOU WITH YOUR SUBSCRIPTION

YOU GET 16 pages of data each month through the mails. These data sheets are printed on very heavy stock, with holes punched in the proper places to fit the loose leaf binder. The data sheets as published in

"RADIO" are only specimen sheets—merely to show you how the service is compiled. 192 Data Sheets within a year . . . a one year subscription to "RADIO" and the loose leaf binder . . . all for \$2.00.

MAIL THE COUPON AND YOUR CHECK, M. O. OR CURRENCY TODAY

"RADIO," 428 Pacific Building,
San Francisco, California.

Here is \$2.00 in FULL PAYMENT for a one year subscription to "RADIO," a one year subscription to the PRICE AND DATA SHEETS and a LOOSE LEAF BINDER for holding the data sheets.

Name _____

Street and No. _____

City and State _____

(Note: If you are already a subscriber to "RADIO" send \$2.00 and have your subscription extended for another year and get the Data Sheet service and binder FREE.)

SPECIAL TWO YEAR OFFER . . .

Get this entire service for two years for only \$3.00.

Two people can subscribe to this offer for \$3.00, also. Tell your service man about it.

Will You Kindly Ask Your Dealer
Friends to Subscribe to "Radio"
and This Data Sheet Service?

Dealers in your neighborhood will subscribe to this service. Kindly show it to them and ask for their subscription. We will mail you a liberal commission check upon receipt of the order.

RADIOLA 44 RECEIVER

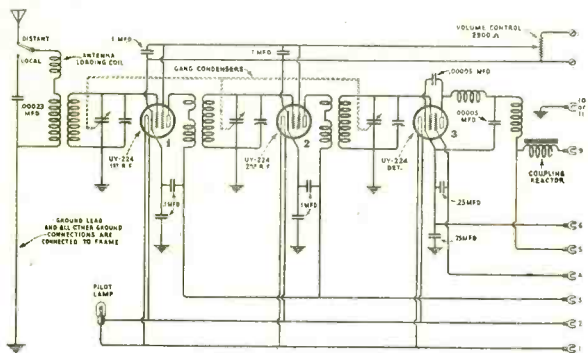

Radiola 44

A-C DAYTON RECEIVER

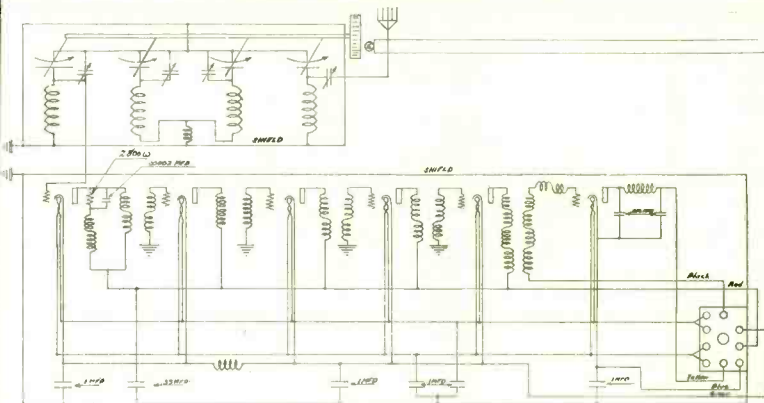
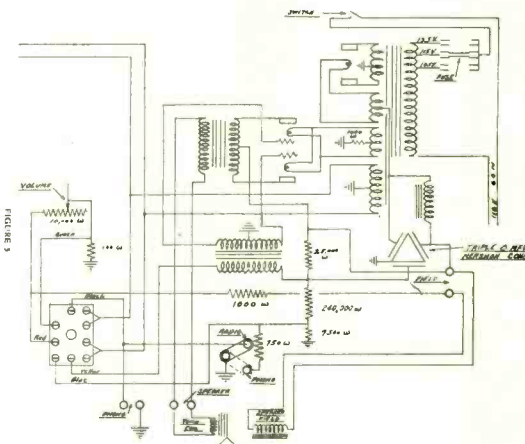

FIGURE 4

NOTE: CIRCUIT DIAGRAMS

For Radiola 66 Receiver and Power Unit—Steinite Models 40-50-102 Receiver and Power Unit—Earl Models 21-AC, 41, and 32-AC, will be mailed to Data Sheet Subscribers before the next issue of "RADIO" goes to press.

A. C.
Dayton
Power
Unit
for
Above
Receiver



CIRCUIT DIAGRAM OF PEERLESS ELECTROSTATIC SERIES

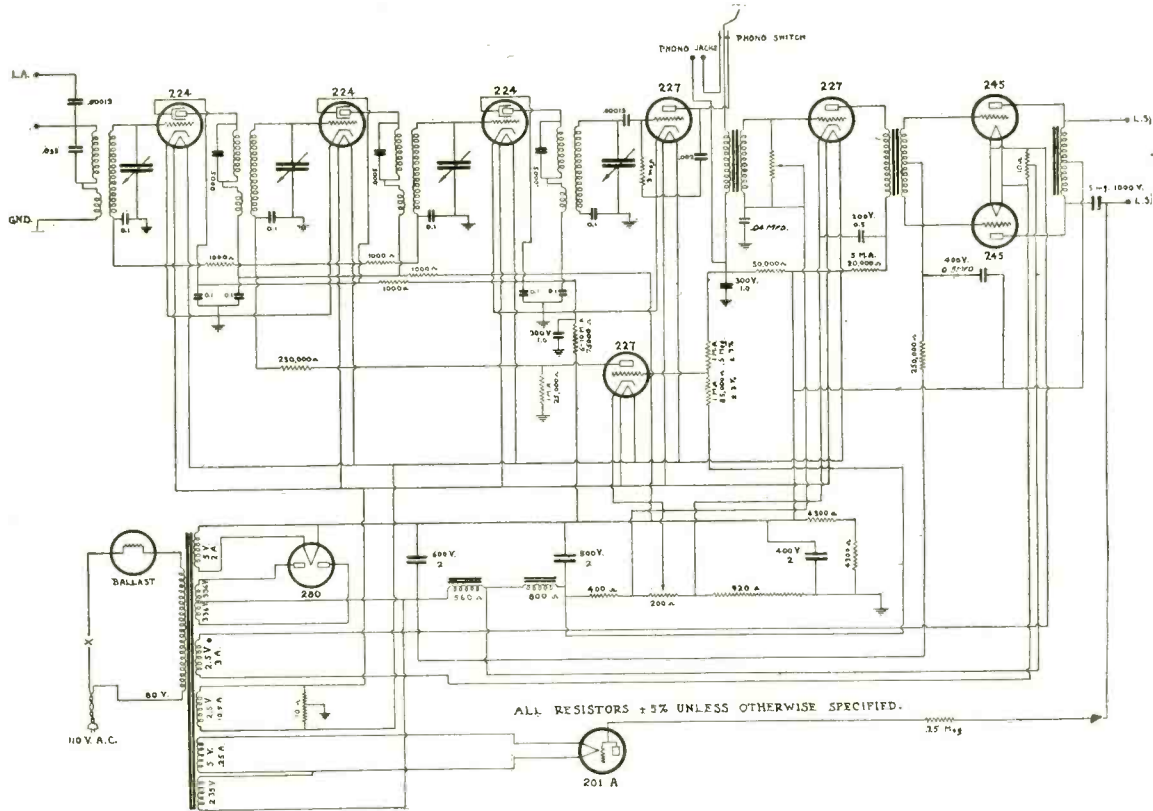

CIRCUIT DIAGRAM OF FADA 75 AND 77 RECEIVERS

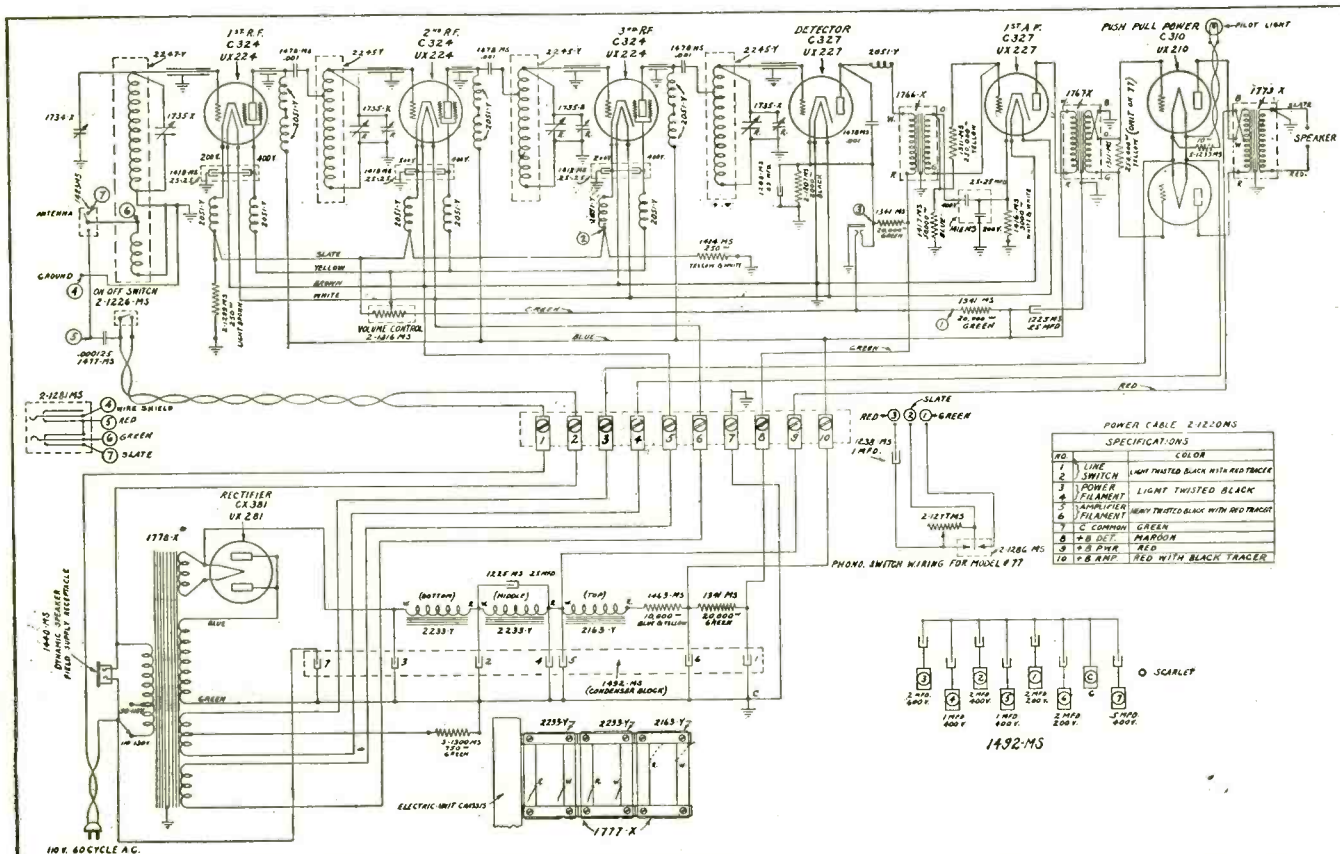

BUILDINGS COMPLETED THIS YEAR

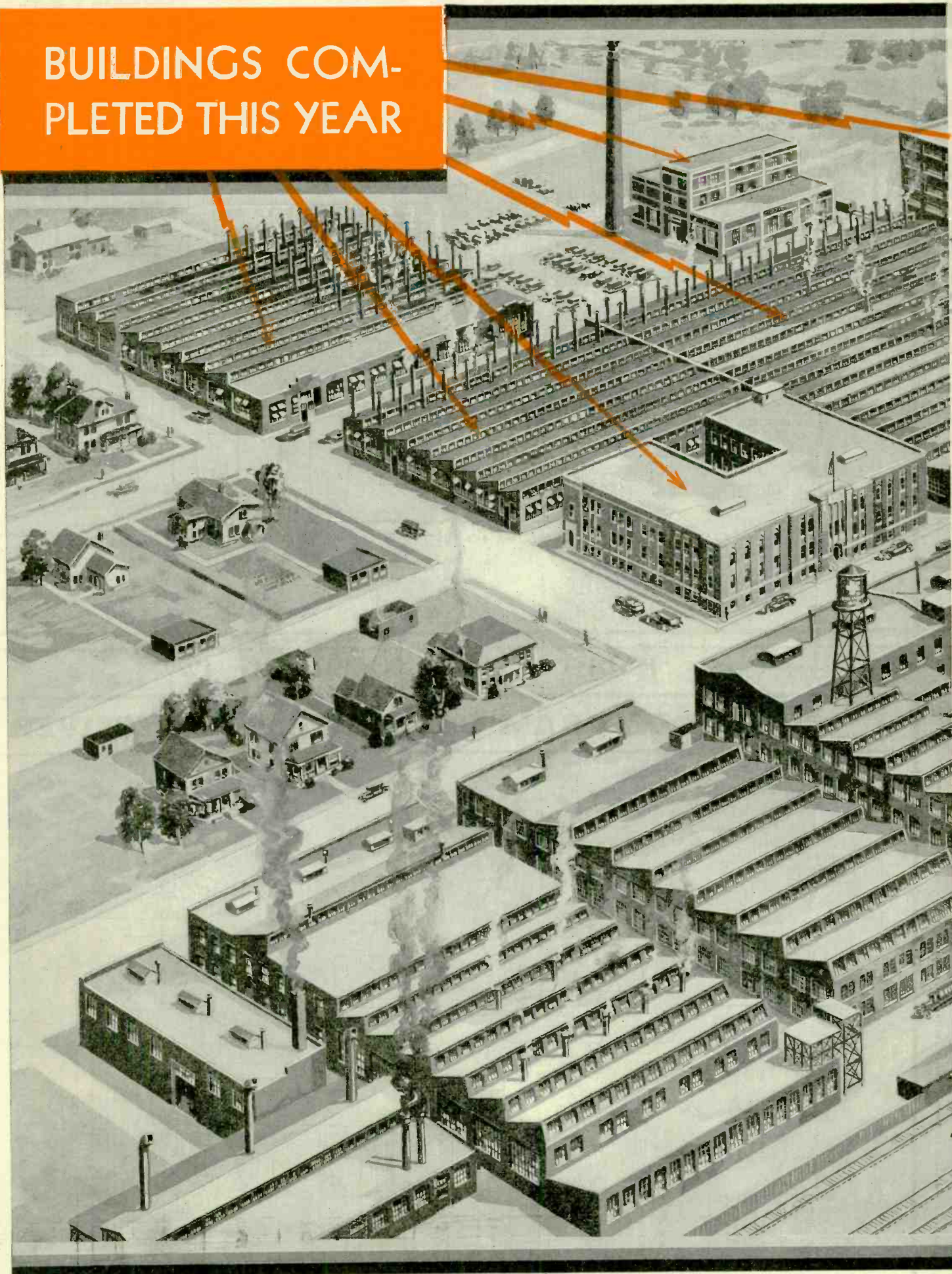

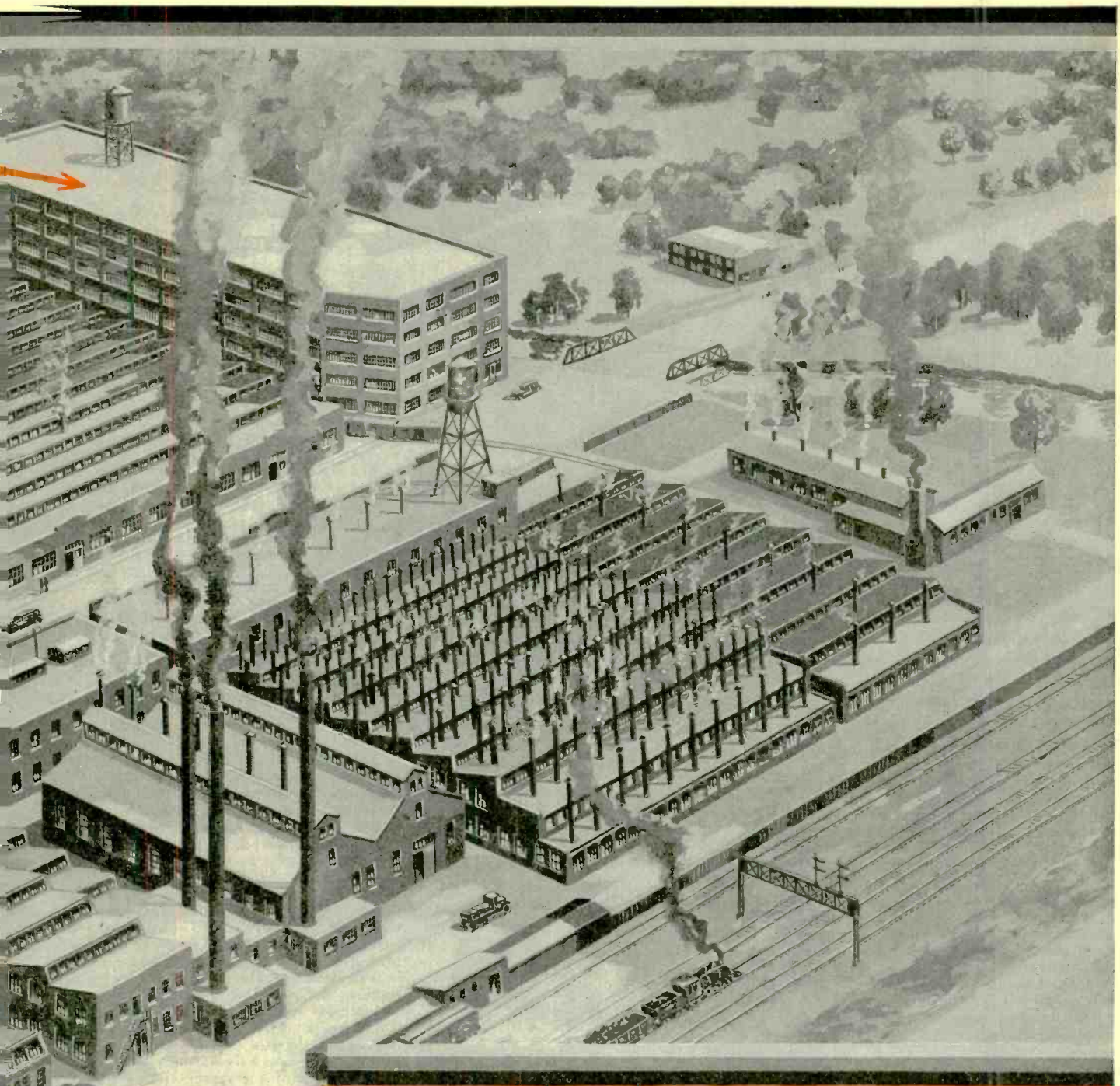

• THESE completed buildings, and the acres of equipment now being installed, are eloquent testimony of Dudlo's faith in radio. « » The coming season will find Dudlo fitted as never before to assume its responsibility—the industry's preferred source of supply for wire and coils.

DUDLO MANUFACTURING COMPANY, FORT WAYNE, IND.

*Division of General Cable Corporation
See the Dudlo Exhibit at the Chicago Radio Show—Booth AA9*

Tell them you saw it in RADIO

Kit Reviews

THE H-F-L MASTERTONE

THE new H-F-L Mastertone is a completely built a-c superheterodyne chassis wired by the High Frequency Laboratories ready for installation in a cabinet with a loudspeaker. The panel is 7 by 21 in. and the baseboard $7\frac{1}{2}$ in. deep. It requires ten tubes, including five '24s, three '27s and

filter system is equipped with a heavy choke and $24 \mu\text{f}$ Mershon condensers. A 10-wire Jones plug-in cable connects the power plant to the receiver.

The input circuit is of the conductive tuned type, permitting the use of a short antenna, either the screen-backing of the console or a short length of wire. The receiver is claimed to give equalized gain over

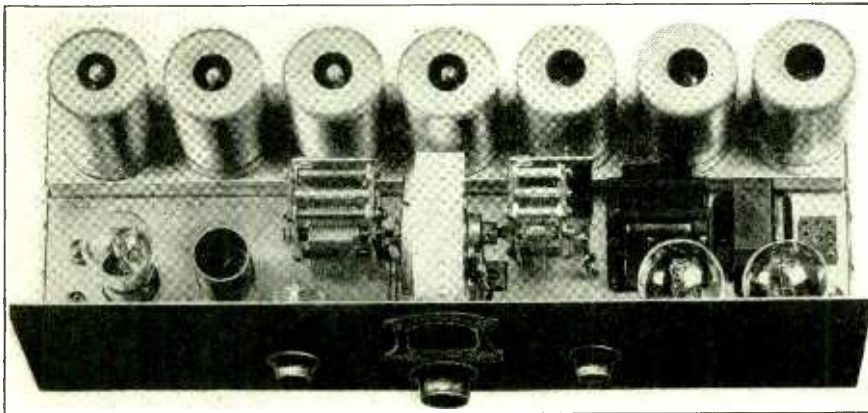

H-F-L Mastertone Chassis

two '45s, together with an '80 rectifier. It has single-dial one-spot tuning.

The amplification system is built around the a-c screen-grid tubes, four of which are used in the intermediate frequency stages with five tuned circuits which are individually adjustable, and the fifth as a power detector with 175 volts on the plate. The three '27 tubes are used in the oscillator, first detector, and first audio stage, which is impedance coupled. This is followed by the two '45 tubes in push-pull in the second audio stage, this being transformer coupled and of the interspace type. The high voltage to the plates of the two '45 tubes is fed through a center-tap push-pull impedance which enables the use of any type of loudspeaker. A plug-in jack provides for phonograph pickup connection to three stages of a-f amplification. All stages and tubes are individually shielded.

The power supply system is equipped with an automatic line ballast to take care of line fluctuations from 85 to 130 volts. The

entire frequency range and to have extreme sensitivity, good selectivity, and fine tone quality.

Tuning is accomplished with the single central knob with a vernier antenna tuner for fine tuning on distant stations. The right hand knob controls volume and is equipped with a line switch for tuning the set on or off. A ground wire is seldom necessary as the set is grounded through the power supply.

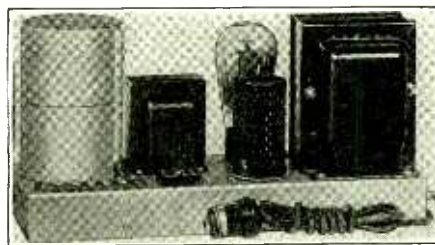

H-F-L Power Plant

THE LINCOLN 8-40 A-C SUPERHETERODYNE

THIS kit employs a-c tubes throughout, with '27's in the oscillator, second detector and first a-f stage, '24's in the first detector and the two i-f stages, and two '45's in push-pull in the second audio stage. The intermediate stages are peaked at 475 kc; this being variable to some extent by the tuned primaries of the transformers; thus affording "one-spot" tuning, or the elimination of the bothersome harmonics to which the older types of superheterodynes have been subject.

The antenna is connected to a tap in the first detector tuning inductance, making an autotransformer of the latter, of which the portion from 2 to 3 is the primary and the remainder is the secondary. The secondary, through the pickup coil, supplies the detector grid with the incoming signal. The pickup coil, being coupled to the oscillator grid coil, also provides the detector grid with the oscillations generated by the oscillator. These are of a frequency 475 kc away from those of the incoming signal. The output of the detector, or mixer, is at the beat frequency and is amplified by the i-f amplifier which is tuned to this frequency (475 kc). Then it is rectified by the second detector and further amplified by the a-f stages.

In order to make it possible to gang the oscillator tuning condenser with that of the first detector, a fixed condenser was connected in series with it. The effect of this system is a slight increase in the minimum and a slight decrease in the maximum capacities in the tuning range. Bias is supplied to the oscillator grid by means of a resistor between cathode and ground. This is bypassed in the usual manner. A trimmer has been shunted across the detector tuning condenser in order to align it with the oscillator condenser. A $.00015 \mu\text{f}$ grid condenser, shunted with a 2 megohm leak, is used in the detector grid lead. The cathode is grounded, grid detection being used. The screen-grid is connected to the 75-volt source which supplies the oscillator plate as well as the screen-grids of the i-f tubes. The three i-f transformers which couple the i-f tubes and the second detector are discussed in detail following the analysis of the circuit.

The plates of the three screen-grid tubes are supplied with 180 volts through a care-

(Continued on Page 68)

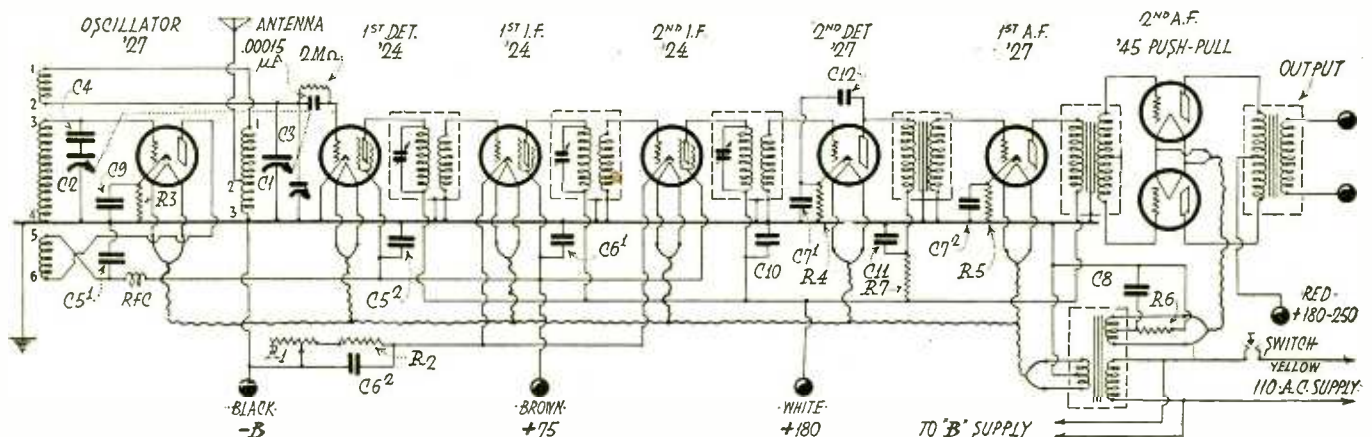

Circuit Diagram of Lincoln 8-40 A-C Superheterodyne

How many turns will it make this year?

Your profits in tubes depend on your turnover. And your turnover depends upon the number of lines you carry.

A. B. C. stuff? Yes. But it is surprising to find that some radio dealers are carrying 20, 25 and 30 different brands of tubes.

Actual figures

You can easily prove the value of increased turnover in terms of profit. Take the following case: Sales \$30,000, margin of profit 30%, operating expense \$7,500, average inventory at selling price \$5,000. Here is a turnover of 6 times a year and a yearly profit of \$1,500. With 7 turnovers—annual profit doubles—\$3,000. With 8 turnovers profit is \$4,500—and so on.

The lines you concentrate on must be well-known brands of the highest quality

When a dealer decreases his number of brands, he must be sure that each line he carries has these two features:—

1. Must be of the highest quality.
2. Must be nationally accepted merchandise.

The quality of CeCo tubes is beyond question.

Two foremost manufacturers and two large tube distributors, by actual laboratory tests, proved that CeCo tubes have 30% to 50% longer life—and ordered, in aggregate, over 5,000,000 tubes.

CeCo is nationally known

CeCo tubes are sold from coast to coast. The CeCo Couriers broadcast every Monday night over the Columbia chain.

We are embarking on an extensive national advertising program. If you stock and display the CeCo line a good share of this business resulting from this campaign is bound to come to you.

This book shows you how to increase your tube sales

Send for this book. Following are only a few of the many helpful suggestions for building up tube sales that it contains:

- 1—The size and development of the radio market.
- 2—The percentage of profit in tubes.
- 3—The growing replacement market for tubes.
- 4—How quality tubes cut losses on set sales and service.



The AC 224 Screen Grid Tube was developed and perfected by CeCo over a year and a half ago.

Licensed under patents and applications of the Radio Corporation of America, the General Electric Company, and the Westinghouse Electric and Manufacturing Company.

Ce Co Manufacturing Company, Inc.

PROVIDENCE, R. I.

CeCo Manufacturing Company, Inc., Dept. 810, 1200 Eddy St., Providence, R. I. Send me a copy of the dealer book "Tomorrow in the Tube Industry."

Name _____

Company _____

Address _____

ANNOUNCING ~

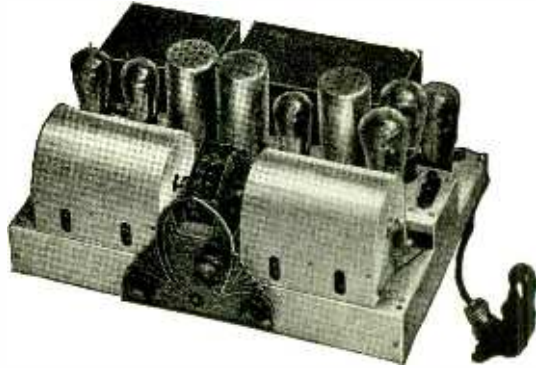

Antenna-less

MANDEL Screen Grid Chassis

THE first radio that satisfactorily receives distant stations *without an aerial, loop, or ground.* In the Mandel Screen-Grid Chassis atmospheric static is greatly reduced, and distortion is totally absent. No other radio possesses these outstanding qualities. Those who recognize fine construction in radio, will turn to the MANDEL.

Built for those who wish to increase their profits by marketing a fine radio under their own name.



MANDEL Electro-Dynamic Speaker

Made to match the fine quality of the MANDEL Chassis. Wired for 90 to 125 volts, 50 to 60 cycles, alternating current, or for direct current operation in connection with the MANDEL Chassis. Also made to operate from a 6-volt storage battery.

The MANDEL Electric Co.

2159 No. California Avenue

Chicago, Ill.

Makers of Fine Radio Apparatus Since 1920

West Coast Representative

WM. G. LANDES

905 Mission Street, San Francisco, Calif.



CONTROLS THE TRAFFIC THRU YOUR TUBES

Like the corner cop directing traffic, AMPERITE controls tube voltage. *Self-adjusting, dependable, accurate.* A type for every tube—A. C. or D. C. \$1.10 with mounting (in U. S. A.) at all dealers.

Radiall Company,
561 Broadway, New York
FREE "Amperite Blue Book" of modern circuits and valuable construction data. Write Dept. PR10.

This symbol in a radio diagram means—



The "SELF-ADJUSTING" Rheostat

PRICE SHEETS!

Revised Monthly

A New Service in "RADIO"

See Page 57

"RADIO"

Pacific Building

San Francisco

Tell them you saw it in RADIO

(Continued from Page 66)
fully shielded lead. The cathodes of the two i-f tubes are returned to ground through a fixed resistor designed to supply the minimum grid bias, and a variable resistor which increases this bias with an increase in resistance. This constitutes the volume control.

Plate rectification is employed in the second detector, the grid bias being supplied by means of a resistor between cathode and ground. The cathode is bypassed to the plate through one condenser and to ground through another, the latter being shielded. The plate voltage is obtained from the 180-volt line, through a resistor which drops it to the required value and through the primary of the first a-f transformer.

Grid bias for the first a-f tube is supplied by a resistor between the cathode of this tube and ground, the grid return, as in the case of the i-f stages, being connected to the transformer shield. The last audio stage is in push-pull. No output transformer is provided in the receiver proper as this usually accompanies the dynamic speaker. The grid bias resistor between the filament center tap and ground is located near the filament transformer; the latter being mounted in the chassis of the kit and having two 2½ volt secondaries, one for the '45 tubes and the other for the heater type tubes.

The Intermediate Frequency Transformers

TRANSFORMERS have proved to be the most practical and efficient means of coupling vacuum tubes in the cascade amplifier. There are four variations of transformer coupling: untuned, tuned primary, tuned secondary, and tuned primary and secondary.

The untuned transformer is successful in low frequency amplifiers, but at high frequencies little gain can be obtained because of the short circuiting effect of the input and output impedance of the vacuum tube. A three-electrode vacuum tube has about the same capacity between the grid and the filament as between the plate and the filament. The effect of tuning either the primary or the secondary of a coupling transformer is to remove the effect of either the input capacity or the output capacity of the tube. The removal of either of these two capacities has a remarkable effect upon the gain of a stage, for the input impedance of a three-electrode tube at a frequency of 500 kilocycles is about 30,000 ohms.

When the primary is tuned, the plate to filament resistance of the tube, which is in parallel with the tuned circuit, has the effect of a small series resistance placed in the tuned circuit. This tends to reduce the sharpness of resonance or selectivity, as well as the gain of the stage. The effect of the parallel resistance increases as the plate to filament resistance decreases. Since the plate to filament resistance of a three-electrode tube is of the order of 10,000 to 20,000 ohms, the tuned primary transformer, coupled between three-electrode tubes, would have an equivalent series resistance of sufficient value to have a measurable effect upon the selectivity and gain of the transformer.

A tuned circuit has a very high impedance to the flow of a current of the same frequency to which it is tuned. At a frequency of 500 kilocycles it is possible to get an impedance of several hundred thousand ohms. This impedance increases with both the efficiency as well as the inductance of the coil. In a three-electrode tube with a plate to filament resistance of less than 20,000 ohms it does not take a very large impedance in the primary of the transformer in order to get a considerable portion of the generated voltage across the primary. This means that it does not take very close coupling between the primary and secondary of a tuned secondary transformer to get sufficient reflected impedance into the primary.

It is not possible to get all of the gain out

of a transformer when used between three-electrode tubes, for a condition of instability and a tendency towards oscillation appears when the gain reaches a certain value per stage. The maximum gain, of course, can only be reached with good shielding, bypassing of each stage to eliminate coupling by common impedance, and neutralizing. There would be no object in using a tuned primary and tuned secondary transformer for coupling three-electrode tubes because it is not possible to use all of the gain obtained by tuning only the secondary even with perfect shielding and neutralization. From these considerations, it is evident why it has been standard practice in designing transformers for coupling three-electrode tubes to use the tuned secondary method.

The four-electrode screen-grid tube has radically different properties from the three-electrode tube. The presence of a screen between the grid and the plate reduces the capacity between these elements. The screen does not materially change the input, or grid-to-filament capacity, but considerably increases the plate-to-filament capacity. This means that the short circuiting effect of the output capacity of a screen-grid tube is several times the short circuiting effect of its input capacity. Since tuning either the primary or the secondary of a transformer has the effect of removing either the output or input capacity, respectively, tuning the primary immediately suggests itself.

The effect of the screen is to greatly increase the plate-to-filament resistance from a value of less than 20,000 ohms to a value of the order of 500,000 ohms. With the three-electrode tube it was not difficult to get a primary impedance at least equal to the plate-to-filament resistance of the tube.

A tuned secondary transformer which was satisfactory for the three-electrode tube having a possible primary impedance of 50,000 ohms would allow very little gain when used with screen-grid tubes because of the very small proportion of the total plate circuit impedance which the primary of the transformer would represent. A tuned primary would, however, have a very high impedance and would make it possible to get a much larger proportion of the voltage generated in the tube across it. It is evident that if the primary impedance of the transformer were equal to the plate-to-filament resistance of the tube, that only one-half of the voltage would appear across the primary. From these considerations, it is easily seen that the primary of a transformer used with screen-grid tubes must be tuned.

In the case of the screen-grid tube, the plate-to-filament resistance is so high that its effect upon the tuned primary in producing an equivalent series resistance is negligible. This means that there would be no loss of selectivity in tuning the primary, but a considerable increase in voltage amplification would be effected.

After determining that the primary of the transformer must be tuned, there is still left one remaining possibility for improvement, namely, tuning both the primary and the secondary. Tuning the secondary, of course, would eliminate the short circuiting effect of the input capacity of the tube. When both the primary and secondary are tuned a maximum transfer of energy no longer takes place with close coupling, requiring instead, a very loose coupling. Since space limitations eliminate the possibility of separating the primary and secondary by a space of 6 inches or more, it is necessary to turn one of the coils so that it is practically at right angles to the other.

Although the transformer with tuned primary and tuned secondary is capable of the greatest gain it was found that the gain of the transformer in which the primary alone was tuned was more than could be successfully controlled. At 475 kc the gain

of the latter is 75 per stage; a gain that was found too great for stable operation even though the greatest care was used in shielding and bypassing.

Amplification is of little value unless it is accompanied by selectivity. The intermediate frequency of 475 kilocycles was chosen because the selectivity is much better at a higher frequency than at a low frequency, and because this frequency gives one spot reception. Selectivity is determined not only by the frequency of the intermediate, but by the ratio of the inductance of the tuned circuit to the tuned circuit resistance. At a frequency of 475 kilocycles it was found that a single layer solenoid has the highest ratio of inductance to effective resistance of any type of winding. For this reason solenoids for both primary and secondary are used. No wood or low dielectric substance is used. The primary winding is composed of 470 turns of No. 36 wire wound evenly on a bakelite tube having a clearance of 1 in. from winding end to case. Inside, and at the grid end of the primary winding, is placed another bakelite tube on which 100 turns of No. 36 wire are wound for the secondary. At the top of the transformer is mounted a .00007 μ f variable condenser which is connected across the primary winding. This condenser is similar in action to the Lincoln No. 101 I. F. transformer, and accurately tunes each stage to the exact frequency desired, at the same time compensating for all different tube capacities and characteristics.

The final conclusions were that for maximum usable gain the tuned primary transformer using single layer solenoids for both primary and secondary coils mounted in fully enclosed copper shielding and operating at a frequency of 475 kilocycles, gave maximum amplification combined with maximum selectivity.

No matter what your resistance problem may be—whether an unknown high resistance value for a critical receiving circuit or a heavy duty low resistance value for grid-biasing the largest audio power tube or even transmitting tube—

Remember **CLAROSTAT** for Every Purpose
there's a

Write for literature

Clarostat Mfg. Co., 287 N. 6th St., Brooklyn, N. Y.

Your Old Jewell 199 Set Analyzer Is N. G.

As it is, it won't work on the new screen-grid sets. You've got to buy a new set analyzer or send the old one back to the factory, pay \$22.50 plus transportation for the changeover and wait 60 days for its return. Or, if you're wise, you'll bundle it up, mail it to us and

Let Us Make the
Changeover for **\$13.50**

including all parts, labor, accessories and complete instruction for the operation of the remodeled Set Analyzer. What's more, we'll hustle it

BACK IN 10 DAYS

Send yours in now and be ready to shoot trouble in screen-grid sets.

NEW JEWELL MODEL 409

A 4-Instrument Set Analyzer
for Expert Service Men
\$93.38 F. O. B., Spokane, Wash.

SPOKANE RADIO CO., INC.
528 First Avenue Spokane, Wash.
Complete Mail Order Service for Dealers
and Service Men

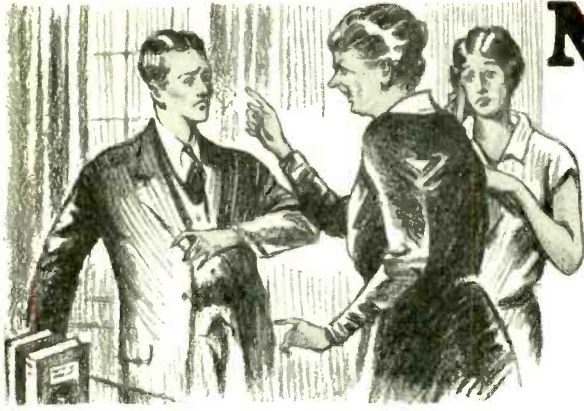

MARRIED LIFE USUALLY ~

Is smooth and successful enough *provided* there is not too much interference from outsiders. And that's just the way with a good radio; the set may be perfect—but many a dealer and set owner will rise up to testify that A-C line interference will ruin the best reception. Spoils sales for the dealer and enjoyment for the set owner.

What a relief, after a perfectly good set has been bringing in the buzz and roar, killing reception generally, then to get a **THERMATROL FILTROL** on the job bringing back the clear music you have a right to expect. There is a **FILTROL** for every requirement all carefully designed to protect your set against noise coming over the A-C line from motors, generators and other electrical apparatus.

THERMATROL FILTROLS are outstandingly superior because they are scientifically designed and thoroughly well constructed. Capacitance and inductance exactly balanced to give the best results in each unit. Ample space for extra heavy condensers thoroughly insulated to insure against any possibility of trouble even under the worst conditions. Special air-cooled chokes that prevent overheating with heavy overloads.

And yet our volume of production makes it possible to offer this superior line of **FILTROLS** at very reasonable prices.

MOTOR FILTROL

For direct application to oil burners and other interfering apparatus. Handles up to 1/2-h.p. motor. Built to be wired into the circuit.

No. 548, Price \$15.00

FILTROL JR.

Plugs ahead of household appliances such as vacuum cleaners, sewing machines, electric fans, etc.

No. 450, Price \$3.50

THE NEW FILTROL

Plugs in the power line ahead of the set itself. No wiring. Can be installed in a minute.

No. 460, Price \$12.00

To find out if your trouble is A-C line noise, disconnect the aerial and turn the set up to full volume. If noise still continues you need a Filtrol. If there is no noise with aerial disconnected, your trouble is not from the A-C line.

THERMATROL Line Voltage Controls are standard with service men everywhere for the protection of A-C tubes against heavy voltages. They are compact, stick tight in the socket, have multiple voltage outlets and cannot be knocked out of adjustment when installed.

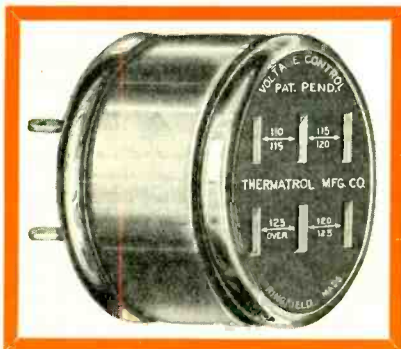

LIGHT DUTY

No. 200

Price \$1.75

For sets up to 6 tubes

HEAVY DUTY

No. 210

Price \$2.00

For all larger sets

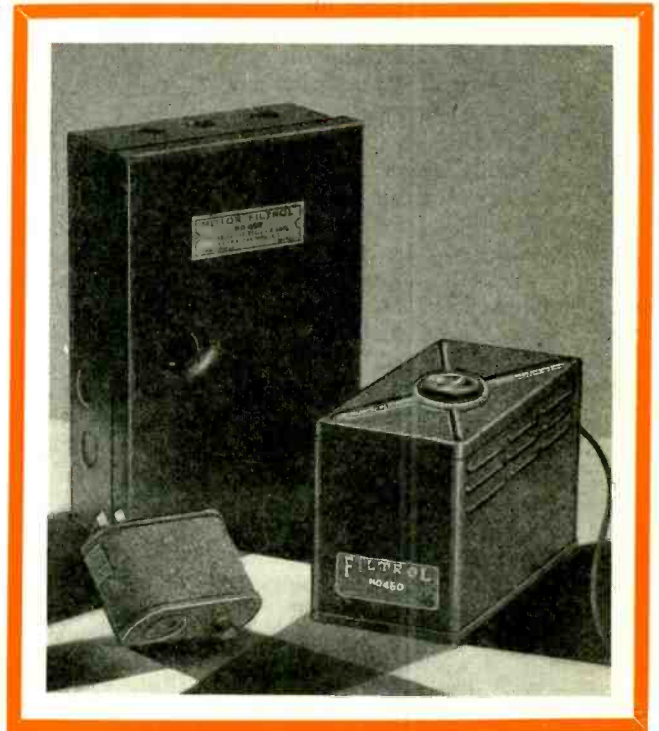

THERMATROL MANUFACTURING CO.

Springfield, Mass.

MAIL THIS COUPON

THERMATROL MANUFACTURING CO.,
52 Willow Street, Springfield, Mass.

Please send me full catalog FREE

Please ship the following at once C. O. D. Check enclosed

No. 460 No. 458 No. 450 No. 200 No. 210

Name _____

Address _____

Jobber _____

Tell them you saw it in RADIO

DESIGN OF R-F TRANSFORMERS

(Continued from Page 46)

optimum value of t cannot always be used, notably in the case where the transformer is to follow a screened-grid tube. In such circumstances it would usually be found that the optimum primary would be such as to itself tune to some point in the broadcast band, with results that would be distressing.

For the benefit of those who find it necessary to rely wholly on the approximation to the coupling factor k , it has usually been found that the approximation errs rather on the low side, so that it is permissible to increase the transformer ratio a trifle over that calculated. Moreover, some compensation for any slight reduction in amplification resulting from a transformer ratio a little greater than the optimum is found in the enhanced selectivity secured thereby. Where a measurement of the mutual inductance can be made, k can of course be secured with fair accuracy and the ratio t altered in line with any alteration in k .

Since the equivalent primary dynamic resistance into which the tube feeds is equal to k^2/t^2 of the dynamic resistance of the secondary (calculated from the formula $R=L_2/Cr_2$) readers might find it interesting to calculate this resistance into which the tube feeds in the above example and see how exactly it fits the well-known requirement that for optimum performance the load shall be equal to the operating impedance of the tube itself.

It is not proposed to enter into a lengthy discussion on modes of construction, since these will readily suggest themselves to the reader and further experiment in this direction is highly desirable. Care should be taken, however, that the requirements developed from theoretical considerations are not overlooked, and it is with this in mind that the following suggestions are made:

(1) In order to maintain k at the highest possible figure and thereby gain enhanced selectivity while still loading the tube properly, the primary should be wound directly over or under some portion of the secondary and should not be wound spaced from the secondary on the same former.

(2) With the same object in view, the primary should be spaced over a considerable part of the winding length of the secondary. Browning, of course, advocates the use of a slot wound primary; if this construction should be adopted, the winding length of the secondary should be reduced to the point where increase in secondary resistance becomes serious, in order to maintain k at a reasonably high figure.

(3) The transformer ratio should be determined from equation (8) in the manner previously illustrated, and while

some increase in transformer ratio with the object of increasing selectivity is permissible, this should not be too great; in view of the writer's previous article, it is almost unnecessary to add that the secondary resistance should be as low as can be obtained with the dimensions permissible.

(4) A point which is not brought out in the simple theory given here is that the capacity between primary and secondary windings, as well as the self-capacity of the primary, should be reduced to the lowest possible limits. Advantage should be taken of the low dielectric constant of air to reduce this

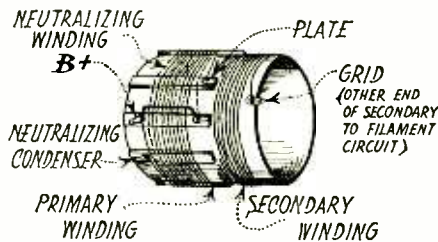

Fig. 6. Method of Winding Transformer

capacity. Thus the primary may be wound over eight hard rubber spacing strips (perhaps 3/16 in. wide by 1/8 in. thick) spaced at equidistant intervals around the secondary and held in position with rubber bands until the winding is completed; the ends of the winding may be soldered to tags held by bolts passed up from the underside of one or two of the spacing strips, the heads of the bolts being heavily countersunk so as not to come in contact with the secondary. Alternatively, the primary may be wound on a former of a smaller diameter than the secondary former, care being taken that there is a clear air space on all sides between the primary winding and the interior of the secondary former; where a slot-wound primary is used, the primary should not quite fill the slot, and it might even be advantageous to turn down the wall of the slot nearest the high potential end of the secondary a little in order to leave an air space here. The turns of the primary should be spaced (except where slot-wound) in order to reduce self-capacity, and since primary resistance is immaterial, should be wound with the finest gauge of wire which the constructor is willing to manipulate; No. 44 is not too small, and No. 34 should be regarded as the maximum permissible, except where extreme mechanical strength is necessary. The effects of such capacity as remains may be reduced to some extent by keeping the primary towards the low-potential portion of the secondary.

(5) It should be remembered that in cases where neutralization is effected by means of a center-tapped primary, the tapping being connected to $B+$ (a cir-

cuit of this type is illustrated in Fig. 4) the true primary is only the portion connected between $B+$ and the plate of the tube, and it is the ratio of the square roots of the inductances of the secondary and of this portion of the primary which is given by (8). The remainder of the primary, or, as it would perhaps be better termed, the neutralizing winding, is additional; with this circuit, where the primary and secondary are not concentric, it will be found that neutralizing is effected more readily when the primary and neutralizing windings are interwound, the beginning of the primary and the end of the neutralizing winding being connected together and to $B+$.

The description will be clarified by a reference to the illustration of Fig. 6, which also shows the method of winding the primary over strips of insulating material spaced around the secondary; the strips may be of hard rubber or formica, the latter material having the advantage of not softening under the heat of the soldering iron and so loosening the bolts securing the tags. Strips shaped to a knife edge might have some slight advantage, while production facilities would permit the adoption of a moulded skeleton former for the primary of such a size as just to slide tightly over the secondary winding.

"Condensers to be CARDWELL or equivalent"

appears quite frequently in specifications for receivers and transmitters intended for real service.

WHY?

Because maximum performance is demanded and, insofar as condensers are concerned, the designers are insuring it by specifying the best.



Transmitting Condensers for powers up to 50 K. W.

Receiving Condensers in all Standard capacities.

Send for Literature
Write for Literature

The
**ALLEN D. CARDWELL
MFG. CORPN.**

81 Prospect Street, Brooklyn, N. Y.



GEARS

In stock—immediate delivery
Gears, speed reducers, sprockets, thrust bearings, flexible couplings, pulleys, etc. A complete line is carried in our Chicago stock. Can also quote on special gears of any kind. Send us your blue-prints and inquiries.

Write for Catalog No. 100

Chicago Stock Gear Works
769-773 W. Jackson Blvd. Chicago, Ill.

A Beautiful *NEW* PANEL PLATE

For the Famous HAMMARLUND DRUM DIAL

RICHLY embossed, pebbled bronze in the modern mode. It has grace and charm appropriate to the superb dial mechanism back-panel that delighted thousands of set builders last season. The control knob can be mounted anywhere on the panel. Illuminated scale.

Write Dept. PR10 for
Details

HAMMARLUND
MANUFACTURING
COMPANY
424-438
W. 33rd Street
New York, N. Y.

For Better Radio
Hammarlund
PRECISION
PRODUCTS

AEROVOX BUILT BETTER CONDENSERS AND RESISTORS

Moulded Mica Condenser Acknowledged Standard

ACCURACY, minimum dielectric losses and freedom from change under the influence of varying temperature, weather and chemical action have contributed to the acknowledged pre-eminence of the moulded mica condenser for use in radio frequency circuits.

In Aerovox Moulded Mica Condensers—made in a variety of shapes and sizes to fit every requirement—only the best grade of India Ruby mica, pure tinfoil plates and high quality bakelite are employed. High quality materials, skilled workmanship and constant research combine to produce a moulded mica condenser that is accurate, permanent and efficient.

Send for Catalog

Complete specifications of Aerovox moulded mica condensers and other units are contained in a complete catalog that will be sent free of charge on request.

The Research Worker

contains, each month, valuable information on radio design. It will be sent free on request.

AEROVOX WIRELESS CORP.

80 1/2 Washington St., Bklyn., N. Y.

PRODUCTS THAT ENDURE

Choice of 1200 Newest RADIO VALUES

SEND for our 1930 catalog. Filled with amazing values in screen-grid radios, push-pull audio, console, kits, parts. All standard makes and guaranteed merchandise.

FREE

WESTERN RADIO MFG. CO.
129 W. LAKE ST. CHICAGO ILL.



Does your radio set stand the "visitor test"?

Your set may seem "good enough" but do your friends share your opinion of its quality? It will always be open to unpleasant criticism until you get exact reproduction of the studio broadcast. No matter what kind of a set you have it can be made tone-true by replacing the inferior transformers with one of the AmerTran audio systems.

You will get music from your old set that you never thought possible before—and it doesn't make any difference how old or out of date it is either. With the AmerTran Power Amplifier (Push-Pull for 210 tubes) and the ABC Hi-Power Box you can make your old set as modern as any set, regardless of price—and have the finest toned set possible commercially.

See your dealer or write to us.

AMERICAN TRANSFORMER COMPANY
Transformer Manufacturers for more than 29 years
63 Emmet St. Newark, N. J.



AmerTran Push-Pull Power Stage (illustrated above)—completely wired with input transformer and a choice of 4 output transformers depending on speaker and power tubes. Price, east of Rockies—less tubes—\$36.00.



AmerTran DeLuxe Audio Transformer (illustrated above). Standard of Excellence. 1st Stage; Turn Ratio, 3; 2nd Stage; Turn Ratio, 4. Price, each \$10.00.

AMERTRAN

TROUBLE SHOOTING A POWER UNIT

(Continued from Page 27)

respectively of the test panel. The high resistance rheostat is adjusted until some predetermined current, say 40 ma, is indicated. Switch No. 1 is then set on tap No. 1 and the voltage output at this load current will then be shown on the d-c voltmeter. If the current required by a receiver is known, it is possible to adjust the rheostat for this current and to then read the maximum voltage that can be obtained under this load.

The average unit should show an output of at least 135 volts while delivering a current of 30 ma. If the voltage reading is low, the trouble is probably due either to a defective rectifier or a shorted bypass condenser across some section of the voltage dividing resistance. The substitution of a good rectifier tube will determine whether the trouble is in the tube. If there is no output, there can be any number of reasons, the most likely being a shorted filter condenser whose location can be found as already described.

If it is desired to check the various voltage taps of the unit for output while it is under load, switch No. 1 should be set on point 2 and the insulated test prod lead connected to post No. 2 should be touched to the different voltage taps and the voltage read. If the voltage is over 300, the switch should be set on point No. 3 which will connect the voltage multiplier in the circuit so that the maximum range of the meter will be 600 volts.

Condenser Tests

TO TEST filter condensers for shorts, leaks or an open, switch No. 1 should be set on point 4 which connects 150 volts of *B* storage batteries in series with the 300 volt range of the high resistance voltmeter. A clip lead from post No. 1 is clipped on to one terminal of the filter or bypass condenser and the lead with the insulated test prod from post No. 2 is touched to the other terminal of the condenser. The push button marked "continuity" (No. 1) is pressed and if the condenser is good, the needle of the high resistance voltmeter will swing up and then return rapidly as the condenser charges up to the value of the d-c volts from the batteries. After this quick swing there should be no further indication shown on the voltmeter.

A reading will indicate a leaky condenser and the failure of the needle to either swing or indicate would show that there was an open between the condenser terminals and the condenser. When testing a condenser make certain that it is discharged first by shorting the terminals of the condenser.

The capacity of filter and bypass condensers can be measured with a fair degree of accuracy by setting the a-c voltmeter switch No. 2 on point 4. The lead from post No. 5 is clipped to one terminal of the condenser and the test prod from post No. 6 is touched to the other terminal. When push button No. 2 is pressed, it connects the a-c line voltage, usually 110 volts, in series with the condenser and the 150 volt scale of the a-c voltmeter. As the reactance of the condenser varies with the capacity, the amount of current flowing through the voltmeter will change with the capacity. That is, the highest capacity condenser will give the highest reading on the voltmeter.

A calibration curve of the a-c voltmeter as a capacity meter can be made by taking a number of high grade condensers of different rated capacities and plotting the voltmeter readings obtained through the condensers against their capacities.

It will be noted that whenever the switch is set for measuring capacity there is a 2000 ohm resistor shunted around the a-c voltmeter. The reason for this is that the voltmeter used was of the repulsion type and the resistance (6100 ohms) of the voltmeter was too high to give any appreciable change in the voltmeter reading with a change in capacity. When the 2000 ohm resistor is shunted around the meter, the current taken by the combination is large enough to cause an appreciable voltage drop across the reactance of the condenser.

Transformer Voltage Readings

THE HIGH voltage windings of a power transformer can be checked by reading its voltage. This voltage can be easily measured by clipping a test lead from post No. 5 to the *B*- terminal of the *B* power unit and touching the insulated test prod from post No. 6 to the plate and then to the grid terminals of the rectifier tube socket in a 280 type of unit, the plate terminal of the rectifier tube socket in a 281 type of unit or to each of the filament terminals of the rectifier tube socket in the Raytheon type of unit. Be sure that the insulated test prod is used because the voltage on some types of power units is high enough to be dangerous. The rectifier tube should be removed while making this test.

In conclusion it may be said that many of these troubles will never occur in a power unit if it is always connected to a load which will keep the voltage somewhere near the point for which the unit was designed. When the load is removed the filter and bypass condensers may be subjected to voltages perhaps fifty per cent greater than when operating with load.

TRANSLATING RADIO LANGUAGE

(Continued from Page 32)

tion frequencies. These measurements are plotted on a graph which shows, for each modulation frequency, the ratio of the output voltage at that modulation frequency to the output voltage at a modulation frequency of 400 cycles per second.

DISTORTION is "a change in wave form . . . when the output wave form is not a faithful reproduction of the input wave form." It is caused by the introduction of spurious frequencies which are not present in the input, but which appear in the output. Its effect on the human ear is highly variable and is frequently heard as an over-emphasis of certain notes, or as blurred or muffled tones. Consonants may also be suppressed.

These spurious frequencies may be introduced by the r-f amplifier, detector, or a-f amplifier and may be due to many different causes. If the r-f amplifier is tuned too sharply the sidebands are cut off and the high notes are not reproduced; if it is operated too close to the point of oscillation, the oscillating frequency will distort the sidebands and high notes. If the detector is overloaded by a strong signal so that its grid voltage becomes either too negative or too positive the sound is distorted. Insufficient grid bias or poor transformers in the audio amplifier also introduce distortion.

Modern practice recognizes that a certain amount of side-band cutting is desirable in order to eliminate the noise caused by heterodynes between modulated carriers on adjacent channels. In most receivers the output level at 5000 cycles is about 20 db less than the output at 1,000 cycles. Nor is there much object in a receiver's passing frequencies below 50 cycles, when "hearing" begins to become "feeling."

Power detection largely does away with the possibility of overloading the detector tubes. When used with one stage audio frequency amplification there is also less likelihood of the introduction of a-c hum into the output. Other refinements in receiver design, such as automatic volume control or automatic and remote tuning control, while they add to the convenience of operation and correspondingly increase the price, should have no effect on the three fundamental characteristics: selectivity, sensitivity and fidelity.

W7VV and W7AKP pound brass on the tugs Irene and Elmore, respectively. These tugs are near Everett, Wash.

PERRYMAN

RADIO TUBES

A Perryman Tube for Every Purpose

PERRYMAN A. C. TUBES

and accompanying Rectifiers and Power Amplifiers

DETECTOR-AMPLIFIERS

P. A. 227—heater type, for use with unrectified A. C. current direct on the filament through stepdown transformer. Exclusive Perryman processes have eliminated excessive hum and produced far above average life for this type of tube.

***P. A. 226**—for use with unrectified A. C. current direct on the filament in radio frequency amplification stages and first audio frequency stages.

POWER AMPLIFIERS

All tubes in this group are equipped with exclusive Perryman process oxide coated filaments. A product of Perryman chemical laboratories, unusually rugged, active and long-lived.

***P. A. 245**—This is the new power tube with longer life and greater undistorted output.

***P. A. 112-A**—a general purpose tube for radio frequency and audio frequency amplification. Can also be used as a detector. Filament current, one quarter-ampere.

***P. A. 171-A**—for last stage audio amplification. Quarter-ampere filament current.

***P. A. 210-A**—Super-power amplifier, delivers full volume of undistorted output. Especially suitable as an oscillator for amateur radio transmission.

***P. A. 250**—Super-power amplifier specially designed for amplifying circuit devices. Used in last audio stage of many new A. C. receivers.

***P. A. C. 224**—This is a new radio frequency amplifier of the screen grid type for A. C. operation.

RECTIFIERS

***P. R. 280**—a full wave rectifier, employing exclusive Perryman process oxide coated filament, insuring long life, satisfactorily used in power plants of most A. C. sets. Maximum D. C. output 125 mils.

***P. R. 281**—a half-wave rectifier, using exclusive Perryman process oxide coated filament, delivering an output of 110 mils. Used chiefly in the power plant of power amplifiers and B eliminators.

PERRYMAN D. C. TUBES

DETECTOR-AMPLIFIERS

***R. H. 201-A**—a general-purpose tube famous for its long life and fine quality.

R. H. 199—built in two type bases, miniature (small U. V.), long pin (standard V. X.). Rigidly made and especially reinforced.

P. A. 120—for last audio stage operated with 3-volt dry battery supply.

P. A. 200-A—a super sensitive detector tube of soft vacuum (gaseous) type. Pronounced ability to strengthen weak signals. Uses 45 volts on plate.

***P. A. 240**—especially designed for first audio resistance coupled amplification. It is a high mu tube and may also be used as a detector.

(*) Perryman Tubes equipped with the Patented Perryman Bridge.



The Patented Perryman Bridge

... holds the filament, plate and grid, top and bottom, in permanent, parallel alignment. This sturdy construction feature is exclusive to Perryman Tubes.

The Perryman Spring

... allows for the uniform expansion and contraction of the filament due to temperature changes. Another construction feature exclusive to Perryman Tubes.

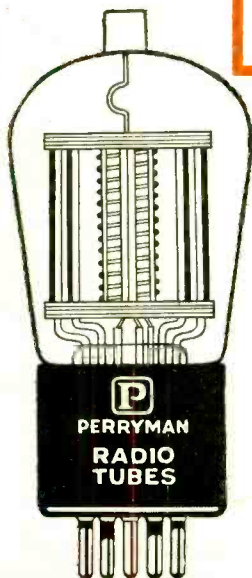

***P. A. C. 224**
The new screen-grid type of radio frequency amplifier for A. C. operation in the new screen-grid sets. Note the exclusive Perryman Bridge construction. This assures longer life and uniform characteristics.

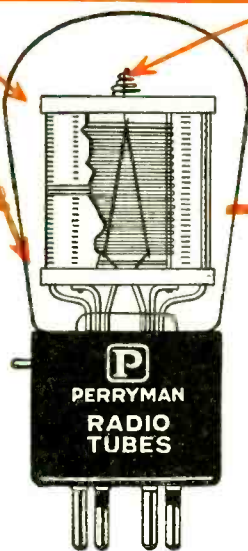

***P. A. 245**
The new A. C. power tube with the exclusive Patented Perryman Bridge and Tension-spring on each filament. Longer life and higher volume of undistorted output are the result of this sturdy and exact construction.

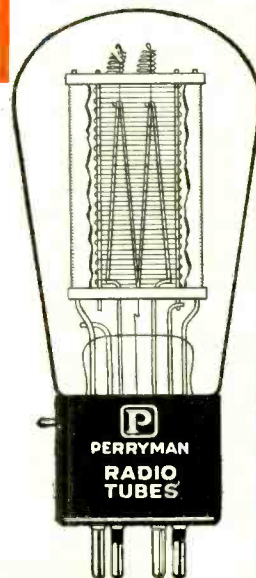

PERRYMAN ELECTRIC COMPANY, INC.

4901 HUDSON BOULEVARD, NORTH BERGEN, N. J.



Carton of four Eveready Raytheon B-H Tubes

MANY OF THE
"B" ELIMINATORS
YOUR CUSTOMERS
ARE USING
NEED NEW
RECTIFYING
TUBES
EVEREADY
RAYTHEON
B-H

WITH millions of "B" eliminator units sold in the past few years, quite a number must be used by your customers. The great majority of such units are designed and built especially for the original gaseous rectifying tube, the famous B-H. Tell these customers what a surprising difference in reception a new rectifying tube will make. Sell them new Eveready Raytheon Tubes.

You can buy Eveready Raytheon B-H Tubes in handy cartons of four tubes each. Keep a carton on your counter.

NATIONAL CARBON CO., Inc.
General Offices: New York, N. Y.
Branches: Chicago Kansas City
New York San Francisco
Unit of Union Carbide and Carbon Corporation



Trade-marks

TELEVISION
STANDARDIZATION

(Continued from Page 36)

Commission. The RMA Television Committee has recommended that the Commission consider the advisability and possibility of assigning a separate channel on which a standard synchronizing frequency may be broadcast. The use of such a frequency would be very broad, it is believed, in other scientific services. Standard recommendations relating to scanning are being retained for the present. The RMA recommends that scanning at the receiving end be from left to right, and from top to bottom in uninterrupted sequence, looking directly at the object.

Standard practices for television experimenters—not rigid standards regarding speed elements—are being recommended by the RMA Television Committee. Assuming that the first successful television probably will be from talking picture films, it is recommended that experimenters use discs to give 48 by 57½ picture elements, at speeds of 15, 20 and 24 frames per second, and also 60 by 72 at 20 and 24 frames per second. Most talking pictures are projected at 24 frames per second, and a slower rate, it is believed, would not bring as satisfactory results, although there is admitted difficulty in obtaining the higher speed with standard motors.

Television engineers are of the opinion that it is too early to adopt fixed standards for disc speed or hole arrangement of television transmitters, and that it is too early to impose rigid standards on the television art to which it is hoped and believed amateurs will make valuable contributions.

GET ONTO THOSE CURVES

(Continued from Page 29)

2,000 cycles a loss of almost 4 db is noted; at 4,000 cycles the loss is 8 db and at 5,000 cycles the volume drops a total of 11 db, just past the point where it begins to be noticeable. In this receiver, then, the critical ear should be able to detect a very slight attenuation to the high notes, while the best the ordinary ear could do would be to perceive the fact that the tones, especially in the human voice, were not as "full" as in a more faithful receiver. This is due to the fact that the fullness of a musical tone is dependent upon the harmonics of which it is comprised. These, being on the higher frequencies, of course, have been reduced in strength.

At 1,400 kc a better fidelity curve results, one in which the high notes show less loss. This is borne out by the broad shoulder of the 1,400 kc selectivity curve in Fig. 1. At 600 kc, just as we should have suspected from

(Continued on Page 76)



NEW ENGLAND MILLS offers everything in radio at Wholesale Prices that spell real savings! That's what you will find in this great catalog just off the press, featuring Radio's newest creations in sets, kits, parts and supplies. Everything in our catalog is backed by the guarantee of this old, stable concern and its vast resources, accumulated through 17 years of faithful service to its customers.

Radio Dealers Save Money

on complete radio sets of every description, dynamic and magnetic speakers, A. C. and all other types of tubes, eliminators, batteries, radio cabinets—in fact everything required by dealers for resale or servicing. Buy right, sell right and make money.

Set Builders and Repair Men

Earn big money by rebuilding and modernizing old sets. Catalog contains everything required for this work; also the latest nationally renowned kits—knocked down or completely assembled chassis ready to install in table or console cabinets, all at wholesale prices.

A. C. Electric Radios

Large selections of the finest A. C. Electric, 6, 7, 8 and 9 tube chassis and complete sets obtainable at the amazingly low prices we quote. Every modern radio improvement is embodied in these marvelous electric radios. Backed by guarantee of satisfaction of this 17 year old institution.

Battery Sets for Unwired Homes

Rural communities with homes not wired for electric radios offer a good market for battery sets, repairs and replacements. We have a large stock of batteries, eliminators, speakers, tubes, transformers, coils, and all kinds of accessories for battery sets. Best known, nationally advertised goods, such as Cunningham, Sonatron and Arcturus tubes, Burgess batteries, Jewel instruments, Belden Products, Utah, Temple, Farrand and other popular dynamic and magnetic speakers.

Send for Free Book—NOW!

Radio dealers, agents, set builders, service men, etc., cannot afford to be without the New England Mills catalog. We maintain a complete radio service department, supervised by expert radio engineers who will help you with all your radio problems. All goods catalogued are stocked for immediate shipment. Write for this book today. It's FREE! Send request on business stationery. Catalog also contains complete line of tires, tubes, auto supplies, electrical and sporting goods.

NEW ENGLAND MILLS CO.
851 Washington Blvd. Dept. 60 Chicago, Ill.

SEE PAGE 57

The Biggest \$2.00
Worth of Radio
Information

FROST-RADIO

wants you to have a copy of its valuable 16-page Parts Catalog **FREE**

We want every reader of RADIO who has not yet received his copy to send for our big 16-page Parts Catalog containing a vast amount of useful information, in addition to illustrating and describing the complete line of Frost-Radio Parts and accessories. It describes our big special offer to radio set builders. It tells about special hook-ups, short cuts, "how to do things better." Get your copy of this book today. Remember, it's FREE for the asking. So just mail the coupon NOW and get your copy by return mail.



FROST-RADIO WIRE-WOUND RESISTORS

Made in four different sizes, all metal shell, with resistances ranging from fractional to 10,000 ohms, and with or without D. C. Battery Switches . . . Frost-Radio Carbon Element Resistors are made in several types, Bakelite or metal shell cases; distinguished by low hop-off, in fractional ohms if desired; also may be combined with A. C. switch.

HERBERT H. FROST, Inc.

Main Office and Factory

ELKHART, INDIANA

FREE

TO OBTAIN OUR CATALOG JUST FILL OUT AND MAIL THIS COUPON

HERBERT H. FROST, Inc.
160 N. La Salle Street, Chicago

Send me your 16-page Parts Catalog by return mail. I understand it will be sent to me FREE and postpaid.

Name.....

Address.....

City.....State.....

Potter Condensers

Replacement Blocks and Bypass Units

Now Available for "B" Eliminators and Power Supply Units for Service and Repair Men

Potter Filter Blocks

RR-245	Condenser Block for single and push-pull 245 type tube amplifiers	\$19.75
T-2900	Condenser Block for the single 250 type tube amplifier....	\$20.00
T-0295	Condenser for the push-pull 250 type tube amplifier.....	\$22.50
T-2098	Condenser Block for single 210 type tube amplifier.....	\$20.00
T-280-171	Condenser Block for power pack with 280 type tube rectifier	\$18.00

The Potter Co.

North Chicago, Illinois

A National Organization at Your Service

LOS ANGELES



Convenience
Comfort & Hospitality

You will appreciate the excellent service and moderate rates. The city's most centrally located hotel. One block from Pershing Square—convenient to all leading shops, theatres, financial institutions and electric depots for all resorts.

Garage adjoining.

All Outside Rooms—Each With Bath
One Person - - \$2.50, \$3, \$4
Two Persons - - \$3.50, \$4, \$5

Unexcelled Food—Friendly Prices
FRANK SIMPSON, JR., Director

Hotel Savoy
Sixth & Grand

SERVICING

—is it an asset or a liability to you?

HOW many radio dealers are there who having tried to operate their own servicing department have given it up in disgust and "farmed out" the work to an outside service agency? Throughout the retail trade radio servicing has occasioned more grief and put more red figures in the ledger than any other branch of the radio business.

Yet it has been demonstrated time and again since the Weston Model 547 Radio Set Tester was brought to perfection and put on the market that radio servicing can easily be made one of the most profitable departments of radio retailing. With this set tester the service man's work is reduced to a certainty. No more is it necessary for the service man to waste time hunting for trouble. Model 547 gives him the answer instantly. The speed with which his work is accomplished reduces the cash loss occasioned by waste of time and enables him to do ten jobs in the same time it formerly took him to do four. Furthermore, his work is final.

Once the job is done there is no necessity for a return call and the customer is satisfied and becomes a friend of the organization which uses the Model 547 Weston Radio Set Tester as its "trouble shooter."

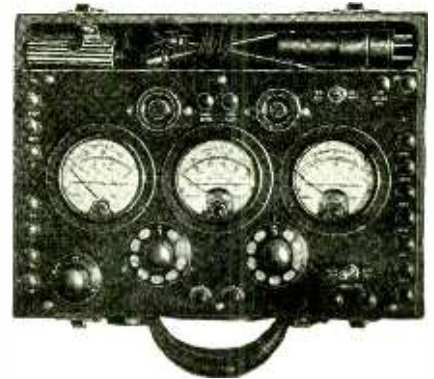

Weston Model 547 is provided with three instruments—all 3 3/4" in diameter and furnished with bakelite cases. Carrying case, movable cover, panel and fittings also are made of sturdy bakelite.

A-C Voltmeter—750/150/16/8/4 volts. The three lower ranges are brought out to the Tester plug, and all five ranges are brought out to binding posts. 750-volt range is for testing secondaries of power transformers. 16-volt range is to provide for 15-volt A-C tubes. Operations have been reduced—only one selector switch being necessary.

D-C Voltmeter—High range increased to 750 volts. Other ranges—250/100/50/10/5—all six ranges brought out to binding posts and Tester plug.

D-C Milliammeter—Double range—100/20 MA provides for lower readings with better scale characteristics.

Tests—On A-C sets the heater voltage and plate current can be read throughout the test while the D-C Voltmeter may be indicating test bias or cathode voltage.

Self-contained, double sensitivity continuity test provided. This can also be used for measuring resistance as well as testing for open circuits. Grid tests can be made on A-C or D-C screen-grid tubes—also the "27 tubes when used as a detector—without the use of adapters. Two sockets on the panel—UY tube adapters eliminated.

WESTON ELECTRICAL INSTRUMENT CORP.

600 Frelinghuysen Avenue
NEWARK, N. J.

Weston
PIONEERS SINCE 1888
INSTRUMENTS

Tell them you saw it in RADIO

75

A Jensen ELECTRO-DYNAMIC SPEAKER

TO MEET EVERY NEED

JENSEN Standard Speaker

Has eight inch cone. Extremely fine tone quality and excellent volume. Used extensively for modernizing earlier model radio receivers. Unit, AC, \$32.50; DC, \$25.00. In Jensen Model 6 Cabinet with AC Unit, \$50.00, DC Unit, \$42.50.



JENSEN Concert Speaker



Used by many of America's leading set manufacturers in their 1930 console model receivers. The standard of comparison for all reproducers. Ten inch cone. Unit, AC, \$35.00; DC, \$27.50.

JENSEN Auditorium Speaker

Unequaled where tremendous volume is required. Used extensively for public address systems, talking movies, and in auditoriums and large halls. Twelve inch cone. Unit, AC, \$70.00 (less tube); DC, \$55.00.



The IMPERIAL



Acclaimed, upon its introduction, as America's finest and most beautiful reproducer. Equipped with either the Concert or Auditorium Units. Prices, with Auditorium AC Unit, \$100.00 (less tube); with DC Unit, \$90.00; with Concert AC Unit, \$80.00; DC Unit, \$72.50.

Jensen Electro-Dynamic Speakers are made in types to meet every present day need. Write for technical data and attractive trade discounts

JENSEN RADIO MFG. CO.
6601 S. Laramie Ave. 212 Ninth Street
Chicago, Ill. Oakland, Calif.

LICENSED UNDER LEKTOPHONE PATENTS

GET ONTO THOSE CURVES

(Continued from Page 74)

Fig. 1, the high notes begin to drop at 400 cycles and are practically unheard at 5,000 cycles. It should be remembered that these fidelity curves are taken at maximum sensitivity and that, just as the selectivity curves broaden out as the sensitivity is lowered the fidelity curve straightens up. Like all curves their greatest practical value lies in their comparison with curves of other receivers, not to the ideal.

IDEAS FOR THE BENCH MAN

(Continued from Page 50)

coil design. The resonance effects at high frequency are due to leakage reactance, i. e., flux not linking both primary and secondary coils, and by coil capacity. The loss at high frequencies is due to internal coil capacity, principally in the secondary. It was found possible to reduce both these effects by a form of coil construction which sandwiches the primary between two sections of the secondary. This type of winding not only reduces leakage reactance by increasing the coupling between primary and secondary, but also reduces the internal capacity of the secondary by breaking it up into two pieces.

In many of the better grade transformers, silicon steel has been used as a core material. The coils are of the sandwich type. The result is a transformer possessing a practically flat frequency characteristic from 30 to 6000 cycles, furnishing faithful rendition of programs. Acknowledgement for information contained herein is made to papers published by the General Radio Company.

IT'S A SELLER!

**CORWICO
VULCAN
LIGHTNING ARRESTER**

\$1

It also dissipates accumulated static charges—an exclusive feature you can talk about and sell.
If your jobber cannot supply you with Corwico Vulcan Lightning Arresters, order a sample carton of six direct.

CORNISH WIRE COMPANY
26 Church Street, New York City

**MAKERS OF
CORWICO BRAIDITE HOOK UP WIRE**

Thordarson Transformers and Chokes

For Use With

"245" Type Power Tubes and "224" Screen Grid Power Detectors

Input Couplings

Single "245" tube, from any radio amplifying tube, use any one of three transformers

R-260	\$5.00
R-300	8.00
R-400	9.00

(R-400 especially suited to "226" and "227" tubes)

Push-Pull "245" tube, from any audio amplifying tube. Use 1-to-1 ratio input transformer..... T-2408 \$8.00

Use 2-to-1 ratio input transformer..... T-2922 12.00

Screen grid power detector "224" to any single power tube, use "Autoformer" for choke-resistance type of standard circuit..... R-190 \$5.00

Screen grid power detector "224" to any push-pull power tubes use R-190 Autoformer for parallel feed to detector plate and 2-to-1 coupling transformer..... T-2922 \$12.00

Speaker Couplings

Single "245" tube to dynamic speaker with built-in transformer to cone speaker, or to magnetic speaker—Use either one of two transformers.....

T-2876	\$6.00
T-2901	12.00

Use choke condenser coupling, employing one choke..... R-196 5.00

Single "245" tube to moving coil of dynamic speaker—Use transformer..... T-2902 \$12.00

Push-pull "245" tubes to dynamic speaker with built-in transformer, to cone speaker, or to magnetic speaker—Use coupling transformer..... T-2880 \$12.00

Use choke coupling, employing double choke..... T-2420 8.00

Push-pull "245" tubes to moving coil of dynamic speaker—Use either one of two transformers....

T-2629	\$10.00
T-2903	12.00

Filament Supplies

For six "224" screen-grid tubes or six "227" tubes—Use filament transformer (10.5 amps at 2.5 volts)..... T-3660 \$9.00

For two "224" tubes or two "227" tubes and one or two "226" tubes use double voltage transformer..... T-3081 \$6.00

Power Compacts

For filament current, plate current and bias on "245" push-pull power stage, also plate current for set. Contains filter chokes. Uses one 280 rectifier tube..... R-245 \$24.00

For filament current, plate current and grid bias on single "245" power tube and one "226" audio tube, also plate current for set. (Requires extra T-3081 filament transformer.) Contains filter chokes..... R-480 \$17.00

THORDARSON RADIO TRANSFORMERS

Thordarson Electric Manufacturing Co.
Transformer Specialists Since 1895

WORLD'S OLDEST AND LARGEST EXCLUSIVE
TRANSFORMER MAKERS

Huron and Kingsbury Streets, Chicago, Ill.,
U. S. A.

Now....

you can get into the **BIG MONEY!**

*Bigger sales units and bigger profits per unit . . .
Sell \$350 to \$1000 and MORE... Easy-to-handle
installations all over your neighborhood*

BIG BUSINESS! And it's easy for you to capture! Just imagine . . . every theater and dance hall, every hospital and apartment house in your district is a logical user of broadcasting entertainment. By simply stretching out your hands for it, you can secure your share of this big-unit, big-profit business. Get into Power Amplification! Sell the equipment . . . make the installations . . . get bigger advertising value . . . and keep your organization busy making real money for you all the year around!

Show the business men in your area how a modern system of A-C Power amplification will draw big crowds and make big money for them. We make the heart of the system, **POWERIZER Amplifiers** employing the new UX-245—UX-250 Tubes. Our new Control Panels and Amplifier Racks afford ideal flexibility in arranging audio-distribution to suit local conditions. Capitalize our years of experience. Consult us freely!

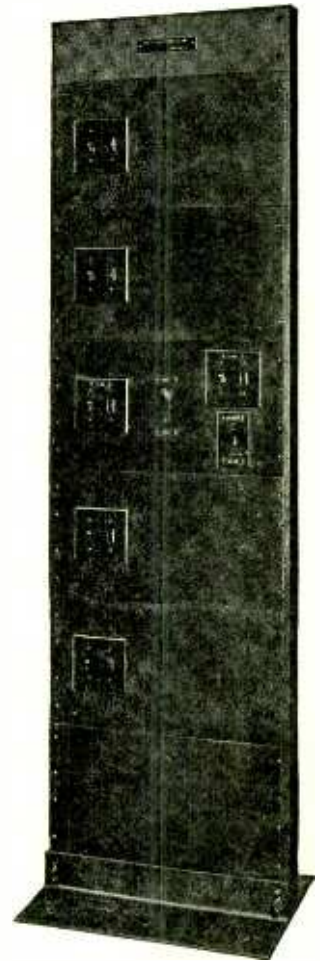

Send for Bulletin No. PR 1028

POWERIZER

Power and Super Power

AMPLIFIERS

Licensed by Radio Corporation of America and Associated Companies

RADIO RECEPTOR COMPANY, Inc.

106 Seventh Ave.

New York, N. Y.

Service agencies in important cities.

**POWERIZER 2-channel
amplifier panel, ideal for**

Amusement Parks	Dance Halls	Riding Academies
Aviation Fields	Factories	Sanatoriums
Band Stands	Gymnasiums	Skating Rinks
Baseball Parks	Hospitals	Sporting Arenas
Camps	Hotels	Stadiums
Churches	Playgrounds	Steamships
Circuses	Public Parks	Swimming Pools
Civic Centers	Race Tracks	Theaters
Convention Halls	Railroad Depots	Yacht Clubs
	Restaurants	

Tell them you saw it in RADIO

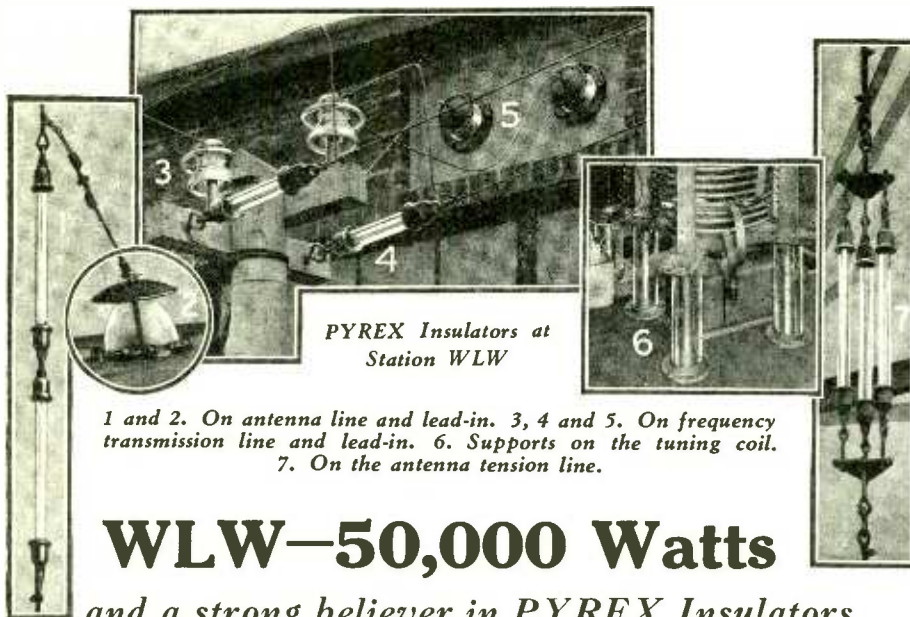

PYREX Insulators at Station WLW

1 and 2. On antenna line and lead-in. 3, 4 and 5. On frequency transmission line and lead-in. 6. Supports on the tuning coil. 7. On the antenna tension line.

WLW—50,000 Watts

and a strong believer in PYREX Insulators

THAT PYREX Insulators have vindicated their right to exclusive use in this fine new station is evident from the following comment by J. A. Chambers, Technical Supervisor: "We feel that PYREX Insulators have minimum leakage and that they do their part in maintaining quality and range. Our installations have proven unusually strong, durable and free from breakage. The insulating quality is satisfactory in fog, rain, etc."

An investigation of the 600 American broadcasting stations showed that PYREX Insulators were almost universally used on the antennae, that the larger and new stations favor PYREX Entering Insulators on the lead-in, and that where conditions invite the use of stand-off, pillar and bus-bar types, PYREX Insulators are given the preference.

There is a suitable type and size for every radio service and our PYREX Radio Insulator booklet with all listed and priced, makes the correct selection easy.

Write us for a copy and get PYREX Insulators from your nearest supply house, or if necessary from us direct.

CORNING GLASS WORKS, Dept. 65
Industrial and Laboratory Division: CORNING, N. Y.



NEW EQUIPMENT FROM THE RADIO MANUFACTURERS

The Weston set tester, model 547, is equipped with an eight-range d-c voltmeter, a five-range a-c voltmeter, both equipped with a bi-polar switch for connecting the various ranges to the tester plug, and a double-range d-c milliammeter. The d-c voltmeter covers the 5, 10, 50, 100, 250 and 750-volt ranges as well as reading 5 and 100 ma. The milliammeter covers the 20 and 100 ma ranges. The a-c voltmeter is

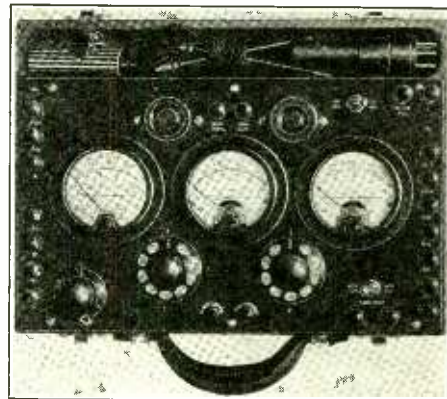

for 4, 8, 16, 150 and 750 volt maximum readings. In addition to a four-prong tester plug with a five-prong adapter, there are two sockets on the panel, one for four-prong and the other for five-prong tubes. All voltages can also be brought in through binding posts. All the varied tests which can be made with this outfit are described in a complete book of instructions which also includes test data for many factory-built sets. The tester is contained in a bakelite case with a compartment for accessories and small tools; it is 12½ by 9 by 3¼ in. in size and weighs 10 lbs.

The Trimm chassis electrodynamic speaker is obtainable in two models for cabinet installation. Model DV 102 is provided with an output transformer which matches the voice coil and the conventional type of power amplifier tubes. Model D 100 is for use with sets which are equipped with an

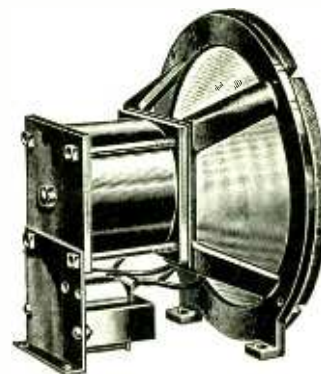

output transformer. Both models require high voltage direct current to energize the field coils. They are claimed to combine wide range with true tone fidelity and to furnish extreme volume with mellowness.

Electrad layer-wound high resistances are recommended for use as plate resistors, voltmeter multipliers and general laboratory work calling for ratings of from 10,000 to 250,000 ohms. The units are 2 in. long with a maximum diameter of 5/8 in. and consist

(Continued on Page 80)



BE A RADIO DOCTOR



Radio servicing offers the biggest opportunity for the man interested in radio. About 10,000,000 receivers need service some time or other, many are naturally inefficient and can be improved on.

The Radio Doctors, Inc., is the only institution teaching exclusively radio repairs, having specialized on this phase of radio for a number of years.

\$3,000 to \$5,000 per year

The professional "Radio Doctor" receives \$2.00 or \$3.00 per visit and is welcomed in the best of homes—may I tell you more about this new, fascinating and extremely profitable business? Write now for free booklet, "Why the Radio Doctor." (Early inquiries will receive a blueprint of a recent well-known manufactured superheterodyne.)



E. W. PARKER, Pres. RADIO DOCTORS, INC.
Dept. R-1, 131 Essex Street Salem, Mass.

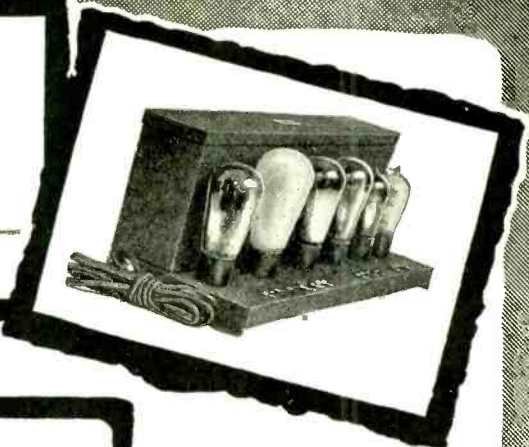
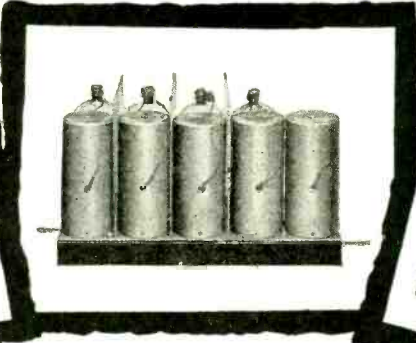
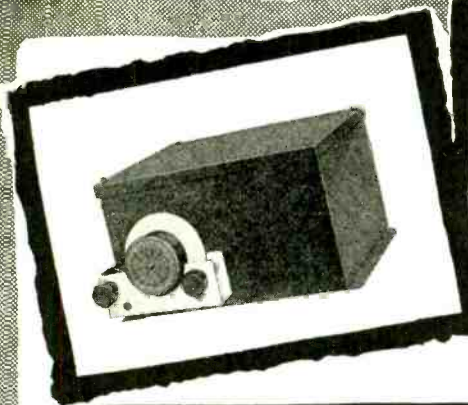

111

THE BIG IMPORTANT NUMBER IN 1930 RADIO

Number 111 is Remler's masterpiece, the components which combine to give you \$300 worth of radio equipment for \$80.

Knock-out Features

- | | |
|----------------------------|----------------------------|
| AC Shield-Grid R. F. | Single-Dial Control |
| Shield-Grid Power Detector | Parallel First Audio Tubes |
| Band-Pass Selector | Two "45's" in Push-Pull |
| Five-Gang Condenser | Speaker Field Supply |

Check these Features

against any and all competition. What more could you ask? And every feature is employed as only Remler can employ it—to give you the finest possible radio performance.

A NEW DEAL for the Experimenter

Here is a group of components that you can handle with real pride . . . no more apologies in competing with factory-built receivers.

The Number 111 sells on its outstanding superiority. Selectivity without loss of quality such as only a band-pass selector properly used can give. Tone quality the inevitable result of the combination of "45" tubes in push-pull and Remler Audio Components.

THESE REMLER DISTRIBUTORS

will serve you promptly and courteously. They are parts specialists and carry a full line of Remler Parts as well as those of other manufacturers. You can place your entire order with any one of them with the assurance that it will be filled completely, *with the parts you specify.*

- OFFENBACH ELECTRIC CO.
1452 Market St., San Francisco, Calif.
- RADIO SUPPLY CO.
912 So. Broadway, Los Angeles, Calif.
- NEWARK ELECTRIC CO.
226 W. Madison Street, Chicago, Ill.
- RADIO JOBBERS, INC.
142 Liberty St., New York City, N. Y.

GRAY & DANIELSON MANUFACTURING CO.

260 First Street, San Francisco

10 VOLUMES
of Radio Information
in 128 pages for only

50c

THE 1930 REMLER MANUAL AND DATA BOOK

Table of Contents

- Electrical Constants in Table Form
- Electrical Symbols
- Ohm's Law and Impedance Calculations
- Tuning Condensers.
- Radio and Audio Chokes
- Why the By-Pass Condensers?
- R. F. Selector Circuits
- Coil Design and Tables
- Tube Data
- The Power Detector.
- Audio Amplifiers
- Power Supply and Filter Data
- Loud Speakers
- Phonograph Pick-Ups.
- Automatic Volume Controls
- Receiver Kinks.
- Complete Remler Catalog.

The book that every experimenter needs. Up-to-Date. Edited by Remler Engineers. Mail Your Order Direct to Us.

LIKE A CAR WITH A BALKED GAS LEVER IN HEAVY TRAFFIC

Your foot on the gas brings a jerky response . . . you're holding up traffic that's anxious to move.

Your variable resistance feeds the "gas" to your radio receiver . . . and there's all the difference in the world if it's a CENTRALAB.

Quiet, even flow of current without a crackle or a sputter . . . that's CENTRALAB performance. . . a scientifically constructed precision control for the modern radio receiver.

Write for Free Booklet "Volume Controls, Voltage Controls, Their Uses"



This shows the exclusive rocking disc construction of Centralab volume control. "R" is the resistance. Contact disc "D" has only a rocking action on the resistance. Pressure arm "P" together with shaft and bushing is fully insulated.

The tailor uses the same principle as Centralab. He does not want to ruin the garment by placing the iron on it so he places a cloth in between. Centralab controls cannot ruin the resistance because the rocking disc is in between the pressure arm and the resistance.

The action of the usual wire wound control after it has been in use for some time is like dragging a stick over a cobblestone pavement.

Centralab

CENTRAL RADIO LABORATORIES

20 Keefe Ave.

Milwaukee, Wis.

SILVER THE KING

24 Kt. Gold
Pure Silver
Soft
Copper

Gosilco Super Aerial Wire

Gold over Silver on Copper

Greatly Increased DX Range. 50% More Volume—Clearer Tone—35% Sharper Tuning—Non-Corrosive. Endorsed by Sparton Engineers. Gerald M. Best, Van Buren, World's DX Champion. A permanent investment. No. 14, 100 ft., \$4.00; 75, \$3.25; 50, \$2.50. Pat. App. 12728. If dealer cannot supply you, write us. Over 50,000 GOSILCO Aerials in use—There's a Reason.

Eastern Jobbers Write. Exclusive Territory

GOSILCO RADIO PRODUCTS CO.

6420 Marbrisa Ave.

Huntington Park, Calif.

Northern California Customers Order Your GOSILCO SUPER AERIAL WIRE from

Radio Dealers Supply Service

Wholesale Division of



1452 Market Street

San Francisco, California

(Continued from Page 78)

of Nichrome wire wound in generously insulated layers around a refractory tube. The entire unit is covered with a heavy coating of moisture-proof enamel of unusual elas-

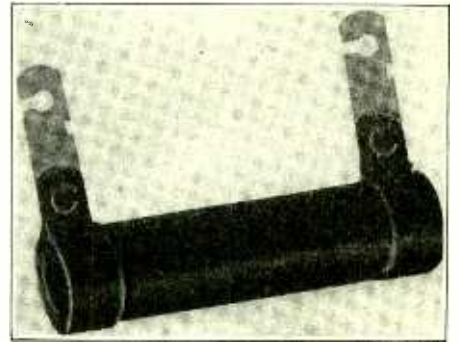

ticity, baked on at only 400 degrees to prevent loosened connections and fractured wire. Contact bands and soldering lugs are of Monel metal. The lugs are solder-dipped for easy soldering. All parts expand equally under load.

Pattern 408 Jewell set analyzer contains a tube merchandising case in addition to the four instruments and test equipment contained in Pattern 409. It gives plate volt-



age, plate current, filament, and grid voltage readings simultaneously. The new kit has two compartments, size $4\frac{1}{4} \times 11\frac{1}{4} \times 5\frac{1}{8}$ inches, and a drawer, size $11\frac{1}{4} \times 10\frac{3}{8} \times 2\frac{1}{4}$ inches, for the purpose of carrying tools and replacement tubes.

The Brach Arres-tenna is a combined lightning arrester and light-socket aerial for use with a-c sets. As its filter circuit in-

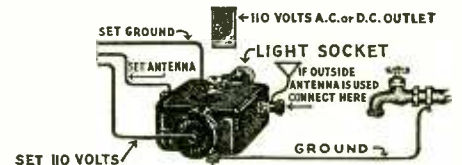

cludes a condenser it increases the capacity of the aerial circuit and often improves reception. It is designed to give complete protection against lightning which may enter either through the aerial or through the 110 volt service wiring.

The Dubilier Disturbo-Ducon is an interference preventer consisting of a balanced network of inductance and capacity which may be applied in the power line either at the receiver or at the source of disturbance.

Therm-A-Trol Filtrals consist of a balanced combination of capacitance and air-cooled inductance designed to eliminate interference from motor-operated appliances. No. 458 is built for installation in the line circuit at the interfering motor and No. 460 either at the

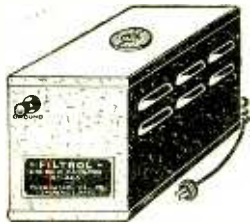

motor or at the radio set. The former has a housing like a standard cutout box and the latter is housed lacquered metal box with 5 ft. plug-in cord and outlet into which the cord from the radio set can be plugged.

Therm-A-Trol No. 210 voltage control consists of a ventilated wire-wound resistance element with four taps designed to protect a-c



tubes against excessive line voltage. It may be plugged directly into the outlet, is compact in size, and is insulated with bakelite and asbestos. It is rated to carry 75 or 150 watts.

The new Premier Model 724 is a seven-tube chassis which uses four '24 tubes in the three r-f stages and power detector, a '27 tube in the first audio, and two '45 tubes in push-pull in the second audio stage, together with

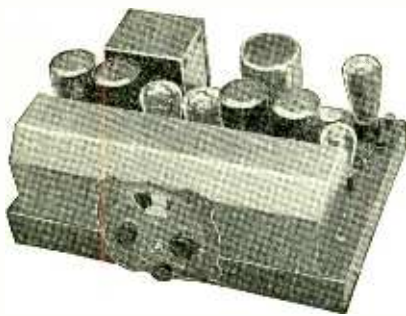

an '80 tube as rectifier. The circuit has been specifically designed to use screen-grid tubes. A Mershon condenser is used in the power plant which has field coil terminals for a d-c dynamic speaker and has a phonograph pick-up. The chassis is of all-metal construction and thoroughly shielded.

The Toman super pick-up has a detachable head and a supporting arm which is jointed for easy play. The volume control is an integral part of the base. Its cord is provided with tips which may be plugged either into the phono-jack of the receiver or into one of two adapters which fit the prongs of the detector tube. The base has three mounting holes for attachment to the motor board.

This Message Covers America



More than
4200 full color, 24 sheet posters
in 460 cities and towns, in 40 states!

THINK of the effect of this huge billboard campaign on your sales. It starts next month!

No matter where your store is located it is sure to be near or in some trading center where your customers will see these posters. This posting is one of the forms of advertising to be used to help De Forest dealers.

Make this campaign your campaign.

Make it work for you day and night. Identify your store as De Forest headquarters in your neighborhood by utilizing the large array of window material and dealer helps.

If you haven't already had the money-making De Forest dealer proposition outlined to you, write to us at once and we will place you in touch with the De Forest jobber in your territory.

DE FOREST RADIO COMPANY, JERSEY CITY, N. J.

de Forest
AUDIONS

"RADIO" Is No Longer Sold on Newsstands

Subscribe now to insure yourself against missing a single issue

SPECIAL RATES TO DEALERS: \$2.00 PER YEAR

"RADIO"

Send your subscription to the office nearest you

415 Lexington Ave.
New York City, N. Y.

307 No. Michigan Ave.
Chicago, Ill.

86 St. Botolph St.
Boston, Mass.

428 Pacific Bldg.
San Francisco, Calif.

Tell them you saw it in RADIO

Special Test Equipment



for use in the service laboratory is soon to be announced. This will include an oscillator for measuring the over-all response characteristic of a receiver for the entire broadcast band.

Write for Bulletin R-1

GENERAL RADIO COMPANY

30 State Street
Cambridge, Massachusetts

274 Brannan Street
San Francisco, California

DeJUR-AMSCO

Condensers Meet All Modern Radio Requirements

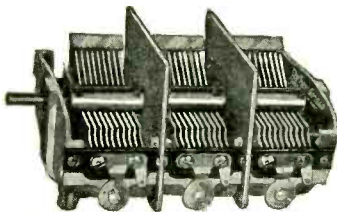

This is our shielded multiple condenser for screen-grid work. It can be had in all combinations with or without dial assembly. It is exceedingly low loss.

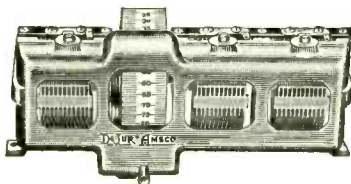

Shown above is the DeJur Amsco Standard Multiple Condenser available in all combinations with or without dial assembly.

Write for Engineering Data and Working Drawings. Send us your specifications and let us quote. Samples on request.

DeJUR-AMSCO CORPORATION

BROOME AND LAFAYETTE STREETS

NEW YORK CITY

RADIO Questions and Answers

By NILSON & HORNUNG

AT LAST, a book covering practically every conceivable radio problem and question has been published! This book, just off the press, is crammed full of highly important new radio information. It will be invaluable to those who wish to take examinations for their Commercial, Broad-

cast, Radiotelephone or Amateur License. For this book is intended especially for students and operators who are about to take the government examination for a radio operator's license. It gives over four hundred actual examination questions and shows how they should be answered.

\$2.00
PER COPY
POSTPAID

RADIO

PACIFIC BUILDING
SAN FRANCISCO

FILTERETTE SECTION

(Continued from Page 56)

Traffic signals! Averting countless accidents, turning the haphazard scramble of yesterday into the smooth, rapid flow of modern traffic.

A boon to man, unquestionably. But not such a boon to radio.

Do not blame the manufacturer because his signal blinker interferes with your radio reception. He is already

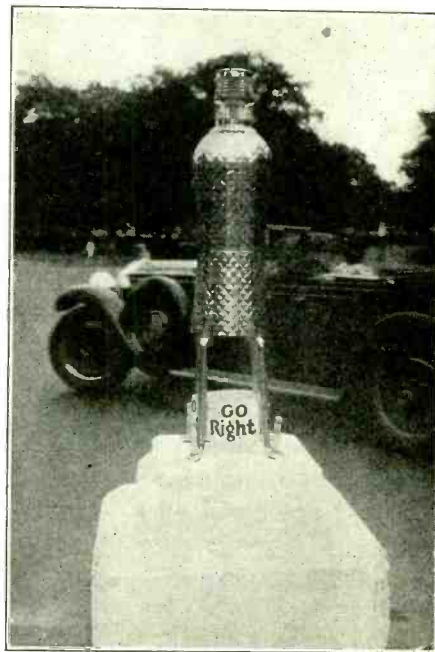

striving earnestly to banish the smallest public objection to his product: that is only good business.

His co-operation has made possible the Tobe Filterette for traffic signals, a positive preventive of radio interference from that source. It was he who loaned to Tobe Laboratories the apparatus on which engineers conducted the experiments which gave to the public this modern radio safeguard, Filterette.

Do not be disappointed if your new set picks up more interference than the old one. It ought to—it's a better set. Let us tell you how to enjoy your radio to the fullest, untroubled by needless "man-made static."

A request brings complete information on how to identify it, how to trace it, and when found, how to stop it. Write now!

KEYED TO MASS PRODUCTION

In contrast to last year, when the rush of fall orders found the company newly moved into their enlarged quarters at Canton, Massachusetts, and with their machinery only partly set up and assembled, the Tobe Deutschmann Corporation this year boasts of a smoothly running organization comprising seven buildings, including their justly celebrated "Interference Laboratory," not shown in the photograph.



"The Speaker OF THE YEAR"

—In these cabinets of true Early American design combine the skill of scientist and wood worker to produce an instrument that marvelously reproduces everything from the talking voice to a symphony orchestra.

Write dep't D for descriptive folder and address of nearest sales office.

Dealers can carry a more complete, convenient and less expensive stock by purchasing separate units.

WRIGHT DE COSTER, Inc.
ST. PAUL, MINNESOTA

MAJESTIC REPLACEMENT CONDENSER BLOCKS

By the foremost manufacturer of radio-condensers

List Price

PL-1223

For Majestic B Eliminators, Super B and Master B Models...\$8.00

PL-1737

For Majestic B Eliminators, Special Master B Model...\$11.00

PL-1309

For the Power Unit of the 1928 Majestic Set...\$10.00



Without exception, these are the best ever made. They are condensers of superlative excellence—built on the wealth of manufacturing experience and practicing experience and practice which have made Dubilier condensers the standard of the industry. They are designed and tested to give ten years, or more, of service. This testimony is typical:—"Get these in at earliest date—we have had perfect service from all of the Dubilier that we have used, which is more than can be said of some other makes."

WARNING! Replace with Dubiliers!

"You can forget the condensers, if they are Dubiliers!"

Dubilier

CONDENSER CORPORATION

342 Madison Avenue

New York City

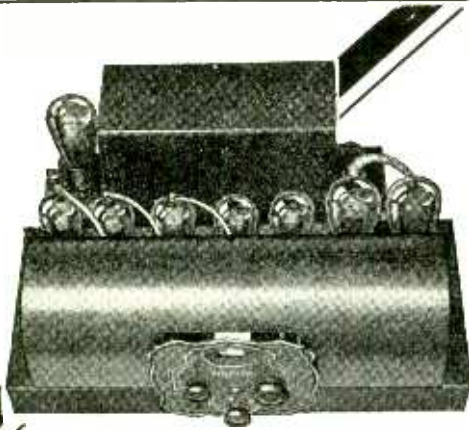

PICTURED ABOVE IS CHASSIS MODEL 724

Up to the minute with every desirable sales feature is the 7-tube (8 with rectifier) screen-grid Premier chassis model 724. Eye value, tone, volume and distance. Push-Pull amplification, all-metal 100 per cent shielded, phonograph pick-up, and latest tube combination employing four 224 Screen-Grid, one 227, two 245's in push-pull and one 280 type tube.

Radio's Newest!

Screen Grid Under Your Own Private Brand

You can avail yourself of every new radio development through Premier's Modern *Different* Merchandising Plan.

SCREEN-GRID—Radio's most recent creation—may be had with your own brand name attached. Set your own price—fix your own profits. Secure rock-bottom price by buying direct from factory. That's the way to profitable radio sales.

PREMIER MERCHANDISING PLAN

Gives you every opportunity to meet changing market conditions. You need not sign burdensome contracts, or buy in huge quantities to secure "exclusive." You are not restricted to certain territories or hampered by excessive inventories. On the other hand, through selling under YOUR OWN BRAND NAME, you are boosting yourself, not the other fellow, and are increasing your own good will. It's today's plan of selling radio at greatest possible profit! Investigate!

Write for Complete Information

Premier Electric Company

1811 Grace Street

Chicago, Illinois



All the Dope!

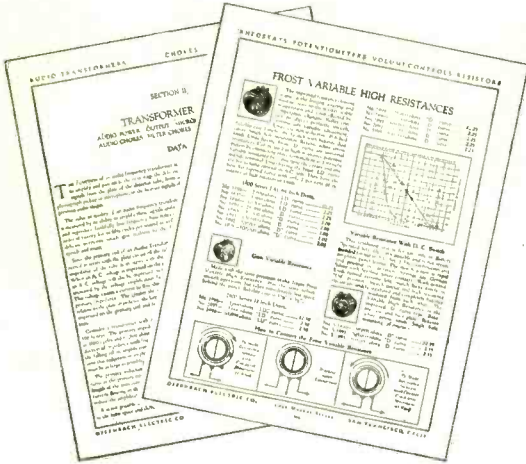

SAMPLE PAGES

In this Remarkable Textbook Price List



Charts, Curves, Data, Formulae! Order at Once Your

WHOLESALE

RADIO CATALOG and DATA BOOK

Nothing Like it Ever Before!

Two hundred pages of technical data, general information, and descriptive matter, covering the 155 lines of parts handled by the OFFENBACH ELECTRIC COMPANY. Charts, Curves, Formulae, everything that Set Builder, Ham,

and Dealer should know about radio parts and accessories. Printed on high grade paper, nicely bound, and all for One Dollar. Put your name and address here, and mail this ad. with One Dollar. No extra copies will be printed, so be sure to reserve yours. DO IT NOW!

MAIL THIS ADVERTISEMENT WITH \$1.00

Name _____

Address _____

◀ NO ORDERS ACCEPTED AFTER OCTOBER 15, 1929 ▶



WHOLESALE

"The House of a Million Radio Parts"

1452 Market Street

San Francisco, California

A RADIO PARTS GUIDE

The New YAXLEY

Catalog



Send for it today for complete listings of Radio Convenience Outlets, Connector Plugs, Rheostats, Fixed and Grid Resistances, Jacks, Jack Switches, Phone Plugs, etc.

YAXLEY MFG. CO.

Dept. A, 1528 W. Adams St., Chicago, Ill.

SEND FOR SHORT WAVE BOOK—IT'S FREE!

Shows how to make new design short-wave receivers and short-wave adapters. How to use the new screen-grid tube in D-C and A-C circuits. How to make short waves get long distance. Latest information on all new radio developments. It's free. Send for copy today.

AERO PRODUCTS, Inc., Dept. 599A
4611 E. Ravenswood Ave., Chicago, Ill.

Name _____

St. and No. _____

City and State _____

FREE RADIO GUIDE

SEND FOR IT

This book tells about newest startling developments. How to take advantage of the new wrinkles in radio, television, short wave, etc. Pictures and descriptions of thousands of new ideas. Shows new A-C Screen Grid tube and other sets, kits, parts, accessories and supplies at wholesale prices. Shows you how to save money on these and many home necessities besides. New edition now ready. Send for it today—NOW!



BARAWIK CO. 189-A Canal Ssa., Chicago, U. S. A.

Mail me free Radio Guide as advertised.

Name _____

Address _____

City _____ State _____

SALESMEN WANTED!

Men to call on radio dealers, jobbers and service men to sell "RADIO'S" Price and Data Sheet Service and loose leaf binder for same. Liberal commissions. Large territory. Write at once for complete details.

PUBLISHERS OF "RADIO"
Pacific Bldg., San Francisco



90 ambitious men and young men
who are awake to the opportunities
in **RADIO**

RICH REWARDS in RADIO

Be a Radio Expert

This book tells you where the GOOD JOBS are what they PAY how to GET one

I start many in Radio at two and three times what they were making before.

The \$10,000 and \$15,000 a year men of the future will be picked from those who get in now.

I GIVE YOU THE RADIO PARTS FOR A HOME EXPERIMENTAL LABORATORY

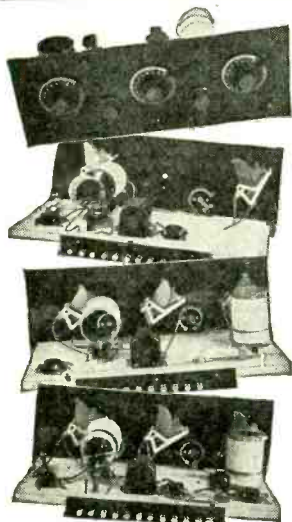

WITH THEM YOU CAN BUILD 100 CIRCUITS. 4 YOU BUILD ARE SHOWN HERE MY BOOK EXPLAINS THIS PRACTICAL, FASCINATING WAY OF LEARNING RADIO AT HOME

Jumped from \$35 to \$100 a week

"I had the pleasure of earning \$110 last week servicing and selling sets. I have made as high as \$241 in two weeks. Before I entered Radio I was making \$35 a week."

J. A. Vaughn,
4202 Arsenal St.,
St. Louis, Mo.

Ever so often a new business is started. You have seen how the men who hooked up with the automobile, motion picture and other industries at the right time are now the \$5,000, \$10,000, \$15,000 a year men—**independent, satisfied.** The same opportunities they had in those industries—the chances that made them rich, are now being offered you in Radio. Radio's growth has already made hundreds of men wealthy. Many more will become rich and independent in the future. Get one of these fine jobs for yourself.

Radio's big growth making hundreds of fine jobs every year

I am doubling and tripling the salaries of men and young men by training them for Radio's good jobs. My training fits you for Radio factories, broadcasting stations, a spare time or full time business of your own, operating on board ship which gives you world-wide travel without expense, commercial land stations, research laboratories and many other branches. Talking Movies, Public Address Systems, Radio in Aviation, Screen-Grid Tubes, A. C. Sets and many other of the latest developments are included in my world famous trainings.

Opportunities so great that many make \$5 to \$25 a week extra almost at once

The day you enroll I will show you how to do ten Radio jobs easy to find in every neighborhood. Frank Golden, 329 Walnut St., Newark, N. J., says—"I made over \$900 in my spare time in about 10 months." G. W. Page, 1801 21st Ave., S., Nashville, Tenn., made \$935 in his spare time while taking his course.



□ \$400 a month

"I was making good money, but could see the opportunities in Radio. Believe me, I am not sorry as I have made more than ever. I have made more than \$400 each month. The Radio field is getting bigger and better every day."

J. G. Dahlstead,
1484 So. 15th St., E.,
Salt Lake City, Utah.



Seldom under \$100 a week

"My earnings seldom fall under \$100 a week. My profits for the past three months were \$577, \$845, \$465. If your course cost 4 or 5 times more I would still consider it a good investment."

E. E. Winborne,
1414 W. 48th St.,
Norfolk, Va.

I will train you at home in your spare time

Hold your present job. My 50-50 method of training, half from lesson books and half from practical experiments using Six Big Outfits of Radio Parts given without extra charge, makes learning at home easy, fascinating. It is unequalled. It gives you practical Radio experience while learning. You don't have to be a high school or college graduate. Many of my most successful graduates didn't finish the grades.

Your money back if not satisfied

That is the agreement I make with you. I am so sure that I can satisfy you that I will agree to return every penny you pay me for tuition if, upon completion, you are not satisfied with the lessons and instructions received. Could anything be fairer?

ACT NOW—

Find out about Radio's opportunities for success and bigger pay

My book gives you the facts, what your prospects are for the future, how you can get in without delay, what you can make. It explains my practical method of training with my home experimental laboratory, how my Employment Department helps you find a job upon graduation and many other features that have made N.R.I. training unequalled. There is no obligation. Simply fill out the coupon below and mail it. Do it today.

**J. E. Smith, President
Dept. 9W75
National Radio Institute
Washington, D. C.**

This Coupon is good for one FREE COPY of my Valuable Book *Mail it now*

J. E. Smith, President,
National Radio Institute, Dept. 9W75
Washington, D. C.

Dear Mr. Smith: Without obligating me send your book explaining Radio's opportunities for bigger pay and your method of training at home in spare time. I understand that no agent will call on me.

Name _____

Address _____ Ave _____

City _____ State _____

The champion that can't find a challenger!

CUSTOM BUILT

SCOTT *World's Record* RADIO

Dare after dare, published through the Nation's press has invited receiver manufacturers to equal the verified World's records held by Scott Custom-Built Radio and to meet this receiver in open competition of any kind. That not a single answer has been forthcoming is significant. The Scott record of 117 programs 6000 to 8000 miles distant received over a period of 13 weeks still stands—and the Scott World's Record Custom-Built A-C Shield Grid 10 is still champion, just as its designer and the laboratory workers who hand-built it intend that it shall always be. The claims made for this laboratory product are readily substantiated by demonstration.



E. H. SCOTT

Send TODAY for BROCHURE

The two units of The Scott A-C Shield Grid 10; namely, the receiver and the power pack containing the finest amplifier possible to produce, are illustrated and fully described in a beautiful brochure sent free. Likewise, a line of specially built console cabinets finer than any heretofore shown in the industry are illustrated. Send coupon at once. TERRITORY OPEN If you are interested in selling Scott Custom-Built Radio in a protected market, indicate on the coupon below.

SCOTT TRANSFORMER CO., 4450 Ravenswood Ave., Chicago, Illinois

—Clip and Mail NOW!—

RM.10
 SCOTT TRANSFORMER CO. NAME.....
 4450 Ravenswood Ave., Chicago, Ill. ADDRESS.....
 Send me illustrated brochure. CITY..... STATE.....
 Send me franchise dealer's proposition.

Wholesale Prices

—for Dealers, Agents and Set Builders
RASCO HAS IT—PROMPT DELIVERY



Our huge Wholesale Radio catalog No. 19 (2ND EDITION) is a valuable encyclopedia—a liberal Radio education. Mailed immediately on request—absolutely

FREE

1500 Illustrations, 6000 articles

From many years in the Radio Mail Order Business, we have learned how an organization must be efficiently run to gain and retain the good will of our customers. Radio Specialty

Co. ships orders promptly!—offers you 100% quality merchandise on a strict money-back basis.

Our catalog contains the largest assortment of completely assembled all-electric AC Receivers at amazingly low prices, and other Radio Merchandise, including such lines as Pilot—Silver—Marshall—Carter—Aero—Yaxley—Tobe—Hammarlund—Amer Tran—Cunningham—Dongan—Thordarson—Muter, etc., etc. The latest improvements in Radio are listed and thoroughly described in this great catalog: AC All-Electric Sets with self-contained ABC power supply—Public Address Amplifier systems—AC Set Converters—A and B eliminators—Dynamic Speakers and Units—Magnetic Speaker Chasses—250 Tube Amplifiers—Airplane Cloth Speakers—Push-Pull Power Amplifiers—Electric Phonograph Turn-Tables—Combination Radio and Electric Phonograph Consoles—Speaker Tables—Short Wave Sets and Adapters—Shield Grid Tube Kits—Television Parts—Electric Household Appliances, Vibrators, Tools, Workshops Cameras, etc., etc. Logically, how can you afford to be without our catalog? Send for one now!

RADIO SPECIALTY CO.
 100F Park Place New York, N. Y.
Radio's Oldest Mail Order House

See Page 48

The Biggest \$2.00 Worth of Radio Information

USE THE CLASSIFIED ADS IN "RADIO"
They Bring Results
 Mail Your "Ad" Now

Great New Book On

Power Amplifiers

FROM the Diagrams and Instructions in this new FERRANTI book you can build 10 different wonderful Power Amplifiers using new UX17L, UX250, and even the very new UX245 tubes. Follow the FERRANTI instructions and your Power Amplifiers will have high gain, flat response level, natural tone, tremendous power. Endorsed by engineers and reproduction experts. Sent postpaid for 15¢ coin. Write for YOUR copy today.

FERRANTI, Inc.
 230 W. 42 St. Dept. 18
 New York N. Y.

SAVE MONEY ON RADIO!

LARGE DISCOUNTS

On Lafayette All-Electric, Screen-Grid Radio Receivers
 The 1930 Lafayette Screen-Grid Radio Set is the sensation of the field. We offer you an opportunity to sell this tremendously popular receiver to people who want the finest in radio. Most liberal discounts to dealers and agents. Because of the tremendous demand for the Lafayette it sells at a price amazingly low.

30-DAY FREE TRIAL!

The 1930 Lafayette has every new feature of radio construction.
 Screen-Grid Volume Selectivity
 All Electric 245-Push-Pull Amplification
 Illuminated Single Dial Control
 Clearest Reception of Any Set on the Market!

30 Different Cabinet Models. Finest Custom-built work. AND—a 30-Day Free Trial on Every Lafayette Set. Unconditionally Guaranteed!

WE OFFER GREATEST BARGAINS ON NATIONALLY KNOWN PRODUCTS

WHOLESALE PRICES on nationally-known merchandise! Biggest discounts on standard equipment. TREMENDOUS SAVINGS. Everything shown in our newest 1930 Catalog—just out! Nothing to compare with it! Immediate personal service on all your orders.

MAIL COUPON FOR BIG CATALOG—ABSOLUTELY FREE

DEALERS—AGENTS—Mail the coupon below AT ONCE for your FREE copy of the new 1930 Wholesale Radio Service Catalog. See our money-saving bargains—beautifully reproduced in color. Over 200 pages of big specials. You buy under our "Satisfaction or money back guarantee." Get your copy today. Rush coupon!

TEAR HERE. FILL OUT AND MAIL
WHOLESALE RADIO SERVICE COMPANY
 36 Vesey Street Dept. A-12 New York City
 Name.....
 Street.....
 Town..... State.....

NEWEST 1930 CATALOG

"RADIO" Is No Longer Sold on Newsstands

Subscribe now to insure yourself against missing a single issue
 SPECIAL RATES TO DEALERS: \$2.00 PER YEAR

"RADIO"

Send your subscription to the office nearest you

415 Lexington Ave. New York City, N. Y. 307 No. Michigan Ave. Chicago, Ill. 86 St. Botolph St. Boston, Mass. 428 Pacific Bldg. San Francisco, Calif.

LOOSE LEAF BINDER

FREE 6 x 9-in. loose leaf binder for data sheets given free with one year subscription to "Radio." **SUBSCRIBE NOW!**

RADIO ADS

A CLASSIFIED ADVERTISING SECTION
READ BY BETTER BUYERS

Discontinued Merchandise and Job Lot Advertising Must Be Plainly Indicated as Such

REMITTANCE MUST
ACCOMPANY ALL ADS

RATES: 8 CENTS PER WORD / \$6.00 PER DISPLAY INCH

RADIOADS FOR THE NOVEMBER ISSUE SHOULD REACH US BY OCTOBER TENTH

"RADIO THEORY AND OPERATING"—4th edition revised, by Mary Texanna Loomis, President of Loomis Radio College, member Institute of Radio Engineers. The leading radio text and reference book of the day. Used by more than 300 radio schools, universities, high schools and technical colleges, and by all the Government radio schools. The book contains 992 pages, 800 illustrations, is right up to date, and is really a whole library on radio. Among the many subjects covered are marine radio operating, radio compass work, land radio operating, television, broadcasting, radio construction, repairing and servicing, airways communications, radio accounting, message forms, junior engineering, and the 1929 radio laws. For sale by bookdealers throughout United States and many foreign countries. Price \$3.50, postage paid. Buy of your bookdealer, or send check or money order to Loomis Publishing Company, Dept. 12, Washington, D. C.

AMATEURS-EXPERIMENTERS-BUILDERS—We serve over 4000 IRE, ARRL, etc., experimenters and "nuts." Full discounts. \$50,000.00 stock approved parts—no sets. Over four pounds, catalog, circuits, data, prepaid, 50c. Weekly bulletins (new items, results of experiments, etc.) 20 weeks, \$1.00. Sample experiments "Over the Soldering Iron" magazine, 25c. Transmitting data, price list, etc., 25c. Kladag Radio Laboratories, established 1920, Kent, Ohio.

450 REVIEW QUESTIONS—Supplement to the textbook "Radio Theory and Operating." Just off press. Designed for the home study work of persons preparing for Government examinations. Valuable assistance to instructors and students. Price 25 cents in coin or postage. Loomis Publishing Company, Dept. 25, Washington, D. C.

GENERAL RADIO WAVEMETERS GIVEN FREE. The type 247-W wavemeter is yours, free of all cost, with only one subscription to "RADIO" for two years. Full price for the wavemeter and the subscription to "RADIO" is only five dollars. No further payments of any kind to make. Only

a few of these wavemeters left. Get one now—act quickly. Send \$5.00 and your order to "RADIO," 428 Pacific Building, San Francisco, Calif.

LAST CHANCE! This is the last time that we can offer you a copy of Professor Hermann Schnitzel's humorous book of radio lectures—"Und Comes It Now." Only a handful of copies left. Get a copy free with a subscription to "RADIO" for 4 months. Full price for the book and the subscription to "RADIO," only one dollar. "RADIO," Pacific Bldg., San Francisco, Calif.

RADIO MEN WANTED—Positions wanted—Agencies wanted—Merchandise wanted and for sale—All of these matters can be brought to the attention of readers of "RADIO" with an advertisement in this RADIOAD Section. The rate is eight cents per word. One ad will convince you. More and more advertisers are using these columns. They pay! Mail your ad now for the next issue. "RADIO," San Francisco.

SALESMEN ATTENTION!—Chance to make extra money selling our complete radio index log to dealers. Write for sample and information. Shield Press, P. O. Box 1634, Indianapolis, Ind.

SELL Pilot "Super-Wasp" receivers, 14 to 500 meters, built and tested, \$40.00 or "Super-Wasp" kit, \$29.00. We pay postage. Gussie Groth, Hartley, Iowa.

JEWELL RADIO SERVICE SET PATTERN 117, Weston A-C Voltmeter Model 528, Sterling R408 Tube and Set Tester, Jewell Radio Set Analyzer Pattern 199. Mello Heald eleven receiver in cabinet. G. R. Ewalt, Herington, Kansas.

SALESMEN WANTED—Screw-holding screw driver. Amazing brand new patented invention! Retail \$1.50. Factories, garages, electricians, auto, radio owners buy on sight! Exclusive state territory. Genuine opportunity. earn big money. Free trial offer. Jiffy 1027, Winthrop Bldg., Boston.

HELP WANTED

WANTED—Men to work with National Radio Service organization. No selling scheme. Radio Doctors, Inc., Dept. R, Essex St., Salem, Mass.

WANTED—Radio men to demonstrate MONARCH screen grid radio receivers. Easy work and big profits. Write for full information, also data for large buildings. The MONARCH Radio, 205 W. Wacker Drive, Chicago, Ill.

SITUATION WANTED

RADIO Broadcast Engineer, now employed, wants work in California. Plenty of experience.—Composite, and Western Electric. Write care "RADIO," Pacific Building, San Francisco.

FOR SALE—MISCELLANEOUS

600-volt, 5-ampere Storage B Battery, Charger, Panel and Rack—\$25.00, or \$2.00 per 50-volt bank, Hankins, KGEF.

MAGNAFORMER A-C 29 wired, with tubes, short-wave coils. Set tested and repeaked by designer. Fiat Loop. Muter console dynamic speaker. Home-made console for set. Best offer gets outfit. 39 West Union Street, Canton, Pennsylvania.

FOR SALE—1929 Kolster 8-tube set, perfect condition. \$75.00 complete. Sterling tube rejuvenator and set analyzer, \$5.00 each. Radio Man, Box 36, Richvale, California.

NAVY SURPLUS—800 radio generators and battery dynamotors, D-C and 500 cycles. List. Harry Kienzie, 501 East 84th Street, New York.

BACK ISSUES WANTED

WANT one copy "RADIO," September, 1926 issue. Will pay reasonable price for same. C. P. Hering, 2415 29th Avenue, San Francisco, Calif.

SAVE MONEY!

"Radio Engineering" and "RADIO"—Both for a full year
\$3.00

"Radio News" and "RADIO"—Both for a full year
\$3.00

TWO MAGAZINES FOR A LITTLE MORE THAN THE PRICE OF ONE

SUBSCRIBE NOW!

"RADIO"

Pacific Building San Francisco

SCORE for FERRANTI

2½ miles of wire

Inductance of 175 henries with 1 mill D. C.

FERRANTI A. F. 5 is the only commercially available transformer with TWO and ONE-HALF MILES of wire in its windings and 26,000 turns in its Secondary Coil.

Having the highest Primary Inductance of any transformer that you can buy, you are assured of a higher energy transfer at all frequencies, as well as of positive 25 cycle reproduction.

A. F. 5 Audio Transformer \$14
Ferranti O. P. M. C. series Output Transformer Improves Reception \$16

Write for correct type for your speaker

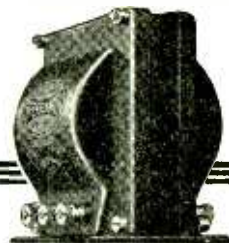

Of course you want such transformers. Then insist on FERRANTI from your dealer. Write us if he will not supply you.



Inc.

130 W. 42nd St. Desk 110
New York, N. Y.

NOW—cash in on fall buying with these low-priced KOLSTERS!



Model K-5
Height 42", width 25½",
depth 19"

THOUSANDS of these famous KOLSTER sets were sold during the slack summer selling period. Now, with the added activity of the fall buying season they will be easier to sell than ever before! Stock up! Our exceptionally low prices mean sure sales and good profits for you—an ideal item to feature this fall. Many dealers have already placed their orders—get yours in today!

This radio equipment is KOLSTER built, packed in the original Kolster cases and cartons, shipped direct to us from the Kolster factory.

Every Set and every Electro-Dynamic Reproducer is BRAND NEW; each bears the Kolster guarantee tag and original serial number.

Our ability to buy these world-famous KOLSTER RECEIVERS and REPRODUCERS for cash, enables us to offer them at remarkably low prices, a fraction of their original cost.

And we control the exclusive sale of this merchandise as we have bought the entire stock.

Even special lower prices are offered on purchases of these sets in lots of five or more—Think it over!

Licensed Under Patents of the Radio Corp. of America and
Lectophone Corp.



Model 6-H
Height 53", width
27", depth 18½"

K O L S T E R

ELECTRO-DYNAMIC REPRODUCER

Combined with 210 Power Amplifier
and "B" Supply Unit

Features

1. Electro-Dynamic Reproducer (10¼ in. dia.)
2. 210 Power Amplifier. Fine tone quality.
3. Supplies "B" voltage, if desired.
4. Can be used with any electric or battery set.
5. Complete A-C Electric Operation.
6. Beautiful pencil-stripped walnut cabinet.

This finely matched, rugged unit comprises a complete heavy duty Electro-Dynamic Reproducer, including a 210 Power Amplifier with "B" supply unit, all self-contained in a steel frame. It weighs 45 pounds, without the cabinet. The cabinet itself is of pencil-stripped walnut, beautifully designed with Cathedral grille. It is equipped with switch for control of house current to Reproducer, power unit and amplifier. A pilot light indicates when the Reproducer is in operation.

If desired, the 210 Power Amplifier will also supply 22, 67 and 90 volts "B" current, sufficient for any set using up to 8 tubes. An automatic voltage regulator tube, UX-874, maintains the "B" voltage silent and steady.

This Electro-Dynamic Reproducer

can be used with any battery or A-C set, replacing the last audio stage or be used with all tubes of the set. Wherever used, it will bring out every shading and range of tone; every note is reproduced with utmost faithfulness, pure and undistorted. It will modernize any radio receiver.

The following tubes are required for its operation: 2—UX-281 (for full-wave rectification); 1—UX-210 (for super power amplification); 1—UX-874 (for voltage regulation). For use with phonograph pickup, one additional audio stage is recommended between the pickup and this Reproducer.

A 20-ft. cable is included with each instrument. Operates direct from 50-60 cycle, 110-120 volt A-C current.

List Price, \$175.00 (less tubes)

Going at **\$33.50!**

Lots of 5 or more \$29.50 ea.

K O L S T E R

SIX-TUBE CONSOLE RECEIVER

With Built-in Kolster
Electro-Dynamic Reproducer

Features

1. Beautiful highboy console of burl walnut with maple overlay.
2. Kolster K-5, Electro-Dynamic Reproducer with built-in 210 Power Amplifier included for fine tone quality (see opposite page).
3. Famous Kolster 6-tube T. R. F. circuit.
4. Hairline selectivity, Distance Reception.
5. Single dial control—simple to operate.

The entire set can be operated direct from the A-C light socket, 50-60 cycle, 110-120-v., by simply adding any "A" supply unit and a small 4½-volt "C" Battery. The built-in Electro-Dynamic Power Reproducer furnishes the "B" supply current to the set. A switch snaps the receiver in or out of operation and a pilot light tells instantly when set is in operation. The single dial control makes this the simplest of receivers to operate.

This Receiver Employs the Famous Kolster T.R.F. Circuit

It operates on either indoor or outdoor antenna using three stages of R-F detector and two stages of A-F. The three point tap switch aerial adjuster operated from panel gives hairline selectivity. A loose coupled coil in conjunction with tap switch increases the distance getting value of the receiver. In addition, the 210 power amplifier built into the model K-5 Dynamic Reproducer, achieves remarkable tone quality. In this receiver is embodied everything looked for in modern radio.

The combination Kolster Set and Electro-Dynamic Reproducer is housed in a beautiful console of burl walnut with maple overlay. Full swinging doors found only in the finest cabinets add to its beauty. The receiver uses 6—UX-201A tubes and the Electro-Dynamic Reproducer uses 2—UX-281, 1—UX-210, and 1—UX-874 tubes.

List Price, \$295.00 (less tubes)

Going at **\$48.50!**

Lots of 5 or more \$44.50 ea.

AMERICAN SALES COMPANY

TERMS: 20% cash with order, balance C.O.D. f.o.b., New York. (2% Discount for Full Remittance with



Size 6" x 5" x 3 1/2"

Capacity	Rated D-C Working Voltage
2.0 mfd.	1000 V
1.0 "	800 V
1.0 "	800 V
3.0 "	400 V

AEROVOX or Dubilier

High Voltage Filter Condenser Blocks

Finest non-inductive High Voltage Filter Block. Made to be used with UX-250 Power Tubes but can be used safely in filter circuits of eliminators or high power Amplifiers in any combination of capacities desired.

Each Unit is equipped with long, heavy, flexible insulated leads, convenient for easy wiring, and also has mounting brackets. Latest design.

The insulation resistance of these Condenser Blocks is in excess of R.M.A. and N.E.M.A. standard requirements.

Due to the request of the manufacturers of these Condenser Blocks we cannot divulge the high list price of same.

Special \$2.50

The New Gould Kathanode



List Price \$39.50

Unipower

GOULD PRODUCT

(With Built-in Relay)

Automatic Radio "A" Power From Light Socket

Model A-C—6 K (Six Volt) Furnishes rich, smooth, unflinching "A" current, without any trace of hum. No rewiring necessary in your set. Equipped with a new noiseless Balkite Charging Unit which has four graduated charging rates and in addition one booster rate (1 1/2 amperes) for an emergency charge, which enables it to properly take care of all sizes of sets and conditions of operation. Operates on 110-120 V., 50-60 cycle A-C current. Complete with extra fuse.

Special \$9.75

Lots of three—\$8.50 ea.
Lots of six—\$7.50 ea.

FREED-EISEMANN

SIX TUBE RECEIVER



(For Battery Operation)

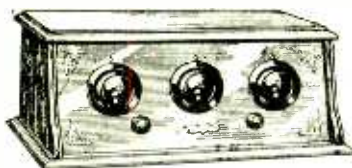

Model No. 130

List Price \$80.00 (less tubes)

Size 18 3/4" x 10 1/2" x 9 3/4"

Features:

- Completely Shielded
- 3 Stages R-F, 1 Detector
- 2 Audios (1 Power Tube)
- Stippled Panel
- Genuine Mahogany Cabinet—
- Cable Attachment

An excellent summer number for customers preferring an inexpensive set for camp, bungalow or touring trip. This Freed-Eisemann Set is ideal for portable use.

Built of the finest of parts. Uses 5—UX-201A tubes and 1—UX-171A tube. Wired for "C" Battery.

Special \$9.50

Lots of 5 or more \$9.00 each

Genuine UX200

Radio Tubes



List Price \$1.75 ea.

Bakelite UX face detector tube drawing one ampere.

Due to the extreme low prices of these tubes, we cannot allow replacements. However, every tube is brand new and packed in the original factory sealed carton, we having purchased them direct from the Radio Corporation of America.

Special 13c ea.

\$6.50 Per Carton Sold only in Carton Lots of 50

POWERIZER



PXY-1 MODEL R-20 Complete "A B & C" Eliminator and 210 Power Amplifier

It is a "B & C" Eliminator furnishing "B & C" current to the entire Radio Set, also a Super Power Amplifier furnishing "A, B & C" current to the 210 power amplifying tube. Simple to connect, no rewiring necessary in the set. Comes equipped with an adapter plug which is inserted in the last audio tube socket. Has filament windings which will also supply A-C current for the A-C tubes, if desired. Uses the UX-210 super power and the UX-280 full-wave rectifying tubes. Using this Powerizer with any Battery or Electric Set will bring out the finest tone reproduction and volume, comparable with the results obtained from any of the best modern receivers.

Operated direct from light socket; 110-120 V., 50-60 cycle, A-C current.

LIST PRICE \$59.00 EA.

Special \$15.00

(Complete with Harness)

Manufacturers ! and Jobbers

We are prepared to offer cash for surplus stocks of Radio Merchandise. This means, of course, stock in first class condition and in such volume that insures a good value to our many established buyers. Send details of your offerings for Remittance with order.

19-21 WARREN ST., NEW YORK

order.) All units offered are BRAND NEW, packed in original factory sealed carton and fully guaranteed.

HOTELS FOR RADIO TRAVELERS



CINCINNATI'S FINEST

ONE of the Nation's outstanding hotels embodying every modern convenience that so attracts travelers throughout the world.

Rates: \$2.50 and Up

JOHN L. HORGAN
Managing Director

Hotel Sinton
CINCINNATI



ON THE OCEAN FRONT

The Breakers ATLANTIC CITY N.J.

Preferred—

In all seasons by those who know and wish the best upon either the American or European Plan.

Sensible Rates Withal!

HILLMAN MANAGEMENT

HOTEL MONTCLAIR

Room and Bath
Tub and Shower
\$3 to \$5
per day

For 2 persons
\$4 to \$6
per day

Suites
\$8 to \$12
per day

Special Monthly
and Yearly Rates

49th to 50th Sts.
Lexington Ave.
NEW YORK CITY

800 Rooms
Each with Tub
and Shower

Radio in Every Room

3 minutes' walk from Grand Central. Times Square, Fifth Avenue Shops important commercial centers, leading shops and theatres nearby. 10 minutes to Penn. Station.

Grand Central Palace
only 2 short blocks away



S. Gregory Taylor,
President

Oscar W. Richards,
Manager



THE Commodore Hotel

Where Radio Friends Meet

250 Outside Rooms, all with Private Bath. Rates: Single, \$2.00 up; Double, \$3.00 up.

JACK DUFF, *Manager*
MRS. HILDA FOOTE, *Owner*

On West Seventh Street at Lucas
LOS ANGELES, CALIF.

Now Open in New York The HOTEL GOVERNOR CLINTON

Opposite Penn. R. R. Station
New York's new hotel truly expressive of the greatest city. 1200 pleasant rooms each with Servidor, bath, circulating ice water and radio provisions.

ROOMS
from
\$3.00

E. G. KILL
General Mgr.

31ST STREET

7TH AVENUE

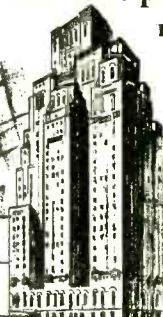

LATZ INC.

ARTHUR H. HALLORAN - - Editor
 P. S. LUCAS - - - Associate Editor
 H. W. DICKOW - Business Manager
 A. I. RIVETT - - - Draughtsman
 FRANK C. JONES - Technical Adviser

RADIO

Established 1917

Published Monthly

Address all communications to

"RADIO"

Pacific Building, San Francisco, California

NEW YORK - 415 Lexington Avenue
 Phone: Murray Hill 5992
 CHICAGO - 307 North Michigan Avenue
 Phone: State 6079
 SAN FRANCISCO - Pacific Building
 Phone: DOuglas 0136
 BOSTON, MASS. - 86 St. Botolph Street
 Phone: Commonwealth 4873

Subscription Price, \$2.50 per year in
 U. S. and Canada
 \$3.00 in Foreign Countries

Entered as second-class matter at
 Post Office at San Francisco, Calif.

VOL. XI

OCTOBER, 1929

No. 10

CONTENTS

Winning the Customer by Efficient Service Methods..... 21 <i>By D. A. Brown</i>	Standards for Television..... 36
Automatic Volume Control for Reducing Noise..... 23 <i>By Boris S. Naimark</i>	As the Trade Thinketh..... 41
A Mobile Public Address Plant..... 24	Radiatorial Comment 42
Trouble Shooting a Power Unit..... 26 <i>By B. E. Estes</i>	Design of R-F Transformers..... 44 <i>By D. L. Bedingfield</i>
Get Onto Those Curves..... 28 <i>By P. S. Lucas</i>	Analysis of Majestic Model 90..... 47
Translating Engineer Language Into Customer Conversation 30 <i>By Arthur Hobart</i>	Analysis of Gilfillan Model 100..... 49
Servicing Electric Phonographs..... 33 <i>By Clinton Osborne</i>	Ideas for the Bench Man..... 50 <i>By Walter Doyle</i>
Television in Natural Colors..... 35 <i>By John P. Arnold</i>	Radio Pick-ups 51
	Filterette Section 53
	New Equipment from the Radio Manufacturers..... 78

INDEX TO ADVERTISEMENTS

IN THIS ISSUE

Aero Products, Inc..... 84	Jensen Radio Mfg. Co..... 6-76
Aerovox Wireless Corp..... 71	Jewell Elec. Inst. Co..... 17
Allied Radio Corp..... Inside front cover	C. R. Leutz 8
American Sales Co..... 88-89	Lincoln Radio Corp..... 40
American Transformer Co..... 71	Mandel Electric Co..... 67
Amrad Corp., The..... 5	National Carbon Co., Inc. (Eveready Raytheon)..... 7-74
Arcturus Radio Tube Co..... Outside back cover	National Radio Institute 85
Automatic Radio Mfg. Co..... 14	New England Mills 74
Barawik Co..... 84	Norden Hauck, Inc..... 92
Browning Drake Corp..... 3	Offenbach Electric Co..... 84
Capehart Autom. Phono. Corp..... 161)	Pacific Radio Sales..... 12
Cardwell 70	Pacent Electric Co..... 16B, 16C
CeCo Manufacturing Co..... 67	Perryman Electric Co..... 73
Chicago Gear Works..... 70	Pilot Radio & Tube Corp..... 10
Central Radio Laboratories..... 80	Potter Co., The..... 75
Clarostat Manufacturing Co..... 68	Radiall Co. 67
Classified Ads 87	Radio Doctors 78
Corning Glass Works..... 78	Radio Specialty Co..... 86
Cornish Wire Co..... 76	Radio Receptor Co..... 77
Crosley Radio Corp..... Inside back cover	Samson Electric Co..... 11
Cunningham, E. T., Inc..... 18A, 19, 19A, 20	Savoy Hotel 75
De-Jur-Amsco 82	Scott Transformer Co..... 85
DeForest Radio Co..... 81	Short Wave and Television Labs..... 2
Dubilier 83	Silver-Marshall, Inc. 37, 38, 39
Dudlo Mfg. Co..... 64-65	Spokane Radio Co..... 68
Electrad, Inc. 21	Supreme Instruments Corp..... 4
Ferranti, Inc. 87	Thordarson Elec. Mfg. Co..... 76
General Radio Co..... 82	Thermatrol Mfg. Co..... 65
Gilfillan Bros., Inc..... 15	Tobe Deutschmann Corp..... 16A
Gosilco Radio Products Co..... 81	Triad Manufacturing Co., Inc..... 1
Gray and Danielson Manufacturing Co..... 79	Ware Mfg. Corp..... 9
Hammarlund Manufacturing Co..... 71	Western Radio Mfg. Co..... 86
Herbert H. Frost, Inc..... 75	Weston Electric Inst. Co..... 75
High Frequency Labs..... 18	Wright DeCoster, Inc..... 85
Hytron Corp. 13	Yaxley Manufacturing Co..... 84

HERE IS THE PERFECT BROADCAST RECEIVER

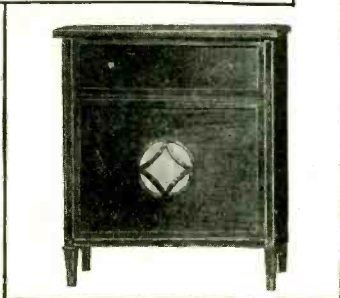

The New Admiralty Super-10 is the very apex of Modern Research Engineering.

It is a brand new receiver for the radio connoisseur which we believe represents final superiority over any broadcast receiver now being manufactured or contemplated.

Strictly custom-built, this new model meets the requirements of those that want the best. It is, in fact, the Highest Class Receiver in the World.

SUPER FEATURES

10 Radio Tubes—Super Power—Complete self-contained electric operation—Exceedingly compact—Simplified controls—Full Vision Tuning Indicators—Uses Heater type A.C. Screen Grid and Power Tubes—Super Selective—Band Pass Filter Effect—Hum Eliminator—Line Voltage regulation—Scientifically correct shielding—Great range with sensitivity control—Minimum antenna requirements—Improved push-pull audio system—Perfect reproduction with great volume—Arranged for Electro-Dynamic Loudspeaker—Adaptable for short-wave television work—Universal wave-length range for use in any part of the

world—Phonograph pickup connection—Special Weston Meters for voltage and tuning resonance—Protected against moisture for tropical and marine installation—Built strictly according to U. S. Navy Standards—Cabinets of finest selected Mahogany and Walnut—Exquisite console combinations available—Entirely custom built—Thorough air test by receiving engineers on all classes of reception for range and quality of reproduction—Sold direct from factory and through selected franchise dealers in the principal cities of the United States and foreign countries—Unconditionally guaranteed against defects.

**THE
NEW**

Attractive illustrated descriptive literature on request

ADMIRALTY SUPER-10



Write, telegraph or cable today!

NORDEN-HAUCK, INC., Engineers

1 to 9 South Street

Cable: NORHAUCK

Philadelphia, Pa., U. S. A.

MORE big news in radio

\$62

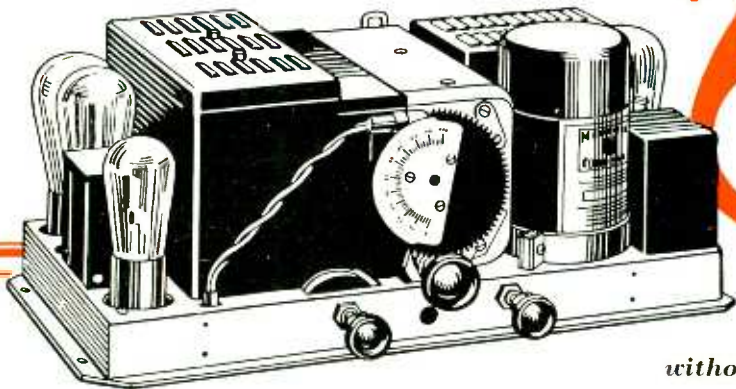

WITHOUT TUBES

*Shown here
without front panel*

The

CROSLEY MONOTRAD

*...a 7-tube Screen Grid
Receiving Unit*

ALL the wonderful qualities of a Screen Grid—plus an exclusive new feature, *Triple Range Control*—yours, now, in this latest Crosley Model 30-S, the Monotrad!

And at a new low price—the *lowest prevailing price* in Screen Grid sets. Only \$62, without tubes. This model of the Monotrad, in its simplest form with front panel, may be installed in bookshelves, etc., or in any cabinet you may have. The Monotrad is also available in a wide range of cabinets produced by six of the country's leading cabinet manufacturers, in addition to the Crosley models shown at the right.

Through means of the exclusive Triple Range Control, the full power of the set can be adjusted to local, nearby, and distant stations. This ingenious device makes possible a

flexibility of control never before achieved.

Note, too, that the Monotrad utilizes: Two 224 Screen Grid tubes in R. F. stages; one 227 tube as power detector; one 227 first audio tube, resistance coupled; two 245 power output tubes, connected push-pull; one 280 rectifier tube—seven in all. The Monotrad also has the Neutrodyne circuit.

Little wonder that this "biggest news of all" is creating such a sensation in the industry. The nearest Crosley distributor will gladly have you examine it thoroughly, test it critically. Get in touch with him today—or write us direct.

THE CROSLEY RADIO CORPORATION
Powel Crosley, Jr., Pres.
Cincinnati, Ohio
Home of WLW



Crosley 31-S, incorporating the Monotrad, \$67 without tubes. Also available with legs at \$72. With Crosley Dynacoil Speaker, as shown, \$28 extra



Crosley 33-S incorporating the Monotrad, complete with the Crosley Dynacoil Speaker, at \$115.00 (without tubes). Western prices slightly higher

You're there with a

CROSLEY

Cut your service calls in half...

sell *ARCTURUS Tubes*



137
FACTORY
INSPECTIONS
GUARD
ARCTURUS
QUALITY

Service calls cost money. Many of them are due to burnt out tubes... noisy tubes... tubes that soon lose their efficiency.

Arcturus *Blue* A-C Tubes are so well designed and carefully built that they cut costly tube trouble to the minimum. Dealers who equip all their A-C sets with these exceptional tubes have found by actual experience that *Arcturus Tubes* cut service calls 50% or more.

This means greater profits from set sales, and thoroughly satisfied customers. Arcturus *Blue* Tubes make any A-C set do its best because they act in 7 seconds, do away with hum, give true tone and hold the world's record for long life.

If you are not now selling these perfected tubes, write for all the facts and join the ranks of satisfied retailers who are making more money with Arcturus.

ARCTURUS RADIO TUBE COMPANY
NEWARK, N. J.

ARCTURUS

BLUE **A-C**
LONG-LIFE **TUBES**