

MARCH, 1928

25 CENTS

# RADIO

(REG. U. S. PATENT OFF.)

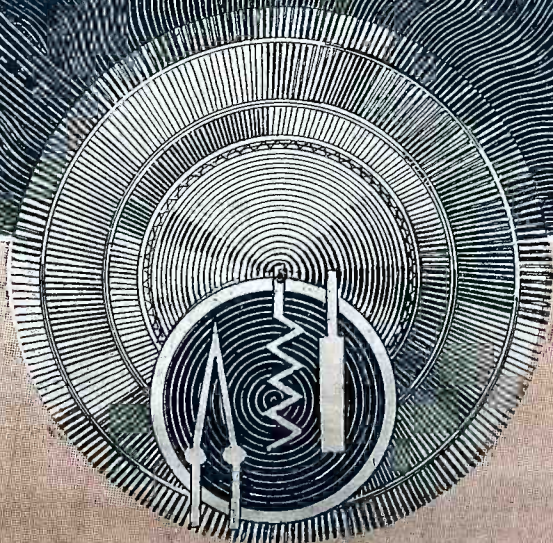



# Cunningham

RADIO TUBES

The AC way  
is the modern  
way

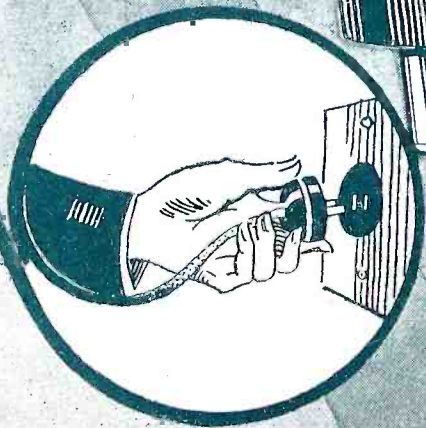

For better reception  
with any A C set, use  
CUNNINGHAM

A C Tubes CX 326 and C 327

These tubes eliminate batteries — just  
plug into your house lighting circuit and  
enjoy modern radio reception. It is just  
that simple.

E. T. CUNNINGHAM, Inc.

NEW YORK

CHICAGO

SAN FRANCISCO



# We Build Into Them

the exact features required for a custom-built set, features gained in our twenty-three years of radio experience. Every Remler part is designed, manufactured, and tested in accordance with strict precision standards . . . The parts illustrated on this page are for use in the new Shield-Grid Tube Circuits. They were put on the market only after we had proved that each of them was perfectly adapted to the job it must do . . . We build Performance-Plus into every Remler Part.

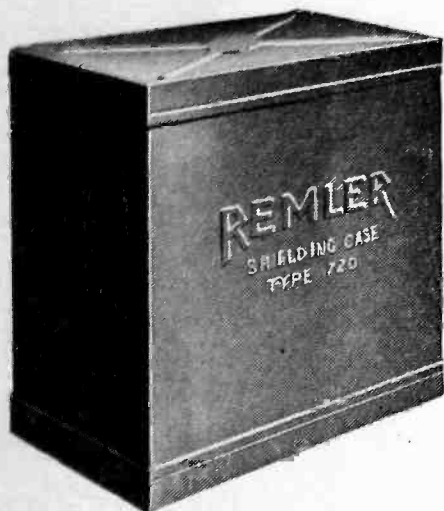

Remler Shielding Case  
Pure Sheet Copper  
No. 720

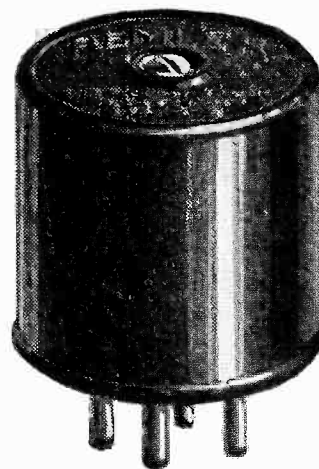

A Series of Long-Wave  
Coupling Devices  
Nos. 612-14

# You Get Out of Them

exactly what you need for the successful operation of custom-built sets. You get quality and uniformity that we put into every part bearing the name, REMLER. The Remler parts illustrated herewith have been designed for YOU, so that you can take advantage of the great gain per stage and the oscillation-free amplification which the marvelous new shield-grid tube offers.

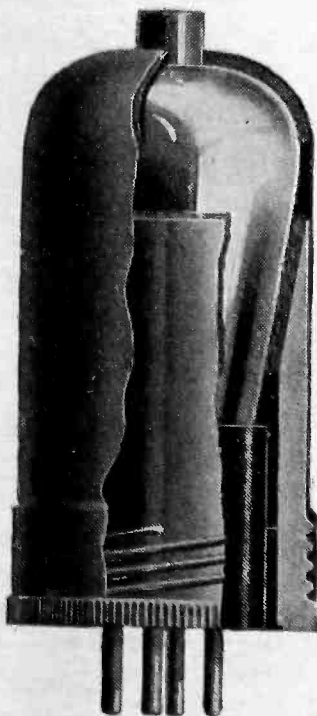

A Series of Tube  
Shields  
Nos. 54-55-56



Sold Through Jobbers

## REMLER

Division of

GRAY & DANIELSON MFG. CO.

260 FIRST STREET

NEW YORK

SAN FRANCISCO

CHICAGO

Eastern Warehouse: Elkhart, Ind.

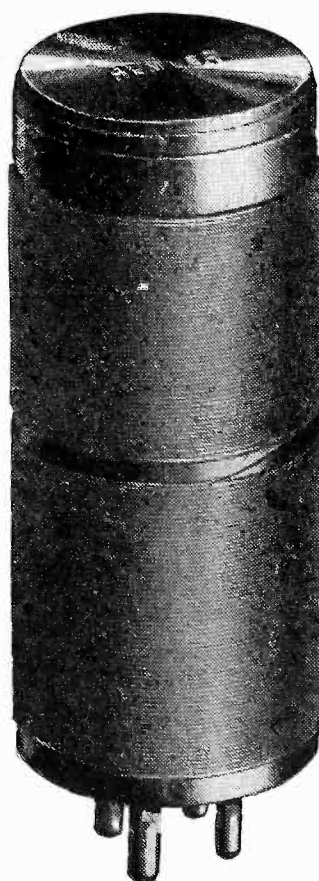

A Series of Plug-In  
Transformers  
Nos. 550-51-60-61-70

Tell them that you saw it in RADIO

for improved  
musical performance

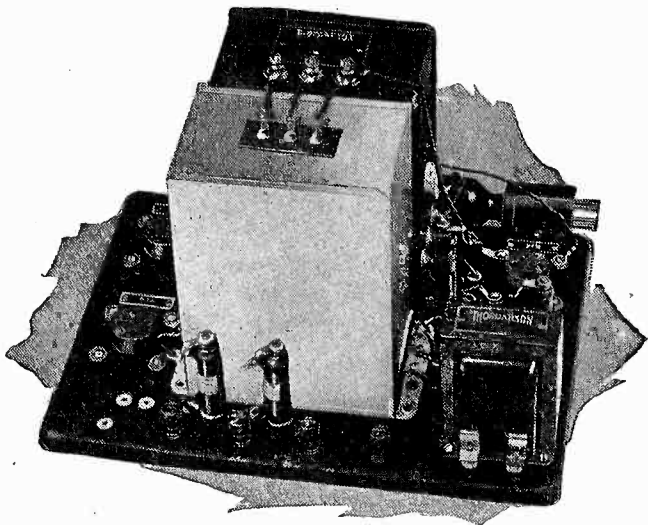

# THORDARSON

## 210 Power Amplifier and Plate Supply

Easy to build — Simple to install — Economical  
to operate — Quiet in performance

**F**ULL rich tonal reproduction with a generous supply of power for the heavier tones. You can bring your receiver up to these present standards of reception by building this Thordarson 210 Power Amplifier and B Supply.

**Easy to build.** Every effort has been made to make assembly as simple as possible. The metal baseboard is equipped with all sockets and binding posts mounted. All necessary screws, nuts and hook-up wire are furnished complete; simple pictorial diagrams are supplied. You can assemble this unit in an hour.

**Simple to install.** No changes in receiver wiring are necessary. This amplifier can be attached to set in a moment.

**Economical to operate.** Highly efficient and cool in operation. Consumes less current than a common 50 watt lamp.

**Quiet in performance.** The reliability of Thordarson engineering assures you of unquestionable performance and quietness in operation.

FOR SALE AT ALL GOOD PARTS DEALERS

Write for this free booklet

THORDARSON ELECTRIC MFG. CO.  
500 W. Huron St., Chicago

GENTLEMEN: Please send me, free of charge, your booklet describing your 210 power amplifier on the metal baseboard.

Name .....

Street and No. ....

Town .....

State .....

3575 G

# RADIO

With Which Is Incorporated "Radio Journal"  
Established 1917

Published Monthly by the Pacific Radio Publishing Co.

ARTHUR H. HALLORAN,  
Editor

H. W. DICKOW,  
Business Manager

GERALD M. BEST,  
Technical Editor

A. I. RIVETT,  
Draughtsman

Entered as second-class matter at Post Office at  
San Francisco, Calif.

Copyright 1928 by the Pacific Radio Publishing Co.

Address all communications to

PACIFIC RADIO PUBLISHING COMPANY  
Pacific Building, San Francisco, California

Vol. X

MARCH, 1928

No. 3

## CONTENTS

RADIOTORIAL COMMENT: BUILDING READER CONFIDENCE .....	11
WHAT IS THE MARCONI BEAM?.....	12
By J. Garrick Eisenberg	
MODIFICATIONS OF THE 115 K. C. SUPERHETERODYNE .....	16
By Gerald M. Best	
COIL CONSTRUCTION .....	18
By Byron Wade	
THE SPECIAL FOUR TUBE RECEIVER.....	19
By Francis Churchill	
WHICH POWER TUBE TO USE.....	20
By Arthur Hobart	
THE JUNGLE S O S.....	21
By P. J. Clark	
FILTERS .....	22
By Samuel G. McMeen	
RADIO PICTURES .....	22
TUNED R. F. AMPLIFIERS.....	24
By B. F. McNamee	
VOLTAGE REGULATION FOR A. C. DEVICES .....	25
By Clinton Osborne	
EXPERIMENTAL SHOP METHODS.....	26
By Samuel G. McMeen	
QUERIES AND REPLIES.....	27
THE COMMERCIAL BRASSPOUNDER .....	28
By P. S. Lucas	
PACIFIC COAST RADIO COMPASS AND FOG STATIONS .....	29
By L. O. Doran	
BELGIAN B-82 .....	30
By E. A. Tubbs	
A 1928 SHORT WAVE RECEIVER WITH SHIELDED GRID TUBE .....	31
By Francis Churchill	
RADIO KIT REVIEWS.....	32

## Forecast for April

The April issue of RADIO will be largely devoted to a discussion of various practical methods for the operation of radio receivers from alternating current supply. This will be the most complete exposition of the subject yet presented. It will include directions for adapting the 115 k. c. superheterodyne for series connection. In addition there are several articles on the practice and theory of radio, as well as the usual departments.



RADIO IS BETTER WITH BATTERY POWER

cells make the Layerbilt  
last longest of all  
EVEREADYS

UNTIL the Eveready Layerbilt "B" Battery was invented, the one-and-one-half-volt cylindrical flashlight dry cell was the unit of construction. Fifteen of these cells connected in series and sealed in a package make a 22½-volt "B" battery and 30 of them make a 45-volt battery.

The only way these cylindrical cells can be assembled in a box is to stand them side by side, connecting them electrically by soldered wires. This assembly unavoidably leaves open spaces between the cells. To hold the cells in place and prevent breaking the connecting wires, the spaces customarily are filled with pitch. Fully one-half of the cubic contents of such a battery is wasted.

To avoid these disadvantages of the cylindrical cell type of construction the Eveready Layerbilt was designed. In place of the round cell we invented and perfected a square-cornered, flat cell. Such cells packed tightly

*Illustrated to the right is the cylindrical cell type of "B" battery construction. Note the waste space between the cells.*



*This is the patented Eveready Layerbilt, the unique "B" battery that contains no waste spaces or materials between the cells. No other battery is made like it.*

Eveready Layerbilt, which contains these highly efficient, patented cells. This is the longest-lasting, most economical and convenient Eveready "B" Battery ever produced. Like all other Eveready Radio Batteries, it provides Battery Power, which is pure Direct Current, silent, uniform, the only

kind of current that gets the best out of a radio set. The remarkable Eveready Layerbilt gives you Battery Power for the longest time. When buying batteries, insist on the Eveready Layerbilt. **NATIONAL CARBON CO., INC.** New York  San Francisco  
*Unit of Union Carbide and Carbon Corporation*

together make the Eveready Layerbilt solid as a brick, no wires to break. Moreover, the flat cells are more efficient—active materials produce more current when in the flat shape than the same quantity of materials produce in a cylindrical cell.

For modern sets, use the



Tuesday night is Eveready Hour Night  
*East of the Rockies*  
9 P. M., Eastern Standard Time  
Through WEAJ and associated  
N. B. C. stations  
*On the Pacific Coast*  
8 P. M., Pacific Standard Time  
Through N. B. C. Pacific Coast  
network

**EVEREADY**  
**Radio Batteries**  
*-they last longer*

The air is full of things you shouldn't miss

Tell them that you saw it in RADIO



# Abox

## "A" BATTERY ELIMINATOR

Licensed by The  
Andrews-Hammond Corporation, under Patent No. 1,637,795 and applications



### Change to A. C. Operation

now that it is so simple, so easy, and so much better.

And best of all you can still use your same set without alterations and the same tubes—simply remove the old storage battery and charger, make two connections to the Abox and plug in.

The Abox draws current from the light socket only when the set is in use. *It contains no battery.*

The ABOX "A" ELIMINATOR is made in two models, one for sets using eight or less 6-volt tubes, including the new A type power tubes, and one for sets using ten or less 4-volt tubes.

Any "B" Eliminator can be used in connection with an ABOX to completely electrify your radio set. For full information see your dealer or write direct for free descriptive circulars.



\$32<sup>50</sup>

Input—110 volts, 50-60 cycles A. C.  
Output—6-volt direct current, 2 amperes.  
Shipping weight, 25 lbs.

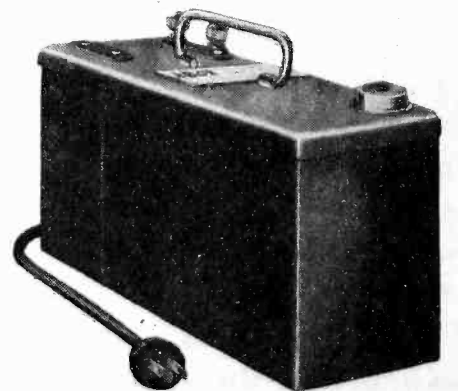

Four-volt model for sets using 4-volt tubes. Fits Radiola battery compartment. Size, 8 3/4 inches long, 4 inches wide, 6 7/8 inches high. Output—.6 amperes, 4 volts D.C. Price

\$27<sup>50</sup>

All prices slightly higher on West Coast

## The ABOX Company

215 North Michigan Avenue

Chicago, Illinois



# I Will Train You at Home to Fill a Big-Pay Radio Job

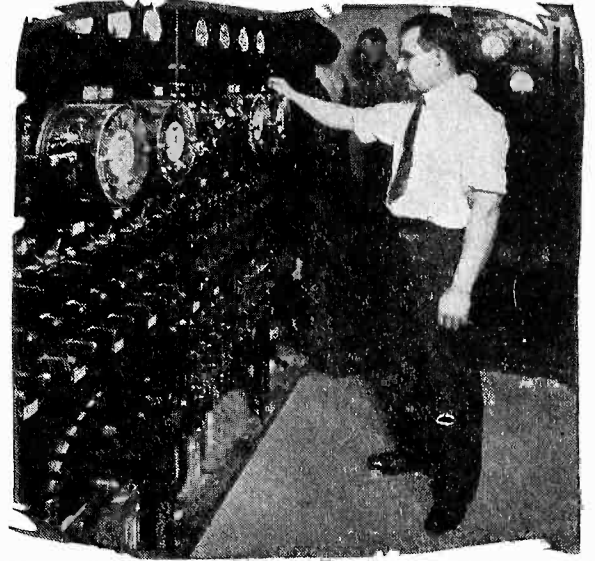
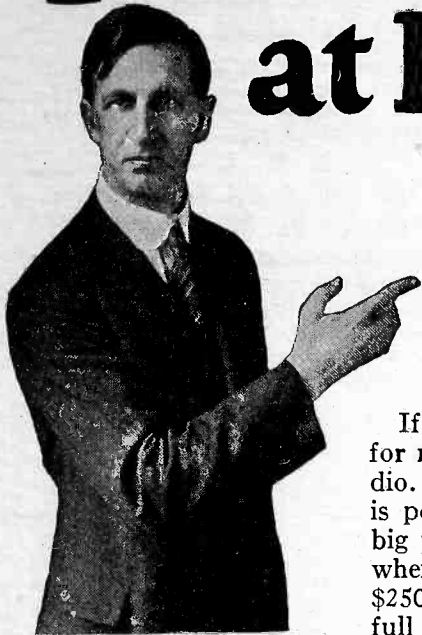

## Here's the PROOF

Made \$185 in  
Three Weeks  
Spare Time



"I have met with continued success. For instance, recently I realized a profit of \$185 in three weeks

\$1.50 an hour. I have been making good money almost from the time I enrolled. The N. R. I. has put me on the solid road to success."

Peter J. Dunn, 901 N. Monroe St., Baltimore, Md.

Made \$588 in One Month

"The training I received from you has done me a world of good. Some time ago during one of our busy months I made \$588. I am servicing all makes of Radio receiving sets. My boss is highly pleased with my work since I have been able to handle our entire output of sets here alone."

Herbert Reese, 2215 So. E St., Elwood, Indiana.

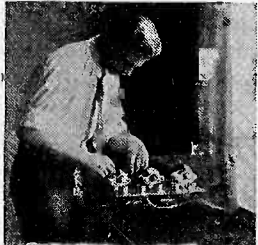

Earns Price of Course in One Week Spare Time

"I have been so busy with Radio work that I have not had time to study. The other week, in spare time, I earned enough to pay for my course. I have more work than I can do. Recently I made enough money in one month spare time to pay for a \$375 beautiful console all-electric Radio. When I enrolled I did not know the difference between a rheostat and a coil. Now I am making all kinds of money."

Earle Cummings, 18 Webster St., Haverhill, Mass.

If you are earning a penny less than \$50 a week, send for my book of information on the opportunities in Radio. It's FREE. Clip the coupon NOW. A flood of gold is pouring into this new business, creating hundreds of big pay jobs. Why go along at \$25, \$30 or \$45 a week when the good jobs in Radio pay \$50, \$75 and up to \$250 a week. My book "Rich Rewards in Radio" gives full information on these big jobs and explains how you can quickly become a Radio Expert through my easy, practical home-study training.

### Salaries of \$50 to \$250 a week not unusual

Get into this live-wire profession of quick success. Radio needs trained men. The amazing growth of the Radio business has astounded the world. In a few short years three hundred thousand jobs have been created. And the biggest growth of Radio is still to come. That's why salaries of \$50 to \$250 a week are not unusual. Radio simply hasn't got nearly the number of thoroughly trained men it needs. Study Radio and after only a short time land yourself a REAL job with a REAL future.

### You Can Learn Quickly and Easily in Spare Time

Hundreds of N. R. I. trained men are today making big money—holding down big jobs—in the Radio field. Men just like you—their only advantage is training. You, too, can become a Radio Expert just as they did by our new practical methods. Our tested, clear training makes it easy for you to learn. You can stay home, hold your job, and learn quickly in your spare time. Lack of education or experience is no drawback. You can read and write. That's enough.

### Many Earn \$15, \$20, \$30 Weekly on the Side While Learning

My Radio course is the famous course "that pays for itself." I teach you to begin making money almost the day you enroll.

My new practical method makes this possible. I give you SIX BIG OUTFITS of Radio parts with my course. You are taught to build practically every type of receiving set known. M. E. Sullivan, 412 73rd Street, Brooklyn, N. Y., writes, "I made \$720 while studying." Earle Cummings, 18 Webster Street, Haverhill, Mass., "I made \$375 in one month." G. W. Page, 1807 21st Ave., Nashville, Tenn., "I picked up \$935 in my spare time while studying."

### Your Money Back if Not Satisfied

I'll give you just the training you need to get into the Radio business. My course fits you for all lines—manufacturing, selling, servicing sets, in business for yourself, operating on board ship or in a broadcasting station—and many others. I back up my training with a signed agreement to refund every penny of your money if, after completion, you are not satisfied with the course I give you.

### ACT NOW—64-page Book is FREE

Send for this big book of Radio information. It won't cost you a penny. It has put hundreds of fellows on the road to bigger pay and success. Get it. Investigate. See what Radio has to offer you, and how my Employment Department helps you get into Radio after you graduate. Clip or tear out the coupon and mail it RIGHT NOW.

J. E. SMITH, President,  
Dept. 3-R, National Radio Institute  
Washington, D. C.



You can build  
100 circuits with  
the six big outfits  
of Radio parts  
I give you

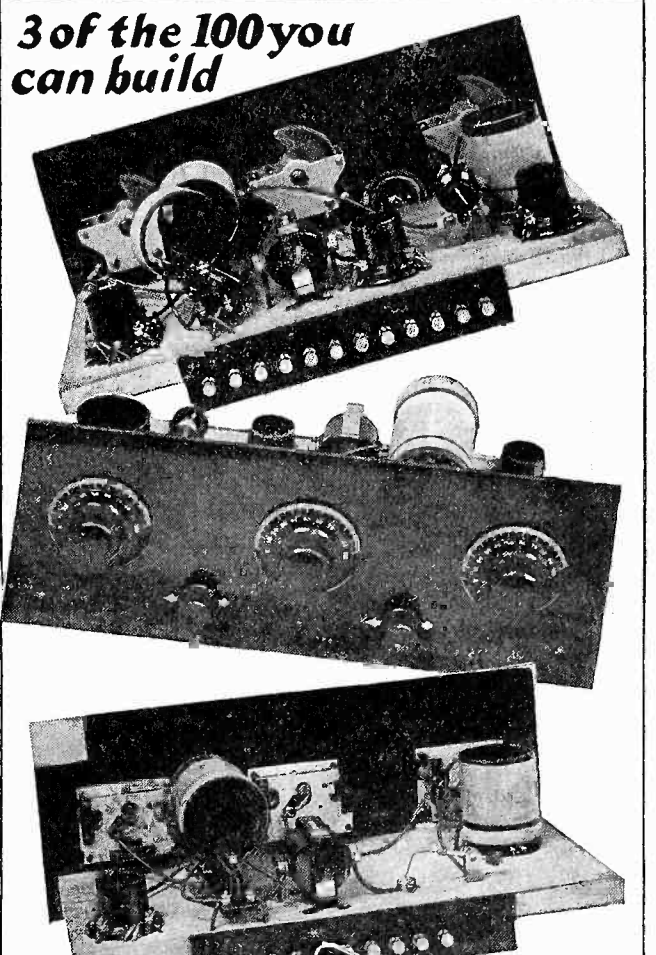

Find out quick  
about this  
practical way  
to big pay



### Mail This FREE COUPON Today

J. E. SMITH, President,  
Dept. 3R, National Radio Institute,  
Washington, D. C.

Dear Mr. Smith: Kindly send me your big book "Rich Rewards in Radio," giving information on the big-money opportunities in Radio and your practical method of teaching with six big outfits. I understand this book is free, and that this places me under no obligation whatever.

Name..... Age.....  
Address.....  
City..... State.....  
Occupation.....

Employment Service to all Graduates

Originators of Radio Home Study Training

Tell them that you saw it in RADIO



# Acclaimed for its Tone

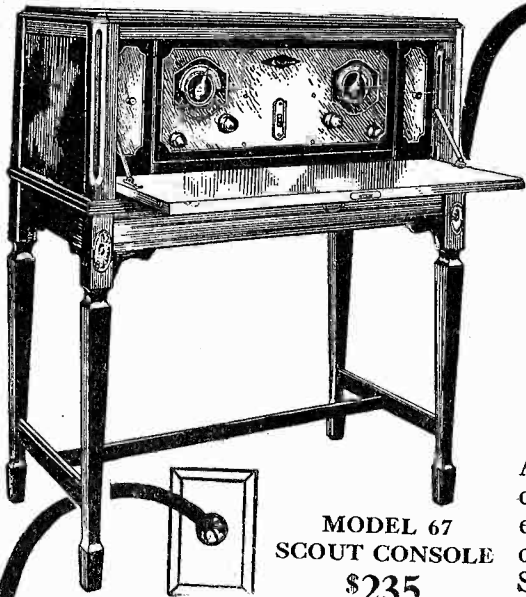

MODEL 67  
SCOUT CONSOLE  
\$235

## Sleeper Electric Radio

Made in Both  
AC and DC Types

At radio shows throughout the country, in the laboratories of experts, in the homes of Sleeper owners, in fact wherever the Sleeper Electric Radio is compared with other receivers, whether battery operated or electric, the Sleeper Electric is acclaimed for its glorious tone and marvelous volume. The Sleeper Electric Radio does away with all batteries, chargers, eliminators and other accessories necessary with other receivers. Once the Sleeper Electric is connected to your home lighting socket your power supply is as sure and dependable as your electric light. Ask your dealer for a demonstration, or write for circular giving full particulars.

We Invite Communication from Western  
Distributors and Dealers

**SLEEPER RADIO & MFG. CORPORATION**  
GORDON C. SLEEPER, President  
462 Washington Avenue, Long Island City, N. Y.

# Sleeper

### This Coupon Will Save You 50c

You pay \$1.50 to a newsdealer for six copies of "RADIO." You pay only one dollar for six copies by subscription. Save 50 cents. Send this coupon and \$1.00 to "RADIO" today and the next six issues will be mailed to your address. The saving is worth-while.

Name.....  
Street and No.....  
City and State.....

### RADIOADS

⊗ ⊗ ⊗  
A Classified Advertising Section Read by Better Buyers.

⊗ ⊗ ⊗  
The rate per word is eight cents net. Remittance must accompany all advertisements. Include name and address when counting words.

⊗ ⊗ ⊗  
Ads for the April Issue Must Reach Us by March Fifth

**SUPERHETERODYNE SET.** 8 Tube Custom-Built, ULTRADYNE. Walnut cabinet. Voltmeter. Built in Loop. Bargain \$100.00. Another \$75.00 or trade. Both in perfect condition. Radio, 4105 Pine, St. Louis, Missouri.

**SHORT WAVE SETS**—Fifty of them on hand. Two tube sets \$15.75 each. Short Wave Coils \$2.50 per set. Write. Ray Basham, Richmond, Missouri.

**SAVE 50%.** Send \$2.50 now for a full year subscription to both "RADIO" and "CITIZENS RADIO CALL BOOK." Both books mailed to your address for a full year for the price of "RADIO" alone. Next issue of CALL BOOK will be out March 1st. Better order now to be sure to get the March issue. Send your subscription to "RADIO," 433 Pacific Bldg., San Francisco, Calif.

**TRANSCONTINENTAL RECEPTION.** Radio engineer develops wonderful set. Send \$1.00 for blue prints, detailed data. M. P. Gilliland, 1117 Foothill St., South Pasadena, Calif.

**INFRA DYNE**—Last year's model, without cabinet or tubes, in A-1 condition in every respect; \$50 takes it. Has Camfield coils, walnut engraved panel, illuminated dials, high grade audio amplifier, volt-meter, other expensive equipment. Parts alone list at \$135. G. M. Best, 1460 Grand Ave., Piedmont, Calif.

**MOTOR GENERATORS, DC and AC, all sizes.** Bargain prices on all kinds of radio generators and motor generators. For example: 100 watt 27.5 volt DC and 300 volt DC double current generators \$15.00 each. Full ball bearing types, in first class shape. 900 cycles self-excited 200 watt alternators, used, but in fine shape. \$17.50 each. Other bargains. Write for list. D. B. McGown, 435 Pacific Bldg., San Francisco.

**KOLSTER DECREMENTER**—Cost new \$375.00. Excellent condition. Will trade for what have you worth \$50.00 or will sell for only \$50.00. Complete with coils and genuine leather carrying case. Useful for many purposes such as checking coils, etc. Good buy for some laboratorian. C. H. Cannon, 462 25th Ave., San Francisco.

**PRESS AND PUBLIC** concede it to be the best ever produced. "Radio Theory and Operating" by Mary Texanna Loomis, member Institute of Radio Engineers, lecturer on theory of radio, Loomis Radio College. Thorough text and reference book; 886 pages, 700 illustrations, handsome, flexible binding. Price \$3.50, postage paid. Used by Radio Schools, Technical Colleges, Universities, Government Schools, Department of Commerce and Engineers. At bookdealers, or sent on receipt of check or money order to Loomis Publishing Company, Dept. X, 405 9th St., Washington, D. C.

**WANTED**—Men to work with National Radio Service Organization. No selling scheme. Co-Operative Radio Doctors, Dept. P, 131 Essex St., Salem, Mass.

**SELL**—2 Acme transformers, Leach relay, Aero transmitter complete, meters. Elmer Lawton, Plymouth, Ill.

**DO YOU GET TIRED** of buying "B" batteries? A lifetime Edison will solve your troubles. Good, live, large size elements connected with pure nickel wire, electrically welded, 7c pair. All parts for sale. Sample cell and dope sheet, 10c. Paul Mills, Woodburn, Oregon.

**USED SETS OF ALL KINDS AT BARGAIN PRICES.** Radiola X, in fine shape, \$50.00, tubes and batteries new. D. C. BOSCH CRUISER, with tubes, list \$90.00. Almost new, \$55.00. Western Electric Cone Speaker, used but perfect, \$20.00. Pacent Cone Speakers, new, in original boxes, \$15.00. Other bargains. Send for free list. If you don't see what you want, we can get it for you. Alexandria Radio Shop, 5410 Geary Street, San Francisco, Calif.

**DC GENERATOR** 2000 volts 1500 watts, 1750 RPM, plain bearing, 1750 RPM. Used but in fine shape. \$125.00. Geo. Belling, 1904 Foothill Blvd., Oakland, Cal.

**SHIP AERIAL**—Genuine SAWCA heavy duty 718 and 722 Silicon Bronze ship aerial exactly as employed by ocean liners, ships, wireless and major broadcasting stations. Conductivity, pick-up energy and distance range, greater than any antenna wire available. Prices, per foot, 722, two cents. 718, three cents. Sample of either size ten cents. Ship Aerial Wire Co. of America, 217 Wyckoff Ave., Brooklyn, New York.



# POWERIZER

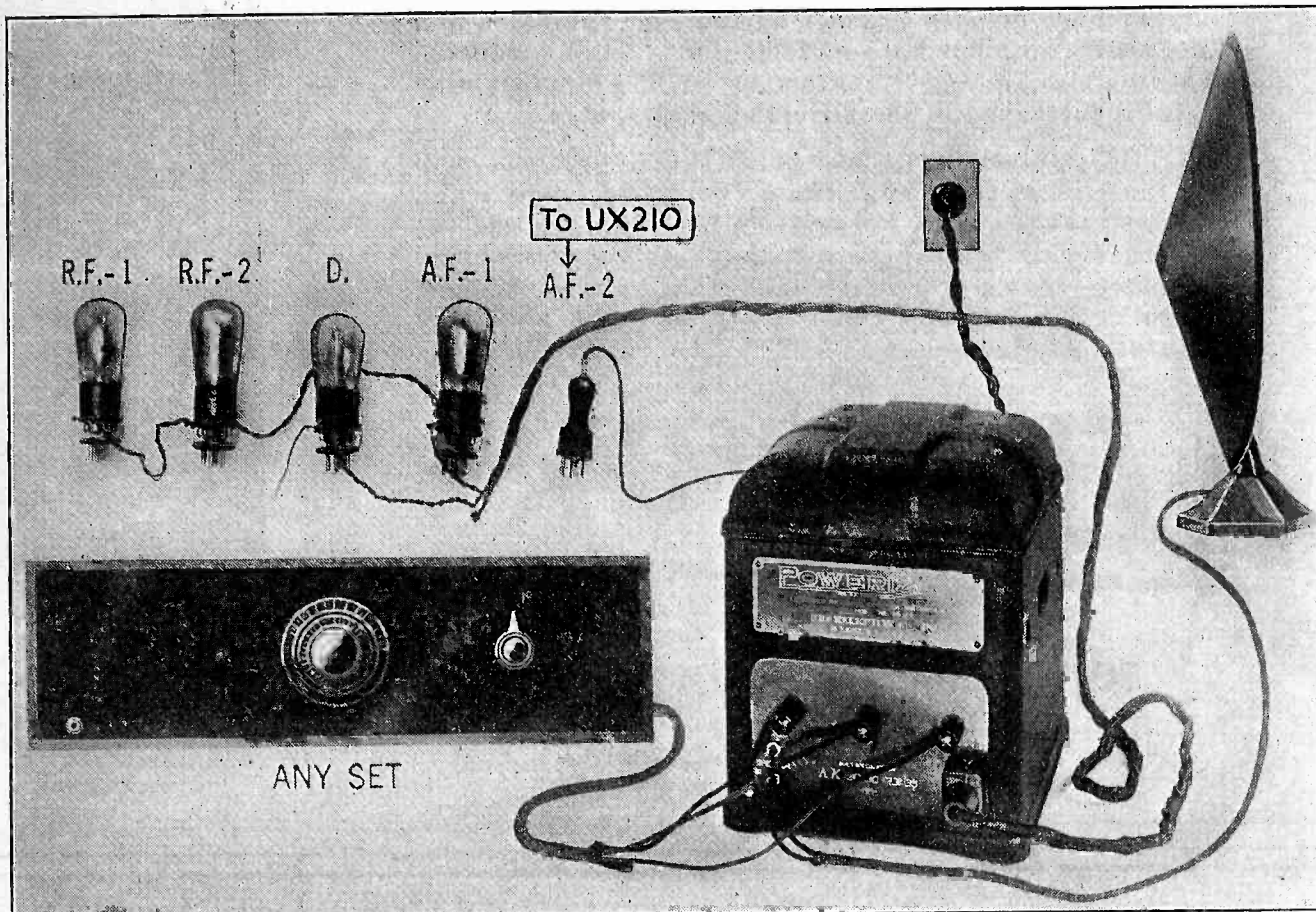

**POWERIZER** NOT ONLY MAKES EVERY RADIO SET AN A C ALL ELECTRIC, BUT ALSO MAKES EVERY SET A "DE LUXE" A C ALL ELECTRIC USING THE A C RADIOTRONS WITH POWER AMPLIFICATION [U X 210 OR C X 310].

**POWERIZER** EQUIPMENT IS NOW OPERATING SUCCESSFULLY ON THOUSANDS OF STANDARD SETS.

General Model for Tuned R. F. and Neutrodyne.....	<b>\$60</b> Tubes extra. (With Harness)
For Radiola Model 20.....	<b>\$59</b> Tubes extra. (With Harness)
For Radiola 28 or 25 with Pack.....	<b>\$84</b> Tubes extra.

*Write for Bulletin PR 1018 and 1019*

**RADIO RECEPTOR CO.,** 106 SEVENTH AVE.  
NEW YORK CITY



# Truth Conquers

**E**NGINEERING recognition of a radio product is the greatest recommendation possible.

The acceptance of such product by the best engineers and set designers, signifies but one fact—that "truth conquers"—that the design and manufacture of the product was truthfully portrayed in the advertising.

AEROVOX statements about AEROVOX products will stand the closest scrutiny because the product will stand the closest analysis . . . Recognition by engineers and set designers means that these men have thoroughly tested the product—that a product recommended by a well known engineer or kit designer, can be used with the assurance of greatest satisfaction.

## AEROVOX

"Built Better"

70 Washington St., Brooklyn, N. Y.

Write for literature and Aerovox Research Worker



AEROVOX non inductive filter condensers are specified exclusively for use in the Power Pack designed by Mr. G. M. Best for use with his new 115 K C Superheterodyne

Selected for its Quality

# FROST-RADIO

Again is exclusively Specified by Gerald M. Best, who now selects it for his new Revolutionary 1928 Superheterodyne

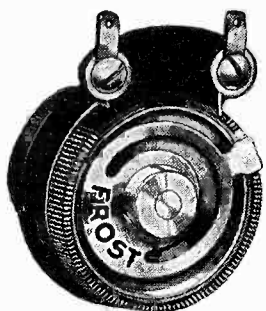

FROST-RADIO

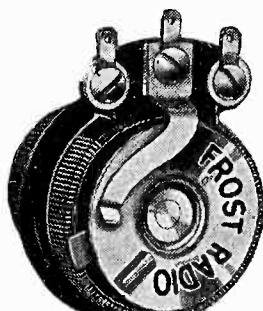

FROST-RADIO

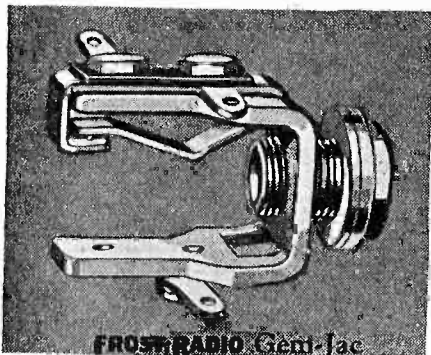

FROST-RADIO Gem-Jac

**I**N specifying Frost-Radio for exclusive use in his startling and revolutionary 1928 Superheterodyne, Gerald M. Best again shows the implicit confidence he places in these famous parts. Mr. Best has specified Frost-Radio on numerous occasions in his other circuits because he has found it admirably suited to the quality of reception his circuits must and do deliver.

In his 1928 Super Mr. Best makes use of the following Frost-Radio parts:

- 1 S-1910 10 ohm Frost Gem Rheostat, with combined filament switch.
- 1 No. 1922 200 ohm Gem Potentiometer.
- 1 No. 1882 200,000 ohm Frost De Luxe Variable High Resistance Unit.
- 1 No. 954 Frost Single Closed Circuit Gem-Jac.

When you build Best's 1928 Super be sure to use only genuine Frost parts, as specified. Your dealer can supply these parts. See him today.

## HERBERT H. FROST, INC.

NEW YORK

ELKHART, IND.

CHICAGO

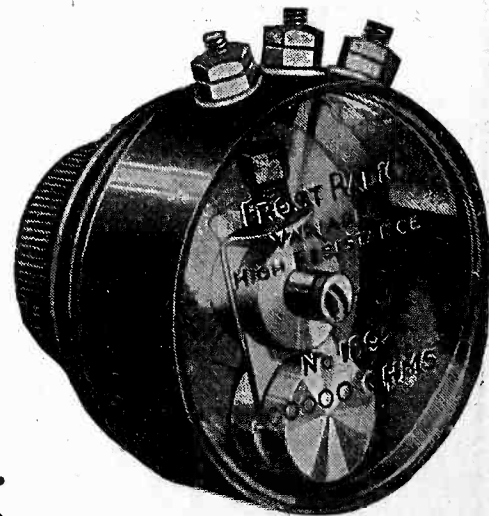

FROST-RADIO



# Finer Performance than you've ever enjoyed!

Light-Socket Power ~  
Fidelity of Reproduction  
made dependable by complete

## AMERTRAN *Units*

The AmerTran ABC Hi-Power Box. List price \$102.50, east of the Rockies. Complete with rectifying tube.



**A**N average receiver can be made one of the finest of modern instruments by the use of AmerTran products. For quality reproduction—limited only by the perfection of the speaker—for noiseless reliable power without the nuisance of batteries or chargers—these companion units set a new high standard of performance. Be sure to see them before you consider a new receiver this year. Cased in compact cabinets, they may be installed in a console, where your batteries used to be, or placed wherever convenient.

The A B C Hi-Power Box requires no attention or adjustment after installation. It delivers uniform, dependable power from the house-current—supplying sufficient voltage and current for Push-Pull 210 tubes and all other A C tubes required in a modern receiver. The complete unit contains AmerTran designed equipment with a power transformer having separate windings to provide AC filament current for power tubes, the 281 rectifying tube, heater current for three or four UY-227 AC tubes, and current for four or five UX-226 raw AC tubes.

See these new AmerTran products on demonstration at any store displaying the sign "Authorized AmerTran Dealer" or, if you cannot obtain them, write direct to this Company. Both wired units are licensed under patents owned or controlled by R C A and must be sold complete with tubes.

With either an AC power supply system or batteries, you'll find the fidelity of reproduction brought to your set by the AmerTran Push-Pull Power Amplifier actually limited *only* by the perfection of the speaker. This Amplifier introduces a new standard of quality to audio amplification. It connects to the detector of any good receiver and may be entirely AC operated. The input to the speaker is free from distortion and objectionable AC hum—the energy output is increased especially at the lower musical frequencies bringing greater clarity at high or low volume. Furnished with cable and plug the amplifier connects directly with the ABC Hi-Power Box.

These two units are designed to work together, and when used with a good tuner and speaker will reproduce without exaggeration a philharmonic orchestra or pipe organ as though actually present.

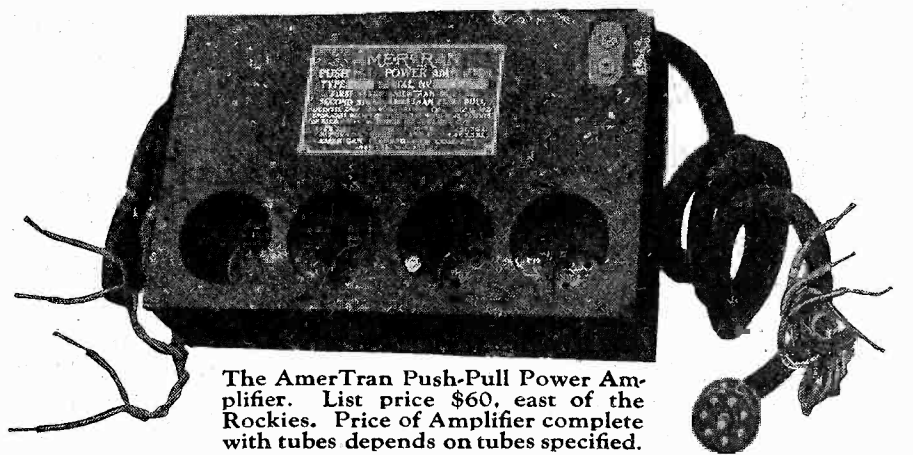

The AmerTran Push-Pull Power Amplifier. List price \$60, east of the Rockies. Price of Amplifier complete with tubes depends on tubes specified.

### AMERICAN TRANSFORMER CO.

176 Emmet Street : : : Newark, N. J.

Pacific Coast Office: Chronicle Bldg., San Francisco

"Transformer Builders for Over 27 Years"

Tell them that you saw it in RADIO



VITROHM RESISTORS.....IN EVERY INDUSTRY.....IN EVERY LAND

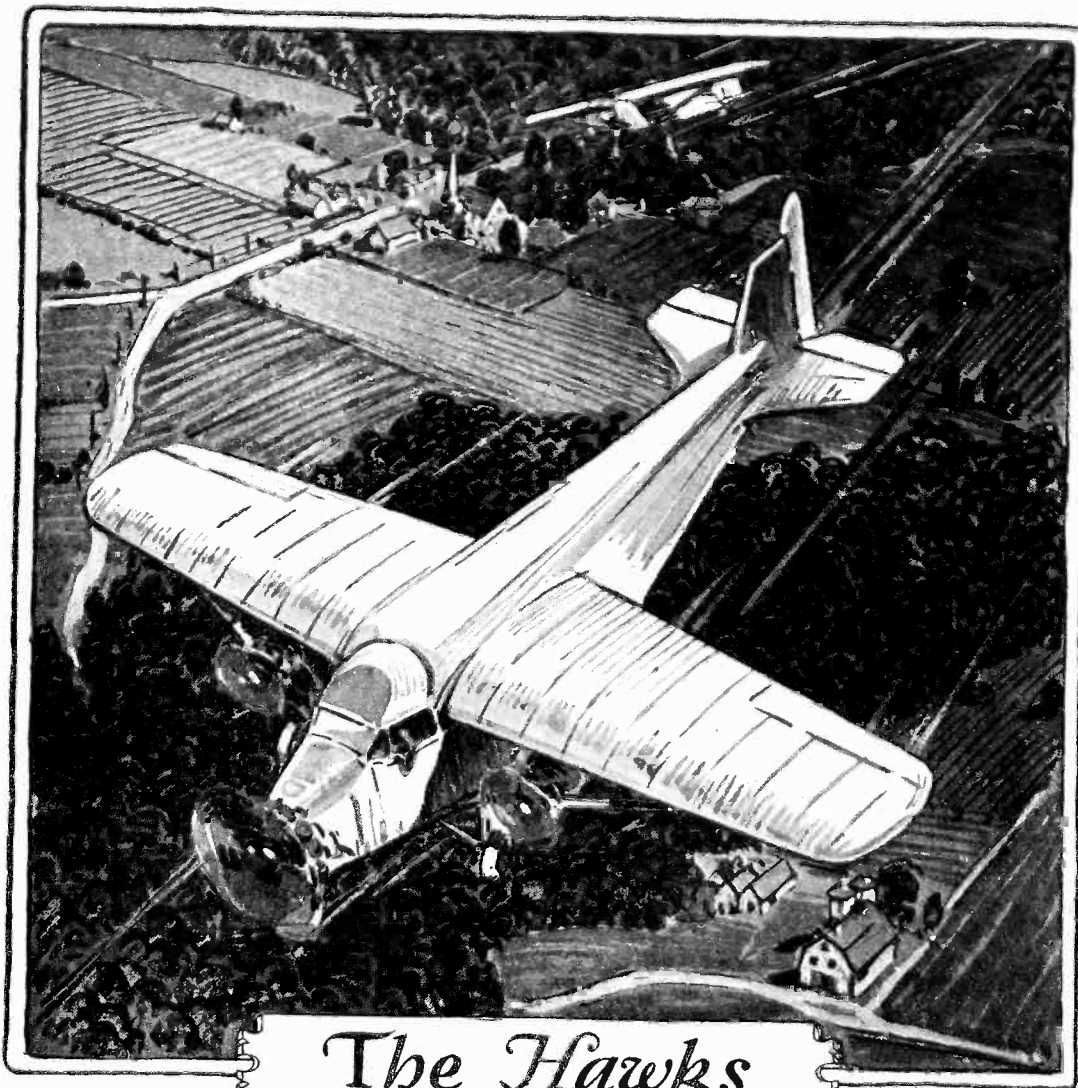

*The Hawks*



5000 ohm, tapped center, Vitrohm grid leak for transmitting circuits of 1000 watts or less. This resistor is used frequently in airplane transmitters. It is priced at \$2.80.

*Vitrohm Resistors*  
for radio

¶ Vitrohm Resistors are made by winding a special resistance wire upon a refractory tube and protecting both the wire and terminal contacts with fused-on vitreous enamel. This process has been used by Ward Leonard Electric Co. for more than 36 years.

¶ *Circular 507*, describing Vitrohm Radio Resistors, and "*Vitrohm News*" will be sent you without charge upon request.

*".....switch on, sir....."*

WITH the drop of his arm, the pilot signifies that he is ready to take his ship of the air to her own element. A few years ago, that roar of motor and short dash across the field meant the loss of all contact with the ground, until the flight was ended.

Today, radio maintains constant communication between airplane and ground. The pilot, or navigator, receives and gives instructions; learns of changing conditions, and is able to protect better airplane and cargo.

It is interesting to know that Vitrohm Resistors are specified most frequently by the designers of airplane radio transmitters.

In the air, on and under the sea, at the poles, in every industry, in every land you will find sturdy, permanently accurate Vitrohm Resistors—always making good.

**WARD LEONARD ELECTRIC CO.**

MOUNT VERNON, N.Y.

38-32-33-1



# RADIO

WITH WHICH IS INCORPORATED "RADIO JOURNAL"

VOLUME X

MARCH, 1928

No. 3

## *Radiatorial Comment*

Many readers are losing confidence in the statements published in radio magazines. This is not because of any lack of truth in the statements made, but rather because of the definite specifications of parts to be used in assembling equipment whose construction is described.

### **Building Reader Confidence**

The wise reader generally knows of several other brands that will fulfill the intended purpose as well or better than the one specified. Naturally he resents any such attempt to insult his intelligence and regards with suspicion other published statements concerning which he may not be so well informed.

These are bold, bad words. But they state a fact which radio editors have not had the courage or power to face. The reading pages of most of the radio magazines are filled with publicity for radio manufacturers. During the past year even RADIO has departed from its original policy of not specifying exclusive parts and has printed publicity which masqueraded as editorial matter. This was done because it was feared that the advertising which makes it possible to deliver a magazine to the subscriber could not be secured without some editorial tie-in.

But no magazine can succeed unless it holds the confidence of its readers. Nor can an editor preserve his self-respect, much less the respect of his readers and advertisers, if he allows the publication of articles which are dictated by advertisers.

So RADIO has resumed its former policy of describing circuits without exclusive specification of parts when equally good substitutes are made by several manufacturers. With the large number of really good transformers, coils, condensers, sockets, tubes, etc., which are now available, the reader should be free to exercise his own choice.

In many cases this will obviate the purchase of new parts whose equivalents are already in the builder's junk box. It requires a knowledge of the inductance, capacity or resistance of a device and when possible these constants will be published. The constructor also often wishes to make his own parts, using dimensional data published in the article.

However, it would be presumptuous for any magazine to claim that its contributors and editorial staff can present all the facts without the assistance of the manufacturers, many of whom

maintain more extensive research laboratories than any magazine. They develop most of the worthwhile ideas which help the man who is interested in the theory and practice of radio. While this may be pure publicity from one point of view, it is good editorial material from another.

So a special section of the magazine is being devoted to the review of the salient features of new kits and for the presentation of interesting data from the radio manufacturers. This information is published without payment of author's fees and without charge to the manufacturer. Its publication is not predicated upon space in the advertising columns. It is accepted solely on the basis of its probable reader interest.

Then again, in the presentation of such an editorial article as will be a feature of the April issue—a complete discussion of methods for the a.c. operation of receivers—due credit will be given to the manufacturers who have developed and applied useful ideas. The point at issue is that this be done frankly and above board, without attempting to induce the reader to buy a lot of parts which are specified because the manufacturers thereof are advertising in the magazine.

This policy may cause a decrease in the number of pages because of the absence of support from manufacturers who insist upon specification of their parts. But we believe, with the assurance of reader confidence based upon the integrity of the editorial pages, that the better class of manufacturers will recognize the value of a medium in which they can tell the facts in their display advertising and not have to rest upon the crutch of house organ publicity. As the number of legitimate advertising pages increases, so will the number of legitimate reading pages.

The time for unmasking has come. Things are to be what they seem and skim milk is not to masquerade as cream. In this, its eleventh year of publication, RADIO is resolved to be worthy of the confidence which readers have in it and not to be guilty of any intentional deception. Most of the manufacturers to whom this policy was announced late in 1927 regard it as the first step in the right direction and prophesy that it will be eventually adopted by all radio magazines which are not in the house organ class.



# What is the Marconi "Beam"?

An Explanation of its Functioning and a Description of the Australian Installation For Short Wave Communication With England

By J. Garrick Eisenberg

EVER since Senatore Marconi created such a profound impression several years ago with the announcement that he had developed a directional communication system concentrating all its energy into one narrow beam, there has been a keen desire in technical circles to learn something about the actual *modus operandi* of this new transmission development, and its reliability on commercial schedules as compared to existing systems. When the opportunity was afforded me therefore to visit Australia, and view at first hand the mysterious circuits about which so much was heard—and so little really known—it meant the culmination of a desire which I suppose most transmission engineers fostered, and one I had myself only remotely expected to have gratified. It meant, too, an excellent chance to make a comparative study, since I was leaving at Manila, what was considered to be the most modern of American installa-

tions—KZET, Manila Radio—typifying our standard practice in the high frequency field. These transmitters, roughly comparable in power with those of the new British system, used several different antennas, but all simply variants of the "broadcast" order. So the relative efficiency of the much vaunted beam was, indeed, a matter of interest to me.

It might be well, however, before beginning a discussion of this so called beam system, to have a clear visualization of what this transmission appears like in space, for I have found considerable confusion to exist on this point. If, for example, we compare it to the rays of a searchlight converging sharply to a narrow point, then the term "beam" is a misnomer.

To illustrate, on the Australia to Great Britain circuit, the longest radio link in existence, the beam at the receiver station is approximately 20 degrees wide, which means that the re-

ceiver band is some 1200 miles broad! Perhaps somewhere in the infinity of space the beam does converge to a narrower point, but halfway across the globe it still covers a fairly wide territory.

The polar curve shown in Fig. 1, taken under actual operating conditions on this circuit, gives a clear idea of what the "beam" really would look like could it be photographed. The lines portray a series of unit radiations having different reflection angles. Each line has its separate field, the combined intensities of which produce a dense wave front having maximum intensity at the focal point. The heavy outlines enclose the maximum field set up by these radiations. This diverges considerably from a true beam plotting as the stray fields even extend for some distance directly behind the screen.

We must perforce admit that it is only in a relative sense a beam; yet the

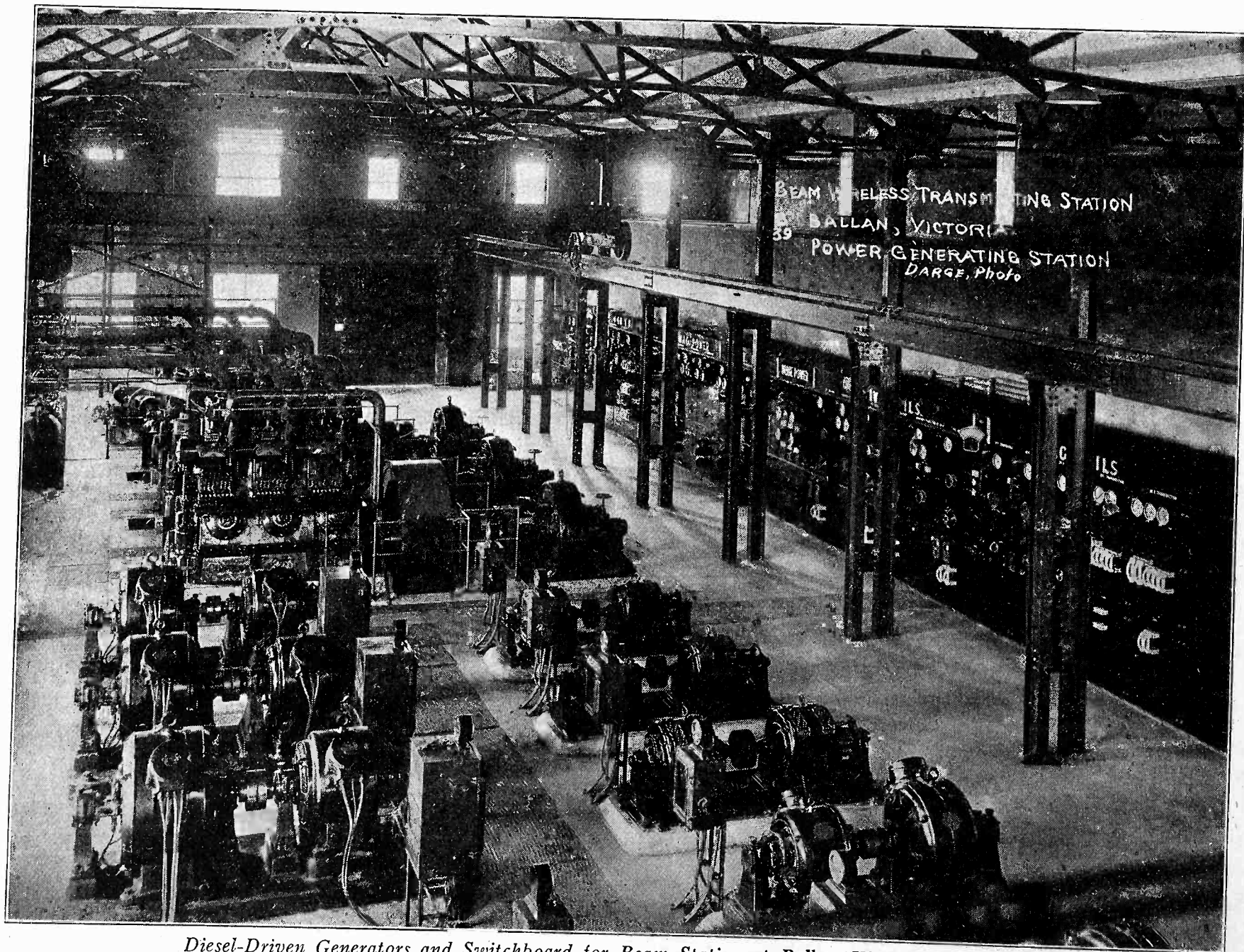

Diesel-Driven Generators and Switchboard for Beam Station at Ballan, Victoria, Australia.



tremendous advantage of confining the radiated energy to even such a degree is quite apparent. And since there is no other commercial system at present even remotely approaching the characteristics of a true beam, it is advisable for the lack of a better designation, to refer to the system under discussion as the Marconi beam.

Having gone so far, we can hardly avoid a description of the actual functioning of the antenna system in producing the results shown; I trust this will appear somewhat more lucid than the heretofore published descriptions and will serve to dispel the air of mystery that has cloaked the operation of these installations.

I gained the impression from Marconi's early descriptions of the system that the reflector was arranged in a true parabola, being focused in the familiar manner of a searchlight reflector to give the radiated energy its beam-like propensities. As a matter of fact, his original experiments were carried out along these lines, but in the development of the system for commercial purposes Mr. C. S. Franklin, of the Marconi engineering staff, found that practically the same results could be obtained by simply varying the phases in the different antennas making up the complete system, thus obviating the necessity of the parabola arrangement.

This simplified the construction problems immensely and also permitted a two-way channel to be swung from the same towers, by suspending antennas on either side of the vertical reflectors. A

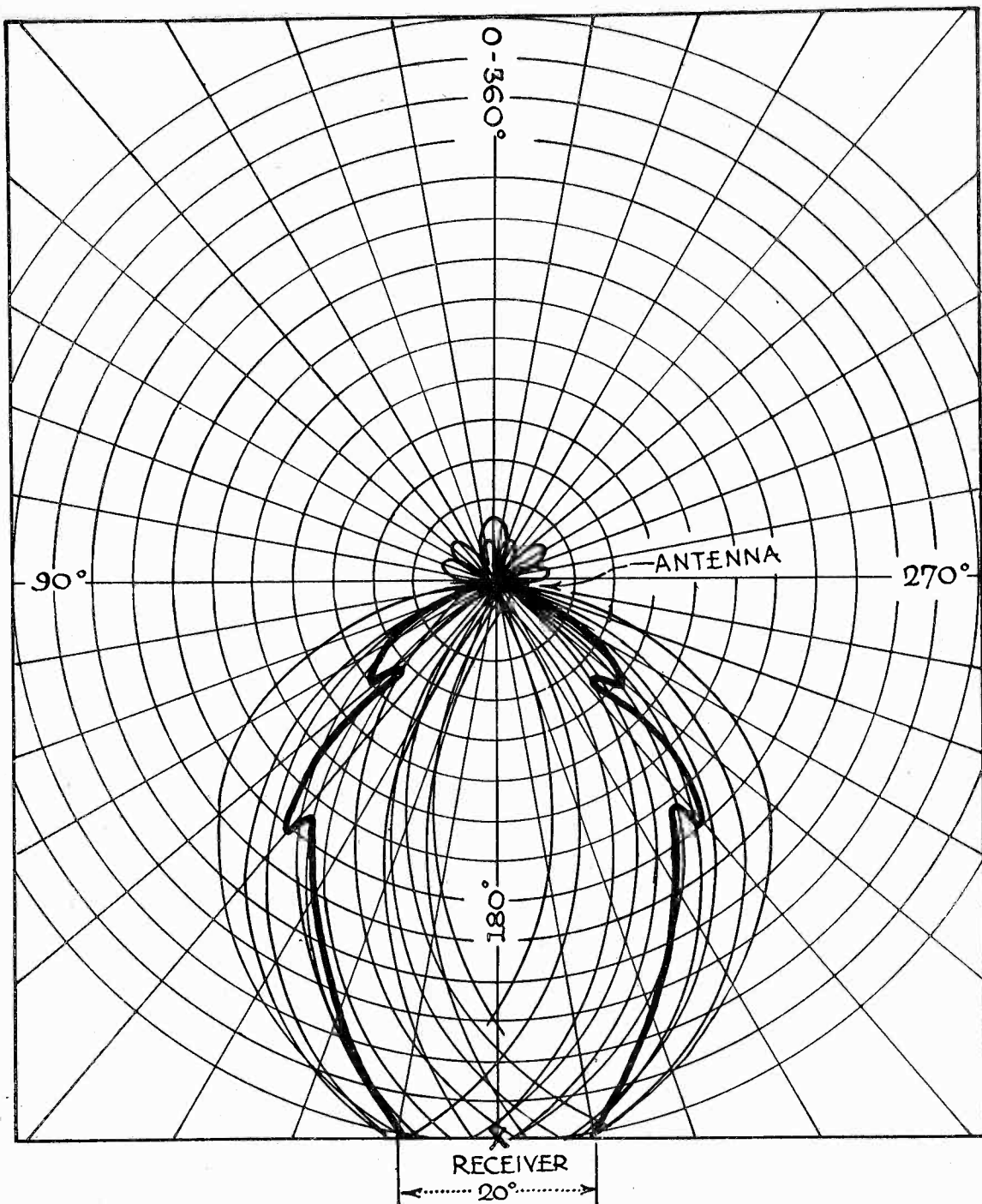
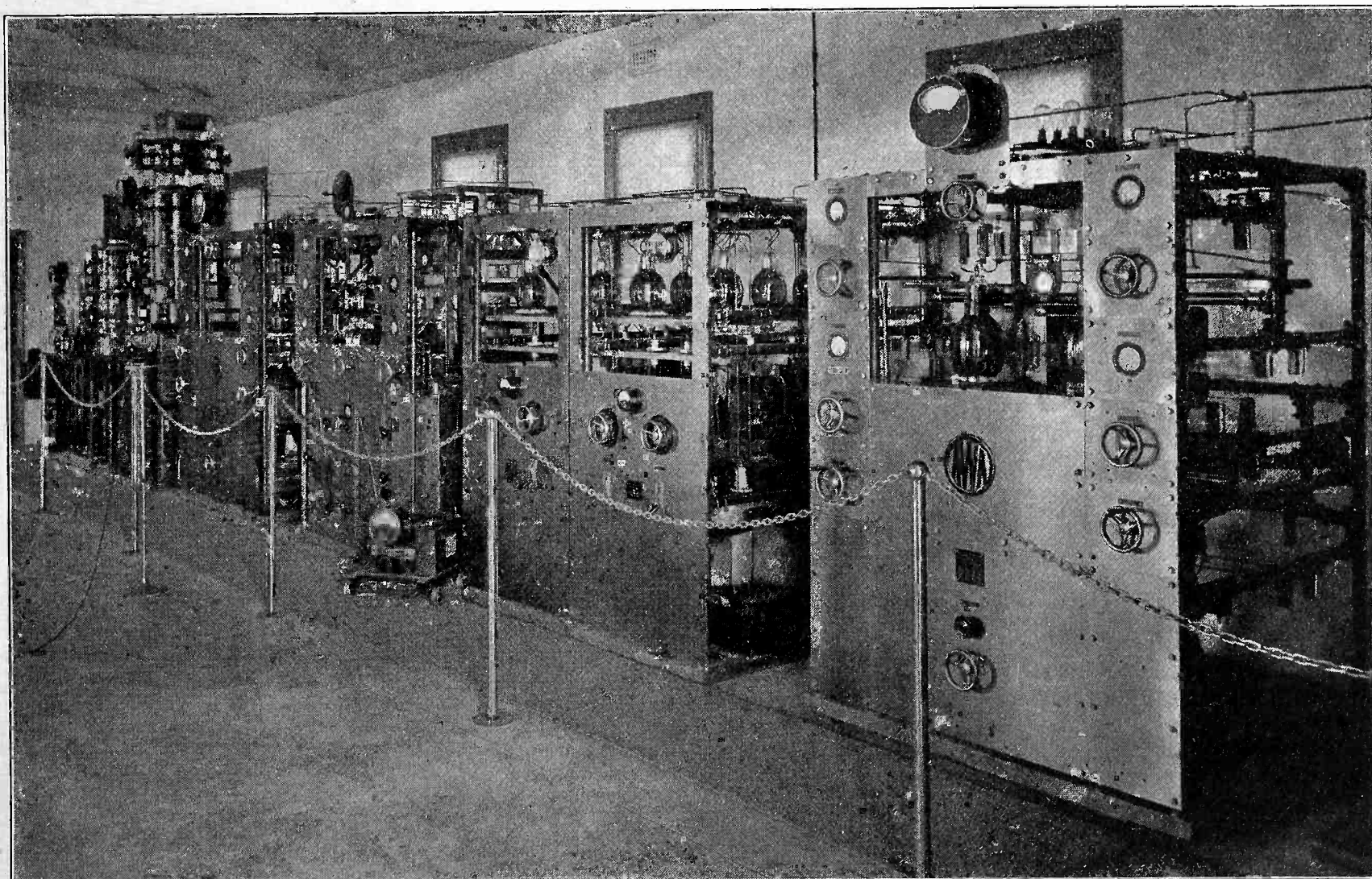

Fig. 1. Polar Curve of "Beam" Radiation From Multiple Antenna With Back Screening.



Short Wave Transmitters at 3LO, Melbourne, Showing Copper Strips Around Power Tubes for Equal Heat Dissipation and Equi-Potential Strips.



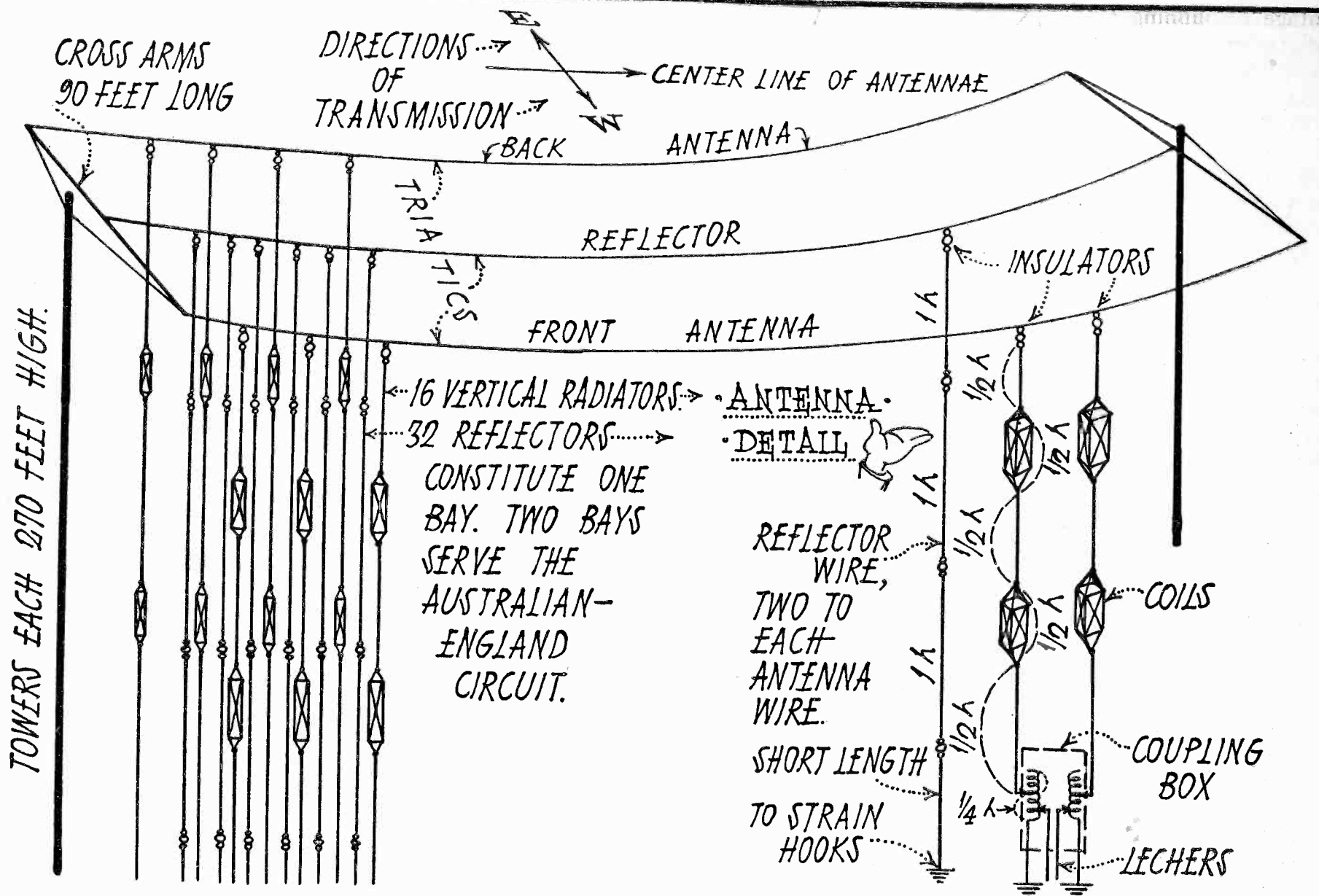

Fig. 2. Sketch of Antenna and Reflector System.

glance at Fig. 2 shows how the antennas and reflectors are suspended from the tower crossarms, making the same reflector serve doubly, and permitting transmission in alternate directions. It should be pointed out here that the antenna system is in reality made up of a series of vertical radiators which can be considered in effect as separate antennas—a good point to keep in mind.

As the diagram shows, the antenna system is laid out in a straight line—at right angles to the direction of transmission, and consists of 32 vertical radiators behind which are placed the 64 resonators of the reflector system. Each of these separate antennas is made up in three sections, the upper two consisting alternately of a half wavelength of vertical radiator and a special half wave coil arrangement, while the lowest section consists of the half wave vertical with quarter wave coil to ground.

The whole kernel of the scheme is the adjustment of the phases in each of the separate verticals to give an actual plus or minus variation from the half wave that determines the transmission angle. So our so-called beam in reality consists of a number of unit radiations, fed in exact phase from the common high frequency source and therefore additive, which are projected from various angles to a common focal point.

The antenna-coil relation is what gives

the particular phase relation in each vertical; the quarter wave coil is in practice adjusted to give a "lifting" angle at the base of the wave front. The reflectors are also arranged in three section units, each unit approximately one wave length long and insulated from one another at points corresponding to the lower end of the coils in the antenna proper. They are suspended at a distance of a quarter wavelength from the radiators behind the direction of transmission, their function being to act as resonators—reflecting in an additive direction—at the operating wavelength.

If we will consider the beam antenna as no more than a multiple-tuned, short wave antenna plus "back screening," it becomes easy to understand. As a matter of fact, the same results can be obtained with the long wave multiple-tuned system, for Alexanderson observed that when his downloads were adjusted slightly out of phase the radiation from them became directional. The radiation resistance of the long wave system un-

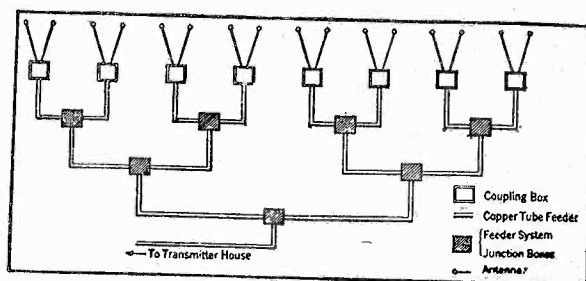

Fig. 3. Section of the Lecher Feed.

der such conditions, however, drops off considerably, so that this method could not be effectively applied there. Nevertheless, the relationship between these two systems, which are ordinarily thought of as being so vastly different, is well illustrated by the common effect.

The separate antennas are each fed in exact phase by lecher feeds, one section of which is shown in Fig. 3. By thus making the paths to each pair of antennas exactly equal, the phase of oscillations will be identical along the entire system. The antennas are led into the coupling boxes in pairs, each box containing two quarter-wave base coils. The distributor is supported about 18 in. above ground and is totally shielded along its entire length. Standing waves are checked by meters at various points, readings being taken at the transmitter house.

These lecher feeds introduce additional complications of construction, since the paths to the various radiators must all be exactly equal for the proper phase balance. The flexibility of the system in operation is therefore all the more impressive.

There are two of these multiple branched distributor systems on the Australia-England circuit, and provision is made for transmitting in either an easterly or westerly direction around the globe. The longest path of darkness



is the determining factor, of course; at certain periods of the day the 12,000 mile west-to-east great circle route will afford considerably better results than the opposite path from east to west, a mere 9000 miles. We accomplish much the same purpose with our "broadcast" transmissions by shifting to a band more suitable for the time period, but it is somewhat startling to watch an engineer casually reverse an innocent looking knife switch in the lecher feeds, make a slight readjustment at the transmitter panel for maximum radiation, and then nonchalantly remark "We are now transmitting around the other side of the world." Really, that's all there was to it.

Perhaps the point in which most interest lies, is whether the beam overcomes fading of signals at certain periods. Obviously there would not be a necessity for the two way circuit if this were true, and the fact that it does not, serves to stress again that it is not a true beam. If it were, and could be tilted to any angle at will, it would afford us an easy solution to this problem, which is presumably engendered by a shifting of the hypothetical Heavyside layer.

Notwithstanding this drawback, common to all high frequency transmission as yet, these circuits maintain an average 15 hour daily schedule with London at a speed not less than 100 words per minute. Weigh those figures well, for they are worth thinking about. The estimate of 15 hours is my own—the Marconi engineers are somewhat less conservative I believe—and applies to normal traffic conditions. I doubt whether the circuits are "all out" at any time, but when one considers that at this speed, the minimum permissible, something like 90,000 words can be handled

during a 15-hour operating period, then a fair idea is gained of their traffic efficiency.

As a further illustration: on my first visit to the central office at Melbourne, I was shown over the telegraph circuits, then later proceeded to the receiver station at Rockbank. Before my arrival the engineer in charge had been notified that central office had something for me, and upon returning that day, was delighted to receive a copy of a message conveying greetings from the London end of the beam. Now, the interesting point is that this note, shot over both halves of the circuit, it had been arranged of course by the Melbourne office, came through at a speed of 150 words per minute in broad daylight, and in less than an hour's elapsed time! It was in no sense a stunt, and being handled as a "service note" would go through in more or less leisurely fashion.

Let's go back to the technical again. Those of you who have listened to the beam transmissions may have remarked the steady characteristic of the note. This is a resultant of the unique keying scheme whereby the power supply is held absolutely constant, eliminat-

ing the power wobble noticeable at many high frequency stations.

Fig. 4 illustrates roughly the manner in which this is accomplished. No attempt has been made to draw in the various circuits, since they do not differ radically from our own—a neutralized power amplifier of about 18 kw. feeds the antenna, being in turn driven by a master oscillator—I have merely shown a schematic of the tube relay action by which the power load is kept constant.

The tube marked CT is the control valve or relay, and with key up draws a fairly high plate current by virtue of its positive bias. This in turn puts a heavy positive swing on the grids of the two succeeding tubes in the absorber circuit, which are normally rated at 1 kw. plate dissipation each. The heavy plate current drawn by these tubes under such conditions is largely dissipated in heat, however, in the resistance bank marked AR. In practice this is an air cooled unit of considerable proportions, and of such predetermined value that the sum of the drop across it, plus the current drawn by the absorber tubes, will equal the normal load in the oscillatory circuits. (Continued on page 36)

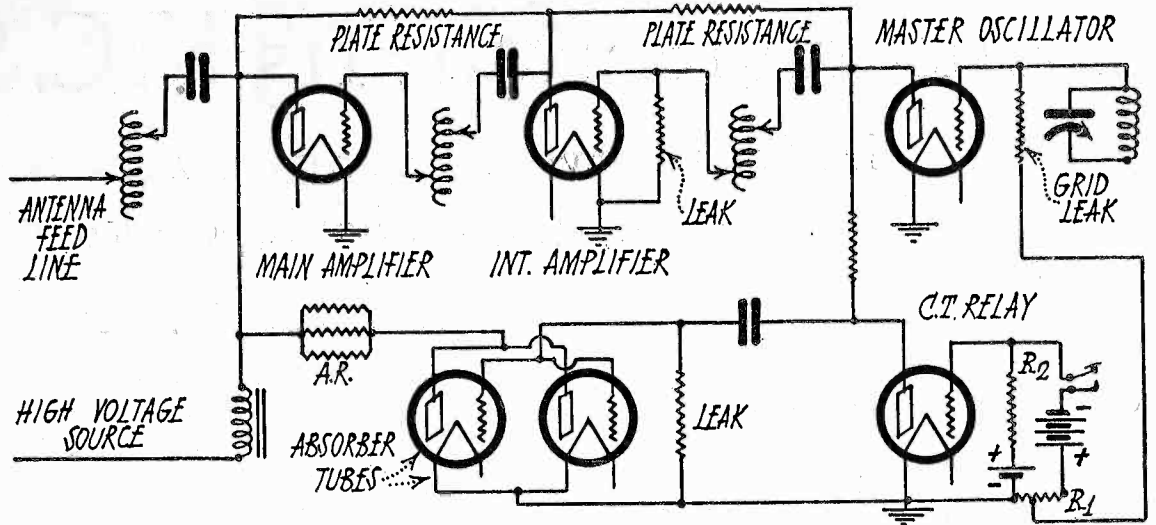
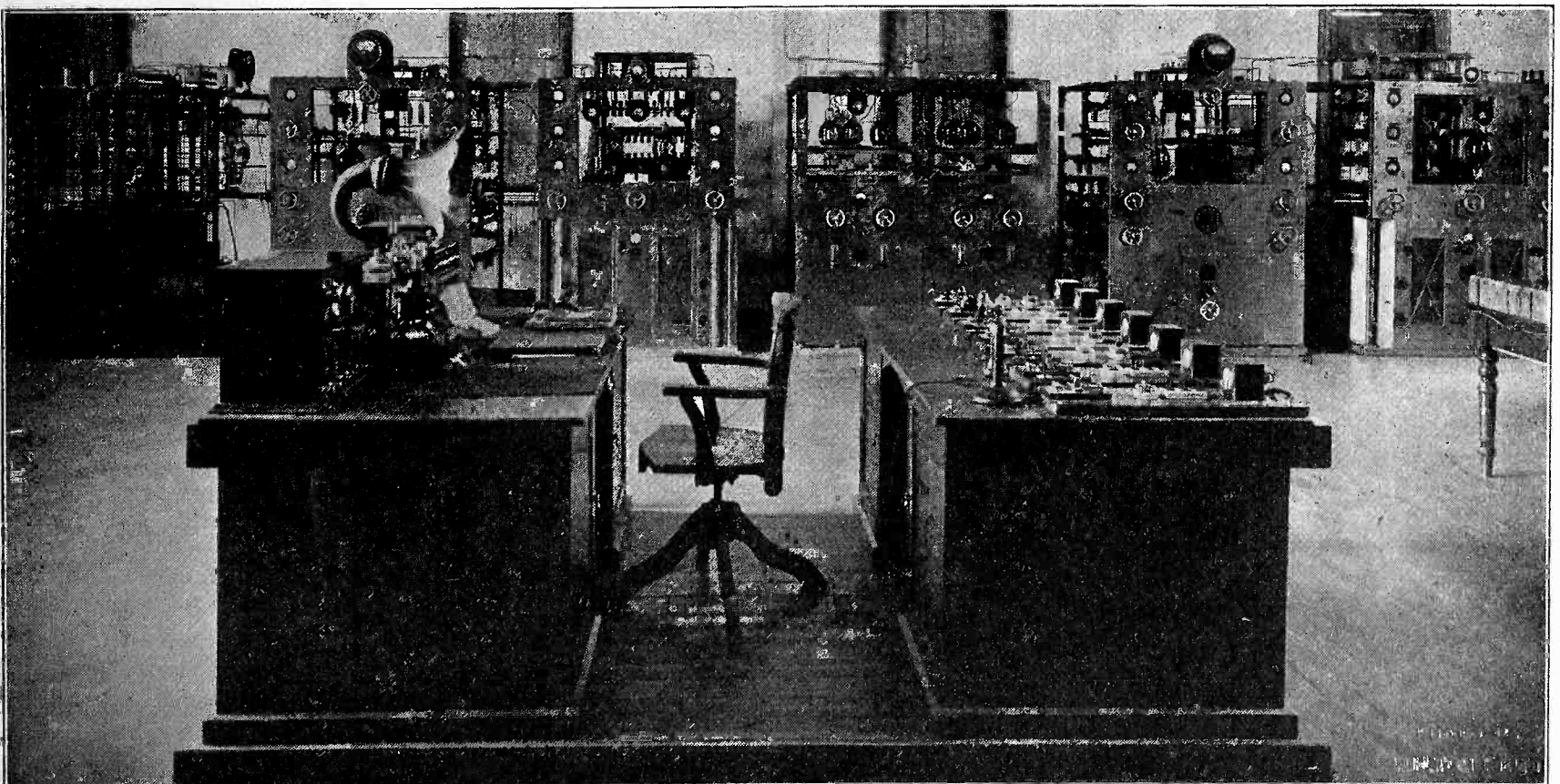

Fig. 4. Keying Scheme.



5 KW. Beam Transmitter at Radio Central, Pennant Hills, Sydney, Showing Brass Panels and Support Frames.



# Modifications of the 115 K. C. Superheterodyne

## Directions For Converting It to a 5-Tube Set For Local Reception, Adding Regeneration and Using "A" Tubes

By Gerala M. Best

SINCE the original model of the 115 kilocycle superheterodyne with shielded grid tubes was described in January RADIO, work has been continued with the idea of improving it where possible. Naturally, by continued experiment with the circuit, certain improvements are bound to be discovered, and it is intended to publish these whenever it seems advisable.

In the schematic wiring diagram, Fig. 1, are shown two minor changes which will benefit those who have already built the receiver, and will enable those who are contemplating its construction to change the original wiring diagram.

The principal improvement is to install a jack switch on the front panel, preferably to the left of the group of controls at the center of the panel, to cut out the oscillator, intermediate frequency amplifier stages and the detector, when receiving local stations. The switch is of the double pole-double throw variety, and has six contacts. The output of the mixer tube, which is the plate terminal, is connected to the center blade of one set of contacts, and the two springs associated with this blade are connected to the primary plate terminal of the first audio transformer and the input to the intermediate frequency amplifier. In this way, the output of the mixer tube is fed either to the intermediate frequency amplifier, or the audio frequency amplifier, so that in the case of the latter, the mixer tube serves as a detector, and the receiver has only five tubes, with two stages of shielded grid r.f. amplification, detector and two stages of audio frequency amplification.

This is adequate for practically any type of local reception and prolongs the life of the four tubes not used as well as cutting down on the total current consumption of the set. This method has been employed in several receivers in the past, notably the infradyne, with excellent results, and to convert the receiver into a superheterodyne for extreme selectivity and distance, it is only necessary to turn the switch. The other set of contacts in the switch is used to break the filament circuit to the four tubes not wanted for local reception, the method of wiring being shown on the diagram.

One precaution should be observed in using this switch, in that when the filament voltage for the eight 3-volt tubes is adjusted to the proper value,

if the switch is operated and four of the tubes cut out, a current drain of .36 amperes is removed from the 10 ohm rheostat, and the voltage to the remaining 3-volt tubes will rise by several tenths of a volt, necessitating a readjustment of the rheostat to avoid overloading the tube filaments. If an A battery eliminator is used, so that the current drain in the filament circuit is of no object, a 10 ohm fixed resistance may be connected as shown in the diagram, and no fluctuation in filament voltage will occur for either setting of the switch, since the fixed resistance will draw about the same amount of current as the four tubes which have been cut out of the circuit. The argument might immediately be raised as to the necessity of installing the switch if no saving in A current is to be made, but this is really a minor consideration, since the main saving is in longer life for two shielded grid tubes, which are expensive, and in making the receiver a one-dial set for locals, which would undoubtedly be appreciated by the other members of the family who may not be expert in the operation of a two dial set.

If trouble is had from oscillation when the switch is connected, an r.f. choke of at least 3 m.h. inductance may be connected in series with the wire from the audio transformer primary to the switch, at the point marked in dotted lines. It may also be necessary to connect a .0005 mfd. by-pass condenser between this wire, at the switch, and the shield cans, in extreme cases.

Another improvement is the installation of regeneration in the mixer tube circuit. It is a well known fact that in any tuned r.f. receiver the tuned circuit next to the detector tube is broader than the other tuned circuits, due primarily to the effect of the grid condenser and leak in the detector grid. By introducing a small amount of regeneration in the input to the mixer tube, this tuned circuit can be made much sharper, so that the overall selectivity of the front end amplifier is improved to a noticeable degree.

A fixed tickler coil has been found the most satisfactory, the method of connecting the coil being shown in Fig. 1. To control the amount of regeneration, a variable 2000 ohm resistance is shunted across the coil. When the resistance is at maximum, the greatest amount of regeneration is obtained, and when set

at minimum, there is no resistance whatsoever. In order to install the tickler coil in the receiver with a minimum amount of changes, a new coil has been developed, in the same style as the oscillator coil, with six terminals, using a special bakelite terminal strip which is placed over the coil socket and has two springs at each side which engage the extra pair of contacts on the coil. This transformer has been coded No. 564, and in building a new receiver, it should be ordered in place of the No. 560 normally used.

Old No. 560 coils may be converted by first removing the secondary winding and winding on 114 turns of No. 25 double silk wire in the form of a solenoid, similar to that of the antenna coil. Remove the primary by unscrewing the two prongs in the coil base which hold it in place, and take off 150 turns of the primary winding, leaving a total of 100 turns. On a 1¼ in. tube about 1 in. long, wind 18 turns of No. 25 double silk wire for the tickler, and mount it in the top of the tubing supporting the secondary, bringing out the tickler terminals to the two soldering lugs mounted on the outside of the secondary.

With the No. 564 coil a bakelite fitting will be included, so that the only change which need be made in the circuit is to wire in the tickler coil by disconnecting the wire going from the plate of the mixer tube to the pickup coil in the oscillator circuit, and running the plate lead first to the tickler coil, and from there to the oscillator pickup coil.

The 2000 ohm variable resistance, which may be any standard make, is mounted on the front panel in place of the 200 ohm potentiometer. The latter, when once adjusted, is seldom used, and hence can be mounted on the baseboard between the two drum dials. This can be done by means of a small strip of brass bent in the form of a bracket, or it can be bent back from the panel and supported by its connecting wires in the case of an installation which has already been completed.

The primary turns are removed from the input coil to the mixer tube because this augments the improvement obtained by introducing regeneration. It need not be done if the selectivity is already up to the requirements of the particular location of the receiver. In order to make all three coils match accurately with the three gang condenser, the other



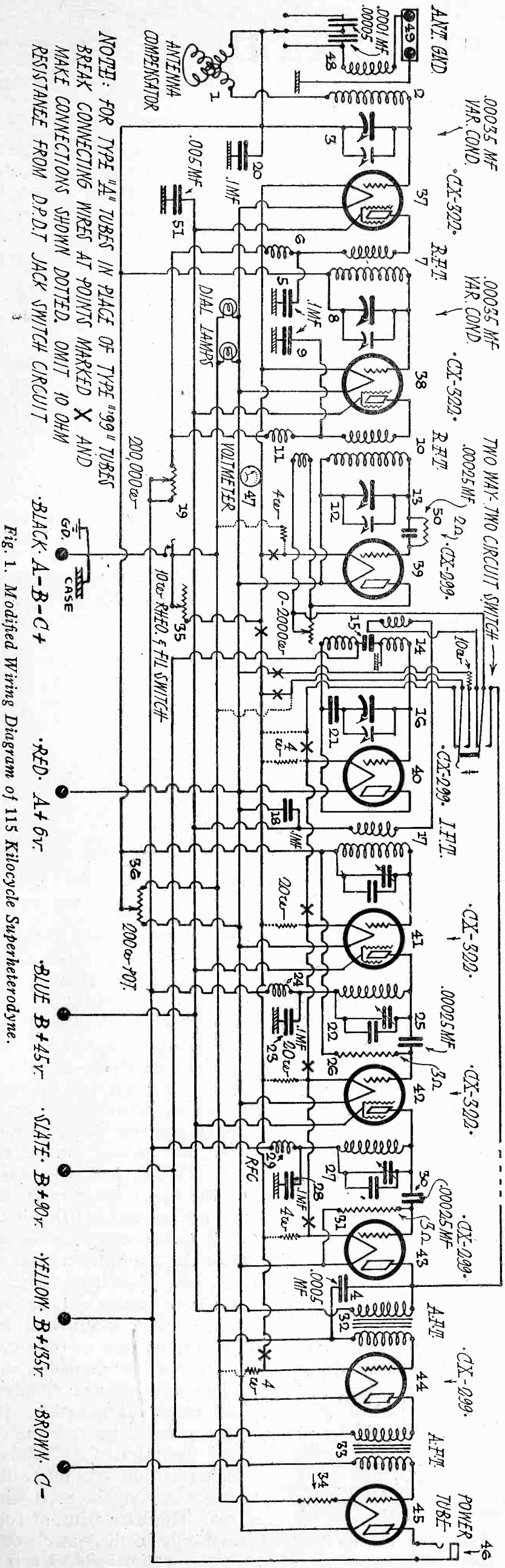

Fig. 1. Modified Wiring Diagram of 115 Kilocycle Superheterodyne.

No. 560 coil secondary should be re-wound into a solenoid, using 114 turns of No. 25 double silk. In the case of a new installation, a No. 562 coil may be purchased with the changes already made. It should be understood that the above change is for the purpose of improving the selectivity under adverse conditions, and slightly increasing the range of the receiver, and will be of most interest to the DX hounds.

It should also be noted that the two shielded grid tubes in the tuned r.f. amplifier may have their grid returns connected to the slider of the 200 ohm potentiometer, in parallel with the grid returns of the two i.f. amplifier tubes, and thereby avoid the use of the C battery normally required. It has been found that no difference in the operation of the r.f. amplifier occurs with this change, and it has been incorporated in the circuit diagram, Fig. 1.

Judging from the letters which have been received from some of our readers, there still exists a certain amount of prejudice against using the type 99 tube as a detector or first audio amplifier, and questions are asked as to the changes necessary in the circuit to incorporate A tubes in the mixer, oscillator, detector and first audio sockets. To meet this request, Fig. 1 shows the necessary modifications in dotted lines, the connections being broken at the points marked X and new connections made to follow the dotted lines. A fixed filament resistance or automatic filament control of 4 ohms each should be used to control the detector and first audio tubes, and resistances of 4 ohms each of the same type for the oscillator and mixer tubes. No other changes need be made in the circuit, except that the resistance connected in the jack switch circuit for equalizing the voltage in the filament circuit will have to be omitted.

In defense of the type 99 tubes and their use in the 115 kilocycle super, it may be said that a type 99 tube, with 90 volts plate and  $4\frac{1}{2}$  volts negative grid, will overload a type 210 tube operating at maximum plate voltage and negative grid potential, when a transformer of 2:1 ratio or higher is connected between the 99 and 210 tubes. This is standard practice in the Victor Electrola and the Brunswick Panatrop, the two leading electric phonographs, where the amplifier consists of a type 99 and a type 210 tube, and there is no overloading whatsoever of the 99 tube, nor any evidence of distortion. If the 99 tube will overload the power stage, it goes without saying that the same tube as a detector will overload a 99 tube 1st stage when operating at maximum output, and thus there will be absolutely nothing gained by using the A tube. Since the shielded grid tube is a 3 volt tube, it is obviously best from the stand-

(Continued on page 34)



# Coil Construction

By Byron G. Wade

**S**ELF-SUPPORTING inductance coils can easily and cheaply be constructed by following the instructions here given. The materials needed are: 4 oz. amyl acetate, 4 oz. acetone and a piece of celluloid about 3x5 in. square and 1/32 in. thick. Pour 3 oz. each of the amyl acetate and acetone into a 10 oz. bottle, into which also are put narrow strips of the celluloid, corking the bottle tightly. Shake this occasionally and allow to stand for 24 hours, when the solution should be about the consistency of molasses. If it is too thick it may be thinned by adding equal parts of the amyl acetate and acetone.

Next you will need a sheet of thin celluloid. It should be of sufficient width to equal the length of the coil and an inch or so longer than the circumference of the coil.

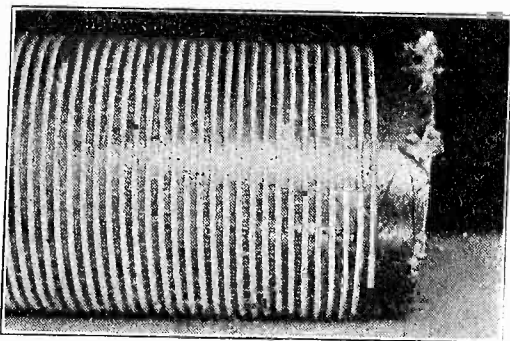

*Space-Wound Coil After Spacing Wire Is Removed.*

Several old 5x7 cut-film negatives may be cleaned by soaking in a solution of baking soda and hot water. Let them soak four or five minutes, then remove the emulsion from one side and the gelatine from the other by brushing with a stiff bristle brush. Rinse them in warm water and dry with a towel. Sheets of celluloid prepared in this manner are better than the thicker celluloid used for automobile side curtains as they are much thinner and easier to handle.

A good cement may be made by mixing 1 oz. each of amyl acetate, acetone and acetic acid (glacial) in the order named. Apply this solution with a small water color brush to one side of the celluloid to be cemented and press the area of the two sheets of celluloid firmly together with the fingers, taking pains to force out as many of the air bubbles as possible. This patch will dry in two or three minutes and if properly made, cannot be torn apart.

A piece of cardboard tubing as large as the diameter and as long as you want the coil is now needed. Some method must be devised to turn the tubing while winding the wire on it. This can be done by taking a brass or soft iron rod long enough to extend some distance beyond each end of the tubing and bending a crank at one end. Cut some wood-

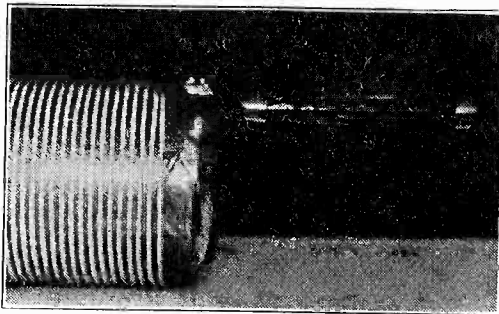

*Separating the Celluloid from the Tubing With a Knife.*

en plugs to fit each end of the tubing and bore a hole through these large enough for the rod. With a supporting bearing at each end you will have an efficient coil winder.

The coil is wound solid with no space between the turns. When this is completed fasten each end of the wire to the tubing so there is no chance of the wire loosening. Apply three coats of celluloid solution (first solution named), allowing each to dry for one hour. After the third coat has been applied, allow it to dry three hours.

By inserting an ice-pick or a screwdriver between the wire and the tubing on one end, you can mash the tubing inward. With a long-nosed pair of pinchers get a firm grip on the part forced away from the wire and twist it until the tubing rolls up and comes out, leaving the wire standing, bound together by the celluloid coating on the outside. It will be very rigid and no amount of bending will cause it to unravel. A coil wound this way can be cut up and used as desired.

Another method of winding is to use the thin celluloid sheeting for support. The desired width of celluloid is wrapped around the cardboard tubing and the ends allowed to lap about 1/4 in. Apply the celluloid cement to one edge, press the surfaces together, still leaving it on the cardboard tubing. When the patch is dry you may proceed to wind the wire over the celluloid and apply the celluloid solution in the same manner as before. This method has the advantage of being more rigid than the previous one. At the same time the celluloid lining allows the smaller coils that are also lined to be mounted inside the

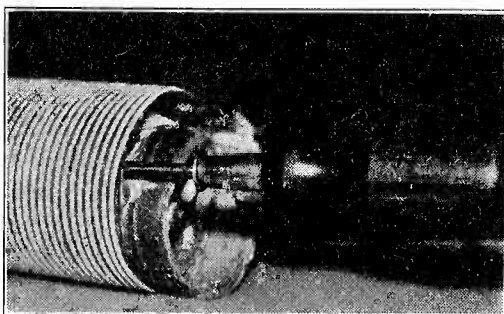

*Crushing the Cardboard Tubing Prior to Removal.*

larger. By using strips of celluloid and cement it can be done easily.

Space-wound inductances require more care and skill. Prepare the tubing, place the celluloid sheeting around it, and cement the edges together. Instead of winding it with one wire, divide the wire so that you have two separate wires each long enough to wind half the length of the coil. Fasten the ends of both wires into the tubing, wind the coil with both wires side by side, keeping the turns very tight. When the wire is on, fasten the end of one wire to the tubing and unwind the other, being careful not to displace the remaining wire. This done, apply the celluloid solution, but use more care in order not to spoil the spacing. It is advised to brush around

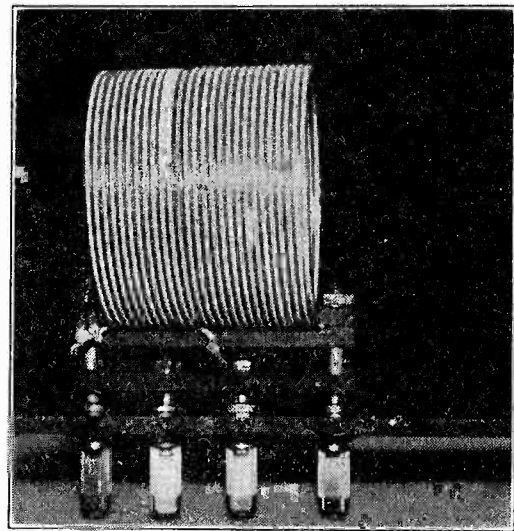

*Piece of Finished Coil Mounted for Use.*

the coil rather than lengthwise. The coil needs only one application of the celluloid solution. If more is applied it is likely that the celluloid sheeting will dissolve, making it difficult to remove the coil. Both this, and the other coil containing celluloid on the inside, can usually be removed by running a knife blade in between and around the celluloid and the tubing at each end. As a rule, the tubing can be readily pulled out. If not, you have merely to resort to the first method of crushing the tubing inward and twisting it out.

It is not necessary to use a spacing wire the same size as the other; in fact you may use a size to give any desired width of space. String is not recommended as it is soft and does not make for even spacing of the turns.

Do not use enameled wire. The celluloid solution will dissolve the enamel and cause discoloration. It is unnecessary to use it because the celluloid solution itself forms an insulating coating. Either cotton covered, silk covered or bare wire may be used with equal success. The bare wire, of course, is to be used only in the space wound coil. The

*(Continued on page 42)*







ing the panel. The panel can be fastened to the baseboard with screws and a couple of small brass angles as shown.

The picture shows the method of mounting the r.f. coils and wiring. All of the wiring is done with No. 18 dcc. bell wire from hole to hole in the baseboard. This type of wiring is done by first screwing down all parts to the baseboard and then drilling  $3/32$  or  $1/8$  in. holes through the baseboard near all socket, coil, etc., terminals. All of the battery leads possible should be run in before the panel is fastened to the baseboard.

#### LIST OF PARTS FOR FOUR-TUBE RECEIVER

- 1—Tandem variable condenser, .00035 mfd. per section
- 1—Variable .00035 mfd.
- 1—Midget variable, 50 mmfd.
- 2—Audio transformers
- 1—Audio output transformer
- 4—Tube sockets and tubes
- 3—R.F. transformers
- 2—R.F. chokes, 85 millihenry
- 1—X-L variocoupler, .001 mfd. maximum
- 7—Binding posts
- 1—18x9x $1/2$  in. panel
- 1—18x7x $3/16$  in. panel
- 2—Vernier dials
- 1—Combination filament switch and volume control
- 1—Rheostat, 10 ohms
- 2—Amperites, 1A and 4A
- 2—By-pass condensers, 1 mfd.
- 1—Grid condenser, .0001 mfd.
- 2—Leaks, 2 meg. and 5000 ohms

When the set is ready for operation with tubes in their sockets, the condensers  $C_4$  and  $C_5$  should be set for about half value and the tuning condensers varied until a local station is picked up.  $C_4$  and  $C_5$  can be adjusted partially on local stations but the final adjustment should be made on distant stations.  $C_4$  should be set at a small enough value so that the r.f. tube does not oscillate when the volume control rheostat is cut clear out, that is for maximum volume.  $C_5$  should be adjusted with a screw driver until the detector will just oscillate any place over the whole tuning range when the regeneration control  $R_2$  is cut clear out, that is zero resistance.

In the set shown in the picture, a .0005 condenser was used for  $C_1$  but a .00035 mfd. will cover the broadcast band.

## WHICH POWER TUBE TO USE

By Arthur Hobart

The choice of a tube to give the greatest power output in the last stage of a transformer-coupled audio frequency amplifier depends upon several factors. These include not only the available plate voltage, but also the grid voltage delivered from the previous stage and the load resistance of the loudspeaker.

A loudspeaker requires power for its operation and not merely voltage, as do the vacuum tubes used in the previous stages. The greater the power output in watts which the tube can deliver, the greater the volume of sound from the speaker. It has been determined that a tube delivers its maximum undistorted output to a load whose impedance is twice the plate impedance of the tube, assuming that the plate and grid voltages are adjusted to the optimum values.

The impedance of the coils in the loudspeaker or output transformer depends upon the audio frequency. For the average cone speaker it varies from 1000 ohms at zero frequency (direct current) to 30,000 ohms at 5000 cycles. The impedance of a tube depends on the plate voltage, decreasing as the voltage increases. A 71 tube has the lowest impedance, 2000 ohms at 180 volts plate, which is about one-third that of the other power tubes. Consequently, it is necessary to use an output transformer, having an impedance of at least 4000 ohms, not only to prevent d.c. current from burning out the speaker windings, but also to give maximum volume. Some manufacturers are now making output transformers designed for use with a specific power tube.

The average loudspeaker requires about 100 milliwatts (0.1 watt) to give good volume for a small room. By having reserve power up to 500 milliwatts, sufficient volume may be secured for a large room or for dancing. Such additional power may also be needed to actuate a non-sensitive speaker or to

maintain volume as  $B$  batteries drop in voltage. A standard public address system, such as is used for large auditoriums, deliver from 30 to 50 watts.

Four types of tubes are generally used as power amplifiers, the 20, 12, 71 and 10. Their impedances at 135 volts plate are respectively 6600, 5000, 2200 and 8000 ohms. Consequently the 20 tube seems to be best adapted for use with a loudspeaker or output transformer having an impedance of 13,200 ohms, the 12 for one of 10,000 ohms, the 71 for 4400 ohms and the 10 for 16,000 ohms. It is customary to measure these impedances at a frequency of 1000 cycles. None of the other standard tubes, except the a.c. 26 or 27 are able to deliver 100 milliwatts.

The 12 and 71 types require  $1/2$  ampere filament current at 5 volts. The 12A and 71A tubes take  $1/4$  ampere at 5 volts, being otherwise similar in characteristics to the  $1/2$  ampere types. The 10 tube requires  $1 1/4$  amperes at  $7 1/2$  volts for filament supply. The 20 tube is not a true power amplifier but is used in sets limited to a 3-volt filament supply. It is capable of giving an undistorted power output of 105 milliwatts at 135 volts  $B$ ,  $22 1/2$  volts  $C$ , and 26 volts peak input from the previous stage.

The output power varies as the square of the input voltage. Thus doubling the voltage on the grid of a power tube quadruples the power in the plate circuit. As the average output of a detector tube is only about 0.3 volt, it is not sufficient to give 100 milliwatts from any tube. A preceding audio stage is necessary to give sufficient input voltage to the power stage.

To determine the input voltage is a matter of simple calculation for a two-stage amplifier when the amplification factor of the first tube and the voltage ratios of the transformers are known. Merely multiply the detector output voltage by the amplification factor by .9,

(Continued on page 46)

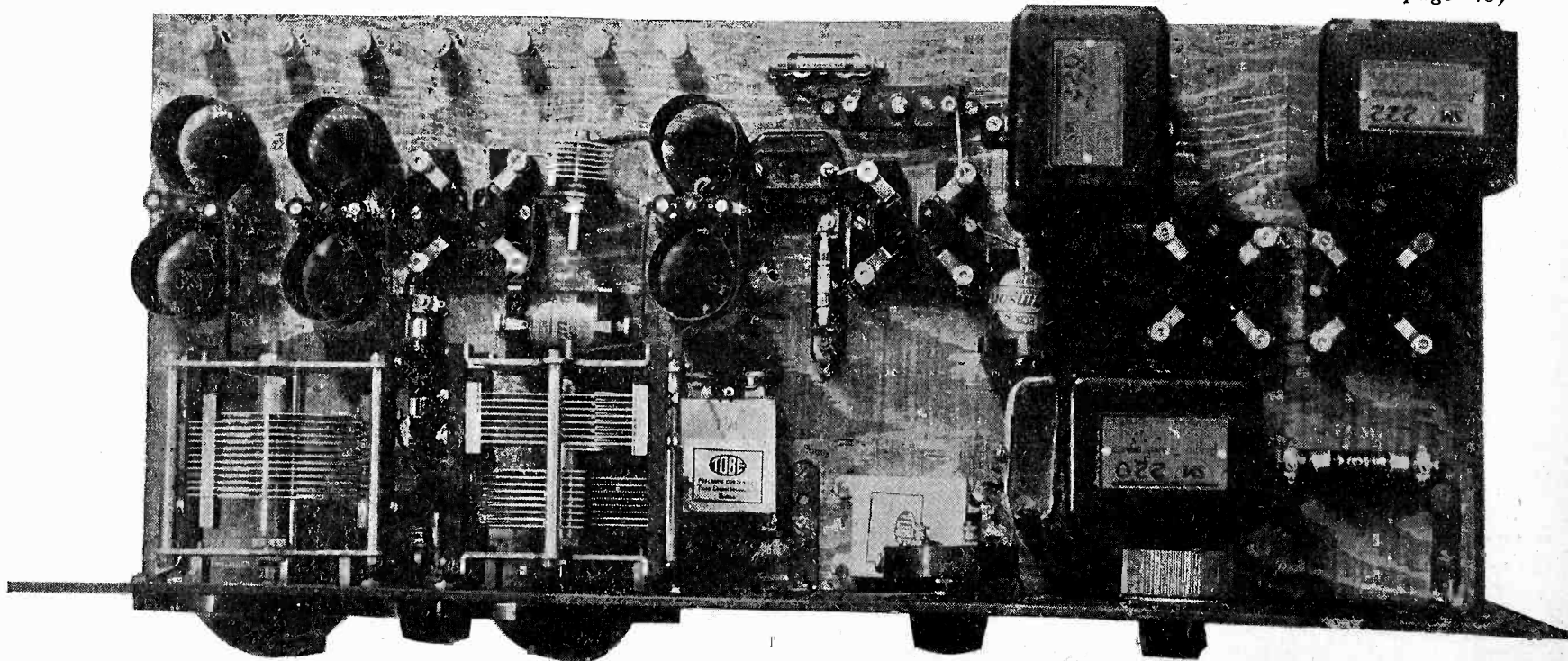

Top View of Four Tube Capacity Coupled Receiver.



# The Jungle SOS

By P. J. Clark



"A pair of piercing black eyes fixed in a steady gaze upon a large snake."

"**A**W COME on Joe, let's go, maybe we won't get another chance to see this place and then you'll be sorry." Bill Weston had been urging his pal, Charlie Bell, to make a trip to Kandy, a town perched on a mountain about seventy-five miles above Colombo.

"Not a chance, Bill," replied Charlie, "You know every time we take one of these trips we end up with broken heads or missing the ship. Nothing doing; this time I'm going to stick around and enjoy the scenery from the dock."

The pals were radio operators on the round-the-world cruiser *Evolution*, which had docked at Colombo the night before. It seemed that every time the two shipmates went ashore together something thrilling was bound to happen to them.

"Just think of all the things we will miss if we don't go," pursued Bill. "They are going to have that big Indian religious parade and festival, and I hear that the tourist agency has picked the Queens Hotel for the night. Boy! Just think of a chance to stretch out in a real bed for a change."

A big grin spread over the face of young Bell, for sleep was his long suit and if nothing else would induce him to give in, the mention of a real bed would always bring him to see the reasoning in his pal's arguments.

"Well, maybe it wouldn't be such a bad idea at that, Bill," answered Charlie. "But if we go I am going to pack that little portable outfit with me. You never can tell when it might come in handy."

"**W**ELL, we're off and nothing has happened yet, old wet blanket," shouted Bill, as the big Apperson eight made the first of the turns in the high winding roadway which led to the mountain town.

"Don't crow yet young fellow, the day is just starting," retorted Charlie, and then grabbed for a support as the big car gave a lurch and careened dangerously. The driver had spun the wheel to escape running through a flock of chickens which had wandered onto the highway.

The ride continued without mishap and they finally arrived at an old estate about half way up the mountain, part of which had been set aside for a zoo. After looking over the wild animals their curiosity was aroused by several boxes with open tops, over which a piece of wire screening was thrown. Under the screening of each box was a hooded cobra.

Crouched on his heels near one of the boxes was an old native whose sole duty was to guard the snakes. The rest of the employes fought shy of him as one possessed of the devil. His outstanding

feature was a pair of piercing black eyes, now fixed in a steady gaze upon a large snake in a box close by. The snake, with a weaving motion, was slowly lifting its diamond shaped head, its beady eyes set full upon those of the old man.

Suddenly, with a low guttural sound and displaying more agility than he seemed capable of, the old man sprang to his feet, grabbed an elephant pike, and made a wild lunge at Bill Weston. Bill, at that moment, was backing away from a snake which writhed in death from a blow which he had just struck. Several of the zoo attendants leaped forward and intercepted the madman, who retreating, muttered threats in his native tongue.

"Gosh, Bill, I had a mighty close call that time," gasped Charlie. The cobra had been within striking distance of him and was coiled for a spring when Bill had jumped and killed it. "Where did that thing come from?" he continued, pointing to the dead reptile.

"It must have just slipped in from the jungle," replied Bill, "I've heard that they follow the scene of their kind and I suppose this fellow was just curious. But what do you think made that old guy rush at me like that?"

"I guess his mind must be off, taking

(Continued on page 37)



# Filters

By Samuel G. McMeen

**I**N chemistry a filter is a sheet of paper or a pledget of absorbent cotton in a glass funnel, for the purpose of letting through a liquid and stopping solids. In ventilating engineering, a filter is a device that will pass air and stop solid matter. In electrical engineering, a filter is a combination of inductances and capacitances that will let through certain frequencies of current and stop other frequencies.

The arrangement of these elements varies with the intended use, whether for quieting the output of a motor-generator in a transmitting set or for multiplex transmission of speech. In all possible arrangements the inherent qualities of the inductance and capacitance elements assert themselves, in that the capacitances pass the alternating currents with the least change when they are of high frequency and the inductances with the least change when they are of low frequency.

The water analogy for electrical actions often fails or is only partially exact, but the mental picture of a filter

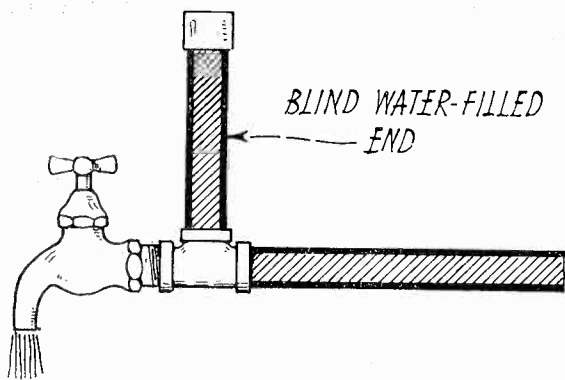

Fig. 1. Water Hammer.

may be assisted by Fig. 1, in which a length of water-carrying pipe is shown as constituting a water hammer. Whenever the water is allowed to flow from the faucet and then is shut off, a resounding thump is heard, due to the sudden change in pressure at the blind end.

The inertia of the water is responsible for the thump, and advantage is taken of that property in the hydraulic ram, which, as shown in Fig. 2, has an ad-

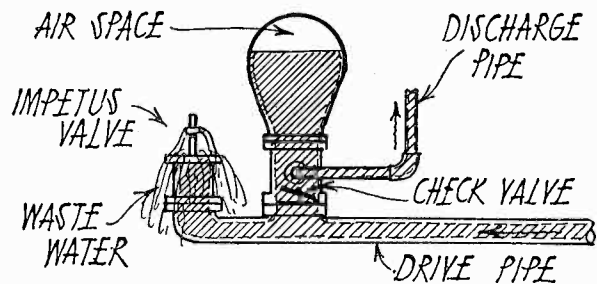

Fig. 2. Hydraulic Ram.

ditional element in the air chamber at the top. Just as the water column has inertia, so has the inductance in a filter. Just as the air chamber has elasticity,

so the condenser cares for the high frequencies. The ram as a whole offers a fair analogy of a complete electrical filter.

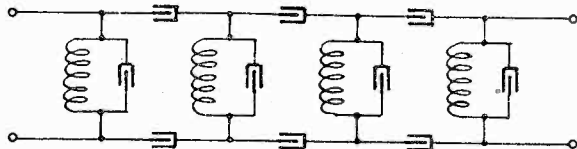

Fig. 3. Typical Carrier System Filter.

Fig. 3 shows the arrangement of inductances and capacitances making up a typical carrier circuit filter. It will be observed that there are only capacitances in the series circuit of the two wires of the line, and that the shunt bridges are composed of inductances and capacitances, themselves respectively in shunt with each other. This arrangement constitutes a band pass filter, and is sketched from a filter designed to pass the upper side band of a carrier of 9000 cycles or the lower side band of a carrier of 11,000 cycles. All frequencies outside the band for which the filter is transparent are excluded by the joint action of the inductances and capacitances.

Just as it is possible to exclude all but the frequencies of a certain band, so one can shut out all frequencies below a certain point, and so have a filter especially adapted to pass high frequencies only. Such a device is known as a high pass filter, and, as would be the natural and expected technique, has capacitances in series with the two wires of the line and inductances in shunt. The capacitances let through the high frequency alternations and the inductances by-pass the low frequency alternations. As a result, the lower frequencies are either choked out or are shunted out, and so never get over into the output side of the filter. See Fig. 4.

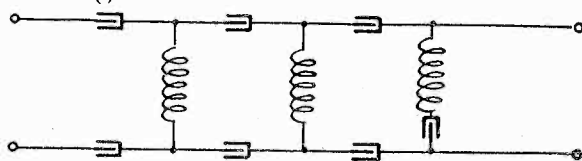

Fig. 4. High-Pass Filter.

Utilizing the same fundamental qualities of inductances and capacitances, placing the inductances in series with the line and the capacitances in shunt, gives a low pass filter, for in this arrangement the lower frequencies are allowed to go through and the higher frequencies are shunted out by the condensers. See Fig. 5.

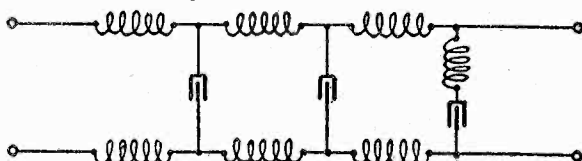

Fig. 5. Low-Pass Filter.

In the problem of smoothing out the ripples in the output of a motor-generator, the solution must be reached by the cut-and-try method, because the nature and amount of noise cannot be measured and described. The cure in almost all cases, however, consists in placing an inductance in series with the leads from the generator and condensers across those leads. Often it is of advantage to divide the capacitance and put a part of it next to the generator and the rest after the inductance.

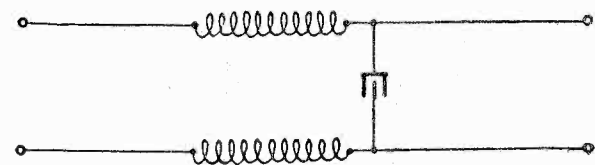

Fig. 6. Filter for Motor-Generator.

The matter of the condensers is simple, as they must be bought in any case and their values are additive when used in parallel. The inductances or chokes present more of a problem, and we are glad to reproduce, through the courtesy of the American Radio Relay League, a page from QST and the Radio Amateur's Handbook, which gives full data concerning chokes. It covers fully the range required for inductances for filters for motor generators and rectified alternating current.

## RADIO PICTURES

Radio reception of still pictures in the home is now an accomplished fact and will be common practice by the end of this year. Several eastern stations, including WEA, WGY and WOR, are transmitting pictures on their regular speech channels, and others are preparing for transmission on short wave lengths.

Full details of the receiving equipment are not yet available but will be published in the near future. The general principle of operation is reception, detection and amplification of a carrier wave which has been modulated by variations in light intensity instead of sound. The output of the amplifier, instead of being fed to a loud speaker, is applied to the terminals of a sensitive lamp, such as the Moore neon lamp, which converts variations in electrical current into variations in light intensity.

These variations in light intensity pass through holes in a revolving disc onto a sensitive photographic film upon which is impressed a picture similar to that sent from the transmitting station. This is photographically developed to give the picture. The most difficult problem is to attain synchronization.



DESIGN DATA FOR INDUCTANCE COILS WITH IRON CORES. Weight of Steel taken as  $480 \frac{\text{lbs}}{\text{cu. ft.}} = 0.28 \frac{\text{pounds}}{\text{cubic inches}}$

CORE SIZE	INDUCTANCE	EQUIV GAP	*ACTUAL	GAP	NO. TURNS	FLUX DENS.	WINDING FORM	MEAN TURN	FEET OF WIRE	RESISTANCE (D C)	WEIGHT OF COPPER	CORE DIMENSIONS		POUNDS STEEL	
												Long Piece	Short Piece		
Cross Section	HENRYS	(G)	Decimals	Nearest Fraction	(N)	(B) Lines to inch	b	c	inches	WIRE	(D C)	COOPER	Long Piece	Short Piece	STEEL
1/2 x 1/2	0.5	.040"	.017"	1/64"	1600	6500	0.42"	0.28"	3.0	400	82.5	1.00z	1/2 x 1.6"	1/2 x .50"	0.30
	1.0	.041	.019		2300	9000	0.50	0.33	3.2	615	127.0	1.5 "	1/2 x 1.7	1/2 x .55	0.31
	5.0	.043	.023		5200	20000	0.75	0.50	3.8	1670	345.0	4.0 "	1/2 x 1.92	1/2 x .75	0.37
	10.0	.046	.030	1/32"	7600	27000	0.90	0.60	4.2	2640	545.0	6.5 "	1/2 x 2.1	1/2 x .85	0.41
	15.0	.048	.035		9500	32000	1.00	0.68	4.5	3510	725.0	8.5 "	1/2 x 2.2	1/2 x .85	0.43
3/4 x 3/4	5.0	.043"	.023		3500	13000	0.62"	0.42"	4.5	1310	271	3.25oz	3/4 x 2.4	3/4 x .75	1.0
	10.0	.046	.030		5000	18000	0.73	0.49	4.75	2000	411	5.0 "	3/4 x 2.5	3/4 x .75	1.0
	15.0	.048	.035		6300	21000	0.82	0.55	5.0	2630	544	6.5 "	3/4 x 2.6	3/4 x .75	1.05
	20.0	.052	.044	3/64"	7600	24000	0.91	0.60	5.2	3280	678	8.0 "	3/4 x 2.7	3/4 x .85	1.1
	50.0	.070	.100	7/64"	14000	33000	1.25	0.83	6.0	7000	1445	1LB 1 "	3/4 x 3.0	3/4 x 1.0	1.25
1 x 1	10.0	.046"	.030	1/32"	3800	14000	0.64"	0.43"	5.6	1760	364	4.25oz	1 x 3.0	1 x .75	2.1
	15.0	.048	.035		4800	16000	0.69	0.49	5.8	2310	478	5.5 "	1 x 3.0	1 x .75	2.1
	20.0	.052	.044	3/64"	5700	18000	0.78	0.52	5.9	2800	580	6.75 "	1 x 3.1	1 x .75	2.2
	50.0	.070	.100	7/64"	11000	25000	1.10	0.75	6.7	6130	1270	15.0 "	1 x 3.5	1 x 1.0	2.5
	100.0	.100	.250	1/4"	18000	29000	1.40	0.93	7.4	11000	2280	1LB 10 "	1 x 3.8	1 x 1.1	2.75
2 x 2	100.0	.100"	.250	1/4"	8900	14000	0.97"	0.65"	10.4	7700	1590	1LB 3oz	2 x 5.5	2 x 1.0	14.5
1/2 x 1/2	0.5	.040"	.017	1/64"	1600	13000	0.55"	0.38"	3.4	450	46	2.20z	1/2 x 1.6	1/2 x 0.63	0.31
	1.0	.041	.019		2300	18000	0.66	0.45	3.6	700	72	3.5 "	1/2 x 1.75	1/2 x 0.70	0.35
	5.0	.043	.023		5200	39000	1.00	0.68	4.5	1950	200	9.5 "	1/2 x 2.10	1/2 x 0.95	0.43
	1.0	.041"	.019		1500	12000	0.53"	0.37"	4.3	540	56	2.70z	3/4 x 2.10	3/4 x 0.63	0.87
	5.0	.043	.023		3500	26000	0.83	0.56	5.0	1470	151	7.2 "	3/4 x 2.5	3/4 x 0.80	1.05
10.0	.046	.030	1/32"	5000	35000	1.00	0.67	5.4	2250	230	11.0 "	3/4 x 2.6	3/4 x 0.95	1.12	
1 x 1	5.0	.043"	.023		2600	20000	0.71"	0.49"	5.8	1250	130	6.10z	1 x 2.8	1 x 0.75	2.0
	10.0	.046	.030	1/32"	3800	27000	0.86	0.58	6.1	1940	200	9.5 "	1 x 3.0	1 x 0.85	2.2
	15.0	.048	.035		4800	32000	0.96	0.65	6.4	2550	260	12.5 "	1 x 3.1	1 x 0.90	2.25
	10.0	.046"	.030	1/32"	1900	13000	0.60"	0.42"	9.5	1500	160	7.5oz	2 x 4.66	2 x 0.60	11.5
	15.0	.048	.035		2400	16000	0.68	0.46	9.7	1900	200	9.5 "	2 x 4.75	2 x 0.66	12.3
20.0	.052	.044	3/64"	2900	18000	0.75	0.51	9.8	2400	250	11.5 "	2 x 4.85	2 x 0.75	12.5	
50.0	.070	.100	7/64"	5300	24000	1.00	0.70	10.5	4600	480	1LB 6.5 "	2 x 5.50	2 x 0.95	14.0	
100.0	.100	.250	1/4"	8900	28000	1.33	0.90	11.2	8300	860	2LB 8 "	2 x 5.90	2 x 1.15	16.0	
1/2 x 1/2	0.5	.040"	.017	1/64"	1600	32000	0.90"	0.60"	4.2	550	22.5	7oz	1/2 x 2	1/2 x .85	0.40
	1.0	.082	.120	1/8"	3200	32000	1.30	0.85	5.1	1350	55	1LB 1 "	1/2 x 2.5	1/2 x 1.10	0.50
	0.5	.040"	.017	1/64"	1000	21000	0.72"	0.46"	4.7	390	16	5oz	3/4 x 2.3	3/4 x 0.71	0.96
	1.0	.041	.019		1500	30000	0.90	0.58	5.1	640	26	8 "	3/4 x 2.5	3/4 x 0.83	1.05
	1.0	.041"	.019		1100	22000	0.75"	0.50"	5.8	530	22	6.5oz	1 x 2.9	1 x 0.75	2.10
5.0	.086	.170	1/64"	3700	35000	1.40	0.92	7.3	2260	92	1LB 12 "	1 x 3.6	1 x 1.20	2.7	
2 x 2	5.0	.043"	.023	1/4"	1300	23000	0.82"	0.53"	9.7	1050	43	13oz	2 x 4.9	2 x 0.80	12.7
	10.0	.050	.040	1/64"	2000	32000	1.05	0.68	10.5	1750	71	1LB 6 "	2 x 5.2	2 x 1.0	13.8
	15.0	.096	.200	13/64"	3300	28000	1.35	0.86	11.1	3060	125	2 " 6 "	2 x 5.5	2 x 1.1	14.7
	20.0	.104	.280	9/32"	4000	32000	1.43	0.95	11.5	3820	156	2 " 15 "	2 x 5.6	2 x 1.2	15.2
	10.0	.046"	.030		1300	22000	0.81"	0.53"	14.0	1510	62	1LB 3oz	3 x 6.9	3 x 0.8	39
15.0	.048	.035		1600	26000	0.90	0.60	14.2	1900	77	1 " 7 "	3 x 7.0	3 x 0.85	40	
20.0	.052	.044	3/64"	1900	30000	1.00	0.65	14.4	2300	93	1 " 12 "	3 x 7.1	3 x 0.9	41	
50.0	.140	.330	1/3"	5000	28000	1.60	1.10	15.9	6600	270	5 " 2 "	3 x 7.8	3 x 1.35	46	
100.0	.200	.600	19/32"	8400	34000	2.10	1.40	17.0	12000	485	9 " 3 "	3 x 8.3	3 x 1.65	50	
1/2 x 1/2	0.5	0.16"	.35	1/32"	3200	32000	1.80"	1.20"	6.4	1700	35	2LB 10oz	1/2 x 3	1/2 x 1.45	0.62
	0.5	0.08"	.170	1/64"	1480	30000	1.25"	.83"	6.0	735	15	1LB 2oz	3/4 x 2.9	3/4 x 1.1	1.26
	1.0	0.16	.35	1/32"	3000	30000	1.75	1.20	7.2	1800	37	2 " 13 "	3/4 x 3.5	3/4 x 1.5	1.6
	0.5	0.04"	.02	1/64"	800	32000	0.90"	0.60"	6.2	410	8.5	0LB 10oz	1 x 3.0	1 x 0.85	2.2
	1.0	0.082	.17	1/64"	1600	31000	1.30	0.85	7.1	945	19	1 " 8 "	1 x 3.5	1 x 1.0	2.5
5.0	0.387	.75	3/4"	7800	32000	2.90	1.90	11.0	7000	143	10 " 14 "	1 x 5.2	1 x 2.2	4.2	
2 x 2	1.0	0.041"	.019		560	22000	0.75"	0.50"	9.8	460	9.4	0LB 12oz	2 x 4.9	2 x 0.75	12.7
	5.0	0.086	.17	1/64"	1800	32000	1.35	0.90	11.3	1700	35	2 " 10 "	2 x 5.5	2 x 1.15	15.0
	10.0	0.184	.40	13/32"	3800	33000	2.00	1.30	12.8	4100	83	6 " 6 "	2 x 6.2	2 x 1.5	17.3
	5.0	0.043"	.023		860	30000	1.00"	0.60"	14.2	1000	21	1LB 10oz	3 x 7.1	3 x 0.85	40.0
	10.0	0.092	.20	13/64"	1840	31500	1.40	0.92	15.3	2350	48	3 " 10 "	3 x 7.5	3 x 1.15	43.5
15.0	0.130	.30	19/64"	2620	32000	1.65	1.10	16.0	3500	71	5 " 7 "	3 x 7.8	3 x 1.4	46.0	
20.0	0.175	.38	3/8"	3500	32000	1.90	1.25	16.6	4850	99	7 " 8 "	3 x 8.1	3 x 1.5	48.0	
50.0	0.432	.80	13/16"	8700	32000	3.00	2.00	19.2	14000	282	21 " 8 "	3 x 9.3	3 x 2.3	58.0	
100.0	0.900	1.50	1/2"	16700	31500	4.10	2.80	22.0	31000	620	47 " 5 "	3 x 10.5	3 x 3.1	68.0	

\* The Actual Gap can only be an approximation owing to the many factors which may effect fringing of flux, permeability of core, etc. It must be adjusted by trial until the proper value of inductance is obtained or better yet, until the set up operates at the best point.  
 † The values of (B), the flux density, are those obtained with all D.C. & no A.C., or the effective B if all A.C. The maximum value in the latter case will be 1.41 x B as given in the case of rectified A.C. applied to coil with no previous smoothing the maximum B may be 1.57 times the values given

(Reproduced from "The Radio Amateur's Handbook" with the permission of the publishers, The American Radio Relay League, Inc., Hartford, Conn.)



# Tuned R. F. Amplifiers

## A Simple Explanation of the Causes and Prevention of Oscillation For the Man Who Services Them

By B. F. McNamee

**N**O RADIO frequency amplifier reaches the theoretical ideal of giving equal increase of selectivity and gain for all wavelengths without some tendency to oscillate. The simple form of amplifier shown in Fig. 1, for

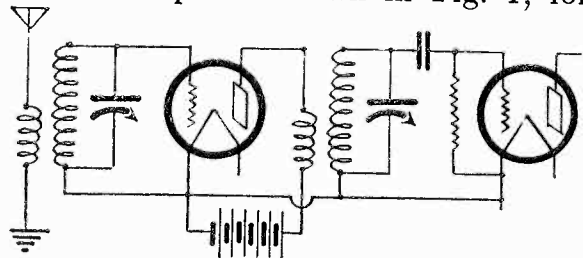

Fig. 1. Simple Form of R.F. Amplifier.

example, oscillates on the shorter wavelengths and amplifies poorly on the longer ones. But by various expedients it is possible to design an amplifier which closely approaches the ideal, particularly as regards lack of oscillation.

Most of these expedients for reducing oscillation depend upon some method of reducing the couplings which cause it. These couplings may be magnetic, conductive and/or capacitive.

Magnetic coupling between coils is partially avoided by placing them at an angle of minimum coupling or by using coils designed to have a minimum external magnetic field. It is almost entirely eliminated by shielding the individual stages. The magnetic couplings between the several stages of an r.f. amplifier may either aid or oppose oscillation, depending upon their direction. This fact is familiar in any regenerative circuit. If the aiding and opposing couplings are equal in amount the amplifier is balanced so that oscillation does not occur.

Conductive coupling is ordinarily caused by the use of one conductor to carry the currents of two or more circuits. To prevent it each r.f. coil should be separately connected to its own condenser rotor and each plate lead from the common B battery should be through a separate bypass condenser, the filament side of each circuit being connected to its proper tube socket. If only a single 1 mfd. bypass condenser is used, the plate leads should come to it separately and the lead from it to the filament should be short. A choke coil between each bypass and the plus B terminal aids in keeping r.f. current out of the common battery.

Capacitive coupling from plate to grid of each tube cannot be avoided except in the shielded grid tubes. Its direction is such as to cause oscillation, but it may be neutralized by an equal amount of

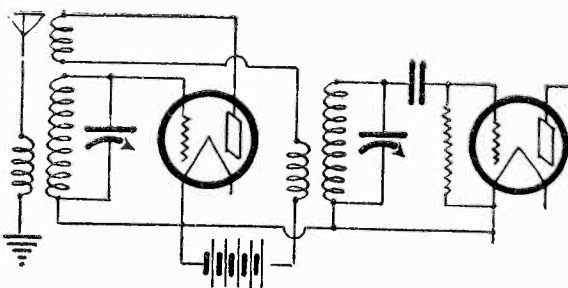

Fig. 2. R.F. Amplifier With Reversed Tickler.

coupling in the opposite direction. Fig. 2 shows a reversed tickler coil whose position may be adjusted to balance the tube's capacitive coupling with an opposing inductive coupling. But this scheme is not desirable because different positions are required to balance at different wavelengths and frequent variation is necessary to prevent oscillation as different stations are tuned in.

Fig. 3 shows the use of a neutralizing condenser *N* to balance the tube capacity, as is found in neutrodyne sets.

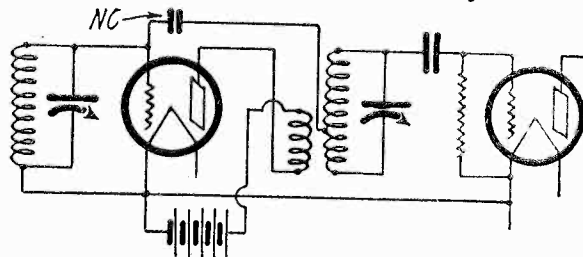

Fig. 3. R.F. Amplifier With Neutralizing Condenser.

Its one side is connected to the grid and its other to a point whose r.f. potential is opposite to that of the plate. This is accomplished by winding the transformer primary and secondary in the same direction around the form with the plate and grid connections at opposite ends of the respective coils. By tapping the secondary at the same number of turns from the filament connection as there are turns in the primary, the potentials will be equal and opposite. If the capacity of *N* is then made equal to the grid-plate capacity, their actions on the grid will cancel. In some neutrodyne sets *N* is connected from one grid to the next, thereby using a higher feedback voltage and a smaller capacity to obtain balance.

Considerable neutralizing capacity may be introduced by the close proximity of certain parts, especially condenser stators. Thus the grid end of one coil may be so close to the stator connected to the next grid that the capacity between them is just sufficient to neutralize that stage. Consequently it is not wise to change the relative position of parts in a set unless the effects are known.

Adjustments for neutralization may be made either by the "dead tube" method or by oscillator test. The former depends upon the fact that the signal from one tuned circuit "feeds forward" to the next through the grid-plate capacity of the tube, even when its filament is not lit. So by insulating the filament prongs with paper, the condenser connected to the grid of the dead tube can be adjusted to give minimum sound in the speaker after the set has been tuned to give maximum loudness. The set should be tuned to about 250 meters as this is the wavelength causing the greatest oscillation in most broadcast receivers. This process is repeated for each r.f. tube.

Changing the neutralizing condenser may change the tuning. So all stages should be kept in tune while making these adjustments. Nor should the neutralizing condenser be adjusted with a metal screw driver whose capacity affects the adjustment. A screw driver made of hard wood or bakelite rod slotted at one end to receive a small piece of sheet brass is suitable.

For the oscillation test first remove all r.f. tubes except that just preceding the detector, tuning its grid and plate circuits to 250 meters. Then slowly adjust the neutralizing condenser until the point of no oscillation is found, making sure that the circuits stay in tune. Then repeat the process for each r.f. tube in turn. Any failure to neutralize may indicate the presence of inductive or conductive couplings between the tuned circuits.

Controllable regeneration may be provided by means of a variable neutralizing condenser or a tickler coil in the plate circuit of the detector tube, or one of the r.f. tubes may be coupled to one of the tuned-grid circuits. While a certain amount of regeneration is helpful in bringing in weak stations, too much causes distortion.

Other systems of control, such as grid or plate resistances, constant coupling, etc., will be discussed in a future article. Tuning of single control r.f. amplifiers was discussed by the author in September, 1927, RADIO.

Rust may be removed from tools by immersing them in hot lye solution for half an hour, washing, and then immersing in a solution of one part of hydrochloric acid to two parts of water for a few minutes.



# Voltage Regulation For A. C. Devices

A Discussion of the Cause Together With Several Suggested Remedies For the Cure

By Clinton Osborne

**A** PROBLEM which has been confronting experimenters, manufacturers and the ordinary radio consumer alike, ever since the introduction of radio power devices which obtain their source of current from the electric lighting mains, has been that of smoothing out the fluctuations in line voltage due to shifting loads, and preventing a fluctuation in the volume and amplification produced by the radio receiver.

In practically every city and town where the supply is alternating current at 50 or 60 cycles, the line voltage is assumed to be 110, and the rating on the average socket power device is 110 volts, 50 or 60 cycles. Some apparatus is provided with taps on the primary of the input transformer, notably in the case of *B* power supply units, so that in case the line voltage is 115, 120 or 125 volts average, the connection to the primary may be adjusted to suit local conditions.

Each 110 volt house lighting circuit is supplied from a step-down transformer located on a pole in the neighborhood. From this transformer, the feeder wire branches out with taps to the various houses, until a certain limit of distance from the transformer is reached where the size of the wire and the average load on the line at the peak load time of day reduces the voltage to a certain minimum. Those houses located close to the transformer will have the highest voltage, and, obviously, those at the end of the line will have the lowest voltage. The transformer usually supplies 125 volts with an output of from 2 to 10 kilowatts, and so quite often the voltage at houses nearby measures from 115 to 120 volts at the peak load hour, while those at the greatest distance will have voltages running from 105 to 110, with occasional instances where it has been below 100 volts for considerable periods of time.

If it were only a question of measuring the line voltage in each home equipped with a radio receiver having a.c. equipment, and adjusting the primary taps on the input transformers, where taps are provided, to suit the line voltage, the problem would be easy. But it so happens that, due to shifting loads in various parts of the power system, the line voltage varies at different times of the day. When the highest obtainable voltage at the off hours of the day is only 110, the variation becomes serious.

For example, a *B* eliminator is de-

signed for 110 to 115 volt service, and uses as a rectifier tube a type -13 full wave rectifier, having two plates and two 5 volt filaments. While the 5 volt rating on these filaments is conservative, and they will still deliver the proper amount of space current at slightly lower voltages, they are not operating at their maximum output when the filament voltage drops appreciably, say to 4.4 or 4.3 volts, and the output of the *B* eliminator will be thereby proportionally reduced. If the line voltage is 110 volts during the day, and drops to 100 volts at night, this will cause approximately a 10 per cent reduction in filament secondary voltage, and also in effective plate voltage. Each of these reductions will affect the output of the *B* eliminator, and the additive effect of the two may so reduce the direct current supply of the receiver as to cause a distinct fading of signals, and in some cases render the set inoperative until the voltage taps on the eliminator have been re-adjusted.

A typical case is offered in a town supplied by a small steam-driven power plant which is not capable of delivering full 110 volts to the lines during peak loads. In the evening, when everybody turns on their lights, a *B* eliminator output drops in voltage until the radio set no longer operates, and the owner is forced to wait until some of the lights have been turned off, and the line voltage rises to a point where the eliminator can deliver sufficient current to supply the receiver. The input transformer is supplied with taps, but these are from 110 to 125 volts, and are of no use to him, since the line voltage never reaches even the minimum value except during the early hours of the morning when the set is not generally used.

There are two generally known methods of correcting this trouble. One is to design the power transformer with a primary having a voltage about half of the line voltage, and placing in series with it an iron wire resistance lamp to absorb the other half of the line voltage, thus automatically regulating the effective voltage across the transformer primary by absorbing more or less current according to the temperature of the iron wire, whose resistance varies appreciably with temperature changes. This method is employed in the Radiola 104 loud speaker amplifier, in the various electric phonograph amplifiers, and has proved to be very successful. It is important,

however, to note that the resistance lamp can be used for only one specific installation, where the current flowing through the primary is a known amount, and where the transformer is designed to go with the particular lamp used. Even though a *B* eliminator were designed for a 55 volt primary instead of 110 volts, the lamp used in the Radiola combinations might not be applicable unless the current required by the *B* eliminator was approximately the amount needed by the Radiola amplifier. Hence this method is confined to certain factory built devices, and is not much help to the man who already has a *B* eliminator and wishes to correct an annoying condition.

The other method is to regulate the voltage of the *B* eliminator output by means of a two element tube filled with an inert gas such as neon. This tube is commonly called a glow tube. When connected across the negative and positive 90 volt terminals of the *B* eliminator, it keeps the output voltage constant, even with large variations in the output voltage of the eliminator. By absorbing more or less current, according to the voltage impressed across it, it affects all the other voltage taps of the eliminator as well, and compensates to a large extent for the fluctuations in line voltage which would ordinarily cause annoying changes in volume in the receiver. Unfortunately, there are many thousands of *B* power supply devices not equipped with this tube, and which would require extensive modifications before the tube could be used. Furthermore it is good only for regulation of the 90 volt supply.

There is, however, another method by which line fluctuations can be quickly compensated for at a relatively small expense. This uses an auto-transformer, or voltage booster, which is placed be-

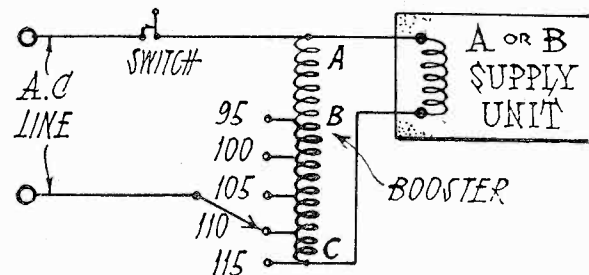

Fig. 1. Circuit Arrangement of Voltage Booster.

tween the line and the power consuming device, to step up or down the voltage to the required value.

The circuit arrangement of this booster, with respect to the line and the input transformer of the power device, is

(Continued on page 44)

# Experimental Shop Methods

## Making a Bug Key, Fusible Alloys, Cutting Glass and Miscellaneous Kinks

By Samuel G. McMeen

THE construction of a bug key for the rapid transmission of telegraph signals is an interesting task for the craftsman. Such a key is operated by a left-hand motion of the finger pieces to make a dash and a right-hand motion to make a dot or a series of dots, whether one or several depending upon how long the pressure to the right continues. As the maximum number of dots used is five, the key can be set for the greatest duration per dot, thus giving the best radio sending without straining the hand and arm.

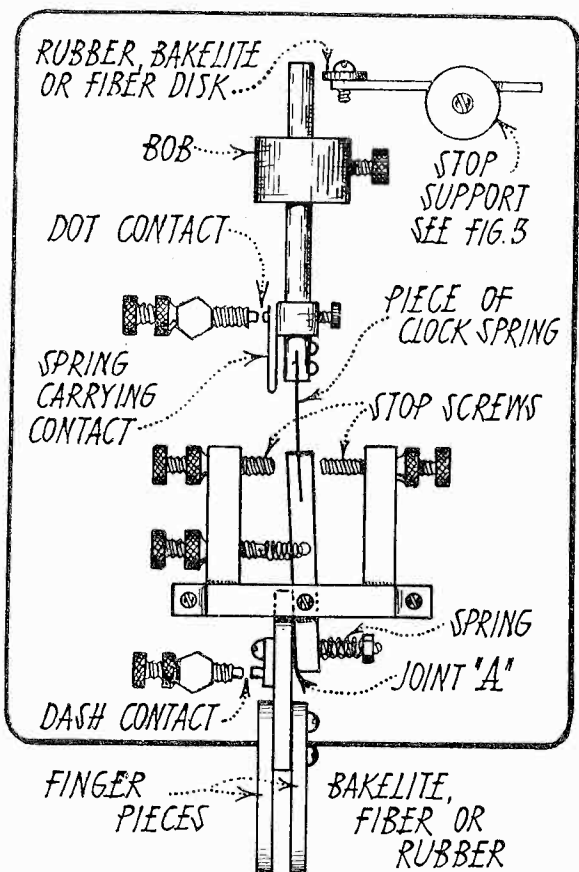

Fig. 1. Plan of Bug Key.

The plan view of a sturdy model is shown in Fig. 1. The base, shown in outline, is made of 1/2 in. cast iron, 3 1/2 by 6 in. The rough casting from the foundry can be smoothed with a shaper, planer, or disc grinder. If these tools are lacking in the amateur shop, it may be taken to a commercial shop.

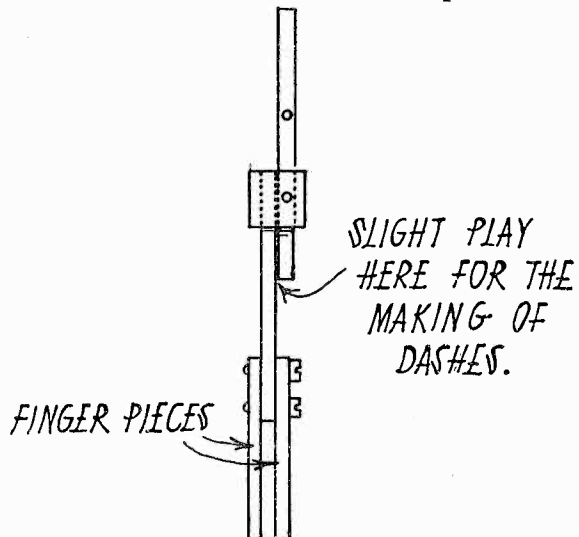

Fig. 2. Detail of Dash-Bar.

The double motion of the key is made possible by the piece of clock spring and the joint A, shown in Fig. 1. A spring 2 in. long by 7/16 in. wide by .013 in.

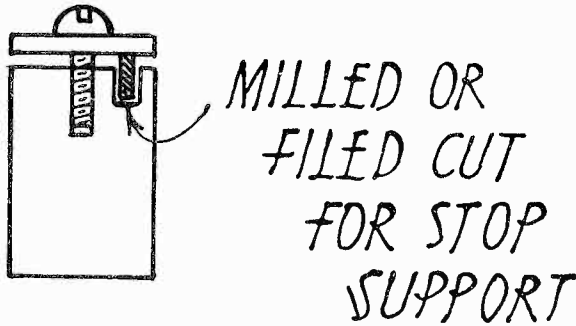

Fig. 3. Detail of Stop Support.

thick gives sufficient stiffness for the vibratory motion that produces the dot. The joint is shown in more detail in Fig. 2. The slight play referred to in that figure allows the part moved by the finger-pieces, and integral therewith, to move far enough to the left to close the dash contact without moving any other part except the round rod carrying the bob. This moves against the stop at the top of Fig. 1, whose detail is shown in Fig. 3. It is slotted to support the arm that carries the bakelite or fiber disc which acts as the stop.

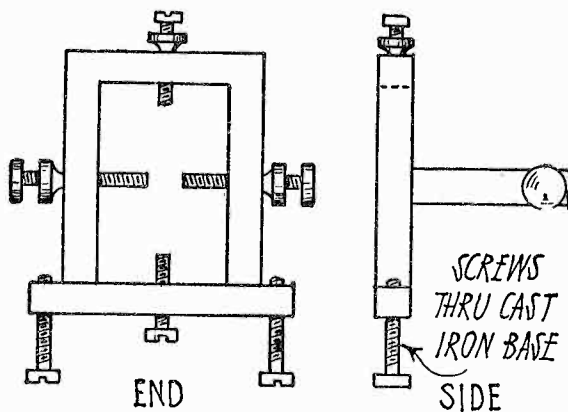

Fig. 4. Side and End Views of Main Arch.

Fig. 4 shows the side and end views of the main arch of the key and Fig. 5 shows the finger-pieces. These can be fashioned of hard rubber on an abrasive disc and can be smoothed to a glossy finish.



Fig. 5. Detail of Finger-Pieces.

FUSIBLE alloys have a number of useful radio applications. One is as a solder for hard-drawn copper wire such as an aerial whose strength should not be weakened by heating it until it is softened. This may be avoided by boiling the soldering-copper in water until it is hot enough to melt the alloy, when the joint may be soldered with any ordinary flux. Either of the following formulas are satisfactory: (1) bismuth 50 parts, lead 31 1/4 parts, tin 18 3/4 parts, for an alloy melting at 200 degrees Fahrenheit; (2) bismuth 50 parts, lead 25 parts, tin 12 1/2 parts, cadmium 12 1/2 parts, for an alloy melting at 150 degrees F. The melting points can be lowered by adding mercury, but the hardness then falls off proportionally.

Fusible metal may also be used in a circuit arrester designed to interrupt the current when it reaches a pre-determined amount. Such a device, as shown in

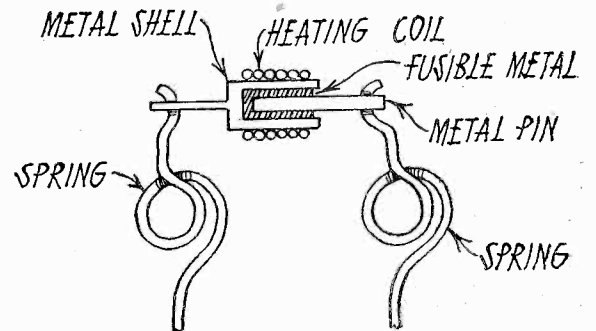

Fig. 6. Fusible Metal Arrester.

Fig. 6, consists of a metal shell surrounded with a coil of resistance wire and filled with a fusible alloy into which a pin is soldered. The excess current melts the alloy and the springs pull the device apart.

SHEET glass may be cut with a diamond or rotary cutter. If it is very thick, first cut a line with a cutter and then apply at one edge a tool shaped

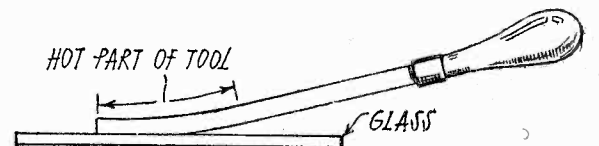

Fig. 7. Cutting Glass With a Heat Tool.

as in Fig. 7, its point being red hot. As the tool is drawn slowly along the line, a crack will follow magically in its wake. The same procedure can be applied to a jar or tube by bending the tool to the proper contour.

The top of a glass jar may be cut off by filling it with cold water to the point where the cut is desired and placing it in a container which is filled with water to nearly the same level. Wrap a length of candle wicking around the jar at the

(Continued on page 44)





# QUERIES *and* REPLIES



Questions of general interest are published in this department. Questions should be brief, typewritten, or in ink, written on one side of the paper, and should state whether the answer is to be published or personally acknowledged. Where personal answer is desired, a fee of 25c per question, including diagrams, should be sent. If questions require special work, or diagrams, particularly those of factory-built receivers, an extra charge will be made, and correspondents will be notified of the amount of this charge before answer is made.

I have an 8 tube superheterodyne which I am going to rewire. Is it advisable to use insulation over all the wires or is it better to use bare bus-bar wire?—E. C. G., Rochester, N. Y.

Insulation of all wiring in the set is a safe rule to follow and has little or no effect on the results which will be obtained with the receiver. Bare bus-bar wire introduces the hazard of short circuits, and does not present a neat appearance after the wire tarnishes.

Please publish a circuit for the new 115 kilocycle superheterodyne, with but seven tubes, omitting the tuned r.f. amplifier ahead of the first detector and incorporating some type of tuned circuit ahead of the 1st detector which will give good selectivity in anything but the most congested local districts.—W. C. H., San Francisco, Calif.

The circuit is shown in Fig. 1. As there is but one sharply tuned circuit, that of the input transformer between the mixer and the first i.f. amplifier tube, it is necessary to use a selective antenna tuner, for otherwise the set will tune so broadly that in any but the country districts distant reception will be impossible. The antenna circuit consists of a series variable condenser, a loading coil of 100 turns of No. 24 d.c.c. wire wound on a 2½ in. tube, and a coupling coil with center tapped secondary. The coupler consists of a primary having 35 turns of No. 28 or 30 double silk wire wound on a 1 in. form, placed inside of a 2 in. tube on which is wound 90 turns of No. 24 enameled or silk-covered wire with a tap at the 45th turn. The regeneration obtained with the feedback condenser will improve the selectivity of the tuned circuit to which the mixer is connected, and by careful adjustment of the rotor in the coupling coil, as well as the tuning of the series condenser, the proper degree of selectivity may be obtained. For local reception, this condenser may

be set at maximum and the set tuned as a two dial set. With a loop antenna substituted for the antenna coupling coil secondary, the set will be selective unless it is located close to a powerful station.

I have an old Western Electric 7-A push-pull amplifier, but have no tubes for it. What type of tubes would be most satisfactory in this amplifier, and can I operate the filaments from a.c.?—A. R. R., Troy, N. Y.

Type 112 tubes should be used in the push-pull stage, which formerly used type 216-A

to the amplifier should then be made in accordance with the diagram shown in Fig. 2. A step-down transformer having a 1½ and a 5 volt winding should be used, with a center tap for the latter winding. A plate voltage of 90 should be applied to the first tube, and as high as 157½ may be used with the push-pull tubes, with 10½ volts C bias.

Will a simple, one tube circuit using a coupler for the antenna, and a variometer in the plate circuit be satisfactory for copying code?—E. G., Longview, Wash.

With a tuner having a 15 turn primary and

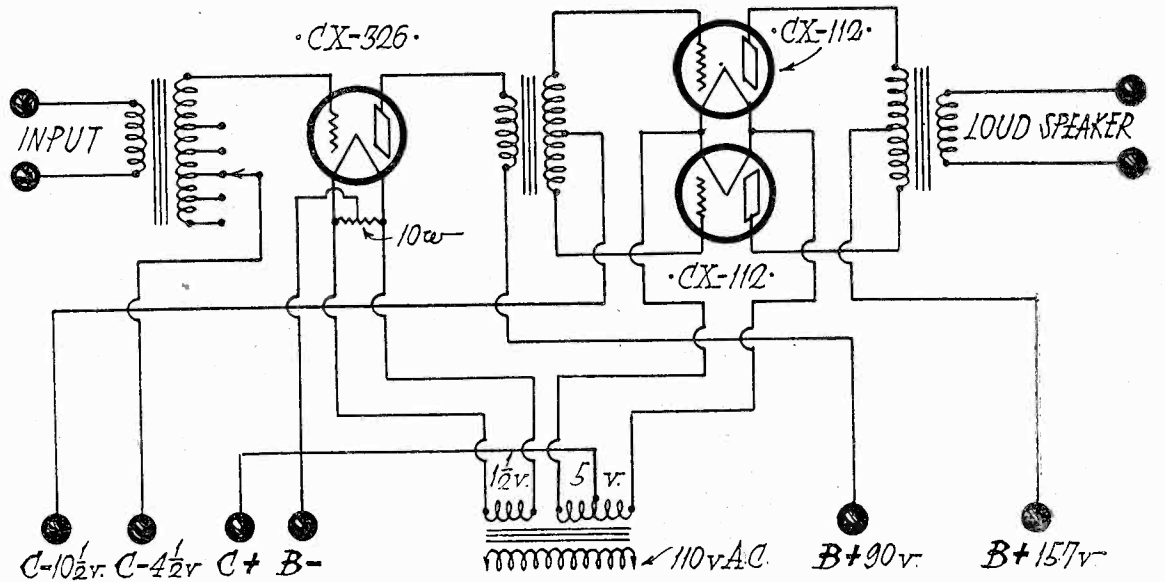

Fig. 2. Changes in Wiring of Western Electric Power Amplifier.

Western Electric tubes. As no filament regulation is provided, the amplifier should be opened up, and the proper resistances inserted, where a storage battery is to be used. If the amplifier is to be a.c. operated, the filament circuit for the first audio tube should be separated from that of the push-pull stage, and a type 326 a.c. tube used. Modifications

75 turn secondary, on a 3 in. tube, you will be able to copy either c.w. or spark signals on 600 meters without difficulty, although the ship wavelengths are hardly the best waves to listen on for code practice, due to the abbreviations used by commercial operators in handling ship to shore traffic. The vari-

(Continued on page 41)

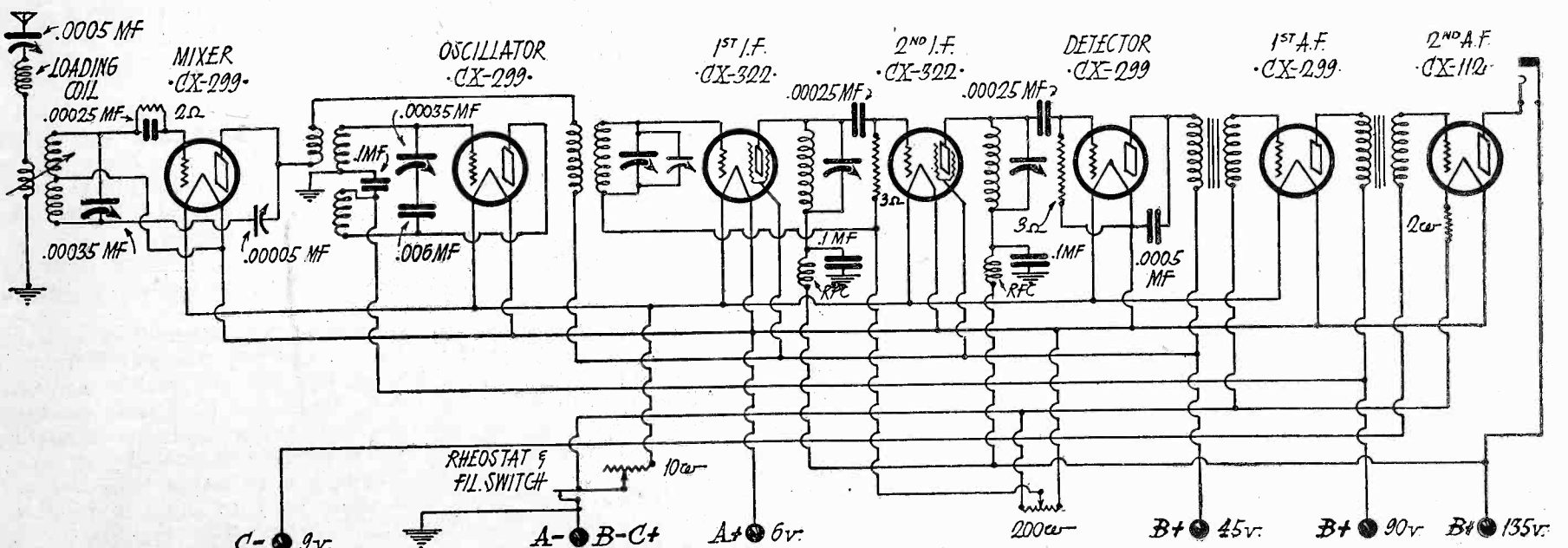
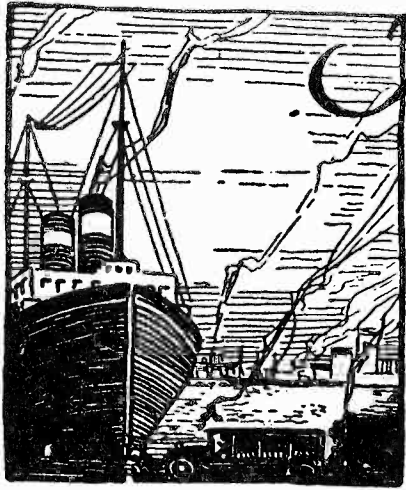

Fig. 1. Circuit for Best 115 Superheterodyne Using Seven Tubes.



# The COMMERCIAL BRASSPOUNDER

## A Department for the Operator at Sea and Ashore



Edited by P. S. LUCAS  
R. O. KOCH, Great Lakes Correspondent



### REMEMBER OLE WAS AND WSH?

The above line (vestige of 1930) was swiped from a letter from Paul A. Sirard, S. S. *Belleplaine*, as we were unable to think of any better way to introduce this tender subject than by looking forward a couple of years to the time when anyone who remembers the I. W. T. and its stations will be classed as an "old-timer."

By the time this is on the newsstands and in the static rooms and radio shacks, every brasspounder afloat will have learned that the Independent Wireless Telegraph Company has passed out of the picture. And some will have put on mourning and some will have grinned in an unholy glee, for, during the last eight years the war that has been raging between I. W. T. and R. C. A. has been, to the operators in their ringside seats, like a great football game, first one then the other having the advantage.

And now the game is over, leaving the spectators in a slight quandary as to what the final results will be as regards the operating personnel of the companies. Of course those who have been R. C. A. men will have the advantage at first, *providing they have unconditionally made good*; but after a few months have passed we hope that things will have straightened out and prejudices will have been forgotten. From then on every operator in the R. C. A. service will have to gain the confidence of that company, for over 90% of the available jobs will be handed out through its offices.

Advantages and disadvantages in the new regime have been held forth. It is good to think that more ships will be toting tube transmitters and radio compasses henceforth. That will be a sign of progress, although, we must admit, at the expense of a company which has been deadlocked by the other's patent rights. It has been suggested, also, that it would be easy for the R. C. A. to lower operators' wages, now that competition has been so greatly reduced. Perhaps, but it is hard to understand how any modern corporation of the standing of the R. C. A. can overlook the psychological fact that if its employees are not treated fairly and squarely the greatest efficiency cannot be had. We are wondering how small a few dollars off the long end of a pay check would look when stacked up alongside the actual cash lost to the company through carelessness and inefficiency; and how much of this carelessness and inefficiency could be traced to the wrong mental attitude of the employee as a result of unfairness on the part of his employer.

And, while wondering about that, we are hoping that the R. C. A. will recognize its duty to its operators and that the operators will recognize their duty to their company. Certainly the one and only means of making this move a profitable one for all concerned is —co-operation.

### UH, UK & UM

By Don E. Self

I am taking you at your word about this station writeup stuff and adding hereto a description of the three newest TRT installations: "UH" S. S. *Castilla*, "UK" S. S. *Iriona* and "UM" S. S. *Tela*. Perhaps some of the readers of the department have heard these trick calls and wondered about the stations. The ships are sailing under the Honduran flag on the usual fruit and passenger run from WNU to the tropics. I am writing especially of "UM" but the three ships are practically the same, as the TRT makes a practice of standardizing equipment and operating methods.

The transmitter is the RCA model ET-3626-B. There are two wave-length ranges, the lower one 600-1250 meters with an output of 500-700 watts cw or icw, and the upper one 1250-2500 meters with an output of 500 watts cw. The circuit is the master-oscillator type using a UV-211 as an exciter, a UV-211 as an audio-oscillator and six UV-211s as amplifiers. Keying is done through a Leach break-in relay, which, besides providing the usual break-in facilities, controls the grid circuit, stopping oscillation and applying a negative voltage to both the exciter and amplifier tubes for insuring blocking while the key is open. The set is very flexible and tuning to any wavelength may be done in ten or fifteen seconds and locked in any position. With a two-wire antenna and 900 volts on the plates, radiation is 12 to 14 amperes on 600 meters cw, and 9 to 11 amperes on 600 meters icw. On 2100 meters cw, radiation is 6 to 7 amps. The front panel of the transmitter is built flush with the bulkhead of one side of the operating room, exposing the different meters and tuning controls. Access to the tubes is gained by a small perforated door opening forward on this panel. The "works" however, are in the battery room adjoining. Tone frequency of the icw note is varied by the use of condensers controlled by a switch which changes the tube grid bias at a 500, 700 or 1000-cycle rate. A break-in relay is coupled to a variable resistance in series with the generator field, which keeps the plate voltage steady while keying the transmitter. The battery charging panel is installed in the bulkhead alongside the transmitter panel. Along the forward bulkhead of the operating room is the operator's desk on which is the receiver, the "Operator's Control Box" for starting and stopping the motor generator and controlling the transmitter tube filament voltage, a typewriter and an auxiliary power converter for eliminating A and B batteries. Ordinarily the receiver is supplied with batteries, however, as this converter has been found to cause considerable hum and it is therefore kept only as emergency apparatus. The receiver is the Wireless Specialty type IP-501 with a wavelength range of 300-8000 meters, coupled to a Wireless Specialty type Triode-B two-stage audio amplifier. Across the other side of the room is a breast-high desk for the use of

passengers writing messages and a telephone which allows communication with the bridge, chief engineer, purser and chief steward. A bookcase, fan, clock and the usual "signboards" of a radio shack complete the picture of the operating room.

In the battery room adjoining, is the motor-generator set, storage batteries, transmitter (proper), a switch panel for controlling the emergency lighting system, a closet for spares and a small work bench that folds against the bulkhead. The M-G set is a small, compact, two-bearing Westinghouse. The motor is 4-pole compound wound for 100-125 volts having two armature slip rings from which 77-volt, 60-cycle, single phase power is taken for filament heating (through a transformer). The generator is 2-pole, shunt wound, separately excited which supplies a potential of 1200 volts at 1750 r. p. m. The emergency equipment is made up of fifty-six Exide Ironclad cells, type MV-11, 116 volts, 174 ampere-hours capacity.

A radio direction finder is installed in the chart room. It is the usual RCA DF set, built by Wireless Specialty, and is the Model ER-1445.

These ships carry two licensed operators and continuous watch is kept while at sea.

### A FEW WRINKLES

By Rawson B. Dixon

Although the following ideas are not all mine, I have found them useful and I believe they are worth passing along.

After charging lead-acid batteries, wipe off the tops of the cells with a rag wrung out of a soda-bicarbonate solution. You can mooch the soda from the cook. Although many operators already are hep to this idea, there are many who aren't. Some operators smear vaseline over the tops of the cells. This serves no useful purpose, but is messy and makes it more difficult to wipe the tops of the cells dry. Vaseline should be used only on the terminals. Better yet, give the battery terminals a coat of shellac. Shellac will answer the purpose as well as vaseline and it makes a cleaner and more permanent job.

In cleaning the arc chamber of a 2 kw. arc, use a medium grade of steel wool. This quickly cleans and polishes the metal in one operation. When using steel wool it is advisable to wear a pair of old gloves, as bits of the steel may work under the skin and fester.

Turpentine will remove verdigris from copper and brass and has no corrosive effect on the metal.

With converted P-8 transmitters considerable trouble is sometimes experienced from the scratching of the filament supply converter commutator. Shunt a 3 or 4 mfd. condenser across the commutator and the scratching will be almost entirely eliminated.

A final wrinkle is to buy a loose-leaf note book and either copy or paste in it all the valuable information that appears in the Brasspounder's Department of RADIO.



PACIFIC COAST RADIO COMPASS  
AND FOG STATIONS

By L. O. Doran

Note that in many cases the transmitter for radio compass stations is located at some distance from the compass receiver. When plotting a bearing furnished by a station use the position given for the receiver. If the ship itself takes a bearing on the transmitter of a radio compass station use the position of the transmitter.

When requesting signals from a station, ships should use the abbreviation: "QTG—Please transmit your station call sign for 45 seconds in order that a bearing may be obtained."

In sending signals for a bearing, the ship should make its call sign at intervals followed by the letters MO, continuously for 45 seconds. 800 meter wave length.

Point Loma, Calif.—NPL  
Receiver —32° 42' 21" N. 117° 15' 17" W.  
Transmitter—32° 44' 15" N. 117° 03' 53" W.  
Arc of calibration—185 to 250 degrees.

Point Hueneme, Calif.—NMD  
Receiver —34° 08' 43" N. 119° 12' 30" W.  
Transmitter—34° 08' 43" N. 119° 12' 12" W.  
Arc of calibration—150 to 320 degrees.

Point Firmin, Calif.—NPX  
Receiver —33° 42' 19" N. 118° 17' 37" W.  
Transmitter—33° 42' 22" N. 118° 17' 36" W.  
Arc of calibration—94 to 292 degrees. Out of commission at present.

Point Arguello, Calif.—NPK  
Receiver —34° 34' 38" N. 120° 38' 32" W.  
Transmitter—34° 34' 38" N. 120° 38' 41" W.  
Arc of calibration—170 to 353 degrees. The calibrated area between 135 and 160 is overlaid and bearings in this sector should be used with caution.

Imperial Beach, Calif.—NPZ  
Receiver — 32° 35' 12" W.  
Transmitter— 117° 07' 54" W.  
Arc of calibration—184 to 344 degrees.

San Francisco Entrance Group—NPI, NLH and NLG. NLH is the control station.

Farallon Islands, Calif.—NPI  
Receiver —37° 41' 59" N. 122° 59' 56" W.  
Transmitter—37° 41' 52" N. 123° 00' 00" W.  
Arc of calibration—0 to 360 degrees.

Point Montara, Calif.—NLH★  
Receiver —37° 32' 02" N. 122° 31' 07" W.  
Transmitter—37° 32' 04" N. 122° 31' 05" W.  
Arc of calibration—176 to 351 degrees. The bearings are questionable in the sector 170 to 185. Unreliable in the sector 340 to 355. Unreliable for vessels NW and within 15 miles of the Farallons in the sector 292 to 295. Unreliable for vessels N of Point Reyes in the sector 319 to 355.

Point Reyes, Calif.—NLG  
Receiver —38° 02' 13" N. 122° 59' 36" W.  
Transmitter—38° 02' 10" N. 122° 59' 36" W.  
Arc of calibration—120 to 2 degrees.

Eureka, Calif.—NPW  
Receiver —40° 41' 49" N. 124° 16' 33" W.  
Transmitter—40° 41' 45" N. 124° 16' 19" W.  
Arc of calibration—204 to 10 degrees.

St. Georges Point, Calif.—NYW  
Receiver —41° 47' 00" N. 124° 15' 04" W.  
Transmitter—None. NPW is control station.  
Arc of calibration—178 to 10 degrees.

Empire, Oregon—NPF  
Receiver —43° 23' 03" N. 124° 18' 58" W.  
Transmitter—43° 20' 38" N. 124° 13' 36" W.  
Arc of calibration—65 to 10 degrees.

Columbia River Entrance Group—NZR and NZS. (Note—NZR formerly used call NPE.)  
Fort Stevens, Oregon—NZR  
Receiver —46° 11' 32" N. 123° 59' 15" W.  
Transmitter—46° 11' 37" N. 123° 58' 28" W.  
Arc of calibration—170 to 90 degrees.

Klipsan Beach, Wash.—NZS★  
Receiver —46° 27' 53" N. 124° 03' 16" W.  
Transmitter—46° 27' 54" N. 124° 03' 11" W.  
Arc of calibration—155 to 345 degrees.

Destruction Island, Wash.—NOJ  
Receiver —47° 40' 29" N. 124° 29' 02" W.  
Transmitter—47° 40' 30" N. 125° 29' 00" W.  
Arc of calibration—0 to 360 degrees.

Tatoosh Island, Wash.—NPD  
Receiver —48° 23' 41" N. 124° 44' 13" W.  
Transmitter—48° 23' 28" N. 124° 44' 04" W.  
Arc of calibration—160 to 90 degrees.

Straits of Juan de Fuca Group—NFT, NFH and NFN.  
New Dungeness, Wash.—NFT  
Receiver —48° 10' 32" N. 123° 07' 56" W.  
Transmitter—48° 10' 26" N. 123° 08' 06" W.  
Arc of calibration—240 to 120 degrees.

Smith Island, Wash.—NFH  
Receiver —48° 19' 04" N. 122° 50' 39" W.  
Transmitter—48° 19' 12" N. 122° 50' 35" W.  
Arc of calibration—0 to 360 degrees.

Cattle Point, Wash.—NFN  
Receiver —48° 27' 05" N. 122° 57' 45" W.  
Transmitter—48° 27' 17" N. 122° 57' 41" W.  
Arc of calibration—120 to 280 degrees.

Note especially that compass bearings from the stations are reliable only when they fall within the arc of calibration.

PACIFIC COAST RADIO FOG SIGNALS

All Fog Signal Beacon Stations operate on 1000 meters, spark or icw, continuously during fog and otherwise as mentioned in the notes for each station.

★Los Angeles Harbor Light Station, Calif.  
.....33° 42' 31" N. 120° 15' 03" W.  
Sounds every 180 seconds; single dashes for 60 seconds, silent 120 seconds. Signal also sounded daily in clear weather from 9 to 9:30 AM and from 3 to 3:30 PM, P.S.T.

★Point Arguello Light Station, Calif.  
.....34° 34' 38" N. 120° 38' 59" W.  
Sounds every 180 seconds; groups of 3 dashes for 60 seconds, silent 120 seconds. Also sounded daily in clear weather for first 15 minutes of each hour, 5 PM to 7 AM, P.S.T.

★Point Sur Light Station, Calif.  
.....36° 18' 24" N. 121° 54' 03" W.  
Sounds every 180 seconds; groups of one dot, 2 dashes, one dot (.-.) for 60 seconds, silent 120 seconds. Also sounded daily in clear weather from 9 to 9:30 AM and from 3 to 3:30 PM, P. S. T.

★San Francisco Lightship, Calif.  
.....37° 45' 03" N. 122° 41' 30" W.  
Sounds every 180 seconds; groups of two dashes for 60 seconds, silent 120 seconds. Also sounded in clear weather from 9 to 9:30 AM and from 3 to 3:30 PM, P.S.T.

★Blunts Reef Lightship, Calif.  
.....40° 26' 04" N. 124° 30' 14" W.  
Sounds every 180 seconds; single dashes for 60 seconds, silent 120 seconds. Also sounded clear weather from 9 to 9:30 AM and from 3 to 3:30 PM, P. S. T. and for the first 15 minutes of every even hour from 10 PM to 6:15 AM.

★Cape Blanco Light Station, Oregon  
.....42° 50' 15" N. 124° 33' 46" W.  
Sounds every 90 seconds; groups of one dash and one dot (-.) for 60 seconds, silent 30 seconds. Also sounded in clear weather, 10-10:30 AM and 4-4:30 PM and for the 2nd 15 minutes of every even hour from 10:15 PM to 6:30 AM, P.S.T.

★Columbia River Lightship, Oregon  
.....46° 11' 01" N. 124° 11' 04" W.  
Sounds every 180 seconds; groups of 3 dashes for 60 seconds, silent 120 seconds. Also sounded in clear weather 8:30-9 AM and 2:30-3 PM and for the first 15 minutes of every odd hour from 9 PM to 7:15 AM, P.S.T.

★Grays Harbor Light Station, Wash.  
.....46° 53' 19" N. 124° 06' 57" W.  
Sounds every 180 seconds; groups of 4 dashes for 60 seconds, silent 180 seconds. Also sounded in clear weather 7:30-8 AM and 1:30-2 PM, P. S. T., and first 15 minutes of every even hour from 10 PM to 6:15 AM.

★Umatilla Reef Lightship, Wash.  
.....48° 10' 03" N. 124° 50' 25" W.  
Sounds every 150 seconds; single dashes for 6 seconds, silent 90 seconds. Operated only on request. The operator stands watch for the first 15 minutes of every hour from 8 AM to 8:15 PM, P.S.T. Call WWBP.

★Swiftsure Bank Lightship, Wash.  
.....48° 31' 44" N. 125° 00' 00" W.  
Sounds every 180 seconds; groups of 2 dashes for 60 seconds, silent 120 seconds. Also sounded in clear weather 9-9:30 AM and 3-3:30 PM and for the second 15 minutes of every even hour from 10 PM to 6:15 AM, P.S.T.

★Cape Spencer Light Station, ALASKA.  
.....58° 11' 48" N. 136° 38' 24" W.  
Sounds every 180 seconds; single dashes for 60 seconds, silent 120 seconds. Also sounded in clear weather from 10 to 10:30 AM and from 4 to 4:30 PM, P.S.T. and for the first 15 minutes of every even hour from 11 PM to 9:15 AM, P.S.T.

Requests for special transmission of signals from lightships should be made during watch periods on 600 meters.

THE SWITCHING SYSTEM  
AT KOK

By R. O. Koch

I should begin this with an apology, for I hardly have sufficient knowledge of the subject to do it justice. To do the job right, one should visit "both ends" of KOK and get first hand information including a good look at the mechanism, itself. However, Lucas wants something on it for this issue, so I shall try to give you a general idea of how the switching system at KOK works. Perhaps a more lucid description will be attempted at a later date, or better still, one of the ops at KOK might be persuaded to enlighten us further.

Since KOK has used the nice new bottle set, a seemingly superfluous group of dots are frequently heard. (Perhaps superfluous things should be expected from a BOTTLE set. HI.) Ops not knowing the reason for the dots have used their imagination as to why they are transmitted. Has the gang at KOK suddenly become impatient and irritable, or do they take delight in testing the dot side of the bug? Decidedly neither! The dots are necessary in order that the various switches at the transmitting station (Clearwater) can be manipulated over a single pair of wires by the man on watch at the receiving station some twenty-five miles distant.

At the transmitting station there are a number of tuning forks, each of which vibrate at a different frequency. They are arranged so that each controls a separate switch when set into vibration. They are set into vibration electrically; that is, by interrupting an electric current at the resonant frequency of the desired tuning fork. Thus, only one tuning fork will respond and throw the corresponding switch, even though all are connected to the same pair of wires. By pressing the proper button (which automatically transmits the dots at the proper frequency) the operator can turn the power on or off and QSY at will. These facilities were not available with the old rotary spark.

Since the new tube transmitter is keyed over the same pair of wires that are used in the switching system, the keying relay also responds to the vibrations intended for the tuning forks, and so some five or six dots are transmitted each time a switch is thrown, before the power is automatically cut off by the controlling tuning fork.

I hope that this will give some idea of what it's all about. It will at least serve to remind you that the ops at KOK are as habitually good-natured and efficient as ever.

## TO ALL OPERATORS

By Henry Malarin

The following has been suggested by coast station operators who feel that uniformity in handling traffic would speed up the ship to shore service and lessen interference.

All transmissions to the coast stations should be of the following form: Example 1:

PREAMBLE: Radio Nr 1 WMP CK7 Radio SS Matsonia 8AM Oct 3rd . . . .

ADDRESS: John Doe

San Francisco . . . . .

TEXT: Arriving Matsonia Love . . . .

SIG: Henry . . . . .

Example 2:

Radio Nr 2 WMP CK7 MSG SS Matsonia 8AM Oct 3rd . . . .

Matson

San Francisco . . . . .

Arrive quarantine 7 AM . . . . .

Diggs . . . . .

Example 3:

Radio Nr 3 WMP CK7 PDH Opr SS Matsonia 8AM Oct 3rd . . . .

Etc. There is no such thing as DH from a ship to a coast station except "DH Medical" and "DH CO."

The use of Radio or Rdo is optional before the number of the message but it, or any prefix which determines the class of the message, must be sent after the number which indicates the check or number of words. Never prefix the number of the message with the class of service and omit it after the check. If QRM or QRN or any other reason interferes the receiving operator may miss this part and come in on the number of the message. Then if no designation comes after the ck, it will be classed as a regular paid radio and abstracted accordingly.

The following are the prefixes in present use:

RADIO: Regular paid traffic.

DH CO: To company controlling coast station.

MSG: Ship's business via controlling co.

PDH FRANK 1234: Franked messages. Do not send Frank number in service instructions.

PDH OPR: Paid Deadline Operator.

PAID SVC: Referring to message, change of address.

DH MEDICAL: Requesting medical advice.

SB: Ship's business messages when the coast station makes a special rate for this class of traffic; KPE, VAE, VAK, etc.

TR: Position reports for publication.

SVC: Referring to messages; non-delivery, etc.

In the case of TR and SVC messages the transmission is prefixed TR or SVC and the number of the message omitted.

Example:

TR WMP 8PM SS Matsonia San Francisco for Honolulu 1234 west of San Francisco . . . .  
Cmdr . . . . .

The above form is the way your TR is copied and transmitted to the newspapers. Any change in this procedure causes the receiving operator unnecessary work in changing your form to the above when he copies. The use of QRD, QRF and QRB in the original transmission is very poor form. If it is necessary to repeat any of the details of the TR then the "Q" signals are acceptable.

In certain cases abbreviations of the forms suggested above or parts may be omitted entirely, but it must be a part of the operator's business to be absolutely sure that the receiving operator understands the abbreviations and omissions. Cases of this kind usually result where the same operators are working together and handling more than the ordinary amount of traffic.

If the sequence of the above forms is followed it will assist greatly in the handling of traffic and fewer breaks will occur with the consequent speeding up of the service.

## BELGIAN B-82

By E. A. Tubbs

ED-7CZ, pre war NU-6CZ

At Uccle, a suburb of Brussels, is located the short wave station B-82, which furnishes communication between Belgium and the Belgian Congo. This station is, by arrangement with the Belgian government, owned and operated by the Société Belge Radioélectrique. It has two transmitters, located in the same building, one for daylight transmission on 15 meters and the other for night transmission on 38.5 meters. This 38.5 meter station can also be adjusted to 25 meters in case of heavy QRN on 38.5 meters.

Power is furnished to the station at 220 volt, three phase, 50 cycles. This is stepped up to 15,000 volts and rectified by a bank of six Marconi MR-2 rectifying tubes, two of which are connected in parallel on each phase. This rectified current is then passed through a filter, composed of several large iron core chokes and a number of large paper condensers, so that a steady current at 13,000 volts is obtained for the plate supply.

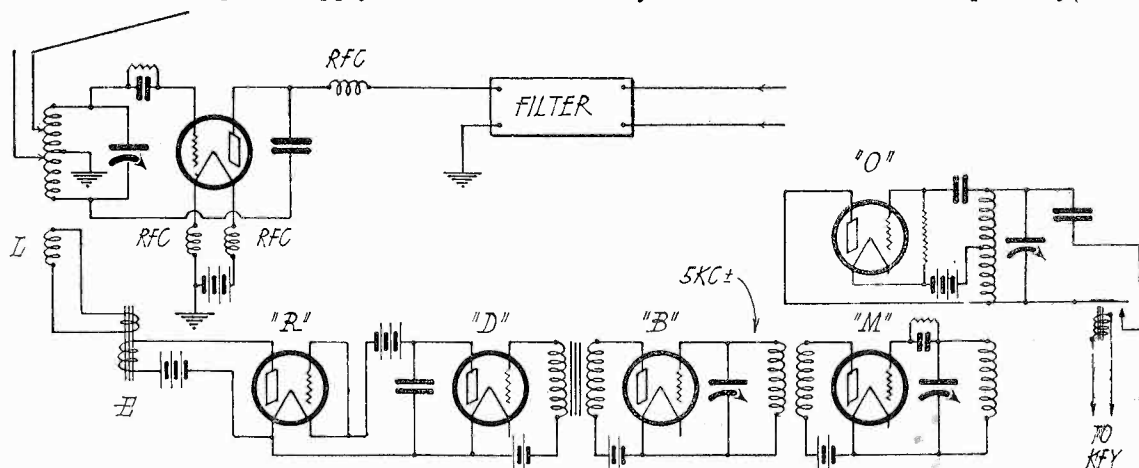

Fig. 1. Circuit Diagram of 38.5 Meter Transmitter.

The filament of the transmitting tube is heated by a 600 amp. hr. storage battery which is charged by Tungar outfits. There is no reserve power equipment, so it is only possible to work one transmitter at a time.

Fig. 1 shows the circuit used in the 38.5 meter transmitter. A French 20 kw. water-cooled tube is used. The circuit of the 15 meter transmitter is substantially the same except that no condenser is used in the tuned circuit. The same type tube is used in both transmitters. The condensers and inductances of both sets are mounted on quartz rods.

The frequency stabilization system employed is due to M. Chireix, chief engineer of the Société Française Radioélectrique. This is shown in Fig. 1. Here O is a constant frequency oscillator, which is adjusted to a frequency differing from the frequency of the transmitter by 5,000 cycles, thus giving 5,000 cycle beats in tube M. The grid circuit of tube B contains a circuit which is tuned slightly to one side of 5,000 cycles, so that any change in the beat note will cause an increase or decrease in the voltage applied to the grid of B, which will in turn cause a change in the d.c. component of the plate current of tube D. This d.c. component is used to heat the filament of tube R which is so adjusted that any change in filament temperature causes a correspondingly large change in plate current. This plate current of tube R is used to saturate the iron core E. This core is worked on a bend of its curve, so that any change in the current flowing in the plate circuit of R causes a change in the inductance of circuit L, which in turn causes the frequency of the transmitter to shift. This whole system—except E and L—is located in a small completely shielded room.

The engineers at the station assured me that the system gave excellent results; but, be that as it may, I can't help feeling grateful to the gods that it has not fallen to my lot to be responsible for the maintenance of such a system.

Keying is accomplished by changing the frequency of the oscillator O, which in turn changes the frequency of the transmitter, thus producing a "spacing and marking wave."

The Creed system of automatic transmission is used. That is the dots and dashes are first machine-punched on a strip of paper which is then fed into the automatic Wheatstone transmitter.

The 38.5 meter set uses a half wave, voltage-fed antenna placed at an angle about midway between vertical and horizontal. It is elevated about 10 meters above the ground. The feeder system is the well known "zep-pelin" system.

Perhaps the most interesting thing about this station is the antenna for the 15 meter set. This antenna is also the invention of M. Chireix. It is theoretically equivalent to the antenna developed by Mr. Franklin and used by the Marconi beam systems. But M. Chireix's antenna has a big advantage when it comes down to the practical problem of exciting it. With the Franklin aerial it is necessary to excite each wire separately, whereas

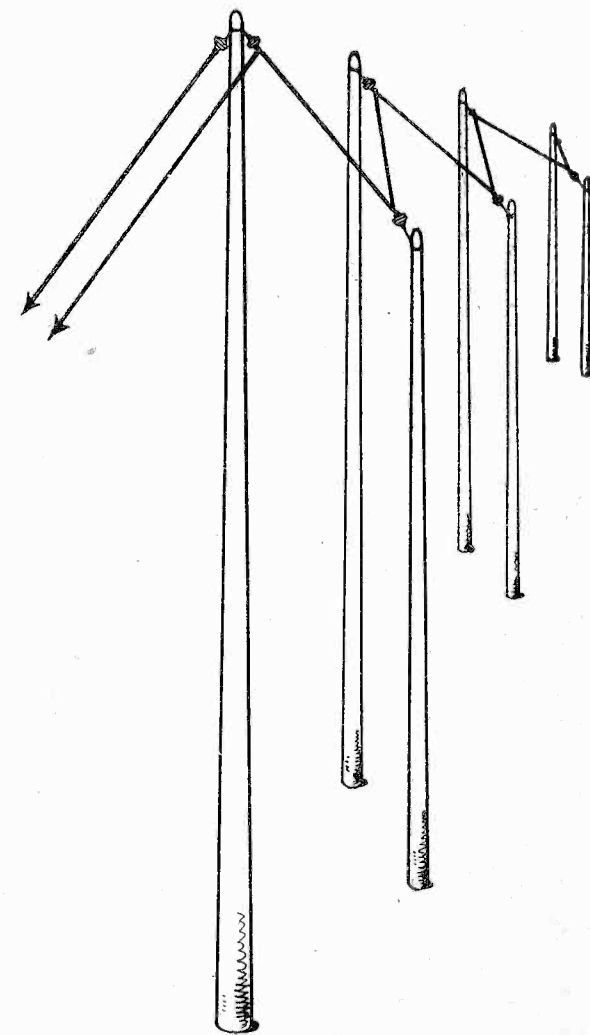

Fig. 2. The Chireix Antenna

with the Chireix aerial it is only necessary to excite it at one point.

Fig. 2 shows a sketch of the antenna. It is composed of one wire, zig-zagged back and forth so that each length is at about a 90 degree angle from its neighbors. Each straight length is a half wavelength long, so that we

(Continued on page 42)



# With the Amateur Operators

## A 1928 SHORT WAVE RECEIVER WITH SHIELDED GRID TUBE

By Francis Churchill

Since amateurs of all nations are to operate in narrow bands of the so-called 20, 40, 80 and 150 meter wavelengths, a short wave receiver should be made to cover these bands most efficiently. It is no longer necessary to have the receiver tune over a wide band in order to get both foreign and U. S. amateurs, which is an advantage as far as tuner design is concerned. The receiver can be made with a small midget tuning condenser, having a maximum capacity of 25 or 30 mmfd. and a plug-in coil for each band.

In the receiver shown in the picture, this idea has been utilized, and in addition a stage of r.f. amplification is used. This stage em-

amateurs, but is compact and cheap. The feedback control resistance  $R_3$  is of a new improved type and is very quiet in operation. It is in combination with the filament switch so one knob controls both.

It is a great advantage to have only one main tuning control since that leaves one hand free for copying. The r.f. stage tunes sharply enough so that it has to be fairly well matched up with the detector tuning condenser if any r.f. gain is to be obtained. The detector tube circuit tunes very sharply so that the overall receiver is more selective than most receivers, and the signals are louder with respect to background noise.

The actual construction of such a receiver is generally modified by each individual in order to use available parts. This is a perfectly good plan providing the circuit con-

stants are correct, that is, the right size of condensers, coils, etc., are used. The shielded can for the r.f. amplifier can be made out of sheet copper or aluminum of about 6x6x6 in. in size. The variable tuning condenser  $C_2$  should be mounted in the side of the shielded can so as to line up with the drum dial. The other tuning condenser  $C_5$  can be mounted in the regular dial support provided for that purpose. In mounting  $C_2$  the panel, base-board and drum dial should be assembled first, then the proper location for  $C_2$  can be readily located. The trimmer condenser  $C_3$  should be mounted in can with the knob controlled from the front of the panel. This allows it to be set to the correct position for any one plug-in coil.

The antenna coupling condenser  $C_1$  should also be mounted inside of the metal can in order to keep the control grid of the r.f. tube shielded well from the grid of the detector tube, or rather the plate leads of the r.f. tube.  $C_1$  can be any type of midget condenser of not more than 30 mmfd. capacity as a maximum value.

The coil sockets and coil forms are available on the market. Two of the former and eight of the latter should be obtained and the coils made especially for each amateur band, two similar coils for each band. The coils for the twenty and forty meter bands can be wound with No. 16 dsc. wire for the secondaries and No. 32 dsc. wire for the ticklers. For the 80 and 150 meter bands No. 26 enameled wire was used for the secondaries and No. 32 dsc. for the ticklers. In each case, only the detector coil  $L_2$  has a tickler winding  $L_3$ , and it is wound in the saw slot near the base of the coil form. The table below gives the number of turns used in the receiver shown.

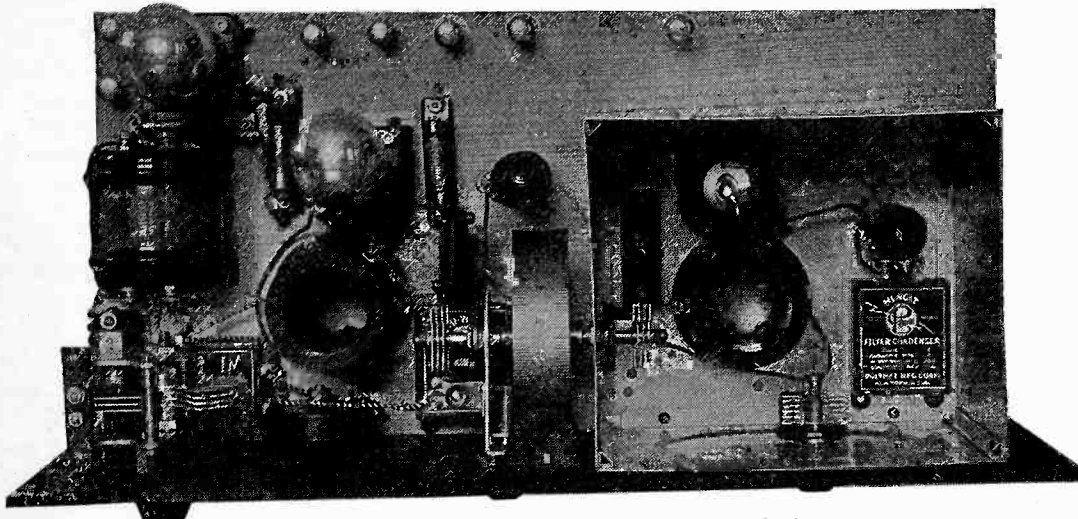

Short-Wave Receiver With Shielded Grid Tube.

plays a shielded-grid tube and gives good amplification in the amateur bands. Fig. 1 shows the circuit which is a stage of r.f. amplification, an oscillating detector and a stage of audio.

The r.f. stage is shielded from the rest of the set to eliminate feedbacks. The entire set could be shielded to good advantage if power qrm is bad in the locality in which the receiver is used.

The one tuning control is a drum dial with a midget variable condenser,  $C_2$  and  $C_5$  mounted on each side. The feedback in the detector circuit is controlled by means of either a variable condenser  $C_7$  or the variable resistance  $R_3$ , preferably by the latter as it has less effect on the detector tuning. The condenser  $C_7$  has a double purpose as it not only acts as a feedback condenser but as a "trimmer" condenser for  $C_5$  in order to line up the r.f. and detector tuned circuits. The midget condenser  $C_3$  acts as the trimmer for the first tuning condenser  $C_2$ .  $C_3$  is a midget condenser with only one rotor plate. This condenser is quite necessary because, by its use  $L_1$  and  $L_2$  can be identical, and  $C_2$  and  $C_5$  can be efficiently ganged together.

The audio amplifier is one stage with a 3 to 1 ratio transformer and a 201A type tube. The secondary of the audio transformer is shunted by a 100,000 ohm leak  $R_2$  in order to get away from the detector tube howl that occurs when it starts to oscillate. Without this leak the detector produces a bad howl when just barely oscillating and it is on this point that the tube should be operated for maximum sensitivity.

Three radio frequency chokes were used and are located at points of low r.f. potential. The receiver will operate without them fairly well, but it is best to use them as shown in Fig. 1. The type used is not especially efficient at the very high frequencies used by

$L_1$	
20 meter band—	4 turns No. 16 dsc.
40 meter band—	13 turns No. 16 dsc.
80 meter band—	22 turns No. 26 e.
150 meter band—	70 turns No. 26 e.

$L_2$		$L_3$	
4	turns No. 16 dsc.	7	turns No. 32 dsc.
13	turns No. 16 dsc.	10	turns No. 32 dsc.
22	turns No. 26 e.	12	turns No. 32 dsc.
70	turns No. 26 e.	15	turns No. 32 dsc.

(Continued on page 42)

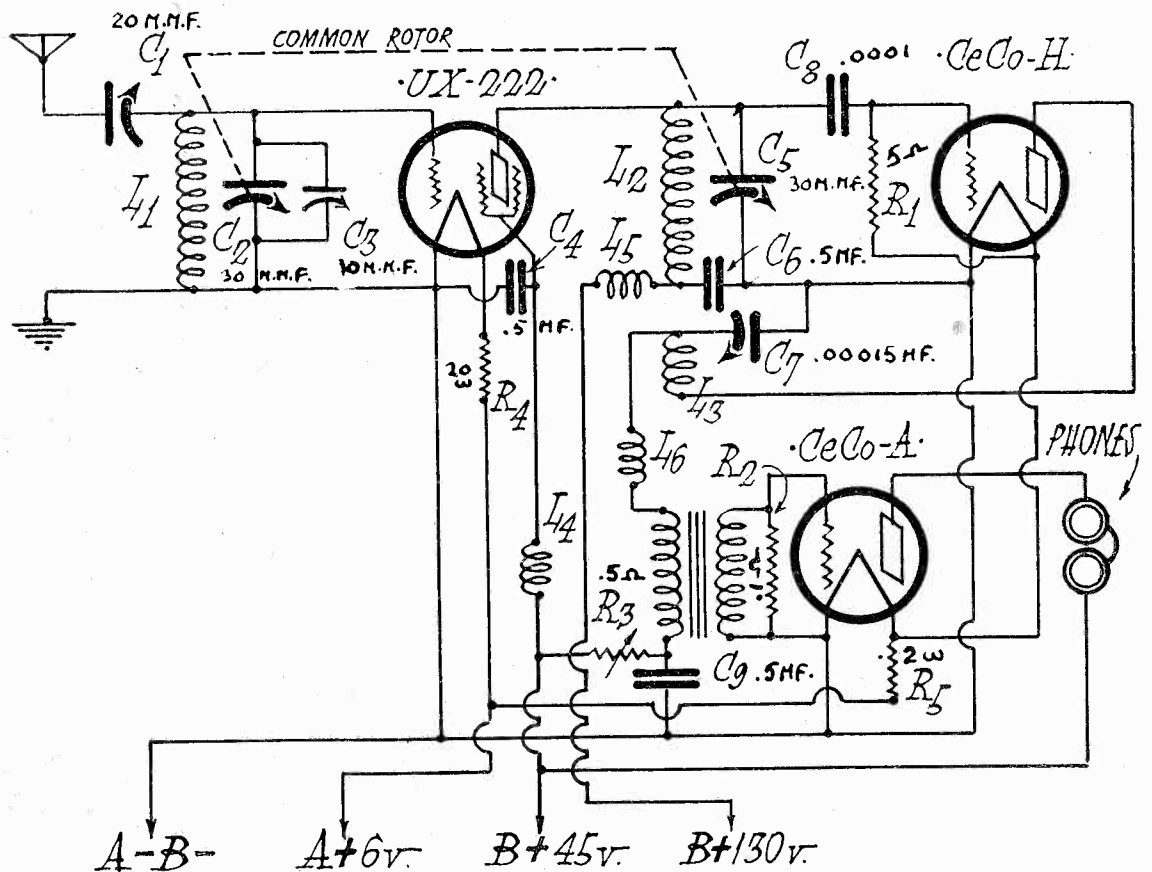

Fig. 1. Circuit Diagram of Short-Wave Receiver.

$C_1$ —20 mmfd. max.  
 $C_2, C_5$ —20 to 30 mmfd. max.  
 $C_3$ —10 mmfd. max.  
 $C_4, C_6, C_9$ — $\frac{1}{2}$  mfd. bypass

$C_7$ —.00015 mfd. max. var.  
 $C_8$ —.0001 mfd.  
 $R_1$ —5 meg.  
 $R_2$ —0.1 meg.

$R_3$ —0.5 meg. max. var.  
 $R_4$ —20 ohms  
 $R_5$ — $\frac{1}{2}$  amp. Polytrol  
 $L_1, L_2, L_3$ —See text  
 $L_4, L_5, L_6$ —r.f. chokes

# Radio Kit Reviews

## ADAPTING THE BROWNING- DRAKE TWO-TUBE KIT TO THE SHIELDED GRID TUBE

The new double grid tube can be used in the r.f. stage of the Browning-Drake two-tube kit described in January RADIO by a few simple changes. These include (1) shorting out the primary of the r.f. transformer and substituting a  $\frac{1}{2}$  mfd. condenser and r.f. choke, (2) shielding the r.f. stage, (3) inserting a  $\frac{1}{2}$  mfd. condenser between the tube's plate and a connection to ground, and (4) putting a 10 or 15 ohm resistance in the filament circuit to reduce from 6 to 3.3 volts. A neutralizing condenser is used to balance the very small capacity between the tube's plate and control grid, thus giving greatest efficiency for the regeneration on the r.f. transformer. These changes are shown in Fig. 1.

the first tuned circuit, as shown by dotted lines in Fig. 1. In many cases, however, especially if the .0001 mfd. series antenna condenser adds enough capacity, the trimmer condenser will take care of any difference between the two singly-controlled tuning condenser settings throughout the waveband. A few experiments will determine whether it is needed in a given installation.

Suitable shields and instructions for their use may be secured from the Browning-Drake Corporation. The  $\frac{1}{2}$  mfd. condenser between the shield grid and ground is essential when using this tube.

The 10-15 ohm resistance in the filament circuit not only cuts the 5 volts used with the 300-A or 240 detector to 3.3 volts for the screened grid tube, but also supplies biasing current. If a 3 volt supply and -99 tube is

blocking condenser, which, if connected to the grid of the second tuning circuit (to get at this condenser the top of the shield on the r.f. compartment will have to be removed), a distinct click will be heard if this circuit is oscillating. Now turn the tickler back to where oscillating just ceases. Turning the trimmer condenser will then throw this circuit into oscillation if the neutralizing condenser is not properly set. The neutralizing condenser should be then set until the above test is satisfactory and the trimmer condenser has no effect on oscillations produced in the second circuit. It will be found that this trimmer condenser is almost at a minimum value.

Too much cannot be said in favor of using the screened grid tube as a radio frequency amplifier. The amplification obtainable is tremendous and the operator can easily get down to the noise level with little or no difficulty.

## BOOK REVIEWS

"Practical Radio Telegraphy," by Arthur R. Nilson and J. L. Heornung; 380 pages, 5½ x 8 in., published by McGraw-Hill Book Co., New York City. Price \$3.00.

This is an instructive text written primarily for those preparing to pass the examination given to applicants for license as a commercial operator. The authors have had long experience and great success in teaching students at the Radio Institute of the West Side, Y. M. C. A., New York City. The book starts with an elementary explanation of electricity and gradually builds an understanding of the principles of radio transmitting and receiving equipment. As this is done without the use of mathematics it is easily comprehended by one who lacks such training.

Much of the material has not been previously published in book form. For instance, new R. C. A. vacuum tube transmitters are described and illustrated, including a complete ship's diagram for tracing trouble from the d.c. mains to the antenna insulator, Arc and spark apparatus, including that of independent manufacture, is completely covered. The operation of radio direction finders, and of remedying their troubles, are described in detail.

On the whole, it is a reliable, adequate and well-balanced text which admirably fulfills its primary purpose and in addition will be valuable to commercial operators who wish to brush up on the details of sets they may be called upon to handle.

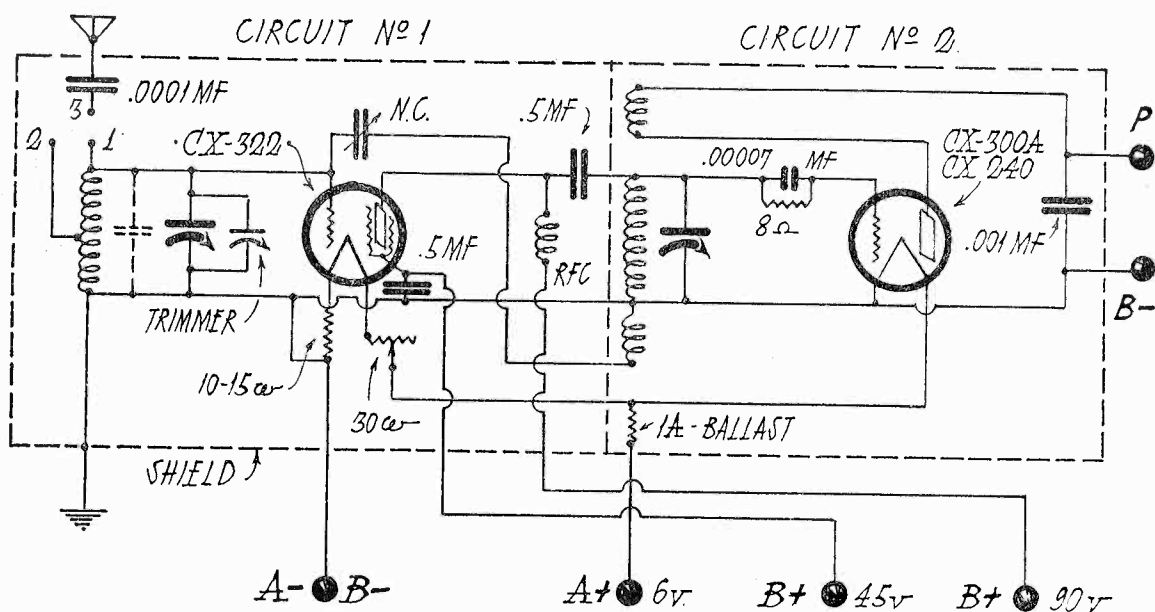

Fig. 1. Circuit Diagram of Browning-Drake

The primary of the r.f. transformer is shorted out because of the tube's very high impedance. This direct coupling (really an auto-transformer) requires a parallel feed system consisting of the  $\frac{1}{2}$  mfd. condenser and choke coil, thus keeping r.f. current out of the B supply. The tube's plate is connected directly to the stator of the second tuned circuit.

As this puts the plate-screen grid capacity across the second tuning condenser it may be necessary to put a 15 mmfd. condenser across

used as a detector, this resistance is not necessary.

When the receiver is completed and connected up it may be neutralized by setting the dial at about 20 on the scale and turning the tickler in either direction until a distinct click is heard in the loud speaker or telephones. Adjust the tickler coil until this circuit is not oscillating. A test to determine whether or not the set is oscillating is to place the finger on the terminal of the  $\frac{1}{2}$  mfd.

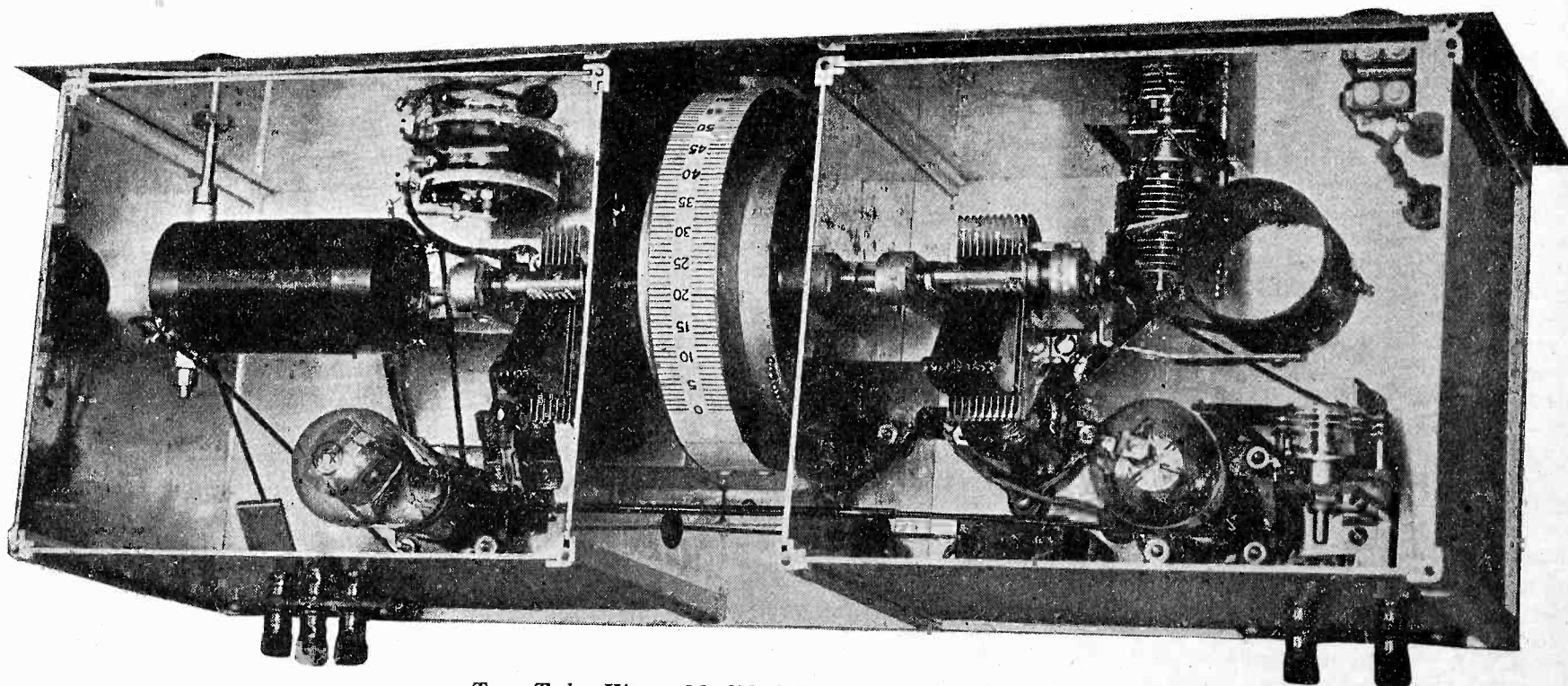

Two-Tube Kit as Modified for Screened Grid Tube.



# Owners tell the Story of INFRADYNE Performance

## From Australia

"I really cannot praise the Infradyne enough; it is a beautiful Receiver and suits Australian conditions."—Cliff N. Lewis, Melbourne, Australia.

## From Experience

"From experience, I can safely say that you, without a doubt, have, in the Infradyne, the greatest set on the market."—W. M. Aiken, 12 Arnold Street, Jamestown, New York.

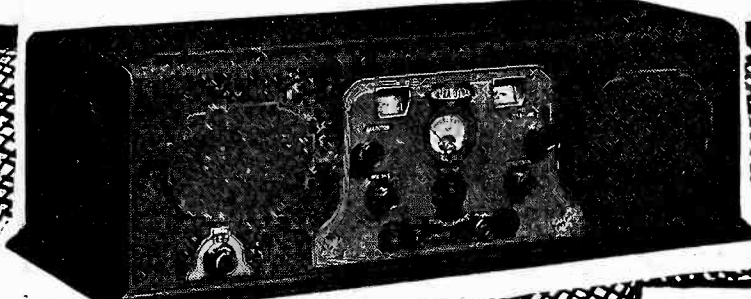

## Without a Hitch

"I have very recently completed one of your 1928 model Infradynes. Due to your care in furnishing the detailed information as to wiring and hook-up, it worked without a single hitch as soon as hooked up. After two weeks of use must say that for selectivity and quality nothing I have had has ever equalled it. I have covered the country from Maine to Florida and from New York to California. I can receive dozens of distant stations through the locals and believe me that is saying something when one understands what receiving conditions here in New York are."—Edward E. Lippner, 127 West 81st St., New York, N. Y.

## Unbeatable

"I am the proud owner of an 'Infradyne Set,' and after using it for nearly a year, I am still of the opinion that it is unbeatable in every way; I have given the set every test possible, and have yet to hear a set that in any way approaches its beautiful tone, its selectivity, or volume."—John F. Parrish, 2801 South Hill Street, Los Angeles, Calif.

## Results Far Excel

"I have been building up sets on order for four years, confining my work exclusively to Superheterodynes of the best quality, but the results obtained from the Infradyne far excel anything I have ever built up."—E. G. Hastings, 665 Meeting Street, Charleston, S. C.

## Best in America

"The reception on coast stations is the best I have ever heard as less static is noticeable. Have owned several sets, including Supers, and know your Infradyne is far superior to them all."—A. J. Cordrey, 2259 Rosemont Ave., Chicago, Illinois.

## No Room for Comparison

"Wish to apologize for not having answered your previous letter, but have been working night and day trying to keep this town supplied with Infradynes. I think that the Infradyne is going to do something that other sets have not done, and that is to sell good during the summer months. As far as telling what an Infradyne will do in accordance with other sets, there is no room for comparison for the Infradyne will out-demonstrate any set for selectivity and tone quality."—R. F. Nehrlund, 1012 W. Sprague Ave., Spokane, Wash.

## Coast-to-Coast

"I am more than pleased with my 1928 Infradyne, and while I have not tuned in any foreign station, loud speaker reception of coast-to-coast stations, Mexico and Cuba, is a regular thing."—James F. Overton, Houston, Texas.

## Remarkable Qualities

"If you have anyone who wishes to know the real ability of the Infradyne, kindly refer them to me. I shall be more than pleased to tell them fully of its remarkable qualities. You may feel at liberty to publish this letter as a testimonial regarding the qualities of the Infradyne."—Clyde L. Hume, 924 Broadway, Nashville, Tenn.

## Every Orchestra

"We find that with the Infradyne we have a range and a selectivity that is more than we ever hoped for, and, as one guest remarked, we have 'every orchestra in the country on our dining-room balcony.'"—Noah's Ark, San Mateo, Calif.

## Extraordinary Selectivity

"I think you have designed a wonderful Receiver. The amplification is enormous, the tone quality splendid, particularly with the 171 tube and the Western Electric Cone. It is selective to the most extraordinary degree and should be an excellent distance getter. I have logged about seventy stations, within about a radius of 1300 miles, but I have not sat up at night to try for any great distance."—F. P. Gowing, 43 Lincoln Street, Boston, Mass.

## Finest Receiver

"I thought it might interest you to know that during my considerable experience in the building parts of Europe, and my special acquaintance with the now numerous applications of the Supersonic Heterodyne principle, I consider the new Remler Infradyne Receiver, which I have just built, certainly the finest Receiver yet conceived. I would also like to add that the above Receiver reproduces music and speech with a much better quality than some of the most expensive Supers or Straight Multi-Valve Receivers now being put on the market."—C. Tavaniotis, 7 St George's Terrace, Regent's Park, London, N.W. 1.

## Absolutely Uncanny

"In regard to the Infradyne, I wish to say that I, personally, and also everyone who has heard an Infradyne built by us, is of the opinion that it is the very last word in radio design; its performance is absolutely uncanny. I enclose a list of stations which have been received in the past few weeks—a remarkable list I think you will admit."—Robert H. Hemming, 362 No. High Street, Columbus, Ohio.

## So Valuable

"The Infradyne is proving so valuable to me, and so satisfactory to my most critical customers, that it is a real pleasure to tell you of my success. In the last five months I have built and sold about twenty-five Infradynes. Most of these sets have gone to owners who have owned several receivers and who know the difference between ordinary and remarkable reception. The merit of the Infradyne itself, plus the selling assistance which you are giving the professional set-builders will assure the outstanding success of the circuit."—Roy N. Francis, 1346 Polk Street, San Francisco, Calif.

Use the coupon below to get further information about the Infradyne.

REMLER DIVISION, GRAY & DANIELSON MANUFACTURING CO.  
260 First Street, San Francisco, Calif.

Please send me complete information about the Infradyne and folder describing all Remler Parts.

Name..... Street..... City.....

Do you build and sell sets?.....

Tell them that you saw it in RADIO

THE 115 K. C. SUPER  
(Continued from page 17)

point of design and simplicity to use 3 volt tubes in the rest of the circuit wherever possible, and this has been done.

In the pictorial wiring diagram of the set in the January issue, and in the blue prints that have been prepared, the connections to the antenna compensator are not as clear as might be. The midget variometer which is connected in series

with the secondary of the first coil of the r.f. amplifier is held in place by means of a brass strip in the form of a bracket, and to this strip the connection to the grid returns of the two r.f. amplifier tubes is made, as well as one side of the midget variometer. The connections to this brass bracket should be soldered, as there is no soldering lug or terminal screw on the top of the bracket. The pictorial diagram shows the wire from the secondary of the antenna coil going to the lug A on the back of the variometer, and this should be changed to the lug B on the front of the variometer, nearest the front panel as shown in Fig. 2. Otherwise, only half of the variometer, the rotor, is connected in the circuit, and the variometer is inoperative.

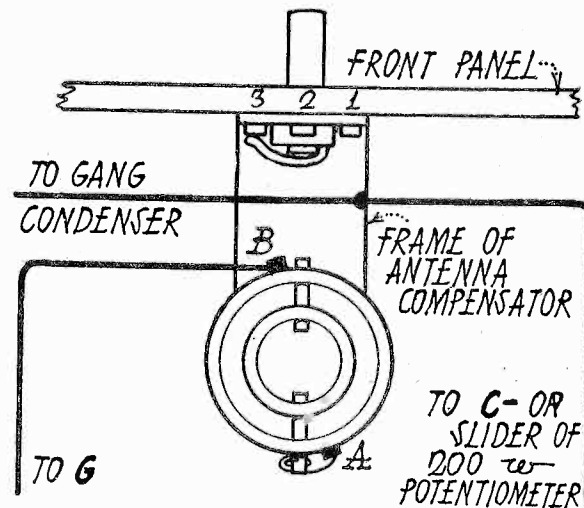

Fig. 2. Antenna Compensator Wiring.

For those who are interested in winding their own coils, the following data are given: Antenna coil, No. 550 has a secondary of 110 turns of No. 25 double silk wire wound on a 1½ in. form. Primary is 20 turns of No. 28 silk wound bundle fashion on a 1¼ in. diameter, and placed at one end of the secondary. The r.f. transformer, No. 560, has secondaries of the statically balanced type, consisting of two windings of 61 turns each, wound in the same direction, but with the outside ends of the two coils connected together, and the inside ends used as the grid and filament connections. The primary winding is 250 turns of No. 36 single cotton covered wire wound honeycomb or scramble fashion on a ¼ in. hub, and placed at the bottom end of the coil.

The oscillator coil has two stator windings of 49 turns each of No. 25 double silk, with ⅛ in. spacing between the two windings. The plate coupling coil is placed inside the oscillator coil, and consists of 18 turns of No. 25 double silk on a 1¼ in. tube. Data for the regenerative r.f. coil and its mate, the first r.f. transformer, has already been given in the text. All coils are mounted on bases having four prongs of the same type as standard A tubes, so that home-made coils may be mounted on the bases of worn out tubes.

## LEARN TO SEND THE EASY WAY

Reg. Trade Marks  
Vibroplex  
Bug  
Lightning Bug

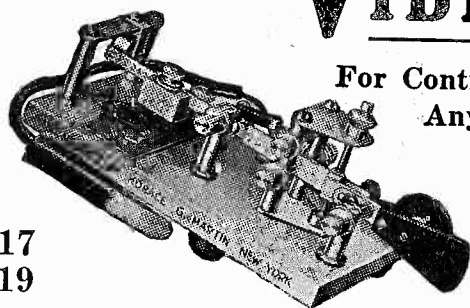

With The Improved Martin

# VIBROPLEX

For Continental or Morse Code  
Any speed from 10 words  
per minute up

Japanned Base, \$17  
Nickel-Plated, \$19

Easy to learn and easy to operate. Simply press the lever—the Vibroplex does the rest. Adjustable to any speed from 10 words per minute up. Saves the arm, prevents cramp and improves sending 50 to 100%. Over 100,000 users. No station complete without this up-to-date BUG.

### SPECIAL RADIO MODEL

Equipped with Extra Heavy, Specially Constructed Contact Points to break high current without use of relay. Sent anywhere on receipt of price. Money order or registered mail. Liberal allowance on old Vibroplex.

**\$25**

Insist on the Genuine Improved Martin Vibroplex. The Vibroplex Nameplate is YOUR protection. Order NOW!

THE VIBROPLEX CO., Inc.

825 BROADWAY

Cable Address "VIBROPLEX" New York

NEW YORK

## Bargains for Ye "Hams"

2MA Co. is now largest concern run by hams for hams in the U. S. No delays—prompt service. Money back guarantee. All standard apparatus. Lowest prices in the U. S.

REL 20-40 or 80 meter transmitting inductance double with coupling rods, complete, each	\$8.85
AERO 20-40 or 80 meter transmitting coil kits. Also 15-130m. S. W. Receiving coils	\$9.75
THORDARSON, NEW TYPE—Combined plate and fil. transformers; 650 v. plate and v. fil. windings with mid taps	\$6.20
80 watt fil. trans. 8 v. with mid tap	6.10
150 watt fil. trans. 12 v. with mid tap	7.85
100 watt plate trans. 350 and 550 v. with mid tap	10.90
450 watt plate trans. 1000 and 1500 v. with mid tap	16.40
JEWELL 3 in. Flush Mounting AC or DC voltmeters, milliammeters—any scale readings	\$5.95
Antenna thermo-ammeters, any scale reading	9.80
CARDWELL New Type Condensers T 199 .00085 mfd.	\$8.90
New type cond. T 183 B .00015	8.90
New type cond. T 147 B .00045	8.90
GRID LEAKS—Large General Electric 5000 ohm	\$1.45
Large Ward-Leonard Cent. tap 5000 ohm	2.45
Small Ward-Leonard Cent. tap 5000 ohm	1.80
Crescent Lavite 5000 ohm special	2.20

### FIXED CONDENSERS

SANGAMO By-Pass Condensers—Large .002 mfd., 500 volt	\$ .50
Up to .005, 3500 volt	1.50
.002 mfd., 5000 volt	1.75
FLECHTHEIM Guaranteed Filter Condensers. 2 mfd., 1000 volt	\$2.75
4 mfd., 1000 volt	4.75
1 mfd., 2000 volt	2.75
2 mfd., 2000 volt	4.35
4 mfd. 2000 volt	6.95

(Flechtheim filter condensers are guaranteed against break down. Blown condensers will be promptly replaced without charge.)

Pyrex Standard Sockets for 202s, 210s, etc., 65c.

Products at Lowest Prices Ever Sold.

Money Back Guarantee.

Radio 2MA Co. 168 Washington St. New York City

## Tested and Matched Tubes

OF COURSE, your set will work 25% better, as a general rule, if all the tubes are precisely matched and hand-picked for best characteristics as to radio frequency amplification, detection, oscillation and audio stages. We have a complete tube testing device for accurately doing this work. We make no extra charge for hand-picking and matching tubes. Any type of tube can be supplied. Several days' time must be allowed for testing, packing and shipping.

**D. B. McGOWN**

435 Pacific Building

San Francisco California

At \$600 this famous  
**Cabinet**  
has no equal!

The Blue Ridge  
7"x18"x10" Mahogany  
or Walnut Finish

Send us your order or write for catalog and full information. 12 hour service, factory to you.

**Southern Toy Co. Inc.**  
MANUFACTURERS HICKORY N.C.



MEMBER  
**RMA**

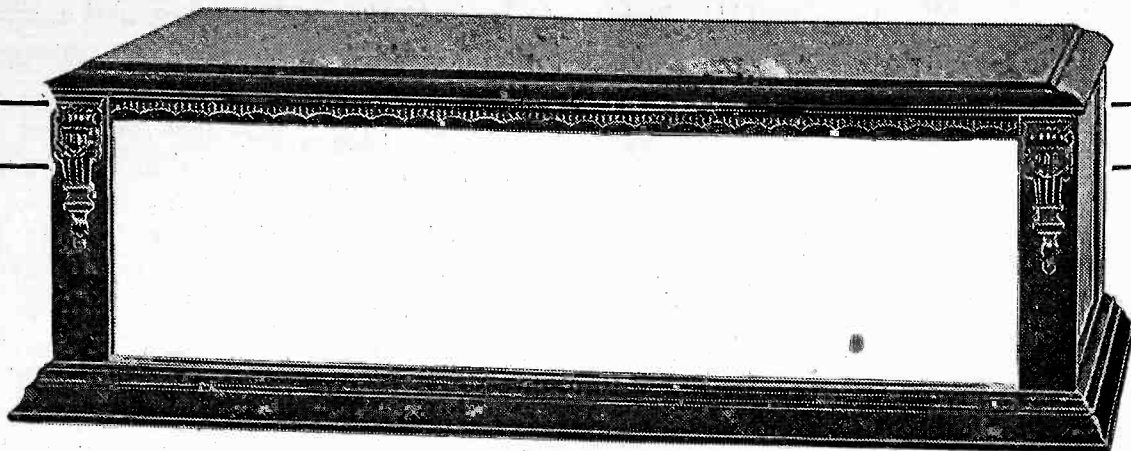

*The specified cabinet by Best for his great SUPERHETERODYNE. A beautiful housing for this deluxe receiver. Selected by Best for its excellent workmanship and superior construction.*

## Gerald M. Best's Authorized Cabinet for his new SUPERHETERODYNE

**C**HILLICOTHE Radio Cabinets are designed by experienced Radio Specialists. This genuine walnut cabinet was originally designed and built for the Gerald M. Best Superheterodyne Receiver. The top is piano-hinged; base, rail and posts are solid walnut. Top and sides are of scientifically constructed, laminated walnut to eliminate warping or splitting. Standard equipment; removable baseboard, 26 x 11 inch.

Front panel space 7x26 inch. Opex lacquer piano finish.

**H**ERE in this new creation by the Chillicothe Furniture Company, you will find authentic, distinctive design, simplicity and unsurpassed convenience,—truly a pleasant combination.

Interesting booklets on Chillicothe Radio cabinets will be cheerfully mailed upon request. A letter to Department R, Chillicothe Furniture Company, Inc., Chillicothe, Missouri, will demonstrate how these cabinets will improve your set.

### CONSTRUCTION

The same ideals which the Chillicothe Furniture Company has at all times expressed in the construction of their genuine walnut Dining Room Suites, have been carried into this new field of radio cabinets, and built in "The Walnut Center of America," by this reliable firm, you are assured of a radio cabinet superb.

*"Built in the Walnut Center of America"*

# CHILLICOTHE RADIO CABINETS

CHILLICOTHE FURNITURE COMPANY

INCORPORATED

Chillicothe, Missouri

*The CHILLICOTHE console, massive and beautiful, will satisfy the needs of the buyer who wants individualized custom-built cabinet work. Write for circulars on our line of consoles.*

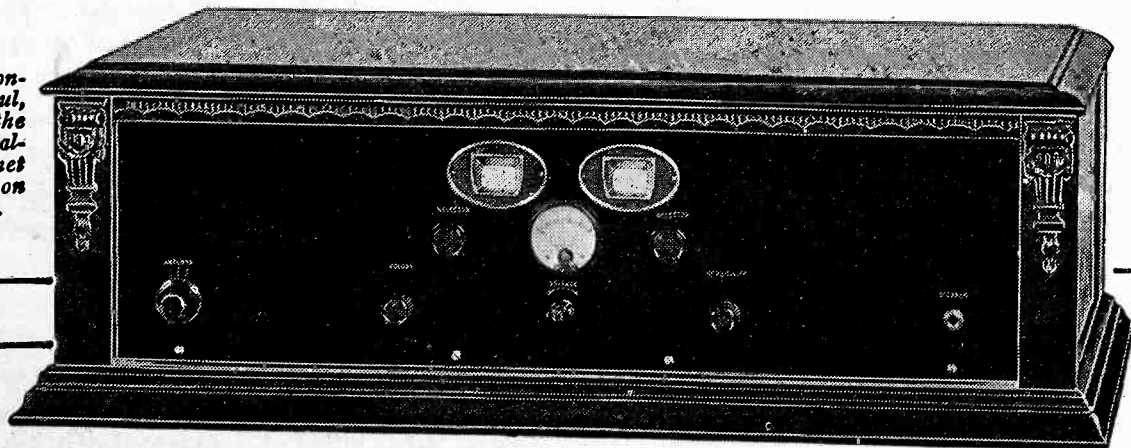

*Here is pictured the Best SUPERHETERODYNE in the specified CHILLICOTHE table cabinet. Decorative motifs enhance the beauty. You will be pleased with the excellent finish of this cabinet.*

Tell them that you saw it in RADIO

# MAGNAVOX

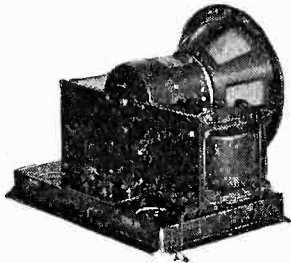

## R500 Unit Dynamic Power Speaker and power amplifier combination

THE wonderful Magnavox Dynamic Speaker, with a matched power unit, self-contained on steel frame, is ready for installation in any radio set or phonograph cabinet having space available of 14 in. wide and 12 in. high.

Power unit for 105 - 125 volts 60-cycle A. C. supply. Requires one 316B type rectifying tube and one 310 or 210 type amplifying tube. Can replace last audio tube of set or use all tubes of the set. For use with phonograph electrical pickup head two additional audio stages recommended between pickup and R500 unit.

Only the dynamic type of speaker can bring out the full qualities of reproduction demanded today. With this carefully matched power unit the combination is the highest grade of radio device. Price \$120 for complete unit less tubes. Write for speaker bulletin.



Loby  
Cabinet

LOBY MODEL  
R500 Unit in handsome cabinet, finished in rich old English brown mahogany. \$165.00, less tubes.

The Magnavox Company  
Oakland, California

## THE MARCONI "BEAM"

(Continued from page 15)

With key down, the control valve is blocked by the high negative bias and the operating circuits then draw normal load, the master oscillator picking up its positive potential through the drop across resistance *RI*.

It is the simplicity of the circuit which permits such high keying speeds to be attained—up to 300 words per minute can be handled in this manner—for the only mechanical unit is the line key, the valve *CT* acting as a high speed relay. Another result of this desirable elimination of peak load surges, which can not fail to impress one, is that most of the oil cooled tubes in these circuits have given more than 5,000 hours life already; a rare, not to say unknown occurrence under ordinary keying methods. Incidentally, the British refer to key down—key up, as "mark" and "space." It reminded me of the Smith Brothers broadcasting.

So far we have neglected the receiver system. In effect its antennas are identical with those at the transmitter, being in this case pointed toward the oncoming wave. The same type of lecher feed is used to carry the antenna energy to the receiver, the coupling in coil consisting of only a few turns of inductance. The receivers themselves are of the separate heterodyne type, corresponding to our super in function, the signal being heterodyned twice and then passed through band filters having a sharp cut off on either side. In the last stage a thousand cycle note from an oscillator is mixed with the signal to modulate it. The result is a beautifully steady signal on the line, with a beat guide for the central office to monitor on. Then, if the signal should swing slightly, the adjustment can be made at the central office receiver which rectifies again and "demodulates" the signal before it goes to the tape. Not a bad stunt at all, for, after the first adjustments have been made, central office can take care of the signal itself.

The directional effect of the beam antenna is quite noticeable in the elimination of atmospherics, this being its main function at the receiver end. Only the atmospherics progressing along the same path as the signal, and within the 20 degree sector, have any effect, and, as a result, during most of the day the received signal is remarkably clear of extraneous interference. Overhead antennas were used at the receiver station to demonstrate this effect and, while the signal received on this type of antenna appeared of normal strength, the noise background immediately shoots up when such a changeover is effected. Whether the beam would compare favorably with the short wave Beveridge in this respect is a matter of pure conjecture, since I

have had no experience with the latter type of antenna.

Nor would it be fair here to make any operating comparisons with the installation previously mentioned at Manila Radio. At the time of my departure these circuits had been in operation a brief two months, whereas the Australian circuit has been under way for several years. However, a good basis of comparison should be afforded by the Australia-to-Montreal circuit which opened for test several weeks before my departure from Sydney. Bays are used for this circuit—48 antenna radiators and 96 reflectors—the wider angle giving a more sharply converging "beam" than the Great Britain circuit. The Marconi engineers have expressed themselves eminently satisfied with the test results and within six months there should be some reliable data available on the operating characteristics of this link.

I think it pertinent in concluding, to acknowledge the courage of Signor Marconi in cutting away from twenty odd years of long wave broadcast developments and returning to the starting point of all wireless communication—the Hertzian high frequency reflector. His company had been responsible for the installation of many of the long wave transmitters, involving millions of dollars. In my personal opinion, his high frequency directional transmitters are unquestionably the peer of any communication system so far developed, yet as pointed out, they are still a long way from achievement of a real beam form. I believe, in fact, that they mark only the first step in the progressive development of such directional systems, and that we are even now on the threshold of discovering data which will lead to the establishment of a system capable actually of projecting its energy in true beam-like fashion. When this has been accomplished we will have attained very close to the ultimate of efficiency in point to point communication. It is hardly necessary to remark that it will be a development of the high frequency field, which by comparison and in its potentialities, still remains virginal.

The lead terminals from the plates of storage battery cells may be "burned" or melted with a small blow-pipe flame formed of acetylene mixed with air. The air should be in proper proportion to make the flame non-luminous. The lead should be heated until limpid and allowed to flow into an iron mold assembled from sheets and bars clamped together.

Celluloid may be attached to wood, paper, glass or rubber by applying alcohol to the celluloid and pressing it upon the other substance.

Tell them that you saw it in RADIO



THE JUNGLE S O S

(Continued from page 21)

care of these snakes," answered Charlie. "But let's get out of here before something does happen to us."

At this suggestion both boys raced for the machine, little thinking that this episode was to prove the start of a very exciting day.

"WELL that must be the Queens where we are to find a night's rest," said Bill. Before his words were finished the driver brought the car to a stop in front of a large hotel. "Let's have a look at the room, old man, and then see some of this town before dark," suggested Bill.

Charlie agreed to his pal's idea, and before long the two boys were delving into the secrets of the mysterious old town. A couple of hours passed in this manner until Charlie, with a pretext of looking at an old Indian fakir performing feats of magic in the street, whispered to his partner.

"Say Bill, what do you think that fellow wants with us? He has been following us for an hour or so. I don't like the way he keeps track of us."

"Oh I daresay it's just a case of nerves with you, Charlie," replied Bill, who was noted for his optimism.

"Well we will see if it is," answered Charlie in a tone that made Bill agree to his suggestion that they make several round about moves to see if the fellow was really following them.

"I guess you are right, old man, I owe you an apology," confessed Bill. The two shipmates had been circling and dodging for half an hour, but their tracker was still in sight.

"You can just bet I was right. Let's get a riksha and head for civilization," said Charlie. Fitting his words to actions, he beckoned an idle riksha runner who soon landed the boys safely at their hotel.

An hour later two well-fed young sailormen stepped out onto the porch which surrounded the hotel, and with two comfortable looking chairs spotted, started in their direction. Suddenly, and without a word, Charlie whirled and, jumping the rail, made for a figure on the other side of the street. Bill was close behind his chum and was just nearing the two on the opposite side when Charlie's agitated voice reached his ears.

"Say, fellow, what are you following us for?" Bill arrived to find Charlie facing the native who had been trailing them. "All right, talk up now or we'll have you taken up to the hoose gow, savvy?" continued Charlie.

"Ah, but the sahib must not be angry," replied the native in very good English, "I am but a guide and I have been waiting an opportunity to offer you my services."

# Dealers!—Set Builders!—

Get Your Kits and Sets Here

Save Money

Save Time

Get Better Service

## ALL THE SEASON'S WINNERS

Infradyne

S. M. Shield Grid "6"

G. M. BEST 115 K. C.

TYRMAN "70"

Large Stock on Hand—Write for Prices

All of the above are sold either in complete kit form or any of the parts will be sold separately. Our price sheet has everything itemized with individual prices.

We carry a large stock on hand at all times and can make immediate delivery on anything listed here. You can save from two days to a week by placing your orders with us and taking advantage of our prompt service. If you are in a rush, wire us your order and fifty per cent of the remittance and shipment will go forward the same day.

### We Will Build Any Kit to Order

This is a special service which you cannot duplicate anywhere else. If you are in doubt about how to build up your first kit, order it here and let us build it for you. The work will be done quickly, by competent, experienced men, charges will be reasonable and the built up set will look like a factory-built receiver when it leaves here. All built-up kits are tested on DX before shipment. Write for our build-up prices.

## Jensen Dynamic Speakers

Cabinet Type  
(Illustrated)

\$65.00

Console Type  
(out of cabinet)

\$47.50

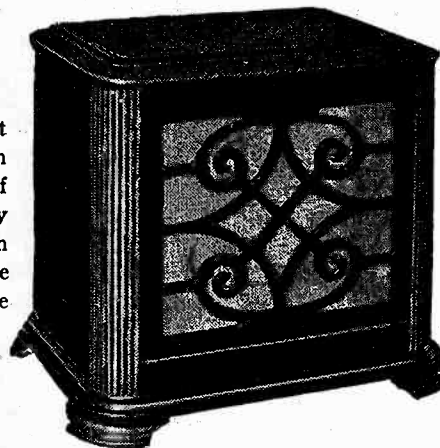

This loudspeaker is without question the finest that can be bought at any price. If your customers want the very best, investigate the Jensen Speaker, and order a sample for demonstration. Immediate delivery on either type.

#### Custom-Built Power Speaker

A power amplifier, built right into the Jensen Speaker illustrated. Everything goes inside the speaker cabinet. The finished power speaker is the same size and looks just the same as in the cut. This power speaker has absolutely the finest tone of any musical instrument ever made. Will give enough volume to fill an auditorium—and without distortion. Price, complete with CX-381 and CX-310 tubes, \$130.00.

## Sargent-Rayment Station Isolator

#### Dealers

If you do not stock the Station Isolator you are missing the most profitable item of the 1927-28 season. Progressive dealers everywhere are buying quantities of them and making more profit than on any other item in their stores. Free, attractive counter display card furnished when desired. Order a demonstrator C. O. D. and ask details of our special dealer plan on these popular little instruments.

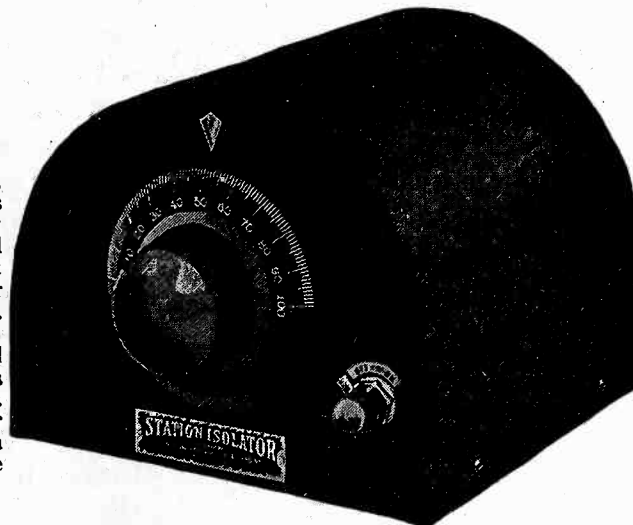

#### Set Builders

Here is an item that your clientele will thank you to demonstrate to them. Follow up old sales with an item that will make you an extra profit and renew an old friendship with your customer. Order a sample C. O. D. and ask for full details about this. You cannot afford to let your competitor be first in your territory with the Station Isolator.

Made in Two Models—\$10.00 and \$17.50

Write for our latest catalog

## Radio Constructors Corporation

357 TWELFTH STREET

OAKLAND, CALIF.

Tell them that you saw it in RADIO

# JENSEN

## DYNAMIC SPEAKER

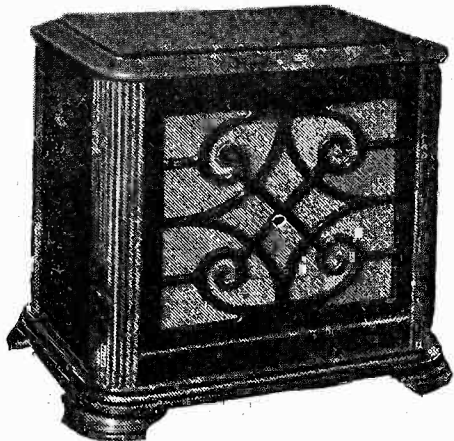

**Free Floating Coil and Cone  
No Friction . . . No Stress**

**EMBODYING** the dynamic, or moving coil principle, designed by Peter L. Jensen, the Jensen Speaker presents at all volumes perfect reproduction of voice and instrument precisely as broadcast. Its tonal range is the truest and greatest ever achieved in a radio reproducer.

*Engineers in one of the nation's great laboratories pronounced the Jensen Speaker superior to any other tested by them and immediately bought a quantity of Jensen Speakers for use in their own homes.*

The Jensen Cabinet Speaker combines charm of appearance and perfection in radio reception. Height 14 inches, width 16 inches, depth 12 inches, shipping weight 34 pounds.

Type D44 Standard 6 volt field  
15 ohms).....\$65.00

Type D45 (Special field 2250 ohms).. 67.50

### The Unit

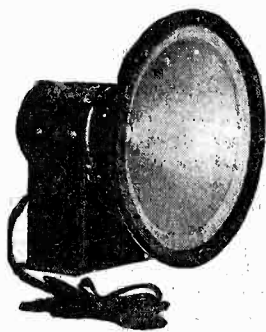

The Jensen Unit may be purchased separately and is the same as used in the cabinet speaker. It is capable of the same perfect reproduction when used with suitable baffle and can easily and quickly be installed in consoles, radio or phonograph cabinets.

Type D4 is wound with standard field winding and has a resistance of about 15 ohms, draws less than four-tenths amperes from a 6 volt "A" power supply.

Type D5 is wound with special field winding, having a resistance of about 2250 ohms. This field may be used as a choke in a power amplifier circuit or in such a manner that it obtains its magnetic energy from the plate supply. At 80 to 90 volts it will draw from 35 to 40 milliamperes.

Both types of Jensen Dynamic units are equipped with a step-down transformer with a ratio of 25 to 1, so no other output transformer is necessary.

Height 10 3/4 inches, width 10 inches, depth 8 1/2 inches, shipping weight 24 lbs.

Type D4 (Standard 6 volt field).....\$47.50

Type D5 (Special field)..... 50.00

All types will safely carry the output of 171-210 or 210 push pull power amplifiers.

*If you are unable to get either the Jensen Cabinet Speaker or Unit locally, send the coupon below, giving us the name of your dealer, and we will see that you receive complete information.*

*Licensed under Magnavox Patents.*

JENSEN RADIO MFG. CO., "R3"  
212 Ninth Street, Oakland, Calif.

Send full details about the Jensen Dynamic Unit and its use in phonograph or radio cabinets.

Name.....

Address.....

Dealer's Name.....

Address.....

"Well that is a pretty poor way of offering us your services, by trailing us all afternoon, old man," said Bill.

"You do not understand, sahib, but I am not the common street guide," said the native. "It is said throughout Ceylon that I, Abed Rey, am the best jungle guide on the island. I have but tried to keep you in sight so that when you had tired of the drab doings of the people, I might offer you my services in leading you to the wondrous beauties of the jungles."

Neither of the boys answered at once, but stared at the guide. He was a tall, dark-skinned young man garbed in native attire and but for his exceptionally intelligent face and his educated manner he might never be singled out from any of the other natives.

"Say, I'm sorry fellow," finally replied Charlie, "But you have been wasting your time. We don't intend going to any jungles and . . . ."

"Wait a minute Charlie." Suddenly Bill came to life and, taking his pal by the arm drew him to one side, and in a lower voice continued, "I don't trust this fellow any too much, but wouldn't this be a good chance to get out and try that portable outfit. We have packed it all of the way up here and it seems a shame to carry it back again without a trial."

"It would be a mighty good test at that, Bill," answered Charlie. "Say, if we could raise some amateur from the middle of the jungle it would prove that set without a doubt."

After questioning the guide as to the time it would take to make the trip and gaining various other bits of information, they finally decided to go. The boys returned to their hotel room and when they emerged each carried a brown canvas bag, thrown over their shoulders like a knapsack.

Accompanied by their guide, who looked well pleased at his success in thus easily obtaining a commission, they turned their footsteps toward the jungle, which started where the town left off. Within a short while they were picking their way through the underbrush, choosing slightly worn trails where possible. They had traveled about a mile into the woods when their guide broke the silence for the first time.

"If it pleases the sahibs, they will remain here a moment and I shall see what lies ahead." Without waiting for a reply he plunged into the jungle and for a moment the boys could hear him crashing about.

"This is some . . . ."

Charlie never finished his sentence for several natives appeared as if by magic and threw themselves at the two young pals. After a brief struggle the boys, being hampered by the loads on their backs, were overpowered and found

themselves confronted by a circle of serious-faced natives.

With prods and native gibbering they were forced along a narrow trail which soon brought them to a little clearing on which was built a bamboo shack into which they were thrown.

"Now what does all of this mean?" asked Charlie as soon as he caught his breath. "Gee but this place has a funny odor, snaky if you ask me."

They were not left long in doubt, for before Bill could answer, a small shutter in the side of the shack moved back and the face of their recent guide peered through. "Now the young sahibs may soon look upon some of the beauties of our jungles," he leered in a tone full of sarcasm.

"What is this all about? If you want money we will give you what we have," spoke up Bill.

"No, sahib, we do not want money, but the cobra must be revenged. This morning you made the fatal mistake of killing a sacred cobra in the presence of our most worshipful master who poses to be an employe of the Royal Indian Zoo. To offset the vengeance of the cobras we must have a just revenge. Surrounding this shack are snake dens with the only exits leading into this shack. The snakes are well fed now but they will soon become hungry and start in search of food. Then will our revenge be complete. For you there is no escape." The shutter was drawn and with horror-stricken looks in their faces the boys stared at each other.

"The man is a fanatic," fairly shouted Bill. "It looks as though we were goners, unless . . . ."

"Yes, unless this portable can bring us help," broke in Charlie, who was now the more possessed of the two. "It certainly is a lucky thing that they did not take it away."

Bill's natural optimism was immediately aroused and they began to unpack the contents of the canvas bags. Bill rigged up a makeshift antenna, stretching the wire back and forth across the room, while Charlie commenced assembling his apparatus. It was half an hour later that he finally made the battery connection and started the little dynamotor that furnished the power for his transmitting tubes.

"I hope they don't hear this hum outside, Bill," said Charlie and in the same breath asked, "Will it start those snakes to investigating? You watch the room while I try for some results."

Anxiously Charlie bent over the key and the SOS crashed out into the jungles.

"Not a thing, Bill," reported Charlie after struggling with his apparatus for the better part of an hour. "It is getting so dark now we won't be able to see if anything crawls into the shack."

Tell them that you saw it in RADIO



"Let me try it, Charlie, and you take this flashlight. If you hear a sound, flash the light." The switch was made and Bill filled the air with the SOS and described to the best of his ability the shack in which they were held prisoners.

"That's the end Charlie," suddenly spoke up Bill, "I guess the outfit wasn't made for jungle work," and with a twist of his hand he gave the receiving condenser a spin.

"Boy! It's music," almost shouted Bill, clasping the ear phones closer to his head. "A broadcasting station, Charlie, and they are playing . . . Charlie they are playing 'The End of a Perfect Day'."

"Well, that doesn't mean it's the end of us, Bill. If they can get through, so can we. I am going to raise the wave a little and maybe we can break in on some broadcast listener who can read us," answered Charlie, as he made the necessary changes.

SOS, SOS, again and again the call went out into the air and then with a dying moan the dynamotor stuttered and came to a dead stop.

"It's all over now, Bill, the battery is completely gone," said Charlie in a dejected tone.

"Well, we will die fighting anyway, old man," answered Bill. "Let's get something to protect ourselves."

"That's the sad part of it, there's not a thing in the shack that will do us any good. I made note of that fact while I was putting the set together," said Charlie.

"That old set is going to come in handy yet," declared Bill. "Why that panel will make an ideal weapon against these snakes. You get that and I will take care of the light."

The boys waited in the darkness with bated breaths, trusting that help was near at hand, when the sibilant hissing of a giant cobra broke through the stillness. Holding tight to each other the boys remained motionless until the hissing grew louder and the scrape of a heavy body crawling over the floor of rough bamboo was heard. Bill flashed the light in the direction of the sound and there, in the small circle of light, appeared the repulsive head of the intruding cobra.

Charlie stepped cautiously forward, holding his piece of paneling in front of him ready to strike. The cobra had stopped and was raising his hideous head when Charlie leaped at it and struck a vicious blow. The blow fell short by inches and their only weapon slipped from his hands and went clattering to the far side of the room. Charlie jumped back and Bill, becoming excited, threw the flashlight full at the head of the weaving, hissing snake. The room was plunged into utter darkness as the flashlight crashed into the opposite wall.



## A. C. Meter For Filament Control

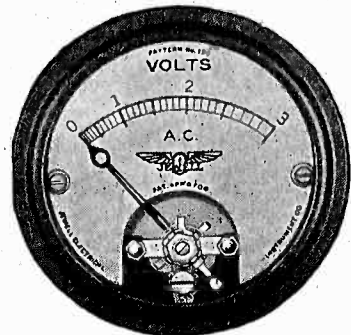

Pattern No. 190  
A. C. Voltmeter

The advent of vacuum tubes having filaments excited from alternating current has created the necessity for an absolute means of controlling the voltage applied to the filaments. Variation in house lighting voltage is often such that a permanent setting of the filament rheostat cannot be made with any assurance that it will be correct for more than a few minutes. Again the characteristics of the radio set are frequently found to be such that a particular setting of the filament rheostat is necessary to eliminate objectionable hum.

For A. C. filament control the Jewell Pattern No. 190 A. C. panel mounting voltmeter is ideal. It has a body diameter of 2 inches and in general appearance is the same as the Jewell Pattern No. 135. The movement is an accurate, moving vane type, designed for continuous service with special modifications for the small size case. Energy consumption is very small.

The instrument is available in ranges of 0-1.5, 0-3, 0-8, 0-10, 0-15 and 0-150 volts.

Write for descriptive circular No. 1145.

## Jewell Electrical Instrument Company

1650 WALNUT STREET, CHICAGO

"28 Years Making Good Instruments"

BLUE ::  
PRINTS

For BEST'S New 115  
KILOCYCLE SUPER

Now Ready for Mailing  
"RADIO," San Francisco, Cal.

\$1.00  
POST  
PAID

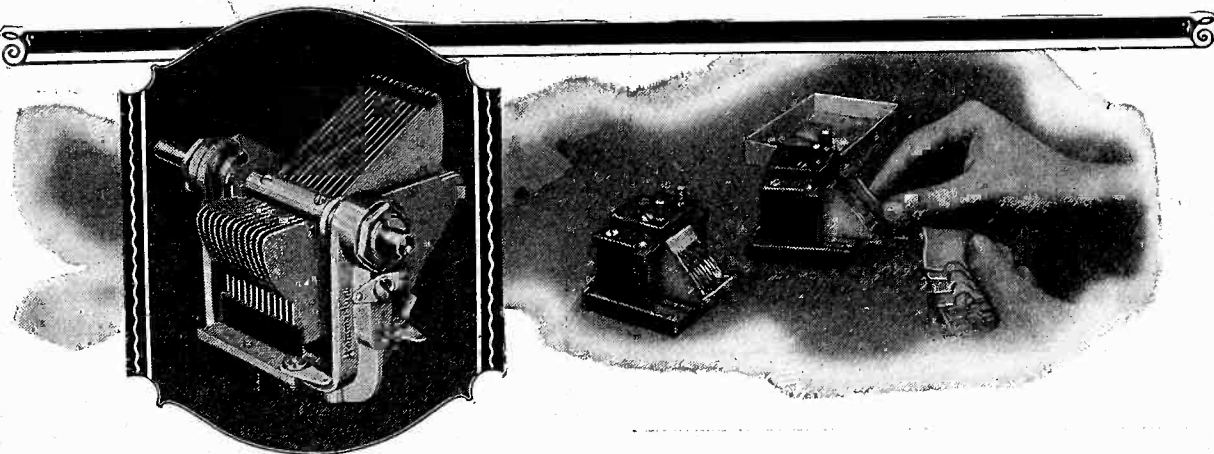

### HAMMARLUND "Midline" CONDENSER

Soldered brass plates with tiebars; warpless aluminum alloy frame; ball bearings; bronze clock-spring pigtail; full-floating, removable rotor shaft permits direct tandem coupling to other condensers. Made in all standard capacities.

Write for Folder

HAMMARLUND MFG. CO.  
424 - 438 W. 33rd Street, New York

Pacific Coast Representatives  
HENDER-SELTZER CO.  
711 E. 14th St., Los Angeles  
377 Brannan St., San Francisco

### Hammarlund Accuracy Assured

Michael Angelo, the great artist, once said, "Genius consists in the capacity for taking infinite pains." While we are too modest to claim that Hammarlund Products are the result of genius, we do insist that they have attained leadership because we take the pains to make them right. Above is shown how accurate alignment of Hammarlund Condenser plates is assured—firmly anchored in a metal holder, each plate in its own slot, while the tie-bars and solder are applied.

For Better Radio  
**Hammarlund**  
PRECISION  
PRODUCTS

Tell them that you saw it in RADIO



—at Slight Cost  
—in a Few Moments

Your Set Can Be  
A C-Operated

There is a Dongan A C Transformer designed specifically for each of the approved A C Tubes.

For instance here is  
No. 6512



A remarkably well-designed and sturdy A C Transformer, mounted in a crystallized, lacquered case, equipped with lamp cord and plug outlet for B-Eliminator, also tap for control switch. Operated with 4 UX-226, 1 UY-227 and 1 UX-171 R. C. A. Tubes. \$5.75 list

Then you can have exactly the same transformer without plug outlet and control switch tap—No. 6515 for \$4.75 list

Ranging in price from \$3.50 to \$5.25, there are 10 other A C Transformers, operating with the approved A C Tubes.

No. 4586

A superlatively fine Transformer. For use with from one to eight UX-226, two UY-227 and two UX-171 tubes. \$8.00 list

No. 5552

A complete ABC Power Supply Unit. For use with from one to eight UX-226, two UY-227 and two UX-171 tubes and 85 mil. gaseous rectifier tube.

Send check or money order if your dealer cannot supply you.

Customer Set Builders—

Write for our special proposition to Custom Set Manufacturers.

Dongan Electric Manufacturing Company  
2981-3001 Franklin Street Detroit

TRANSFORMERS OF MERIT FOR FIFTEEN YEARS

## New LOG BOOK Now Ready

A clever log book giving spaces for logging dial setting for any U. S. or Canadian station. Also a complete list of all stations by call letters. A separate list of stations by states. Another list of stations by meters, starting at low wavelengths in numerical order. A directory of stations. Calls, waves, kilocycles and meters in alphabetical order. Printed on bond. Handy size. The best 25 cent investment you can make. Limited edition. Order your copy NOW.

25c PER COPY POSTPAID  
PACIFIC RADIO PUB. CO.  
Pacific Building San Francisco

## Your Radio Cabinet

should receive some attention if you wish to preserve its original beauty.



Atmospheric conditions cause the finish to check and lose its lustre, and soon a once beautiful instrument becomes faded and ordinary.

## Varnite Radio Polish

is a scientific compound, designed especially for Radio Cabinets, Phonographs and wherever a superior polish and restorative is required.

It restores the grain of the wood to its original beauty, preserves the finish and prevents checking.

Use VARNITE to clean the panel on your Radio, it will prevent "blooming" and that "foggy" appearance.

It is easily applied and leaves no greasy surface to collect dust. Sold by leading radio dealers everywhere or by mail postpaid.

Insist on the genuine, there is no substitute for VARNITE.

Price 50 cents

Manufactured and guaranteed by

**DAVIS CHEMICAL CO.**  
93 MASSACHUSETTS AVE. BOSTON, MASS.

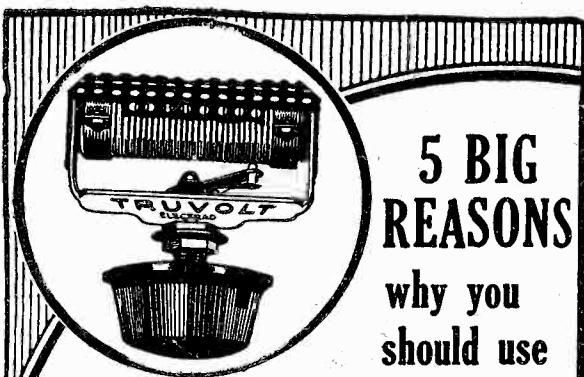

5 BIG  
REASONS  
why you  
should use

## TRUVOLT RESISTANCES

In building Eliminators  
and Power Sets

1. Unit develops less heat due to greater radiation surface.
2. This assures long life with non-varying accuracy.
3. Choice of radio designers and engineers.
4. Made entirely of copper-nickel alloy resistance wire—the finest known.
5. Especially adapted to power devices and electrified sets.

A full line of Variable, Fixed and Tapped Wire-Wound Resistances for All Radio Purposes.

Write for Complete Free Truvolt Resistance Circular.

Dept. 16-E, 175 Varick St., New York

**ELECTRAD**

The hissing stopped for a moment, only to be taken up again from several points in the room.

"We have got them all going now I guess, Charlie old man," whispered Bill. "It sure is an awful way to pass out, but . . ."

Excited voices reached the ears of the two imprisoned boys. Voices that brought cries of relief to the boys, for commands were being shouted in the language of the good old U. S. A. A moment later the door of the shack was thrown open. The two boys bounded forward toward safety, carrying with them in their rush, the man who had unlatched the door.

Gathered in the clearing was a party of several men while others were beating about in the undergrowth. Two of the men came running towards the boys who were standing in a bewildered daze before them.

"A close call boys, but everything is all right now," spoke up a tall heavily built man. "I am the American consul here."

The group gathered around the two pals to hear their story. After relating their nerve-trying experience, the consul again interrupted to tell them of his part in the play.

"We were having a dinner party and for entertainment had tuned in on station YOQ. All at once your signals broke in and we were placing the blame on some ship for causing interference when my son, who has been an amateur radio operator, picked out your SOS. My head servant knew the location of this shack so we gathered together some of the native police and came as fast as we could travel. Thank heaven we reached you in time."

The noise caused by the men searching in the nearby undergrowth became more pronounced and then three men, half carrying and half dragging the body of a man, stepped from the shadows. Reaching the group of waiting men they dropped their gruesome burden to the ground.

"Why, Bill, it's the old snake tender of the zoo," shouted Charlie in an excited voice. "And," he continued, "he is dead."

"Yes, boys, he is dead," said the consul. "He has been bitten by a snake. It looks as though the cobras had their revenge."

The measurement of flat-head screws includes the head while that of round-head and fillister-head screws is from under the head.

The visibility of centers and lines scratched on iron or steel with a scribe can be improved by coppering the surface of the work with copper sulphate solution. The lines show white on a red ground.



## QUERIES AND REPLIES

(Continued from page 27)

ometer will enable you to pick up c.w. signals by making the detector tube oscillate, so as to heterodyne with the incoming signal to form an audible beat note.

**Can shielded grid tubes be used in the Radiola 17 a.c. set? If so, where are they installed?**—H. W. L., Philadelphia, Pa.

The voltages supplied to the filament and heater circuits of the Radiola 17 are not right for the shielded grid tube, and there are other considerations which make the tube unsatisfactory for use in the receiver in any of the sockets. The shielded grid tube requires special design in the r.f. transformer, and the arrangement of terminals in the tube base is different from the standard, so that extensive rewiring of the set would have to be done. Undoubtedly this tube will be available for use in a.c. sets as soon as its design has been perfected by the tube manufacturers.

**Have a full wave tungar battery charger of 2 ampere capacity which I wish to use as an "A" eliminator by floating it across my present six volt battery, which is defective and does not hold its charge, but which I believe can be used as a makeshift filter condenser. Please give me the necessary data for constructing a filter choke so that there will be no hum in the "A" current supply circuit.**—H. B. S., Chicago, Ill.

As long as the battery does not become a short circuit, due to the wooden or rubber separators between the plates breaking down, the arrangement you suggest will be satisfactory. For the filter choke, you will require a core made of silicon steel, the strips being 1 1/4 in. wide and piled 1 3/4 in. high, to form a rectangle having outside dimensions of 4 1/4 x 7 in., and an inside window 1 3/4 x 4 1/2 in. An air gap of 1/32 in. should be placed at opposite sides and ends of the core, a piece of cardboard of that thickness being sufficient to keep the core pieces from touching. For the two coils, which are wound on opposite legs of the core, wind 890 turns of No. 18 cotton-covered wire, making a total of 1780 turns on the two coils. The windings must be connected series aiding, the outside terminal of one coil being connected to the inside terminal of the other. The choke should be placed in the positive charging lead, and if complete filtering action is not obtained, it may be necessary to place a variable resistance between the rectifier side of the filter choke and the negative lead, to stabilize the circuit somewhat. This resistance should be in the neighborhood of 20 ohms, and should be capable of carrying at least 1/2 ampere.

**In constructing the 50 watt power amplifier shown in November RADIO, what objections are there to using impedance coupling for the output of the 50 watt tube rather than an output transformer? Are there any changes necessary for using the type UX-852 power tube?**—R. S. O., South Bend, Ind.

Impedance coupling can be used, but requires a high voltage blocking condenser of the same type as used in the filter circuit, so that the cost of the condenser alone will be greater than that of an output transformer. The blocking condenser should be at least 4 mfd. and preferably larger, as a great deal of power will be handled, and a small blocking condenser will make an appreciable difference in the low frequencies. No changes need be made in the circuit for the 852 tube, as the filament voltage is the same as for the 203-A, and the tube will stand even higher plate voltages than the latter.

## ANOTHER SPECIAL OFFER!



### UNI-RECTRON POWER AMPLIFIERS



Model AP-935

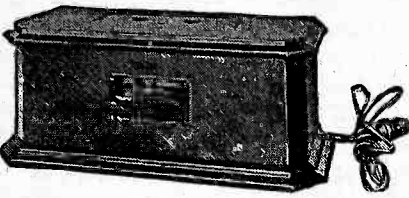

The volume and quality delivered will be a revelation.

Also by removing the input and output transformers it can be used as a source of power for an oscillating or transmitting tube, furnishing power for all circuits, grid, plate and filament.

Every one new and packed in original factory carton

AMERICAN SALES CO., 19-21 WARREN ST., NEW YORK CITY

As the Uni-Rectron stands it is a super power amplifier, which can be used in connection with any radio set and loud speaker. Binding posts are provided for input to the Uni-Rectron and output to the speaker. Requires no batteries for its operation. It obtains its power from the 110 volt, 60 cycle alternating current lighting circuit of your house.

The UX-210 super power amplifying tube and the UX-216B or 281 rectifying tube are used with this amplifier, which cannot overload. From the faintest whisper to the loudest crash of sound—R. C. A. Uni-Rectron amplifies each note at its true value. High and low notes are all treated alike.

List Price \$88.50

(Without tubes)

Special at \$19.75

each

## SAVE \$2.00

Subscribe Now to "RADIO" and "CITIZENS RADIO CALL BOOK" both for \$2.50 "RADIO" San Francisco

### Quality Radio Products

INCLUDE

## Potter Condensers



Potter Manufacturing Co.  
No. Chicago, Ill.

Pacific Coast Offices  
905 MISSION STREET  
San Francisco California

## FREE RADIO! BOOK!

40 pages chock-full of vital information for radio set builders. 14 new Aero circuits—receivers, transmitters, radiophones, short wave—fully described. Complete construction data, schematics, photos, etc. Exactly the book you've wanted. Write for FREE copy TODAY. Address AERO PRODUCTS, Inc., Dept. 103, 1772 Wilson Ave., Chicago, Ill.

### Newest Log Book

Completely Revised  
25c per copy

"RADIO" San Francisco



ENGINEERING  
PAMPHLET

ON

B POWER SUPPLY  
AND  
AMPLIFIER DESIGN

HERE is a new 12-page book, 8 1/2" by 11", containing blueprints of the circuits, photographs and full lists of parts for the construction of all the newest and most modern Power Amplifiers and Power Supplies. The latest development of Samson, General Radio, Silver-Marshall, Thordarson, National Co., Acme, etc., for high quality, high power audio reproduction. Invaluable for all set builders and home constructors of Radio. Send for it today. Use the coupon below.

PRICE  
25¢

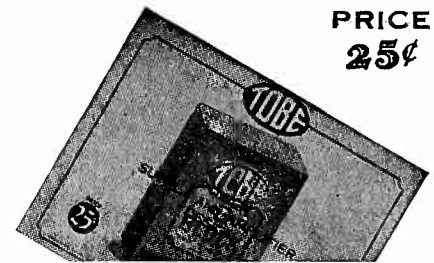

Tobe Deutschmann Co.  
Cambridge, Mass.

Gentlemen: Please send me your new book "TOBE B-POWER SUPPLY AND AMPLIFIER DESIGN." Enclosed please find 25c.

Name .....

Address .....

Tell them that you saw it in RADIO

# SM 630-SG.

## Shielded Six Screen Grid Tube

### Receiver

# \$97.00

For the Complete Kit

## Ready for Immediate Delivery

ONE of the fastest selling kits yet placed on the market. It promises to be the most popular circuit of the new season. Owners everywhere report remarkable results—beyond expectation. The factory is swamped with orders but we can make shipments right now—AT ONCE. We have tested the new receiver thoroughly. It has passed our most rigid requirements. We offer it to you with the assurance that you will be more than pleased with the results obtained.

### All Parts in One Kit

Nothing else to buy. Everything in a complete kit—excluding cabinet and tubes. Complete full size blueprints and elaborate detailed instructions for assembly and wiring included with kit. The retail price for everything is only \$97.00. Usual trade propositions apply to dealers and community set builders. Write at once for details.

### Completely Wired Sets

Let us wire your SM "630-SG" receiver for you. Professional workmen are at your service. Our charge for wiring this receiver is only \$17.50. Tested, inspected and guaranteed to do the work. We also wire these sets for dealers. Write for prices on this work.

### Screen Grid Tubes

Shielded grid tubes now in stock. Prompt shipments made anywhere. Three of these tubes are required for the Silver Marshall 630-SG screen grid tube set. Get your tubes from us when you purchase the kit. In addition to the CX322 tubes you will require two CX301-A and one power tube. We can supply these also. Usual dealer prices prevail. **\$6.50 Each**

Order by wire—if you are in a hurry. Shipments go out same day your order reaches us. Let us show you what real mail order service means.

### Dealer Catalog

Ready for Mailing

GET YOUR COPY NOW

We ship by mail to dealers all over the U. S.—C. O. D. orders filled if half cash accompanies order.

## Radio Constructors Corp.

357 Twelfth St., Oakland, Calif.

### SHORT WAVE RECEIVER

(Continued from page 31)

The secondary windings should be made with the grid connection going to the top of the coil and the filament or battery lead to the bottom. The tickler coils should be wound in the same direction as the winding  $L_2$  and then the plate lead will be the outside turn. The idea is to get the windings  $L_2$  and  $L_3$  in the same direction as if they were part of a helix in the Hartley circuit with the plate and grid leads from opposite ends. In this case, the "helix" is split and a couple of condensers are cut in series  $C_6$  and  $C_7$ . No. 26 enameled wire was used for the larger coils because the coil forms are threaded so that the spacing is about correct. Where No. 16 wire was used, the spacing should be about the diameter of the wire so that it fits into about every second or third thread or slot. At the time this receiver was constructed there were no suitable ready-made coils on the market so it was necessary to construct some.

The radio frequency choke coils  $L_4$ ,  $L_5$ ,  $L_6$  can be constructed if such is desirable.  $L_4$  and  $L_5$  can be made by winding about 400 turns of No. 38 or 40 wire on an ordinary empty thread spool. The two leads should be made of heavier wire.  $L_6$  should be a little more efficient and can be made by winding about 200 to 300 turns of the same small wire on a  $\frac{1}{2}$  or  $\frac{3}{4}$  in. tube. The chokes described will cover all of the amateur bands satisfactorily.

As to actual results with the receiver, these can be checked easily by connecting the antenna, through a very small capacity of about 5 mmfd. to the grid end of coil  $L_2$  and removing the r.f. tube. The volume on some distant amateur will be much greater when the set is then put back to normal and of course retuned. The harmonics of broadcast stations hundreds of miles away can be heard and the call letters distinguished when using the r.f. tube on account of the increased sensitivity.

### BELGIAN B-82

(Continued from page 30)

have a loop of high potential at each junction. In Fig. 2 a "zeppelin" feed is shown.

In such an antenna the radiation is at right angles from the plane of the antenna considered as a whole. The plane of this 15 meter antenna at Uccle is placed at an angle of 45 degrees from the horizon, so that the energy is sent up into the air in the direction of the Belgian Congo. Of course energy is also radiated in the opposite direction i. e., towards the ground; and undoubtedly an improvement could be obtained by placing a reflecting system between the aerial and the ground. But such good results are being obtained that this is not thought to be worth while.

### COIL CONSTRUCTION

(Continued from page 18)

celluloid will form a protective covering and the bare wire will not corrode or become unsightly. Neither will the cotton or silk covered wire be affected by moisture.

The celluloid solution may also be used to hold coil windings in place, form a protective coating and make an excellent varnish for any metal, wood or hard rubber object, etc. It can be used for patching auto side curtains, repairing tortoise-shell 'specs,' repairing motion picture film and almost any article that is constructed of celluloid.

Tell them that you saw it in RADIO

### FOREIGN BROADCAST STATIONS

(Continued from February RADIO)

City	Call	Wave-length Meters	Power Antenna Watts
<b>CUBA</b>			
Guanajay	1AZ	275	5
Habana	PWX	400	500
Habana	2AB	200	10
Habana	2BB	250	15
Habana	2CG	350	15
Habana	2CT	200	5
Habana	2GF	192	10
Habana	2MA	215	50
Habana	2MG	284	20
Habana	2MU	265	10
Habana	2OK	350	100
Habana	2OL	257	100
Habana	2RK	315	20
Habana	2TW	270	20
Habana	2UF	275	10
Habana	2XX	225	5
Habana	6RG	200	20
Hershey	2FG	200	20
Mariano	2JF	246	5
Mariano	2JL	294	5
Matanzas	5DW	270	100
Sagua la Grande	6HS	200	10
Sancti Spiritus	6KP	195	20
Santiago	8HS	200	20
Santiago	8BY	250	100
Santiago	8FU	225	15
Santiago	8IR	190	20
Santiago	8JQ	130	20
Tuinucu	6KW	340	100
Tuinucu	6XJ	278	100
<b>Haiti</b>			
Port au Prince	HHK	361.2	1,000
<b>Mexico</b>			
Chihuahua	CZF	310	250
Mazatlan	CYR	475	250
Merida	CYY	548	100
Mexico City	CYA	300	500
Mexico City	CYB	275	500
Mexico City	CYH	375	100
Mexico City	CYJ	400	2,000
Mexico City	CYL	400	500
Mexico City	CYO	425	100
Mexico City	CYX	325	500
Mexico City	CZE	350	500
Monterrey	-----	311	250
Oaxaca	CYF	265	100
Puebla	CYU	312	100
Tampico	CYQ	322	100
Tampico	CYZ	-----	20
Torreon	CYM	225	1,500
Vera Cruz	CYC	337	50
Vera Cruz	CYD	-----	-----
<b>Salvador</b>			
Salvador	AQM	482	500
<b>SOUTH AMERICA</b>			
<b>Argentina</b>			
Buenos Aires	B2	275	100
Buenos Aires	D3	253.3	100
Buenos Aires	LOJ	270	1,000
Buenos Aires	LOL	236	2,000
Buenos Aires	LON	210	5,000
Buenos Aires	LOO	252	1,000
Buenos Aires	LOQ	261	500
Buenos Aires	LOR	344.8	1,000
Buenos Aires	LOS	291.2	5,000
Buenos Aires	LOT	400	1,000
Buenos Aires	LOV	361.5	1,000
Buenos Aires	LOW	303	1,000
Buenos Aires	LOX	380	1,000
Buenos Aires	LOY	315.8	1,000
Buenos Aires	LOZ	330	1,000
Cordoba	H5	275	100
Cordoba	H6	250	20
La Plata	LOP	425	1,000
Mendoza	LOU	380	500
Mendoza	M6	348	10
Rosario	F2	270	100
Santa Fe	F1	279	20
<b>Bolivia</b>			
La Paz	-----	175	50
La Paz	-----	300	50
<b>Brazil</b>			
Bahia	SQAD	350	50
Curytiba	SQAF	340	8
Juiz de Fora	SQAY	380	200
Pernambuco	-----	310	300
Ribeirao Preto	SQAK	350	10
Rio de Janeiro	SQAA	400	2,000
Rio de Janeiro	SQAB	320	500
Rio de Janeiro	SQAJ	260	250
Santos	SQAI	280	10
Sao Paulo	SQAB	225.4	1,000
Sao Paulo	SQAG	365	1,000
Sorocaba	-----	425	-----
<b>Chile</b>			
Antofagasta	CHAO	-----	-----
Concepcion	CMAI	345	1,500
Santiago	CMAC	360	1,200
Santiago	CMAD	320	1,000
Santiago	CMAE	280	100
Tacna	CMAT	550	200
Talcahuano	-----	-----	-----
Temuco	CMAK	245	100
Valparaiso	-----	400	50
<b>Paraguay</b>			
Asuncion	-----	-----	12
<b>Peru</b>			
Lima	OAX	360	1,500

(Concluded in April RADIO)



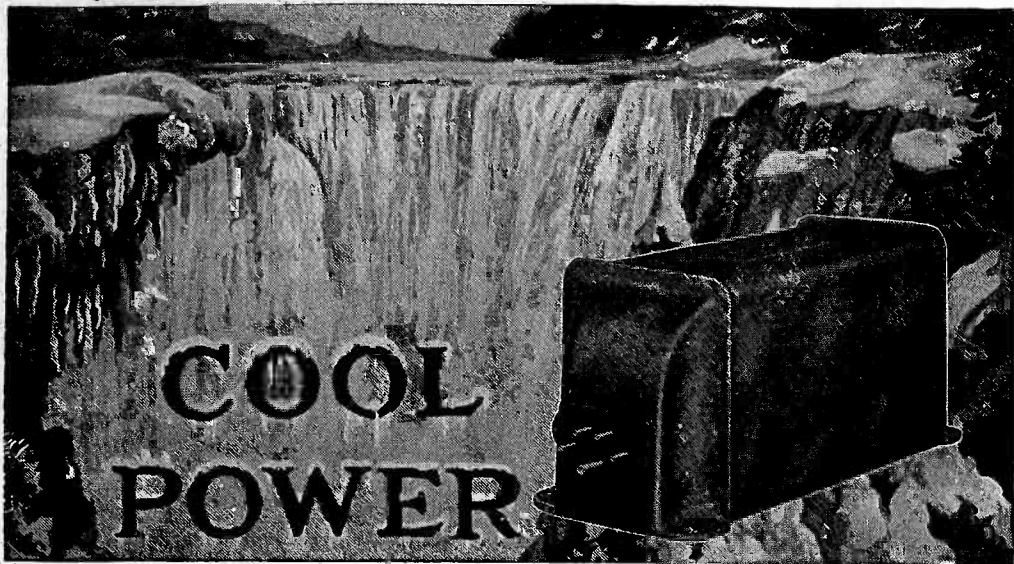

Samson Power Blocks No. 210—The only block which will supply 500 volts at 80 mils to two 210 tubes.

### Powerize with Samson Units for Best Results

For new SAMSON Power Units insure the best there is in radio current supply by

1. Doing away with hum, motor boating and poor voltage regulation.
2. Remaining so cool after 24 hours continuous operation under full load that they will be well within the 20° rise of temperature specified by the A.I.E.E.
3. Being designed to more than meet the specifications adopted by the National Board of Fire Underwriters.
4. Insuring safety against shock because of protected input and output terminals.
5. Insuring for all tubes the correct filament voltages specified by their manufacturers.
6. Compensating for lighting circuit voltage variation by the use of a specified input plug and terminal block to which is attached a 6 ft. flexible rubber-covered connecting cord and plug.

Our Power Units bulletin descriptive of these is free for the asking. In addition, our construction bulletin on many different "B" Eliminators and Power Amplifiers will be sent upon receipt of 10c. in stamps to cover the mailing cost.

Our book—"Audio Amplification"—accepted as a manual of audio design by many radio engineers—contains much original information of greatest practical value to those interested in bettering the quality of their reproduction. Every radio enthusiast should have a copy.

**Samson Electric Co.**

Manufacturers  
Since 1882

MEMBER  
**R.M.A.**

Main Offices at  
Canton, Mass.

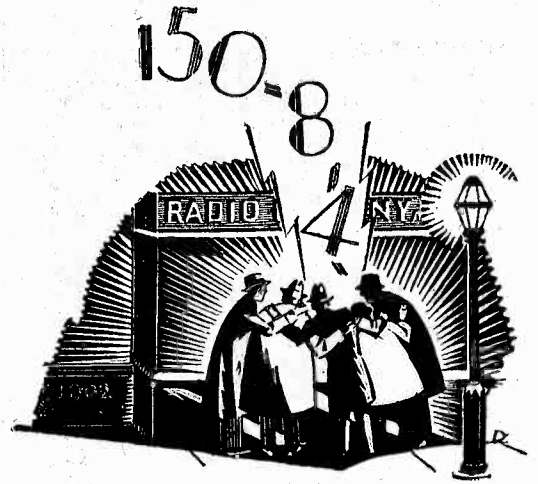

## IN A HUDDLE?

Yes! But it's not a football signal.

They're looking at the **NEW WESTON TRIPLE RANGE A. C. VOLTMETER** for measuring the A. C. supply and tube voltages in connection with **A. C. RECEIVERS**

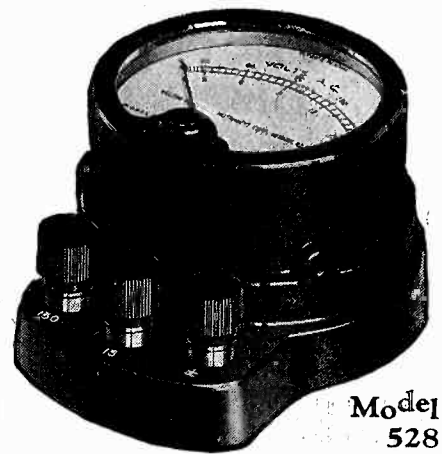

150/8/4 volts

THIS new A. C. portable voltmeter—the latest addition to the famous Weston line of Radio Instruments—has been eagerly awaited by the entire fraternity of radio interests, experimenter and set owner alike. With the advent of the new A. C. receivers, everywhere one heard the question—"What kind of an instrument do we need now?" And here it is, an exquisite design, typically Weston in construction and performance. The highest quality, yet moderately priced. See your dealer and place your order now. Get in ahead of that inevitable rush when Weston announces a new development.

WESTON ELECTRICAL INSTRUMENT CORPORATION  
156 Frelinghuysen Ave., Newark, N. J.  
Pacific Coast Representatives

GRAYBAR ELECTRIC COMPANY, Inc.  
84 Marion Street  
Seattle, Wash.  
J. H. SOUTHARD  
San Francisco, Calif.

A. A. BARBERA  
Los Angeles, Calif.  
REPAIR SERVICE LABORATORY  
682 Mission Street  
San Francisco, Calif.

**WESTON**  
RADIO  
INSTRUMENTS

## FREE Wholesale Radio Catalog

Dealer-Set Builders! Save Money!

Send for this book of bargains. Everything in Radio—all the newest hook-ups. Sets, kits, parts, cabinets, consoles and supplies. If you want the best for the least money, you need this catalog.

SHURE RADIO COMPANY  
345 V. West Madison St., Chicago, Ill.



## SEND FOR THE NEWEST

From Chicago's Oldest Radio Jobbers. The Most Valuable Radio Catalog.

Write for your copy today—IT'S FREE!  
Telephone Maintenance Company  
123-5 S. Wells St., Dept. 66, Chicago, Ill.

EVERYWHERE  
good radio is found—there  
also are used genuine

**NATIONAL**  
RADIO PRODUCTS

NATIONAL CO., INC., MALDEN, MASS.  
W. A. Ready, Pres.

## DRAKE'S RADIO CYCLOPEDIA

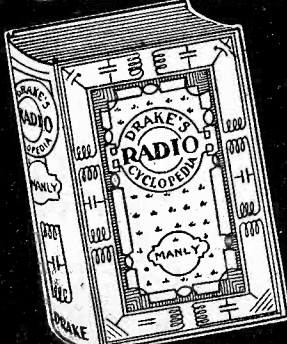

1928 Edition, complete, up-to-date. Full information on A. C. and Screen Grid Tubes. Over 900 pages, 1025 illustrations. For service and Repair Men, Dealers, Salesmen, Experimenters and Designers. At dealers or by mail, \$6.

FREDERICK J. DRAKE & CO.  
1014S Michigan Ave. Chicago.



Radio  
Interference  
Filters

Positively

Reduce Radio Interference from Household Motors, Etc. Write for Booklet.

Tobe Deutschmann Company  
Cambridge, Mass.

Tell them that you saw it in RADIO

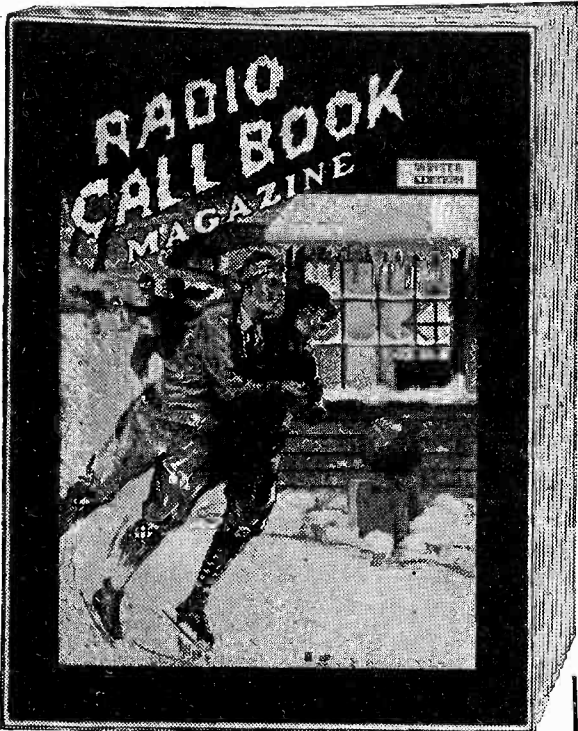

# New Issue Now on Sale

WINTER  
EDITION

of Citizens

228  
PAGES

Radio  
Call  
Book

Another great issue of this COMPLETE RADIO CYCLOPEDIA is now on sale — everywhere. Replete with each and every new idea of the winter season. The newest circuits—AC receiver design and conversion — beautiful rotogravure section of broadcast artists and station personnel. Roto section of "AMPERE ANDY'S ASSISTORS," helpful hints for the home constructor. Complete call book of all the broadcast stations. Log charts and a wealth of data—all under one cover. Nothing like it anywhere. Every radio fan needs this new edition of CITIZENS RADIO CALL BOOK. Every new kit is described in detail. Elaborate working instructions and pictorial diagrams. Many new hints on power amplifiers. Get your copy right now. Order direct from the publishers if your dealer is sold out.

**50c** Per Copy at  
Radio Stores and  
News Stands Everywhere

Citizens Radio Service  
Bureau

508 South Dearborn Street  
CHICAGO, ILLINOIS

## VOLTAGE REGULATION

(Continued from page 25)

shown in Fig. 1. The booster consists of a single winding with taps, placed on a silicon steel core whose dimensions are shown in Fig. 2.

One side of the booster coil is common to both the line and the input transformer. This side should preferably be the grounded side. In case the device is to be used to step up voltages, the input transformer is connected as in Fig. 1. In case the line voltage is too high the arrangement shown in Fig. 3 is used. A tap switch varies the connections of one side of the a.c. power circuit to the booster, and may conveniently be mounted on the side of a small box which can be constructed to house the booster.

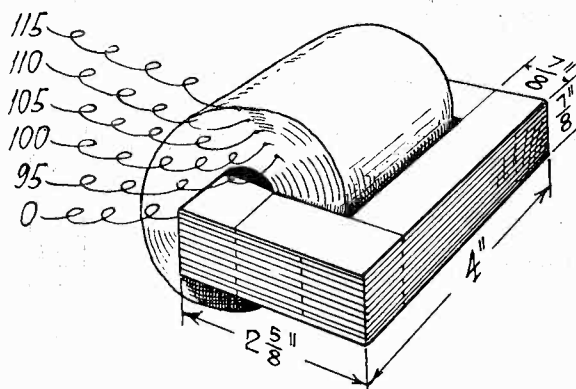

Fig. 2. Construction of Booster Transformer.

The core is made of strips of silicon steel  $\frac{7}{8}$  in. wide, piled in the form of a rectangular frame, the short pieces being  $\frac{7}{8}$  in. wide and  $1\frac{3}{4}$  in. long, and the long pieces  $3\frac{1}{8}$  in. long by  $\frac{7}{8}$  in. wide. These are piled to form a window  $\frac{7}{8}$  in. by  $2\frac{1}{4}$  in. Of course the booster coil must be wound first. This is made by first making up a cardboard form in the shape of a spool, with the hole for the core approximately  $1\frac{1}{4}$  in. wide. On this spool wind 950 turns of No. 24 enameled or cotton covered wire, this being the section marked *A-B* in Fig. 1. Cut the wire at this point, and bring out a flexible lead as the first tap, and then continue winding the coil with No. 20 enameled or cotton covered wire instead of No. 24, for the section from *B* to *C*. Taps should be brought out every fifty

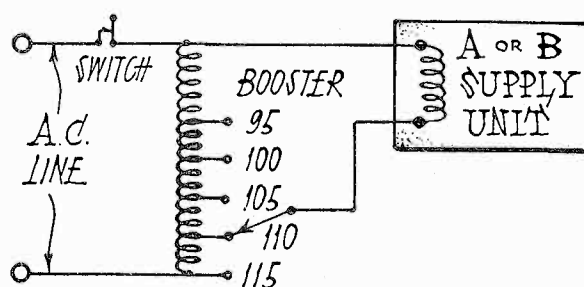

Fig. 3. Circuit for Stepping Down the Line Voltage.

turns, or at 1000, 1050, 1100 and 1150 turns, the latter being the end of the coil.

The reason for using heavier wire for the section *B-C* is that this section is where the transforming action takes place, and there will be more current

flowing through this section than through the section *A-B*. No. 20 wire could be used for the entire coil, but this is poor economy, and also would make the coil so much larger that a larger core would have to be used.

The usual precautions of placing a layer of empire cloth or insulating paper on the coil form before the first turns are wound on should be observed, and another layer of the cloth should be placed between each layer of wire, as well as on the outside of the coil after it is finished. Shellac should be used liberally to hold the coil together and prevent the turns from becoming loose at the ends of the coil when the cardboard form is removed.

In operation, the booster switch is set to 110, and the *A* or *B* power unit adjustments made so that the proper amount of direct current will be delivered to the receiving set. If the line voltage drops so that the operation of the set is affected noticeably, the tap switch is set at 105 or 100, according to the drop in line voltage. It should seldom be necessary to set the switch at 95, and if this occurs often in a community having supposedly excellent power service, a complaint should be made to the power company to install a larger transformer or otherwise improve service conditions.

In sets having a.c. tubes, where the filaments are heated by a step-down transformer, the problem of voltage regulation is not severe, since where a tube filament is rated at  $1\frac{1}{2}$  volts, 1.05 amperes, as in the case of the type 226 a.c. tube, a variation of 10 volts in the line supply would cause slightly more than one tenth of a volt in the filament supply. This is not sufficient to cause an appreciable change in the plate current of the tube, and hence is not noticed. The same is true of the heater type tube, where the heater voltage is  $2\frac{1}{2}$  and the heater current  $1\frac{3}{4}$  amperes.

## EXPERIMENTAL SHOP METHODS

(Continued from page 26)

level of the water inside, saturate the wicking with alcohol, and ignite it. The glass will then break unevenly at the inside water level. The edge can be smoothed with a file lubricated with turpentine and camphor solution.

Glass tubing may be broken into desired lengths by filing a mark on the side, grasping the tubing in the closed hands with the mark away from the thumbs as laid along the tube, and bending it as if to bring the ends of the tube toward the body.

Leather may be cemented to leather or many other substances with gutta percha dissolved in carbon bisulphide until the mixture has the consistency of molasses in summer.

Tell them that you saw it in RADIO



# Thousands

WILL TELL YOU!

# Majestic 'A' and 'B' Units



Electrify Any Radio Set  
and give

## Better Radio Reception

THAN ANY OTHER FORM OF ELECTRICAL RADIO POWER

See your nearest dealer today — any good radio store. Try Majestics on your set and note the difference.

You plug Majestics in and forget them.

GRIGSBY-GRUNOW-HINDS CO., 4540 Armitage Ave., Chicago  
W. J. Seroy, Pacific Coast Sales Manager, 122 Broadway, Oakland, Calif.

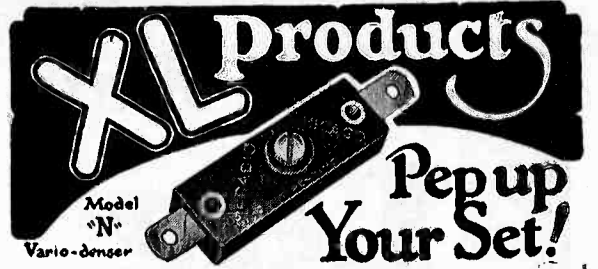

## VARIO DENSER

Quick, easy tuning — more volume, clearness, stability with an X-L VARIO DENSER in your circuit. Endorsed by experts. Specified in all the latest hook-ups.

MODEL "N"—Micrometer adjustment easily made, assures exact oscillation control in all tuned radio frequency circuits. Neutrodyne, Roberts two tube, Browning-Drake, Silver's Knock-out. Capacity range 1.8 to 20 micro-microfarads.

Price ..... \$1.00

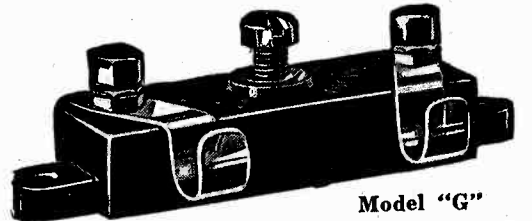

Model "G"

MODEL "G"—Obtains the proper grid capacity on Cockaday circuits, filter and intermediate frequency tuning in superheterodyne and positive grid bias in all sets.

Capacity range:

Model G-1 .00002 to .0001 M. F. D.  
Model G-5 .0001 to .0005 M. F. D.  
Model G-10 .0003 to .001 M. F. D.

Price, each with grid clips ..... \$1.50

X-L PUSH POST — Push it

down with your thumb, insert wire, remove pressure and wire is firmly held. Vibrations will not loosen. Releases instantly. A push post that excels in appearance, action, service and convenience. Price each ..... 15c



X-L Push Post

X-L PUSH POST PANEL—

Seven push posts mounted on black insulating panel with permanent white markings. Soldering lugs, raising bushings and screws for mounting, etc., in box complete. Price ..... \$1.50

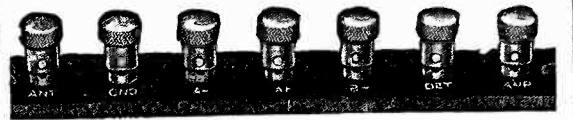

X-L Push Post Panel

FREE — New, up-to-date book of wiring diagrams showing use of X-L units in the new LOFTIN-WHITE constant coupled radio frequency circuit, and in other popular hook-ups. Also the Goodwin Aperiodic Detector Circuit which adds a stage without adding tuning controls. Applicable to any set. WRITE TODAY!

## XL Radio Laboratories

2428 Lincoln Ave.

Chicago, Ill.

SELL YOUR EXCESS PARTS  
Through a Classified Ad in RADIO  
Mail Your "Ad" Now

## POWER CONE UNIT

For large and small cones, drum, flat wood, or any other type of speaker diaphragm. Operates on "A" battery current. Gives greater volume and depth of tone on small cone than other units give on 3 ft. size. Latest design of Clyde J. Fitch, Inventor of Ensco 3 ft. cone. Sent postpaid or C. O. D. Set builders—write for special offer.

FANSPEAKER RADIO CO., Dept. W,  
74 Dey St., New York, N. Y.

Gentlemen: Send me one power cone unit for which I enclose \$12. If not satisfactory, I will return it in 10 days and you are to refund full amount.

Name.....

Address.....

If C. O. D. shipment is desired, mark here

The next 6  
issues of "RADIO"  
for 1 dollar

Subscribe Now

## New LOG BOOK Now Ready

A clever log book giving spaces for logging dial setting for any U. S. or Canadian station. Also a complete list of all stations by call letters. A separate list of stations by states. Another list of stations by meters, starting at low wavelengths in numerical order. A directory of stations. Calls, waves, kilocycles and meters in alphabetical order. Printed on bond. Handy size. The best 25 cent investment you can make. Limited edition. Order your copy NOW.

25c PER COPY POSTPAID  
PACIFIC RADIO PUB. CO.  
Pacific Building San Francisco

A HOMEY HOTEL IN THE HEART  
OF NEW YORK

## THE New Flanders

47th to 48th STREET EAST OF BROADWAY

One of the finest Hotels in TIMES SQUARE

Single Rooms with Running Water, \$2.00  
Double Rooms with Running Water, \$3.00  
Single Rooms with Bath . . . . \$2.50  
Double Rooms with Bath . . \$3.50

Special Weekly Rates  
F. W. BIZEL, Resident Manager



Tell them that you saw it in RADIO

# A Fine New Log Book

Just Out!

25 cents

We believe this to be the best and most practical log book yet issued. It is so complete and so simple to use that we can sell it to you on a money-back basis if you are not entirely convinced that it is the best booklet of its kind yet published. All the new listings, changes, etc., corrected to December 1st. Right up to date. Spaces provided for logging all stations in the U. S. and Canada. Send a quarter for your copy now. We pay the postage. Immediate deliveries.

"RADIO"

435 Pacific Building

San Francisco

California

## RAJAH SOLDERLESS SNAP TERMINALS

Instantaneous in Operation — Positive Contact. For Panel, Ground and Battery Connections.



Patented—Sept. 23rd, 1924.

The Base Stud is tapped and furnished with 8-32 screw and washer. This fits all "B" Batteries with screw-posts.

Used on

TUNGAR - RECTIGON - PHILCO - EXIDE  
Terminal, complete,....15c Extra Base Studs....5c

Furnished with

BAKELITE FERRULES

In Three Colors

BLACK — RED — GREEN

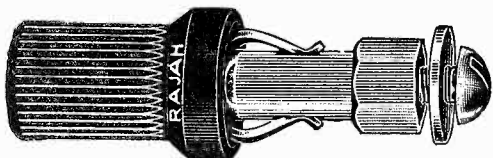

LIST PRICE - 25 Cents Each

Distributors

MARTIN WOODARD CO.

438 Phelan Building, San Francisco, Cal.  
28 E. Sprague Avenue, Spokane, Wash.  
Terminal Building, Seattle, Wash.  
229 Pine Street, Portland, Oregon

THE RAJAH CO.  
BLOOMFIELD NEW JERSEY

## POWER TUBES

(Continued from page 20)

the product of the turns ratios of the two transformers. (The .9 is approximately correct for well-designed audio transformers.) Thus with a detector voltage of 0.3 an amplification factor of 8 for a 01A tube and two 1:3 transformers, the input is  $.3 \times 8 \times .9 \times 3 \times 3 = 19.4$  volts.

The minimum plate potential for supplying 100 milliwatts from any of the standard tubes, except the 71, is 135 volts. The 71 tube will give 105 milliwatts with 90 volts *B*,  $16\frac{1}{2}$  volts *C*, and 4000 ohms load resistance.

When the plate potential is limited to 135 volts, the 112 tube gives 120 milliwatts with 9 volts *C* and 10 volts peak input, the 71 tube gives 350 milliwatts with 27 volts *C* and 28 volts peak input, but the 10 tube, at this plate voltage, gives but 64 milliwatts. With 10 volts input a 71 tube gives only 30 milliwatts, whereas a 12 tube is overloaded by an input greater than 11 volts. So it is evident that at 135 volts plate and input voltages less than 11, the 112 tube will deliver the most power.

In this day and age 135 volts is not considered sufficient for power amplification unless two output tubes are connected in parallel. Going to 180 volts *B*, the 26 a.c. tube with  $16\frac{1}{2}$  volts *C* has an output of 160 milliwatts to a 20,000 ohm load; the 27 a.c. tube with  $13\frac{1}{2}$  volts grid gives 140 milliwatts to an 18,000 ohm load, the 12 type with  $13\frac{1}{2}$  volts grid gives 308 milliwatts to an 8800 ohm load; the 71 type with  $40\frac{1}{2}$  volts grid gives 710 milliwatts to a 4000 ohm load and the 10 type with 10 volts *C* and 10 volts input delivers 145 milliwatts. So at this plate voltage the 71 type is superior. If greater power output is desired at 180 volts, two 71s can be connected in parallel or push-pull to deliver 1.4 watts, which is almost equal to the maximum undistorted output of a single 10 tube.

At 250 volts *B* and 18 volts *C* the output of a 10 tube is 340 milliwatts, increasing to 950 milliwatts with 350 volts *B* and 25 volts *C* and to 1500 milliwatts with 425 volts *B* and 35 volts *C*, provided that the peak input voltage from the preceding stage is approximately the same as the *C* voltage in each case.

## NEW RADIO CATALOGS

*Samson Inductance Units* is the title of a helpful pamphlet from the Samson Electric Co., of Canton, Mass. It contains practical explanations, formulas and tables of coil resistance, inductance and capacity at various frequencies. Examples are given for calculating these factors and converting them to meet the standard dimensions of the Samson Coil Form.



# Live

Where uptown and  
downtown meet

That's what everyone would like to do—combine country quiet with Broadway activities.

And that's exactly what this hotel offers you.

The serenity of Central Park; where two of New York's most desirable thoroughfares meet. Central Park West and 72nd Street, —and yet just 10 minutes from leading shops and theatres.

*Appointments, service, cuisine unexcelled, in keeping with its international reputation.*

Booklet sent free on request  
on New York and Hotel Majestic

*Opeland & Townsend*

Proprietor

## Majestic Hotel and RESTAURANTS

Two W. 72nd St., New York

Entire Block Fronting Central Park

General Headquarters:

New York Automobile Club

The Majestic Hotel, Central Park West  
at 72nd Street, New York City.  
Without obligating me, please send me free  
Booklet on New York and Hotel Majestic.

Name.....

Address.....

Radio 11-27



Master the Code  
Wireless or Morse—at home with the TELEPLEX Automatic Code Instructor. No better method for self-instruction exists. Quick—easy—thorough. Endorsed by U. S. Navy. The only instrument that Reproduces actual sending—messages, radiograms, etc. Any speed. Complete Course furnished. Thirty times as many words as any other instrument. Avail yourself of the TELEPLEX for a quick mastery of the code. Write for booklet R. TELEPLEX CO., 76 Cortlandt Street, New York.



# DISTANCE *lends* ENCHANTMENT



Write for your copy of this book. There is no cost nor obligation on your part.

When you buy or build a radio set make sure that it has Copper Shielding. Where long distance reception is desired Copper Shielding is essential. It is a refinement to your set that will enable you to hear the programs of distant stations much more clearly.

*Copper Shielded sets give:*

- BETTER RECEPTION
- FINER SELECTIVITY
- IMPROVED TONE QUALITY

By virtue of its easy working qualities and its high conductivity Copper Shielding is a decided improvement to any set.

## COPPER & BRASS

RESEARCH ASSOCIATION

25 Broadway, New York

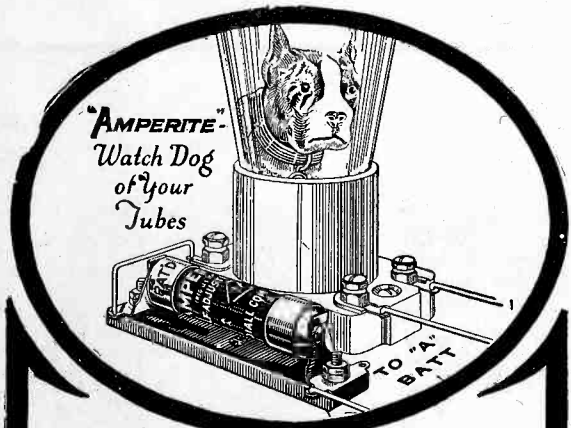

### Insuring Tube Efficiency

AMPERITE alone gives utmost life and performance from tubes. Because AMPERITE alone keeps the filament voltage, or temperature, constant, despite "A" battery variations. Particularly needed with Battery Eliminators. Simplifies wiring and panel design. Eliminates hand rheostats and guessing. Proved for 6 years. Entirely different from fixed filament resistors. There is no alternative. Insist on AMPERITE. Price \$1.10 with mounting (in U. S. A.) At all dealers. Free—Write for "Amperite Book" of season's best circuits and latest construction data, to Dept. **RS**.

RADIALL CO., 50 Franklin St., New York

# AMPERITE

The "SET-ADJUSTING" Rheostat

## BIG REWARDS!

Big rewards await you in Radio if you want to make more money quickly. Millions are being made by others. Get your share NOW. Get the complete facts. Send for Free complete booklet and guide of money-making opportunities, all ready for you. Be first to get this. BARAWIK CO., Dept. 852, Chicago, U. S. A.

## YAXLEY

APPROVED RADIO PRODUCTS

Cable  
Connector Plug  
Specified in the  
BEST SUPER

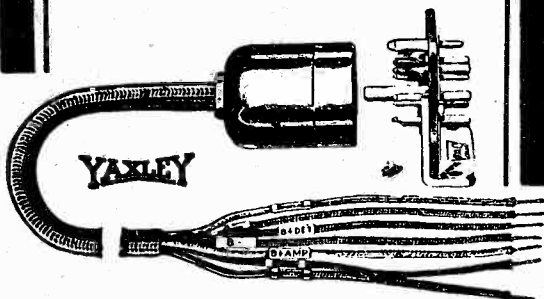

Every kit builder will get a great deal of satisfaction out of this radio convenience that brings battery wires to the set in one neat compact cable. The Cable Connector Plug shown above is for installing right in the set. Once hooked up, correct connections are assured—you cannot put it together improperly. For the BEST SUPER as well as for all leading sets insist on the Yaxley Cable Connector Plug.

At All Dealers

YAXLEY MFG. CO.  
Dept. A—9 So. Clinton Street  
Chicago, Ill.

## The Braid Covers the Solder!

**CORWICO**  
**BRAIDITE**  
HOOK-UP WIRE

The insulation on Braidite can be quickly and easily drawn back for soldering and then replaced so that there are no exposed sections of bare wire or unsightly soldered connections. Braidite is the only stranded insulated wire that holds its shape permanently after bending, others twist and get out of place. Another feature—you cannot scorch Braidite with a soldering iron; most others burn up like a fuse. Use Braidite in the next set you build.

**Cornish Wire Company**  
30 Church St. N. Y. City

If your dealer cannot supply you, order from us direct.

25' Stranded Braidite...35c  
25' Solid Braidite .....30c

Made in red, green, yellow, brown and black.



Tell them that you saw it in RADIO

**People Who Demand Better Results are buying their Laboratory Matched Kits from me. All the latest Kits can be supplied promptly**

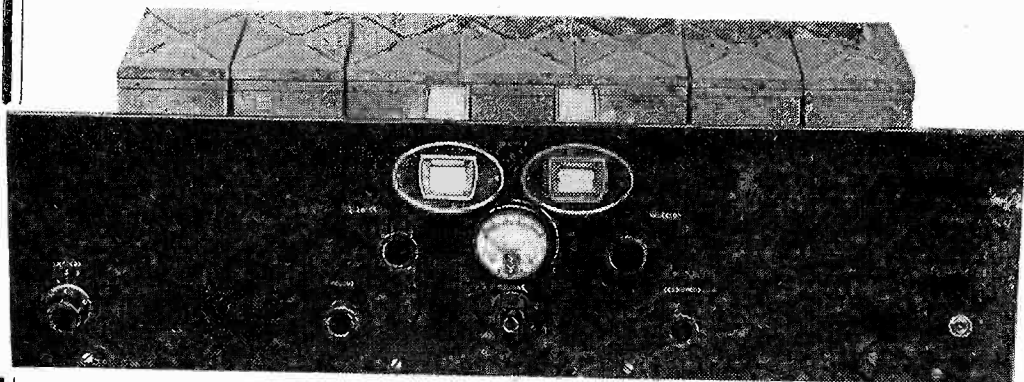

Illustration Shows Best's New 115 K. C. Super

**Silver Marshall \$97<sup>00</sup>  
Screen Grid Six**

One of the most popular sixes of the new season is the S-M Screen Grid receiver, using the new screen grid tubes. A complete kit, with everything needed to build the set for only \$97.50. A real distance getter. Great volume on "DX." Thoroughly matched and tested in our laboratory.

Mail Orders taken care of within 24 hours

**D. B. McGOWN'S RADIO LABORATORY**  
435 PACIFIC BUILDING  
SAN FRANCISCO, CALIF.

**G. M. Best's 115 K. C. Super**

There has never been anything better in radio than Best's new 115 Kilocycle Super using the new shielded grid tubes. Perfect 10 kilocycle selectivity and volume to spare. Smooth handling without the usual background noise. Noted for its silent operation. Indications point to a record sales event, unparalleled by any other kit of the season. Let us ship the complete set of parts to you—exactly as specified by Best. Rigid laboratory test of parts made before shipment. Everything matched to insure positive results. Good receive-

ers demand proper matching. We are equipped to do the work for you perfectly. No extra charge for this service. You pay the list price for the parts—\$151.00. If bakelite subpanel is wanted add \$8.00. Price includes drilled and engraved front panel and every item precisely as shown by Best in his own model. We also supply matched CX-322 or UX-222 shield grid tubes at \$6.50 each. Shipment made 24 hours after receipt of order to allow ample time for matching and testing of parts.

**Testing & Calibration Service**

We can test any and all makes of radio devices. Intermediate frequency transformers matched and peaked for \$2.50 per set. Wavemeters calibrated. Condensers and Coils matched and calibrated. Special engineering service and advice on any radio problem. Scientific instruments available for properly matching complete sets of tubes, audio transformers, etc. Buy matched parts and be safe. We sell parts for any of the new kits of the season at retail prices and make no further charge for the matching and testing. Try this new service. It will please you.

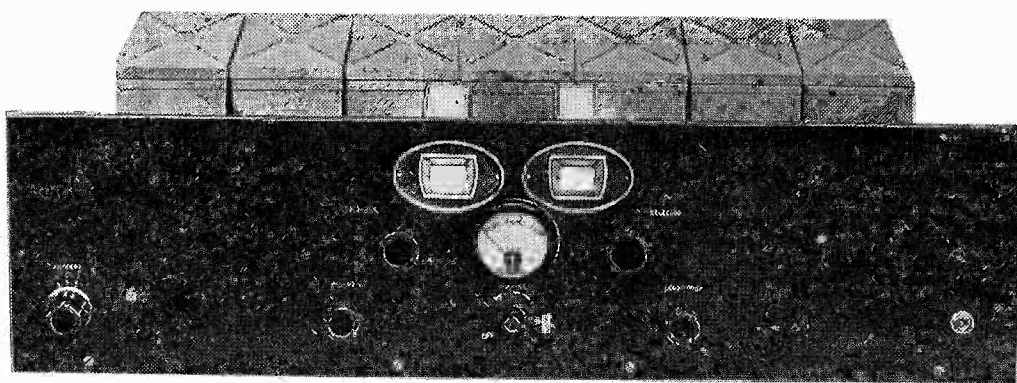

**Best's New Superheterodyne**  
Gives You Positive 10 Kilocycle Separation

HERE—at last—is the one receiver for which no further claims need be made. It speaks for itself. Every statement made by Best has been substantiated. "Your claims are too modest"—some have told us. "So much power that we can hardly control it"—says another. "East Coast stations brought in through Pacific Coast Locals with pure 10 kilocycles selectivity." The set will now sell

itself upon its merit for the balance of 1928. More of them will probably be built than of any other circuit of the season. Entirely new—different and a professional, factory-like appearing job. 115 kilocycle operation with shielded grid tubes. Each stage individually shielded in sturdy cans. Acclaimed nationally as the finest receiver of them all.

**Full Size Instructions and Working Prints 25" x 38"**

**\$1<sup>00</sup>**  
POST-PAID

We have a complete set of full size working instructions ready for mailing. These instructions have been compiled by Best himself. Put up in package form. Full size pictorial diagram—drilling template for panel and baseboard layout. Easy to follow. Be sure you get Best's original instructions. They will be sent to you on the same day your order reaches us. Add 60 cents if delivery by air mail is desired. We are making air mail delivery of prints daily.

-----  
 "RADIO," 433 Pacific Building,  
 San Francisco, California.  
 Here is \$1.00. Rush, postpaid, the full size  
 working prints for building Best's 115 Kilocycle  
 super.  
 Name.....  
 Street and No.....  
 City and State.....



# Quality Reproduction



The General Radio Type 285 Transformers are designed to have a high inductance value with a low distributed capacity. This combination sustains both the upper and lower ends of the amplification curve. These transformers are available in two ratios as follows:  
 Type 285-H 1 to 6  
 Type 285-D 1 to 3  
 Price .....\$6.00 each

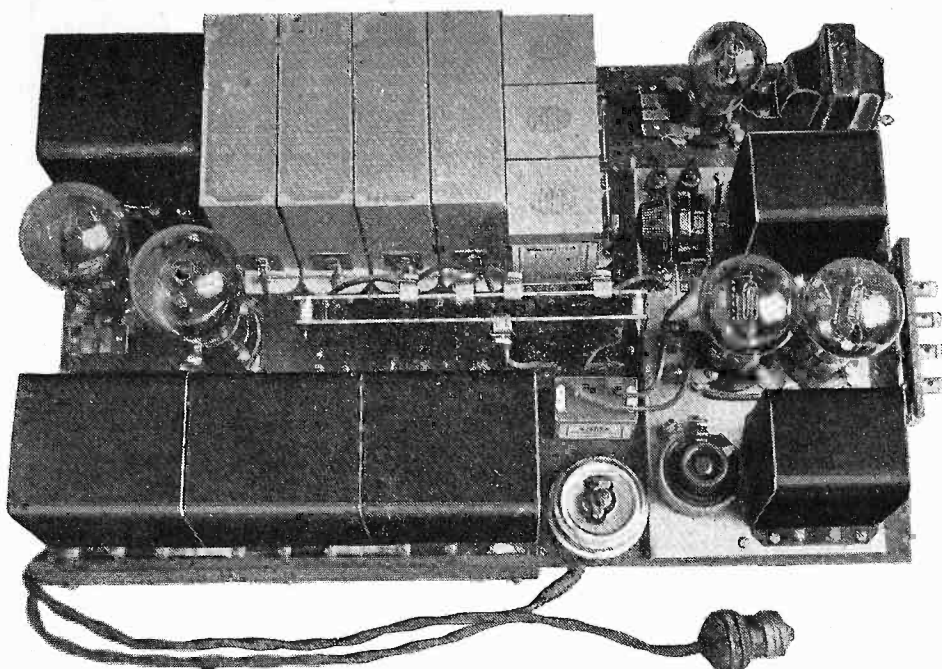

For those people who demand the most perfect reproduction obtainable, a power amplifier is a necessity. A power amplifier is not intended primarily to increase the volume of a set, but rather to make use of tubes capable of delivering to the speaker considerable energy. To a certain extent the greater the power output the better the quality. The Amplifier illustrated above is a complete two stage A. C. operated device constructed of General Radio units, and is capable of remarkable reproduction together with great volume. Write for folder describing this amplifier.

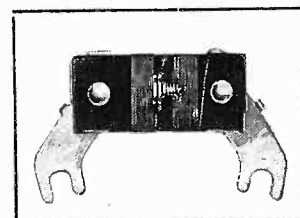

The Type 439 center tap resistance is adaptable to any socket in which the new A. C. tubes may be used.  
 Type 439 Center Tap Resistance.....\$ .60



The Type 366 Choke is actually two chokes assembled in one case and is mounted in the same type and size of case as the Type 365 Transformer. The direct current resistance is low, reducing the voltage lost in the Chokes to a minimum.  
 Type 366 Filter Choke.....\$8.00

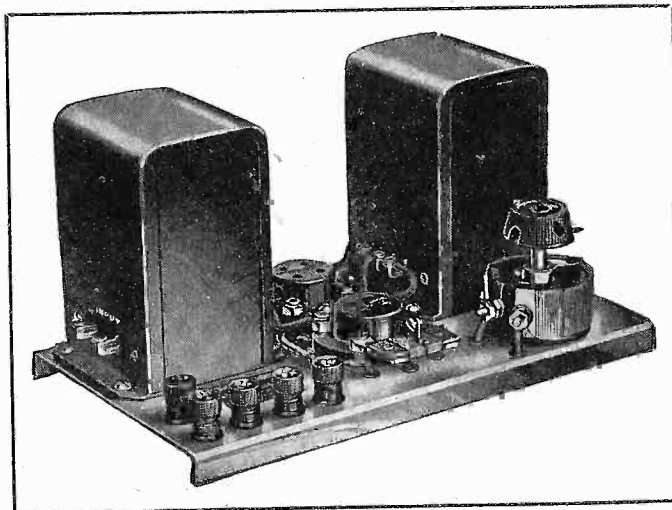

In a search for an amplifier which would give the maximum in quality and volume the push-pull method has proved particularly satisfactory. The Type 441 unit is licensed by the Radio Corporation of America for radio amateur, experimental and broadcast reception only, and under the terms of the R.C.A. license the unit may be sold only with tube.  
 Type 441 Push-Pull Amplifier.....\$20.00

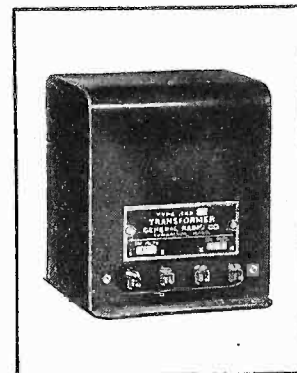

The primary of the Type 365 Transformer is designed for a 110 Volt 60 Cycle circuit. The high voltage secondary consists of two sections of 275 Volts each. There is also a 7.5 Volt secondary.  
 Type 365 Rectifier Transformer .....\$8.00

WRITE FOR OUR LATEST BULLETIN NO. 929

## GENERAL RADIO QUALITY APPARATUS

GENERAL RADIO CO.

30 STATE ST., CAMBRIDGE, MASS.

# BUILD YOUR OWN A.C. SET

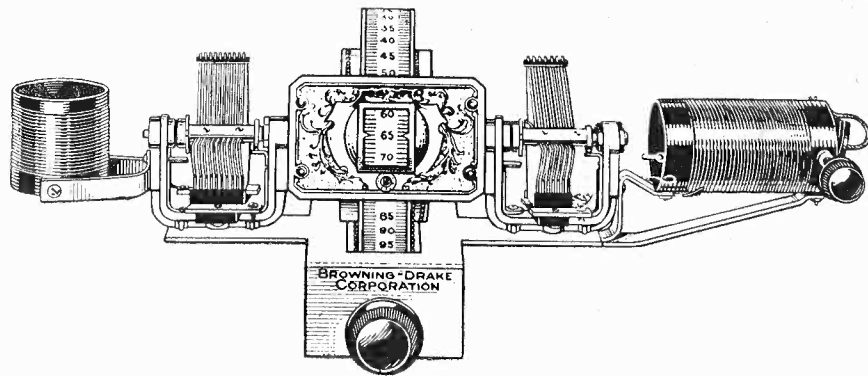

## The New Official Browning-Drake Kit

### Units that are Right

With the New Official Browning-Drake Kit and other specified Browning-Drake parts it is easy to build a good receiver. Below is pictured the Foundation Unit for the five tube kit-set, which is ready drilled. Small neutralizer and trimmer condensers; choke coil, and other units matched and measured to assure results are specified by Browning-Drake to enable ease and accuracy in custom set construction.

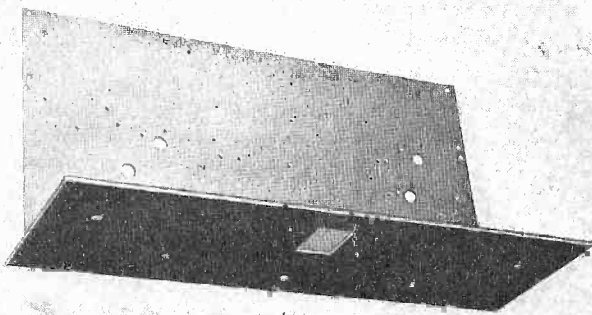

The Five Tube Official Foundation Unit

Reliable A.C. operation depends upon good parts. With the New Official Browning-Drake Kit as the basis, it is easy to build a good receiver using A.C. tubes in connection with the proper power supply to operate direct from the light socket.

Both the Official Browning-Drake five tube Kit-Set and the New Type T Tuner may be wired for either battery or A.C. operation.

The Browning-Drake Construction Manual can be obtained from your dealer or direct for

25c

### A Fine Cabinet

Attractive and sturdy Browning-Drake cabinets designed especially for the Official Assemblies may be obtained by those who wish to house their kit-receivers in a manner befitting the excellence of their apparatus and workmanship. Finished in beautiful two tone Duco Italian walnut, this cabinet harmonizes with the finest furnishings.



The Official Kit-Set in Cabinet

THE BROWNING-DRAKE CORPORATION



CAMBRIDGE, MASS., U.S.A.

# BROWNING-DRAKE RADIO