

FEBRUARY, 1928

25 CENTS

RADIO

(REG. U. S. PATENT OFF.)

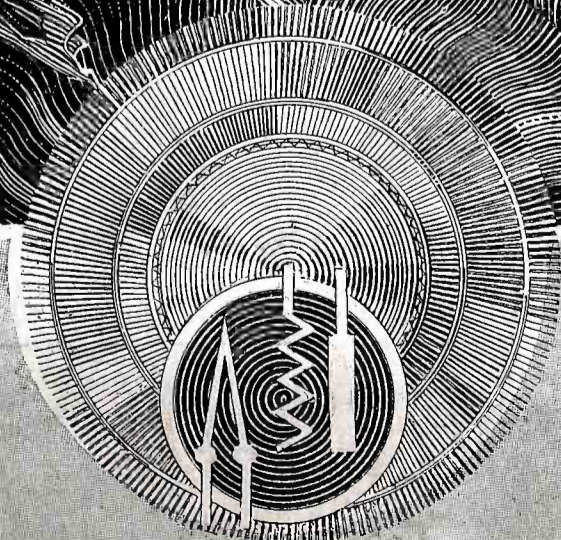
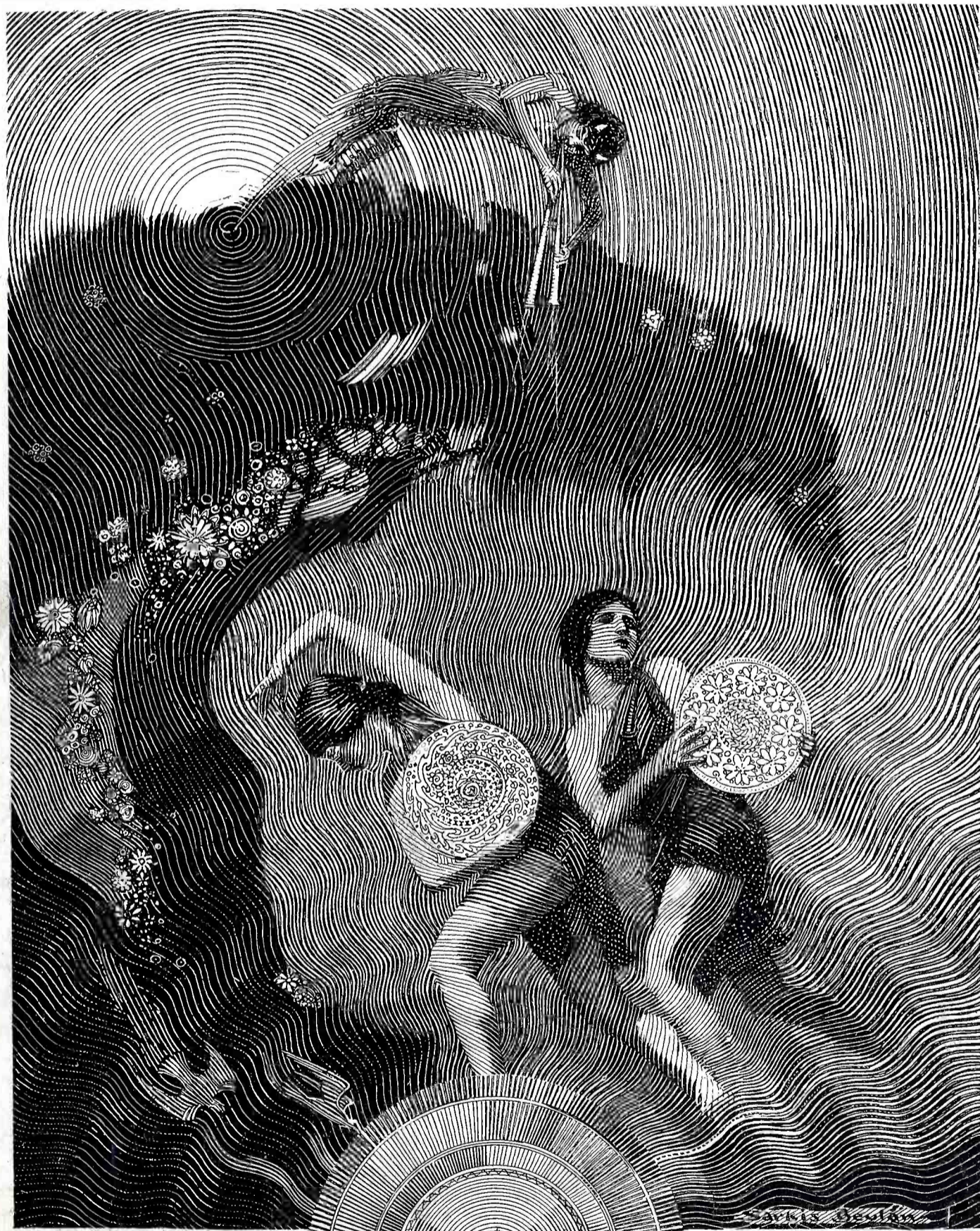

**IN THIS
ISSUE**

**— MORE ABOUT THE 115 K. C. SUPER
AIRPLANE RADIO • • PHOTOELECTRIC CELLS**

Cunningham RADIO TUBES

CX326



C327



Answer
AC
requirements
in modern
Electric



Radio Reception

THE popular demand for the latest and most improved A C power receivers calls for the latest development in A C tube construction.

Cunningham A C tubes CX-326 and C-327 are outstanding in their performance and will bring your A C power receiver up to its highest efficiency.

See that these two tubes are doing their duty along with other Cunningham tubes in your A C receiver.

With A C Power
Receivers Use
Cunningham
A C Tubes

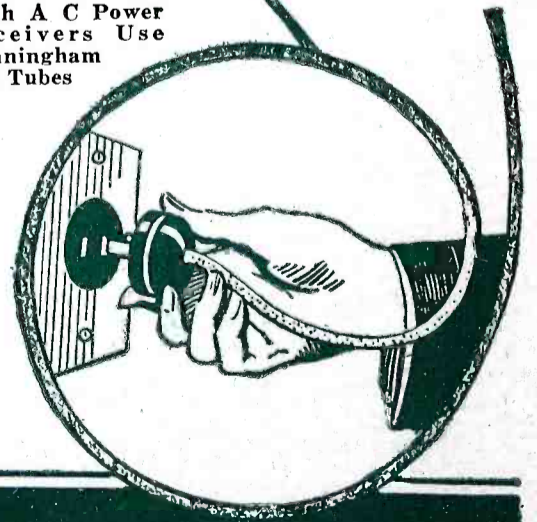

E. T. CUNNINGHAM, Inc.

NEW YORK

CHICAGO

SAN FRANCISCO

Radio is better with *Battery Power*

Why pay for waste space? Buy the EVEREADY LAYERBILT

- it's every inch a battery



This is the Eveready Layerbilt, the unique "B" battery that contains no waste spaces or materials between the cells; the longest lasting of all Evereadys.

IN DRY cell "B" batteries made up of cylindrical cells more than one-third of the space is wasted. That's inevitable. No matter how closely you pack a group of cylinders, there always will be spaces between them. Usually these spaces are filled in with pitch or other substances, to prevent movement of the cells during shipment and breakage of the wires connecting cell to cell. Think of it—over a third of the space inside the ordinary battery is filled with inert packing material!

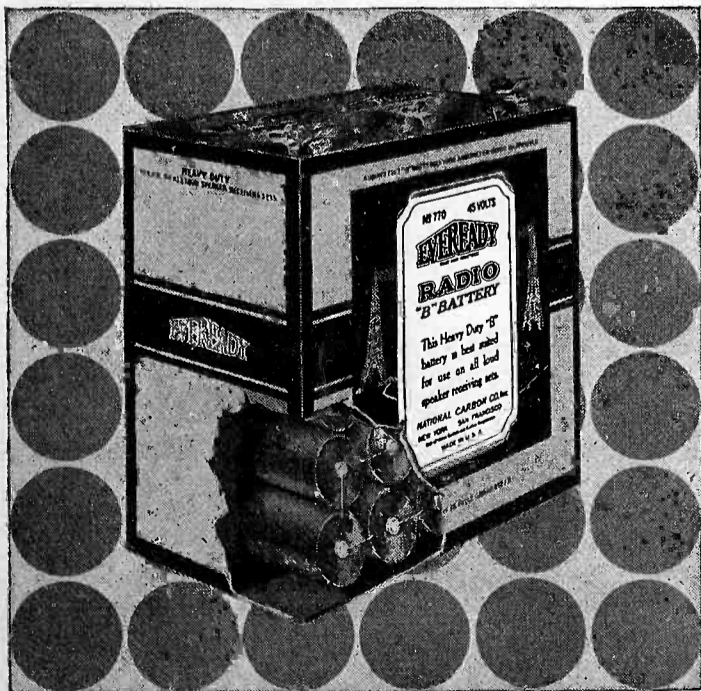

In the Eveready Layerbilt "B" Battery No. 486 there are no waste spaces between the cells and no useless materials. Instead of cylindrical cells, this extraordinary battery uses *flat* cells. It is built in layers and assembled under pressure into a solid block. Electrical connection between cell and cell is automatic, by pressure of the entire side of each cell against its neighbor.

The most surprising thing about this construction is that it actually makes the active materials more efficient. A given weight of them produces more current, and lasts longer, than the same amount when put in the cylindrical cell form. This was the unexpected result of researches into methods of utilizing the hitherto waste spaces. Scientists now know that the flat shape is the most efficient form for the cells in a "B" battery. No wonder the

Illustrated to the left is the cylindrical cell type of "B" battery construction. Note the waste space between the cells.

Eveready Layerbilt is the longest lasting and therefore most economical of all the Evereadys.

Only Eveready makes the Layerbilt. Its exclusive, patented construction is Eveready's greatest contribution to radio enjoyment, giving new economy and convenience to battery users. The Eveready Layerbilt, of course, provides Battery Power—silent, reliable, independent, guarantor of the best reception. For modern sets, use the Eveready Layerbilt.

NATIONAL CARBON CO., INC.
New York  San Francisco
Unit of Union Carbide and Carbon Corporation

Tuesday night is Eveready Hour Night
East of the Rockies

9 P. M., Eastern Standard Time
Through WEA and associated N. B. C. stations

On the Pacific Coast
8 P. M., Pacific Standard Time
Through N. B. C. Pacific Coast network

EVEREADY
Radio Batteries
-they last longer

The air is full of things you shouldn't miss

Tell them that you saw it in RADIO

RADIO

With Which Is Incorporated "Radio Journal"
Established 1917

Published Monthly by the Pacific Radio Publishing Co.

ARTHUR H. HALLORAN,
Editor
GERALD M. BEST,
Technical Editor

H. W. DICKOW,
Business Manager
A. I. RIVETT,
Draughtsman

Branch Offices:

New York City, 20 East 42nd St.
Chicago, 307 N. Michigan Ave.
Boston, 86 St. Botolph St.
Kansas City, Mo., Davies & Dil-
lon, 707 Land Bank Bldg.

Rates:

Issued Monthly, 25c a copy.
Subscription price, \$2.50 per year
in the U. S., \$3.00 per year else-
where.

Correct Addresses:

Instructions for change of address
should be sent to the publisher
two weeks before the date they
are to go into effect. Each old
and new address must always be
given.

Advertising:

Advertising Forms Close on the
First of the Month Preceding
Date of Issue.

Member Radio Magazine Publishers' Association
Entered as second-class matter at Post Office at San Francisco, Calif.
Copyright 1927 by the Pacific Radio Publishing Co.

Address all communications to

Pacific Radio Publishing Company

Pacific Building, San Francisco, California

VOLUME X

FEBRUARY, 1928

NUMBER 2

CONTENTS

	PAGE
RADIOTORIAL COMMENT	17
RADIO PLANE DISPATCHING	18
<i>By Geo. S. Morris</i>	
RADIO GUIDANCE OF AIRCRAFT	19
<i>By Haraden Pratt</i>	
MORE ABOUT THE 115 KILOCYCLE SUPERHETERODYNE.....	21
<i>By G. M. Best</i>	
SYNCHRONIZING WITH MATCHED CRYSTALS.....	22
PLAYING WITH A PHOTOELECTRIC CELL.....	23
<i>By Samuel G. McMeen</i>	
CHARACTERISTICS OF THE PHOTOELECTRIC CELL.....	25
<i>By John P. Arnold</i>	
METHODS OF INCREASING SELECTIVITY.....	26
<i>By F. L. Ulrich</i>	
THE STEAM TRANSMITTER.....	27
<i>By Paul Oard</i>	
THE CAPACITY COUPLED R. F. RECEIVER.....	28
<i>By Francis Churchill</i>	
LOW MU TUBES AS R. F. AMPLIFIERS.....	31
<i>By Nelson P. Case</i>	
HOW TO CALIBRATE A RECEIVER.....	32
<i>By B. F. McNamee</i>	
AERODYNE 6 A. C. RECEIVER.....	33
A GOOD THREE STAGE POWER AMPLIFIER.....	34
QUERIES AND REPLIES.....	35
THE COMMERCIAL BRASSPOUNDER.....	36
<i>Edited by P. S. Lucas</i>	
WEST PACIFIC WEATHER CODES.....	39
<i>By L. O. Doran</i>	
FOREIGN RADIO BROADCASTING.....	40
A LOW POWER MASTER OSCILLATOR.....	41
<i>By Francis Churchill</i>	
A GOOD SHORT WAVE PHONE.....	42
<i>By R. Wm. Tanner</i>	
KFLF	44
<i>By Wallace S. Wiggins</i>	
PROTECTING VACUUM TUBES AGAINST BURNOUT.....	57
<i>By Clinton Osborne</i>	
RADIO OPERATING AS A MEANS TO LARGER OPPORTUNITIES.....	61
<i>By C. B. Cooper</i>	
USES FOR BURNED OUT TUBES.....	61
<i>By R. Wm. Tanner</i>	
SUB-PANEL DIAL MOUNTING.....	62
<i>By Don C. Wallace</i>	

Forecast of Contents for March Issue

G. M. Best follows up his first two articles on the 115 kilocycle superheterodyne with some practical suggestions on testing and trouble shooting. These are based not only upon his own experience with the set but also upon that of others who have built and operated this receiver.

— : —

R. J. Robbins has designed an inexpensive drum dial which can be made by any amateur constructor from material out of his junk-box. Full directions are given by text and diagram.

— : —

E. F. Kiernan gives complete instructions for converting an old type electro-dynamic horn speaker into a modern cone speaker.

— : —

For the constructor, also, Byron G. Wade tells how to make self-supporting inductance coils.

— : —

The amateur operator and the experimenter in short wave broadcast reception should be interested in Francis Churchill's 1928 Short Wave Receiver. It uses one stage of r. f. amplification with a shielded grid tube, an oscillating detector and one stage of audio. Plug-in coils are employed for each band.

— : —

Another circuit for the experimenter to play with is the Clement 4, so-called because it uses four tubes and is designed by Frank Clement Jr. Two of the tubes are shielded grid. Single drum control is used for tuning.

— : —

S. G. McMeen, in his series of articles on "Experimental Shop Practice," tells how to make a bug key. He also contributes a simple exposition of the theory of electrical filters.

— : —

The fiction feature is "The Jungle SOS" by P. J. Clark.

— : —

From the seven-tube capacity coupled r. f. receiver described in February RADIO, Francis Churchill has developed a four-tube set which is easier to build. It is quite sensitive and selective with its one stage of r. f. amplification and regenerative detector.

— : —

Clinton Osborne illustrates and describes the construction of a voltage booster which will care for many troubles with socket power units.

— : —

For the service man B. F. McNamee explains the reasons for various troubles with tuned r. f. amplifiers, giving practical suggestions for their correction.

— : —

Harry R. Lubcke has a constructional story on the Torusolenoid coil as adapted to broadcast reception.

Profits in ... Custom-Built Sets

This Proves It

Robert Lavoy says that he has sold more than 30 of the 1928 Infradynes. He is a man that has cashed in on custom-built sets.

δ δ δ

Gerald McKinlay writes that since starting into business in September, he has sold twelve 1928 Infradynes.

δ δ δ

B. V. Kershner writes that he has sold 69 Infradynes since starting to build them in the middle of last year's season.

δ δ δ

Clyde L. Hune, of Nashville, Tennessee, writes: "If you have anyone who wishes to know the real ability of the Infradyne kindly refer them to me. I shall be more than pleased to tell them fully of its remarkable qualities. You may feel at liberty to publish this letter as a testimonial regarding the qualities of the Infradyne."

δ δ δ

H. F. Wilkins, of Chicago, sends a log of 80 outside stations received during one week, and says: "This far exceeds the performance of the 1926 and 1927 Infradyne. We have made several of the 1927 and now are busy on the '28's."

δ δ δ

R. F. Nehrhood, of Spokane, Washington, writes: "Wish to apologize for not having answered your previous letter, but have been working night and day trying to keep this town supplied with Infradynes. I think that the Infradyne is going to do something that other sets have not done and that is to sell good during the summer months. As far as telling what an Infradyne will do in accordance with other sets, there is no room for comparison, for the Infradyne will out demonstrate any set for selectivity and tone quality."

If you know radio, we will help you to make some "real money," and you can have a business where the profits are only limited by your own efforts. Today, thousands of Professional Set-Builders are making from two to ten times as much as they ever made before. They are filling a real need; they are meeting the demand for custom-built radios.

Better Reception Costs Less

Tens of thousands of buyers are not satisfied with factory-made sets. They know that they can get more for their money from a custom-built set. They demand the skill and interest which only a professional Set-Builder can give.

The 1928 INFRADYNE

Many Professional Set-Builders are making the 1928 Infradyne their big seller. This circuit, marvelous in performance, and wonderful in appearance, is a dominant favorite. But you can make and sell any number of different circuits and still take full advantage of the assistance which we render to all Professional Set-Builders.

Remler Service

Our service to you includes:

1. Suggestions for starting out, sales helps, and advice on any situation which you may face.
2. Business cards, bill-heads, and letter-heads, in two colors, furnished at cost.
3. Our new Bulletin Service, describing all important circuits, listing parts and costs, with schematic diagrams and general information. Furnished without cost.
4. Advice from our Technical Department, and real help in overcoming any technical difficulty.
5. Merchandising assistance from our Sales Department to help you get customers and make a satisfactory profit on each sale.

Now Let's Go

All the experimenting has been done. Now is the time to hit the ball hard and to concentrate on an established and profitable circuit. Read the column at the left. See what results others are getting. Figure out if your ability is worth more money than you are making now. If so, fill out the coupon. You will hear from us by return mail.

REMLER
BULLETIN NO. 1
SECTION
DEC. 15, 1927

SERVICE FOR SET BUILDERS
GRAY & DANIELSON MANUFACTURING CO. 260 FIRST STREET SAN FRANCISCO, CALIFORNIA

NEW IMPROVED H.F.L. NINE-IN-LINE SUPER KIT
H. F. L. UNITS
MANUFACTURED BY
HIGH FREQUENCY
LABORATORIES
1430 NORTH WELLS ST.
CHICAGO

BLUE PRINTS NO. 70. \$1.50 SET
CITIZENS RADIO SERVICE BUREAU
442 N. DEARBORN ST. CHICAGO

1 500 Ohm Resistor	1.00	1 500 Ohm Resistor	1.00
1 100 Ohm Resistor	1.00	1 100 Ohm Resistor	1.00
1 50 Ohm Resistor	1.00	1 50 Ohm Resistor	1.00
1 25 Ohm Resistor	1.00	1 25 Ohm Resistor	1.00
1 10 Ohm Resistor	1.00	1 10 Ohm Resistor	1.00
1 5 Ohm Resistor	1.00	1 5 Ohm Resistor	1.00
1 2 Ohm Resistor	1.00	1 2 Ohm Resistor	1.00
1 1 Ohm Resistor	1.00	1 1 Ohm Resistor	1.00
1 500 Ohm Resistor	1.00	1 500 Ohm Resistor	1.00
1 100 Ohm Resistor	1.00	1 100 Ohm Resistor	1.00
1 50 Ohm Resistor	1.00	1 50 Ohm Resistor	1.00
1 25 Ohm Resistor	1.00	1 25 Ohm Resistor	1.00
1 10 Ohm Resistor	1.00	1 10 Ohm Resistor	1.00
1 5 Ohm Resistor	1.00	1 5 Ohm Resistor	1.00
1 2 Ohm Resistor	1.00	1 2 Ohm Resistor	1.00
1 1 Ohm Resistor	1.00	1 1 Ohm Resistor	1.00

GOLD THROUGH JOBBERS

FOR DESCRIPTION SEE OTHER SIDE

MR. GEO. H. CURTISS, Sales Manager,
Gray & Danielson Mfg. Co.,
260 First Street, San Francisco, Calif.

I build and sell radio sets []. I do not build radio sets to sell []. Style of business: Store [] Shop [] Home [].

The kind of sets I build.....

Remarks.....

Name.....

Street.....

City..... State.....

DISTANCE *lends* ENCHANTMENT



When you buy or build a radio set make sure that it has Copper Shielding. Where long distance reception is desired Copper Shielding is essential. It is a refinement to your set that will enable you to hear the programs of distant stations much more clearly.

Copper Shielded sets give:

**BETTER RECEPTION
FINER SELECTIVITY
IMPROVED TONE QUALITY**

By virtue of its easy working qualities and its high conductivity Copper Shielding is a decided improvement to any set.

COPPER & BRASS

RESEARCH ASSOCIATION

25 Broadway, New York



*Write for your copy of this
book. There is no cost nor
obligation on your part.*



Right by Might!



A FLIP of the switch — sweet, mellow music — and simultaneously, Nature's mightiest force is thrusting — pulling — straining — fighting — for control.

A lonely flaw — the slightest weakness — and you lose. The electrical energy in your eliminator is always striving mightily to rupture — to break down — the filter condensers.

Scientific design — construction — testing — and conservative electrical rating are the combative agencies which curb and control this rebellious force.

AEROVOX FILTER CONDENSERS have proved themselves . . . They withstand these mighty assaults day after day — month after month — year after year.

Aerovox Filter Condensers have been thoroughly tested by Mr. G. M. Best, and are exclusively specified by him for the power pack designed for the new Best superheterodyne. The power pack for this excellent receiver is described in this issue.

Yours for perfect satisfaction.

AEROVOX

"Built Better"

70 Washington St., Brooklyn, N. Y.

Selected for its Quality

FROST-RADIO

Again is exclusively Specified by Gerald M. Best, who now selects it for his new Revolutionary 1928 Superheterodyne

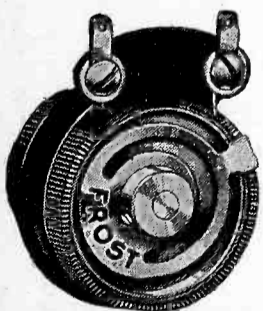

FROST-RADIO



FROST-RADIO

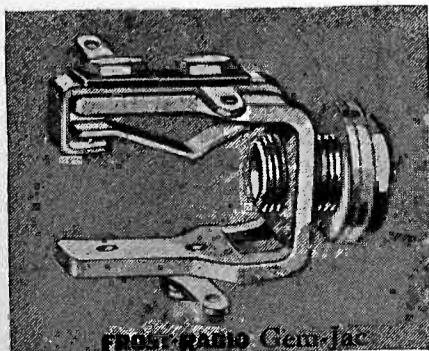

FROST-RADIO Gem-Jac

IN specifying Frost-Radio for exclusive use in his startling and revolutionary 1928 Superheterodyne, Gerald M. Best again shows the implicit confidence he places in these famous parts. Mr. Best has specified Frost-Radio on numerous occasions in his other circuits because he has found it admirably suited to the quality of reception his circuits must and do deliver.

In his 1928 Super Mr. Best makes use of the following Frost-Radio parts:

- 1 S-1910 10 ohm Frost Gem Rheostat, with combined filament switch.
- 1 No. 1922 200 ohm Gem Potentiometer.
- 1 No. 1882 200,000 ohm Frost De Luxe Variable High Resistance Unit.
- 1 No. 954 Frost Single Closed Circuit Gem-Jac.

When you build Best's 1928 Super be sure to use only genuine Frost parts, as specified. Your dealer can supply these parts. See him today.



FROST-RADIO

HERBERT H. FROST, INC.

NEW YORK

ELKHART, IND.

CHICAGO

Tell them that you saw it in RADIO

Shieldplate ^{Type S.P. 122 Shielded Grid} Tube

Radios' Greatest Last-Minute Achievement.

Makes possible such circuits as
BEST'S SUPERHETERODYNE
DESCRIBED IN THIS ISSUE

Exclusively Specified!

The Shieldplate Tube, Type SP 122 is exclusively specified in Best's Superheterodyne—Tyrman "70" Shielded Grid Amplimax—Camfield Seven, and all other leading Shielded Grid Circuits.



NOTE THESE 6 POINTS of SUPERIORITY

1. Amplification constant is 175 compared with constant of 8 in general purpose tubes.
2. Oscillation is entirely eliminated.
3. It is self-neutralized.
4. "A" Battery drain is only .131 amperes.
5. Operates on 3 volts.
6. Brings in DX stations like locals.

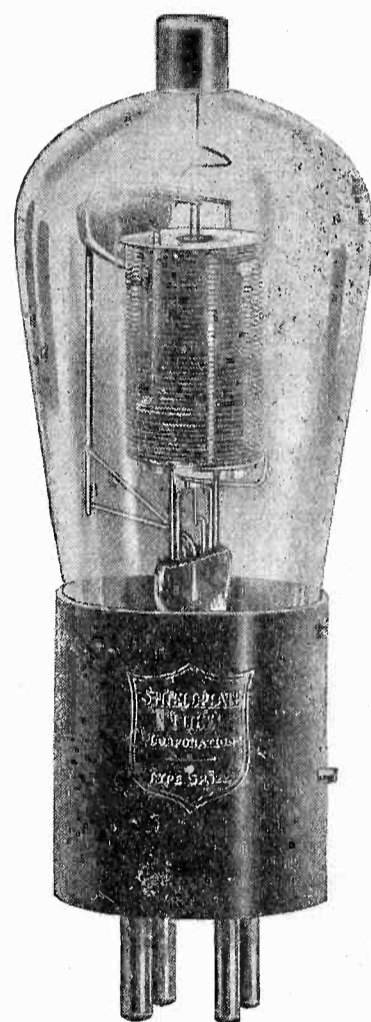

Type SP 122
Price \$6.50

GUARANTEED

The Shieldplate Tube Corporation guarantees these tubes to be just as represented, or your money cheerfully refunded.

If your Jobber cannot supply you order direct from the factory. Include money order with your request or we will ship C. O. D.

JOBBERs and DEALERS

To insure immediate delivery wire your order today. All orders filled in rotation.

SHIELDPLATE TUBE CORP.

208 S. La Salle St.
Chicago, Ill.

Shieldplate Tube Corp.
Dept. R, 208 S. La Salle St.
Chicago, Illinois

Kindly send free booklet describing the Shielded Grid Tube, Type SP 122 and its many uses.

Enclosed find check for \$..... Send me.....Shieldplate Tubes, Type SP 122.

Name.....

Address.....State.....

Jobber.....

Now Ready for Immediate Delivery!

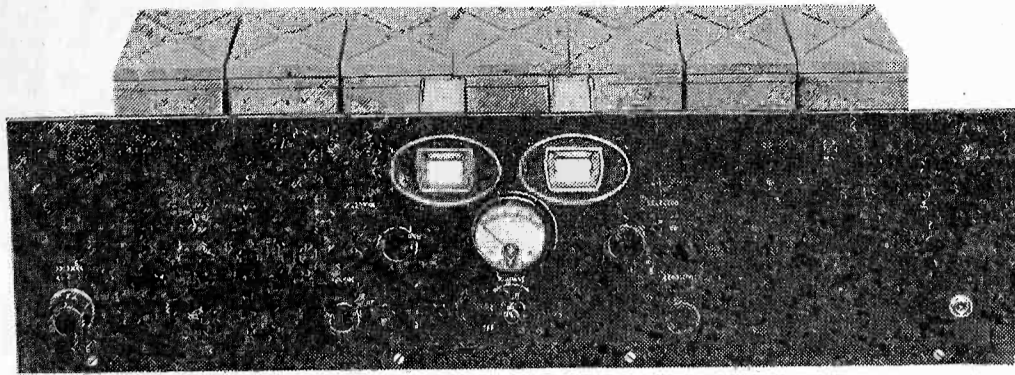

BLUE PRINTS

for

Best's New Superheterodyne

25" x 38" Plans in Full Size. Complete Instructions.

NOW you can get Gerald M. Best's official copyrighted instructions for building his new 1928 Model 115 Shielded Grid Tube Superheterodyne and assure yourself in advance of building the greatest receiver in all radio history. Best has given much thought and time towards the preparation of these large prints and detailed instructions for building his latest model. The drawings are unusually clear—simple and extremely easy to follow. We believe these new prints are the simplest of their kind we have yet seen and the wiring plans are in full size—heavily drawn and reproduced in order to prevent any possibility of error in the assembly and construction of the receiver. There is a full size drilling template for the front panel. Another sketch gives you the full size pictorial wiring diagram and the other sketch shows the diagram in schematic form. All sketches, illustrations and instructions are on one extremely large sheet, adequate for posting on the wall. The plans and instructions are packed in one sealed envelope and will be mailed to you by first class mail immediately upon receipt of one dollar. We urge you to get your prints now. The demand will be unusually heavy.

ATTRACTIVE FOR WINDOW DISPLAY

The complete working prints for building the new superheterodyne make an attractive dealer window display. They are printed on white glossy stock. Dealers are invited to write for prices in quantities. These plans will help boost the sale of parts.

HEAVY ENAMELED PAPER

The full size working prints are on a heavy grade of enameled stock, printed in deep blue. They will withstand much wear. Will not tear easily. We know you will be pleased with the neatness and originality of these new instructions.

Use the Coupon. Order Now.

Attach a dollar bill, check or money order to the coupon and get it in the mail before you turn this page. We promise to mail your prints on the same day your order reaches us. Special delivery shipments will be made when ten cents is added to cover charges. Air mail deliveries upon receipt of 60 cents additional.

\$1.00
Postpaid
Anywhere

R
2-27

"RADIO"
433 Pacific
Building, San
Francisco, Calif.

Here is \$1.00 for which you will immediately mail me a complete set of full size working prints and instructions for building G. M. Best's new 1928 Model 115 Super.

Name.....

Street and No.....

City.....

State.....

Dealers and Jobbers Are Asked To Write Us For Trade Proposition

MEMBER
RMA

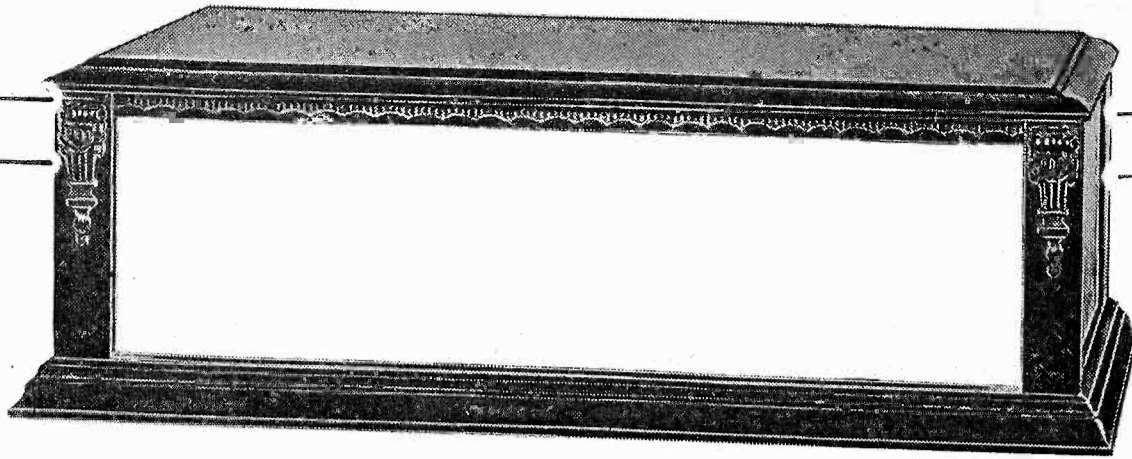

The specified cabinet by Best for his great SUPERHETERODYNE. A beautiful housing for this deluxe receiver. Selected by Best for its excellent workmanship and superior construction.

Gerald M. Best's Authorized Cabinet for his new SUPERHETERODYNE

CHILLICOTHE Radio Cabinets are designed by experienced Radio Specialists. This genuine walnut cabinet was originally designed and built for the Gerald M. Best Superheterodyne Receiver. The top is piano-hinged; base, rail and posts are solid walnut. Top and sides are of scientifically constructed, laminated walnut to eliminate warping or splitting. Standard equipment; removable baseboard, 26 x 11 inch.

Front panel space 7x26 inch. Opex lacquer piano finish.

HERE in this new creation by the Chillicothe Furniture Company, you will find authentic, distinctive design, simplicity and unsurpassed convenience,—truly a pleasant combination.

Interesting booklets on Chillicothe Radio cabinets will be cheerfully mailed upon request. A letter to Department R, Chillicothe Furniture Company, Inc., Chillicothe, Missouri, will demonstrate how these cabinets will improve your set.

CONSTRUCTION

The same ideals which the Chillicothe Furniture Company has at all times expressed in the construction of their genuine walnut Dining Room Suites, have been carried into this new field of radio cabinets, and built in "The Walnut Center of America," by this reliable firm, you are assured of a radio cabinet superb.

"Built in the Walnut Center of America"

CHILLICOTHE RADIO CABINETS

CHILLICOTHE FURNITURE COMPANY
INCORPORATED

Chillicothe, Missouri

The CHILLICOTHE console, massive and beautiful, will satisfy the needs of the buyer who wants individualized custom-built cabinet work. Write for circulars on our line of consoles.

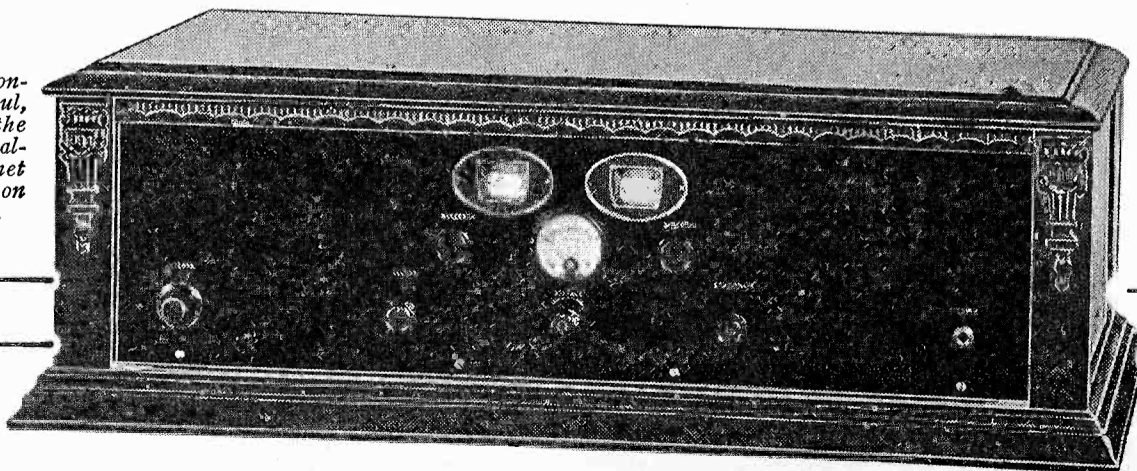

Here is pictured the Best SUPERHETERODYNE in the specified CHILLICOTHE table cabinet. Decorative motifs enhance the beauty. You will be pleased with the excellent finish of this cabinet.

AMERTRAN Now Offers

Complete Light-Socket Power with Fidelity of Reproduction

The AmerTran ABC Hi-Power Box.
List price \$95, east of the Rockies.
Rectifying tube extra.

No batteries, liquids or chargers.
No attention or adjustment necessary.
Uniform, dependable power from the house current.



You know already the well-earned reputation of AmerTran parts. Now investigate these latest achievements, and by comparison judge their merit. Certainly you will select them for long life, and quiet, reliable operation.

BEFORE you think of another set, think what these new AmerTran products will do for the one you have. The ABC Hi-Power Box will deliver smooth power to plate and filament from the light socket, supplying sufficient voltage and current for push-pull 210 tubes and all other AC tubes required in a modern receiver. There is no fussing — no weak reception due to run-down batteries. This complete unit contains AmerTran-designed equipment, with a power transformer having separate windings to provide AC filament current at $7\frac{1}{2}$ volts for two 210 power tubes, a similar winding for the 281 rectifying tube, a third winding at $2\frac{1}{2}$ volts — providing heater current for three or four UY-227 AC tubes, and a fourth winding providing current at $1\frac{1}{2}$ volts for four or five UX-226 raw AC tubes. These capacities are ample for practically every set, with a generous margin of safety.

The Hi-Power Box may be placed in the base of a console or under a table away from the set. With its black finish, nickel trimming and hinged cover it will be suitable anywhere.

With either an AC power supply system or batteries, you'll find the fidelity of reproduction brought by the AmerTran Push-Pull Power Amplifier actually limited *only* by the perfection of the speaker. Operated from the AmerTran ABC Hi-Power Box, the input to the speaker is free from distortion and objectionable AC hum. The energy output is increased especially at the lower musical frequencies, bringing greater clarity at high or low volume. The amplifier connects to the detector of the receiver and may be entirely AC operated. It is furnished with cable and plug to connect directly with the Hi-Power Box. One of the important parts of this amplifier is the well-known AmerTran DeLuxe audio transformer.

These two companion units are designed to work together, and when used with a good tuner and speaker will reproduce without exaggeration a philharmonic orchestra or pipe organ as though actually present.

The AmerTran Push-Pull Power Amplifier. List price \$60, east of the Rockies. Tubes extra.

A new standard of quality in Audio Amplification. The tone you have always wanted. Connects to the detector of any good receiver.

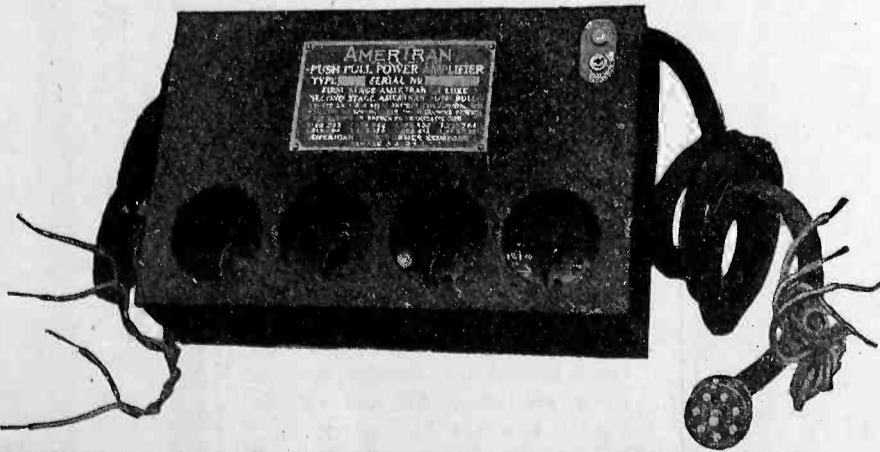

See these new AmerTran products on demonstration at any store displaying the sign "Authorized AmerTran Dealer" or, if you cannot obtain them, write direct to this Company.

Both wired units are licensed under patents owned or controlled by RCA and must be sold complete with tubes.

AMERICAN TRANSFORMER CO.

176 Emmet Street : : : Newark, N. J.

"Transformer Builders for Over 27 Years"

Pacific Coast Office: Chronicle Bldg., San Francisco

PANELS for BEST'S New SUPER

DRILLED AND ENGRAVED BAKELITE PANELS AND SUB-PANELS—EXACTLY AS SPECIFIED BY GERALD M. BEST IN THIS ISSUE OF "RADIO"

Immediate Deliveries. Mail Orders Promptly Filled

SAVE hours of time and labor. Let us supply you with the completely drilled, engraved and finished panels, sub-panels and bases for Gerald M. Best's new superheterodyne. Our business is to supply this material exactly as specified by Best. We have taken his original working drawings and have made our front panels, baseboards and sub-panels to his exact specifications. Each hole is drilled exactly where it ought to be. Our workmanship is guaranteed to be 100% accurate. Beautiful front panels in Bakelite, finished in walnut or black at your option. Holes drilled for drum dials, meter and controls. Engraving in white or gold for all control and dial markings, just as Best specifies. We are ready to make deliveries right now—TODAY. Eastern business solicited. We can supply any quantity of these panels on quick notice.

BAKELITE Panels

In walnut, curly walnut or mahogany. Exact size as specified by Best. All holes drilled. Fully engraved. White or gold..... **\$9.60**

In Black Bakelite..... **\$8.70**

BAKELITE Sub-Panels (Base-Board)

Best specifies a wood sub-panel but if you want to make a "De Luxe" receiver use a Bakelite Sub-Panel, cut, drilled and finished to exact specifications as shown by Best. Price of Bakelite Sub-Panel in black..... **\$8.90**

WOOD Base-Boards

A sturdy high grade wood baseboard, lacquer finished, with all cutting as shown in Best's picture diagram in this issue. Price..... **\$3.90**

We Carry a Complete Stock of Bakelite Rods, Sheets and Tubes. We Can Supply Panels for Any Kind of Sets

Panels for Any Kits described in "RADIO" or other magazines can be supplied to order. C. O. D. shipments made when half cash accompanies order.

*Dealers & Jobbers
please write
for details*

MAIL ORDERS

Complete sets of panels and sub-panels sent by parcel post on same day your order is received. Include postage for four pounds when parcel post shipments are wanted.

W. A. VETTER

24 Twelfth Street San Francisco

NEW CORWICO BRAIDITE Hook-up Wire The Braid Slides Back

To make a connection with Braidite, simply shove back the insulation. When you have finished soldering, the insulation slides right back into place, leaving no exposed sections of bare wire. Braidite is the fastest and easiest hook-up wire to work with, and it also makes the neatest and most workmanlike looking job. Although far superior Braidite costs less than ordinary hook-up wires. USE BRAIDITE IN THE NEXT SET YOU BUILD. If your dealer cannot supply you write us direct.

25 Ft. Stranded Braidite.....35c
25 Ft. Solid Braidite.....30c

Made in red, green, yellow, brown and black.

CORNISH WIRE COMPANY
30 CHURCH ST. N. Y. CITY



Because of its superiority, Braidite is specified in all the leading popular circuits of the day and is used by most of the leading set manufacturers.

YAXLEY APPROVED RADIO RODUC

Cable Connector Plug Specified in the BEST SUPER

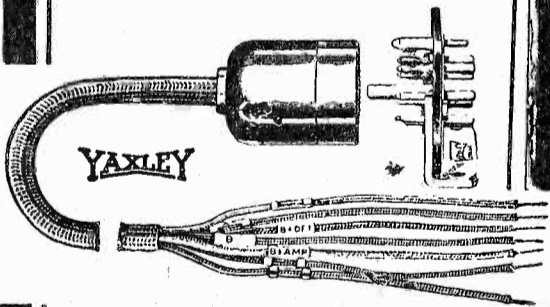

Every kit builder will get a great deal of satisfaction out of this radio convenience that brings battery wires to the set in one neat compact cable. The Cable Connector Plug shown above is for installing right in the set. Once hooked up, correct connections are assured—you cannot put it together improperly. For the BEST SUPER as well as for all leading sets insist on the Yaxley Cable Connector Plug.

At All Dealers

YAXLEY MFG. CO.
Dept. A—9 So. Clinton Street
Chicago, Ill.

Complete Parts For:

G. M. BEST'S
SHIELDED GRID TUBE
SUPERHETERODYNE
\$153.00

HAMMARLUND-ROBERTS KIT HI-Q SIX

All Ready to Change Over to Shielded Grid Tube Operation.

\$75.00 Complete

All Parts in Stock for
"LYNCH NATIONAL FIVE"

Equamatic, Nine-In-Line, Infradyne, Brown-Ing-Drake, Phasatrol, R. B. Lab., Cockaday 28, Tyrman Ten, Magnaformer, and other Popular Circuits.

Write Us First.

M. & H. Sporting Goods Co.

512A Market St.

Philadelphia, Pa.

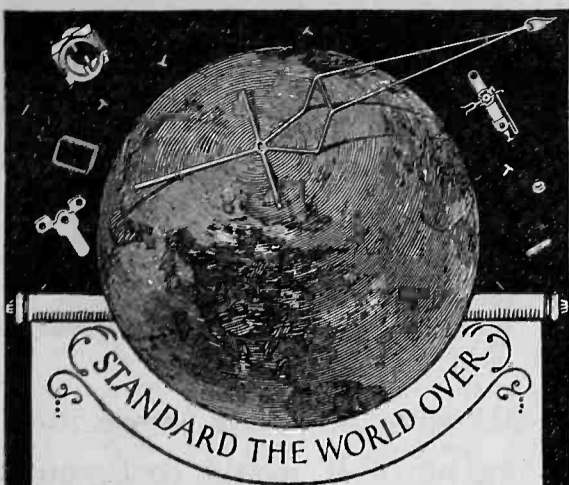

Q R V ?

For the International Test in February—

Make sure that your antenna ammeter is the best obtainable. Success or failure depends upon the stamina, accuracy and overload capacity of your instruments. "Westons" are the original Thermo-Couple types. Other makes are necessarily only imitations. The following superior features of the Weston Model 425—3 1/4" Thermo-Milliammeters challenge comparison.



Definite assurance of your output. Accurate readings after hours of constant service.

Extra large overloads will not burn out these meters. They will stand the following currents without damage:

- 500 milliamperes range—1 Ampere
- 250 milliamperes range—750 M.A.
- 125 milliamperes range—500 M.A.

Model 425 is ideal for short wave transmission, as it has a very low internal electrostatic capacity. For this reason it gives the true value of the current in the circuit, and does not disturb the constants of your transmitter.

Model 425 is made in ranges from 125 M.A. to 20 amperes. The overload capacity of ammeters, from 1 to 20 ampere ranges is 50%.

WESTON ELECTRICAL INSTRUMENT CORPORATION
156 Frelinghuysen Ave., Newark, N. J.

Pacific Coast representatives
Graybar Electric Company, Inc.
84 Marion St., Seattle, Wash.
J. H. Southard, San Francisco, Calif.
A. A. Barbera, Los Angeles, Calif.
Repair Service Laboratory
682 Mission St., San Francisco, Calif.

WESTON

RADIO

INSTRUMENTS

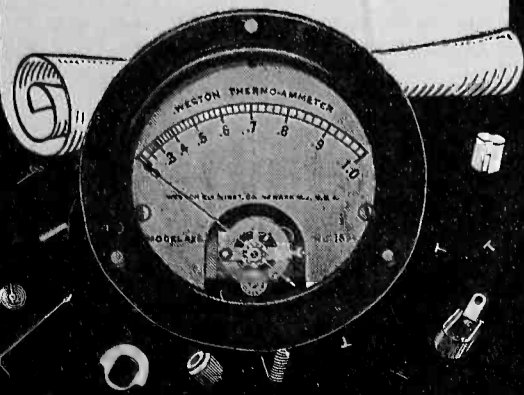

Form 1220-B

WESTERN UNION

J. C. WILLEVER, FIRST VICE-PRESIDENT
NEWCOMB CARLTON, PRESIDENT

SYMBOLS	
DLT	Day Letter
NMT	Night Message
NL	Night Letter
LCO	Deferred
CIT	Cable Letter
WLT	Week End Letter

The filing time as shown in the date line on full-rate telegrams and day letters, and the time of receipt at destination as shown on all messages, is STANDARD TIME.

Received at
 AS 96 105 NL. SAN FRANCISCO CALIF 14
 STERLING MANUFACTURING CO.
 2831 PROSPECT AVE CLEVELAND OHIO.

YOU WILL BE PLEASED TO LEARN THAT GERALD BEST HAS SELECTED YOUR MODEL R93 A POWER UNIT FOR LIGHTING FILAMENTS HIS SUPER HETERODYNE AND WILL EXCLUSIVELY SPECIFY AND ILLUSTRATE THIS DEVICE IN OUR FEBRUARY ISSUE OUT ON JANUARY TWENTIETH.

PUBLISHERS OF RADIO SAN FRANCISCO.

RECEIVED BY
THE STERLING MFG. CO.
DEC 15 1927
Handled by *LSH*

The "A" Unit selected by Gerald Best

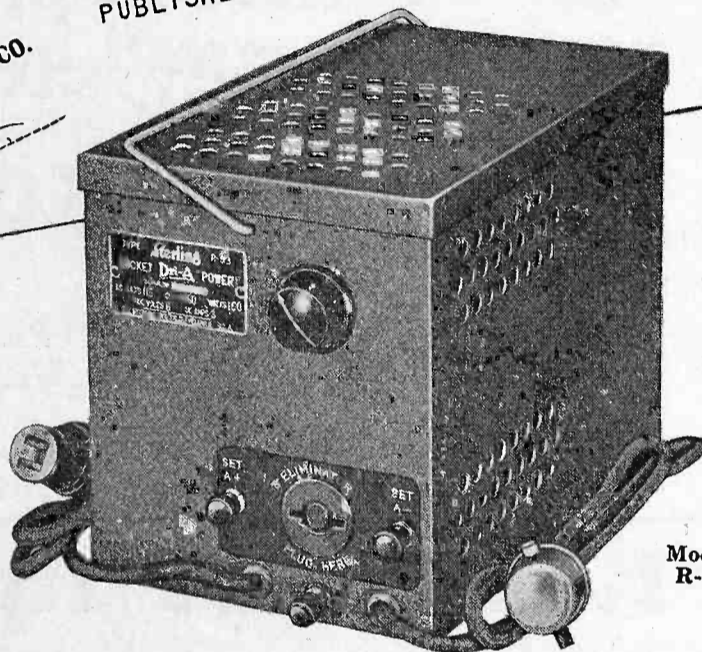

Model R-93

for his new Super - - (see p. 21 of this issue)

WHETHER you build the new Best Super, or whether you already own a good radio, the fact that Mr. Best recommends the Sterling "A" Power No. R-93 should go far in deciding your choice of an "A" Power Supply. Here is an "A" Power that is dry—it does not contain or require a drop of liquid at any time. Is silent. Uses the reliable 3 amp. Tungar bulb.

Together with any Sterling "B" Power Unit this "Dri-A" converts any battery-operated set into a true A. C. set, when the single switch on the unit controls all power and radio reception.



Sterling "B" Power R-81, the high quality "B" that, together with R-93 gives complete A. C. operation for all sets of 5 to 8 tubes.

Dealers all over the country are featuring the permanent Sterling "Dri-A" Power Supply. Manufactured by The Sterling Mfg. Company, Cleveland, Ohio.

Sterling

A. C. Power Supply

Any Set Sterling Powered is an A. C. Set

Model R-93
"Dri-A" Unit
\$39.50
including bulb
Model R-81
"B" Power Unit
\$28.50
including Raytheon
Tube
Prices slightly higher
Far West and Canada

2 RADIO MAGAZINES 1 ...FOR THE PRICE OF 1

"CITIZENS RADIO CALL BOOK" and "RADIO"—a full year's subscription to both magazines for the price of a one-year subscription to "RADIO" alone.

\$2.50 is the full price of this liberal money saving offer

— Save 50% —

YOU save \$2.50 by subscribing now. It would cost you \$5.00 a year to buy these copies from a news dealer. Save 50%. Get in on this big offer before you turn this page. Get double value for your money. "CITIZENS RADIO CALL BOOK" is published four times a year. "RADIO" is published twelve times a year.

You can extend your subscription for one year if you are already a subscriber.

SEND \$2.50 TODAY BY CHECK, MONEY ORDER OR STAMPS. YOUR SUBSCRIPTION WILL START WITH THE NEXT ISSUE

Ready for Immediate Shipment!

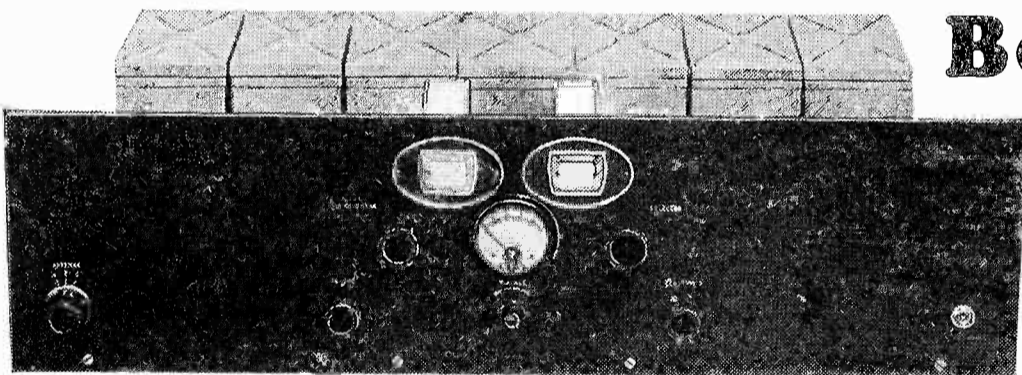

Best's 115 K. C. Super Parts

Also parts for any of the Season's New Kits. Each Kit Laboratory Matched and Tested. No extra charge for this service.

Most Spectacular Receiver. Extremely Selective.

Here, at last, is Best's masterpiece. The new 115 K.C. SUPER using four of the new shielded grid tubes. Tests have proven it to be the most selective receiver yet developed. Unusual volume on long distance reception due to the use of shielded grid tubes and extremely quiet in operation. Clean cutting 10 kilocycle separation. Use only specified

parts. We supply all of the parts needed, exactly as specified by Best. The complete parts, without tubes or cabinet, is \$153.00, including the two essential tube ballast shields. Individual parts can also be supplied. CHILLICOTHE specified cabinets \$25.00. Full size working drawings and instructions \$1.00 postpaid.

SHIELDED GRID TUBES \$6.50 each. Any make. Now ready for immediate shipment to you. Each tube laboratory tested.

Tested Tubes

Multitube receivers work much better when matched and picked tubes are used, as has been shown by orders and re-orders from those who have had this experience. Just advise the type of set that you have, and state the number and type of tubes wanted, and hand picked tubes will be supplied, each marked for the specific socket that it is to be used in. MATCHED TUBES supplied at the regular retail price; no extra charge for matching.

Matched Audio Transformers

An audio frequency amplifier, with the tubes carefully selected and picked to exactly match the transformers supplied will assure you of the utmost in tone quality. Any kind, make or type of audio transformers, either with or without output transformers or filter can be supplied without extra charge for matching and picking, and the proper individual tubes can be supplied at the same time.

INTERMEDIATE FREQUENCY TRANSFORMERS

Intermediate frequency transformers — all makes and types—can be matched and peaked to exactly their highest efficiency,

depending on the tubes used. The price for matching, where a complete set of transformers and filter are supplied is \$2.50 per set, condensers and other units extra. Transformers rewound completely to any desired frequency, \$2 per transformer.

Write for Prices on Special Testing and Calibration Work

D. B. McGOWN
Radio Laboratorian

435 Pacific Building

San Francisco

All Shipments Filled Promptly. Mail Order Business Solicited.

How's Your Old Audio Amplifier

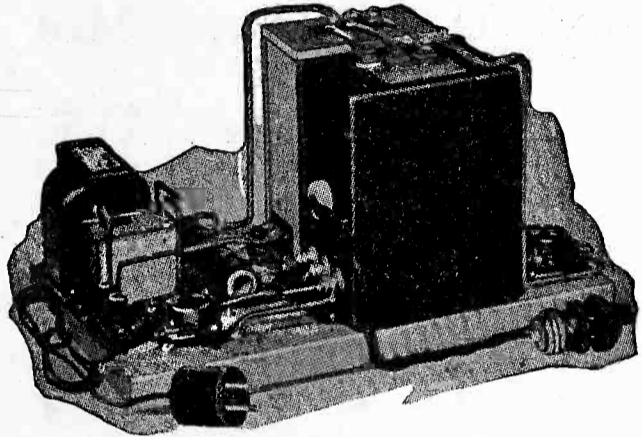

**THORDARSON 171 TYPE
POWER AMPLIFIER**

Built around the Thordarson Power Compact R-171, this power amplifier supplies "A," "B," and "C" current for one UX-171 power tube and B-voltage for the receiver. Employs Raytheon B. H. rectifier.

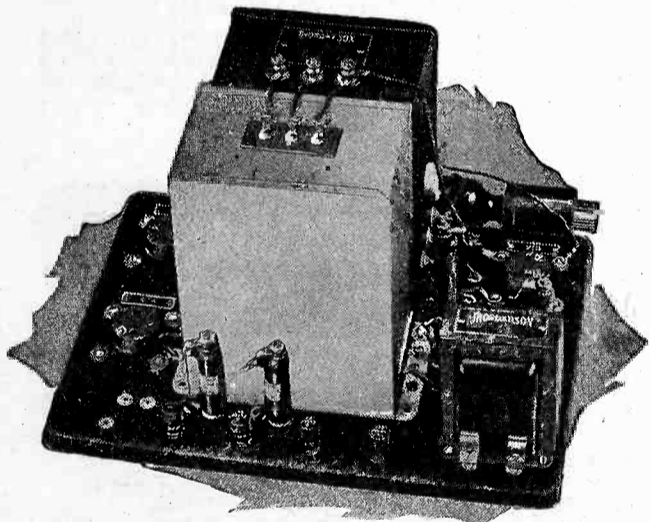

**THORDARSON 210 TYPE
POWER AMPLIFIER**

This amplifier, mounted on a special metal chassis, uses the Thordarson Power Compact R-210. Provides "A," "B," and "C" current for one UX-210 power tube and "B" voltage for the receiver. Employs one 216-B or 281 rectifier.

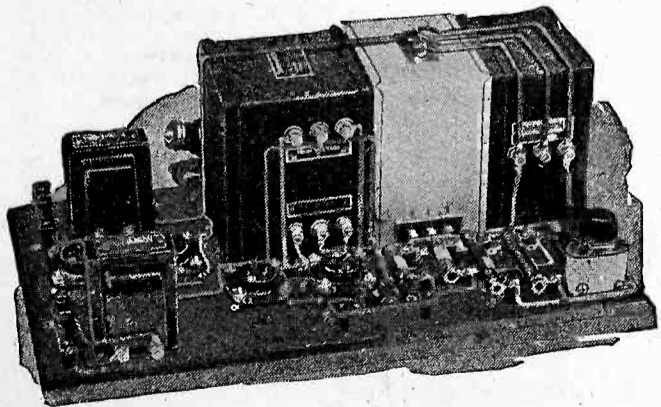

**THORDARSON 210 PUSH-PULL
POWER AMPLIFIER**

This heavy duty power amplifier operates two 210 power tubes in push-pull and has an ample reserve of power for "B" supply for the heaviest drain receivers. Built with Thordarson Power Transformer T-2098, and Double Choke Unit T-2099.

A Home Assembled Thordarson Power Amplifier Will Make Your Receiver A Real Musical Instrument

IMPROVEMENTS in the newer model receiving sets are all centered around the audio amplifier. There is no reason, however, why you cannot bring your present receiver up to 1928 standards of tone quality by building your own Thordarson Power Amplifier.

With a screw driver, a pair of pliers and a soldering iron you can build any Thordarson Power Amplifier in an evening's time in your own home. Complete, simple pictorial diagrams are furnished with every power transformer.

The fact that Thordarson power transformers are used by such leading manufacturers as Victor, Brunswick, Federal, Philco and Willard insures you of unquestionable quality and performance.

Give your radio set a chance to reproduce real music. Build a Thordarson Power Amplifier.

Write today for complete constructional booklets sent free on request.

THORDARSON

THORDARSON ELECTRIC MANUFACTURING CO.
Transformer Specialists Since 1895
WORLD'S OLDEST AND LARGEST EXCLUSIVE TRANSFORMER MAKERS
Huron and Kingsbury Streets — Chicago, Ill. U.S.A.

8572

RADIO DEALERS' SUPPLY SERVICE

Wholesale Division of

Set Builders
and
Service Men

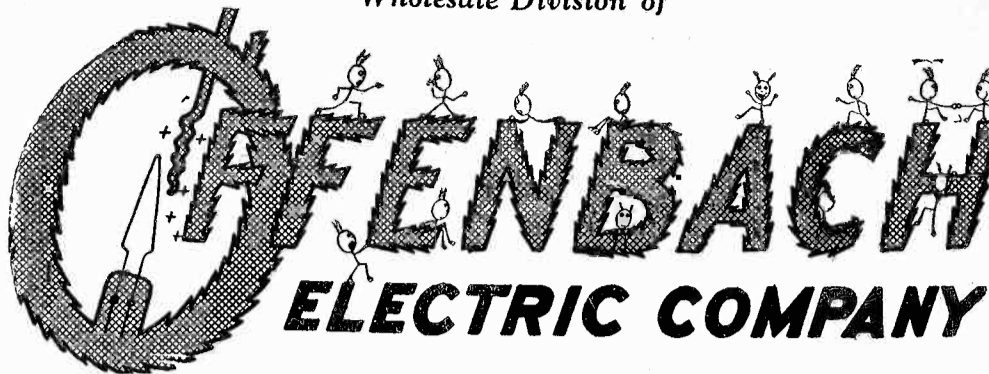

Radio Dealers
and
Set Agents

Announces that their Wholesale Department will supply the needs of Dealers, Community Set Builders and Service Men

"The House of a Million Radio Parts"

\$100,000.00 Radio Stock Always on Hand

Write for Quotations **NOW!**

Scott's World's Record Super 10

Unquestionably one of the outstanding successes of the season. We have a stock of Scott Selectone Transformers on hand as well as the associated

parts for building this receiver. Let us supply your wants for building the newest kits. Write for prices.

Gerald Best's Blueprints for his 115 K.C. Super

Full size working prints by the originator of this famous circuit. This new receiver is far in advance of anything announced this season and will prove to be the biggest seller. Write for prices of parts. Get your blueprints from us now. Price.....\$1.00

CECO TUBES

Complete stock of tested CECO tubes always on hand. Nothing better. We endorse them. A. C. tubes ready for shipment now. ALL CECO TUBES INDIVIDUALLY TESTED BEFORE SHIPMENT.

CABINETS

The popular size 7x26x12 deep cabinets for Best's 115 K.C. Super, Tyrman, Scott and any other set of 7x26 inch size. Immediate shipment on this size cabinet. A beautiful job—priced far below inferior cabinets. Price \$21.00

We also carry a SIGNAL 7x26x10 cabinet at \$10.50

GET quick deliveries by purchasing your radio parts and accessories from the Pacific Coast's largest and oldest radio supply house. No delay in waiting for your parts to arrive from the East. Our reliability is unquestionable. We guarantee our discounts to dealers and set builders to be the equal of Eastern prices. We can make quicker shipments—saving you from ten to twenty days' delay. The saving in transportation charges is another item worthy of your consideration.

MAIL ORDERS

Prompt shipments by mail. Your orders are shipped a few hours after they are received. Shipments made anywhere by parcel post or express. Complete mail order department now operating. Especial attention paid to all Western orders. A trial will convince you. Let us have your next order.

Ferranti and Jefferson Audios

The experienced radio man knows the quality of Ferranti and Jefferson transformers. We have a large stock on hand and can make prompt ship-

ment. These transformers are noted for their superior qualities and we believe them to be the best on the market.

Aerovox Resistors

Aerovox has the reputation of making merchandise of merit. Their products are specified by Gerald M. Best for

his new Super. We can supply you with the Aerovox Resistors for the latest circuits.

Some of the lines we carry and of which we are factory jobbers

- | | | |
|-------------------------|----------------------------|---------------------------|
| A-1 Crystals | Central Radio Labs. | Muter Parts |
| Acme Apparatus Co. | Daven Parts | Mastercraft Tube Re- |
| Acme Wire | Dyal Quietron Caps | newers |
| Aerovox | DeLuxe Cords and Cables | Naald Parts |
| Alhambra Fonotex Paper | Dubilier Condensers | Perfecto Solder Fluid |
| American Beauty Solder- | Electrahot Soldering Irons | Pyrex Insulators |
| ing Irons | Bretwood Leaks | Quadriformer Coils |
| Amperite | Elkon Chargers and | Qualitone Loops |
| Amsco | Eliminators | Raytheon Tubes |
| Ambroid Cement | Erla Sets and Parts | Rajah Connectors |
| Baldwin Units | Ferranti | Racon Air Column Horns |
| Baritone Speakers | Fiat Loops | Scott Selectone Trans- |
| Barkelew Electric Co. | Formica Panels | formers |
| Baer Ground Clamps | General Radio | Sterling Meters |
| Bakelite Panels | G.R.P. Knocked Down | Superette Phones |
| Balsa Speaker Units | Kits | Signal Cabinets |
| Blax Polarizers | Jewell Meters | Solder Dipt Lugs |
| Benjamin Sockets | Johnson Trickle Chargers | Steinite Eliminators |
| Bodine Loops and Coils | Kits | Sterling Parts |
| Brach Controlits | Jefferson | Thorola Coils |
| Brielle Units | Jones Plugs | Timmons Speakers |
| Brielle Knocked Down | Karas Parts | Twin Coupler Coils |
| Kits | Kellogg Transformers | Tritox Westinghouse |
| Clarostat | and Wire | Chargers |
| Cannon Ball Speakers | Kester Solder | Tobe Condensers |
| Ceco Tubes | Kodel | Transcontinental Coils |
| Celatsite Wire | Kuprox | Victoreen Parts |
| Chelton Midget Cond. | Kurz-Kasch | Vitalitone Units and Kits |
| Conrad Books | Maximite Batteries | X-L Condensers |
| Carborundum Crystals | Morris Ball Antenna | |
| Cannon Ball Phones | Mueller Clip | |

Radio Dealers' Supply Service

Wholesale Division of

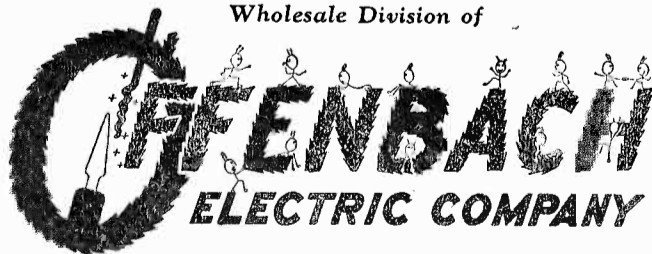

1452 Market Street
SAN FRANCISCO
CALIFORNIA

MAIL COUPON NOW FOR DEALER PRICE SHEETS

OFFENBACH ELECTRIC CO.

1452 Market Street, San Francisco, Calif.

R2

Please enter my name on your mailing list as per your advertisement in "RADIO."

I am a.....
(State here whether you are a dealer or professional set builder)

Name.....

Street and Number.....

City and State.....

The radio leadership of 1928

NOW
\$90

180 volts on the output tube plate!
Gigantic UNDISTORTED volume from the Bandbox!

Power! Power! POWER! A feature of the Crosley AC Bandbox that lifts it head and shoulders above competition! 170 to 185 volts on the plate of the power output tube! Comparative checkings of competitive radios show interesting figures. Under identical testing conditions the Bandbox shows a full 170 to 185 volts on the plate of the 171 power output tube. Other radios show from 100 to 110 and 130 to 140 volts on the plate of the output tube. The 171 power tube should have 180 volts. This better than 40% superiority in one case and 25% in the other is the difference between *today's* radio and yesterday's!

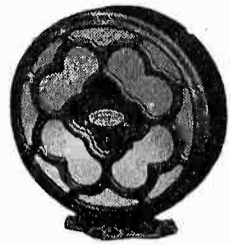

Musicone
Type D
\$15

Crosley Musicones are famous for their value. This new drum style is no exception. Its low price of \$15 is in keeping with Crosley traditions. It instantly demonstrates its soundness by immediate and enormous sales.

The Crosley Bandbox is the marvel it is because of Powel Crosley, Jr.'s, fundamental attitude in the engineering laboratories. "Produce the best you can — then we'll figure how to

602 Double Unit AC BANDBOX Single Unit

704

make and sell it in sufficient volume to keep the price low" is his constant admonition.

The Bandbox is a genuine Neutrodyne receiver. Totally and completely shielded, the acute sensitivity and sharp selectivity of the Bandbox is amazing.

Contributing much to the success of this 1928 wonder radio is the Mershon Condenser in the power element of the set. Not being paper, the danger of its blowing out is entirely removed so that the desired *heavy voltage* can be used to produce the acoustic and volume results so greatly desired. IT IS SELF-HEALING. It does not have to be replaced as is the case with paper condensers. The capacity of smoothing condensers in Crosley power units is 30 mf. Other sets use only a fraction of that condenser capacity. Undersize condensers, transformers, etc., are used in order to build down to a price. Crosley builds up to a standard!

The AC Bandbox is purposely made in two models — the 602 in a double unit — the 704 self-contained. This is to provide maximum adaptability in all sorts of surroundings and uses.

The 602 double unit provides console cabinet installation in ALL kinds of consoles.

The 704 is for those who want the entire set in one cabinet. The two sets are identical in elements, design and performance. The physical difference is solely to meet the human differences of taste and necessity.

The size of the 704 is 17 $\frac{1}{8}$ in. long by 12 $\frac{1}{4}$ in. wide and is 6 $\frac{1}{8}$ in. high.

Battery type Bandbox 601 — \$55

SELF CONTAINED

\$95

Approved Console Cabinets manufactured by Showers Brothers Co. of Bloomington, Ind. and Wolf Mfg. Industries, Kokomo, Ind. are sold to Crosley dealers by H. T. Roberts Co., 1340 S. Michigan Ave., Chicago — Sales Representative.

THE CROSLEY RADIO CORPORATION
CINCINNATI, OHIO

Powel Crosley, Jr.

Crosley is licensed only for Radio Amateur, Experimental and Broadcast Reception.

NEW
401 Dry Cell Type
Bandbox
Junior

A new dry cell receiver with all the features of the Bandbox — selectivity, sensitivity, volume and appearance. For places where AC current or storage battery service is not available. Costs about 2 $\frac{1}{2}$ c per hour to operate.

\$35

"You're there with a Crosley"

CROSLEY

RADIO

Montana, Wyoming, Colorado, New Mexico and West, prices slightly higher.

Write Dept. 19, for descriptive literature.

Tell them that you saw it in RADIO

Radio Plane Dispatching

By Geo. S. Morris

THE greatest practical use of radio in aviation, as yet, is in plane dispatching. The wire telegraph, that indispensable aid to train dispatching, is not as available to the new companies which operate regular airplane service as it is to the railroads. So several of them are using radio telegraphy instead.

Its prime use is in advising as to weather conditions, upon which depends the safe and profitable organization of an air mail and travel organization. It is also used in conducting such routine business as making passenger reservations, ordering supplies and determining the probable time of plane arrival.

Its use in these respects is well exemplified in the system installed by the Western Air Express, Inc., in the maintenance of service between Los Angeles and Salt Lake City via Las Vegas, Nevada, at each of which points is installed identical radio transmitting and receiving equipment. Two wavelengths are used, 43 meters and 60 meters.

For 43 meter transmission at the Los Angeles station the antenna is a single 25 ft. wire at a 35 degree slant with a single 25 ft. counterpoise, running east-southeast. The 60 meter combination is similar except that the wires are 50 ft. long and run west-northwest. The receiving antenna is a 50 ft. single wire running southwest and using a ground instead of a counterpoise. The directive arrangements were adopted after many experiments to determine the most suitable.

The transmitters are operated on the

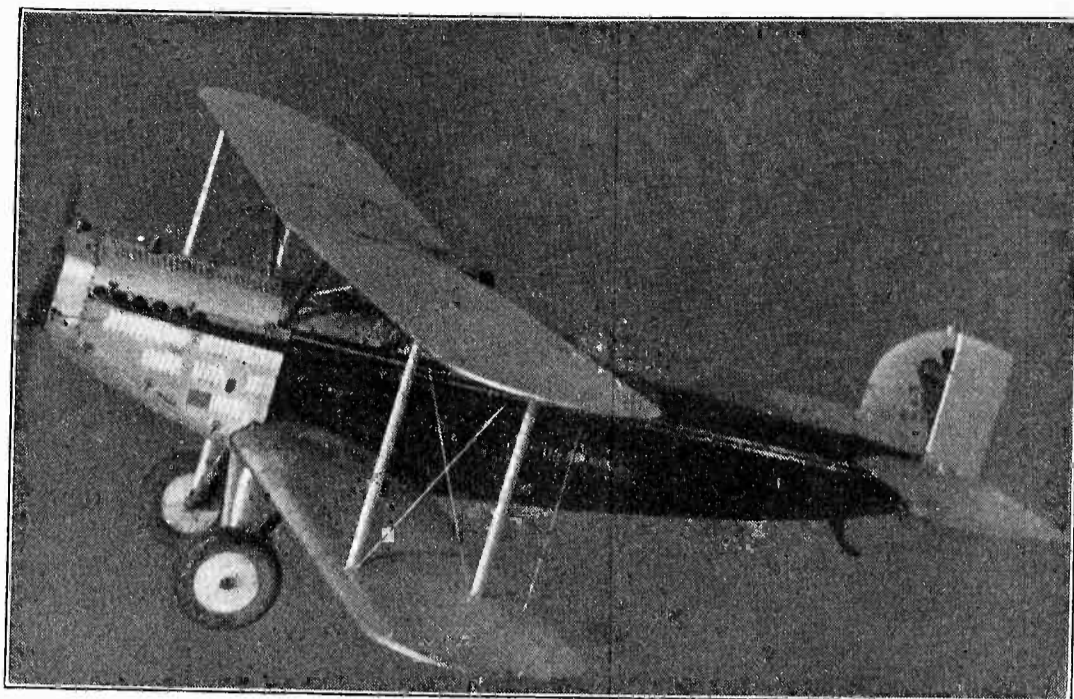

Western Air Express Plane in Flight.

natural period of the system in use. For point-to-point communication this seems better than working on a harmonic, though it makes tuning for resonance more critical. One reason for operating the transmitter on its fundamental is that the signals "hang-on" longer during skip periods.

The equipment inside the "shack" includes a three tube short wave receiver employing Northern Electric "peanuts" in the conventional two coil capacity feed-back circuit, using interchangeable coils for changing quickly from short wave to long wave. Brandes phones are furnished and I have a Utah bell speaker which sometimes is brought into use for QRX. The receiver has a range of from 13 meters to about 150 meters, covering

most of the commercial short wave bands.

The transmitter is a modified Hartley self-rectifying circuit using two 250 watters from Germany. With 3000 volts on the plates and drawing a current of only 50 mils, with filament voltage of 10, the normal antenna current is 3.5 amps on 43 meters and over 5 amps on the 60 meter wave. Signals from Los Angeles are reported R-9 through the entire day at Las Vegas.

Immediately below the high frequency panel is the power rack consisting of two transformers, one 2kw 3000 to 5000 volt and the other 10 to 18 volt, with a center tap on each. The 2kw high voltage transformer has two primaries for use on either 220 or 110 volt 50 cycle supply line. The low voltage transformer is built for the same use. There are three relays, a circuit breaker and resistance block, completing the power rack.

A time lag relay is used for automatically operating the circuit breaker and can be set for any duration of time with bellows that break the line when key is not depressed. This relay is in the supply line working through a 6 volt battery which operates the relay, the latter in turn working the lag time relay through another relay in the key circuit through suitable resistances for use with a straight key or with a bug. The latter is used mostly, with the straight key for ASZ during heavy QRN.

The Western Air Express, Inc. has had only four forced landings due to mechanical mishap since April 17, 1926. The pilots have flown an average of 1200 miles a day between Los Angeles and Salt Lake City. An average of five hundred 15-word messages are handled monthly at each terminus. Of course the op at Las Vegas handles twice that amount.

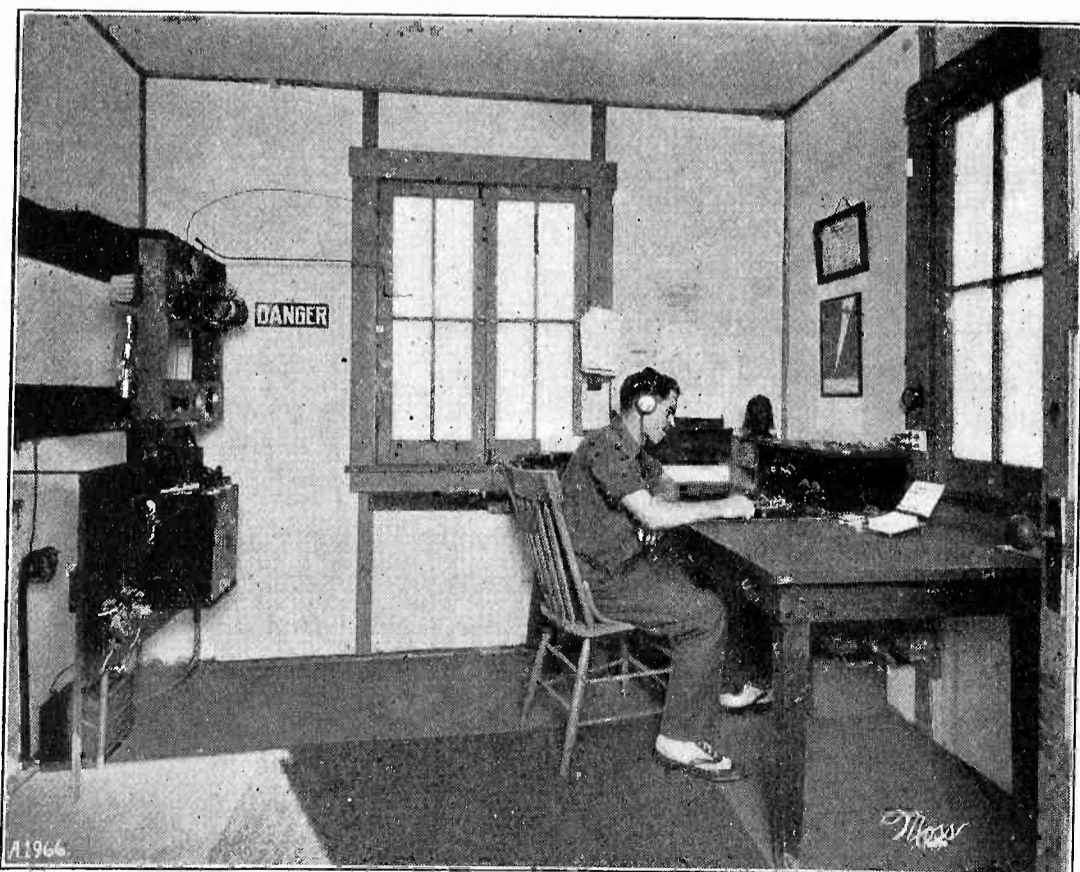

Radio Operating Room at Los Angeles Station.

Radio Guidance of Aircraft

A Summary of Tests as to the Effectiveness of the Crossed Coil Radio Beacon for a National Airway System

By Haraden Pratt

NOT until the development of the crossed coil radio beacon were coil antennas found to be practical equipment on airplanes for determining the bearings of radio stations. The great amplification needed with small coils gave a high noise level that prevented any close observation of the minimum signal during rotation of the coil when the usual form of radio compass was employed. And various other methods also proved impractical until crossed coil beacons were installed at several stations in the East and West.

This beacon consists essentially of two large coil antennas disposed in two vertical planes fixed at an angle with each other. This two-coil system is free to be rotated about a vertical axis. When the coils are similarly excited at radio frequency, signals of equal intensity from each will be heard on a receiving set located along any one of the four vertical planes bisecting the angles between the planes of the coils. At other points the signal intensities from each coil will be different. This marking off in space of a vertical equisignal plane constitutes the directive feature of the crossed coil type of beacon, and this equisignal zone is frequently referred to as the course set down by it.

In its practical application, and for convenience in construction, the beacon used in this country employs a radiating system of two large fixed single-turn loops. A suitable goniometer interposed between these loops and the power source permits of its rotation, the rotation in space of the equisignal zones. A mechanical device automatically transmits the letter A on one coil and the letter N on the other. These are so interlocked that a continuous long dash is heard along the equisignal zone. The width of this zone where the dash only is heard depends largely upon the acuteness of the observer's attention, and may vary between limits, for example, from $1\frac{1}{2}$ to 3 degrees.

For the guidance of aircraft the crossed coil beacon possesses several obvious advantages—

1. There is no zone of minimum or maximum signal strength to be observed.

2. Location of the course or beam is secured by an automatic comparison of two signals.

3. Regardless of the position of the aircraft within a wide angle when off the course, this beacon furnishes a definite signal enabling the craft to locate,

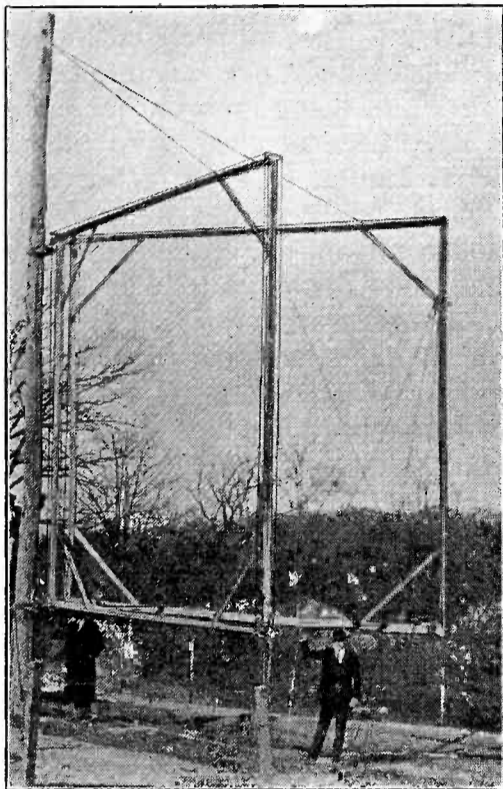

Experimental Crossed Coil Antenna.

and return to its proper course. This characteristic permits temporary detours to be made during flight around stormy areas or obstructions, a very important and valuable feature.

4. The airplane uses an ordinary receiving set with the usual trailing wire antenna, permitting signals to be received under the most favorable conditions as regards minimum sensitivity of airplane receiving set to local noise and disturbances.

5. An airplane may be guided along a set and invariable airway regardless of wind drift.

These advantages had much to do with the selection of this type of beacon for application to our national airway system, particularly those over which schedule mail airplanes operate.

To secure information of a practical nature, receiving equipment was recently installed on a mail airplane operating between the airports of Cleveland and New York, over an airway approximately 380 miles long. Two directive beacons were available, one at the New York terminal and the other at a point 170 miles west at Bellefonte, Pa. The frequency used was 290 kc. The radiating loops were of a triangular shape 300 ft. long and 80 ft. high. The current in each loop was 8 amperes. This route crosses the Allegheny mountains whose rough topography and prevalent fog and clouds cause this to be a particularly favorable region for these experiments.

The accuracy of the directive beacon as a guide had already been established as of a high order, through considerable use in the past, but upon examination of the situation it was learned that previous experience had been confined to daylight flying. Night flights were, therefore, undertaken last summer and results inconsistent with those secured by day were immediately observed. During the first flight it seemed impos-

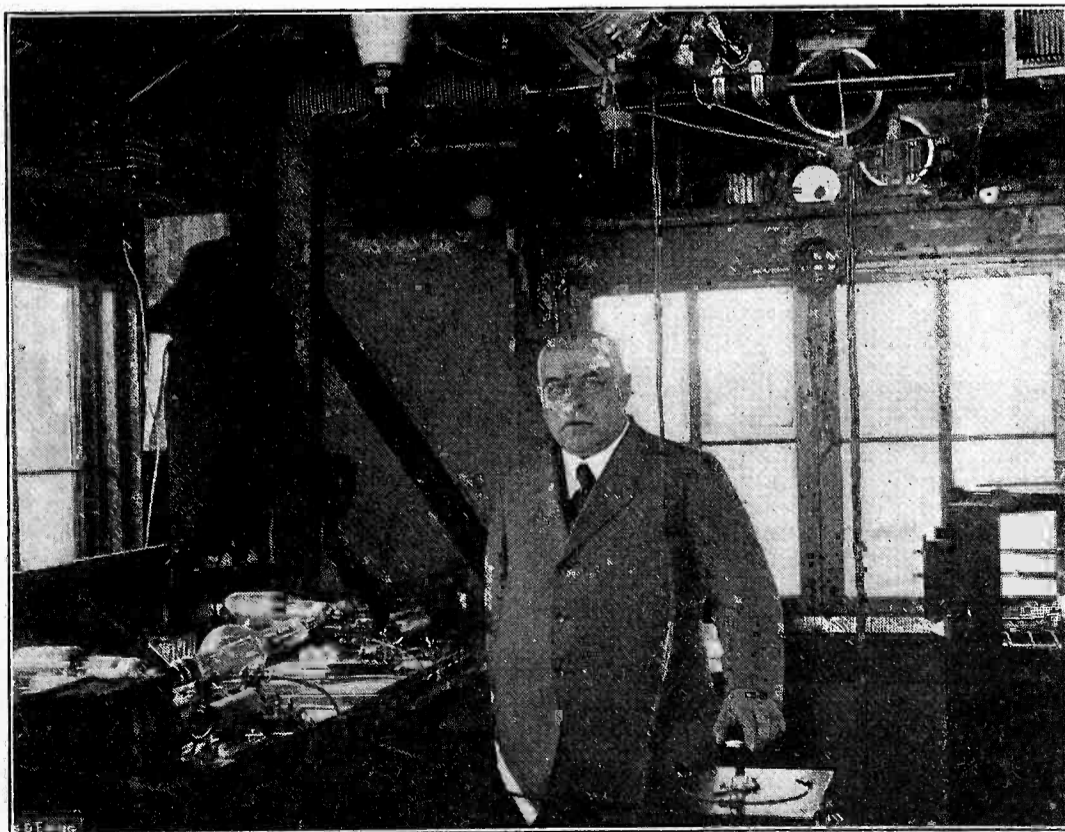

Copyright by Harris & Ewing.
Inauguration of Aircraft Radio Beacon at College Park, Md., by Dr. George K. Burgess,
Director of U. S. Bureau of Standards.

sible to keep the airplane on a course corresponding to the interlocking dash signal. No sooner was this signal received when it would change to the letter A or letter N. No amount of manipulation of the airplane would improve the situation. The dash signal would come and go at intervals of a few minutes. It soon became apparent that at this distance, which was about ninety miles, no accurate fixed course existed but that the equisignal zone was moving about in an indefinite way.

This disconcerting effect indicated that a study of the phenomenon must be made, and several night flights up to distance of 175 miles from the beacon were undertaken. In every case the shifting of the zone or course was noticed. The general results secured from five flights made at an average altitude of 2,000 feet, may be stated as follows:

1. Within 25 miles of the beacon the shifting was not of a serious nature.
2. At 50 miles the shifting became pronounced but due to the zone being stationary in its proper position for possibly 75 per cent of the time, the beacon could still be depended upon.
3. At a distance of 100 miles the shifting became very pronounced and persisted for more than 50 per cent of the time.
4. At 125 miles the beacon was of no further value as a guide.
5. The shifting of the zone was gradual so that at first one would be inclined

to think it due to the movement of the airplane.

6. It appeared that the topography of the country between the beacon and the airplane exerted a considerable influence on the extent of the variation.

7. Exceptional variations in shift over as much as 100 degrees in azimuth were noted, but in general the change was confined to within possibly 25 degrees.

8. Beyond 15 miles the fading of the general level of signal received was very severe during flight over mountains. Several variables being involved, no conclusions have been reached as to the relative contribution of each factor, except that more steady signals were observed at fixed points on the ground than in the air, at similar distances from the beacon.

A few observations of the Bellefonte beacon at night have been made on the ground at Washington. While present, the shifting phenomenon was less pronounced than that observed in the air. On a night flight from Harrisburg to Washington no shifting of the zone was noticed, using signals from a beacon at College Park, Md. As there are no marked mountain ranges near College Park, these observations would indicate that topographical features have no important bearing on the matter of these variations.

To shed further light on the question, two sets of nighttime measurements on the Bellefonte beacon have recently been made, one at a point 22 miles and another 32 miles distant, both locations being in mountainous territory. Records

obtained with a graphic field intensity recorder were made of signals using both a vertical antenna and a coil antenna placed in a vertical plane extending towards the beacon. Ratios of the variability to average field intensity were observed to be,

at 22 miles with coil antenna 0.25
with vertical antenna zero
at 32 miles with coil antenna 0.44
with vertical antenna 0.07

Ratios of the variability to the maximum field intensity were observed to be,
at 22 miles with coil antenna 0.43
with vertical antenna 0.05
at 32 miles with coil antenna 0.56
with vertical antenna 0.1

Rotating the coil antenna around its vertical axis so as to receive minimum signal showed a variation in the direction of the arriving field as large as 30 per cent over a ten minute interval.

In closing I might mention that although the equisignal zone ordinarily remains stationary in its correct position during daylight hours, sudden shifts of a few moments duration have been noticed in the mountainous country, particularly when flying down river valleys at altitudes of 1,000 to 1,500 feet.

KDKA at Pittsburgh broadcasts simultaneously on 315.8, 62.5 and 27 meters nightly, except Sundays, between 8 and 10 p. m. Occasionally the 42.95 meter wavelength is used. Transmission on 2.5 meters has been abandoned for the present.

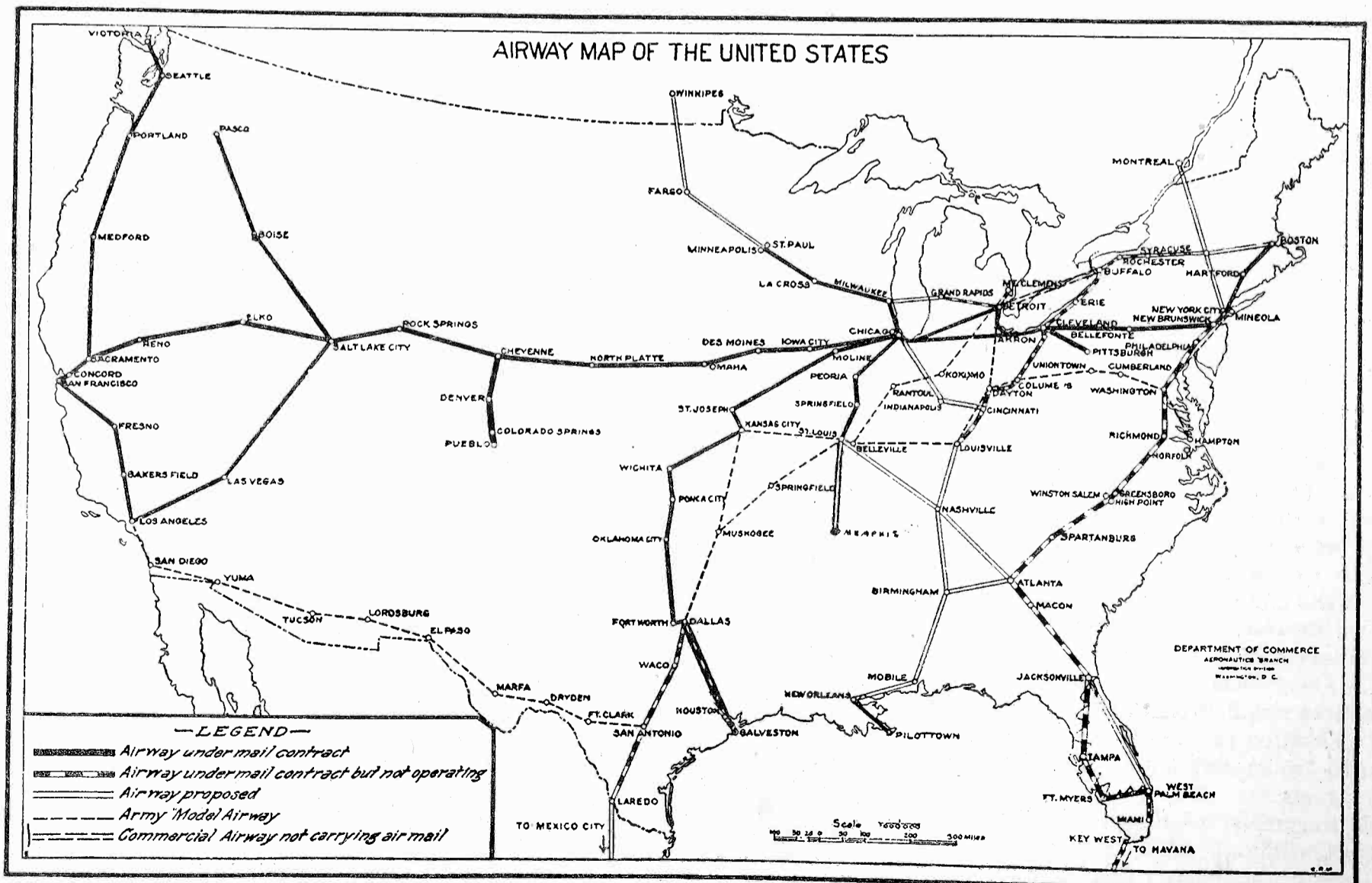

The location of the various air mail routes, operating, temporarily suspended, and proposed.

More About the 115 Kilocycle Superheterodyne

By Gerald M. Best

IN THE January issue of RADIO, detailed instructions for building the new shielded grid 115 kilocycle super were given, together with the circuit for a battery operated model using a maximum of 135 volts *B* supply. Naturally there are many who wish to use the house lighting circuit to supply *A* and *B* current for the receiver, and who also wish to employ a power amplifier tube having a higher power output than that obtained with the 112-A or 371-A tubes, consequently the equipment shown in the picture of the set with its accessories has been chosen to meet these requirements.

The *A* current is supplied by a Sterling R-93 Dri-A Power Supply, which is shown at the right of the receiver. This outfit consists of a full wave rectifier using a new style three element tungar bulb, a filter system, and current adjusting rheostat, mounted in a metal container. Its circuit diagram is shown in Fig. 1, with the connections for the *B*

they are a dead short circuit to any a.c. ripple which may pass through the chokes. A voltage cutout relay is connected across the output of the filter, so that in case the load is removed by turning off the filaments in the receiver, the primary voltage is interrupted, and a high voltage cannot then build up in the filter circuit and burn out the tubes when they are again connected in the circuit. The output voltage is controlled by means of a 5 ohm rheostat placed in the negative rectifier lead, so as to suit the particular current requirements of the receiver. This *A* supply is free from annoying a.c. hum, and requires no attention.

For the *B* supply, a combined power amplifier-*B* power plant was selected, with a type CX-310 power tube, CX-381 rectifier and CX-374 glow tube as voltage regulator. A list of parts used in building the power plant is given on the next page, together with the circuit diagram, which is shown in Fig. 2.

The Thordarson resistance kit for the power amplifier contains four resistances, one of which is 8000 ohms, with a tap taken out 1200 ohms from one end. This tap provides 135 volts for the shielded grid tube plates, a binding post for this voltage being furnished with the metal plate on which the apparatus is mounted. A combination power transformer and filter choke is used, so as to occupy as little space as possible, and minimize connections.

The voltage divider which makes possible the obtaining of 45, 90 and 135 volts for the receiver is of the fixed type, with a CX-374 glow tube shunted between the 90 volt positive and the negative terminals to give steady output voltage. A 1 mfd. bypass condenser for the 135 volt tap is mounted on the top of the baseplate, as is shown in the picture.

The connection of the power amplifier to the output of the receiver is made by means of an adapter which is plugged into the last audio tube socket in the receiver, the power tube in the latter having been removed. This adapter is the same as a tube base and has a single flexible wire connected to the grid prong, with the other end of the wire connected to the grid terminal of the CX-310 power tube, as can be seen in Fig. 2.

The *C* bias for the power tube is obtained by means of a 1000 ohm resistance in the negative *B* return lead, so that the voltage drop in the *B* supply,

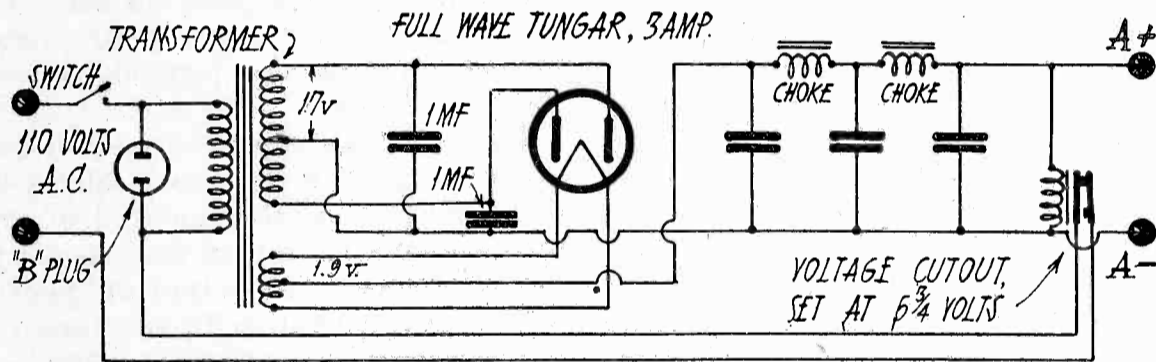

Fig. 1. Wiring Diagram of "A" Power Supply.

eliminator circuit indicated by the words "B Plug," across the primary winding of the power transformer.

The 110 volts a.c. is stepped down to 1.9 volts to light the filament of the tungar bulb, while two secondaries of 17 volts each are connected in series for the plate supply voltage. The positive of the rectified voltage is taken from the center tap of the rectifier filament winding, and the negative is at the center tap of the plate secondary. Filter condensers of a special dry type are used, the capacity being so high that

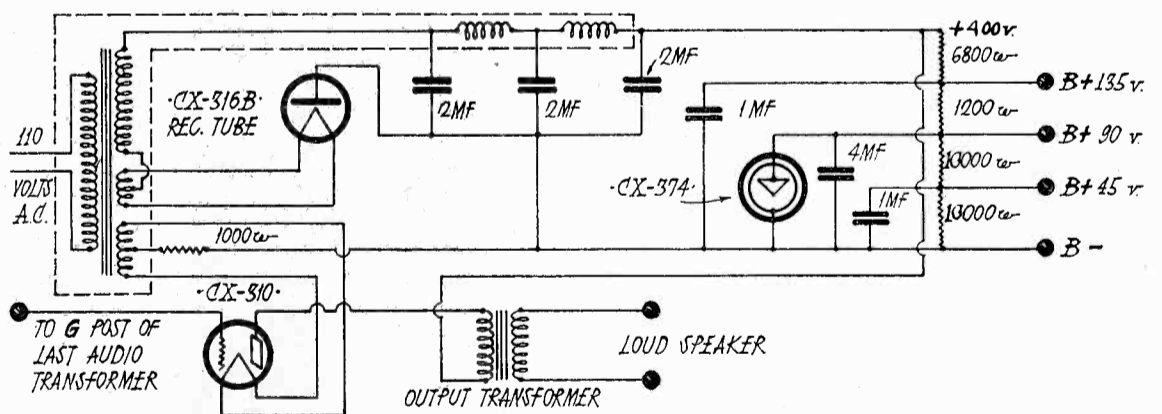
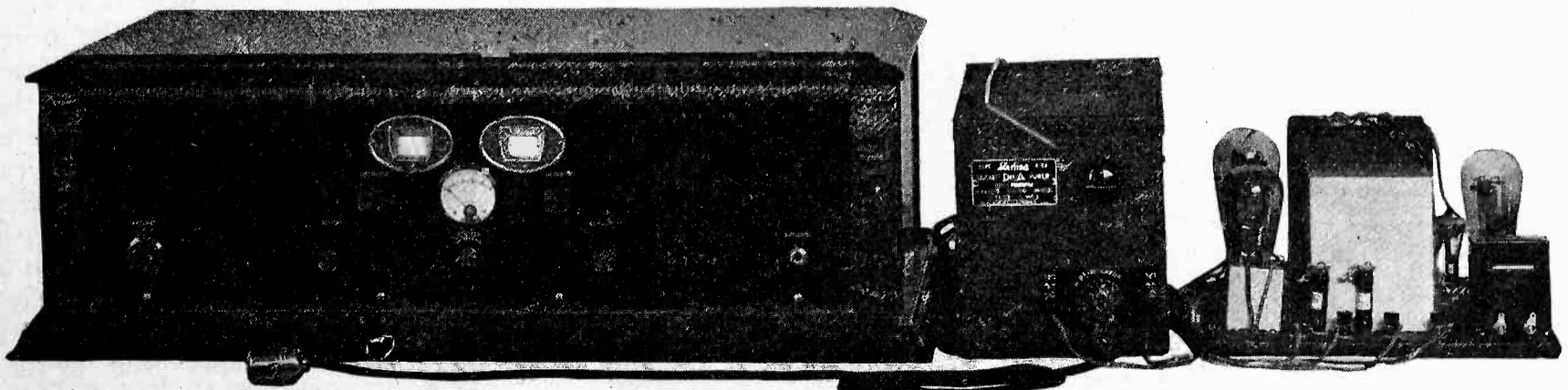

Fig. 2. Circuit Diagram of Power Amplifier "B" Supply.



Receiver in Chillicothe Cabinet, with "A" and "B" Power Supply Units.

through this resistance, provides approximately 25 volts negative grid potential. The *C* battery wire in the Yaxley battery cable is connected to the negative *B* terminal, as an extra *C* battery will not be needed. The loud speaker is connected to the secondary of the output transformer, instead of to the jack on the panel of the receiver. No changes are made in the circuit of the receiver itself, due to the use of the 310 power amplifier, and no adjustment of voltage from the *B* supply will be required, since the resistances are fixed, and the glow tube automatically takes care of the load.

To turn on the receiver, press the snap switch at the end of the long cord attached to the *A* power supply, and adjust the rheostat on the latter until the main rheostat on the receiving set panel brings the filaments to 3.3 volts at approximately mid scale. Plug in the *B* power supply to the outlet on the front of the *A* power unit, and the set is ready for operation.

A slight change in the schematic wiring diagram for the superheterodyne, as shown in the January issue, should be made, in order to improve reception. The *C* bias for the shielded grid tubes is shown as $-1\frac{1}{2}$ volts, with the positive *C* connected to the negative *A*. Increase this *C* bias to $4\frac{1}{2}$ volts, with the positive *C* connected to the positive *A* instead of to the negative *A*. In this way, the actual *C* bias on the grids of the CX-322 tubes will be $-1\frac{1}{2}$ volts, since the voltage drop of 3 volts across the filaments of the tubes will be subtracted from the total *C* voltage of $-4\frac{1}{2}$.

LIST OF PARTS FOR POWER SUPPLY

- 1—Sterling type R-93 Dri-A power supply
- 1—Thordarson R-210 power compact
- 1—Aerovox condenser block for 210 compact, 2, 2, 2, 4, 1 mfd.
- 1—Thordarson resistance kit. Two 10,000, one 1,000, one 8,000 ohms
- 1—Thordarson R-76 speaker coupling transformer
- 1—Thordarson metal base for 210 compact
- 1—Aerovox 1 mfd. bypass condenser
- 1—CX-381 rectifier tube
- 1—CX-310 power tube
- 1—CX-374 voltage regulator tube

In order to more clearly show the assembly of the stage units, a picture of one unit is shown in Fig. 3. A number of holes are drilled in the base of each stage shield. On close inspection it will be seen that they are not uniform. At each end are four large holes through which the interconnecting wires are passed through the shield. One of these groups of four holes has another pair of small holes midway between the large pairs, for the coil socket screws. The shield base should be mounted on the baseboard with this end of the base towards the front panel. The other four large holes have a pair of small holes placed near the back of the shield, but closer to one pair of large holes than the other, and it is in the latter that the tube socket mounting screws are placed. The mounting screws should have their heads down, with the lock nuts placed on top of the sockets; otherwise, the nuts would project below the bottom of the coil sockets, and would prevent placing the .1 mfd. by-pass condensers in their correct position. The position of the grid leak mounting and grid condenser is also shown in the picture.

In the constructional data for the receiver, the size of the bakelite shelf

for the antenna series condensers and the antenna-ground binding posts was omitted. The bakelite piece is of $\frac{1}{8}$ in. stock, 2x2 in. square, with the two binding posts placed at one edge, and the two series condensers fastened together by bending one terminal of each condenser at a right angle and passing a machine screw through a hole drilled through the bakelite. The shelf is kept away from the baseboard by means of two pieces of $\frac{1}{4}$ in. brass tube through which the mounting screws are passed.

SYNCHRONIZING WITH MATCHED CRYSTALS

In one of the Yale laboratories two piezo-electric crystals, entirely separated from each other, are now maintaining rates of r.f. oscillation so nearly identical that no audible heterodyne exists between the radio circuits they control. This experiment, conducted under the direction of Prof. N. I. Adams Jr., of Sloane Laboratory, New Haven, Conn., has been designed to show the possibility of using such a pair of "matched crystals" to control two or more broadcasting stations operating on the same wavelength within interfering range, without producing heterodynes or squeals.

Discussing his experiments, Professor Adams says: "To test the feasibility of the scheme temperature-controlled crystal oscillators have been constructed in the laboratory. The output of these is fed into a regenerative detector, and the resulting beat-note sufficiently amplified by a three-stage resistance coupled amplifier to operate the Frahm-type (vibrating-reed) frequency meter. The crystals are rated at 1210 kilocycles by the General Radio Company of Cambridge, Mass., who loaned them for this investigation. Each crystal is placed in a Dewar flask, together with a small mercury-thermostat control of commercial type, a miniature electric-light bulb for a heater, and a sensitive thermometer which reads directly to one-tenth of a degree, Centigrade. The two units are thus entirely independent. When properly adjusted the temperature variation of either thermostat as indicated by the thermometer is not over 0.1° C. Continuous observations on the beat-note frequency shows an extreme variation of 20 cycles which is well within the desired range of inaudibility. The entire thermostat equipment of each crystal occupies less than a cubic foot of space, and although not portable in present form, it can easily be designed to be so.

"The preliminary conclusion is that the sub-audible beat may be maintained with very little supervision, in the case of well-constructed, crystal-controlled transmitters."

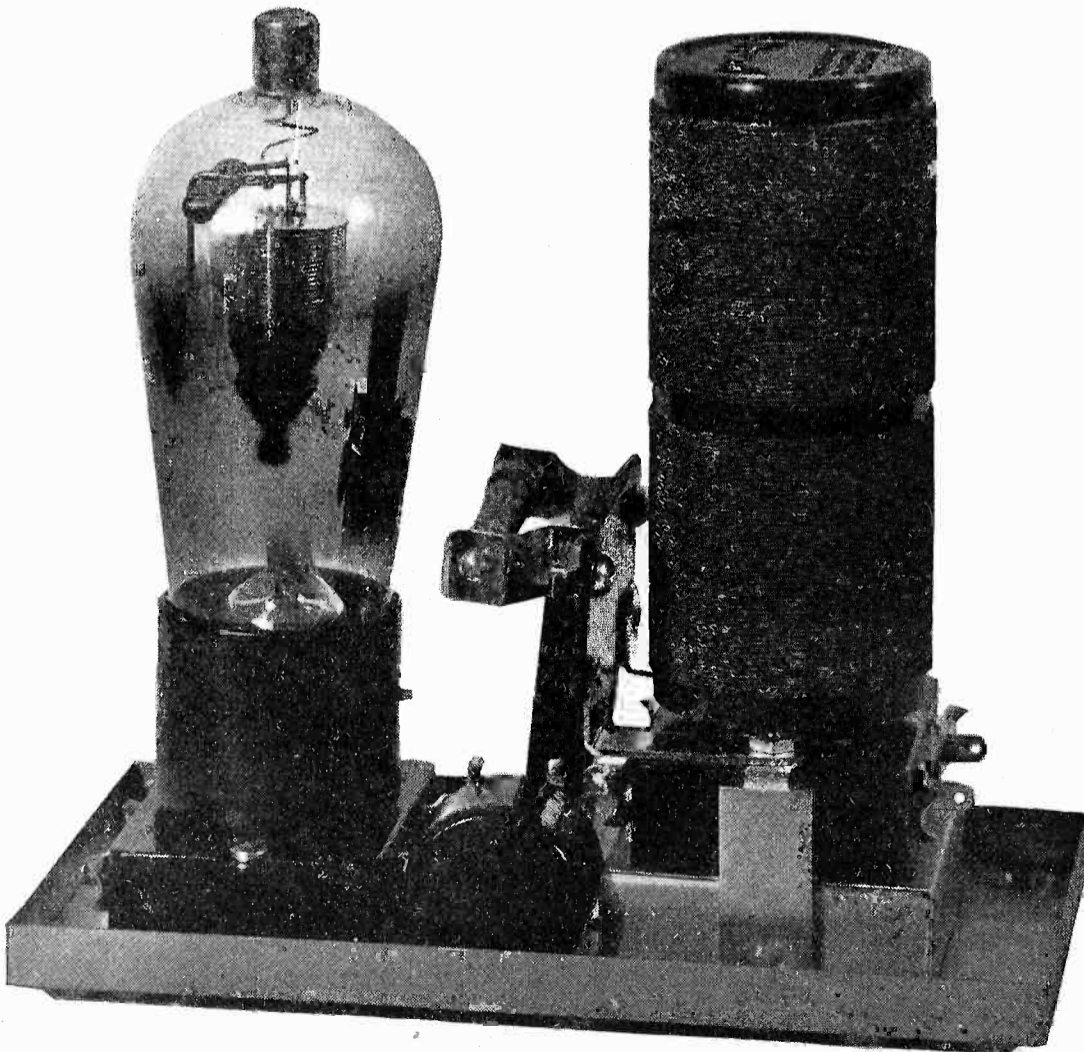

Fig. 3. Details of Shielded Stage Construction.

Playing With a Photoelectric Cell

A Simple Explanation of Its Theory and Use, Together With an Account of Its Many Applications to Modern Scientific Marvels

By Samuel G. McMeen

THESE are four metals that have the rather remarkable property of giving off electrons when impacted by light, and so changing a nonconducting path into a conducting one. These metals are sodium, potassium, caesium and rubidium.

When incorporated into form to produce a usable device, the metal, whichever it is, may well be coated on the inner surface of the glass shell of a vacuum tube. A connection from this film of metal is brought out to the base or elsewhere. A second element of metal is placed somewhere in the inside of the cell, and it also is given a connection to the outside of the device. The vacuum having been pumped to a high degree, the cell is ready for use as a light-observing apparatus.

When light strikes the sodium or other metal coating on the inside of the glass, usually through an uncoated portion of the glass wall, left bare of metal for that reason, the internal resistance may be said to fall, and an external source of electromotive force can pass a current through the cell. What is believed to happen, stated more exactly, is that the electrons thrown off by the metal coating constitute an electric current which flows through the cell and in the external circuit containing the electromotive force. It is interesting to note that the direction of motion of the electrons is from the sodium or other coating toward and to the middle electrode, just as they flow from filament to plate via the grid in a thermionic tube.

Such tubes are now available for experimental use. One of them has the novel distinction of an inner sodium coating secured by electrolytic deposit from fused sodium nitrate on the outside of the glass. Others use potassium hydride.

The uses of photoelectric cells are already many, and new uses will without doubt suggest themselves as the device becomes more widely known. The cell can do all that a selenium cell does and do it incomparably better. Indeed, the selenium cell is a disappointment, on account of its slow response or sluggishness of recovery. The rare-metal vacuum cell is free from this fault.

To use it as a light-detector or a light-measurer, one has merely to connect it in series with a battery of from say 4 volts to 300 volts, and this also in series with a rather sensitive measuring instrument. Either of the galvanometers here-

before described in this series of articles will serve very well. What is wanted is a device that will measure in millionths of an ampere. An idea of the sensitivity of the cell can be had from these facts: With an illumination of 200 foot candles and a voltage at the source of 20 volts the cell will pass one microampere. With 1000 foot candles and 150 volts the cell will pass ten microamperes.

Fortunately a vacuum tube amplifier will magnify the small current passed by the photoelectric cell. We show the ordinary, unamplified arrangement in Fig. 1 and the amplifier setup in Fig. 2.

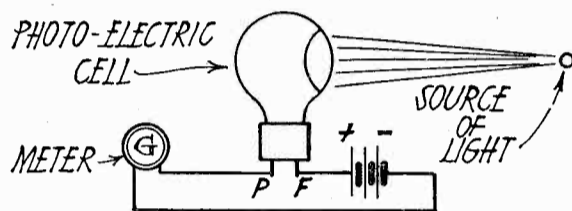

Fig. 1. Simple Circuit for a Photoelectric Cell.

In the case of Fig. 1, it is to be noticed that the poling is with the negative terminal to the sodium lining of the cell, while the positive terminal is carried to the filament. Considering the sodium as the equivalent of the plate in a thermionic tube or tungar, it is to be observed that the photoelectric cell connections are just the reverse of those in radio tubes.

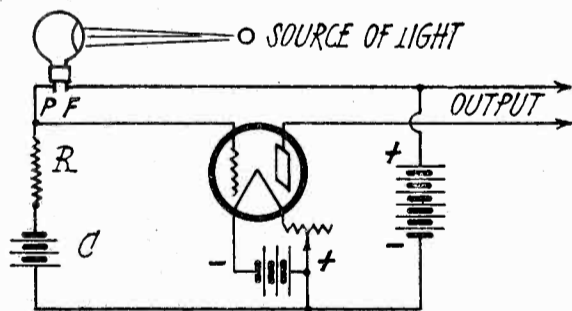

Fig. 2. Photoelectric Cell with Amplifier.

In the case of amplification, as shown in Fig. 2, there is required a C battery of $3\frac{1}{2}$ volts with 100 volts on the plate of the amplifier tube, rising to say 6 or 7 volts when the B voltage is raised to around 200 volts. The arrangement shown for amplification is of the resistance coupled type, R being about 10 megohms to give 10,000 fold amplification. The output is taken from the plate and positive battery terminals.

In certain shop work it is needful to count moving objects. A photoelectric cell can be set to operate as the shadow of the moving thing falls upon it.

Dr. Alexander Graham Bell's photophone at first utilized a beam of light

rays for voice transmission, that beam being caused to impinge upon a selenium cell. Later the selenium cell was displaced by burnt cork in a glass tube which gave off the sounds directly, without the intervention of any electrical means. The action was probably thermal and not optical. Now that the photo cell is available a renewed interest will be in evidence in the photophone. One of its possible forms is shown in Fig. 3.

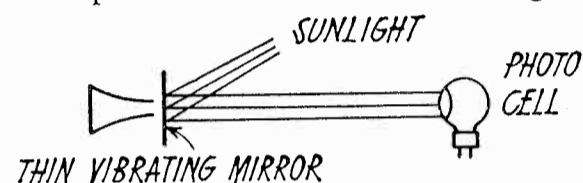

Fig. 3. Principle of the Photophone.

In this arrangement a sheet of the thinnest glass obtainable is silvered on one surface and set up in relation to a conical mouthpiece, so that speech or other sounds can vibrate the glass. The rays of the sun or an arc lamp are then reflected from the glass diaphragm to the photoelectric cell, where they are converted into audible speech by the use of either the circuit of Fig. 1 or Fig. 2, depending upon the degree of amplification required.

As a useful refinement it is well to receive the rays on the photoelectric cell through a pasteboard cylinder, so as to exclude other rays than those that come from the vibrating mirror. Thus modernized, and made so much more responsive, the photophone ought to find new applications, even though its range is limited by the earth's curvature.

A little less simple, but rather effective, is the photophone arrangement

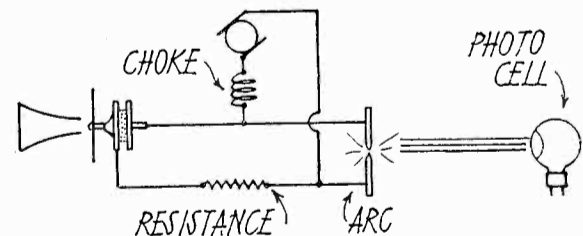

Fig. 4. Photophone With Arc Light.

shown in Fig. 4. Here the source of light is an arc lamp, preferably driven by direct current, with a choke in series with the generator and lamp to smooth out the commutator ripples. The function of the resistance in the microphone leads is to prevent the latter from bursting into flames.

Up to this time of writing the outstanding commercial application of the photoelectric cell is in the transmission of pictures. In this process, a negative or positive film is bent around a glass

blue-violet part of the spectrum. At either side of this point the sensitivity falls away sharply, and in practice the actual response of a cell to light of any wavelength is usually determined by its specific sensitivity. The specific sensitivity is stated in terms of the coulombs of electricity passing through the cell per erg of incident light energy for a given voltage impressed across its terminals. The following measurements were made with a cell of this type and show how the sensitivity falls away from its maximum:

Wavelength (A°)	Coulombs/Ergs
4000	5×10^{-10}
4500	2×10^{-9}
5500	1×10^{-10}

It may readily be seen from these figures that a source rich in blue-violet light will produce a greater response from the cell. The working range of these cells, however, is between the limits of 3500 to 6000 A, or from below the yellow up into the ultra-violet. The maximum sensitivity of the alkali cell may be compared with that of the average eye which lies in the yellow-green part of the spectrum.

Operating voltages vary from 100 to 250 volts depending on the characteristics of individual cells. Excessive potentials are harmful as well as the use at temperatures above 30 degrees Centigrade. In regard to these facts it is always best to adhere to the manufacturer's instructions.

In Fig. 4 is shown a typical circuit

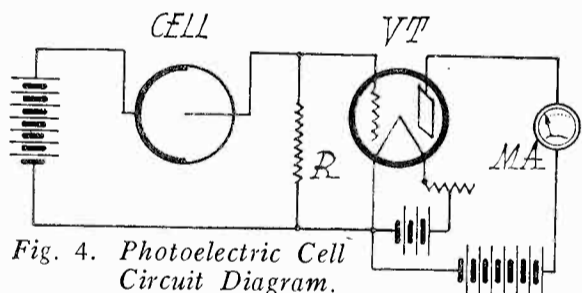

Fig. 4. Photoelectric Cell Circuit Diagram.

diagram with the photoelectric cell placed in the grid circuit of a three-element tube, and so arranged to give a deflection of the plate millimeter or to operate a sensitive relay. The UX-171 is a very good tube to use in this connection. Many other circuit arrangements are possible and may be more suitable for different purposes. For instance, it is possible to use alternating potentials across the cell and thus make use of the house-lighting system.

Several receivers may be operated from a single antenna by employing a coupling tube whose plate circuit includes the primary windings of the first r.f. transformer of each receiver. The tube's grid circuit is shunted by a variable high resistance between antenna and ground. A separate A battery controlled by a relay switch from each receiver feeds this tube's filament circuit. The scheme is good only for local reception because of the energy loss through the resistance to ground.

METHODS OF INCREASING SELECTIVITY

By F. L. Ulrich

THE average radio receiver can produce music or speech in sufficient volume to satisfy the listener, but when the programs are spoiled by interference from other local stations, the receiver falls short of satisfactory performance. Increasing the volume brings up the level of static or interference proportionally. So it is necessary to improve selectivity by some method which does not alter the set itself.

One such method is to add a wave trap or resonator, for which a favorite

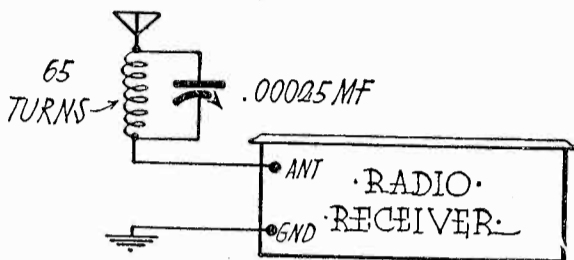

Fig. 1. Most Commonly Used Wave Trap Circuit.

circuit is shown in Fig. 1. This consists of an inductance coil of 65 turns of No. 26 d.d.c. wire on a 3-in. tube and a variable condenser of .00025 mfd. connected in shunt. It is placed between the antenna and the binding post on the set. By adjusting the condenser so that the tuned circuit is resonant at the frequency of the interfering station, interference from the latter may be practically eliminated, unless the station which is to be received is very close in frequency to that of the interfering station.

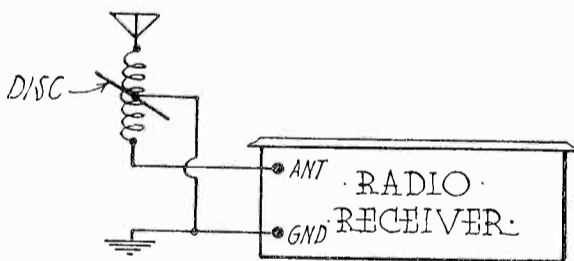

Fig. 2. Modified Wave Trap.

Another form of wave trap is shown in Fig. 2, with a sketch of the actual construction of the trap shown in Fig. 3. This trap does away with the variable condenser, and instead makes use of a round metal disc which rotates inside the inductance, thereby changing

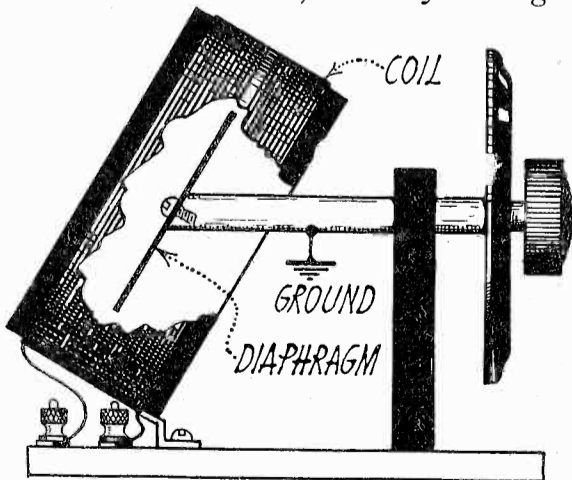

Fig. 3. Constructional Details of Special Wave Trap.

the inductance-capacity value of this circuit according to the position of the disc. When the disc is parallel to the coil turns, it will act as a short circuited turn and lower the inductance, while when it is at right angles, it will have little effect on the inductance, which will then be at its highest value.

This device may be constructed by winding an inductance of 40 turns of No. 26 d.c.c. wire on a 3½-in. tube, with a brass or copper disc 2½-in. in diameter placed inside the coil. The disc may be made of 1/32 in. sheet brass, or an old telephone receiver diaphragm may be used if other material is not handy. Obtain a piece of brass rod 4 in. long and ¼ in. wide, cutting off the rod at an angle of 45 degrees on one end so as to mount the diaphragm at a slant. Drill a hole with a No. 27 drill in the end having the angle face, and tap it for an 8/32 screw. Drill a hole in the center of the diaphragm with a No. 21 drill, and with a round head brass 8/32 screw, fasten the diaphragm in place on the end of the rod. Mount the coil at an angle of 45 degrees, as is shown in Fig. 3, so that when the dial is set at zero, the disc and plane of the coil turns are parallel. The rod may be mounted on any convenient support, such as a small piece of 3/16 in. bakelite fastened to a wooden baseboard.

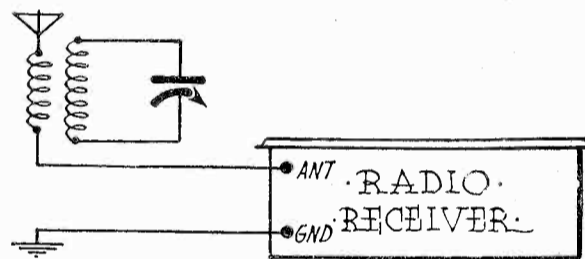

Fig. 4. Absorption Wave Trap Circuit.

In Fig. 4 is shown another method of increasing selectivity by the absorption method, in which the wavetrapp circuit is isolated, and coupled to an inductance placed in the antenna circuit. Any standard r.f. transformer may be used for this purpose, the secondary serving as the wavetrapp circuit, and the primary being placed in series with the antenna.

An ordinary 2 ampere tungar battery charger may be used as an A battery eliminator by connecting five 1½ volt dry cells in series across the output of the charger, with the positive of the 7½ volt group of dry cells connected to the positive charging lead, and the negative of the dry cell group to the negative charging lead. The dry cells act as a filter condenser of high capacity, and will last practically their shelf life, since little current is drawn from them while the set is in operation. It is important, however, to turn off the receiving set filament switch as well as the 110 volt power input to the charger, when finished with reception, for otherwise the dry batteries will quickly be run down.



The Steam Transmitter

By Paul Oard

WITH young Raule now firmly established on the metropolitan detective force, following his capture of Lefty Blackburn, notorious gangster, dope peddler and all around bad man, work on the force for Raule settled into a matter of routine.

Raule's knowledge of radio had helped to popularize him on the staff. He had ungrudgingly given of his time in shooting trouble in the broadcast receivers of several of the men and had built up a receiving set for use at headquarters for those who were on the desk shift at the office, and on whose hands the time often hung heavy.

One morning, while engaged in target practice on the indoor range, Raule was called to Captain Matty's office. Entering, he found another man seated opposite Matty. He turned as Raule entered the room, and after a moment's groping, Raule placed him as Smith, the prohi operative who had acted as their guide in the Battaliana affair, in conveying their car to a hiding place near the scene of action. He shook hands with Smith and seated himself in the chair indicated by Matty.

"Raule," asked the captain, "what do you know about wireless code?"

"Well," answered Raule, "I jerked juice for the old Marconi, Limited, for two years, and I've kept up on it since quitting the sea. I can do my twenty words a minute both ways, yet, I guess."

This answer of Raule's was not understating the case, for while at sea Raule had been known for his "timed fist" with his sharp, accurate and rapid style of transmitting, and his no less marked skill in reception. In fact, at one time it was said that he could transmit two independent messages at one time, working both hands, and at the same time mentally copy a third on the headset, but as how much of this little yarn is cold fact, is not generally known. Raule was not given to boasting.

"Very good," replied Captain Matty. "Now, to make matters brief, I am loaning you to Mr. Voorhees here," indicating the man whom Raule had known till now as Smith. Answering Raule's unspoken question he continued, "Mr. Voorhees you have heard of any number of times as director of the local prohibition unit, and as under cover agent at large, he naturally travels under a number of aliases, of which Smith is as good as any. I think that you will appreciate

the fact that in taking you into confidence in revealing Mr. Voorhees as his actual self, I am depending upon your own good judgment in keeping the identity of Mr. Voorhees to yourself. This decision is prompted by your past record in great part, of course."

Matty paused for a moment. Raule realized that he could now safely feel that he had at last made the grade, for otherwise Captain Matty would not have revealed the identity of Voorhees, that mysterious, illusive and shadowy figure who flitted through prohibition raids and investigations, almost legendary in character, so carefully was his actual identity covered, unknown to even the majority of prohibition officers themselves. It was Voorhees who had done more to disrupt the ranks of the big rum running outfits than any other ten men together, and the secrecy that surrounded him did nothing toward lessening his prestige.

"Now," went on Matty, "it is not our practice to make the force over into a prohi unit. In the affair in which you landed Lefty Blackburn, you and Dawson were loaned to the prohibition officers because it afforded an excellent

(Continued on page 46)

The Capacity Coupled R. F. Receiver

An Extremely Sensitive Seven Tube Set For Use With a Loop Antenna

By Francis Churchill

THIS is a two control, seven tube receiver which is used with a loop aerial. The enormous amplification given by the special radio frequency amplifiers gives sufficient pick-up with a loop aerial even on distant broadcast stations.

The set consists of four stages of tuned radio frequency amplification of a special type in which each tube is capacitively coupled to the next. The r.f. amplifier was designed to give good gain per stage and constant gain over the broadcast band as well as excellent characteristics as regards not cutting off the higher audio frequencies.

Most r.f. amplifiers, and especially superheterodynes, tune so sharply that the side bands of the broadcast station are cut off and the music or speech loses its naturalness. In some receivers this effect is so bad that the frequencies even down to 1000 cycles per second are affected and practically none of the higher frequencies get through to the loud speaker. With the present assignment of frequencies of the broadcast stations by the radio commission, more attention can be paid to quality, since extreme selectivity is no longer as necessary.

The receiver is extremely easy to adjust after it is wired. The parts do not have to be adhered to for best results. The coupling condensers C_3, C_4, C_5 and C_6 in Fig. 1 are 50 mmf. variable midget condensers so that nearly any combination of coils or tubes can be used by proper adjustment of these capacities. In case the Sickles coils are unobtainable, Aero, Precision or other shielded coils may be used with but slight change in layout. The receiver uses a three-tapped loop for pick-up with a separate tuning condenser and is more sensitive than the usual five and six tube receivers using a long outdoor antenna.

Reference to Fig. 1 will show that each r.f. transformer is used as a tuned impedance with the primary used as a special neutralizing and gain balancing

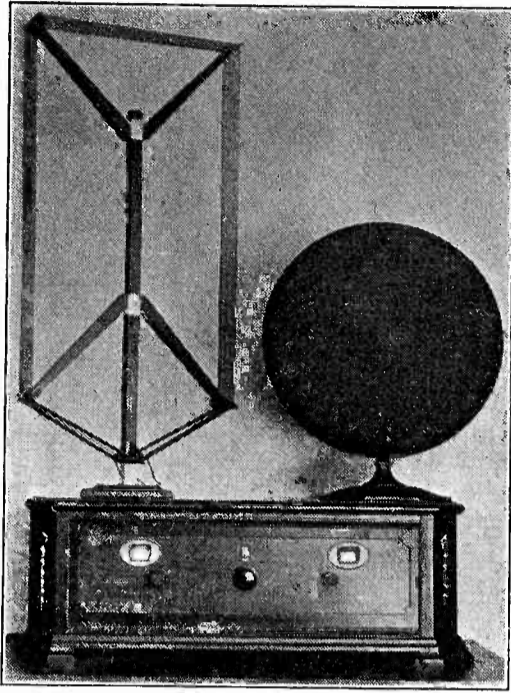

Completed Receiver.

winding. The secondaries of the r.f. transformers are connected across the grid and filament of each tube as usual but instead of a primary or plate coil, a coupling condenser is used. The use of a capacity coupling instead of electromagnetic coupling results in nearly constant coupling as far as that particular part is concerned. A coupling capacity of 20 mmf. offers about 14,000 ohms impedance near the upper end of the broadcast band and about 5000 ohms at the lower end. Either of these two values are very small in comparison to the extremely high impedance of the grid circuits, so that percentage difference is negligible over the broadcast band.

These coupling condensers should be of such a value that the grid circuits will be tuned fairly sharply, but not so much so that the upper audio frequencies are lost due to side band cut-off. These condensers put the plate to filament impedance of the r.f. tubes across the grid tuned circuits so that if these capacities are too large, the effective impedance across the grid to filament of each tube will be too small. This re-

sults in lowered signal strength and very broad tuning, which is undesirable. The use of even as large a value of coupling capacity as 20 mmf. as mentioned before, would seem to be entirely too large but for the fact that there is a certain amount of regenerative effect in each tube circuit which makes the set tune more sharply.

Actually there is a certain best value of coupling capacity to use, this value depending on the size of the "neutralizing" condensers C_7, C_8 and C_9 , and the type of tubes used. The condensers C_7, C_8 and C_9 are neutralizing condensers after a fashion and so reduce the regenerative effect introduced by the coupling condensers when their value is fairly large. When using the type 199 tube in the r.f. stages, about 50 mmf. is correct for the condensers C_7, C_8 and C_9 though not enough to fully neutralize the tube capacities.

The reason for such a large value of capacity for a neutralizing condenser is because of the ratio of turns between the secondary windings and the neutralizing windings. These latter windings are the usual primary or plate coils which would be used in most r.f. amplifiers for coupling plate to grid. The reason, as explained before, for not using a primary winding is due to the extreme variation of "effective" coupling over the broadcast band.

The most important effects of the "neutralizing" condensers C_7, C_8 and C_9 are in obtaining constant gain or amplification over the broadcast band. These condensers are more effective in neutralizing at the lower end of the broadcast band, due evidently to the more effective coupling between the two windings of each r.f. transformer at the shorter wavelengths. It can be proved mathematically that as the tuning condensers across the secondary or tuning coils are decreased in capacity, the regenerative effect in the tube circuits increases. Fortunately the effective resist-

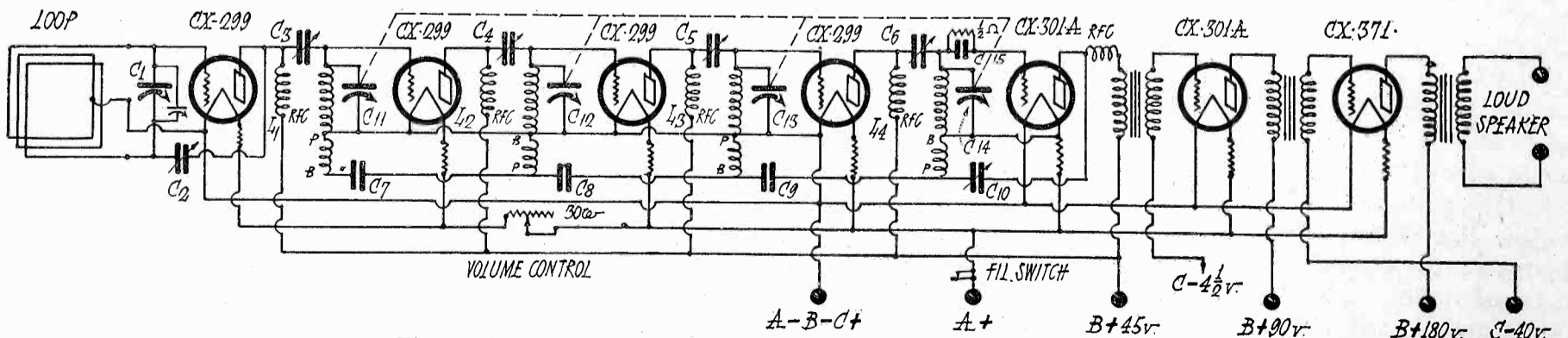

Fig. 1. Circuit Diagram of Capacity Coupled R. F. Receiver

C_1 —0.0035 mfd. variable condenser C_2 —50 or 100 mmf. maximum C_3, C_4, C_5, C_6 —50 mmf. max. C_7, C_8, C_9 —50 mmf. fixed C_{10} —50 mmf. max. gang, .00035 mfd. per section $C_{11}, C_{12}, C_{13}, C_{14}$ —A C_{15} —0.0025 mfd. fixed

ance of each tuning coil also increases at the higher frequencies, so this partially compensates for the increased regenerative effect. The special neutralizing circuit arrangement compensates for the resultant regenerative effect mentioned above so that very nearly constant amplification is obtained over the range of 200 to 550 meters. In this respect it is so much better than the usual seven to ten tube set, that there is no comparison even in those sets where an attempt is made to obtain constant or nearly constant coupling.

In each of the r.f. tubes, the *B* battery is fed in through radio frequency chokes L_1 , L_2 , L_3 and L_4 which are constructed so that their impedance is very high over the broadcast band, about 80 millihenrys in each choke. Over the broadcast band, these chokes act as extremely small condensers of about 4 mmf. apiece and so are quite efficient for this purpose. This minute capacity, and also the plate to filament and grid to filament capacities of the r.f. tubes, are in effect shunted across the tuning condensers and so do not do any real harm.

Another r.f. choke, L_5 , is used in the plate circuit of the detector tube to keep the r.f. voltage component out of the audio frequency amplifier. Some of this r.f. voltage is fed back through the midget condenser C_{10} to the last r.f. coil or transformer. The primary winding in this transformer then acts as a tickler or plate feedback coil for the detector, and also as one neutralizing winding for the last r.f. amplifier. Part of this feedback voltage through C_{10} also finds its way back through C_9 so that the regenerative effect is small, just enough to make the detector circuit a little more selective. The selectivity of the detector circuit in this case is about the same as a negative bias detector would be without regeneration, but is several times as sensitive. A grid bias detector with its very high plate impedance should not be worked directly into an audio frequency transformer which would then have a poor low frequency characteristic.

A three-tapped loop is used because it is more selective than a two tapped loop. Only a small portion of the r.f. energy in the plate circuit of the first r.f. tube is fed back to the plate winding

of the loop aerial through the condenser C_2 . C_2 should be a small condenser, preferably of the 0-50 mmf. size. The loop aerial used with this set has a special thumb-screw tightening adjustment to take up slack in the windings of the loop, so that it can be jarred without changing the frequency to which it is tuned.

Volume control is obtained by means of a rheostat in the filament of the first two r.f. amplifier tubes. Amperite resistances reduce the 6 volt battery supply to 3 volts for each of the 199 type tubes and the volume control rheostat is in series with the two Amperite resistances in the first two stages. This prevents the possibility of operating the filaments at more than the rated filament voltage. The use of Amperites makes it possible to use any kind of tube by simply plugging in the proper resistance.

The reason for controlling the volume in the r.f. amplifier is to avoid overloading the following r.f. tubes and, more important, to avoid overloading the detector. The grid-leak detector will not stand much power so plenty of audio amplification should be used. Otherwise the higher audio frequencies will be lost in the detector. If extreme overloading of the detector occurs, the low frequencies seem to be lost even more than the high notes.

The pictures of the set give a pretty good idea of the general layout of the equipment on the baseboard and panel. In building such a set, the sockets, condensers, etc., should be laid out on the baseboard and then moved around slightly until the personal desires of the constructor are satisfied. The arrange-

ment of the apparatus is not especially important since shielded coils are used, the latter being mounted below the baseboard.

The arrangement as shown is as follows: the loop connects to three binding posts on the first r.f. amplifier and single variable tuning condenser. From there, the r.f. energy is amplified through successive stages tuned by the four gang condenser till it gets over to the detector, which is located at the right end in the picture of the top view. The audio frequency amplifier is located over at the other end of the baseboard, this being best in order to have the controls appearing on the front of the panel in a symmetrical arrangement. By using a walnut veneer panel with the Remler drum dial controls, a really beautiful receiver results. These dials give a large dial space or length in tuning so that the set is extremely easy to tune, the dials being illuminated also.

The four gang condenser is made up from a Remler three gang condenser and a reverse rotating single condenser. The latter can be obtained now from the manufacturers. The method of mounting the fourth condenser is simply by means of an extra brass mounting plate, adjacent to the drum dial, and $1\frac{1}{2}$ in. coupling sleeve. This coupling sleeve is a piece of brass tube, $\frac{1}{4}$ in. inside diameter and has two set screws, one near each end, which clamp the condenser shaft to the short shaft inside of the drum dial. Since this condenser shaft rotates in an opposite direction to that of the usual condenser, the plates of this fourth condenser turn in the same direction as do the plates of the three-gang condenser.

In the picture showing the bottom of the baseboard, the general layout of the shielded coils, the r.f. chokes, the Amperite filament resistances, and the three special neutralizing condensers are shown. These neutralizing condensers are located near the edge of the panel and connect between the "plate" coils of each r.f. transformer. It should be noticed in Fig. 1 that terminal marked $+B$ connects to the can shield and filament in the last r.f. coil, the terminal marked *P* or Plate in the next, the $+B$

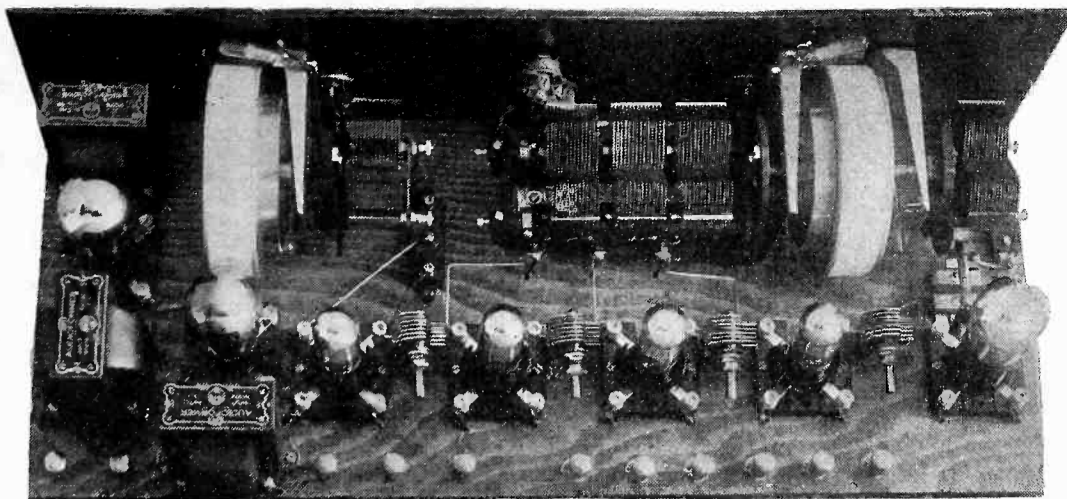

Rear View of Capacity Coupled R. F. Receiver

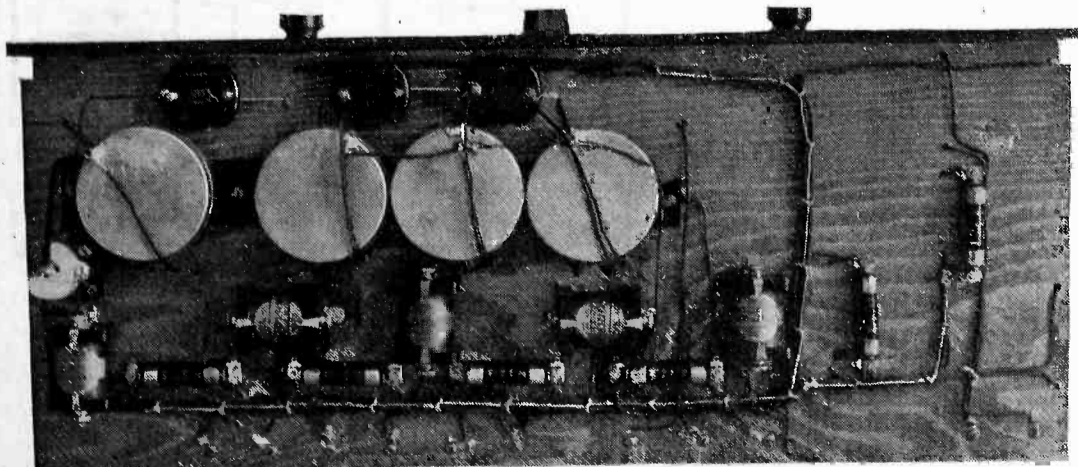

Bottom of Baseboard.

in the next, and *P* again in the first coil. This reversal in direction of winding is necessary in two of the coils or transformers in order to obtain the correct phase relations for neutralization. If there is a mix-up in this part, the condensers C_7 , C_8 and C_9 , will cause the r.f. amplifier to oscillate rather than neutralize it.

The baseboard, a dry spruce board about $9\frac{1}{2} \times 23 \times \frac{1}{2}$ in. in size, is supported by the panel with two fairly heavy angle braces and a couple of wood screws through the panel into the baseboard. The latter is raised about an inch above the lower edge of the panel as about $1\frac{1}{2}$ in. space is needed below the baseboard for the coil and r.f. chokes. The cabinet used with this set has the bottom sunk down about $\frac{3}{4}$ of an inch, leaving $1\frac{3}{4}$ in. below the baseboard. This is an important item to be considered because sufficient room should be left above the baseboard to properly mount the condensers and drum dials unless a slot is cut in the baseboard for the drum to rotate through.

The wiring of the set was done mainly with bell wire in the form of cabling. All of the battery leads were run around under the baseboard and brought up through holes to the socket terminals. The easiest method is to start from the battery binding post and run to every socket or terminal which, according to the wiring diagram shows that connection. By drilling $\frac{1}{8}$ in. holes through the baseboard, sufficient room is provided so that the wire can be looped up to each terminal and back again. After

- PARTS FOR CAPACITY COUPLED
R. F. RECEIVER**
- 1—Remler three gang condenser, .00035 mfd. per section
 - 1—Remler condenser, .00035 mfd.
 - 1—Remler condenser .00035 mfd., rotation reversed
 - 2—Remler drum dials
 - 1—Coupling sleeve and reversed condenser support (Remler)
 - 4—Shielded r.f. transformers (see text)
 - 3—Sangamo fixed condensers 50 mmf.
 - 1—Electrad grid condenser, .00025 mfd.
 - 1—Electrad grid leak $\frac{1}{2}$ megohm
 - 5—Cardwell or Hammarlund midget condensers, 50 mmf. maximum.
 - 7—Frost tube sockets
 - 1—Qualitone loop aerial
 - 2—Audio frequency transformers
 - 1—Output transformer
 - 11—X-L push binding posts
 - 1—X-L Variodenser, type N, 20 mfd. max.
 - 1—X-L Variodenser, type G-1, 100 mfd. max.
 - 5—Samson r.f. chokes, type 85
 - 2—Amperites, type 112
 - 1—30 ohm Frost rheostat and filament switch
 - 4—Amperites, type 6v-199
 - 4—Type 199 tubes
 - 2—Type 201A tubes
 - 1—Type 171 power tube
 - 1—Walnut veneer panel $7 \times 24 \times \frac{1}{4}$ in.
 - 1—Spruce baseboard $9\frac{1}{2} \times 23 \times \frac{1}{2}$ in.

this wiring has been done, a large part of it can be laced together with cord, which makes a neat job and also affords less chance of trouble later. About the only leads that should be run in bus wire are grid and some plate leads in the r.f. amplifier and detector.

The coupling condensers, located between tube sockets, are held in place by the bus wire leads to the plate and grid terminals of the sockets. This provides very short leads with less chance of interstage capacitive and inductive coupling. Shielded coils were used for the same purposes and while these are probably not as efficient as unshielded coils, still the overall r.f. amplification is enormous. Shielding each r.f. stage sep-

arately would make it difficult to properly control a four-gang condenser, besides taking considerably more space. The Remler condenser is so staggered in each section that a "grid" section is next to the "filament" plates of the next r.f. stage so that there is very little undesirable capacitive coupling between stages.

After such a receiver is wired up and ready to be tested, the coupling condensers C_3 , C_4 , C_5 and C_6 should be set at about $\frac{1}{3}$ of their maximum capacity and the feedback condensers C_2 and C_{10} at about minimum capacity. Some local broadcast station should then be tuned in and then the loop turned until this station is nearly inaudible. This should occur when the loop is at right angles to the direction to the station unless one lives in a stucco house with its wire screen shielding. When the signal is nearly inaudible, the coupling condensers can all be advanced until the maximum gain with good audio quality is obtained. Adjustment of the feedback condenser C_2 will make the loop aerial tune more sharply and increases the sensitivity of the circuit.

Too much regeneration at any point in the circuit will ruin the audio frequency characteristic and the overall amplification curve will fall off rapidly on the higher audio frequencies. Some super dx fiend, who might want to try for great distances, can couple an outside aerial to this type of receiver through a midget 0-50 mmf. condenser connected directly to the grid of the first tube.

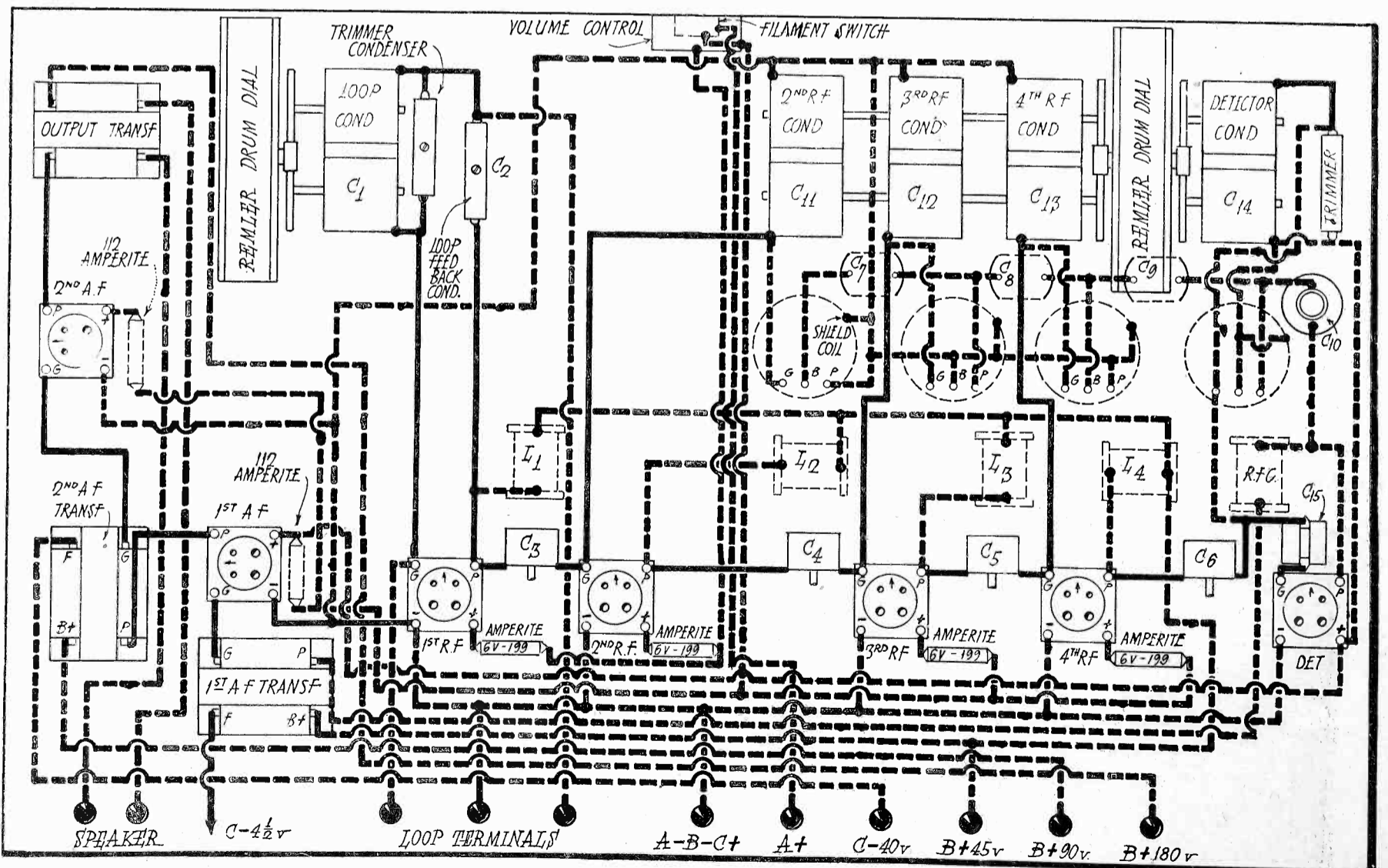

Pictorial Diagram of Capacity Coupled R. F. Receiver.

Low Mu Tubes as R. F. Amplifiers

A Critical Analysis of Amplifier Efficiency

By Nelson P. Case, E. E.

SINCE tubes of the UX-171, CX-371 type have appeared upon the market, we have all become familiar with the red and white label which is pasted around them. Its warning "For use in last audio stage only," has apparently been taken all too literally, as the writer does not remember having seen anything in the current literature to indicate that any attempts were being made to utilize these excellent tubes for any other purpose than to feed the loud speaker with plenty of undistorted power; with the exception, of course, of their use as oscillators in low-power amateur transmitters. This is surprising, to say the least, as there are excellent theoretical grounds for believing that these tubes should work very well in the modern types of tuned radio frequency amplifiers. It is the purpose of this article to present some of these, in the hope that it will stimulate a little research in this neglected field.

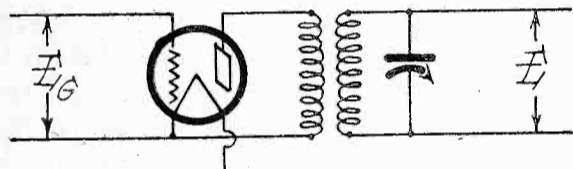

Fig. 1. Single Stage of Tuned R.F.

Let us consider the circuit shown in Fig. 1. This represents a single stage of tuned r.f. amplification. The amplification obtained by this stage is measured by the ratio E/E_G .

This circuit can be analyzed more readily if we replace it by the equivalent circuit, shown in Fig. 2. Obviously, we wish to secure the maximum value of E for a given value of E_G . Since $E = i_2 X_C$, where i_2 is the current which circulates around the tuned circuit and X_C is the reactance of the tuning condenser at the particular frequency used, it is evident that any condition that will make i_2 a maximum will give the maximum value of E .

Since there is always a certain amount of resistance in the tuned circuit, the flow of current in this circuit is always accompanied by the expenditure of power. The amount of this power is $i_2^2 R$, where R is the equivalent resistance in series with the tuning condenser and the secondary of the radio frequency transformer. Hence we see that when i_2 is a maximum, the power absorbed in the secondary circuit is also a maximum.

The condition for maximum power in this circuit is given by the equation

$$\frac{Z_M^2}{Z_2} = Z_1 + R_P \quad (1)$$

where Z_M is the mutual impedance between the primary and secondary of the transformer, Z_2 is the total impedance around the tuned circuit, Z_1 is the impedance of the primary of the transformer, and R_P is the plate resistance of the tube. These impedances are the absolute values, i.e., values without regard to sign.

The physical interpretation of this equation is that the impedance introduced into the plate circuit on account of the presence of the tuned secondary should be equal to the impedance of the plate circuit itself. Of course, for the resonant condition, Z_2 will reduce to R ; moreover, Z_1 is usually quite small compared to R_P . Therefore we can say that the condition for greatest amplification is that the mutual impedance between the transformer windings is equal to the square root of the product of the plate resistance of the tube and the equivalent series resistance of the tuned circuit, or

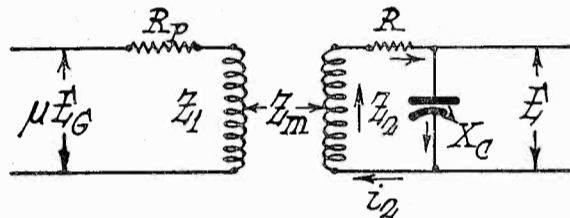

Fig. 2. Electrical Equivalent of Fig. 1.

$$Z_M = \sqrt{R_P R} \quad (2)$$

without doing much violence to the actual facts. The mathematical proof of these equations is beyond the scope of this article, but the interested reader can verify them by referring to "A Method for Maximization in Circuit Calculation," W. v. B. Roberts, Proc. I. R. E., Oct., 1926.

Since X_M varies directly as the coupling, we see from equation (2) that the higher the plate impedance of the tube used, the closer must be the coupling in order to secure the maximum amplification. Now if sensitivity were the only factor to be considered in the design of the amplifier, we would get more amplification per stage by using a high impedance high mu tube with close coupling than by using a low impedance low mu tube with relatively loose coupling. Unfortunately, however, present day broadcasting conditions are such that selectivity is equally as important as sensitivity, and selectivity can only be secured by loose coupling between stages, unless several stages are used. The result is that designers have deliberately cut down the coupling until satisfactory selectivity was obtained, with

the result that the impedances no longer match, and thus the amplification suffers.

If a low impedance tube is used, the optimum value of coupling should be sufficiently loose to give excellent selectivity, and at the same time the amplification per stage would still be at a maximum, and should be considerably more than is obtainable when using a standard all-purpose tube with loose coupling between stages.

The writer is aware of the fact that the plate impedance of the tube is transferred to the secondary to a greater or less extent, according to the coupling, thus affecting the selectivity at optimum coupling, and that the figure of merit for a radio frequency amplifier tube is usually taken as $\mu/\sqrt{R_P}$, which would indicate an advantage in favor of the higher mu tubes. It seems to the writer, however, that other factors make this figure of questionable value. For instance, the geometrical capacity from grid to filament increases, in a general way, with mu, and this affects the effective grid-to-plate capacity in such a way that the tendency to oscillate increases faster than the gain per stage. This causes difficulty in multi-stage loss-controlled amplifiers, and it is the writer's opinion that such amplifiers will be much better when adapted to operation with low mu tubes, although it is probable that somewhat better results can be secured with a high mu tube where the amplifier consists of only a single, neutralized stage.

In any case, it seems that there is ample theoretical background to justify further investigation into the possibilities of low impedance tubes as radio frequency amplifiers, especially since the advent of the new quarter-ampere filament in these tubes. This eliminates the objection of heavy current drain for the filaments, and they will operate satisfactorily as radio frequency amplifiers with plate voltages much below those necessary for power operation. They should work nicely with $67\frac{1}{2}$ volts on the plate, which would mean a current of only about 6 milliamps per tube, with 12 volts C bias. This is no more than a UX-201-A will draw with 90 volts plate and no C battery, conditions which are all too common in even the better sets.

The writer would like to hear from readers who obtain any interesting results with low mu tubes as r.f. amplifiers.

How to Calibrate a Receiver

Simple Directions for Using an Oscillator to Determine the Wavelengths Corresponding to Dial Settings of Short Wave and Broadcast Receivers

By B. F. McNamee

BUILDERS of short-wave receivers often wish to calibrate the tuning dial in meters or in kilocycles. The most obvious way of doing this is to tune in an accurately calibrated oscillator which will cover the wavelength range of the receiver, but at the present writing such oscillators are very scarce. There is usually available, however, an oscillator which will cover the broadcast band from 200 to 550 meters. Such an instrument was described by the writer in RADIO for September, 1927, page 29. 60-cycle a.c. may be used on both plate and filament for the present purpose.

It is well known that the harmonics of such an oscillator may be tuned in easily on a short-wave receiver. The wavelengths of these harmonics will be the exact integral divisors of the oscillator wavelength; for example, if the oscillator is set at 300 meters, it can be tuned in on 150, 100, 75, 60, 50, 42.86, 37.5, 33.33, 30, etc., meters. So far, simple enough, but now a method must be provided for ascertaining just which one of these harmonics the receiver is tuned to.

Most short-wave receivers use several "plug-in" coils, each of which covers, with the tuning condenser used, a particular band of the short waves. It is desired to plot, for each coil, a curve showing the wavelengths for the various condenser dial settings. For this purpose a measurement should be made every ten divisions of the dial.

Set the dial on the receiver at 10, and increase the regeneration to just below the oscillating point if a modulated oscillator is used. If a battery-operated, non-modulated oscillator is used, increase the regeneration to just above the oscillating point. Place the oscillator within a few feet of the receiver. Start the oscillator at 200 meters and turn it slowly upward, until it is heard in the receiver. Make note of the oscillator wavelength, and continue to turn, counting the number of points on the oscillator dial at which it is heard in the receiver (the receiver is not changed during this process). Also make note of the highest wavelength at which it is heard. This process is repeated with the receiver dial at 20, 30, etc.

For each receiver calibration point notes have now been made of the lowest wavelength, the highest wavelength, and the number of points on the oscillator dial which were heard in the receiver.

Now find the difference between the highest and lowest wavelengths, and divide it by the number of points less one. For example, in one particular case, the oscillator was heard when set at 244 and 549 meters, and at four intermediate points, making six points in all. The difference is 305, which divided by 5 gives us 61 meters for the wavelength to which the receiver is tuned. We could of course take the difference between the wavelengths of any two successive points, and would therefore not have to divide, but this would involve greater chance of error from inaccuracies in oscillator calibration, or in the readings.

To explain the reasoning on which this rule is founded, take the above example, where the wavelength was found to be 61 meters. The oscillator can be heard in the receiver only when its wavelength is an exact multiple of 61. Four times 61 is 244, the lowest setting of the oscillator which could be heard. As the oscillator wavelength is moved up, all its harmonics are moved up, and the next point at which the oscillator can be heard must be when one-fifth of its wavelength equals 61, or at 305 meters. It will also be heard when it reaches 366, 427, 488 and 549 meters, which are 6, 7, 8, and 9 times 61 respectively. Obviously the difference between these successive wavelengths is 61 meters.

Sometimes there is good reason to suspect the accuracy of our broadcast band oscillator, and therefore the short-wave receiver calibration may be somewhat in error. It can be checked and corrected in the following manner. There is usually a broadcast receiver available, either in the same room with the experiment, or connected up in some other part of the building. If the oscillator can be heard in it, it is not necessary to move it. Tune in some broadcast station selected for its wavelength accuracy; (there are now several of them that are rated in this respect by the Bureau of Standards). Now turn the oscillator dial until it heterodynes with the broadcast station in the receiving set, and set the oscillator accurately at zero-beat. The broadcast receiver may then be shut off. The harmonics of the oscillator will then be the exact harmonics of the station: for example, if KGO, Oakland (384.4 meters) is chosen, they are 192.3, 128.2, 96.2, 76.9, 64.1, 54.9, 48.1, 42.7, 38.4, 35, etc., meters. If the calibration of the short-wave receiver is correct, the

oscillator will be heard each time the set is tuned exactly to one of these wavelengths; if incorrect, the curve will always be sufficiently close to tell which harmonic wave has been tuned in, and the curve can be corrected by shifting it as indicated by the corrected points.

If the above method of correction does not provide as many points on the curves as desired, an oscillator can be set up at exactly twice the wavelength of the broadcast station, by tuning in the broadcast station and heterodyning it with one-half the oscillator wavelength, obtaining zero-beat as before. This will double the number of points obtained by the previous method, and of course the number can be multiplied to any extent in a similar manner.

Carrying the same idea further, we have a method of calibrating a long-wave oscillator, or a long-wave receiver which can be made to oscillate, as most of them can, from a standard wavelength broadcast station. The station is tuned in on a broadcast receiver, and the long-wave oscillator placed close to the latter and turned on. As the oscillator is increased in wavelength, a heterodyne whistle will be heard every time its wavelength is an exact multiple of the wavelength of the station. Usually we know approximately the wavelength of some point on the oscillator dial, and we can use this for our approximate starting point. Suppose it is known that the lowest wavelength of the oscillator is approximately 3000 meters, and that the broadcast station is on 384.4 meters. Seven times this is 2690, and eight times it is 3075 meters. It is evident that when the first heterodyne whistle is heard, as the oscillator is increased from its lowest wavelength, it will be at 3075 meters. The next whistle will occur at nine times 384.4, or 3461 meters, and so on.

A standard wavelength broadcast station, a broadcast receiver, and a short wave receiver, constitute the means necessary for accurately calibrating a broadcast-band oscillator. Tune in the station on a broadcast receiver and heterodyne the oscillator with it to zero-beat, when the broadcast receiver may be shut off. Now tune the short-wave receiver to, say, one-tenth of this wavelength. If KGO is chosen, it may be tuned to 38.4 meters. The set should be far enough from the oscillator to make the tuning very sharp. As the oscillator

(Continued on page 62)

Radio Kit Reviews

AERO-DYNE-6 A.C. OPERATED RECEIVER

The construction of the Aero-Dyne Six for use with the new CX-326 and C-327 a.c. tubes is a relatively simple matter. By reference to the circuit diagram, it will be seen that the proper terminal voltage values are shown. The filament supply transformer should be one having windings giving 1.5, 2.5 and 5 volts. The unit supplying B voltage may be dry cell blocks or any high class type of B eliminator.

The wiring for the filaments of the tubes may be either twisted pair or bus bar wire. Bus bar will make a neater job and is large enough to carry the relatively large current without appreciable voltage drop. It will be well to run the wires parallel to each other and as close as possible—making use of spaghetti for insulation.

Perhaps a word of caution regarding the filament voltages of the a.c. tubes will not be amiss. These tubes are extremely delicate and will not stand higher voltages than their prescribed rating for any length of time. It is preferable to make use of a low voltage a.c. voltmeter but in the absence of this the minimum voltage with which satisfactory operation of the tube can be secured is used.

The layout and general construction of the a.c. operated Aero-Dyne is practically identical with that of the battery operated Aero-Dyne 6. As shown on the diagram, the 6 ohm potentiometer is located on the sub panel just behind the first condenser. The 1/5 ohm rheostat is mounted on the panel, and is used to control the filament voltage on the CX-326 tubes.

The Yaxley cable is used to connect the filament transformer to the appropriate circuits in the receiver. The con-

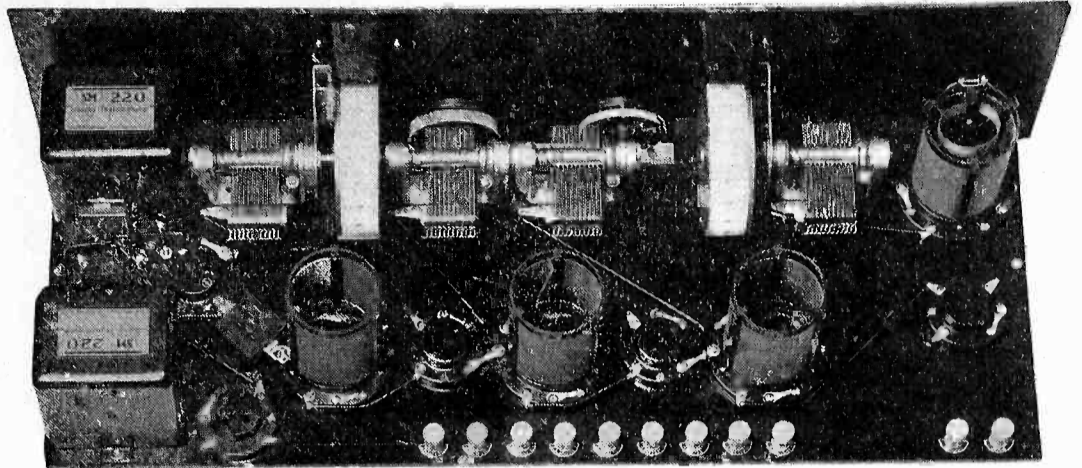

Rear View of Aerodyne-6 with D.C. Tubes.

- PARTS REQUIRED**
- 1—General Radio 440 filament transformer
 - 11—X-L binding posts
 - 1—Benjamin 5 prong socket
 - 1—Polymet E-Z grid leak mounting
 - 1—Yaxley cable No. 660
 - 2—Yaxley 6 ohm resistances
 - 2—Yaxley 3 ohm resistances
 - 1—Yaxley 300 ohm resistance
 - 1—Yaxley 6 ohm potentiometer
 - 1—Carter .00025 mfd. condenser
 - 1—Carter .001 mfd. condenser
 - 1—Carter .0015 mfd. condenser
 - 1—1/5 ohm Carter rheostat
 - 1—0-200,000 ohm Carter variable resistor
 - 2—Tobe 1 mfd. condensers
 - 1—Tobe 2 meg. grid leak
 - 4—Hammarlund .0005 condensers
 - 2—S-M drum dials
 - 2—S-M type 220 audios
 - 5—S-M No. 511 sockets
 - 1—Aero foundation kit for Aero-Dyne-6 A.C. receiver
 - 1—Aero coil kit U-16

ductor plate is mounted just to the left of the 171 socket on the rear of the sub-panel. Wires colored green and slate are used for the 1.5 volt line, brown and red wires carry the 2.2 volts for the heater of the CX-327 and the black and yellow wires are for the 5 volt winding. The blue wire is not used.

Besides this Yaxley cable, eleven binding posts should be mounted in the order shown on the circuit diagram. The receiver has been stabilized against oscillation and the correct voltages as bias for the CX-326 tubes is specified as a negative 12 volt bias. If it is desired

that the receiver be operated nearer the oscillating state, reduction of the negative bias to a value of about 9 volts should accomplish the desired result. A negative voltage of 40 is used for biasing the 171 tube.

When putting the receiver in operation, the 6 ohm potentiometer located on the sub-panel just to the rear of the first tuning condenser should be adjusted for minimum hum. It should be possible to entirely eliminate the hum or at least reduce it to an exceedingly low order.

In cases where interference is caused by the electric motors used in vacuum cleaners or vibrators, the trouble may often be reduced by shunting two 1 mfd. bypass condensers connected in series, across the 110 volt line, at the outlet where the electrical appliance is connected. The mid point of the two condensers is connected to ground, preferably through a 6 ampere fuse, so that in case one of the condensers became defective, the fuse would operate and prevent a fire. Of course, any motor which produces bad radio interference is usually in need of attention, such as cleaning the brushes and commutator, which can be done by any reliable electric service shop.

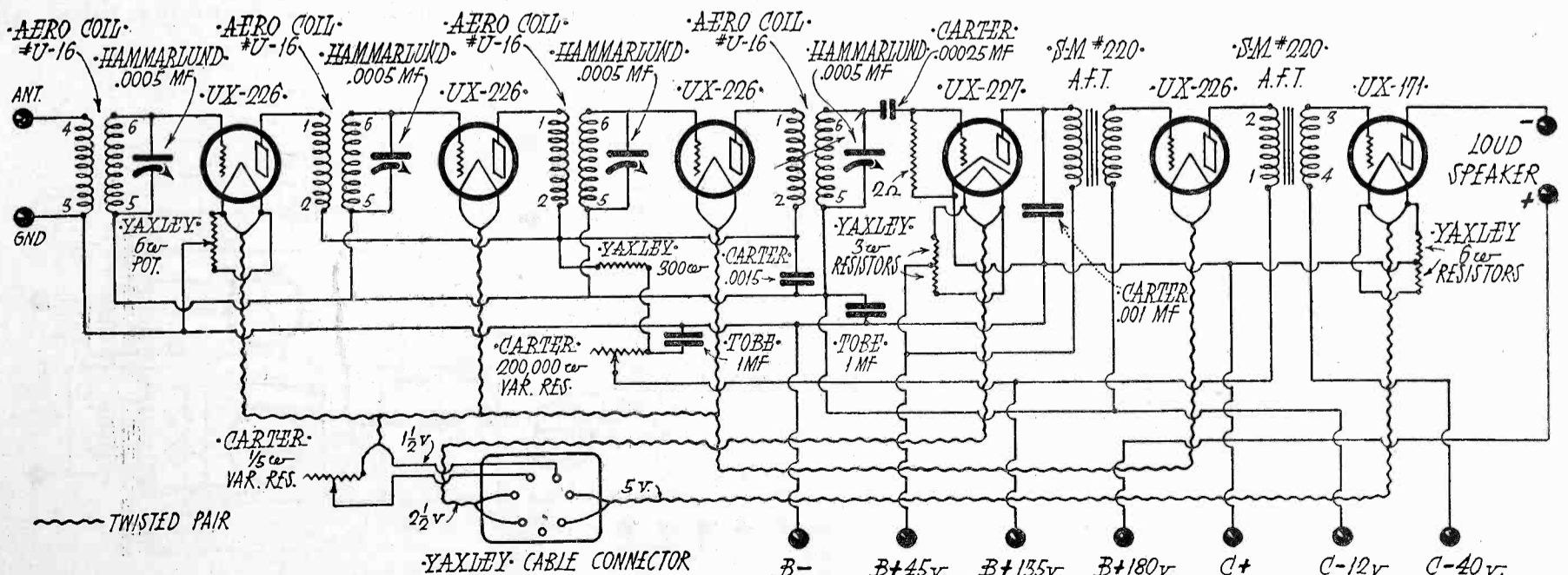

Circuit Diagram of Aero-Dyne 6 With A. C. Tubes.

A GOOD THREE-STAGE POWER AMPLIFIER

This three-stage power amplifier has been designed to amplify frequencies between 30 and 8000 cycles with less than 8 per cent difference in their output voltages. It is adaptable for use with any set, not only as a power amplifier, but also as a *B* eliminator. With its output of from 6 to 8 watts it is capable of giving tremendous volume without distortion and of maintaining sufficient reserve for full and well-rounded tones at all frequencies.

It employs double impedance coupling for the first and second stages with CX-112 tubes and for the third stage has a push-pull transformer with two CX-310 tubes. The double impedance coupling gives good gain and allows the use of a low resistance grid-leak so that the grid is quickly restored to its normal potential in case an unusually strong signal has been impressed upon it.

The push-pull transformer has a split secondary whose center is connected to the tube filaments through a grid biasing resistance. This acts as a grid return for both tubes, the grids thus being 180 degrees out of phase. When one grid is positive the other is negative. This allows a great variation in grid voltage without distortion and gives more than twice the output obtainable from a single tube.

As there is no phase shift within the tubes this split secondary also causes a 180 degree phase difference in the a.c. components of the two plate circuits. This is counteracted by using an output transformer with a split primary whose center tap is connected to the positive end of the plate voltage supply. The secondary is connected directly to the speaker.

The filaments of the first two tubes are supplied from a d.c. source in order to prevent voltage amplification of an a.c. ripple. The filaments of the two tubes in the last stage are operated without hum from raw a.c. furnished by low voltage windings on the power transformer.

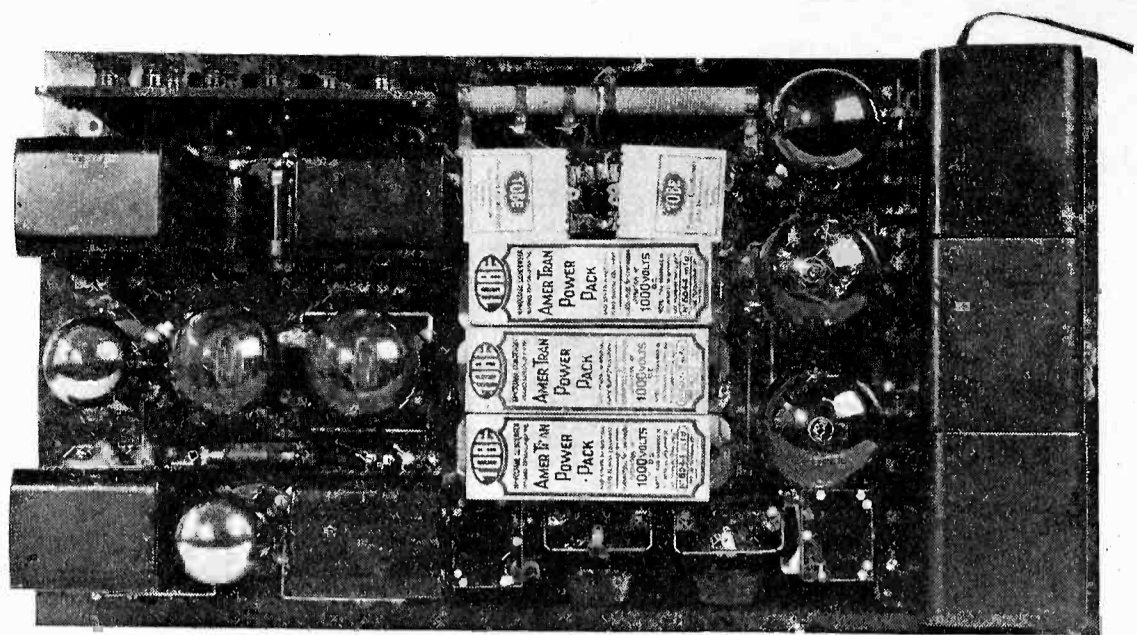

Top View of Completed Amplifier.

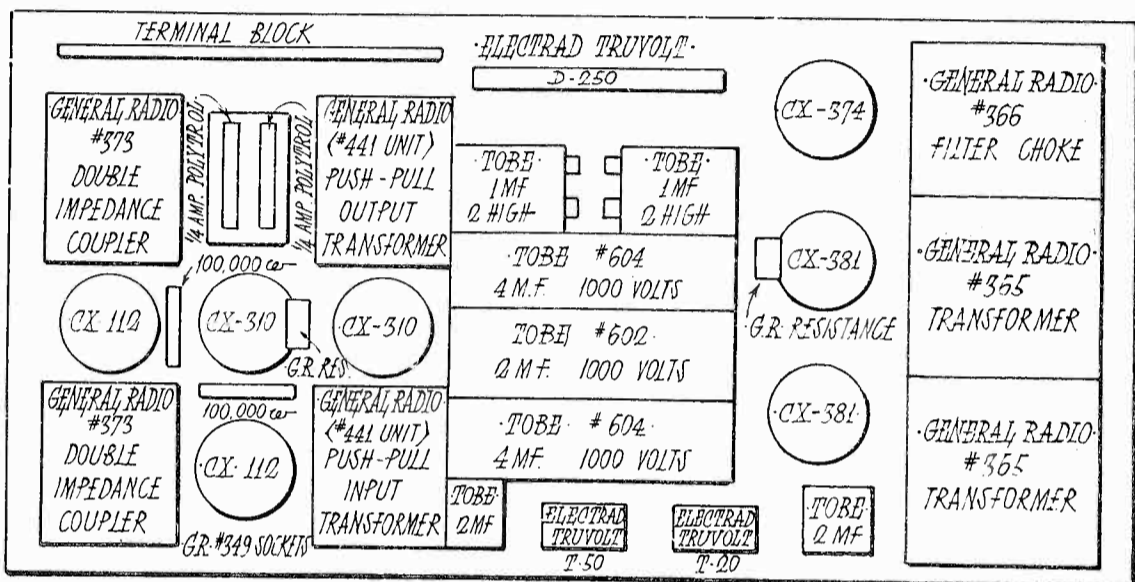

General Layout of Parts.

Stability is insured by grounding all cases to the negative *B* lead. The grid circuits of each tube are separated by blocking resistances which are especially necessary since the grid bias for the first two tubes is secured by a voltage drop across a resistance which is common to their plate circuits.

The picture shows the general layout of parts and the circuit diagram the wiring connections. At the extreme upper right is the filter choke and below it the two power transformers. Their primaries are connected in parallel and

their secondaries in series so that their point of connection becomes the center tap, which is grounded to the negative *B*. The center taps on each secondary are not used.

Their high voltage output is fed to the plates of two CX-381 tubes to give full-wave rectification. The filaments are lit from one of the filament windings on the transformers and the center tap of the resistance connected across the filaments becomes the positive high voltage terminal. These rectifying tubes and

(Continued on page 56)

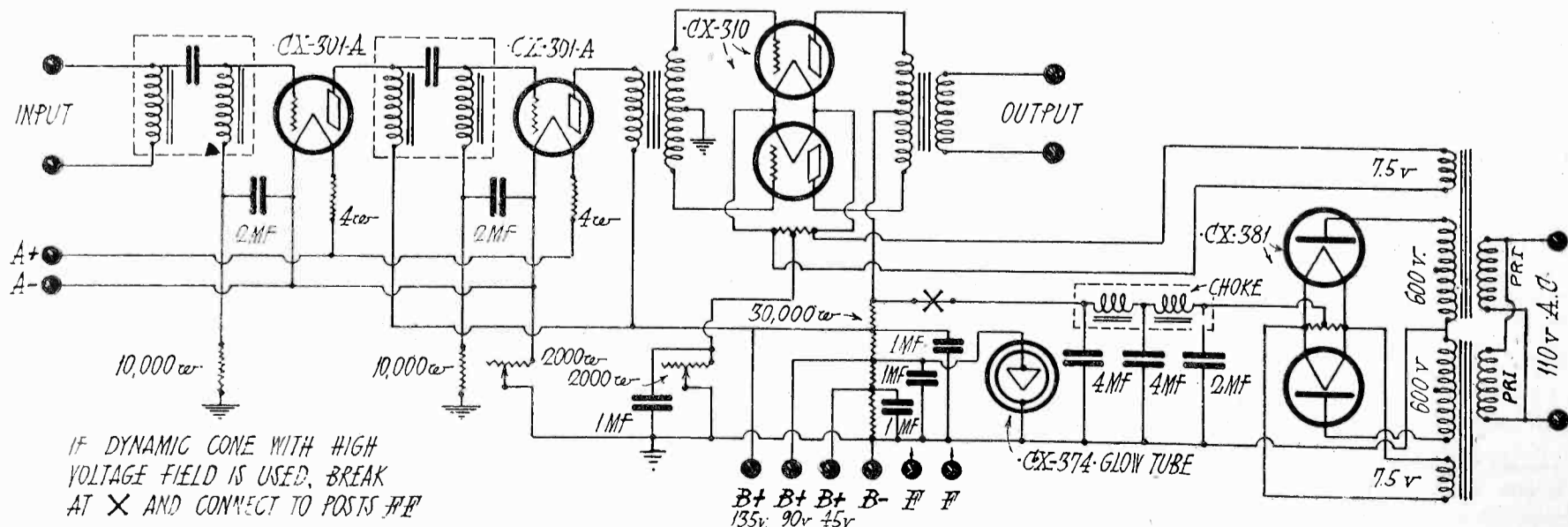

Diagram of Completed Amplifier.

RADIO FOR FEBRUARY, 1928



QUERIES and REPLIES



Questions of general interest are published in this department. Questions should be brief, typewritten, or in ink, written on one side of the paper, and should state whether the answer is to be published or personally acknowledged. Where personal answer is desired, a fee of 25c per question, including diagrams, should be sent. If questions require special work, or diagrams, particularly those of factory-built receivers, an extra charge will be made, and correspondents will be notified of the amount of this charge before answer is made.

Please publish a circuit diagram for a superheterodyne using as many parts from the old Pressley circuit as is possible, with a stage of r.f. ahead of the 1st detector, a.c. tubes throughout and a pair of 210 tubes push-pull in the power stage. Would a set of the new Precision diamond cut coils be satisfactory for this circuit?—F. G. K., Jackson Heights, N. Y.

A circuit such as you specify is shown in Fig. 1, except that no stage of tuned r.f. is used ahead of the first detector-oscillator tube, due to the fact that a special oscillator coil would have to be constructed, the data for which is not available. Due to the use of a.c. tubes, a special volume control must be used across the primary of the second intermediate transformer. It is assumed that the power plant used to supply the pair of 210 tubes in the push-pull amplifier will also be used for B voltage for the rest of the tubes in the circuit. Type 226 tubes are used in the intermediate and 1st audio stages, and type 227 tubes in the oscillator-detector and second detector tube sockets.

Have a set of 3000 meter transformers for which I would like to construct a filter. Please give me directions for winding the filter. How does the Tropadyne compare with the ordinary superheterodyne circuit?—Z. B., Penokee, Kan.

A filter for 3000 meters, 100 kilocycles, may be wound as follows. Turn out a wooden spool with a 1 in. hub, 3/8-in. slot, with walls thick enough to make the spool mechanically strong. For the primary, wind 200 turns of No. 30 s.c.c. wire on the hub, and then wind on a layer of insulating paper. Over the paper wind 500 turns of No. 36 s.c.c. wire, for the secondary. The end of the primary next the hub is the plate, the other end of the primary the positive B, the inside secondary is the filament terminal, and the outside secondary goes

to the grid. Tune this filter with a .0001 mfd. fixed condenser shunted across the secondary. The Tropadyne circuit is a superheterodyne using intermediate frequency transformers tuned by variable condenser units which may be adjusted by the constructor for the most efficient tuning of the amplifier.

Would like to build a 6 tube 99 type superheterodyne, using a crystal second detector. Please show connections for an antenna, as I do not wish to use a loop.—H. E. B., Battle, Mont.

A six tube receiver of the type you require is shown in Fig. 2. A fixed crystal detector is

99 tubes in series, and can only get 15 to 20 milliamperes in the 180 volt "B" lead. What is wrong?—H. W. L., St. Paul, Minn.

The eliminator should give at least 120 milliamperes at 150 to 175 volts, so that you either have a defective transformer, low emission rectifier tubes, or you have too much resistance in the lamp bank controlling the filament current to the 99 tubes, as well as in the fixed and variable resistances controlling the current for the plate circuits. For a set such as yours, there should be two 25 watt and two 10 watt mazda lamps, making a total

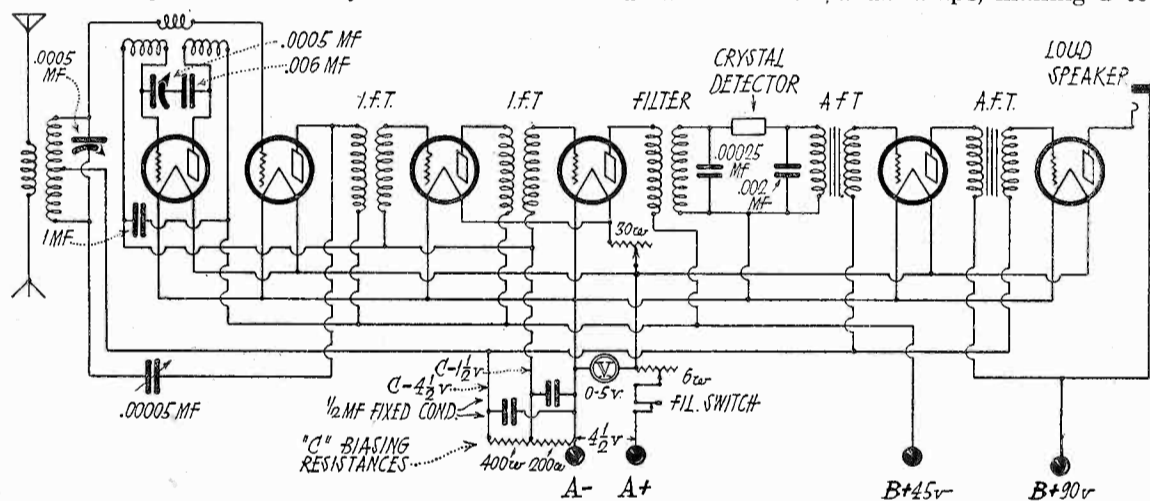

Fig. 2. Circuit for Six-Tube Portable Superheterodyne.

shown for the second detector, with a vacuum tube first detector. If the power output of the second audio stage is not sufficient, a type 120 power tube may be substituted, and the B and C battery voltages for the last stage increased to 135 and 22 1/2 volts respectively.

Am having trouble with my "ABC" eliminator, which is used to supply current to an 8 tube Best superheterodyne. It does not supply enough current to the

d.c. resistance of 4000 ohms. If all lamps were of the 10 watt size, then the resistance would be entirely too high, or about 5600 ohms. Try substituting a 25 watt lamp in place of one of the 10 watt lamps, and measure the current flowing through the filament circuit. Do not shunt an ordinary voltmeter across the positive and negative filament supply, as it will draw so much current that it will give a

(Continued on page 58)

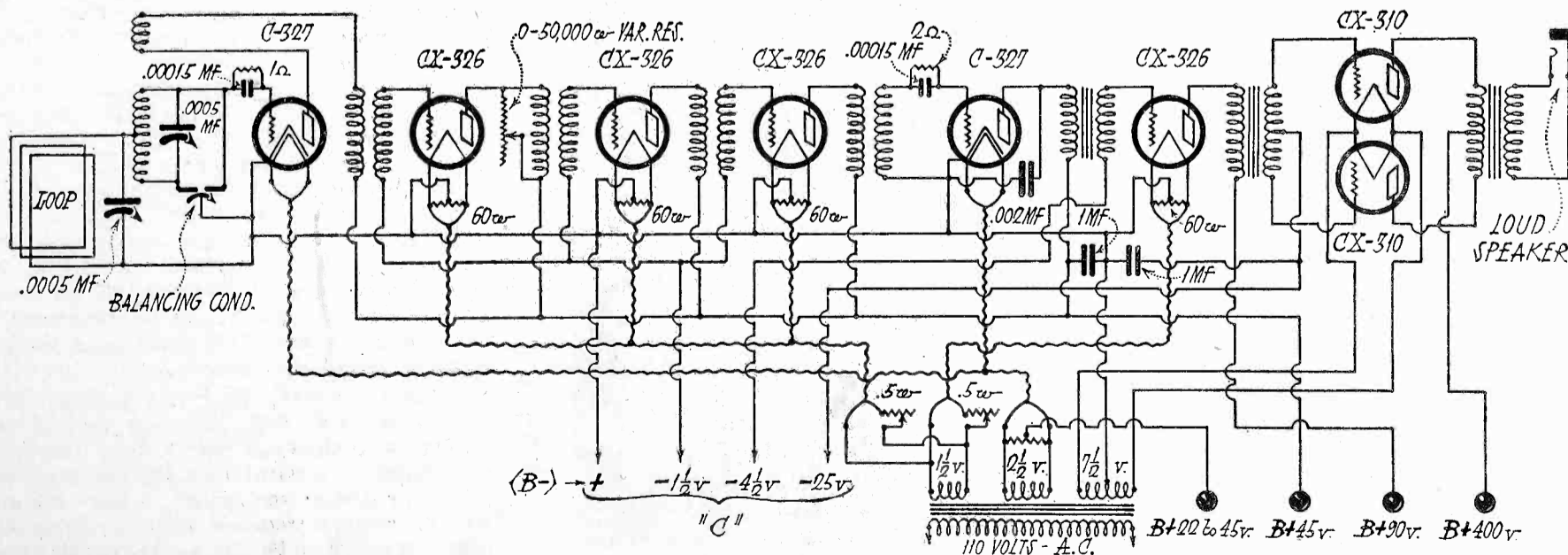
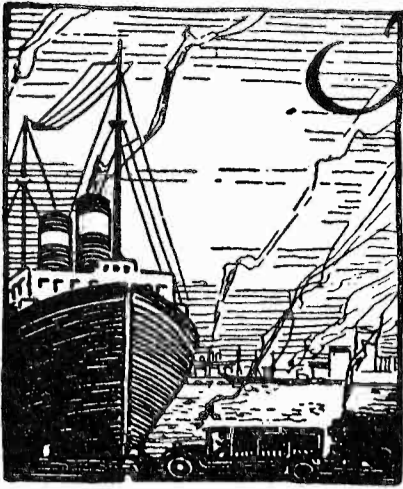

Fig. 1. Presley Superheterodyne A. C. Tubes.



The COMMERCIAL BRASSPOUNDER

A Department for the Operator at Sea and Ashore



Edited by P. S. LUCAS

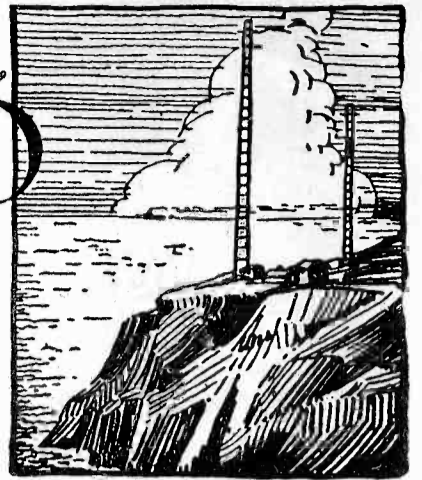

Swiped from a well known BCL magazine: QUESTION—I am annoyed here at San Pedro with the wireless sets. (N. B.—Don't confuse this with radio). Isn't it unlawful for these amateurs and commercial operators to interfere with the broadcast programs? If so, to whom should I complain, or what course should I take?

Now what's the idea of you fellows breaking up all our fine programs just to fill the air full of a lot of blah blah ble blahs et cet? There should be a law making you keep quiet during the 24 hours the broadcasting stations want to sell polka dot shirts and entertain the folks with a snappy toe-dance. Why don't you float your apparatus on a raft outside the 12 mile limit or further and operate by remote control? Amateurs!

Back to life again, we are pleased to announce that in this particular instance the questioner ran up against one of our own fraternity, who pointed out to him, at great length, that the commercial stations were functioning long before BCLs were thought of and that the service rendered by them was very, very important. Selah! We win!

P. S. Lucas, Editor,
Commercial Brasspounder Dept., RADIO.

I was interested in the discussion of the SE-143 in these columns by Mr. Wade of the S.S. *San Gil*. The tickler on this tuner is of such size as to afford good regeneration on waves from 1500 to 7000 meters so it is hardly to be wondered at that its performance is poor on the shorter waves. Furthermore, any such receiver, no matter how well designed, when stripped of its regenerative feature, is not on a par with a decent loose coupler and a sensitive piece of galena as a receiver; that is considering the average valve supplied as a detector on ships.

In other words regeneration is the whole story even with an efficient set. Tuning the plate circuit by means of a suitable variometer as was suggested is satisfactory. I use an affair known as the "regenerette." When brought out many years ago by the old Chicago Radio Laboratory for use with loose couplers; this is simply a tapped coil for roughly tuning the plate and a grid coil on a rotor for inductive feedback. This works perfectly right from the first degree on the dial at the first tap. In dropping to the lower waves it is only necessary to short the regular tickler.

This receiver resonates very sharply; consequently all three controls must be varied to shift only a few meters in wavelength. It occurred to me that the obvious thing to do would be to eliminate the antenna series condenser and leave this circuit roughly tuned over a small band. The aerial connection is placed on the right hand binding post of the primary load connections. Then for waves 400 to 800 meters the antenna switch rests on either the second or third tap, depending on the natural period of the aerial. When using the transmitter inductance in series as in a break-in system, the first tap is best. 140 I found to be the best coupling adjustment. This can be determined by test, however.

This leaves but the tuning and regeneration controls; the selectivity and sensitivity are yet satisfactory.

The next thing to occur to me was to use the unused primary condenser so as to control the regeneration on the panel instead of having to reach over to the outside tickler. It was tried as a bypass but didn't allow sufficient variation so it was finally connected so as to tune the plate coil. This worked fine, it only being necessary to change taps on the plate coil for the short waves around 350 meters. There are about 30 turns on the 3 in. form for 500 to 900 meters; below that a tap at 15 and 20 turns is necessary.

The SE-1420 tuner, as I remember it, is on the same order as this though it is more of a precision job, I believe. Anyway, the same ideas are applicable to it. In tuning tube circuits in any tuner the shunt capacities should be maintained at low values for best signals. Series capacitance in the aerial circuit however, should not drop below .0004 or .0005 mfd. for good signal strength.

Yours truly, WM. L. JEPSON.

RADIO ACTIVITIES OF C. R. P. A.

By Bruce Piersall, KDMH, KLJ

The Columbia River Packers Association of Astoria has operated ships and canneries in Alaska for many years, and during the past decade or so, has relied to a great extent upon radio for communication between the company's main office in Astoria and its two canneries, one in Chignik and the other in Nushagak. Due to the fact that the mail arrives and leaves the canneries at monthly

intervals only, the service rendered by "Sparks" is of great value. Even radio messages, however, have usually taken several hours from filing time to delivery, until this last summer when short waves came in for their share of traffic handling, and overcame, as usual, most of the obstacles which have been holding back the longer wave apparatus.

A 15 watt transmitter, belonging to Luverne Shatto, 7KH, of Astoria, was employed. It was of the tuned plate-tuned grid type, using two UX-210 tubes in parallel, with plug-in coils for working on 40, 80 and 600 meters. 450 volts of storage batteries supplied the plate, with a switching arrangement making it possible to use the 500 cycle alternator of the spark set in series with the batteries. This served to increase the signal strength with its added voltage as well as steady the note, but the alternator created such an interference in the receiver that pure d.c. was used almost entirely.

Mr. Al Whittel, secretary of the company in Astoria, is an ardent short wave man and operator of station 7KS, therefore we were able to keep a regular schedule with both 7KS and 7AIX (also of Astoria). Both of these stations handled traffic in a way that would make anyone proud to work them, and we found that this was true of most all the so-called "hams," many of them surpassing commercial operators in good fists and intelligent all-round operating.

The company's vessel *Memnon*, KDMH, is a Shipping Board vessel of 8800 tons, carrying a Federal 2 kw. arc, model "X." With it a nightly schedule was kept with KFS on 2400 meters without trouble, although we noticed that after passing through the Unimak Pass all signals came in considerably weaker than before.

The cannery station, KLJ, at Nushagak, is equipped with a 1 kw. Navy Standard, and is used to keep schedules with the other cannery at Chignik, KNP, and with KMT, Libbyville. The set was designed for warship usage and has an elaborate power panel containing a maze of switches for emergency generator, different ship lights, etc., but most of that paraphernalia is not in use in its present location.

NPL press was copied on a separate honeycomb coil receiver, the SE-1220 being used for handling traffic. The latter receiver, as most everyone knows, was not built to tune up to NPL's wavelength, hence the honeycomb job.

In former years there has been much wailing and gnashing of teeth among Bristol Bay operators who tried to work NPS' spark outfit, but since his installation of the tube CW. last summer and his adoption of a working wave of 2680, all is serene.

In all probability KLJ and possibly KNP will be blessed with 100-watt crystal controlled short wave rigs next spring. The writer is engaged at present drawing diagrams and plans for these sets, which, when installed, will be a great forward step in satisfactory communication between God's country and the land of polar bears, mosquitos and mud.

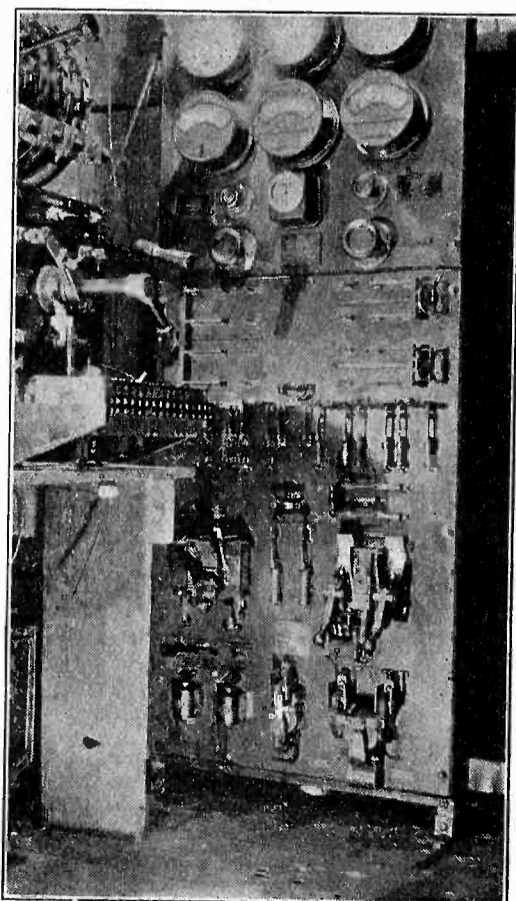

KLJ at Nushagak, Alaska.

RADIO FOR FEBRUARY, 1928

THE NEEDS OF COMMERCIAL RADIO

By L. B. Dustin

(Continued)

(Here is the second installment of the article in which Mr. Dustin takes up the situation at sea, as it is now, always has been, and—But we hope it will soon be corrected. There are some points in this series of articles which it would be well to remember. When the chance comes, you may be able to talk the shipping company out of a good receiver or whatever you need.)

Our next consideration is the receiver. Here there is even more to be wished for, than on the transmitting side, especially considering the fact that an operator who really deserves the name, will use his receiving controls ten times as much as his key.

To begin with, while most of the receiving sets now in commission are ex-crystal tuners, with various kinds of tube detectors and amplifiers attached, the crystal is usually conspicuous by its absence. In fact, as a rule, there is not a good piece of crystal aboard. Have we all forgotten what good work can really be done with a crystal properly selected and used, and at a great deal lower cost than tubes? A crystal detector could be used to advantage for half the time, with a saving in tube and battery upkeep. Any old timer will agree that a first class galena detector is as sensitive as any non-oscillating electron tube. Why then not keep the crystal in commission and use it, unless the operator is DX hungry, even when he is within easy range of any station that may have traffic for him.

To return to the tuner itself. The designers of receiving sets for ships must have been well aware of the operator's weakness for listening in on every other wave than the ship calling wave, when some station is trying to raise them. This is the only way I can account for the narrow latitude of wavelengths of most ship tuners, which, in the days when 300 meters was a standard ship wave, would not tune below 500 meters, and when a great many of the important weather, time signal and press schedules were sent on 2000 to 2800 meters, very effectively failed to reach the desired wave by a few hundred meters. Theoretically I suppose these tuners would respond to wavelengths from 300 to 2500 meters. No doubt they would when coupled to a driver at that frequency, but for all practical purposes at any distance their actual usefulness on those waves was nil. The receiver might as well have been designed to respond only to waves around 600 meters, with a gain in efficiency and saving in space.

To realize the maximum service from marine equipment, the receiver should efficiently respond to a wide band of wavelengths, at least from 300 or lower to 5000 meters. This would include practically all the waves on which weather, hydro information, time signals, press and broadcasts are sent in different parts of the world. In order to cover such a wide band of frequencies it might be necessary to have more than one tuner, but the added gain in possible service would amply justify the expense. It might be contended that press and broadcasts are unnecessary luxuries aboard ship, but that depends upon the viewpoint, whether you are aboard a ship or not.

The added prestige that it gives radio in general, and the operator in particular, who in general has none too much, is certainly worth the comparatively small added expense. The wireless man with his very light duties, as compared with the rest of the crew, is often considered as more or less useless impedimenta aboard ship, especially by the type of old salts who "have sailed without 'em for forty years, and can get along without 'em for another forty."

Although wireless is very valuable to the owners in insurance saving, and in dispatch-

ing vessels and numerous other ways, the amount of work actually performed by the operator is small, and he is naturally apt to be looked on as "the passenger" by others aboard the ship. This attitude is far from being conducive to getting the maximum service which is possible from a station, when there is recognition of its full capabilities, and co-operation and good will toward the operator. Therefore if ships were equipped with receivers which covered the broadcast band, and also the long waves, so that press could be copied, there would soon be a different attitude toward the wireless department and radio in general.

Then, too, there is coming to be more and more information broadcast from radiophone stations, such as weather, time signals and press and market reports, which are of value or interest to vessels, and often available when the longer wave stations cannot be picked up, due to interference, missed schedules, static, etc. Often the master of a radio equipped vessel will be more particular about getting his daily press regularly, scant though it may be, than he will be about weather reports, or time signals, and will judge sparks' ability as an operator accordingly.

So, whether press and broadcasting are considered luxuries or not, they, like many another luxury, are more apt to become considered a necessity than some of the more prosaic, if more useful services that radio can render. At least the "ocean news" is a valuable advertising agent for marine radio that can not be overlooked. It should be remembered also that not a few of the "skippers" of today are the port captains and managers of steamship companies of tomorrow, and the impression they get from their experiences with radio aboard their vessels today will determine their attitude toward it tomorrow when they are in a position to pass still more far-reaching decisions for or against wireless under their jurisdiction.

Personally, I believe it imperative, and becoming increasingly more so, that any station not actually engaged in more or less continuous point to point communication, on a limited number of wavelengths; and ship stations in particular; be equipped with sensitive receivers covering the entire range of wavelengths. A ship station is practically required to furnish everything from music and lectures on 200-550 meters, regular ship communication and compass bearings on 600-900 meters, radio beacon bearings on 1000, up to press and time signals from the hipower stations on waves of several thousand meters. Also with the development and increasing use of the ultra short waves for dependable long distance daylight communication, there will eventually be a need for receivers capable of including the highest frequencies. There is at least one station now sending press on 40 meters regularly. The opportunity to listen to high speed long wave circuits will also aid in improving the receiving standard among marine operators.

Among our friends the BCL's there is a growing and well founded antipathy for the radiating receiver or blooper, which should be encouraged until they ultimately become extinct, as there is no valid reason or excuse for their existence, with the continual improvement of super-sensitive, non-radiating circuits. They are in reality violating the law, in operating an unlicensed transmitter.

A radiating receiver aboard a ship, however, does not necessarily fall under the same ban. In the vicinity of large ports where the number of ship stations within a comparatively small area is large enough that interference from oscillating receivers is possible, there is little likelihood of trouble from this cause. The listening operator is unlikely to keep his receiver above the oscillating point as he approaches the zone of congestion, due to the fact that the added sensitivity is not

needed in such close proximity to the land stations. At sea there is little chance for interference due to the distance between stations, so that it is only a negligible percentage of the time during which a radiating receiver aboard ship can be a source of interference.

There are a number of occasions however, when this radiation can be used to very great advantage, for communication over short distances. How often have many of us been at the point of tearing our hair at the efforts of some newly fledged key artist, to ascertain the name of a passing ship, which is probably almost within hailing distance, on full power or very little less? The operator on the passing ship is probably not on watch, or refuses to answer, but the "old man" has asked sparks to find out "what ship that is," and the conscientious "op" is burning up the air in the vain attempt to find out. There are often more legitimate reasons for carrying on communication with nearby ships or stations, in fact probably the majority of communications, of value in navigating and handling the vessel, are carried on at very moderate or short distances, such as obtaining information regarding docking, local weather and landing conditions, information from nearby vessels, compass bearings and such. For just such cases, the radiation from an oscillating receiver can be very useful for distances up to ten or fifteen miles and more under favorable conditions, with the added advantage of creating practically no interference, and not requiring the use of the large set. Also, (this is to be repeated only in a stage whisper), it might furnish an outlet for the energies of the too enthusiastic key pounder, who is prepared, nay, *itching* for every possible opportunity to lay finger to key.

Accordingly, let it be suggested that a readily available means of keying the receiver radiation for transmitting, be incorporated in receiving sets, and wired into existing ones. If this were universally done, all operators would soon realize its value, and still more "signal space time," be made available for useful occupation.

When this method of communication is used, it is of course the heterodyne note of the other transmitting receiver, that the operator hears, not his own radiation, consequently the two stations can break each other, which is an advantage that no operator will deny. It can be used on any wavelength to which the receiver is capable of tuning, which gives a large range in which to dodge interference. It does not seem that this should meet with any opposition from the powers that be, considering the short range of such radiations, on any wavelength.

Let us consider one more piece of apparatus, the utility of which is fast becoming recognized, but has not been universally enough adopted as yet,—the radio compass installed aboard ships. With radio beacons in operation all along our coasts, and more projected, from which accurate bearings are readily obtainable, there is yet a very small percentage of vessels equipped with direction finders.

Nor is this the only use to which a radio compass can be put by a resourceful operator. A direction finding loop can be used to work through heavy interference. It is very often of importance to know the direction of signals, as for instance in case of vessels passing in a fog. In time of disaster the exact position of an SOS is often impossible to obtain, either because his power is reduced or fails altogether before he can send it. The radio compass equipped vessel can get a direct bearing on the signal and "follow its radio nose."

This is no idle dream. I have an instance in mind where a coastwise passenger vessel, the *Alaska*, bound from San Francisco for Seattle, running through a heavy fog until her position was doubtful, went ashore off the coast of Oregon. In such a case the navigator usually does not know exactly where he is, or he

would give a wider berth to the dangerous spot where he comes to grief. Even supposing he knows the exact position where he is lying helpless, it will often be very difficult for any other navigator to come directly to him through the same fog, or thick weather, to render the immediate assistance which is so urgently necessary in such cases. In this case the nearest ship, which picked up the SOS, although but a few miles away, cruised helplessly around through the pitch dark, foggy night, unable to save the despairing souls, so near and yet so far. The *Alaska's* wireless was in commission the greater part of the night, yet the rescuers could not locate its direction with the usual type of receiver. All that could be done was to wait till daylight and hear from the lips of a few half drowned survivors, the story of the night's horror. This is but an instance of scores of similar cases. Radio direction finders are perhaps too expensive and difficult of operation and installation to be recommended as standard equipment, but they could be installed on the majority of ships with great benefit, and added possibilities of service from the radio room.

To be concluded.

MISSISSIPPI RIVER RADIO

By Bill West, KMOX

Yes there are "mud scows" on the old Mississippi that carry radio, and incidentally, they use it. The Inland Waterways Corporation is an organization operated by the government for the purpose of demonstrating the practicability of freight transportation on the Mississippi River and also on the Warrior River in Alabama.

On the Mississippi section there are six tunnel type towboats which shove tows of 10,000 tons up and down the river, making the trip from New Orleans to St. Louis in approximately eighteen days. Then there are three self-propelled barges, each carrying 1800 tons, that make the same trip but only require three weeks for the entire round trip so that one of the three boats leaves New Orleans each Saturday. In addition there are now four large sternwheel towboats which carry 2 kw. Navy standard sets. The six tunnel type towboats carry regular P-8 2 kw. transmitters. The express barges carry the 1 kw. Navy standard sets. No, there isn't so much interference given the BCLs as the wave is 1100 meters. Incidentally these jobs beat anything at sea—as jobs. There is a certain regularity about the trips that appeal to some of us and yet there isn't the salt sea and the color of foreign ports. The writer had the pleasure and the interesting experience of a berth on one of the express boats, the *Gulfport*, for over a year. So much for the boats.

In order to maintain communication there is a land station at the Memphis, Tenn. terminal. Originally it was a 5 kw. spark but later 100 watts of cw replaced it and now we understand it is 500 watts. It handles all the traffic on the Mississippi section even with the new upper river division between St. Louis and St. Paul which was inaugurated the past season.

This new division will have four towboats in operation this coming season and the sets aboard are all tube. It seems probable that the spark equipped boats will shortly be using cw also.

The Warrior River division has a number of towboats running between Mobile and Birmingham, Alabama, on the Warrior River. There are two land stations on this section, one at Mobile and one at Birmingham. They have recently been converted to cw. There is one boat in service between Mobile and New Orleans running through the Sound that carries a spark transmitter, also a 1 kw spark on 1100 meters. This is the *Tuscaloosa* whose call I forget. Mobile is WPM, Memphis, Tenn. is WPI and some of the other calls are Str.

Mobile KFME, Str. Birmingham KFMJ, Str. Gulfport KFMD; KDVX, KDVI and KDQX are some of the others. Any of the seagoing fraternity may see these boats lying either at the Immigration Station in New Orleans or just below the foot of Canal Street at the Bienville Street docks as well as at various other points in the harbor taking on their cargoes of sugar, canned pineapple, model Ts or bauxite from the Central Americas.

TRs are sent every 3 hours beginning at 6 AM to 9 PM, according to boat lights along the river banks.

SERVICE MESSAGES

By J. J. McArdle, KFS

A few hints on service messages.

SVC—Service
 SYS—See your service
 OUR—Our message date
 RE—Refer
 RD—Report of delivery
 DFS—Disregard former service messages
 ADDS—Address
 UNDELD—Undelivered
 NOB—Not on board
 NAH—No after hours
 NSA—No such address
 NSN—No such number
 NSS—No such street
 GSA—Give same address
 GBA—Give better address
 LC—Addressee said to have left city forward unknown
 YR—Your
 DISPSN—Disposition

Examples of a good service form.

Svc KDSV.
 Gba yr 18 radio 5th Chang sined Sam 8 Waverly Place unknown there.
 San Francisco per KFS 5th.

Svc KFS.
 Sys 18 Radio 5th Chang sined Sam correct adds 9 Waverly Place.

KDSV 5th.

Svc KDSV.
 Yr 15 Radio 5th Weepoo 905 Grant Ave. sined Lee undeld unknown advise.
 San Francisco per KFS 5th.

Svc KDSV.
 Yr 15 Radio 5th Weepoo 905 Grant Ave. now deld DFS.
 San Francisco per KFS 5th.

Svc XBW.
 Yr 9 Radio Maxwell sined Commander undeld NAH.
 San Francisco per KFS 5th.

Svc KFS.
 Sys 9 Radio Maxwell sined Commander deliver in morning RD.

XBW 5th.

Svc KDYK.
 Yr 19 Radio 5th Charles Watson 1100 Bush sined Tom undld LC advise dispsn.
 San Francisco per KFS 5th.

Svc KFS.
 Sys 19 Radio 5th Charles Watson sined Tom cancel, file and check.

KDYK 5th.

Cancel, file and check means, that no further delivery will be made. The message will be filed with charges standing. Some ops use C F and C for cancel, file and check.

JAPANESE SYNOPTIC WEATHER CODE

By L. O. Doran

These coded reports are sent by JTJ Kobe, JFRA Tokyo and JMAA Keijo, Korea. A code group of 5 letters or of 4 letters and 1 figure is sent for each observation station, thus: A UD B 6 or A UD B W.

The first letter indicates the name of the observation station as in the lists hereafter. The second and third letters give the barometer reading according to the tables. The fourth letter defines the weather and wind force according to the tables and the last letter or figure the wind direction.

JTJ and JMAA use the same code (4 letters and 1 figure), except that the code for the list of stations is different. JFRA uses the same list of stations as JTJ but uses a letter code for wind direction.

JMAA Code, First Letter

A—Ishigaki-jima	O—Mokpho
B—Naha	P—Wuelpart Isl.
C—Naze	Q—Dairen
D—Kagoshima	R—Choshun
E—Sakia	S—Tsingtao
F—Nagasaki	T—Shanghai
H—Fusan	U—Mukden
I—Koroyo	V—Ushio-misaki
J—Gensan	W—Niigata
K—Seishan	X—Shoseito
L—Yuki	Y—Yinkow
M—Ryugampo	Z—Tientsin
N—Chemulpo	

The list is not always sent in alphabetical order and all of the stations may not be included.

JTJ and JFRA Code, First Letter

Code	Location	Lat.	Long.
A	Ishigaki-jima, Loo Choo Islands	24	124
B	Naha, Loo Choo Islands	26	127
C	Naze, Loo Choo Islands	28	129
D	Miyazaki, Japan	31	131
E	Shiwomisaki, Japan	33	130
F	Nagasaki, Japan	32	129
G	Shimonoseki, Japan	33	130
H	Chosi, Japan	35	140
I	Hachijo-jima	33	139
J	Chichi-jima, Bonin Islands	27	142
K	Fukui, Japan	36	136
L	Niigata, Japan	37	139
M	Sappora, Hokkaido, Japan	43	141
N	Nemoro, Hokkaido, Japan	43	145
O	Mokpho, Korea	34	126
P	Sonjin, Korea	40	129
Q	Ryojun-ko, Korea	38	121
R	Changchun, Manchuria	43	125
S	Tsingtao, China	36	120
T	Shanghai, China	31	121
U	Hobei, Formosa	25	121
V	Hammatsu, Japan	34	137
W	Asmori, Japan	40	140
X	Fusan, Korea	35	129
Y	Rasa Island	24	131
Z	Macka, Saghalien	47	142

JFRA does not send the list in alphabetical order and may omit several stations. JTJ sends the list alphabetically but may omit several stations.

Barometer, 2nd and 3rd Letters

In the barometer code, double letters running from AA to ZZ are used. The code as originally written applied to readings in millimeters. It has been converted to inches here and somewhat simplified.

Barometer Code

28.35 BU	28.94 HO	29.53 OI	30.12 UD
.39 CE	.98 HY	.57 OT	.16 UN
.42 CO	29.02 II	.61 PD	.20 UX
.46 CY	.06 IS	.65 PN	.24 VY
.50 DI	.09 JC	.68 PX	.28 VR
.54 DS	.13 JM	.72 QH	.32 WB
.58 EC	.17 JW	.76 QR	.35 WL
.62 EM	.21 KG	.80 RB	.39 WV
.66 EW	.25 KQ	.84 RL	.43 XF
.70 FG	.29 LA	.88 RV	.47 XP
.74 FQ	.33 LK	.92 SF	.51 XZ
.78 GA	.37 LU	.96 SP	.55 YJ
.82 GK	.41 ME	30.00 SZ	.59 YT
.86 GU	.45 MO	.04 TJ	.63 ZD
.90 HE	.49 MY	.08 TT	.67 ZN
			.71 ZX
			.75 ZZ

If other letters are received than the two shown after each reading in inches, simply add an extra point for each series of three letters, thus: For UD the reading is 30.12 inches. If UE, UF or UG are received add .01, making the reading 30.13 inches. If UH, UI or UJ is received add .02. If UK, UL or UM is received add .03.

The same sequence applies following any reading, thus:

	Add .01	Add .02	Add .03
28.46	CY-CZ DA DB	DF DG DH DC DD DE	
29.17	JW-JX JY JZ	KD KE KF KA KB KC	
30.12	UD-UE UF UG	UK UL UM UH UI UJ	

The letters in the series from AA to BT are omitted to simplify the code.

Weather and Wind Force Code 4th Letter

Wind Force	Beaufort Scale	Calm	Light	Fresh	Strong	Hurricane	Typhoon
		0-1	2-3	4-5	6-7	8-9	10
Clear	A	A	B	C	D	E	
Cloudy	F	F	G	H	I	J	
Rain	K	K	L	M	N	P	
Snow	Q	Q	R	S	T	U	
Fog	V	V	W	X	Y	Z	

Wind Direction Code

Last letter or figure of each group.	JTJ CODE	JFRA CODE
0—Calm		O or C—Calm
1—NE	F—NNE	T—SSW
2—E	G—ENE	U—SW
3—SE	H—ESE	V—WSW
4—S	E—E	W—W
5—SW	P—ESE	X—WNW
6—W	Q—SE	Y—NW
7—NW	R—SSE	Z—NNW
8—N	S—S	N—N

JTJ follows the synoptic code with another code group of 20 letters which gives the position of the high and low pressure areas. This latter code is not given as it requires extensive translation tables and exactly the same information is sent by JFRA in English following the code report.

In JFRA plain language reports the word TUNGHAI is used for Eastern Sea and the word RYUKYU for Loo Choo Islands.

Japanese Warnings

Form "A" Typhoon and Depression Warnings

Prefix "MS". 16 figures are sent without a break. To translate, the figures are separated into groups as follows:

2 18 12 135 32 2935 14

The different groups have the following meanings:

Groups 1st,	1—Depression	Group 7
	2—Typhoon	00—Unknown
2nd—Date		01—NNE 09—SSW
3rd—Time		02—NE 10—SW
4th—Longitude East		03—ENE 11—WSW
5th—Latitude North		04—E 12—W
6th—Depth in inches		05—ESE 13—WNW
7th—Direction		06—SE 14—NW
		07—SSE 15—NNW
		08—S 16—N

Form "B" Storm and Gale Warnings

Prefix "MS". Three figures are sent. Several of these three figure groups may be combined and sent without a break. The three figures translate according to the following tables:

1st—Location	2nd—Cause of Warning
1—Yellow Sea	1—NE Gale
2—Eastern Sea	2—E Gale
3—Japan Sea	3—SE Gale
4—North Japan Sea	4—S Gale
5—Eastern Sea of Japan	5—SW Gale
6—Southern Sea of Japan	6—W Gale
7—Southeast of Japan	7—NW Gale
8—Near Formosa	8—N Gale
9—North Coast of China	9—Storm threatens
0—South Coast of China	0—Snow storm threatens
	3rd—Remarks
	0—No remarks
	1—Will blow
	2—Will slack tomorrow
	3—Will continue tomorrow
	4—Strong winds but fine weather

Japanese Ship Weather Code

These reports are made at 6 AM, Noon and 6 PM, ship's time when in range of a coast station. Prefix "MS" followed by a preamble in the Japanese telegraphic code, then 10 figures sent without a break. To translate, the figures are separated into 10 groups as follows:

08 18 127 31 2947 03 8 3 6 3

Groups: 1st—Date. 08—8th. 15—15th, etc. 2nd—Time. 06—6 AM. 12—Noon. 18—6 PM.

- 3rd—Longitude East.
- 4th—Latitude North.
- 5th—Barometer in inches.
- 6th—Wind direction. Same as given above

for typhoon warnings except that in the ship's code the figures 00 mean calm.

7th—Wind force. Beaufort scale. 0 to 9.

8th Weather	5—Rough
0—Clear	6—Very high
1—Fine	7—Violent
2—Cloudy	10th Direction of Swell
3—Rain	0—No swell
4—Snow	1—NE
5—Fog	2—E
6—Thunder Storm	3—SE
7—Haze	4—S
	5—SW
9th Sea	6—W
0—Smooth	7—NW
1—Calm	8—N
2—Small sea	
3—Disturbed	
4—Moderately rough	

The example at the end of the first paragraph above would read:

8th, 6 PM, Longitude 127 East, Latitude 31 North, Barometer 29.47 inches, Wind ENE-8, Rain, Very High Sea, SE Swell.

In the Noon and 8 PM exchange of weather reports between ships on the Oriental steamer routes all Japanese ships use the Beaufort Notation Code for weather as follows:

B—Blue sky, clear	M—Mist
BC—Part cloudy	O—Overcast
C—Cloudy	Q—Squally
D—Drizzle	R—Rain
F—Fog	S—Snow

Hong Kong Synoptic Weather Code

Seven groups of figures are transmitted for each observation station according to the following arrangement:

1 2971 99 83 06 2 1

Groups: 1st—Name of observation station as in list.

- 2nd—Barometer in inches.
- 3rd—Temperature, dry bulb thermometer.
- 4th—Ditto, wet bulb.
- 5th—Wind direction, as in table below.
- 6th—Wind force, Beaufort scale 0 to 9.
- 7th—Weather, as in table below.

Missing observations are indicated by the letter "Z."

STATIONS	WIND DIRECTION
1—Nagasaki, Japan	ZZ—Calm
2—Oshima, Loo Choo Islands	00—N
3—Naha, Loo Choo Islands	01—NNE
4—Ishigaki-jima, Loo Choo Islands	02—NE
5—Ichang, China	03—ENE
6—Hankow, China	04—E
7—Changsha, China	05—ESE
8—Shanghai, China	06—SE
9—Foo Chow, China	07—SSE
10—Amoy, China	08—S
11—Swatow, China	09—SSW
12—Taihoku, Formosa	10—SW
13—Koshun, Formosa	11—WSW
14—Pescadores, China Sea	12—W
15—Hong Kong, China	13—WNW
16—Pratas Island, China Sea	14—NW
17—Phulien, Indo China	15—NNW
18—Tourane, Indo China	
19—Cape St. James, Indo China	
*20—Basco, Philippines	
*21—Aparri, Philippines	
*22—Manila, Philippines	
*23—Legaspi, Philippines	
*24—Tacloban, Philippines	
*25—Iloilo, Philippines	
*26—Surigao, Philippines	

WEATHER
1—Fine and clear
2—Cloudy or overcast
3—Rain
4—Fog
5—Thunder storm

*Numbers 20 to 26 are not sent in the evening report.

This code report is followed by a plain language report giving general conditions in Oriental waters. Typhoon warnings follow the plain language report when necessary.

Indo China Weather Reports

These reports are compiled by the Phulien Observatory, located near Haiphong in Tongking. The plain language report (in French) gives observations at 4 PM (local time) at various points on the coast, and is made up as follows:

1st—Barometer. Given in figures for Hong Kong, Phulien and Cape St. James and whether rising, falling or stationary at other places.

2nd—Wind direction and force in Beaufort scale.

3rd—Weather.

4th—Temperature. Centigrade scale.

5th—State of the sea.

The information is sent in this order for each observation station. A translation table for the French words most commonly used is also given. The French "E" is often used in these reports (...).

The coded report gives observations taken at 6 AM, local time, and is composed of four groups of figures, one group to each station as follows:

1st—Phulien, Tongking.

2nd—Cape Tientcha. Near Tourane.

3rd—Cape St. James. Near Saigon.

4th—Fort Bayard. Kwang Chow Wan.

Each group except the last contains 7 figures. The first 3 figures indicate barometer readings in millimeters with the initial figure 7 omitted, thus: 547 equals 754.7 m/m.

The next two figures indicate wind direction according to the table on the next page.

The next indicates wind force in Beaufort scale 0 to 9.

The last figure indicates the state of the sea according to the table and is omitted from the last group.

When the observations of any station are missing, the whole group is sent as zeros.

Conversion Tables

BAROMETER

Millimeters to Inches (1 m/m equals 0.03937 inches)			
m/m	Inches	m/m	Inches
710	27.95	740	29.13
711	.99	741	.17
712	28.03	742	.21
713	.07	743	.25
714	.11	744	.29
715	.15	745	.33
716	.19	746	.37
717	.23	747	.41
718	.27	748	.45
719	.31	749	.49
720	28.35	750	29.53
721	.39	751	.57
722	.42	752	.61
723	.46	753	.65
724	.50	754	.68
725	.54	755	.72
726	.58	756	.76
727	.62	757	.80
728	.66	758	.84
729	.70	759	.88
730	28.74	760	29.92
731	.78	761	.96
732	.82	762	30.00
733	.86	763	.04
734	.90	764	.08
735	.94	765	.12
736	.98	766	.16
737	29.02	767	.20
738	.06	768	.24
739	.09	769	.28

Add .004 inch for each tenth millimeter. Thus 750.5 m/m equals 29.53 plus .02 or a total of 29.55 inches.

If the reading in millimeters is above or below those given in this table multiply the reading in m/m by .03937.

Thermometer Centigrade to Fahrenheit	Thermometer Centigrade to Fahrenheit	Thermometer Centigrade to Fahrenheit
C. F.	Fahrenheit	Fahrenheit
0—32	12—53.6	25—77
1—33.8	13—55.4	26—77.8
2—35.6	14—57.2	27—80.6
3—37.4	15—59	28—82.4
4—39.2	16—60.8	29—84.2
5—41	17—62.6	30—86
6—42.8	18—64.4	31—87.8
7—44.6	19—66.2	32—89.6
8—46.4	20—68	33—91.4
9—48.2	21—69.8	34—93.2
10—50	22—71.6	35—95
11—51.8	23—73.4	36—96.8
	24—75.2	37—98.6

Indo China Typhoon Warning Code

Example: "Obs de Phulien le 4 a 17h45 Typhon Signalez 1521246."

The date is indicated by "le," the hour by "a" and the minutes by "h."

The first two figures of the group indicate Latitude N. The next two indicate Longitude East with the initial figure omitted, thus 21 equals 121.

The 5th and 6th figures indicate the direction or condition as in tables 1 and 2.

(Continued on page 60)

FOREIGN RADIO BROADCASTING

By Lawrence D. Batson,
Electrical Equipment Division

Broadcasting is now provided by 431 stations in 57 foreign countries, in addition to the 685 operating in the United States and its non-contiguous territories. Europe has 196; North America outside the United States, 128; South America, 52; Asia, 18; Oceania, 28; and Africa, 9.

The division of stations by countries gives Canada, 59; Cuba, 47; Russia, 38; Sweden, 30; Australia and Germany each, 24; Argentina, 22; United Kingdom, 20; France and Mexico each, 18; Spain, 15; Brazil, 12; Chile, 9; Finland, 7; Switzerland, 6, and Austria, 5. There are 4 each in Belgium, Czechoslovakia, Uruguay, India, Netherlands East Indies, and New Zealand; 3 each in Italy, Poland, China, Japan and South Africa; 2 each in Denmark, Estonia, Hungary, Irish Free State, Norway, Portugal, Bolivia, and Algeria, and 1 each in Iceland, Latvia, Lithuania, Luxembourg, Netherlands, Turkey, Yugoslavia, Costa Rica, Haiti, Paraguay, Peru, Venezuela, Ceylon, Chosen, Kwangtung, Straits Settlements, Canary Islands, Egypt, Morocco and Tunisia.

Outside the United States, the most powerful broadcasting stations are those at Motala, Sweden, and Moscow, Russia, these two having 40,000 watts each. Russia also has a 20,000-watt station at Moscow, and one of 10,000 watts at Leningrad. Daventry, England, operates on 16,000 watts. A station of power ranking above 40,000 watts is reported to be under consideration in the Netherlands.

BUSINESS OF BROADCASTERS

The broadcasting service of foreign countries is provided by governments, organizations, merchants, manufacturers, broadcasting companies, and private citizens. The ownership of 34 broadcasting stations has not been reported.

Governments own and operate 77 stations; associations and institutions 87; commercial and industrial establishments 69; broadcasting companies 127; and private citizens 33. Of the government stations, 2 are municipal, 16 provincial, and 59 national, the latter being subdivided into 33 operated by ministries of communication, 2 by ministries of education, and 4 by ministries of war, the 20 stations in the United Kingdom being administered by an independent government broadcasting commission.

Radio organizations operate 65 of the 87 stations in the organization group, church organizations 6, and educational institutions 5. Aviation, political, military, radio merchants' and theosophical societies operate the remainder.

Merchants, mostly electrical and radio, have 35 stations, manufacturers maintaining 5. The stations operated by publishers number 15, most of these newspapers, by railways 3, and grain dealers and farmers co-operatives 2 each; telephone companies, hotels, sales agents, theaters, and power companies are represented by but a single station each.

Radio amateurs account for the largest number of the broadcasting business group, with 40 stations. Nationwide chains include 29 stations, 21 of them being owned by companies holding national broadcasting monopolies. Local broadcasting companies each operating but a single station number 31. Regional monopolies with exclusive broadcasting rights in only a limited part of the country, own 27. Private citizens, control 33; in a sense these are of the amateur class though their stations are of the broadcasting classification.

Fifteen broadcasters have part time use of stations owned by other organizations. Four of these are church organizations, 1 a radio society, 2 are publishers, and 1 a railway, the latter having arrangements with 8 stations in different cities.

LIST OF BROADCASTING STATIONS

The following list of broadcasting stations is taken from the files of the Electrical Equipment Division, into which is gathered all available material regarding foreign broadcasting stations. Reports from representatives of the Departments of State and Commerce stationed in foreign countries are the source of considerable information included. Additions and changes are largely from the pages of foreign radio magazines; much data has been supplied by American companies.

City	Call	Wave-length Meters	Power Antenna Watts
EUROPE			
Austria			
Graz	365.8	500
Innsbruck	294.1	500
Klagenfurt	272.7	500
Vienna	ORV	577	1,500
Vienna	517.2	7,000
Belgium			
Antwerp	265.5	100
Brussels	BAV	508.5	1,500
Liege	205	100
Liege	294.1	100
Czechoslovakia			
Bratislava	OKR	300	500
Brunn	OKB	441.2	300
Brunn	OKB	441.2	500
Prague	OKP	384.9	5,000
Denmark			
Copenhagen	337	700
Soro	1,153.8	1,500
Estonia			
Tallinn	1,200	100
Tallinn	408	500
Finland			
Bjorehborg (Pori)	254.2	100
Helsingfors	500	1,000
Helsingfors	240	2,000
Jakobstad (Pietersaarki)	275	200
Jyvaskyla	297	200
Lahtis	318	180
Tammerfors (Tampere)	400	250
France			
Agen	2BD	297	250
Bordeaux	419	1,500
Chateau Thierry
La Bamboul
Lyon	YN	480	1,000
Lyon	291	500
Marseilles	351	300
Mont de Marsan	390	300
Montpellier	252.1	200
Paris	350	500
Paris	341	1,000
Paris	308	250
Paris	1,750	3,000
Paris	EPTT	458	1,000
Paris	FL	2,650	4,000
Rennes	294	1,500
Toulouse	MRD	260	1,000
Toulouse	389.6	2,000
Germany			
Berlin	438.9	800
Berlin	566	400
Berlin	AFT	1,250	4,000
Bremen	400	140
Breslau	315.8	750
Dortmund	283	300
Dresden	294.1	700
Elberfeld	468.8	750
Frankfort-on-Main	428.6	750
Freiburg	577	750
Hamburg	394.7	4,000
Gleiwitz	250	750
Hanover	297	750
Kassel	272.7	750
Kiel	254.2	750
Koenigsberg	329.7	4,000
Langenburg	468.8	2,500
Leipzig	365.8	750
Muenster	241.9	1,500
Munich	535.7	300
Munich	535.7	4,000
Nurnberg	303	750
Stettin	252.1	750
Stuttgart	379.7	4,000
Hungary			
Budapest	MTI	555.6	2,000
Budapest	1,050	400
Iceland			
Reykjavik	333.3	100
Irish Free States			
Cork	6CK	400	1,000
Dublin	2RN	319.1	1,500
Italy			
Milan	IMI	322.6	1,500
Naples	INA	333.3	1,500
Rome	IRO	449	3,000
Latvia			
Riga	KCX	526.3	2,000
Lithuania			
Kovno	2,000	2,000
Luxemburg			
Luxemburg	217.4	250
Netherlands			

City	Call	Wave-length Meters	Power Antenna Watts
Hilversum	HDO	1,060	1,000
Norway			
Bergen	370.4	1,500
Oslo	370.4	1,500
Poland			
Krakow	422	1,300
Poznan	270.3	1,300
Warsaw	1,111.1	8,000
Portugal			
Lisbon	PIAA	267.8	500
Lisbon
Russia			
Astrakhan	RA26	700	1,000
Baku	RA45	750	1,200
Bogorodsk	RA8	750	700
Dneprovsk	RA30	525	1,000
Erivan	RA49	950	1,200
Gomel	RA39	925	1,200
Irkutsk	RA57	1,100	500
Ivanovo-Vosnesensk	RA7	800	900
Kharkov	RA43	475	4,000
Kiev	RA45	775	1,200
Koursk	RA34	750	1,000
Krasnodar	RA38	513	1,000
Krementchug	RA60	400	50
Leningrad	RA42	1,000	10,000
Leningrad	RA59	150	350
Minsk	RA18	950	1,200
Moscow	RA1	1,450	40,000
Moscow	RA2	450	500
Moscow	RA3	675	20,000
Moscow	RA4	450	300
Nizhni-Novgorod	RA13	840	1,800
Novo-Sibirsk	RA32	1,117	4,000
Odessa	RA40	1,000	1,200
Orechovo-Suev	RA53	850	80
Petrovavlovsk	RA64	350	45
Petrovavlovsk	765	2,000
Rostov	RA14	820	4,000
Saratov	RA32	420	200
Stavropol	RA20	675	1,200
Sverdlovsk	RA15	1,050	500
Tashkent	RA27	800	2,000
Tiflis	870	4,000
Tiflis	RA11	2,100	300
Tomsk	RA21	300	150
Vel Ustjuk	RA16	1,010	1,200
Vladivostok	RA17	456	1,500
Vologda	RA41	700	1,200
Voronezh	RA12	950	1,200
Spain			
Barcelona	EAJ1	344	1,000
Barcelona	EAJ13	277.8	1,000
Bilbao	EAJ9	438	500
Bilbao	EAJ11	294.1	500
Cadiz	EAJ3	344	500
Cartagena	EAJ16	294.1	500
Madrid	EAJ2	400	500
Madrid	EAJ7	375	1,000
Malaga	EAJ25	50-250	100
Oviedo	EAJ19	201.3	100
Salamanca	EAJ22	405	500
San Sebastian	EAJ8	272.7	500
Seville	EAJ5	400	1,000
Seville	EAJ17	344	500
Zaragoza	EAJ23	566
Sweden			
Boden	SASE	454.5	1,000
Boras	SMYB	230	250
Eskilstuna	SMUC	275.2	250
Falun	SMZK	400	750
Gavle	SMXF	204.1	250
Goteborg	SASB	416.7	1,000
Halmstad	SMSB	215.8	250
Helsingborg	SMYE	235	250
Hernosand
Hudiksvall	SMSL	248	250
Jonkopings	SMZD	201.3	250
Kalmar	SMSW	253	250
Karlsborg	SASF	1,365	5,000
Karlskrona	SMSM	201.3	250
Karlstad	SMXG	220.6	250
Kristinehamn	SMTJ	202.7	100
Linkoping	SMUV	588.2	250
Malmo	SASC	229	1,000
Motala	1,304.5	40,000
Norrkoping	SMVV	272.7	250
Orebro	SMTI	566	250
Ormskoeldsvik
Ostersund	720	1,000
Saffle	SMTS	252.1	500
Stockholm	SASA	416.7	1,500
Sundsvall	SASD	545.6	1,000
Trollhattan	SMXQ	277.8	1,000
Uddevalla	SMZP	294.1	100
Umea	SMSN	252.1	250
Varberg	SMSO	297	100
Switzerland			
Basel	HB3	1,000	300
Berne	411	1,500
Geneva	HB1	760	500
Lausanne	HB2	850	600
Zurich	500	1,000
Zurich	100	50
Turkey			
Osmanieh	1,200	6,000
United Kingdom			
Aberdeen	2BD	500	1,500
Belfast	2BE	306.1	1,500
Birmingham	5IT	326.1	1,500
Bournemouth	6BM	491.8	1,500
Cardiff	5WA	353	1,500
Daventry	5XX	1,600	16,000

(Continued on page 59)

With the Amateur Operators

A LOW POWER MASTER OSCILLATOR

By Francis Churchill

This transmitter consists of a low-powered oscillator and an associated amplifier, the frequency of transmission being determined by the master oscillator. The amplifier is regenerative, so a 112 tube as an oscillator will swing the grids of a pair of 210 tubes very nicely. Even a 201A tube will work if the adjustments are made properly.

In order to cover the 20, 40, 80 and 150 meter bands, it was necessary to use an inductance system which would make it possible to simply plug in different coils for the different bands. This is easily accomplished in the amplifier since the plate coil has only two leads. But the usual Hartley or other circuits do not lend themselves readily to plug-in coil systems. The ultra-audion circuit works fine on short waves, 5 and 20 meters, but is inefficient above that. Changing it as shown in Fig. 1 to a modified Colpitts circuit by adding the midget condenser C_4 from grid to filament, makes it an efficient oscillator for any amateur band. The advantage of this circuit is that the inductance has only two leads so can be readily used as a plug-in coil.

When a 112 oscillator is used with one or two 210 amplifier tubes or a 201A oscillator with 112 amplifiers, a nice arrangement can be used in the amplifier circuit. A high negative bias is used on the grids of the amplifier through a r.f. choke, and this causes the plate current of the amplifiers to fall to about zero if the oscillator is turned off or the transmitting key is open. This arrangement is used in one of the largest west coast broadcast stations and saves a lot of high-powered costly tubes when anything goes wrong. The theory of the circuit seems to be that the amplifier takes power from the oscillator during the positive half of the r.f. cycle and furnishes power to the plate circuit L_1C_1 . This circuit L_1C_1 acts as a sort of tank circuit and supplies the antenna with power in the usual manner.

The amplifier is coupled to the antenna by means of the usual loosely coupled antenna coil and the antenna tuned to resonance by means of a series condenser. The coupling to the oscillator is through a small variable condenser C_3 of 50 mmf. maximum value. C_3 can

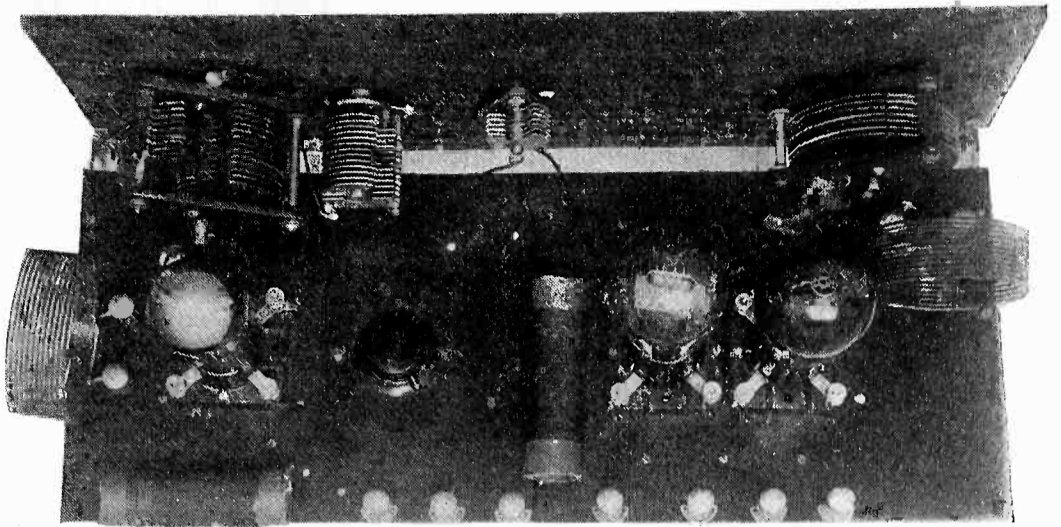

Rear View of Completed Transmitter.

be connected to either the plate or grid end of the coil L_2 .

The oscillator can be crystal controlled if a good quartz crystal is available, but for all practical purposes the oscillator as shown is quite effective and the emitted wave is very steady and there is no waver when received on an oscillating receiver. The oscillator is arranged so that voice transmission may be used by throwing the two single pole switches shown in Fig. 1 and leaving the transmitting key closed.

The "modulation" transformer consists of an old bell ringing transformer with the 14 volt winding connected through a switch, a 6 volt battery and a hand-transmitter. The 110

volt winding is in series with the B battery and so when the transmitter is spoken into, the voltage varies on the plate of the oscillator. The bell transformer gives about a 1 to 8 ratio so that the plate battery is added to and subtracted from sufficiently to give a good percentage of modulation. For low power this method is superior to loop modulation.

While on the subject of amateur phones, the arrangement shown in Fig. 2 can be used very nicely for using phones with a 50 watt oscillator. The modulator is a 171 tube with a 45 volt negative bias on the grid. The modulation transformer should be of the usual type with a ratio of 25 or 30 to 1 and a $\frac{1}{4}$ or

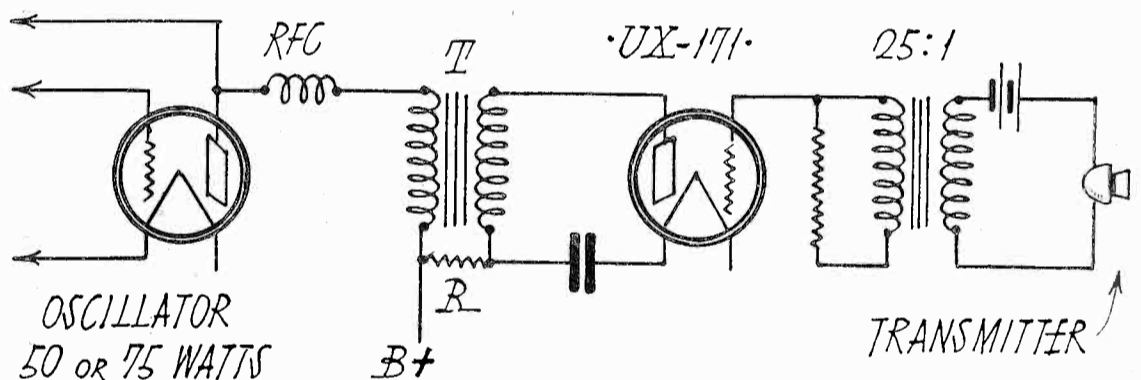

Fig. 2. Circuit for Using Phone With 50 Watt Oscillator.

$\frac{1}{2}$ megohm leak shunted across the secondary.

The transformer T can be an ordinary 20 or 30 henry filter choke with a "primary" winding put on for the plate circuit of the 171 modulator tube. The ratio should be between 2 to 1 up to 5 to 1 depending on the type of 50 or 75 watt tube used. The higher the plate impedance of the oscillator is, the greater the ratio allowable. This means that if the filter choke has 4000 turns, the primary turns should be somewhere between 800 and 2000.

The 1 mfd. condenser C acts as an audio frequency return and the resistance R is used to lower the plate voltage to 180 volts for the 171. This resistance R should be about 40,000 ohms and capable of carrying 20 mils continuously when 1000 volts are used on the oscillator plate. The resistance should be adjusted in value until the plate of the 171 tube is about 20 mils.

Coming back to the transmitter shown in Fig. 1, the four r.f. chokes merit attention. These chokes were made to cover all of the amateur bands and are made as follows: on a 1 in. cardboard tube, which has previously been coated with a mixture of celluloid and acetone and then baked, wind about 30 turns of No. 34 or 36 d.s.c. wire spaced slightly. Then continue the winding for about 120 turns

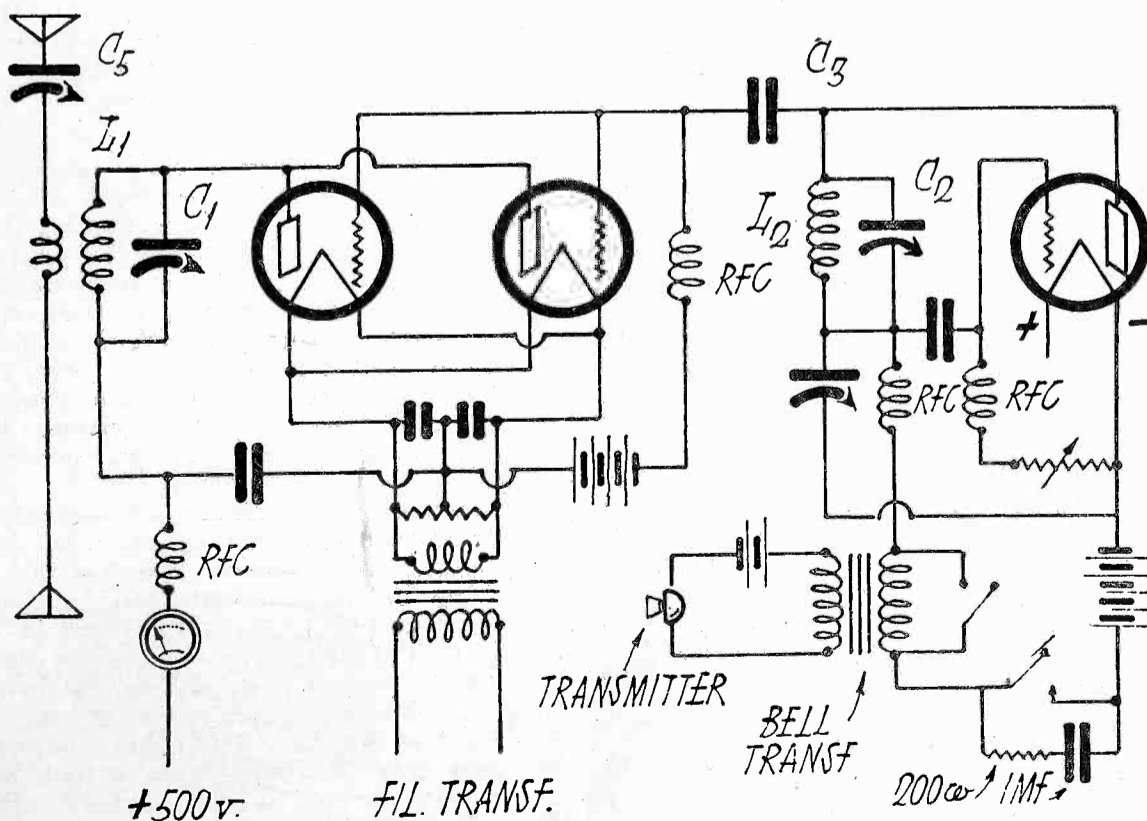

Fig. 1. Modified Colpitts Circuit for Short Wave Transmitter.

more wound close together, then add another 150 turns bunch wound. This choke should be connected with the space wound end of the choke towards the grid or plate connection.

Measurements of these chokes by means of beat oscillators, showed an effective capacity of less than 1 mmf. as an average. Coating lightly the finished winding with a mixture of celluloid and acetone increased the effective capacity about 1 per cent which is negligible, so it is advisable to thus make the choke moisture proof. The same number of turns wound on the same form but with turns close together gave a coil with a capacity as high as 3 mmf. except at resonance of fundamental or harmonics of the coils.

This transmitter wasn't made to be copied exactly but simply to suggest some helpful hints or problems for the amateur who is interested in transmitting with key or by phone. If the keying arrangement shown in Fig. 1 is used, a switch should be used to short circuit the bell transformer winding in order to prevent a warble in the emitted wave. The key sparking, including key click, can be largely eliminated by means of a 200 ohm resistance and a 1 mfd. condenser in series, shunted across the contacts of the key.

In adjusting such a set, the condensers C_4 and C_3 should be set at minimum value to start. The C battery of the amplifier should be sufficiently high in value to reduce the amplifier plate current to a few mils when the oscillator key is open. C_4 should be increased enough so that the oscillator functions smoothly with a minimum plate current. C_5 , C_3 and C_1 should then be varied, after C_2 and L_2 are on the proper wavelength, until the antenna current is a maximum and can be keyed properly.

RADIO NU-6EA

The picture shows the 20-meter transmitter at nu-6EA, owned and operated by Howard C. Seefred at 343 South Fremont avenue, Los Angeles, California, U. S. A. This transmitter consists of a UV-203A (50 watt) tube with 1100 volts of raw a.c. on the plate in a Hartley circuit. The receiver is a three coil regenerative with two steps of a.f. Both transmitter and receiver are home-made.

The antenna is a four-wire cage hanging from the top of a 101-ft. pole. No counterpoise or ground is used. The same antenna is used on the receiver with no ground connection.

The harmonic system works the best at this location, which is surrounded by apartment houses and hotels. QRM is bad at times from autos and power line leaks. Despite these difficulties, this 20-meter radio station has held two-way communication with eg-6YV (Mr. S. F. Evans, No. 3 Clarence Crescent, Whitley Bay, Northumberland, England), oz-2AC (Gisborne, New Zealand), oz-2XA (Wellington, New Zealand), and WNP (S.S. Bowdoin,



20-Meter Transmitter at 6EA.

located in harbor north of Labrador, QSRed radiogram to Glendale, Calif., for radio operator's mother). Its 20-meter signals have been reported heard by eg-5HS (London England), eg-6MU (Belfast, Northern Ireland), sc-2AH (Valparaiso, Chile), and Mr. Frank Pemberton, No. 115 Cambridge Road, Wimbledon, London, England.

A GOOD SHORT WAVE FONE

By R. Wm. Tanner

There has been a lot of talk against the 85 meter fones. Poor modulation and plate supply and swinging seem to be the greatest objections. It is well known that constant current modulation gives the most perfect speech and that a master oscillator power amplifier set emits a purer, steadier note than an oscillator coupled direct to the antenna.

To construct a M.O.P.A. radio fone with constant current modulation would require a lot of power tubes, due to the fact that the modulator must be the same size as the tubes to be modulated. In this type of transmitter, good results cannot be had by modulating the oscillator. Therefore the power amplifier must be modulated. Supposing two UV-210's are

to that required by the UV-201-A tubes, although a fixed resistance can be used here. A 30 henry iron core choke is connected in the positive lead going to the plates of the modulator and intermediate amplifier. The C bias for the modulator is between 4 and 6 volts and about the same for the speech amplifier, depending on the plate voltage.

The transformer between the modulator and speech amplifier should be of the very best and have a ratio of not more than 3 to 1. The modulation transformer can be an amplifying transformer with the primary removed and 150 turns of No. 26 wire wound in its place. A Clarostat shunted across the secondary of the amplifying transformer makes a fine volume control and keeps the speech clear of blasting.

A Western Electric 284-W microfone is the best I have used. In case one of these is not at hand, any good low resistance mike can be used. A very neat mounting for the microfone can be made by taking an old bakelite variometer and removing the stator windings and the rotor. Suspend the microfone, minus the shell, on pieces of rubber 1/2-in. wide inside of variometer stator. Cover holes with gold cloth and you have a good imitation of

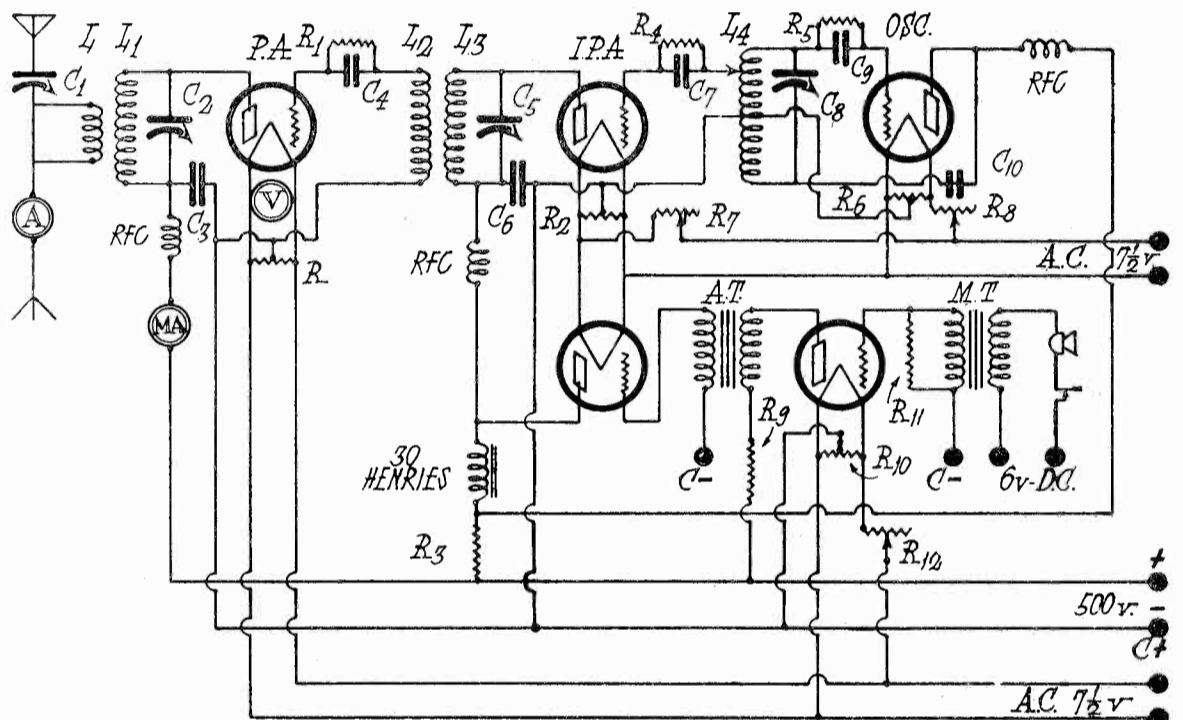

Fig. 1. Circuit Diagram for 85-Meter Fone Transmitter.

C_1, C_2, C_5, C_8 —.0005 mfd. condensers
 C_3, C_6 —.002 mfd. condensers
 C_4, C_7, C_9, C_{10} —.0005 mfd. condensers
 L_1, L_2 —7 turns No. 12 wire
 L_3 —16 turns No. 12 wire
 L_4 —15 turns No. 12 wire tapped in center
 R_1, R_2, R_6, R_{10} —200 ohm potentiometers

R_3, R_4 —5,000 ohm grid leaks
 R_5 —10,000 ohm grid leaks
 R_7, R_8 —Clarostats
 R_9, R_{11}, R_{12} —10 ohm rheostats
 R_{10} —.25 megohm
 A —0 to 2 amp. hot wire ammeter
 MA —0 to 150 MA milliammeter
 V —0 to 10 v. a.c. voltmeter

to be used as amplifiers. This would require two of the same tubes as modulators and would be quite costly. Cost is usually the first consideration with the average amateur.

It is possible to use an intermediate amplifier between the main amplifier and the oscillator so that constant current modulation is accomplished on this tube. In this case two UV-210's are used as power amplifiers, a UV-201-A as intermediate with a UV-201-A as modulator. The oscillator also uses a UV-201-A tube. The circuit is shown in Fig. 1.

A speech amplifier is shown, although not absolutely necessary. It makes it possible to place the microphone farther away from the operator, thereby cutting out a lot of distortion. The plate supply should be 500-v. direct current from B batteries or motor generator. However, rectified alternating current can be used if properly filtered.

All coils are space wound of No. 12 enameled aerial wire on cardboard tubes 3 in. in diameter. The choke coils have 150 turns of No. 33 s.s.c. wire on small cardboard tubes. I used tubes taken from flashlight cells. Two Clarostats were used to cut down the voltage

the microphones used in broadcast stations.

A few words in regard to tuning will not be out of order. Get oscillator working first. A Hartley oscillator was used in this set as it is almost impossible to keep it from oscillating. Insert hot wire ammeter in series with C_5 temporarily. Tune intermediate amplifier for highest current. Put the hot wire ammeter in aerial lead and tune main amplifier and antenna circuit for highest radiation. Retune all condensers until antenna current is highest with low plate current.

Neutralizing the amplifiers was not necessary in my case as no trouble was experienced with oscillations. Probably this was due to the set being built in units and each unit spaced. If oscillations are troublesome in the amplifiers it is very easy to neutralize them.

It was found that grid leaks and condensers in the amplifiers were as good as C batteries, and easier to install. A 10,000 ohm leak in the oscillator gave almost as much output with lower plate current as one of 5,000 ohms. The intermediate amplifier grid tap on the oscillator inductance is not at all critical. Fixed

(Continued on Page 45)

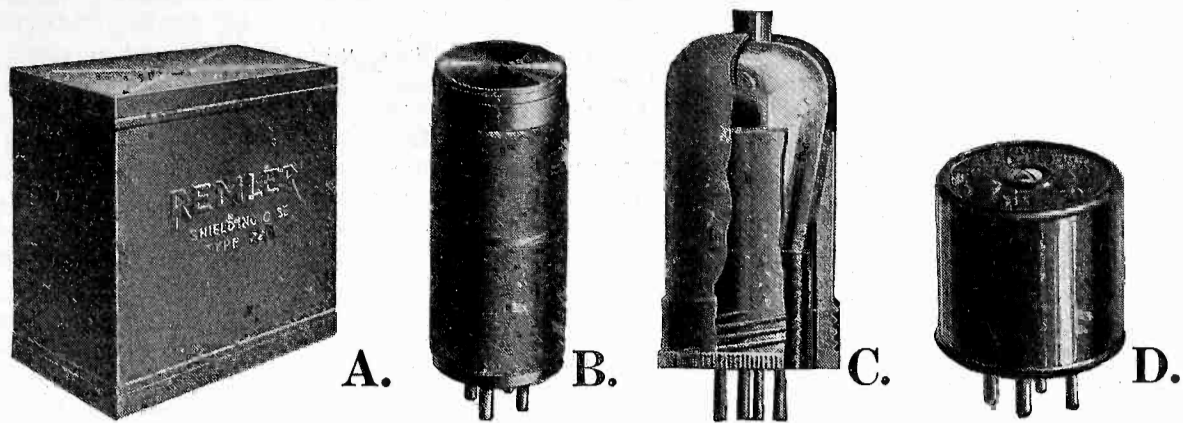

Parts You Need

In the New Shielded Grid Tube Circuits

—of course they carry the name . .

REMLER

Radio grows—and grows—and grows. With every new and worthwhile development, there comes a Remler part to meet the exact requirements of the circuit. These parts are the result of exhaustive laboratory experiments, plus specialized factory experience. Ten years of radio knowledge is back of every Remler part. A reputation for absolute reliability is our greatest asset.

The new shield-grid tube circuits require parts of uniform high quality. That means that you need the four new items illustrated above.

A. A pure sheet copper shielding case which brings to the individual constructor a refinement heretofore available only to the manufacturer with elaborate facilities.

No. 720—Remler Shielding Case.....Price \$3.00

B. A series of plug-in radio frequency transformers satisfying a large range of requirements, demanding a minimum of space and offering a maximum of convenience.

No. 550—Interchangeable Inductance Antenna CouplerPrice \$3.00

No. 551—Interchangeable Inductance Antenna CouplerPrice \$3.00

No. 560—Interchangeable Inductance Interstage TransformersPrice \$3.00

No. 561—Interchangeable Inductance Interstage TransformersPrice \$3.00

No. 570—Oscillator InductancePrice \$4.50

C. A series of tube shields providing electro-static shielding and freedom from tube vibration and microphonic noise.

No. 54—Ballast ShieldingPrice \$1.00

No. 55—Ballast ShieldingPrice \$2.00

No. 56—Tube ShieldPrice \$1.00

D. Long-wave coupling devices designed to meet the exacting requirements of the shield-grid tube; sharply tuned to 115 k.c.

No. 612—Interchangeable Inductance (Input)Price \$4.00

No. 614—Interchangeable Inductance (Interstage)Price \$4.00

The other Remler parts shown below also deserve a place in your shielded tube circuit. The fact that they are specified so often in leading circuits, is proof of their worth.

SOLD THROUGH JOBBERS

Remler Division of

Gray & Danielson Manufacturing Company

260 FIRST STREET
SAN FRANCISCO

NEW YORK

Eastern Warehouse: Elkhart, Ind.

CHICAGO

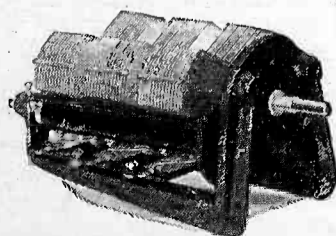

3-in-Line Condenser

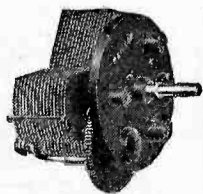

Twin-Rotor Condenser



Improved Socket



Choke Coil

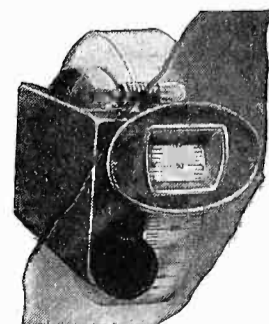

Drum Dial

"KFLF"

By Wallace S. Wiggins, 6CHZ

You have read of the amateur radio operator's deeds of distance, daring and discovery. He can truly say: "The world's mine oyster—even with low power," as his activities are confined only by the physical limits of the earth. The amateur has rushed to the rescue during times of emergency in peace and in war, establishing communication by radio where other methods failed. He has discovered the great possibilities of short waves and has made countless experiments for the benefit of the science. These activities, more or less spectacular, have drawn public attention and admiration by their strikingly unusual aspects, while other worthy accomplishments are unnoticed; except by the amateur "fraternity," perhaps. The following story is one of an amateur operator's devising, determination and dependability. While lacking in much of the sensational, it is accompanied by the satisfaction of having contributed to the large list of amateur radio achievements.

On the night of July 10, 1927, there sailed out of Los Angeles harbor the trim little Diesel-yacht *Ripple*, owned by E. Clem Wilson, oil tool manufacturer of Los Angeles. The *Ripple* is a twin-motored yacht of 113 ft. steel construction with all modern conveniences and is electrically equipped throughout. She was bound for the south seas on a pleasure trip, via the Hawaiian Islands. On board were the owner, his family and guests, and a crew of sixteen. On the top after-deck was a tiny house, from which there ran two wires: one to a four-wire affair between the two masts, and the other and shorter one to a "Pyrex" insulator, a comparatively few feet above the roof of the "shack." Inside the shack was an installation of "lots of radio in little space," one non-skid chair (when anchored), and a long bunk to accommodate the ample longitudinal dimensions of the chief and only operator, L. Elden Smith.

Before he became engaged in "commercial brasspounding," Smith was the operator of amateur station 6BUR, located at Whittier, California, and known the world over for loud and consistent signals. He was section communications manager of the Los Angeles section of the A. R. R. L., and was actively engaged in other radio work including that of the duties of secretary-treasurer of the L. A. Chapter of the I. R. E.

The radio installation on the *Ripple*, signing KFLF, included a "rejuvenated" half kw. 600 meter transmitter (Marconi P5), using one 204-A tube. Operation of this set was fairly successful over short distances. Power was supplied from 110 volt d.c. mains to a 500 cycle motor-generator, and stepped-up by a 500 cycle transformer. This power supply was used for both long and short wave transmitters.

The short wave set, operating between 33 and 45 meters, was a neatly mounted job adjacent to the other transmitter and having its own 204-A tube which was run at an input of from 250 to 300 watts. The "tuned-plate tuned-grid" circuit was used, more of which will be said later. Filament current was supplied by a rotary converter from the 110 d.c. which delivered 11 volts a.c. to the filament through a transformer. Due to fluctuations in the ship's generator voltage, the filament voltage varied also, and it was under these conditions that the "A" tubes proved to be ideal for the work and performed perfectly. The antenna was a single wire with a fundamental of 33 meters, and was run from the shack to the after mast at a slight angle.

Receiving equipment consisted of three sets: CR-6 and CR-7 Grebes covered the long wave bands, while an ordinary "Schnell tuner" with built-in one step audio amplifier in a Grebe CR-9 panel, for vernier use, covered the lower bands. It was on the latter set that most of the traffic was handled. A flock of Burgess B batteries were used which came in handy for plate supply to a temporary 301-A tube transmitter on the return voyage from Hawaii. So much for the equipment.

When the *Ripple* sailed from Los Angeles, the transmitters had not been given their final test because of the limited time for installation. We, who were "standing by" at 6CHZ and 6CQA (6XF-6BRD was not on at that time), listened in vain for two days. I had announced my intention of taking a share of the schedules with KFLF and an equal share of the traffic (free of charge: Mr. Radio Inspector please notice). Several people, including myself were getting rather skeptical about the success of KFLF, when one night I was called on the phone by Don Wallace, 6AM, of Long Beach, (S. C. M. of Los Angeles Section, A. R. R. L.), who informed me that KFLF was calling on 33 meters. I listened, without results, until it finally dawned upon me that my receiver wouldn't go down

to 33 meters! Hastily making the change, I was finally QSO (in communication with) KFLF, and received a message that was not number one!

Explanations followed and it was learned that the yacht had run into some of the worst seas of the whole trip. It had become necessary for Smith to acquire "sea-legs" in a single day, in order to get the set in operation. The first night, all movable articles on the table promptly slid to the floor. These were accordingly made secure and all connections were tightened. The next job was to decrease the very severe electrical noises from non-grounded, lead-covered cables and from the electrical apparatus on board. The worst offenders were the electric fans (very popular at that season), the ice-machine motor, and various and assorted pump motors. With most of this interference eliminated after two days of hard work, one of the most consistent communication circuits by amateur radio was established which lasted for four months and one week. Of the entire time, only two nights were missed and this was due to trouble with the 110 volt ship's generating system. Calvin Smith, operating 6XF-6BRD in Los Angeles, divided schedules with 6CHZ. 6CQA dropped out on account of pressing business. On a few occasions other amateurs assisted in the schedule when power leaks made communication impossible with the above stations, and they are to be commended for their good work.

The method of communication was as follows: Pre-arranged schedules on the day before were maintained daily, at which time KFLF called the particular land station on watch. A message was received from the yacht (averaging 90 words), telephoned to the addressee, and an answer sent back within a few minutes. Sometimes three or four messages were handled in the same way in one evening, and the schedules lasted from a half to three hours—depending upon the amount of time the operator at the land station had free. In this manner, the yacht owner was in constant touch with business and personal interests at home. After the yacht left Hawaii for the south seas and could not hear the commercial press news from the large coastal stations, special press and financial news was sent directly from 6BRD and 6CHZ.

After a few weeks of this, I'll admit that the novelty wore off, but because of the varying experiences of the operator of KFLF and because of my personal interest in him as a friend, the interest of communication was maintained. Personal news was "flashed" both ways. Tests were made under different conditions and many interesting discoveries were made at both ends of the circuit. Due to what is called the "skip distance" effect, the strength of the signals from KFLF was not as great near the coast as when she reached a position some thousand miles out. Signals from KFLF reached an audibility of R8 to R9 just after leaving Honolulu on the southern voyage (Signal strength is represented by letter-numbers from "R1" to "R9." R1 means that the signal is barely audible, while R9 indicates maximum audibility). In the south seas, signals were entirely satisfactory, averaging from R4 to R7, even in the central and eastern parts of the United States.

At this point, I wish to mention two peculiar "fading" effects noticed in the work. While on the voyage to Hawaii, schedules were kept while the yacht was yet in daylight. Just as the sun went down every night, an almost complete "fade out" was noticed at KFLF and 6CHZ for only a few minutes. After the sun had set, normal signal strength returned. On the return voyage from Hawaii schedules were maintained later in the evening—both stations being in darkness. One night promptly at 8:10 p. m., KFLF faded completely out at 6CHZ. The next night

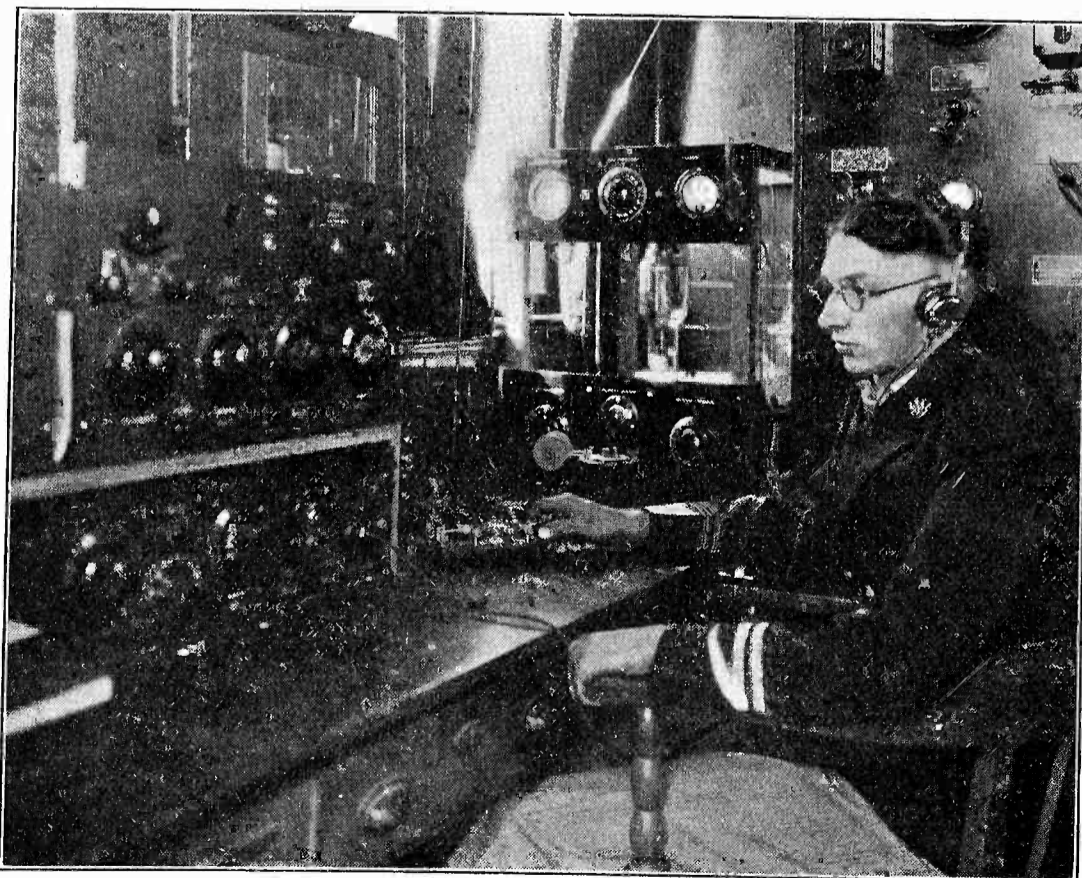

KFLF Wireless Room with Operator L. Elden Smith at the Key.

Smith asked me why I had quit at that time and I explained that he had suddenly faded out. That same night, KFLF faded out suddenly again, but this time it was a few minutes earlier. This peculiar phenomenon continued, in its variations, as the *Ripple* approached the coast until it was impossible to QSO after 7:30 p. m. Daylight communication became *la mode* again. While in the south seas, fading was bad especially *after* storms, but while the winds were tossing the little yacht to and fro it was always possible to work without difficulty.

I wish to stress here the seemingly miraculous steadiness of KFLF's signals. Although at times the *Ripple* was nearly "standing on her beam's ends" her signals did not vary in frequency a single mark on the dial, and it never became necessary to "follow" the signals because of the swinging antenna. All credit is given to the circuit used (tuned-plate tuned-grid) at KFLF, 6BRD and 6CHZ. The thing actually seemed to be unaffected by changes in the antenna system. Even with a swinging antenna, the wave remained practically constant, making reliable communication possible under nearly all circumstances. All operators will appreciate the fact that steady signals meet half the requirements for a successful QSO.

In Honolulu, Smith was treated royally by the local "hams," and he tells us that they are "a progressive lot." He said in part: "I handled some fine schedule work with 6BUC and 6DED on both visits to the islands, arranging for oil and other supplies. While in Honolulu, the Radio Club of Hawaii allowed me the use of 6BUC during the time that KFLF was tied up at the dock. The boys extended me every favor and at the conclusion of our second call at Honolulu they gave a dinner in my honor. They are a 'keen' gang."

Leaving Hawaii, the *Ripple* dropped down to Fanning Island where among the twenty white men on the island, Smith found a "ham"! His name is V. K. Paice and his call is VQ1AJ—a rather long one. His station was in the process of construction and hadn't been heard very far, so Smith helped him to tune his set by taking ashore most of the meters on KFLF. The night after the yacht left the island VQ1AJ worked his first "Yank" when he connected with 6BRD. As Fanning Island is a rather lonely spot, the party only stayed there two days. The island is just a coral atoll near the equator and about 1500 miles from Hawaii, where Smith says a gym suit is full dress. A Pacific Cable relay station is located on the island.

A few days after leaving Fanning Island, an interesting stunt of relaying was carried out when Smith aided in making arrangements for a British ship to unload and load cargoes at the island. A schedule was made with VQ1AJ from KFLF on 33 meters, and the ship was "worked" on 600 meters. All arrangements were made satisfactorily.

From Fanning Island the yachting party went to the Fijis and Samoa. At Apia, Samoa, is located VMG, a large British station. Smith looked this station over and found that it was rated at 20 kw., using spark on 2,000 meters. The authorities are experimenting with short waves and find that they are more successful than the longer wavelengths. Test work is being carried on with other stations at Suva and Australia. Numerous low powered short wave sets have been installed in the various towns about the island of Samoa, working on 44 meters and using 200 volts of B battery power on receiving tubes ("A" type). These little transmitters are used for government business and are operated entirely by natives. Of special interest, Smith said, was the fact that the batteries used to supply the operating power for these transmitters lasted about a year.

At Tonga Island (British Mandate), the operator of the radio station at Vavau holds

down several jobs at one time. He is postmaster, custom officer, radio operator, and secretary-treasurer of the government! The *Ripple's* operator found all the radio men at the British stations to be very much interested in short wave radio. One of the drawbacks to the advancement of this work is the restriction of amateur operation. In contrast to the United States, progress in the use of short waves has been retarded. Smith's opinion on this condition was that "perhaps if the foreign governments had a more favorable attitude toward amateur radio, they would learn more about it."

At Papeete, Tahiti, Smith found an interesting "layout" at BAM—a station owned and operated by George Bambridge. The transmitter employs two "50 watters" in a self-rectified circuit, taking power from the local power plant. BAM has been heard in all parts of the world. Another station owned by Bambridge has the call letters GEO, and is located at his country home about 30 miles from Papeete. This station is rather unique as it gets its power from a water-wheel which is connected to a 32 volt generator. The generator charges a bank of Ford batteries, which in turn supply power to a motor-generator set which delivers 1,000 volts d.c. to one 50 watt tube. "DX" work at GEO is nearly as good as that of BAM. In an ideal location, GEO is not troubled with power leaks, as the station is 30 miles from the nearest power line.

The return to Los Angeles was made via Hawaii, where the yacht remained over a week while it underwent a general cleaning. Repairs were made to the generating system, and the *Ripple* pointed her prow homeward, along the Great Circle route. Every day, the yacht was in communication with the amateur stations on the coast, and as she neared home, schedules were made several times each day. Mr. G. B. Wilson, a brother of the yacht's owner, plotted the course each day as her position was given. In this manner it was possible to know the exact position of the yacht at almost any given instant. This information would have been particularly valuable in case of emergency where assistance was required.

At 10:45 on the morning of November 12, 1927, the good ship *Ripple* rounded the breakwater at San Pedro. This was ended, not without some regret, a very successful voyage and a most remarkable QSO.

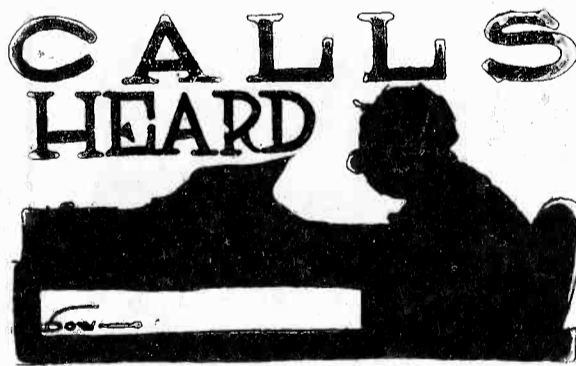

NU6QL, J. R. Wells, Patton, Calif.

OA—7dx, 5by, 3kb, 5lf, 2yj, 7cw, 2mh, 2rz, 5cm, 3es, 3vp, 5mb, 4nw, 5hg, 2hm, 2rc, 2sh, 2no, 2br, 3xo, 3wm, 3lg, 4rm. OZ—laf, lan, lfb, 2ab, 2ac, 2ap, 2bp, 2br, 2ay, 2go, 2xa, 1aj, 3aj, 3au, 3az, 3cg. FO—a5o, a3x. EF—8jf, 8cp, 8kl. SA—ba1. SB—lah, 2ax. SC—2bl, 2ar, 3ag. SU—1oa. OP—1bd, 1dl, 3ac, wucc. AJ—1sk, 2by, 1aw, jaxa. NQ—5ry, 8kp. NR—2fg, 2ea, 2ce, cto. NZ—ez5. ARDI, AQE, ARCX, GX. OC???? 8XZ.

By NU2WZ, J. A. Stobbe, 654 East 23rd St., Brooklyn, N. Y.

80 meters, U. S. A.—1aal, 1acd, 1afb, 1afq, 1agp, 1aku, 1ani, 1aox, 1apl, 1ary, 1axz, 1bav, 1bbe, 1bdo, 1bjp, 1cdx, 1cx, 1jl, 1nf, 1nl, 1pb, 1pi, 1gi, 15b, 15m, 3abm, 3acq, 3ade, 3afa, 3afe, 3afw, 3ahb, 3an, 3bns, 3bj, 3cee, 3cfg, 3cgc, 3co, 3ev, 3mw, 3nf, 3nm, 3nr, 3nu, 3ql, 3qp, 3sn, 3uk, 3um, 4aom, 4qe, 5awv, 5sy, 6cdi, 6wn, 7ahk, 8acm, 8agw, 8akc, 8aki, 8ane, 8anp, 8anx, 8aoc, 8aos, 8aov, 8apb, 8apk, 8apo, 8atq, 8avk, 8ayu, 8ayy, 8bbs, 8bce, 8bcm, 8bgd, 8bja, 8bqe, 8bpr,

8bry, 8bts, 8byg, 8bwe, 8byz, 8bzt, 8bw, 8caj, 8ccz, 8sch, 8cmo, 8com, 8cnz, 8crf, 8crk, 8daq, 8dbm, 8ddt, 8def, 8doq, 8fu, 8gi, 8mf, 8mq, 8oj, 8pt, 8rd, 8vf, 8xe, 9aam, 9aex, 9agr, 9anq, 9ayk, 9awx, 9bcy, 9beb, 9bqv, 9bqx, 9bss, 9bvf, 9bwe, 9bwn, 9byi, 9ceh, 9chc, 9chs, 9cju, 9clw, 9cmr, 9csp, 9ddm, 9dea, 9dlj, 9drh, 9dwn, 9eam, 9eca, 9lv, 9mm, 9ox, 9pg, nc3cb, nixb, naz, kgdc.

40 meters, U. S. A.—1aae, 1abx, 1adl, 1ajd, 1akd, 1aqj, 1asi, 1bat, 1bbr, 1big, 1bna, 1bnl, 1caa, 1cra, 1ccz, 1dp, 1fl, 1ga, 1im, 1jy, 1lu, 1mv, 1qv, 1rf, 1sw, 1uz, 1xi, 3acu, 3aef, 3alp, 3anu, 3apl, 3auh, 3bms, 3bqz, 3dw, 3cc, 3ec, 3gi, 3hi, 3kj, 3ld, 3mv, 3mw, 3pr, 3tn, 3wj, 4ac, 4bu, 4ab, 4jd, 4jl, 4jw, 4ll, 4nl, 4nq, 4oc, 4pe, 4rm, 4sq, 4tn, 4ul, 4um, 4vo, 4zw, 5ads, 5aec, 5ahp, 5as, 5awq, 5hz, 5ry, 5si, 5ts, 5uk, 5vx, 6aak, 6agg, 6amw, 6btx, 6byf, 6byz, 6bzf, 6cco, 6cdk, 6cqt, 6cgr, 6cyi, 6cww, 6czc, 6dau, 6dle, 6ey, 7aat, 7aet, 7gw, 7iz, 7qc, 7ww, 8afb, 8bgw, 8bgi, 8agi, 8alu, 8bgi, 8bgw, 8bjb, 8bjx, 8bvw, 8bbx, 8cer, 8cj, 7cju, 8cnj, 8cnt, 8cnz, 8cxc, 8dhx, 8djf, 8dod, 8eq, 8ro, 8ut, 8vn, 8wk, 9aau, 9aaw, 9aid, 9aof, 9apv, 9aui, 9axz, 9azf, 9baz, 9bcm, 9beq, 9bjw, 9bmb, 9bnb, 9bn, 9bl, 9bqy, 9bul, 9bxj, 9cej, 9crd, 9cvn, 9cxc, 9des, 9dmb, 9ecz, 9ebo, 9efo, 9ege, 9ehr, 9gc, 9ng, eb5zz, ef8ef, nclco, nc3cs, nc3zz, nc4bp, nc9bw, nr2fg, nze5, wnp, yal, ngm, neg.

A GOOD SHORT WAVE FONE

(Continued from Page 42)

close coupling should be used between L_1 and L_2 and between L_2 and L_3 . Two condensers of .006 mfd. capacity were shunted across each potentiometer with midpoint connected to potentiometer arm. These may be small mica receiving condensers.

If the builder cares to use C.W. telegraph, a switch may be provided to cut out modulator and a key inserted in the negative lead of the high voltage.

An M.O.P.A. fone is the smoothest transmitter I ever used and I wish to say that I will never go back to the old sets coupled directly to antenna. In case anyone constructing this set cannot get it working properly, write me in care of RADIO, enclosing stamp and I will be glad to help out.

Changes Your Set Into a Short Wave Receiver

Sent anywhere in U. S. upon receipt of \$15.00 M. O. or C. O. D. upon receipt of \$1.00 to guarantee carrying charges. (Canada and Foreign \$15.60 M. O.)

When ordering state kind of set, also type of tubes such as UV199, UX199, WD11 or 201A.



The SUBMARINER

Will convert your regular set into a short wave receiver and enable you to tune between 26 and 68 meters. This device operates with such sets as T. R. F., Neutrodyne, Superheterodyne and many others. It will operate a speaker when used with sets employing three or more tubes, and no changes, additional tubes or batteries are required. It requires but a few seconds to attach or detach. Operates as a wave changer with Superheterodyne receivers and as a Detector unit with others.

SHORT WAVE

Reception is practical because they penetrate better and there is less static. The "Submariner" wave band includes many powerful stations which broadcast programs. You may also learn code by listening to amateurs from all parts of the world. You will have one of the most efficient short wave receivers when the "Submariner" is attached to your receiver. Nothing else like it on the market. Get a "Submariner" so as to have command of the short wave activities as well as the broadcast band.

ORDER TODAY

We guarantee the "Submariner" to operate with your receiver.

Address

J-M-P MANUFACTURING CO., Inc.
Dept. 26 Milwaukee, U. S. A.

Tell them that you saw it in RADIO

G. M. Best's New Super

We have
all the
Parts
in Stock

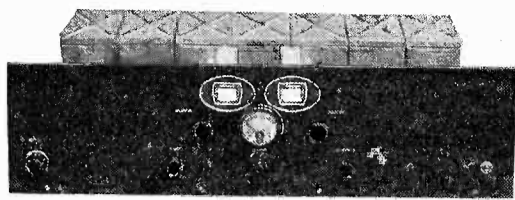

Panel View of Superheterodyne

Complete
BLUE PRINTS
and Building
Instructions
\$1.00 Postpaid

WRITE FOR ITEMIZED PRICE LIST

The parts for this set are sold either in a complete kit or separately. Our itemized list shows price of each part. Order it all at once, or get only the parts you need. Everything including panel and special base now in stock ready for delivery. Write for our catalog.

Immediate Delivery on Shielded Grid Tubes!

We sell only the TYPE S. P. 122 Shieldplate Tube Corp. Shielded Grid Tube. This tube has been specified in Best's super and other leading shield grid tube receivers **BECAUSE IT IS BETTER.** Please do not ask us to substitute other makes.

\$6.50
Each
Postpaid

SARGENT-RAYMENT STATION ISOLATOR

Double
your
Distance

Double
Selectivity
on Locals

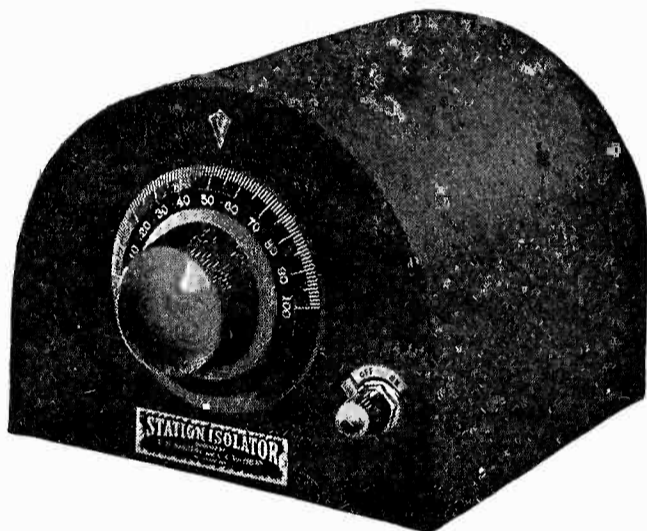

Install it
in 5
Minutes
Write for
Details

SOLD ON 5 DAY MONEY-BACK TRIAL

PRICES

Model "A." For Radiola 16 and 17, Apex, Crosley Band Box, New Freshman Equaphase and Atwater Kent No. 30, 32 and 35. (No tube required)

\$10.00

Model "T." For all other sets that use an antenna and a 6 volt "A" supply. Requires one CX-301-A tube. If tube is wanted, add \$1.50 to remittance

\$17.50

MODEL "DX" 1928 INFRADYNE

"At the Peak of Radio Development"

No shielded grid tubes are needed for the Infradyne. In this receiver the limit of radio sensitivity has already been reached, and accompanying this is a degree of selectivity that is yet to be equalled. The Infradyne is the DeLuxe receiver of radio, both in appearance and in operation. We can supply this either in kit form or built up. Write for price list.

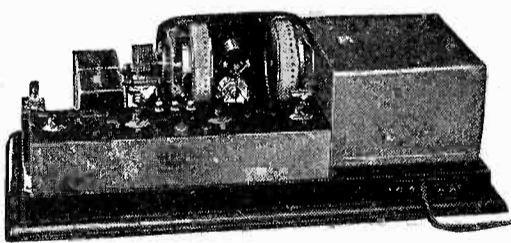

Completely Wired—\$179.50

Jensen Dynamic Speaker

Using the electro-dynamic principle, this speaker marks another step forward in musical reproduction. Cabinet is mahogany, handsomely finished and highly polished. Unless you have tried the Jensen, you have not yet heard the best radio speaker. We say this knowing that there are many that sell for more money.



Price \$65.00

Dealers—

Our prices are low, our service is better. Write us on your letterhead or give proof that you are a dealer. Get prices now on everything listed here and be ready for a big Spring business.

Write for
Catalog

Radio Constructors Corporation

357 TWELFTH STREET

OAKLAND, CALIF.

THE STEAM TRANSMITTER

(Continued from page 27)

chance at securing a man whom we wanted badly for ourselves. However, from time to time, we have been indebted either directly or indirectly to Mr. Voorhees and his force, and just now Voorhees seems to feel that he has need of your services. Therefore, he will discuss the matter he has in mind with you personally, and you will cooperate with him in all possible manner." So saying, he lit a long cigar, and turned to his files on the desk before him.

Voorhees pushed back his hat, picked up a pencil, and outlined a rough sketch of the northern coast line. "The S.S. *Candro*, which is registered under the Panamanian flag, is at the present time not a great distance from here. She is heavily loaded with a Canadian cargo, and is to land it, their god of good luck being willing, at Belindo Beach, here," indicating an indentation in the coast line sketch. "I propose to take charge of the *Candro*, under fire if necessary, as soon as she is within the legal limit. It will save us the trouble of transporting the stuff she lands otherwise over a lot of rough country, as we will bring her directly into port under convoy of a Coast Guard cutter.

"Now, while our information is, as far as we know, from a reliable source, for various reasons that it will not be necessary to go into in detail, I am not wholly satisfied. We know that the ship has cleared from a Canadian port, we know that she has a valuable cargo aboard, but there is a feeling between my men who are in on the inside of this affair, and myself, that we have secured very valuable information in altogether too easy a manner.

"Part of this information came to us through the medium of an operator in the Coast Guard, Trace by name. This man has been with the Coast Guard for some time, and while our data were of such a nature that it would be hard to pin definite suspicion on him, nevertheless he is being watched. Now, while it may sound childish, I work at times on hunches as much as on the real dope, and particularly in view of the fact that Trace has had access to certain information that is very valuable, I feel that he can stand further watching.

"In seizing the *Candro*, we have planned to attack only with a small trusted crew on one of the fastest of the Coast Guard cutters. In considering a job of this size, we would normally take more elaborate steps, but in view of the what we consider necessary secrecy, we are keeping our working force to as small a crew as possible. As certain of our available information came directly through Trace, he has been chosen as the operator on the Coast Guard cutter.

(Continued on page 48)

ALUMINUM

*The mark of
Quality in Radio*

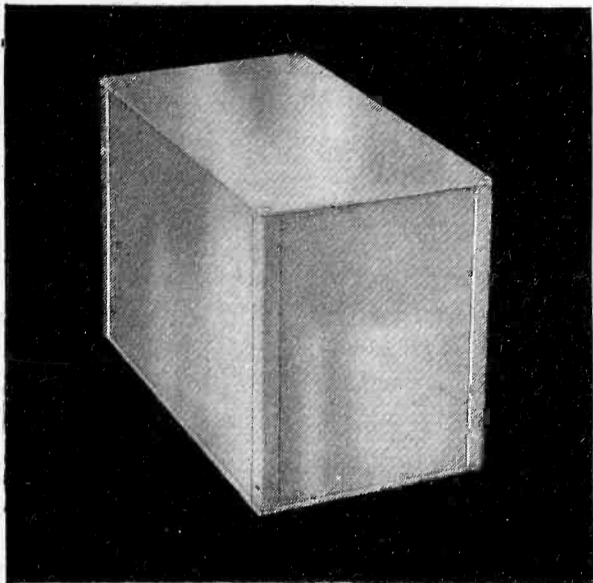

Aluminum Box Shields

*Essential in many
popular amateur sets*

FOR greater selectivity, finer appearance, longer life, lighter weight, use Aluminum Box Shields in the set you build—and look for Aluminum Shielding in the set you buy.

Designers agree on the superiority of Aluminum for shielding. It has become an established factor in radio design—recognized alike by advanced amateur set builders and engineers responsible for commercial production.

Aluminum Company of America's standard box shields, designed especially for amateur sets, are made of heavy Alcoa Aluminum with satin-dip finish, size 5 in. x 9 in. x 6 in. high. They are easily adapted to smaller sizes. They require no soldering.

If your dealer cannot supply you with Aluminum Box Shields send us his name and we will see that he is put in position to service you promptly. Be sure to send, also, for a copy of the new edition of "Aluminum for Radio." It is free.

**THE ALUMINUM COMPANY
OF AMERICA**

2463 Oliver Building Pittsburgh, Pa.

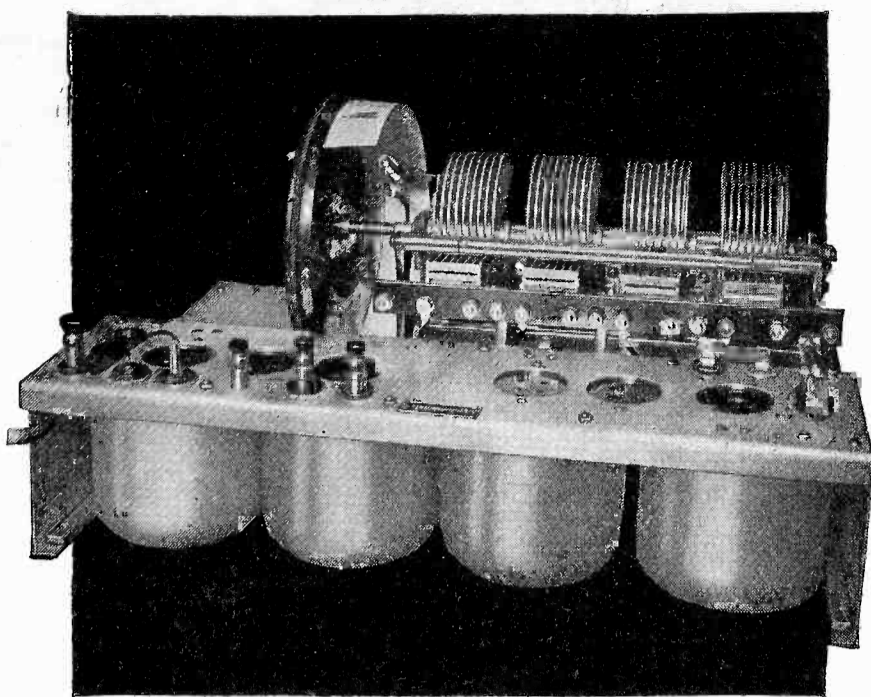

*Aluminum Shields and Other Parts
Zenith Radio Corporation*

RADIO Engineers are using more and more Alcoa Aluminum because of the efficiency with which this *one* metal meets the widely differing conditions encountered in radio design.

In many modern sets you find Alcoa Aluminum Shielding used because of its great effectiveness at radio frequencies. You find condenser blades made of Alcoa special Aluminum sheet because of its narrow limits of tolerance, its uniformity and its lightness. You find Alcoa Aluminum foil preferred for fixed condensers. Countless screw machine radio parts of Alcoa Aluminum are being used.

Sand castings and die castings of Alcoa Aluminum make the finest chasses, sub-panels and loud speaker frames, both because of the combined lightness and strength of Aluminum and because of its permanence and finish. Aluminum, decorated in a variety of rare wood grain effects, is ideal for front panels.

Look for Aluminum in the receiving set you buy. It has come to be recognized as the mark of quality in radio. Your copy of our new booklet, "Aluminum for Radio," will be sent free on request.

ALUMINUM COMPANY OF AMERICA

2463 Oliver Building

Pittsburgh, Pa.

ALUMINUM

The mark of Quality in Radio

Tell them that you saw it in RADIO



Jewell
Lightning Arrestor

Your Set Needs Protection

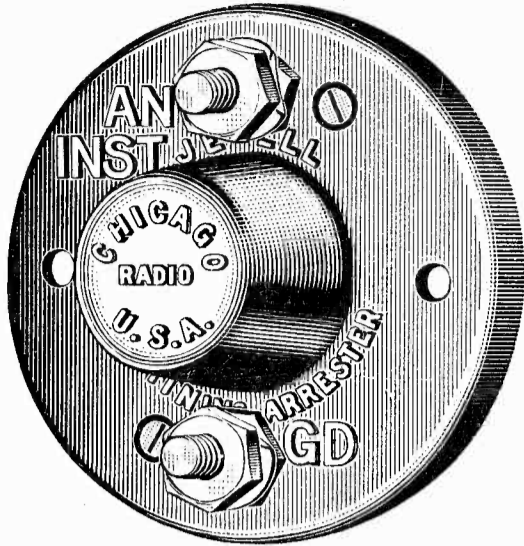

It is hardly reasonable to put your money into an expensive radio set without providing it with the best possible protection against lightning. People are doing this every day and risking the chance of severe damage if not complete destruction of the delicate mechanism in their radio set.

The Jewell Lightning Arrestor will provide as good protection as can be obtained. It consists of a glazed brown porcelain case enclosing an accurately calibrated air gap. The case is sealed with a moisture proof compound which makes it equally suitable for indoor or outdoor installation.

As a further indication of the reliability of the Jewell Lightning Arrestor, it has passed all tests prescribed by Underwriters' Laboratories and is listed as Standard by that organization.

Ask your dealer to show you one or write for descriptive circular No. 1019.

Jewell Electrical Instrument Company
1650 WALNUT STREET, CHICAGO
"28 Years Making Good Instruments"

Thousands

WILL TELL YOU!

Majestic 'A' and 'B' Units



Electrify Any Radio Set
and give

Better Radio Reception

THAN ANY OTHER FORM OF
ELECTRICAL RADIO POWER

See your nearest dealer today — any good radio store. Try Majestics on your set and note the difference.

You plug Majestics in and forget them.

GRIGSBY-GRUNOW-HINDS CO., 4540 Armitage Ave., Chicago
W. J. Seroy, Pacific Coast Sales Manager, 122 Broadway, Oakland, Calif.

BLUE ::
PRINTS

For BEST'S New 115
KILOCYCLE SUPER

Now Ready for Mailing
"RADIO," San Francisco, Cal.

\$1.00
POST PAID

(Continued from page 46)

You will understand that there are some details that I am not at liberty to divulge at present, as to the actual necessity in choosing Trace, in view of my suspicions of him.

"You are to go with us as relief operator to Trace. You will be introduced to him as a new hand breaking in for work on another of the Coast Guard boats. You are supposed to be a new man with only a smattering of code. Trace is an old timer, a crackerjack on the key. What I want you to do is as far as possible to check up on him. You may not get anything on him. He may be all right. Again, he may not. Captain Matty says that he can spare you at the present time, and it will give you a little change of climate."

Followed some further talk in which Voorhees stated that they would put to sea as soon as it was dark, as the approximate position of the *Candro* was known, and it was calculated that she would be picked up around midnight. While, from their information, the *Candro* had cleared for one of the Southern Republic ports, it was her intention to shear in close to Belindo Beach, put part of her cargo on the beach itself, and part into some of the boats of the fishing fleet, to be disposed of in ways best known to themselves. Voorhees arranged with Raule that he would be picked up within the next couple of hours, advising him to bring whatever he felt might be necessary for the trip, which would in any event not be of more than twenty-four hours duration.

That night saw Raule, now traveling under the name of Jackson, aboard a certain Coast Guard cutter, a little lead colored craft, mounting a one pounder on her forward deck, and possessing a general overall air of efficiency that characterizes this service. He was introduced to the various members of the crew, picked men, Voorhees informed him, in accordance with the role laid out for him, and was turned over to Trace, the radio operator, with a half apology from Voorhees for his greenness in matters in radio in general. As Raule sat beside Trace in the small cubbyhole that housed the radio equipment, he cast back in his memory several times in vain efforts to place the man, but finally gave up the attempt, though certain that he had seen him some time in the past.

For the next several hours, as the tiny craft proceeded along the coast line, Raule proceeded deliberately to make an ass of himself insofar as radio knowledge was concerned, messing up copy and displaying a finely studied ignorance in radio matters in general, heightening the ill-concealed air of patronage that Trace had at first evinced for the supposedly green hand. Trace was busily occupied a good portion of the time in

routine dispatches in code from Voorhees, and the reception of answers there-to, and also busily occupied himself in a long series of test calls, explaining to Raule that the transmitter was not operating satisfactorily, although to Raule's practiced senses, camouflaged though they were, the diminutive affair was up on its toes in efficiency. He could sense that Trace regarded him as a novice, and a poor one at that, which was exactly the impression that he wished to convey, although it irked him somewhat. But Raule had a finely developed sense of humor and a good idea of balance, and, feeling that he was carrying out his own part in good shape, was satisfied.

Trace, glancing at his wrist watch, remarked that it was eleven o'clock, and that they should be picking up the spark of the *Candro* at any time. From what remarks he had already made, Raule gathered that the ship was equipped with a powerful transmitter, and that she had been carefully logged coming up the coast, and that a number of her private code messages had been worked out by Voorhees, whom Trace referred to as Smith, apparently not as yet in on the actual identity of the operative. Sweeping his dials back and forth across the commercial band, he checked them suddenly at a high pitched spark. Adjusting his controls carefully, he turned to Raule.

"Ever listen to Jap code?" he asked him. In the headsets, the 500 cycle spark sputtered away in a peculiar jumble of dots and dashes, that to the ear of the average operator would have made no sense whatsoever.

"What do you mean—Jap code?" asked Raule. Now, as a matter of cold fact, Raule in his previous commercial operating days, while jerking juice on the run between the Orient and San Francisco, had put in a good many hours' time in fervently blessing the spark of some Japanese Maru, as the code of the little brown men plowed its way through the reverberating sixty cycle spark from the blower gap of some sister ship in the Inland Sea. While Raule couldn't transmit or receive Jap code, nevertheless he knew Jap code when he heard it. And his query could be read in two meanings when he asked "what do you mean—Jap code?" for decidedly the hashed up mess pounding in was not Jap code, nor any near relation to it.

Whereupon, Trace explained that the high pitched spark was from a Japanese steamer, and that the Japanese used a code of their own in talking with their own stations, a necessary procedure due to the radical difference in the construction of the Japanese language, minus its alphabet and the necessity of resorting to other means of code than we are accustomed to.



Samson Symphonic

PUSH-PULL UNITS

Clarify radio reception
as a Chemist filters liquids

Try this experiment. It probably will assist you to obtain better quality of reproduction.

Listen to your set from three or four rooms distant while people talk and the usual house noises are present. Try to understand speech. Do you actually hear the s's and k's or does your imagination supply them? Can you recognize the high notes of a Stradivarius violin, or do all violins sound alike?

Now replace the audio transformers with the Samson Symphonic and Samson Symphonic Push-Pull Units. Listen again under the same conditions. *Words are now crystal clear and music has a background and a brilliance entirely new to you.*

Send for authoritative information from leading engineers which will be sent for about the mailing cost. Audio Amplification 25c; B-Eliminator and Power Amplifier Construction 10c; Make-'Em-Better Sheet 5c; and Inductance Units Bulletin 10c. All four sent for 50c.



Samson

Symphonic
Push-Pull Units



Manufacturers Since 1882

MEMBER RMA

Main Offices at
Canton, Mass.

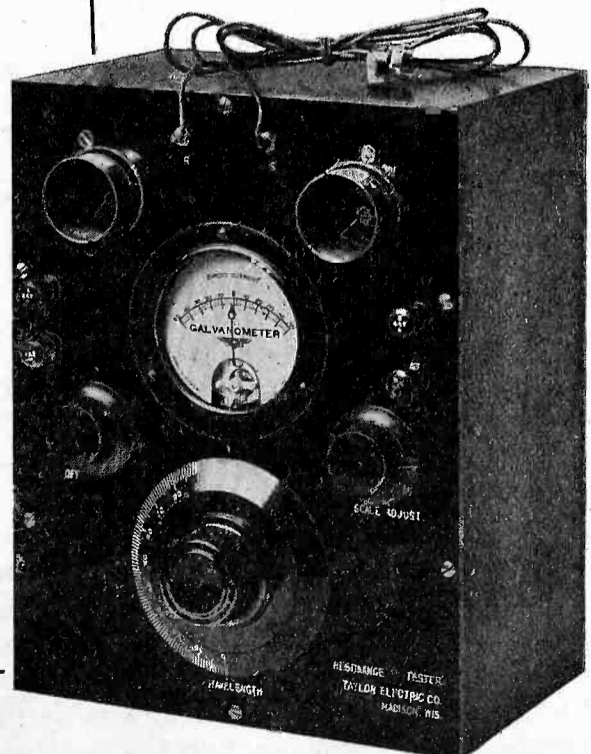

TAYLOR

RESONANCE

TESTER

A self-contained tester, which is designed for balancing and matching radio frequency coils and condenser units. The device is especially efficient and useful for matching the radio frequency units in standard single control tuned radio frequency receivers, and by the use of the RESONANCE TESTER a gang of coils and condensers can be exactly matched and peaked so that no trimmer or external balancing condensers are needed, permitting the operation of single control receivers with the greatest possible efficiency.

Write for catalog

Price \$32.50

TAYLOR ELECTRIC CO.

201 East Washington Avenue, Madison, Wis.

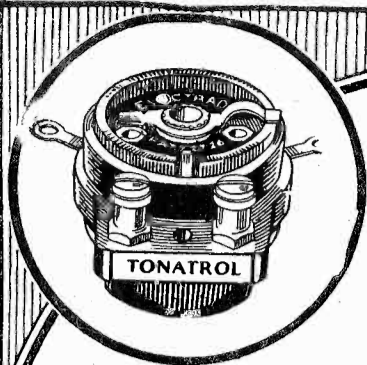

Exclusively
Licensed by
Technidyne
Corporation
under U. S.
Patent Nos.
1593658,
1034103,
1034104.

**Perfect
Control**

for Electrified Sets

TONATROL

A True Tone and Volume
Control

If you have a powerful, electrified set and want a smooth, gradual control of volume—if you want the volume to stay as you set it and not die out or suddenly become too strong, install Tonatrol in your receiver. Thousands of fans everywhere have found Tonatrol the solution to their problem of steady, exact volume. Very easy to install.

Tonatrol—Standard Volume Control \$1.50

Tonatrol—Type W.S. (with filament switch attached), \$2.00

Write for free installation booklet for correct way to control volume.

Dept. 54-D, 175 Varick St., New York

ELECTRAD

Buy An ELECTRIC RADIO

Don't be confused
by electrified or
other "ied" specials.

Freshman EQUAPHASE

IS THE

ELECTRIC RADIO

Raule nodded, and looked wise, all the time thinking at double time. The result of this thinking was that after Trace had finished his explanation, somewhat haltingly given, as though he were still focusing some of his attention on the high pitched notes as they ripped in, apparently from a position close at hand, Raule removed the headset from his ears, stretched himself, barking his fist against the wall of their concentrated quarters, and remarked that he would step out on deck for some fresh air, a natural enough explanation for a purported land lubber.

Once on deck, Raule made his way quickly to the stern, the commanding officer's quarters being located here. Dropping down into the snug quarters, where he found Voorhees and the commanding officer working over a position report, he asked for pencil and paper, and seating himself at the tiny desk, wrote rapidly. He passed the written sheet across to the two men. They read:

Cargo landed coast clear have your direction located by your test calls OK proceeding toward your direction full speed everything set for action

"All of what means just which?" asked Voorhees, reading the transcription a second time.

"I'm not altogether certain myself," answered Raule, in some perplexity. "But I think that Trace can bear investigation."

He then spoke of the reception of the so-called Jap code, and the explanation that Trace had made.

"Yes, but what is unusual about that?" asked Voorhees. "I've copied it myself a number of times—that is, I've noted it," he amended.

"Nothing at all, if it were Jap code," answered Raule, "but it wasn't. In the first place, while I didn't mention it before, I am familiar with the spark of the *Candro*, worked her for a time when I was in the commercial game. There is a slight characteristic waver in her 500 cycle note, not noticeable to any great extent, but there nevertheless. The generator is responsible for it, a heavy overload on the ship's mains—she was built before wireless was included in the design of the electrical equipment. The operators used to have trouble with the chief engineer over using the set on that account.

"Get this! That Jap code was on the *Candro's* spark. And furthermore, it was in clear and readable English, if you read the spark backward."

"If you read the spark backward?" repeated Voorhees. "I don't follow you."

"Yes, so to speak. The operator on the *Candro* is working with a trick key, back-keying, as it were. By that, I mean that he is using a key with the make and break contact on the front end of the key, in place of the usual stop

Tell them that you saw it in RADIO

Micrometric CONTROL for Your Set

The Volume Control Clarostat now makes its bow. It's a little fellow, compact, good looking, inexpensive, handy—just the thing for applying adjustable yet positive resistance in various parts of the set. And it's a genuine CLAROSTAT through and through.

CONTROL

loud speaker volume; match transformers for best tone quality; tune loud speaker to your taste; get maximum sensitivity out of r.f. and detector tubes; control regeneration micrometrically, especially on short waves—all with Volume Control Clarostat. And there are many other ways now becoming popular for improving your set with micrometric resistance control.

VOLUME CONTROL CLAROSTAT

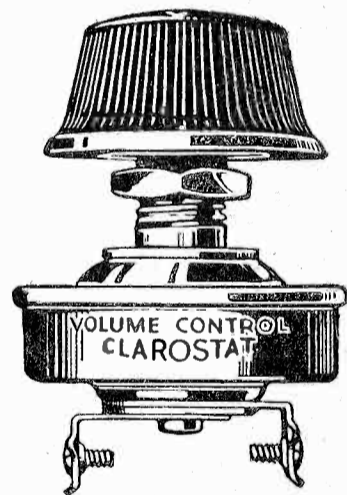

has resistance range of practically zero to 500,000 ohms in several turns of knob. Ample current-carrying capacity for all receiver applications. Holds its resistance adjustment. Silent in operation. Screw terminals. One hole mounting. And only \$1.50.

Of course you must continue to use the larger Standard Clarostat for B-eliminator applications, and the giant Power Clarostat for A-B-C power units, line voltage control, and power amplifiers, as heretofore.

There's a Clarostat for every purpose. Make sure, however, you get a genuine Clarostat—look for distinctive green box and name CLAROSTAT stamped on nickel shell. Don't be fooled!

Ask your dealer for literature on Clarostats and how to improve your radio set. Or write us direct:

American Mechanical Laboratories, Inc.
Specialists in Variable Resistors
285 North 6th St., Brooklyn, N. Y.

MEMBER
A.M.A.



Durham Leadership

The Original Metallized Resistor—Adopted by leading Set Manufacturers—Endorsed by Foremost Engineers—Are Sold by Reputable Dealers!

DURHAM Resistors and Powerohms have won their position of leadership because they have never failed to deserve the recognition of radio leaders who appreciate flawless accuracy and utmost dependability.

Ever since their first appearance, years ago, manufacturers, engineers, professional builders and radio fans have adopted Durhams in steady progression. Today Durhams are in use wherever fine results are a foremost consideration.

If you are not using Durhams now, an experiment with replacements may prove why they are the accepted leaders in their field.



Durham standard resistors are made in ranges from 500 ohms to 10 megohms. Durham Powerohms for "B" Eliminators and Amplifier circuits are made in 2.5 watt and 5 watt sizes in ranges from 500 to 100,000 ohms.

DURHAM
RESISTORS &
POWEROHMS
International Resistance Company
Dept. M, 2½ So. 20th St., Phila.

screw, and with the stop screw in place of the two contacts.

"When the key is at rest, the circuit is closed instead of open, and the spark goes into action. Now if he transmits code in the usual way, the make and break action is reversed, and you get an unintelligible hash, insofar as the 500 cycle note is concerned. But if you listen carefully, you can read the dots and dashes of the code in *spacing* of the dots and dashes. In other words, you read the *break* rather than the *make*. It's a good deal of the nature of the backlash of the arc system, where a few turns of inductance are shorted out by the key in the transmitting circuit, and if you are tuned to the wrong wavelength, you get an unreadable mess, unless you follow the spacing between the closing of the key circuit. Do you follow me? Maybe the explanation is rough, but it covers the idea in a good general way."

"Yes," answered Voorhees, "but what makes you think that Trace has a hand in it?"

"Because he was trying to talk to me and follow the message at the same time," replied Raule. "The *Candro* transmitted the message several times. Trace acted mighty peculiar while the message was coming in."

Voorhees leaned forward and pressed a push button. One of the crew stuck his head in at the doorway.

"Send Trace to me immediately," ordered Voorhees. For the next few seconds he drummed idly on the desk. The commanding officer lit a cigar. Raule waited expectantly.

Trace entered the room. Plainly he was nervous. "Yes, sir," he said.

"Trace," snapped Voorhees, "what does this mean?" shoving the message sheet across the desk toward him. Trace read it, paling visibly.

"Why—why, I don't know sir."

"You don't?"

"No sir."

"Trace," exploded Voorhees, "you are a concentrated triple blank liar." Turning to the commanding officer, and at the same time pressing a push button, Voorhees continued, "I ask that Trace be placed under arrest pending investigation, and that he be placed in irons and confined below deck until we make port. I don't think it advisable that he be loose when we come up on the *Candro*." He bent down and took out a pair of handcuffs from the small handbag that lay under the desk. Trace, at first making a motion as though to resist, and then apparently realizing the futility of the idea, held out his arms.

"I might add, Trace," said Voorhees as he clicked the ratchet on the cuffs, "that it will be a lot easier on you in the long run, if you care to talk. You have been under suspicion for some time. How about it?"

Tell them that you saw it in RADIO



14 Types of A C Transformers and A B C Units for use with All Authentic Makes of Power Tubes

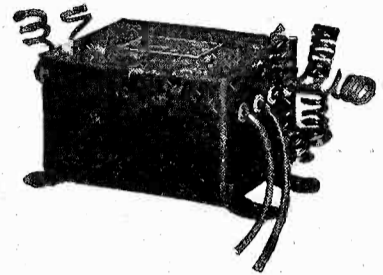

TWO POPULAR TYPES

No. 4586—illustrated here, A. C. Transformer for 1 to 8 UX 226, 2 UY 227 and 2 UX 171 tubes; eliminates need of A battery and charger. \$8 list.

No. 6515—A. C. Transformer, for sets using 4 or less UX 226 tubes, 1 UY 227 tube and 1 UX 171 tube. Only \$4.75 list.

If your dealer cannot supply you at once, send check or money order to factory. Immediate delivery.

Manufacturers

of these 14 types—you can secure several in unmounted style, in production now exclusively for set manufacturers. You are assured promised deliveries. For special information and prices, write or wire at once.

Dongan Laboratories
Authentic Source for Engineering
Data on A B C Operation

Dongan Electric Manufacturing Company
2981-3001 Franklin Street Detroit

TRANSFORMERS OF MERIT FOR FIFTEEN YEARS

Tested and Matched Tubes

OF COURSE, your set will work 25% better, as a general rule, if all the tubes are precisely matched and hand-picked for best characteristics as to radio frequency amplification, detection, oscillation and audio stages. We have a complete tube testing device for accurately doing this work. We make no extra charge for hand-picking and matching tubes. Any type of tube can be supplied. Several days' time must be allowed for testing, packing and shipping.

D. B. McGOWN
435 Pacific Building
San Francisco California

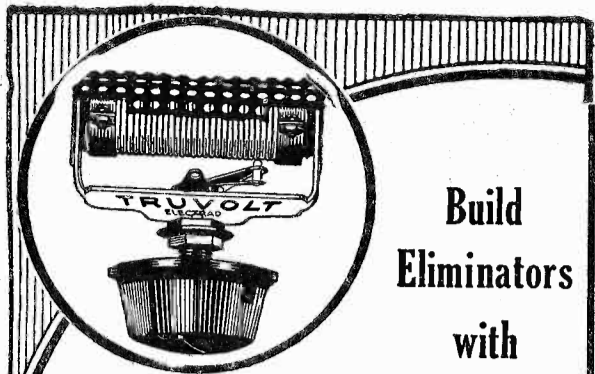

Build
Eliminators
with

TRUVOLT RESISTANCES

IF YOU are building a B-Eliminator or an A. C. Set, use Truvolt all-wire variable and fixed resistances for permanent accurate control. Prominent engineers are specifying Truvolt for power devices of their design. The unique design of Truvolt adapts it specially for B-Eliminators and power devices. Due to maximum heat radiation surface, this unit develops less heat, resulting in longer life with unchanging accuracy.

A full line of Variable, Fixed and Tapped Wire Wound Resistances for Radio Purposes.

Write for Complete Free Truvolt Resistance Circular.

Dept. 16-D, 175 Varick St., New York

ELECTRAD

LATEST LOG BOOK 25c

ALL THE NEW LISTINGS
HANDY POCKET SIZE

"RADIO," Pacific Bldg., S. F., Cal.

RAJAH SOLDERLESS SNAP TERMINALS

Instantaneous in Operation—Positive Contact. For Panel, Ground and Battery Connections.



Patented—Sept. 23rd, 1924.

The Base Stud is tapped and furnished with 8-32 screw and washer. This fits all "B" Batteries with screw posts.

Used on

TUNGAR - RECTIGON - PHILCO - EXIDE
Terminal, complete,....15c Extra Base Studs....5c

Furnished with

BAKELITE FERRULES

In Three Colors

BLACK — RED — GREEN

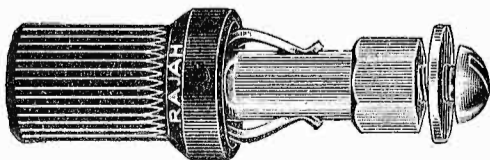

LIST PRICE - 25 Cents Each

Distributors

MARTIN WOODARD CO.

438 Phelan Building, San Francisco, Cal.
28 E. Sprague Avenue, Spokane, Wash.
Terminal Building, Seattle, Wash.
229 Pine Street, Portland, Oregon

THE RAJAH CO.
BLOOMFIELD NEW JERSEY

For a few moments Trace studied the deck. Then he spoke quietly. "All right, I'll talk, Voorhees. Oh, yes, I know who you are," he said with a laugh, "but not because of any promise of immunity. It is a plain choice of between life and death, and my life is still of value to me. And I am going to talk fast. We may sight the *Candro* at any time now, and I would rather get this over with before we come up to her. You'll understand why, shortly.

"Yes, you have written out there what I was copying mentally—a pretty close copy, although how you got it, I don't know, unless you, Jackson, are not as green as you make out," looking keenly at Raule. "Well, here is the dope. The *Candro* is coming for us at full speed, following our direction by means of a loop focused on us while I was testing tonight. She landed her cargo hours ago, and now Batalliana and his gang are out to get you, once and for all, Mr. Voorhees.

"When you put a shot across her bows," went on Trace in an even unemotional voice, "the *Candro* will heave to, according to plan. And when you come up, bow to bow, for they will take care to keep her bow on to you while you are approaching, you will be so close to her that you won't see what is going on at her stern. Her crew will abandon her, taking to a sea sled—she has only a skeleton crew aboard, the rest are ashore now—and before you can get into action, they will be too far away, either for pursuit or shelling, for you won't be able to shell the sea sled as it will swing around the off side of the *Candro* and be behind your stern in a jiffy. The sea sled is equipped with a small transmitter. As she gets away, they will press the key, and you and the crew and the *Candro* and this floating bathtub" (here the commanding officer straightened up aggressively) "will exit, bound for heaven or hell, I don't know which. For, Mr. Voorhees," his voice rose dramatically, "the *Candro* is mined with high explosive, connected to a relay through several stages of audio amplification."

Voorhees started to speak, but Trace held up his hand.

"Yes, you are going to ask where I get off in this deal. Well, I would have gone overboard in the dark, when we would be within a few hundred yards from the *Candro*, with a flash light in my hand. In the preparation for boarding her you wouldn't miss me. The sea sled would pick me up as they swung around the off side of the *Candro*.

"A long chance? Yes, but I've taken them before. Ten thousand dollars if the plan worked out would go to me. Oh, they've been laying for you for a long while, Voorhees. You have caused Batalliana and his gang a lot of grief

Tell them that you saw it in RADIO

No OPEN CIRCUITS
with the
New



all
duty

DAVOHM

After months of research, Daven, the Resistor Specialists, are giving to the Radio Fans of America what they honestly believe to be the most perfect wire wound resistor... Davohm.

Will Not Open Circuit

Davohms are built to the most exacting specifications. The enamel is a special composition which resists the highest temperatures. *Davohms will not open circuit.* Davohms will carry their full rated current capacity plus an overload, safely without excessive heat.

Constant Efficiency

Davohms are accurately rated when you buy them and they remain accurate. If you draw 125 milliamps from a Davohm, it will continue to deliver 125 milliamps indefinitely. No other resistor that we know of will give the same unchanging efficiency as Davohm.

For All Power Packs, A, B and C Eliminators using 171 or 210 Tubes

Davohms are made in 4 sizes in values from 500 to 25,000 ohms and for all current carrying requirements, dissipating all wattages specified in power packs and eliminators using 171 or 210 tubes.

The Resisto-Prop, an exclusive Daven product, makes mounting a simple matter.

At your dealer

Daven Radio Corporation
135 SUMMIT ST. NEWARK, N. J.

DAVOHM

New LOG BOOK

Now Ready

A clever log book giving spaces for logging dial setting for any U. S. or Canadian station. Also a complete list of all stations by call letters. A separate list of stations by states. Another list of stations by meters, starting at low wavelengths in numerical order. A directory of stations. Calls, waves, kilocycles and meters in alphabetical order. Printed on bond. Handy size. The best 25 cent investment you can make. Limited edition. Order your copy NOW.

25c PER COPY POSTPAID
PACIFIC RADIO PUB. CO.
Pacific Building San Francisco

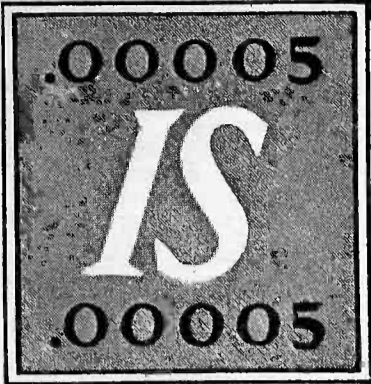

permanently

when Sangamo Mica Condensers are used

Condenser accuracy is not only measured by factory tests of value—it is determined by permanence after heat of soldering, work box knocks, and a year or more of service under all atmospheric conditions!

Sangamo condensers are accurately rated (within 10 per cent of marked value) and of greater importance—they stay accurate. A solid sheathing of pressure-molded bakelite makes that certain.

SANGAMO ELECTRIC CO.
SPRINGFIELD, ILLINOIS

SANGAMO
MICA CONDENSERS

The next **6**
issues of **"RADIO"**
for **1** dollar
Subscribe Now

and cost them a lot of money. Bataliana told me that as long as you were on the job, that there wouldn't be much profit in the booze game. Furthermore, while I am saving my life for the time being, it's only a temporary lease, for Batalliana will not forget—not if I serve time for twenty years. I've talked, but for a reason. Handcuffed here and keeping silence, I'd take a long journey with the rest of you. While there's life, there's hope. It's great if you don't weaken, and I'm a strong man."

"I think I know you," spoke up Raule, "when you spoke of long chances, I placed you. Remember that little gun running episode in Hong Kong in 1912? You sure just got out of the Celestial Empire by a wavelength. I was pulling juice then on a combination operator-purser job on that old American tramp steamer, the *Bender*. I was the one who let you use my cabin while the skipper chased those wild coolies off the ship. He put you to work with the Kanaka crew and that was the last I saw of you."

"So you are the chap who smuggled me into the radio cabin, eh?" replied Trace in astonishment. "Well, if I had known you were going to ship on this Coast Guard cutter, there might have been a different story." He turned to Voorhees, "Jackson here saved my life," he said. "I am sorry that he is mixed up in this mess. However, now that you know the situation, maybe you can work out some solution. It's up to you."

Voorhees was already meeting the situation in his characteristic fashion. "Two can play this game as well as one," he said sharply. "It is obvious that they won't answer any radio calls when we come up close to them, probably the operator won't even be listening in after we're sighted, figuring that you are getting ready to go overboard, and that with the relay set, they won't be able to use their spark anyway. Very good. We will approach them, but cut around to their stern. That will allow us to keep the gun on them if their sea sled is there as you say. When we get within whistling range, you, Raule (dropping the name Jackson), will telegraph them on the whistle, tell them to cut out the foolishness and to stand by ready to take off in their small boats ready to surrender, and if they try any funny stuff we will shell Hail Columbia out of them. Their operator will be able to decode the whistle all right. We are in the vicinity of Belindo Beach now, and if they are looking for us and we are looking for them, we ought to be picking them up at any time. Say," turning to Trace, "whose bright idea was that about using the back spaced key, and why?"

"Mine," said Trace, "afraid that straight code, even if camouflaged,

Tell them that you saw it in RADIO

New AERO Circuits

For Either Battery or A. C. Operation

Proper constants for A. C. operation of the improved Aero-Dyne 6 and the Aero Seven have been studied out, and these excellent circuits are now adaptable to either A. C. or battery operation. A. C. blueprints are packed in foundation units. They may also be obtained by sending 25c for each direct to the factory.



AERO UNIVERSAL TUNED RADIO FREQUENCY KIT

Especially designed for the Improved Aero-Dyne 6. Kit consists of 4 twice-matched units. Adaptable to 201-A, 199, 112, and the new 240 and A. C. tubes. Tuning range below 200 to above 550 meters.

This kit will make any circuit better in selectivity, tone and range. Will eliminate losses and give the greatest receiving efficiency.

Code No. U-16 (for .0005 Cond.)...\$15.00
Code No. U-163 (for .00035 Cond.)... 15.00



AERO SEVEN TUNED RADIO FREQUENCY KIT

Especially designed for the Aero 7. Kit consists of 3 twice-matched units. Coils are wound on Bakelite skeleton forms, assuring a 95 per cent air dielectric. Tuning range from below 200 to above 500 meters. Adaptable to 201-A, 199, 112, and the new 240 and A. C. tubes.

Code No. U-12 (for .0005 Cond.)...\$12.00
Code No. U123 (for .00035 Cond.)... 12.00

Note—All AERO Universal Kits for use in tuned radio frequency circuits have packed in each coil with a fixed primary a twice-matched calibration slip showing reading of each fixed primary AERO Universal Coil at 250 and 500 meters; all having an accurate and similar calibration. Be sure to keep these slips. They're valuable if you decide to add another R. F. Stage to your set.

A NEW SERVICE

We have arranged to furnish the home set builder with complete Foundation Units for the above named Circuits, drilled and engraved on Westinghouse Micarta. Detailed blueprints for both battery and A. C. operation and wiring diagram for each circuit included with every foundation unit free. Write for information and prices.

You should be able to get any of the above Aero Coils and parts from your dealer. If he should be out of stock order direct from the factory.

AERO PRODUCTS, Inc.
Dept. 103
1772 Wilson Ave. Chicago, Ill.

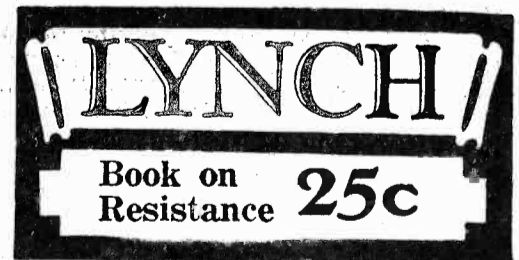

WRITE!

Send for full details covering our line of "B" and "AB" power devices.

KIMLEY ELECTRIC CO.
441 E. Ferry Street Buffalo, N. Y.

A Fine New Log Book Just Out! 25 cents

We believe this to be the best and most practical log book yet issued. It is so complete and so simple to use that we can sell it to you on a money-back basis if you are not entirely convinced that it is the best booklet of its kind yet published. All the new listings, changes, etc., corrected to December 1st. Right up to date. Spaces provided for logging all stations in the U. S. and Canada. Send a quarter for your copy now. We pay the postage. Immediate deliveries.

"RADIO"

435 Pacific Building
San Francisco California



Never Wears Out

Your first cost is the only cost. Then why not enjoy permanently the better tube performance and prolonged tube life alone offered by

AMPERITE

The "SELF-ADJUSTING" Rheostat

Keeps filament voltage constant despite "A" battery variations. Simplifies wiring, panel design, tube control, tuning. Insist on AMPERITE. Nothing else can possibly perform as well. Unconditionally guaranteed.

Price \$1.10 with Mounting, (in U. S. A.) for sale by all dealers.

RADIALL CO.
50 Franklin St., N. Y.

FREE

"Amperite Book" of latest circuits and construction data. Write Department R-2

SEND FOR FREE CATALOG

From Chicago's Oldest Radio Jobbers. The Most Valuable Radio Catalog.

Write for your copy today — IT'S FREE!
Telephone Maintenance Company
123-5 S. Wells St., Dept. 66, Chicago, Ill.

might excite suspicion, and it would be a difficult matter to work it out with the radio equipment set up in the wheel house as it is. Anybody normally would think it was Jap code that we sent, and give it no further thought. I could copy mentally without trouble, when necessary."

"What was the reason of all those test calls," asked Raule, "when the transmitter was OK? To enable them to get compass bearings on us?"

"Father ought to call you son," grinned Trace, "you're so bright. Yep, that was the reason."

A seaman jerked the door open. "Lights dead ahead, sir," he reported.

They made their way to the deck. Some two miles ahead of them lay a ship. The Coast Guard craft, under full speed of her powerful engines, swung out and away from the craft, swinging in a circle around for her. It could be seen that Voorhees was carrying out his original intention of coming up under her stern. Peering through his night glasses, Voorhees remarked, "That is the *Candro* all right. And lit up like a house afire, instead of being darkened like a respectable rum runner should. Well, my hearties, we will give you a run for your money."

As she circled, the cutter decreased her distance between the other ship and herself by moving in at the same time. Through the light of a mist covered moon, it could be seen that figures were running along the deck of the *Candro*, and at the same time, her prow swung around in an apparent attempt to keep her bow on to the Coast Guard cutter. But the little craft was too swift, and in a short time lay astern. Under the square high stern of the *Candro* lay a small flat craft, the sea sled that Trace had told of.

The one pounder on the prow of the cutter spoke. A tracer bullet flashed to one side of the *Candro*. Another one over her mast. Another one to the opposite side. Raule at the whistle cord of the cutter jerked the cord sharply in the call letters of the *Candro* three times.

Slowly he coded the following:

Surrender take to small boats if you try to escape sea sled will shell you at once answer on your whistle no funny stuff.

For a few moments after the transmission, the two ships floated silently on the sea. Two men crouched at the one pounder in the prow. The helmsman stood impassively at the wheel of the cutter. Voorhees calmly broke open a package of gum, offering Raule a stick.

The steam whistle of the *Candro* did not respond as readily as did the compressed air whistle of the cutter. There was a preliminary rumble as though it were clearing its throat, then haltingly came back the beginning of the answer:

OK we wi—

Tell them that you saw it in RADIO

Bargains for Ye "Hams"

2MA Co. is now largest concern run by hams for hams in the U. S. No delays — prompt service. Money back guarantee. All standard apparatus. Lowest prices in the U. S.

REL 20-40 or 80 meter transmitting inductance double with coupling rods, complete, each	\$8.85
AERO 20-40 or 80 meter transmitting coil kits. Also 15-130m. S. W. Receiving coils	\$9.75
THORDARSON, NEW TYPE—Combined plate and fil. transformers; 650 v. plate and v. fil. windings with mid taps	2-7½ \$6.20
80 watt fil. trans. 8 v. with mid tap	6.10
150 watt fil. trans. 12 v. with mid tap	7.85
100 watt plate trans. 350 and 550 v. with mid tap	10.90
450 watt plate trans. 1000 and 1500 v. with mid tap	16.40
JEWELL 3 in. Flush Mounting A C or D C voltmeters, milliammeters — any scale readings	\$5.95
Antenna thermo-ammeters, any scale reading	9.80
CARDWELL New Type Condensers T 199 .00035 mfd.	\$8.90
New type cond. T 183 B .00015	8.90
New type cond. T 147 B .00045	8.90
GRID LEAKS — Large General Electric 5000 ohm	\$1.45
Large Ward-Leonard Cent. tap 5000 ohm	2.45
Small Ward-Leonard Cent. tap 5000 ohm	1.80
Crescent Lavite 5000 ohm special	2.20

FIXED CONDENSERS

SANGAMO By-Pass Condensers — Large .002 mfd., 500 volt.	\$.50
Up to .005, 3500 volt.	1.50
.002 mfd., 5000 volt.	1.75
FLECHTHEIM Guaranteed Filter Condensers. 2 mfd., 1000 volt.	\$2.75
4 mfd., 1000 volt.	4.75
1 mfd., 2000 volt.	2.75
2 mfd., 2000 volt.	4.35
4 mfd. 2000 volt.	6.95

(Flechtheim filter condensers are guaranteed against break down. Blown condensers will be promptly replaced without charge.)
Pyrex Standard Sockets for 202s, 210s, etc., 65c.
Products at Lowest Prices Ever Sold.
Money Back Guarantee.

Radio 2MA Co. 168 Washington St.
New York City

RADIO Agents Wanted

Make Big Money in Spare Time

Demonstrating the Famous Trego Radios and Phonographs to your friends. Made in both Five and Six-tube Tuned Radio Frequency Sets, at prices ranging from \$49.50 to \$173.80; also the last word in Portable Phonographs; ideal for home, motor trips, camps, etc. \$15 and \$25. As well as hundreds of other fast selling articles for agents

TREGO RADIO MFG. CO. DEPT. NO. 1
1427 Chestnut, Kansas City, Mo.

FREE Wholesale Radio Catalog

Dealer-Set Builders! Save Money!
Send for this book of bargains. Everything in Radio—all the newest hook-ups. Sets, kits, parts, cabinets, consoles and supplies. If you want the best for the least money, you need this catalog

SHURE RADIO COMPANY
345 V. West Madison St., Chicago, Ill.

EVERYWHERE

good radio is found—there also are used genuine

NATIONAL

RADIO PRODUCTS

NATIONAL CO., INC., MALDEN, MASS.
W. A. Ready, Pres.



Radio Interference Filters

Positively

Reduce Radio Interference from Household Motors, Etc. Write for Booklet.

Tobe Deutschmann Company
Cambridge, Mass.

Then with a crashing, smashing shock and roar came the explosion. The sea shuddered as though flattened out under an immense hammer. The air shock all but flattened out those standing on the deck of the cutter. High in the air rose the black pall of smoke—fragments of wreckage rained down on the cutter.

For a half hour the cutter cruised in the vicinity of the explosion. No survivors of course were found. The commander, after consultation with Voorhees, ordered the craft to put around and head for port.

"How do you figure it out, Raule?" asked Voorhees as with the commanding officer they sat in the tiny galley over a cup of coffee, discussing the affair.

"I have a theory," said Raule, reaching for a doughnut. "It is only a theory, and it will have to remain one until the end of time, but it is feasible and entirely probable. The steam from the whistle set off the relay which in turn set off the dynamite charges, or TNT or whatever it was."

"Well, your back keying idea sounded funny," said Voorhees, "but it turned out to be correct, so this may be correct also. Go ahead and explain. It can't be any more strange than events to date."

"When I was in the commercial game," answered Raule, "I had occasion to note several times, especially in hazy weather, as it is tonight, that when the whistle was blown, that a steady stream of static electricity would leap the anchor gaps between the antenna and ground connections. This discharge of static was caused by the friction of released steam, traveling with considerable speed in leaving the whistle, against the outer atmosphere. Now, the explosion occurred while he was answering us on the whistle. You may have noted that the Candro's whistle was a young barrel in size, and put out a heavy jet of steam. The static wave created in this case, and very highly damped, covering a wide band of wavelengths over a limited area, was undoubtedly of sufficient intensity to operate the sensitive relay coupled as Trace said to several audio stages. Though the relay might have been tuned to a special wave remote from possibility of ordinary interference, the static wave was so broad as to operate it anyway. That is my theory, and it's better than the next one."

And while Voorhees thoughtfully chewed gum, Raule excused himself and turned in for a few hours of belated sleep, feeling that he had at least earned his trip aboard the cutter.

LYNCH

Equalizers make rheostats unnecessary. A type for every tube and combination of tubes.

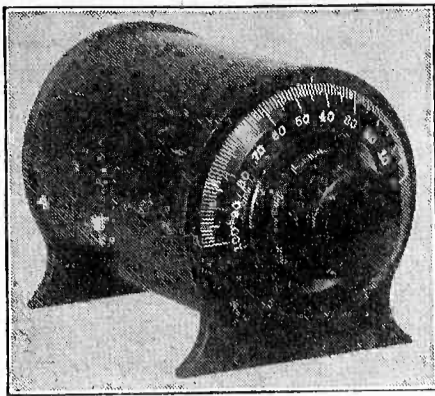

Not a wave trap but a wave booster (Pat. Pend.)

\$4.75 COMPLETE

WHAT SOME OF OUR USERS SAY

Dear Sirs: Sometime ago I purchased a Reesonator from you. It is very good and works fine. I now get distant stations when all New York City radio stations are broadcasting.

I will give you a list of stations that were all received from 6:00 p. m. to 12:00 p. m. eastern standard time when New York City stations were broadcasting. WMAK, WOC,

KDKA, WBL, WCAU, WRVA, WOWO, WOK, WJR, WSM, WICC, WSEA, KFKX, KTNT, WYN, KYW, WSAI, WTIC, WBBM, WSB, KMOX, WMBB, WCX, WWAE, WIP, WHAM, WBAL, WCCO, WTAM, WCFL, WLS, WOW, WSYR, KWKL. These stations could not be received before 12:00 p. m. without using the Reesonator. Respectfully, Edwin H. Eberle, Mt. Vernon, N. Y.

Gentlemen: Please send another Reesonator C.O.D. It is worth five times your price. Absolutely does all you claim for it. Would not be without one. Sold mine to a neighbor and he is delighted with same. Sincerely, I. D. Rankin, Lamesa, Texas.

WE GUARANTEE SATISFACTION

Try one for three days at our risk. If not thoroughly satisfied your money will be cheerfully refunded.

F. & H. RADIO LABORATORIES
Dept. 106 Fargo, North Dakota
REFERENCES:
Dunn's or Bradstreet's Fargo National Bank
Dealers' Inquiries Solicited

VOLUME • DISTANCE

Sharp Tuning
WITH THE AMAZING

REESONATOR

TRADE MARK

The Reesonator is an instrument designed to balance the antenna to the receiving set and increases the volume and selectivity of your machine. It will enable you to play with dance volume stations which are barely audible or sometimes entirely inaudible without it. It will also decrease battery consumption 30 per cent, as you do not have to apply as much power to obtain the desired results. It does not require tuning for every station you receive; only when additional selectivity or distance is required. It is attached externally to the machine and can be attached by anyone in a minute. Reesonator as illustrated is especially designed for Atwater-Kent Models 30-32-35, Radiola Models 16-17 and Crosley Bandbox Radios. When ordering, state type of machine on which Reesonator is to be used. Equivalent to two extra tubes in your machine.

SEND COUPON NOW

F. & H. RADIO LABORATORIES
Dept. 106 Fargo, North Dakota

- I enclose check or money order for \$4.75 for which send me a Reesonator postpaid.
- Send Reesonator C.O.D.
- Send Dealer's Proposition.
- Please send Literature.
- Send Name of Jobber.

Name.....
Address.....State.....

ANOTHER SPECIAL OFFER!



UNI-RECTRON POWER AMPLIFIERS



Model AP-935

As the Uni-Rectron stands it is a super power-amplifier which can be used in connection with any radio set and loud speaker. Binding posts are provided for input to the Uni-Rectron and for output to a loud speaker.

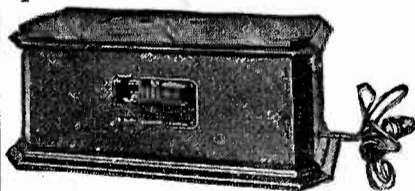

If it is desired to use the unit as a source of high-voltage supply (375 volts) for a UX-210 as an oscillator, it will only be necessary to solder leads to the UX-210 socket in the Uni-Rectron, so that the oscillator tube may be placed close to the transmitting inductance in order to keep the oscillating leads as short as possible.

The Uni-Rectron is, therefore, a double-duty device—it is a high grade power amplifier, which by removing the input and output transformers, can be also used as a source of power for an oscillating or transmitting tube, furnishing power for all circuits, grid, plate and filament.

Every one new and packed in original factory carton

List Price \$88.50
(Without tubes)

Special at \$19.75

each

AMERICAN SALES CO., 21 WARREN ST., NEW YORK CITY

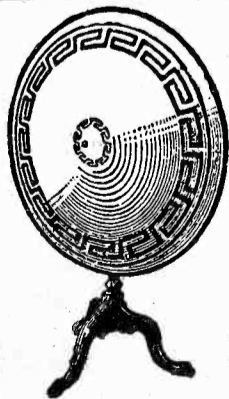

The New POWERTONE 36" GIANT Cone Speaker Kit (Double Edge)

A speaker of beauty, tone quality and has the characteristics of the higher priced speakers. Can be assembled in less than an hour.

The POWERTONE kit consists of:

- 1 POWERTONE UNIT
- 1 Designed Front Sheet
- Fonotex Paper
- 1 Back Sheet Paper
- 2 Metal Rings
- 1 Metal Bracket
- 1 Apex
- 1 Tube Cement
- 1 Set Screws, Nuts
- 1 Stand
- Full Instructions

\$12.00

Incl. Stand FREE

Powertone Cone Unit \$5.50

Dealers and Jobbers Write for Proposition

POWERTONE ELECTRIC CO. 218 FULTON ST., N. Y. C.

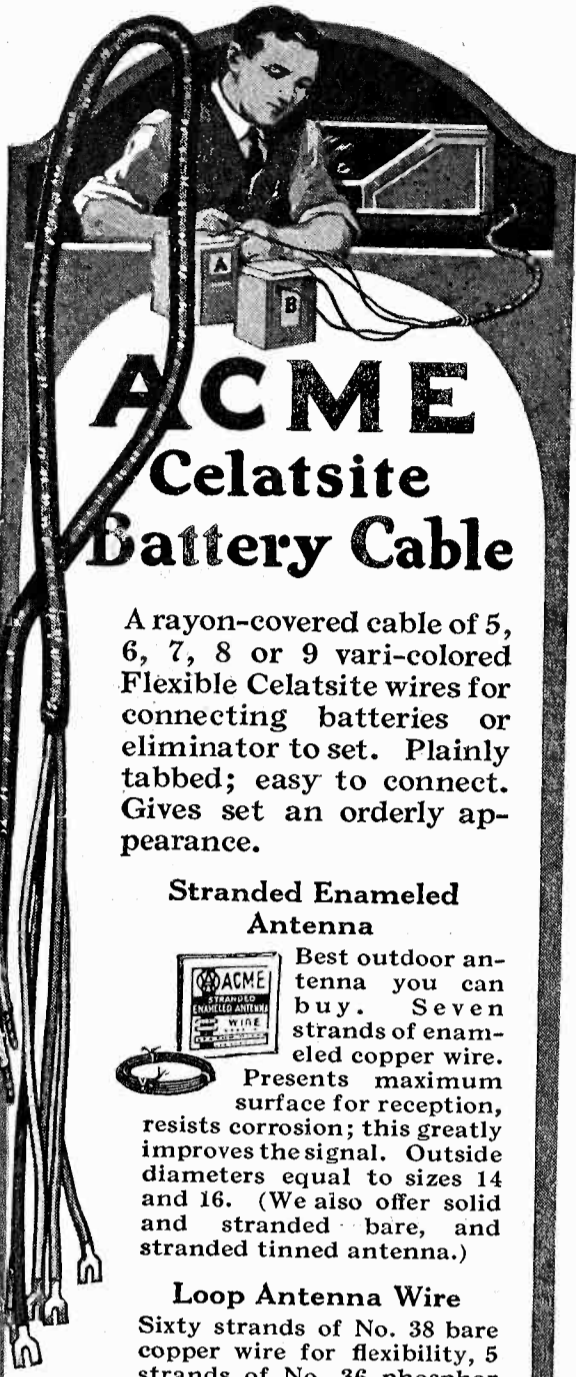

ACME Celatsite Battery Cable

A rayon-covered cable of 5, 6, 7, 8 or 9 vari-colored Flexible Celatsite wires for connecting batteries or eliminator to set. Plainly tabbed; easy to connect. Gives set an orderly appearance.

Stranded Enamelled Antenna

Best outdoor antenna you can buy. Seven strands of enamelled copper wire. Presents maximum surface for reception, resists corrosion; this greatly improves the signal. Outside diameters equal to sizes 14 and 16. (We also offer solid and stranded bare, and stranded tinned antenna.)

Loop Antenna Wire

Sixty strands of No. 38 bare copper wire for flexibility, 5 strands of No. 36 phosphor bronze to prevent stretching. Green or brown silk covering; best loop wire possible to make.

Flexible Celatsite for sub-panel wiring

A cable of fine, tinned copper wires with non-inflammable Celatsite insulation. Ideal for sub-panel or point-to-point wiring. Strips easily, solders readily. Nine beautiful colors; sold only in 25 ft. coils, in cartons colored to match contents.

Acme Celatsite Wire

Tinned copper bus bar hook-up wire with non-inflammable Celatsite insulation, in 9 beautiful colors. Strips easily, solders readily, won't crack at bends. Sizes 14, 16, 18, 19; 30 inch lengths.

Spaghetti Tubing

Oil, moisture, acid proof; highly dielectric — used by leading engineers. Nine colors, for wire sizes 12 to 18; 30 inch lengths. (We also make tinned bus bar, round and square, in 2 and 2½ ft. lengths.)

Send for folder
THE ACME WIRE CO., Dept. R
New Haven, Conn.

ACME WIRE
MAKES BETTER RADIO

A GOOD THREE-STAGE POWER AMPLIFIER

(Continued on page 34)

the 874 voltage regulator tube appear just to the left of the power transformers.

Next to the left are the high voltage filter condensers and directly back of them is the tapped 25,000 ohm resistance which supplies the necessary intermediate voltages, a 1 mfd. condenser bypassing each tap. In front of the filter condensers are the two C biasing resistances, one for the tubes in the first and second stages and the other for the two tubes in the third stage. The small condensers in front are connected across the two blocking resistances in the grid circuits of the first tubes.

The filter section is the conventional two section high inductance in series with the load and the bank of condensers in shunt with the load.

To the left of the condensers are the two push-pull transformers with the power tubes between them. At the extreme left are the double impedances.

PARTS LIST FOR AMPLIFIER

- 2—Type 365 General Radio power transformers
- 2—Type 373 General radio double impedance couplers
- 1—Type 366 General Radio filter choke
- 1—Type 441 General Radio push-pull amplifier unit
- 5—Type 349 General Radio sockets
- 1—Type 439 General Radio center tap resistor
- 1—Type D250 Electrad fixed resistor
- 2—Type T 20 Electrad Truvolt resistors
- 2—¼ amp. Polytrols and mountings
- 2—100,000 Polymet Puremetal resistors
- 2—Type 604 Tobe 1000 volt condensers
- 1—Type 602 Tobe 1000 volt condenser
- 6—Type 301 Tobe low voltage condensers
- 12—Eby binding posts
- 1—Coil Braidite hookup wire
- 10 ft.—Rubber covered ignition cable
- 2—112-A tubes
- 2—310 tubes
- 1—874 tube
- 2—381 tubes

All of this equipment is mounted on a 11¾x22¾x¼ in. bakelite baseboard on the bottom of which is centered and clamped a 9¾x20¼x1/16 in. sheet of brass. Five holes are drilled through the brass and the bakelite, one at each corner and one in the center, through which five supporting legs are secured with 8/32 machine screws. These legs are of 1 in. bakelite rod.

After the positions of the mounting holes are determined by laying out the parts on the board, the holes are marked with a center punch and drilled with a No. 27 drill to clear 6/32 screws. The brass is connected to the negative B lead. The apparatus is mounted with machine screws and nuts.

The wiring should preferably be under the panel; holes being drilled for this purpose. These should be countersunk in the brass to eliminate sharp edges. Wires from the low voltage windings of the power transformers to the tube filaments should be run in twisted pair to eliminate stray fields. Rubber covered ignition cable should be used for all high voltage leads.

Tell them that you saw it in RADIO

Your Radio Cabinet

should receive some attention if you wish to preserve its original beauty.



Atmospheric conditions cause the finish to check and lose its lustre, and soon a once beautiful instrument becomes faded and ordinary.

Varnite Radio Polish

is a scientific compound, designed especially for Radio Cabinets, Phonographs and wherever a superior polish and restorative is required.

It restores the grain of the wood to its original beauty, preserves the finish and prevents checking.

Use VARNITE to clean the panel on your Radio, it will prevent "blooming" and that "foggy" appearance.

It is easily applied and leaves no greasy surface to collect dust. Sold by leading radio dealers everywhere or by mail postpaid.

Insist on the genuine, there is no substitute for VARNITE.

Price 50 cents

Manufactured and guaranteed by
DAVIS CHEMICAL CO.
93 MASSACHUSETTS AVE. BOSTON, MASS.

SAVE \$2.00

Subscribe Now to "RADIO" and "CITIZENS
RADIO CALL BOOK" both for \$2.50
"RADIO" San Francisco

Quality Radio Products

INCLUDE

Potter Condensers



Potter Manufacturing Co.
No. Chicago, Ill.

Pacific Coast Offices
905 MISSION STREET
San Francisco California



VARIO DENSER

Quick, easy tuning—more volume, clearness, stability with an X-L VARIO DENSER in your circuit. Endorsed by experts. Specified in all the latest hook-ups.

MODEL "N"—Micrometer adjustment easily made, assures exact oscillation control in all tuned radio frequency circuits. Neutrodyne, Roberts two tube, Browning-Drake, Silver's Knock-out. Capacity range 1.8 to 20 micro-microfarads.

Price \$1.00



Model "G"

MODEL "G"—Obtains the proper grid capacity on Cockaday circuits, filter and intermediate frequency tuning in superheterodyne and positive grid bias in all sets.

Capacity range:
 Model G-1 .00002 to .0001 M. F. D.
 Model G-5 .0001 to .0005 M. F. D.
 Model G-10 .0003 to .001 M. F. D.

Price, each with grid clips.....\$1.50

X-L PUSH POST—Push it down with your thumb, insert wire, remove pressure and wire is firmly held. Vibrations will not loosen. Releases instantly. A push post that excels in appearance, action, service and convenience.

Price each 15c

X-L PUSH POST PANEL—Seven push posts mounted on black insulating panel with permanent white markings. Soldering lugs, raising bushings and screws for mounting, etc., in box complete.

Price \$1.50



X-L Push Post



X-L Push Post Panel

FREE—New, up-to-date book of wiring diagrams showing use of X-L units in the new LOFTIN-WHITE constant coupled radio frequency circuit, and in other popular hook-ups. Also the Goodwin Aperiodic Detector Circuit which adds a stage without adding tuning controls. Applicable to any set. WRITE TODAY!

XL Radio Laboratories

2428 Lincoln Ave. Chicago, Ill.

SELL YOUR EXCESS PARTS
 Through a Classified Ad in
 "RADIO" See Page 79

POWER CONE UNIT

For large and small cones, drum, flat wood, or any other type of speaker diaphragm. Operates on "A" battery current. Gives greater volume and depth of tone on small cone than other units give on 3 ft. size. Latest design of Clyde J. Fitch. Sent postpaid or C. O. D. Set builders—write for special offer.

FANSPEAKER RADIO CO., Dept. W,
 199 Fulton St., New York, N. Y.

Gentlemen: Send me one power cone unit for which I enclose \$12. If not satisfactory, I will return it in 10 days and you are to refund full amount.

Name.....

Address.....

If C. O. D. shipment is desired, mark here

PROTECTING VACUUM TUBES AGAINST BURNOUT

By Clinton Osborne

As tube burnouts are ordinarily caused by accidental contact between the plate and filament leads within or around a receiver, the first obvious precaution is thorough insulation of all wires. For further safety this should be supplemented by placing a resistance in each positive B supply lead or by a fuse or high resistance at the negative B battery.

The connections for the former method are shown in Fig. 1 which is the circuit diagram of the external filament and plate supply ordinarily used for a 6-tube set requiring 135 volts of B battery with taps at 45 and 90 volts. Assuming 1/4 amp. tubes, their normal filament drain is 1 1/2 amperes at 6 volts. As this current value should not be exceeded if burnout is to be obviated, the proper resistance values should be figured from Ohm's Law, $R=E/I$.

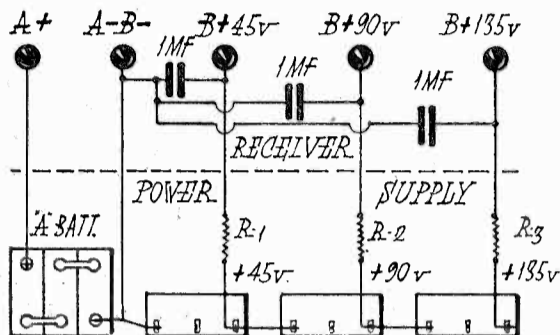

Fig. 1. Method of Installing Protective Resistances.

If the maximum allowable I be arbitrarily set at 1/2 ampere, $R_1=45 \div 1/2=90$ ohms, $R_2=90 \div 1/2=180$ ohms, and $R_3=135 \div 1/2=270$ ohms. Each of these resistances should be bypassed by a 1 mfd. condenser in the set, but never mount the resistances inside the set as this would allow the unprotected B battery connecting wires touch the A battery binding posts if carelessly handled.

In the case of sets using type 99 tubes, the values of protecting resistance would in each case be higher, as each 99 tube draws .06 amperes, with .12 amperes for the power tube, type 120. Allowing 1/4 ampere as the maximum safe current in case of a B battery short circuit, R_1 would be 180 ohms, R_2 would be 360 ohms, and R_3 would figure 540 ohms. In selecting resistances, both for type A or 99 tubes, the nearest even figure in ohms should be used, as resistances of odd values such as those given above are not easily obtained.

For R_1 , and type 99 tubes, a 200 ohm resistance may be used, for R_2 a 350 ohm resistance, and for R_3 , a 500 ohm resistance will be near enough for all practical purposes.

Another method of protecting the tubes in a receiver is to install a fuse in the negative B lead. At various times, fuses for this purpose have been placed on the market, but where not obtainable,

(Continued on page 58)

Tell them that you saw it in RADIO

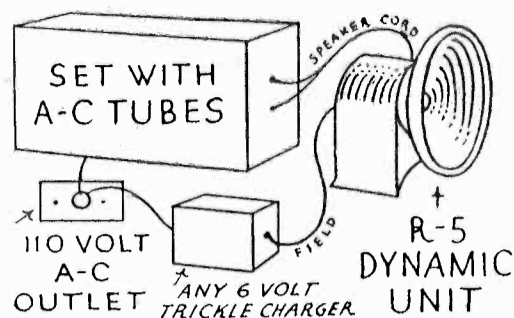

MAGNAVOX Dynamic Speaker UNIT

(Type R-4, 6 volts, D. C.)

Hook it up like this sketch because the 6 volt rectified output of any standard trickle charger or "A" rectifier will energize the field of the MAGNAVOX 6 volt Dynamic power speaker unit.

R-4 unit only \$50. Easily fitted into any cabinet.



Aristocrat
 Model
 Dynamic
 Speaker
 Complete
 6 volt \$85
 110 volt \$90

Only the Dynamic type speaker can bring out the full qualities of reproduction demanded today.

Write for speaker bulletins

The MAGNAVOX Co.

Oakland, California

FOREIGN RADIO BROADCASTING

(Continued from page 40)

City	Call	Wave-length Meters	Power Antenna Watts
Dundee	2DE	294	200
Edinburgh	2EH	288.5	500
Glasgow	5SC	405.4	1,500
Hull	6KH	294	200
Leeds, Bradford	2LS	277.8-252.1	500
Liverpool	6LV	297	200
London	2LO	361.4	3,000
Manchester	2ZY	384.6	1,500
Newcastle	5NO	312.5	1,500
Nottingham	5NG	275.2	200
Plymouth	5PY	400	200
Sheffield	6FL	272.7	200
Stoke-on-Trent	6ST	294	200
Swansea	5SX	294	200
Zagreb	Yugoslavia	275.2	100

NORTH AMERICA

City	Call	Wave-length Meters	Power Antenna Watts
Canada			
Brantford, Ont.	CFGC	296.9	50
Burnaby, B. C.	CFYC	410.7	500
Calgary, Alta.	CFAC	434.5	500
Calgary, Alta.	CFCN	434.5	1,800
Calgary, Alta.	CJCJ	434.5	250
Calgary, Alta.	CNRC	(Uses above stations)	
Charlottetown, P. E. I.	CFCY	312.3	100
Cobalt, Ont.	CKMC	247.8	5
Edmonton, Alta.	CHCY	516.9	250
Edmonton, Alta.	CHMA	516.9	250
Edmonton, Alta.	CJCA	516.9	500
Edmonton, Alta.	CKUA	516.9	500
Edmonton, Alta.	CNRE	(Uses above stations)	
Fredericton, N. B.	CFNB	247.8	25
Halifax, N. S.	CHNS	322.4	100
Hamilton, Ont.	CHCS	340.7	10
Hamilton, Ont.	CKOC	340.7	50
Iroquois Falls, Ont.	CFCH	499.7	250
Kamloops, B. C.	CFJC	267.7	15
King, York Co., Ont.	CFRB	291.1	1,000
Kingston, Ont.	CFMC	267.7	20
Kingston, Ont.	CFRC	267.7	500
London, Ont.	CJGC	329.5	500
Midland, Ont.	CKPR	267.7	50
Mission City, B. C.	CJCU	247.8	5
Moncton, N. B.	CNRA	322.4	500
Montreal, P. Q.	CFCF	410.7	1,650
Montreal, P. Q.	CHYC	410.7	750
Montreal, P. Q.	CKAC	410.7	1,200
Montreal, P. Q.	CNRM	(Uses above stations)	
Moose Jaw, Sask.	CJRM	296.9	50
Ottawa, Ont.	CKCO	434.5	100
Ottawa, Ont.	CNRO	434.5	500
Prescott, Ont.	CFLC	296.9	50
Preston	CKPC	247.8	7½
Quebec, P. Q.	CHRC	340.7	5
Quebec, P. Q.	CKCI	340.7	22½
Quebec, P. Q.	CKCV	340.7	50
Quebec, P. Q.	CNRC	(Uses CKCV)	
Red Deer, Alta.	CKLC	356.9	1,000
Regina, Sask.	CHWC	312.3	15
Regina, Sask.	CJBR	312.3	500
Regina, Sask.	CKCK	312.3	500
Regina, Sask.	CNRR	(Uses CKCK)	
St. Hyacinthe, P. Q.	CKSH	312.3	50
Saskatoon, Sask.	CFKC	329.5	500
Saskatoon, Sask.	CHUC	329.5	500
Saskatoon, Sask.	CJWC	329.5	250
Saskatoon, Sask.	CNRS	(Uses above stations)	
Scarboro, Ont.	CJYC	291.1	500
Scarboro, Ont.	CKCX	(Uses CJYC)	
Sea Island, B. C.	CJOR	291.1	50
Summerside, P. E. I.	CHLC	267.7	25
Toronto, Ont.	CFCA	356.9	500
Toronto, Ont.	CHIC	356.9	500
Toronto, Ont.	CHNC	(Uses CKNC)	
Toronto, Ont.	CJBC	(Uses other stations)	
Toronto, Ont.	CJSC	(Uses CKCL)	
Toronto, Ont.	CKCL	356.9	500
Toronto, Ont.	CKNC	356.9	500
Toronto, Ont.	CKSM	(Uses CFCA)	
Toronto, Ont.	CNRT	(Uses CFCA)	
Unity, Sask.	CHSC	267.7	50
Vancouver, B. C.	CFCQ	410.7	10
Vancouver, B. C.	CFCT	329.5	500
Vancouver, B. C.	CHPC	(Uses CHPC)	
Vancouver, B. C.	CKCD	410.7	1,000
Vancouver, B. C.	CKFC	410.7	50
Vancouver, B. C.	CKWX	410.7	10
Vancouver, B. C.	CNRV	291.1	500
Winnipeg, Man.	CKY	384.4	500
Winnipeg, Man.	DNRW	(Uses CKY)	
Yorkton, Sask.	CJGX	475.9	500

Costa Rica

City	Call	Wave-length Meters	Power Antenna Watts
San Jose			
Caibarien	6EV	250	50
Camaguey	7AZ	225	10
Camaguey	7EV	190	5
Camaguey	7GT	195	5
Camaguey	7LO	230	20
Camaguey	6YR	200	20
Caney	8KP	180	30
Caney	8LC	300	30
Ciego de Avila	7BY	235	20
Ciego de Avila	7FU	200	10
Ciego de Avila	7HF	192	10
Ciego de Avila	7IR	193	20
Cienfuegos	6BY	260	200
Cienfuegos	6JQ	275	10
Cienfuegos	6KC	240	10
Colon	5EV	360	5
Elia	7SR	350	500

(Continued in next issue)

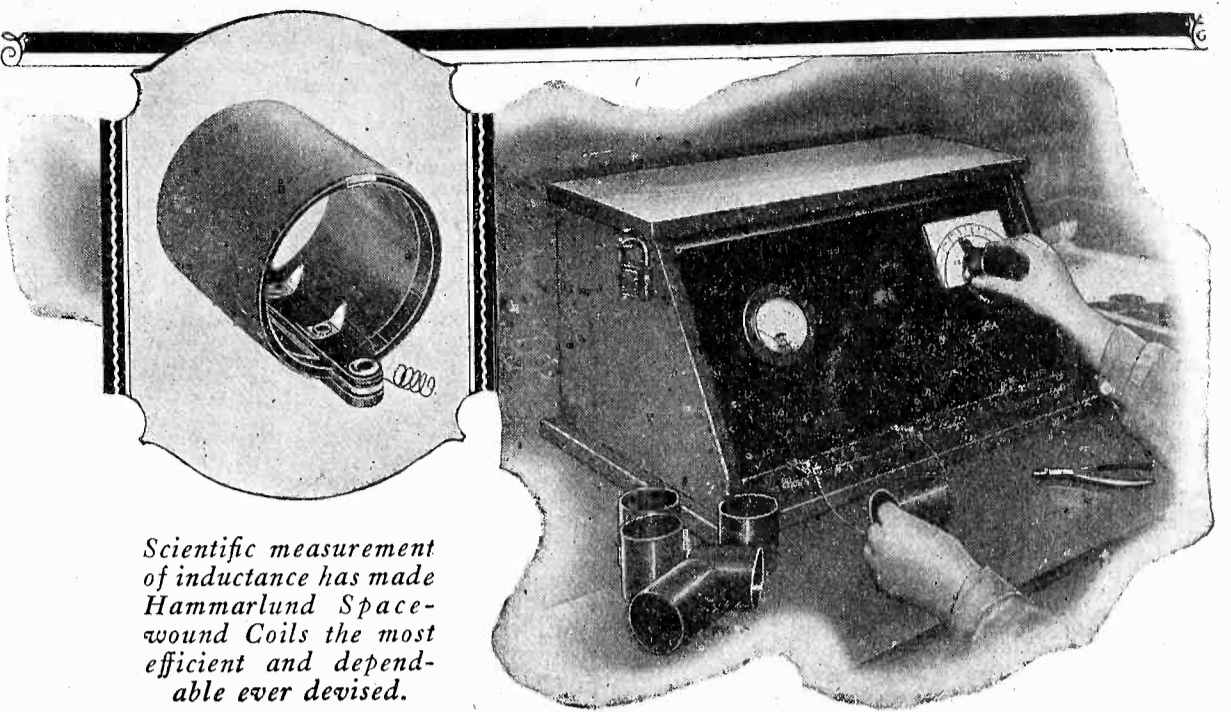

Scientific measurement of inductance has made Hammarlund Space-wound Coils the most efficient and dependable ever devised.

Hammarlund Coil Inductance Scientifically Measured

NOT very long ago, so many turns of wire on such and such size core were considered accurate enough for inductance measurement.

But in this age of multi-tuned, single-control circuits, guess-work is out of the question. Coils must be matched to the finest degree. Not satisfied merely with producing the most efficient type of coil, Hammarlund devised the instrument, pictured above, to insure accurate measurement of inductance values.

You can depend on Hammarlund precision. It means standardized quality and assurance that you get what you pay for.

Your dealer sells Hammarlund Matched Coils for the latest popular circuits.

HAMMARLUND MANUFACTURING COMPANY
424-438 West 33rd Street, New York

Pacific Coast Representatives
HENGER-SELTZER CO.

711 E. 14th St., Los Angeles—377 Brannan St., San Francisco

More than a score of radio designers officially specify Hammarlund Precision Products for their newest circuits.

For Better Radio
Hammarlund
PRECISION
PRODUCTS

Dealer Inquiries invited concerning several new and appealing Hammarlund developments, having a wide sales demand.

PHOTO-ELECTRIC CELLS
THE BURT CELL

Without Fatigue — Highly Sensitive — Absolutely Reproducible — Instantaneous in Response

The BURT-CELL is made by a new method and should not be confused with any other photo-electric cell. By a special process of electrolysis, the photo-electric metal is introduced into a highly evacuated bulb directly through the glass wall of the bulb, giving photo-electric material of absolute purity. The superiority of the BURT-CELL is due to these features, making possible results never before obtainable.

Described in Bulletin No. 271.

We also manufacture the STABILIZED OSCILLOSCOPE — the only VISUAL OSCILLOGRAPH having a lineal time axis and no inertia—giving an accurate picture of high frequency wave forms.

Write for Bulletin 273

DR. ROBERT C. BURT, Manufacturing and Consulting Physicist 327 S. MICHIGAN AVE., PASADENA, CALIF.

ABC Powerizer

*makes every
set a De Luxe
electric*

Alternating current flows
uninterruptedly into new
A.C. Radiotrons in set
Finest tone quality in radio

NOW you can have any
radio set powerized—all
ready to plug into light socket.
No batteries, jellies, trickle
charger eliminator units. Al-
ternating current direct to
A.C. Radiotrons in set is the
only practical scientific
method of electrification.

Deep bass notes—vibrant
chords of the organ—are re-
produced with the richness
and mellowness achieved only
by powerized amplification.

Write for literature explaining
details of real A B C socket-power
and tone quality.

RADIO RECEPTOR CO., Inc.
106 Seventh Ave., New York, N. Y.

LICENSED BY RADIO CORPORATION OF
AMERICA AND ASSOCIATED COMPANIES

Atwater Kent Model—List without tubes
\$60.00. Radiotrons UX-280 and UX-210,
\$14.00.

Universal Model—for majority of 6-tube RFL
and Neutrodyne circuits. Without tubes
\$60.00. Radiotrons UX-280 and UX-210,
\$14.00.

Radiola "20" Model—List without tubes
\$59.00. Radiotrons UX-280 and UX-210,
\$14.00.

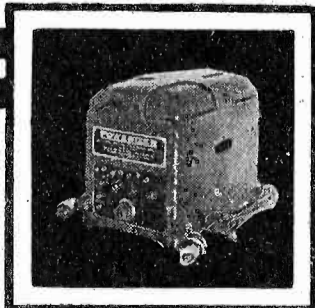

WEATHER CODES

(Continued from page 39)

The 7th figure indicates the radius and intensity as in table 3.

The Latitude and Longitude given, indicate the center of a circle within which the typhoon center may be and the 7th figure shows the size of this circle.

TABLE 1—DIRECTION Same code as given for Wind Direction.	TABLE 2—CONDITION 51—Forming 52—Two centers 53—Direction unknown 54—Stationary or very slow 56—Re-curving 58—Filling up	TABLE 3—RADIUS AND INTENSITY Radius of circle in miles...Code—Intensity 120...1—Unknown 120...2—Severe 60...3—Unknown 60...4—Severe 5—Deepening 30...6—Unknown 30...7—Severe 8—Exceptional velocity 9—Continental depression 0—Position uncertain
---	---	---

This Typhoon Warning Code is sometimes used by FFZ Zikawei, Shanghai.

Translation Tables

Indo China Weather Reports

Observation Stations in plain-language report	3—Disturbed 4—Moderately rough 5—Rough 6—Very rough 7—High 8—Very high 9—Violent
Hong Kong Fort Bayard Phulien North Gulf Tonking South Gulf Tonking Cape Tientcha-Tourane Cape Varella Cape Padaran Cape St. James	Words commonly used Agite—disturbed Assez—generally Baisse—fall Beau—fine, fair Belle—calm Brouillard—fog, mist Brunier—drizzle Brumeux—fog, haze Cap—Cape Couvert—overcast Est—East Faible—weak Forte—strong Grosse—large Hausse—rise Houleuse—swell Inconnu—unknown Legere—slight Nord—North Nuageux—cloudy Ouest—West Peu—small Pluie—rain Sud—South Tres—very
Wind Direction Code 00—Calm	
02—NNE 04—NE 06—ENE 08—E 10—ESE 12—SE 14—SSE 16—S 18—SSW 20—SW 22—WSW 24—W 26—WNW 28—NW 30—NNW 32—N	
Sea Code 0—Calm 1—Very smooth 2—Smooth	

XRT Tsing-Tao, China, Weather Code

Four groups, each of 5 figures are sent. They are represented symbolically as follows:

BBBDD FwwVC NTTdd WAPPS

BBB. Barometer reading in millimeters, the initial figure 7 being omitted, thus 586 equals 758.6 m/m. See conversion table.

DD—Wind Direction 00—Calm	08—Overcast 10—Rain 12—Squally 14—Lightning 16—Fog 18—Dense fog 20—Misty 22—Snow 24—Hail 26—Thunder shower 28—Gale 30—Thunder
02—NNE 04—NE 06—ENE 08—E 10—ESE 12—SE 14—SSE 16—S 18—SSW 20—SW 22—WSW 24—W 26—WNW 28—NW 30—NNW 32—N	

V—Visibility 0—Very dense fog 1—Dense fog 2—Fog 3—Moderate fog 4—Thin fog 5—Visibility poor 6—Vis. moderate 7—Vis. good 8—Vis. very good 9—Vis. excellent	C—Cloud Form 1—Cirrus 2—Cirro stratus 3—Cirro cumulus 4—Alto cumulus 5—Alto stratus 6—Strato cumulus 7—Nimbus 8—Fracto cumulus 9—Stratus 0—Cumulus nimbus No code—no cloud
F—Wind Force Beaufort scale 0 to 9	N—Cloud Direction 0—Variable 1—NE 2—E 3—SE 4—S 5—SW 6—W 7—NW 8—N 9—None
WW—Weather 00—Fair 02—Cloudy 04—Much cloud 06—Dense cloud	

TT Temperature. Centigrade scale. If minus, 50 is added to the figure, thus: —15 is sent as 65. Conversion Table on page 24.

dd Difference between the wet and dry bulb thermometers.

0—Fair 1—Cloudy 2—Much cloud 3—Overcast 4—Rain	W—Past Weather 5—Snow 6—Fog 7—Dense fog 8—Hail 9—Thunder shower
--	--

A—Tendency of Pressure 0—Stationary 1—Irregular 2—Increasing continuously 3—Decreasing continuously 4—First decreasing then increasing 5—First stationary then increasing 6—First stationary then decreasing 7—First decreasing then stationary 8—First increasing then stationary 9—Thunder nose in barometer
--

PP Difference of pressure three hours previous in millimeters and tenth millimeters. If the difference is 0.5 m/m, the code is 05. If the difference is PLUS, add 50 to the code for wind direction.

S—Characteristics of Swell 0 None or slight 1 Moderate swell 2 Heavy swell 3 Long low swell 4 Confused swell	5 6 7 8 9	Sea smooth to moderate Sea rough
---	-----------------------	-------------------------------------

This code is used by XRT both in the 600 meter broadcast schedules and in the report sent to XPI on 2800 meters spark at 0030 GMT.

CONVERSION OF GMT.

By Robert A. Estes (ex KOKR,
now S. S. Dora)

The new op who has to figure a sked's time whenever he gets his PX, WX, or time ticks, will find the following table useful. It is simple to keep only one time in the shack, such as that at the point of embarkation or that of the station he copies. To use this table, for instance, WNU sends press at 0430 and 1630 GMT. According to the table this corresponds to 10:30 a. m. and p. m. C. S. T.

GMT	EST	CST	PST
0000	7:00 a.m.	6:00 a.m.	4:00 a.m.
0100	8:00 a.m.	7:00 a.m.	5:00 a.m.
0200	9:00 a.m.	8:00 a.m.	6:00 a.m.
0300	10:00 a.m.	9:00 a.m.	7:00 a.m.
0400	11:00 a.m.	10:00 a.m.	8:00 a.m.
0500	12:00 m.m.	11:00 a.m.	9:00 a.m.
0600	1:00 p.m.	12:00 m.m.	10:00 a.m.
0700	2:00 p.m.	1:00 p.m.	11:00 a.m.
0800	3:00 p.m.	2:00 p.m.	12:00 m.m.
0900	4:00 p.m.	3:00 p.m.	1:00 p.m.
1000	5:00 p.m.	4:00 p.m.	2:00 p.m.
1100	6:00 p.m.	5:00 p.m.	3:00 p.m.
1200	7:00 p.m.	6:00 p.m.	4:00 p.m.
1300	8:00 p.m.	7:00 p.m.	5:00 p.m.
1400	9:00 p.m.	8:00 p.m.	6:00 p.m.
1500	10:00 p.m.	9:00 p.m.	7:00 p.m.
1600	11:00 p.m.	10:00 p.m.	8:00 p.m.
1700	12:00 mid.	11:00 p.m.	9:00 p.m.
1800	1:00 a.m.	12:00 mid.	10:00 p.m.
1900	2:00 a.m.	1:00 a.m.	11:00 p.m.
2000	3:00 a.m.	2:00 a.m.	12:00 mid.
2100	4:00 a.m.	3:00 a.m.	1:00 a.m.
2200	5:00 a.m.	4:00 a.m.	2:00 a.m.
2300	6:00 a.m.	5:00 a.m.	3:00 a.m.

Newest Log Book

Completely Revised
25c per copy

"RADIO" San Francisco

LYNCH

Heavy duty resistors for
all standard power packs.

RADIO OPERATING AS A MEANS TO LARGER OPPORTUNITIES

By C. B. Cooper

Advisory Committee West Side Y. M. C. A.
Radio Institute, New York City

BROADCAST station management and radio merchandising are two opportunities which lie ahead of the radio operator as a goal for expanding accomplishment. Radio merchandising is a much broader field for those who are of the salesman type, more lucrative. Any clerk or radio merchandiser or radio factory employe is better qualified to succeed if he has the ground work of radio operating as the base of his knowledge.

The fundamental principle of every effort in radio is first an understanding of the art, and no one should understand the fundamentals better than a radio operator. From this base or foundation he can branch out to every phase of the business. The industry today is filled with ex-operators who hold excellent positions as engineers, salesmen and even presidents. There is no business or art that is destined to play so important a part in the lives of men as is radio. It needs courteous men of courage and integrity. Radio has become the God-given voice of the ship at sea. The voice that has saved thousands of lives. An efficient radio operator is master of such a voice and upon his nerve, loyalty and proficiency will depend the lives of all aboard his ship, should disaster emergencies arise.

There are few things more alluring to the average young man than the thought of becoming proficient in a vocation that will take him to all parts of the world. This is the privilege of the radio operator aboard ship. It represents a broadening experience with all the educational advantages of extended travel. However, if this is all one sees in radio operating it would be better for him never to learn this art. The radio operator aboard ship is always exposed to the dangerous disease which might be called "operators' itchy feet." It is caused by the infection or bite of the wandering bug and produces a continuous desire to change from ship to ship, the victim's whole thought being centered on trying to find or see something new.

The radio operator should not look upon his job as a life work, but as an immediate livelihood, a brain training and a stepping stone to something better. Here is a chance for one to profit by the opportunities with which operating brings one in contact. In this field one can find out whether his main bent is in the direction of engineering or business. Here one has opportunities to read and study these matters.

Another source of knowledge and training is found in the messages that pass through the radio operator's hands. They expose the very heart of people's

private lives and business. To the operator is entrusted the inside phases of life and commerce that even confidential friends or employes of the sender do not know. Much can be learned concerning human nature, and much knowledge can be acquired concerning various lines of business into which the skillful radio operator can hope to be graduated. The radio operator performs a tremendously important piece of the world's work.

USES FOR BURNED OUT TUBES

By R. Wm. Tanner

Nearly every one throws away tubes when they are burned out. Have you ever stopped to think of the many uses the bases could be put to? It is a simple matter to break the glass and scrape away the wax that holds the base to the tube. The prongs can be heated by a blow torch or over a gas flame and the connecting wires removed.

Now as to the uses: Amateurs nowadays use tuners that require from two to six coils for the different wave bands. This type of set makes use of a special coil mounting with four jacks. Each coil has four plugs on a strip of insulating material. The complete mounting costs two or three dollars. Why not save this money for more important parts and mount the different coils on old tube bases? One of the new bakelite UX sockets can be used as a mounting. This makes a cheap and compact job and is really neat in appearance.

The bases can also be used for plug-in r.f. choke coils. A choke designed for the 80 meter band will not be as effective in the 20 or 40 meter bands, therefore use a plug-in choke for each band. Choke coils for receivers can be scramble-wound of fine wire, No. 32 to 40, and made small enough to fit into the bases. Cut a piece of cardboard the size of the inside diameter of the base and push down on top of the coil. Then pour in melted sealing wax and you have a fine looking, compact little piece of apparatus.

A transmitting choke coil would necessarily have to be of large wire, No. 26 or 24 gauge, so just wind it on a cardboard tube small enough to fit snugly into the tube base and fasten with collodion. For broadcast receivers the bases can also be used for plug-in coils, chokes or r.f. transformers.

The bases are convenient wherever a plug and jack arrangement is required. I use this stunt for connecting a two stage audio frequency amplifier to either a short wave amateur tuner or a broadcast tuner. Also to plug a microphone into my transmitter.

I will not give any advice on how to mount the bases to coils as nearly everyone has ideas of his own. Be sure to use the new UX and not the old UV bases as the prongs are longer and make a better contact.

Tell them that you saw it in RADIO



Live

Where uptown and downtown meet

That's what everyone would like to do—combine country quiet with Broadway activities.

And that's exactly what this hotel offers you.

The serenity of Central Park; where two of New York's most desirable thoroughfares meet. Central Park West and 72nd Street, —and yet just 10 minutes from leading shops and theatres.

Appointments, service, cuisine unexcelled, in keeping with its international reputation.

Booklet sent free on request on New York and Hotel Majestic

Opeland Townsend

Proprietor

Majestic Hotel and RESTAURANTS

Two W. 72nd St., New York

Entire Block Fronting Central Park

General Headquarters:

New York Automobile Club

The Majestic Hotel, Central Park West at 72nd Street, New York City.

Without obligating me, please send me free Booklet on New York and Hotel Majestic.

Name.....

Address.....

Radio 11-27

At \$6.00 this famous
Cabinet
has no equal!



The Blue Ridge
7" x 18" x 10" Mahogany
or Walnut Finish

Send us your order or write for catalog and full information. 12 hour service, factory to you.

Southern Toy Co. Inc.
MANUFACTURERS HICKORY N.C.

RADIOADS

δ δ δ

A Classified Advertising Section Read by Better Buyers.

δ δ δ

The rate per word is eight cents net. Remittance must accompany all advertisements. Include name and address when counting words.

δ δ δ

Ads for the March Issue Must Reach Us by February Fifth

PRESS AND PUBLIC concede it to be the best ever produced. "Radio Theory and Operating" by Mary Texanna Loomis, member Institute of Radio Engineers, lecturer on theory of radio, Loomis Radio College. Thorough text and reference book; 886 pages, 700 illustrations, handsome, flexible binding. Price \$3.50, postage paid. Used by Radio Schools, Technical Colleges, Universities, Government Schools, Department of Commerce and Engineers. At bookdealers, or sent on receipt of check or money order to Loomis Publishing Company, Dept. X, 405 9th St., Washington, D. C.

TYRMAN TEN—Complete wired. In beautiful cabinet. Perfect condition. 2000 mile range easily. Sharp as a razor. Must sell at once and will sacrifice for \$75.00, without tubes. C. S. Ford, 153 Occidental Ave., Burlingame, Calif.

FOR SALE—No. 700 Remler Infradyne Amplifier \$12.00. A. Dittman, Brownsville, Texas.

KOLSTER DECREMETER—Cost new \$375.00. Excellent condition. Will sell for only \$50.00. Complete with coils and genuine leather carrying case. Useful for many purposes such as checking coils, etc. Good buy for some laboratorian. C. H. Cannon, 462 25th Ave., San Francisco.

DO YOU GET TIRED of buying "B" batteries? A lifetime Edison will solve your troubles. Good, live, large size elements connected with pure nickel wire, electrically welded, 7c pair. All parts for sale. Sample cell and dope sheet, 10c. Paul Mills, Woodburn, Oregon.

PRACTICAL RADIO is unusually successfully taught by the McKay Instrument. Co. Students study at home, know Radio and earn big money. Railway Exchange Building, Portland, Oregon.

REMLER - BEST 1925 - 26 SUPER — Complete, matched tubes included. (No cabinet.) Stromberg-Carlson audio transformers. Professionally constructed. Works coast-to-coast and how! Bargain at \$50 even. First money order takes it. Wm. P. St. Sure, 3001 Park Boulevard, Oakland, Calif.

\$100 PER MONTH in your home, folding and mailing circulars. We furnish everything. Particulars and samples 25c. Adams Mailing Service, S-1292, Greenfield, Ohio.

Are you making money in radio? If not, send for booklet. Co-Operative Radio Doctors, Dept. P, 131 Essex St., Salem, Mass.

USE WHAT OCEAN LINERS AND SHIPS USE—Genuine SAWCA 722 Silicon Bronze Ship Aerial. The most efficient antenna wire obtainable. Price two cents per foot. Ship Aerial Wire Co. of America, 217 Wyckoff Avenue, Dept. C, Brooklyn, New York.

WRITE about our efficient line of "B" and "AB" Power Devices. Kimley Electric Co., 441 E. Ferry St., Buffalo, N. Y.

MOTOR GENERATORS, DC and AC, all sizes. Bargain prices on all kinds of radio generators and motor generators. For example: 100 watt 27.5 volt DC and 300 volt DC double current generators \$15.00 each. Full ball bearing types, in first class shape. 900 cycles self excited 200 watt alternators, used, but in fine shape. \$17.50 each. Other bargains. Write for list. D. B. McGown, 435 Pacific Bldg., San Francisco.

BARGAINS IN USED SETS—Magnavox, 6 tube set, complete with tubes and batteries, dry B and 60 AH storage A battery; cone type loud speaker, \$65.00. Radiola-Brunswick. Phonograph and radio combination, cost over \$450.00. In perfect shape, cabinet looks like new, receiver is Radiola Superheterodyne, with good assortment of high grade phonograph records. New tubes and batteries, \$115.00. Home-made Browning-Drake, with tubes and speaker, all mounted in polished hardwood cabinet, \$25.00. All F. O. B. San Francisco, Cal. Other bargains. Write for list. Alexandria Radio Shop, 5410 Geary Street, San Francisco, Calif.

SUB-PANEL DIAL MOUNTING

By Don C. Wallace

THE unobtrusive and pleasing panel mounting for a radio dial, such as the National type B, shown in the accompanying picture, can be easily made by the aid of a scroll saw and a couple of small wood files. This

a 5/8 in. walnut panel cut out with a scroll saw so as to fit around the dials and the knob on panel *a*; panel *c* was of 1/8 in. walnut veneer cut so as to fit over the dials. The dials are carefully glued in position as shown in Fig. 1b.

The result is a compact, good-looking walnut panel with concealed dials.

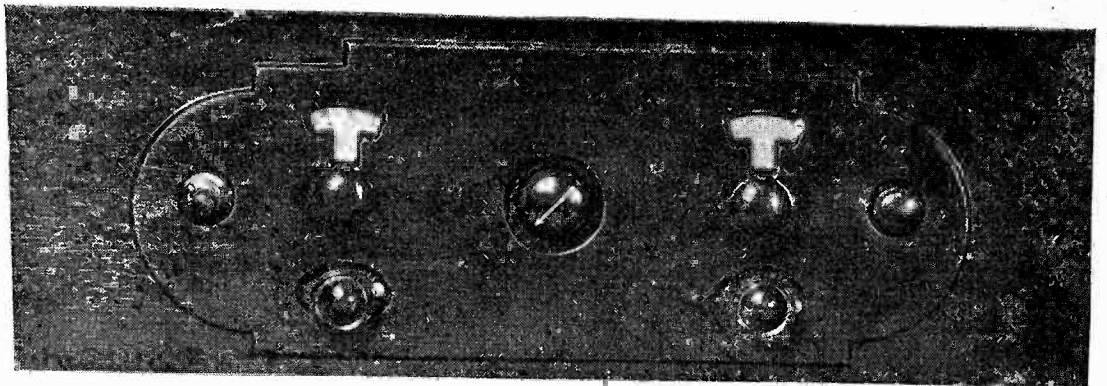
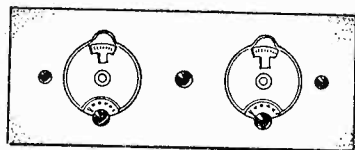

Fig. 1a. Suggested Panel Mounting for Radio Dials.

is done by placing two wood panels over the usual panel mounting, shown in Fig. 1a.

As accomplished by Clarence A. Lander of Seattle, Wash., panel *a* was 5/8 in. soft pine board 7x18 in.; panel *b* was



DIALS FASTENED TO 3/8" PANEL IN USUAL MANNER. PANEL 7" x 18"

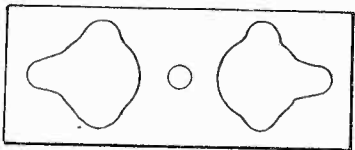

5/16" WOOD PANEL CUT OUT WITH SCROLL SAW.

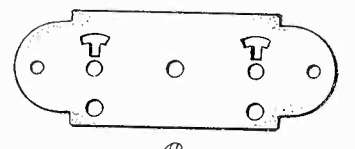

1/8" VENEER PANEL. HOLES CUT OUT WITH SCROLL SAW.



1/8" VENEER PANEL. 5/16" WOOD PANEL. 3/8" MAIN PANEL.

Fig. 1b. Details of Panel Mounting.

HOW TO CALIBRATE A RECEIVER

(Continued from page 32)

dial is rotated, it will be heard in the receiver each time it reaches a wavelength which is an exact multiple of 38.4. These are (in the broadcast band) 230.4, 268.8, 307.2, 345.6, 384.4, 422.4, 460.8, 499.2, and 537.6 meters. We thus have nine accurate calibration points well spread out over the desired band.

In the above discussion tuning is expressed in wavelengths instead of frequencies, because it is believed that the majority of experimenters think in the former term, and desire their calibrations in wavelengths. If the calibrations are made in frequencies it will result in the elimination of most of the fractions, and will present a better picture of conditions generally and especially on the very short waves. To make a frequency calibration, knowing the frequency of a good broadcast station, follow the same methods, as above outlined, except that the harmonics are obtained by multiplication instead of division.

A HOMEY HOTEL IN THE HEART OF NEW YORK

THE *New Flanders*

47th to 48th STREET

EAST OF BROADWAY

One of the finest Hotels in TIMES SQUARE

Single Rooms with Running Water, \$2.00
 Double Rooms with Running Water, \$3.00
 Single Rooms with Bath \$2.50
 Double Rooms with Bath . . \$3.50

Special Weekly Rates

F. W. BIZEL, Resident Manager

Tell them that you saw it in RADIO

The biggest Edition—

The biggest edition ever published. Brimful of newest information, latest circuits and hook-ups, new revised list of world's broadcasting stations with schedules and new wave lengths in meters and kilocycles. 264 pages of news, ideas, and valuable information for fans, set builders, radio dealers and everyone interested in radio's advancement.



Citizens' Radio Call Book

NEW NOVEMBER, 1927 EDITION

On Sale Now at Newsstands and Radio Stores

Wonderful Rotogravure Section

One of the big features of the new Call Book is the 16-page rotogravure section. It is replete with photographs and views. Your favorite radio artists, pictures of studio life, prominent announcers and other features are shown in actual photographic views.

Complete Details on Newest Circuits

Every Receiver Designed and Thoroughly Tested in Our Laboratories

Complete constructional details on the newest modern radio circuits are given, including the Silver-Marshall A.C. Shielded Six, Improved Aero-dyne Six, Camfield Shielded Grid Seven, Citizens Super Nine, Madison-Moore International "One-Spot," Lincoln Quality Super Nine, Thompson Super Seven, Walker Vari-Unit Receiver, Thordarson Power Amplification System, Victoreen Universal Receiver, Magnaformer 9-8 A.C. Super, La Peer AR-9 Super, National Browning-Drake with Power Amplifier, Silver-Marshall Laboratory Model A.C. Shielded Super, Tyrman Super Ten with A Battery Elimination, R.G.S. Octamonic Super, World's Record Super Eight, Camfield Super-Selective Ten, The Knickerbocker Four.

A Complete Radio Cyclopedia

Be sure that you get the CITIZENS RADIO CALL BOOK, the original and most widely circulated publication of its kind. Accept no substitutes. Published four times yearly, September, November, January and March. On sale now at newsstands and radio stores the world over, or subscribe now and be sure of receiving each issue as published. Use the handy coupon below and mail in now.

Mail
This →
Coupon
Today!

CITIZENS RADIO SERVICE BUREAU, Inc., Publishers
508 South Dearborn St., Chicago, Ill., Dept. R, U. S. A.

(RE)

Date.....192.....

Please enter my subscription for the CITIZENS RADIO CALL BOOK for [] one year, \$1.75; [] two years, \$3.25; [] three years, \$4.50. Enclosed please find.....in payment for same, mailed postpaid four times yearly, January, March, September and November. Canada and Foreign, \$2.00 yearly.

Name.....

Address.....

City.....

State.....

Tell them that you saw it in RADIO

When I first started making real important money I used to go down to the bank, draw out a roll—and just thumb it over in my office and grin! That's how good it felt to get success and big money, after years at a low-paid job.

Success and Big Money Were For Others, Not Me

Believe It or Not, That Was What
I Thought of Myself Just
Twelve Short Months Ago

I'M telling you, just one year ago I'd never seen a hundred dollar bill in my life outside of a bank.

You'd think I'm kidding you if you saw the fine Radio business I own now. But it's gospel truth. Just twelve months ago I was only a poorly paid clerk, and I thought success had passed me by.

All my crowd in those days—the fellows I met in the pool-hall and at the bowling-alleys—said a fellow had to *have* money to make money. They claimed there was no chance for a fellow whose family didn't have money or some business to start him out in. And I'd decided they must be right.

I guess at that time I had just about given up hope. I thought there must be some kind of a mystery about making a lot of money. But I was due for a big awakening. Did I get it? Oh, boy! Read my story and judge for yourself.

IT all started one day last summer, when Helen, the girl I wanted to marry, was leaving for the seashore. Of course I went to the station to see her off.

As I stepped onto the station platform Bob Oakes and Wilmer Pratt had just rolled up in their cars. They climbed out with their arms full of bundles—books, expensive candy, flowers, all sorts of things. Well sir, I wished I could have swallowed in one gulp the little box of drugstore candy I had bought for Helen—it certainly looked pitiful beside all that stuff.

We three stood there talking to Helen until train-time, while Helen's mother looked me up and down. Like any young girl's mother would, she had my financial standing already sized up within thirty-five cents. Cheap suit, cheap hat, she took it all in. And you could see on her face all the time what a lot of nerve she thought I had to give Bob and Wilmer a run for Helen.

Well, to make a long story short, Helen was nice, but her mother stood there looking scornful whenever she glanced my way, and she hardly spoke to me at all. I felt about as welcome as the measles, and as uncomfortable as the itch. I began to wish that I and my cheap suit and cheap hat could sink through the floor, but I stayed there and stuck it out.

WHEN Helen's train finally left, I slunk home, ashamed and humiliated. I went upstairs to my room and sat there with a lump in my throat, getting hotter and hotter and more ashamed of myself. Then I began to see red and redder.

Finally I jumped up and banged the table. "I'll show 'em," I growled through clenched teeth. "There *must* be some way for a man to make *real money!*" An idea suddenly flashed through my head.

Hastily I began thumbing the pages of a magazine on the table, searching for an advertisement that I'd seen many times,

but passed up without thinking, an advertisement telling of big opportunities for trained men to succeed in the great new Radio field. With the advertisement was a coupon offering a big free book full of information. I sent the coupon in, and in a few days received a handsome book, telling about opportunities in the Radio field and how a man can prepare quickly and easily at home to take advantage of these opportunities. I read the book carefully and when I finished it I made my decision.

WHAT'S happened in the twelve months since that day, as I've already told you, seems almost like a dream to me now. For ten of those twelve months I've had a Radio business of my own! At first, of course, I started it as a little proposition on the side, under the guidance of the National Radio Institute, the outfit that gave me my Radio training. It wasn't long before I was getting so much to do in the Radio line that I quit my measly little clerical job, and devoted my full time to my Radio business.

Since that time I've gone right on up, always under the watchful guidance of my friends at the National Radio Institute. They would have given me just as much help, too, if I had wanted to follow some other line of Radio besides building my own retail business—such as broadcasting, manufacturing, experimenting, sea operating, or any of the score of lines they prepare you for. And to think that until that day I sent for their eye-opening book, I'd been wailing "I never had a chance!"

NOW I'm making real money, own a good car, stand high in my town, can borrow money at the bank any time I might want it. I'm getting some real *fun* and *enjoyment* out of life, not just *existing* from pay-day to pay-day.

And—just listen to this! Bob was in my place only the other day, and asked me for a job! Wilmer is still getting along pretty well on his father's money but he'd trade places with me any day.

Tell them that you saw it in RADIO

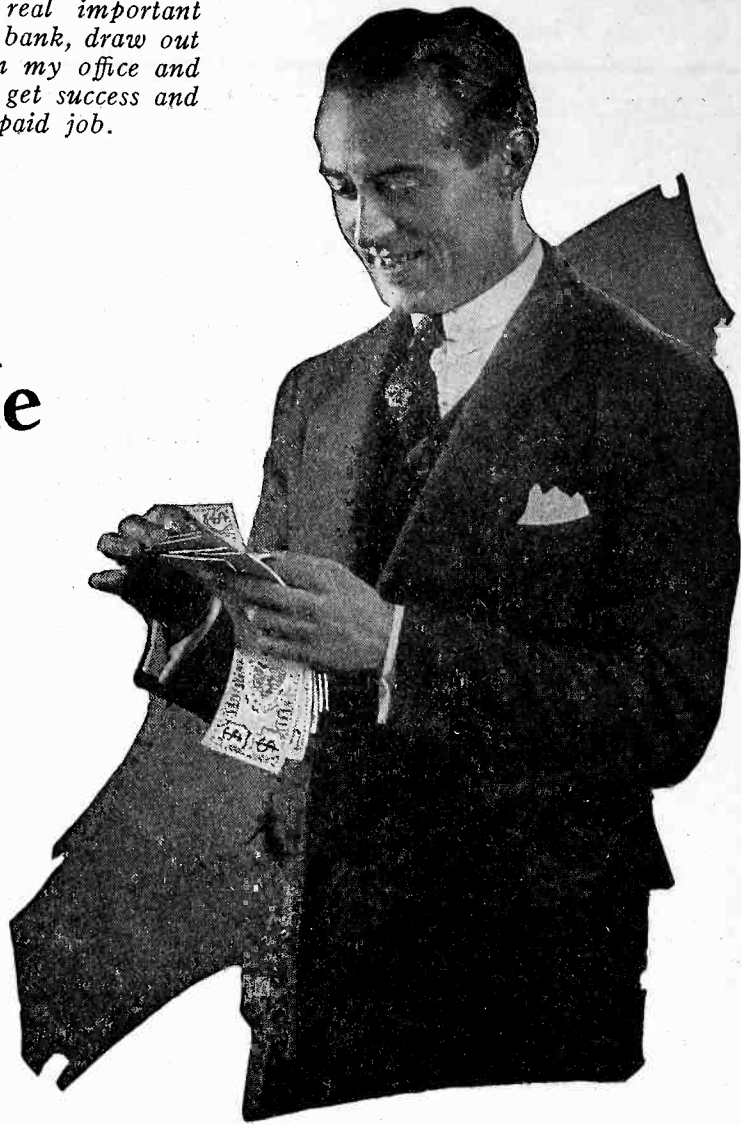

And Helen? Well—the honeymoon will be spent in Honolulu, starting two months from tomorrow!

HERE'S a real tip. Think it over—are you satisfied? Are you making enough money, at work that you like?

This new Radio game is a live-wire field of golden rewards. The work in any of the 20 different lines of Radio, is fascinating, absorbing, well paid. The National Radio Institute—oldest and largest Radio home-study school in the world—will train you inexpensively in your own home to know Radio from A to Z and to increase your earnings in the Radio field.

Take another tip—no matter what your plans are, no matter how much or how little you know about Radio—clip the coupon below and look their free book over. The information it will give you is worth a few minutes of anybody's time. You will place yourself under no obligation—the book is free, and is gladly sent to anyone who wants to know about Radio. Just address: J. E. Smith, President, National Radio Institute, Dept. 2R, Washington, D. C.

J. E. SMITH, President,
National Radio Institute,

Dept. 2R, Washington, D. C.

Dear Mr. Smith:

Please send me your 64-page free book, printed in two colors, giving all information about the opportunities in Radio and how I can learn quickly and easily at home to take advantage of them. I understand this request places me under no obligation, and that no salesmen will call on me.

Name.....

Address.....

Town.....

State.....

Quality Units for A C Operation

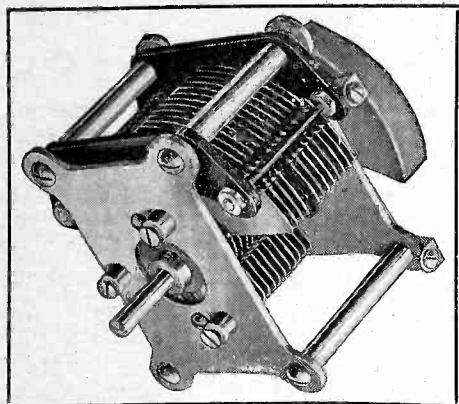

Type 334-F Variable Condenser
Price \$4.25

With the introduction of the new AC tubes the construction of a receiver utilizing the house lighting current for the power has become very much simplified. It should be remembered, however, that only quality parts should be used if best results are desired.

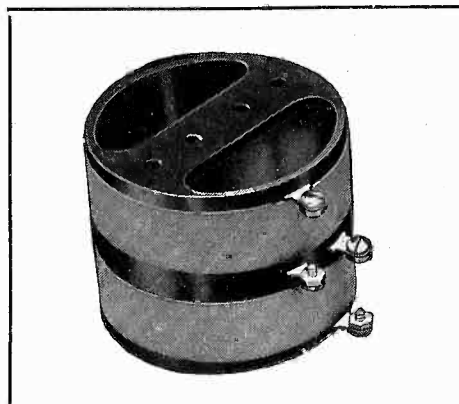

Type 277 Inductance and Coupling Coils
Price \$1.25 and \$1.50—according to range.

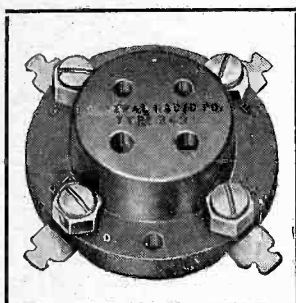

Type 349 Socket for UX or CX tubes
Price 50c.

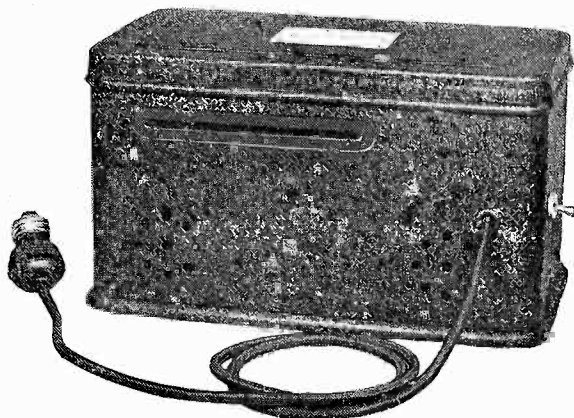

Voltages from the Type 441 Plate Supply and C bias unit are secured from a variable wire wound voltage divider, making the voltages secured adaptable to any existing type of receiver. The rectifying system has a total capacity of 120 milliamperes.

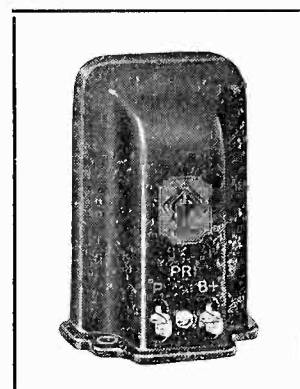

Type 285 Audio Frequency Transformer available in both 1 to 6 or 1 to 3 ratios.
Price \$6.00 each

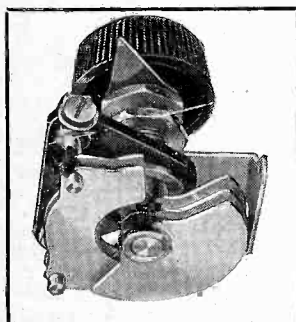

Type 368 - A Micro-Condenser, 15 mmf. \$1.25
Type 368 - B Micro-Condenser, 50 mmf. \$1.50

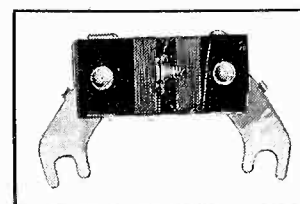

Type 439 Center Tap Resistance
Price 60c.

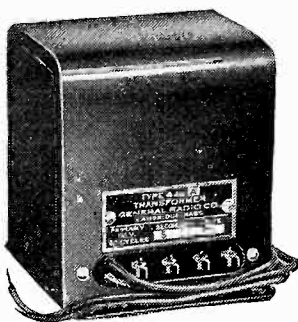

The Type 440 - A Transformer supplies voltages for all popular tubes and sufficient current for all ordinary receiver requirements. Designed for use on 105-125 volt (50-60 cycle) A. C.

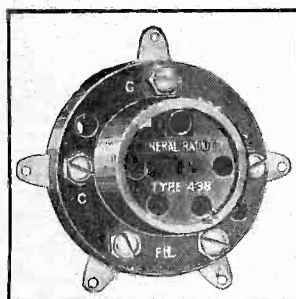

Type 438 Socket for UY tubes
Price 50c.

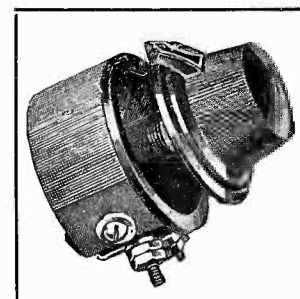

Type 410 Rheostats—available in five sizes
Price \$1.25 each

GENERAL RADIO

Laboratory Equipment

PARTS AND ACCESSORIES

WRITE FOR BULLETIN NO. 929

GENERAL RADIO CO.

30 STATE ST., CAMBRIDGE, MASS.

Now!
It Is Easy To Build
A Real Good Radio

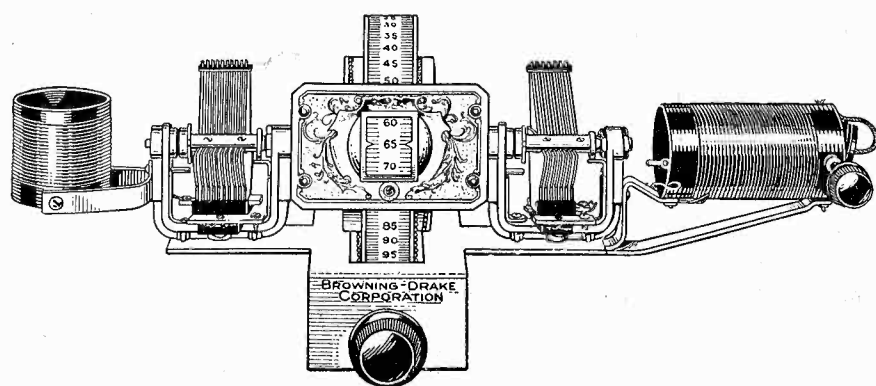

THE NEW OFFICIAL BROWNING-DRAKE KIT

THIS new Official Browning-Drake Kit is an advance in radio design and engineering. An exclusive product of the Browning-Drake Corporation, it incorporates electrical and mechanical refinements which simplify construction of receiving apparatus and assure efficient operation.

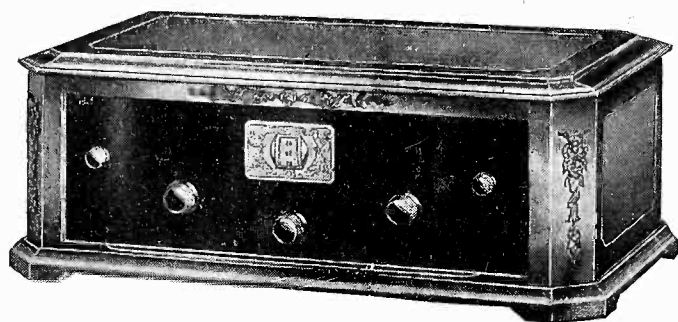

ONE knob controls the single drum illuminated dial, giving a new smoothness of tuning with absolutely no trace of backlash. Coils and condensers are "precision-placed" in the laboratory.

With this new Kit as a basis, it is easy to build either the new Official Browning-Drake five tube Kit-Set, or the new Official Browning-Drake Two Tube Tuner which may be used with any one of the power amplifiers tested and specified by the Browning-Drake Laboratories.

Attractive cabinets are supplied for these new Kit receivers.

Constructional booklets may be obtained either from your dealer or direct, for 25 cents.

BROWNING-DRAKE CORPORATION

CAMBRIDGE



MASS.

BROWNING-DRAKE
RADIO