

# RADIO

Established 1917

Volume VII

MAY, 1925

No. 5

## *Radiatorial Comment*

**A**S amateur transmission on short wavelengths is disturbing many radiocast listeners, the Department of Commerce is seriously considering the imposition of a requirement that all amateur transmitters again be silent during the evening concert hours. The present regulations allow transmitters using wavelengths below 85 meters and employing a pure continuous wave or full wave rectification to operate at all times, "provided no interference is caused other services."

The proposed requirement of silent hours will work a hardship on those amateurs whose perfection of equipment enables them to operate without interference. Directions have frequently been given in these columns for obviating several of the sources of trouble which can be cured by slight refinements in design or construction.

The most frequent trouble-maker, particularly with crystal receivers, is impact excitation of neighboring aerials from powerful amateur transmitters. The obvious remedy is to operate with low power during the early evening hours. The amateur may also be able to induce the crystal user to get a tube receiver which is not so susceptible to impact signals.

Key thumps are responsible for many complaints. With d. c. plate supply these can be cured by shunting the key contacts with a 30-ohm resistance in series with a 1mfd. condenser. With a. c. plate supply they can be reduced in intensity by placing the key in the lead between the tube filament and the secondary of the plate transformer or by placing a small choke in the key circuit to keep out the radio frequency current.

If an amateur transmitter is modulating the wave from a nearby radiocast station the amateur should remain silent. This is voluntarily done by Schenectady, N. Y. amateurs between 7:00 and 11.00 p. m. A superheterodyne or tuned radio frequency receiver may likewise be affected unless it has a grounded shield. Harmonics from a superheterodyne oscillator may also heterodyne with amateur signals so as to produce bad interference. This can often be corrected by shielding and by reducing the plate voltage of the receiver until the tube barely oscillates.

The immediate applications of these several hints may be sufficient to head off the impending prohibition. Persistent offenders should be visited by fellow amateurs who can explain that this restriction on all can be avoided only by co-operation.

Many A. R. R. L. committees are not only working along these lines but are investigating all complaints of code interference so as to determine their origin. The present privilege is too valuable to amateur work to allow its loss without struggle.

**M**OST of the radio supervisors have been obliged to hang out the "waiting list" sign insofar as wavelength allocations to new radiocast stations in their respective districts are concerned. The ether waves between 215 and 545 meters are saturated. Two bodies cannot occupy the same place at the same time.

As all the available places have been assigned a division of time on the same wavelength seems to offer the only immediate solution to this vexing problem. This is a concession which the present user is loath to give, arguing that as a pioneer he is entitled to protection. The would-be occupant argues that the air is free and that discrimination should not be exercised against the late-comer. In some cases the new comer has been able to arrange for the pioneer to assign his privileges. Both are often actuated by a self-interest which blinds them to the public interest in the matter.

Secretary Hoover, in his wisdom, is giving a fair trial to the plan of self-regulation rather than strict governmental regulation of radiocasting. The entire situation is strangely like that which prevailed among the early California Argonauts. Coming to a land having no established law and order, they protected themselves by adopting local customs which later became law. Such of these laws as pertain to the use of water are peculiarly applicable to the use of the air for radio—and may well be adopted as a precedent in settling this most contentious question.

The basis of the present water law in most of the western states is the doctrine of prior appropriation, "first in time is the first in right." This doctrine is modified by recognizing the rights of a subsequent claimant who proposes to put the water to a higher use and a greater development than the first appropriator. As the public is the real owner of the water, whoever is prepared to give the best service to the public is granted the right to use the water.

The right to the use of public waters is granted for a definite time, after which the title reverts to the government if due compensation is paid for the equipment wherewith the water is utilized. The rights are lost if abandoned; an annual license fee is charged, and they cannot be capitalized.

From this brief summary it is evident that many of these principles of water law are applicable to the regulation of radio, not only in the case of radiocasters but also of other ether users. Such problems, peculiar to radio, as do not fit into the plan can be settled by mutual agreement among the several interests, as was strikingly accomplished at the last Radio Conference.

# Electrical Transmission of Pictures

A Graphic Account of How it is Done and What Future Developments May be Anticipated

By G. M. Best

AS Calvin Coolidge took the oath of office as President of the United States on March 4th on the steps of the Capitol, a photograph was taken, hurried to the telephone office in Washington, developed immediately and by means of a picture transmitting device was sent over telephone lines to New York, Chicago and San Francisco simultaneously. It was received and developed in San Francisco one hour after its exposure and therefore two hours before our Pacific clocks indicated the same hour as that at which the President began his address. As we all remember,

system which has been so highly perfected by the scientists and engineers of the telephone company.

It is anticipated that before this article appears, a commercial picture transmission service will have been announced by the American Telephone and Telegraph Company. It is understood that this service at first will be of a two-way character connecting the three cities of San Francisco, Chicago, and New York. This will mean that an individual in New York, for example, a representative of a newspaper or of a picture service could file at 8 a. m. a photograph, draw-

whether wire or radio, supplies the fundamental requirements for the electric transmission of pictures. It furnishes a channel of communication over which information can be passed quickly and, given the proper agreement or understanding between the operators at the sending and receiving ends, this information could readily be such as to enable the receiving operator to reconstruct with any previously agreed degree of accuracy whatever picture the sending operator might have before him.

For example, the operators might agree to divide up pictures into a regular checkerboard arrangement of little squares. They might call the square in the upper left hand corner No. 1, that next to its right No. 2 and so on across and down through the checkerboard arrangement, reaching finally the last square in the lower right hand corner whose number might, for example, be No. 10,000. Then beginning with square No. 1 the sender might transmit a message consisting of the following: No. 1 white, No. 2 grey, No. 3 grey, No. 4 black, No. 5 white and so on through the whole series of 10,000 squares. The shades of grey or the colors which the sending operator would associate with each square would of course correspond with those in the picture so that upon the receipt of the message the receiving operator, who might be a thousand or more miles away, would immediately fill in his black checkerboard with the designated shades or colors. He would thereby obtain a copy of the original picture, the accuracy of which is obviously determined by the fineness of the checkerboard and the number of distinct greys or colors which have been recognized in the message.



*Electrically Transmitted Picture of the Coolidge Inaugural*

this picture and several others transmitted upon the same occasion appeared in the afternoon editions of the San Francisco newspapers. No longer can there be any doubt that the art of electrical communication can make pictures of news value available at great distances with practically the same rapidity as telegraphic dispatches.

The electrically transmitted inaugural photographs were sent by the American Telephone and Telegraph Company over its long distance telephone lines by means of apparatus developed by its engineers. The apparatus was the same, except for minor changes, as that used last summer to transmit daily series of pictures of the Republican National Convention from Cleveland to New York and daily series of the Democratic National Convention from New York to Chicago. One of the inaugural photographs as received in San Francisco is reproduced herewith to show the accuracy of the

ing, handwriting exhibit or other graphical record for transmittal to San Francisco which should reach there say an hour later or 6 a. m. local time leaving ample margin for its use in the afternoon editions of the newspapers.

Any telephone or telegraph circuit,



*Electrically Transmitted Picture of Tornado Damage at Murphersboro, Ill.*

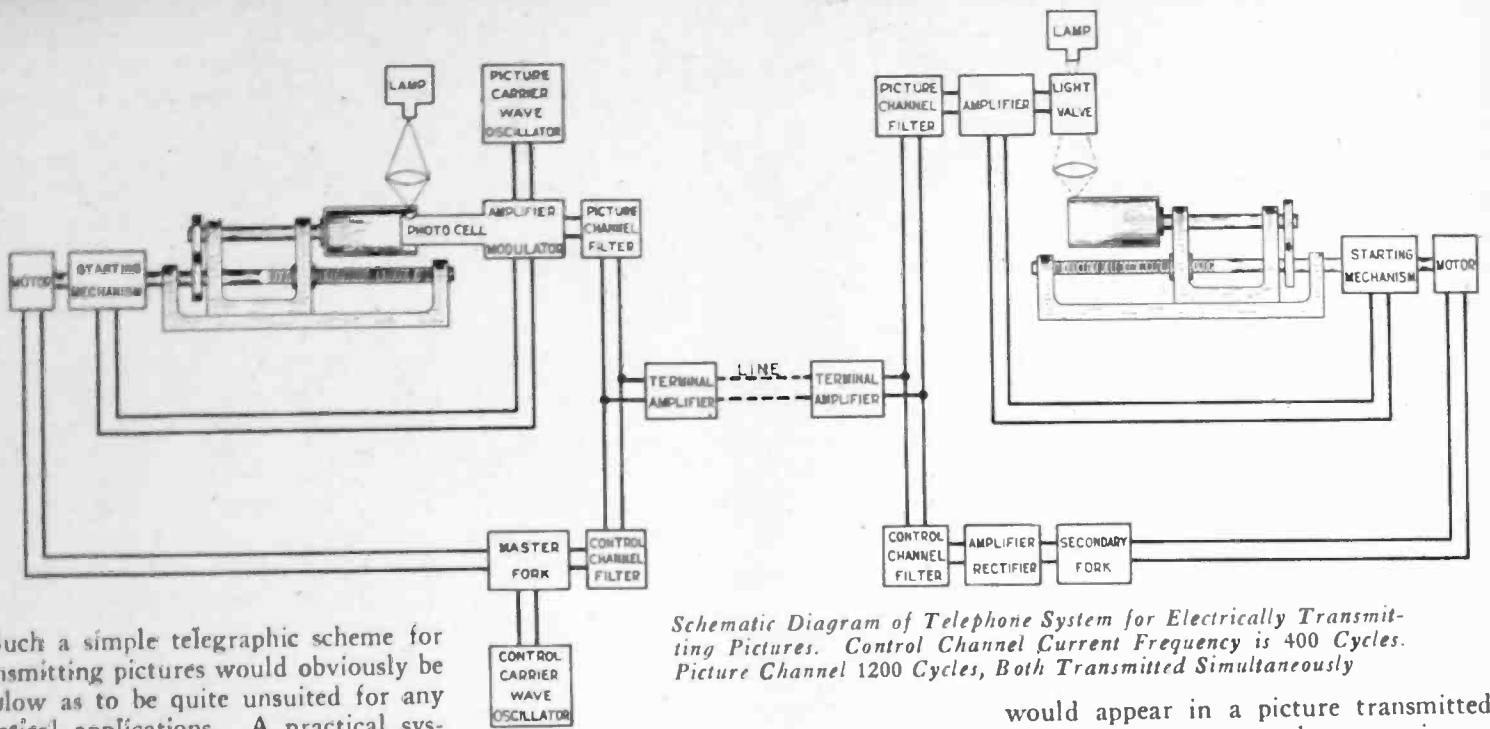

*Schematic Diagram of Telephone System for Electrically Transmitting Pictures. Control Channel Current Frequency is 400 Cycles. Picture Channel 1200 Cycles, Both Transmitted Simultaneously*

Such a simple telegraphic scheme for transmitting pictures would obviously be so slow as to be quite unsuited for any practical applications. A practical system must reduce the time required and expense involved to the very minimum and this means that the operations involved in breaking up the original picture into little elements and the re-assembling of these at the distant end must be made automatic. It also means that the determinations of the degree of light or shade in each element and its later reproduction at the receiving end must occur automatically. These have been accomplished to a high degree of perfection in the system of picture transmission which has been developed by the engineers and scientists of the Bell System and which it is reported will shortly be made available for public use. It operates so rapidly that a complete picture such as that of President Coolidge reading his inaugural address can be transmitted even thousands of miles in

about seven minutes. Line drawings, handwriting and printing can also be transmitted.

The reader will doubtless have noted from what has just been said that, from a theoretical point of view, there need be no essential difference between a picture transmission system which sends over a wire line and one which sends by radio. However, all of the circumstances of the two cases are not exactly similar. Transmission of messages by radio is always subject to uncertain influences from static, from fading and stray atmospheric electrical conditions. When picture transmission signals are propagated by radio, they are subject to disturbances and distortion by these atmospheric conditions. For example, the static that we are all familiar with in our radio sets as a series of sharp crackles and pops

would appear in a picture transmitted by radio as more or less conspicuous blemishes.

A diagram illustrating, in a schematic manner, the operation of the system of the telephone engineers comprises one of the accompanying illustrations. The picture to be transmitted is first copied photographically on a transparent film. This film is inserted in the transmitter simply by rolling it up into a cylindrical form. During operation a very small and intense beam of light shines through the film onto a photoelectric cell within. The film is rotated at a uniform speed and by means of a screw mechanism is caused to advance parallel to the axis of the cylinder. The motion of the light relative to the cylinder is therefore the same as that of a phonograph needle relative to a cylindrical record. In this way, each minute portion of the picture in

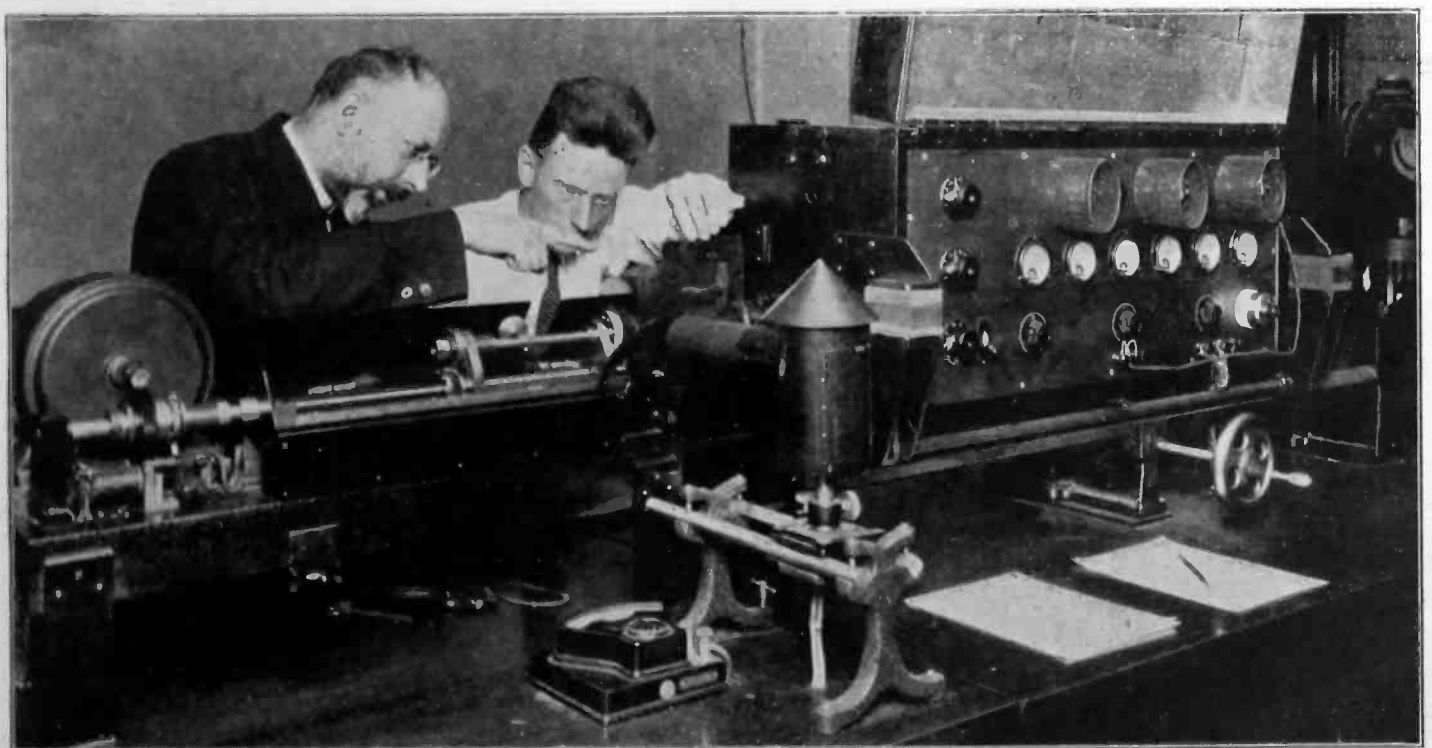

*Transmitting Apparatus with Synchronizing Motor at Left and Amplifier of Photo-Electric Cell Current Output at Right*

turn affects the intensity of the light reaching the photoelectric cell. This variation in the amount of light striking the sensitive surface of the cell gives rise to a current which, through the agency of a vacuum tube amplifier and modulator, controls the current flowing through the telephone line.

At the receiving end an unexposed photographic film is rotated under a beam of light in a manner similar to that at the transmitting end. The two films are caused to rotate at exactly the same speed and the impulses starting from the photoelectric cell at the sending end control, by means of a new device known as a light valve, the amount of light reaching the film at the receiving end.

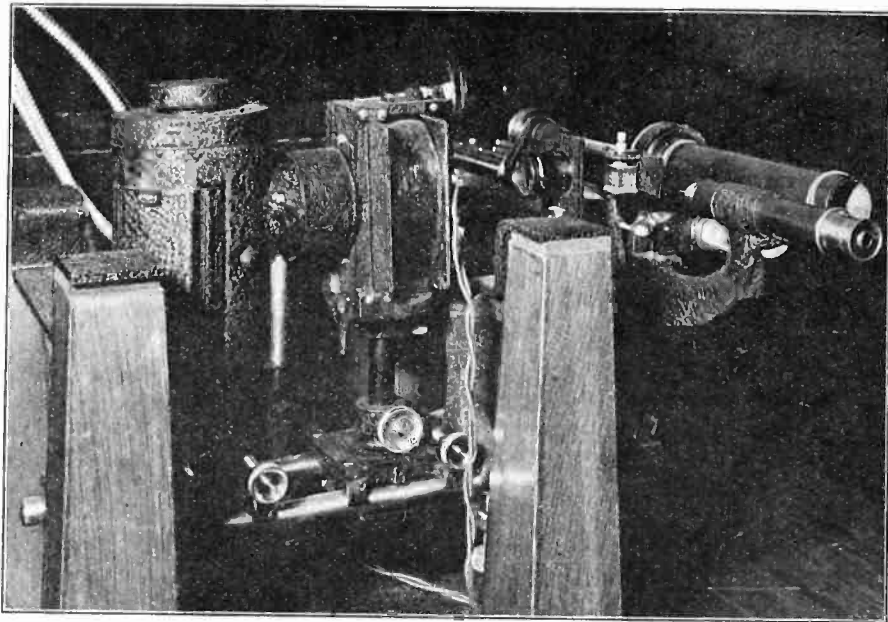

*Receiving Apparatus with Lamp House at Left and Photographic Film at Right, Light Valve and Focusing Lens Between with Synchronizing Motor in Background*

The major details of the system developed for radio transmission by the Radio Corporation may also be represented by the preceding diagram. This system uses a picture at the sending end in the form of a transparent film. Light is received through this film on a photoelectric cell. The current from the cell is amplified and then is transmitted by means of a radio carrier wave rather than a telephonic carrier wave. At the receiving end the recording, while it may be done photographically, is usually performed on a piece of paper by means of pen which traces ink lines of variable length depending upon the degree of light and shade of the original picture. Both systems require that the transmitting and receiving mechanisms rotate in exact synchronism with each other.

Other systems for transmitting pictures telegraphically, that is pictures consisting of a black and white structure, are also being tested out under practical conditions of wire transmission. Notably among these are the Telepix system and the Belin system. It is reported that these two systems, instead of using a transparency, a beam of light and a light

sensitive cell at the transmitting end, employ etched metal cylinders. The time consumed in the preparation of etched cylinders is considerable under present methods and the overall transmission of such a system shows up at a disadvantage with respect to systems using photographic transparencies.

The major use of electrically transmitted pictures will doubtless always be the dissemination of news, but many minor applications are certain to arise from time to time. For example, the telephone system of transmitting pictures can give an extremely faithful copy of the original and therefore can be used for the transmission of original messages or documents such as autographed letters and signatures. In this connection,

By the use of electrically transmitted pictures construction work or repair work might be saved from very costly delay.

From the earliest days of experimentation in the transmission of pictures it has been recognized that one of the most important public services would be for police identifications. The quick transmission of portraits would enable pictures of escaping criminals to be placed in the hands of officials at ports of embarkation and elsewhere within a few hours of the time a man is first wanted. The transmission of finger prints may be even more important. Recently, the Police Department of New York selected a finger print of a criminal whose complete identification data were on file in the principal cities of the country and this single finger print, with a code description of its classification, was given to the telephone engineers for transmission to Chicago. This was transmitted to Chicago and the received picture of the finger print was identified by the Chicago police within two minutes and the name of the criminal reported back to New York.

There is much conjecture at present as to the possibility and practicability of electrovision, included in which term are the so-called "radio movies." It was recently remarked by one inventor, who has successfully transmitted pictures electrically, that all he needs to do now to produce radio movies is to speed his apparatus up. It is interesting to calculate how much he would have to speed it up. A 5x7 in. picture built up of a structure consisting of 60 elements to the inch will project on a screen satisfactorily. The image appearing on the screen therefore, regardless of its size, contains approximately 125,000 separate images. In present day motion picture work the pictures projected on the screen follow one another at the rate of 16 per second. This brings the total number of elements which must be handled every second to about 2,000,000. Present day picture transmission systems do not handle more than a few hundred elements per second. Hence it follows that an improvement in the speed of transmission by some 5,000 to 10,000 times would be required for radio movies.

there arises the possibility of sending autographed telegrams and thus avoiding all possibility of error in copying. Nor is it impossible that check signatures may be so sent as to be honored. Messages in foreign languages that employ alphabets not suitable to telegraph coding opens up another possibility. Thus it has been estimated that Chinese writing can be transmitted more rapidly by this method than in any other way.

The need frequently arises for the quick transmission of drawings or blue prints of engineering work in progress.

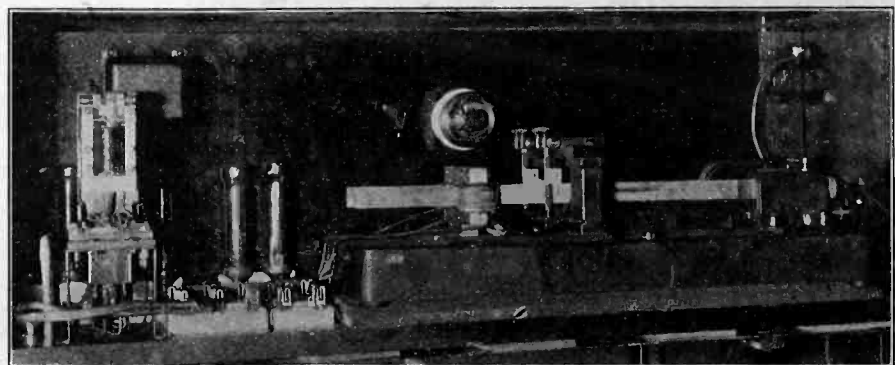

*Tuning Fork for Synchronizing Motors at Each End of Line*

# Tales of the Tube Wreckers

An Interesting Account of How the Mis-Use or Fault of a Vacuum Tube is Determined by Test

By Volney G. Mathison

**N**O, this tube doesn't seem to work in my set worth a cent. With my old tube I can hear 2-Hello, London, three blocks away from my ear-phones with the aerial and ground unhooked, the *B* battery dead, and the filament rheostat off; with this new tube I can't hear KGO running wide open on his 2,000-watt transmitter with his aerial hanging right over my back yard.

"Um, yes, it did work pretty good the first day I had it; but it seemed to burn dim on my battery, so I connected in two batteries. That made it work better, and I put in one more battery, and it shone bright and sounded nice as anything just one evening; but it never has since and I'm sure it isn't any good at all and I want my money back.

"What! You can't refund any money on this tube just because I worked it a couple of hours on 12 volts *A*-battery! Why, a friend of mine bought a tube here once and he connected the *B*-battery up wrong and blew it out instantly, and this company replaced it for him, so I don't see why I shouldn't get something for my tube, too. You say you've stopped handing out Christmas presents for hot-air stories! Now, I think this is a piece of highway robbery. I'm going to write a six-page letter to all the magazines you advertise in, and to Mr. Hoover and President Coolidge, telling them all about the way you've treated me. I'll never get anything from you again. Good day."

**H**OW little the average owner of a radio set knows about tubes is positively alarming. This statement is made humbly and without aim to offend anyone; it is based on nearly two years of investigating tubes in the laboratories, among the jobbers, and behind the retail sales counter.

The radio vacuum tube, particularly the dry-cell type, is the visible symbol of a vast amount of scientific research; it is a product of the highest knowledge of electrochemistry, glass-manufacture, and radio engineering available today. This device, without doubt one of the most wonderful and delicate that the world of science has ever produced, must unfortunately go into hands that are often unknowingly careless and rude; it must run the gauntlet of probing screwdrivers, 300 per cent excess filament voltage, excessive jarring, twisting, banging, "reflexing," overloading, and a dozen other destructive evils. If the chemi-

cals of the dynamite manufacturer were freely toyed with by the uninitiated, we should expect and get city-shaking explosions, and when small boys dig into jewelled watches we are not surprised to see spinning wheels and flying hair-springs; then why, if we ignorantly misuse or destroy in a flash the eight silvery tubes in our superheterodyne, should we feel that the manufacturer of them is some sort of criminal who has cunningly done us out of half a month's pay?

Many radio users seem to consider the vacuum tube as merely a kind of miniature incandescent lamp that may be knocked about from socket to socket, without ill effect. This is a mistake; indeed even an ordinary electric lamp

The higher the temperature of the heated filament, the more rapidly is the thorium content driven out. If a type-199 tube is operated on an excessive filament voltage for a short time, the tiny amount of thorium in its slender filament will be almost entirely burnt up, with the result that the tube will become inoperative, though still lighting perfectly. This condition is commonly called "paralysis," but the term is not any too accurate.

Most tube users have noted on the printed enclosures furnished with some tubes that an injured tube may be rescued by leaving it lighted for a time with the *B*-battery off. The idea of this is simply that if the filament has

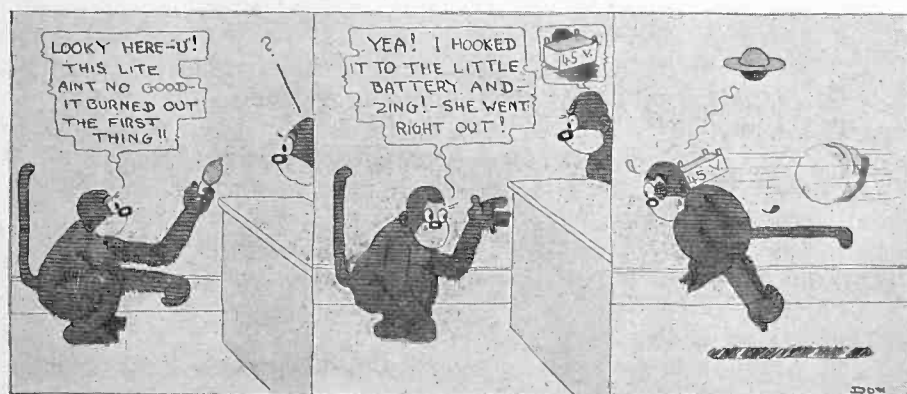

would be short-lived were it subjected to similar treatment. Electric lamps are operated on current supply sources that are fixed and invariable as far as the lamp users are concerned. One cannot run the voltage on his 110-volt lamps up to 175 or 350 or more, and most every one has some sort of idea as to what would happen if this could be done; whereas in the case of the vacuum tubes in a radio set, the voltage is under the control of the user himself, and the unhappy tubes are entirely at his mercy.

There can be, furthermore, no practicable comparison between an electric lamp and a radio tube. The function of an incandescent lamp is solely to illuminate through the heating of a piece of tungsten wire to suitable brilliance in a moderate vacuum; while the radio tube is almost a delicate living thing, aquiver with marvelous activity every moment. Its fragile tungsten filament is thoroughly impregnated with a rare element, thorium, a member of the radium group, which, with the application of heat, and proper electrical tension, disintegrates and disperses with an emission of trillions of electrons.

been overheated, the thorium content on or near the surface of the wire will have been dispersed, while some thorium will remain among the inner molecules of tungsten, and by keeping the filament red hot for a while this remaining thorium will be caused to diffuse out toward the surface of the wire. If the tube has been badly overheated, this procedure will not do much good, as there will be hardly a trace of thorium left in the filament. Generally speaking, a de-thoriated filament can be detected through its burning brighter on a given voltage than a good filament; but this is difficult to tell about by merely looking at the lighted tubes, because the non-uniformity of the silvery magnesium vacuum-getter condensed inside the bulb will cause a variation in the apparent brilliance of the filament, or will conceal it altogether.

The richness of the thorium content in the filament is one of the principal factors governing the sensitivity of the tube. A tube with high electronic emission will give good amplification, because a slight variation in grid potential will give a large variation in plate current;

# Electrical Transmission of Pictures

A Graphic Account of How it is Done and What Future Developments May be Anticipated

By G. M. Best

AS Calvin Coolidge took the oath of office as President of the United States on March 4th on the steps of the Capitol, a photograph was taken, hurried to the telephone office in Washington, developed immediately and by means of a picture transmitting device was sent over telephone lines to New York, Chicago and San Francisco simultaneously. It was received and developed in San Francisco one hour after its exposure and therefore two hours before our Pacific clocks indicated the same hour as that at which the President began his address. As we all remember,

system which has been so highly perfected by the scientists and engineers of the telephone company.

It is anticipated that before this article appears, a commercial picture transmission service will have been announced by the American Telephone and Telegraph Company. It is understood that this service at first will be of a two-way character connecting the three cities of San Francisco, Chicago, and New York. This will mean that an individual in New York, for example, a representative of a newspaper or of a picture service could file at 8 a. m. a photograph, draw-

whether wire or radio, supplies the fundamental requirements for the electric transmission of pictures. It furnishes a channel of communication over which information can be passed quickly and, given the proper agreement or understanding between the operators at the sending and receiving ends, this information could readily be such as to enable the receiving operator to reconstruct with any previously agreed degree of accuracy whatever picture the sending operator might have before him.

For example, the operators might agree to divide up pictures into a regular checkerboard arrangement of little squares. They might call the square in the upper left hand corner No. 1, that next to its right No. 2 and so on across and down through the checkerboard arrangement, reaching finally the last square in the lower right hand corner whose number might, for example, be No. 10,000. Then beginning with square No. 1 the sender might transmit a message consisting of the following: No. 1 white, No. 2 grey, No. 3 grey, No. 4 black, No. 5 white and so on through the whole series of 10,000 squares. The shades of grey or the colors which the sending operator would associate with each square would of course correspond with those in the picture so that upon the receipt of the message the receiving operator, who might be a thousand or more miles away, would immediately fill in his black checkerboard with the designated shades or colors. He would thereby obtain a copy of the original picture, the accuracy of which is obviously determined by the fineness of the checkerboard and the number of distinct greys or colors which have been recognized in the message.

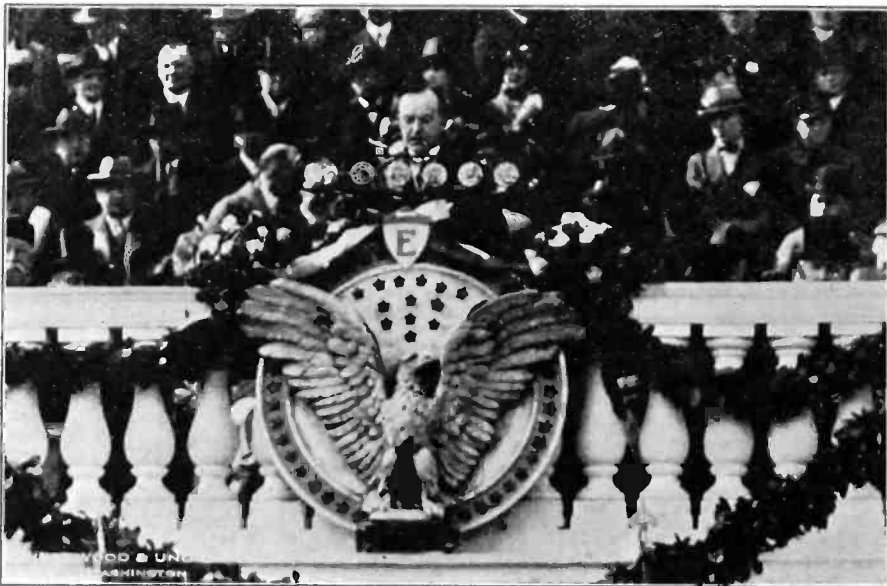

*Electrically Transmitted Picture of the Coolidge Inaugural*

this picture and several others transmitted upon the same occasion appeared in the afternoon editions of the San Francisco newspapers. No longer can there be any doubt that the art of electrical communication can make pictures of news value available at great distances with practically the same rapidity as telegraphic dispatches.

The electrically transmitted inaugural photographs were sent by the American Telephone and Telegraph Company over its long distance telephone lines by means of apparatus developed by its engineers. The apparatus was the same, except for minor changes, as that used last summer to transmit daily series of pictures of the Republican National Convention from Cleveland to New York and daily series of the Democratic National Convention from New York to Chicago. One of the inaugural photographs as received in San Francisco is reproduced herewith to show the accuracy of the

ing, handwriting exhibit or other graphical record for transmittal to San Francisco which should reach there say an hour later or 6 a. m. local time leaving ample margin for its use in the afternoon editions of the newspapers.

Any telephone or telegraph circuit,



*Electrically Transmitted Picture of Tornado Damage at Murphysboro, Ill.*

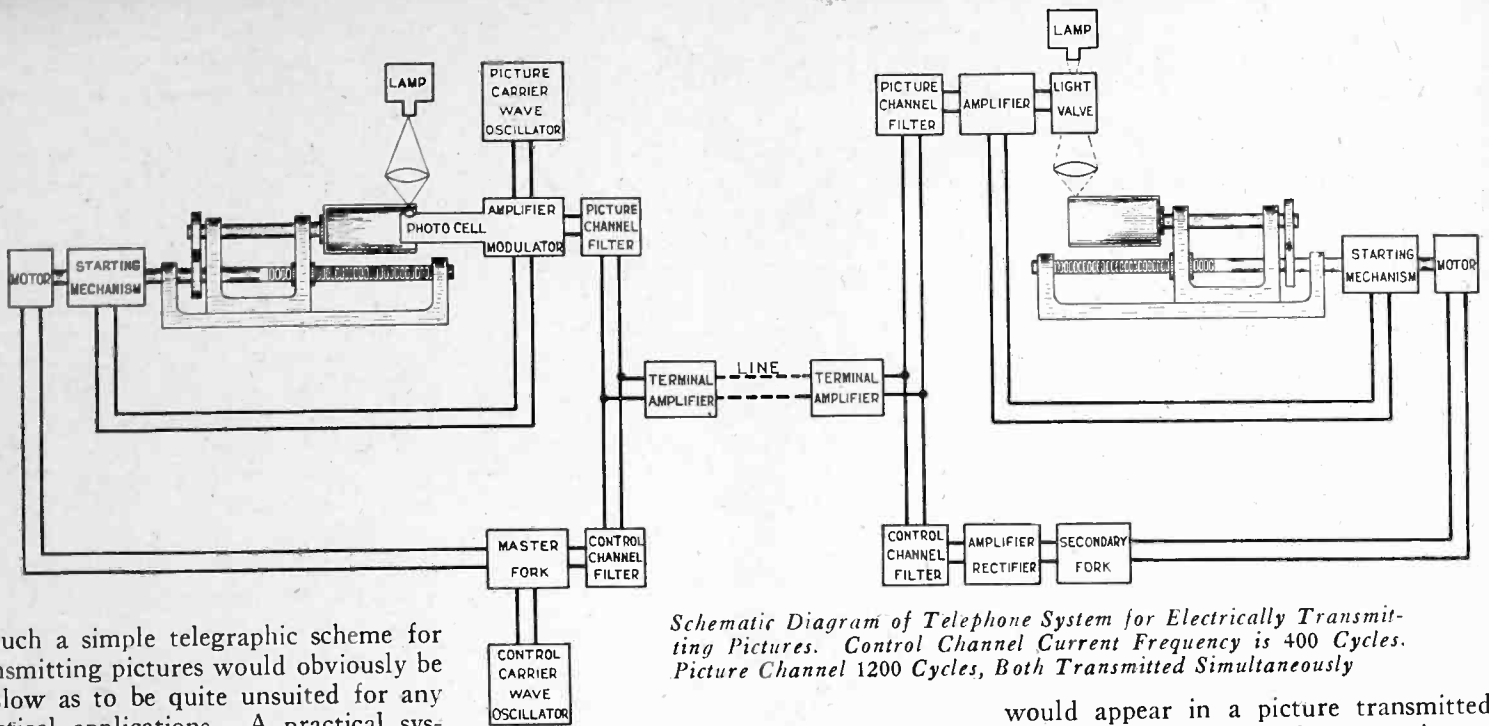

*Schematic Diagram of Telephone System for Electrically Transmitting Pictures. Control Channel Current Frequency is 400 Cycles. Picture Channel 1200 Cycles, Both Transmitted Simultaneously*

Such a simple telegraphic scheme for transmitting pictures would obviously be so slow as to be quite unsuited for any practical applications. A practical system must reduce the time required and expense involved to the very minimum and this means that the operations involved in breaking up the original picture into little elements and the re-assembling of these at the distant end must be made automatic. It also means that the determinations of the degree of light or shade in each element and its later reproduction at the receiving end must occur automatically. These have been accomplished to a high degree of perfection in the system of picture transmission which has been developed by the engineers and scientists of the Bell System and which it is reported will shortly be made available for public use. It operates so rapidly that a complete picture such as that of President Coolidge reading his inaugural address can be transmitted even thousands of miles in

about seven minutes. Line drawings, handwriting and printing can also be transmitted.

The reader will doubtless have noted from what has just been said that, from a theoretical point of view, there need be no essential difference between a picture transmission system which sends over a wire line and one which sends by radio. However, all of the circumstances of the two cases are not exactly similar. Transmission of messages by radio is always subject to uncertain influences from static, from fading and stray atmospheric electrical conditions. When picture transmission signals are propagated by radio, they are subject to disturbances and distortion by these atmospheric conditions. For example, the static that we are all familiar with in our radio sets as a series of sharp crackles and pops

would appear in a picture transmitted by radio as more or less conspicuous blemishes.

A diagram illustrating, in a schematic manner, the operation of the system of the telephone engineers comprises one of the accompanying illustrations. The picture to be transmitted is first copied photographically on a transparent film. This film is inserted in the transmitter simply by rolling it up into a cylindrical form. During operation a very small and intense beam of light shines through the film onto a photoelectric cell within. The film is rotated at a uniform speed and by means of a screw mechanism is caused to advance parallel to the axis of the cylinder. The motion of the light relative to the cylinder is therefore the same as that of a phonograph needle relative to a cylindrical record. In this way, each minute portion of the picture in

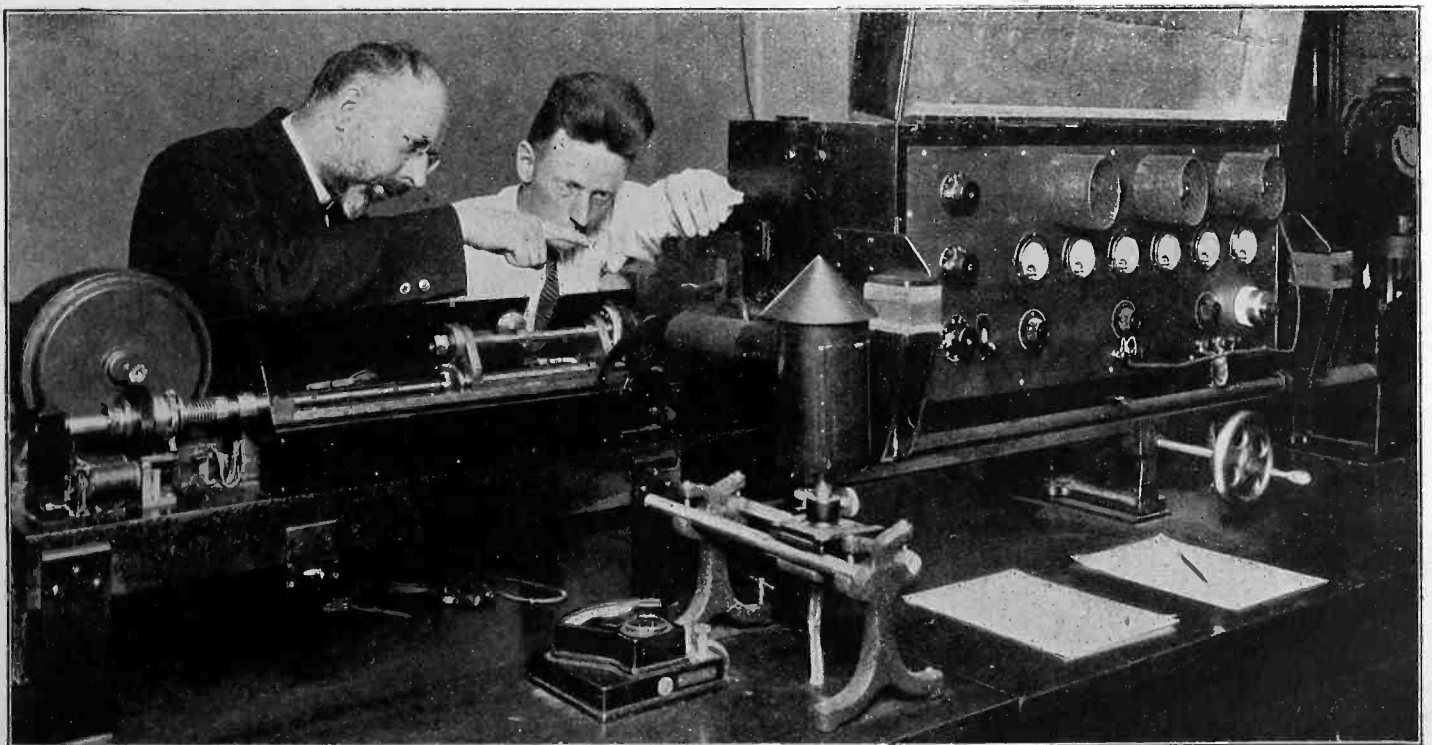

*Transmitting Apparatus with Synchronizing Motor at Left and Amplifier of Photo-Electric Cell Current Output at Right*

turn affects the intensity of the light reaching the photoelectric cell. This variation in the amount of light striking the sensitive surface of the cell gives rise to a current which, through the agency of a vacuum tube amplifier and modulator, controls the current flowing through the telephone line.

At the receiving end an unexposed photographic film is rotated under a beam of light in a manner similar to that at the transmitting end. The two films are caused to rotate at exactly the same speed and the impulses starting from the photoelectric cell at the sending end control, by means of a new device known as a light valve, the amount of light reaching the film at the receiving end.

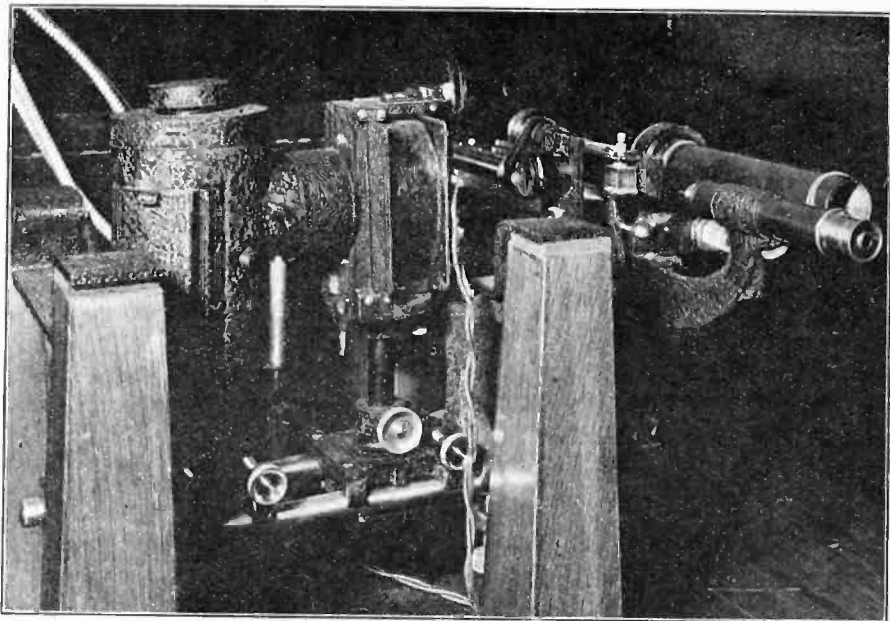

*Receiving Apparatus with Lamp House at Left and Photographic Film at Right, Light Valve and Focusing Lens Between with Synchronizing Motor in Background*

The major details of the system developed for radio transmission by the Radio Corporation may also be represented by the preceding diagram. This system uses a picture at the sending end in the form of a transparent film. Light is received through this film on a photoelectric cell. The current from the cell is amplified and then is transmitted by means of a radio carrier wave rather than a telephonic carrier wave. At the receiving end the recording, while it may be done photographically, is usually performed on a piece of paper by means of pen which traces ink lines of variable length depending upon the degree of light and shade of the original picture. Both systems require that the transmitting and receiving mechanisms rotate in exact synchronism with each other.

Other systems for transmitting pictures telegraphically, that is pictures consisting of a black and white structure, are also being tested out under practical conditions of wire transmission. Notably among these are the Telepix system and the Belin system. It is reported that these two systems, instead of using a transparency, a beam of light and a light

sensitive cell at the transmitting end, employ etched metal cylinders. The time consumed in the preparation of etched cylinders is considerable under present methods and the overall transmission of such a system shows up at a disadvantage with respect to systems using photographic transparencies.

The major use of electrically transmitted pictures will doubtless always be the dissemination of news, but many minor applications are certain to arise from time to time. For example, the telephone system of transmitting pictures can give an extremely faithful copy of the original and therefore can be used for the transmission of original messages or documents such as autographed letters and signatures. In this connection,

By the use of electrically transmitted pictures construction work or repair work might be saved from very costly delay.

From the earliest days of experimentation in the transmission of pictures it has been recognized that one of the most important public services would be for police identifications. The quick transmission of portraits would enable pictures of escaping criminals to be placed in the hands of officials at ports of embarkation and elsewhere within a few hours of the time a man is first wanted. The transmission of finger prints may be even more important. Recently, the Police Department of New York selected a finger print of a criminal whose complete identification data were on file in the principal cities of the country and this single finger print, with a code description of its classification, was given to the telephone engineers for transmission to Chicago. This was transmitted to Chicago and the received picture of the finger print was identified by the Chicago police within two minutes and the name of the criminal reported back to New York.

There is much conjecture at present as to the possibility and practicability of electrovision, included in which term are the so-called "radio movies." It was recently remarked by one inventor, who has successfully transmitted pictures electrically, that all he needs to do now to produce radio movies is to speed his apparatus up. It is interesting to calculate how much he would have to speed it up. A 5x7 in. picture built up of a structure consisting of 60 elements to the inch will project on a screen satisfactorily. The image appearing on the screen therefore, regardless of its size, contains approximately 125,000 separate images. In present day motion picture work the pictures projected on the screen follow one another at the rate of 16 per second. This brings the total number of elements which must be handled every second to about 2,000,000. Present day picture transmission systems do not handle more than a few hundred elements per second. Hence it follows that an improvement in the speed of transmission by some 5,000 to 10,000 times would be required for radio movies.

there arises the possibility of sending autographed telegrams and thus avoiding all possibility of error in copying. Nor is it impossible that check signatures may be so sent as to be honored. Messages in foreign languages that employ alphabets not suitable to telegraph coding opens up another possibility. Thus it has been estimated that Chinese writing can be transmitted more rapidly by this method than in any other way.

The need frequently arises for the quick transmission of drawings or blue prints of engineering work in progress.

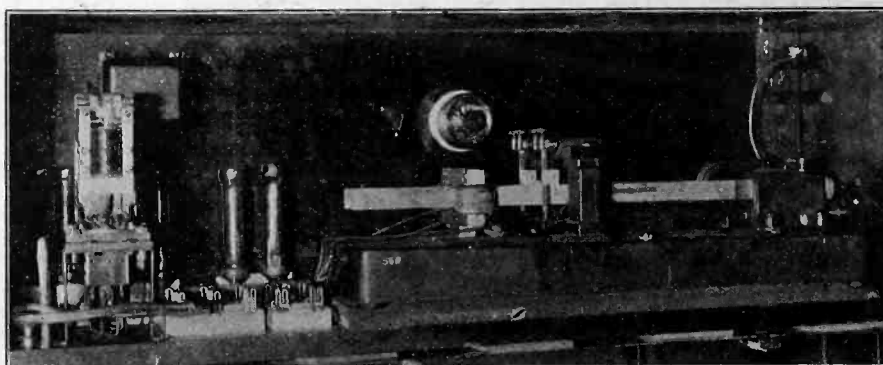

*Tuning Fork for Synchronizing Motors at Each End of Line*



# Tales of the Tube Wreckers

An Interesting Account of How the Mis-Use or Fault of a Vacuum Tube is Determined by Test

By Volney G. Mathison

**N**O, this tube doesn't seem to work in my set worth a cent. With my old tube I can hear 2-Hello, London, three blocks away from my ear-phones with the aerial and ground unhooked, the *B* battery dead, and the filament rheostat off; with this new tube I can't hear KGO running wide open on his 2,000-watt transmitter with his aerial hanging right over my back yard. "Um, yes, it did work pretty good the first day I had it; but it seemed to burn dim on my battery, so I connected in two batteries. That made it work better, and I put in one more battery, and it shone bright and sounded nice as anything just one evening; but it never has since and I'm sure it isn't any good at all and I want my money back.

"What! You can't refund any money on this tube just because I worked it a couple of hours on 12 volts *A*-battery! Why, a friend of mine bought a tube here once and he connected the *B*-battery up wrong and blew it out instantly, and this company replaced it for him, so I don't see why I shouldn't get something for my tube, too. You say you've stopped handing out Christmas presents for hot-air stories! Now, I think this is a piece of highway robbery. I'm going to write a six-page letter to all the magazines you advertise in, and to Mr. Hoover and President Coolidge, telling them all about the way you've treated me. I'll never get anything from you again. Good day."

**H**OW little the average owner of a radio set knows about tubes is positively alarming. This statement is made humbly and without aim to offend anyone; it is based on nearly two years of investigating tubes in the laboratories, among the jobbers, and behind the retail sales counter.

The radio vacuum tube, particularly the dry-cell type, is the visible symbol of a vast amount of scientific research; it is a product of the highest knowledge of electrochemistry, glass-manufacture, and radio engineering available today. This device, without doubt one of the most wonderful and delicate that the world of science has ever produced, must unfortunately go into hands that are often unknowingly careless and rude; it must run the gauntlet of probing screwdrivers, 300 per cent excess filament voltage, excessive jarring, twisting, banging, "reflexing," overloading, and a dozen other destructive evils. If the chemi-

cals of the dynamite manufacturer were freely toyed with by the uninitiated, we should expect and get city-shaking explosions, and when small boys dig into jewelled watches we are not surprised to see spinning wheels and flying hair-springs; then why, if we ignorantly misuse or destroy in a flash the eight silvery tubes in our superheterodyne, should we feel that the manufacturer of them is some sort of criminal who has cunningly done us out of half a month's pay?

Many radio users seem to consider the vacuum tube as merely a kind of miniature incandescent lamp that may be knocked about from socket to socket, without ill effect. This is a mistake; indeed even an ordinary electric lamp

The higher the temperature of the heated filament, the more rapidly is the thorium content driven out. If a type-199 tube is operated on an excessive filament voltage for a short time, the tiny amount of thorium in its slender filament will be almost entirely burnt up, with the result that the tube will become inoperative, though still lighting perfectly. This condition is commonly called "paralysis," but the term is not any too accurate.

Most tube users have noted on the printed enclosures furnished with some tubes that an injured tube may be rescued by leaving it lighted for a time with the *B*-battery off. The idea of this is simply that if the filament has

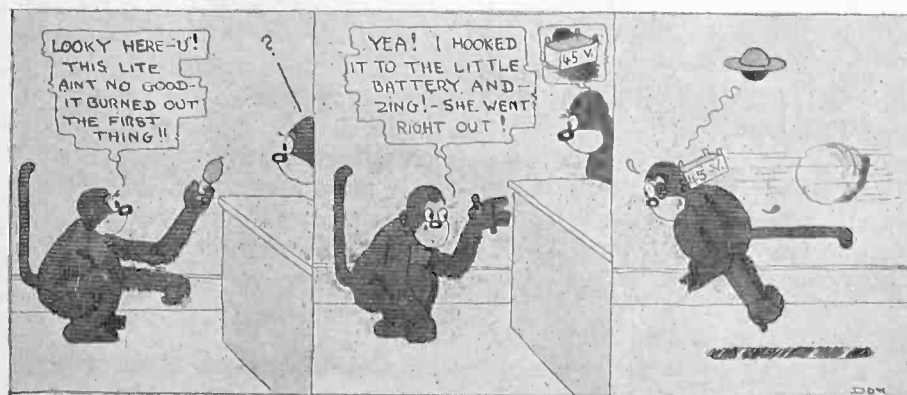

would be short-lived were it subjected to similar treatment. Electric lamps are operated on current supply sources that are fixed and invariable as far as the lamp users are concerned. One cannot run the voltage on his 110-volt lamps up to 175 or 350 or more, and most every one has some sort of idea as to what would happen if this could be done; whereas in the case of the vacuum tubes in a radio set, the voltage is under the control of the user himself, and the unhappy tubes are entirely at his mercy.

There can be, furthermore, no practicable comparison between an electric lamp and a radio tube. The function of an incandescent lamp is solely to illuminate through the heating of a piece of tungsten wire to suitable brilliance in a moderate vacuum; while the radio tube is almost a delicate living thing, aquiver with marvelous activity every moment. Its fragile tungsten filament is thoroughly impregnated with a rare element, thorium, a member of the radium group, which, with the application of heat, and proper electrical tension, disintegrates and disperses with an emission of trillions of electrons.

been overheated, the thorium content on or near the surface of the wire will have been dispersed, while some thorium will remain among the inner molecules of tungsten, and by keeping the filament red hot for a while this remaining thorium will be caused to diffuse out toward the surface of the wire. If the tube has been badly overheated, this procedure will not do much good, as there will be hardly a trace of thorium left in the filament. Generally speaking, a de-thoriated filament can be detected through its burning brighter on a given voltage than a good filament; but this is difficult to tell about by merely looking at the lighted tubes, because the non-uniformity of the silvery magnesium vacuum-getter condensed inside the bulb will cause a variation in the apparent brilliance of the filament, or will conceal it altogether.

The richness of the thorium content in the filament is one of the principal factors governing the sensitivity of the tube. A tube with high electronic emission will give good amplification, because a slight variation in grid potential will give a large variation in plate current;

whereas a tube with low emission can give only a small maximum plate-current variation, regardless of grid potential. In other words, a tube with de-thoriated filament will simply give a weak response.

Vacuum tubes can be damaged in any one of many different ways. The quickest and most usual way to destroy a tube, of course, is to divert 90 volts of *B*-battery into the filament. Various fusible devices have been put on the market to protect the tubes from blow-out, but my personal experiences with these have been disastrous. Some of them interfere with the proper operation of the set; others have a tendency to blow out when no danger is present and fail to blow when the critical moment does arrive.

Filament, plate, and grid are sometimes "shorted" or brought into actual contact inside the tube by handling it too roughly or through heavy jarring. When carting a radio set over a rough country road, the tubes should be removed and packed in their original boxes. Tubes can also be injured by pulling them out and sticking them into sockets, with the filament current turned full on. This practice does not seem to do much harm, however, if the *B*-battery is off, as the electrical tensions within the tubes are then absent.

Some folks are very careful to protect their tubes from sudden death by *B*-battery electrocution, and then murder them more slowly, but no less surely, by riding them on excessive filament voltage, the result of which has already been dwelt upon. This is particularly true of the owners of cheap and badly-designed radio-frequency sets. It is not always strictly the fault of the user, as many of these sets will not operate without burning up the tubes. Some of the very low-priced five-tube sets on the market are nothing but death-pits for your unsuspecting tubes. So, too, are many of the homemade sets that have been constructed of fifteen-cent-store "bakelite," and other imitation radio parts of inferior quality. The volume and distance that you can get satisfactorily from a given investment in a radio set is more or less limited; if you want more volume and more distance than you can get with the tubes normally lighted, it will pay you to junk your set and get one with more tubes in it. It is cheaper to operate eight type-199 tubes on  $2\frac{3}{4}$  volts than to try to run five or six on  $3\frac{1}{2}$  volts, as some are doing. Do not put too much faith in circuits that are alleged to get five-tube power on three tubes, or "ten-tube power on two tubes," and so forth. When you attempt to crowd the functions of six tubes into two or three, the tubes suffer; so does the tone of your music, and the thickness of your pocket-book.

Operating tubes on abnormally high

*B*-battery voltage is injurious, though not so much so if the grids are correctly biased. High plate voltage generally means correspondingly high filament voltage with consequent damage. Unusual plate potential also tends to ionize the minute traces of gas in the tubes and may cause the vacuum to break down.

Defects often exist or develop in tubes, and manifest themselves in various ways. A very common complaint by tube users is that their tubes are "noisy." The causes of noise in a radio set are numerous, however, and are not usually in the tubes. Unscientific circuits, careless wiring, corrosive soldering pastes, poor insulating materials and imperfect sockets—together with external interference from electric elevators and power lines—cause more than eighty per cent of all "tube noises." Trouble is often experienced through the use of fixed condensers in important circuits which are widely inaccurate in capacity. There are only a few sockets on the market that are satisfactory; some are too stiff, and there is danger of twisting the tubes loose in their bases; others are much too weak and never make good contact.

Noises from within the tube itself are most often due to the presence of gas. If the elements, grid, plate, and mounting wires, inside the tube are not chemically pure, they will slowly release gases that will lower the vacuum, with consequent unstable operation, loss of volume, and excessive howling. Another source of trouble lies in the delicate filament's getting against the grid and making contact with it. This sort of tube will either be entirely dead when lighted, or will cause a terrific rattling and crackling in the loud-speaker, upon being slightly jarred.

Microphonic ringing noises in tubes are due to mechanical vibration of the plate or grid, or both. In very sensitive circuits this trouble may be experienced with the best of tubes. The only cure for it perhaps would be to manufacture the tubes with the grid and plate rigidly anchored on heavy glass pillars, with resultant complications in construction and greatly increased cost of production.

A good tube will sometimes have a tendency to howl, because of insufficient aging. The cure for this is to leave the tube normally lighted with the *B*-battery on, for an hour or two. If you have a tube that is inclined to howl in audio frequency, give it an over-night aging before condemning it. Be sure first, however, that the howling is not due to something outside the tube. The only test is to put some other known good tube in the same socket and see how it acts.

A frequent cause of tube trouble, in the case of the 199 type, is the oxidation of the soldered contact buttons on the base. These should be brushed with sandpaper; and if one button is found to be higher than the others, it should be filed down until they are all at a uniform height.

THE large tube manufacturers are finding it necessary to adopt an extremely stringent policy in admitting claims for replacement of alleged defective tubes. The tubes are subjected to a series of tests before being sold and also after being returned with a claim for replacement. The major tests are six in number; the object being to determine the following points: emission, oscillation, vacuum, base-wire connections, amplification, and (if the tube does not light) the cause of burn-out.

The emission test is made on a machine which contains the theoretical circuit of Fig. 1. This consists practically of a filament-lighting circuit with stepless resistance control, and a plate circuit with 90 volts potential which passes through a milliammeter and a protective ten-watt lamp. The purpose of the lamp is to limit the maximum flow of plate current through the milliammeter and prevent the destruction of that delicate and costly instrument should the elements inside the tube under test be short-circuited or the lead wires wrongly connected to the tube prongs.

Placing a tube in the circuit shown in Fig. 1, with the grid disconnected, causes an electronic emission from the filament to the plate. The amount of this emission depends upon the richness of the thorium element in the filament.

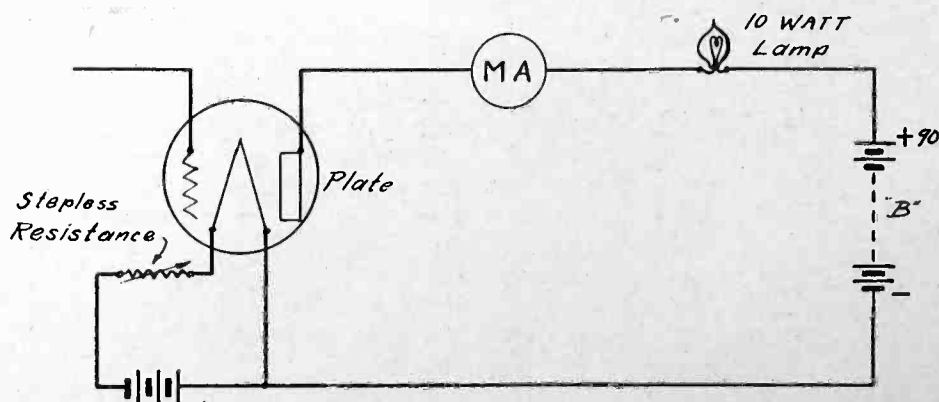

Fig. 1. An Interesting Circuit for Testing Filament Emission

A new 201-A-type tube will pass a current of from 6 to 10 milliamperes through the plate circuit, with 90 volts potential, grid open, and 5-volt filament pressure. A type-199 tube will read from 4 to 8 milliamperes under similar conditions with 3 volt filament supply. Type 201-A tubes reading below 4 milliamperes on this circuit may sound fairly good in audio frequency circuits, but they are almost sure to be weak in radio frequency. A low reading, say from one to three milliamperes, indicates that the thorium content of the filament is exhausted and that the effective life of the tube is at an end.

The second, and one of the most effective over-all tests, is the oscillator-test. A theoretical circuit for testing the oscillatory qualities of a tube is shown in Fig. 2. This is a simple regenerative arrangement, with a milliammeter in the plate circuit, as before.

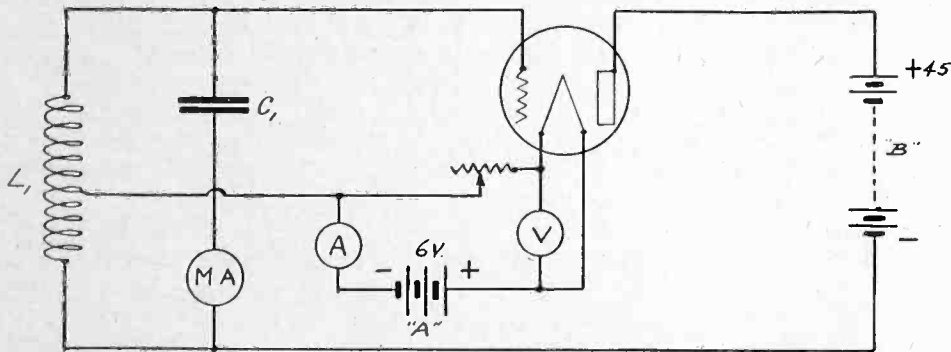

Fig. 2. Circuit for Oscillator Test

Good 201-A, WD-11 and 199 tubes should read above 3 milliamperes on this circuit at a plate potential of 45 volts, type 200 tubes likewise on 22½ volts. The oscillation test machine used by one manufacturer has a variable feedback coupling from plate to grid circuit and readings are taken to determine the comparative degree of feedback coupling required to cause oscillations to begin. Tubes requiring excessive feedback are discarded.

The reading of the milliammeter in the plate circuit of Fig. 1 is an accurate test of the electronic emission, provided that the vacuum in the tube is practically perfect. Should the tube contain a slight amount of gas, this gas will ionize and conduct a variable amount of current across from the plate to the filament, with consequent increased deflection of the milliammeter. This gives a false reading, as the meter indicates both the current due to emission and the current due to leakage through the ionized gases. As a rule, a gassy tube is instantly detected by the passage of an abnormal plate current, this current often amounting to 35 or 40 milliamperes and violently deflecting the milliammeter. Sometimes, however, the amount of gas in the tube is so slight that the milliammeter will be deflected only to the extent that would indicate a good tube were the current due entirely to emission and not

to ionization. In order to find out, therefore, whether the plate current is due to gas or to emission, the circuit of Fig. 1

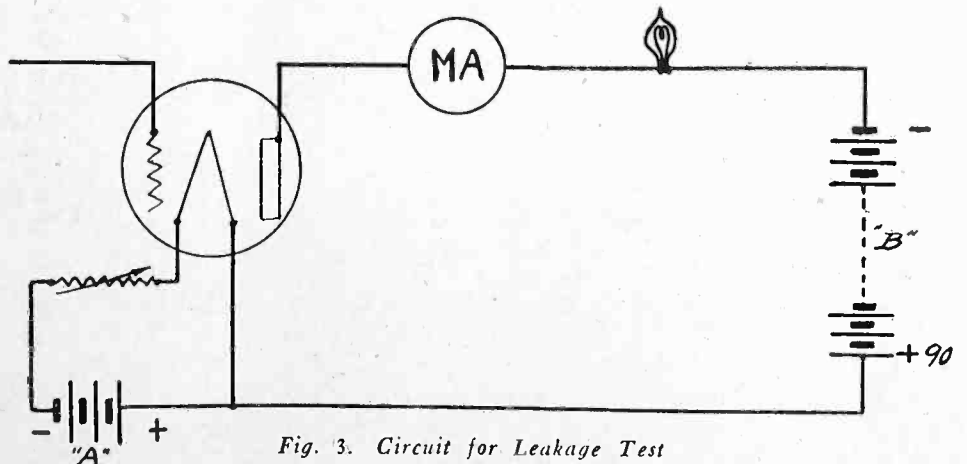

Fig. 3. Circuit for Leakage Test

is rearranged to that of Fig. 3. This is the same thing, except for one interesting point: the plate of the tube is given a high negative polarity, instead of the usual positive.

In this way the emission from the filament is entirely checked, and if any current gets across through the vacuum it will be due principally to leakage through gas, not through electronic emission. The deflection of the micro-milliammeter in the plate circuit of Fig. 3 will therefore register quite accurately the value of the vacuum, without regard to the condition of the filament. A low reading of the meter will indicate a high vacuum.

The fourth test circuit is shown in

and there might be the cause of some innocent tube-buyer being turned into a half-crazed hunchback of neutrodyne  
(Continued on page 72)

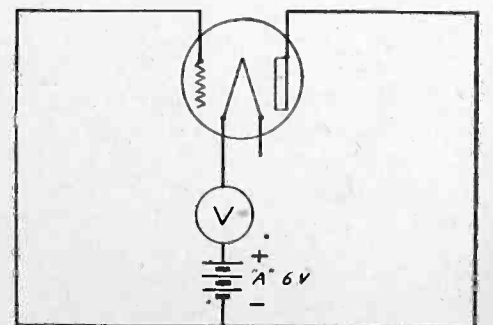
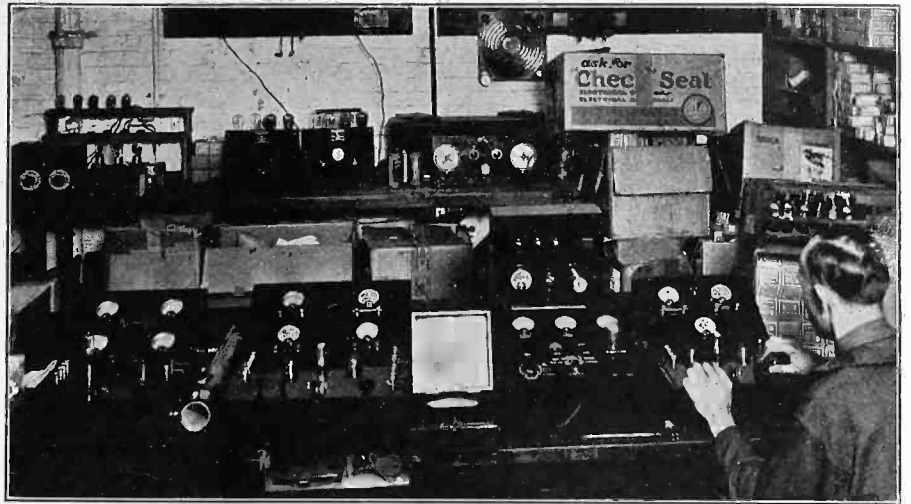
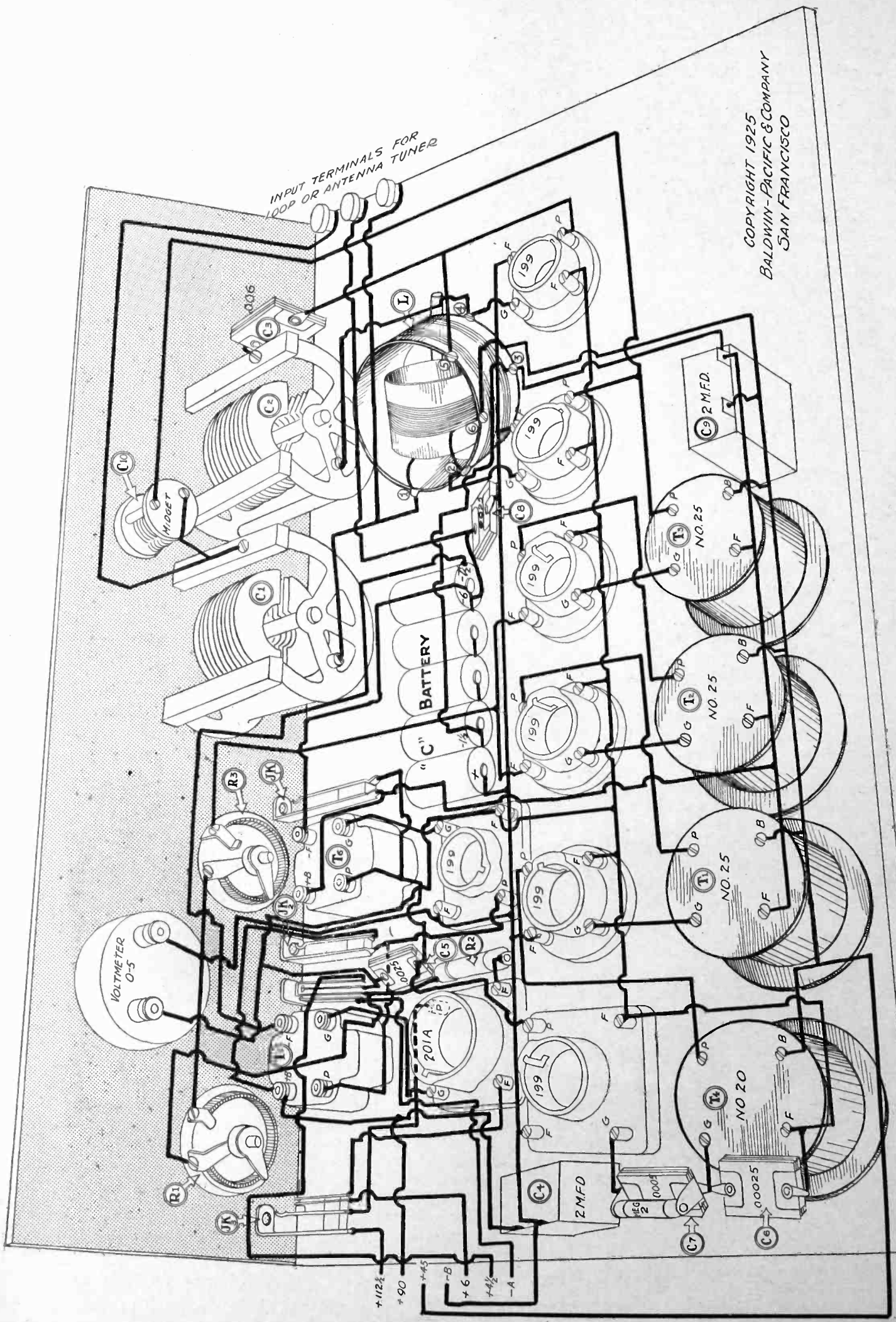

Fig. 4. Circuit for Checking Lead-Wire Connections and for Locating Short-Circuited Elements



Section of Replacement-Testing Laboratory

Fig. 4. In the factory it is used to check the connection of the lead wires from the bulb to the base prongs, and in the replacement laboratory to locate short-circuited elements. As the tubes come from the exhaust machine in the course of manufacture, they each have four copper-clad wires sticking out from the bottom. These wires are soldered into the hollow base-prongs by girl operatives: sometimes during the hot summer days in Jersey, when the big reserve stocks of tubes are being built up, one of these young ladies may have her thoughts upon canoeing on the Hudson or promenading at the Palisades, and instead of putting wire No. 4 into prong No. 4, she puts it into No. 3, and then



INPUT TERMINALS FOR  
LOOP OR ANTENNA TUNER

COPYRIGHT 1925  
BALDWIN-PACIFIC & COMPANY  
SAN FRANCISCO

Pictorial Wiring Diagram of Best's Improved 45,000 Cycle  
Superheterodyne. Supplementing Article in January, 1925 RADIO.

# The Concert Selector

A Non-Radiating Four-Tube Receiver Using One Stage of Regenerative Radio Frequency Amplification

By Lloyd C. Greene

THE "Concert Selector" (name registered with U. S. Patent office) is an extremely selective, sensitive and efficient radiocast receiver, designed by the author to function with four tubes. It employs one stage of regenerative, tuned, radio frequency amplification, a non-regenerative detector, and two stages of audio frequency amplification.

Our experience has proven that the regenerative radio frequency amplifier is superior to either two stages of non-regenerative radio frequency, or one stage of radio frequency and regenerative detector. The radio frequency stage is neutralized.

The radiation ordinarily associated with such a combination is obviated by the use of a clarifying selector whose construction is described later. This gives such loose coupling with the antenna coil that there is practically no transfer of energy between the oscillating coil and the antenna, and consequently no blooming.

Oscillation in the first tube is controlled by a potentiometer with a .005 mfd. by-pass condenser which admits only the direct current component of the grid current to the comparatively high resistance winding and gives a smooth, positive control of the oscillations.

The other variation from standard

## List of Parts

One panel, 7x18x3/16 in.  
Three 3 3/4 in. dials.  
One .0005 mfd. variable condenser.  
One 200-ohm potentiometer.  
One Type CS clarifying selector.  
One Type VT-25 variotransformer.  
Four sockets.  
One .005 mfd. fixed mica condenser.  
One .00025 mfd. condenser with 10 meg. ohm grid leak.  
Two battery switches.  
Four filament control cartridges (or rheostats).  
Two double circuit jacks.  
Two audio frequency transformers.  
Twelve binding posts.  
One baseboard, 18x10x5/8 in., 19 ft. spaghetti, wire, etc.  
One .002 mica condenser.

practice is the use of a vario-transformer to couple the plate circuit of the r. f. amplifier to the grid circuit of the detector. This device, whose construction is described, is merely an efficient type of tuned radio frequency transformer built on the variometer principle. With a UV-199 tube it gives a voltage amplification of from 11 to 18 times for wavelengths from 200 to 600 meters respectively when the amplifier is in the non-regenerative condition. When regeneration is admitted an amplification of 30 for one stage has been attained under laboratory conditions.

Filament control cartridges (Culver-Stearns) are used in place of rheostats in the sets built by the author. These are available in different styles to supply the correct voltage for any type of tube

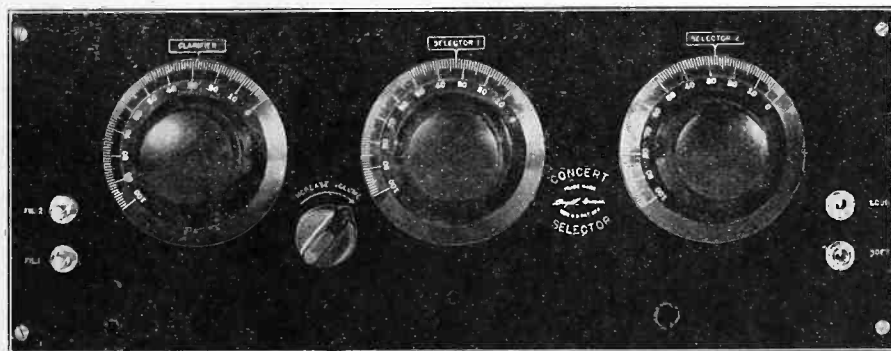

Fig. 1. Front Panel Layout

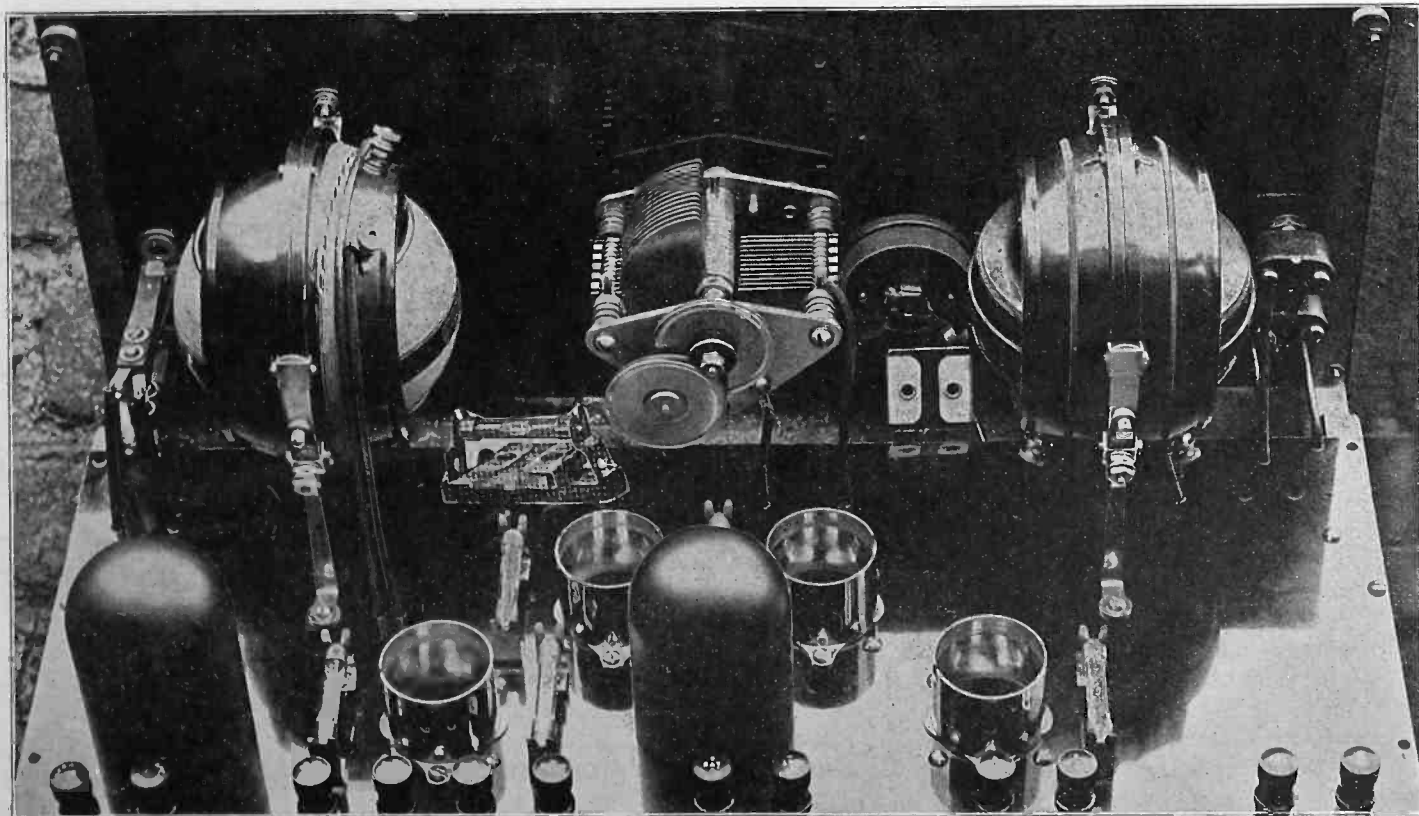

Fig. 2. Rear View of Greene Concert Selector

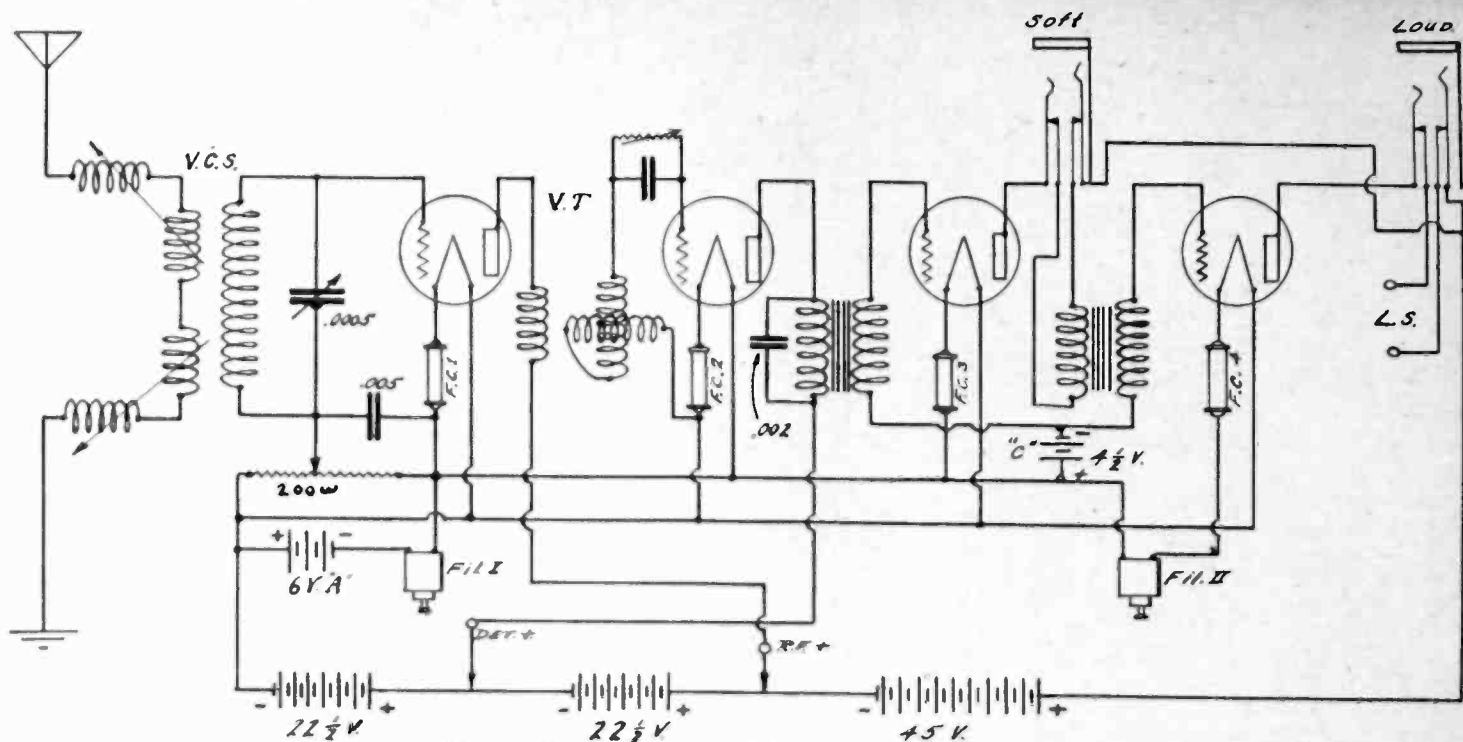

Fig. 3. Circuit Diagram of Greene Concert Selector

used, assuming a 6 volt *A* battery supply. They obviate the danger of over-voltage to thoriated tungsten filaments.

The general arrangement of parts in the completed set is shown in Fig. 2. Most of the wiring is concealed beneath the baseboard. On the panel, from right to left are the battery switches, clarifying selector, potentiometer with .005 mfd. fixed condenser, variable condenser, variotransformer, and two jacks. On the baseboard are the four sockets with associated filament control cartridges, grid leak and condenser, audio transformers and twelve binding posts.

The front panel view in Fig. 1 shows the dials for the clarifier, the 1st selector (variable condenser), and the 2nd selector (variotransformer), together with the filament switches, at the extreme left, the potentiometer control, and the jacks.

The circuit diagram is shown in Fig. 3. *V.C.S.* and *V.T.* are respectively the variable clarifying selector and the variotransformer. It will be noted that no condenser is used in tuning the grid circuit of the detector tube. Attention is called to the position of *FC-1*, *FC-2*, *FC-3* and *FC-4* in the filament leads and to the separate voltage tap for the r. f. tube plate.

Fig. 4 shows the relative placement and wiring of parts. The  $10\frac{1}{2}$  in. spring between the shafts of the clarifying selector and the variotransformer is chosen so as to give maximum amplification. Using UV-199 or C-299 tubes the entire radiocast range can be covered without oscillation of the r. f. tube when using direct negative grid return. With "A" tubes it oscillates only between 450 meters and then only when the potentiometer is advanced far toward the negative side.

Tuning will be found quite simple. The left hand dial controlling the clarifying selector should be set at 50 for the trial. Then by varying the two dials marked *Selector 1* and *Selector 2* up and down the scale keeping within a few degrees of each other, stations will be picked up. Any tendency of the tubes to oscillate should be controlled by the potentiometer which should be advanced further toward the positive side as the wavelength being received is lowered. After a station has been picked up the proper setting of the clarifier dial will make the receiver as sharp as is desired. The setting of the clarifier should be followed by a slight readjustment of the condenser dial marked *Selector 2*.

When the bottom switch on the left hand side of the panel is turned on the first three tubes are lighted. The plug for the telephones or loudspeaker should then be inserted in the bottom jack marked *soft*. By turning on the second left hand switch at the top the fourth tube is lighted and the plug may be inserted in the upper jack marked *loud*. Turning off the bottom switch extinguishes all the tubes. The loudspeaker may be connected to the terminals provided for it on the terminal board in the rear. When the plug is inserted in either jack the signals are cut off from the speaker. When the plug is removed the speaker operates. Care should be taken to connect the speaker with the proper polarity so that the maximum of volume and quality will be obtained. A comparison of the two possible connections will determine the proper polarity.

In placing the tube sockets the notch in the socket shell provided for the pin of the tube must be placed as shown in Fig. 4. In mounting the potentiometer on the panel be sure to attach three pieces

of wire, one to each binding post, before mounting it on the panel. This will save considerable time and much patience. These wires should be about two feet long.

It will be noticed in Fig. 4 that some of the binding posts are indicated as dotted circles. This means that the binding posts are on the bottom of the instrument. For instance, all the binding posts on the clarifying selector are on the bottom of the instrument. When the clarifying selector is properly mounted on the panel all four posts on the instrument point downward toward the baseboard. When the variotransformer is properly mounted the outside windings of this instrument are next to the variable condenser and *not* next to the jacks. It is very important to mount these two instruments in the manner described.

When setting the dials of the completed selector for zero reading see that the wires which run from the rear shaft to the edge of the rotor of the clarifier and variotransformer extend to the right when the instrument is viewed from the front of the receiver. The condenser should have all of the plates to mesh for a dial reading of 100.

Before commencing to wire your receiver check up on the assembly of apparatus on both panels and baseboard. Make sure that your sockets are properly arranged else the wiring directions which follow will be of absolutely no value to you. In checking the placement of parts study Figs. 2 and 4.

Have at hand a good clean soldering iron, string solder, soldering paste, a pair of wire cutters and a piece of old cloth with which the soldering iron should be frequently wiped. Use as little soldering paste as possible and wipe

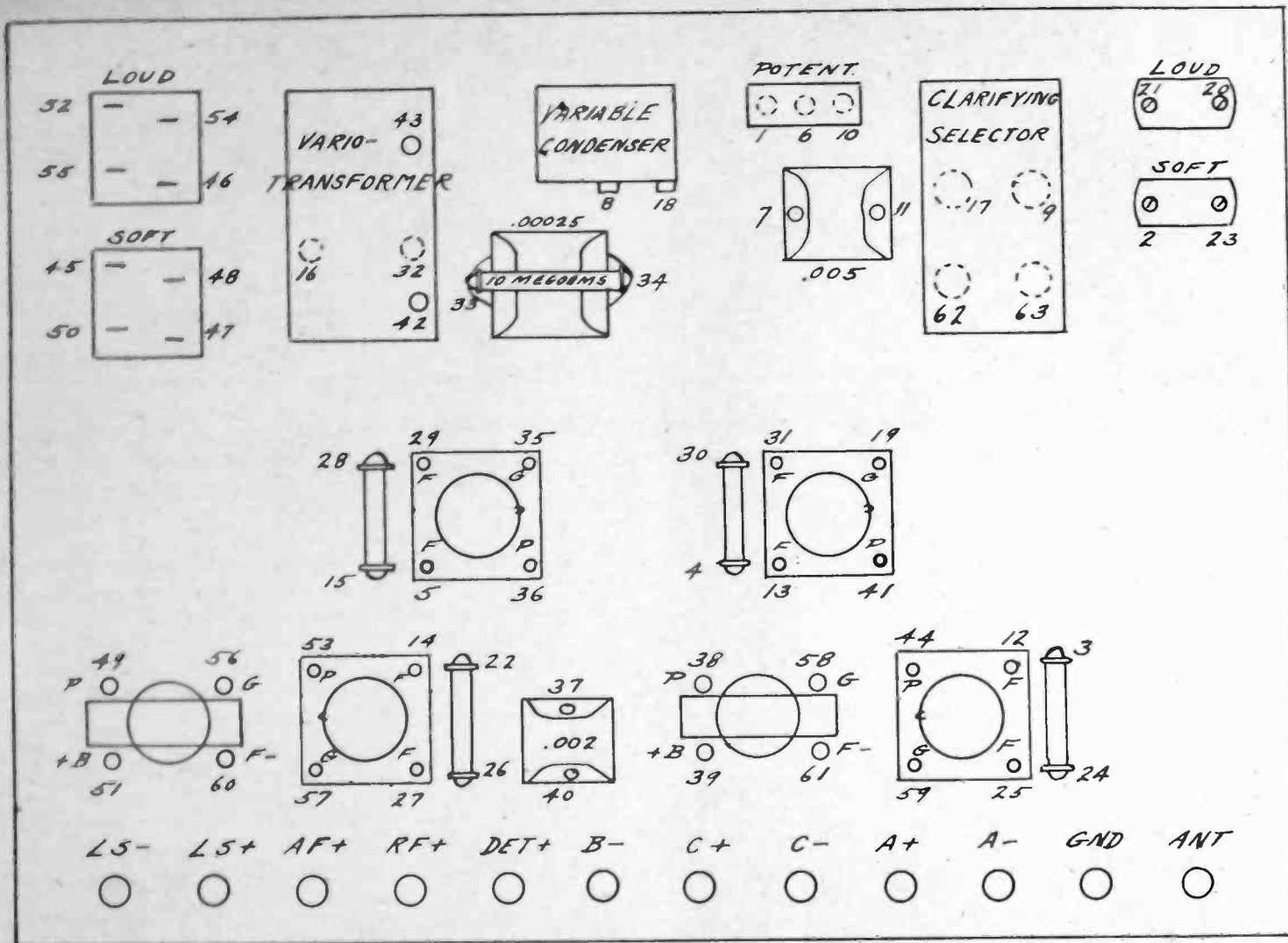

Fig. 4. Wiring Diagram

clean every soldered joint before proceeding. Cover the wire with lengths of spaghetti as you proceed. Don't hurry the wiring. This practice in building radio sets usually results in an improperly wired instrument which will not function. Then follows a mountain of trouble in locating the fault and a lot of shifting and changing which a little more time and a little more care would have obviated. There's nothing to be gained by hurrying, so let's not do it.

Wire your set from Fig. 4.

Beginning with the wire attached to the post on the potentiometer marked 1 continue on to posts marked, 2, 3, 4 and 5, in this order. Spaghetti should be cut to the proper lengths and slipped over the wire as you proceed.

The next piece of wire begins at post 6, continuing on to 7, 8 (movable plates of variable condenser) and 9.

Another piece of wire should connect points 10, 11, 12, 13, 14, 15 and 16.

Now run a wire from 12 to the A positive and B negative posts.

Join with a single piece of wire, 17, 18 (fixed plates of variable condenser) and 19. Join 2 and 20. Join 21 and 22. Join 23 with A negative and C positive posts.

With separate pieces of wire connect 24 to 25, 26 to 27, 28 to 29, 30 to 31, 32 to 33, 34 to 35.

Connect 36 to 37 and continue to 38.

Connect 39 to 40, and continue to DET positive post.

With single pieces of wire join 41 to 42; 43 to RF positive post; 44 to 45; 46 to 47 and continue to AF positive post. In making connections to the soldering tabs on the phone jacks, solder to these tabs with reference to numbers on the top spring, the next lower spring, the spring next, the bottom and the bottom spring. Don't pay any attention to the direction in which the soldering tabs point as some jacks in this respect are just the reverse in construction to those illustrated in Fig. 4.

Connect 48 to 49; 50 to 51; 52 to 53; 54 to speaker negative post; 55 to speaker positive post; 56 to 57; 58 to 59.

Join with a single piece of wire 60, 61 and C negative post. Connect 62 to antenna post, and 63 to ground post. This completes the wiring of the set.

The concert selector will operate under extremely adverse conditions as regards antenna and ground when using the large tubes. With tubes of the UV-199 class a long antenna and a good ground connection are necessary. A good antenna and ground is of course desirable with the larger tubes, although the writer has had excellent success with a 25 foot wire for an antenna and a nondescript ground on a heating system, bringing in stations 1,000 miles or more away. It is recommended that an an-

tenna 75 to 100 ft. long between supports be used with as good a ground as can be made. We regard with suspicion grounds to radiators, drain pipes and the like. The cold water pipe is usually the best bet.

Thousands of receivers of this type are now in use in New England. Excellent reports are being received daily on their performance. Stations as far away as Rome, Italy, IRO, have been received and this reception confirmed. Another user has written to OAZ, Lima, Peru, for confirmation of his reception. We hold these two tempting morsels out to the radio enthusiast as examples of what can be done with a single stage of good radio frequency. Superheterodynes take notice. Freak reception you say? Granted. Let us regard them as the proverbial straw which shows which way the wind blows.

#### Construction of Special Parts

FOR the experimenter and others preferring to construct the Langbein & Kaufman clarifying selector and vario-transformers complete dimensions and diagrams are given herewith. In each instrument the winding form is made of special hard rubber having a low dielectric loss. The wire used for winding is No. 24 double silk covered and is held in place by a compound of para rubber

(Continued on page 60)

# Atmospheric Electric Phenomena

A Simple Scientific Statement of the Causes of Static Disturbances and the Method of Wave Propagation

By Milo E. Tressler, E. E.

**S**TATIC is the name applied to the disturbances heard in radio sets caused by atmospheric electric discharges, earth currents, auroral discharges, sun spots, electrified rain, hail or snow particles. These atmospheric phenomena are entirely distinct from man-made static.

But very little has been written in the magazines available to the radio man about the fact that the air around him is electrified continuously, there being a difference of potential of about 200 to 300 volts between his head and his feet when walking out of doors in an open field in fair weather, and as high as 20,000 to 30,000 volts when a thunder storm is directly overhead.

This potential gradient (the voltage between two points divided by the distance between them) may be measured by means of sensitive electro-static voltmeters or electrometers and some form of collector which makes contact with the air.

In an open plain, surfaces of equal potential are parallel to the earth's surface but when any conductor such as a tree, pole or high building is present, these equi-potential surfaces tend to come very close together at the top of these

tend to give rise to a potential gradient of 11,000,000 volts per meter on top of the pole. But this is more than sufficient to ionize the air, that is, fill it with electrified particles which are conductors. Such a phenomenon may sometimes be seen at night as St. Elmo's fire, appearing as a faint glow on the tops of shrubbery or grass in the open fields and may also be heard as a hissing or crackling sound from the points of lightning rods on houses or barns. It is familiar to many as the corona effect on high voltage transmission lines.

Actual measurements with the water-drop or flame collector developed by Lord Kelvin, or with an ionium collector, have shown that the total potential on an ordinary antenna is of the order of 700 volts in normal fair weather. This is not sufficient to cause an appreciable disturbance in a radio receiving set. But in the case of storms, where the potential gradient may be from 10 to 100 times normal and the atmosphere contains much more electricity on the rain drops, snow or fog particles, the discharge may be so great and so irregular as to cause considerable disturbance.

The normal potential gradient de-

tute show a daily variation of potential gradient which is believed to be due to the rotation of the magnetic axis around the earth's axis which brings the north magnetic pole nearest to the sun at one time of the day and the south magnetic pole at another time. It is found that the maximum potential gradient occurs when the north magnetic pole is nearest the sun and the minimum when it is farthest away. These facts indicate that the electric charge of the earth is very intimately related to an electric radiation from the sun. There is also an annual variation with a minimum of 113 volts per meter in the May-July period and a maximum of 137 volts in the February-April period.

Under the force of this potential gradient, the negative ions in the air move out from the earth and the positive ions move in toward the earth's surface, the sum total of these movements giving conductivity to the air. This conductivity is so small that it is best expressed in terms of its reciprocal, its resistance, which is tremendously great. Measurements and calculations show that the air's resistance is about  $4.1 \times 10^{15}$  ohms at the earth's surface and about 40,000 ohms per centimeter cube 60 miles above the surface. This latter value is sufficiently low to make space at this altitude a good reflector of radio waves and gives rise to the theory of a conducting layer of the atmosphere known as the Heaviside layer.

Calculations of the actual current flow from the earth to the upper atmosphere gives an estimate of 1700 amperes for the whole earth or about 3.7 micro-amperes per square km. (9.6 micro-amperes per sq. mile) during fair weather. This may increase enormously under a thunder-cloud. The current flowing through a thunder-cloud from top to bottom is estimated to be about 2 amperes. Lightning flashes, rain drops and snow fall are also the means of transferring a considerable quantity of electricity from the air to the earth.

These data are indicative of the cause of static but until a great many more observations have been made over large areas, it is difficult to accurately predict conditions. Amateur radio men can be of great assistance in making these observations. The actual methods employed are relatively simple and may be found described in the publications of the Carnegie Institution of Washington, Physical Review, etc.

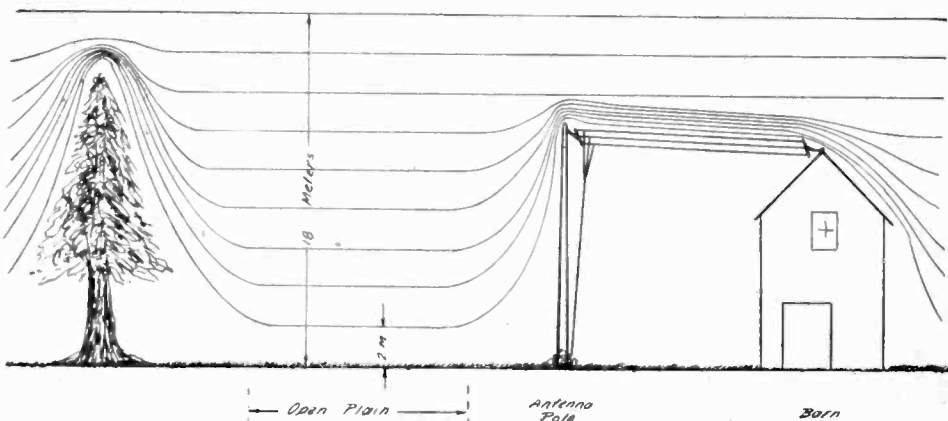

Fig. 1. Equipotential Surfaces in Open Air Over Tree, Plain, Antenna, etc.

projections, thereby causing the potential gradient to become very high. This is shown graphically in Fig. 1.

If the potential gradient were 150 volts per meter over the plain, as is common in fair weather, and if all of these equipotential surfaces were crowded into the first centimeter above the top of an antenna pole 11 meters high, the potential gradient at the top of the pole would be about 156,000 volts per meter. Likewise, a highly electrified thunder-cloud directly overhead may

creases as the distance from the earth's surface increases until it is about one volt per meter at 10 kilometers (6.2 miles) altitude. This would make a total normal potential difference of about 750,000 volts between the earth's surface and a point about six miles above it. The reason for this is that the earth's surface has a preponderantly large charge of negative electricity and the air and the upper atmosphere an excess of positive electricity.

Observations by the Carnegie Insti-



# The Single Control Tuned R. F. Receiver

A Discussion of the Principles Underlying the Commercial Design of a Variable Inductance Tuner

By Don Lippincott,

Engineer Magnovox Radio Department

IT MAY be taken as an engineering axiom that as great a degree of simplicity as is consistent with satisfactory operation is always desirable. The hitch comes when we start to define "satisfactory operation." As long as the handling of radio receivers was confined to professional or trained operators, the constant endeavor was to get the utmost in sensitivity and selectivity. Simplicity of operation, while recognized as desirable, was considered of such minor importance that receivers with from ten to twenty controls were not unusual.

The advent of radiocasting necessitated a revolution in design. The only really simple receiver then available was the single circuit regenerative tuner. There is no need to dilate here upon the shortcomings of the single circuit tuner. The only reason for mentioning it is to point out that its simplicity was more than sufficient to overbalance its numerous defects and to make it, for more than a year, the largest selling receiving set, nor was it displaced until other receivers were developed which were almost equally easy to operate. The public continued to buy single circuit receivers even while it complained of their lack of selectivity.

The commercialization of the tuned radio frequency amplifier offered a direct challenge to the designer of the single tuning control receiver. The suggestion of the three dials tuning almost the same is too obvious to be ignored, and many experimenters attempted to gear them together.

Such a scheme necessarily fails of satisfactory operation. We have, let us

say, three tuned circuits which must remain in resonance for all positions of the tuning control, i. e., the product of inductance and capacity must be the same in all three circuits. No matter how nearly identical we make our tuning condensers, we still have the capacity of the antenna to account for in our first circuit. Couple the antenna as we may, it still represents an indeterminate capacitance  $C_0$ , which prevents accurate resonance over the entire scale.

It is true that by designing the antenna condenser plates according to a different law than that used for those in the inter-tube networks a circuit could be obtained which would balance, at least to a first approximation.

There is another solution, however, so much simpler and more satisfactory that it is a shame not to use it. Our indeterminates are capacitances. Let us, therefore, make our inductances the tuning variables and vary them all in accordance with the same law. We may then add the necessary capacitances to our three circuits to bring them into resonance, and once resonant they will continue so throughout the tuning range.

This is the fundamental idea behind the design of the Magnovox TRF receiver, but in practice it has been carried beyond this so as to make the set applicable to a wide range of antenna capacities, to compensate for the antenna inductance, and to increase selectivity. As may be seen from Fig. 1 the condenser  $C_1$  is connected directly across the antenna and ground binding posts of the receiver, putting the antenna capacitance (which we may take as being somewhere between 100 and 500 mmf.) in parallel with a fixed capacitance of 1000 mmf. In series with these combined capacities

is the small adjustable "ratio condenser"  $C_v$ , which is adjusted in practice to about 125 mmf. With the antenna capacitance at 100 mmf. the effective capacitance across the tuner figures  $112\frac{1}{4}$  mmf. At 500 mmf. it is  $115\frac{1}{2}$  mmf. Hence a change of 400 mmf., or 500 per cent, in antenna capacitance changes the tuning capacitance by but  $3\frac{1}{4}$  mmf., or less than 3 per cent, which is readily compensated for by a slight adjustment of  $C_v$ , and the slight changes in effective antenna capacitances with wavelength, due to its inductance, are made wholly negligible. The selectivity obtained with this arrangement is comparable to that given by a small aperiodic primary.

Control of oscillation is important in any tuned radio frequency amplifier, and in the present instance a new application has been made of the old principle of control by loading the tubes.

The output circuit in this, as in practically all modern multi-tube amplifiers, is a parallel resonant circuit, in which the circulating current is dependent upon the impedance of the circuit branches, the tube simply supplying the  $I^2R$  losses in the circuit. A traditional method of control is to increase  $R$ , which so raises the demand on the tube that sufficient voltage cannot be built up across the grid-plate capacity to cause oscillation. The same thing, however, may be done by decreasing the impedance of the branches of the parallel circuit, and thus raising  $I^2$ . In this case, however, the power delivered by the tube is made available as additional voltage on the succeeding grid, instead of being thrown away as heat.

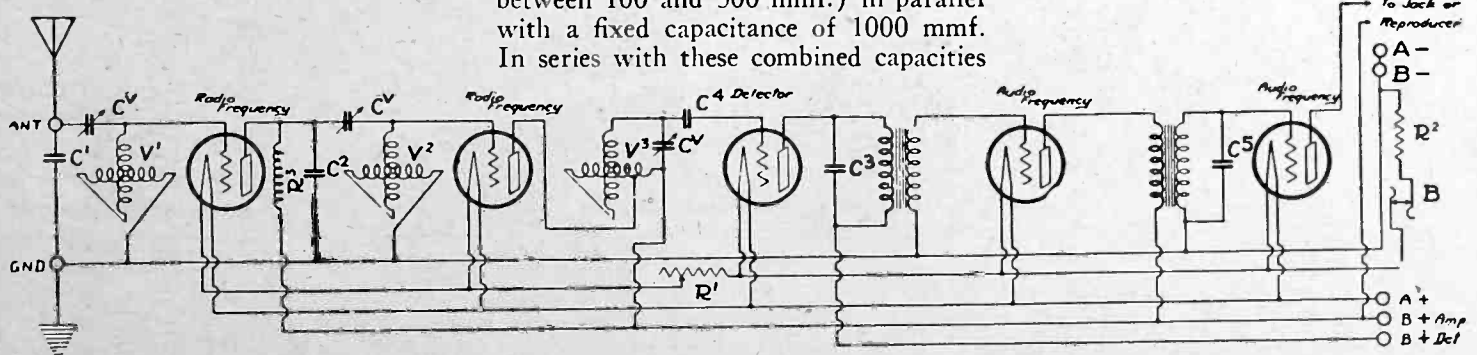

Fig. 1. Wiring Diagram of Single Control Receiver

B—battery switch.  
 $C_1$ —antenna coupling condenser, approx. 1000 mmf.  
 $C_2$ —2nd coupling condenser, approx. 1000 mmf.

$C_3$ —1st audio by-pass condenser, approx. 1000 mmf.  
 $C_4$ —grid condenser, approx. 150-200 mmf.  
 $C_5$ —2nd audio by-pass condenser, approx. 500 mmf.

$C_v$ —adjustable ratio condensers, approx. 10-150 mmf.  
 $R_1$ —volume control, approx. 10 ohms.  
 $R_2$ —fixed resistor, approx. 8 ohms.  
 $R_3$ —radio frequency choke.  
 $V_1, V_2, V_3$ —variometers on unit control.

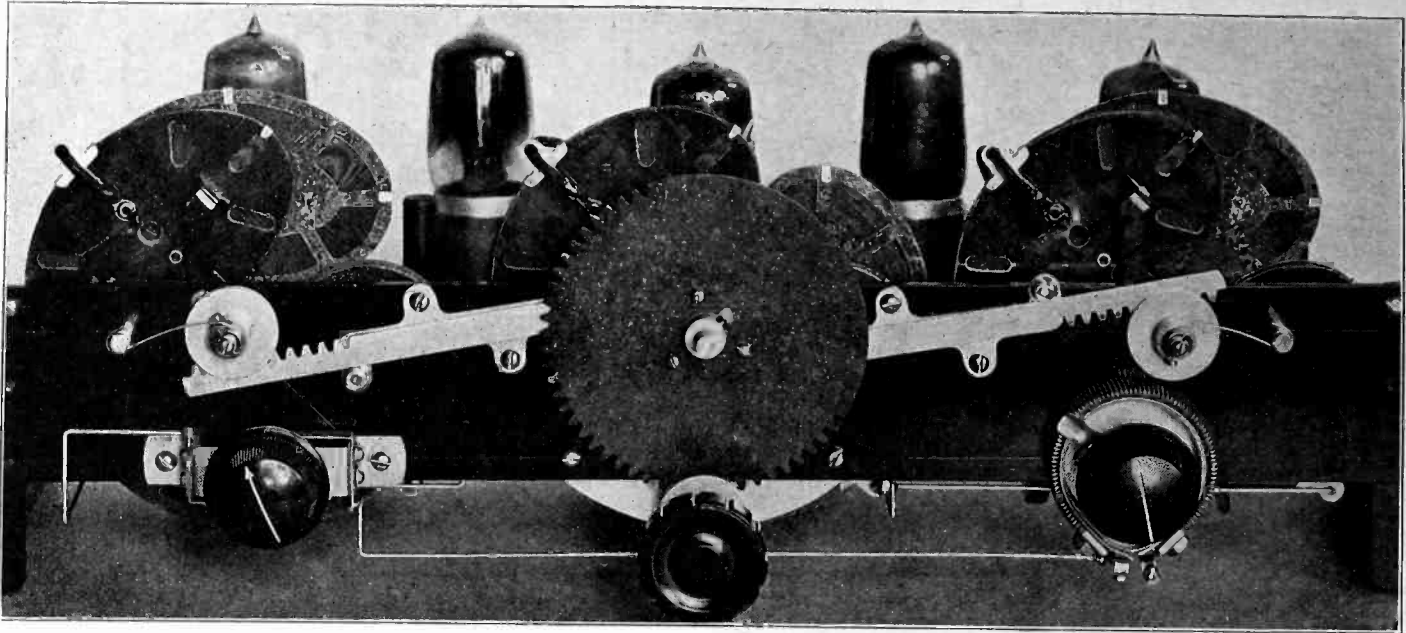

Fig. 3. Front View of Single Control Receiver

Consider a resistanceless circuit like that of Fig. 2, which is in resonance to an oscillating voltage applied between terminals 1 and 2. The branch  $C_1C_2$  has a negative reactance equal to the positive

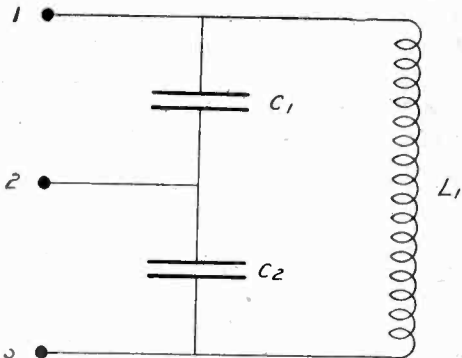

Fig. 2. Principle of Resonant Circuit

reactance of  $L_1$ . Suppose now we transfer our oscillating potential to the terminals 2 and 3. The negative reactance  $C_1$  has then been subtracted from the negative branch and added to the positive branch, leaving the two sides of the circuit still equal, but smaller by the reactance of  $C_1$ , with the circulating cur-

rent correspondingly higher. If the circuit contains resistance the reasoning is no longer exact, but it still remains substantially true. This, it will be seen, is the output circuit of the first tube of our receiver.  $C_2$  has here a value of about 1000 mmf.  $C_1$ , on the other hand, has a capacity only about  $\frac{1}{8}$  as great. Since equal (or nearly so) currents flow through both, the voltage across  $C_1$  is eight times that across  $C_2$ , while that across the inductance is equal to the sum of the other two or nine times the output voltage of the first tube. Therefore it may be seen that any increase in the size of  $C_2$  which may be necessary to supply enough damping to prevent oscillation justifies itself by giving increased amplification to the next tube.

The radio frequency choke coil has an extremely high impedance and a natural wavelength of about 600 meters. The effect of its inductance on the circuit is minimized exactly as is that of the antenna.

The output of the second tube is tapped across a portion of the inductive re-

actance in its output circuit instead of a portion of its capacity reactance purely for mechanical reasons. The effect is identical.

Damping is not a quantity that "stays put." It varies at different frequencies, and therefore in order to maintain sensitivity over the entire wave band it is necessary to provide a means of changing the impedance of the circuit relative to the tubes. This is done by the volume control rheostat, which raises the impedance of the tubes by decreasing their filament emission on the higher wavelengths, where the damping in the circuit becomes less.

It can be seen that with this circuit, unit tuning becomes wholly a manufacturing problem. How accurate is it possible to make coils and supports so as to give the same inductance for the same angular position in all circuits? It was to meet this problem that the construction shown in the pictures was adopted. There is no production tool better adapted to exact duplication of results than

(Continued on page 70)

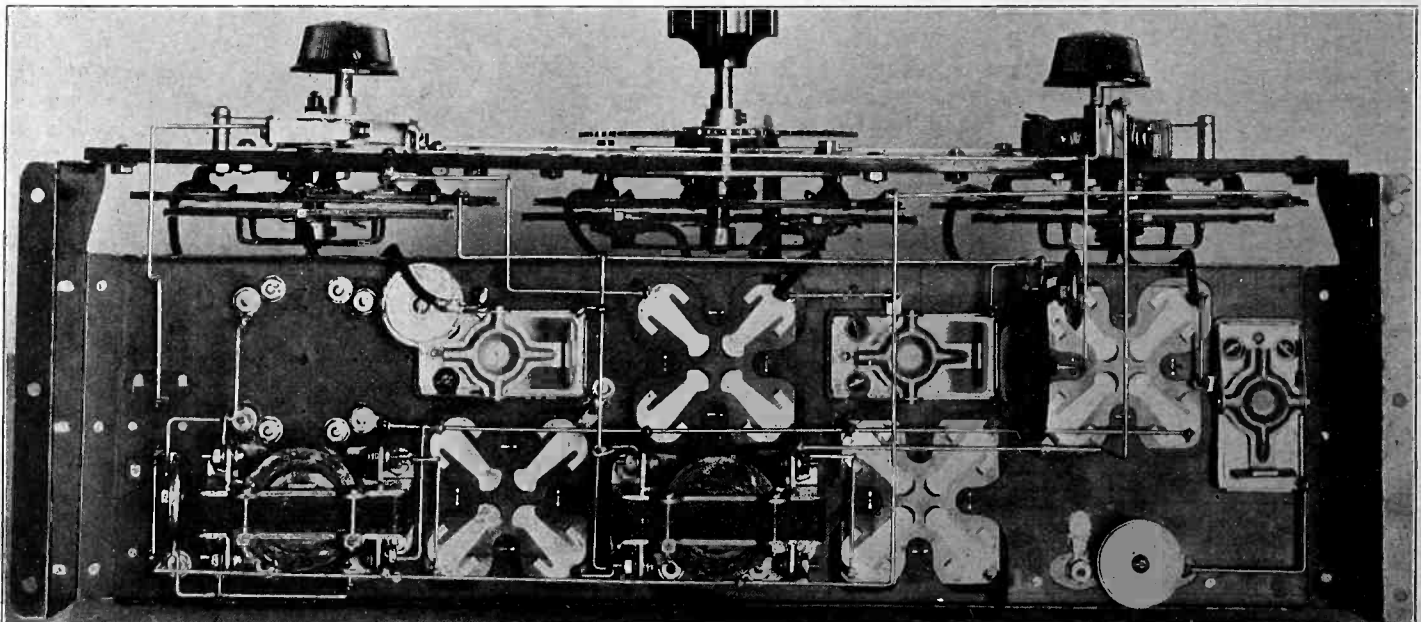
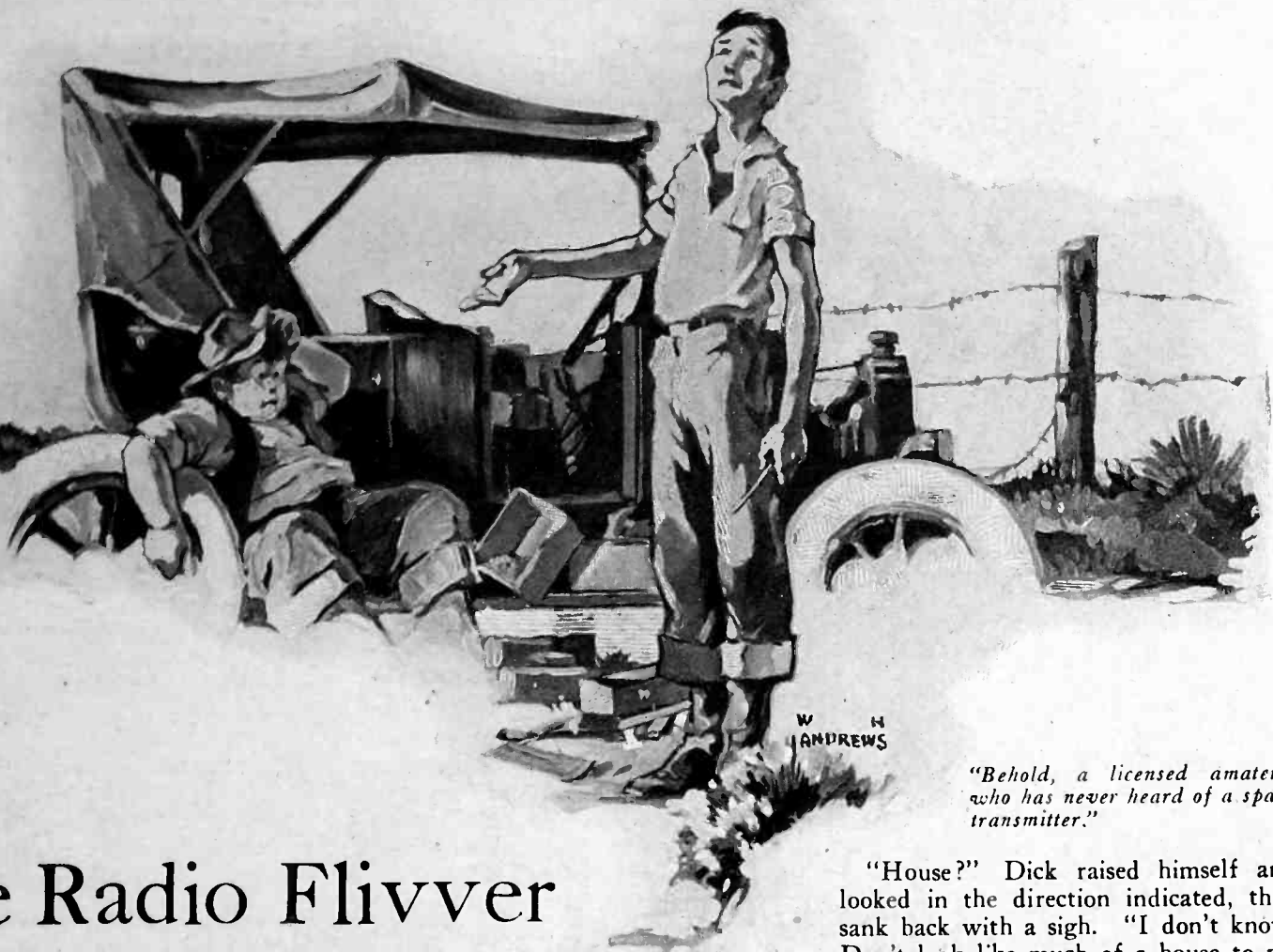

Fig. 4. Under Side of Sub Panel



"Behold, a licensed amateur, who has never heard of a spark transmitter."

# The Radio Flivver

By Willard Wilson

"PORKY" Brown dragged his long, loosely jointed carcass from beneath the sagging middle of his stalled flivver, and gazed dolefully at his companion.

"Well," his stocky little chum snapped out, "what's the matter with the beast?"

"I think it's stalled, Dick," said Porky solemnly.

"Stalled!" Dick snorted. "It didn't take any lunatic as big as you are to tell me that. What I want to know is why is it stalled, and if we are going to get to the Radio Club tonight?"

"I—I don't know." Porky looked about despairingly. "It seems to be all there, but it just won't run I guess."

He settled down limply on the fender, his legs dangling in the thick dust.

His companion eyed the unlucky conveyance with disgust for a minute, then suddenly started as if a thought had hit him.

"Is there any gas in it?"—he yelled fiercely.

"Gas?" Porky looked dazed. "Why—why I don't know."

"No, I suppose you don't," Dick remarked with deep sarcasm, "but it might not hurt anything to look and see."

He unscrewed the cap of the tank, and a deep groan rose from his lips. The tank was empty. In fact, it was so empty that even the smell had been

wafted away on the hot summer air. At his discovery all hope left him.

"Darn!"—he muttered slowly; and climbing over into the back seat he slouched down as if ready to spend the night in that particular posture.

Porky rose slowly from the battered fender.

"Well," he grunted, "it isn't going to get us any nearer town by 'darning' around about it. Can't we get some gas for the thing around here somewhere?"

His voice brightened perceptibly.

"Oh sure! Sure!"—Dick told him. "Just walk back about four miles to your dad's ranch and lug out a pail of it. He may let you have one of the horses to ride back. Or if you want to walk the five miles to town you can get Jake Peters to bring out his tow car and pull us in."

Porky drooped, but suddenly began to scan the horizon. Dick noticed his search, and gave another contemptuous grunt.

"You don't need to be looking for anyone on this road," he said. "Nobody will come along till they begin to haul the milk to town in the morning."

Porky straightened up.

"What's that house?"—he asked, pointing to a disreputable little shack on the edge of a gully a few hundred yards away.

"House?" Dick raised himself and looked in the direction indicated, then sank back with a sigh. "I don't know. Don't look like much of a house to me—probably some Mexican hangout."

"Well, I'm going to try it," Porky announced dubiously. "You never can tell. I might be able to get some gas or something."

After a brief but painful scramble over the rocks and cactus, he arrived at the hut. By several vigorous series of thudding knocks on the rickety door, he persuaded a sleepy looking Mexican to open it cautiously and peer out.

"Howdy," said Porky.

"Buenas dias," said the other.

"Me no sabe Spanish," explained Porky.

"Yo no hablo el ingles," grinned the Mexican.

The lanky gas-hunter scratched his head in perplexity, then opened a fresh attempt to convey an impression of his need to the other.

"Me want some gas," he articulated slowly, but the Mexican grinned.

"Yo no—" he began; but Porky stopped him by pointing to the motionless car, and then making diverse strange signs and motions intended to convey the impression that the tank was empty. At the conclusion of a particularly impressive performance in which he had acted as if pouring something down his attenuated neck, a flash of intelligence crossed the Mexican's face.

"Si!"—he exclaimed, beaming, and rushed back into his shanty, presently returning with a little flat bottle half

(Continued on page 48)

**THE LETTERS OF A DEEP SEA OP**

In which he discusses an experimental antenna tuning unit.

S. S. JEST WESTER,  
Singapore, S. S.,  
December 23rd.

Dear Jack:

Well old kid, here we are again; me and Mr. Underwood's portable punching machine. Hope you have a very Merry Xmas and a Hootchy New Year. We pull out for Zamboanga tomorrow so our Xmas will be spent at sea as is usual.

I haven't had an awful lot to do lately except sit around and plot against radio. Result, another brain storm. It don't amount to much but I've had a lot of fun with it and might as well pass you the dope. The original germ of the idea was gleaned from a British circuit I found in a magazine out here. I have elaborated and adapted it as follows:

A flexible antenna tuning unit with which almost any desired circuit can be arranged; the main idea being that different tuning arrangements work better on different antennas, according to the length, location, etc.

The general scheme consists of a 3 in. tube wound with 70 or 80 turns of fairly heavy DCC wire, tapped every 10 turns; the tap turns being soldered to Fahenstock clips after being brought out over a thin strip of insulating material. Mount on a bread board with a .0005

mfd. variable condenser, some flexible leads and four binding posts.

Gaze on the Rembrant in Fig. 1 and note carefully the four flexible leads, also the Fahenstock clips on the coil taps. It is only necessary to properly combine these elements and a multitude of circuits

(Continued on page 59)

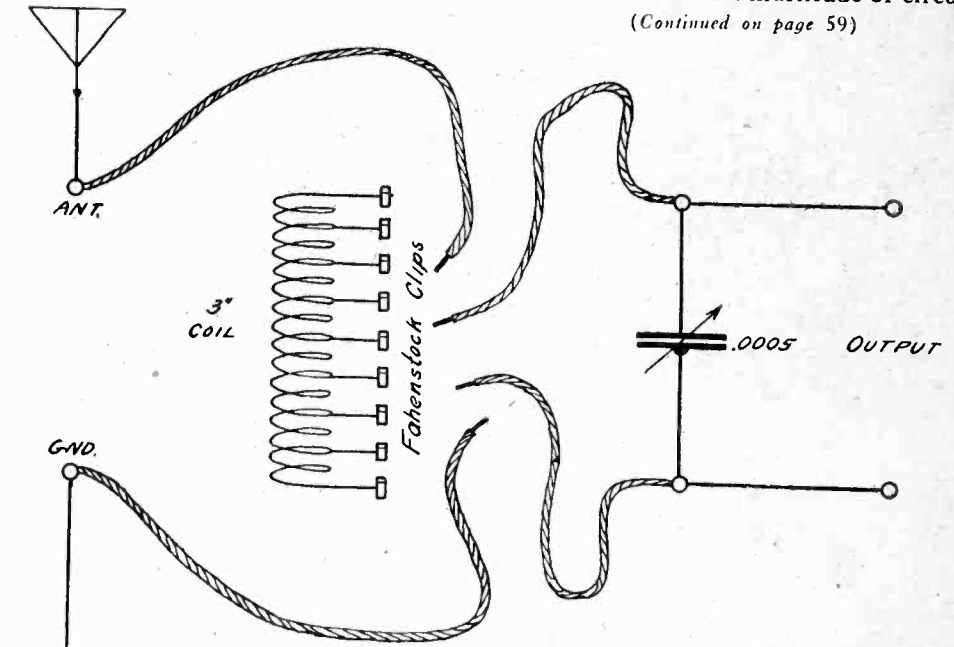

Fig. 1. Experimental Antenna Tuning Unit

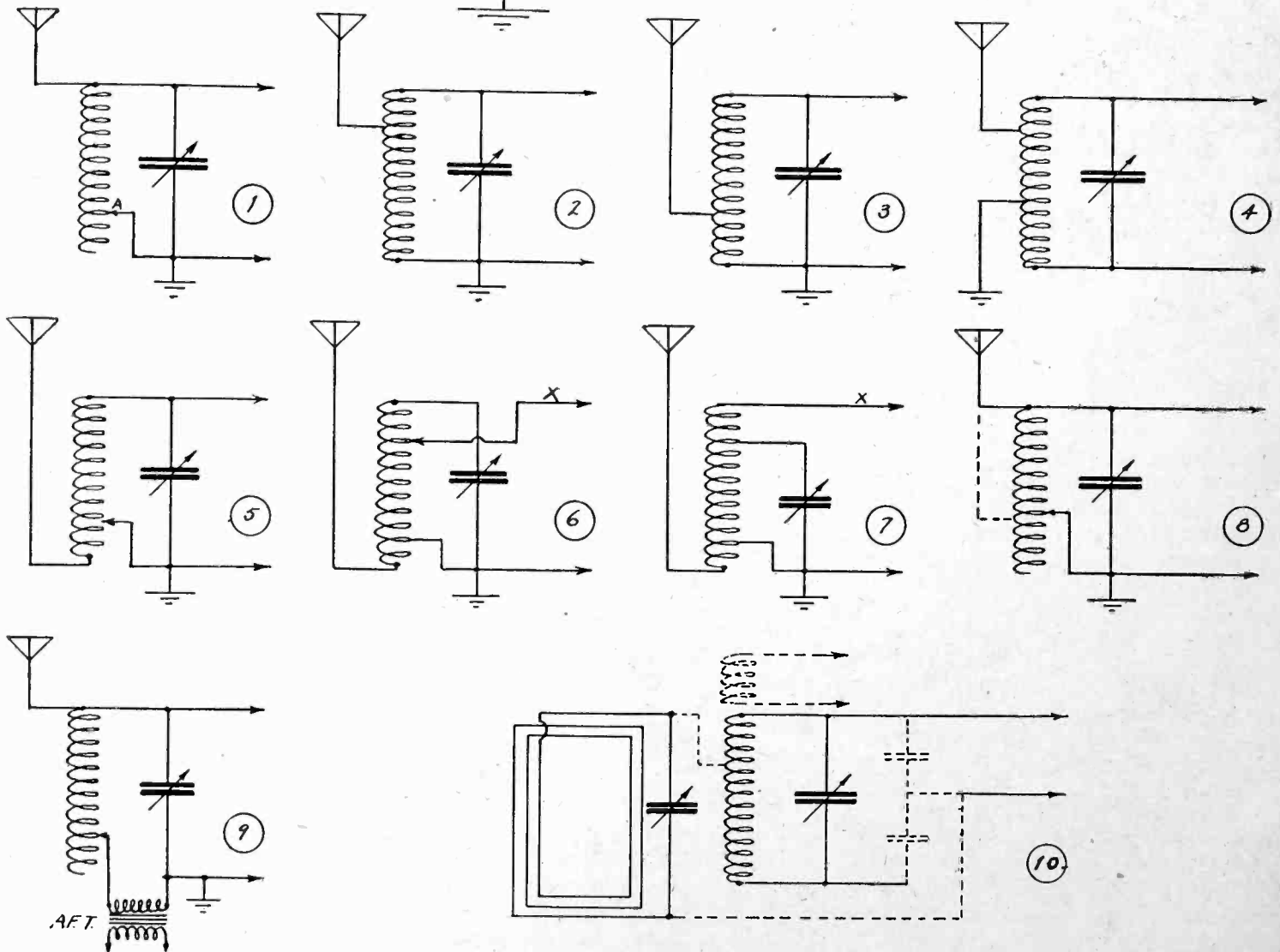

Fig. 2. A Few of the Variations Obtainable.

(1) Ordinary Paralleled Circuit wherein "A" taps various wavelengths. (2), (3) and (4) Variations of (1) for improving selectivity on various antennas, (5) Haynes

DX Tuner. (6) Extra grid tap circuit "X" used in Grimes circuit and some Neutrodyne. (7) Reinartz all wave tuner. (8) Alternative short antenna connections

for short waves when using 10 to 20 turns of coil across condenser. (9) Addition of audio transformer for reflex circuit. (10) Arrangement for loop reception with Pressley Super

# Charge It!

## Complete Directions for the Construction of a Vibrating Rectifier for Charging a Storage Battery

By Keith LaBar

EVERY once in a while someone gets ambitious and writes an article on how to make a homemade battery charger. But usually we are prevented from making a charger because we do not know how to substitute things we have for the parts called for in the article. Materials for a charger cannot be bought at the corner radio store. They must be dug up out of nothing. We will tell of the places pay dirt is most likely to be struck.

The chief, and most important ingredient of a charger is the transformer, and the character of any transformer rests upon the quality of iron used. We are usually told by writers that if silicon steel (really very soft iron of the best quality) necessary to the happiness of the transformer is not to be obtained we may substitute with stove pipe iron. This means we must cut about a hundred or more pieces by hand to make a success of the thing. Now the stove pipe iron of fiction is not what it is cracked up to be. The iron that has been sold to us as stove pipe iron was most treacherous stuff. Using the family snips on this iron will temporarily ruin the strongest hand. If it will cut, it twists up into most unfriendly shapes where it defies the most coaxing efforts of the hammer to flatten it. In addition the feather edge produced has to be ground off or it will provide a path for eddy currents to run the light bill a little higher.

So you see why some of us go to great lengths to get good iron. Well, one man's junk is another man's riches. The light and power company of your town is troubled now and then with burnt out pole transformers. A few turns short and the whole thing has to be scrapped. They usually burn off the insulation, reclaim the copper, and throw away the core. Four of us peered inquiringly into the murky depths of the Missouri River one lazy Saturday afternoon looking for a barrel of this core that was rumored to have been dumped in a short time before.

The core is thrown away because it does not pay to ship it. So it may be purchased at an exceedingly low rate, and if the man in charge of the department likes your looks he may give it to you. Even if they charge you for it enough to make your transformer ought not cost more than four bits. (Economy note—Doll your sister up in overalls and get her to ask for it).

If a complete transformer may be pur-

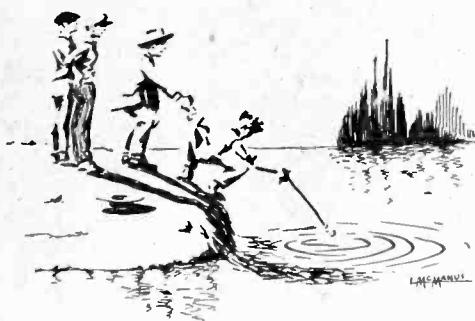

"The Iron Fishers"

chased with windings intact by all means buy it. What is wanted is the smallest of the pole transformers, about the size of a man's head. We have usually paid about \$2.10 or less, mostly less, although friends have reported paying as much as \$3.75. However, these were not burnt out, but merely old style, and were carefully kept intact and used for 1,100 volt plate supply for C. W. transmission. The wire to be obtained from them is very useful, both for the building of our transformer, and just to have around.

The two forms of iron used to the greatest extent in these small transformers is given in the figure. We have

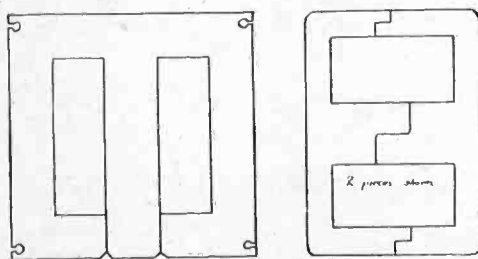

Forms of Iron Used in Core

shown the charger built with the square iron although any other kind may be used by slightly shifting things around. With such iron we build transformers known as the "shell type." Winding the primary over or under the secondary and not on a separate leg of the core gives better voltage regulation. That is, the voltage drop from no load to full load is less.

The number of turns on the transformer is determined by several things, frequency, primary voltage, area of core, and so on. By using a larger core the number of turns is lessened and the thing is easier to make. As core is less expensive than wire, it is better to use a larger core. Bulk is nothing to us. There is a certain theoretical minimum limit of turns for any particular value of these things, and we will show why this is so.

The action of a transformer depends upon two things. Magnetic lines of force are produced in the iron by current flowing in the coils. These lines of force react in turn upon any surrounding turns and produce an electromotive force in the windings. Iron will hold only a certain density of magnetism. The softer the iron the more it will hold. Even the best iron can be magnetized only to a certain point and can go no further. With a certain value of magnetism the voltage produced by a transformer varies as the number of turns. Now this applies to voltage produced in the primary by lines of force cutting the turns as well as the voltage produced in the secondary.

Let us imagine a current flowing through the primary, due to connecting it across 110 volts A. C. There is a high momentary current and the flux rises to the saturation point. This flux produces a voltage across the primary bucking or opposing the line voltage. If there is a sufficient number of turns this back electromotive force is nearly equal to the line voltage and the current then drops to a low value. This lowering of the current reduces the back electromotive force so that the current in the primary does not meet with so much opposition and it increases a little and things come to an equilibrium with this steady current, called the magnetizing current, very small. If there is an insufficient number of turns, the flux goes up to the saturation point, and tends to produce the opposing E. M. F. But this E. M. F. does not approach the line voltage by a great deal, and the power runs away in the form of heat. If the magnetism could go up to a higher value the current would cut itself down, but it can't. So we use enough turns to keep the magnetic flux below the saturation point, where everything is jake.

When power is absorbed from the secondary circuit, the action of the current flowing in this circuit is to decrease the density of magnetism which in turn decreases the back E. M. F. in the primary, which then allows more current to flow, this current being in proportion to the power used. In making some transformers where power is cheap and copper is high, they are made deliberately inefficient with a smaller number of primary turns than they ought to have. Transformers for intermittent work also fall in this class. As it is probably as

easy for us to make an efficient transformer as a poor one, we will be generous with the iron and wire. Here is a table of primary turns to use with a certain area of core of good iron and a frequency of 60 cycles. For 50 cycles use 6/5 these figures. Values as low as 2/3 or less of this can be used with a large drop of efficiency. You pay the light bill, not I.

or 100 watts for half time or an average of 50 watts. This shows we must use wire heavy enough to carry double the current indicated by the ammeter. A wire of 10 amp. carrying capacity is then needed. Still again, if we use too large a wire we can never hope to get it in the space in the iron. It is an eternal compromise between what is theoretically efficient and what is practi-

cally possible. About the lowest limit is No. 14 S. C. C.

Two or three smaller wires may be wound simultaneously and connected in parallel to equal one large wire. In this case one should be careful to wind them side by side and use the same length of wire for each. Two strands of a wire is equal to a wire three sizes larger, as 2 of No. 18 equals 1 of No. 15.

The number of secondary turns is to the number of primary turns as the ratio of the voltages between them. A good value for the secondary is 10 volts with 1/11 of the number of primary turns used. If relatively small wire is used for the secondary a few extra turns may have to be wound on to compensate for voltage drop. A few turns may even be wound on over the whole thing if the charger does not charge fast enough to suit requirements.

Delivering a constant potential, these chargers give a tapering charge. The current is at a high value at first, and, as the battery comes up the current drops off, until as full charge is reached the current may be a fourth of the initial current. Nothing is the matter with the charger if it does this. It is the best way to charge a battery.

The windings are wound by hand on a cardboard spool, the low voltage side being wound first if you are short on heavy wire. A layer of tape or empire cloth goes over this and then the primary winding goes on. Do not use enameled wire for the primary unless it is

(Continued on page 62)

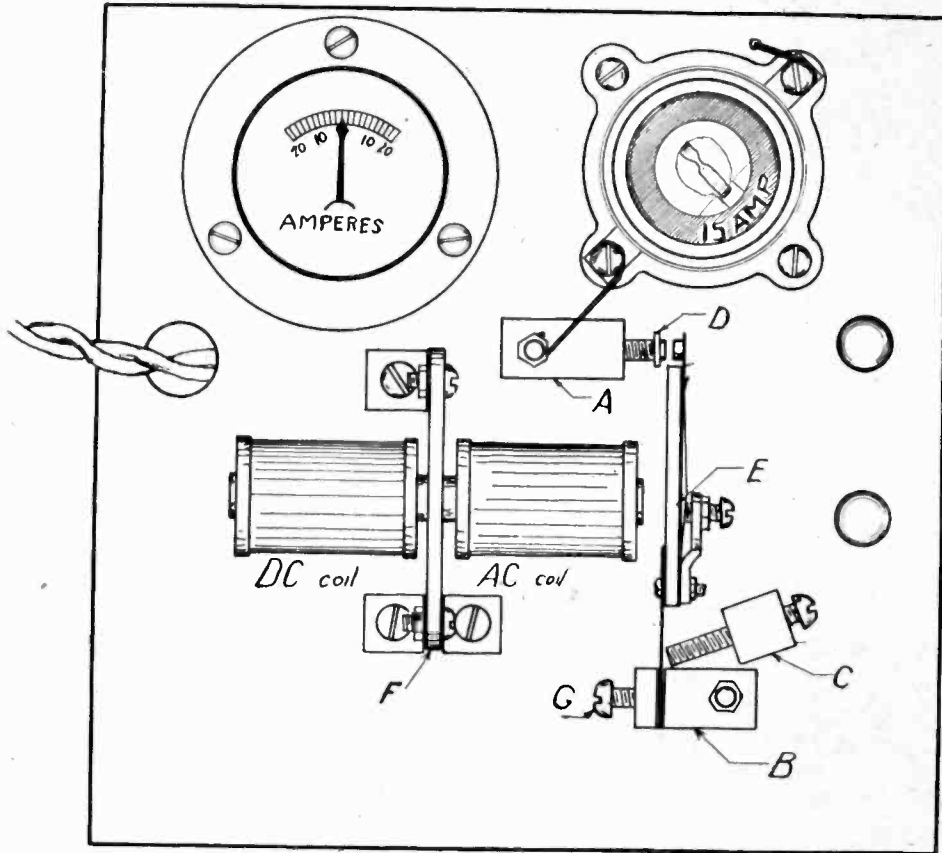

Charger Panel

Section	Area	Pri- mary turns	Prac- tical figure
1 1/2 x 1 1/2	2 1/4 sq. in.	525	525
1 1/2 x 2, etc.	3 sq. in.	392	400
1 1/2 x 2 1/4	3 1/2 sq. in.	348	350
2 x 2, 1 1/2 x 2 5/8	4 sq. in.	296	300

Doubling the core halves the turns.

The larger the wire used, the better the transformer, as there is a smaller heat loss and smaller voltage drop. We wish to limit any probable damage done by this heat rather than save power here. For our primary current of about 1 ampere it is the height of conservativeness to use nothing smaller than No. 20. Personally, we have got by using No. 24.

For the heavy current side we must use heavy enough wire to carry a current of at least 5 ammeter amperes which means in a battery charger a current of double this value for half the time, due to the habit of chargers of using only half the cycle. The heat loss caused by a current of 10 amperes half the time is not that caused by a current of 5 amperes all the time. With a 5 ampere current and a resistance, say to make things easily seen, 1 ohm, the losses would be 5<sup>2</sup>x1 or 25 watts. With a 10 ampere current the losses are 10<sup>2</sup>x1

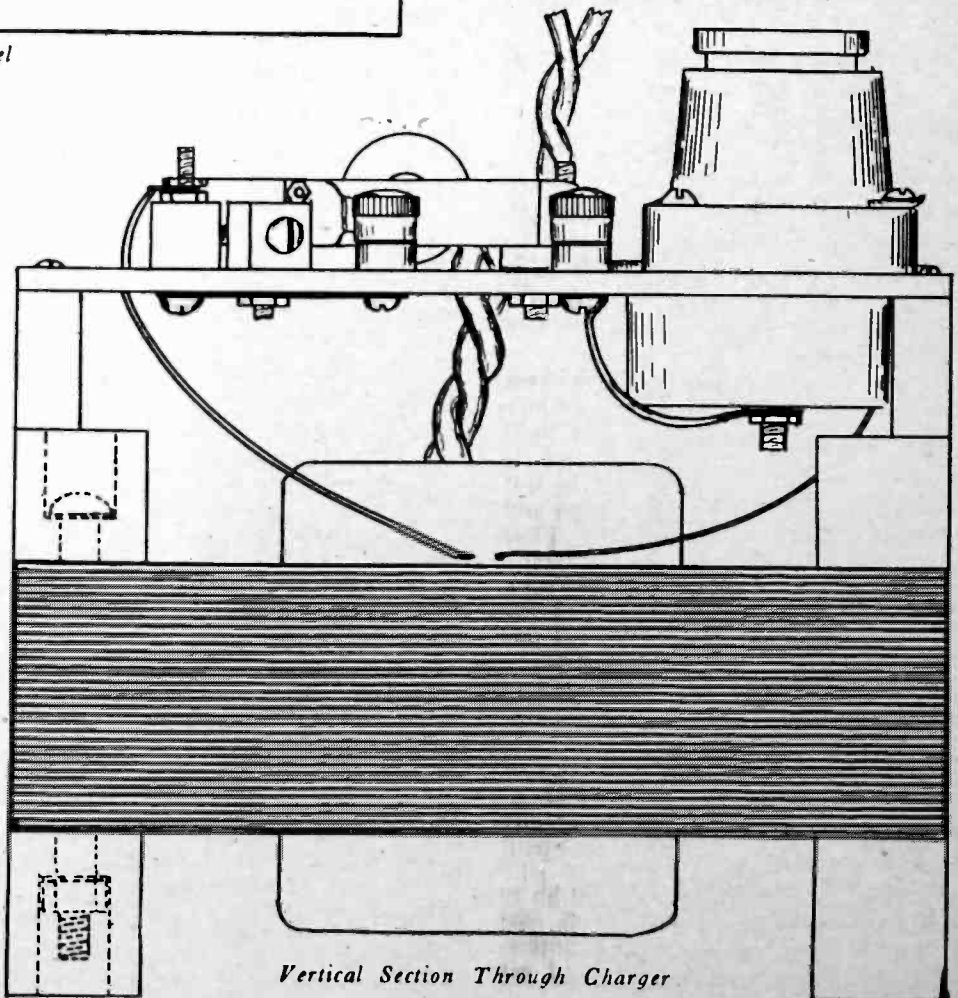

Vertical Section Through Charger

# Effects of Transformer Impedance and Capacity on Audio Frequency Amplification

A Critical Analysis of How Performance is Affected by Low Primary Impedance and by Secondary and Inter-Winding Capacities

By G. M. Best

THE great difference in the characteristic curves of a poor and a good audio frequency transformer is largely due to the fact that the primary impedance of the poor transformer is low as compared to the vacuum tube impedance, especially at low frequencies. On the other hand, the primary impedance of a good transformer is at least as great as the tube impedance for all frequencies.

The effect of low transformer primary impedance may be illustrated by Fig. 1, a circuit which is the equivalent of a vacuum tube circuit for alternating

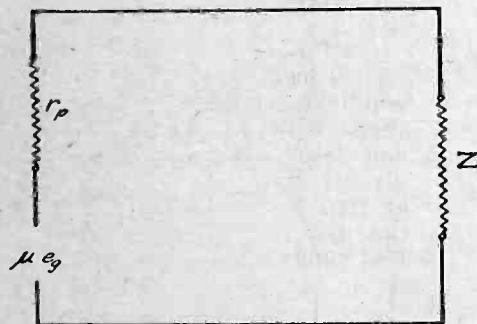

Fig. 1. Equivalent of Vacuum Tube Circuit

current. A voltage  $e_g$  is impressed upon the grid of the vacuum tube. This is increased  $\mu$  times by the amplifying action of the tube ( $\mu$  usually has a value of 6 or 7). Consequently a voltage of  $\mu e_g$  is impressed upon the plate circuit  $r_p$ . The plate impedance  $r_p$  is connected in series with the load impedance  $Z$  of the transformer primary. Obviously, if  $r_p$  is large as compared to  $Z$ , most of the available voltage  $\mu e_g$  will be lost in the resistance  $r_p$ .

If the impedance of the transformer were independent of frequency then the characteristic would be flat over the entire range. But most of the impedance is actually due to the inductance whose inductive component is directly proportional to frequency. Hence at low frequencies the impedance is always small as compared to its value at high frequencies. If, even at these low frequencies, the impedance  $Z$  of the transformer is still large as compared to  $r_p$ , then very little change with frequency will occur in the available voltage at the terminals of  $Z$ . On the other hand if the impedance is small as compared to  $r_p$  at low frequencies, then the increasing impedance with frequency will cause relatively large increases in the terminal voltage on  $Z$ .

To illustrate, suppose  $r_p$  is 10,000 ohms and that  $Z$  varies from 90,000 to 900,000 ohms. The percentages of the voltage  $\mu e_g$  appearing across  $Z$  will then be 90 per cent and 99 per cent respectively, a total change of 9 per cent. If, however,  $Z$  varies in the same ratio (vis. 10 to 1) but has a lower value of 9,000 and an upper value of 90,000 ohms, the corresponding percentages will be 47 per cent and 90 per cent respectively, or a total change of 43 per cent. The second case therefore involves much more distortion than the first.

Most transformers with poor low frequency characteristics have insufficient primary impedance at low frequencies. Greater impedances can be obtained only by winding with more turns of wire (subject to limitations to be mentioned later) or by increasing the magnetic permeability of the iron core, since this quantity is a direct factor of the inductance. Special grades of silicon steel having high permeability are used in the best transformers. It is probable that future development will be in the direction of better core iron for transformers.

If the ratio of transformer primary impedance to the impedance of the tube determines in such large measure the frequency characteristic, then a given transformer should give characteristics of different shapes with tubes having different plate impedances. Actual measurements and plotted curves show that a transformer which is quite satisfactory with one tube may be a very poor match for another.

They also suggest a means of improving the characteristics of a poor transformer by adapting to it the proper tube or voltage. Thus the curve for a poor 12,000 ohm transformer shows a much better characteristic with a 6,000 ohm tube than with a 15,000 ohm tube. The following table shows how changes in plate voltage improved the characteristics of another poor transformer (30,000 ohm primary impedance) used in the plate circuit of a C-301A tube with plate voltages of 45, 90 and 135 respectively:

Voltage	Amplification Voltage Ratios						
	Cycles per second						
45	95	200	500	1000	2000	3400	5000
90	6.	7.7	16.7	25	30.5	23.7	17.7
135	8.	10.4	21.7	28.2	31.	31.	25.
	10.5	14.4	26.7	32.	39.7	37.8	36.2

The  $C$  potentials were 1.5, 4.5 and 9 volts respectively. The results with the highest voltage were clearly the best.

It is largely because of these impedance relations that transformers having turn ratios greater than about 5:1 have such poor frequency characteristics. There is a fairly definite limit to the number of turns of wire which may be wound on the secondary of an amplifying transformer so that most manufacturers have resorted to the practice of using about the same number of secondary turns with fewer primary turns to get a higher ratio. This automatically makes the primary impedance less—seriously so at low frequencies—so that the high ratio transformer may give even less amplification at the low frequencies than that having a low ratio.

For example it was found in tests of certain 3:1 and 6:1 transformers of the same make that the amplification of the 3:1 transformer was more than twice that of the 6:1 at 95 cycles and not until about 400 cycles did they become equal. By the time 2,000 cycles was reached the 6:1 transformer was giving nearly twice the amplification of the 3:1, as might be expected, since its primary impedance is here sufficiently large to obtain nearly the full voltage available. After 2,000 cycles the amplification dropped off again due to the distributed capacity of the secondary winding as will be explained later. Obviously the 6:1 transformer is not very desirable if quality is any consideration.

As a check upon the behaviour of these two transformers a special transformer was wound with two exactly equal primaries and two secondaries. The secondaries were connected in series and the frequency characteristics were measured first with the two primaries in series, and then with only one primary. This gave the condition of doubling the turn ratio by reducing the primary turns to one-half while keeping all other conditions exactly the same. The result was, as expected, that the higher ratio condition had a much worse frequency characteristic than the lower one.

## Effect of Shunted Capacities

IT is important to remember that the impedance relations between tube and transformer which have thus far been set forth are responsible only for the low frequency characteristics of the transformers. If the impedance due to the inductance and resistance of the transformer alone were the only one to be considered all transformers would

have quite flat characteristics beyond the frequency where primary impedance is greater than say ten times the tube impedance. The fact that, on the contrary, many transformers have falling high frequency characteristics while others have rising ones is due primarily to the effect of various capacities between the turns of the windings. Since the secondary winding has from two to ten times as many turns of wire as the primary, its distributed capacity is naturally much larger than that of the primary, and this capacity alone explains practically all of the falling off of amplification at the higher frequencies.

Since the distributed capacity has the effect of a condenser in parallel with the coil it may be represented as in Fig. 2, where  $L_p$  is the primary inductance,

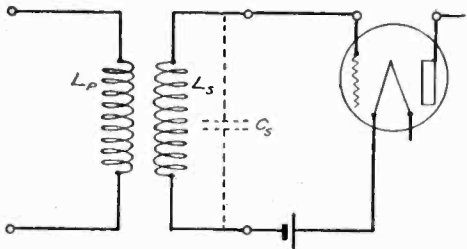

Fig. 2. Equivalent Effect of Distributed Capacity in Transformer Secondary

$L_s$  the secondary inductance, and  $C_s$  the secondary distributed capacity. The primary distributed capacity is not shown since its effect is small compared to that of  $C_s$ .

Now it is obvious from the figure that  $L_s C_s$  forms a tuned secondary circuit which, if resonant at some audio frequency, should result in maximum amplification at this frequency and a falling off of amplification at higher frequencies due to shunting effect of  $C_s$ . This, then, explains the apparent "humps" in the frequency characteristics of many transformers. That the effect is, in fact, a

resonance effect could be proven if by bridging an additional capacity across the secondary terminals the resonance hump were pushed down to a lower frequency and the high frequency amplification still further reduced. Fig. 3 shows just this effect as the result of actual measurement. Curve I is the frequency characteristic of a typical transformer and curve II is the resulting characteristic with .001 microfarads bridged on the secondary of the transformer. The resonant hump has been pushed down from somewhere near 2,500 cycles to about 700 cycles, and the 5,000 cycle amplification has been reduced from 25.7 to 3.8! These curves illustrate the serious effect on quality of bridging condensers across transformers, particularly the secondary windings.

A second and still more convincing proof that the "resonant hump" is really a resonance effect is provided by bridging a non-inductive resistance across either the primary or the secondary winding choosing suitable values in either case. If there is no resonant (oscillatory) current in the transformer windings the loss introduced by this resistance will depend only on the impedances involved, and will continuously increase from a small value at low frequencies to a relatively large value at the higher frequencies. If, however, there has been an actual circulatory or resonant current at the hump frequency this current will be largely damped out by the non-inductive resistance load (on either primary or secondary) and the loss due to this resistance will now be greatest in the region of the hump, diminishing toward the higher frequencies.

Such a shunted resistance is often a good way to improve the characteristic

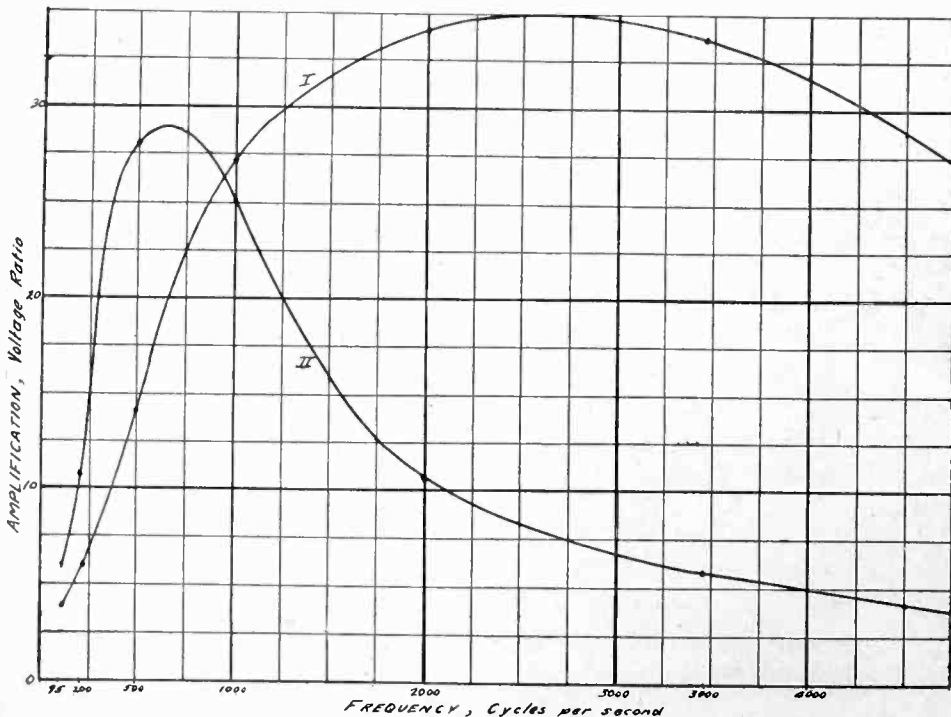

Fig. 3. I.—Frequency Characteristic of Typical Transformer. II.—Same with .001 mfd. Condenser Shunting Secondary

of a transformer. The resistance may either be a low one on the primary side or a high one on the secondary side. The best value will, of course, vary with the tube and transformer used. There is also, obviously, some best compromise between improvement in quality by this method and the unavoidable loss of volume which accompanies it. The correct resistance is therefore best found by trial for any given case. However, before making any tests to determine this shunt resistance be sure your  $B$  and  $C$  battery potentials are right so that there can be no question of poor amplitude characteristics in the amplifier. A good pair of headphones is preferable to a loud speaker for observing the changes in volume and quality obtained.

#### Effect of Inter-winding Capacities

THERE is a second type of capacity in transformers which sometimes produces remarkable effects and which, if the windings are properly proportioned, may result in a transformer whose high frequency characteristic is exceedingly flat. This is the capacity between the two windings of the transformer and may be represented by the small dotted condensers of Fig. 4. The

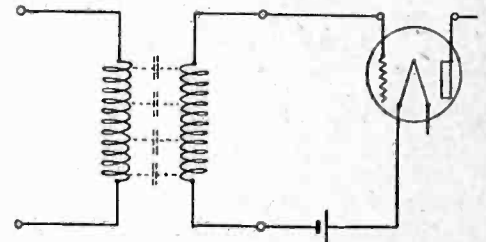

Fig. 4. Equivalent Effect of Inter-Winding Capacity

many small condensers of this figure may be replaced, so far as their effect is concerned, by a single capacity as in Fig. 5 connected to the primary and second-

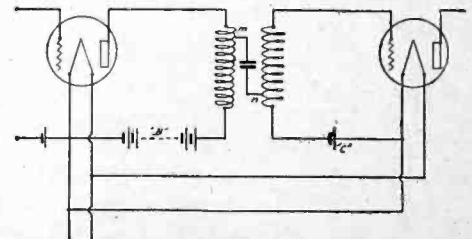

Fig. 5. Circuit Diagram Showing Inter-Winding Capacity

ary windings at points which are determined by the relative positions and proportions of the windings.

Suppose, for example, that this effective capacity acts between a point  $m$  near the plate terminal of the primary winding and a point  $n$  near the  $C$  battery terminal of the secondary winding as shown in Fig. 5. Since this capacity is generally small there will be negligible effect at low frequencies but at high frequencies an appreciable amount of current may flow from the plate of the tube thru this capacity and the small portion of the secondary winding to the filament circuit instead of passing thru

(Continued on page 68)



# The Uni-control Regenerator

Simple Constructional Directions for the Novice  
Desiring to Build a One-Tube Set

By R. J. Robbins

A RECEIVER which costs little to make, delivers surprising results, and may be built and operated by even the most inexperienced tyro can be adapted from the DeForest ultra-audion. The cost for a one-tube set should not exceed \$9.00 exclusive of the tubes, batteries, antenna and phones.

The original DeForest circuit consists of but a single coil which carries both grid and plate currents, while in this one a separate plate coil is employed for loose coupling, and as a tickler. Most of the experimenters who have tried out this set declare that it is singularly free from the radiation which generally characterizes the straight ultra-audion. The entire tuning is accomplished by but one vernier dial operating a .0005 mfd. variable condenser. The regeneration is controlled entirely by the rheostat. Unlike the Armstrong regenerative circuit the DeForest regenerative employs the *plate* coil as the primary pickup agency. In this it partakes somewhat of the nature of an untuned, aperiodic primary and the regulation tickler coil. The control, however, is much more uniform over the whole tuning range and some of the distances covered by local enthusiasts who have built it are almost beyond belief. The best reception thus far reported by reliable parties at Portland, Maine, is Hasting, Neb.

## LIST OF PARTS

- 1 Panel 7x10x3 16 in.
- 1 Baseboard 6x9x5/8 in.
- 1 Variable Condenser .0005 mfd.
- 1 Socket, any good make.
- 2 Spiderweb coil forms 5 in. diameter.
- 1 Grid-leak condenser .00025 mfd.
- 1 Rheostat, resistance to suit tube.
- 1 Vernier dial.
- 1 Open circuit phone jack.
- 6 Binding posts.
- 1 Fixed condenser .001 or .002 mfd.
- 1 2-in. Rheostat dial.
- 1/2 lb. No. 24 D. C. C. magnet wire.

The panel layout will depend upon the parts selected, most of which are accompanied by a template showing location of holes to be drilled. The general arrangement is shown in Fig. 1.

The baseboard layout is shown in Fig. 2. Only one of the spider-web coils is shown. The coils are mounted on a roundhead 8/32 machine screw 1 1/4 in. long which fits into a 3/16 in. hole drilled through the baseboard as shown in the rear panel view of Fig. 3. The socket is mounted with the

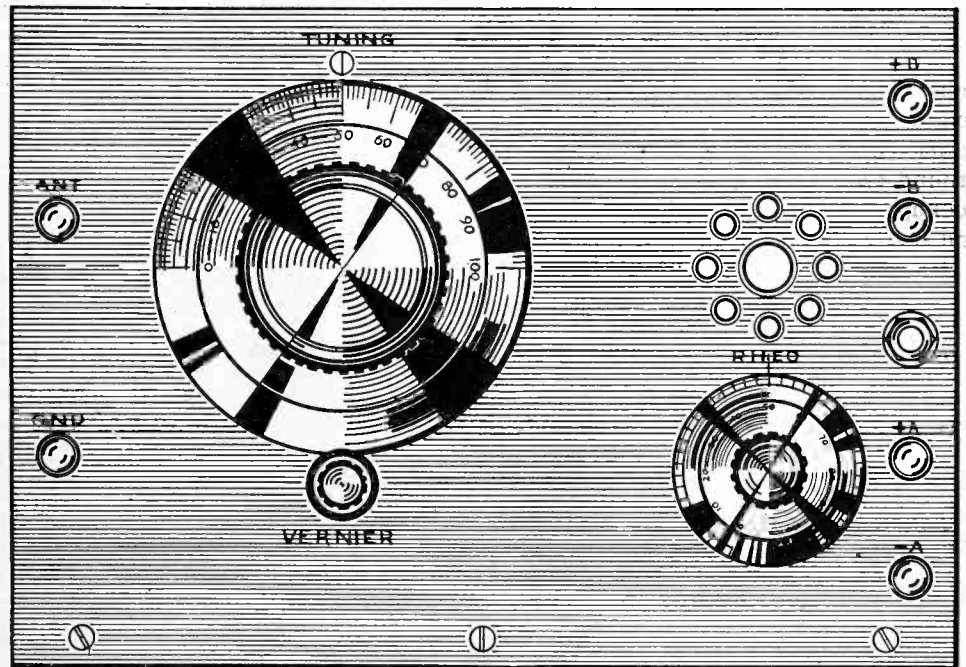

Fig. 1. Front Panel View

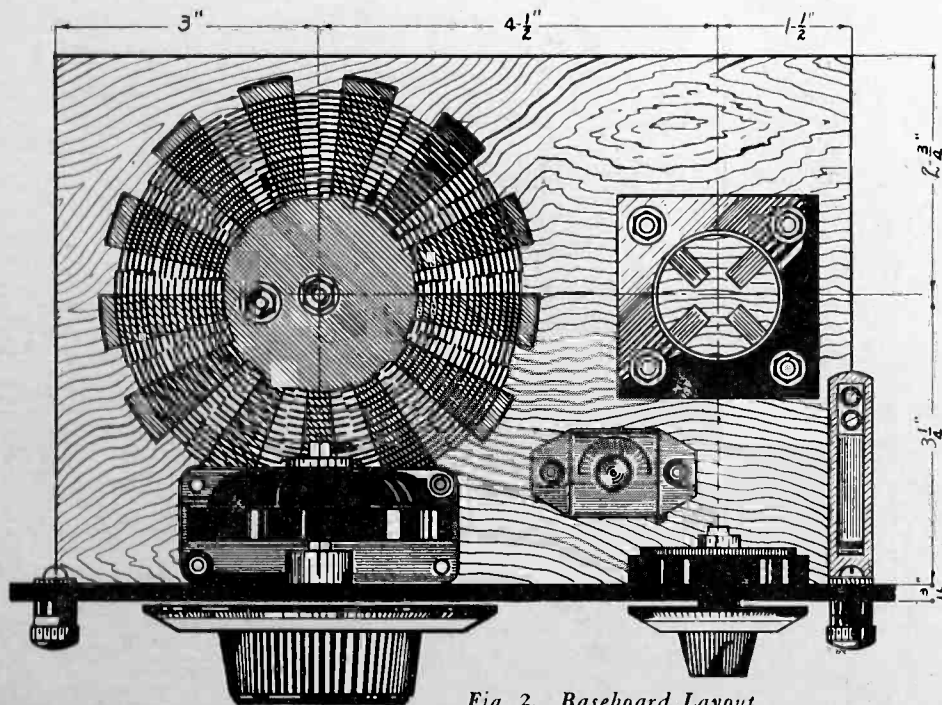

Fig. 2. Baseboard Layout

grid and plate terminals facing the spider-web coils.

The spider-web coils consist respectively of 50 and 20 turns of No. 22 DCC wire and are mounted by means of washers and nuts so as to have 1/2 in. separation. The 20 turn plate coil is the lower and the 50 turn grid the upper. The windings should run in the same direction.

The panel is now screwed in place and the condenser, rheostat, jack and binding posts are mounted in their proper places. This completes the assembly work and we are ready to do the wiring.

The circuit is shown in Fig. 4. Keep all wiring widely spaced and as short and direct as possible. All connections should be carefully soldered.

The two spider-webs are connected as follows: Secondary or grid coil, center

## AN INEXPENSIVE ANTENNA MAST

By E. C. NICHOLS

A 60 ft. mast is a very deceiving thing and is usually considered as a secondary matter in connection with the installation of a receiving set, but when the erectors have one suspended in mid-air their respect for it increases as it ascends to a perpendicular position.

If the mast is made up in three sections with three systems of guy wires, each section may be considered as a simple strut and will permit the use of a small cross section which has the advantage of light weight and presents a small surface to wind pressure. For a section or strut 20 ft. long a cross section 2 in. square will be ample. These

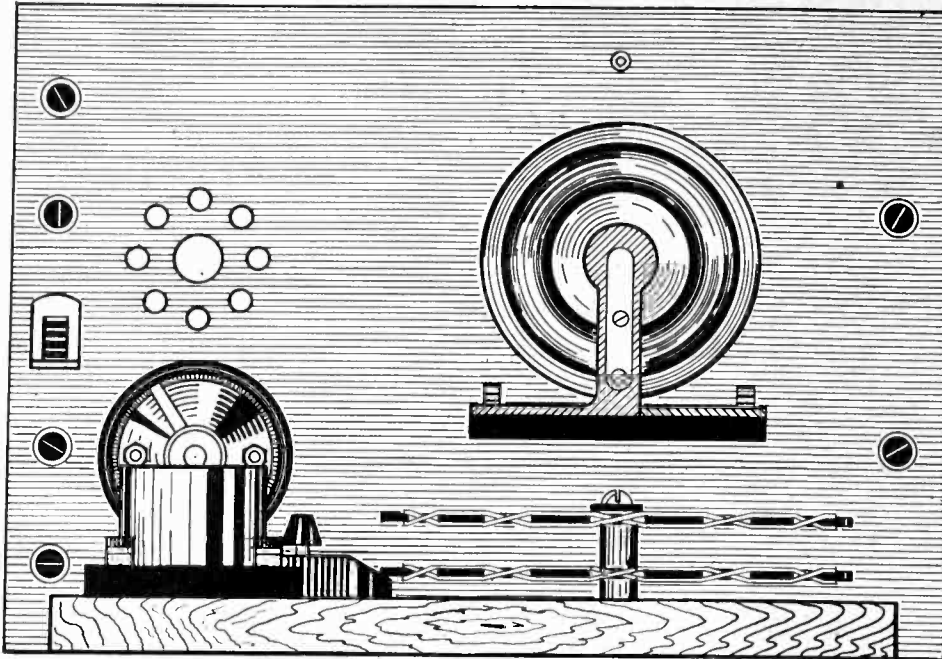

Fig. 3. Rear Panel View

terminal to filament and condenser rotor, outer turn to fixed plates of condenser and to grid condenser. Plate coil or primary, outer terminal to antenna and plate, inner terminal to ground and r.f. bypass condenser. The hookup is not in the least complicated and no great difficulty should be experienced in getting the job done. Spaghetti covering for all the bus wire is advised for the sake of tube life-insurance. The matter of getting the right value for the r.f. condenser will be more or less a matter for experimentation. Some get good results with a .001 while

others prefer a larger value. Much depends upon the tube used.

In action this set is very positive and will operate with fair uniformity over practically all of the effective tuning range of the condenser. A rheostat with means for extremely fine adjustment like the Bradleystat or Fil-ko-stat will find an appropriate application here, especially as so much of the success of the set hinges upon this feature. The tuning procedure is simple. Turn the condenser dial slowly until the signal becomes audible. If the tone is not clear reduce the rheostat until volume reaches the right value commensurate with clarity. Further improvement in quality will be obtainable by minute adjustments of the variable grid-leak. If all directions have been followed faithfully you should have a set capable of surprising power and of a very fair degree of selectivity considering the simple means employed for the tuning.

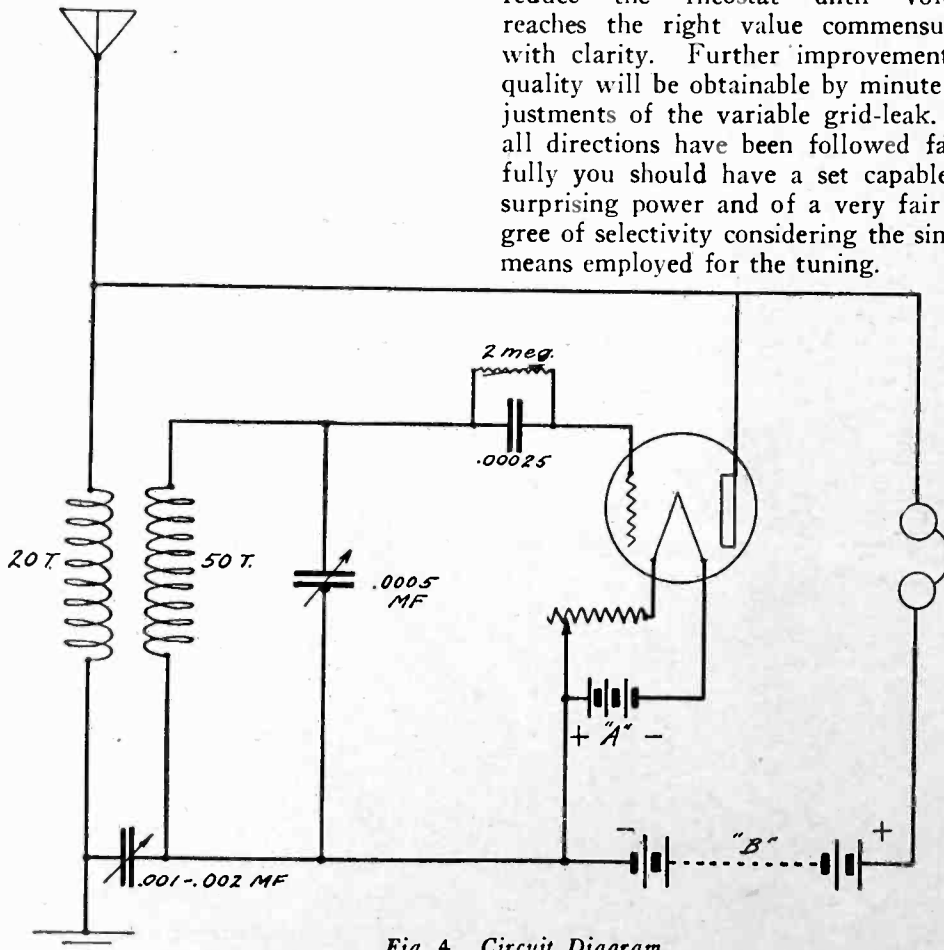
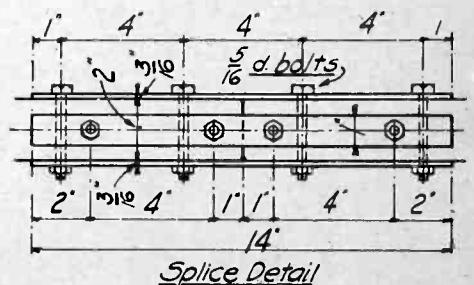
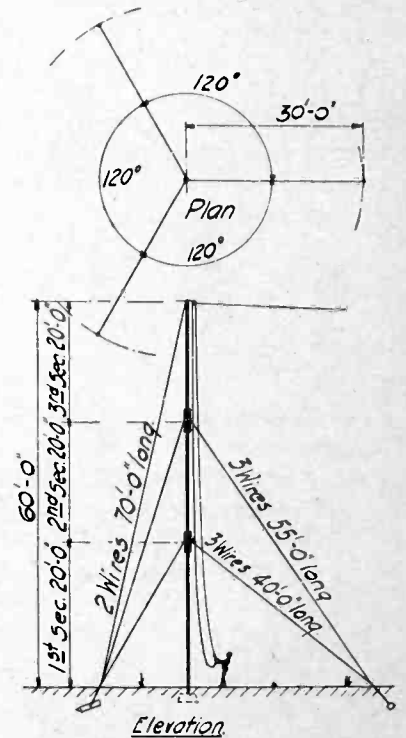

Fig. 4. Circuit Diagram



struts should be selected from clear straight stock of Oregon pine, yellow pine or spruce, free from twist or warp and well seasoned. Whether surfaced or rough is immaterial but it should have at least two coats of good paint.

The splices at the joints are made of 1x3/16x14 in. iron and are drilled for 5/16 in. bolts as shown in detail. The guy wires are No. 14 galvanized iron wire. A smaller wire should be avoided as kinks are sure to result and a broken mast with the first heavy wind. Three wires support each section except the top

(Continued on page 67)

# Increasing the Pickup of the Loop Receiver

Various Simple Methods of Improving Distant Reception for the Owner of the Tailor-Made Set

By E. E. Griffin

**I**N THE competitive race for hanging up distance records, the owner of a loop receiver, after assuring himself that he is master of tuning intricacies, comes to the realization that in all probability his receiver has definite limits, even if pushed. The sport of outdoing your neighbor's super with your less expensive set is still under the skin, however, and various means must be resorted to in accomplishing the desired result.

The possessor of the factory built or kit assembled receiver wisely assumes that all possible is being delivered from his set, as is; and therefore is quite reluctant in making extensive alterations. In only one of the following methods are any changes in wiring necessary, and the outlay in expense for material is negligible.

In the instructions accompanying many manufactured sets is the suggestion of grounding one side of the loop to slightly improve reception, and some sets are provided with a bindingpost for this purpose. If no post is provided, this connection to ground can be made from either side of the *A* battery, but preferably from the loop terminal where it connects to the set. The ground wire should be run to the nearest water or gas pipe or radiator, and should be secured so that clean bare wire is in contact with bright scraped metal of the pipe or radiator. Also the side of the loop grounded is important, and should be, on the average receiver, the terminal that connects to the rotary plates of the first tuning condenser, marked *R* in Fig. 1. If it is not possible to trace this con-

nection, it may be determined by connecting to each loop terminal in turn, and noting the position of tuning of a known station on the first condenser dial. When connected to one post the tuning will be more affected than when on the other. The proper post is the one where tuning will be found nearest normal settings. The pickup will be slightly greater owing to the increased antenna effect.

The pickup can be still greater increased by the addition of a small antenna in the form of a single wire from 10 to 30 ft. long, run down a hallway, or placed on the picture moulding around a room, one end being left free and the other connected to the opposite post of the loop from the ground connection, Fig. 1, *A*. This gives the circuit as diagrammatically illustrated in Fig. 1, *B*. Single conductor lamp cord is excellent for this indoor antenna. It should not be over 30 ft. long. Any greater length will so add to the capacity of the circuit as to make it impossible to tune to the shorter wavelength stations. The settings of the loop tuning condenser for any given station will be shortened in proportion to the length of added lead.

When searching for distant stations with this method, it is well to resolve the loop a complete half turn or 180 degrees on each station picked up to find the point of maximum reception. Although the loop is pointing toward the direction of the station, one side will give much greater response than the other. The reason for this is that with such a short antenna, the energy picked up on the loop alone will practically equal the energy

picked up by the antenna, and with the loop turned in one direction the energy of one will be in opposition to the energy of the other, resulting in only slight response in the receiver, even though the circuits are in tune. When the loop is turned in the opposite direction or one-half turn, the energy of the loop is assisted by the antenna energy, resulting in maximum response of the receiver, wherein we have the fundamentals of unilateral reception.

Much greater pickup is possible with a longer antenna, but it is necessary to insert a small fixed condenser of the order of .0001 to .00025 mfd. capacity in series with the lead in order to keep the tuning of the loop condenser within the band of radiocast waves. The capacity of this condenser is not critical and in general the ordinary .00025 grid condenser will suffice except for the extremely short waves, where a smaller capacity will be required. The condenser is connected in the circuit at the point marked *x* Fig. 1.

In using the longer lengths of indoor antenna, and for use of the conventional sized outdoor antenna a special tapped loop is preferable. A connection is taken from the wiring of the loop at a point so as to include from one-fourth to one-fifth of the total number of loop turns, in the antenna circuit. This gives in effect the circuit as in Fig. 2 *B*, a popular form of connection employed in many factory built sets. The loop in this case acts only as an inductance, as its directional effects are completely overcome by the larger antenna. As an experiment and to obtain this result without injury to the loop insulation, the tap can be temporarily made by pushing a steel sewing needle through the insulation of the loop wire at the desired point so that the needle makes connection to the wire. The circuit formed by antenna loop and ground should not contain more than one-fourth of the total number of turns of the loop, or otherwise the tuning of the set will be greatly affected as in the first method given. Also, if the loop is wound with Litz wire, tapping in any manner or piercing with a needle is not advisable, as damage to the enameled insulation of the fine wires composing Litz is detrimental to reception under any conditions.

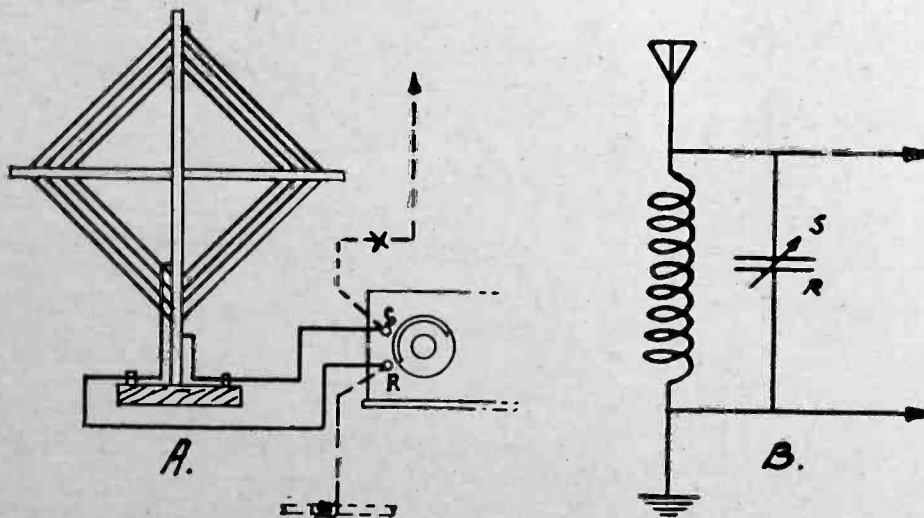

Fig. 1. Auxiliary Ground and Antenna Connections for Loop Aerial

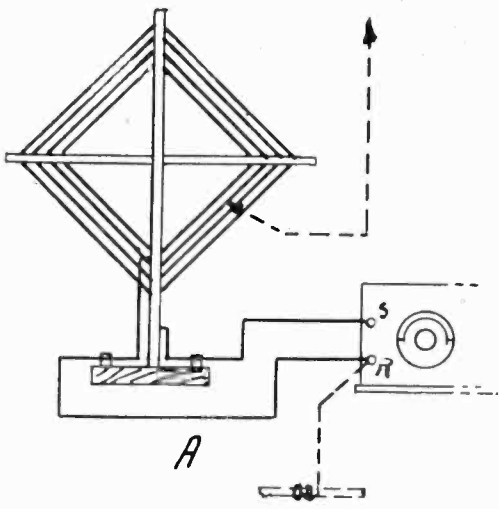

Fig. 2. Tapped Loop and Antenna

The alternative in the case of Litz, and giving practically the same results is illustrated in Fig. 3. Four or five turns of wire are closely wound near the turns of the loop and connected in circuit with the antenna and ground, the ground connection being removed from set entirely. This gives in effect the form of coupled circuit used in many neodynes, and possesses the advantage of not affecting the tuning settings of the receiver. These added turns may be wound on the framework of the loop or supported in circular form by short lengths of twine from the loop stays. The pickup is slightly less than with the preceding method, but is offset by the advantage in not being as susceptible to strays and man-made static, as in the direct coupled method. This last coupled method is recommended for sets having three connections between loop and set instead of the usual two.

The well known form of light-socket antenna may be used if an outdoor antenna is not available in all methods where a large antenna is specified. If not available one can be quickly made up using an ordinary adapter, a .001 mfd. fixed condenser and a few feet of single conductor lamp cord. Connection is made from one terminal only of the adapter to one side of the mica conden-

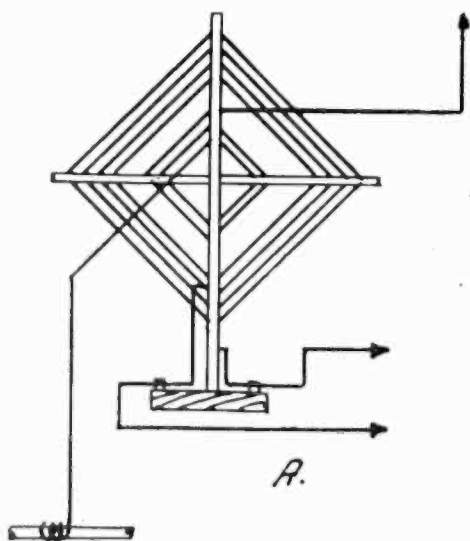

Fig. 3. Coupled Loop and Antenna

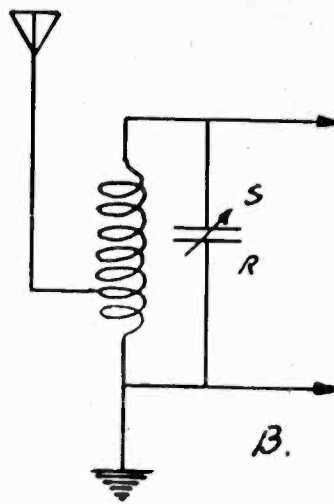
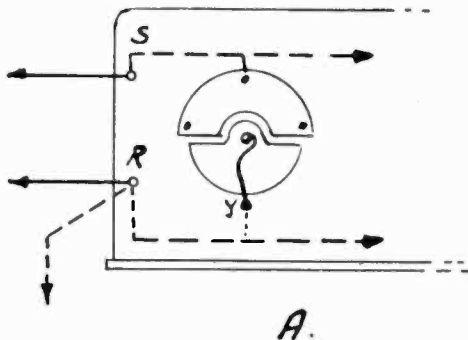

Fig. 4. Changeover from Loop to Antenna Connection

ser, and a sufficient length of wire connected to the opposite side of the condenser to run to the loop. This small condenser should be securely wrapped with tape so as to prevent any possibility of shock should the upper side be touched. In use the presence of this small condenser is disregarded, as its pur-



pose is to insulate the lighting current from the set, while at the same time passing the radio frequency currents. The connection from it is regarded in all respects as a large antenna, but its effectiveness in reception is largely governed by local conditions, house wiring, etc., and its greatest disadvantage lies in the fact that it picks up all local electrical disturbances. Its usefulness in any locality or room of a house can be determined only by trial.

In localities where interference and static are not objectionable the method shown in Fig. 4 can be used with great success. The greatest pickup possible is obtained, and with a large antenna and the average loop receiver everything above the noise level and above static and stray audibility can be put on the loudspeaker. The connection to the rotary plates of the loop tuning condenser, in Fig. 4, is broken at *y*, and the antenna connected to them. The ground wire may be fastened to the lead disconnected from the plates, or may be connected to post *R*. Some loop receivers have provision made for this connection, a link between two posts being in the circuit antenna and ground giving the circuit

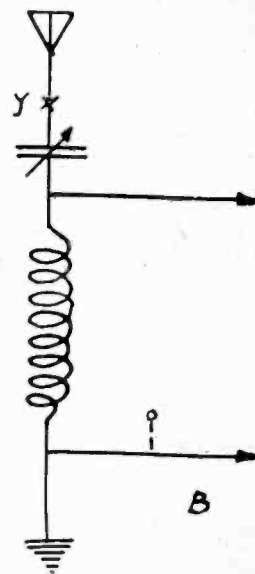

at *y*. Removing the link and connecting antenna and ground giving the circuit as in Fig. 6 B, the loop, as before, acting as an inductance only. In a set not already provided with this connection, it may be impossible to tune to the longer waves when using this method. This being the case, a small condenser of the order of .0001 or .00025 mfd. connected directly across the loop will remedy.

If it is not desired to get into the set to make connections, the same results may be obtained by the addition of a 23-plate (.0005 mfd.) variable condenser, used with a long antenna and connected in circuit at *x*, Fig 1. In this case, the loop tuning dial of the set may be placed at zero and all tuning done with the added condenser. Greater selectivity, however, will be obtained by using small values of the added condenser, and bringing the set into tune by use of the regular tuning dial.

For those who have no access to an outdoor antenna, and for reason of local interference cannot successfully use the light socket antenna, the following two methods are recommended.

The first is the use of a larger loop directly connected to the set in place of the loop supplied. The current pickup

(Continued on page 66)

# The Why and How of Low Loss Apparatus

A Simple Theoretical Discussion of How Volume and Selectivity are Thereby Increased

By M. Buchbinder

THE preponderance of low loss apparatus being placed upon the market, including coils, condensers, vacuum tube sockets and so on, is possibly due to the fact that the radio public is beginning to require greater selectivity and better and more economical distance results than heretofore. The most important pieces of low loss apparatus are doubtless the low loss coil and the low loss condenser. These act in the same way towards improving radio reception—namely by reducing the resistance of the tuning circuit. No matter whether your receiving set comprises a single circuit or a series of tuned radio frequency combinations, the principles which underlie its operation are quite uniform.

The elements of any tuned circuit are inductance, capacity and resistance. One of these alone introduces energy losses—namely, the resistance. In building up a low loss receiving set one has to concentrate upon the reduction of this item to as low a value as is practically possible. We shall first describe the effect upon reception of a decrease in resistance and then show how in practice the receiving set may be made low resistance or "low loss."

Very minute indeed is the power of a radio signal as picked up by the antenna. If it is speech or music and not merely an unmodulated continuous wave, the signal causes a definite electromotive force to be impressed upon the tuned receiving circuit, of very complex character or wave form. In practice such a complex wave may be considered to be a series or the sum of several pure continuous waves differing slightly in frequency from one another, the average frequency being that to which the receiver is adjusted. Possibly this can best be visualized by a citation of figures. Thus a program at 300 meters or 1,000,000 cycles is entirely equivalent to a pure continuous wave of 1,000,000 cycles, another at 1,001,000 cycles plus another at 1,002,000 cycles and so on until all the musical notes present are accounted for. It is not our contention that these are the *exact* frequencies present but the point is that always *some* series will truly represent the complex modulated radio wave. The advantage of such a conception is that we can avoid the theoretical

difficulties in considering a complicated modulated wave and assume that the signal is a pure, continuous, harmonic function.

Our problem is to find the effect upon the simple receiving circuit containing inductance  $L$ , capacity  $C$  and resistance  $R$  of a pure harmonic electromotive force  $e=E \sin \omega t$  which is the mathematical expression for the induced electromotive force as the radio wave strikes the antenna or loop.

Here  $E$  is the maximum electromotive force,  $\omega$  is the angular velocity or 6.28 times the frequency of the wave.

We wish of course to find the current created by this electromotive force since the current is what determines our volume of sound. Fortunately the answer to the problem is given directly by a formula application of Ohm's law as applied to alternating current circuits. The current is always the electromotive force divided by the impedance—

$$I = \frac{E}{\sqrt{R^2 + \left(\omega L - \frac{1}{\omega C}\right)^2}} \quad (1)$$

Where  $I$  is the maximum current.  
 $R$  is the resistance

$\omega L - \frac{1}{\omega C}$  is a quantity called reactance and symbolized by  $X$ . The whole denominator is termed the impedance.

$$\text{Then } I = \frac{E}{\sqrt{R^2 + X^2}} \quad (2)$$

Now when the circuit is *tuned exactly* the reactance is made equal to zero or

$$\omega L - \frac{1}{\omega C} = X = 0 \quad (3)$$

Hence  $I = \frac{E}{R}$  in this special case.

We wish to know two separate things: first, how will a reduction in resistance affect the current; second, how will a reduction in resistance affect the character of tuning or the selectivity. The answer to the first question comes directly by a glance at (3). Manifestly if  $R$  is reduced  $I$  is increased in proportion. If it were theoretically or practically possible to reduce our resistance to absolute zero we should get an infinitely loud signal. This reduction is not possible since we can never eliminate the radiation resistance of the antenna or loop. Nevertheless we come to the conclusion that the direct result of the use of low

loss apparatus will be an increase in received current, therefore in both volume and distance results.

How will "low loss" affect the character of tuning? To gauge this we must assume that the receiver is *not* exactly in tune with the radio signal. If the receiver is not in tune with any signal we should like it to be inaudible—that is, we want a very loud signal when tuning is exact but none at all when tuning is slightly off. As before stated, when the circuit is in tune with the electromotive force the reactance is zero. When it is not, the reactance has some value which we shall call  $X_0$ . Now in order to see whether a large  $R$  or a small  $R$  is conducive to sharp tuning let us assume the two extremes—a very large resistance and a very small resistance. If  $R$  is very large we have the condition

$$I = \frac{E}{\sqrt{R^2 + X_0^2}}$$

in which  $R$  is much greater than  $X_0$ . In that case the denominator  $\sqrt{R^2 + X_0^2}$  is not very much different from the denominator  $R$  when the circuit was exactly in tune. Hence the current does not greatly change as we change the tuning by rotating our variable condenser. In other words tuning is broad and the circuit is not selective.

Consider for a moment the case when  $R$  is very low. Then as before when the circuit is exactly tuned to the electromotive force  $X=0$  and  $I = \frac{E}{R}$

When the condenser is slightly rotated the reactance is no longer zero but equals some definite value which we shall call  $X_1$ . The impedance of  $Z_1$  becomes  $\sqrt{R^2 + X_1^2}$ . The addition of  $X_1^2$  to the very small  $R^2$  causes a radical change in the quantity  $R^2 + X_1^2$  and therefore in  $Z_1$ . The current therefore suffers a marked reduction. If  $R$  be made extremely small then we need change the condenser setting (namely  $X_1$ ) only the slightest amount in order to cause a material drop in  $Z_1$ , and in received current.

These considerations can best be emphasized by a suitable use of figures. Let us assume an electromotive force of 1 volt ( $E=1$ .) Let us start with a high resistance circuit  $R=100$ . Then when

we rotate the condenser a definite amount from the position of exact resonance with the incoming wave, let us assume the reactance  $X_1$  becomes equal to 1 ohm.

Then at resonance—

$$I = \frac{E}{R} = \frac{1}{100} = .001 \text{ amps.}$$

When *detuned* slightly—

$$I_1 = \frac{E}{\sqrt{R^2 + X_1^2}} = \frac{1}{\sqrt{100^2 + 1^2}} = .001 \text{ (very nearly)}$$

Thus there is *little change* in current under these conditions.

Now consider the action of a low loss circuit under the same circumstances. Here  $R$  is low, equal to 1 ohm for example—

Then at resonance—

$$I = \frac{E}{R} = \frac{1}{1} = 1 \text{ amp.}$$

When *detuned* slightly—

$$I_1 = \frac{E}{\sqrt{R^2 + X_1^2}} = \frac{1}{\sqrt{1 + 1}} = \frac{1}{1.4} = .71$$

Thus the current has been changed from 1 to 0.71 amps, a reduction of 30 per cent.

These figures show that the use of low loss apparatus has greatly increased volume, namely as 1 is to 0.001. They also show that the use of low loss apparatus has greatly increased selectivity, namely as no noticeable reduction compares with a 30 per cent reduction in received current.

It must be emphasized that the figures taken are not necessarily typical but merely indicate the *effect* of a reduction in resistance upon volume and selectivity.

We now pass on to a consideration of the *how* of low loss apparatus. In the case of condensers the chief loss is not ohmic resistance but rather dielectric loss-dissipation of energy in the non-metallic insulating supports of the rotor and stator of the device. To minimize this factor different manufacturers have hit upon different methods. All agree upon the minimizing of the *amount* of insulating material and upon its location at points in the field where the electric intensity is lowest. Whereas old style condensers had large end plates of bakelite, rubber or fiber, the newer low loss condensers have metallic end plates and the insulation is usually on the sides of the condenser running in the direction of the axis. Other makers have evolved insulating materials which are claimed to be of lower intrinsic loss than bakelite or rubber—yet all agree on using as little as possible.

Losses in coils again are chiefly present in the dielectric rather than the copper. The dielectric here is the frame upon which the coil is wound as well as the wire insulating material. Low loss coils are as nearly self supporting as mechanically possible—that is they are wound upon skeleton frames rather than tubing. Also the individual turns are slightly

*Continued on page 65*

## LOWLOSSING EVERYWHERE

By CARLOS S. MUNDT

Are you a lowlosser? Have you joined the growing ranks of the latest radio organization? This article sets forth how you may qualify whether you be an amateur, an old time "op," or just a B. C. L.

The low loss idea has come to stay. Anyone can see that a scheme which minimizes the useless energy and therefore gives a bigger return of useful energy is worth while. In the old days we threw a set together and were satisfied to have it work. Now, we seek to build a set *intelligently* and with special regard for the *materials of construction*, for attention is now being directed to the worth and efficiency (both electrical and mechanical) of the things which enter into a radio set.

Let us start by considering the antenna. Most folks are content to put up some kind of an antenna, just so long as it contains wires and is on top of the house. Well, if you are a low-losser you will take care in selecting the site for the antenna. Put it on the house if you will, but take care that it reasonably clears nearby objects. Sheet metal chimneys will not improve your antenna efficiency. Neither will metal gutters, nor a slate roof. If you can, put the whole affair out in the "great open spaces."

Use *few insulators*, and have these few *good ones*. "The best is the cheapest" in the long run. Use a non-corrosive wire, such as enameled or tinned. Use a large enough size (No. 14 at least). Do not have the antenna overly long, nor need it contain many wires. For ordinary reception or even amateur transmission a single wire will suffice.

Next, we have the question of the antenna lead-in. This may take one of several forms: (a) is the ordinary "window strip" form, which may be made or purchased; (b) is the regular lead-in bushing. Care should be taken that a good electric connection is made; (c) shows a fairly good home-made lead-in, consisting of a long porcelain tube through which the wire is run and fixed into place by pouring in melted sulphur, wax or paraffin. It is wise to bring in the lead-in through glass if possible; otherwise a fairly wide strip

*Continued on page 77*

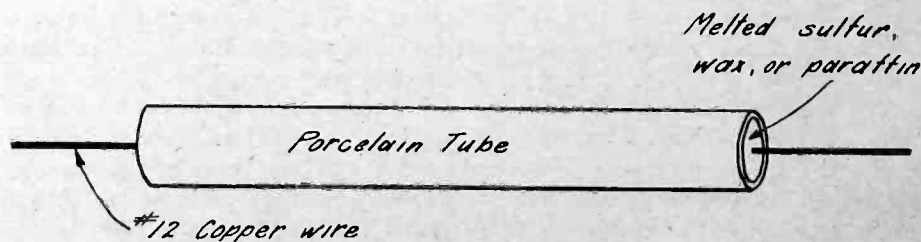
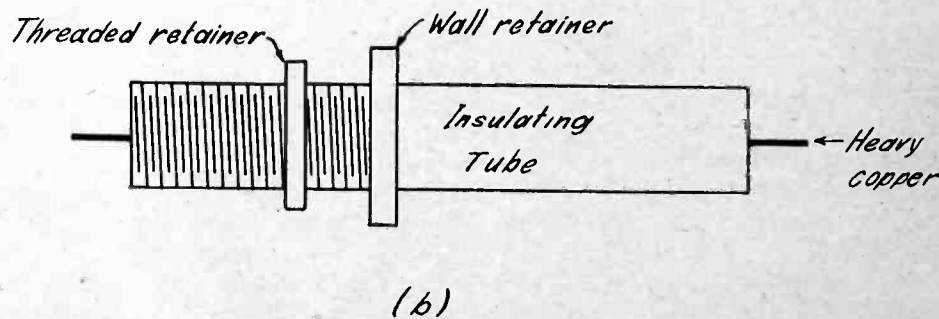
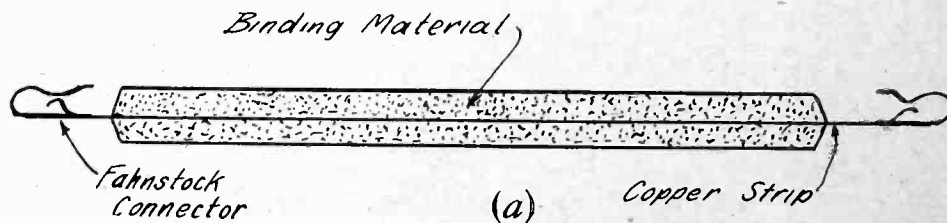
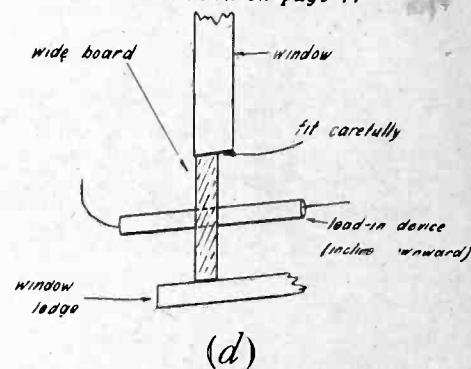

(C)  
Various Lead-In Devices

Tell them that you saw it in RADIO

# Dodging Absorption

## Suggestions for Eliminating Absorption of Radiations from a Capacity Coupled Circuit Having Energy Coupling

By Alexander Maxwell 9BRE-6CKG

**U**NDoubtedly the most annoying factor in short wave work is the disagreeable habit of all nearby metal in soaking up the juice radiated, instead of letting it get out into the air. On 200 meters this is not so pronounced, for the natural period of the nearby furnishings, unless of large size, is below the wave transmitted. On the 80 meter band it becomes apparent, on the 40 meter band it is quite evident, and on those waves lower it is so pronounced as to cause a serious handicap to all those who are not fortunate enough to reside in an ideal location, and very, very few of us are. It seems that every rain pipe, fire escape, light and telephone line, tin roof and kindred object has its finger in the argument. The best way to avoid this evil is to move away or else tear out all the metal work in the community, but as often this is rather impractical the next best thing is to strike a point of compromise.

The only solution seems to be in building a transmitter that will put all the energy on a narrow, sharp wave, with no side bands or harmonics. And when this is done, take a wavemeter and determine the wave of all offending hardware and then tune the set to a wave that does not conflict. This sounds impractical and difficult, but for the "ham" who has average patience and ability to tune it will be easy, and most likely a pleasure.

The transmitter in question is the lately released, though quite old, capacity coupled set. This one has many advantages, but it also has several drawbacks, but none bad enough to cause discouragement. It tunes sharp, so sharp in fact that difficulty will be experienced in raising stations unless they are listening exactly on the wave. There is no mush or thump that will cause the nearby radiocast listeners to mutter words of bile, and there are no harmonics to stray loose through the neighborhood and get mixed up in all sorts of places.

The difficulty comes in getting the set to work for the first time. There seems to be no fixed rules of procedure as yet, and it is a case of cut and try. Also the tubes run hot. There is no danger of surges or flashovers, but it seems that a high plate current is needed to make the set function. The plate current for a 50-watt tube ran 150 mils in the capacity coupled circuit in comparison with 85 mils in

the coupled Hartley, with the same antenna current. This seems to be a great drawback, but it is not so, for all the energy that goes into the aerial does so on a single wave, and repeated tests show that the signal at the receiving end is much stronger and steadier than with the coupled Hartley.

An improvement in results, though a complication in operation, will be obtained by using an energy coupling circuit. This simple device will choke out all side bands which will otherwise slip through to the antenna due to overloading the tube. The plate will be cooler and the ammeter will read only slightly less. To obtain best results the coupling coil should fit inside the inductance and

Do not ground the center tap of the filament transformer, and if AC or brute force RAC is used there is no need for bypass condensers across the transformer windings.

Use plenty of turns in the plate circuit and as few as possible in the grid. Figure on having a turn in the plate circuit for every ten mils to be passed and you will have about the right size. This means that for a large tube, more coil will be needed. If the same rule is applied to the grid coil it will work out, only in this case it is three mils per turn. About three turns for a fifty-watt tube is correct, and will insure the most stable operation. Try juggling the grid leak and condenser.

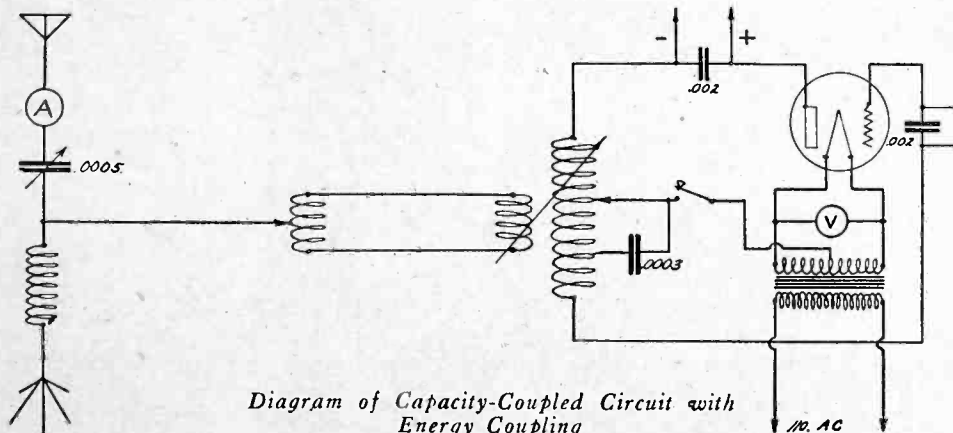

Diagram of Capacity-Coupled Circuit with Energy Coupling

be variable so that the correct position and number of turns will be easily obtained.

In building the set the regular oscillator may be used without modifications. However it is best to have a fixed condenser to tune the primary, for the tuning is so sharp on the lower waves that moving it a degree will often change the wave several meters. In locations where there is excessive vibration this is objectionable. The solution seems to be in using a fixed condenser and varying it by sliding a clip around on a turn of the inductance. When the correct position has been found the clip may be removed and the wire soldered in place, insuring freedom from future trouble. A condenser suitable for this use is found in the Radio Corp. fixed series condenser with three taps. For 80 meters, the middle tap of this condenser bridged across four turns of a Radio Corp. inductance is about right. Best results will be obtained by using as large a capacity and as small an inductance in the circuit as is possible with stable oscillation of the tube.

The energy coupling circuit consists of two 6 turn coils exactly alike. Wind these on cardboard or bakelite tubes and have the two coils at least a foot apart. One of them must fit inside of the inductance and be movable. Channels made of strips of cardboard or bakelite will serve the purpose, and will prevent the coil from coming in contact with the inductance.

A variable tap from the free coil goes to the nodal point of the antenna circuit. This tap must go exactly to the nodal point and not a little ways off if best results are to be secured.

A nodal point is not as illusive as might be imagined. The approximate location may be determined by taking a grounded wire and touching it on the aerial inductance in different places. The spot where no decrease in antenna current occurs is the spot wanted. Sometimes it will be found that the nodal point is halfway up the leadin, or else out on the counterpoise. If so, it must be brought in to the inductance, or at least near it by means of loading coils, series condensers, or both. Greatest efficiency

is obtained at a point which is about two-thirds of the natural period, that is, operating below the fundamental.

In tuning the set, decide on the wave you want first. Then tune the antenna to that wave by means of a wavemeter and a buzzer, and be sure that the buzzer is inductively coupled. Next tune the oscillator to the identical wave. Do this carefully, as it is important.

Now connect up the energy coupling circuit. It will be found that there is a certain spot on the inductance from which a maximum transfer of energy is obtained. Place the coil in inductive relation to this point and leave it there.

Take the tap from the other coil of the coupling circuit and place the clip

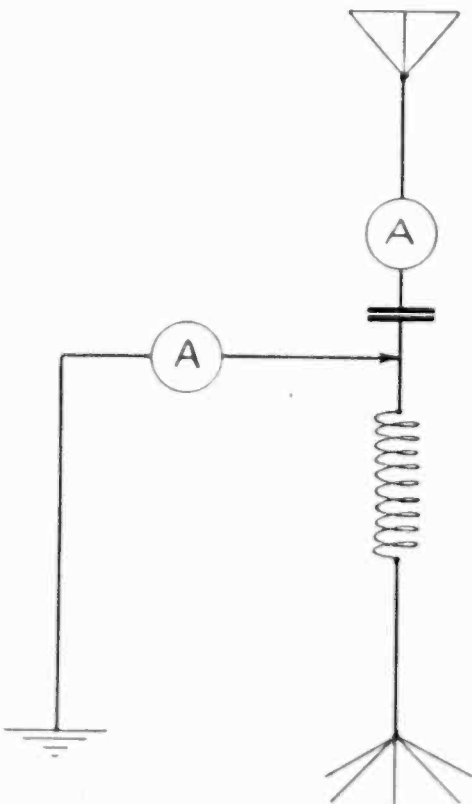

Finding Nodal Point

on the nodal point of the antenna circuit. Now if everything has been done correctly the set will work, but if you have slipped up a meter or so, the ammeter will remain at zero. Don't be discouraged, try again.

The radio frequency transmission line, that is, the wire between the coupling coil and the antenna system may be as long as you wish, taking for granted you intend to use moderation. It will work up to 50 feet, but above that I can't say, for I have not tried greater distances. In case the set refuses to work, then insert a small fixed condenser in this lead, and it will probably remedy the trouble.

Do not have the counterpoise load coil and the coupling coil setting parallel, for then the energy will transfer by induction and the whole purpose will be defeated.

In large sets, the lines of force emitted from the inductance are so great that nearby objects are in the field and get a liberal deluge of juice which belongs in the aerial. Have the set located in the middle of the room, and keep all wires as much out of the field as is possible. A station in West Virginia solved this problem by having the inductances of his reversed feedback transmitter suspended from the roof of the shack, and the rest of the set on the floor, 10 ft. below, with three leads running up to the inductance. He figured that he might as well get his capacity between wires as with a condenser, and besides then he could use a smaller inductance. By the cards he has and the ease with which he gets out it looks as if the system was a success.

With the transmitter working the next task is to get at the absorption of the neighborhood tinware. A portable receiving set will have to be made for this test. Strictly speaking it is not a true receiving set, for it is not all present. It is more of a wavemeter, but as it is not intended to be calibrated, and would not be accurate if it was it cannot be called that. Let's call it an absorption meter and have done with it.

The materials needed are a 15 turn coil of bell wire, a 5-plate condenser, grid leak and condenser, tube, socket, batteries, phones and tickler. Make the tickler large enough to let the tube oscillate violently. It can be fixed at maximum and forgotten, for as long as the set works there is no need to adjust it. What is wanted is violent oscillation and not sensitiveness. Take a small fixed condenser, a phone condenser will do, and fasten it to a flexible lead with a clip on the free end and the other end fastened to the coil. The exact spot for fastening may be determined by experiment.

When the absorption meter is finished, fasten the clip to the antenna lead, place a brick on the key, and rotate the condenser till the beat note is heard. Mark the place on the dial of the condenser and then check to be sure you have made no errors. It is best not to wear the phones during this test, for the signals will be loud enough to hear without any trouble, and if the series condenser should happen to puncture you would have to

order some new ears or maybe something worse.

Now if your set will stand having the key down for a half hour or so you can go out and test. If not have someone there to run it.

Take your absorption meter and test all the rain pipes, water and gas pipes, fences, and whatever else is handy. If the natural period of any of them is anywhere near the wave emitted current will be absorbed, and a sound will be heard in the phones when a wire is attached. If the peak comes on the transmitted wave or within a meter of it, then you have located one of the reasons why your signals are not getting through to Africa. Make notes of your finds, and if there are over a dozen, then shift your wave to another band. But if there are no more than three that are troubling you, then by shifting your wave slightly you can reach a point where your signals will glide through between the absorbing bands, and your DX will increase in proportion.

There is still much to be done in the perfecting of this circuit. It has great possibilities, and if developed may solve the ever increasing problem of QRM, as well as making long distance transmission a daily occurrence, instead of an occasional event.

In connection with the use of the electric lighting circuit and a condenser as a substitute for an outside aerial it has been found that a Balkite B current supply set provides sufficient condenser action in many cases. The ground post of the current supply set is connected to the ground post of the receiver and the antenna post of the receiver is connected to the regular ground on the water system. As the current supply set is connected to lighting circuit this scheme obviates separate antenna connection of any other kind.

The Ministry of Communications has announced that six privately owned radiocast stations will be operating in Japan during 1925 and that the prohibition against receivers will be removed. But one station will be allowed to a city. The Government has been operating an experimental station at Shiba Park on a wavelength of 385 meters.

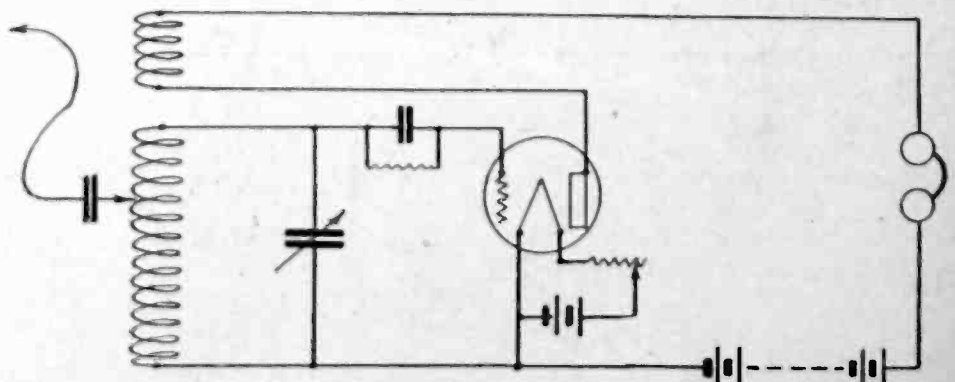

Absorption Meter



# A Practical Remote Control System

By C. H. Campbell, IIV

IT frequently happens that the amateur who lives in the city hasn't enough room for a good transmitting antenna and is forced to be satisfied with poor results or build the station at a different location. This generally means constructing a shack, which is quite a job and has several other disadvantages as the best DX is usually done on cold winter mornings.

H. E. Nichols, IBM, was in this predicament but by means of the remote control device shown in Fig 1, he is now able to enjoy the advantages of an efficient radiating system while sitting at home by his warm fire-side.

The transmitter is nearly a thousand feet from the house, in the middle of a large open lot. Two masts 70 ft. high support a handsome T antenna and the lead-in drops straight down to the transmitting set which is housed in a box right under the middle of the aerial. A large radial counterpoise extends out in all directions.

With reference to Fig. 1, *R* is a telegraph relay which opens and closes the filament circuit of the vacuum tube. *S* is a telegraph sounder to which the transmitting key is fastened as shown in Fig. 2. The sounder operates the key, thereby opening and closing the plate or grid circuit—whichever is your favorite form of keying. *K* is the operating key at the house. This key is shunted by a resistance, the value depending on the sensitivity of the instruments used, but will probably be between 15 and 25 ohms. *T* is a switch and *B* is a 6-volt battery.

The operation is as follows: When the switch *T* is closed a current flows through the resistance, along the line, and through the sounder and relay. The resistance has weakened the current to such an extent that it will not operate the sounder, but will close the relay which is more sensitive. This lights the filament of the tube. Now as the key is pressed, the resistance is shorted and a stronger current will flow which actuates the sounder, closing the plate supply. When finished transmitting open the switch *T* and the filament will be

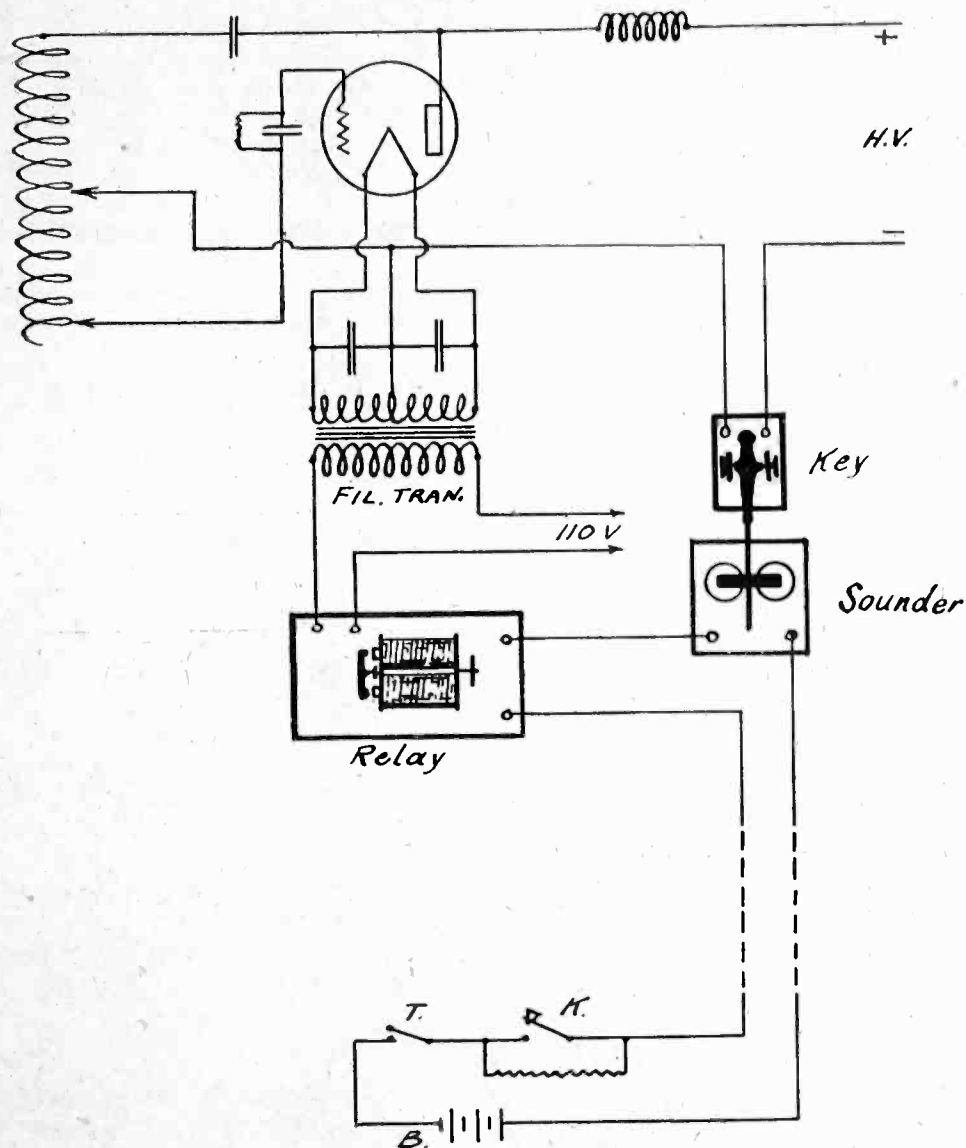

Fig. 1. Remote Control System at IBM

turned off. Should the key be pressed accidentally, there is no danger of the high potential being applied to the vacuum tube before the filament is lighted, because the circuit is broken unless *T* is closed.

It is advisable to use a D.P.S.T. switch at *T* and connect a flashlight bulb and battery in series across the extra pair of contacts. The light will remind the operator not to leave the vacuum tube lighted when through

transmitting. At this station it has paid for itself many times in tube life.

The remote control system just described has been in operation a little more than a year, and since the original adjustment has not required any attention nor has it failed to function.

All call letters for U. S. ship, commercial, governmental and radiocasting stations are confined to the letters and variations thereof that may make four combinations of the letters from KDA to KZZ, from NAA to NZZ and WAA to WZZ. These are fixed by an international agreement which assigns other identifying letter combinations to other nations. In general, K letters are assigned to western radiocast stations, the W letters to eastern stations and the N letters to governmental service. Exceptions to this rule are found, especially in the case of early radiocast stations. As the K three letter combinations have been about exhausted many four letter calls are now coming into use.

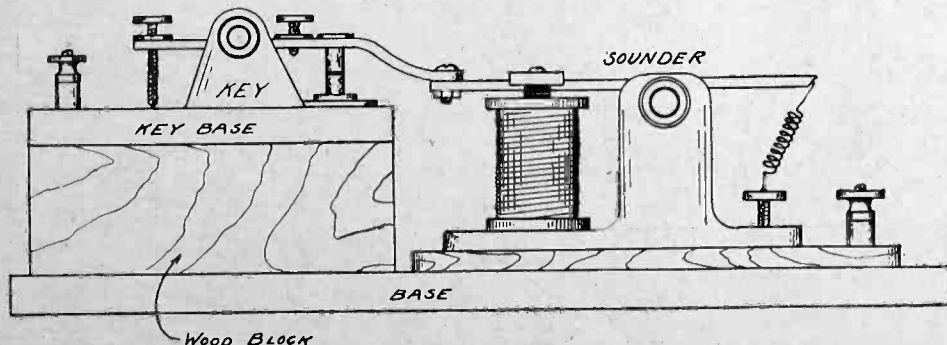

Fig. 2. Method of Mounting Key and Sounder



# QUERIES and REPLIES



Questions submitted for answer in this department should be typewritten or in ink, written on one side of the paper. All answers of general interest will be published. Readers are invited to use this service without charge, except that 25c per question should be forwarded when personal answer by mail is wanted.

Please publish the circuit of the Harkness Counterflex receiver. Can ordinary reflex coils be used in this circuit and how does it differ from other reflex circuits.

—M. K., Hermosa Beach, Calif.

The circuit of the Harkness Counterflex is

I would like to learn of a good two tube reflex receiver using a crystal detector. Please publish a diagram, for use with the new Magnovox tubes.

S. H. C., Seattle, Wash.

The circuit shown in Fig. 1 answers your requirements. This circuit will work with

circuit to employ a storage battery, with UV-201-A tubes, that we are publishing such a circuit in Fig. 2. If UV-199 tubes are to be used throughout, the only change necessary is the main filament rheostat, which should be 6 ohms, and the voltmeter should be 0-5 volts scale instead of 0-8 volts. If the large tubes are used, extra precautions should be taken to prevent oscillation in the intermediate stages, since the mutual conductance, or ability to amplify, of the larger tubes is greater than that of the C-299 and the arrangement of apparatus as described in the January, 1925 article may not permit the use of the large tubes without shielding. It would be well to shield the back of the panel and the inside of the cabinet with sheet brass, copper or tinfoil, and place a partition so that the oscillator coil, tube and condenser are shielded from the rest of the set. It may be necessary to place a partition between each intermediate transformer and its associated tube. All the shields mentioned above should be connected to the negative A battery and to a good waterpipe ground. If the amplifier still oscillates and none of the above precautions stop the oscillations, then it will be necessary to insert a potentiometer, or "losser" in the circuit so that the grids of the three intermediate stages are connected to the filament circuit through the potentiometer. To install the potentiometer, disconnect the grid return connections on the secondary of each intermediate frequency transformer and tie all three terminals to the slider of the potentiometer. Connect the outside terminals of the potentiometer across the filament circuit at a point in the circuit nearest to the sockets of the three intermediate amplifier tubes.

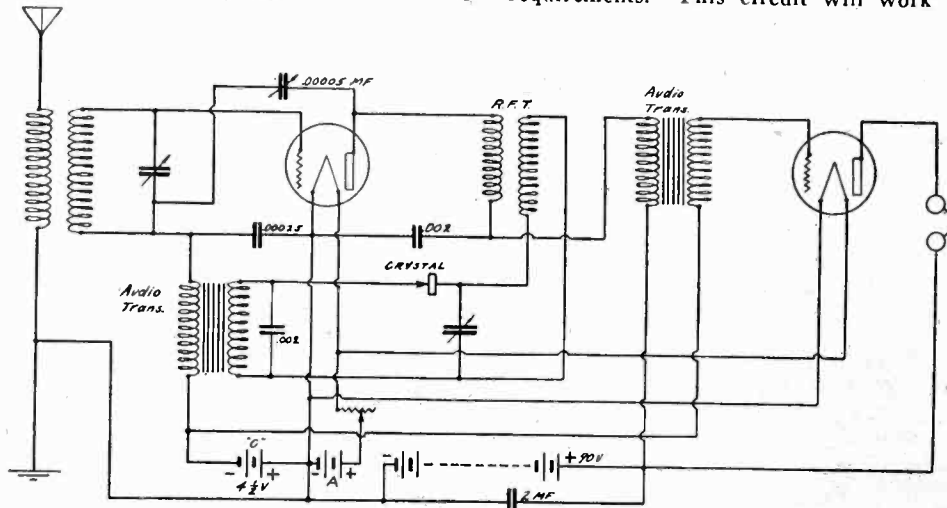

Fig. 1. Harkness Counterflex Circuit

shown in Fig. 1. Ordinary reflex coils may be used for the radio frequency transformers in this circuit as it does not differ from other reflex circuits in the arrangement of the coils. The only difference between the Counterflex circuit and other two tube reflex circuits is in the name and the insertion of the small feedback condenser between the plate and grid circuits of the first tube. This is in reality an adaptation of the Rice circuit.

any of the standard tubes now on the market.

Please publish the circuit of the Improved Best Superheterodyne so that I can use a storage battery for filament supply. I cannot read the complicated filament circuit diagram shown in January RADIO.

—W. E. P., Lee Summit, Mo.

So many of our readers have written asking for a circuit diagram showing how to adapt the Improved Best Superheterodyne

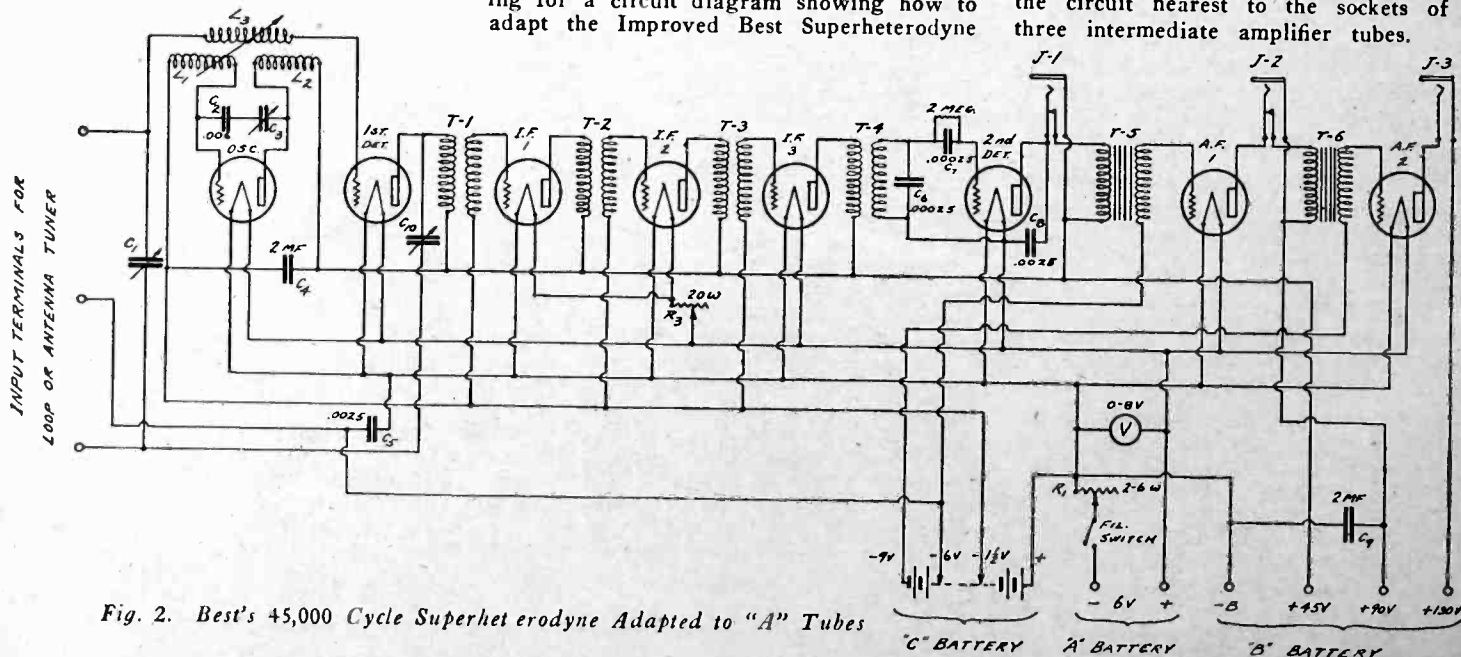

Fig. 2. Best's 45,000 Cycle Superhet erodyne Adapted to "A" Tubes

Can a 32 volt lighting plant be used to charge a storage battery? Would it be necessary to convert the D. C. into 110 volt A. C. in order to charge the battery? I would like to have a circuit for the Improved Best Superheterodyne using UV-199 tubes throughout.

—H. D. W., Bowerston, O.

Assuming that the lighting plant is capable of furnishing at least 10 amperes at 32 volts, the plant could be used to charge a 6 volt battery at 5 amperes and yet be able to furnish the additional power ordinarily required for the lighting load. The battery should be placed in series with a 5 ohm resistance capable of carrying 5 amperes, and bridged across the 32 volt line, making sure that the positive of the battery is connected to the positive of the line. It would be necessary to install a motor generator set with 32 volt motor and 110 volt A. C. generator in order to obtain 110 volts A. C., which would be very uneconomical. You would then have to rectify the A. C. in order to charge the battery and would find yourself at the end of a vicious circle wherein you would be the loser by paying the high cost of apparatus and operation. The first method of charging direct from the line is the best one. On page 68, Fig. 8 in January 1925 RADIO is shown a circuit diagram showing how to adapt the Improved Superheterodyne to UV-199 tubes throughout.

Please tell me if the self neutralizing coils for the neutrodyne are better than the regular tube wound coils and how are they made.

—A. M. S., Santa Cruz, Calif.

Most self neutralizing coils are made with the neutralizing condenser already installed and adjusted for the average tube. The inductances used in the self neutralizing coils are usually the same as those furnished with the separately adjusted outfits. The average values for the coils are as follows: Primary 15 turns of No. 26 D. S. wire wound on a 2 3/4 in. tube. Secondary 65 turns of No. 26 D. S. wire wound on a 3 in. tube and placed over the primary coil. A tap is taken out at the 12th turn of the secondary, for connection to the neutralizing condenser.

I am unable to obtain No. 36 single silk wire for use in winding the transformers for the Best Superheterodyne, but can get No. 36 double silk wire. Please tell me if the double insulated wire will make any great difference in the design of the coil. Would soft iron wire of No. 24 gauge be all right for the cores of the intermediate frequency transformers?

—H. S., Brocton, N. Y.

The use of double silk insulated wire will require slightly greater space on the spool, for the secondary winding, but it will not make sufficient difference in the resonant point of the secondary to require a change in the number of turns in the secondary. No. 24 soft iron wire will serve as core material, but it is advisable to obtain the finest wire possible, in order that the required number of lines per inch, or flux density, be maintained in the core. Crowd as much of the No. 24 wire as is possible, into the core space provided for it.

Please publish a circuit diagram for a crystal set using Cockaday coils.

—W. B. F., Wilmington, Del.

The Cockaday coils were designed for use in a regenerative vacuum tube circuit and in our opinion would not be efficient for use with a crystal detector. The crystal, being a relatively insensitive device, requires a greater amount of energy from the antenna than does the vacuum tube and hence the tuned circuit provided for the Cockaday receiver is too selective for the ordinary crystal and will greatly reduce your volume.

I have a single circuit tuner with one stage of audio frequency amplification, that I use in connection with a Western Electric 14-A loud speaking outfit. How can I rewire the tuner to cut out the squealing and improve the selectivity? If a stage of radio frequency amplification would help, I would be glad to add the necessary apparatus.

—H. V. L., Chicago, Ill.

In Fig. 3 we have shown the circuit diagram of your receiver modified by the addition of one stage of radio frequency amplification. The coils used in the circuit are the Browning-Drake type, which can either be purchased ready made, or built by yourself as desired. For directions in construction, see the article by Volney D. Hurd on page 13 of April RADIO. It will be necessary for you to abandon the single circuit tuner if you wish to get maximum results with your radio frequency amplifier, but as the coils are inexpensive to make, this should not be a serious drawback to the change.

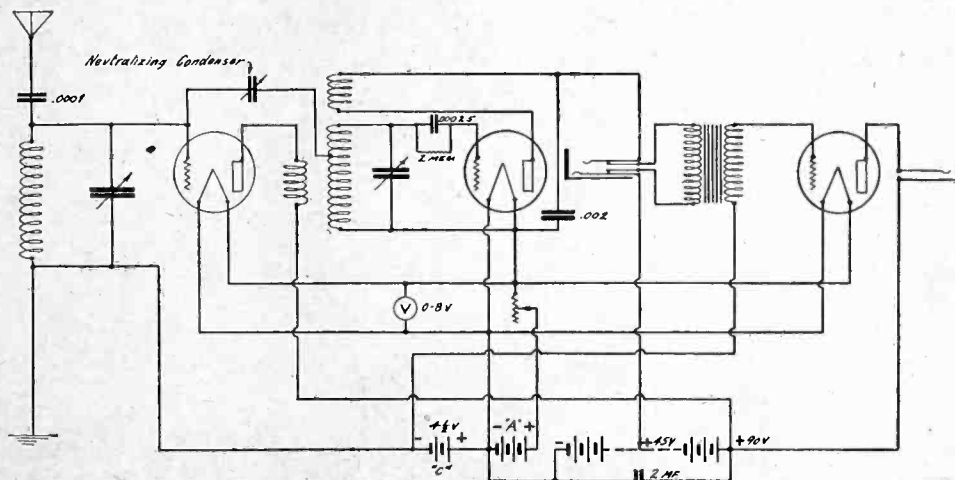

Fig. 3. Improvements in Single Circuit Receiver

Why is it not advisable to use over 45 volts in the intermediate frequency amplifier of the Best Superheterodyne? Would it be advisable to use a variable mica or air condenser across the secondary of the tuned transformer in place of the fixed mica condenser now provided?

A. L. S., Sacramento, Calif.

Since the amount of energy being handled by the intermediate frequency amplifier is quite small and the gain in amplification caused by increasing the plate voltage is very small, 45 volts is the optimum value for the C-299 or UV-199 tubes. A variable condenser of .0005 mfd. shunted across the secondary of the tuned transformer will tune the transformer to its resonant frequency but requires an extra adjustment and an expensive piece of apparatus. If you purchase a high grade mica condenser of .00025 mfd. you should not need the variable condenser.

I have a Radiola Regenoflex receiver using four WD-11 tubes. I am never quite sure as to just what is the correct current for these tubes. The directions say to light them to a dull red, but opinions differ as to the exact color. Could I connect a voltmeter or other indicating device to the set in order to operate the tubes in the most economical manner? At what voltage reading is it most economical to discard old 22 1/2 volt B batteries and install new ones? My set seems to work as well when the 90 volt battery has dropped to 65 volts as with a new battery. Is this good practice?

—J. A. G., Los Angeles, Calif.

The filament current of each WD-11 tube in your receiver should be .25 ampere. This makes a total of 1 ampere for the entire set

of four tubes and an ammeter having a range of 0-1.5 amperes placed in series with the negative A battery lead between the batteries and the filament rheostat will give you the best indicating device. A voltmeter should not be used with oxide coated filament tubes as these tubes use a current adjustment for the filament rather than filament voltage. When a 22 1/2 volt B battery has dropped to 17 volts, it is time to remove the battery from the circuit, especially in a receiver not provided with a by-pass condenser bridged across the B battery circuit. You may be able to receive over as great a distance with a B battery of 65 volts as with 90 volts plate, but your power output will certainly be greatly reduced. It is well to keep the battery above 80 volts if you are accustomed to operate your loud speaker with considerable volume. A good idea for the conservation of the batteries is to keep an extra 22 1/2 volt block on hand and place a few cells at a time in series with the main battery as it drops in voltage.

Will you please tell me if it is possible to use a WD-11 tube in a 1 tube reflex circuit.

—A. T., Washington, D. C.

A WD-11 tube will work very well in a single tube reflex receiver. You cannot efficiently operate a loud speaker with the one tube, but you should obtain good head-phone volume over a reasonable distance.

I am interested in the article on "sending and receiving with one tube," as published in February RADIO. Please tell me if this set could be used for 80 meter work and whether two variable condensers are necessary if the antenna is worked on its fundamental wavelength.

—W. S., Whittier, Calif.

For 80 meters, the secondary coil L should be 15 turns, coil ST should be 18 turns and the tickler coil RT should consist of 15 turns. It would be advisable to have the two air condensers available in any case.

I have a five tube tuned radio frequency receiver that squeals very badly on most settings of the filament rheostat, especially when tuned to maximum volume on distant stations. How can this trouble be cured?

—V. H. P., Sonoma, Calif.

From the rather lengthy description of your trouble, it would appear that you have coupling between stages in your radio frequency amplifier, or else you have a high resistance B battery. If you have not already done so, install a 2 microfarad paper condenser in the set, connected between the negative and positive B battery terminals that supply the radio frequency tubes. Ground the cores of the audio frequency transformers

Continued on page 61

# With the Amateur Operators

## TRANSMITTER AT 3BHY GETTYSBURG COLLEGE, GETTYSBURG, PA.

By E. G. PORTS, *Inst. Dept. Physics*

THE transmitter at 3BHY is of standard design with special attention to details. The oscillating circuit is a loose coupled Hartley with shunt feed of high voltage. The scheme of modulation used in the Heising system. For speech amplification three stages of audio frequency are used. The first two stages are General Radio transformer coupled with 160 volts plate battery and 13 volts grid bias using 5 watt W. E. tubes, filaments supplied with 6 volt storage battery. The last stage is push pull using All American transformers, with 5 watt W. E. tubes, plates supplied with 300 volts AC (using one 216 kenotron and filter circuit in B battery eliminator of our own design—nothing unusual) grid bias battery of 24 volts, filaments supplied with another 6 volt battery. For mike we use a Thorola loud speaker, leads of speaker connected to input of first stage audio frequency, no battery used.

In antenna circuit, in addition to the coupling coil which has about 2 in. coupling and is of pancake variety of 8 turns, placed at plate end of oscillation transformer is a TCA loading coil as required and Cardwell 43 plate receiving condenser to lower wave. Latter may be shorted out of circuit if not required. The oscillation transformer is standard RCA using 12 turns between plate and filament tap and 5 between filament and grid. This coil is tuned with a 60 plate variable condenser—double spaced of our own make—design very similar to Cardwell transmitting VC which no doubt could be used.

The plate of oscillator is connected through .002 mfd. 7,000 volt mica condenser to end of OT next to antenna inductance. The grid of oscillator is connected through .002 mfd. 7,000 volt condenser shunted by 5,000 ohm RCA grid leak to the 17 turn of OT. The 12 turn from plate end of OT is connected to center of bypass condensers and then to center tap of filament transformer. We might note here that bypass condensers are used between center tap of filament transformer and outside taps of .01 mfd. each and that the filament tap of OT is connected first to the point between these bypass condensers which are placed as near as possible to oscillator tube and thence to center tap of filament transformer which is placed under the table on which parts are mounted. The position of filament bypass condensers is important in making radio frequency path as short as possible.

The plate of oscillator is connected to plate of modulator through a single layer radio frequency choke coil on a 3 in. tube 3 in. long wound with No. 24 or 26 DCC wire. From plate of modulator lead goes to plate reactor which is a 50 hen. adjustable air gap iron core choke. Separate milliammeters are placed in leads of oscillator and modulator tubes. Plate voltmeter is connected from plus of high voltage to minus at point back of above 50 hen. choke. If connected next to plate of modulator instead of back of choke the effects of the choke are spoiled. The grid of modulator is connected to output coil of pushpull transformer thence to grid bias battery which is variable from about 80 to 120 volts and thence to center tap of filament transformer. The negative of high voltage after it leaves filter network is also connected to center tap which point is grounded to protect transformer.

The plate supply of the tubes is filtered RAC using 4 Amrad S tubes for rectifying. The high voltage AC is supplied by one of the surplus RCA transformers delivering

1,500 volts on each side of center tap of high voltage winding. Two S tubes are used in parallel in each lead with 25 watt Mazda lamps as balancing resistances. The output of the rectifier is fed through a filter net work as follows—first a 1 mfd. 1,750 volt condenser is across from plus to minus leads, then in plus lead is inserted a variable air gap 40 hen. iron core choke, then two 1 mfd. 1,750 volt condensers are across the plus and minus leads, and again in plus lead is placed a 33 hen. variable air gap choke which is shunted by a .06 mfd. paper condenser and then another 1 mfd. condenser is across the leads (at this point we also have plate voltmeter). Plus lead is connected to the 50 hen. plate reactor spoken of before. In the primary of the plate transformer is placed variable resistance to vary the voltage applied to S tubes.

The filament voltage is under constant observation by means of filament voltmeter which is one instrument very necessary to transmitting equipment. Also we would call particular attention to the fact that the filament voltage is regulated by means of rheostat in primary circuit of transformer which is only proper place to use regulating rheostat.

From the above it is seen that there is nothing unusual about 3BHY's equipment. However we might say that results we are now obtaining were not gained overnight. Constant work, testing, adjustment, study, etc. for about three years gave us our final result. We built our own filament transformer, our plate reactor, filter chokes, and VC tuning condenser. We might say here that before building the VC tuning condenser we had tried mica dielectric condensers, oil dielectric, etc., but none gave the results of the air dielectric condenser we

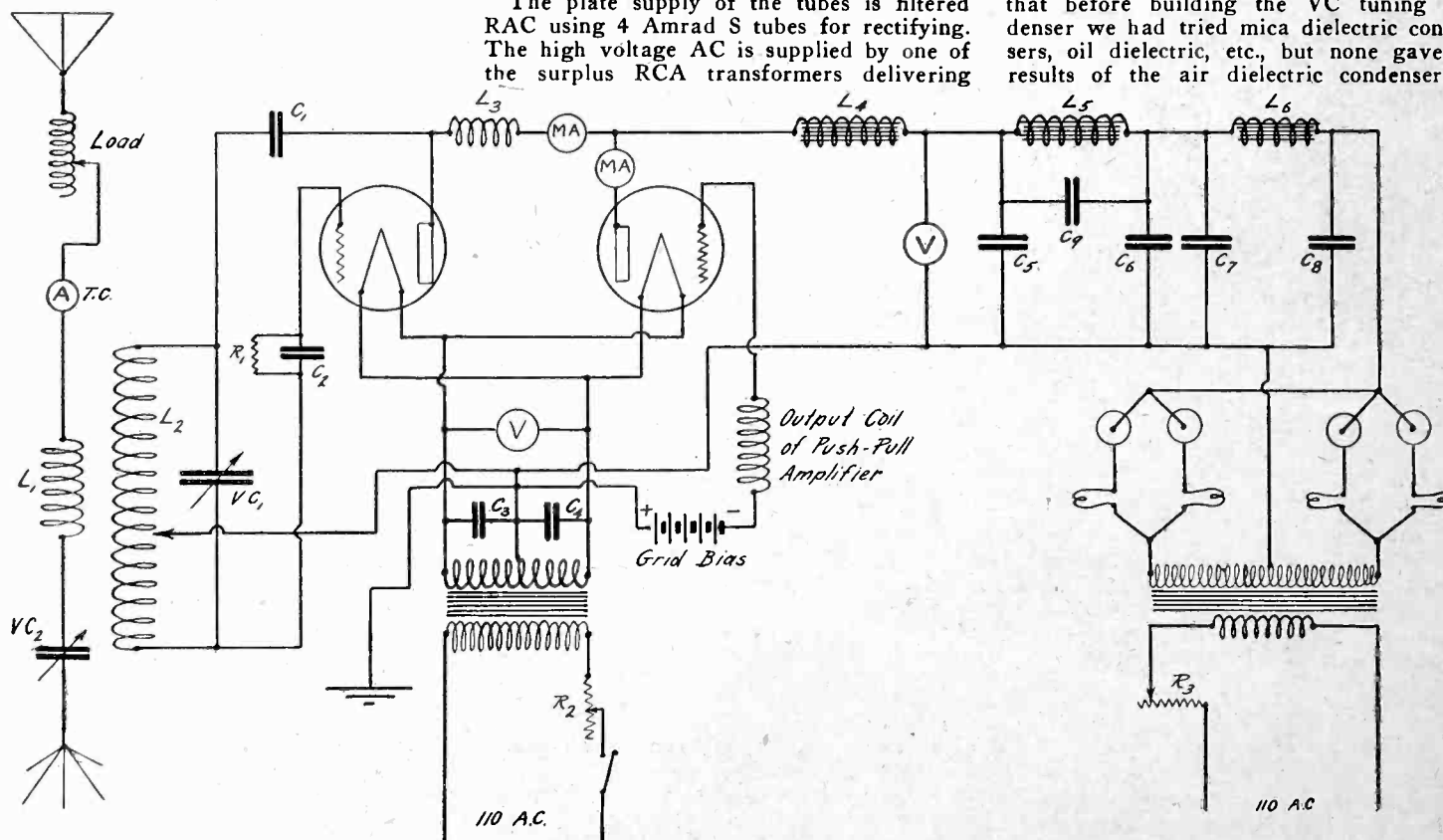

Circuit Diagram of Loose Coupled Hartley Transmitter at 3BHY

VC<sub>2</sub>=43-plate Cardwell  
VC<sub>1</sub>=60-plate special  
L<sub>1</sub>=8-turn pancake  
L<sub>2</sub>=RCA oscillation transformer.  
L<sub>3</sub>=radio frequency choke

L<sub>4</sub>=50 hen. adjustable choke  
L<sub>5</sub>=40 hen. adjustable choke  
L<sub>6</sub>=33 hen. adjustable choke  
C<sub>1</sub>=C<sub>2</sub>=0.002 mfd. 7,000 volt  
C<sub>3</sub>=C<sub>4</sub>=0.01 mfd. paper condenser

C<sub>5</sub>=C<sub>6</sub>=C<sub>7</sub>=C<sub>8</sub>=1 mfd. 1,750 volt filter condenser.  
C<sub>9</sub>=0.06 mfd. paper condenser.  
R<sub>1</sub>=5000 ohm RCA grid leak.  
R<sub>2</sub>=rheostat in primary of filter transformer.

now use. The filter must be "tuned" by varying air gaps in inductances until AC hum is eliminated. In the oscillator circuit we must cut down the number of turns between filament and grid taps as much as possible and still have tube oscillate if we are to expect tube to run cool. Quite a bit of experimenting will be required to get best operation of oscillator. Filaments should always be lighted first and then plate voltage applied gradually and tubes watched if they are to give service. We have only two fifty watters and have been using same two for almost three years and they still are going fine.

Our antenna system up to February 12 was a 6 wire taper cage—maximum height 120 ft.—total length including down lead about 150 ft. Counterpoise is a 7 wire affair 60 ft. long. On February 12 above antenna gave way to wind storm and we put up instead a single wire No. 12 enameled and reports seem to indicate no loss in signal strength. In last antenna maximum height is about 135 ft. and total length 165 ft. Antenna is guyed very rigidly and well insulated. Counterpoise is also well insulated.

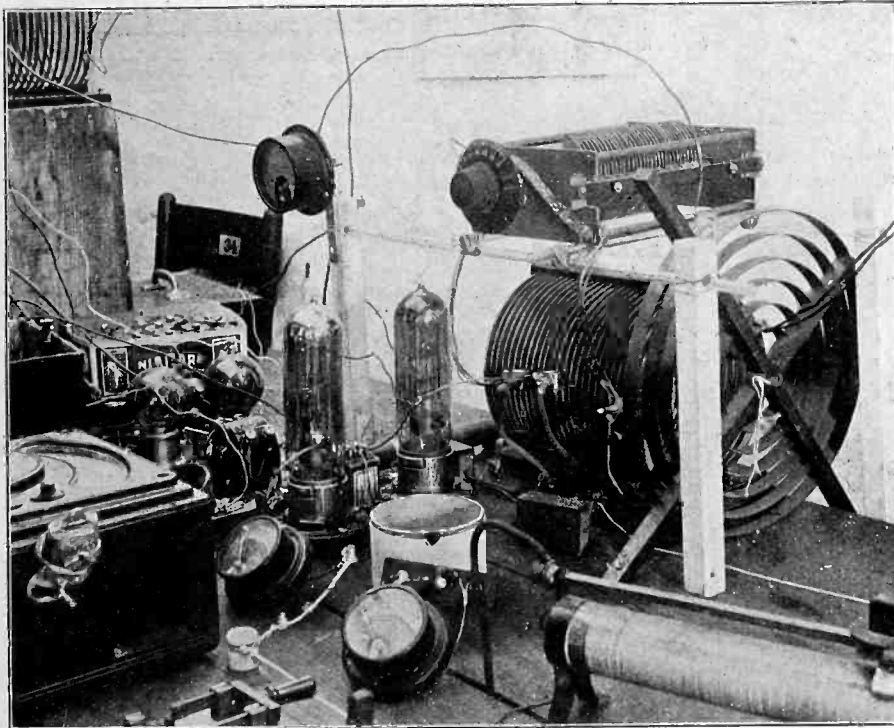

Transmitter at 3BHY

The transmitter proper is located in basement of recitation hall and we bring antenna and counterpoise leads in through center of glass windows as widely separated as possible. The transmitter is spread over three tables, attention taken to place parts so as to get best results.

In tuning we adjust VC so that we get least change in antenna ammeter needle when mike is spoken into, rather than for maximum radiation. Thus we insure that upward and downward modulation are about equal.

One thing of importance is the amplification we use. By means of it we supply enough voltage variation to almost completely modulate output of oscillator. The normal oscillator current is about 150 mls at 1,200 volts. When mike is working it may drop as low as 40 mls and since we know the needle of MA cannot follow voice frequencies we feel sure that output is modulated to even greater extent.

On 50 watt tubes we use plate voltages as high as 1,250 and 1,300 without undue heating. With such equipment we have covered up to February 16, 36 states, 4 pro-

vinces of Canada, and Cuba on voice, everywhere pronounced perfect and very QSA. In daylight we have reached Butler, Mo. on voice. Radiation in antenna is usually about 1.5 amps.

With the above equipment using 5 watters instead of 50 watters we have applied plate voltage of 850 at 75 mls and have been reported QSA and perfect up to 1,000 miles, radiation in this case is about .6 amps in antenna.

A little further note of antenna might be well. We are located rather badly in that only support is bell tower in which is located large iron water tank and covered with grounded lightning rods. Also buildings practically surround antenna. But we guyed downlead away from building as far as possible and made it very rigid. But by sticking it high up in the air we have increased the radiation resistance which is useful resistance in radiation to such an extent that while radiation current is low the effective height is great and from experience here we favor the antenna being as high as possible.

9NE has been assigned to Erland Olson, 272 Wilder Street, Aurora, Ill., operating 5 watts C W and phone. All cards answered.

# CALLS HEARD



By Albert E. Searlett, Jr., 23 Cooley Place, Mount Vernon, New York

U. S.: 6aak, 6aao, 6afg, 6ajl, 6ame, 6anb, 6bac, 6bbq, 6bbv, 6bcw, 6bhx, 6biv, 6bjj, 6blw, 6bni, 6bnv, 6bpf, 6bur, 6cct, 6ceq, 6cfs, 6cgc, 6cgo, 6cgw, 6chs, 6chx, 6cnl, 6con, 6cor, 6cqd, 6ceq, 6css, 6ctc, 6ea, 6ew, 6gt, 6jp, 6lj, 6of, 6pl, 6ql, 6on, 6sb, 6ts, 6xad, 6xi, 6zh, ket, ngg, 7abb, 7adm, 7afo, 7agg, 7ajy, 7akk, 7ald, 7df, 7eb, 7fg, 7gl, 7gm, 7gr, 7gv, 7jq, 7kv, 7lj, 7ls, 7ly, 7mf, 7wg. Canada: 5go, 5hc. England: 2jf, 2kf, 2ky, 2nb, 2nm, 2od, 2yb, 2sh, 2wj, 5lf, 5nn, 5gv, 6nf. Mexico: 1aa, 1af, 1n, 1x. France: 8fq. Rorto Rico: 4je, 4sa. Germany: pox. Brazil: wjs. Cuba: 2lc. New Zealand: 2ac. Australia: 2bk. Holland: oll, pct. Hawaii: 6xo. Miscellaneous: hp, gd. QRAs?

By SALY, 1625 Clinton Ave., Rochester, N. Y.

6adt, (6afh), (6amf), 6amm, (6asv), 6awm, 6awt, (6bdv), (6bik), (6bin), (6bmw), (6bni), (6bnr), (6bra), (6bve), (6cej), 6cgo, (6cgw), (6clv), (6cmg), (6epc), (6css), 6eb, (6nx), (6vo), (6ua), (7abb), (7acm), (7acy), 7dd, (7fl), (7fq), (7lj), (7ly), 7qd, 7sy, (7uj). British: (2cc), (2jf), 2kz, (2nm), (2od), (2sh), 2sz, (2wj), (2yq), (5ls), (5pu), (5rz). French: (8ba), (8ct), (8fq), (8go), (8tk), 8sm. Dutch: (oll), onl, (ore). Cuban: (2lc). Mexican: 1aa, 1af, 1b, 1k, 1n, 1x, Bx. Argentina: CB8. Phone—British: (2od). Specials: Nerik, (Nfv), Nkf, Wgh, Wir, Ket, 5xh, 6xi, 6xo. Foreign: Lpx, Lpz, Poz, G-2yt.

By L. Donald Koons (SAVY, Waverly, N. Y.) at 303 College Ave., Ithaca, N. Y.

(80 meter band) 4hs, 4tj, 4ua, 4uk, 4xe, 5aaz, 5afu, 5amu, 5arb, 5asz, 5co, 5ek, 5hp, 5ka, 5lh, 5lu, 5ot, 5ox, 5sd, 5xau, 6cgo, 6qi, 7df, 9adg, 9afo, 9aif, 9aiu, 9amq, 9aoo, 9asv, 9axt, 9bjl, 9bkr, 9bna, 9bnk, 9bpt, 9caj, 9cej, 9cgn, 9co, 9cur, 9cvi, 9cvo, 9cxc, 9dat, 9dcx, 9djv, 9dke, 9dpi, 9dpl, 9dyn, 9eex, 9eib, 9elb, 9hk, 9ja, 9la, 9lz, 9ny, 9pb, 9sr, 9zd, lpx, lpz, nam, nkf, wir.

By GALV 1026 Park St., Alameda, Calif.

1ajx, 1bkr, 1cmx, 1ga, 1xmu, (2axf), 2con, 2kx, 3cky, 3hh, 4dv, 4pd, 5aw, 5all, (5aiu), (5afu), 5aic, 5apq, (5ati), 5go, (5mz), 5ox, 5ps, 5rq, 5vf, 5ew, 5nq, 8af, 8aol, 8bf, 8ced, 8dae, 8deb, 8dgv, (8cci), 8xe, 8ze. Canadian: 4bg, 4eo, (5bm), (5cp), 5ef, (5hg), 5hh). Mexican: 1aa, 1k, bx. New Zealand: 4ag. Australia: 2bk, 2yg, (3bd). Brazil: wjs. Java: ane, eva, wvn. QRA?

By Lester Wallace Reed, 414 N. Lake Ave., Pasadena, Calif.

2ck, 2cee, 4ll, 5gi, 5apq, 5arh, 5ati, 5adm, 5ew, 5ft, 5ls, 5ox, 6pg, 6aja, 6pz, (6bks), (6bqu), 6asv, 6cso, 6crd, 6cww, 6aam, 6car, 6gv, 6an, 6cab, many more, 7aek, 7alk, 7aha, 7eo, 7ok, 7mf, 7si, 8ago, 8abs, 8bcp, 8ba, 9bqu, 9bcw, 9eak, 9et, 9aob, 9ee, 9ees, 9ded, 9dmj, 9caa, 9cy.

By GBAV, 1362 Fergar St., Fresno, Calif.

1aac, 1abp, 1af, 1afa, 1ajx, 1alw, 1asy, 1axn, 1bql, 1bzt, 1cab, 1cmp, 1cmx, 1cpc, 1er, 1fm, 1km, 1mo, 1no, 1pl, 1rd, 1xam, 1yb, 2aan, 2abd, 2ac, 2ad, 2ale, 2aug, 2avu, 2bj, 2bjx, 2bm, 2bn, 2bta, 2cg, 2cpk, 2hv, 2ky, 2mk, 2rk, 2sz, 2wu, 2xi, 3bau, 3bnu, 3bss, 3fv, 3hj, 3kq, 3te, 3tr, 3wo, 3xr, 4ah, 4dv, 4eg, 4er, 4fm, 4fz, 4gn, 4gw, 4jr, 4ll, 4my, 4oi, 4tj, 4tw, 4uc, 4uy, 4wj, 5acz, 5aec, 5aiu, 5am, 5aom, 5apq, 5apy, 5asb, 5atf, 5aut, 5aw, 5bc, 5bp, 5bz, 5co, 5jb, 5lh, 5lr, 5saut, 5aw, 5bc, 5bp, 5bz, 5co, 5jb, 5lh, 5lr, 5ls, 5ox, 5pl, 5qy, 5rg, 5rw, 5uk, 5vu, 5zai, 5za, 6's and 7's too numerous, 8aal, 8agp, 8ah, 8ajq, 8alg, 8aly, 8ars, 8ase, 8bcp, 8bfe, 8bk, 8bse, 8cjp, 8cp, 8czy, 8dgv, 8dmz, 8jj, 8jq, 8pl, 8sf, 8uf, 8wo, 8ze, 8zz, 9afo, 9ark, 9ase, 9ato, 9avj, 9axt, 9bal, 9bbw, 9bcy, 9bdw, 9beu, 9bje, 9bju, 9bku, 9bna, 9bpy, 9bwb, 9ccx, 9cdv, 9cea, 9cgo, 9clg, 9cz, 9czo, 9ded, 9dms, 9dse, 9efn, 9ehw, 9ejy, 9elb, 9elh, 9eli, 9ev, 9hn, 9ig, 9iw, 9on, 9vz, 9xi, 9zn. Will qsl to any of the above on request. QRK GBAV?

Continued on page 44

## DX AT 6XAD-6ZW

Stations worked: 1ii, 1zt, 1abf, 3ou, C4eo, 5ac, 5an, 5ags, 8dae, 8dfm, 8abm, 8dse, HVA (Hanoi, French Indo China), PKH (Soerabaja, Java, Dutch East Indies. 6XAD was heard at Macao, China, near Hongkong, according to a report received from a Portuguese amateur at that place.

# FROM THE RADIO MANUFACTURERS

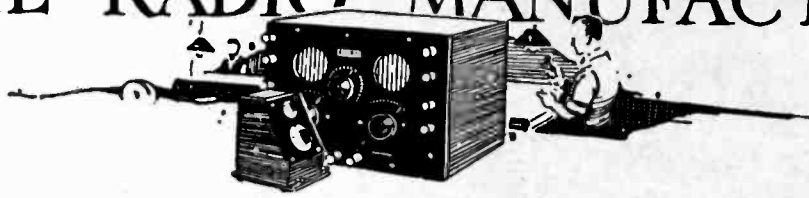

The Jefferson Tube Rejuvenator is a device for conveniently bringing the thorium to the surface of the thoriated tungsten filament of a tube thereby increasing the electron emission. Two sockets are provided, one for the "A" type of tube and the other for the "99" type. The device is connected

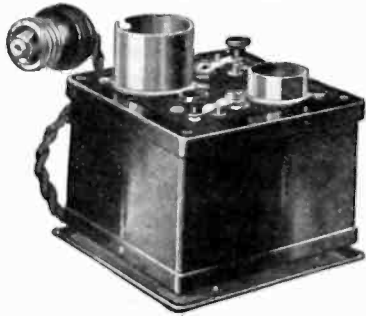

to the 110 volt 60 cycle a. c. lighting circuit, the tube inserted and given a 45-second high voltage charge by means of switch *H* and then given a ten-minute low voltage heating by means of switch *L*. Any owner of a multi-tube set will find it advantageous to use this device on each of his tubes about once a month.

The Sangamo mica fixed radio condenser is claimed to be accurate within 10 per cent of the marked capacity and to sustain its original accuracy under all conditions.



It is made in all standard sizes with or without grid-leak clips. It is completely sealed in a bakelite case to make it impervious to atmospheric changes.

The Blax Polarizer is a device that enables the use of alternating current filament supply instead of storage battery for reflex sets using a crystal detector. It is used with an ordinary bell ringing transformer

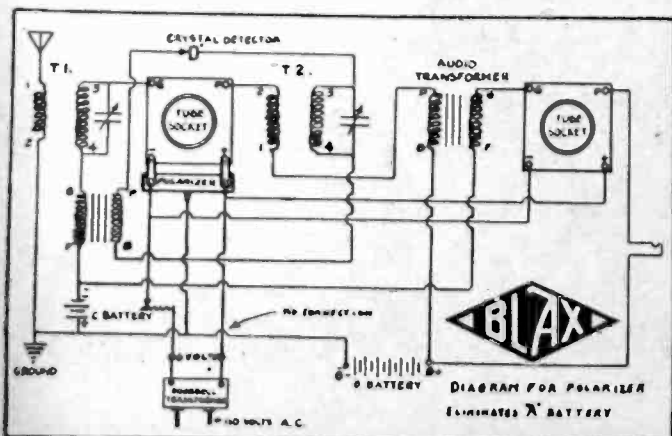

which steps down the 110 volt a. c. supply to the 6 volts necessary for filament heating. If a storage battery is desired at any time the polarizer will not interfere with its functioning.

The General Radio Type 303 Vernier Dial is provided with a brass gear firmly swedged to the back of the dial. Its accurately machined teeth are engaged by small fibroil pinion which is kept in close contact



by a spring arm. The dial is finished in frosted silver with black graduated scale. It is claimed to have no back lash. It is equipped with a celluloid hair line indicator.

The Kellogg Reproducer combines a magnetically modulated diaphragm and a horn designed to deliver the entire auditory range of sound waves with little or no distortion. The electromagnets and pole pieces are spaced and shaped to allow the utmost amplitude of the diaphragm without chattering. The electro-magnets are of unusually high impedance and the permanent magnet has an unusual intensity of magnetism. The opposite action of these magnets on the metal diaphragm—one varying the intensity of the magnetic pull and the other cushioning its movement—gives a magnetic modulation that prevents overloading and gives fine reproduction of the lowest and highest notes. The unit is adjustable to the output requirements of any audio frequency amplifier.

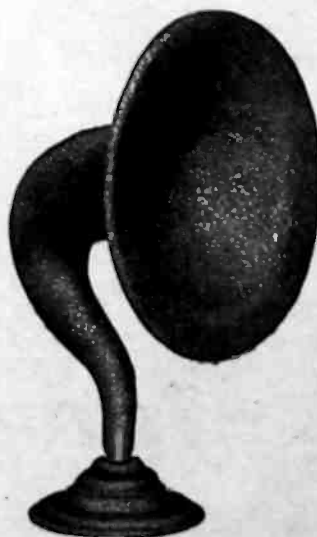

The Acme battery charger is a double duty rectifier for charging both *A* and *B* batteries. It is made in several styles, the one-tube model illustrated charging *A* batteries

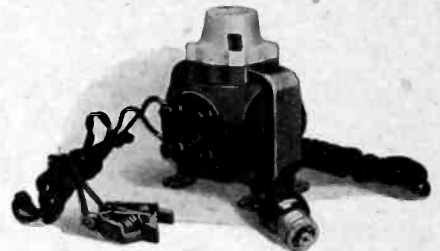

at 2½ amperes rate and *B* batteries at ¼ to ½ ampere. It is supplied with battery clips and extension cord and plug, but without tube.

## NEW RADIO CATALOGS

The 1925 Radio Catalog of the Schneitter Radio Co., of St. Joseph, Mo., is a 152-page illustrated listing of many popular parts and complete receivers.

The H. H. Eby Mfg. Co. of Philadelphia are distributing to dealers and jobbers an attractive new catalog of their binding posts with "the top which does not come off." The various styles of posts described include both the metallic and hard-rubber types, the latter being engraved in twenty-five different markings to accommodate all hook-ups.

## PUBLICATION RECEIVED

Bureau of Standard Technologic Paper No. 265, "Theory and Performance of Rectifiers." Price 20 cents from Supt. of Documents, Government Printing Office, Washington, D. C. This comprises a study of the performance of aluminum and tantalum electrolytic rectifiers, the two-element vacuum tube rectifier, and the magnetic vibrating type. It includes a complete theoretical discussion and the results of practical tests.

"Measurement of Electrical Resistance and Mechanical Strength of Storage-Battery Separators" by C. L. Snyder, Technologic Papers of U. S. Bureau of Standards No. 271, Price 10 cents.

This paper outlines a method of measuring the resistance of storage-battery separators and gives the results of measurements on separators of several kinds of wood. The effect of thickness of the separators, the method of treating them, and the effect of concentration and temperature of sulphuric acid solutions on resistance and mechanical strength of the wood are described.

"Tables for the Calculation of the Mutual Inductance of Circuits with Circular Symmetry About a Common Axis," by F. W. Grover, Scientific Paper No. 498, U. S. Bureau of Standards. Price 10 cents.

These tables do away with the necessity of selecting a formula and laboriously completing the values. The desired values of the mutual inductance of two coils is obtained by taking the product of the geometric mean of the radii and a factor taken by interpolation from a table. An accuracy of one part in 10,000 is readily attained.

# The two outstanding parts in radio!

Give low losses and amplification without distortion to any set

**Q**UANTITY and distance are what a radio set must give. To insure Quality, amplification without distortion is essential. And to insure Distance, low losses are essential. That is radio in a nutshell.

People in whose sets Acme Transformers are used, are sure of hearing concerts "loud and clear" so a whole roomful of people can enjoy them.

The Acme A-2 Audio Amplifying Transformer is the part that gives quality. It is the result of 5 years of research and experimenting. It gives amplification without distortion to any set. Whether you have a neutrodyne, superheterodyne, regenerative or reflex the addition of the Acme A-2 will make it better.

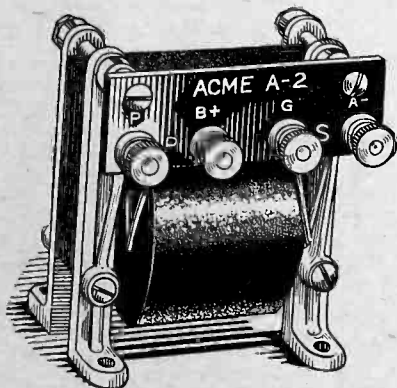

Acme A-2 Audio Frequency Amplifying Transformer

To get the thrill of hearing distant stations loud and clear, your set must have low losses, for it is low losses that give sharp tuning to cut through the locals, and it is low losses that allow the little energy in your antenna to come to the amplifier undiminished. That's what the Acme condenser will do for any set. And it will do it for years because the ends can't warp, the bearings can't stick, and the dust can't get in and drive up the losses several hundred per cent.

The Acme Reflex (trade mark) owes its success and its continued popularity to these two outstanding parts in the radio industry, for low losses and amplification go hand in hand.

Use these two parts in the set you build. Insist on them in the set you buy.

Send 10 cents for 40-page book, "Amplification without Distortion"

WE HAVE prepared a 40-page book called "Amplification without Distortion." It contains 19 valuable wiring diagrams. In clear non-technical language it discusses such subjects as Radio Essentials and Set-building; How to make a loop; Audio frequency amplifying apparatus and circuits; Instructions for constructing and operating Reflex ampli-

fiers; How to operate Reflex receivers; Antenna tuning circuits for Reflex sets; "D" Coil added to Acme four tube reflex; "D" coil tuned R. F. and Reflex diagrams; and several more besides. It will help you build a set or make your present set better. Send us 10 cents with coupon below and we will mail you a copy at once.

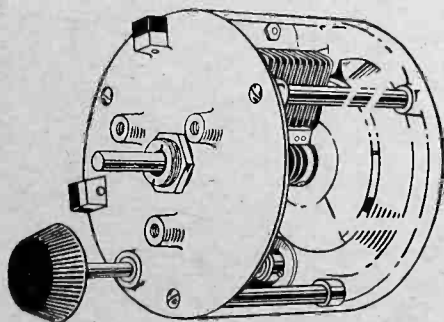

Acme Low-Loss Condenser

ACME APPARATUS COMPANY  
Transformer and Radio Engineers and Manufacturers  
Dept. D4, Cambridge, Mass.

SEND THIS COUPON

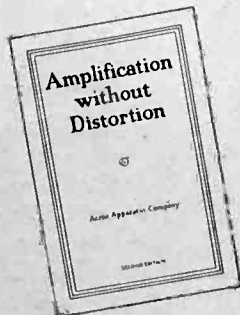

ACME APPARATUS COMPANY,  
Dept. D4, Cambridge, Mass.  
Gentlemen:  
I am enclosing 10 cents (U. S. stamps or coin) for a copy of your book "Amplification without Distortion."

Name.....  
Street.....  
City..... State.....

# ACME ~for amplification

# Only specialists can make good fixed condensers

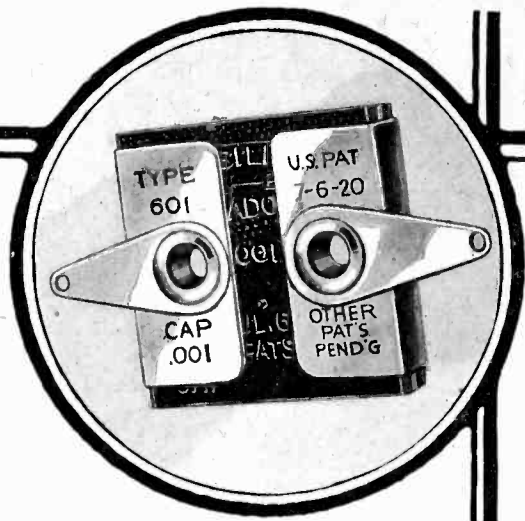

THE small fixed condensers in your radio set are there to help you get clear reception. If these little condensers are not made *most accurately* the quality of reception you get—even though your set may be excellent in all other respects—will be greatly impaired.

You will find that nearly all sets made—in fact, over 90% of them—are equipped with Dubilier Micadons. This is the name by which all Dubilier fixed condensers are known.

Be sure your set—whether you buy it or build it—is equipped with Micadons. They are made by *specialists*.

# Dubilier

CONDENSER AND RADIO CORPORATION

## CARTER

New and Original

Radio Receptacle Jack for Wall Mounting \$1.00

For mounting in baseboard or on wall for aeriels and ground, "A" battery and extending loud speaker, etc. For use in homes, hotels, institutions, hospitals, clubs, etc. Jack extends only 1/8" back of plate and is completely enclosed; fits any standard outlet box; takes all standard plugs.

Any dealer can supply or write us for further information

In Canada, Carter Radio Co., Limited, Toronto

Coast Distributors:  
ATLANTIC-PACIFIC  
AGENCIES  
CORPORATION  
204 Rialto Building  
San Francisco, Calif.

**Carter Radio Co.**  
201 S STATE STREET  
CHICAGO

Offices in Principal Cities

## CALLS HEARD

Continued from page 41

By GATS, William Reeves, 5075 Hub St., Los Angeles, Calif.

1aay, 1ajx, 1ary, 1aww, 1bbe, 1bes, 1bgq, 1bkb, 1bqb, 1cak, 1co, 1fd, 1kc, 1pa, 1pl, 1py, 1rd, 1sz, 1te, 1wl, 1zt, 1xw, 1xav, 2aan, 2aay, 2apk, 2ana, 2axf, 2bgi, 2bqu, 2brb, 2brc, 2bsc, 2bum, 2buy, 2cee, 2cjb, 2cnk, 2cqz, 2cty, 2cvj, 2cxy, 2ag, 2br, 2by, 2ka, 2ke, 2kf, 2pb, 2pd, 2rk, 2zb, 2xam, 3apv, 3bjp, 3bta, 3bva, 3bwj, 3cdg, 3chc, 3chg, 3as, 3lw, 3ot, 3wb, 3yo, 4bq, 4cr, 4do, 4eq, 4fd, 4gw, 4hs, 4io, 4jr, 4kl, 4ku, 4my, 4oa, 4pb, 4rk, 4sb, 4tj, 4tw, 4ur, 4xe, 5aaq, 5acf, 5acl, 5acm, 5adh, 5adv, 5aeq, 5afu, 5ahw, 5ail, 5aiu, 5aiy, 5ajj, 5ajt, 5ajs, 5akn, 5ame, 5amw, 5asb, 5asz, 5atx, 5be, 5bj, 5ca, 5ck, 5cn, 5ew, 5ft, 5in, 5kv, 5kw, 5lg, 5lh, 5lu, 5lv, 5oq, 5ot, 5ox, 5ps, 5pm, 5qd, 5qy, 5rv, 5se, 5sd, 5br, 5ty, 5uk, 5vf, 5vu, 5zas, 5zai, 5za, 8aal, 8abs, 8aby, 8acm, 8aly, 8bmt, 8bpa, 8btf, 8byn, 8cbp, 8cei, 8cjd, 8ckm, 8cqs, 8cyi, 8do, 8dae, 8bk, 8bp, 8do, 8er, 8fn, 8fu, 8gz, 8kc, 8pl, 8nb, 8rd, 8wa, 8wx, 8zz. Commercial: nkf, nerk-1, nog, npg, npl, ket, 4who gra?. Australian: 2yg. Canadian: 1ar, 2eo, 3ni, 4io, 5ba, 5ef, 5go. Mexican: 1b, 1x, 9a, bx. New Zealand: 4aa, 4ag. Portugese: 4fr. Above heard on detector only. Would be more than glad to qsl es. Would appreciate a check on my signals vy qrk? Please note new qra.

By Dick Pitner, Sioux City, Ia.

On short waves: 1aac, 1aae, 1aap, 1aay, 1abs, 1afc, 1afj, 1ag, 1aja, 1ajg, 1ajo, 1ana, 1ar, 1at, 1atj, 1atq, 1aw, 1axl, 1axz, 1ayp, 1azn, 1azr, 1bbe, 1bcr, 1bdh, 1bdx, 1bes, 1bhm, 1bhn, 1bie, 1bis, 1blb, 1bqi, 1bqk, 1bsd, 1bv, 1bv, 1bv, 1bz, 1bzb, 1cab, 1cbg, 1ccz (?), 1cfa, 1cjc, 1ckp, 1cmp, 1cph, 1eri, 1da, 1dd, 1eg, 1er, 1fd, 1gs, 1hk, 1ii, 1kc, 1lw, 1py, 1qn, 1sf, 1sn, 1vc, 1ve, 1wl, 1xam, 1xu, 1xw, 1yd, 1yb, 1zt, 2aan, 2aay, 2abt, 2ach, 2adm, 2ag, 2ahw, 2aju, 2am, 2avg, 2bgi, 2brhe, 2big, 2bgm, 2bma, 2bmn, 2bqp, 2bqu, 2br, 2bsc, 2bw, 2cft, 2cg, 2cgb, 2cjb, 2cla, 2cmx, 2cns, 2cpa, 2cpk, 2cub, 2cvf, 2czr, 2dd, 2ds, 2fo, 2fz, 2gk, 2ke, 2ld, 2mu, 2ds, 2fo, 2fz, 2gk, 2ke, 2ld, 2mu, 2my, 2pd, 2rk, 2tp, 2wr, 2xd, 2xq, 3aa, 3adp, 3adq, 3aip, 3ajd, 3alx, 3apu, 3apv, 3aqr, 3avk, 3awa, 3bco, 3bei, 3bfq, 3bj, 3bjp, 3blp, 3bmz, 3bqf, 3bss, 3bta, 3bv, 3bwj, 3ca, 3cc, 3cdg, 3cdj, 3cdn, 3cdv, 3cej, 3ce, 3cf, 3ch, 3chg, 3eh, 3fc, 3gk, 3hd, 3hg, 3hs, 3in, 3jw, 3ll, 3mf, 3mq, 3nf, 3od, 3ot, 3sm, 3tf, 3tp, 3wx, 3xm, 3xr, 3zs, 4ai, 4ak, 4bq, 4bw, 4cp, 4db, 4dv, 4eb, 4fz, 4jk, 4kk, 4kl, 4ku, 4mb, 4rm, 4si, 4sx, 4ti, 4tj, 4tv, 4tw, 4ws (qra?), 4xe, 4bek (qra?), 5aa, 5aaq, 5aav, 5abc, 5acf, 5acl, 5add, 5ade, 5adh, 5ads, 5aef, 5aeq, 5aex, 5afu, 5agk, 5agl, 5agt, 5ahj, 5aic, 5ais, 5aiy, 5ajn, 5amb, 5am, 5amh, 5amk, 5amt, 5anf, 5aor, 5aot, 5apk, 5apm, 5apu, 5apy, 5asj, 5asz, 5ath, 5an, 5atq, 5atx, 5aup, 5aur, 5bg, 5bs, 5bw, 5ek, 5ev, 5dm, 5dw, 5ef, 5eq, 5er, 5hd, 5hv, 5lk, 5lr, 5ls, 5lu, 5mq, 5nj, 5ot, 5ov, 5ox, 5pl, 5qx, 5rg, 5sd, 5se, 5sh, 5tq, 5uo, 5uk, 5ur, 5vl, 5vo, 5xat, 5xau, 5zaj, 5zas, 5zav, 5ab, 6abb, 6abx, 6afg, 6afh, 6afm, 6ahp, 6ajl, 6ajq, 6akw, 6alg, 6amo, 6aqd, 6awt, 6bas, 6bcp, 6bh, 6bj, 6bjx, 6bqa, 6bul, 6bvr, 6ca, 6cbb, 6cct, 6ccy, 6cej, 6cfs, 6cgc, 6cgv, 6cig, 6cmg, 6cqe, 6crs, 6cto, 6cw, 6cwl, 6cva, 6ea, 6gr, 6im, 6jl, 6ne, 6of, 6oi, 6pl, 6qi, 6rm, 6ti, 6ua, 6vc, 6zh, 7abb, 7dd, 7fi, 7fq, 7gb, 7gt, 7gj, 7lg, 7mb, 7mg, 7mx, 7nt, 7qd, 7ry, 7sf, 7zn (qra?). 8's and 9's too numerous. Porto Rico: 4sa. Mexico 1n, bx Canada: 1ef, 2am, 3ac, 3au, 3gu, 4fv.

At 6AIB and 6BSC, Route 3, Box 130, Orange, Calif.

1aao, 1ajx, 1ams, 1are, 1aww, 1axn, 1bsd, 1cmp, 1cmx, 1gs, 1rd, 1yb, 2aan, 2adm, 2anm, 2avg, 2brb, 2bsc, 2cgj, 2cnk, 2cpk, 2czr, 2fo, 2rk, 2xam, 3chg, 3xi, 3xo, 4fz, 4tj, 4xe, 5afb, 5afu, 5ap, 5bj, 5ls, 5nw, 5qy, 5ty, 7afn, 7dj, 7gr, 7lg, 7lq, 7uj, 7ya, 8aol, 8aul, 8dfk, 8dme, 8fm, 8pl, 8vq, 8ze, 8axb, 9axs, 9bkk, 9byc, 9cf, 9coc, 9dmj, 9dps, 9eak, 9eam, 9xhp, 9zt, A2ds, A2yl, A3bq, C2be, C2cg, (C3gf), C4ab, C4bb, C4fv, C4io, C5ba, C5ef, C5gf, C5hp, Mb, M1aa, M1af, M1n, Rcb8, Z1ao, Z2ac. All cards answered. Please state if you have hear 6AIB or 6BSC. Tnx.

At 2BUY, Bradley Beach, N. J.

4gw, 4lg, 4je, 4pb, 4pi, 4tr, (4ua), 4ux, 5ac, 5bj, 5hj, 5kq, 5sd, 5xh, 5af, 5ail, 5ajm, 5alu, 5apu, (6cc), 6vd, 6xi, 6xo, 6agh, 6cgv, 7dd, 7vq, (9and). Canada: 1ae, 1af, 1an, 1ar, 1dd, 1dj, 2be, 3adn, 3ael, 3mv, 3nf, 3ph, 4cr. Cuba: 2lc, 2mk, (dz) pse qsl qra! Dutch: oaa, onl, ofa. Italian: 1mt, 1do. Mexican: 1af, 1n, 1aa. England: 2jf, 2kz, 2od, 2sz. Miscellaneous: bg, wjs, wth? All cards answered! All qsl's appreciated!

Continued on page 46



# Lacault Scores Again!



The new Ultra-Lowloss condenser is the latest improved radio device designed by R. E. Lacault, formerly Associate Editor of Radio News, the originator of Ultradyne Receivers and now Chief Engineer of Phenix Radio Corporation.

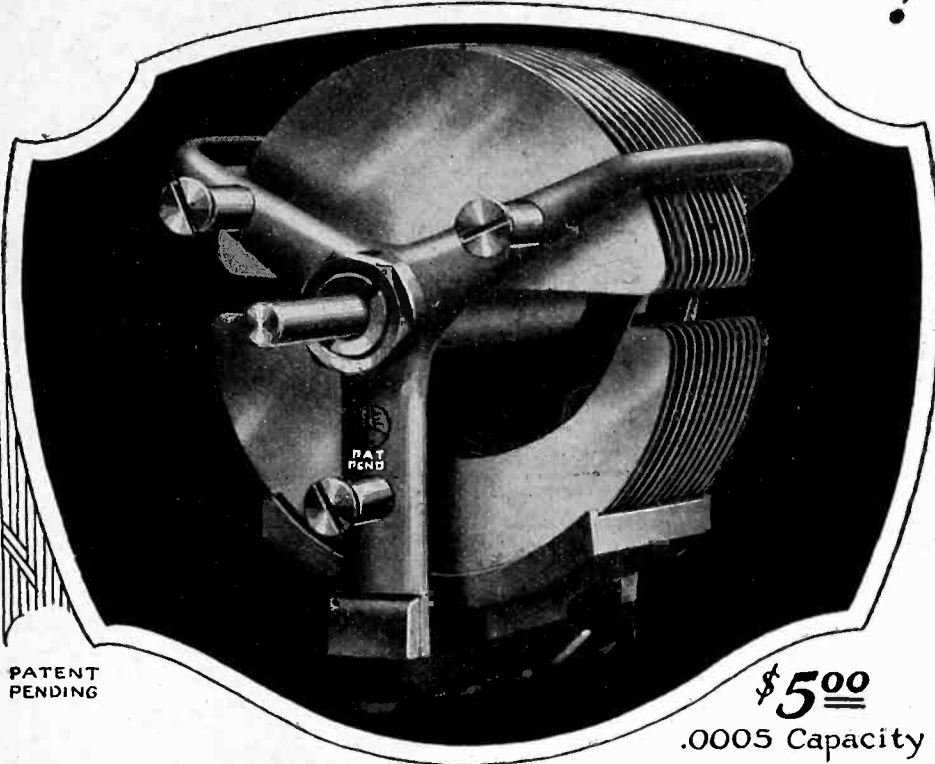

PATENT PENDING

**\$5<sup>00</sup>**  
.0005 Capacity

## ULTRA-LOWLOSS CONDENSER

**L**IKE every Lacault development, this new Ultra-Lowloss Condenser represents the pinnacle of ultra efficiency—overcomes losses usually experienced in other condensers.

Special design and cut of stator plates produces a straight line frequency curve, separates the stations of various wave lengths evenly over the dial range, making close tuning positive and easy.

With one station of known frequency located on the dial, other stations separated by the same number of kilocycles are the same number of degrees apart on the dial.

In the Lacault Ultra-Lowloss Condenser losses are reduced to a minimum by use of only one small strip of insulation, by the small amount of high resistance metal in the field and frame, and by a special monoblock mounting of fixed and movable plates.

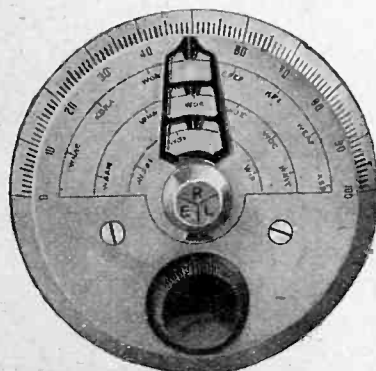

### ULTRA-VERNIER TUNING CONTROL

Simplifies radio tuning. Pencil-record a station on the dial—thereafter, simply turn the finder to your pencil mark to get that station instantly. Easy—quick to mount. Eliminates fumbling, guessing. Furnished clockwise or anti-clockwise in gold or silver finish. Gear ratio 20 to 1.

Silver \$2.50 Gold \$3.50



This seal on a radio product is your assurance of satisfaction and guarantee of Lacault design.

*At your dealer's, otherwise send purchase price and you will be supplied postpaid.*

*Design of low loss coils furnished free with each condenser for amateur and broadcast frequencies showing which will function most efficiently with the condenser.*

#### To Manufacturers Who Wish to Improve Their Sets

The Ultra-Lowloss Condenser offers manufacturers the opportunity to greatly improve the present operation of their receiving sets.

Mr. Lacault will gladly consult with any manufacturer regarding the application of this condenser to any circuit for obtaining maximum efficiency.

*Pacific Coast Representatives: CARL A. STONE CO., 644 New Call Bldg., San Francisco, Calif.; 1116 Miner Ave., Seattle, Wash.; 429 Insurance Exchange Bldg., Los Angeles, Calif.*

**PHENIX RADIO CORPORATION, 114-B EAST 25th ST., NEW YORK**

Tell them that you saw it in RADIO

# This Wonderful Loud Speaker at Direct Factory Price \$9.85

Send no money — Pay postman or expressman



**FULL SIZE**  
Bell — 12 1/4 inches.  
Height — 19 1/2 inches.  
Diaphragm — Finest made — no chattering.  
All metal throughout.

If we sold you this horn through dealers, the price would be at least \$18. Of that the dealer gets 40 per cent. The jobber gets another 20 per cent. Our factory-direct-to-you method saves you all these middlemen's profits. Moreover you get a full-size horn whose beauty of tone and handsome finish will delight you. All metal construction; Florentine brown stipple finish. No wood, paper-mache or cheap substitute.

## Guaranteed — Try it 5 Days Free

Try it 5 days. Then if for any reason you wish to return it, we'll refund you every cent of your money, without quibble or question.

### 5-Tube \$75 Receiver

This Dexter Radio Receiver has a range of 1500 to 3000 miles. Two stages radio frequency; detector; two stages audio amplification. Laboratory tested parts wired to Naval standards. Genuine mahogany cabinet. Every set individually tested. You can't buy its equal at retail below \$75. **TRY IT 5 DAYS FREE** — If you don't find it the clearest, full-toned receiver costing up to \$75 you've ever heard, return it. We'll refund your money.

**\$48.50**



### Deal With Responsible Manufacturers Direct

The Dexter Metal Mfg. Co. is 37 years old. Your banker can tell you about our financial standing. We've a long record for dealing honestly and fairly and every word printed here has our full responsibility behind it.

**Special Offer** — Dexter Receiver, Loud Speaker, *Exide* A Battery 80 amp; Two *Ray-O-Vac* 45 volt B Batteries; 5 tubes, tested and guaranteed perfect; 100 feet finest strand aerial wire; 50 feet heavy insulated lead-in and ground wire; *Weston* plug; two insulators; ground clamps; fixture wire — all complete **\$89.50**

Or — Dexter 5-Tube Receiver and Dexter Loud Speaker — special combination offer **\$57.00**

ESTABLISHED 1888 **DEXTER METAL MANUFACTURING CO.** Address Radio Engineering Division L  
10-14 S. 18th Street, Philadelphia, Pa.

"Elements of Radio Communication"  
By Lieut. E. W. Stone  
A Book That Every Radio Fan Should Have.  
**\$2.50**

SENT POSTPAID ANYWHERE  
**PACIFIC RADIO PUB. CO.**  
Pacific Bldg. San Francisco



**ON ONE TUBE**  
BIG FREE BOOKLET tells the story. California users of **CROSS COUNTRY CIRCUIT** hear Atlantic Coast, Canada, Cuba, Mexico and Hawaii. Atlantic Coast users hear England to California. Our new plan makes this set easiest and cheapest to build. One hour puts in operation. One tuning control. No soldering. Any novice can do it. **BIG BOOKLET FREE** or complete instructions for 25c stamps or coin.  
**VESCO RADIO CO.**  
Box R-117, Oakland, Calif.

Continued from page 44  
By H. C. C. McCabe, 71 Holloway Road, Wellington, New Zealand  
U. S. A.: 1cm, 1ow, 1are, 1comp, 1wy, 1bes, 2cqq, 2mc, 2cpa, 2yl, 3bw, 3chg, 4lo, 4ku, 4fg, 4fz, 4kl, 5zal, 5in, 5ox, 5uk, 5kc, 5ka, 5lu, 5dgc, 5dw, 6vc, 6cnl, 6zh, 6bgc, 6ajh, 6rn, 6cmu, 6ahp, 6cct, 6alv, 6awt, 6crs, 6ase, 6eb, 6cgw, 6ne, 6ao, 6ts, 6cto, 6ew, 6tl, 6csw, 6cso, 6mme, 6amm, 6ea, 6bra, 6aji, 6vw, 6cqe, 6wp, 6ccb, 6ol, 6cgc, 6blk, 6clp, 6chl, 6arb, 6chx, 6ckf, 6alw, 6ccy, 6cej, 6cix, 6cfs, 7mf, 7gq, 7ij, 7ajv, 7alf, 7in, 7kre, 8t??, 8tr, 8vg, 8kc, 8cej, 8ice, 8bau, 9zt, 9clq, 9xi, 9amb, 9dqu, 9eam, 9zy, 9bmj, 9bcj, 9bhy, 9cdv, 9axx, 9cjc, 9cqn. Mexican: Bx. Canadian: 5BA 5AN, 5CT.

By OQUE, 524 Wood Street, West, Lafayette, Ind.  
1af, 1ag, 1ak (1aac), 1aae, (1adm), 1adw, 1aes, 1aki, 1aox, 1aqm, 1atq, (1axl), 1axn, 1bn, 1bal, (1bbg), 1bbr, 1bcc, 1bcr, 1bgz, 1cak, 1cpv, (1cre), 1db, 1df, 1ga, (1gs), 1ft, 1hn, 1ky, 1my, 1rd, 1rr, 1te, 1wy, (1xm), 1yb, (1yd), (2at), (2aey), (2ate), (2avg), (2bee), (2bqc), (2brb), (2bxy), (2cbg), (2cpk), (2cpo), (2crb), 2cvs, (2ctq), (2me), 2pv, 2sz, 3ac, 3aea, (3aew), (3bg), 3bay, 3bgi, 3btq, 3cc, 3ccv, 3chg, 3dh, 3ex, 3hs, 3oq, 3sm, (3tp), 3tq, (3wm), 3zo, 3zm, (3zs), (4bq), 4dv, (4eb), (4fj), (4fm), 4fv, 4fz, 4jr, 4lo, 4ku, (4ml), 4wg, 5ap, (5all), 5ais, 5alu, 5amu, (5amw), 5aqw, (5arj), 5atp, (5asj), 5avm, 5ck, 5dm, 5hj, 5hp, 5hu, 5ig, (5is), 5nj (5ox), 5qy, 5uj, 5ur, (5uv), 5wo, 5ab, 5ac, 5ap, 5aam, 5aao, 5agk, 5ahp, 5aji, 5ajq, 5akw, 5alw, 5ano, 5apw, 5arb, 5baa, 5bbc, 5bhl, 5bhx, 5bjj, 5blu, 5bmw, 5bny, 5bb, 5bra, 5bri, 5bua, 5bur, 5bvg, 5cbb, 5cet, 5cfs, 5cgc, 5cgk, 5chl, 5chx, 5cix, 5ckf, 5ckw, 5cnl, 5cov, 5cqe, 5cro, 5crr, 5cse, 5cso, 5css, 5cto, 5cty, 5cva, 5cwy, 5gg, 5gy, 5ja, 5jy, 5mh, 5mp, 5ne, 5nx, 5oi, 5ua, 5ut, 5vd, 5vw, 7afo, 7ahl, 7ahq, 7bn, 7dd, 7dj, 7gr, 7gs, 7gy, 7ku, 7lq, 7lr, (7mf), 7rs, 7sp, 7us, (8afn), (8ctk), (8cyl), (9agl), (9beu), (9bkb), (9bjj), (9cmb), (9dac), (9dfh), 9's and 8's over 500 miles. Canada: (1el), (2bv), 2am, 3afp, (3ly), 3nl, (3nf). Mexican: 1a, 1x, 1aa, 1af. Cuba: 2LC, npl, 1pz, ket, wgh, 2xam, nfv, wjs, nkf. Receiver 1BGF trans. 20 watt input. Would greatly appreciate reports from 6 and 7 districts. Every card answered.

By DAPY, 3337 Oak Park Ave., Berwyn, Ill.  
1aao, (1apa), 1cmx, 1da, 1ga, 1mk, 1qm, 1xm, 2aan, 2aay, 2acp, (2aep), 2anq, 2bqc, 2brb, (2bt), 2cdp, (2cg), 2cmt, (2cmx), 2fj, 2sz, 3adp, 3bmz, 3boj, 3buy, 3bwj, 3cb, 3cd, 3fu, 3gg, 3hg, 3mv, (3na), 3ts, 3zg, 4eq, 4fz, 4gw, 4hr, 4it, 4ku, 4lo, (4og), 4si, 4tj, 4ts, 4tw, 4vo, 5ade, 5afv, (5amb), (5anl), (5ann), 5anv, 5ati, 5ce, 5ck, 5di, 5gl, 5go, (5gq), (5lm), 5lh, 5nw, 5ox, 5qh, 5qz, 5vf, 5wy, 6alw, 6pl, 6zh, (8agw), (8ale), (8bfo), (8blg), 8ccq, 8cmt, 8cql, 8dbl, (8dol), (8hi). Nines too numerous. Canadians: (3it), 3ph, 3wv. U. S. Fones: 2rb, 3bhy, 3wf, 5apz, (8art), 8brc, 8bw, 8dqn. Miscellaneous: nerk-1, noel, wgh. A card awaits every qsl. qrk?

By Donald Cordray, 508 N. Market St., Canton, Ohio  
(1afy), (1biq), (1rr), (1ask), (1cde), (1acw), (1afj), (1avz), (1qb), (1cke), (1bbk), (1afi), (2cdp), (2av), (2cdh), (2bvg), (2bbx), (2aer), (2aq), (2cxg), (2aku), (3ay), (3aam), (3aft), (3buv), (3bvn), (3hu), (3mk), (3na), (3pp), (3cj), (3tu), (3qw), (3jf), (3cu), (3tp), (4hr), (4lo), (4dv), (4og), (4vf), (4ma), (4un), (4uc), (4mf), (5ar), (5adz), (5att), (5aek), (5br), (5auq), (5atw), (7sf), (8axc), (8ahw), (8ak), (8arw), (8atz), (8bkr), (8bqa), (8byt), (8cep), (8ckp), (8cnz), (8cva), (8ckn), (8dde), (8dbm), (8dlv), (8dqf), (8wy), (8aks), (8ajz), (8axt), (8boy), (8ahm), (8bx), (8qm), (8alv), (9alm), (9aot), (9avy), (9avk), (9baz), (9bjp), (9cfu), (9dbi), qra? (9dhj), (9dpc), (9dwz), (9eaw), (9cbe), (9bn), (9my), (9doo), (9buc), (9dbj), (9eg), (9dy), (9me), (9em), (9byl), (9cab), qra? (9aud), (9hd), (9dya), (9cod), (9avb), (9awg), (9eja), (9dqf). Mexican: (1b) qra pse qsl. Canadian: (4hh), (3acf), (3fu), (3af2), 4ll, 4do, 4ff, 4eg, 5acf, (9) 5alz, 5aaq, 5alz, 5arl, 5rm, 5ln, 5agq, 5asz, 5sd, 5uj, 5wa, 6atw, 6awt, 6ea, 6xad, 6buc, 6chx, 6opc, 6cso, 6cul, 6kt, 6ll, 6pz, 6rv, 6uo, 6qi, 6et, 6cti, 6chx, 6bay, 6bav, 6alv, 6csn, 6atx, 6bpc, 6aac, 7lw, 7fs, 7ji, 7hg, 7lv, 7ku, 7oy, 7zz, 7wy, 7ww, 7dj, 7st, 7zz, 7zt. British: 2kf, 2od, 6ag, 5fi, gra, pci—pse qsl. New Zealand: NZ4ak, NZ4ak, qra? Porto Rico: 4io, 4jf, qra? Will qsl to any of the above or any who hear me.

Continued on Page 69

Tell them that you saw it in RADIO

Leading set makers use more Thordarsons than all competitive transformers combined. What better evidence is there that Thordarsons are best?

**ZENITH**  
**KENNEDY**  
**Radiodyne**  
**THERMODYNE**  
**ULTRADYNE**  
**MURDOCK**  
**OZARKA**  
*Pfanstühl*  
**MICHIGAN**  
**Deresnadyne**  
MALONE LEMON  
MASTER RADIO  
**ROYAL**  
*Howard*  
*Pathe*  
**HARTMAN**  
**AUDIOLA**  
**EAGLE**  
GLOBE AND  
MANY OTHERS

*Follow their lead*  
use  
**THORDARSON**  
Super  
**TRANSFORMERS**

Exclusive!  
THORDARSON SQUARE  
COIL LEAK-PROOF  
CONSTRUCTION

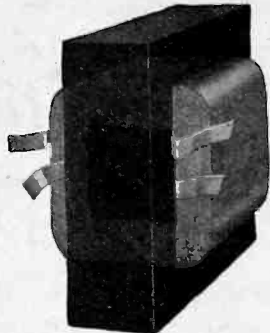

The Thordarson-made layer-wound SQUARE coil fits snugly around the square core. No air space between coil and core (exclusive!)—no lost energy, no lost volume (especially on low notes), no leaks from primary to cause howls in set. Oversize core provides 50% larger magnetic circuit—minimizes core losses, prevents oversaturation. No rivets or screws through core to cause short circuits or eddy current losses between lamination (exclusive!) Do you wonder Thordarson produces more transformers for more makers of quality sets than all competitors combined?

**Uniformity Guaranteed!**

Thordarsons run absolutely alike, absolutely uniform; always "match up" perfectly; always amplify evenly over the entire musical scale. Satisfaction unconditionally guaranteed by the world's oldest and largest exclusive transformer makers (transformer specialists for 30 years). For the finest amplification obtainable at any cost, follow the lead of the leading set makers—build or replace with Thordarsons. Audio Frequency: 2-1, \$5; 3½-1, \$4; 6-1, \$4.50. Power Amplifying, pair, \$13. Interstage Power Amp., each, \$8. Any store can supply you. If dealer is sold out, order from us.

Write for latest hook-up bulletins free!

**THORDARSON ELECTRIC MANUFACTURING CO.**  
*Transformer specialists since 1895*  
**WORLD'S OLDEST AND LARGEST EXCLUSIVE TRANSFORMER MAKERS**  
**Chicago, U.S.A.**

Australian Representatives: *Walart Electric Mfg. Co., Ltd., Sydney*

Send for Trial Subscription—\$1.00 for Six Months



**HERCULES AERIAL MAST**

20 Ft. Mast \$10  
40 Ft. Mast \$25  
60 Ft. Mast \$45  
All steel construction. Complete with guy wires and masthead pulley. We pay the freight.  
S. W. HULL & CO.,  
Dept. G6, 2048 E. 79th St.  
Cleveland, Ohio

Write for literature and FREE Blueprint

*DeForest License*



**HONEYCOMB COILS**

The Universal all-wave inductance. Back and front panel mountings. Send 25c for Super Het., R. F. and Honeycomb Coil Circuits and Complete Catalog.  
Chas. A. Branston, Inc.  
818 MAIN ST. BUFFALO, N. Y.  
DEPT. 12

**Exide**  
**RADIO BATTERIES**

"Built First. Coto -to Last"  
**INSIST ON THE SILVER PLATED AIR CONDENSER FOR YOUR RADIO SET.**

**THE RADIO FLIVVER**

*Continued from page 23*

full of a pale, amber fluid—all of which, he managed to explain, could be obtained for the paltry sum of five dollars.

"Bueno," he grinned, with a suggestive gurgling in his throat. "Bueno!" He rubbed his fat stomach unctuously.

Porky shrank back, horror-stricken.

"No! No!"—he chattered, and fled precipitately back to the flivver.

Dick heard his chum's rapid return, and sat up with awakened interest. But he slumped back as he saw no prospects of gas.

"Just running to get a little exercise," Porky explained apologetically.

"Humph!" Dick grunted without enthusiasm.

Porky resumed his seat on the fender and began dragging his feet about in the yellow dust—a sign, with him, of deep concentration.

"How far is it to town?"—he asked abruptly, after a few moments of dust-pervaded silence.

"Told you once," said Dick. "It's five miles."

"Well, I guess there's nothing else to do," Porky sighed sadly. "It'll take about two hours on this road."

"You can just leave the 'we' out of it," roared Dick suddenly. "You asked me to ride to town with you in your flivver, and I'll be hanged if I'm going to walk in just because you were such a donkey-headed boob as to forget to fill the gas tank. I stay right here in this seat, and you can walk all the way to New York for all I care."

He settled himself rebelliously on the rear cushion and began an exaggerated snore.

"Well," Porky rose reluctantly to his feet, "I guess it is kinda up to me for getting us into this mess. We could walk to town easy enough—but you don't want to. Ugh!" He sighed resignedly. "It'll be a lot of trouble, but I guess I'll have to telegraph in to the club. All the fellows will be listening for any amateur stuff they can hear to-night."

The snoring ceased abruptly.

"Telegraph?" Dick poked his head out savagely. "What the dickens do you mean—telegraph? Have you got a portable transmitter in your pocket?"

"Well—no," Porky admitted modestly. "But I have the car."

"Car!" Dick groaned wearily. "A lot of good it's doing you without any gas. Besides, it's not even a car—it's a flivver!"

"Just the same," Porky bristled, "that doesn't keep it from having as much radio material in it as any other car."

"Radio material?" Dick gazed at him solicitously. "Really, my boy, you'd better let me feel your pulse. Is your head feeling all right?"

"My head's working a darn sight bet-

*Continued on page 50*



# Thompson Radio



## an instrument worthy of great music

**N**OW that the mechanics of radio transmission have been brought to a high state of perfection, programs are getting better and better. Artists of world-wide repute are bringing their talents to the broadcasting studio. Completing the cycle of perfection is the Thompson receiver, which delivers these improved programs *precisely* as they are put upon the air.

The great operatic arias; the blended strings, woodwinds and brass of the symphony orchestra; restful chamber music; the foot-agitating rhythm of America's great dance orchestras; the natural voice of a great statesman — the Thompson brings them all in to you in the tones of realism. "Thompson Tone stands alone," music-lovers say.

### *Thompson has the background*

Behind the Thompson Neutrodyne is a radio and engineering background unmatched in the industry—fifteen years' experience in designing, developing and manufacturing intricate and delicate radio apparatus for the armies, navies and commercial institutions of the world. Add this to the Neutrodyne superiorities in general

and you have a receiving set that stands alone in the world of music.

In the Thompson Radio, range, volume and selectivity are likewise outstanding. These superiorities and Thompson Tone are what induced high-class music dealers and dealers in high-class radio and electrical equipment to seek the Thompson franchise. These dealers are glad to demonstrate the Thompson in your home, and to extend, if you wish, reasonable terms.

### *Distance with volume*

An unique transformer (an exclusive Thompson engineering feat) permits the use of six tubes in the Thompson Neutrodyne—an achievement heretofore confined to the laboratory. Distant programs that come in faintly (if at all!) on ordinary receiving sets are delivered with the volume of nearby broadcasts on the 6-tube Thompson.

Like the reserve power of the 90-horse-power automobile, the superpower of the 6-tube Thompson Neutrodyne is there when you need it. The 6-tube Thompson Concert Grand can be used with 6 tubes, 5 tubes or 4 tubes by merely moving a simple plug from one socket to another. Truly a power range possible with no other Neutrodyne on the market.

### *Three sets from which to choose*

The 6-tube Thompson Concert Grand sells at \$180. This is unquestionably the finest thing in radio today at any price. There is also the 5-tube Thompson Parlor Grand which sells at \$145. Thompson quality throughout, but with one tube less than the Concert Grand. Then there is the 5-tube Thompson Grandette which sells at \$125. This differs from the Parlor Grand chiefly in size and cabinetwork.

### *Arrange now for demonstration*

In the quiet of your home, free from disturbing influences, hear the Thompson Neutrodyne. The Thompson dealer will bring a set to your home and demonstrate it under operating conditions which any set you buy will have to meet. This will give you the opportunity to *let your ear decide*.

Radio programs are getting better day by day. To hear them at their best, you need the musical marvel of radio — the Thompson Neutrodyne. Arrange for the demonstration now!

R. E. Thompson  
Mfg. Co.,  
30 Church St.,  
New York.



# THOMPSON RADIO

The 6-tube Thompson Neutrodyne Concert Grand, \$180

The cabinetmaker's skill is revealed in the design and grace of every Thompson Radio. A thing of beauty that intrigues the interest of the most esthetic.

Thompson Speaker, \$28

To get best results from the Thompson or any other good receiver, use the Thompson Speaker. Extremely sensitive. Contains oversize magnet and coils, amplifying armature, diaphragm in scientific cone shape, and includes simple thumb-screw volume-regulator. Uses no battery current. For supremely natural home radio—the Thompson Speaker!

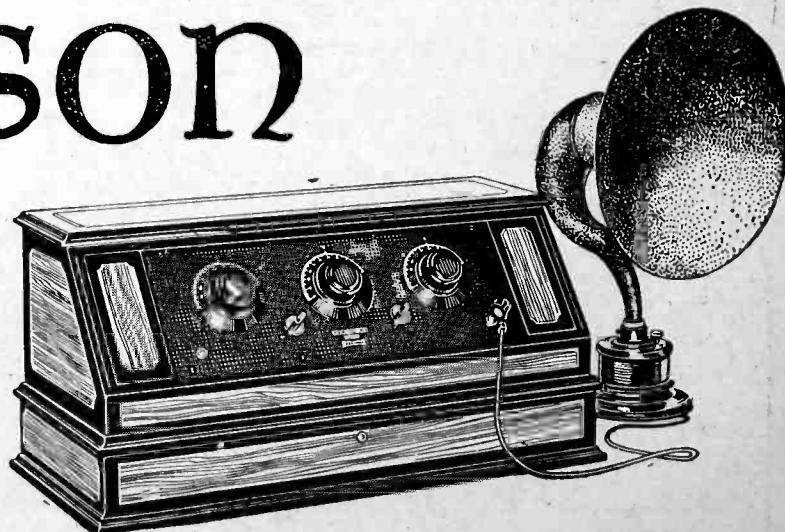

# Standardyne

## WILL DO THIS FOR YOU TOO!

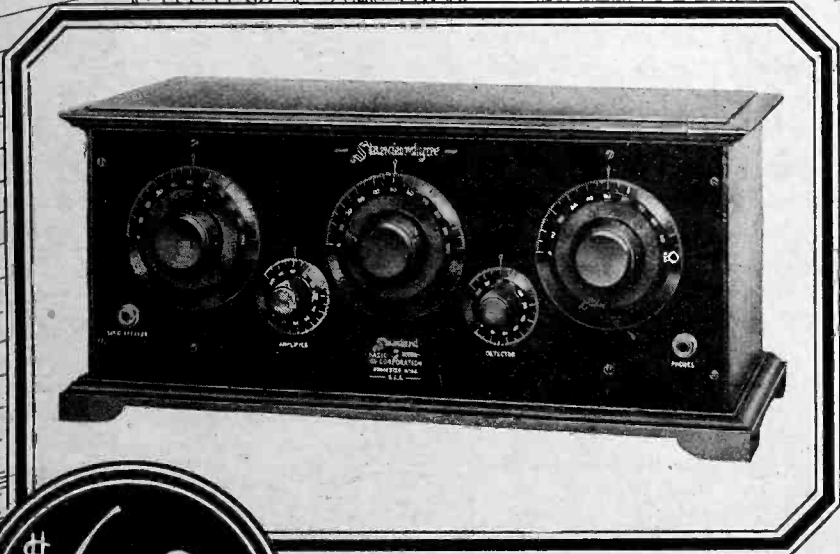
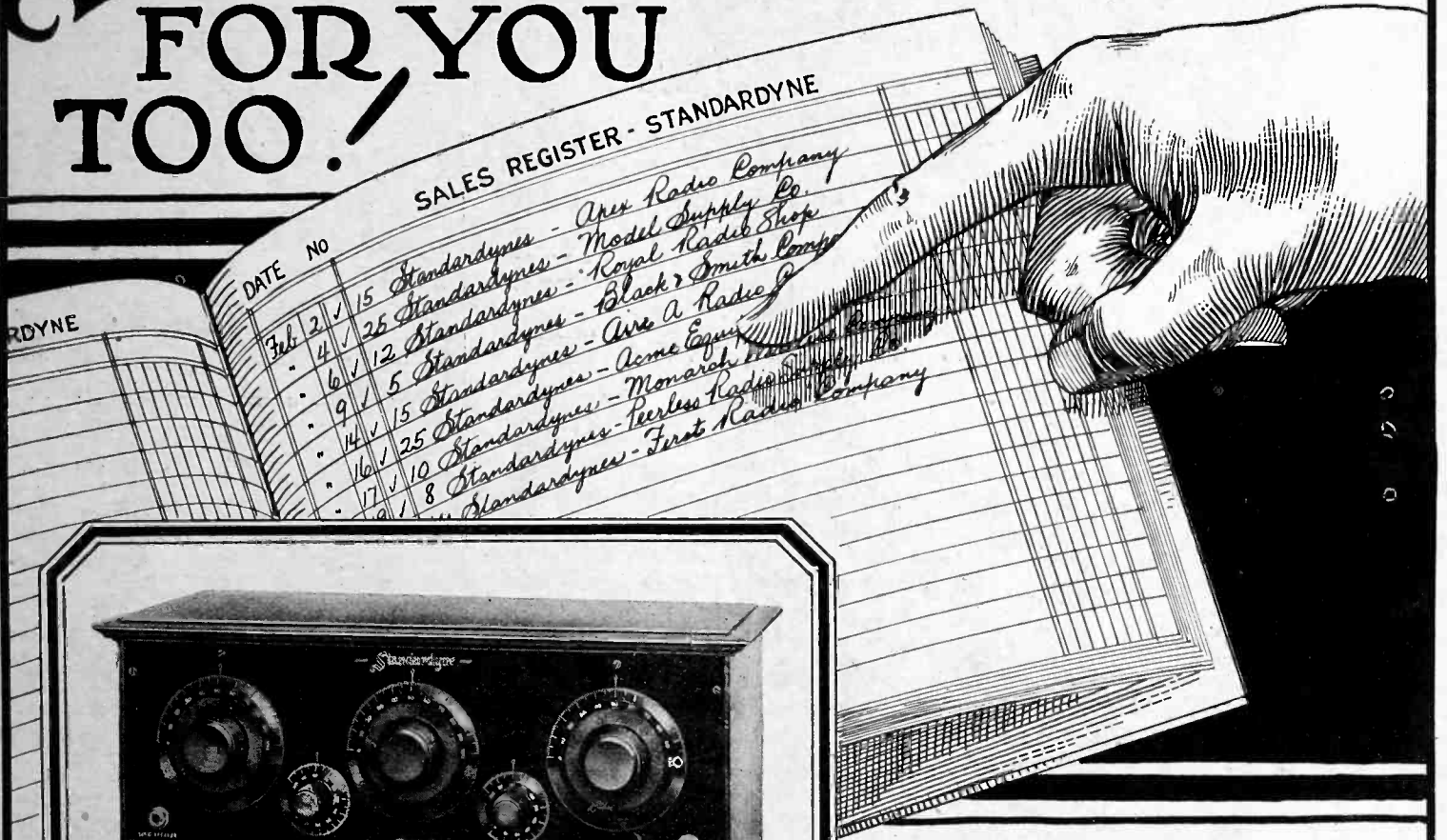

**\$60**

WITHOUT ACCESSORIES

### THE 5 TUBE RADIO FREQUENCY SET WITH FAMOUS RE-ACTED CIRCUIT

DELIGHTED owners of Standardyne Radio Sets all over the country look forward every night to the pleasure of listening to Far Distant Stations. And they are never disappointed.

Standardyne Distance Performance is always dependable.

That's why hundreds of Standardyne fans are added to the rapidly growing list of pleased owners each week.

These owners appreciate a set which couples with Dependable Distance Performance, rare beauty of cabinet design, complete lack of annoying distortion and noise, selectivity which eliminates the undesired station immediately, and volume clear and strong.

For information regarding distribution rights in your territory write us



Standardyne



The Standard Radio Corporation

41 Jackson Street  
Worcester, Mass.

Tell them that you saw it in RADIO

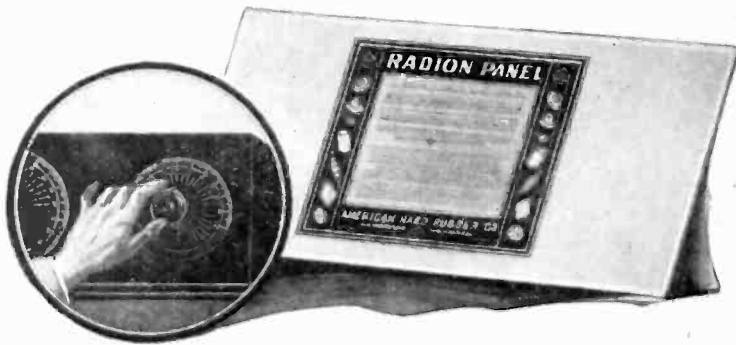

## “I selected it for its high insulating qualities—It cuts down the losses in the circuit”

THOSE were the exact words of a prize-winner in a radio set-building contest, when asked why he used a Radion Panel. Like thousands of others, he had found by experience that there is nothing quite like Radion for real results.

Our engineers developed Radion Panels especially to order for radio. Losses from surface leakage and dielectric absorption are exceptionally low. And low losses mean clearer reception, more volume and more distance.

**Easy to work—moisture proof—resists warping**

Radion is easy to cut, drill and saw. You need not have the

slightest fear of chipping. Radion resists warping. It's strong. It's moisture proof. It comes in eighteen stock sizes and two kinds, black and mahoganite.

Radio dealers have the exact size you want. The use of Radion by the manufacturers of ready-built sets is almost invariably a sign of general good quality in that set.

### Send for booklet, “Building Your Own Set”

Our new booklet, “Building Your Own Set,” giving wiring diagrams, front and rear views, showing new set with slanting panel, sets with the new Radion built-in horn, lists of parts and directions for building the most popular circuits—mailed for ten cents.

AMERICAN HARD RUBBER COMPANY

Dept. M5, 11 Mercer Street, New York City

Chicago Office: Conway Building

Pacific Coast Agent: Goodyear Rubber Company, San Francisco, Portland

# RADION

*The Supreme Insulation*

## PANELS

*Dials, Sockets, Binding Post Panels, etc.*

AMERICAN HARD RUBBER CO.,  
Dept. M5, 11 Mercer St., New York City.

Please send me your new booklet, “Building Your Own Set,” for which I enclose 10 cents (stamps or coin).

Name \_\_\_\_\_

Address \_\_\_\_\_

# RADIO INSTITUTE OF AMERICA

TRAINING IN ALL COMMERCIAL BRANCHES OF RADIO

If you cannot attend the Radio Institute of America in person the same instruction can come to you through our recently inaugurated “HOME STUDY COURSE”—Investigate.



Detailed information free on request.

Conducted by

THE RADIO CORPORATION OF AMERICA

28 Geary St.

Phone Garfield 4200

San Francisco, Calif.

98 Worth St.

Phone Franklin 1144

New York City

Continued from page 48

ter than yours,” Porky returned heatedly. “You would be willing to sleep in that seat the rest of your life if the only way you could get out was to use your brains—if you have any.”

Dick looked up at his usually reticent companion with a startled air.

“You don’t mean—Porky, you’re not going to try to build a radio set out of this car, are you?”

“Yes,” his companion snapped, “I am. That is, I’m going to build a transmitting set.”

“Transmitter!” Dick relaxed again with a sigh of pity. “A transmitter! I was afraid of it. This experience is too much for him—it’s affecting his mind.”

Porky turned an angry red.

“If you don’t shut up,” he threatened, “this experience is going to be too much for you, and something besides your mind will be affected. Get up from that seat and let me get the tools.”

Dick languidly rose and stretched himself out beside the road.

“Anything I can do for you?”—he inquired solicitously.

“Yes,” Porky mumbled from the lower extremities of the car where he was engaged in pulling out all the wires he could lay his hands on. “If you think you have a mind, you might try to rig up some kind of aerial. It ought not to be so very hard—you can use a piece of that barbed wire fence.”

He threw out a pair of pliers from beneath the car.

“You don’t need to bother about getting it up high,” he informed Dick. “I guess the fence posts are about as high as you would want to climb anyway. The main idea in making an aerial is to have a wire stretched in a fairly straight line and the insulation scraped off at one end.”

“Insulation? Umph!” Dick grunted sorrowfully. “Did the poor little radio inventor think that the barbed wire was insulated?”

Porky flung down a wrench with a crash.

“Look here you poor prune,” he shouted wrathfully, “have you got enough brains to make some kind of an aerial, or must I do it myself?”

“Sure! Sure!”—muttered Dick rapidly, astounded by his friend’s outburst. “I was only fooling!”

“Huh,” sputtered Porky, and crawled greasily back under the stalled machine.

A few minutes later Dick returned to the car, pulling behind him one end of a strand of barbed wire. He found Porky busily sorting over a curious array of material which he had piled on the running board. At one end was a stack of various connecting wires evidently obtained from the ignition system; next to those, the coils from the inductance box; then came three drycells; last of all was

Continued on page 52

# Ensign

## VARIABLE CONDENSER

### A New Idea in Condensers!

The ENSIGN is a totally DIFFERENT condenser. It is built on an entirely different principle. It leaves the beaten path of the rotor type. It avoids the pitfalls of high resistance which all the so-called "Low-Loss" types cannot escape entirely from. It electrically is perfect. It mechanically is perfect. It is the first and only condenser with an absolute STRAIGHT WAVE line from zero to 360 degrees. It is the first condenser with a real MINIMUM capacity. It is the first and only condenser with losses really so low they cannot be measured. This exceptional efficiency means a condenser that finds and brings in stations no rotor type condenser can equal. It means ease of tuning. It means distance, volume and clarity you cannot get from old-fashioned condensers. It means a condenser so PERFECT in electrical efficiency it can be used on Low Wave sets with the same ease and success as on broadcast station sets.

### How the Ensign is Made

The ENSIGN plates are SQUARE. The grounded movable plates (rotor on usual type) slide back and forward but do not REVOLVE. They mesh with the stators by sliding into and between the stators. They do this *cornerwise*. (See illustration at right.) There always is a SQUARE of varying size in the intersected area. The increase or decrease of capacity must always be geometrically CORRECT and EXACT. This factor gives the ENSIGN its straight WAVE line. This straight wave line starts at ZERO and continues throughout the range of the condenser, spacing the wavelength divisions evenly over the entire dial of 360 degrees. Not only is this a desirable factor in tuning in broadcasting stations of the usual wavelengths from 200 to 600 meters, but you can use the lower wavelengths down to zero on the same straight wave line, if you care to experiment with the low waves this summer. This factor also is of immeasurable value to the amateur code operator. It gives him his first really efficient condenser for his work.

Electrically the ENSIGN is the most perfect condenser on the market. The plates are firmly SOLDERED AT THREE POINTS. This means rigidity and absolute insurance against warping and shorting. There are only TWO points of insulation. These are on the stator plates. (See illustration at top.) These posts are of hard rubber and because of the minimum amount of dielectric, removed from the field of the condenser, the lowest possible losses are obtainable. The ordinary condenser ranges from a maximum of 500 M. M. F. down to about 16 M. M. F. The ENSIGN Condenser ranges from 500 M. M. F. down to approximately 3 M. M. F. This gives a range in wavelength of over fifty meters greater than the average condenser in any given set.

There is no need of a vernier arrangement on the ENSIGN. The ENSIGN dial is of 360 degrees instead of 180 degrees, and the rack and pinion movement of plates enables the operator to separate each station easily and quickly. There are no levers to pull and yank and no extra knobs or dials to twist and adjust. There is no crowding of stations at any one point on the dial. All are distributed evenly and it is a pleasure to tune the ENSIGN.

These Coast Jobbers Carry Ensign Condensers:

RADIO SUPPLY CO.

920 So. Broadway, Los Angeles, California

W. E. & W. H. JACKSON

865 Mission Street, San Francisco, California

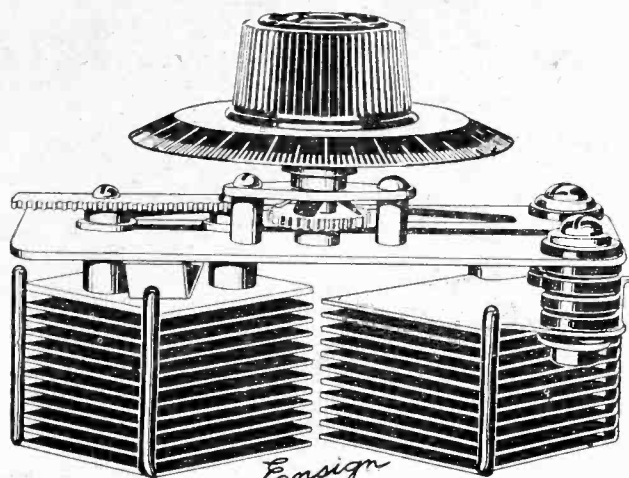

PATENT PENDING VARIABLE CONDENSER ALL RIGHTS RESERVED

Side view of ENSIGN Condenser, showing it open, set a minimum capacity. Note rack and pinion movement of plates. This view gives an excellent idea of its construction and operation and will enable one to visualize how efficiently we have accomplished the seven objects outlined in this advertisement and for the first time have given you all you could ask for in any condenser.

#### PRICES:

14 plates, 250 M.M.F. \$4.50  
19 plates, 350 M.M.F. \$4.75  
25 plates, 500 M.M.F. \$5.00

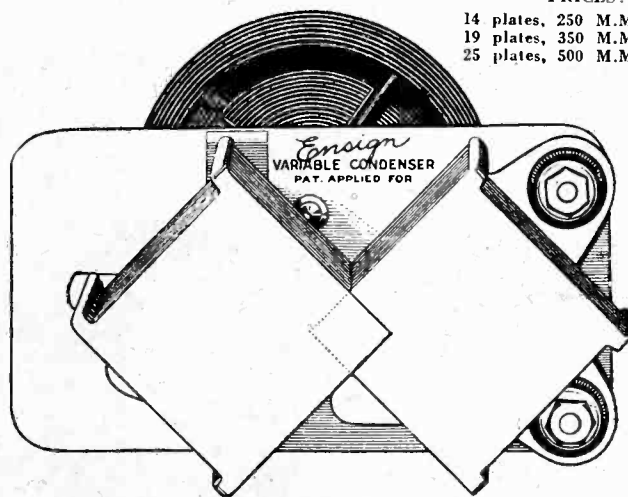

Bottom view of condenser with plates partly closed. Note that one set of plates slides into the other set cornerwise and do not rotate. As visualized, there is always a square of varying size in the intersected area. The increase or decrease is always geometrically exact, spacing the wavelength graduations evenly over the entire dial.

### Seven Features

- 1 An absolute straight line condenser from one end of dial to the other.
- 2 Has lowest minimum capacity of any variable condenser.
- 3 Has lowest losses of any condenser at any price.
- 4 Uses entire dial and insures ease of tuning not obtainable by any other condenser.
- 5 Construction absolutely prevents warping or shorting of plates.
- 6 The most sturdily built variable condenser on the market. You won't have to worry about it breaking down under the most strenuous use.
- 7 Has One-Hole Mount. May be mounted sidewise or vertically and takes up less room than other condensers.

Distributed in the West by

**BALDWIN-PACIFIC & CO.**

Pacific Building, San Francisco, Calif.

Manufactured by

**CARLETON SANDERS**

Mishawaka, Indiana

# Attention ~ Set Manufacturers!

Our Special "Selector" Variable Condenser With Self-Balanced Coils Attached Is the Equipment You Have Been Waiting For---at a Price You Can Afford to Pay

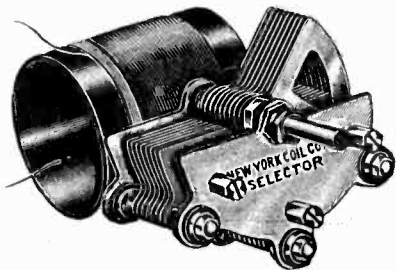

Condenser and Transformer as shown, list price **\$3.75**

To enable you to successfully manufacture a five tube, popular priced radio receiver consisting of two stages of tuned radio frequency, detector and two stages audio, combining selectivity, volume, true tone, distant reception and simplicity.

Our "SELECTOR" Low Loss Grounded Roter Variable Condenser, "The Manufacturer's Special," answers the demand for a ruggedly constructed efficiency instrument at an exceptionally low price.

List Price \$2.75	.0005	(23 Plate)
List Price \$2.50	.00035	(17 Plate)

**Get manufacturers price and descriptive literature**

New York Precision Mica Fixed Condensers---Choice of Leading Manufacturers and Radio Engineers. All Capacities. Price, 35c-75c.

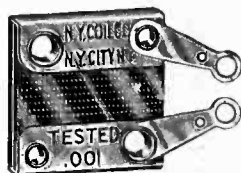

## NEW YORK COIL COMPANY

338 Pearl Street, New York City, N. Y.

*Pacific Coast:*

**MARSHANK SALES COMPANY**

926 Insurance Exchange Bldg., Los Angeles, California  
Also San Francisco and Portland

## PROFESSIONAL SET BUILDERS! and dealers who build sets

**WE** will shortly begin a series of newspaper advertisements, featuring the work of individuals and dealers who build sets using Cardwell Condensers.

If you build to specification or from original design, it will be to your interest to communicate with us immediately.

Ask for details of plan. Be sure to give name of your jobber.

ALLEN D. CARDWELL MANUFACTURING CORP.  
81 Prospect Street, Brooklyn, N. Y.

*Continued from page 50*

a pile of little thin metal strips which Porky had reaped from somewhere with no evident benefit to the internal mechanism of the car.

Dick laid down the end of the barbed wire, gingerly.

"There's your aerial," he snorted. "It reaches over to that post." He neglected to state that it probably reached much farther than that. The barbs were so sharp, and the wire was so tangled that he had not bothered to cut it loose from the rest of the fence.

He gazed skeptically at Porky's motley array of material.

"What are you going to do with all that junk?"—he inquired.

"I told you I was going to make a transmitter," replied Porky coolly.

"Yes?"—grunted the other boy insolently, sweeping the contents of the running board with a scathing glance. "How in thunder do you think you can run a transmitter tube with three dry cells?"

"Transmitter tube?" Porky roared with amazement. "Why, you undergrown ass, do you think I'm carrying transmitter tubes around in my pocket for emergency?"

Well, if you haven't any tube, then how can you make a transmitter set?"—Dick yelled triumphantly.

"Well—I'll be darned!" Porky mopped his greasy brow weakly. For a moment he stood there uncertainly, then he raised his eyes upward, at the same time pointing an accusing finger at his rotund chum.

"Behold, Oh heaven," he pronounced, "a licensed amateur radio operator who has never heard of a spark transmitter!"

Dick flushed angrily.

"Shut up, you skinny boob," he growled. "Of course I've heard of spark sets. But they're harder to make than tube transmitters—they have whole rows of switches and condensers and things."

Porky looked at him scornfully. "That's what comes of letting all you young idiots have a license just because you learn to pound off a few letters in code. A lot of 'switches and things'"—he snorted disdainfully. "If you wait about ten minutes you will see one that hasn't a lot of switches and things."

Once started on his constructional operations, the lanky radio ham was a rapid worker. First, he hooked the dry cells to one of the spark coils and tested it until he got a strong spark from the output terminals. To these terminals he connected pieces of wire which, in turn, were connected to two pieces of flat strip metal. The two strips, when placed close together, formed a crude spark gap. With two other strips he contrived a makeshift key which he included in the circuit.

Thus, by pressing down on one of the

*Continued on page 54*



# What the Trirdyn gets where it's hotter than Summer!



Crosley Trirdyn—on the Sahara Desert at mid-day—brings in Radio-Paris on the loud-speaker!

only at mid-day, but in February—in Northern Africa and far hotter than any American summer.

The picture above, a post card snap shot sent from Tunis to Mr. Crosley, by D.F. Keith of Toronto, Ont., tells this story on the other side:—

Tunis, North Africa, March 3, 1925

Dear Mr. Crosley:

Fishing here is rotten but radio is fine. On the Sahara, using three tubes on the Trirdyn circuit, reception from Paris came through on the loud-speaker. Along the south coast of the Mediterranean, using this set, six or eight high power European stations came in with good volume by day-light and all of them after dark. Can you usually get a few American after 1 a. m. Can you fish with us this year?

Cordially,  
(Signed) D. F. Keith

Further details on the margins of the picture:—

Sahara Desert, 250 miles south of Algiers, February, 1925. Receiving noon-day concert from "Radio-Paris", Paris, using aerial and counterpoise.

Who said summer in America is a poor time for radio—if the receiver is a Crosley Trirdyn? Every radio fan—actual and aspiring—is invited to think this over and then act.

On the Trirdyn is the beautiful new Crosley Musicone, radio's most startling development. The Musicone's abilities and its beauty are so superior that we expect it to replace half a million loud-speakers this year. \$17.50.

The Crosley Radio Corporation, 519 Sassafras St., Cincinnati  
Powel Crosley, Jr., President

# CROSLEY RADIO

## Better~Costs Less

**\$65<sup>00</sup>**  
Accessories Extra

**Crosley Trirdyn Special**

Three tubes better the results of five or six

A highly efficient, non-radiating combination of tuned radio frequency, Armstrong regeneration and reflexed amplification.

New cabinet, sloping panel  
Battery self-contained  
Exclusive Crosley 3-tube circuit



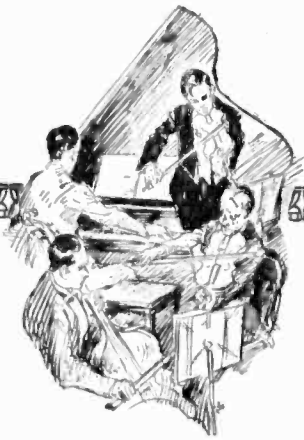

## Do You Hear Each Instrument Distinctly?

With the unique design of Rauland-Lyric comes a peculiar excellence. There is brought before you, as a noted critic remarked, "the very personality of each artist", as he explores the resources of his instrument. Such a quality, indeed, as to render insignificant, in any radio set, the added cost of Rauland-Lyric Amplification.



Rauland-Lyric is a laboratory-grade audio transformer designed especially for music lovers. The price is nine dollars. Descriptive circular with amplification curve will be mailed on request. All-American Radio Corporation, 2654 Coyne Street, Chicago, Ill.

**Rauland-Lyric**  
AN  
**ALL-AMERICAN**  
TRADE MARK  
**TRANSFORMER**

The Choice of Noted Music Critics

Continued from page 52

strips, it came in contact with the other and a buzzing, purple spark crackled across the spark gap.

"Huh! That much of it works," admitted Dick grudgingly.

Porky measured with his eye the distance to the post where the aerial led.

"That ought to give us a low enough wavelength," he muttered.

He hooked on the barbed wire aerial to one side of the spark gap, and with a short piece of wire grounded the other side to the chassis of the car.

"I guess that's all," he said quietly.

He tapped off a few preliminary buzzes to get his finger used to the awkward key, then sent out a brisk attention call.

"Call 6PUG—that's the radio club," Dick suggested.

"Umph!"—grunted Porky. "I thought you said that this thing wouldn't work."

"Who says it is working," retorted Dick. "But you can't tell but what some ham a couple of blocks away might hear you."

"Couple of blocks!" Porky glared at him. "If you think there's somebody living about a couple of blocks from here, why don't you go borrow some gas from them?"

"Go on," commanded Dick sourly. "You better get busy with your ticker. I'll get one of the seats out of the car so you can spend the night in comfort. You can tick away to your heart's content—or until the batteries run out."

"Huh," grunted the lanky youth. "I guess these batteries will last a darn sight longer than they're needed."

"Yeh! I suppose we'll both be dead before morning."

Porky gave another contemptuous grunt, and laying his finger on the improvised key he sent a series of dots and dashes crackling across the gap. Dick sat up suddenly.

"Hey, you fool," he yelled. "What do you think this is—a shipwreck? Sending out an SOS call! You'll have everybody in the U. S. looking for a sinking ship loaded with screaming women and children!"

"Thanks." Porky nodded toward his chum with a gratified smile. "So you really think my little set can be heard all over the U. S.?"

"Heard all over a cow lot," retorted Dick scornfully. "But you don't need to make a fool of yourself out here in this desert even if no one is listening. Start sending your message to the club, if you are going to."

"All right," Porky nodded seriously. "I guess I ought to have a short message—one that I can repeat over and over." he knitted his brows thoughtfully.

"How's this," his companion offered. "Stalled on way to town. Bring tow car. Dick and Pork."

Continued on page 56

Balkite Battery Charger. Charges 6 volt "A" storage batteries.

Price \$20  
East of Rockies \$19.50  
In Canada \$27.50

Balkite "B"—replaces "B" batteries and dry cells. Operates from light socket.

Price \$55  
In Canada \$75



## An unfailing power supply for both circuits

Here at last is an unfailing power supply for your radio set. Balkite Radio Power Units furnish constant uniform voltage to both "A" and "B" circuits and give your set greater clarity, power and distance. The Balkite Battery Charger keeps your "A" storage battery charged. Balkite "B" replaces "B" batteries entirely and furnishes plate current from the light socket. Both are based on the same principle, are entirely noiseless and are guaranteed to give satisfaction. Sold by leading radio dealers everywhere.

FANSTEEL PRODUCTS CO., Inc.  
North Chicago, Ill.

PACIFIC COAST DISTRIBUTORS  
Seattle, George H. Maire, 95 Connecticut St. San Francisco, A. S. Lindstrom, 274 Brannan St. Los Angeles, Lombard J. Smith, 324 N. San Pedro St. Portland, H. A. Killam, 146½ N. 10th St.

FANSTEEL **Balkite** Radio Power Units

BALKITE BATTERY CHARGER  
BALKITE "B" PLATE CURRENT SUPPLY

New LeFAX RADIO HANDBOOK—\$2.00

(Seventh Edition)

in bound form. For sale by "RADIO," San Francisco

**RADIO CATALOG**  
**AND HOOK-UPS FREE**

Get great new catalog, fresh from the press, including the very latest set in complete coils, parts and accessories. 250,000 customers testify to our wonderful service and reliability. Complete instructions and programs for making the most practical popular sets. **FREE! SEND QUIC!** (Get your own.) Names of friends who are interested in Radio.  
**THE BARAWIK CO.**  
Dept. 115 23-49 So. Clinton Street Chicago

# THESE PARTS GIVEN FREE!

## Some Worthwhile Premium Offers for Getting New Subscribers to "RADIO"

You readers of "RADIO" who buy copies from news dealers are offered a free premium if you subscribe for one year. You save money on the magazine and get a premium besides. You who know this magazine are best qualified to tell others how it will help them to an intelligent understanding of radio. As a reward for your efforts in so doing, the publishers of "RADIO" offer you a selection of parts, one or more of which are needed by every set builder. Every conversation about radio always gives a chance to talk about "RADIO." Any one of these parts will be given as a premium. Your own subscription counts, of course. Or you can extend your subscription for another year and get one of these premiums.



### This Transformer Given Free!

The illustration shows the REGAL audio transformer, given free with only two subscriptions to "RADIO" for one year each or one subscription for two years. Full price, \$5.00.



### FREE PHONES

"Pennsylvania" 2000 ohm head-set as shown. Free with two subscriptions for one year or one subscription for two years. Full price, \$5.00.

LOOK

The following premiums are also offered. You have your choice of one of the following with only one subscription for one year, \$2.50:

- Three 199 Sockets
- Radio Log Book
- Radio Map of the U. S.
- Lefax Radio Handbook

USE THE  
COUPON  
MAIL IT  
NOW!

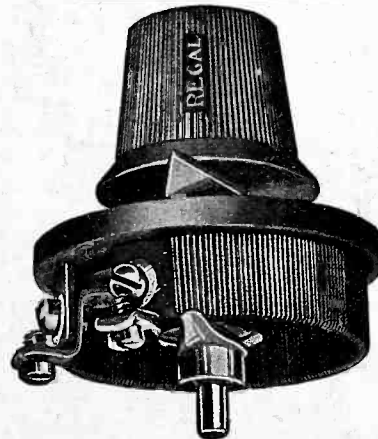

### RHEOSTATS FREE!

Latest REGAL rheostats, complete with bakelite knob as shown. Two of these rheostats free with one subscription for one year. State whether 6 or 30 ohm type wanted. Full price of this great offer only \$2.50.

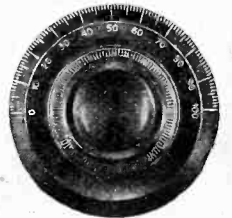

### DIALS

4-inch bakelite dials with 1/4" shaft hole. Three of these dials free with only one subscription for one year. Full price, \$2.50.

### Condensers Given Free

23-plate high grade variable condenser given free with one subscription for one year. Full price, \$2.50. You can't beat this great offer.

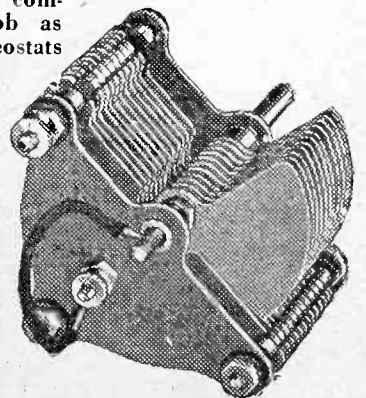

**DON'T DELAY.** Get your order in the mails right now and get double value for your money.

"RADIO," Pacific Building,  
San Francisco, Calif.

Herewith is \$....., for which you will send "RADIO" for.....years to the person whose name appears below. In addition to the subscription, you will also send the following premium, absolutely free of charge to:—

Name.....

Address.....

City and State.....



## This NEW Super-Horn

Brings Magic Clearness to Radio

The new Kellogg *Symphony* Reproducer is a new-type horn recently developed by our experts—based on the magnetic diaphragm principle.

It brings to radio a marvelous tone-quality, a beauty you have never heard before. Attaches to any set and can be adjusted for the particular "volume" requirements of the set.

At all radio dealers. Ask for it by name. See it, hear it—compare!

## KELLOGG SWITCHBOARD & SUPPLY COMPANY

Chicago, Ill.

**KELLOGG**  
Symphony  
Reproducer

With Every  
Kellogg  
Radio Part,  
Use—  
Is the Test



Price  
**\$20**

## "B" BATTERIES

AN  
**EVEREADY**  
PRODUCT

At Standard Prices

43V. Batteries, tinned  
22½V. Batteries, Navy Type  
22½V. Batteries, Commercial Type

Latter two types especially adapted to  
Cunningham and Radlotron Tubes.

Postage Prepaid Anywhere in U. S.

**ETS HOKIN & GALVIN**

Wireless Engineers

10 Mission Street San Francisco

## Every Radio Fan should have this Book

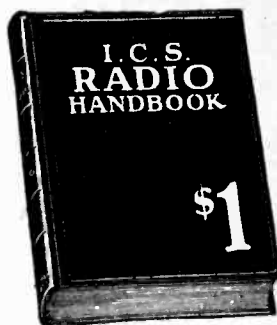

JUST OUT  
514 PAGES

Compiled by  
**HARRY F. DART,**  
E.E.

Formerly with the  
Western Electric Co.,  
and U. S. Army In-  
structor of Radio.  
Technically edited by  
F. H. Doane

**NO MORE** need you turn from book to book, hoping to find what you want. It is all here, in 514 pages crammed full of every possible radio detail. Written in plain language, by engineers for laymen. More than 100,000 sold.

**IT EXPLAINS:** Electrical terms and circuits, antennas, batteries, generators and motors, electron (vacuum) tubes, many receiving hook-ups, radio and audio frequency amplification, broadcast and commercial transmitters and receivers, super-regeneration, codes, etc.

Send \$1 today and get this 514-page I. C. S. Radio Handbook—the biggest value in radio today.

International Correspondence Schools  
Box 8262-C, Scranton, Penna.

I enclose One Dollar. Please send me—post-paid—the 514-page I. C. S. Radio Handbook. It is understood that if I am not entirely satisfied I may return this book within five days and you will refund my money.

Name.....

Address.....

Check here  and enclose \$1.50 if you wish the de luxe edition, bound in Leatheroid.

## ANTENELLA

No Aerial or Antenna Needed

The Complete  
Efficient and  
Economical  
Aerial



Why pay \$10 Only \$1.25

or more to have an aerial spoil the appearance of your home? Antennella eliminates all unsightly wiring, lightning arresters, etc., and precludes the possibility of dangerous grounding on a power line. It also stops "canary bird" re-radiation from nearby oscillating sets interfering.

**ANTENELLA**

is not only a real distance getter, but also overcomes troublesome static.

At your Dealer, otherwise  
send purchase price and you  
will be supplied postpaid.

**Chas. Freshman Co. Inc.**  
Radio Receivers and Parts  
FRESHMAN BUILDING  
240-248 WEST 40TH ST—NEW YORK, N.Y.

## ARE YOU A SUBSCRIBER?

Send for Trial Subscription

\$1.00 for Six Months

Tell them that you saw it in RADIO

Continued from page 54

The radio mechanic glared at him. "That's not my name," he shouted.

Dick grinned maliciously.

"Do as you like," he said magnanimously. "Make it Clarence Archibald Brown. It's the name your folks gave you so I guess you have a right to use it."

Porky snorted, then hunched over and began pecking at his key. For thirty dusty minutes there was no alien sound to disturb the silence of the oncoming night except the spitting crackle of the bluish spark leaping across the gap. At the end of thirty minutes there was an alien sound—a sound coming from the direction of town.

It was not the pulsing roar of the low-slung racing car which comes throbbing around the corner in the second chapter of a love story—it was at first merely an irritating, scratching chug which rapidly assumed the popping sound of a machine gun into which cartridge belts are being fed with occasional cartridges missing.

By the time the sounds had penetrated Dick's ears, they were accompanied by a regular series of varied clanks and rattles which betrayed, even at that distance, the approach of another mechanical beast of burden. Dick sat up with a somewhat shamefaced expression on his face.

"That's Jake Peter's old tow car all right. Maybe your old spark plug sender did do a little good."

"Umph!"—responded Porky, beginning to pull apart the connections of his improvised means of communication, and throwing the whole jumble indiscriminately into the back seat. Finally he cast off the barbed wire aerial and climbed into the front seat with Dick.

"Now don't start any of your witty conversation with Jake," he warned his chum sourly. "He's not so sweet tempered as I am and he's likely to heave off the tow rope and leave us stranded half-way to town if you make him sore. And the next time, you can bet your fat neck I won't stay with you and telegraph for aid—I'll walk!"

"I—I won't," gurgled Dick ambiguously.

In silence they watched the rattling car approach, turn around, back up to their front wheels, and stop. A little squat man, clothed inclusively in a pair of grease covered coveralls and a shapeless cap dismantled from the front seat, extracted a worn tow rope from the tool box, and coupled the stalled machine to his own aged vehicle with a few deft knots. Not until he had completed his task did he make an endeavor to discover the identity of the car's occupants. When he did, he swore convulsively.

"I only wish that I had knowed it was ye two young devils which need towin' in," he roared.

"Why?"—asked Dick, disregarding the kick Porky gave his shins.

"Why? Ye blitherin son of a flea bitten sea wolf! If I had knowed it was ye two worthless apes do ye think I would have shook all my bones apart ridin' over this god-forsook road to pull ye into town?"

He looked at the rope as if half determined to untie it, but finally climbed back into his seat, puffing and blowing with wrath like an angry little pig.

A half hour later they jangled into the garage. From the rear of the shop sounded a telephone bell's insistent ringing. Without a word to the boys, Jake got out and hurried over to the phone.

"Let's go on over to the club," Porky said as he stretched his lengthy legs. The fellows will just be beginning their long distance work."

"What about the flivver," Dick asked.

"Leave it alone," said Porky shortly. "We can stay with one of the fellows all night."

Suddenly it became apparent that there was some unpleasant news being communicated to Jake over the phone. His voice had been at first merely a shrill bark. Now it had risen to a high scream.

"Didn't tow in the right car—been waiting an hour—clear over by Brown's ranch—" He broke off with a tremendous explosion of rage, slammed the receiver against the wall—and came charging toward the two boys.

"Ain't you the two fellows that called up and said you had burned out about and waived his fists frantically. about and waived his fists frantically.

Porky gazed at him, astounded.

"W-why no. We just telegraphed in to the radio club and—"

"Telegraphed—blah!"

The garage man let out a muffled grunt of fury and grabbed up the first thing his eye happened to fall on—a heavy wrench.

"Let's go!"—said Porky suddenly. The wrench hit the wall where they had been standing—but they were already on the other side. Simultaneously, and with no appreciable lapse of time, they turned the corner a block away. Even in their hasty departure, Dick could not repress a triumphant taunt.

"Now what do you think of your 'radio flivver'"—he inquired sarcastically, as soon as he could get his breath comfortably. "Some fellow got stalled and called up the garage, and then Jake comes along and mistakes us for him and tows us in. Lot of good your telegraphing did!"

"Shut up," said Porky dangerously. "Who was the fellow who never heard of a spark transmitter?"

"Who was the one who thought he could make one—and couldn't," croaked Dick quickly.

"Huh!"—grunted Porky. "Huh!"—and lapsed into a dark blue, dignified silence.

# It's Out!

A new, complete manual on  
the 45,000 cycle super-  
heterodyne — **\$1.00**

**SAVE  
\$1.50**

A most remarkable introductory offer. The book sells for \$2.50. The special introductory price is only \$1.50—good only for 60 days.

Truly a great publication. A complete instruction manual containing numerous detailed articles on the construction of various types of 45,000 cycle superheterodynes. Many graphic illustrations; full page perspective photographs; extremely simple methods of wiring and layouts; helpful hints on construction and the complete data needed for building both dry and storage cell types of sets. You can hardly afford to be without a copy of this book. It's worth many times the price.

**SPECIAL INTRODUCTORY PRICE,  
ONLY \$1.00 POSTPAID**

The coupon saves you \$1.50. All orders received during April and May will be filled at the special \$1.00 price. Then the price goes up to \$2.50. We anticipate a heavy demand for this book. Better get your order to us today. Attach check, money order or a dollar bill to the coupon and mail it now!

"RADIO," Pacific Bldg., San Francisco, Calif.

Here is \$1.00. Immediately send me a copy of the new Superheterodyne Manual, regularly selling for \$2.50.

Name.....

Address.....

**Make  
\$100  
a Day**

**FREE INSTRUCTION TELLS HOW**

Many Sales Are Half Profit When you sell our nationally advertised radio sets and supplies. We Guarantee your success, under the "Gould Plan," by allowing you to return goods which you do not sell. It would pay you to get our price list and free instructions Write for it.

How To Sell. Federal Radio Co. 100 East 13th St. Kansas City, Mo.

**"COMO DUPLEX"**

The World's Standard Push-Pull Transformer, \$12.50 per pair. Send for descriptive literature. COMO Apparatus Corp., 448 Tremont St., Boston, Mass. Washington and Oregon Representative

C. E. GAY

166 Lowndale St., Portland, Oregon

See the New! - - - -

**MONTROSE LOW LOSS  
CONDENSER \$2.50**

A new efficient condenser at a new low price. 23 plate, cap. .0005.

UNITED RADIO LABS. of the Montrose Mfg. Co. 1333 Fulton St., Brooklyn, N. Y.

**Wire-Nuts for joining**

radio antenna and lead-in wires in one minute without solder, tape or tools.

Many other uses. A million perfect joints have already been made with these new Wire-Nuts.

Listed by Underwriters' Laboratories. Booklet free. Ask your dealer for Wire-Nuts.

We will send 3 Wire-Nuts post paid on receipt of 25c. R. TORK COMPANY, 8 W. 40 St., New York

Send for Trial Subscription—\$1.00 for Six Months

# The Adventures of BURGESS RADIO BATTERIES

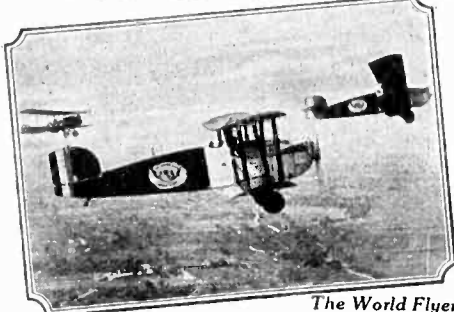

The World Flyers  
Carried Burgess

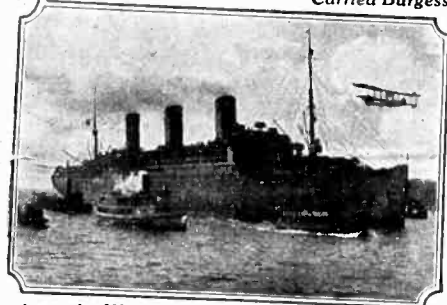

They're in the Wireless  
Room of the Leviathan



U. & U. Photos.

Standard Equipment of  
United States Submarines

Remarkable are the adventures of Burgess Radio Batteries. And where there's danger—upon, above or below the earth, sky and sea, will be found Burgess Batteries—laboratory products.

"Ask Any Radio Engineer"

**BURGESS BATTERY COMPANY**

Engineers DRY BATTERIES Manufacturers

Flashlight - Radio - Ignition - Telephone

General Sales Office: Harris Trust Bldg., Chicago

Laboratories and Works: Madison, Wisc.

In Canada: Niagara Falls and Winnipeg



Eventually the two boys reached the house where a select number of hams held weekly sessions of the radio club. Porky opened the door reverently and tiptoed across the room toward the group of tense, strained faced boys who were packed about a horn from which issued a reedy, far-away whisper.

One of the boys looked up as Porky and Dick entered.

"Gosh!"—he breather, awedly, "three thousand miles!"

Dling-ding-dling. The telephone in the corner set up a discordant racket. With a unanimous groan of disgust everyone turned and glared at it.

"I'll answer it," said Porky, and they all turned back to the squeaking voice.

Porky took down the receiver, went through the customary form for beginning a telephone communication, then began to listen. At first he was unconcerned; then his face showed interest, which in turn gave way to blank amazement. A moment more, and it was clear that he was in the throes of several emotions. Suddenly his face went white, and he made a grab at the wall to steady himself.

"N-no!"—he chattered into the phone, evidently in answer to a question. "They aren't—that is, we don't know anyone by those names!"

He replaced the receiver on the hook and stumbled toward the door, motioning for Dick to come.

"Do you know who that was," he choked, as soon as they were on the porch.

"How could I know," responded Dick insolently. "Aren't you the only one who knows anything about telephony?"

Porky gritted his teeth with rage.

"Well, I'll tell you," he shouted.

"That was the government operator at that station a hundred miles up north. He wanted to know if you and I were here."

"You and I?" Dick's jaw dropped in astonishment. "What the dickens did he want to—"

"He wanted to get us into a mess," snapped Porky.

"Mess?" Dick was shaken out of his usual nonchalance with a jolt. "W-what have I been doing about radio to make him want—"

"Yes! What have you been doing!"—Porky yelled. "If you had a little brains you would have been learning something about it!"

"And I suppose the government operator called you up to tell you that," Dick sneered.

"No. He was looking for some fellows—us to be exact—and he was getting all primed to take away our licenses. He said that about an hour ago some young fools began sending a message to 6PUG about being stalled on some road to town. They were clear off the amateur wavelength, on his government wavelength, and they came in so strong

# FREE DIALS

Get 3 Four-inch

Bakelite Dials positively free. Send us your subscription to "RADIO" for 1 year (\$2.50) and we will mail you 3 four-inch dials as a premium.

"RADIO," San Francisco

## MATHISON'S POLAR CRYSTAL

Mined North of the Arctic Circle

Gives sharper tuning, more volume and longer life. A solid, sparkling silver ore, not "doped" or coated. The most sensitive radio crystal in the world. A postal card brings you one. Price each.....85c

MATHISON SILVER ORES CO.  
OF ALASKA

American Agents

Radio Owners Service Co.

660 Twelfth Street, Oakland, Calif.

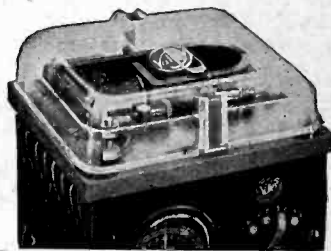

## For All Batteries

### Valley Battery Charger

For 2-volt peanut tube cells, for 6-volt A batteries and for 24-volt B batteries in from one to four units, the Valley Battery Charger is the only charger which you need.

Plugs into the ordinary light socket like a fan or other household necessity. Just as easy to operate. Takes about a dime's worth of current to bring your battery up to full charge.

Quiet in operation.

Full 6-ampere charging rate.

No liquids. No bulbs.

It has a grained and engraved Bakelite panel which harmonizes with any radio set. Clear glass top shows the simple, patented working parts at all times. Scientifically planned and substantially made by experienced manufacturers of storage battery charging equipment.

At radio dealers everywhere. Further information gladly furnished on request.

## Valley Electric Co.

Rialto Bldg., San Francisco

Tell them that you saw it in RADIO



**The Famous Truly Portable  
TELMACO P-1 Receiver**

*Four Tubes Do the Work of 7*

Coast-to-coast reception. Aerial, loud speaker, and batteries self-contained. Carry from room to room—take it anywhere. Size 8"x10"x18". Total weight only 26 lbs. Complete with tubes and batteries, \$125.00 \$143.50. Receiver only . . . . .

**P-1 KIT SAVES YOU MONEY!**

In response to a popular demand we now offer the Telmaco P-1 Receiver in kit form. This contains all parts, as built by us, including case, drilled and engraved panel, and illustrated instructions. \$80.00 Complete kit . . . . .

Ask your dealer or write us. Descriptive folder free.

Radio Division:

**Telephone Maintenance Co.**  
20 So. Wells St. Dept. A, Chicago, Ill.



Quality Radio Exclusively Established 1918

A Pleasant Surprise Awaits the User of  
The A. C. H. Sharp Turner Dials

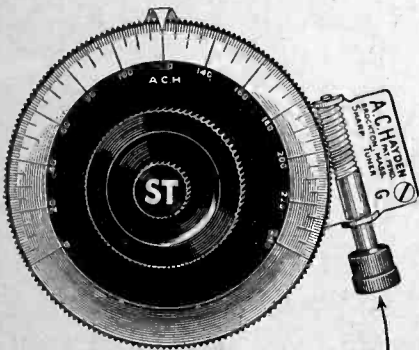

**Why the A.C.H. is different**

3 in. DIAL → ACH → 156-TO-1  
4 in. DIAL → ACH → 215-TO-1

Will improve any receiving set,  
making difficult tuning easy

**MONEY BACK GUARANTEE**

Price 3-inch size...\$2.50 Price 4-inch size...\$5.00  
Regular fitting 5/16 shaft 1/4 and 3/16...5c ea. extra

Extra Advantage of the A. C. H.

1. Can be attached or removed from any instrument.
2. Rough tuning same as any dial.
3. Movement so fine that the eye cannot detect but the ear can.
4. Automatically locks instrument so no jar can disturb it.
5. Dial grounded reducing the body capacity to a minimum.
6. Special dial 2 graduations where ordinarily one.

Mail Orders sent Prepaid in U. S. A.

**A. C. HAYDEN RADIO & RESEARCH CO.**  
Brocton, Mass., U. S. A.

**THE MOZART GRAND CO.**  
Manufacturing Fine  
Radio Reproducing Apparatus  
at 235-40 Elizabeth Avenue  
Newark, N. J., U. S. A.

for half an hour that all the long distance work was blotted out and not a single message came through from the east!"

"Holy Cow!" Dick gasped with amazement. "And he is a hundred miles north!" He looked at his chum with something akin to reverence. "Your old transmitter wasn't a—flivver after all!"

"Flivver!" Porky all but tore his hair. "Of course it wasn't a flivver. Do you think I would have made it if it wouldn't have worked?"

He shook his skinny finger under Dick's nose.

"What I want to know," he roared, "is why we were on that high wavelength? The distance from the car to that post where you tied the aerial was only about a hundred feet and—"

"Great flopping jellyfish!"—Dick gurgled, as a great light suddenly smote him. "Y-you don't suppose that that could have made—"

"What made what?" Porky grabbed him by the coat and began shaking him back and forth as if he would choke the words out of him.

"That I didn't cut—the aerial loose from—the rest of the fence—" wheezed Dick feebly.

"Great shades of Marconi!" Porky smote the air aimlessly. "I might have known it! And you a licensed amateur!"

He glared at his cowering chum.

"Did it matter? And you didn't cut the aerial loose from the rest of the fence! That fence reaches for ten miles—and we were using the whole blame thing for an antenna. He groaned with fervent disgust. "Did it matter? It's a darn wonder we weren't on a twenty mile wavelength instead of a few hundred meters."

Suddenly his face was distorted with a sublime and tremendous wrath; he charged toward his chum, his arms flailing about like the spokes on a Ferris wheel.

"Out!"—he thundered. "We don't want sap-headed idiots like you in this radio club! Beat it!"

"But Porky," protested Dick faintly, "how can I get out to the ranch tonight if—"

"Walk!"—whooped Porky. "Walk, you radio flivver!"

Dick wavered uncertainly on the edge of the porch.

"Get!"—shouted Porky, with a tremendous sweep of his fist.

Dick got.

**DEEP SEA OP.**

*Continued from page 24*

can be evolved. Some of them are shown in the smaller diagrams.

For a dyed-in-the-wool experimenter like yourself this rig should be as handy as a third arm as it makes it possible to try most of the new circuits as fast as the magazines spring them. For instance,

see No. 10, in which the original outfit plus the gear in the dotted lines makes up the single tube oscillator and tuner for the Pressley Super-Het.

The outfit would probably be considerably improved if the coil were wound in the low-loss basket weave style but its too blamed hot out here to attempt anything which involves so much work. Will be looking for a letter from you in Manila. Adios and

Best 73's,  
**MICKEY DORAN,**

**Finer Selectivity**

Equip your receiving set with Apex Vernier Dials. They will greatly increase the efficiency of any set. Make tuning positive—bring in distant stations. Your dealer has them. If not, send \$2.00 for Royal Brass Finish—\$2.50 for Satin Silver Finish, or \$3.50 for DeLuxe Gold Plated (24k).

**APEX SUPER 5**

This highly efficient tuned radio frequency receiver is most advanced in design and construction. An instrument that meets every critical expectation of the radio enthusiast.

Housed in a highly finished walnut cabinet, complete with Jones Multi-plug Battery Cable. All settings highly gold plated. Sells for \$95 complete excepting accessories.

At All Good Dealers  
**APEX ELEC. MFG. CO.**  
1410 W. 59th St. Chicago  
Dept. 510

**"RADIOCAST WEEKLY"**

A 48-Page Magazine of Programs, Photos, etc., of Pacific Coast Broadcasting Stations  
5c per Copy--Radiocast Weekly  
433 Pacific Bldg., San Francisco

WITH better and more powerful broadcasting—

and with a sensitive, responsive Telemonic III receiver—the fascination of radio continues this year, regardless of the calendar.

Write to Danziger-Jones, Inc. Dept. R, 25 Waverly Place, New York, for Booklet, "The KIT of a Thousand Possibilities."

## TELOS RADIO

ALL TYPES  
**RADIO \$1.50**  
**TUBES**

We Ship C.O.D.

FULLY GUARANTEED

All Tubes Tested on Laboratory Radio Tube Testing Machine

Style 0199 .06 Amp. 3.4 Volts—Amplifier—Detector  
Style 0201A 1/4 Amp. 5.6 Volts—Amplifier—Detector  
Style 012 25 Amp. 1 1/2 Volts—Amplifier—Detector  
Style 0200A 1/4 Amp. 5.6 Volts—Detector

Buy Direct and Save the Middleman's Profit

**RADIO TUBE MFG. CO.**  
154 Nassau St., Dept. 60, New York

**\$1.00 SUPER-HET**  
**MANUAL**  
"RADIO"

Pacific Building San Francisco, Calif.

Wholesale Distributors of Nationally Known  
**RADIO SUPPLIES**  
DEALERS—Send for price list and discount sheet  
**COSMOPOLITAN RADIO APPLIANCE CO., INC.**  
321 Broadway, New York, N. Y.

**NA-ALD**

Na-ald DeLuxe Sockets are the only ones with these 3 exclusive features—lowest loss, lowest capacity and positive side-scraping contact. Send for booklet and laboratory test. Alden Mfg. Co., Dept. G3, Springfield, Mass.

**ELKAY**

Tuning Devices

Are the "Heart and Soul"

of the

LLOYD C. GREENE

Concert Selector

and the

**ELKAY**

Super-Selector

Pat'd.

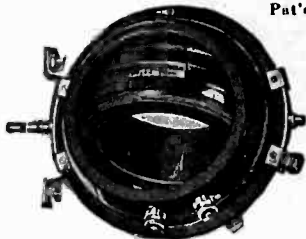

L+K Variable Clarifying Selector

—an aerial tuner that gives needlepoint selectivity and clears up signals to full musical brilliancy. \$7.00.

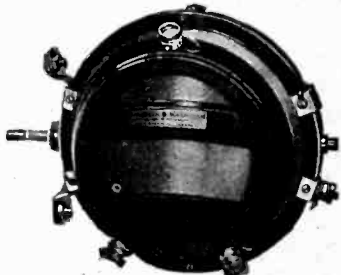

L+K Variotransformer

—a transformer that gives the amplification of two ordinary fixed R. F. transformers, without reflexing. \$8.50.

**MAKE MONEY BUILDING SETS FOR OTHERS**

We will show you how to build radio sets for your friends. It's a good field for steady work or spare time and is very profitable. We supply complete parts, blueprints and expert advice. Write for our offer. It may be the turning point of your life.

**THE LANGBEIN-KAUFMAN RADIO CO.**

511 Chapel St., Dept. D, New Haven, Conn.

L+K Products

TUNERS **ELKAY** SETS, KITS

**ELIMINATE Your STORAGE "A" BATTERY**

for Reflex Radios

**BLAX A.C. POLARIZER**

Uses Electric Light Current—saves your recharging costs and bother. First small cost of Blax is last. Nothing to get out of order. Thousands already giving satisfaction. Ask your Dealer.

**SEND \$1. bill** or send your name and we will mail BLAX with Special diagram.

DEALERS AND SET MAKERS—WIRE FOR PROPOSITION—

**BLACK BROS. Inc.**  
503 BLACK BLDG.  
LOS ANGELES.

Send for Trial Subscription \$1.00 for Six Months

Tell them that you saw it in RADIO

## CONCERT SELECTOR

Continued from page 19

in solution. Both instruments are shaped and operated like a variometer.

The inside of the clarifying selector's stator form carries the winding which in shunt with the variable condenser, forms the tuned grid circuit of the r. f. tube. On each side of the outside of the stator form are two 3-turn windings which are connected in series with each other and in series with two similar windings on the rotor. All these in series are connected between the antenna and ground. The motion of the rotor within the stator as controlled by the Clarifier Dial controls the coupling of the receiver to the antenna and is in

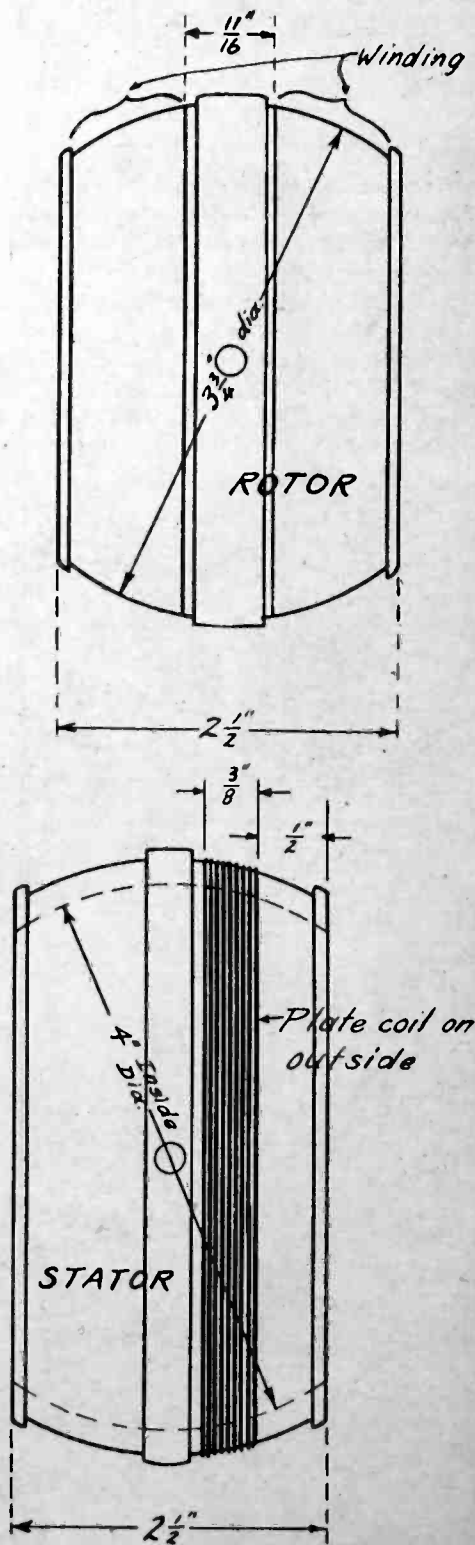

Fig. 6. Dimensions for Variotransformer



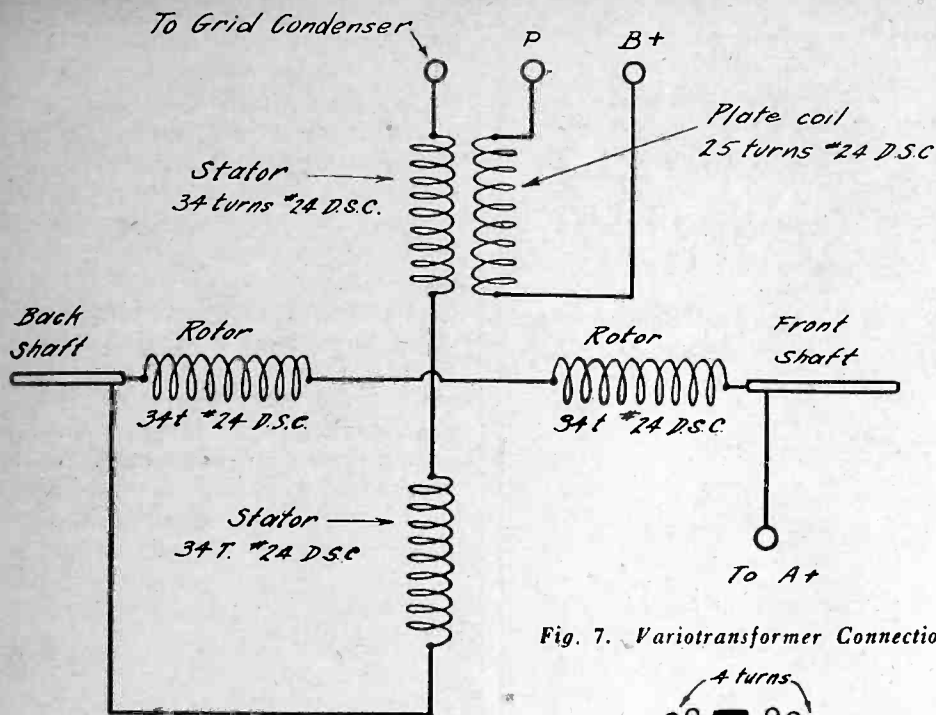

Fig. 7. Variotransformer Connections

effect a selectivity control. When the rotor is set so that the field of the two small windings are aiding the coupling to the antenna is at a maximum and the receiver tunes less sharply. When the two coils oppose each other the coupling to the antenna is zero except for the insignificant amount of static coupling which may exist between the grid coil and the antenna coils. Any value midway of these extremes may be selected at will by a suitable setting of the left hand dial. With this dial set at 100 the coupling to the average antenna has been designed to fall just above the point of maximum signal strength, for the amount of amplification which the selector affords.

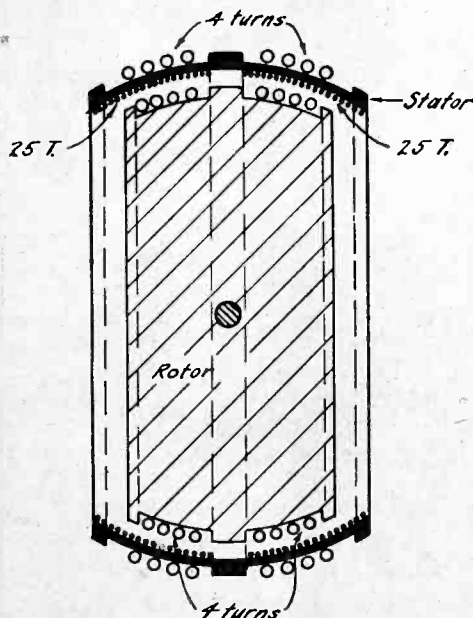

Fig. 5. Clarifying Selector Connections and Construction

With any radio frequency amplifying receiver a definite amount of coupling will be found, above which the signal strength will fall off. The selection of this peak for all wavelengths is done by means of the clarifying selector. With zero setting the receiver is so sharp that it is an easy matter to pass stations without hearing them at all, unless the variable condenser is turned very slowly. For this reason the variable condenser is equipped with a fine mechanical vernier dial. In accordance with the rest of the receiver the variable condenser is of low loss design. It should have a maximum capacity of .0005 mfd. and a low minimum. The clarifying selector used with such a condenser will cover the range from 170 to approximately 570 meters.

The clarifying selector stator has 50 turns of No. 24 D.S.C. on the inside (25 turns on each half) and 8 turns on the outside (4 turns on each half). The stator form has the same dimensions as the variotransformer stator. The rotor has 4 turns on each side wound near the edges directly under the same turns as the stator. The diameter of the rotor is the same as that for the variotransformer, but is  $1\frac{3}{8}$  in. thick instead of  $2\frac{1}{2}$  in. The method of winding and connecting is shown in Fig. 5.

The variotransformer dimensions are shown in Fig. 6 and method of connection in Fig. 7. The plate coil consists of 25 turns bank-wound on the outside of the stator form directly over that half of the stator which connects to the grid of the detector tube. This winding is slightly in excess of  $\frac{3}{8}$  in. in width and placed  $\frac{1}{2}$  in. from the edge of the form as shown in Fig. 6.

The stator winding consists of 68 turns (34 on each half). The rotor has the same number of turns.

## QUERIES AND REPLIES

Continued from page 39

to the negative A battery, assuming that the negative A connection is tied to the ground.

I built a superheterodyne set in accordance with instructions from May, 1924 RADIO. Please tell me why I have to apply all the volume possible before getting local stations with the set.

—P. D., no address given.

If it is necessary to turn the volume control rheostat to a maximum position before being able to operate the loud speaker from local stations, there is trouble in your set. Our first thought is either vacuum tubes or batteries and we suggest that you take your tubes to a dealer who has a good tube testing device, in order to locate the defective tubes, if there are such. Test your batteries for voltage; while the set is running, as a drop of 10 volts in the 45 volt circuit will greatly reduce the amplification. It may be that the .00025 mfd. condenser bridged across the secondary of the tuned transformer is not the correct value. Try substituting a new mica condenser having a guaranteed capacity value, for the old one. Test the connections of the C battery, for if the battery is reversed the set will be very inefficient.

# Lloyd C. Greene Concert Selector\*

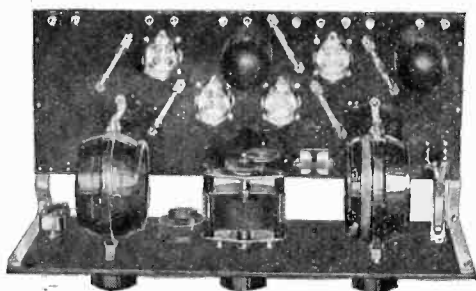

**Kit Complete \$65.00**

With it you can make your set exactly like the factory made set. Everything required comes with this kit. The bakelite baseboard and panels are drilled and brackets are furnished for mounting the engraved front panel ready to slide into cabinet or to use in skeleton frame. The simple instructions necessary, as well as all the parts, will enable you to complete a real Lloyd C. Greene Concert Selector that will look like and act like the factory made set.

Write for complete information to

**CULVER-STEARN'S MFG. COMPANY**

Worcester, Mass., U. S. A.

\*Trade Mark Reg. U. S. Pat. Off.

**Send \$1.00** for a trial subscription to "RADIO" for 6 months.

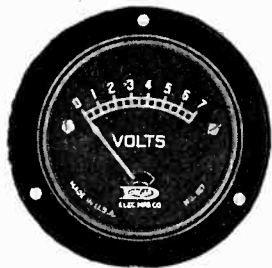

**TYPE P**

Black Enames Finish. Three Holes in Flange for Panel Mounting. 2" Diameter.

List Prices:

0- 7 volts	\$1.25
0- 50 volts	1.25
0-100 volts	1.50

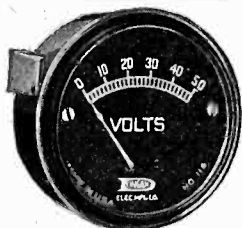

**TYPE N**

Handsome Nickel Rim With Black Bezel Clamp Style Mounting.

List Prices:

0- 7 volts	\$1.75
0- 50 volts	1.75
0-100 volts	2.00

# DONGAN

## VOLTMETERS

Necessary for Efficient Radio Reception

Set Manufacturers and Fans now realize that efficient radio reception depends on correct tube and B battery voltage. Only in that way can you enjoy good radio all the time.

Dongan Voltmeters will keep an accurate check on your set operation. Accuracy over the entire range of scale, definite readings that can be relied upon feature Dongan Voltmeters—designed and manufactured by a company who has specialized for 15 years in the production of high-grade electrical instruments.

Dongan High-Resistance Voltmeters possess sufficient ohms per volt to insure efficient operation and are ruggedly built to give years of service.

Four types for all purposes  
Capacities from 0-7 to 0-100 volts

DONGAN QUALITY AUDIO TRANSFORMERS  
are built in ratios 2-1, 3½-1, 6-1

**DONGAN ELECTRIC MFG. CO.,**

2981 Franklin Street, Detroit, Mich.  
Transformers of Merit for 15 Years  
Distributors for Western Coast:

SIERRA ELECTRIC CO.—515 Market St., San Francisco; 443 S. San Pedro St., Los Angeles; 222 Hinkley Bldg., Seattle, Wash.  
ROBINSON SALES CO.—53 Fourth Street, Portland, Oregon.

## CHARGE IT

Continued from page 26

wound smoothly and each layer is covered with insulation. If you have lots of wire and lots of room to wind it in, the primary does not even have to be wound in layers. Merely wind it to about ¼ in. in depth all along the tube, then put a layer of insulation and continue with winding. In winding it is necessary to count the turns, of course. Keep a pencil and a piece of paper handy and at every 50 turns put down how many turns have been wound on. If you interrupt the winding even for a minute put down the number. It is no joke to lose count. A pound of No. 20 ought to be enough for the primary.

The transformer is held at two sides by strips of wood over and under, which serve as a base and a place to fasten the

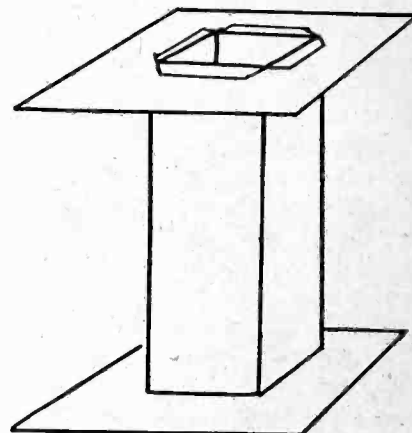

Cardboard Spool for Winding. (Keep full of Lead Pencils to Prevent Collapse While Winding)

top panel. These two wooden strips are fastened together with countersunk bolts which, if the laminations are punched, may run through the iron, or if they are not punched, may extend on each side of the iron. On top of these strips is fastened a bakelite panel to carry the vibrator coils and the vibrator. For our charger a 7x7 panel was used. An old panel should be used, one that has served its time and that is ready to retire. It isn't worth the money to buy a new panel. Bakelite is really necessary only for the vibrator and coils. Wood may be used to mount the rest of the stuff, the fuse plug and ammeter on.

The ammeter is a product of the auto wrecking yards. Four bits. The dime

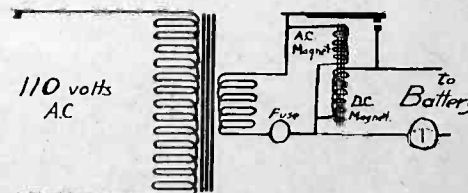

Wiring Diagram for Charger

store has fuse plugs. The binding posts should be good and heavy. The battery is connected to these.

The vibrator and magnets are interesting. Good mounted contacts are

## SHARPEST TUNING

When You Use a  
**LOPEZ**

Low Loss Tuner

Price \$10.00

At your dealer's or sent postpaid

A. C. LOPEZ & CO.

334 Fifth Avenue, Dept. R-4  
New York City

## MELCO

SUPREME RECEIVER

BY

AMSCO PRODUCTS, INC.  
BROOME & LAFAYETTE STREETS, NEW YORK  
443 PACIFIC BLDG., SAN FRANCISCO, CALIF.

hard to prepare so we use the replaceable unit of the Homecharger. For a buck you get a whole part that wiggles back and forth and the contact it hits against. Some parts must be constructed to hold these Homecharger parts. A brass block (A in the figure) is made to hold the contact D. It may be made any size within reason. Two holes are drilled to fasten it to the panel. They may either go all the way through and bolted to the panel or drilled part way and tapped. In the end of the block a hole is drilled and tapped 8/32 to hold the contact. The threads of the contact are of odd size and so will make it impossible to screw it in very far. This does not matter particularly. This hole must be drilled at least 3/8" up from the panel to allow the vibrator to clear the panel.

Part B clamps tight upon the vibrator. It is also composed of a piece of square brass rod, about 1/2x1/2x1 1/2 in. The most important dimension here is to get the set screw G over as close as possible to the edge of the block toward the vibrator. This is because the spring is very short. The slot the spring fits in is made with a hacksaw. The set screw is an ordinary 8-32 screw with the end filed flat. Tightening the screw too tight is sure to strip the threads in the brass block. Here as in the other block two vertical holes are drilled to fasten it to the panel. Part C is a small block with but two holes. The horizontal one serves to carry the screw that adjusts the distance between the contacts and serves somewhat to vary the charging rate. It is drilled and tapped for a short distance at the bottom for fastening to the panel. A lock nut should be used with the long adjusting screw.

The electromagnets may be obtained from an old telephone ringer or telegraph sounder or may even be built out of an iron rod with pieces of composition for the ends. They are about 1 in. in diameter and 1 1/4 in. long. Larger ones may be used as long as they are the same size. They are wound with No. 28 or 30. They are tapped 8-32 at one end so we cut the head off a machine screw and fasten the magnets end to end, putting in iron strips in between so we can fasten the magnets to the panel. This

# MARWOL

BABY GRAND  
FIVE TUBE TUNED RADIO FREQUENCY

*Three-fold Beauty*

THE beauty of the Marwol Baby Grand is three-fold beauty of reception, beauty of appearance and with these the beauty of remarkably low cost.



Marwol 5-Tube  
Tuned  
Radio Frequency  
Model A-1  
\$60.00

Here is a splendid little sturdy all-round set that contains the highly successful Marwol Circuit of the Model A-1, only more compactly—therefore offers the same extraordinary selectivity and range, with ease of operation, that makes the Marwol today's best radio buy for the money!

A light compact receiver easily convertible into an ideal portable set for summer use. Write for descriptive folder. At your dealers—otherwise send purchase price and you will be supplied postpaid.

West of the Rocky Mountains  
\$45.00

\$40<sup>00</sup>

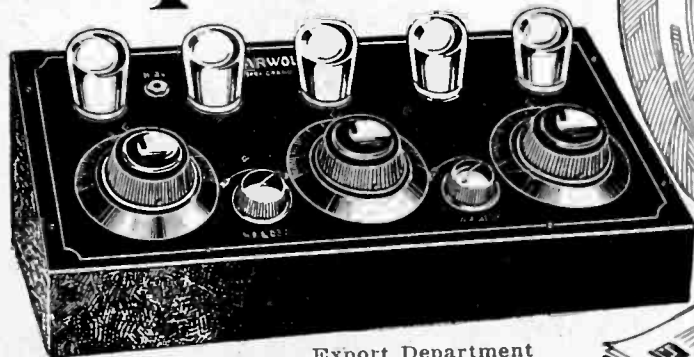

Export Department  
Zeta-Be Company,  
30 E. 42 St., New York  
Cable Address: ZETABECO



Marwol Radio Corp., 85-F Mercer St., New York City

## ARE YOU A SUBSCRIBER?

Send for Trial Subscription  
\$1.00 for Six Months

## IXL RADIO CRYSTALS

The most sensitive long distance Radio Crystal known. AWe all over, no dead spots. Price 50 Cents

U. C. BATTERY AND ELECTRIC CO.  
2158 University Ave., Berkeley, Calif.

## "AIR ROAMER"

A McCall Compensated Circuit set, simple to operate, extremely selective, giving true tones, rugged and economical. Write for details.

KILBOURNE & CLARK MFG. CO.

Seattle, Washington

Branches: Portland, Ore.; Los Angeles; San Francisco. Distributors: Pacific Electrical Company, Sydney, Australia.

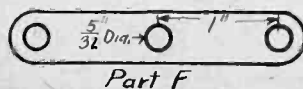
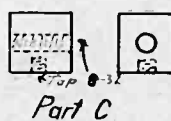
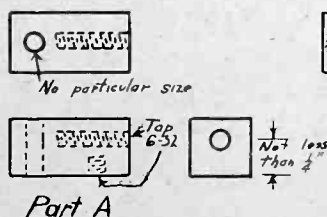
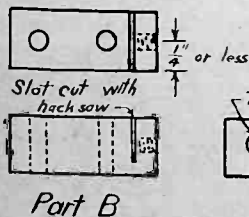

Constructional Details of Parts

Tell them that you saw it in RADIO

**pep**  
up your set  
with good tubes

"I DIDN'T think that tubes made such a difference—until I changed to MAGNATRONS." That's what one enthusiastic MAGNATRON user wrote us.

You, too, will be pleasantly surprised by the way that MAGNATRONS "pep" up a set and give it a new lease on life.

MAGNATRON DC-199, DC-201A, and DC-199 with large base sell for only \$3 each at your dealer's.

CONNWEY ELECTRIC LABS.,  
309 Fifth Ave., New York  
Factories, Hoboken, N. J.

# MAGNATRONS

long strip is drilled at the end and is fastened to the panel with L pieces.

It is very important to have the vibrator and the contact blocks fixed solidly to the panel. If this is not done it is impossible to "tune" the vibrator and the charger, instead of giving out a steady hum, will go "ooo ah ooo ah ooo ah, etc." This shows that there is a slow movement back and forth of the parts in addition to the steady vibration due to the A. C.

There is a certain ritual to be observed for best results when mounting the junk on the panel. The part holding the vibrator is mounted first. Then the block with the contact in place is laid on the panel and mounted so that the distance between the contacts is about 3/32 in. The A. C. coil is connected to the transformer and the D. C. coil to a storage battery and we see if the vibrator vibrates when the magnets are brought near to the vibrator. If possible we wish to fasten the magnets in such a position that the vibrator vibrates smoothly when both D. C. and A. C. magnets are on but does not vibrate at all and the contacts do not touch when the A. C. magnet is off but the D. C. is still on. If this happy condition is not attained the fuse must be slightly unscrewed when starting and stopping the charger for if the contacts touch when the A. C. is off another fuse is gone. Remember that the A. C. magnet is nearest the vibrator.

If now we have the vibrator and magnets fixed in position we may try a sample of charging to see if it really works. The transformer is connected to the battery in series with the vibrator contacts and the ever present fuse plug. The fuse is left out. Take a piece of wire and bridge the fuse plug. If the charger changes its note and takes on a steady buzz and the ammeter flops over to one side and there is very little sparking at the contacts it is charging O. K. But if the contacts splutter and flash fire and the ammeter spasmodically hiccups, pause a moment. The wrong half of the cycle is being used. Either reverse the A. C. magnet or the D. C. magnet; not both.

When everything is finally wired up and put in shape the charger will give a little more current than when temporarily wired. This is because a change in resistance in the secondary windings, due to shortening leads affects the charging current slightly. So use heavy wire for wiring the charger up. The battery may be connected to the binding posts in either direction. Flexible cords with clips may be substituted for the binding posts on the panel.

If the vibrator does not vibrate through a wide arc the charging current is reduced only slightly and the hum is very materially reduced. It should not spark at all if properly ad-

**MARVELDUS NEW AUDIO TRANSFORMER**  
adds a musical quality to any set far beyond anything you ever heard before.

**KARAS HARMONIK**  
Amplifies low, middle and high tones—all to the same big volume, thus eliminating distortion. Brings out the vital harmonics and overtones of music. Price \$7.00. Write Karas Electric Co., Dept 59-39, 4040 N. Rockwell St., Chicago

**GLOBE LOW-LOSS TUNERS**

Loses Nothing  
Tunes Every Radio  
Impulse the Aerial  
Receives

Patented December 9, 1924

No Metal	Large Wire
No Eddy Current Losses	Self Supporting
Little Insulation	Anti-capacity Windings
Low Distributed Capacity	Low R F Resistance

GET ORIGINAL GLOBE COILS

Standard Tuner (Broadcast Range)	\$7.00
Short Wave (35-135 Meters)	\$7.00
For Superdyne Circuit	\$8.50
R F Transformer	\$6.00

Circular on Request. Dealers and Jobbers Write.

**Globe Radio Equipment Co.**  
217 West 125th St., N. Y. C.

**\$2.00**

All Types  
Guaranteed

Send money order plus 10 cents Postage and we will send you a New Tube. No old Tubes required.

**C. A. W. Laboratories**  
608 Chestnut St.  
Suite 405 Philadelphia, Pa.

**CRESCENT LAVITE RESISTANCES**  
Absolutely non-inductive

12,000	LIST
48,000	\$1.50
50,000	EACH
100,000	
Ohms	

Special resistances to order \$2.50. When better resistances are made they bear the Crescent label.

**CRESCENT RADIO SUPPLY CO.**  
1-3-5 Liberty St., Jamaica, N. Y.

**25c**

BEST'S NEW  
SUPER-HET  
REPRINTS  
"RADIO"  
San Francisco, Calif.

justed, but this is hard to do, and if we succeed in getting it down to where it gives a little flash once in a while that is good enough. If it sparks a little do not tinker with the adjusting screws for half an hour. Let it alone for a while and the high parts of the contacts wear off a little and the sparking ceases.

After a long period of use the contacts may have to be filed smooth. If they are not kept reasonably smooth the current is cut down materially. With a very thin file they may be filed without removing them.

If tire tape was used in the transformer do not become alarmed if a thin wisp of smoky vapor is seen rising from the transformer. The tar is good for your sore throat. It soon all evaporates off, anyway.

A 15 amp. fuse is a good size. A discharged battery may be shorted through some of the 20's and nothing happens, which is poor business.

We have tried to give all the little things here that you would wish to know. One may have many big mistakes in a battery charger and nothing happens, but the little mistakes cannot be detected and eradicated so easily and cause more trouble.

Even if you never build a charger yourself and merely buy one, it is interesting to know how one is made and the many things that must be kept in mind when designing it.

## LOW LOSS APPARATUS

*Continued from page 34*

spaced so that the electrical intensity in the wire insulating material, whether cotton or silk, is reduced. Sometimes bare wire is used and always varnishes are avoided because of their high intrinsic capacity and energy dissipating effects.

In conclusion it is well to summarize our results. The use of low loss apparatus is the greatest aid in securing selectivity which is at our disposal. Furthermore it is a means of preserving the minute amounts of energy picked up by the antenna circuit and of increasing our range and volume of signal. There are some elements of a radio equipment which may be chosen at random with very fair results—such as dials, rheostats, sockets and the like. These need be only *mechanically* good for maximum or nearly maximum electrical efficiency. But where *electrical* excellence is needed as in the case of coils, condensers and transformers each item used must be as low loss as possible and a reduction in losses will have a direct effect upon the volume, distance and selectivity results obtained.

# Silver-Marshall

## RADIO EQUIPMENT

110 SOUTH WABASH AVENUE, CHICAGO, ILLINOIS

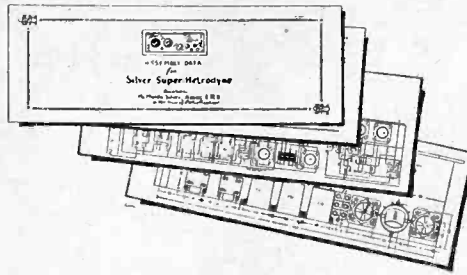

Authorized Plans  
for the  
**SILVER SUPER**  
prepared under supervision of  
**McMurdo Silver**  
A. I. R. E.

Full-size working blueprints and the most complete instruction data ever offered the set-builder can now be obtained for the Silver Super, as described by its designer in Radio Broadcast and elsewhere. With these plans and a few simple tools the merest beginner in radio can build this "Electrical Masterpiece" and obtain results heretofore restricted only to more experienced builders. The plans include a baseboard layout, pictorial wiring diagram, large clear photographs of built-up models, and a point-to-point wiring plan that leaves no opportunity for error.

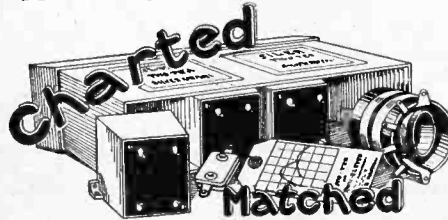

Put Laboratory Equipment  
in Your Old Super

With a set of S-M Two-Ten (interstage) and Two-Eleven (filter) Transformers, and a Silver Oscillator Coupler the amplification of your old super can be increased from 1½ to 2½ times, and its overall efficiency vastly improved. Each transformer supplied with its characteristic curve on a tag. Set of Matched and Charted Transformers and Oscillators in a carton. Price ..... \$26.50

Send for the "Why" of Silver Circuits



(Above)—Weston Radio Plug for instant change from head-set to loud-speaker with a close-gripping automatic plug in that has made it standard equipment with manufacturers.

(At Right)—Weston Table Voltmeter, Model 489, double range (150 to 7.5 volts)—a handsome precision instrument that insures the most careful and prolonged use of any receiving set, warning of trouble when it starts and saving many times its cost by prevention.

## Make Radio RELIABLE

The scientific precision and the practical help supplied by Weston Instruments for the radio expert and enthusiast is now available at every good radio dealer's counter.

Ask him to give you a copy of "Weston Radio Instruments" showing how they improve reception, prolong tube life, locate trouble and place radio on a pleasurable basis.

Weston  
Electrical Instrument Corp.

156 Weston Ave.

Newark, N. J.



STANDARD THE WORLD OVER  
**WESTON**

Pioneers since 1888



Tell them that you saw it in RADIO

# Three dials free

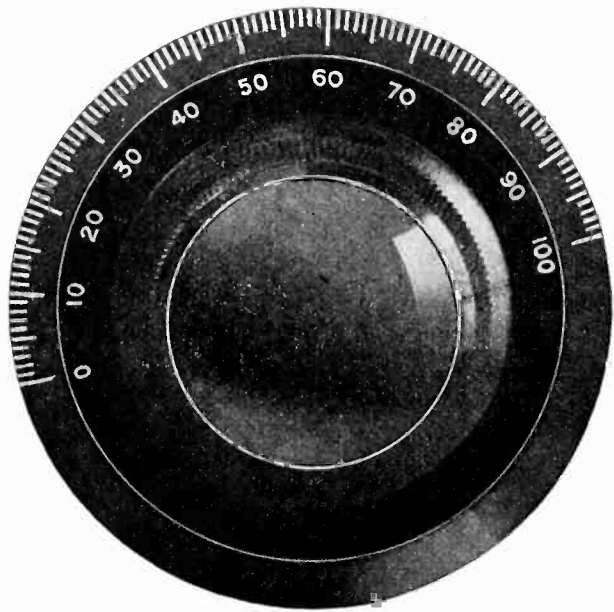

**S**END us your subscription to "RADIO" for one year. It costs but \$2.50. In return for your subscription, we will immediately send you three four-inch dials as illustrated. These dials have 1/4-inch shaft holes. They are well made and beautiful in appearance. This offer will be withdrawn after May 30th. Simply send us \$2.50—tell us to send you "RADIO" for one year and ask for three four-inch dials. The dials will be mailed to you on the same day your subscription reaches us. Now is the time to get in on this big offer.

## "RADIO"

Pacific Building

San Francisco, Cal.

### You Should Read It!

The Only Book of Its Kind

"The Radiobuster"  
A remarkable  
book of 12 complete  
radio stories

Only \$1  
Postpaid  
Per copy

112 pages full of  
genuine radio humor.  
Many thrilling stories  
of radio life at sea.

Mail Your Order Today. The Supply Is Limited!

**Pacific Radio Publishing Co., Inc.**

Pacific Building  
San Francisco

17 West 42nd St.  
New York, N. Y.

157 E. Ontario St.  
Chicago, Ill.

### LOOP RECEIVER

Continued from page 32

of a loop varies directly with its area and directly with the number of turns on the loop so the best for a large pickup is one embracing the greatest area available, and having the greatest number of turns possible with small enough inductance to be capable of tuning within the broadcast band. The largest loop that can be placed in an average room will be about 8 ft. square, and should have four turns of wire spaced 1 1/2 in. apart. This will require about 130 ft. of wire. Lamp cord is recommended, but other wire will give good results. A loop of this size can be constructed in a few moments by driving four small brads in the form of an 8 1/2 ft. square in the moulding and baseboard on one side of a room, and suspending the wires by heavy twine, spiderweb fashion. Since a loop of this size cannot be rotated, it is best to choose the side of the room in line for reception of the most distant stations, disregarding the locals, or, still better so that the flat side of the loop faces the local stations. The locals will undoubtedly be received with sufficient volume regardless of the loop's position when of such dimensions. The flat side facing the locals will also help in tuning through. The increased pickup by the use of this large loop is surprising compared to the smaller 2 to 4 ft. ordinarily used with the set. However, it has the disadvantages of being stationary, and also some loss of selectivity.

The relative selectivity can be preserved at the expense of another control in the method illustrated in Fig. 5. The

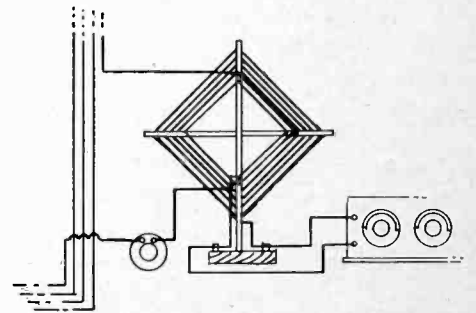

Fig. 5. Coupling Large and Small Loops

large loop is tuned separately by a .0005 variable condenser, and coupled to the regular loop of the set by 3 or 4 turns of wire wound or suspended in the manner of Fig. 3. Fair coupling between the two may be had by simply placing the small loop parallel and close to the larger, rotating the smaller loop 180 degrees or one-half turn to get maximum reception, as in the first method given. When the small loop is turned in the wrong direction, tuning of the larger acts to trap out the desired signal, therefore the coupling as illustrated is recommended.

In conclusion, it must be borne in mind that any receiver capable of efficient operation on a small loop is an

extremely sensitive instrument, and the advantages of any means employed to increase its pickup will be apparent only on the more distant and fainter signals. The fact generally is that the nearby and more powerful stations are too strong to permit of good quality reception, and amplification must be reduced for clear signals. Other methods than those given will be immediately suggested to mind, such as a larger loop, tuned coupled circuits, etc. Also, there are many possibilities in unilateral reception as suggested by the first method. Two stations of equal strength and on the same wave may be easily separated if in somewhat opposite directions.

### ANTENNA MAST

*Continued from page 30*

which has two guy wires, the antenna serving as the third.

Usually one attempts to erect the mast as a whole and runs into difficulties. If the lower section is erected first with the iron splices bolted in place ready to receive the second section, carefully plumb-ed and guyed, the placing of the second and third section is a simple matter. The foot need go into the ground only 4 or 5 in. and should be well tarred.

After the first section is erected a ladder of sufficient length can be supported and lashed to it. Bolt the second and third sections together and fix their respective guy wires in place, not forgetting the pulley and halyard for the antenna at top. Now by using the antenna as a guy and having two persons on the ground to steady the mast by manipulating the guy wires, a third man on the ladder may raise the two sections hand over hand and place the lower end of the second section into the splice ready for it and bolt it into place.

To facilitate the lifting of these two sections two sliding rope loops should be provided, one fastened to the lower end of the second section and sliding on the first section, the other fastened at the top of the first and sliding on the second. Now the whole mast should be plumbed and guyed.

This method of procedure may sound elaborate, but it saves much hard labor and results in a fine workmanlike job—a straight mast of true nautical style.

The following is a list of material for a mast 60 ft. high:

- 3 Pcs. of pine or spruce 2"x2"x20'.
- 8 Pcs. of iron 3/16"x1"x14".
- 32 Bolts 5/16" diam.x2 3/4" long.
- 1 Halyard 1/4"x110' long.
- 1 Pulley.
- 430 Feet No. 14 galvanized iron guy wire.

# VOLUME



3 1/2 TO 1      5 TO 1

**IF YOU** want volume without distortion, use Supertran Audio Transformers. They are shielded, assuring absolute protection against damage to the coil while mounting.

**\$6** AT ALL DEALERS

Distributed by

Philip Chandler & Co., Boston, Mass.; L. W. Cleveland & Co., Portland, Me.; Gray Sales Co. Philadelphia, Pa.; The Beckley-Ralston Co. Chicago; Waite Auto Supply Co., Providence R. I.; Coast Radio Supply Co., San Francisco Radio, Ltd., Montreal, Canada.

**FORD MICA CO., INC.**  
33 E. 8th Street      New York



REGISTERED U.S. PATENT OFFICE

## AUDIO TRANSFORMER



**Premier**  
**"CROFOOT"**  
**Vario Condenser**  
"Look for the Red Stripe"

Write for free copy of Premier Bulletin No. 94 giving full description of the many new features of this remarkable low loss condenser, as well as particulars of all Premier Quality Radio Parts. "CROFOOT" has lowest minimum capacity; only five minute phase angle loss; tuning ratio of 1 to 74. Made of brass and hard rubber throughout, for low resistance. \$2.75 to \$3.75. Complete with E-Z-TOON Vernier Dial, 75 cents extra. Write for bulletin and FREE HOOK UPS.

Premier Electric Co., 3813 Ravenswood Ave., Chicago

**PREMIER Quality Radio Parts**

**Solicitor of Patents and Trade Marks**  
**Counsellor in Patent Causes**  
**Specializing in Radio & Electrical Inventions**

**JOHN FLAM**

formerly of the Examining Corps, U. S. Patent Office, also of the Patent Department, General Electric Company

**MEMBER OF THE FEDERAL BAR**  
1000 Merchants National Bank Bldg.  
LOS ANGELES, CALIF.



**18 STYLES ENGRAVED**  
A Marking for Every Need in  
**"Read'em" Binding Posts**  
"The Knobs Can't Come Off"

The New and Improved Post that Improves the Appearance of Every Set.



The Utmost in Quality at the Lowest Price at Your Dealer's or Sent Post-paid.  
15c Each

**MARSHALL-GERKEN CO.**  
Toledo, Ohio



## RADIOCAST WEEKLY

48 Pages of  
Programs, Photos, Humor,  
Musical Reviews, Schedules,  
Tables, Editorials, Etc.

**5c Per Copy**      Radiocast Weekly  
433 Pacific Bldg.,  
SAN FRANCISCO

**CIRCUITS!**  
**CIRCUITS!!**  
**CIRCUITS!!!**

Of All Kinds, For All Pocket-books

## RADIO WORLD

The first nat'l. illus. radio weekly  
8-days-in-advance programs  
Helps for the novice and expert  
A Great Question and Answer Dept.  
Latest price quotations by national advertisers on sets and parts. Do not buy anything until you consult the Radio World advertising columns.

15c per copy, all newsdealers; \$6 per year (52 nos.); \$3 six months; \$1.50 three months.  
**SPECIAL TO RADIO READERS:** Send \$1 for ten issues, or \$6 for 52 issues, and we will send you Radio (San Francisco) as a premium.

**RADIO WORLD**  
1493 BROADWAY      NEW YORK CITY

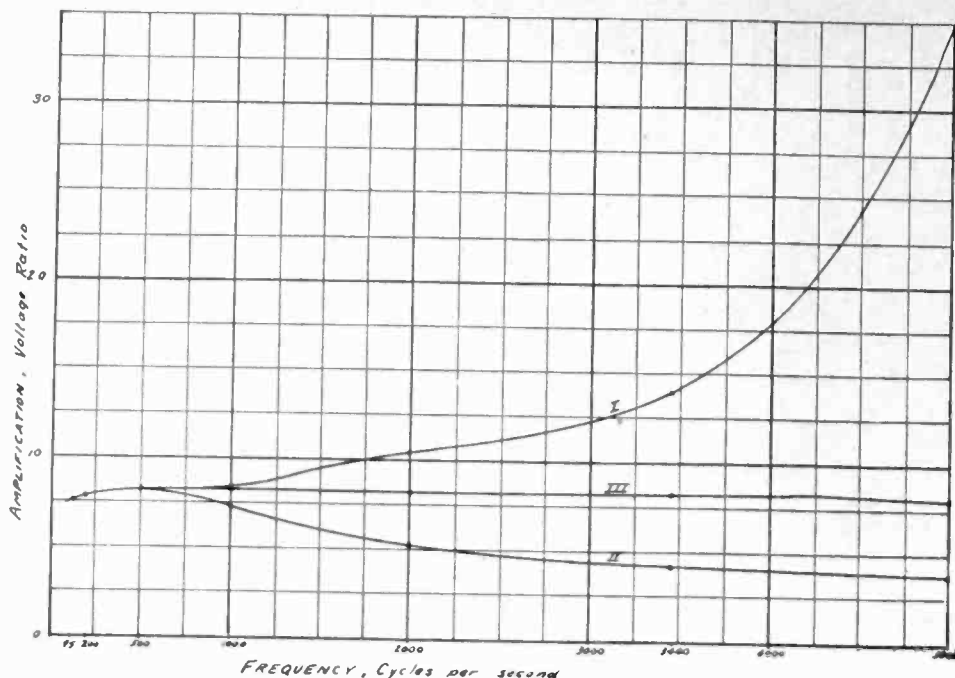

Fig. 7. Characteristics of 1:1 Transformer. I.—Normal. II.—With 500,000 ohms in Series with "C" Battery, and III.—With 240,000 ohms in Series

## AUDIO FREQUENCY AMPLIFICATION

Continued from page 28

the transformer primary and the *B* battery. Since it passes thru only a part of the secondary winding this winding becomes an auto transformer whose ratio is determined by the position of the point *n*. If this ratio is high and that of the transformer itself is low there may actually be an increase in amplification at the high frequencies instead of a decrease.

An excellent example of such a result is shown by curve I, Fig. 7. This transformer has a 1:1 ratio and a primary impedance, at 1,000 cycles, of over 300,000 ohms. Because of this high impedance the curve rapidly reaches a fairly steady value with increasing fre-

Continued on page 69

## A SUPERHETERODYNE CABINET

By Gordon F. Carpenter

The radio cabinet shown by the accompanying pictures and drawings was made by the writer in the woodworking shop of the high school at Harrington, Wash. The wood used was red gum, which gives an attractive finish when waxed and polished. The inlay is holly wood.

The legs, after being turned out on a lathe, were mortised and tenoned to the cabinet. The lid works on the same principle as a phonograph top. The door in front also functions as a desk. The two drawers are at the bottom and are used for *B* batteries and programs.

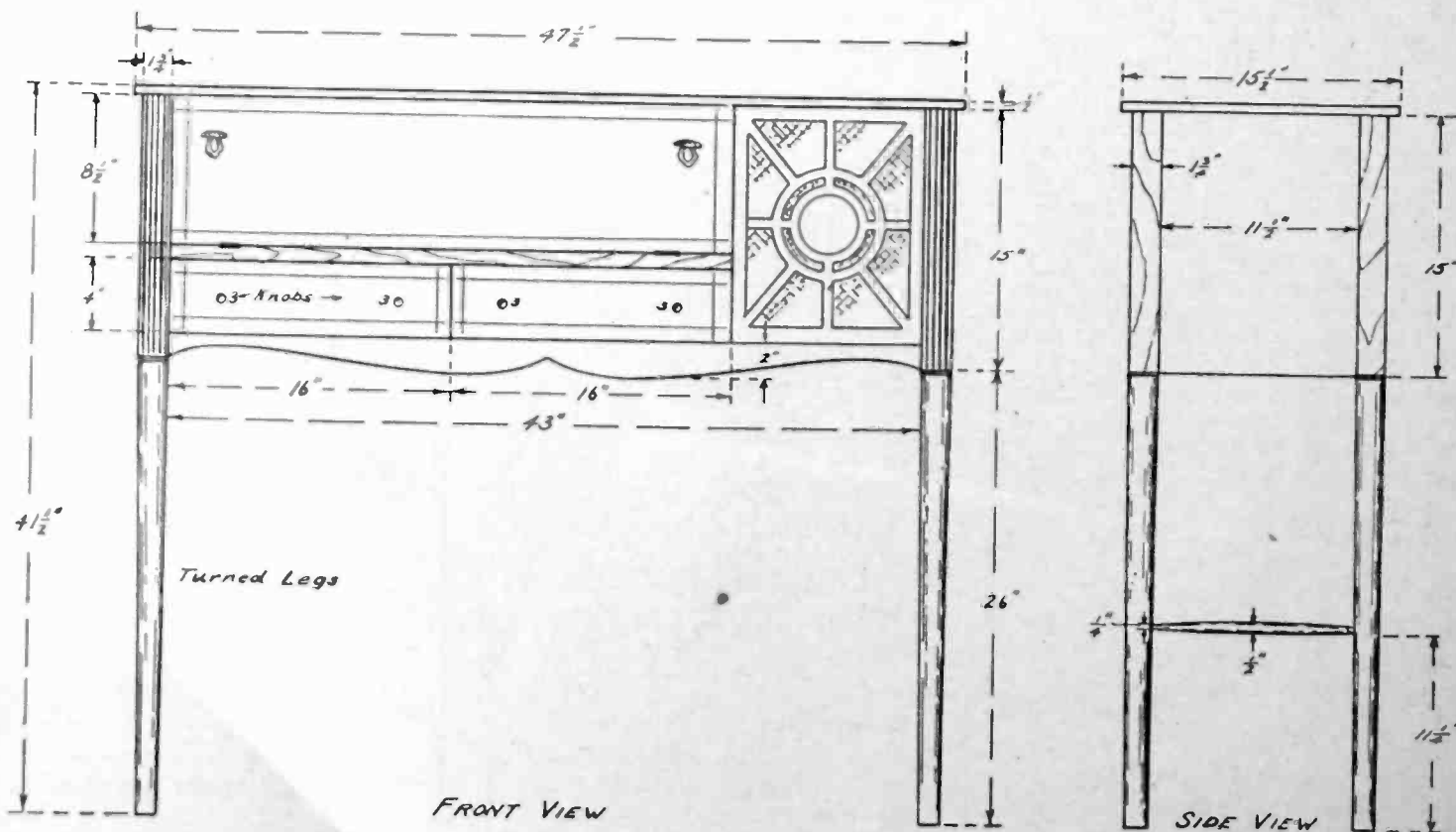
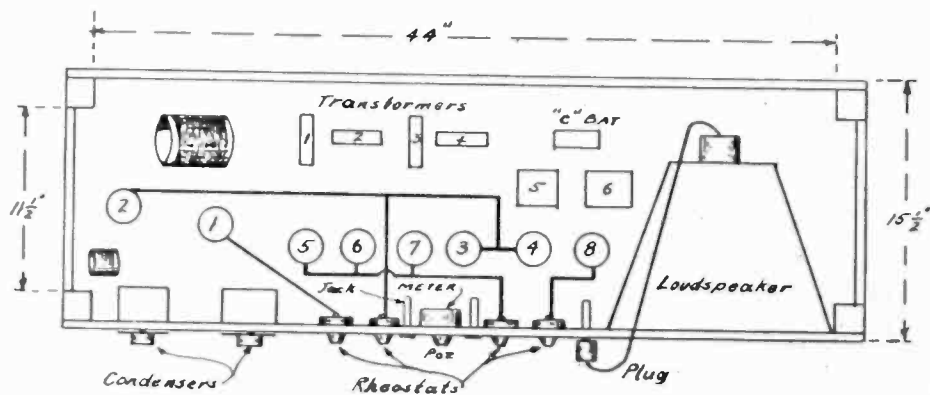



quency. However, instead of the customary falling off of amplification at the higher frequencies it begins to rise again at about 1,000 cycles, the curve becoming steeper and steeper until at 5,000 cycles the amplification is nearly 5 times as great as at 500 cycles.

Now, if the theory is correct, that this phenomenon is the result of a current flowing thru the intertube capacity (Fig. 5) to the filament circuit, via the C battery, then it should be possible to make the high frequency characteristic fall in the usual manner by simply inserting a sufficiently high resistance in series with the C battery, as shown in Fig. 6. This resistance serves the double

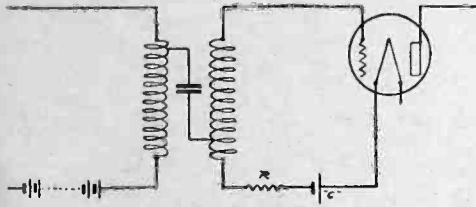

Fig. 6. Addition of High Resistance to "C" Battery Circuit

purpose of reducing the current flowing in this parasitic circuit and at the same time introducing, because of the *ir* drop due to this current, a potential 180 degrees out of phase with that induced in the transformer.

To test this conclusion a resistance of 500,000 ohms was placed in series with the C battery as suggested and curve II of Fig. 7 resulted. Here the effect of the parasitic current has been almost entirely removed and the transformer exhibits the expected falling characteristic at high frequencies due to secondary distributed capacity. The resonant hump is at about 400 cycles. It is particularly interesting to note that the point at which curve II begins to fall is almost the same as that at which curve I began to rise and, further, that the curve below 500 cycles remains entirely unchanged. This last fact proves that the effect is due to current flowing thru a capacity whose value is so small that the current is negligible below 500 cycles.

Logically we should expect that somewhere between zero and 500,000 ohms a compromise resistance could be found which would give quite uniform amplification of the whole range. Accordingly the resistance was adjusted until the amplification at 5,000 cycles was just equal to that at 200 cycles and a new set of measurements taken. The required resistance was found to be 240,000 ohms and the resulting curve is shown at III, Fig. 7. This curve is remarkably flat over the entire range and the result would be a very excellent coupling device except that the amplification is rather low due to the 1:1 ratio of the transformer.

Some of the transformers which exhibit this effect of inter-winding capacity, with rising frequency characteristic as a

result, have fairly large turn ratios though none of these have yet been found in which the turn ratio exceeds 5:1. This is due to the fact that, in a transformer whose turn ratio is high, as much amplification will result from the current which flows thru the primary winding to the B battery, and thereby induces a potential in the secondary of the transformer, as from the part which flows thru the parasitic circuit via the C battery. Hence the latter current causes no increase in amplification.

One transformer which has a very excellent low frequency characteristic and good amplification has a rather objectionable rise after 1,500 cycles. However, by placing 100,000 ohms in series with the C battery the objectionable rise can be largely eliminated and the entire characteristic caused to approach as near to the ideal as has yet been obtained. A brief discussion of the future possibilities of transformer coupling will be found near the close of this article together with a summary of suggestions for improvement of existing transformers both by the manufacturer and the user.

(To be continued)

#### CALLS HEARD

Continued from page 46

By SADA, 13503 Emily St., E. Cleveland, Ohio

England: 2ku, (2od), (2nm), 2sz, 5nn, (2kf), 6gh, (6nf), (2jf), 2nb, 6lj, 2ru, 5lf, (2sh), 2kz, 6vp, 6bh, 2pf, 2cc, 2lz. Fone: 2nm, 2kz. France: 8ab, 8ct, 8gk, 8go, 8sm. Holland: oll, onl, oba, pci. Denmark: (7ec). Argentine: lor, lpx. Brazil: wjs. Costa Rica: sj. Cuba: 2lc, (2mk), Bermuda: (ber). Porto Rico: (4sa), 4je. Germany: pox. Mexico: (bx), 1aa, 1au, 1af, 1n, (1x), 9a. Unknown: lr, slac, ur, ca. Hawaii: 6bpr. Others: ket, 6xo, 6xi, nerk-1, wvat, nqg, njv. Canada: (1ar), 1am, 1an, (1bu), 1dj, 1dq, 1ei, (4cr), 4bb, 4eo, 4dq, 4io, 4fv (5ba), 5bz, 5ef, 5go, 5hc. Cards to the above on request. QRK 8ADA?

By GAE, George W. Carter, 4409 South Harvard Blvd., Los Angeles, Calif.

1aap, lark, lcing, 1er, 2af, 2bfr, 2bgl, 2cm, 2cub, 2gk, 2kf, 3bnu, 3cvj, 3oe, 3te, 3xm, 3yo, 4gw, 4jy, 4kl, 4ni, 4tj, 5aaz, 5alc, 5asb, 5asv, 5asz, 5aw, 5ba, 5ew, 5gm, 5ls, 5nq, 5rg, 5uk, 7acm, 7afo, 7aha, 7akk, 7au, 7cw, 7cy, 7dd, 7ec, 7fq, 7gb, 7gj, 7gr, 7gy, 7kc, 7lq, 7lj, 7mb, 7nx, 7lh, 7qd, 7ug, 7ws, 8aly, 8bau, 8bit, 8bf, 8bz, 8cu, 8pl, 8ve, 8aek, 9aib, 9aol, 9bdf, 9beu, 9bkr, 9bwl, 9cak, 9cap, 9cdv, 9cea, 9cfs, 9cgn, 9csg, 9cid, 9co, 9ded, 9dlj, 9eak, 9eiq, 9kh, 9mc, 9on, 9ph. Canadian: 5go. Special: WGH, NPG. Australian: 1aa. Mexican: 1k. Please QRK my lonely fiver. All cards answered.

By U6EA, H. C. Seefred, 343 South Fremont Ave., Los Angeles, Calif.

Dx heard and worked outside of U. S. A. Indo-China: hva. Australia: 2ds. New Zealand: 2ac, 4ag. Porto Rico: 4je, 4sa. Hawaii: 6ceu. Mexico: 1aa, 1b, (bx), 9a. Canada: (2cg), 4cb, 4cr, (4dq), 4eo, (4fv), (5ak), (5an), (ba), 5bc, 5bz, 5cn, 5ct, 5ef, 5gf, (5go), 5hc, (5hs). Heard on a homemade low-loss tuner with detector and 2 steps of audio amplification using antenna with out ground connection.

By 5AQW-5ANP 223 South Third St., Enid, Okla.

Australian: 3bq, 2ds, 2ac. Canadian: 1el, 1dd, 1dq, 1fr, 2be, 2bn, 3aec, 3arh, 3afp, 3ly, 4ar, 4cr, 4fz, 5as, 5hc, 5go, 9bw. France: 8sm, 8em. England: 2sz, 2kf, 2kw, 5ws, 6lj. Mexico: 1el, 1aa, 9a, 1x, 1x, bx, 1b, ex 5acb. Netherlands: ear2. Cuba: 2by. Argentine: 9tc, lpx, lpx. New Zealand: 4aa, 4ag. Colombian: 5tt. Unknown station: ber, nfv, nerk1, nkf, whc, prk, pa2, ket, kgh, wgh.

Continued on page 76

## FREE Booklet and "Hook-ups"

Write Today

See Below

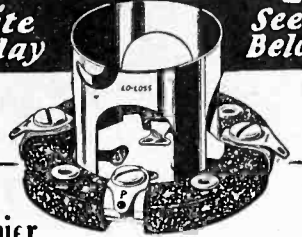

Premier

### "Lo Loss" Tube Socket

Checks Current Losses

What is it that saps current strength? Insulation leakage, poor contact and mutual capacity between parts. The Premier "LO LOSS" Tube Socket is specially designed to stop such losses. The bakelite cross section is thin to prevent phase angle losses between terminals. All metallic parts are arranged for minimum capacity. Positive contact is insured by cam action lock and self cleaning action of contact spring on tube prong. One piece contact spring have twice ordinary deflection range. Skeleton barrel permits inspection of contacts at all times. Price 90 cents.

SEND FOR BULLETIN NO. 94

showing complete line of Premier Quality Radio parts. Ask your dealer for Premier free hook-ups. If he cannot supply them, write us, mentioning his name.

PREMIER ELECTRIC CO.

3813 Ravenswood Avenue

Chicago

# PREMIER

## Quality Radio Parts

## Best for Reflex

and Crystal Sets  
**FRESHMAN**

Double Adjustable  
Crystal Detector

No more searching for the sensitive spot.

Merely turn the knob as you would a dial.

For base or panel mounting, complete with Freshman Super-Crystal At your dealer's, otherwise send purchase price and you will be supplied postpaid.

CHAS. FRESHMAN CO., Inc.  
240 W. 40th St., New York

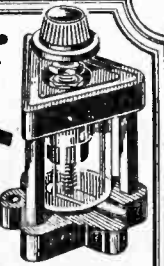

\$1.50

ARE YOU A SUBSCRIBER?  
SEND FOR TRIAL SUBSCRIPTION  
\$1.00 FOR SIX MONTHS

## FREE CATALOG FREE

NEW COCKADAY  
4 CIRCUIT TUNER

WITH RESISTANCE  
COUPLED AMPLIFIER

It will be well worth your while to use the identical parts specified by Mr. Cockaday without changes or substitution of any kind. Complete parts, including drilled panel and set of three full-sized blue prints.

COMPLETE KIT, \$54.75

WHOLESALE RADIO SERVICE CO.

Dept. R-9 Church Street N. Y. C.

*Continued from page 22*

the punch press, so coil spools and supports are blanked and formed on these machines. Automatic counters are of course used to insure uniformity as to the number of turns per coil, but as an additional check each coil is placed in a circuit with a condenser and a thermo galvanometer which is coupled by a single turn with a vacuum tube oscillator. A standard coil shows a reading of 50 on the galvanometer scale. One turn over or under brings the reading down to 5 or less, and the failure of the inner turn of the coil to "hug" the core by as little as  $\frac{11}{32}$  in. will insure its rejection, as will poor insulation between turns.

The mutual inductance between the coils is fixed in the same sort of device as is used for checking their self inductance. The variometers are locked in the short-wave, or bucking position, but with the rotors loose on the shafts, and the coils as close together as they will go. In this position there is no discernible deflection of the galvanometer. A device like a miniature screw-jack, fitted over the end of the shaft, is now used to pull the rotor and stator apart, and as the coils separate the galvanometer deflection mounts rapidly. The distance is accurately set for the maximum reading for each variometer in succession and the coils are firmly secured at this distance.

Two further checks are obtained on this setting before the sets are packed for shipment. After the sets are wired, but before they are installed in the cabinets, they are tested at 250, 420 and 525 meters, and if it is possible to improve the tuning on the long wavelength by the ratio condensers after they have been adjusted on the short one, the set is rejected and sent back for re-alignment.

This test is repeated, with weaker signals, after the set is ready for shipment, and if it passes satisfactorily, the O. K. tag goes in and it is at once wrapped and sealed.

The question has frequently been asked, "How accurately does all this hold?" to which my only answer is this: I took a standard set "off the line," and installed it in my home. I lined it up for my antenna and the set of tubes used, and closed the lid, after which, using the single selector dial, I tuned in nineteen stations in forty minutes, including St. Louis at 546 meters, Chicago on 536 and 380, Calgary at 400, Los Angeles on 469, 385, 360 and 278, and Long Beach on 234, all on the loud speaker. No claim is made that this is phenomenal reception from the San Francisco Bay District, but the claim is put forward that it proved the unit tuner commercially arrived.

# ROBERTS!!!

(Trade Mark)

Have you tried that Wonder Circuit using  
Reflex, Regeneration and Neutralization

*Developed by Walter Van B. Roberts of Princeton*

? ? ? ?

*Radio Broadcast says—"It is the Best We Have Ever Seen"*

Easy to Build with the Genuine **\$8.00**  
NAZELEY ROBERTS UNITS

Real Low Loss Coils Wound on Celoron Bakelite Forms, All Mounted  
Ready for Installation. Complete Instructions.

The only coils officially approved by Walter Van B. Roberts, E.E.Ph.D.

Complete Kits { 2-Tube \$53.00, with Portena Loop \$60.00  
4-Tube \$70.00 " " " \$77.00

## J. NAZELEY CO.

571 Hudson Street  
NEW YORK

Pacific Coast Rep.:  
Baker Smith Co., Call Bldg.,  
San Francisco, Calif.

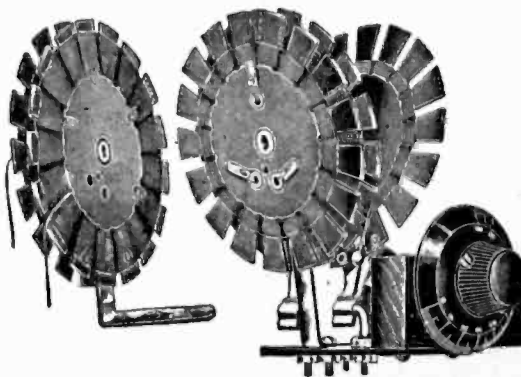

The New  
**CHELSEA**  
SUPER-FIVE

West of Rocky Mountains.....\$55.00  
East of Rocky Mountains.....\$50.00  
Chelsea Radio Co., Chelsea, Mass.

"--truly remarkable!"

The National  
Regenaformer

for the Browning-Drake circuit. A  
4-tube set that's a wonder. Send for  
Bulletin 105R.

NATIONAL COMPANY  
110 Brookline St., Cambridge, Mass.

NO AERIAL  
NO LOOP

THE  
**Antennaphone**  
REPLACES THE AERIAL

IMPROVES RECEPTION  
Easy to install. Not attached to, but  
merely placed under the telephone.  
Sold with a money-back guarantee.  
AT YOUR DEALER or sent by  
mail complete with insulated wire  
upon receipt of One Dollar.  
ANTENNAPHONE CO.  
90 West St. New York City

New LeFAX RADIO  
HANDBOOK—\$2.00  
(Seventh Edition)  
in bound form. For sale by  
"RADIO," San Francisco

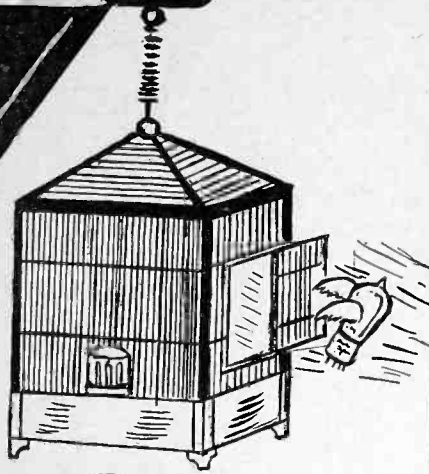

# Finally!

THE GREATEST  
SENSATION IN  
THE RADIO  
INDUSTRY



**S**UPERTRON, always a good tube, is now better than ever. Supertron is making Radio History, by being the first to make the tube price what it should be. A national advertising campaign will tell the whole world that the best tube should retail for not more than \$2.00. That includes a fair profit to the manufacturer and the trade, and amply provides for a guarantee and service to the public with complete satisfaction. They will all follow Supertron, but the Industry and the public will always appreciate Supertron, because Supertron did it.

# \$2.00

ALL TYPES

No Argument Guarantee

Distributors, Jobbers, Dealers, Factory Representatives  
and Public—we welcome you. Write Now.

SUPERTRON MFG. CO., INC., 32 UNION SQUARE, NEW YORK CITY

# REG. U.S. PAT. OFF. SUPERTRON A GOOD TUBE.

Tell them that you saw it in RADIO

# TOWN-CRIER SPEAKER



The Voice that Thrills!

Price \$17.50  
WEST BY ROCKES \$16.49

## THE TOWN CRIER

affords clarity, volume, tone range—most natural reproduction. It is vibration-proof... without wooden or metallic sounds. Small, compact, sturdy—not easily overturned. Unit of the finest type. It is the Superior Speaker!

**SALES REPRESENTATIVES WANTED**  
**WHITE**  
The TOWN CRIER is a master instrument. It represents the last word in Radio Speakers. It is made right, to sell right, and stays sold. Dealers and Jobbers will find the Gale Sales and Advertising Plan well worth investigating. Write us for complete data and discounts.

**DEALERS—JOBBER**  
Samples sent for your inspection.  
Circulars Upon Request.

**GALE RADIO LABS.**  
2814 Irving Park Blvd. Chicago

## TUBE-WRECKERS

Continued from page 15

who dreams of howling tubes in his sleep. It happens also that in the course of shipment and distribution the elements of a tube may become shorted together, as already stated. To insert such a tube into a large set, particularly into a superheterodyne, is extremely hazardous and has actually resulted in a mysterious instant destruction of all the other seven tubes in the set. When getting tubes for a five or an eight-

was really defective through a weak or poorly welded filament, or whether it was blown out through the application of a misconnected B-battery.

The questionable tube is first put into the flame of a gas-jet which causes the silvery magnesium condensed on the inside of the bulb to vaporize and recondense on some other cooler part of the glass, leaving the entire top end of the bulb clear and transparent. If you wish to see the inside of a 201-A or 199 tube, you can easily do so by heating any part

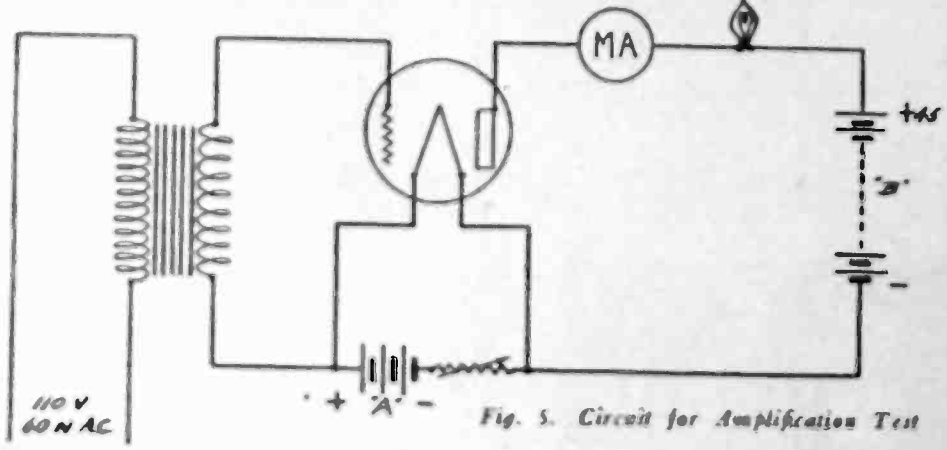

tube set it is worth while to test each tube separately before putting them all together in the big receiver.

The fifth test circuit, which is shown in Fig. 5, applies an alternating current potential to the grid so as to determine the amplification constant of a tube. This test has been found of less value than the others, and it therefore will not be dwelt on here.

A remarkable new testing machine of German invention, called a "tube-candler" is beginning to appear in this country. Its purpose is to find out whether a tube which the buyer claims "lighted only three minutes and then went out,"

of the bulb for a few moments in an alcohol or gas flame, whereupon the getter will clear off.

When the upper part of the bulb of the damaged tube has been rendered transparent in the gas flame, the tube is placed in the candling machine, which is theoretically sketched in Fig. 6. A powerful battery of incandescent lamps in this instrument throw their beams into the radio tube, thereby illuminating the interior. The shield around the tube keeps light from escaping externally. The brilliantly lighted bulb is carefully inspected through a magnifying instrument, which is focussed upon the bulb, as shown. This affords a greatly enlarged view of the grid, plate, and burnt-out filament. If the filament was blown out through the misconnection of B-batteries, the ends of the tungsten wire will show a bead; globules of fused metal will also be seen sticking to the adjacent grid and on the plate. If, on the other hand, the filament went out simply through weakness or poor weld,

# The Quiet NILES



## Battery Charger

TAKES LESS TIME

The only charger that uses both sides of alternating wave in charging. Converts 75% of current into battery charge—at 1 to 10 amperes rate. Quick action. Low expense. Model A for 6-cell batteries, \$29.00; Model AB for 6-cell and 24-cell batteries, \$21.00. West of Rockies, \$1.00 extra. Ask Any Radio Dealer.

**NILES MANUFACTURING COMPANY**  
Dept. 73, Ypsilanti, Mich.  
Cable Representatives: GARD & CROSS,  
1000 Pine St., San Francisco, Calif.

# de Forest

The Greatest Name in Radio

ARE YOU A SUBSCRIBER?  
SEND FOR TRIAL SUBSCRIPTION  
\$1.00 FOR SIX MONTHS

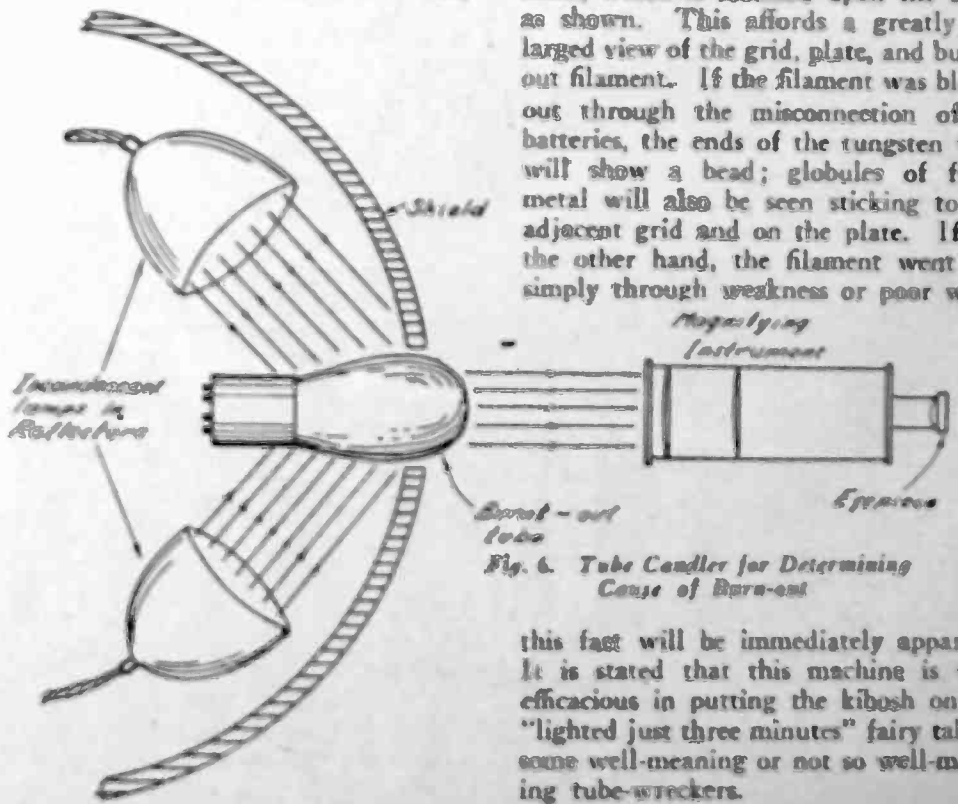

this fact will be immediately apparent. It is stated that this machine is very efficacious in putting the kibosh on the "lighted just three minutes" fairy tale of some well-meaning or not so well-meaning tube-wreckers.

Tell them that you saw it in RADIO

THE number of ways that some folks have thought up for taking advantage of tube manufacturers and sellers is hardly short of astonishing. One well-worn scheme for getting the best of the "graftin' copperation" is to buy a set of tubes and use them severely for two or three months, or until they are considerably dethoriated; then to buy a new set of the same make and type of tubes and the following day to return to the dealer with the *old* set and allege with quivering lips and tearful eyes that these are the brand new tubes the purchaser reluctantly surrendered three big berries apiece for "just day before yesterday."

It was once my misfortune to sell a dusty-looking gentleman a set of six tubes that tested remarkably well in every way, but which he nevertheless kept only five days and then returned,

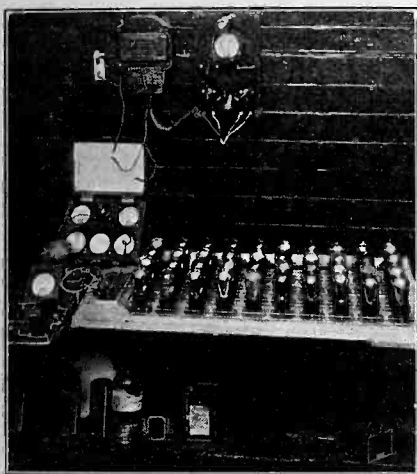

Break-Down Test Rack in Laboratory Where Tubes are Given a 12-hour Endurance Test

declaring them to be unsatisfactory. Second tests showed the tubes to be in perfect order. A refund was nevertheless made to the customer, because of his insistence that the tubes were not right. Three days later, riding on a suburban train, I recognized friend customer sitting in the seat ahead of me with another man.

"I drove out to Niles Canyon with the wife, last week," he was saying to his companion. "We took our new portable radio along and it sure worked fine. I was afraid the jarring over the canyon road would wreck my tubes, so I took along a bunch of bootlegs, instead of my old stand-bys. The bumping and jarring didn't hurt them after all and we had a lot of fine music way out there in the woods; sure enjoyed it."

"What kind of tubes were those you say you took out?" inquired the other.

"Oh, I've forgotten the name of them," replied friend ex-customer. "I took them down to the store where I bought them and got my money back."

Then, again, perhaps Mr. Twist-Itch's twelve-tube super-bunkodyne starts going bolshevik. He has a sneaking idea that something or everything is wrong with his bank of tubes, but he cannot

## New and Improved

\$5.50

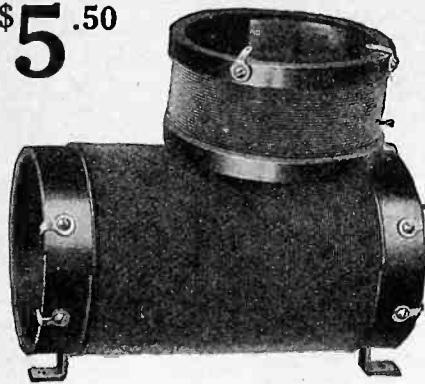

### Authorized Cockaday Coil!

No more loose windings—special new feature holds coil windings fast. Built throughout of moulded hard rubber, not affected by atmospheric conditions. Wound with No. 18 D. S. C. copper wire.

The only coil specified by L. M. Cockaday in his New Four Circuit Tuner with Resistance Coupled Amplification because it meets all his specifications. Described in October POPULAR RADIO as Cockaday Precision Coil. Hundreds have substituted this quality coil for those of inferior make and are amazed at the improved reception, selectivity and general D-Z results.

At your dealers, otherwise send purchase price and you will be supplied postpaid.

IN CANADA \$7.75

Canadian Distributor, Perkins, Ltd.  
Montreal-Toronto-Winnipeg

PRECISION COIL CO., Inc.  
209-C Centre St., New York

## SET BUILDERS

Get This---

If you are building neutrodyne, radio frequency circuits, or using hook-ups of any sort where simplified condenser tuning is important, just stop right now and investigate the

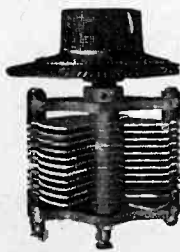

### One Knob Low Loss Vernier Condenser PROUDFOOT

Here is a condenser that eliminates the preliminary adjustment of the vernier plate before definite logging is possible. Vernier plate lines up with group plates at zero and operates as one of them. Vernier adjustment is then made by turning upper half of knob in the opposite direction.

See the Proudfoot today. If your dealer hasn't one, write us for detailed circular. Made in four sizes and priced right.

Number of Plates	M. F. C.	With Vernier Dial and Knob	Without Vernier Dial and Knob
13	.00025	\$3.75	\$3.25
17	.00035	4.40	3.90
25	.0005	4.50	4.00
43	.001	5.75	5.25

CRUVER MFG. CO., 2456 W. Jackson Blvd., Chicago, Ill.

ARE YOU A SUBSCRIBER?  
SEND FOR TRIAL SUBSCRIPTION  
\$1.00 FOR SIX MONTHS

**Obsolete**



Take the  
**"GUESS"**  
Out of Tube  
Control

**\$1.10**  
Everywhere

with

AMPERITE—the Self-Adjusting rheostat, takes care of tube current better than any expert operator could regulate it. No more hand rheostats or filament meters necessary. Brings the most out of each individual tube automatically. Simplifies wiring, doubles tube life, lowers set cost. Approved by all leading laboratories. Used in every popular construction circuit.

**RADIALL COMPANY**  
Dept. R.-10, 50 Franklin St., New York City

Write for  
**FREE**  
Hook-ups



**AMPERITE**  
REG. U. S. PAT. OFF.  
"means right amperes"



For battery, antenna and ground leads

## Jones MULTIPLUG

THE STANDARD SET CONNECTOR

Lombard J. Smith  
24 N. San Pedro St., Los Angeles, Calif.  
A. S. Lindstrom  
274 Brannan St., San Francisco, Calif.  
Mr. H. A. Killam  
146 1/2 N. Tenth St., Portland, Oregon  
Mr. G. H. Maire  
95 Connecticut St., Seattle, Washington  
**HOWARD B. JONES**  
614 S. Canal St., Chicago

## GEM TUBE A Guaranteed Radio Tube within reach of all

Every tube guaranteed. A tube for a dollar of \$3 value. A trial order will convince you as it has thousands of others. Send your orders at once.

Orders sent C.O.D. parcel post

Type .. 201A		<b>ALL</b>
Type .. 200		<b>\$ 1.00</b>
Type .. 199		<b>EACH</b>
Type .. 199A		

Dealers write for discounts.

**GEM TUBE CO.**

Dept. R., 200 Broadway, New York City

## "THE RADIOBUSTER"

Written by the author  
of "On the Trail of  
the Tube Sharks"

This wonderful book sells  
for only \$1.00

**PACIFIC RADIO PUB. CO.**  
San Francisco

# THE SILENT FRANCE MULTI-DUTY SUPER-CHARGER

**Knows No Equal!**

In superior performance, freedom from trouble, convenience, and in quietness the France Super-Charger knows no equal.

Up to 120 volts of "B" battery can be charged IN SERIES without the fuss and trouble of wire changing. It also economically charges "A" or "C" batteries at a 5 to 7 ampere rate, tapering as battery is charged.

Price of Super-Charger, \$22.00; West of Rockies, \$23.00; Canadian prices furnished upon request. Write us for name of nearest dealer, also literature describing and illustrating the France Super-Charger.



The France Mfg. Co.

10323 Berea Road Cleveland, Ohio

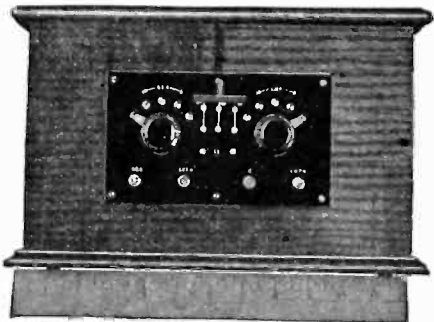

## WHY THIS NEW KIC-O MULTI-POWER UNIT IS BETTER!

Here are the reasons why thousands of radio fans are discarding the less efficient "B" power devices for the KIC-O:

1. The Kic-o multi-power unit combines one heavy capacity nickle-zinc alkaline storage "B" battery, and one Multi-Polar recharger into a compact, durable, well built unit.
2. Simplicity of operation—attach to any light socket and operate with panel switch.
3. Extreme low cost of current from lighting line.
4. Current delivered at more constant voltage.
5. Large capacity makes it very desirable for heavy drawing Nentrodyn and Superheterodyne receivers.
6. No shedding or buckling of plates.
7. Every unit guaranteed against electrical or mechanical defects.
8. A permanent power plant that will last for years.

And the hundreds of letters we have received from enthusiastic KIC-O owners prove, beyond a doubt, the unqualified superiority of the KIC-O.

### PRICES

#### Multi-Power Units (No recharger required)

130 Volts	.....	\$43.50
100 Volts	.....	35.00
PZ indicates panel type batteries with switches. CZ is plain type without switches.		
VOLTAGE	M. A. H.	TYPE PZ
130	2500	\$36.00
100	2500	27.50
70	2500	21.50
45	2500	16.00
22½	2500	7.50

#### KIC-O Chargers

Type K-1 Single Unmounted	.....	\$1.50
Type K-2 Single Mounted	.....	3.50
Type K-3 Multi-Polar Mounted	.....	5.00
KIC-O Special Charger Chemicals (one cell)	.....	.50

Write today for complete information.

**KIMLEY ELECTRIC CO., Inc.,**  
2661 Main Street Buffalo, N. Y.

A New Price  
**15c**

Plain or Engraved  
in 25 Markings  
The Tops Don't Come Off

ANT

LONG ANT

SHORT ANT

LOOP

PHONE

GND

INPUT

A+ BAT -

SPEAKER +

SPEAKER -

A BAT +

A BAT -

B BAT +

B BAT -

C BAT +

C BAT -

B AMP +

B DET +

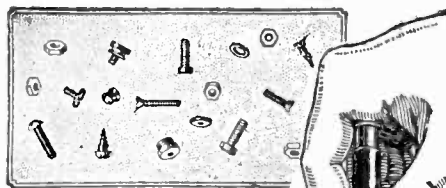

## ONE C & C REACHIT

### WRENCH TAKES THEM ALL

No necessity to pick over a half dozen wrenches to fit one nut when you use a REACHIT wrench. It not only fits all sizes but automatically HOLDS THEM ALL firmly (with adjustable jaws) while getting into the intricate positions.

**NO OTHER WRENCH CAN DO THIS**  
It assures a tight connection in the hard-to-get-at places.

A REAL TOOL FOR MECHANIC, ELECTRICIAN & RADIO BUILDER  
Nickel finish—Hardened Jaws and Fully Guaranteed.

PRICE \$1.00

If your dealer cannot supply, will be sent post paid on receipt of above amount and your dealer's name

**CAUFMAN & CLOUGH CO.**  
Wilmington Delaware

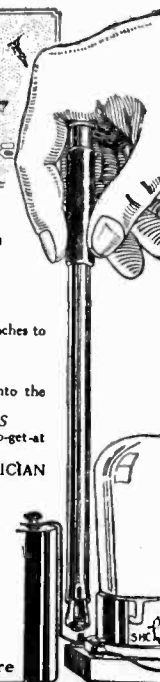

## Make Your Own Set at Half Cost!

THE GENUINE SHAMROCK-HARKNESS TWO-TUBE REFLEX ..... **\$35**

# SHAMROCK

FOR SELECTIVE TUNING

Dept. 32A, 196 Waverly Ave. Newark, N. J.

### JANUARY "RADIO"

**25c** Per Copy Only a Few Left

"RADIO" SAN FRANCISCO

be sure. Forthwith to the store to purchase a fresh armful and back home to experiment. From socket to socket, back and forth, in and out, go the tubes, and still the super-bunkodyne acts like a baby with sore gums and a sand-burr between its toes. Finally the amazing discovery is made that the young shoe-clerk snipe who lives in the adjoining flat has quietly appropriated the far end of Mr. Twist-Itch's aerial and has attached thereto a lead-in from his one-tube, 1,000 squeal-power regenerative howler. Mr. Twist-Itch, after duly destroying the illegitimate lead-in or tap-off, relievedly gathers up his armful of new tubes, now more or less scratched, dirtied, and tarnished; rolls them up in their soiled wrappers and shoves them into their frayed boxes; and then sallies forth to the store to demand refund or credit, because he has no use for them. Perhaps this sounds somewhat exaggerated, so let us take a glimpse at this letter, which is from a presumably intelligent mechanical engineer:

Gentlemen: I am sending you under separate cover four 199 tubes, which I should like repaired and returned at your earliest convenience. If it is possible to make two of these tubes above the average as detectors, when operated with two amplifiers off a single rheostat, I would like to have you do so, as I have been unable to find two really good detectors in the standard 199s. I have a super-het of \_\_\_\_\_ parts and like it immensely, but honestly believe I went through six dozen tubes before I found the eight required that would give desired results.

Yours very truly,

And later:

Gentlemen: I hardly know what to say as to my tubes, inasmuch as I have just made some relative tests of the tubes I now have in my set, which puts me more at sea than before.

As before stated, I have a superheterodyne receiver, using the Best circuit. The set functions perfectly using the tubes now in it, although these eight tubes represent the culling of about six dozen tubes. I have a few spare tubes which I have accumulated from time to time, but none of these extra tubes will permit the set to work at its full efficiency.

Yesterday I bought a new Cunningham bakelite base tube, which I culled from a dozen tubes, testing the tubes in a Harkness set for audibility. It was a whale of an amplifier as far as audibility went and on my test showed 3 m-v (whatever that means). In the super, in any position, all it did was squeal, as soon as I reached resonance. However, it was a good amplifier, and I think the most quiet tube I ever tried. I am taking it back today.

The italics, folks, are mine, not the mechanical engineer's. The layman's viewpoint, in regard to tubes in superheterodynes, seems to be that if some tubes will work in a super, all should do so, otherwise they are not up to standard. However this may be, if the tube manufacturers were to take back all the tubes that fail to give maximum results in a super, they would in about three weeks be facing a deficit that would make Germany's obligations to the Allies look like a corner store grocery bill. Strictly

speaking, the layman's viewpoint may be correct, but as a matter of fact it is at present an impossibility for any manufacturer to conform to it. Too many variable factors are involved in the making of a radio tube to enable the commercial production of an article that will be absolutely uniform.

Here is another letter of a more ferocious sort. It is from a "Dealer in Harness, Heavy Hardware, and Cowhides," up in the Siskiyou mountains, and throws a most entertaining sidelight on the remote nooks and corners to which radio is penetrating:

"Dear Sirs: Ure letter of the 22d is to hand and it is intirely unsatisfactory along with the tubs, which is more so because they ain't got no vollume and my boy has lost the sale of three of his superhydrodromes on account of these infernal tubs. I paid for them things for him in good faith and I want my muneey back, so I am going to rite to the P. O. at Washington, D. C. and show up this graftin coperation for using the mails and governments parcellpost to kerry on sich a business. I hate like the duce to git stung, not for 5 cents, even if I have to spend 3 times the muneey. But to advertise them tubs like they do, I most certainly will advise all the magazines just what kind of deal they are helping to hand out to us unwarry suckers like me up hear in these 1-horse towns. Looking forwird to getting back my muneey and postige, I am,  
Yours trully

And a second epistle:

"Dear Sirs: We have just found like you said them confounded battrys from Seattle is sweating like dishrags and so it is no wonder the tubs don't work as they are working first rate in the barber's nuterdyne next door, but we have quit the radio business up here because it is making us nervous recks showing peeppil how to run them sets which is never running unless nobody but us is hearing them, and my wife is sick as hell of the botheration and I am sickir of it, so I am still looking forwird to getting my muneey back, and postige,  
Yours trully

A few final words of thoroughly experienced advice. Do not operate 199 tubes on more than 3 volts or 201-A tubes on more than 5 volts filament potential. Buy a voltmeter and put it in your set; it will pay. Limit B-battery voltage to 112 1/2 for 201-A tubes, 90 for 199 tubes, and 45 or 67 1/2 for WD-11s and WD-12s. Do not force thunderous volume from 199 tubes; if you must have deafening sound use 201-A or 202 tubes in your final audio-frequency sockets.

Last and of special importance to superheterodyne users: Remove all your tubes at least once a month and have them tested by a radio concern that has a good tube-testing machine and that knows how to use it. Almost without fail, one or two of your six or eight tubes will begin to "go flat" or die before the others, and it will be necessary to ride this flat tube on excess filament voltage to get normal volume, with consequent overload and damage to your other seven perfectly good tubes. Continually, day in and day out, super-

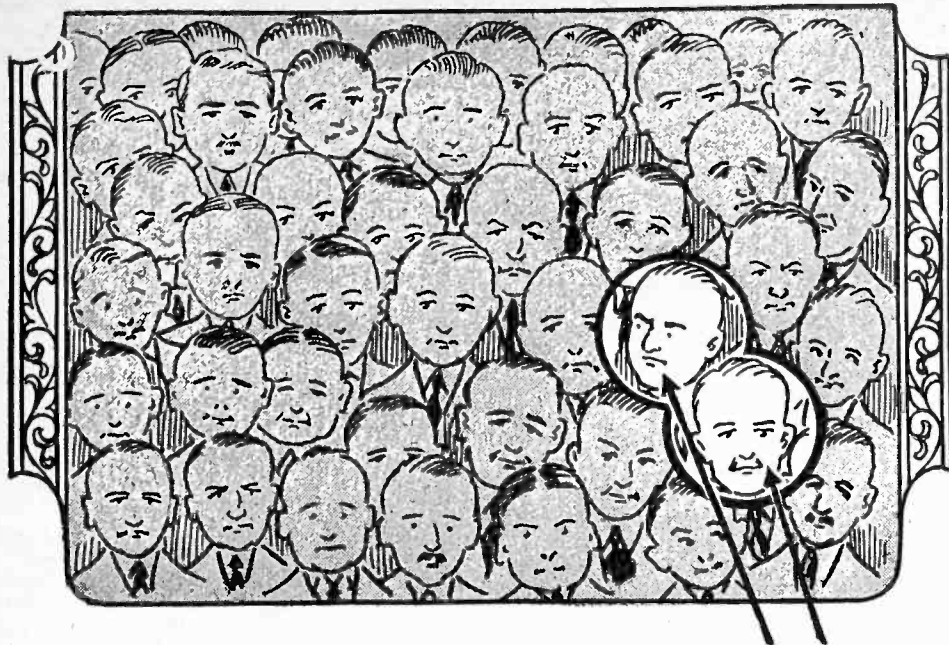

**Mr. Manufacturer:**

**Would you write 100 letters to 100 people to reach just two men?**

Then, before you invest your advertising dollars—**THINK!** An analysis shows that publications of general circulation, newspapers and magazines, devote less than 2% of their reading columns to radio—proving that, in the opinion of their own editors, less than 2% of their readers are interested in radio. In fact, many general publications carry no radio editorial matter. Therefore—98% of your investment is lost! On the contrary, the radio magazine offers 100% radio editorial—attracts 100% potential buyers.

Spend your advertising appropriation in Radio Magazines. Be sure of the greatest possible return on your advertising dollar.

**Radio Magazine Publishers Association, Inc.**

THIS ASSOCIATION IS COMPRISED OF THE LEADING RADIO MAGAZINES

**BUY THE**  
**FIL-KO-ARRESTER**  
LIGHTNING  
SCIENTIFICALLY CORRECT  
*with the '100% Guarantee*



This radio lightning arrester is warranted to protect your set from lightning, with a guarantee to pay you \$100, or to repair your set, should it be damaged through any fault of the arrester. The "umbrella" shield keeps dust, moisture, etc., from the Bakelite insulation, preventing leakage losses from aerial to ground. This makes certain that all radio impulses reaching the antenna pass through your set, assuring maximum reception.

Listed as standard under the re-examination service of the National Board of Fire Underwriters.

If your dealer has none, send his name with remittance direct to Dept. R525.

DX INSTRUMENT CO., HARRISBURG, PA.

\$1.50  
\$2.25 IN CANADA

**DURHAM**  
**Grid Leaks**



Used by Eagle, Howard, Thompson, Zenith and others. Fit all sets. Sold on guarantee.

**50c** Metallized Fixed Leaks  
18 sizes; under 1/4 meg., 75c; over 1/4 meg., 50c.

**75c** Glass Sealed Variable Leaks  
3 sizes fit all sets; 75c each for 1/10, 5 and 10 megs.

At dealers or postpaid

**DURHAM & COMPANY, Inc.**  
1936 Market Street · Philadelphia, Pa.

ARE YOU A SUBSCRIBER?  
SEND FOR TRIAL SUBSCRIPTION  
\$1.00 FOR SIX MONTHS

# PYREX

PYREX is the trademark of a special material which possesses distinctive properties as a radio insulating material. It is not an ordinary glass.

PYREX insulation is used by the U. S. Navy, Coast Guard, Shipping Board, Air Mail, etc.

PYREX insulators for your antenna cost 45 cents each. They improve reception.

**Insist on PYREX**

**CORNING GLASS WORKS**

*Industrial and Equipment Div.*

CORNING, N. Y.

heterodyne users are ruining six or seven perfectly good tubes by running up filament voltage to force emission from one or two dethoriated tubes. Test the tubes and lay aside the dethoriated tube, rather every thirty days; and when one drops much below normal, replace it at once than try to keep on with it and destroy all your other tubes. The tube and B-battery expense of an eight-tube super-heterodyne is from four to eight dollars a month, if the set is used much. If you do not feel that you can stand this, you should be wiser to limit yourself to the much more economical 5-tube neutrodyne, using 201-A tubes. The super is the Rolls Royce of radio, the neutrodyne is the Buick, the two-tube Harkness the Ford, and the crystal set is the bicycle. No one expects to get forty miles to the gallon out of a huge touring car, but some folks expect to get about forty thousand hours out of a delicate thorium-tungsten filament one-third the size of a human hair which is emitting billions of electrons every second it is lighted.

In the meantime, work goes on steadily in every big tube laboratory to improve the tube and to reduce the cost of production. But the policy of the manufacturers in regard to replacements will probably become even more stringent than at present.

## CALLS HEARD

*Continued from page 69*

By R.049, Jean Jolly, 105 Rue Lesage, Rheims (Marne), France

1af, 1aau, 1abn, 1afn, 1apc, 1ary, 1azr, 1bk, 1bdx, 1bgd, 1bhm, 1bkr, 1bbp, 1bzt, 1cc, 1cab, 1cak, 1crl, 1dl, 1er, 1ga, 1ht, 1kr, 1nd, 1rd, 1rr, 1vd, 1yb, 2ag, 2aay, 2abt, 2axk, 2azy, 2bab, 2bcy, 2blm, 2bm, 2bqh, 2br, 2brb, 2buy, 2cby, 2chj, 2cnd, 2cns, 2cpd, 2cvf, 2cvj, 2cxy, 2dl, 2lc, 2le, 2sd, 3bco, 3bva, 3lg, 3lw, 3mf, 3rdp, 3ur, 4ba, 4du, 4fm, 4hj, 4kh, 4ot, 4uc, 4uf, 4uk, 8au, 8adg, 8alk, 8aly, 8avl, 8bcm, 8be, 8ben, 8bfe, 8bl, 8chk, 8cj, 8dgl, 8dgp, 8do, 8mjm, 8rvl, 8ry, 8ua, 8vq, 8vt, 8xe, 9bzk, 9ek, 9hp, 9kb, wl. Qsl crds to any of above on request. All crds ansd. and appreciated.

By 2BEE, No. 1057 Grant Ave., Bronx, New York City

(4bk), 4du, (4dv), 4eq, 4je, 4jr, 4kl, 4kt, 4ll, 4ol, 4pt, 4pv, (4ly), 4sa, 4tf, 4tv, 4tw, 4vp, 5abn, (5ac), (5ag), (5alc), (5all), (5ajn), (5aom), (5apj), (5anj), 5aur, 5bz, 5ew, 5hl, 5hs, (5hy), (5in), (5bj), 5lh, (5lm), (5lr), (5ls), 5ph, 5ql, (5uk), 5zal, 5zas, 6add, 6ahp, 6ahq, 6ajq, 6anb, 6ar, 6arc, (6bbq), 6bh, 6bku, 6bmo, 6cau, (6cbb), 6cgc, 6cgv, 6chs, (6clv), 6cng, 6cno, 6cpf, (6cqe), 6cso, 6css, 6dah, 6dar, 6dax, 6dhv, 6ea, 6eb, 6iv, (6ja), 6jp, 6no, 6ol, 6rn, 6ua, 6wp, 6xbn, (6zbt), 6zh, 7abb, 7adf, 7adg, 7afg, 7afu, 7ald, 7ao, (7av), (7dd), (7df), 7dj, (7fq), 7ly, 7rd, 7rq, (7uj), 7vg, 7vh, 7zc, 7zf, 7zn. Canadian: (4cb), 5ba, 5gf. Cuba: 2lc, 2lm, 2mk. Mexico: (1aa), 1af. English: 2cc, 2kz, 2nm, 2od, 2rb, 2sz, 5li, 5uq, 5vq. French: 8bv, 8gm, 8sm. Dutch: Orn, oll, onl. Miscellaneous: J-1er, CH-3rq, M 1M S-EAR2, R-CB8, NZ-2ac, NKF, NFV, NQG. We will QSL upon receipt of a card. QRK?

By SBLP, SACI, J. Healy, 125 Spruce Ave., Rochester, N. Y.

(1adb), (2box), (3zo), (4tv), (5ac), (5al), (5ajn), (5ls), (5vz), 6eb, 6ao, 6cc, 6ol, 6zd, 6awt, 6akw, 6ajl, 6b2b, 6buw, 6bdv, 6cbb, 6cto, 6cmu, (6chs), 6cmo, 6cae, 6csr, 6cgv, 7dd, 7es, 7f2, 7g2, 7lr, 7ly, 7mf, (8awx), (9afo). Can. (1dd), (2au), (3nf), 5ba, 5kw. 5 watts hr. with indoor antenna 8 counterpoise. Reports appreciated and 2SL'ed. Crd to any of above on request.

*Continued on page 79*

# YANKEE TUBES—

*Proven Beyond All Doubt—*

**“THE ACE OF INDEPENDENTS”**

**TYPES 199-201 A**

**\$ 3.00**



Sold only thru well-established retail dealers

Distributed by  
W. E. & W. H. JACKSON  
San Francisco  
MARSHALL-WELLS  
Portland  
THE BANTA COMPANY  
Los Angeles  
RADIO SUPPLY CO.  
Los Angeles

DEALERS—Write to the distributor in your territory as shown below for attractive proposition.

**BALDWIN PACIFIC & CO., San Francisco**

(PACIFIC COAST REPRESENTATIVES)

## RADIO DEALERS WANTED

BIG DISCOUNTS ON STANDARD PRODUCTS

**W. C. BRAUN CO.**

32-40 S. Clinton St., Chicago  
ASK DEPT III FOR DEALERS CATALOG

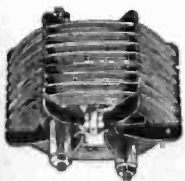

**THE ANDREWS PADDLEWHEEL COIL**  
A low-loss inductance. Improves tone quality and increases signal strength and selectivity.

Price, with bracket, \$3.00  
RADIO UNITS, INC.  
1303 First Ave., Maywood, Ill.

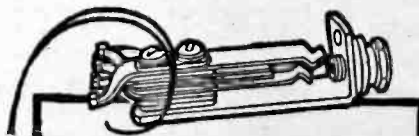

**B. M. S. JACKS** have the exclusive cupped fantail lugs, which make soldering easy. The Jacks are made of solid brass, while the springs are of phosphor bronze. Made in all styles. Ask your dealer.  
Distributed by **F. L. TOMLINSON & CO.**

443 S. San Pedro Street, Los Angeles, Calif.  
Pacific Bldg., San Francisco





**LOW LOSSING EVERY-  
WHERE**

*Continued from page 34*

of board is fitted into place in the jamb of the window and the lead-in arrangement brought through it (d).

The ground connection is the place of most criticism. Our poor old water pipes could tell a real tale of being over-worked electrically. It is true that a water pipe connection is usually convenient to make. But at least make it a good one. File the pipe or faucet *clean and bright*. Use a ground clamp, which only costs a few cents. Provide as *short and direct* a lead as possible to the set. If you want to be a real lowlosser try a "Round's Round" ground, described in RADIO sometime ago; or try a driven-in ground in a moist place. Better yet, sink a large sheet of copper in a well or stream, if you are so fortunate as to be near either. Remember that soldered connections are a positive necessity.

A counterpoise is a splendid thing for the transmitter, and may well be installed as an adjunct to a receiver. It consists in its usual form of several radiating wires placed under the antenna as nearly as is possible. The wires are placed near, but not on, the ground and *well insulated from it*. This means the choice of good insulators (glass or porcelain) and the use of *few* points of support in order to minimize chances of leakage. For transmission on the lower wavelengths a counterpoise of two wires will work very well in conjunction with a one-wire antenna. In case but little backyard space is available the antenna may slant down from a pole on the roof of the house and the counterpoise be on the roof (but well insulated from it) and as nearly symmetrically placed with respect to the antenna as is possible. It has even been suggested that both antenna and counterpoise be erected on the same pole from a top crossarm, but such an arrangement will no doubt be practicable only for the short wave transmission.

Coming now to the receiver itself we have a troublesome problem. There are so many types of receivers that it seems difficult to lay down general rulings applicable to all. Yet, on the other hand, there seem to be certain practical considerations along the low loss idea which should apply to any set, no matter what kind. These are as follows:

1. Use a *real* socket, made of a good insulating material, and providing tube contact from the *side* of the prongs as well as the bottom. Eliminate tube noises and lower resistance. Your *tube* is the *heart* of the set—give it a chance!

2. Use an honest-to-goodness grid leak and forget that India ink idea. If you use a regenerative receiver you will be several steps nearer heaven if the grid leak is *variable*. Whether variable or not, make it the best.

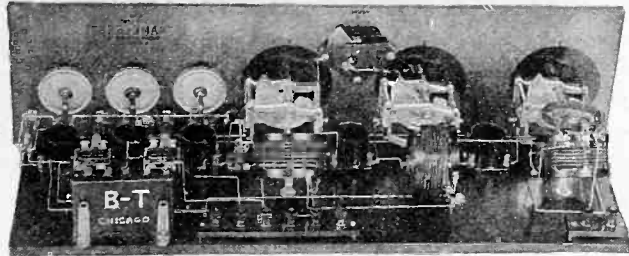

**A Set You Can Rely Upon**

Have you ever had the experience of logging almost every station in North America? And then—the very next night after you have bragged about your radio all day and a bunch of friends are in to listen, the same set refuses to drag in anything over 500 miles away, and that with difficulty? We all demand from our radio whatever the make, distance, selectivity, tone quality; but there is another characteristic that applies peculiarly to the B-T "NAMELESS" and that is *Consistency*. Once you have it logged—go back and get it.

Because of the circuit itself and the efficiency of B-T apparatus used in its construction, the "NAMELESS" has that extra sensitivity, a reserve power to go out and bring them in even when atmospheric conditions are not the best.

The "NAMELESS" is a combination of a circuit designed for the parts and the parts designed for the circuit with a method of construction that insures success to even the most inexperienced builder.

Kits containing the essential parts for the "NAMELESS" can be purchased at all reliable radio stores. Descriptive bulletins describing the "NAMELESS" may be had from your dealer or by mail at your request.

**BREMER-TULLY MFG. CO.**

532 S. CANAL STREET

CHICAGO, ILLINOIS

**GET A LOUD SPEAKER UNIT WITHOUT COST!**

The new BIG THREE RADIO CORPORATION phonograph unit is given free this month only in return for one subscription to "RADIO" for one year. The price for a year's subscription to "RADIO" is only \$2.50. The phonograph unit is given to you without one cent of cost. Only a few on hand. Orders must reach us before May 20th. Get one of these dandy units now.

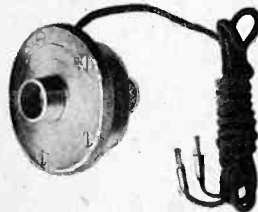

Here is the BIG THREE RADIO CORPORATION phonograph unit. A wonderful premium for your subscription to "RADIO" for one year.

Newsstand buyers of "RADIO" should take advantage of these big subscription offers. You get "RADIO" for one year—mailed to your home—and a good radio premium to boot.

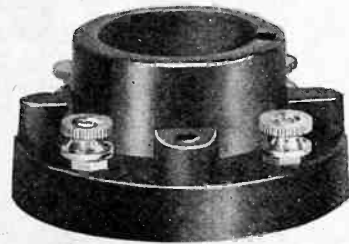

Three of these 199 type sockets given free with one subscription to "RADIO" for one year. The entire cost to you is only \$2.50. A limited number of these premiums on hand. All orders must be in no later than May 20th.

**"RADIO"**

Pacific Building, San Francisco, California

**Log for Your Radio**



NEW 64 page log. Holds 400 stations. Shows calls, cities, wave lengths, & dial settings, remarks, etc. TUNING SUGGESTIONS. Station list by wave lengths—by states, etc. Owners' Map. TROUBLE AIDS. Other valuable information. So convenient. Worth many times small cost. A joy to use. GENUINE De Luxe leather cover. Only \$1.

Send No Money. Pay postman after log arrives. Postpaid if pay with order. MONEY REFUNDED if not DELIGHTED. Order today—NOW. Postal will do RADIO PRINTERS, Dept. 3474 Mendota, Illinois



**FROST-RADIO  
MUSETTE**

"The Stradivarius of Radio"

Black Finish . \$12.50  
Silver or Gold Finish \$20

For perfect reproduction of all instruments and the human voice Musette cannot be excelled. Hear it at your dealers.

HERBERT H. FROST, Inc.  
314-24 W. Superior Street Chicago



Price \$1.10

**"PASSED BY UNDERWRITERS"**

The Jewell Lightning Arrester, in Brown Porcelain Case, is sold by leading Radio Dealers everywhere.

Jewell Electrical Instrument Co.  
1650 Walnut St., Chicago

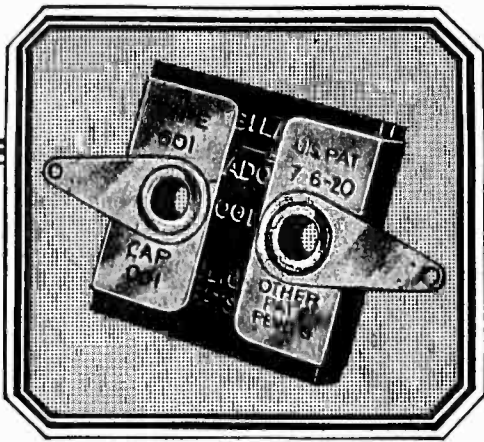

# MICADONS

## Condensers of Fixed and Permanent Capacity

You will have condensers that maintain their capacity if you buy Micadons. These accurate Dubilier condensers are found in over ninety per cent of all sets made by amateurs and manufacturers throughout the country. The experts specify Micadons.

The name Dubilier on a condenser has the same meaning as the name Sterling on Silverware—highest quality. There is a Micadon for every circuit—different types are made for different requirements.

For free booklet showing method of soldering Micadons in radio circuits, address: 45-49 West 4th Street, New York

# Dubilier

CONDENSER AND RADIO CORPORATION

## HEATH

RADIANT CONDENSERS

For Real Radio Reception  
HEATH RADIO AND ELECTRIC MFG. CO.,  
208 First Street, Newark, N. J.

## TELOS RADIO

Write for a free copy of our new, handsomely illustrated booklet, "The KIT of a Thousand Possibilities."

DANZIGER-JONES, Inc.,  
Department F. 25 Waverly Place  
New York, N. Y.

Subscribe to "RADIO"—\$1.00 brings it for 6 Months

## The Andrews Deresnadyne

RADIO RECEIVING SET

Combines tone quality and selectivity with distance and volume. Price \$150 without accessories

ANDREWS RADIO CO., 327 S. La Salle St., Chicago

3. Pick out a *low loss* condenser. This means one with a small amount of insulating material, and that not in the dielectric field; it means good electrical contact, preferably by soldering and pig-tailing. The low loss idea has brought several excellent condensers on the market.

4. Wire your set to stay. This means a good soldering job, using a non-corrosive flux (rosin is good). Use wire of good size—either bus bar or drawn copper—and make the leads as short as possible *without* placing all instruments too close to each other. Do *not* run too many leads parallel to each other (especially grid and plate leads). Use lugs to avoid sloppy terminals.

5. Make up *real* coils. Several suggestions were given in the February RADIO in the writer's article entitled "The Experimenter's Short Wave Low Loss Tuner." In making the coils have the amount of insulating material as small as possible, obtain good mechanical strength, and use enameled wire or "bell" wire. The coil wound on air cannot be made, but we can make a fair substitute. Remember that cotton absorbs moisture readily, thus defeating your low loss idea; hence, avoid cotton covered wire. Silk covered is not so bad, but is still open to the objection. If you *must* use either, then by all means give your coil a coat of collodion as a protective measure. Any wooden parts used in coil construction should be boiled in paraffin.

6. Your 'phones should be connected *right*. Look for the cross or colored cord. This lead is supposed to go to the positive (plate) side. If you are not sure about your 'phones *find out*.

7. Don't crowd your apparatus. Buy a panel and baseboard amply large. The interaction of several pieces may cause losses in your set; you therefore will find it advantageous to space well.

The above but briefly indicates the many places in which the careful fan may apply the low loss idea. Go over your set carefully and check yourself. Actually rate your set on a point basis as follows:

	Max.	Score
I. Antenna .....	10	.....
II. Antenna lead-in .....	10	.....
III. Ground .....	10	.....
IV. The Set:		
1. Socket .....	10	.....
2. Grid leak .....	5	.....
3. Condenser .....	20	.....
4. Wiring .....	5	.....
5. Coils .....	20	.....
6. Phones .....	5	.....
7. Arrangement... ..	5	.....

Can you honestly claim a total of 100 points? Can you honestly claim that any one item is entitled to a full score? Get some friend to rate your set and see how his total compares with yours.