

June, 1922

CIRCULATION
OVER 60,000

25 Cents

RADIO

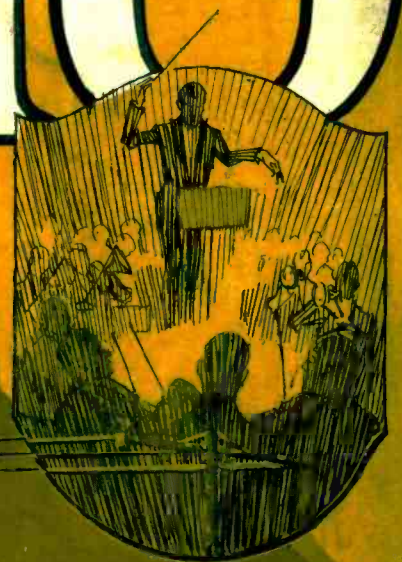

**Over the
"waves"**

*Everything for
the radio user*

*—enjoying a
special con-
cert number
broadcasted
from Rock
Ridge (KZY)
Oakland, Cal.*

Atlantic-Pacific Radio Supplies Company

638 MISSION STREET
SAN FRANCISCO, CALIFORNIA

Operating (KZY) Rock Ridge Station,
Oakland, Cal.

EASTERN OFFICE AT
5 KIRK PLACE, NEWARK, N. J.

www.americanradiohistory.com



CUNNINGHAM
C-300
GAS CONTENT
DETECTOR

\$5⁰⁰

PATENT NOTICE.
Cunningham tubes are covered by patents dated 11-7-05, 1-15-07, 2-18-08 and others issued and pending. Licensed only for amateur or experimental uses in radio communication. Any other use will be an infringement.

CUNNINGHAM TUBES

Nationally recognized as the tube giving clearest reception for all makes of

HOME RECEIVING EQUIPMENT

The remarkable results that Cunningham Tubes give in Home Receiving Sets has given them national recognition as the tubes which give clearest reception for any type Receiving Set, for both spark and C. W. Telegraph and Telephone.

In addition to its remarkable detector properties, low B. battery, quietness in operation, Type-C-300 is a free and persistent oscillator for regenerative amplification and C. W. reception and functions without distortion of the received signals.

Write for further particulars to your nearest dealer, or write to us direct.

E. J. Cunningham

Trading as
AUDIOTRON MFG. COMPANY

248 First Street, San Francisco, Calif.
154 West Lake Street, Chicago, Ill.



The trade mark GE is the guarantee of these quality tubes. Each tube is built to most rigid specifications.



Lawrence Mott, 6XAD, President

G. G. Griffeth, 6AA, Secretary

H. O. de la Montanya, 6AUL, Treasurer

NEW DX RECORD BY 6ZAC, 6ZF AND NOF

No better argument as to the efficiency of C. W. is needed than the remarkable results that are being secured by 6ZAC with the set designed and constructed by members of the C. W. Association of America. The astounding reception by 6ZAC, as first reported in these columns, are being equalled by his transmitting work. This station is owned and operated by Clifford J. Dow at Wailuku, Maui, Hawaii. Mr. Dow is the Hawaiian representative of the C. W. Association of America and is setting a pace for other members of the association to emulate.

For the first time in the history of American amateur radio, on the evening of April 13th, 1922, 6ZAC succeeded in reaching the Pacific Coast with his signals, actually WORKING five stations in one evening. Numerous messages were exchanged with these mainland stations, with little or no difficulty on account of interference.

A new long distance record was also established when 6ZF, W. W. Lindsay, Jr., at Reedley, in central California, received a message from NOF, a naval station of low power and situated in Washington, D. C., acknowledged its receipt, and relayed it IMMEDIATELY to Dow at Wailuku, thus making the total distance the message was transmitted at approximately 5000 miles. This eclipses any previous relay records, as the amateur has been limited by the bounds of the United States or Canada, and Dow's entry into the field with a powerful transmitting set will enable him to work directly with not only the Pacific Coast, but stations east of the Rockies as well, judging from the number of eastern stations he has been hearing lately.

As this article is being written, a letter from Dow is at hand, reporting continued reception of 2FP, Brooklyn, N. Y., on a wavelength of 200 meters. This is by far the greatest distance that amateur signals have been consistently heard, and the evidence submitted by Dow shows that his work is not freaky, but steady and reliable, night after night. 2FP is using one 250 watt tube, and his record of 5000 miles is without doubt the longest distance yet covered by an amateur station.

The transmitter used by Dow was described in detail in the May issue of RADIO, so that no further description of it is necessary except to say that it employs two 50 watt tubes in a self-rectifying circuit with 60 cycle alternating current source. The set was shipped from San Francisco late in March, and arrived at Wailuku on April 1st, ready to set up. Some delay was experienced, however, with the antenna system, as Mr. Dow's receiving antenna was wholly inadequate for transmitting purposes, so a new and much larger one had to be erected. On April 10th a 90 ft. mast was placed in position and a four wire cage antenna of a very durable nature was strung between the top of the mast and the roof of a nearby building. A seven wire counterpoise was placed 55 ft. underneath the antenna, or 35 ft. above the ground. This produced an antenna system of very low resistance, as later tests showed. Two days were spent in tuning the transmitting set to the proper wave, and a radiation of 6.5 amperes was obtained when the power supply was at the proper voltage.

A quotation from Mr. Dow's log will perhaps give the reader the best description of how he finally got across on the 13th:

"The set was adjusted Wednesday evening, but owing to doubt about the wavelength, was not worked. Next day got a check from Honolulu that she was O. K., so that evening I made a lot of noise along about 8:30, trying to get

Mr. Babcock (6ZAF) and slip him the first honors, but he wasn't with me, and when 6ZQ (Berkeley, Calif.) nearly knocked me out of my chair with his loud spark, I worked him for an hour. He took my two messages without repeats and gave me one. Guess no one expected me over there, so didn't hear anyone else after him. Friday evening Mr. Babcock was the second station to work trans-Pacific, for I took a message from him. Then I worked 6ZQ again, giving him SEVEN messages. Sure takes 'em nicely, so it must be SOME signal, to work through the interference present in the San Francisco Bay district. He said he can probably work me through anything. I took one message from him, and then after chewing the rag for over an hour, I heard 7YA, Boise, Idaho, very QSA on the one step I use always, asking 6ZQ to QSP me. Didn't need to be QSP'd, but told him to go ahead. He said that I was nicely QSA there. Took a message from him. 7YA is 2805 miles and Berkeley is 2355 miles from Wailuku, on the great circle. Saturday evening I worked Mr. Babcock again and also 6ZQ, 6ZF, Reedley, Calif., 6ZI, Oakland, Calif., and 7YA, exchanging messages with all of them."

The Saturday night that Dow describes above will remain for a long time in the memory of those who had the good luck to be listening in when 6ZAC commenced to call CQ. By Saturday many had been notified that Dow was on the air nightly, and all those

Continued on page 90

ADDITIONAL DX AT 6XAD

- | | | |
|---------------------------|------------------------|-------------------------|
| 1ARY—Burlington, Vt. | 8CBJ—Lockport, N. Y. | 9DZJ—Great Bend, Kans. |
| 1BDU—Winthrop, Mass. | 8ZO—Columbus, Ohio. | 9BTA—Ottawa, Ill. |
| 1BHW—Hartford, Conn. | 8ARD—Cleveland, Ohio. | 9BFG—Clear Lake, Iowa. |
| 1BLN—Westfield, Mass. | 8AXN—Brocton, N. Y. | 9DWX—Chicago, Ill. |
| 3AAG—Hilton Village, Va. | 8BZY—Detroit, Mich. | 9BAD—Ellendale, N. D. |
| 3AFW—Clarendon, Va. | 8ACF—Washington, Pa. | 9AQE—Eldorado Kans. |
| 3HS—Chevy Chase, Md. | 8AXK—Cincinnati, Ohio. | 9ARZ—Clear Lake, Iowa. |
| 3ARN—Chevy Chase, Md. | 8AMM—Webster, N. Y. | 9BJI—Denver, Colo. |
| 3CG—Newton, N. J. | 8FT—Troy, Ohio. | 9AVP—Waukegan, Ill. |
| 3IL—Washington, D. C. | 8IZ—Milan, Ohio. | 9IF—Giltner, Neb. |
| 3ADX—Bywood, Pa. | 8BOQ—Cleveland, Ohio. | 9DKY—Mason City, Iowa. |
| 3NB—Sarnia, Ontario, Can. | 8AGK—Lancaster, N. Y. | 9BED—St. Louis, Mo. |
| 5BP—Houston, Texas. | 8AXY—Fairmont, Va. | 9YAJ—Northfield, Minn. |
| 5GI—Birmingham, Ala. | 8AM—Detroit, Mich. | 9OX—Louisville, Ky. |
| 8BXX—Norwalk, Ohio. | 8BSF—Buffalo, N. Y. | 9AVZ—Pierre, S. D. |
| 8BIP—Syracuse, N. Y. | 8ANM—Pittsburg, Pa. | 9AOY—Chicago, Ill. |
| 8NB—Rochester, N. Y. | 9DZI—Columbia, Mo. | 9FN—Kansas City, Mo. |
| 8VY—Kalamazoo, Mich. | 9EA—Duluth, Minn. | 9XT—Collegeville, Minn. |
| 8HJ—Elmira, N. Y. | 9DSJ—Hutchinson, Kans. | |

NB—The above records have been made since the publication of a former DX list, in the April number.—ASSOCIATE EDITOR.

DIGEST OF RECENT RADIO PATENTS



Prepared by White, Prost & Evans, Patent Attorneys, San Francisco, who have been particularly active in the radio field for many years, and from whom may be obtained further information regarding any of the patents listed below.

M. C. A. Latour, Pat. No. 1,405,523; Feb. 7, 1922. Audion or lamp relay or amplifying apparatus.

This patent describes a scheme of connections for amplification by lamp relays 1, in which the ratios of transformation of transformers T_1 , T_2 and T_3 are chosen so as to get the maximum amplification. These ratios are deduced mathematically in the patent. For good effects, these transformers must also be wound to have minimum losses and low distributed capacity. To eliminate "howling," the cores M_1 , M_2 and M_3 are connected to a source so as to define their potentials.

J. B. Morrill, Pat. No. 1,406,996; Feb. 21, 1922. Electric wave ranging system.

A scheme is described for locating an object with respect to three fixed points. This is accomplished by sending waves from each point A, B, or C, each having its distinctive carrier frequency, modulated by A. C. generators 2. These modulated waves are received by the object, and the difference in phases between the modulations is used to determine the differences in the distances from A, B and C to the object. From this data it is possible to locate the object.

F. K. Vreeland, Pat. No. 1,407,103; Feb. 21, 1922. Receiving system for radio telegraphy and telephony.

A scheme for eliminating strays or statics in a receiving circuit is described. An element S is connected in parallel to the primary p of a transformer which serves to transmit the signals to an electrostatic receiver D. For heterodyne receiving a generator G may also be used to supply energy to the receiver circuit by way of transformer s_2 , p_2 . The element S is preferably an electrolytic cell which may be so arranged that only impulses beyond a given intensity can pass through. In this way the relatively weak signals must go through the circuit T, P, and T_1 while the strays are by-passed through S. The provision of circuits T and T_1 resonant to the signal frequency makes the device function still more satisfactory.

R. H. Marriott, Pat. No. 1,407,205; Feb. 21, 1922. Radio receiving system.

In order to neutralize atmospheric disturbances such as "static," two receiving circuits are used comprising antennae 1 and 10. The circuit including antenna 1, coils 15, 16 and 17 is tuned to signal frequency, and is coupled by coils 17, 48 to a detector circuit including the crystal 20 and telephone 23. The circuit including antenna 10, coils 15 and 45 is tuned to half the frequency of the signaling waves, but due to the unidirectional conductors 41, 44 and coils 42, 43 and 47, energy at this frequency is transformed into energy at twice the frequency and is made to oppose the energy received in coil 48. In this way the disturbances only are neutralized, because the antenna 10 does not respond to signaling waves appreciably, and therefore the energy transmitted through coil 47 represents only that due to atmospheric disturbances.

J. B. Bolitho, Pat. No. 1,407,245; Feb. 21, 1922. Amplifying device for use in wireless telegraphy.

A detector and amplifier tube 1-2-3 is coupled to the antenna circuit and is so arranged that the grid voltage is almost at the point where it can oscillate. The received signals cause these oscillations to be initiated. However, an electrical quenching device is used to stop the oscillations periodically. This is accomplished by means of a source of A. C. such as the tube 29-30-31 of a frequency differing materially from that of the signaling wave. This source is connected in the plate circuit of still another tube 12-13-14, in which circuit there is also located a coil 22 coupled to and opposing coil 9. As the potential on plate 12 is varied by source 12-13-14, the coil 22

periodically quenches the oscillations by opposing the coil 9.

R. R. Beal, Pat. No. 1,410,730; March 28, 1922. Radio oscillation generator.

An arc generator is described, which consists of two members 5 and 6 hinged together at 4, between which there is a narrow arc chamber 22. Each member 5 or 6 carries a pole piece 8 or 16 and energizing coils for influencing the arc. The magnetic circuit is completed by the outer shells of members 5 and 6. The production of a hydrogen atmosphere is effected by dropping liquid hydrocarbon through cup 28 and passage 29 into

Continued on page 54

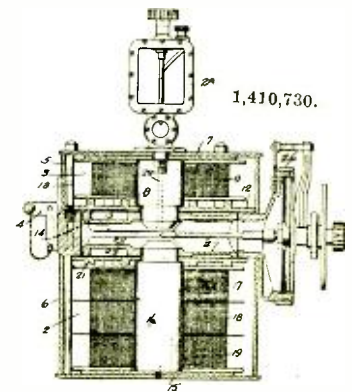
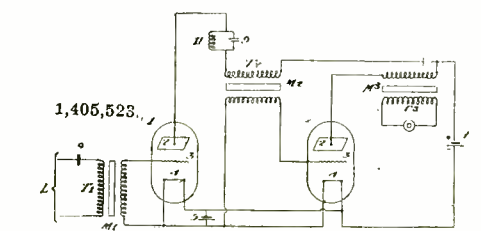
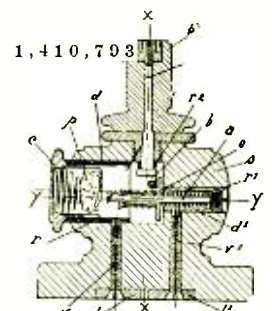
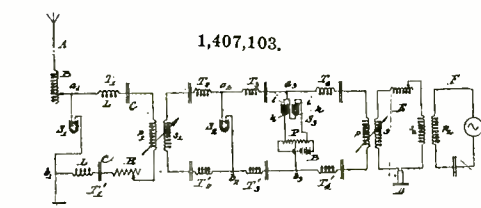
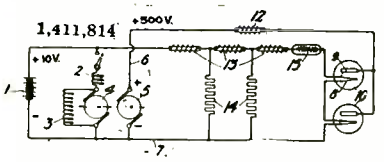
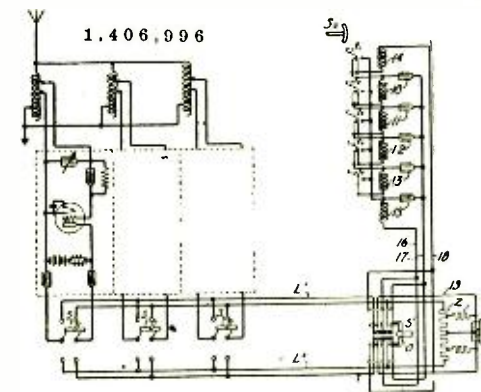
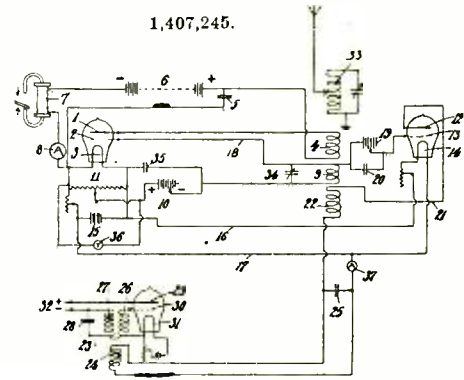
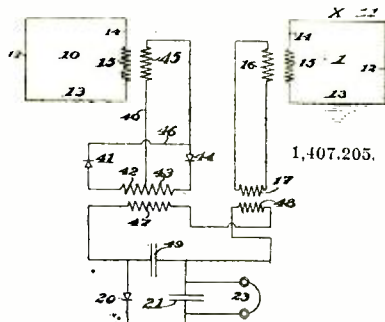

With the U.S. Radio Inspector.

Conducted by
Major U. F. Dillon



NEW NAVAL RADIO WEATHER REPORTS

Weather reports are now broadcasted twice daily from NPG, the San Francisco Naval Radio Station, in accordance with a new code system. The noon (75th meridian time) bulletin is on 4650 meters, C. W., the 10.30 p.m. bulletin on 1908 meters, spark.

The bulletins are divided into two parts, the first giving surface and upper air weather conditions observed at various Pacific stations, and the second giving observed pressure conditions, forecasts and storm warnings.

FIRST PART

The first part begins with the letters USWB (U. S. Weather Bureau), followed by the observing station key letters shown herewith, and concluded with two or more 5-unit groups of figures.

KEY-LETTERS AND STATIONS

Alaska ¹	
DH	Dutch Harbor
EA	Eagle
JU	Juneau
NM	Nome
SK	Sitka
TN	Tanana
VZ	Valdez
United States	
TAT	Tatoosh Island, Wash.
SE	Seattle, Wash. ²
NH	North Head, Wash.
PD	Portland, Ore.
RO	Roseburg, Ore.
EUR	Eureka, Calif.
RB	Red Bluff, Calif.
SM	Sacramento, Calif. ²
SF	San Francisco, Calif. ²
FN	Fresno, Calif.
SLO	San Luis Obispo, Calif.
LA	Los Angeles, Calif. ²
DI	San Diego, Calif. ²
HL	Helena, Mont.
BS	Boise, Idaho
LD	Lander, Wyo.
WM	Winnemucca, Nev.
R	Reno, Nev.
SLC	Salt Lake City
MD	Modena, Utah
DV	Denver, Colo.
GJ	Grand Junction, Colo.
SA	Santa Fe, N. Mex.
PH	Phoenix, Ariz.
YU	Yuma, Ariz.
HO	Honolulu, T. H.
Canada	
ED	Edmonton, Alberta
KA	Kamloops, B. C.
CY	Calgary, Alberta
SC	Swift Current, Sask.
PR	Prince Rupert, B. C.

BEAUFORT SCALE

Scale No.	Designation	Miles	
		Statute	Nautical
0	Calm	0-3	0-3
1	Light Air	3-8	3-7
2	Light Breeze	8-13	7-11
3	Gentle Breeze	13-18	11-16
4	Moderate Breeze	18-23	16-20
5	Fresh Breeze	23-28	20-24
6	Strong Breeze	28-34	24-30
7	Moderate Gale	34-40	30-35
8	Fresh Gale	40-48	35-42
9	Strong Gale	48-56	42-49
¹ Ten	Whole Gale	56-65	49-56
¹ Eleven	Storm	65-75	56-65
¹ Twelve	Hurricane	75	65

¹Note—The code does not admit of force in excess of 9 being sent. Therefore, the figure 9 will be used for all wind forces 9 to twelve inclusive.

For example, 99852 means 29.98 in. barometric pressure, wind from south, with force 8 to 10 miles per hour.

SECOND GROUP gives (1) state of weather at surface at 8 a.m. in one figure, i. e., 1=clear, 2=partly cloudy, 3=cloudy, 4=raining, 5=snowing, 6=thunder storm, 7=sleet or hail, 8=dense fog; (2) barometric tendency as to rise or fall in hundredths of an inch during two hours preceding observation indicated by one figure, i. e., 0=change of less than .04 inch, 1=increase of .04, 2=decrease of .04, 3=increase of .06, 5=increase of .08, 6=decrease of .08, 7=increase of .10, 8=decrease of .10, 9=increase or decrease of .12 or more; (3) clouds expressed in three figures indicating the tenths of sky covered, the kind of clouds and the direction of cloud movement, as follows:

0	1/10 or less	Kind of clouds.	Direction.
1	2/10 to 3/10	1/10 clouds or less, kind not shown	no movement
2	3/10 to 4/10	upper clouds	north
3	4/10 to 5/10	stratus cumulus moving slowly	northeast
4	5/10 to 6/10	stratus cumulus moving rapidly	east
5	6/10 to 7/10	cumulus moving slowly	southeast
6	7/10 to 8/10	cumulus moving rapidly	south
7	8/10 to 10/10	stratus moving slowly	southwest
8		stratus moving rapidly	west
9		nimbus moving slowly	northwest
		nimbus moving rapidly	

For example, in the second group 30855 means cloudy weather, pressure change less than .04 inch during preceding two hours, 8 to 10 tenths clouds, cumulus clouds moving rapidly south.

THIRD GROUP of five figures. The first figure, 3, identifies the group, the second figure gives the direction of the wind and the third figure the wind force at 250 meters elevation, the fourth figure the wind direction and the fifth figure the wind force at 500 meters elevation. For example, 35163 means observations at 250 and 500 meters, wind blowing from south with force 1 (3 to 8 statute miles per hour) at 250 meters, wind blowing from southwest with force 3 (13 to 18 miles per hour) at 500 meters.

FOURTH GROUP has same arrangement as third group for 1000 and 1500 meters.

FIFTH GROUP has same arrangement as third group for 2000 and 3000 meters.

SIXTH GROUP has same arrangement for 4000 meters except that has only three figures followed by XX.

SEVENTH GROUP. The first figure, 7, identifies the group, the second and third figures

indicate the elevation in multiples of 100 meters, the fourth and fifth figures show wind direction and force, respectively at that elevation. For example, 71785 means at 1700 meters elevation wind blowing with force 5 (20 to 28 miles); 71954 means at 1900 meters wind blowing from south with force 4 (18 to 23 miles).

In all groups the letter X is substituted for missing data.

SECOND PART

The second part of the bulletin is in plain language and consists of a synopsis of general pressure distribution, wind and weather for ocean zones, storm warnings, and flying weather forecasts by zones.

There are two marine zones covered by this service, North Pacific Coast and South Pacific Coast. Aviation zone 13 comprises Oregon and Washington, 14 California, 10 Idaho and Montana, 12 Nevada, Utah and Arizona.

Similar weather information is transmitted from NPD, Tatoosh Island, Wash., on 1654 meters; NPE, North Head, Wash., on 2700 meters; NPW, Eureka, Calif., on 2650 meters; NPX, San Pedro, Calif., on 1851 meters; NPR, Dutch Harbor, Alaska, on 2250 meters; NPM, Honolulu, T. H., on 2250 meters.

HOW RADIO SIGNALS ARE ASSIGNED

To date the Department of Commerce has assigned 18,700 commercial radio call sig-

nals based on combinations of three international radio call letters, out of the whole alphabet assigned for this purpose to the civilized nations. All commercial transmitting stations in this country are licensed and given calls by the Radio Section of the Bureau of Navigation of the Department of Commerce, in accordance with the allotment of letters by the International Bureau of the Telegraphic Union at Berne, Switzerland.

To be exact, the United States may use all the three and four letter calls beginning with the letter N, all calls beginning with W, and combinations beginning with K, except from KAA to KBZ, which belongs to Germany. These are not all available for commercial use, however, as the Navy is assigned all calls starting with N, while the Army uses calls from WUA to WVZ, and WXA to WZZ.

In issuing commercial calls, the Radio Section divides the country into two sections, giving the eastern section the initial letter W, and western stations K. The three letters except for a few that have been cancelled, are very scarce today and doubling has begun. Westinghouse Electric, Pittsburgh, as an example.

¹Alaskan reports included in a.m. bulletin are observations taken previous p.m.; those in p.m. bulletins are observations taken a.m. current date.

²Stations with which upper air observations are included in the p.m. bulletin regularly; and in the noon bulletin when obtained in time.

FIRST GROUP gives (1) three figures representing actual barometric pressure in inches and hundredths, except that first figure of full reading is omitted, i. e., 998 means 29.98 inches, 014 means 30.14 inches; (2) wind direction expressed in one figure, i. e., 0=calm, 1=north, 2=northeast, 3=east, 4=southeast, 5=south, 6=southeast, 7=west, 8=northwest; (3) force of wind (Beaufort scale) expressed in one figure as follows:

KDKA; and Radio Service Corp. has just received WAAX.

The above system applies only to Governmental and commercial sending stations, when an amateur, of which there are 16,000 sending, applies for a call, international regulations do not prevail so the international letters are not used. For amateurs, the country is divided into nine sections, each with a significant numeral.

To designate special stations, such as experimental, technical schools and special amateur senders, the letters X, Y, and Z are inserted following the district symbol and preceding the other letters, as for example, 9ZF, Sioux City Radio Laboratory, Iowa, and 7XH, Oregon Agricultural College.

While we have but begun to assign calls, the system is capable of expansion, as mathematical calculations on "combinations" will prove, so that the 3 initial letters assigned us for international calls will "hold us for some time" and the 9 Divisions of Amateurs call be subdivided if necessity demands it.

FINAL RECOMMENDATIONS FROM WASHINGTON RADIO CONFERENCE

The final recommendations from the Washington Radio Conference are much the same as the tentative recommendations as printed in April RADIO, with a few important changes as noted below. These recommendations are embodied in a bill to be presented to Congress and probably to be passed during the present session after which they will become effective.

In the final recommendations four bands are provided for government and public broadcasting, 1050-1500 meters, 700-750 meters 200 miles or more from the sea-coast, 650-700 meters 400 miles or more from the sea-coast, and 485-495 meters.

For private and toll broadcasting is allotted a band from 285 to 485 meters except for coastal regions where 285-315 meters and 425-475 meters must be kept open, and for border regions account should be taken of wavelengths used in neighboring countries. The band 100-150 meters is also allocated for this service.

The wave band from 525 to 650 meters is reserved for marine radio telegraphy.

A restricted special amateur wave of 310 meters is allowed for use by a limited number of inland stations where it is necessary to bridge large sparsely populated areas as to overcome natural barriers.

The band from 275 to 285 meters is for city and state public safety broadcasting and by special arrangement to private detective agencies.

Amateur telegraphy and telephony is assigned an exclusive band from 150 to 200 meters and from 200 to 275 meters in conjunction with technical and training schools where radio instruction is given. An amateur is defined as "one who operates a radio station, transmitting, receiving, or both, without pay or commercial gain, merely for personal interest or in connection with an organization of like interest."

It is recommended that damped wave stations be assigned the band of lowest wavelengths, interrupted or modulated continuous wave radio telegraphy stations the next band, radio telephone stations the next band, and finally unmodulated continuous wave radio telegraph stations the band of highest wavelengths. It is recommended that amateurs be permitted to carry on broadcasting within the wavelength band assigned by the Secretary of Commerce to amateur radio telephony.

The degree of public interest attaching to a private or toll broadcasting service is to be considered in determining its priority in the granting of licenses, in the assignment of wave frequencies, and in the assignment of

permissible power and operating time, within the general regulations for these classes of service.

It is recommended that direct advertising in radio broadcasting service be absolutely prohibited and that indirect advertising be limited to a statement of the call letters of the station and of the name of the concern responsible for the matter broadcasted.

It is recommended that when all available wave frequencies in any geographical region are already assigned, no further licenses for broadcasting be granted in that region until cause arises for the revocation of existing licenses.

It is recommended that private or toll broadcasting stations transmitting time signals shall transmit only official time signals and with authorization from and under conditions approved by the Secretary of Commerce and that the transmission of signals of such character or wavelength as to deliberately interfere with the reception of official time signals constitutes grounds for the revocation of suspension of the transmitting stations or operator's license.

It is recommended that license requirements for the operator of a radio telephone transmitting station include a knowledge of radio transmitting and receiving apparatus and of the International Morse Code, sufficient to receive at a rate of not less than 10 words per minute.

CREDIT SHOULD BE GIVEN WHERE CREDIT IS DUE

It has come to the Editor's attention that the article on a "Stand-By and Tuned Continuous Wave Receiver," published on page 19 of the March, 1922, RADIO by R. E. Lake was apparently taken from an article on "Some Modern Vacuum Tube Circuits and Their Operation," by J. Scott-Taggart which appeared on page 25 of the October, 1919, issue of the Wireless Age.

NATIONAL RADIO CHAMBER OF COMMERCE OFFICERS

Plans for the functioning of the newly organized National Radio Chamber of Commerce, which was formed in New York recently, were drawn up at a meeting held by the association. The officers elected were: Alex Eisemann, of the Freed-Eisemann Radio Corporation, president; Charles Keator, of the De Forest Radio Telephone and Telegraph Company, first vice-president; William Dubilier, of the Dubilier Condenser Company, second vice-president; Frank Hinners, of the Home Radio Corporation, secretary, and Joseph D. R. Freed, of the Freed-Eisemann Radio Corporation, treasurer.

Functioning of the new organization will tend to remedy certain conditions which have arisen in the radio industry as a result of its tremendous growth within the last few months, the dispatch says. It will also group together manufacturers whose radio products are of such dependable character as to maintain favorable public opinion toward the radio industry.

The original group consisted of about fifteen manufacturers. To this body there will be added, by invitation, about twenty additional concerns whose business standing and whose products are known to be of high order. New concerns will be eligible after their apparatus has been passed upon by a board of five members. It is planned to exclude from the membership manufacturers who are now turning out radio apparatus which has been found to be untrustworthy, and which will eventually bring radio into disfavor on the part of purchasers of such undependable apparatus.

CALLS HEARD



Readers are invited to send in lists of calls heard from stations distant 250 miles or more from their own station.

BY KHM, E. LIVESSEY, LIHUE, H. T.

On April 5th at 8:30 p.m. heard 6gr calling 6lc; 6ajh calling 6ib. Also heard a C. W. calling 8bri. At 9 p.m. got 6ajh qsa calling 6aak and also got 6zf in qsa. 6zf was working and didn't hear him call. The arcs and khk bothered me a great deal.

On April 9th at 8:25 p.m. Scl came in good and called 9zaf. Then I picked up a C. W. station at 9:50 p.m. and copied the following: "rr 2 hr to H S Shaw 1jk—tnx fr ??? sined John L Reinartz 1qp." Steady qr and khk busted him up considerable, but he was in good all the time.

BY 600, SAN FRANCISCO

5za, (6ak), (6ea), 6fh, (6gd), 6ka, (6ku), 6ky, (6lv), 6zf, 6zn, (6zx), 6zz, 6aa, 6alu, (6agp), 6agu, 6awp, (6bcd), 6beg, 6bes, 6bet, 6bty, 6bir, 6bak, 6bik, 6bmn, 6bjd, (7dp), (7oz), 7na, 7zu, 8eu, 9kp, 9wd, 9wu, 9ps, 9pi, 9amb, 9ayu, 9xaq, 9dva, 9zaf, 4cb (Can.).

600 reported by 8bzy, Detroit, Mich.; 9dws, Champaign, Ill., and 9wd, Denver. C. W. 5 watts, radiation .72 on 195 meters (all C. W.).

BY 6AMK, LOS GATOS, CALIFORNIA

1bcg(cw), 4cb(cw), 5za, 6aa, (6aak), (6abx), 6abk, 6ack, (6adl), 6aei, 6ain, (6aik), (6ald), 6ali, 6amp, 6aoc, 6aru, 6arn, 6asi, 6asa, 6aty, 6awi, 6ag, 6ax, 6bx, 6bic, 6bde, (6bfz), 6bgr, 6cu, (6en-cw), 6ea, (6eb), (6fh), 6gl, (6gt), (6gx), 6hy, 6ic(cw), 6ij(phone), (6ky), 6lc, 6lk, 6lg, 6lo, 6ay, (6to), 6ti, (6uo), (6vh), 6wg, 6zy(cw), 6zq, 7bk, 7cc, 7z, 7gt, 7gk, 7hi, (7ke), 7kb, 7ly, 7mu, 7ny, 7nz, 7nn, 7nq, (7ot), (7oz), 7nq, 7to, 7ya, (7ys), 7yl, 7zj, 7zv, 7zk, 7zs, (7mf), (7hf), (7iw), (7fi), (7tj), cl8, 9ax, (9bd), 9zn.

BY 6AHP, POMONA, CALIF.

Spark—5if, (5of), 5xb, 5xd, (5xu), 5yq, (5za), 5zad, (6oh), (6qr), (6uo), 6ot, 6aj, 6ya, 6zm, (6zz), (6zam), (6aah), (6afn), (6afp), (6abx), (6ajr), (6ark), (6ape), (6app), (6aru), (6asv), (6ath), (6atg), (6awh), (6bak), (6bar), 6baz, 6bbr, 6bfp, 6bft, 6bkr, (6ahq wkd. with 1/16 spk. coil abt. 50 mi.), 7bh, 7bk, 7bp, 7bx, 7ck, (7ch), 7ed, (7hf), (7ks), 7in, 7iw, 7jd, 7jw, 7ly, (7mf), (7mp), 7mu, (7ot), (7ti), 7om, 7o, 7qn, 7qt, (7yj), 7zb, 7zq, 7zj, 7zp (7zt), 7zo, 7zm, 7zv, 7zu, (cl8), 9nr, 9aq, 9aqc, 9xai, 9yah, 9dsd. C. W.—1bcg, Can. 4cb, 6bn, 6af, 6ad, 5za (6cu), (6en), (6gd), (6gy), 6ef, 6hc, 6jd, (6ka) (6kh) and (6ky) cw and fone, (6mn), 6my, (6vm) cw fone, 6wv Colo. cw fone, (6za), 6zb, (6zz), (6bcd), 6abq, (6ahv), wkd. with receiving set cw, (6aif), (6zd), (zf), 6xac, (6zt), 6xh, 6xa, 6xaf, (6asv), (6awt), (6ja) cw and fone, 7tq, 7xf fone and cw, 8dr, 8aq, 8ain, 8brl, 8bum, 8cfs, 9ji, 9nx, 9wd, 9aja, (9amb), 9ps, 9ayu, 9dva, 9bex, 9dtm, 9xaq, 9zaf, 9zac, 9bji 9dth, 9xm.

BY C. S. PERKINS, 347 SO. FREMONT AVE., LOS ANGELES

Spark—6bl, 6ca, 6dj, 6dt, 6gr, 6ig, 6ii, 6ik, 6im, 6io, 6lr, 6mc, 6ne, 6oz, 6qr, 6ra, 6ra, 6tc, 6tf, 6tj, 6to, 6tu, 6xl, 6zm, 6zq, 6zz, 6aad, 6aal, 6aan, 6aac, 6ajv, 6ajr, 6aor, 6awr, 7mf. C. W.—6ku, 6tw, 6zz, 6awt.

BY 6ASN, BERKELEY, CALIF.

5ig, 6bv, 6gt, 6hr, 6ry, 6iv, 6kc, 6lc, 6ol, 6od, 6om, 6qr, 6zm, 6zz(cw), 6aak, 6aeh, 6aeg, 6ahq, 6akv, 6aki, 6ain, 6amn, 6avr, 6aw, 6bjv qra pse, 6zaq qra pse, 7bh, 7bk, 7gr, 7ke, 7mf, 7og, 7mw, 7ot, 7sn, 7wg, 7wo, 7ya, 7zm, cl8.

BY 9BD, BARRON HOTEL, VANCOUVER, B. C.

C. W.—(4cb), 4ua, 4ft, (5ct), 5za, 5xu, 6en, (6ka), (6zi), (6zf), 6bb, 6awt, 6akw, 6arb, 6asj, (6ku), 6xh, 6bes, 6vm, 6zg, 6bcd, 6zn, 6ky, 6nx, 6fh, 6alv, 6zx, 6nz, Mauii, T. H., 7na, 7mf, (7dp), (7we), 7nn, 7sc, 7xf, (7rn), cl8, (7qt), 9amb, 9ayu, 9zaf, 9wd, 9wu. Spark—(6ark), 6as, (6ajr), 6bnn, (6au), (6ain), 6abx, 6ala, (6ib), 6ic, (6ng), 6gr, (6vk), 6pm, (6lk), 6ol, 6zam, 6zq, (7bk), (7bh), (7ed), 7gj, 7jd, 7kb, 7qn, (7ir), 7to, 7oh, 7hi, 7iw, 7ys, 7ya, 7zm, 7zk, cl8.

All stations hearing 9bd on spark, C. W. or phone use qsl if distance is over 500 miles. W. D. Wood, Barron Hotel, Vancouver, B. C.

Continued on page 40

NEW APPARATUS AND SUPPLIES

FROM THE RADIO MANUFACTURERS



GIBLIN-REMLER NEW INDUCTANCE COILS

Thomas P. Giblin, the man who developed the honey-comb and the duo-lateral inductance coils for radio work, has developed a new type of coil which is claimed to be more efficient and compact than either of the others. This new coil is being made by the Remler Manufacturing Co. of San Francisco, who have also devised an improved form of mounting which is shown in the accompanying illustration.



Giblin-Remler New Inductance Coil

The chief problem in the design of coils has been to secure maximum inductance with minimum capacity in a compact unit. The relatively high distributed capacity in the usual multi-layer form of winding is reduced in the honey-comb and duo-lateral coils by means of a lattice winding of copper wire with space or air cells between layers. But this likewise reduces the effective inductance.

In the new Giblin-Remler coil, cotton yarn is wound in the form of a lattice simultaneously with copper wire which is wound in parallel turns. The yarn separates the layers of wire by means of cotton and air cells, thus securing a maximum copper and insulator space in a given volume.

The new type of coil has a distributed capacity of 8.8 micro-microfarads as compared with 23 micro-microfarads for an equivalent honey-comb coil. This gives a greater tuning range for a given coil, greater selectivity and sharper tuning. It also materially reduces the high frequency resistance and is equally efficient on all wavelengths.



Improved Remler Coil Mounting

A NEW CRYSTAL SET

A neat and compact type of crystal receiving set is being made by the Radio Equipment Co., which has recently been formed at San Francisco with H. A. Fletcher as president, Syd Bramley as treasurer and H. A. Wadsworth as secretary. The set is attractively housed in a well-finished oak cabinet. It employs a crystal detector with variable inductance and fixed capacity; being designed for reception of 150 to 650 meter waves.



Reco Crystal Set

The Radio Devices Co., manufacturer of wireless equipment, has been formed with offices at 693 Mission St., San Francisco by B. F. McNamee and H. M. Johnson. Mr. McNamee is a well known radio engineer and author of a series of articles in RADIO. Mr. Johnson is an experienced designer and shop man. Special attention is to be paid to

the building of radio devices and sets for special purposes and to the reconstruction and improvement of existing sets.

THE ADAPTOLA

The Adaptola is a convenient and efficient device invented by Bert B. Gottschalk of San Francisco, for converting at will any phonograph into a radio loud speaker. The phonograph manufacturers have perfected acoustical chambers which are superior to the usual type of horn for sound reproduction.

The device is attached to the phonograph tone arm after the reproducer has been removed. It holds any make of telephone re-



The Adaptola

ceiver which is merely connected by a wire to the phone terminals of the radio set. It is being manufactured and distributed by the Radio Supply Co. of San Francisco.

LARGE DISTRIBUTING COMPANY ORGANIZED AT INDIANAPOLIS

The Capital Radio Supply Company, with headquarters at Indianapolis, has recently been organized to take care of Indiana, Ohio and Kentucky. The officers of the company are: Harry C. Stutz, who is president of the H. C. S. Motor Car Company, president; N. C. Hildenberg, vice-president; C. P. DeVoss, secretary and treasurer; and Carl Kennan, manager. This company has a large dealer organization in the three states and represents many of the largest and best known manufacturers of radio equipment, including Grebe, Kennedy, Remler, King Am-phi-tone, Hipco Batteries, Brandes, Signal, Western Electric, and others.

NEW KELLOGG PRODUCTS

The Kellogg Switchboard and Supply Co. are making a head set which is claimed to be as efficient as it is light in weight and small in size. The shell is non-metallic and encloses all terminals. The cap is of the most approved design, the concave surface being the result of years of practical telephone receiver construction. When two people desire to use one set or one receiver each in listening, the head band is instantly removable and as equally easy to replace when desired.

This No. 59A head set is wound to 1200 ohms per receiver.

This company is also manufacturing and distributing molded lamp sockets to fit all standard four prong based vacuum tubes for radio work. These bases are in an attractive brown color with an extra heavy solid base 7/16 inch in thickness. Four German silver springs with rounded ends are firmly held in position in deep grooves and cannot touch the mounting surface. Plus and minus, grid and plate terminals are plainly marked in the mold at each binding post. These are double end nickel plated with hexagon, and knurled surface nuts. Connection can be made under the socket as well as from the top of the binding post. These sockets are 2-3/16 inches square with round corners

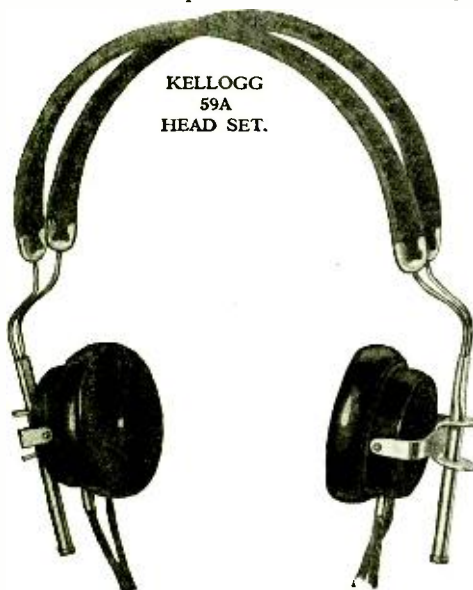

Kellogg No. 59A Head Set

and with total depth of 1-1/4 inches.

Of the same material, the Kellogg Company are turning out aerial strain insulators of various widths and lengths, drilled with suitable molds at ends for the antenna wire and supports. These insulators answer every requirement and are of great strength. The lengths are 2, 3, 4 and 6 inches, and they come in two styles, a flat bar and round rod with brass rings firmly embedded in each end. These insulators stand a direct pull of approximately 350 pounds.

For transmitting stations, the Kellogg Company is building a microphone or

transmitter, which is exceptionally reliable for this work and which is a product of many years manufacture. The particular type for wireless work is known as the 21A. This microphone, of course, is of the type where the transmitter and receiver are mounted on one standard, similar to so called foreign style telephones, and exactly the same in general construction as the regular Kellogg microphone or "grabaphone" as it is known to the telephone trade.



Kellogg Molded Lamp Socket

MEETING THE DEMAND FOR RADIO

It is announced by the Radio Corporation of America that the April production of vacuum tubes reached 150,000. The production schedule for May calls for a total delivery of 175,000 vacuum tubes. The program will reach 200,000 or more in June, according to public and trade requirements.

Crystal detectors served the purposes of most amateurs in the early days. The great demand for vacuum tubes is a development of the past three months, due entirely to the sudden popularity of broadcasting. Although machines play a part in the major processes of manufacture, tubes are still largely made by hand. Hand work plays a far more important part in making vacuum tubes than in any other piece of electrical apparatus with which the public is familiar. Manufacture of the delicate vacuum tubes used as detectors, transmitters and amplifiers, has been subject to the usual difficulties in bringing about quantity production.

During the first eleven months of 1921 the factories produced for the Radio Corporation of America an average of 5000 tubes per month. This rate of production, small as it seems now, was gradually producing a surplus. Then suddenly in one or two territories broadcasting jumped into popular favor over night. On December 30 the production schedule was increased to 40,000 tubes per month. In January of this year the Radio Corporation of America pushed the schedule

to 60,000 per month—a figure largely in excess of the demand at that time.

The present concerted demand, due to the further expansion of broadcasting, came early in February. On February 3 the factories were asked to do everything in their power to reach 75,000 vacuum tubes—to try to reach it during that month. They did their utmost. They came close to the production goal, and the following month, March, they not only reached 75,000, but bettered it by several thousand. April calls for 150,000 and May for 175,000.

In the event that no surplus results from the present expanded program, facilities will be further increased. It is easier to increase production now than it was four months ago, because it is easier to increase the size of a large and well trained organization than to build a new one. Technically trained forces are required in the factories, which are working with skill and energy.

ANNUAL REPORT RADIO CORPORATION OF AMERICA

The corporation's operating account for 1921 shows gross income from transoceanic communication, \$2,138,625; from sales, \$1,468,919; from marine service, \$533,298—a total of \$4,160,844. The operating and administrative expenses, depreciation of plant and cost of sales totalled \$3,762,231. Other income amounted to \$28,186. The net profit, applied against amortization of patents, was \$426,799.

The corporation's balance sheet shows assets of \$35,712,084, as follows: Plant and equipment, \$12,702,086; patents, patent rights, contracts, goodwill, etc., \$16,584,845; stocks of subsidiary and associated companies, \$598,000; current assets, \$4,910,923; deferred charges, \$916,228. The liabilities are: Preferred stock (\$5 par value), \$19,779,870; common stock (no par value), \$12,039,607; current liabilities, \$954,471; deferred liability, \$620,000; reserves for depreciation, \$2,318,135.

The K. & L. Electric Company has opened a broadcasting station at 427 Olive Street, McKeesport, Pennsylvania. The particulars of this station are as follows: Call letters, WIK; wavelength, 360 meters; schedule of operation, Sunday, 1:30 to 2:30 P. M. and 6:30 to 7:00 P. M.; and 6:30 to 7:00 P. M. daily; and 9:30 to 10:30 Tuesday and Thursday evenings; range 500 miles.

The General Apparatus Company, Inc., New York City, manufacturers of G. A. Standardized parts and supplies since 1918, will now be known as The Sleeper Radio Corporation.



The Radio Store of Paul F. Johnson

KENNEDY
EQUIPMENT

▼▼
Type 220
Regenerative Receiver
with Type 525
Two stage amplifier

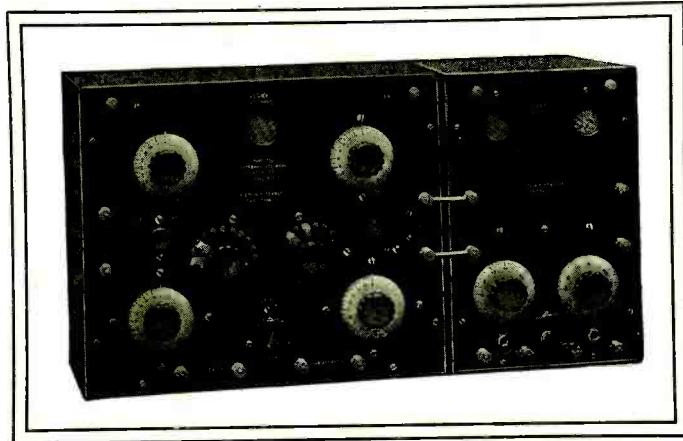

KENNEDY
EQUIPMENT

▼▼
All Kennedy
Regenerative Receivers are
Licensed under
Armstrong U.S. Patent
No. 1,113,149

The Maximum of Quality and Value in Modern Radio Receivers

For those who want Radio amusement, news, market and weather reports, and educational features, Type 220, we believe is the best buy on the market. It tunes with high efficiency over a range of wave lengths of 175 to 3,100 meters.

Kennedy Receiver Type 220 is an intermediate-wave regenerative receiver, designed for those who want a range of wave lengths somewhat more comprehensive than provided by the ordinary short-wave instrument. Due to its careful design it operates with remarkable effectiveness over a tuning range of 175 to 3,100 meters.

Without doubt this receiver represents the greatest concentrated quality value in radio receivers on the market today. Those who seek amusement, music, news, market and weather reports, and educational

features "out of the air" will find great satisfaction in the use of this receiver.

Maximum effectiveness, with a high degree of selectivity on all wave lengths within its range is assured by the design of this receiver, which makes use of the accepted principles of the best radio engineering practice in the elimination of resonance in unused inductance sections; the avoidance of the possibility of high resistance contacts in electrical circuits; the exclusive use of inductively coupled circuits, and the employment of the necessary precautions for minimizing energy losses.

Write for latest bulletins describing Kennedy Quality Radio Equipment

THE COLIN B. KENNEDY COMPANY
INCORPORATED

RIALTO BUILDING

SAN FRANCISCO

Tell them that you saw it in RADIO

PEERLESS

Radio Equipment for Concerts



Detector; Peerless PR-75 concert type with tube.

Amplifier; Peerless Type PA-60 Two Stage, with Automatic Filament Control and Tubes.

Magnavox; Type R-3. Loud Speaker.

Willard Special Radio "A" Battery, 86 Volt "B" Battery, pair of Phone Head-sets, Aerial and Ground Wire, Ground Clamp and Insulators. Complete Equipment \$225.00.

Equipment as above, except with Type PR-100 Detector for long distance receiving \$325 with 2 stages of Radio Frequency Amplification.

So simply arranged that anyone without Radio experience whatever can adjust for concert.

PEERLESS RADIO LABORATORIES

Incorporated
MANUFACTURERS OF
PEERLESS RADIO RECEIVING OUTFITS AND PARTS

Western Offices and Factory: 50 Second Street

San Francisco, California

Telephone Douglas 4190

Dealers:

Be First in Your Territory

Oakland Agent:

P. B. VANCEL,
280 Bacon Building

CALLS HEARD

Continued from page 30

BY GASJ, 929 60th ST., OAKLAND, CALIF.
Spark—(7bb), (7ga), (7gg).
C. W.—5za, (6alu), (6awp), 6bcd, 6bes, (6bkd), (6cu), (6gd), 6jd, 6ku, 6xad, 6zac 6zf, 6zz, 7dp, 7na, (7nn), (qt), 9acu, (9amb).

BY ASA S. KELLER, MONROE, WASH.
Spark—5ak, 5cn, 6ajr, 6ark, 6gr, 6km, 6tu, 6va, 7acg, 7acn, 7as, 7bb, 7bf-dalite, 7bh, 7bk, 7cu, 7ed, 7fi, 7fr, 7ge, 7gj, 7hd, 7iw, 7iy, 7jd, 7jf, 7jw, 7kj, 7ly, 7mf, 7mu, 7nn, 7nw, 7nz, 7ot, 7oz, 7tg, 7to, 7wg, 7yl, 7ys, 7zv.
C. W.—(Can.) 4cb, 4is, 5ct, 5la(1), 5wn, 5za (not verified yet), 6aat, 6adm, 6aib, 6ak, 6aw, 6awp, 6awt, 6bcd, 6bge, 6en, 6fh, 6gy, 6ka, 6ki, 6ku, 6nx, 6oo, 6tw, 6vm, 6xad, 6zf, 6zi, 6zx, 7bs-dalite, 7dp, 7hi, 7hm, 7hs, 7mf, 7na, 7nc, 7nf, 7nn, 7qt, 7rn, 7sc, 7we, 7zu, 9amb, 9ayu, 9bft, 9bji, 9pi, 9ps, 9wu, 9xaq, cl2.
Fone—6ku, 7rn, 7zu.

BY 7VX, GEORGE FREEMAN, 5411 SOUTH L ST., TACOMA, WASH.

Spark—6ak, 6as, 6cc, 6ex, 6fh, 6fn, 6gf, 6gr, 6gx, 6ib, 6ic, 6im, 6iv, 6km, 6lc, 6ld, 6ng, 6st, 6tu, 6vk, 6vx, 6zq, 6zu, 6abu, 6ajh, 6ajr, 6akt, 6ala, 6alu, 6amk, 6aqu, 6arc, 6ark, 6avd, 6awb, 6abk, 6bnn, 6zam, 7ed, 7cn, 7cu, 7ed, 7gj, 7gq, 7hf, 7iw, 7jd, 7jf, 7kj, 7ly, 7mf, 7mp, 7nc, 7nn, 7nw, 7nz, 7oh, 7ot, 7ox, 7oz, 7to, 7ve, 7vo, 7vz, 7wg, 7ya, 7zk, 7zm, 7zv. Canadian—4cb(cw), 5ak, 5cn, 5ct, 5do, 9ax, 9bd.
C. W.—7rn, 7nf, 6ak, 6cu, 6ea, 6en, 6gy, 6ka, 6km, 6nx, 6oo, 6xh, 6zf, 6zx, 6aat, 6akw, 6arb, 6awt, 6bes.

BY 6OL, E. M. WHITE, 1509 SO. BRAND BLVD., GLENDALE, CALIF.

Worked—5za, 6ah, 6ak, 6ar, 6as, 6cp, 6ex, 6fh, 6gf, 6gr, 6gt, 6gx, 6hc, 6ib, 6ic, 6im, 6km, 6mz, 6ng, 6oc, 6oh, 6pi, 6po, 6pr, 6qk, 6qr, 6qt, 6sk, 6tc, 6tu, 6uq, 6vk, 6vx, 6wg, 6xh, 6zb, 6zi, 6zu, 6zz, 6za, 6ab, 6aak, 6abk, 6abm, 6abw, 6ada, 6aeh, 6aei, 6afp, 6agf, 6aid, 6aih, 6ajh, 6ajr, 6akl, 6ang, 6aph, 6aqu, 6ark, 6arw, 6atq, 6aud, 6auu, 6avx, 6bgj, 6biu, 6bjv, 6bnn, 7mf, 7to.
Heard—5of, 5xd, 6bm, 6fk, 6gk, 6no, 6to, 6tv, 6vz, 6auu, 6abx, 6acr, 6acw, 6afn, 6afy, 6ahv, 6aif, 6ain, 6alv, 6anr, 6st, 6ath, 6atu, 6aty, 6auc, 6aup, 6avb, 6awh, 6bcj, 6bcz, 6zd, 6zam, 7ed, 7bk, 7bp, 7cn, 7gj, 7in, 7iw, 7jd, 7ke, 7kb, 7ks, 7mu, 7tj, 7zt, 7zv.

BY 6AKC, 515 CLAYTON ST., SAN FRANCISCO

One tube, c s spider webs—5pg(cw), 5za(cw), 6ea, 6eb(sp-kcw), 6cv(cw), 6cw, 6en(cw), 6ff, 6gi, 6ka(cw), 6kc, 6ks, 6lc, 6lu, 6mh, 6mk, 6od, 6ol, 6sk, 6vo, 6wk, 6aak, 6aau, 6abm, 6abx(sp-kcw), 6acr, 6acu, 6acy, 6aeh, 6aei, 6agf, 6agp, 6ahw, 6aic, 6aif, 6ail, 6aio, 6aix, 6ajr, 6akl, 6ald, 6ale(cw), 6alf, 6ali, 6alu(cw), 6amf, 6amq, 6aod(cw), 6aoe, 6ape, 6aqp, 6arc, 6ark, 6asv, 6aum, 6avr, 6awp, 6az, 6zu, 6zn(cw), 6zs, 6zz(cw), 7ba, 7bp, 7bk, 7cc, 7cn, 7op(cw), 7gi, 7hf, 7iw, 7ke, 7kj, 7mf, 7mu, 7nn, 7oz, 7tj, 7tq(cw), 7ya, 7zj, 7xh, 7zt, 7zp, cl8.

BY GEORGE & CHAS. C. WHYSALL, SOMI (EX-6TV)

1gm, 2aje, 2aaf, 2bml, 2el, 2fp, 2xj, 3ajd, 3abb, 3arn, 3alu, 3bfu, 3eh, 3jo, 3zo, 3zx, 4ag, 4bi, 4bw, 4fd, 4gl, 4gn, 5aby, 5da, 5do, 5fo, 5gr, 5hk, 5jf, 5mo, 5nd, 5pe, 5sm, 5xu, 5ye, 6zz(cw) on 375, 8axn, 8ait, 8bdu, 8cno, 8cke, 8ea, 8ft, 8ib, 8mz, 8rg, 8sp, 8vq, 8xak, 8yu, 8za, 8ze, 8zo, 9aon, 9aiu, 9asj, 9ayw, 9azf, 9awz, 9atn, 9aqu, 9afk, 9amq, 9aul, 9afn, 9bvc, 9cao, 9cba, 9dzi, 9dug, 9dzh, 9dxc, 9dix, 9day, 9dad, 9dmj, 9lf, 9ug, 9uh, 9vl, 9yb, 9yc, 9zj, kyw, kdka, woh, wgy, wjz, wwj, wubc.

BY SAGO

(1ii), 1qp, (1rd), 1xm, 1ze, 1azw, 1bus, 1cak, (1cmk), 2bg, 2fp, (2nz), 2sq, 2wi, 2wt, 2xq, (2zk), 2zs, (2aab), 2ajf, 2amo, 2aqh, (2ayv), 2awl, 2bak, 2bea, (2beb), (2beh), (2bfz), 2bgt, 2bnc, (2btj), 2byw, 2ccd, (3ba), 3bz, 3ca, 3cc, 3cg, (3em), (3fm), (3fs), 3gh, 3hg, 3hj, (3iz), 3jj, 3km, 3lr, (3qv), (3qz), (3rv), 3xl, (3zv), (3aad), 3aag, 3aay, (3adx), 3anj, (3aln), 3apq, (3aqh), (3aqr), 3aso, 3asw, (3bfs), (3bfu), 3bhl, (3blf), 3btk, 4as, (4az), (4bf), 4bq, 4by, 4dq, (4eu), 4ft, (4gl), 4il, 4kc, 4xd, 4ya, (4zc), (4ze), 5da, 5ek, 5fv, 5ho, 5jb, 5nz, 5pm, 5uu, 5wo, 5za, 5aam, (6bo), 6zz, (6xad), (8bk), (8bo), 8bu, (8ge), 8gw, (8hj), (8ih), 8iq, (8kh), 8pc, 8qb, (8se), 8vj, (8vy), (8uk), 8wy, 8zg, 8z, 8aan, (8adg), 8adm, 8agz, 8aii, (8aim), 8ais, (8amd), 8amf, 8anc, 8aqz, (8ari), 8ark, 8arw, 8avd, 8avo, (8awm), (8awp), 8awy, 8axk, 8bbd, 8bca, 8bei, 8bey, 8bfz, 8bgv, 8bit, 8blv, 8box, (8brm), 8bun, 8bus, (8bxa), (8bzv), 8cix, (8cid), 8pp, 9ct, (9dv), 9ei, 9fm, 9fz, 9hw, 9hy, 9if, (9il), (9io), (9iz), (9ki), (9kp), 9le, 9lg, 9ps, 9pw, 9qe, 9sl, 9so, (9uc), 9wa, 9wk, 9xi, 9ze, 9zg, 9zi, 9aap, 9aas, 9aau, (9aav), 9aay, 9aeg, 9aja, (9ajh), (9akd), 9amd, 9amu, 9ane, 9aqa, 9aqz, (9ark), 9arn, 9asd, (9ate), 9ayh, (9bed), 9bjb, 9blc, 9blo, (9bri), 9dam, 9dax, 9dct, 9dof, 9dun, (9dq), 9axi, 9zae; Canadians: (8bp), (8iz), (3fo), 9al.

Continued on page 45



DUDLO MAGNET WIRE

put up in the new fractional pound package offers you the opportunity to obtain Dudlo high grade wire in the insulation and amount you need to wind those new coils or to complete your hook-up.

All wire is of the regular Dudlo high standard of quality wound on a light weight attractive metal spool and is packed in a distinctive carton on one side of which is listed a table of wire diameters.

Sold by leading jobbers and dealers everywhere.

Look for the yellow carton and the Dudlo trademark.

DUDLO MANUFACTURING CO.

FORT WAYNE,

WESTERN REPRESENTATIVE

A. S. LINDSTROM

INDIANA

111 New Montgomery St., San Francisco, Calif.

Tell them that you saw it in RADIO



Become a Radio-trician

Learn at home the greatest profession of today and the future. Become a master of radio installation, operation, maintenance repair, mechanics, design, inspection, salesmanship and invention.

THE world is aflame with Radio. Never before in the history of the country has an industry leaped to the forefront as rapidly as this great, new science. Hundreds of thousands of radio receiving sets are in operation—tens of thousands of sending stations will be erected—and this enormous craze is permanent. Even today manufacturers are months behind their orders! Improvements are being made every day which must increase the demand for radio equipment to even *greater* proportions than now.

Men of foresight, men of vision know what this means. Never before has there been such an opportunity. Radio-tricians are needed today everywhere. More and more will be needed as the demand for radio installation, radio operation, radio maintenance, radio repair, radio salesmanship becomes greater and greater.

Wherever you go, there are hundreds of radio sets to be installed—wherever you go, thousands upon thousands of dollars worth of radio equipment is being sold—wherever you go, there are radio sets to repair; and if you seek adventure, there are radio sending stations calling to you from ships and land stations all over the world.

The Pioneer School

The National Radio Institute has a record of over

8,000 students. It is the pioneer school. It teaches every phase of radio from the ground up. It teaches by means of actual practice, actual assembling of a radio outfit, actual operation of radio equipment. It teaches by problem and principle so that National Radio-tricians are in demand everywhere.

Here is a profession which is paying enormous earnings to men all over the country today—a profession that will make hundreds of men wealthy—a profession far more lucrative than that of any other technical or mechanical employment you can secure.

What will you do?

The world is aflame with radio. What are you going to do to "cash in" on the demand for men, for equipment, for experience? Are you going to sit idly by wondering what it is all about, or are you going to make the most of this, the greatest opportunity presented to men of ambition in 50 years?

Write at once for the complete catalog to the National Radio Institute. This is the turning point in your life. Upon your decision *this instant* may depend your entire future. Mail the coupon, or write a letter NOW—for your own sake!

NATIONAL RADIO INSTITUTE

Radio Headquarters

Dept. 1086

N. W., Washington, D. C.

NATIONAL RADIO INSTITUTE, *Radio Headquarters*
Dept. 1086 N. W., Washington, D. C.

Please send me your book telling how I can become a Radio-trician through your Home Study Course, in my spare time. I am enclosing 10c (stamps or coin) to cover cost of packing and mailing.

Name

Address.....City.....State.....

Copyright, 1922, National Radio Institute

Tell them that you saw it in RADIO

GIBLIN-REMLER

A NEW COIL DEVELOPMENT

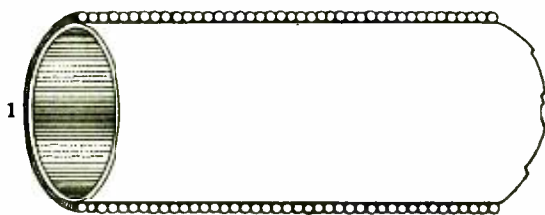

Assume that the above single layer coil consists of 1000 turns and that the capacity between turns is Y . Then $1000 Y$ is the total self capacity of this inductance.



20 layers high
50 turns per layer
 $20 \times 50 = 1000$ turns

Reduce the length of coil 1 by winding a multi-layer compact inductance of 1000 turns (20 layers of 50 turns). The inductance will be greater than coil 1 due to the greater mean diameter of the turns. The capacity between turns is still Y , but an additional capacity between layers equal to $50 \times Y$ (the mean of the number of turns in each two layers) has been added. This increase in internal capacity makes the coil unsuited for use as an inductance.



The capacity between layers and between turns is reduced by spacing, but this results in a loss of inductance.

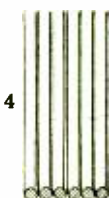

Maximum inductance is obtained by winding the turns close together. This is the method used in the new Giblin-Remler Inductance, combined with a new method of separating the layers.

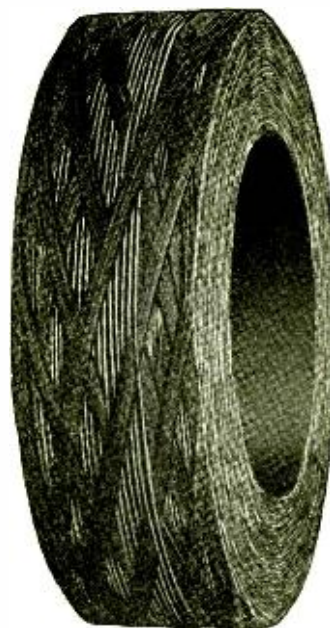

GIBLIN'S NEWEST AND GREATEST DEVELOPMENT OF A COMPACT INDUCTANCE COIL

THOMAS P. GIBLIN, originator of the Honeycomb and Duo-Lateral Coils has been working for years to produce an even more efficient inductance coil. Success has at last been achieved in the Giblin-Remler Inductance Coil.

REMLER RADIO MFG.
248 FIRST STREET, SAN FRANCISCO, CALIF.
E. T. CUNNINGHAM, General Manager

Tell them that you saw it in RADIO

INDUCTANCE COILS

INTERCHANGEABLE WITH ALL COIL MOUNTINGS

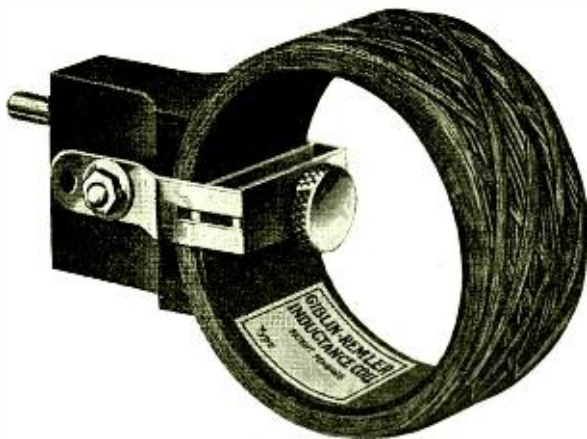

Made by an entirely new process, Giblin-Remler Inductance Coils are infinitely more effective in operation and superior in workmanship to any coil on the market today. Its performance for concentrated inductance cannot be approached—it is



In the new Giblin-Remler Coil Cotton Yarn is wound into the form of a lattice and simultaneously the wire is wound into the coil in parallel turns. The cotton yarn separates the layers of wire with cotton and air cells. The air cells are extremely important in reducing the high frequency resistance. This method of winding gives maximum copper space and insulation space in a given volume. The insulation between layers is greatest at the points of maximum potential difference.

equally efficient on all wave lengths. The self capacity of the new Giblin-Remler Inductance is 100% less than any previous compact inductance—this low self capacity gives selectivity and sharp tuning for a given coil. This is especially advantageous to the amateur who usually has an antenna of low capacity. The high frequency resistance is lower than any previous type.

Giblin-Remler Inductance Coils are patentable—they are manufactured by patented machinery. You can purchase them from any authorized Remler Dealer.

Order Giblin-Remler Inductance Coils at once from your nearest dealer—or send direct to us. Learn how remarkably they will improve the performance of your set.

COMPANY
154 W. LAKE ST., CHICAGO, ILL.
Apparatus That Radiates Quality

Type and Number of Turns, Mounted	Price, Mounted	Type and Number of Turns, Unmounted	Price, Unmounted	Inductance in Millihenrys at 1000 cycles Accuracy 1/2%	Natural Wave Len. in Meters, Accuracy 1/2%	Distributed Capacity in micro-microfarads, Accuracy 1%	Wave Length Range in Meters using Condenser of .001 max. and .00004 mfd. min.		High Frequency Resistance in Ohms at Wave Length Shown				
							Minimum	Maximum	200	500	1000	2000	
RG 20M	1.50	RG 20U	.70	.030	39	14.3	63	334	1.1
RG 25M	1.50	RG 25U	.70	.041	47	15.2	75	389	1.5
RG 35M	1.50	RG 35U	.70	.083	87	25.4	128	550	3.5
RG 50M	1.60	RG 50U	.80	.169	114	21.6	185	785	8.8	4.4
RG 75M	1.65	RG 75U	.85	.377	163	19.8	266	1170	28.3	12.1	6.2
RG 100M	1.70	RG 100U	.90	.666	217	19.9	358	1550	80.3	26.8	12.6
RG 150M	1.75	RG 150U	.95	1.503	281	14.8	512	2320	1000	2000	5000	10000
RG 200M	1.80	RG 200U	1.00	2.68	374	14.7	690	3110	69.8	23.8	7.1
RG 250M	1.90	RG 250U	1.10	4.20	424	12.1	860	3880	50.6	12.5
RG 300M	2.00	RG 300U	1.20	6.11	494	11.2	1030	4680	87.5	19.9
RG 400M	2.10	RG 400U	1.30	11.04	618	9.7	1380	6300	141	29.3	13.8
RG 500M	2.30	RG 500U	1.50	17.50	747	9.0	1730	7900	54.6	22.3
RG 600M	2.40	RG 600U	1.60	29.2	1024	10.1	2260	10250	93.1	34.9
RG 750M	2.65	RG 750U	1.85	39.0	1249	11.3	2660	11850	2000	5000	10000	20000
RG1000M	3.40	RG1000U	2.50	71.6	1620	10.3	3570	16000	111	43.8
RG1250M	3.80	RG1250U	2.90	108.0	1930	9.7	4380	19700	64
RG1500M	4.40	RG1500U	3.50	159.8	2300	9.3	5300	23800	123

These tests have been made by Robert F. Field of Cruft High Tension Electrical Laboratory, Harvard University, Cambridge, Mass.

THE NEW REMLER COIL MOUNTING

SIMPLE TO MOUNT. TIGHTENING BAND BUILT INTO MOUNTING. ELIMINATES FIBER BAND. MOLDED BAKELITE. INTERCHANGEABLY USED WITH REMLER COIL AND PANEL TYPE PLUGS.

The plug terminal is slotted twice at right angles, insuring smooth, easy plugging.

The tightening band is nickel plated. Three holes provide the necessary adjustment and prevent any slipping.

The plug is molded bakelite, buffed finish. The contour is shaped to the coil.

The solder terminals are countersunk, eliminating possible injury to coil winding.

The slot in the tightening band holds the pressure plates in alignment.

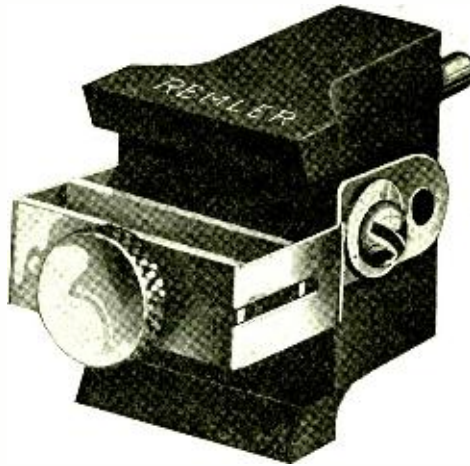

The plug and jack terminals are interchangeable with all standard plug and panel mountings.

The tightening band is securely held to the plug.

The lower plate absorbs the pressure on the coil.

The upper plate applies tension to the tightening band parallel to the sides of the coil.

A turn of the thumb screw separates the pressure plates and securely clamps the coil to the plug.

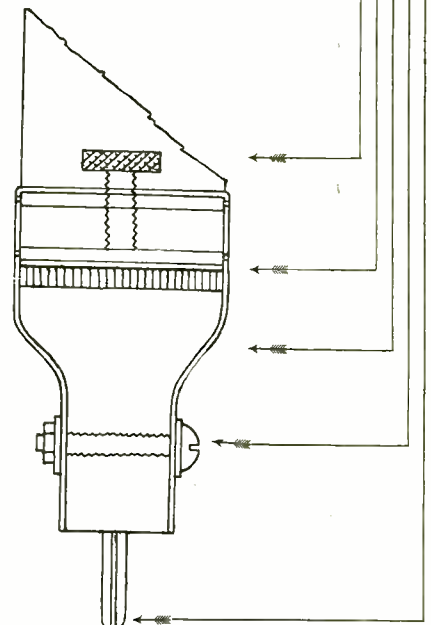
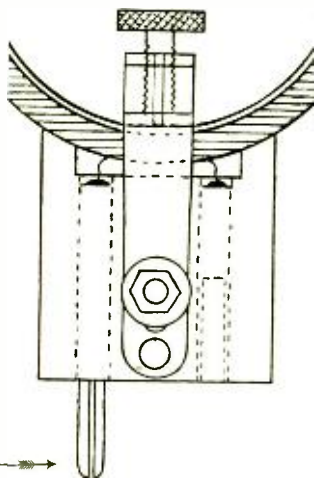

This new Remler Coil Mounting with its improved and original features is built especially for the new Giblin-Remler Coils. The plug can be used interchangeably with all Remler coil and panel type plugs.

The metal tightening band—an important Remler feature—eliminates the annoying fibre band and assures perfect tightness at all times. By simply turning the thumb screw the coil is rigidly fastened to the coil contour of the bakelite plug. There is no fibre band to become damp and stretch or to loosen the coil from its mounting.

Built complete by Remler, every operation is checked to insure a smooth working, simple operated plug—a plug with a Remler Guarantee.

PRICE

No. 48—20 to 750 turn coils.....70c

No. 49—1000 to 1500 turn coils.....80c

Amateurs:—Write for catalogue and name of nearest Remler dealer.

REMLER RADIO MFG. COMPANY

248 First St.,
San Francisco, Calif.

E. T. CUNNINGHAM,
General Manager

154 W. Lake St.,
Chicago, Ill.

Tell them that you saw it in RADIO

CALLS HEARD

Continued from page 40

BY 5TC, BOX 1557, FT. WORTH, TEXAS
 Spark—5aby, (5ao), 5fo, 5hk, (5hz), 5jb, 5jd, 5jf, 5kc, (5kp), 5py, (5ra), (5tg), (5sm), (5ue), 5xa, 5xu, 5yg, 5zl, 5zs, (8zo), 8ft, (9abv), (9acn), (9ams), (9apk), (9apn), (9aqz), (9arg), (9avx), (9avz), 9ayl, 9ayw, (9azh), (9asd), 9drn, 9wi, 9wt.
 C. W.—1beg, 2bef, 4by, 4gl, 4zc, 5bm, 5la, (5oi), (5pb), 5xb, 5za, 6bes, 6ale, 6xad, 7zu, 7zm, 8aqo, 8avy, 8axb, 8bdo, 8uc, (9aog), 9bjb, (9ble), 9dky, 9dsm, (9dta), 9dzc, 9io, 9km, 9of, 9wq, (vry qsa) 9zl.
 Fones—6wv, bb5, woh, 5za, 5hl, 5xu, 9zaf, 9bnd, 4cb, wrr, 5ir.

BY 6ADR, 2319 ASHBY AVE., BERKELEY, CALIF.

Spark—(6fh), 6gt, 6gd, (6hv), 6ic, (6iv), (6ke), 6lk, 6od, (6wg), (6aak), (6aeh), 6agk, (6ahf), 6ahq, (6ain), 6aio, (6ajh), 6ajr, (6aki), (6amn), 6ark, (6avd), (6awx), (6bai), (6bdz), (6bmp), (7bj), 7bh, (7bk), 7ed, 7hu, (7hf), 7ke, (7kj), 7g, (7gq), 7gt, 7mf, 7mu, 7ot, 7oz, 7td.
 C. W.—5za, (6cu), 6en, 6jd, 6ka, 6gv, 6gd, (6bes), 6za, 6zz, 6xad, 6zac, 7rn, 7nf, 7qt, 7we, 7xf(chopper-voice), 8agz, 8aim, 9anf, 9amb.
 Anyone hearing 6aor pse. QSL. All cards answered promptly.

Continued on page 52

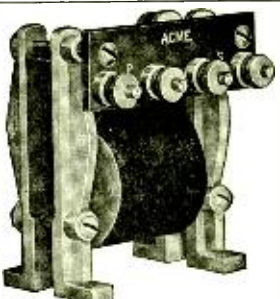

Amplify your signals with ACME Transformers

SPECIALIZATION in building transformers as in all other lines results in a high degree of efficiency. Whether you build your own apparatus or buy assembled outfits insist on the use of proven units. Acme Transformers in your vacuum tube amplifier equipment magnify voice and music as well as code without distortion and without howling. They are priced as low as specialized quantity production permits, with due regard for quality. At all Radio dealers.

ACME APPARATUS CO.
 182 Massachusetts Ave.
 CAMBRIDGE, MASS.
Transformers & Radio Engineers & Mfrs.



RECO
Short Wave Crystal Receiving Set
Price \$12.00

Built of solid oak hardwood cabinet, Bakelite panel, bussbar wiring, and finished in every way equal to a high priced set.

TYPE C6
TUNES TO WAVE LENGTH FROM 150 to 650 METERS ON AVERAGE AERIAL

A Radiophone receiving set designed in accordance with the most recent developments in Radio technique. Constructed of the very best materials, with unique and easily adjusted detector.

DO NOT OVERLOOK THE FACT
 That a cheap Radio receiving set will not give the satisfactory results guaranteed by the manufacturers of this instrument.

DESIGNED FOR MAXIMUM EFFICIENCY TO RECEIVE BROADCASTING OF MUSIC, CONCERTS, LECTURES, ETC.
BUILT TO LAST FOREVER — ABSOLUTELY FOOL PROOF

J. R. O'DONNELL, 171 Second Street, San Francisco, Cal.
 843 Traction Ave., Los Angeles, Cal.

Sole distributors for Pacific Coast, Australia, Hawaiian Islands, and Asiatic Countries.
 For Eastern territory **RADIO EQUIPMENT CO., INC.** 333 Jones Street, San Francisco, California
 write,

IMMEDIATE DELIVERY

WESRAD
 MOUNTED
Amplifying Transformer
 AUDIO FREQUENCY

*It brings in those Weak Signals
 Latest and Most Efficient Design*

\$5 JOBBERS • DEALERS **\$5**
 Write for Attractive Proposition
 USE OUR NEAREST STORE

WESTERN RADIO ELECTRIC CO.
 1200 Franklin St., Oakland, Cal. 637 So. Hope St., Los Angeles, Cal.

Prompt Service

We have the stock and facilities to ship your order within 2 hours after receipt. We carry all standard apparatus at list prices.

Radio Maps 50c

Something you need right now. Gives Broadcasting Stations, location, schedules, etc.
 Send for your copy now.

Standard Radio Co.
 59 East Adams St.
 CHICAGO, ILL.

LOS ANGELES —

The Busiest Radio Store in California

The Radio Concert Equipment Co.
 WILL BRENNAN - MANAGER

Mail orders given prompt attention

"The Finest in Radio"
 734 West Sixth St. Los Angeles

Tell them that you saw it in RADIO



Teagle



No. T-100



No. T-101



No. T-106



No. T-105



No. T-102



No. T-103
No. T-104

N-S NAA CRYSTALS



N-S "RED-HEAD" PHONES

Introducing Seven Better Radio Instruments

15 years of direct contact with the radio field has enabled us to develop these products. Each has new and unusual features that place it far ahead of common types—not one is a rushed-on-the-market experiment.

HERE THEY ARE

No. T-100 Reversible Rheostat—all metal type for table or panel mounting. For use with any detector or amplifier bulb—smooth action, perfect contact, substantial pointer with insulated knob. —a better rheostat
Price \$1.00

No. T-101 V. T. Socket—Mechanical features that make it the only socket on the market that is genuinely rigid and strong when used for panel mounting and yet perfectly adapted to table or base mounting. All metal with Bakelite contact support. —a better socket
Price 75c

No. T-106 Adaptaphone—Converts the sound chamber of phonograph into a loud speaker. Made of high-grade rubber. Will not scratch or mar parts of phonograph. Not necessary to remove cap from receiver. Will fit all phonographs except the Brunswick. —a better adapter
Price \$1.00

No. T-105 Crystal Detector—New and ingenious design provides every adjustment to facilitate proper contact with the crystal. Contact wire can be moved to any point on crystal. Pressure can be easily regulated. Contact wire instantly renewable. —a better crystal detector
Price \$1.00

No. T-102 Stopping Condenser—Heavy metal plates of novel design form substantial case for condenser. Mica dielectric, capacity .0029 MF. Highly nicked and polished. mounted on insulating base. Can be removed for panel mounting. —a better stopping condenser
Price 75c

No. T-103 Grid Condenser, of similar design as above. Proper capacity for grid circuit in V. T. Hookups. —a better grid condenser
Price 40c

No. T-104 Moisture - Proof Variable Grid Leak—arranged for front of panel mounting in connection with Grid Condenser. Nicked and polished cover. —a better grid leak
Price 60c

—and better than ever
the famous

N-S "Red-Head" Phones—3000 ohms. A triumph in Radio Receiver design. Beauty of design and ruggedness of construction coupled with a supreme sensitiveness are features that make "Red-Heads" the ideal telephone receivers for radio work.
Price with Cords \$8.00

—and

N-S NAA [Arlington Tested] Supersensitive Crystals, individually tested and packed in convenient metal boxes. Galena, Silicon or Goldite, price each 25c. Same mounted in cup, 40c each.

Number yourself among our thousands of friends and customers who know the reliability and accuracy of N-S Radio Products.

Send for *Bulletin B* which describes these products in detail

Dealers: Write for our very attractive proposition. IMMEDIATE DELIVERY



The Newman-Stern[®]
Teagle Radio Division
CLEVELAND - OHIO

"M. P. M." NATURE'S FINEST

SUPER-SENSITIVE
HIGHEST TEST
(NOT OBSOLETE CUBE)

DETECTOR - CRYSTAL

(DIRECT FROM MINE)

Notice:—Fully-as-good-as-a-tube when used with new Crystal-Amplifying Inductance, and keeps your Set cut in at all times without battery or cost.

Insist on "M. P. M." AT YOUR DEALER, or MAIL \$1 Bill, M. O., or Check for LARGE BOX, absolutely guaranteed, to

Million Point Mineral Co.

San Francisco Office—1254 Clay St.

Dealers:—If you want to handle the Best Mineral on Earth, write for attractive trade proposition.

Pacific Radio Exchange

439 Call Building
SAN FRANCISCO

Manufacturers and Jobbers

Write for
trade proposition

"PARADEX" Vacuum Tube Receiving Set

"PARADIO" Crystal Receiving Set

Latest Concert Receivers

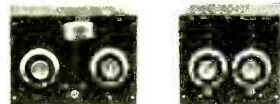

Receiver Amplifier

Illustration shows the two units of this improved concert receiver. Units can be purchased together or separately. Highly polished mahogany cabinets with hinged tops. Connections are all made at the back, doing away with the unsightly connection posts in the front. Receiver, \$35.00; Amplifier, \$45.00. Complete set with batteries, aerial, phones, and all equipment, \$150.00. We carry a complete line of standard radio equipment. Write us for literature.

LEVY ELECTRIC COMPANY

1230 Polk Street San Francisco

10c. Charges Your Storage Batteries AT HOME WITH AN F-F Booster

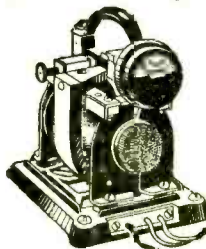

Charges Autos' Radio

So you will never have to give up in disgust when working a distant station. Is it not gratifying to feel your Batteries will never fail & to be always ready to "Listen In" & receive all Radio Broadcasting, never having to tell Friends Your Batteries are dead. The F-F Battery Booster is a rugged Charging Apparatus, un-failing in its ability to deliver service day and night; requiring no skill to operate; charges automatically and operates unattended. Screw Plug in lamp socket, Snap CLIPS on Battery Terminals and watch the gravity come up. AMMETER shows amount of current flowing. Everything Complete in Compact Self-Contained Portable CHARGING UNIT. F-F BATTERY BOOSTERS are Automatic FULL WAVE MAGNETIC RECTIFIERS with Infusible Carbon Electrodes, for 105-125 Volt 60 Cycle A. C. These Types Last a Lifetime. PRE-WAR PRICES: Type 6 Charges A 6 Volt Battery at 6 Amperes \$15 Type 12 Charges 12 volt Battery at 5 Amperes \$15 Type B Charges 2 to 100 Volt Radio B Batteries \$15 Type A-B Charges Both A & B Batteries \$20 Type 1612 Charges 12 Volt Batteries at 7 Amperes..... \$24 Type 166 Charges 6 Volt Batteries at 12 Amperes..... \$24 Type 1626 Combination Type Charges Both 6 and 12 Volt Batteries at 1st and 7 Amperes..... \$36

The Larger Types are recommended for Large Batteries, or where time is limited. Shipping Weights Complete With Ammeter & Clips 12 to 15 lbs. Send check for Prompt Express Shipment. If via Parcel Post have remittance include Postage & Insurance charges, or order us to ship Type desired G.O.D. Order Now, or Write Immediately for FREE Descriptive BOOSTER & ROTARY Bulletins 33 & 33A.

FRANCE MFG. CO. General Offices and Works: CLEVELAND, OHIO, U. S. A. Canadian Rep.: Battery Service & Sales Co., Hamilton, Ontario, Can.

Tell them that you saw it in RADIO

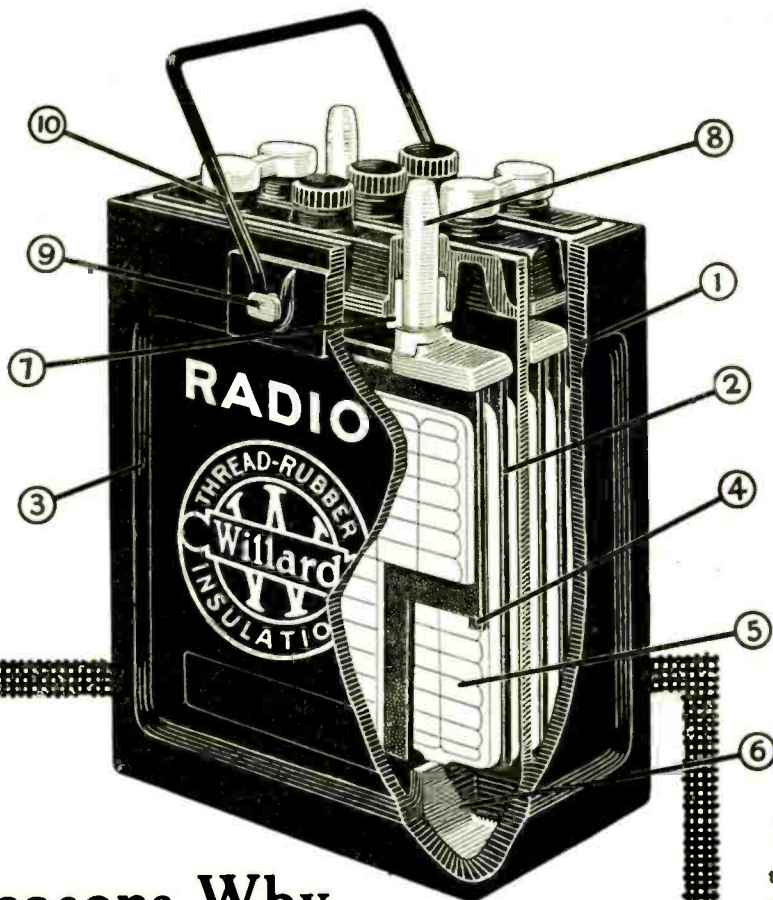

The Willard All-Rubber Radio "A" Battery (shown here) is designed especially for radio use.

Ten Reasons Why The Willard All-Rubber Radio "A" Battery is Better

These reasons, back of the success of this specially designed battery, are as definite as those responsible for the success of the Willard Threaded Rubber Battery, which is now standard original equipment on 195 makes of cars and trucks. Ask for particulars from your dealer or at the nearest Willard Battery Station.

The Willard Radio "B" Battery is a 42-volt rechargeable storage battery, with leak-proof glass jars and Threaded Rubber Insulation. Assures freedom from frying and hissing ground noises.

WILLARD STORAGE BATTERY COMPANY
Cleveland, Ohio

Made in Canada by the

Willard Storage Battery Company of Canada, Limited, Toronto, Ontario

Willard **THREADED RUBBER BATTERY**

1 The rubber case is made in one piece, thoroughly insulating the battery from cells to ground and from cell to cell, and effectively preventing all ground noises.

2 Plates are insulated with Threaded Rubber Insulation, which by reason of its uniformity allows every part of each plate to do an equal share of work.

3 Battery is shipped in absolutely Bone-Dry condition so that it is brand new when you get it.

4 Insulators are made with special heavy ribs to meet the special requirements of the radio battery.

5 Plates are extra heavy to provide current at steady voltage for considerable periods.

6 Sediment chambers are large to eliminate all possibility of short circuits at plate bottoms.

7 Posts are sealed by soft rubber gaskets, so that solution cannot seep out between post and cover.

8 Terminal posts are high to permit easy grip of battery clamps.

9 Brass knobs sunk into the sides of the rubber case provide a firm hold for the handle.

10 Handle made of a heavy rod furnishes easy means of carrying the battery.

Tell them that you saw it in RADIO

CHOOSING YOUR APPARATUS

The spread of radio enthusiasm over the country has brought in its wake a host of new companies and instruments. Radio products of all kinds and qualities are flooding the market. The new purchaser, not being familiar with the names of the old established radio companies, has little to guide him in his choice.

We, accordingly, ask you to weigh the fact that the General Radio Company was one of the earliest manufacturers in the field of high-grade radio instruments. It has for years maintained a research laboratory for the development of new apparatus. Our instruments are in daily use at the Bureau of Standards radio laboratory, the radio laboratories of the Army and Navy, the principal college and commercial research laboratories throughout the country, as well as by thousands of citizen radio enthusiasts.

We have not allowed the enormously increased demand to cause us to discard our rigid inspection system or to lay aside our development work. We have a reputation to maintain.

When you purchase radio instruments, we ask you to give consideration to these facts. Every instrument we make is guaranteed. When you think of Radio, think of GENERAL RADIO.



TYPE 231A
AMPLIFYING TRANSFORMER

A noteworthy example of our instruments is the amplifying transformer illustrated in the cut. This transformer is designed to give the maximum amplification possible, using a Radiotron UV-201 tube. It has an impedance ratio of 15 and an energy amplification of 400.

PRICE, COMPLETELY MOUNTED \$5.00

Send For Free Radio Bulletin 911C

GENERAL RADIO COMPANY

Massachusetts Avenue and Windsor Street
CAMBRIDGE 39 MASSACHUSETTS

Standardize on General Radio Equipment Throughout
CARRIED BY LEADING DEALERS

BRACH VACUUM Radio Lightning Arresters

More Than A Quarter Million In Use

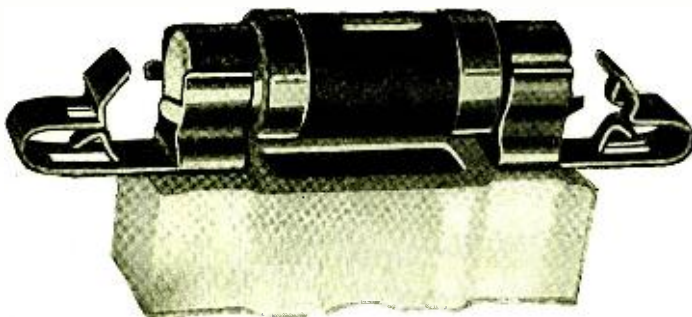

Most sensitive—most positive safeguard against lightning and static. Operate automatically, cannot become grounded, cannot become clogged with dirt.

No weak or lost signals.

APPROVED by National Board of Fire Underwriters, Fire Insurance Companies, Fire Departments, Railroad and Telegraph Companies and U. S. Army.

WARNING! Brach Vacuum Gap Arresters are protected by letters patent, allowed and pending. Infringements will be fully prosecuted.

Manufactured by
L. S. BRACH MFG. CO. 127-129 Sussex Ave., Newark, N. J.
16 Years Specialists in Lightning Protective Apparatus

Tell them that you saw it in RADIO

10 WATT C. W. SET

Continued from page 17

struction considerably easier. In connecting the two coils together in the center tap care should be taken that the winding will be continuous in one direction around the core.

No description will be given as to the construction of the cores of the transformers, as the method is familiar to all amateur radio men and the dimensions are clearly shown in the drawings. The iron used should be a good grade of transformer iron if full efficiency and rated output of the transformers is expected. These transformers when properly constructed will have a capacity of approximately 50 watts each.

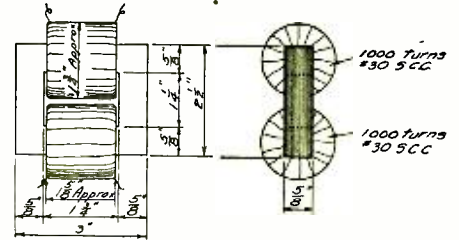

Fig. 10. Smoothing Choke

The method of mounting the transformers can be seen from the drawings and no lengthy description is needed. The object in making the mountings of this type with the terminal panels on top was to have a transformer which would take up the least amount of space possible on the base of the set and to use up some of the extra space below the inductance and behind the tubes.

Each transformer is provided with two binding posts for the 110 volt side and three for the secondary side, the middle post of the three being the center tap of the transformer.

The coils of the smoothing choke are made up in much the same manner as the high voltage secondaries. They are each wound with 1000 turns of No. 30 S. C. C. copper wire. If the builder purchases about two pounds of No. 32 S. C. C. copper wire for the high voltage secondaries he will undoubtedly have some left over which can be used for the smoothing choke coils if desired. As was the case with the high voltage secondaries, these coils need not be wound in layers.

The mounting of the choke can well be of the type similar to the transformers. Four binding posts should be provided for connections to the coils. By this means three values of inductance can be obtained, the inductance of one coil alone, twice this inductance when both coils are in series and about one-half the inductance of one coil when they are connected in parallel. The purpose of this choke is to smooth out the current supplied to the tubes and if made large enough would make the

Continued on page 50

Bradleystat

REGISTERED U. S. PAT. OFF.

PERFECT FILAMENT CONTROL

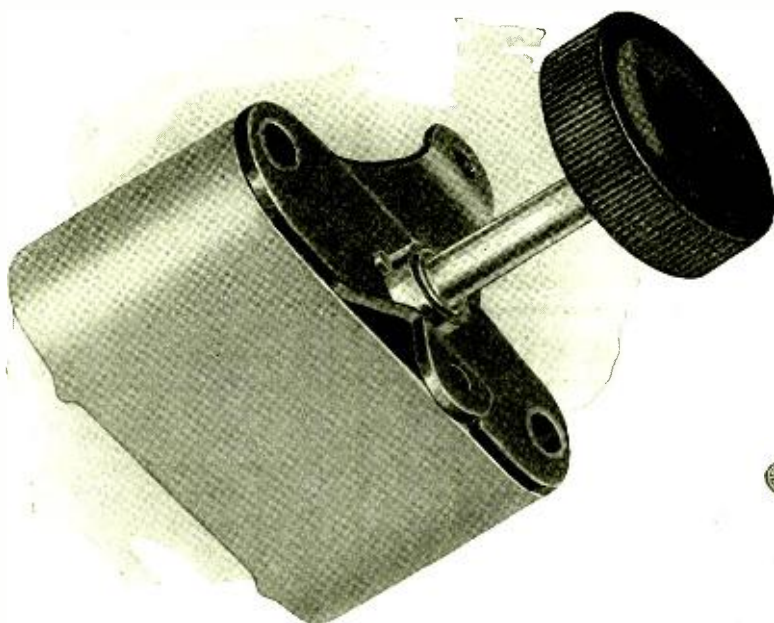

Price \$1.85

at all radio dealers. Add 10c
postage when ordered from

Allen-Bradley Co.

288 Greenfield Ave., Milwaukee, Wis.

THE STORY OF THE BRADLEYSTAT

About the time when Marconi startled the world with his famous wireless message across the Atlantic, a series of experiments were under way in the city of Milwaukee to prove a new idea for controlling electric motors in steel mills. Little did these intrepid experimenters dream, at that time, that this idea would some day revolutionize current control in the giant field of RADIO, which then was born.

The new idea was to eliminate wire-wound rheostats for current control, and use carbon discs under pressure. Everyone said it could not be done.

That was over twenty years ago! Today, graphite compression rheostats

from the electric furnaces of the Allen-Bradley Company are used in every industry, on battleships, in mines, and every place where electric current must be under precision control.

The latest contribution to RADIO is the Bradleystat, the result of twenty years experience and research. It controls the filament current of your $\frac{1}{2}$ to 1 ampere receiving tubes and your sending tubes up to $2\frac{1}{2}$ amperes, as no other type of rheostat can. The control is so perfect, so stepless, so noiseless that wire-wound rheostats seem crude in comparison. For your own satisfaction and delight, insist on the Bradleystat.

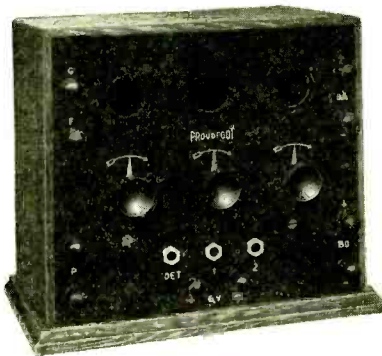

FRONT VIEW

PROUDFOOT AUTOMATIC FILAMENT CONTROL DETECTOR 2 STAGE AMPLIFIER

\$55.00

**CAN BE USED
WITH ANY TUNER**

EXACT DUPLICATE
WITHOUT
FILAMENT CONTROL CIRCUITS
\$45.00

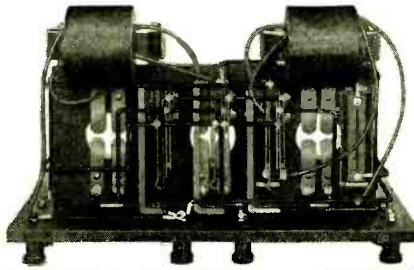

BOTTOM VIEW SHOWING AUTOMATIC
CONTROL CIRCUITS

CRUVER MFG. CO.
2456 W. JACKSON BLVD.
CHICAGO, ILL.

10 WATT C. W. SET

Continued from page 48

signals approach very close to the characteristics of a tube set with d.c. supply. However, the larger the choke the greater will be the drop of voltage across it and a greater terminal voltage will be required at the transformer terminals. With the above transformer and choke the voltage impressed on the tubes is between 400 and 500 volts. As each tube is working only one-half of the total operating time and neither tube is working when the key is up, it is possible to work the tubes now on the market up to about 750 volts in this circuit without any noticeable harm. If the builder should desire he may dispense with the smoothing choke entirely.

The grid leak is mounted on the tube shelf between the two sockets, and the grid condenser C_2 is mounted directly below on the under side of the tube shelf. The two condensers C_3 and C_4 are preferably mounted on the back of the panel toward the outside edges at some convenient point as shown in the photographs. The condensers C_5 and C_6 can be mounted directly on top of the filament transformer. The chokes L_3 and L_4 can be either 250 turn honeycomb coils or about 400 or 500 turns of No. 26 S. C. C. copper wire wound on thread spools. In the latter case a small brass bracket can be fastened to one end of the spool for fastening the chokes directly on the binding posts of the transformer. All wiring of the set should be of the rigid bus bar type and should not be smaller than No. 14 bare copper wire.

As to the actual methods of operation the builder is referred to the many articles that have appeared in this and other magazines on the subject. More can be learned in a half hour of experimenting with the various adjustments than can be learned by reading pages of written description. It may be noted, however, that a critical adjustment of condenser C_1 will be necessary for every change in the position of the aerial or plate taps.

The entire set can be constructed at moderate expense and the results that can be obtained will well repay the builder for his efforts in constructing it.

Condensers in series reduce the effective capacity of a circuit whereas condensers in parallel increase it. Consequently a variable air condenser is placed in series with an aerial to decrease the capacity so as to tune to shorter waves and is connected in parallel with a coil of wire or another condenser to increase the capacity and thus tune for longer wavelengths.

"Somerville Radio Specials"

SOMERVILLE CONDENSERS THE LINE NOW COMPLETE

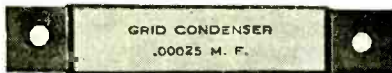

Grid Condenser, .00025 Mfd.....	\$0.25
—Above, with 1/4 Meg. Grid Leak....	.40
Grid Condenser, .0005 Mfd.....	.25
—Above, with 1 Meg. Grid Leak....	.40
Phone Condenser, .001 Mfd.....	.25
Phone Condenser, .002 Mfd.....	.40
Phone Condenser, .005 Mfd.....	.70

Quadrupled production of our famous CW Condenser enables us to make a new price schedule.



1000V. C.W. Condenser, .0005 Mfd....	\$0.60
1000V. C.W. Condenser, .001 Mfd....	.60
1000V. C.W. Condenser, .002 Mfd....	.60
750V. C.W. Condenser, .005 Mfd....	.80
500V. C.W. Condenser, .01 Mfd....	1.00

Above ratings are for D.C. only. When used with A.C., a safety factor of 75% should be observed. Each condenser is tested at double above ratings, and any found defective should be returned for replacement.

SOMERVILLE DIAL INDICATORS

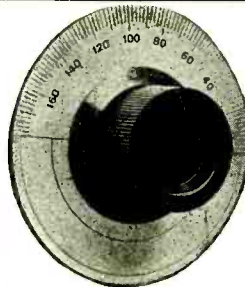

For 3/16, 1/4 and 5/16 in. shafts.
4 in. dia...\$1.75
3 1/4 in. dia. 1.60
Knob only... .80
Postpaid from us
by return mail,
or from your
local dealer.

This is the first metal dial with flanged knob and has the following exclusive advantages over imitations:

The knob is of real bakelite and will retain shape and finish.

The dial is of brass heavily plated with real silver and coated with special non-peeling lacquer, which preserves the silver finish long after nickel dipped and "German" silver dials are mottled and tarnished.

The heavy brass bushings and special method of assembly assures a dial which runs true on the shaft.

The surface finish permits writing call letters on the lower calibration space.

The dial is insulated from shaft bushing, and when grounded acts as a shield from capacity effect from body.

INSIST ON THE ORIGINAL AND BEST

SOMERVILLE 22 1/2v. "B" BATTERY, now ready, \$1.75

Has 5 positive knurled terminals, 16 1/2v., 18v., 19 1/2v., 21v. and 22 1/2 volts. Made to our specifications by one of the world's foremost battery manufacturers. Twice the capacity of the small signal corps size. Should last six to nine months.

EVERYMAN'S SECTION

The Westinghouse AERIOLA-SENIOR is admirably adapted for the hotel room or apartment as well as for an extended camping trip. It does away with the bulky storage battery, which must be charged constantly, as the vacuum tube requires but 1/25th the energy of the regular tube, and operates from a single dry cell, and small "B" battery.

Complete With Tube, Two Batteries, **\$67.25** Postpaid, East of Mississippi, and \$8 pair Head Phones, West of Mississippi, \$1.00 Extra.

Temporary antenna may be made from a pound roll of annunciator wire, price 70c.
STANDARD WESTINGHOUSE ANTENNA OUTFIT, \$7.50

SOMERVILLE RADIO LABORATORY
RETAIL - SALES - DIVISION
176-178 WASHINGTON ST., BOSTON, MASS.

Tell them that you saw it in RADIO

QUALITY

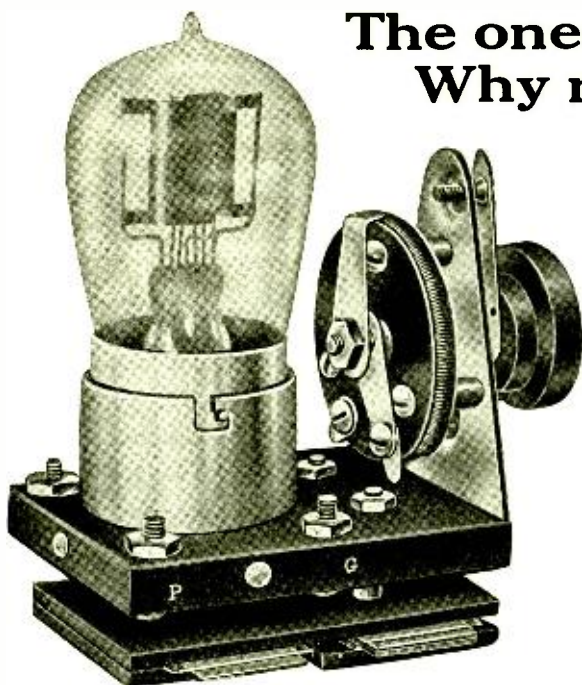

**The one thing you pay for in the end
Why not get quality when you buy**

**Your First Radio Instruments
Buy
Wireless Shop Apparatus
AND BE ASSURED OF THE QUALITY**

NO. 40 WIRELESS SHOP DETECTOR UNIT

A complete detector control, designed for back of panel mounting. By using this new unit it is very easy for the novice to build up a receiving set. All that is necessary is to drill three holes in your front panel, mount the unit and wire it to your tuner. Unit consists of socket for tube, rheostat, mica grid condenser and mica by-pass condenser. The bulb is not included. And the price is so low that you cannot afford to assemble the separate instruments yourself. A knob and pointer is supplied. Price (postage extra)..... \$5.00

The No. 40 detector unit and No. 41 amplifier unit is fully described in our bulletin No. 3, which will be mailed for the asking.

Variable Condensers

When you buy a variable condenser, you want the product of a real instrument shop. Of the many different instruments used in radio work, the variable condenser and head receiver are two that must be made right, by men that know, and have passed through the experimental stage. "Wireless Shop" variable condensers have an enviable reputation for "QUALITY", and this reputation has been honestly earned by strictly high grade material and workmanship. We have been manufacturing variable condensers for nearly eight years, and have developed a special line of equipment for performing each and every manufacturing operation required. "QUALITY" not "PRICE" is our slogan. The "PRICE" is as low as is consistent with "QUALITY". The 23 plate, No. 230, sells for \$3.60. The 43 plate, No. 430, for \$5.25. Twelve other sizes are fully described in our bulletin No 1. Ask for it.

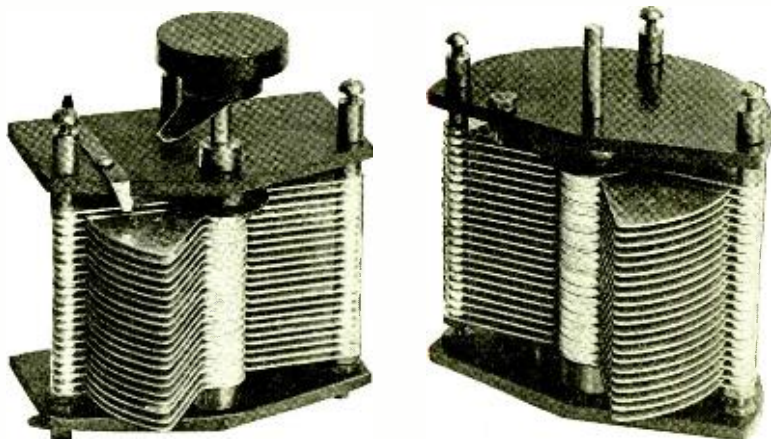

THE WIRELESS SHOP
A. J. EDGCOMB

1262 West Second Street

Los Angeles, California

Tell them that you saw it in RADIO

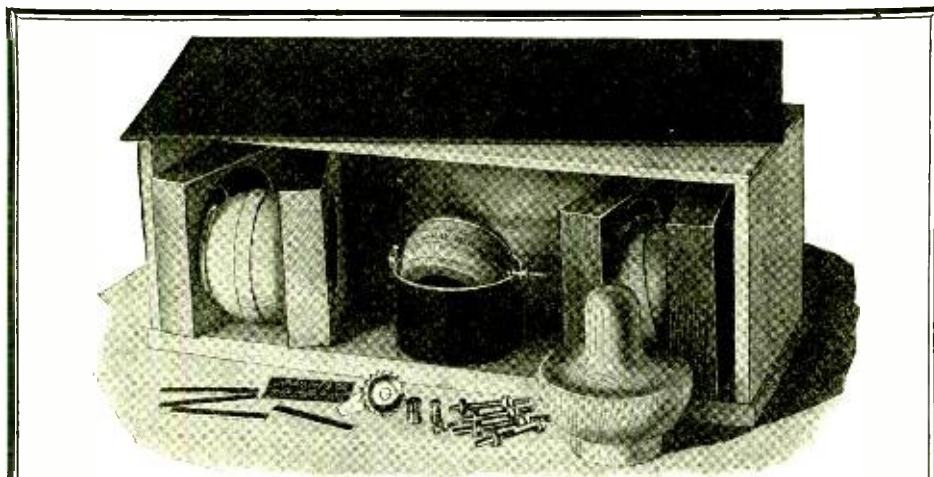

J-RAY UNASSEMBLED RECEIVING APPARATUS

Self Assembling Saves You 50 to 75 Per Cent.

JR-1. \$19.00 Unwound. \$23.00 With All Windings.

We herewith present our new line of Radiophone Receivers, Vacuum Tube Detectors and Amplifiers in knocked-down or unassembled form.

Each set comes with all holes drilled, directions furnished, etc., making it a very simple and at the same time highly interesting and instructive process assembling the various parts. Each piece of apparatus mounts directly to the drilled Formica Panel, by means of the screws and nuts provided. Wire supplied for making connections.

- JR-1—Unassembled Receiver. Consists of the following parts; Hand rubbed Oak Cabinet, 18½x7x7 inches, hinged top; 6 Binding Posts; Polished Formica Panel to fit (all holes drilled); 7 Contact Points; Grid and Plate Variometers and Varicoupler, complete ready to assemble; 3 J-Ray White Enamelled Dials (not shown); 1 Switch Lever; 2 Stops; all necessary brass parts, screws, etc., for completely assembling the set with directions. Price (with winding form for stator windings)..... \$19 00
- JR-2—Same as above, but with all Vario Windings in place..... 23 00
- JR-3—Unassembled Receiver with V. T. Detector and 1 Stage Amplifier, all in one cabinet. Consists of the complete set of parts for JR-2, plus 2 Crosley or J-Ray Sockets; 2 Fada Rheostats, 1 Amplifying Transformer, 1 Grid Condenser; extra Binding Posts; brass parts, etc., complete with directions. Extra holes provided in panel for mounting Rheostats and Sockets. Price..... 33 00
- JR-4—V. T. Detector and 1 Stage Amplifier. (Consists of Stained Oak Cabinet, 9¼x7x5, hinged top; drilled Formica Panel to fit; 2 Sockets; 2 Rheostats; Grid Condenser; Amplifying Transformer; Binding Posts, etc.)..... 16 50
- JR-5—V. T. Detector and 2 Stage Amplifier. Same as JR-4, but with extra Tube Socket, Rheostat and Transformer..... 22 50
- JR-6—Two Stage Amplifier, without Detector..... 20 00
- Receiver Cabinet only..... \$5 50. Panel..... 2 25
- Detector and Amplifier Cabinet..... 2 85. Panel..... 1 15
- 2 Variometers, (Grooved Stators) and 1 Coupler, K-D, with all hardware..... 10 00
- Our new Amplifying Transformer, 10-1 ratio, unwound..... 3 75
- Crystal Receiving Set, complete, without Phones..... 10 00

Write for bulletins.

J-RAY MFG. CO. 1618 Chestnut St., St. Louis, Mo.

CALLS HEARD

Continued from page 45

BY 6AKW, R. F. D. NO. 1, LANCASTER, CALIF.
 6pj, 6gr, 6aau, 6avs, 6aud, 6tu, 6amk, 6to, 6ald, 6aim, 6ajr, 6bam, 6ark, 6ib, 6ak (cw & voice), 6vk, 6ng 6zx, 6zam, 6zj, 6ex, 6cc, 6apl, 6bip, 6zaa, 6za, 6zt, 6abu, 6arj, 6zz (cw), 6zi, 6im, 6ku, 6ic, 6ada, 6gf, 6ala, 6gy, 6atu, 6fh, 6xwi, 6ha (cw), 6cb (cw probably Canadian), 6dm, 6za (cw), 6cn, 6sk, 7nn, 7zm, 7ly (cw), 7wg, 7mp, 7jd, 7mf, 7xb (cw), 7cs, 7zj, 7nw, 8bx, 9amb (cw), 9ayu (cw), 9dva (cw), 9dzj (cw), 9ps (cw), 9dh (cw), 9bji (cw).

QSL if you pick up my C. W. sigs. Just got station in operation April 5th at present location.

Continued on page 56

“SHAMCO PRODUCTS”

Amateurs: Send 5c in stamps today for our new Catalog L showing complete line of parts, raw materials and high grade apparatus.

Dealers: Write for our attractive proposition.

THE SHOTTON RADIO MFG. COMPANY, INC.

8 Market St. Albany, N. Y.

**“ILLINOIS” THE RELIABLE
 MADE RIGHT - STAYS RIGHT**

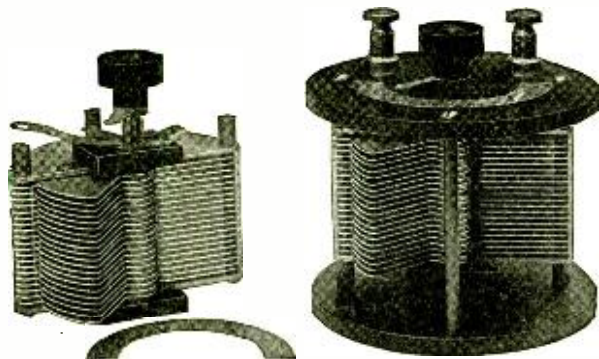

STYLE No. 1.

STYLE NO. 2.

Three Styles: No. 1, Panel; No. 2, Open Type as shown; No. 3, Fully Encased. Anti Profiteer. Less than pre-war prices. Fully assembled and tested.

	Style No. 1	No. 2	No. 3
67 Plates,	\$7.00	\$8.00	\$8.50
43 “	3.50	4.50	4.75
23 “	2.75	3.75	4.00
13 “	2.25	3.25	3.50

Money back if not satisfied. Just return condenser within 10 days by insured Parcel Post.

Options:—With Style No. 1—Instead of Scale and Pointer, a 3. inch Metal Dial at 50 cents extra, or a 3. inch Bakelite Dial at \$1.00 extra. Large Knobs. Both excellent values. Or we will, if desired, supply the Condenser with smooth 3/16 inch center staff, without Scale, Knob and Pointer, at 15 cents off the list to those who prefer to supply their own dial.

Vernier with single movable plate applied to 13, 23 or 43 plate condenser, \$3.00 extra.

We allow no discounts except 5 per cent on orders of 6 or more.

Sent Prepaid on Receipt of Price

Except: Pacific States, Alaska, Hawaii, Philippines and Canal Zone add 10c. Canada add 25c.

Foreign Orders other than Canada not solicited.

G. F. JOHNSON, 625 Black Ave.



VERNIER

Springfield, Illinois

Tell them that you saw it in RADIO

CROSLEY HARKO SENIOR RADIO RECEIVER

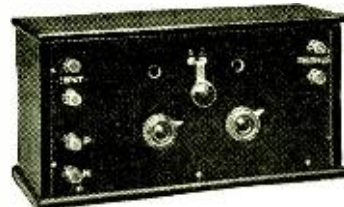

Complete tuner and audion detector assembled on a formica or other high grade dielectric panel, mounted complete in mahogany finish cabinet. Range, 150 to 600 meters, non-regenerative hook-up. Price without battery, tube or phones.....\$16.00

CROSLEY TWO-STEP AMPLIFIER



Complete with amplifying transformers, sockets, rheostats, switch, binding posts, etc., mounted on formica panel in mahogany finished cabinet. Price complete as shown in illustration.....\$25.00

We make a complete line of radio apparatus. 'It's better—and costs less'

Send for circulars.

CROSLEY MFG. CO.

Radio Dept. P-5 Cincinnati, Ohio

MAGNAVOX Radio



ANY a natural born "radio enthusiast" has so far been discouraged from taking up this wonderful new science by the restrictions inherent in the use of the telephone head set—or an unsatisfactory "loud speaker".



No wireless receiving set is complete without the Magnavox Radio



Radio brings it
MAGNAVOX tells it

Magnavox Radio

R-3

with 14-inch horn

ideal for use in homes, amateur stations, offices, etc.

R-2

with 18-inch horn

serves the requirements of professional use for large audiences, dance halls, etc.

The Magnavox Power Amplifiers

insure getting the largest possible power input for your Magnavox Radio. Can be used with any "B" battery voltage up to 1000.

2 and 3-stage



Whatever your *previous* experience with radio has been, a new world of usefulness and enjoyment awaits you in the service of *Magnavox Radio*.

Attached to any commercial receiving set, the Magnavox Radio reproduces every sound in full volume, transforming wireless telephony from a scientific "fad" into a universal *home entertainment and inspiration*.

The Magnavox Radio makes it possible to hear all that is in the air as if it were being played on your phonograph. Any dealer will demonstrate, or write us for descriptive booklet and name of nearest dealer.

THE MAGNAVOX COMPANY

Oakland, California

New York Office: 370 Seventh Avenue, Penn. Terminal Building

Tell them that you saw it in RADIO

FEDERAL

Radio Apparatus Will Simplify Your Operation



FEDERAL HEAD TELEPHONE
Afford a comfortable, light-weight sensitive headset which will meet the most rigid requirements. Best material obtainable used throughout and each pair of receivers are carefully matched in tone. Their ability of perfect reproduction of speech and sound have made them extremely popular and desirable by all classes of radio experimenters.

PRICE IN U. S. A.

- No. 53-W Head Telephones,
2,200 ohm.....\$8.00 per set
- No. 52-W Head Telephones,
3,200 ohm.....\$10.50 per set

Federal Anti-Capacity Switches should be used in circuits where ordinary switches would have too high a capacity, with resulting loss in signal strength. Phosphor bronze springs, silver-plated; roller type cams; Bakelite insulation; silver contacts.



Price in U. S. A., \$2.80

THERE ARE MANY IMMITATIONS ON THE MARKET BUT FOR DURABLE EFFICIENCY DEMAND FROM YOUR DEALER THE GENUINE **FEDERAL**

Federal Telephone & Telegraph Co.

Buffalo, N. Y.

RADIO PATENTS

Continued from page 34

chamber 22. Passageways 15 and 23 are also provided for a cooling medium.

A. Bonnefont, Pat. No. 1,410,793; March 28, 1922. Crystal detector for wireless telegraphy.

The crystal p is entirely enclosed in a base member s, but may be rotated from the outside by means of the cap c. The sensitive exploring point is the end of spring r, wound around the sleeve e slidable on shaft a, and urged toward the crystal p, by spring n. The point is moved up and down by rotation of a crank arm t which carries the crank pin b engaging the collar of sleeve e. By rotating this shaft t, the sleeve e may be also slightly rotated due to the knurling on pin b, and in this way a sensitive point may be readily obtained. Furthermore the crystal p itself rotates about an axis non-concentric with respect to shaft a, and this makes possible a large variety of adjustments.

H. M. Stoller, Pat. No. 1,411,814; April 4, 1922. Power system for radio apparatus.

A power tube system suitable for such work as with airplanes is described, in which there is minimum weight. The power tubes 10 receive their filament current from a storage battery 1. This battery also operates a motor generator set 4-5, for supplying the plate circuit with high voltage. To eliminate the effect of the low amplitude audio frequency current due to the brushes and commutator of machine 4, filter circuits comprising choke coils 13 and resistances 14 are used in the filament heating circuit. By proportioning the impedances and resistances properly, the A. C. is substantially eliminated.

HERE IT IS!



¾ actual size

STEVENS
Radio Panel

WINDOW
Patent Pending

The one thing necessary to complete your panel
IT'S THE FINISHING TOUCH
Ventilates the cabinet and keeps out dust and insects

Black or Nickel Finish
Price \$1.00

At your dealer's or by mail
DEALERS

Write for prices on this fast selling accessory



Makers of Radio Accessories
434 60th St.
OAKLAND, CALIFORNIA

THE BEST LOUD SPEAKER IS YOUR Phonograph when used with the "Easy" RADIO - PHONOGRAPH CONNECTOR

Just slip the sound box (reproducer) off your talking machine, and replace it with the "Easy" Connector. Then your head phone will fit the connector perfectly. Phonograph horns are scientifically made to give the greatest possible amplification. Your complete receiving outfit can be placed in the record compartment of your phonograph. Then your RADIO apparatus becomes a beautiful piece of furniture instead of an unsightly conglomeration of parts—does not in any way harm the phonograph for playing records.

No. 2 Model, now ready, fits all Victor Phonographs and Victrolas, and all other machines with tone arm same size as Victor. Sent anywhere postpaid for **\$1.50**
DEALERS: Radio and phonograph dealers are making big money on the rapid sale of this item. Every phonograph owner is a sure buyer. The discounts are attractive. Deliveries almost immediate. Orders filled in rotation.
BOYD FULLER & CO., 8446 Grand River Ave., Detroit, Mich.

THE ONLY RADIO WEEKLY

RADIO WORLD

Every seven days
Beautifully illustrated; special articles
Helps for the amateur
\$6.00 a year; \$3.00 six months;
\$1.50 three months; Trial subscription
\$1.00 for 8 issues.

Sample copy, 15 cents.
Advertising rates on application.
Radio World Company
1493 Broadway New York City

Tell them that you saw it in RADIO

NEWS OF BROADCASTING STATIONS

Continued from page 29

- KWH—Los Angeles Examiner, Los Angeles, Calif.
- KOO—Modesto Evening News, Modesto, Calif.
- WAAQ—New England Motor Sales Co., Greenwich, Conn.
- WAAE—St. Louis Chamber of Commerce, St. Louis, Mo.
- KOE—Spokane Chronicle, Spokane, Wash.
- WAAN—University of Missouri, Columbia, Mo.
- WAAS—Georgia Radio Co., Inc., Atlanta, Ga.
- KPO—Hale Bros, Inc., San Francisco, Calif.
- WAAP—O. W. Taylor, Wichita, Kan.
- WAAB—Times Picayune Pub. Co., New Orleans, La.
- WWZ—John Wanamaker, New York, N.Y.
- WAAV—Athens Radio Co., Athens, Ohio.
- WAAW—Omaha Grain Exchange, Omaha, Nebraska.
- WBAB—Andrew J. Potter, Syracuse, N.Y.
- WAAX—Radio Service Corps, Pitts., Pa.
- WAAV—Yahrling-Raymer Piano Co., Youngstown, Ohio.

THE EMPORIUM BROADCASTING STATION

The Emporium broadcasting station at San Francisco is on the seventh floor of the large department store. The antenna is of the four-wire T type 80 ft. long, supported by two 60 ft. steel pipe poles. A cage type lead-in is used. The transmitting set, part of which is shown in the accompanying photograph, is of five watts capacity. The oscillating circuit is the Colpitts, while the Heising system of modulation is used. The normal radiation is 1½ amperes on 360 meters.

A standard type of regenerative receiver and two step are used. The room is specially constructed for the broadcasting of orchestra numbers and other special features of public interest. The broadcasting range, as reported under ordinary circumstances from out of town stations, is 185 miles daylight, while close to 700 miles have been covered on tests at night.

A counterpoise consisting of 3000 ft. of wire is used for the ground. This counterpoise is 200 ft. long and 20 ft. wide.

Desert Power and Water Company, Kingman, Arizona, has established a radio apparatus sales department in charge of James H. Davidson, radio engineer, formerly in the navy service. Because of the distances of Arizona points from present broadcasting stations only equipment of the better class with ample range will be handled. It is expected radiophones will be in great favor at the many semi-isolated mines and mining camps of Northern Arizona and the installation of a broadcasting outfit at Kingman is anticipated.

The Record, at Fort Worth, Texas, has installed a 200-watt radiophone for broadcasting press, weather and concerts.

The Hatfield Electric Co. has opened a broadcasting station at 531 North Meridian Street, Indianapolis, Ind. The call letter is WOH. Regular programs will be broadcasted from this station every Monday, Wednesday and Saturday evenings at 8:30, central time.

WESTINGHOUSE RADIO BATTERIES

Eliminate all Battery Troubles from Radio Sets

The Westinghouse "A" Battery is a full capacity, low voltage, slow discharge, long-life storage battery built exclusively for radio work.

For "B" battery requirements Westinghouse has perfected a baby storage battery. No more throwing away exhausted cells. No more continuous "B" battery expense.

The Westinghouse "B" is a permanent battery. It never has to be replaced. It will discharge its load with constant, steady voltage. Then it can easily be recharged. It gives continuous service to the point of exhaustion without growing "scratchy." If your vacuum tube is inclined to be noisy you can adjust the contact on the Westinghouse "B" to take off the exact voltage the V. T. requires.

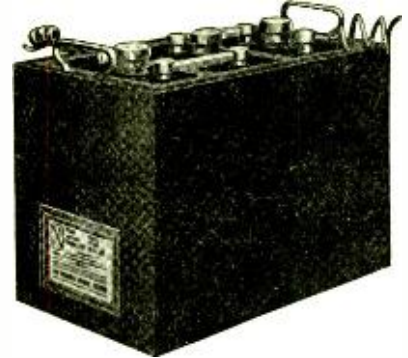

Get a Westinghouse "A" and "B" from your dealer or the nearest Westinghouse Battery Service Station and eliminate all your radio battery troubles.

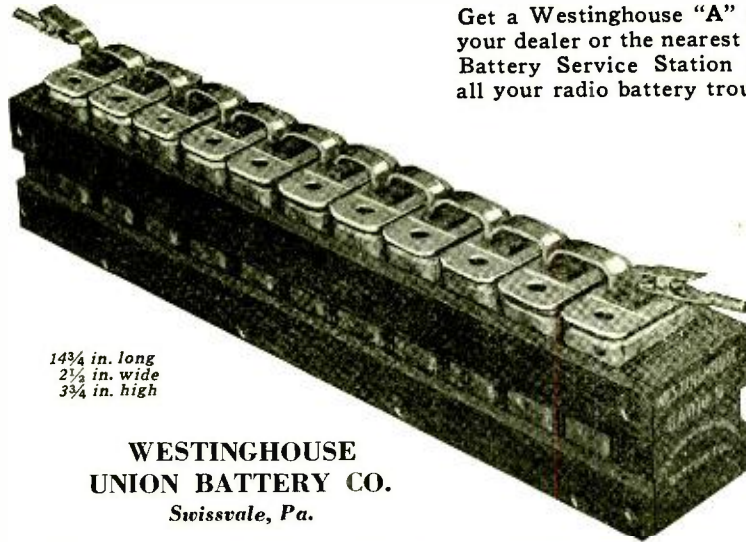

14¾ in. long
2½ in. wide
3¾ in. high

WESTINGHOUSE UNION BATTERY CO.
Swissvale, Pa.

"The best Westinghouse can build."



Mica Grid Condenser and Grid Leak Mountings

From .00005 to .00025 MFD.....	\$.50
From .0003 to .0005 MFD.....	.65
Grid Leak Mounting only.....	.25
Triple Coil Mounting.....	5.00

Variable Condensers

.0005 MFD	\$4.50
.00075 MFD	5.00
.001 MFD	6.00
.0015 MFD	7.50

Kindly add 5c for Postage
MONTROSE MFG. CO.

619 St. John's Place, Dept. E, BKLYN, N. Y.

The 'QSA' Line of Radio Equipment

Larger business has made necessary larger space and larger stock. So we have moved into new quarters where we will be better able than ever to supply your wants. Items listed below are in stock for immediate delivery.

Radiotron UV 202 5 Watt Power Tube.....	\$8.00
Federal No. 226-W Amplifying Trans- former	7.00
Paragon VT Socket No. 30.....	1.00
FADA Panel Mounting Rheostat.....	1.00
Eveready No. 776 Variable "B" Battery	3.00

Catalog of "QSA" equipment sent for 10 cents which will be refunded on initial purchase or FREE with order from this advertisement. Get on our mailing list. We have something interesting to say to you each month.

INDEPENDENT RADIO SUPPLY CO.

3239 Ogden Ave., Chicago, Ills.

Tell them that you saw it in RADIO

Radio Frequency Transformers

The R. T.—1 Transformer Works on All Standard Makes of Tubes

For Amateur and Broadcasting Range 175-500



Type RT-1, Price \$6.00

Mr. Amateur: Hook up a radio transformer ahead of your detector and get acquainted with stations you have not heard before.

The Type RT—1

- Transformer of special R. F. iron core construction. (Patent pending.)
- Transformer having complete shielding.
- Transformer covering the amateur wave-length efficiently.
- Transformer giving maximum amplification per stage.
- Transformer designed by former Government radio engineers

RADIO SALES CORPORATION

National Distributors for Radio Service Laboratories
10 EAST 43rd STREET NEW YORK CITY

75c Ea.



KELLOG V-T SOCKET the durable socket

Kellogg molded lamp sockets fit all standard four prong based vacuum tubes. Extra heavy solid base 7/16 inches thick. Four German silver springs with rounded ends firmly held in position in deep grooves, cannot touch mounting surface. Double end nickel plated binding posts. Connections can be made under the socket as well as above. A practically indestructible construction. 75c each, postpaid.

COMPLETE RADIO EQUIPMENT
The item above is merely a sample of the excellent line of radio equipment that is handled by the Apex Radio Company, Inc. All orders for sockets or other standard equipment will be filled the day received. Send two cent stamp for our new price bulletin.
APEX RADIO CO., INC. 1105 W. 69th St. Chicago, Ill.

RTS

The New RTS Standard Detector Panel will please all amateurs. Sent complete without tube two batteries for only **5.95** Postpaid by Insured Parcel Post
Send for complete circulars now
Radio Testing Stat'n, Dept. A, Binghamton, N.Y.

CONNECTICUT

RADIO EQUIPMENT
Variable Condensers, Transmitters, Head Bands, Panel Switches, Etc.
Connecticut Tel. & Elec. Co., Meriden, Conn.

THE CLASSIFIED ADS ON PAGE 94 WILL INTEREST YOU!

Do You Want REAL SERVICE?

Let us have your order, learn what REAL SERVICE means. Shipments made within 24 hours.

SEND FOR YOUR COPY OF CATALOGUE No. 22

THE SERVICE RADIO EQUIPMENT COMPANY

DESIGNERS — MANUFACTURERS -- DISTRIBUTORS
225 Superior Street Toledo, Ohio

Tell them that you saw it in RADIO

CALLS HEARD

Continued from page 52

BY 7BS, 605 BOYLSTON N., SEATTLE, WN. Can. 4cb, 5za, 6en, 6gy, 6jd, 6ki, 6xh, 6xad, 6xw, 6zf, 6zi, 6aif, 6bla, 7ni, cl3.

BY 6AME, BOX 218, RIVERBANK, STANISLAUS CO., CALIFORNIA

On one tube—5zq, 8agz, 8cid, 8de, 8sp (Fairmont, W. Va.), 8uj, 8xm, 8xv, 9ak, 9bji, 9kp, 9zaf (fone and cw), 9zj, 9zy, 9ax (Can. spk.), 9bd (Can. spk. and cw), dd5 (fone), vlj.

On choke coil one step—5ak (spk.), 5if (spk.), 5xb (spk.), 5xd (spk.), 5yq (spk.), 5za (spk., cw and fone), 5zz, 8aav, 8aim, 8agu, 8bf, 8bfx, 8box, 8caz, 8cgx, 8ib, 8jl, 8in, 9aik, 9aja, 9akd, 9alu, 9amb, 9aqa, 9aqu, 9ayu, 9ayv, 9avz (spk.), 9awm, 9bac, 9bex, 9bbf, 9bik, 9dtm, 9dva, 9dvb, 9dvt, 9dzj, 9fm, 9io, 9ix, 9ji, 9jr, 9nx, 9pi, 9wd, 9wu, 9xaq (spk. and cw), 9yak (spk.), 9yal (spk.), 9zac, 9zal (fone), va2, cl3, cl8 (spk. and cw), bf2, nof (Washington, D. C.).

Would like QRA from the above stations who have not received my QSL.



FOUR SETS OF PHONES!

25c will buy a set of Multiple Binding Post Connections (patent pending) which provide the only practical means of attaching as many as 4 pairs of telephone receivers to a pair of ordinary binding posts.

Dual connection set provides same connection in attaching Magnavox and outfit to storage battery.

Either set will be sent postpaid upon receipt of 25c in coin or stamps. Satisfaction guaranteed or money back.

Portable Wireless Telephone Co.

Dep't A, Commercial Bank Building
STOCKTON, CALIFORNIA
Attractive Dealer's Proposition.

Tuning Coils

Cross Weave Tuning Coils, the heart of a receiving set—just the coils for bringing in the Radiophone broadcasting stations. 180 to 500 meters. Price \$1.25 each, or set of three coils, Primary, Secondary and Tickler coils, \$3.50 per Set with circuit diagram.

CONDENSERS

Grid and Phone condensers made of the best material obtainable, \$1.00 each.

PANELS

Of Gumwood Black Finish

Treated with a special process made by us. Will not Warp or Shrink and is not affected by Temperature changes. Waterproof and possesses High Dielectric properties. Easily machined and will not Crack or BREAK. Looks as good as Bakelite. We are prepared to ship promptly the following sizes:

8" x 6" x 1/4" thick.....	\$.60	8" x 12" x 1/4" thick.....	\$ 1.50
8" x 7" x 1/4" thick.....	.75	9" x 14" x 1/4" thick.....	1.75
6" x 10 1/2" x 1/4" thick.....	1.00	12" x 14" x 1/4" thick.....	2.20
6" x 12" x 1/4" thick.....	1.25	12" x 21" x 1/4" thick.....	3.00

Strips 3 1/2" x 8; 3 1/2" x 8; \$.40 each; 3 1/2" x 10, 3 1/2" x 12, \$.80 each; 3 1/2" x 18, \$.75 each.

Add Postage for 1 lb. for Panels up to 6 x 12 x 1/4; and 2 lbs. for larger sizes.

We will be pleased to quote prices on these panels out to a different size on receipt of your specifications. NO FREE SAMPLES.

NATIONAL RADIO CO.

Marshall, Minn.
Dealers: Write for our proposition

More New Pacent Radio Essentials

Pacenter Audioformer

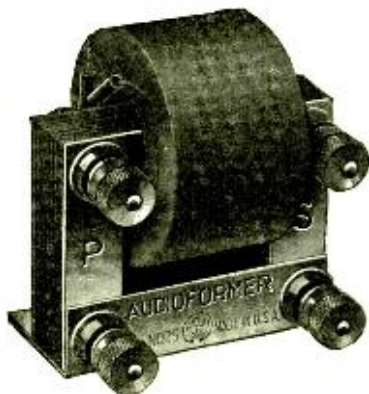

Here is the smallest and most efficient audio-frequency transformer on the market today. It is being manufactured especially for the reception of radio telephone music and speech and is so designed as to give maximum efficiency at all audio-frequencies. The Pacent-made Audioformer will make music worth listening to.

Catalog No. 25
Pacenter Audioformer Price . \$6.00

Dubilier Type 600 Condenser



This condenser manufactured by the Dubilier Condenser Company by the superior Dubilier process can be secured for your receiving equipment. The Dubilier Type 600 Condenser has accommodations for a grid leak, yet the condenser costs less than a grid leak or a condenser purchased separately, and is provided with Fahnestock connectors. Use Dubilier Condensers.

Capacities up to 0.005 mfd.
Price \$0.75

Capacities over 0.005 to .01 mfd.
Price \$1.00

Pacenter Crystal Detector



The Pacenter Crystal Detector is perfect in construction and reasonable in price. It is dust-proof, rust-proof and fool-proof. Has moulded top and base with glass cover. Crystal instantly accessible. All parts heavily nicked and highly polished. A truly beautiful instrument incorporating every feature a good detector should have. Pacent-made and Pacent-stamped.

Catalog No. 30 Crystal Detector Stand.
Price. \$1.50

Ask your dealer to show you these and other Pacent Essentials.

150 Nassau St. _____ **Pacenter Electric Company, Incorporated** _____ New York City
LOUIS GERARD PACENT, President

MEMBER OF RADIO SECTION. ASSOCIATED MANUFACTURERS OF ELECTRICAL SUPPLIES

ELMCO Apparatus

Elmco—No. S-1 Tuner, and A-3 Detector, and Two-Stage Amplifier . . \$100.00

Elmco—No. S-1 Detector and Two-Stage Amplifier 60.00

Elmco—No. S-1 Tuner 40.00

Elmco Crystal Detector, receiving set complete 28.00

Write for Catalog No. R-1.

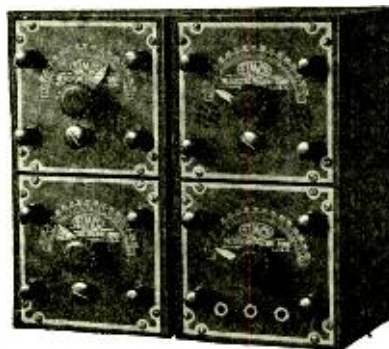

The Electric Machine Corporation

Indianapolis, Indiana

Tell them that you saw it in RADIO

Atlantic-Pacific Radio Supplies Co., Inc.

Radio Supplies

Consulting

Designing

Constructing

Engineers

Atlantic-Pacific Radio Supplies Co., Inc.
648 Mission Street
San Francisco, Cal.

C — THE — W MANUAL

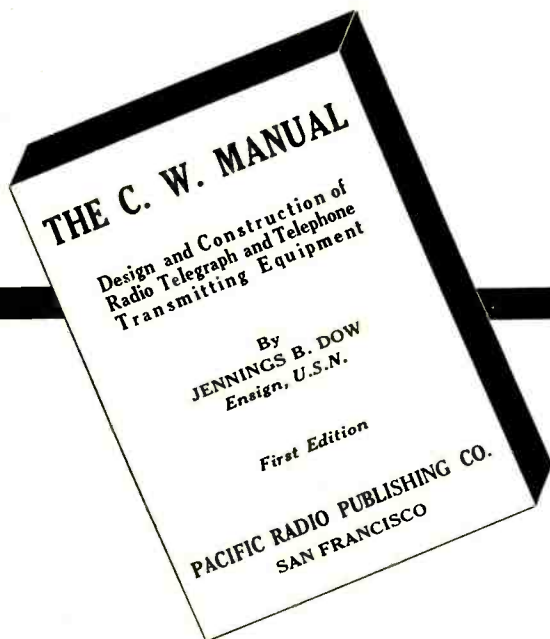

Jennings B. Dow, U. S. N.
AUTHOR OF THE C. W. MANUAL

**The Only Complete Textbook
Of Its Kind on the Market**

*Tells You How to Construct
Any Type of Tube Transmitter*

EVERY radio experimenter should have a copy of The C. W. Manual. Don't be content with a receiving set. Install a transmitter and talk—by voice or telegraph—to your radio friends. It's fascinating and simple. Anybody can construct a small vacuum tube transmitter by following the directions outlined in this book. Discard that troublesome and noisy spark transmitter and install one of the highly efficient transmitters described in The C. W. Manual. Everything in C. W.—from the smallest tube set to the transmitter that employs 250 watt tubes—is described in detail. A small, inexpensive tube transmitter will outdistance the expensive spark and assure you of reliable communication under almost any atmospheric conditions.

The C. W. Manual contains 112 pages of the most timely data on the vacuum tube transmitter and power amplifier. There are eleven chapters—profusely illustrated, and detailed drawings accompany every phase of the subject. The book is substantially bound in board and is just the right size to fit your pocket. The author of The C. W. Manual has many years of C. W. experimenting to his credit and all apparatus described in the book has been thoroughly tested to his entire satisfaction.

\$ 1.00

Per Copy Postpaid
Anywhere in the
United States.

Profit from the experience of those who know. Put your transmitter in the better class. Experience the joy of long distance communication and record breaking that is not possible with the obsolete spark transmitter. Get your C. W. or telephone set on the air before the static season is here. Work right thru the summer without a break.

DEALERS: Write for attractive proposition.

CONTENTS

- | | |
|---|---|
| Chapter I—The Vacuum Tube Transmitter Circuit. | Chapter VII—A Ten Watt Power Amplifier. |
| Chapter II—C. W. Circuits to Date. | Chapter VIII—Design and Construction of a 250 Watt Amplifier and C. W. Transmitter. |
| Chapter III—Experimental Phone Circuits. | Chapter IX—Rectifiers of Plate Supply Current for Transmitting Vacuum Tubes. |
| Chapter IV—Ten Watt C. W. Transmitter, I. C. W. Transmitter and Phone Set Using Direct Current. | Chapter X—Design of a Low Powered Circuit for Duplex Operation. |
| Chapter V—Design and Construction of Ten Watt C. W. Transmitter for Use on A. C. | Chapter XI—Notes for the Experimenter and Constructor. |
| Chapter VI—An Inexpensive 50 Watt C. W. Transmitter. | |

THE FIRST EDITION WILL BE
READY FOR DISTRIBUTION
ON JUNE 15th. MAIL THE
COUPON TODAY and
we will reserve a
copy for
you.

RADIO
465 Pacific Bldg.,
San Francisco.
Herewith is \$1.00
for which you will send
The C. W. Manual to—

Name

Address

6-22

Tell them that you saw it in RADIO

The McTIGHE STORAGE "B" BATTERY

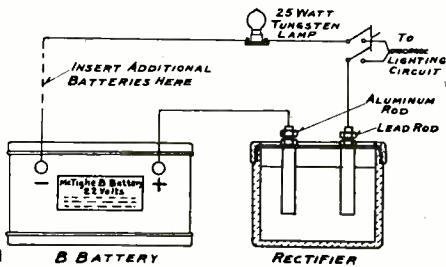

The McTighe Storage "B" Battery is of the alkaline type, is the most satisfactory source of plate potential, and can be charged from your lighting circuit for less than one cent. Can also be charged from farm lighting systems.

In ordinary service a one hour charge will last for several weeks.

The Battery is furnished in a 24 volt unit in an attractive case.

It is noiseless, and cannot be injured by accidental short circuit, overcharging or by standing idle.

Descriptive leaflet on request.

PRICES

Battery	\$4.00
Rectifier	1.50
Rubber Filler25

F. O. B. Irwin, Pa.

ECONOMIC APPLIANCE COMPANY
Successors to McTighe Battery Co.,
Irwin, Pa.

STATEMENT OF THE OWNERSHIP, MANAGEMENT, CIRCULATION, Etc., REQUIRED BY THE ACT OF CONGRESS OF AUGUST 24, 1912.

Of "RADIO," published monthly at San Francisco, California, for April, 1922.
State of California,
City and County of San Francisco—ss.

Before me, a notary public in and for the State and county aforesaid, personally appeared H. W. Dickow, who, having been duly sworn according to law, deposes and says that he is the business manager of the "RADIO," and that the following is, to the best of his knowledge and belief, a true statement of the ownership, management (and if a daily paper, the circulation), etc., of the aforesaid publication for the date shown in the above caption, required by the Act of August 24, 1912, embodied in section 443, Postal Laws and Regulations, printed on the reverse of this form, to wit:

1. That the names and addresses of the publisher, editor, managing editor, and business managers are:

Publisher, Pacific Radio Publishing Co., Inc., 465 Pacific Bldg., San Francisco, California.

Editor, Arthur H. Halloran, Berkeley, California.

Managing editor, none.
Business Manager, H. W. Dickow, San Francisco, California.

2. That the owners are: (Give names and addresses of individual owners, or, if a corporation, give its name and the names and addresses of stockholders owning or holding 1 per cent or more of the total amount of stock.)

Arthur H. Halloran, Berkeley, California.

H. W. Dickow, San Francisco, California.

3. That the known bondholders, mortgagees, and other security holders owning or holding 1 per cent or more of total amount of bonds, mortgages, or other securities, are: (If there are none, so state.) None.

4. That the two paragraphs next above, giving the names of the owners, stockholders, and security holders, if any, contain not only the list of stockholders and security holders as they appear upon the books of the company but also, in cases where the stockholder or security holder appears upon the books of the company as trustee or in any other fiduciary relation, the name of the person or corporation for whom such trustee is acting, is given; also that the said two paragraphs contain statements embracing affiant's full knowledge and belief as to the circumstances and conditions under which stockholders and security holders who do not appear upon the books of the company as trustees, hold stock and securities in a capacity other than that of a bona fide owner; and this affiant has no reason to believe that any other person, association, or corporation has any interest direct or indirect in the said stock, bonds, or other securities than as so stated by him.

H. W. DICKOW,

Business Manager.

Sworn to and subscribed before me this 22nd day of March, 1922.

(Seal) MARTIN EDELMAN.
(My commission expires April 7, 1922.)

Hook Up With a WIZARD BATTERY

A special made "moisture proof" "B" battery of guaranteed long life—a veritable power house. As high in quality as it is low in price.

No.	Size	Wgt., Lbs.	Volts	Price
1623 Plain.....	2x3 3/4 x 2 1/2	1	22 1/2	\$1.00
1623 Variable.....	2x3 3/4 x 2 1/2	1	22 1/2	1.20
1625 Plain.....	4x6 3/4 x 3	5	22 1/2	1.85
1625 Variable.....	4x6 3/4 x 3	5	22 1/2	2.25
1626 Plain.....	8x6 3/4 x 3	10	45	3.75
1626 Variable.....	8x6 3/4 x 3	10	45	4.15
1630 Variable.....	3x6 x 2 3/8	2 3/4	27	1.80
1632 Variable.....	5x6 x 2 3/8	3 3/4	45	2.80

At your dealer or write direct

WIZARD BATTERY CO.
173 Lafayette Street, New York City

NEW MOTORS FOR ALL PURPOSES
STANDARD MANUFACTURERS
PROMPT DELIVERY

ALL SIZES UP TO 5 H.P.

We Specialize In Small Motors & Generators

ALL PHASES AND FREQUENCIES IN STOCK AT ALL TIMES

Largest exclusive Mail Order Small Motor dealers in the world.

CHAS. H. JOHNSTON, Box 38, West End, Pittsburgh, Pa.

WIRELESS TELEPHONE GENERATORS
500 VOLT - 100 WATT - 3400 R.P.M.
FOR MOUNTING MOTOR GENERATOR SETS.

\$28.50 EACH

WRITE FOR CATALOG

NOVO

Vacuum Tube

"B" Batteries

FOR

Wireless Sets

22 1/2 to 100 Volts

19 Different Sizes

Plain and Variable

FULLY GUARANTEED

Noiseless in Operation

Write for catalog and prices

Novo Manufacturing Co.

424 W. 33d St. 531 So. Dearborn St.
NEW YORK CHICAGO

AT LAST—
A Real Book On
RADIO

Just off the press!
A concise, non-technical treatise on Radio for the Layman.
Simple language, diagrams and everything. One that you can really understand.

THE RADIO LIBRARY—Vol. 1
Price 30c

THE RADIO PUBLISHING CO.
1427-29 LIBERTY AVE., PITTSBURGH, PA.

Dealers Write

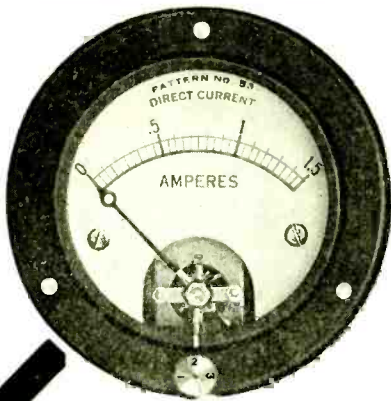

Pattern No. 53

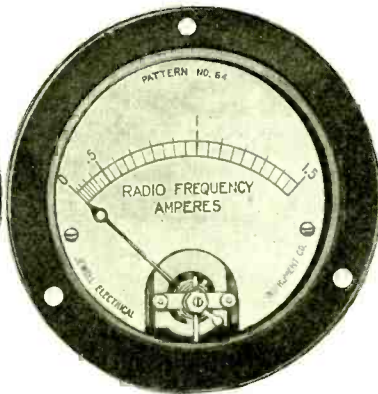

Pattern No. 64

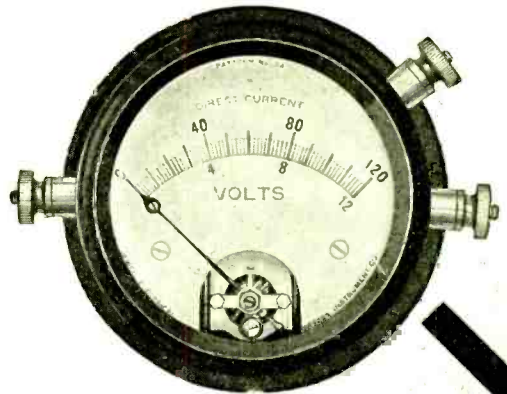

Pattern No. 54

NEW RADIO INSTRUMENTS

GET OUR NEW RADIO CIRCULAR

To get maximum efficiency from any tube receiving set, the filament current must be under proper control. To obviate using an instrument for each tube, we designed our No. 53 Triplex Filament Ammeter. For current control an ammeter is supplied with three self contained shunts, permanently in the circuit, the switch in the flange connecting the ammeter across any shunt. Also supplied as a 0-10 Voltmeter for voltage control.

Price, 0-1.5 Amps. or 0-10 Volts, \$10.00

The Pattern No. 64 instrument shown above is a thermo-couple type of antenna ammeter and is the most satisfactory which has been produced by any manufacturer. It has no appreciable temperature error nor has it any zero shift as in the hot wire instrument. This instrument is one of the three inch Jewell Instruments now generally recognized as standard for radio work.

Price, 1 to 15 Amps., \$12.00

Our double range Pattern No. 54 instrument shown above fills the need for a low priced portable instrument for checking battery voltage. 0-12-120 volts is the range usually supplied, which takes care of the "A" battery under all conditions and the "B" battery up to the highest commonly used for receiving. Other ranges, such as 0-10-100, 0-10-50 or 0-8-80, can be supplied.

Price, 0-12-120 Volts, \$10.00

ORDER FROM YOUR DEALER



JEWELL ELECTRICAL INSTRUMENT CO.
CHICAGO



GREAT WESTERN RADIO CORPORATION

San Francisco, Cal.

Office and Factory - 19 Minna St.

**Immediate Deliveries On
our latest radio products**

Rheostats - Variable Condensers - Dials - Sockets
Amplifying Transformers - Grid Condensers
Radio Frequency Receivers - Vacuum Tube Detectors and
Amplifiers - Non-Regenerative Receivers.

Parts of All Kinds -- Wholesale and Retail

Meet The Demand - Order From US

*Dealers—Write or Wire for Trade Proposition
We Guarantee Delivery - Act Now - Don't Delay*

Tell them that you saw it in RADIO



LEMCO
EQUIPMENT

"If You Want the Best"

CRYSTAL RECEIVING SETS

Compact, self-contained very selective and efficient. Bus bar method of wiring. Attractive mahogany finished cabinet, with lid arranged to close without disconnecting wires.

Responds to Wavelengths up to 900 Meters

Receives speech and music from broadcasting stations within 50 mile radius, and radio telegraph messages for several hundred miles.

\$12.00

Sold on a money-back guarantee. If your dealer cannot supply you, order direct from this ad. Write for Bulletin No. 100L.

DEALERS—Write for Special Proposition.

- No. 340—"LEMCO" Receiving Set as illustrated..... \$12.00
- No. 340-A—No. 340 Outfit and Couch 3000 ohm Head Set..... 20.00
- No. 340-B—No. 340-A Outfit and Complete Good Antenna Outfit..... 24.00

LEE ELECTRIC AND MFG. CO.

Sierra Electric Company

Distributors
515 Market St., San Francisco,
629 Wesley Roberts Bldg., Los Angeles

June **EMPIRE RADIO** **Bulletin**
FOR IMMEDIATE SHIPMENT

VACUUM TUBES

- Audiotrons (Double Filament Type) ..\$6.00
- Radiotron UV 200 (Detector Tube) ... 5.00
- Radiotron UV 201 (Amplifying Tube) 6.50
- Radiotron UV 202 (Power tube, 5-watt) 8.00

VARIOMETERS AND VARIOCOUPERS

- Fischer Variometer (Small Size).....\$4.50
- Fischer Variometer (Large Size)..... 7.00
- Fischer Variocoupler (Small Size).... 5.00
- Fischer Variocoupler (Large Size).... 7.50

"B" BATTERIES

- 22½ V. (Small Size) "B" Battery...\$1.00
- 22½ V. (Large Size) "B" Battery... 2.00
- 22½ V. (Large Size Tapped) "B" Battery 2.20
- 45 V. (Large Size Tapped) "B" Battery 4.00

SETS

- Federal Jr., complete with aerial equipment\$25.00
- Aeriola Sr., Westinghouse Set..... 65.00
- Two Step Amplifier, for use with Aeriola Sr. 30.00
- Magnavox, Type R-3, for Radio Use. 45.00
- Vocarola, Westinghouse Loud Speaker 30.00

MISCELLANEOUS

- Moulded Vacuum Tube Socket.....\$.75
- Fada Rheostat 1.00
- Thordarson Amplifying Transformer. 4.50
- Acme Amplifying Transformer..... 5.00
- Chelsea Amplifying Transformer.... 4.50
- Federal Amplifying Transformer.... 7.00
- Radio Frequency Transformer..... 6.00
- Audiotron Adapter 1.50
- Western Electric Phones..... 15.00
- Chelsea Variable Condenser, .0005... 4.25
- Chelsea Variable Condenser, .001... 4.75
- Chelsea Bakelite Dial, 3 in. diameter 1.00

Empire Radio Corporation

Manufacturers and Distributors of Radio Apparatus

271 West 125th Street

New York City

WE USED OUR BEAN

IN DESIGNING

THE PARKIN DIAL RHEOSTAT (pat. pending) and by mounting the resistance element in a circular groove in the back of a 8" molded Bakelite dial eliminated one part and saved you the cost of a dial. The groove being recessed, allows the dial to clear the panel by the usual distance of 1-16". An off position is provided and a stop on the dial engages the stationary contact at the extreme positions. The 360-degree rotation insures fine adjustment. A brass bearing insures a true running dial and smooth action.

All figures and graduations are filled with brilliant white enamel. All brass parts nickel plated. Bakelite knob. Resistance is 5 ohms, carrying capacity 2 amps.

- No. 77 Parkin Dial Rheostat, postpaid.....\$1.75

FOR SALE BY ALL LEADING DEALERS

Send for free catalog, No. 3, describing our complete line.
Dealers: Write for proposition.

PARKIN MFG. CO.

SAN RAFAEL, CALIF.

Tell them that you saw it in RADIO

THE CONQUEST OF OUGLAMUCK

Continued from page 19

"No," I replies, weakenin', "I s'pose not."

"And now," resumes Hell-Fire, relieved-like, "since it's all settled that you're takin' th' job, just sit down here an' I'll give you th' dope on buildin' th' station. Th' transmitter is a five-kilo-watt Hellkum Special——"

"Then I quit right here!" I announces, startin' to get up again. "Th' set at KVI is also a Hellkum Special——an' I been fixin' an' fightin' around with it from th' day I arrived to th' day I left. Th' only way to operate them Hellkums is with a sledge-hammer."

"But this is a latest improved Hellkum Special," explains Hell-Fire, soothing-like. "It's got twice as much junk on it as th' old type, an' ya see that makes it twice as easy to run."

"Well," I replies, a little mollified, "seen' it's that way——"

"It's a real easy rig to install, too," says Hell-Fire, producin' a blue-print th' size of a windjammer's mainsail, which has a lot of geometry problems an' Egyptian hydroglyphics drawn all over it. "Here's a simple little plan of th' power-house and transmitter-room. You see, after ya put up th' power-house accordin' to th' buildin'-plans, all ya hafta do is to put in this concrete foundation for your main alternator, an' another for your direct-current excitin'-generator; then over here a couple more concrete beds for th' spare alternator an' exciter, an' down here in th' center is th' fifth an' heaviest foundation to set your diesel engine on. Ya don't hafta worry if all these different bed-bolts in th' concrete should happen to get a thousandth of a inch or so out'a place, because most of your belts will stay on, even if th' machines are out that much.

"There is a synchronous-gap mounted out on th' end of th' alternator-shaft, and th' transmitter-panel goes up alongside th' alternators; then you are all through, except for buildin' th' separate receivin'-shack, which stands over here fifty feet away from th' power-house; an' there are fourteen lines of conduit to put in between th' two shacks, carryin' wires for th' generator rheostats an' meters on th' control-panel alongside your operatin' desk, an' six push-rod switches to change wave-lengths without leavin' th' receivin'-shack, an' a water-coolin' system for th' diesel-engine, an' a fuel-oil heater to set up, an' a distant-control automatic break-in key, an' th' receivin' apparatus, an' a few other similar little trifles.

"Then you are all ready for business, only of course you hafta put up th' two hundred-an'-fifty-foot wireless-masts, an' guy 'em to stand th' hundred-mile gales that blow all th' time on



WARNING to Patent Infringers

Various types of crystal detectors, renewals therefor, and crystal detector radiophone receiving sets now being offered for sale employ the inventions of one or several of the following United States patents (commonly referred to as the Pickard patents), the property of the Wireless Specialty Apparatus Company.

836,531	904,222	924,827
886,154	912,613	1,104,073
888,191	912,726	1,137,714
13,798 (reissue of 877,451)	963,173	1,225,852
933,263	1,104,065	1,257,526
1,213,250	1,118,228	1,136,044
1,136,045	1,136,046	1,136,047

THE above patents cover, among other things, the most efficient circuit arrangements of apparatus commonly used in crystal detector radiophone sets, various kinds of crystal members, means for mounting the crystals and holding the mounting, special forms of contacting conductors for the crystals, mechanism permitting the user's selection of contact points of the contacting conductor on the crystals.

Authorized crystal detectors now are available through the distributors of the Wireless Specialty Apparatus Company, also renewals therefor, and complete crystal detector radiophone receiving sets, all in large quantities, which are sold under the various above-mentioned patents.

The Wireless Specialty Apparatus Company purposes to prosecute, vigorously, all infringers of its patents, and therefor, those manufacturers, distributors, jobbers and dealers who have not been authorized as yet are warned to cease the manufacture or the sale or distribution of crystal detectors, renewals therefor, or crystal detector radiophone receiving sets or any other radio devices which infringe these patents.

Unauthorized distributing or selling, wholly independent of manufacturing, is just as much an infringement as the manufacturing itself, and any seller is separately liable to suits for accounting for damages or profits in addition to injunction.

For their own protection, the distributors, jobbers and dealers who yet may be offering for sale unauthorized crystal detectors, renewals therefor, or complete crystal detector radiophone receiving sets, should demand a guarantee from the manufacturer from whom they purchase radio equipment holding them harmless in case of damage suits arising through their distribution and sale of radio apparatus which infringes the above-mentioned patents.

Crystal detectors, renewals therefor, or crystal detector radiophone receiving sets made and sold with the authorization of the Wireless Specialty Apparatus Company can be readily identified by the data of the above patents and restriction notices prominently marked on the apparatus.

WIRELESS SPECIALTY APPARATUS COMPANY

BOSTON, MASS., U. S. A.

Established 1907



Insist on Getting

U. S. EAGLE GALENA, 25 Cents

U. S. EAGLE GOLDENA, 35 Cents

MOUNTED U. S. EAGLE GALENA and GOLDENA, 2-in-1, 50 Cents

Patent Applied For.

Marvelous Crystals of sensitivity; Improve your Radio Reception by the use of these Crystals. No better on the American Market. Each Crystal is packed in a container and labeled U. S. Eagle Galena or U. S. Eagle Goldena.

Attractive proposition for dealers and jobbers. Immediate shipment. Will use your own labels on request. Also in bulk.

EVERYTHING IN RADIO SUPPLIES

SEND FOR CATALOGUE

U.S. RADIO CO. of PENNA., Inc.

Distributors and Manufacturers of Radio Apparatus
Corner Ferry and Diamond Streets
Pittsburgh, Pa., U. S. A.

HOMCHARGE YOUR BATTERY for A Nickel

No fuss, trouble, dirt—no moving of batteries—loss of time—no effort on your part—no technical or professional knowledge needed.

THE HOMCHARGER

successfully meets all charging conditions, and is the only rectifier combining the following essential Homcharging features.

1. Self polarizing. Connect battery either way and it will always charge. No danger of reverse charging, runned battery or burnt out Rectifier.
2. No delicate bulbs to break or burn out. Only one moving and two wearing parts. These are replaceable as a unit, after thousands of hours use, at small cost. Cannot be injured by rough handling.
3. Operation stops and consumption of current ceases immediately upon disconnecting battery.
4. The only charger costing less than \$100.00 that will fully charge a battery over night. Gives battery a taper charge—exactly as recommended by battery manufacturers. Guaranteed not to harm your battery even though left connected indefinitely.
5. Highest efficiency of any three or six cell charger made.
6. No danger of fire. Approved by the Underwriters.

THE AUTOMATIC ELECTRICAL DEVICES CO.
117 West Third Street, Cincinnati, Ohio

Branch Offices — New York — Chicago — Pittsburgh —
Los Angeles — New Orleans — Detroit
—Toronto — Philadelphia — Baltimore
—Dallas.

*Largest Manufacturers
of Rectifiers in the World*

ATTENTION MOTORISTS

Will charge your auto battery as well as radio battery. Send for Bulletin No. 58 for further information. For sale by all radio, electrical and accessory dealers or shipped express prepaid for purchase price. \$18.50 \$20 west of the Rockies.

Tell them that you saw it in RADIO

Ouglamuck, an' hang up a couple aerals, one fer short an' one fer long waves. Ya see, there ain't nothin' to it, because everything is already done on these drawin's—all ya hafta do is follow them."

By this time Hell-Fire has me swamped in a flood of plans an' blue-prints enough to build a couple of Panama Canals, an' more comin' to view every minute.

"Yes, it's real kind of you to build th' station on this cloudburst of scratch-paper," I agrees, dazed-like. "It don't leave me hardly nothin' to do a'tall. What kind of a joint is Ouglamuck—where is it, anyway?"

"Why, don't ya know where Ouglamuck is!" exclaims Hell-Fire, surprised-like. "It's up in th' Berin' Sea, four-hundred miles beyond th' last uninhabited island in western Alaska. It's s'posed to be a swell place—lots 'a snow an' rocks, an' everything. You'll like it fine."

AN' this is how it was that after pitchin' an' divin' for fourteen days in a blindin' snow-storm, with foam-in' white mountains of sea-water breakin' over us an' freezin' on the spars an' riggin' till the "Pirate King" turns into a solid chunk of white, snow-caked ice, I finally hears th' anchors go rumblin' down one stormy night, an' gets out in the gray, gusty morning to find th' schooner lyin' in the middle of a little bowl-shaped harbor surrounded by high rolling snow-covered hills, which swept back a few miles to the bases of three stupendous white-coned volcanoes all straight in a row, the middle one twice as high as the other two and with steely frozen clouds hangin' around its crater. On th' inner side of the harbor squatted a bunch of white-painted buildin's an' a small wharf—th' codfish company's diggin's—an' about a mile back up on th' hill ground straggles a few old tumble-down shanties an' round, dome-shaped dugouts of a Siwash village, all half-buried under the frozen white snow-drifts.

As I stands out on th' poop-deck of th' "Pirate King," watchin' th' schooner come alongside th' ice-crust-ed ranshackle wharf, which snuggles out along th' foot of a high snow-streaked black cliff, a jagged hundred-pound rock comes tumblin' down th' face of th' bluff, whishes along past my ear, clearin' me by about a quarter of a inch, an' lands with a heavy scrunch square on top of my suit-case, squashin' it out flat as a pancake.

Gatherin' up th' remains of my tooth-paste an' safety-razor, I climbs up onto th' wharf, where a considerable con-vo-cation of hard-lookin' codfish snailers an' clam-faced Siwashes silently sizes me up with a bunch of unwelcome stares.

SIGNAL IS NOT "SIDE-LINE" WIRELESS APPARATUS



In these days of rapid Radio development, many companies, with an eye to the "easy markets" have brought out Radio equipment as a sort of "side-line."

"Side-Line" apparatus is the kind to "side-step," if you want to take pride in your outfit and you are building for permanency.

Whether you are in Radio for profit, or pleasure, it is good to know that

SIGNAL WIRELESS APPARATUS

is manufactured according to best commercial and government standards—by a company specializing in Radio equipment. SIGNAL Wireless Apparatus has been developed by Signal Radio experts in Signal Laboratories—and is BUILT FOR BUSINESS.

SIGNAL BACK MOUNTED VARIABLE CONDENSER

You can drop Signal Condensers, No. 76 & 77, to the floor from a considerable height without damaging plates or spoiling adjustment. They are very rigidly built. Instead of using aluminum .015" in thickness for the plates, as is usual with ordinary amateur construction, Signal plates are .026" thick.

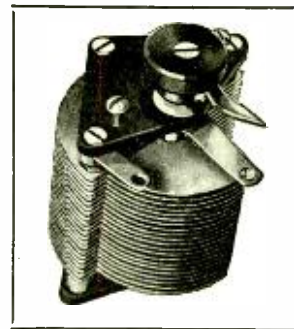

CUT OUT AND MAIL COUPON NOW

New Signal Wireless Bulletins describing Signal Wireless Apparatus are free for the asking. Simply fill in and mail this request-coupon.

SIGNAL ELECTRIC MANUFACTURING COMPANY

Menominee, Michigan

COUPON

Send me the new Signal Wireless Bulletin W.

Name

Company

City

State

Tell them that you saw it in RADIO

THE RADIO STORE

90 NORTH LOS ROBLES AVENUE
PASADENA, CALIFORNIA

ALTISSIMO RECEIVING AND LOUD SPEAKING OUTFIT.....	\$740.00
Kennedy Universal Receiver—type 110.....	\$250.00
Kennedy Two Stage Amplifier—type 525.....	85.00
Western Electric Headset—type 1002-C.....	15.00
One Detector and two Amplifier Tubes.....	18.00
Magnavox Loud Speaker—type R-2 with 18" horn.....	85.00
Magnavox Three Stage Power Amplifier—type AC-3.....	110.00
Amplifying Transformer.....	7.00
Three 5-watt Power Amplifying Tubes.....	24.00
B Batteries.....	24.00
Edison Storage Battery—6 cell 75 amp. hr.....	78.00
Tungar Rectifier—5 ampere 50 cycle.....	36.00
Antenna Equipment.....	8.00
ALTISSIMO OUTFIT with 60 cycle Tungar Rectifier.....	\$734.00
AUDITORIUM RECEIVING AND LOUD SPEAKING OUTFIT.....	\$620.00
Kennedy Intermediate Receiver—type 220.....	\$125.00
Western Electric Headset—type 1002-C.....	15.00
One Detector Tube.....	5.00
Magnavox Loud Speaker—type R-2 with 22" horn.....	110.00
Magnavox Three Stage Power Amplifier—type AC-3.....	110.00
Magnavox Modulation Transformer.....	12.50
Magnavox Hand Transmitter.....	25.50
Amplifying Transformer.....	7.00
Three 5-watt Power Amplifying Tubes.....	24.00
B Batteries.....	63.00
Edison Storage Battery—6 cell 75 amp. hr.....	78.00
Tungar Rectifier—5 ampere 50 cycle.....	36.00
Antenna Equipment.....	9.00
AUDITORIUM OUTFIT with 60 cycle Tungar Rectifier.....	\$614.00
ALTADENA RECEIVING AND LOUD SPEAKING OUTFIT.....	\$540.00
Kennedy Intermediate Receiver—type 220.....	\$125.00
Kennedy Two Stage Amplifier—type 525.....	85.00
Western Electric Headset—type 1002-C.....	15.00
One Detector and Two Amplifier Tubes.....	18.00
Western Electric Loud Speaker Outfit—type 10-A.....	161.00
B Batteries.....	27.00
Edison Storage Battery—5 cell 75 ampere hour.....	65.00
Tungar Rectifier—5 ampere 50 cycle.....	36.00
Antenna Equipment.....	8.00
ALTADENA OUTFIT with 60 cycle Tungar Rectifier.....	\$534.00
ALTADENA OUTFIT with Willard Wireless Storage Battery, 6 volt 80 ampere hour, & 50 cycle Tungar Rectifier.....	\$503.00
ALTADENA OUTFIT with Willard Wireless Storage Battery, 6 volt 80 ampere hour, & 60 cycle Tungar Rectifier.....	\$497.00

Prices subject to change without notice

PAUL FRANKLIN JOHNSON

This loud speaker has many unusual features, first and foremost being the swivel adjusting device which allows the horn to be swung into any desirable position. Secondly, it is constructed in such a manner that a simple turn of an adjusting screw will allow almost any kind of a head phone being used for the loud speaker.



RICHMOND

Loud Speaker

Price without phone

\$7.00

F. O. B. Richmond

Patent Applied For

HEAVY PAPER HORN

Will Fit Any Phone

It will be a valuable addition to your station as the workmanship is excellent.
The stand is of Mahogany finished wood.

RYAN RADIO COMPANY

429 BARRETT AVENUE
RICHMOND, CALIFORNIA

Tell them that you saw it in RADIO

"Don't notice th' rocks," chirrup one insignificant-lookin' hyena-faced little gink, who I later learns goes by th' confidence-inspirin' cognomen of Double-Cross Picketts, as another descendin' slab of granite brushes th' snow off of my mackinaw an' busts a plank in th' wharf. "Some of 'em is kinda detached up there."

"Yeh—easy to push over, huh!" I retorts, returnin' generously th' friendly butcher-knife glares of my supercordial reception committee.

"Here comes Big-Gun Beardsley," whispers one of th' gang, in a awed tone, like it was th' emperor of Japan. "He's comin' to clean him up."

Followin' th' fearful-like glances of th' assembled assassins, I observe comin' down th' hill toward th' wharf what seems to be a steam-hammer-fisted cross between a grizzly-bear an' a rusty shotgun, who is staggerin' around under th' crushin' weight of a cast-iron bullet-slinger with a handle like a ocean liner's crank-shaft an' a barrel like a German howitzer. Comin' swaggerin' out on th' wharf, like a Russian-Fin battleship in a beam sea, when he sees me, he stops still an' begins curlin' up his lip like a mad-dog. Th' friendly Ouglamuckites immediately proceeds to form a circle around th' two of us; an' so settin' down my pancaked grip, I cheerfully waits to see what is comin' next on th' bill-of-fare of hostilities.

"An' so you're th' fishtail-faced wireless engineer who's gonna be th' superintendent 'a Ouglamuck, eh!" he snarls, in a tone like somebody tryin' to grind up iron spikes in a coffee-mill. "You're th' lightnin'-catchin' freak who's gonna tell us snailers what t' do who been pullin' codfish before you even knowed where Alaska was at, are you—you donkey-eared son of a stale bakin'-powder biscuit!" With his face bucklin' up into th' lovin' expression of a chunk of shell-shot armor-plate, he reaches down on his hip for his ninety-calibre gunpowder-burner.

Now, if I'd been a greenhorn fresh from th' States, right then my heart would'a swallowed my liver, an' I'd 'a dropped dead on th' spot; but you see, I'd already been in this country of dislawfulness an' unorder long enough to learn a thing or two about these brimstone-belchin' gunpowder artists. Stoopin' down an' grabbin' hold of th' big rock that had been pitched down th' bluff at me, I rises up an' busts this trouble-huntin' maniac on th' side of his bean with it.

"Urrumph!" croaks Mr. Beardsley; an' disconnectin' himself from his high-power Krupp, he reclines gently downward onto th' wharf with th' squashy ka-plunk of somebody droppin' a rotten canteloupe.

RHAMSTINE★ PRODUCTS

May be purchased with assurance that they will give complete satisfaction. Each is guaranteed to do so.

Definite evidence of their superiority is revealed in the knowledge that Rhamstine* design has been imitated; but Rhamstine* craftsmanship has not been equaled.

Go to any good dealer in Radio Supplies and purchase the genuine Rhamstine* products.

PLUGS AND JACKS
AMPLIFYING TRANSFORMERS
V. T. SOCKETS
V. T. BATTERIES
THE ADAPT-O-PHONE
MODULATION TRANSFORMERS

Folder showing the Rhamstine* line of Radio Products
will be sent on request

Manufactured by

J. THOS. RHAMSTINE★

2152 E. Larned Street

Detroit, Michigan

★ Maker of Radio Products

Tell them that you saw it in RADIO

Radio Frequency Amplifier

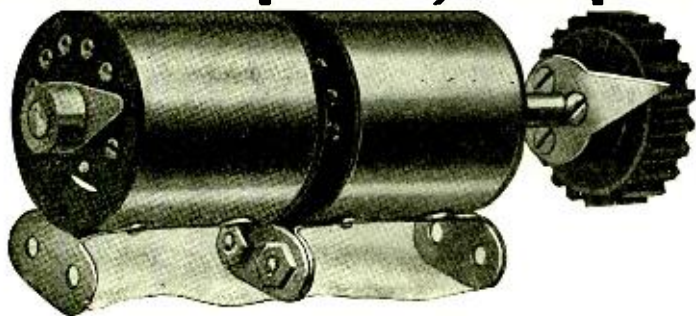

Two Type 5000 Transformers in Tandem for 2 stage control
Pat. Applied For

There is nothing that opens up a wider field on the receiving end for the amateur and experimenter, than radio frequency amplification.

After an extensive investigation of the various types of tube couplings possible for radio frequency amplification, we have developed the above units (two are shown) with a view to giving maximum efficiency and greatest ease of control, at a reasonable price.

Tuning each stage is not necessary. Only one adjustment necessary to cover fairly wide bands of wave-lengths with several stages.

Transformers for several stages can be mounted in tandem with single control which greatly simplifies the manipulation of the set.

Remember that radio frequency amplification will increase the range, the selectivity and the satisfaction you can get from your receiver. A loop antenna will be far more effective with radio frequency amplification.

These units will cover wave-lengths from 180 to 750 meters.

TYPE 5000 RADIO FREQUENCY AMPLIFYING TRANSFORMERS,
PRICE \$5.50

For Single Stage (without Knob and Pointer)

COTO-COIL CO. 87 WILLARD AVE.,
PROVIDENCE, R. I.

THE MODULATOR

The Real AMATEUR RADIO Magazine
Published Monthly—\$1.00 a Year, 10 Cents a Copy
"WRITTEN FOR AMATEURS BY AMATEURS"

BLUE PRINTS—Series C Honey- HOW TO MAKE A C. W. SET,
comb Regenerative Set, and Two by L. M. Cockaday, 2XK. 8 page
Step Amplifier, 17"x22", 50 cents booklet, fully illustrated. 25 cents
postpaid.

Proposition to Dealers

THE MODULATOR PUBLISHING COMPANY
140 Pearl Street New York City

SOMETHING NEW

Made to Please You and Priced to Please
Your Pocketbook

By departing from conventional design in audion sockets we have combined the advantages of all, the disadvantages of none and a price lower than any. Think of it—a sturdy, easily mounted socket that is heat proof, has bakelite-dilecto insulation, handy binding posts, etc., all for 75c.



Type 126, Tube Socket
Price 75c Postpaid

And here's a smooth running rheostat that takes panel space 2 inches in diameter, needs one hole to mount, has six ohm resistance, all off and all on positions and a brass panel bushing. Priced at 90c.



Type 122 Rheostat
Price 90c Postpaid

THE WILCOX LABORATORIES
LANSING, DEPT. J., MICHIGAN

Binding Posts, Contact Points, Switch Levers, Etc.

Quality goods only. For Manufacturers and Dealers

— Made by —

PREMIER DENTAL MFG. CO.

Get our literature

56 N. Second St., Philadelphia, Pa.

"Wow—he hit Big-Gun Beardsley!" howls one of th' codfish snailers, like he couldn't believe his eyes—an' th' whole circle of was-gonna-be attendants to my funeral instantly evaporates in all directions.

Removin' Big-Gun's belt, I buckles it on; then pickin' up th' dethroned emperor of Ouglamuck's howitzer, I advances up th' hill an' takes possession of th' office. There ain't nothin' much in it to take possession of, however, because, as th' looney-lookin' tradin'-store clerk explains, th' bookkeeper had took a notion to quit a couple days before an' burned up all th' books an' company correspondence. Alaskan codfish-station bookkeepers always burns up their books when they quit—it simplifies matters a lot for their successors.

Locatin' th' company superintendent-shack, I throws out all th' pots, dishes, an' old clothes I finds in it; an' when Big Gun comes to life, I orders him to pack his truck into one of th' fishermen's shacks—which he does with a dazed, stupified-lookin' expression, like he couldn't decide whether he was only sufferin' from a mince-pie nightmare or gone plumb cuckoo.

A little later, Double-Cross Picketts comes breezin' in like he is after somethin', but when he sees me, he seems to change his mind.

"Excuse me," he splutters, startin' to back out, "I didn't know you were goin' t' live here."

"Well, I am—an' I'm gonna stay here, too!" I barks. "Where's Big-Gun's squaw?"

"Big-Gun's squaw," he repeats, stut-terin' like he was so rattled he'd forgot his own name. "Why, she—she's visitin' her Siwash relations down to Unalaska Island—"

"When Mrs. Big-Gun gets back," I says, givin' Picketts a hard, straight look in th' eye that sends him grabbin' fer th' door-knob, "you can tell her that so long as her old man acts decent, he is fisherman straw-boss—but from now on I'm th' guy who's runnin' this here camp. Get me!"

"Yezzir!" says Picketts, turnin' th' color of skimmed milk; an' he excuses himself out'a th' door.

THE next day, I chooses a site up on the hill above the codfish company's building for th' new wireless station. I decides where to set the two masts, lays out the positions of the different sets of mast-guy anchors, and marks off the foundations of the power-house and receivin'-shack. But when I goes to start th' codfish snailers to work packin' lumber an' gear up onto th' hill from th' wharf, I runs against a snag.

"We ain't here to work—we only fish," th' bunch in th' bunk-house informs me, very respectful-like, but with

Tell them that you saw it in RADIO

all th' indignity of a assembly of crown princes. "Th' Siwashes up in th' village does all th' common work."

I tries to argue with 'em, but I soon sees they'd sooner be shot than work; so I hikes up to th' Aleute settlement on th' hill. I discovers th' village priest, a old chimpanzee-faced grasshopper with forty years tobacco-juice coagulated in his whiskers, out in front of his ram-shackle, saggy-roofed shrine, busy shin-in' up an old brass ship's bell set up on a post alongside th' one-hinge door. I ascertains there are thirty-five employable braves in th' village; an' after spendin' three hours convincin' th' old soul-merchant that *wirelessuck* is absolutely disconnected with th' devil, I finally gets him to agree to his bucks workin' on th' station.

Early next mornin' the natives report for work—an' no radio engineer ever had a classier construction-gang than my thirty-five flat-faced fish eaters with their super-intellectuality of solid granite. I sets one crew to packin' lumber an' other materials up from th' wharf, details another detachment to begin drillin' up on th' hill in preparation for blastin' out holes for the mast-guy anchors, an' puts a third division to clearin' away th' snow an' makin' ready for th' power-house an' receivin'-shack foundations.

Just when everything is gettin' nicely started, there suddenly begins a slow, imperative clanging, like a city fire-alarm, up in th' native settlement; an' lookin' toward th' village, I sees that old tobacco-whiskers is out bangin' on his bell. With th' first *clang*, all my Siwash construction-crew drops their drills an' shovels, or whatever they had in their hands an' strikes out for th' village—an' with th' last *dong*, they are all enveloped in th' dog-house shrine. There is no more work that afternoon. The next day th' same performance takes place again. Th' third day I am gettin' pretty infuriated—an' then Double-Cross Picketts comes along an' offers to explain it.

"It's old Two-Bits, th' priest," says Double Cross. "He's s'posed to have some kind of a mysterious spirit roostin' with him up there in th' salmon-eaters' temple; an' when this here spirit tells him to, he calls in all th' Siwashes by whangin' on th' bell an' collects a quarter apiece from 'em—then th' services is over till th' next time. But they can't work no more th' same day."

Thankin' Double-Cross for this information, I hikes up th' hill to see old Two-Bits.

"Hereafter, when that spiritualistic quarter-snatcher 'a yours starts naggin' ya, it'd be a lot more convenient fer both of us if you'd just breeze down to th' office an' take a check fer th' whole amount," I suggests, politely—and old

—you can't buy a better receiving set anywhere AT ANY PRICE

\$40.00

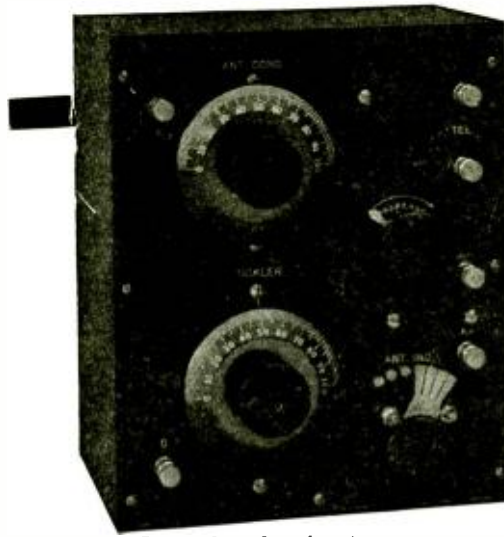

Licensed under Armstrong U. S. Patent 1113149.

SPECIFICATIONS

Clapp-Eastham Type H. R. Regenerative Receiver

- Panel—Condensite, handsomely finished.
- Cabinet—Solid Mahogany.
- Condenser—Balanced type, 2 Rotary, 3 Stationary plates. Built on Vernier.
- Dials—Indestructible metal. White figures on black ground.
- Antenna Inductance—Wound in Formica Tube.
- Plate Inductance—Wound on molded ball.
- Binding Posts—Black Rubber Covered.
- Switch—Fan Blade.
- Rheostat—C. E. Type H 400.
- Circuit—Single circuit regenerative. Licensed under Armstrong U. S. Patent No. 1113149.
- "B" Battery—Contained in compartment inside cabinet or external as desired.

QUALITY—and at a reasonable price—is the appeal that the Clapp-Eastham Type H. R. Regenerative Receiver makes to men who know wireless equipment. The specifications and the Clapp-Eastham reputation tell them the story. Regenerates perfectly on wavelengths of 180 to 825 meters. We frequently hear of its covering distances far in excess of any other set of its capacity. The quality in the solid mahogany Cabinet is reflected all throughout the set. Ask your dealer to show it to you. If he's temporarily out—and he may be, because the demand has been phenomenal—write us. Send 6c in stamps for the C-E Radio Catalog. If you're at all interested in wireless you ought to have it.

CLAPP-EASTHAM COMPANY
RADIO ENGINEERS
140 Main St., Cambridge, Mass.

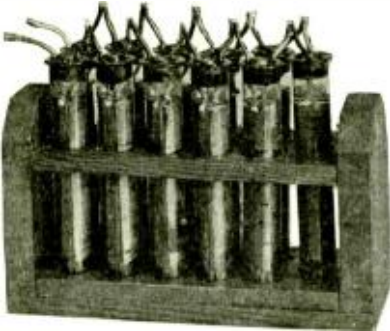

Permanence of Performance is Assured by the use of

SNELL CELLS

22 v., 11 cells.....\$5.50
 44 v., 22 cells.....10.00
 88 v., 44 cells.....20.00
 F.O.B. San Francisco

THE STORAGE "B" BATTERY THAT DELIVERS THE PROPER VOLTAGE FOR FROM 3 to 5 YEARS

MANN & SNELL

4733 Geary St. San Francisco, Cal.

Tell them that you saw it in RADIO

Phone Kearny 2778

PACIFIC RADIO SCHOOL

ARC & SPARK SYSTEMS

Hours:

1 to 5 P. M.

7 to 9 P. M.

433 Call Bldg.,

San Francisco, Cal.

Send for descriptive circular.

Manufacturers of

C W

Apparatus and

ONE TO SIX STAGE AMPLIFYING RECEIVING SETS

Send 10c for catalogue

The American Radio Sales & Service Co.
MANSFIELD OHIO



—RADIO INSTITUTE—

OF AMERICA

Conducted by the greatest and most experienced radio telegraph organization in the world.

Thorough training given in radio operating, traffic, and in damped and undamped systems.

Tuition ten dollars a month for either the day or evening sessions or both combined.

Prospectus mailed on request

RADIO CORPORATION OF AMERICA

Phone Douglas 3030

331 New Call Bldg., San Francisco

Try

REYNOLDS RADIO Service

(Old)

"9ZAF"

from DENVER

(New)

"KLZ"

A COMPLETE SERVICE—PROMPT SHIPMENTS

GREBE

KENNEDY

CLAPP-EASTHAM

MAGNAVOX

REMLER

Mid-west's
largest
WIRELESS
Supply House

FEDERAL

DeFOREST

WESTINGHOUSE

ARKAY

BRACH LIGHTNING
ARRESTERS

REYNOLDS RADIO CO., Inc.

613 19th Street
DENVER, COLO.

DISTRIBUTORS, DEALERS—WRITE FOR PROPOSITION

Two-Bits agrees that it would.

Five weeks later, I runs the cement for my generator and engine foundations. The power-house is pretty well along now, but no roof on yet. Th' temperature is stickin' around thirty below zero; and as freezin' will ruin freshly-run concrete, I sets up an old cook-stove over the cement forms an' details a couple of Siwashes to carry a red-hot fire, to keep th' place warm.

Late that night somebody comes thumpin' an' hammerin' on my shack, raisin' such a infernal racket that sleepy an' tired as I am, I have to get up. Goin' shiverin' to th' door, who does I find outside but old Two-Bits.

"Check!" he chirrup, comin' directly to th' point, an' stickin' out his mitt.

"Say, look here, you pestilential old flea, ya been down to th' office twice already today fer a check!" I barks.

"Ya better send that confounded graft-grabbin' spirit 'a yours off to th' country fer a rest!" With this I slams th' door shut in his face an' jumps back between my blankets. Half-an-hour after, as I doze off to sleep, I seems to hear th' distant ringin' of a bell—an' in th' mornin', when I struggles out through th' icy wind to th' power-house to have a look at my cement foundations, I finds th' stove cold an' deserted, th' concrete forms froze an' busted, and my templets which it took me two weeks to line up all warped to th' devil.

Spoutin' a Mississippi River of cuss-words, I catapults up to th' village; an' draggin' old Two-Bits like a squeakin' weasel out of his hole, I bangs his be-whiskered nut against his blasted bell until I figures I've bumped his trouble-raisin' spirit humbug out of him so complete that it'll take it five years to get admittance back into his belfry again.

The following week, I have th' five foundation molds remade, th' templets reset; and I runs th' cement again. That night I wakes up to find another cold snap comin' on. I gets up right away an' beats it out to th' power-house to fire up th' cook-stove myself, not carin' to take any more chances on th' peanut-brained Siwashes. Besides, a couple of cases of th' high-percentage dynamite I was usin' to blast out th' holes fer th' mast-guy anchors had disappeared mysterious-like durin' th' day, an' somehow I was feelin' a uneasy presentation of impendin' devilment.

About one o'clock in th' mornin', as I was sittin' dozin' by th' red-hot stove in th' power-house, th' whole island is suddenly shook by a terrific jarrin' *w-h-o-o-m!*—an' then rocks an' boards comes rainin' down with such a crashin' racket that I wonders if all three of th' Ouglamuck volcanoes have blowed up together. It was too dark then to see what really had happened, but in th' mornin' when I looks out, I discovers

Tell them that you saw it in RADIO

4 HOUR SERVICE!

WE ASSURE YOU OF THE MOST PROMPT SERVICE

Our Radio Mail Order Service is gaining much popularity on account of the **FAST SERVICE**. We ship your order within four hours of its receipt. After you tire of waiting days—or maybe weeks—for your supplies, try Warner Brothers' Radio Mail Order Service and you will use no other. Following are a few items that we have in stock:

VARIABLE CONDENSERS

Kilbourne and Clark Type

.0001 7 Plates	\$2.00
.0002 13 Plates	2.50
.0003 17 Plates	3.00
.0005 23 Plates	3.50
.0007 31 Plates	4.00
.001 43 Plates	5.00
.0015 63 Plates	7.20

HORNS

TIN HORNS	\$1.00
Papier-Mache	1.50
36 inches long	

EVEREADY "B" BATTERIES

No. 765, 22½ Volts	\$2.00
No. 766, 22½ Volts, tapped	3.00
No. 774, 43 Volts, tapped	5.00

REMLER APPARATUS

810 Jr. Rheostats	\$1.00
811 Rheostats	1.75
813 3 Amp. Rheostats	1.75
92 VT Socket	1.50
330 Audion Detector Panel	8.00
331 Amp. Panel	6.00
333 Amp. Panel	9.00
400 3 Coil Mounting	6.50
96 Variable Grid Leak	.60
97 Grid Condenser	.35

SOCKETS

92 REMLER Socket	\$1.50
156 GENERAL RADIO	1.50
550 MURDOCK	1.00
DEFORREST Moulded Bakelite	1.10
CROSLY Porcelain	.60
KELLOGG	1.00

AMPLIFYING TRANSFORMERS

UV-712 Radio Corporation	\$7.00
231A GENERAL RADIO	5.00
226W FEDERAL	7.00
A2 ACME, unmounted	4.50
A2 ACME, semi-mounted	5.00
A2 Fully mounted	7.00
Thordarson	4.00

VARIOMETERS

REMLER 505 Moulded Bakelite	\$6.00
OUR OWN TYPE	4.50

JACKS AND PLUGS

FEDERAL 1421 Open Circuit Jack	\$.70
FEDERAL 1422 Single Circuit Jack	.85
FEDERAL 1423 Double Circuit Jack	1.00
FEDERAL 1435 Automatic Filament Control Jack	1.20
FEDERAL 1438 Automatic Filament Control Jack	1.50
WESTERN ELECTRIC Plugs	1.30
FEDERAL Plugs	2.00
PACENT UNIVERSAL	1.25
NEW FEDERAL Universal Plug	1.75
BHAMSTINE Plug and Jack, complete	1.50

FEDERAL PLEIPHONES\$14.00

RHEOSTATS

REMLER Jr.	\$1.00
FADA—with new Knob	1.00
GENERAL RADIO No. 214 7 ohm or 2½ Amp. 2 ohm	2.50
DEFORREST, new type	1.20
PARAGON	1.50
MURDOCK 560	1.00

RADIO FREQUENCY TRANSFORMERS

MURAD T-11, 160 to 500 meters	\$6.00
MURAD T-11A	6.50
MURAD T-11B	7.00
RADIO ENGE. CO.	6.00

OUR OWN BRAND

6 Volt 70 A. H.	\$16.00
Philadelphia 6 V. 60 A. H.	16.00

VARIO-COUPLES

REMLER 503 Vario-Coupler	\$5.40
REMLER 505 Coupler on Unit Panel	12.75
OUR OWN TYPE	3.75

REMLER QSA HONEYCOMB COILS

ALL SIZES AT STANDARD PRICES.

Now that you have read the list, get that order into the mails without delay. If there is something that you want and don't see it listed here, write us anyway and we will get it for you. Our two stores save still more time in getting your apparatus in a hurry. Enjoy the pleasure of real service for a change. Send us your orders.

WARNER BROTHERS

TWO STORES

San Francisco.
350 Market Street
Phone Douglas 4639

Oakland, Cal.
22nd & Telegraph Ave.
Phone Lakeside 6223

"CHELSEA"

No. 50 Amplifying Transformer

was designed for use with the present day models of vacuum tubes, and when so used produces remarkable amplification, with minimum noise. It is well adapted for table mounting or may be panel mounted in any position.

Terminals are marked for best connection. Only highest grade materials and workmanship employed. Its high efficiency together with its neat appearance and compactness, makes it a predominating feature in any radio receiving equipment.



Price as shown, \$4.50

Unmounted . . \$3.75

Bulletin sent upon request.
Purchase from your dealer.
If he does not have it, send to us.

CHELSEA RADIO COMPANY
150-156 Fifth St. Chelsea, Mass.

Tell them that you saw it in RADIO



The ——— "Adaptola"

"Radio Through Your Phonograph"

FOR YOUR PHONOGRAPH

Attach the "Adaptola" to ANY phonograph and use the sound box as a loud speaker for amplifying your radio music. FAR SUPERIOR to any type of metallic loud speaker horns. Fits your phones.

Price—\$3.50 Postpaid in the U. S.

From your Radio Dealer or direct from us. (Give make of your phonograph.)

Jobbers & Dealers:—Write for trade proposition.

The Radio Supply Co.

111 New Montgomery St., San Francisco

Last Month

We asked you to watch this space for further details of our plan regarding a new Radio Store in Los Angeles

This Month

We announce our temporary location in El Monte
—13 miles East of Los Angeles

COMPLETE STOCKS - PROMPT SERVICE

May we have your name and address for our mailing list?

COAST RADIO COMPANY

AN ORGANIZATION OF PRACTICAL RADIO ELECTRICIANS WITH 15 YEARS OF RADIO EXPERIENCE

And Now—

3 New Puget Receiving Sets

Complete, Efficient, Durable

Send now—before you forget it—for free new descriptive catalog—just off the press. It includes scores of items of interest to radio operators.

Whatever you want in radio—it's here.

Northwest Radio Service Co.

1637 Westlake Ave., Seattle, Wash.

"Makers of the Puget brand."

that th' superintendent-shack I have been livin' in has completely disappeared out of existence—th' place where it had stood lookin' like a shell-hole in Flanders.

Steppin' out to have a closer look, th' first citizen I runs onto is Big-Gun Beardsley.

"I never done it! I never done it!" he yelps, backin' away, his face turnin' th' color of a dirty blanket. "Honest, I never done it!"

"Who's accusin' ya?" I inquires, gently quietin' him down with a convenient chunk of lava-rock.

WHILE waitin' for th' concrete-work to set, I prepares to raise the two masts. After three days of heavin' an' pullin', gettin' up a pair of heavy fifty-foot shear-legs, a screechin' hundred-mile gale comes whoopin' over th' island an' leaves our work about as conspicuous as a couple of frankfurters five minutes after you've given 'em to a hungry kyoodle.

Th' second pair of shear-legs goes sailin' off into th' Bering Sea th' same way, but th' third time, I gets them to stay long enough to set up th' mainmasts—two sawed timbers twenty inches square and ninety feet long. This accomplished, I prepares to send up th' sixty-foot topmasts, which are also sawed timbers, a foot square, and fitted to be spliced to the mainmasts with heavy iron clamps.

We starts up th' first topmast, with a tackle rigged, of course, so that all heavin' is done on the ground; and when th' topmast begins to rise above the mainmast-head, I details four gangs of Siwashes to slack away th' four sets of stays as th' timber goes up, so as to keep it perpendicular. Siwashes get dizzy when they are elevated more'n twenty-one inches off'n th' earth; so while they heave on th' tackles and slack off th' stays, I have to camp all alone on th' mainmast-head to keep everything workin' smooth.

At last the topmast has come up nearly into place—and then while I am roostin' up there ninety feet above th' world, with that heavy topmast-timber swayin' up into th' clouds above me, what does I hear but th' slow, dismal *dong dong dong* of 'Two-Bits' infernal bell—and instantly all my mud-headed Siwash riggin'-crew lets go of tackles, stays, foot-ropes, an' preventers, an' goes gallopin' off to answer th' call of th' quarter-collector, leavin' me an' my wireless-pole to start swingin' down through space with th' graceful, breath-catchin' swoop of a shootin' star.

Almost before I can realize what is happenin', th' whole world rises up an' hits me in th' back—an' th' next thing I know, I feels myself in a dim, far-away dream, bein' carried down th' hill

Tell them that you saw it in RADIO

MONARCH Radio Head Sets



Code No. 2-A 2000 ohms.
Code No. 1-B 2500 ohms.
Code No. 1-C 3000 ohms.

We have built high grade telephone equipment for a quarter of a century, and are well qualified to manufacture high quality Radio equipment.

Inquiries from Jobbers Solicited

Monarch Telephone Mfg. Co.
FORT DODGE, IOWA

MURDOCK No. 56 RADIO RECEIVER



2000 Ohm Double Set **\$5.00**
3000 Ohm Double Set **\$6.00**

Reliable Service Unequaled Values
Guaranteed to Satisfy

Sold on 14 Days' Trial—Money Back if not Satisfied

Wm. J. Murdock Co.

342 Washington Avenue, Chelsea, Mass.

BUY MURDOCK APPARATUS
FROM YOUR DEALER

PACIFIC SALES OFFICE
509 Mission St. San Francisco, Cal.

SERVICE-TESTED RADIO EQUIPMENT

We have determined to secure a portion of the radio business on the Pacific Coast and realize that to do so we must offer some inducement to make our efforts successful. Our idea of the reasons that Western amateurs do not purchase from Eastern markets on a larger scale is that we dealers are located too far away from would-be customers. To eliminate objections arising from this handicap we have inaugurated our "SERVICE-TESTED" plan of selling equipment. Every article which we ship out will be tested thoroughly in our laboratories before it is sent to our customer. There will be no such things as tubes which do not oscillate or "B" batteries which go dead in a short time for the simple reason that any of these articles will be exhaustively tested in ACTUAL SERVICE before the purchaser receives it.

Secondly we will pay all postage charges on orders exceeding \$5.00. This will make our equipment even cheaper than it can be bought on the coast where prices are often higher than listed by the manufacturer. It is needless to mention that our prices are strictly list as can be seen by the following list:

Radio Corporation Products

We are distributors and jobbers for the Radio Corporation of America and always carry a complete stock of their apparatus. We list below their complete line and in addition can supply you with the Radio Corporation C. W. instruction book at 25c per copy.

Item	VACUUM TUBES	List Price	Item	KENETRON RECTIFIERS	List Price
1	Radiotron (detector) UV-200	\$ 5.00	6	20-watt Kenotron, UV-216	\$ 7.50
2	Radiotron (amplifier) UV-201	6.50	7	150-watt Kenotron, UV-217	26.50
3	Radiotron (5-watt) UV-202	8.00	VACUUM TUBE SOCKETS		
4	Radiotron (50-watt) UV-203	30.00	8	Porcelain Socket (for UV-200, 201, 202, 216) UR-542	1.00
5	Radiotron (250-watt) UV-204	110.00	9	Porcelain Socket (for UV-203 and UV-217) UT-541	2.50
POWER TRANSFORMERS FOR C.W. SETS			10	Bakelite Socket (for UV-200, 201, 202, 216) UP-552	1.50
12	325-watt, UP-1368	25.00	11	Mountings (250-watt tube) UT-501, UT-502	2.00
13	750-watt, UP-1016	38.50	SPECIAL CONDENSERS FOR C.W. SETS		
A—Filament heating Transformer for UV-204, UP-1633			35	Antenna Series Condenser, 7500 V., .0003, .0004, .0005 mfd., UC-1015	5.40
B—Power Transformer for UV-204, UP-1636			36	Plate and Grid Condenser—3000 V., .002 mfd., UC-1014	2.00
C.W. ACCESSORIES			37	Special Condenser—10,000 V., .00025 mfd., UC-1803	5.00
14	Oscillation Transformer UL-1008	11.00	38	Special Condenser—.002 mfd., 6000 V., UC-1806	7.00
15	Magnetic Modulator (1/2 to 1 1/4 amp.) UT-1643	9.50	VACUUM TUBE DETECTOR ACCESSORIES		
16	Magnetic Modulator (1 1/2 to 3 1/4 amp.) UT-1357	12.00	39	Interval Amplifying Transformer, UV-712	7.00
17	Magnetic Modulator (3 1/2 to 5 amp.) UT-1367	17.00	40	Special "A" Battery Potentiometer, PR-536	2.00
18	Filter Reactor (160 mill amp.) UP-1626	11.50	41	Tabular Grid and Plate Condenser	
19	Filter Reactor (300 mill amp.) UP-1627	15.75		.00025 mfd. UC-567	1.20
20	Plate Circuit Reactor, UP-415	5.75		.0005 mfd. UC-568	1.35
21	Filter Condenser 1/2 mfd.—750 V., UC-1631	1.35		.001 mfd. UC-569	1.50
22	Filter Condenser, 1 mfd.—750 V., UC-1632	1.85		.0025 mfd. UC-570	2.00
23	Filter Condenser, 1/2 mfd.—1750 V., UC-1634	1.50	42	Grid Leaks	
24	Filter Condenser, 1 mfd.—1750 V., UC-1635	2.30		UP-509, .05 megohm	UP-518, .75 megohm
25	Transmitter Grid Leak (5-watt tubes), 5000 ohms UP-1719	1.10		UP-510, .1	UP-519, 1.0
26	Transmitter Grid Leak (50 and 250-watt tubes), 5000 ohms. UP-1718	1.55		UP-511, .15	UP-520, 1.25
27	Antenna Ammeter, 0-2.5 amp., UM-530	6.00		UP-512, .20	UP-521, 1.5
28	Antenna Ammeter, 0-5 amp., UM-533	6.25		UP-513, .25	UP-522, 1.75
29	Sending Key UQ-309	3.00		UP-514, .30	UP-523, 2.00
30	Microphone Transformer UP-414	7.25		UP-515, .40	UP-524, 2.50
31	Filament Rheostat (for UV-200, 201 and 202) PR-535	3.00		UP-516, .50	UP-525, 3.00
32	Filament Rheostat (for UV-203 and 204) PT-537	10.00		UP-517, .60	UP-526, 4.00
33	Rotary Grid Chopper PX-1638	7.25		UP-527, 5.00	each \$0.75
34	Shaft Bushings for 1/4" or 1/8" motor shaft	.20	43	Grid Leak Mounting UX-543	.50

Send 15c for our complete literature

ELECTRICAL SPECIALTY COMPANY, 48-50 South Front Street, Columbus, Ohio

Tell them that you saw it in RADIO

6 "LEDUX" Volt

Storage Batteries

Efficiency
economy
durance

Radio Special

Guaranteed Two Years

60	AMPERE HOUR	NINE PLATES PER CELL	\$ 15⁰⁰
90	AMPERE HOUR	11 PLATES PER CELL	\$ 17⁵⁰

Manufactured by—

LARSON & ZINNAMON

439 Golden Gate Ave., San Francisco, Calif.

Dealers—Write For Proposition

Mail Orders Promptly Attended To

by th' sourdoughs. After while they lays me down on th' snow; an' then I can faintly hear Big-Gun Beardsley an' Double-Cross Picketts arguin' whether to take me to my shack or bury me right away.

"Th' ground's froze too hard—we can't dig it," I hears Double-Cross sayin', like somebody a thousand miles away. Finally they lugs me into my shack an' leaves me there.

Some time in th' night, I comes to, to find a lantern burnin' alongside me an' old Two-Bits standin' over me with a dried bear-paw in one hand an' a rusty fish-head in th' other, industriously spielin' off some kind of a Siwash incantation racket. When he sees me blinkin' at him, he leaves off his black magic an' drops down on th' floor.

"Me no ring bell!" he blubbers, over an' over. "When him ring, me sleep—me no know who ring!" He is shiverin' like a sick cat, an' I can see he's tellin' th' truth. Afterwhile he goes away with his salmon-head an' grizzly-paw medical equipment, and I falls into a good sleep.

In th' mornin' I gets up feelin' all right, except for a slight pain in th' back like I'd been kicked in th' pants by fifty thousand army mules. A little unsteady, I perambulates up to th' company cook-house an' strolls in just as th' codfish snailers are settin' down to breakfast. They all seem to be discussin' my defunction real rejoiceful-like—until they sees me steppin' toward my seat at th' head of the table. For about fifteen seconds there is a dead silence in that cook-house shack that would have made th' stillness of th' tombs of Egypt sound like a scandal in a boiler-shop—then synchronously decidin' not to bother about eatin' any breakfast, they gracefully displaces themselves out of th' ham-an'-eggs hang-out, takin' most of th' window-sashes with them as they go—all except Big-Gun Beardsley, who couldn't leave because he'd fell over flat on th' table, with his face stuck in a pot 'a mush.

After this, there follows a few days of peace. Then one afternoon a little sail-boat drops into th' harbor; an' pretty soon Double-Cross Picketts brings me some news.

"Spitzka Tillafaganouck, th' Siwash queen 'a Attu Island has heard about ya, Unkillable," he informs me. "She's come t' give ya th' once over, an' if she likes your looks, she's gonna marry ya."

"Looks like there's always somethin' interestin' goin' on round this unpeaceful island, don't it?" I comments.

"She's nicknamed Th' Husband-Snatcher," resumes Double-Cross, cheerful-like. "She's buried a man reg'lar every winter fer th' last twenty-eight years, besides a few odd ones in between

—high Grade
Regenerative
Receiver
—for
Immediate
Delivery

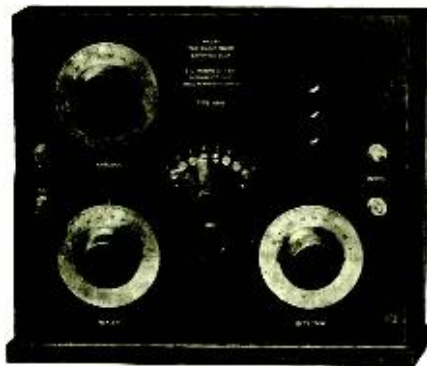

Licensed Under
"Armstrong" Patents

Specifications: "Hobrecht" Type H. B. 1

PANEL: Grained Formica
CABINET: Solid Mahogany
CONDENSER: Balanced
Type, 23 plate

DIAL: German Silver
ANTENNA: Inductance wound
on Formica Tube
PLATE Inductance: Mahogany
Variometer.

This will appeal to the most discriminating buyer. Its normal wavelength is from 180 to 800 meters. The condenser being 50% over capacity, it will tune in time signals on 1600 meters.

Battery connections are brought out in rear. No unsightly wires in front of cabinet. Particular attention has been paid to the little refinements and Receiver tunes most beautifully. While simple, retains all the efficiency of more complicated apparatus.

Price \$70.00

Rheostats, Phones and Sockets for immediate delivery, also Colin B. Kennedy Co. and Magnavox lines. Dealers propositions open.

Hobrecht's

Operating KVQ
1014 6th SACRAMENTO, CALIF. Phone Main 654

Tell them that you saw it in RADIO

—an' now she's out scoutin' after another victim—"

"Lissen, Picketts, I ain't scared of no darned female on earth," I commences to orate—an' then I sees somethin' approachin' in our direction that freezes me cold. Comin' down th' trail is a Siwash battle-axe so ugly that—well, Shotgun Sykes over at Unga is married to a old squaw so horrific-lookin' that when Shotgun sends a photo of her to his aged parent back in Pennsylvania, th' old man keeled over dead when he saw it—an' Shotgun Sykes' old hag is pretty as a handful 'a orange blossoms alongside of this female nightmare which appears to have struck Ouglamuck Island.

"A-a-a-h, you *wirelessuck!*" she clicks, gazin' at me with th' sweet, amorous smile of a Rocky Mountain wild-cat fixin' to jump on a chipmunk; "u-m-m—fine man!" Her snappin' tar-black lamps nails me fast to th' spot, like a squab pigeon hypnotized by a rattlesnake, an' I can't budge or speak till she goes away.

"You're done fer, you're done fer," doles Double-Cross Picketts, like a funeral chant. "You're absopositively done fer—nobody she made up her mind to marry has ever got away from her."

"Who's afraid 'a that old buzzard-faced eater of rotten salmon!" I sputters, breakin' out of my trance an' tryin' to act indifferent-like, though th' cold shivers are still playin' leap-frog up an' down my back-bone.

"Wait—just wait," jangles Picketts, like a chime of weddin' bells.

But I don't wait. Both the masts are up and well-guyed by this time; and now, pitchin' th' parts of th' diesel-engine together, I belts it up to one of th' small direct-current generators, an' hangin' up a bunch of big mazda-lamps with some rough grape-vine wirin', I makes my workin' hours from six o'clock in th' mornin' to midnight. I had been kinda thinkin' of stayin' at Ouglamuck an' holdin' down th' superintendent berth for a while, but now my ambition has got converted into a desperate intention of gettin' this confounded wireless-station to workin' long enough to locate th' nearest floatin' craft, an' then to beat it off th' blasted island before that blood-curdlin' combination of a toothless rhinoceros an' a devilfish gets her deadly tentacles around me an' drags me down into th' black sea of squawtrimony. You may think it wasn't nothin' to get such frozen feet about—but if you ever have a Queen Tillafaganouck come sailin' after you—

A few days later, as I finishes settin' up th' main alternators an' begin assemblin' th' transmitter-panel, I observes that all th' squaws an' dirty-faced kids up in th' village are embellishin' th' walls an' roof of th' soul-savin' hang-out with fresh green spring-alder

"COPPERWELD"
TRADE MARK REG. U.S. PAT. OFF.

LEAD-IN AND GROUND WIRE
RUBBER INSULATION—BROWN BRAID

IS THE APPROVED COPPER-CLAD
STEEL WIRE REQUIRED BY THE

National Board of Fire Underwriters
IN THEIR 1922 RADIO REGULATIONS

*The high-grade insulation is covered by a glazed brown braid.
No soiling of walls nor woodwork.*

BUY IT IN CARTONS
WITH INSTALLATION DIRECTIONS

COPPER CLAD STEEL COMPANY
OFFICE AND WORKS BRADDOCK P. O., RANKIN, PA.
NEW YORK CITY OFFICE 30 CHURCH ST. WESTERN SALES REPRESENTATIVES:
STEEL SALES CORPORATION, CHICAGO, ILL.

Radio Dept.—Braddock P. O., Rankin, Pa.

"COPPERWELD"
TRADE MARK REG. U.S. PAT. OFF.

Made by the Molten Welding Process

ANTENNA WIRE
50% Stronger Than Copper

Better than copper or strands for
aerials. Doesn't stretch or sag.

The permanently welded copper
exterior makes it ideal because of
"skin effect" phenomena of radio
currents. Standardized by the larg-
est manufacturers of radio equip-
ments.

Sold everywhere in 100-foot and 200-foot cartons.

BUY IT IN CARTONS
We deliver from stock

COPPER CLAD STEEL COMPANY
OFFICE AND WORKS BRADDOCK P. O., RANKIN, PA.
NEW YORK CITY OFFICE 30 CHURCH ST. WESTERN SALES REPRESENTATIVES:
STEEL SALES CORPORATION, CHICAGO, ILL.

Radio Dept.—Braddock P. O., Rankin, Pa.

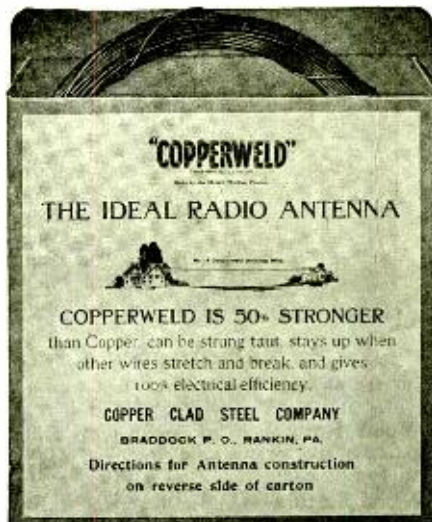

BEACON

Can Supply You with all Radio
Parts and Sets.

BEACON RADIO & ELECTRIC CO
246 Greenwich St., near Park Place New York City

1/4" Sliders—Brass 20c; Nickel 25c.
1/4" Slider Rods—Brass 15c; Nickel 20c.
Crystal Detectors, nickel plated on Mahogany base, \$1.00.
Double, Nickel Slider Tuning Coils, \$3.00.
Contact Points, threaded with nuts, 20c doz.
Compo. cap, Nickel base Binding Posts, 7c ea.
Plain Nickel Binding Posts, 3 1/2c each.
Large Stocks—Immediate Shipments
Liberal Discounts to Dealers
F. JOS. LAMB COMPANY
1940 Franklin St. Detroit, Mich.

USE THE CLASSIFIED ADS
If you have Something to Sell or Exchange

Tell them that you saw it in RADIO

Keep Up To The Minute On RADIO

READ the three interesting and instructive books by JAMES R. CAMERON, whose text books are used and indorsed by the U. S. Army, Navy, and Dept. of Public Instruction.

How to Build Your Own Radio Set

Full instructions with diagrams and drawings which make it easy for beginner to build his own set.

25 cents

Radio Dictionary

Words and terms relative to Radio parts and equipment clearly defined—with tables and information.

50 cents

Radio for Beginners

A book that deals with the subject from A to Z, and so written that the amateur can understand it.

One Dollar

Buy Them From Your Dealer Today or Direct From

TECHNICAL BOOK CO.

130 West 42nd St.

New York

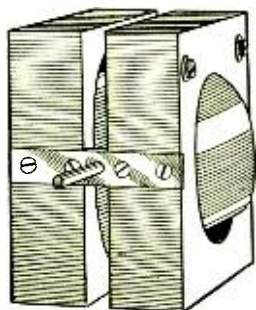

Complete Postpaid \$5.00

Make Your Own Receiving Set

These Variometers are specially designed for the reception of wavelengths of 150 to 650 meters. Two of them—used with any standard variocoupler—will make a regenerative receiver that will bring in loud, clear and properly tuned signals. Brass bearing plates are sunk flush so that you can mount the variocoupler tight against your panel. Complete, ready to use, postpaid, only.. \$5.00

Variometer Parts—At Factory Prices

For the amateur who wants to wind his own variometer, we furnish the wooden parts and all necessary wire, screws, hardware, etc.

Wood Rotors—4" diameter, 2" wide, grooved for windings, postpaid, each **90c**

Wood Stators—4 3/4" square, with slots for bearing plates, postpaid, per pair **\$1.00**

Wire, etc.—Complete set of all wire, screws, and hardware needed to wind and assemble the complete variometer as shown in illustration above, **70c** postpaid, per set

Send us your specifications for cabinets, panels, or any other wood parts wanted. Be sure to get our prices.

DEALERS: These variometers are made in our own factory and are ready for immediate shipment. Write for our very attractive offer.

NATIONAL RADIO CO., Inc. 1302 S. Vandeventer, St. Louis, Missouri.

BERKELEY CALIF.

Headquarters for Radio Supplies and Storage Batteries

U. C. BATTERY and ELECTRIC CO.

2158 University Ave.



Firco Radio Apparatus

For sale by all prominent dealers

JOHN FIRTH & CO., INC.

Pioneers since 1901

709 Sixth Ave.

New York

branches. That night, while I am toilin' by electric light, throwin' condensers, synchronous-gap, and sendin'-transformer into workin' relations, all of a sudden I feels somethin' like a cold steel blade stickin' me in th' back, an' jerkin' around quick, I finds th' Queen 'a Darkness is standin' in th' door, smilin' at me as beautiful as a starvin' timber-wolf.

"Me marry you," she slithers, with th' caressin' tenderness of a female gorilla, as I stands froze to th' spot with the rotary-gap disk in one hand and a crescent-wrench in th' other. "To-morrow night!"

That evening I don't stop work at midnight. In fact, I never stop no more at all. After that it's just one wild dash, slingin' together receivin'-gear, audions, aerial-switch, sendin'-key, voltmeters, rheostats, lead-in, all flyin' around in one mad tangle of wires, tape, an' tools. As darkness comes again and I sees all th' village turnin' out dolled up in their Sunday's-best fur-hides an' beginnin' a bonfire parade beatin' on pots, kettles, an' dish-pans, I have already throwed the transmitter into some kind of tune an' got hold of th' government Bering Sea patrol, "Seals Protector."

"Come full speed fer Ouglamuck!" I whoops on th' key, th' minute I makes connection. "There's a fleet of fifteen Jap seal-poachers showed up ten miles off th' island—make a dash before they get away with every fur-seal in th' place!"

Of course this is a big lie, th' only Jap in sight bein' Fried-Beans Mino, th' codfishermen's cook, but I figures that anything is justified in such a emergency as this. Before I can hear th' cutter's answer, a dark, icy chill slowly settles over th' shack like the cold dead breath of th' Arctic; an' glidin' in through th' door with th' slipperish stealth of a scaly poison snake comes Queen Tillafagafanouck, dressed in flowin' Siwash weddin'-robes of red-fox fur, and a wreath of green alder sprigs droopin' around her cranium.

"Come!" she commands in a blood-freezin' yowl, like a bloodhound at th' throat of a escaped convict. "Me marry—"

But I never hears th' rest, because I crashes out through th' window like I was th' projectile of a German seventy-mile gun, an' makes one headlong leap down th' half-mile trail to th' beach, intendin' to grab a dory or a rowboat, or a piece 'a plank, or anything—but down at th' wharf, I finds Double-Cross waitin' in a power-boat with th' engine runnin' an' all set to go.

"You're a friend in need, Picketts!" I pants, as I swoops aboard in one flyin' dive. "Shove off!"

Early next morning, we meets th' "Seals Protector" twenty miles off th'

Tell them that you saw it in RADIO

Compare it with ANY
It SPEAKS for ITSELF

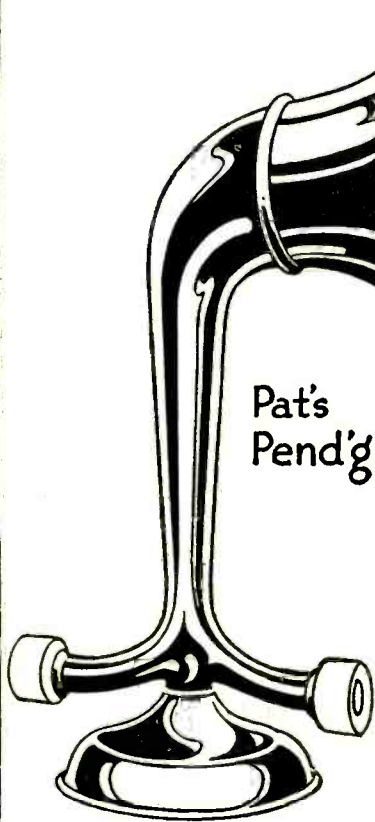

Pat's
Pend'g

PRICE \$12.00
F. O. B. New York City

INTRODUCING THE
KING "AM-PLI-TONE"
A RADIO SURPRISE

LISTEN TO THE CONCERTS, NEWS AND
DANCE WITH A KING "AM-PLI-TONE"

Just slip your head phones on the "AM-PLI-TONE" and you and your friends will be *SURPRISED!*

Polished cast aluminum body with nickel plated base and horn. No sheet metal is used. The tinny sound is left out. The volume is *DOUBLED* because *TWO* head phones are blended into one *POWERFUL* tone.

A big hit, a big seller, and immediate deliveries. Dealers and distributors, what more can you ask? Write today for territory—KING "AM-PLI-TONE."

NOTICE—All infringers of this device will be vigorously prosecuted.
82 Church St., New York City

DUPLEX Victrola
Attachment \$5.00

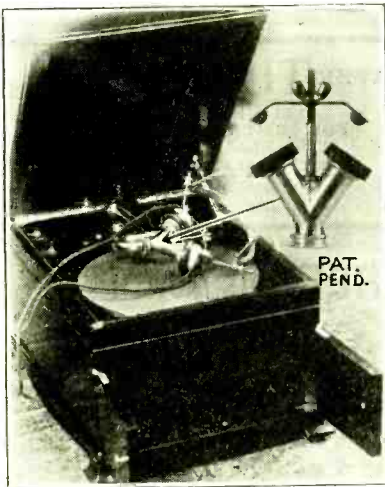

PAT.
PEND.

Make a first class loud speaker of your head phones and Victrola with a Duplex. Highly polished aluminum and nickel plate. Take any size head phones. Just what every one has been looking for.

If your dealer does not have the Duplex we will ship postpaid on receipt of price. State make of Talking Machines when ordering.

Mfg. by
W. B. McMASTERS
WHEELING, W. VA.

WHAT YOU HAVE BEEN LOOKING FOR—A REAL

AMATEUR
RADIO
DIRECTORY

Complete List of all Amateur Stations in the United States,
including Special Stations and Broadcasting Stations.

—also—

Notes on the construction of a complete receiving set.
Calibration of a receiving set without the use of a wavemeter.

Price \$1.00 Per Copy

Order from your dealer—if your dealer hasn't them, send direct.

PUBLISHED BY

Radio Directory and Publishing Co., Dept. "B" 45 Vesey St.
New York City, N. Y.

Do not send stamps. Dealers—write for proposition.

GOING UP!

The subscription price for "RADIO" has been increased to \$2.50 a year. Subscribe before June 30th at the old rate of \$2.00.

Why Pay Three Dollars a Year For Single Copies When You Can Save a Dollar by Subscribing Now?

Tell them that you saw it in RADIO

Warren Radio Loop

NO
A
E
R
I
A
L



LESS
S
T
A
T
I
C

If Dad says—

"NO AERIAL ON THIS HOUSE" don't allow his QRM to worry you, but purchase a

WARREN RADIO LOOP

The LOOP that made the Radio Roller Chair famous on the Boardwalk at Asbury Park, N. J.

Is just the thing for an apartment or den. Is light in weight and easily portable. Is produced under a new principle. Is wholly enclosed, thereby protecting the winding.

Is used in place of an outside aerial. Is a regular indoor aerial. Is adapted for receiving in moving vehicles. Takes the "tic" from static. Eliminates all danger from lightning. Can be used with any receiving instrument. Can be used without tuner.



This picture of the Radio Roller Chair showing the Warren Radio LOOP was used as cover designs on "Wireless Age" and "Radio News" and featured in many other magazines and newspapers in the United States.

Send your order through your dealer or direct to us with his name.

Type-A-737 (300-700 meters)..... \$10.00
Type-A-7236 (175-1000 meters)..... 12.00

V-DE-CO RADIO MFG. CO.

DEPT. C, ASBURY PARK, N. J.
Send for bulletin—No. S101

FORMICA PANELS

Black Sheets, Both Sides Polished
You can get panels cut to order from this high quality material and it will cost you only .02½ per sq. in. 3/16" thick.
Immediate Shipment - Postage Prepaid
DAVID RADIO SUPPLY CO.
P. O. Box 596, Reedley, Calif.

RAY-DI-CO RADIO SUPPLIES

for Service and Satisfaction
Write, wire or phone us for prices and information.

RAY-DI-CO ORGANIZATION

1547C N. Wells Street Chicago, Ill.

island. Bidding good-bye to my one best friend, Picketts, I gets aboard; and when I feels th' good old ship's deck under me, I collapses with pure relief. Th' next day, when th' cutter is already half-way to Unalaska, I starts explainin' things to th' captain.

"I downed that fire-belchin' fish-boss, Big-Gun Beardsley, easy enough," I says, "but when that Queen Tillafascratchalot—"

"Big-Gun Beardsley!" exclaims th' grizzled old skipper of th' *Seals Protector*," surprised-like. "Big-Gun Beardsley is not the fish-boss at Ouglamuck—he's only a common ornery Alaska bad-man. The boss's name is Picketts—Double-Cross they call him. Queen Tillafagafanouck is his wife."

"Well, of all tha—" I begins—but it's no use puttin' down what I said after that, because I know th' editor won't print it, anyway.

N. B.—The falling of the wireless-mast related above—except that the real cause of the accident is still a mystery—is a true incident, which happened to the author while constructing the radio station at Pirate Cove, Alaska (KOXN). I actually fell over seventy feet onto frozen ground, and regained consciousness several hours later uninjured, except for a blood-blister under one fingernail—to the vast chagrin of some of my sourdough friends. The inhabitants of the Shumagin Islands regard my escape as a miracle—which it undoubtedly was.
V. G. M.

200-5000 METERS REGENERATIVE RECEIVER

Continued from page 19

on how to make a bank winding, so this will not be treated here.

With the coils completed and tested for use, the panel grained and finished and condensers mounted, proceed to mount the variometers, then the coils. The photos show the method of mounting the coils; thin sheet brass angle strips were bent to shape, holes drilled, and screwed to the sub base. By this method

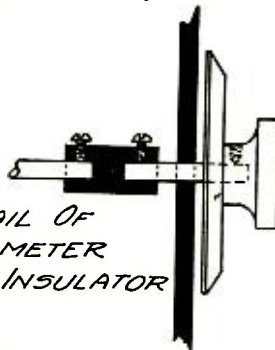

DETAIL OF VARIOMETER COUPLING INSULATOR

any part may be removed for attention at any time. The variometers and coils set about 1½ in. back of the panel. The ¾ in. insulator bushings break up the shafts on these and coupling, which

Tell them that you saw it in RADIO

Nationally Advertised

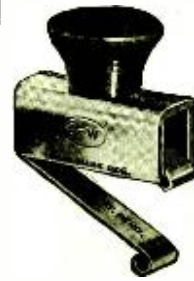

G-W Sliders and Rods

G-W sliders make perfect electrical contacts due to a patented bow spring which presses firmly against the slider rod, and a spiral tip contact spring which tunes on a single wire and slides across the coil easily in either direction without cutting the wire.

3/16" 25c

1/4" 30c

Plenty of Other Sliders But None With the Advantages of G-W

More G-W Sliders sold than all other makes combined.

The G-W Improved Detector

Corrects the faults common to most detectors. Position will not loosen after setting. Entirely new design of crystal cup—no screws—locks automatically. Mechanically and electrically perfect. Up to the usual G-W Quality Standard.

Distributors Wanted

Gehman & Weinert

Manufacturers of G-W Radio Products
42 Walnut St., Newark, N. J.
Address inquiries to Dept. C.

CABINETS

We build Cabinets for any size panel, in any finish. Will quote on one or a thousand. Please send your specifications.

NATIONAL CABINET CO.

Dayton, Ohio

PAPER TUBES FOR WIRELESS

ALL SIZES ON HAND FOR IMMEDIATE DELIVERY. WHOLESALE AND RETAIL
BAEHM PAPER CO., INC.
219 FULTON ST. NEW YORK
Big Discounts to Dealers

FREE THIS MONTH

VACUUM TUBE

WIRELESS RADIOPHONE & CODE SET

Also the Wonderful OMNIGRAPH Set for learning the Code, best Theory and Text Books given FREE with our Simplified

Spare Time Professional Home Course LEARN WIRELESS

The demand for experts exceeds supply. Pays \$125 to \$250 monthly up to \$10,000 a year or more

COURSE FOR AMATEURS

SHORT—LOW COST
Non-technical, qualifies you for Amateur License.



FREE

LEARN-O-GRAPH

Code Sender and Text Books with Amateur Course Free Booklet—"How to Become a Wireless Operator."

New York Wireless Institute

154 E-Nassau St., New York City

helps in getting rid of hand capacity effect. The copper shield is cut to have each unit, except the main primary and secondary coils, covered, a strip being left to connect each section of the shield. The photo shows how the main coils are related in the assembly, but the panel drilling will take care of that.

The circuit used is one of the earlier Armstrong's—fones in the filament line, with a switch on the audion control to shift the fones to the plate line. The long waves require, for a sure fire effect, the fones in filament line. On the short waves this will also do nicely and is very sharp in tuning, but there seems to be some advantage on concerts, etc., by having the fones in the plate line. A fixed mica by-pass .001 condenser may be used.

The wiring diagram should be followed strictly—there is an advantage in so doing. The plate variometer as well as the grid are both in the lower legs of the circuit, and the coupling ring is next to grid.

In operating, for 200 to 375, we switch out the secondary condenser, and of course the secondary coil. Also, the primary switch is placed on short, which gives us essentially the standard variometer short wave set, and it is operated accordingly. Fones may be on long or short, but short will probably be best.

For 600 to 1200 meters we may leave the fones still on short. The third tap of secondary coil is brought in, as well as the secondary condenser, to about 10 points. The primary is advanced to tap 5 and condenser 50. It will be found that the set now operates as before, only on 600 meters, the feed back of plate variometer on the coil giving good regeneration at about 50 points. The grid variometer is turned to zero. Or, the grid variometer may be used as a condenser, placing the condenser at zero, but leaving it in the circuit. This will give us variometer tuning on 600. The difference in signals will be very slight, speaking well for the secondary coil, of which three taps are in use. Or, a third way is to cut out the secondary coil entirely and tune with the combination of secondary condenser and grid variometer. The first method is preferred by the writer.

The coupling may be used either side of the vertical at about 15 degrees from vertical, which is rather loose, and with proper plate variometer in use, extremely sharp. The coupling dial is set on, so that 50 points marks the coupling ring at right angles to the primary.

Passing on thru the various waves from 752 to 1900 meters, the coupling will be better in the vicinity of 45 points, or left of vertical.

With all the secondary coil in use, and practically all the primary, for waves

"B" BATTERIES

AN

EVEREADY

PRODUCT

43V. Batteries, tapped..... \$5.00
 32½ V. Batteries, Navy Type..... 3.00
 32½ V. Batteries, Commercial Type..... 2.00

Latter two types especially adapted to Cunningham and Radiotron Tubes.
 Postage Prepaid Anywhere in U. S.

ETS-HOKIN & GALVAN

Wireless Engineers
 10 Mission Street San Francisco

\$4.00 3000 Ohms



IMMEDIATE DELIVERIES — POST PAID
 Audibility Unsurpassed—Money Back if Dissatisfied. Antenna Wire—7 Strand
 Tinned 150 Ft., \$1.60
 TOWER MANUFACTURING COMPANY
 9 Station St., Brookline, Mass.

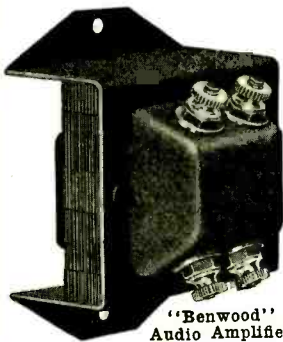

"Benwood" Audio Amplifier

Full 4 to 1 Amplification Without Howling or Squealing

THE new "Benwood" Transformer is specially made to get maximum amplification when used with any bulb on the market.

It is completely sheathed in metal, avoiding all inductive effects, so that it gives full 4 to 1 amplification without howling or squealing. The base is 2½" x 3¾", height only 2"—ideal for either base or panel mounting. The core is best laminated steel, giving highest transference of energy—it will bring in your phone signals loud, strong and clear. The "Benwood" Amplifying Transformer, each.....\$5.00

FINER TUNING

Signals Louder and Clearer

A PROPERLY designed variometer brings in signals very much louder and clearer than the various other types of inductances on the market. With this fact in mind we have designed the "last word" in variometers—the "Benwood." Inductances are wound with double cotton covered wire and no shellac, paint or varnish is allowed to cover the wire and diminish the effectiveness.

The "Benwood" features are — minimum distributed capacity, minimum distance between stator and rotor, large size wire on both coils, positive contact bearings and proper design. This variometer will get splendid results on wave lengths from 150 to 650 meters with the average variocoupler. Price, each.....\$5.00

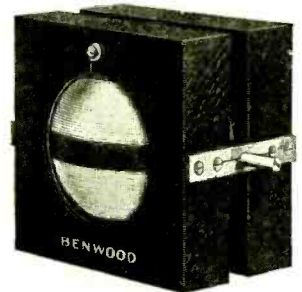

"Benwood" Variometer

The New, Improved "Benwood" Dial Controls

THE "Benwood" dial controls all have solid Bakelite knobs of extra large diameter, which minimize all bodily capacity effects, and the new tapered design fits the fingers perfectly. The knurling is particularly fine and sharp.

SOLID BAKELITE KNOB AND DIAL

Graduated 0° to 100°—all markings clearly defined in white and stamped into the solid Bakelite—won't wear off. Rib on reverse side prevents turning too far. Set screw deeply countersunk and easily reached.

	Diam.	Depth	Knob at base	Each
BC-7 "Benwood" control	3¼"	1½"	1½"	\$1.75
BC-8 "Benwood" control	4"	1¾"	2"	\$2.00

Specify whether ¼" or ⅜" drilling is required.

SOLID BAKELITE KNOB—METAL DIAL

Has the same tapered solid Bakelite knob as BC-7 and BC-8, but has metal dial. Finely graduated from 0° to 180°.

BC-9N "Benwood" control—Nickel plated Dial, each 80c
 BC-9 "Benwood" control—Black Metal Dial, each 80c

Specify whether ¼" or ⅜" drilling is required.

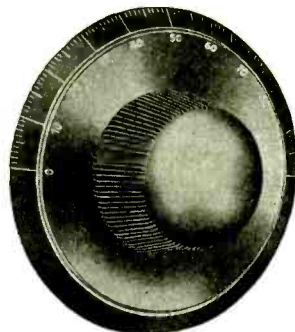

The above photo shows the new, improved "Benwood" Dial Control—note the handy, finely knurled, tapered knob.

DEALERS—We manufacture high grade radio apparatus in our own factory and have stock ready to ship. Write or wire for our liberal dealers' discounts.

CATALOG—Send 10c in stamps for the Benwood catalog and price list, also complete catalog and price list of DeForest Radio Equipment.

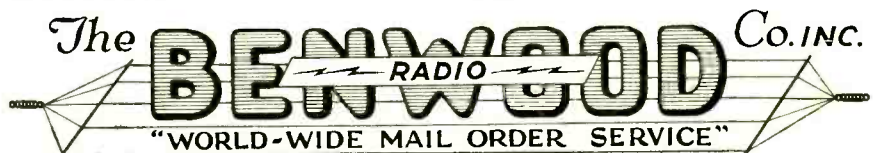

1113 OLIVE STREET, ST. LOUIS, MO.

Tell them that you saw it in RADIO

DELAWARE HARD FIBRE

The Incomparable Insulation

DELAWARE HARD FIBRE today enjoys the distinction of being the leading product of its kind, being superior to hard rubber, porcelain and composition materials for insulating purposes. It is the best insulation that can be secured for your radio apparatus. It should be used for panels, coil cases, end plates, knobs, bushings and other insulating parts in your wireless outfit. Let our Development Department help you solve your insulating problems. Further information and samples gladly furnished on request to our main or branch offices.

BRANCH OFFICES:

New York, 50 Church Street	Boston, 170 Summer Street
Pittsburgh, 1st Nat'l. Bank Bldg.	Philadelphia, Fuller Bldg.
San Francisco, 235 Pine Street	Rochester, 1040 Granite Bldg.
Toledo, 415 Ohio Bldg.	Dayton, 314 Dayton Savings & Trust Bldg.
Chicago, 564 West Monroe Street	
New Haven, 209 Plymouth Bldg.	

MAIN OFFICE AND FACTORY

DELAWARE HARD FIBRE CO.
WILMINGTON DELAWARE

HERE SHE IS!

THE NEW NORTHWESTERN VARIOCOUPLER

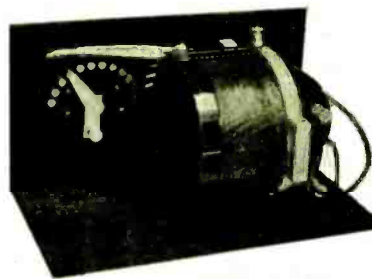
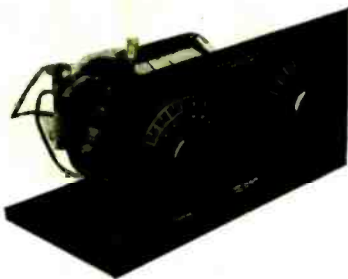

Panel $9\frac{1}{2} \times 5\frac{3}{8} \times \frac{1}{8}$.	XX Bakelite Throughout.	"No Dielectric" Rotor.
Twelve point back connected Switch.	Silver Plated.	
Aluminum Brackets.	Wire—No. 20 Double Silk, Green.	
Mounted Unit	We're	Unmounted
as shown	Trebbling	Coupler Only
\$15.00	the Factory.	\$6.50

HALLOCK AND WATSON RADIO SERVICE

122 PARK STREET

"KGG"

PORTLAND, ORE.

ATTENTION AMATEURS!

7 strand No. 22 Antenna Wire, 75c per 100 feet.

Enamel Wire No. 22 to No. 30 B. S., 85c per pound on 1 pound spools.

THE QUAKER LIGHT SUPPLY CO.

728 Arch St., Philadelphia, Pa.

Magnet Wire
AT SPECIAL PRICES
Send For Our Prices
IZENSTARK RADIO CO.
509 S. State St., Chicago



New design TU-WAY Plugs—Jacks—Variable Condensers—Head Sets—Rheostats—V-T Sockets
If your jobber does not carry our products, write us direct.

2000 to 3000, there will be some feed back between the two main coils, and now the coupling must be on the other side of center, or about 65 to 70. In effect, it loosens or uncouples the two main coils.

On arc stations 3000 to 5000, the coupling will be near 50, and fine whistling click points may be obtained by varying coupling.

These click points may be found on any wave in the range of the set by having the coupling at approximately the settings given and causing the bulb to oscillate by overdose of tickler. By swinging the primary or secondary condensers if on long, or the primary condenser and grid variometer if on short, one may readily tell how near the circuits are in resonance, and more important, how sharply tuned, as when the silent point in shifting the condenser, covers several degrees, it may, by changing coupling whichever way needed, be made so sharp as to make one degree throw the circuits off resonance if a spark is wanted, or cause an arc to amplify nicely at the spill over point.

The coupling is very important, and makes a big difference in sharpness and amplification, provided the circuits are in resonance and the tickler is brought to near the spilling point. If, however, no attempt is made to take advantage of loose or proper coupling and the plate is carelessly tuned, much of the amplifying properties will be missed. The point to keep in mind is to make the set do on all waves as it does on the short end, and it will do it with good amplifying factor.

NAA, for instance, is tuned as follows: We know his secondary setting is all the secondary coil, and condenser 25. We also place our primary on 11th tap, put the condenser in shunt to 10 degrees and bring tickler to about 60, where it will spill, or should, if fones in filament, and bulb and batteries in good shape. If the coupling should be at 45, immediate increase of signal strength will be noticed by changing to 60. The primary condenser, or secondary, should be moved a shade, to see if a point can be found which will give the natural spark tone, which would indicate resonance. If now we are sure we have the exact tuning point, after several trials we advance tickler gradually and also coupling. The tickler may stand five degrees, anyhow keep it just under spilling, and advance the coupling. At about 70 degrees the signal will have an increase in amplification of about four times over the start.

By using a special 27 plate or slightly larger secondary condenser, the range of receiver may be increased by also loading the primary. Under no circumstances would I increase the dimensions of the secondary coil, as it is right. I

Tell them that you saw it in RADIO

BURGESS "B" BATTERIES

BURGESS "B" Batteries assure clear receiving, increase the efficiency of any receiving set, and they are cheapest in hours of service.

BURGESS "B" Batteries are sold by every progressive Radio Dealer and Jobber. "Look for the Black and White Stripes."

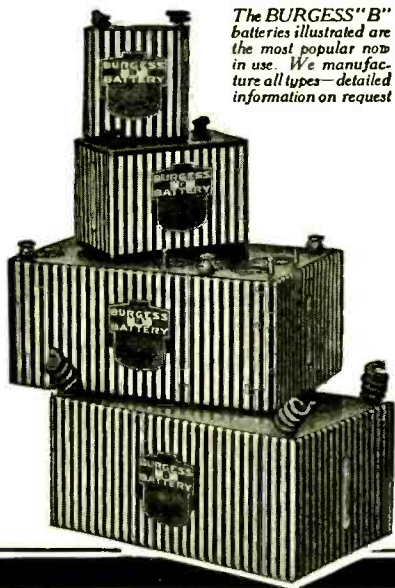

The BURGESS "B" batteries illustrated are the most popular now in use. We manufacture all types—detailed information on request

A postal card from you brings full information by return mail. Why not write to us today? Dept. A

BURGESS BATTERY COMPANY DEPT. A

Offices and Warehouses:

CHICAGO
111 W. Monroe St.

NEW YORK
50 Church St.

BOSTON
136 Federal St.

MADISON
Wisconsin

KANSAS CITY
2109 Grand Ave.

ST. PAUL
2362 University Ave.

*In Canada: BURGESS BATTERIES, Ltd.
701 Wellington Ave., Winnipeg*

OVER 300,000 SOLD—WHY? "ASK ANY RADIO ENGINEER"

Tell them that you saw it in RADIO

RADIO

Established 1917 as Pacific Radio News

Volume IV

for JUNE, 1922

Number 6

CONTENTS for JUNE, 1922

	PAGE
Radiatorial Comment	9
New C. W. Station at Presidio of San Francisco.....	10
An Inexpensive 50 Watt C. W. Transmitter.....	11
By J. B. Dow	
Crystal Detection with Tube Amplification.....	13
By GERALD M. BEST	
A 10 Watt Self-Rectifying C. W. Set.....	15
By O. SCHUWENDT	
Scratchi Flunks in Severe Test	18
By DAVID P. GIBBONS	
The Radiophone	18
By EARL ENNIS	
The Conquest of Ouglamuck	19
By VOLNEY G. MATHISON	
A 200 to 5000 Meter Regenerative Receiver.....	21
By R. C. ANDERSEN	
The Radio Direction Finder	23
By F. A. KOLSTER AND F. W. DUNMORE	
A Radio Primer	25
By H. A. EVELETH	
Protecting Radio Sets from Lightning.....	27
By L. S. BRACH	
6EA and A Novel Indoor Antenna.....	28
By H. C. SEEFRED AND L. F. SEEFRED	
News of the Broadcasting Stations.....	29
An Accurate Way to Wind Radio Coils.....	30
By EDWIN G. BAKER	
V. T. Detector and Loose-Coupler Hook Up.....	30
By HARRY E. THOMAS	
Pacific Radio Trade Association Demonstration Set.....	31
Queries and Replies on C. W. Practice.....	32
C. W. Association of America	33
Digest of Recent Radio Patents	34
With the U. S. Radio Inspector	35
Radio Club News	36
New Apparatus and Supplies	37
Calls Heard	40

RADIO is Published Monthly by the
Pacific Radio Publishing Co., Inc.,
Pacific Building, San Francisco, Calif.

ARTHUR H. HALLORAN, *Editor.*
LAWRENCE MOTT, *Associate Editor.*
GERALD M. BEST, *Technical Adviser.*
O. SCHUWENDT, *Engineering Draughtsman.*
H. W. DICKOW, *Advertising Manager.*
Branch Offices: 147 Sixth Ave., New York City;
6442 Ingleside Ave., Chicago;
140 So. Oxford St., Los Angeles, Cal.

Advertising Forms Close on the First of the Month
Preceding Date of Issue

Issued Monthly, 25c a copy. Subscription price \$2.50 per year in the U. S., \$3.00 per year elsewhere. Instructions for change of address should be sent to the publisher two weeks before the date they are to go into effect. Both old and new addresses must always be given.

Entered as second-class matter at the Post Office at San Francisco, Calif., under the Act of March 3, 1879.

Copyright, 1922, by the Pacific Radio Publishing Co.

Forecast of Contributions for July Issue



Major Laurence Mott

Because of his keen interest in the progress of citizen radio, with a view to its paramount usefulness to the War Department, should occasion arise, Lawrence Mott, associate editor of RADIO has been commissioned a Major in the Signal Corps, ORC-USA, by the President. The results achieved at 6XAD have been of great interest to General Squier, the Chief Signal Officer, for whom Major Mott has written several especially requested articles, dealing with the phenomena of his station, and the local conditions, geographic, etc., at Catalina Island, Calif. An additional list of his recent d. x. work appears on another page of this issue. In the July number, Major Mott will have an article of vital interest to every real operator.

Prof. A. K. Aster has prepared an able paper on "Design of Iron-Core Audio-Frequency Choke Coils." This paper is illustrated by practical examples that should enable any intelligent amateur to design coils to meet given requirements.

G. W. Cattell, radio engineer with the navy, will again have some of his writings in these columns in an article on "Resistance and Susceptance Diagrams," which will afford an easy and quick method of analyzing radio circuits.

B. F. McNamee, one of the few men who really knows vacuum tubes, will tell about the how and why of "The Vacuum Tube As An Amplifier," in simple language that clarifies this complex subject. The subject of vacuum tubes will also be discussed by H. A. Eveleth in his series of articles in "The Radio Primer."

The next installment in J. B. Dow's "C. W. Manual" will be concerned with a 250-watt power amplifier. The complete book will be ready about June 15th, anticipating the completion of the series in RADIO by several months.

Those of our readers who have been enjoying the clever verse and grid leaks by Earl Ennis will welcome the announcement that he has some real fiction dealing in a most humorous but prophetic style with future developments in radio music. David P. Gibbons, in his inimitable "Japradionese," takes a fling at broadcasting.

“
 The right path is near,
 says Mencius,
 yet men seek it afar off,”
 The right Receiver is here—
 the Grebe CR-5—
 The wise Radioist
 need seek no further!

Doctor Wu



H.A. Wiley

GREBE RADIO

Licensed under
 Armstrong U. S. Patent,
 No. 1113149.

RADIO APPARATUS

*Distributors of Reliable Radio Apparatus to Schools,
Colleges, Radio Clubs and Experimenters
All Over the World!*

"PITTSOCO"

Specializing on RADIO
CORPORATION'S Products



"PITTSOCO"

Now has three Stores.
Send us your orders.

The present tremendous demand for Radio Apparatus has practically made it impossible for us to render our usual SERVICE.

Reasonably prompt delivery however can be made on the items listed.

AMPLIFYING TRANSFORMERS

No. P-1 General Radio, semi-mounted.....	\$ 5.00
No. 50 Chelsea, semi-mounted.....	4.50
No. A-2 Acme, semi-mounted.....	5.00

ANTENNA WIRE

"Pittsoco" No. 14 Hard drawn copper, (80 ft. per lb.) per lb.....	.40
500 ft. (Special value).....	2.25
"Pittsoco" 7 strand No. 22 tinned copper, per ft.....	.01
500 ft.....	4.00
1000 ft.....	7.50
"Pittsoco" 7 strand No. 20 Phosphor bronze per ft.....	.02
500 ft.....	7.50

ANTENNA INSULATORS

No. P-1 Electrose Ball insulator.....	.35
No. P-2 Electrose 4 inch strain insulator.....	.45
No. P-3 Electrose 10 inch strain insulator.....	.75

"A" BATTERIES (Storage Batteries)

Yale 6 volt 60 Ampere-hour.....	18.00
Yale 6 volt 80 Ampere-hour.....	21.00
Yale 6 volt 100 Ampere-hour.....	25.00

Note.—These batteries are shipped carefully crated and fully charged ready for use.

"A" BATTERY RECTIFIERS

No. P-1 Tungar, 5 ampere type, complete with bulb..	28.00
No. P-2 Tungar, 2 ampere type, complete with bulb..	18.00
No. P-3 F F Battery Booster, 5 ampere type.....	15.00

"B" BATTERIES

No. 763 Eveready, 22.5 volt, small size.....	1.75
No. 766 Eveready, 22.5 volt, large size, 16½ to 22½ volts.....	3.00
No. 774 Eveready, 43 volt, large size, variable.....	5.00

CRYSTAL RECEIVING SETS

Aeriola, Jr., Westinghouse, complete with telephones	\$25.00
Every-man's DeForest, complete with telephones	25.00

CONDENSERS (Variable)

No. 1 Chelsea, fully mounted, .001 Mf.....	5.00
No. 2 Chelsea, fully mounted, .0005 Mf.....	4.50
No. 3 Chelsea, unmounted with dial, .001 Mf.....	4.75
No. 4 Chelsea, unmounted with dial, .0005 Mf.....	4.25
No. 367 Murdock, fully mounted, .001 Mf.....	4.50
No. 368 Murdock, fully mounted, .0005 Mf.....	4.00
No. 3660 Murdock, unmounted without knob and dial, .001 Mf.....	4.00
No. 3680 Murdock, unmounted without knob and dial, .0005 Mf.....	3.25

JACKS (Radio Type)

No. P-1 Open circuit.....	.70
No. P-2 Closed circuit.....	.85
No. P-3 Two circuit.....	1.00

LOUD SPEAKERS

Arkay, horn only, satin finish.....	5.00
Federal Pleiophone, complete with phone.....	14.00

PLUGS

No. 34-B Firco, round type.....	2.50
No. P-1 Western Electric.....	1.10

SOCKETS

No. 156 General Radio, improved model.....	1.50
No. P-1 Chelsea.....	1.00
No. P-2 Clapp-Eastham, bakelite type.....	1.00
No. UR-542 Radio Corporation.....	1.00

TELEPHONES

No. 56 Murdock, 2000 ohms.....	5.00
No. 56 Murdock, 3000 ohms.....	6.00
No. 2A Stromberg Carlson, 2000 ohms.....	7.50
No. P-1 Holtzer-Cabot, 2,200 ohms.....	8.00

Let "PITTSOCO" fill your orders for any of the above items.
Our SERVICE on these at the present time will please you.

F. D. PITTS CO., Inc.

12 PARK SQUARE

Woolworth Building,
Providence, R. I.

3 STORES

BOSTON, MASS., U. S. A.

276 Worthington Street
Springfield, Mass.

Tell them that you saw it in RADIO

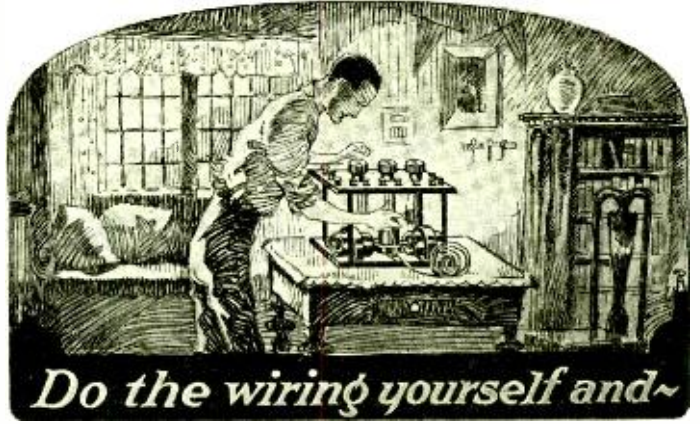
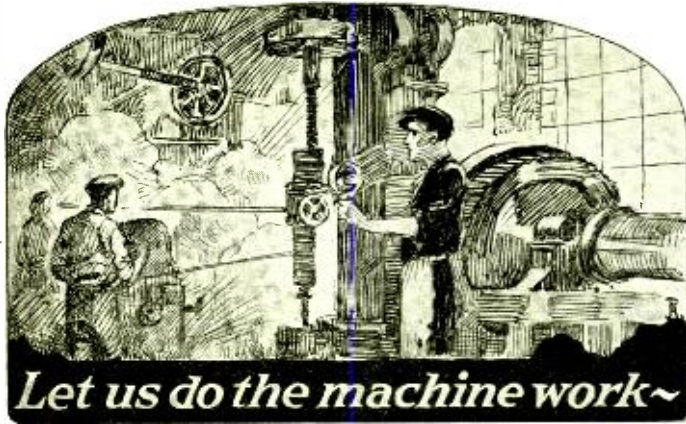

Save 20% or More on the Cost of High-Grade Radio Instruments!



Multiple Wave Tuner—Here you obtain in a single instrument the equipment to receive all classes of signals on all known wave-lengths—150 to 25,000 meters. Minimum number of controls provide extreme simplicity of operation, yet the design renders the tuning especially sensitive and selective.
 Price, completely assembled, F. O. B. New York, \$45.00
 Set of 18 DL Coils, to receive all the most used wave-lengths, \$40.00.



Detector and Two-Step Amplifier—Your choice of two types, Commercial or Amateur. The commercial type is assembled from the most costly, efficient units available. Radio Corporation UV-712 transformers and General Radio tube receptacles typify the quality thru-out. The Amateur type is an exact duplicate, except that transformers and sockets of high efficiency, but lower cost, are used.
 Prices, F. O. B. New York:
 Commercial type, unwired... \$55.00
 Amateur type, unwired... 47.00
 Here is clear saving of \$10.00 in either case, thru the "Standard" Plan.

THERE are two parts in the building of radio apparatus; first the actual panel drilling and assembling, and second, the wiring.

The first is essentially machine work. At the same time, because it is machine work, it is really the less expensive part of the entire assembly.

The wiring, which is hand work, is the expensive part and also the part which you can do just as well yourself. The Standard Plan gives you an opportunity to secure commercial grade correctly assembled apparatus at prices only slightly more than you would pay for the individual instruments.

The Standard Plan ASSEMBLED but not WIRED!

The Standard Assembling Company makes a complete line of parts—fully ASSEMBLED but not WIRED. The actual machine work is done in a splendidly equipped factory. The workmanship is not excelled anywhere. The individual instruments and parts are of the highest quality obtainable and are bought in tremendous quantities at big discounts.

The wiring, which is expensive hand work, is left for you to finish. You can incorporate your own circuit if you wish, or, you can follow the wiring diagrams which are provided with every instrument.

Take advantage of the Standard Plan and save the expensive wiring costs. Only in this way can you get fully assembled high quality apparatus at such low prices.

Take this opportunity to *try* the Standard Plan at *our* Risk!

So confident are we that you will be delighted with the Standard Plan, that we will ship any Standard instrument for your inspection without obligation. Simply send a deposit of $\frac{1}{3}$ the purchase price with your order. Examine the instrument carefully. If satisfactory remit the balance, but if you are not fully convinced that Standard apparatus is the best value in radio today, simply return the instrument and your deposit will be refunded less carrying charges.

STANDARD ASSEMBLING COMPANY

Dept. A, 19 Bridge St., N. Y. C.

If you do not wish to order at once, at least send 2c for the complete details of the Standard Plan and descriptive literature of all Standard instruments. This coupon is for your convenience. We suggest that you fill it in now, so that you can get the Standard bulletins in time to save money on your next purchase

Standard Assembling Company,
 Dept. A, 19 Bridge Street, N. Y. C.
 Gentlemen—I enclose 2c. Please detail of the Standard Plan by return mail.

Name.....
 Address.....
 City.....
 State.....

Tell them that you saw it in RADIO

Crystal or Vacuum Tube Detection with the same set

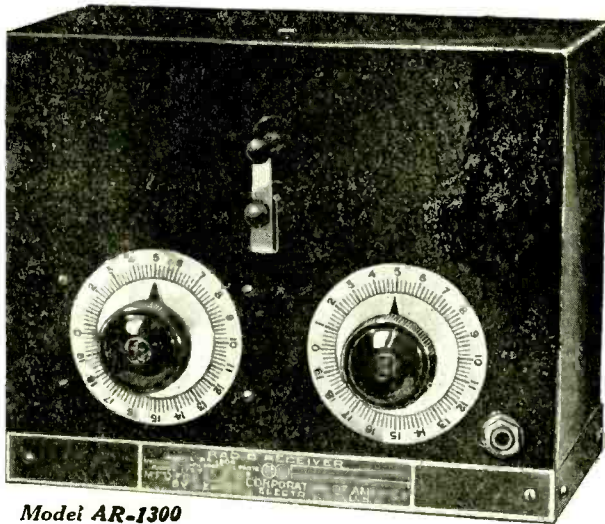

Model AR-1300

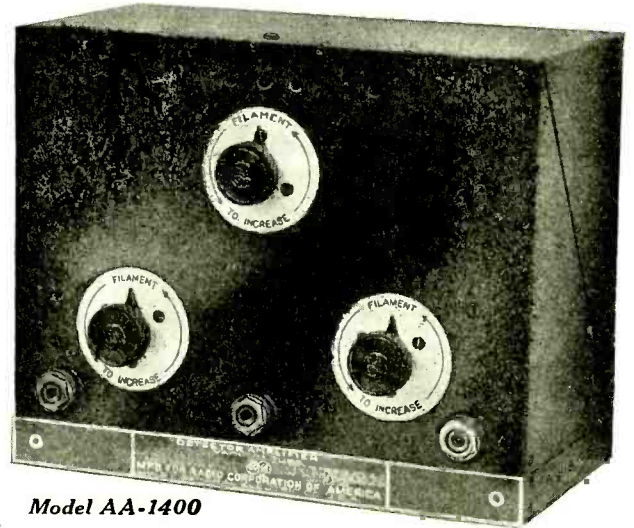

Model AA-1400

These two sets (radio receiver Model AR-1300 and Detector Amplifier Model AA-1400) meet the demand of the novice who wishes to start with a simple crystal detector and later to pass on to vacuum tube detection and amplification at minimum cost.

Radio receiver Model AR-1300 is a new tuner for the broadcast enthusiast. Used as a crystal detector it is a complete receiver. Used with Model AA-1400, here shown, the crystal detector is switched off and amplification is controlled by regeneration.

Detector Amplifier Model AA-1400 consists of a vacuum tube detector and two stages of audio-frequency amplification. It

is especially adapted for use with receiver Model AR-1300 to increase the strength of broadcasted concerts. The individual filament control permits close regulation of the received energy. Distortion of broadcasted music is avoided by a special high-frequency resistance across the secondaries. Three telephone jacks insure ideal selectiveness ranging from simple tube detection to two stages of amplification.

PRICES (NOT INCLUDING ANTENNA, TUBES, AND BATTERIES)

Radio receiver Model AR-1300 \$50.00
 Detector Amplifier Model AA-1400 75.00
 Total for Combination \$125.00

See these New G. E. Products at Your Nearest Dealer

Radio  **Corporation**
of America

Sales Department, Suite 1804
 233 Broadway, New York City



Rain Won't Injure Your Formica Panels

FORMICA does not absorb moisture so its insulating quality is never affected by weather or even by soaking in water. It does not swell or shrink and never warps. The handsome high gloss finish does not deteriorate. It looks good for years—and is good!

Formica has been approved as Radio Insulation by the navy and the signal corps. It is by far the most widely used Radio insulating material.

Formica is easy to machine, and helps you do a workman-like job on your panel. You can buy it cut to size for a standard Radio panel. All you need to do the work is a drill.

Dealers: We supply you with display cards for your store and Formica printed matter. We cut panels to size for you if you wish—and co-operate in every way possible. Extensions to our plant have just doubled our capacity.

The Formica Insulation Company
4616 Spring Grove Avenue Cincinnati, Ohio

SALES OFFICES

50 Church Street, New York, N. Y.
9 South Clinton Street, Chicago, Ill.
414 Finance Building, Cleveland, Ohio
1042 Granite Building, Rochester, N. Y.
422 First Avenue, Pittsburgh, Pa.

Sheldon Building, San Francisco, Cal.
932 Real Estate Trust Bldg., Philadelphia, Pa.
321 Title Building, Baltimore, Md.
415 Ohio Building, Toledo, Ohio.

FORMICA

Made from Anhydrous Redmanol Resins

SHEETS TUBES RODS

Tell them that you saw it in RADIO



Medal and Diploma received at World's Columbian Exposition, Chicago, 1893



INSULATION MADE IN AMERICA

Louis Steinberger's Patents



Medal and Diploma received at World's Fair, St. Louis, 1904



Globe Commercial Co., San Francisco, Cal., Factory representative on the coast.

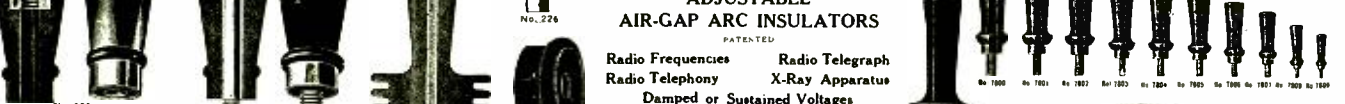

ELECTROSE ADJUSTABLE AIR-GAP ARC INSULATORS PATENTED Radio Frequencies Radio Telegraph Radio Telephony X-Ray Apparatus Damped or Sustained Voltages

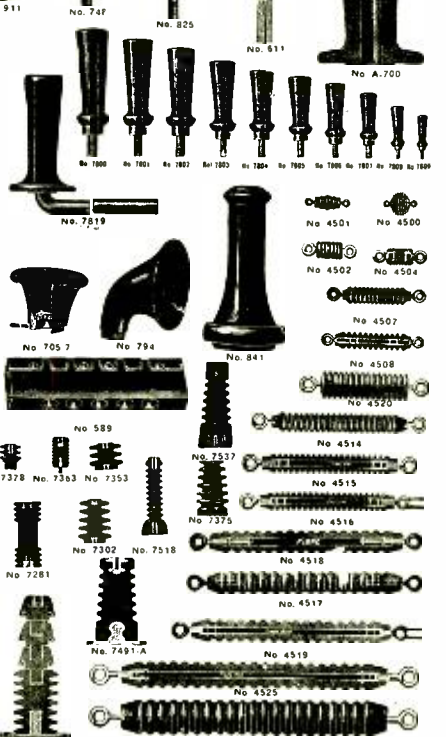

"Electrose" is made in a number of grades for various requirements, each grade possessing special characteristics. Insulators and Insulating parts and devices of special sizes and forms, designed and made to order.

SOLE MANUFACTURERS



60-82 Washington St. 27-37 York St. 66-76 Front St. 1-23 Flint St. Brooklyn, N. Y., America

Tell them that you saw it in RADIO

Radiotorial Comment

THEY wrong radio who speak of it as a fad. For f-a-d is only for a day, while radio is here to stay. Although it will not displace the wire telephone any more than the telephone displaced the telegraph or the telegraph superseded the mail, radio opens up new avenues of communication which are not adequately met by the older agencies.

Radio constitutes one of the most revolutionary factors yet introduced into the life of the people. What existing habits of civilization it will upset is as difficult to prophesy as it was to foresee what changes would be wrought by the locomotive, the automobile or the airplane. Today it is largely a novel source of entertainment. Tomorrow it will be a vital necessity in business and domestic life.

With the opening up of a wider band of wavelengths for broadcasting purposes and with improvement and greater diversity in the character of programs broadcasted, geographical barriers will be eliminated, general knowledge and culture advanced, and radio as a permanent institution so intimately woven into the warp and woof of every day life as to become indispensable.

THE real radio amateur is not a receiver but a transmitter. The present popular interest in news and concert reception will ultimately be converted into a greater interest in sending. With the opening up of a wider band of wavelengths for amateur use and with the development of more sharply tuned transmitting equipment will come an enhanced opportunity for active transmission instead of mere passive reception.

The final recommendations of the Washington Radio Conference open up a broad wave band from 150 to 285 meters for amateur use. This more than doubles the present opportunity for operators and will make it possible for more work to be done with less interference than in the past. There is strong probability of early Congressional action in this matter so that within a few weeks there will be room on the air for thousands of new transmitting stations. There is likelihood, also, that as time goes on the broadly tuned spark set will be prohibited by law, though long before this is done most operators will be employing the more efficient and satisfactory continuous wave equipment which is now becoming available at low prices.

Meantime, until these changes are brought about, the sending enthusiast should wait a time with patience, just as he did during the war when the government put a stop to amateur radio. He can enjoy the concerts, study the code and electrical theory, and get ready for his examination for a first class license. When he finds that his transmission is interfering with the pleasure of others he will be wise to voluntarily lay off a little. For he should realize that

if he makes himself a nuisance the privileges which he is soon to enjoy will be revoked. The amateur's future is in his own hands to make or mar. This is written in the broad spirit of one who desires to encourage the amateur and experimental use of radio, but who foresees the danger of restriction if some immediate consideration is not given the rights of others.

THE advent of radio has perturbed the music trades. Decreased phonograph sales are attributed to the increased sale of receiving sets. Music publishers are commencing to require royalties on songs sung over the radio and actors' associations are forbidding their members to broadcast their acts. The musicians' unions are fearful that radio entertainment and dance music will kill the market for their services.

Yet these are short-sighted and selfish views which will soon be broadened as the real vision and musical mission of radio is better understood. Increased sales of phonograph records advertised over the air will partly compensate for decreased sales of instruments. Music publishers will find it more efficient to introduce new songs to big audiences by radio than by hiring "pluggers" to sing before small audiences. Actors will realize that theatre-goers want to see as well as hear. Musicians will find a great demand for their services at broadcasting stations. And all should realize that it is useless to try to stem the tide of progress.

But these brief reasons as to the futility of opposing radio entertainment are trivial as compared with the tremendous popular interest and education in matters musical that radio is stimulating. It has long been recognized that anything bringing music to the people promotes the sale of musical instruments in the home. After a person has enjoyed a certain piece of music over the air, the desire is created to hear it often with an instrument of his own instead of waiting until the piece is again broadcasted. No better means can be imagined for popularizing classical music and teaching the people to discriminate against jazz. So, without question, radio should be welcomed as an able instrumentality for advancing the cause of better music.

Furthermore we venture the prediction that every music house will soon sell radio receiving sets. Many are already doing so, two of the largest manufacturers of musical instruments are now making and selling radio sets to the music trades, and the logical step is for the phonograph people to get into line with radio equipment housed in handsome cabinets of period furniture as an ornament to the home. Radio is not a competitor but an active co-operator in bringing an appreciation of music to all the people.

New C. W. Station at Presidio of San Francisco

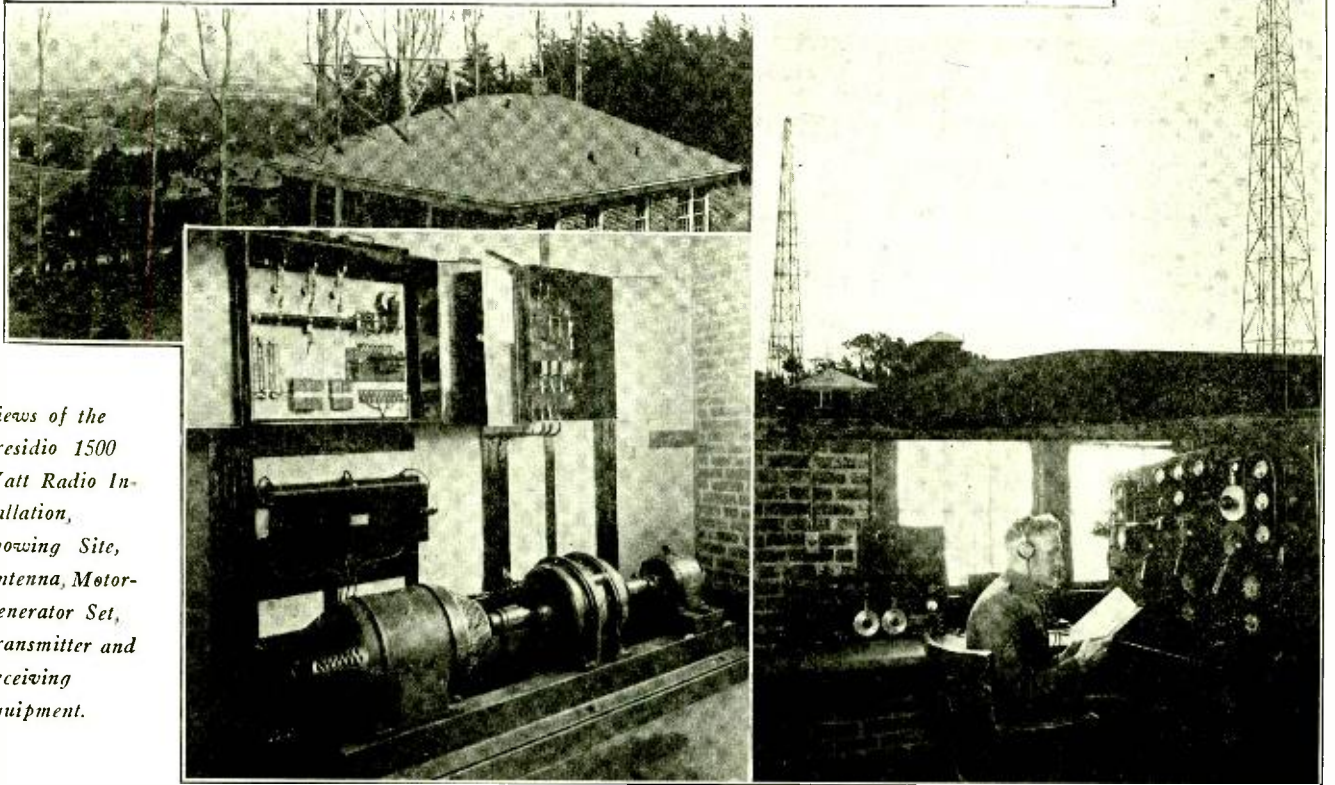

Views of the Presidio 1500 Watt Radio Installation, Showing Site, Antenna, Motor-Generator Set, Transmitter and Receiving Equipment.

SITUATED on the highest point in the Presidio of San Francisco and overlooking San Francisco Bay, WVY, the new U. S. Army Radio Station, is now on the air after six months of preparation, construction and experimentation. With a power input of 1.5 K. W. to the antenna, this new station is expected to hold regular communication with similar stations at Fort D. A. Russell, Cheyenne, Wyo., Fort Douglas, Utah, and eastern stations.

WVY is to be the control station for all army radio traffic in the Ninth Corps Area and constitutes one of the units for official communication by radio telegraph between Washington, D. C. and the headquarters of the different corps areas and also for broadcasting weather bureau reports.

This station is also to be used by the Signal Corps Radio School as a means for educating amateur radio enthusiasts in radio telegraphy and telephony through broadcast telephone lectures and code lessons at stated speeds five nights a week.

The transmitting switchboard is arranged for quick change from C. W. buzzer modulator or telephone transmission at from 1000 to 3100 meters, the normal operating wavelength being 2150 meters. Telephone broadcasting will probably be on 1450 meters. The panel is equipped for remote control on both C. W. telegraphy and telephony so that communication can be maintained from headquarters without the necessity of the operator being at the station. As may be seen from the picture, the tubes, inductances, condensers and other transmitting instruments are compactly housed directly at the rear of the panel.

A power input of 1500 watts to the antenna is secured from a double motor-generator set supplying 1500 volts to the v. t. plates and for field excitation. The filaments are A. C. lighted and operate on a potential of 11 volts.

A 300 ft. six-wire flat-top aerial is used for transmission and normal reception. The aerial is supported by two 150 ft. steel towers. The ground system consists of an extensive network of buried copper wire radiating from the station. The antenna and ground were constructed to secure as low resistance as possible, tests indicating a total of only $5\frac{1}{2}$ ohms during normal San Francisco weather.

The receiving equipment consists of a regenerative 200 to 8000 meter tuner connected to either a loop aerial for elimination of interference, a subterranean antenna about 2000 ft. long or a large antenna for reception on commercial wavelengths. All parts of the equipment are shielded. Auxiliary to the receiver is an amplifier consisting of three steps of radio and two steps of audio frequency amplification with an external heterodyne for use with the radio frequency amplifier.

The station was constructed under the direction of the Ninth Corps Area Signal Officer, Lieut. Colonel Sebring C. Megill, Signal Corps, and officer in charge of installation; Captain C. I. Hoppough, Signal Corps, Radio Officer, Ninth Corps Area. Captain Hoppough was assisted by Sergeant Richard Tavers, Signal Corps, and students of the Signal Corps School, Presidio of San Francisco.

An Inexpensive 50-Watt C. W. Transmitter

Sixth Installment of "The C. W. Manual"

By J. B. Dow, Ensign U. S. N.

THE first thought of the average experimenter as to an inexpensive 50-watt C. W. transmitter may quite easily rest upon a motor generator involving an expenditure of \$150 alone, or he might visualize an arrangement of apparatus consisting in part of two rectifying tubes at the modest price of \$60.

With 60 cycle alternating current available, two circuits may quite easily be developed to eliminate both of the expensive combinations referred to above and at the same time provide an installation which will operate fully as satisfactorily as any that might be used involving the eliminated apparatus.

Fig. 46 illustrates a circuit employing a single 50-watt tube as an oscillation generator and using a source of high voltage alternating current pre-rectified by an arrangement of forty easily constructed rectifier units. The previous chapter dealt in part with the construction of such units.

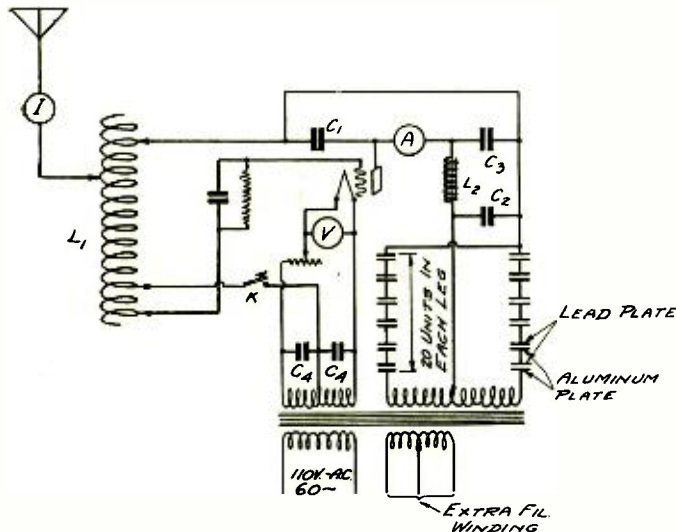

Fig. 46. Circuit Using One 50-Watt Tube as Oscillation Generator and Pre-rectified A. C. Power Supply

The details of the transformer, T, Fig. 46, follow, and it might be added that the output of this transformer is sufficient to supply four 50-watt tubes or a combination of two 50-watt tubes and two rectifier tubes.

Upon one of the longer legs of a core having a 2 by 2 inch section and a 6 by 3 inch window, wind a primary coil of 175 turns of No. 11 or 12 S. C. C. wire in three layers, insulating the winding from the core with 8 wraps of 10 mil fish paper, and each layer from the next with one wrap of the same material. Tap the primary at the following turns for voltage control: 165, 169, and 173. Over the primary place 8 wraps of 10 mil fish paper. Next, wind two secondary sections to fit over this, of 2400 turns of No. 24 enamel insulated wire in 32 layers. The 5 mil fish paper between each layer should be 2 in. wide and this will permit of a winding space of 1 5/8 inches wide. Each section should be tapped at the 1600th turn and with the two sections connected in series with a midtap at the point of connection the output voltage will be approximately 935 or 1450 on each side of the midtap.

The filament heating secondaries should be wound upon the other long leg of the core over 8 wraps of 10 mil fish paper. These units should comprise two 22 turn coils of No. 8 D. C. C. magnet wire in two layers with midtaps, and will provide ample current at a potential of 12 volts for the filaments of power and rectifier tubes.

Connection posts for all taps may be brought out to a

suitable panel secured to the core structure.

The filter circuit, C₂ C₃ L₂, may be modified by the elimination of the choke L₂, and the capacity C₂, if it is not contemplated to control the output telephonically. The capacities C₂ and C₃ should be of the order of a microfarad and designed to withstand the maximum voltage used. The choke coil L₂ has been described in detail in a previous chapter.

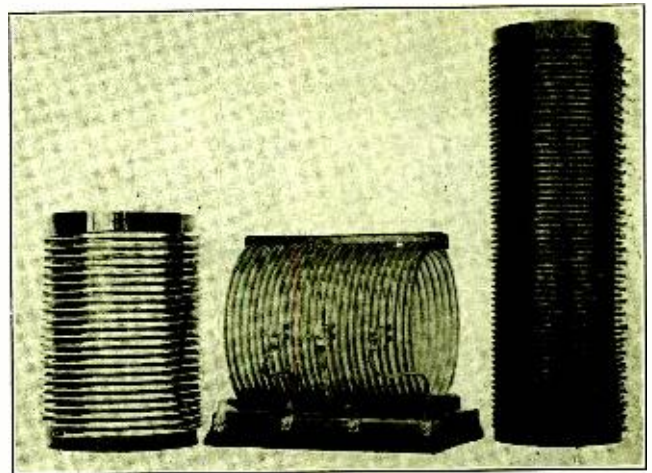

Fig. 45. Well Designed Types of Inductances

It will be observed in Fig. 46 that the capacities C₁ and C₃ are apparently shunted and the total capacity is the sum total of the two. It is obvious, therefore, that C₁ may be eliminated if the filter circuit, or more pertinent the capacity C₃, is in such proximity to C₁ that the reactive effect of intervening conductors is negligible. If the filter circuit is appreciably distant from C₁, this condenser should have a capacity of approximately 0.01 microfarad. The details of such a condenser may be found in Fig. 34.

The filament heating secondary, Fig. 46, is bridged by two one microfarad paper telephone condensers, C₄, and the midpoint of this arrangement is connected to the midpoint of that secondary to the key K.

The voltmeter, V, in the circuit facilitates the adjustment of the filament and is recommended in lieu of an ammeter for this purpose.

The grid leak of Fig. 27 or an equivalent one of 5000 to 10,000 ohms should be used in conjunction with a small capacity of 0.002 microfarad to obtain a sufficiently negative potential for efficient operation.

Fig. 45 shows three well designed types of inductances such as may be used at L₁. On the left is one constructed of 1/4 inch O. D. copper tubing and manufactured by Heintz and Kohlmoos; the center one is the well known Radio

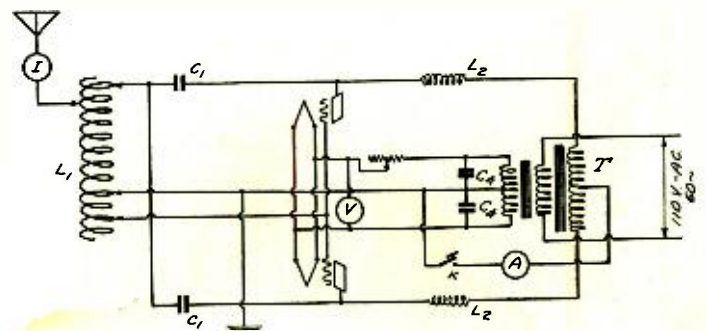

Fig. 47. Two-tube Self-rectifying Circuit

Corporation device made up of edgewise wound copper strip, and on the right is one designed by the author for use in the output circuit of a 250-watt power amplifier. This latter inductance is constructed with a special transmitting Litz.

The milliammeter, A, reading to 250 M. A., and the radiation ammeter, I, reading to 5 amperes, complete the circuit.

As previously stated, Fig. 47 represents a two tube circuit in which the principal of self rectification is employed, one tube availing itself of one-half of the alternating current cycle, and the second tube the other half.

The nomenclature of this circuit conforms to that of Fig. 46, except that L_2 are radio frequency choke coils having an inductance of approximately two millihenries. Honeycomb coils may be used for this purpose.

A 10-WATT POWER AMPLIFIER

THE reader's attention was called to the power amplifier in a previous chapter, as a device for reproducing in greater magnitude currents having an alternating or pulsating nature. For experimental use, especially in shore installations, this device has a multiplicity of ad-

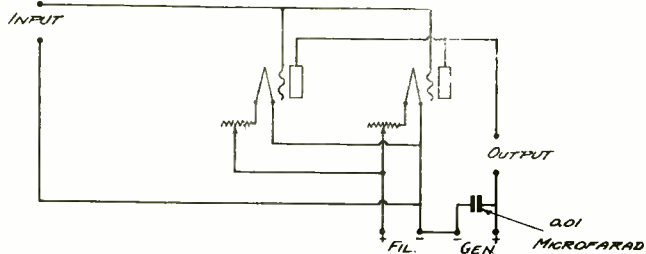

Fig. 48. Power Amplifier Circuit

vantages over other power generators of the vacuum tube type which operate in circuits involving different principles and which have been considered heretofore. Some of these advantages may be stated briefly as follows:

(1) Practically all experimenters who are using vacuum tube circuits for the first time are prone to begin by constructing low power equipment involving, for example, one or two 5-watt tubes, or one 50-watt tube. The progressive experimenter of today spares little expense in making his installation the best that can be had and very often even a small set represents an outlay of several hundred dollars.



Fig. 50. 10-Watt Power Amplifier

The time soon comes when a more powerful installation is required and, ordinarily, the construction of a 5 or 10-watt set does not, for example, permit of the mere substitution of two 50-watt tubes to form a 100-watt set, or the substitution of a 250-watt tube to form a ¼ kilowatt set. To scrap, or reconstruct the low-powered equipment then represents a distinct loss. Few experimenters are aware of the fact that by the addition of a power amplifier having the desired output all of the advantages of totally new equipment may be had and many more, which are inherent in the power amplifier.

(2) The frequency of the emitted wave is more or less independent of the constants of the antenna circuit, consequently, fading of the received signal is less liable to occur because of a swaying antenna or moving objects in the electro-static field of the antenna. Such fading is very pronounced in present day experimental C. W. transmitters not

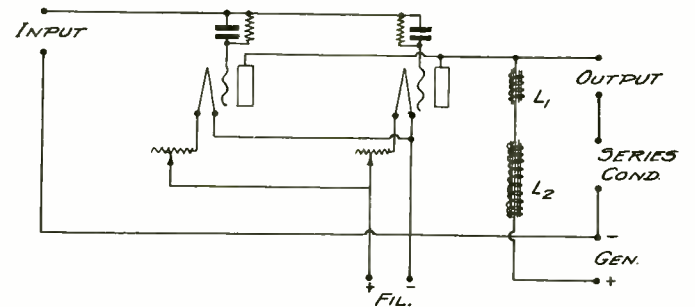

Fig. 49. Circuit for Use Either as an Amplifier or Oscillator

employing the amplifier as a means of obtaining the desired power output.

(3) In ordinary radiophone circuits involving even moderate powers (50 watts) it is very difficult to obtain the telegraph to telephone transmitting range ratio that is possible with much lower powers (5 watts) and oftentimes the experimenter is discouraged to learn that with his new 50-watt set he is obtaining no greater telephone range than was had with a previously constructed 5-watt set, although the radiation current is many times greater. This is due to the fact that the percentage modulation of the emitted wave is lower in the case of the higher-powered equipment. Distortion of the emitted wave also follows low percentage modulation. The use of the power amplifier overcomes all these difficulties, for the entire wave is amplified and the same percentage modulation obtains as was the case with the lower-powered equipment.

(To be continued)

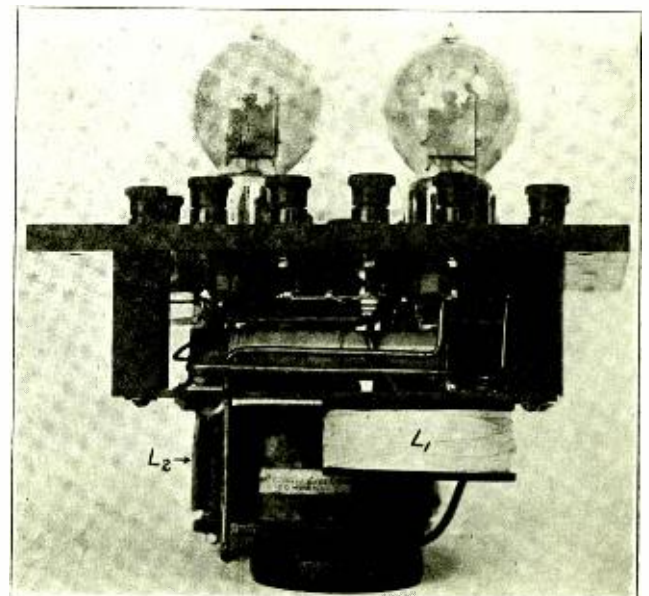

Fig. 51. Interior of 10-Watt Power Amplifier

Crystal Detection With Tube Amplification

By Gerald M. Best

THE present country-wide interest in radio has brought forth some queer looking pieces of apparatus, both new and old, and the German Army field receiving set shown here is so unique that a short description of its principal features will prove of interest to all.

The complete outfit was captured by Capt. John Robertson of the British Army in 1918 and has since reposed in the ex-soldier's pile of souvenirs. His description of how he captured the set is as follows:

"Just after the big German drive of 1918 had been stopped and we were counter-attacking all along the line, I

form of mine, but a wireless apparatus of some kind. Anyhow, having had some past experiences with our friend the enemy, I took no chances and cut all the wires and went on with the war.

"Later on I had some spare time and went back to investigate the boxes, ultimately getting them back to my headquarters, where I got a signaller friend to explain things a little to me. Incidentally I might mention that the trenches overhead were taken and retaken about half a dozen times while we were below in the tunnels."

Wishing to take advantage of the numerous concerts, he recently had the set adapted for American tubes, since

seen the wavelength changing switch, with settings of 120-180, 160-250, 240-400 and 300-800 meters. The primary air condenser (Luftdrahtkreisabst) is directly under the wave control switch, and is cut out of a solid block of aluminum, as is the secondary air condenser (Zwischenkreisabst), at the right of the panel. At the top of the panel, in the center are the two replaceable units, the test buzzer and the crystal detector, the latter being of the composition mineral type, with soft iron contact spring. The coupling control dial occupies the center of the panel, and a switch to cut the secondary air condenser in or out of the circuit is at the upper right hand

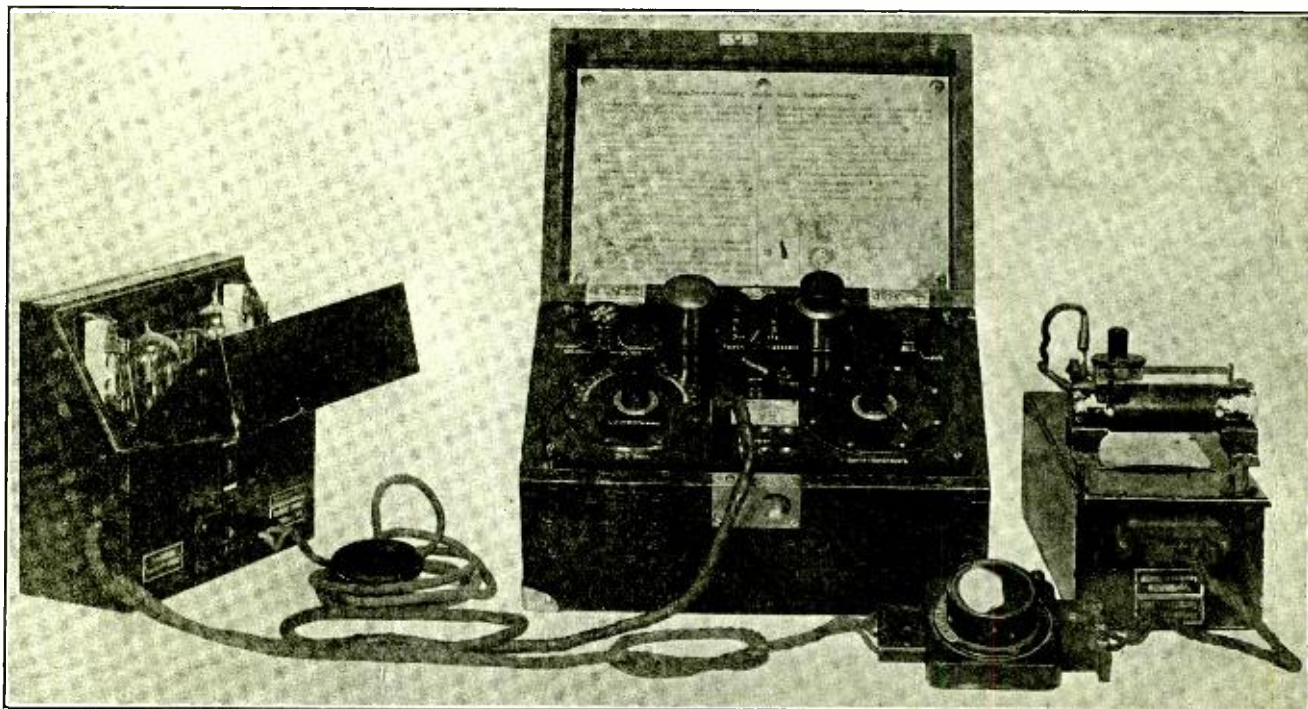

Fig. 1. Complete German Army Field Receiving Set

was with my division just south of Arras. We attacked Boisieux-au-Mont (P. de C.), taking that place, Croiselles and other villages, in several days very heavy fighting, and were finally halted by the Hindenburg line in front of Bullecourt, that 'health resort' of the Australians. This we prepared to attack and I had a fighting patrol to take into the Hindenburg tunnels which ran all the way under the Hindenburg line. I had also to deal with any 'booby traps' and mines I found there. After several incidents with traps and enemy parties, I came on one elaborate trap which puzzled me a lot. I sent my men back a bit and then proceeded to investigate—very gingerly—in the dark.

"It took me some little time to realize that the elaborate mess of wire and mysterious boxes was not a new

the German tubes were burned out, and is now enjoying the daily entertainment which the ether affords.

Referring to Fig. 1, the assembled apparatus is seen to include a tuner with crystal detector, a two stage amplifier and a battery box, which is complete with voltmeter, flexible connections and a filament rheostat. All instruments are connected with flexible cords and plugs, not a binding post or lug being used. Each plug is plainly marked to show the proper location and even a novice could easily connect up the set.

The tuner is the outstanding feature and shows the manner in which the Germans constructed their war radio equipment to withstand heavy shocks, and the wear and tear of trench use, yet remain withal scientific instruments of precision. At the left hand side of the tuner is

corner of the set.

Fig. 2 shows the back of the panel, with the primary and secondary inductances and the various switches. All wiring is done with square copper wire, enameled in colors for ease in tracing the connections. The primary inductance consists of 120 turns of litzendraht wire wound in a three inch roll and fastened to a micarta disk by means of silk threads. This coil is tapped every 30 turns, and the leads brought out to the wavelength changing switch. The secondary coil is wound in the same manner as the primary and consists of 80 turns of litz mounted on a small disk. The coil, which is separated from the primary about one inch, is rotated eccentrically with respect to the primary to give 180 degrees coupling and produces wonderfully sharp tuning through

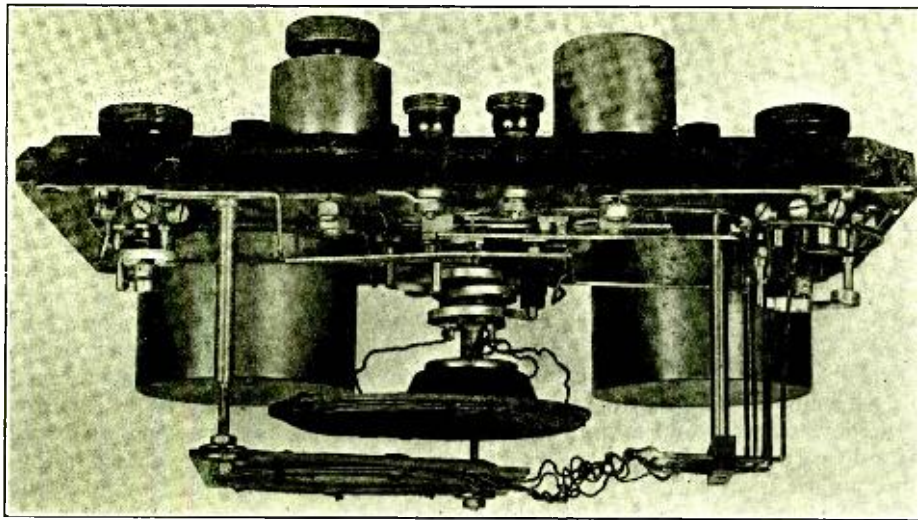

Fig. 2. Back of Panel

the entire range of the set. The secondary air condenser is calibrated in terms of the wavelength in meters, and by aid of the buzzer (which is bridged across the primary circuit when adjusting), the circuit may be made resonant at the desired wavelength without the necessity of listening for the actual radio signals.

The two stage amplifier (Verstärker) is remarkably similar to the present day vacuum tube sets, and consists of a step-up transformer for the input to the first tube, an intertube transformer, and two type EVN-171 Telefunken vacuum tubes.

One of these tubes is illustrated in Fig. 3, and shows the peculiar construction of the elements. The filament is of tungsten, in the form of a horse-shoe, and requires a current of about one-half ampere at four volts. The grid is spiral in shape, and is directly above the plate, all three elements being held in place by the glass stem. Tubes of this type have no tips at the top of the bulb, this point being at the lower end of the tube, concealed by the base. Its characteristics are similar to the AP amplifier, and it delivers about the same amount of power.

A switch provided on the front of the amplifier cabinet enables the operator to connect the phones either to the crystal

detector only, or the two stage amplifier, the switch lighting the filaments at the same time the phones are connected to the amplifiers. The filament current is controlled by an external rheostat, shown in Fig. 1 on top of the battery box. A voltmeter is employed to adjust the filaments to the proper voltage. The plate battery consists of four 22½ volt units, to furnish 90 volts, and four small American radio type batteries of 22½ volts made a perfect fit in the battery box.

Fig. 4 shows a schematic circuit of the entire assembly of apparatus.

After replacing the German sockets and tubes with American types, and cleaning the switch contacts, the set was connected to an amateur antenna for a test. On 200 meters, amateur spark signals were copied up to 750 miles at night, and 300 miles in the daytime, while on 360 meters the concerts from KFC in Seattle, Washington, were plainly audible in San Francisco. This proves that successful amplification of crystal detector signals is quite possible. While such a method is not advocated where a vacuum tube detector is available, it is of interest to know that such a thing can be and has been done, even many years ago.

Trans-Pacific Naval radio service for commercial and press purposes has been extended until June 30, 1925, by means of a bill signed by President Harding. This extension, however, does not apply to messages designated for China, as that service terminates on January 1, 1924, on account of international wireless agreements. The signing of this bill relieves many business concerns and news services, especially on the Pacific Coast, as the present commercial facilities are said to be inadequate and expensive.

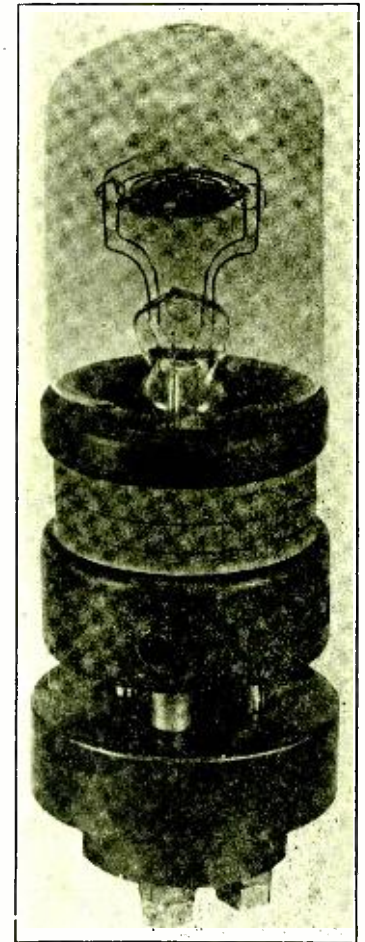

Fig. 3. EVN-171 Telefunken Vacuum Tube

The radio-equipped hotel is a probability of the near future with a radio receiving phone in every room. The Hotel Bellevue of San Francisco now supplies the patrons of its dining room with radio concerts by means of a pair of phones on each table. Seventy of these phones are connected to a central receiving set consisting of a detector and two stages of amplification.

Canned wireless was secured by W. E. Weaver of Hespeler, Ontario, when he used a dictaphone to record the music given by his loud speaker when KDKA was on the air at Pittsburg, Pa.

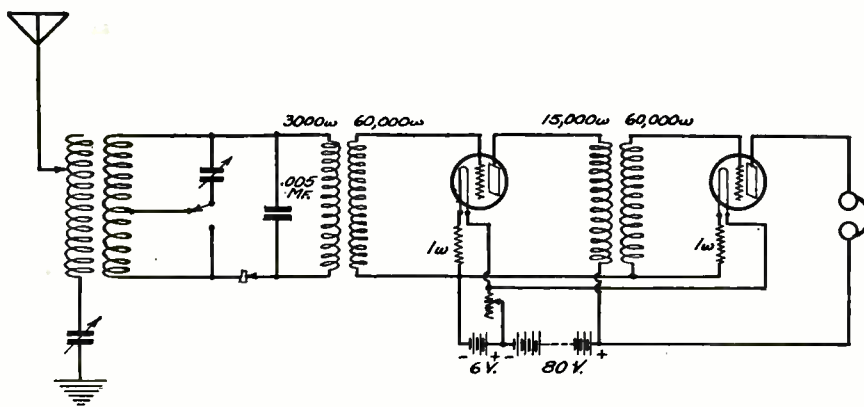

Fig. 4. Schematic Circuit of Crystal Detector and Two Stage Tube Amplifier

A 10-Watt Self-Rectifying C. W. Set

By O. Schuwendt

IN the following article the writer will describe the construction of a small and compact C. W. set of a type now in much favor. The set is entirely self-contained and is about as compact as can be made without lowering the efficiency by overcrowding the panel. The table space required is only 10 by 10 in., while the overall height is only 14 in.

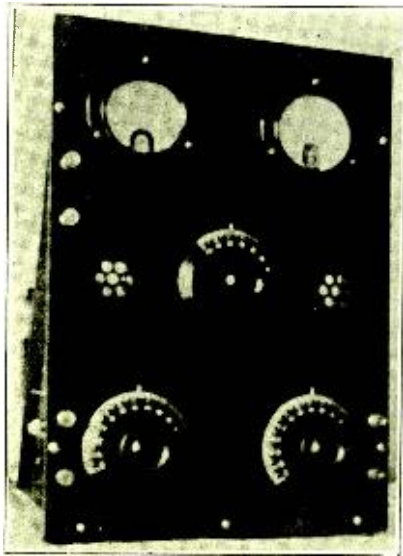

Fig. 1. Front View of Set

eliminate the high voltage on the key right at the operator's finger tips which is so easy to get against and is far from pleasant. The low voltage transformer is designed to deliver 8 volts terminal voltage and is provided with a center tap on the low voltage side. The high voltage transformer is of the split secondary type giving approximately 750 volts on each side of the center tap. It should be remembered that these transformers have been designed for the use of only two tubes and while they might stand an additional load it is not recommended.

With reference to the wiring diagram shown in Fig. 4, the following nomenclature is used:

- L₁ Main inductance.
- L₂ Grid coil.
- L₃ and L₄ Radio frequency chokes.
- L₅ 25 henry smoothing choke.
- C₁ Grid coil tuning condenser .0005 to .001 mf.
- C₂ Grid condenser .0005 mf.
- R₁ Grid leak, 10,000 ohm semi-circular graphite potentiometer sector.
- C₃ and C₄ Blocking condensers, .002 mf., preferably mica, able to withstand at least 1000 volts.
- R₂ and R₃ Filament rheostat, 1½ ohm 3 amp. capacity.

- C₅ and C₆ .001 mf. condensers. Can be of paper dielectric type.
- T₁ Filament heating transformer.
- T₂ High voltage transformer.
- K Key.
- MA Milliammeter, 0-150 milliamps either hotwire or dc. type.
- HWA Hotwire ammeter, range 0-2 amps.

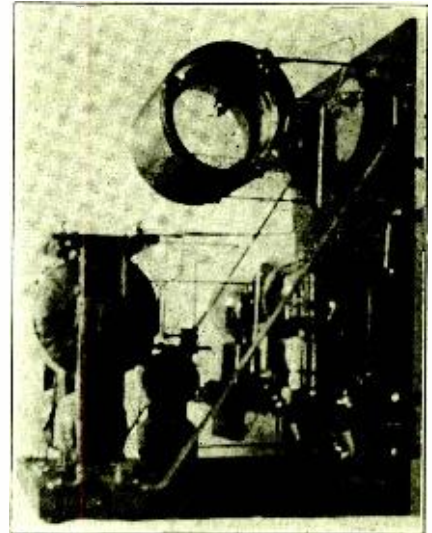

Fig. 2. Rear View of Set

The set uses two 5-watt tubes in the circuit known as the reversed feed-back or British Aircraft circuit, which has been slightly modified to allow the self-rectifying feature to be used. This modification has the additional advantage of putting nearly all the various parts at ground potential, which is to be desired.

Figs. 1 and 2 are pictures of the set which will serve to give the builder a clearer conception of some parts which might not be made clear otherwise. In Fig. 3 is shown the assembly drawings of the set with general overall dimensions. Although the choke coil can be placed under the tube shelf as shown it would be preferable to place it between the shelf and the transformers, where there is enough room and which will allow the connections of the choke to be reached more readily for purposes explained later. Similar mountings to those of the transformers can be provided for the choke, as was done in the case of the set built by the writer.

There are two transformers provided, one for lighting the filaments of the tubes and the other for the high voltage for the plates. The main object in having the two transformers is that it enables the primary side of the high voltage transformer to be controlled rather than the secondary or high voltage side in telegraphing. This will

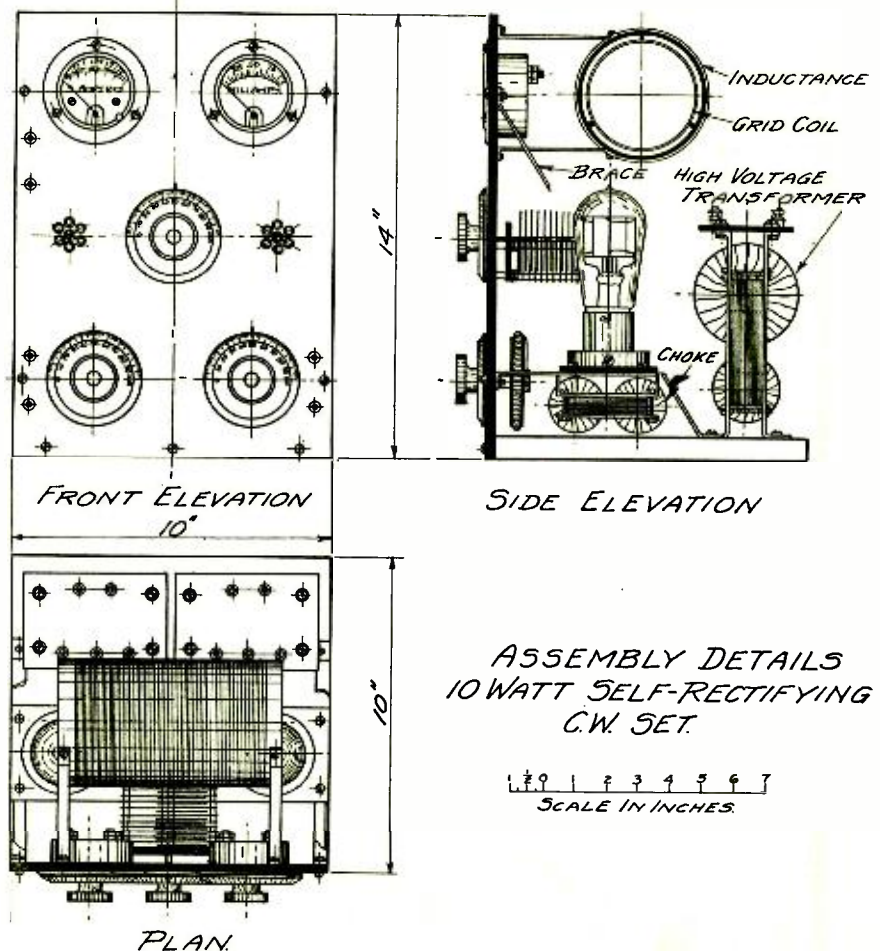

Fig. 3. Assembly Details, 10-Watt Self-Rectifying C. W. Set

In constructing the set it is well to begin with the laying out of the panel. This is made of $\frac{3}{4}$ in. bakelite or formica. The dimensions for the location of the various holes and their respective sizes are shown in Fig. 5. Before attempting to do any drilling the builder should lay the panel out to full scale on a sheet of drawing paper with all holes

The inductance can be one of the various types now on the market or the builder can purchase a threaded formica tube and wind his own inductance. It should be about 4 in. in diameter and should have at least 30 turns of No. 12 or 14 bare copper wire. No switches are provided for varying the inductance, but this can be accomplished by an im-

proved clip of some kind and after all adjustments have been made and the set is tuned to the proper wavelength the two variable leads should be soldered in place. This does away with a mass of connections and is really the most efficient method of making the connections to the inductance.

The grid coil may be made up in practically any manner which the builder may desire, but the writer would recommend a method which is both simple and effective. A tube, preferably of formica, about $\frac{1}{2}$ in. less in diameter than the inside diameter of the main inductance tube, should be wound with 25 turns of No. 14 D. C. C. wire. A tap should be taken off at the 10th turn, which will enable the operator to obtain either 10, 15, or 25 turns on the inductance coil as might be required in his particular circumstances. The proper end of the grid coil to be connected to the ground will have to be determined after the set is put in operation in much the same manner as the proper connections for a tickler coil in a receiving set. The grid coil can be fastened inside the main inductance either by means of small

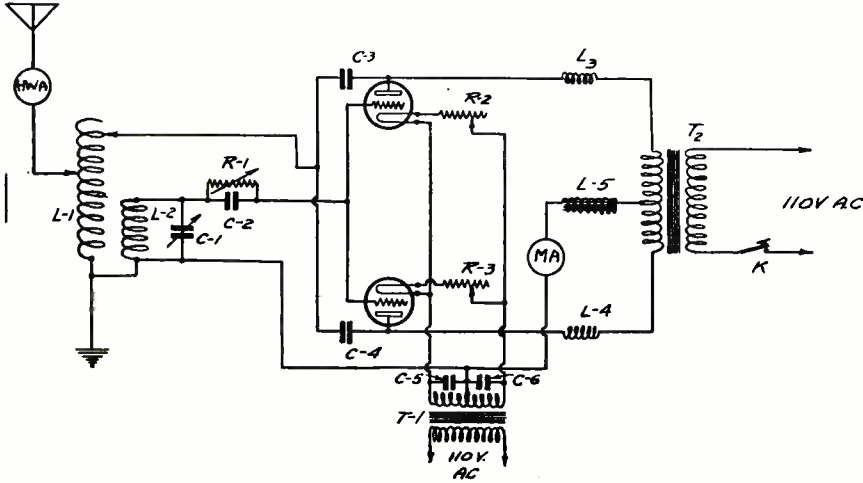

Fig. 4. Hook-up for 10-Watt Self-Rectifying C. W. Set

located on it. This is then fastened to the panel and the centers for the holes should be marked through on to the panel with a sharp prick punch. This method gives a good center for the drill and insures an accurate layout of the panel. It is well to drill through the panel first with a small drill for all holes before drilling through with the specified size of drill. The observation holes are made by drilling through with a small drill as stated above and then countersunk with a $\frac{3}{8}$ in. diameter drill on each side, after which the hole is drilled on through with a $\frac{3}{4}$ in. drill. The large holes for the meters will probably present the greatest difficulty in drilling the panel and if no other means is at hand the builder will probably have to drill a series of small holes around the circumference of the opening and afterwards smooth the hole with a half-round file. After the holes are all drilled the builder may either grain the surface of the panel or polish it as may suit his fancy.

The tube shelf is a simple job as it requires only a few holes to be drilled as indicated in the drawing in Fig. 5. The braces and tube shelf brackets are each made up as also shown in the above mentioned figure from $\frac{3}{32}$ in. thick by $\frac{1}{2}$ in. wide brass and should present no difficulties.

The base consists of a piece of mahogany or other suitable wood $\frac{3}{4}$ in. thick by 10 in. square. The edges should be slightly rounded to improve the appearance and should be given a couple of coats of shellac before fastening the panel to it. Four small rubber headed tacks should be provided underneath at the corners of the base.

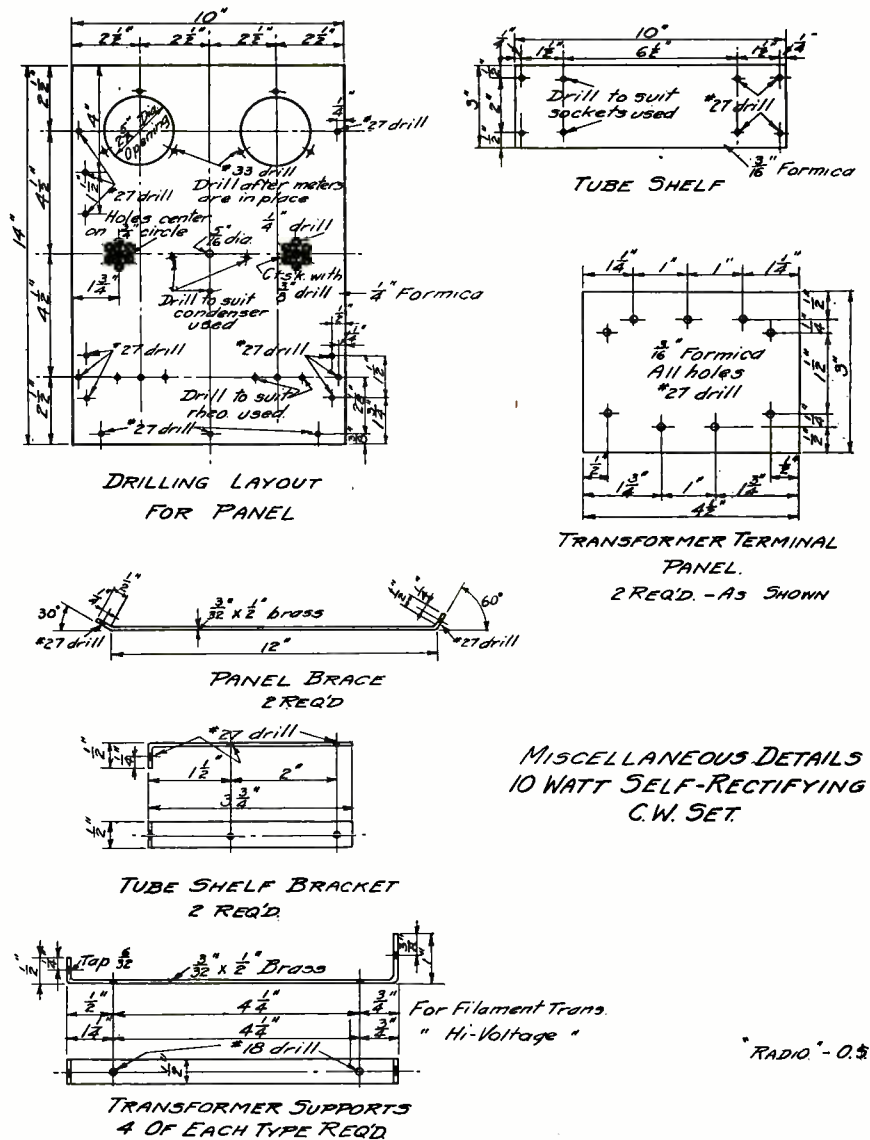

Fig. 5. Miscellaneous Details, 10-Watt Self-Rectifying C. W. Set

bakelite or formica wedges or by means of small brass brackets, or any other method that the builder might prefer.

The main inductance might well be fastened to the panel by means of brass brackets as shown in the assembly drawing. If placed as shown the upper screw in the meter flanges can be used as one fastening and the other bracket can be fastened by a screw countersunk in the panel and hidden behind the flange of the meter. Binding posts are provided for aerial and ground connections and for the key and power. The two at the upper left hand part of the panel are for the aerial and ground connections and those directly below are for the key. The other two binding posts on the right hand side of the panel are for power leads.

As can be seen from the various details of the set, standard pieces of apparatus have been used wherever possible, such as: General Radio hotwire ammeter, Jewell milliammeter, Remler rheostats, General Radio sockets, etc. Almost any type of variable condenser of the required capacity can be used across the grid coil as no high voltage is applied across it and there is no danger of it breaking down.

The construction of the transformers is an interesting part of the construction of the set and the builder should not become doubtful when he reaches this point, as it is not as difficult a job as might be expected. It will be necessary to rig up a small winding device of some sort which may be nothing more than a square block of wood of the proper size for the coils mounted on a shaft and provided with a crank. If the builder can devise a means for fastening a speed indicator or revolution counter of the common type at the end of the shaft to keep track of the number of turns much time can be saved and the work made much easier. This will enable the winding form to be revolved at a speed greater than the speed of the crank by driving the form by means of a belt and having the crank fastened to a large pulley that can be made from half inch wood. A sketch of the method used by the writer in winding his transformer is shown in Fig. 7. This also shows the wooden side pieces that are used in winding the secondary sections. These are not necessary for the primary windings.

In winding the transformers the primaries should be considered first. A

square form is made of medium weight cardboard in one thickness and should measure $1\frac{1}{4}$ in. on a side and should be about 3 in. long. A few layers of paper are wound on the square wooden form of the winding rig to make a fairly

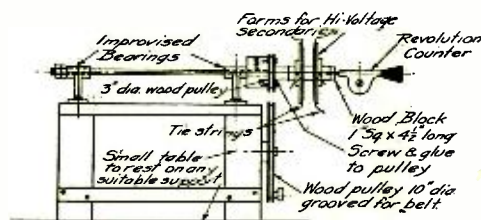

Fig. 7. Winding Rig

snug fit for the square tube made above and the latter then slipped on over this. The primary of the filament transformer is to have a total of 735 turns of No. 24 D. C. C. copper wire and the primary of the high voltage is to have 765 turns of the same size wire. The two primaries together will take about one pound of wire. In winding the coils each layer is wound with one turn less than the preceding layer and this will give a tapered form to the winding. After winding the coils are slipped off of the winding rig, the square cardboard form is trimmed flush with the edges of the winding and the coils are then wrapped with either empire cloth tape or with linen tape which is later varnished or shellaced. It should be noted that the square cardboard form is allowed to remain inside the coil.

The low voltage winding of the filament transformer is also wound on a square cardboard form identical with the one above and has 54 turns of No. 14 D. C. C. copper wire with a tap taken off at the center of the winding or 27th turn. The cardboard form is also cut off flush with the winding and left inside after which the coil is wrapped as before.

The secondaries of the high voltage transformer are each wound separately. These are wound on square cardboard forms as were the other coils, but it is also necessary to provide circular discs with square holes on each side of the winding. The blocks shown on the winding rig in Fig. 7 are used in this case in order that the coil may be wound to a given size. The space between the side pieces should be just $1\frac{1}{8}$ in. Four strings should be put on the form in such a way that when the winding is completed they can be tied and the winding held securely in the desired shape. The coil is then slipped off the winding rig, the inside form trimmed to size, the circular pieces trimmed down to the limits of the coil and then the coil should be wrapped as before. Each secondary section is wound with 5200 turns of No. 32 S. C. C. wire and need not be wound on in layers which will make the con-

Continued on page 48

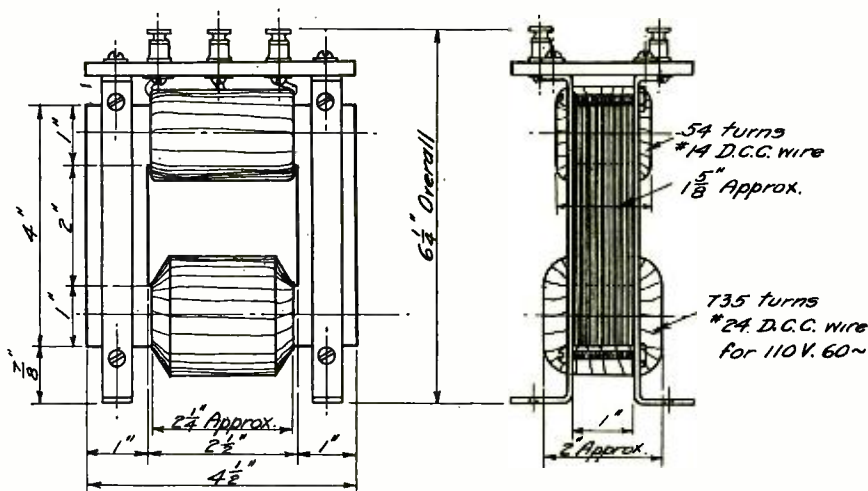

Fig. 8. High Voltage Transformers

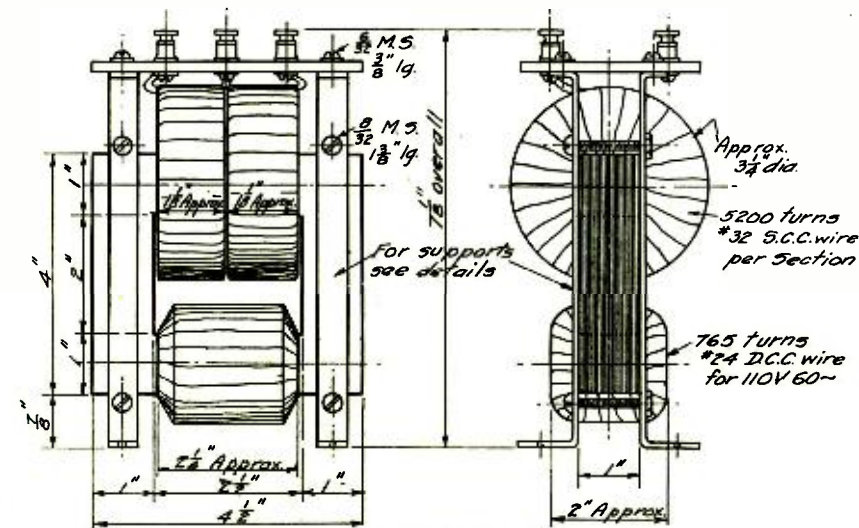

Fig. 9. Filament Heating Transformer

Scratchi Flunks in Severe Test

By David P. Gibbons

To Editor "RADIO" (which pours soothing oils on troublesome ether at welcome intervals):

Dear Mr.—

On opening day of month which have just left us behind—to witty, May One (National Holiday for Bolsheviks), my cousin Scratchi make very vain attempt to gain new style license.

Before he go for exam. Scratchi have devote several daily hours at local ham foundry gathering speed and can copy group-spasms like 6BJW2 and so forth at thirty per, so for grand final he give himself special tryout at NPG's spark press. He claim world record, as he grab all of regular code letters and quite a few of Indian signs and Hungarian characters which operator insert to make press of interest to the generally public. He then make brief trip on luxurious lumber tub and for practicing, he revise downward all apparatus on board it. While doing thus one day, mate of this ocean blood-hound stick head into shack and yap out:

"Hay, you! I smell something like burning rubber!"

"I should inform jap-eyed universe that you always do so!" Scratchi quiz him. "Mightbe heated bath would assist you!"

Such nasty cracker make the 90% Scowegian person quite rattle and he blow out: "Shut down! Pipe up! you poverty fish! I should knock you along for roe of ferry buildings!" But Scratchi throw lightning switch into neutral and fill shack with blue fiery-works and mate go away from there.

On return he approach Hon. Govt. Insp. for slight receiving test which are all he believe necessary for such. Jolly Insp. Gent however remove this depression and express details of examinings which brite youths must pass thru from now onwards when desiring tickets. My cousin tell me in very peevy speech what he think of these, and whilst I think sometime he are rather silly burro, as Limo one time inform him, yet, as even you can see, Mr. Editor, he have perhaps cause for present burstup.

First question which he pose at Scratchi are to know if he possess startled memory for people with faces, and my cousin assure him: "Indeed yes, I have first rank diploma from Mr. Rott's Memorial Corresponding School, and can call back time when NPX last answer ship call."

"That count ten points," say Hon. Insp., "since to be purser you must rapidly detect stowaways and bums from company officials making underground trips. What are your experience as good mixer and shaker?"

My cousin deny he are chasing bartender job, but Insp. tell him that good purser must be expert handshaker and easy mixer amidst all classes including movie actresses and so forth.

"But I are only seeking radio test for operating license," Scratchi blurb with vacant expression of really bug.

"That come last," shoot examiner gent, "and only count two points. I now wish to discover if you have some freight clerking abilities concealed on your person," and he donate to my cousin lengthy list of edisons which he must answer right off the batter. For an instance, here are some:

(1) What are true rate on ripe tomatoes, burlapped and folded flat?

(2) How should you classify shovel handles, in glass, not decorated and how many per cents extra for refrigerating same when not requested by shipper?

(3) Give correct rate on eggs, nested, but not otherwise indicated by names.

(4) What are rate on fresh bootleg in boxes, bales, barrels, cases, cartons, lockers, trunks, gunnysax an' everything?

When my cousin have arrived at number four he was waving head sideways like movie comedian who have just received heavy policewallop on dome, but number five was the cat's mustache and he crumble over in exhaust. Hr. nr. 5. How would you classify Ford car which come on board with no paint scratched, no fenders dented or bent and no lamps or tires missing?

Insp. endeavor to insert in Scratchi's mind that this one are mere absurd goak, but he seem slightly dizzy upstairs still and make serious response thus:

"I should wait until after bedtime story hour, and then, taking large

monkey's wrench along, crawl into cellar of ship where such car are stowed and I should make this Lizzie conform to rule 3-11-33 or hop into ocean or both."

Scratchi then require to know how many other knowledge branches are necessary to grasp such combination positions, and examer announce he must learn inside story of hash-making so as to assist steward and must also take intense course in squeegee technick to help along bo'sun dept.

"How far shall this combination exude?" Scratchi deplore in quenched tone.

"Until ship crew are again one man job like well known Nancy's Brig," say merry tester gent. "Then operator will do everything from skippering to cooking."

"Everything?" gasp Scratchi.

"Except operate!" yip Inspeck.

So, wishing you several kinds of luck, Mr. Editor, I still remain your combination reader and writer,

HILOLI NOGO.

THE RADIOPHONE

By EARL ENNIS

A mystery box, held in the hollow hand of Science—

A lamp aglow with whirling atoms caught from space,

A shore where billows ripple in from distance oceans,

A force that startles—like a slumbering giant's face.

Man's listening ear—new-tuned to higher rhythms,

Hears here the conch-shell roar of unseen time—

Through this, he tears another veil asunder, And lifts himself another inch from out the slime.

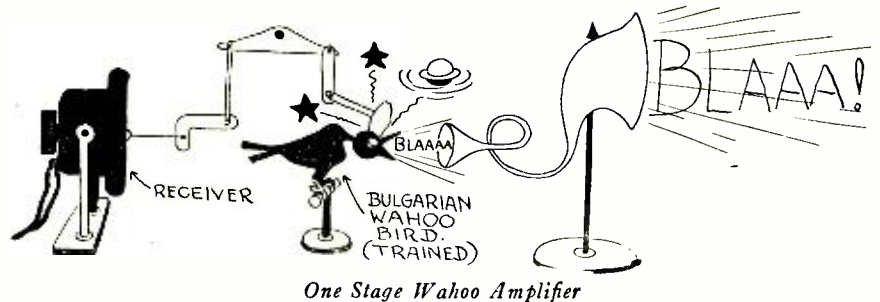

The Conquest of Ouglamuck

A Samuel Jones Story

By Volney G. Mathison

I HEAR there's some rumors goin' around in th' United States that I've abandoned my old peaceful profession of brass-poundin' an' degenerated into one of them highbrow conglomerations of hydrophobic algebra, discomposed electrons, an' dumfoundin' decrements otherwise known as radio engineers. But I want to make it plain that all them reports about my havin' adopted a new system of defraudin' my employers out of three squares a day an' a place to sleep are nothin' but low-down misrepresentations.

Radio engineerin' an' myself have separated company. Constructin' wireless stations is all right in books an' amateurs' wood-sheds—but not in Alaska. Buildin' power-houses an' raisin' hundred-an'-fifty-foot wireless-masts up among th' Siwashes an' snow-blizzards of th' Aleutian Islands is interestin' work; but hereafter I am selectin' some kind of a more soothin' occupation—such as mixin' up nitroglycerin' in a bomb factory, or piloting a flyin'-machine with a busted rudder in a cyclone.

Long about last Christmas, I quits poundin' brass at KVI over on Unga Island, on account of th' insufficient feministic environments; an' after makin' preparations to disunite myself from Alaska on th' east-bound mail-boat, I decides to breeze over to Popoff Island to say farewell to Hell-Fire, my desperate brother-in-radio at KOXN.

Ramblin' in my fishin'-dory around to Pirate Cove, th' hard-boiled hangout where KOXN is dislocated, I finds Hell-Fire sittin' solitary-like up on th' lop-sided wharf, in th' freezin' north wind, his heavy red mackinaw peaked up around his ears, an' lookin' about as joyful as a tom-cat spendin' the evenin' on a back-alley ash-can.

He reciprocates my cheerful greetin's by kickin' his shins against th' side of th' old salmon-barrel he's roostin' on, like a

sourdough tryin' to bust th' ice out a' th' family wash-basin after a cold night, an' remains about as conversible as a Point Barrow iceberg until I remarks that I'm permanently removin' myself off of Shumagin Island *terra firma* in th' mornin'.

"You're quittin' KVI?" he scrunches, twistin' his neck about a sixteenth of a inch.

"Quit already," I repeats.

"Then you're just in time to take a

operator for KOXN won't be here till th' May mail-boat; so I can't leave. You can go an' put up th' station; an' if you want'a operate it afterward, ya can.

"It's gonna be a swell job, because th' company are plannin' on a combination operator-superintendent to boss th' whole works at Ouglamuck—in fact all th' instructions about it are lyin' up there in th' company office right now. Th' sourdough who is runnin' th' joint

at present is showin' too much favor to th' fishermen, an' th' company is disratin' him to straw-boss—so between handlin' th' wireless station an' rulin' over th' codfish snailers, you'll be th' big pebble on th' Ouglamuck beach."

"An' how does th' present Ouglamuck fish-boss feel about gettin' deflated of his authority?" I inquires, prudent-like.

"Oh, he's nothin' but a little calf-livered shrimp," Hell-Fire assures me, careless-like. "Only his squaw is a kinda fractious old hag. Th' company have already sent four different superintendents up to Ouglamuck, an' I've been told that she bothered 'em a little—knifed a couple, an' poisoned one, an' th' last one she made drunk an' burned him up sleepin' in his shack. Ya see, she figures that if her old man loses his job she loses her meal-ticket—"

"Say, I think you better go yourself," I breaks in, somehow feelin' a shortage of exuberance over this proposition. "I might consider relievin' you here at KOXN—"

"Yes, but I can't leave now anyway," intersperses Hell-Fire, decided-like. "I've paid in a hundred an' fifty dollars fer a season's seat in th' spring stud-poker tournament which begins next month up in Five-Ace Sharpeneck's shack—an' ya don't expect me to pass up a whole spring stud-poker tournament just to go an' build a darned wireless station some place, do ya?"

Continued on page 62

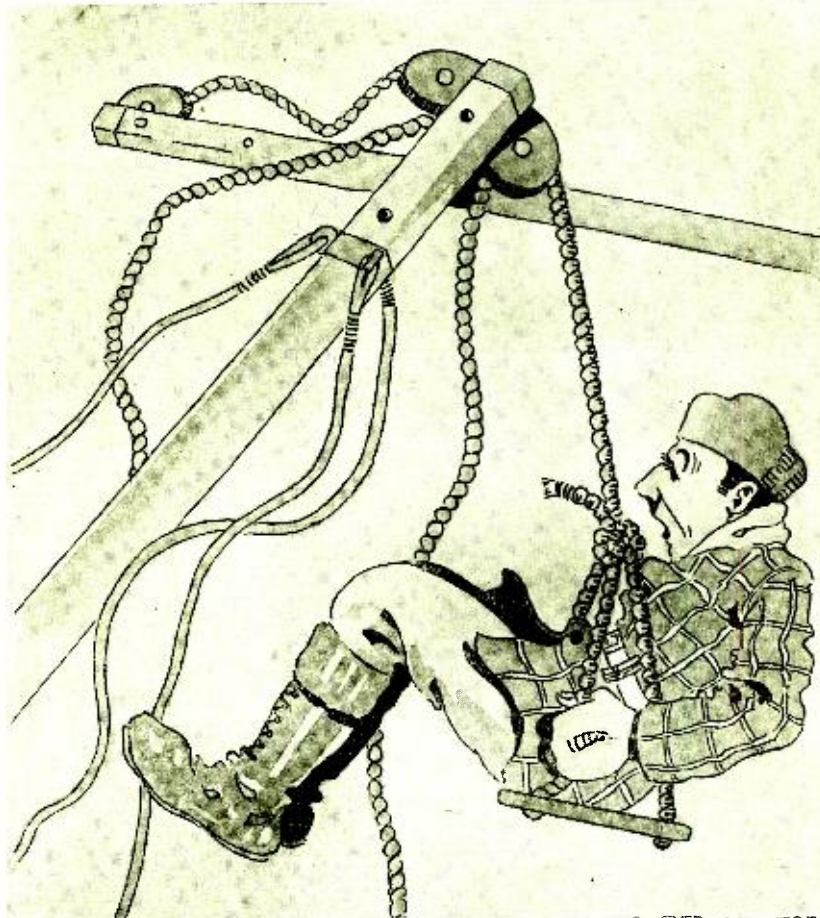

"Leavin' me an' my wireless-pole to start swingin' down through space with th' graceful, breath-catchin' swoop of a shootin' star."

fine job!" exclaims th' infamous builder of KVI and KOXN, his physiognomy crackin' loose into a bunch of refrigerated smiles, like a river breakin' up after a hard winter. "Come up to th' shack, an'—"

"I come over here to say good-bye—not to get another darned hunk of brass to pound," I objects; but Hell-Fire refuses to listen.

"Th' schooner 'Pirate King' is comin' in from Frisco with a load of gear to build a wireless station at th' company's fishin' dump out on Ouglamuck Island," he explains, draggin' me up to his shack; "I'm s'posed to build it, but th' relief

DESCRIPTION OF STATION 2LH

2LH is located at the highest point in White Plains, 22 miles north of New York City and 5 miles west of Long Island Sound. The aerial system consists of a ten-wire cage, 65 ft. long and 70 ft. high. An 18-wire "clock" counterpoise is located beneath the aerial and 8 ft. above ground. A one-wire aerial 200 ft. long is used for receiving, making possible a break-in system.

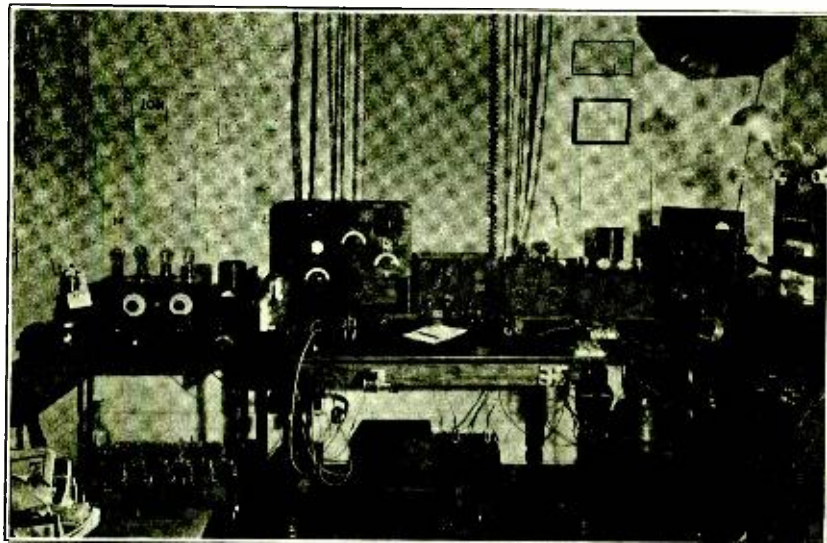

Station 2LH

Normal radiation on four 5-watt tubes is about 4 amperes, 2.8 amperes on two tubes. Until recently but two tubes were used most of the time. 2LH's signals have been reported in 40 states and stations in over 30 states have been worked and traffic handled. Voice signals have been reported as far west as Chicago.

The transmitter consists of four 5-watt tubes, all used as oscillators in a circuit similar to that used by 8LF, 2AID and several other prominent stations. A new rectifier scheme is used which results in a note similar to that obtained from a motor generator set. Voice modulation, even at a very short distance, is nearly perfect, which is unusual for an a.c. phone set. This new rectifier has been given a thorough test at 2LH and it is much superior to anything tried before.

Description of picture from left to right is as follows: Radio frequency experimental set, motor generator 450 volts, experimental 5-watt C. W. set. Pre-war tuner still used for NAA and navy signals. Westinghouse R. C. tuner and amplifier. Radio frequency amplifier, experimental 100-watt C. W. set and the 20-watt set. Battery charging panel on extreme right. Electrolytic rectifier in use at time picture was taken is beneath left hand table.

The operators at 2LH are William S. Halstead and Fred Sipp, signatures DC and FS respectively.

MODIFY RADIO REGULATIONS

THE National Board of Fire Underwriters has issued tentative regulations covering radio receiving installations, that disclose considerable modification as compared with the requirements previously issued by fire underwriters.

The specifications that follow were drawn up by a special committee of the National Fire Protection Association,

graph transmitting stations where antennae of considerable height and length were used and where the hazard of high potential equipment had to be considered.

The recent widespread installation of radio telephone receiving sets has necessitated a revision of the regulations. The receiving set having an indoor antenna is considered devoid of hazard. With any receiving set, the publication says, the principal danger is from lightning brought in over the antenna to the equipment, or to some part of the building. Where there is no exterior antenna this hazard is removed.

The following specifications are for receiving stations only:

RULE 86

NATIONAL ELECTRICAL CODE

Specifications: (For Receiving Stations Only.)

ANTENNA

a. Antennae outside of buildings shall not cross over or under electric light or power wires of any circuit carrying current of more than six hundred volts, or railway trolley or feeder wires, nor shall it be so located that a failure of either antenna or of the above mentioned electric light or power wires can result in a contact between the antenna and such electric light or power wires.

Antennae shall be constructed and installed in a strong and durable manner and shall be so located as to prevent accidental contact with light and power wires by sagging or swinging.

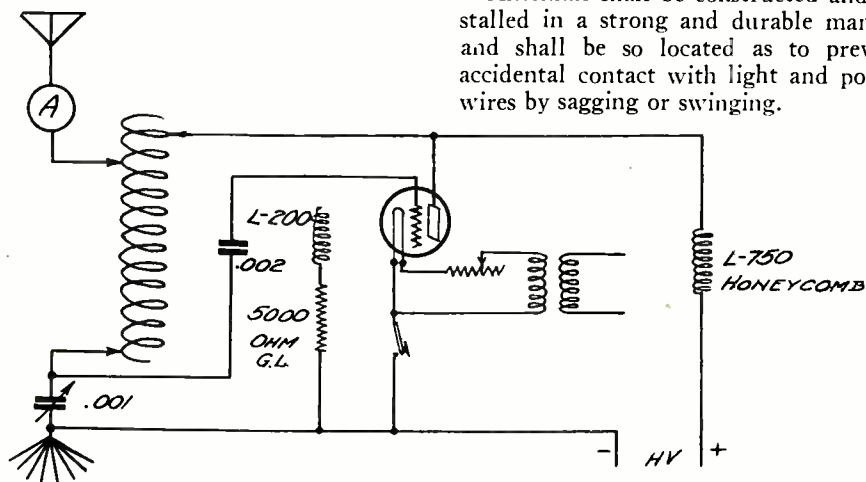

Circuit Diagram, 2LH

which is the authority for the National Electrical Code and whose findings are standards of engineering practice. Besides the underwriting organizations represented upon this special committee, engineers acting for the American Radio Relay League, American Telephone and Telegraph Company, Radio Corporation of America and the Independent Telephone Association, also participated.

The new rules are being published as proposed amendments to be included in future editions of the Electrical Code. It is stated that the requirements contained in the current edition of the code were based largely on the hazards incident to the equipment of wireless tele-

Splices and joints in the antenna span, unless made with approved clamps or splicing devices, shall be soldered.

Antennae installed inside of buildings are not covered by the above specifications.

LEAD-IN WIRES

b. Lead-in-wires shall be of copper, approved copper-clad steel or other approved metal which will not corrode excessively, and in no case shall they be smaller than No. 14 B. & S. gage except that approved copper-clad steel not less than No. 17 B. & S. gage may be used.

Lead-in-wires on the outside of build-

Continued on page 86

A 200 to 5000 Meter Regenerative Receiver

By R. C. Anderson, Long Beach, California

THE receiver about to be described is the outcome of a strong desire, after several years experimenting in amateur radio, for something better—a receiver which would work like the average amateur variometer short wave sets, with the same selectivity plus increased range to cover commercial stations, time signals, and medium wave arc stations. The set can be made by

on the panel, or sub base, at such distance that the windings will be about two inches apart, is a factor of value on the long waves.

The dead end switch on primary is very essential, and it is necessary to connect like diagram so as to short the portion disconnected, or it will be useless. Likewise, it is essential to short the last

tap of the secondary coil to the switch center to eliminate dead end effects and render calibration, as given later.

The panel is best laid out and drilled first, then the switches, tops and condensers assembled. Later the coils and sub base and variometer may be mounted temporarily for alignment, and lastly the parts dissembled, the panel grained first with fine sand paper, finishing with oil stone powder, and oil.

The panel is exactly $17\frac{1}{2} \times 8\frac{1}{2}$ and may be drilled as per sketch and dimensions. The holes for taps and switch centers will of course have to be made to suit the kind of switches used. I used Remler switches, Fada series-par switch, Remler dials, and a Tuska variometer for the plate side, while a Remler or Tuska may be used for the grid side. If Remler is used it will be necessary to remove 5 turns from each side of the center of both rotor and stator, to give the proper minimum. The Tuska is of right inductance value.

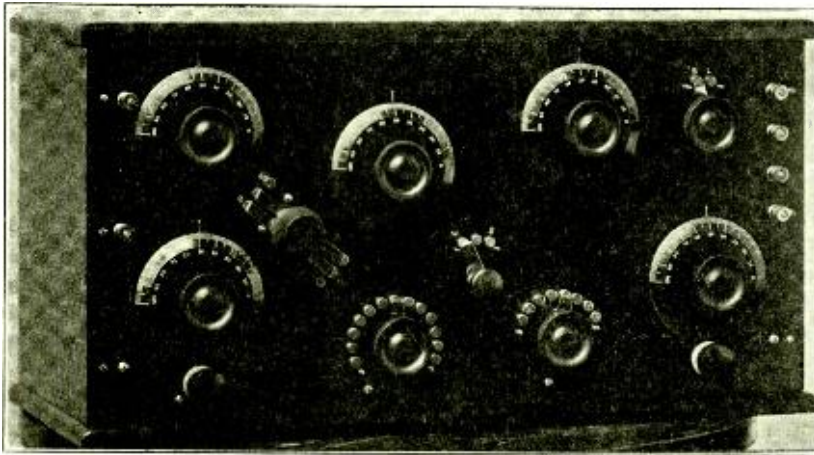

Front of Panel

the average amateur who has a few good tools and some mechanical knowledge at a cost for material and parts of about \$50. The cabinet will cost from \$4 to \$12, depending on the finish.

The parts needed comprise the following:

- 2 variometers of good make (I use 1 Remler and 1 Tuska).
- 2 variable condensers, one 43 plate and one 23 plate (or 29 plate) (Wireless Shop).
- 2 $\frac{1}{8}$ in. formica tubes, 4 in. diameter and average $4\frac{1}{2}$ in. long.
- 1 coupling ring and assembly (should be made in a good shop). Or, formica tubing will be fine, if can be had in proper diameter—secondary, $3\frac{3}{4}$ in. long, primary $4\frac{1}{2}$ in. long.
- 1 series parallel switch.
- 5 3-in. dials, 4 switches, 6 binding posts.
- 1 bakelite panel, $8\frac{1}{2} \times 17\frac{1}{2}$, by $\frac{1}{8}$ or $3/16$.
- 1 piece of thin copper sheeting for shield.
- 3 coupling bushings, of fibre or some good insulating material for bar and coupling shafts.
- About $2\frac{1}{2}$ doz. switch points, stops, etc.
- 275 feet of No. 22 D. S. wire for primary.
- 375 feet of No. 24 (or No. 26) D. S. wire for secondary.
- 50 feet of No. 24 D. S. wire for coupling ring, together with some bus bar wire, etc., for wiring the cabinet.

If the experimenter will make this set to exact detail, he will have something to be proud of, as practically every detail of the design has some part to play in the final performance.

For instance, the coupling ring with a flat face, is far sharper in tuning than a regular oval face coupling ball. Also, the placing of the coils at right angles

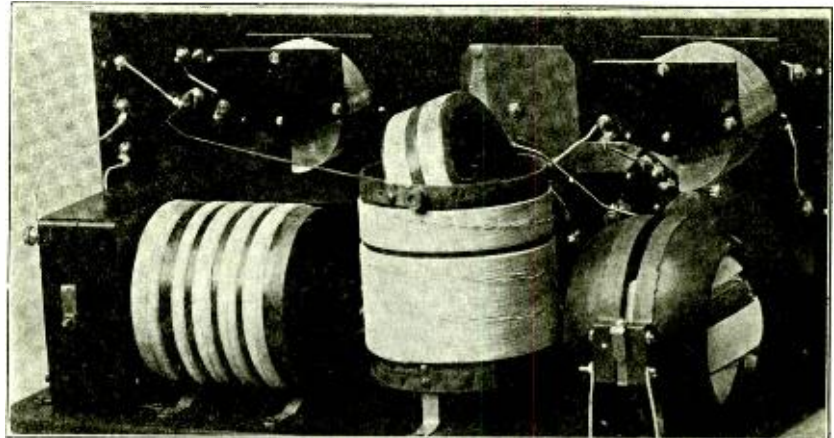

Rear of Panel

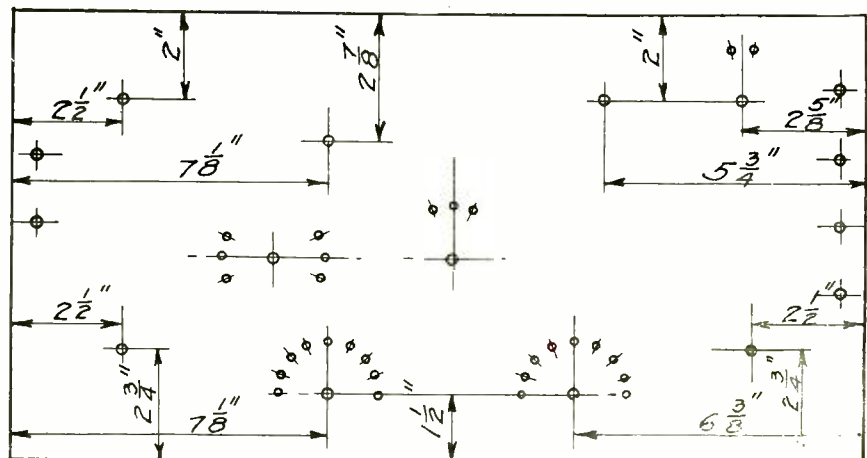

Panel Layout

With the panel drilled and switches assembled, 1 in. radius on switches and condensers mounted, a sub base of three ply veneer $\frac{3}{8}$ in. thick and $\frac{3}{4}$ in. less in length from each end of panel, by about 7 in. wide, should be mounted to panel, allowing panel to go $\frac{1}{4}$ in. below bottom side of sub base.

We are now ready to make and assemble the coils. The primary coil is made as follows:

The coupling assembly having been drilled and mounted for trial, at a point about $\frac{3}{4}$ inch from end of core, start the winding, right hand direction, and make it 2 bank until 55 turns have been wound on, tapping as you wind at the 7th, 17th, 27th, 39th and end of winding. These taps will represent, with a one-wire aerial of about 200 ft. long and an average of 40 ft. high, and the primary condenser in series, 200, 275, 375, 475, 600, 650 meter waves respectively.

tap 10, at 162nd; tap 11, at 190th; tap 12 at 226th, and tap 13 at 262nd, the end of winding.

Using the condenser series, these taps represent the following waves, conden-

The 3rd tap is taken at 74th, and the 4th tap will be at 110th, the end of first section. At this point a $\frac{1}{4}$ in. space is left for the mounting bracket, and the second section started, which

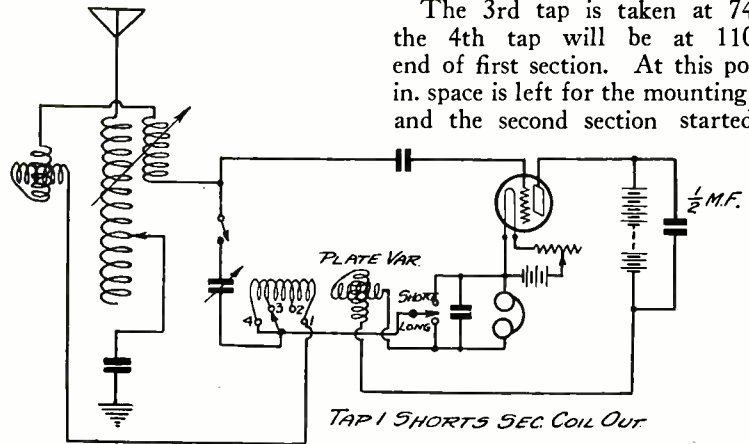

Circuit Diagram

will consist of 46 turns, and the end will be tap 5, representing the 952 wave. The next section has 68 turns and the end of it will be tap 6, or about 1200 meters. The fourth section contains 62 turns and its tap 7 represents 1600 meters approximately. The last section has 73 turns and makes tap 8, the end of winding, and corresponds to about 1900 meters. The calibrations given are meant to be in conjunction with about 10 degrees of the secondary condenser in use. Our idea is to use a minimum of capacity in tuning and give our plate variometer a strong feed back effect.

Two thousand five hundred meters will tune with all the coil in use and 25 points of the condenser. Four thousand six hundred and fifty meters, Mare Island arc time sigs, will tune at about 95, nearly the maximum of secondary condenser. The 600 meter wave will tune on tap 3, and condenser at 10, and 800 meters at tap 4, and condenser about the same.

The coupling ring was turned for me by the Wireless Shop from mahogany to the following dimensions, to fit the core: Diameter over all $3\frac{3}{8}$ in., thickness $\frac{3}{8}$ in., width $1\frac{1}{2}$ in., with a $\frac{1}{4}$ in. center space to separate windings, and also a slight narrow edge each side to hold winding. The face of winding space exactly flat. Forty-four turns of No. 24 D. S. will fill the ring exactly. Rod is $\frac{3}{16}$ in. brass.

No shellac should be used on any of the windings, but Squibb's collodion may be used sparingly in reinforcing the edges of the bank sections. Many articles have appeared from time to time

Continued on page 78

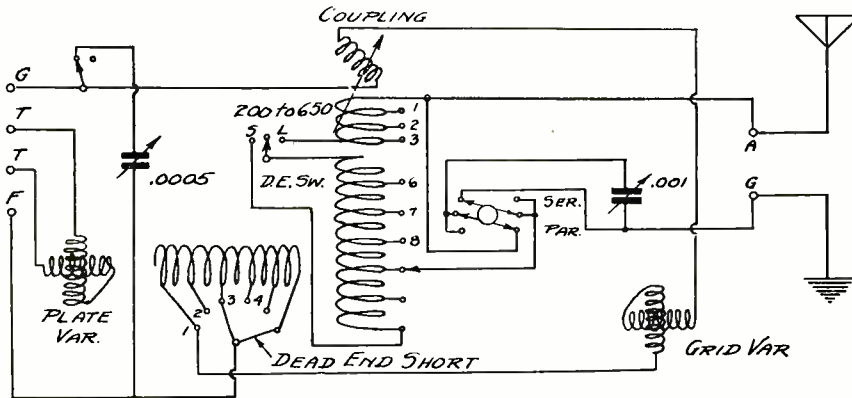

Wiring Diagram

These figures will vary with a different aerial, but there is a good overlap and unless the aerial should have a capacity much less than the one above, the range of from 200 to 650 meters will be covered by the above tappings, and furthermore, if the condenser be switched to shunt, the range will be increased to 1200 meters.

So much for the short end of primary, which by means of the dead end switch shown in diagram, is practically a separate primary.

The 360 to 375 wave for music and experimental stations will tune on tap three, and series condenser about 30. Six hundred meters will tune at tap five (end of winding) and series condenser 50. I strongly recommend using the primary condenser in series on all waves up to 2000 meters on account of sharpness.

Starting our main primary winding at a point $\frac{3}{16}$ in. separation (which should connect to D E switch as per diagram) from end of the first section, we proceed to wind a continuous section of 3 bank type, tapping as we go as follows:

Tap 6, 16th turn, which will be the 69th turn from the beginning; tap 7, at 90th; tap 8, at 111th; tap 9, at 134th;

ser at about 50: Tap 6, 752; taps 7 and 8, 800 to 952; taps 9 and 10, 1200 to 1400; taps 11 and 12, 1512 to 1800; taps 12 and 13, 1800 to 2000.

With the condenser in parallel we tune 2500 meters on the 11th tap and condenser 10, and so on increasing, with all the coil in use, the condenser will reach about 5000 at maximum. The coupling rod should go thru core about $\frac{3}{8}$ in. above beginning of winding.

The secondary coil is made of 4 bank winding wound to right, sectionalized into 5 parts with about $\frac{3}{16}$ in. space between each section. The first section is started $\frac{1}{8}$ in. from margin and wound to the 41st turn, at which point a tap is taken, being tap 2, as the first tap shorts out the coil and represents the beginning of winding.

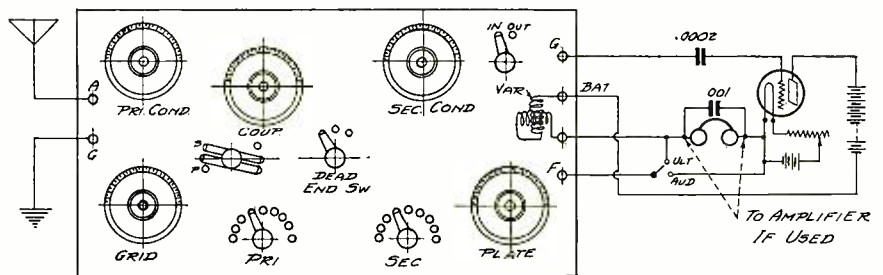

Receiver Hook-up to Audion Control

The Radio Direction Finder

Abstract of Bureau of Standards Paper No. 428

By Frederick A. Kolster and F. W. Dunmore

THE direction finder whose principles and operation are here described is installed on shipboard where it may be operated by the navigating officer who can take bearings at any time in any one or more of the radio fog signalling stations established and operated by the Bureau of Lighthouses. Sailing charts show the location of these stations, whose characteristic signals are automatically transmitted during fogs or such time as may be necessary.

The fundamental radio circuit is made up of inductance and capacity. These elements appear in various forms, and in the ideal circuit, as shown diagrammatically in Fig. 1, the inductance

ing electromagnetic wave depends largely upon its physical dimensions, generally the size and height of its elevated area and in special types of antennas, mainly upon the length of the antenna wires.

Referring now to Fig. 3, we have what may be considered as the reverse of the antenna system shown in Fig. 2. In this case energy is received in the system by virtue of the fact that its inductance L is exposed to the incoming electromagnetic wave or, in other words, energy enters the system by way of its inductance, thereafter to be transferred to its capacity.

The inductance of coil L depends

in the direction C or D , or exactly normal or at right angles to the plane of the coil L , then the signal intensity is zero. In all other directions the intensity varies in accordance with the figure-of-eight characteristics in Fig. 4. For example, in directions OE or OF , OG or OH , the distances ON or OQ respectively represent the relative signal intensities as compared with the maximum OM or OP .

It is immediately apparent, therefore, that if the coil L in Fig. 3 is of sufficiently small dimensions to permit rotation about its vertical axis, signals transmitted from any given source will be received with gradually varying de-

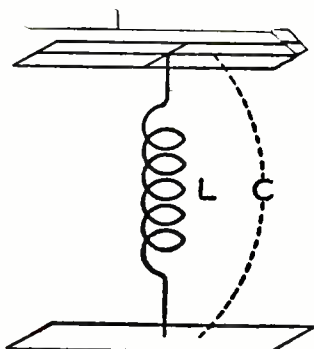

Fig. 2. Antenna Consisting of Elevated Conductors (Condenser Type)

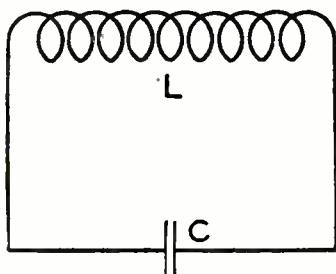

Fig. 1. Simple Radio Circuit

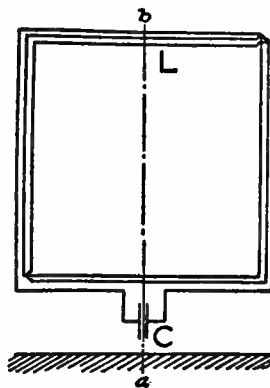

Fig. 3. Antenna Consisting of Closed Coil (Inductance Type)

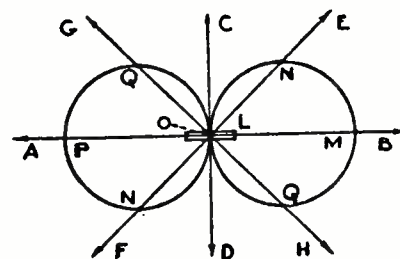

Fig. 4. Theoretical Directional Characteristics of Closed Coil Antenna

is entirely concentrated or lumped in the coil L , and the capacity is likewise concentrated or lumped in the condenser C .

Power may be supplied to such a circuit either by applying a resonant voltage across the condenser C or by inducing a resonant voltage in the coil L , or by action of both in proper phase relation.

In the ordinary antenna circuit, as used in present-day radio communication, we find, generally speaking, that the inductance is substantially concentrated in the form of a coil L , and that the capacity is formed by a conductor or group of conductors elevated above the ground, the elevated conductors forming one plate of the condenser and the ground or counterpoise forming the other plate, as shown in Fig. 2.

It may be said, therefore, that energy is received in the ordinary radio antenna system by virtue of the fact that its capacity is exposed to the incoming electromagnetic wave, or in other words, that energy enters the system by way of its capacity, thereafter to be transferred to its inductance. The electrical capacity of an antenna as well as the potential impressed upon it by the incom-

ing electromagnetic wave depends largely upon these factors as well as the resistance of the circuit. For given physical dimensions, however, any value of inductance may be obtained by winding the proper number of turns in the coil L , so that the electrical dimensions of the coil system are not so dependent upon its physical dimensions as in the ordinary antenna system. As a matter of fact, a coil system of very small dimensions as compared with an antenna may be used for the reception of radio signals.

Although the coil-receiving system is superior in many respects to the antenna system, its chief advantage lies in its directive properties. If the coil L in Fig. 3, for example, is rotated about its vertical axis ab , the received signal intensity from any given source of transmission will vary approximately in accordance with the diagram shown in Fig. 4.

Maximum signal intensity OP or OM is obtained when the plane of the coil L lies in the direction of the source of transmission A or B . If the source is

degrees of intensity until the coil becomes normal or at right angles to the direction in which the transmitting source lies, at which time the signal intensity becomes zero. This position of silence is critical, and therefore may be used to indicate, with great accuracy, the line of direction of the source.

It is upon these simple principles that the direction finder as developed at the Bureau of Standards is based.

As the result of a long series of calculations and experiments, radio fog signalling equipment has been permanently installed on the Fire Island and Ambrose Channel light vessels and at the Sea Girt light station on the New Jersey coast. The radio transmitter is of the quenched spark type, supplied from a 500 cycle, 1-kw. generator. The automatic signalling system at the last named is designed to transmit a characteristic signal consisting of three dots sent out in rapid succession at frequent intervals. The Fire Island light station sends out two dots, and the Ambrose Channel light station single dots. The wavelength is 1000 meters.

A typical shipboard installation is that on the lighthouse tender *Tulip*, as illus-

trated herewith. The direction finder coil consists of 11 turns of insulated wire wound on a rigid skeleton form 4 ft. square. The coil is attached to a shaft which extends into the pilot house through suitable bearings and supported on ball-bearings to permit ease and uniformity of rotation by means of a hand wheel. The bearing of the signalling station is read directly on the magnetic compass card.

A calibration or correction curve was made by taking simultaneous visual and radio bearings as the *Tulip* cruised around the station. This connection scale was attached to the binnacle as shown in the illustration.

From the electrical circuit of the direction finder it will be noted that the variable condenser C_0 together with the coil L_0 form the main receiving circuit which is tuned to the signaling wavelength. Connected across the condenser C_0 , either directly or through a potential transformer P , is the vacuum tube amplifying and detecting apparatus D . This consists of a three-stage radio-frequency amplifier, a detector, and a two-stage audio-frequency amplifier made up as a unit with a minimum number of operating adjustments.

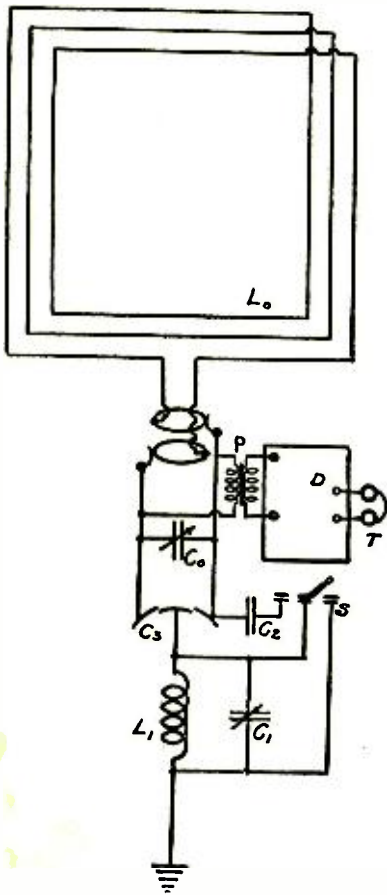

Fig. 7. The Direction Finder Circuit

The telephone receivers T are located in a fixed position at a sufficient distance from the magnetic compass to avoid any effect upon the compass due to the magnets within the telephone receivers. A brass tube is attached to the

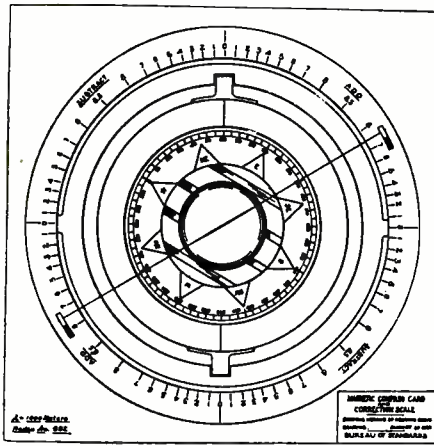

Fig. 6. Magnetic Compass Card and Correction Scale Showing the Direct-Reading Method of Obtaining a Corrected Radio Bearing.

telephone receivers with a flexible rubber tubing completing the circuit to the earpieces worn by the observer. By the proper choice of the length of the brass tube a desirable quality is given to the signal tone by virtue of acoustical resonance.

The auxiliary circuits of the direction finder are controlled by the switch S . With this switch closed to the right, the middle plates of the double condenser C_3 are directly grounded. The double condenser is utilized to bring about electrical symmetry of the coil system with respect to earth. In other words, by adjusting the middle plates of the condenser C_3 to the right or left, the earth connection is brought to the electrical mid-point of the coil system, and the parasitic effects are eliminated, that is to say, the signal received in the telephones T results only from the energy directly received in the coil L_0 .

With the switch S closed to the left, a small condenser C_2 is connected across half of the double condenser C_3 and the inductance L_1 and tuning condenser C_1 are inserted in the ground lead. Under these conditions, the coil system is no longer electrically symmetrical with respect to earth, and received energy enters the coil circuit L_0C_0 directly through the tuned ground circuit of which the capacity of the complete coil system to earth forms a part.

By the proper adjustment of the capacity C_2 and the circuit L_1C_1 , a complete unidirectional effect can be obtained as previously described.

In the practical operation of the direction finder, all tuning adjustments remain set for the 1000 meter wavelength of the signaling station. Switch S is closed to the right when observing the line of direction of a given signalling station and to the left when it is desired to determine the sense of direction. In other words, to determine the line of direction of a station, the coil system which is directly grounded at its electrical mid-point by throwing switch S to the right is rotated to the position of

critical silence, at which time the plane of the coil is normal to the direction of approval of the signalling wave. To determine the sense of direction of the station switch S is closed to the left and the coil rotated to the position of maximum signal intensity at which time the plane of the coil is in the direction of approval of the signalling wave and pointing toward the signalling station as indicated by an index pointer provided for that purpose.

Radio on pilot boats is used at the mouth of the Seine River in France to report the arrival of all vessels and to receive instructions as to where ships are to be placed in the harbor.

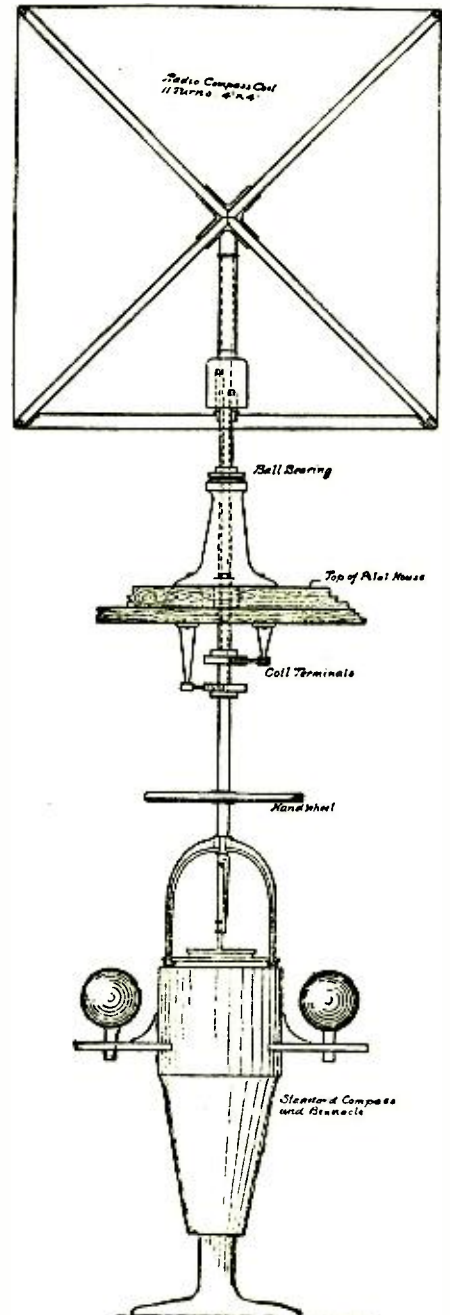

Fig. 5. Radio Compass as Installed on Tulip

A Radio Primer

By H. A. Eveleth

INDUCTANCE AND CAPACITY

Before the details of receiving and transmitting apparatus and circuits are taken up a clear understanding of the meanings of inductance and capacity should be had. The efficient operation of sending apparatus and the tuning of receiving apparatus depends on the proper adjustments of inductance and capacity.

When an electric current flows through a wire a magnetic field is established about the wire. A compass needle placed near the wire will be deflected. If the current is stopped or if there is a variation in the intensity of the current the magnetic field will cease or vary in intensity and a current will be established in the wire in a direction opposite to that of the current which caused the magnetic field to be established. This is due to the fact that the wire is cut by the lines of magnetic force when the magnetic field varies in intensity and, as already explained, a current is set up in a conductor when it is cut by a moving magnetic field. This phenomenon is called self-induction.

If the wire is coiled, the effect will be much more pronounced because the adjacent turns of the coil will combine their effects and the total self-induction will be much greater than if the conductor were a straight wire. The circuit is said to have greater inductance.

A circuit which can store electrical energy is said to have capacity. Do not confuse this with the storage battery which does not store electrical energy but changes electrical energy to chemical energy and later delivers an electric current by chemical reaction. A condenser is used to give capacity to a circuit. A condenser consists of two conductors separated by an insulator, or dielectric, as it is called. For instance, it may consist of two metallic plates separated by a sheet of glass, two conductors separated by air or sheets of tin foil separated by paper. The aerial and the earth and the air between the two form a condenser. The capacity of the condenser depends on the nature of the dielectric, the distance between the conductors, the size of the conductors and the voltage or potential to which the condenser is subjected.

The wave-length of a circuit depends on the product of its inductance by its capacity. Two circuits are in resonance or in tune when the products of the two are equal. A receiving set includes inductances and capacities, the values of which can be varied, and the receiving circuit is tuned to the wave-length of the transmitting station by

adjusting the values of inductance and capacitance.

THE SIMPLE RECEIVING SET

The simple receiving set should include an inductance or a capacity, the value of which can be changed so that we can tune to the wave-length of the transmitting station. It must include a detector of some kind to rectify the inaudible radio frequency oscillations received from the transmitter circuit to an audible frequency which will act on the telephone receivers and produce an audible sound.

The variable condenser usually consists of two sets of metallic plates. One set is stationary and the different plates or sections are spaced a short distance apart. The other set of plates can be revolved so that they slide in between the plates of the first set but at the same time do not touch. Since the capacity is affected by the space between the two sets of plates it will be realized that maximum capacity is obtained when the leaves of the movable set are exactly opposite those of the stationary set and minimum when the movable plates are withdrawn. If this variable condenser

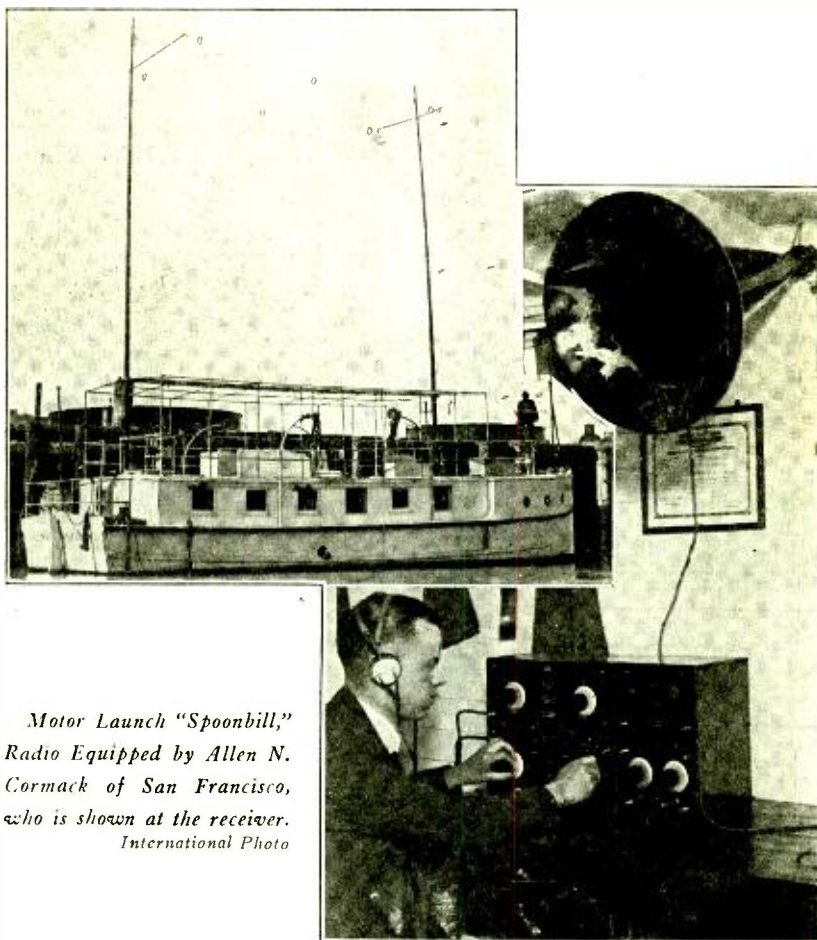

*Motor Launch "Spoonbill,"
Radio Equipped by Allen N.
Cormack of San Francisco,
who is shown at the receiver.
International Photo*

The variable inductance may consist of a coil of wire with taps taken off at intervals and brought to a series of contacts so that the number of turns in the active part of the coil can be varied. The inductance is connected in series with the aerial and the ground wire. When the wave-length of the three combined, that is, the wave-length of the aerial-inductance-ground circuit is equal to the wave-length of the passing ether waves from the sending station this open-circuit, as it is called, will absorb the most energy from the passing ether waves and the open-circuit will be in tune with the sending station.

is shunted around the inductance, that is, connected across the terminals of the inductance, it can be used to increase the wave-length of the open-circuit beyond that which could be secured with the inductance alone and it also permits of a closer adjustment of wave-length when used with the inductance because it gives a combination adjustment of both inductance and capacity. The inductance coil may have ten turns to the tap. Using the coil alone we could not get closer adjustment than in steps of ten turns. Using both inductance and variable condenser we could get any fraction of ten turns.

The variable condenser may be connected in series with the inductance and ground or inductance and aerial to reduce the wave-length of the open-circuit, thus giving an effective wave range lower than could be secured with the inductance alone.

Remember this—A condenser in multiple with an inductance is used to increase wave-lengths and a condenser in series with an inductance is used to decrease wave-lengths.

The detector of the simple receiving set must be fairly sensitive, easy to adjust and should not require the use of a battery to operate it.

Before the advent of the vacuum tube detector, crystal detectors were used almost universally. There was one form, the electrolytic detector, which consisted of a very fine platinum wire dipping into a solution of 20 per cent nitric or sulphuric acid, the rectifying action depending on the electrolysis which takes place. But in those days radio apparatus was hard to procure and the amateur usually had to make his own and it was some job both to make and operate an electrolytic detector—and platinum wire came high.

The carborundum crystal was introduced about the same time and the writer remembers using this form in commercial work aboard ship back in 1912. It was very crude as a detector but it had a faculty of holding its adjustment when the ship was buffeted about.

The silicon detector followed and then the Perikon and the Pyron (special crystals) and finally came the galena. For all around work the galena is perhaps the best. A galena crystal is held firmly in a clamp and a very fine, bare copper wire (No. 36 or smaller) is fastened to a movable arm so that its end can be made to touch the crystal at different points and with varying pressure. The point of the wire is run over the crystal until a sensitive spot is found and the pressure is varied until the signals are heard with maximum intensity. The end of the wire should be clipped off every few days to present a new surface and a thin layer of oil may be put on the crystal to exclude moisture. A disadvantage of this type of detector is that a slight mechanical shock may disturb the point and throw it out of adjustment.

It seems that when certain substances are placed together in not too close contact they have the property of producing a pulsating direct current when an alternating current passes through them. In some crystals the ratio of current flow is as high as 400 to 1, that is, current flows in one direction 400 times as easy as in the opposite direction. This rectifying action takes place between the galena crystal and the fine copper wire and the high-frequency currents generated

in the receiving circuits pass through this crystal rectifier, in part at least, and the resulting pulsating direct current flows through the windings of the telephone receivers and affects the diaphragms.

There must be some kind of apparatus to change the audio frequency current into sound and the telephones serve this purpose. The magnets of the telephones are wound with very fine silk-covered or enameled copper wire so as to get the greatest number of turns in the smallest possible space and the resistance is anywhere from 1000 to 3000 ohms. This makes an extremely sensitive device which responds to very small currents.

copper wire to wind one layer on the spool.

A small battery clip to hold a piece of tested galena.

Two or three inches of No. 36 bare copper wire. Mount so that one end rests lightly on the galena.

Three binding posts.

One pair 2,000 ohm Murdock phones.

Connect the aerial to one end of the spool winding and the fine wire to the other end. The second end of the fine wire rests on the galena. Connect the clip to ground and shunt the phones around the galena. Wiggle the free end of the fine wire around on the galena. You will be surprised!

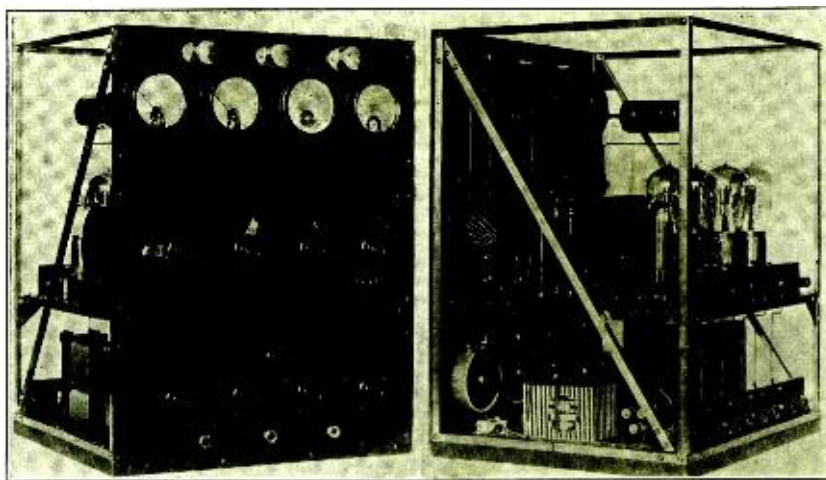

9FM, a Neat and Compact C. W. Transmitter

A small fixed condenser, that is, one whose capacity is fixed, is usually shunted across the terminals of the phones. The impedance of the phone windings is considerable and the condenser serves as a by-pass for the radio frequency current, the detector and phones being connected in series, but the audio-frequency pulsating current passes through the phone winding.

There are a number of these "crystal" home receiving sets on the market today and they are satisfactory for local receiving. These sets usually consist of a variable inductance, a crystal detector and phones with fixed condenser. The inductance consists of a single layer of wire with taps brought out to switch points so that more or less turns can be used as desired.

Anyone, with little trouble and less expense can construct a portable receiving set which will enable them to receive music or code signals. Hang about 75 feet of bell wire out of the window for an aerial and use the radiator or water-pipe for a ground.

To make the most simple kind of portable set get the following material:

A cardboard or wood box three inches square by two high.

An empty spool $\frac{3}{4}$ inch in diameter by $1\frac{1}{2}$ inches long.

Enough No. 28 or No. 30 insulated

9FM—A NEAT AND COMPACT C. W. TRANSMITTER

Home radiophone builders well may study the accompanying pictures of a 20-watt phone set built by 9FM, Dr. Sidney J. Blum, Shukert Bldg., Kansas City, Mo. They stand in a class by themselves for effective portrayal of a set which is clever and compact in design and neat and workmanlike in construction. This has worked the Atlantic Coast many times. It has a radiation of 2.4 amps., with 500 volt plate current.

9FM also operates a 100-watt C. W. transmitter which has worked with 6XAD, Catalina Island, and has been reported QSA from Vancouver, B. C. This set gives a radiation of 2.8 amps. with 800 volts rectified ac. on the plates of two 50-watt tubes and 9 volts on the filament. Dr. Blum is making some changes in his location to do away with poor aerial and operating conditions—and is also going to try the use of two dc. generators in series—500 and 800 volts—instead of using rectified ac.

Protecting Radio Sets From Lightning

By L. S. Brach

The purpose of this explanation is to off-set any fear in the reader's mind as to the possibility of the radio antenna conducting lightning currents into the house. Generation of lightning is the building up of small charges of electricity which accumulate on moisture. These charges combine as the moisture forms into fog, clouds and raindrops, and subsequently becomes so heavy as to discharge to other clouds or to the earth. It is the presence of moisture in the air that permits the conductance of the discharge between the clouds and the earth.

The damage done by lightning may be caused either by the direct stroke of the discharge striking a wire or by an inductive charge being built up in the wire by reason of the flash of lightning passed between two clouds or between clouds and the earth. All lightning discharges have an area of electrification, and wires located within this zone are subject to the induced potential which would, if not properly side-tracked into the earth, enter into the apparatus and result in damage. Direct discharges are always too violent to be protected against except by the antenna wire itself, which generally melts and breaks the circuit. Even a heavy switch will not cause suitable protection, but the possibility of such a condition occurring would be no greater with the antenna than it would be without.

The strength of the induced charges in lines depends upon the nearness of the direct discharge, length of line and its position in the electrified zone. It is safe to say that the longer the antenna circuits, the more subject they are to being affected by passing storms. These tests reveal that discharges occur in two different ways; one is the brush discharge in which lightning passes through insulating material readily and is harmless in passing; the other occurs in a line of thread-like discharge and with it sufficient heat is produced to cause damage to the parts between which the discharges occur. In the designing of arresters, we treat only with the latter type of discharge, and it is essential that protectors must carry such discharges freely and without injury to themselves. The most efficient arrester is therefore one that will instantaneously and repeatedly dissipate the largest amount of energy without being affected.

The potential at which an arrester should discharge should be determined by the insulation of the apparatus or circuits that are to be protected. For example: If the apparatus is tested to withstand 500 volts between its windings and other parts, the protector should discharge at a potential of approximately

375 to 400 volts, that would insure an operation of the arrester in preference to the damage of the insulation. It is possible to design arresters that will discharge at different potentials to a certain degree, but in this we are limited in getting below 375 volts in practical types of arresters.

Another test which will reveal the sensitiveness of an arrester to static current is the comparison of the efficiency of the arrester with an adjustable air-gap, thereby getting an air-gap equivalent. The process in doing this is to have two needle points supported in a way that a micrometer adjustment may be had. These are to be held in multiple with the arrester and an electric generator. The separation at which the needle gap is adjusted when the arrester will start to assume the discharge in place of its passing across the needle point would give a value to the arrester as in the air-gap equivalent. Therefore, when we say a certain arrester has an air-gap equivalent of .001 or .002, we mean that the arrester will start to discharge the current from a generator when held in multiple circuit with a needle held that distance apart.

There are three principal designs of lightning arresters, the air-gap, vacuum, and high resistance types. In addition to this there is the choke coil, but choke coils, when used, are generally found in combination with one of the three types mentioned. The air-gap design depends on its efficiently bringing close together two electrodes, one connected to the line and one connected to ground. The air between the two electrodes acts as the insulation for the normal operating currents. Air-gap arrester electrodes are generally made with carbon or metal as the conducting medium forming the electrodes. The efficiency of this arrester depends on the closeness of the two electrodes. It is necessary to keep in mind that in this design, there is always present danger of the two electrodes fusing together by passing discharge or the serrated points burning back and its effectiveness thereby changing—due to the lengthening of the gap.

The vacuum arrester consists of two electrodes held in a fixed position in a sealed chamber from which the air has been exhausted, and through this vacuum we find that inductive currents readily pass, even when the electrodes are held much farther apart than in the air-gap types, and equally good results obtained. The vacuum types are practically free from the fusing together of electrodes or the collection of moisture or dust on the operating parts. It is a well known fact that discharges will

occur at a lower potential between conductors at a given separation in a vacuum than in air, and this fact has been taken advantage of in the designing of protectors so as to provide protectors of low voltage potential discharge value having a fairly high carrying capacity.

The high resistance medium arrester consists of a composition block, generally a mixture of carborundum or silicon with a clay binder, placed between the line and ground. The carborundum has the property of conduction and the clay binder acts as an insulator. The binder being porous and the conductive material being in very small particles, it is found that when mixed together we have an insulating mass with small conductive particles that arrange themselves in a way that the total mass is of exceptionally high resistance, but static current will pass from particle to particle through the binder and then discharge itself. While this type of arrester is sensitive to static currents it will not discharge at a low potential, and is therefore of little value for protection against crosses, but highly sensitive to lightning induction.

For radio antenna protection we have depended entirely on the efficiency of the vacuum type. We believe it is the best suited, inasmuch as with the other types, if constructed on efficient lines, they would take off, or cause to be lost, some of the radiophone voice currents, thereby affecting the strength of the receiving current to that extent.

Tube reception with a c. lighting current, thus doing away with the necessity of batteries, is being developed by the U. S. Bureau of Standards. Briefly, the scheme is to utilize a 60 cycle lighting current for both filaments and plates of the electron tubes. The amplifier recommended in the report has three radio-frequency stages, and two audio-frequency stages, and requires a crystal detector. A 60 cycle current when used in an ordinary amplifier carries a strong hum, or ripple, offering serious interference with messages, but this is eliminated by balancing resistances, grid condensers and special grid leaks of comparatively low resistance, a telephone transformer in the output circuit and a crystal detector instead of an electron tube. It is said that the amplification was as good with alternating current as with direct. The complete set is light and compact for portable use.

C. W. Station 6EA

By H. C. Seefred

The a.c. C. W. transmitter as shown in the accompanying picture consists of one 5-watt "Cunningham" tube, a "General Radio" V. T. socket, a "Jewell" filament 0 to 15 voltmeter, a "General Radio" filament rheostat, a "Boston" radio key, two 5000 ohm "Radio Corp." grid leaks, a "Murdock" 23 plate variable condenser for the grid, a "Wireless Shop" C. W. variable condenser for grid-tickler coil, an "Eldredge" hot-wire ammeter, a home-made antenna inductance (34 turns of No. 12

home-made two stage amplifier, and "Type E" Baldwin phones. An old brass automobile horn attached to a "Type C" "Baldwin" phone is used for visitors during concert hours.

Throughout the past winter I have obtained fair results on C. W. reception, having heard 2FP, 8XV, 9XM, 9NX, Canadian 9BD, 9AMB, 9BEX, 9BJI, 9DTH, 9DTM, 9WD, 9XAQ, 9ZAF, WV6, CL8, 7XF, and 5ZA, all over 800 miles from Los Angeles.



Transmitter and Receiver at 6EA

D. C. C. copper wire wound on a mush cardboard box), a home-made grid-tickler inductance (6 turns of No. 18 D. C. C. copper wire wound on a mush cardboard box and same inserted in the larger box), a home-made C. W. plate voltage transformer (500 turns of No. 14 D. C. C. copper wire on primary with 40 turns of No. 12 D. C. C. copper wire wound over primary with middle tap for filament voltage, and 2800 turns of No. 31 D. C. C. copper wire for secondary). Also use the old spark oil immersed condenser shunted across secondary of plate voltage transformer to smooth out the tone. The transformer used to be an old spark transformer built in 1912 and used till 1921. Primary was rewound and all secondary "pan-cake" sections taken off except four of them. Plate voltage, about 750 volts, and antenna radiation is from 1.5 to 1.7 amps. (hot-wire readings) using no elevated insulated counterpoise. Just the regular ordinary antenna and ground system are used. The famous British Aircraft grid-tickler C. W. circuit is also used.

During only one month which the a.c. C. W. was in operation, I have communicated with 9DVA, 7XG, 7DP, 7LN, 6ZAM, 6QR, and also many others in California.

The C. W. receiver as shown in the accompanying photo consists of three home-made spiral wound inductances (primary, secondary and tickler), "De Forest" variable condenser with vernier attachment for secondary tuning, a

RADIO CONFLICT BETWEEN GOD AND MAMMON

SCENE: Two broadcasters, one a church representative, and the other operating a news broadcasting station.

NEWS BROADCASTER: "Well, you fellows are required to co-operate with all the rest of us, why and who are you to say that you won't stand by during the 11:00 and 12:30 period?"

CHURCH BROADCASTER: "The proposition of our sermons being interrupted is preposterous. Why, God himself demands that we be given this period."

NEWS BROADCASTER: "All right, then, as soon as you present a letter from God, stating the necessity of your continuous operation, I'll withdraw my objections entirely."

A baseball game report by radio was recently given by a newspaper reporter who covered the opening game of the Washington and New York Yankees team with a radio-phonograph. From the time the first batter stepped to the plate until the last one fanned, all local radio fans got the game inning by inning, if they listened in. Hereafter when the Washington team is in Washington the radio reporter will cover the game for all local fans who cannot attend, it is announced.

A NOVEL INDOOR ANTENNA

By L. F. SEEFRED, Radio 6EB

NO MORE will it be necessary to string up one long wire to hear the concerts. That is, providing you are not located in a house that has all its wiring in grounded conduit. Otherwise you will be able to construct an antenna for about one dollar which can be taken down every day, moved to any room in the house, or coiled up and put away in a suit case. The accompanying drawing shows how to make it. Ordinary

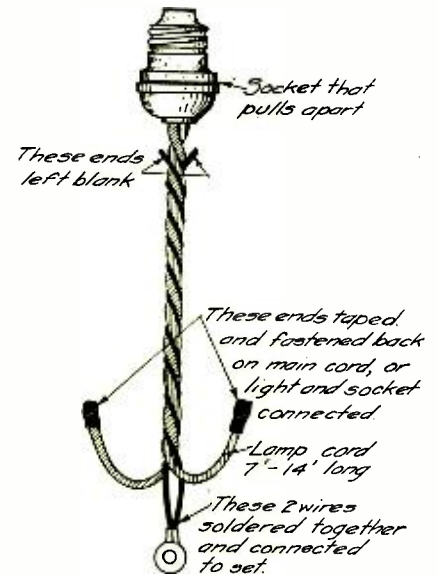

International photo
Connection for Using Lighting Circuit
as Aerial

single wires will do to twist around the cord, but I used two wires, 16 strands of No. 28 D. C. C. each. The ends of the drop cord may be taped to prevent shorting, or a light and socket may be connected so you can read the paper or listen to the concerts.

I used this type of antenna not long ago while I was in bed one week with the "flu." It worked fine on crystal for listening to signals around town, while with an audion detector I could hear all long distance work as well as with a 125 ft. one-wire antenna. Amplifiers help a great bit, of course, and no hum is received from the alternating current on the house wires. I took an antenna of this type over to a fellow's house who has not been in the game long, and he was surprised to see that it worked better than the antenna (4 wires) he had erected above his house.

Try it out, folks, but don't send on it. If you want to see fire-works, wait until the Fourth of July!

Four stages of amplification in tandem is equivalent to over 100 miles of standard cable which corresponds to a power amplification of over three billion times.

News of the Broadcasting Stations

KJM OF FRESNO, CALIF.

A new broadcasting station has been established by the San Joaquin Light & Power Corporation at Fresno, Calif. This station is operated by R. C. Denny, under the call letters KMJ and is licensed to broadcast three concerts weekly, on Sundays 5:00 to 6:00 P.M. and on Tuesdays and Fridays, 7:00 to 8:00 P.M.

The power company is experimenting with the radio telephone as an emergency means of communication, supplementary to the private telephone lines for system operation or dispatching. This is the primary object in the broadcasting,

thing simple of adjustment with no rotary machinery to get out of order and not even any "B" batteries to run down. Nothing to do but talk, and replace a burned out tube occasionally. One 50 watt oscillator tube is used, which gets its filament current from the UP-1016 transformer and its rectified plate current through two UV-217 Kenotrons from the same transformer. The radiation is 2 amperes with the absorption loop modulation. Tube modulation will be used as soon as there is another 50 watt tube available. Jewel meters are used, the following being considered necessary for such a set:

while final filament adjustments are by rheostats in connection with the 0 to 15 voltmeter.

The aerial is the ordinary flat top T type at an elevation of 75 feet above the earth, with a counterpoise of identical dimensions suspended directly beneath it, at a distance of 40 feet. Preliminary tests indicated a consistent day range of well over 100 miles. Mr. Denny would appreciate getting reports on reception of these concerts from points at any considerable distance from Fresno.

NEW BROADCASTING STATIONS

- WMB—Auburn Electrical Co., Auburn, Maine.
- WEB—Benwood Company, Inc., St. Louis, Mo.
- WDZ—James L. Bush, Tuscola, Ill.
- WPE—Central Radio Co., Inc., Kansas City, Missouri.
- WCK—Stix-Baer-Fuller, St. Louis, Mo.
- KNR—Beacon Light Co., Los Angeles, Calif.
- KXS—Braun Corporation, Los Angeles, Calif.
- WAAH—Commonwealth Electric Co., Inc., St. Paul, Minn.
- KZI—Cooper, Irving S., Los Angeles, Calif.
- WAAJ—Eastern Radio Institute, Boston, Mass.
- KON—Holzwasser, Inc., Los Angeles, Calif.
- WAAL—Minnesota Tribune Co., Minneapolis, Minn.
- WAAG—Mullins Electric Co., Tacoma, Wash.
- WAAM—I. R. Nelson Co., Newark, N. J.
- KSS—Prest and Dean Radio Research Lab., Long Beach, Calif.
- WAAO—Radio Service Co., Charleston, W. Va.
- KNV—Radio Supply Co. of Calif., Los Angeles, Calif.
- KJC—Standard Radio Co., Los Angeles, Calif.
- WSB—Atlanta Journal Co., Atlanta, Ga.
- KQP—Blue Diamond Electric Co., Hood River, Ore.
- KUS—City Dye Works & Laundry Co., Los Angeles, Calif.
- WAAG—Elliot Electric Co., Shreveport, La.
- WAAK—Gimbel Bros. Dept. Store, Milwaukee, Wis.
- WAAR—Groves-Thornton Hardware Co., Huntington, W. Va.
- KXD—Herald Publishing Co., Modesto, Calif.
- WAAZ—Hollister Miller Motor Co., Emporia, Kansas.

Continued on page 55

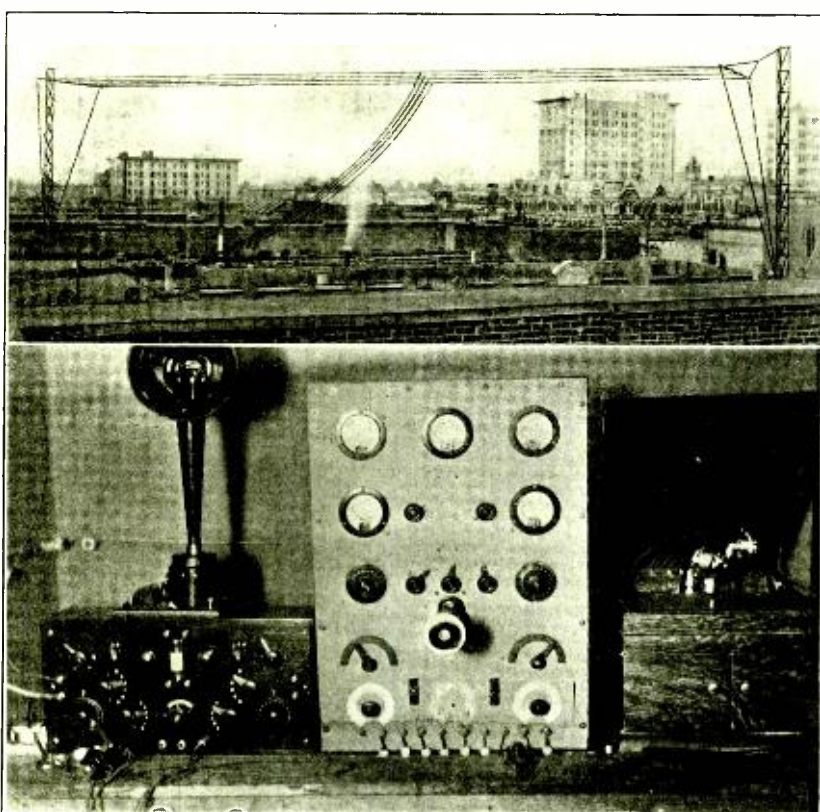

Aerial and Transmitter of KJM

which will serve as a means of testing into the mountains and to all parts of the power system. Secondly, it provides entertainment for the consumers, patrons and employees of the company over the entire system. Post card announcements of the week's program will be mailed out to all parties desiring same.

The transmitting set shown in the accompanying photograph was built by Mr. Denny and consists principally of Radio Corporation apparatus. The prime idea in the design was to develop a set that was as near fool proof as possible to make it, something to simply be plugged in on the alternating current at any of the power houses and operated by any of the operators in any emergency when the phone lines should fail. Some-

1-0 to 150 volt, 60 cycle A.C., 1-0 to 15 volts, 60 cycles A.C., 1-0 to 5 amps. radio frequency, 1-0 to 1500 volts D.C. and 1-0 to 500 milliamps, D.C. The 0 to 150 voltmeter indicates which tap of the power transformer to work on

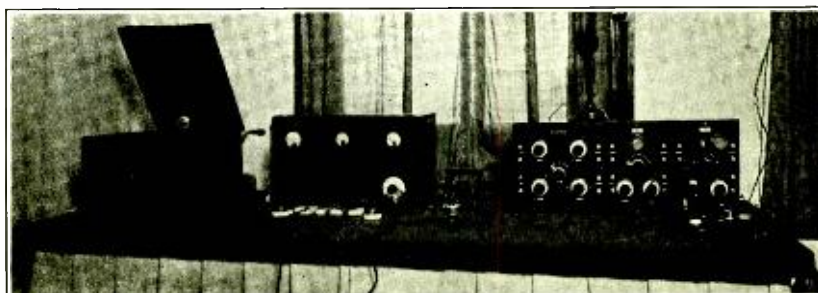

The Emporium's Transmitter

AN ACCURATE WAY TO WIND RADIO COILS

By EDWIN G. BAKER

CONSIDERABLE difficulty is usually experienced in winding coils for electrical instruments, especially in keeping a uniform tension on the wire so that it is wound tight, and in properly guiding it so that the turns are close together. The following description of how to do this should prove helpful to any one who has access to a lathe.

To keep the wire at an even tension it is run between two wooden blocks clamped in the tool post. The blocks are mounted one above the other at

gives 50 turns to the inch. Set the lathe to cut fifty threads per inch. If there is no corresponding thread on the lathe, use the next higher figure, as this will run the carriage slower and have a tendency to pack the wire. To equalize the slower feed, the compound rest should be set at right angles to the cross-slide, and an occasional turn of the compound handle will keep the wire in perfect alignment.

The accompanying sketch shows the set-up of the lathe inside the tail-stock, including the reel.

NICKEL IN THE SLOT RADIO STATIONS NEXT

With radio telephony in its present

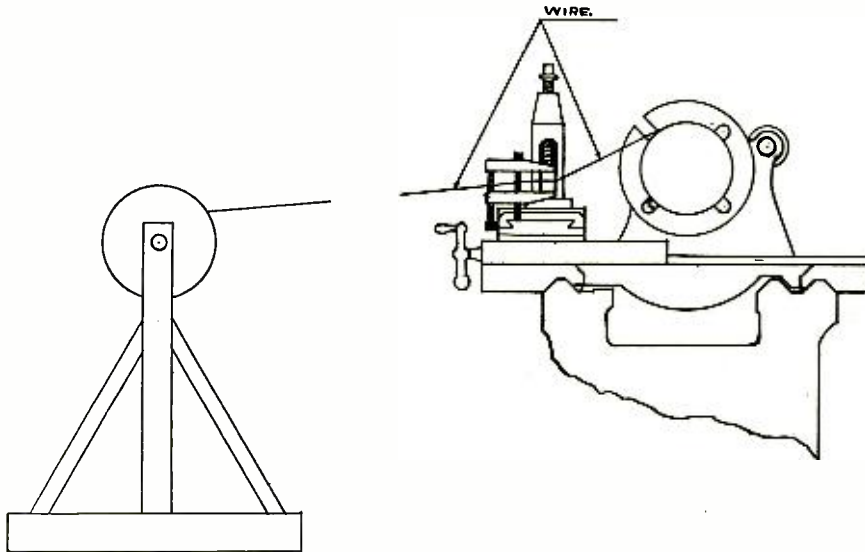

Lathe Set-up for Winding Coils

right angles to the tool post and clamped tight. A small clamp is screwed on the end of the blocks and tightened just enough to put sufficient tension on the wire. This arrangement not only keeps the wire tight, but guides it as well. The spool of wire can then be run loose on any temporary reel.

To wind the wire snug, i. e., one turn tight against the other, which is especially necessary in slide tuning-coils, the carriage of the lathe must be fed forward exactly the thickness of the wire for each revolution of the spindle. To do this by hand is very difficult, for if the carriage is moved too slowly, the wire will crawl upon the former turn, and if too fast it will leave a space. Recourse can therefore be had to the thread cutting feed. The first thing to know is the thickness of the wire in thousandths of an inch. If a micrometer is not at hand, this can be had from a table of wire sizes. When the thickness is found it is only necessary to divide it into one thousand to find how many turns there will be to a linear inch. This is read directly as threads per inch on the chart of the lathe. For example, if it is required to wind a coil with No. 24 wire, the diameter is found to be .020 and divided into one thousand

stage, it only remains for some enterprising person to open public radio phone booths, wherein any citizen may drop a coin and "listen in." He could choose his entertainment from the daily schedules, which need by no means be limited to music, but might include press dispatches, baseball bulletins, prize fights by rounds, and election returns. Those who have no home radio receiver will undoubtedly soon have the privilege of renting one temporarily when desirous of "hearing" what is in the air. It is an opportunity for some genius to combine a nickel-in-the-slot machine with a wireless receiving set.

HOOK-UP FOR V. T. DETECTOR AND LOOSE COUPLER

By HARRY E. THOMAS

For the amateurs who have changed from crystal detector to the vacuum tube detector, using the loose coupler for tuning with the straight detector hook-up without regeneration, I am putting at their disposal the hook-up I use, making use of a slide tuning coil, two variable condensers and two home-made honeycomb coils.

Many amateurs who change from crystal to tube use just the loose coupler as a tuner, as I said before, discarding all other apparatus which they used with the crystal. Two variable condensers, a tuning coil, and two home-made honeycomb coils were all that were necessary for me to get results unthought of when I used the plain circuit.

I do not mean to say that I discovered a sensational new circuit. Nothing of the sort. I merely mean to bring out the fact that discarded apparatus sometimes comes in very handy.

I placed the slide tuner in the filament circuit instead of a variometer and inserted the two honeycombs, of three or

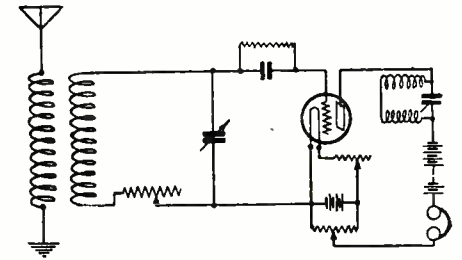

Hook-up for V. T. Detector and Loose Coupler

four layers each connected in series in the plate circuit, straddling a variable condenser across.

At my present location, San Francisco, I am using a one-wire aerial 30 ft. high and about 35 ft. long. I get the concerts around the bay 5 ft. from the phones, receive ships four and five days out, and can read NPE and NPC fairly well. I hear amateurs in the seventh district, 6ZZ in Arizona and 6KC in San Diego. I copied a ninth district amateur also, and do most of my tuning with the plate variable condenser.

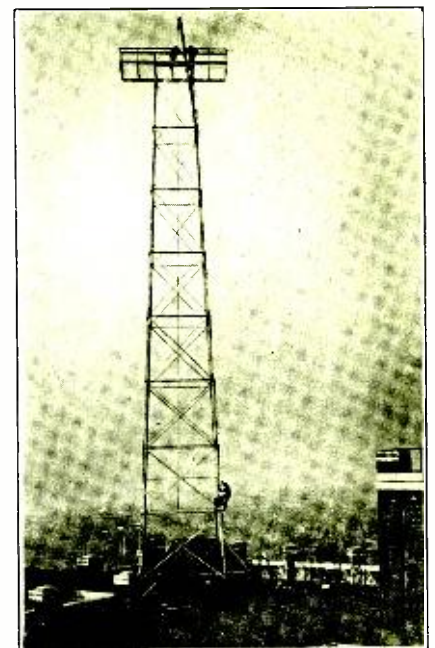

International Photo
American Tel. & Tel. Company's Toll Broadcasting Station Tower at 24 Walker St., New York City

TRADE ASSOCIATION INSTALLS DEMONSTRATION SET

As part of a comprehensive campaign of radio education the Pacific Radio Trade Association has installed an all-wave receiver with Magnavox power amplifier in the Engineers' Club of San Francisco. This set is used for demonstration of concert and code reception in conjunction with popular lectures given before the various clubs and associations whose special meetings may be held in the club rooms. The set is made up of parts contributed and assembled at the expense of the association members.

The entire set is housed in a handsome oak cabinet with a built-in sound box, much after the style of a Victrola. The sound box opens in a grill 6 in. high and 22 in. wide. Across the front

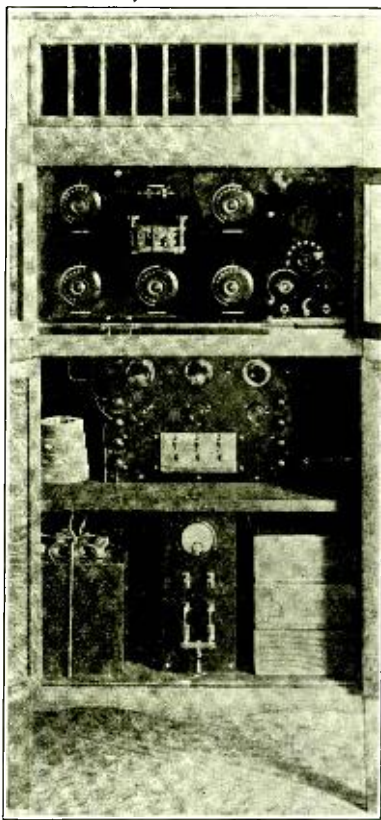

All-Wave Radio Demonstration Set

of the cabinet, beneath the grill, is a pair of glass doors, behind which are placed the tuning apparatus and detector controls. The lower portion of the cabinet has a pair of oak doors. The power amplifier, the storage battery, B batteries, the battery charger and space for accessories are in this lower box.

The storage battery is provided with vents which carry the gases given off by the solution out through the rear of the cabinet, thus preventing these fumes from injuring the apparatus. A switch throws the storage battery to either charge or discharge, and a voltmeter shows the condition of charge. The only terminals on the exterior of the cabinet are the aerial and ground bind-

ing posts and a cord and plug for connecting to an A. C. lamp socket, to provide the current for charging the storage battery.

A pair of phones is provided so as to be plugged in instead of the loud speaker for tuning in the various stations. Duo-lateral coils are used for wavelengths over 600 meters, but for amateur work and music broadcasting, a short wave regenerative circuit is used, consisting of a variometer and two variocouplers. A "wiggle" switch is used to select either the short or long wave tuning apparatus.

The experience of a great many who have tried to combine short and long wave tuning apparatus has been that efficiency was sacrificed in doing so. This difficulty has been overcome in the pres-

ent set by a rather novel circuit, so that both long and short wave apparatus are just as effective as if either was used alone for its particular work.

A RADIO DETECTIVE STORY

William J. Burns, chief of the Department of Justice Bureau of Investigation, told a story recently in which radio took the part of Sherlock Holmes. A dapper and bright young man appeared one day before the sales manager of a large radio manufacturing plant, and explained that he wanted to purchase a very fine receiving set for a local high school. He was greeted cordially

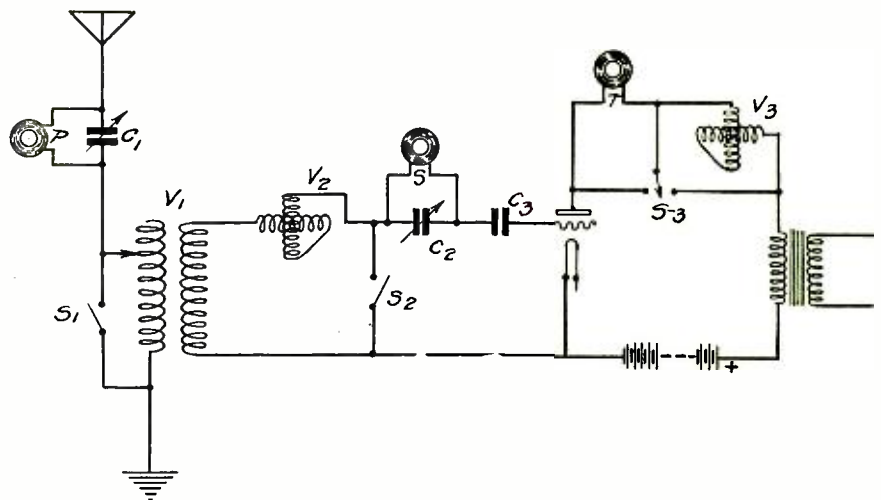

Diagram of All-Wave Receiver

ent set by a rather novel circuit, so that both long and short wave apparatus are just as effective as if either was used alone for its particular work.

The circuit is shown in the diagram. V_1 is a variocoupler and V_2 and V_3 are variometers. P, S, and T are plugs for the primary, secondary and tickler duo-lateral coils respectively. C_1 and C_2 are variable condensers, and C_3 a small fixed grid condenser. S_1 , S_2 and S_3 are three of the four blades of a 90 capacity switch. When S_1 and S_2 are opened, S_3 is closed to the left, and with no honeycomb coils in place we have the usual type of short wave regenerative set, with one exception: that is, the variable condenser C_2 is in series with the fixed condenser C_3 and permits of very fine regenerative adjustments. For very long wavelengths, honeycomb coils of suitable size are plugged in to P, S, and T, and the "wiggle" switch is thrown to the long wave position. This closes S_1 and S_2 , and closes S_3 to the right. C_1 now becomes a parallel primary condenser and C_2 a parallel secondary condenser. The short wave coils are now all short circuited, so that there is no tendency for the set to tune to both long and short waves at the same time.

This combination provided for ca-

pacitative regeneration on short waves and inductive regeneration on the longer waves. The usual type of power amplifier is provided with 350 volts B battery.

and the best of the house's set were demonstrated. Ordering an expensive set, he managed somehow to secure delivery without payment, and then disappeared. The set also vanished from the place it had been shipped to originally, much to the chagrin of the manufacturers, who decided to advertise their loss through radio itself, being able to give a very accurate description of the young man, who had a noticeable scar on his cheek.

Chapter two opens in an apartment where a genial and fine appearing young man, with a scar on his cheek, is entertaining his friends with a new receiving set. Suddenly the instrument begins to tell of the manufacturer's loss and give a detailed description of the thief—unmistakeably the host! The consternation of the guests may be imagined. The next morning a very worried mother paid for the instrument which her son had wanted so badly, he had evolved the above scheme for getting it, whereupon the manufacturer dropped the matter.

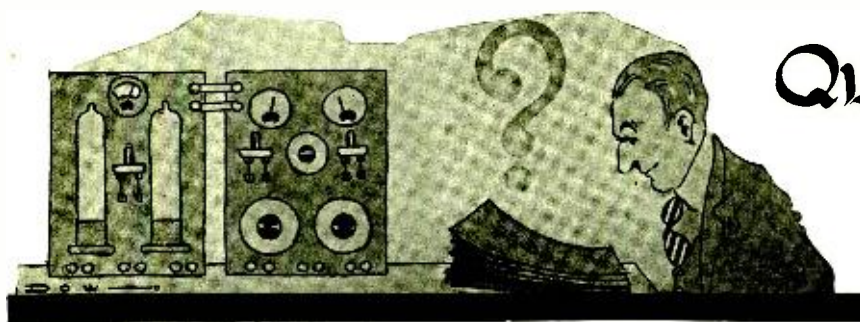

Queries & Replies

on C.W. practice

by

Gerald M. West,

Technical Advisor.

Questions submitted for answer in this department should be typewritten or in ink, written on one side of the paper. All answers of general interest will be published. Readers are invited to use this service without charge, except that 25 cents per question should be forwarded when personal answer by mail is wanted.

If a slanting L antenna were used, with a counterpoise, for transmitting, would the entire length of wire used in the counterpoise be figured as the ground lead? If the regular ground was used in conjunction with the counterpoise, would this length of ground wire be figured in with the length of wire used on counterpoise? H. S., Sand Springs, Okla.

No. Figure to the point where the counterpoise commences to branch out. In the second case, figure the length of the ground lead and neglect the counterpoise in your computation.

Please publish the hook-up of a five-watt C. W. set using A.C. on both plate and filament. G. W. C., Portland, Ore.

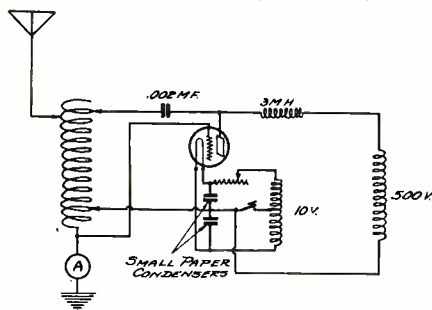

Fig. 1

The circuit requested is shown in Fig. 1.

In April RADIO, page 18, regarding construction of tuner, Fig. 3, what would be the wavelength range of this set when connected to an antenna 115 ft. long, 30 ft. high, of two wires, 6 ft. apart? Would it be any advantage to put on more of the 10 complete turns if added wavelength range is desired? O. M. S., Berlamont, Mich.

About 1200 meters. Added turns on the inductance would raise the wavelength, but it is not desirable to load the coil too much, as its efficiency would be greatly impaired.

Please publish a circuit employing the Armstrong hook-up in connection with two variometers and a variocoupler. F. S., Marion, Ohio.

This circuit was published in March RADIO, on page 29. If you cannot obtain a copy of this number, write and I will send you a copy of the circuit.

What are the proper honeycomb coils for the 150-25,000 meter set described in February RADIO? H. E. T., Oil City, Pa.

Coils of 500 and 1500 turns are the ones required.

Can you give me instructions for making a set capable of receiving 1000 miles or more? C. A. B., Weeping Water, Neb.

The set described in articles by D. B. McGown, in March and May issues of RADIO, will cover 1000 miles under favorable conditions.

CORRECTION—The Editor wishes to correct Fig. 2 on page 28 of April RADIO, where an electrolytic rectifier is shown. The elements in the two jars at the top of the sketch should be interchanged, so that the aluminum plates are connected to the positive D. C. lead.

Am unable to get a Wayne transformer for use as a choke coil in the power amplifier circuit described in March RADIO. Does the Thordarson bell ringing transformer have the proper inductive value for use in place of the Wayne (30 Henries)? A. K. L., Vancouver, Wn.

Apparently the Wayne transformer is a scarce article, as several others besides yourself have been experiencing difficulty in locating such an article. A very satisfactory choke can be constructed by winding 5000 turns of No. 28 or No. 30 enameled wire on a half inch core made of fine iron wires. This coil would then have the same general appearance as a telephone induction coil, and while it would probably not have as high an inductance as 30 henries, yet it would be sufficiently high to answer the purpose. If you do not care to wind the coil, secure several 500 ohm ringer coils from an old telephone and connect them in series.

Please advise whether one should use iron or copper to build shields around each stage of a 3 stage radio frequency amplifier. U. J. B., Metcalf, Ariz.

Thin sheet copper would be preferable where the cabinet is to be of wood.

How can one determine which of the 110 volt A.C. mains in the house, is grounded? J. H. R., Los Angeles, Calif.

The easiest way is to bridge an ordinary 110 volt Mazda lamp between the ground and each of the two line wires in turn. The wire which is not grounded will light the lamp, thus indicating which of the two has the ground connection.

Claremont, Calif., April 7, 1922.

Editor RADIO—Dear Sir:

I should like to protest against your statement that cages have no electrical advantages.

In RADIO for April, 1922, page 26, you admit that "This 'skin effect' increases with the frequency and at very high frequencies the current flows entirely on the surface of the conductor." On a flat-top antenna, this means the two outside wires carry all the current going to the antenna, by reason of the "skin effect." Hence every flat-top antenna is a two wire antenna in effectiveness, and all flat-tops must have high resistance. "Considering the radio circuit and resistance in general, it may be said that aside from the power losses entailed by the resistance in the circuit, it has also the effect of increasing the damping of the oscillations taking place in that circuit and of lowering the 'sharpness of resonance.' Increasing the resistance in such a circuit will cause it to tune 'broad,' all other constants remaining the same."

This probably explains the "broad C. W." "Since the antenna may be considered as a simple radio circuit, it is apparent that if we

want sharp tuning and a 'persistent' antenna, we should keep the ohmic resistance of the system as low as possible." A boost for the cage!

To turn to the Transatlantics, we find the cage vindicated again. 1BCG, the "wonder station," used an eight-wire cage, and he was "wonderfully steady" (QST). 2FD, with six-wire cage, was fine, clear, and strong. 1RU, six-wire cage, was "strong and clear." 2BM got through with a cage and a rotten note. 1YK had a four-wire cage 27 ft. high, overloaded a 50-watt tube to 72 watts, used a Hartley circuit, and yet got across in spite of bad QRM. His cage is the only redeeming feature of his set. 1AFU with a twelve-wire vertical cage shoved three messages to an English amateur. Reception of an American station by an ordinary receiver on the English midget antenna! The cage is all there in theory and practice. A certain unlicensed ham with a 50 ft. six-wire cage and a flivver coil with gap between antenna and ground was believed to be a local ham in a large city thirty miles away. He is shut down now. The same ham took a 110 volt relay, converted it into a buzzer and was heard three miles away on the same antenna.

To get back to the original article, it was stated that cage antennae were used because the hoops would hold up any wires shot away. Spreaders could be put at intervals on the flat-top antenna and accomplish the same result. Thus that explanation cannot hold, and efficiency is the only explanation left.

By the way, why do the descriptions of "high-efficiency C. W. sets" include an elaborate method of changing waves by an elaborate array of variable condensers, high-resistance switch contacts, etc. On the good old spark outfit, we didn't change wave from 175 m. to 375 m. every few minutes. We just threw on our power and punched the key. We look for a C. W. set on the same setting as an hour before if we wish to hear him, and if you change your wave all over, we can't hear you. Incidentally the DX, C. W. outfits don't change their waves. Their set is out of the way and they just have one switch to throw the power on the whole outfit. Quick come-back. Let's get away from "trick C. W." A READER.

NOTES FROM THE OPERATORS

Radio call 7FX has been reassigned to Albert C. Gordon, 964 N. E. 28th St., Portland, Ore.

Call 6RR has been reassigned to Dr. C. P. Ballard, 415 N. Gower St., Los Angeles.

Call 6IV is Lloyd E. West, 342 Main St., Riverside, Calif.

6AGP is Paul Talbot, 310 W. 2nd St., Pomona, Calif. 6AOW is D. H. and G. A. Keet, 131 Sierra St., Riverside, Calif.

HESLAR

*the "sterling" of
the Radio World*

THE Heslar Radio Corporation, although new in organization, is old in experience. Headed by former Lieut. O. F. Heslar, U. S. N., who has had fourteen years of Radio experience with the government and has made many important improvements in Radio apparatus, this large organization is manufacturing Radio sets and equipment that will simplify the Radio art.

Into every HESLAR product goes the highest standard of material, the finest craftsmanship and every HESLAR product features important improvements, that have immediately placed HESLAR equipment in great demand. We are already producing jacks, variable condensers, sockets, phones and other apparatus, that show marked advance over the present equipment. Ask for literature on these improved HESLAR creations.



**Know this Sign as
your Guide to de-
pendable Radio
Equipment**

**Heslar Radio Equipment
Features Last Minute
Improvements.**

Dealers: Awake to the wonderful opportunities in radio and who realize the demand for superior quality and advanced apparatus will be quick to get in touch with this large organization. WRITE FOR TERRITORY AT ONCE—NOW.

**Heslar Radio Makes The World
Your Neighbor**

H E S L A R

RADIO CORPORATION

INDIANAPOLIS, U. S. A.

DEPT. "B"

TRADE **ESCO** MARK

ROLL OF HONOR

These (and other) Institutions Use Our Motor-Generators

U. S. Coast Artillery School
 Mass. Inst. of Technology
 Tulane University
 University of Missouri
 University of Iowa
 University of South Dakota
 James Milikin University, Ill.
 Ohio State College
 Lafayette College
 Alabama Polytechnic Inst.
 Wm. Hood Dunwoody Inst., Minn.
 Millings Polytechnic, Mont.
 Phila. School of W. T.
 Denver School of Mines
 Oakmont Public School, Pa.
 Dominion Observatory, Can.
 Hammond Research Lab'y.
 Hydro-Electric Commission, Can.
 Burnham Co., London—Paul
 F. Godley

U. S. Military Academy
 Princeton University
 Fordham University
 Clark University
 University of Florida
 Queens University, Canada
 Penn. State College
 Oberlin College
 College St. Croix, Canada
 Western Radio Inst., Cal.
 Rice Institute, Texas
 Commercial Radio Inst., Balto.
 Asbury Park Radio School
 Northwestern School of W. T.
 Riverside School District, Cal.
 Simplex Radio Lab'y., Penn.
 Colorado State Milita
 Union Stock Yards, Chicago
 Henry Ford, Detroit

ESCO Motors, Dynamotors, Generators, Motor-Generators

SOLD BY PRINCIPAL DEALERS EVERYWHERE



Ask for Bulletin 237,
 Listing Over 200 Combinations.

ELECTRIC SPECIALTY CO.

215 South Street
 STAMFORD, CONN., U. S. A.

Immediate Delivery on Quality Condensers!

THE NORTHRAD VARIABLE

Plates of polished half-hard aluminum; end pieces of milled Bakelite sheet. Soldered pig-tail connection to movable plates—no wiping contacts. Navy type knob with polished nicked pointer. Curved entering edges minimize hand capacity effects. Dielectric losses negligible.

23-Plate, .0005 Microfarads \$3.60 43-Plate, .001 Microfarads \$5.25

Add postage one pound

NORTHERN RADIO & ELECTRIC CO.

Operating
 Post-Intelligencer
 Radio Broadcast

606 Pine Street
 Seattle, Wash.

Phone
 Elliott
 2512

How to make the Vacuum Tube
 Wireless Receiving Set, Detector
 and 2 Stage Amplifier Sets.

50c

Dealers Proposition on request. Send for
 TRIAL ORDER—12 COPIES \$4.00

ARCHWAY BOOKSTORE
 Seattle, Wash.

RADIO For Everybody

What do you want to know about Radio? Hook-ups, diagrams, laws, codes, code-work, definitions, testing instruments, use of equipment—everything you want to know fully explained and answered in the Quiz Book. New edition now ready. Read this wonderful book for the best way to use your equipment, instruments—or to prepare for Government examinations for Operator's license, etc., etc. Price only \$1.00. Money-back guarantee. Send for it today.
 National Radio Institute, Dept. 1102, Washington, D.C.

have successfully loaded the set up to POZ, but this is another matter, and could be done in various ways. It speaks well for the circuit and the plate side, however, to carry oscillations up to this point without changing filament. I leave filament rheostat at one point for all waves.

The circuit used has been used by me for the past five years and is economical on filament battery, easy on the tube (I have an old tube which must have lasted its natural life about four times), and very sure in results. It is far superior to any circuit I know of, and I have tried all of them. The so-called ultra audion is similar, but not the same.

In closing would say that the beginning of primary winding should go to the aerial post. The beginning of the coupling ring winding, when it is turned full inductive close coupling in the primary core, should go to the grid post, and the end of winding, which would be the part of ring outside of primary coil, should go to the grid variometer. With this polarity and the coupling ring turned right angles, or 50 points on dial, then turning to left or toward zero, will close couple inductively, and turning to right or towards 100, will loose couple, by means of reversing the winding terminals, in the case of long waves, though it would close couple again on short waves, 50 to 100, but with reversed terminal effect.

The coupling values given apply to the wiring being done as stated in this paragraph. Needless to say, the variometers should be studied and dials put on so that the inductive value increases turning to the right. And in the case of the plate variometer this must not only obtain, but the polarity of terminal to plate must be such that a feed back effect on the longer waves is obtained when the secondary coil is put into the circuit. Primary and secondary switches increase to left.

With close attention to details, perfect mounting of switches so that perfect contacts are made, and especially in operation, see that the contact is good on the first tap of secondary coil, when this is to be thrown out of the circuit (as otherwise, by reason of end of coil being

"How to Make Your Own Wireless Receiving Set" 25c

One Seattle store sold 200 copies in 4 days. Dealer proposition on request. Send for trial order; 12 copies, \$2.00.

ARCHWAY BOOKSTORE, Seattle, Wash.

RADIO PANELS

Cut exactly to size and shipped within 12 hours. $\frac{1}{4}$ inch thick \$.01 $\frac{1}{2}$ c per square inch, $\frac{1}{8}$ inch .02c. Made of the highest grade black fibre. This material possesses high di electric strength, is inexpensive, unbreakable, easy to work and takes a nice finish. Special offer 6x6 $\frac{1}{4}$, .50c. We pay postage.

RADIO INSTRUMENT & PANEL CO.
 Box 75, CICERO, ILLINOIS

Tell them that you saw it in RADIO

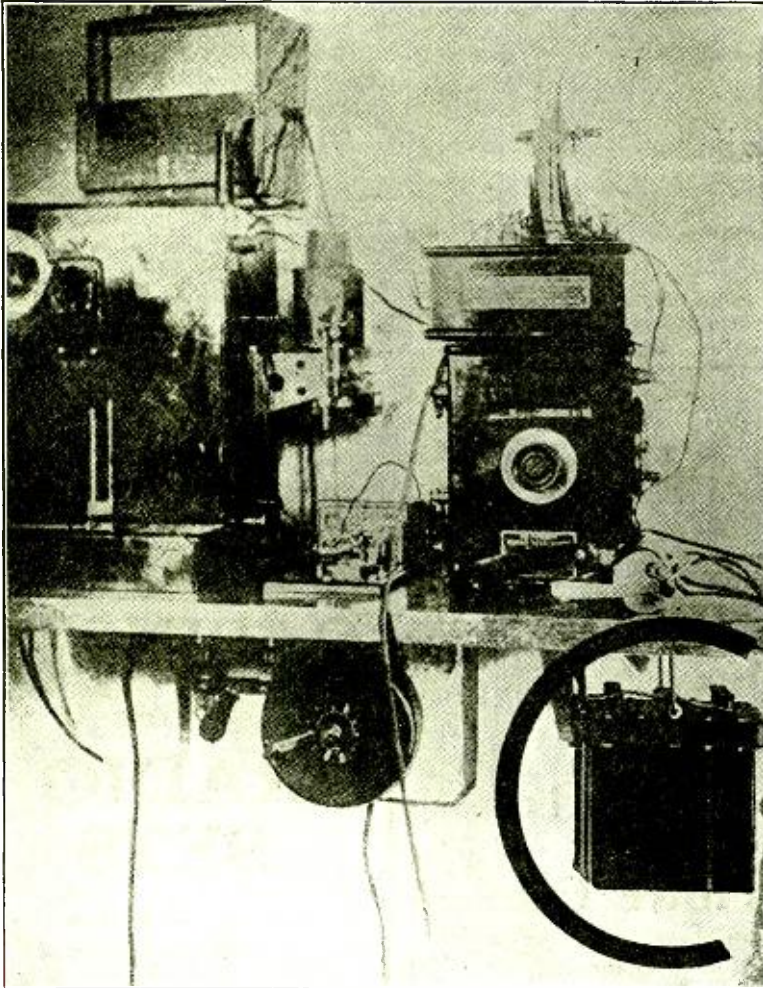

“Built Right Since 1903”

**First Set of
Wireless Telephone
Instruments**

FOR THE
United States Navy
INSTALLED ON THE
Flagship Connecticut

**WITHERBEE
Radio A**

← **BATTERY**

**is the sole source of
current.**

Witherbee A Batteries are designed and built to meet the particular conditions prevailing in Radio CW Service.

They are constructed with extra heavy plates suited for slow discharge work thus insuring against voltage variations. Extra thick, specially treated separators are used which prevent internal discharge.

The entire construction is such that Witherbee Batteries may undergo continuous cycles of complete discharge and in addition may stand idle for long periods—without being harmed. The strong, clean Witherbee hard rubber case is the ideal enclosure for radio service. These cases have been a specialty of the *Witherbee* organization for nineteen years for use in the home or in the office where acid leaks would be fatally destructive. These cases have soft rubber bottom rests making them safe, clean and insuring perfect insulation.

“Built Right Since 1903” is the Witherbee slogan—and specifically applies to *Witherbee* Radio A Batteries.

For further information for the trade write:

WITHERBEE STORAGE BATTERY CO., Inc.

643-655 West 43rd Street
NEW YORK CITY, N. Y.

Builders of batteries since 1903 for automobile starting, lighting, ignition, etc.



Tell them that you saw it in RADIO

HERE'S A FEW OF THE EBY LINE



Commander H



Ensign H



Sergeant



Corporal

Posts shown are most suitable for radio use.
Our prices are attractive and our deliveries prompt.

THE H. H. EBY MANUFACTURING CO., 605 Arch St., Philadelphia, Pa.

shorted to switch, the whole coil effect would be in when not wanted), I think the experimenter who will construct one of these receivers will be more than pleased, and with increasing interest with experience in operating and finding the fine points of merit which exist, and which have proven themselves time and again. In fact after some experience one can lay down rules for operation which will prove the best for the various waves and exact calibration, which will minimize the seemingly many things to do in tuning.

The set is just as easily handled on any wave as the standard 200-600 meter set, and if carefully made, together with good audion control, batteries up in voltage, etc., no troubles will be had in operation. No need to change audion controls, fone or grid condensers, if right for the tube in use.

RADIO PANELS

And other insulation for Wireless Work

BAKELITE-DILECTO

GRADE XX BLACK WAS USED BY THE GOVERNMENT DURING THE WAR FOR THIS PURPOSE. IT IS THE

Standard of the World

THE CONTINENTAL FIBRE CO.

NEWARK, DELAWARE

DUCOMMUN HARDWARE CO., 219 Central Ave., Los Angeles, Cal.

CALIFORNIA ELECTRIC SUPPLY CO., 643 Mission St., San Francisco

233 Broadway, New York City
75 Fremont St., San Francisco, Cal.
301 Fifth Ave., Pittsburg, Pa.

332 S. Michigan Ave., Chicago, Ill.
411 S. Main St., Los Angeles, Cal.
89 Wellington St. W., Toronto, Ont., Canada.

CABINETS

for

RADIO SETS

Woodwork of every description. Let us build your cabinets.

Best Material

Finest Workmanship

Write for Catalog and Prices

Nicoll & Co.

190-198 HOOPER ST.

Telephone Market 1761

SAN FRANCISCO, CAL.



HERE THEY ARE

LOOK THEM OVER AND ORDER FROM BELOW LIST

Volts	type	kind	taps	price
22.5	Large	varia.	5	\$2.50
22.5	Large	plain	.	2.10
22.5	Small	varia.	5	1.50
22.5	Small	plain	.	1.25
45	Parl 45	plain	.	4.00
45	Parl 45	varia.	6	4.50

All about our mystery ad next month

PORT ARTHUR RADIO LABORATORY
PORT ARTHUR, TEXAS

IN STOCK

Holtzer-Cabot Headphones. Navy headband, nickel plated case, carefully made. \$8.00

Murdock type 56 headset
2000 ohm - \$5.00
3000 ohm - 6.00

Federal Radiofone Receiver

The leading low-priced radio set. Complete ready to connect to your aerial. It works! \$25.00

Special — 100 ft. of aerial wire with the set during June.

Aerial Wire

7 strands of No. 22 pure copper. Only 65c per hundred ft. \$6.00 per thousand.

WE HAVE THE AMPERITE

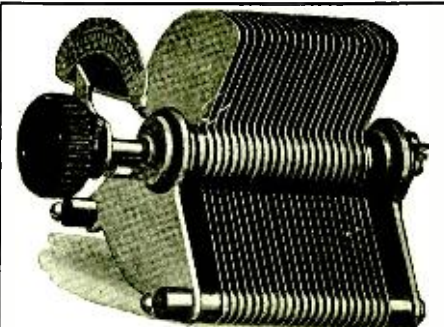

43 plate Variable condensers (.001 M. F.).....\$6.50 each
25 plate Variable condensers (.0005 M. F.)..... 5.00 each
11 plate Variable condensers (.00025 M. F.).... 4.35 each
3 plate Variable condensers. Used as vernier... 3.25 each
(Above prices include knob, pointer and dial)

Hard Rubber panels for above, extra.....75c each

Please do not compare these condensers with any built to sell at a low price, as our apparatus is intended for the critical amateur.

Immediate Shipments

Dealers: Order samples, and get our prices.

F. JOS. LAMB COMPANY

1940 Franklin St.

Detroit, Mich.

Tell them that you saw it in RADIO



The CAPITAL Serves Indiana, Ohio and Kentucky



Interior of Salesroom

THE Capital Radio Supply Company, located at Indianapolis, was organized by prominent business men for the purpose of supplying this territory with the finest, most dependable and efficient radio equipment made.

Among the prominent manufacturers who are represented by this company are Grebe, Kennedy, Remler, King Am-pli-tone, Hipco Batteries, Western Electric, Signal and Tuska.

Because of the financial strength, the experience and efficiency of the organization and the geographical location, the Capital Radio Supply Company is logically the distributor to successfully handle this rich territory.

CAPITAL RADIO SUPPLY COMPANY, Inc.

Indianapolis, U. S. A.

Tell them that you saw it in RADIO



The Enormous Demand for the TELMACOPHONE

Is the *Best Evidence* that it is
the *Greatest*
Value on the
market.



Fully
Guaranteed
Price \$20.00
Complete

Equipped with Baldwin Type C Unit. Inverted horn reflected tone. Equal to any other horn twice its length. Designed and perfected by expert acousticians. Complete in every detail. No extras to buy. Nothing to get out of order.

Price without Baldwin Unit, but with cap attached, \$14.00

We advise the purchase of the TELMACOPHONE without Unit for those who have Baldwin Unit of their own.

DEALERS—We are distributors for nearly all standard lines. Full discounts on the Telmacophone. Write for proposition on our complete line.

Only after the most exhaustive tests and comparisons with the other loud speakers; and only after the most thorough research, laboratory tests and field demonstrations has the TELMACOPHONE been perfected.

TELMACO Amplifiers, Receivers, Detectors, Variometers, and Variocouplers have earned a national reputation for quality, endurance, and satisfaction not excelled by any other line. You can expect equal satisfaction from the Telmacophone.

RADIO DIVISION
TELEPHONE MAINTENANCE CO.

20 S. Wells St.

Dept. A

Chicago, Ill.

"Sign of  Long Life"

TRADE MARK

THEY LIFT YOUR RADIO SET ABOVE THE ORDINARY



Ace Batteries are constructed to give the utmost "B" battery service. By reason of special manufacturing process they solve the "B" battery problem.

Get them at your dealer
and write for catalog

ACE BATTERY MANUFACTURING CORP.

Gen. Offices 495 Broome St. New York City Factory 359 W. Bdway

MODIFY RADIO REGULATIONS

Continued from page 20

ings shall not come nearer than four (4) inches to electric light and power wires unless separated therefrom by a continuous and firmly fixed non-conductor that will maintain permanent separation. The non-conductor shall be in addition to any insulation on the wire.

Lead-in-wires shall enter building through a non-combustible, non-absorptive insulating bushing.

PROTECTIVE DEVICE

c. Each lead-in-wire shall be provided with an approved protective device prop-

RADIO

CATALOG

FREE

Our corps of Radio experts are now designing and building improved Radio apparatus and we want every Radio fan on our mailing list so that we can send literature covering our apparatus as developed. Kindly state the type of set you have or contemplate installing and give us the names and addresses of your Radio friends so that we may place their names on our mailing list.

Maxum Radio Company

5837 Woodland Avenue
Philadelphia, Pa.

Tell them that you saw it in RADIO

erly connected and located (inside or outside the building) as near as practicable to the point where the wire enters the building. The protector shall not be placed in the immediate vicinity of easily ignitable stuff, or where exposed to inflammable gases, or dust, or flyings of combustible materials.

The protective device shall be an approved lightning arrester which will operate at a potential of five hundred (500) volts or less.

The use of an antenna grounding switch is desirable, but does not obviate the necessity for the approved protective device required in this section. The antenna grounding switch if installed shall, in its closed position, form a shunt around the protective device.

PROTECTIVE GROUND WIRE

d. The ground wire may be bare or insulated and shall be of copper or approved copper-clad steel. If of copper the ground wire shall be not smaller than No. 14 B. & S. gage, and if approved copper-clad steel it shall be not smaller than No. 17 B. & S. gage. The ground wire shall be run in as straight a line as possible to a good permanent ground. Preference shall be given to water piping. Gas piping shall not be used for grounding protective devices. Other permissible grounds are grounded steel frames of buildings or other grounded metallic work in the building and artificial grounds such as driven pipes, plates, cones, etc.

The ground wire shall be protected against mechanical injury. An approved ground clamp shall be used wherever the ground wire is connected to pipes or piping.

WIRES INSIDE BUILDINGS

e. Wires inside buildings shall be securely fastened in a workmanlike manner and shall not come nearer than two (2) inches to any electric light or power wire unless separated therefrom by some continuous and firmly fixed non-conductor making a permanent separation. This non-conductor shall be in addition to any regular insulation on the wire. Porcelain tubing or approved flexible tubing may be used for encasing wires to comply with this rule.

Continued on page 92

"Superior" Receiving Set \$4.75



In Cabinet complete as shown
Guaranteed to bring in signals as loud or louder than any other crystal set made, regardless of price. We will prove this to your satisfaction or refund your money.

Parts ready "SUPERIOR" set ready for assembling \$3.25

Genuine "STEINMETZ" Tested Galena Absolutely the most sensitive that can be had. In sealed tin box, 15c At your dealers or STEINMETZ WIRELESS MFG. CO. 5706 Penn Avenue Pittsburgh, Pa.

"Read 'Em" Binding Posts

"Radio's Greatest Convenience"



17 Styles—Packed in Cartons, 25 or 50 Each Style

- | | | |
|--------------------|---------------------------|--------------|
| Antenna | Ground | Condenser |
| Tickler | Plate | Detector |
| Secondary | Phones | Primary |
| A-Battery — | Grid | Filament |
| A-Battery | B-Battery — | B-Battery |
| Variable Condenser | A Positive and B Negative | Battery Post |

QUALITY—The quality built into every post is consistent with the high Marshall-Gerken standard. "Read 'Em" binding posts are a distinct aid to correct hook-up and add materially to the appearance and efficiency of any set. They are standard with discriminating users.

Complete Post and Knob - - 15c Each
Ask for "Read 'Em's" at Your Dealer's

The Marshall-Gerken Co.
Quality **RADIO** Products
MANUFACTURERS—DISTRIBUTORS
Toledo, Ohio, U. S. A.

Variometers Couplers \$3.75 Each

Wound but unassembled
\$3.00 Each

These instruments embody best workmanship and materials. all wooden parts genuine mahogany, coupler primary wound on Formica tubing. Wound to assure maximum results for short wave work. Shafts 3/16 inch. With Chelsea Dial and Knob \$1 extra. Send for bulletin describing panels, parts and other apparatus.

FREDERICK WINKLER, JR.
304 Columbus Av., New York, N. Y.

WIRELESS CATALOGUE

WHETHER you are interested in a complete radio receiving outfit, or a half a dozen binding posts, you'll find the particular instrument, best for your needs, in Corwin's catalogue. Send 10 cents, (credited to your first order) for your copy today! Where's the nearest mail box?

A.H. CORWIN & CO.
4 West Park St. Dept. G
Newark New Jersey

Tell them that you saw it in RADIO



Saves the
Filament
Every
Time

No
"Short"
Can Get
By It!

PROTECT Your TUBES

No matter how much excessive amperage, or what causes it, even accidental short circuiting in your set, you can never "burn out" a bulb protected by the

RADECO Safety Fuse

FOR VACUUM TUBES

Slips directly on the filament terminals right where the current goes in. Fits any standard bulb used in any standard socket. Positively does not affect the efficiency of your set. Equally good for meters and other delicate Radio instruments.

Order by Mail **4 for \$1** Buy from Your Dealer

Save the cost of a Tube. Buy Now!

Radio Equipment Co.

630 Washington Street
BOSTON, MASS.

Oldest Exclusive Radio Store in
New England

We carry at all times a complete stock of standard Radio sets and parts at standard prices. Order from any standard catalog.

PORTS — SERVICE

No. 50 Ports Detector Unit with Jack..... \$9.00
No. 75 Ports Amplifier Unit with Jack..... 15.00
No. 35 Ports Grid Condenser..... .50

Fresh Stock No. 774 Eveready B. Bats., Tapped 43 Volts..... 5.00
Fresh Stock No. 201 Hi-Gee B. Bats., 22½ Volts..... .90

EVERYTHING RADIO — SEND FOR BULLETIN

QST RADIO SHOP 3305 Belmont Ave.,
FRESNO, CALIF.

Can You Use Anything in This List?

- | | | |
|---------------------|------------------------|-----------------------|
| Loop Aerial | Knob | Duo-Lateral Coil Plug |
| Flat Top Aerial | Dial | Triple Coil Mount |
| Single Wire Aerial | Switch Lever | Duo-Lateral Coils |
| Cage Aerial | Switch Points | Phones |
| Umbrella Aerial | Rheostat | Loud Talker |
| Variometer | 1 Stage Amplifier | Series Par. SW. |
| Varicoupler | 2 Stage Amplifier | Anti-Cap. SW. |
| Short Wave Receiver | 3 Stage Amplifier | Switch Stops |
| Long Wave Receiver | Amplifying Transformer | Binding Posts |
| VT Detector Cabinet | Variable Condenser | Short Wave Hookup |
| Tube Socket | Grid Leak | Long Wave Hookup |
| Storage Battery | Grid Condenser | Loop Set Hookup |
| Storage "B" Battery | Plug | Det. Cab. Hookup |
| | Jack | |

You can make everything in that list if you follow our plans and instructions. Use raw material, obtainable anywhere. Lots of it in your own shop or around the house. You can have any range receiver desired and at a price well within your reach, without the delay of getting finished parts from distant points. This set of real blue prints from drawings gives every detail of construction, showing the various devices assembled, also each component part individually. Printed instructions accompany them. You will save their cost on the detector cabinet alone.

THE BIGGEST VALUE IN RADIO

Complete Set Blue Prints and Instructions \$3.00 Postpaid. (No stamps.)
1929 McCausland Ave., St. Louis, Mo.

THE PLAN BUREAU

1929 McCausland Ave.

ST. LOUIS, MO.



Mitchells Radio Cabinets

We manufacture a complete line of Radio cabinets, in American Black Walnut, Quartered White Oak and Genuine Mahogany. Quick deliveries—quantity production prices.

Some of our latest refinements:—Lock joint construction, 110 degree stop butts, felt pad bottoms. Write for prices.

The Robert Mitchell Furniture Company
CINCINNATI, OHIO

Cabinet woodwork since 1836.

CONDENSITE
CELORON
makes high type
**Radio
Panels**



WHEN you think of radio insulation, think first of Condensite-Celoron, for this remarkable material is an all-purpose insulation of the very finest type—extremely high in surface and volume resistivity—extremely high in dielectric strength—and low in dielectric losses. It is adaptable to every machining process—takes an attractive finish—and engraves cleanly. You can obtain it in rods and tubes of standard sizes and in two colors—natural (brown) and black.

Write today for our Celoron Radio Panel Guide containing full information.

Diamond State Fibre Company
BRIDGEPORT (near Philadelphia), Penna.
Branch Factory and Warehouse, Chicago
In CANADA: Diamond State Fibre Co., of Canada, Ltd., Toronto.



The sign of quality
Radio Apparatus

Meyberg Service *plus* Quality Apparatus

In the stores of the Leo J. Meyberg Company may be found Radio Apparatus that reflects the highest type of sound merchandising method. Quality merchandise is built around the name Meyberg—it stands for the best in all manufactured lines of Radio Apparatus.

New printed 6th District Call Book now ready. 50 cents postpaid.

Dealers: Order your copies to supply the immediate demand.

LEO J. MEYBERG CO.

Operating the Fairmont Hotel
Radio Station **KDN**, San Francisco

Operating Hamburger's
Radio Station **KYJ**, Los Angeles

Send two-cent stamp for NEW Concert Schedule.

San Francisco, Cal.
428 Market Street

950 South Flower Street
Los Angeles, Cal.



UV712
Amplifying Transformer

Tell them that you saw it in RADIO

MAKE NO MISTAKE!

**THE KLOSNER
VERNIER
RHEOSTAT**

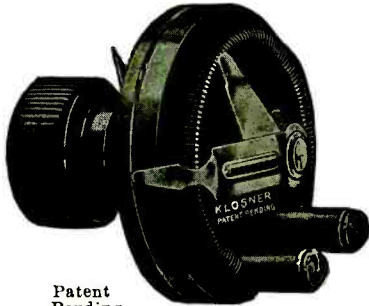

Patent
Pending

is the only Vernier Rheostat made having the exclusive feature of using but

One Single Knob

for both rough and fine adjustments. This feature allows the symmetrical appearance of the single knob to be retained when mounted on a panel with other instruments, and, at the same time adds to the simplicity and ease of operation in obtaining the necessary fine adjustments for best results from the modern critical vacuum tubes, especially when receiving phone and C. W. signals.

We invite comparison with any other filament rheostat now made.

Look for the name KLOSNER moulded on the base.

Your dealer has them, or send direct to us.

Price \$1.50

Shipping Weight, One Pound
A Two Cent Stamp Brings
Interesting Literature.

Made Only by The Originators

**Klosner Improved
Apparatus Company**

2024 Boston Road, New York City, N. Y.
Dept. R

TRACO

Loud Speaker

Price \$40

Complete F. O. B. San Francisco

Vernier Controls \$1.15

**Radio Appliance Co.
INC.**

158 Fifth Street
San Francisco

NEW DX RECORD

Continued from page 33

possessing efficient transmitting sets were primed to cover what would be to them a record distance. Hence, at one time the writer heard no less than eight stations, from CL8, at Camp Lewis, Wash., to 6ZZ, at Douglas, Ariz., all frantically calling 6ZAC. And Dow was kept busy answering them, one after another and clearing whatever traffic they had for him. At times his signals were so loud that with the aid of a two step amplifier and an ordinary loud speaker, they could be copied in any room of a five room house, which will give some idea of how well Dow was getting across. On this same Saturday night, one of his tubes became defective and he has been working the coast ever since on ONE 50 WATT TUBE, with about the same signal strength, the only difference being that the note is rough and not so easy to read as when both tubes are in the circuit.

Wonderful work has been accomplished by Atlantic and Pacific Coast amateurs in the past, using a group of 5 watt tubes, or one or more 50 watt tubes, but it is thought that Dow has set the pace for real DX, where the calling station calls three times, signs his own call the same, and receives immediate answer from the distant station. Records made only as the result of continuous calling for fifteen minutes at a time cannot be considered remarkable feats with C. W. at the stage of development which it now enjoys, and only serve to cause unnecessary interference. With a chain of efficient C. W. stations scattered at distances of 1000 miles, across the continent, and Dow's station at Wailuku, we can expect New York-Honolulu relays as a nightly occurrence, with a minimum of interference, and the maximum of interest.

Station 6EA heard 6ZAC readable on detector and stronger on one or two steps of amplification working on I.C.W.—"QRH" between 6ZZ and 9ZAF around 375 meters on April 21st and 22nd between 11:30 P. M. to 12:30 A. M. trying to work California 375 meter stations. "QRN" rather bad.

Station 6EA worked 9ZAF and 6ZZ on 5 watts AC-CW.

Station 6EA's 5 watter heard by 6ZAC at Hawaii.

BY GAME, BOX 218, RIVERSIDE, STANISLAUS CO., CALIFORNIA

On one tube—5zq, 8agz, 8eld, 8de, 8sp (Fairmont, W. Va.), 8uj, 8xm, 8xv, 9ak, 9bj, 9kp, 9zaf, (fone and cw), 9zj, 9zy, 9ax (Can. spk.), 9bd (Can. spk. and cw), dd5 (fone), vlj.

On choke coil one step—5ak (spk.), 5if (spk.), 5xb (spk.), 5xd (spk.), 5yq (spk.), 5za (spk., cw and fone), 5zz, 8aav, 8aim, 8agu, 8bf, 8bfx, 8box, 8caz, 8egx, 8ib, 8jl, 8in, 9aik, 9aja, 9akd, 9alu, 9amb, 9aqa, 9aqu, 9ayu, 9ayv, 9avz (spk.), 9awm, 9bac, 9bex, 9bbf, 9bik, 9dtm, 9dva, 9dvh, 9dvt, 9dzj, 9fm, 9io, 9ix, 9ji, 9jr, 8nx, 9pi, 9wd, 9wu, 9xaq (spk. and cw), 9yak (spk.), 9yal (spk.), 9zac, 9zal (fone), va2, cl3, cl8 (spk. and cw), bf2, nof (Washington, D. C.).

Tell them that you saw it in RADIO

For

BETTER

Results

USE

EVEREADY

'A' & 'B'

**BATTERIES
With Your
RADIO SET**



FOR SALE

By Better Radio Supply Dealers
everywhere



Made on the Pacific Coast

By

**National Carbon
Co., Inc.**

599 Eighth Street
San Francisco, Cal.

The Largest and Finest Show Room in New York City

If you are in doubt what Radio set you should buy—write us—we handle only the best, well known, and guaranteed makes:

RADIO CORPORATION ACME
GREBE WESTERN ELECTRIC
 WESTINGHOUSE
PARAGON AMRAD

Western Electric Loud Speaking
Telephone Outfit No. 10A.....\$161.00
Pink-a-Tone Complete Set..... 25.00
King Am-plitone 12.00
Arkay Horns 5.00

HEAD PHONES

Murdock, Brandes and Federal

A large and complete stock of all parts for making sets—everything you need.

CABINETS BAKELITE DIAL SWITCHES
VARIO-METERS VARIO-COUPERS

"AETCO" Honey Comb Cells

Our own manufacture and fully guaranteed. Complete with flexible leads for connection and will not loosen up in varying the position of the coils attached. AETCO Type A1-Triple Coil Mounting, \$5.00.

Send 10c for large Illustrated Catalog

American Electro Technical Appliance Co.
227-229-235 Fulton Street New York

"ANCHOR" RADIO LIGHTNING PROTECTOR

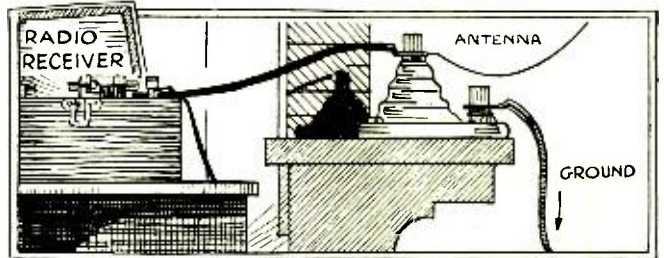

**High Insulation—Preserves Signal Energy
Weather Proof—Easy to Install—Price \$1.50**

With the Anchor Radio Lightning Protector on the job your equipment and home are as safe as under normal conditions, though thunder and lightning are rending the skies outside.

This efficient device is built and tested to comply with the NEW Underwriters regulations.

Offers a free path to excess potentials as well as to the direct bolt of lightning. Every current with strength enough to interfere with the operation of your instrument is shunted harmlessly to the ground.

The thing that distinguishes the Anchor Radio Lightning Protector is its simplicity. As plain and rugged as ingenuity can make it—and for that reason 100% efficient. Constructed of porcelain and metal in a form that is specially designed to withstand the elements. No parts to become water-soaked; no vacuum to deteriorate. The Anchor Protector is thoroughly weather-proof.

No Ground Switch
Required

R Co. R

Send for Illustrated
Folder Today

RADIO RECEPTOR CO., Inc., No. 1 Madison Ave., N. Y. City

Universal Radio Co.

121 Prince St., New York, N. Y.

Manufacturers of

V. T. SOCKETS

Single, Double, Triple

VARIABLE CONDENSERS

JACKS

Double, Single

CRYSTAL SETS, Etc.

Radio Equipment of the Better Kind

FOR IMMEDIATE DELIVERY

No. 22 Enameled Magnet Wire, 35c per lb. on full spools (7 to 12 lbs.). Bakelite Panels and Gorton Machine Engraving to order.

F. JOS. LAMB COMPANY

1940 Franklin St. Detroit, Mich.

GALENA CRYSTALS

50c pays for a lump of "Cascade" Galena—enough for 6 or more detectors. Also supplied in bulk or granules. Discount to dealers.

HARRY G. ALLEN CO.,

908 E. Post St., Seattle, Wn.
Distributors for Kilbourne & Clark
Radio Equipment

A POSTAL CARD

Will Bring Our Latest
RADIO FOLDER

THORDARSON ELECTRIC MFG. CO.
513 S. Jefferson St. CHICAGO

BRONX RADIO EQUIPMENT CO.

Manufacturers of Quality

VARIOMETERS

VARIOCOUPERS

VAR. CONDENSERS

RHEOSTATS

CRYSTAL DETECTORS

INDUCTANCE SWITCHES

BAKELITE PANELS, SHEETS

AND TUBING

TRANSFORMERS

DIALS

PLUGS

JACKS

LIGHTNING SWITCHES

GRID CONDENSERS

SOCKETS—Single, double and triple

SWITCH POINTS

BINDING POSTS

SPAGHETTI

WIRE—Bare copper and D. C. C.

Dealers' and Distributors' Propositions Open

IMMEDIATE DELIVERY

Manufacturers and Distributors

687 Courtlandt Avenue

Bronx, N. Y. C.

HAVE YOU SUBSCRIBED?

YOU CAN SAVE A DOLLAR BY MAILING US YOUR
SUBSCRIPTION TO "RADIO" BEFORE JUNE 30TH.

Tell them that you saw it in RADIO

SHIP OWNERS RADIO SERVICE INC.

80 Washington St., New York City
RADIO DISTRIBUTORS

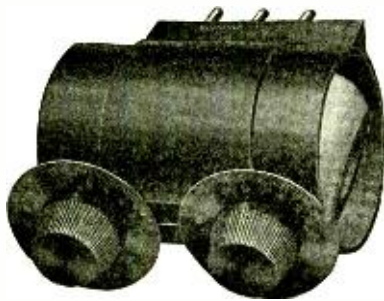

SORSING "TUNIT" . . . \$15.00
PAT. APPLD. FOR

The "Tunit" is a balanced primary attachment for use with the standard triple coil mounting, allowing ultraefficient reception on wave lengths from 160 to 600 meters.



"SOCOSTAT" \$2.50

Combination Rheostat and Socket for table or panel mounting. The knurled disc will fit through a panel slot. The socostat is a space-saver.

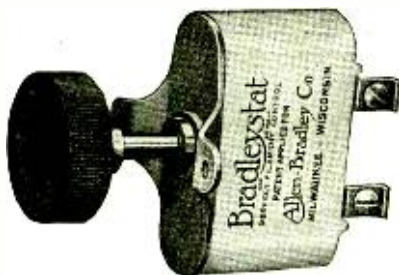

"BRADLESTAT" \$1.85

A self-contained, Vernier adjustment rheostat operating on the graphite disc principle. Ideal for multi-tube control in Radio-frequency circuits. Will carry up to 2½ amperes on 6 or 12 volt circuits.



"FRAMINGHAM" RHEOSTAT, \$1.00

The only rheostat incorporating a panel brushing to give rigidity. The detail of construction and design makes this a highly desirable instrument. For table or panel mounting.

Purchase from your dealer

IMMEDIATE DELIVERY!

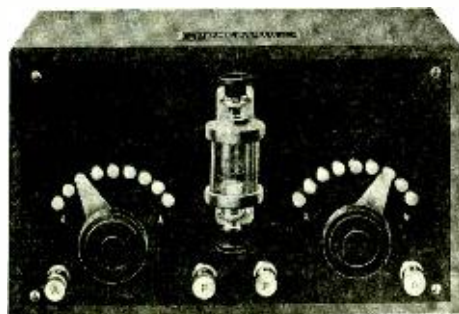

- Special Glass Enclosed Dust Proof Detector.
- Super Sensitive Crystal Set in Woods Metal.
- Formica Panel.
- Bakelite Knob.
- Handsome Appearance.
- Size 5½x9½x3.

DEALERS:—Write for Our Proposition

D. H. McGORKLE MFG. CO.

319 12th ST.

OAKLAND, CALIF.

Tell them that you saw it in RADIO

MODIFY RADIO REGULATIONS

Continued from page 87
RECEIVING EQUIPMENT GROUND WIRE

f. The ground conductor may be run inside or outside of building. When receiving equipment ground wire is run in full compliance with rules for Protective Ground Wire, in Section d., it may be used as the ground conductor for the protective device.

BY 6ZD (OLD 6APP) AT 1258 W. PIERCE ST., PHOENIX, ARIZ.

Spark—5aa, 5by, 5az, 5if, 5lc, 5oh, 5pd, 5pp, 5qa, 5xa, (5xb), (5xd), (5xj), 5xt, (5xu), 5yi, 5yo, 5yk, 5yl, 5yn, 5za, 5zc, 5ze, 5zf, 5zj, 5zl, 5zr, 5zs, 5zu, 5zv, 5zx, 5zaa, 5zab, 5zac, 5zaf, 5zag, 5zak, 5zai, 5zam, 5as, 6hm, 6dw, 6eb, 6er, 6ex, 6fi, 6fh, 6jw, 6jy, 6ka, 6kc, 6hc, (6hy), 6if, (6gp), (6lc), 6le, 6mh, 6ny, 6nl, 6od, (6ob), (6ol), 6ot, 6pj, (6pp), 6pr, 6po, 6qt, (6qr), 6rs, 6sj, 6su, 6tf, 6vx, 6vm, 6vz, 6wz, 6zk, 6zu, 6zx, (6zz), 6zaa, 6zal, (6zam), (6xb), 6auu, 6abh, 6abw, 6abx, 6ael, 6aeh, 6acn, 6adn, 6afu, 6aif, 6afp, 6agf, (6agp), (6ain), 6ajf, (6ajr), 6ajl, (6ajh), 6akl, 6alv, 6amk, (6ama), 6ang, 6aor, 6ape, 6aph, 6apo, 6ark, 6ask, (6ath), 6auc, 6aud, 6avn, 6aso, 6asj, 6if, 6aol, (6atq), 6baj, 6bbo, 6bgg, 7bh, 7bk, 6ck, 6fi, 5iw, (7id), 7jw, 6ln, 7ly, (7mp), 7mu, 7gp, 7ry, 7ij, 7vo, (7ya), 7yg, 7y, (7zm), (7za), (7zt), (7zv), 7zu, (7zs), 9aeg, 9dsd, 9dze, 9wu, 9zx, 9zn, 9zt.

C. W.—4as, 4by, 4gl, 4xf, 5an, 5ci, 5dz, 5ek, 5hh, 5sb, 5za, 5xj, 5xu, 5zac, 5zag, 5zak, 6ak, 6eb, 6en, 6gr, 6jd, 6jf, 6ka, 6ky, 6rr, 6xad, 6xaf, 6sh, 6za, 6zaf, 6zb, 6zt, 6zq, 6zz, 6aat, 6ale, 6alu, 6aoz, 6avy, 6awt, 7zu, 9amb, 9bjj, 9zyu, 9ble, 9dtm, 9dth, 9dva, 9nx, 9wd, 9zaf, 9xaf,

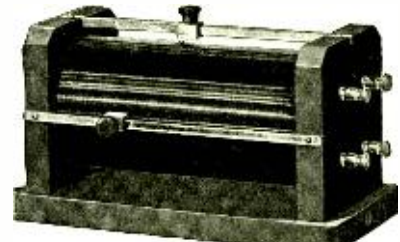

LAMB Tuning Coils. Two nickel sliders and rods; four nickel binding posts. Coil contains about ½ lb. No. 22 enameled Magnet Wire. Mounted in hard wood ends and base. Price \$3.00. Code word, ACE.

F. JOS. LAMB CO.

1940 Franklin St. Detroit, Mich.

Radio Head Phones

World's Largest Distributors of

RADIO HEAD PIECES



We represent 30 manufacturers, showing 75 types and designs, priced from \$5.00 to \$15.00. Following is a partial list of manufacturers:

- | | |
|--------------|---------------|
| Manhattan | Levering |
| Thompson | Everett |
| Frost-Phones | Electric |
| American | Leich |
| Connecticut | Electric |
| Western | Elmwood |
| Dictagraph | Holtzer-Cabot |
| Cory | |

Phones on hand for immediate shipment. Ask us for the phone you want. Special—100-ohm single receivers made by old reliable telephone maker. List—\$2.50. Agents Wanted Everywhere. Get literature and discount sheet.

D. E. POLCZYNSKI & CO.

26 Capitol Bldg.—1550 Broadway
Detroit, Michigan, U. S. A.

RADIO MANUFACTURERS Attention! For Efficiency—

SHAW Moulded Insulation PRODUCTS

Moulded insulation to fit your every need Exactly. For we manufacture it according to *your own* specifications and moulds. That's the SHAW way. Try it—"for efficiency." We neither retail nor wholesale. We manufacture only. Submit your specifications for a SHAW estimate.

SHAW INSULATOR COMPANY

Henry M. Shaw, President

Frank H. Shaw, Vice President and Gen'l. Manager.

638 MISSION STREET, SAN FRANCISCO

5 KIRK PLACE, NEWARK, NEW JERSEY

UNIFORM YOUR UNITS

BUY THE BEST—ADD THE BEST—AND YOUR RESULTS
WILL BE THE BEST

REGENERATIVE RECEIVERS

No. CR-4 Grebe 175-680 meters....	\$85.00
No. CR-5 Grebe 175-3000 meters....	80.00
No. CR-8 Grebe 175-1000 meters....	80.00
No. CR-9 Grebe 175-8000 meters with det. and two stage amplifier, com- plete	130.00
No. RA Westinghouse 150-700 meters....	88.00
No. RC Westinghouse 150-700 meters....	132.50
Aeriola "Jr."	25.00
Aeriola "Sr."	75.00

SOCKETS

No. 550 Murdock.....	\$1.00
No. UP-552 Radio Corp.....	1.50
No. UR-542 Radio Corp.....	1.00
No. UT-541 Radio Corp.....	2.50
No. 80 Paragon.....	1.00

AMPLIFYING TRANSFORMERS

No. A-2 Acme, Semi-mounted.....	\$5.00
No. UV-712 Radio Corp.....	7.00
No. 231 Gen. Radio.....	5.00

JEWELL METERS

No. 54 for D. C. Standard readings..	\$8.00
No. 54 for D. C. 500 volts	16.00
No. 54 for D. C. 1000 volts	23.00
No. 54 for D. C. 1500 volts	29.00
No. 64 Radio Frequency	12.00
No. 74 A. C. Standard reading	8.00

THE MAN WHO KNOWS
BUYS IT FROM



VACUUM TUBES

No. UV-200 Detector	\$5.00
No. UV-261 Amplifier	6.50
No. UV-201 5 watt transmitter....	8.00
No. UV-203 50 watt transmitter....	30.00
No. UV-204 250 watt transmitter....	110.00

ATLANTIC-PACIFIC

A. P. Detector.....	\$5.00
A. P. Amplifier.....	6.50

Send us your orders for Tubes.
Our stock is complete.

LOUD SPEAKERS

No. A-3 Magnavox, new type.....	\$45.00
VOCALOUD, station type	30.00

TELEPHONES

Type C Baldwins.....	\$12.00
Type E Baldwins.....	13.00
Type F Baldwins.....	14.00
No. 56 Murdock 2000 ohm.....	5.00
No. 56 Murdock 3000 ohm.....	6.00
No. 2500 Mesco 2000 ohm.....	6.00
No. 2501 Mesco 3000 ohm.....	7.00

RHEOSTATS

No. 25 Paragon	\$1.50
No. 214 General Radio	2.50
No. 560 Murdock	1.00
No. 120-A FADA, new type.....	1.00
No. 810 Remler, 4 ohm.....	1.00

"B" BATTERIES

No. 768 Eveready 22½ volts	\$2.25
No. 768 Eveready 22½ volts tapped	3.00
No. 5156 Burgess 22½ volts tapped.	3.00
No. 2156 Burgess 22½ volts, extra large	4.50

BOOKS

C. W. Instructions.....	\$0.25
Practical Wireless, by Bucher.....	2.25
Experimenters' Manual, by Bucher..	2.25

Please include sufficient postage with
all C. O. D. orders.

"We give all we can for what we get—Instead of—Getting all we can for what we give"

MISSOURI RADIO SUPPLY COMPANY

4623 Maryland Ave.

ST.

LOUIS

MISSOURI

Tell them that you saw it in RADIO

★ ★ RADIO ADS ★ ★

A CLASSIFIED ADVERTISING SECTION READ BY 60,000 BUYERS

The rate per word is five cents, net. Remittance must accompany all advertisements. Include name and address when counting words.

ADS FOR THE JULY ISSUE MUST REACH US BY JUNE FIRST

TRANSMITTING APPARATUS

BARGAIN: 650 volt motor-generator, new windings and commutator, with filter coils and rheostat, \$50.00. Honeycomb receiver, complete with DeForest mounting, short wave coils, socket, rheostat, variable condensers, etc., \$25.00. D. Skilling, 2960 Linden Ave., Berkeley, Calif.

FOR SALE: Type B. Thordarson $\frac{1}{2}$ K. W. Transformer \$15; Benwood gap 10 point, aluminum case, 3450 R.P.M. $\frac{1}{2}$ H.P. Westinghouse induction motor complete \$30; Murdock O. T. \$3.50. Carl Schneider, 76 Caselli Ave., San Francisco.

FOR SALE: $\frac{1}{2}$ kilowatt spark, \$45. Will sell separately. Leonard Tate, 807 6th St., Anacortes, Wash.

FOR SALE: 5 watt radiophone transmitter less tube and batteries, \$30.00. Uses three 22 $\frac{1}{2}$ B batteries for plate. Good for 5 to 10 miles voice. Also radio supplies of all kinds. Amateur Radio Shop, 115 Napa Road, Vallejo, Calif.

MOTOR GENERATOR FOR SALE. 1.5 KW capacity, 120 cycles, two bearing machine. ECK make, in good condition. Motor 110 V D.C. Shaft extended for synchronous rotary gap. Price F.O.B. San Francisco, Calif., \$65.00 cash. D. B. McGown, 1247 47th Avenue, San Francisco, Calif.

FOR SALE: 1 KW Acme transformer, with protective chokes, new condition—\$25.00, rotary gap, 24 tubes spark thru type, 8" Micamite disk, 1/12 HP induction motor, 1740 RPM (new) \$25.00, glass plate oil immersed condenser, about .006, \$10.00. Also have key, and hotwire ammeter (0-2.5, Roller Smith). E. D. Barrett, Merced, Calif.

Two .004 special high voltage (40,000) Dubilier condensers, suited for United "coffin"—\$15.00 each; good condition. D. B. McGown, 1247 47th Avenue, San Francisco, Calif.

For sale—Victor Motor Generator, runs on D. C., generates both D. C. and A. C., \$35.00. Write for particulars. A. E. Davies, 1327 Grove St., Berkeley, Calif.

RECEIVING APPARATUS

PLANS FOR HOOK-UP, full instructions for wiring, tuning and receiving, cost of parts and other valuable information sent on receipt of 25 cents. This information will save you many dollars and much time. Indispensable to the amateur. Get lectures and concerts free by owning your own. Wavelength 150 to 20,000 meters. Radio Engineers, B 354, Hornell, N. Y.

DO YOU want complete regenerative, honeycomb, tuning and detector unit including 2 tubes, phones, B battery, slightly used, for \$70! Write C. Graham, E. 1643 Wellesley Ave., Spokane, Wash.

TESTED GALENA CRYSTALS. From our own mines. Shaped and tested at the mine in best standard hook-up, direct to user. A real crystal, not a pinhead. Twenty-five cents postpaid. Five for \$1.00 to group buyers. Ozark Crystal Co., Box 1, Morrellton, Mo.

FOR SALE—Universal Amplifying Transformer, mounted, \$4.50; new Remler Cam Switch, \$2.40. M. Howe, Canton, N. Y.

FOR SALE:—Regenerative Receiver, Grebe C. R. 5 type, \$35.00. Also receiver with two step Grebe C. R. 9 style. Jay Tapp, 126 E. Anaheim St., Long Beach, California.

HAVE QUANTITY SALESMAN'S SAMPLE REGENERATIVES for sale half price. Just the set you want. Wonderfully efficient. Made of best materials by master craftsmen. Encased in beautiful grained leather covered cabinet. Easy to operate; no capacity effects. A wonder for CW and phones. Equals a Paragon. Will be placed on market soon, retailing at fifty-five dollars; will sacrifice samples at \$24 each. This is a bargain. Every one in excellent condition; like new. Fully guaranteed. Grasp this opportunity—order one today—now! (Photo free.) Master Engineering Company, Department R, Omaha.

RADIO MADE EASY. Illustrated book in plain English, containing impartial advice for purchasers, rules for erection of equipment, location of broadcasting stations, wireless code, etc., 30c cash. National Radiophone Co., Patton Bldg., Milwaukee, Wis.

Variocoupler and variometer parts for immediate delivery: Variometer rotors (large size) 60c. Variometer sides per paid 60c. Variocoupler 3 $\frac{1}{2}$ " Rotors 50c. Postpaid. A-1 Woodworking Company, 1338-42 San Julian St., Los Angeles, California.

MURDOCK PHONES. With each pair of No. 56 type Murdock Phones we will give as premium one Dubilier mica by pass condenser, suitable for either regenerative or crystal circuits. No. 56 Phones 2000 ohms \$5.00 each, 3,000 ohms \$6.00 each. Twelve hour service or your remittance returned. Postpaid and insured. The Kehler Radio Laboratories, Dept. R, Obilene, Kansas.

Radio Receiver, intermediate wave complete with detector and amplifier, \$110. Short wave regenerative receiver with detector, \$40. Compact crystal receiver, \$20. Other good values in new and used apparatus. R. Watson, 160 32nd Av. Phone Bay View 793, San Francisco.

For Sale—Custom built Type CR8 receiver with antenna condenser & Series Parallel switch. Renler Variometers & Variocoupler, completely shielded no body capacity, Chelsea Loading coil & Variable Grid Leak built in. Tuska dials. Panel Gordon engraved. Will work loud speaker on one stage. Cabinet 6x21". \$180.00.

For Sale—Custom built three stage amplifier, Filament control jacks, Filament ammeter, Radio Corp. Transformers, Paragon rheostats and dials, Panel Gordon engraved Cabinet 6x14". Will work a Magnavox. \$135.00.

For Sale—150-25,000 Meter receiver and two stage amplifier. Gordon engraved Panel, complete with 17 QSA coils and stand. Cabinet 6x10". A Beautiful instrument and it works. Jack & pug controls. \$150.00. Two Stage Amplifier, with jacks, \$45.00. Hyman, 1708 West 23d Street, Los Angeles, Cal. All letters answered.

VARIABLE CONDENSERS: Plates 4c, Rotary Washers 10c dozen, Stationary 5c, Shafts 25c, Supporting Rods 5c, Tops and Bottoms 25c pair, Knobs 15c. Parts for 23 Plate—\$1.85; 43—\$2.85. Assembled \$1.00 extra. Panel and Table Mounting Types. Dials 35c. Gravenstede, 84 Hancock Avenue, Jersey City, New Jersey.

Representatives wanted in every locality to handle standard makes of receiving equipment. We teach you how to install, furnish selling plans, etc. Only small capital required. National Radiophone Co., Patton Bldg., Milwaukee, Wis.

"Here's your chance!" **Receiving set complete** consisting of large variocoupler in neat box, detector, 3000 ohm phones, phone condenser, and large variable condenser. Only \$30.00. Don't rush. Chas. Arthur, Rosemont, Pa.

MISCELLANEOUS

SELLING OUT. Below cost two 60 ft. poles and aerial complete, \$17, delivered within 20 miles. Write Pierce, 1915 E. Villa, Pasadena.

FOR SALE: Cash only—All new—Paragon RA-10 \$58.00, Paragon 10 Watt phone set \$59.50, Motor generator \$56.50, 1 K.W. D103 Dubilier condenser \$40.00, Jewell 0-10 thermo Ammeter \$11.00, used 1300 watt transformer \$29.75, 1500 watt \$32.75, Amrad 1 K.W. Gap \$19.75, J-Ray Gap \$27.75, R. Stewart, No. 5 Kron Flats, West Lafayette, Indiana.

Salesmen wanted calling on radio trade to handle our line of insulators and condensers, and Vernier attachments. Also our new Projector. M. M. Fleron & Son, 113 N. Broad St., Trenton, N. J.

NAME PLATES and DIALS for RADIO APPARATUS: Decalcomania (Transfer Process) and Etched Metal. Highest quality of work, reasonably priced. Prompt Delivery. Mail me your specifications and a quotation will be submitted by return mail. Robert W. McKnight, 723 Pacific Building, San Francisco.

OUR AGENTS ARE CLEANING UP ON PHOENIX DEPENDABLE APPARATUS. WRITE PHOENIX RADIO AND PARTS CO., CINCINNATI, OHIO.

WANTED—A few Western Electric VT-1's, VT-2's and head sets for use in our laboratory. Must be perfect. State quantity and lowest price. Reading Radio Shop, Box 6, Reading, Massachusetts.

7 Strands No. 22 tinned antenna wire 75c per hundred ft.; unassembled detector panels with all parts and formica panel \$3.75; DeForest home sets each \$30.00; Clapp-Eastham H. R. \$32.00; Westinghouse \$120.00. Will swap for Grebe apparatus 350 volt motor-generator set, and a Westinghouse set complete. Write for other bargains. If it's radio, we have it. Henry Kulikowski, Ansonia, Conn.

FOR SALE—Kennedy Receiving Set with cabinet, three stage amplifier, Magnavox, aerial wire (300 feet), batteries, tubes, everything complete for \$225. Address all communications to T. S. Boro, Jackson, California.

WANTED—Radio Apparatus and parts of all kinds. Send bulletins, net price lists and delivery sheet. Dealers with surplus stock write giving all information. A. E. Hancock Co., Radio Dept., Austin, Texas.

For radio frequency amplifiers: 50,000 ohm Lavite resistance units, \$0.40; .01 or .015 mfd. Signal Corps condensers, \$0.40; D. P. D. T. key switches, \$0.90; Telephone plugs, \$0.45; universal jack, \$0.40. Bargain list for stamp. Western Instrument Repair Co., 314 N. Fairfield, Chicago, Ill.

PATENTS

PATENTS ON RADIO—My special experience and compilation of patents and literature enables me to advise inventors and manufacturers on radio inventions and patents. JOHN B. BRADY, Ouray Building, Washington, D. C., formerly with Radio Division, Navy Department, and Secretary, Government Radio Board, Investigating radio patent situation.

INSTRUCTION

BKUMA YRLSBUG—TWO HUNDRED beginners tell how memorized wireless code in thirty minutes to two hours. Booklet, 10 red stamps. Dodge, Box 220, Mamaroneck, N. Y.

TELEGRAPHY—(Morse and Wireless) and Railway Accounting taught thoroughly; big salaries; great opportunities. Oldest, largest school. All expenses low—can earn large part. Catalogue free. DODGE'S INSTITUTE, Hass St., Valparaiso, Indiana.

RADIO BOOKS

"Arc Radio Manual," published by the engineers of the Federal Telegraph Company of San Francisco, and written in simple, interesting manner. Well illustrated with diagrams and photographs of the various types of arc radio apparatus used on shipboard and in shore stations. Price \$2.50 per copy, postpaid in the U. S. For sale by Pacific Radio Pub. Co., Pacific Bldg., San Francisco.

"License Quiz Book," for passing the U. S. Government radio examinations. The most popular selling radio book. Contains 106 pages of radio information. 80 illustrations. 250 questions and answers. Deals with every new radio development. Price \$1.00 per copy, postpaid anywhere in the U. S., or given free with a one year subscription to "RADIO." Pacific Radio Pub. Co., Pacific Bldg., San Francisco.

Build your own Radiophone. Instruction book ten cents. Radio Service Institute, No. 2000 14th Street, Washington, D. C. —3t

Remember—

You paid the news dealer 25c for this copy of "RADIO." Twelve issues will cost you \$3. Subscribe at the \$2.00 a year rate before June 30th and save a dollar.

Tell them that you saw it in RADIO

Dealers, We Are Ready!

Immediate Delivery On All Parts

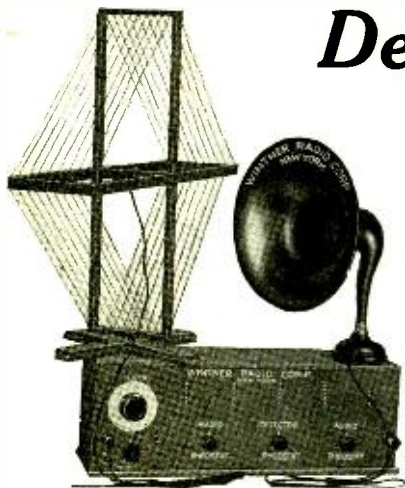

Our products endorsed by the foremost talent in the art. Every article laboratory tested and certified. Complete sets and sundry parts. Attractive discounts to dealers and distributors. Jobbers please write. Radio Fans have your dealers write for information.



WINTNER RADIO CORP.

115 W. 30th Street, New York City

Telephone Watkins 0373-0374

RADIO RECEIVING PHONES

We Repair and Rewind Them
If you have a pair of telephone receivers we can rewind them to any ohms you desire. We have a few pairs of rebuilt receivers on hand. Write for our prices.

THE RADIO SHOP

321 West 40th St., Indianapolis, Ind.

YOU MUST CHARGE YOUR OWN STORAGE BATTERY

THE RIGGS RECTIFIER

DOES IT FINE

6 volt; 5 amp; 60 cycle

UNRESERVED GUARANTEE:

Your money back, if YOU WANT IT

\$12.50

Postpaid, anywhere

East of Denver, address THE RIGGS MFG. CO., Urbana, Ohio

Denver and west, address W. H. RIGGS

P. O. Box No. 304, Everett, Wash.

GOULD THE LIGHT MAN OF STOCKTON, CALIF.

WIRELESS Music Receiving Outfits For Auto, Camping Trips or Home Use

RADIO, THE NEW VOICE OF THE AIR
Largest Stock in San Joaquin Valley

Colin B. Kennedy Long Wave Type 110. Intermediate Wave 220. Short Wave Receivers No. 281, also 2 Stage Amplifiers to match. Radio Shop New Model Receiver \$70.00; 2 stage \$55.00. Clapp Eastham Receivers \$40.00; 2 Stage \$35.00. Magnavox R-3 \$45.00. Large stock Amplifier Transformer \$5.00. 3 in. dials \$1.00. Jacks. Turney Spider Web Magnet Wire, all sizes. Flexible Antenna Wire for Portable Sets. Variable Condensers, 23 and 43 Plate. Signal Apparatus, Remler Parts, Detector and Amplifier Tubes, Radio Books. Connecticut, Brandes, Liberty, Kellogg and Baldwin Phones. B Batteries, 23V, 43V, 90V and 108 Volts.

HEAR US ON THE AIR—RADIO PHONE STATION KJQ

GOULD, The Light Man

615 E. Main Street

Stockton, Calif.

\$1.00

Brings you a copy of the *second* edition of the License Quiz Book. Every radio experimenter needs a copy. Limited supply on hand. Send us your order today.

For Sale by "Radio," Pacific Building, San Francisco

Tell them that you saw it in RADIO

Kellogg Wireless Supplies

THE KELLOGG SWITCHBOARD & SUPPLY CO. have been making high grade, sensitive telephone receivers and apparatus for the past twenty-two years.

The result of our experience is built into our wireless receiver, making it unusually sensitive, durable, light in weight, and of neat design.



Kellogg Lamp Socket

KELLOGG LAMP SOCKET

Kellogg molded lamp sockets fit all standard four prong vacuum tubes.

Extra heavy solid base 7/16 inch thickness. Four German Silver springs with rounded ends, firmly held in position in deep grooves. Cannot touch mounting surface. Double end, nickel plated binding posts, hexagon and knurled surface nuts. Binding posts plainly marked for wiring. Connection can be made under the socket as well as above.

Kellogg sockets are 2 3/16 inches square with round corners, with a total depth of 1 1/4 inches.



Kellogg No. 59A Head Set

Kellogg Strain Insulators

Kellogg No. 1 strain insulators are made of Kellogg Bakelite, 1 inch wide and 6 inches in length with suitable holes drilled at the ends for the antenna wire and support.

Kellogg No. 3 strain insulators consist of a Bakelite rod in which are firmly inserted metal end rings. These insulators stand a direct pull of approximately 350 pounds.

Nos. 4, 5 and 6 are the same as No. 3 except the length.

The lengths are: No. 3, 3 inches; No. 4, 4 inches; No. 5, 4 inches; and No. 6, 6 inches.



Kellogg Insulator

KELLOGG SWITCHBOARD and SUPPLY COMPANY
MANUFACTURERS OF STANDARD TELEPHONE EQUIPMENT
CHICAGO, ILL.



Music from the Clouds

FOR those who want the ultimate in wireless telephone receiving sets, Continental has assembled this complete outfit—"unexcelled for radio telephone reception." This is a set that anyone can use to entertain a group of friends. It is also an outfit which,

in the hands of an expert, produces record-breaking results. Tested, proven units are combined to form a complete installation without a weak link. The entire installation, ready for erection, includes every item of equipment, as follows:

Paragon RA Ten Regenerative Receiver.....	\$75.00
Paragon DA 2 Vacuum Tube Detector and Two-Step Amplifier....	65.00
Radio Magnavox.....	45.00
1 pr. of Western Electric Phones.....	15.00
3 Vacuum Tubes.....	18.00
4 Eveready "B" Batteries.....	12.00
1 6-volt 60-80 ampere hour storage battery.....	17.50
1 General Radio antenna series condenser.....	5.50
Continental No 3 antenna equipment.....	20.00
	\$273.00

The heart of this splendid set is the world-famous Paragon R. A. Set, for which Continental is the exclusive wholesale distributor.

Ray-Di-Co, 1547 N. Wells St., Chicago, and The Benwood Co., 13th and Olive Sts., St. Louis, are sales agents in the middle west.

CONTINENTAL RADIO AND ELECTRIC CORP.
 6 WARREN STREET NEW YORK CITY
"New York's Leading Wireless House"

Mail Order Department and Executive Offices, 15 Warren St., New York

They do
in

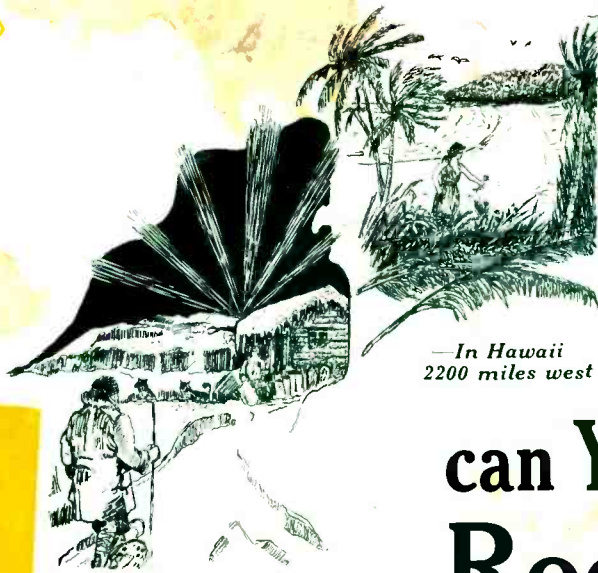

—In Alaska
2500 miles north

—In Hawaii
2200 miles west

—In New York
2600 miles east

—In Porto Rico
3000 miles southeast

can YOU hear KZY Rock Ridge?

If you miss any of the feature programs of Rock Ridge Radio Station, (KZY) Oakland, California, you are missing a real radio treat.

On 360 meters wave length, Rock Ridge broadcasts special music daily between 3:30 and 4:30 P. M., Pacific time; press reports, sport bulletins and farm news daily between 6:45 and 7:00 P. M., Pacific time; a special sermon and sacred music each Sunday between 11 and 12 A. M., Pacific time, and other appropriate entertainment each Sunday between 3:30 and 4:30 P. M., Pacific time.

Under favorable weather conditions, these concerts and other features are heard from Alaska to Cuba, and from New York to the Hawaiian Islands. Can you beat the distance records shown above? Write us when you hear Rock Ridge. We are always glad to correspond with listeners-in.

Atlantic-Pacific Radio Supplies Co.

638 MISSION STREET
SAN FRANCISCO, CALIFORNIA

Operating (KZY) Rock Ridge Station,
Oakland, Cal.

EASTERN OFFICE AT
5 KIRK PLACE, NEWARK, N. J.

ABBOTT-BRADY PRINTING CORP., S. F.