

AUG.

AN ALL-PURPOSE METER

1938

See Page 9

RADIO WORLD

Reg. U. S. Patent Off.

PHOTO-CELL RELAY

See Page 23

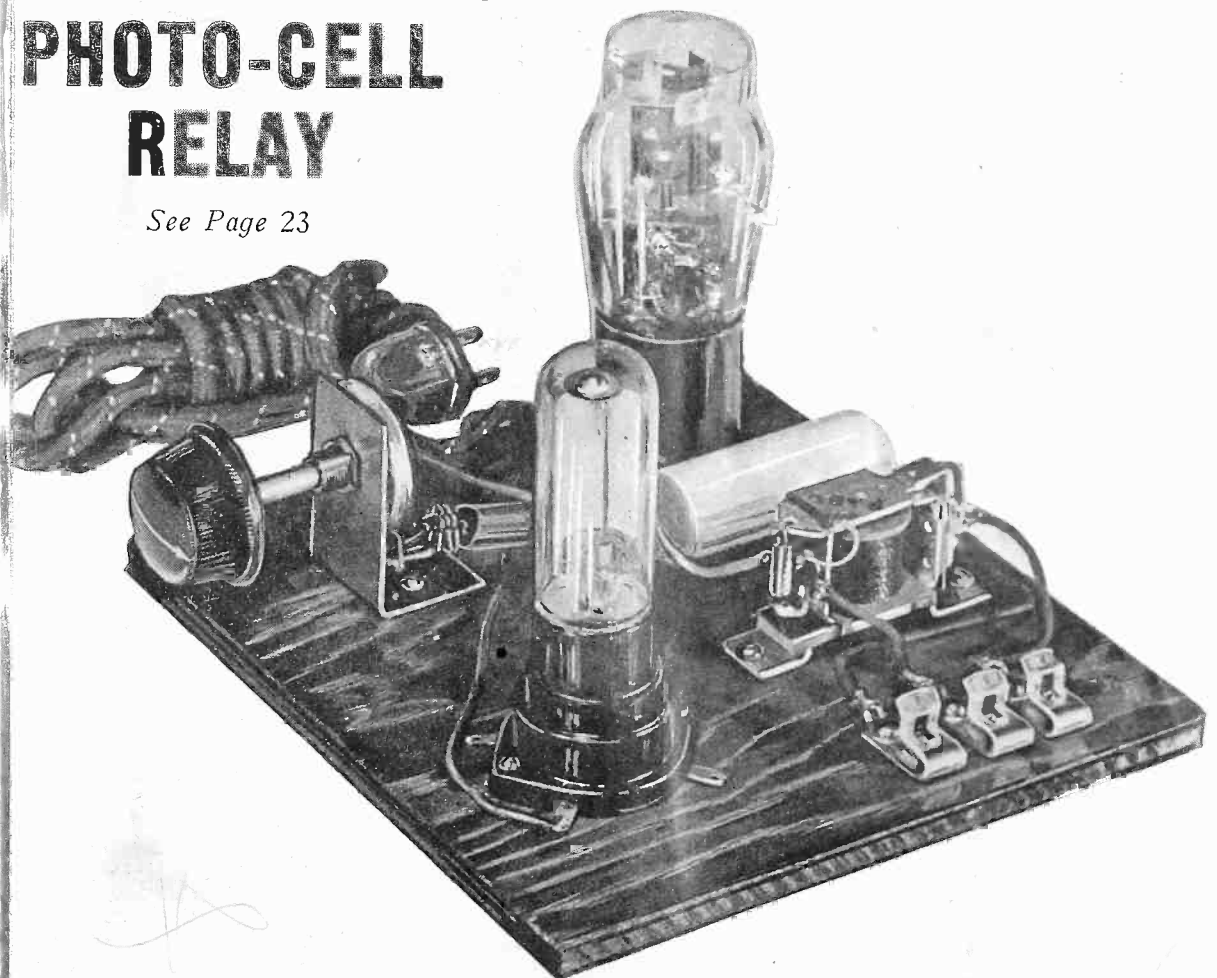

25c Per Copy

FOCALIZATION

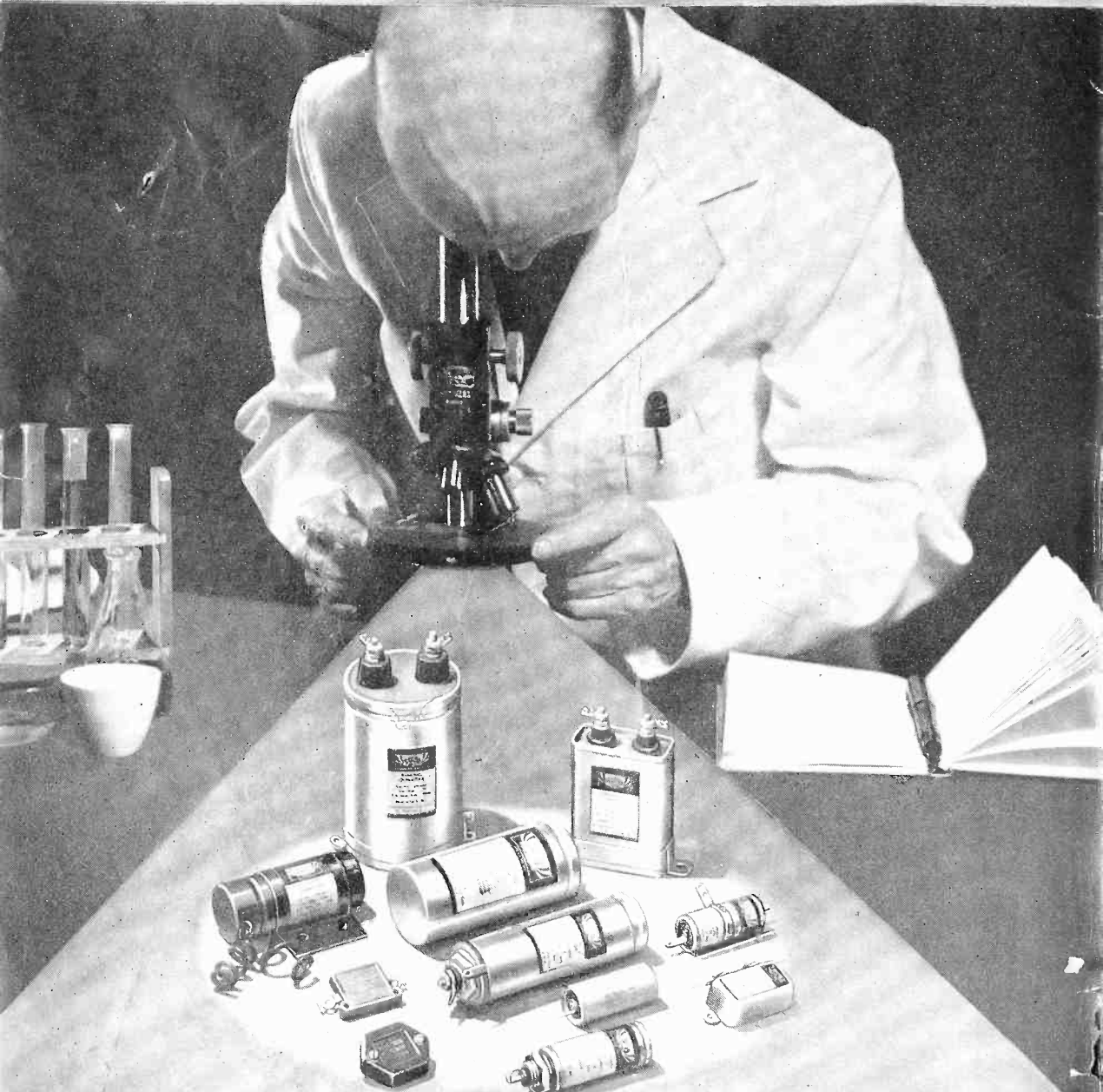

For over a quarter of a century, the combined efforts and ingenuity of Cornell-Dubilier have been focused on the production of capacitors—and capacitors alone. This focalization of research and manufacturing experience is directly responsible

for the production of dependable capacitors. Today, Cornell-Dubilier offers the greatest values obtainable in capacitors for every radio and electrical need. Get to know C-D's. Write for Catalog No. 160, free on request.

Products of the world's oldest and largest exclusive manufacturer of capacitors

CORNELL - DUBILIER ELECTRIC CORP.
1000 Hamilton Boulevard, South Plainfield, New Jersey

I WILL TRAIN YOU AT HOME IN SPARE TIME FOR A GOOD RADIO JOB!

**FREE BOOK TELLS HOW
MAIL COUPON**

Do you want to make more money? Radio offers many opportunities for well-paying spare time and full time jobs. You don't have to know anything about Radio or electricity, give up your present job, leave home or spend a lot of money to become a Radio Expert.

**Many Radio Experts Make
\$30, \$50, \$75 a Week**

Radio broadcasting stations employ engineers, operators, station managers and pay up to \$5,000 a year. Spare time Radio set servicing pays many \$200 to \$500 a year—full time jobs with Radio jobbers, manufacturers and dealers as much as \$30, \$50, \$75 a week. Many Radio Experts operate full time or part time Radio sales and service businesses. Radio manufacturers and jobbers employ testers, inspectors, foremen, engineers, servicemen, paying up to \$8,000 a year. Radio operators on ships get good pay, see the world besides. Automobile, police, aviation, commercial Radio, loud speaker systems are newer fields offering good opportunities now and for the future. Television promises to open many good jobs soon. Men I trained have good jobs in these branches of Radio. Read their statements. Mail the coupon.

**There's a Real Future in Radio for
Well Trained Men**

Radio already gives jobs to more than 300,000 people. In 1937 Radio enjoyed one of its most prosperous years. Nearly \$500,000,000 worth of sets, tubes and parts were sold. Over 5,000,000 home Radios were sold—25,000,000 homes (4 out of 5 in the U. S.) now have one or more sets. Over 1,800,000 auto Radios were sold—5,000,000 cars now have Radios. Every year millions of sets go out of date, are replaced with newer models. Every year millions of dollars are spent on transmitting equipment, Television developments, etc. The \$30, \$50, \$75 a week jobs have grown from a few hundred 20 years ago to thousands today. And Radio is still a young industry—developing fast.

**Many Make \$5, \$10, \$15 a Week Extra
in Spare Time While Learning**

Almost every neighborhood needs a good spare time serviceman. The day you enroll, I start sending Extra Money Job Sheets showing how to do Radio repair jobs. Throughout your training I send plans and ideas that made good spare time money for hundreds. I send Special Equipment to conduct experiments, build circuits, get practical experience. I ALSO GIVE YOU A COMPLETE, MODERN, PROFESSIONAL ALL WAVE, ALL PURPOSE RADIO SET SERVICING INSTRUMENT TO HELP SERVICE SETS QUICKER—SAVE TIME. MAKE MORE MONEY.

**This FREE BOOK has Helped Hundreds
of Men to Make More Money**

**J. E. SMITH, President, Dept. 8GM4
National Radio Institute, Washington, D.C.**

Dear Mr. Smith: Without obligation send me free the Sample Lesson and your 64-Page Book, "Rich Rewards in Radio" telling about spare time and full time Radio opportunities, and how I can train for them at home in spare time. (Please write plainly.)

NAME..... AGE.....
ADDRESS.....
CITY..... STATE..... 14X1



I Give You Practical Experience

My Course is not all book training. I send you special Radio equipment, show you how to conduct experiments, build circuits illustrating important principles used in modern Radio receivers, broadcast stations and loud speaker installations. I show you how to build testing apparatus for use in spare time work from this equipment. Read about this 50-50 method of training—how it makes learning at home interesting, quick, fascinating, practical. Mail coupon.

Money Back Agreement Protects You

I am sure I can train you successfully. I agree in writing to refund every penny you pay if you are not satisfied with my Lessons and Instruction Service when you finish. I'll send you a copy of this agreement with my Free Book.

Find Out What Radio Offers You

Act Today. Mail the coupon now for "Rich Rewards in Radio." It's free to any fellow over 16 years old. It points out Radio's spare time and full time opportunities and those coming in Television; tells about my training in Radio and Television; shows you letters from men I trained, telling what they are doing and earning. Find out what Radio offers YOU! MAIL THE COUPON in an envelope, or paste on a penny post card, NOW!

**J. E. SMITH, President, Dept. 8GM4
National Radio Institute,
Washington, D. C.**

**MAIL
COUPON
NOW!**



**J. E. SMITH, President
National Radio Institute
Established 1914**

**HERE'S
PROOF**

**Works for
State of
Illinois**

"If I had not taken your Course I would still be digging ditches. I am working for the State of Illinois, operating a 1,000 watt transmitter. Anyone wants to write about your Course. I be glad to answer."
**LEWIS, Police Radio
man WQPM, Macomb, Ill.**

**Worked up
to While
Earning**

"I picked up \$100 while working and I that easy money—the I gave my spare work did not interfere with my other business."
**OPIS DENTON,
Lorain Ave., Cleve-
Ohio.**

**Lesson on Radio
Servicing Tips FREE**

"I prove that my Training set what you need to do Radio. My sample text, "Radio Troubles" and "Their and Kennedy," covers a list of Radio troubles in A.C., battery, universal, T. R. E. superhetero-all-wave, and other types of sets. And a cross brace system gives you probable cause and a way to locate and cure these set troubles. Special section is devoted to receiver check-up, alignment, balancing, neutralization and testing. Get this free. No obligation.

**He Tested WAY
to BETTER PAY**

A FREE BOOK FOR EVERYONE IN RADIO

RADIO-CRAFT—complete in everything radio men need, gained popularity and leadership in a few years. Never once has **RADIO-CRAFT** shortened its stride of editorial progress. Broader in news scope—excellence in illustrations—continued improvement in editorial technique—accuracy in wiring diagrams and schematics—these are the basic ideals upon which **RADIO-CRAFT** success has been achieved.

To all readers of this announcement the Publishers present a **SPECIAL OFFER**—A **SEVEN MONTHS' SUBSCRIPTION TO RADIO-CRAFT** and a **FREE COPY** of the **1938 RADIO REFERENCE ANNUAL**. If you are a regular subscriber, you may also take advantage of this opportunity just the same. The publishers will be glad to extend your present subscription an additional Seven Months, and at the same time, send you a **FREE** copy of this book.

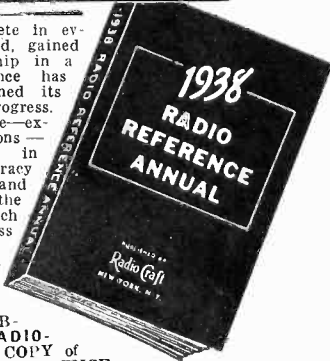

Contents of the 1938 RADIO REFERENCE ANNUAL

SET BUILDING—This particular section of the 1938 **RADIO REFERENCE ANNUAL** contains a description of a number of important, as well as interesting receivers. They are as follows: A Simplified Converter; A Farm Battery Receiver; An Executive's A.C.-D.C. Desk Set; Handy Book-End Novel Receiver. Other receivers described are: Crystal Set, Portable Battery Receiver, and several others. Each receiver is described accurately, complete with constructional data and parts list.

SERVICING—This chapter is devoted to Radio service instruments in general. Special emphasis is given to a number of the more essential instruments—they are: Service Oscillators, Mixer Circuits, V.T. Voltmeters and an Interference Eliminator.

PUBLIC ADDRESS—For those who find public address their chief interest, here you will find complete design and construction on a P. A. Tuner; a Handy Amplifier; and an Infinite Baffle Loud Speaker.

TEST EQUIPMENT—Radio Service Men who prefer to build their own equipment will find all the construction details necessary for building the following: Condenser Analyzer, Midget Oscilloscope with 1" and 2" tubes; Service Audio Oscillator.

GENERAL INTEREST ARTICLES—A variety of topics have been selected for their interest and importance. These subjects cover—Home Broadcaster; Remote Set Tuning; Carrier-Type Interphone Systems and a number of others.

MISCELLANEOUS—A comprehensive Index of important articles which appeared in **Radio-Craft** during 1937. This section also includes data on recently developed tubes and many other helpful hints and suggestions.

64 PAGES ● **OVER 90 ILLUSTRATIONS**



RADIO-CRAFT

99 Hudson St.
New York City

MAIL
COUPON
TODAY

RADIO-CRAFT R.W. 8-38
99 Hudson Street, New York, N. Y.

Gentlemen: Enclosed you will find my remittance of One Dollar (\$1.00) for which enter my subscription to **Radio-Craft** Magazine for Seven Months. Send me, **ABSOLUTELY FREE**, and **POSTPAID**, my copy of the **1938 RADIO REFERENCE ANNUAL**.

New Subscriber Extend present subscription

Name

Address

City..... State.....

(Send remittance by check or money order. Register letter if you send cash or unused U. S. Postage Stamps.)

AIR CONDITIONING

HOME-STUDY COURSE, SPECIAL

Complete Chicago Technical Society course, regularly priced at \$10., now can be yours at a give away price. Get into Air Conditioning. **\$2.95**

Order today or write for free details.
SUPREME PUBLICATIONS
3727 WEST 13th STREET CHICAGO, ILL.

FREE RADIO AND PARTS CATALOG!



ALLIED'S new Spring Catalog is packed with news for every Ham! 164 pages, all latest Amateur Gear—all leading lines, transmitters, receivers, transceivers; over 12,000 parts, new kits of all types. 52 new Knight sets. Test Equipment; P.A. Send Postcard today.

ALLIED RADIO CORPORATION
Dept. 16-H-38, 833 W. Jackson Blvd., Chicago

SPECIAL 2-FOR-1 OFFER RADIO WORLD

Radio World is \$2.50 a year (12 issues), 25c. per copy. Canada and foreign, \$3.00 yearly. Offers of Radio World and other worthwhile publications for one full year on each (NET):

- RADIO WORLD and RADIO NEWS, \$3.50.
- RADIO WORLD and SHORT-WAVE and TELEVISION, \$3.50.
- RADIO WORLD and POPULAR SCIENCE MONTHLY, \$3.50.
- RADIO WORLD and RADIO-CRAFT (12 issues), \$3.50.
- RADIO WORLD and RADIO INDEX (monthly, 10 issues), stations, programs, etc., \$3.50.
- RADIO WORLD and EVERYDAY SCIENCE AND MECHANICS (monthly), \$3.50.
- RADIO WORLD and BOYS' LIFE (monthly, 12 issues), \$3.50.
- RADIO WORLD and TRUE STORY (monthly), \$3.50.

Select any one of these magazines and get for an entire year by sending in a year's subscription for **RADIO WORLD** at the regular price, \$2.50, plus a small additional amount, per quotations above. (Add \$1.50 for extra foreign or Canadian postage for both publications.)

Name

Address

City and State.....

- If renewing an existing or expiring subscription for **RADIO WORLD**, put cross in square.
- If renewing an existing or expiring subscription for other magazines, put cross in square.

Special Trial Offer for Radio World only: \$1.00 for 5 months, postpaid. Mail order with remittance to Radio World Office. NET.

RADIO WORLD, 145 W. 45th St., New York

My FREE Book Tells How I TRAIN YOU PERSONALLY to make GOOD MONEY in RADIO



Read How
These Fellows
Made Good

ACTUALLY SET YOU UP FOR BUSINESS!

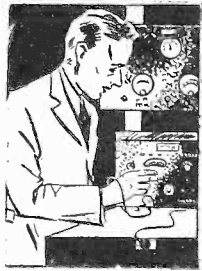

NO EXPERIENCE NEEDED

Fellows . . . here's the greatest opportunity you've ever had to enter the fast moving Radio industry. If you are ambitious, I can train you at home for a good paying full or part time job . . . with a big future ahead. My training is distinctly new and different. It starts right at the very beginning of Radio and thoroughly covers all branches and phases in an interesting, concise, simply worded style. Nothing is left out.

CLEARED \$150 IN SPARE TIME

A. H. Lanolo, Northbridge, Mass., writes: "Since enrolling, I have cleared a net profit of more than \$150 in spare time . . . and I am not one-half through the Course yet. Honestly, I cannot understand how you can give so much 'dope' for so little money."

DELUGED WITH WORK

Edwin A. Gammon, Auburn, Me., writes: "Your Course is so thoroughly good and practical it is hard to pick out one part that is better than any other. Due to the knowledge I have gotten from it, I have been deluged with work for the last month, achieving good results with Radios which had been unsatisfactorily tackled by other servicemen. You deserve all the credit!"

BE YOUR OWN BOSS . . . EARN WHILE YOU LEARN

A remarkable advantage of the Sprayberry Course is that you may be equipped to set up a handy home laboratory . . . right at the start. Then I show you how to get profitable spare time Radio service jobs . . . moreover I show you how to do these jobs efficiently. Thus, you are able to gain real, practical experience and add easy cash to your bank account while you're learning.

Complete TELEVISION Training Included!

YOU GET THIS PROFESSIONAL EQUIPMENT



Absolutely the finest equipment offered with any Radio Course is available to Sprayberry students. You get an All-Wave, All-Purpose Analyzer, Rider Manuals (7,076 pages), Tool Kit, Electric Eye Outfit and Experimental Apparatus.

QUIT DREAMING

Make a Future for Yourself

It is easy enough to sit idly by and envy those fellows who have good paying jobs and are building toward splendid incomes and real security in the future. But these fellows are no smarter than you. The essential difference is that they have taken the initiative to pull themselves up by their own bootstraps. You can do the same thing. Don't just "wish" for more money . . . start training for it . . . RIGHT NOW.

REMEMBER, The Sprayberry Course is Sold Under an Iron-Clad, Money Back Agreement.

Get My Free Book

SERVICEMEN!

Get the facts concerning my advanced Course for men already in Radio. Learn the newest methods, circuits and short cuts. Terms as low as \$3.00 per month. All Courses, features, etc., described fully in big 48-page FREE BOOK. Send for it.

**DON'T PUT IT OFF . . .
ACT AT ONCE!**



Mail Coupon Now

SPRAYBERRY ACADEMY OF RADIO
F. L. Sprayberry, Pres.
135-H University Place, N.W.
Washington, D. C.

Please send me FREE copy of "MORE MONEY IN RADIO."

Name
Address
City State

(Mail in envelope, or paste coupon on postcard.)

RADIO CITY PRODUCTS CO.

88 PARK PLACE

NEW YORK CITY

SERVICEMEN

HERE'S HOW TO

MAKE MORE ACCURATE TESTS MORE THOROUGH TESTS and SAVE MONEY at the same time

MODEL 432—TROUBLE SHOOTER

\$5.95

Pocket size with D'Arsonval 0-1 milliammeter, accurate within 2 per cent. Meter has zero adjust (highly essential on volt-ohm-milliammeters) in addition to zero adjust in ohmmeter.

- D.C. Voltmeter (1000 ohms per volt), 0-5; 0-50; 0-500; 0-1000 volts.
- D.C. Milliammeter 0-1 and 0-10.
- Ohmmeter 0-500; 0-50,000; 0-500,000.

Low ohm scale permits measurements of 1/10 ohm—a range that permits measurements of shorted turns, contact resistance, etc.

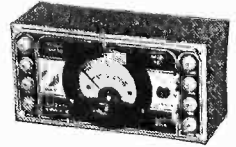

307 NEW DYNOPTIMUM TEST TUBE CHECKER

- All of the new tubes can be tested on model 307 including 0Z4, cold cathode rectifiers, magic eyes, etc.
- Tests all ballast tubes.
- The only low price tube checker that accurately tests tubes in accordance with R M A Specifications.
- Three-inch square D'Arsonval meter accurate within 2 per cent.
- Continuously variable line voltage control — direct reading on meter.

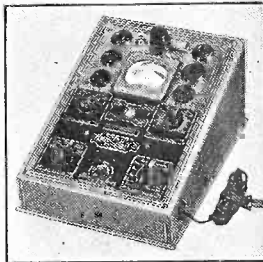

- Short and leakage test for each individual element—neon indication.
- Excellent quality throughout—highly attractive appearance.

You'll be proud to own model 307 compared to other testers selling up to \$30.00.

\$16.95

Counter Model 307C

Model 307P—Combination portable counter model, \$18.95

NEW MODEL 444—A.C.-D.C. MULTITESTER

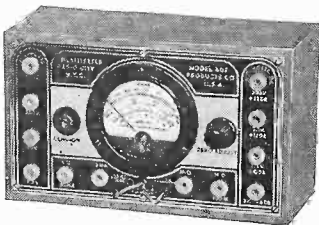

22 meters in 1 in this 3½-inch D'Arsonval milliammeter, 0-1 movement; exceptionally useful low ohm range as available on expensive meters. All Ohmmeter ranges can be balanced without use of test probes. Quality, sure grip tip jacks—fine materials and construction.

- A.C. Voltmeter: 0-5/0-50/0-500 0-1000
- D.C. Voltmeter: 0-5/0-50/0-500 0-1000—all at 1000 ohms per volt
- Output meter: same as A.C. Voltmeter
- Ohmmeter: 0-500/0-50,000/0-500,000
- Milliammeter: 0-1/0-10/0-100
- D.B. Meter: -12 to +8/8-28/28-48/34-54 decibels

\$9.95

RADIO CITY
PRODUCTS CO.

"DEPEND ON DEPENDABLE"

88 PARK PLACE
NEW YORK, N. Y.

THOR'S SENSATIONAL NEW SPOTLIGHT VALUES

MUSIC WHILE YOU RIDE

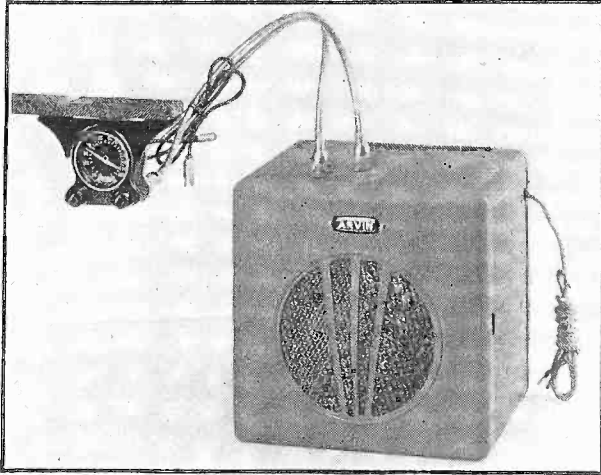

ARVIN AUTO RADIO

Single unit receiver, one hole mount. Six tube superheterodyne using 1-78 R.F. 1-6A7 Oscillator, 1-78 I.F. 1-75 2nd Detector AVC, 1-41 Output, 1-84 Rect. with plug-in Vibrator. 3 Gang condenser provides sharp tuning and full Dynamic Speaker gives excellent response. Brown metallic case measures 9" high, 9" wide 7" deep. Control head fits under dash on all cars. No spark plug suppressors needed. Supplied complete in factory sealed cartons with all mounting bolts, cables head, tubes. Ready to work and guaranteed 100%. Made by the makers of the famous Arvin Car Heaters. Limited Quantities. Full Instructions.

\$16⁹⁵ Complete,
Ready to
Install

ARVIN ALL-WAVE CHASSIS

Sensitive 8-tube Superheterodyne.

Band Coverage in 3 Tuning Ranges.

16-50, 50-170, 170-550 Meters.

Power Beam Output, 5 Watts.

Travelite Spot Tuning, 6" Dial.

Uses 1-6A8 Oscillator; 1-6K7 1st I.F.; 1-6K7 2nd I.F.; 1-6H6 Diode Detector AVC.

1-6F5 Driver; 1-6V6 Power Beam Output; 1-5Y3 Rectifier; 1-6E5 Electric Eye.

Full Range Tone Control.

Chassis measures 14½" long, 10" deep, 8¼" high.

Complete with 8 octal glass tubes, dial and eye frames, mounting bolts and Jensen 8" Dynamic Speaker.

12" Dynamic Speaker Supplied, \$2.00 extra.

\$19⁶⁵ Complete,
Ready to
Work

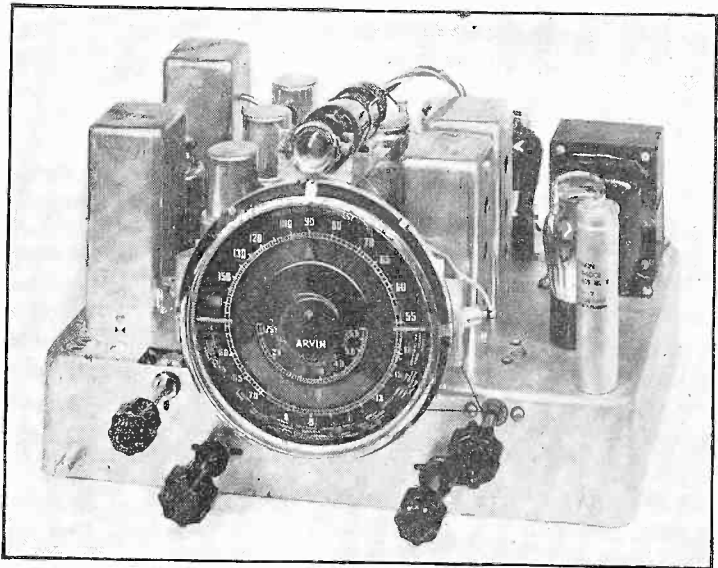

RCA
VICTOR

Record Player
Crystal Pickup
Latest Model

\$8⁹⁵

ORDER DIRECT

THOR RADIO

60 DEY STREET, NEW YORK

24 hour Mail Order Service F.O.B. New York

SHURE
ZEPHYR

Crystal Pickup
Model 99B
List Price, \$10

\$4⁸⁹

RADIO WORLD

Seventeenth Year

ROLAND BURKE HENNESSY
Editor

MARTIN POSNER
Technical Editor

PRESTON MACK
Circulation Manager

HERBERT E. HAYDEN
Advertising Manager

TABLE OF CONTENTS for AUGUST, 1938

A Meter for Many Servicing Purposes 9 <i>Per-Stage and Static Tests Made</i>	Crystal Phenomena Demonstrated 35
An Inductance - Capacity Bridge 12 <i>New Development Avoids Phase Errors</i>	Tube Checker Range Extended 36
Television Pickup Improved 17 <i>Halation Reduced, Definition Increased</i>	Earphones for Troubleshooting 38
A New Modulation Method 18 <i>Used in a 120 KC-50 MC Signal Generator</i>	The Lattice Structure 40 <i>Bridge Circuit Becomes Selective</i>
A Portable Phonograph Player 20	Editorials 42
Wattage Brings Up Problems 21 <i>Standard Rating Doesn't Answer All Questions</i>	High-Speed Crystals Control Station Frequencies 43
A Photo-Cell Amplifier 24	A Compact Volt-Ohm-Ammeter 44 <i>Panel is Only 2½ x 5 Inches</i>
Peaking with D-C Voltmeters 25	Right or Wrong? 47 <i>Propositions Put, Answers Given</i>
Leakage Causes Large Errors 26 <i>In High-Voltage-Resistance Meters</i>	The Voltage Doubler Explained 48
A 5 and 10 Meter Transceiver 29	Numerous Uses for Pilot Lamps 50
	Rectifier and Detector Circuits 53
	Forum — Letters to Editor 54
	Radio University 55 <i>Readers' Questions Answered</i>

Vol. XXXI, August, 1938. No. 4. Whole No. 718. RADIO WORLD, published monthly by Hennessy Radio Publications Corporation, 145 West 45th Street, New York, N. Y. Editorial and executive offices, 145 West 45th Street, New York, N. Y. Executives of RADIO WORLD: Roland Burke Hennessy, editor; Preston Mack, business manager; Herbert E. Hayden, advertising manager. Officers of corporation: Preston Mack, president-treasurer; Martin Posner, vice-president; Daisy Mayer, secretary. Entered as second-class matter March, 1922, at the Post Office at New York, N. Y., under Act of March 3rd, 1879.

SUBSCRIPTION RATE

Price 25 cents per copy. Subscription \$2.50 per year (12 issues); \$1.25 per six months (6 issues); postpaid in the United States and Possessions; \$3.00 per year, \$1.50 per six months, postpaid in all other countries. Remittance for foreign subscriptions should be by International money-order (postal or express) or draft against or discountable at New York bank.

RADIO WORLD is distributed by the American News Company and its Branches

A Simple Universal Meter

Using a Negative-Resistance Tube on Any Current Supply

By Martin Posner
Technical Editor.

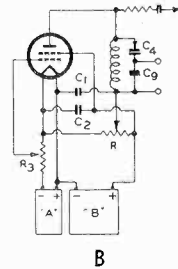
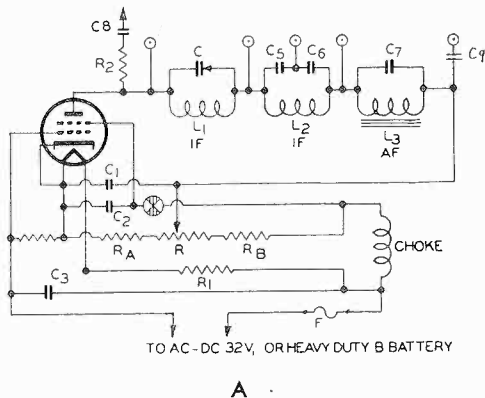

FIG 1
 The circuit of a compact generator of i-f, r-f and a-f signals is shown at A, while B represents the same circuit connected to a small A cell and a light-duty battery.

A LONG with the ubiquitous volt-ohm-milliammeter, a generator of i-f, r-f and a-f signals has long since become recognized as an indispensable piece of equipment in service work. The circuit of a simple and flexible arrangement which furnishes a number of radio, intermediate and audio modulation frequencies is shown in Fig. 1A. It may be plugged into a.c. of any frequency, d.c., 32-volt lines, or across a heavy duty B battery; or across the combination of a small A battery in series with a light-duty B battery, as shown in Fig. 1B. It can be made even lighter and smaller than the ordinary ohmmeter. No special parts are needed—probably any dealer or serviceman can assemble it in short order from stock on hand. It is based on the two-terminal dynatron oscillator, stripped of laboratory frills and reduced to the simplest form of practical utility.

When the voltage on the plate of a tetrode is lower than the voltage on the screen grid, the electrons that get through the screen grid mesh may strike the plate with a velocity sufficient to eject other electrons from it, much as pebbles hurled into a body of water throw up a spray of droplets.

ELECTRON SPLASH

If the electron "splash" is sufficiently violent the electrons may fly out so far that instead of falling back on the plate they come under the influence of the larger positive charge on the nearby screen, and constitute a reverse current from the plate—the "secondary emission" current—which subtracts from the normal or primary plate current. Within a limited range below screen voltage, increasing the voltage on

the plate increases this reverse current and therefore decreases the resultant plate current. In this state the tube is said to have a "negative resistance," because it acts to reduce the plate current for an increase in plate voltage, an effect opposite to that of a normal or "positive" resistance.

If a voltage pulse is applied to a coil and condenser combination, the circuit will be caused to oscillate, that is, a current will be caused to circulate back and forth between the coil and the condenser, but because of the resistance it encounters in the circuit, this oscillating current will quickly die down, its energy being frittered away in the form of heat.

NEUTRALIZING EFFECT

Now a negative resistance has the property of neutralizing the normal resistance in a tuned circuit by continually supplying sufficient energy to it at the right time to allow the current to keep on circulating in it. Therefore, when a tube acting as a negative resistance is placed across this coil-condenser circuit, the impulse will start it "oscillating" (at a frequency determined mainly by its inductance and capacity), and this oscillating current, once started, will continue as long as the required voltages and the filament emission are maintained.

What would happen if an additional circuit resonant to a different frequency were placed in the plate circuit? The interesting answer is that it, too, can be made to oscillate at its particular period. This means that we can have two or more simultaneous oscillations of different frequencies, and we can take out either one
(Continued on following page)

(Continued from preceding page)
separately or both mixed together, that is, the one modulated by the other. If one circuit is tuned to a radio frequency and another to an audio frequency then we can get an r-f signal, or an a-f signal, or an r-f signal with an audio modulation, as well as sundry harmonics of both produced by non-linearity in the operating characteristics of the tube.

SELECTION OF TUBES

Referring now to the diagram in Fig. 1A, the tube is a low heater current screen-grid tetrode like the 36, if used on an a-c or d-c line, or a low filament current screen-grid tetrode like the 32, if used across a heavy-duty B battery. On 32-volt lines either tube may be used and a small 22½-volt B battery inserted in series with the screen lead at point x. For operation on small A and B batteries, as in Fig. 1B, a tube like the 32 is used. R₁ is a voltage-dropping resistor, a resistor line cord, or an ordinary small light bulb of the right value to pass the heater current for the tube and the supply voltage used. R₂ is a section of R₁ used to provide a small negative bias on the control grid. F is a fuse, or a pilot light which will act as a fuse in case of shorts. Ch is an r-f choke and C₁, C₂ and C₃ are small condensers to bypass the plate and screen circuits and to help keep the oscillation out of the line. L₁ is a small universal-wound i-f coil tuned by the adjustable condenser C₄. L₂ is an r-f coil fixed-tuned to two (or more) frequencies in the broadcast band by C₅ and C₆, one of which may be adjustable.

L₃ is a small audio choke, preferably of low resistance (or it may be a winding on an a-f transformer or a similar winding with a large parallel condenser). The resonance frequency may be fixed by the i-f/r-f bypass condenser C₇. R₂ is the output limiting resistor, C₈ the output coupling condenser, and C₉ a safety condenser in the low potential output lead. R is a potentiometer used to find the best operating point for the tube. It and R₃ serve to control the amplitude and the harmonic content of the oscillations. The pin jacks are for shorting out the unused circuits. Or, to be in style, push-button connections may be adopted.

MORE SIMPLIFICATION

Fig. 2 represents still further simplification. The control grid is tied to the cathode. Potentiometer R is replaced by a voltage divider consisting of two pig-tail resistors, R_a and R_b; a tap on R₁ will also serve the purpose. L₁ is now tuned by adjustable condenser C₄ and C₆, giving two i-f positions, which may be 175 and 455 kc. If this circuit is adjusted to 180 kc, for example, its harmonic frequencies lying in the broadcast band can be picked out, beginning with the third at 540 kc and continuing with 720, 900, 1080, 1260, 1440 and 1620 kc. Or, if adjusted to 150 kc, a corresponding series of harmonics will fall at 600, 750, 900, 1050, 1200, 1350, 1500 and 1650 kc, a very useful series.

Audio modulation is furnished by the supply

frequency and its harmonics when used on a.c., by the commutator ripple when used on d.c., and by L₃ when used on batteries or d.c.

The process of calibration is quite simple if a broadcast receiver with a kilocycle dial is available. When the signal generator, which should be shielded and loosely coupled to the receiver, is oscillating properly, tuning the set will produce a series of whistles where station carriers heterodyne with generator harmonics. Supposing there are no stations on these frequencies, then these harmonics can be heard by virtue of their audio modulation as 60, 120 or 1,000 cycle notes, as the case may be. As the dial on the receiver is turned the series of harmonics as illustrated in the preceding paragraph will be heard, evenly spaced on the kilocycle scales. The difference between any two consecutive responses is the fundamental frequency of the generator circuit. By adjusting C₄ it is always possible to shift this fundamental so that one of its harmonics will heterodyne with some high-wave broadcaster whose frequency is known.

HIGH ACCURACY

For example, referring to the harmonic series listed above for a 180 kc fundamental, suppose we have no reliable station at 720 kc, the fourth harmonic, but we may have a good one on 700 kc, like WLW. Then a slight readjustment of C₄ will change the generator fundamental so as to bring its fourth harmonic into exact synchronism with 700 kc.

The series of harmonic notes, as explained above, would now be heard on 525, 700, 875, 1,050, 1,225, 1,400, 1,575 and 1,750 kc. Taking the difference between any consecutive two of these we see the new fundamental generator frequency to be 175 kc. This calibration process is not nearly as complicated as it sounds. A little first-hand experience will show how very simple it really is. Yet the accuracy is high, because the checking is done directly against known station frequencies.

Besides those mentioned above, there are a good many other useful applications of this unit, particularly with a meter in its plate circuit. Among these are checking tubes, comparing gain, matching coils and condensers, and checking coil and condenser losses.

RESONANCE METER

The meter can be the d-c milliammeter in your ohmmeter. With this meter switched in, the signal generator becomes a resonance indicator, too, so that a set can be aligned visually without a station or loudspeaker being needed. This arrangement is illustrated in Fig. 3, which shows a diagram of a low resistance (0-1000) and a high resistance (0-1 meg) ohmmeter or continuity tester, with the necessary switching for selecting either range, as well as for using the milliammeter in either the ohmmeter or the signal generator. Plain midjet knife switches are shown for simplicity, although

(Continued on following page)

neater arrangement can be worked out with the midget multi-circuit jacks.

In the ohmmeter circuit R_4 is used to bring the current in M exactly to full scale with test leads shorted. R_6 serves to keep the oscillator plate circuit closed, a requirement of the switching system used. If the plate current is within the range of the millimeter, R_6 should be about 100 times the meter resistance, while if the plate current is higher than the meter range, the resistance of R_6 should be low enough

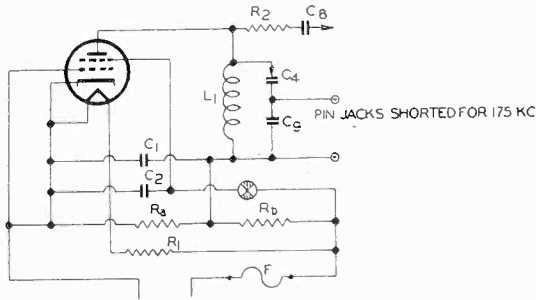

FIG. 2

Simplified version of Fig. 1A for maximum economy. For 455 kc the pinjacks are left unshorted.

to shunt out the excess current from the meter.

In operation, the generator would be set at the chosen frequency and loosely coupled through R_2C_6 , or through a few turns of wire around L_1 , to the circuit to be aligned. When this circuit is exactly tuned to the generator frequency it

absorbs a maximum of energy from the generator, and this resonance peak is shown by a sharp shift of the plate meter needle.

This action suggests a simple method of matching coils and condensers. Suppose a tuned circuit is loosely coupled to the generator, and the condenser dial turned till the resonance peak is found. Then if a coil with different characteristics is substituted for the standard, the condenser setting for resonance will be different, and this new reading will indicate the magnitude and direction of variation from the standard, of the coil under test. In the same way condenser capacities can be compared, and gang sections matched or tracked. A great many other enlightening experiments that are possible with this equipment will readily suggest themselves.

Campaign is Waged on Bootleg Senders

Washington.

Action against unlicensed persons who use transmitters is being waged with renewed vigor by the Federal Communications Commission. A large percentage of the offenders are youngsters. In one recent instance the Federal Court remanded the convicted offender to a juvenile court so that he might be placed on probation with a suspended sentence. In another instance a \$100 fine was imposed.

The law provides that a license must be possessed by the operator of a transmitter, and also that the station must be licensed. Considerable trouble has arisen in regard to five-and-ten meter transceivers. The receiving is O.K. without a license, but not the transmitting.

Push-Buttons Protested

Push-button tuning has aroused the protests of some small stations. It is contended that their constitutional right is invaded, as only a few stations may be selected by push buttons, and the small stations are unlikely to be selected, therefore the set owner, favoring the easy manipulation of the buttons, never tunes in the small stations. As against this argument it is contended that knob tuning accompanies push-button sets, and that full freedom of station

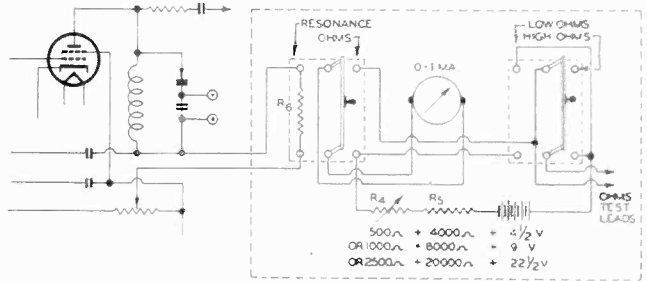

FIG. 3

Ohmmeter circuit with simple switching to change from low resistance to high resistance range, and a switch to shift the millimeter into the signal generator for resonance indication.

selection for button positions it afforded, so it is up to each station to make itself desired.

Radio Aids Weather Bureau

Washington.

The Weather Bureau is using radio to advance the science of foretelling the weather. The latest device is a free balloon that reaches heights above the stratosphere, hence higher than man himself has penetrated. Indicating devices record and transmit facts on the conditions in the outer layer of the atmosphere, and when the balloons return to earth the Weather Bureau is in possession of verified information on which to base its predictions.

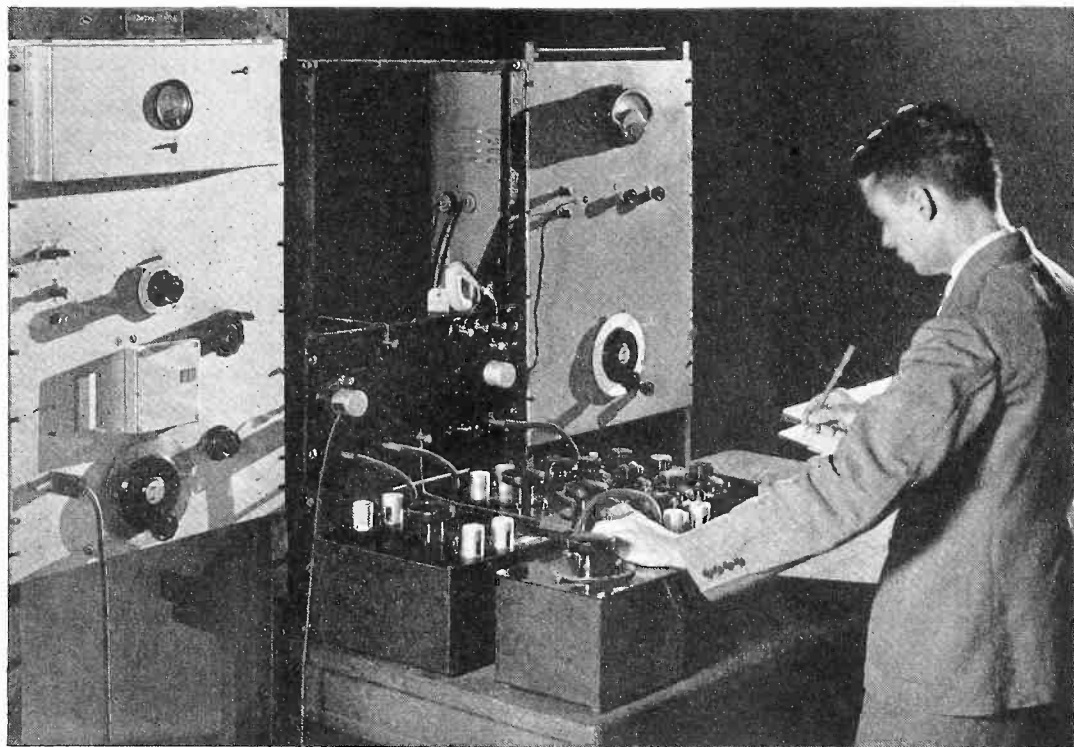

Inductance and Capacitance Bridge

By S. J. Zammataro

Transmission Apparatus Development, Bell Telephone Laboratories

A BRIDGE designed for miscellaneous uses in the laboratory should be capable of measuring both inductive and capacitive impedances. It should be able, moreover, to measure both types of impedances with equal convenience and accuracy whether their Q values are high or low. Such a bridge has recently been developed for the frequency range from 30 to 10,000 cycles to be used in measuring impedances of lines and apparatus for program transmission.

Before the detailed design of the bridge was begun, it was decided to employ capacitance standards for measuring the inductive as well as capacitive impedances, because condenser standards are not only less expensive than inductance standards, but are more stable with frequency, and more compact. It was decided also to use a shunt arrangement of the standard capacitance and resistance because such an arrangement lends itself to simpler shielding.

MOST DIRECT METHOD

With the choice of the type and arrangement of the working standards thus settled, it was

apparent that the most direct manner of measuring capacitive impedance was by the familiar comparison bridge with equal ratio arms. This arrangement is shown schematically in Fig. 1. As is customary in such bridges, a resistance— R_s in the diagram—is used to shunt any high unknown resistance components of the unknown capacitance so that the resistance of the arm cd can be measured by the resistance standard R_s . Such a bridge determines the unknown impedance in terms of its parallel components, which is preferred for capacitive impedances.

The simplest change required to connect such a bridge so that it could measure inductive impedances would be to provide a switch for transferring the condenser standard from the ad to the cd arm of the bridge. This would give the parallel resonance arrangement shown schematically in Fig. 2.

THE INDUCTANCE PROBLEM

Such a method of measuring inductive impedance, however, is not so direct and convenient as is the previous arrangement for measuring capacitive impedance. In the first place, fre-

quency enters into the determination, with the result that it must be more accurately known and controlled than would otherwise be necessary. Also, the readings of the condenser standard must be converted into equivalent inductances by computations. Finally, the determina-

cuit offers the same convenience and simplicity of operation in measuring inductive impedances that the comparison circuit does for capacitive impedances. When the bridge is balanced, the relations are such that the series components of an inductive impedance in the arm CD are proportional to the parallel components of a capacitive impedance in the AB arm. In other words, a positive impedance is related to a positive admittance.

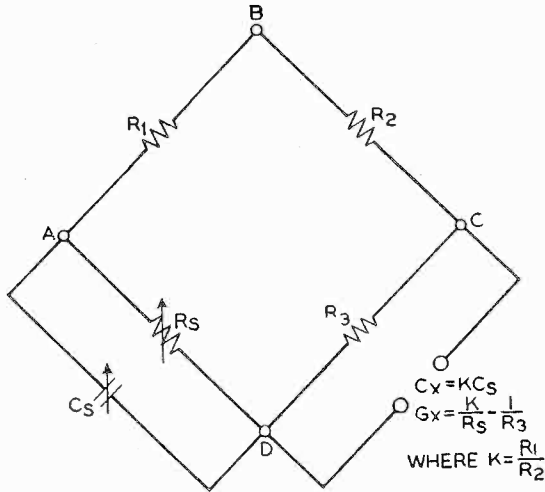

FIG. 1

Schematic of parallel comparison bridge with equal ratio arms

tion yields the parallel components of the unknown, while for inductive impedances the series components in general are of major interest.

If in the original arrangement of Fig. 1, however, a switch were used to interchange the AB and AD arms, and to change the position of R_3 , the comparison circuit would be changed to a Maxwell circuit, as shown in Fig. 3. This cir-

The proportionality factor is the product of R_1 and R_2 , for which reason the bridge is classed as the product-arm type in contrast to the ratio-arm type, where the proportionality factor is the ratio of the arms R_1 and R_2 .

It is apparent that the product $R_1 R_2$ may be made to give a simple relationship between the inductance and capacitance units, so that the bridge becomes essentially direct reading. Thus by making the product equal to 10^6 , one microhenry of the unknown inductance corresponds to one micromicrofarad of the standard capacitance. The resistance component of the unknown, as already stated, is given in terms of the conductance of the AB arm. The resistance R_4 is inserted in series with the unknown to keep the total resistance of the CD arm above a given minimum that can be measured within the range of the standard R_s . This use of resistance R_4 is analogous to that of R_3 in the comparison circuit, where its function is to keep the conductance in the CD arm above a definite minimum. By use of these two arrangements of the bridge arms, therefore, the same testing procedure may be followed whether the unknown impedance is inductive or capacitive, since direct reading is provided for the reactance component, and substitution for the resistance component.

(Continued on following page)

FIG. 2

Schematic of parallel resonance bridge or Maxwell circuit, which offers convenience and simplicity of operation in measurement of inductive impedances.

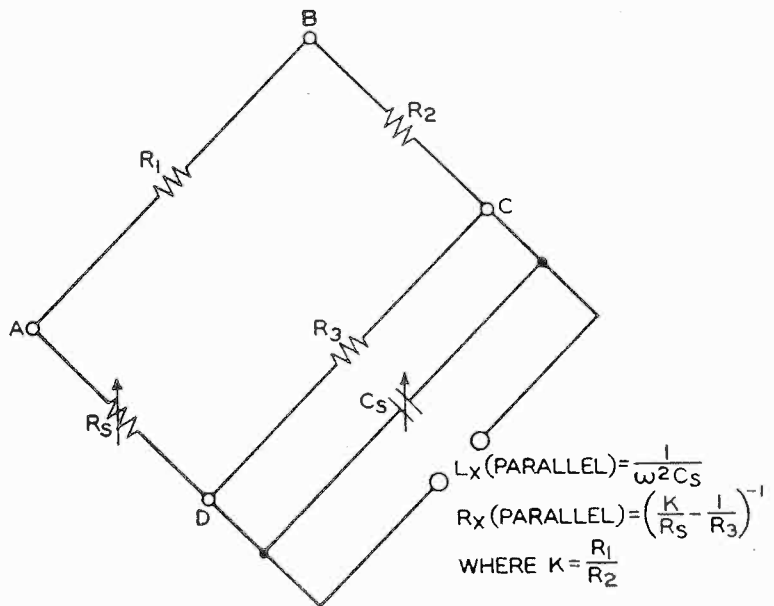

(Continued from preceding page)

Although the product-arm bridge reduces inductance measurements to a simplicity on a par with capacitance measurements, it results in a more difficult design. The symmetry of the network of a comparison bridge permits simple disposition of shielding; and the compensation of the residual impedance or admittance of corresponding elements can easily be pre-

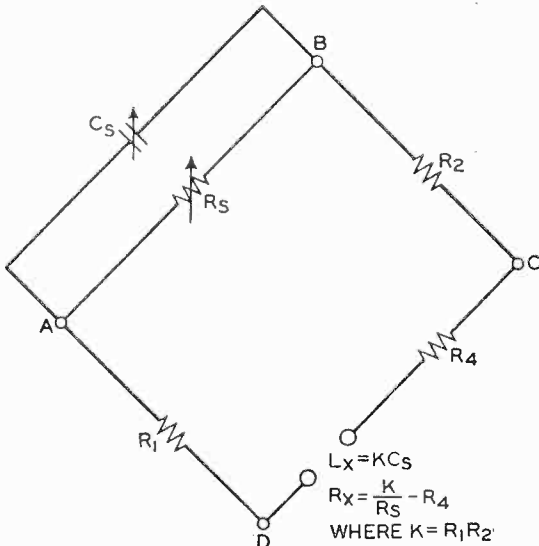

FIG. 3

Schematic arrangement of Maxwell or product-arm type of bridge, with unknown in series.

served over a wide range of conditions. In addition, the equality of the ratio arms, both in magnitude and phase, is relatively easy to secure and maintain. The product-arm bridge, on the other hand, imposes a more elaborate

shielding scheme; and the product adjustment of the fixed arms requires a more painstaking technique.

The complete shielding arrangements for the two types of circuit are shown in Figs. 4 and 5. Two double-shielded transformers are used in tandem across the supply corners of the product-arm circuit instead of a single transformer with triple shielding, to secure a more economical construction. In designing a composite bridge that could function as either type, it was necessary to strike a judicious compromise between the theoretically complete shielding shown in Figs. 4 and 5 and the less perfect shielding that would permit a ready interchange of connections and still yield the desired accuracy. The modified shielding finally adopted for the composite bridge is shown in Fig. 6 which corresponds to the arrangement of the circuit with the key thrown for inductance measurements.

The elements designated by lower-case letters are adjustments incorporated after the bridge is assembled, and have required more than the usual share of attention because of the dual function of the bridge.

CLOSE ADJUSTMENT NEEDED

With the comparison bridge, for example, main adjustment requirement is that their difference is no important restriction of the absolute values of the fixed arms R_1 and R_2 . The difference in magnitude and phase be zero. With the product-arm bridge, on the other hand, the product of these arms must be a specified value, and the sum of their phase angles must be zero. To satisfy both sets of requirements, R_1 and R_2 must be closely adjusted, and the residual capacitance and inductance of each—including the portion contributed by the shielding—must be compensated to give zero phase angle in the

FIG. 4

Complete shielding arrangement for the comparison bridge used to measure inductive impedances.

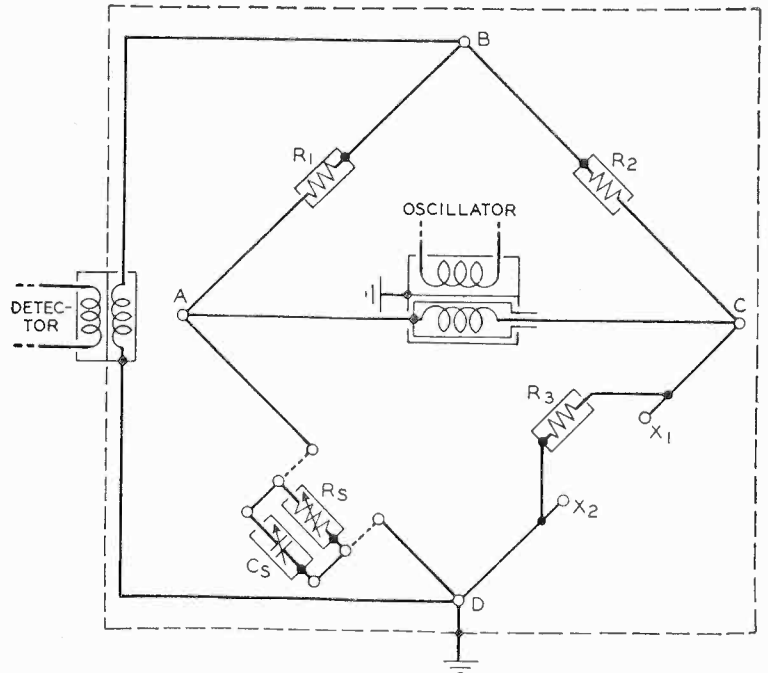

separate arms. It is important, moreover, to minimize the residual reactance that needs to be compensated so that the effective resistance

when the condenser standard is set on zero. With the product-arm circuit, on the other hand, the zero residual capacitance of the stand-

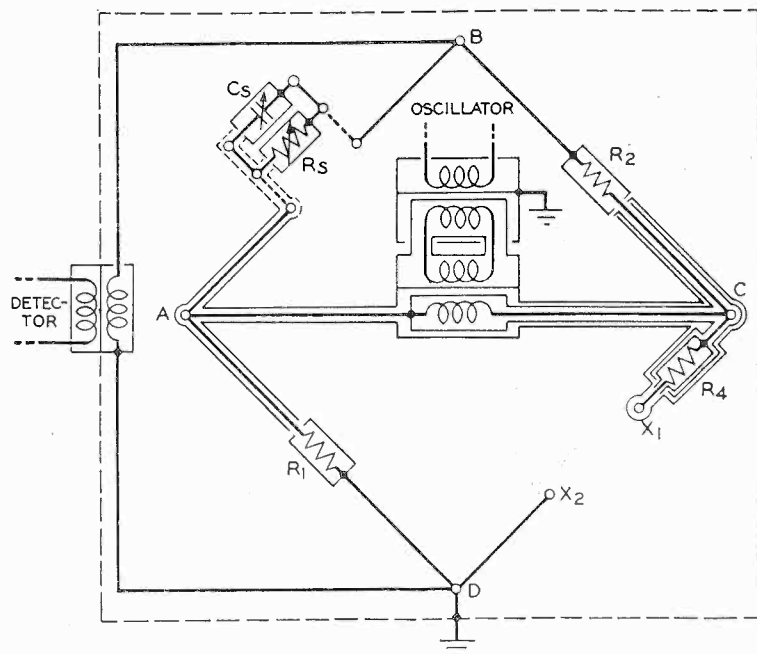

FIG. 5
Complete shielding for the product-arm bridge.

of the arms will remain sufficiently constant. The phase angle compensation of the arms R_1 and R_2 is indicated in Fig. 6 by the inductances l_1 and l_2 . Inductance l_3 compensates for the residual capacitance across the cd arm of the product-arm circuit, but it is switched out of the circuit for the comparison connection. Instead, the cd arm residual capacitance is padded by C_3 to balance the standard arm AD

and C_s is compensated by inductance l_4 so that the range of inductance will extend down to zero. The key K_3 serves to disconnect the d corner of the bridge from ground when the ground-potential condition is to be controlled by the unknown. Keys K_1 and K_2 , operated together, effect the interchange of circuits with no other manipulation.

(Continued on following page)

FIG. 6
Shielding adopted for new composite circuit when arranged as a product-arm bridge.

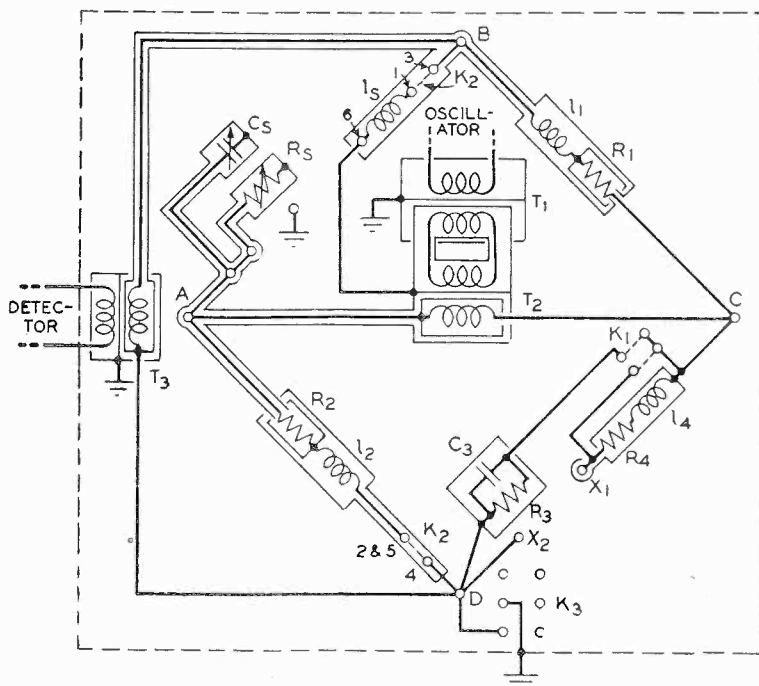

(Continued from preceding page)

The various adjustments have been made with sufficient accuracy to insure satisfactory performance over the frequency range from 30 to 10,000 cycles. The values of the fixed arms

In the model constructed, the adjustable capacitance and resistance standards are made up as separate units which may be readily connected to the rest of the bridge circuit by coaxial plugs and jacks. This arrangement in-

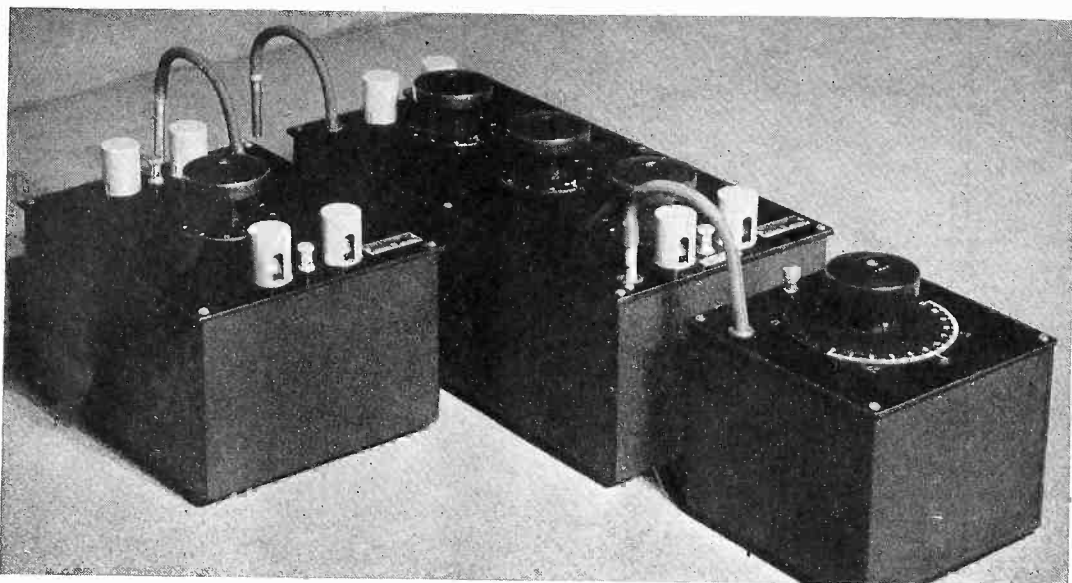

FIG. 7

The capacitance standard comprises three units.

R_1 and R_2 are made $10^{1/2}$ ohms each, so that with the product-arm circuit, one micro-microfarad in the capacitance standard C_s measures an inductance of ten microhenries in the arm cd . Since the standard has a total range of ten microfarads, inductances up to one hundred henries can be measured. The range for capacitance measurements, of course, is up to ten microfarads—the range of the capacitance standard. These reactance ranges can be measured for all values of Q normally encountered.

creases the portability of the equipment, and allows the standards to be available for other uses. The condenser standard, shown in Fig. 7, consists of three shielded units: an air condenser, a three-decade box of mica condensers, and a single-decade box of paper condensers, which is used for the largest steps. The resistance standard is a six-decade box adjustable up to 10,000 ohms in 0.01-ohm steps. The bridge unit proper is assembled on an aluminum panel and covered with an aluminum box, which serves as an overall ground shield. The appearance of the panel from the rear with cover removed is shown in Fig. 8.

This new bridge will prove especially useful in making frequency measurements of the impedance of networks in which the sign of the impedance may change many times over the test band.

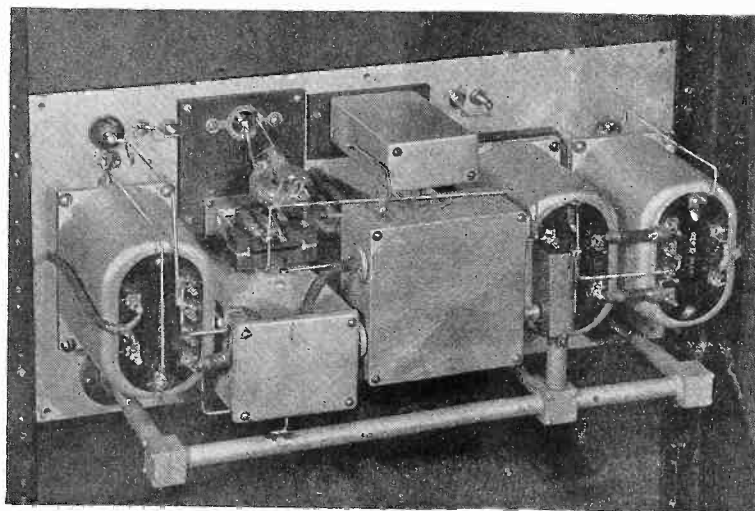

FIG. 8

Rear view of bridge with cover removed

Television Pickup Improved

Reproducing Tubes Made Sensitive

RECENT improvements of television pick-up and reproducing tubes make possible brighter and clearer images at the receiver with less illumination of the subject televised.

Dr. R. B. Janes and Mr. W. H. Hickok described to the Institute of Radio Engineers improved pickup or "Iconoscope" tubes in which tubes of the general type now employed in the field tests were made three times as sensitive through research in the chemistry and physics of photo sensitive surfaces. The scientists also conducted experiments in the field of optics, and by improved glass envelopes for the tubes have been able to transmit images to the "mosaic" within the tube with greater clarity and sharpness of focus.

The increased sensitivity thus obtained at the point of pick-up is added insurance against their being reproduced in the receiver with the characteristics of an under-exposed photograph. It was revealed that the improved Iconoscopes were now receiving practical test by NBC engineers in the field tests.

NEW MATERIALS USED

A paper by Dr. R. R. Law considered advances in providing greater contrast in the images reproduced in Kinescope tubes. It was pointed out that, desirable as "bright" images may be, this quality is not sufficient in itself for the clearest possible picture reproduction. Accordingly, Dr. Law's recent researches have been concerned with the improvement of "contrast" in television receiving tubes.

In the course of this paper it was demonstrated how light-transmitting materials of different kinds and varying thickness would interfere with the clarity of the image. Such interference is known as halation, and is caused by light being dispersed beyond the edges of an object to create "fuzzy" reproduction.

By introducing a thin layer of darkening material on the glass end of the Kinescope through which the picture must be viewed, Dr. Law has reduced halation in the received picture. It was stated that 20 per cent absorption of light reduced halation to one-sixth its previous value.

SIX-FOLD GAIN

Closer to the frontier of pure research, and consequently somewhat more remote from practical application, were the revelations of Mr. H. Iams, Dr. G. A. Morton and Dr. V. K. Zworykin. This paper reported on the progress of the RCA laboratories in combining the electron image tube with the Iconoscope to provide a six to ten time increase in sensitivity. In this "super Iconoscope" the scene to be televised is focused on a photo-cathode surface. Light striking the surface knocks out electrons from its further side in proportion to its intensity at any point.

These electrons are focussed by "electrical lenses" on a second surface, comparable in function to the mosaic of an Iconoscope but of material capable of most efficient "secondary emission" instead of photo sensitivity. A single electron, striking this surface, may dislodge as many as ten electrons from its materials. This is the principal of several reasons for its increased ability to convert light into electrical impulses.

Also important are the facts that the photo-sensitive cathode receiving the original picture may be made more sensitive than the usual mosaic of an Iconoscope, and the final electron stream, by virtue of the succession of impacts, has greater velocity.

Another possible approach to Iconoscopes of increased sensitivity was described by Dr. Zworykin and J. A. Rajchman in their joint paper dealing with the "electrostatic electron multiplier." This is a device in which electrons are made to bounce from surface to surface, dislodging several times their number at each impact. It has been calculated that it is theoretically capable of amplifying an impulse 200,000,000 times. Obviously, such a device, successfully coupled to an Iconoscope, should increase its sensitivity enormously.

STEEL BALL DEMONSTRATED

When RCA scientists announced the creation of the electron multiplier, in 1936, the bouncing electrons were controlled by a magnetic field. However, magnetic fields in immediate proximity to the Iconoscope present problems, because magnetism is also used to control the beam that scans the picture within the tube.

In the electrostatic electron multiplier, the magnetic field is eliminated in favor of other control, which does not interfere with the normal working of the Iconoscope. The engineers have thereby removed a large obstruction from their path toward the "candid" Iconoscope of the future, which will get clear pictures under adverse conditions of illumination.

The presentation of the paper was accompanied by a demonstration in which the action of electrons in the electrostatic electron multiplier was shown by a clever mechanical device. A steel ball, representing an electron, was rolled across a sheet of rubber stretched over shapes comparable to those of the electrodes in the tube. The shapes being at different levels, corresponding to the different electrical potentials in the tube, gravity caused the ball to follow a path like that which an electron would take in the tube.

In general, three of the four papers of the symposium dealt with increased sensitivity of pick-up devices, and the other with the deliberate sacrifice of some of this "brightness" at the receiving end, in favor of better "sharpness" in the image viewed.

Novel Modulation

In an All-Wave Signal Generator

By Carlton Burroughs

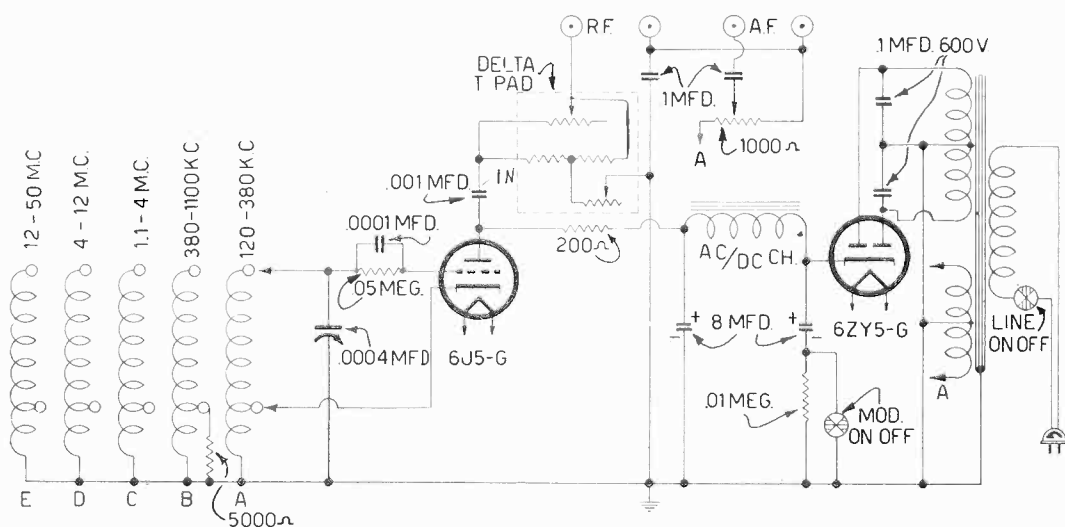

FIG. 1

A five-band signal generator, 120 k.c. to 50 m.c. (six meters), using practically choke input to rectifier filter for introducing 120-cycle modulation.

SO little a change as placing the grid leak in series, instead of across the tuned circuit from grid to cathode, made quite an operating difference in the signal generator shown in Fig. 1.

The first fact noted was that the stability of the oscillation frequency and amplitude was improved. Actually the grid current was measured, and it changed much less over any one band, and was more nearly the same over all bands, though not equal over all of them. The grid-current determination is valuable in reporting the stability condition.

Another fact that showed up was that the frequency range was increased. So with five bands, starting at 120 kc, it was possible to end up at 50 mc, i.e., go down to six meters. The tuning condenser maximum was 400 mmfd.

THE R-F ATTENUATOR

With the oscillation bands working nicely, and all of them calibrated, using principally a piezo-electric calibrator, and aided by generator harmonics of low-frequency fundamentals, compared with known broadcast station frequencies, the next consideration was the introduction of a suitable attenuator, or r-f volume control.

This was not such an easy matter. The usual potentiometer device, with its greatly changing load effect, or change of effectiveness with

position of the lever, naturally did not prove satisfactory. Something was required that presented a fairly constant impedance, and that something finally was selected as a delta T pad, which consists of two rheostats working in opposite directions, so that the total resistance does not change appreciably with change in the quantity taken from the output voltage, this constancy being aided much by connecting two equal resistors in series, having input go to one series end, output slider to the other and one end of the compensating rheostat to the other series end. The resistor values were 200 ohms each for fixed segments and rheostats, and the load resistor directly in the B-line feed was also 200 ohms. This combination afforded a relatively constant impedance of 200 ohms.

LEAKAGE PROBLEM

After the T pad was working properly the oscillator was tested for leakage. It is always imperative to keep this as low as possible, for if the leakage is appreciable the extent of control exercised by the attenuator is reduced, and finally, for the worst condition, it may be said simply that the control does not work. This is only because so much energy gets to the receiver under test because of the leakage paths, so-called feeding through the line, that whatever effects are produced by the attenuator are small by

comparison, for the leakage is independent of attenuation. Also, much of the leakage is due to causes other than the line cord.

In one form the generator was of the a-c/d-c type, but this method, though simple, was discarded because solution of the leakage problem then became almost prohibitively difficult. The line is connected right into the oscillating circuit, in a sense, so much leakage was to be expected.

An expedient is to reduce the intensity of the

include any of the well-tried circuits, except that with a self-excited oscillator, of the triode type particularly, it is difficult to find a good method of modulating without serious detuning and other bad effects. However, if the B supply input is practically changed to choke input, the most effective part of the filter is removed—the condenser adjoining the rectifier—and therefore hum is present. Since a full-wave rectifier is used, and has the effect of doubling the pulses, hence the frequency, instead of 60-cycle modula-

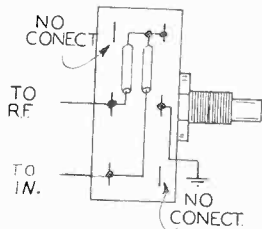
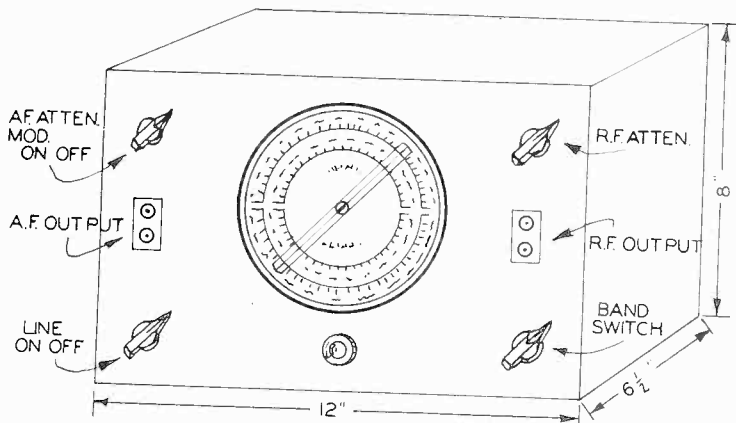

FIG. 2
At left, layout of the signal generator's shield cabinet. Above, physical connections to the delta T pad. The two little tubings represent the fixed resistors on the control.

original oscillation, and then perhaps add an amplifier, so that the output will be built up strongly, without leakage increase. This requires an extra tube and is, besides, not a real solution but only a makeshift.

TOLERATES NO OPENINGS

The generator was always contained in a steel cabinet, and it soon became obvious that hardly any openings could be tolerated. On the one hand it might be advantageous to have louvres for ventilation. On the other hand they would increase the leakage by reducing the shielding effect. Finally there were no uncovered holes, except the hole through which the condenser shaft passed, and this was made so small that there was only 1-64 inch clearance. Then two shield cabinets were used instead of one, with improvement. The leakage, under single or double shielding methods, was low, and to what extremes one desires to go depends on the minimum allowable leakage. There will always be some leakage.

It was found beneficial for high-frequency oscillation intensity to use a B choke instead of a resistor. As the current is small, an a-c/d-c choke is sufficient. Due to the relatively low resistance, 500 ohms or less, the voltage dropped isn't serious, and therefore a substantial B voltage, around 200 volts, is applied to the oscillator tube plate.

The d-c drop through the 200-ohm load resistor is negligible.

NOVEL MODULATION

For audio oscillation it would be practical to

tion, which many consider too low in frequency, we have 120 cycles, which provides an acceptable tone. Also the modulation is conveniently introduced, by capitalizing on what is a flaw under other conditions, i.e., too much hum. Here we want some, anyway.

There will be a reduction in the B voltage due to the effective removal of the condenser next to the rectifier when modulation is "on," for at this point there is now no voltage-maintaining circuit formerly present, but if the r-f oscillator is stable, as this one is, the change in B voltage produces negligible change in frequency.

TEST FOR FREQUENCY CHANGE

The test may be made by beating with a station, without modulation of the signal generator, and then introducing modulation. Naturally there will be a small change in beat frequency, and by listening one may estimate whether it is much or little. The beat, if adjusted fairly high in audio frequency, can be distinguished from the modulation tone. The frequency difference on introducing modulation proved to be little, so the method was adopted.

If a low percentage modulation and smaller frequency-changing effect on the r-f oscillator is desired, the resistor shown as .01 meg. (10,000 ohms) may be made smaller, or the modulation on-off circuit may be moved over to the other side of the choke. Then choke-condenser input would be maintained, but there would be little capacity across the output, as the series

(Continued on following page)

A Portable Phono-Player

By L. M. Feiler

Engineer, Allied Radio Corp.

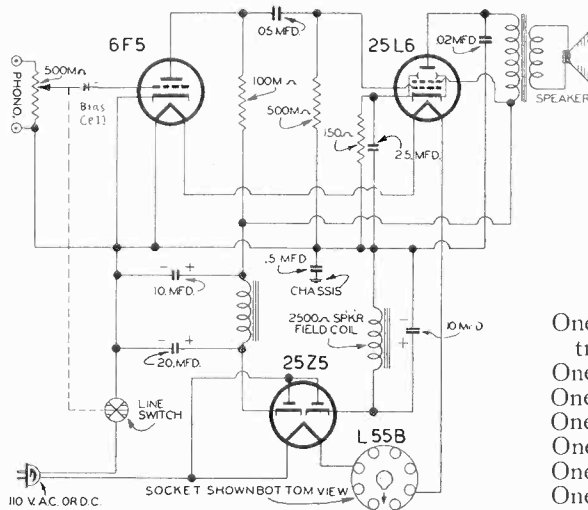

LIST OF PARTS

- One Mallory bias cell holder.
- One Mallory bias cell unit.
- One phono input jacks strip.
- Three octal sockets.
- One 6-prong socket.
- One line cord and plug.
- One 100,000-ohm, $\frac{1}{4}$ -watt resistor.
- One 500,000-ohm $\frac{1}{4}$ -watt resistor.
- One 150-ohm, $\frac{1}{2}$ -watt resistor.
- One midget filter choke.
- One unit of 20 mfd. and 10 mfd. 150-volt electrolytic condensers.
- One 50,000-ohm volume control and switch.
- One .05 mfd. 600-v. condenser.
- One .5 mfd. 200-v condenser.
- One 25 mfd. 25-v. condenser.
- One .02 mfd. 600-v. condenser.
- One 10 mfd. 150-v. condenser.
- One 6 inch, 2,500 ohm field dynamic speaker with output transformer.
- One chassis.
- One metal tube grid cap.
- Tubes: One 6F5, one 25L6, one 25Z5, and one L55B.

THE highly-efficient phono input amplifier circuit illustrated uses the minimum of parts, gives more than two watts of undistorted audio power, and will operate properly from any 105-120 volt d-c or 25 to 60-cycle a-c source. This unit is made with phonograph turntable and pickup mounted in a handy carrying case. The radio builder may also construct the amplifier and assemble the complete unit.

The amplifier uses a straightforward circuit with a 6F5 high-gain triode to drive a 25L6 beam output tube. A six-inch dynamic speaker easily handles the power output. A 25Z5 tube serves as a half-wave rectifier, and a total 30

mfd. of filter capacity eliminates hum. A completely-drilled chassis is available for correct mounting of all parts.

Any high-impedance magnetic or crystal pickup may be used. Ordinarily a 78 rpm phono motor having a 12" turntable will be best, but for special requirements a dual-speed, 33 $\frac{1}{3}$ -78 rpm motor may be used.

(Continued from preceding page)
resistor almost eliminates the capacity effect. In this way a very small modulation percentage is introduced, whereas by the first-mentioned method the percentage modulation was around 30.

The 6J5-G tube, used as r-f oscillator, is the same as the 6C5 metal tube and the 76, in general, and is an excellent oscillator. That is also a general truth as applied to triodes. The rectifier likewise is a glass tube, of rather new vintage, the 6ZY5-G, selected because it stands the voltage and current requirements amply, and has a 6.3-volt heater, thus permitting a single winding for heaters of both tubes.

Since it might be desirable to take off some a-c voltage for testing audio amplifiers, a connection through condensers is made to half of the 6.3-volt winding, affording a little more than 3 volts, ample for such purposes. However, as reduction may be desired, a control to accomplish this is included, and constitutes the

audio attenuator. Adjusting this has no effect on modulation of the r.f.

The separate output audio frequency is 60 cycles, as taken from the line.

The parts of which this signal generator was built are commercially obtainable, including tuning condenser, five coils, six-position two-circuit switch, frequency-calibrated scale, pointer and delta T pad. The sixth position may be used for shorting the grid slider to ground to remove r.f. when only a.f. is desired as output.

Fig. 2 gives the arrangement of parts if a vernier drive or airplane dial is used for the condenser and also gives the physical connections to the pad. The shield cabinet was a foot wide, 8 inches high and a little more than half a foot front to back.

[List of parts supplied on request to Technical Editor, RADIO WORLD, 145 West 45th Street, New York, N. Y.]

Wattage Rating of Resistors

Has Been Standardized, But There's Difficulty in Leeway

By Maxwell W. Porter

THE Office Humorist is looking over our shoulder, full of helpful suggestions for better titles for this piece. "What's in Ohms" he offers, or "When is a Watt not a Watt?" Bright Student says he knows: "When it's a volt-ampere." But according to the experienced amateur and the service man the real answer is "When it's in a 50-watt resistor."

How many watts in a 50 watt resistor? Who knows? runs the argument. If Superb Ohms

now have active regulatory bodies to help us, and of course we can always fall back on the known integrity of reputable suppliers, and depend on them to give us "Good Goods and Straight Dope." Still, it would be nice to know a little more about resistors, anyway . . . if only to enable us to choose them for our needs more intelligently or to help these suppliers to do so for us.

If we take for granted the use of materials

FIG. 1
Temperature - resistance graph of Nichrome, a nickel-chromium alloy with a very high specific resistivity, so that a high resistance can be wound in a small space.

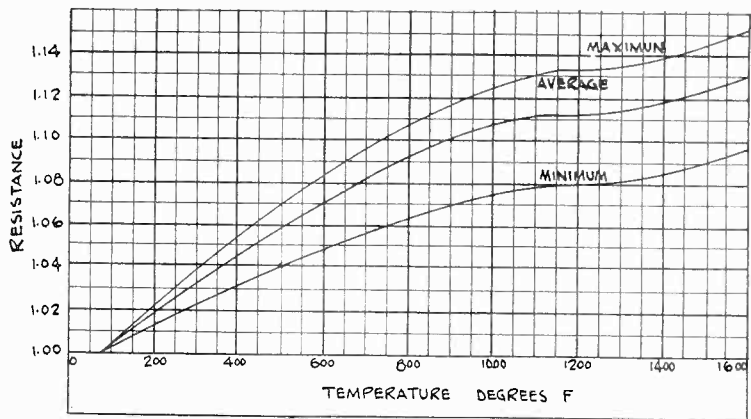

Courtesy Driver-Harris Company

Corporation says to us, "Yes, sir, this a genuine 1,000-ohm resistor," our trusty ohmmeter quickly tells us that the said resistor is indeed 1,000 ohms, plus or minus. But should the hereinbefore mentioned Superb Ohms Corporation add, "And here, sir, is a gorgeous 50-watt resistor," who can say them nay? There is no trusty "watt-meter," alas, and there are many unanswered questions, alas again. We do not know why this firm calls it a 50-watter, when Intercosmic Ohms, Inc., labels a similar resistor 75 watts, and The Ohms Company calls it 25 watts. We do not know how hot it will get, nor how long it will last, or won't, nor why; nor are any additional data given from which computations might be made. So we are left entirely in the dark befuddled by competitive ratings that don't rate.

INTELLIGENT CHOICE REQUIRED

These are gloomy thoughts, and make us feel like the blind man in the pitch dark room looking for a black hat which isn't there. But we are not quite so badly off as that, for we

of good quality, and putting aside for the present the more staggering refinements of analysis, it may be stated that the useful life of a given resistor depends simply on how cool it runs. This in turn depends on how readily the resistor can radiate its heat. Effective radiation is proportional to the surface area exposed to a cooler medium, and this area is determined by the size wire used and by the winding concentration.

EFFECT OF SIZE

The larger the wire, the more of it is needed for a given resistance, and so the larger must be the form on which it is wound. Generous design therefore results in a relatively sizable—and *relatively* expensive—resistor. Such a resistor of course will not warm perceptibly on full load, it will lead a cool and peaceful existence, and live to a ripe old age.

This is an excellent enough state of things. But now commercial competition, which we have met before, often to our benefit, sometimes to our

(Continued on following page)

(Continued from preceding page)

woe, clamors to be reckoned with; and competition being what it is, it is not long before a certain competitor, thinking how to undersell his fellow man, adopts without too much publicity the use of an inferior grade of wire, and spreads it over a big, but cheap, form. This gives him a resistor that *looks* like "big value": it will appear to have everything, and it will—everything from asthma to zoothapsis*. Another competitor with the same bee in his bonnet takes another tack; he decides to use a smaller wire size. With this simple expedient he kills two

decide on a definition of "Safe" from the viewpoints of the useful life of the resistor under various operating conditions, and of its effects on surrounding equipment; and we should then agree to abide by this definition in rating the resistor.

PURPOSE OF ENAMEL

The wire usually used is one of the nickel-chromium alloys. It is chosen with regard to its specific resistivity, temperature co-efficient of resistivity, durability, and other useful or special characteristics.

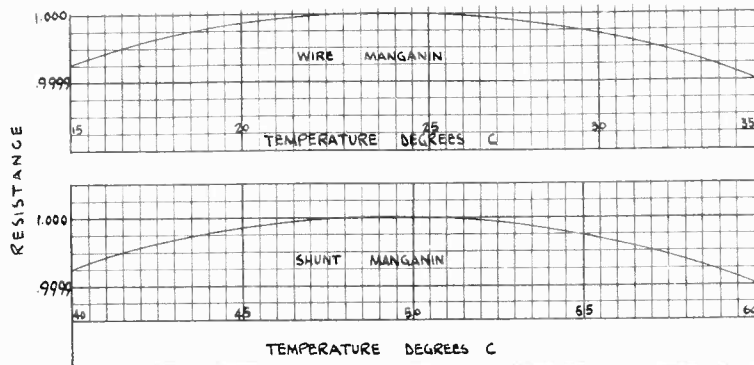

FIG. 2
Temperature-resistance graph of Manganin. This is a wire with an extremely low temperature coefficient, and is therefore useful in applications where resistance must not vary in value regardless of temperature changes, as for instance in meter shunts and multipliers.

Courtesy Driver-Harris Company

birds with one stone: he reduces the cost, since a smaller bulk of material is required for the same R; and he produces a resistor with the same "ohmage" in maybe half the space. This resistor, however, is bound to have a pretty hot time of it, a merry life but a very short one. Moreover, it will precipitate breakdowns in neighboring equipment, fading, frequency drift in oscillators and other tuned circuits, and a host of related annoyances not pleasant to contemplate.

VITAL CONSIDERATIONS

So the bald statement that a given 5,000-ohm resistor is rated at 50 watts has little or no value. It does imply that presumably the maker believes that this is a 5,000-ohm resistor which will not fuse when passing 100 milliamperes, or when placed across 500 volts: the formula for this being $W = I^2 R$, or E^2/R , or EI . But it does not tell us how hot the resistor will get when dissipating the 50 watts, nor how long, consequently, it may be expected to last.

Now in actual practice, it would be unconventional to design an immortal resistor, with a receiver appended thereto. We are obliged to try to produce a resistor consonant in size with the dimensions of the apparatus of which it is to be but a part, and with a useful life on a par with that of the other components. To make a given resistance as small as it may safely be made involves a careful examination of all the many factors affecting its operating characteristics: we must have figures on resistance wire life versus temperature, we must know under what conditions of temperature and ventilation it is to be used; furthermore we must

To keep down the size as well as the temperature of the finished resistor the wire is enameled so that the turns may be wound closely, and then from tables the largest wire size practicable for a given resistance is determined. It is then wound on a refractory form having good heat conductivity. The form may be said to act like a matching transformer, absorbing the heat concentrated on the small hot wire surface in contact with it and distributing it to a large cooler air surface. A similar function is performed by a heat conductive coating, with a good radiating surface, poured over the winding to make intimate contact with that part of the wire not actually touching the form. This coating serves to keep the wire in place, to guard it against mechanical injury, and to exclude moisture and corrosion.

It is a well-known fact that under the influence of changes of temperature all materials expand and contract at different characteristic rates. As a result, resistors may develop displaced or strained windings, "hot-spots," and cracks in the coating, but these effects are avoided when wire, form and enamel are given sensibly the same temperature coefficient of expansion so that all parts of the resistor might change uniformly. Terminals need special attention, to avoid imperfect joints and to eliminate strains resulting in high contact resistance, noise, arcing and disintegration of the ends of the winding. Temperature also affects the specific resistivity of the wire, so that the cold and hot resistances may differ appreciably.

STANDARD HAS BEEN ADOPTED

A standard for maximum wattage rating of
(Continued on following page)

*Zoothapsis: Premature burial.—Tech. Ed.

A Photo-Cell Kit Set

That Provides Many Possibilities

By M. N. Beitman

Allied Radio Corporation

EVERY day new applications are found for photo-cell equipment. We are well familiar with the mysteriously swinging doors, automatic drinking fountains and animated window displays. In industry, too, photo-cell equipment has found hundreds of uses and is now considered an indispensable tool. For the task of counting, sorting and checking, no other piece of equipment nor any human being can offer any competition to the efficiency and accuracy of photo-cell methods. The matching of colors has been greatly simplified, and the

high-speed counting has been made possible with this "electric eye."

Many new uses of photo-cell equipment are yet to come. Servicemen and experimenters should acquaint themselves with the principles of this art and be ready to service and build this type of apparatus. An excellent way to start

LIST OF PARTS

- One line cord resistor, 290 ohms.
- One Knight photo-electric tube.
- One type 43 tube.
- One four-prong socket.
- One six-prong socket.
- One baseboard, 6 x 7 inches.
- One volume control bracket.
- One 2,000-ohm potentiometer.
- One 500-ohm, 2-watt carbon resistor.
- One 20-megohm IRC resistor, ½ watt.
- One small knob.
- One 8 mfd. 200-volt electrolytic condenser.
- One GM relay, single pole double throw.
- Five feet of hook-up wire.
- Three Fahnestock clips.
- Seven ⅜ wood screws.
- Four ⅝ wood screws.

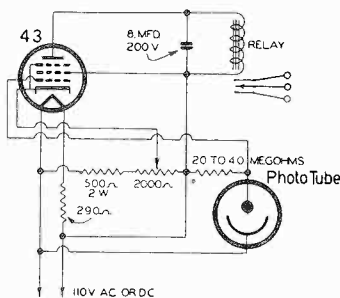

The simple photo-cell amplifier circuit.

is to build a simple single tube photo-cell amplifier.

SENSITIVITY ADJUSTMENT

The unit illustrated on the front cover can be built for around \$5, including photo-tube, is self-powered and may be operated from 110 volts a.c. or d.c.; the absolute minimum of inexpensive parts is used; and the breadboard layout simplifies the mounting and wiring.

A type 43 tube serves as the rectifier and

(Continued on following page)

(Continued from preceding page)

resistors of the type we are discussing has been promulgated by the National Electrical Manufacturers Association and Radio Manufacturers Association, Inc. This is defined as the input in watts needed to raise the temperature of the hottest part of the resistor by 250° Centigrade or 482° Fahrenheit, when it is surrounded by at least a foot of free air, and the surrounding temperature is not over 40° C. or 104° F. It is such a maximum that is now usually used in labelling resistors; a cool rating would be only 25% as high. If a resistor is to be used under such good ventilation conditions, well and good, but if, as is usual, it is to be placed in a small, crowded space where ventilation is poor, or the surrounding temperature is high, or where it is close to vulnerable parts like condensers, then a much higher wattage resistor

becomes advisable, or a combination of several smaller ones. Another point that is worth noting is that resistors suffer from high disruptive forces of transient voltage peaks just as condensers do when the power supply to reactive circuits is switched. It is also useful to remember that if for example the voltage is doubled the current through the resistor is doubled, and doubling the current, as a glance at $watts = I^2 R$ will show, is equivalent to quadrupling the wattage to be dissipated by the resistor. For all these reasons, and others, in actual use when it is desired to give full consideration to the life of the resistor and to the welfare of the surrounding equipment, a resistor rated, as described above, at 25 watts may well be replaced by a unit or an assembly similarly rated at 100 watts.

—M. P.

(Continued from preceding page)

amplifier. The constant bias on the control grid will depend on the amount of light and must be adjusted to a sensitive point by means of the 2,000-ohm potentiometer. When connected to a source of a-c power, the unit operates one-half of the time and the 8 mfd. electrolytic condenser across the relay serves to eliminate chatter.

Consider the circuit at the point where a positive potential exists on the side of the line connected to the relay and screen grid of the type 43 tube. If the control grid of this tube is not biased to a cut-off point, a certain amount of energy will pass through the plate circuit and activate the relay. The actual bias on the grid will depend on the internal resistance of the photo-tube and also on the setting of the potentiometer.

With the photo-cell receiving a definite amount of light, the potentiometer may be adjusted so that the plate current is just below the point where the relay will have sufficient energy to pull down the armature. Now if the source of light is reduced the internal resistance of the photo-tube will rise and cause a higher positive potential to be applied to the grid and counteract the negative potential obtained through the drop in the potentiometer circuit. The net rise of the control grid voltage will cause additional plate current to pass and the armature of the relay to move down to the magnet pole.

Since the armature has a contact on each side, it will make another circuit and break the previously made circuit. In this manner, associated equipment may be started or stopped with the decrease of light, or with the increase of light.

The parts may be placed on a 7" square plywood base. The layout illustrated should be followed in order to reduce the size of connecting leads. The entire unit may be placed in a closed container with an opening to admit light and thereby increase the sensitivity of the circuit.

This unit may be used for a number of simple photo-cell applications and will be most sensitive where stray light is shielded away and the control light is directed on the photo cell. Generally, photo-cells are more sensitive in localities where comparative darkness exists. In such cases a small amount of additional light is sufficient to operate the unit. On the other hand, in well-lighted places considerable difference in light intensity may be required in order to activate the equipment.

[Other Illustration on Front Cover]

Amplifier Trouble

YOU'VE built up a 10-watt PA amplifier which has two 6J7 microphone channels feeding one grid of a 6N7 dual triode, with phonograph input to the other grid. The plates are hooked in parallel and transformer-coupled to two 6F6's in push-pull. You use a 12" P.M. (permanent magnet) speaker. Everything looks right but hum level is high. As a student you would like to know what causes that.

There are many possible causes of hum in such a case, because it may be due to the tubes, to the power supply, or to electromagnetic or electrostatic pickup, etc. As to the tubes, check them by replacement. Is your filter ample? You may need more filter capacity. Are the filter condensers of good quality and are they operated well within their voltage rating? If poor or defective, they may leak between sections. Are the chokes adequate for their task, i.e., have they sufficient inductance at the current they are required to pass? Try separate resistance-capacity filters for the screens and plates of the 6J7's and the 6N7, and the grids of the 6F6's. Try running the screens of the power tubes to the output of the second choke, if you use a two-stage filter, and run the B plus lead (the center tap of the output transformer primary) to the junction of the two chokes. Try the effect of eliminating the bias currents from the 6J7 control grid circuits by substituting a battery in the grid return or a Mallory bias cell in the leads to the grid caps. (In fact, it is excellent practice, when possible, to substitute batteries, first for heaters, then for the various plate, screen and control grid potentials to see when the hum disappears.) Note the effect of reversing the supply plug, also the effect of grounding the chassis. Be sure the mike leads and speaker cable, as well as all other high potential leads, are shielded and the shielding joined to the chassis. Also join one side of the speaker winding and the speaker frame itself to the chassis. Check power transformer and filter chokes for lamination hum. Finally there is the likely possibility of coupling between inductive parts and the input push-pull transformer. This can be checked by rotating this input transformer in respect to the power transformer, filter choke, speaker field or output transformer. Sometimes microphonic action in the tubes makes a hum audible, so check carefully the tubes and the method of mounting them. Another anti-hum test is to reverse connections to input transformer primary.

FREAK RECEPTION

As radio grows more and more conservative, less and less attention is paid to freak reception. Twelve or so years ago it used to be news, sometimes front-page newspaper news, that a station a thousand or more miles away had been heard on a crystal set. A few years ago not the newspapers so much, but the technical press,

would give considerable space to long-distance five-meter reception, say, between the United States and England. Many reports of 5-meter reception between New York and Chicago were circulated. But freak reception is usually distorted and has no value. Steady, reliable coverage is all that counts.

D-C Voltmeter for Peaking

Avoids Cutting a Lead or Using Adapters

By Harry Bordeau

RESONANCE indication is commonly obtained in receivers by putting a current meter in series with a plate lead, which requires opening the circuit, or by using an output meter.

The insertion of the series meter should have minimum detuning effect on the circuit and therefore some adapters that perform the opening-up process without requiring cutting a lead do not render the best service because of high capacity introduced to ground.

This opening process is performed by removing the tube, inserting the adapter in the empty socket, and inserting the tube in the adapter. Thus a means is provided for interrupting the circuit in which current is to be measured, and the meter is in effect put between the tube and the adapter to complete the otherwise open circuit.

THE BETTER WAY

Watching the d-c current flow for resonance indication is the better way to align a receiver, for instance peak an i-f channel, because then the rectified i-f voltage is operated on and this depends on the i-f wave amplitude. The same preference applies to the r-f level, although there the difference may not be so great. A sharp indication is obtainable.

The rectified carrier in any case influences the meter, directly or indirectly, and thus one gets as close as possible to a determination of the very factor that he is interested in.

With the output meter method, where an a-c meter is put across the voice coil or the primary of the output transformer (usually with a stopping condenser as protective device), the modulation of the test signal, if increased, will increase the reading, as only the modulation really is read, and thus some untoward cause may produce an increased reading even though the circuit is being tuned instead of detuned. Also the indication is not so sharp. That is why it is better to operate directly on the carrier, for the modulation does not affect the average value of the carrier, and most of the detectors—really second detectors and a-v-c supply rectifiers—are of the diode type that respond to the average.

VOLTMETER METHOD

A way of avoiding the use of adapters and of preventing the need to cut a lead for insertion of the meter in series is not to use current mea-

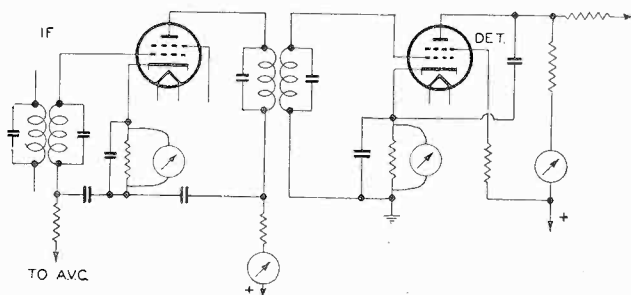

The voltmeter at left and the one second from left afford ready means of resonance determination.

surement as such, but use a voltmeter. The diagram shows two current meters in plate circuits, first of an i-f tube (second meter from left), next of a biased detector tube (meter at extreme right), whereas the two other meters are across the biasing resistors and measure the voltage appearing across these resistors.

DETECTION NEEDED

It is clear that any of the meters must be associated with circuits that are themselves detectors, not merely amplifiers, or are influenced by detecting characteristics. However, a-v-c controlled amplifiers are influenced by the detecting characteristic therefore behave as vacuum-tube voltmeters for the present purpose, and afford great ease of measurement, with considerable sensitivity. Maximum downward deflection denotes resonance, so start with the meter reading nearly full-scale.

Since the meter will swing downward, if the range is properly chosen, the maximum intensity signal received should not quite bring the needle to zero, i.e., cut off the plate current in the a-v-c controlled tube completely. Therefore nearly the whole meter scale may be used for indicating purposes, and the meter thus makes a very fine resonance indicator for permanent installation in a receiver.

Some form of resonance indicator is required on a-v-c controlled sets because judging response by the ear is unreliable. At positions a little this or that side of resonance as great a quantity of sound is heard as at resonance, due to the levelling effect of a.v.c., therefore to avoid off-resonance distortion, the indicating device is relied on. The set is properly tuned in when the needle reads as far down as it can be made to go as the result of the voltage input from the station tuned in.

Errors Due to Leakage In Measurement of High Voltages and Resistances

By Arthur B. Meade

WHEN an attempt is made to have an instrument measure high voltages, two principal factors must be taken into consideration: leakage and voltage breakdown. Insufficient attention is given to both.

The wire used for making the connections should have a high breakdown voltage rating. This is not difficult, as wire that does not cost much can be obtained that will withstand 10,000 volts before the insulation gives way. Such wire would be generally satisfactory for a voltage range of 2,500 volts r.m.s., or about 3,500 volts d. c. As a matter of conservatism, however, even smaller voltages would be preferable where such wire is used, so that it can be seen that very high breakdown voltage wire is advisable. This may well be rubber-covered for great safety.

The leakage itself represents a resistance path and it exists even along a short length of the insulation on the wire. Moreover, it is not constant, changing with moisture principally. That is another reason why rubber covering is favorable, as it is a good insulator against both voltage and moisture.

SERIES AND PARALLEL

As the wires of the instrument usually touch at some places an effect equal to that of putting the leakage resistance of the wires themselves in series takes place. However, between the wires connecting the various parts for a particular range and the panel, there is additional leakage, which is parallel resistance. Naturally the parallel paths are the most troublesome.

Most of the parts contribute considerably to the leakage and with the exception of the wires affecting unused services of the moment, the leakages are in parallel, and therefore the total resistance may become relatively low. For a range of 500 volts the leakage begins to show up, because even on an instrument of fair sensitivity, 1,000 ohms per volt, the required value of the multiplier resistance may be considerably more than the theoretical value computed without regard to leakage.

It may be assumed that for an ordinary instrument a leakage of around 100,000,000 ohms is satisfactory, as to its effect on general performance, or as to safe operation, but even such a value has to be considered from the viewpoint of accuracy if the leakage has the effect of shunting the load resistor.

VALUES EXPERIENCED

In a particular instrument on which numer-

ous tests were made the average leakage was 90,000,000 ohms, and unless a multiplier resistor computed as 500,000 ohms without respect to leakage, were raised to 503,000 ohms, an appreciable reading error took place. While the leakage may be variable in the absence of special precautions, the variations themselves will not prove so serious in effect on accuracy, if allowance is made at once for average leakage.

Without regard to the sensitivity of the instrument, the leakage for voltage ranges may be considered in regard to the computed multiplier resistance alone. In nearly all instances the leakage does not call for any special consideration until the multiplier resistance assumes the theoretical value of 250,000 ohms; certainly at 100,000 ohms and under the leakage, comprising a high resistance in shunt, has small effect, because the shunting is done across a resistor already low.

Leakage that appears across the input posts only, and as applied to the voltage source under measurement, will have next to no effect on voltmeter circuits, even when voltages in high-resistance circuits are being measured, because never is the measured circuit anywhere nearly as high in resistance as the leakage, and besides the instrument under consideration, a normal voltmeter, draws current, usually one milliampere full-scale, or perhaps even as little as 50 microamperes in the more expensive instruments, yet the resistance between posts will be far higher than the shunt resistance presented to the measured circuit by the voltmeter itself. Therefore the internal leakage is what counts most from the viewpoint of scale accuracy.

PORCELAIN TYPE WASHERS

The posts or tip jacks do play a part, especially if a metal panel is used, for the connectors are insulated from the panel by fibre washers, usually, and these are not of the highest form of resistance or insulation. It is possible with a megger, reading to 100,000,000 ohms, to read the leakage directly, and it may be a value near full-scale of such an instrument.

Naturally, when there is leakage in the instrument due to various causes, and leakage between two posts or jacks, there can be a leakage reading between any jack and the panel, although no part of the instrument is purposely connected to the panel electrically, and it is assumed, although wrongly, that there is perfect insulation between post and chassis.

Both for voltage protection purposes and for accuracy, especially with great reduction in

leakage increment due to moisture, porcelain type washers may be used on posts or jacks. These washers have an extruded collar and should fit snugly into the hole drilled in the panel. Unfortunately, these higher-grade washers are not easy to obtain, and only very careful manufacturers of precision instruments use them for this purpose, and then usually for the sole purpose of giving finest protection on high-voltage ranges (say, above 1,000 volts).

It is sufficient for general purposes to use only one such washer on the common post or jack, although better to include such a washer on all posts or jacks.

STANDOFF INSULATORS

Still better would it be, although rather costly, to use standoff insulators, with corrugated surfaces, for then the leakage path is made longer, the leakage is less because the insulation is better, two ways of saying the same thought.

Some mention has been made of other parts. Since switches are popular it is well to remember that the switch contributes leakage, also that any tests made for a particular range must be made with the switch set for that range, and not set for some other range that throws the switch and its leakage out of circuit when an attempted measurement is made. Where multiplier resistors in the megohm range are required this precaution is very necessary.

Bakelite will offer very excellent resistance or insulation and may be used even for the high-voltage instruments, but it should be at least general purpose Bakelite, as the Bakelized canvas type has more leakage than desired on high-voltage uses, especially between parts that penetrate it, when the effect of the canvas seems to show up, although the leakage between the polished surfaces is about on a par with that of the more usual type of Bakelite, i.e., the results are excellent. Bakelite washers, however, of the type described in the discussion of porcelain washers, are so extraordinarily hard to get that it is scarcely worth while asking for them. Fully-protective washers are made in Isolantite, but usually are supplied only to manufacturers, because the servicing and experimenting fields have not made any particular demand for them, and besides haven't had much experience with high voltages.

WHY HIGH-VOLTAGE RANGES?

However, amateurs are well used to voltages of a substantial order, but they are fairly aware of the insulation requirements and how to meet them, at least in their transmitters, although when it comes to measuring instruments they seem to forget that the same requirements exist.

Servicemen will have something more to do with high voltages when television arrives as a commercial entity, and meanwhile have their cathode-ray oscilloscopes, practically all of which, with 3" diameter tubes, have voltages of 1,000 volts or more.

It can be seen therefore that the inclusion of a high voltage range in any instrument immediately brings up problems, but they can be

Leakage in Test Leads Fact Often Overlooked

ONE of the factors concerning leakage that hardly ever is given the least consideration is the effect of test leads. The insulation rods in which the probes or 'phone tips are seated naturally go directly to circuit being measured, only the path is supposed to be non-conductive.

If the insulation on the wire itself that constitutes the leads proper is of the best, no trouble will be experienced from that source. But even if the wire is perfect, if the insulation rods do not furnish all the insulation they should, for instance are made of fibre, the leakage may be so great that in measurements in the megohm range the error introduced by pressing the fingers strongly against the rods, especially at the ends near the tips, may amount to as much as 20 per cent.

In considering the purchase of test leads, therefore, it would be well if they could be tested on a high-resistance measuring circuit, so that the shunting effect of the pressure of fingers against the rods would show up. If a sensitive meter is used, and even if the ohmage range is not high, some additional battery voltage, say, 45 volts, with extra limiting resistor, to get somewhere near, though not beyond full-scale, will extend the range enough and enable an adequate test of the leads.

solved satisfactorily, after due consideration is given to the leakage factors.

What the leakage may be in any given circumstance may be determined in the usual way. The calculated value of the multiplier resistor is known, the value actually required to attain full-scale deflection on a high-voltage range is inserted, then removed entirely and measured, and the leakage, or unknown shunt, is equal to the product of the two knowns divided by the difference.

STRANGE RESULTS EXPLAINED

The foregoing accounts for some strange readings that experimenters get when they try to build an instrument with a high-voltage range, and find that the voltage always reads much too high, and the higher the range (hence greater value of multiplier resistance required) the greater the error, always in the same upward direction. The answer, of course, is that the multiplier is modified by the leakage and in reality isn't as great as what was supposed.

If the instrument is examined critically for all possibilities of leakage—assuming the operator has sufficient resourcefulness to think of

(Continued on following page)

(Continued from preceding page)

all the causes—it will be found that there are points at which improvement can be introduced, and by using the best insulators the device can be so made that the calculated resistors will suffice. That is, multipliers chosen by the usual formula $R=E \div I$, will afford proper voltage readings, because the leakage resistance instead of being around 100,000,000 ohms (100 meg.) may be around 1,000,000,000 ohms (1,000 meg.) But by the time that has been accomplished the experimenter will have spent considerable money on insulators and will have adopted a few unique means of achieving his end, and enlarged the size of the originally-planned instrument.

WORDS OF CAUTION

It is therefore, permissible to allow the

Adelman Five Years in C-D Executive Post

Leon L. Adelman was honored on the fifth anniversary as general advertising and sales manager of Cornell-Dubilier Electric Corporation. He has produced greatly increased sales over the whole period and has added to his large list of friends.



LEON L. ADELMAN

Adelman got interested in radio at the age of nine—he is 35 now—and as soon as possible became a ham. (His call is W2AFS). As radio editor of "Science and Invention" and "The Experimenter," technical and associate editor of "Radio News," contributing editor of RADIO WORLD, he kept right in the forefront of radio activities.

As a counter salesman in radio's pinafore days, Adelman learned first-hand the requirements of radio parts buyers and dealers. Later, as laboratory assistant and service manager for the F. A. D. Andrea Company, he came to know the faults to which radio sets were prone and the importance of quality parts in avoiding service troubles.

Adelman became assistant advertising manager and publicity director for the pioneer Charles H. Freshman Company; next, assistant sales manager of Hammarlund Manufacturing Company, Inc. For a time after that he operated his own company, Leon L. Adelman, Inc., exporters and importers. Then he joined the Cornell-Dubilier forces.

presence of leakage of the 100 meg. average order, and include resistors as multipliers that are properly larger, according to the unknown parallel resistance formula of product divided by difference. The denominator is the *difference* and not the sum.

Especially in the construction of a small instrument there is every necessity for great precaution, because whatever leakage there is between post collar and its shank can not be reduced, but only the leakage in this location that exists because of the intended insulating washer can be better.

Using proper insulation wire for connections, keeping wires apart if their insulation resistance is not particularly high, and not over-exposing the instrument to dust, grime and moisture, will help make performance come up to expectations.

A few words of caution are in order, although the sense of them is included in the foregoing discussion.

If actual measurements are being made, a large fixed resistor serving as the calculated value of multiplier, and a variable series resistor of perhaps ten per cent. of the fixed one, serving as adjuster, so that an accurately-known input voltage provides full-scale reading on the instrument, the measurement of the value of the total resistance required for insertion must be made without the presence of leakage. It is best to disconnect the total resistance and measure it independently, or at least disconnect one end of the resistor from the instrument, and then measure the sum.

BRIDGE IS BEST

The only method whereby highly accurate resistance measurements may be expected is by using a bridge. Since even a good bridge is not as expensive as some think it is, servicemen and experimenters generally should investigate the possibilities of buying such an instrument.

The usual ohmmeter will not give readings sufficiently accurate, particularly on the crowded part of the scale. Very little is ever said about the accuracy of ohmmeters, and perhaps there is not even a suitable standard of accuracy acceptable to all, but if the resistance in every instance could be measured to five per cent. that would be something. But here we desire accuracy of one per cent. or better. Bridges can afford that, the readability not being constant, but varying with the ranges, sometimes attaining .01 per cent.

The leakage is not a consideration in relation to current shunts, because the leakage resistance is high and the desired shunt is of low resistance.

However, in the measurement of high resistance the same general considerations apply as were set forth for high voltages, except that now the leakage between the posts is what matters, for it is here that the unknown high resistance is connected, and the unknown is shunted by the leakage at posts or jacks, just as the voltage multiplier resistors were shunted by the leakage internal to the instrument.

Five and Ten Meter Duplex Operation

By Herman Cosman

FIG. 1 shows the circuit of a three-tube, battery-operated transceiver for the ultra-short wave bands. The same antenna and the same frequency serve in both instances. A throw-over switch changes the circuit connections from those of a modulated oscillator transmitter to those of a super-regenerative receiver. A dual triode tube, type 19, is used as the oscillator with its two sections in parallel for increased efficiency.

When the switch is thrown to transmit, the sequence of operation is as follows:

SENDING

The microphone output is coupled to the 500,000-ohm potentiometer, which regulates the input to the 1B4 voltage amplifier. The output of this tube is resistance coupled to the 1F4, which is a battery-type power amplifier with a

(Continued on following page)

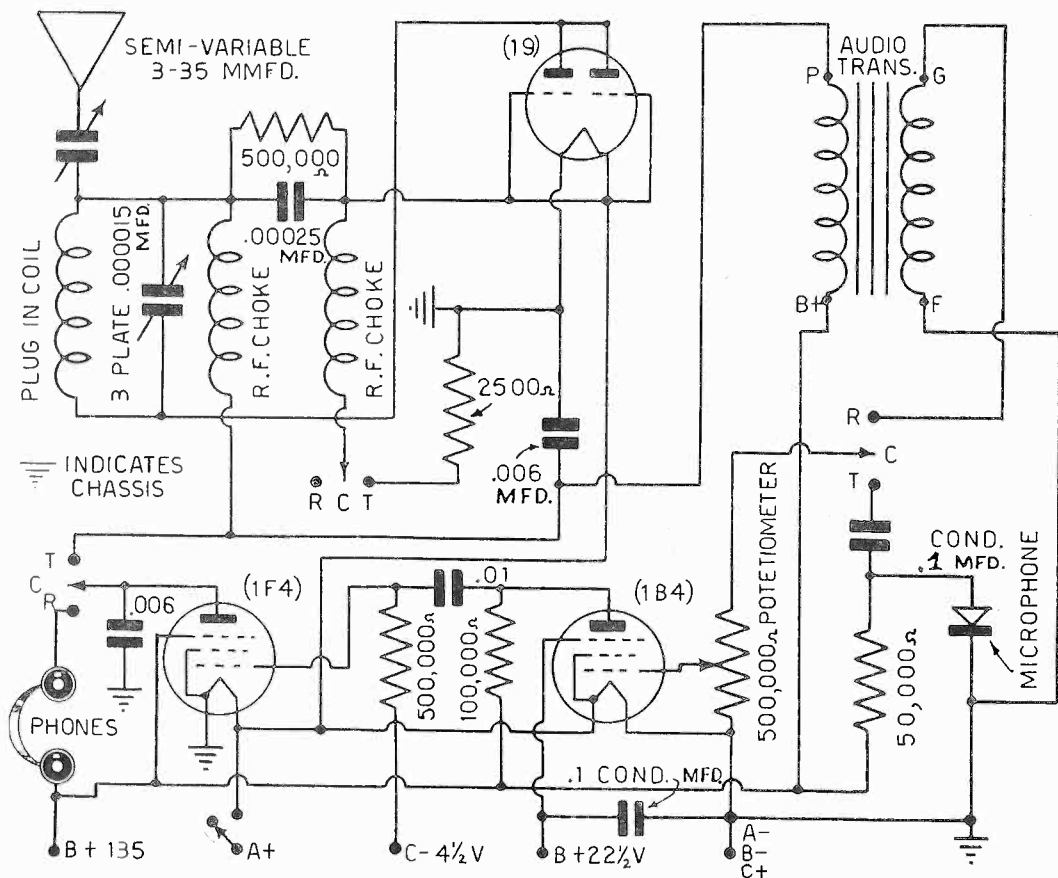

FIG. 1

Grid of the 19 oscillator is returned to the plate to produce super-regeneration in this five-and-ten meter transceiver. The simultaneous switch positions are T for transmit and R for receive, C representing the common, or moving segment. The RCT decks are ganged. See the pictorial diagram of the wiring.

(Continued from preceding page)
 high mutual conductance. The audio plate load of the 1F4 is the primary of the audio transformer, which is used as a choke, the secondary being disconnected during transmission. The plate supply of the 19 is taken in series with the audio voltage developed across this primary according to the Heising method of modulation. An r-f choke and a .006 mfd. condenser serve to keep the r-f out of the audio circuits and to prevent effective short circuiting of the oscillator plate load by the audio primary. Through one of the contacts of the switch the 2,500-ohm resistor in series with another r-f choke is connected with grid and cathode of the oscillator to furnish the required operating bias for efficient oscillation. The modulated output of the oscillator is fed through the semi-variable condenser to the transmitting antenna.

RECEIVING

When the switch is thrown to the receiving position a number of rearrangements takes place. The oscillator coil now becomes a tuned receiving coil feeding the 19, which now serves as

a grid leak detector in which super-regeneration is obtained in a simple and effective manner by returning the 500,000-ohm grid resistor to the plate side of the audio transformer instead of to the cathode. This puts a positive potential on the grid and results in a violent blocking action at super-audible frequency, thereby providing the periodic quenching of the tube's tendency to self-oscillate, essential to the process of super-regenerative amplification. The detected audio output is now amplified by the AFT, the 1B4, and the 1F4 which now feeds the headphone.

COIL DATA

The plug-in coils consist of No. 14 copper wire, wound on 3/8" diameter, then removed and used without supporting form. The 10-meter coil has ten turns, the 5-meter coil has 5 turns. Even with fewer turns, oscillation can be maintained, and results obtained to 2 1/2 meters, but not very reliably.

The coil inductance can be altered to suit, after winding as prescribed, by pulling the turns farther apart (lessening inductance) or by pressing them closer together.

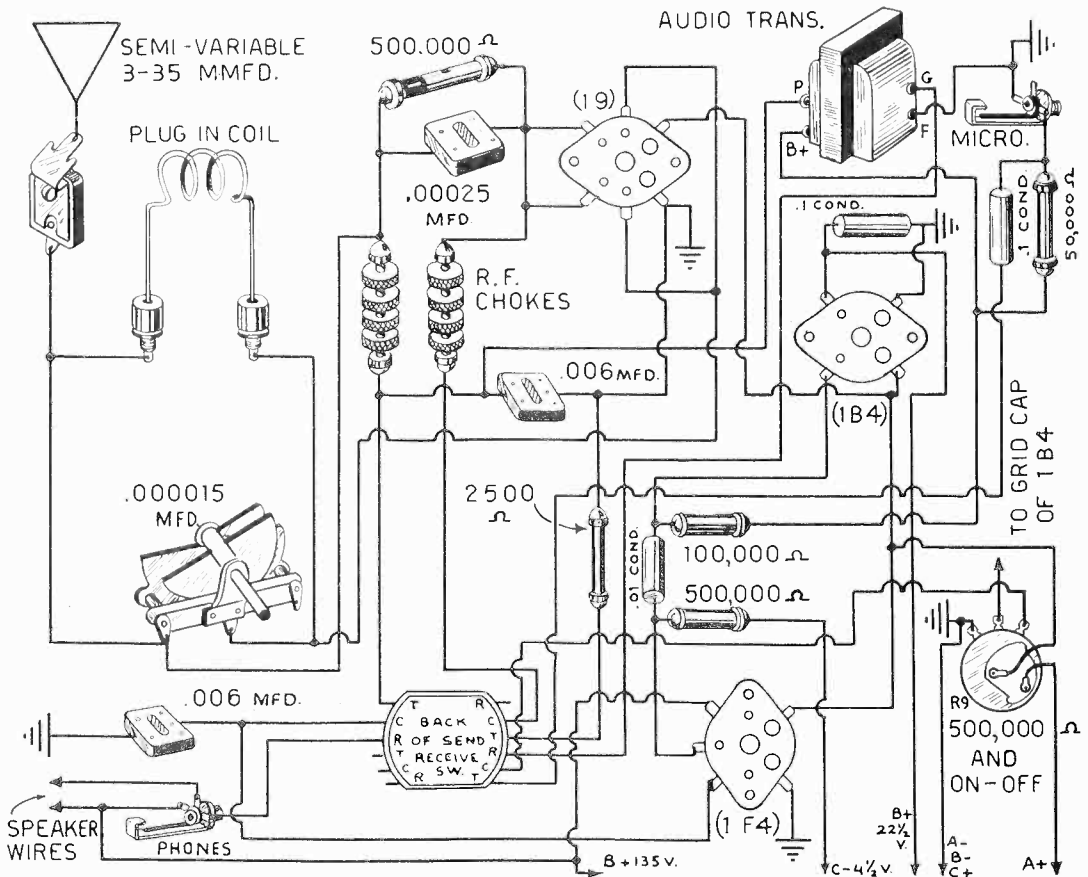

FIG. 2

The plug-in coil fits into tip jacks, and since No. 14 wire is used, the fit is satisfactory without providing any special terminals for the coils. The pictorial diagram above is of exactly the same circuit as the wiring diagram shown in Fig. 1.

Great Advances Embodied in METEOR, a New Multimeter

METEOR'S

TEN EXCLUSIVE FEATURES

METEOR is an outstanding laboratory type instrument combining accuracy, dependability and a high safety factor. Coupled with the technical features is an arresting beauty of layout and casing.

Among METEOR'S exclusive advantages are:

1. All measurements are made from only two tip jacks. *Exclusive with METEOR.*
2. Only two controls are used for all measurements, due to a new but fully-tested combination circuit. *Exclusive with Bernard multimeters.*
3. Use of a separate a-c/d-c switch has been eliminated, so that when the selector switch is set for any range the proper service (a-c or d-c) is automatically rendered, with no possibility of mistake. *Exclusive with METEOR.*
4. If the selector switch is set for taking a-c measurements but d-c is applied, or if set for d-c measurements and a-c is applied, the meter will not read. *Exclusive with METEOR.*
5. Separate switch positions are used for all d-c ranges and separate positions for all a-c ranges, while separate resistors are used for each. *Exclusive with Bernard multimeters.*
6. Switch stops, controls and meter scale are each three-color-coded. You can see at a glance the type of measurements the instrument is set to make, so that you automatically refer to the correct, identically-colored scale on the meter. *Black identifies d-c, red identifies a-c and green identifies resistance services, on the two switches and on the meter scale. Exclusive with METEOR.*
7. In METEOR the output meter service ranges are combined with the general utility a-c ranges without any additional switching and without requiring an external condenser. Moreover, the output meter voltage readings give the *true values*, not merely relative values, even including the lowest range. *Exclusive with METEOR.*
8. Although having 5,000-ohms-per-volt sensitivity on d.c., METEOR costs *less* than equal-sized instruments of *one-fifth* the sensitivity (1,000 ohms per volt). *Exclusive with METEOR.*
9. The meter scale is unusually open and easy to read, even on a.c., occupying all the useful area of a full-sized 4" square, Bakelite-cased meter with a long knife-edge color-contrasting pointer. *Exclusive with Bernard multimeters.*
10. The meter proper is placed at the bottom of the panel, where it will be nearest the eye and therefore easiest to read, while the ohms adjuster is to the right of the meter, making the most-often-used control most easily reached. The twin jacks are also at the bottom, to the left of the meter. With this arrangement leads do not tangle with the controls and do not obstruct clear view of the meter face. At the top is the selector switch, with large bar handle and large lettering beside each switch bar, identifying both the type of service and the particular range of that service for all ranges and services. *Exclusive with METEOR.*

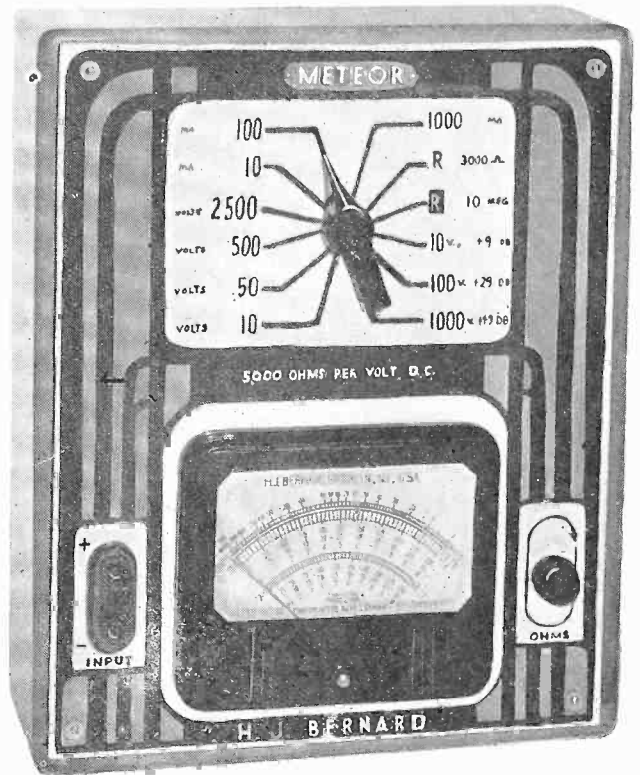

METEOR is housed in an exquisite, heavy, fine wood cabinet and has a four-color panel with modernistic motif and simplified controls. It equals 18 instruments in one.

SPECIFICATIONS

D-C VOLTS in four ranges: 0-10, 0-50, 0-500 and 0-2,500 volts, all at 5,000 ohms per volt.

D-C CURRENTS in three ranges: 0-10, 0-100 and 0-1,000 milliamperes (one ampere).

RESISTANCE in two ranges: 0-3,000 ohms (very clearly direct reading to one ohm) and 0-10,000,000 ohms.

DECIBELS in three ranges: -10 to +55 DB.

OUTPUT METER in three ranges: 0-10, 0-100 and 0-1,000 volts.

Etched metal panel 8" x 10" in four colors, all batteries and output condenser for a.c. \$ **17⁹⁰**
self-contained; housed in a handsome cabinet.
Shpg. wt. 10 lbs. Model 384. Net price

See Your Jobber

H. J. BERNARD

317 THIRD AVENUE, BROOKLYN, N. Y.

Telephone: TRIangle 5-5963

METERETTE The Best Pocket Instrument

**5,000 OHMS
PER VOLT D. C.**

THIS NEWLY-DEVELOPED, OUTSTANDING VOLT-OHM-MILLIAMMETER IS HOUSED IN RADIO'S HANDSOMEST CABINET, WITH REMOVABLE HINGED COVER AND FELT-LINED BOTTOM.

**INSULATED
MULTIPLIERS;
MANGANIN
SHUNTS**

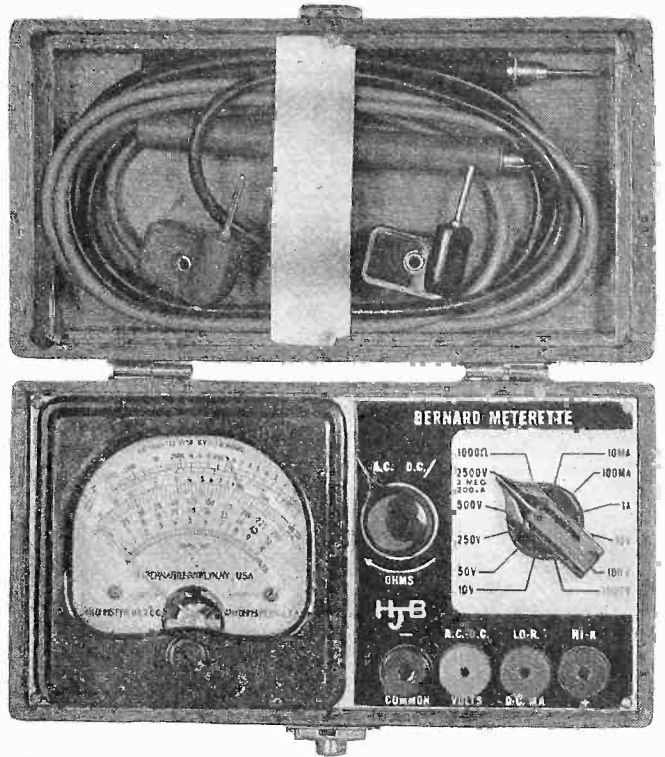

THE first combination of precision, high sensitivity and low cost in a universal meter, this volt-ohm-milliammeter is the *best* switch-type pocket instrument made. Although using a full-sized 3" meter, 0-200 microamperes, it is made in the *smallest* assembly. It is the only pocket meter reading up to 2,500 volts.

METERETTE uses an exclusive combination circuit. Features heretofore thought unobtainable are embodied in METERETTE. Carefully worked out, these developments are mature products of unhurried craftsmanship, truly time-tested *before* being offered to the public.

Special Introductory Offer!

We will supply FREE with each order a set of test leads, a 90-day guarantee card covering not only the instrument as a whole but *every part in it*, and a specially instructive set of directions. Net price, Model 381...

\$13.90

Remit with order. Add postage for 3 lbs. Postmaster will tell you the postage. If ordering C.O.D. enclose \$1 with order.

The new features include:

1. A combination of the a-c/d-c switch with the ohms adjuster, thus eliminating a control, and simplifying and expediting operation.
2. (a) Avoidance of confusion between a-c and

OPEN-BOX MODEL

METERETTE is also obtainable in a nicely-finished gumwood cabinet without cover and less test leads. Merely the box is different. Order Model 381-J

\$12.90

See Y
H. J. BERNARD,

Telephone: TRIangle 5-5963

Switch Type Instrument Made!

-c voltage readings, one coinciding color, red, being used to identify the a-c position of the a-c/d-c switch, red serving also to identify the a-c positions of the selector switch and the a-c scale on the meter. All are *red*. All d-c services are in *black*.

b) Separate positions of the selector switch are used for the a-c ranges and separate positions for the d-c ranges. An exclusive confusion-eliminating service.

c) The a-c multiplier resistors are entirely separate from the d-c multiplier resistors, thus increasing a-c accuracy.

Moreover, the a-c voltage scale on the meter is unusually open and nearly linear, and a-c sensitivity is 1,200 ohms per volt.

The use of individual resistors permits increased accuracy of a-c voltage measurements and allows d-c voltmeter service at the full sensitivity of the meter, 5,000 ohms per volt. In other instruments, for reasons of economy, individual multiplier resistors are *not* used, but instead a shunt is placed across the meter for d-c, thus reducing the d-c sensitivity about one-third. METERETTE was engineered for highest performance and utility, without resort to makeshifts. METERETTE is both easy and safe to use. It comprises 14 instruments in one.

The meter is balanced like a fine watch and has a highly-damped movement that serves to bring the pointer quickly to rest at the true reading. The pointer is knife-edged. The upper end is finished in red, enabling closest readings because of the sharp contrast between the *red* part of the pointer and the *black* graduations of the d-c scale. At the lower end the pointer is finished in aluminum to provide similar sharpness of contrast for easy readings of the *red* graduations of the a-c scale.

METERETTE presents original development, sturdy construction and high safety factor for long life. In appearance and performance METERETTE is a progressive contribution to the instrument field.

Jobber

17 Third Avenue, Brooklyn, N. Y.

SPECIFICATIONS

1. D-c volts in five ranges at 5,000 ohms per volt: 0-10, 0-50, 0-250, 0-500 and 0-2,500 volts.
2. Resistance in two ranges: 0-2,000 and 1,000-2,000,000 ohms. Highest resistance range at lowest battery voltage (3 v.) of any pocket tester.
3. D-c currents in four ranges: 0-200 microamperes; 0-10, 0-100 and 0-1,000 milliamperes.
4. A-c volts in three ranges at 1,200 ohms per volt: 0-10, 0-100 and 0-1,000 volts.
5. Accuracy on d-c volts and currents, 2%; on a-c volts 3%; on resistance, greater than that of any other switch type pocket meter.
6. Universal meter consists of a d'Arsonval type d-c instrument of 200 microamperes sensitivity, and a licensed copper-oxide rectifier. The meter has a highly-damped movement, for quick stoppage of pointer on deflection, a finely-balanced pointer and a stable zero adjuster. The pointer is knife-edged and duo-colored. It sharply contrasts with the colors of the graduations it indicates. The extended scale on the meter is more striking in design and easier to read than that on any other pocket instrument, and is etched in colors on permanent metal.
7. Despite the high value of resistance measurable, only three volts of battery are required for the resistance services. Two pencil type flashlight cells are used. Compactness, economy and long battery life result.
8. Multiplier resistors are 1 per cent. accurate and are fully insulated, therefore hold their accuracy at all altitudes and in all climates. Hermetical sealing is complete.
9. Highest safety factors. All wire used for connections passes 10,000 volts breakdown test. Safety factor of the copper-oxide rectifier is 300 per cent. Voltage drop across the rectifier at full-scale deflection on any a-c voltage range is always the same, even at 1,000 volts input, and never even equals one volt. Thus the rectifier is relatively free of effects from internal heating and external ambient temperatures, and the a-c accuracy is maintained high while rectifier life is prolonged.
10. Exclusive circuit with new and valuable features. The a-c/d-c switch is combined with the ohms adjuster, thus making possible for the first time a multi-tester with only two controls. Confusion of a-c readings with d-c readings is prevented because there are separate switch positions and separately coinciding coloration of scale and switch-stop markings for a-c and d-c uses. This is made possible by the use of separate resistors for a.c. and separate resistors for d.c.
11. Brilliantly engineered, both electrically and mechanically, with shelf type internal construction, great rigidity of mounting and symmetry of compact assembly, all methods having been given exhaustive tests for accuracy, long life and ability to withstand abuse.
12. The most strikingly beautiful appearance of any test instrument, regardless of size or cost, due to design of the colored etched-metal panel, with red, green, brown and white tastefully contrasted against a black field, and to the remarkable solid Philippine mahogany cabinet with its hand-rubbed autumn-leaf finish, and removable cover into which test leads may be fitted. Cabinet fittings are chromium-plated. The cabinet is supported on a felt lining to avoid slippage and scratching.
13. Ready accessibility for rapidly making measurements in a full range of services.
14. Smallest-sized precision multimeter, panel being only 3 x 5-13/16 inches, the lowest-priced precision, high-sensitivity multi-tester, and the best switch-type pocket instrument made.

ECONOMETER

14 Instruments in One

\$7.90

SPECIFICATIONS

ECONOMETER is a switch-type pocket-sized volt-ohm-milliammeter with simplified controls and two-color, separate-position system for distinguishing a-c from d-c readings. Econometer consists of 14 instruments in one and makes all the basic electrical measurements. The services and ranges are:

D-C VOLTS in four steps: 0-5, 0-10, 0-100 and 0-500 volts, **ALL AT 1,000 OHMS PER VOLT.**

A-C VOLTS in four steps: 0-5, 0-10, 0-100 and 0-500 volts.

RESISTANCE in two steps: 0-400 ohms and 300-250,000 ohms, with self-contained 3-volt battery of the pencil flashlight type. One full-scale setting suffices for both resistance ranges.

DIRECT CURRENT in four steps: 0-1, 0-10, 0-100 and 0-1,000 milliamperes (one ampere).

Simplified Controls Enable Speedy Measurements with Accuracy

ECONOMETER combines the ohms adjuster and the a-c/d-c switch in one control in a new circuit, thus reducing the total number of controls to two, exclusive with Bernard multimeters. Also, there are separate selector switch positions for a-c readings and separate positions for d-c readings. All a-c positions and readings are in red and all d-c ones in black, so that the colors coincide to eliminate confusion as to whether one is on a-c or d-c service.

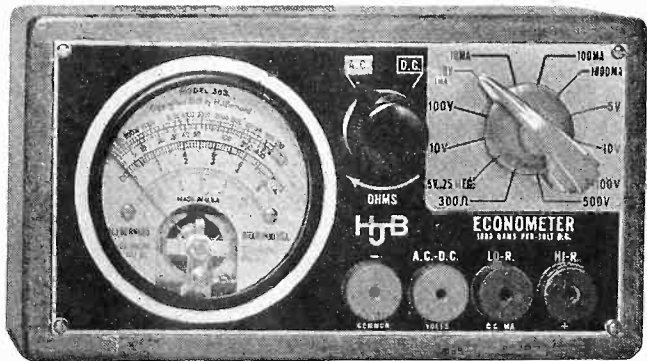

Rectifier Has 300% Safety Factor

Speed with accuracy is made easy. Separate multiplier resistors are used for a.c. and separate ones for d.c. for greatest accuracy.

A patented copper-oxide rectifier is used for the a-c service in a new limiting circuit that requires a drop across the rectifier at full-scale reading of any a-c range equalling only 0.6 volt, although the rectifier rating is 2.9 volts. This prevents overheating of the rectifier and prolongs its life.

The meter is full-sized 2" round type, with sharp

pointer and an unusually extended scale that makes reading very easy. The scale is in two colors while the panel is metal-etched with a five-color scheme.

ECONOMETER is housed in a handsomely finished wood cabinet, only 5-7/16 x 2 3/8 x 3 inches, the smallest housing of any multimeter. It really fits in your pocket. Shipping weight 3 lbs. Model 383. Net price.....

\$7.90

COLOR-CODED SWITCH STOPS AND DIAL SCALE!

H. J. BERNARD, 317 THIRD AVENUE, BROOKLYN, N. Y.

Telephone: TRiangle 5-5963

Oscillating Crystal

An open crystal (right), a crystal in vacuum (left), and an earpiece used in comparing the two types and also the length of time it takes for a coil-condenser system to stop oscillating.

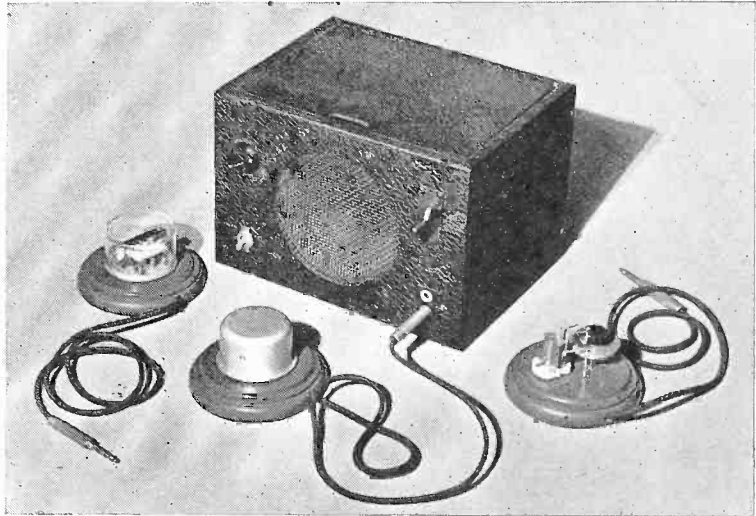

THIS apparatus was used by Dr. O. E. Buckley, of Bell Telephone Laboratory, in a talk before the American Institute of Electrical Engineers in New York City to show the small damping effect in a crystal-controlled oscillator compared with that in a coil and condenser circuit which oscillates at the same frequency.

Two crystals and a coil-condenser unit are provided. One of the crystals is exposed to the air to demonstrate the damping effect of atmospheric pressure and the other is enclosed

in an evacuated container. The output of the oscillator is heterodyned with another current to produce an audible frequency and applied to a loudspeaker after the power is cut off.

The crystal in vacuum vibrates about ten times longer than the unprotected one and about 1000 times longer than the coil-condenser oscillator. Breathing moist air on the open crystal damps it so heavily that it ceases to vibrate.

A crystal in a vacuum oscillates about 80,000 times before its amplitude is reduced one-half. This equals a seconds pendulum beating 2 days.

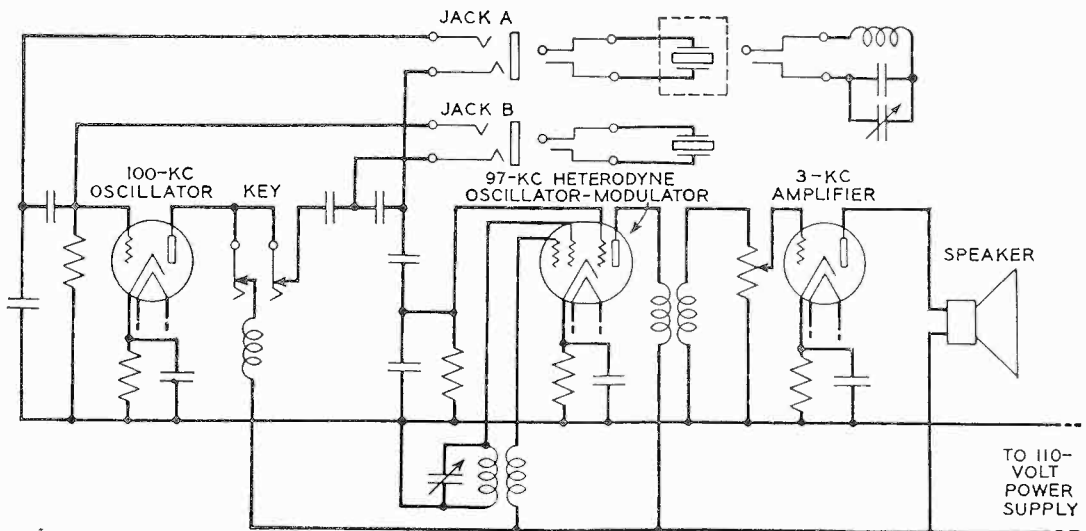

Circuit in which fascinating facts about crystals were determined. A crystal in vacuum vibrated ten times longer, and about 80,000 times before its amplitude was halved.

Adjustments for Tube Checker

Additions Made to Chart

By R. K. Wheeler

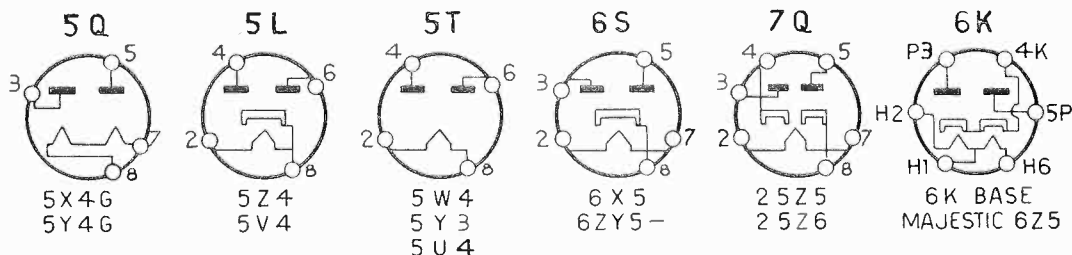

FIG. 1

Left-hand block, the five methods of bringing out the filament and cathode in octal rectifier tube bases. Right-hand block, how Majestic 6Z5 is tested without adapters.

WHILE the construction of the tube checker, described in the June issue of *RADIO WORLD*, is not particularly difficult, there is a chance for confusion when interconnecting the socket terminals, and some care should be exercised in this operation. This is especially true in the case of the 8-pin socket, where the connections have been made to provide for checking the greatest number of tubes with a minimum of adjustments.

It should be noted that terminal No. 7 is connected to the cathode line, while terminal No. 2 is connected to the filament selector switch. Reference to tube base diagrams will readily show the reason for this arrangement. At present there are five methods used in bringing out the filament and cathode in 8-pin rectifier tube bases. These bases are known as 5Q, 5L, 5T, 6S and 7Q, as shown in Fig. 1, listing on the left-hand block the tubes that use these bases, while at extreme right, Fig. 1, there is the base for the Majestic 6Z5.

CHECKING OCTAL TUBES

As the connections of the 8-pin socket in the checker are shown, the tubes using four of these base styles, 5L, 5T, 6S and 7Q, may be checked correctly by proper manipulation of No. 4 and No. 8 switches, no adapters or other switching being required. At the present there are only two new special-purpose tubes using the 5Q base, which are not likely to be encountered by the service man for some time to come, and then in no great quantity.

When the checker has been completed it may be necessary to adjust the current through the meter, so that readings will conform to the

tube tables. A new tube of reliable make, requiring a test setting around 70, should be plugged in.

The 201A is well suited for this check as it heats up quickly and the construction is sufficiently rugged to permit quite a bit of knocking around. If the tube is new, the series resistor R1 should be adjusted until a meter reading of about .9 ma is had. The final value may be as high as 6,000 ohms, but in any event should not be less than 4,000 ohms.

INSERTING EXTRA RESISTANCE

When this adjustment has been made, a check should be made for tubes requiring a low reading, such as the 25z5. With the quality selection at position 10, a new 25z5 should also produce a meter reading of around .9 ma. If the meter pointer runs off-scale on such tubes, it should be brought to the correct setting by inserting a very small resistor, about 25 ohms, as shown in Fig. 2. This resistor should not be more than 50 ohms, and in *no case* should it be used to make the adjustment first described for tubes requiring a setting of 70.

With the meter readings checked at the two points described, other tubes will check very closely at the values given in the tables. The test settings are not critical, especially in the case of weak tubes. For example, it has been noted that a tube such as the 24A if checked definitely as weak will still check "weak" even if the "Q" selector is advanced as much as 20 points, that is from 52 to 72.

GOOD GENERAL UTILITY

A typographical error is noted on page 14 of the June issue which may be confusing to

Five Economical Battery Type Tubes Announced

Five tubes for battery sets, all of them requiring only 1.4 filament volts, four of them at 50 milliamperes, have been announced. They permit economical operation, as the B drain also is small. The tubes are:

1A5G and 1C5G, power output pentodes, the 1C5G at 100 ma, however.

1A7G pentagrid converter.

1H5G diode-triode.

1N5G, r-f and i-f pentode amplifier.

They may be filament operated from a 1½-volt dry cell of suitable current capacity, or dry cells in parallel, for large installations.

the reader. In referring to the filament and cathode of the 5z4, etc., which are brought out to a common terminal, the correct terminal is No. 8, not the No. 3 as printed.

Some discrepancies are also noted in the tube chart, corrections being herewith submitted. A table listing additional types of tubes is also appended.

While some stress has been placed on the few tubes that cannot be checked without adapters, the reader should not let these acknowledged shortcomings outweigh the true value of such a checker. In actual service, it has been the writer's experience over a period of several months that only about one tube out of 500 actually encountered could not be checked without adapters or other changes. This seems to the writer to be a high degree of utility.

MAJESTIC 6Z5

After inspection of the basing arrangement of the Majestic type 6z5 it will be seen that this tube can be checked without adapters. In order to check this tube Switch No. 2 is thrown to "negative" or the cathode line. Since heater pin No. 6 is already connected to the same line this places the two sections of the filament in

Additional Tubes					
[Add to chart in June issue]					
Type	Q	Sw.	Type	Q	Sw.
210	70	0	24	54	4
12A7	20	4-6	48	28	5
18	44	5	485	48	4
19	46	0			
Octal Base					
Type	Q	Sw.	Type	Q	Sw.
5y3	50	8	6L5	48	8
6A5	30	0	6N6	60	8
6A8	42	8	6s7	48	8
6B4	30	0	6T7	36	8
6c5	46	8	6U7	40	8
6d5	46	8	6v6	32	8
6d8	52	8	6v7	46	8
6F6	46	8	6y7	30	8
6K8	40	8	5y3	50	8
6F8	30	8-4	25B6	26	8
6J5	30	8	26L6	26	8
6K5	30	8	25N6	50	8
6K6	54	8			
Corrections					
Type	Q	Sw.	Type	Q	Sw.
55	46	5	25z5	10	3-4
83v	16	0			

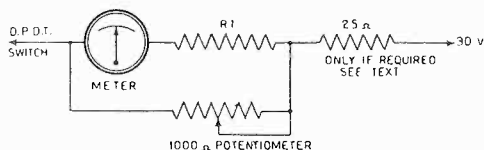

FIG. 2

The insertion of an additional resistance, shown as 25 ohms, though some other value may be required.

parallel, and the tube is then checked with 6 volts on the filament. As the cathode of the tube is brought out to pin No. 4 the No. 4 switch is also thrown to the negative position. The quality selector setting is 22. See Fig. 1, extreme right.

Sturdy Wafer Socket Made by Hammarlund

Hammarlund has a new wafer socket designed especially for use in sound equipment and other similar apparatus where a great many tube changes cause socket failure. Such failures in the industrial field cause interruptions in programs and mean expensive servicing.

Featuring two-piece construction, this socket is built of low-loss natural-color bakelized canvas. Contacts are heavy, non-corrosive metal reinforced with sturdy steel clamps to insure perfect electrical contact and long life. Such construction has been available heretofore only in the more expensive ceramic type.

In all standard pin arrangements, this socket

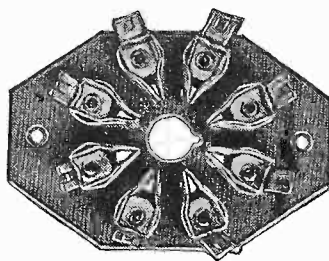

is intended to reduce service costs and equipment failures.

Trouble-Shooting On a Small Budget

A GOOD pair of 'phones or a 'phone unit can be regarded as a meter with the difference that the ear, instead of the eye, "reads" the scale. Combined with the ear such a unit makes an inexpensive instrument which will respond to a

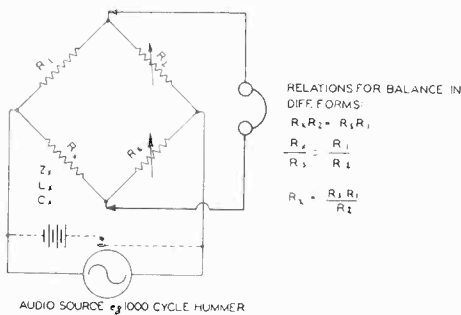

FIG. 1

A versatile bridge circuit which can be used to find R , Z , L , C values.

surprisingly small value of current, or rate of change of current. But the 'phone unit need not necessarily be able to *measure* the current in order to be useful, for by taking advantage of the very low threshold of hearing it can also be used to indicate, very accurately, when a current just appears or just disappears.

A meter which serves to show a central point of zero or minimum current is called a "null" indicator and is used in bridge circuits, such as Wheatstone's bridge, to indicate the condition of balance (Fig. 1). The 'phone unit makes a sensitive null indicator, replacing delicate and expensive meters that are easily damaged, since it can handle with no damage to itself an enormous ratio of maximum to minimum signal. Bridge measurement is the preferred method of determining electrical values. Another similar use for the unit is as the indicator in zero beat methods of matching coils and condensers (Fig. 2.)

AUDIO BRIDGE

In Fig. 1 is shown the circuit of a simple bridge using an audio frequency voltage supply, and the 'phone unit as the null or minimum sound indicator, for measuring or comparing resistance (R) and impedance (Z) values, as well as inductance (L) and capacitance (C) values of coils and condensers having a good Q or power factor. But suppose no alternating current source is available to supply the bridge. Can our earphone be of any use there? It can: we use a battery instead of the audio source, *but* put a push-button in series with the battery; then keep closing and opening the circuit while adjusting the standard R_s until the sound

of the *click* disappears or is reduced to a minimum; at this point the value of the unknown element is given by the basic bridge formula, which can be written in a number of ways:

$$\frac{K_x}{R_s} = \frac{R_1}{R_2} \quad R_x R_2 = R_1 R_s \quad R_x = \frac{R_1 R_s}{R_2}$$

From this it is easy to notice that if R_1 is made equal to R_2 , so that $\frac{R_1}{R_2} = 1$, the unknown value R_x simply equals the value of the known or calibrated standard, R_s .

CONTINUITY TESTING

In the applications described in the preceding paragraph's the phone unit seems to have been used to signal the precise appearance of nothing. In service work, however, we often want an instrument to herald the discovery of something (the trouble, preferably). No doubt it is true that the better set analyzers on the market do this job admirably. Yet (without wishing to bring back the old "screwdriver" days) it can be argued that the analyzers' complication and expense are not always warranted; besides, they are not always convenient to carry along; and, what is more to the point, are not always at hand when needed—for various good reasons. Here, too, the 'phone unit can be pressed into service; with the addition of a small C battery it gives us a most useful little trouble-shooter.

Take continuity testing of resistors, circuits, or leaky condensers, as an example of the sensitivity of the 'phone unit. If 4.5 battery volts are applied and the circuit resistance is 4.5 meg., the current flowing would be only one microampere, impossible to see on even a 0-1 milliammeter. But this same current pulse is easily detected in the 'phone unit as a click. Even a rough quantitative test, at least of the order of magnitude, of resistance, capacitance, current and voltage values can be made with earphones, simply by comparing the loudness of the resulting clicks.

Noisy contacts, resistors, or controls can often be tested in the same way without further

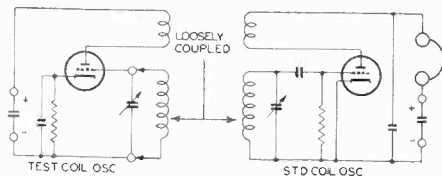

FIG. 2

Zero beat arrangement for checking the values of coils and condensers.

Perhaps you have not given the earphone all the consideration it deserves as a test instrument. Not only is it very sensitive but it can be applied to numerous service uses. The Technical Editor tells you quite a few of them.

amplification, although more voltage may be required. (Fig. 3).

Or consider the testing of small condensers for an open. It is readily possible to detect

set is dead because the output transformer secondary or the moving coil of the dynamic speaker is shorted, wholly or between layers. Defects of this character can be easily shown up by the unit, but are not even readable on most analyzer meters because the normal circuit resistance here is so low. To test for such a condition connect the unit as a test speaker between plate and B plus across the primary of the output transformer, or from plate to plate in the case of a push-pull transformer in series with isolating condensers. It is used in this position without disturbing the loudspeaker. Or one terminal of the 'phone can be clipped directly to the chassis and the other to the plate through an isolating condenser. A good signal

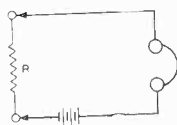

FIG. 3
Leakage resistance and continuity testing connections.

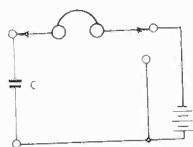

FIG. 4
Testing condensers for open circuits and efficiency.

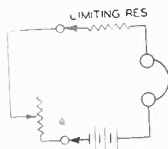

FIG. 5
Testing variable resistors, as well as other elements, for noise.

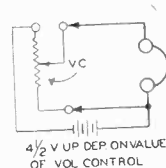

FIG. 6
Testing potentiometers and volume controls for noise.

with this small voltage a capacity so small that it would take 90 volts plus a sensitive meter to enable one to see the corresponding kick of the needle. To separate the click due to the leakage path in an imperfect condenser from the click produced by charging of a good condenser, close the circuit through battery and 'phones, then take the battery out and close the circuit again. If you then hear a click, that shows the presence of a condenser, for ability to store a charge of electricity is the property of a good condenser. If you heard the click the first time but not the second time, it shows that the first click was due only or mainly to a resistance path.

Well, what else can be done with the earphone? It can be used as a microphone and as a loudspeaker for testing purposes. Suppose a

in the earpiece shows up the shorted or partly-shorted secondary or moving coil at once; for there obviously would be no response in the test earphone if the trouble were not here but elsewhere. Figs. 11 and 12.

Suppose that signals are dead or weak but the speaker is all right. Then use the unit, in series with a .1 mfd. blocking condenser, as a test microphone. Place it, for example, across the detector grid leak, or in series with the grid in the case of a biased detector, or across a diode load resistance or from grid to ground in a duplex diode-triode, or across phonograph input terminals of an amplifier, or across the plate load of a biased detector, etc.; and talk into it.

If the volume, depth and quality impress you
(Continued on following page)

FIGS. 7 TO 10

These show where to connect 'phone unit when used as a test microphone, with different detector and audio input circuits. Figs. 7 and 8, top, left to right, 'phones across grid leak, with stopping condenser; also cutting in on biased detector. Fig. 9 (lower left) shows pickup at 'phone input and Fig. 10 access to audio across a diode load resistor.

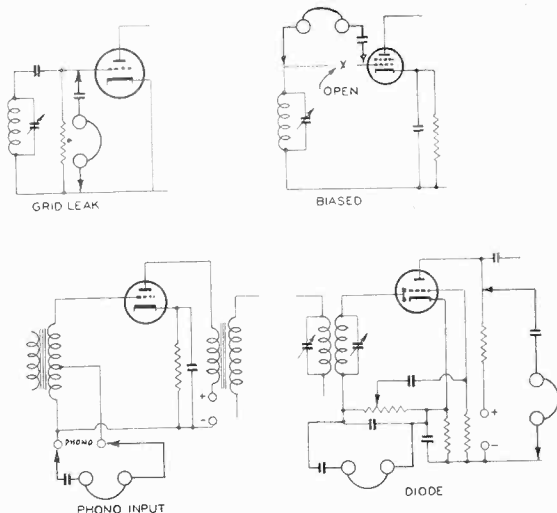

The Lattice Structure

A Selective Bridge of Many Uses

By Conrad Peele

THE criss-cross-looking diagram, Fig. 1, is that of a filter network known as a lattice structure. The lattice formation has been considerably to the fore in recent crystal band-pass circuits. Crystals are shown in the diagram, although lattice filters may use either electro-mechanical resonators or electrical resonators like coils and condensers.

The general impression conveyed by the appearance of the lattice structure is that of a very special sort of network, decorative but mysterious and unfamiliar.

When the lattice structure is broken down to its basic elements it turns out to be nothing other than the familiar bridge net. As such it is shown, redrawn with respective elements, in their correct relative positions, in Fig. 2. Comparing this figure with the diagram of the straight Wheatstone bridge of Fig. 3, the identity of lattice structure and bridge net is apparent.

EQUI-POTENTIAL CONDITION

In Fig. 4 the bridge is redrawn, to make more obvious the essentially simple character of the bridge function. When the elements are rearranged in this way it is seen that the circuit amounts to two voltage dividers across a voltage source, and it is then easy to grasp the fact that equally apportioned tapping points on both voltage dividers will be at the same potential, i.e., there will be no potential difference between them and therefore a meter connected be-

tween these two points will read zero. This is the condition described as balance.

A bridge is generally intended to be balanced so that resistance, capacitance and inductance, and similar values, may be accurately determined. The point therefore arises, How does a bridge give selectivity?

While it may appear puzzling at first sight, a little dissection will remove the riddle.

If instead of the crystals in Fig. 2 we imagine that the arms consist of the more familiar condenser-coil combination, then it is apparent that at a given frequency of the input e.m.f. each of the arms of the bridge has a definite impedance, given by the formula

$$Z = \sqrt{R^2 + \left(\omega L - \frac{1}{\omega C} \right)^2}$$

in the case of a series resonant circuit, or for a parallel resonant circuit, $L \div CR$.

FLOW OF OUTPUT CURRENT

We know that a bridge can measure the value of an impedance and that the bridge is balanced, so that no e.m.f. is available at the output terminals, when all the arms are equal, or when the ratio between arms 1 and 2 is the same as the ratio between arms 3 and 4. (See diagrams.) But if the value of one impedance is changed, the bridge is of course no longer balanced and an unbalance current flows in the output circuit. That can be made to happen when frequency of the input e.m.f. is changed by such

(Continued from preceding page)

as normal, everything considered, the a-f end is absolved—the trouble must then lie in the circuits ahead of the detector. If, however, the trouble is somewhere in the audio end, it can be easily tracked down by step-by-step investigation in the same fashion, either backward from the speaker, or forward from the detector.

Incidentally, it will pay to try letting customers see you using ear phones on their sets. A surprising number of earphone sales can be made if attention is drawn to such inherent advantages as the clarity of reproduction and the privacy that may be had with an earphone outlet.

MARTIN POSNER.

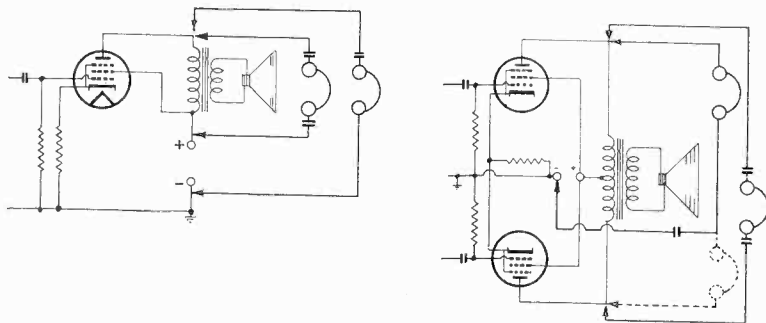

FIGS. 11 AND 12
Where to connect
phone unit when used
as a test speaker on
single-ended and push-
pull outputs.

an arrangement of the arm structures that bridge balance becomes a function of frequency.

Looking back at Fig. 2 we see that this structure can constitute a frequency-dependent bridge. If all the crystals (or coil-condenser circuits) are equal there is no output. But if one crystal is not exactly the same a large unbalance component appears due to the steepness

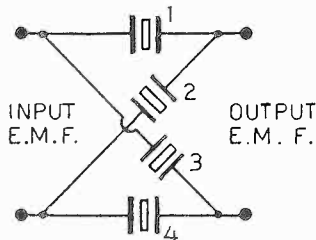

FIG. 1. A lattice filter network, showing generalized resonant members.

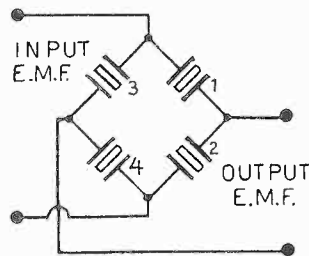

FIG. 2. Fig. 1 redrawn to show the identity to the familiar bridge structure.

of its impedance curve. The extent of the unbalance current in the bridge can be made greater also by increasing the amplitude of input em e.m.f.

Now this arrangement can be used to compare or adjust crystals, crystal-holders, tuned LC circuits, small capacities, etc.

HOW TO GET SELECTIVITY

Of course it is not essential that all four arms be impedances of the same class. For example, in the crystal bridge commonly used in communication receivers—the so-called single-signal supers—only one crystal is generally used, the other arms being coils and condensers. But in any event if the four arms are equal they will remain so at all frequencies (Fig. 2), so that if we change frequency nothing is gained, because the arms still will remain balanced, having the same ratio in respect to each other, and we still don't have any selective action from the bridge.

Now how shall we treat the bridge so that we will get selectivity? We can do it if we make arms 2 and 3 (Fig. 2), whether crystals or coil-condenser combinations, resonant to the

input frequency, while arms 1 and 4 are impedances of a different class, namely resistors equal to each other and also equal in value to the impedance of each of the two resonant circuits.

BRIDGE BALANCED

Now the bridge is balanced at one frequency because arms 2 and 3, the resonant arms, lose their reactive character and become pure resistances. Hence at this one frequency all the arms are resistive and all are equal to one another.

Suppose now that the frequency is changed slightly. The impedance of the resistive arms does not change, but the impedance of the resonant circuits decreases.

As a result the ratio between arms 1 and 2 is no longer the same as the ratio between arms 3 and 4 and therefore voltage of the input e.m.f. appears across the output terminals. Hence the bridge is selective.

Better Bridge Readings for High Unknowns

The bridge is the standby for accurate measurements of resistances, inductances, capacities and other constants, because it is easy to operate, is more reliable than other methods generally, and depends in its most common form on a null indication.

In measuring resistance a battery is used, and the unknown is placed in one arm, the controls in the other arms being worked, until balance is attained. Some bridges do not have the indicating device built in and therefore usually consist merely of decade boxes, where resistances starting from .1 ohm may be selected on one knob up to one ohm, then on another knob from one ohm to ten ohms, etc., with final knob up to perhaps 10,000,000 ohms, which is a satisfactory limit in radio work.

When the bridge is used for measurement of high resistance it is not so accurate, largely because the observation error is greater, i.e., it is hard to see the small difference between perfect balance and a little unbalance. In fact, rotating the smallest-unit control may give no difference in reading over its range.

A way to get around that is, once the bridge is as nearly balanced as practical, to increase the voltage supply, say, ten times at least. It may be increased a good deal more. Then the difference between slight unbalance current zero current is readily observed. The bridge should be nearly balanced before voltage is increased to safeguard the indicating galvanometer.

FIG 3 A straight Wheatstone bridge, using d.c. for input and a meter for indication.

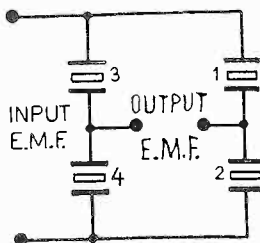
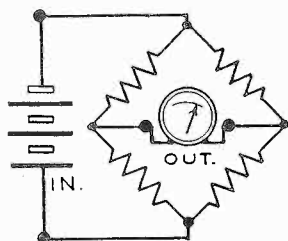

FIG 4 A generalized bridge redrawn, to make bridge function more apparent.

RADIO WORLD

Seventeenth Year

ROLAND BURKE HENNESSY, *Editor*

MARTIN POSNER, *Technical Editor*

RADIO WORLD is published monthly by Hennessy Radio Publications Corporation: Preston Mack, President-Treasurer; Martin Posner, Vice-President; Daisy Mayer, Secretary.

Prince of Experimenters

MICHAEL FARADAY, who seems never to have used a mathematical symbol in his work, and often deplored his lack of mathematical knowledge, has been justly called the prince of experimenters. Writing on the occasion of the Faraday Centenary in celebration of the hundredth anniversary of his discovery of electromagnetic induction, the late Lord Rutherford spoke with unstinted admiration of Faraday's remarkable powers of penetrating to the root of a subject by a number of well-designed and well-executed experiments.

In Faraday's "Collected Researches," one is struck, at every turn, by such freshness of thought and outlook, combined with a clarity of exposition, that it is difficult to recall that most of his work was written nearly a century ago at a time when our knowledge of electricity and magnetism was still in its infancy.

It is not at all easy, Lord Rutherford goes on to say, to grasp fully today the conditions under which Faraday's researches were carried out. Though most of the simpler chemical materials and reagents were available, apart from a balance there was little if any physical apparatus at that time. While fairly large permanent magnets and small electromagnets had been constructed, there was no method of measuring the magnetic field, but its strength was gauged by the weight of iron the magnet would support.

Apart from frictional machines of a simple type, primary batteries were the only source of supply of the electric current, and the batteries to give a large current had to be made up each day. There were no instruments for the measurement of the current delivered by the battery, but this was gauged by the rough and ready method of determining the length of platinum wire the battery could heat to incandescence. Ohm's law had still to be formulated, and there was no clear idea of voltage and resistance. Bare copper wire was available, but this had to be insulated by winding with twine or calico by hand. The length of wire used to make a coil was always carefully mentioned, as was also the size and efficiency of the battery, for these facts sufficed for anyone who wished to repeat the experiment. The meagerness of measuring ap-

paratus and accessories made for rapid progress where the experiments were simple and no great accuracy was sought. When, however, precise measurements of quantity were required Faraday was quick to develop suitable methods.

But Faraday was more than a great experimenter. The mainspring of all his principal researches from the beginning of his scientific career was the underlying unity of all the forces in Nature. In the introduction to a famous paper recording the discovery of a new relation between electricity and light he makes this statement:

"I have long held an opinion, almost amounting to conviction, in common, I believe, with many other lovers of natural knowledge, that the various forms under which the forces of matter are made manifest have one common origin; or, in other words, are so directly related and mutually dependent that they are convertible, as it were, one into another, and possesses equivalents of power in their action."

The following passage appears in another paper by Faraday, at the conclusion of a splendid series of investigations into the properties of dielectrics, and shows his characteristic modesty and thoroughness:

"I put forth my particular view with doubt and fear, lest it should not bear the test of general examination; for unless true it will only embarrass the progress of science. It has long been on my mind, but I hesitated to publish it until the increasing persuasion of its accordance with all known facts, and the manner in which it linked together effects apparently very different in kind, urged me to write the present paper. I as yet see no inconsistency between it and Nature, but, on the contrary, think I perceive much new light thrown on it by her operations; and my next papers will be devoted to a review of the phenomena of conduction, electrolyzation, current, magnetism, retention, discharge, and some other points with an application of the theory to these effects, and an examination of it by them."

The Magic Secret

BECAUSE of the increasing complexity of modern all-wave superheterodynes and the many refinements and operating luxuries incorporated in them, satisfactory operation has become more and more dependent on *exactness*—accuracy of electrical values, accuracy of relative values, and accuracy of adjustment of the numerous tuned circuits involved.

As a result most troubles are nowadays, in the language of the medical man, a matter of functional unbalance (as when leakage disturbs avc vs. nsc control levels, rather than of organic breakdown (a shorted power supply, for example). One obscure defect today accounts for more surface symptoms than ever before and it is easy to waste much time and energy chasing one false clue after another—treating the symptoms of the ailment rather than its cause. This naturally makes effective trouble-shooting a good deal more of a problem so that recourse

(Continued on following page)

High-Speed Crystals

Their Mechanical Vibrations Help Make Transmitters Precise

TWENTY million vibrations per second—just 16,666,666 times faster than the normal human heartbeat—is the phenomenal mechanical speed achieved by a tiny quartz crystal used in a new oscillator developed by General Electric engineers for maintaining constant frequencies in radio transmitting. Incredible as this may seem, the present crystal's terrific "heartbeat" may soon be surpassed if a speedier one now being perfected is successful.

It is the super-speed "beat" of the quartz crystal which permits constant frequencies to be maintained in radio transmitting. The oscillators enable radio broadcasters to hold their transmitters to assigned wave lengths in sending out programs or messages.

PECULIAR PROPERTIES

The peculiar electrical characteristics of the quartz were first discovered by Madam Marie Curie during her research with radium. Quartz is a natural mineral growth and has almost the hardness of a diamond. Regardless of where obtained, and no matter how large or small it may be, quartz always occurs in nature in a hexagonal (six-sided) shape, usually with each end tapering to a point. Angles of the hexagon and points are always the same. Specimens of quartz have been known to attain a length of six feet and a weight of one ton.

Although found in almost every part of the world, quartz for crystals in the new oscillators is obtained from Brazil, where the most nearly perfect specimens are found. The new oscillator has been developed specifically for radio transmitters used by airplanes or ships, and can withstand sudden severe changes in temperature and humidity without permitting broadcasting frequency to vary.

The quartz crystal which attained the speed of 20 million vibrations per second will be used

(Continued from preceding page)

now must be had to logical systems of localizing the defects by a considered process of eliminative tests. This boils down to a method of introducing an appropriate signal into the successive portions or function-channels of the set, examining the character and the degree of the response in each, and noting how interrelated channels work together.

Such a procedure—let us call it the "generator-channel" method—when intelligently applied eliminates much needless hunting and checking and much exasperation, for it very soon confines the work to the actually defective portion of the set. However, such procedure alone (or, indeed, any other "system") is no infallible, sure-fire method that magically makes it possible for any one to put his finger on the trouble with his

eyes shut and one hand tied behind him. Of course there is no such method.

There is only one magic secret in troubleshooting: sooner or later every successful serviceman learns that his "Analyzer" is not an analyzer; *he* himself is the real analyzer. He learns to depend on good test equipment, but is not led by the persuasive expositions of those with commercial axes to grind to expect that the instrument should call out the guilty grid leak when he presses the button. He understands that his "Analyzer" is, after all, only a "fact-finding body"; that its function is to disclose facts about the set under test; and that it is up to the serviceman *himself* as "judge" and analyzer to interpret those facts and to weigh their significance in accordance with the laws of his science.

for a radio transmitter having a frequency of 20 megacycles, or 20,000 kilocycles. It is about 15 mils, or 15/1,000 of an inch thick and is approximately one inch square.

A finished crystal may be square, rectangular, or circular in shape. If ground to the approximate size and thinness of a dime, a quartz crystal would oscillate at the rate of 7,500,000 times per second, and maintain a transmitting frequency of 7,500 kilocycles.

Infinite care must be exercised in processing the crystals to the exact size required to maintain various frequencies. A "rough cut" is first made from the quartz as it is found in its natural hexagonal state. Because the quartz itself is made up of millions of tiny hexagonal shapes, the rough crystal thus obtained must be cut through the electrical and optical axis correctly if it is to have the desired properties and be usable.

The rough crystal is ground mechanically as far as possible, and then by a hand process it is literally polished to the desired thinness for a particular frequency.

BEAT METHOD USED

Determining when the crystal has been ground to the desired size is accomplished in a manner similar to the process of tuning a piano. The crystal is "beat" or heterodyned against a primary standard that is checked daily with the Arlington time standard, and at least twice each week against the frequency transmission of the Bureau of Standards in Washington.

The finished crystal is placed between two metal plates, which afford a means of connecting it to the vacuum tube circuit.

Mounted in its holder, the crystal is ready to become part of the transmitter circuit—with its phenomenally fast "heartbeat" of millions-of time each second.

Compact Multimeter

For D.C. and A.C., Using a 2" Meter, 0-1 Ma, But With Scale You Really Can Read

By A. J. L. Baldwin

THE most compact of volt - ohm - milliammeters for universal service—a.c. and d.c.—is made possible by a unique circuit built around a 2 in. meter of one milliampere sensitivity. A single-deck, 12-position switch and four tip jacks are used for selection of range and function. All told, fourteen instruments in one, this device has a panel only $2\frac{1}{2} \times 5$ ins., and may be put in a box only 2 ins. deep.

Four voltage ranges each for a.c. and d.c. are 0-5, 0-10, 0-100 and 0-500 volts. The reason for interposing the 10-volt range, although it only doubles the lowest range, is that 10 volts is very important for enabling reading of 6.3 heater volts on the best part of the meter scale. In radio sets 6.3 volts predominates for heaters, and the supply source, though usually a.c., is often d.c., so the same sequence is used for both.

VALUABLE SERVICES

Thus eight of the "fourteen instruments in one" are accounted for and there remain the two resistance ranges and the four d.c. current ranges. For low ohms the backup circuit is used, with 50-ohm center, enabling close reading down to one ohm and up to 300 ohms. The backup is so-called because full-scale deflection is established, with 3-volt pencil type battery and limiting resistance, while the un-

known is placed directly across the meter only, causing the needle to move backward.

The high ohms measurement is the conventional series circuit, where the unknown closes

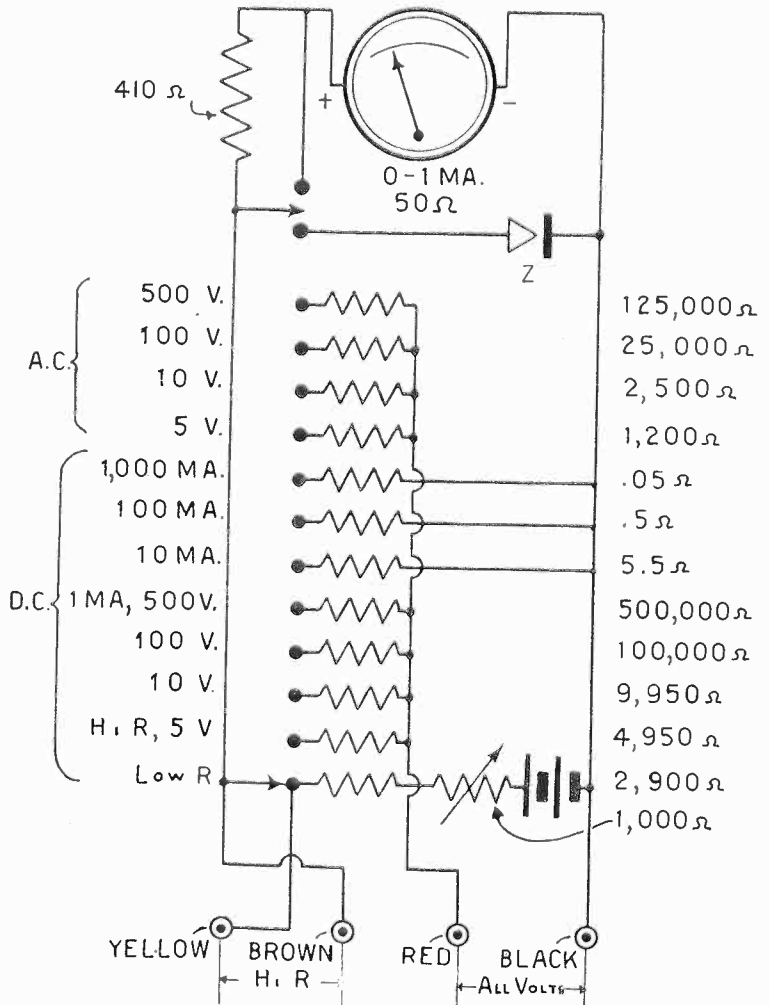

FIG. 1

Fourteen instruments in one are represented by this circuit, using a 0-1 milliammeter, a single-deck switch and few parts in general despite wide application. Low resistance and all current are measured between the black and brown posts.

the open and causes the needle to go up instead of down. Thus the two scales on the meter read in opposite directions. The range of high resistance is 300 to 250,000 ohms.

At one setting the meter is exposed to the operator at its base sensitivity, one milliampere. This is necessary if small currents are to be read without disturbing the circuit constants, for the meter thus introduces only its own resistance of 50 ohms, always negligible in radio and audio circuit d-c supply where the current is one milliampere or less, i.e., microamperes, for the resistance in the measured circuit is high.

TESTED VALUES GIVEN

The 0-100 scale may be read as 0-1,000 microamperes by multiplying by ten when connections are made for the most sensitive current range. The other direct current ranges are 0-10, 0-100 and 0-1,000 milliamperes, the last-named equalling one ampere.

All values are given on the diagram, except the battery voltage, which has been given elsewhere. All values may be followed with confidence, except that for best accuracy on a-c there may have to be some departure from the specified 1,200 ohms for 5 volts, 2,500 ohms for 10 volts, 25,000 ohms for 100 volts and 125,000 ohms for 500 volts. Only some, if any, of these values would have to be different, due largely to characteristics of the copper-oxide rectifier Z.

The diagram is drawn so that what would be the plate if a tube were used goes to the meter minus and may be called the anode of the copper-oxide disc. The triangle represents the cathode. This viewpoint prevents confusion, even though taking a few harmless liberties with a more complicated but more accurate analysis. The actual connections are not affected by the simplified symboling adopted.

CONNECTIONS TO RECTIFIER

In the disc used the lug of the rectifier that goes to meter minus is nearer the nut, while the lug nearer the slotted head of the mounting screw goes to one position of the single-pole, double-throw switch. This switch is combined with a 1,000-ohm or 1,500-ohm rheostat, so that a single control provides both adjustment for full-scale deflection and a-c/d-c switching. Also a common mistake is thus rendered impossible: erroneous resistance readings due to a separate switch being accidentally left at "D. C." can not take place, because in making the ohms adjustment the SPDT switch can not be at any position except "D. C."

So an instrument is built that has only two controls: (1), selector switch and (2), combined ohms adjuster and a-c/d-c switch.

INGENUITY USED

The services are made so numerous by a little ingenuity. For instance, low ohms occupies position No. 1, reading from right to left on the wiring diagram, or left to right on the panel layout. The unknown is put between the top (black) and the second from bottom

(Continued on following page)

Directions for Using Compact Multimeter

The type of service is selected at the tip jacks, plus adjustment of the a-c/d-c control. The range is selected at the selector switch. There are three general types of services:

Volts: Use the two left-hand tip jacks (Fig. 2) for reading all voltages. For a-c volts turn the ohms adjuster to extreme left, until switch snaps on, and ohms knob points to "A. C." For reading d-c volts turn ohms adjuster to the right, at or anywhere beyond the bar marked "D. C." In either case turn the selector switch to the desired range. The sensitivity on d. c. is 1,000 ohms per volt.

Currents: Use the left-hand jack and the jack second from left to measure direct currents, and have the ohms adjuster knob point to "D. C." or anywhere to the right of that mark. Turn the selector switch to the desired milliampere or ampere range. The base sensitivity of the meter (one milliampere) may be used by leaving the test leads connected for current, but turning the selector switch to the "500 V-1 MA" position, with ohms adjuster at "D. C." For microamperes multiply the 10 ma scale by 100 (representing 0-1,000 microamperes), or for milliamperes divide the 0-10 scale by 10.

Resistance: Low resistance is measured by the backup method at the same posts used for currents. Turn selector switch to "300Ω" and adjust the meter so its needle points just to full scale. The unknown will move the needle backward. High resistance is measured by first using the low ohms position for bringing the meter needle exactly to full-scale deflection, then turning the selector switch one step to the right (.25 meg.) and reading the unknown between the two right-hand tip jacks. Setting the selector to ".25 meg." brings the meter needle to zero. Inserting the unknown high resistance causes the needle to move to the right. High resistance measurement is the only service for which the black tip jack (extreme left) is not common. Only one full-scale deflection is required for both resistance ranges.

The black tip jack is common negative for d-c volts and currents and so marked. The red tip jack is positive for d-c volts. The jacks have no polarity for a. c.

The meter scale has a-c volts in red, calibrated 0-5 and 0-10 volts. For 100 volts multiply the 10 scale by 10. For 500 volts multiply the 5 scale by 100. The d-c scales are in black and the a-c scales in red.

(Continued from preceding page)

(brown) posts (Fig. 1). By moving the selector switch one notch to the left the battery circuit is opened, so that for high resistance measurement the circuit is closed by the unknown. A post (bottom, yellow) connected to the tab of Position 1, gives access to meter positive, so contact is made between that post and the adjoining one (brown). It is of course impera-

the instrument, not only because this is the first really comprehensive and well-readable scale on a 2-inch meter, but also because the calibrations are very accurate for the right values of resistors as specified, excepting the a-c ranges, as already noted.

For approximate results the a-c voltages may be read, using the designated values, but it is better to insert just the right resistors, chosen

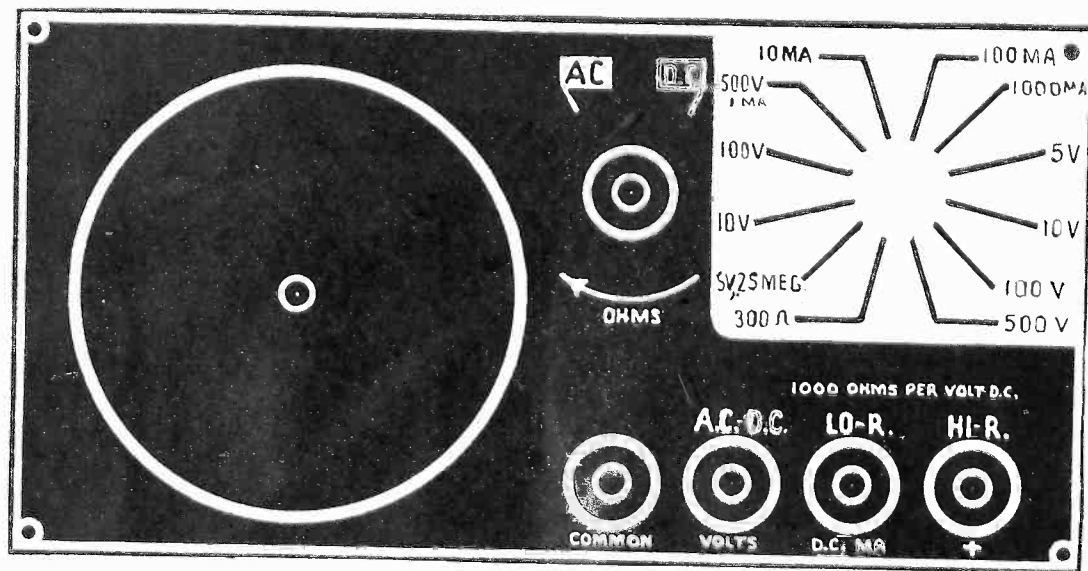

FIG. 2

The panel arrangement, actual size. The large hole at left is for the meter.

tive to use the right posts for making measurements, otherwise there will certainly be great error, or possibly even damage to the meter. It is always necessary to exercise precaution with meters, especially not to apply voltage when the posts are selected for current readings, because then a ruinously high current may be passed through the meter that practically shorts the voltage supply.

The meter scale is very easy to read, even though the meter is of the 2-inch type, because the calibration arcs are unusually extended and a two-color scheme is used. The meter and the other parts are commercially obtainable, so the device is really for constructors, many of whom have special panels on which they desire to put a compact multimeter.

Tests of a serious nature may be made with

when known full-scale voltages are applied.

The circuits are established by switching in the following general manner: For all voltages resistors are put in series with the meter. On a c. the rectifier is switched in, with a limiting resistance of 410 ohms. On d.c. the limiting resistor is shorted out as the rectifier is removed from the circuit. Low resistance is read by switching the battery and adjustment circuit (considered as a unit) across the meter and the unknown is introduced across the meter also. The high resistance setting leaves the battery circuit open, to be closed by the unknown. Direct current is read across the meter, shunts being used for ranges above one milliamper.

[List of parts supplied on request to Technical Editor, RADIO WORLD, 145 West 45th Street, New York, N. Y.]

RESISTORS FOR METER SHUNTS

Resistors used for meter multipliers and shunts should have small sensitivity to temperature, and be protected against moisture. The use of insulated resistors takes care of the moisture. However, if resistors based on carbon are used, instead of wire-wound resistors, then the resistance may go down as temperature increases, causing erroneous readings on the meter. Special methods of treating carbon re-

duce this effect, so that one may readily make a test for himself. With a multiplier or shunt resistor correctly chosen when the full-scale voltage is applied, bring a hot soldering iron close to, but not touching, the resistor, and note if there is any considerable change of meter reading. If there is, then the resistor should not be used. Even wire-wound resistors are affected by temperature changes.

Right or Wrong?

Propositions

1. Filament type tubes, like the 30, may be used in series, even when it is necessary to provide well-isolated circuits, because the coupling between the common A and B supply is negligible, if the batteries are fresh.
2. A rectifier is defined as a device that passes current in one direction only, so that when a.c. is applied, unidirectional pulsating current results. There may also be some current in the reverse direction, as in dry-disc rectifiers for instance, or in vacuum-tube detectors, which indicates how far the rectifier departs from the ideal of a device with a right-angled cut-off characteristic.
3. The reason for the use of elbows on test leads is to protect the leads when they are being pulled out of jacks, as well as to protect the wire from bending and twisting strains, because the pressure is taken up by the molded elbow and does not directly affect the test leads themselves.
4. The full-wave rectifier circuit utilizes only half the total input a-c voltage, because a center tap has to be provided. Each half of this voltage alternately operates one of a pair of rectifiers.
5. A linear amplifier is also a high fidelity detector, although of low sensitivity, and the fidelity results from the d-c current change being proportionate to the a-c input.
6. Ohm's law is believed to have no real exceptions and defines the relationship of resistance, voltage and current.

Answers

1. Wrong. When thorough circuit isolation is desired, it is inadvisable to use filament type tubes in series, because the B currents of some tubes add to the A currents of other tubes. This not only endangers the filaments of some tubes but also provides common grid and plate coupling, giving rise to regenerative or degenerative effects, according to the number and sense of the common currents.
2. Right. The definition describes a perfect rectifier. In practice this perfection is not always essential. While current in the reverse direction reduces the effectiveness of rectification, in general a rectifier is satisfactory if the ratio of forward to reverse currents is high. One scientist has defined a rectifier as "a substantially unidirectionally current-conducting element or device."
3. Right. Pulling by the leads and bending of jack springs are prevented, and twisting and bending strains on the ends of the cable strands are taken up in the elbow.
4. Right. It is true that for half-wave rectification, the full winding could be used and the applied a-c voltage would be doubled (neglecting supply losses). The *peak* value of the rectified pulsating current wave in the load resistor is therefore twice as great as in the full-wave case, but the *d-c* load current would be no greater. This is because a d-c meter measures the average value of the current over the whole cycle. The peak current in the half-wave rectifier may be twice as great but against this must be balanced the fact that the current is zero for fully half the time, so that we have to average the value of the average current in one half-cycle over an additional equal period of zero current. On the other hand the full-wave rectifier supplies twice as many current pulses per cycle, and the current is zero only for an instant. As the average value of the load current from a full-wave rectifier (when the supply wave rises and falls according to the sine law) works out to .63 of the peak value, the average value in the half-wave case is therefore one half of this or .315 of the peak. Obviously 63 per cent. of 500 volts for example is the same as 31½ per cent. of 1,000 volts. However, condensers or chokes in the rectifier circuit alter the foregoing relations.
5. Wrong. A linear amplifier by itself is an amplifier and not a detector. So long as the input-output characteristic is linear the direct current in the plate circuit must change as much in one direction as in the other, hence there will be no net change, regardless of the input amplitude.
6. Right and wrong. Ohm's law ($R = E \div I$) always gives the value of any element when the other two are known; and when all three elements can be varied independently, it can predict new values of one element when another element is changed. But when the value of an element, R for example, is itself dependent on the current in it or the voltage across it, no such prediction is possible without a knowledge of the curve of the function. Such resistance elements are referred to as non-Ohm's-law resistances and are exemplified by the resistance of a vacuum tube, or, as a matter of fact, of any conductor with an appreciable temperature co-efficient of resistivity.

The Voltage Doubler

And Other Rectifier Circuits

By Percy Warren

THE voltage doubler has some useful advantages, especially in economical directions, and therefore an understanding of its operation is imperative to servicing and even to experimental requirements. Whence is the doubler

will be nearly equal to the peak of the a.c. This may be taken as an equal-ratio voltage situation.

Next we have a full-wave rectifier, of the familiar pattern found in B supply rectifiers,

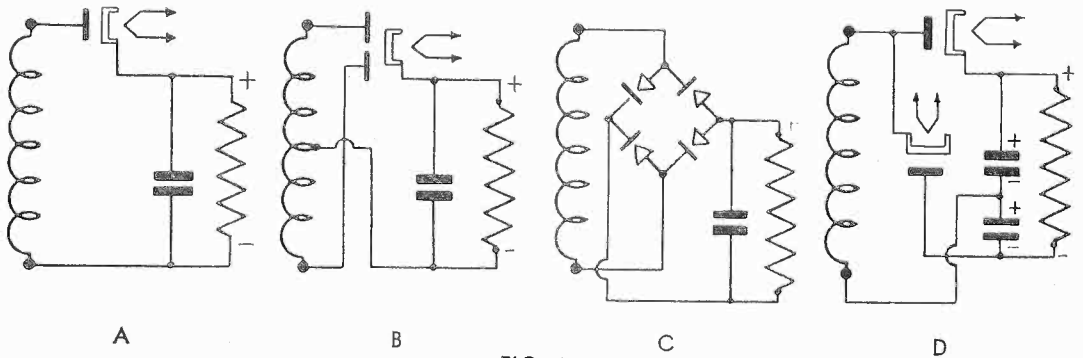

FIG. 1

Starting from left are shown a half-wave rectifier, a full-wave rectifier that, for equal winding, center-tapped, delivers one-half the d-c voltage of the other circuit; next a full-wave bridge rectifier and finally a voltage doubler.

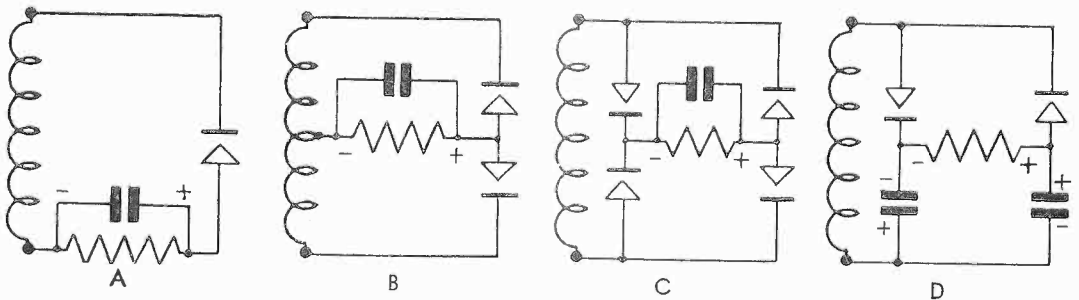

FIG. 2

The same circuits as in Fig. 1 are shown in the same order, but the diagrams are redrawn from their conventional manner in such a way as to bring out the points of similarity or contrast.

derived? How does it work? What makes it double? What does it double? How is the economical attainment achieved?

We have here four diagrams, the second row, Fig. 2, being a repetition of the first row, Fig. 1, the redrawing bringing out the four cases in the conventional diagrams so that by symmetry comparison is made easier.

RECTIFIERS COMPARED FOR VOLTAGE

Taking Fig. 1A, we have a half-wave rectifier. This may develop a d-c voltage equal to the peak of the a-c input, provided that the condenser across the load resistor is large enough. If that condenser can hold the charge delivered by the peak of the a-c wave until past the time of the next positive alternation, then the d.c.

and we can see that since the secondary is center-tapped, so that if the secondary has the same number of turns as before the voltage appearing across each rectifier is halved by center-tapping, the d-c voltage in the second instance, other factors being equal, will be only half the voltage obtained in the first instance. Thus the full-wave rectifier may be said, in this sense, to sacrifice half the voltage. But it does render filtration twice as good for the same constants.

In the half-wave rectifier there is a current pulse only once during each cycle. Within the positive alternation the rectifier conducts; during the negative alternation the rectifier idles, so that most of the time the rectifier is loafing, and the frequency of the pulses is equal to the frequency of the a.c.

In the full-wave rectifier there is a pulse during each alternation, hence two pulses per cycle, therefore the frequency of the ripple voltage is twice that of the half-wave rectifier, and twice that of the frequency of the input e.m.f. The better filtration arises from the fact that the frequency is doubled, and the impedance of the filter system is halved, and the filter bypasses the ripple component more effectively.

FOUR TIMES AS MUCH

It is also possible to have a full-wave rectifier wherein the untapped secondary is used, just as in half-wave rectification, and this is done by the bridge method shown in Fig. 1C. The condenser is across the load resistor. This type of rectifier is sometimes used by amateurs and in other transmitter applications.

Again using the untapped winding, assumed to be the same in all respects as in the half-wave and bridge instance, we may obtain nevertheless twice the output voltage of the half-wave winding by using two rectifiers reversed in respect to each other, Fig. 1D. Thus four times as much d-c voltage is obtained as from the full-wave rectifier, Figs. 1B, 2B.

Considering now the Fig. 2 series, we can compare very quickly, because of the simplicity of the way the connections are shown, the circuits of the half-wave rectifier, in A, the full-wave in B, the bridge in C and the doubler in D.

What we want to know particularly right now is how the doubler does its doubling.

WHAT CONDENSERS DO

We saw that in any instance when a large condenser is put across the load resistor it raised the d-c voltage. This was due to the inherent capability of a condenser in storing electricity. If one looks at the polarity symbols in the diagrams he finds that positive is toward the cathode and negative toward the anode, considering d.c. only, and of course the condenser assumes the same polarities. In the Fig. 2 series, the rectifier is treated as if the plain line is the anode and the triangle the cathode, as in tube symbols. If the filter condenser is large enough in capacity, and the resistance across it is comparatively large, there will be little discharge by the condenser, and the voltage will be maintained during the rectifier's non-conducting interval, and even carry over for a longer period, hence the d-c voltage will be maintained. A large capacity takes a long time to discharge through a given resistance, and a large resistance will take a long time to discharge a given condenser.

In Figs. 2A, B and C the condenser is plainly shown across the resistor. In Fig. 2D we do not see this single condenser, but the capacity is present, as a second glance confirms, because it is composed of two condensers in series. The condensers therefore do their expected maintenance work, if large enough, and it is around them that the explanation of the doubling action pivots.

Here is the explanation:

We saw in the bridge circuit four rectifiers, each pair of series-opposing rectifiers in parallel with the input. Now we find in the doubler that all we have done is to replace the two rectifiers in the lower legs of Fig. 2C with the two condensers in Fig. 2D. If we compare the rectifiers in the lower leg of Fig. 2C with the condensers in the lower leg of Fig. 2D we find that the series arrangement prevails for them, and the polarities agree. Assume that the condensers in the voltage doubler are electrolytics, just to emphasize the polarities.

REVERSE RECTIFIERS

The two rectifiers in the doubler are reversed in respect to each other and both are across the input. (The condensers are assumed to have negligible impedance.) Take the rectifier at left in Fig. 2D. When the lower part of the rectifier receives the positive a.c. pulse that rectifier conducts and charges the condenser at left to a d-c value equal to the peak of the a-c voltage. Note the d-c polarities. When the next alternation occurs, the right-hand rectifier conducts, for the upper terminal of the coil is now positive (a.c.), and the condenser at right becomes charged to the same voltage as the other condenser was charged, only the polarity is reversed, because the rectifiers are reversed. We found that the condensers are in series as a filter capacity across the load resistor. We now also find that the polarities are in series. Hence the d-c voltage across each condenser is equal to the a-c peak voltage, and these d-c voltages are in series so the maximum d-c output at no load, or with infinite capacity, would be twice the peak a-c transformer voltage. This will be twice the voltage obtainable from the same transformer in the half-wave rectifier circuit of Figs. 1A and 2A, and four times the voltage obtainable from the same winding used in the full-wave circuit of Figs. 1B and 2B.

GOOD FILTRATION

As the charging pulses appear twice per cycle, just as in the full-wave case, filtering is equally good. The doubler thus is a convenient and inexpensive way of obtaining higher voltages with equipment usually on hand, when, for example, the experimenter needs such voltage for cathode-ray and ham experiments, meter checking, etc.

Remember that the rectifier tubes must be able to stand the reverse peak voltage, which may reach twice the peak supply. The same is true of the transformer insulation between windings, i.e., it must be adequate for service at higher voltages, which it would be if the transformer were well-made, even if originally operated as a full-wave input supply at half the total voltage.

As to the condensers, fortunately the series arrangement necessary for the functioning of the voltage doubler makes it unnecessary to use full-voltage rating condensers, since each of the two condensers shown gets no more than the transformer voltage, or half the total d-c voltage output.

Handy Uses for Pilot Lamps

They Offer Inexpensive Possibilities

By A. G. Goldborough

THE lowly pilot lamp has highly important possibilities in radio work. While its use for some purposes is very familiar, its value in other directions is not fully appreciated. So

pilot lamp be used on the receiver, to denote when the set is "on," the lamp would be shunted by a fixed resistor, around 10 ohms or so, because normally .3 ampere is required by the

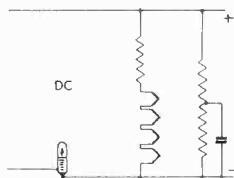

FIG. 1

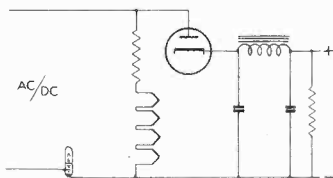

FIG. 2

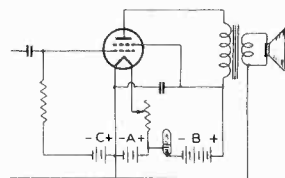

FIG. 3

A pilot lamp as just a pilot lamp, usually with a 10-ohm resistor across it, may be used in a d-c set, as shown at left, in series with series heaters of the radio tubes. At center the lamp is common to the A and B circuits for a-c/d-c use. In either instance the lamp may serve as fuse, as it does at right in a battery set.

here is a list of six of the purposes to which the little bulbs may be applied:

1. The usual purpose of a pilot lamp, to signify that a circuit is closed.
2. As a trouble lamp, whereby there is a glow only when something goes wrong.
3. As a fuse. In this instance the current rises to such a great height that the poor little lamp's life is extinguished, for the filament is opened by overheating. The attractive feature is that the lamp is very inexpensive and available in a wide range of currents.
4. As a small known resistance when cold, in fact, a resistance in vacuum. Also, if the characteristics are at hand, as a known resistance under various degrees of current passing through the filament.
5. Metering. This is illustrated by the measurement of power even under circumstances otherwise difficult, e.g., high-frequency transmitters or specially powerful high-frequency receivers. The basis of operation is that of illumination comparison.
6. Use of the non-linear characteristic. In this connection a current-regulating system can be worked out; limiting arrangements like a-v-c, or expanding arrangements like automatic volume expansion.

PILOT OR FUSE

In connection with the foregoing tabulation consider the diagrams illustrating the use of the little pilot lamps. Fig. 1 shows a d-c supply, with the lamp itself in series with a series heater circuit. If it is merely intended that a

radio tube heaters, and most of the pilot lamps used are intended for smaller current, so the difference is passed through the shunt resistor.

On the other hand, suppose that what is mainly desired is a fuse. Then it is not intended to protect the lamp from presence of excessive current, but, quite to the contrary, to protect the heaters at the expense of the lamp, hence the lamp would be so included as to remain intact on normal current and "blow" on large excess current. It must be remembered that the lamp is intended to "go" first, or rather, to "go" alone, and not carry the heaters with it. The pilot bulbs cost a few cents, the radio tubes a good deal more.

Fig. 2 illustrates a fuse use, where not only the heaters but the rectifier tube and the filter condensers affect the little bulb. Should the tube short or should a filter condenser blow, or should a short occur in the limiting resistor that cuts down the line voltage to the required voltage across the total heater series, the fuse-bulb will afford protection.

USE IN BATTERY SET

In battery-operated devices, using vacuum tubes, insertion of the little lamp between B minus and filament protects the radio tubes (a power tube is shown in Fig. 3), because should the bypass condenser from B plus to filament short, the lamp will "go," and thus the B batteries will be protected, and also the excessive voltage due to B voltage accidentally applied in the direction of the filament circuit of the radio tube, will most likely destroy the little bulb and leave the big ones unharmed.

Another way of using the small lamp is to

put it in series with the B minus lead of a full-wave rectifier, such as is commonly found in the B supply of a receiver. This is the same general sort of use as putting the lamp between B minus and filament in the battery set previously discussed. Again the lamp serves as a fuse, and any short of filter condenser next to rectifier, or of rectifier output, will burn out the fuse.

The metering use is one of particular interest to amateurs, although it is of value to servicemen, also. Amateurs are often at a loss to make high-frequency power measurements, a difficult task at best, if a very high order of

in Fig. 5. When it is thrown to the right the d-c current through the meter M is read, for a particular brilliance of the lamp. When thrown to the left, a.c. is introduced, and it may be of audio or radio frequencies, and even of fairly high radio frequencies. It is assumed that all r-f measurements are made into a low impedance, e.g., a coupling turn or two are used, and the lamp not put directly across a tank circuit.

Now, when the switch is thrown for r-f effect on the lamp, and then to the right for d-c effect on the lamp, if the operation is quickly done, after some preliminary adjustments for approximate equalization, actual equalization of

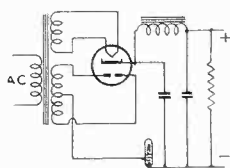

FIG. 4

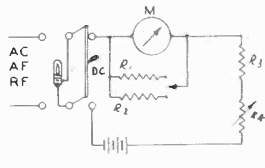

FIG. 5

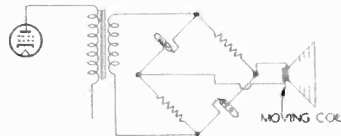

FIG. 6

Put in series with B minus in a full-wave rectifier, the little bulb acts as fuse in case condenser, rectifier tube, filter condenser or d-c output is shorted. Center diagram illustrates metering. Thus power measurements may be made even at high frequencies. At right two lamps are used in a volume-expander circuit.

accuracy is to be maintained. However, since highest accuracy may not be requisite, and also because the pilot lamp affords much better accuracy than many imagine, the comparative method may be introduced in two ways.

MEASUREMENT OF POWER

One is to have two lamps of equal illumination sensitivity, i.e., the same amount of current through them will light up both with the same brilliance. This may be determined quite closely by eye, using two lamps in series, so the same current must flow through both, and applying the voltage, with limiting resistor interposed, if necessary, and testing lamps that way until two are obtained that do produce equal illumination. It is well to note the action when the current is changed, i.e., slowly reduced to a low value, and even slowly increased to a value about 10 per cent greater than the rating of the lamp. Thus equal characteristics throughout are verified. If more convenient, the voltage across the lamp may be considered, instead of the current, and compared to the normal rating voltage, e.g. 2.5 volts, 6.3 volts, etc.

If instead of the two-lamp method a single-lamp comparative measurement is preferred, this may be made as shown in Fig. 5. Here we have a d-c circuit to the right, consisting of a voltage source in series with which is a fixed and an adjustable limiting resistor, the meter M registering current. R_1 and R_2 are shunts, which may be used for increasing the current range. R_3 and R_4 simply represent the means of varying the current until on a.c. and d.c. the bulb shows equal brilliancy.

USE OF SWITCH

A double-pole, double-throw switch is shown

illumination can be achieved, whereupon the a-c current (r.m.s.) is equal to the d-c current, hence we have a universal meter. Due to the persistence of vision and the fact that there is an inherent lag in the lamp, the switching can be so quickly performed that it will be impossible to detect by eye alone that there was any switching at all.

POWER COMPUTED

Since the current in both instances is now known, the power in either circuit may be computed, if the resistance of the lamp or the voltage across the lamp is known.

Since it is easier to work with d.c., if another voltmeter is used, so as not to disturb the circuit conditions, and is put across the lamp filament, the true d-c voltage across the lamp is known, and the r-m-s voltage across the same lamp for a.c. being the same, the power in both instances may be computed from the formula $W = EI$, where W is the power in watts, E is the voltage across the lamp in volts and I is the current through the lamp in amperes. A sine wave is assumed in the a-c example.

Whether the voltmeter across the lamp, even if a low-resistance voltmeter, disturbs the circuit conditions, may be determined by observing the current meter, which should not change reading when the voltmeter is used. Since the lamp filament resistance is low, anyway, even a voltmeter of a few hundred ohms per volt would be really sufficient.

Since the voltage drop across the filament is known, and the current through the filament likewise is known, the resistance of the lamp under the operating conditions may be computed from $R = E \div I$, where R is the resistance

(Continued on following page)

Unconventional Hartleys

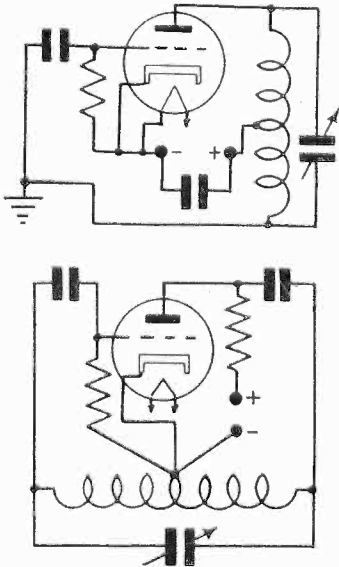

FIGS. 1 and 2

An unconventional Hartley (Fig. 1) is at top, while below is conventional circuit (Fig. 2).

HARTLEY oscillators sometimes take forms very different from the usual connections. One such departure is shown in Fig. 1. Here the grid is grounded instead of the plate, and moreover the plate supply is of the series-fed type, while the grid supply is shunt-fed.

Figs. 2 and 3 also represent the Hartley circuit, but in different aspects. These figures are drawn to bring out the essential features of how the Hartley oscillator functions. This pro-

cedure is helpful in understanding the action and in designing working oscillators.

Note the loading and the voltage-dividing effects of grid and plate resistors (Figs. 2 and 3) on the respective windings.

While Fig. 2 is a redrawing of a conventional Hartley with shunt feed for both grid

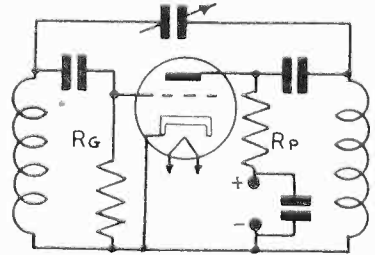

FIG. 3

It is not essential that the windings be inductively coupled.

and plate, Fig. 3 brings out a less commonly remembered fact about the Hartley, i.e., that inductive coupling between grid and plate windings is not essential to its functioning. It can be seen from Fig. 3 that grid-plate feedback coupling is brought about by the tuning condenser itself.

In all the drawings the coils are shown centertapped. However, the best position for the cathode tap is not necessarily at center. The tap may be higher or lower, depending on the Q of the coil and on the tube characteristics, such as mutual conductance.

Also r-f chokes may be used in series with grid and plate resistors, and plate feed may be through r-f chokes alone.

(Continued from preceding page)

in ohms, E the voltage in volts and I the current in amperes. The current if in milliamperes is treated as a decimal part of an ampere, e.g., 150 milliamperes equals .15 amperes.

The wattage computation should check now, on the basis of $W = I^2R$, where I^2 is the square of the current, or, for a current of .15 ampere we have, as the square, .0225 ampere.

Of course the small lamps have a small wattage rating, .945 watts for the 6.3-volt lamp that is intended to pass 150 milliamperes (.15 ampere). Hence the measurements must be within the capacities of the lamp.

The filaments are usually of tungsten, which has a positive temperature co-efficient (resistance increases with temperature), whereas carbon lamps, not normally found in this small series, have a negative coefficient of temperature.

The tungsten lamps lend themselves to volt-

age regulation of sorts, because the resistance rises to limit the current, when greater resistance is needed.

The non-linear characteristic has been applied to radio receivers for volume-expansion purposes, as shown in Fig. 6, whereby two opposite arms of an unbalanced bridge consist of the lamps, while the other arms are resistors or other impedances, the speaker being connected at the output.

Under these circumstances the increase of amplitude, due to the stronger modulation at the broadcasting station, impresses a larger voltage across the secondary of the output transformer, the resistance of the lamps increases due to the increased current, the bridge, if balanced at zero signal, becomes unbalanced, hence the amplitude across the speaker increases, and the louder the signal the louder the signal. A similar arrangement can be used for automatic negative feedback.

Related Rectifier and Detector Circuits

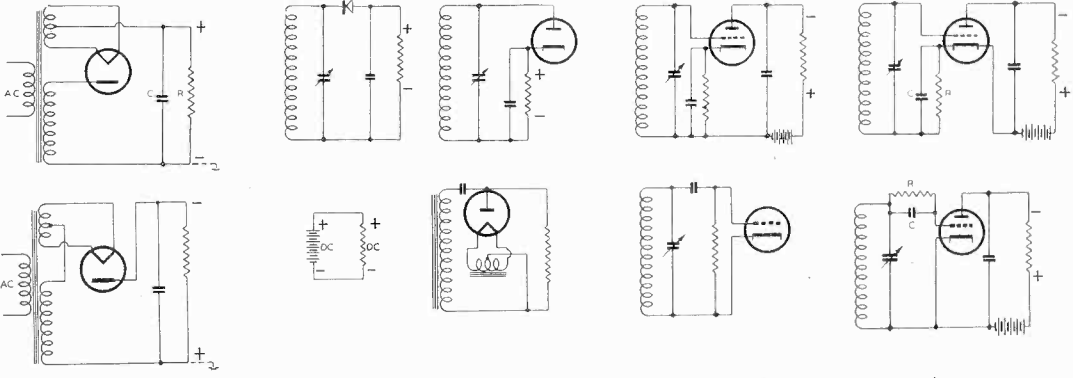

BY rectifier we mean a device that receives a.c. and delivers d.c. that can be used as an energizing power supply. By detector we mean a device that removes the carrier from a modulated carrier and leaves only the audio-frequency component, to enable hearing the intelligence. Here we have a representative group of detectors and rectifiers. Top left shows a conventional

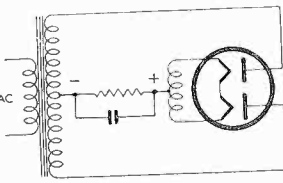
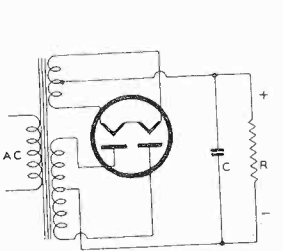

half-wave rectifier, d-c polarities marked. R is the load and C is the filter condenser. Directly below that diagram is a half-wave rectifier, cathode-ray type.

Looking at the top row, second from left, we find a series crystal detector, with load resistor polarities shown. Next is a plain diode (tube) detector, while the biased detector is shown in the next diagram.

The last diagram on the top line, as well as the last one on the second line, and the second from last on the second line, are all grid leak detectors. At end of the first line the grid leak is simply shown in an unusual position. The grid-leak detector second from end on second line has the form of a parallel half-wave rectifier shown in the diagram in third position of second line.

The diagrams in the two vertical columns, both sides of the page, are all alike as full-wave rectifiers, including biased and grid-leak full-wave detectors in the

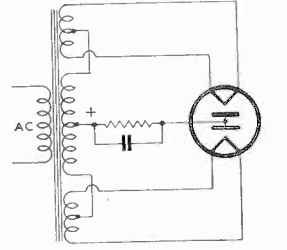
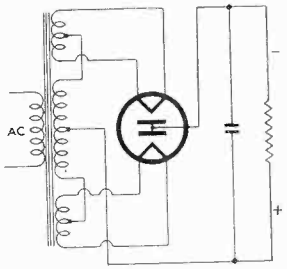

next to the last and last diagrams in the right column. The top drawing in both columns shows conventional full-wave analogs of the first pair of half-wave rectifiers; the next below each is a redrawing to bring out their bridge form.

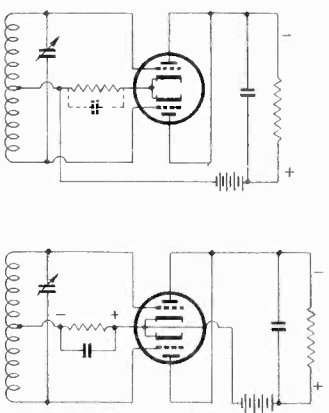
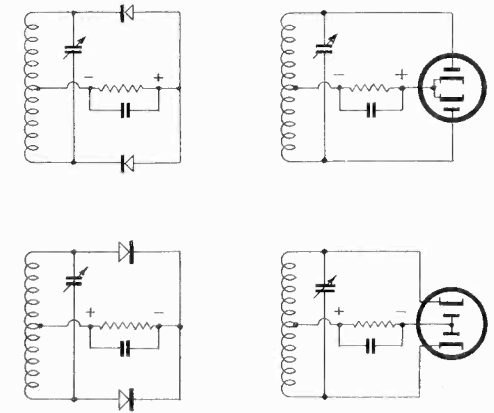

Forum

WARM WORDS ON THE I-F PROBLEM

EDITOR RADIO WORLD:

I WISH that you would be so kind as to publish the following facts that every technically intelligent "ham" knows. It might enlighten the RMA boys a wee bit.

460 kc isn't free of signals or hash and probably never will be because of the crowded conditions on the ship channels.

Using an i.f. of 460 kc for a receiver tuning 550-1600 kc, the first image is from 167% to 58% increase of the dial frequency and takes in broadcast, police, amateur, and point-to-point images.

Using an i.f. of 1725 kc for a receiver tuning 550-1600 kc, the first image is from 627% to 215% increase of the dial frequency and does not take in any densely populated frequencies. The 1725 kc region is rarely used and the "hams" would gladly refrain from using 1715 to 1735 kc if the R.M.A. would come half way. Little things called Faraday shields placed in between the windings in i-f cans will prevent the passage of 3450, 5175, 6900 kc, etc. However, I imagine that the cost is beyond the considerations of the R.M.A.

460 kc takes in images 1470 kc to 2520 kc; 1725 kc takes in images 4000 kc to 5050 kc; 460 kc oscillators radiate from 1010 kc to 2060 kc; 1725 kc oscillators radiate from 2275 kc to 3325 kc.

When there is a popular program on 1360 kc, operation for signals under R8 rating is impossible around 1820 kc. There is also much interference on 3640 ks and some on 5460 kc, the second and third harmonics of these oscillators. More isolation should be used between oscillators and antenna circuits and all parts carrying oscillator currents should be completely shielded.

Hams can do nothing but explain away B. C. L's complaints on "birdies" as just plain R.A.M. carelessness or indifference.

Thus the listener is entitled to a better break and since the problem can be solved for the listeners' benefit, that should be done without delay.

GEORGE DONADIO (W80MM)

Some good points, W80MM, but the whole problem is a bit less simple. There may be just a little to say for the R.M.A. committee that has been struggling with this problem of standardization. And what are your angles, servicemen? Perhaps you "R.M.A. boys" don't feel too thoroughly chastened to give a few contrite words, too. This is something important to chew on for all of us, with so many ramifications that we feel that all well-considered views should see the light of day. So more power to your pens, and we'll stay close to our cyclone cellar.

UNFAIR COMPETITION

EDITOR RADIO WORLD:

I AM a small public address operator working within a radius of 75 miles of Columbus, Ind. I am typical of the hundreds of sound men the country over who possess perhaps two complete systems and are radio servicemen. Men in our class are more than glad to work any form of a P.A. job, whether it's a small bingo game or a fair grounds grandstand job.

On three occasions this summer I have lost contracts for fair ground grandstand installations because an oil company offered to furnish free to the fair a modern, up-to-date sound car just for the right to advertise gasoline. Is this fair to us men who make our living from our sound equipment? In one city nearby I withdrew my bid because a local sound man who had a wife and family needed the job. Their circumstances were such that the \$50 or \$75 net would assist them greatly. Yet the oil company sound truck came in and worked the job for absolutely nothing. This is not giving the sound man an even break. We can't afford to do jobs for nothing.

FREDERICK PRESTON,
1631 Lafayette Ave., Columbus, Ind.

We understand your predicament very well and certainly sympathize with the difficulties of a small operator having to buck not only price competition from within his own business but the free services rendered by competitors who go far outside their own fields. It would be well, we think, for you first to take up your grievance with the company that occasions it, explain the disastrous effect it has on your own business, and ask them what their feelings would be if with each sound job you do you gave away free gasoline. Thus try on a sincere, human basis to present your case so that the justice of your request will be appreciated.

—EDITOR.

* * *

LEAKAGE PROBLEM SOLVED

EDITOR RADIO WORLD:

OSCILLATOR leakage has been given considerable attention in your columns.

One of the best ways, I found, to get minimum leakage was to use an oscillator that did not oscillate violently, because there is a certain threshold beyond which the percentage leakage goes up greater than the percentage increase in oscillation intensity.

Besides the foregoing precaution, the signal generator should be contained in a shield box, iron sufficing, but the openings should be minimum. This point is particularly important in relation to the dial system, and a method should be used for small shaft opening. You are right in saying that the a-c/d-c type of construction should be avoided if minimum leakage is desired. The obvious reason is that the oscillation voltage is coupled to the line cord and the cord thus acts as a transmitting antenna and you have leakage in superabundance.

E. G. BEST

Radio Construction UNIVERSITY

Answers to Questions on the Building and Servicing of Radio and Allied Devices

TOTAL HARMONIC DISTORTION

CAN the per cent. of total harmonic distortion be computed by adding the separate percentages of each of the harmonics present?—P. M.

No. The total harmonic distortion in per cent. is found by taking the square root of the sum of the squares of the percentages of the harmonics in the series.

* * *

INSULATION OF STRATOSPHERE

IS it true that at stratosphere altitudes of several miles the air is more rarefied and is therefore a better electrical insulator?—E. L. P.

On the contrary, surprising as it may seem, the air up there is a much poorer insulator, owing to ionization by ultra-violet rays. At such altitudes the intensity of these rays is very high, but by the time they have penetrated down to sea level through an increasingly dense atmosphere, their energy has been very largely absorbed.

* * *

HUM AND CRACKLES

RECENTLY I had occasion to modernize an old Crosley receiver by replacing the older type tubes with 58's for r-f and i-f stages, 57 first detector, 56 oscillator and 56 second detector. The power tube is a 47. I made the necessary voltage changes and installed a new eight-inch speaker. One of my troubles is hum and is heard when the switch is turned on, disappearing when all the tubes have warmed up. Another difficulty is distortion. When the set is first turned on there is a pronounced crackling in the speaker, which disappears as soon as the set warms up, but returns intermittently. Also I am located quite close to a local station on 1320 kc and when I tune in this station with antenna connected there is bad overload distortion. The other local, on 750 kc, does not cause this trouble, although also quite close and using even greater power.—L. R. C.

You will probably find that your set will pick up the 1350 kc station with the antenna disconnected. This condition may require shielding the input leads, coils, tubes and condensers, or, in fact, the set as a whole. If the set is already well shielded, it may suffice to couple your antenna through a very small capacity which may be shorted out with a switch when receiving on other parts of the dial; or a dual volume control circuit can be tried, which

cuts down the r-f input to the first stage, as well as reducing the gain. A series wave trap, shunting the input posts, may be needed to help in an aggravated case. It is possible that your other distortion trouble is linked up with the your hum and your crackling trouble. See if the hum still comes in with the rectifier out; or with the 47 out; also with the second detector out. Try also replacing each separately with a new one. Try testing for leakage in grid coupling condensers and grid filter condensers, as in power-tube and a-v-c circuits; or, if transformer-coupled audio is used, leakage between windings or to the core, particularly likely in moist, warm weather in such parts and in other parts of the set, too. The filter condensers may be defective or overvoltaged, with leakage between sections, which might upset power tube hum-bucking and biasing circuit. This condenser trouble could cause all three of your complaints. A field hum might be balanced out by an opposing hum from the tubes after they heat up to account for the disappearance. See if shorting the voice coil increases the hum, as it could if the voice coil were picking up the hum by induction from the field. It is important in making such tests as all those enumerated above actually to replace the respective parts, as the defect may appear only in the presence of the full operating stress. Other general suggestions are: see if more filter capacity helps, or try a speaker with a hum-bucking winding.

* * *

SET STOPS DEAD AT 600 KC

I HAVE run into peculiar trouble in servicing a superheterodyne of the older type which uses one 77 as both oscillator and first detector. The set goes dead around 600 kc although it works all right at higher frequencies and even at the low-frequency end of the dial.—L. V.

Assuming that the ordinary tests have been made we can suggest a very likely explanation of and remedy for your trouble. In this type of combined oscillator-detector circuit the oscillator tuned circuit has to be completed through the B supply, and in good design a paper condenser of .1 mfd. is used for this purpose, even though large electrolytic capacity already exists between the d-c potentials. We have found that under certain conditions the length of the leads of the electrolytic condenser, including that part which is inside the condenser, may

(Continued on following page)

Forum

WARM WORDS ON THE I-F PROBLEM

EDITOR RADIO WORLD:

I WISH that you would be so kind as to publish the following facts that every technically intelligent "ham" knows. It might enlighten the RMA boys a wee bit.

460 kc isn't free of signals or hash and probably never will be because of the crowded conditions on the ship channels.

Using an i.f. of 460 kc for a receiver tuning 550-1600 kc, the first image is from 167% to 58% increase of the dial frequency and takes in broadcast, police, amateur, and point-to-point images.

Using an i.f. of 1725 kc for a receiver tuning 550-1600 kc, the first image is from 627% to 215% increase of the dial frequency and does not take in any densely populated frequencies. The 1725 kc region is rarely used and the "hams" would gladly refrain from using 1715 to 1735 kc if the R.M.A. would come half way. Little things called Faraday shields placed in between the windings in i-f cans will prevent the passage of 3450, 5175, 6900 kc, etc. However, I imagine that the cost is beyond the considerations of the R.M.A.

460 kc takes in images 1470 kc to 2520 kc; 1725 kc takes in images 4000 kc to 5050 kc; 460 kc oscillators radiate from 1010 kc to 2060 kc; 1725 kc oscillators radiate from 2275 kc to 3325 kc.

When there is a popular program on 1360 kc, operation for signals under R8 rating is impossible around 1820 kc. There is also much interference on 3640 ks and some on 5460 kc, the second and third harmonics of these oscillators. More isolation should be used between oscillators and antenna circuits and all parts carrying oscillator currents should be completely shielded.

Hams can do nothing but explain away B. C. L's complaints on "birdies" as just plain R.A.M. carelessness or indifference.

Thus the listener is entitled to a better break and since the problem can be solved for the listeners' benefit, that should be done without delay.

GEORGE DONADIO (W8OMM)

Some good points, W8OMM, but the whole problem is a bit less simple. There may be just a little to say for the R.M.A. committee that has been struggling with this problem of standardization. And what are your angles, servicemen? Perhaps you "R.M.A. boys" don't feel too thoroughly chastened to give a few contrite words, too. This is something important to chew on for all of us, with so many ramifications that we feel that all well-considered views should see the light of day. So more power to your pens, and we'll stay close to our cyclone cellar.

UNFAIR COMPETITION

EDITOR RADIO WORLD:

I AM a small public address operator working within a radius of 75 miles of Columbus, Ind. I am typical of the hundreds of sound men the country over who possess perhaps two complete systems and are radio servicemen. Men in our class are more than glad to work any form of a P.A. job, whether it's a small bingo game or a fair grounds grandstand job.

On three occasions this summer I have lost contracts for fair ground grandstand installations because an oil company offered to furnish free to the fair a modern, up-to-date sound car just for the right to advertise gasoline. Is this fair to us men who make our living from our sound equipment? In one city nearby I withdrew my bid because a local sound man who had a wife and family needed the job. Their circumstances were such that the \$50 or \$75 net would assist them greatly. Yet the oil company sound truck came in and worked the job for absolutely nothing. This is not giving the sound man an even break. We can't afford to do jobs for nothing.

FREDERICK PRESTON,
1631 Lafayette Ave., Columbus, Ind.

We understand your predicament very well and certainly sympathize with the difficulties of a small operator having to buck not only price competition from within his own business but the free services rendered by competitors who go far outside their own fields. It would be well, we think, for you first to take up your grievance with the company that occasions it, explain the disastrous effect it has on your own business, and ask them what their feelings would be if with each sound job you do you gave away free gasoline. Thus try on a sincere, human basis to present your case so that the justice of your request will be appreciated.

—EDITOR.

* * *

LEAKAGE PROBLEM SOLVED

EDITOR RADIO WORLD:

OSCILLATOR leakage has been given considerable attention in your columns.

One of the best ways, I found, to get minimum leakage was to use an oscillator that did not oscillate violently, because there is a certain threshold beyond which the percentage leakage goes up greater than the percentage increase in oscillation intensity.

Besides the foregoing precaution, the signal generator should be contained in a shield box, iron sufficing, but the openings should be minimum. This point is particularly important in relation to the dial system, and a method should be used for small shaft opening. You are right in saying that the a-c/d-c type of construction should be avoided if minimum leakage is desired. The obvious reason is that the oscillation voltage is coupled to the line cord and the cord thus acts as a transmitting antenna and you have leakage in superabundance.

E. G. BEST

Radio Construction UNIVERSITY

Answers to Questions on the Building and Servicing of Radio and Allied Devices

TOTAL HARMONIC DISTORTION

CAN the per cent. of total harmonic distortion be computed by adding the separate percentages of each of the harmonics present?—P. M.

No. The total harmonic distortion in per cent. is found by taking the square root of the sum of the squares of the percentages of the harmonics in the series.

* * *

INSULATION OF STRATOSPHERE

IS it true that at stratosphere altitudes of several miles the air is more rarefied and is therefore a better electrical insulator?—E. L. P.

On the contrary, surprising as it may seem, the air up there is a much poorer insulator, owing to ionization by ultra-violet rays. At such altitudes the intensity of these rays is very high, but by the time they have penetrated down to sea level through an increasingly dense atmosphere, their energy has been very largely absorbed.

* * *

HUM AND CRACKLES

RECENTLY I had occasion to modernize an old Crosley receiver by replacing the older type tubes with 58's for r-f and i-f stages, 57 first detector, 56 oscillator and 56 second detector. The power tube is a 47. I made the necessary voltage changes and installed a new eight-inch speaker. One of my troubles is hum and is heard when the switch is turned on, disappearing when all the tubes have warmed up. Another difficulty is distortion. When the set is first turned on there is a pronounced crackling in the speaker, which disappears as soon as the set warms up, but returns intermittently. Also I am located quite close to a local station on 1320 kc and when I tune in this station with antenna connected there is a bad overload distortion. The other local, on 50 kc, does not cause this trouble, although also quite close and using even greater power.—L. R. C.

You will probably find that your set will pick up the 1350 kc station with the antenna disconnected. This condition may require shielding the input leads, coils, tubes and condensers, or, in fact, the set as a whole. If the set is already well shielded, it may suffice to couple your antenna through a very small capacity which may be shorted out with a switch when receiving on other parts of the dial; or dual volume control circuit can be tried, which

cuts down the r-f input to the first stage, as well as reducing the gain. A series wave trap, shunting the input posts, may be needed to help in an aggravated case. It is possible that your other distortion trouble is linked up with the your hum and your crackling trouble. See if the hum still comes in with the rectifier out; or with the 47 out; also with the second detector out. Try also replacing each separately with a new one. Try testing for leakage in grid coupling condensers and grid filter condensers, as in power-tube and a-v-c circuits; or, if transformer-coupled audio is used, leakage between windings or to the core, particularly likely in moist, warm weather in such parts and in other parts of the set, too. The filter condensers may be defective or overvoltaged, with leakage between sections, which might upset power tube hum-bucking and biasing circuit. This condenser trouble could cause all three of your complaints. A field hum might be balanced out by an opposing hum from the tubes after they heat up to account for the disappearance. See if shorting the voice coil increases the hum, as it could if the voice coil were picking up the hum by induction from the field. It is important in making such tests as all those enumerated above actually to replace the respective parts, as the defect may appear only in the presence of the full operating stress. Other general suggestions are: see if more filter capacity helps, or try a speaker with a hum-bucking winding.

* * *

SET STOPS DEAD AT 600 KC

I HAVE run into peculiar trouble in servicing a superheterodyne of the older type which uses one 77 as both oscillator and first detector. The set goes dead around 600 kc although it works all right at higher frequencies and even at the low-frequency end of the dial.—L. V.

Assuming that the ordinary tests have been made we can suggest a very likely explanation of and remedy for your trouble. In this type of combined oscillator-detector circuit the oscillator tuned circuit has to be completed through the B supply, and in good design a paper condenser of .1 mfd. is used for this purpose, even though large electrolytic capacity already exists between the d-c potentials. We have found that under certain conditions the length of the leads of the electrolytic condenser, including that part which is inside the condenser, may

(Continued on following page)

Thorne's Radio Coil Winder

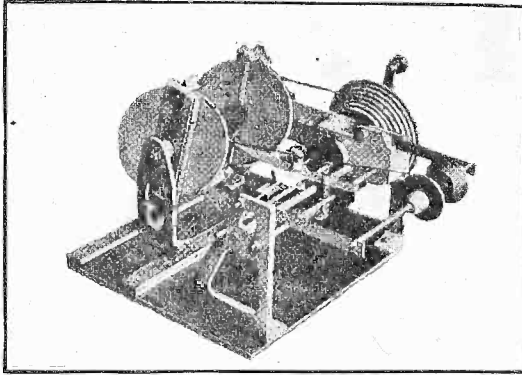

Patented

Will wind transformers, straight or honeycomb coils and ear phone armature, revolution recorder. 14 speed changes.

Write for illustrated circular RW38 and prices. Designed for the amateur and radio repair shop.

MIAMI LABORATORIES, INC.
951 N. W. THIRD STREET, MIAMI, FLORIDA

Bringing you up-to-date on current electronic engineering practice

Just Out!

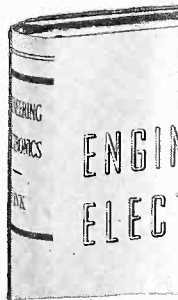

ENGINEERING ELECTRONICS

By **DONALD G. FINK**
Managing Editor, *Electronics*

358 pages, illustrated, \$3.50

Here is a new book to meet the engineer's need for a working introduction to electron tubes and the design of circuits for their application. The circuits described have to do with power transformation, electrical communication and industrial control and measurement problems.

McGRAW - HILL BOOK CO., INC.
330 West 42nd Street, New York City

When writing to Advertisers please mention that you saw the Advertisement in **RADIO WORLD**.

(Continued from preceding page)

have so much inductance that, being in parallel with a paper condenser of .1 mfd. or so, the circuit resonants around the low-frequency portion of the broadcast band. Being in series with the oscillator tuned circuit it becomes a parallel resonant wave trap or rejector circuit, preventing sufficient oscillator output to work the set, or even constituting a sufficient load to stop the oscillation entirely at this frequency.

GENERATOR KIT \$3.42

Five coils and tuning condenser for signal generator covering 120 kc to 50 mc in five bands; direct-reading frequency scale; knob; pointer; diagram; instructions. Shipping weight 3 lbs.

DISCOVERY LABORATORIES

187-K FIRST ST., BROOKLYN, N. Y.



HAMS— FANS!

The 1938 edition of the famous Hammarlund Short Wave Manual is chock full of high and ultra-high frequency receivers and transmitters. No ham or experimenter can afford to be without a copy.

Send 10 cents for your copy now!

HAMMARLUND MFG. CO., INC.
424 WEST 33rd STREET, N. Y. C., DEPT RW-8

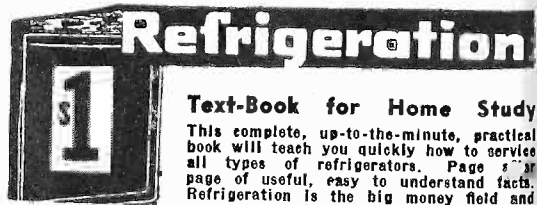

Refrigeration

Text-Book for Home Study

This complete, up-to-the-minute, practical book will teach you quickly how to service all types of refrigerators. Page 573 of useful, easy to understand facts. Refrigeration is the big money field and you can get into it after studying this

textbook. Size 8½ x 11 in. Priced at only \$1.00, postpaid. Send for your copy now.

SUPREME PUBLICATIONS

3729 WEST 18th STREET

CHICAGO, ILL.

Time switches, seconds or minutes from.....59 cents up
Continuous ringing (locking drop) relay.....59 cents
Yale key operated switch, the key is removable in "off" or "on" positionSpecial \$1.75

Relays, Solenoids, ALNICO Magnets and other experimental supplies.

BLAN, THE RADIO MAN
64 Dey Street, Dept. 8-38, New York City

Get These Books Now! Make 7 Months to Pay for Them

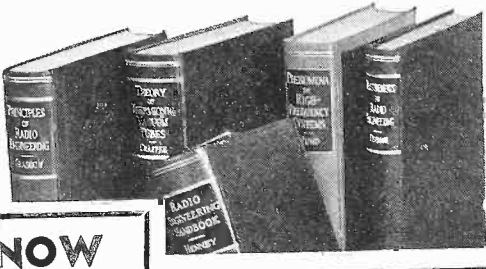

NOW
this high-powered radio engineering library sent to you for 10 days' trial—at a special price and terms

These books cover circuit phenomena, tube theory, networks, measurements, and other subjects—give specialized treatment of all fields of practical design and application. They are books of recognized position in the literature—books you will refer to and be referred to often. If you are a researcher or experimenter, if your interest in radio is deep-set and based on a real desire to go further in this field—you want these books for the help they give in hundreds of problems throughout the whole field of radio engineering.

RADIO ENGINEERING LIBRARY

Especially selected by Radio World's staff of experts to give most complete, dependable coverage of subjects needed by all whose fields are grounded on radio fundamentals

- 5 volumes, 3064 pp., 2000 illustrations
- Glasgow's PRINCIPLES OF RADIO ENGINEERING
- Terman's MEASUREMENTS IN RADIO ENGINEERING
- Chaffee's THEORY OF THERMIONIC VACUUM TUBES
- Hund's PHENOMENA IN HIGH-FREQUENCY SYSTEMS
- Henney's RADIO ENGINEERING HANDBOOK

Special Low Price and Easy Terms
Bought singly, the five volumes comprising this library would cost you \$25.00. Under this offer you save \$1.50 and, in addition, have the privilege of paying in easy installments beginning with \$2.50, 10 days after receipt of the books, and \$3.00 monthly thereafter. Take advantage of these convenient terms to add them to your library now.

SEND THIS ON-APPROVAL COUPON
MCGRAW-HILL BOOK CO., Inc.
330 W. 42nd St., New York, N. Y.

Send me Radio Engineering Library, 5 vols., for 10 days' examination on approval. In 10 days I will send \$2.50, plus few cents postage, and \$3.00 monthly till \$23.50 is paid, or return books postpaid. (We pay postage on orders accompanied by remittance of first installment.)

Name.....
 Address.....
 City and State.....
 Position.....
 Company..... Dept. RW-8-38
 (Books sent on approval in U.S. and Canada only.)

A COMBINATION OFFER! RADIO WORLD and "RADIO NEWS"

\$3.50

Canadian and Foreign, \$1.50 extra on this offer.

You can obtain the two leading radio technical magazines that cater to experimenters, service men and students, for one year each, at a saving of \$1.50. The regular mail subscription rate for RADIO WORLD for one year is \$2.50. Send in \$1.00 extra, get "Radio News" also for a year—a new issue each month for twelve months. Total 24 issues for \$3.50 and \$5.00 for foreign countries.

RADIO WORLD 145 West 45th Street, N. Y. City

CHASSIS-CABINETS PANELS & CANS

STANDARD SIZES ON HAND
SPECIAL SIZES MADE TO ORDER

KORROL RADIO PRODUCTS CO.
350-354 Greenwich St. RW-8-38 New York City

Everything in Radio
1938
RADOLEK
COMP.

The Most Complete Radio

Buying Guide **FREE!**

Everything you need in radio. It's all in this new RADOLEK RADIO PROFIT GUIDE. Every repair part for every receiver. Newest radio receivers. New 1938 model public address amplifiers, output for 5 to 100 watts. New model public address speakers. Test instruments. Technical books. Special equipment. Leading standard brands. Every item guaranteed. It must be right or we make it right.

And everything under one roof. You get what you want promptly, and exactly what you want. Radolek's immense stock plus Radolek's efficient organization insures you fastest service. 25,000 service men depend on this service and benefit by Radolek's lowest prices. Send now for your copy of Radolek's Radio Profit GUIDE. It will help you make more money.

-----RADOLEK-----

601 W. Randolph, Chicago, Dept. G-20

Send me the 1938 Radolek Radio Profit Guide **FREE.**

Name.....
 Address.....
 Serviceman? Dealer? Experimenter?

FREE! FREE! FREE! FREE! FREE!

THE RADIO SERVICING AND CONSTRUCTION MANUAL

Worth regularly \$5.00, but free to Superior Instrument purchasers. Handsome black leatherette binder. All data and diagrams clearly reproduced on 6" x 11" x 8½". Over 275 pages. More than 300 diagrams. The beginner as well as the advanced technician will find this book a veritable treasure house of radio information. Photographs, diagrams, construction kinks and hints for building the simplest sets to the most elaborate multitube jobs. Service hints and kinks to make shop work easier and more profitable. The following gives a very limited description of the valuable radio information this wonderful manual contains. Every technician will be proud to own one. HOME RECORDING—Complete data and construction diagrams for recording radio programs. "How to Make Your Own" apparatus, etc. HIGH FIDELITY FROM OLD SETS—This interesting chapter in the MANUAL gives all the material necessary to modernize the sound reproducing end of your radio receiver or amplifier sound system. Baffle data, charts and tables for computing baffle board size and shape for fidelity improvement, etc. REFERENCE DIAGRAMS OF POPULAR SETS—This section alone is of inestimable value to the serviceman. More than 150 complete diagrams of commercial, all-wave radios are included. RADIO THEORY—Work can be speeded and made more profitable by the use of short cuts and practical time savers that come only from a thorough knowledge of radio theory. SHORT WAVE KINKS AND SHORT CUTS—The result of many years of radio experience is condensed into this section of the MANUAL. INTERFERENCE, NOISE REDUCING, and SHORT WAVE AERIAL DATA—Complete data and construction details for the design and construction of the more modern types of antenna. Noise reducing types, doublets, etc. SHORT WAVE CONSTRUCTION—Complete construction plans, diagrams and chassis layouts for a number of efficient sets. NOTE: When ordering more than one instrument you are, of course, entitled to more than one manual. We, therefore, suggest that you accept the extra book to be used as a gift for a friend.

MODEL 1130-S

SIGNAL GENERATOR

WITH AUDIO FREQUENCIES

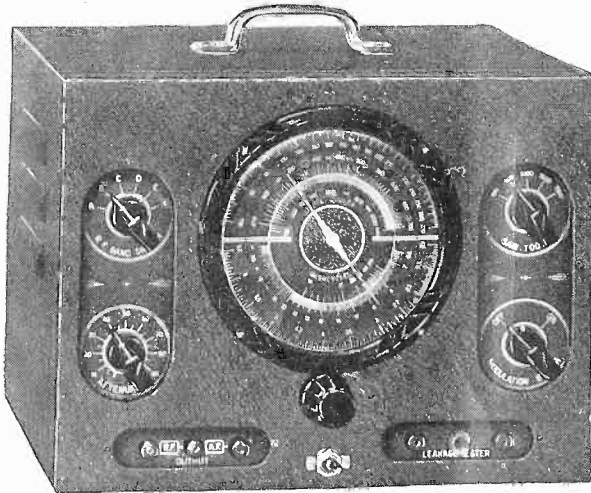

It is with the greatest pride that we announce this new model 1130-S Signal Generator. We predict it will be a great success and meet with the approval of the severest critic. Price considered, it's the finest instrument on the market today. Note the features listed below and judge for yourself! Comes housed in a grey crystalline shielded cabinet with recessed name plates. 6" airplane dial.

SPECIFICATIONS:

1. Combination R.F. and Audio Signal Generator, R.F. 100 kc. to 100 Mc., A.F.—100-7,500 cycles. All direct reading, all by front panel switching.
2. R.F. and A.F. output independently obtainable alone or with A.F. (any frequency) modulating R.F.
3. Accuracy is within 1% on I.F. and Broadcast bands; 2% on higher frequencies.
4. Audio frequencies in 5 bands; 100, 400, 1000, 5000, and 7500 cycles.
5. Giant airplane full vision direct-reading dial.
6. Condenser and other leakages tested to 100 megohms.
7. All services on 90-130 volts A.C. or D.C. (any frequency). Model 1130-S comes complete with tubes, test leads, carrying handle, instructions. Size 12" x 9" x 6½". Shipping weight 15 pounds. Our net price

\$1185

THE NEW MODEL 1110-S

AC-DC VOLT-OHM MILLIAMMETER

A MIDGET IN SIZE—A GIANT IN PERFORMANCE!

Here, without doubt, is the lowest priced, full service instrument ever offered! Permits every possible measurement with absolute accuracy and simplicity of operation. Accuracy 2%. 3½" d'Arsonval type 0-1 meter. Precision resistors. Attractive etched panel. Housed in a modern striped fabricoid case.

SPECIFICATIONS:

0-1.5 volts D.C.	0-100 ma. D.C.
0-15 volts D.C.	0-500 ma. D.C.
0-25 volts D.C.	0-15 volts A.C.
0-75 volts D.C.	0-40 volts A.C.
0-500 volts D.C.	0-75 volts A.C.
0-1 ma. D.C.	0-200 volts A.C.
0-10 ma. D.C.	0-1200 volts A.C.
0-500 ohms	500-500,000 ohms, low ohms read to 1 ohm.

Model 1110-S supplied complete with batteries, test leads and instructions. Size: 8½" x 5" x 3¼". Shipping weight, 5½ pounds. Our net price.. **\$785**

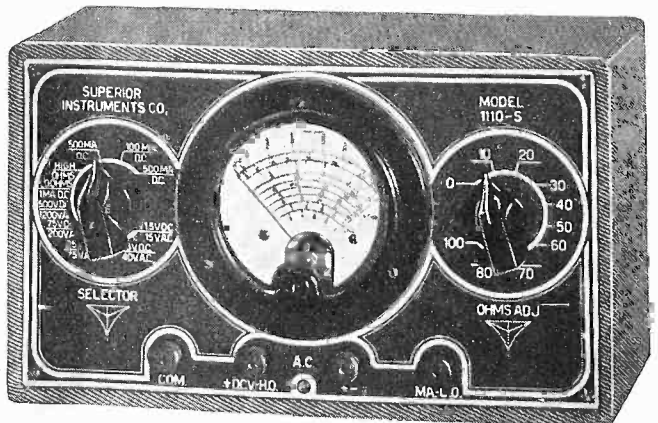

SUPERIOR INSTRUMENTS COMPANY

136 LIBERTY STREET

(PREMIUM OFFER DEPT.)

NEW YORK, N. Y.

"TOKFONE"

PEP...PUNCH...PRICE

THE MOST COMPLETE LINE OF INTER - COMMUNICATING EQUIPMENT

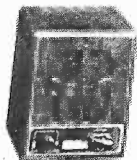

Tokfone Jr. Master Station

The TOKFONE JR. comes with master and remote station and 50 ft. of wire ready to install. This is a low-priced two-way intercommunicating system designed for use among executives, professionals, hospitals, garages, homes, drug stores, etc. Also available for three-wire system called our TOKFONE JR. S-W with switching arrangement on sub-station to cut out background noises at slight additional charge. Net price..... **\$10.75**



Tokfone Jr. Remote Station

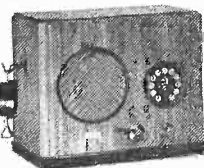

Tokfone Model 142EA Master Station

Model 142EA comes equipped with an earphone for private conversation. It is a complete two-way intercommunicating system from 2 to 11 stations, with a selector switch, low-priced, efficient, economical and fastest method of holding direct two-way amplified communication between two or more persons or departments. Ideal for use for hotel paging, hospitals, department stores, factories, offices, etc. Comes complete with master, remote station and 50 ft. of wire. Net price..... **\$12.95**

Also available with switching arrangement to cut out background noises at small additional charge.

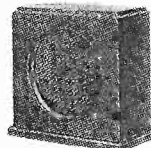

Tokfone Model 142E Remote Station

TOKFONE MODEL 510 MASTER STATION equipped with earphone, selector switch, volume control, 50 ft. of wire, ready to install. Gives you complete inter-communication between any stations or any group of stations.

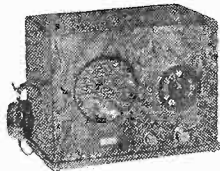

Tokfone Model 510 Master to Master Station

Direct conversation can be had with this system without the use of a talk-listen switch. Comes with earphone and ready to use. Per station net **\$12.00**

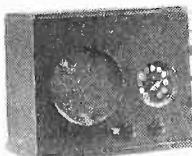

Tokfone Model 141 Master Station

TOKFONE MODEL 141 is a two watt Beam Power System comes complete with master, 50 ft. of wire and one remote station. Ideal for use where great volume is desired for offices, factories, small industrial plants, garages, etc. Up to 10 stations can be hooked up with this system. Net price.. **\$17.50**

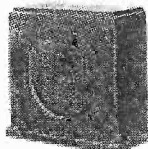

Tokfone Model 141A Remote Station

The **TOKFONE WIRELESS MODEL 140** Inter-Communication System which comes complete with two units, both units being master stations. No wire is necessary to hook up these systems as they work direct over the AC or DC 110-volt line.

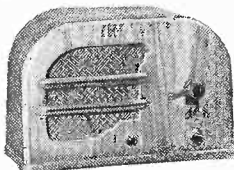

Tokfone Model 140 Wireless Communicator

All that is necessary to put the TOKFONE Wireless Model in operation is

to plug each station into the nearest outlet. Truly a miracle of modern science. Especially useful in the home where it may be used between the kitchen and playroom, or kitchen and sickroom or kitchen and bedroom to carry on conversation between the children or the invalid as the occasion may arise. Net price per pair **\$17.95**

TOKFONE Model 144 comes complete with master station, Hypower Supply, sub station and 100 ft. of wire and is a 10 watt combined paging and inter-communicating system which uses 6" P.M. speakers throughout. This system has a master switch for paging all outlying stations simultaneously, selector switch for calling single outlying stations. Outlying

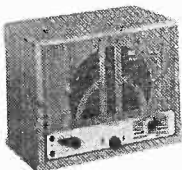

Above illustration shows complete Model 144 system comprising master sub station, Hypower Supply

stations can call the master station, etc. Also comes available with switch and three wire system to shut out background noise. Extremely sensitive and powerful using 2-6B5 push pull on the output. Master, sub station, Hypower Supply and 100 ft of wire, net **\$32.95** Three Wire Model 144SW at slight additional charge.

LICENSED, by agreement with Electrical Research Products, Inc. UNDER PATENTS OWNED or CONTROLLED BY WESTERN ELECTRIC CO. AND AMERICAN TELEPHONE AND TELEGRAPH COMPANY.

Send for Catalog Showing Complete Line

REGAL AMPLIFIER MANUFACTURING CORP.

16 WEST 17th STREET

Cable address: "Ramcoamp"

NEW YORK CITY

RADIO BOOKS

Mathematics of Radio Servicing

Complete home-study training in useful radio mathematics. Explains and interconnects simplified arithmetic and algebra with everyday radio problems. 8½ x 11 in.

Public Address Systems

A practical handbook, full of useful information, well illustrated. Considers in detail various microphones, radio and phono inputs, feed-back, mixing and volume controls, use of vacuum tubes, coupling, loudspeaker placement, DB, and hundreds of other points. Many actual circuit diagrams. Everything about P. A.

Radio Servicing Short-Cuts and Money-Making Ideas

A new and different book that tells how radios can be repaired quickly with the absolute minimum of test equipment. Proves that by actual test 9 out of 10 sets can be repaired with simple tools and ohmmeter. The author, M. N. Beitman, has been in the service work for years and kept data on these important helpful facts. Page after page of practical and money-making ideas applicable to all sets.

Special price, 50¢ each book, postpaid.

SUPREME PUBLICATIONS 3729 W. 13 St. Chicago, Ill.

KNOWLEDGE

Practical

RADIO MATHEMATICS

A new handbook considers in detail, various phases of radio servicing. Explains the use of simple arithmetic and algebra in connection with units, meters, Ohm's Law, A.C., ohmmeter testing, wattage rating, parallel and series circuits, tubes, curves, DB, inductance, etc., etc.

Principles of

PUBLIC ADDRESS SYSTEMS

Another well written book by M. N. Beitman. Packed with needed information on this complex subject, well illustrated. Everything about P. A. from microphones to speaker placement. Many circuit diagrams.

Price, 50c each book.

Literature on request.

SUPREME PUBLICATIONS

3729 W. 13th St.

Chicago, Illinois

TREASURE-HUNTING CIRCUITS

By J. E. ANDERSON

Radio devices for locating buried treasure, deposits of ore bodies, etc., open a vast field for potential riches. A detailed discussion by J. E. Anderson appeared in the January, 1938, issue. Send 25¢ for a copy

RADIO WORLD

145 West 45th St., N. Y. City

CLASSIFIED ADVERTISEMENTS

7 cents a word. \$1.00 minimum.

HIGH GRADE GOLD, ORE SPECIMENS, rare, beautiful. 50 cents postpaid. Copy, California Mining Journal, mining information, free with order. Sybil Mines, French Gulch, Cal.

WANTED TELEVISION CAMERA AND RECEIVER, disc type, sixty lines or better. Fully described. Box No. 765, Jefferson, Ohio.

HAVE YOU BACK NUMBERS of Radio World, for March, July, November, 1936; Jan., Feb., March, April, July, 1935? If so, please communicate with Radio World, 145 West 45th St., New York, N. Y.

SUGAR DIABETICS—Send for free booklet. Otto Cisky, Leeburg, Florida.

RADIO EXPERIMENTERS AND SET BUILDERS; parts and kits of parts for Improved Little Giant R235, six tube R233, Pre-amplifier R228, Portable battery R223, Little Giant R220 and 205 and 6 volt R238. Guaranteed specified parts. Lund Manufacturing Co., Dept. R.W., 43 East Ohio, Chicago.

HAVE YOU BACK NUMBERS of Radio World, for April, July, September, October, November, December, 1936; February, March, April, June, 1937; February, May, 1938? If so, please communicate with Radio World, 145 West 45th St., New York, N. Y.

AMATEUR RADIO LICENSES,

HOME STUDY COURSE IN CODE AND THEORY

REASONABLE, EFFICIENT and THOROUGH. RESULTS GUARANTEED.

AMERICAN RADIO INSTITUTE

1430 North Dearborn Parkway, Chicago, Illinois

MAILING LISTS

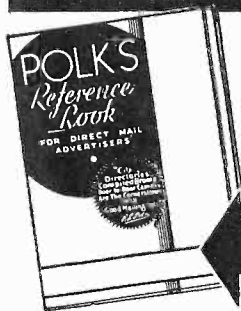

GET OUR FREE REFERENCE BOOK and MAILING LIST CATALOG

FREE

Gives counts and prices on accurate guaranteed mailing lists of all classes of business enterprises in the U. S. Wholesalers—Retailers—Manufacturers by classification and state. Also hundreds of selections of individuals such as professional men, auto owners, income lists, etc.

Write today for your copy

R. L. POLK & CO.

Polk Bldg.—Detroit, Mich.

Branches in Principal Cities

World's Largest City Directory Publishers

Mailing List Compilers. Business Statistics. Producers of Direct Mail Advertising.

Literature Wanted

Readers whose names and addresses are printed herewith desire trade literature on parts and apparatus for use in radio construction. Readers desiring their names and addresses listed should send their request on postcard or in letter to Literature Editor, Radio World, 145 West Forty-fifth Street, New York, N. Y.

- Stanley A. Greenstein, 5716 Willow Ave., Philadelphia, Penn.
- Jack Heiman, 2903 E. Cherry St., Seattle, Wash.
- John R. Cruik, 1213 B St., S.E., Washington, D.C.—Service equipment and service parts.
- W. O. Dellinger, Medaryville, Ind.
- W. H. Mount, 24 Maple St., Princeton, N. J.
- Joseph Salomon, Manager, Radio Laboratory, Grand Rue, Port-Au-Prince, Haiti, West Indies.
- Wm. Armour John Keller, R.D. No. 7, West Chester, Penn.
- H. Cables, Radio Service, Roblin, Man., Canada.
- C. Colley, P. O. Box 64, Powderly, Ala.
- W. Schlicht, 30 Decker St., Buffalo, N. Y.
- Wm. Block, Caixa Postal 99, Bahia, Brazil, So. Amer.
- E. Sproul, 1125 Grand Concourse, New York City.

- Al. Grzegorzewicz, c/o State Sanatorium, Howell, Mich.
- H. A. W. Versfeld, G. E. B., Ngawai.—(Java.), D. E. I.
- Wm. Evory, R. No. 3, Coudersport, Penn.
- L. B. Prosnitz, 295 Madison Ave., New York City.
- Lanny DeAcutis, 1772 East 172nd St., Bronx, New York City.
- Derrell Shearer, Rock Creek San., Pe Ell, Wash.
- W. J. Souldane, 90 Wilmot Road, Dartford, Kent, England.

BLUEPRINTS

POCKET VOLT-OHM-MILLIAMMETER

ALL the rage these days is the pocket-sized volt-ohm-milliammeter. Our Blueprint No. 381 shows how to build such an instrument, using a perfected circuit invented by H. J. Bernard. It is based on a 0-1 milliammeter and permits use of the scale as it exists on the meter for all a-c and d-c voltages and d-c currents. Data for the two resistance ranges are given. The instrument size is 3x5 $\frac{1}{2}$ x3 inches and the ranges are: 0/10/100/1,000 volts d.c. at 1,000 ohms per volt, 0/16/100/1,000 volts a.c. (unusually extended scale) 0/1/10/100/1,000 milliamperes d.c. 0/500 ohms and 0/250,000 ohms.

A twelve-position, single deck switch is used, four binding posts, an on-off switch and an ohms adjuster. The instrument circuit is of highly advanced design and thoroughly engineered.

SIGNAL GENERATOR

COVERING from 120 kc to 40,000 kc (40 mc), the Signal Generator covered by our Blueprint No. 382 has all the finest features for practical servicing.

The generator operates on 90-130 volts a.c. or d.c., provides two forms of amplitude modulation and also built-in frequency modulation. Both the line frequency and a 400-cycle note are available for modulation. The output attenuator (volume control) is effective on all bands, as leakage, or line-cord feedback, is at minimum.

The r-f oscillator is a 6J5G, the rectifier a 37, 76 or 1-A.

This is a highly perfected and expertly engineered signal generator designed and developed by H. J. Bernard.

Order one or both.

25c
Each
(Postpaid)

RELIABLE RADIO CO.

143 W. 45 St., New York, N. Y.



A Will costs only one dollar. It insures her with your worldly possessions, saves family disputes, litigation, lawyers' bills, and saves your wife untold troubles if anything should happen to you.

Our booklet of Standard Last Wills and Testaments with extra clauses so that in secret, without other legal aid, exactly the kind of Will desired can be made.

Select the Will you like best and copy it on the legal blank Will form that comes with our booklet. Full, simple, clear instructions tell how to sign and have it witnessed so it can be made absolutely legal and non-breakable.

Will Booklet and Legal Form complete, One Dollar.

Money Back on request.

Address Dept. F. C., Radio World, 145 West 45th Street, New York City.

RADIO WORLD AND POPULAR MECHANICS MAGAZINE—Radio World is \$2.50 a year, and Popular Mechanics Magazine is \$2.50 a year. Popular Mechanics Magazine does not cut rates, but Radio World will send both publications to you for one year for \$3.75. RADIO WORLD, 145 West 45th Street, New York City.

Expertly Selected Radio Books

Best Calculated to Advance Your Knowledge and Expedite Your Operative Technique



Undisputed Leader of All Radio Service Books

Alfred A. Ghirardi's "Modern Radio Servicing" is the standard book in the field. It contains everything you need to know about radio servicing as it is practiced today by the most successful organizations in the country. All about test instruments, their theory, operation and construction, complete with circuit diagrams. All the latest test and repair methods and trouble-shooting short-cuts. All the most successful repair methods. Big sections on noise and interference "spotting" and elimination in broadcast and all-wave sets; on aligning receivers (including cathode-ray method); AVC and QAVC circuits; auto radio; sales and advertising; etc. More than 1,300 pages. 749 illustrations. Order Cat. MRS, postpaid, \$4.00.

Ghirardi's "Radio Field Service Data," new edition, has more than 400 pages of practical "bench data"—twice as much as the first edition. I.F. peaks for 5,226 superhets, including 1937 models. "Case Histories" for over 1,500 receivers, giving actual trouble symptoms and remedies for each one. Ignition system data, interference remedies, and electrical wiring diagrams for all cars. Latest data on glass and metal tubes. In all, more than 70 different charts, diagrams and tables arranged in handy form for quick reference. Now in loose-leaf form, it is easily kept up to date with the Supplements issued every January and June. Order Cat. RFS, postpaid, \$2.50 (includes supplements for one year).

Combination price of \$6 gives you both these indispensable servicing books, together with one year's supplements to the Data Book. Order Cat. COMRFS.

Other Top Selections

"THE INDUCTANCE AUTHORITY," by Edward M. Shiepe. Enables winding radio-frequency solenoids to 1% accuracy without computation. Order Cat. INA @ \$2.00, postpaid. Price includes 18x20" inductance-capacity-frequency chart as supplement.

"MEASUREMENTS IN RADIO ENGINEERING," by Frederick Emmons Terman, revealing the measurement equipment and technique, from the pen of a great authority. 400 pages, 6x9. 208 illustrations. Order Cat. TMRE, postpaid, \$4.00.

"PRACTICAL RADIO COMMUNICATION," by Arthur R. Nilson and J. L. Hornung, a complete instruction course and reference guide in radio station operation. Principles, systems, equipment, operation (including short and ultra waves). 754 pages, 6x9; 435 illustrations; flexible cover. Order NHPRC, postpaid, \$5.00.

The Handiest Handbook of All!

A handbook is handy when it "has what it takes," is expertly referenced, and quickly provides authoritative solutions. This Keith Henney's "Radio Engineering Handbook" certainly does. It's a great book for engineer or experimenter. Really

24 reference books under one cover. 850 pages, 4 1/2 x 7, fully illustrated. Flexible cover. Order Cat. HREH, postpaid, @ \$5.00. New edition.

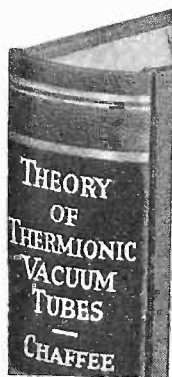

The Tube Authority

A fundamental treatise, comprehensive and authoritative. "Theory of Thermionic Vacuum Tubes," by E. Leon Chaffee, Professor of Physics, Harvard University, covers the field. A knowledge of algebra and some calculus are necessary for full appreciation of the contents. Treatment is mathematical. 652 pages, 6x9; 357 illustrations. Order Cat. CTTVT, postpaid, @ \$6.00.

Any or All of Above Books Sold on Five-Day Money-Back Guarantee!

BOOK DEPARTMENT, RADIO WORLD, 145 W. 45th ST., N. Y. C.

TAKE THE *Easy* WAY TO LEARN RADIO

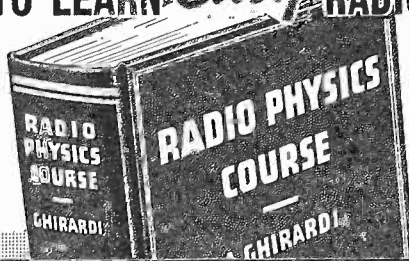

Ghirardi's 1 VOLUME RADIO PHYSICS COURSE \$4-
972 pp.

YOU too can pick up RADIO quickly—if you will let Ghirardi help you. In almost no time at all you'll completely master the subject, because Ghirardi's 972-page home-study RADIO PHYSICS COURSE is such easy reading, so simple, so absorbing, and so exciting that you won't lay it down from the time you start with simple electrical theory to where you wind up with television under your belt! Ghirardi makes everything about RADIO ELECTRICITY, SOUND—and even TELEVISION—as simple as A B C! That's why more radio schools and students use it than any other radio book in the world. They say it's the best there is—at any price!

What You Will Learn from This Book!

Sound, Speech and Music . . . Electrons . . . Electric Current . . . Electric Units and Circuits . . . Resistance . . . Ohm's Law . . . Batteries . . . Magnetism . . . Electromagnetism . . . Transformers . . . Inductance . . . Condensers . . . Alternating Current Circuits . . . Filters . . . Electrical Measuring Instruments . . . Radio Waves and Radiations . . . Broadcast Stations . . . Receiving Equipment . . . Vacuum Tubes . . . Radio and Audio Frequency Amplification . . . Superheterodynes . . . Loud Speakers . . . Battery Operated Receivers . . . Power Supply Units . . . Electric Receivers . . . Automobile and Aircraft Receivers . . . Phonograph Pickups . . . P. A. Systems . . . Short-Wave Receivers . . . Photo-electric Cells . . . Television . . . Antennas and Grounds . . . Testing and Servicing Receivers . . . Sound Motion Pictures . . . Appendixes . . . 856 Review Questions for Self-Study . . . AND LOT'S MORE!

Quick Action Gets You Started!

The 506 illustrations alone are worth much more than the amazingly low price of only \$4 for the entire book! When are you going to start? Don't put it off—get going—learn RADIO NOW. It's easy from this one great book! Remember every penny of your money back if not fully satisfied! Books sent postpaid anywhere!

Snip this Coupon out!

-MAIL IT NOW!

Enclosed find \$4. Send my RADIO PHYSICS COURSE at once, postpaid (Foreign \$4.50).
 Send me a free circular describing this book.
 Name _____ State _____
 Street & City _____

MONEY-BACK GUARANTEE!

"AN HOUR A DAY WITH RIDER"

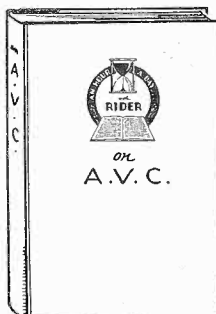

John F. Rider has written a series of pocket-sized books, 60c each, with the idea readers will spend an hour a day reading and studying them, and thus acquiring a full servicing knowledge. Latest of these is devoted to automatic volume control (a.v.c.). The subject is fully covered. 64 pages. Well illustrated. Order Cat RAVC postpaid @ 60c

"ALTERNATING CURRENTS"

"Alternating Currents in Radio Receivers," Hour-a-Day, is a comprehensive book covering the basic functions of the various components of a radio receiver, what each unit does and how it works. Various types of parallel and series resonant circuits, different kinds of coupling, inductance, reactance, impedance, and how these electrical phenomena are employed in radio practice, are fully explained. 80 pages. Order Cat. R.A.C., postpaid, @ 50c.

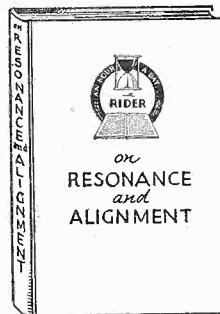

A clear explanation of what happens when a circuit is tuned to resonance. All types of circuits described and how and why they work. How these circuits should be aligned so that maximum efficiency is obtained. Knowledge of the latest high fidelity i-f. amplifiers is becoming more and more necessary and "Resonance and Alignment" tells what you should know about all this. 64 pages. Order Cat R.R.A. postpaid, @ 60c

"D. C. VOLTAGE DISTRIBUTION"

Every receiver contains some sort of d.c. distribution system supplying the d.c. voltages from the power unit to the elements of the tubes. The many different forms these systems take are thoroughly described in Rider's "D.C. Voltage Distribution," which explains networks from the simplest to the most complicated. The calculations of the value of the resistors and their wattage ratings are more clearly described than ever before. In this brand new combination of theory and practice. 64 pages. Order Cat. EDCVD, postpaid, @ 60c.

4 Above four "Hour-a-Day" books are all of the series published to date. All have hard covers. The order of their publication is No. 1 A.C.; No. 2, Resonance; No. 3, D.C.; No. 4, A.V.C.]

RIDER'S MANUALS

Vol. VII—(new) Rider's Volume VII has 1800 pages! This is the biggest and best Manual that has ever been published. In Volume VII the number of manufacturers has been increased and therefore the size of the book was increased. The greatest collection of servicing data ever gathered and not only from the large manufacturers, but the smaller ones as well. Not only 1936-37 sets, but many old timers. 100-page Index . . . \$10.00
 Vol. VI—Data on sets produced up to October, 1935—the start of the metal tube era—are contained in this Manual. Double-Spread pages are used for the more complicated receivers. 1240 pages, \$7.50
 Vol. V—Sets manufactured up to October, 1934—and older sets, too—are covered in this volume. Electrical and mechanical data are given so that everything is where you want it. 1,200 pages, \$7.50
 Vol. IV—In this volume will be found information on receivers manufactured up to March, 1934. 1,060 pages . . . \$7.50
 Vol. III—Sets released from the middle of 1932 to June, 1933 are presented in this volume. 1,070 pages . . . \$7.50
 Vol. II—Data are here contained on sets manufactured between early 1931 and the middle of 1932. Many sets unavailable when Vol. I was published will be found in Vol. II. 800 pages . . . \$6.50
 Vol. I—This volume contains information on the old timers—from 1919 up to 1931—and there are still many of these in use today. 1,000 pages, \$7.50 [Order Rider Manuals by volume numbers as listed above. Remit with order. Books will be sent postpaid.]
 RADIO WORLD, 145 W. 45th St., New York, N. Y.

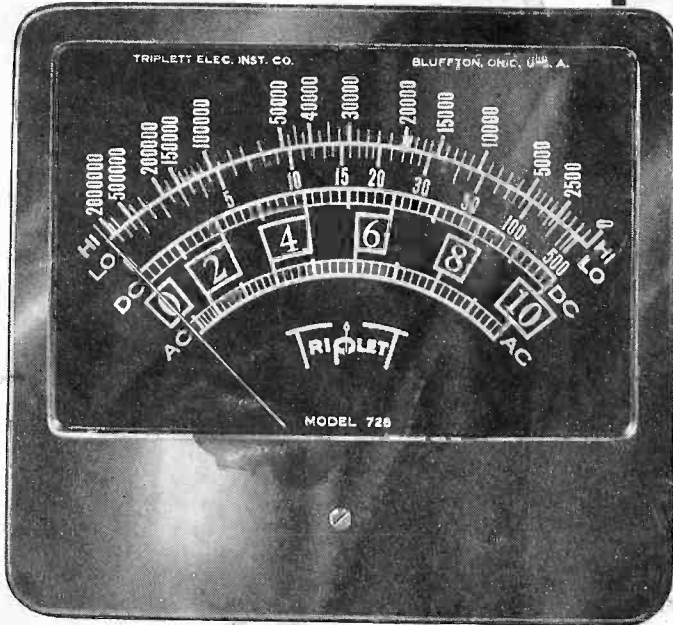

INCREASE
Readability
Impressiveness
OF YOUR
PANELS

New 7" Foundation Instrument
25,000 Ohms per volt D.C.
Extra Long 6" Scale

Uses attractive glass dial with edgewise illumination. Dial face is black with scale markings for A.C., D.C. and resistance ranges in beautiful contrasting colors of red, white and yellow.

This new 7" foundation instrument is ideal for the service panel. Besides increasing accuracy with its extra long 6" scale, the heavy glass dial with its contrasting colors for each individual scale adds lustre to any shop. Priced down to the pocketbook of any serviceman. Molded case, semi-flush mounting. No screws exposed.

7" Foundation instrument only,
 Dealer Price\$18.33

A.C.-D.C. Kit only (less instrument),
 Dealer Price\$11.17

A.C.-D.C. Control Box, completely assembled (less instrument), Dealer Price\$15.67

This control box contains all necessary switching mechanism, shunts, resistors, plug-in rectifier, terminals, wires, batteries, etc., as furnished in A.C.-D.C. Kit, but completely assembled in compact box ready to hook up and use. Box is metal with black wrinkle finish. Silver and black etched panel.

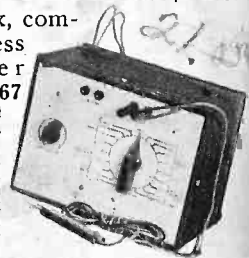

With kits listed, following readings can be obtained with this instrument: D.C. Volts, 0-10-50-250-1000 at 25,000 Ohms per Volt; 0-50-250 Microamperes, 0-1-10-50-250-500 Milliamperes; 1/2 to 500 Low Ohms; backup circuit; 20,000, 200,000 Ohms and 2 Megohms at 1 1/2 Volts. Uses additional batteries for higher resistance measurements. A.C. Volts, 0-10-50-250-1000 at 1000 Ohms per Volt. Plug-in type copper oxide rectifier easily replaced in case of overloading.

★ **SEE YOUR JOBBER OR WRITE DIRECT** ★

TRIPLETT
Precision
ELECTRICAL INSTRUMENTS

The Triplett Electrical Instrument Co.
 277 Harmon Dr., Bluffton, Ohio

.....Please send me more information on
 New 7" Foundation Instrument;

.....Kit;Control Box.

Name

Address

City..... State.....