

OCT.  
1937

# RADIO WORLD

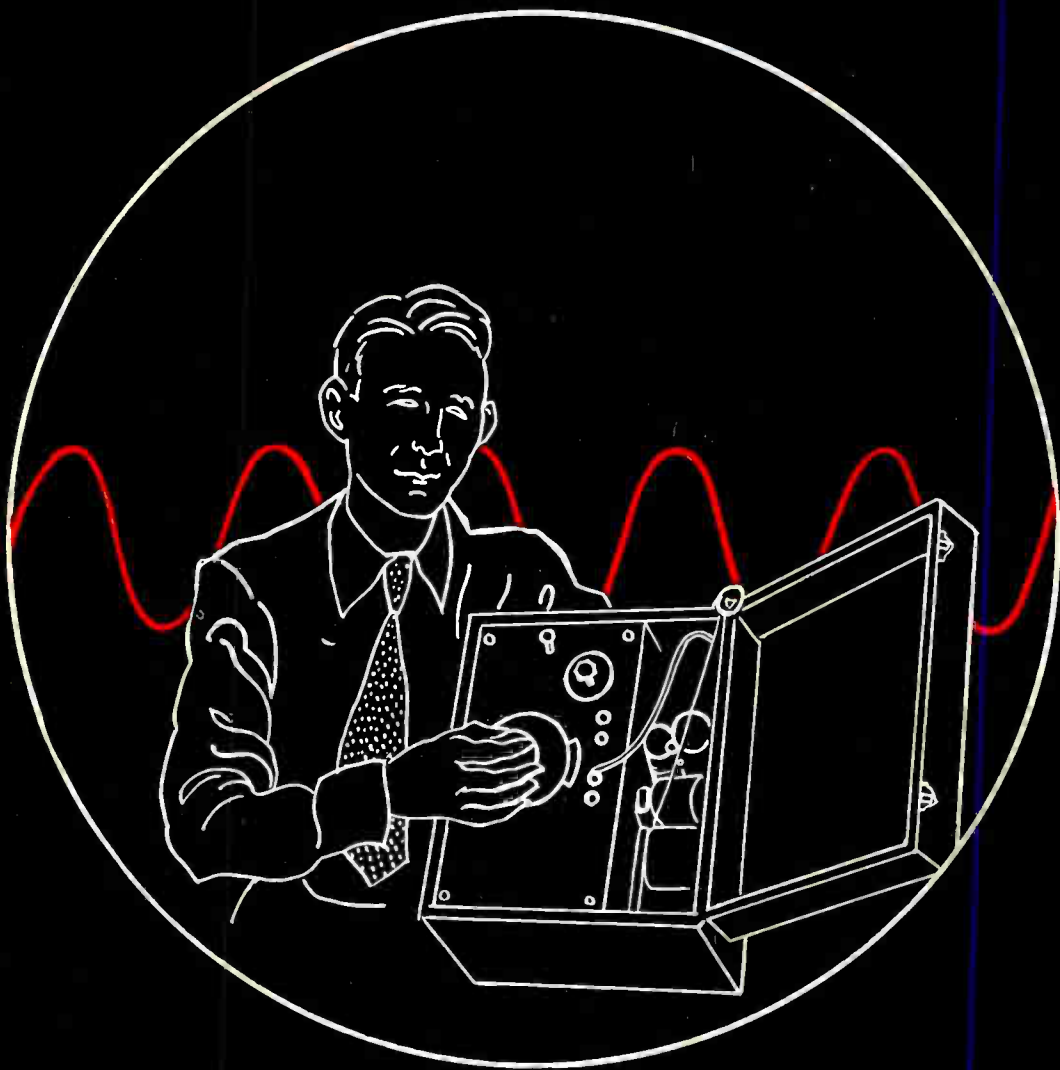

25¢  
PER COPY

# WHEREVER UNINTERRUPTED OPERATION IS ESSENTIAL



Type 52



Type 59



Type TB



Type TJ

## CORNELL-DUBILIER CAPACITORS

No citation could be more impressive than the acceptance of Cornell-Dubilier capacitors in installations where unflinching service is imperative. The Coast Guard Cutter in the far reaches of the Arctic . . . the China Clipper spanning the Pacific . . . the Broadcast Station in New York . . . all depend on transmitters which are equipped with C-D capacitors.

Carefully engineered and constructed to withstand every degree of abuse, and having served dependably in every phase of the radio and electrical industries for more than twenty-seven years . . . C-D capacitors are the internationally accepted standards. Look for the C-D trademark. It is truly a symbol of quality. Complete technical literature supplied on request.

★ *World's Oldest and Largest Exclusive Manufacturers of Capacitors* ★

Photographs courtesy U. S. Coast Guard Service,  
Columbia Broadcasting System, Pan-American  
Airways, Inc.

• MICA • DYKANOL • PAPER • WET and DRY ELECTROLYTICS •  
*Cornell-Dubilier Electric Corporation • 1024 Hamilton Boulevard • So. Plainfield, N. J.*



# **CORNELL-DUBILIER**

## **ELECTRIC CORPORATION**

### **South Plainfield, New Jersey**

# Read what happened



**YES!**

I'll take your training. That's what S. J. Ebert said. He is making good money and has found success in Radio.

to these  
two men  
when I said:



**NO!**

I'm not interested. That's what this fellow said. Today he would be ashamed if I gave you his real name and salary.

## I will Train You at Home in Spare Time for a GOOD JOB IN RADIO

These two fellows had the same chance. Each clipped and sent me a coupon, like the one in this ad. They got my book on Radio's opportunities. S. J. Ebert, 104-B Quadrangle, University of Iowa, Iowa City, Iowa, saw Radio offered him a real chance. He enrolled. The other fellow, whom we will call John Doe, wrote he wasn't interested. He was just one of those fellows who wants a better job, better pay, but never does anything about it. One of the many who spend their lives in a low-pay, no-future job, because they haven't the ambition, the determination, the action it takes to succeed.

But read what S. J. Ebert wrote me and remember that John Doe had the same chance: "Upon graduation I accepted a job as serviceman, and within three weeks was made Service Manager. This job paid me \$40 to \$50 a week compared with \$18 I earned in a shoe factory before. Eight months later I went with station KWCR as operator. From there I went to KTNT. Now I am Radio Engineer with WSUL. I certainly recommend the N. R. I. to all interested in the greatest field of all, Radio."

**Get Ready for Jobs Like These  
Many Radio Experts Make  
\$30, \$50, \$75 a Week**

Do you want to make more money? Broadcasting stations employ engineers, operators, station managers and

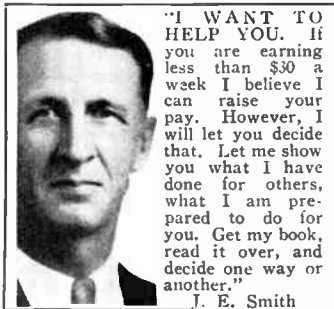

"I WANT TO HELP YOU. If you are earning less than \$30 a week I believe I can raise your pay. However, I will let you decide that. Let me show you what I have done for others, what I am prepared to do for you. Get my book, read it over, and decide one way or another."  
J. E. Smith

pay up to \$5,000 a year. Spare time Radio set servicing pays as much as \$200 to \$500 a year—full time Radio servicing jobs pay as much as \$30, \$50, \$75 a week. Many Radio Experts operate their own full time or part time Radio businesses. Radio manufacturers and jobbers employ testers, inspectors, foremen, engineers, servicemen, paying up to \$6,000 a year. Radio operators on ships get good pay and see the world besides. Automobile, police, aviation, commercial Radio and loud speaker systems offer good opportunities now and for the future. Television promises many good jobs soon. Men who have taken N. R. I. Training are holding good jobs in all these branches of Radio.

**Many Make \$5, \$10, \$15 a Week Extra  
in Spare Time While Learning**

Almost every neighborhood needs a good spare time serviceman. The day you enroll I start sending you Extra Money Job Sheets. They show you how to do Radio repair jobs, how to cash in quickly. Throughout your training I send you plans and ideas that have made good spare time money for hundreds of fellows. I send you special Radio equipment, show you how to conduct experiments, build circuits illustrating important Radio principles. My training gives you valuable, practical experience, while learning.

**Get My 64-Page Book Free**

Mail the coupon now for "Rich Rewards in Radio." It's free to anyone over 16 years old. It points out Radio's spare time and full time opportunities and those coming in Television; tells about my Training for Radio and Television; shows you letters from men I have trained, telling what they are doing and earning; tells about my Money Back Agreement. MAIL THE COUPON in an envelope, or paste it on a penny post card—NOW!

**J. E. SMITH, President  
National Radio Institute,  
Dept. 7KM4, Washington, D.C.**



**MAIL  
THIS NOW**

### FOR FREE BOOK OF FACTS ABOUT RADIO

J. E. SMITH, President, National Radio Institute,  
Dept. 7KM4, Washington, D.C.

Dear Mr. Smith: Without obligation send me free the Sample Lesson and your 64-Page Book, "Rich Rewards in Radio," telling about spare time and full time Radio opportunities, and how I can train for them at home in spare time. (Please write plainly)

Name ..... Age .....

Address .....

City ..... State ..... 14X-1

### Lesson on Radio Servicing Tips FREE

I'll prove that my Training gives practical, money-making information, that it is easy to understand—that it is just what you need to master Radio. My sample lesson text, "Radio Receiver Troubles—Their Cause and Remedy," covers a long list of Radio receiver troubles in A.C., D.C., battery, universal, auto, T. R. F., super-heterodyne, all-wave, and other types of sets. And a cross reference system gives you the probable cause and a quick way to locate and remedy these set troubles. A special section is devoted to receiver check-up, alignment, balancing, neutralizing and testing. Get this lesson Free. No obligation.

# FULL 2 VOLTS OUTPUT



**AUDIO  
B. F. O.**  
0-10,000  
Cycles.

The **AUDIOMETER** has Superior's Lifetime Black Crinkle Finish, fired in a vast furnace. Windowed dial cutout, smart marked panel and leather handle aid in producing the fetching appearance.

IT is sad news to you when stock you own crashes below its previous lowest level, good news when some instrument you need is produced at a selling price far below the lowest previously recorded. Such a record-breaking fact attends the introduction of our audio beat frequency oscillator, the **AUDIOMETER**. This precision device covers 0-10,000 cycles, with direct-frequency reading 8-1 vernier dial (plus costly planetary drive) and direct-reading output volts, 0-2 volts. Besides the attenuator, or output voltages control, there are on-off switch, zero frequency adjuster (lower center) and two output tip jacks. There are five tubes, of which two serve as amplifiers.

**BRILLIANTLY** engineered, so output is a perfectly stable, pure sine wave at all frequencies, and there are no dead spots, weak spots or soft spots, the **AUDIOMETER** is carefully made in our modern factory by un-hurried experts. It has two separate tubes as r-f oscillators, an abnormally large ratio of capacity to inductance in both, a rectifier and a two-stage audio amplifier. Hence full 2 volts output are obtained, about eight times the voltage delivered by the usual beat frequency oscillator that costs from twice to ten times as much. Besides being an outstanding engineering achievement, the **AUDIOMETER** has a most fetching appearance. Complete, with test leads. (Shipping weight, 7 lbs.).  
Net price .....

**\$14.40**

## The New **ALLMETER** for Rapid, Accurate **\$10.40** Measurements

The **ALLMETER** is a multi-purpose meter, 1,000 ohms per volt, d'Arsonval movement, for measuring a.c. and d.c. volts, a.c. and d.c. currents, capacity, decibels, resistance and inductance.

Volts and milliamperes, 15-15-750.  
Capacity, .01-50 mfd., including electrolytics.  
Decibels, for total change of 42 db.  
Resistance, .03-500 and 500-500,000 ohms.  
Inductance, 5 to 1,000 henries.



The Allmeter, 21 instruments in one.

A copy of "The Inductance Authority" **FREE** with order for either of above instruments.

ORDER DIRECT FROM

**SUPERIOR INSTRUMENTS CO.** 136 Liberty St., New York, N. Y.  
Dept. RW10

Send for our free Catalogue PV, in colors, describing our complete line.

# EVERYTHING IN RADIO *at Lowest Prices*

FOR DEALERS · SERVICEMEN · SOUNDMEN · AMATEURS · EXPERIMENTERS

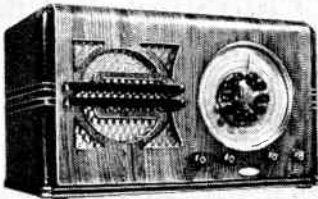

**65 GREAT NEW KNIGHT RADIOS!**  
Automatic Tuning, powerful performance and rich tone are the outstanding features of the new KNIGHT Radios. 5 to 16 tubes, for AC, AC-DC, 6 Volt, 32 Volt, Battery and Auto operation. Beautiful Console, Chairside, Phano-radio, Table and Chassis models.

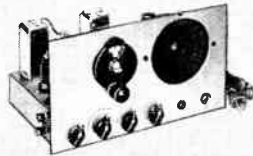

**32 TESTED AND APPROVED KITS!**  
From a 1 Tube Set to 14 Tube Super-het. Write for Free Parts Lists for: 1 Tube Set (R209); 2 Tube AC-DC (R211); Flashlight Cell Set (R227); 3 Tube (R224); Call System (R242), etc.

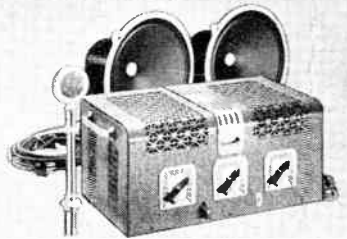

**26 MODERN P. A. SYSTEMS!**  
KNIGHT "Integrated" P. A. Systems from 8-60 watts—portable, permanent, and mobile—for 110 Volt, 6 Volt and Universal operation. P. A. for every need!



**26 LATEST AMATEUR RECEIVERS!**  
All leading makes—National, Hallicrafters, RCA, Sargent, Hammarlund, etc. Newest RCA, Utah and All-Star X-mitters; books, parts, tools. ALLIED is Amateur Headquarters!

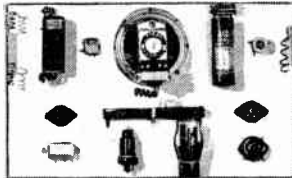

**12,000 RADIO PARTS!**  
The 1938 ALLIED Catalog offers a tremendous assortment for building or repairing any circuit. It enables you to spot the part you want—conveniently, quickly, accurately!



**68 NEWEST TEST INSTRUMENTS!**  
Here's Radio's most extensive line of test instruments—new 2" Cathode Ray Oscilloscope, Oscillographs, Analyzers, Tube-Checkers, Set-Testers, Meters, etc.

*Allied's 1938 Catalog*  
**BRINGS YOU THESE AMAZING NEW DEVELOPMENTS**

WRITE FOR ALLIED'S NEW 1938 CATALOG—  
RADIO'S LEADING SUPPLY GUIDE!

Send for this great book today—164 big pages packed with Everything in Radio! Thousands of parts, dozens of radio sets, kits, Public Address systems, Amateur receivers, test instruments, books, tools, etc.—at money-saving prices. It's new, complete, and entirely different from any other radio book ever published. Make your radio buying easier and more profitable—write for your FREE 1938 ALLIED Catalog now—it's Radio's easy-to-read, easy-to-shop, easy-to-order-from book!

*Free*  
SEND COUPON

164 PAGES PACKED  
WITH RADIO VALUES



Allied Radio  
Dept. 16-K8

833 W. Jackson Blvd.  
Chicago, Ill.

Send me your FREE 1938 Radio Catalog.

Name

Address

City  State

**ALLIED RADIO**  
CORPORATION  
833 WEST JACKSON BLVD., CHICAGO, ILL.

# Now You Can Get MORE MONEY IN RADIO



F. L. Sprayberry

## AN AMAZING FREE BOOK

that shows how you can earn from \$30 to \$60 a week.



### TEST YOURSELF ON THESE QUESTIONS

In installing an antenna for short-wave reception, using a coupling transformer, what trick can you use to avoid transposition blocks in the downlead?

?

In trying to locate hum during shortwave reception with an output meter across the B supply, should you, or should you not, disconnect the antenna first?

?

Would it be all right to use the 524 metal rectifier tube in a set having a single 6L6 output tube, and also in a set using two such power tubes in push-pull or in parallel?

?

You'll know the complete and correct answer to these and thousands of similar practical questions, once you've taken my training. You'll have Radio at your fingertips—and that means cash in the pocket. Get the facts about my training—get my book "More Money in Radio" today!

**T**HERE'S money in Radio for men who go after it the right way. Folks are paying cash to have old circuits rebuilt, while tricky service jobs on the new sets provide steady income for men who know how to handle the work. The free book "More Money in Radio" tells you about my advanced home-training plan—a three-way program of theory, practice, and business methods—which qualifies you to make money quick. You MUST read this book!

#### Earn \$5 to \$25 in Spare Time

You wouldn't be reading this if you weren't interested in Radio—consequently, you're the man I want to help. You know enough about Radio to make fast progress with my training. Almost from the start, you can make between \$5 and \$25 in spare time, servicing sets. I show how to get the business and how to handle it—why not make your hobby pay you cash?

#### A Job or Your Own Business

You can earn while you learn, and my training fits you for a good job in any one of Radio's many fascinating branches. Many

of these jobs pay \$30 to \$60 a week, and more. Also, my training actually sets you up for business for yourself.

#### Big Professional Outfit

It sets you up for business because I send you genuine Triplett Tester, Rider Manuals, tools, etc., Eby Electric Eye, work sheets, and much more.

#### Special Advanced Course for Servicemen

Also, if you are already in the business, remember I have a SPECIAL COURSE FOR SERVICEMEN, with terms as low as \$3 a month.



## ALSO SENT FREE TO YOU One of my famous "Business Builders"

I want you to see how I do it, and judge for yourself about my training, so, in addition to my free book "More Money in Radio," I'll send you absolutely free one of my famous "Business Builders." Get these two free books now. See what Radio offers you—see how YOU can get bigger pay and a real feature. Mail the coupon TODAY!

### HERE'S HOW YOU CAN START

Mail This Coupon Now!

F. L. SPRAYBERRY, Sprayberry Academy of Radio, 35-L University Place, Washington, D. C.

Please send me, without obligation, "More Money in Radio" and complete facts about your new type of training.

Check here if you are interested in the ADVANCED SERVICE COURSE.

Name ..... Age.....

Address .....

City..... State.....

Paste this coupon on a penny postcard and mail TODAY.

### WHAT OTHER MEN ARE DOING

**DELUGED WITH WORK:** "Your course is so thoroughly good and practical that it is hard to pick out one part that is better than any other. Due to the knowledge I have gotten from it, I have been deluged with work for the last month, achieving good results with radios which had been unsuccessfully tackled by other service men. You deserve all the credit, and I can't tell you how much I appreciate your course." Edwin A. Gammon, Auburn, Me.



**\$10 TO \$25 A WEEK SPARE TIME:** "Thanks to the Sprayberry Practical Course (for which I would not take anything or any price). I am now making on an average of from \$10 to \$25 a week in spare time work, and if this keeps up I may go in for full time Radio servicing and sales. Thank you again."—Walter Davis, Baltimore, Md.

### Radio Electrical Measuring Instruments

repaired, Calibrated, built to order. Accurate measurements made on coils, resistors, condensers, etc. Reasonable.

**Peldyne Company**

Engineering Building  
Chicago, Illinois

### CHASSIS-CABINETS PANELS & CANS

STANDARD SIZES ON HAND  
SPECIAL SIZES MADE TO ORDER

**KORROL RADIO PRODUCTS CO.**

232 Greenwich St. R.W. 10-37 New York City

When writing to Advertisers please mention that you saw the Advertisement in RADIO WORLD.

# SENSATIONAL

is only a mild word  
with which to describe

## FILMANIA

BY PAUL D. HOSIER

The most daring book of "behind the scenes" true stories and facts ever written about glamorous Hollywood and the Motion Pictures.

### SPECIAL HALF-PRICE OFFER

For a very limited time, orders will be accepted for this astounding book at \$1.50 a copy—one-half the regular price—postage prepaid if cash is sent with your order. Send for your copy TODAY.

**PAUL D. HOSIER**

Author and Publisher

5826 Hollywood Blvd., Hollywood, Cal.

972 PAGES  
ONLY \$4-  
200 PHOTOS  
USED IN 82 COUNTRIES  
EQUAL TO 36 BOOKS  
WEIGHS 4 POUNDS  
508 ILLUSTR.

**THE MOST FOR YOUR MONEY**  
*in Ghirardi's 1 Volume*  
**RADIO PHYSICS COURSE**

Would you be satisfied with 10 times your money's worth? Here's a bargain better than that! You can get the famous Ghirardi radio course, complete in one huge 92-page illustrated volume that's equivalent in contents to at least 36 ordinary radio books. Just think of it!—a single book that will explain and make the whole fascinating field of RADIO, ELECTRICITY, and SOUND clear and easy to you no matter how slight your previous training. Plain, understandable language, freedom from unnecessary mathematics, and more than 500 clear illustrations make it the world's best, easiest, and most interesting book to learn radio from. That's why it is used by radio schools—used by students—used and recommended by everybody in "the radio game" the world over. Everyone says it is the greatest radio book ever written for self-instruction. Take a tip from those who know—get Ghirardi and teach yourself. You can't beat it no matter how much you pay! And you get it all at the amazingly low price of only \$4. Mail the Coupon at right—AT ONCE! Remember—every penny of your money back if not fully satisfied!

### What You Will Learn From This Book!

- Sound, Speech and Music
- Electrons . . . Electric Current
- Electric Units and Circuits
- Resistance . . . Ohm's Law
- Batteries . . . Magnetism
- Electromagnetism . . . Transformers
- Condensers . . . Inductance
- Current Circuits . . . Filters
- Electrical Measuring Instruments
- Radio Waves and Radiations
- Broadcast Stations
- Receiving Equipment . . . Vacuum Tubes
- Radio and Audio Frequency Amplification
- Superheterodynes . . . Loud Speakers
- Battery Operated Receivers
- Power Supply Units
- Electric Receivers . . . Automobile and Aircraft Receivers
- Phonograph Pickups . . . P. A. Systems
- Short-Wave Receivers . . . Photoelectric Cells
- Television . . . Antennas and Grounds
- Testing and Servicing Receivers . . . Sound Motion Pictures
- Appendices . . . 856 Review Questions for Self-Study
- AND LOTS MORE!



Paste this Coupon on a Postcard. MAIL IT NOW!

**To: RADIO & TECHNICAL PUBLISHING CO.**  
45 ASTOR PLACE • NEW YORK

Encl. find \$4. Send my RADIO PHYSICS COURSE at once, postpaid. (Foreign \$4.50)

Send me a free circular describing this book.

Name . . . . .

Address . . . . . (Dept. RW-107)

**MONEY-BACK GUARANTEE!**

# RADIO WORLD

SERVICING, MEASUREMENTS AND DEVELOPMENTS

Sixteenth Year

ROLAND BURKE HENNESSY  
*Editor*

H. J. BERNARD  
*Publisher*

HERBERT E. HAYDEN  
*Advertising Manager*

## Table of Contents for OCTOBER, 1937

<b>The Multivibrator, a New Servicing Tool</b> . . . . . 9 <i>It Makes Bow as Dead-Spot Remedy</i> By H. J. Bernard	<b>Maximum Ratings</b> . . . . . 32 <i>Also Life and Performance of Power Tubes</i>
<b>Right or Wrong?</b> . . . . . 13 <i>Propositions Put and Answered</i>	<b>Faultless Oscilloscope</b> . . . . . 34 <i>Diagram for 1-in or 2-in. Tube</i>
<b>A Serviceman's Beat Frequency Oscillator</b> . . . . . 14 <i>Home-Built, Based on Bureau of Standards Circuit</i> By Frank G. Simonds	<b>Rectifier-Amplifier VTVM</b> . . . . . 36 <i>Bridge Type Indicating System</i> By H. J. Bernard
<b>Bridge Type Capacity Meter</b> 23 <i>Measurements, 5 to 20 Mfd.</i> By William A. Hunt, Jr.	<b>Service Type VTVM</b> . . . . . 39 <i>Made From Parts Around the Laboratory</i> By William A. Hunt, Jr.
<b>Gentlemen Prefer Mhos</b> . . . . . 24 <i>Computation of Parallel Resistance Simplified</i> By Emil H. Buchwald	<b>Four-Sense Servicing</b> . . . . . 40 <i>Sight, Sound, Smell, Touch Used</i> By M. N. Beitman
<b>An Emission Type Tube Tester</b> . . . . . 26 <i>Simplest Circuit, Minimum Parts</i> By Joseph T. Bernsley	<b>Frequency Measurements</b> . . . . . 42 <i>Audio, R. F. and I. F., with Generator</i> By Sidney S. Fleischman
<b>Why a Cathode Drive?</b> . . . . . 28 <i>Much Better Fidelity Attained</i> By W. M. Perkins	<b>Radio Progress</b> . . . . . 48 <i>Tubes and Crystals Particularly Affected</i>
<b>How Vibrators Work</b> . . . . . 30 <i>And When They Don't How to Test Them</i> By F. E. Wenger	<b>Very Critical Bias</b> . . . . . 51 <i>Marks 6C8G Power Tube</i>
	<b>Capacity and Inductance Measurement</b> . . . . . 52 <i>When There Are Different Line Frequencies</i> By J. A. Woolsey
	<b>New Products</b> . . . . . 55
	<b>Radio University</b> . . . . . 57

Vol. XXX, October, 1937. No. 7. Whole No. 709. RADIO WORLD, published monthly by Hennessy Radio Publications Corporation, 145 West 45th Street, New York, N. Y. Editorial and executive offices, 145 West 45th Street, New York, N. Y. Executives of RADIO WORLD: Roland Burke Hennessy, editor and business manager; H. J. Bernard, publisher; Herbert E. Hayden, advertising manager. Officers of corporation: Roland Burke Hennessy, president-treasurer; Roland Burke Hennessy, Jr., vice-president, H. J. Bernard, secretary. Entered as second-class matter March, 1922, at the Post Office at New York, N. Y., under Act of March 3rd, 1879.

### SUBSCRIPTION RATE

Price 25 cents per copy. Subscription \$2.50 per year (12 issues); \$1.25 per six months (6 issues); postpaid in the United States and Possessions; \$3.00 per year, \$1.50 per six months, postpaid in all other countries. Remittance for foreign subscription should be by International money-order (postal or express) or draft against or discountable at New York bank.

RADIO WORLD is distributed by the American News Company and its Branches



# MULTIVIBRATOR SERVICING

## Makes Its Bow as Dead-Spot Remedy

By H. J. Bernard

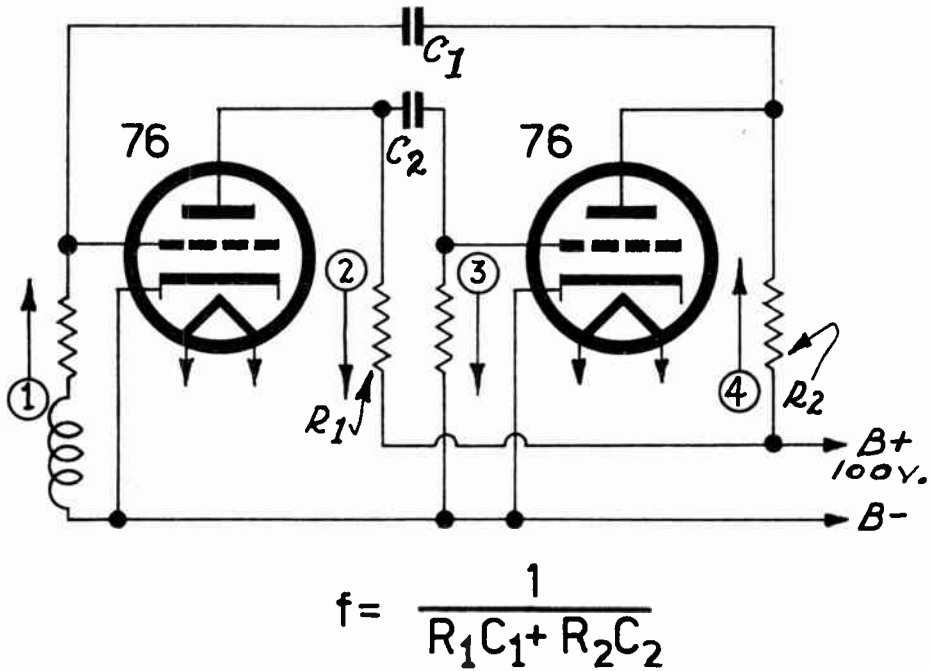

FIG. 1

The basic diagram of the multivibrator, with the formula that yields the approximate frequency. The arrows with circled numbers at the tails indicate the instantaneous direction of signal current flow. The circuit is seen to be a two-stage resistance-coupled amplifier with output fed back to the input in phase.

**M**ULTIVIBRATORS are now regarded in the service field as devices something like automobile vibrators, whereby you can obtain a.c. from d.c., but not giving enough power to be used in car sets. However, as the initiate are aware, multivibrators do not vibrate mechanically. They are electrical devices solely, and are basically two resistance-coupled amplifier stages so arranged that, by feedback in phase, violent oscillations are produced, rich in harmonics. Ordinarily so great an harmonic content would be considered objectionable—the departure from the favored sine wave is terrific—but from this supposed vice we get the virtue of harmonics useful up to the 150th and even beyond. What use is that in service work? We shall see.

Two Frenchmen, Abraham and Bloch, first put the multivibrator together, gave it a name and used it for its harmonic supply. In laboratories the device has been used since then, to produce accurate frequencies from a single standard frequency, using harmonics, not only simply but complexly. For instance, if you have a frequency standard at 100 kc, the harmonics produced would naturally be small in amplitude, as sine wave is what would be found in a frequency standard like that. But if the multivibrator is made to operate at 100 kc also, which may be done very accurately by zero beating, aided by another phenomenon, so the standard controls the multivibrator, it is easy to check frequencies to 1,500 kc and be-

*(Continued on following page)*

(Continued from preceding page)  
 yond, the limit being determined by the sensitivity of the detecting system more than by the exhaustion of the multivibrator harmonics.

**TWO-TUBE MULTIVIBRATOR**

Fig. 1 shows a multivibrator, using two tubes in a resistance-coupled positive feedback circuit. There are four arrows with encircled numbers. Suppose the signal voltage is rising in the grid circuit of the left-hand tube, as the arrow indicates, then the signal voltage is falling in the plate circuit of the same tube, because of the 180 degree reversal of phase that occurs in

connects the plate of the second tube back to the grid of the first we have positive feedback. Also we have a means of approximately determining the frequency of oscillation, the formula being imprinted on the circuit diagram.

**ELUSIVE CIRCUIT INDUCTANCE**

An r-f choke coil is shown in the grid circuit of the first tube, as high an inductance as you can conveniently obtain, which may be an inclusion due to habit, for if that coil is omitted oscillations still will be present, and indeed it may be noticed that the coil does not figure in the formula. Thus with the coil out we

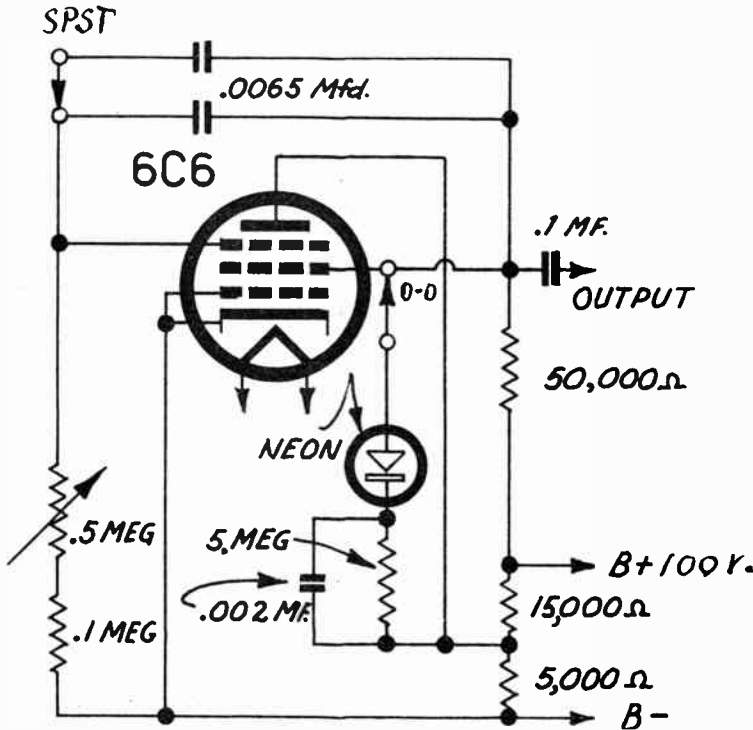

FIG. 2  
 This circuit seems the same, and produces waves that look the same and behave the same, as those produced by the two-tube multivibrator. The mu of this negative-resistance oscillator is positive, just as is the mu of the multivibrator. The neon circuit is auxiliary, producing modulation, when needed, by on-off switch O-O.

the tube. Thus Arrow 2 points downward. Now we have a stopping condenser, assumed large enough to be of no effect save to separate the d-c voltages, and we have a signal voltage drop across the resistor in the grid leg of the second tube. The direction of the voltage is the same as that in the plate leg of the previous tube, because the two voltages are the same in all respects, or you might say there is only one voltage, just as there can be only one a-c potential and no phase difference across two parallel resistors at any instant.

But the plate circuit of the second tube represents a reversal just as did the plate circuit of the first tube. So now we have the signal voltage rising, just as it did at the grid input to the first tube. That is, the two unequal voltages are in phase—unequal because there has been amplification in the second tube, as well as in the first. Now if a condenser

have an oscillating circuit that doesn't have any inductance. The idea has been thought up that the inductance of the leads, and of the elements of the tubes, etc., supplies the deficiency, but this is done probably out of proper respect for the requirement that there be inductance otherwise there can be no oscillation. To satisfy our theories, the lead-wire inductance assumption is entirely acceptable, though probably far from the fact. If by inductance we mean the production of a lagging phase in the current, we may find this present by other means than those associated with coils, as for example in the automatic frequency control systems, whereby the bias effect of the control tube upon the circuit is the same as that of an inductance, because of the current phase lag.

The resistors in the plate circuits of the two tubes and the condensers between the plate and grid circuits are seen to be the ones that

control the frequency, therefore the output would be taken from the grid circuit, where the loading would not have an effect on the frequency produced.

### NICE TO HAVE OUTPUT COUPLING

Multivibrator diagrams are commonly shown

with limiting and timing circuit. This will produce a tone of a few thousand cycles.

Now, considering the 6C6 oscillator, which is classed as a negative resistance type, the voltages in the screen and suppressor circuits are in phase, so if we put a condenser between these two elements, we obtain oscillations, just as we

FIG. 3

The circuit of Fig. 2 is shown with bottom view of the sockets exposed, so that the grids will be connected to proper terminations, for unless this is done there will not be any oscillations. The circuit is best suitable for audio purposes, though by coil loading of the suppressor circuit, leaving the suppressor - screen condenser fixed, and putting a variable condenser across the coil, even radio frequencies could be produced, to 15 mc.

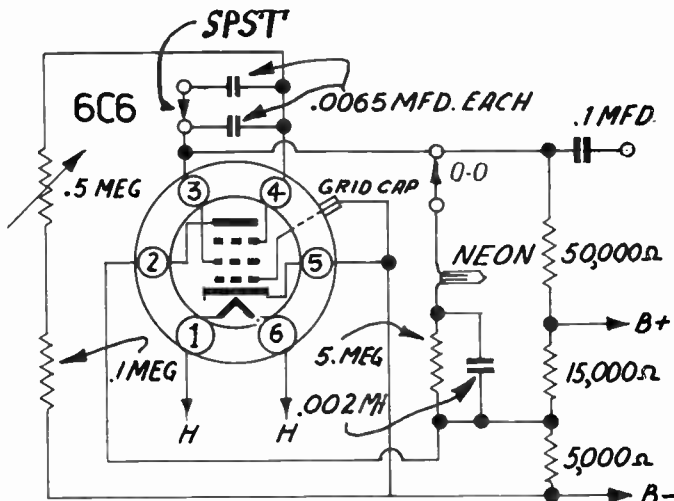

devoid of output coupling means, as if the oscillations were just intended to be present, but never observed or used, so for grid loads we could have 1 meg. resistors, and for output, either grid load could consist of two .5 meg. in series, output taken through a large capacity condenser connected to the joint of the resistors. This halves the output voltage but doubles the already large freedom from external molestation.

We have considered the multivibrator as a two-stage resistance-coupled circuit wherein the output was fed back in phase with the input. That is practically the standard definition, and yet we may have a single-tube multivibrator, now presented from this original viewpoint, although the circuit is not new to our readers.

### PRODUCING THE FREQUENCIES

In Fig. 2 we have a 6C6, circuited as follows, in dissecting the diagram from bottom up: The heater is connected to a 6.3-volt supply. The cathode is connected to B minus, and the normal control grid is connected to the same place. Next in the order of ascension is the screen, and that has a 50,000-ohm load resistor, leading to maximum B voltage. (It is ample to have 100 volts for all multivibrators). Next is the suppressor, which is returned to B minus through a resistance. The plate is connected to an intermediate B voltage. Between screen and suppressor is a condenser. The output is taken from the screen itself through a .1 mfd. condenser. The other output post is B minus.

Aside from this audio oscillator there is a relaxation oscillator consisting of a neon tube,

did in the multivibrator by likewise using condensers between in-phase circuits. But there are differences between the two-stage multivibrator circuit and this one, for instance, the frequency determination is mostly on the basis of one capacity and one resistance. The capacity is that between screen and suppressor, and the resistance is that between suppressor and B minus. If the suppressor resistance is adjustable we may change the frequency considerably, but not enough to cover 50-10,000 cycles, so we duplicate the capacity, and then cover approximately half the band at one setting of the switch SPST, and the rest at the other setting. Adding capacity lowers the frequency. Adding resistance does likewise.

When the resistance in the suppressor circuit is too low the frequency is too high or there is stoppage of oscillation, so it is well to include the .1 meg. limiting resistance.

Previously mention was made of the fact that a frequency standard can control the multivibrator, and this is because the circuit has a very low inertia, and will "prefer" to work at multiples or submultiples of injected frequencies. So, as in oscilloscopy, we inject a little of some external voltage of desired frequency, and the multivibrator will move over to the nearest convenient multiple or submultiple frequency, very obligingly. It will not stubbornly adhere to its own frequency.

### POINTS OF IDENTITY

So now we have an audio oscillator covering 50-10,000 cycles in two steps, referred to as a  
(Continued on following page)

## How to Calibrate a 10 Kc MVB

At present the multivibrator as a separate instrument is a likely choice of the serviceman, for he may greatly increase the effectiveness of his work. For instance, the check-up is featured in servicing, and what does this consist of? Testing the receiver to determine if the performance is up to par, testing components and adjuncts, such as tubes and speakers, and giving the set a cleaning. But suppose there are "holes" in the tuning? How shall they be found? About the only way would be to tune a generator step by step over each band, a very tedious and unprofitable process, and of course never done in actual service practice. And yet the test is important. So the multivibrator comes in to save the day. There is no need to say the manufacturer should have turned out the set without "holes" in it. If the manufacturers had turned out everything par excellence they wouldn't have sold enough sets to create an industry, as prices would have been prohibitive, and besides if everything was perfect the one imperfection would be, No Service Business.

Many might want to try the 10 kc type of multivibrator, but perhaps would find it difficult to determine when and if the device was actually producing 10 kc. If the one-tube MVB is used, and in the suppressor leg the two resistors are .05 meg. each, and one of them adjustable, rheostat style, the frequency may be achieved. It is checked thus: Tune a sensitive receiver that has fairly accurate calibration, from low-frequency end of the broadcast band to 600 kc. The total responses, modulation present, should be equal to one more than the number of channels. For station waves even weakly receivable, there will be the customary beats, which aid the verification. Output of multivibrator is coupled to the antenna of the receiver, along with the antenna itself, if one desires beats with stations.

*(Continued from preceding page)*

negative resistance oscillator, also as a positive mu oscillator, because when the signs of the signal voltages are multiplied in suppressor and screen circuits the result is positive. (With the ordinary oscillator it is negative). But it should be noticed that with the multivibrator also the result is positive. So we have these points common to both forms:

Mu is positive.

They behave just the same, in swinging to a multiple or submultiple of an injected frequency, i.e., have a low order of inertia.

The wave form of the oscillation is of the square type, reminiscent of the parapets of medieval castles.

The harmonics are rich, and useful to the 150th and beyond.

The inductance is missing from both.

There isn't any difference in performance or behavior between Figs. 1 and 2, and therefore it is submitted that if Fig. 1 is a multivibrator, so Fig. 2 is a multivibrator. It is just like the case of the missing inductance. A theory had to be invoked to produce inductance, which was all right, but the behavior already was the same as if inductance were present, and therefore effective inductance was present. When two things seem alike, look alike and behave alike it is better to say they are the same than to invent theories pretending they are different.

### FIXED FREQUENCY OSCILLATION

One fact about the variable-frequency type oscillator, as in Fig. 2, is that the amplitude is not constant for the various frequencies. In some uses that is of no importance, but in general test work it is, and a variable beat-frequency oscillator can produce practically a flat characteristic. So we shall not consider Fig. 2 particularly as a variable-frequency oscillator, but as a fixed-frequency oscillator, and shall

select the oscillation frequency as 10 kc. Now, the very moment we have done that we have produced a service instrument of value. It has been hinted that the harmonics go on and on, and whether there is response or not depends on the sensitivity of the receiver. Given a sufficiently sensitive receiver, the 1,000th harmonic should prove quite as useful as the hundredth. So if we couple the output of the multivibrator to the input of a receiver, and if we turn the receiver dial over its full span on each band, provided we have introduced modulation into the 10 kc, we shall hear a response all over the dial, all bands. An output meter will respond to the modulation. If there are dead spots we hear or see no response. Therefore we have a means, for the first time, of checking a receiver that is in the shop for repair, to determine whether there are dead spots in the tuning, and there are plenty of such "holes" in all-wave receivers on the short waves!

Another use is to feed a signal generator voltage to the intermediate amplifier, at the intermediate frequency, and, connecting the multivibrator to the antenna input of the receiver, turn the set's dial. Now the notes will be produced due to the beats between r-f and i-f oscillations, provided the set is responsive to the r-f at all points, and of course no modulation would be required. Also, output meter would provide the check-up. There is no need to produce any noise. When no beat is present there is no output meter reading.

If we have a signal generator, and desire to check whether it stops oscillating, or loses pep. over parts of the tuning, we may use the multivibrator without modulation, and let the beat between signal generator and multivibrator determine the presence of oscillation. Earphones may be put in plate return of either signal generator or multivibrator.

# RIGHT OR WRONG?

## PROPOSITIONS

1. A diode rectifier is nonlinear on low-voltage ranges and linear on high-voltage ranges because the behavior of the tube is different when the loading is increased, thereby obliterating the capacity and inductance effects otherwise present, which contribute the impurity that results in low-scale crookedness of the characteristic curve.
2. The test of whether a resistor is of too small a wattage rating for the purpose used is that the resistance changes when current is passed through the resistor, therefore the circuit performance is upset, and results are poor.
3. The present trend among broadcasting stations is to erect vertical type antennas and to introduce some directivity so that the service areas will be increased or there will be more nearly uniform distribution of radiated energy consistent with the distribution of population.
4. The radio method used for stopping airplanes in flight is to radiate a modulated wave that is automatically detected by the dissimilar metals of which the plane is made, and to have the modulation frequency variable, until the frequency of the propeller revolutions is duplicated, whereupon by out-phasing of the modulation pulses, the motor revolutions are neutralized, and the plane falls to earth.
5. Iron is suitable for an antenna, including an upright iron pole, and it is likewise satisfactory to use iron or steel wire, vertically or horizontally, the necessary precaution being taken to safeguard the iron or steel from the elements with best of insulation, to avoid rust, etc.
6. A tube is said to be saturated when all the electrons emitted by the cathode are drawn over to the anode, and therefore the emission type of tube tester is one which tests the tube under the condition of saturation.

## ANSWERS

1. Wrong. The results appear nonlinear for low voltages and linear for high voltages not because the tube behaves any differently but because for high voltages the non-linearity is masked by the smallness of the effect of the tube as a current-limiting agency, compared to the greatness of the current limitation by the load resistance. Where a great part of the current is due to the tube's own resistance there is curvature. Where a small part of the current is due to the tube there is linearity. But the tube characteristic is the same in both instances.
2. Wrong. Most resistors change their resistance when current is passed through them. Roughly, the wattage of the resistor is too low if the resistor gets entirely too hot. The technical definition relates the heat dissipation to a certain degree of freedom from surrounding objects.
3. Right. More and more stations are using the vertical antenna, and the heights are becoming increasingly greater.
4. Wrong. There is no known method of stopping airplanes in flight by radio.
5. Right. The use of iron pipe aerials on roofs, with coupling transformers to a transmission line, and line-to-set transformers at the receiver end, is growing.
6. Right. The saturated tube, since its current can not be increased, represents a suitable condition for test purposes.

# A SERVICEMAN'S B.F.O.

## Based on Bureau of Standards Circuit

By Frank G. Simonds



The oscillator and amplifier fit nicely into a wooden box. The author is manipulating the dial.

**T**AKING liberties with the National Bureau of Standards may not be the soundest and safest course, but when the Bureau has certain standards it must meet, that are far beyond those required in radio servicing, an instrument perfected for those high standards may be adapted to service requirements. That is exactly what has been done with a five-tube beat-frequency oscillator, so that while the main considerations are preserved, certain more exacting refinements are omitted.

The result has been very satisfactory, the output voltage for the most part is constant, as well as high, and the wave form is in general of sine shape.

The only problem was calibration.

In an audio oscillator depending on the beat phenomenon it is very important that the two radio-frequency oscillators, one of fixed, the other of adjustable frequency, should be stable. High capacity across the tuned winding, and tight coupling between that coil and the tickler, enable satisfactory stability. Neither oscillator should react upon the other. Tuning one should not tune the other, or slightly changing the loading of one should not make a marked frequency change either in that one or in the other. The independence is maintained by shielding well the tube and tuned circuit gen-

erally of each r-f oscillator, and minimizing the common external impedance.

### PROPER TERMINATION VITAL

The objective is to make the only coupling between the two oscillators intentional, and that coupling is a series one as input to a separate detector, which had a grid-leak-condenser circuit with a time constant of .02, equivalent to a frequency of  $1 \div .02 = 50$  cycles, so there will be support for the difficult low notes.

I say they are difficult because it is in the low frequency region that the wave form begins to depart from the sine shape, in other words, harmonics may abound, thus distortion appears. However, the time constant should be such as to give the low notes their full opportunity to be reproduced, and whatever happens to the wave form becomes then more a matter of proper stabilization, termination and loading, than of detection.

It is of course necessary to provide some amplification, to get an output voltage of, say, one volt or a little more, and a one-stage amplifier is shown. The low-note situation again becomes difficult, because the amplifier has to do justice, so the stopping condenser is made large in capacity, and the grid resistor in the amplifier stage as large as is consistent with other and conflicting requirements.

### WHERE FLATNESS DISAPPEARS

Just as there is a drop in voltage at the low frequencies, so there is one at the high frequencies. This particular oscillator covers the audio span of 5-10,000 cycles, of which frequencies of 30 and below are not considered useful, though there is response to 5 cycles, while those above 30, and particularly of 50 and above, are excellent as to wave form. Then when one gets around 7,000 cycles the former flatness of response again disappears.

It may be said that the reduction in low-note intensity is due to the smallness of the series capacity, and that of high-note intensity to the largeness of the parallel capacity. That is, tube output and wiring capacity in conjunction with the necessary load resistors produce a drop in the voltage curve for the high frequencies, and the voltage drop in series capacity or degeneration loss reduces the low frequencies.

An annoying trouble sometimes is experienced in this connection, although absent from the present oscillator. The capacity-resistance circuit at output of detector or amplifier instead of being a low pass filter may produce a dead spot, constituting a trap covering a hundred



(Continued from preceding page)

curacy, gain per stage and overall rapidly derived with the aid of an output meter, and any calibration in output volts would be sensibly applicable to this part of the band, but not to the very lows, as already set forth.

The coil winding data are imprinted on the diagram. The 56 turns of No. 24DCC wire may be put on first, starting near one end of the tubing, and then the 16 turns, same size wire, at the other end, the remaining space having the 40 turns of No. 24DCC approximately centered. The start for this third winding may be closely estimated on the basis of the winding space equalling two-thirds that of the largest winding, so subtract this quotient from the open space, divide by 2, and find just where to start the 40 turns.

It will be noticed from the diagram that the 40 turns constitute the tickler, the 56 turns the winding across which is the tuning capacity, while the 16 turns is the pickup coil. Since the two pickup coils are series connected, with an equal voltage constantly across each, the two voltages are cumulative as put into the detector tube. The two r-f oscillators are at left and right, detector is second from left, amplifier-output tube third from left.

### CAPACITY PROBLEM

There is not much of a problem attached to getting the inductances practically identical, especially if the tuned windings in both instances take up exactly the same winding space (distance along the axial length of the tubing). But the capacities do present a problem.

It will be recalled that a certain capacity exists in one of the circuits and is duplicated in the other. Take the fixed frequency oscillator. That has the tuning capacity externally included, also wiring and tube capacities. The adjustable frequency oscillator has, besides this, tuning condenser minimum. One stiff requirement, if there is any intention of building more than one such oscillator, and retaining the same calibration, is that the fixed frequency be exactly the same in all instances, however obtained (no matter by what combination of inductance and capacity). However, with equal inductances, the popular method, the capacities would have to be equal, and semi-precision .002 mfd. mica dielectric condensers are necessary (1% accuracy). By using a little extra capacity, some part of a .0001 mfd. variable in the fixed frequency circuit, a particular pilot frequency is easily obtained. This condenser is put on the front panel and is used as a frequency adjuster, or alignment aid, as without some such provision the oscillator will not repeat the low frequencies for which it was calibrated. The so-called zero adjuster therefore preserves accuracy. It might be less of a temptation if it was of the setscrew type, air dielectric, instead of being shafted and knobbed.

The variable is any condenser you may select, preferably of not more than .00035 mfd. capacity, although capacity down to .0003 mfd. may be used without missing the 10,000 cycle extreme, provided less than half of the zero-adjuster condenser capacity is used (less than .00005

mfd or 50 mmfd.). The tuning curve of the variable condenser alone is of no significance. Straight line capacity suffices.

### THE RADIO-FREQUENCY TIEDOWN

It is now possible to buy equipment that includes coils, condenser and calibrated scale for such a beat frequency oscillator, although for slightly different feedback arrangement, so that the task of calibrating, which may take six hours, is avoided, and all that is necessary is to tie down the oscillators at their radio frequencies.

Because the radio frequency must be known, it is selected to fall fundamentally or by low order harmonic in the broadcast band. A popular selection is 700 kc, perhaps because a station on that frequency uses great power and can be received over a greater portion of the United States with sufficient beating strength than any other. This station is WLW, Cincinnati.

The secondaries have a self-inductance of some 300 microhenries, and with the capacities suggested will strike a frequency, instead, of 185 kc at minimum and nearly 200 kc at maximum. For a little more capacity to yield 175 kc, it would be practical to align a superheterodyne closely at 175 kc i. e., beat a signal generator with 700 kc to be sure by verified harmonic there is no substantial frequency error, and adjust the fixed frequency oscillator to yield 175 kc, by injecting into the i-f channel and adjusting, although the channel already has signal generator feeding it. The second frequency is adjusted to zero beat with 175 kc. Or, since no duplication is to be practised, only a calibration run off for use on a single instrument, any frequency conveniently near 175 kc, and attained by the mentioned capacities, may be used. The span will not be greatly altered, and the 10 kc width will be more than covered.

### CALIBRATION AID

In an ac-dc model, for which commercial equipment is obtainable, the same number of tubes is used, but a somewhat different operating basis, and with not quite as much output as from the a-c model.

The two radio-frequency oscillators are 76's, and the zero frequency difference exists when they are at 70 kc. The whole span is exhausted when the additional capacity, obtained from turning the variable to maximum, changes the frequency to not much more than 80 kc. This is a difference of 10 kc. If tenth harmonics are used from the variable, and a response obtained in a sensitive broadcast receiver, preferably using stations for zero beating, in urban sections quite a few points might be obtainable. Again we greet WLW, the frequency of which is  $10 \times 70$  kc.

It is now plainly evident that operating at a low radio frequency has the advantage of permitting calibration on the basis of known radio frequencies and their differences. This solves a calibration problem for those who have no resort to audio standards.

The coils used in the universal model are of the pie-wound universal type, that have very low distributed capacity and pretty good Q for coils of small physical dimensions. The low



distributed capacity is no particular advantage here, but a coil with as good a Q as practical helps produce a larger voltage and maintains a good enough impedance to prevent premature locking.

### CIRCUITS MADE RIGHT

By using very loose inductive coupling between the two coils, positioning them about an

mer built into the variable, plus an extra extensible-frequency oscillator,  $O_7$ , is augmented by a trimmer, whereby the total minimum capacity is brought up to .00126 mfd., when the 100 mfd. variable is at minimum.

### REGISTERING 70 KC

It is with this sum capacity that the 70 kc is registered in the variable, and duplicated in

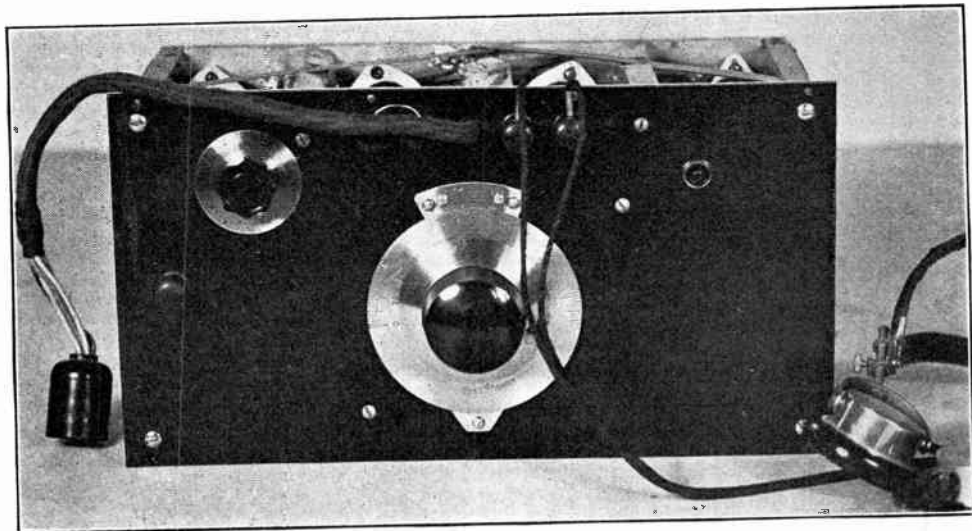

National Company's velvet vernier dial, with true vernier scale, graces the front panel. Thus, by reading to one part in 1,000, it is possible to run a very close curve. Zero adjuster is at upper left. The power supply connector is at left, and earphones and their connection are revealed at right.

inch apart, the intensity of the audio output was sufficient, and yet the generator produced frequencies down to 10 cycles. It is not pretended that a beat-type oscillator is of much use for such low frequencies, if freedom from harmonics and high degree of stability are requisite, but the point is made that the tuned circuits must be pretty good to permit 10-cycle response, and coupling must be critically right.

If the lowest note obtainable is much higher than 10 cycles, which is a frequency you can almost count, or at least can approximately identify because of the motorboating effect, then the coupling has to be made weaker. This inductive coupling, by the way, is additional to some slight degree of chance coupling that obtains due to adjacency of tubes, parts, common supply impedance, etc.

The coils, of 2.5 millihenries commercial rating (actually slightly less, and of 1 per cent. accuracy), have paralleled fixed condensers across them, one of .0016 mfd. and the other of .0005 mfd. It was found easier to obtain the critically correct reference value of .0012 mfd. that way. Variations in capacity of the largers could be compensated by opposite variations of the smaller, so that when paralleled the two capacities always would equal .0012 mfd. to better than .5 per cent. Then the capacity in the variable-frequency oscillator,  $O_7$ , is augmented by the tuning condenser's minimum and by a trim-

mer built into the variable, plus an extra extensible-frequency oscillator,  $O_7$ , is augmented by a trimmer, whereby the total minimum capacity is brought up to .00126 mfd., when the 100 mfd. variable is at minimum.

The fixed oscillator has the same capacity complement, except for the variable condenser and the built-in trimmer of that condenser. It has, however, the auxiliary trimmer, the same as the variable, the 100 mmfd. compression type (hand mounted). Since the value 100 mfd. appears three times, it should be noticed that twice it represents a compression trimmer, whereas in the third instance it is the variable condenser itself, identified by the curved arrow denoting rotor.

The time constant of the leak-condenser in the variable oscillator is such that radio frequencies are well served, not so that audio frequencies, because none are intended to be there, or to be taken out of that tube. However, in the fixed-frequency oscillator, which serves also as the detector, the time constant is equal to  $10 \text{ meg.} \times .002 \text{ mfd.} = .02$ , and the frequency is  $1 \div .02 = 50$  cycles. This is the same condition as obtained in the a-c-operated audio oscillator. It is not intended to state that lower frequencies than 50 cycles can not be handled, but merely that frequencies as low as 50 cycles

(Continued on following page)

(Continued from preceding page)  
are handled very well as to the audio functioning of this detector.

### LOADING THE CIRCUITS

The detector output requires low resistance loading, and .05 meg. (50,000 ohms) represents about maximum, to avoid loss of high notes and trapping. The grid leak following may be 1 meg. The 6C6 amplifier tube will stand a larger resistance load, and thus maintain a good voltage gain per stage, using .25 meg. plate load,

district as example, since we are forewarned our radio-frequency range will be about 70 to 80 kc, we select those frequencies that fall within this range, perhaps taking some frequencies higher than 80 by a small amount, but none lower than 70, because all systems will start and must start at 70 kc, though where they terminate will depend much on the capacity of the variable condenser. We have assumed 100 mmfd. as the maximum of the variable, to attain somewhat higher than 80 kc, and therefore we may tabulate the frequencies for local stations:

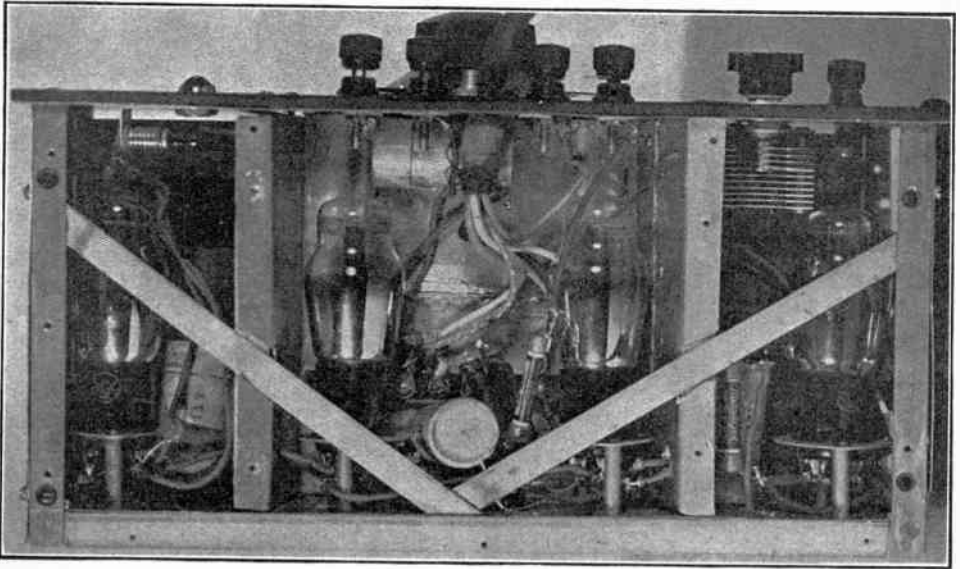

The device is used with components in this position, so the tubes are erect, therefore this may be interpreted as a rear view. The cautious shielding is apparent. The zero adjuster is the condenser at upper right.

again followed by 1 meg. grid leak. The output potentiometer may be .25 meg., also, and a high impedance circuit is thus presented to the grid of any amplifier, which is what is desired usually. For any special matching purposes a transformer would have to be connected from output to amplifier, for instance, where one was maintaining a transmission line.

### SUBMULTIPLES TABULATED

With a radio-frequency basis the calibration is robbed of much of its difficulty. Since broadcasting stations are used, ones are selected that come in well, and the positions of which are known on the receiver dial, as well as the published frequencies. Do not read the frequencies from the dial, as they may be only approximate. The published frequencies are divided by numbers from 2 up, say, to 20, except that for stations of 1,450 kc and higher the division may as well include the 21st harmonic. It is clear now that low frequencies are obtained, and their relationship by harmonics to the station frequencies.

Taking typical stations in the metropolitan

TABLE I

Station	Radio Frequencies, Kc.			Audio Freq. Cy.
WMCA	71.250	81.428	1,250	11,428
WEAF	73.333	82.500	3,333	12,500
WOR	71.000	78.888	1,000	8,888
WJZ	76.000	.....	6,000	.....
WNYC	73.636	81.000	3,636	11,000
WABC	71.666	78.182	1,666	8,182
WAAT	72.308	78.333	1,508	8,333
WHN	72.143	77.692	2,143	7,692
WLWI	73.333	78.333	3,333	8,333
WTNS	73.750	78.666	3,750	8,666
WNEW	73.529	78.125	3,529	8,125
WHOM	72.500	76.315	80.555	2,500 6,315 10,555
WMBQ	71.429	75.000	78.942	1,429 5,000 3,942

### CHECKING FACILITIES

The responses in the sensitive receiver will confirm the range as being correct, because the stated number of responses will obtain for each station, and also nearly thirty audio frequencies may be obtained, and their dial positions. From these data a curve is run, using large-sized cross-section paper, at least ten squares of ten to the inch, and the missing frequencies obtained by extrapolation.

The list shows the stations by call letters, the frequencies being omitted, as the fundamentals

finally do not retain any significance in the method of application, while the subharmonics or low radio frequencies are listed under the heading "Radio Frequencies, Kc." Since the mutual frequency is 70 kc, the audio tones are due to the difference between 70 kc and the subharmonic frequencies listed alongside the call letters. Taking only the first example, WMCA, which is on 570 kc, incidentally, the eighth subharmonic is 72.250 kc and the seventh subharmonic is 81.428 kc, while the resultant tones are  $72.250 - 70 = 1.25 \text{ kc} = 1,250 \text{ cycles}$ , and  $81.428 - 70 = 11.428 \text{ kc} = 11,428 \text{ cycles}$ . As already noted, the high-frequency terminal can not be predicted without knowledge of the maximum capacity of the condensed to be used. A 100 mmfd. variable goes far enough and gives optimum spreadout.

Now it may be realized that the calibration is developed around a curve drawn on cross-section paper and based on known radio frequencies. There are only two responses for stations listed with two, three for those with three r-f numbers, and only one for a particular station. If agreement exists between experimental results and the tabulated expectancies, coincidence is perfect, the frequencies generated are literally those they are supposed to be, and confirmation is absolute. There is serious error if responses are either more numerous or fewer, provided of course the recommended 100 mmfd. maximum for the variable is neither seriously exceeded or diminished.

### FINDING 70 KC

There are only two ways of producing the calibration—one by checking the radio frequencies and computing the differences, the other by taking the actual audio tones produced and comparing them with known audio frequencies. The first method has been explained, and is based on harmonics zero beating the radio frequencies of the variable with the fundamentals of the stations, and noting the frequencies.

A point yet to be explained completes the r-f method. How may one register the 70 kc for the fixed-frequency oscillator, since there is no local station on 700 kc, and WOR, on 710 kc, may upset plans of using WLW, which is around 600 miles away. An alternative is to use a station on 1,400 kc, as there are usually locals on this assigned frequency, and in New York City this is true, only a station is not on the air every night. The harmonic order then would be the 20th of 70 kc. that produces 1,400 kc.

### NOT WITH EAR, PLEASE

An alternative method is to find the 70 kc point on the variable, by extrapolation, if need be, or direct comparison, if possible, and simply tune the fixed circuit so that the frequency difference is zero. This is the front panel adjustment of a setscrew governing a compression type condenser. An air-dielectric type might be better, but there would have to be readjustment for practically each day the oscillator is to be used, and during the period of use practically any type condenser will hold well enough.

Now for the direct comparison, which is easier

if one has the equipment, perhaps the first piece of advice that is absolutely necessary is that you can not take a known audio frequency, generate an unknown so that the two sound as if they are the same frequency, and, trusting your ears, say that the second frequency is equal to the first and proceed accordingly. The ear is not a precision instrument. Moreover, it is affected by intensity as well as by pitch. There is nothing else to do save use a visual indicating system, which means for you that some sort of

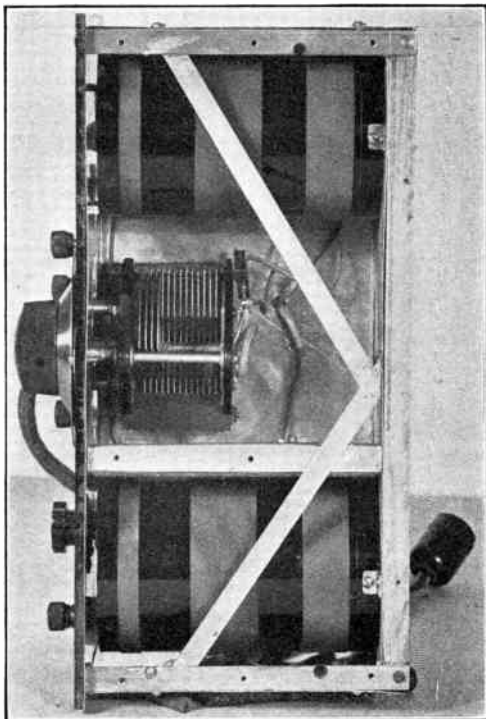

Looking at the interior from the front (adhering to the assumption the tuning panel is considered the top), we find the large coils plainly in view, also the continuation of the bracing method of shield construction.

tube arrangement is imperative. The present reference is to finite beats, not zero. The ear suffices for "zeroing."

If there is power enough, two lamps may be lighted, usually of the gas-glow type, one by one circuit, the other by the other, until the stroboscopic effect causes them to act in step.

Servicemen equipped with an oscilloscope may put the known audio frequency into one of the deflection plates (using amplifier) and the unknown into the other, and as both are sine waves, the frequency adjustment is made until the equality pattern appears. This is not the sine wave pattern so familiar to us when one of the frequencies is saw-tooth, e.g., the horizontal sweep frequency. Here we have no saw-tooth

(Continued on following page)

The power supply almost could be wired from the photograph of the connections. The underneath view reveals the power transformer below and the bleeder resistor above. The socket is for the 80 tube, the only tube used in this part of the device. There is room in the carrying case for the power supply, along with the oscillator proper, so that in reality the outfit becomes a unit rig.



The exterior view of the power supply is such that the same relativity is preserved as in the bottom view. For instance, the transformer is at bottom and the tube at top. Besides, the B choke is shown to be a husky one, as it is imperative to get rid of all traces of hum, 2 per cent being intolerable, as one of the many generated frequencies is 60 cycles and another is 120 cycles. It is the 120-cycle hum that is the nuisance in a full-wave rectifier, on the other hand, the doubled frequency makes the filtration half as difficult. All photographs are of the oscillator built according to the circuit on page 15.

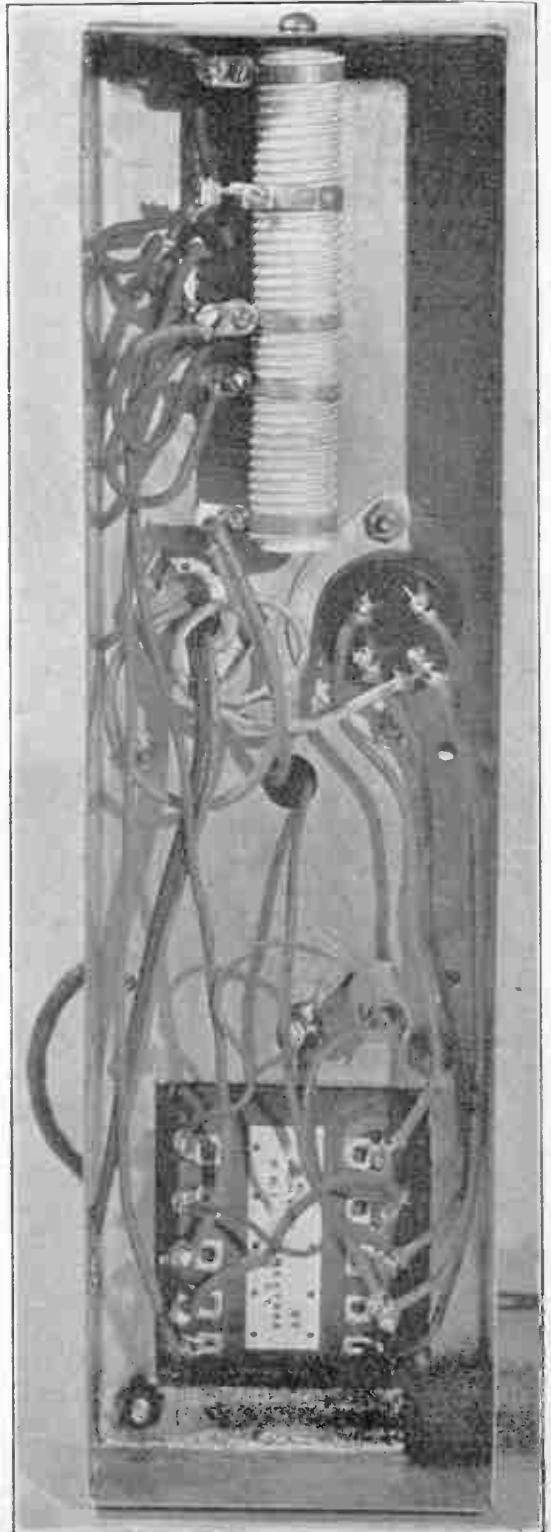



(Continued from preceding page)

The generator frequency is unmolested. Hence the only change reflected in any way in or through the generator is that the harmonic order is different. If the second station frequency is higher, the harmonic order is lower. If the second station frequency is lower, the harmonic order is higher. At all hazards, divide the second station's frequency by the generator frequency, select the nearest whole number, and you have the harmonic order to apply to the known generator frequency. Suppose the second station was 570 kc, a note was heard, it was equal to harmonic order  $570 \div 142 = 4.14$  approximately, nearest whole number 4, so the fourth harmonic of 142 kc or 568 kc, was beating with 570 kc, the difference is 2 kc, and the hitherto unknown audio frequency turns out to be simply 2,000 cycles. Thus we can go along a great way, getting practically all the frequencies we need, except very low ones, say, from 300 cycles down, but these can be checked by using multiples of the 60-cycle line frequency in a separate detector circuit, with separate inputs, control grid and suppressor, and a current meter in the cathode leg. Watch needle for revolution to zero frequency.

After we have left the generator unmolested, and picked up audio tones by station beating, and ascertained the frequencies of those tones, we may molest the generator. Revert, say, to 570 kc, and slightly readjust the generator to 142.5 kc, so that the fourth harmonic of 142.5 kc now equals 570 kc exactly. Now tune in the second station, 710 kc, previously the first, and use the fifth harmonic of 142.5 kc, which is 712.5 kc. Now the note is equal to  $712.5 - 710 \text{ kc} = 2.5 \text{ kc} = 2,500$  cycles. The process is not numerically reversible. Different audio frequencies result, depending on whether generator is changed.

### THE SYMBOLIC FORMULAS

The rhetorical formula, or explanation in words, is rather long, and the application of the method is made to seem thereby to be complicated, whereas it is simple, as the symbolic formula shows for the case of generator unmolested, and different stations used, that cause finite beats.

First let it be said that the zero beat condition is established because

$$F_x = nF_0 \pm F_s$$

where  $F_x$  is the audio frequency in kilocycles,  $n$  the harmonic order of generator frequency  $F_0$  in kilocycles, and  $F_s$  is the station frequency in kilocycles. The sign is such as to produce a result in the audio region, in kilocycles.

Now for the "generator unmolested" formula,

$$F_x = mF_0 \pm F_s$$

where  $F_x$  is the audio in kilocycles,  $m$  is another harmonic order, higher or lower than  $n$  of the first instance,  $F_0$  is the generator fundamental frequency in kilocycles as before, and  $F_s$  is the station frequency in kilocycles, though now a different station frequency.

For the case of generator frequencies changed, same station always used,

$$F_x = o, p, \dots F_0 \pm F_s$$

which is the same as for zero beat, except that

any harmonic orders o.p., etc., may be expected, and the beat will be finite, not zero.

If only the generator were accurate enough the case would be so simple for all purposes. The unknown would be equal to the difference in generator frequencies:

$$F_x = F_{GA} \pm F_{GB}$$

where  $F_x$  is the audio frequency,  $F_{GA}$  is the generator frequency for zero beat with a station, and  $F_{GB}$  the generator frequency for any finite beat within audio bounds, or beyond.

## Three New Phototubes Announced by RCA

RCA Manufacturing Company, Inc., Radio-tron Division, is making available through transmitting-tube distributors three new phototubes as follows:

921 gas phototube (cartridge type)

922 vacuum phototube (cartridge type)

923 gas phototube.

The 921 and 922 are small in size and built in a new way. They have a short double-ended construction which eliminates the conventional base and provides a long insulating path between electrodes. The terminals at either end are in the form of metallic buttons, so designed as to permit inserting each phototube easily and positively in a clip mounting. Features of these new simplified tubes are their lower cost, their low interelectrode capacitance, and their convenience in circuit arrangement.

Although these two new tubes are alike in appearance, the 921 is a gas phototube, while the 922 is a vacuum phototube. These phototubes, because of their high sensitivity to infrared radiation, are particularly useful in applications where incandescent lamps are employed as light sources.

The 923 is a gas phototube of the conventional type. It is similar mechanically and electrically to the 918, but has a shorter overall length.

## Delta Buys Paragon; Shiepe Is Head of Both

Delta Radio Company, 135 Liberty Street, of which Edward M. Shiepe is manager, has bought the business of Paragon Radio Products Co., manufacturer of cathode-ray oscilloscopes. Both businesses will be conducted at Delta's factory and both will be under Mr. Shiepe's management, but the Paragon name will be retained for merchandising purposes. The former owner of Paragon is Joseph T. Bernsley, radio author and designer. He will be retained by Delta in a consulting capacity.

### JEFFERSON HAS NEW BULLETIN

Bulletin PA-14 describing Jefferson automatic bias for Class B modulators has just been published by Jefferson Electric Company, Bellwood, Ill. The bulletin contains, besides a general engineering discussion of the principles involved, complete diagrams of circuits and necessary instructions. It will be sent on request made to R. Benson, care of the company.

# Remedying a Wobbler Defect False Trace Due to Amplitude Modulation

By O. M. Owsley

*RCA Engineering Department*

**A**MPLITUDE modulation takes place to some extent, in all test oscillators using rotating condensers, etc., as means of frequency modulation. This amplitude modulation cannot be checked by simply rotating the condenser by hand and measuring the output voltage, as it occurs due to the rate of change or frequency (dynamic characteristic of circuit). It can only be found by comparing the visual picture with the alignment curve taken with laboratory curve drawing equipment. This amplitude modulation (output less at one end of sweep band than other) causes a properly aligned circuit to appear misaligned when viewed on the oscillograph.

When frequency modulation is accomplished electronically it is possible to overcome this defect by the proper compensating network so that the resonance curve as viewed on the oscillograph screen is an exact duplicate of one drawn by point to point test methods or one drawn by laboratory curve drawing equipment.

Misalignment due to amplitude modulation as it occurs in the older systems of frequency modulation is quite noticeable in the older type of radio receivers using peaked i-f transformers and is extremely so in the newer type flat topped i-f transformers. This misalignment may cause serious receiver interference from adjacent channel transmitters.

It should be pointed out here that it is almost impossible to compensate an oscillator over a wide frequency range (90-32,000 kc) for pure frequency modulation. Since the absence of amplitude modulation is such an important qualification our unit was developed on the beat frequency principle with frequency modulation taking place at a fixed frequency, 800 kc. When this 800 kc oscillator is properly compensated the mixed output, regardless of frequency, will be free from amplitude modulation.

This, therefore, makes for the highest type of performance.

## A Bridge Type Capacity Meter

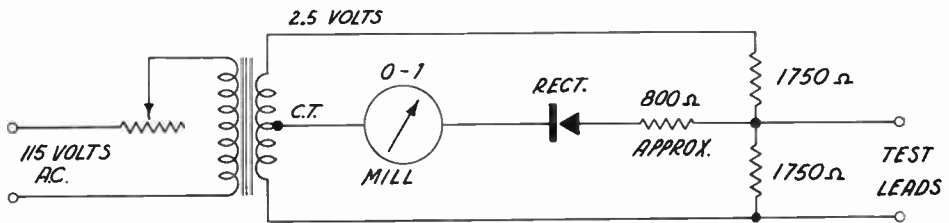

No current flows through the meter when the circuit is balanced. The unknown creates unbalance.

**T**HIS capacity tester will check condensers from .5 mfd. to 20 mfd. This well covers the important electrolytic range. A bridge arrangement is used. As long as there is no unbalance in the 1750 ohm bridging resistors there will be no indications on the meter, but the meter will read any unbalance. A short circuit will cause the meter to read full-scale deflection. The 0-1 milliammeter in conjunction with a copper-oxide rectifier and 800 ohm series resistance simply reads a-c volts with a full-scale deflection of about 1.5 volts. A 1,000 ohm variable resistance was used in the 115-volt lead to take care of any voltage variation. Calibration is attained by comparison with a

commercial capacity meter or by using several paper condensers of known capacity. The markings on commercial condensers will not suffice.

The operation of the meter is similar to that of an ohmmeter. Most electrolytic condensers in radio circuits may be checked without disconnecting the leads to the condensers. As long as the shunting resistors are above 3,000 ohms the meter will be little affected by them. Most of these shunt resistances may be disconnected by pulling the speaker plug. Checking the value of electrolytic condensers is important to good radio service work and will save many some-back troubles. —William A. Hunt, Jr.

# GENTLEMEN PREFER MHOS

## In Computing Parallel Resistance

By Emil H. Buchwald

THE calculation of resistance values for direct current circuits is comparatively simple. This is especially true of series circuits, but the parallel circuit might present some difficulty. However, with practice, the parallel circuit calculation may be handled as easily as the series circuit.

When computing resistance circuits it is necessary to have a unit of computation in the same way as the grocer needs the pound to compute the weight of coffee, or sugar. The electrical unit for resistance is the ohm, named after Dr. G. S. Ohm, a scientist of long ago. The ohm however is somewhat intangible; one cannot pick it up and handle it like a block of wood. Rather it is the measure of a certain property a conductor exhibits when submitted to an electric current. When a pressure of one volt is impressed on a circuit and a current of one ampere flows, then that circuit has a resistance of one ohm. Hence it is seen that the ohm depends on the volt and the ampere for its definition.

For parallel resistance circuit calculation it is more convenient to turn the ohm around and use it in the reverse order. Literally this means the ohm is called the "mho." Mathematically it means that the value in ohms is divided into 1. Now one ohm is exactly equal to one mho, for if one ohm is divided into 1, the quotient is 1. If 1 is divided by 5 ohms, then the mho, which incidentally is the reciprocal, is .2, a decimal fraction. On the other hand, if 1 is divided by  $\frac{1}{2}$  ohm, or .5 ohm, the number of mhos is 2, a whole number.

For any value in ohms more than 1, the

mho is always a decimal fraction, and for any value in ohms less than 1, the mho is a whole number, or a whole number plus a decimal fraction. In other words, the mho is the reciprocal of the ohm, and to find the mhos a conductor has, the value in ohms is divided into 1. There are mathematical tables for values of 1 divided by other numbers.

### TURNING THINGS AROUND

Since the ohm has been turned around, the property it represents must also be turned around, hence the mho is a unit of conductivity instead of resistance.

To find the total resistance of a number of resistances in a series circuit, it is merely necessary to add the various resistance values and the sum is the total resistance of the circuit in question. This is for direct current circuits. For alternating current circuits some mathematical gymnastics are necessary to compute the total resistance, especially for the higher frequencies. We shall confine ourselves to d.c.

To find the resistance of the parallel circuit it is convenient to use the mho. For an example, in Fig. 1 are three resistances in parallel, namely 5, 10 and 15 ohms. Incidentally, the total resistance of the parallel circuit is always less than the resistance of the smallest value in that circuit. Thus the total resistance of the circuit in Fig. 1 is less than 5. Changing these values into mhos:

$$\begin{aligned} 1 \div 5 &= .2 \text{ mhos} \\ 1 \div 10 &= .1 \text{ " } \\ 1 \div 15 &= .066 \text{ " } \end{aligned}$$

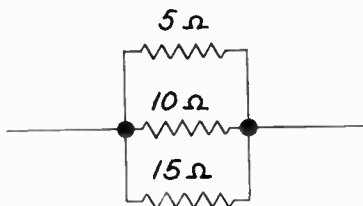

FIG. 1

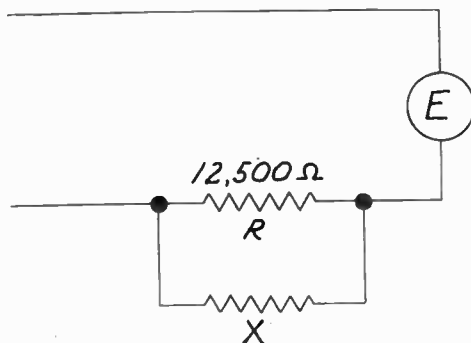

FIG. 2



Now these values are added together

$$\begin{array}{r} .2 \\ .1 \\ \hline .066 \\ \hline .366 \text{ mhos} \end{array}$$

Thus the circuit has a conductivity of .366 mhos. To change this figure into ohms it is divided into 1

$$1 \div .366 = 2.73 \text{ ohms}$$

This is the total resistance of the circuit.

### MILLIAMMETER EXAMPLE

Fig. 2 constitutes a practical example. Here is a 0-1 millimeter connected in series with the resistance R to form a voltmeter reading

necting the lamp directly in series with the tubes and resistance RL means that a current of .3 ampere will flow through it. This is equivalent to raising the terminal voltage across the lamp to about 7.5 volts.

### FINDING VALUE OF R

Since the lamp is designed for a 6.3 volt potential, the higher voltage is likely to be disastrous, hence it is necessary to use a shunt resistance R to alleviate the strain. The lamp and the resistance R may be considered as separate entities with a potential of 6.3 volts across it. As the lamp handles .25 ampere, the resistance R must take care of .05 ampere to bring the current up to .3 ampere. Thus according to Ohm's law we find that a resistance

FIG. 3  
A practical example that the set-builder faces when designing an ac-dc set. The tubes are of the .3 ampere heater type.

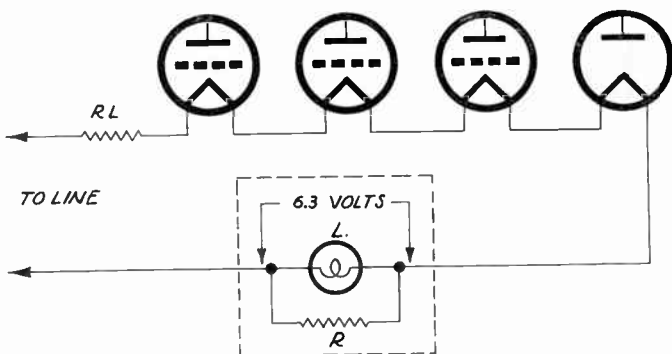

up to 10 volts. The resistance R however is somewhat high for the 10 volt range, having some 2,500 ohms more than necessary. To bring the resistance down to 10,000 ohms it is necessary to "pad" the resistance R by connecting a resistor in parallel with it. First the number of mhos of R must be determined, and dividing;

$$1 \div 12,500 = .00008 \text{ mhos}$$

The required resistance is 10,000 ohms for a ten volt range, and the conductivity is

$$1 \div 10,000 = .0001 \text{ mhos}$$

Now the conductivity of the padding conductance X is the difference between the actual conductance and the required conductance, thus;

$$\begin{array}{r} .00010 \\ .00008 \\ \hline .00002 \text{ mhos} \end{array}$$

This is the value in mhos of the padding conductance X, and to find the resistance in ohms, this value is again divided into 1

$$1 \div .00002 = 50,000 \text{ ohms}$$

Hence a resistance of 50,000 ohms is required in parallel with R to reduce the total resistance to 10,000 ohms.

Fig. 3 constitutes an example which the set builder faces when designing an ac-dc radio. The tubes T are the type that draw .3 ampere at 6.3 volts, or at 12 volts, as the case may be. The pilot lamp L is 6.3 volt at .25 ampere. Con-

necessary to carry .05 ampere at 6.3 volts is

$$6.3 \div .05 = 126 \text{ ohms.}$$

This is the value of R.

This problem may be solved by using the mho instead of the ohm, as follows:

The total current flowing in the circuit is .3 ampere. The voltage across the lamp circuit is 6.3. According to Ohm's law, the resistance of the circuit is 21 ohms. The reciprocal, or the mho of this value is .0476, and this the desired conductivity. But the actual conductivity is the reciprocal of the resistance of the lamp. According to Ohm's law, the resistance of the lamp is 25.2 ohms. Changing this value into mhos we have; .0397 mhos. Now the difference between the desired conductivity and the actual conductivity is

$$\begin{array}{r} .0476 \\ .0397 \\ \hline .0079 \text{ mhos} \end{array}$$

Hence an additional conductance of .0079 mhos is necessary to bring the conductivity of the circuit up so that it will pass .3 ampere at 6.3 volts. Now, dividing .0079 mhos into 1:

$$1 \div .0079 = 126 \text{ ohms.}$$

This is the value of R.

The mho is as important in calculating parallel resistance circuits as the ohm is in calculating the series circuit.

# EMISSION TUBE TESTER

## With Table for Nearly All Tubes

By Joseph T. Bernsley

**M**OST of the tube testers in use today are of the emission type. In effect, all tubes thus become diodes under test, because of the interconnection of all elements except the cathode. Hence we have cathode and anode. The quality of the tube is determined by the amount of current flowing when a given voltage (a.c.) is impressed for rectification. It is usually recommended that 30 volts be used as this supply.

The circuit herewith enables the testing of all types of tubes, and the actual tests have been made on many tubes, so that the use of a direct-reading meter of the Good?-Bad type becomes practical. This is a 0-5 milliammeter manufactured by Readrite Meter Works.

### THE GANGED SWITCHES

There are two ganged switches. One is a double-pole, double-throw switch, used for tube test or short test selection. Naturally the first test to make is whether any of the elements are shorted, and if they are, the neon tube associated with the short-test circuit will glow.

The other ganged switch is three-pole, double-throw, and is identified by the A and B designa-

tions on the diagram. The positions of Selector 2 and Selector 3 are very important, for the tube testing depends on these, therefore a table has been prepared for practically all tubes, with the filament volts to be used, the position to be established for each particular tube on the 5,000-ohm rheostat, which is graduated 0-100 and is nonlinear and called Selector 2, also the A or B setting for Selector 3.

### THE FIVE SOCKETS

All information in connection with the switching and the identifications is included on the circuit diagram. The five sockets used are, left to right, UX, UY, six-prong, dual seven-prong, and octal. The dual seven-prong means that the socket is so constructed that both the small and medium sized tube bases are accommodated in the seven-pin series.

Two grid caps are used, one for the regular type tubes, the other, the miniature kind, for the octal tubes, including metal and glass.

### OPERATING INSTRUCTIONS

This instrument should be plugged into a 110 volt, 60 cycle a-c line only. To test tubes insert

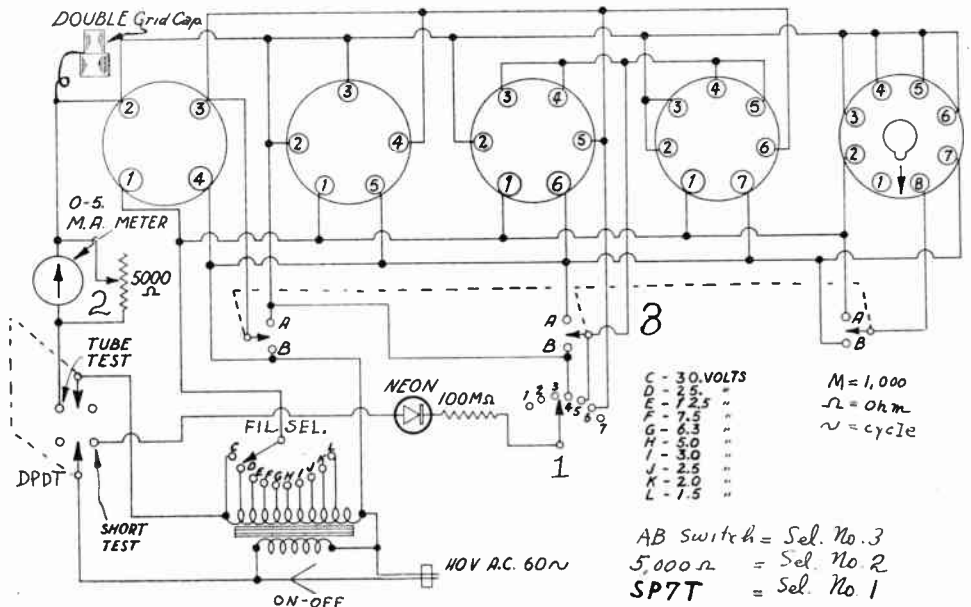

Chosen for its simplicity and ruggedness, this circuit permits the testing of tubes by the emission method. It requires a minimum of parts and operations. The table on opposite page coordinates the indicating meter to the positions of two main controls for determination of tube merit.

the tube in its proper socket, set the respective switches to the positions indicated in the chart below and turn the power supply switch to the "on" position. The emission reading will be obtained almost immediately if the tube is of the filament type, whereas it will take a few seconds in the case of heater type tubes. Care must be taken when setting the respective selector switches, especially in the case of filament voltage switch, as an incorrect setting may destroy the tube. The toggle switch labelled "Tube Test" and "Leakage Test" should be thrown to the "Tube Test" position when the tube is to be tested. When leakage tests are to be made this switch should be thrown to the desired position and selector switch No. 1 rotated from position 1 to 7, meanwhile watching the neon tube carefully for a glow.

When testing for leakage, using the neon tube. If both neon electrodes light more than once, the tube under test is shorted.

The short test is made first, then the tube's emission test.

When testing tubes, only those tubes which indicate an emission which falls within the portion of the scale (indicated as "GOOD") should be passed. Those tubes which have an emission which is indicated in the "?" or "Bad" portion of the scale should be rejected.

**KIND WORDS**

I have read your magazine since first published and still like it.

O. B. MILLAR  
Box 192, Coalinga, Calif.

\* \* \*

I think RADIO WORLD is the finest magazine for servicemen.

ROGER POULIN  
121 Cartier Ave.,  
Quebec City, P.Q., Canada

Type	Fil Volt.	Sel. 2	Sel. 3	Type	Fil Volt.	Sel. 2	Sel. 3	Type	Fil Volt.	Sel. 2	Sel. 3
O1A	5.0	55	A	15	2.0	60	B	81	7.5	63	A
1A4T	2.0	62	A	18	12.5	50	B	83V	5.0	20	A
1A6	2.0	71	B	19	2.0	43	B	84/6Z4	6.3	25	B
1B4	2.0	61	A	20	3.0	67	A	85	6.3	40	B
1B5/25S	2.0	60	A	22	3.0	65	A	89	6.3	44	B
1C6	2.0	62	B	24A	2.5	55	B	99	3.0	67	A
1F4	2.0	43	A	25A6	25.0	29	B	182R/482B	5.0	43	A
1F6	2.0	62	A	25B5	25.0	43	B	183/483	5.0	46	A
1V	6.3	27	B	25L6	25.0	25	B	485	3.0	43	B
2A3	2.5	28	A	25Z5-6	25.0	20	A	<i>G Tubes</i>			
2A5	2.5	49	B	26	1.5	26	A	1C7G	2.0	62	B
2A6	2.5	35	B	27	2.5	55	B	1D5G	2.0	62	B
2A7	2.5	40	B	30	2.0	60	A	1D7G	2.0	71	B
2B7	2.5	57	B	31	2.0	60	A	1E5G	2.0	61	B
5W4	5.0	48	B	32	2.0	60	A	1E7G	2.0	40	B
5Z3	5.0	33	A	33	2.0	52	A	1F5G	2.0	43	B
5Z4	6.3	22	B	34	2.0	60	A	1F7G	2.0	62	B
6A3	6.3	28	A	35/51	2.5	46	B	1H4G	2.0	60	B
6A4/LA	6.3	43	A	36	6.3	50	B	1H6G	2.0	60	B
6A6	6.3	41	A	37	6.3	43	B	1J6G	2.0	43	B
6A7	6.3	45	B	38	6.3	41	B	5F4G	5.0	20	B
6A8	6.3	39	B	39/44	6.3	45	B	5X4G	5.0	30	A
6B5	6.3	60	B	41	6.3	48	B	5Y3G	5.0	42	B
6B7	6.3	57	B	42	6.3	40	B	5Y4G	5.0	46	A
6B8	6.3	57	B	43	25.0	31	B	6B4G	6.3	28	B
6C6	6.3	41	B	45	2.5	45	A	6B8G	6.3	57	B
6D6	6.3	41	B	46	2.5	42	A	6D8G	6.3	14	B
6E6	6.3	42	A	47	2.5	44	A	6J5G	6.3	26	B
6F5	6.3	30	B	48	30.0	25	B	6K5G	6.3	28	B
6F6	6.3	38	B	49	2.0	48	A	6K6G	6.3	48	B
6F7	6.3	40	B	50	7.5	58	A	6L5G	6.3	45	B
6H6	6.3	27	B	53	2.5	41	A	6N6G	6.3	46	B
6J7	6.3	38	B	55	2.5	42	B	6S7G	6.3	41	B
6K7	6.3	38	B	56	2.5	42	B	6T7G	6.3	34	B
6L6	6.3	34	B	57	2.5	44	B	25B6G	6.3	29	B
6L7	6.3	30	B	58	2.5	35	B	6D5G	6.3	40	B
6N7	6.3	30	B	59	2.5	41	B	<i>Majestic Tubes</i>			
6Q7	6.3	34	B	71A	5.0	51	A	2S/4S	2.5	27	B
6R7	6.3	36	B	75	6.3	35	B	2ZZ/G84	2.5	27	A
6X5	6.3	25	B	76	6.3	43	B	6C7S	6.3	59	B
10	7.5	61	A	77	6.3	36	B	6D7S	6.3	33	B
6C5	6.3	45	B	78	6.3	47	B	6E7S	6.3	38	B
12A	5.0	39	A	79	6.3	57	A	6Y5S	6.3	30	A
12A7	12.5	56	B	80	5.0	50	A				
12Z3	12.5	21	B								

U -50 -100 -150 -200 -250 -300 -350 -400  
CATHODE VOLTAGE IN REFERENCE TO PLATE

FIG. 3

The cathode characteristics of the 6C5.

# Wuv Hef A Driven

## HOW VIBRATORS WORK

### and When They Don't, How to Test 'Em

By F. E. Wenger

Engineer, The Triplett Electrical Instrument Company

**P**RESENT day automobile radio servicing can be speeded up by the use of a vibrator tester. Before describing the testing of vibrators I believe it is well to take the mystery out of the operation of vibrators. Successful servicing of auto radios is entirely dependent upon the serviceman's understanding of the fundamentals of vibrators and their associated circuits.



F. E. WENGER

Vibrators should be called automatic switches whose time constants are governed largely by the mechanical construction of the vibrator or switch.

Fig. 1 shows the interrupter type vibrator connected in full-wave circuit. Current from the A battery flows through the center tap of the

transformer in the lead marked A HOT, and with the reed in the upper position, the current flows with the arrows. The reed remains momentarily in the upper position until the electromagnet draws the reed to the lower position, when current is interrupted through the upper section and starts flowing in the lower section of the transformer.

#### PULSATING D.C. PRODUCED

The contact with the reed is made momentarily until the electro-magnet again returns the reed to the top position. The electro-magnet is not shown in the circuit as this can be either a series or a shunt type coil. It is easily seen how the speed of the reed and the dwell of the

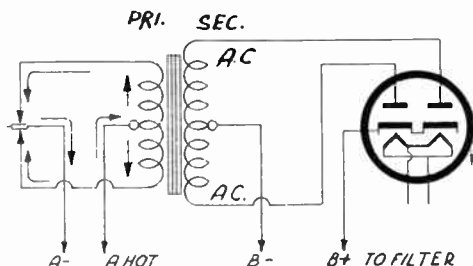

FIG. 1

A full-wave circuit, using the interrupter type vibrator. The electromagnet is not shown. A tube rectifier is used.

contacts will produce pulsating direct current in the primary of the transformer. This pulsating current is reflected as a-c voltage on the secondary. The transformer ratio is generally 40 to 1. Thus we have an alternating voltage in the secondary of the transformer forty times that of the battery.

After we have a-c voltage in the secondary this is rectified in the interrupter type vibrator the same as a-c voltage and current are rectified in the conventional a-c power pack. Filtering is substantially the same as that for home receivers and is designed for the frequency of the vibrator.

Fig. 2 shows the synchronous type vibrator. Please note the current in the primary takes the same path as it did in the interrupter type vibrator. However, the reflected voltage in the secondary is rectified somewhat differently, as it does not use a tube, but uses the same reed to interrupt the current in the primary and to pass current in only one direction.

During the first part of the cycle one-half of

## How Cathode Characteristics are Obtained

(Continued from preceding page)

a plate-to-cathode voltage of 150 volts, the grid-to-cathode voltage is zero, since the difference between the grid-to-plate voltage and the plate-to-cathode voltage is zero. From the plate characteristic curves, we find the plate current is 15 milliamperes for zero volts on the grid and 150 volts on the plate, which gives us one point. For the second point, let us take a plate-to-cathode voltage of 148 volts, the grid-to-cathode voltage is -2 volts, since the difference

between the grid-to-plate voltage (-150 volts) and the plate-to-cathode voltage (-148) volts is -2 volts. From the plate characteristic curves, we find the plate current is 10 milliamperes for -2 volts on the grid and 148 volts on the plate. For the third point, let us take a plate-to-cathode voltage of 146, giving us a grid bias of -4 volts, this applied to the curves gives us a plate current of 5.7 milliamperes. Continuing this procedure, the complete cathode characteristic curves are obtained.

the tube in its proper socket, set the respective switches to the positions indicated in the chart below and turn the power supply switch to the "on" position. The emission reading will be obtained almost immediately if the tube is of the filament type, whereas it will take a few seconds in the case of heater type tubes. Care must be taken when setting the respective selector switches, especially in the case of filament voltage switch, as an incorrect setting may destroy the tube. The toggle switch labelled "Tube Test" and "L'kge Test" should be thrown to the "Tube Test" position when the tube is to be tested. When leakage tests are to be made this switch should be thrown to the desired position and selector switch No. 1 rotated from position 1 to 7, meanwhile watching the neon tube carefully for a glow.

When testing for leakage, using the neon tube. If both neon electrodes light more than once, the tube under test is shorted.

The short test is made first, then the tube's emission test.

When testing tubes, only those tubes which indicate an emission which falls within the portion of the scale (indicated as "GOOD") should be passed. Those tubes which have an emission which is indicated in the "?" or "Bad" portion of the scale should be rejected.

### KIND WORDS

I have read your magazine since first published and still like it.

O. B. MILLAR  
Box 192, Coalinga, Calif.

\* \* \*

I think RADIO WORLD is the finest magazine for servicemen.

ROGER POULIN  
121 Cartier Ave.,  
Quebec City, P.Q., Canada

Type	Fil Volt.	Sel. 2	Sel. 3	Type	Fil Volt.	Sel. 2	Sel. 3	Type	Fil Volt.	Sel. 2	Sel. 3
O1A	5.0	55	A	15	2.0	60	B	81	7.5	63	A
1A4T	2.0	62	A	18	12.5	50	B	83V	5.0	20	A
1A6	2.0	71	B	19	2.0	43	B	84/6Z4	6.3	25	B
1B4	2.0	61	A	20	3.0	67	A	85	6.3	40	B
1B5/25S	2.0	60	A	22	3.0	65	A	89	6.3	44	B
1C6	2.0	62	B	24A	2.5	55	B	99	3.0	67	A
1F4	2.0	43	A	25A6	25.0	29	B	182R/482B	5.0	43	A
1F6	2.0	62	A	25B5	25.0	43	B	183/483	5.0	46	A
1V	6.3	27	B	25L6	25.0	25	B	485	3.0	43	B
2A3	2.5	28	A	25Z5-6	25.0	20	A				
2A5	2.5	49	B	26	1.5	26	A	1C7G	2.0	62	B
2A6	2.5	35	B	27	2.5	55	B	1D5G	2.0	62	B
2A7	2.5	40	B	30	2.0	60	A	1D7G	2.0	71	B
2B7	2.5	57	B	31	2.0	60	A	1E5G	2.0	61	B
5W4	5.0	48	B	32	2.0	60	A	1E7G	2.0	40	B
5Z3	5.0	33	A	33	2.0	52	A	1F5G	2.0	43	B
5Z4	6.3	22	B	34	2.0	60	A	1F7G	2.0	62	B
6A3	6.3	28	A	35/51	2.5	46	B	1H4G	2.0	60	B
6A4/LA	6.3	43	A	36	6.3	50	B	1H6G	2.0	60	B
6A6	6.3	41	A	37	6.3	43	B	1J6G	2.0	43	B
6A7	6.3	45	B	38	6.3	41	B	5F4G	5.0	20	B
6A8	6.3	39	B	39/44	6.3	45	B	5X4G	5.0	30	A
6B5	6.3	60	B	41	6.3	48	B	5Y3G	5.0	42	B
6B7	6.3	57	B	42	6.3	40	B	5Y4G	5.0	46	A
6B8	6.3	57	B	43	25.0	31	B	6B4G	6.3	28	B
6C6	6.3	41	B	45	2.5	45	A	6B8G	6.3	57	B
6D6	6.3	41	B	46	2.5	42	A	6D8G	6.3	44	B
6E6	6.3	42	A	47	2.5	44	A	6J5G	6.3	26	B
6F5	6.3	30	B	48	30.0	25	B	6K5G	6.3	28	B
6F6	6.3	38	B	49	2.0	48	A	6K6G	6.3	48	B
6F7	6.3	40	B	50	7.5	58	A	6L5G	6.3	45	B
6H6	6.3	27	B	53	2.5	41	A	6N6G	6.3	46	B
6J7	6.3	38	B	55	2.5	42	B	6S7G	6.3	41	B
6K7	6.3	38	B	56	2.5	42	B	6T7G	6.3	34	B
6L6	6.3	34	B	57	2.5	44	B	25B6G	6.3	29	B
6L7	6.3	30	B	58	2.5	35	B	6D5G	6.3	40	B
6N7	6.3	30	B	59	2.5	41	B				
6Q7	6.3	34	B	71A	5.0	51	A	2S/4S	2.5	27	B
6R7	6.3	36	B	75	6.3	35	B	2ZZ/G84	2.5	27	A
6X5	6.3	25	B	76	6.3	43	B	6C7S	6.3	59	B
10	7.5	61	A	77	6.3	36	B	6D7S	6.3	33	B
6C5	6.3	45	B	78	6.3	47	B	6E7S	6.3	38	B
12A	5.0	39	A	79	6.3	57	A	6Y5S	6.3	30	A
12A7	12.5	56	B	80	5.0	50	A				
12Z3	12.5	21	B								

*G Tubes*

*Majestic Tubes*

# WHY USE A DRIVER WITH CATHODE LOAD?

By W. M. Perkins

Commercial Engineer, National Union Radio Corporation

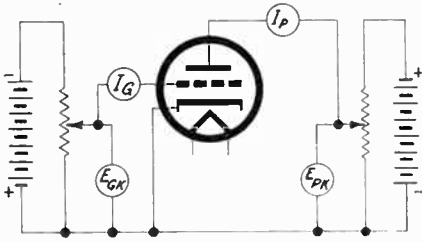

FIG. 1

Circuit for taking the plate characteristic curves. Input is to left of the tube, output to right.

BY placing the load in the cathode circuit rather than in the plate circuit of a vacuum tube, the characteristics of an amplifier are greatly changed. The circuit is commonly referred to as a cathode-loaded amplifier. It is a special case of degeneration and may be treated as such when one considers the feedback voltage being equal to the output voltage. When so considered, it is possible to predict the characteristics of such an amplifier.

The operation of such a circuit may be analyzed graphically in a manner similar to that used in analyzing amplifier tube performance from the usual tube characteristic curves. Graphical presentation of tube characteristics in the most common form is a family of plate current versus plate voltage curves for various values of grid bias. Data for these curves are obtained by measuring the tube in a circuit similar to the one shown in Fig. 1. From this family of curves, several of the more important characteristics of the tube can be obtained for various grid bias and plate voltages.

The slope of the  $E_p$ - $I_p$  curve at any point is the plate resistance at the defining voltage condition.

## $R_p$ , $G_m$ AND $\mu$ DEFINED

The ratio of the change in plate current, produced by a small change in grid voltage, to that change in grid voltage is the mutual conductance.

The ratio of the change in plate voltage, necessary to counteract the effect of the small change in grid voltage upon the plate current, to the change in grid voltage is the amplification factor. The power output and distortion may be obtained from the family of curves by drawing a load resistance line through the operating point. The points of intersection yield the data necessary to compute the power output and distortion.

It is to be noted that the slope of the load resistance is determined graphically by the use of the plate voltage scale and plate current scale but in the opposite direction from that of the plate resistance. The reason for the opposite slope is that the voltage across the load resistance is equal to the plate voltage supply minus the voltage of the plate, thus the actual voltage across the load resistance is in the opposite direction from that of the plate voltage scale.

The cathode-loaded amplifier may be treated in an identical manner provided the characteristic curves are taken so that they directly apply to cathode loading. The data for such a set of curves can be obtained by measuring a tube in a circuit such as shown in Fig. 2.

## BOTH CHARACTERISTICS

As in Fig. 1, that part of the circuit to the left of the tube is the input circuit, while that part to the right of the tube is the output circuit. The only differences between the two circuits are that the cathode circuit and the plate circuit have been reversed and the polarity of the supply voltage has been reversed. Plate characteristics are obtained by using the circuit in Fig. 1, while cathode characteristics are obtained by using the circuit in Fig. 2.

The cathode characteristics of a type 6C5 are shown in Fig. 3. From this, the amplification factor is found to be slightly less than unity; the cathode resistance to be extremely low; and the grid-to-cathode mutual conductance to be identical to the grid-to-plate mutual conductance in the normal circuit. There is, however, no  $180^\circ$  phase shift as in the normal grid-to-plate mutual conductance.

By plotting several load lines through an operating point, and computing the power output and distortion, several characteristics of such an amplifier are readily seen:

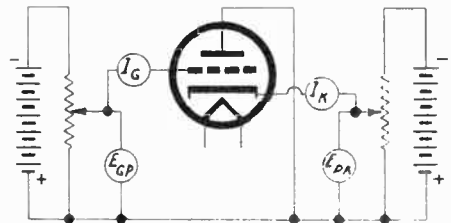

FIG. 2

This circuit is for obtaining the cathode characteristic. The only difference between this and Fig. 1 is reversal of polarities.

- (1) The load resistance which yields maximum low distortion power output is several times larger than the cathode resistance.
- (2) The distortion is very low.
- (3) The power sensitivity is extremely low.
- (4) The optimum load resistance is roughly equal to the plate resistance of the tube. In the case of a 6C5, operating at 250 volts total supply, the optimum load resistance is 15 per cent greater than the plate resistance.

### COMPARISON OF LOADING

Cathode loading and plate loading on a 6C5 are compared in the following table:

Loading	Total Supply Volts	Plate Current (No. Signal) Signal Volts (RMS)	Load Resistance Ohms	Power Output Milliwatts	Distortion	Tube Res. Ohms	Tube Res. Load Res.
Plate ...	250	7.2	23,000	235	5%	10,500	0.457
Cathode ..	250	7.2	12,000	325	2.4%	500	0.042

One of the outstanding differences is the ratio of the tube resistance to load resistance. The cathode-loaded tube has a ratio of only 0.042, while that of the plate-loaded tube is 0.5. This is a factor of great importance in cases where the value of the load impedance varies considerably throughout the cycle.

A typical example is that load imposed upon a driver stage by an output stage which is designed to draw grid current during part of the input cycle. In such a case, a cathode-loaded driver will be able to drive the output stage harder, keeping within distortion limits, than the plate loaded driver by a factor much greater than the ratio of power output and distortion would indicate.

The cathode characteristic curves may be obtained from the usual published plate characteristic curves by taking into account the voltage relations between the two circuits. In the cathode characteristic curves the grid voltage is relative to the plate and not to the cathode as is the plate characteristic curves (compare Figs. 1 and 2). It follows that the grid voltage relative to the plate is equal to the algebraic sum of the grid voltage relative to the cathode and the plate voltage relative to the cathode. Since these last two voltages are those used on plate characteristic curves, the plate current for a given grid-to-plate voltage and plate-to-cathode voltage may be found by using the above relation.

### CATHODE CHARACTERISTICS' BASIS

As an example, let us solve several points for a cathode characteristic curve for the type 6C5 for a grid-to-plate voltage of -150 volts. For

(Continued on following page)

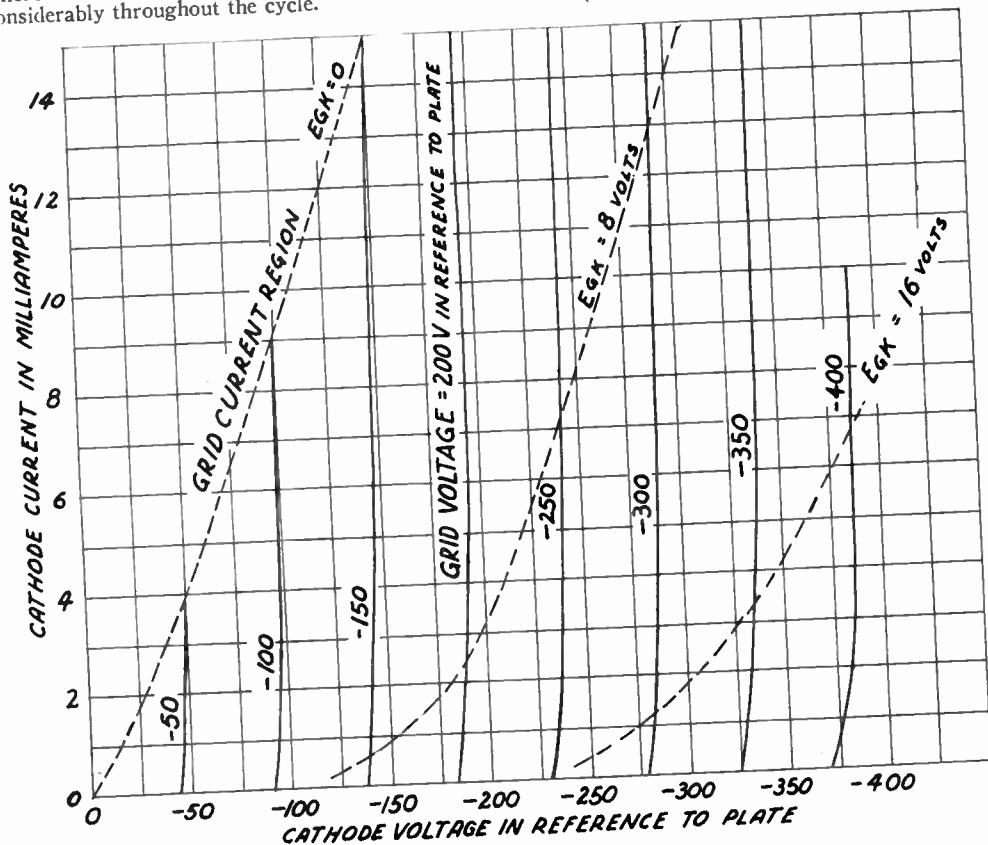

FIG. 3

The cathode characteristics of the 6C5.

# HOW VIBRATORS WORK

## and When They Don't, How to Test 'Em

By F. E. Wenger

Engineer, The Triplett Electrical Instrument Company

**P**RESENT day automobile radio servicing can be speeded up by the use of a vibrator tester. Before describing the testing of vibrators I believe it is well to take the mystery out of the operation of vibrators. Successful servicing of auto radios is entirely dependent upon the serviceman's understanding of the fundamentals of vibrators and their associated circuits.



F. E. WENGER

Vibrators should be called automatic switches whose time constants are governed largely by the mechanical construction of the vibrator or switch.

Fig. 1 shows the interrupter type vibrator connected in full-wave circuit. Current from the A battery flows through the center tap of the transformer in the lead marked A HOT, and with the reed in the upper position, the current flows with the arrows. The reed remains momentarily in the upper position until the electromagnet draws the reed to the lower position, when current is interrupted through the upper section and starts flowing in the lower section of the transformer.

### PULSATING D.C. PRODUCED

The contact with the reed is made momentarily until the electro-magnet again returns the reed to the top position. The electro-magnet is not shown in the circuit as this can be either a series or a shunt type coil. It is easily seen how the speed of the reed and the dwell of the

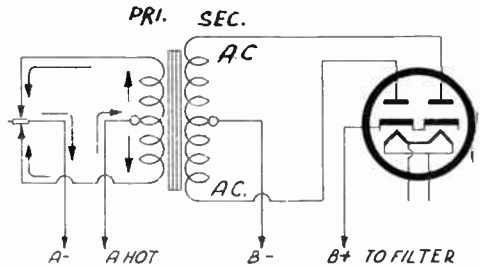

FIG. 1

A full-wave circuit, using the interrupter type vibrator. The electromagnet is not shown. A tube rectifier is used.

contacts will produce pulsating direct current in the primary of the transformer. This pulsating current is reflected as a-c voltage on the secondary. The transformer ratio is generally 40 to 1. Thus we have an alternating voltage in the secondary of the transformer forty times that of the battery.

After we have a-c voltage in the secondary this is rectified in the interrupter type vibrator the same as a-c voltage and current are rectified in the conventional a-c power pack. Filtering is substantially the same as that for home receivers and is designed for the frequency of the vibrator.

Fig. 2 shows the synchronous type vibrator. Please note the current in the primary takes the same path as it did in the interrupter type vibrator. However, the reflected voltage in the secondary is rectified somewhat differently, as it does not use a tube, but uses the same reed to interrupt the current in the primary and to pass current in only one direction.

During the first part of the cycle one-half of

## How Cathode Characteristics are Obtained

(Continued from preceding page)

a plate-to-cathode voltage of 150 volts, the grid-to-cathode voltage is zero, since the difference between the grid-to-plate voltage and the plate-to-cathode voltage is zero. From the plate characteristic curves, we find the plate current is 15 milliamperes for zero volts on the grid and 150 volts on the plate, which gives us one point. For the second point, let us take a plate-to-cathode voltage of 148 volts, the grid-to-cathode voltage is  $-2$  volts, since the difference

between the grid-to-plate voltage ( $-150$  volts) and the plate-to-cathode voltage ( $-148$ ) volts is  $-2$  volts. From the plate characteristic curves, we find the plate current is 10 milliamperes for  $-2$  volts on the grid and 148 volts on the plate. For the third point, let us take a plate-to-cathode voltage of 146, giving us a grid bias of  $-4$  volts, this applied to the curves gives us a plate current of 5.7 milliamperes. Continuing this procedure, the complete cathode characteristic curves are obtained.



the secondary is delivering current to the reed, and during the second half of the cycle the other half of the secondary is delivering current to the reed. Thus we have accomplished rectification, passing current in one direction only, without the use of a tube. The center tap of the secondary in this instance becomes B+.

The two reeds can be electrically insulated from each other, as is necessary in some radio sets where the negative return is below ground potential. However, the reed works in synchronism with the primary, hence we have self-rectification.

By the foregoing description and a study of the action of the vibrator and a study of the circuits, it will be noted that the transformer and filter systems are separate parts of the vibrator proper and should be tested and analyzed the same as similar circuits are in conventional home radios.

### TWO IMPORTANT CONDENSERS

Not shown in the drawings, but an important part of the vibrator function, are the two small buffer condensers which are either incorporated as a part of the vibrator or incorporated in the power pack of the complete unit. These condensers form a very useful service in limiting and suppressing the arc across the contacts due to the making and breaking of the current on the primary side. These condensers are placed in the secondary instead of the primary circuit. Although the voltage must be very much higher, the capacity can be very much lower there, as their action is reflected in the primary circuit. The capacity of this condenser, whether incorporated as an integral part of the vibrator, or in the power pack proper, should never be changed, as the entire vibrator has been designed for this particular capacity.

In the preliminary check of the vibrator and the power pack, much guesswork can be eliminated by knowing the circuit and understanding a few of the troubles which can happen to vibrators and their power packs such as the following:

### TROUBLES AND CURES

Shorted filter systems, shorted buffer condensers, grounded filter systems, shorted transformers, shorted wiring or shorted rectifier tubes, may cause no B voltage. Also no battery voltage may be delivered to the vibrator, which can be caused by a blown fuse, a burned switch, a broken A lead or any one of the numerous other suggestions which will come to mind.

After the cause for the absence of B voltage has been discovered, correct it and proceed to test the vibrator in the Triplet Model 1670 Vibrator Tester, as a shorted filter system and other shorts, such as buffer condensers, rectifier tube, transformer secondaries, etc., can damage the vibrator by overloading the contacts. It might be stated here that rarely, if ever, do the power transformers give trouble.

If the B battery voltages are low, the battery voltage must be checked, as well as the resistance of all leads from the battery to the vibrator.

Check for high resistance shorts in the rectifier circuit.

Check the rectifier tube, buffer condensers and for troubles which cause low voltage in the usual home radio.

The vibrator should also be checked in the new and complete Triplet Model 1670 Vibrator Checker.

Hash is a problem of circuit design, shielding, both magnetic and electrostatic, proper radio-frequency filtering, proper ground, mechanical arrangement of the receiver and the sensitivity of the receiver. Engineers have taken care of the hash problem in the design of the receivers and if hash is present it should be traced to its source. Do not attempt to eliminate hash by "doctoring" the vibrator. In severe cases manufacturers of the vibrators do furnish hash eliminators.

Intermittent operation can be caused by defective vibrators due to sticking contacts, loose

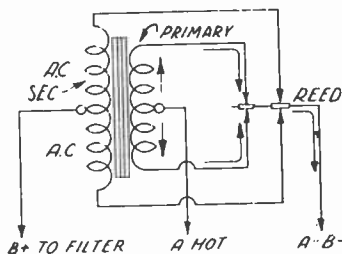

FIG. 2

The synchronous type vibrator. The reed gets current during the first alternation of the cycle and also during the second alternation. Current is in only one direction. Therefore we have rectification.

contacts in the power pack and other symptoms the same as in a conventional a-c receiver. Eliminate these by checking the vibrator in a Triplet Model 1670 Vibrator Checker.

### USUAL NOISES

Vibrators with unusual mechanical noise are caused by the vibrator touching other parts of the housing, the internal assembly, or by loose parts which vibrate with the operation of the vibrator.

A vibrator tester's primary purpose is to detect defective vibrators which will no longer function or operate properly with their associated circuits and the Triplet Laboratory obtained a number of vibrators in various stages of deterioration and worked closely with the manufacturers of vibrators so a tester could be designed which would give the serviceman every needed test.

In the analysis of vibrator trouble it was found that defective vibrators had two distinct characteristics:

1. The vibrators would fail to start properly on very low voltage such as 5.5 volts on a 6-volt battery.
2. The vibrators would operate unevenly, causing a variation in the output voltage.

# The Relation of Maximum Ratings to Life and Performance of POWER OUTPUT TUBES

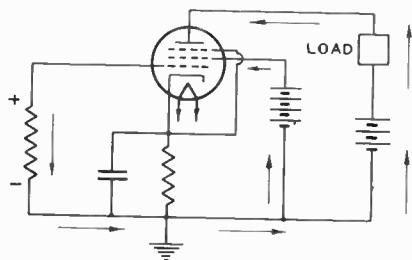

FIG. 1.

Overheating the heater also may seriously increase the temperature of the other tube elements. Flow of secondary electrons then reduces the effective bias on the tube. Arrows indicate the direction of current flow due to grid emission and also apply to the effect of gas presence.

**M**AXIMUM ratings for each type of power output tube are established on the basis of life tests and operating performance. Experience indicates that when one or more maximum ratings are exceeded for an appreciable time, the serviceability of a tube type may be impaired—life may be shortened, or performance may be unsatisfactory. It is the purpose of this Note to discuss the significance of output tube ratings, to show how certain maximum ratings may be unintentionally exceeded in practice, and to suggest means for reducing the possibility of exceeding maximum ratings.

A voltage, current, power, or resistance value which is followed by the word "maximum" should not be exceeded for an appreciable time under steady-state conditions. In an output tube, for example, a plate potential of "250 volts maximum" signifies the recommended maximum d-c voltage which may be applied between plate and cathode under steady-state conditions. The instantaneous value of plate potential may vary from zero to 500 volts during operation, but it is necessary that the plate potential indicated by a d-c meter shall not exceed 250 volts.

## HEATER RATING

Frequency and wave form of the alternating plate potential may be important. Thus, in a d-c amplifier, the frequency and wave form of the applied signal may be such that the instantaneous plate potential remains at 500 volts for an appreciable time. Maximum ratings for output tubes do not hold for such unusual applications; maximum ratings obtain only for operation in normal radio-receiving circuits.

Heater or filament voltage is given as a normal (rated) value unless otherwise stated. In

a radio receiver, apply rated heater voltage to the tubes under average line-voltage conditions; experience indicates that a good average value of line voltage is 117 volts (rms). The design of heaters is such that a rise in line voltage to 125 volts does not seriously reduce tube life. The values of average and maximum line voltages used in this Note are those recommended by Radio Manufacturers Association, Inc.

Some tube types have a maximum heater-voltage rating. These types are not recommended for use in applications where the maximum heater-voltage rating is exceeded for an appreciable time during normal operation. Thus, the voltage of a battery in an automobile may rise to 8 volts; a tube type which has a maximum heater-voltage rating of 7 volts is not recommended for use in an auto-radio receiver.

An important effect of operating a heater above its maximum rating for an appreciable time is that tube life is reduced. Excess heater voltage may also cause the temperature of other elements in the tube to rise to abnormally high values. When the control grid of a tube is overheated, for example, it may emit electrons, which are attracted to screen and plate. The current due to these electrons flows through plate, screen and control-grid circuits. When the resistance in series with the grid circuit is high, the voltage drops in the grid circuit resistance due to grid-emission current is high and the polarity of this voltage is such as to oppose the normal negative bias on the tube. This condition is illustrated in Fig. 1.

## LOSS OF BIAS EXPLAINED

The loss in bias due to grid emission causes high plate and screen currents, which increase the temperature of plate and screen. When the temperature of plate or screen becomes high enough, occluded gas is driven from the elements of the tube; this gas is ionized by electron bombardment. Positive gas ions then bombard the cathode. Positive ion bombardment of the cathode causes loss in active emitting area of the cathode and increased cathode temperature.

The effects are usually cumulative; the action continues until emission from the cathode falls to a very low value. It is seen from this brief explanation that two precautions may be taken to reduce the effects of possible grid emission: (1) do not exceed the maximum recommended value of d-c resistance in the grid circuit and (2) do not exceed the recommended maximum value of heater voltage for an appreciable time.

A value of grid bias is established for given operating conditions to permit the most satisfactory operating performance. Insufficient grid bias may cause distorted reception and possible in-

# FAULTLESS OSCILLOSCOPE DIAGRAM SUITS 1" OR 2" TUBE

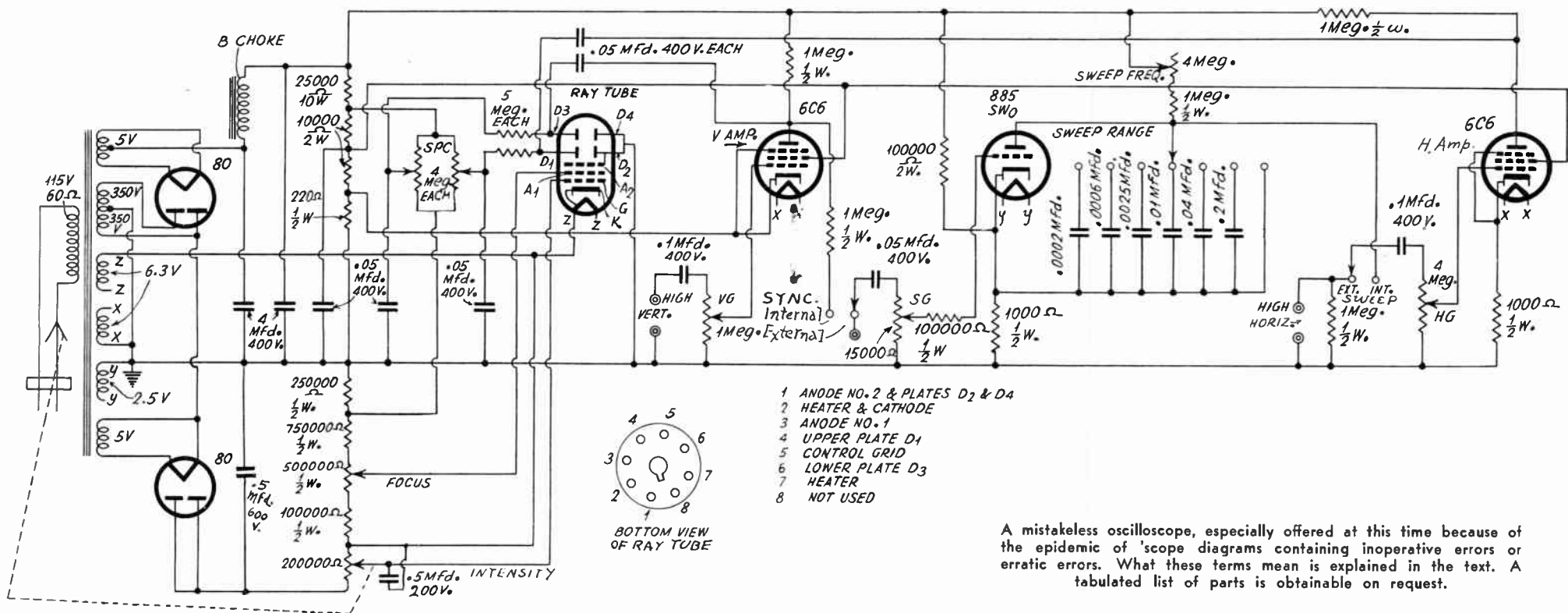

THE printing presses haven't been doing quite the right thing by the oscilloscope, therefore some enthusiasts who build their own find to their sorrow that they get no performance whatever. The periodical technical press has had its troubles getting "straight" diagrams into the "book," and even manufacturers have been sending out, unfortunately in teeming thousands, diagrams that have inoperative errors in them. An inoperative error, a phrase now being introduced for the first time, means that the mistake makes the device inoperative.

It is admittedly very hard, when hurrying to comply with a schedule, to get all connections straight in such an elaborate outfit as a cathode-ray oscilloscope with amplifiers, and all the trimmings that modern radio service work requires that it possess. Either the schedules should not be made so hard to meet or the diagrams made with mistakeproof, instead of merely waterproof, ink.

## THE CRAZE FOR A PHRASE

Herewith is published a diagram that did not originate at RADIO WORLD's laboratories at all, but was sent in by the publicity agent of a manu-

facturer whose name is noted in oscilloscopy. We do not mention the maker's name, not because we desire to deny him credit, but because we want to spare him discredit. He sponsored the diagram of a scope that contained two errors, one of the inoperative type, and the other of the erratic type. An erratic error is one that permits operation, but not stable and dependable operation. This phrase was also composed for the occasion, at no extra charge.

We spent an hour and a half checking the circuit, and can say that it is a very excellent one when the mistakes are taken out. We give ourselves credit only for having exercised appellate jurisdiction, and say that the manufacturer's original jurisdiction was faulty in two particulars.

## APPORTIONMENT OF TIME

The two errors mentioned were (a) no screen voltage put on the amplifiers, and that was the fatal mistake, or mortal or inoperative error; and (b) two unequal resistors were in the load circuits of the deflecting plates, one 5,000,000 ohms, the other 5,000 ohms, the unfatal, venial or erratic error.

It took us only five minutes to find these two

mistakes, and one hour and twenty-five minutes to discover there were no other mistakes. And then we had the circuit drawn out in our own general style, and we checked the draftsman carefully, finding he had added three errors of his own, because he hadn't used mistakeproof ink, either. We ran the diagram through our fault-finding machine and so now, after all the turmoil, you have at long last a diagram on which you may fully rely, using either the 2" or the 1" tube, with no changes whatever except the tube. Even the socket is the same, and the connections to it.

The controls are plentiful, and usually draw comment of a nature not quite admiring, but nobody who has to manufacture oscilloscopes for sale, or who has to make them fulfill a certain range of quick utility, can ever suggest the elimination of a control without decreeing the elimination of a service. And what the instrument must do is render service. So don't say: "I'll fix this thing up right. I'll omit the spot-centering controls. Superfluous!"

The idea is that the circuit is right just as it is—positively guaranteed to be mistakeproof—and thus one of the rarities in the aggregation of oscilloscope circuits.

Six tubes are used. Two are rectifiers. Two are amplifiers. One is the cathode-ray tube. The sixth tube is the gas-discharge sweep oscillator, which may be an 885. Vertical and horizontal inputs are provided, including external horizontal input, though normally the sweep oscillator, considered internal, is used. Also synchronization may be internal or external. There is no conductive access to the cathode-ray tube's plates, however, as amplifiers must be used, this being considered advisable because of the low voltages of the unknown inputs in most service work. All three inputs are subject to gain control, e.g., VG for vertical gain, HG for horizontal gain, and SG for synchronization gain.

## FLAT AMPLIFIER

The rectifiers are used in series so that there will be independence of impedances of supplied circuits—freedom from interaction simply attained.

SPC, to left of the ray tube, represents two spot-centering controls.

The bypass condensers are omitted from the amplifier biasing resistors intentionally, so that there will be some negative feedback.

# RECTIFIER-AMPLIFIER VTVM with Bridge Type Indication

By H. J. Bernard

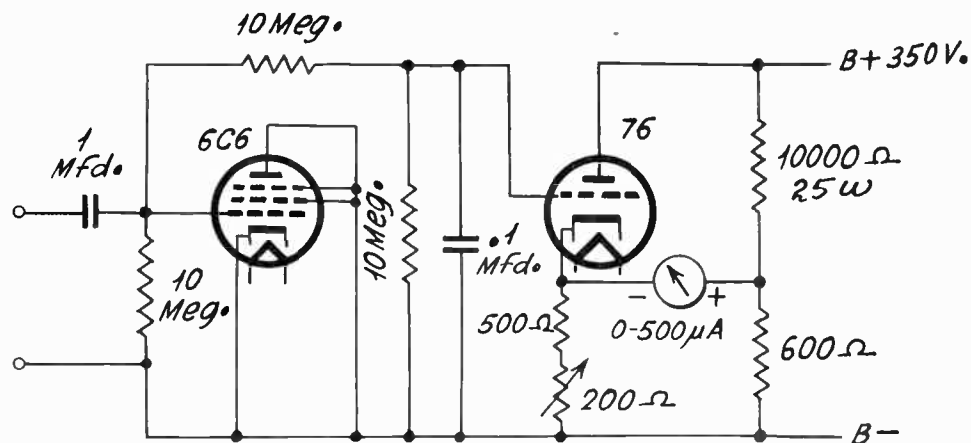

FIG. 1

The condenser-diode rectifier, with direct-coupled amplifier, and using a bridge type indicating system. A zero-current condition is established through the electromagnetic meter, and the more sensitive this meter, the better this indication. The response is almost linear even for the low range of 1.2 volts full-scale deflection.

RECTIFIERS are gaining fresh attention in measuring instruments. The bimetallic types are being made with smaller electrical capacity and with special circuits helpful to the calibration and reducing the rectifier inertia. The thermionic rectifier is making practically its first wide entrance in the servicing instrument field.

Considering the vacuum tube, it too has rectifier inertia, which disappears when the rectifier is loaded with high resistance. A few hundred thousand ohms just about suffice as minimum, therefore with a 0.1 millimeter a few hundred volts would be the full-scale deflection for the single range. However, for draw reduction it is advisable to have the load resistance still higher, therefore it is in the megohm range, and something around a thousand volts is full-scale for the single range. Electromagnetic meters two or three times as sensitive avoid the excess of the range.

It should be noticed that the rectifier thus circuited will respond up to the maximum and to all voltages between, except that the difference will be small in needle movement for small voltage differences, say, 10-volt steps.

## FIDELITY AMPLIFIER

It becomes therefore practically requisite that there be an amplifier, and for reasons of

non-discrimination it had better be direct-coupled and of the negative feedback type. We may then obtain voltage readings at the amplifier that represent the same multiple of the input voltage, regardless of the frequency of the input, until deep in the megacycle range, when the input capacity and other factors begin to have some reactive effect.

If the electromagnetic instrument is of the 0-500 microampere type, and if 10 meg. is considered as the load resistor, full-scale deflection of a simple rectifier would be 5,000 volts. If an amplifier is used, since there will be additionally resistance in parallel, if all three resistors are equal, as in Fig. 1, the series 20 meg. in parallel with the load of 10 meg. equals an effective load of 6.7 meg. Consider then that for a 500 microampere movement full-scale would be 3,350 volts. If an amplifier is used it is possible to have full-scale represent 1.2 volts, which would appear to result from an amplification of 2,800 times. Though the result is the same as if the amplification were that, the increased sensitivity is not due to such amplification but to the much greater conductance. If the amplifier is viewed as a current amplifier, rather than as a voltage amplifier, the viewpoint is much more nearly correct, since conductance is the figure of merit of a tube voltmeter, and not voltage gain.

jury to the tube because of high plate and screen current. Excessive grid bias will reduce sensitivity and in many cases increase distortion. Excessive plate and screen dissipation may injure a tube by driving occluded gas from the tube structure. Ionization of gas in a tube may ruin its cathode, as previously described.

## WHY LOAD RESISTANCE IS LIMITED

A maximum value of grid resistor is usually specified. These maximum values limit the effects of grid emission and gas current. Gas current produces the same effects as grid emission. A negatively biased grid attracts positive gas ions; the direction of flow of these gas ions is such as to reduce the grid bias by an amount equal to the voltage drop across the grid resistor. Thus it is necessary to limit the resistance value of a grid resistor to insure good tube life.

The recommended maximum value of grid resistance is higher for self-biased operation than for fixed-bias operation. A difference is permissible because a loss in bias due to gas or grid-emission effects is nearly counterbalanced by an increase in voltage across the self-bias resistor.

Maximum voltage, current and dissipation ratings may be specified for a screen grid. The maximum-voltage rating is the highest value of d-c voltage that may be applied between screen and cathode. When the screen voltage is higher than maximum, screen dissipation may become excessive. Excessive screen dissipation, in turn, may cause electron emission from the screen or high gas current; the undesirable effects of gas and grid emission have been discussed previously.

A maximum screen-current rating may be specified in order to fix a value of screen dissipation. A screen-current rating is necessary, because more than rated screen current may flow when normal screen voltage is applied. For example, normal plate current of a tube may be 100 ma. and the normal screen current may be 5 ma. for certain voltage conditions. If the plate voltage is removed, the screen current may rise to 80 or 90 ma., even though screen voltage and control-grid bias are normal. It is for this reason that plate voltage should not be removed from a screen-grid tube while screen voltage is applied.

## CONCERN ABOUT SCREEN CURRENT

The rise in screen current with signal is important in many cases. This rise in d-c screen current is due to the effect of the plate voltage in influencing the value of screen current. This effect may be explained with the aid of Fig. 2.

A zero-bias plate and screen characteristic is shown for a typical pentode. With load line (1) and an applied signal great enough to swing to zero bias, the minimum instantaneous plate potential is  $e_1$  and the peak value of screen current is  $i_1$ . With a much smaller load (2) the minimum instantaneous plate potential is  $e_2$  and the peak value of screen current is  $i_2$ . Because the value of d-c screen current depends on the maximum instantaneous value of the general symbol,  $i$ , the screen dissipation may exceed the recom-

mended maximum value at full output when a high value of load is used. Thus, the practice of choosing a load on the basis of highest power output at acceptable distortion should be supplemented by measurements of screen current. It may be necessary to sacrifice power output in order to operate the tube within the maximum ratings. Maximum screen-voltage rating should not be exceeded when the line voltage is reasonably high; experience indicates that maximum screen-voltage rating should not be exceeded when the line voltage is 125 volts (rms) or more.

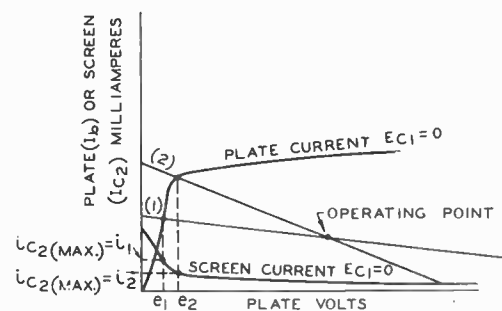

FIG. 2.

Plate volts compared to plate and screen currents. At the operating point the screen voltage is normal, but if the tube is improperly loaded, screen current at rated power output may become very excessive.

Maximum plate-voltage, plate-current, and plate-dissipation ratings for each tube type are usually specified. An important effect of exceeding recommended maximum plate ratings is to shorten tube life; the reasons for short life under these conditions are similar to those given under "Screen Ratings."

## LARGE CHANGE CITED

Zero-output the full-output plate and screen conditions may be illustrated by an example. Consider two 6L6's operating in push-pull with 400 volts applied to the plates and 300 volts applied to the screens. At zero output, plate current for two tubes is 102 ma. and plate dissipation is  $400 \times 0.102 = 40.8$  watts (tube tubes); zero-output screen dissipation is  $300 \times 0.006 = 1.8$  watts. At full output, plate current for two tubes is 230 ma. and power output is 60 watts; plate dissipation is, therefore,  $400 \times 0.230 = 92 = 60 = 32$  watts (two tubes). Screen current at full output is 20 ma. (two tubes), and screen dissipation is  $300 \times 0.02 = 6$  watts (two tubes). Thus, screen dissipation increases from 1.8 to 6 watts and plate dissipation decreases from 40.8 to 32 watts as power output increases from zero to 60 watts. Experience indicates that maximum plate ratings should not be exceeded when the line voltage is 125 volts or higher.

[The foregoing is Application Note No. 79. Copyright 1937 by RCA Manufacturing Company, Inc.]

### WIDER VOLTAGE RANGE

If a wider range of voltages is to be measured under similar conditions, then the amplifier tube bias has to be increased, and plate voltage likewise, or at least the bias increased, while the plate voltage may be unchanged or even decreased. Fig. 3 adopts the method of increasing the bias and decreasing the plate voltage simultaneously. The upper limit of measurement is governed by the B voltage.

A tube is used that enables as much current as practical, and the idling current is cancelled out, so that the meter needle is at rest (zero or maximum), and is influenced only by the changes in plate current. If the change is large for a small difference of input voltage, the equivalent of high gain is attained.

### THREE INTERESTING ASPECTS

The method shown in Fig. 1 is very interesting from three aspects:

First, it represents a minimum draw on the measured circuit, because only during the peak

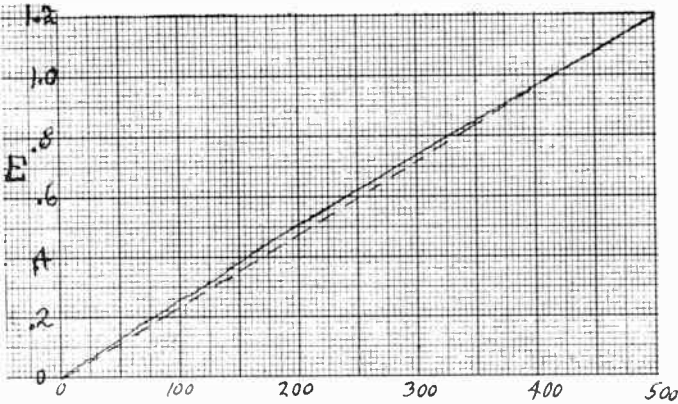

FIG. 2

The actual r-m-s voltages, E, are compared to the meter current in microamperes (horizontal), for the circuit shown in Fig. 1. Although several setups were used, with different tubes, the self-same curve was reproduced. The solid line is the reality. The dashed line represents linearity.

of the unknown is current taken. The rest of the time the rectifier is inactive, because the anode is effectively negative, made so by the direct current voltage in the load resistance, which is in series opposing with the a.c. Therefore, as the d.c. endures and the a.c. drops, only during the positive peak is the rectification process maintained. Though the peak current is not insignificant, the duration of the peak compared to the rest of the positive alternation is insignificant, and the accuracy of the measurement is not molested by the short-duration drain. During the negative cycle there is no rectification at all.

The second point of interest is that the rectifier itself being gaited to a certain full-scale deflection, if the meter is moved back into the rectifier leg, in series with the load resistor, a range around a few thousand volts obtains. Fig. 2 is a curve taken of the Fig. 1 circuit, the dashed line representing linearity, and the solid line the reality. How close to linearity the reality is may be seen at a glance. For the 5

per cent accuracy usually ascribed to tube voltmeters, a linear scale could be used and no special calibration need be run, just the terminal voltage ascertained, and the factor computed that relates the voltage to the reading. This factor is a constant.

### CAN BE MORE NEARLY LINEAR

This is not acute linearity, not the best result, for if the amplifier's cathode loading runs to higher resistance than shown, the straightness is almost absolute, for the negative feedback is increased. However, Fig. 1, and the curve, may be duplicated and the curve relied on, because several small setups of this type were made experimentally, with different makes of tubes, and all were in extraordinarily close agreement.

The third interesting feature is the simple method I propose for getting around the difficulty of cancelling the idling current from the meter. It will be remembered that if a vacuum tube is connected in a standard circuit that there

will be plate current flow at no signal input. Moreover, the current flow may be greatly in excess of what a sensitive meter will handle. The problem is to combine the use of the sensitive instrument with cancellation of the idling current, for then a small input or change will react in large degree upon the indicator.

If a bleeder circuit is established across the B supply, so that the voltage across a section of the bleeder is exactly equal to the voltage drop in the biasing resistor in the tube's cathode leg, then a meter connected across the two equal potentials will read zero. It may be a voltmeter or a current meter, it makes no difference which, if the potential difference is zero, because no current will flow, hence the multiplier resistance (if a voltmeter is used) loses all significance. Of course, the moment current flows the limiting resistor acquires its usual effect and importance.

### AUGMENTATION OF CURRENT

Current considerations are controlling in a

(Continued from preceding page)

tube voltmeter, in which we are always trying to bring the current up to the capabilities of the electromagnetic meter, and so we may say of the bridging meter that it is an unbalance current indicator.

Because of the direct coupling the voltage appearing on the amplifier grid due to the rectified signal or carrier is negative, so the rise of input causes a drop in plate current, hence the potential between cathode and B minus in the biasing leg falls. All that is necessary to acknowledge this state is to reverse the meter connections. Then at zero potential difference meter still will read zero, for no current is flowing, but when the signal upsets the balance, the needle will move upward (to right) because the bleeder voltage, deemed constant, is now more positive than the cathode (to which meter negative goes).

The indicator is therefore a calibrated type in a bridge circuit, where one ratio arm is  $R_p$ , the plate resistance of the tube (plate to cathode), the other ratio arm on that side being the cathode biasing resistance, made adjustable for zero difference setting of the electromagnetic meter. On the opposite side the bridge arms are the two resistors comprising the voltage divider in the bleeder circuit of the B supply.

### FACTS ON OPERATION

The type of measuring instrument representing by Fig. 1, which follows to some extent the development introduced by General Radio Company in condenser-diode rectifier and amplifier, offers however the different balancing method. The circuit has the prime virtues of nonreaction and performance. While, as shown, it represents only a single voltage range, it is the most important range in tube voltmeter work. If the 500-ohm resistor and the 600-ohm resistors are

reduced about equally, the range may be made .5 volt full-scale. If the cathode resistance is increased, using much larger rheostat, and B voltage taps on meter arranged in steps, up to 150 volts or so may be read. A voltage divider system, Fig. 3, is permissible for increasing the range. Here 5/15/50/150 are the full-scale deflection values.

The condition of true balance—no current through the meter—is extremely important, as a false balance may be easily established, and thus introduce considerable error. The meter is therefore used without shunt or multiplier for the indication of zero current. For preliminary approximation precautionary multiplier (.25 meg.) may be included.

The low voltage range adjustment for zero current is the only very critical one. Ease attends higher ranges than a few volts.

Now that true balance is indicated, it will occur to the experimentally minded that all one need to do is to measure the d-c voltage between positive of the meter and B minus. Hence the electromagnetic meter could be switched, so that meter negative is taken from cathode and put to M minus through a multiplier. Thus may the range be extended, though hardly sufficiently. To make the voltage range high enough the cathode leg resistor would have to be increased, and B tap in steps, as previously expounded.

The voltages read are the peak volts because only the peaks influence the circuit, and only positive peaks. If it is desired to read the voltages in r-m-s values, then one way would be to calibrate for them, or, for a self-calibrating circuit, shunt the electromagnetic meter so that .3 of the current flows through the shunt to .7 through the meter for full-scale deflection. Thus, if the meter resistance is known, the shunt should be three times the meter resistance.

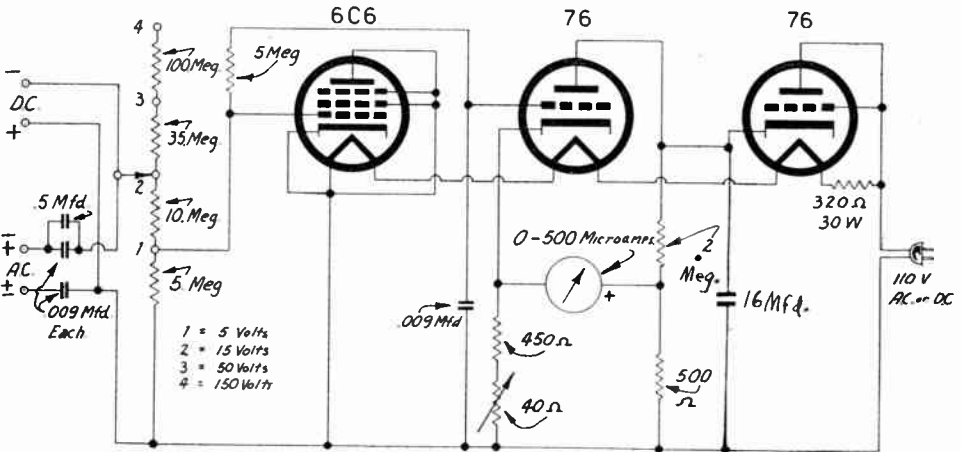

FIG. 3.

The first tube, 6C6, is used as a diode, the normal grid serving as the anode, and the combined other elements as the cathode. The input to this rectifier tube is through two condensers for a-c measurements. Since one side of the line is grounded, the small condenser, below, which has mica dielectric, offers no obstruction in the measurement of a grounded system. For d.c. condensers are omitted.

# VTVM for Service Bench

By William A. Hunt, Jr.

Chief Engineer, WALR, Zanesville, O.

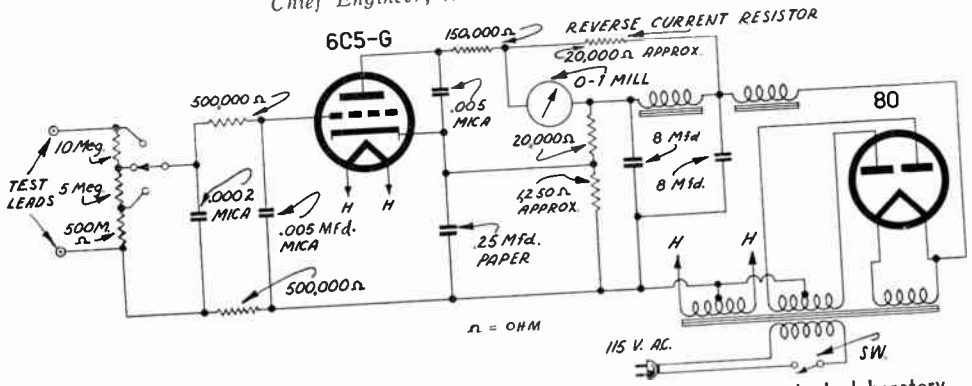

Circuit diagram of the tube voltmeter constructed of parts around the author's laboratory.

THE above voltmeter was constructed for radio service work. It is useful in measuring d-c voltages in high resistance circuits such as a-v-c and bias voltages which are found in the modern radio. It does that with ease and does not affect the circuits being measured. Automatic volume control voltages may be measured directly at the grid cap of control tubes by placing a 1 meg. resistor in series with the negative test lead at the grid cap. Used in this manner with a radio that has a v. c. it makes an excellent output meter, as the a-v-c voltage is the rectified carrier voltage.

## ALIGNMENT AID

This permits the adjustment of alignment condensers with visual indication of results. On the 15-volt range (on my meter it is 17 volts full scale) a sensitivity of 1 meg per volt is attained. At the same time the meter is very rugged. No matter what voltage is applied to the test prods (within reason) the indicating milliammeter cannot pass more than 2 mills. This will not damage the indicating meter.

Thus we have a very sensitive as well as a very rugged meter.

In the actual construction of the voltmeter the switching arrangement and the indicating meter were mounted on the panel of the test bench.

The rest of the voltmeter was mounted in an old Zenith power pack and placed under the bench, out of the way. Only the filter chokes of the original power pack were retained. Approximately 250 volts d. c. were developed across the bleeder and this permitted about 12 ma to flow.

## STABLE OPERATION

An idling current of 0.2 mills flowing through the 6C5G tube was counterbalanced by current flowing through the reverse-current resistor of approximately 20,000 ohms. Condensers were used in the grid, plate and cathode circuits to stabilize the meter and to prevent a. c. from reaching the tube.

The voltmeter as constructed is stable and little affected by changes in supply voltages. Calibration is attained by noting the deflection of the meter when measuring B batteries.

## "Radio Stars of To-day," Brilliant Eichberg Book

Robert Eichberg has put together a fetching book called "Radio Stars of To-day," representing a sincere effort to conduct the reader behind the scenes, and make him feel he has been through all the most interesting phases of broadcasting, including meeting the stars.

Eichberg has been in radio himself, as columnist, author, reporter and publicity man, almost since the beginning, and has marked all his work with fine imagination and tasteful execution. The present volume is no exception, as the whole presentation is so thorough, so engaging and so artistic, that this impartial book represents more than it pretends. It is a

panorama of the most successful broadcasting of to-day and will have historic value. So it is doubly fortunate the format is artistic.

Done in large cloth quarto, with a brilliant jacket, 275 illustrations and 218 pages, the volume deals with each celebrity in an intimate, friendly and entertaining way. Yet it is all very impartial, a bona fide record produced with complete independence. It makes a grand gift volume, and though early sales should be large, the publishers, L. C. Page & Company, Boston can confidently look forward to a large Christmas business on this volume. The price is \$3.50.

H. J. BERNARD.

# FOUR-SENSE SERVICING

## Everything Except Taste Is Used

By M. N. Beitman

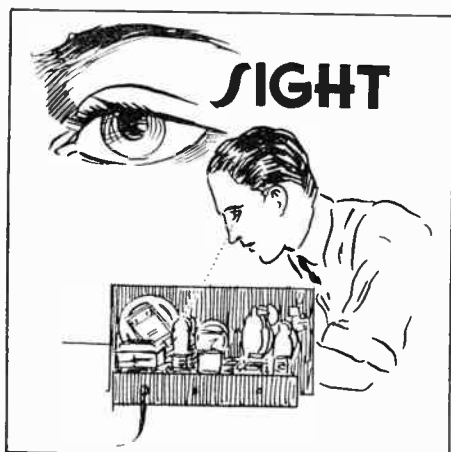

MUCH has been said about servicing radio sets with elaborate test equipment, but little has been printed on how to do a good servicing job with minimum of testing apparatus. Of course, certain types of adjustments and repairs do require special equipment or may be performed in less time with test units of an advanced nature, but what about the numerous simple jobs? An actual careful investigation disclosed that about 90 per cent of all radio repair jobs can be successfully performed with a volt-ohm-milliammeter and the regular tools. And, what is more striking, 40 per cent of radio jobs encountered could be handled without test equipment. The author certainly does not recommend doing away with test equipment, but in the absence of the required equipment for more rapid and closer repairs he does advocate an attempt at servicing radio sets if the difficulty is almost self-evident.

The time required for the actual mechanical task of mounting a part or soldering a number of connections is not variable to any large degree and, therefore, economy of time results only from the quick location of the trouble source.

### A TYPICAL EXAMPLE

If you noticed a broken tube, would you bother to connect a signal generator to that set for a stage-by-stage test? No, you would simply replace the tube, turn on the set, and if the set played right would assume the fault repaired. This is an example of a typical service job that does not require any test equipment. The part may be a condenser, a resistor or a

choke or transformer, but the visual inspection is applicable in every case. Look for the trouble, smell for the trouble.

"That part (power transformer) smoked a long time before the set stopped playing," says the lady of the house.

You will naturally suspect a burned-out power transformer, probably overloaded by a faulty filter condenser or a power supply short. A simple test with an ohmmeter will locate the exact trouble and save much unnecessary testing.

The complaint was poor tone. Push-pull output stage, 45's used, one of the 45's had no glow of the filament with the set turned on. Yes, the no-glow 45 tube was burned out, the circuit out of balance, the biasing resistor too small for the single operating tube, and possibly no bypassing of the resistor, thus reducing sensitivity.

### SHORT-CUTS ABOUND

In the case of a noticeably burned carbon resistor, suspect a shorted associated by-pass condenser. This resistor should also be replaced in such cases. It pays at all times to try to locate the difficulty by a quick examination before using test equipment.

Intermittent trouble, if due to resistors, sometimes is disclosed by the fact they get too hot.

There are many short-cuts in servicing that will completely eliminate difficulties and are very easy to apply. Consider the instance of hum developing on strong local stations. This fault often may be completely solved by connecting a .1 mfd. 600 volt paper condenser from one side of the transformer primary to the chassis of the radio set. This keeps the radio set from





being modulated by a-c when tuning in a strong carrier and many new sets are supplied with such condenser arrangement.

Electrolytics sometimes fail properly to filter the circuit and under careful test will show

if no change is noticed the unit is at fault. Either there is an internal short or an open circuit.

The most common radio trouble calling for the serviceman is condenser failure. In a set with operating power supply there must always be a d-c voltage across any bypass circuit (this also includes the electrolytics). If no voltage exists across a condenser it is shorted. This simple test may be performed with a piece of wire; quickly and momentarily short the suspected condenser and watch for a spark when the contact is again broken. Lack of a spark, provided there should be a voltage present over 10 volts, indicates a shorted condenser. A voltmeter test would be a little more accurate.

An inexpensive test for condenser leakage is obtained by using a neon lamp in series with a source of d-c voltage. The required d-c can be supplied by a triode tube in a half-wave rectifier circuit. For about 90 volts d-c a quarter watt neon bulb should be used. The condenser to be tested is connected in series with the lamp and the d-c supply.

Intermittent flashing of the neon lamp indicates a leaky condenser. This test is suitable for paper units from .001 mfd. to several microfarads, but cannot be used for electrolytics. Leakage in electrolytics is natural, about one ma per microfarad is ordinarily expected.

### THE AUTO SET VIBRATORS

The most common replacement in automobile radios is the vibrator. In sets of this type having erratic operation suspect the vibrator first. If you have a stock of replacement units, try using a vibrator that you know is in good condition. Perhaps this will complete the service job.

Although a-v-c for real analysis and service requires sensitive test instruments, ordinarily successful servicing can be accomplished with nothing more than an examination and simple tests. Common faults are due to bad condensers and resistors. The tube associated with the circuit may also fail and cause trouble. Test and examine the associated parts and usually the

*(Continued on following page)*

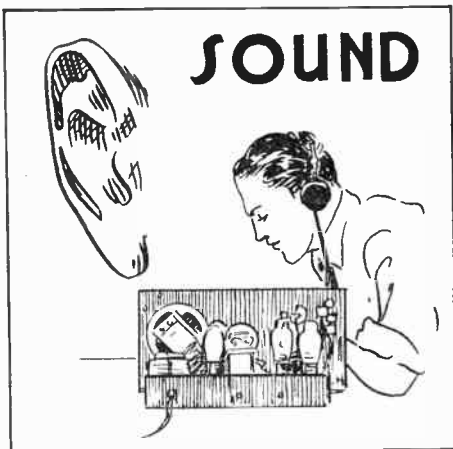

only a fraction of their original capacity. If the electrolytic condensers do not appear to be in good shape and the set has a loud hum, it is best to replace these units. If the complaint of hum really has no bearing, but is due to too critical a listener, an 8 mfd. or larger condenser placed across the filter circuit will solve this problem.

### TONE AND VOLUME CONTROLS

On practically every radio job, where the radio uses a cable drive, the servicemen have an opportunity to perform an extra service. Since the failure of the tuning mechanism comes about slowly, the people using the radio fail to realize how the tuning control once properly operated. A repair job here nets a quick profit and builds real good will. Obviously no dial replacement or repair requires any testing instruments. A quick inspection should show the trouble and this should be followed with a quickly made, neat repair.

Remember that a dial cable replacement does not call for a realignment of the set except in the early Atwater Kent and other models where the variable condensers are coupled by means of cables.

### LOOK FOR THE D-C VOLTAGE

A large number of radio repairs centers around the tone and volume controls of the radio sets. These units receive about as much handling and mechanical motion as the tuning dial and consequently do wear out with time. A volume control fault is easily detected even by the non-technical owner of the radio. To detect the fault (without instruments) notice if the volume change is gradual; if it is sudden the arm does not make good contact or the resistance is worn out in spots. Another positive test is to short the different terminals of the control;





type, and the guide is illumination. When the output meter is connected across the primary of an output transformer, in any receiver that is built for speaker operation, the tube will light on stations or other modulated carriers, and at close resonance will light most brightly.

It has been said that modulation is provided as a standard practice, a single tone being meant, but in the design shown the audio frequencies are adjustable, from 25 to 10,000 cycles, and in three bands, as follow: (1), 25 to 400; (2), 400 to 5,000 and (3), 5,000 to 10,000 cycles.

## SIGNIFICANCE OF LIGHT

A single-deck, three-position switch is used for selecting the three fixed condensers that provide the range, while the 1 meg. potentiometer, used in rheostat style, decides the frequency within that range. These frequencies may be direct reading, the same as are the radio frequencies.

The presence or absence of modulation is controlled by SPST on-off switching. Two switches are in series, one being on the 1 meg. rheostat. However, since audio frequencies are generated, it is sometimes of value to be able to obtain them independently, and therefore an output is provided through a condenser of suitable capacity for handling audio frequencies (.05 mfd.). So there are two posts, one for r.f., the other for a.f., and a common in center. Modulation switch must be "on" for this service.

When the audio frequencies are being produced there is illumination in the neon lamp associated with this circuit. The higher the frequencies, the greater the illumination, until finally if the illumination were permitted to become that of a normally ignited neon tube, there would be no oscillation.

It will be noticed that the leakage checking method, applicable to high capacity condensers particularly, depends on the closing of an open circuit by the unknown condenser. Since the same neon lamp is now in circuit under the same conditions, there will be illumination to a greater or less degree, and particularly oscillations of low frequency depending on the condition of the unknown condenser.

## SIGNIFICANT CONTRAST

An important contrast prevails. When the modulation switch is at "on" position the lamp lights steadily, which is all right. When the unknown condenser is shorted the lamp also lights steadily, though the condenser is bad. If the condenser flashes often, or is illuminated continuously, it is defective or totally shorted.

A good rule to follow is that for the general run of condensers of 1 mfd. up, the flashes should not occur more than one each second, for if they do the condenser is too leaky for good service, whereas if there is just continuous illumination the condenser is shorted. For smaller capacities, however, one flash every three seconds should be the rule, whereas for larger capacities than 10 mfd., affecting only electrolytics, two flashes per second should be permitted before the condenser is ruled out. The

tests as prescribed are of good average value. It is quite possible, however, that a condenser that flashes a bit too often, against the rules just laid down, may give satisfactory service in a B filter, where large leakages are often tolerated. It is a matter of selecting limits, and those chosen are on the side of greater rather than less rigor.

So remember that it is all right for the neon to light continuously when the modulation switch is at "on" position, and there is something wrong when there is continuous lighting in the condenser leakage test.

The same type neon tube is used in the output meter, which is entirely unrelated to the signal generator, for the meter's purpose is to be influenced by the receiver output, whatever is put into the set, which may include a station. It so happens the output of the generator is most commonly put into the receiver, but that does not alter the fact of the output neon tube's utter independence of the generator.

## TUBE CONSIDERATIONS

The radio-frequency part of the circuit has an attenuator, consisting of a 40-ohm potentiometer, connection being made to the antenna post of the receiver from the "high" side of the r-f output. This would be a red post marked "R.F." The other output, for audio, would be a red post on the other side of the common black post, and marked "A.F."

The tube used as r-f oscillator is a 6A7 but may be any other tube with .3 ampere 6.3 volt heater, so long as an independent calibration is to be run. A commercial calibration was based on the 6A7 used as triode. The rectifier, also a 6A7 in the diagram, serving as diode, may be any other diode that subscribes to heater requirements (for instance, the 1V), or may be a triode, (76, 37, etc.) used as diode, by interconnecting plate and all other elements save cathode and heater.

The r-f oscillator is a Hartley of the shunt feed type. The cathode is returned to a tap near one end of the coil. Wherever coils are wound in increasing circumference, due to turns on turns, the grid connection would be at the outside (end of winding), the grid return at inside (beginning of winding, next to the bobbin or form), while the tap would be identified as an emerging double wire as usually the winding is stopped, the wire doubled back, then the two leads soldered together to form the single tap connection. If the coils are connected the wrong way there will be trouble, possibly no oscillation, perhaps a great deal too much, causing erratic behavior, and the pre-calibrated frequency scale could not be followed. The ranges would not be duplicated. They are, as shown on the diagram, from 100 kc to 22 mc, in five steps, using .00036 mfd. for tuning. If there are two condenser sections, this is the larger, and the smaller one is not used.

## WHAT IT DOES

The principal purpose of the signal generator is to produce known radio frequencies, including frequencies used in intermediate amplifiers, so  
(Continued on following page)

(Continued from preceding page)

that receivers may be tested and aligned at designated frequencies. To introduce the output of the signal generator into the channel being tested or aligned, two methods apply. If the intermediate amplifier is being checked, then a short-circuiting wire is connected between antenna and ground posts of the receiver, and the r-f output post of the generator is connected by a wire to the circuit being checked. If the intermediate amplifier already has been aligned, so that attention is being devoted to the r-f level, there is no shorting wire used but the generator output is connected to the antenna post of the receiver, by a wire from the generator's r-f output post. The aerial is removed from the receiver.

Sometimes the receiver is so sensitive that the coupling at the r-f level has to be weaker than just outlined, whereupon instead of connecting a wire conductively from the generator to the antenna post of the receiver, there is no continuous metallic connection, but instead two wires, one from antenna post, the other from generator, are twisted together a few turns, and that provides capacity coupling of sufficient degree. The adjustment for desired output voltage of generator is made at the volume control or attenuator.

### A LITTLE DISTINCTION

The designation of frequencies is somewhat confusing, because terminology is poor in radio. All the frequencies emitted by the coil-condenser tuned oscillator are radio frequencies. All the frequencies emitted by the condenser-resistor tuned oscillator are audio frequencies. The radio frequencies include those commonly referred to as "r.f." and also include intermediate frequencies, abbreviated to "i.f." The distinction is made because there are four levels of frequencies in a superheterodyne: local oscillator, station carrier, intermediate carrier and audio. The station carrier frequencies are referred to loosely as radio frequencies, even though, as explained, all frequencies except the audio are radio frequencies truly. The radio range may be said to include 20,000 cycles (20 kc) up, say, to 1,000,000,000 cycles (1,000 megacycles). The audio range then would be considered to extend from just above zero frequency (which is d.c.) to 20,000 cycles.

The place to make the connection for the r-f checkup is obviously the antenna post, while the return circuits may be connected to ground, by running a wire from the common to ground, assuming also the receiver is grounded. However, to get the signal through it is not at all necessary to use external ground in connection with the generator, as there is sufficiency of automatic ground, due to one side of the house line being grounded.

If one is servicing a receiver concerning which he has the manufacturer's directions, he should follow those closely, as there are special problems and methods applicable to receivers that are best known to the makers of those sets. However, in the absence of manufacturer instructions, and assuming a superheterodyne with pentagrid converter tube, the output of the

signal generator is connected to the control grid of the converter, which causes voltage of the signal generator frequency to appear in the output of this combination tube, with minimum of disturbance, such as detuning, of the rest of the i-f circuit.

If there are two separate tubes, one for local oscillator, the other for modulator, then the connection is made to the control grid of the modulator. Due to fairly low impedance of many signal generator outputs, including his one, it is sometimes advisable to make the connection from generator output to control grid through a 10,000-ohm resistor.

The connection methods just proposed presume that the alignment will be made on the basis of first tuning the first i-f coil. The signal generator is set at the desired intermediate frequency, the identity of this frequency being obtained by the operator, either from manufacturer's data, or from a magazine article, or otherwise, but must be known in advance with certainty.

### NEON LAMP SENSITIVE

The generator is used at full output, in case there is gross mistuning in the intermediate amplifier, and the plate condenser is turned until response is heard, or is maximum. For multi stages all coils may have to be made nearly right before anything is heard. The condenser across the coil in the plate circuit of the modulator or pentagrid converter tube may not have great effect. Then the grid circuit coil (feeding the next stage, or first i-f tube) is tuned. The two can be told apart because there is a voltage between plate condenser and coil shield, determined by meter test, or by momentary shorting with a screw driver. The shorting method is often used but is bad practice.

Then the next stage is tuned likewise, until the amplifier is provisionally aligned. What the indicating system is does not matter. To produce sound in the speaker it is necessary either to introduce modulation into the r-f oscillator, or to use the beat system, but modulation is easier, and the instrument provides for it. Aside from hearing, one may use an output meter, connected at low voltage scale across the voice coil, or at higher voltage scale across the primary of the output transformer, only if there is filter capacity in the output meter circuit. Such an output meter would be an electromagnetic type (usual needle type meter, for a.c.), or may be the output meter (neon lamp type) included in this instrument, the filter capacity being present. For both purposes, hearing and seeing, modulation is necessary.

It is practical to notice very small changes in illumination intensity, so that alignment, by the neon peaking method, is well conducted, although an output meter of the needle-pointing type will give absolute instead of relative values.

### ALIGNING FOR A.V.C.

The alignment can not be considered complete without regard to certain other important factors related to the i-f circuit. First,

suppose the receiver has a.v.c. This would naturally include in the i-f channel, and it is well known that a.v.c. tends to produce an even result although the inputs are uneven. But that is true only when the input is large enough to make the a.v.c. work effectively. For very weak input voltages the a.v.c. effect is less, and may be zero, as in some circuits the a.v.c. is delayed, until, say, the second detector voltage reaches even as much as 10 volts. Anyway, the object is to put in a weak voltage from the generator, and this is done by turning the attenuator down until the output is so low that you can just about hear it. In some instances the neon lamp as output meter will not then provide adequate indication because the generator output has been purposely kept so low.

For a.v.c. alignment the preferable meter is an electromagnetic type, a 0-500 microammeter, or more sensitive similar instrument, connected in series with the second detector. It may be in series with a diode load resistor, for such a second detector, or in series with a plate load resistor. If a plate resistor is concerned the meter should be so used that there is no danger of more current being passed through it than its full-scale deflection current. With diodes and their loads no such danger exists for 0-500 microamperes.

### COMBINATION TEST

The test now is to make the alignment so nicely that the meter needle either increases or decreases up to that point where any change is a decrease in volume. Thus listening is combined with viewing. Most detectors in present-day receivers cause the needle to kick up (increased reading as alignment becomes more nearly right), while leak-condenser detectors, using the triode or pentode, cause the plate needle to kick down as alignment progresses. Then as sound has verified the direction of reading change consistent with increased gain, the process is not carried on a bit farther than the point where the increase of gain stops, and loss begins.

After the i-f level has been aligned, attention is paid to the r-f and oscillator levels, the combination known as the mixer or converter. This is not to be confused with a short-wave converter, which is a preselector and mixer, and something quite different from a superheterodyne mixer stage. Again manufacturers' directions are followed, but in their absence the bands are tackled as follows:

First, the standard broadcast band. The frequencies are to be tied down in three places. Usual procedure allows for only two: capacity adjustment for a low and for a high frequency, with no allowance for inductance adjustment of the oscillator, or equivalent purpose. We therefore apply a refined technique.

Two frequencies are selected for tiedown by capacity. One is 600 kc, by adjustment of a series padding condenser, the other is 1,450 kc, by adjustment of a parallel trimmer capacity. In practice the high-frequency work is done first, the local oscillator parallel trimmer being adjusted until the response is loudest, or de-

flexion is greatest, or light is brightest, for 1,450 kc fed from generator to set, with attenuator turned down so the output is low enough not to make the response objectional.

### DOUBLE RESPONSE

If the i.f. is 456 kc or thereabouts small danger exists that a mistake will be made by tuning the oscillator to a frequency 456 lower than, instead of higher than, the station frequency (generator output frequency), since the difference is more than 900 kc in these cases. But if the intermediate frequency is low, say, 175 kc, then extreme care must be taken as follows: The response comes in a two settings of the trimmer. The one that must prevail is the setting that requires the smaller amount of trimmer capacity (less engagement of plates, or, for setcrew type condenser, screw not turned so much to right). Unless this precaution is taken it will be impossible to align the receiver, and general performance will be weak, distorted and squealy.

Now the trimmers on the tuning condenser sections for the station frequency level are adjusted, generator unmolested, until maximum output obtains.

Next the condenser is rotated (it is called "rocking") about the point where 600 kc should come in, about one-quarter the way from the opposite end of the dial, while feeding 600 kc from generator to receiver, and adjust the series padding condenser for maximum response. After this is done, the parallel trimmer of the local oscillator may require a slight readjustment, the r-f trimmers none, because of the small effect of the series capacity on the parallel capacity so determine this by test, reverting to 1,450 mc from generator.

### MULTIVIBRATOR METHOD

The rocking method need not be practised if the multivibrator method of alignment is used. By this method the signal generator is used only for aligning the intermediate amplifier, and possibly for deciding the right oscillator frequency where a mistake can be made. However, the generator could be confined to the i-f channel, and the multivibrator used, as set forth in another article in this issue. The reason is that if output is watched, it will be fairly uniform over the broadcast band, when alignment is proper, and if there is much more output at the tiedown points, then the too-low oscillator local frequency was used, and the change is made.

The multivibrator, of 10 kc type, will produce harmonics, and the two capacity tiedown points are correct when the condensers are properly set for the dial ends, and pointer indicates the proper test frequencies (1,450 and 600 kc) for the test settings on the receiver dial, and parallel and series condensers are adjusted until maximum output is obtained, because, with one exception already noted, the output will be maximum for these two only when the towdown is correct.

It is not a fact that the intermediate frequency has to be exactly what is printed on some circu-

(Continued on following page)

## COAXIAL CABLE GETS A LIFT

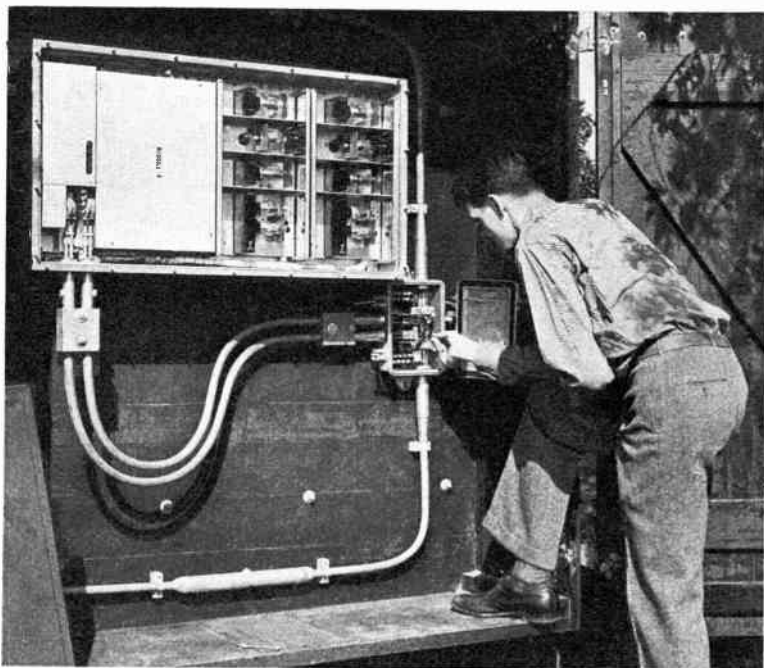

A relay station en route, New York to Philadelphia, over which distance the first coaxial cable in this country has been laid. It is experimental field work, following great success in the laboratory in carrying frequencies vital to television. It holds promise of overcoming television distance barrier.

### Use of MVB at Antenna Input

(Continued from preceding page)  
lar or diagram, because the information is correct only when the factors determining that results are correct, including oscillator inductance. That may be slightly off. So cause the signal generator to generate a beat when weakly coupled to the intermediate channel (running a wire close to, not connected to, second detector, and joining wire to generator output post). Resolve the beat to zero. A multivibrator at antenna input would be just the thing, as it would always supply an oscillation frequency, hence a beat is assured. Otherwise the antenna serves sufficiently to bring in a station at or near 1,000 kc. Leave generator as it is, and listen carefully. For any note or beat heard, resolve the generator to zero beat again, requiring its retuning, and now realign the i-f channel at this new indicated frequency, and readjust the 1,450 kc settings, repeating the processes already detailed. The change in i.f. matches the i.f. to the inductance of the local oscillator.

There are other bands to be aligned in many superheterodynes. The dial pointer may be put at the same two positions as before (equivalent to 1,450 kc and 600 kc on the broadcast

band, but much higher frequencies now). The adjustments are made at the set dial-indicated frequencies, using the same method.

If a receiver has a condenser with tracking section, there is no series adjuster, and if no manufacturer instructions are at hand, align trimmers for the middle of the band, around 1,000 kc.

Tuned radio frequency sets are similarly aligned but at 1,500 kc.

The signal generator is also referred to as a test oscillator. This one works on 90 to 130 volts a.c. or d.c., and the a.c. may be of any commercial frequency (25, 40, 50 or 60 cycles). On d.c. the line plug must be inserted a particular way, otherwise there will be no oscillation. Reverse the plug in the outlet if no results accrue. For a.c. the plug may be inserted either way. Thus indirectly a test of an unknown line condition may be made—if oscillation results from connection made both ways, the line is a.c. If oscillation results only when the connection is made one way, and not the other, the line is d.c. What the line voltage is cannot be determined by this method, but any proper voltmeter will measure that.

# RCA Promoting Big Plant Reported for Television

A REQUEST by the Radio Corporation of America to officials of the town of Harrison, N. J., for permission to put up a large plant across the way from the present RCA tube works, that employs 8,000 persons, was said to be related to increased television activities. No official announcement was made, but persons associated with the city government, as well as persons on the RCA payroll, admitted privately that the object was to devote the new factory to television. Whether it was for the manufacture of television receivers could not be learned.

The city officials intimated that there would be no opposition to the RCA request for taking over the new site for additional activities.

So far there has been great hesitancy by RCA and others in making any move whatever toward the regular production of television programs on an entertaining basis and the accompanying production of receivers.

## BIG RISK INVOLVED

The principal reason is that the financial undertaking is too enormous to justify any chances, in the admitted inability of the engineers to assure transmission and reception of a steady, reliable type. One night results might be excellent, the next night poor, and the engineers, who even can not overcome fully hour to hour shifts of extraordinary degree, are slow about wanting the manufacturing and sales departments to get active on a premature proposition.

However, other corporations than RCA are busy on television, too, and to an extent force the hand of the present leader in the field. Particularly does RCA want to get the complete jump on its network rival, the Columbia Broadcasting System, because RCA feels it has done the big developmental job, and should have first and undisputed position in the television broadcasting field. As for receivers, that is another story, for while RCA has license ownerships, always some other company, a licensee of RCA, occupies first place as the quantity receiver manufacturer, and RCA must, from experience, expect to be licked again at receivers.

## GOOD, BAD, AWFUL

The unreliability of transmission and reception of the cathode-ray type has made the engineers demand more and more time. Recently an oral attempt was made by RADIO WORLD to get the engineers of several companies to select a tentative television date, for introduction

of whatever degree of attainment exists by then, was declined all around with thanks, though the date proposed was Christmas, 1938. This is not to say that cathode-ray television is not good, or is not nearly ready. It totally eclipses all mechanical systems, and when it is good it is very, very good, but when it is bad it is awful.

For instance, RCA has some 75 receivers around the metropolitan area, which are observed regularly by its employes, mostly engineers, and the confidential report of those who do observe is that the results are "not so hot." It is realized great strides have been made in the past few years, even months, but that does not deny the greater improvement deemed necessary before television will be fully dependable for local service. When it can attain network standing is a question that tempts the daring only of wildest guessers, as there is nothing known to science that would lead the initiate to assume that network television is practical. The two methods in view, coaxial cable and short-wave relay, are purely experimental. At present the cable method might cost a couple of million dollars a mile, strewn across the country, while the short-wave relay is much farther removed from attainment than is the electronic television system itself.

## THE CRY FOR ACTION

On the opposite side of the argument are those who have been counselling RCA and others to go ahead with television, because it is good enough. It has been pointed out that when the automobile was first introduced, and for years thereafter, it did not run infallibly, yet the public was satisfied, and the industry grew, and improved its product while growing. This has been true of the steamship, the telephone, telegraph, railroad, radio and many other branches of science. From the viewpoint of commercial daring, with not too much attention to the habitual conservatism of engineers, it is argued that television should be publicly introduced now. Foreign countries—England, for example—have done more with less.

Recent improvements of experimental programs and the increased facilities so that costume and makeup would approach that required for the public opening day indicate that the day itself draws nearer. Just when it will arrive depends on commercial judgment or a forced hand, the latter being the case of a large corporation being compelled to accept the judgment of a smaller and rival corporation.

# RADIO PROGRESS

By H. J. Bernard

## SOME INPUT CAPACITIES HIGH

HYGRADE-SYLVANIA has reported on the effective input capacities of an assortment of tubes, at usual operating voltages, with usual plate loads. Capacitance values are the averages of five tubes of each type:

Type	Effective Input Capacitance In Micromicrofarads	Plate Load In Ohms
6C5	42	50,000
6C5G	50	50,000
6C6 (Pentode)	8	250,000
6C6 (Triode)	38	50,000
6F5	162	250,000
6F5	120	100,000
6F5G	155	250,000
6F5G	124	150,000
6F6	26	7,000*
6F6G	28	7,000*
6J5G	75	50,000
6K5G	107	100,000
6K6G	38	7,600*
6L6	29	2,500*
6L6G	52	2,500*
6Q7	84	250,000
6Q7	64	100,000
6Q7G	91	250,000
6Q7G	73	100,000
6R7	37	50,000
6R7G	35	50,000

\*A-C impedances—all other loads shown are resistors.

\* \* \*

## POWER AND DRIVING

ANOTHER pointer from Hygrade-Sylvania is that in the selection of tubes for driver stages, in which it is most desirable to introduce negligible distortion, the maximum power output to be utilized should be limited to about one-half that listed in usual cables, since the values tabulated are usually obtained with maximum signal voltage swing and therefore contain more harmonics than could generally be tolerated for driver stages.

\* \* \*

## NO GLORY IN THIS

RADIO in Greece is less than what it might be. A country with a population equal to that of New York City, Greece hasn't a single broadcasting station, and by the way has only three amateur stations—SV1KE, SV1CA and SV1NK—all in Athens. Imagine how flourishing the servicing business must be. All radio sets are imported, but quotas are restricted, so

the law of the land limits the quantity of reception. And since all reception depends on outside stations, short waves come in handy, especially in Summer, when standard wave broadcast transmission is noisy. With 5-tube sets at \$67.50 to \$72, 7-tube sets \$90 to \$126, and 10-tube sets \$180 to \$225, prices high because of dealer monopoly, due to quota, one understands why there are only 5,000 to 6,000 set sales a year; or less than one set per thousand population. Some high-powered foreign executive with a free hand, plus Greek Government cooperation, could do a great deal for both Greece and radio.

\* \* \*

## A CUSTOM REVERSED

A NEW tube for high-frequency use, therapy or otherwise, with maximum output at 50 megacycles, but well operative to 100 mc. is Westinghouse WL-461, with closely-spaced elements. It is usual to make the spacing fairly wide, to reduce capacity effects. But note why Westinghouse reversed the usual procedure:

In most ultra high frequency or short wave applications it is advisable to use two tubes in a push-pull or similar circuit. The most convenient way to use the tubes in this type of circuit is to place them end to end with the thimbles spaced approximately one inch apart. This results in the shortest possible leads and also gives considerable economy in the space required.

The inter-electrode capacitance of a high frequency tube should be kept to as low a figure as possible. A convenient way to accomplish this is by using wide spacing of the elements; namely, by using a plate of rather wide dimensions so that the spacing between the filament, grid, and plate, are as large as possible. However, investigation has shown that an equally important consideration is the time required by the electrons in traveling from the filament to plate with the rapid reversals of polarity encountered in high frequency service.

The time of flight of the electrons from the filament to plate becomes an appreciable part of the radio frequency cycle at the shorter wavelengths and if the electrical spacing is large the plate voltage changes lag the grid voltage changes by an appreciable amount. This tube uses, therefore, rather close spacing between the electrodes to keep the transit time at a reasonable figure and very short internal connectors to counteract the increased inter-electrode capacity.



## IMPROVED WIRE RECORDING

**M**AGNETIC recording and reproducing always has had a fascination, but results were not up to par until recently. C. N. Hickman has an article about it in "Bell Laboratories Record," showing the method now used for excellent results.

It will be recalled that about thirty years ago a Danish professor, Poulsen, invented a system of recording speech on a steel wire drawn rapidly past the iron cores of a set of coils. Speech current in the coils caused a magnetic pattern to be left in the wire. When the wire thus treated magnetically was drawn past a set of reproducing poles, a current was induced in the surrounding coils, which was similar to that used for recording. The system offered a number of desirable characteristics. The record could be kept indefinitely and yet could readily be wiped out by a strong, steady field if it were wanted only temporarily. In addition no processing was required, and no precautions had to be taken to avoid external vibration in the recording mechanism. In spite of these advantages, however, and the many attempts to commercialize it, no practical results were obtained until recent years.

There were several reasons for this failure, which only recent developments have been able to overcome. In general, it arose from the use of round wire, from the establishment in the wire of magnetic elements that had large components along their length, and from the lack of satisfactory magnet materials. Another shortcoming was the lack of suitable amplifiers, which at the present time are easily procured. The developments which have changed this situation were carried on largely in Bell Laboratories, he says, and consist chiefly of improved magnetic material, the use of a very thin and narrow tape instead of a round wire, and the use of perpendicular magnetization—that is, the magnetic elements in the tape have no appreciable component along the length of the tape.

At the time of Poulsen, although he had suggested its use, steel tape of suitable magnetic characteristics was not available so that a wire had to be used. A wire, however, is bound to twist around its axis, and if its magnetic elements were transverse, a twist of ninety degrees would result in no currents being induced in the reproducing coils. To avoid this, it was necessary to produce in the wire magnetic elements that were chiefly parallel to the axis, so that their effective strength was not seriously changed by axial twisting of the wire. The highest frequency that can be reproduced is a function of the axial length of the magnetic elements in the wire and the speed with which the wire is moved. With comparatively long magnetic elements, which is necessary where their length is mainly along the axis of the wire, high speeds are necessary, and these high speeds produce excessive wear on the pole-pieces and have other disadvantages.

Besides possessing these objectionable features the longitudinal method of magnetization produces a certain distortion in the sig-

nals that is inherent. To produce magnetic elements in the wire or tape that have large axial components, it is necessary to offset the poles with respect to each other, and this results in a leakage flux that causes the distortion.

One great improvement brought about by the developments of these Laboratories consists in providing a better magnetic material, in rolling it into a thin tape, and in properly heat-treating it. With a tape, the twisting tendency is avoided so that perpendicular magnetization can be employed, with the two poles placed directly opposite each other.

\* \* \*

## DICTATORIAL CRYSTAL

**H**ERETOFORE a crystal exercised part through dominant control of the frequency, but now there's a dictatorial crystal that controls it completely. S. C. Hight tells about it in "Bell Laboratories Record."

The need for a rugged portable sub-standard of frequency has led to the development of a new type of quartz plate with low temperature-coefficient, and a stabilized circuit in which the crystal has complete control of the frequency. This makes the sub-standard independent of variations in the supplied voltage and of circuit reactances.

The essential element of the frequency standard is a quartz plate which, because of its piezoelectric properties, vibrates when an alternating current is applied across its face. Although of electric origin, this vibration is mechanical and the fundamental frequency like that of all vibrating plates depends on the size, and the density and elasticity of the material of which the plate is made. The elasticity and hence the frequency of vibration changes with the temperature and, in the case of quartz, also with the direction in which the crystal is cut relative to the natural axes of the crystal.

It has been found that quartz plates of low temperature-coefficient can be made by cutting the crystal in certain directions with reference to the crystal axes. These cuts are related to the electric axis (x), the mechanical axis (y) and the optic axis (z).

The possibility of making plates with low temperature-coefficients to operate at frequencies below the broadcast band has recently been investigated by the Laboratories. The results disclosed two new types of quartz crystal elements which operate at frequencies below five hundred kilocycles. They are cut parallel to the electric axis and their frequency depends on the dimensions of the large face of the plates.

The new plates which are designated by the letters CT and DT have many unique advantages over their predecessors. The frequency may be lowered as well as raised by a simple abrasion. Also, the temperature-coefficient is small.

\* \* \*

**R**ADIO tubes are evacuated, that means vacuum pumps are used, also that the extent of vacuum must be measured. Westing-

(Continued on following page)

# A Regulator of Line Voltage

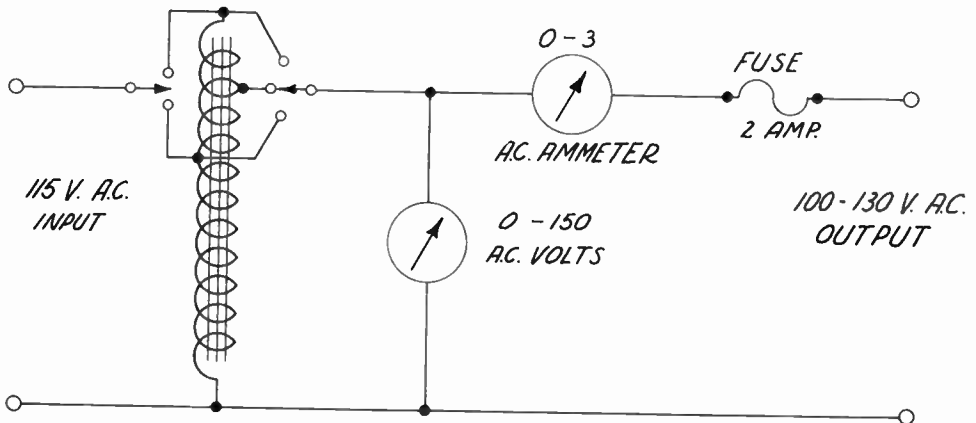

A receiver power transformer was used in constructing this device. —William A. Hunt, Jr.

In the above circuit the auto-transformer is a regular power transformer such as is used in radio receivers. Only the primary and filament windings are used. The sum of the voltages of the filament windings was 15 volts in this case. These filament windings must be phased properly to each other and to the primary in order that their voltages may add. Then by using the

above switching arrangement a variable output voltage may be obtained. The amount of current passed will depend on the lowest current carrying capacity of the filament windings. In this case it was 3 amperes. This regulator is useful in "cut-out" service jobs, and is perfectly safe to use, as a change of voltage of 10 per cent should not harm any radio.

(Continued from preceding page)

house pressure-indicating tube WL-762, a new product, measures all sub-atmospheric pressures, and it is interesting to know how it is done.

The tube utilizes a filament mounted in a bulb which is equipped with a UX type of base. One end of the bulb is provided with an exhaust tubulation by which the tube may be connected with the vacuum system, in which measurements are to be made. The base affords an easy connection with the circuit.

The essential part of the tube is the filament which is made of platinum ribbon. The operation of the tube depends upon the conduction of heat from the heated filament to the bulb and thence to the surrounding atmosphere.

At atmospheric pressure there is a definite rate of cooling of the heated filament by the particles of air which carry the heat from filament to the bulb. As the amount of air in the tube is reduced the rate of conduction of heat from the filament to the bulb decreases, resulting in an increase in filament temperature. Hence the resistance of the filament increases, causing the current in the filament circuit to decrease. The increase in resistance continues as the vacuum conditions are improved or as the air pressure and consequently the number of molecules of air are decreased. The same phenomenon occurs if the tube is used in measuring pressure conditions of gases other than air. The unit should be calibrated for the specific gas which it is desired to measure.

## Terman's "Engineering" In New Second Edition

McGraw-Hill Book Company, Inc., of New York City, has just published a new edition of "Radio Engineering," by Frederick Emmons Terman, professor of electrical engineering, Stanford University. This second edition of a very popular volume has 813 pages, compared to 688 in the first edition, and has 475 illustrations, compared to 418.

The book gives a comprehensive treatment covering all phases of radio communication, written from the viewpoint of an engineer by an educator who also has had a great deal of practical experience. Measurements are one of the professor's strong points, and he registers this strength splendidly.

The first part of the book is devoted to the theory of tuned circuits and the fundamental properties of vacuum tubes. The second part considers radio receivers and transmitters, wave propagation, antennas and direction finding. In this part of the book are chapters on radio aid to navigation, sound equipment, and a new chapter on television. The new volume costs \$5.50, an increase of 50 cents.

### ENOUGH?

One tube manufacturer is said to have had enough of metal tubes and will make them for replacement only.

# Power Tube, as in 6C8G, Can Have VERY CRITICAL BIAS

THE advantages of the 6C8G tube as Class B output of battery-operated receivers, for 6.3 volt operation, is stressed by Ken-Rad Tube & Lamp Corporation.

Recent experimental data showed this tube to possess power output capabilities of unusual merit for such receivers. Low heater current together with low plate current makes the tube especially attractive for this type of application from the viewpoint of economical operation, a factor of paramount importance in battery operated receivers. The types 19 or 1J6G and 38 have been considered and used by design engineers for output tubes but these types for this service have several disadvantages. The type 19 or 1J6G are two-volt filament types and a series resistor is required for six-volt operation. The type 38 has the disadvantage of being a pentode and when operated at a 180 volt power supply only gives 1 watt output at a total distortion of 8%. The 6C8G possesses none of these disadvantages, and if operated under Class B conditions will supply sufficient power to insure good volume level when used with a good speaker.

## OPERATED NEAR CUTOFF

Plate current versus plate voltage characteristics of the 6C8G allow the tube to be operated Class B with relatively low values of bias, which is very fortunate, as fixed bias is imperative for satisfactory operation, and in this case may be supplied from the heater voltage supply, Ken-Rad sets forth.

Data are given from the viewpoint of receiver operated from vibrator type power supplies, using a storage battery. However, operation of the 6C8G is not restricted to this application and it may be used in receivers utilizing batteries for the B supply.

Two complete sets of operation characteristics for the 6C8G as a Class B output tube, one at 135 volt plate supply and the other set at 180 volt plate supply, showed in each case the tube was operated very near cut-off on the transfer characteristic. The bias required for 135 volt plate supply operation is -4 volts and for the 180 volt supply -5 volts. This bias is easily obtained from the heater supply by grounding the positive heater leg and tapping a resistor shunting the supply, the grid return of the tube being brought back to the tap. In both instances of operation a 6L5G was used as a driver, its plate supply voltage being kept the same as the output tube supply voltage.

## CRITICAL BIAS

Bias on the 6C8G used as a Class B tube is very critical. Deviation of the bias one volt in either direction from the rated values gives rise

to high distortion at low signal levels. For example, if the bias for the 180 volt supply condition is made 6.0 volts instead of 5.0 volts as rated, the third harmonic, at a driver signal voltage of .5 volt rms, will be approximately 10% and the second and fifth harmonics correspondingly higher. Similar increases in distortion will result at low signal voltages under the 135 volt plate supply condition if the bias is other than that given.

In line with what has been said regarding bias the question immediately arises as to what will happen as the battery voltage decreases due to approaching end of life. In receivers utilizing vibrator type power supplies operated from a storage battery this question is easily answered. As the battery voltage falls, the bias voltage decreases as does the plate supply voltage. These voltages will fall, as has been found, in almost exactly the same proportion with the fall in supply battery voltage, hence, very near optimum bias will result for the greater part of the life of the battery.

For the 135 volt supply condition optimum operating conditions occur at a plate to plate load of 18,000 ohms and an interstage transformer turn ratio of 2/1 total primary to 1/2 secondary. Similar conditions are optimum for the 180 volt condition. The low signal distortion for the 135 volt condition, while not as low as for the 180 volt condition, is still acceptable, being less than 6% total at a signal of .5 volt to the 6L5G grid.

## Another Condenser Works Taken Over by C-D

The demand for Cornell-Dubilier industrial capacitors has reached such overwhelming proportions that the well-known South Plainfield condenser plant has taken over the condenser manufacturing equipment and sales staff of the Electric Machinery Manufacturing Co., Inc., of Minneapolis. Cornell-Dubilier capacitors for power factor correction in industrial plants and electric distribution systems have received wide acclaim in the industrial world as "money-savers."

According to Octave Blake, president of the Cornell-Dubilier Electric Corporation, the additional equipment supplements the modern machinery already housed in the eleven buildings covering more than thirty-three acres. The enlarged sales staff adds considerably to the previously extensive sales coverage of the Cornell-Dubilier Electric Corporation in the United States.

# Capacity and Inductance Measurement for Different Line Frequencies

By A. J. Woolsey

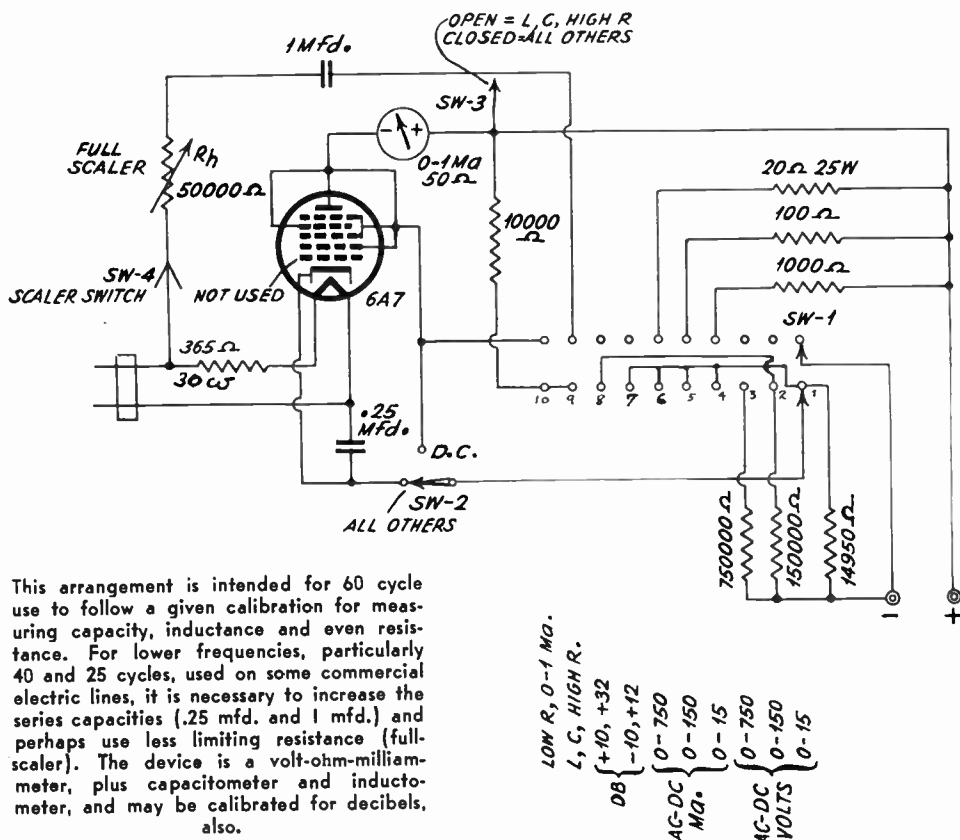

This arrangement is intended for 60 cycle use to follow a given calibration for measuring capacity, inductance and even resistance. For lower frequencies, particularly 40 and 25 cycles, used on some commercial electric lines, it is necessary to increase the series capacities (.25 mfd. and 1 mfd.) and perhaps use less limiting resistance (full-scaler). The device is a volt-ohm-milliammeter, plus capacitometer and inductometer, and may be calibrated for decibels, also.

THE services performed by the instrument shown in the diagram are listed at lower right of that diagram and are shown to include inductance, capacity and high resistance. Also, low resistance is accounted for, by the reverse scale method, due to shunting the meter, but as there is no reactive aspect of that measurement, we shall confine ourselves to inductance capacity and high resistance.

The current through the rectifier tube is limited by some form of resistance. This resistance may appear as pure resistance, as for example the rheostat of 50,000 ohms, some resistance of which is always in circuit, or may appear in that special form of resistance that arises from inductance and capacity. The purity of the

resistance merely means the rheostat is 100 per cent. resistance, hence has no inductance, no capacity. This is true within the sense of the frequencies under consideration.

## THE OHMMETER METHOD

What might be called rather loosely the impurity of the capacity or of the inductance is known technically as the reactance, the factor causing opposition or retardation effect to change with frequency. The reactance is one component of impedance. Others include the a-c resistance, which is practically constant with frequency, and the d-c resistance. It is the reactance that does, or should, contribute practically all of the change, as the general methods

applied ascribe to the reactance all the change produced by the impedance. This is often done in service practice, and is entirely allowable, if in the design of the instrument the constants to be measured are such as to be within safe limits.

When it comes to d-c measurements we refer to the ohmmeter method as being one whereby a voltage supply is interrupted by a limiting resistance for producing fullscale reading when the circuit is closed, and by additionally introducing the unknown in series, the current is lessened. The reason for full-scaling is that conditions change from day to day, or even from hour to hour, in the voltage supply, whatever it is, and including batteries. The hourly consideration is a bit strong in respect to batteries, but not to the a-c line, which may be affected by loading, phases, etc. So the meter needle is made to read maximum by an adjustment (here on the full-scaler) and then the circuit is opened, and closed again only by inserting the unknown. The greater the obstruction offered by the unknown the less current will flow. Since readings start at full-scale, marked 0, for ohms, they must progress from that to  $1 \div 0$  or infinity, but we put down a finite number somewhere close to where infinity appears, or would appear, and call that the limit of reading. The less current the higher the unknown resistance.

## ASCERTAINING REACTANCE

So much for the ohmmeter method. It is of the same general nature as the impedance method, where exactly the same process is used, except that limiting agencies may include capacities and inductances, as well as resistances, whereas on d-c series capacities would cause an open circuit, and inductances have little effect, compared to the inductance magnitudes.

Considering the two series condensers, 25 mfd. and 1 mfd., as resistors, because for a given frequency capacities come down to a condition where the opposition is equal to that of a pure resistance of some value, we may neglect all factors for the moment save the reactance. Thus we ascertain the capacity reactance from a formula, which sets forth that  $X_c$ , the capacity reactance in ohms, is equal to the number one, divided by 6.28 times the frequency times the capacity. Let us see what the capacity reactance is for a condenser of 1 mfd. It is the number one divided by (6.28 times 60 times .00001). Fundamental units are used—capacity reactance in ohms, frequency in cycles per second, capacity in farads. The answer is 2,650 ohms. Notice from the expression that the smaller the capacity the higher the reactance and the greater the capacity the smaller the reactance in ohms. Therefore with condensers the reactance is inversely proportionate to capacity—the bigger the smaller, the smaller the bigger, so to speak.

## HOW CAPACITIES ARE CALIBRATED

As condenser leakage may be measured otherwise (not in this instrument) and for a good

condenser will be small, capacities may be determined accurately, say, to 10 mfd., and with crowding from 10 to 50 mfd., this part scarcely called measurement, but, say, good approximation. Merely inserting the unknown condenser produces the reduction of current that is reflected in a scale calibrated in terms of such reduction but ascribing the change to capacity alone. Actually the scale for such purpose is prepared from a calibration run, using accurate standards of capacity, the other capacity values extrapolated from a curve based on the known values.

Reactance means change of current with frequency, for a constant applied voltage, so that the unit possessing reactance behaves as if it were a pure resistance of a different value for every different frequency. We could not consider such an infinite number of resistance values, so we call the unit's property an impure resistance, simply because it does not consist of nothing else but resistance. We have found that it possesses capacity in one instance. Now let us have a regard to inductance.

By inductance, when any frequency so low as 60 cycles is concerned, we always mean inductance in henries, i. e., high inductance. There is no use trying to measure radio-frequency coils at 60 cycles. So we have to investigate the inductive reactance  $X_L$ , in ohms, and we find it to be equal to 6.28 times frequency times inductance. All units are fundamentals, ohms, cycles and henries. This form therefore is exceedingly simple, and if we seek the inductive reactance of a one-henry coil we find it to be equal to 376.8 ohms. And the higher the inductance in henries, the higher the reactance, as the ratio is direct, not inverse. So 2 henries would have an inductive reactance of  $2 \times 376.8$  ohms. In the case of a 1 mfd. condenser, 2,650 ohms reactance, a 2 mfd. condenser by comparison would have a reactance of  $2,650 \div 2 = 1,325$  ohms, as we have found that condensers and coils work in opposite directions, the condensers being inverse and the coils direct.

## VIEWED AT 60 CYCLES

So 376.8 is a sort of magic number, for us, because it appears in the divisor of the capacity reactance equation and as a multiplier in the inductive reactance equation. But it is a magic number for 60 cycles only. It is the result of  $6.28 \times 60$ . For 50 cycles the number would be  $6.28 \times 50$  or 314; for 40 cycles 251.2, and for 25 cycles 157.

The same capacity in series with the line, when used for 25 cycles instead of 60 cycles, does entirely too much resisting, so to speak, or more than twice as much, the ratio being represented by the ratios of frequencies, 60 to 25, or 12 to 5. If that is true, then 157 should be  $5/12$  of 376.8, and just for fun see if it isn't.

We may take a 60-cycle view of the circuit as follows: Assume that the line voltage is 117 volts, which is an acceptable average, and a favorite one among manufacturers who have to make devices to work properly from the line. Assume that the direct current through the meter equals the alternating current through

(Continued on following page)

## INFINITE EFFECT IN FINITE SPACE

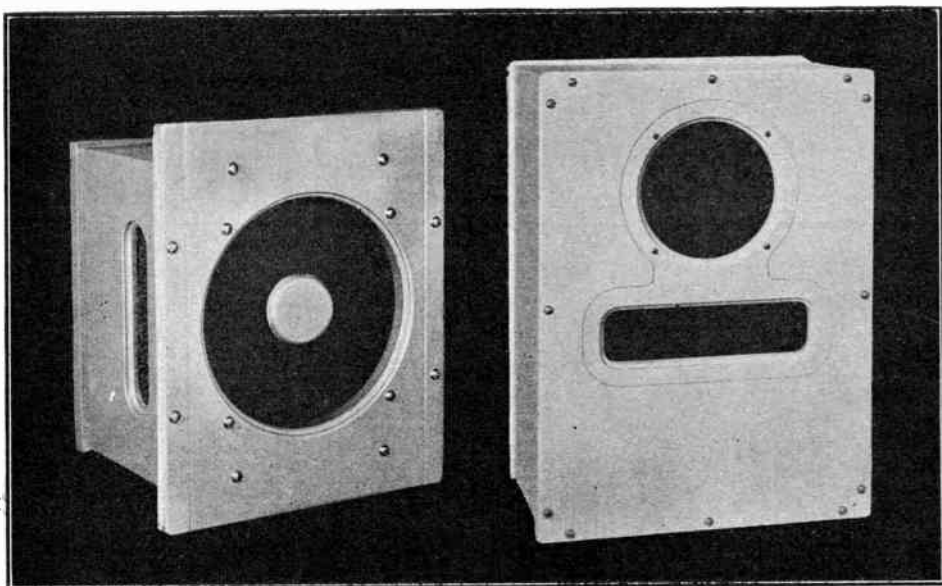

Model KV at left and Model KM at right.

Jensen offers Peri-Dynamic reproducers in kit form. Model KM is for voice and musical instruments, hence for radio sets, phonograph reproductions, etc., whereas KV is suitable where only voice is concerned.

The setups embody the bass reflex principle, which is a method of reinforcing the low notes, to prevent their attrition due to baffle shortcomings. In general, the result approximates that of an infinite baffle. All the parts are supplied, and the buyer does the simple assembling. There are four speaker sizes and four enclosure sizes. Hinges are extra for tilted assemblies.

## Methods of Determining Constants

(Continued from preceding page)

the resistance network, which is a fair assumption because the rectifier is of the peak type. Then the total obstruction to current flow, including every factor, is represented in ohms by  $117 \div .001 = 117,000$  ohms. Of this the two series condensers, 1 mfd. and .25 mfd., represent equivalent series resistances of 2,650 and  $4 \times 2,650 = 5 \times 2,650 = 13,250$  ohms. The rheostat has 50,000 ohms, assumed at maximum for this purpose, so we have 63,250 ohms, and the difference between that and 117,000 ohms must be ascribed to the rectifier.

The following apply: For 40 or 50 cycles, use 25,000 ohm rheostat; for 25 cycles, use 25,000 ohm rheostat. Also make series condensers 2 mfd. and 1 mfd.

The larger the two series condensers are the greater is the change in the direction of removing their obstruction, and the lower the frequency the line may be. Therefore these could be several microfarads each, or the effective series capacity may be increased in the

ratio of the lower frequency divided into 60. Then the rheostat too could be somewhat smaller.

It is entirely practical to omit the condensers for the lower frequencies, or even for 60 cycles, but their presence adds an advantage, in that coils may be measured with or without d-c through the windings, in or out of their accustomed circuits, and without danger of shorting the line or interfering with the accuracy of the reading.

A-c and d-c volts on the instrument are made applicable in the usual way. Currents are read because of voltage drop across known resistors, which introduces a little more resistance into the measured circuit than normally, but is a handy method. The decibels are based on a zero level of 3.75 volts, assumed to be working into an infinite impedance, and represent a calibration applied to two a-c volts scales. The range is minus 10 to plus 12 for the 0-15 volt range, and tip .20 for the 0-150-volt range, e. g., plus 10 to plus 32, a total change for two ranges of 42 db.

# NEW PRODUCTS

## Triplett Bench Panels Offered in Three Styles



One de luxe and two master testers are accommodated by Model 1403.

Triplett Laboratory Test Bench Panels, in three cabinet styles, offer facilities for a complete service laboratory. Any Triplett master or deLuxé type tester may be installed. Cabinets may be obtained complete with testers, or the units can be added as required.

Model 1403, shown here, accommodates one deLuxé and two master testers. Model 1402 has compartments for two de luxe instruments, and Model 1404 will hold any four master units. Installation is such that testers may easily be removed for field use. Any two or more cabinets may be bolted together to form a continuous panel.

Cabinets are of sturdy metal construction with black wrinkle finish. Panel front is attractively trimmed in red and white. Large drawer at bottom for accessories. Height  $22\frac{1}{2}$ " ; width 16" ; depth  $7\frac{7}{8}$ " at bottom and 5" at top. Write to the Triplett Electrical Instrument Co., Bluffton, O., for complete information.

## Micamold Power Resistors Coated Under Live Steam

Micamold has recently announced a complete line of cement coated resistors in ratings from 10 watts to 100 watts.

The standard line is of conventional construction and dimensions. The resistors are in both the fixed and variable types with sliders and brackets. Special types can be supplied to manufacturers' specifications.

The cement coating is processed in live steam so that the resistor is proofed against humidity, said E. B. Tyler, sales manager.

The resistance wire used has a low temperature coefficient and it is hard soldered to the lugs to prevent an open or noisy connection.

## New-Knight Amplifiers Have Streamlined Cases



Streamlined cases mark the new line of Knight amplifiers, sold exclusively by Allied Radio Corp.

Allied Radio Corporation, 833 West Jackson Boulevard, Chicago, has available a new complete line of matched unit Knight Sound Systems to meet every public address requirement. These systems include such features as calibrated output indicator, universal input, streamlined cases, built-in mixer, metal tubes and polarized plugs and receptacles.

Knight sound systems and amplifiers are available for permanent, portable and mobile installations, for 6 volt, 110 volt, and universal operation. Of special interest are the new Knight intercommunication systems and centralized p.a. systems, especially suitable for schools, hospitals, hotels, department stores, institutions, etc. The amplifier illustrated is one of the many described in the 156 page Allied catalog.

## Allied's Big '38 Catalogue Offers Complete Coverage

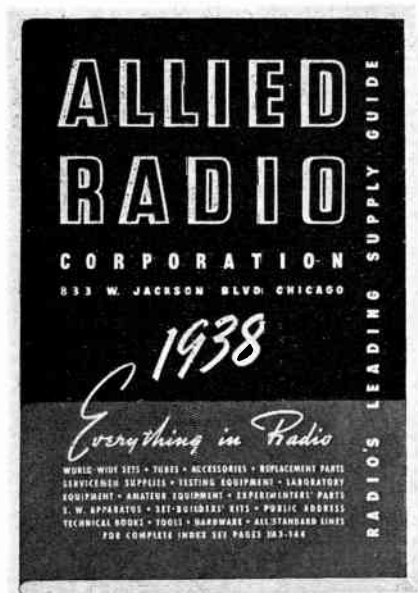

A reproduction of the front cover, which in the original is in colors.

Allied Radio Corporation, Chicago, announces the release of a new 1938 catalog. It contains 164 pages and includes more than 12,000 exact duplicate and replacement parts; sixty-one new Knight radios; amateur receivers, transmitters and transceivers; build-your-own kits; public address systems; test instruments; books, tools, etc. Unique features of this book are its convenient arrangement of the parts, portions and the separate amateur, public address, test equipment and radio set sections. A free copy may be obtained by writing to Allied Radio Corporation, 833 W. Jackson Boulevard, Chicago, Ill.

## Allied Radio Expands; Now Occupies 50,000 Ft.

Allied Radio Corporation, of Chicago, announces the expansion of its facilities to include an additional 10,000 square feet of space in its building at 833 West Jackson Boulevard. This marks the second space increase in the last two years and gives Allied more than 50,000 square feet—all under one roof—to house its complete organization.

The expansion was attributed by A. D. Davis, president, to the steady increase in business.

"We have enjoyed one of our most successful seasons during the past year," he said, "and we look forward to even greater activity this Fall."

Allied has a unique advantage in that the

entire organization is housed in one building. Offices, display rooms, stock rooms, laboratory and shipping department have been planned and organized to permit centralized co-ordination.

Allied specializes exclusively in radio and handles complete lines of radio receivers, parts, public address equipment, and accessories, servicing dealers, servicemen, amateurs and institutions all over the world.

## Three C-D Condensers Fulfill AC-DC Needs

Cornell-Dubilier's boon for radio servicemen is the new type UM series of universal replacement electrolytics for A.C.-D.C. sets. C-D engineers, in designing this series, were cognizant of the great expense to servicemen in stocking exact duplicates, and the time consumed in obtaining them. It is now possible by stocking only three replacement condensers to quickly and economically service the capacity filter of any A.C.-D.C. receiver.

Color coded leads, with color key clearly printed on the C-D label, assure the radio serviceman of simple and accurate hookup. A complete listing of these universal electrolytics can be found in catalog 151-A, obtained by writing to the Cornell-Dubilier Electric Corporation, South Plainfield, N. J.

## Twin Gadget Makes Fast Work of Trouble Shooting

The Twin Gadgets, one for auto radio, the other for home radio, are printed systems of expert service information that enable the solution of knotty problems in a moment. The stiff pages, staggered to maximum of about 5x1¼ overall, are riveted together in one corner, and thus when the thumb index at one end is consulted, the proper page is selected by rapid pivot on the rivet, and there you have your information, always at the same topical reading level, and what can not be fully concluded on one side is continued on the reverse side, at the same level.

Let us take as an example the eleven characteristic ailments, classified in the thumb index, and the nine possible sources of likely trouble appearing permanently on the base, and apply our problem of intermittent reception to the Auto Radio Gadget. We put our right thumb on the thumb index, where Intermittent Reception appears, then we pivot the gadget open, and find a long list of possible sources of trouble, all aligned under the front-cover topical headings of sources, an alignment carried through on every page.

The Twin Gadgets are the work of Alfred Ghirardi, famous technical radio author and servicing expert, and cost 50c each. They are published by Radio & Technical Publishing Company, 45 Astor Place, N. Y. City.



# RADIO CONSTRUCTION UNIVERSITY

Answers to Questions on the Building and Servicing of Radio and Allied Devices.

## SHUNT RESISTANCE DATA

Will you please let me know the value of unknown resistance when shunting a 500-microampere movement of 126 ohms internal resistance? Please give computed points, also interpolations in steps from one ohm up.—K.I.C.

The following data were computed from the formula

$$R_x = \frac{R_m}{(I_m \div I_o) - 1}$$

where  $R_x$  is the unknown,  $R_m$  the meter resistance,  $I_m$  the full-scale current and  $I_o$  the read current through the shunted meter:

Micro-amperes	Ohms	Micro-amperes	Ohms
495	12,600	150	54
475	2,400	100	31.5
450	1,136	50	14
425	724	25	6.63
400	504	20	5.25
350	293	15	3.8
300	188	10	2.57
250	126	5	1.3
200	84	2.5	.63
125	42		

Micro-amperes	Ohms	Micro-amperes	Ohms
4	1	264	140
7.5	2	274	150
12.5	3	282	160
16	4	288	170
19	5	296	180
23	6	302	190
27	7	309	200
30	8	335	250
33	9	358	300
37	10	367	350
40	11	375	400
44	12	399	500
47	13		
50	14	Not Linear From Here On	
52½	15		
Linear From Here On		412	600
67½	20	423	700
81	25	430	800
95	30	437½	900
122½	40	443	1,000
142½	50	448	1,100
160	60	452½	1,200
180	70	456	1,300
195	80	458	1,400
220	90	461	1,500
222½	100	470	2,000
235	110	480	3,000
244	120	486	4,000
256	130	489	5,000

From the foregoing a curve was run and from the curve the following values obtained:

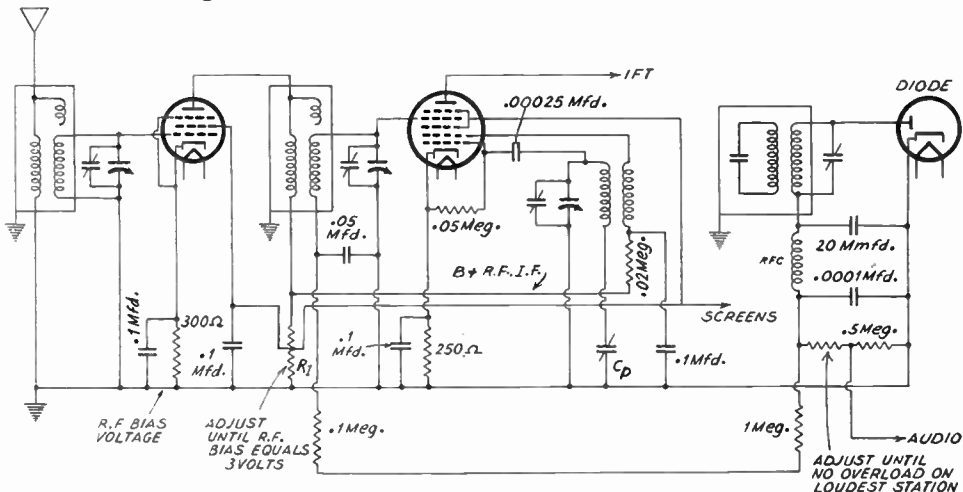

With r-f bias correct, second detector filtered, overload on strong signals is avoided by using full rectified voltage for a.v.c. and less for the maximum radio takeoff. See text on following page.

**AVOIDING CUTOFF**

**I**SN'T there some way of adjusting a superheterodyne so that there will be no overload on loud signals? Strong locals play havoc with my super, which has a.v.c. If the plate voltage is not fully under control, what would be a good method of assuring that the no-signal bias on the r-f tube was 3 volts?—P. L.

The diagram on the previous page shows the mixer and r-f stage of a superheterodyne, omits

of the rheostat but the used part. Then replace with a fixed resistor of equal value. Another way is to heighten the a-v-c effect. Increasing B voltage on a diode-biased amplifier, shown on another diagram, helps a lot. You do not supply your diagram, but if by any chance you have a cathode leg resistor in a diode-triode or diode-pentode second detector and amplifier, the likelihood is you are running a positive grid at times. Send in the diagram of your receiver for analysis.

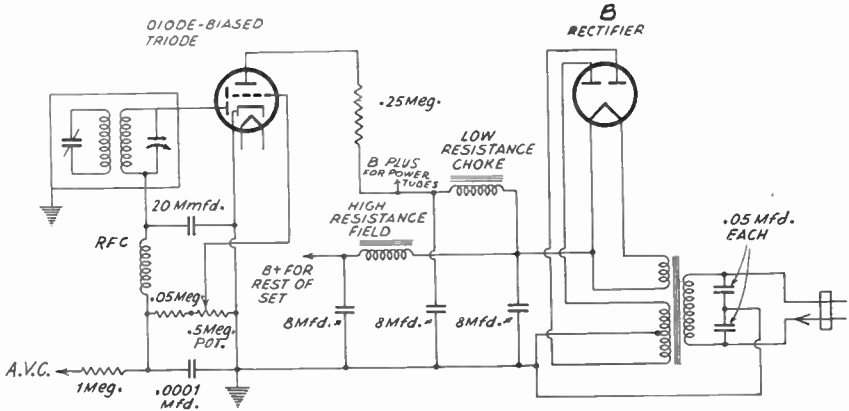

Here instead of the amplifier following the diode-biased triode getting a medium plate voltage, it gets a high one, due to low resistance choke.

the i-f channel, but shows the input to the diode, and the rectified signal voltages. The bias on the first tube may be made just 3 volts by putting a meter across the cathode circuit self-biasing resistor, and adjusting the screen voltage until the meter reads 3 volts from cathode to B minus. The overload may be corrected by taking off less than the total rectified voltage. Use a rheostat of 250,000 ohms, and adjust it until the strongest local causes no overload. Then remove the rheostat and measure the amount of resistance that was used. Be careful in attempting to follow these directions that you do not measure the unused part

**TWO CURRENTS, ONE RESISTOR**

**I**F the power tube carries more current than the rest of the tubes in a series chain of heaters, how can the limiting resistance be determined?—I. R. D.

The current carried by the power tube is made controlling, and the rest of the tubes are series chained as usual, but across this series is put a resistance large enough to increase the total current on that side to the same quantity, as flows in the power tube heater. The voltage drop is easily computed, as the tube heater voltages are known, and are added up, the sum

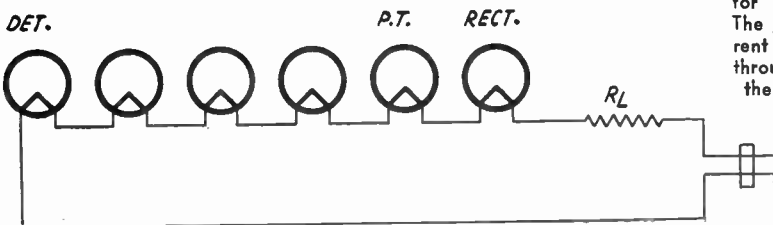

RL is the limiting resistance for the comment current. The power tube heater current is greater than that through the other tubes by the current through R<sub>n</sub>.

is subtracted from the line voltage. The resultant voltage is divided by the current, and the answer is the resistance ( $R_L$ ). Of the similar tubes, say, at .3 ampere, with the power tube at .4 ampere, the resistance paralleling the .3 ampere tubes carries .1 ampere at a voltage equal to quantity previously obtained, less the power tube voltage drop. The .3 ampere tubes may be figured as 21-ohm resistors, at 6.3 volt drop across heaters, so if there are four such tubes, or 84 ohms, the parallel resistor,  $R_b$ ,

The capacities are marked, and the polarities of the condensers are designated.  
\* \* \*

**WHO RULES THE ROOST**

**W**HAT is the proper way to place a radio set in a home? Do not conditions vary in different homes so that no one rule applies? —K. V.

Conditions certainly do vary. Principally the reverberation period is different. Homes with

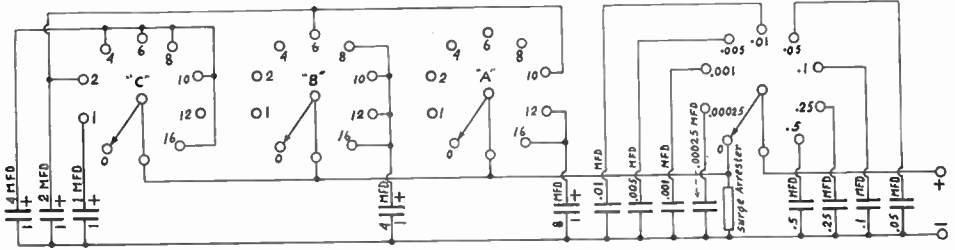

Various capacities in a selector circuit, using four switches.

would be three times 84 ohms, or 252 ohms, and two or three watts would do. The limiting resistance  $R_L$  is therefore  $E \div I$ , where  $E$  is the total voltage dropped by all the tubes' heaters, and  $I$  is the common current (level of power tube).

many drapes, carpets, curtains, etc., are likely to have a low period. In practice, not much attention is paid to any of these factors. Instead, the lady of the house decides that the radio would look best in a certain place, and there it goes.

\* \* \*

**CAPACITY SELECTOR**

**F**OR selecting various capacities, so by test it is possible to ascertain which capacity value is best for a particular purpose, will you please show a selector circuit, wherein the condensers are used in series, in parallel, etc., to minimize the number, but retaining full capacity selection?—K. E. D.

Such a circuit is shown herewith, which is one based on a device sponsored by Sprague.

**SIGN OR NO SIGN?**

**I**S it a sign that a condenser is electrolytic, or partly so, when one end is marked by some identification, and if so is this always equivalent to the grounded end, or end to be grounded? I notice some condensers have "Gnd" marked at one terminal.—P. W.

No, that is no test. Electrolytics are usually marked positive and negative. Mica condensers would not be marked for terminals, but paper condensers might be. Foil termination is identified for grounding.

**New Dynamic Mike by American**

A new dynamic microphone, as illustrated, has been introduced by American Microphone Co., Inc., Los Angeles, Calif. It has a bullet-shaped housing and is referred to as a multi-purpose microphone. It is of the moving-coil, permanent magnet type, is semi-directional, and permits of either close or distant pickup. The frequency response curve supplied by the manufacturer shows relative flatness, with most excellent uniformity from 60 cycles to 2,800 cycles, a slight rise there-



after to 4,500 cycles, and a small drop to 7,500 cycles, after which there is a small rise to

10,000 cycles. The level is approximately minus 55 db.

As an all-purpose microphone, says the manufacturer, the dynamic is unsurpassed, because most rugged, long lived and relatively free from trouble. Being a pressure type instrument results in the good response to near or distant sound. There are two models, the D-5, list \$32.50, impedance 10,000 ohms, up to 50 feet of cable useful, and the D-5, impedance 50 ohms, for low-level mixing, list price, \$27.50.

## Meissner Sets Record with Catalogue and Instructions

The most complete catalogue ever issued by a coil manufacturer has just been released by Meissner Manufacturing Co., Mt. Carmel, Ill., and consists of 32 pages, crammed with most interesting facts and figures about coils made in the enormous Meissner plant. It is particularly attractive to the serviceman, experimenter and amateur, and is offered free on request.

Meissner has done a great deal of engineering of receivers and adapters, and as a result has a great wealth of kit circuit diagrams, information on constants, including coils, that has been gathered together in an attractive big book with two-color cover that sells for 50 cents. The circuits contained therein are alone worth more than the asking price, and besides there are intimate data so detailed, even to drafting specifications for each chassis, that a builder has all the information he needs. Besides, the catalogue is included in this 112-page book.

Meissner maintains a New York office at Roye Sales Agency, 11 Warren Street, where Bill Carduner is sales manager of the jobbing division.

### A CORRECTION

On page 18 of the September, 1937, issue, appeared a transceiver diagram that requires correction. The end of the secondary feeding 33 is not grounded directly, but reaches ground only through the 750 ohm biasing resistor. The .001 mfd. condenser thus removed goes across the 33 filament. The fixed condenser from RFC to ground is .0005 mfd. Ground is left-hand side of the 33 filament.

## Literature Wanted

Readers whose names and addresses are printed herewith desire trade literature on parts and apparatus for use in radio construction. Readers desiring their names and addresses listed should send their request on postcard or in letter to Literature Editor, Radio World, 145 West Forty-fifth Street, New York, N. Y.

- Les. V. Douthat, Albert Street, Ringwood, Victoria, Australia.
- Jack M. Valoy, 125 So. Gage St., Los Angeles, Calif., on receivers, transmitters, oscilloscopes, and other test instruments, plus all available technical data.
- F. A. Wallace, 115 F. St., S.E., Auburn, Wash.
- Elmer Fischer, 5962 Brecksville Rd., Brooklyn Sta., Cleveland, Ohio.
- E. W. Hatfield, Seventh Avenue, Moultrie, Georgia.
- Roger Poulin, VE2LH, 121 Cartier Ave., Quebec City, P.Q., Canada.
- O. B. Millar, Box 192, Coalinga, Calif.
- F. J. Kemp, 715 Dovecourt Rd., Toronto, Ont., Canada.
- Louis Ulrich, W6LRM, Azuso, Calif.
- Al. Linowit, 669 Moon St., Akron, Ohio.
- L. Tamcred, 490 E. 181st St., Bronx, New York City.
- Donald H. Jacobs, Arcturus Radio Tube Co., 720 Frelinghuysen Ave., Newark, N. J.
- J. J. Demarest, U.S. Engineers, Natchez, Miss.
- Richard A. TenEyck, W2JJT, 9 Conger Ave., Haverstraw, N. Y.
- Charles Miesel, 60-35 Saunders St., Elmhurst, N. Y.
- Edward Slater, 8518 Leander St., Detroit, Mich.
- W. A. Taylor, 123 W. 34th St., Richmond, Virginia.
- Walter P. Bobreck, 105 No. 8th St., Brooklyn, N. Y.
- Frank Frisch, W2JVU, 1409 Brook Ave., New York City.
- Carl S. Seigfreid, 1022 Madison Ave., Reading, Penna.
- George McGunagie, 3048 Texas Ave., Pittsburgh, Penna.
- Earl L. Fenner, 303 Wrexham Ave., Columbus, Ohio.
- Daniel Farkas, W2INO, 1140 College Ave., New York City.
- E. A. Roberts, 210 Henderson St., Plymouth, Penna.
- B. H. Matthies, Seymour, Conn.
- Arthur F. Trumbore, 323 Lincoln Ave., Bellevue, Pittsburgh, Penna.
- Harry Johnson, 476 East Street, Buffalo, N. Y.
- Gerard E. Lavellee, W2JYA, 1649 Bayshore Ave., New York City.
- Henry J. Geist, W3AOH, Box 12, Churchville, Penna.
- Lester Rounds, R.F.D. No. 2, Lorain, Ohio.
- Louis Moore, P.O. Box 722, Nogales, Ariz.
- John J. O'Lalor, 17 Kenwood St., Brookline, Mass.
- Earl H. Sincerbox, R. F. D., Wassaic, New York.
- John G. Tate, W3FYW, 205 Simpson Road, Ardmore, Penna.

*Like Lightning!*

### Ghirardi's TWIN GADGETS Spot Set Troubles

Speed Up Your Service Work with the handiest little service aids that ever came to the rescue of hard-working service men! They're great!

### TWIN "TROUBLE SHOOTERS"

Here's how they work: you take up your Gadget; pick out the card marked for the Trouble Symptom you find; flip the card around—and there you'll see all the tests to make and all the remedies in a flash. One for HOME radios—one for AUTD radios—each gives Tests and Remedies for over 400 troubles. Save you time and money. Clip a dollar to this ad and send for your pair now. Radio & Technical Publ. Co., Dept. RW-107, 45 Astor Pl., N. Y.

Money Back Guarantee



MAIL NOW!  
**\$1 FOR THE PAIR**

## Refrigeration

**\$1**

**Text-Book for Home Study**

This complete, up-to-the-minute, practical book will teach you quickly how to service all types of refrigerators. Page after page of useful, easy to understand facts. Refrigeration is the big money field and you can get into it after studying this textbook. Size 8 1/2 x 11 in. Priced at only \$1.00, postpaid. Send for your copy now.

### SUPREME PUBLICATIONS

3729 WEST 13th STREET

CHICAGO, ILL.

**RADIO WORLD AND POPULAR MECHANICS MAGAZINE**—Radio World is \$2.50 a year, and Popular Mechanics Magazine is \$2.50 a year. Popular Mechanics Magazine does not cut rates, but Radio World will send both publications to you for one year for \$3.75. **RADIO WORLD**, 145 West 45th Street, New York City.

## CLASSIFIED ADVERTISEMENTS

7 cents a word. \$1.00 minimum.

**AMATEUR RADIO, Commercial Radiotelephone and Radio-telegraph licenses, complete training. Resident and correspond-ence courses. Every graduate a licensed operator. NEW YORK WIRELESS SCHOOL, 1123 Broadway, New York.**

**ELECTRIC RAZOR, FAMOUS \$10—Shaves dry, close, only \$7.95. Agents, dealers wanted. Economic Products, Box 561, Ambridge, Penna.**

**LABORATORY TESTED** one tube all-wave Transmitter. Diagram and instructions, 15 cents. L. R. Laboratories, Box 202, Jewell, Iowa.

**WANTED ORIGINAL POEMS, SONGS,** for immediate consideration. Send poems to Columbian Music Publishers Ltd., Dept. 95, Toronto, Can.

**HAVE YOU BACK NUMBERS** of Radio World, for May, August, 1935, or April, June, September, October, 1936? If so, please communicate with Radio World, 145 West 45th St., New York, N. Y.

**MAKE YOUR OWN PRODUCTS.** Employ agents yourself. Toilet articles, soap, extracts. We furnish everything. Valuable work free. National Scientific Laboratories, 1950 R.W. Broad, Richard, Va.

**RADIO EXPERIMENTERS AND SET BUILDERS:** parts and kits of parts for improved Little Giant R235, six tube R233, Pre-amplifier R228, Portable battery R223, Little Giant R220 and 205 and 6 volt R238. Guaranteed specified parts. Lund Manufacturing Co., Dept. R.W., 43 East Ohio, Chicago.

## BULBS FREE

To spread the fame of our bulbs every-where, we will send you **FREE** a nice assortment of **HYACINTHS, TULIPS, NAR-CISSI, IRISES, CROCUS,** etc., etc. 350 bulbs in all, all guaranteed to flower next spring and summer. It suffices to send us for carriage, packing, etc., a one-dollar note by registered letter, and to mention your name and full address in block letters. Please do not send coins or stamps. Men-tion the name of this paper. Dispatch carriage paid all over the world without increase in price.

## JAN VAN GALEN

*Bulb Grower*

VOGELENZANG, near Haarlem  
HOLLAND, Europe

## A COMBINATION OFFER! RADIO WORLD and "RADIO NEWS"

### \$3.50

Canadian and Foreign, \$1.50 extra on this offer.

You can obtain the two leading radio technical magazines that cater to experimenters, service men and students, for one year each, at a saving of \$1.50. The regular mail subscription rate for **RADIO WORLD** for one year is \$2.50. Send in \$1.00 extra, get "Radio News" also for a year—a new issue each month for twelve months. Total 24 issues for \$3.50 and \$5.00 to foreign countries.

**RADIO WORLD, 145 West 45th Street, N. Y. City**

## SAVE UP TO 33 PER CENT.

On the Following Standard  
Reference Works

### During October, 1937, only

(Subject to Exhaustion of Stock)

#### TESTING RADIO SETS

By J. H. REYNER. Third edition, revised and enlarged. 239 pages. 115 illustrations. Published at \$4.50. Sales price..... **\$3.25**

The technique of scientific testing and the art of trouble-shooting are thoroughly discussed.

#### PRACTICAL ACOUSTICS FOR THE CONSTRUCTOR

By C. W. GLOVER. 463 pages 236 illustrations. Published at \$7.50. Sales price..... **\$5.00**

A comprehensive treatise which deals with the whole subject of sound in a practical manner.

#### RADIO INTERFERENCE AND ITS SUPPRESSION

By J. H. REYNER. 130 pages. 55 illustrations. Published at \$4.00. Sales price..... **\$3.00**

The fundamental principles governing the suppression of radio interference are explained at length.

#### VECTORS FOR ELECTRICAL ENGINEERS

By E. MALLET, D.Sc. 184 pages. 115 figures. Published at \$4.50. Sales price..... **\$3.00**

The author discusses in detail the application of the vector diagram to the solution of diverse electrical problems.

Orders accompanied by remittance will be shipped postpaid. Otherwise, delivery charges are added. As quantities are limited, intending purchasers are advised to order promptly.

## THE SHERWOOD PRESS

Box 552, Edgewater Branch  
CLEVELAND, OHIO

## TELEVISION

"TELEVISION WITH CATHODE RAYS," by Arthur H. Halloran. Farnsworth and Zworykin systems fully explained. The treatment is mathematical. It is a book for the well-grounded radio man who has vision, the man who wants to be among the first to cash in when the pictures go on the air commercially, but is not for novices. 100 pages or more of supplementary data. Price \$2.75 postpaid including Supple-ments).

### RADIO WORLD

145 West 45th Street, New York City, N. Y.



## STUDY RADIO

PAY AFTER GRADUATION

Entirely new, different Radio Servicing Course prepared with the help of 40 leading radio manufacturers. Planned to fit you immediately into a good pay radio job. We are so sure you will make real money after graduation that (except for one small down payment) we will let you pay later, out of your radio earnings. Write today for this "Earn Your Way" plan. It's Free.

**RADIO TECHNICAL INSTITUTE** 3729 West 15th St.  
Chicago, Ill.

Copy of "The Inductance Authority" FREE with order for any of these three instruments

# DeLuxe Superior GENEMETER

100 Kc to 100 Mc  
Signal Generator  
With Variable Audio

**\$14.40**

Complete with Four Tubes

**FEATURES:**

1. Direct reading in frequencies, 100 kc —22 mc, in five bands, all fundamentals by front-panel switching. Ultra band by harmonics to 105 mc, also direct-reading.
2. Direct reading in frequencies, 25—10,000 cycles, in three bands, all fundamentals, by front-panel switching.
3. R.F. and A.F. outputs independently obtainable alone, or with A.F. (any frequency) modulating R.F.
4. Output meter for connection across primary of receivers' output transformer for peaking with modulation "on."
5. R.F. is subject to attenuation, and oscillation leakage is minimum.
6. Condenser and other leakages tested to 100 megohms.
7. Main dial protracted on 7½" diameter, used full size, with precision pointer (no parallax), and 4-to-1 vernier planetary drive.
8. All services on 90-130 volts a.c. or d.c.

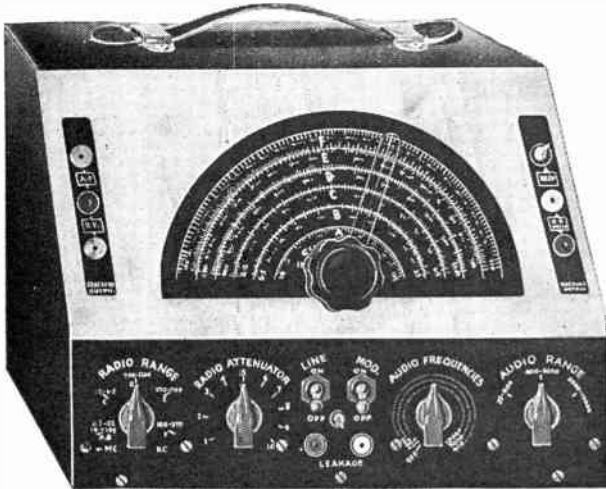

Shipping weight, 10 lbs.

**The Superior Tube Tester**

Price is only.. **\$10.40**

Shipping weight, 10 lbs.



Our Tube Tester tests all 4, 5, 6, 7, 7L and octal base tubes, including diodes, triodes, pentodes and tetrodes, by the reliable and rapid emission-test method, using direct-reading "Good—?—Bad" meter. Rugged, foolproof, it has minimum of adjustments.

**The Superior Infinometer**

Price is only..... **\$10.40**

Shipping weight, 10 lbs.

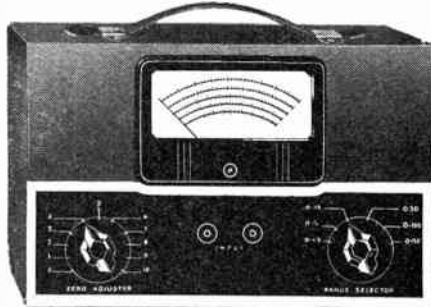

Using our giant-size 0-500 microammeter, A B supply and a d-c amplifier are the basis of our new INFINOMETER. This is a four-range instrument for measuring a.c. (any frequency) and d.c., both by the vacuum tube voltmeter method, drawing practically no current. Eight scales—four a.c., four d.c.—are for 5-150-150 volts.

The INFINOMETER opens to servicemen for the first time the opportunity of owning a practically infinite resistance voltmeter that measures all frequencies with impartial accuracy, to 50 megacycles, and also d.c.

Own for the first time a meter that draws practically no current from any measurement you make and that enables you therefore to read voltage across a diode resistor, no matter how tiny the current through that resistor, no matter how high the resistance. A-v-c voltages quickly measured, trouble located that otherwise balks you. And measure voltage of any frequency, including per-stage gain, r.f., i.f., or a.f. Complete with three tubes.

ORDER DIRECT FROM

## SUPERIOR INSTRUMENTS COMPANY

DEPT. RW 10—136 LIBERTY ST., NEW YORK, N. Y.

Send for Our Free Catalogue in Colors

# GENERAL SHORT-WAVE AND PUBLIC ADDRESS MANUAL

Bound in cardinal red leatherette, this manual includes articles on the construction of short-wave receivers from one to nine tubes, inclusive, and all values between, supers and t-r-f, with the clearest illustrations, both photographic and draughting. Besides the usual plain circuit diagram there is a pictorial diagram for each circuit. And all the photographs are informative. Portable short-wave sets, design and winding of coils for short waves and broadcasts (intimately illustrated).

List of short-wave stations, with meters and kilocycles and hours on the air; trouble-shooting, and forty other topics, all done well.

The public address section contains data on different systems, how to use them, and offers opportunities to turn public address work to profit. Besides, there are articles on testing and servicing not encompassed by the title of the manual—signal generators, broadcast home and portable sets, analyzers, formulas, capacity data. Everything plainly told, simple language, from microphones to speakers.

50c a copy. Sent free with trial 5 months' subscription for \$1.00.

RADIO WORLD, 145 West 45th St., New York City

Is your husband, son or nephew interested in radio? Why not send him RADIO WORLD for the coming year? We will send him, at your request, a letter so that he will receive it the day before his birthday telling him of your generosity and thoughtfulness. For \$2.50 a year in the United States he will be reminded of your unselfishness every time the magazine arrives. RADIO WORLD, 145 West 45th Street. New York, N. Y.

# MILLION TUBE TESTER



FEATURES:

1. Emission
2. Metal Tubes
3. Shorts Hot
4. Leakage Hot
5. Resistance
6. Electrolytics
7. By-pass Condensers
8. D'Arsonval Meter

MODEL CP

**\$13.95**  
NET

MODEL TM, with large 3" square D'Arsonval Meter and Continuous Line Voltage Adjustment, Net ..... **\$16.95**

Your Jobber's Name and 20% Deposit Required on All Direct Orders.

Send for Free Literature!

# MILLION Radio and Television Laboratories

595 N. Union Street, Chicago, Ill.

*Meissner*

## INSTRUCTION BOOK

Containing complete detailed wiring instructions, diagrams, schematics, pictorial diagrams, chassis layouts, alignment data and operating instructions for 20 modern circuits.



12

20

Pages

Circuits

On Sale at All Leading Jobbers

**MEISSNER MFG. CO.**  
Mt. Carmel Illinois

## New, high-powered Radio Books

1. Terman's RADIO ENGINEERING New 2nd Edition

Covers all phases of radio communication, including television. \$5.50

2. Eastman's FUNDAMENTALS OF VACUUM TUBES

Discusses the principal types of vacuum tubes and the laws underlying each. \$4.00

3. Everitt's COMMUNICATION ENGINEERING New 2nd Edition

Step-by-step analyses of the major problems confronting the radio and telephone engineer. \$5.00



### SEND THIS ON-APPROVAL COUPON

McGraw-Hill Book Co., Inc., 330 W. 42 St., N. Y. C.

Send me the books encircled below for 10 days' examination on approval. In 10 days I will pay for the books, plus a few cents for postage or return them postpaid. (We pay postage on orders accompanied by remittance.)

1      2      3

Name .....

Address .....

City and State .....

Position .....

Company ..... RV 9-37

(Books sent on approval in U. S. and Canada only.)





## INDUCTANCE BOOK

**Free!** Every solenoid for every radio-frequency or intermediate frequency may be wound of standard wire on standard form diameters without any computations by using "The Inductance Authority," by Edward M. Shiepe. This \$2 book sent free, postpaid, with supplement, on receipt of \$5 for a 2-year subscription for RADIO WORLD.

RADIO WORLD, 145 W. 45th St., N. Y. C.

When writing to Advertisers please mention that you saw the Advertisement in RADIO WORLD.

## SPECIAL 2-FOR-1 OFFER RADIO WORLD

Radio World is \$2.50 a year (12 issues), 25c. per copy. Canada and foreign, \$3.00 yearly. Offers of Radio World and other worthwhile publications for one full year on each (NET):

- RADIO WORLD and SHORT-WAVE and TELEVISION, \$3.50.
- RADIO WORLD and POPULAR SCIENCE MONTHLY, \$3.50.
- RADIO WORLD and RADIO-CRAFT (12 issues), \$3.50.
- RADIO WORLD and RADIO INDEX (monthly, 10 issues), stations, programs, etc., \$3.50.
- RADIO WORLD and SERVICE (monthly), \$3.50.
- RADIO WORLD and EVERYDAY SCIENCE AND MECHANICS (monthly), \$3.50.
- RADIO WORLD and BOYS' LIFE (monthly, 12 issues), \$3.50.
- RADIO WORLD and TRUE STORY (monthly), \$3.00.
- RADIO WORLD and LIBERTY (weekly), \$3.00, U. S. only.

Select any one of these magazines and get for an entire year by sending in a year's subscription for RADIO WORLD at the regular price, \$2.50, plus a small additional amount, per quotations above. (Add \$1.50 for extra foreign or Canadian postage for both publications.)

Name .....

Address .....

City and State.....

- If renewing an existing or expiring subscription for RADIO WORLD, put cross in square.
- If renewing an existing or expiring subscription for other magazines, put cross in square.

Special Trial Offer for Radio World only: \$1.00 for 5 months, postpaid. Mail order with remittance to Radio World Office. NET.

RADIO WORLD, 145 W. 45th St., New York

## You need these 2 books

### RADIO SERVICING SHORT-CUTS and Money Making Ideas

A completely new and different book tells how radios may be repaired quickly with the absolute minimum of test equipment. Proves that by an actual test 9 out of 10 radios can be fixed with simple tools and volt-ohmmeter. The author, M. N. Beltman, for years in the servicing profession, realized and kept data on these facts. Page after page of practical information. Many real money-making ideas and hints applicable to all sets (Size: 8 1/4 x 11 in.)

### PUBLIC ADDRESS SYSTEMS

A practical handbook, full of useful information, fully illustrated. Considers in detail various microphones, radio and phonograph inputs, acoustic feed-back, mixing and volume controls, use of vacuum tubes, interstage coupling, power amplifiers, output coupling, loud speaker placement, the decibel, P.A. measurements, power level, and other points of importance, including actual circuit diagrams of tested P.A. systems.

Price, 50c each book.

## SUPREME PUBLICATIONS

3727 West 13th St., Chicago, Illinois



LOWEST  
PRICES

GUARANTEED  
QUALITY

FASTEST  
SERVICE

The New 1938 Radolek Radio Profit Guide contains complete showings of Radio Repair Parts, Radio Receivers, Public Address Amplifiers, Speakers, Microphones, Test Instruments, Technical Books, Special Tools. Leading Standard Brands. Everything you need in the Radio Business, all at Lowest Prices. You save money at Radolek!

Every item you get from Radolek is guaranteed. It must be right or we make it right. Standard merchandise produced by leading Manufacturers with Radolek's guarantee added!

Everything in Radio promptly when you want it—and exactly what you want. Radolek's efficient organization backed by a huge stock of standard guaranteed quality merchandise insures you the fastest service in the Radio business. 25,000 Servicemen customers depend on Radolek service and benefit by Radolek's LOWEST PRICES. Send Now for the Radolek Radio Profit Guide. It will help you make money.

## RADOLEK

601 W. RANDOLPH, CHICAGO, Dept. G-11

Send me the 1938 Radolek Radio Profit Guide FREE.

Name .....

Address .....

Serviceman?  Dealer?  Experimenter?

USE  
 PHOTOGRAPHY  
 TO MERCHANDISE  
 YOUR NEW LINES

*We offer a complete  
 Photographic Service*

ORIGINAL ILLUSTRATIONS

REPRODUCTIONS

*any size, any quantity*

for salesmen's portfolios, direct mail

ENLARGEMENTS and BLOW UPS

MURALS, MONTAGES

TRANSPARENCIES

MOVIE SLIDES

also a special department for individual portraiture, hand-colored reproductions and enlargements of favorite photographs and snapshots.

*Consult us on your next photographic problem.*

**NATIONAL STUDIOS, Inc.**

Dept. A

226 WEST 56th STREET ♦ COLUMBUS 5-7260 ♦ NEW YORK CITY

*Established 1907*

*Photographers to Radio World and the World of Radio*



# COIL FORMS

... *for* EVERY PURPOSE

IN the laboratory or home workshop— wherever precision receivers, transmitters, and miscellaneous devices are being developed or built for ultra-short waves, short waves, or the broadcast band—HAMMARLUND coil forms are always the choice! Such is the unanimous approval because only in HAMMARLUND coil forms will be found the advanced design, craftsmanship and finest materials that afford the required outstanding efficiency! For instance, the popular priced "SWF" moulded forms are of "XP-53" dielectric—the remarkable new low loss insulating material that is so rugged, durable and has such an unusually low power factor. The forms are natural in color with no artificial coloring to cause losses. They are also groove ribbed for air spaced windings and have flange grips for easy handling. Meter indexes are also supplied for wave length inscriptions. A special threaded shelf, moulded inside, permits the mounting of an "APC" air condenser for fixed tuning or band spread. Made with four, five, or six prongs.

For transmitting, a jumbo "XP-53" coil form is available. Completely wound "XP-53" coils are made, too, to cover from 10 to 560 meters.

Ceramic "CF" forms of extruded Isolantite for efficient high frequency reception under all conditions are also made by HAMMARLUND. These have a recessed black enameled wooden handle with removable paper disc, a non-skid surface, and numerous holes for winding. Available in four, five and six prong types. For ultra-high frequencies, HAMMARLUND has developed special "CF-M" Isolantite coil forms, 1 1/8" in diameter, with non-skid surface and plenty of mounting holes.

Get the "tops" in results by using HAMMARLUND coil forms! Send for new "37" catalog with further details.

### MAIL COUPON BELOW!

HAMMARLUND MFG. CO., Inc.  
424-438 West 33rd St., N. Y. C.

Please send "37" catalog.

Name .....

Address .....

City..... State.....



# HAMMARLUND

# ASK YOUR JOBBER TO SHOW YOU THE DIFFERENCE

**Model 735  
Pocket Volt-Ohm-  
Milliammeter  
does all your  
D.C. Testing**

**Readrite**  
TESTERS **RANGER** METERS *has*

## ★ MOLDED CASE

A totally insulated case of great strength, beautiful appearance and extremely durable.

## ★ LOW LOSS SELECTOR SWITCH

Without a selector switch much more time must be spent in testing . . . no wires to plug in for changing ranges; special low loss switch minimizes contact errors.

## ★ BATTERY TEST LEADS and ACCESSORIES INCLUDED

You do not have to pay extra for this essential equipment.

## ★ ACCURACY

Guaranteed within 2% comparing with the precision of the most elaborate testers. High class material and workmanship means this tester will maintain its accuracy.

Model 735 has a Triplett D'Arsonval type precision instrument with easily readable scales. Ranges are 15-150-750 volts at 1000 ohms per volt; 1/2-15-150 M.A.; 1/2-1000 low ohms; 0-100,000 high ohms at 1/2 volts. Provisions for external batteries for higher resistance measurements. Has selector switch for all ranges and individual zero adjustment for resistance measurements. Silver and black etched panels.

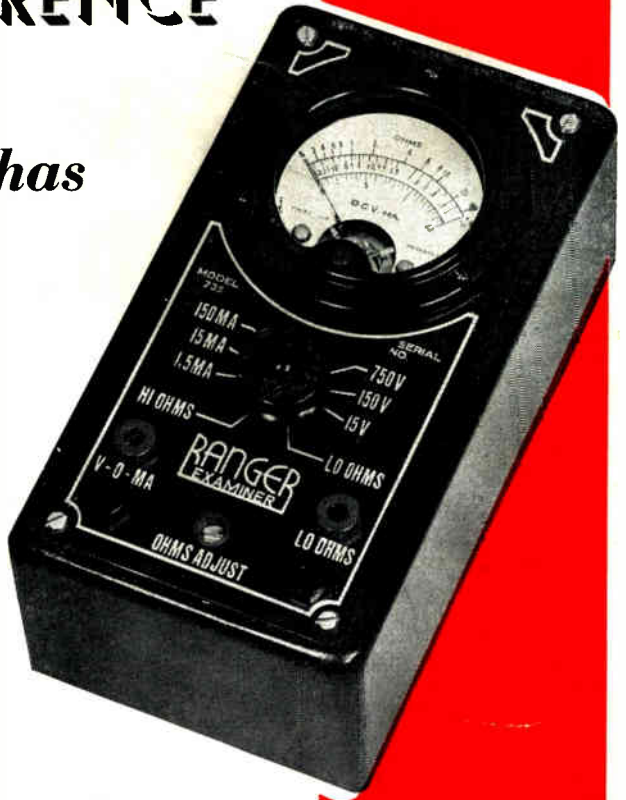

**PRECISION  
BUILT  
ONLY**

**DEALER PRICE . . . Complete**

**\$10.80**

See our display, Booth No. 105, Radio Parts Show, N. Y. C.

**Readrite**  
TESTERS **RANGER** METERS

READRITE METER WORKS  
1027 College Drive, Bluffton, Ohio

Please send me more information on Model 735.

I am also interested in .....

Name .....

Address .....

City ..... State .....