

# THREE I.F. AMPLIFIER STAGES IN THE SUPER-PRO

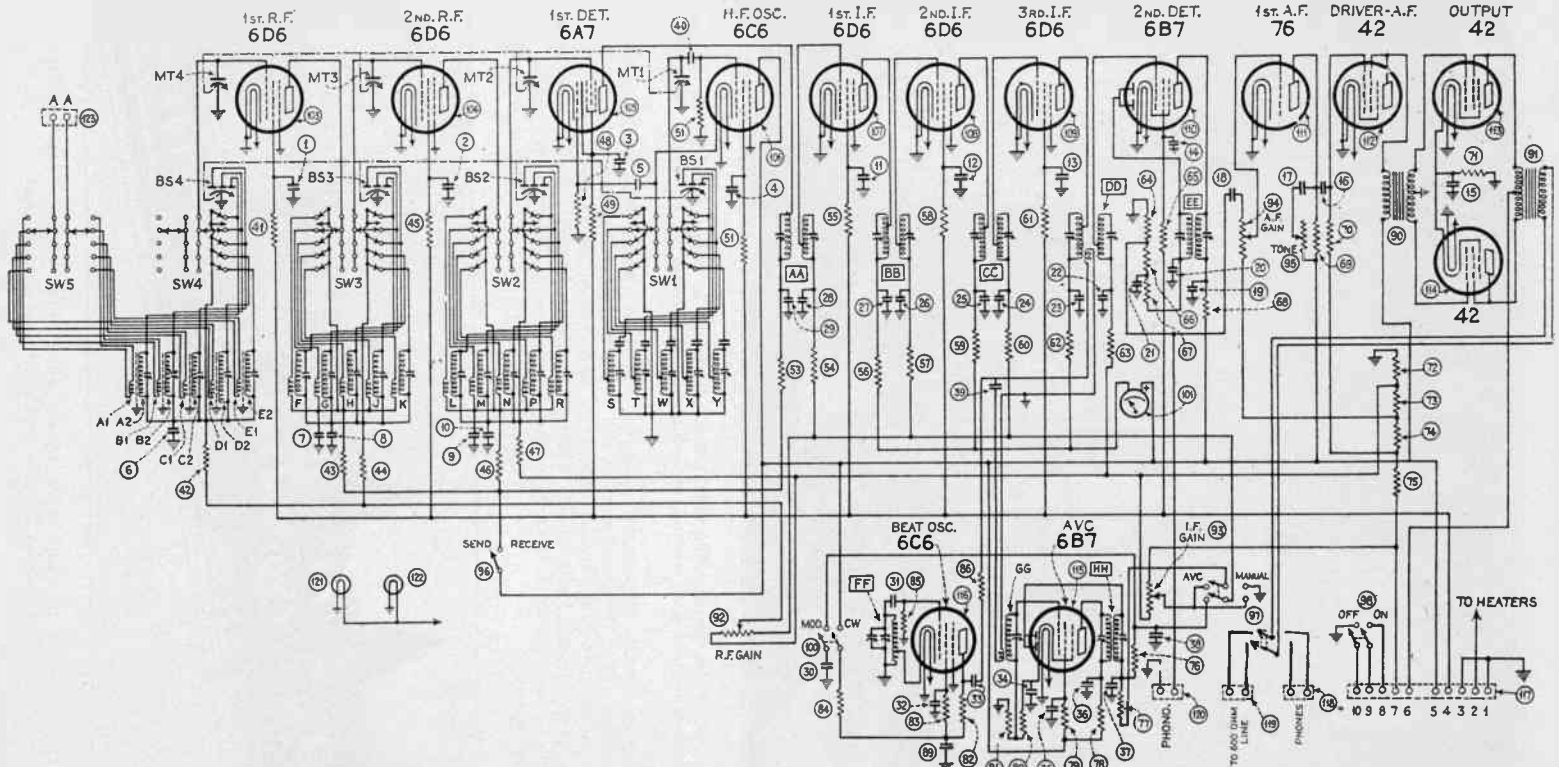

Three i.f. stages, where no more than two have been used before, characterize the Super-Pro. The selectivity is adjustable at the i.f. level by inductive coupling control from the front panel. No detuning results. A two-tube power supply is a separate unit, hence sixteen tubes are used.

(Continued from page 19)

conducting path of metallic particles between contacts. Nor is it possible to get dirt or other foreign matter into the contact. No moving part carries current to cause noise or to provide stray coupling, and the circuit isolation and shielding by the sections is remarkable.

Silver-plated, short-circuiting springs automatically short the four spring contacts at all times. All five positions are passed through by one revolution of the switch shaft. The five contact points, 72° apart, are very definitely located by an accurate and positive detent mechanism. No stop is used, so that the switch can be continuously rotated in either direction. The timing of the cams and arrangements of contacts are such that the circuit through one set of knives is not broken until contact is made with another set. This avoids sparking in the

detector; three 6D6's in three 465 kc. i.f. stages; a 6B7 as a combination fourth i.f. and diode beat detector; a 6C6 as a low-frequency beat oscillator; a 6B7 for a.v.c.; a 76 as a resistance coupled a.f.; a 42 as a Class "A" driver; two 42's as a Class "AB" push-pull audio output; a 5Z3 as a B voltage rectifier, and a 1-V as a grid voltage rectifier.

The tuning coils are mounted on individual isolantite bases, which are in turn secured to the shielded partitions of the lower half of the tuning unit. There are twenty-five coils in all, five for each of the five bands.

In each band the input circuit consists of two coils—antenna or primary coil, and a grid or secondary coil. These two coils are effectively shielded from each other electrostatically

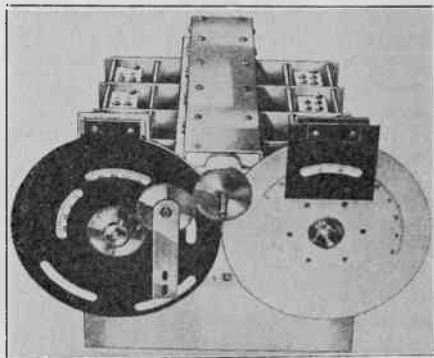

Front view of the receiver in its shield cabinet, and an exposition of the tuning controls. The central shaft operates the coil switch, the left-hand shaft the main condenser gang, and the right-hand shaft the bandspread condenser, which spreads over 20 divisions the band covered by one division of the other.

sections which handle plate current and also prevents open grid circuits when the switch is turned.

ly by a Faraday screen placed between them. The transfer of energy from the antenna to the grid is thus limited to pure electro-mag-

(Continued on next page)

### Uses Sixteen Tubes

There are sixteen tubes in the receiver. There are two 6D6's in two stages of tuned r.f.; a 6C6 as a high-frequency oscillator, electron-coupled to the first detector; a 6A7 first de-

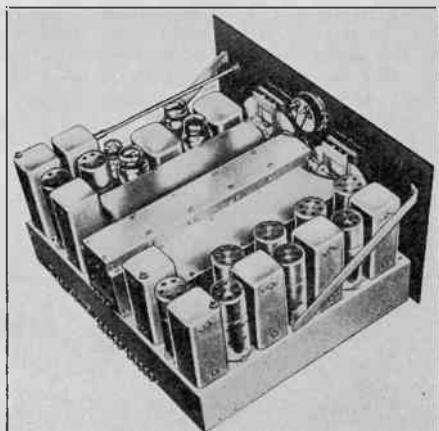
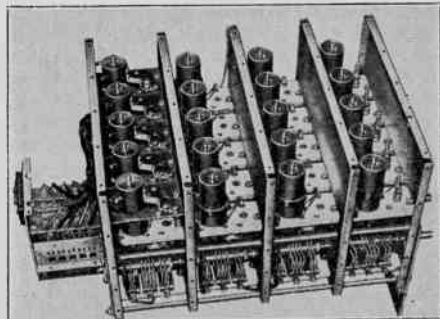

An underneath view at left, showing the 25 coils, five for each of five bands. At right, rear angular view of a finished chassis.

# How to Use the 6L6

## Beam Tube Operating Conditions Listed

**T**HE 6L6 is a new type of tetrode intended for use in the power-output stage of an a.f. amplifier. Unlike most existing tetrodes, the 6L6 does not exhibit any secondary-emission effects at low plate and control-grid voltages; its characteristics, therefore, resemble those of

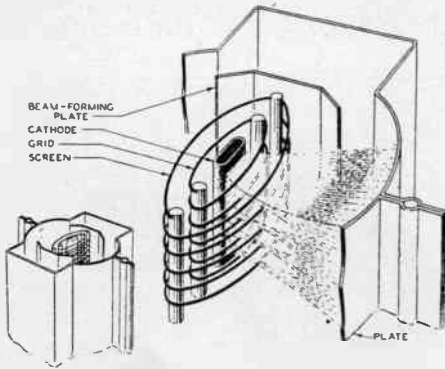

Sketch showing formation by grid wires of beam sheets.

the usual power-output pentodes. Some unique features of the 6L6 are high power output, high efficiency, and high power sensitivity.

When the plate voltage of the usual tetrode is less than the screen voltage, an appreciable number of secondary electrons, which are emitted from the plate because of bombardment by primary electrons, are attracted to the screen; the plate current, therefore, is greatly reduced. For this reason, the plate voltage of the usual tetrode should not swing below the screen voltage if the output is to be substantially free from distortion. A zero-potential suppressor grid ( $G_3$ ), positioned between screen ( $G_2$ ) and plate (P), serves to prevent the loss of plate current due to secondary emission. Hence, in a pentode, the plate voltage ( $E_b$ ) can be made less than the screen voltage ( $E_{c2}$ ) without appreciable secondary-emission effects.

### Operation of the 6L6

Table I lists a number of fixed- and self-

bias operating conditions for the 6L6. The subscript (1) used with the designations Class A and Class AB indicates that grid current does not flow during any part of the input-voltage cycle. The subscript (2) indicates that grid current flows during part of the input-voltage cycle.

#### SINGLE-TUBE OPERATION—CLASS A<sub>1</sub>

**Condition 1.** With 375 volts on the plate, 125 volts on the screen, and a bias of  $-9$  volts, the power output of the 6L6 is approximately 4 watts for either fixed- or self-bias operation; the distortion, which is mainly second harmonic, is 9 per cent. This operating condition is especially desirable when high power sensitivity is desired. For example, in a radio receiver, the 6L6 may be driven to full output by a type 6H6 diode detector without the use of an intermediate a-f amplifier stage. With this connection, the control grid should not draw current during any part of the input-voltage cycle; hence, the least-negative instantaneous grid voltage should not be less than approximately  $-1.0$  volt. Because of low plate and screen currents, this operating condition is also desirable when a 6L6 is to be used with a high-voltage, low-current source of power.

**Condition 2.** Approximately 4 watts output can also be obtained from a single 6L6 when 200 volts are applied to both plate and screen, as indicated in Table I. However, because the plate current is comparatively high, this operating condition should be used only when a low-voltage, high-current source of power is available. Although the power outputs of conditions 1 and 2 are approximately equal, the load, bias, and peak signal voltage for negligible control-grid current are different.

**Conditions 3 and 4.** Two operating conditions are recommended when an output of approximately 6.5 watts is desired from a single 6L6. With 300 volts on the plate and 200 volts on the screen, a peak signal of 12.5 volts is required for full output. With 250 volts applied to both plate and screen, a peak signal of 14 volts is required for full output. The most desirable operating condition depends on the voltage-current capabilities of the power-supply source and the importance of having high power sensitivity. *(Continued on next page.)*

## Circuit Has Inductance Adjuster

*(Continued from preceding page)*

netic coupling. The third and fourth coils in each band are special radio frequency transformers and the fifth is the high frequency or heterodyne oscillator coil. Each coil has a trimming capacitor mounted on its Isolantite

base for circuit alignment to the high frequency end of its range. At the low-frequency end alignment is accomplished by adjusting the inductance by means of a metal disc on an adjusting screw mounted in a friction bushing, which in turn is mounted in the top of each coil form.

(Continued from preceding page)

A study was made of variation in power output and harmonic distortion with load resistance for the 250-volt condition. As the load resistance is increased from a low value, the second-harmonic distortion decreases and the power output increases; however, the third harmonic, which is more objectionable to the ear than the second harmonic, also increases. The output with a 2,500-ohm load resistance, which is recommended for the operating condition, is nearly maximum and its distortion is mainly second harmonic. The curves showed the relation

ating condition with self-bias for 375 volts on the plate and 250 volts on the screen is not recommended. For the load resistance shown in Column 5, the d-c plate current rises with power output. Consequently, the zero-signal bias should be less than the maximum-signal bias in order that optimum conditions exist at maximum output. With the zero-signal bias, however, is less than -17.5 volts, the maximum dissipation rating of the tube is exceeded. It is possible to use a higher load resistance than that recommended for fixed-bias operation in order to minimize second-harmonic distortion and the attendant rise in d-c plate current. With

TABLE 1  
SUMMARY OF OPERATING CONDITIONS FOR THE 6L6

Condition	SINGLE-TUBE OPERATION										PUSH-PULL OPERATION									
	No.1		No.2		No.3		No.4		No.5		No.6		No.7		No.8		No.9		No.10	
	A <sub>1</sub>		A <sub>2</sub>		A <sub>3</sub>		A <sub>4</sub>		A <sub>5</sub>		A <sub>1</sub>		AB <sub>2</sub>		AB <sub>1</sub>		AB <sub>2</sub>		AB <sub>1</sub>	
Kind of Bias	Fixed	Self	Fixed	Self	Fixed	Self	Fixed	Self	Fixed	Self	Fixed	Self	Fixed	Self	Fixed	Self	Fixed	Self	Fixed	Self
Heater Volts*	6.3	6.3	6.3	6.3	6.3	6.3	6.3	6.3	6.3	6.3	6.3	6.3	6.3	6.3	6.3	6.3	6.3	6.3	6.3	6.3
Plate Volts	375	375	200	200	300	300	250	250	375	250	250	400	400	400	400	400	400	400	400	400
Screen Volts	125	125	200	200	200	200	250	250	250	250	250	250	250	300	300	300	250	300	250	300
D-C Grid Volts*	-9	-9*	-11.5	-11*	-12.5	-11.6*	-14	-13.5*	-17.5	-16	-16*	-20	-19*	-25	-23.5*	-20	-25	-20	-25	-20
Peak A-F Grid Volts	8	8.5	11.5	11.5	12.5	12.5	14	14	17.5	32*	35.6*	40*	43.8*	60*	67*	67*	67*	67*	67*	67*
Zero-Sig. D-C Plate Current (Ma.)	24	24	52	55	48	51	72	75	57	120	120	88	96	102	112	88	102	88	102	102
Max.-Sig. D-C Plate Current (Ma.)	26	24.3	57	56	55	54.5	78	78	67	140	130	124	110	152	128	168	168	168	168	230
Zero-Sig. D-C Screen Current (Ma.)	0.7	0.7	3.5	4.2	2.5	3	5	5.4	2.5	10	10	4	4.6	6	7	4	6	4	6	6
Max.-Sig. D-C Screen Current (Ma.)	2	1.8	5.7	5.6	4.7	4.6	7.3	7.2	6	18	15	12	10.8	17	16	13	20	17	14	20
Load Resistance (ohms)	14000	14000	3000	3000	4500	4500	2500	2500	4000	5000*	5000*	8500*	8500*	6800*	6800*	6000*	3800*	6000*	3800*	**
Distortion - Total %	9	9	9	9	11	11	10	10	14.5	2	2	2	2	2	2	2	2	2	2	**
- 2nd Har. %	8	8	8.7	8.7	10.7	10.7	9.7	9.7	11.5	-	-	-	-	-	-	-	-	-	-	**
- 3rd Har. %	4	4	2.5	2.5	2.5	2.5	2.5	2.5	4.2	2	2	2	2	2	2	2	2	2	2	**
Max.-Signal Power Output (Watts)	4.2	4	4	4	6.5	6.5	6.5	6.5	11.5	14.5	13.8	26.5	24	34	32	40	40	40	40	40
Power Sensitivity (milliwatts/volt*)	131	111	60.6	60.6	83.3	83.3	66	66	75.1	28.4	21.8	33.1	26	27.2	19.7	24.6	18.8	24.6	18.8	18.8
Efficiency (%)	42	42.8	32	32.5	37.3	37.7	30	30.6	43.2	37.2	38.3	50	52	51.6	58	56.8	61.2	56.8	61.2	61.2
Peak Grid-Input Power (Mr.)	0	0	0	0	0	0	0	0	0	0	0	0	0	0	0	0	180*	350*	180*	350*
Bias Resistor (ohms)	-	365	-	185	-	220	-	170	-	-	125	-	190	-	200	-	-	-	-	-

\*Subscript (1) indicates that grid current does not flow during any part of the input-voltage cycle. Subscript (2) indicates that grid current flows during some part of input-voltage cycle.  
 \*\*With zero-impedance driver and perfect regulation, plate-circuit distortion does not exceed 2%. In practice, plate-voltage regulation, screen-voltage regulation, and grid-bias regulation should be not greater than 5%, 5%, and 3%, respectively.  
 #An output of 20 watts can be obtained at the grid-current point of Condition 9.  
 ##An output of 23 watts can be obtained at the grid-current point of Condition 10.

\*When the 6L6 is operated at maximum ratings, the heater voltage should not exceed 7 volts.  
 \*Maximum resistance in the grid circuit should not exceed 0.1 megohm for fixed-bias operation nor 0.5 megohm for self-bias operation.  
 \*No signal.  
 \*Grid to grid.  
 \*Plate to grid.  
 \*Driver stage should be capable of supplying this power to the grids of the 6L6's at low distortion. The effective resistance per grid circuit of the Class AB stage should be kept below 500 ohms and the effective impedance at the highest desired frequency should not exceed 700 ohms.

between distortion and power output for the recommended 250-volt operating condition; the relation between signal voltage and power output is also shown.

**Condition 5.** The maximum operating condition for a single 6L6 is given in Column 5 of Table I. With 375 volts on the plate, 250 volts on the screen, and -17.5 volts bias, the power output is approximately 11.5 watts. Although the total harmonic distortion is 14.5 per cent, it is mainly second harmonic. Because of plate dissipation requirements, a corresponding oper-

this condition, electrode voltages indicated in Column 5 may be used for self-bias operation; however, the distortion will be mainly third harmonic.

**PUSH-PULL OPERATION—CLASS A,**  
**Condition 6.** Two type 6L6 tubes may be connected in push-pull when high output at low distortion is desired. As shown in Column 6, Table I, approximately 14 watts at 2 per cent total distortion can be obtained with this connection when 250 volts is applied to plates and  
 (Continued on next page)

(Continued from preceding page)  
screens. Since the bias and plate-to-plate load have been selected for a small size in d. c. plate current, it is advisable to use these operating conditions when the regulation of the power-supply source is comparatively high.

#### PUSH-PULL OPERATION—CLASS AB<sub>1</sub>

**Condition 7.** When connected in push-pull and driven to the grid-current point, two 6L6 tubes with 400 volts on the plates and 250 volts on the screen will give approximately 250 watts at 2 per cent distortion. Since the data given in Column 7 obtain for operation without grid current, high-resistance grid circuits may be used. The rise in d. c. plate current with the signal voltage is appreciable with fixed bias; therefore, a power supply having good regulation should be used in order to approach the power output shown in the Table. (The effect of plate regulation on power output and distortion will be discussed in a future Application Note.)

**Condition 8.** With 400 volts on the plates and 300 volts on the screens, two 6L6's will give more than 30 watts where the circuit is designed for zero grid current at maximum signal, as shown by the data of Column 8.

#### PUSH-PULL OPERATION—CLASS AB<sub>2</sub>

**Condition 9.** When approximately 40 watts output is desired from type 6L6 tubes with 400 volts applied to the plates and 250 volts to the two screens, it is necessary to draw grid current during part of the input-voltage cycle. The conditions for this service are shown in Column 9, Table I. At 40 watts output, the total plate-circuit distortion does not exceed 2 per cent. However, grid-circuit distortion, which is due to the resistance and leakage inductance of the driver transformer and to the impedance of the driver tube, should be considered when evaluating the overall distortion. For low grid-circuit distortion, it is necessary to use a low-impedance driver tube and the input-coupling transformer should have low resistance and small leakage inductance. Because the rise in the d. c. plate current is appreciable, it is necessary to use a well-regulated power supply in order to approach the power output shown in the Table. The power output at the grid-current point is 20 watts at 1 per cent distortion.

**Condition 10.** With 400 volts applied to the plates and 300 volts to the screens of the two type 6L6 tubes, outputs up to 60 watts can be obtained, as shown in Column 10. The power output at the grid-current point is 23 watts at 0.6 per cent distortion.

### Power Sensitivity and Efficiency

The large oval-shaped cathode, aligned grids, and close grid-to-cathode spacing are largely responsible for the high power sensitivity of the 6L6. The power sensitivities shown in Table I have been calculated from the relation:

$$p = \text{Power Sensitivity} = P/E^2$$

where P is the power output and E is the r-m-s signal voltage. When tubes are connected in parallel or in push-pull, P is the total power output delivered to the load and E is the total

r-m-s signal voltage applied to the input. Thus, if a push-pull amplifier furnishes twice the power output of a single-tube amplifier when the same signal voltage is applied to the grid of each tube in both amplifiers, the power sensitivity of the single-tube amplifier will be twice that of the push-pull amplifier. When the two tubes are connected in parallel, the power sensitivity is four times that of the push-pull amplifier. The power sensitivities shown in Table I were computed on this basis and are expressed in milliwatts/volt<sup>2</sup>.

The efficiency (8) of a power-output tube is defined as the ratio of the power output to the power input. In a tetrode or pentode, the power input is the sum of the powers supplied to plate and screen. The efficiencies for the ratings shown in Table I have been computed in accordance with this definition.

For a given power dissipation in the plate and screen of a pentode or tetrode, only a fraction of the power supplied to the plate circuit is converted into useful power output. Because of the inherently small screen current in the 6L6, a very large percentage of the plate and screen power is supplied to the plate; consequently, high power output and efficiency are possible.

The recommended maximum plate and screen dissipation of the 6L6 is 24 watts; the recommended maximum screen dissipation is 3.5 watts. For Condition No. 10, which represents optimum tube performance, the plate-circuit power with maximum signal is  $400 \times 0.23 = 92$  watts; the screen power is  $300 \times 0.02 = 6$  watts. The total input power is 98 watts; the power output is 60 watts. The efficiency, therefore is  $60/98 = 61$  per cent. The power supplied to plate and screen is  $98/60 = 38$  watts for two tubes. With no signal applied, the power input to plate and screen is  $400 \times 0.102 + 300 \times 0.006 = 42.6$  watts for two tubes, which is slightly less than the recommended maximum rating.

Copyright 1936 by RCA Manufacturing Co., Inc.

## Literature Wanted

Readers whose names and addresses are printed herewith desire trade literature on parts and apparatus for use in radio construction. Readers desiring their names and addresses listed should send their request on postcard or in letter to Literature Editor, Radio World, 145 West Forty-fifth Street, New York, N. Y.

- Harry Shosh, 2339 Wyandotte, Detroit, Mich., on kits of coils for oscillator construction.  
Charles F. West, operator, "6&FM," P. O. Box 152, Sunol, Calif., on all lines, from insulators to commercial equipment.  
R. Thistlewhite, Thomas Jefferson High School, 38th & Compton Ave., Los Angeles, Calif.  
H. E. Harmer, 5349 Inverness St., Vancouver, B. C., Canada, on parts and accessories for radio construction and also units and construction materials for exponential horns.  
C. W. Waller, 115 Oak St., ewton, Kans.  
Jack Englert, 19409 Andover, Detroit, Mich.  
X. J. Coughlin, 2319 N. Karlov Ave., Chicago, Ill.  
Carl Baker, 1768 S. W. 16th Terr., Miami, Fla.

# A Volt-Ohm-Milliammeter

## Separate AC Voltmeter in Tester

By Herbert E. Hayden

**E**NLARGING the usefulness of meters one has, or creating a rig with them as the basis, adding a few parts, improves one's knowledge and technique, as well as establishing an economic basis of operation. Ever so many experimenters and service men have facilities for making better and more convenient measurements, in the last analysis doing their work better, but put up with a lot of inconvenience simply because they defer the time when they will do the little extra work that will provide them with a better means to a better objective.

### Sensitivity in Ohms Per Volt

We shall take up the case of the possessor of a sensitive current instrument for d.c. measurements, and of an a.c. meter of the substantial current-drawing type. That is, the a.c. meter is not sensitive. For most of the measurements we intend to make it need not be.

As for the d.c. meter, multipliers may be obtained of the resistance values required, or if one possesses wire-wound precision resistors of a given sequence, often the meter may be adjusted so that these resistors may be used. Actually, that is what was done in the present instance. The instrument was more sensitive than 0.1 milliamperere. The multipliers accorded with the numerical ranges invited by the meter scale on the basis of one milliamperere total current flowing. All that was necessary therefore was to shunt the meter so that the total current flowing when the meter read full scale was one milliamperere, of which about 340 microamperes passed through the shunt (Rps), the rest through the meter.

The instruments actually used in the rig shown herewith were a 0-660 microampere d.c. galvanometer and a 0-145 volt a.c. voltmeter. Thus if the d.c. meter were used as a voltmeter, by inserting suitable series resistors called multipliers, the meter would be about 1,550 ohms per volt. The a.c. meter drew 20 milliamperes at full scale, hence had a sensitivity of 50 ohms

per volt. If the full-scale deflection current is known the sensitivity in ohms per volt may be determined by solving for the reciprocal of the current in amperes. That is, divide the full-scale deflection in amperes into the number one. Hence for the two cited examples:

$$\frac{1}{.00066} = 1,550 \text{ ohms per volt}$$

$$\frac{1}{.02} = 50 \text{ ohms per volt.}$$

### What Was Done With AC Meter

For the d.c. instrument the information supplied on or with the meter will enable this determination, but for the a.c. meter this may not be so, hence an a.c. meter of good accuracy should be put across the present a.c. meter for checking. The so-called standard

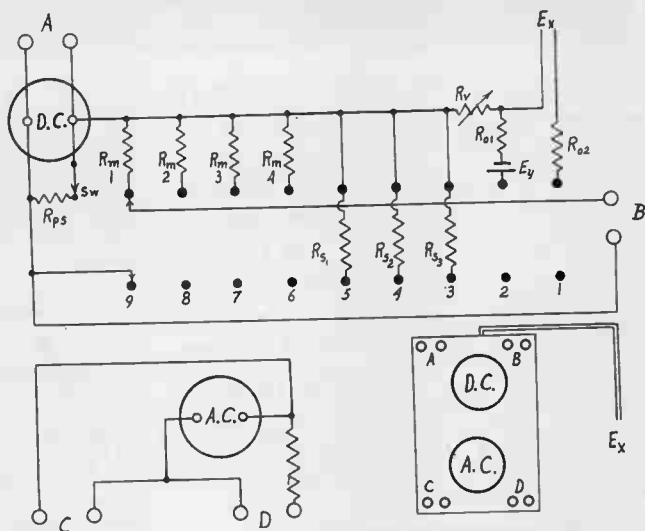

The separate a.c. and d.c. meters used in a rig with nine-position, two-circuit switch. Inset corresponds panel parts to circuit. The circuit is that of a volt-ohm-milliammeter. Ey is the 1.5 volt dry cell, Ex a higher voltage external battery.

a.c. meter had better be of the rectifier type to assure minimum of current drain.  
(Continued on next page)

(Continued from preceding page)

Quite some extension of the d.c. meter is to be made, but usually the a.c. meter is sufficient if it covers the line voltage range and also reads smaller voltages. In the present instance the a.c. meter had a multiplier, found inside the case, and besides using this normal connection (145 volts maximum) a tap was taken at the magnet winding of the meter itself, maximum being 35 volts then. The meter current presently could be ascertained, the voltage by the way having been determined for the low range terminal by using a Triplett Universal meter at its a.c. position. This is a rectifier type instrument.

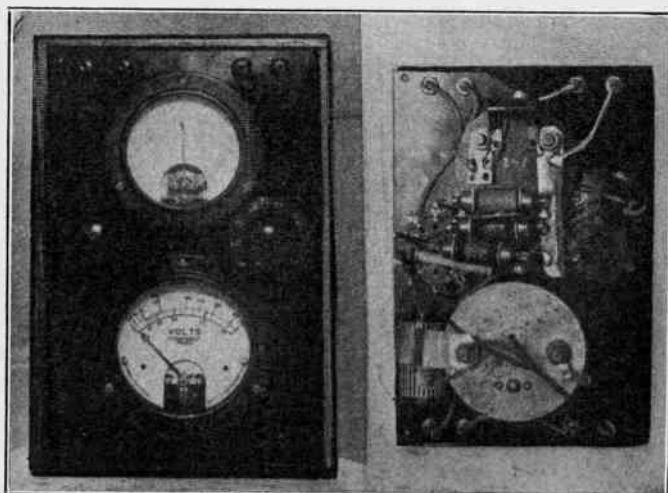

Front and rear views of the instrument. The respective meters have the same relative positions in the two views, the d.c. meter on top. The shunt across the d.c. meter is shown at right top. At this particular stage the d.c. meter was used at 1 milliamperes sensitivity, without switch for the shunt. The 1.5 volt dry cell for the medium resistance range is plainly in view.

By applying 35 volts that afforded full-scale deflection, and then putting a resistor across the meter, adjusted until current was halved, though the voltage was unchanged, this improvised shunt was therefore made almost exactly equal to the meter resistance. The shunt was measured externally on a d.c. ohmmeter and the meter resistance was ascribed to this reading. The resistance was 1,750 ohms, so full-scale current was the voltage (35 volts) divided by the resistance (1,750 ohms), equals .02 ampere, or 20 milliamperes.

When a check was made with a precision a.c. current meter, the error was found to be less than 2 per cent. at full scale, but would increase if the reduction factor were applied throughout the calibrated scale, so the meter scale was marked specially, using the rectifier instrument as guide, so keep the accuracy high all the way on the low range.

### Treatment of DC Meter

Of course few will have just the d.c. meter that was used, but the principle is the same, so what was done with the d.c. meter will be told.

Besides the sensitivity of the meter, the actual scale on the meter has to be considered, as the voltage and current extensions should apply convenient factors. For the present purpose the easiest factor, 10, was selected. The

galvanometer read 30-0-30, so the d.c. voltages selected were 3, 30, 300 and 3,000. The currents were 660 microamperes; 3, 30 and 300 milliamperes, and besides there were two resistance ranges, 0-10,000 ohms and 0-2 meg.

A nine-position, two circuit switch was used, enabling all the d.c. measurements at a pair of posts, marked B, except the smallest current. Since there were 30 divisions and full scale deflection of the meter alone was 660 microamperes, there were 22 microamperes per division.

On account of the ready obtainment of wire-wound resistors in even thousands of ohms

the meter was shunted for all service save 660 microamperes, when the shunt was switched out, so that the total current flowing with shunt in was one microampere, at full scale. Thus the sensitivity was reduced to 1,000 ohms per volt, and the voltage multipliers became 3,000, 30,000 and 300,000 ohms, while a carbon resistor of 3 meg. was used for the 3,000 volt purpose.

### Checking for Change

The use of such a resistor is not consistent with continued accuracy, as the resistance of the carbon multiplier changes, however, it is easy to find out when this takes place, by using the meter in a precision way at 300 volts full scale, then switching to the other scale (30, 3,000 volts) and noting whether the reading is close to 300, at the third bar. The high voltage range was intended as an emergency only, and therefore the rather expensive 3 meg. wire-wound resistor was not considered imperative at the moment.

In the diagram Rps represents the more or less permanent shunt resistor, its value 100 ohms, on account of the resistance of the d.c. meter. It is necessary only to adjust a series circuit consisting of meter, a resistor and a 1.5 volt dry cell, until half a milliamperes flows, using around 3,000 ohms per 0.1 millimeter, halve the amount of the limiting resistor (which

is adjustable, around 3,000 ohms maximum), all subject to measurement, to create the one milliampere condition, and adjust a 400 ohm rheostat across the meter until the reading is full scale. Start with only a small amount of the 400 ohms across the meter when making the test, be sure it is not zero, and gradually increase the resistance until meter reads full scale.

### Making Shunts

Now we duplicate with a wire-wound fixed resistor the value of shunt thus obtained and have Rps.

The multipliers we have discussed. These are Rm1, Rm2, Rm3 and Rm4. The current-extension shunts, Rs1, Rs2 and Rs3, preferably are made with the aid of a wide-range current meter, borrowed for the occasion, if need be, fine magnet wire as used in winding r.f. coils being used, starting with short circuit of the meter, with a series circuit set up for a small part of the intended maximum current. Suppose the range of 3 milliamperes is to be created. Then set up a circuit with one milliampere flowing, adjust the shunt until the meter reads one milliampere where it should so read (not full scale), then increase the current in the supply circuit alone, until 3 milliamperes flow, shunt still across the treated meter now out of circuit, and with that meter back in circuit adjust the shunt a bit, if necessary, for full-scale deflection this time.

In the same way the higher ranges of current are taken care of, except that for large current through the shunt sensibly related wire diameter must be used, for carrying capacity. Wire charts give the necessary information.

The method of making the shunts, therefore, does not require any calculation.

### Safety Factor

It should be noticed that the resistance measurements, are made at or near one end, in fact, the highest resistance is measured at extreme switch position (1), whereas the highest voltage reading is at the other terminal (9).

This arrangement is purposely introduced for high safety factor. No damage can be done to the meter at either ohmmeter position, but the high resistance range was selected because this circuit is open until the external battery (45 volts) is connected in. The other or medium resistance position has a self-contained 1.5-volt dry cell.

Also, the highest voltage range is the one that affords best protection against meter application to voltages so high as to damage the meter. Every time one is finished with the instrument, therefore, the knob is turned to extreme left or extreme right, so any connection made to an unintended range of the meter by carelessness in the next use is one that is open or has a very high resistance in it (3 meg.) as protection for the meter.

If the d.c. instrument is itself a 0-1 milliammeter, no permanent shunting is required, the 100 ohms are omitted, therefore, and the switch Sw1 also is left out. If the scale reads 01

then the voltages may be 1, 10, 100 and 1,000 at full scale. The currents may be 1, 10, 100 and 1,000 milliamperes, a range of one milliampere to one ampere.

### Ohmmeter Accuracy

The resistance measurements, as made by the author, are computed each time, from the voltage, the current and the limiting resistor, as it is too hard to prepare an accurate resistance scale and put it on the meter. Also, it is time-consuming to make the computations, but that is the most accurate way. The accuracy requirement for resistors is usually not very great, however, and a chart could be referred to, as the one printed in the May, 1936 issue, page 48. Chart and direct-reading ohmmeter have about the same accuracy, which is less than the accuracy by computation.

The ohmmeter part of the rig described herewith consists of two ranges, first for 0-10,000 ohms, using a 1.5-volt dry cell, 1,000 ohm fixed carbon resistor and a 3,000 to 5,000 ohm maximum rheostat. A 1,000 ohm carbon fixed resistor will suffice, and the variable will enable adjustment. This is made as follows: When the measurement is to be made the meter needle is inspected to see that it reads exactly zero, and if it does not, the zero adjuster is turned until there is exact coincidence. Then with switch Sw2 at position 2 the B terminals are shorted, and the variable resistor, Rv, value just given, is turned until exactly full-scale deflection is read. The cell used is 1.5 volts, approximately, and is marked Ey in the diagram.

For the high resistance range Ro1, the 1,000 ohm carbon resistor, is not used, but Ro2, around 3 meg., is in series with Rv. It is therefore advisable to get a carbon resistor of 40,000 to 42,000 ohms, and adjust Rv for full-scale deflection just prior to making each high resistance measurement. Therefore Rv is used for both ranges as the adjuster.

## 22,869,000 Families, 74% of Total, Have Receivers

In studies of radio broadcast markets for advertisers, the Committee of the American Association of Advertising Agencies, the Association of National Advertisers, and the National Association of Broadcasters has issued preliminary estimates on radio ownership. American families owning radio sets on January 1, 1936, numbered 22,869,000, or 74 per cent. of the total of 30,919,300 American homes, according to the committee's survey. In 1930 a little over 60% of American homes had sets. This compared with last year's estimate of 21,456,000, an increase of 6.6 per cent.

The joint committee estimated that 4,400,000 sets were sold in the United States last year exclusive of 1,100,000 automobile sets, and that of the domestic sales in 1935 it was estimated that 32.1 per cent. were bought by families not previously owning sets. The latter estimate was based on a questionnaire to radio dealers.



# High Fidelity Detection

## Twin Diode in Balanced Circuit

By Warren E. Woodward

WHEN the 6H6 is used as a full-wave detector, without a center-tapped secondary feeding it, push-pull may be developed without sacrifice of voltage, compared to the a.c. input.

The plate of one diode of the twin diode metal tube is connected to the cathode of the other diode, while the load resistor is connected across the remaining elements, and its center grounded. Also, one terminal of the secondary coil that supplies the a.c. input is grounded, therefore the system is well applicable to tuned radio frequency sets, also, although shown here in a two-band superheterodyne.

The tube operates as a full-wave detector because during any given cycle one diode conducts for one alternation, the other diode meanwhile idling, whereas during the succeeding or opposite alternation the previous idler becomes conductive, and the previous conductor idles. Therefore during the complete cycle, which consists of two successive alternations, there is detection.

### Unity Voltage for Push-Pull

The two diodes are reversed in respect to each other, and when one of them is conducting, the condenser across the other is discharging through the conducting tube and the load resistor. So the input a.c. voltage would be the full amount available, instead of only half that amount as would arise from the use of a center-tapped secondary which equally divides the voltage.

However, the effect of the condenser dis-

charge is that of voltage doubling, and the circuit is substantially the same as that used in the conventional voltage-doubling B rectifier circuits, for the 25Z5 and 25Z6. So instead of having half voltage we would develop double voltage. For introduction of the push-pull circuit we must halve this doubled voltage, thereby returning to unity voltage, since each tube fed from the balanced detector circuit received only half the rectified voltage.

### Feeding the Driver

In the present instance we desire to feed a driver. Since the d.c. voltage, represented by the pulsating voltage drop across the load resistor, is always negative in respect to ground, there would be zero bias on one tube or the other when its associated diode section was idling, some distortion due to grid current would result, and the output tubes' life greatly shortened, were direct coupling used. Special bias compensation could be introduced, with some dissymmetry, but it is simpler to include stopping condensers, so that the driven tubes may be biased conventionally, since freed from the d.c. of the detector.

### Condensers as Converters

Since there is d.c., though pulsating, flowing

*(Continued on page 30)*

## New Professional Recorder

Universal Microphone Co., Inglewood, Cal., has issued a new professional recording machine. The new model is designed for cutting from the inside out or the outside in. There is a special timing bar with the speed regulated at 90, 110 or 130 lines per inch. Other improvements include a new motor and a novel development in the counter shaft which allows instantaneous changing of speed or lines per inch. The turntable is of a more massive design than the previous model, and the new floating head incorporates adjustments,

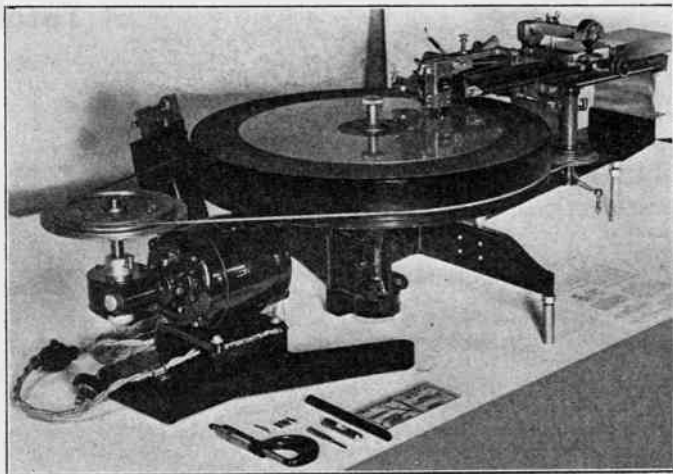

# BALANCED DETECTOR IN AN 11-TUBE SUPERHETERODYNE

July, 1936

RADIO WORLD

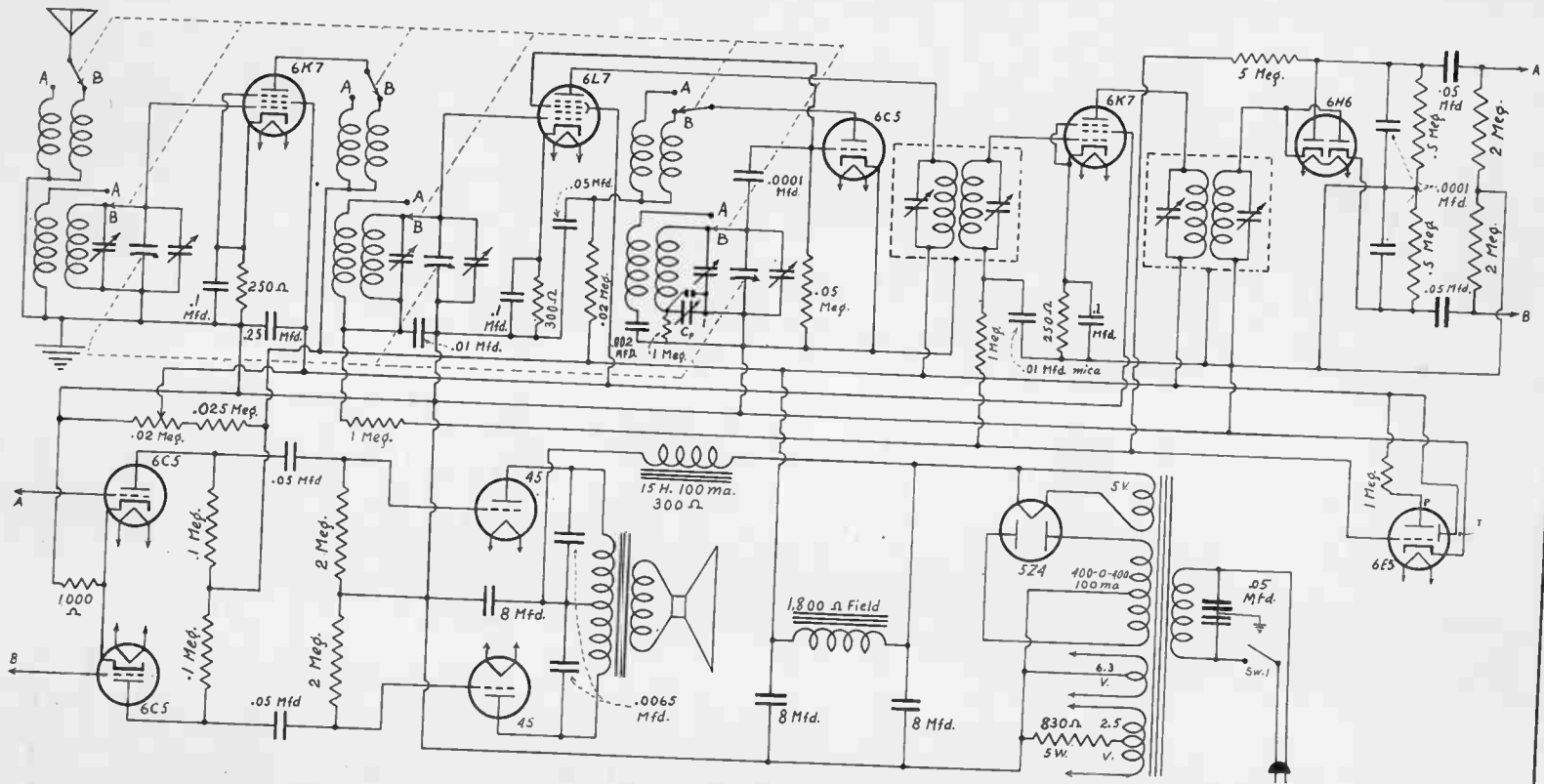

Two bands are covered, standard broadcast and foreign short-wave. The 6H6 is the balanced detector, enabling push-pull operation of driver and output without interstage transformer coupling. P is plate and T is target of the 6E5.

(Continued from page 28)

in the detector load resistor, if direct coupling were used there would be d.c. input to the drivers. If we include stopping condensers the input to the driven tubes, which have their usual leaks, becomes a.c.

The pulsating d.c. charges the stopping condensers, which discharge through the leaks, and since there is an equal split of phase, one condenser is charged or charging when the other is discharged or discharging. The voltages are equal but opposite in phase, and therefore the push-pull requirement is fulfilled. It might not be completely fulfilled with direct coupling because all changes could be negative, equivalent to suppression of one of the sidebands. Since one sideband is the same as the other this would not make much difference, save as to amplitude, even though not fulfilling strictly the technical push-pull requirement.

The detector itself is not push-pull, but permits a push-pull output. The .05 mfd. stopping condensers act as converters, in that the pulsating d.c. applied to them is changed to a.c. Assuming negligible condenser leakage, very important for the stopping purposes in such a circuit, it would be impossible for any d.c. to arrive at the driver grids, because a condenser will not pass d.c. Hence if there is any input to the driver grids, with resistance-capacity coupling, that input must be a.c. And true push-pull practically requires that the input be a.c.

### Avoidance of Grid Current

The driver tubes should be negatively biased sufficiently to prevent grid current even under operation beyond the point where the output tubes are loaded up, and meters in these grid circuits will enable the determinations. It is always good practice to have the output tubes the first to overload, as many sets with theoretically high output at low distortion level really can not be worked at full power tube capability because of distortion that arises earlier in point of time and position.

The output is about 10 watts at 5 per cent. distortion, with 350 d.c. volts from B plus return of the 45 plates to ground, using self-bias of a somewhat higher negative potential than usual. One reason for the increases in negative grid bias is to introduce further safeguard against grid current in the final tubes, when operation is within the stated output level. The usual Class AB permits of some small grid current. This we would avoid. In the cases of both the drivers and the output tubes, absence of grid current is essential to the inclusion of grid leaks. So we dispense with transformer and minimize hum.

The balanced detector is of the same type as shown originally by Orval LaFrance in the April 1st, 1933, issue of RADIO WORLD, when two tubes were used, as the twin diode was not available at that time. However, Mr. LaFrance and J. E. Anderson discussed the circuit from later viewpoints in the November, 1935, issue.

### Strengthening Low Notes

In a practical case the biasing resistor in the output stage was 830 ohms, selected also with

another attainment in view. While the negative bias should not be less than 65 volts, there is some leeway as to resistance selection on the basis of better matching of the speaker's output transformer, which might not have just the correct impedance.

If the left-hand 8 mfd. condenser is temporarily omitted (speaker field to ground) by breaking either positive or negative connection when the set is turned off, when the set is made to go again there will be a little hum. It may be necessary to put ear close to the speaker to hear it, especially if it is assumed that the chassis is not in a console, and therefore the speaker is without baffle.

If the resistor is of 1,000 ohms, and adjustable, e. g., the Electrad exposed wire-wound type with the contact band, the resistor connected to circuit at one terminal permanently, and to band for the other connection, sliding the band reduces the resistance. Be careful not to slide it even half way, but do make the adjustment until the hum is maximum. This is a good approximation of proper circuiting for low-note response, as the hum frequency, due to full-wave rectifier, will be twice the line frequency, hence 120 cycles instead of 60 cycles, and the bias may be adjusted within the prescribed limits for maximum hum. That is the same as using a 120 cycle test frequency.

The tubes in the output circuit therefore are made to have an impedance at a small signal input well matched to the output transformer, provided the output transformer was nearly right in the first place. Then the 8 mfd. condenser that was detached from the circuit may be restored.

The combination of negative bias and matching considerations was used in the selection of 830 ohms, and particularly orchestras did sound different, since the low notes came through far better.

### Loss of Bias

Another expedient in the same direction is to increase the value of the grid leaks in the output stage, but because of the bare possibility of some accidental grid current such increase would have to be attended with acceptance of a smaller power output, meaning an operating condition consistent with absence of grid current.

The objection to grid current is based largely on the resultant distortion. The voltage developed across 2 meg. is two volts per microampere, and for half the cycle, one alternation, one of the power tubes would lose bias. At 10 microamperes grid current the loss would be 20 volts, developed across the 2 meg., and at 30 microamperes there would be practically no negative bias. Moreover, output tube life would be shortened.

If volume is slowly built up, with 0-1 milliammeter in the grid circuit of one of the output tubes, the level at which grid current begins to flow may be noted, and the receiver constantly operated below that level. For a practical installation, if the strongest local is tuned in with volume control near minimum, meter in the grid circuit of a 45, turn up the con-

trol and note when grid current starts flowing. If none starts though the control is all the way up, volume maximum, then no special precaution is necessary, provided the test is being made at night.

If grid current does flow at some position of the volume control below maximum setting, then the aerial may be shortened until grid current absence is noted with control full on. A series antenna condenser introduces the electrical shortening just as well as does the physical reduction in antenna length. Try .0001 mfd.

### Resonance Indicator

Since there is automatic volume control, applied to the sole intermediate frequency amplifier tube and to the control grid of the 6L7, it is necessary to have a resonance indicator, for the quantity of sound output can not be used as resonance guide because over a small band of frequencies the sound quantity will hardly change. Inclusion of a ray indicator tube is therefore shown (6E5). However, a d.c. voltmeter across the biasing resistor of the i.f. tube, will serve the purpose, extreme deflection of the needle being guide for resonance. This is a sharp method, too.

If a meter is used, a range of 0-5 or 0-6 volts is satisfactory. Then at no carrier input the needle is about half way, whereas when a carrier is tuned in, even a weak one, the needle will deflect a little. In actual operation the deflection always will be to lower readings, except when the meter is used as indicator in lining up the i.f. channel with strong output from a signal generator. If the input is very weak it will cause the same needle behavior as would a carrier, whereas if the input is strong, the needle would move the other way, and maximum deflection would be the guide. However, it is preferable, with all a.v.c. systems, to feed a small test signal to the i.f. amplifier. Full directions for the simple voltmeter method of a.v.c. channel peaking have appeared in these columns (June, 1936, RADIO WORLD).

By using intermediate transformers having a high Q (low losses) the selectivity and sensitivity at the i.f. level will be sufficient, and there will be no sideband cutting on account of this part of the chain.

### Oscillator Grid Current

At the r.f. level there is no danger of such cutting, either, but the problem resolves itself largely into getting enough into the modulator at the high radio frequencies. To accomplish this the primaries of the antenna and modulator coils are of the high impedance type. The oscillator primary, or tickler, need have only enough turns to produce oscillation of an intensity that creates grid current not more than 500 microamperes and not less than 100 microamperes. A 0-1 milliammeter in series with the .05 meg. grid leak enables measurement of the grid current. The object of having enough grid current is to insure sufficient modulation of the 6L7 by the oscillator, incidentally to improve the oscillator stability. If necessary, to produce the grid current results just outlined, the 20,000-ohm limiting resistor in the oscillator plate leg

may be reduced to 15,000 or 10,000 ohms. If the parallel trimmers of antenna, modulator and oscillator stages are set for the highest frequency band, following standard method of lining up near the high frequency end, the added capacity required for the oscillator stage, standard broadcast band, may be supplied by the capacity between primary (tickler) and secondary. Thus the primary would be separately wound and slid over the oscillator secondary, being used in a sense as condenser, until alignment at the selected high frequency test point of the broadcast band is completed. This is quite a job, an engineer could do it, but the standard practice is to use trimmers and all commercial coils are made on that basis.

### The Two Bands Covered

The circuit is intended for the standard broadcast band and the foreign short-wave band. The frequency coverage is 530 to 1,600 kc and for the other band the frequencies are about ten times as high, although really the frequency ratio is a bit larger.

## Coil Winding Data for Skip-band Set

For an intermediate frequency of 456 kc the following coil winding information applies:

### STANDARD BROADCAST BAND

*Aluminum Shields at Least 2" diam.*

**R.F. Coil**—Secondary, 127 turns No. 32 enamel wire, close wound, on one inch form diameter. Two turns of insulating fabric over secondary, near one end (bottom, usually). Primary, wound over fabric, 30 turns No. 32 enamel or other fine wire.

**Modulator Coil**—Same as r.f. coil.

**Oscillator Coil**—Secondary, 80 turns No. 32 enamel wire, close wound, on one inch form diameter. Two turns of insulating fabric over secondary, near one end (bottom, usually). Tickler, wound over fabric, 35 turns No. 32 enamel or other fine wire.

**Padding Capacity**—Series leader adjusted to 383 mmfd. Use .00025 mfd. fixed mica and Hammarlund 70-140 mmfd. (Cat. MICS-140) in parallel.

### SHORT WAVE BAND

*No Shields Used in Following Coils*

**R.F. Coil**—Secondary, 8½ turns No. 20 enamel, close wound. Leave 1/16 inch space and wind 10 turns No. 32 enamel or other fine wire for primary.

**Modulator Coil**—Same as r.f. coil.

**Oscillator Coil**—Same as r.f. coil.

**Padding Capacity**—Fixed mica condenser of .0015 mfd. (Cornell-Dubilier Cat. No. 3L5D15).

# How the Magic Eye Works

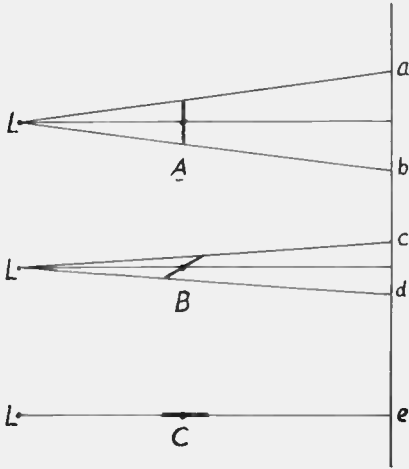

The three line drawings at the left illustrate the principle of the magic eye. Let  $L$  be a point source of light and  $ab$  a screen. Between the light and the screen place a very thin, opaque strip. Suppose it is placed as at  $A$ , broadside toward the light. The shadow angle  $aLb$  is maximum. If the light obstruction is placed as at  $B$ , in which its plane makes an angle of 45 degrees with the screen, the shadow angle  $cLd$  is much smaller than it was in the preceding case. Finally, if the obstruction is placed as at  $C$ , with the thin edge toward the light, the shadow angle is reduced to zero and the shadow to a very thin line. The magic eye works on the same principle but electrons moving at high speed are used instead of light. The turning of the obstruction is also done electrically, in effect. Nothing mechanical is turned for the effect is produced by deflecting electrons.

## Protection for the Power Cord

The power cord from a set usually emerges at the rear. When the cabinet is pushed up against the wall the cord is often crushed or badly abraded. A short is likely to occur at the damaged point, and the short in turn may result in serious consequences. As a protection against damage to the cord a wooden clearance strip or cleat may be attached to the back of the cabinet. This will prevent the cabinet from being shoved up against the wall and

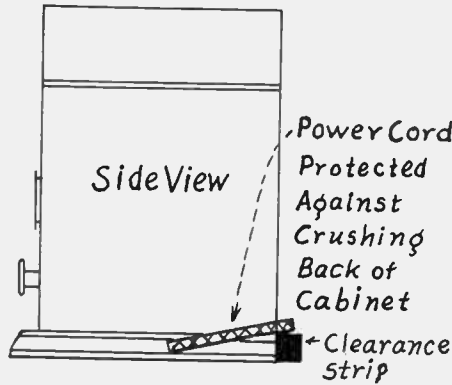

will always leave plenty of room for the cord. Another good precaution to take is to tape the cord at the point where it emerges from the cabinet either with friction tape or self-vulcanizing rubber tape. It will save trouble later.

If a short circuit results from scraped insulation of the cord, if the a.c. wiring is fused, the fuse will blow. If not fused there is danger of fire. Hence the precaution about the cord is important.

## Simple Battery Type Generator

Those who wish to build a simple and effective oscillator can do no better than to build a Hartley. It is dependable and it is also rich in harmonics so that it is easy to calibrate and versatile in application. The diagram at the right is that of a four-band oscillator in which the maximum value of the tuning condenser is 400 mmfd. Practically the entire useful radio frequency range is covered without resorting to harmonics, except that this is desirable. The circuit is self-modulated. That is, the grid leak and condenser have been chosen so that there is blocking at an audio frequency. The coupling between the output post and the plate circuit is extremely loose.

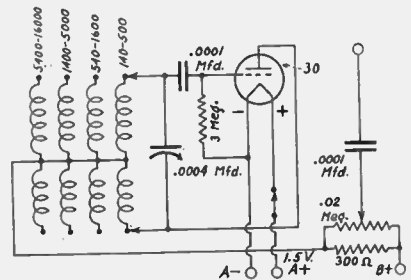

# CHARACTERISTICS CHART OF THE 17 ALL-METAL TUBES

TYPE	NAME	BASE	SOCKET CONNECTIONS	DIMENSIONS MAXIMUM OVERALL LENGTH X DIAMETER	CATHODE TYPE	RATING				USE Values to right give operating conditions and characteristics for indicated typical use	PLATE SUPPLY VOLTS	GRID VOLTS	SCREEN VOLTS	SCREEN MILLI-AMP.	PLATE MILLI-AMP.	A-C PLATE RESISTANCE OHMS	MUTUAL CONDUCTANCE MICROMHOS	VOLT-AGE AMPLIFICATION FACTOR	LOAD FOR STATED POWER OUTPUT OHMS	POWER OUTPUT WATTS	TYPE
						FILAMENT OR HEATER		PLATE	SCREEN												
						VOLTS	AMPERES														
6A8	PENTAGRID CONVERTER	SMALL OCTAL 8-PIN	FIG. 8A	3 1/8" x 1 5/16"	HEATER	6.3	0.3	250	100	CONVERTER	250	{ - 3.0 min. }	100	3.2	3.3	Anode Grid (#2): Supply 250 max. volts; Current, 4.0 ma. Oscillator-Grid (#1) Resistor, 50000 ohms. Conversion conductance, 500 micromhos.				6A8	
6C5	DETECTOR * AMPLIFIER TRIODE	SMALL OCTAL 8-PIN	FIG. 8Q	2 5/8" x 1 3/8"	HEATER	6.3	0.3	250	—	CLASS A AMPLIFIER	250	— 8.0	—	—	8.0	10000	2000	20	—	6C5	
6F5	HIGH-MU TRIODE	SMALL OCTAL 5-PIN	FIG. 8M	3 1/8" x 1 5/16"	HEATER	6.3	0.3	250	—	BIAS DETECTOR	250	{ - 17.0 approx. }	—	—	Plate current to be adjusted to 0.2 milliamperes with no signal.				6F5		
6F6	POWER AMPLIFIER PENTODE	SMALL OCTAL 7-PIN	FIG. 7S	3 1/4" x 1 1/8"	HEATER	6.3	0.7	315	315	CLASS A AMPLIFIER	250	- 2.0	—	0.9	66000	1500	100	—	6F6		
										CLASS A AMPLIFIER	250	- 16.5	250	6.5	80000	2500	200	7000	3.0	6F6	
										PUSH-PULL CLASS AB, AMPLIFIER	375	- 26.0	250	—	Power output value is for 2 tubes at indicated plate-to-plate load.				6F6		
6J7	TRIPLE-GRID DETECTOR AMPLIFIER	SMALL OCTAL 7-PIN	FIG. 7R	3 1/8" x 1 5/16"	HEATER	6.3	0.3	250	125	SCREEN-GRID R-F AMPLIFIER	250	- 3.0	100	0.5	2.0	exceeds 1.5 meg.	exceeds 1500	—	—	6J7	
										BIAS DETECTOR	250	- 4.3	100	Cathode current 0.43 ma.		Plate coupling resistor 500000 ohms. *Grid coupling resistor 250000 ohms.				6J7	
6K7	TRIPLE-GRID SUPER-CONTROL AMPLIFIER	SMALL OCTAL 7-PIN	FIG. 7R	3 1/8" x 1 5/16"	HEATER	6.3	0.3	250	125	SCREEN-GRID R-F AMPLIFIER	250	{ - 3.0 min. }	125	2.6	10.5	600000	1650	990	—	6K7	
										MIXER IN SUPERHETERODYNE	250	- 10.0	100	—	Oscillator peak volts = 7.0				6K7		
6L6	BEAM POWER AMPLIFIER	SMALL OCTAL 7-PIN	FIG. 7A <sub>c</sub>	4 5/16" x 1 3/8"	HEATER	6.3	0.9	375	250	SINGLE-TUBE CLASS A, AMPLIFIER	300	- 12.5	200	2.5	48.0	—	—	4500	6.5	6L6	
										PUSH-PULL CLASS AB, AMPLIFIER	400	- 25	300	—	Power output value is for 2 tubes at indicated plate-to-plate load.				6L6		
										PUSH-PULL CLASS AB, AMPLIFIER	400	- 25	300	—	Power output value is for 2 tubes at indicated plate-to-plate load.				6L6		
6L7	PENTAGRID MIXER A AMPLIFIER	SMALL OCTAL 7-PIN	FIG. 7T	3 1/8" x 1 5/16"	HEATER	6.3	0.3	250	150	MIXER IN SUPERHETERODYNE	250	- 3.0	100	6.2	2.4	Oscillator Grid (#3) bias, - 10 volts. Grid #3 peak swing, 12 volts min. Conversion conductance, 350 micromhos.				6L7	
										CLASS A AMPLIFIER	250	- 3.0	{ 100 max. }	5.5	5.3	800000	1100	880	—	6L7	
6N7	TWIN-TRIODE AMPLIFIER	SMALL OCTAL 8-PIN	FIG. 8B	3 1/4" x 1 5/16"	HEATER	6.3	0.8	300	—	CLASS B AMPLIFIER	250	0	—	—	Power output value is for one tube at stated load, plate-to-plate				6N7		
6Q7	DUPLEX-DIODE HIGH-MU TRIODE	SMALL OCTAL 7-PIN	FIG. 7V	3 1/8" x 1 5/16"	HEATER	6.3	0.3	250	—	TRIODE UNIT AS CLASS A AMPLIFIER	250	— 2.2	—	0.5	Gain per stage = 43				6Q7		
6R7	DUPLEX-DIODE TRIODE	SMALL OCTAL 7-PIN	FIG. 7V	3 1/8" x 1 5/16"	HEATER	6.3	0.3	250	—	TRIODE UNIT AS CLASS A AMPLIFIER	250	- 9	—	9.5	8500	1900	16	10000	0.28	6R7	
25A6	POWER AMPLIFIER PENTODE	SMALL OCTAL 7-PIN	FIG. 7S	3 1/4" x 1 5/16"	HEATER	6.3	0.3	180	135	CLASS A AMPLIFIER	95	- 15	95	4.0	20.0	45000	2000	90	4500	0.9	25A6
										CLASS A AMPLIFIER	180	- 20	135	7.5	38.0	40000	2500	100	5000	2.75	25A6

⊙ Grids #3 and #5 are screen. Grid #4 is signal-input control grid.  
 \* For Grid-leak Detection—plate volts 45-100.  
 ▲ Grids #2 and #4 are screen. Grid #1 is signal-input control grid.

⊠ Grid #3 connected to grid #1.  
 ⊡ Applied through 20000-ohm voltage-dropping resistor.  
 ⊣ Applied through 200000-ohm plate-coupling resistor.

\*\* For grid of following tube.  
 ■ Either A.C. or D.C. may be used on heater.

5W4	FULL-WAVE RECTIFIER	SMALL OCTAL 5-PIN	FIG. 5T	3 1/4" x 1 5/16"	FILAMENT	5.0	1.5	—	—	FULL-WAVE RECTIFIER	Maximum A-C Voltage per Plate ..... 350 Volts, RMS Maximum D-C Output Current ..... 110 Milliamperes										5W4
5Z4	FULL-WAVE RECTIFIER	SMALL OCTAL 5-PIN	FIG. 5L	3 1/4" x 1 5/16"	HEATER	5.0	2.0	—	—	FULL-WAVE RECTIFIER	Maximum A-C Voltage per Plate ..... 400 Volts, RMS Maximum D-C Output Current ..... 125 Milliamperes										5Z4
6H6	TWIN DIODE	SMALL OCTAL 7-PIN	FIG. 7Q	1 3/8" x 1 5/16"	HEATER	6.3	0.3	—	—	TWIN-DIODE DETECTOR RECTIFIER	Maximum A-C Voltage per Plate ..... 100 Volts, RMS Maximum D-C Output Current ..... 4 Milliamperes										6H6
6X5	FULL-WAVE RECTIFIER	SMALL OCTAL 6-PIN	FIG. 6S	3 1/4" x 1 5/16"	HEATER	6.3	0.6	—	—	FULL-WAVE RECTIFIER	Maximum A-C Voltage per Plate ..... 350 Volts, RMS Maximum D-C Output Current ..... 75 Milliamperes										6X5
25Z6	RECTIFIER-DOUBLER	SMALL OCTAL 7-PIN	FIG. 7Q	3 1/4" x 1 5/16"	HEATER	25.0	0.3	—	—	VOLTAGE DOUBLER	Maximum A-C Voltage per Plate ..... 125 Volts, RMS Maximum D-C Output Current ..... 100 Milliamperes										25Z6
										HALF-WAVE RECTIFIER	Maximum A-C Voltage per Plate ..... 250 Volts, RMS Maximum D-C Output Current per Plate ..... 85 Milliamperes										

⊙ Plate voltages greater than 125 volts RMS require 100-ohm series-plate resistor.

Copyright, 1936, RCA Manufacturing Co., Inc.

Of the seventeen tubes listed above, five are rectifiers and are grouped at the bottom of the chart. Of the twelve others, three are double purpose (if one omits pentagrid converters). These three are two duplex diode triodes and the twin triode, 6N7. One of the others is high mu in the triode.

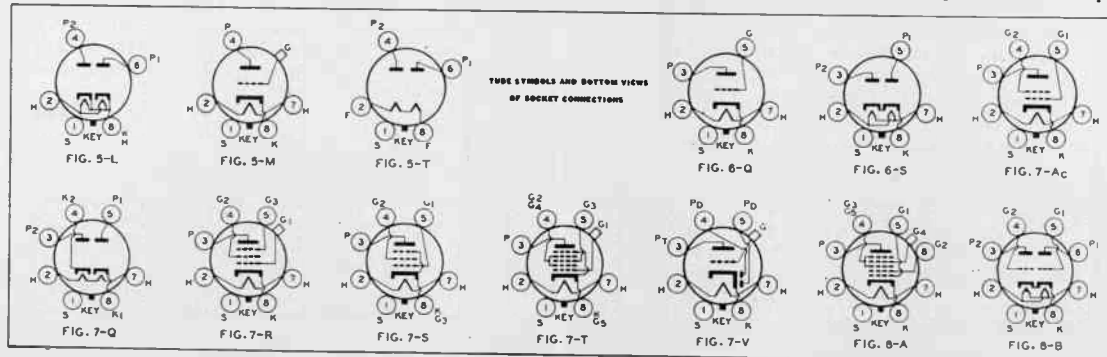

The all-metal tube line has been increased since the first release of all-metal tubes a little more than a year ago. A notable recent addition is the 6F6 beam power amplifier tube. Note there is a new dual triode, 6N7, somewhat like the 53, 19 and 6A6. See 6L6 article on page 22 of this issue.

# Generator's Use Extended

**ADVANCED STEP IN SERVICING PRACTICE INTRODUCED WITH MEASUREMENT OF CAPACITY, INDUCTANCE, AC RESISTANCE, Q, MODULATION AND OUTPUT VOLTS—"GENECEIVER" IS THE NAME FOR IT**

**By Herman Bernard**

## I.

### Measurement of Frequencies

**B**ESIDES the basic requirement of measuring radio frequencies, with or without modulation, a signal generator may be used in connection with the measurements of capacities and inductances within the radio-frequency spectrum.

When frequencies and capacities are measured, that work is complete. However, with inductances it is often desirable to inquire more deeply into them than the mere answer in microhenries or millihenries. Frequencies present no problem save of accuracy and stability. Condensers as used at radio frequencies are of such merit as seldom to require additional investigation after determination of capacity. Coils, however, invite more information than the mere inductance discloses. The figure of merit of the coil is desired. This is the *Q*. In connection with the *Q*, or independently, the a.c. resistance of the coil may be determined.

So it is advisable to have a system that permits the measurement of frequencies in kilocycles, condensers in microfarads and micro-microfarads, coils in millihenries and microhen-

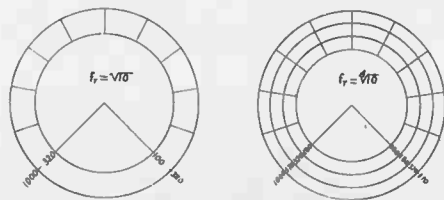

At left, example of 270 degree condenser, capacity ratio 10, frequency ratio the square root of ten. Two calibrations are decimal repeating. At right, frequency ratio the fourth root of ten, so four calibrations are decimal repeating.

### Decimal Repetition Applied to Bandsread

The author introduced to radio the decimal-repeating dial in 1933. Two scales appeared, the frequency ratio of the tuning condenser being based on the square root of 10. This root is 3.162, but 3.2 was used for safety and overlap. Thus the square of the frequency ratio, the capacity ratio, was at least 10. After reading one separate calibration, the next separate one was used for the second band, then for the third band the first band multiplied by 10 gave the correct result, and for the fourth band the second multiplied by 10. The next sequence, for a fifth and last band, was to multiply the first by 100.

If the cube root of 10 is used for frequency ratio the fourth band represents the first multiplied by 10, the fifth represents the second multiplied by 10.

In the present instance, for greater bandsread, the author has selected the fourth root of 10 for the frequency ratio (1.76) and added a bit for safety and overlap (1.81). Thus four bands are calibrated, and repeat themselves. The fifth equals the first times 10, the sixth the second times 10, the seventh the third times 10, the eighth the fourth times 10, the ninth the first times 100, the tenth the second times 100, the eleventh the third times 100.

The general system works indefinitely up and down, hence frequencies lower than 100 kc may be used (57 kc to 100 kc, 32 kc to 57 kc, etc.) The reason for the whole system is to give more dial space to the calibrations than otherwise possible, as the "concentric vice" is minimized.

—EDITOR.

# The All-Metal Tube Identification System

**By Merle V. Alltrop**

**A**S new editions of tube manuals probably will not be published until the Fall, the characteristics of the standard metal tubes are given herewith, including connections to sockets, bottom views being presented. All tubes issued to June 15th are included.

It will be noticed that of the seventeen all-metal tubes, all are of the heater type, save one, the 5W4, and that is naturally enough a rectifier.

In the first column of the chart, under the heading "Type," is given the tube designation, comprised of two numbers separated by a letter. The first designation therefore is numerical and refers to the literal or approximate heater or filament voltage. In regard to the numbers "5" and "25" these are literal, as the heater or filament voltages are to be just those. But where "6" is the numerical prefix, the literal voltage is to be 6.3 volts.

### The "End Number"

The decimal fractional voltage does not appear in the prefix. However, the correct voltage always may be read under "Rating," seventh column, subdivision being "Volts" of "Filament or Heater." The letter refers roughly to purpose, and the suffixed number (at end) to the number of elements, counting cathode as one.

The second column gives the "name" of the tube, or the words used to describe it, hence this gives an insight into the tube's purpose. In the third column the tube base is described, the same for all the all-metal tubes so far, except for the distinguishing characteristic of the number of pins brought out. The small octal socket permits a total of eight pins being brought out, at bottom, but tubes not requiring all eight outlets have blanks for the difference. It often happens, however, that the sockets themselves will have eight holes, hence it is easy to put the wrong tube in a socket, with possibilities of serious results. Some effort was made to reduce or prevent this hazard by introducing blanked sockets, but these aroused considerable opposition from manufacturers of servicing instruments, as a single analyzer plug could not then be used for metal tubes without adapters.

### Socket Connections

The socket connections are shown in drawings that not only give the numbers of the elements according to the standard system of counting left-hand bottom as 1, and proceeding clockwise, but also carry letter designations revealing the nature of the element. H represents heater, K cathode, G grid, P plate. S is the tube envelope, practically always grounded. If there are more than one grid or plate numerical subscripts identify which grid is which, the numbers corresponding to the recognized identification of these grids. Also the drawings show the relative position of the elements, as for instance whether a certain grid is between cathode and plate, or between cathode and some other grid. The figure numbers of the drawings appear in the fourth column of the chart, under "Socket Connections," and one should then refer to the proper figure number for the underneath view of the socket connections.

In some instances a grid is brought out at top cap (control grid). This is drawn as an oblong outside the tube circle, nearest pin 5.

### Still Growing

Additions are now almost constantly being made to the list of metal, glass and metal-glass tubes. The total number of tube types used in receivers is so large that service men naturally have some difficulty in remembering them. However, the subject requires study, and as a beginning why not memorize the names and purposes of the seventeen all-metal tubes?

[See chart and drawings on following two pages.]

# Output Includes Doublet Connection

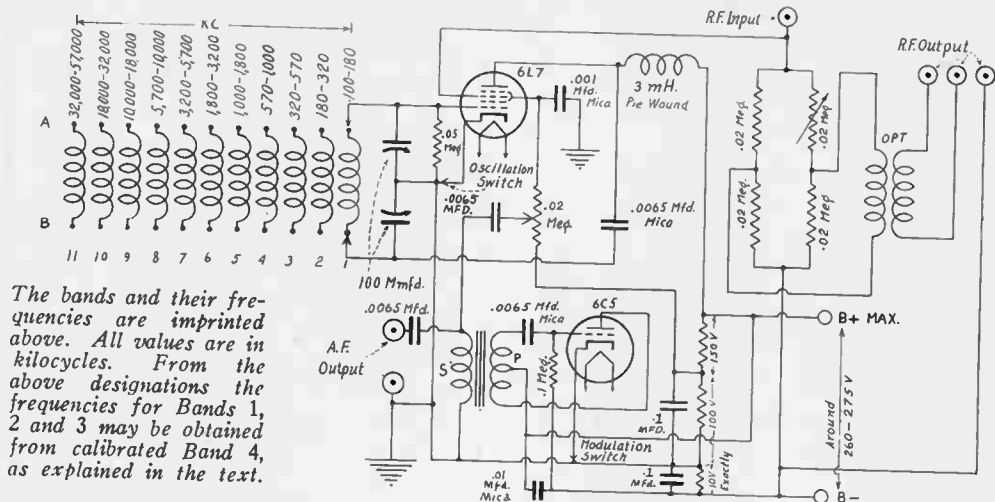

The bands and their frequencies are imprinted above. All values are in kilocycles. From the above designations the frequencies for Bands 1, 2 and 3 may be obtained from calibrated Band 4, as explained in the text.

An eleven-band modulated-unmodulated signal generator, 100 kc to 57,000 kc, using a Colpitts circuit. The output, because taken from the third grid, is small, but sufficient for servicing sets and making additional measurements with extra equipment. A bridge is balanced for zero output and unbalanced for any degree of output up to half the total. Percentage modulation is adjustable.

## LIST OF PARTS

### Coils

Eleven coils, one for each of eleven bands, as described in the text.

One 3 millihenry pie-wound r.f. choke.

One output r.f. transformer, consisting of high inductance and medium inductance honeycombs, closely coupled. High inductance for primary. Values not critical. One millihenry and 250 microhenries suggested.

One midget push-pull input transformer, for modulation transformer.

### Condensers

One two-gang National Company 100 mmfd. straight wavelength condenser, or one National Company 100 mmfd. two-gang straight frequency line condenser.

Four mica .0065 mfd. condensers.

One .001 mfd. mica.

Two .1 mfd. paper, 300 volts.

One .01 mfd. mica.

(Fixed condensers are Cornell-Dubilier.)

### Resistors

Three .02 meg.

One .02 meg. wire-wound rheostat (or potentiometer used as rheostat.)

One .02 meg. wire-wound potentiometer.

One .1 meg.

One 25,000-ohm, 10-watt or higher rating voltage divided, with sliders, so that voltages may be adjusted as imprinted on the diagram.

### Other Requirements

Chassis Dial Two octal sockets.

Six binding posts or tip jacks.

One eleven-position, two-circuit switch.

Two separate single circuit switches (r.f. oscillation on-off, a.f. oscillation on-off.)

One 6L7, one 6C5 tube.

ries, as well as in a.c. resistance and Q. The coil method should permit the separate measurement of inductance of primary and secondary of an r.f. transformer, also the mutual inductance, and the capacity measurement should be invoked to determine the coil's distributed capacity, as to primary and secondary independently, also the mutual capacity between windings, and of course it should be possible to

measure in all the foregoing aspects a single-winding coil, save only as to the mutual capacity or mutual inductance between windings, as there is only one winding.

### Tube Voltmeter as Detector

Such a system opens the way to measure-  
(Continued on next page.)



## Four-Band, Decimal-Repeating Dial

(Continued from preceding page)

ments that, while not now regularly performed in radio servicing, will have to be so performed in the near future. With the apurtenances the basic signal generator becomes much more useful, and problems now practically insoluble become simple to solve. And everything becomes direct reading, either in absolute values, or from two readings on a calibrated dial.

Some detecting system is necessary, therefore the signal generator, heretofore only a transmitter, becomes in reality a transceiver, for it can receive waves and measure them, just as well as it can transmit, besides enabling measurement of frequency in a separate receiver, or the establishment of a particular frequency in a channel to be aligned.

Such a detecting device may be a vacuum tube voltmeter. This, too, can be made direct reading. Also, the values read may be in root mean square values or peak values, by switching. For most purposes r.m.s. are desired, but for percentage modulation a system that operates as peak meter, however calibrated, must be used. So the tube voltmeter may serve to measure the percentage modulation applied to the r.f. oscillator of the signal generator, as well as being used as output meter separately.

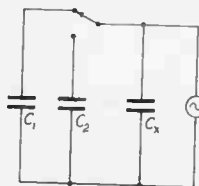

$C_x$  represents the distributed capacity of the circuit, independent of the tuning condenser.  $C_1$  and  $C_2$  stand for the minimum and maximum capacities of the tuning condenser.

Of course modulation may be taken out separately, so audio amplifiers may be checked.

### Oscillates at High Frequencies

The signal generator, the first unit, should have full frequency coverage, and this would be served by a range of 100 kc to 25,000 kc (25 mc), but we show a system that extends from 100 kc to 57,000 kc, or 3,000 meters to 5.26 meters, all on fundamentals. Measurements above 57,000 kc, i.e., below 5.26 meters, may be made by harmonics, as only the second harmonics of the last band need be used for 64,000 kc to 114,000 kc, or 4.685 to 2.63 meters.

Eleven coils are used because there are commercial switches with eleven positions, two circuits, but a twelfth coil could be inserted, to cover 57,000 to 114,000 kc, if the switch can be obtained, because a Colpitts circuit will oscillate even at those high frequencies. Usually the other type oscillators can attain very high

### Avoid This Mistake in Common Formula

Any who have had trouble reconciling practice with theory in adjusting to a given frequency ratio may have been misled by the following formula, where  $C_x$  now represents the total minimum capacity in circuit and  $C_{max}$  represents the maximum capacity in circuit:

$$\frac{C_x + C_{max}}{C_x} = \text{Capacity Ratio}$$

The formula is true, but the total minimum capacity consists of the minimum capacity of the tuning condenser plus the sum of the distributed capacities.  $C_{max}$  represents the total circuit capacity, which does not include the minimum capacity of the tuning condenser, because that represents merely the capacity of the condenser at one setting (minimum), and the quantity never occurs again. You can find  $C_x$ , the total minimum capacity in this case, but not knowing what is the tuning condenser's minimum, or capacity range, less than the intended ratio or range will be covered, the larger the minimum capacity of the tuning condenser. In other words, the tuning condenser capacity is assumed to be zero, which it never is, and the farther it is from zero, the more serious the error.

Suppose the formula were applied here.

$$\begin{aligned} \text{Then } \frac{C_x + 50}{C_x} &= 3.24. \\ C_x &= 22.34 \text{ mmfd.} \end{aligned}$$

The maximum would have to be 50 + 22.34 or 72.34 mmfd. and the minimum 22.34. The ratio would be correctly 3.24. But assign any value except zero to the tuning condenser for minimum, say, 10 mmfd. Then the circuit minimum would be the difference, or 12.34 mmfd. At the maximum capacity setting there would be 12.34 + 50 mmfd., or 62.34 mmfd. This ratio of 62.34/22.34 is 2.79, instead of the required 3.24.

frequency generation only by turning into Colpitts oscillators, which happens because the tube capacities then become small reactances, the grid-to-cathode and plate-to-cathode capacities being operatively in series at these frequencies. At lower frequencies the normal form of such other circuits takes hold.

With the Colpitts only a single winding coil

# Bands and Coil-Winding Data

is needed, a substantial advantage to those who wind or prepare their own coils.

The circuit requires a two-gang condenser. If the minimum capacity of each section is low enough, and other distributed capacities maintained low, 100 mmfd. per section may be used. The two in series yield a maximum of 50 mmfd.

## The Capacity Ratio Attained

The distributed capacities of the circuit must not be large, even though the rated 100 mmfd. condenser may have actually higher maximum capacity and thus simplify the problem. Effectively the tuning condenser capacity will be halved, so the maximum is taken as 50 mmfd. The allowable distributed capacity, present in coil, tube elements, socket, switch, wiring etc., may be computed as follows:

Designating the *distributed* capacity total as  $C_x$ , add to it the maximum capacity of the condenser, 50 mmfd. effective here, and divide by  $C_x$  plus the minimum capacity of the tuning condenser (which is half that of a single section). For 15 mmfd. minimum per section 7.5 mmfd. are effective. This equals the capacity ratio, which is the square of the frequency ratio.

$$\frac{C_x + 50}{C_x + 7.5} = 3.24$$

$$C_x = 11 \text{ mmfd.}$$

The sum of the tuning condenser minimum and the distributed is then equal to 18.5 mfd. and the sum of the maximum and the distributed is 71 mmfd.

The minimum capacity of the condenser has to be known, otherwise there are really two unknowns and one known and no solution is possible.

On the basis of the maximum total capacity, taken as 72 mmfd., the inductance is selected, the low frequency of a band therefore is reached

## VTVM Direct Reading in Peak Volts and RMS Values Also

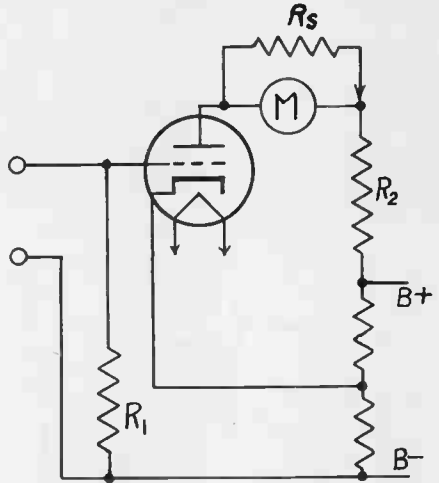

The tube voltmeter.  $R_1$  is in the megohm range,  $R_2$  causes full scale deflection of the 0-1 milliammeter M when the a.c. input is exactly one volt. Grid is biased to cutoff, so peak volts are read directly on M. The shunt  $R_s$ , if made to take up .3 ma, results in direct reading of M in r.m.s.

and the high frequency end takes care of itself. The following table is based in a frequency ratio of 1.81, doubly to assure enough coverage for decimal repetition of four basic scales, capacity ratio 3.273:

Band	Calibrated Kc Range		Inductance Microhenries		Winding Data
	Terminal Kc	Terminal Kc	Terminal Kc	Terminal Kc	
1	100- 180	100- 181	36,000	See Note	
2	180- 320	180- 325.8	11,000	See Note	
3	320- 570	320- 579.2	3,600	See Note	
4	570- 1,000	570- 1,031.7	*1,030	See Note	
5	1,000- 1,800	1,000- 1,810	360	See Note	
6	1,800- 3,200	1,800- 3,258	110	130 t. No. 32 enamel 5/8" diam.	112 T.P.I.
7	3,200- 5,700	3,200- 5,792	36	68 t. No. 28 enamel 5/8" diam.	73 T.P.I.
8	5,700- 10,000	5,700- 10,317	11	31 t. No. 28 enamel 5/8" diam.	73 T.P.I.
9	10,000- 18,000	10,000- 18,100	3.6	19 t. No. 20 enamel 5/8" diam.	29 T.P.I.
10	18,000- 32,000	18,000- 32,580	1.1	8 t. No. 20 enamel 5/8" diam.	29 T.P.I.
11	32,000- 57,000	32,000- 57,920	.36	4.2 t. No. 20 enamel 5/8" diam.	29 T.P.I.

\*Special reason for this. See text, first new paragraph, page 43, col. 1.

NOTE: Turns may be removed from commercial universal-wound (honeycomb) coils of larger inductance to strike the specified values for the first five bands. The other coils are solenoids to be tight-wound as per winding directions. T.P.I. stands for turns per inch of wire size used. Terminal Kc are specified as guides for precision laboratories. The high frequency terminal is a bit higher than the last calibration used on any band.

(Continued on next page)

# How to Calibrate Your Own Dial

(Continued from preceding page)

The circuit diagram shows an r.f. oscillator, using the 6L7 tube, feedback from plate through the .0065 mfd. mica condenser. Just this particular capacity need not be used here, or as grid condenser of the audio oscillator, but represents minimum capacity. Mica dielectric should be used in both instances.

Output is taken from the third grid. The sequence of the grids may be seen from the diagram, counting from the cathode in ascending order. Thus, the first grid is the control grid, in which circuit the .05 meg. leak is placed. The second and fourth grids constitute the screen, for which there is a single socket terminal or tube base pin. In series with the

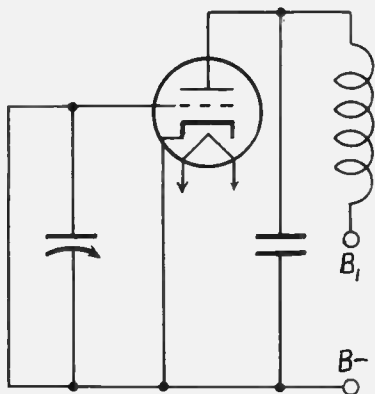

Such a circuit for high frequencies, where the wires that seem to be shorts are really impedances, may behave as a Hartley or a Colpitts. If the frequencies are very high Colpitts operation is to be expected.

screen is a potentiometer of .02 meg., bypassed by .001 mfd. mica condenser. At 100 kc, the lowest frequency of the r.f. oscillator, the condenser reactance is small and as the frequencies increase this impedance reduces. However, little of the audio frequency is bypassed by this condenser, so that modulation is introduced into the r.f. oscillator through the screen circuit, and varied as to percentage by adjustment of the .02 meg. resistor, which is a wire-wound potentiometer.

The plate r.f. choke coil should be pie-wound so that the distributed capacity is low. It has been possible by this method of winding a universal coil and joining them in series to keep the distributed capacity even as small as 1 mmfd., since the distributed capacities are in series.

## The Output Attenuator

The output attenuator uses the bridge method. Looking at the bridge from top to bottom as

shown, when the left-hand upper fixed resistor equals the left-hand lower fixed resistor, and when the variable at upper right is made to equal to fixed one at lower left, the bridge is balanced, and there is no output. Then by adjustment of the variable, as much output may be taken as is desired, up to half the total. If the full total is desired, then the lower left-hand resistor should be made variable, as well as the upper right-hand one, the bridge balanced with the two variables, and the attenuation established by varying first one, then the other. However, the two variables, if used in the bridge, should not be ganged, because if ganged might be difficult to balance properly.

It is not contended that the output attenuation device is constant impedance, in fact, it works because of inconstant impedance, nor is it asserted that true balance can be established at the very high frequencies without adding other equipment. The capacity effects become serious, and capacity balance in commercial rheostats would be accidental.

## R.F. Bypassing

Of the three posts for output (upper right), the two at left are for doublets, whereas for a grounded circuit, connect a conductive bar from the middle post to the right-hand post, and use the left-hand and center posts for output, "high" being at left. It is not necessary to ground the shield cabinet other than to B minus, but if done when calibrating should be maintained thereafter.

Any suitable B supply may be used. The oscillator circuit as shown is complete save for the B supply. That is, all the filtration needed for the radio and audio frequencies is

## How to Determine Percentage Modulation

Since the tube voltmeter is of the peak volts operating type (however calibrated) it will measure conditions necessary for determination of percentage modulation.

$$M = \frac{100 \text{ Ed}}{E_c}$$

where M is the modulation in percentage, Ed is the difference between the voltage readings taken with a carrier alone and with carrier modulated, and Ec is the voltage reading of the carrier only. The formula applies to single tone modulation, not to speech, music, etc., where percentage modulation, ever changing, scarcely can be measured by any method, therefore can be only averaged. Diagram on p. 39.

## Bridge Used as Output Attenuator

included. The B supply could have a filter of 15 henries or higher inductance audio choke, and two 8 mfd. electrolytic condensers, one next to the rectifier, the other left after the choke. Then the .01 mfd. mica condenser (lower center) would be across the second 8 mfd. filter condenser, but the .01 mfd. should be included for its effect on radio frequencies, to which an electrolytic condenser may present a rather high impedance. The .01 mfd. is included as a safeguard in that respect, even though the circuit is a Colpitts in which the electrolytic's high impedance would not be of any serious consequence, since the .00065 mfd. condenser from plate to lower section of the dual tuning condenser is of itself safeguarding in this respect.

The voltage divider, to right of the 6C5 audio oscillator tube, may be 25,000 ohms, 10 watts or more, and equipped with two end connectors and two sliders between them. Put the sliders about one-third from each end, set the full circuit going, and then, using a voltmeter of 1,000 ohms per volt, adjust the total B voltage distribution so that there are exactly 10 volts between B minus and adjoining slider, then 100 volts between that slider and the other, and let the remaining voltage, around 150 volts, be what it may, provided that the total B voltage does not exceed 275 volts. Recheck these values now and establish them on the basis of the slightly altered conditions.

If the total exceeds 275 volts another slider is needed, adjusted so that 260 volts are read between it and B minus, and then the previous procedure is undertaken on the 260-volt basis.

The audio transformer is a so-called midget push-pull input type, and therefore a cheap transformer is intended. A good one will generate a frequency too low in pitch (not too low in volume). The frequency can be changed somewhat by using different leak values. The circuit shows .1 meg. If there is no oscillation reverse the connections to the secondary S of the audio transformer, and if that doesn't work, increase the double the value of the audio grid leak.

### Getting Ready to Calibrate

It will be necessary to calibrate the r.f. oscillation frequencies and the result may be communicated to charts, as laboratories might do, in which case they understand the process. While experimenters and service men prefer direct reading, therefore the data on such preparation will be given.

An airplane dial could be used, continuously rotatable type (no end stops), so that a condenser of 270 degrees rotation, such as the National Company's Model Cat. ST-100 may be used. This affords one-third more spread-out, or sort of bandspread, than if a 180-degree rotation condenser were used, and the greater the bandspread the greater the practical ac-

curacy of reading the dial, always a goal. The glass is removed from the dial, so that the scale disc may be taken out. Scouring powder and soft rag, both from the kitchen, will remove the present numerical scale from a celluloid base disc.

Since there are four bands to calibrate, and they repeat themselves decimally for every fifth ensuing band, describe four circles with a compass to allow sufficient room for inscribing the frequencies and bars later. Then restore the scale disc, but not the glass. Mark the scale with condenser end stop positions.

The lugs intended to hold the glass in place may have been broken off, being brittle, but short lengths of copper bus bar may be soldered where the lugs were, and bent to serve the same purpose of holding the glass in place, after the calibration is completed, as until then we desire access to the scale disc.

### Using Part of Broadcast Band

When the disc is replaced it is usually held by the setscrew that engages the pointer. Those

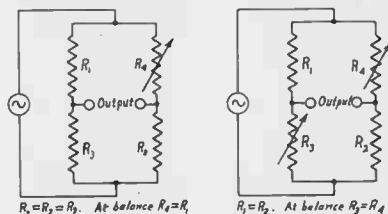

At left is the bridge as shown in the generator diagram, enabling half output but at less constant impedance. By using two .02 meg. variables, instead of one, full output is attainable (right).

desiring knife-edge readings may thin down the pointer on any emery wheel, over the distance to be used practically for readings, then turn the sharp edge toward the disc of the dial, requiring a 90 degree turn, done with the aid of flat-nosed pliers. Stiff paper between the plier jaws will prevent corrugating or niching the pointer, in case the pliers have thatched jaws.

A receiver is necessary for calibrating the broadcast band and lower frequencies, using the broadcast band of the receiver. Preferably this should be a tuned radio frequency set. A super could be used by experienced radioists, if the set has very good image suppression. The fourth band is first adjusted, a coil of greater than 1,100 microhenries (1.1 millihenries) inductance being used and turns taken off, until a beat is struck with a station at 1,000 to 1,030 kc, with condenser at a bit more than zero setting. If there is a station at 1,030, 1,040 or 1,050 kc use that. Then turn

(Continued on next page)

## All Scales Hinge on One Calibration

(Continued from preceding page)  
toward the other extreme capacity and pick up 570, 580, 590 or 600 kc.

### Cover the Prescribed Range

Note whether there is some dial displacement left. If so, return to the high frequency end, turn in the trimmer a bit, remove turns to restore the original beat at the original setting, and try the low frequency end again. When nearly the whole dial is apparently encompassed for 570 to 1,030 kc, lightly pencil in all settings and their frequencies, including all stations of known frequency that you can receive. Be sure to cover 570 to 1,030 kc at least, or up to 1,050 kc if need be.

When all the possible registrations are completed for this band the scale disc is removed from the dial again and held to a drawing board, or cardboard covering a wooden bench, and a protractor is placed over the disc. The

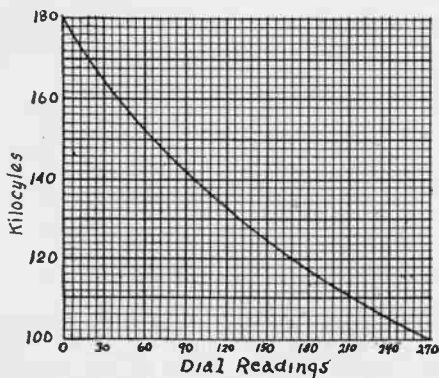

Draw the curve through dots that fall in a natural curve or straight line, and ignore jagged-curve effects as due to experimental error.

protractor should be of the 360 degree type, if a 270 degree condenser is used. Now the degrees are written on a large sheet of cross-section paper (squares of tens, ten to the inch), degrees on the left-hand side, frequencies beneath the lowest line. The frequency difference of the range is 461.7 kc or more (difference between terminal frequencies), so ten squares, top to bottom, may be used, 5 kc for each difference between adjoining lines, which would take care of a difference of 500 kc. From the registered points the curve may be drawn.

### Simplifying Curve Accuracy

Sometimes a French curve helps to join the dots. Often it introduces error. A simple method is to take four points, draw a light straight line between the two extreme points of the four under consideration, and draw lightly with fine line, hard sharp pencil, the curve

shape, free hand. Then take four more points, the last of the previous four being the first of the new four, and repeat the process. Carry the curve to the end (total degrees of condenser). It should be quite regular, though not necessarily a perfectly straight line. No odd peaks or valleys should appear. For some condensers it will be a large departure from straight line, at least for much of the curve's path.

Any radical departure from the general contour of the curve may be neglected as a false reading.

Now select the degrees representing even tens of kilocycles. In any case of verification by beats use the degrees read from protractor, not from curve. Then, using the protractor, lightly mark on the selected scale of the dial, the bars for 570, 580, 590, 600 kc, etc., to 1,030 kc or a bit higher. Identify the frequencies (600, 700, 800, 900, 1,000).

Restore the dial scale, which will fit correctly only in a given position, due to guide lugs, and check against the stations of known frequencies used originally, and try also to check against other stations, not previously used, and the more checking the better.

### Getting "Between the Bars"

Once more remove the dial, on which any necessary corrections have been marked, neatly erase undesired lines, and ink in the correct bars with a fine ruling pen, using waterproof black ink (India ink).

It will be noticed that the bars are more widely separated than one would expect for 10 kc differences, as we have much more band-spread than normally encountered in sets. Also, the fourth band, the one we are working on, is to be multiplied by ten for the eighth band. So the scale as it stands represents also 5,700 to 10,300 kc, bars separated 100 kc, which is not close enough.

So divide each ten kc space between divisions of the 570-1,300 kc band into five equal parts, requiring four more bars between present "tens," and make these shorter in length than the 10 kc bars. Slightly lengthen the 100 kc bars (600, 700, etc.) to distinguish them, also, from the 10 kc divisions.

The division into five equal parts may be difficult for some, especially if the dial scale is small, although warning was given it should be large as possible. At all hazards, divide the 10 kc bars in half. But if equal parts can be managed, by all means do it that way. In either instance, a pair of dividers may be used. They are set so that between the particular divisions they will go five times when the points are in series. Enough pressure is used to register the points with the dividers themselves, after the correct distance is determined. Even if the condenser used is not straight frequency line, the small differences

# Generator Low Frequencies Identified

under consideration may be treated linearly, as outlined, dividers reset on each 10 kc example, for all small changes are linear within the precision of our instruments.

## The Three Other Bands

We have done no more than to calibrate one band, but from that one band we may obtain tentatively the calibration for the three others, then, having the four, will be able to repeat decimally the first for the fifth, the second for the sixth, etc. Here is how the tentative values are obtained:

It is clear we need three more bands, as the total must be four so that fifth may repeat the first decimally, etc., therefore divide the low frequency terminal of the band just completed by the low frequency terminal of the next lower band. The frequencies are 570 and 320, and the dividend is 1.781. The high frequency end of the band we are estimating on is 570 kc, the same as the low frequency of the band we just completed calibrating, but at the other end of the dial.

Having the factor, select the frequencies of the second band in steps of 10 kc, by multiplying the frequencies we want by the factor 1.781. Thus, 320 is taken care of by 570 kc, because 1.781 divided into 570 kc was our basis of obtaining the factor. Next 330 kc is taken care of by 330 x 1.781, or 588 kc of the fourth band; 340 by 340 x 1.781, or 605 kc; 350 by 350 x 1.781 or 625 kc, etc., until we come to 570, which when multiplied by 1.781 equals 1,011.517. Of course we can not read frequencies that close, but 1,010 kc would be ample, (better than .2 per cent).

## Approximately is Pretty Good

One reason why these other scales are temporary and tentative is that the odd frequencies can not be read closely. Another reason is that there might be a slight difference in distributed capacities in coils, affecting the high frequency end of a band, and frequencies thereabouts.

Nevertheless we do get a calibration, usually a good one, and besides we will check it in reality.

We calibrated the fourth band and estimated the third. Now let us also estimate the second. The factor is 3.1667, obtained by dividing the low frequency of this band, 180 kc, into 570 kc, the low of the calibrated fourth band. Now we select the frequencies we desire, also 10 kc apart, multiply them by the factor, find the positions in reference to the calibrated scale, and finish this band tentatively. The frequencies are 180, 190, 200, etc., to 320. Then we have only the first band left. Divide 100 into 570 (the desired low frequency terminal by the calibrated low frequency terminal) and get

the factor 5.7. So select the frequencies of the first band, 100, 110, 120 kc, etc., to 180 kc, and multiplying each by 5.7, select the frequency on the calibrated scale and finish the first band. Now we have the four bands.

The work has been done from the low end of the broadcast band to lower frequencies, e.g., intermediate frequencies as used in super-heterodyne channels, because it is easy to check against stations in the standard broadcast band. We adhered to 10 kc, although separation closer than this will be needed finally for the low frequency bands. Remember that the fourth band, the calibrated one, is final already. We would want perhaps 1 kc separation on the first, 2 kc on the second and 5 kc on the third. This can be taken care of later, especially as practice on the first band will afford all the experience necessary for the closer absolute

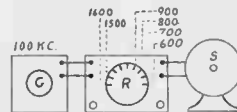

Since for low-frequency calibration of a generator (G), there will be several or numerous responses in a standard broadcast band receiver (R), the generator frequency is equal to the frequency difference between any two consecutive-response settings of the receiver. Generator is not molested. S represents the speaker.

calibration of the low frequency band. The relative separation will be about the same.

## Checking Low Frequencies

Now low frequency coils may be inserted, inductance reduced until beats are established with broadcasting stations. Select local stations, divide their frequencies by 2, 3, 4, 5, etc., make up a list, and you will see the generator fundamental frequencies that will beat with broadcast station frequencies, the stations of course being ones receivable in your location. Particularly helpful is the circumstance where two or more receivable stations of known but different frequencies produce the same smaller number (subharmonic) when divided by different integers. For instance, 570 kc may be one station frequency. Divided by 3 this yields 190. So if the generator produces 190 kc and zero beats with 570 kc you have a good check. But some other station of higher frequency may be divisible by a higher number to yield the same 190 kc. For instance when 760 is divided by 4 the answer is 190. So when the generator is at 190 kc we zero beat with 570 kc, then turn the receiver to 760 kc (in New York City this is true), pick up the zero beat again, and have one absolute confirmation.

(Continued on next page)

## Establishing Small Dial Differences

*(Continued from preceding page)*

The only other precaution is to turn the receiver dial from zero beat with one station to higher or lower frequencies, signal generator unmolested, to be sure that the consecutive responses in the receiver are not separated in frequency by half 190 kc, that is, 95 kc, as for 95 kc there would be zero beats under the same circumstances as before, only the responses in the receiver would be 95 kc apart. This check, while not close in frequency, as judged from the receiver, is nevertheless a very accurate one, as it eliminates possibility of error.

*Whatever frequency the generator is producing, the consecutive responses in the receiver (generator not molested) are separated in frequency by the fundamental frequency of the generator. So a frequency calibrated receiver comes in handy.*

The same accurate points now are established on the three tentative bands as was done before on the fourth band, as many as possible, and they should be numerous. A curve is drawn for each band, using the precision points as established by beating, and the scale subdivision conducted as before.

### Short-Wave Coils

When the short-wave coils are introduced, their inductance is adjusted, if any adjustment is needed, for the low frequency terminal. The winding data are closely given in the table herewith, but apply to unshielded coils. If shielding is used, a little more "bare" inductance is needed, to compensate for the reduction of inductance caused by the aluminum or copper shield. If the coils are used unshielded, but some of them are put near a metal chassis, if the metal is or contains iron, the inductance will increase, and wire may be removed.

The rule to follow is to set the generator at the intended frequency as read on the dial, at or near the low frequency terminal, with coil

inserted, and if the reading is too low in frequency zero beat test, more turns are needed, and if it is too high in frequency fewer turns are needed. Of course for small coils only a fraction of a turn may have to be taken off, or the inductance may be decreased simply by spacing the winding, using finger pressure, and when the right spacing is established, applying some National Company coil dope. To increase inductance press the turns more tightly together, although there is small leeway in this recommendation if tight winding really was used originally.

### Calibrate for Final Condition

So in the foregoing manner the entire calibration is completed. It is not a difficult task at all, but it takes a little pains. If any unusual conditions arise, consult your radio knowledge, for you will find the answer readily. For instance, if you think you can calibrate under one condition and duplicate the settings in practice under some other condition, remember that the change you have introduced is the one to complain of, and recalibrate or, better, institute calibration conditions just as they will be. This applies particularly to the placement of the coils, grounding of the metal chassis, and whether coils are shielded, all broached already. Not specifically mentioned previously is the fact that the metal cover of the cabinet must be placed in position before the calibrating is done, or the calibration conditions retained (no cover on) to follow the scale. However, this is about the same idea as included in the warning of the effect of iron on the inductance.

### Question of Accuracy

No hesitancy need be felt about the decimal-repeating method being accurate to one per cent. or better, as the distributed capacities can be maintained sufficiently uniform to assure that result.

## Any One Can Extend Generator Practice

Measurements of radio-frequency capacities, circuit minimum capacities, self-inductance and mutual inductance of coils,  $Q$  of coils and circuits (selectivity factor) may be made in conjunction with a signal generator. RADIO WORLD hereby presents an authoritative article including these important extensions to signal generator practice. An outstanding objective has been to reduce the operation to simplicity, and avoid computation. Frequencies of course are directly read from a generator, and it is possible to make the capacity and inductance readings direct, also, although special condenser calibration would be required. If a little computation is used, constituting hardly more than simple arithmetic, the principal determinations can be readily made, without calibrating more than the generator and the external variable condenser. The final results are useful to all, and it is not necessary to be able to follow the mathematics whereby the simple results were produced. Special formulas had to be devised to introduce this simplicity, but, as stated, the results are independent of appreciation of the mathematical development.—EDITOR.

# Close Measurement of Inductance

## II. Measurement of Inductances

Of the measurements proposed to be made the one surrounded by the greatest practical difficulty is that of inductance, because of the wide range of unknown inductances to be covered without elaborate switching, the accuracy desired, and the inadvisability of introducing much calculation.

Since inductance and capacity in parallel create a resonant circuit, the inductance may be computed from a formula derived from the following:

$$159,200$$

$$f \text{ cycles} = \sqrt{L \text{ microhenries} \times C \text{ microfarads}}$$

The inductance therefore would be related to squared terms and there would have to be slide rule manipulations for each determination.

A good deal of calculation was done in an effort to obtain a formula that would give accurate results with elementary arithmetic as the only calculation, and of half a dozen developed, the three most promising ones will be discussed, and their advantages and disadvantages set forth.

### Case No. 1

The first one considered responses in a tube voltmeter due to the fundamental and second harmonic of a generator energizing the unknown coil, across which was a calibrated variable condenser. Thus the generator was set at a frequency half that of combination of unknown coil and the variable condenser across that coil. The capacity setting of the variable condenser had to be at least four times the apparent minimum capacity to be read, so that as the capacity was decreased, another response would be noticed, due to the new resonant frequency in the unknown coil-known condenser circuit being twice that of the original. The generator did not have to be molested, since the condition that made the fundamental of the generator excite the measured circuit also made the second harmonic of the generator excite the measured circuit in which the capacity seems now less than one-fourth the previous value. The reason for exceeding the calibrated 1-to-4 ratio is that the capacity ratio is the square of the frequency ratio, and the frequency ratio being two the capacity ratio must be four literally.

### The First Formula

We are dealing with a calibrated variable condenser and while the circuit capacity ratio must change as 1 to 4, the readings on the condenser must change no greater than that

ratio, in other words the apparent change must be greater than the real change, due to including the distributed capacity of the circuit under measurement. When you add capacity in parallel you decrease the capacity ratio for any given angular displacement. The 1 to 4 displacement calibrated on the condenser therefore is not enough, though not much more is required for second harmonic use.

The formula for realizing on the relationship of the minimum and maximum capacity readings was

$$L \text{ microhenries} = \frac{19,000}{(C_{\max} - C_{\min}) F^2}$$

in which  $C_{\max}$  and  $C_{\min}$  are in micromicrofarads and  $F$  is in kilocycles. The factor 19,000 is derived from  $3/(4\pi)^2$ , the reciprocal of the denominator, being .019, and the 19,000 resulting from changing the capacities and frequency to convenient terms. (Really 19,044.)

It will be noticed that the frequency is a squared term, and to get rid of that difficulty it is practical to make  $F$  equal to 138, since the square of 138 is 19,000, therefore the numerator becomes unity and the formula is

$$L \text{ microhenries} = \frac{1}{C_{\max} - C_{\min}}$$

where  $C_{\max}$  and  $C_{\min}$  are again in micro-  
(Continued on next page)

## CASE NUMBER 1

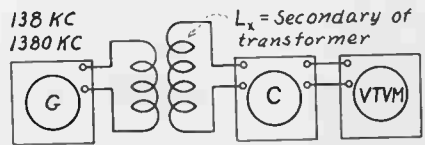

$$L_x \text{ microhenries} = \frac{1}{C_{\max} - C_{\min}} \text{ for } 138 \text{ kc}$$

$$L_x \text{ microhenries} = \frac{100}{C_{\max} - C_{\min}} \text{ for } 1,380 \text{ kc}$$

The capacities are in micromicrofarads.

G represents generator at 138 or 1,380 kc.  $L_x$  is the unknown inductance. C is a calibrated variable condenser.  $C_{\max}$  is the high capacity setting of that condenser to pick up the fundamental of the generator, 138 or 1,380 kc.  $C_{\min}$  is the smaller capacity for picking up the second harmonic of the generator. The capacities are in micromicrofarads. For large inductances use 138 kc, for small inductances use 1,380 kc. All answers are in microhenries. VTVM is the vacuum tube voltmeter



# Inductance from Wavelengths Squared

(Continued from preceding page)  
microfarads, and the computation is greatly simplified.

Further, if the frequency  $F$  is made 1,380, the numerator becomes 100:

$$L \text{ microhenries} = \frac{100}{C_{\max} - C_{\min}}$$

## Can't Measure High $L$

Two settings of the generator would be used, one 138 kc, the other 1,380 kc, using fundamentals for two wide ranges of unknown inductance, and the calibrated condenser setting changed until the next response is picked up, the second harmonic, and simple arithmetic applied. (Really 137.84 and 13,784 kc.)

Since the unknown coil may be very large in inductance, of the value of many millihenries, even a small amount of capacity of the calibrated condenser across it would strike a resonant frequency much lower than the lowest to which the generator tunes, and that applies practically to any generator. So by this method measurement of such high inductance is ruled out. Also, some danger exists in confusion of harmonic orders. If the fundamental and the second harmonic must be the exciting frequencies, suppose one makes a mistake and uses the second and third harmonics? The blunder is enormous. There is no measurement at all, since the formula as given does not apply to this condition.

However, some radioists no doubt will find application for the method.

### Case No. 2

If instead of using a particular generator fre-

## CASE NUMBER 2

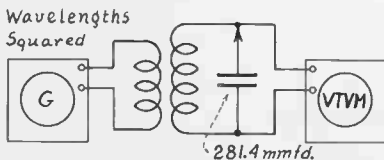

$$L_x \text{ millihenries} = \lambda_2^2 - \lambda_1^2$$

The wavelengths  $\lambda_2$  and  $\lambda_1$  are in meters.

Generator  $G$  is calibrated in wavelengths squared and must produce a wavelength equal to that when the 281.4 mfd. condenser is out, next a higher wavelength when the fixed condenser is in. The difference as read on  $G$  in wavelengths squared is equal to the unknown inductance directly in millihenries. A calibrated variable condenser may be in circuit for wider latitude, and does not change the result.

quency, suppose we try to make available all the generator frequencies, and change the capacity across the unknown inductance? Squared terms will arise again, and will be simplest in wavelengths, therefore we set up the formula

$$L \text{ microhenries} = \frac{\lambda_2^2 - \lambda_1^2}{4\pi^2 V (C_{\max} - C_{\min})}$$

where  $\lambda$  is wavelength in meters, the capacities are in micromicrofarads, and  $V$  is the velocity of the wave in meters per second (300,000,000).

$$L \text{ microhenries} = \frac{\lambda_2^2 - \lambda_1^2}{3.5532}$$

If we change the capacity across the unknown coil by 281.4 micromicrofarads (mmfd.) the formula becomes

$$L \text{ microhenries} = \frac{\lambda_2^2 - \lambda_1^2}{1,000}$$

and if we make  $L$  in millihenries instead of in microhenries, we have direct reading in millihenries:

$$L \text{ millihenries} = \lambda_2^2 - \lambda_1^2$$

The change of capacity has to be 281.4 mmfd., but it does not make any difference from what capacity it is changed. For instance, the distributed capacity of the coil may be used as  $C_{\min}$ , and then  $C_{\max}$  would be the sum when the 281.4 mmfd. fixed condenser was put across the coil. Within acceptable accuracy we could make the condenser 280 mmfd.

### Limitations Set Forth

The principal disadvantage of this system lies in the fact that for semi-direct reading of results, at least two generator bands must be calibrated in wavelengths squared, besides each of the four bands being calibrated in frequencies in kilocycles. However, the National condenser mentioned has a straight line wavelength shape, so the wavelength squared would follow the same evenly separated wavelength bars, only bearing squared values of wavelengths this time. The conversion from frequencies to wavelengths can be made from a table, and the squared terms taken from slide rule readings.

Another disadvantage is that large values of inductance can not be measured, as the generator wavelength must be equal to or higher than the wavelength of the measured circuit, so that there will be responses in the tube voltmeter. Wavelengths of the generator lower than the wavelength in the measured circuit can not produce a response in the VTVM. Suppose the generator condenser at maximum is equal to the fixed capacity of 280 mmfd. in the measured circuit, then no inductance can be measured that is higher than the inductance of the largest coil in the generator.

# Unknown Inductance Put in Series

The measurement is dependent on capacity, the fixed 280 mmfd. condenser, and the distributed capacity of the coil, but it is independent of absolute values of wavelength or frequency. By putting a calibrated variable condenser across the measured circuit, the range is extended downward in inductance, for values of the unknown, also what may be the setting of the calibrated condenser is not otherwise material. The three factors of (1) wide range of selection in the generator, despite limitation of the magnitude of the inductance that may be measured; (2), independence of absolute wavelengths generated; and (3), independence of absolute minimum capacity in the measured circuit, contribute much to the utility of the scheme. The method will be found valuable for independent practice where direct reading is not of importance.

## Dual Generation

It will be observed that the measured circuit can be stripped of one of its shortcomings, applicable to both inductance measurement methods so far discussed, by making the measured circuit a generator of itself, for then there is no limit to the magnitude of the unknown inductance, and the tube voltmeter would be associated with the principal generator, which of course then is really used as a receiver.

That is, the measured circuit will generate harmonics, so however low the frequency or high the wavelength produced in the measured circuit, the responses can be noticed in the receiver (the principal generator, also generating at the same time, to enable zero beating).

There may be some possibility of harmonic confusion, and absence of accuracy, if the measured circuit is itself generating. Also, the preferred practice among users is to have the unknown circuit associated with the indicating device. It was intended to solve the problem under the preferred procedure of tube voltmeter in the unknown circuit.

## Case No. 3

Naturally, the first thought was that if a given inductance of known value were used, the magnitude of the inductance that could be measured would not be limited in any practical sense if the unknown inductance were put in series with a known inductance. Always the resultant inductance would be less, so if a known inductance were selected, which with a high capacity setting of a calibrated variable condenser produced a response in the generator at a particular frequency, then as  $L_x$  was inserted in series, if  $L_x$  were large the condenser would have to be turned to only a little higher capacity, again to restore to the measured circuit, resonance at the assigned frequency. The limiting factor is that the genera-

tor frequency determines the accuracy of the inductance measurement, but zero beating the generator at or near its 100 kc setting, with a station of a frequency that is a multiple of 100 kc (e.g., 600 to 1,600 kc in steps of 100 kc in the standard broadcast band) would enable accurate establishment of the frequency, and the point may be marked specially, or the generator adjusted to be specially accurate at this point, using the existing 100 kc reading. However, the generator discussed in this article would be accurate in frequency to better than one per cent. The higher the accuracy at the selected frequency the better.

## Things to Remember

Since the generator's low frequency is limited, if  $L_x$  is assumed zero for Case No. 3 (posts for the unknown short-circuited) the standard inductance  $L_s$  can not be higher than will be permitted by the minimum capacity of the calibrated condenser and the selected single  
(Continued on next page)

## CASE NUMBER 3

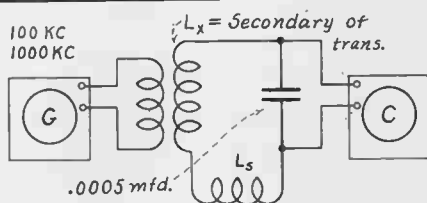

$$L_x \text{ millihenries} = \frac{L_s (C_{\text{max}} - C_{\text{min}})}{C_{\text{min}}} \text{ for}$$

100 kc, when  $L_s = 5.06$  millihenries.

$$L_x \text{ microhenries} = \frac{L_s (C_{\text{max}} - C_{\text{min}})}{C_{\text{min}}} \text{ for}$$

1,000 kc, when  $L_s = 50.6$  microhenries.

The capacities are in micromicrofarads.

Two frequencies are used, 100 kc and 1,000 kc, obtained from the generator G.  $L_s$  is a standard inductance. For range extension two inductances may be used, one just ten times that of the other. Values of 50.6 microhenries (for 1,000 kc) and 5.06 millihenries (for 100 kc) are suggested. The minimum circuit capacity is .0005 mfd. (500 mmfd.), and enough capacity is added to the calibrated variable's minimum to attain this. If desired, with some sacrifice of accuracy, due to crowding, the inductance  $L_x$  may be read directly from the dial by calibrating the dial of C also in inductance, always starting at minimum capacity.

## Three Inductance Methods Compared

(Continued from preceding page)

frequency of the generator. Remember that always the same generator frequency is used, and we may select 100 kc. Also no harmonics are used. Always the fundamental of the generator is put into the test inductance circuit. Also, we must *increase* the capacity of the calibrated condenser from its first setting, to restore resonance, that is, must make up by additional capacity for the frequency increase occasioned by the reduction of inductance when the unknown was put in series with the known inductance. A large unknown coil will decrease the effective inductance only a little, therefore require only a small increase of capacity.

For range extension we use a frequency equal to  $10 \times 100$  kc and an inductance equal to  $L_s/10$ . Increasing the frequency that way avoids the use of  $L_s/100$ , an awkwardly small inductance.

### Formula for Series Unknown

The formula is independent of frequency, requiring only that a particular frequency be used, is also independent of the known standard  $L_s$ , and the only variables are the capacities:

$$L_x = \frac{L_s (C_{\max} - C_{\min})}{C_{\min}}$$

where  $L_x$  is the unknown inductance,  $L_s$  is the standard inductance, both in the same terms, no matter what those terms are; and the capacities  $C_{\max}$  and  $C_{\min}$  also may be in any identical terms. If  $L_s$  is in microhenries,  $L_x$  is in microhenries, and  $C_{\max}$  and  $C_{\min}$  must be in farads, microfarads or micromicrofarads, etc., i.e. in identical terms.

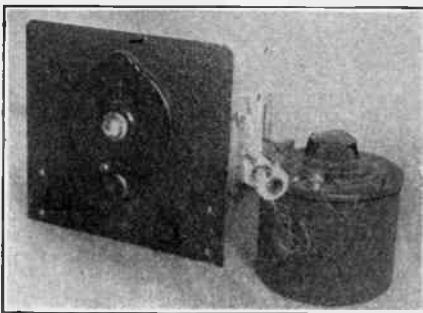

Signal generator (left), intermediate frequency coil being shown between the generator and the calibrated condenser. The inductance of each winding, also the mutual inductance, may be measured, likewise the distributed capacity of either winding alone, and the mutual capacity between windings.

$C_{\max}$  is the higher capacity reading,  $C_{\min}$  the lower capacity reading, whatever they are.

However, we are engaged in a specific problem, the determination of unknown inductances of radio-frequency values, and these will require a wide range, so we desire to have answers in millihenries, for large inductances, and in microhenries for medium and small inductances.

We have noticed one fact in particular, that for a specific value of  $L_s$ , the standard inductance, we find the unknown only by increasing the capacity in circuit. That points to one basic requirement, that to establish 100 kc originally, the lowest frequency deemed obtainable, if we select some given inductance for  $L_s$  and short the terminals for the unknown, so that the capacity is across  $L_s$  alone, the resonant frequency must be equal to 100 kc. So if we select, say, 500 micromicrofarads (mmfd.) we would need about 5 millihenries inductance to strike 100 kc.

### Upper Limit of Inductance

It is advisable also to set an upper limit of unknown inductance, so that a minimum change of capacity may be considered. So assume 100 millihenries as the maximum of  $L_x$ , the unknown inductance. This is inordinately large. Then the known or standard inductance  $L_s$  should be 5.06 millihenries for a change of 30 mmfd. Notice that 500 mmfd. was the selected capacity. This means it is the *minimum*, not the maximum capacity of the condenser. The calibrated variable having its own minimum, enough more is added to constitute 500 mmfd., and then the maximum capacity is this increment plus the maximum of the variable itself. Assume values of 50 mmfd. minimum and 500 mmfd. maximum of the variable, 450 mmfd. fixed capacity added in put in parallel. The total capacity range is from 500 to 950 mmfd., a difference of 450 mmfd., the same *difference*, of course, as if the fixed capacity had not been added.

Now on the basis of a minimum of 500 mmfd. and a variation of 450 mmfd., we strike 100 kc. with  $L_s$  at 5.06 millihenries, when  $L_x$  is 100 millihenries. So if we start at the minimum capacity and turn the calibrated condenser, we may note the first point at which a response is obtained, and the capacity then present is a measure of the unknown inductance.

The natural curve of the variable condenser alone makes a very crowded one for differences between large inductance, but since we put a large fixed capacity across the variable we straightened out the curve materially.

To be absolutely direct reading naturally for any wide range there must be some crowding, but if the standard  $L_s$  is multiplied by the capacity difference, this product divided by 500 mmfd., no specific starting point on the cali-

# Measurement of Mutual Inductance

brated condenser is necessary, and somewhat higher accuracy will result. However, direct reading being so important for rapidity in servicing, the single frequency and single starting point (minimum capacity) are used.

## Merit in All Three Methods

All three methods of inductance measurement are excellent. A rather critical attitude was taken as to Cases No. 1 and No. 2 only because of the assumed requirement that direct reading should prevail in the interest of rapidity in servicing. Limitation of the magnitude of inductance that may be measured, although taken seriously, for generous scope, may not amount to much in practice, where inductances of greater than 250 microhenries seldom need be considered, and inductances in the millihenry range are nearly always in positions that require no particular accuracy. In experimental work many will desire to apply Case No. 1 or Case No. 2.

Case No. 1 is distinctive, because if the first capacity setting is large, as it should be, to pick up the fundamental, then the second setting will represent a considerable apparent capacity difference, as read from the condenser, for picking up the second harmonic now. So there is no crowding. It is necessary, however, to strike the fundamental, and that means the inductance to be measured must be somewhat of the same order as the inductance of the coil in the generator band being used for the measurement.

Also, Case No. 1 measures the pure inductance. It does not lump the distributed capacity with the inductance and from a resonant determination ascribe the effect entirely to inductance, a method that could lead to seri-

ous error. Case No. 2 also has the advantage of measuring the pure inductance, as the distributed capacity is taken as the minimum, and the added fixed capacity is compared to the effect of the other in terms of differences of wavelengths squared. The computation of inductance on the basis of the facts thus gleaned eliminates the treatment of distributed capacity as in inductance. The computations in both cases are not a bit difficult, being no more than simple arithmetic, really.

## Pure and Impure Inductance

In Case No. 3 the pure inductance is not measured but only the apparent inductance. That is, the distributed capacity is treated as if it were inductance. However, such a method has been entirely acceptable all through radio practice, provided the distributed capacity was very small compared to other capacity used in inductance determination. Due to the series inductance circuit, where the standard itself has a tiny distributed capacity, the total distributed capacity of two coils being less, the circumstances are as favorable as in most inductance measurements. But, in addition, there is a permanent fixed capacity of 500 mmfd., which includes the variable condenser's minimum. Under any and all circumstances 500 mmfd. minimum is compared to one or two micromicrofarads, thus making the coil's distributed capacity negligible.

Case No. 3 has limited scope, 100 millihenries to around 300 microhenries, but if Ls is made one-one hundredth of its former value the values of Lx would be one-tenth the former, or 1,000 to 3 microhenries, provided, however, the condenser were large enough, with

*(Continued on next page)*

## Meaning and Sound of Greek Letters Used

The following Greek letters are used in the text with the customary significance, as stated:

Letter	Sound	English	Meaning
$\lambda$	lambda	l	wavelength in meters
$\mu$	mu	m	one-millionth (micro)
$\pi$	pie	p	3.1416

Besides, English letter m is used for one-thousandth (milli).

Hence one millihenry, one one-thousandth of a henry, is 1 mh, and one-millionth of a henry is one microhenry, 1  $\mu$ h.

Multiples of 10, as 1,000,000,000 (one thousand million) may have the total number of ciphers after the "one" appear as an index of the 10, thus 10<sup>9</sup>.

## Shielding of Coil Reduces Inductance By About 10 Per Cent

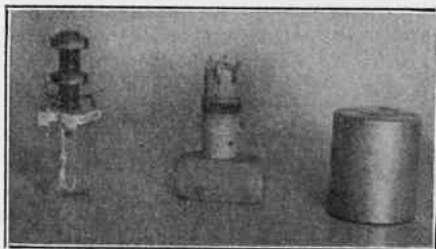

Intermediate frequency transformer (left) taken out of shield for measurement that way; a broadcast band oscillator coil (center) unshielded; and (right) the shield which, placed over either coil, reduces inductance about 10 per cent.

# Mutual Inductance from Capacities

(Continued from preceding page)

50.6 microhenries, to strike 100 kc. This requires .005 mfd., which could be the new minimum (fixed) capacity, replacing .0005 mfd. (500 mmfd.). However, with 50.6 microhenries it is simpler to use a new frequency, 10x100 kc, so turn the generator to 1,000 kc for measurements in the microhenry range, using 3 to 1,000, and for the millihenry range use 1 to 100 millihenries.

## Mutual Inductance

As for the condenser calibration, it should include the tube voltmeter circuit, e.g., the tube itself, the socket, the wiring, etc., as they become a natural part.

It is possible to obtain commercially calibrated condenser that serve the purpose, or on the basis of an inductance standard, the distributed capacity of which is known, any variable condenser may be calibrated. This topic will be discussed under capacity measurements.

Knowing the inductance of a single winding, for instance, is part of the determination of the quantity of a coil. If there are two windings, the generator should be connected to the primary and in such a way as not materially to reduce the primary inductance. Besides the self-inductance, if there are two windings we might desire to ascertain the mutual inductance. And after such facts are obtained we would like to find out the quality of the coil, e.g., its  $Q$ , which is the inductive reactance divided by the a.c. resistance. The inductive reactance at any particular frequency may be computed from the inductance, the answer being in ohms,  $X_L = 2\pi fL/10^9$ , for  $X_L$  in ohms,  $f$  in kc and  $L$  in  $\mu$ h. The a.c. resistance may be measured easily. By that time we have obtained about all the knowledge that we may reasonably expect from a simple coil measuring system that enables rapid manipulation. We could add to our knowledge the distributed capacity of each winding and the mutual capacity of two windings. However, the capacity considerations properly are classified under capacity, which will be treated separately.

In connection with the determination of  $Q$  of a coil we have the rig for determination of the  $Q$  of a circuit, and as finally everything turns out to be a circuit, and not an isolated constant, we shall pay attention to circuit  $Q$  determination.

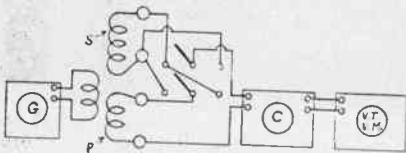

Mutual conductance is also susceptible of dynamic determination. The series switching is shown.

Besides the self-inductance of one of two windings, it is helpful, sometimes important, to know the mutual inductance. This is a measure of the inductive coupling between the two. More closely, the coefficient of mutual inductance represents the flux turns linking winding A per unit current passing through winding B. For mutual inductance the skin effect is small, therefore the measurement is practically independent of frequency, and is sometimes even made for radio coils at telephone frequencies, using a bridge.

There are several ways of measuring mutual inductance. Since we have a method of measuring the self-inductance when primary and secondary are connected in series both possible ways, we may determine these quantities and thus use the simplest formula for mutual inductance. The two ways of connecting the primary and the secondary are in series aiding and in series opposing. It is enough to know that one terminal of the primary is connected to one terminal of the secondary, and the measurement is made at the free ends of the two windings. Then the primary terminal that was free is put at the same secondary terminal, the formerly connected primary terminal is now free, along with the same secondary terminal that was previously free, and the method is repeated. Two different values of self-inductance are obtained and from these the mutual inductance is computed:

$$M = \frac{L_2 - L_1}{4}$$

## Condenser Method Not as Easy

Besides giving the answer in terms of coefficient of mutual inductance, the solution guides one to the correct polarities of coil connections for establishing equal secondary inductances, important in receivers intended to be tuned closely at radio-frequency levels by gang condensers.

Since the self-inductance is different for each of the two coil connections, primary in series—assistance to the secondary, primary in series opposition to the secondary, the calibrated variable condenser may be used for obtaining the value of the coefficient of mutual inductance. Suppose that  $C_1$  is the capacity needed to tune to resonance with the generator when the windings are connected in series aiding, and  $C_2$  the higher capacity needed to restore resonance in the VTVM circuit when the two coils are in series opposition, then  $C_1 L_2 = C_2 L_1$ , where the subscripts are larger for larger values of capacity or inductance.

Assuming that the tuning condenser capacity is large compared to the self-capacity of the coils, or that the inductance measurement is of pure inductance (and our three inductance cases fulfill one or the other of these requirements), then

# Coil's A.C. Resistance and Q

(Continued from preceding page)

$$M = \frac{C_2 - C_1}{16 F^2 C_1 C_2 \pi^2}$$

A single frequency is used in these cases of measuring the mutual inductance. It does not matter what the frequency is. Therefore it may be one of the frequencies compulsory for other purposes.

The Q of a coil may be taken as its figure of merit, and consists of the inductive reactance divided by the a.c. resistance. As inductive reactance is determined from a simple formula, and not actually measured, we introduce the frequency, multiply it by 6.2832 and multiply this by the inductance. The formula has been given for answer in ohms when the frequency is in kilocycles and inductance is in microhenries.

## What Inductance Is

The inductance of a coil is the effect that it has in retarding the flow of alternating current. The coil has direct current resistance, and this does not change. It has a.c. resistance, which changes only a little with frequency, not enough to matter, but at any reasonable frequency the a.c. resistance is much greater than the d.c. resistance. The opposition that the coil offers to a.c. due only to the inductance of the coil is the inductive reactance, and therefore the reactance is an expression of the inductance of the coil in terms of its opposition to a.c. flow, stated in ohms, and applicable to a particular frequency.

### III.

## Measurement of Coil's A.C. Resistance

The a.c. resistance of the coil may be measured by supplying a radio frequency to the coil, using a generator, and measuring the voltage across the coil, using the vacuum tube voltmeter. Then insert a non-inductive variable resistor in series with the coil, and adjust the resistor, with tube voltmeter only across the coil or only across the resistor, until the voltage read is half what it was before, input frequency and all other factors unchanged. Now of the total voltage, which drives the same current through coil and resistor, half is across the coil and half across the resistor, and the amount of external resistance introduced is therefore equal to the resistance of the coil, since equal resistances across an e.m.f. divide the voltage equally. The answer is the a.c. resistance of the coil because the a.c. and the d.c. resistance of the external resistor is the same. The d.c. resistance of the coil may be measured on a d.c. ohmmeter, but is not ma-

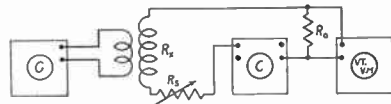

$$R_x = R_s - R_o$$

When  $R_s$  is shorted VTVM reads  $\frac{E}{2}$ .

When  $R_s$  is finite VTVM reads  $\frac{E}{2}$ .

Method of measuring the a.c. resistance ( $R_x$ ) of a coil, by shunting the tube voltmeter with  $R_o$  (10 ohms for .1 ampere per one volt), and adjusting  $R_s$  until  $E$  reads half what it did when  $R_s$  was zero.

terial, since the d.c. resistance has an effect on the a.c. resistance and is therefore enveloped with it in a manner not requiring segregation.

Very excellent coils have low a.c. resistance, say, 10 ohms at the low frequency end of a band in which they are to be used. As the frequency increases the a.c. resistance increases, about in the same order. So at a frequency twice the one at which the original measurement was made the a.c. resistance would be about double.

## Reasonable Values

Commercial coils have much higher a.c. resistances than these. While 100 ohms is inordinately high, nevertheless the external rheostat may go that high, and preferably there should be a rheostat of 20 ohms in series, so the total will be 120 ohms. The sum of the resistances read from these calibrated rheostats will be used for closer determinations. The 100-ohm instrument would not permit of close readings for good coils.

The rheostat calibration may be made on the basis of d.c., with a good ohmmeter, and if non-inductive resistors are not obtainable, measure the inductance to be sure it is very low compared to the inductance of the coil under test.

Thus the coil's Q may be determined by dividing the computed inductive reactance by the a.c. resistance.

### IV.

## Measurement of Q

However, since we have a tube voltmeter, we may use a simpler method of determining the Q of a coil. We are using a good variable condenser, therefore its a.c. resistance will be negligible, compared to the a.c. resistance of the coil under test, even a very good coil, and in radio servicing only medium grade coils may be expected at best. The limitations of space, closeness of shields and to windings, and other factors account for this.

(Continued on next page)

# Distributed Capacity Measured

(Continued from preceding page)

If we take a reading of the tube voltmeter at resonance, that will be the highest value of voltage we can attain, with constant amplitude from the generator. Now if we detune the generator by a given amount we shall find that the voltmeter reading is reduced, and soon comes practically to zero. How rapidly this decline takes place, in the sense of the smallness of the frequency change necessary to produce a given voltage, is a measure of the coil's selectivity factor, or  $Q$ . It has to do with the effective resistance of the coil at that frequency, as the selectivity factor is based on the effective resistance.

Another view of the same situation is that  $1/Q$  is a measure of the losses in the coil, so when the coil is low-loss the  $Q$  is high. Since  $1/Q$  is the power factor, the lower the power factor the lower the losses. In earlier days the power factor of r.f. circuits was treated as decrement, an expression reflecting the resistance of the circuit at a particular frequency.

Now, if we reduce the voltage from the maximum attained at resonance, the calibrated variable in parallel with coil, we may alter the generator frequency until the reading is .707 of the original value (.7 is close enough in practice), and note the frequency. Then do the same in the opposite direction from resonance. From the frequencies as thus determined, (a) resonance; (b) lower than resonance by a voltage factor of .7; (c), higher than resonance by a voltage factor of .7, we may determine the  $Q$ .

$$Q = \frac{f_r}{f_2 - f_1}$$

where  $Q$  is a number,  $f_r$  is the frequency of resonance,  $f_2$  is the higher frequency for producing a voltmeter reading of .7 the resonant voltage, and  $f_1$  is the lower frequency for producing .7 the resonance voltage.

The total voltage difference is the sum of the two .707 + .707 or 1.41, or 1.4 practically.

This method is made almost direct reading

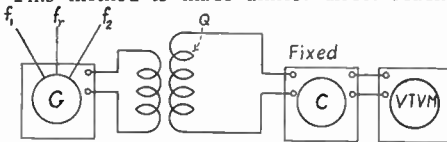

Read  $E$  once. Read  $0.7E$  twice.

$Q = \frac{f_r}{f_2 - f_1}$  where  $f_r$  reads  $E$ ,  $f_2$  and  $f_1$  read  $.7E$ .

Determination of the  $Q$  of a coil or circuit. Three readings are taken. One, at resonance, is a guide ( $f_r$ ). The two other frequencies,  $f_2$  and  $f_1$ , are those that reduce the VTVM reading to .7 that at resonance.

by adjusting generator output to make VTVM read full scale, then having second and third readings taken at .7 ma on a 0 — 1 ma.

The preceding formula applies because

$$\frac{f_r}{f_2 - f_1} = \frac{2\pi f_r L}{R} = \frac{X_L}{R} = Q.$$

## V. Measurement of Capacity

The variable condensers used at radio frequencies have capacities from a few micro-microfarads to about 500 mmfd. Even the condensers across intermediate frequency coils fall within this classification, although they are set once and left thus. Besides, there are fixed capacities to consider, some of them very small, for instance, the distributed capacities of coils. Where a coil has two inductively associated windings there is some capacity coupling between the windings, often large enough to measure with the instruments we are considering. Tubes have input and output capacities, also capacities between and among elements, whereas sockets, wiring, switches and the like also contribute capacity.

The fixed condensers of the mica dielectric group, usually running from a few micro-microfarads to .01 mfd., also should be subject to accurate measurement.

The condensers under consideration, being in the radio-frequency classification, which broadly includes intermediate frequencies, must be accurately measured, whereas large capacities, such as used in filters of B supplies, need not be so accurately determined.

### Few Micro-microfarads to .05

The best way to measure condensers of radio-frequency capacity values, as already classified broadly, is by using radio frequencies.

The calibrated condenser  $C$  includes the capacity effect of the tube voltmeter in all considerations broached, therefore with the aid of  $C$  we may determine small and medium capacities, say, if  $C$  is 500 mmfd. maximum, from a few micro-microfarads even to .05 mfd.

To provide a capacity range large enough, both the series and the parallel connection of the unknown condenser  $C_x$  will be recommended. First let us take up the case of the series condenser, intended mainly for measuring capacities larger than the maximum of the calibrated condenser.

If we put the unknown in series with  $C$ , and connect a coil across the circuit, from one terminal of  $C_x$  to one terminal of  $C$ , the other condenser terminals being joined, we shall decrease the capacity in the circuit, because a

# Larger Capacities Determined

series condenser does that. If C is considered as set at less than maximum capacity, with C<sub>x</sub> terminals shorted, if we put a fundamental frequency into the test circuit from G, if we insert the series condenser we increase the frequency, but can restore the original frequency by making up for the difference, turning C to higher capacity. The larger C<sub>x</sub> is, the smaller will be the amount of extra capacity to be added by turning C to higher capacity, and for values of C<sub>x</sub> smaller than C we would have to turn C a great deal, hence start with a low value of C, and in some instances would be required to turn it more to than we actually can, because the minimum capacity of C becomes a limiting factor.

It can be seen that the unknown capacity can not be read directly from the calibrated condenser, nor determined as a simple difference, but there is an easy and familiar formula for the solution:

$$C_x = \frac{C_2 \times C_1}{C_2 - C_1}$$

where C<sub>x</sub> is the unknown series condenser, C<sub>1</sub> is the setting of C with unknown terminals shorted, and C<sub>2</sub> is the setting of C at the larger capacity, required to restore resonance, after C<sub>x</sub> has been inserted and has increased the frequency of the receiver (test circuit).

It is therefore a simple matter of obtaining the product and dividing it by the difference. That, remember, takes care very well of capacities equal to or greater than the maximum of C, say, 500 mmfd. to .05 mfd. Although smaller capacities than 500 mmfd. could be measured the same way, the substitution method is simpler and works better for medium capacity values.

The substitution method consists of putting C<sub>x</sub> across a coil, feeding a fundamental frequency to this circuit from G, gaining maximum deflection in the tube voltmeter, and then removing C<sub>x</sub> and turning C until the same deflection is obtained. Then the capacity setting of C, as observed from a direct-reading dial, is the same as the capacity of C<sub>x</sub>, barring any error due to harmonics. This error may be

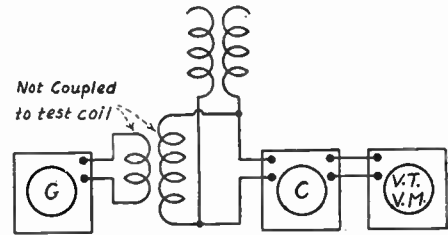
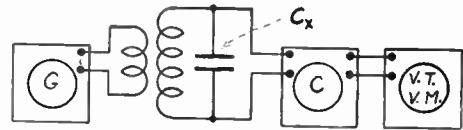

$$C_x = \frac{d}{3} - C_1$$

where C<sub>x</sub> is the unknown, d is the difference of read capacities of C for fundamental and second harmonic, and C<sub>1</sub> is the lesser of the two read capacities.

Measurement of distributed capacities and mutual capacities, also any other small capacity.

eliminated by setting the generator for maximum deflection, then turning generator to a frequency half that originally used, so that the second harmonic of the new generator frequency will actuate the tube voltmeter, although not necessarily with as pronounced a deflection. C<sub>x</sub> and the capacity of substituted C are the same if the tube voltmeter responses are only two for the same for the two generator settings.

A residual error, despite the precaution just outlined, is due to the distributed capacity of the coil, leads, etc., but this distributed capacity is deemed to be very small compared to the value of C<sub>x</sub>. What is the distributed capacity of the coil or anything else, within the tiny capacity range, say, 1 to 15 mmfd., may be determined conveniently by resorting to harmonic practice.

Suppose C<sub>x</sub> is now considered to be the distributed capacity of the coil and there is no other unknown capacity to be measured. Since C is calibrated, and includes the capacity of VTVM, these calibrated capacities under consideration are absolute. The capacities due to fundamental and second harmonic, or fundamental and higher than second harmonic, or due to respective harmonics of any order, are relative. That is, for any harmonic ratio there is a particular capacity ratio. For the fundamental and the second harmonic the capacity ratio is 4. That means that if a single frequency is generated fundamentally by G and picked up by a coil-condenser system, and detected, one-quarter the capacity necessary for picking up the fundamental will be required for picking up the second harmonic.

(Continued on next page)

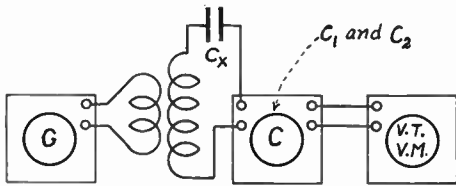

$$C_x = \frac{C_2 \times C_1}{C_2 - C_1}$$

where C<sub>x</sub> is the unknown, C<sub>2</sub> is the higher capacity setting of C and C<sub>1</sub> the setting. Larger capacities measured by putting the unknown in series. The frequency of G is always the same and is optional.



## Purposes Served by Measurements

(Continued from preceding page)

If there were no extra capacity in circuit the 4-to-1 ratio would be observed on the calibrated condenser, but the apparent ratio is increased when the unknown capacity is across C, since the variable condenser now has to be turned to smaller capacity to make up on the pressure of Cx. The lower capacity to which C must be turned is a measure of the capacity of Cx, not directly, however.

The formula relating the distributed capacity of the coil under test, or any other small capacity, to the apparent capacity ratio of the calibrated condenser follows:

$$Cx = \frac{d}{3} - Cmin$$

where Cx is the unknown capacity, d is the difference between the two capacity settings of C, one for fundamental the other for second harmonic response, and Cmin is the smaller capacity setting, the one resulting in second harmonic response. Cmin is C<sub>1</sub> in the caption, page 53.

It is therefore practical to measure the distributed capacity of the coil, and since this becomes known, it may be subtracted from the capacity determination where Cx is an external condenser across the same coil, and thus the error, though slight, due to the coil's distributed capacity is also eliminated.

The foregoing formula applies strictly and only to fundamental and second harmonic.

### Use of Smaller Condenser

If by any chance two calibrated condensers are to be used, one small, the other large, an easy way of improving the convenience of this system is to take the maximum capacity of the condenser, with VTVM capacity included, and used a fixed capacity of exactly three times that value, to be cut in. Then since the generator frequencies are wide range, the fundamental is selected to which the circuit responds with the fixed capacity and the calibrated condensers's maximum included, and when the fixed condenser is switched out, calibrated condenser still maximum, the capacity will be one-quarter the former total. Then, since C, the calibrated condenser, is small, the angular rotation of C to determine the second harmonic setting will be greater, a sort of bandspread, and closer readings naturally are enabled when the calibrated condenser is small, since only small values are to be read at the second setting of C. The formula remains exactly the same, but the bandspread improves the working accuracy. It is a matter of improved manipulation only.

While as to coils distributed capacities are the most important capacity considerations, the capacity between windings is well worth investigating, especially if the one winding is over the other, or if there is purposely an absence of inductive coupling, and a turn or so

of wire is used for capacity coupling. This may run to around 12 mmfd. for the high-gain r. f. coils in which this method is popular, and the capacity may be measured for this condition and others by connecting adjacent terminals of primary and secondary to the measuring circuit, and leaving the other terminals of the coils open. If the windings have a common point, as an antenna coil with grounded primary and secondary, open this connection so that the coil will have two distinct, unconnected windings.

### Remedying Troubles

The measurements discussed in this article are directed to fundamental quantities, and ability and equipment to make all of them will be economically required of service men and experimenters, as better and better receivers of wider and wider scope are made.

When troubles in a receiver are due to inductance and capacity misfits in the circuit, at present it is largely impossible for the service man ever to ascertain the real cause of the trouble, and he therefore can not make the repair. The difficulty arises often in connection with tracking superheterodynes, erroneous inductance always rendering tracking impossible. Likewise, wrong capacities will lead to the same blank wall in any attempt to solve tracking problems.

Capacities across audio signal line, for instance detector r. f. bypass from plate, may be too large, therefore almost wiping out the high-pitched audio frequency tones and producing muffled voice. Sections of gang condensers may be hopelessly out of synchronism, and only by precision measurement could this be ascertained, as well as the magnitude of the error.

If a spoilt coil has to be replaced in an r. f. circuit, based on an identical other coil in circuit, the inductance may be measured, and a replacement wound. If one is unable to compute the required turns, the answers may be obtained without computation by direct-reading of charts found in a book entitled "The Inductance Authority."

### Vital Measurements

If poor performance is ascribed to some indefinite cause, when a coil is bad, or a condenser turns leaky, the Q measurement will disclose the fact and at once point to the remedy. If the coil seems to be all right, except that the Q measurement suggests replacement, you can measure the inductance required, using the ailing coil, and wind or buy better grade coil of the same inductance. If a band can not be covered, due to inexplicably large minimum capacity, this minimum can be measured and traced. In oscillators this is sometimes due to absence of grid leak and condenser where they are required.

There isn't anything electrical that goes into

# A Small, Iron-Core Set

## New I.F. Coils Improve Results

By Jack Goldstein

HERE is a little broadcast-band superheterodyne, using iron-core intermediate-frequency transformers. The selectivity and gain were better than when plain transformers of the same winding type were used.

Also, to line up the intermediate channel properly a signal generator was found necessary when the iron-core transformers were used, because of the very high sensitivity. With ordinary transformers the author always had been able to line up the i.f. on such a set for satisfactory performance, even if not exactly at the specified frequency, using some station near the middle of the dial. Not so with the set with iron-core i.f. transformers. Only one station was received, and it was erroneously believed at first that the oscillator was not oscillating, until the generator played its important part.

### Judging Antenna Length

The receiver uses a two-gang condenser, capacity .000365 mfd., and a short indoor antenna. About twenty feet of wire indoors will be maximum, perhaps less wire will be found advisable in cities, so that image suppression will be better. The shorter the antenna, the higher the selectivity at the r.f. level. And since there is only one tuned circuit at this level, all the selectivity one can obtain is welcome, limited only by the fact that the antenna must be at least long enough to eradicate any rushing sound when a station is being received.

The r.f. coil is of the high-gain type, and consists of a honeycomb primary of one millihenry inductance not inductively coupled to the

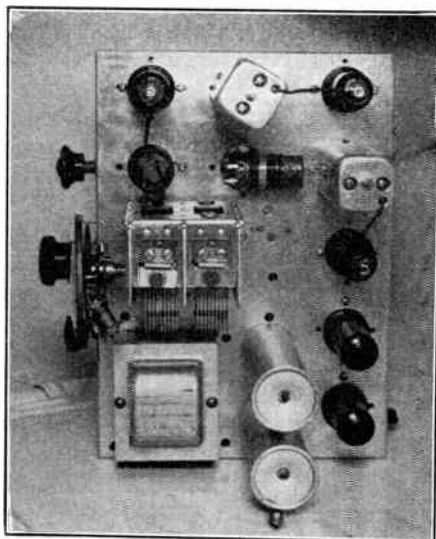

View of the top taken from an angle.

secondary, although the primary shown in the diagram might suggest such inductive coupling. Then two turns of wire leading from the honeycomb are wound around the secondary, near the

*(Continued on page 57)*

## High Accuracy in Measurements

*(Continued from preceding page)*

a receiver that is too insignificant to measure, and especially with the advancing importance of high frequencies, where small capacities have a large effect, should there be means of measuring those capacities. Also, television, whatever its status, since it will be in the high frequency carrier region, will require many measurements for proper servicing.

The success to be attained in servicing is directly related to the capability of making every measurement that a cautious manufacturer would have to make of the parts that go into the set to enable him to rate them in familiar terms. The day of a screwdriver as the sole test instrument passed years ago, and the day of requirement of scientific servicing arrived years sooner than many appreciated.

The measurements discussed in this article

should have been within the easy scope of the service man two or three years ago, whereas hardly a service man can tackle even one of them to-day. Hence so much effort and space were devoted to the problem, especially since high accuracy is the goal throughout.

The popular bridges, using carbon resistors for some arms and a variable wire-wound for the adjustment, and covering enormous ranges, may be accurate to 10 per cent., maybe a little better, but the order of accuracy we have sought is better than one per cent. Actually, most measurements have been made in practice, with the methods outlined, to .5 per cent. That is accuracy, and accuracy is what the service man wants. Or, if he doesn't want it, at least he needs it, though he may not now realize the fact. Every advance in servicing is toward greater accuracy. Never a move toward less accuracy.

# High-Performing Five-Tube Super With Iron-Core Intermediate Coils

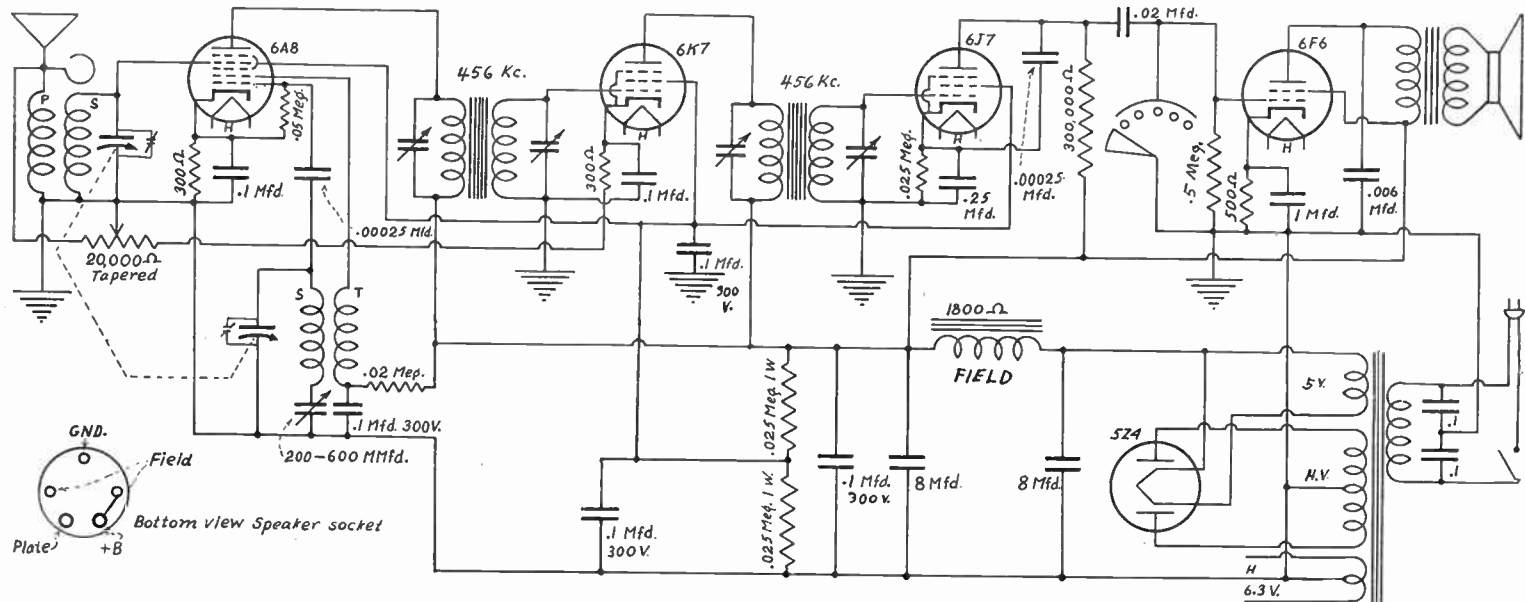

With this simple, little superheterodyne for standard broadcast reception a great deal of distance reception was enjoyed. If a short antenna is used the results as to image selectivity are sufficient. The inter-channel selectivity is excellent, also the i.f. sensitivity, due to the use of iron-core i.f. transformers. Four all-metal tubes are used and glass rectifier.

## LIST OF PARTS

### Coil

One shielded antenna coil and one shielded oscillator coil (oscillator for 456 kc). See text.

Two shielded 456 kc iron-core i.f. transformers, primary and secondary tuned.

One power transformer, known commercially as 6.3 volt transformer for five-tube set. Primary, 115 volts, 60 cycles. Secondaries: (a), 5 volts, 2 amperes; (b), 350-0-350 volts, 85 milliamperes rating or higher; (c), 6.3 volts, center-tapped, 2 amperes.

Dynamic speaker, 7,000 ohms load output transformer; speaker field, 1,800 ohms. Speaker equipped with UY (five prong) plug.

### Condensers

One two-gang .000365 mfd. tuning condenser with trimmers built in.

Two .00025 mfd. mica.

One .006 mfd. mica.

One .02 mfd. paper or mica (mica preferred). Seven .1 mfd. paper (Two at least of 300 v. d.c. rating. Rest may be of lower voltage rating, 200 v.).

One .25 mfd. paper.

One 1 mfd., paper, or electrolytic 25 volt-rating.

Two 8 mfd. electrolytic condensers, 500 volt d.c. rating. (Condensers across i.f. coils are built into those units).

### Resistors

One 20,000-ohm wire-wound tapered potentiometer with a.c. switch built in.

Two 300 ohm. One 500 ohm.

One .02 meg. One .05 meg.

Two .025 meg. (two of these one watt rating).

One .03 meg. One .5 meg.

(Resistors not specified as to wattage may be half or third watt).

### Other Requirements

Chassis. Three knobs.

Three grid clips. One dial.

One Filterette tone control.

One a.c. cable and plug.

Six sockets: four of these are octals, one is UX (four hole) and the other is UY (five hole).

The UX is for the rectifier, the UY for the speaker plug.

(Continued from page 55)

intended grid connection, for the capacity coupling effect. The coil is of commercial manufacture, but may be improvised by putting a small honeycomb inside the tubing on which the antenna coil is to be wound, so that the honeycomb is at right angles to the secondary. Hence when antenna is connected to the honeycomb, the other end of which winding is grounded, there should be scarcely any pickup. In this way the critical angle of minimum inductive coupling—theoretically zero coupling—is attained. Then the two turns are put around the secondary, as described.

### Coil-Winding Information

The secondary may consist of 130 turns of tightly wound No. 32 enamel wire on one inch diameter tubing. The inductance will be just right when the coil is put inside an aluminum shield of not less than 2 inches inside diameter.

The oscillator coil may have any of three different values of inductance, depending on which of three possible cases is followed for tracking. The case selected by the author is the one in which the oscillator minimum capacity is ascribed, and is larger than the minimum capacity across the antenna secondary. This means that the oscillator trimmer condenser is screwed farther down than the equivalent unit across the antenna secondary.

The oscillator coil may consist of 85 tight-wound turns of No. 32 enamel wire for the secondary, two turns of wrapping paper, and primary of 32 turns of the same size or finer wire wound over the paper, closely and tightly, near what is to be the grounded end of the secondary. The tube will oscillate only when the tickler is connected a certain way, so if oscillation fails, reverse the connections to the tickler.

There should be enough coupling between tickler and secondary to produce husky oscillation, yet not so high an amplitude as to overload the modulator. There are two convenient checks. If a 1.5-volt dry cell is put between cathode and ground instead of the 300 ohm resistor in the 6A8 circuit, grid grounded, and the plate current read when all other connections to the tube are complete, this may be taken as the highest quantity of plate current to be permitted for any setting of the variable condenser across the oscillator, when that condenser is padded at least approximately right. Usually the highest current obtains near the minimum capacity setting of this condenser. Remove the 1.5 volt cell, restore the 300 ohms and have the set going.

### Adjusting Tickler

Now test whether the plate current is excessive. This is done by rotating the oscillator tuning condenser (which moves along with the antenna secondary tuning section). If it is excessive, reduce tickler turns. If it is far from maximum, put on more tickler turns. You have enough tickler turns when a 0-1 milliammeter between the .05 meg. grid leak and cathode reads .5 milliamperes or a bit less at the con-

(Continued on next page)

(Continued from preceding page)

denser setting where grid current is maximum.

The oscillator coil, by the way, is to be shielded in the same way as the other one. Make all tests with coils in their shields and ground all shields. The inductance is 10 per cent. too high, or even more greatly excessive, when the shields are not in place.

### Tiedown Points

The tiedown points are 600 kc, for the series paddler (200-600 mmfd. adjustable unit) and 1,450 kc for the parallel trimmer on the oscillator. Measure off a radius 2 inches from the hub of the dial, with condenser set at minimum, then measure 1.25 inch on a straight line to the left, from the top of this radius. This line is horizontal. The point where it terminates may be extended radially to the area where the dial pointer indicates, and the condenser is turned until the pointer registers this position. Then the oscillator trimmer is turned down until there is response at 1,450 kc, and next the antenna trimmer is adjusted until this response is made maximum. That finishes the minimum capacity adjustment.

At 600 kc the dial is rocked about the supposed position where this frequency will come in, meanwhile the series paddler is adjusted until response is maximum. This finishes the tracking, unless one desires to make a slight readjustment of the oscillator is parallel trimmer to remedy possibly small displacement from the required capacity setting due to the effect introduced by the change made in the series paddler.

### Standard Circuit

The circuit is standard and is similar to circuits used by set manufacturers.

Ahead of the power tube the odd-looking device is a Filterette tone control. The five little circles engaged by the fan-type switch represent terminals of fixed condensers the other terminals of which are common to the grid. So as

more capacity is cut in, high pitched audio frequencies are reduced. This provides the tone control, or bass accentuator.

### Speaker Plug

The speaker plug diagram is given. The "grid" terminal, marked ground, may be so used by picking up the speaker frame, which it is well thus to ground. The field of the speaker is the B choke and will reduce hum more when connected one way than when connected the other way, so try both methods.

Some constructors do not know how much can be accomplished with a small set such as this. They are recommended to try it, for they will be surprised at the excellence of the performance, the great amount of distance reception obtainable, and the large volume output, even on distant stations.

## Ultra Waves Now Used for Secret Facsimile

A system of sending facsimiles on ultra short waves, with absolute secrecy and privacy, was opened by RCA between New York City and Philadelphia.

Automatic repeater stations, which catch the micro waves flying in both directions and fling them on to their destinations at New York and Philadelphia, are located at New Brunswick, N. J., and Arney's Mount, near Trenton, N. J. Since the range of three meter radio waves is virtually limited to line-of-sight, the points of reception and transmission for each of the stations were selected to provide the most distant optical horizon. In New York and Philadelphia, therefore, the antennas are located atop tall office buildings, whereas the intermediate points of New Brunswick and Arney's Mount were chosen for their favorable terrain.

## New Triplett Tube Tester Ten Instruments in One

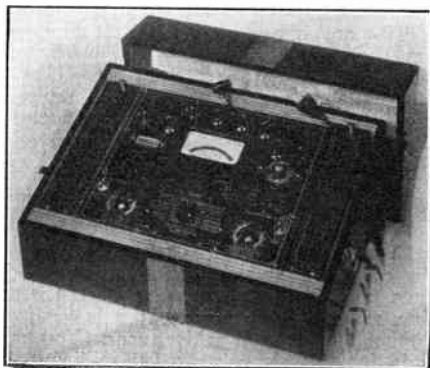

Triplett Model 1501.

Demand for compactness in radio servicing equipment is answered by the Triplett Model 1501 Multi-Purpose Power Output Tube Tester which combines the equivalent of ten separate units in one instrument.

This addition to the popular Triplett line instantly rejects any glass, glass-metal or metal tubes that will not perform in a radio receiving set. It tests tubes for their worth by amplification tests, neon short tests, separate diode tests, metered paper condenser tests (for short and open) electrolytic condenser leakage tests; dc voltmeter and milliammeter, ohmmeter, ac voltmeter, decibel meter, and impedance tests. The instrument is furnished in a quartered oak case with sloping panels for either portable or counter use. Model 1501. List price is \$70. The manufacturer is the Triplett Electrical Instrument Co., Bluffton, Ohio.

# POWER plus PORTABILITY At LOW COST!

PORTABLE CRYSTAL P.A.

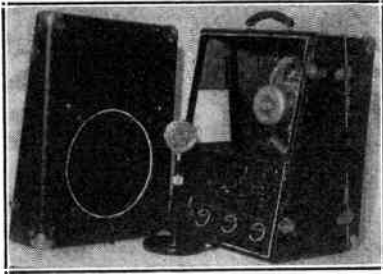

THOR presents in this model a truly compact high quality Portable outfit. Complete with all components. This system is ideal for any application. The sound specialist who requires the finest in tone reproduction can purchase this outfit to fill a multitude of purposes at an exceptionally low price. This outfit presents a perfect sound system for the theatre, dance orchestra, lecturer, entertainer and for all rentals. All units fit together to form one complete unit. Entirely portable. Amplifier contains all controls including speaker supply. Crystal Pre-Amplifier and Selector Switch to operate one or two speakers as desired.

Complete system with all parts as listed. Crystal mike and floor stand included. Ready to operate..... **59.90**

## BABY GRAND

3-TUBE POWER AMPLIFIER using 57-2A5-80 to deliver full 4 watts output. Manual volume and tone controls mounted on control board. An ideal P.A. rig for home record reproduction and communication work. Completely self-powered. Overalls parts. Complete in black crackle case, built-in Rola 6" Speaker and 3 **10.95**



RCA tubes for AC Size 10x6x7. Shipping weight 18 lbs. Universal AC-DC. 25Z5-6C6-43 complete..... **11.95**

## MIGHTY MITE AMPLIFIER

FULL 4-WATT OUTPUT from 57-2A5-80. Volume and tone control on rack. A rugged compact with oversize parts that fills a multitude of purposes, 2500 ohm. Speaker used as choke. Size 8x7x6. Shipping weight 12 lbs. Completely wired ..... **5.95**



Set of 3 RCA tubes 1-57, 1-2A5, 180... **1.21**  
8" Dynamic Speaker with Output Transformer to match ..... **2.29**

SEND FOR FREE DIAGRAMS—  
Shortwave—Battery—Amplifiers—Tuners

ORDER DIRECT FROM THIS AD 24-HOUR SERVICE



167 Greenwich Street, near Cortlandt St. New York City

## EMERSON AUTO 6 A

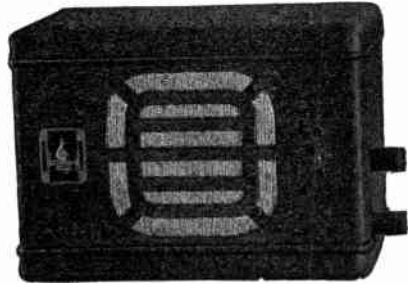

Compact in size, 9 1/2" wide, 6 1/2" deep, 8 1/2" high. Complete with RCA tubes, all mounting bolts and instructions. Backed by Thor's satisfaction guarantee. Ride to music with a genuine EMERSON. **21.50**

## BATTERY PORTABLE



Portable Battery Receiver, 6-Tube Powerful Super-heterodyne using new sensitive low drain 2-volt tubes. 3-1 B 4, 1-30, 1-950, 1-52, 3-6 A 6 G, condenser, RCA inductor speaker. All self contained with batteries in leatherette case, 11" x 7" x 17". Tuning range 1700-540 kc. Dial calibrated in kilocycles. Battery unit delivers 135 volts B, 3 volts A, 4 1/2 volts C, an ideal set for all portable uses, highly sensitive rugged and economical. Complete with tubes and batteries, ready to operate. Fully guaranteed. Shpg. weight, 25 lbs.

**\$19.95**

## THOR'S HI-FIDELITY TUNER

A 5 Tube TRF tuner designed solely for quality reception in conjunction with P.A. outfits. Covers the broadcast band with a circuit using Litz wound coils and 4 wax condensers with the following tubes:

3-8D6, 1-76, 1-80.

Available in 2 1/2 volt models. Completely mounted on chassis, 10 1/2 x 13 1/2 x 8 with aeroplane dial and built-in plug for P.A. outfit so switch turns both at one operation. Sensitivity and tune controls incorporated in tuner. Supplies all its own voltages from built-in power pack. Complete kit of parts including **11.50**

all diagrams and instructions. Ready to wire

Set of 5 RCA tubes. Shipping weight **2.29**

20 lbs. ....

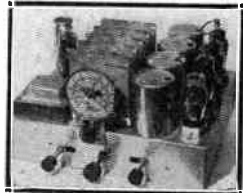

Mail orders require 20% deposit all items over 10 dollars. 24-HOUR SERVICE

## CLASSIFIED ADVERTISEMENTS

7 cents a word. \$1.00 minimum.

**MAKE \$10.00 DAILY**, manufacture new products. Sample and outfit, 10 cents coin. Paye, Sneedville, Tennessee.

**TAKE ADVANTAGE OF LOW YEN.** Two elegant genuine silk neckties postpaid from Japan, \$1.00. Order through Roscoe, California branch. Satisfaction absolutely guaranteed. John Hayes, 9142 Wheatland Ave., Roscoe, California.

**WE NEED TEACHERS** at once for vacancies now listed; write us your qualifications. Teachers' Exchange, Kansas City, Kansas.

**AUTO RADIO SERVICE MEN!** Send one dollar for complete instructions and material for reconditioning worn Vibrators. Results positive. R. Morrissey, 138A Riverside Ave., Medford, Mass.

**USED I. C. S. COURSES** bought, sold, rented. Bargain catalog free. R. Whaley, Fort Payne, Alabama.

**OPPORTUNITIES. MAKE JOB FOR YOURSELF.** Start profitable business without capital. Part or full time. Send 25c for plan. McCrea, Box 158, East Akron, Ohio.

### A COMBINATION OFFER! RADIO WORLD and "RADIO NEWS"

## \$3.50

Canadian and Foreign, \$1.50 extra on this offer.

You can obtain the two leading radio technical magazines that cater to experimenters, service men and students, for one year each, at a saving of \$1.50. The regular mail subscription rate for RADIO WORLD for one year is \$2.50. Send in \$1.00 extra, get "Radio News" also for a year—a new issue each month for twelve months. Total 24 issues for \$3.50.

RADIO WORLD, 145 West 45th Street, N. Y. City



## G R E A T E S T

Book Ever Printed  
for Radio Amateurs  
and Experimenters  
1936 EDITION

of *'THE RADIO Handbook'*



**ALMOST 400 PAGES  
ONLY \$1.00 PER COPY**

▲ Many radio books are published, some you'd like to have, others you ought to have, and just a few others you **MUST** have. Here is one of the **MUST** list—"The Radio Handbook," with transmitter and receiver circuits galore, a wealth of fundamental radio information for amateur and experimenter, and what's more, everything authoritative. Imagine! Almost 400 pages, and only \$1, *postpaid*. Send that dollar now, get the book quickly, and study it slowly, when finished you'll know amateur radio and experimenting, if you don't now. And if you do now, you'll think you didn't after you have.

Send Check, M. O. or Currency to:

**R A D I O W O R L D**  
145 WEST 45th STREET, NEW YORK CITY

### METAL CHASSIS

We can supply chassis for any make receiver, experimental or otherwise.

Inquiries should be accompanied with sketch and complete details enabling us to give quick service as to prices and delivery.

Dept. R.W. 736

**KORROL MFG. CO., Inc.**  
232 Greenwich St. New York City

# Coil Winding Made Easy

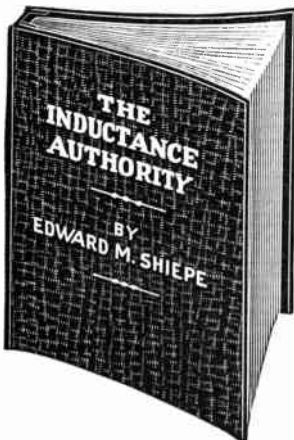

The biggest help anyone can get who desires to wind radio-frequency coils for any frequency from just below the audio range to the fringe of ultra frequencies is to have a book that tells just what inductance is required for the condenser one possesses, and just how many turns of any kind of wire on any sensible diameter are needed to produce that inductance. "The Inductance Authority," by Edward M. Shiepe, gives you all that information, to an accuracy of one per cent. Send \$2.00 and book will be mailed you postpaid; or send \$5.00 for a two-year subscription for Radio World and this valuable book will be sent free.

RADIO WORLD

145 WEST 45TH STREET, NEW YORK CITY

# "NOISE SILENCER"

## ELIMINATES "MAN-MADE" STATIC!

The noise "Check Valve", a development of James J. Lamb, editor of QST, has been acclaimed as one of the greatest discoveries in radio! Attached to any superheterodyne receiver, it eliminates noises caused by any sparking motors (oil burners, vacuum cleaners, fans, etc.) automobile ignition, high tension lines, dial telephones, etc. Reduction of noise as high as 1000 to 1 in power on sharp interference!

Just attach the noise silencer unit to rear or side of your receiver and make three simple connections. A few minor adjustments as outlined in the instructions and you enjoy real noise-free reception. Works on all wave-lengths. The louder the interference the easier it is to completely cut it out!

HARRISON presents a very compact version of this amazing invention as described in QST and other magazines. A neat metal case measuring only 2" x 5½" x 4½" houses all necessary parts and the three tubes. Draws only negligible current from receiver.

For SUPERHETERODYNE Receivers only. (Both BCL, SWL, and Amateur). Mention make and model of set when ordering.

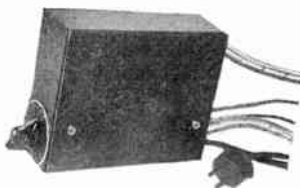

### COMPLETE KIT

of all necessary first grade parts, crystal finished cabinet, with all holes drilled, and complete instructions, less tubes, unwired.

**\$3.85**

Three Sylvania metal tubes..\$2.50  
Completely wired, ready to attach and operate, with tubes .....\$8.55

**FREE!** Send Stamp for Complete Diagram and Instruction Sheet

VISIT OUR NEW STORE  
(Between Vesey, Barclay and Greenwich Sts.)

# HARRISON RADIO COMPANY

12 WEST BROADWAY

RW-7

NEW YORK CITY

...perfect radio tuning

# MAGIC LION

You'll want one of these Cathode Ray Tuning Indicator Units!



Complete with tube \$8.75

Here's the last word in visual tuning indication. A high efficiency unit and tube housed in a beautiful bronze finish metal statuette. This combination of art and science will delight you! MAGIC LION brings the latest feature of high priced new radios to your present set. Easily quickly installed. Order from your jobber or write. (Specify type of cathode ray tuning tube desired—2E5, 6E5 or 6G5).

Magic Lion Mfg. Co. 56 Gold St., N. Y.

## RADIO ENGINEERING

RCA Institutes offers an intensive course of high standard embracing all phases of Radio. Practical training with modern equipment at New York and Chicago schools. Also specialized courses and Home Study Courses under "No obligation" plan.



Dept. WR-36  
RCA INSTITUTES, Inc.  
75 VARICK STREET, NEW YORK, N. Y.  
1154 MERCHANDISE MART, CHICAGO, ILL.

Recognized Standard in Radio Instruction Since 1909

WHEN WRITING TO ADVERTISERS  
PLEASE MENTION THAT YOU SAW THE  
ADVERTISEMENT IN RADIO WORLD.

## SPECIAL 2-FOR-1 OFFER RADIO WORLD

Radio World is \$2.50 a year (12 issues), 25c per copy. Canada and foreign, \$3.00 yearly. Trial sub., 5 issues, \$1.00. Offers of Radio World and other worthwhile publications for one full year on each, (NET), as follows:

- RADIO WORLD and SHORT-WAVE CRAFT, \$3.50.
- RADIO WORLD and POPULAR SCIENCE MONTHLY, \$3.50.
- RADIO WORLD and RADIO-CRAFT (12 issues), \$3.50.
- RADIO WORLD and RADIO INDEX (monthly, 10 issues) stations, programs, etc., \$3.50.
- RADIO WORLD and EVERYDAY SCIENCE and MECHANICS (monthly), \$3.50.
- RADIO WORLD and SERVICE (monthly), \$3.50.
- RADIO WORLD and TRUE STORY (monthly), \$3.00.
- RADIO WORLD and BOYS' LIFE (monthly), \$3.50.
- RADIO WORLD and LIBERTY (weekly), \$3.00 U. S. only.

Select any one of these magazines and get for an entire year by sending in a year's subscription for RADIO WORLD at the regular price, \$2.50, plus the additional amount, per quotations above. (Add \$1.50 for extra foreign or Canadian postage for both publications.)

Name .....

Address .....

City and State.....



## MAILING LISTS



GET OUR FREE  
**REFERENCE  
BOOK and  
MAILING  
LIST CATALOG**  
**FREE**

Gives counts and prices on accurate guaranteed mailing lists of all classes of business enterprises in the U. S. Wholesalers—Retailers—Manufacturers by classification and state. Also hundreds of selections of individuals such as professional men, auto owners, income lists, etc.

Write today for your copy

## R. L. POLK & CO.

Polk Bldg.—Detroit, Mich.  
Branches in Principal Cities

World's Largest City Directory Publishers  
Mailing List Compilers. Business Statistics.  
Producers of Direct Mail Advertising.

## SUBSCRIBE NOW!

RADIO WORLD, 145 West 45th St., New York City. Enclosed please find my remittance for subscription for RADIO WORLD, one copy each month for specified period.

- Two years, 24 issues, \$4.50.
- One year, 12 issues, \$2.50.
- Trial sub., 5 issues, \$1.00.  
(50c extra per year for Canadian and foreign postage.)
- This is a renewal of an existing mail subscription (Check off if true).

Name .....

Address .....

City .....

## Easy to Duplicate Circuits We Print

PARTS for all circuits described constructionally in RADIO WORLD are obtainable. If trade names are not identified in text, identification can be obtained quickly by addressing Information Editor, RADIO WORLD, 145 West 45th Street, N. Y. City.

### IRON CORE I.F.

GET in line with the latest developments in coil design. Use iron-core i.f. transformers and increase selectivity and sensitivity. Results are amazing. Let us prove it with our latest iron-core i.f. transformers for 456-470 kc (adjustable within this range), double tuned on top. As much gain and selectivity with one iron-core i.f. stage (two coils), as with two stages (three coils) using ordinary transformers. Shield size 3.5 x 1.5 inches. Price, postpaid. \$1.15 each.

### TWO-GANG SUPER

One high-gain r.f. and one oscillator coil, both shielded, for 365 mmfd. condenser (requires 200-600 mmfd. padding, not supplied). Both postpaid .....\$1.25

### "FAVORITE" T.R.F. SET

Set of three special shielded coils for Metal-Tube "Favorite" T.R.F. Set described in April, 1936, issue of Radio World. All three, postpaid. \$1.85

### FREE DIAGRAMS

Enclose stamped self-addressed envelope for free diagrams of t.r.f. and superheterodyne circuits for home construction.

### RADIO DESIGN COMPANY

1353 Sterling Place

Brooklyn, N. Y.

## Radio World Advertising Rates

	1 time	12 times
Full Page—5½x8" .....	\$75.00	\$60.00
½ Page—5½x4" or 2½x8" .....	37.50	30.00
¼ Page—2½x4" .....	18.75	15.00
⅛ Page—2½x2" .....	9.38	7.50
One inch, single column....	5.00	4.00
Agate line .....	.38	.34
Classified—7c. per word, minimum	\$1.00.	

### Color Pages (2 colors):

Inside front cover.....	\$90.00
Inside rear cover.....	90.00
Back cover .....	90.00

## WALLY'S

Largest dealer service in the city.  
Cracker-jacks on tough installations and motor noise elimination.

(Authorized All Makes)  
AUTOMOTIVE AND MARINE SPECIALISTS  
HUDSON TERMINAL GARAGE BLDG.

61 Day Street, 1 block south Fulton St., New York City  
Worth 2-8080                      Worth 2-5151

# H. G. CISIN'S \$2 AIR SCOUT JUNIOR ALL WAVE KIT

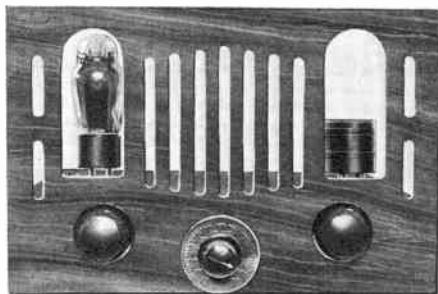

Complete \$2 Kit includes all parts, tube and two coils covering 70 to 550 meters as well as picture wiring diagram and instructions.

Auxiliary Parts (sold only with kit) consist of 2—flashlight "A" batteries, 10c ea.; 22½ volt "B" battery, 75c; wood chassis kit, 45c; 10 to 20 meter coil, 25c; 15 to 45 meter coil, 25c; 40 to 80 meter coil, 25c.

Vincent M. Poll of 1201 Wood St., Dubuque, Iowa brought in VK3ME, Melbourne, Australia, JVN Nazaki, Japan as well as many European stations on his \$2 Air Scout Junior. Carleton Whitney, 20 Chestnut St., Needham, Mass. received Spain, England, Germany clear as a bell. Thousands of other immensely satisfied owners.

**AMPLIFIER KIT:** Complete with Speaker, Tube and all parts ..... \$3.50  
**SPECIAL OFFER:** LOUD SPEAKER MODEL AIR SCOUT JUNIOR KIT, consisting of \$2 Kit and \$3.50 Amplifier Kit ..... Only \$5.00

H. G. CISIN, Chief Engineer

**ALLIED ENGINEERING INSTITUTE**  
 Dept. 6C, 98 Park Place, New York, N. Y.



## Great CATALOG with Everything in RADIO

### You need . . . these 2 books

#### PRINCIPLES of PUBLIC ADDRESS SYSTEMS

A practical handbook, full of useful information, fully illustrated, written by M. N. Beitman, an engineer and noted authority on audio amplifiers.

Considers in detail various microphones, radio and phonograph inputs, acoustic feedback, mixing and volume controls, use of vacuum tubes, interstage coupling, power amplifiers, output coupling, loud speaker placement, the decibel, P.A. measurements, power level, and other points of importance, including actual circuit diagrams of tested P.A. systems.

#### MATHEMATICS of Radio Servicing

Introduces and explains the use of arithmetic and elementary algebra in connection with units, color code, meter scales, Ohm's Law, alternating currents, ohmmeter testing, wattage rating, series and parallel connections, capacity, inductance, mixed circuits, vacuum tubes, curves, the decibel, etc., etc., and has numerous examples.

Plainly written and easy to understand. Only useful data included. M. N. Beitman, author. Size, 8½ x 11 in.

Price, 50c each book.

#### SUPREME PUBLICATIONS

3727 West 13th St., Chicago, Illinois



Write for the new ALLIED Spring and Summer Radio Catalog for 1936.

A complete book, a man's size book, an honest book, with 136 value-loaded pages. Four complete sections—an elaborate "Ham" Section, a complete new Set-Builders Section, a handy Service Section, a luxurious Public Address Section, 10,000 parts; kits, sets, tools, books, etc.—Everything for Everyone in Radio. Write now for your copy.

**FREE**  
 Spring & Summer  
 CATALOG

### ALLIED RADIO

ALLIED RADIO CORP. Dept. WR  
 833 W. Jackson Blvd., Chicago, Ill.

Send me your FREE Spring and Summer Catalog.

I am especially interested in.....

Name.....

Address.....

City..... State.....

# ATTENTION!! Experimenters **SHORT-WAVE** Builders, Servicemen—"RACO" "Shows You How To Build Your Own"



**Raco makes it possible for you to build your own Signal Generator as pictured on the left.**

This instrument has been on the market for the past two years, as our Model No. 339 All Wave Direct Reading Signal Generator. The highest requirements of precision and convenience for all around work are met in the Model No. 339 to measure frequencies from 54—17000 kc. and line up channels. It also serves for determining the frequency of a station that is being received. Model No. 339 is outstanding because though All-Wave, Switch type, Direct Reading, Airplane Dial, Attenuator, Removable Modulation, it will give you accuracy of better than 1% and compares favorably with models selling at five times the cost. There is no experimenting on your part, no tinkering with matching coils, calibrating curves, just assemble and wire with our easy panel layout. We have done the laboratory developing and research work. . . . NOW we enable you to purchase the heart of the instrument and its necessary components as follows:

Unit 339-A—Precalibrated coils with band switch (covering frequencies from 54—17000 kc.)	\$2.10
Unit 339-B—Calibrated direct reading airplane dial with plated escutcheon	\$1.45
Unit 339-C—Variable condenser to match (.000402)	\$1.05
Unit 339-D—Crystalline cabinet, panel and base punched and drilled, with attenuator plate	\$1.65
Unit 339-E—Neon modulator lamp and 350 ohm AC-DC line cord	\$ .65

## We Will Supply With Any Unit Full Wiring Instructions



Write for free descriptive circular on the Haynes R-S-R and other RACO PROD-UCTS kits.

Unit R-3—Crystalline panel and base, drilled and punched ready to assemble	\$1.70
Unit R-4—Raco 4½ inch airplane dial with escutcheon	\$1.35
Unit R-5—Three matched R. F. chokes	\$ .60
Unit R-6—Matched dynamic speaker with panel grill	\$1.85
Unit R-7—Audio and AC-DC chokes	\$1.35

### Haynes R-S-R 2½-555 Meter Receiver

As featured in Radio News, N. Y. Sun, Radio World, Short-Wave Magazines and others. **ACCLAIMED** the finest all purpose all wave receiver. The only set to give you so large a coverage. Guaranteed for foreign reception, apex and 5 and 10 meter stations. Thrill as you build the RACO way and **SAVE**.

Unit R-1—Completely wired switch coil assembly covering 15 to 555 meters with switch name plate. Condenser required .00014 cap. \$2.20

Unit R-2—Completely assembled tuning device mounted on bakelite base covering 2½ to 10 meters complete with coils and trimming condenser \$2.10

**RADIO CONSTRUCTORS LABS. 136 Liberty St., N. Y. C., N. Y.**

# Here's a New Signal Generator that "Does Everything" — Only \$12.40

**T**HE latest model signal generator, T-37, from the laboratories of Superior Instruments Company, besides affording all-wave coverage on fundamentals, and other usual advantages, contains exclusive and vitally valuable features. Although priced sensationally low, Model T-37 makes higher priced devices suffer by comparison.



## Surprisingly Comprehensive Performance!

**T**AKE, for example, two of the outstanding refinements: The radio-frequency output may be taken from a high impedance or a low impedance post, with attenuation present for either. Also, the front panel has two extra posts that enable leakage tests. Thus condensers may be checked for leakage, so may tubes, and other normally high resistance circuits, otherwise difficult to test. For instance, the usual ohmmeter will not check them; conditions in the megohm range must be handled.

The radio-frequency coverage is from 100 kc to 20 mc, in five bands, selected by front panel switch. These bands are:

- (A) 6 to 20 mc
- (B) 2 to 6 mc
- (C) 660 to 2,000 kc
- (D) 220 to 660 kc
- (E) 100 to 220 kc

The dial is direct reading in frequencies, and the five coil-switch positions are designated alphabetically, also in frequency ranges. Full particulars of other functions are imprinted on the panel scale.

Model T-37 works on 90-130 volts, a.c. or d.c. The a.c. may be of any commercial frequency.

## Sensational in More Than Price Only!

Two type 37 tubes and a neon tube are used. One of the 37's is used as Hartley r.f. oscillator, the other as the rectifier. The neon tube is the audio oscillator.

The modulation, or tone, is about 1,000 cycles, and may be included or excluded, as desired, by front panel switching.

The purpose of Model T-37 is to enable adjusting the intermediate and radio-frequency amplifiers, 100 kc to 20 mc, at precisely the right frequency, getting each circuit in exact tune, for maximum gain and maximum selectivity. Model T-37 enables the lining up of superheterodynes and tuned radio frequency sets.

As another unusual feature, posts are included for separate audio output, at two amplitude levels, so that the tone may be used for checking public address systems, audio amplifiers in receivers, and speech amplifiers in transmitters.

Model T-37 is all-purpose, finely made, sturdily built, the most generous offering of a standard signal generator. Order one now.

Model T-37, All-Wave Signal Generator, wired, calibrated, tested; complete with three tubes, in shield cabinet with carrying handle and instructions (shipping weight 7 lbs.).....\$12.40

**SUPERIOR INSTRUMENTS COMPANY**  
**139 CEDAR STREET, NEW YORK, N. Y. Dept. W-7**

**HURRY!**  
GET THIS

**FREE**

**RADIO CATALOG**

Anything and everything in radio—Sets, Parts, Tubes, Kits, Amateur Equipment, Sound Amplifiers and Systems. Whatever you need when you need it—plus the fastest, most dependable service in the field! Send for this FREE catalog—the shopper's guide to radio—used by fans, amateurs, experimenters, service men and dealers. Shows lowest Wholesale prices on standard nationally advertised radio merchandise. Mail convenient coupon NOW!



WHOLESALE RADIO SERVICE CO., INC., DEPT. G-11  
100 SIXTH AVENUE, NEW YORK  
Please RUSH a FREE copy of your big, exclusive radio catalog.

NAME .....

ADDRESS .....

TOWN ..... STATE .....

**WHOLESALE RADIO SERVICE CO.**  
CHICAGO, ILL.  
901 W. JACKSON BLVD.  
NEW YORK, N.Y. ATLANTA, GA.  
100 SIXTH AVE. 430 W. PEACHTREE ST NW  
BRONX, N.Y. NEWARK, N.J.  
542 E. FORDHAM RD. 219 CENTRAL AVE.

**TRANSFORMERS**

FOR ALL PURPOSES

for example:

**TRANSCEIVER TRANSFORMERS**

- F-532-B—Microphone and Plate Primaries to Grid Secondary. Uncased, light weight, Net.....\$1.92
- F-533-B—Transceiver Output from plate of 33, 38, 41, etc. to 130,1000 or 2000 ohm handset or phones..\$1.00
- F-536-B—Similar to F-532-B but for more powerful Transceiver using a 19 as push-pull R.F., 30 as audio driver, and 19 as Class B Modulator .....\$1.95
- F-534C—Class B Input, 30 driver to 19 Grids Class B .....\$1.80
- F-535-B—Class B Output from 19 Twin to modulate 19. Sec. handles plate current of r.f. stage, impedance approx. 2700 ohms, or any 7 watt stage approx 50 m.a. at 135 volts.....\$1.17



**General Replacement Transformers**

will be found in our CATALOGUE No. 51-C

- Three examples out of 161:
- No. 210—300-0-300 V. 40 m.a.; 2.5 V. 5.5 A; 5V. 2A.....\$1.11
  - No. 209—330-0-330 V. 60 m.a.; 2.5 V. 8.75 A; 5V. 3A.....\$1.80
  - No. 1103—Single Plate to Push-pull Grids .....\$1.98



High Fidelity Audio Transformers for Public Address, Broadcast and Amateur Stations will be found in our catalogues No. 70, No. 70-A. Description of all types for microphones, matching, interstage, and output, all fully cased and shielded. Useful diagrams included.

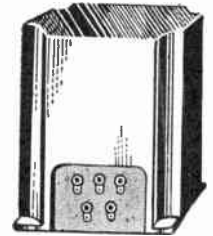

**AMATEURS!**

SEND FOR CATALOGUE No. 52-C



Contains nearly a hundred stock transformers and chokes for all power phone and C.W. rigs, designed by Boyd Phelps. W2BF, W9BF. Illustration shows FTP-56 which delivers 1/2 K.W. and costs \$9.50 net.

Any of the above catalogues free for the asking. If in a hurry, order direct from this ad or see your local jobber. If he does not have these lines tell him he is missing something well worth while.

**FRANKLIN TRANSFORMER MANUFACTURING COMPANY**

607-609 22nd Ave. N.E., Minneapolis, Minn.

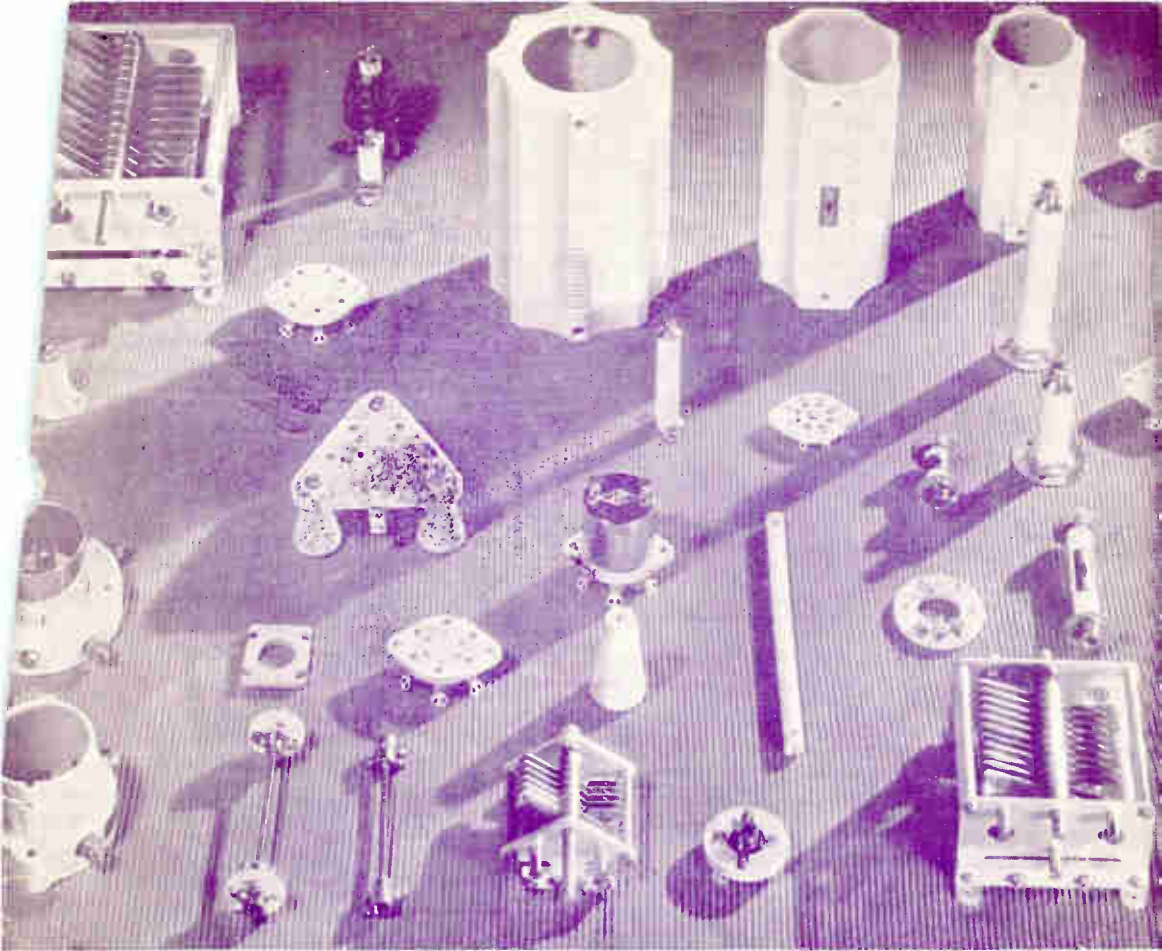

• National offers a thoroughly engineered part for nearly every radio purpose. The entire line cannot be compressed into our twenty-page catalogue, much less a single page. But look over the group above. Transmitting condensers from the little 1000 volt TMS in the foreground to the 12,000 volt TMA at the rear. Low loss ceramic coil forms for every amateur band. Low loss sockets for nearly every tube type, from acorns to power pentodes. Flexible couplings from the little TX-12, which will work around a corner, to the big fellows for heavy condensers, high voltages, and low-losses. Strain insulators, spreaders, lead-ins for the antenna; stand-offs, chokes, dials for the rig. National has what it takes.

NATIONAL



COMPANY

# DUST...

## "THE ENEMY OF PRECISION"

IS SEALED OUT OF



**FACTORIES**

Photos show relative size of "NEW" 3" square instruments. Triplett 3" Instruments now available in all popular ranges at attractive prices.

QUALITY in fine instruments is dependent upon infinite care in manufacturing. Dust, because of its minuteness, is truly the enemy of precision.

In the new Triplett factory dust is sealed out: the entire manufacturing space is airconditioned and the air is filtered. The temperature—another important factor in building precision instruments—is permanently controlled, both winter and summer. A truly modern plant, modernly

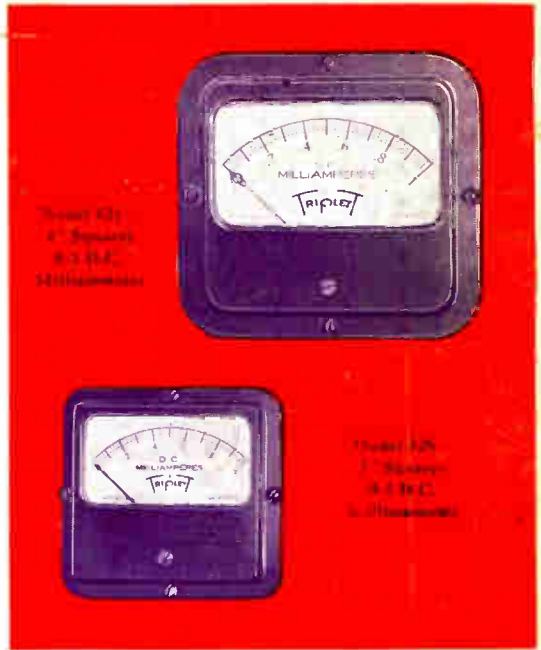

equipped for producing today's most modern instruments.

Try Triplett Instruments for a new conception of Quality.

TRIPLETT MANUFACTURES a complete line of all sizes and styles electrical measuring instruments for radio, electrical and general industrial purposes both standard and custom built. If you have an electrical instrument problem, write to TRIPLETT.

**See them at your jobbers**

*Write for details.*

### MAIL THIS COUPON:

Triplett Electrical Instrument Co.  
277 Harmon Dr., Bluffton, Ohio

Without obligation, please send me

..... More information on NEW Square Instruments.

..... New 1936 Catalogue.

Name .....

Address .....

City..... State.....

