

BLUEPRINT OF 5 TUBE 2½ TO 555 METER SET

RADIO WORLD

REG. U. S. PAT. OFF.

WORLD

THE HOW-TO-MAKE-IT MONTHLY 14th Year 25c Per Copy

NEW NOISE SILENCER

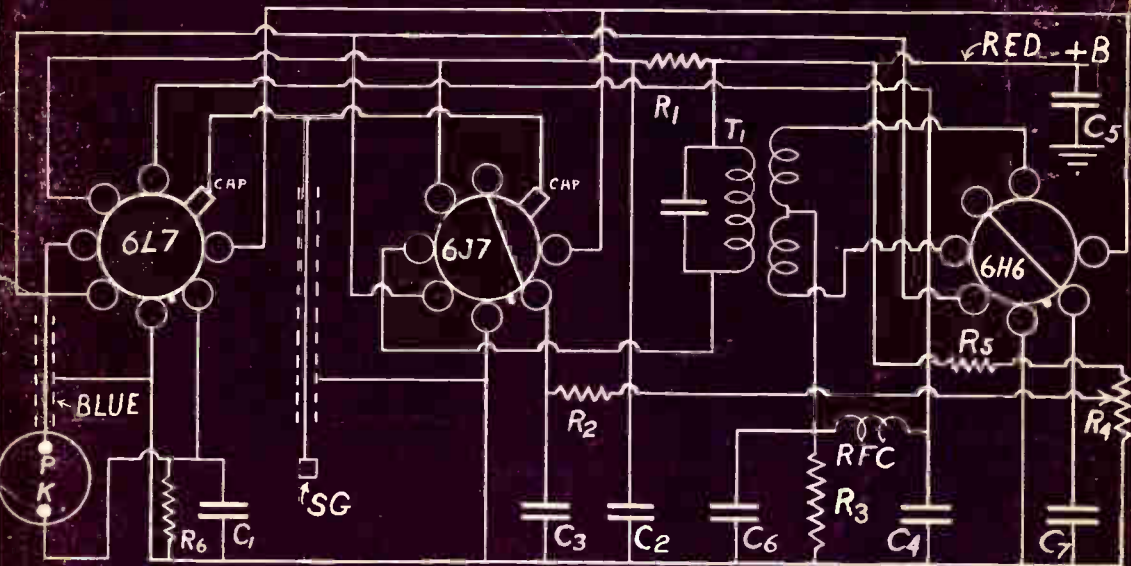

Diagram of a noise silencer. The plug PK picks up plate and cathode of the last i.f. tube at socket. The 6L7 replaces the removed tube, though on the separate chassis. Heaters are shown in parallel, for connection to 6.3 volts a.c. or d.c. For constants see page 11.

MARCH
1936

CORNELL- DUBILIER

Dry Electrolytic

CONDENSERS



THE built-in quality and inherent dependability of a condenser is a factor that cannot be measured on any known metering device. It is a factor that can only be established after years of consistent and unfailing service.

FOR the past twenty-six years Cornell-Dubilier has been supplying the radio and allied fields with condensers of every description. That these renowned condensers have been giving uninterrupted, dependable service is substantiated by the fact that the largest transmitting stations, United States Government departments, leading radio set manufacturers, specify and use C-D capacitors.

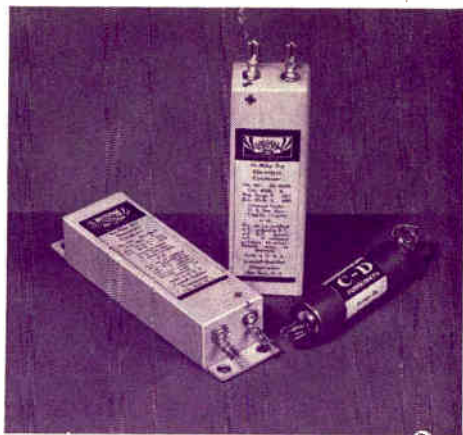

Check these outstanding features of the C-D line of electrolytic condensers:

- ✓ Hermetically sealed in three containers.
- ✓ Manufactured with the High Formation anodic plate.
- ✓ Precise construction—no corrosion—longest life.
- ✓ Constant capacity characteristics at all temperatures.
- ✓ Negligible leakage, and power factor.
- ✓ Available with either lug or wire lead terminal assembly in cardboard and aluminum containers.
- ✓ For panel or sub-panel mounting.
- ✓ Complete capacity range at voltages from 25 to 500 volts.

ALSO A COMPLETE LINE OF
PAPER, MICA and DYKANOL CONDENSERS

Remember! All C-D condensers are unconditionally guaranteed for one year.

Available at all leading distributors. Descriptive literature on the complete line furnished upon request.



CORNELL-DUBILIER

C O R P O R A T I O N

4343 BRONX BOULEVARD • NEW YORK

EILEN 6A SHORT WAVE RECEIVER

A Giant in Performance

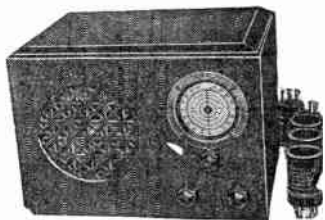

The most compact, powerful, and efficient short wave receiver of its kind in the short wave field. Uses 6K7—6F7 (twin 2 in 1 tube) — 6C5 — 12A7 (twin 2 in 1 tube) hi-gain tubes as RF amplifier, screen grid regenerative detector, **POWERFUL 3** stage audio frequency amplifier, rectifier and complete built in power supply. Operates entirely from the 105 to 130 volt AC or DC house lighting system. Entirely self contained. No external accessories whatever required.

FULL 6 TUBE PERFORMANCE — BAND SPREAD TUNING CONTROL — built in loud-speaker — automatic headphone jack — beautiful, large, illuminated airplane type vernier dial—smooth regeneration control — large 3 winding low loss inductances — selectivity, and volume that will amaze you—all combine to make this an unusual value in short wave apparatus that you cannot afford to miss. **ORDER YOURS TODAY! YOU'LL NEVER REGRET IT!**

Heavy, black shrivel, finished metal chassis and cabinet. Must be seen to be appreciated. Capable of good foreign SW reception under proper conditions.

Eilen 6A Kit, of necessary parts, coils for 9½-200 M. and instructions.....\$ 7.45
 Beautiful cabinet, extra 1.25
 Set of matched tubes..... 3.15
 Special loudspeaker 1.45
 Broadcast band coil 1.25

SPECIAL: Complete kit, cabinet, tubes, loudspeaker and BC coil..... 12.45

Labor for wiring and testing, extra.....\$ 1.50

FREE: Large, illustrated, catalogue of short wave receiving and transmitting kits, parts and accessories. Send for **YOUR** copy.

PROMPT SHIPMENTS.

20% deposit on C.O.D. orders

EILEN RADIO LABORATORIES

136 Liberty St., New York, N. Y.

Dept. RW 3

FREE



Right up to the minute! Every last minute price change! Every latest development! All leading manufacturers represented! What more can anyone ask from a catalog!

You'll find a large selection of Lafayette Public Address Equipment . . . amplifiers from 3½ to 100 watts for every conceivable occasion, complete system, portable and mobile. There are auto radios, aeri-als, parts and accessories while a big section is devoted to receivers from 4 to 24 tubes.

Remember — **NO** non-essentials; only fast selling profit-making summer sellers! Be sure to get your copy today.

EXCLUSIVE HAM CATALOG

If you have not received your copy of this specialized catalog written by amateurs for amateurs—send for it today on your Q.S.L. card. 68 pages crammed with Ham stuff, data, valuable information.

NEW LAMB NOISE SILENCER

We carry all the parts for this new development . . . at lowest WHOLESALE prices.

Wholesale Radio Service Co.,
WHOLESALE RADIO SERVICE CO.,
 100 Sixth Avenue, Dept. RW-36
 New York, New York.
 Please send me your new Spring Catalog No. 61

Name
 Address
 City..... State.....

WHOLESALE RADIO SERVICE CO.

CHICAGO, ILL. • NEW YORK, N.Y. • ATLANTA, GA.
 501 W. JACKSON BLVD. • 100 SIXTH AVE. • 200 W. FLAUCHTREE ST. N.W.
 BRONX, N.Y. • NEWARK, N.J.
 542 E. FORDHAM RD. • 316 CENTRAL AVE.

I WILL TRAIN YOU AT HOME

IN SPARE TIME FOR A

GOOD RADIO JOB!



J. E. SMITH, Pres.,
National Radio Institute



Manager, Radio Service Dept.



"Before taking the N.R.I. Course, I was a 'funkey' in a furniture store. Now I have a job as manager of the Radio Service Department of one of Mississippi's largest furniture stores."
—DAVID J. SCHUMAKER, R. 3, Box 105-F, Vicksburg, Miss.

Earn Money Quick in Radio

"I joined the N.R.I. and in a few weeks I worked three hours and made clear one five dollar bill. Since that time I have gotten married, bought my home, and have one of the nicest jobs a man has ever known."
—E. LAMAR JOHNSTON, 250 Fifth Avenue, Rome, Georgia.



Get my **FREE LESSON** on Radio Servicing Tips I'll prove that my training is practical, money-making information, that it is easy to understand—that it is just what you need to master Radio. My sample lesson text, "Radio Receiving Troubles—The Cause and Remedy" covers a long list of Radio receiver troubles in A. C., D. C., battery, universal, auto, T. R. V., super-heterodyne, all-wave, and other types of sets. And a cross reference system gives you the probable cause and a quick way to locate and remedy these set troubles. A special section is devoted to receiver back-up, alignment, balancing, neutralizing and testing. Get this lesson free. No obligation. Just mail coupon.

FREE BOOK TELLS HOW MAIL COUPON

Act today for better pay. Act today to break away from a low pay, no-future job—to get away from having to skimp, scrape to pay your bills. Mail coupon for my free 64-page book. It tells you how I will train you at home in your spare time to be a Radio Expert; about my training that has helped hundreds of men to make more money.

Many Radio Experts Make \$30, \$50, \$75 a Week

Consider these facts—think of the good jobs they stand for. Over 20,000,000 Radio sets in use, over 600 broadcasting stations, over 40 manufacturers of Radio sets, over 2,000 manufacturers of parts, over 100 Police Departments Radio equipped, airplanes and airports Radio equipped. Thousands of ships touching every seaport of the world, are Radio equipped. Over 35,000 stores selling sets and parts, over 2,000,000 autos Radio equipped. Loud speaker systems wherever people gather, indoors and outdoors. Commercial Radio stations dotting our coast lines. Radio a big industry—is growing bigger. A few hundred \$30, \$50, \$75 a week jobs have grown to thousands in recent years.

Get Ready Now for Jobs Like These

A spare time or full time service shop; installing, maintaining, operating—broadcast, aviation, commercial, ship, television and police stations. A Radio retail or service business of your own. Installing, maintaining, servicing, loud speaker systems. A service or sales job with a store or jobber. I'll train you for good jobs in many branches of Radio.

Many Make \$5, \$10, \$15 a Week Extra in Spare Time Almost at Once

Every neighborhood can use a good part time serviceman. The day you enroll I start sending you Extra Money Job Sheets which quickly show you how to do Radio repair jobs common in almost every neighborhood. Get my book—see for yourself that many of my students make \$200 to \$1,000 in their spare time while learning.

Your Money Back if Not Satisfied

I'll make this agreement with you. If you are not entirely satisfied with my Lesson and Instruction Service when you finish, I'll refund your tuition.

Find Out What Radio Offers

Mail the coupon. My book of information on Radio's spare time and full time opportunities is free to ambitious men. Read what Radio offers you. Read about the training I give you. Read letters from graduates—what they are doing and earning. There's no obligation. Mail coupon in an envelope or paste it on a penny post card NOW.

J. E. SMITH, President
National Radio Institute, Dept. 6CM4
Washington, D. C.

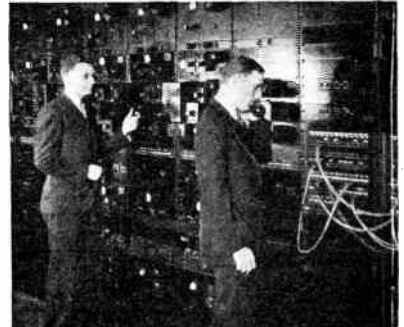

Save Money—Learn At Home My Special Equipment Gives You Broad, Practical Experience

Hold your job. No need to leave home and spend a lot of money to become a Radio Expert. I'll train you quickly and inexpensively right at home in your spare time. You don't need a high school or college education. Many of my successful graduates didn't finish grade school. My practical 60-90 method of training—half with lessons, half with Radio equipment I furnish—gives you broad practical experience—makes learning at home easy, fascinating, practical and quick. There is opportunity for you in Radio. Old jobs are becoming more complicated—many need better trained men. New developments are making new opportunities. Short waves, loud speaker systems, police Radio, auto Radio, aviation Radio, Television—Radio's newest uses are covered by my Training. Here's a field that's growing. It is where you find growth that you and opportunity.

I have helped hundreds of men make more money



MAIL THIS NOW!

J. E. Smith, President
National Radio Institute, Dept. 6CM4
Washington, D. C.

Dear Mr. Smith: Without obligation, send me the Sample Lesson and your free book about spare time and full time Radio opportunities, and how I can train for them at home in spare time. (Please write plainly.)

Name..... Age.....
Address.....
City..... State..... 14X1

The Tested Way to BETTER PAY

RADIO WORLD

The How-to-Make-It Monthly—Fourteenth Year

ROLAND BURKE HENNESSY
Editor

HERMAN BERNARD
Managing Editor

HERBERT E. HAYDEN
Advertising Manager

Table of Contents for March, 1936

The Noise Silencer 6	Output of Battery Sets Compared 29
<i>Machine Gun Static Often wiped Out</i> By Charles Ellington Woods	<i>Single 33 Against Class B 19 or 49's</i> By Leonard W. Allenby
Four Tube All Wave Set 12	A New Combination Universal Receiver 32
<i>Metal Tubes, Universal Type, Plugin Coils</i> By Guy Stokely	<i>Regenerative Switch Type, 15 to 555 Meters, and Super-regenerative, 2.5 to 15 Meters</i> By A. J. Haynes
Interference Suppression in Suppressors 14	Three New Tubes 42
<i>Analysis of Trouble Sources, With Remedies</i> By J. E. Anderson	<i>6R7 Metal, 1A4 and 1B4 Glass</i>
Pee-wee Micro Wave Transmitter 19	Handy Home-Made Bridge 43
<i>Used in Remote Control to Main Station</i>	<i>Simplified Circuit Produces Accurate Results</i> By Frank G. Simonds
High Superheterodyne Performance 20	Service Bureau 52
<i>Some Considerations Affecting Superiority</i> By Brunsten Brunn	<i>Curing Troubles in A.V.C. Circuits; Adjusting 6E5 Time Constant; Preventing Dead Spots in Receiver; Shields for Rectifier Tubes; 84 Current Rating Increase; Phonograph Amplifier for Volume Expansion</i>
Extra Speakers 21	Signal Generator Practice 58
<i>More Profit for the Service Man</i> By M. N. Beitman	Radio University 60
Accuracy in a Tube Voltmeter 22	<i>Answers to Questions on the Building and Servicing of Radio and Allied Devices</i>
<i>Two Range Instrument for R.M.S.</i> By Herman Bernard	

Vol. XXVIII, March, 1936. No. 14. Whole No. 690. RADIO WORLD, published monthly by Hennessy Radio Publications Corporation, 145 West 45th Street, New York, N. Y. Editorial and executive offices, 145 West 45th Street, New York, N. Y. Executives of RADIO WORLD: Roland Burke Hennessy, editor and business manager; Herman Bernard, managing editor; Herbert E. Hayden, advertising manager. Officers of corporation: Roland Burke Hennessy, president-treasurer; Roland Burke Hennessy, Jr., vice-president; Herman Bernard, secretary. Entered as second-class matter March, 1922, at the Post Office at New York, N. Y., under Act of March 3d, 1879.

SUBSCRIPTION RATE

Price 25 cents per copy. Subscription \$2.50 per year (12 issues), postpaid in United States and Possessions; \$3.00 per year postpaid in all other countries. Remittance for foreign subscription should be by international money-order (postal or express) or draft against or discountable at New York bank.

RADIO WORLD is distributed by the American News Company and its Branches

The Noise Silencer

Machine Gun Static, Bothersome on Short Waves Particularly, Wiped Out —Big Interest in Device Stirs Industry

By Charles Ellington Woods

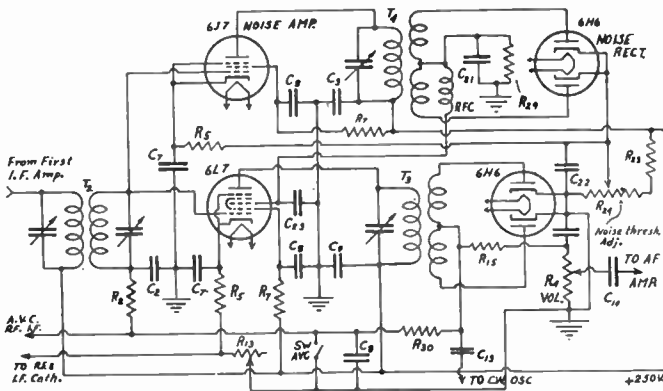

The heart of the noise silencer circuit, showing the second i.f. amplifier, 6L7; the signal detector, lower 6H6; the noise amplifier, 6J7; and the noise rectifier, upper 6H6. The correct connections to the remainder of the receiver are indicated by arrows. The terminal connected to C13, intended for beat oscillator when the receiver is to be used solely for broadcast reception. The noise is suppressed in the 6L7 by voltage from upper 6H6.

MATERIAL progress has been made recently in the reduction or elimination of noise from reception. The results have been generally satisfactory, so much so that silencing circuits have been applied to hundreds of receivers, particularly superheterodynes, and a brisk business in manufacturing them, or selling parts for their construction, has sprung up.

The fundamental basis of the circuit that has attracted so much attention is the division of the intermediate frequency carrier into two tubes, 6L7 and 6J7, so that feed to detectors takes place in two dissimilar channels, to develop in the external channel, with extra amplification, a rectified voltage that is applied to the internal channel as bias control. The external channel is given a somewhat speedier action than the internal channel, so that the large amplitudes represented by disturbing influences are amplified in the external channel, and the bias is raised on the internal channel before the noise is audible.

Not a Cure-All

The system therefore is that of a squelch circuit. The principle is the same, although the action is applied differently, because a squelch circuit as previously existing was intended primarily to stop reception of noise in an amplifier from which automatic volume control was absent due to no signal, in other words, to squelch inter-channel noise.

Since the principle invoked is the same, per-

haps it is well to say a few words about the original squelch circuit. The action is sometimes called automatic noise suppression, but one should bear in mind firmly that the noise meant is that which is produced in the receiver, principally because with a.v.c. removed the circuit becomes regenerative and gets below the noise level, whereas the new circuit has to do with noise caused by certain types of motors, spark coils, thermostats on heating pads, telephone dials, vacuum cleaners and the like, noise originated outside the receiver, generally classified as man-made static, although not all forms of even such static are eliminated by the new silencer.

The automatic noise suppression circuit for receiver-originated noise consists of a sharp cutoff audio amplifier tube so voltage gated that when the audio frequency voltage reaches a certain height it produces a high enough negative bias on the tube to stop it from conducting. That is, the tube becomes biased to cutoff of plate current.

New One Works at I.F. Level

When the amplitude is less than that producing cutoff, the signal flows right through. Since the noise is much greater than any likely signal, the system works. Therefore the automatic noise suppressor, or squelch tube, operates as a silencer *when there is no carrier input*, but when the noise is large nevertheless, as produced in the receiver, due to amplification

of tube noises, shot effects, contact potential and thermal agitation.

The new noise silencer is actuated by a radio frequency level—the intermediate frequency voltage as found in the tube ahead of the set's second detector, usually—and therefore does not operate at audio frequencies. This is one essential point of difference.

The input to the noise amplifier, or external circuit, is established by connecting together the No. 1 grids, overhead caps, of the two

effective Q can not be high, due to the close coupling, hence the transfer of energy is over a wide band.

The reason for the low Q is to make the circuit operative over a larger span of modulation resulting from the noise input. When the intermediate carrier is thus amplified over a wide band, and rectification in a diode is introduced, the d.c. in the diode load is applied to Grid No. 3 of the 6L7 that is really in the internal, or regular receiver, circuit. This grid

Back view of the noise amplifier and suppressor. The 6H6 shown is the noise rectifier, one of the other tubes is the 6J7 noise amplifier, and the other is the 6L7, which is also the second i.f. amplifier. The can at left contains the extra required i.f. transformer, marked T4 in the diagram on opposite page. The threshold control is represented by the shaft at left.

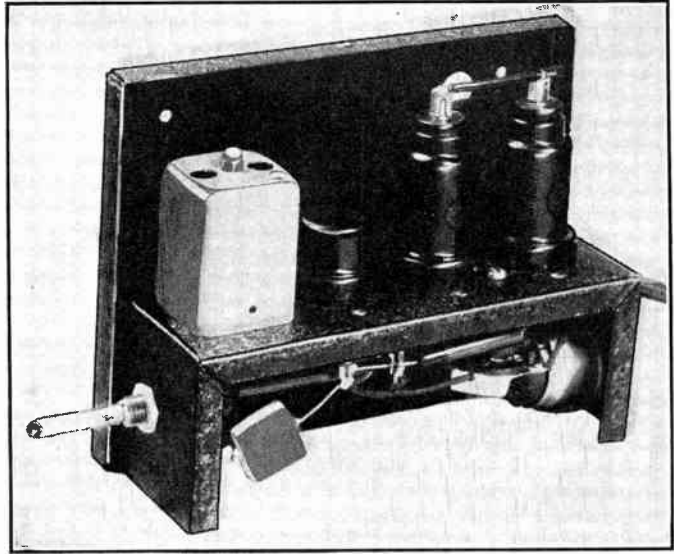

tubes, two because it is necessary to substitute a 6L7 for the last, usually second, i.f. tube in the receiver. This is done by a socket plug picking up cathode and B plus in the socket position in the receiver formerly occupied by the second i.f. amplifier.

Low Q Coupling Coil

It has been said that the two circuits are dissimilar. The one in the set is orthodox, let us say, and the one in the external circuit, or noise amplifier, is such as to develop low selectivity. A transformer is used with primary and secondary closely coupled, primary alone is tuned, secondary of low Q . The transformer's

has a sharp cutoff, just as the tubes used at audio level in the inter-channel noise suppressor have a sharp cutoff, e.g. 57 and 6C6.

The effect of the noise on the carrier is that of modulation, and when the noise is such that the resultant modulation consists of periodically repeating frequencies, especially with wave forms rather sharply defined, the new noise silencer circuit works best.

Works Well on Machine Gun Static

This type of man-made static is called machine gun static, because it has regular repetitive characteristic of machine gun fire, besides
(Continued on next page)

Why the Silencer Can Not Be Heard

When a pulse repeats itself a given number of times a second, below 10,000 times, it can be heard, and is called an audible or audio frequency. Thus if there is silence, interrupted 1,000 times a second by an impacting device, we hear a 1,000 cycle note. However, if there is music being played, and it is interrupted 1,000 times a second, or at some other such frequency, the effect is not noticed, because of the persistence of hearing. The ear carries the last previous sound over, just as the eye uses persistence of vision to make 24 still pictures a second give the illusion of motion, as in the movies. Hence the noise silencer does not produce a note of the frequency of its actuation.

(Continued from preceding page)

being of high amplitude. The other general classification of man-made static is called the hash type, and is rather heterogenous, sounding something like escaping steam. Hence the noise that results in modulation of the lower frequency type is well suppressed by the noise silencer circuit that has just been introduced, and which was developed by James J. Lamb, technical editor of QST.

Laymen have been calling Mr. Lamb's circuit a static eliminator, but Mr. Lamb has not been calling it that. The lay public, when it thinks of static, calls to mind those most heterogenous and baffling transients, usually of low amplitude level, that accompany long distance reception or are present when there is an abundance of electricity loose about the reception point, as when a storm is approaching, present, or leav-

device is introduced at the intermediate frequency level, and the answer would be that there the amplitude is sufficiently high to enable the control to be most effective, and also there is only one frequency to consider, for at the other r.f. level, that of the station carrier itself, it would be necessary to introduce an amplifier that was a switch type all wave circuit of its own, a considerable complication. Otherwise it would be desirable to have the control act on as early a stage as possible, although it can be seen that moving it forward from the conventional squelch circuit at audio frequencies, to a special noise silencing circuit operating essentially at the intermediate frequency, is in the right direction.

Where Lag is a Benefit

If the action of the noise silencer is not more

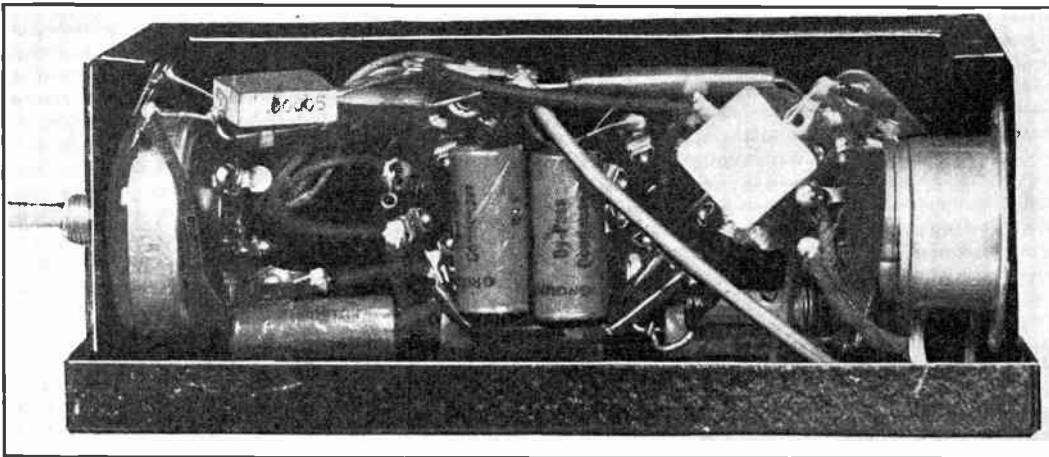

Subpanel view of the noise silencer adapter. Noise threshold control is seen at left and a male line connector at right.

ing. That type of static is not of the regularly repetitive frequency type and also is generally of too low amplitude to be serviced by the new noise silencer.

Limitations Stressed

It must be borne in mind that the present development applies only to man-made static, as distinguished from natural static, and not to all types of man-made static, but mainly to that type which is regularly repetitive at an equivalent low frequency of modulation, and of extremely high amplitude. Compared to the usual modulation of a station, which may average 30 per cent., the type of noise to which the Lamb circuit well applies has amplitudes at least twice as great, and even ten to twenty times as great, or even more.

This may be compared to an atrociously bad case of overmodulation, and it may be said that when the circuit would be greatly overloaded and draw grid current the noise amplifier is effective in producing sufficient negative bias to avoid this current and stop amplification in the controlled circuit.

The question well may be asked why this

rapid than the action of the main or internal intermediate amplifier, then some noise effects will be present. It is assumed that the internal amplifier is subjected to a.v.c., therefore it has resistor-capacity filters, and the values of the resistance and capacity determine the time constant of the circuits. The internal second detector or true signal detector is subject to the same time constant considerations. Therefore the time constant is made larger in the external or noise amplifier, so that the effect of the noise control will be speedier than the effect of the a.v.c. on the main i.f. amplifier. That is, some lag is present in the main amplifier compared to the noise amplifier, and audibility of any noise present is prevented by the failure of the filter capacity to discharge through the filter resistor in time to render reception audible, until the quenching circuit has taken effect.

While the noise amplifier circuit has been described as the external one, and the regular feed to the second or signal detector in the set as the internal one, there is no necessity that the two amplifiers and detectors be on separate chassis. It merely so happens that at present, since the device was brought out with

the idea of constituting a unit applicable to a good many sets, suppliers have been furnishing chasses wired for this purpose, to be connected to the receiver.

Connections Set Forth

The connections are as follows:

1. —The last i.f. amplifier tube, referred to generally as the second i.f. tube as the noise silencer is more effective on sets with two i.f. stages, is removed from its socket in the receiver.
2. —A tube base that has cathode and plate wired to two outgoing leads is plugged into the vacated second i.f. socket, so that the primary of the i.f. transformer feeding the second detector in the set is picked up, and as also the cathode. The cathode connection is necessary so that the B voltage will be effective.
3. —Since the noise amplifier requires A and B voltages, the heater voltage may be taken from the line, through a dropping resistor, and the B voltage from B plus of the receiver, usually plate return of the power tube. Cathode biasing takes care of the voltage for the 6J7 in the noise amplifier, and so that A, B and C voltages are complete.
4. —The grid clip that formerly went to the second i.f. tube has not been used yet, and this is connected to the grid of the 6L7, which is on the external chassis and which becomes the substitute second i.f. tube by the connections previously set forth. As has been said, the control grids (No. 1) of 6L7 and 6J7 tubes in the noise amplifier are interconnected.

Shielding Precaution

The lead going from the grip clip of the receiver to the grids of these two tubes in the noise silencer should be of shielded wire, with sheath grounded. Since the amplitude is high at this point, all indirect pickup should be carefully avoided, and it is advisable to use shielded wire also on the interconnection between the two grids in the noise amplifier, and ground this sheath, too, although a bit awkward. A smooth bolt with threaded end may be secured to the chassis, and a lug fastened to the other and upper end of this perpendicular adjunct. The lug is soldered to the interconnecting wire sheath.

Various trials of the noise silencer have confirmed its effectiveness, but not its universality. The limitations have been set forth, both by Mr. Lamb and in this article.

While the effect is present on all frequencies of reception, it so happens that the type of interference with which the noise silencer best copes is present on bands that the amateurs are interested in, particularly the bands relatively free of natural static are sensitive to certain motor and concomitant emanations, so that where there should be bliss there is much havoc, and the noise silencer brings a good meed of benefit in these regions.

Benefits Are Widespread

Also, receptionists who tune in short waves

are in or close to the amateur bands, and in general, short wave reception is attended by a greater effect from machine gun static than is the standard broadcast band. So the usefulness of the silencer spreads to fields beyond those for the benefit of which it was primarily intended. Moreover, even the types of interference against which the new silencer is not a complete barrier are reduced somewhat, because a relative effect is introduced, due to the curvature of the cutoff.

6L7 Moves Into First Place

The new noise silencer also has another advantage. It does not introduce modulation distortion such as is present in customary squelch circuits operating at audio frequencies. This absence is due to the inherent capabilities of the 6L7 tube, which for its signal control

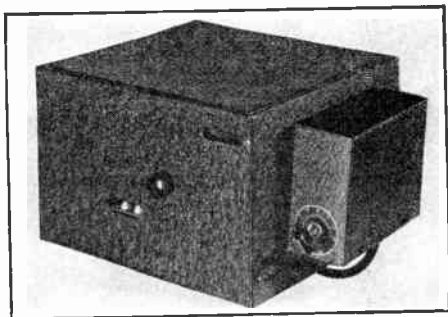

Here the noise silencer is shown attached to a receiver.

grid (No. 1) has a remote cutoff, and for its other control grid (No. 3) has a sharp cutoff.

Hence a strong impulse may be fed into the tube by way of Grid No. 1 without producing any serious distortion, yet the action of a properly biased Grid No. 3, always maintained negative respect to Grid No. 1, introduces sharp control in an otherwise independent and high mu circuit. The loading of Grid No. 3 may be such as to leave the rest of the tube functioning free of any bad influence from the sharp cutoff grid. In this respect the 6L7 stands alone, combining anomalous advantages of smoothness and sharpness, both present only where needed. For this and other reasons the 6L7 stands out as the most important receiving tube.

It is not necessary that the tube replaced by the 6L7 through the plug connection shall be a metal tube, indeed most of the devices have a six pin plug, indicating glass tubes, but it is necessary to use the 6L7, by substitution as indicated. Even if the receiver has 2.5 volt heater tubes, the separate heater supply for the noise amplifier tubes enables the use of the metal tubes that take 6.3 volts.

Two Makeshifts to Avoid

It is not safe to take the heater voltage for the noise amplifier from a set that supplies such

(Continued on next page)

voltage to the heaters of the tubes it contains, as the two extra tubes may cause an increase of current drain on the transformer winding beyond what was intended, that is, the winding would be overloaded, and the performance of the receiver proper would be reduced. Nor is it safe to take the B voltage for the noise amplifier from some place other than the B plus after the filter choke, because there may be, and usually is, a series dropping resistor

must be exercised to avoid shorting the line, as the noise amplifier returns these are to one side of the line, the receiver with which this device is used may have chassis grounded, and by connecting to the convenience outlet the wrong way, and grounding the receiver chassis, that is, picking up both sides of the line in that manner, a short could be introduced. For universal use it is recommended therefore that a circuit breaker be included in the noise

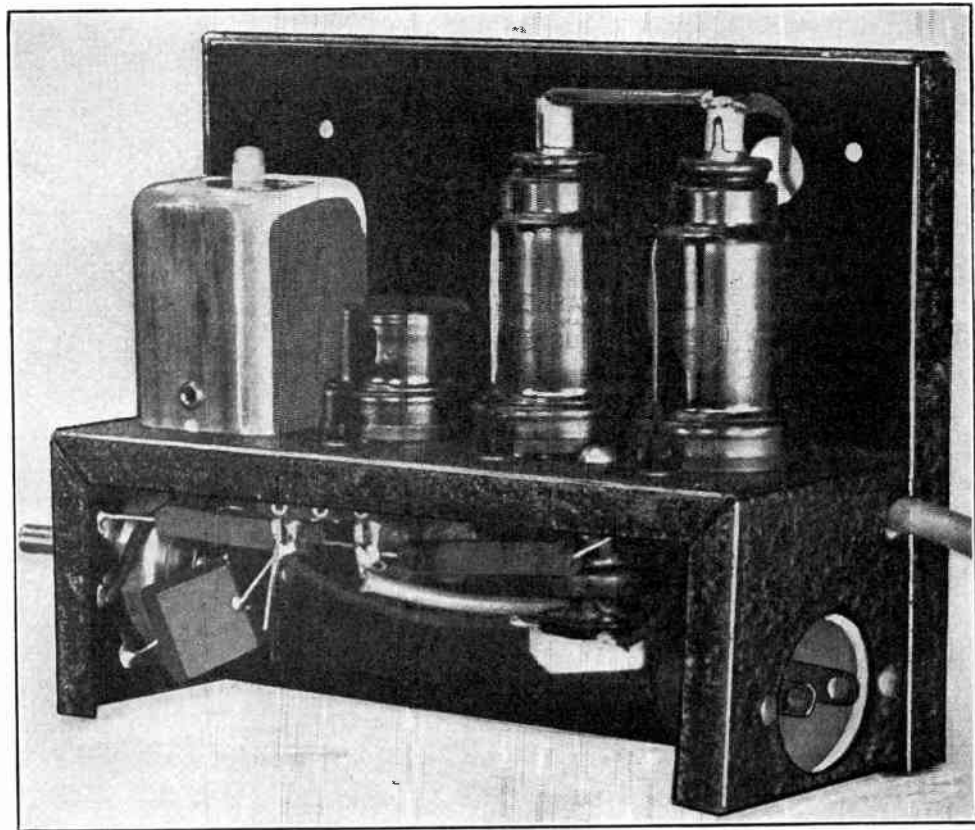

Another rear view of the noise silencer attachment. The grid lead which connects both grid caps is seen passing through a hole, whence it goes to the secondary of the second i.f. transformer in the receiver.

through which the additional and originally unintended B current must flow, the extra B drain reducing the B voltage on all tubes served through this resistor, hence reducing the performance of both receiver and noise amplifier. If the B voltage is too great at B plus after the filter choke, then a separate resistor, bypassed at in the noise amplifier to ground, may be introduced.

Avoid Line Shorting

The circuit has been shown for adaptation, mostly, but it is practical to build it into a receiver, as said, also to have it arranged with its own B supply. If a universal circuit is to be attempted, for the noise silencer, then care

amplifier, in series with its line feed, as a short will open the relay, the silencer's wall plug next would be reversed as to connection, and then, the relay now being closed, it will not open, since the polarities are right and safe.

The front cover diagram shows the circuit for the noise silencer that the Leeds photographs depict. The schematic accompanying the article is for appreciation of the circuit at a glance.

Connections and Adjustments

The circuit diagram on page 6 shows in schematic form the noise silencer, with returns to other cathodes of the main receiver.

Constants for Front Cover Diagram of Noise Silencer Circuit

Coils

T1—One transformer of same frequency as i.f. of the receiver. Primary alone tuned. Secondary center tapped and tightly coupled to primary.
RFC—One 15 millihenry r.f. choke.

Condensers

C1, C3, C7—.1 mfd. 200 volt. C4—50 mmfd.
C2, C5—.1 mfd., 400 volt. C6—.0001 mfd.

Resistors

R1—50,000 ohms. R4—5,000 ohm pot.
R2—400 ohms. R5—25,000 ohms.
R3—100,000 ohms. R6—600 ohms.

[If series heaters are used, connect one side of 6H6 to 333 ohm 30 watt line cord, one side of 6L7 heater to line, and complete series connections through the 6J7 heater.]

The external unit is supposed to be connected to an existing receiver. Just how the connections are to be made will be mentioned in respect to this particular diagram, although the general case has been tabulated.

At the extreme left of the diagram is the legend "From First I. F. Amp." As the transformer T2 is in the silencer, it is clear that the terminal lead should be connected to the plate of the first i. f. amplifier and also that the plate should first be disconnected from the intermediate transformer that follows it. Special attention is called to the fact that it says "First Amplifier." Emphatically this does not mean the mixer. If there are not two stages of i. f. amplification the silencer will not work satisfactorily, because the noise level is not great enough to shut off the gain in the 6L7. Many have made the mistake of connecting a silencer to a small receiver in which there was not enough amplification.

The control grid of the noise amplifier, which in this case is a 6J7, is connected to the control grid of the 6L7 so that the input to the noise amplifier is the same as that to the second i. f. amplifier. In both the noise amplifier and the regular i. f. amplifier there are, therefore, two stages before the diode detector.

At the extreme right is a terminal marked "To A. F. Amp." This goes to the grid of the first audio tube. Going leftward through condenser C14 we come to the potentiometer R4. This is the regular manual volume control in the receiver.

At the right of the lower 6H6 is a potentiometer R24 which is labeled "Noise Thresh. Adj." This is adjusted until the squelching is most effective, or to compromise between noise and signal, since the greater the noise or suppression of noise the lower the effective sensitivity of the receiver.

Heater Connections

The connections of the heaters of the tubes are not indicated. A good way of heating the tubes pertaining to the noise silencer is to provide a separate 6.3 volt transformer for them. Some units have been designed for plugging into the socket of the second i. f. amplifier, but this is not recommended, for reasons already stated. If the heaters are connected in series they should have an independent limiting resistor.

Not in years has anything in radio created such lively and healthy interest as has the new noise silencer, and it is a pleasure to compliment Mr. Lamb, and QST on this real accomplishment.

ADVANTAGE OF FUNDAMENTALS

For a signal generator covering three bands, intended to be 140 to 500 kc, 540 to 1,600 kc and 1,400 to 5,000 kc, the third constituting repetition of the first tier of a direct frequency reading dial and multiplication of the readings by 10, the dial itself is simplified.

All frequencies are read on fundamentals, the advantage being that the generator can be set to a particular frequency and the receiver can be tuned to that frequency for response. Except for this, frequencies higher than the highest (above the 5,000 kc considered in this example) may be measured by harmonics.

COMPARISON OF COILS

In the broadcast band solenoids and the like are better than honeycomb coils. But if the primaries have a great deal of inductance, while the gain is high, the selectivity is low. Therefore high impedance primaries are all right for a small set, but a larger one, of which much selectivity is expected, would not be as well off with the high impedance primaries.

Metal Tube Speaker Set

**REGENERATIVE ALL WAVE RECEIVER USES
6K7, 6F7, 6C5 AND 12A7**

By Guy Stokely

Eilen Radio Company

A CASUAL glance at the diagram of the Eilen 6A short wave receiver, or at the receiver itself, would indicate that it is a four tube receiver. And that is true if we count only the number of tube envelopes. If we count functions we find that there are actually six tubes, because the 6F7 contains within the same bulb a triode and a pentode, and the 12A7 contains a rectifier for the B supply and also a power pentode. The sensitivity of this receiver, therefore, is much greater than the four envelopes would lead us to believe.

The first tube in the circuit, which is a high gain 6K7, is coupled directly to the antenna by means of a 50,000 ohm receiver. Thus there is small danger of feedback into the antenna and consequent interference in case the circuit should oscillate. The 6K7 feeds into the plugin coil and this in turn feeds into the control grid of the pentode section of the 6F7. The fact that the tuned circuit is put after a tube and not after the antenna makes the circuit not only more sensitive but also much more selective. Both of these qualities are greatly enhanced by regeneration, which is controlled by means of a 100,000 ohm potentiometer, R7.

Where Detection Occurs

It will be noticed that in the lead to the pentode grid (cap) are a stopping condenser and grid leak, C2 and R3 respectively. Thus the detection occurs in the pentode grid circuit. This leaves the triode section of the tube as a straight audio amplifier, resistance coupled to the pentode.

Following the triode section of the 6F7 is a 6C5 metal tube, which is resistance coupled to both the triode of the 6F7 and to the pentode section of the 12A7. The voltage gain in the 6C5 is comparatively high for a tube that is

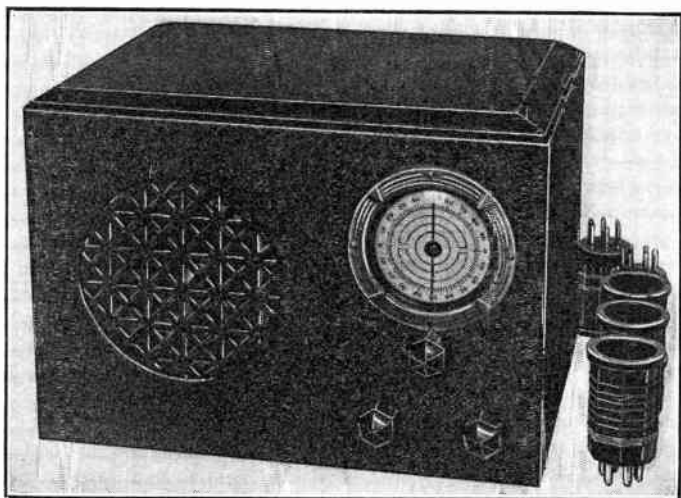

In a neat housing the circuit is arranged with controls at right. Below the airplane dial is the knob actuating it. The two knobs on the same plane are on a 100,000 ohm switched potentiometer as regeneration control (left) and on a small parallel bandspread condenser. The speaker grille is at left. Five plug in coils are used.

rated as a general purpose tube. The gain in the power pentode is also high. Therefore the gain in the audio amplifier is great. Yet the amplifier is stable.

The rectifier section of the 12A7 supplies plenty of current and voltage for the five stages in the circuit. The filtering of the B supply is done by means of a small filter choke L1 and two 8 mfd., 200 volt electrolytic condensers C11.

The heaters of the various tubes are series connected and the excess voltage is dropped in a line cord. Thus excess heat is kept out of the receiver and is dissipated outside. This helps to insure long and useful life to the electrolytic condensers.

5 Mfd. Bypass Condenser

Across the bias resistance R12 for the power pentode is a 5 mfd., 25 volt electrolytic condenser. Thus the power amplifier is well protected against degenerative effects on the lower audio frequencies.

(Continued on next page)

The circuit as shown uses two metal tubes, 6K7 and 6C5, and two glass tubes, 6F7 and 12A7 (rectifier-pentode). The metal tubes may be replaced by 6D6 and 76, by those who prefer glass tubes throughout. Results are excellent either way. The circuit is for 90-130 volt universal operation (a.c. or d.c., also a.c. may be of any commercial line frequency). See all-glass tube layout, page 28.

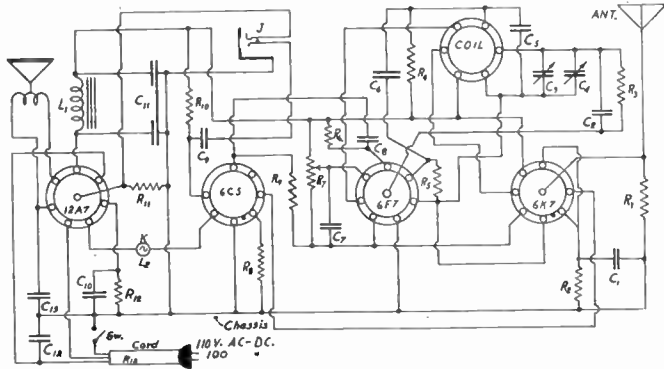

A phone jack is provided in the plate circuit of the 6C5. At this stage there is just enough power to operate the phones with comfortable volume.

In the tuned circuit are two variable condensers, C3 and C4. The maximum capacity of 63 is .00014 mfd., and it is used for rough tuning.

The maximum capacity of C4 is only 14 mmfd., and this condenser is used for band spreading.

A magnetic speaker is used in the receiver. This type is used so as to leave as much current and voltage for the amplifier. Thus no other tube is needed to supply the current for a field coil.

LIST OF PARTS

Coils

L1—Filter choke in B supply.
Five plug-in coils.

Condensers

C1, C6, C7—.01 mfd. tubular.
C2, C5—.00025 mfd. mica.
C3—.00014 mfd. tuning.
C4—.000015 mfd. band-spread.
C8, C9, C12—.01 mfd. tubular.
C10—5 mfd., 25 volt electrolytic.
C11—Dual 8 mfd., 200 volt electrolytic.
C13—.006 mfd.

Resistors

R1—One 50,000 ohms.
R2—One 700 ohms.
R4, R6, R10—Three 150,000 ohms.
R3, R5—Two 2 meg.
R7—One 100,000 ohm pot.

R8—One 2,500 ohms.
R9, R11—Two .25 megohm.
R12—One 4,000 ohms.
R13—One 250 ohm line cord (for five 6.3 volt heaters and 6.3 volt pilot lamp).

Other Requirements

SW—Line switch (on R7).
K12—Pilot light.
One magnetic speaker.
J—Headphone jack.
Three grid clips (two large and one small).
One airplane dial.
Three knobs.
Sockets (two sevens, two eights, and one six).
One small metal chassis.
One cabinet.
Tubes: one 6K7, one 6F7, one 6C5 and one 12A7 (6D6 and 76 may replace metal tubes, but socket connections of diagram then do not apply).

STRONG GENERATOR

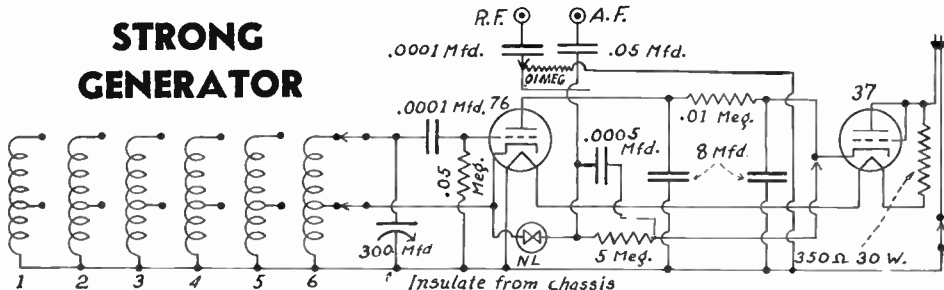

This 100 kc to 60 mcg. signal generator delivers a husky output.

Interference in Supers

Analysis of Trouble Sources—Remedies Suggested

By J. E. Anderson

[Beats in superheterodynes, with a theoretical discussion applying to the three radio frequency levels, were discussed in last month's issue by the author, a specialist on the topic. This month interference problems in a super are dissected.

—EDITOR.]

WHEN superheterodynes were first popularized, the intermediate frequency was low in order to get a high order of amplification with stability of the circuit. The development of new tubes and the invention of stabilizing devices have now made it possible to use a high intermediate frequency without any loss in amplification or stability.

It should be remembered that the intermediate frequency amplifier and filter accepts the intermediate frequency to which it has been tuned regardless of the source of the intermediate frequency. A signal having the proper frequency will pass through if it comes directly from a station operated on this frequency just as well as if it comes from the interaction of two higher frequencies. It will come through also if it is produced by the beating of any two frequencies, for example, the harmonics of the carrier frequency and the oscillator frequency, or by the beating of the fundamental of one and any harmonic of the other. There is an infinite number of ways in which the proper intermediate frequency can be produced.

Number of Combinations

The number of possible combinations which will yield the intermediate frequency can be illustrated effectively by the aid of symbols. Let S be the frequency of the carrier and let m be a whole number expressing any of its harmonics. Likewise let H be the oscillator frequency and n the number of any of its har-

monics. Either m or n may have any value from unity to infinity, just so it is a whole number. Then mS will be the frequency of the m th harmonic of S and nH will be that of the n th harmonic of H . If these harmonics beat in a modulator, and if they are so related that $ms - nH = f$, or so that $nH - mS = f$, we have the proper condition for producing the intermediate frequency acceptable to the filter. Here f is used for the intermediate frequency for simplicity and H and S are used for the radio frequencies for the same reason.

The Normal Case

Now m and n can have any values whatsoever as long as they are integral, and therefore it is clear that there is an infinite number of possibilities. When $m = n = 1$ we have the two fundamentals beating to produce the intermediate frequency. This is the normal case in most superheterodynes, and it is clear that there are two possible adjustments of the oscillator when m and n are equal to unity. Every superheterodyne, whether it is called "one-spot" or not, has these two adjustments of the oscillator at which a given signal can come in. Theoretically, a true "one-spot" superheterodyne is not possible; practically it can be approached. The meaning that can be attached to the term "one-spot" will be discussed later.

Since m and n in the above formulas can be assigned any integral values whatsoever, it is clear that for any signal, or value of S , there is an infinite number of points on the oscillator dial at which that signal will come in, at least theoretically. Practically the number may be quite limited.

Suppose the oscillator dial has been calibrated in frequency so that H not only represents the oscillator frequency but also the dial setting. Let us rewrite the equations given above as the

FIG. 1

These drawings illustrate the production of extra responses in a superheterodyne which are due to harmonics. The secondary repeat point P_2 at right is caused by second harmonics and corresponds to an oscillator frequency of $S + f/2$ when S is the signal fundamental $S + f$ is the oscillator setting that gives the main peak P_1 .

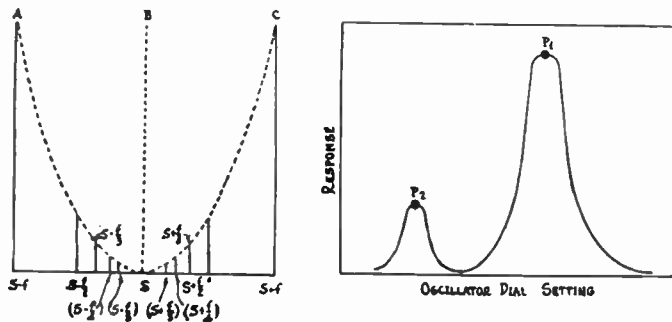

conditions for the production of the intermediate frequency in the forms $H = (mS - f)/n$ and $H = (mS + f)/n$. Assume that S is fixed, or that we are considering a single carrier frequency. Also assume that f is fixed by the tuning of the filter. Both m and n can vary in any manner just so they remain whole numbers.

Under these conditions, the value obtained for H , no matter what the values of m and n , is a possible setting of the oscillator that will bring in the signal carried by S . Not all, however, will be within the tuning range of the oscillator condenser, and those that are off will not cause any trouble. Moreover, not all will be of sufficient intensity to cause appreciable interference. The values obtained when m and n are large will be weak.

We saw that when the two harmonic numbers were unity we have the normal two points at which a given signal comes in on the superheterodyne. Suppose $m = n = 2$. The two second harmonics are beating, and these give rise to two points on the dial at which the

signal have a frequency of 1,200 kc. Substituting these values in the above formulas we obtain two values for H , namely, $H = 575$ and $H = 625$ kc. Both are within the tuning range of the oscillator when this has the same inductance and capacity as the radio frequency tuner. Frequencies much lower than 1,200 kc could not be received on the second harmonic settings, but all higher could.

When the intermediate frequency is higher and when the oscillator has been designed to receive on only one setting not many broadcast stations can be received on the second harmonic. For example, if the intermediate frequency is 400 kc the lowest frequency of the oscillator is 930 kc. If these values be substituted in the formulas and we solve for S we get $S = 2,300$ and $S = 1,500$ kc. One of these is above the tuning range of the oscillator and the other is slightly below. Hence the 1,500 kc frequency is one of few that can be received on the second harmonic, and this on only one of the possible settings. Thus it would appear that 400

FIG. 2

Image interference. At A the oscillator frequency is half way between two carriers, S and S' , so $S + f = S' - f$, where f is the intermediate frequency. Zero beat would result between the two intermediate carriers, but not between the two sets of sidebands. At B, $S + f$ and $S' - f$ differ slightly and a squeal results.

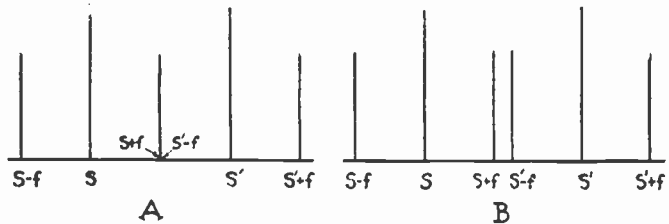

same signal comes in. If we let $m = n = 3$, we get two additional points. If we take higher integral values, we get two points at which the same signal comes in for every value. Since there is no limit to the whole numbers, there is no limit to the number of points at which the signal comes in.

Interference Analyzed

There is a definite limit, however, to the place on the dial where they can come in. They all lie between the two normal points determined by letting the two harmonic numbers, m and n , equal unity. As the harmonic numbers increase the location of the repeat points converges on the dial where the carrier S would tune in.

Even in a superheterodyne in which the oscillator can be set independently of the radio frequency tuner many of the high frequency broadcast channels can be tuned in on the second harmonic. Let us illustrate by assigning values to our symbols. In the first place m equals unity and n equals 2. Hence our formulas become $H = (S - f)/2$ and $H = (S + f)/2$, which give the two settings for bringing in signal S . Now let the intermediate frequency be 50,000 cycles per second and let the desired

kc or somewhat higher is a suitable intermediate frequency from this point of view.

Second Harmonic

If we make the intermediate frequency 200 kc the oscillator range should be from 730 to 1,800 kc. Putting 200 and 730 in formulas for f and H respectively and solving for S , we get 1,300 and 1,700 kc. Thus we can receive all stations above 1,300 kc on the second harmonic, provided that the oscillator can be tuned independently of the radio frequency tuner. Such separate control of the oscillator passed out of vogue, except for ultra frequency receivers.

The second harmonic of the oscillator is not important enough to exert any influence on the choice of the intermediate frequency. The subject was brought up simply to explain the appearance of certain repeat points. If the circuit has been designed properly repeat points will not cause any interference even if a station could be received with some intensity on the second harmonic.

Sometimes a certain signal can be received at two points close together as illustrated in

(Continued on next page)

(Continued from preceding page)

Fig. 1. The main point may be at P_1 and the other at P_2 . The height of P_2 is much exaggerated as compared with that of P_1 . The second maximum, P_2 , is due to the second harmonics of both the signal and the oscillator and corresponds with $S - f/2$ in Fig. 1, when $S - f$ is the main setting. $S + f/2$ gives another maximum corresponding to $S + f$, but this is usually weaker because $S + f$ is weaker.

These secondary maxima are sometimes confused with similar responses due to close coupling between two tuned circuits in the filter, because when two tuned circuits are coupled very closely the response has nearly the shape of the curve in Fig. 1. In some circuits the lower maximum, as P_2 , may be due to the combined effect of the two.

Image Interference

If the intermediate frequency is high, the coupling between the oscillator and the modulator loose, and the radio frequency tuner is reasonably sharp, there is no reason for worrying about the multiplicity of repeat points indicated. The receiver in modern practice is arranged mechanically so that only one of the normal settings of the oscillator is utilized, without fear that the many repeat points will cause interference, by condenser ganging.

The most perplexing problem that arises in connection with the design of superheterodynes is that of minimizing the so-called *image interference*. This type of interference is peculiar to the superheterodyne and arises from the fact that a signal of any given frequency comes in at two normal settings of the oscillator, namely, that at which the oscillator frequency is greater than the signal frequency by the amount of the intermediate frequency and that at which the oscillator frequency is less than the signal frequency by the same amount. For example, if the signal frequency is S and the intermediate frequency is f , then if the oscillator is set at either $S + f$ or $S - f$, the signal comes through the filter, because in either case the frequency f acceptable to the filter is produced with the signal carrier S .

Now suppose there is another signal carrier of frequency S' which has not been tuned out completely at the modulator. This will likewise come through if the oscillator is set at either $S' + f$ or at $S' - f$, for again the frequency f acceptable to the filter is produced in the modu-

lator. Now if the two signal frequencies are related so that $S + 2f = S'$, that is to say, so that $S + f = S' - f$, the two signals S and S' will get through at the same setting of the oscillator. Interference results unless one of the carriers has been tuned out completely before it gets to the modulator.

How Word "Image" Arises

The use of the term *image* to describe the interference is due to the fact that the two normal settings of the oscillator are symmetrically located in the frequency scale about the signal carrier frequency, just as the image and object are symmetrically located with respect to a plane mirror. For example, let S , Fig. 3, be a plane mirror and let some object be located at $S + f$. The image of this object will appear to be located at $S - f$, the image and object distances being equal. Now suppose there is another plane mirror S' , parallel to the first and located a distance $2f$ to the right of S . Let there be another object at the point $S' + f$ to the right of S' . Since the object distances are the same for the two mirrors, and the mirrors are a distance $2f$ apart, it is clear that the image in the second mirror appears to be in the same position as the object in front of the first mirror. That is to say, the image $S' - f$ coincides with the object $S + f$. Of course there is no real coincidence for the image is virtual, not real.

In the electrical case, however, there is real coincidence, for real beat frequencies are produced both with S and S' when the oscillator is set half way between.

In most instances the intermediate frequency of the filter is such that the image of one frequency does not exactly coincide with the object of the other, for this can only happen when the intermediate frequency is an integral multiple of the spacing of broadcast channels, which is usually 10 kilocycles. Even if the intermediate frequency is nominally an integral multiple of this spacing, say 50 kilocycles, the frequency may actually be 49 kilocycles, for example.

Minimization of Image

The only practical method of minimizing image interference is to tune out the carrier of the undesired signal before it reaches the modulator. That means that the radio frequency tuner ahead of the modulator must be

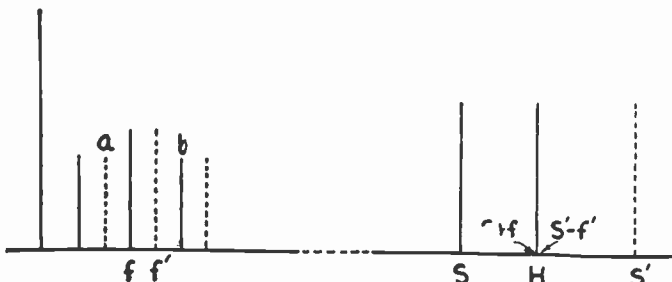

FIG. 3
Clashing of sidebands of the two carriers S and S' when the oscillator is nearly half way between, or at H . The subcarriers are f and f' , extreme left. The region of clashing sidebands is ab .

very selective. Ordinarily, a single radio frequency tuner is not sufficient to suppress the unwanted carrier to the point where image interference is not a nuisance. The higher the intermediate frequency the less need the pre-modulator selectivity be for a given suppression of any signal which might cause image interference.

The intensity of the squeal is proportional to the intensities of the two sub-carriers f and f' and these in turn are proportional to the intensities of the two carriers S and S' at the modulator. If the radio frequency tuner ahead of the modulator is so sharp that when it is set for the frequency S , the suppression of S' is practically complete, the sub-carrier frequency f' will be so weak that the audio beat between f and f' will not be of audible intensity. But if S' is not thoroughly suppressed, f' will have considerable intensity. Yet the beat produced between f and f' may be so feeble that it cannot be heard except during moments when the signal carrier S is unmodulated, that is, when no sound impinges on the microphone associated with S .

If the heights of the vertical lines erected at S and S' in Fig. 3 represent the intensities of the two signals at the modulator, the case represented is that when both are equal. The radio frequency tuner must suppress one of these, say S' , so that its intensity could be represented by only a dot above the horizontal line.

Case of Sidebands

So far we have considered only the beats between the two sub-carriers f and f' . But each of these is associated with two sidebands extending about 10,000 cycles above and below each sub-carrier. It is clear that when the sub-carriers themselves are so close together that they produce an audible beat the sidebands will overlap. The frequencies in one group would beat with those in the other. These beats, however, would not be sustained like the beats between the two sub-carriers, since any given note that impinges on either microphone is not sustained. If one of these notes were sustained for a moment, it is not likely that a sustained note from the other microphone would be sounded at the same time. But just the same, there is room for much clashing and momentary beating.

It is easy to imagine what would occur if the two interfering signals were equal at the modulator and the oscillator were set so that both came through. The result would be about the same as if two orchestras were playing different selections in the same room, the one giving no attention to the other. Indeed, the result would be much worse, for the heterodyne squeal and many other beat frequencies would be present which would not be there if the orchestras were playing in the same room.

Clashing of Sidebands

Fig. 3 illustrates image interference and the clashing of sidebands. S is the desired carrier

and S' that of the interfering signal. The oscillator setting is represented by H , the value of which is such that the beat f is that of the intermediate frequency filter. H also produces a beat frequency f' with S' . These two beat frequencies are placed lower down the frequency scale to the left in approximately their proper relation. The squeal heard in the loud-speaker is represented by the distance $f' - f$. The short dotted lines symmetrically placed about f' are the outside limits of the sidebands of f' , and the short solid lines about f are the outside limits of the sidebands of f . The region of clashing of sidebands is ab .

Very Low I.F.

For illustration let $S' = 1,000,000$ and $S = 900,000$ cycles per second. Also let the intermediate frequency f be 47,500 cycles per second. Then $H = S + f = S' - f = 947,500$. Since the difference between S' and S is 100,000 cycles and f is 47,500, f' is 52,500 cycles. The squeal between f and f' will be 5,000 cycles.

As the oscillator dial is turned, the point H moves and both f and f' change in value, and so does the squeal produced by the beating between the two sub-carriers. The volume of sound from either signal also changes, the maximum occurring when a sub-carrier is equal to the frequency to which the filter is tuned.

When the intermediate frequency is very low, for example, 30,000 cycles per second, the radio frequency tuner has to be exceptionally selective in order that a signal carrier causing image interference may be tuned out effectively. For example, suppose the two signals are 1,500 and 1,440 kilocycles and the second of these is desired without any interference from the first. When the oscillator is set at 1,470 kc both signals will come through the filter unless one of them has been tuned out completely before it reaches the modulator. If we wish to receive

(Continued on next page)

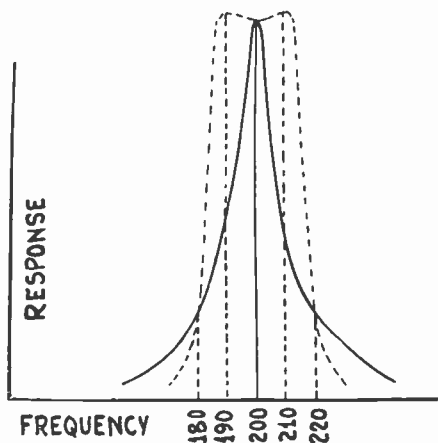

FIG. 4

Curves showing the difference between the transmission characteristic of a simple tuner (solid line) and of a band pass filter (dotted line).

(Continued from preceding page)

the 1,440 kc signal we tune the radio frequency circuit to this frequency.

Need for Preselection

But the other signal is only 60 kc away, and therefore it requires a high selectivity to cut it out. Even in many ordinary receivers the 1,500 kc signal would interfere considerably with the desired signal.

In a superheterodyne the interference from the beating of the two subcarriers would be much more severe than the direct interference between the two signals in the ordinary receiver. Hence the selectivity in the radio frequency level would have to be greater in order to reduce the squeal to a value below audibility. This is taken care of by adequate preselection.

This is one reason for not using a low intermediate frequency. Another reason we have already stated, namely, that if the IF is low the selectivity of the filter is likely to be too great. There are other reasons. For example, if the intermediate frequency is low it is difficult to separate it from the audio frequencies in the plate circuit of the detector by means of the usual bypass condenser and radio frequency choke. If the intermediate carrier is suppressed thoroughly by these devices, the higher audio frequencies are also suppressed. The effect of this is the same as excessive selectivity in the tuned filter, namely absence of high notes and excessive bass in the loudspeaker. Music would lack brilliancy, speech would be muffled, and consonants would be indistinguishable. Still another reason for avoiding a low intermediate frequency is the tendency of the oscillator frequency to be pulled over to the natural frequency of the radio frequency tuner.

As the intermediate frequency is increased these difficulties become less and less important. Suppose, for example, we use an intermediate frequency of 200 kc. If now we want to receive a signal on 1,440 kc the oscillator can be set at 1,640 or 1,240 kc. The 1,500 kc signal will no longer interfere. There are two possible signals which could interfere, namely, 1,840 and 1,040 kilocycles. Each one of these differs from the frequency of the desired signal by 400 kc, twice the value of the intermediate frequency. It does not require a very selective circuit to tune out a signal differing by such a high value.

Effect of Ganging

It is also relatively simple to separate in the plate circuit of the detector by means of r.f. chokes and bypass condensers a frequency of 200 kc from one of 10 kc without appreciably suppressing the lower frequency. Also with a 200 kc difference between the tuned circuits there will be no tendency for the two to "pull together." The selectivity in the i.f. level need not be so great that it would suppress the sidebands, because the r.f. selectivity is effectively much greater.

It is possible to use a still higher intermediate frequency, and, indeed, some circuits have been built with a frequency as high as 515 kc.

When the higher frequency setting is used the oscillator is designed so that the range is from $530 + f$ to $1,600 + f$, in which f is the intermediate frequency employed. Therefore if f equals 400 kc, the frequency range of the oscillator is from 930 kc to 2,000 kc.

It is clear that if the oscillator can be adjusted independently of the radio frequency tuner, some of the broadcast stations can be received on both settings even when it has been designed to receive on only one. For example, suppose the intermediate frequency is 400 kc. The lowest frequency of the oscillator is 930 kc, as we found above. Since $1,330 - 400$ equals 930 kc, it is clear that any station having a frequency of 1,330 kc or higher can be received on the lower setting as well as on the higher.

When a superheterodyne is designed to receive on the higher oscillator setting only, the tuning mechanism is usually arranged so that only one setting is possible and so that the oscillator is set at this automatically when the radio frequency tuner is set for the signal carrier. A superheterodyne so arranged is usually called a "one-spot," but as we have found above, a true "one-spot" is not possible. Arranging the tuning mechanism in any way does not alter the electrical features of the circuit; it merely makes it impossible to select one of the points. If there should happen to be image interference on the only available setting, that would be unfortunate. But, as we have emphasized, when the intermediate frequency is high and the premodulator tuner is selective, there is little likelihood that the image interference will be of nuisance intensity.

Prices Are Reduced On Nine Metal Tubes

Following are former and present reduced list prices on metal tubes:

	Old	New	Amt.	Per Ct.
5Z4	\$2.00	\$1.60.....	.40.....	20
6A8	2.00	1.75.....	.25.....	12½
6C5	1.50	1.25.....	.25.....	16⅔
6F5	1.75	1.25.....	.50.....	28½
6F6	1.75	1.50.....	.25.....	14
6H6	1.50	1.25.....	.25.....	16⅔
6J7	1.75	1.60.....	.15.....	8.6
6K7	1.75	1.50.....	.25.....	14
6L7	2.00	1.75.....	.25.....	12½
6Q7	2.00	2.00.....	0.....	0
6X5	1.75	1.75.....	0.....	0

PURCHASE LOAN PLAN EXTENDED

The Supreme Instruments Corporation, Greenwood, Miss., announces four new laboratory models applicable to purchase by Government loan through the Federal Housing Act. The new line includes the 385 automatic analyzer-tube tester, the 339 deluxe analyzer, the 89 deluxe tube tester and the 189 signal generator.

PEEWEE MICRO WAVE TRANSMITTER

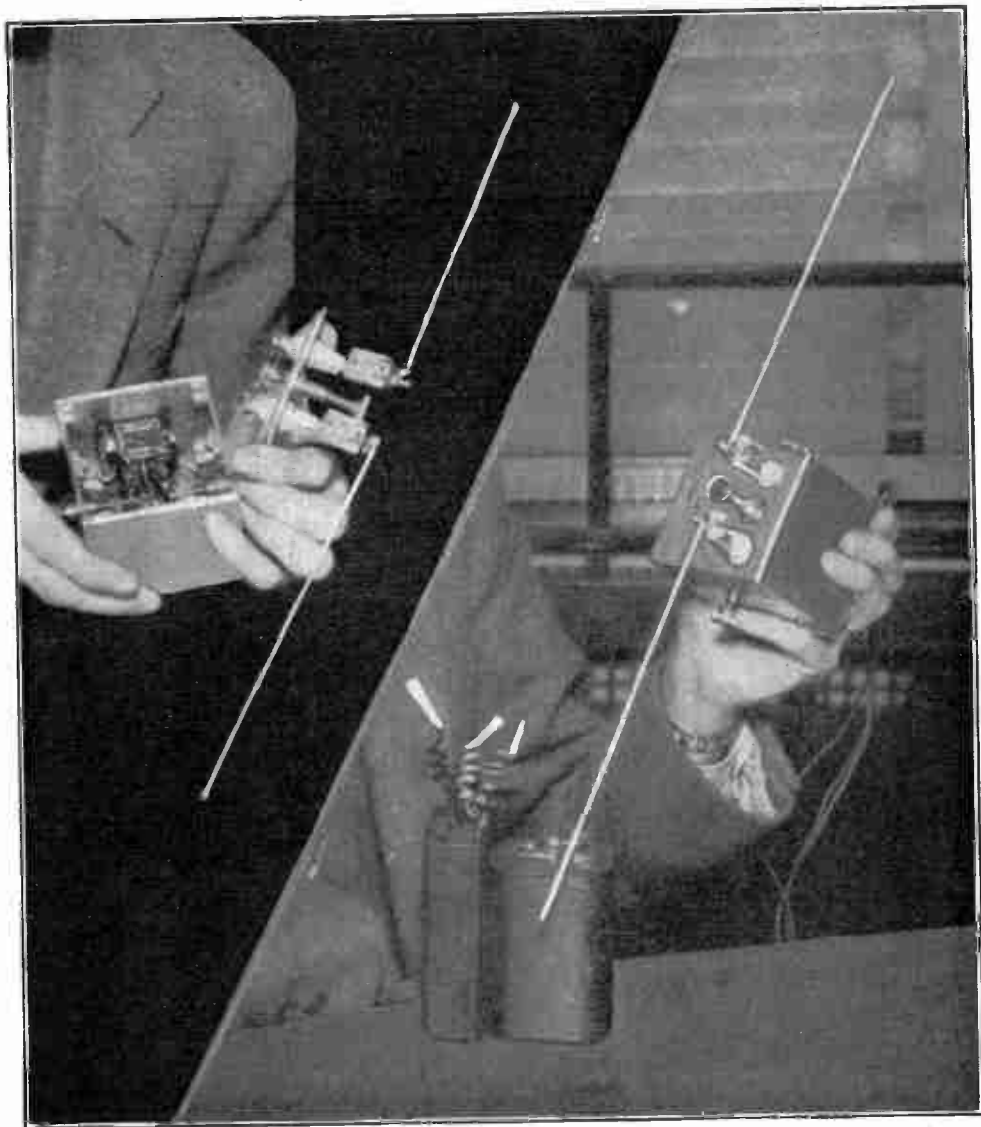

The hands are those of O. B. Hanson, chief engineer, National Broadcasting Company, and what they hold is the micro wave transmitter he designed, using an acorn tube and batteries.

A SMALL micro wave transmitter for broadcasting has been developed by O. B. Hanson, chief engineer of the National Broadcasting Company. Distances up to four miles were attained by the midget "radio station," which can be held in the palm of the hand. The device operates at one meter and below. It is not intended for broadcasts direct to listeners' radio sets, but for use with a microphone at any point of origin, to send to the main station and thus extend the scope of pickup for networks.

The unit enables announcers to circulate at will among large assemblages for broadcasting or to feed a public address system from the floor.

The set is a three-inch cube, with two ten inch rods as antenna. It transmits at a power of two-tenths of a watt.

B current is fed to the midget set by a 90 volt battery. The A and B battery unit weighs less than 4 pounds, the transmitter less than a pound.

Circuit is standard, layout unusual.

High Super Performance

Considerations for Establishing Superiority

By Brunsten Brunn

IN a superheterodyne the first frequency is that of the station, the second that of the local oscillator. The two frequencies must differ by the intermediate frequency.

When the oscillator condenser is mounted on the same control as the radio frequency tuning condenser it is necessary that the plates of the condenser of the oscillator have a special shape so that the generated frequency at any setting may exceed by the correct amount the frequency to which the other circuits are tuned, or that a series padding condenser be used, except for very short waves. For example, if the intermediate frequency is 200 kc the oscillator must have a frequency of 730 kc when the radio frequency tuners are set at 530 kc and it must have a frequency of 1,800 kc when the radio frequency tuners are set at 1,600 kc. No matter to what frequency the circuit may be tuned, the oscillator must be set 200 kc higher. Since this constant difference must be maintained it is clear that the rates of change of capacity in the circuits must be different, for the radio frequency tuners change from 530 to 1,600 kc while the oscillator changes from 730 to 1,800 kc. In one case the ratio of the extreme frequencies is 3.2 and in the other it is only 2.46. The corresponding ratios of capacity are the squares of the frequency ratios.

Special Exception Noted

There is one exception, and that is when all the condensers involved are accurately of the straight line frequency type, for then it is only necessary to displace the oscillator condenser with respect to the other condensers by an amount corresponding to the intermediate frequency. This frequency difference will be maintained throughout the range, since the variation of capacity in all the condensers maintains the frequency proportional to the displacement. If this is to succeed, the distributed capacity in each circuit must have been taken into account when designing the straight line frequency condensers.

When the oscillator condenser is put on the same control as the other tuning condensers it is not practical that the inductances in all the circuits be the same. It is only necessary that the product LC, of the inductance and the capacity in the radio frequency circuits, be larger than the corresponding product in the oscillator circuit by the amount which determines the intermediate frequency. There are many different combinations possible, but to get the best combination in any case requires considerable calculation. The constants should be chosen so that the desired frequency band covers as much of the dial as possible. For example, when the

dial is set at one extreme the circuit should be tuned to 530 kc, and when at the other extreme it should be tuned to 1,600 kc, if the broadcast band is desired.

This adjustment is effected by proportioning the minimum capacity in each circuit to the variable portion of the capacity.

High Intermediate Frequency

If the intermediate frequency is high, say over 400 kc, it is not necessary that the premodulator selectivity be very great. Two moderately selective radio frequency circuits, with one amplifier between them, should be enough in any broadcast receiver. This, however, supposes that a relatively small antenna, or that loose coupling between the antenna and the first tuner, be used. If a long antenna closely coupled to the first tuner be used, the selectivity will not be high enough. If loose coupling results in weak signals, it is much better to boost them by adding another stage of intermediate frequency amplification than by employing close coupling.

The selectivity in the radio frequency level must be relied on to suppress any image interference and that in the intermediate frequency level to suppress carriers which differ less than twice the intermediate frequency from the desired carrier.

The sensitivity of the superheterodyne largely depends on the intermediate frequency amplifier, for by far the greater amplification is obtained in this section of the receiver. The number of stages that should be used in this amplifier depends on the amplification that is required and the type of tubes used. When screen grid tubes are employed it is doubtful that more than two i. f. stages can be utilized advantageously.

Amplifiers may be constructed with either battery type or a.c. tubes, according to the type of current that is available. There is little difference between the two, although the a.c. screen grid tubes now available give a slightly greater amplification than the battery type screen grid tubes.

The 10 Kc Multiple

Many writers on the superheterodyne have advocated the use of an intermediate frequency which is not an exact multiple of 10 kc, but one which is an odd multiple of 5 kc, on the ground that such a frequency would result in less squealing and less image interference. There is now justification for this. There will be squealing and interference regardless of the intermediate frequency, unless the interfering carrier is tuned out before it reaches the modulator, subject to the conditions which have been discussed already.



EXTRA SPEAKERS

**MORE FUN OUT OF LIFE FOR THE USER,
MORE PROFITS FOR THE SERVICE MAN**

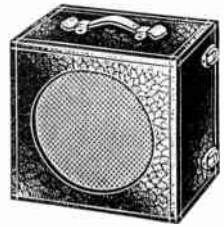

By M. N. Beitman

Allied Radio Company

THE new profitable field of installing additional extra speakers is open to all servicemen and experimenters. While it is generally known that magnetic speakers may be connected with ease to almost any radio, this possibility has not been commercialized to any great extent.

For example, most homes have only one radio, naturally retained in one room of the house. To hear radio programs in other sections of the house this radio set must be played at volume levels that prove nerve-wracking to all close to the radio and annoys neighbors due to loudness.

Other Applications

Another extensive application of extra speakers is found in schools where it may be desired to serve more than one room with radio programs from a single radio set. Many modern radios are sufficiently powerful satisfactorily to operate up to a dozen additional extension speakers with excellent volume.

During the summer season many persons find it desirable to place an extension speaker on their porch or in their garden. This application alone offers unlimited opportunities.

Extension speakers may also be used for advertising purposes. Store owners quickly realize that an outside speaker mounted above the door will attract the attention of passersby and bring in extra trade.

Standard Connection Methods

Additional speakers for various applications may be connected to practically any radio set simply and inexpensively.

Any good quality magnetic speaker is suitable for use as an extension speaker. For best results the speaker is coupled to the radio power tube or tubes in the following conventional manner.

In sets using a single power tube, a lead is brought out from the plate prong of the power tube through a .1 mfd. paper condenser.

The return lead of the loudspeaker is connected directly to the chassis of the radio set. Where two tubes are used in push pull in the output stage, extra reproducer is connected

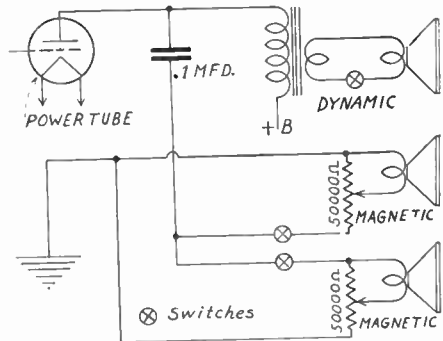

How to connect other speakers to a set with single output tube, applicable also to sets with parallel and push pull output tubes. If push pull output is present the same speakers as shown above may be used, connected as set forth in the text. The switch connection to the upper 50,000 ohms is meant to be continuous.

through .1 mfd. condensers to the two plates of the power tubes.

These simple methods of connecting additional speakers, while satisfactory for many ordinary requirements, do not provide for shutting off either the main or the extension speaker, or for varying the volume of the extension speaker.

How to Include Switches

By incorporating a simple single pole switch in the extension speaker lead, and one switch in the voice coil circuit of the main speaker, either or both speakers may be operated at will.

The volume of the extra speaker may be controlled by means of a 50,000 ohm potentiometer in a voltage divider circuit. These two added refinements are illustrated in the diagram showing the final stage of a radio set equipped with two extra speakers.

Servicemen and others engaged in radio work are strongly urged to take advantage of the money-making opportunities that lie in the installation of extra speakers. Almost everyone realizes the advantages offered by extension speakers and is a likely prospect for such an installation.

Accuracy in a Tube Voltmeter

Two Range Instrument for R.M.S. Values

By Herman Bernard

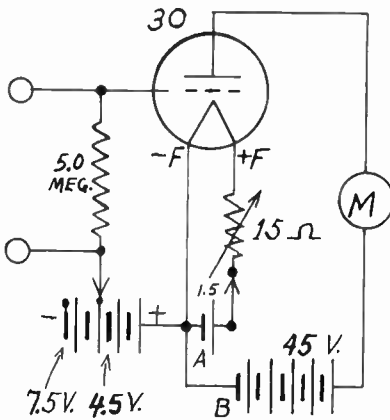

Tube voltmeter, two ranges, for .5 to 4.8 and 2.8 to 7 volts, r.m.s. The two curves shown elsewhere were produced from this rig.

A CALIBRATED vacuum tube voltmeter may be constructed following the diagram herewith. If a low range a. c. voltmeter is at hand, one may calibrate the change in plate current in terms of 0-1 d. c. milliamperere readings, against the a. c. input voltages. The 60 cycle line frequency may be used. The calibration will hold satisfactorily for very much higher frequencies, including radio frequencies, possibly to above 20 mc.

The meter is M. The a. c. input volts are expressed in terms of d. c. plate current. The calibration is not direct reading, since the actual plate current is read, and this must be related to the a. c. input volts. A chart is made up, wherein the milliamperere readings are the abscissas, and the causing a. c. input volts are the ordinates. Unless one is prepared to protract his own scale and replace the one on the meter, the chart will have to be consulted for actual a. c. values when the tube voltmeter is used for measurements.

One Range .5 to 4.8 A.C. Volts

The basis on which the present small device exists is that filament voltage is applied to the tube from a No. 6 dry cell (1.5 volts), and a rheostat of 15 ohms is put in the positive leg of the filament. This will be used for one of two adjustments. From negative A to plate the 45 volts of B battery are connected, the meter in series, while the grid is negatively biased 4.5 volts minimum, or given a second and higher bias, by switching. Use of 4.5 negative bias on the 30 tube, with 45 plate volts, yields full scale deflection for 4.8 a. c. input volts, 7.5 minimum.

A high resistance between grid and grid return assures that the negative bias is present the moment the set is turned on, to protect the meter. If the leak were absent the rig would permit zero bias and the plate current would greatly exceed 1 milliamperere, perhaps bend the meter needle. The minimum bias is selected as 4.5 volts because then, with 45 plate volts, the plate current will be not too near zero. It is not advisable to use the system so that the plate current is seemingly cut off, as then there is no positive assurance that the same reference or starting point is established each time, since still more and more negative bias will not move the needle below zero. Hence a definite starting point slightly past zero is selected. The stated voltage apportionment takes care of that, for 50 microamperes represents .5 volt a. c. input. Changes below 50 mca are too crowded on the meter for reference value.

Selection of Tube

A good 30 tube must be used, otherwise the plate current will be too low or, for a "second" tube, probably much too high, due to gas. Also, the B batteries should be fresh.

On account of the rheostat adjustment the calibration does not depend exclusively on the terminal voltages, but the adjuster is set so that when the switch is at the 4.5 volts negative bias position the zero a. c. input value coincides with 25 microamperes. This is midway between zero and the first division out of 20 on many 0-1 milliamperere, or may be determined by dividing the total number of divisions into the full scale current (1,000 microamperes), the result being the number of microamperes per division. Then 25 microamperes may be read at an even bar or estimated closely enough if that value falls between two bars.

How Rectification Arises

The object, as stated, is to have a definite starting point, and the rheostat permits return to that starting point, with minimum disturbance of the rest of the circuit. The rectifying curve of the tube remains practically the same for a very long time, hence the circuit is adjusted to permit repetition of reference to that curve despite some changes in terminal voltage.

Since the plate current is not far from zero, the negative alternation of the input cycle is suppressed for a. c. input volts of .5 volt up. The changes of voltage that affect the grid are then from zero axis to positive values and back to zero again, with negative repetition skipped, and a return to the positive cycle. This is not

only rectification, but it comprises in operation a peak voltmeter, or crest voltmeter. What the plate milliammeter reflects is the peak value of the a. c. voltage.

The device therefore may be used for approximate percentage modulation measurement, the percentage modulation being computed from the formula $100 D/c$, where D is the difference between the two voltages read, with and without modulation, and c is the voltage read without modulation. Therefore in radio practice c would represent the carrier without modulation.

R.M.S. and Peak Voltages

Although literally the circuit performs as a peak voltmeter, that does not mean that the calibration must be in peak volts. There are two usual terms for expressing a.c. voltages, and these are peak and root mean square values. The peaks are the highest voltages or measurement of the crest of the wave, since in a.c. the voltage is not constant but varies

from zero to maximum positive, declines to zero, then drops below the zero axis to negative values, reaching maximum negative, and returning to zero to begin the positive ascension again. If a large number of points on the resultant curve is taken, and the values squared, and these squared terms added, and then the square root of this sum extracted, we have the root mean square value of the voltage, the one most commonly used. R.m.s. applies in all a.c. voltmeter practice unless the contrary is stated, when the words "peak" or "crest" appear somewhere on the instrument face. If we use an r.m.s. voltmeter for input calibration, the curve is for r.m.s. Peak values are computable, equaling 1.41 times the r.m.s. values.

Calibration Without A.C.

If direct current voltage is applied to the grid then the calibration may be made without resort to a.c. by applying the following factors for bias of 7.5 d.c. maximum, answers being in r.m.s. (Continued on next page)

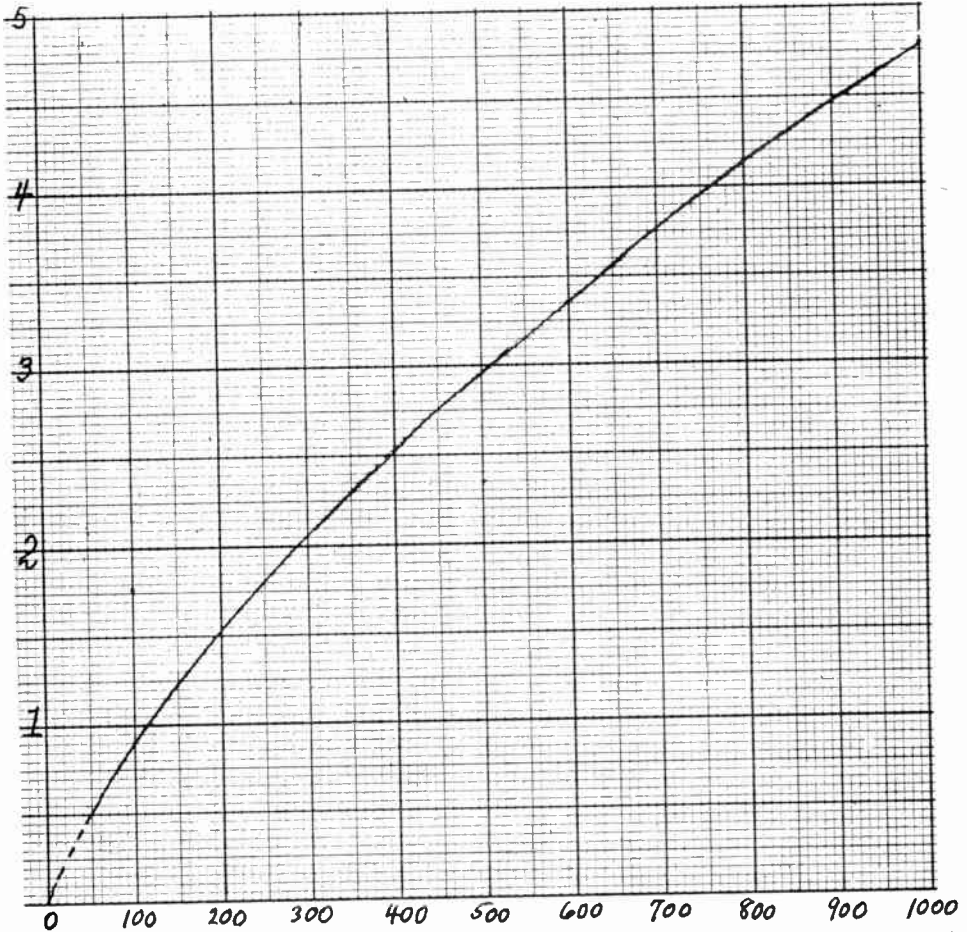

Curve for 4.5 volts negative bias, 45 plate volts, and rheostat adjusted so that at no a.c. input the current reading is 25 microamperes in the plate leg of a 30 tube. The values on the perpendicular plane (a.c. volts) are called the ordinates, and those on the horizontal (microamperes) are called the abscissas. Root mean square volts are given. The circuit used was the one diagrammed on preceding page.

(Continued from preceding page)

Plate Microamperes	Multiply D.C. Grid Bias By
50	.7667
100	.7667
200	.6833
300	.7500
400	.7500
500	.7500
600	.7566
700	.7500
800	.7166
900	.7250
1000	.7667

If we have an r. m. s. voltmeter we may connect low voltage a. c. to the voltmeter, and across the input to the rig, and by using different values of low voltage, get the plate meter readings, and draw the curve relating the two, as was done in the tests that produced the curves herewith.

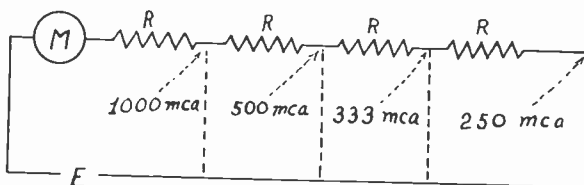
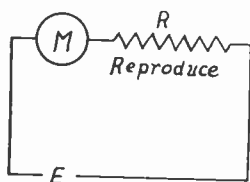

One way to check the 0.1 millimeter. R is the resistance required to create full scale deflection when E is applied, and for E = 45 volts up, is in ohms 1,000 times the voltage applied. Establishing numerous such equal resistors in series allows calibration in step of $1/nR$, where n is the number of resistors. Case of four resistors is illustrated

One way to calibrate, then, would be to use a low resistance potentiometer (say, 2,000 ohms) across a 5 volt winding of a power transformer, one side of meter and also grid to sliding arm, other side of meter, and winding, to grid return. Then by moving the arm the voltage may be changed from maximum (which may be around 6 volts, on account of small load on the secondary) to zero. If the a. c. voltmeter used draws much current, as nonrectifier types are likely to do, the voltage will be lower than for small load. Anyway, the meter will tell the true voltage. Somewhat more than 1 milliampere could flow without grid current being drawn, but care should be exercised not to put in excessive a. c. voltage.

The low voltage range is the valuable one, since the instrument is to be used mostly for measuring radio frequencies at points where the voltage is seldom more than a few volts, and even in local oscillators of superheterodyne receivers may not exceed the range of the present rig. If larger values than 5 volts r. m. s. are to be measured, more biasing voltage is used, and in the diagram the addition of 3 volts, to constitute 7.5 volts of negative biasing, is shown.

Meter Accuracy

It would be preferable for multiple ranges to have the rig so made that the maximum bias is present, to protect the tube and meter, unless

a switch is thrown, because with possibilities of measuring larger voltages the peril of introducing them when the tube voltmeter is not set for such low sensitivity is greatly increased, due to human nature, thus imperiling the plate meter.

The course then would be to apply the unknown a. c. voltage when the rig is in its safety position, and decrease the bias by switching, to the lower range, until a deflection is noticed on the meter. The protection could be applied by having a spring attached to the bias switch to hold the switch in the protective position, especially if there are to be only two positions, when commercial toggle switches that perform the service may be used.

A calibration run for the 7.5 volt negative bias, plate voltage unchanged, showed 2.8 volts r. m. s. input made 50 microamperes flow in the meter, and 7 volts r. m. s. produced full scale deflection.

Those who would build the simple rig, and who will not have the facilities for calibration, would no doubt like to know to what extent they may rely on the curves. The batteries, the tube, the rheostat leak, and the meter are at hand, then the only question is, will the curves hold?

Since they are based on the tube characteristic the curves in themselves are reliable, even when the voltages at the terminals are a bit off, as the scheme was to rely strongly on the tube, and institute conditions that allowed for compensation until the current flowing was 25 microamperes for the 4.5 volt negative bias example, at no a. c. input. No extra adjustment is needed for the 7.5 volt negative bias condition, as the first setting, for the 4.5 volt negative bias condition suffices. The second adjustment, mentioned previously, is simply setting the meter needle exactly to zero when there is no current through the meter.

Perhaps a serious deviation will be due to meter inaccuracy if one depends on the published curves. The manufacturer's guarantee of accuracy of 2 per cent. for a 0-1 milliammeter refers to full scale deflection only. At lower currents the accuracy may be less.

As a test, a string of five 0-1 milliammeters, all of different manufacture, all high grade, was used, and all squared off nicely at 1 milliampere, but deviation began to set in even at .9 ma (900 mca). Therefore a preci-

sion type plate meter, costing some sixty dollars, was used in the calibration, and so far as any meter is substituted for a precision type, the accuracy may not be better than 6 per cent, where one depends solely on the curves.

The inaccuracy due to the meter you may use will be rather around the middle of the curve, since at the full scale the meter will be as guaranteed, whereas the minimum utilized current, whatever it is, reads 50 microamperes, and so the rig is tied down at two points, like a superheterodyne, with no control over the middle, also like a superheterodyne.

The possessor of the meter may use the accuracy of full scale deflection of that very meter to note the deviation for smaller currents. Since a 45 volt B battery is at hand, the resistance needed to attain full scale deflection when only battery, meter and resistor are in series, is 45,000 ohms. So use a 30,000 or 40,000 ohm fixed resistor, and a 10,000 to 20,000 ohm variable, in series, and adjust until the meter reads exactly full scale.

Making Meter Semi-Precision

Then make up another resistance network of the same type, then another, then another, etc. When the second is added to the first the current is halved, and is 500 microamperes, no matter what it reads on the meter; when the third is added the current is one-third, or 333 microamperes, and when the fourth is added the current is 250 microamperes.

By inserting a measured resistance of 900,000 ohms, the correct setting for the 50 microampere tiedown point will be established, and enough points can be obtained to run a curve that relates meter readings to actual current through the meter. Then the two curves illustrating this article may be used reliably. Also the meter has been made semi-precision as to service, because the true currents to 2% may be determined from a curve relating meter readings to real current.

Another way is to set up the circuit of the tube voltmeter, for 4.5 volts negative bias, and connect a potentiometer of around 2,000 ohms across the 5 volt winding of a filament or power

transformer. Then get four equal high resistors, .1 meg or more each, and two equal resistors each half the value of the others. Say that the resistors consisted of five of .1 meg. and two of .05 meg. Connect the resistor network, with the two smaller resistors at and next to the same end, to the tube voltmeter input. Adjust the potentiometer until full scale deflection is obtained, and call that 4.8 volts r. m. s. Then connect the tube voltmeter grid to the joint between the two equal "half" resistors. This is equal to .5 volt and should read 50 mca.

Use for the Network

Each of the larger resistors represents one fifth of the total voltage, each of the smaller ones one-tenth.

Now connect the VTVM input to the next joint, equals .95 volts approximately, and current through the meter is 100 microamperes; at next step, it is 1.9 volts, or 280 microamperes; next, 2.85 volts, 500 mca; next, 3.8 volts, 720 mca; finally again 4.8 volts, 1,000 mca.

If a calibration is made, using any particular plate meter, there is no need for accuracy in that meter, since the a. c. input voltage is compared to what the meter reads, and if the current isn't what the scale discloses, nevertheless the scale indication reflects the a. c. input volts accurately. This applies only to use of the same plate meter in later measurements.

Those who have a rectifier type instrument naturally have a low voltage scale available and may use that, plotting for measured r. m. s. input although the accuracy will be no greater than that of the a. c. meter itself, which is usually 5 per cent, again meaning full scale deflection.

Checking Rectifier Type Meter

The rectifier type meter has the rectifier, and that represents a resistance at the particular frequency, the meter alone having some resistance too, yet both are considered together if series resistance is added to maintain full scale deflection when the voltage is doubled.

(Continued on next page)

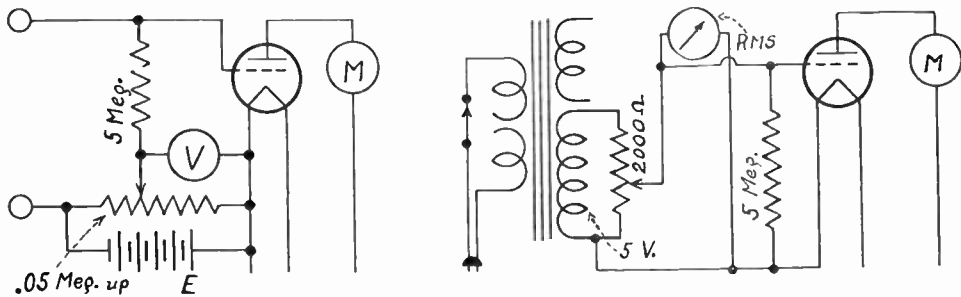

The same biasing battery to be used permanently may be connected as shown at left, voltmeter V reading the d.c. bias. The r.m.s. value of input is a factor of the d.c. reading. See page 28 for factors. At right, calibration with an r.m.s. voltmeter of any type is illustrated. The primary is meant to be continuous.

(Continued from preceding page)

Take the 2.5 volt center tapped winding of a power or filament transformer, and measure the voltage from tap to one side and tap to the other side. If they measure just the same, then the tap is at center and voltage from tap to one side is introduced to rectifier and meter through a series of 2,000 ohm rheostat carefully set at full resistance. Reduce the rheostat resistance slowly until meter reads full scale. Measure the external d. c. resistance.

Formula for Unknown

Now use the full five volts, center tap ignored, starting with rheostat at full resistance, and reduce resistance until deflection is again maximum. The rectifier and meter together have a resistance equal to half the value of the larger resistance externally applied, minus the smaller resistor externally applied, so $R_x = (R_{max}/2) - R_{min}$, where R_{max} is the larger external resistor and R_{min} the smaller external resistor.

Now the meter and rectifier sum resistance is known, and allowance made for it as if it were a series resistance, so that when the resistance network is set up as before, the resistors are calculated to be equal, say nine of them, the extra tenth comprising two half value resistors, and then the meter is checked by the knowledge the standard (full scale) current is reduced to 900, 800, 700, 600, 500, 400, 300, 200, 150 and 100 microamperes at the various positions below maximum. If the rectifier type meter requires a shunt for total 1 ma flow, the shunt may be present or absent without affecting the result, because full scale is the criterion and the actual current does not matter, only the proportion. The shunt when in service for measurements made by the meter will not affect the proportion.

Reasons for the Leak

The tube voltmeter diagram shows the inclusion of a leak of 5 meg. The value was made that high so that there would be minimum loading effect on the measured circuit. However, there will be some tiny current flow-

Divide Mu Into Ep to Obtain Cutoff Bias

The plate voltage on the tube voltmeter is 45 volts. The μ of the tube is 9.3. Therefore the plate current is too low to read on the meter—"cut off," as the saying is—at 45/9.3 or 4.84 volts negative bias. The 4.5 volt value is the nearest cell potential multiple and therefore was selected for minimum bias.

Incidentally, the plate current change per volt bias change may be noted from some position on either curve. Take the 5-volt curve. At 3 volts r. m. s. the current is 510 mca, at 4 volts it is 760, difference 250, which is the mutual conductance in micromhos. This conductance, G_m , is equal in mhos to the plate current change in amperes per volt change on the grid, hence in micromhos is equal to the current change in microamperes per volt change on the grid. Between 1 and 2 volts the same test shows 175 micromhos for G_m , which therefore is different over various parts of a tube's characteristic curve.

ing in this resistor when measuring, hence the tube voltmeter is not of the non-current drawing type, although the tube grid circuit proper does not draw any current, on account of the high negative bias, and the limitation of a. c. input volts to values that do not run the grid positive, when it would draw current.

One reason for the leak is to make sure that the negative bias is applied to the tube right away, for if the grid were open there would be no bias, or erratic bias characteristic of floating grid, and depending somewhat on surrounding objects if in close proximity. With no intentional bias the plate current would run high enough to endanger the milliammeter.

Another reason for the leak is that some circuits to be connected to the tube voltmeter for measurement likely would not have d. c. continuity, hence the external circuit to be measured could not be depended on for application of the bias through that circuit's d. c. continuity.

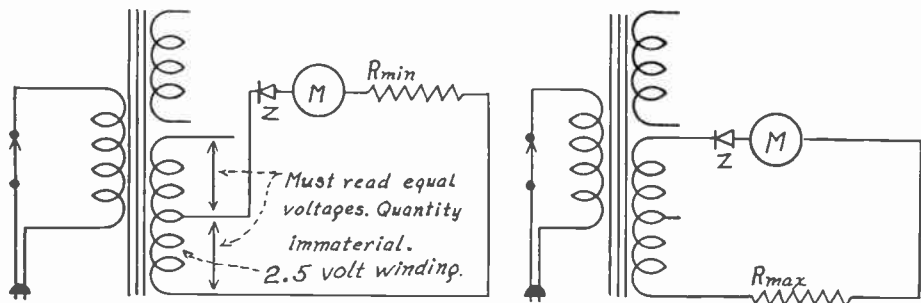

How to ascertain what is really the impedance of the copper oxide or other rectifier Z, in a universal meter. Series meter-rectifier circuit is connected across half of a 2.5 volt c.t. winding, R_{min} reduced from 2,000 ohms maximum until current is full scale. Then larger R_{max} alone in series for use of full winding, R_{max} adjusted to full scale current. Then $Z = (R_{max}/2) - R$ and is treated as pure resistance R_x . The meter resistance is included automatically in R_x because always present.

For instance, if the output of a tuner is to be measured, where there is a detector plate load and stopping condenser, the condenser prevents the continuity of a d. c. circuit, and would leave the tube voltmeter input open to that extent.

Avoiding Current Draw

Nevertheless it is recognized that some will desire to use the tube voltmeter under conditions where no current whatever is drawn by the measuring device from the circuit to be measured, for in some few instances that requirement should be fulfilled, as when measuring a. v. c. voltage. There may be a diode load resistance of 1 meg. or more, especially more when counting the filter resistors in the grid return circuits of controlled tubes, and then the tube voltmeter would draw about one-sixth of the total current under the best conditions, and in some special instances much more. This would cause the measurements to be erroneous to a large degree.

To use the instrument as a non-current-drawing device requires some precautions, though they are simple. The first is to determine whether the circuit to be measured assures d. c. continuity. For low resistance circuits, a few hundred ohms d. c. resistance or so, the milliammeter itself may be used, since if terminals are brought out the meter may be put across the circuit to be measured and if there is d. c. continuity the needle will deflect downward a little.

Check on Continuity

Of course an ohmmeter always may be used, especially one that includes sensible deflections for high resistances, of the order of 1 meg. It is not imperative to know the d. c. resistance of the circuit to be measured, only that continuity exists.

So the tube voltmeter is connected to the circuit to be measured, and a switch put between the grid leak and the grid, previously
(Continued on next page)

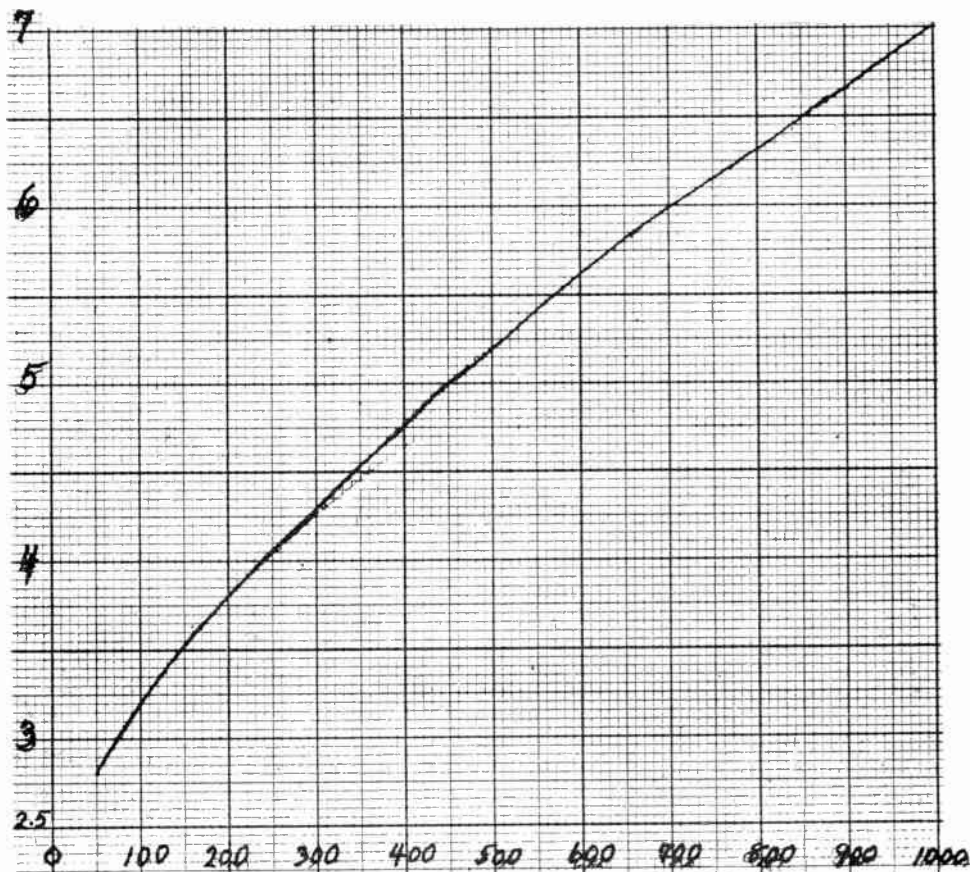

Calibration of the tube voltmeter circuit for 7.5 volts negative bias. This calibration and the other were made with precision r.m.s. voltmeter and precision 0-1 milliammeter. D.c. may be used for input and any 0-1 milliammeter for independent calibration. See text.

(Continued from preceding page)

closed, is opened, as it is known that the load will establish the continuity requisite for applying the d. c. bias. If this switch is sprung, so as to remain closed until held open momentarily, danger to the instrument is minimized. This switch would be additional to what is shown in the schematic diagram.

The 4.5 volt negative bias is minimum, as less would cause too much plate current to flow, a peril to the meter and killing too much of the scale. The minimum condition permits use of 80 per cent. of the 0-1 milliammeter scale, starting at 50 microamperes, and going to full scale, 1,000 microamperes.

More than one value of higher negative bias may be used. This diagram shows 1.5 volts added, total 7.5 volts, for the second value. This was done because there are biasing batteries of 7.5 volts that also afford a 4.5 volt tap, but the overlap is admittedly large, 2.3 volts. This may be useful, however, for measurements from 3 to 4.8 volts r. m. s., because they may be made at one bias position then at the other, and the two results averaged. The accuracy of a tube voltmeter is not usually as good as that of high grade electro-mechanical instruments, but methods of improving accuracy are discussed in the text and may be followed safely.

LAYOUT FOR GLASS TUBE REGENERATOR

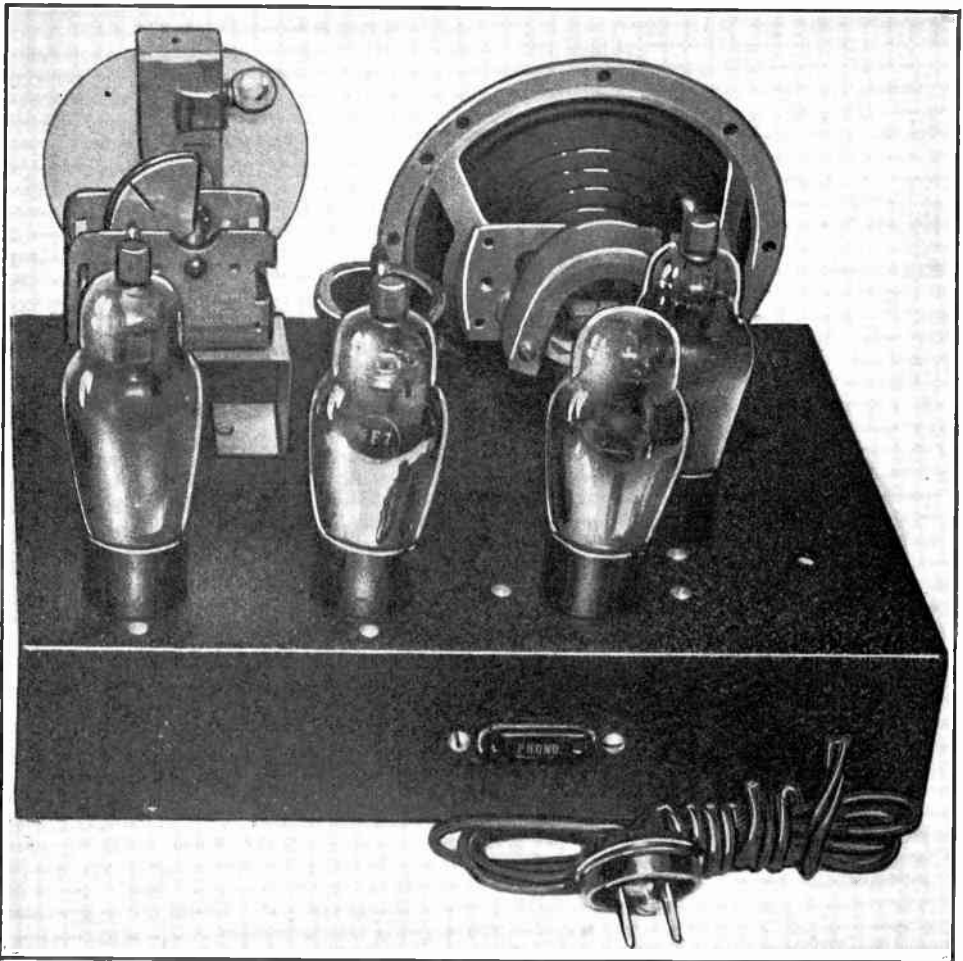

A buffer, a regenerative detector and two audio stages, with rectifier, are used, as in the set described on pages 12 and 13, for which this serves as layout also. The 76 and 6D6 are used above in place of 6C5 and 6K7.

Output of Battery Sets

Single 33 Compared to Class B 19 or 49's

By Leonard W. Allenby

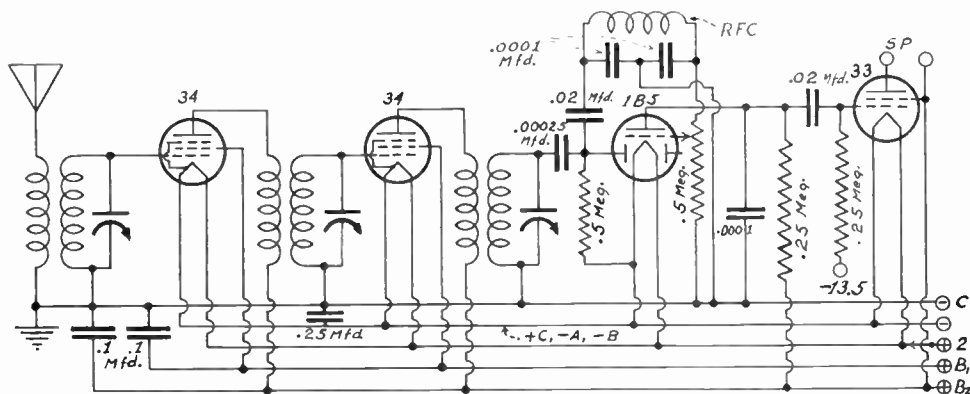

The total filament drain of this battery operated tuned radio frequency set, with single 33 output tube, is .44 ampere. The negative filaments are at left, the positive filaments at right. Terminals at extreme right are: B plus No. 2, 135 volts; B plus No. 1, 67.5 volts; plain 2 is A plus, while A minus is directly above. C plus is connected to A minus, and the line marked C represents minus 3 volts.

THE power output of battery operated receivers, using a single 33 pentode, a single 19 or two 49's, has been measured, and the results show that the 33 is considerably behind the two others. In general, the 19, which consists of two tubes in one envelope, worked Class B, gives greater output for the same distortion level, than the 49's in the same class of service, for large or small outputs.

Certain limits were selected, within the capabilities of the three methods, so that for the single 33, Class A, an output of .8 watt was selected, the total harmonic distortion then being 8.5 per cent., the root mean square input voltage, 500 cycles, 10 volts.

The 19 in Class B service allowed 1.85 watts output, 8 per cent. distortion, 6.5 volts r.m.s. input.

The 49's in Class B provided 1.58 watt output, 6.5 per cent. total distortion, 6.7 volts r.m.s. input.

33 Superior at Low Volume

Since these factors concern large output, the 19 provides about 20 per cent. greater output than the 49's at about the same distortion level, although the third harmonic distortion is most of the 19's total.

When it comes to low volume levels, however, as is to be expected from the nature of Class B, the showing is better for Class A, that is, the 33, where .25 watt, 4.4 volts r.m.s. input,

compares to .18 watt for the 19, with 1.5 volts r.m.s. input, and .12 watt for the 49's, 1.5 volts r.m.s. input, all for 2.25 per cent. total harmonic distortion.

What makes the single tube attractive, therefore, is that if one is content with small power output, the quality is better. From the economical viewpoint, also, if a 2B5 tube is used as detector and driver, the 2B5's triode may be resistance coupled to the pentode output tube. The filament current for 1B5, 30 driver and 19 is 380 milliamperes, for 1B5, 30 and two 49's is 360 milliamperes, and for 1B5 and 33, 320 milliamperes. When economy of operation is imperative, considering the filament drain, these facts must be borne in mind.

New Amplifier Tubes

Of course other tubes will be required in a receiver. In the first diagram is shown the schematic circuit for a tuned radio frequency set, using a three gang condenser, two 34's as r.f. amplifiers, 1B5 as detector-driver, and 33 as output tube, total drain .44 ampere. The filament voltage in all instances is 2 volts.

The two other diagrams represent superheterodynes, the same as except for the output tubes. The triode of the 1B5 feeds the 30 driver, which works into the 49's in one instance, and into the 19 in the other. The 1A4

(Continued on next page)

BATTERY AUDIO OUTPUT TABLE

	P.O.	T.H.D.	R.M.S.
Single 33 Class A	.8	8.50	10.0
	.5	5.00	7.0
	.25	2.25	4.4
19 Class B	1.85	8.0*	6.5
	.36	5.0*	2.0
	.18	2.25	1.5
49 Class B	1.58	6.50	6.7
	.3	5.00	2.5
	.12	2.25	1.5

P.O.=Power Output in Watts.
 T.H.D.=Total Harmonic Distortion in Per Cent.
 R.M.S.=A. C. input volts, 500 cycles, r.m.s. values.
 * Mostly third harmonic.

and bottom of the shield, even if the bottom is open when you are winding the coil. It will be at least partly closed when the shielded coil is put on a chassis. In other words, center the coil in the shield in two directions.

A thin application of coil dope is to be made in each coil. Allowed to dry before the coil is wired in any circuit.

The oscillator capacity at minimum should be larger than the r.f. capacity for the oscillator inductance specified, so turn down the oscillator parallel trimmer more than the r.f. trimmer. Directions for lining up superheterodynes were printed in the January, 1936, issue, pages 45, 46 and 47.

15 Watt Lafayette Amplifier, 124 DB Gain, Small Housing

A high-gain, low-cost public address amplifier, available in metal and glass tube models, is offered by Lafayette Radio Manufacturing Co., Inc., of New York City. Amplification of 124 decibels in a unit measuring only 9½" by 16½" by 9½" high makes use of a pre-amplifier unnecessary even when using a microphone of the lowest output level now commercially available.

Eight tubes are used. The 6F6's are output of the metal tube model 251-A. A glass-tube model, 247--A, is also available, 42's as output.

Input impedances are high; output impedances are from .7 to 15 ohms, 250 and 500 ohms.

Output is 15 watts to a 500 ohm line, frequency response reported as three decibels between 50 and 10,000 c.p.s., harmonic content at maximum output, 6%. Hum level is 45 db below sound output, and power consumption from a. c. line is 90 watts.

The amplifier is distributed exclusively by Wholesale Radio Service Co., Inc., of New York, Chicago, Atlanta, and Newark, N. J.

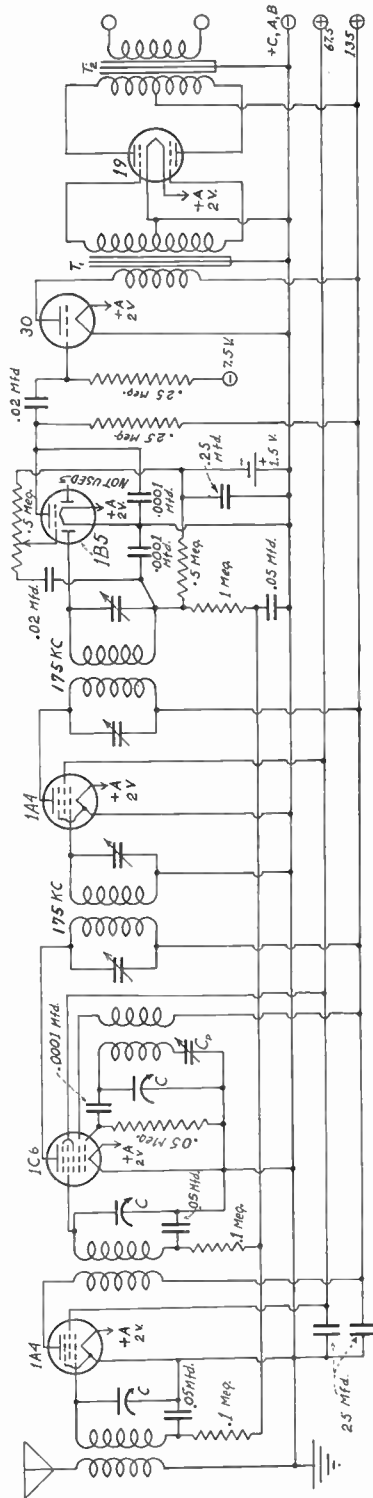

The same circuit as that of the other superheterodyne, with a 19 tube as Class B output.

A. J. Haynes' Latest Circuit

A 2½ to 555 Meter Receiver, the R-S-R

IT COMBINES REGENERATION AND SUPER-REGENERATION — FULLEST PARTICULARS ON CONSTRUCTION

By A. J. Haynes

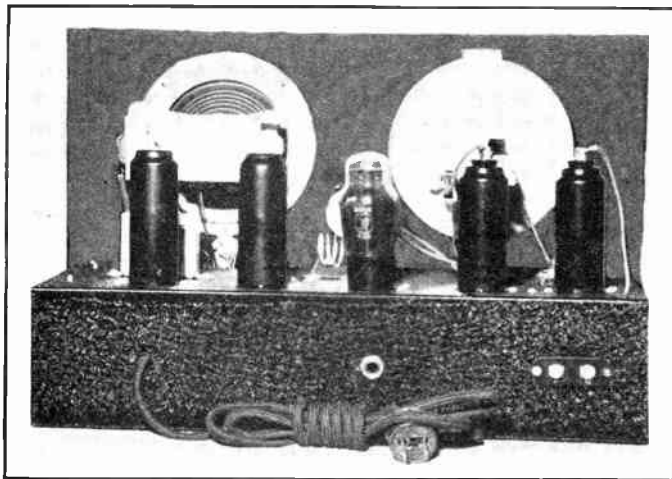

The waves below 15 meters are worked super-regeneratively. The detector is the glass triode, shown in blueprint and in schematic diagram as a 76, but at left as a 37, as the two tubes are interchangeable as to service in this receiver and socket accommodation. The phone jack, applicable to all bands, is shown at rear. The twin assembly provides the antenna-ground posts.

THE R-S-R Receiver was designed for the all wave enthusiast and experimenter to enable him to have the entire active radio frequency spectrum literally at his fingertips. Beside the increasing activity on the 5 and 10 meter bands, more than two dozen of the new so-called "Apex Class" stations have been licensed for experimental broadcasting on wavelengths between 5 and 10 meters. Their unofficial designation as "Apex" stations is due to the fact that they are all strategically located on the tops of the highest buildings in our metropolitan centers.

With a receiver that can slide smoothly over all of these ultra-high frequencies there are surprises and thrills galore for even the blasé old time "dial twister."

Circuit Discussed

The R-S-R employs a combination regenerative and super-regenerative circuit. A radio frequency buffer tube and electron coupled regenerative detector are used on wave lengths from 555 down to 15 meters with a simple but efficient band switching coil arrangement which eliminates plug-in coils over this range.

On the ultra high frequencies simple band switching is not practical and straight regeneration becomes too critical. Thus, from 15 meters down (down meaning to well below 2½ meters, the low limit depending on the

particular tube used and the care exercised in the wiring) super-regeneration is utilized with small self supporting plug-in coils.

The regenerative circuit is probably the most important as well as the most interesting circuit ever developed in radio. It is also the most abused. A poorly designed and constructed regenerative receiver can be just as pesky and useless as any other bad set and perhaps a bit worse. On the other hand, given a fair location and adequate antenna, a good regenerative receiver can deliver excellent long distance reception with a minimum of noise.

It is a peculiarity of this circuit that its efficiency is not as dependant upon the quality of the parts used in it as upon the circuit design and arrangement; though the L/C ratio should be large, the proper detector tube impedance screen voltage is provided.

For fine distance work very smooth and accurate regenerative control is not only of the greatest importance, but is an absolute necessity. In the early 1920's when this type of circuit was the only one we had, a receiver with "sticky" regenerative control or "fringe howl"—so common today—would not be tolerated.

Dual Regeneration Control

In designing the R-S-R every effort was made to obtain the smoothest and most stable
(Continued on page 37)

BLUEPRINT OF 5 TUBE SET, 2½ TO 555 METERS

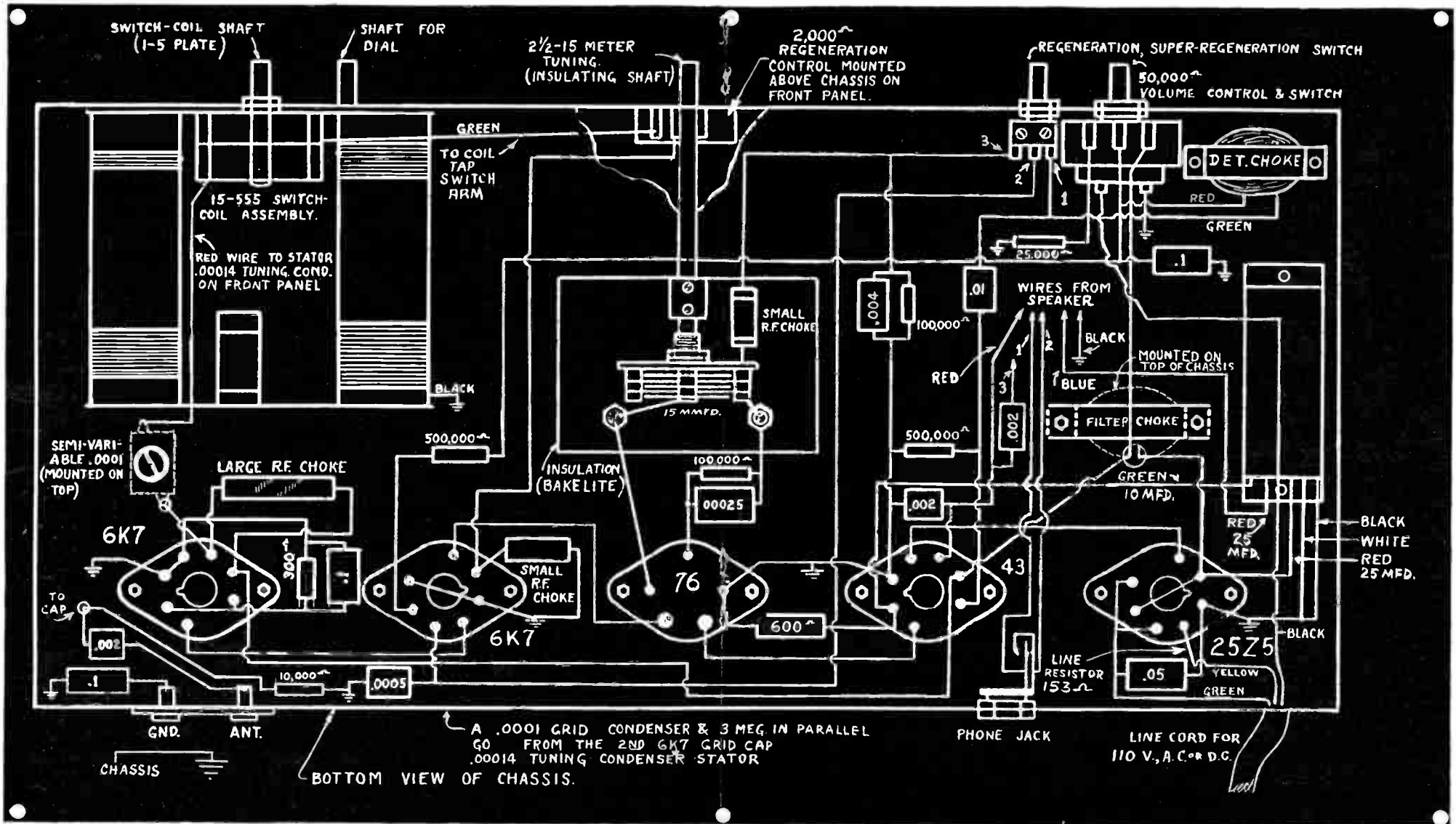

The wiring as seen from the bottom is illustrated. Numbers for units not designated represent mfd. The tuning condenser is on top of the chassis,

above the coil switch unit, hence not visible. The rotor (frame) is grounded to chassis. The stator connects to the semi-variable .0001 mfd.

condenser. See notation, upper left. The regeneration-super-regeneration switch is numbered: (1) = common; (2) = 15-555 meters; (3) = ultras.

SENSATIONAL PRICE REDUCTIONS ON THE LATEST RADIO EQUIPMENT!!

Electrophone

Portable Electric AC Motor with Hi-Impedance Audak Pickup, in leatherette case 12x12x8. General Electric Motor with speed regulator and 10-in. plate. Built-in volume control and switch. Can be attached to any set. Needs no transformer. Shpg. wt. 24 lbs. Plays 10" and 12" records. Complete with cords & needle box. **13.50**



FADA



3 Band Superheterodyne 6 Tube. Universal AC or DC. Uses 1-6A7, 2-6D6, 1-75, 1-43, 1-25Z5. Automatic volume control, 3 gang condenser, tone control, dual ratio vernier dial calibrated in meters and kilocycles. Covers 19-55, 200-550, 1000-2000 meters. Full foreign and broadcast band plus long wave weather report band. Beautiful mahogany cabinet 18 in. high, 8 in. deep and 12 in. wide. Shpg. wt. 35 lbs.; large dynamic spkr. Complete with RCA tubes..... **24.50**

General Electric

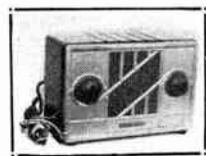

Battery Set. Compact 3 tube portable in metal cabinet. Sensitive and selective. A fine toned set for economical operation. Works on 3 45v. B batts. and 6-volt A supply. Uses 1-78, 1-77, 1-38. Size 10 in. long, 6 1/2 in. high, 5 in. deep. Bronze finish. Shpg. wt. 15 lbs.

Complete with RCA tubes, less mbatteries **9.95**

General Electric



AC Battery Charger—5 ampere hour charging rate. Uses new GE mercury charger bulb. New steering column attachment simplifies charging your car battery. Automatically tapers as battery charges. Metal container with handle. Shpg. wt. 15 lbs.

Complete with GE bulb and wires... **9.45**

Real Value

Hi-Fidelity

16 Watt Amplifier. Pure Class A. 20-watt peak, less than 2db variation from 20-14,000 cycles. Tubes are 1-83V, 1-57, 1-56, 2-2B6's. 83V. rectifier delivers voltages only when tubes are warm. Manual tone and volume control. Double input with throw selector switch, real Hi-Fidelity reproduction from mike, tuner or pickup.

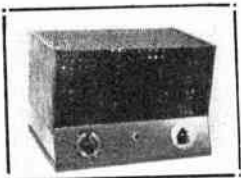

Black Oven-Baked Scratch-Proof Finish and Full Size Protecting Screen, completely enclosing tubes and transformer. Size 12 in. wide, 9 in. high and 8 in. deep. Pilot light indicator on chassis. Shpg. wt., 30 lbs. Speaker field 1000 ohms. Your net price, completely wired, 15 1/2. Set of tubes **3.85**
12" Rola Dynamic to match **3.95**
6-12 Rola Hi-Fidelity Speaker with output transformer **9.95**

More Money-Saving Items

- Genuine Philco Noise Reducing Aerial. Complete with all wires, set and ant. transformers. Shpg. wt., 8 lbs. **2.29**
- Emerson AC-DC Mickey Mouse Compact. Built-in Aerial. Dynamic Speaker. Complete with 4 RCA tubes. Shpg. wt., 15 lbs. **9.95**
- Genuine Home Charger. 5 ampere battery charger, completely dry. Tapering charge prevents overload. Complete with wires and instructions. Shpg. wt., 18 lbs. **4.69**
- Hi Impedance Upco Pickup. Built-in volume control. Needs no matching trans. Size 9 by 2 1/2 in. high. Shpg. wt., 8 lbs. **4.25**

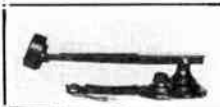

WALCO

Hi-Impedance Pickup. Feeds direct to grid without need of matching transformer. Finely balanced arm. Frequency response fine over entire range. Shipping weight 5 lbs. complete with cord **3.79**

GREEN FLYER
2 Speed—35 1/3-78 R.P.M. Speed Regulator with Governor. For AC current only. Quiet, dependable operation. Complete with 12" plate and mounting brackets. Size: 8" long, 6" wide, 2 1/4" deep. Shpg. wt., 12 lbs. **9.69**
AC-DC model, special \$12.49

Mail Orders Promptly Filled.

We Ship Everywhere. 24-Hour Service

Comet Radio

CORP.
65 CORTLANDT ST. NEW YORK CITY

Order direct from this Ad. C. O. D. Orders require 20% minimum deposit. Print name and address plainly.

KITS, PARTS AND SUPPLIES AT LESS THAN DEALERS NET PRICES! PHONO AND P. A. AMPLIFIERS AT LOWEST PRICES

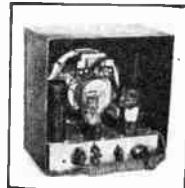

POWERFUL 3-TUBE AMPLIFIER uses 57-2A5-80 to deliver full 4 watts, manual tone and volume controls. Input connections on front panel. Ideal for home record reproduction P.A. and communication work. Complete in black crackle case with Rola 6" Dynamic speaker and tubes. Overall size: 10"x10"x6". Shipping weight, 18 lbs. For AC... **10.95**
Universal Operation, AC-DC. Uses 2525-43-666 **11.95**



AMERICAN 'EL' MICROPHONE 2 button carbon mike, 200 ohms per button. A real sensitive mike. Dependable and rugged. Complete with weighted stand and springs. Shipping weight, **5.19**
8 lbs. 10" high.....
Shielded cable 4c per ft.



1 WATT POWER AMPLIFIER—Heavy duty parts. Uses 57-2A5-80 manual volume and tone controls. Uses 2500 ohm speaker as choke. A rugged compact job that fills a multitude of purposes. Size: 9" x 7" x 6". Shipping weight, 12 lbs. ... **6.95**
Completely wired
Set of tubes.....\$1.21
8" speaker to match.....\$2.29

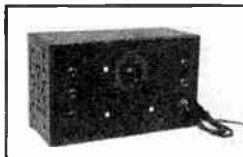

INPUT MIXER BOX. Black crystallized finish metal case containing mike, transformer, battery and volume control plus filter. Selector switch for pickup or mike. Both connect permanently. Shipping weight, 8 lbs. Complete with cord and battery. Overall size: 8" x 5" x 3 1/2" **3.49**

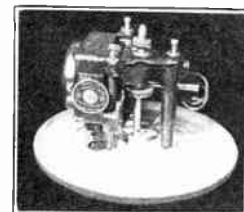

BLUE FLYER MOTOR. An outstanding value in AC phonograph motors. Single speed set at 78 r.p.m. Starts and stops by switch. Induction type motor. Complete with 10" plate. Shipping weight, 15 lbs. **1.89**

Also available in 25-cycle at same price.

8 1/2" MAGNETIC SPEAKER—Sturdy speaker with real tone. \$1.79
SEMI PERMANENT NEEDLES—Plays 20 records faultlessly. Package of 5 **5c**

HAND MIKE. Portable mike attaches to detector tube of set. Complete with instructions. Made by I. C. A. **\$1.89**

GENERAL ELECTRIC V Doublet all wave aerial. Complete with transposition wire, transformer and instructions. Shpg. wt., 10 lbs. **\$3.95**

WE SHIP EVERYWHERE
AM BASSA DOR Phones. Sensitive sturdy set, 3000 ohms. Complete with bulb and flexible band . . . 1.13

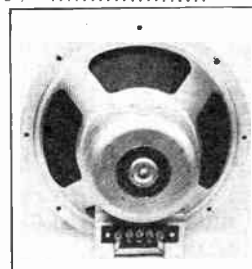

ROLA DYNAMICS
5 inch, specify output desired, 6 or 3000 ohm. Shpg. weight, 3 lbs. **\$1.79**
6 inch, 6, 1800 or 2500 ohm, specify output. Shipping weight, 4 lbs. **\$2.45**
8 inch, 1250, 1800 or 2500 ohm, specify output. Shpg. wt., 6 lbs. **\$2.95**
10 inch, 1000, 1250, 1800 or 2500 ohm, specify output. Shipping weight, 12 lbs. **\$3.45**
12 inch, 1000, 1250, 1800 or 2500 ohm, specify output. Shpg. wt., 13 lbs. **\$3.95**



AUDAK PICKUPS. Model No. 100 Hi-impedance unit feeds direct to grid. No matching transformers needed. Frequency response covers entire tone range. Shipping weight, 2 lbs.



RCA R-93. Portable Phonograph motor and pickup in mahogany case with built in switch and volume control. Attaches to any case without the need of matching trans. Genuine RCA motor and pickup. \$16.50 list. Shpg. wt., 15 lbs. For AC only. **9.75**
Plays 10" or 12" Records

ORDER FROM THIS AD

24-HOUR SERVICE
We are fully equipped to give you the finest and quickest service. We ship everywhere.



167 GREENWICH STREET
near CORTLANDT STREET, NEW YORK CITY

C.O.D. ORDERS
Receive prompt attention. All packages insured, please include postage to cover. Print your name and address plainly. All C.O.D. orders over \$10 require a minimum deposit of 20%. No C.O.D. orders outside U. S.

(Continued from page 32)

regenerative control possible. To this end two regenerative controls are provided. One, the main control, limits the r.f. feedback to the grid circuit, while the other changes the detector tube impedance by varying the screen and plate voltage and gives a very gradual vernier regenerative control. The latter also acts as a volume control, when it is retarded more than half way, limiting the input to the power output tube on strong signals.

Band switching, eliminating the nuisance of plug-in coils, can be made very simple and efficient, particularly in a regenerative circuit, down to about 15 meters. By using five bands, with separate coils, the range can be covered with a low maximum capacity tuning condenser, thus giving reasonable good electrical bandspread. Then an airplane type dial with a 9 to 1 tuning ratio adds sufficient mechanical bandspread to give precise non-critical tuning.

For sensitivity and consistent results below 15 meters it is hard to beat a good super-regenerative receiver. Single control tuning

The bottom view as presented herewith occupies the same relative position as does the blueprint. The five coils are wound on three forms, covering 555 to 15 meters. Above the 15 mmfd. tuning condenser (center, behind long shaft and coupling) would be two pin jacks for the coils used from 15 to 2½ meters. These jacks are seen protruding through the bottom just below the rear of the small tuning condenser.

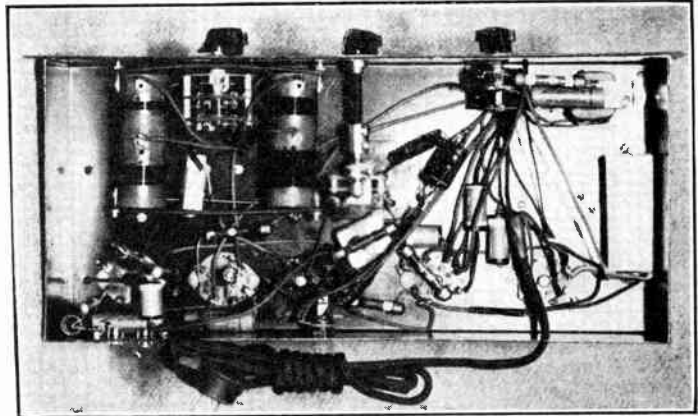

allows these ultra high frequency stations to be logged with absolute accuracy. The particular circuit which has been used in the R-S-R is sensitive and absolutely stable over its whole range. It is brought into use merely by turning the small switch knob directly below the speaker.

The entire super-regenerative tuner is mounted on a hard rubber sub-base panel with exceedingly short leads. Plain, two contact, coils are used for all frequencies below 15 meters and simply plugged into the two pin-jacks on the sub-panel. As the maximum capacity is only 15 mmfd., good electrical bandspread is attained down to the very lowest wavelengths.

When using super-regeneration, hiss control is obtained with the same 50,000 ohm potentiometer that provides vernier regeneration control on the longer wavelengths (located at lower right of panel). This permits the most sensitive "super" adjustment, minimizes radiation, and lets the hiss level be reduced to the vanishing point.

Built-in Power Supply

The R-S-R can be used on either 110 volts

a.c. or d.c. Until some of the new "universal" superheterodynes were developed this type of power supply had a bad reputation because it will give fair results with even a poor filter system and many of the cheap sets used it in this manner to reduce cost. The R-S-R receiver has been designed with an entirely adequate power filter, using a 60 mfd. condenser block and with average tubes and conditions the hum level is well below that of most good commercial receivers, even when regeneration is at maximum. This applies to earphones as well as to loudspeaker reception and is an important feature because most experienced radio experimenters prefer to use earphones for fine work and phones are particularly recommended for the ultra-high frequencies. For this reason a phone jack is provided at the back of the R-S-R chassis and when phones are plugged in the speaker is entirely silent.

Metal or Metal Glass Tubes

The R-S-R has been designed to use the new octal metal tube sockets which will permit the

use of either metal or metal-glass tubes. Both types of tubes provide the simple, effective shielding which is a merit of the new tubes and both give equally good results.

The only exception is the super-regenerative detector, which uses a glass 37 or 76 tube. The first model of the R-S-R used a 6C5 metal tube in this position and it performed perfectly down to 3 or 4 meters but it happened to offer no advantage over the glass tubes, as shielding is not needed here, and the glass tubes, with their lower output capacities, will go on down to well below 2½ meters.

The Buffer Stage

A 6K7 triple grid super-control tube is used as an untuned buffer, or r.f. amplifier, ahead of the regenerative detector. The main purpose of this tube is to stabilize the detector and allow its full regenerative gain to be utilized on all frequencies. It does more than this, however, as it shows a real r.f. gain, particularly on the short wave stations where the coupling has been designed to be most effective.

(Continued on next page)

(Continued from preceding page)

The results obtained from an untuned buffer stage of this type depend on several factors such as the mechanical layout, wiring, tube used, etc. But the most important factor of all is the coupling arrangement between the buffer tube and the regenerative detector. In the first place this should be adjustable, over a reasonable range, to compensate for various tubes, antennas, etc. This also allows the selectivity of the receiver to be broadened or sharpened as desired. This adjustment is ac-

complished in the R-S-R by a semi-variable 100 mmfd. mica condenser.

The rest of the r.f. coupling consists of a specially wound plate choke of rather low value. For some reason it seems to be an accepted custom to use a 2.5 millihenry choke here; perhaps because they can be conveniently purchased anywhere. Such a value gives splendid r.f. gain at the standard broadcast frequencies—so good in fact that the set cannot be used on an average antenna without hearing most of the local stations all over the broadcast band and often on the short wave bands as well.

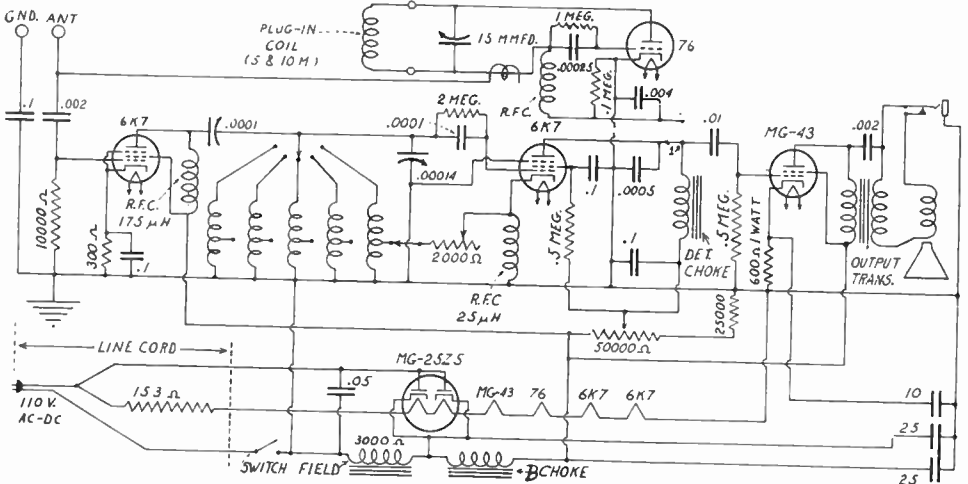

The five coils for 15-555 meters are above the MG-25Z5, a bit to the left. The plug-in coils principally for 5 and 10 meter reception are indicated. Actually 15 to 2 1/2 meters are covered by the plug-in coils. All coil data are found in the text. The second 6K7's grid leak may be 2 to 3 meg. Above 2 meg. is the designation. On the picture diagram a notation refers to 3 meg. Performance is not affected within these resistance limits.

LIST OF PARTS

Coils

- One set of ultra wave plug-in coils (see text).
- One set of tapped coils, 15 to 555 meters (see text).
- One 175 microhenry radio frequency choke
- Two 25 microhenry radio frequency chokes
- One detector plate audio frequency choke
- One audio output transformer
- One B supply choke
- (One loudspeaker with 3,000 ohm field

Condensers

- One 15 mmfd. variable
- One .0001 mfd. semi-variable (compression type)
- One .00014 mfd. variable
- One .0001 mfd.
- One .00025 mfd.
- Two .002 mfd.
- One .004 mfd.
- One .0005 mfd.
- One .01 mfd.
- One .05 mfd.
- Four .1 mfd.
- One block of three electrolytic condensers containing one 10 and two 25 mfd. units

Resistors

- One 300 ohm
- One 600 ohm, 1 watt
- One .1 meg.
- One 1 meg.
- One 2,000 ohm rheostat

- One 10,000 ohm
- One 25,000 ohm
- Two .5 mfd. meg.
- One 2 to 3 meg. (shown as 2 meg. on schematic, referred to as 3 meg. on blueprint).
- One 50,000 ohm pot.
- One 153 ohm, 30w.

Other Requirements

- Four octal sockets
- One five contact socket
- Two small grid clips
- One line switch (may be attached to potentiometer)
- One two pole five position gang switch
- One single circuit closed jack
- One a.c. cable with line cord (153 ohm, 30w.) built in, male plug.
- One single pole double throw switch
- One Bakelite platform with tip packs for ultra wave coils
- One airplane dial with escutcheon
- One 0-100 plate for ultra wave tuning
- One large bar handle for ultra wave tuning
- Three knobs
- Two MG-6K7, one 76 or 37, one MG-43 and one MG-25Z5. (All-metal tubes may replace metal-glass types with no circuit change.)

So the R-S-R was designed primarily as a short wave receiver; a value was chosen for this coupling choke which would place the maximum gain on the short waves and allow only a reasonable gain with good selectivity on the standard broadcast band.

Super-Control Detector Tube

A 6K7, the same type tube as is used in the buffer stage, is used as a detector. The 6J7, which is usually recommended for a detector, also may be used as detector and is interchangeable with the 6K7, but the 6K7 gives a little smoother regeneration and better stability on the higher frequencies although there is not much difference.

Both regenerative and super-regenerative detectors are impedance coupled to the 43 power

panel the airplane tuning dial and its control knob are at the upper left with the band changing switch just below it.

Upper center is the 2,000 ohm potentiometer for rough regeneration control, while directly below it is the super-regenerative tuning control. Just below the speaker is the S.P.D.T. switch for shifting to super-regeneration. In the lower right hand corner is the 50,000 ohm potentiometer, which also carries the "on" and "off" switch for the entire set, and serves the dual purpose of vernier regeneration and volume control above 15 meters and super-regenerative hiss control below 15 meters.

The tube sockets are located along the back of the sub-base as follows (looking from the rear—right to left) M.G.6K7, M.G.6K7, 5 prong glass tube socket, MG43, and MG25Z5.

The legends reveal the identities and purposes of the controls and other parts on the front panel. Because short waves are a principal consideration in the operation of this receiver, and ultra waves come in particularly well, every precaution should be observed to duplicate the designer's placements, even as to front panel. Mr. Haynes spent three weeks developing this receiver and it is well for the constructor to capitalize on his expert efforts.

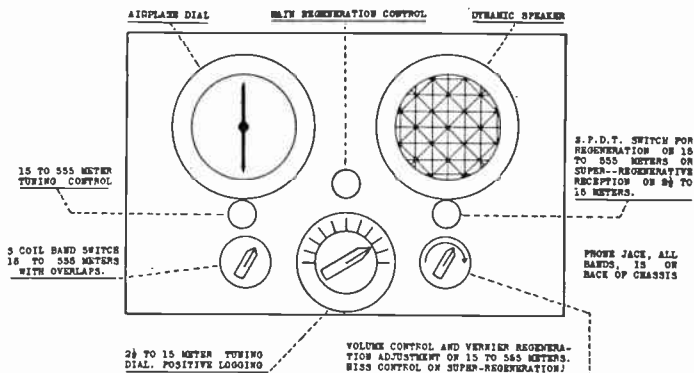

output tube by the same audio choke coil, referred to in the diagrams as the detector choke, thus allowing the speaker or 'phones to be used with either type reception at will. Immediate shift is accomplished by simply turning the small switch knob below the speaker on the panel.

Results with any receiver mean little unless they are comparative. In testing the R-S-R in New York City the usual foreign stations—generally called the foreign locals—were received with good volume while some of the more difficult catches were clearly understandable on earphones. The English station G.S.A. was clearly received using a 4 foot indoor wire as an antenna as were also many 5 and 10 meter amateur phones, some of the latter from the far West. In fact the first 10 meter station received on the R-S-R was an amateur phone station in Denver, Colorado.

One of the interesting things about a good regenerative receiver is the fact that the results attained with it are dependant to a large extent on the skill of the operator. It has a very low noise level and can do remarkably fineDX work in the hands of a person who has learned its proper operation.

Assembly Instructions

A good idea of the location of the various parts on the panel and sub-base can be obtained by reference to the photographs and the pictorial diagram. Looking at the front of

The hard rubber sub-base in which the pin jacks are mounted for ultra wave coils fits over the cut out just in front of the center tube. The B filter choke coil is mounted to the left, behind the speaker.

The large tuning condenser is mounted on its bracket behind the airplane dial and, being on top, fastened to front panel, is not shown in the blueprint of the wiring, though the diagram carries a notation. To the right on the sub-base is the small R.F. semi-variable coupling condenser which controls selectivity.

The airplane dial should be mounted by soldering four short lengths of wire from its frame to the small mounting screws around the circular cutout on the panel. This allows it to be accurately centered and permanently held in place.

Ground Connections Important

Make all wires carrying radio frequency current as short and direct as possible and do not bunch them together. Proper ground returns are important if a receiver is to control well. A good general rule is to return all grounds from by-pass condensers etc., to the socket ground connection of the tube whose immediate circuits they are by-passing. Remember that each metal tube has one contact which connects to its metal shell and this socket connection is grounded to the chassis as near to the socket as possible and this same ground

(Continued on next page)

(Continued from preceding page)

connection should be used for any other grounds associated with that tube's circuits.

The .0001 mmfd. grid condenser with the 3 meg. leak across it is soldered directly to the large tuning condenser stator and a short flexible lead provided for the grid cap.

The remaining parts are mounted underneath the sub-base by means of the screws and mounting holes provided for them as shown on the pictorial diagram.

The small condensers and resistors are self supported by their soldered connections.

Three special r.f. chokes are used. They are all wound on $\frac{3}{8}$ " Bakelite rod. The largest has 220 turns of No. 34 enamel wire while the two smaller identical ones 40 turns of the same wire on the same size diameter.

The Super-Regenerative Tuner

Two of the special choke coils are mounted directly on their respective tube sockets. The longer one is soldered to the plate connection of the r.f. tube socket while a small one is soldered to the cathode connection on the detector tube socket. They should stand vertically away from the socket base and the large one should be kept well in the clear with no wires running along or against it.

The entire tuning assembly for the super-regenerative tuner is mounted on the small hard rubber sub-base panel. The small variable condenser is mounted so that its stator and rotor connections are close to the ends of the pin jacks to which they are soldered. An insulated extension shaft and coupling is used for this condenser as well as a bushing which holds the tuning dial in place and provides a bearing for the shaft. The grid condenser and its 1 meg. leak extend from the small variable condenser stator to the grid terminal of the glass tube socket while a short rigid wire connects the rotor to the plate terminal. Such a compact assembly with very short leads gives good efficiency and smooth super-regeneration on the ultra-high frequencies.

The super-regenerative choke coil (either one of the small ones) is soldered directly to the condenser stator lug and the .004 mf. blocking condenser runs from the other end of this choke directly to the cathode connection on the glass tube socket, which is in turn grounded to the chassis.

Stabilization Introduced

Note the 100,000 ohm resistor which is soldered across this condenser. This serves to stabilize the super-regenerative quenching action at the very high frequencies. With some tubes a lower value of resistance is desirable for best reception below 3 meters. The value given however is correct for most tubes.

The antenna connection to the "super" de-

tor is made by running an insulated wire direct from the antenna post to the grid connection of the tube around which it is wrapped a few times but not actually connected.

It will be noted that the entire power supply is concentrated at the end of the sub-base nearest the speaker. The M.G.25Z5 rectifying tube, filter choke and filter condenser block are all located together here. The 60 mfd. condenser block is divided into four sections, 25, 25, 5 and 5 mfd. each. The red leads are the positive connections to the 25 mfd. sections and connect to either side of the 1tr choke. The green lead is the positive 10 mfd. connection and is connected to the cathode terminal of the M.G.43 socket. The white and black leads should be grounded to the chassis.

The three wires of the power cord should be connected to the filament and plate of the MG25Z5 and the switch in accordance with their colors as shown in the diagram.

Speaker Connections

A 5 inch dynamic speaker is used which is entirely satisfactory for a communication type receiver and actually gives very acceptable quality on broadcast reception. The 3,000 ohm field is connected directly across the power supply, on the rectifier side of the filter choke.

The connections to the phone jack should be carefully noted. A closed circuit jack is used which is cut in series with the voice coil of the speaker so that when the phones are plugged in the speaker circuit is broken and the signal passes through the .002 blocking condenser and phones to ground.

Operation

Any antenna may be used but an average length straight L antenna is about as satisfactory as anything for all around reception. A good ground is particularly desirable with regenerative receivers and hand capacity on the short waves. (Note—Try the power cord plug both ways in the socket for best results as one side of the power line is also grounded.)

CAUTION: Do not let the ground wire touch any part of the receiver except the ground connection on the terminal strip.

The receiver may be made more or less selective as desired by tightening or loosening the small semi-variable condenser at the left end of the sub-base. The proper adjustment of this condenser will depend somewhat on the antenna used. If it is too tight, tuning will be broad and there may be some places in the tuning range where maximum regeneration cannot be obtained—commonly called dead-spots. If it is too loose the signals, particularly in the regular broadcast band, will be weakened and the tuning will become too sharp and critical. The proper adjustment for any an-

Band	Frequency Range	
No. 5	555—1020 K.C.	*130 turns No. 34 En. wire tapped at 8T.
No. 4	1000—2000 K.C.	*52 turns No. 34 En. wire tapped at 7T.
No. 3	1950—4800 K.C.	*27 turns No. 26 En. wire tapped at 5T.
No. 2	4700—10,000 K.C.	*11 turns No. 26 En. wire tapped at 3T.
No. 1	9600—20,000 K.C.	*73 turns No. 22 D.C.C. wire tapped at 8T.

*Wound on $\frac{1}{8}$ " bakelite tubing.

**Wound on $\frac{1}{2}$ " dowel.

tenna and location can be found after a few trials. This condenser also has a secondary effect on the tuning so that if it is changed the stations will shift their position on the dial. This fact makes it impossible to give the exact wavelength ranges of the different bands but they are approximately as given in the coil data tabulation on opposite page.

A substantial overlap is provided between bands and their limits can be shifted up or down by varying the semi-variable coupling condenser mentioned above.

Regeneration

Regenerative receivers are absolutely dependent upon good regeneration for their sensitivity; hence they are only as good as their regenerative control. Two regenerative controls are provided on the R-S-R. The 2,000 ohm potentiometer, controlled by the small knob in the center of the panel, is the main control and is used first when a station is being tuned in. The vernier regeneration control (the 50,000 potentiometer at lower right of panel) is used for the final fine adjustment particularly when tuning in very weak distant stations. It gives precise, gradual control over the greatest regenerative gain possible. This control is so smooth and gradual that when a station is properly tuned in the regeneration can be run right up into "zero beat" without knowing when the oscillation point has been reached.

Working Vernier Control

The vernier control should be kept well over toward the right, and used for final adjustments on weak signals. When it is retarded more

than half way it acts as a volume control to reduce strong signals.

Super-Regeneration

Very few instructions are necessary for super-regenerative operation on the wave lengths below 15 meters. Merely throw the "super" switch (just below the speaker) and you immediately hear the characteristic super-regenerative rushing sound. Tuning is now done with the large pointer dial at the bottom center of panel. It is not at all critical and tunes exactly so a band-spread tuning dial on a super-heterodyne. When a station is "tuned in" the rushing sound disappears *completely* except on very weak carriers and then it can be cut down with the hiss control potentiometer.

Be sure to use sufficient antenna to grid coupling. A small trimmer condenser can be used here if desired instead of just twisting the wire around the grid lead.

When using super-regeneration, stations can be logged exactly on the dial and will always be formed at the same spot unless they change their frequency.

The coils used in the super-regenerative tuner should be wound from No. 14 trimmed copper wire. They are simple, self supporting coils with their ends straightened out so that they can be plugged into the two pin jacks on the hard rubber sub-panel. Any number of coils can be quickly wound in a few minutes for the various bands. Specifications for the 5 and 10 meter band coils are as follows: 10 meters—16 turns No. 14 wire, $\frac{3}{4}$ " diameter; 5 meters—7 turns No. 14 wire, $\frac{3}{4}$ " diameter. After winding, the coils are opened out until their ends will fit the pin jacks which are spaced $1\frac{1}{4}$ inches apart.

New Universal Microphone, Ribbon Type, 1 Inch Thick

The first new product of 1936 to be brought out by the Universal Microphone Co., Inglewood, Cal., is a ribbon microphone housed in a new style, futuristic jet black enamel and chrome polished casing.

This tiny instrument is the result of tests extending over nearly two years. The microphone case is hinged on swivel joints for greater ease in handling and is of course, noiseless in adjustment and operation.

The new Universal ribbon microphone line has been designed for general all-round radio use, including broadcast studios, remote control points, p. a. work, amateur activities and other radio purposes.

The new ribbon microphone and casing will be put on the market in conjunction with Universal's new adjustable stand which can be folded up when not in actual use, or may be adjusted to fit a small or awkward-sized space.

The instrument weighs $1\frac{1}{2}$ lbs., while the dimensions are $2\frac{3}{4}$ x $4\frac{3}{4}$ x 1 inch.

It is customary to use a preamplifier in connection with a ribbon microphone.

Three Ways of Viewing Facts on Oscillation

Regeneration has been explained from many different viewpoints. One way of looking at the phenomenon is that the energy fed back from the plate reduces the effective a. c. resistance in the tuned circuit.

It is well known that the lower the resistance in a tuned circuit the higher will be the current in it, or the voltage across it, for a given electromotive force induced in the coil. Some prefer to look at the action as a reinforcement of the electromotive force, and this view perhaps is the more logical, for the plate signal current flowing in the tickler induces an electromotive force in the tuned circuit, just as a third or coupling winding would, and the two add up vectorially, that is, they add up as all forces do.

If the e. m. f. induced by the plate current is opposed to that induced by the direct signal, the result of the feedback is a weaker signal. If the two e. m. f.'s are at right angles, the regeneration has no effect whatever. It is only when the two are in phase, in whole or in part, that regeneration augments the signal strength.

Three New Tubes, One Metal, Two Glass

Three new tubes have just been announced. One is all-metal, the 6R7 duplex-diode triode, the other glass, the 1A4 and 1B4. The 6R7 is like the 75, the 1A4 is a super control r.f. tetrode and the 1B4 a screen grid r.f. amplifier, both for 2 volt 60 milliamperes d.c. filament for battery sets.

6R7	
Heater Voltage (A.C. or D.C.)	6.3 volts
Heater Current	0.3 ampere
Cap	Miniature
Base	Small Octal 7-Pin
Triode Unit—As Class A Amplifier	
Plate Voltage	250 max. volts
Grid Voltage	-9 volts
Amplification Factor	16
Plate Resistance	8500 ohms
Mutual Conductance	1900 micromhos
Plate Current	9.5 milliamperes

Diode Units

The two diode units are placed around a cathode, the sleeve of which is common to the triode unit. Each diode plate has its own base pin.

1A4	
Filament Voltage (D.C.)...	2.0 volts
Filament Current	0.060 ampere
Plate Voltage	180 max. volts
Screen Voltage	67.5 max. volts
Grid Voltage, Variable.....	-3 min. volts
Plate Current	2.3 milliamperes
Screen Current (Approx.)...	0.7 milliampere
Plate Resistance	960000 ohms
Amplification Factor	720
Mutual Conductance	750 micromhos
Mutual Conductance (At -15 volts bias)	15 micromhos
Grid-Plate Capacitance (With shield-can)	0.007 max. mmfd.
Input Capacitance	4.6 mmfd.
Output Capacitance	11 mmfd.
Cap	Small Metal
Base	Small 4-Pin
Pin 1—Filament +	Pin 4—Filament -
Pin 2—Plate	Cap —Grid
Pin 3—Screen	

(Pin numbers are according to RMA system)

1B4	
Filament Voltage (D.C.)...	2.0 volts
Filament Current	0.060 ampere
Plate Voltage	180 max. volts
Screen Voltage	67.5 max. volts
Grid Voltage	-3 volts
Plate Current	1.7 milliamperes
Screen Current (Approx.)...	0.4 milliampere
Plate Resistance	1.2 megohms
Amplification Factor	780
Mutual Conductance	650 micromhos
Grid-Plate Capacitance (With shield-can)	0.007 max. mmfd.
Input Capacitance	4.6 mmfd.
Output Capacitance	11 mmfd.
Overall Length	4-9/32" to 4-17/32"
Maximum Diameter	1-9/16"
Bulb	ST-12
Cap	Small Metal
Base	Small 4-Pin
Pin 1—Filament +	Pin 4—Filament
Pin 2—Plate	Cap —Grid
Pin 3—Screen	

(Pin numbers are according to RMS system)

2,300 Attend Hamfest of Wholesale Radio

More than 2,300 radio amateurs and short wave fans recently jammed the grand ballroom of the Hotel Pennsylvania, New York City, at the second "hamfest" sponsored by Wholesale Radio Service Co., Inc. of 100 Sixth Avenue, New York City. This is said to be a record. Exhibits of new apparatus by five manufacturers and a series of technical talks kept the crowd occupied from 6 p. m. until midnight. The featured talker of the evening was Robert S. Kruse, engineering editor of "Radio", who gave an illustrated lecture on radio frequency amplifier design and operation.

9-TUBE SET NEXT MONTH

A nine tube all wave set intended for this issue will appear in the April number.

New Metal Dual Type Tube

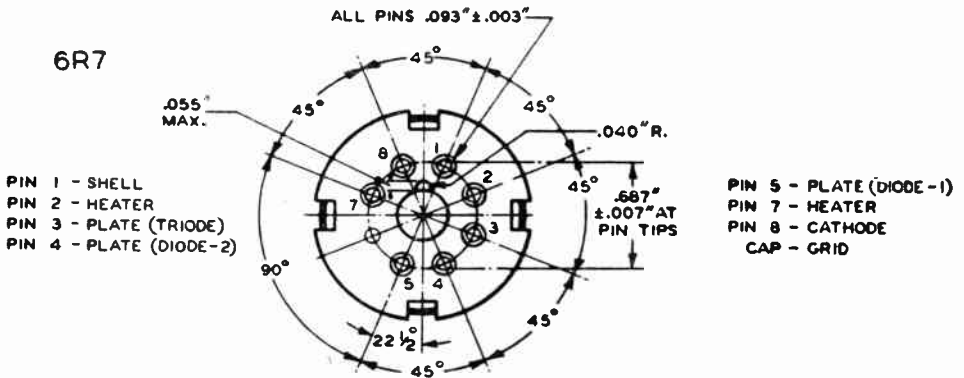

Connections to socket for the new all metal 6R7 duplex-diode high mu triode. The mu is 720. Bottom view of socket is shown.

Handy Home-Made Bridge

Author Reduces Valuable Circuit to Simplicity and Gains Accurate Results

By Frank G. Simonds

Front panel of the bridge Frank G. Simonds built. The dial, at center, is used for the resistance ratio determination. The galvanometer is the oblong instrument to the left of the dial. The a.c.-d.c. switch and the a.c. connection posts are shown. Other connections are to the clips at left.

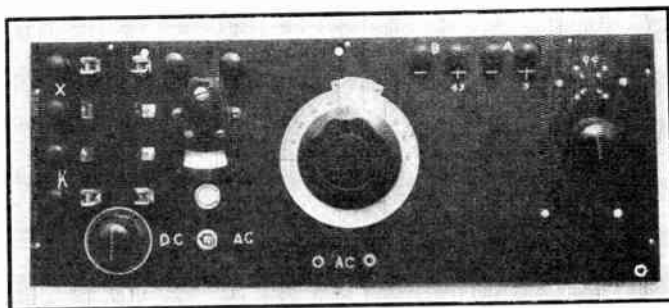

IN spite of all that has been written in various radio publications during the past several years about the Wheatstone bridge it seems that very few amateur experimenters and service men have even familiarized themselves with this extremely versatile and accurate device. It is reasonable to say that any service man who once becomes bridge-minded will be delighted with the accuracy and dependability.

It seems to be commonly believed the bridge is expensive, complicated, slow and cumbersome. In many cases this idea is a hangover from high school days when the physics teacher casually skimmed over the chapter on the underlying principles of the bridge without encouraging questions that might prove awkward, not to say downright embarrassing.

Commercial precision bridges are expensive. But work of a fairly high order of accuracy, within certain rather wide limits, may easily be done on an inexpensive, home made bridge such as is here described. Its construction is not complicated to anyone who has ever built a radio, and its use is neither slow nor cumbersome.

Selection of Voltages

The following example will illustrate the degree of accuracy possible with this home made bridge. The author has a commercial semi-precision resistor marked 100 ohms. Its actual resistance, measured in a commercial laboratory, is 101 ohms. Another marked 500 ohms measures 503.4 ohms. Both fall within the 1% tolerance allowed by makers of resistors commonly used as meter multipliers. By using the 101 ohm resistor as a standard, and the 503.4 resistance as an unknown, the unknown measured 504.45 ohms. The difference between these two values is only .95 ohm.

Assuming that the measurement made in the commercial laboratory is correct, the value ob-

tained with this simple bridge shows the error to be less than one fifth of 1%. This order of accuracy is not claimed for all settings of the dial nor for any and all resistors, but careful work in making the special potentiometer, and the use of heavy wire plus good soldering in the arms of the bridge will easily yield an accuracy of 1% for resistors between 1 ohm and 1 megohm. The accuracy for higher resistors is nearly as high, particularly if the full battery voltage is used. High battery voltage, say 45 volts, makes balancing easier, especially if the balancing meter is not very sensitive. On the other hand high voltages are not desirable for measuring the medium and low resistors. Low resistances draw more current which, in turn, makes the meter needle jump violently. This not only makes balancing difficult but may also burn out the meter.

Ratio of Resistances

First examine that part of the schematic diagram above the dotted line, which is the bridge proper. It consists of four arms or resistances (condensers will be considered presently). X is the unknown resistance whose value is sought. K is a known resistance standard. The nearer the known standard is to the unknown, the higher the accuracy will be. In no case should the known be less than 1/10 of the unknown, nor should the known in any case be greater than 10 times the unknown. It is still more desirable in the interest of accuracy to select a known standard somewhere between 1/5 and 5 times the unknown.

Just how is one to know which one to select for trial out of an assortment of standards? Two methods are available. The first and simplest is to measure the unknown roughly with an ohmmeter and select the standard nearest to it that one has on hand. If no ohmmeter is

(Continued on page 45)

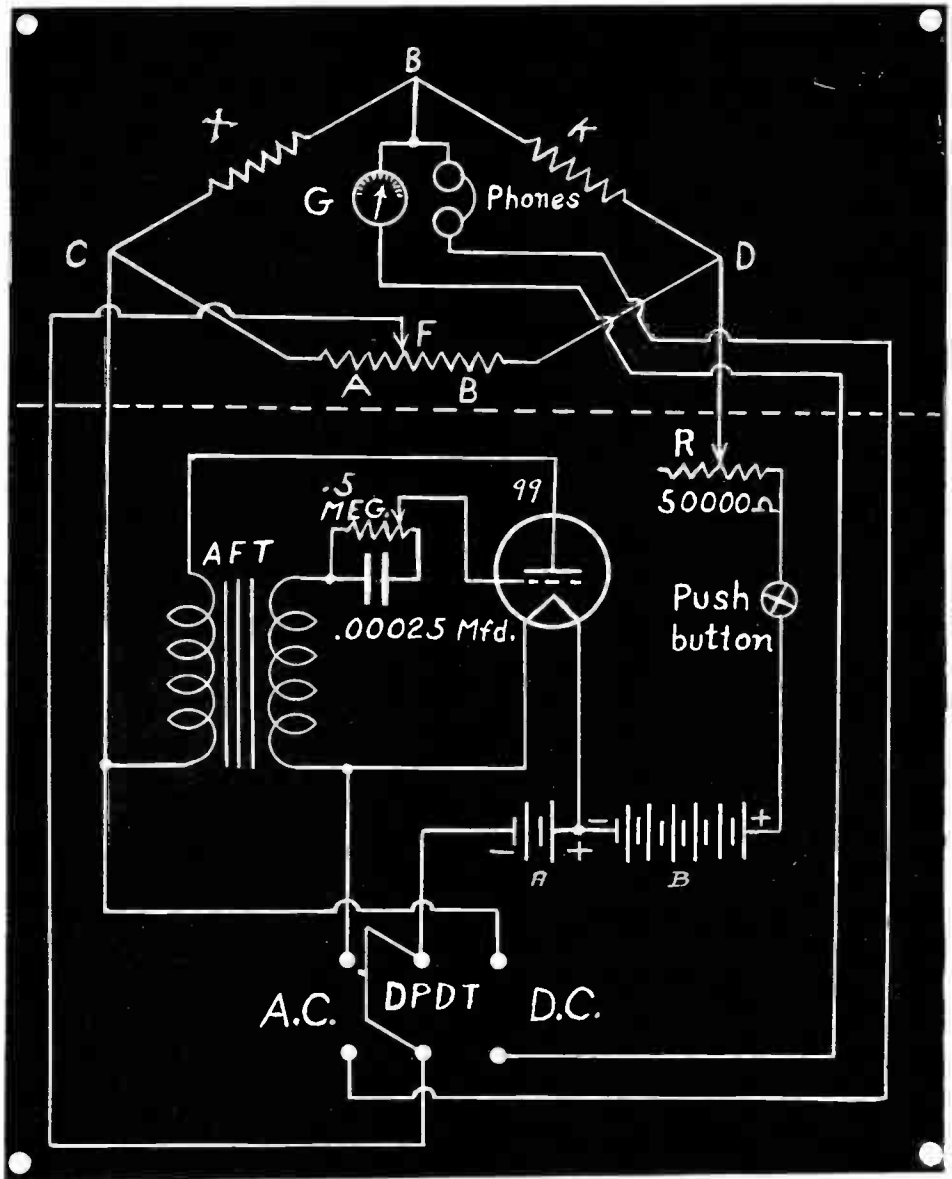

The circuit used by Frank G. Simonds for the bridge he found so very satisfactory.

LIST OF PARTS

One audio frequency transformer
 One .00025 mfd. Cornell Dubilier condenser
 One .5 megohm variable resistor
 One .05 meg variable resistor
 One set of known resistances (standards)
 A slide wire potentiometer (see text).
 One three volt A battery (two No. 6 cells)
 One 45 volt B battery
 One push button switch
 One double pole double throw switch
 One four contact socket
 One 99 type tube One pair of head phones

Three knobs, four binding posts

FOR BRIDGE: 7 x 18" Bakelite panel; 4 binding posts; 2 pair fuse clips for standard resistors; 2 pair leak mounts; phone tip jacks; galvanometer; 4" true vernier dial; drum from Radiola 25 or 28; 3 standoff bushings tapped through with 8/32 thread; brass 1/4" rod, 3" long; sheet brass, 5/8 x 3" for slider arm; spring brass for brush (soldered to slider); resistance element 8" long from 2,000 ohm Electrad Truvolt resistor.

(Continued from page 43)

available use the second method which is to select a standard at random and use the smallest battery voltage obtainable, by cutting in all of the resistance at R (right, center), which is a 50,000 ohm rheostat for controlling the battery voltage.

Operation of the Bridge

The lower arms of the bridge, A and B, are the two parts of a potentiometer separated by the slider. When the resistance of A is increased by turning the slider to the right, the resistance of B is decreased, and vice versa. The

little more than ordinary patience was required to adapt the RCA drum dial.

First carefully pry up the lugs that hold the metal drum and celluloid scale to the Bakelite disc. Take out the disc and with tin snips cut the metal drum to about half its width. Cut the scale to the same width. Put the scale carefully aside. Then cut the metal drum through *crosswise*, making the cut near the center, but not through one of the lugs. Then cut off about 1/16 inch from the half with no lug near the center, so that when the two halves are replaced in the groove in the Bakelite disc, they will be insulated from each other. Do not cut

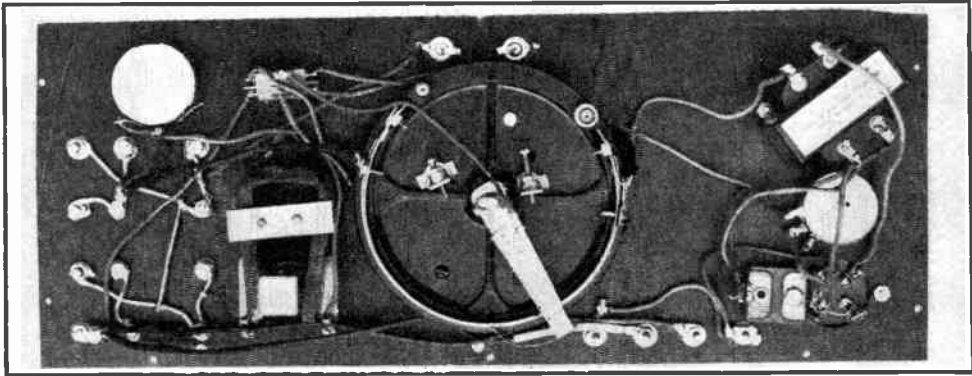

The rear view shows plainly how the drum dial was used in unconventional fashion to solve a difficulty. The slider contacts with some Electrad resistance wire. Besides the controls there is an audio oscillator, using an a.f. transformer of any convenient type.

arms of the bridge, that is the resistances just described, are connected as shown by heavy lines, which represent *heavy* copper wire. The resistances of these heavy connectors should be of the order of thousandths of an ohm if accuracy in measuring low resistances is desired.

Voltage is applied at C and D. The slider F is moved until A bears the same relation to B as X bears to K. When this relationship is established there will be no difference of potential between points E and the slider F and this will be indicated by *no deflection* of the meter needle. The bridge is said to be balanced. To calculate the value of X in ohms, divide A by B. Multiply the quotient by K and this product will be the resistance of X in ohms.

It is not necessary to know the actual values of A and B in ohms. It is merely necessary to know the *ratio* of A to B and this ratio can be read by securing a dial to the shaft of the slider F. This potentiometer and its dial constitute the heart of this bridge in obtaining accuracy. The potentiometer is home made and will be described in detail.

Getting Exactly Half a Circle

The body of the potentiometer is an old drum dial taken from a Radiola 25 or 28. These sets had two such dials, a right and a left. Either will do. Other dials of this general type will also do. Adapting them to this purpose may require a little ingenuity. The author found that

the celluloid scale crosswise. It serves as an insulator to separate the resistance wire AB from the metal drum. Reassemble the drum with the original small metal clamps.

Exactly one half or 180 degrees of the drum is to be used, and the trick is to fasten the two ends of the resistance wire so that the resistance wire (AB) occupies exactly a 180 degree portion of the drum. Do *not* use the numbers on the celluloid scale to mark the 180 degree portion. The author tried it and found that the distance from 0 to 100 was about 5 degrees short of a half circle. The used portion of the drum must be a half circle because the new dial to be attached is one reading from 0 to 100 in an angle of rotation of 180 degrees.

The simplest way to mark the ends of the half circle on the drum is to use a steel straight edge. Lay it on the drum exactly across the center and with a sharp scriber, mark the ends on the celluloid scale.

Improvised Resistance Unit

Next procure the resistance wire AB. This must be a wire that, above everything else, has a uniform resistance per unit of length.

Secondly, it should have a resistance of 40 or 50 ohms per inch. Since number 40 Ni-chrome wire has a resistance of only about 5 ohms per inch, and number 40 is too fine to handle anyway, some other solution has to be found for the most important part of the vital

(Continued on next page)

(Continued from preceding page)

unit of the bridge. A few turns, 7 or 8, of resistance wire taken from an Electrad resistor (the semi-fixed type with ceramic core) proved to be just the thing. The original Electrad resistor was 4 inches long and was one of about 2,000 ohms.

The 7 or 8 turns taken off had a resistance of about 300 ohms. The exact value of AB in ohms is not critical, but trial and error methods have shown that from 300 to 500 ohms are best



It is possible to damage the meter by running too much current through it, as one does not know in advance what the needle position will turn out to be. So a pushbutton is used as a precautionary measure. The barest press gives some idea of whether the needle will be off scale, and the release may be rapid enough always to prevent off-scale occurrence.

for the general run on work. On the first trial AB was made about 2,000 ohms. This proved to be all right for medium and high resistances, but it was difficult to balance the meter when measuring low values such as one ohm. Small holes should be drilled through the celluloid scale and metal drum near the ends of the drum. Carefully cut off a piece of the Electrad resistance wire about 8 inches long and be careful not to pinch or mar the fine winding of resistance wire on the insulated core.

Clamping the Wire

Insert one end of the wire through the small hole at one end of the drum and bend the end of the wire inside the drum to make the wire secure. Then wrap the wire firmly around the drum and fasten the other end in the same manner. The wire will then occupy something more than 180 degrees of the drum. The wire must then be clamped to the drum *exactly* at the ends of the 180 degree angle previously marked on the celluloid scale. This is best done by cutting a fairly heavy brass strip $\frac{1}{4}$ inch wide and as long as the drum is in width. This length would be about $\frac{1}{2}$ inch. Clamp the brass strip in place temporarily with a small mechanic's clamp and drill two holes, one on either side of the wire, right through the brass piece, the celluloid scale and the iron drum. Use a No. 44 drill which will be about right for a 4-36 tap. The holes may be tapped with other sizes but the proper size drill should be used for the tap on hand.

Clamp the wire to the drum with the brass strip and screws just described, and treat the other end of the wire in the same way.

It is now time to secure a shaft and slider. The shaft is simply a $\frac{1}{4}$ inch brass rod about 3 inches long. This may not go through the bearing in the Bakelite disc without forcing. The author corrected this detail by running a $\frac{1}{4}$ inch straight reamer through the bearing, and obtained a capital fit, with no play, and still not too tight. The slider is simply a piece of stiff brass about 3 inches long, $\frac{5}{8}$ inch wide at one end and $\frac{1}{4}$ inch at the other. A $\frac{1}{4}$ inch hole is drilled through the wide end and a thick ($\frac{1}{4}$ inch) washer, with hole and set screw, is soldered to the wide end so that the holes are concentric.

Brush Contacts Lightly

An easy way to do this is to solder the washer to the brass strip *before* drilling the

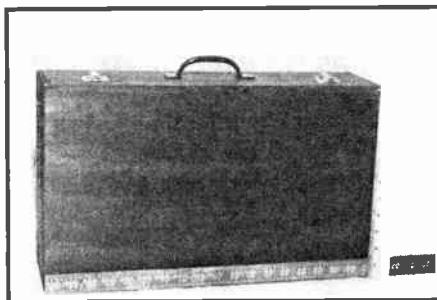

The box is made of $\frac{3}{8}$ " poplar. Its inside dimensions are 18 x 10 x 3". The extra width is used for A and B batteries, standard resistors, condensers, etc. Brass hinges, suitcase clasps and handle complete the outfit.

hole, so that the hole in the washer may be used for a guide. The slider proper, or brush, is made of very thin sheet brass and is soldered to the narrow end of the slider arm so that the brush travels *lightly* over the resistance wire when the shaft is turned. It is best to equip the Bakelite disc with a pair of stops, as shown in the illustration, so that the brush will not run off the ends of the resistance wire. These stops are easily made from small brass angles, screwed to the disc, and equipped with adjusting screws, so that the angular travel of the slider may be made exactly 180 degrees.

Three flathead machine screws (8-32) hold the disc to the Bakelite panel. It is best to place $\frac{1}{2}$ inch brass tubes, cut from brass pipe, between the disc and the panel so that the disc and panel are separated by $\frac{1}{2}$ inch. If the hole (for the shaft) in the panel is made exactly $\frac{1}{4}$ inch in diameter and lined up perfectly with the shaft hole in the disc, the $\frac{1}{2}$ inch standoff tubes are worthwhile, because the separation of the two bearing surfaces takes *all* the loose play out of the shaft. This feature is not absolutely essential, but the careful worker will find it easier to read the vernier dial to 1 part in 1000 when all of the wiggle is taken out of the shaft. The dial will be forgotten for a moment while

we examine that part of the diagram below the dotted line.

No Power Supply

This part consists of the power supply for the bridge. It is an ordinary audio oscillator made from parts found in any radio junk box. A glance at the wiring shows that when the double pole double throw switch is toward the right, the filament of the 99 tube will not light, and also that the combined voltage of the filament and plate batteries will be applied to the bridge at points C and D. The rheostat R is used to reduce the voltage to a low value for measuring low resistors and for trying out a standard resistance as explained above. It can be gradually moved to a higher voltage as the bridge slider approaches the point of balance. The push button between the battery and the rheostat is placed there so that the voltage may be applied momentarily. This is important so that the meter will not be damaged by too high a current when out of balance.

The DPDT switch is placed in the d.c. position when measuring the d.c. resistance of all kinds of resistors and inductors. When a balance has been made as described, the resistance of the unknown is equal to AK/B .

When condensers are to be compared or measured against a standard condenser, the unknown is placed across the posts at X (replacing the resistor shown at top left) and the known is at K, resistor removed. The DPDT switch is thrown to the left, or a.c. position, and 'phones inserted to the 'phone jacks. The tube lights and begins to oscillate with a frequency which is audible in the 'phones, and which is raised or lowered by moving the .5 meg. rheostat which acts as a grid leak. The push button is used to start and stop the oscillation.

Search for No or Small Sound

The bridge slider is moved to a point where no sound is heard in the 'phones, or to the point where the sound is at a minimum. The bridge is then balanced and the value of the unknown condenser is found by the simple formula BK/A . Notice that the condenser formula differs from the resistor formula. Inductance of chokes is also found by comparing the unknown with a known standard, using the audio oscillator for voltage source and the 'phones to detect the point of balance. Use the resistor formula for inductances. It is well to write out the formulas and mount them on the bridge panel.

There is one more important thing to consider and that is the dial with which to read the ratio of A to B. The author tried two old but good looking dials without good results until he found that the scales were not uniform, resulting in large errors. A metal dial with large Bakelite knob and vernier was finally purchased for 90 cents. This dial looked perfect in the box, but it had to be tinkered with a bit to make it work well. The scale was not absolutely uniform, but the error in marking lies very close to 0 and the extremities of the scale are not used anyway, so this error was tolerated. The

hole for the shaft was not strictly concentric with the circumference, so the circumference had to be carefully filed in spots. The vernier consists of a small scale of 10 divisions equal to 9 divisions on the dial. By counting the divisions on the vernier from 0 to the point where both scales coincide, one can read the scale to 1 part in 1000.

The Half Way Mark

The dial must be placed on the shaft so that when it reads 50 the bridge slider is exactly half way between the extremities of travel. This can best be accomplished by comparing two known resistors, determining each in terms of

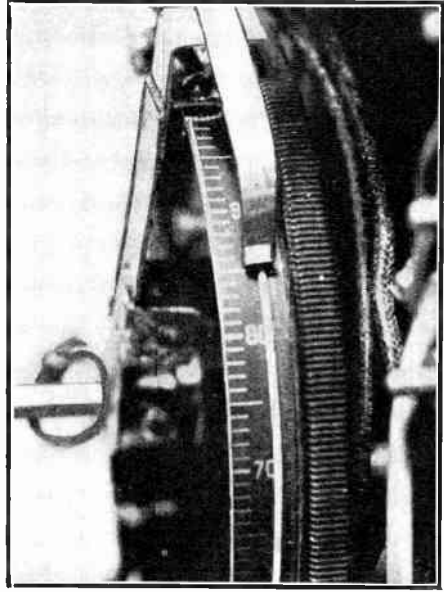

How the actual contact is made. The slider is shown connecting to the circular resistance wire. Solution of the difficulty of obtaining resistance wire that was not of too small resistance for the short length used was found in the use of wire unwound from an Electrad 2,000 ohm resistor.

the other as explained at the beginning of this article. Move the dial, with respect to the slider, so that the two known resistors measure correctly, each in terms of the other. This calibration is made still easier if one has or can borrow two known resistors that are equal. Insert these in the bridge and move the slider until the bridge is balanced. Then set the dial to read 50 without moving the slider, and the bridge is calibrated for all combinations of known and unknown within its limits of accuracy.

The galvanometer can be anything from a compass in a coil of wire to an expensive moving coil type.

The same resistors that are used for multipliers and shunts can be used for bridge standards. (Continued on next page)

must be made for the a.c. resistance and the capacities. When exact balance has been effected the resistance formula is $R_x = R_k A/B$ and the capacity formula is $C_x = C_k B/A$. Both A and B should be nonreactive. As in the previous case the resistance added to either the X-arm or the K-arm must be allowed for in using the resistance formula.

Condensers are more accurately measured with a bridge than small inductances.

Series Antenna Condensers

A variable condenser in series with the antenna, 50 mmfd. being sufficient, improves short wave reception, because it has the effect of matching the antenna circuit to the frequencies of the transmitters desired to be received. It is not a case of resonance, exactly, as a given setting of the condenser is good for an entire band, but it establishes the antenna more efficiently as a wave interceptor. For the broadcast band the series condenser improves selectivity, but reduces input so much that receiver gain has to be raised, and noise results.

Radio Waves Expedite Pea and Potato Crops

Radio waves of several hundred kilocycles have been used by Soviet scientists for bombarding potato and pea seeds before planting. The results are said to have been earlier sprouting and a crop yield of more than 50 per cent. greater than normal. Exposure lasted a minute or so and took place a few months prior to planting.

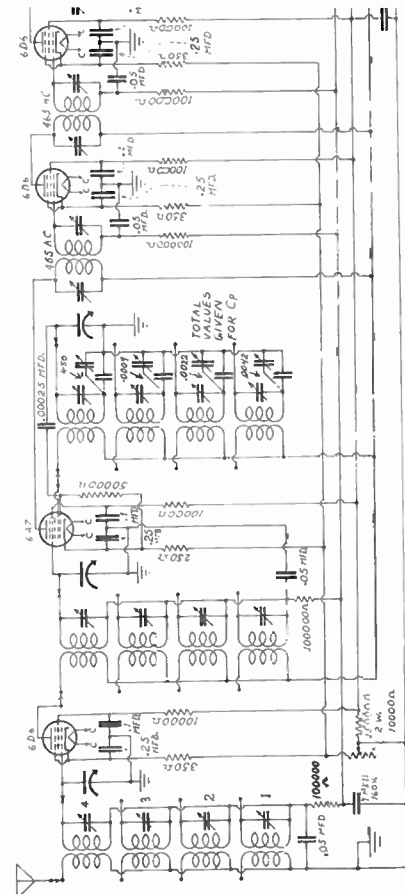

In experimenting with this circuit a ninth tube has been added advantageously.

(Continued from preceding page)

ards if they are accessible, and they can be made so by using resistor clips on all devices where they are used, thus making them easily interchangeable. A pair of binding posts, a pair of grid leak type clips and a pair of fuse clips, wired in parallel are used in the present bridge on the unknown side, and the same combination on the known side so that various kinds of resistors, wire leads, etc. can be put into the bridge quickly and firmly.

Notice that only one switch is used to change the voltage source from d.c. to a.c. The oscillator is started and the balance indicator is changed from meter to 'phones by one flip of the DPDT switch.

When a resistance is measured on a bridge with direct current, the d.c. value of the resis-

tance is obtained, and an exact balance is always possible, even if there is inductance present. Thus the d.c. resistance of a choke coil may be measured just as if there were no inductance present at all. If there is a condenser in series with the impedance no bridge measurement, of course, can be made with d.c.

If an inductance is to be measured, the unknown inductance should be placed in the X-arm and a standard inductance should be placed in the K-arm. An exact balance cannot be obtained by sliding the point F alone, because the a.c. resistances of the unknown and of the known inductance may be different. To obtain exact balance, and not merely an indication of minimum, a variable resistance must be inserted in either the X-arm or the K-arm, depending

(Continued on next page)

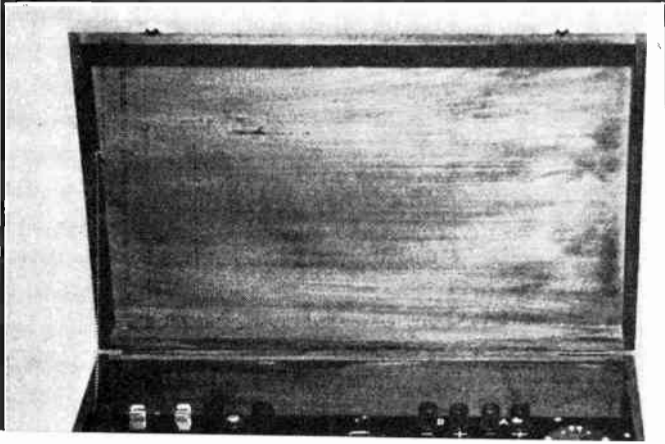

The instrument in its box, with cover open. Binding posts are neatly arranged along the rear of the panel and at left. The 99 tube, used as audio oscillator, fits into the socket behind the knob at right. The push button, included as a wise precaution, is seen just in front of the meter. The ready accessibility of the clips at left is ap-

The "Haynes" R-S-R RECEIVERS 2 1/2-555 METERS

EVERY old-timer remembers A. J. Haynes, of the old Haynes-Griffin Co., who gave us the first tickler regeneration, kit receiver in 1922 (Haynes D-X circuit) and the famous Haynes Super-Heterodyne in 1924, before commercially built "supers" were available. Mr. Haynes established an enviable reputation for never sponsoring a circuit or set that was not technically correct and fool-proof.

It is gratifying to us that he should choose the RADIO CONSTRUCTORS' LABORATORIES to build the final model of his new R. S. R. receiver, and he has authorized us to duplicate this receiver for our customers.

- 2 1/2-555 meters—complete coverage of this tremendous tuning range with no skips or dead spots.
- Band switching (5 bands)—no plug in coils from 15-555 meters.
- Immediate shift from regeneration to super-regeneration is accomplished by merely turning switch knob under speaker.
- Super-regeneration below 15 meters using simple efficient pin-jack plug in coils.
- Dual regeneration control with his reduction control on super-regeneration.
- Adjustable selectivity control.
- Both loud speaker and earphone reception on all bands.
- No line hum, even in earphones.
- Receives the new "Apex" class broadcasting stations between 5 and 10 meters.



BUILT-IN POWER SUPPLY

The R.S.R. can be used on either 110 volt A.C. or D.C. Unlike most universal sets, it has been equipped with entirely adequate

Regeneration and Super Regeneration combined for the FIRST TIME in a single receiver with the greatest tuning range ever incorporated in any radio set.

we examine that part of the diagram below the dotted line.

No Power Supply

This part consists of the power supply for the bridge. It is an ordinary audio oscillator made from parts found in any radio junk box. A glance at the wiring shows that when the double pole double throw switch is toward the right, the filament of the 99 tube will not light, and also that the combined voltage of the filament and plate batteries will be applied to the bridge at points C and D. The rheostat R is used to reduce the voltage to a low value for measuring low resistors and for trying out a standard resistance as explained above. It can be gradually moved to a higher voltage as the bridge slider approaches the point of balance. The push button between the battery and the rheostat is placed there so that the voltage may be applied *momentarily*. This is important so that the meter will not be damaged by too high a current when out of balance.

The DPDT switch is placed in the d.c. position when measuring the d.c. resistance of all kinds of resistors and inductors. When a balance has been made as described, the resistance of the unknown is equal to AK/B .

When condensers are to be compared or measured against a standard condenser, the unknown is placed across the posts at X (replacing the resistor shown at top left) and the known is at K, resistor removed. The DPDT switch is thrown to the left, or a.c. position, and 'phones inserted to the 'phone jacks. The tube lights and begins to oscillate with a frequency which is audible in the 'phones, and which is raised or lowered by moving the .5 meg. rheostat which acts as a grid leak. The push button is used to start and stop the oscillation.

Search for No or Small Sound

The bridge slider is moved to a point where no sound is heard in the 'phones, or to the point where the sound is at a minimum. The bridge is then balanced and the value of the unknown condenser is found by the simple formula BK/A . Notice that the condenser formula differs from the resistor formula. Inductance of chokes is also found by comparing the unknown with a known standard, using the audio oscillator for voltage source and the 'phones to detect the point of balance. Use the resistor formula for inductances. It is well to write out the formulas and mount them on the bridge panel.

There is one more important thing to consider and that is the dial with which to read the ratio of A to B. The author tried two old but good looking dials without good results until he found that the scales were not uniform, resulting in large errors. A metal dial with large Bakelite knob and vernier was finally purchased for 90 cents. This dial looked perfect in the box, but it had to be tinkered with a bit to make it work well. The scale was not absolutely uniform, but the error in marking lies very close to 0 and the extremities of the scale are not used anyway, so this error was tolerated. The

hole for the shaft was not strictly concentric with the circumference, so the circumference had to be carefully filed in spots. The vernier consists of a small scale of 10 divisions equal to 9 divisions on the dial. By counting the divisions on the vernier from 0 to the point where both scales coincide, one can read the scale to 1 part in 1000.

The Half Way Mark

The dial must be placed on the shaft so that when it reads 50 the bridge slider is *exactly* half way between the extremities of travel. This can best be accomplished by comparing two *known* resistors, determining each in terms of

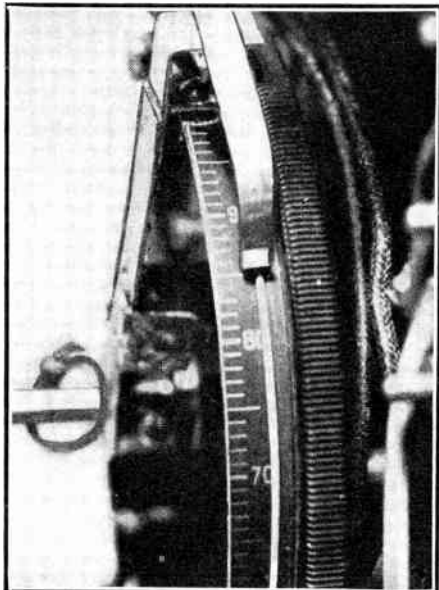

How the actual contact is made. The slider is shown connecting to the circular resistance wire. Solution of the difficulty of obtaining resistance wire that was not of too small resistance for the short length used was found in the use of wire unwound from an Electrad 2,000 ohm resistor.

the other as explained at the beginning of this article. Move the dial, with respect to the slider, so that the two known resistors measure correctly, each in terms of the other. This calibration is made still easier if one has or can borrow two known resistors that are equal. Insert these in the bridge and move the slider until the bridge is balanced. Then set the dial to read 50 *without moving the slider*, and the bridge is calibrated for all combinations of known and unknown within its limits of accuracy.

The galvanometer can be anything from a compass in a coil of wire to an expensive moving coil type.

The same resistors that are used for multipliers and shunts can be used for bridge stand-

(Continued on next page)

(Continued from preceding page)

ards if they are accessible, and they can be made so by using resistor clips on all devices where they are used, thus making them easily interchangeable. A pair of binding posts, a pair of grid leak type clips and a pair of fuse clips, wired in parallel are used in the present bridge on the unknown side, and the same combination on the known side so that various kinds of resistors, wire leads, etc. can be put into the bridge quickly and firmly.

Notice that only one switch is used to change the voltage source from d.c. to a.c. The oscillator is started and the balance indicator is changed from meter to 'phones by one flip of the DPDT switch.

When a resistance is measured on a bridge with direct current, the d.c. value of the resis-

tance is obtained, and an exact balance is always possible, even if there is inductance present. Thus the d.c. resistance of a choke coil may be measured just as if there were no inductance present at all. If there is a condenser in series with the impedance no bridge measurement, of course, can be made with d.c.

If an inductance is to be measured, the unknown inductance should be placed in the X-arm and a standard inductance should be placed in the K-arm. An exact balance cannot be obtained by sliding the point F alone, because the a.c. resistances of the unknown and of the known inductance may be different. To obtain exact balance, and not merely an indication of minimum, a variable resistance must be inserted in either the X-arm or the K-arm, depending

(Continued on next page)



The instrument in its box, with cover open. Binding posts are neatly arranged along the rear of the panel and at left. The 99 tube, used as audio oscillator, fits into the socket behind the knob at right. The push button, included as a wise precaution, is seen just in front of the meter. The ready accessibility of the clips at left is apparent. There is room in the rear for batteries and some accessories.

Intimate Information About the Photographs

The panel view shows the face with meter, dial, binding posts and controls. The knob on the left controls the B battery voltage. No filament control is provided. The knob on the right is the grid leak which varies the a.f. signal, that is the frequency.

The rear view shows a close-up of the back of the panel. The bridge pot is at center, next the galvanometer magnet, and directly below is the DPDT switch. The audio transformer is on the left. The heavy bare wiring on the right parallels the three sets of connections that are provided for both known and unknown.

The large circular object separately shown is the bridge pot turned around. Standoff tubes

separate the disc from the panel by $\frac{1}{2}$ ". It happens to be another drum the author was testing for another purpose.

In the article it is stated the dial turned 180 degrees. In the author's model the resistance wire does occupy exactly 180 degrees of the drum, but stops are set so that the slider does not move quite to the extremes of the wire. This prevents the slider from trying to climb the clamps which fasten the ends of the wire to the drum as it would do if the dial were turned all the way to 0 or to 100. This might bend the end of the slider slightly which would throw off the calibration. The ends of the scale are not used, anyway.

(Continued from preceding page)

on which has the less a.c. resistance, and both the inductances and the resistances must be balanced separately but simultaneously. The variable resistor is put in either arm as required. There will be two formulas of balance. The one for a.c. resistance is $R_x = R_k A/B$ and the one for inductance $L_x = L_k A/B$. These assume that neither A nor B has capacity or inductance.

Capacities can be measured only with alternating current in this circuit. The unknown capacity should be connected in the X-arm and a known standard capacity should be connected in the K-arm. Just as in the case of inductance measurements, no exact balance can be obtained resistance in series with one condenser than the other. A known variable resistor should be added to one of the arms, as required. A condenser which may have a negligible series resistance that radio frequencies may have 1,000 ohms or more at 1,000 cycles, the frequency at which measurements are often made. The lower the frequency used the higher will be the effective series resistance of the condenser. This series resistance must be compensated for if an exact balance is to be expected. Separate but simultaneous balances must be made for the a.c. resistance and the capacities. When exact balance has been effected the resistance formula is $R_x = R_k A/B$ and the capacity formula is $C_x = C_k B/A$. Both A and B should be nonreactive. As in the previous case the resistance added to either the X-arm or the K-arm must be allowed for in using the resistance formula.

Condensers are more accurately measured with a bridge than small inductances.

Series Antenna Condensers

A variable condenser in series with the antenna, 50 mmfd. being sufficient, improves short wave reception, because it has the effect of matching the antenna circuit to the frequencies of the transmitters desired to be received. It is not a case of resonance, exactly, as a given setting of the condenser is good for an entire band, but it establishes the antenna more efficiently as a wave interceptor. For the broadcast band the series condenser improves selectivity, but reduces input so much that receiver gain has to be raised, and noise results.

Radio Waves Expedite Pea and Potato Crops

Radio waves of several hundred kilocycles have been used by Soviet scientists for bombarding potato and pea seeds before planting. The results are said to have been earlier sprouting and a crop yield of more than 50 per cent. greater than normal. Exposure lasted a minute or so and took place a few months prior to planting.

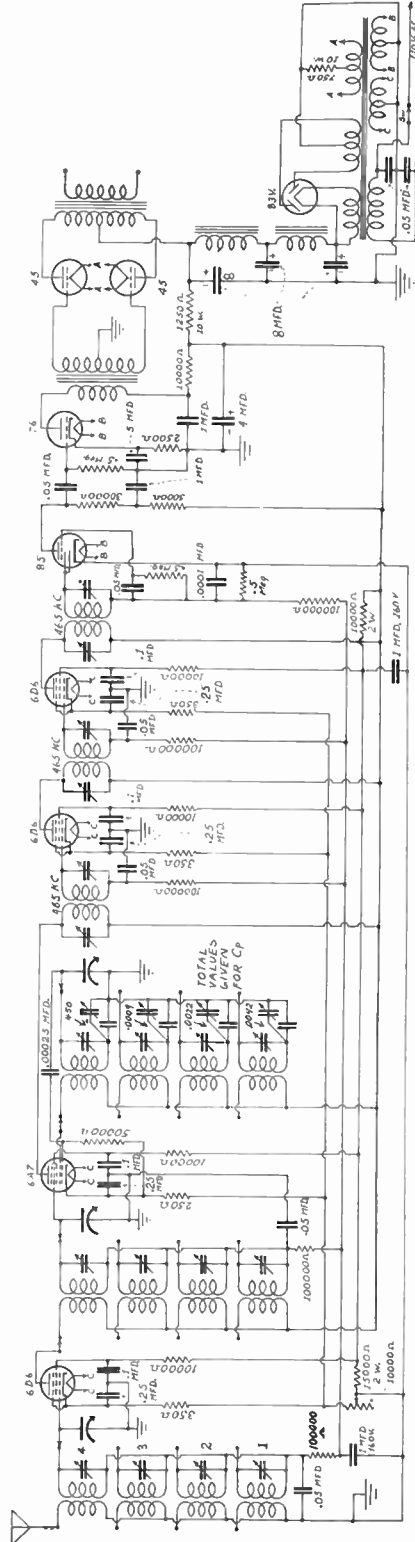

In experimenting with this circuit a ninth tube has been added advantageously as driver (76). A commercial switch coil assembly is used.

The "Haynes" R-S-R RECEIVER

2 1/2-555 METERS

- 2 1/2-555 meters—complete coverage of this tremendous tuning range with no skips or dead spots.
- Band switching (5 bands)—no plug in coils from 15-555 meters.
- Immediate shift from regeneration to super-regeneration is accomplished by merely turning switch knob under speaker.
- Super-regeneration below 15 meters using simple efficient pin-jack plug in coils.
- Dual regeneration control with hiss reduction control on super-regeneration.
- Adjustable selectivity control.
- Both loud speaker and earphone reception on all bands.
- No line hum, even in earphones.
- Receives the new "Apex" class broadcasting stations between 5 and 10 meters.



EVERY old-timer remembers A. J. Haynes, of the old Haynes-Griffin Co., who gave us the first tickler regeneration, kit receiver in 1922 (Haynes D-X circuit) and the famous Haynes Super-Heterodyne in 1924, before commercially built "supers" were available. Mr. Haynes established an enviable reputation for never sponsoring a circuit or set that was not technically correct and fool-proof.

It is gratifying to us that he should choose the RADIO CONSTRUCTORS' LABORATORIES to build the final model of his new R. S. R. receiver, and he has authorized us to duplicate this receiver for our customers.

BUILT-IN POWER SUPPLY

The R.S.R. can be used on either 110 volt A.C. or D.C. Unlike most universal sets, it has been equipped with entirely adequate

Regeneration and Super Regeneration combined for the FIRST TIME in a single receiver with the greatest tuning range ever incorporated in any radio set.

Here is a communication type receiver which will delight the heart of the all-wave enthusiast. Although it is primarily designed for efficiency on the short and ultra-short waves you will be surprised by its selectivity and tone quality on the regular broadcast band.

Band switching is used (5 bands with 5 separate coils) from 555 meters down to 15 meters with R. F. amplification plus regeneration—no plug-in coils.

Electron regeneration coupling with dual regeneration controls, allowing the R. F. feedback and detector tube impedance to be adjusted separately, provide PERFECT regenerative amplification over this entire range, while electrical plus mechanical band spread, with a large 4-inch airplane dial, gives precise, non-critical tuning.

There is no band capacity; nor is there any spot in the entire frequency range which cannot be "tuned in" with smooth, maximum regeneration.

SUPER REGENERATION BELOW 15 METERS

From 15 meters down (and down means well below 2½ meters) an exceedingly stable super-regenerative circuit is brought into use by merely turning the small switch knob just below the speaker. The entire super-regenerative tuner is mounted on a hard rubber sub-base panel with exceedingly short leads.

Plain, two-contact coils are used for all frequencies below 15 meters and simply plugged into the two pin-jacks on the sub-panel. Only one coil at a time is used and as the maximum capacity of the ultra high-frequency tuning condenser is only 15 mmf., non-critical electrical band-spread is attained down to the very lowest wave lengths.

When using super-regeneration, hiss control is obtained with the 50,000 ohm potentiometer that provides vernier generation control on the longer wave-lengths (located at lower right of panel). This allows for the most sensitive "super" adjustment, minimizes radiation and lets the hiss level be reduced to the vanishing point.

RADIO CONSTRUCTORS LABORATORIES

RACO
PRODUCTS

**136 LIBERTY STREET, DEPT. H. W.
NEW YORK CITY, N. Y.**
EXPORT DEPT.: 105 HUDSON ST. NEW YORK CITY

filtering and by-passing (a 60 mf. filter condenser block is used) which has wiped out the line hum, usually associated with this type of power-supply, even when earphones are used.

Most radio men prefer to use earphones for fine work and they are particularly useful on the ultra-high frequencies. A phone jack is provided on the back of the R.S.R. chassis, and when phones are plugged in, the speaker is automatically cut out and entirely silent.

Either metal or metal glass tubes used.

The Haynes R.S.R. has been designed with the new octal metal tube sockets, which will permit the use of either metal or metal glass tubes. We recommend the metal glass type as being equally efficient, and less expensive than the all metal type. The only exception is the super-regenerative detector which uses a glass 76 tube. We find that the latter will go on down to well below 2½ meters because of its lower inter-electrode capacities. Metal glass tubes used are 2-6K7's, 1-43 and 1-25Z5.

YOU WILL NOT BE DISAPPOINTED IN THE "HAYNES R.S.R."

We are making some pretty strong claims for this receiver but we guarantee that you will find the Haynes R.S.R. one of the smoothest operating and most stable regenerative, or super-regenerative sets that you have ever handled, regardless of price!

It is not only an excellent D.X. receiver for foreign broadcast reception but is a sweet job on the ultra-high frequencies giving really efficient reception over the 5 and 10 meter ranges.

ORDER DIRECT FROM THIS AD.

Price of complete Haynes R. S. R. receiver—wired and tested in our laboratory—with black crackle hinged top cabinet, dynamic speaker and 5 tubes (2-MG6K7's, 76, MG43, MG25Z5) ready to plug in and operate..... **\$24⁶⁵**

Complete kit including wired switch coil assembly, less only cabinet and tubes..... **\$14⁹⁵**

Price of complete Haynes R. S. R. receiver—wired and tested in our laboratory—with black crackle hinged top cabinet, dynamic speaker and 5 tubes (2-MG6K7's, 76, MG43, MG25Z5) ready to plug in and operate..... **\$24⁶⁵**

Complete kit including wired switch coil assembly, less only cabinet and tubes..... **\$14⁹⁵**

SERVICE BUREAU

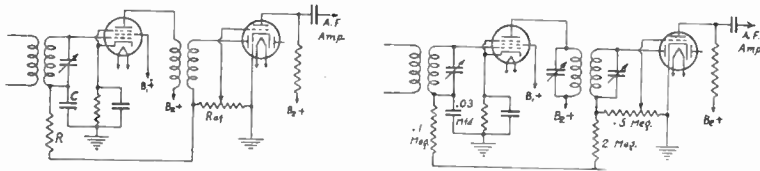

R is the a.v.c. filter resistor, C the filter capacity in the controlled circuit (left). $(R \text{ meg.} + R A F \text{ meg.}) \times C \text{ mfd.}$ should be between .04 and .09 for a.v.c. action not too slow or too fast. At right, correction of distortion by holding the audio impedance of the diode load resistor about the same as the d.c. resistance. One of two diodes is idle in both circuits.

Curing Troubles in A. V. C. Circuits

By Louis Kranz

AUTOMATIC volume control has introduced more difficulties in servicing than any other single development in the past few years.

One of the troubles is that the a.v.c. may be too slow in effect, resulting in no reception for an instant, though the receiver is tuned to a station, and then the music comes in and there is no further trouble while listening to that station. However, in turning to other stations the same fault naturally repeats itself, and if one tunes rapidly the peril of passing over stations is enhanced, especially strong stations of all things. That is true because the a.v.c. tends to be less effective on weak ones, and some systems have time delay, meaning that a.v.c. is not applied at all until the rectified component of the i.f. channel reaches a certain level. It would be true in t.r.f. sets also, but not many of them have a.v.c., and it is usually preferable to omit a.v.c. from such sets for sensitivity reasons, and to a smaller extent, selectivity reasons.

Getting Rid of Sluggishness

The sluggishness of the a.v.c. may be removed by reducing the capacity of the condensers bypassing the filter resistors. Always there is a resistor between the grid return end of the tube in the controlled circuit and the a.v.c. load resistor, and the condenser is from the joint of coil and filter resistor to B minus or ground, usually the same line.

If the resistances are measured the sluggishness may be avoided, and also the companion trouble of too fast an action, which tends to remove modulation of upper frequencies of the audio spectrum, by selecting the proper capacities across these resistors. The way to figure the resistance is to measure it from end of the coil to ground, not merely the resistance be-

tween end of the coil and diode load resistor. Then select a capacity so that when the resistance is expressed in megohms and the capacity in microfarads the resultant figure lies between .04 and .09. This figure is called the time constant. Or, since the resistance is known, because measured on an ohmmeter, divide the resistance in megohms into a selected time constant, say, .06, to ascertain the capacity. Thus, if the resistance is 600,000 ohms, which equals .6 meg, then $.06/.6$ equals .1, which is the value in microfarads, so use .1 mfd.

Some Leeway Provided

Each circuit is individually treated this way, and the result is that the time constant is just about right. If the capacity turns out to be an odd one, since we have selected a medium time constant, the next even capacity obtainable may be within 60 per cent. of the computation, either direction, and still safety prevails.

If one has an ohmmeter that does not read very high resistance values, say, not above 1 meg., the resistors may be measured separately, and then totaled, or a resistor within the ohmmeter scale may be measured independently, then put in parallel with the higher unknown, and the new quantity measured, the value of the resistance found in the circuit being computed. It is equal to the product divided by the difference, using the two values, the single separate resistor, and the resistance when this separate unit is in parallel with the unknown. The formula is $R_x = (R_1 \times R_2) / (R_1 - R_2)$, where R_1 is the larger of the two resistances, that is, the separate resistor, and R_2 is the equivalent resistance when R_2 is in parallel with the unknown.

Besides the time constant problem there are

other serious considerations, and remedying the troubles will improve the reception a great deal. It is intended that a.v.c. shall act as an aid to tone quality, by preventing overloading, but other factors are sometimes introduced that injure tone. For instance, there is capacity enough between the diode and the triode or pentode, where two tubes are in one envelope, to permit radio frequency voltage in the output plate circuit (the one going to B plus). A condenser of .00025 mfd. from plate to cathode, or plate to ground, it makes small difference which, will remedy this trouble.

sistance. Suppose the load resistor is .5 meg., then if a common higher resistance is used, looking toward the controlled tubes—in other words, the first filter resistor—the other resistors may be relatively small. The a.c. and d.c. load impedances are than maintained about equal. They should be as nearly equal as possible, so that high percentage modulation can be handled without distortion.

Reasonable Resistance Values

This trouble is prevalent where the a.v.c.

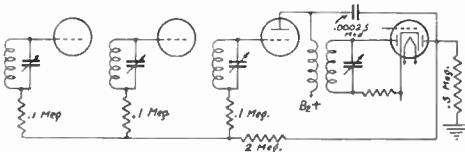
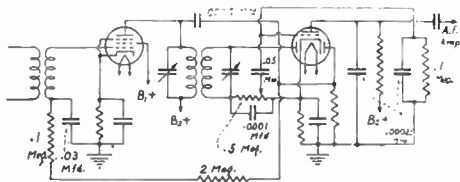

Both diodes used. At left, correction for too sharp a.v.c. action by using primary as feed. Delayed a.v.c. is present, equal to the voltage drop in the biasing resistor in second tube. Distortion due to out of phase a.f. arising from r.f. coupling between diode and grid is corrected by .00025 mfd., plate to ground. The .00025 mfd. across .1 meg. grid load allows no signal through at zero setting of potentiometer. At right, three tubes controlled.

Also the grid circuit of the amplifier tube in the same envelope as the diode may develop a considerable radio frequency voltage due to r.f. coupling by capacity between diode plate and grid, and this condition is avoided by putting a .00025 mfd. condenser across the resistor.

Although the fact seems not to be well understood, the grid circuit is effectively in parallel with the diode load circuit, as far as audio frequencies are concerned. Usually there is a resistor of 500,000 ohms from return of the diode input coil to cathode or ground. Across this resistor the audio frequency pulses are developed, hence the output is taken from this source for delivery to the rest of the audio amplifying channel, even if only one power tube constitutes the remaining means of audio amplification.

Effect of A. V. C. Filter

The practice has been, up to the present, to use a high value of grid load resistor to reduce the shunting effect, but little consideration has been given to the fact that also in effective parallel connection with the diode load resistor is the resistance network of the a.v.c. controlled tubes. This includes the filter resistors, the effective value of which, by the way, is slightly reduced by the plate circuit resistance of the tubes served, but this quantity is too small to require special attention.

Of real import is the fact that the resistance looking out of the diode rectifier, that is, tied to the high side of the a.v.c. rectifier circuit, when that is the same as the audio supply, should be high compared to the diode load re-

voltage is taken from the single diode rectifier that also serves for audio supply, that is, direct coupling or stopping condenser and grid leak are used to convey the audio impulses to the grid circuit of the dual purpose tube, and the same d.c. voltage supplies a.v.c. It is therefore preferable to have a common a.v.c. filter resistor, after the diode, so high in resistance compared to the the d.c. load on the diode as not to impair the a.c. impedance of the load under different conditions of manual volume control setting or a.v.c. action.

A reasonable solution would be to insert a common filter resistor four or five times as large as the diode load resistor, say, if the load is .5 meg., use 2 or 2.5 meg., and then smaller resistors may be used in the individual return filter circuits of the controlled tubes. Such remedy naturally requires that the time constant be reconsidered, since now the required or permissible capacities will be much less. However, if the individual filter resistors are small compared to the common filter resistor, say, .1 meg. compared to 2 meg. or more, then the capacity may be computed on the basis of the 2 meg. value alone for a time constant of .06, requiring .03 mfd. in each position.

Use of Both Diodes

As there are two diodes in the multipurpose tubes of the nature now under discussion, and as one of the metal tubes is simply two diodes in one envelope, it is preferable to use both

(Continued on next page)

New Crosley Chassis Has Volume Expander

A volume expander of an original type is included in the new Crosley receiver, chassis 1155, which is contained in different cabinet models, one of which is known as the Barkentine. The expander is called the Auto-Expressionator.

Powel Crosley, Jr., president of the Crosley Radio Corporation, said:

"Because of the limitations of transmitting equipment it has not been possible to broadcast the full volume range of the loud passages of music. Therefore, the engineer-musician who sits at the controls during a broadcast watches the needle on the panel that indicates the signal strength and reduces the volume when it becomes too great. At the other extreme, the light and soft sounds are so faint that the signals would be lost in remote places were they not increased in volume by the man at the control panel. Expression is thus impaired to the extent that the volume range is restricted.

Puts Back What's Left Out

"The orchestra leader realizing the limitations of the equipment is compelled to reduce the volume and expression accordingly. Thus he does not give full expression to the music in the first place. The Auto-Expressionator not only restores what has been monitored out at the control panel, but amplifies the crescendos played by the orchestra so that the music is received in the way it would have been played were it not for the restrictions previously explained.

"For these reasons it has been impossible in the past, regardless of the type of radio used, to get the program in its full volume range—and consequently its full variation of expression—as played in the studio for the very fact that it was not broadcast in its full volume range and emphasis in the first place. People never received a program as it actually was played; instead, at the best, they received only what the man at the control panel gave them."

The method is somewhat similar in principle

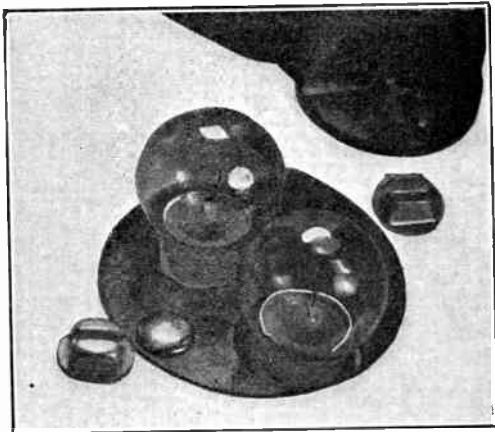

The two lamps used in the volume expanding circuit of the new Crosley chassis.

to that of the Wheatstone Bridge for testing resistance. It consists of a division of the current into two paths. Two small bulbs, similar in appearance to flashlight bulbs, but with specially constructed filaments, cause more current to flow through one path than through the other as the volume increases. For example, as the orchestra increases its volume the Auto-Expressionator produces a greater proportional increase in speaker volume.

Bass Compensation

"The Auto-Expressionator operates continuously during the time it is turned on, even though the bulbs may not be illuminated. In other words, their expressionating effect is immediate and automatic. The radio may be operated with or without the Auto-Expressionator by means of the switch on the front panel of the receiver."

(Continued on page 57)

Compare Designations Below with List on Page 57

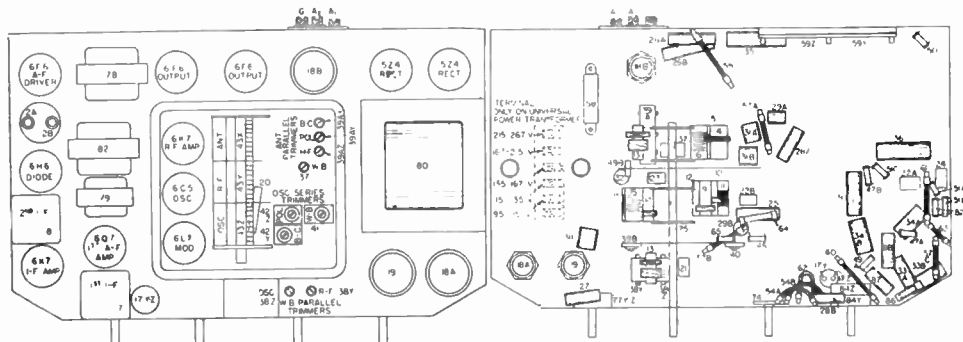

Top view (left) and bottom view, with parts and tubes identified.

PICTURE DIAGRAM OF NEW CROSLY RECEIVER

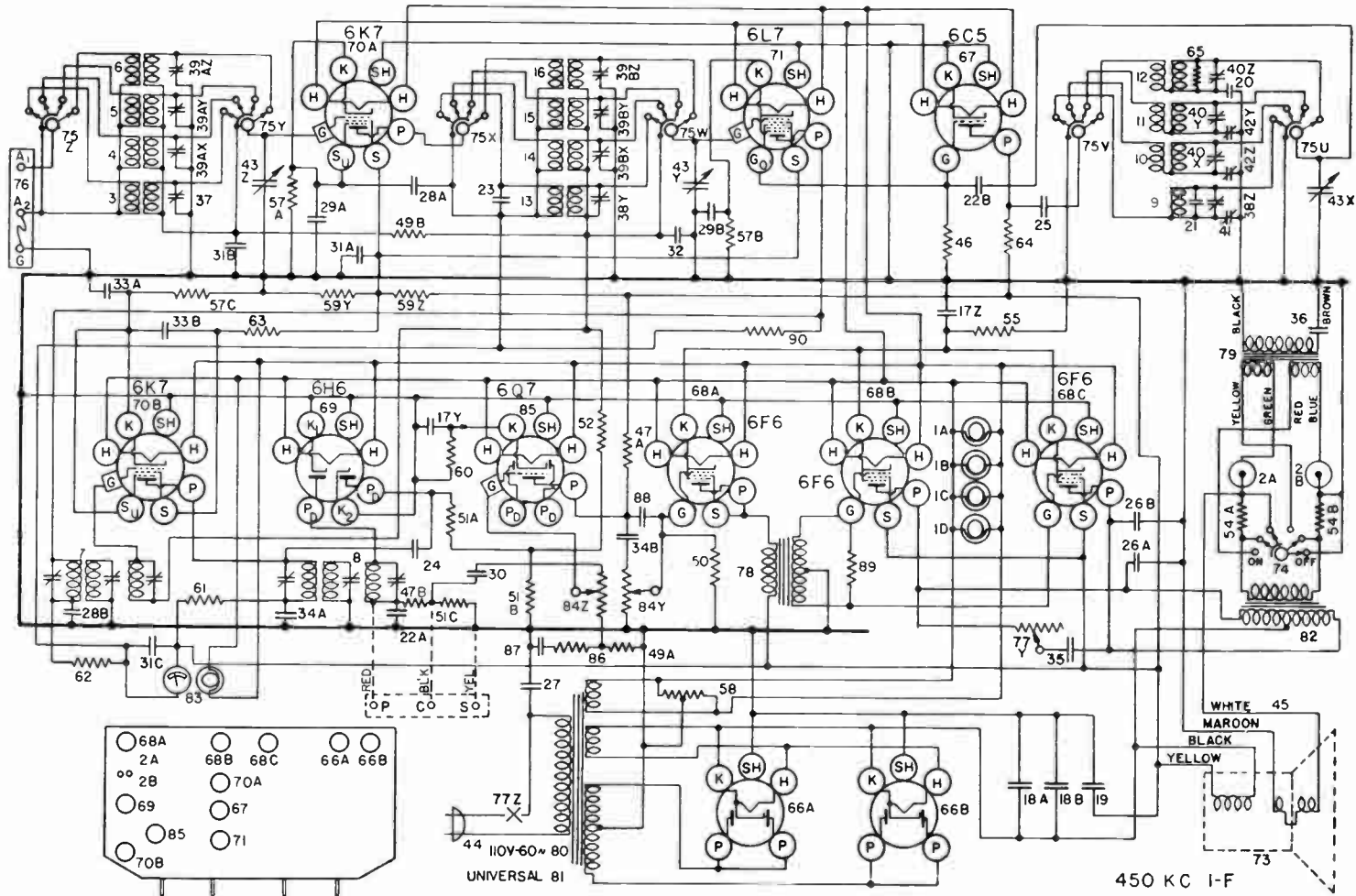

Item No.	Description	Item No.	Description	Item No.	Description	Item No.	Description
49B	300,000 Ohms, 1/4 W. Insul.	72		6	Ant. 6-18 Mc.	31C	.05 Mfd., 200 Volt
49C	300,000 Ohms, 1/4 W. Insul.	73		7	1st I. F. 450 Kc.	32	.05 Mfd., 200 Volt
50	400,000 Ohms, 1/4 W. Carbon	74	Auto-Expressionator	8	2nd I. F. 450 Kc.	33A	.05 Mfd., 200 Volt
51A	500,000 Ohms, 1/4 W. Carbon	75Z		9	Osc. 150-400 Kc.	33B	.05 Mfd., 200 Volt
51B	500,000 Ohms, 1/4 W. Carbon	75Y	Band Selector	10	Osc. 540-1900 Kc.	34A	.05 Mfd., 400 Volt
51C	500,000 Ohms, 1/4 W. Carbon	75X		11	Osc. 1900-6000 Kc.	34B	.05 Mfd., 400 Volt
52	1. Megohms, 1/4 W. Carbon	76	Ant. and Ground	12	Osc. 6-18 Mc.	35	.05 Mfd., 400 Volt
54A	1.0 Ohms, 1 Watt	77Y		13	R. F. 150-400 Kc.	36	.3 Mfd., 160 Volt
54B	1.0 Ohms, 1 Watt	77Z		14	R. F. 540-1900 Kc.	37	Single Ant. Trimmer
55	220 Ohms, 2 1/2 W. Flex.	78	Audio	15	R. F. 1900-6000 Kc.	38Z	Double Section Osc. Trimmer
56		79	Base Compensator	16	R. F. 6-18 Mc.	38Y	R. F. Trimmer
57A	350 Ohms, 1/2 W. Flex.	80	60 Cycle, 110 V. Power	17Z	25 Mfd., 25 Volt	39AZ	Ant. Triple Sec. H. F. Trimmer
57B	350 Ohms, 1/2 W. Flex.	81	Universal Power	17Y	12 Mfd., 25 Volt	39AY	Pol. Trimmer
57C	350 Ohms, 1/2 W. Flex.	82	Push-pull Output	18A	35 Mfd., 400 Volt	39AX	B. C. Trimmer
58	20 Ohms, Wire Wound	83	Shadow-graph	18B	35 Mfd., 400 Volt	39BZ	H. F. Trimmer
59Z	4000 Ohms, Wire Wound	84Z	1st A. F. Grid	19	40 Mfd., 300 Volt	39BY	R. F. Triple Sec. Pol. Trimmer
59Y	4000 Ohms, Wire Wound	84Y	Driver Grid	20	.0056 Mfd., 300 Volt	39BX	B. C. Trimmer
60	2600 Ohms, 1 1/2 W. Flex.	85	Type 6Q7	21	.00025 Mfd., 200 Volt	40Z	H. F. Trimmer
61	1400 Ohms, 3/4 W.	86	6400 Ohms	22A	.0001 Mfd., 200 Volt	40Y	Triple Sec. Osc. Pol. Trimmer
62	1650 Ohms, 1 1/4 W.	87	.017 Mfd., 200 Volt	22B	.0001 Mfd., 200 Volt	40X	B. C. Trimmer
63	2000 Ohms, 1 1/4 W.	88	.001 Mfd., 400 Volt	23	.00025 Mfd., 200 Volt	41	L. F. Osc., Series Trimmer
64	15,000 Ohms, 1 W.	89	5000 Ohms, 1 Watt	24	.00025 Mfd., 300 Volt	42Z	B. C. Osc. Series Trimmer
65	10,000 Ohms, 1/4 W.	90	200,000 Ohms, 1/4 Watt	25	.006 Mfd., 400 Volt	42Y	Pol. Osc. Series Trimmer
66A	Type 5Z4	1A	Dial Light	26A	.004 Mfd., 400 Volt	43Z	
66B	Type 5Z4	B	Dial Light	26B	.004 Mfd., 400 Volt	43Y	3 Section Var. Tuning
67	Type 6C5	C	Dial Light	27	.01 Mfd., 400 Volt	43X	
68A	Type 6F6	D	Indicator Light	28A	.01 Mfd., 400 Volt	44	Power Supply
68B	Type 6F6	2A	Auto-Expressionator Ballast	28B	.01 Mfd., 400 Volt	45	Speaker
68C	Type 6F6	B	Auto-Expressionator Ballast	29A	.02 Mfd., 160 Volt	46	40,000 Ohms, 1/4 W.
69	Type 6H6		Auto-Expressionator Ballast	29B	.02 Mfd., 160 Volt	47A	100,000 Ohms, 1/4 W. Insul.
70A	Type 6K7	3	Ant. 150-400 Kc.	30	.02 Mfd., 200 Volt	47B	100,000 Ohms, 1/4 W. Insul.
70B	Type 6K7	4	Ant. 540-1900 Kc.	31A	.05 Mfd., 200 Volt	48	
71	Type 6L7	5	Ant. 1900-6000 Kc.	31B	.05 Mfd., 200 Volt	49A	300,000 Ohms, 1/4 W. Insul.

TUBE SOCKET VOLTAGE READINGS FOR CROSLY 1155 CHASSIS

Tube	Function	H	P	S	Su	G	K	Go
6K7	R. F. Amplifier	6.3	238	100	3	0	3	—
6L7	Modulator	6.3	230	100	—	0	3.5	-5 to -30
6C5	Oscillator	6.3	140	—	—	-5 to -30	—	—
6K7	I-F Amplifier	6.3	230	95	3	0	3	—
6H6	Diode Detector	6.3	—	—	—	—	—	—
6Q7	A. F. Amplifier	6.3	155	—	—	0	2	—
6F6	Output Driver	6.3	210	210	—	0	17	—
6F6	(2) Output	6.3	360	235	—	0	17	—
5Z4	(2) Rectifiers	5.0	360	—	—	—	—	—

VOLTAGE DROP ACROSS SPEAKER FIELD 125 VOLTS. POWER OUTPUT APPROXIMATELY 15.5 WATTS. POWER CONSUMPTION APPROXIMATELY 140 WATTS. ALL READINGS TAKEN ON 117.5 VOLT POWER SUPPLY.

Four Bands of latest Crosley chassis, No. 1155

The four bands covered by the Crosley set are shown in table at right. The tiedown frequencies for series and parallel trimming are stated also. The highest frequency band has no series alignment, as none is needed.

SERIES AND SHUNT PADDING FREQUENCIES

	Shunt Alignment	Series Alignment
Weather Band (BLUE).....	40 Kc	150 Kc
American Broadcast Band (RED)	1700 Kc	600 Kc
Police Band (GREEN).....	6000 Kc	2500 Kc
High Frequency Band (VIOLET)	18000 Kc	—

FREQUENCIES OF THE FOUR BANDS

BLUE	150 — 400 Kilocycles (U. S. Weather Reports)
RED	540 — 1900 Kilocycles (American Broadcast Band)
GREEN	1900 — 6000 Kilocycles (Police and Amateurs)
VIOLET	6000 — 19000 Kilocycles (High Frequency Band)

Signal Generator Practice

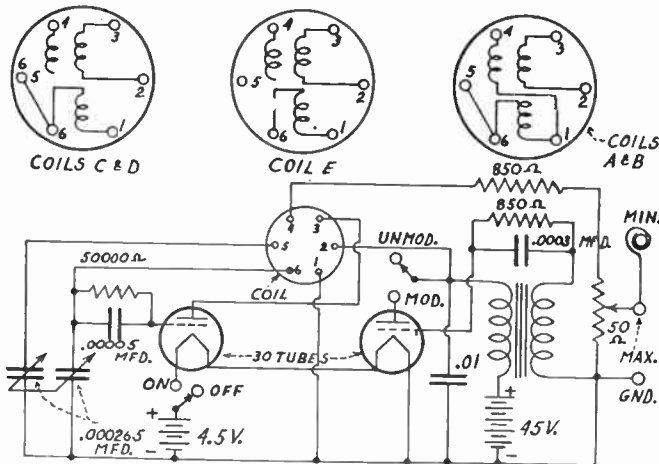

Circuit diagram of battery operated signal generator that has modulated-unmodulated service and attenuator. Plug in coils are used and charts consulted for frequencies.

THE diagram herewith is that of the Readrite Model 554-A Signal Generator. The bands covered are:

- A— 100 to 330 kc
- B— 325 to 1,150 kc
- C— 1,000 to 3,400 kc
- D— 3,000 to 9,200 kc
- E— 9,000 to 20,000 kc

The device is battery-operated.

The fundamental use of a test oscillator is to replace the broadcast signal for test and adjustment of radio receivers. Of special importance to the servicemen are the following uses:

Alignment of i.f., r.f. and oscillator padding circuits. Checking the condition of tubes. To determine the gain in any part of radio receivers. For testing a.v.c. circuits. For checking selectivity. Unless the manufacturer of the receiver instructs otherwise the following sequence may be followed in the alignment of a radio set:

1. The various tuned circuits of the i.f.

amplifier are first aligned properly at the intermediate frequency for which the amplifier was designed.

2. The oscillator parallel trimming condenser should then be adjusted at about 1400 kc. so that it tracks properly at the high frequency end of the dial. Adjust the series padding condenser at about 600 kc so that it tracks at the low frequency end of the dial.

3. Align the radio frequency, the pre-selector, amplifier or tuned circuit last.

If double spot or image suppression circuit is employed in the receiver, the manufacturers' instructions should be consulted for the proper procedure. Maximum transfer of energy in output is only obtained when every section is synchronized properly.

Testing Tubes

To determine the condition of tubes feed the

signal from the oscillator to the aerial and ground connections of the receiver. Connect an output meter to the radio set as described under the heading "Output Meters", substitute new tubes for those in the radio set, one at a time and if the output meter indicates a greater value when each new tube is placed in the set the original tube should be replaced.

To determine the gain in any part of the receiver connect output meter as before and feed signal to aerial connection of radio set. Adjust oscillator to a high output and move the oscillator aerial connection to each succeeding r.f. or i.f. stage, noting the drop in the output voltage as shown on the output meter. Always use the proper frequency and proper scales for the output meter.

To check a.v.c. to determine when it is functioning properly, wide changes in the alignment with a large signal voltage should produce no appreciable change in output.

To check selectivity feed a signal of low value to aerial and ground connections, tune oscillator to perfect resonance, move oscillator signal dial until signal disappears. Note number of kilocycles between resonance and inaudibility.

The accessories: A and B batteries and two type 30 tubes, which are accessible by removing the coil panel, five coils marked A, B, C, D, E, and one pair of oscillator shielded cords.

Operation

After determining the frequency to be covered insert the proper plug-in

coil in 6-hole socket in shield can which is accessible by removing the nickel cap near the toggle switch marked ON-OFF. Connect oscillator Maximum and Ground jacks with the cords to the radio set as previously described. Set the attenuator to approximately 75 on the dial. Set toggle switch marked MOD-UNMOD to position desired. Generally speaking, all oscillator alignments are made with a modulated signal. Consult graph chart for the coil selected. Note dial setting for the frequency desired. Set dial pointer of frequency selector dial to the position as shown on graph. Turn oscillator power on by throwing the OFF-ON switch to the ON position and attenuate the signal to desired level by rotating the attenuator control so that a minimum signal is reached. If further reduction in signal strength is wanted use jacks marked Minimum and Ground. The oscillator cord is shielded and the shield is also the ground connection.

voltmeter tests to determine battery strength. When it is deemed necessary to change tubes a tube of similar characteristics as that supplied with the oscillator should be used.

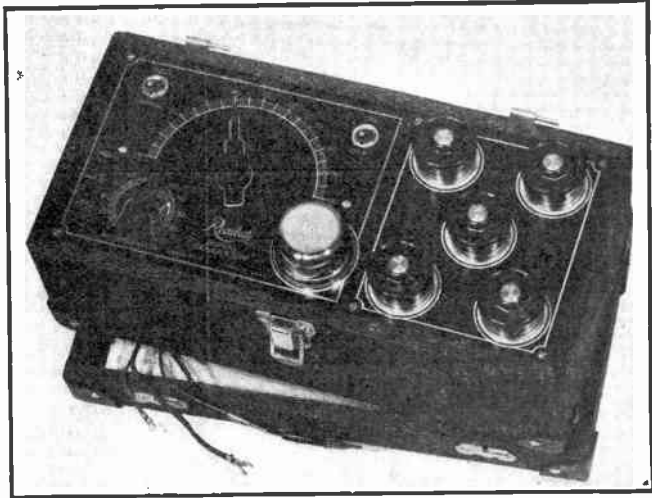

Output Meter

An output meter should always be connected to the radio output when using a signal generator.

To avoid serious energy loss the output meter should be connected between the plate of output tube and chassis. If the output meter does not have a condenser there should be a condenser inserted in the output plate lead. This will prevent a burnout of meter. A .5 mfd. 400 volt condenser is suitable. For sensitive a.c. meters the connection may be made to the voice coil without condenser.

Batteries should be replaced when they have depreciated 33%. Make

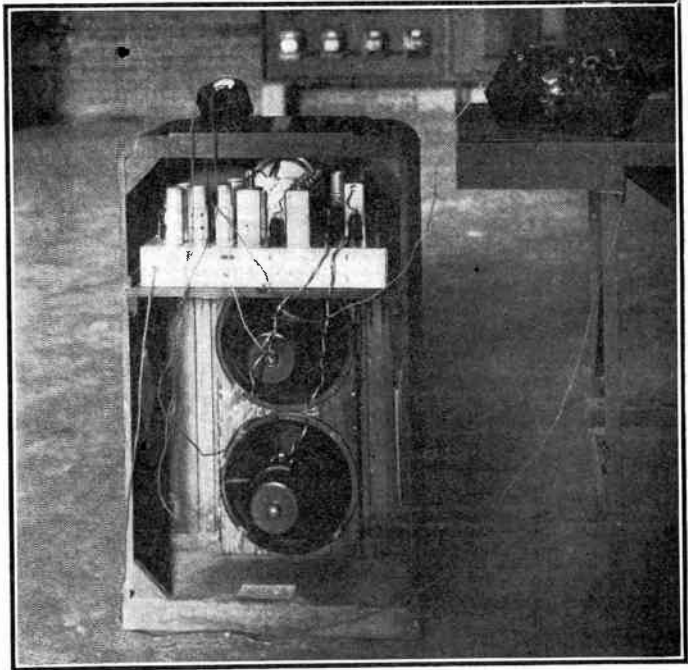

Readrite 554A signal generator connected to aerial and ground posts of a set. On the console top rests a Readrite output meter, connected to voice coil of receiver's speaker. Above, a closeup of the signal generator. Connection through a .1 mfd. condenser to plate of output tube is more useful for low sensitivity output meters.

RADIO CONSTRUCTION UNIVERSITY

Answers to Questions on the Building and Servicing
of Radio and Allied Devices.

Variable Coupling I.F.

HOW is the coupling changed in the new intermediate frequency transformers?—E. C. H.

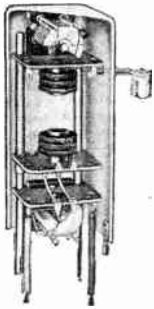

The coils are on platforms. One platform is actuated by rods. By anchoring a rod to the side of a cam, with cam attached to a shaft extending through the front panel, the rotation of the shaft by knob action moves the winding up and down. The Hammarlund variable coupling i.f. transformer is illustrated.

* * *

Power Output Determination

HOW would you suggest that the output power of a small five meter transceiver should be measured at the sending position?—L. D. C.

Accurate frequency power output measurement is always something of a problem. The simplest approximation we can suggest is that you get two pilot lamps that light up with seemingly equal brilliance when the same voltage is put across them (lamps in parallel). Measure the oscillator d.c. plate current with antenna attached, then remove the antenna and wind a few turns of wire, lamp connected to coils terminals. Now inductively couple the lamp to the tank circuit, so that the lamp lights, the coupling being such as to maintain the plate current at the value found previously. Then light the other lamp from a d.c. source to equal brilliance while the other is being lighted by the high frequency, measure the current through the d.c. lamp, also the voltage applied, which may be varied until brilliance is equal, and then compute the wattage in watts as voltage in volts times current in amperes. This then may be taken as the output power. The stunt was tried with a 6.3 volt pilot lamp that at 6.3 volts drew 200 milliamperes (.2 ampere). The coupled lamp shone to approximately equal brilliance, as near as the eye could determine. Therefore the power in the d.c. operated lamp was ascribed to the transmitter output, approximately one and a quarter watts.

Theory of 6B5 Tube

WILL you please set forth the reasons why linearity of performance is attained with the 6B5 tube, especially in view of the impedance variations, and the recommended, indeed inevitable, use nevertheless of direct coupling.—L. K.

In the 6B5 dual triode tube a signal impressed on the No. 1 grid produces a current through the grid to cathode impedance of the output triode and develops a voltage across this impedance which is the signal input to the output triode. As found from a plate current vs. plate voltage curve, the operation of the output triode in positive regions is extremely linear. A study of the distortion characteristics then evolves into the study of the e_2 vs. e_1 curve. If e_2 is a linear function of e_1 the system will be free from distortion.

The voltage e_2 is the product of the current i_1 and the grid impedance R . Now $i_1 = \mu e_1$

$$R_p + R \quad R_p + R$$

$$\text{or } i_1 = \frac{\mu e_1}{R_p + R (1 + \mu)}$$

$$\text{since } e_2 = i_1 R$$

$$e_2 = \frac{\mu e_1 R}{R_p + R (1 + \mu)}$$

e_2 is then a function of the variables R and R_p . These two variables are a function of the signal voltage or e_1 . If we now assume that the ratio of R and R_p is a constant A , the equation becomes

$$e_2 = \frac{\mu e_1 A R_p}{R_p + A R_p (1 + \mu)} = \frac{\mu A}{1 + A (1 + \mu)} e_1$$

$$\text{If } K = \frac{\mu A}{1 + A (1 + \mu)}$$

Then $e_2 = K e_1$

Now the linearity of the complete system depends upon the ratio of R and R_p being a constant. That this is true is proven by the curves of the tube performance. However, it can be shown graphically just how these impedances vary. The plate impedance of the input triode is a function of its grid bias. Now a dynamic curve can be taken and the slope of the curve will be proportional to the R_p of the tube. If the R_p does not vary the curve will be

a straight line. The value of R_L in the cathode circuit is equal to the static grid impedance of the output tube. The curve is not a straight line and R_p varies. A dynamic grid current vs grid voltage curve of the output tube would show the instantaneous input impedance is proportional to the slope of this I_g curve. This impedance varies similarly to the R_p of the driver tube. Through proper design the phase relation and curvature of the two curves are made such that the impedances vary together resulting in a linear relation between e_2 and e_1 . This compensation is the one thing that makes direct coupling possible. If it were not for this the advantages of positive grid operation of a high mu triode could not be realized, due to the difficulty of driving a nonlinear impedance such as this grid and supplying the power required.

* * *

Short Wave Coils

IS it necessary to use air wound coils for very short waves, and especially ultra short? About what is the resistance effect of the form?—L. I.

The resistance of the coil to radio frequencies is increased when the coil is wound on an insulating form. Of course a conductive form is not used, unless of the special type designed for increasing the electromagnetic field. The use of good insulating terminals, compared to free ends, will increase the resistance of a given coil from 2 ohms originally to 2.25 ohms at 600 kc, from 9 ohms to 9.5 ohms at 1,500 kc, and from 12 ohms to 15 ohms at 3,000 kc. Using a complete form for winding, the increase may be greater, but it is not serious, as other factors enter to increase the resistance, usually out of proportion to the small increase due to the form. Shielding, for instance, creates a much higher resistance, and mere placement of an unshielded coil close to a metal chassis has about the same effect. The resultant rigidity, especially when using finer wire than usual, makes the use of a form often highly advisable.

* * *

Cures for Hum

WILL you please give me some pointers on reducing or eliminating hum from a broadcast receiver?—K. L.

If you use an audio transformer, place it at the end of the chassis opposite to the one occupied by the power transformer, or at least as far from the power transformer as possible. If the speaker output transformer is on the chassis the same applies. The increased length of the leads is of not much consequence, as audio frequencies are concerned. If the remoteness recommended can not be conveniently established, put a shield over the audio transformer, consisting of a high permeability casing. This is commercially obtainable. Iron is often not a sufficiently good shield. The high permeability metal consists of a patented alloy of one kind or another. There are several varieties. If the center tap of the heater winding serving the r. f., i. f. and detector and other tubes is connected to ground, try making the connection to the cathode or filament side of

the biasing resistor of the power tube or tubes. If resistance coupled audio is used, interrupt the plate load resistor with another of about the same resistance value, that is, between the end of the load resistor other than plate, and B plus, and from the joint put a high capacity condenser, say, 8 mfd. electrolytic, negative of condenser to ground, positive to joint. This often makes a very effective hum filter. Another place to put such a filter is in series with the grid return of the power tube, the resistor being .1 meg. or higher, condenser inserted as before. But the total d. c. resistance in the grid circuit should not exceed the value recommended in tube manuals for the type of power tube used. Sometimes grounding the speaker frame, or cores of all audio transformers, including output transformer, helps. Interrupt the lead from B plus to the r. f. and i. f. tubes with a 1,000 ohm resistor and put a condenser of .1 mfd. from the tube side of the resistor to ground. If these suggestions do not carry out the purpose entirely, increase the filter capacity next to the rectifier, that is, put 8 mfd. or so more from rectifier filament to negative.

* * *

Difference Between Screws

WILL you please show the difference between wood screws and machine screws? I am a boy who lives on a farm with my aunt, and she can not explain the difference.—L.E.

The illustration shows wood screws at extreme left and right and machine screws



Difference between wood screws and machine screws, illustrated for the benefit of a farm boy whose aunt, with whom he lives, can not supply the vital information.

between them. Of the two machine screws, one is shown with nut affixed. The wood screw is sharply pointed, so it can be driven into wood readily with a screwdriver. The machine screw is to be passed through a drilled hole, usually in a metal piece, and is fastened with a nut put on the foot of the screw. The machine screw has a flat foot, so to speak. Show this to your aunt.

* * *

Formula for Inductance

WILL you please give a formula for obtaining the pure inductance of a coil (eliminating the distributed capacity as an "ap-
(Continued on next page)

The **ONLY TWO** Companion Devices
for Reducing Noise on **ALL** Waves



LYNCH HI-FI Assembled Antenna

All ready to hang. Saves 90% of installation time. Any novice can install it—quickly, easily, correctly. Makes every set perform better. Results are smashing.

LYNCH HI-FI
ASSEMBLED
ANTENNA **\$6.75**
list

NOISE REDUCING TWINS

LYNCH FILTERADIO

Cuts out objectionable noise from the light line. Makes interference from circuit breakers, motor generators, etc., practically negligible. Easy to install; simple to adjust. One type serves all purposes. **\$5.00**
list

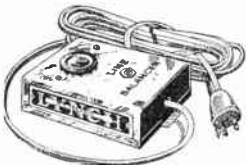

Be sure and see these NOISE-REDUCING TWINS at your jobber's or dealer's. If they cannot supply you, order direct. Write for folder.

ARTHUR H. LYNCH, Inc., Dept. RW,
227 Fulton Street, New York
Pioneer of Noise-Reducing Aerials

RADIO UNIVERSITY

(Continued from page 61)

parent inductance"), answer to be in microhenries?—C. L.

The formula you request is as follows, where L_{mh} is the inductance, F_{kc} the frequency, C the larger and c the smaller capacity; for fundamental and second harmonic:

$$L_{mh} = 19,000/F_{kc}^2 (C \text{ mfd.} - c \text{ mfd.})$$

The use of a calibrated condenser is required, also frequency F in kilocycles, the second harmonic of which is tuned in at setting c mfd. If F could always be 138 kc then L could be $1/(C_{mfd} - C_{mfd})$. For the broadcast band 1,380 kc could be used, with numerator equaling 100, for another band F would be 13,800 and the numerator 10,000. Preferably the unknown should be used in its entirety, primary included, in an actual circuit, so the generator frequency would be fed to an amplifier tube, and the unknown is the coil feeding a tube voltmeter biased to cutoff.

* * *

Loop Operated Battery Set

AS I live in a locality where there are two strong locals that come in from opposite directions, may I not use a loop so as to minimize or eradicate the interference from these stations? There is no electricity where I live.—I. W.

You may use a battery operated superheterodyne such as has the frame coil antenna or loop connected to the input. There will be considerable improvement in the directional selectivity that you require. Also the receiver, if made portable, could be used for finding the direction of a transmitter provided one operated in the clear, away from objects that would cause reflections and deflections, and thus obscure the reality. The finding would be as to the line of reception, but would not disclose whether the carrier originated from one or the other "sense." The direction therefore is ambiguous to 180 degrees. The "sense" is the elimination of this ambiguity to isolate the source. A balancing system is necessary to determine the sense.

LESS OSCILLATOR LEAKAGE

Where a tube is used as strong oscillator, as in a signal generator, a triode often is preferable because leads are shorter and leakage less. An amplifier or buffer stage is then advantageous.

AIR SCOUT JUNIOR DOLLAR RADIO KIT

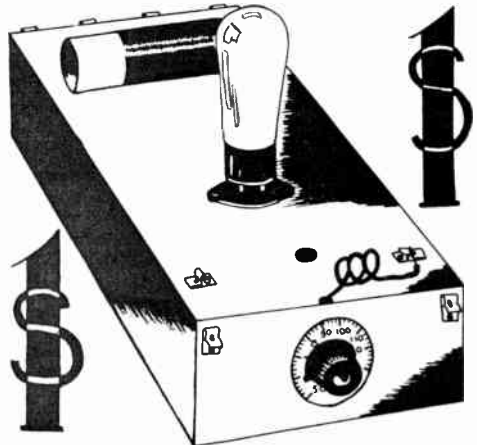

"Only Kit of its Kind in the World"

Thousands of these powerful radio receivers now in use, giving wonderful results. The AIR SCOUT JUNIOR is a real radio—a worthy companion to the world famous All Wave Air Scout. Not a toy nor an attachment. Not a feeble crystal set. For only \$1 we send you every part needed to build this remarkable one-tube receiver including tube and attractive bristol-board cabinet as shown, and set of easy-to-understand directions. Wiring this set gives you valuable radio knowledge. Just a few easy connections and set is ready to use. Filament works on flashlight batteries. Set can be converted later to All Wave or All Electric set at slight extra cost. Order at once!

H. G. CISIN

Chief Engineer Allied Eng. Institute
Dept. RW-3—98 Park Place, New York, N. Y.

Let Me Tell You

About your business, travel, changes, matrimony, love affairs, friends, enemies, lucky days and many other interesting and important affairs of your life as indicated by astrology. Send for your special Astral Reading. All work strictly up-to-date, individual and guaranteed satisfactory. FOR MANY YEARS PRIVATE ASTROLOGICAL ADVISER TO ROYALTY and the ELITE. Write name, address and date of birth plainly. No money required, but if you like send 15 cents (stamps; No Coins) to help defray costs. Address: PUNDIT TABORE, Dept. 529, Upper forjett Street, BOMBAY VII, BRITISH INDIA. Postage to India is 5c.



Radio Police Use Codes for Saving Time

Codes are used in police radio work, usually consisting of numbers, and the general public assumes that this is done for secrecy. However, the police say that radio results are so swift that secrecy is not deemed important, and the codes are really used to save time.

The radio patrolmen, in their cars, called cruisers, know the meaning of the code numbers, as only a few numbers are used. For instance, New York City has 500 police cars and uses only three code numbers.

DX ON ULTRA WAVES

Sometimes even ultra waves strike the ionospheric layer and rebound to earth, which accounts for occasional distance reception below ten meters.

CLASSIFIED ADVERTISEMENTS

7 cents a word. \$1.00 minimum.

ELECTRICAL AND RADIO SUPPLIES

PHOTO CELLS AND RELAYS. Get ready for the Electronic and Television field by experimenting with Pese rugged Photo Cells, \$1.50, and Pese Supersensitive relays, \$3.00. Send 3c stamps for valuable information uses, constructional data. Pese Scientific Products, 4918—13th Ave., Brooklyn, N. Y.

AMATEUR LICENSES, complete training. \$1.50 weekly. Resident and correspondence courses. Students licensed this month: W2JAN, W2JBD, W2JCU, W2JDJ, W2JDD, W2JDR, W2JGS, W2JGV, W2JGX, W2JGY, W2JHF, W2JHV, W2JIE, W2JII, W2JIV, W2JKL. New York Wireless School, 1123 Broadway, New York.

BLACK CRACKLE LACQUER. No spraying or baking. Apply with brush. Quick drying. Gives beautiful Crystalline finish. Fifty cents per can. Jay Francis, 10921 Park Heights Avenue, Garfield Heights, Ohio.

MANUALS AND BLUEPRINTS

"BARGAIN MECHANICS MAGAZINE," Wilmore Ky. Three years. 25c. Advertises Everything!

MISCELLANEOUS

INDIAN RELICS, minerals, books, curios, coins, stamps. Catalogue, 5c. Indian Museum, Northbranch, Kansas.

2000 WHITE BUSINESS CARDS. \$1.50. Eisen, 2132 North Seventh, Milwaukee.

MAKE \$18.00 weekly at home addressing and mailing post-cards and letters. Experience unnecessary. Steady work. Supply furnished. Start now. Complete particulars, send 10c. National Industries, 17 Locust, Dept. 43, Springfield, Mass.

UP TO \$2000.00 each paid for old Cents, 50c before 1916 \$750.00, Old Paper Money \$28.00, Foreign Coins \$150.00, Lincoln Cents before 1932 \$35.00 per 100, etc. Send 25c for Large Illustrated Complete Catalog before sending coins. Romano-coinshop, Dept. 684, Springfield, Mass.

\$50 A WEEK WITH A KODAK. Booklet describing 100 Magazine Markets; 20c silver. R. Howell, Box 526, Los Altos, Calif.

DIVORCES IN MEXICO

Ten days—free information. International Law Office, 441 First National Bank Bldg. El Paso, Texas.

SPECIAL 2-FOR-1 OFFER

RADIO WORLD

Radio World is \$2.50 a year (12 issues), 25c per copy. Canada and foreign, \$3.00 yearly. Offers of Radio World and other worthwhile publications for one full year on each, (NET):

- RADIO WORLD and SHORT-WAVE CRAFT, \$3.50.
- RADIO WORLD and POPULAR SCIENCE MONTHLY, \$3.50.
- RADIO WORLD and RADIO-CRAFT (12 issues), \$3.50.
- RADIO WORLD and RADIO INDEX (monthly, 10 issues) stations, programs, etc., \$3.50.
- RADIO WORLD and SERVICE (monthly), \$3.50.
- RADIO WORLD and TRUE STORY (monthly), \$3.00.
- RADIO WORLD and LIBERTY (weekly), \$3.00 U. S. only.

Select any one of these magazines and get for an entire year by sending in a year's subscription for RADIO WORLD at the regular price, \$2.50, plus a small additional amount, per quotations above. (Add \$1.50 for extra foreign or Canadian postage for both publications.)

Name

Address

City and State

Build Better

**ESICO ELECTRIC
SOLDERING IRONS**



**With Esico
Soldering Irons**

The Esico electric soldering iron demanded by the leading plant superintendents in the country, because of their efficiency—is just the iron you need to complete your home kit of quality tools.

HOT—QUICK SOLDERING—INEXPENSIVE

See your local Esico distributor on a complete line of Esico soldering irons.

ELECTRIC SOLDERING IRON CO., INC.
342 West 14th Street New York, N. Y.

ESICO
REG. U.S. PAT. OFF.

METAL CHASSIS

We can supply chassis for any make receiver, experimental or otherwise.

Inquiries should be accompanied with sketch and complete details enabling us to give quick service as to prices and delivery.

KORROL MFG. CO., Inc. Dept. R.W.-236
232 GREENWICH ST. NE WYORK CITY

GOODBYE, NOISE!

The noise silencer adapter described in the February 1st Sun Radio Page is now available. If you have a superheterodyne receiver install a Leeds "Quiet Can" and abolish those annoying noises forever.

LEEDS RADIO COMPANY

45 VESEY ST. NEW YORK CITY
Dept. R. W. 3

NOISE-SILENCING COIL KIT
Special I. F. (456-465 KC) and
Special R. F. Choke \$1.50 Postpaid
RADIO DESIGN CO.
1353 Sterling Pl. Brooklyn, N. Y.



NAME PLATES

60 different readings for use on
Transmitters, Re-
ceivers, Monitors,
P. A. Systems, etc.
Write for FREE
Catalogue



BUD RADIO, INC.

1937 EAST 55th STREET

CLEVELAND, OHIO

R-F COIL WINDING MADE EASY

ALL you need are any standard wire and coil form and you can wind a radio-frequency solenoid to any requirement from information contained in "The Inductance Authority." No calculation is needed. Quick consultation of simple charts gives the answer in number of turns and gives it with high accuracy. This is the indispensable book for those who wind their own coils.

Sent prepaid anywhere on earth on receipt of \$2.00. Or send \$5.00 for a two-year sub. for Radio World and this valuable book will be sent free as a premium.

RADIO WORLD

145 W. 45th STREET

NEW YORK CITY

You need **2** books

MATHEMATICS

of Radio Servicing

Introduces and explains the use of arithmetic and elementary algebra in connection with units, color code, meter scales, Ohm's Law, alternating currents, ohmmeter testing, wattage rating, series and parallel connections, capacity, inductance, mixed circuits, vacuum tubes, curves, the decibel, etc, etc., and has numerous examples.

Plainly written and easy to understand. Only useful data included. M. N. Beitman, author. Size. 8 1/2 x 11 in.

PRINCIPLES of PUBLIC ADDRESS SYSTEMS

A practical handbook, full of useful information, fully illustrated, written by M. N. Beitman, an engineer and noted authority on audio amplifiers.

Considers in detail various microphones, radio and phonograph inputs, acoustic feedback, mixing and volume controls, use of vacuum tubes, interstage coupling, power amplifiers, output coupling, loud speaker placement, the decibel, P.A. measurements, power level, and other points of importance, including actual circuit diagrams of tested P.A. systems.

Price, 50c each book.

SUPREME PUBLICATIONS

3727 West 13th St.

Chicago, Illinois

SCIENTIFICALLY ENGINEERED COILS

DELTA COILS are precision products, scientifically engineered, and actually reduced to careful practice in operating receivers before production. They are maintained accurate in inductance to two per cent. Peaking at all levels is therefore simply a matter of capacity adjustment, and maximum sensitivity and selectivity will result. Delta coils assure more DX. Prices do not include postage.

SPECIAL care has been taken to provide most accurate oscillator coils, so that tracking problems will be minimized. There are full coverage on each band and sufficient overlap. Broadcast solenoids are **SPACE WOUND** with enamel wire, or **BANK WOUND** with LITZ wire for greater selectivity at small extra cost. Unless specified broadcast coils are enamel space wound.

STANDARD BROADCAST BAND

Tuned Radio Frequency Circuits, Using .00035 Mfd. to .0005 Mfd.

- For Two-Gang Condenser*
- KIT EM-2: antenna coil with high gain primary both inductively and capacitatively coupled to the secondary, and an interstage coil with only capacity coupling to the secondary. All coupling is taken care of in the coils themselves, which are of the high impedance primary, unshielded type. Price of two coils.....\$ 0.95
- KIT EM-2-BW, same as above, but of bank wound Litz wire..... 1.15
- For Three Gang Condenser*
- KIT HJ-3: antenna coil and two interstage coils, in Deltex shields. Price of three coils... 1.74
- KIT HJ-3-BW, same as above, but of bank wound Litz..... 2.34
- For Four Gang Condenser*
- KIT HJ-4: antenna coil and three interstage coils in Deltex shields. Price of four coils.. 2.32
- KIT HJ-4-BW, same as above, but of bank wound Litz..... 2.72
- (Shipping weight of above kits is one pound each, and postage should be included when remitting with order.)

Superheterodyne Circuits Using .00035 to .0004 Mfd. Condenser

- For Two Gang Condenser*
- KIT HJ-2-S: antenna coil and oscillator coil, for 175 kc. unshielded.....\$ 1.05
- KIT HJ-2-S-BW, bank wound (Also for 456, 465 and 520 kc. by adding l.f. to the KIT number, same prices.)..... 1.25
- For Three Gang Condenser*
- KIT HJ-3-S: antenna coil, interstage coil and oscillator coil for 175 kc, all in Deltex shields. \$ 1.74
- KIT HJ-3-S-BW, bank wound (Also for 456, 465 and 520 kc. by adding l.f. to the KIT number, same prices.)..... 2.34
- For Four Gang Condenser*
- KIT HJ-4-S: antenna coil, two interstage coils and oscillator coil for 175 kc, all in Deltex shields.....\$ 2.32
- KIT HJ-4-S-BW, same as above, except bank wound Litz is used..... 2.72
- (Either of above for 456, 465 or 520 kc. oscillator, by adding l.f. to the KIT code; same price.)

NOTE: Padding capacities required for 175 kc. 600-1,000 mmfd.; for 456 and 465 kc. 450-600 mmfd. Padders can be supplied at 60c. Shipping weight on all above kits, with or without padding condenser, is one pound, and postage should be included when remitting with order.



Type of construction used in the 465 kc oscillator coil only. All other shielded coils are attached to the shield proper, and not to a base. The method of attachment is immaterial, but the 465 kc. l.f. can be readily distinguished from the oscillator for 175 kc. l.f. by the shield arrangement.

DOUBLY TUNED INTERMEDIATE TRANSFORMERS

- 175 kc
- MODEL I. F.—175. Shielded l.f. transformer, with control grid lead emerging from top..... \$1.06
- MODEL I. F.—175-D. Shielded l.f. transformer with four leads emerging from bottom, for use with half wave diode second detector..... \$1.06
- MODEL I. F.—175-T. Shielded l.f. transformer for use with full wave diode second detector. Secondary is center tapped..... \$1.14
- 465 kc
- MODEL I. F. 465. Control grid lead through top of shield..... \$1.06
- 520 kc
- MODEL I. F. 520. Control grid lead through top shield..... \$1.06
- MODEL I. F.—520-D. For diode half wave second detector..... \$1.06
- MODEL I. F.—520-T. For diode full wave second detector..... \$1.14

(All i.f. coils, universal wound. Shipping weight of any one, two or three above is one lb. Include postage when remitting with order.)

SIGNAL GENERATOR KITS

The foundation kit consists of: One precision tuning condenser, .0001 mfd. (No trimmer used.) One direct reading frequency calibrated dial. One escutcheon for dial. One coil for 140 to 500 kc. One coil for 540 to 1,600 kc. The above comprises **KIT-SG-FU**, (shipping weight, 3 lbs.) Price \$3.90

Precision condenser furnished with the all wave signal generator kit. No other condenser will track the frequency calibrated dial.

If it is desired to go to higher frequencies, the same calibration is used, 140-500 on the dial being multiplied by ten, i.e., 1,400-5,000 kc, also 540-1,600 is multiplied by ten, to be read as 5,400 to 16,000 kc. Two extra coils are needed, as all frequencies are used on fundamentals.

The kit that enables the coverage 140-500, 540-1,600, 1,400-5,000 and 5,400-16,000, and includes therefore the two extra coils, otherwise the same as the previously tabulated kit, is **KIT-SG-FUC**. Shipping weight, 3 lbs. Price.....\$4.70

R. F. CHOKES

Pie type universal wound radio frequency choke coils of very low distributed capacity, highly suitable for short wave use. They are on Isolantite forms, with stiff wire pigtails. Four to five pies.

- 1 millihenry.....22c
2 millihenries.....26c
2.5 millihenries.....28c
3.5 millihenries.....34c
- For filtering the plate legs of superheterodynes at any l.f. level, we have a special 10 millihenry choke across which is in go a condenser of .05 mfd. Order CII-10 @.....36c

NOISE SILENCER COILS

Closely coupled shielded l.f. transformer; primary tuned, secondary center tapped, not tuned. Specify i.f. Also 15 millihenry suppressor grid choke. **KIT-NS** (both coils) \$1.42

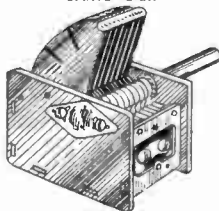

DELTA RADIO COMPANY

137 LIBERTY STREET

NEW YORK, N. Y.

Telephone: REctor 2-6650

Now—a high powered

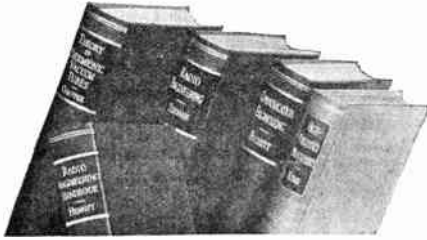

Radio Engineering Library

—especially selected by radio specialists of McGraw-Hill publications

—to give most complete, dependable coverage of facts needed by all whose fields are grounded on radio fundamentals

—available at a special price and terms.

These books cover circuit phenomena, tube theory, networks, measurements, and other subjects—give specialized treatment of all fields of practical design and application. They are books of recognized position in the literature—books you will refer to and be referred to often. If you are practical designer, researcher or engineer in any field based on radio, you want these books for the help they give in hundreds of problems throughout the whole field of radio engineering.

5 volumes, 2891 pages, 2000 illustrations

1. Everitt's COMMUNICATION ENGINEERING
2. Terman's RADIO ENGINEERING
3. Chaffee's THEORY OF THERMIONIC VACUUM TUBES
4. Hund's HIGH-FREQUENCY MEASUREMENTS
5. Henney's RADIO ENGINEERING HANDBOOK

10 days' examination. Special price. Monthly payments. \$26.00 worth of books cost you only \$23.50 under this offer. Add these standard works to your library now; pay small monthly installments, while you use the books.

SEND THIS ON-APPROVAL COUPON

McGraw-Hill Book Co., Inc
330 W. 42nd St., New York, N. Y.

Send me Radio Engineering Library, 5 vols., for 10 days' examination on approval. In 10 days I will send \$2.50, plus few cents postage, and \$3.00 monthly till \$28.50 is paid, or return books postpaid. (We pay postage on orders accompanied by remittance of first installment.)

Name

Address

City and State

Position

Company B W 8-86

TRANSFORMERS

FOR ALL PURPOSES

for example:

TRANSCEIVER TRANSFORMERS

F-532-B—Microphone and Plate Primaries to Grid Secondary. Unceased, light weight, Net.....\$.92

F-533-B—Transceiver Output from plate of 33, 38, 41, etc. to 130,1000 or 2000 ohm handset or phones. \$1.00

F-536-B—Similar to F-532-B but for more powerful Transceiver using a 19 as push-pull R.F., 30 as audio driver, and 19 as Class B Modulator\$1.05

F-534-C—Class B Input, 30 driver to 19 Grids Class B\$.80

F-535-B—Class B Output from 19 Twin to modulate 19. Sec. handles plate current of r.f. stage, impedance approx. 2700 ohms, or any 7 watt stage approx 50 m.a. at 135 volts.....\$1.17

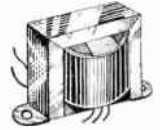

General Replacement Transformers

will be found in our CATALOGUE No. 51-C

Three examples out of 161:

- No. 210—300-0-300 V. 40 m.a.; 2.5 V. 5.5 A; 5V. 2A.....\$1.11
- No. 209—330-0-330 V. 60 m.a.; 2.5 V. 8.75 A; 5V. 3A.....\$1.80
- No. 1103—Single Plate to Push-pull Grids\$.98



High Fidelity Audio Transformers for Public Address, Broadcast and Amateur Stations will be found in our catalogues No. 70, No. 70-A and new No. 53 now being prepared. Description of all types for microphones, matching, interstage, and output, all fully cased and shielded. Useful diagrams and response curves included.

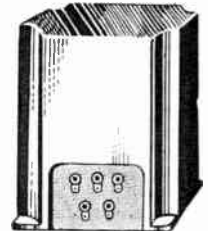

AMATEURS!

SEND FOR CATALOGUE No. 52-C



Contains nearly a hundred stock transformers and chokes for all power phone and C.W. rigs, designed by Boyd Phelps. W2BP-W9BP. Illustration shows ETP-56 which delivers 1/2 K.W. and costs \$9.50 net.

Any of the above catalogues free for the asking. If in a hurry, order direct from this ad or see your local jobber. If he does not have these lines tell him he is missing something well worth while.

FRANKLIN TRANSFORMER MANUFACTURING COMPANY

607-609 22nd Ave. N.E., Minneapolis, Minn.

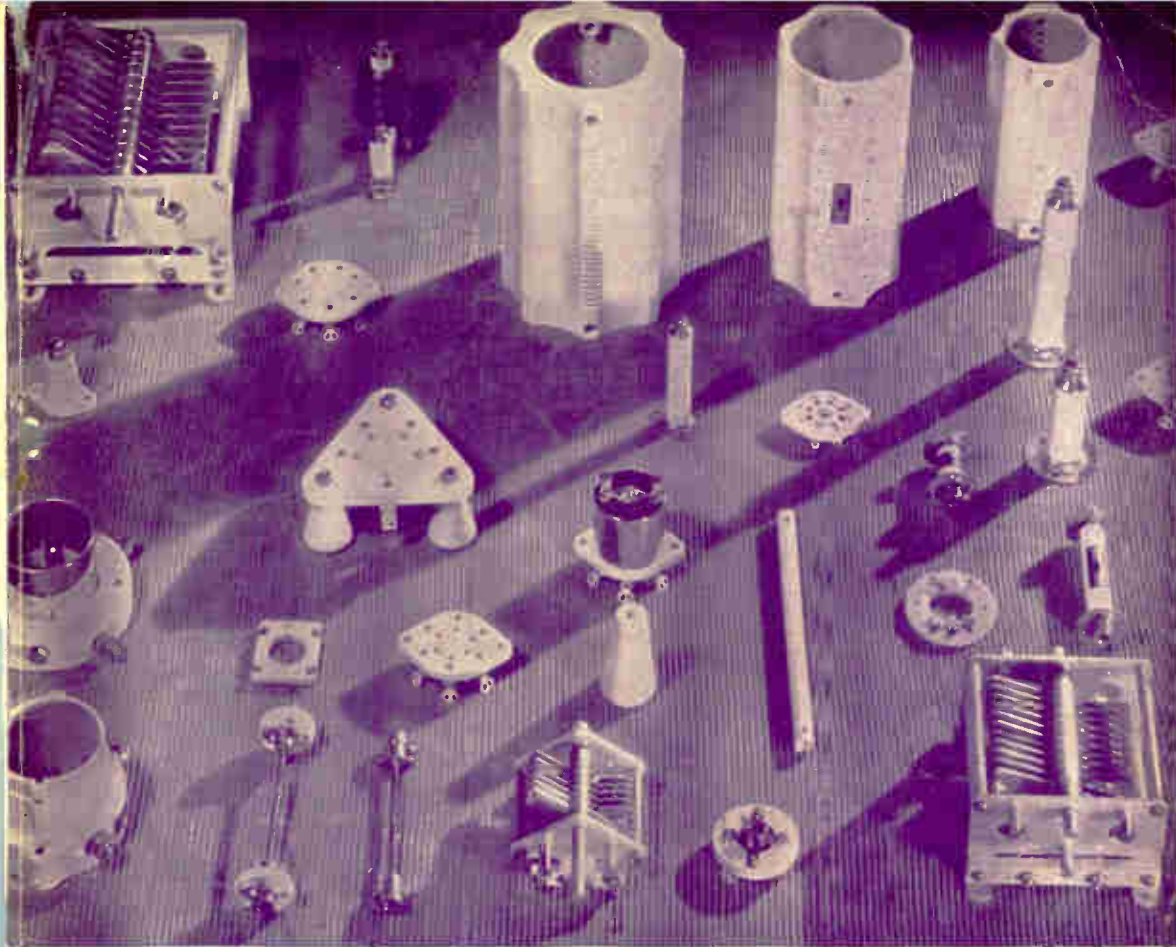

• National offers a thoroughly engineered part for nearly every radio purpose. The entire line cannot be compressed into our twenty-page catalogue, much less a single page. But look over the group above. Transmitting condensers from the little 1000 volt TMS in the foreground to the 12,000 volt TMA at the rear. Low loss ceramic coil forms for every amateur band. Low loss sockets for nearly every tube type, from acorns to power pentodes. Flexible couplings from the little TX-12, which will work around a corner, to the big fellows for heavy condensers, high voltages, and low-losses. Strain insulators, spreaders, lead-ins for the antenna; stand-offs, chokes, dials for the rig. National has what it takes.

NATIONAL



COMPANY

TRIPLETT INSTRUMENTS ARE *Distinctive*

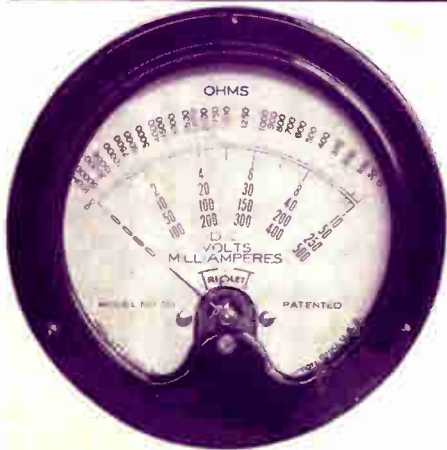

**MODERN
EXTERNALLY**

**PRECISION BUILT
INTERNALLY**

PIVOTS INSERTED LAST
PRESERVING POINTS

BRASS SUPPORT
CEMENTED OVER COIL

ACCURATE
ALIGNMENT

INSULATION
STRIP

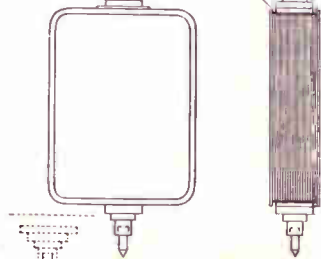

MOUNTINGS OF TRIPLETT PIVOTS

WHY ACCURACY CAN BE GUARANTEED WITHIN 2%

Triplett's Method as illustrated insures true alignment of moving element without strain and with maximum insulation against breakdowns. The pivot points are protected perfectly by the method of assembly—attaching them just before inserting in their sapphire jewel bearings.

Triplett Instruments Represent
Precision Without Extravagance

Model 521 Volt-Ohm-Milliammeter

Is an example of extreme accuracy with long readable scale on metal dials. While guaranteed to be accurate within 2%, graphs made by prominent engineers show scales are accurate to 1%. Something that Triplett care in manufacturing makes possible. Permanent accuracy is a marked achievement in all Triplett instruments.

Body $4\frac{3}{8}$ "", Flange $5\frac{1}{4}$ "", Body Depth $1\frac{1}{2}$ "", Scales $3\frac{1}{8}$ " in length. Knife edge pointers. Molded bakelite case. Finest materials. Flush mounting. Dealer Net Price, \$7.00.

A truly magnificent instrument of very wide application at a remarkably low price.

MAIL THIS COUPON TODAY

TRIPLETT ELECTRICAL INSTRUMENT CO.
273 Harmon Drive, Bluffton, Ohio

Please send me your New 1936 Catalogue.

Name of Ind.....

Name of Company.....

Address

City..... State.....

Triplett Manufactures

a complete line of electrical instruments for radio, electrical and general industrial purposes—both standard and custom built. Write for catalogue. See them at your jobbers. Prices on application.

