

RADIO REG. U.S. PAT. OFF. WORLD

25^c

PUBLISHED SINCE 1922

THE HOW - TO - MAKE - IT MONTHLY ————— August 1935

NEW
ELECTRON
RAY
RESONANCE
TUBE



6 METER
AERIAL
64
Stories Up



WHERE
SUPERS
ARE
LEADING



TILTING TELEVISION AERIAL GREATLY IMPROVES PICKUP

The 6 Meter Beamed Wave Sent Out by a Station Oscillated in a Vertical Direction at Origin, but Leaned Over as It Traversed Distance. Tilting of Receiving Antennas to the Right Phase Boosted the Pickup.

See Page 46.

BUILT *of the* FINEST



Type EB 9120
12 MFD—450 w.v.
525 M.S.V.
List \$1.40

YOUR COST 84c

SINCE 1910 Cornell-Dubilier has been the leader in condenser research and development. Now, as 25 years ago, Cornell-Dubilier leads the field with its latest laboratory development, the "hiformation" assembly process of electrolytic condensers.

Constructed of the finest raw materials, assembled in the world's largest condenser plant, with the most modern equipment, under expert technical supervision, C-D electrolytics are superior right from the start.

By increasing the anodic formation, C-D engineers were able to reduce the current leakage to a negligible level, increase the shelf life 100% and reduce the power factor to a new low of 3%.

PAPER CONDENSERS, hermetically sealed in metal containers are doubly vacuum impregnated and oil cooled. Conservatively rated, C-D paper condensers have given dependable performance for 25 years.

MICA CONDENSERS, manufactured under exclusive C-D patents, are available in complete capacity range up to 50,000 V.

OIL CONDENSERS—Years of development has enabled C-D engineers to introduce to the transmitting field the DYKANOL Condensers. These salient features describe fully this greatest advancement in the condenser industry:—

Non-inflammable.
High dielectric strength and constant.
50% lighter in weight and cubic volume.
Can be operated at 10% over rated voltages.

WHEN YOU BUILD USE C-D QUALITY CONDENSERS

CORNELL-DUBILIER

C O R P O R A T I O N

4343 BRONX BOULEVARD • NEW YORK

Servicemen, Experimenters and Set Builders!



Line filter that reduces line noise and eliminates need for antenna.

Build better new receivers, make old receivers better with new coils of the latest and most advanced types. These improved coils make sets more selective, more sensitive, and quieter in operation.

- I.F. TRANSFORMERS**, 465, 456, and 175 kc, doubly tuned by high grade mica trimmers—3-pie windings with Litz wire—High Q—The very latest development in coils.....List price, \$2.50. **Our price, \$1.00**
- ALL-WAVE SUPERHETERODYNE COIL KIT**, for three-gang variable condenser, tuning bands, 16-50 and 66-200 meters, 540-1, 500 kc, consisting of 6 high frequency coils and 2 Litz-wound I.F. transformers. Circuit diagram included.....List price, \$8.00. **Our price, \$4.00**
- TWO-BAND SUPERHETERODYNE TUNING KIT** for B.C. and foreign short-wave bands (530-1, 600 kc and 16-53 meters), consisting of 4 coils and 2 Litz-wound special I.F. transformers, for two-gang condenser. Complete with coil switch and circuit diagram.....**Price, \$3.00**
- T.R.F. BROADCAST COIL KIT** for 3 or 4-gang condensers. Shielded coils. Three coils for three-gang condenser, four for four-gang. Circuit diagram included.....**Price each coil, \$0.50**
- SUPERHETERODYNE COIL KIT** for broadcast receiver, consisting of two B.C. coils and two special Litz-wound 456 kc, I.F. transformers. For two-gang variable condenser. Diagram included.....**Price, \$2.50**

RADIO DESIGN LINE FILTER AND ANTENNA ELIMINATOR (illustrated)
List price, \$3.00. **Special introductory price, \$1.50.**

We can supply wide choice of radio parts at lowest prices.

RADIO DESIGN COMPANY

98 PARK PLACE, NEW YORK, N. Y.

Free technical advice given by J. E. Anderson, if self-addressed and stamped envelope is included with questions.

RADIO WORLD

The How-to-Make-It Monthly—Fourteenth Year

ROLAND BURKE HENNESSY
Editor

HERMAN BERNARD
Managing Editor

HERBERT E. HAYDEN
Advertising Manager

Table of Contents for August, 1935

An Electron Ray Indicator 5 <i>Tube Facilitates Exact Tuning</i> By Neal Fitzalan	Where Supers Are Heading 30 <i>Larger Inductances, Smaller Bands, Less Noise</i> By Herman Bernard
Ultra Waves in Wall Street 8 <i>Antenna 1,000 Feet Above Sidewalks</i> By Arthur H. Lynch	How to Use the New Tubes 34 <i>1B5/25S Dual Diode Triode and Others</i> By Lionel Rivers
Quality Index for Listeners 13 <i>Bass Drum, Consonants, Overtones Discussed</i> By J. E. Anderson	An Experimenter's Super 41 <i>Resolution of Changes in Four Years</i> By S. G. Bradley
Graphic Help to Constructor 17 <i>A Page of Photographs</i>	High Fidelity R.F. Tuner 44 <i>Detector is Made Non-Overloadable</i> By Sylvan Webb
Shield Effect on Inductance 18 <i>Simplified Measurement Developed</i>	Television on Six Meters 46 <i>Rod Aerials Tilted for More Pickup</i> By Montgomery J. Arden
All Hail the Grid Leak 20 <i>It Serves Splendid Purpose in An Oscillator</i> By Herman Bernard	A Small Three Band Set 50 <i>Switch Type for 530-22,000 Kc</i> By Maxwell M. Hauben
Receiver Detuning Avoided 23 <i>Operation of a Signal Generator Stabilized</i> By I. M. Loughboro	The Thyatron Tube 54 <i>Trigger Action Explained</i> By Morris N. Beitman
Short Wave Converter Factors 28 <i>Practical Helps Applied to Tested Circuit</i> By Louis Kranz	Radio Construction University 56 <i>Readers' Questions Answered</i>

Vol. XXVII, August, 1935. No. 7. Whole No. 683. RADIO WORLD, published monthly by Hennessy Radio Publications Corporation, 145 West 45th Street, New York, N. Y. Editorial and executive offices, 145 West 45th Street, New York, N. Y. Executives of RADIO WORLD: Roland Burke Hennessy, editor and business manager; Herman Bernard, managing editor; Herbert E. Hayden, advertising manager. Officers of corporation: Roland Burke Hennessy, president and treasurer; Herbert E. Hayden, vice-president; Herman Bernard, secretary. Entered as second-class matter March, 1922, at the Post Office at New York, N. Y., under Act of March 3d, 1879.

SUBSCRIPTION RATE

Price 25 cents per copy. Subscription \$2.50 per year (12 issues), postpaid in United States and Possessions; \$3.00 per year postpaid in all other countries. Remittance for foreign subscription should be by International money-order (postal or express) or draft against or discountable at New York bank.

RADIO WORLD is distributed by the American News Company and its Branches

An Electron Ray Indicator

New Tube Facilitates Exact Tuning of Set

By Neal Fitzalan

Bottom view of socket. Identities are:

- (1) Heater
- (2) Plate
- (3) Grid
- (4) Target
- (5) Cathode
- (6) Heater

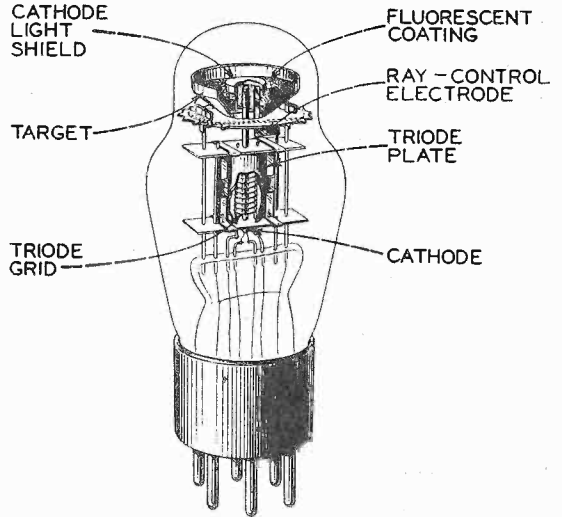
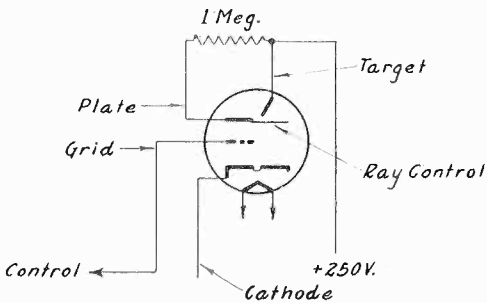
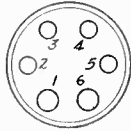

Visual indication is afforded by the new 6E5. A triode used as d.c. voltage amplifier directs electrons to a target, which glows when the electrons strike it. The shadow angle depends on the d.c. voltage on the grid, though not linearly. The arrow marked "Control" is connected to negative of the a. v. c. system of a set.

Appearance of the bulb, location and identification of elements, and "transparent" views of some of the structure of the 6E5.

A SMALL electron ray tube has been announced that is intended mainly for facilitating exactly tuning in a station on a receiver, but is applicable to other uses of an indicating nature. These other uses promise to become numerous, but require experimentation and also some resourcefulness.

How Illuminated Area Changes

The tube is the 6E5. It is in an envelope like that used for small triodes, such as the 56, 76, 37, etc., and draws 0.3 ampere at 6.3 volts on the heater. The cathode is of the indirectly heated unipotential type, and the object of the tube is to serve as indicator of voltage changes. Since the tube may be mounted in any position the bulb may be parallel with the chassis base, to present the fluorescent screen perpendicularly to the eye at front panel, when one tunes a receiver. Otherwise the visual indication may be reflected by mirrors. If the tube is mounted horizontally, the heater pins should be in on the same plane, which is perpendicular to the chassis top.

In the dome of the bulb is a fluorescent target. Thus when electrons strike the target they

illuminate it. Depending on how many target electrons there are, the area of illumination changes. The area of illumination therefore is controlled by target current, which is lower for higher negative biases. The biasing of the grid is used for the control of the total current passed to plate.

The tube is composed of a triode section, the plate of which is extended. The cathode has a pierced mask for confining the directed electrons toward the fluorescent screen, the grid acts as a relay to control the amount of emission taken over, some of the electrons strike the plate and go through a high limiting resistance to B plus, while an extension of the plate receives the remaining electrons, and acts as a sort of secondary emitter to supply the target, more positively voltaged in usual operation, so that there is attraction toward the fluorescent screen.

Cathode Light Kept Out

Since the fluorescent target is circular, and the tube structure is such as to limit the total change to a little more than 90 degrees, full deflection from minimum width to maximum width is accomplished within this shadow angle, approximately. At zero bias therefore illumi-

(Continued on next page)

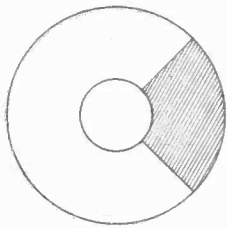

Zero Grid Bias

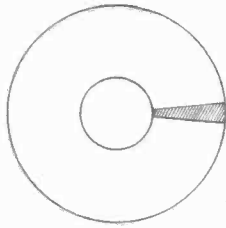

Negative Grid Bias

The shadow angle is represented by the two extreme conditions, zero bias and nearly 8 volts negative. Actual sizes are represented above and at right. The change of angle with voltage is not quite linear.

(Continued from preceding page)

nated area is least, and shadow angle greatest. When the grid goes positive the rate of change of illumination becomes very small and is practically useless, because small changes of applied test potentials produce practically no change in current.

A shield to keep the light of the cathode off the screen blots out part of the screen, so that less than two-thirds of the radius is useful.

As stated, the tube structure determines the contour of the target, or glow screen, the extension of the plate serving as a ray control element. An idea of the visual result of operation of the tube within its prescribed shadow angle indicating limits is shown in an illustration.

Connection to A.V.C.

The triode is used as a voltage amplifier on direct current, biased by the control voltage, which is external. Since this voltage must be negative, because the sensible change starts at zero bias, it is recommended that the automatic volume control circuit be connected as input to the grid-cathode circuit of the 6E5.

This requires that the negative end of the load

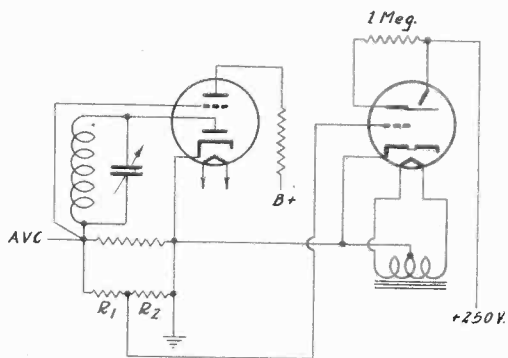

At left, if a diode biased triode supplies a. v. c., and the negative voltage becomes too large for operation of the electron ray tube over its most sensitive part, a series circuit of high resistances, R_1 , R_2 , may be placed across the diode load resistor. If the series resistors are equal the a. v. c. voltage drop applied to the ray tube is halved. At right the division applied to a cathode biased triode, R_1 and R_2 being of the order of a few thousands of ohms.

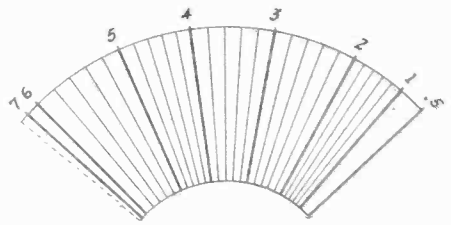

Calibration of d.c. voltage against shadow angle. The voltages are from 0.5 to 7, the divisions being 0.2 volt between 1 and 6 volts inclusive. Calibration for a.c. voltages would be different. The system is suggested for use of the 6E5 as a tube voltmeter.

resistor be connected to the arrow marked "control" in the first diagram, or if the a. v. c. is more complete than this recommendation intends, that less than the full voltage from the a. v. c. tube load resistor be applied, so that the tube is worked within its most sensitive limits. Ways of doing this for two conditions are illustrated. Naturally, for the purposes under discussion the application voltage must be d.c., and the closer the tuning the smaller the shadow area because a. v. c. works backwards.

The Series Resistor

True resonance develops the highest rectified voltage, the greatest automatic volume control effect, and drives the grid of the electron ray tube most negative, hence produces minimum area of shadow. For any action in the opposite direction, that is, where the potential signs are exchanged, the triode of the 6E5 could be biased negatively to 6 volts, and increasing d.c. values would then cause the area of shadow to increase. Moreover, such biased condition permits certain uses of a.c. input voltage, whereby greater angle of shadow with greater amplitude of a.c. test voltage go in step.

The high voltage supply is 250 volts usually.

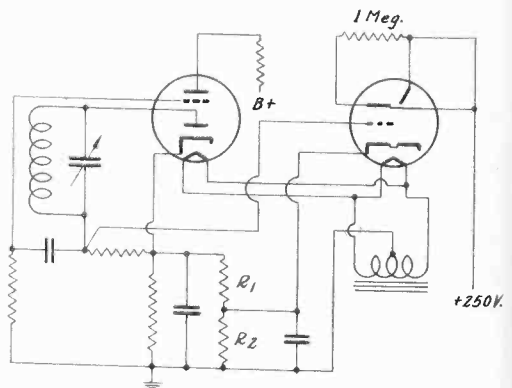

A resistor of 1 meg. is connected between plate and target to reduce the effective voltage on the triode plate. The ray control electrode, because it is an extension of the plate, is governed the same way. With no bias on the triode the plate current is maximum, the area of illumination least because the target voltage is so much higher than the plate's. The plate voltage is considerably lower than 250 volts because to reach the plate the current has to pass through the limiting resistor, and the current is relatively high. As some negative bias is introduced the plate current is reduced and the potential drop in the limiting resistor is lessened. Toward the most negative end, represented by minimum shadow angle beyond which the size of the illuminated space changes too little for perception, the effective plate voltage approaches the supply voltage. Briefly, then, the effective plate voltage works against the grid bias, effective plate voltage being more positive for more negative grid. This enhances the gradation of the illumination with potential.

Target Current Changes Other Way

As the grid is made more negative the plate current decreases, also the shadow angle decreases, but the target current increases. For full scale deflection the change in target current

is from 4.5 milliamperes to 4.7 milliamperes, approximately. It is therefore practical to put a 0-250 microammeter in series with the target circuit, baance out the d.c., and read current in terms of very close potential differences in test potentials.

If d.c. voltages alone are to be considered, the shadow angle could be calibrated in terms of voltage and angle, as is shown approximately in a diagram, which is based on curves of the static operation of the tube. Thus the 6E5 would be used as a d.c. tube voltmeter.

If one desired to use the tube for a.c. measurements, since any voltages effective on the grid would have to be negative, the method is ruled out, unless bias is supplied. So for a.c. input voltages with a fixed bias of 6 or 7 volts, the calibration of the shadow angle could be based on known test voltages applied between grid and cathode, within the sensible range. There could be of course a d.c. voltage calibration, somewhat like the one illustrated, only working in the other direction. The tube voltmeter would be "universal," if it had two scales.

Two Supply Voltage Conditions

When the tube is operated at 200 volts supply to plate and target, with the 1 meg. resistor in-
(Continued on next page)

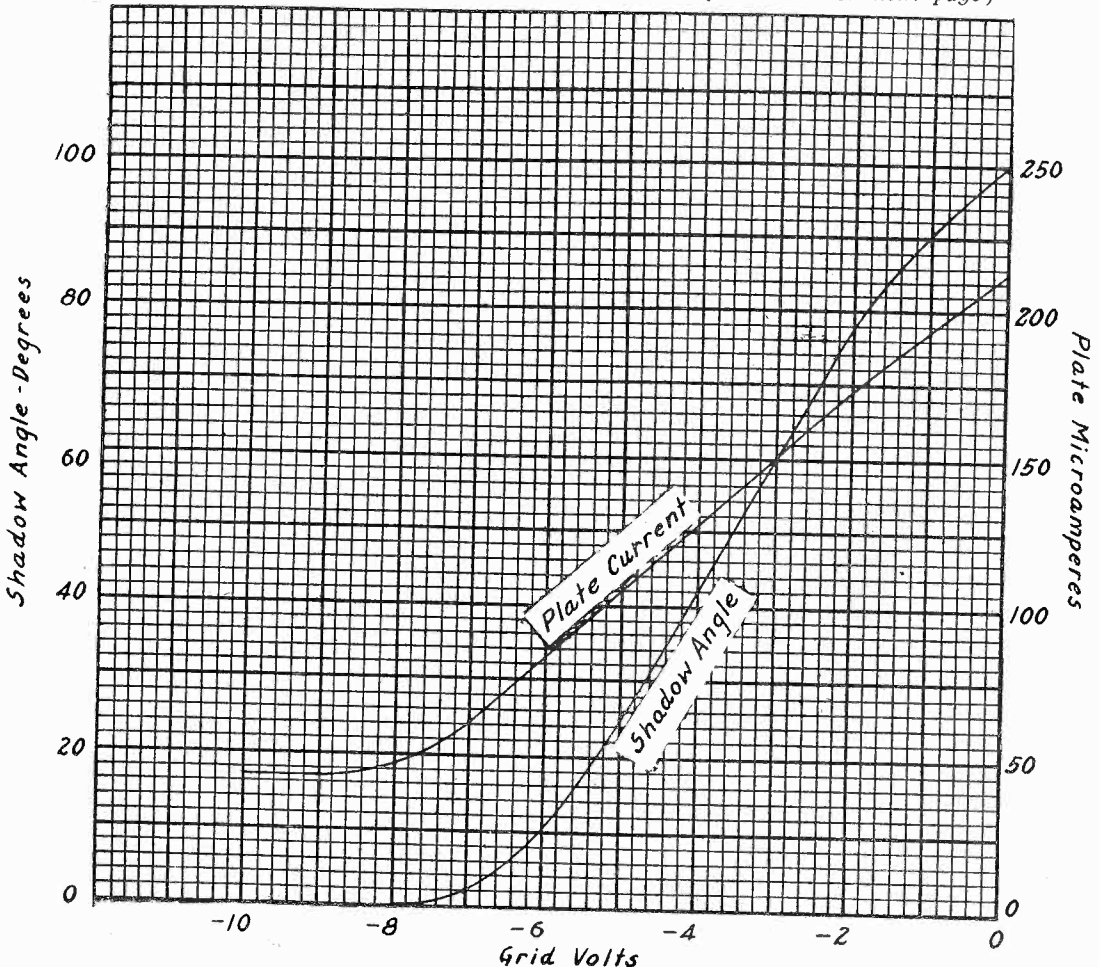

Read shadow angle in degrees at left and refer to voltages on horizontal. Read plate current at right against grid volts on horizontal,

Wall Street Goes in for ULTRA WAVES

Split Doublet Transmitting Aerial 1,000 Feet Above Sidewalks of New York Fed by Long Line Oscillator—
New York to Chicago on 5 Meters Reported

By Arthur H. Lynch (W2DKJ)

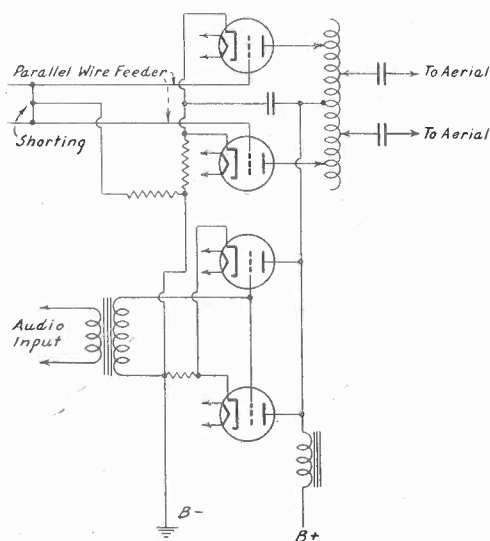

Illustration of the principle of the long line oscillator. This is a method of obtaining stability readily. The desired frequency or wavelength is achieved by proper location of the shorting bar. The output coil at the wavelengths considered may be a turn or two.

A GREAT future exists for the ultra waves. While the distance range is now limited, compared to lower frequencies, the apparatus is simple, often portable, and scientific development has not attained any real heights, compared, say, to standard broadcast band operation. Hence the exploratory thrill is present to a high degree.

Dependable range is taken to be approximately the line of sight, plus 25 per cent. Thus the absolute distance may be increased by increasing the height of the antenna. In that way the visual horizon is made more distant. Another method is to use directivity. Since this is the equivalent of using more power, and since relatively low power is used anyway, it is apparent that getting more power into the antenna, and then concentrating the power in a given direction, should give improved results. Reduction of loss between the output and the antenna is of course in the same direction. It can scarcely be said that ultimate solutions of these problems exist.

Long Line Oscillator Used

We have been trying out some experiments at portable W2DKJ, now used near the top of the building of Bank of the Manhattan Company, 40 Wall Street, New York City, at an elevation of about 1,000 feet. It is so high up that after traveling 60 stories in the main elevator you have to change to the elevator that runs in the tower only and go up four stories more. Then you come to W2DKJ and see a table with ultra frequency super-regenerative and superheterodyne receivers on it, and behind the table a cabinet containing a modulator and the oscillator. Four parallel copper tubings rise from the oscillator almost to the ceiling. Two are in the grid circuits and two in the plate circuits. We have been particularly careful about stability because of appreciation of its importance in ultra wave technique, for reasons which shall be set forth.

Two wires lead from near the top of the long
(Continued on next page)

Direct Reading Scale for Tube Voltmeter

(Continued from preceding page)

cluded, the target current is approximately 4 milliamperes, the triode plate current for zero bias is 0.2 milliamperes, and the triode grid voltage for zero shadow angle is minus 6.5 volts. For 250 volt service, same resistor, target current is 4.5 milliamperes, triode plate current 0.25 milliamperes, triode grid voltage for shadow of zero angle, minus 8 volts. In both instances

90 degree angle represents 0 volts, approximately.

Actually for calibration work the full range is not useful, for instance the angular calibration illustrated stops at 7 volts, though 8 volts are mentioned above. The angle difference is too small to be of much use in calibration, although the full sweep is useful for visual indication of tuning.

(Continued from preceding page)

lines in the direction of the nearest window. These are the transmission line, and they are carried outdoors on a horizontal pole, at the end of which is an insulator separating the two inside terminals of a vertical doublet antenna. Due to the high wind velocity at such an altitude—and the relative freedom from obstruction that makes such height favorable for ultra wave transmission gives the wind the same break—the horizontal pole wobbles a bit, and so does the upright stretch constituting the perpendicular doublet components at the end of the pole. However, this displacement has not caused any noticeable frequency wobble, since the long line oscillator controls the frequency, and does so somewhat in the precise manner of a crystal.

Crystals for 5 Meters Some Day?

As yet there is scarcely anything of crystal control nature applicable to 5 meters and below, although experiments are being conducted at frequencies slightly lower, and excellent success reported, particularly with tourmaline. This crystal is semi-precious, and though little of it is necessary, the slab runs into money. The long line oscillator, already applicable to much lower waves, may have a frequency constancy of 0.02 per cent. When crystals work, under safeguarded conditions, their constancy is of course considerably higher.

Besides the perpendicular doublet antenna there is, in back of it, a perpendicular metal rod established as an experiment in directivity. It is of course difficult to accommodate a full-fledged reflective and directive system even for any wave in the band, 5.357 to 5 meters, the metrical equivalent of the 56 to 60 megacycles allotted to amateurs. Even a Yagi antenna, rather simple of construction, would require, for adequate results, an antenna, a reflector behind, two reflectors on either side, and five directors in a row in front of the antenna. It is intended to elaborate on the directional installation, as it is recognized that the effectiveness of the single reflector used is small, although not so small as to escape notice. More stations hear us when we use the reflector, modest though it is, than when we omit it.

New York to Chicago on 5 Meters

The antenna used now is directed toward Philadelphia, and we have had a great deal of success in contacting stations in that city. We consult automobile road maps to get close directions and find them as good as anything else handy to procure. Magnetic compasses are not so satisfactory in the room where the trans-

(Continued on next page)

The transmitting antenna at the author's location, 1,000 feet above the sidewalks of Wall Street, is a split vertical doublet, with a vertical reflector wire that gives some assistance in concentrating the propagation. Two views are given. Below is shown the author talking into the crystal microphone at his portable station.

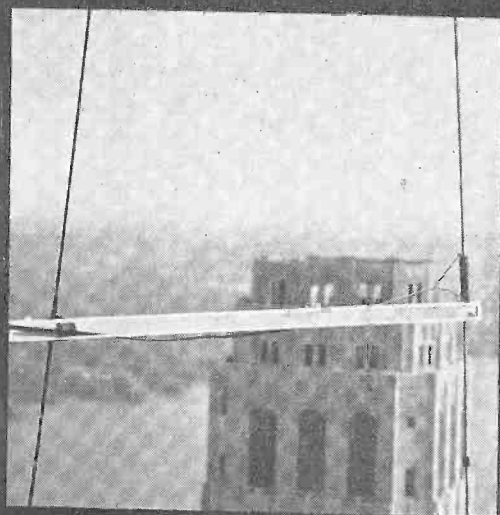
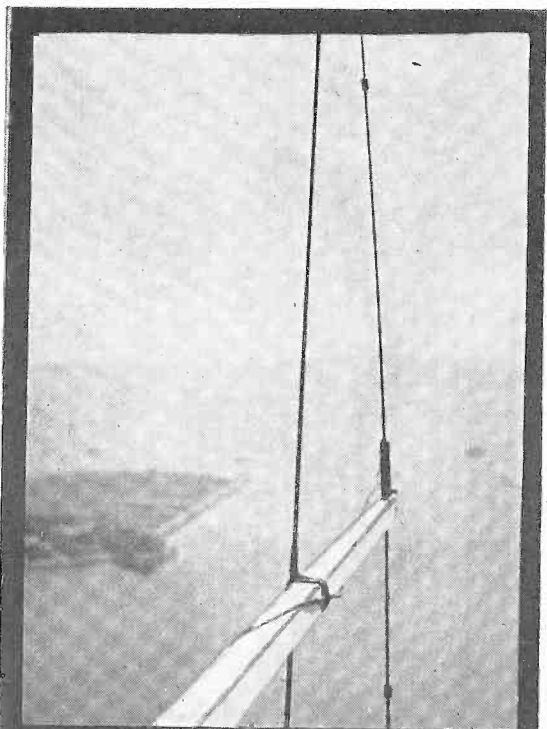

(Continued from preceding page)

mitter is located, due to stray fields from motor generator apparatus used in connection with operation of the building elevators. The circuit breakers unsteady the needle by influencing the earth's magnetic field in the room. The road maps are immune from this influence.

From a window practically at right angles we are erecting an improved antenna directed at West Hartford, Conn., in connection with tests of the American Radio Relay League station. We shall also try out results in a westerly direction, especially as there is temptation due to reports that receivers in Chicago have picked up New York City 5 meter transmissions (not ours, unfortunately). The 800 mile distant range certainly is not to be considered as a reliable service area, but even freak reception over such great distance, compared to the usual small allowance in computations, is exciting as the devil.

The Beckoning Spirit

The adventurous pursuit of improved methods to tame the wild ultra waves for the sake of establishing a reliable and practically standardized technique goes on. The same impulse to put 5 meters and below into the DX class applies today, just as the thrilling temptation was present fourteen years ago when 200 meters was low, and new territory besides, and the next year, when 130 meters, considered outlaw territory of impossible consequence, was tried. Everybody knows how the amateurs went to

lower and lower, lower waves, practically always by compulsion, pre-empted by commercial interests from assumptively choice channels. Now the wavelengths allotted to the amateurs include all frequencies above 110 mcg, or waves below 2.726 meters.

Some work has been done on waves harmonically related to the amateur series, e.g., around 2.5 meters, and a little at around 1.25 meters. New tubes enable better reception and transmission at these very low waves, and possibly still newer tubes will enable improved results on centimeter waves. Very largely the centimeter wave technique is being developed in commercial laboratories and fields, but when the hams take hold no doubt they will expedite matters, as they did in the past, because of the cumulative experience and ingenuity of mass activity.

Parabolas in the Offing

Now there are about 50,000 holders of amateur licenses, and, as I said before, the ultra wave field is very tempting, activities growing fast, so it may be expected that even the present wide activity will be subjected to enormous, sudden growth as soon as the technique is more fully developed, especially by the very amateurs who thus will be attracting their fellows to participation.

While the 5 meter band is the center of ultra wave activity among amateurs, solutions obtained in that band should be, to a great extent, applicable to lower waves, and the day will

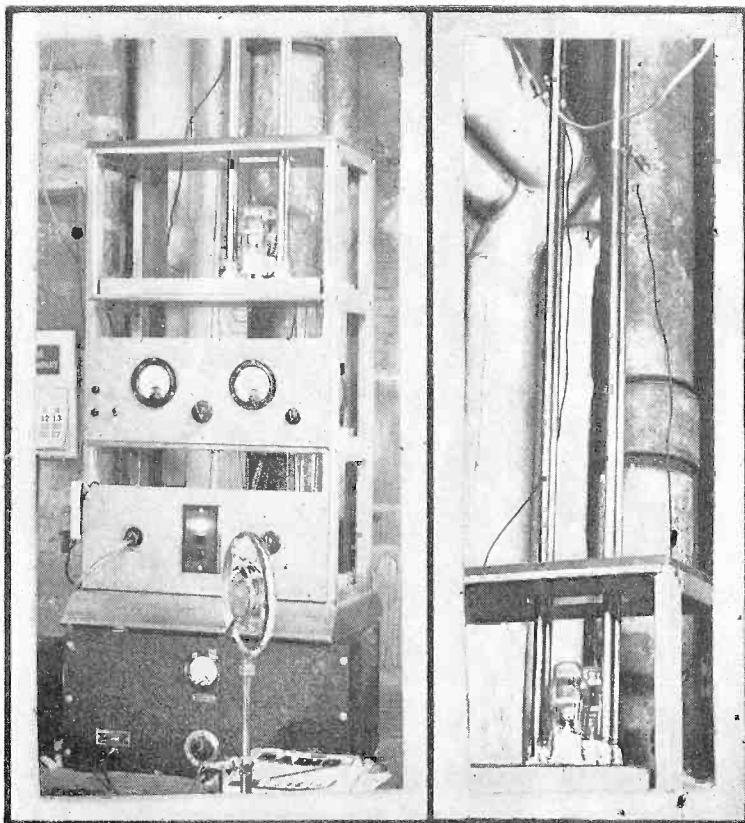

Modulator and power supply feed the two oscillator tubes, located in the top tier of the rack. Extending upward from these tubes are two parallel copper tubings, spaced as closely as practical, consistent with termination at the socket connections. Hence approximately twice the width of a socket determines the spacing, which is not critical. At right these tubings are shown in their upward extension, not completed in the photograph because they practically reach the ceiling. They constitute the "long" lines of the oscillator, though, on account of the low wave, they are really short.

come when amateurs will be using waves so low—measured in centimeters—that parabolic reflectors will be practical. These will be something like the reflectors used in electrical heaters, only somewhat larger, and polished.

From 5 meters down the spaces are wide open, thousands on thousands of stations could be accommodated even today, and as lower waves are mastered, literally millions of stations could be allocated to the ultra wave region, with no more interference than now present on the standard broadcast band, provided that the generations are stable, so that receivers selective may be used.

There is no disguising the fact that broadly

be stable, otherwise the receiver has to be broad to follow the wobblation without loss of the signal, and if the transmitter is stable the receiver must be likewise, to avoid suffering the same loss.

Some Ideas on Stability

It has been pointed out that frequency stability for variable tuning is a greater problem. Also the higher the frequency ratio, the greater this receiver problem is likely to be. It is assumed the receiver would be a superheterodyne, for then the stability requirement is high, but even if the detector of a



Gangway for his wave is gained by the author due to high elevation and some mild beaming effect. Looking in the general direction of Philadelphia this is the aerial fairway.

If the wave were beamed into the gulch of steel and concrete it would meet plenty of reflection and absorption, and probably death.

tuned receivers are necessary today on ultra waves because of instability of the 5 meter transmitters. The use of the long line oscillator or other means of introducing stability is rather unusual practice of the moment. The type of transmission generally is that obtained, say, from a transceiver, especially as such a device may be carried about, and by special rule of the Federal Communications Commission, portable use is approved. So amateurs have such transceivers in automobiles, on bicycles, motorcycles, boats, in homes, etc.

New Leaf from Nature's Book Needed

The problem of frequency stability permeates the whole sphere of radio frequencies, beginning with the lowest and ending with the highest. Nature handles a very high radio alternating current wave called light, and transmits with stability. So maybe man will be able to borrow practices from nature, as he has always done, and called the work invention.

The principal method of frequency stability at low radio frequencies is the crystal. This applies well to transmission because of single frequency working. In reception, if a local oscillator is to be used, it must be practically as stable as the transmitter, otherwise if the receiving system is selective, small changes in oscillator frequency will make large changes of output. Therefore, first, the transmitter must

t.r.f. system is regenerative, about the same rigid requirement applies. Fortunately, the ratios are low.

Followers of cathode ray practice must have noticed that to develop evenly spaced delineations or traces on the screen the sweep frequency, that determines the number of waves that appear, must be stable. The method generally used is to include as a series resistance in the plate circuit of the sweep oscillator a saturated pentode tube. When the pentode is so voltaged that all the electrons are taken over by the plate, then change in plate voltage does not change the plate current, and if this steady current condition is communicated to the sweep oscillator, then the sweep oscillator is stable. Constancy of current, of amplitude, of frequency are physically all the same thing. Hence the saturated pentode offers one possibility, though it limits the current, hence power, and requires that the stabilized oscillator shall be a "master," meaning that it must be used to drive the output tube or tubes, or even drive a driver.

How Shall Waves Be Measured?

A plate or screen series resistor of any so-called pure type helps stability. Circuit constants may be so arranged to work in the same direction. Loading methods for low frequencies are well established as frequency stabilizers. Differential systems can be worked out, whereby
(Continued on next page)

(Continued from preceding page)

any change in one direction is offset by an equal change in the other direction, even to temperature corrections, by using dissimilar metals for their equal-opposite effects.

This is a vastly important topic and it is hoped that there will be concentration on this problem.

By its very nature the frequency stability problem requires close measurement apparatus, but this is not so hard to establish. The usual procedure is to use Lecher wires.

These consist of parallel wires a few inches apart, perhaps 8 feet long or so, with a turn or two for coupling at ends of one, freedom at other ends. The coupling coil is ever so loosely related to the transmitter. Then a block of wood is used as a "shoe," on which a stiff piece of wire, say, No. 14 bare, is secured, so that

the frequency largely. The tube constants enter into the determination, of course, so that in a sense the tube is a part of its own load, and the lines an additional part, for frequency determination. That is all the tuning there is to it and all that is needed.

The modulator consists of two 46's, Class B. For the conditions obtaining a 70 ohm transmission line is used, as the impedance of the split type vertical doublet at the connection point of the feeder is 70 ohms.

Is William Penn Honored!

The first night we used the super-regenerative receiver at our station we worked 30 stations in three hours, three of them in Philadelphia. So far we have logged in a few weeks 225 stations.

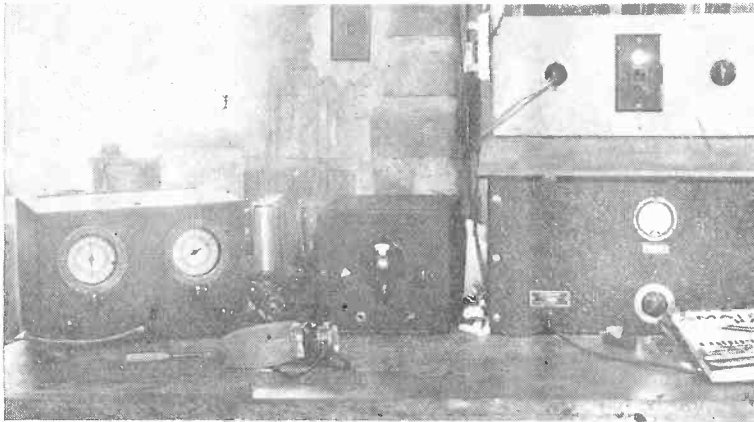

Examples of two receivers used, one of them (left) a superheterodyne with resistance coupled intermediate amplifier, the other a super-regenerative receiver. The question of superiority is still unsettled. On most occasions, however, the super-regenerator is used.

when the "shoe" is moved along the bridge comprised of the parallel wires these wires are apparently shorted.

It will be noticed that abrupt change in an oscillator's current meter will take place at critical points along the line as the shoe is moved, these points representing voltage nodes, or points where there is large current through the short. If the current is large enough the "short" may be replaced by an electric lamp, and the maximum brilliance used as indication.

Measured with a Ruler

The distance between these needle kicks, or illuminations, is half a wavelength, so if the distance is measured in meters and multiplied by two, the unknown frequency is unknown no longer, at least under conditions when the Lecher wire load is present. Whether this is always the same wave or frequency as would be present with Lecher wire removed is open to discussion, because in the first instance extremely loose coupling is always recommended, for the obvious reason of not affecting the tank circuit by the measuring load, or immunizing the tested circuit from detuning by the testing circuit.

We have used the long line oscillator for the improved stability, with two 801's at the output. The position of the shorting strap determines

As for the transmitter, with tubes worked at 45 watts, the effective output is 22 watts, approximately, improvement of the ratio of the effective power to the supply power being something requiring experimenting. Day or night we have an effective range of about 95 miles in the favored direction, this taking care of Philadelphia from our location and present attempted directivity. We have frequently worked the station in Philadelphia's City Hall, operated by Chief Gault, of the Electrical Bureau (W3FGN). The antenna of that station is 547 feet above the street, and sticks up through the hat of the William Penn statue, through which a hole had to be drilled. Hence the hams have a joke about Philadelphia talking through his hat.

Separate Antennas for Sending and Receiving

We use a different antenna for reception and transmission, of course, and certainly use two antennas for working duplex, which consists of two way communication on waves close to each other. A separate receiver and a separate transmitter are necessary for working duplex. By the way, transceivers may radiate somewhat when operated in the receiving position.

The wavelength determination is now on the basis of Lecher wire measurements, and other hams who check up with us now and again.

Bass Drum, Consonants, Overtones

As Quality Index, Applied to T.R.F. Set

By J. E. Anderson

WHEN anybody who knows radio is looking for high fidelity he is also looking for a tuned radio frequency receiver. These two—high fidelity and t.r.f.—go hand in hand. They always have and perhaps always will.

The superheterodyne gained popularity over the tuned radio frequency receiver because of higher selectivity. The reason it had a higher selectivity was that the principal tuning was done at a low intermediate frequency. For a tuner of given selectivity factor, the effective selectivity at 30 kc is ten times greater than at 300 kc and twenty times greater than at 600 kc. But it was this very high selectivity that impaired the quality. The circuits were effectively too selective, so selective that only the lowest rumbles could come through. The life and sparkle of music and speech were tuned out.

Practical Test of Selectivity

The use of a low intermediate frequency did not eliminate all interference. Indeed, it intensified one type, namely, image interference. In an effort to avoid this type of interference, radio engineers progressively increased the intermediate frequency.

In the exact ratio that the image interference was avoided the selectivity of the circuit was reduced. While this reduction in the selectivity improved the quality, not all the image interference and kindred troubles were eliminated. Now the most popular intermediate frequency is 456 kc, which is of the same order of magnitude as the broadcast frequencies. Thus the selectivity of such a superheterodyne cannot be greater than that of a tuned radio frequency receiver of equal number of tuned stages. Yet interfering noises arising from the change in the frequency are present. In the tuned radio frequency receiver they are entirely absent.

That a tuned radio frequency receiver, such as the seven-tube broadcast set described here, is capable of a selectivity somewhat comparable with that of a modern superheterodyne was brought out by a severe test. Two receivers, one this t.r.f. and the other a superheterodyne, were set up side by side. Each was tuned to a distant station of medium power through a strong local station separated from the distant station by only 10 kilocycles. The same antenna was switched from one set to the other. Both brought in the distant station without interference from the local. The 10 kilocycle heterodyne between the two stations was just barely audible in both sets, but it was louder on the

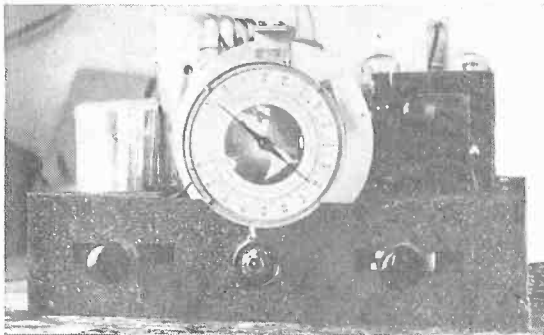

Front of the chassis.

superheterodyne. Of course, in either case this heterodyne can be suppressed when there is no reason for listening to it. The tone control does that, and each set was provided with one.

Less Noise from the T.R.F. Set

The outstanding fact of the test was that the t.r.f. receiver brought in less noise. Perhaps it should be said that it created less noise, for two receivers of any kind having the same selectivity and sensitivity will bring in the same amount of noise, but they may not create the same amount. It is not asserted that the t.r.f. set was quite as selective as the other.

Another test is psychological. When one is forced to listen to radio receivers by the hour the best music soon has the same effect on the nerves as street noises or din of any kind. It wracks the nerves. One has a keen desire to stop the noise regardless of the excellence of the music. But this tuned radio frequency receiver was turned on in the day time, when music ordinarily is not so good on radio, and real music welled forth. All present stopped talking and listened. When in the course of the experiment it was time to turn the set off, several of those present demanded that it be kept going. Compliance with that demand disrupted the work.

Overtones Needed for Quality

But what made the difference? Well, a piano played, and it sounded like a piano. The low notes were rich and full, and the treble sparkled with life. The bass viol played, and there was no mistaking it. It required no imagination to

(Continued on next page)

(Continued from preceding page)

see the player stroking the strings. As far as most receivers are concerned the bass viol player might just as well go out and take a smoke while the orchestra is playing. Perhaps the severest test is the bass drum. When that is heard as well on the radio as it is in the orchestra hall, the set is likely to be good.

But the bass notes alone are not the test. No note struck in music is a pure tone. If it were, it would hardly be music. There are many overtones, and they, too, must be reproduced with their true relative values. If these are not tuned out or suppressed by filters, the reproduced music will be as good as the original. A t.r.f. receiver is capable of reproducing the higher tones. It gives life and reality to the reproduced music.

The announcer's voice, too, is a severe test. Any set will reproduce his vowels well enough, and will make his words intelligible provided the listener is gifted with a little imagination. But not all sets will reproduce his consonants. But a t.r.f. receiver fitted with a good loud-speaker will. When the reproduced speech is so lifelike that no one can tell the voice comes over a radio, then the reproduction is good.

Is it difficult to construct a high fidelity t.r.f. receiver? Not at all. On the contrary, it is easier to build such a receiver than a simple superheterodyne. The simplicity of the t.r.f. receiver is evidenced by the accompanying circuit diagram and the photographs of the completed set. On the left of the chassis is a row of four shielded coils, and between the coils and the four gang condenser is a row of four shielded

LIST OF PARTS

Coils

Four shielded radio frequency transformers
One filter choke

Condensers

One gang of four sections, 365 mmfd. each, with trimmers
Two 0.00025 mfd. mica
One 0.02 mfd. mica
One 0.006 mfd.
One 0.05 md.
Two 0.1 mfd.
Three 0.25 mfd.
Two 5 mfd., 35 volt electrolytic
Two 8 mfd. electrolytic
One 16 mfd. (or two 8) electrolytic

Resistors

One 150 ohm
One 700 ohm

One 20,000 ohm

One 15,000 ohm

Two 0.5 meg.

One 2 meg.

One 50,000 ohm variable, with line switch

One 10,000 ohm potentiometer, tapered

One ballast

One 20 ohm

Other Requirements

Six 6 contact wafer type sockets

One 4 contact wafer type socket

Four grid clips

Four tube shields

One 8-inch dynamic speaker

One line cord and plug

Three knobs for controls

One 12x9.75x3 seven tube chassis

One airplane dial

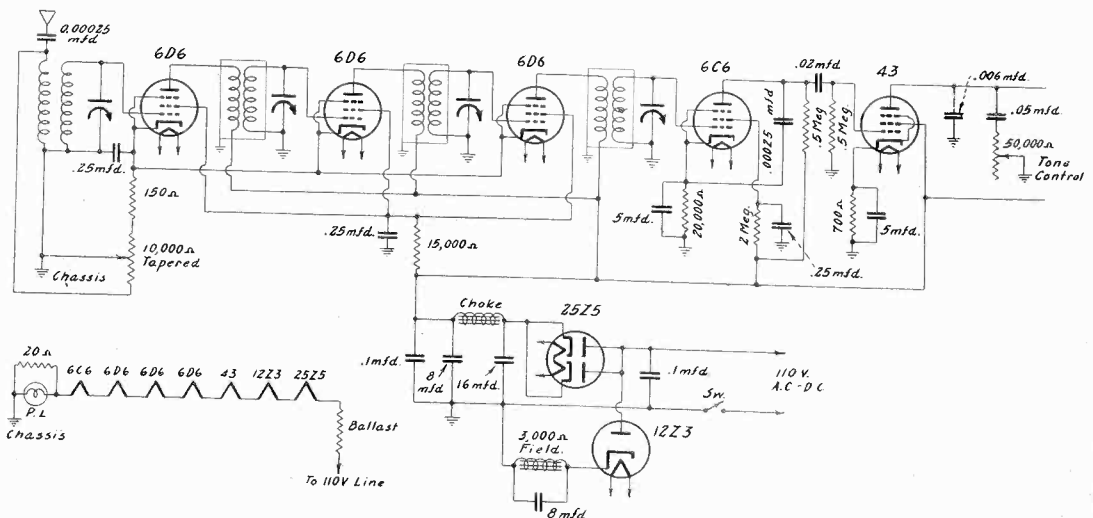

Seven tube universal t.r.f. receiver. Selectivity is obtained by four closely tracked circuits. A separate rectifier is used for the field of the loudspeaker to provide ample power for both the receiver and the field. The ballast may be 75 ohms, 10 watts.

tubes. The first three of these, starting from the front of the chassis, are 6D6's which are super control pentodes. The fourth tube is a 6C6, the detector. In the rear, at right, are three unshielded tubes. The large one behind the tuning condenser is a 43 power amplifier, the next is a 25Z5, which supplies the plate current for all the tubes, and finally there is a 12Z3, which supplies the field current for the loudspeaker. Separate tubes are used for these supplies in order not to overload either one.

Large Dial Needed

Two of the tubes, the 43 and the 25Z5, require 25 volts on the heaters. The 12Z3 requires 12.6 volts, and the others require 6.3 volts each. All these are connected in series. There

The cathodes of the three r-f amplifier tubes are grounded to radio frequency potentials by means of a 0.25 mfd. condenser. The screens of these leads are similarly grounded to high frequency potentials by means of another 0.25 mfd. condenser. A 0.1 mfd. condenser is put across the 8 mfd. electrolytic filter condenser to provide a low impedance path for the high frequency currents in the plate circuits. The electrolytic condenser is effective only on the audio frequencies and the hum from the line.

Since the coupling between the detector and the power tube is by resistance and capacity, some high frequency signal will get past the detector. To prevent the transmission of this a 250 mmfd. condenser is connected between the plate of the 6C6 and the cathode. Even this is not quite sufficient, although it is the largest

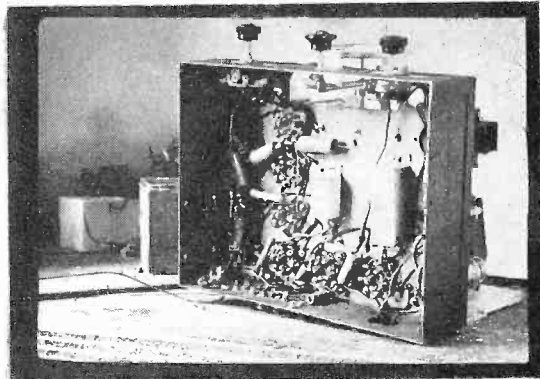
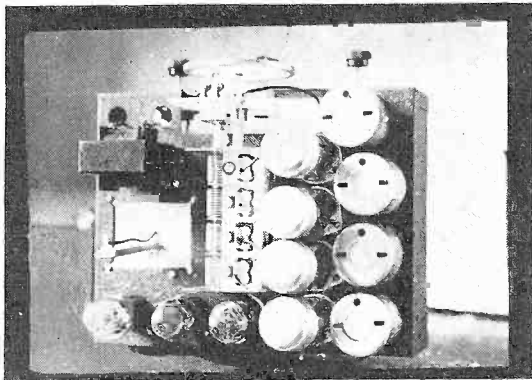

Top and bottom views.

is also a pilot light in this series across which the voltage is 3 volts. Thus the total drop in the various heaters is about 90 volts. The rest of the voltage, 25 volts, is taken up by a ballast of 80 ohms. This ballast is mounted on top of the chassis between the filter choke and the rectifier tubes at the right end of the chassis.

The various small resistors and bypass condensers are mounted under the chassis. There is plenty room for these parts so that there is no difficulty from coupling. The circuit does not oscillate even when all the tubes are going at full sensitivity. The thorough shielding of the coils and tubes, of course, accounts for this more than the ample separation of the small parts under the panel.

The circuit is tuned with a large size airplane type dial. This type is needed in view of the high selectivity of the circuit.

Taper Aids Smoothness

The volume is controlled by means of a 10,000-ohm potentiometer connected between the antenna and the combined cathodes of the three 6D6 tubes, the slider being grounded. A 150-ohm limiting resistor is put in series with the potentiometer on the cathode end to limit the bias when the volume is turned up. The potentiometer resistance is tapered, with the slow resistance change near the cathode. Hence the volume may be controlled smoothly throughout the control range.

condenser that can be used at this point advantageously. For this reason a 0.006 mfd. condenser is connected between the plate of the power tube and ground.

Not Useless After All

It would seem useless to put a bypass condenser across the line at the output to prevent radio frequency transmission, but it is an experimental fact that this 0.006 mfd. condenser is essential. It prevents regeneration on the high frequencies, including audio, which is often so intense that the circuit squeals. The condenser prevents this regeneration.

A glance at the values of the condensers and resistors used in the audio frequency portion of the circuit will show why the low notes come through strong. First we have a 5 mfd. electrolytic condenser across the 20,000 ohm bias resistor for the detector. This condenser is so large that degenerative effects are eliminated on even the lowest audible notes. There is also a condenser of the same value across the 700 ohm bias resistor for the 43. Hence there is no degeneration at this point either. The plate resistor for the 6C6 and the grid leak for the 43 are of 0.5 megohm each. These values are in the interest of high gain at all audio frequencies. The stopping condenser between the 6C6 and the 43 is of 0.02 mfd. capacity, which, in conjunction with the 0.5 meg. grid leak, is high enough to

(Continued on next page)

(Continued from preceding page)

allow the transmission of the lowest desirable tones.

A tone control consisting of a 0.05 mfd. condenser and a 50,000 ohm rheostat, connected in series, is put between the plate of the power tube and ground. It allows the listener to select his own quality. As the resistance is cut out, the output of the high notes is decreased and the output on the low tones is increased relatively.

The screen of the 6C6 is connected through a 2 megohm resistor directly to the highest supply voltage. The effective potential on the screen is therefore much lower than the highest, as is required both for detection and amplification. The value of 2 meg. has been determined experimentally for clearest and maximum output. The 0.25 mfd. condenser between the screen and ground serves to keep the screen at a constant potential regardless of the signal variations.

Directions for Tracking Adjustment

A condenser of 0.1 mfd. is connected across the supply as a preventative of noise. The filter for the B supply consists of one choke and two electrolytic condensers, one a 16 mfd. unit next to the rectifier and one an 8 next to the load. An 8 mfd. electrolytic is also provided for the rectifier serving the field.

No ground is needed with this receiver, and it may be used with either d.c. or a.c. The ground symbol in the circuit diagram signifies the chassis and not an external ground. A good antenna should be used when distant stations are to be received. For local reception only a short length of wire is sufficient.

The connection of the heaters of the tubes is shown in the insert drawing. The pilot light is put next to the chassis because of convenience in wiring. The next tube should be the detector. The order in which the other tubes are connected is not important, and may be as indicated. However, the ballast resistance should be put uppermost, that is, next to the "hot" side of the line.

The adjustment of the tuned circuits for tracking is simple. First a station near 1,500 kc is tuned in with the dial. Then each of the four trimmers is turned until maximum volume is obtained. All this should be done at the lowest volume level that is practical. If the circuit does not tune high enough in frequency, the dial must be reset a little and the trimmers adjusted again.

As soon as the trimmers have been adjusted at the high frequency end, a station near 550 kc should be tuned in. The circuit should track at this end also because the inductances are equal. It may be, however, that there may be slight differences in the tuning condensers. In that case the tracking may not be perfect. If so, do not tamper again with the trimmer condensers, for that can only undo the work that has already been done. Instead, the end plates of the condensers may be bent a little. They have been cut for that purpose. It should only be necessary to bend the last sector of the end plate on each condenser. If these sectors have been bent to effect tracking at the low frequency end, the circuit should be retrimmed at the high frequency end. If only the last sector of the end plate of a condenser has been bent, it should not be necessary to retrim, but there is no harm checking up.

SMALL PORTABLE POWER AMPLIFIER

A simple portable amplifier may be built according to the diagram for use on a.c. There are two audio stages, both with pentode tubes, the first a 6C6 and the second or output tube a 42. From such a small amplifier very large gain is obtainable, and in most uses the attenuator would not be used full on. This is because of the enormous amplifying properties of the tubes. The output is 3 watts at 7 per cent. total harmonic distortion, with smaller actual distortion because full output may not be utilized at all times. The feed to the 6C6 may be a microphone, preferably of the carbon type, with matching transformer having primary suiting the microphone and secondary a high impedance suitable for grid circuit loading. A phonograph pickup may be connected the same way, if of low impedance, or directly in the grid circuit, across the input terminals, if of the high impedance type. A radio tuner's output may be connected to the amplifier input, also, provided the B voltage to the detector is supplied through a plate load in the detector, and a secondary, or a condenser, used, so that positive voltage will not be fed to amplifier grid.

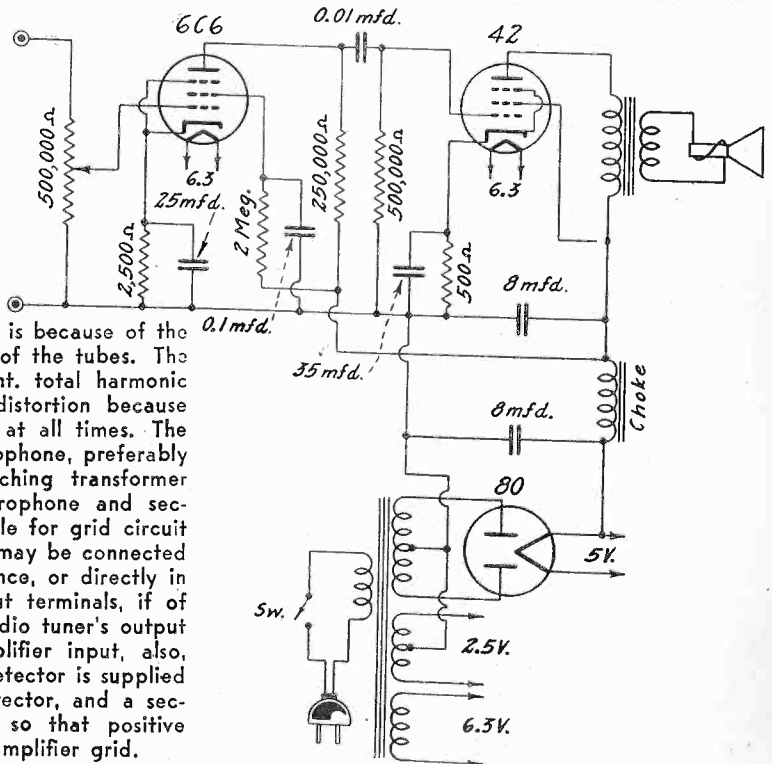

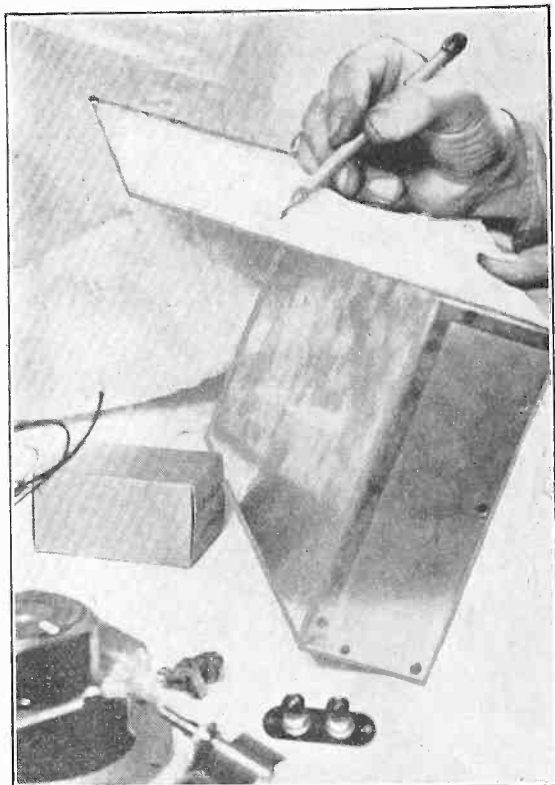

When working with ultra frequency apparatus, have the set removed as far as possible from metal objects, as there is possibly some pickup between such objects and either receiving or sending set. Wavelength then may be changed by moving the set about. Even spools of wire, such as used for winding coils (above) may cause such trouble. No use making a tough face when stray pickup confuses you.

Pencil is nothing to use to mark points for drilling on any sort of panel (above). The mark is not close and definite enough. A scribe does the job so much better. Besides, the small indentation gives an accurate setting for using a center punch to give the drill a good bed, thus preventing the working drill from plowing along the panel.

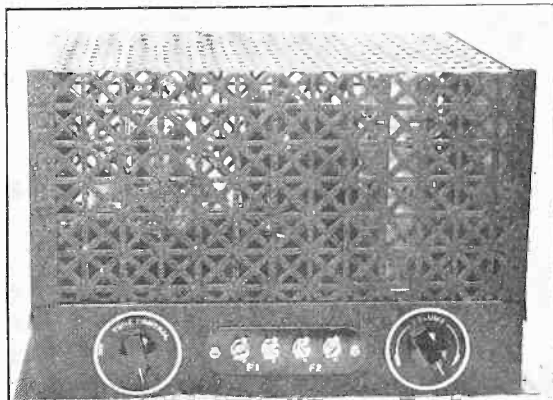
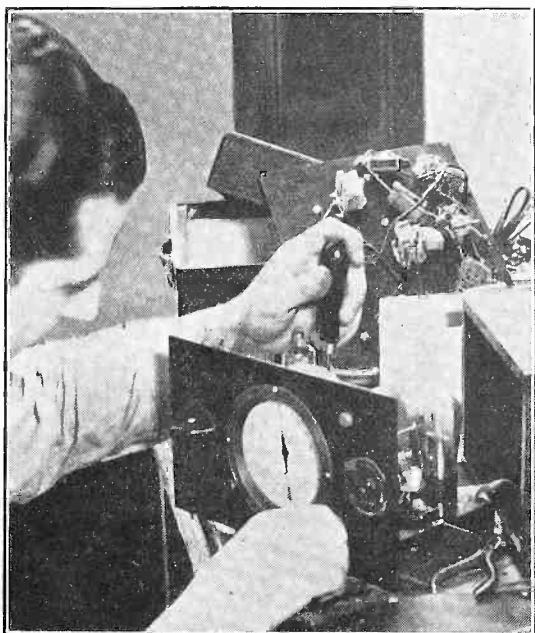

(Above). New metal cabinets for small amplifiers have decoratively stamped ventilating patterns.

* * *

(Left). When making adjustments in a radio device, since the juice is turned on, be careful not to have any tools or other stray conductors near the wiring. Here the experimenter left his side cutting pliers so close to the rectifier tube of a generator that danger of shorting the V voltage and ruining tube or parts was great.

Shield Effect on Inductance

Determined Experimentally or Graphically or Computed

By Walter C. Bramhall

A GRAPHICAL method of determining the percentage inductance drop when a coil is placed in a shield has been worked out for shields longer than the winding by at least the radius of the coil.

The following abbreviations are used:

a = radius of the coil in inches.

b = length of winding of the coil in inches.

A = radius of the shield in inches.

K = a constant related to co-efficient of coupling between coil and shield, derived practically as a squared term from a table.

The length of winding is divided by the coil diameter ($b/2a$) to yield one factor. The coil

radius is divided by the shield radius (a/A) to yield the other factor.

Suppose coil radius $a = 0.375$, length of coil winding $b = 1.5$, shield radius $A = 0.625$, then

$$b/2a = 1.5/0.75 = 2$$

$$a/A = 0.375/0.625 = 0.6$$

Now consult the chart, $b/2a$ being prominent at top and bottom, the factor determined above is 2, so stop at 2 on horizontal. Three major lines from extreme left will be found a/A , the factor above for this is 6, so read on perpendicular line at 2 up as far as 6, carried to extreme left, produces 0.28. This is identified as K^2 . The reduction of inductance is 28 per cent. The effective net inductance is 100 — 28 or 72%

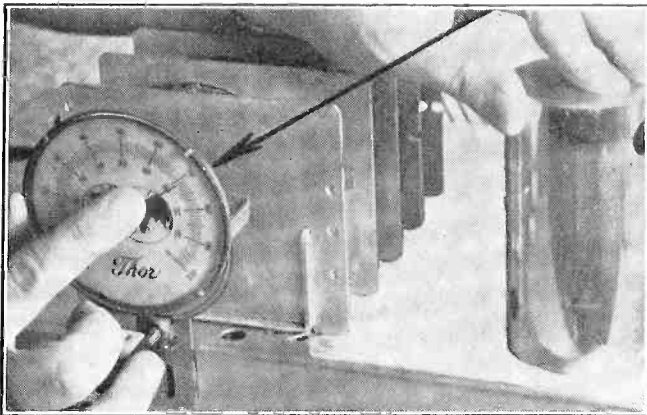

When the shield is on the coil, assuming that resonance is controlled entirely by one section of the gang that tunes the coil, more condenser capacity is needed to attain a certain frequency, compared to shield off coil. Both arrow and finger point to the condenser setting, the dial indicating number 71 for a condenser that closes to the right. Dial numbers increase toward the right, that is, increase of capacity corresponds to numerical increase on the dial.

At right, arrow points to 60 on dial, when shield is not even completely removed. If the shield were entirely off, and out of the field, the condenser would be turned to give a still smaller numerical dial reading, denoting less capacity, because the inductance would increase still more. So if the inductance, with no shielding, is known, the drop in inductance due to the shield may be determined. Besides the usual experimental method, a newly developed formula affords accurate computed results. This formula may be worked largely for a set of curves (next page).



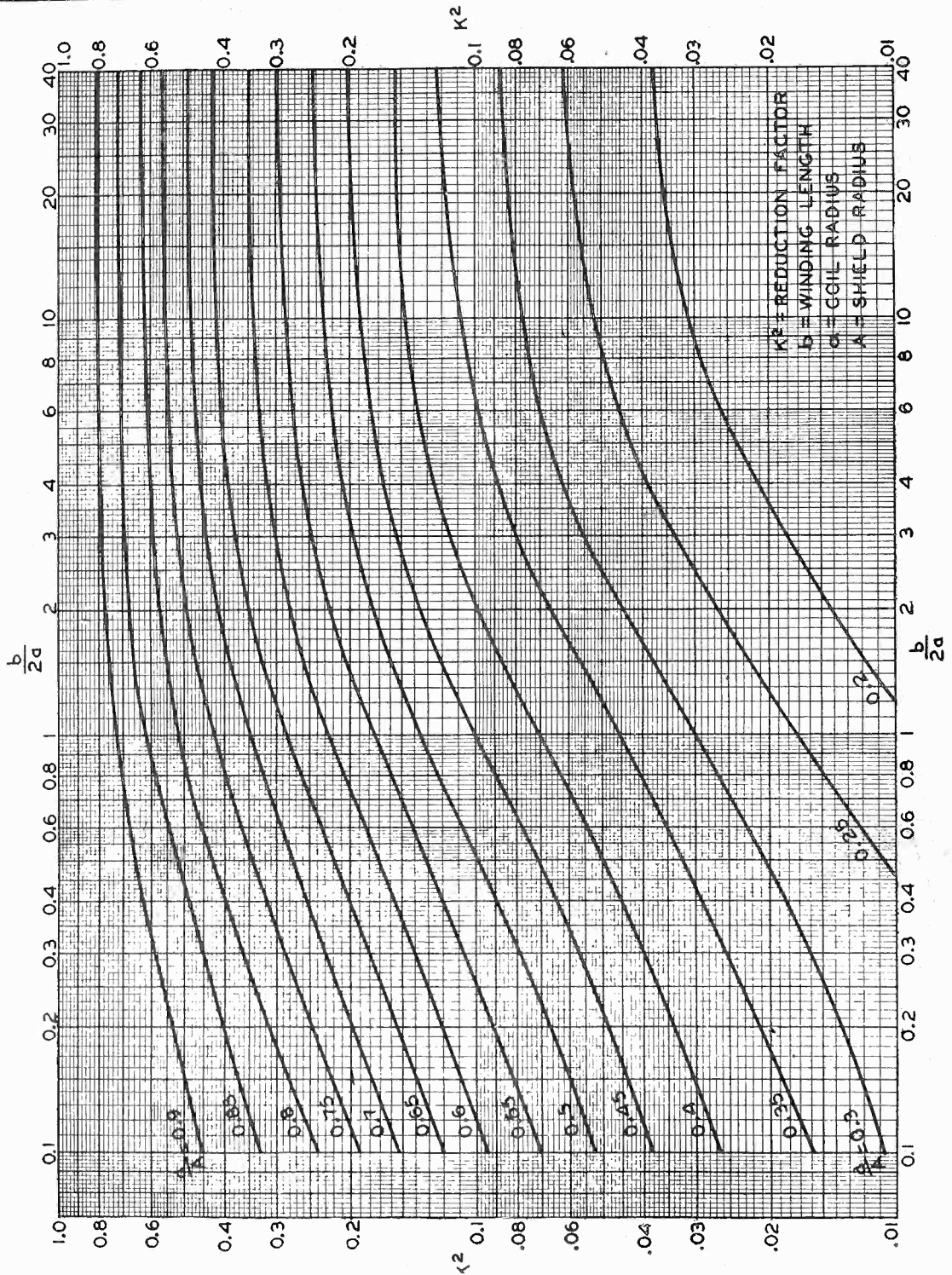

If the inductance of an unshielded coil is known, the resultant inductance after coil's enclosure in a shield may be determined graphically by a slight calculation and resort to this chart. Two numbers are obtained, these are located on the chart, their convergence carried to extreme left, giving the percentage reduction.

Copyright 1935 by
 RCA Mfg. Co., Inc.

All Hail the Grid Leak

It Serves Splendid Purposes in an Oscillator

By Herman Bernard

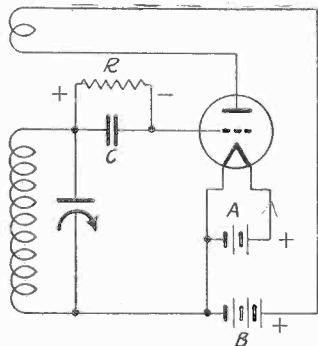

Usual values of grid resistance and grid condenser are used for R and C in an oscillator. The d.c. potentials at the terminals of the grid leak R, being polarized as shown, control the negative bias on the grid of the tube. A triode is illustrated, but the same principle applies to other tubes.

When grid current flows, the polarity of the leak to d.c. potentials is negative toward the grid and positive toward the cathode. This follows from the fact that all emission originates from the cathode, even secondary emission, which consists of electrons from the cathode that strike the plate and are turned back, or become a charge to resist the main current flow. With secondary emission, however, we are little concerned, considering the tubes used as oscillators in superheterodynes and signal generators.

It can be seen therefore that a negative bias is impressed on the grid whenever any grid current flows. The degree of bias, or amount of d.c. grid voltage, depends on the amount of grid current flowing, and on the resistance of the leak. The value of the condenser is not so important in this first consideration, the 250 mmfd. capacity being almost standard for broadcast frequencies, and even higher with a tendency toward 100 mmfd. for all wave coverage.

A GREAT many persons no doubt wonder why a grid leak and condenser are found so often in receivers. They are present in oscillators almost always. Even in the early days of the vacuum tube it was common practice to use a grid leak for detection with a suitable condenser across it to bypass the radio frequencies. More recently fellows who build superheterodynes and signal generators have found out that to achieve a desired tuning ratio it is advisable to include the leak and condenser, especially to track frequency calibrated dials of receivers and generators. Without the leak-condenser or other bias the input capacity is large. Moreover, it has been found that the amplitude of the oscillation is steadier if there is a grid leak. It is well therefore to give the lowly grid leak some consideration.

Action Depends on Grid Current

First of all, let us remember that unless there is grid current flowing there is no advantage in the grid leak. Although grid current flow denotes detection, it frequently happens we do not desire a detecting characteristic. Yet if we use the grid leak for its advantages the detection will be present. We may use loose coupling to have the grid current small, the detecting efficiency low, and the amplitude stability or frequency stability high. Both amplitude, stability and frequency stability are the same thing, in oscillators, that is, they denote steadiness of operation.

An Explanation is Sought

If we analyze the circuit we find that the tube as a triode, let us say, builds up oscillations. Just why oscillations start in any oscillator does not seem to be well known. Why they continue is well understood, but what sets the wheels in motion will stand some explanation.

Unfortunately, it is beyond the knowledge of the present author what is the self-starting cause. Theory would lead one to suppose that electrons are started flowing at or near the resonant frequency of the grid circuit (if that is the tuned circuit) and that other electrons in the plate circuit are set in motion, one current aiding the other, until the net effect is that of no opposition to the grid a.c. voltage, except that imposed by the law of conservation of energy. But that does not explain much.

We find that the tube oscillates in its triode function, and that also the oscillation amplitude or voltage is introduced into the circuit between grid and cathode (filament). Grid current flows when the grid is positively charged by the a.c. or oscillation voltage, and the d.c. potentials are as have been stated, grid negative, cathode positive. This is the same as with any other rectifier. When the plate of an 80 tube has a positive a.c. voltage on it, the tube rectifies, and filament is d.c. positive, plate d.c. negative, because d.c. flows in only one direction, and by definition that is the direction. In reality the d.c. flows in the opposite direction,

but the terms positive and negative were assigned before the intimate fact was known to the science. Meters are calibrated on the accepted basis, and we always proceed on that basis (with mental reservation) so as not to have to change so much what has been firmly though erroneously established.

Just Like Other Diode

Therefore besides the triode functioning as oscillator, where the plate is a considered element, there is operation as a diode, or rectifier, consisting of the grid to cathode circuit. We now have a counterpart of the diode tubes now so popular with their extra tube functioning in the same envelope. The 55 is such a diode, even though it has two plates and may be used full wave. The diode biased triode hookup of the 55, familiar in superheterodyne practice, is therefore the same in principle as is the triode oscillator with leak and condenser. Only the rectifier load resistor is on the high side of the coil in the triode-diode oscillator, whereas it is on the low side of the coil for convenience in the other example. In either instance the load resistance position may be switched.

Since we have a diode biased triode when we have an oscillating triode with leak and condenser, we should have pretty good detection. Indeed we have. But the plate circuit is tied in with the performance as part of the amplifier, that is, all oscillators are amplifiers, and we encounter the amplifier characteristic, which is not quite straight.

If this were otherwise, and if the leak-condenser method could stand greater input, we would have comparable conditions of straight line detection, meaning that the rectified voltage is proportionate to the a.c. input directly. There is a proportion but there is some curvature.

What Value of Leak to Use

Now, when we come to use a grid leak we find that various values are recommended. Perhaps the designers of circuits try out different values and then, noting which seems to be best, select the choicest one. This has been done so often that certain principles may be derived from these experiences.

First, it is obvious that the higher the grid leak resistance, the greater the voltage drop will be across the grid leak, for any stated value of grid current. The leak resistance usually is low compared to the d.c. resistance between grid and cathode with leak out, the coil has negligible d.c. resistance, and so the amount of grid current changes little with leak values due to the leak alone. But there are other considerations.

How Obstruction Is Removed

The radio frequencies put into the tube have to detour the leak and avoid the obstruction, so a condenser is put across the resistor, of such value as to make the obstruction low. The

higher the capacity, the less the obstruction due to the leak. But if the condenser is too small, the damping effect of the leak on the general amplitude of oscillation becomes noticeable, while if both leak and condenser, or their product, are too large, a second frequency of oscillation is set up, not usually noticed if of high frequency, but causing trouble nevertheless. If the product of the two is much too high, an audio frequency represents this new oscillation, and the method is sometimes used for modulating a test oscillator, although it is a bad method for this purpose, because if an output meter is used as resonance indicator on a set, the modulation is so wobbly that the meter needle wiggles badly and defeats attempts to locate resonance.

Superregeneration Reduces Selectivity

It has been stated that an audio frequency may be produced, also a higher frequency. If

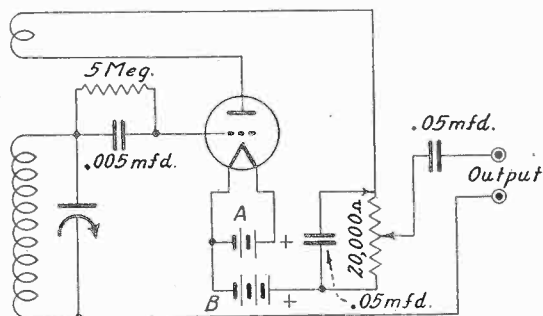

If the leak and condenser values are high enough there will be an additional frequency of oscillation, determined by the leak-condenser's time constant reciprocal. The values shown will produce modulation. Then either the audio output alone may be taken off, by shorting the control potentiometer with a large enough condenser, or the modulated radio frequency output selected (condenser out). Unmodulated radio frequency output becomes impractical without changing the leak or condenser values, or both, and this act would change the radio frequency, hence calibration.

the new frequency, which is additional to the main one of the tuned circuit, is just a bit above audibility, we have introduced the essentials of superregeneration. That is, we have a tube oscillating or regenerating at one frequency, and then we introduce another frequency, which, if low enough, will interrupt the radio frequency oscillation periodically, and thus elevate the saturation point of the tube, or, more plainly, enable much greater sensitivity. However, the radio frequency must be high, so that the new frequency becomes interruptive comparatively fewer times per cycle of the radio frequency, thus permitting the radio frequency to hold to high amplitude for a comparatively longer time.

(Continued on next page)

(Continued from preceding page)

Super-regeneration, or any other use of the high constants for leak and condenser, reduce selectivity. Thus superregeneration is useful on high radio frequencies, where selectivity is unimportant, what ordinarily would be wide band widths becoming a small percentage of the operating frequency. Thus, 1,000 kc at 60 mcg is 1 part in 60. In the broadcast band, ten different stations might be heard at the same time.

The leak condenser hookup affects also the input capacity of the tube. Assuming a circuit in which there is enough oscillation to support a

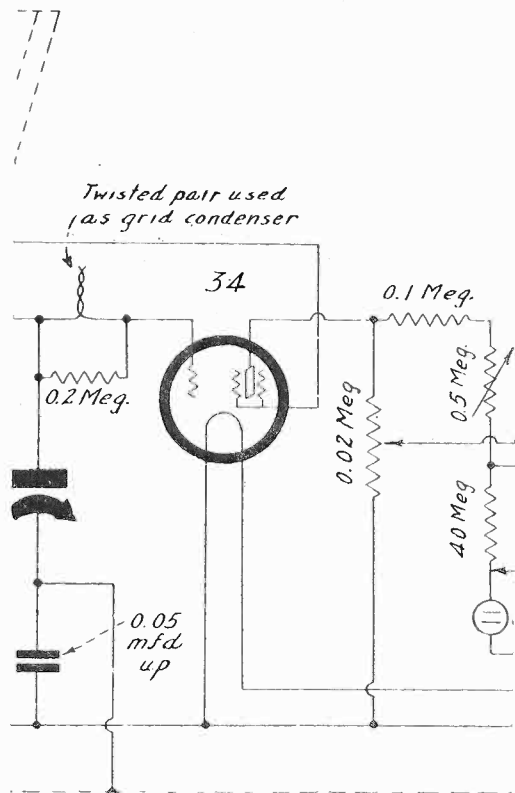

In signal generators, when it is desired to avoid use of compression compensating capacities, which do not stay put, the tuning condenser minimum is used as found, and if the calibration of a scale has been on the basis of a small grid condenser, that condition must be copied. Twisted insulated wire, as used for hookup, may serve as grid condenser, about 3 mmfd. per inch after twisting. Enough grid condenser must be used to establish lowest frequency oscillation.

grid leak of 0.25 meg. without any condenser across the leak, it will be found that the input capacity is increased a little by the leak's presence. Put a very small calibrated condenser across the leak, turn the condenser, and the input capacity (between grid and cathode) will decrease, until a critical value is reached (say, 10 mmfd.) when higher grid condenser constants increase the input capacity.

Thus, at 240 kc, using 100 mmfd, in the tun-

ing condenser across the coil in the grid circuit, 10 mmfd. grid condenser, oscillation was sustained. Increase of the grid condenser to 0.0024 mfd. (across the leak) lowered the frequency to 236 kc, while substituting 0.005 mfd. as the grid condenser, the frequency became 229 kc. It can be seen that the added grid condenser capacity lowered the frequency, and the reason is that the condenser is across the tuned circuit, except as limited by the resistance of the tube.

Increase of the leak resistance, grid condenser held at 100 mmfd., increased the frequency, hence reduced the input capacity.

Oscillators Made More Stable

Since the tube resistance is normally not constant, one may assume that the effect of the grid condenser is not constant, and during each cycle the frequency changes a bit. This is called frequency instability. Some of it is present in nearly every oscillator.

However, it has been stated that the grid leak has a stabilizing effect. This arises from the tendency of the leak to maintain the amplitude steady by changing the bias in pace with the oscillation voltage. The higher the incipient amplitude of oscillation, as when tuning at the higher end of a band, the greater the grid current, the greater the negative bias resulting, and the increased bias limits the amplitude. So with a circuit that tends to be unstable because of the rising characteristic of tuned radio frequency, or increase of feedback with frequency increase, the leak serves as a counter effect, or balance or governor, hence tends to level the amplitude.

Since a condenser is across the leak, it will not bypass all frequencies alike. For a wide range, the condenser across the leak must be large enough to sustain oscillation at the lowest radio frequency, and in general even 50 mmfd. will do this.

In the interest of frequency stability it is well to select a leak of such value above 0.1 meg. as will yield the smallest change in plate current when the oscillator is tuned over the band it covers. If the plate current is constant over the band (most unlikely in practice) the frequency stability is almost perfect, on a par with quartz crystal control. This is true because the tube as a whole is made to behave as a pure resistance. For all wave coverage it may be necessary to use a smaller leak so that stability is averaged over the bands, e.g., 20,000 ohms.

How to Use "Clean Beat" Test

Another test that may be made is to select a combination of leak and condenser that produces the cleanest beat with some other source of oscillation, say, fundamental of local oscillator beating with a station or harmonic of local oscillator beating with a station. In the example of a signal generator the same applies. The beat should be resolvable to what passes for zero, the notes heard this and that side of approximate zero should be free of buzz, wobbliness and roughness, and if a stable source of oscillation is compared to the local oscillator by beating, a detected output should result in a

(Continued on next page)

Receiver Detuning Avoided In Setting Attenuator of Signal Generator

By I. M. Loughboro

MANY users of signal generators have experienced the nuisance of the generator attenuator acting as a volume control of the receiver, particularly for measurements at the levels higher than the intermediate frequency. The output method shown in the generator here-with completely eradicates that trouble.

An output transformer is used, consisting of a two-winding honeycomb coil, larger winding toward the tube, smaller one to output. Thus the primary is larger than the secondary and we have a stepdown transformer. If the secondary is of higher impedance than the primary of the set's antenna coupler, or the set's input generally, the generator may be connected to the receiver without changing the receiver volume or frequency.

This use of inductive coupling, of medium co-efficient, also protects the frequency constancy of the generator, particularly if, as here, the attenuator settings do not affect the d. c. resistance of the load on the generator's output tube. It can be seen a fixed resistor is used as plate load of the amplifier tube, a stopping condenser is connected to one terminal of the attenuator, and the primary of the output transformer has one terminal connected to the slider of the potentiometer. Thus d. c. potentials are intact in the generator, and to the primary of the output transformer is fed as much of the generator output voltage as is desired. Reduction of the amount of voltage taken off is in the direction of shorting the primary, but even a complete short does not change the generator frequency or detune or attenuate the receiver.

Electron Coupling Prevails

The oscillator tube is a 58, used really as a quadrode, the formal plate serving merely as a pickup element. Thus the conduction from generator to following amplifier tube is by the elec-

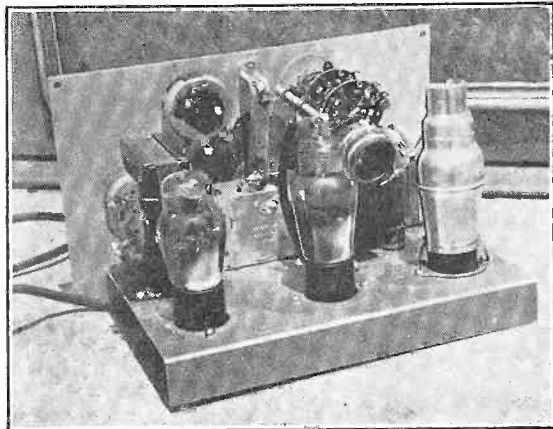

The oscillator tube alone has a shield on it. This adds a bit to the capacity in circuit, perhaps 2 or 3 mmfd., but does reduce radiation from the tube. In fact, the whole outfit, when in a shield box, does not radiate except through the intended outlet, hence does not "feed through the line."

tron coupling method, since the only coupling arising is that due to the electrons impinging on the formal plate, here a pickup grid. There is a small positive oscillation voltage on this element due to the proximity of the formal plate to the moving stream of electrons. This always results in the acquisition of electrons due to mere adjacency. The amplitude of the voltage depends considerably on the load resistance, which should be small to insure low-level here, because of the direct connection to the amplifier tube. This peak amplitude should be less than the bias on the amplifier tube, although of course the polarities are opposite. A check may be made for this, as will be set forth presently.

(Continued on next page)

Getting Close as Practical to Zero Beat

(Continued from preceding page)

d. c. meter needle moving only slowly and evenly. Thus, beat with a broadcasting station, put the mixture into a detector, and watch the needle of the meter in the rectified output. Differences in frequencies between the two, if steady, can be counted up to the rapidity with which one may read the meter needle, say, frequencies from small fractions of a cycle up to five cycles. When the needle moves much faster than five cycles it becomes almost impossible to follow it. Also by this verification will be had of the extreme difficulty of attaining

true zero beat. There will always be some definite difference in practice. That is, the needle will move. The utmost stability, plus precision tuning apparatus, would be required for attainment of even approximate zero beat. What passes for zero beat then is any frequency too low to be heard and of course this is abundant in practical utility, especially in the radio frequencies in the broadcast band or higher. For example, 200 cycles out of 1,000 kc is 0.02 per cent. The best precision oscillators in laboratory practice do not as a rule exceed 0.05 per cent. accuracy.

(Continued from preceding page)

Super-regeneration, or any other use of the high constants for leak and condenser, reduce selectivity. Thus superregeneration is useful on high radio frequencies, where selectivity is unimportant, what ordinarily would be wide band widths becoming a small percentage of the operating frequency. Thus, 1,000 kc at 60 mcg is 1 part in 60. In the broadcast band, ten different stations might be heard at the same time.

The leak condenser hookup affects also the input capacity of the tube. Assuming a circuit in which there is enough oscillation to support a

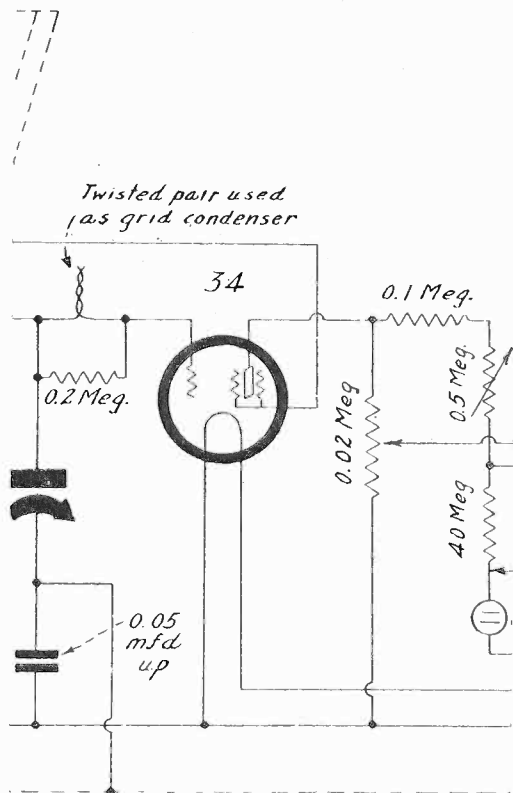

In signal generators, when it is desired to avoid use of compression compensating capacities, which do not stay put, the tuning condenser minimum is used as found, and if the calibration of a scale has been on the basis of a small grid condenser, that condition must be copied. Twisted insulated wire, as used for hookup, may serve as grid condenser, about 3 mmfd. per inch after twisting. Enough grid condenser must be used to establish lowest frequency oscillation.

grid leak of 0.25 meg. without any condenser across the leak, it will be found that the input capacity is increased a little by the leak's presence. Put a very small calibrated condenser across the leak, turn the condenser, and the input capacity (between grid and cathode) will decrease, until a critical value is reached (say, 10 mmfd.) when higher grid condenser constants increase the input capacity.

Thus, at 240 kc, using 100 mmfd, in the tun-

ing condenser across the coil in the grid circuit, 10 mmfd. grid condenser, oscillation was sustained. Increase of the grid condenser to 0.0024 mfd. (across the leak) lowered the frequency to 236 kc, while substituting 0.005 mfd. as the grid condenser, the frequency became 229 kc. It can be seen that the added grid condenser capacity lowered the frequency, and the reason is that the condenser is across the tuned circuit, except as limited by the resistance of the tube.

Increase of the leak resistance, grid condenser held at 100 mmfd., increased the frequency, hence reduced the input capacity.

Oscillators Made More Stable

Since the tube resistance is normally not constant, one may assume that the effect of the grid condenser is not constant, and during each cycle the frequency changes a bit. This is called frequency instability. Some of it is present in nearly every oscillator.

However, it has been stated that the grid leak has a stabilizing effect. This arises from the tendency of the leak to maintain the amplitude steady by changing the bias in pace with the oscillation voltage. The higher the incipient amplitude of oscillation, as when tuning at the higher end of a band, the greater the grid current, the greater the negative bias resulting, and the increased bias limits the amplitude. So with a circuit that tends to be unstable because of the rising characteristic of tuned radio frequency, or increase of feedback with frequency increase, the leak serves as a counter effect, or balance or governor, hence tends to level the amplitude.

Since a condenser is across the leak, it will not bypass all frequencies alike. For a wide range, the condenser across the leak must be large enough to sustain oscillation at the lowest radio frequency, and in general even 50 mmfd. will do this.

In the interest of frequency stability it is well to select a leak of such value above 0.1 meg. as will yield the smallest change in plate current when the oscillator is tuned over the band it covers. If the plate current is constant over the band (most unlikely in practice) the frequency stability is almost perfect, on a par with quartz crystal control. This is true because the tube as a whole is made to behave as a pure resistance. For all wave coverage it may be necessary to use a smaller leak so that stability is averaged over the bands, e.g., 20,000 ohms.

How to Use "Clean Beat" Test

Another test that may be made is to select a combination of leak and condenser that produces the cleanest beat with some other source of oscillation, say, fundamental of local oscillator beating with a station or harmonic of local oscillator beating with a station. In the example of a signal generator the same applies. The beat should be resolvable to what passes for zero, the notes heard this and that side of approximate zero should be free of buzz, wobbliness and roughness, and if a stable source of oscillation is compared to the local oscillator by beating, a detected output should result in a

(Continued on next page)

Receiver Detuning Avoided In Setting Attenuator of Signal Generator

By I. M. Loughboro

MANY users of signal generators have experienced the nuisance of the generator attenuator acting as a volume control of the receiver, particularly for measurements at the levels higher than the intermediate frequency. The output method shown in the generator here-with completely eradicates that trouble.

An output transformer is used, consisting of a two-winding honeycomb coil, larger winding toward the tube, smaller one to output. Thus the primary is larger than the secondary and we have a stepdown transformer. If the secondary is of higher impedance than the primary of the set's antenna coupler, or the set's input generally, the generator may be connected to the receiver without changing the receiver volume or frequency.

This use of inductive coupling, of medium co-efficient, also protects the frequency constancy of the generator, particularly if, as here, the attenuator settings do not affect the d. c. resistance of the load on the generator's output tube. It can be seen a fixed resistor is used as plate load of the amplifier tube, a stopping condenser is connected to one terminal of the attenuator, and the primary of the output transformer has one terminal connected to the slider of the potentiometer. Thus d. c. potentials are intact in the generator, and to the primary of the output transformer is fed as much of the generator output voltage as is desired. Reduction of the amount of voltage taken off is in the direction of shorting the primary, but even a complete short does not change the generator frequency or detune or attenuate the receiver.

Electron Coupling Prevails

The oscillator tube is a 58, used really as a quadrode, the formal plate serving merely as a pickup element. Thus the conduction from generator to following amplifier tube is by the elec-

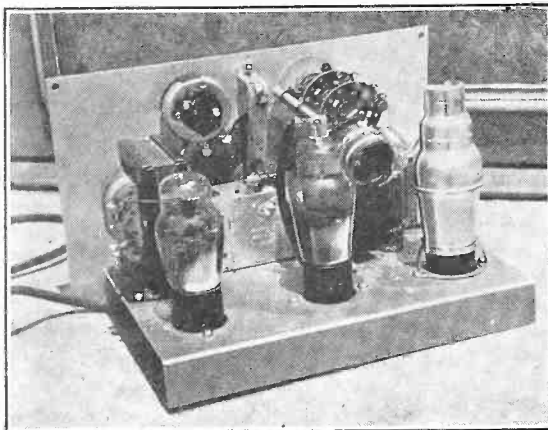

tron coupling method, since the only coupling arising is that due to the electrons impinging on the formal plate, here a pickup grid. There is a small positive oscillation voltage on this element due to the proximity of the formal plate to the moving stream of electrons. This always results in the acquisition of electrons due to mere adjacency. The amplitude of the voltage depends considerably on the load resistance, which should be small to insure low-level here, because of the direct connection to the amplifier tube. This peak amplitude should be less than the bias on the amplifier tube, although of course the polarities are opposite. A check may be made for this, as will be set forth presently.

(Continued on next page)

Getting Close as Practical to Zero Beat

(Continued from preceding page)

d. c. meter needle moving only slowly and evenly. Thus, beat with a broadcasting station, put the mixture into a detector, and watch the needle of the meter in the rectified output. Differences in frequencies between the two, if steady, can be counted up to the rapidity with which one may read the meter needle, say, frequencies from small fractions of a cycle up to five cycles. When the needle moves much faster than five cycles it becomes almost impossible to follow it. Also by this verification will be had of the extreme difficulty of attaining

true zero beat. There will always be some definite difference in practice. That is, the needle will move. The utmost stability, plus precision tuning apparatus, would be required for attainment of even approximate zero beat. What passes for zero beat then is any frequency too low to be heard and of course this is abundant in practical utility, especially in the radio frequencies in the broadcast band or higher. For example, 200 cycles out of 1,000 kc is 0.02 per cent. The best precision oscillators in laboratory practice do not as a rule exceed 0.05 per cent. accuracy.

(Continued from preceding page)

The oscillator is of the tuned grid, inductive feedback type. The element used for feedback is the screen. This fact, plus loose coupling to the amplifier by the electron method, aids the frequency stability of the oscillator. Such stability means that the frequency generated stays the same. It does that to a remarkable degree, assisted somewhat by a resistor of 0.01 meg. in the B plus leg. It is possible to zero beat with a station and listen to a program for a practically unlimited time, without the beat becoming audible, thus indicating that the frequency does not change, say, more than 200 cycles. If the broadcast station frequency is 1,000,000 cycles, a change of 200 cycles would be one part in 5,000, or 0.02 per cent. This is more stability than is within the calibration and reading accuracy of a generator.

Harmonic Methods Outlined

Moreover, any audible beat, or zero beat, may be used, and the attenuator worked from

vantage of predetermining a frequency is practically lost this way, but determination of a frequency to which the receiver is tuned is readily accomplished. This is due to the arithmetic relationship of harmonics to fundamentals.

The general practice is to set the generator going at some easily read frequency, say for the broadcast band between 540 and 1,110 kc, at any setting that yields a response in the receiver. Then turn to the next subsequent generator setting that creates response in the unmolested receiver. Noting the two frequencies read on the generator, multiply them, and divide the product by the difference. Thus, for frequencies read as 1,000 and 900 kc, the product is 900,000 and the difference is 100, so the unknown is $900,000/100 = 9,000$ kc.

A double check method is one that determines the harmonic orders. Taking the lower of two read frequencies that are consecutive in creating receiver response, subtract it from the higher, divide the difference into one read frequency, and the answer is the harmonic order of the other. Suppose 900 kc is read first,

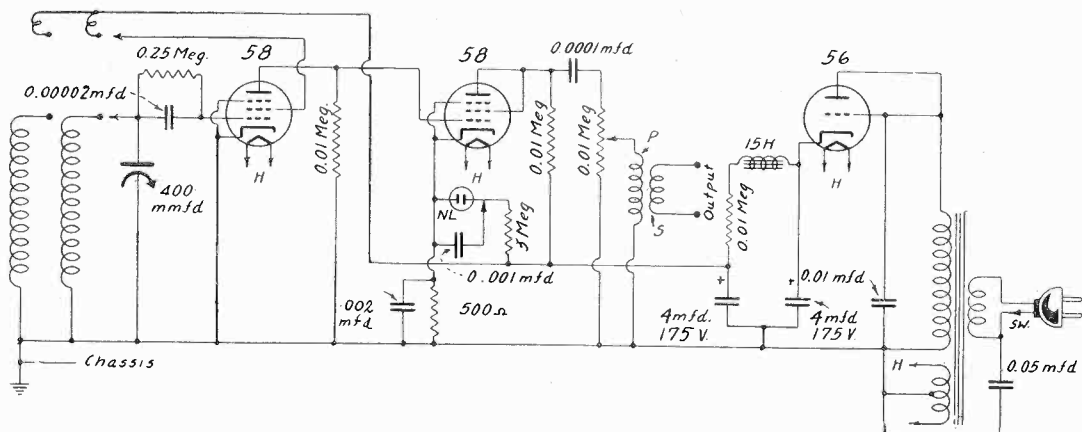

Between the second 58 and the 56 is shown an output radio frequency transformer, included so that receiver sensitivity would be immune from any effect produced by the generator attenuator. It will be noted this method may be used pointedly with a doublet antenna. Otherwise either side of the secondary S, the smaller winding, should be grounded.

end to end, without changing the frequency of the beat, provided chassis is not touched. Besides the electron coupling and the output isolation, the amplifier tube aids freedom from molestation of frequency by output coupling.

The circuit was set up for two band operation, 140 to 500 kc for intermediate frequencies, 540 to 1,600 kc for the broadcast band. Thus it is easy to generate a predetermined frequency in these ranges, using either a calibration curve or a direct frequency reading dial scale. In general, the accuracy of the reading can be held to 1 per cent. This means that no deviation between generated frequency and read frequency is more than 1 per cent. Most of the frequencies read would be accurate to 0.25 per cent.

A device covering the broadcast band, calibrated as accurately as this, may be used with the same percentage accuracy for higher frequencies, by resorting to harmonics. The ad-

1,000 kc next. The difference is 100 kc. Divide this into 1,000 kc, the answer is 10, which is the harmonic order of the *other* read frequency, so the unknown is 900×10 , or 9,000 kc. If the 10 were divided into 900, result 9, the unknown would be $9 \times 1,000$, or 9,000 kc. Note that dividing the difference into one read frequency yields the harmonic order of the *other* read frequency.

By either of these methods, of which the second is preferred, frequencies to 30 mcg may be determined, though, as stated, the predetermination of the frequency is not accomplished as it is when working with fundamentals.

Picking Out One Frequency

However, any one who has some appreciation of what is taking place, can set the receiver

LIST OF PARTS

One block of two 4 mfd. 175 volt cardboard-container electrolytic condensers (black, common, to ground; two reds, plus).

Resistors

One 500 ohm.
Three 0.01 meg. (10,000 ohms).
One 10,000 ohm potentiometer with a. c. switch attached.
One 0.25 meg.
One 3 meg.

Other Requirements

One shield for 58 oscillator tube.
Two grid clips.
One dial and escutcheon.
Three knobs.
One neon lamp without limiting resistor.
One switch for modulated-unmodulated service.
One a. c. cable and plug.
One cabinet.
Two six-hole, one five-hole sockets.

Coils

Two oscillation transformers for intermediate frequency and broadcast bands (third coil may be added, if desired, for intermediate short waves).
One output r.f. transformer, consisting of a honeycomb with primary about 1 inch total diameter on $\frac{3}{8}$ -inch hub, secondary from half to quarter that physical size, separation around $\frac{3}{8}$ inch.
One small power transformer: primary, heater secondary and 1-to-1 secondary.

Condensers

One 400 mmfd. tuning condenser (if trimmer is present, remove it).
One 20 mmfd. (.0002 mfd.)
One 0.001 mfd.
One 0.002 mfd.
One 0.0001 mfd.
One 0.01 mfd.
One 0.05 mfd.

at a frequency that can be specially selected. Suppose the problem is to set the receiver at 10,000 kc. On the broadcast band use 1,000 kc. At least get a response from 1,000 kc, unknown harmonic order. As the generator is turned to lower frequencies another response will be heard in the receiver. This, for 10,000 kc receiver frequency, should be $10,000 / (10 + 1)$, or 910 kc, approximately. If the second frequency read is higher than 910 kc the unknown is higher than 10,000 kc, so, using generator's 1,000 kc again, turn the receiver to the next frequency creating a response, and continue doing this until the two receiver frequencies are 1,000 and 910 kc.

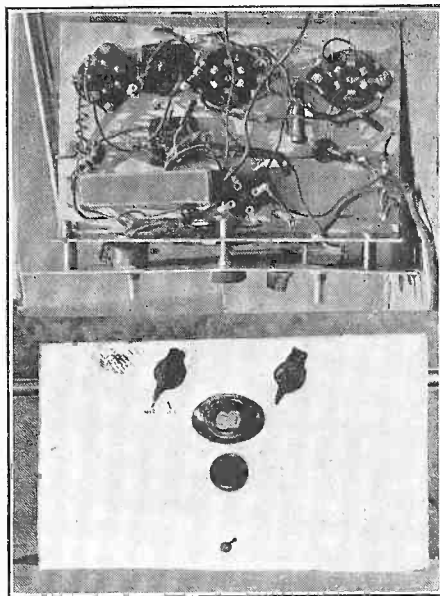

The coil switch and volume control have bar handles. The switch below is for including or removing modulation. The underneath view of the wiring emphasizes the location of the electrolytic condenser block.

The method already stated to be preferred applies the actual harmonic orders and avoids errors of magnitude that arise from slight errors of the components of multiplication. Also, of course, the work can be done by mental arithmetic.

There is another method, devised by Herman Bernard, which may be used as a check.

Consider the case example of A plus B. A is the augend, or number to which addition is made, and B is the addend, or number added to the augend.

Consider the two frequencies read that create consecutive responses in the unmolested receiver, when the generator tuning knob is turned.

When the two read frequencies of the generator that create response in the unmolested receiver are added and the sum divided by the difference, the result is the sum of the augend and addend. Minor fractions may be neglected, as due to experimental error, with no actual error beyond that of the generator.

Example: Suppose the frequencies read are 910 and 1000 kc. The sum is 1910. The difference is 90. Divide 90 into 1910, quotient is 21 and a bit, the extra ignored. The harmonic orders of the read frequencies are always consecutive, that is, 8 and 9, 9 and 10, 14 and 15, etc. Therefore, 21 is the sum of augend and addend. Hence the harmonic orders are 10 and 11, the only consecutive whole numbers that yield 21. The lower harmonic applies to the higher read frequency and the higher harmonic to the lower read frequency. Thus, the unknown

(Continued on next page)

(Continued from preceding page)
is 910×11 , or 10,100 kc. Also, $10 \times 1,000$, or 10,000 kc. The 1% difference could be eliminated if the generator could be read more closely, i. e., 909 instead of 910.

Information Given on Coils

The harmonic technique is of importance only to those who desire to measure frequencies higher than fundamentals of their generators. However, the circuit as shown may be used for inclusion of more coils, so that other bands will be covered. Perhaps one extra band, plus the low harmonic orders of that, would be sufficient. The scale, if direct frequency reading, could be used for ten times the low frequency fundamental; that is, 1,400 to 5,000 kc.

The intermediate frequency coil is a honeycomb, with secondary inductance of about 3.5 microhenries, tickler about one quarter that value; the broadcast coil may be any one with two windings, but removed from any shield about it, and turns adjusted until some station between 540 and 600 kc is read correctly. To make the scale read higher in frequency add turns. To make it read lower remove turns. However, one turn may make a difference of 5 kc, so be cautious.

An intermediate s. w. coil would have 31 turns of No. 28 enamel wire, tickler 15 turns, with $\frac{1}{8}$ inch separation, on $1\frac{1}{8}$ inch outside diameter tubing, all turns close wound.

In tracking a frequency calibrated dial the inductance is a simple selection and is made on the basis of a low frequency setting of the band under consideration, close to the terminal frequency, but the capacity is more serious. This at minimum has to be low for the type of dial that is gaited to a condenser without trimmer. So a switch should be of the low capacity type. Such a switch is standard with Yaxley, Central Radio Corporation, Oak Mfg.

Co., Perfex Controls Company, Soreng-Man-gold and a few others. The Eby switch has low capacity, but for the present particular purpose not quite low enough.

How to Make Grid Condenser

To keep the minimum capacity low, a small grid condenser is used, 0.00002 mfd. (20 mmfd.) This may consist of 12 inches of insulated hookup wire, pushback type satisfactory, twisted tightly together, resulting in a bit less than 6 inches, then coiled again for compactness, the looped and snipped and its opened terminals here used as the plates of the condenser.

The generator should be contained in a metal box and box grounded. There will be no feeding through the line, another advantage. The 0.05 mfd. condenser from line to ground, and the 0.01 mfd. mica condenser from rectifier plate to ground aid this prevention slightly, but the non-feeding-through is practical only on a. c. and battery type generators; that is, can not be accomplished fully with the a. c.-d. c. type.

Modulation is present or absent by switching a parallel condenser in or out of the neon lamp circuit. This lamp is of the type without limiting resistor built in, and may have only pigtailed, being small enough not to require a base or socket. It is not generally carried by supply sources, but is obtainable specially through dealers and others.

Selection of Modulation Intensity

The modulation is not strongly introduced, the voltage being only across the cathode resistor of 500 ohms. If stronger modulation is desired, connect the 0.0001 mfd. condenser across the 3 meg. resistor instead of across the lamp, or move the left-hand neon lamp-condenser connection to the formal plate of the first tube (oscillator). To lower the modulation frequency

(Continued on next page)

An Impromptu Mount for Microphone

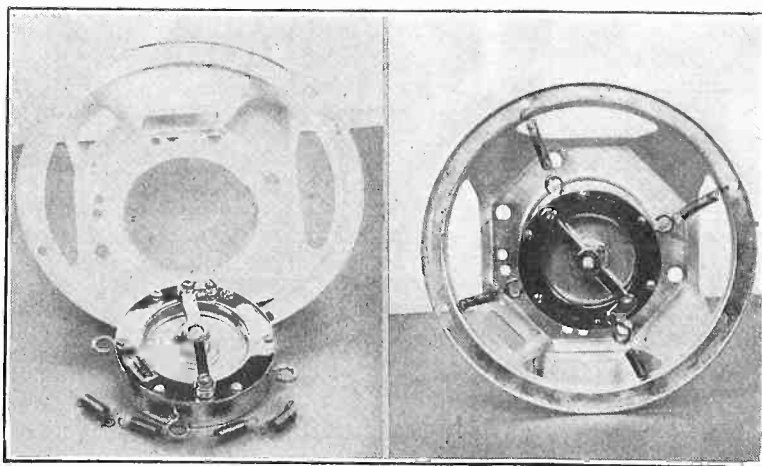

Microphone suspension was solved by an experimenter as follows: First he got a metal housing for a speaker assembly, then he—oh, well, two pictures are worth 20,000 words.

(Continued from preceding page)

use higher resistance than 3 meg. or higher capacity than 0.001 mfd., or have both higher. To increase the frequency, decrease the value or condenser or resistor, but do not use less than 1 meg. resistance.

How to Treat for All Bands

The promised outline of a check on whether the 58 amplifier is properly biased is this: Connect a d. c. milliammeter 0-10 ma range, in series with the cathode or the screen circuit. This requires opening a lead to insert the meter, unless one has a breaking adapter. Have neon lamp wherever it is to be finally. Connect the amplifier 58 control grid to the cathode and note the current reading. The connection to the plate of the first 58 is broken. The meter reading is that which prevails at zero bias of the amplifier 58. Now short out the 500 ohms biasing resistor, disconnect 58 amplifier grid from cathode and put it to formal plate of the oscillator as diagrammed, and note the current reading, which will be higher. Turn the oscillator dial until the largest plate current flows in the amplifier tube. Now open the short of the 500 ohm resistor and see if the plate current reading is at least 10 per cent. less than the reading noted when grid was connected to cathode. If this is not true, increase this resistor until the current flowing is surely 10 per cent. less, when current is largest as resulting from the additive effect of the oscillating tube.

The test merely guarantees operation at some negative bias, to avoid positive grid, and applies only to the band on which the test is made. For

Full Input to Doublet Assured by Generator

The generator described in the accompanying article is one that has an output radio frequency transformer, therefore the two terminals of the secondary may be left free, enabling full coupling to a doublet antenna, or receiver equipped for doublet connections. If the Marconi type antenna is used, then either of the secondary terminals should be grounded, the other terminal used as the high side. This can be taken care of by having three posts at the output, one post grounded, a wire being connected between grounded post and either of the others for use with the Marconi type antenna connections to set.

The tubes specified are for the 2.5 volt series. The rectifier may be a 27 or 56. It is practical to use the 6.3 volt series tubes instead, that is, the 6D6 and the 76 or 37. The only change necessary is to have a 6.3 volt secondary for the heaters, instead of a 2.5 volt secondary.

multiband operation, turn the switch and pick out the band that yields the most current, and the position of the dial on that band that yields maximum particular current. Increase the biasing resistor under that condition, if an increase is required, and then the condition is right for all bands.

By resort to this method the harmonic output is reduced, but is still large enough for working to the fifth harmonic on insensitive sets and to the fiftieth on other sets.

50 Centimeter Parabolic Reflector

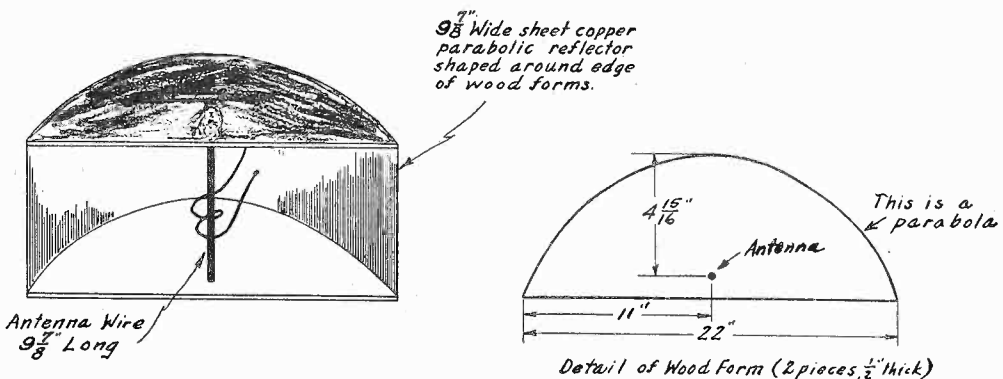

An antenna, consisting of 3/4-inch outside diameter hollow copper, is erected 9 7/8 inches high, two turns coupled to it, and brought to terminals in a housing in which is a parabolic reflector. The copper sheet composing the reflector is the same height as antenna. At right, dimensions of wooden top and bottom supports, and antenna location.

Factors Affecting S.W. Converters

Explanation Applied to a Tested Circuit

By Louis Kranz

The converter principle reduced to very simple practice. Switch controls wave band, line voltage and antenna input.

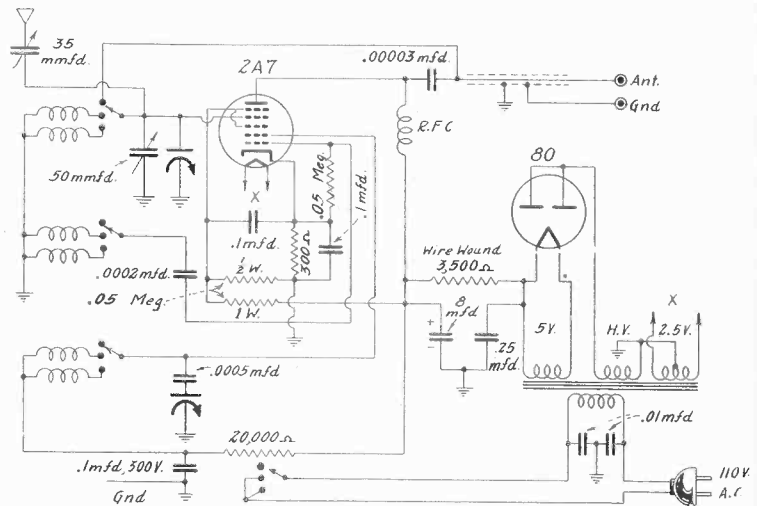

THE short wave converter has had its ups and downs. It started off as a very popular product, but lost ground because results did not come up to expectations. Now it has regained lost popularity because of greater general interest in short waves and the higher sensitivity of receivers.

If the receiver is sensitive enough the short wave converter is always an acceptable product. Whatever results are obtained depend mostly on the receiver. So complaints made against early converters might as well have been directed against the receivers with which they were worked, to equalize the blame. The converters themselves may have been only fair, but the sets may have been no better.

How to Appraise Sensitivity

The attempt to get results by tuning only the oscillator, with no r. f. tuning at all, was a failure, no doubt. The advisability of some tuning at the r. f. level is undisputed today. This applies to the modulator input from the antenna. Besides, a t. r. f. stage is often recommended, for its aid in image suppression, and while the advantage can not be denied, if one desires to build a very simple short wave converter, to cover two bands, at very small cost, he may

do so advisedly, following the circuit diagram given herewith.

With an insensitive set it is no use considering a converter. It is well therefore to make some test of the receiver. The simplest test is that distant stations should be receivable in the standard broadcast band between 600 and 530 kc. Somewhere in that region the receiver will be set for service as intermediate amplifier and second detector. Sensitivity should exist there. Selectivity at this level does not matter quite so much, but if the receiver is a super-heterodyne it will be selective enough, unless mispadded. If two or three distant stations, say, a few hundred miles away at least, are receivable between these frequency limits, then the receiver may be deemed satisfactory for use with a converter.

Use Low End of Broadcast Band

It is necessary to keep the receiver at some such low frequency as suggested, so that the selectivity will stand up, when the short waves are tuned in. One simple way of expressing the approximate relationship of intermediate frequency, selectivity and the gain, is to state that as one increases the i. f. the two other factors decrease as the square of the ratio of the fre-

quencies. If 550 kc is taken as one intermediate frequency, and 1,650 kc as the other for comparison, since the ratio is 3, there would have to be 3×3 or 9 more stages to equal the amplification-selectivity of the lower i. f. condition.

Each converter is padded or intended for some particular intermediate frequency, although for frequencies of short wave stations considered in a two-band device, some leeway exists, because the oscillator frequency even at maximum percentage difference is fairly close to the station carrier frequency. In the coil data given 550 kc was the i. f. basis.

Considering the circuit shown, the series antenna condenser reduces noises of certain types and besides enables adjustment of the electrical properties of the antenna to suit the band in which one is working. There is need for only one particular setting for a band, hence two settings will be selected, and these are naturally

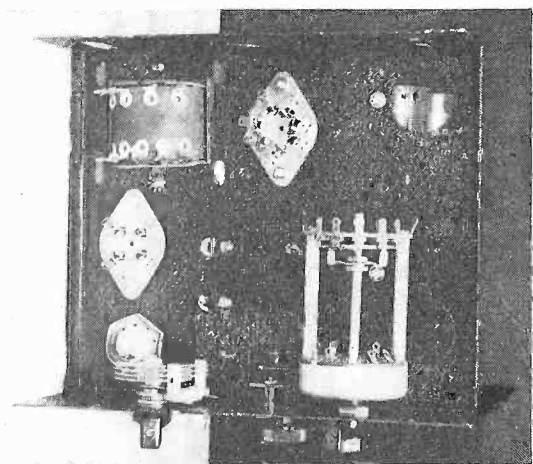

Bottom view of converter prior to wiring. A chassis intended for another purpose was used, hence the extra chassis holes.

correlated to the particular antenna. Therefore the position of the knob may be memorized for each band, or marked on the panel.

Long Aerial Found Advisable

This condenser reduces the effective capacity of the antenna. It does not change the antenna inductance, however, and therefore a long antenna is advisable. In fact, in converter practice it is nearly always well to use a very long aerial, for louder signals and more stations.

If any constructor has doubts about his ability to establish proper padding, he may put a 50 mmfd. condenser across the modulator tuning condenser (shown in the diagram) since the modulator frequency is always lower than the oscillator frequency for intended practice, and then only some slight attention to capacity padding, insertion of a 0.0005 mfd. fixed condenser suffices. The oscillator tuning condenser is in the plate circuit of this particular converter, an unusual but effective position.

A single tube performs the mixing. It is a 2A7, really two tubes in one envelope, a triode

for oscillator and a pentode for modulator. The two arrows at X represent connections to the secondary that powers the heater.

Lower Bias May Be Tried

The box top formation just above is the cathode, from which a 300 ohm resistor is connected to grounded B minus. Some experimenting with this resistor value may prove beneficial, as values down to 175 ohms may be used, and perhaps the sensitivity will increase with lower resistance. The first dotted line on the way up, in the tube circle, is the oscillator control grid (No. 1), connected to cathode through a leak of 0.05 meg. (50,000 ohms). The 0.0002 mfd. condenser near the middle switch section at left is the grid condenser, so it is obvious that the grid circuit is not directly tuned. Next on the way up is Grid No. 2, which functions as oscillator plate effectively, being returned to B plus through a 20,000 ohm resistor. This resistor helps stabilize the oscillator operation. Both the cathode biasing resistor and the oscillator Grid No. 2 limiting resistor are bypassed by condensers. The next element is shown in two parts, united, however, and comprises Grids Nos. 3 and 5, joined inside the tube, constituting the screen. Grid No. 4 is the control grid of the modulator (cap connection), while the remaining element is the familiar plate.

The switch has four poles and four throws. While there are only two short wave bands covered, a third switch position disconnects aerial from the converter and moves it over to the receiver, thus avoiding loosening and attaching at binding posts of converter and set.

Factors Affecting Output Lead

The 35 mmfd. antenna series condenser remains in service, and for use of the receiver alone, at broadcast frequencies, of course, should be set at maximum capacity (plates fully engaged). Reception on the broadcast band then will be quieter, also, but the long wave broadcasting stations may not come in with as much strength as before, although selectivity will be better throughout. The user can make up his mind from experience whether he needs more antenna input for broadcast use on low broadcast frequencies. The fourth switch position controls the a. c. line supply, all right, because current is low.

Output from the converter is made through a shielded lead, sheath grounded. This grounding may be done at the receiver, since there is a ground post there, and a wire soldered to sheath may be connected to that post. Also it may be advisable to ground the lead a second time, now at the converter end, to the converter chassis, which itself is grounded. The type of shield wire used for this purpose should be that with a thick cotton loom, as those with thin serving cause the conductor wire to be too close to the grounded sheath so that too much energy is lost through capacity to ground.

Precaution Against Locals

At all hazards there will be stronger pickup
(Continued on next page)

Where Supers Are Heading

Higher Inductances Indicated, to Reduce Noise—
All Waves in Five Steps Instead of Three—
Broadcast Band Split Up

By Herman Bernard

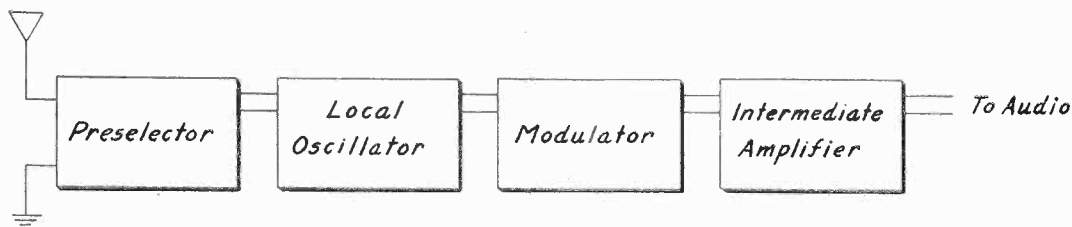

Representation in block formation of the functions of a superheterodyne receiver up to and including the second detector. The preselector aids selectivity principally in the rejection of images. The local oscillator is higher in frequency than the preselector, in popular practice. The modulator is the frequency changer, lowering the signal carrier frequency to the intermediate frequency, which is amplified in the intermediate channel, after which audio values are established by demodulation.

LARGE tuning capacity is the rule today in multi range receivers. The tuning condenser section is nominally 350 mmfd. but usually ranges between 365 mmfd. and 400 mmfd. Thus the tuning ratio may be 3.5, approximately. If broadcast band tuning starts at 530 kc the tuning would go a little beyond 1,800 kc and thus take in some police calls. The desire to encompass the standard broadcast band without switching is the main consideration in selecting

such a large capacity. For multi range coverage then fewer coils are needed, because of the large frequency ratio for each band, another consideration favoring the use of large capacity.

However, there are reasons against use of a large capacity. The main one is that the inductance is necessarily small compared to the capacity, particularly for high frequency bands, and most particularly for the lower frequencies of

(Continued on next page)

Effect of Broadcast Local on S. W. Converter

(Continued from preceding page)

if the cable is not of the shielded type, or if it is, that the shield be not grounded. Thus, to bring in a weak station with greater volume the grounding of the sheath may be temporarily removed, just for the occasion. The reason for including the grounded sheath under ordinary operating conditions is to prevent the connecting device between converter and set from serving as an antenna feeding the set. It is easy to imagine what would happen under some circumstances. If there was a strong local station near the frequency to which the receiver is set the unintentional antenna would pick up enough to actuate the receiver, and the local station's program would mix with programs of all short wave stations received. If it is definitely established that this condition does not exist, then one may omit the shielding of this lead. Again experience alone must yield the correct answer.

The plate is loaded with an r.f. choke coil, and this need not have a high inductance. The

choke inductance and capacity should be sufficient, however, to provide a path of low impedance for the high frequencies present in the output, and a high impedance to receiver input. Roughly, under conditions usually present, the natural period of the input antenna circuit of the receiver with converter disconnected may be around 2 mc. and the choke (R. F. C.) may be of a few millihenries inductance.

The capacity used as d. c. stopping condenser between converter and set is very small, 30 mmfd. to hold up the selectivity.

A small power transformer is used, also an 80 rectifier tube, the hum filtration being sufficient because the B current is trivial, the capacity next to rectifier being 0.25 mfd., 600 volt, and the other filter capacity 8 mfd. Between these is a 3,500 ohm 5 watt resistor.

The converter as constructed operates from 20 to 50 meters (15 to 6 mc.) and from 75 to 200 meters (4 to 1.5 mc.), using a two gang 0.00014 mfd. condenser. Data on construction of the coils are given in Radio University.

(Continued from preceding page)
 each of those bands. The gain is thereby reduced, although this of itself is a slight consideration, since with subsequent circuiting it is possible to atone for any prior sacrifice of gain. But the noise is greater when the inductance is relatively low, the ratio of noise to signal is large, a condition predominant in the first tube, the one fed by the antenna.

Where Volume Control Should Not Be

This first tube's noise ratio is high when the voltage developed across the grid circuit of the tube is low, and small inductance tends to keep that voltage low. It is preferable from the viewpoint of better ratio of signal to noise that not only the inductance be high but also that the first tube be operated close to or at maximum allowable plate current. Maximum B voltage may be applied and minimum bias.

If the conventional inductance values are used it would be of no purpose to tighten the coupling between primary and secondary of the antenna coupler in an effort to reduce noise, because this ratio of signal to noise is not changed, both being increased proportionately. This ratio may be regarded mainly as a function of the operation and loading of the first tube.

Other Noises Discussed

Other aspects of noise are present. In general the noise classes are outside origin and inside origin. Noise from the outside comes by way of the antenna as is sometimes of such frequency origin that loose antenna coupling reduces the trouble. Noise arising in the set is due to tubes, circuiting, loading and voltaging. Uneven electron emission produces the noise known as shot

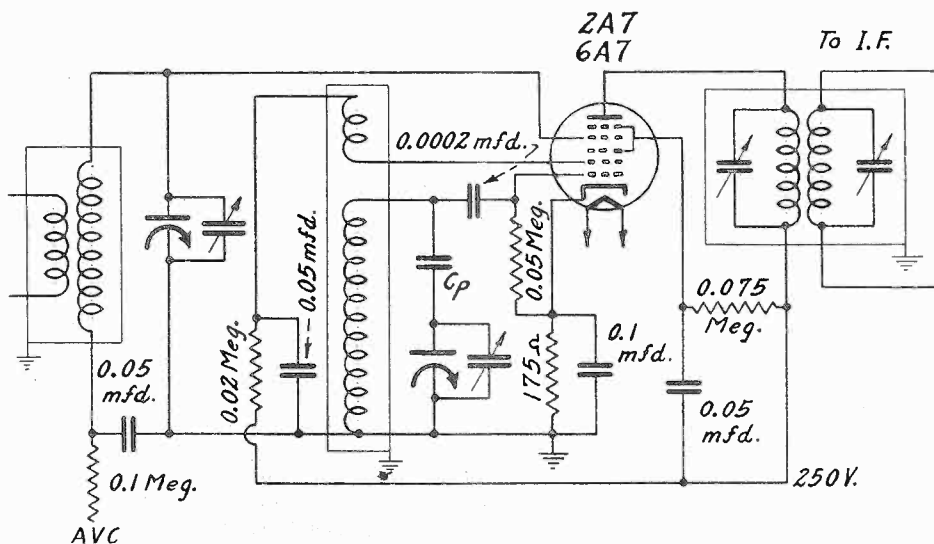

Suitable circuiting for a pentagrid converter tube. The grid leak and condenser values are such that frequencies to somewhat above 20 mc. can be handled without resultant squawking. The condenser is shown as 0.0002 mfd. but may be 0.00025 mfd. harmlessly. The leak is 0.05 meg. (50,000 ohms). The 0.02 meg. resistor in series with oscillator Grid No. 2 (effective as if a plate) aids stability and serves the necessary purpose of limiting the plate current.

If there is volume control by bias alteration on this tube, often present when a remote cut-off tube is used, the increased bias tends to increase the noise. When the bias is high there is some distortion likewise. It is therefore not recommended that such a control be used there, and of course in a superheterodyne it is practical to have the manual volume control affect the audio frequency level instead.

Another objection to the location of a manual volume control in the cathode or screen leg of the first tube is that some detuning arises when the control is moved, serious when there is no preselection. From this viewpoint, such a control at the intermediate level of a superheterodyne would not be objectionable, as the frequency is much lower, and the percentage of frequency change in relation to the tuner ahead is very small, nor would noise be substantially affected.

effect. Operational noise means more noise from a particular use—for instance, conversion—than from another use, as mere amplification.

Noise generally is largely a first tube contribution due to thermal agitation, particularly noticeable at frequencies lower than 7500 kc, and of course full amplification applies to this noise. At higher frequencies the thermal agitation has negligible effect, because of the small impedance of the tuned circuit. The thermal agitation noise is particularly present in the first tube's grid circuit.

Besides this type of noise of course there are set noises such as tube noises due to various causes, among them the irregularity of the electron emission, which produces the shot effect; the noise arising from the converter, which is about twice as noisy as the same sort of tube used merely as an amplifier; and the frequent

(Continued on next page)

(Continued from preceding page)

condition of insufficient modulation of the local oscillator.

It is advisable to keep the local oscillation intensity well up, and use sufficient coupling to the modulator to capitalize on this generous amplitude of oscillation. The feeble oscillators are likely to be more stable, so again a compromise may be necessary, for at the high frequencies (on short waves) frequency stability becomes very important, especially if the receiver is selective in its radio frequency and intermediate levels.

What Determines the Selectivity

The frequency of response does not depend practically on the preselection. Only the amplitude and the degree of selectivity are affected by the r.f. section. The local oscillator itself has no selectivity, and what appears to be its selectivity is nearly wholly the selectivity of the intermediate channel. This is a constant value of selectivity for all signal levels tuned in,

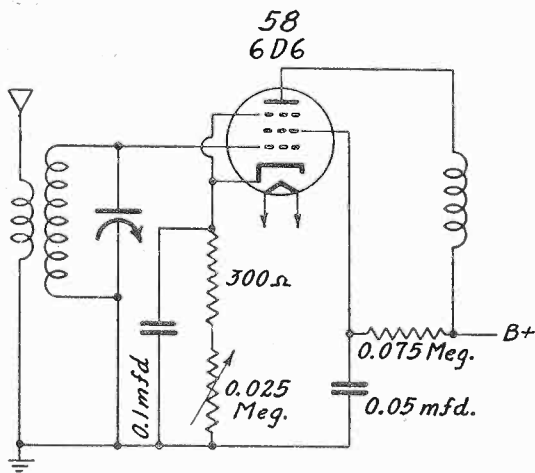

When the 58 is used as first tube, the rheostat value for r.f. gain control may be as shown for a t.r.f. set, but higher for a super, whereas instead of the 0.025 meg., around 0.1 meg. should be used if the tube is a 6D6, even in a t.r.f. set. However, this is not a good location for a gain control in a super, for noise reasons, since this is the first tube. Subsequent tube or tubes might be controlled this way for alteration of r.f. gain.

therefore the proper alignment of the intermediate level is very important.

Since high selectivity is widely used now, the stability of the oscillator becomes more important, because small changes in oscillator frequency now produce large differences in output.

The selectivity of the intermediate amplifier will be greater the lower the intermediate frequency, but the lower the intermediate frequency the poorer the image suppression, and even at the highest intermediate frequency now used, 480 kc or so, the signal carrier frequency

and the oscillator frequency at the shorter waves are almost the same. The difference of only a few percent, makes it hard to prevent local oscillation voltage from building up on r.f. grids. It is difficult under any circumstances to prevent this trouble, when the intermediate frequency is so low compared to the signal carrier frequency. This trouble results in poor ratio of signal to image.

What an "Image" Is

Whatever the intermediate frequency, there will be response when the oscillator is tuned to a frequency either higher or lower than that of the signal carrier frequency, by the amount of the intermediate frequency. If the i. f. is 450 kc, then for any given signal carrier, say, 10,000 kc, there would be a response if the oscillator were at 10,000 + 450 kc or 10,450 kc, and again when the oscillator is 10,000 - 450 kc or 9,550 kc. The difference between the two oscillator frequencies that will bring in the same station is always the same, here obtained from 10,450 - 9,550, thus the difference is 900 kc. This is obviously twice the intermediate frequency.

In present practice the oscillator is higher in frequency than the desired signal carrier frequency, yet when the oscillator and signal carrier frequencies are not far apart, some stray energy gets by that results from the unintentional mixing of the local oscillator frequency with a signal carrier higher instead of lower than the oscillator frequency. Therefore two stations separated by twice the i. f. are receivable at once. Hence two responses are obtained, one strong, from the desired station, the other weak, from the undesired station 2(i. f.) higher than the desired one. It is the undesired one that causes trouble, of course, and it is referred to as the image frequency. Even if there is no station transmitting at the image frequency there may be interference, as there might be some disturbance in the ether at that frequency. From the output of a test oscillator set first at one of the frequencies and then the other (the difference between the two equalling twice the i. f.) the ratio of signal to image is determined. This should be large. The rating is usually given in decibels. Hence you will hear that at 20 mgc the image response is 16 db down.

Smaller Condensers Advised

It is a fact that high inductance does not aid the safeguarding against coupling between local oscillator and an r.f. stage or preselector circuit in the set, but, as has been stated, there is very little that can be done about this coupling, anyway, after the usual shielding precautions have been taken. In addition extensive filtering of return leads may be resorted to, but the coupling may not be reduced much, up to the highest frequencies usually tuned in with all wave sets.

So while there are conflicting considerations, it is nevertheless of importance to keep the inductance as high as practical, because noise attributed to conditions in the first tube have to be kept down, for they receive the full amplification of which the entire system is capable. It should therefore follow that if the short waves are to hold the interest of the general public, that for better support of short wave results, and at the same time improved gain, with noise reduction, at all received frequencies, smaller capacity tuning condensers be used, the broadcast band, and perhaps a bit extra, taken in two steps, and a minimum of five sets of

capacity might well constitute the only parallel padding capacity used. It is effective on the high frequency end of the tuning of any band, but has small effect at the low frequency end, where the inductance is the principal factor. Hence r.f. and oscillator circuits would be sensibly tied down at both ends, a precision practice not now used in any save some expensive professional type receivers.

Attaining S.F.L.

The preferred method of attaining straight frequency line tuning is to have a precision

Use of a separator oscillator. A pickup winding in the cathode circuit of the 58 or 6D6 modulator is tightly coupled inductively to the Hartley oscillator winding. The amplifier type tube rather than the detector type is used as modulator because strong input to the modulator can be better withstood. Putting the biasing resistor between pickup return and ground seems to give better results than putting the coil in this position.

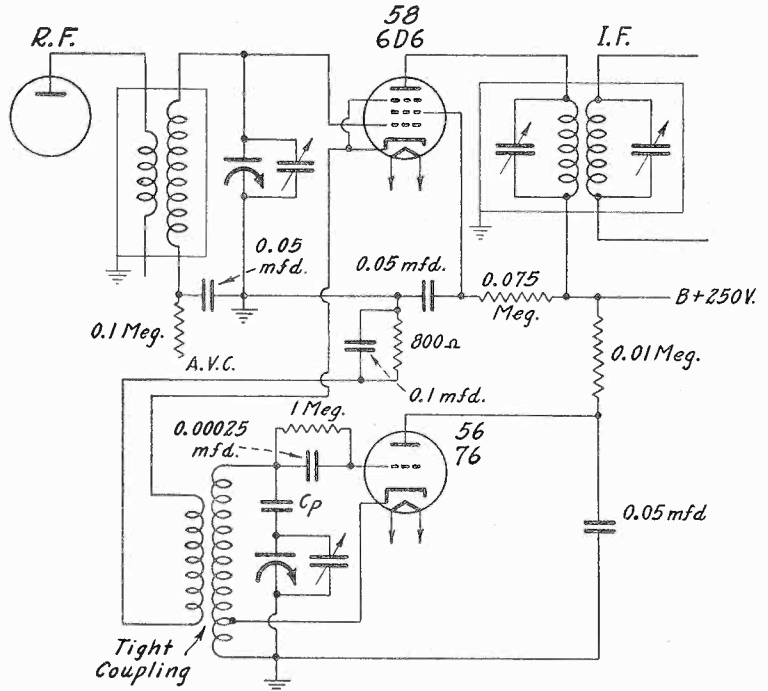

coils used instead of the three so generally used now. That means five sets of coils for the bands, and if switching is used, five switch positions. If there are three coils to a set so one stage of preselection exists, there would be 15 coils, and receivers would become more expensive, but the results would be worth the extra cost.

Moreover, it is confidently expected that such practice will become universal in time, and also that eventually the general production of receivers will have straight frequency line tuning, or close to it, so that there will be about the same mechanical separation on the dial for the same difference in frequency on any band, instead of gross crowding at the high frequency end of a band as now largely obtains. And if true s.f.l. tuning is used, series padding condensers for local oscillators will be unnecessary, inductive padding sufficing amply, when pains are taken to build coils for any band to a given distributed capacity. And this distributed ca-

condenser with shaped plates to accomplish that result. At least one such condenser is on the market. Others of the assumptively s. f. l. type do not achieve the result closely enough. For receiver use, of course, some small deviation from true s. f. l. is harmless, and arises from the difference in minimum capacities introduced in the circuit. In precision generator practice, where results embody computations, of course the tuning must be exactly on the s. f. l. basis. If a relatively large minimum capacity is unobjectionable a midline shaped plate can be made true s. f. l. for about 160 of the 180 degrees of rotation, by using 100 mmfd. for tuning, and a 25 mmfd. trimmer set at about one-third disengagement. Another way, as pointed out by James Millen, is to use a straight wavelength line plate shape, and pad that likewise with parallel capacity. By proper padding either of these methods work well, and if the high capacity end is too "slow" a series capacity may be added, as Mr. Millen suggests.

How to Use the

1B5/25S is Dual Diode Triode for

—Three More M

By Lion

NEW types of metal shell tubes are being announced from time to time, and there is even an occasional addition to the glass envelope type. The newest metal shell tubes are the 6F6 power amplifier pentode, with 42 characteristics, and the 5Z4 full wave rectifier, with 80 characteristics. In the glass envelope line the newest tube is the 1B5/25S, a duplex diode triode for battery operation, 2 volt series.

Besides, the first acorn tube, 955 triode, has been followed with an acorn pentode, the 954, of the same small type of construction, these two tubes having a different appearance than any others in the American category. The acorn tubes are for high frequency work particularly, being useful to 0.7 meter certainly, and possibly to lower than 0.5 meter. For uniformity of appearance, the same type tubes may be used for audio frequency amplification of the rectified signal. They are glass envelope tubes.

Of the tubes just mentioned as having been brought out recently, only the two in glass envelopes are available to the public—the 954 and the 1B5—the metal shell tubes being scheduled for release, some time in the Fall, dates not yet fixed.

Points of 1B5 That Bear Watching

The most general immediate use will be found for the 1B5 because of the growing popularity of battery operated sets for the standard broadcast band and combination of standard broadcast and short waves. The 954 is for ultra short waves, which interest experimenters, and will interest them much more as time progresses.

The 1B5 is the 2-volt equivalent of the 55 and 75, that is, consists of two separate diodes and a triode. The usual use is to have one of the diodes serve detecting purposes, the triode being an audio amplifier, although of course it is practical to use the triode as a radio frequency amplifier, and have it feed either or both diodes.

Practices with which the reader is no doubt familiar, in connection with the use of tubes with two diode plates, are followed in connection with the 1B5, but there are certain points that have to be watched carefully, because the cathode is the filament, and the diode connection affects the detection in a manner that otherwise might pass unsuspected.

How Time Delay Arises

There is shown herewith the circuit for a superheterodyne using the new tube, and since the A current drain is about 0.5 ampere, it is assumed that a 6-volt storage battery would be used, hence the resulting bias on the tubes (with-

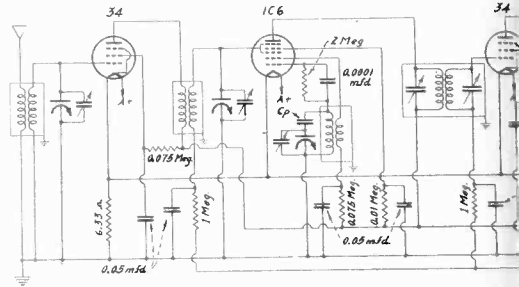

The new double diode-triode tube is used in this circuit. There is delayed a. v. c. action equal to the bias, 4 volts if a 6 volt battery is used, as intended. The net, because of return to positive filament, literally as stated, so batteries to produce them should be a resistor, or C batteries as prescribed connected

out a. v. c. influence considered) is the difference in voltage between the negative filament and negative A, which is 4 volts.

Due to the tube construction, whereby one diode encircles one end of the filament and the other diode the other end, the return of each furnishes a different operating condition. Under the complete circuit diagram are diagrams of three conditions of importance. The first, at left, represents a condition that develops no time delay. The second, at center, is the arrangement used in the completed circuit, there being some delay, here equal to the C bias, which is 4 volts here, the drop in the filament limiting resistor, or difference between negative filament and negative A battery, assuming the 6-volt six-volt source. At right there is shown a method of producing still more delay action.

Taking the total filament area in respect to the diodes as a whole, there is a d.c. potential difference of 2 volts, the filament voltage, and this is interposed between either filament side, because all returns are related conductively to negative filament. Depending on how the diode plate return is made, one has no time delay, some delay or still more delay.

How to Select Proper Diode Plates

The method that creates no delay also requires that only one diode plate be used, and a particular one, at that—the plate surrounding the negative filament (Dp2). The return for

The New Tubes

Battery Use—954 Acorn Pentode Data Local Shell Tubes

elRivers

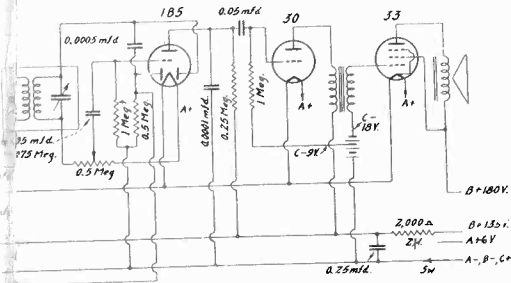

TENTATIVE RATING AND CHARACTERISTICS OF THE 1B5/25S

Filament voltage (d.c.) 2 volts
 Filament current 0.06 ampere

Triode Unit Interelectrode Capacities

Grid plate 3.6 mmfd.
 Grid filament 1.6 mmfd.
 Plate filament 1.9 mmfd.

Triode Unit Class A Amplifier

Plate voltage 135 volts maximum
 Grid voltage minus 3 volts
 Amplification factor 20
 Plate resistance 35,000 ohms
 Mutual conductance 575 micromhos
 Plate current 0.8 milliampere

be battery operated superheterodyne receiver. here the drop in the 6.33 ohm resistor, or regular second detection is delayed 2 volts less, or the driver and output biasing voltages should be less by the amount of drop in the filament negative filament instead of to A minus.

the load resistor, here the fixed resistance of a potentiometer, is made to negative filament. The a. v. c. supply is orthodox, the controlled tubes having their grid returns interrupted by a high resistance that is bypassed by B minus by a diaphragm capacity condenser, and terminated at negative of the diode load resistor.

There are several ways of having the C bias determine the amount of voltage by which the retifying function is delayed, but the method shown in the center drawing, which is the same method as applied to the complete receiver, is preferred. The detector here is the positive filament diode (Dp1) and the return is to positive filament likewise. The a. v. c. action is obtained from the other diode, the return now being to minus, whence the delay arises, equal to the biasing voltage. As previously stated, negative of the A battery is the practical C minus for the full receiver circuit, due to the drop in the filament limiting resistor, and the delay is 4 volts, but for other conditions, C plus to negative filament, a C battery would be inserted and delay equal the amount of voltage thus used. This would be advisable if delay were desired when the A source is 3 volts instead of 6, or a 2-volt air cell.

Negative Filament is Reference Point

If the negative filament diode (Dp2) is the one used for detection, return to filament minus, the other diode for a. v. c., return to C minus,

the filament voltage drop and the bias voltage are cumulative, so for 4.5 volts C battery, and 2-volt filament drop, the delay would be 6 volts. This would be too high perhaps for a battery operated set, and is mentioned only to state the condition.

In making connections, or experimental arrangements, it is necessary to remember that the negative filament is the datum or reference point and therefore all voltages are computed or measured from that basic value of 0. It can be seen therefore that since there is a resistor that drops some voltage in the filament or A circuit, and is in the negative leg, between negative filament and negative A, the negative of battery is more negative, so to speak, than negative filament. That is why a grid return to negative of battery introduces a bias equal to the difference in potential between negative filament and negative of battery.

Why Bottom Socket View Is Shown

The plate and screen voltages are to be measured from negative filament also, although the difference is small as between measurements from B minus to screen or plate, in practice not more than 4 volts, and always will read higher by the amount of the error.

Usually the view of socket as seen from the bottom is given because this is the appearance when the wiring is being performed and when the chassis is turned upside down for servicing, although sometimes free point tests are made

(Continued on next page)

(Continued from preceding page)
 from the top and without even removing the chassis from the cabinet.

The tube is now known as the 1B5/25S, as one manufacturer had such a tube on the market earlier than the others, as the 25S, and has prefixed 1B5, out of courtesy to the others, who would have called the tube only 1B5 but have suffixed the 25S out of reciprocal politeness. The tubes are the same in performance now, and are interchangeable. Probably in the end 1B5 will be the only designation.

The 1B5 may be considered as three tubes in one envelope: two separate diodes and one triode.

Diode Units

Two independent diodes are present, only the filament being common, which it is to triode as well as diodes. Diode plate No. 1 is at negative end of the filament, diode plate No. 2 at positive end of the filament.

The tube base has six pins. The pin numbers according to the system of Radio Manufacturers Association is: Pin 1 = filament plus; Pin 2 = triode plate; Pin 3 = diode plate No. 2; Pin 4

= diode plate No. 1; Pin 5 = triode grid; Pin 6 = filament minus.

The advantage of simple automatic volume control and diode detection are thus conferred on battery sets by the introduction of this tube. The a. v. c. tends to level the amplification, so that stations in general come in at the same volume level, as some aid against fading is present, and if the manual volume control is set once, it needs not be molested when other stations are tuned in. Also, cross modulation is minimized because the strong signals apply proportionately higher bias. Moreover, when tuning in locals, blasting is avoided, as the strong stations do not come so much louder than the weaker locals or semidistant stations. However a. v. c. is not complete in its effect, and a very weak station, since it develops such small extra bias due to a. v. c., practically is free from a. v. c. control. But a delay voltage, if introduced, tends to blot out the very weak stations, defensible from the viewpoint that stations so weak as not afford any enjoyment to listen to are thus removed as a teasing factor in reception, for the noise that would be heard would be perhaps as loud as the signal. The delay

(Continued on next page)

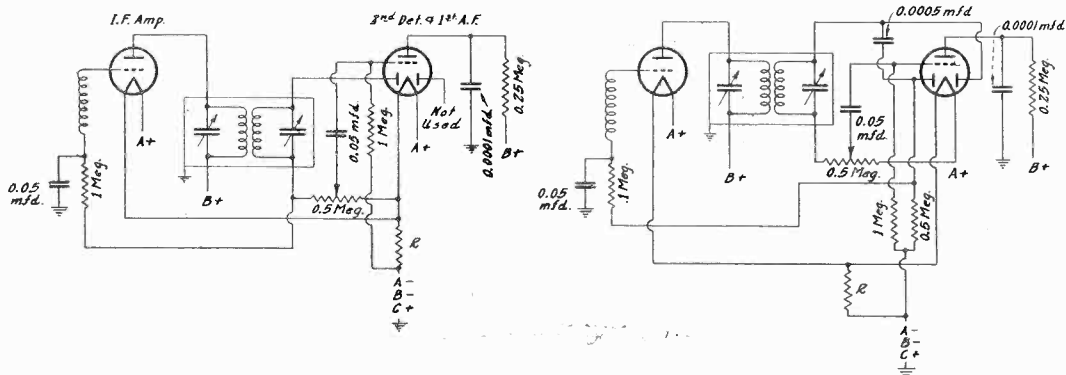

NO DELAY

The circuit directly above illustrates the use of the 1B5-25S as second detector and first audio amplifier in a superheterodyne, with a. v. c. and regular detection present as soon as there is carrier voltage present. R is the filament limiting resistor, selected to drop the difference between the A supply voltage and the voltage required across the filament. Its value depends on the current through it and the amount of the required potential drop across it.

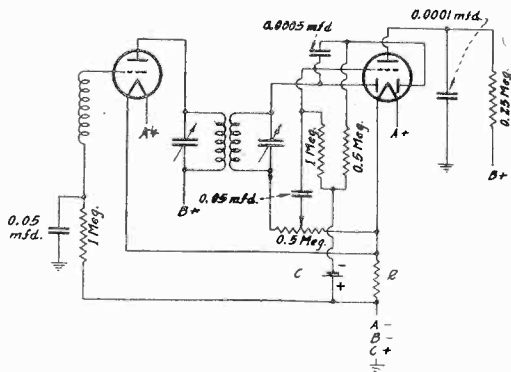

MORE DELAY

This is the method used in the complete superheterodyne receiver,

SOME DELAY

When no delay was used one of the diode plates was not used, either. When some delay is desired both diode plates are in service (above). So, too, with more delay, both diode plates are effective immediately (left). One plate is used for regular detection and the other for rectification for a. v. c. purposes. The drop in the filament resistor is used for triode biasing for no delay and some delay circuits, and in the no-delay circuit to the left of it.

(Continued from preceding page)
voltage makes for quietness of reception and assurance that stations heard come in under conditions worthy of one's listening.

The predominant use, of course, is in a super-heterodyne. While it is practical to introduce a. v. c in a tuned radio frequency set, the necessary adjuncts are such as might reduce selectivity, and the t. r. f. system, while capable of full sensitivity, comparative to a superheterodyne, is difficult to establish on a sufficiently high selectivity basis for exacting present-day needs.

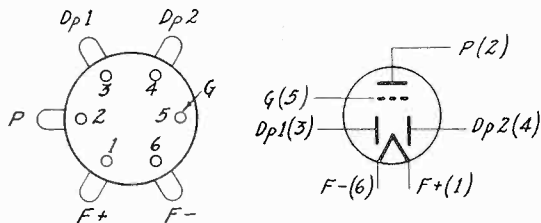

Bottom view of the six hole socket of the 1B5/25S is shown at left, with the corresponding tube pin numbers shown, 1 to 6, and the elements identified in relation to those numbers. At right is usual diagram for the tube, with numbers repeated. In both instances F plus and F minus are self-explanatory, P is plate, Dp1 is Diode Plate No. 1, Dp2 is Diode Plate No. 2 and G is control grid.

Where the suppressor is designated for connection to cathode, this union is made at the socket. Where the adjustment of plate current is prescribed, this may be accomplished by interposing a suitable resistor between cathode and B minus, and bypassing that resistor with a condenser. The resistance value is not critical, from 20,000 to 50,000 ohms having proved satisfactory.

When the tube is used with a.c. feed to the heater, the center tap of the heater secondary of the power transformer should have the cathode directly connected to that center. In the case of d.c. operation, by which is meant in general that the heater terminals are connected directly across the terminals of a 6 volt storage battery, the cathode is led directly to negative of the battery terminal, or indirectly to that destination through the biasing resistor. The customary methods of screen voltage supply in either a.c. or d.c. are applicable, except that if the plate voltage exceeds 250 volts, the series resistor method in the screen lead to drop maximum B to the desired screen potential should not be used, but a bleeder circuit set up.

Good Gain at Ultra Wavelengths

The 954, the second acorn tube, is a pentode. Used as such it enables a gain of three or more in radio frequency amplification at 1 meter. It is intended that the operation be between 0.7 and 5 meters, generally, although of course the tube is applicable to higher wavelengths, and the higher the wavelength the greater the gain, but at waves higher than 5 meters conven-

tional tubes suffice. Also, the 954 may be used as a triode.

The tube is of the heater cathode type, requiring 6.3 volts a.c. or d.c., but this voltage should not vary more than 10 per cent. at any time. Series operation of the heaters is not recommended. Conventional circuits are used. Special ones no doubt will be developed as the tube is subjected to experimental use by amateurs and others.

A suppressor is brought out to a separate terminal and is designated Grid No. 3. The screen is Grid No. 2 and the control grid is Grid No. 1. The plate and control grid are brought out to terminals on a single axis, separated by the height of the tube, while the outlets for the other elements are circumferentially disposed, at right angles to the axis of the plate and grid outleads, with three on one side and two on the other. Of the three, cathode outlet is at center, heater on either

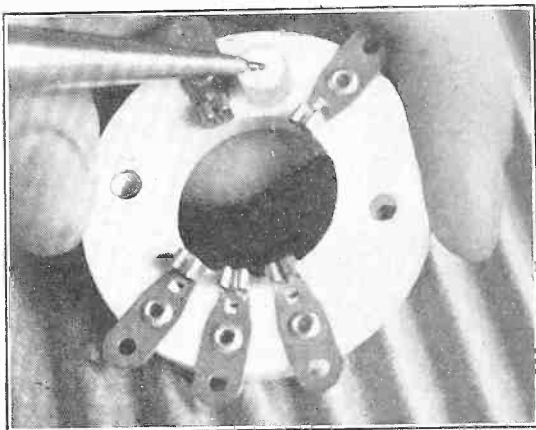

A new socket for the acorn tubes is made of white ceramic and has a locating collar, to which the pencil points.

side of it. The two on the other side are suppressor and screen.

Careful Bypassing Needed

The frequencies being so high, special grounding precautions must be observed. The most important consideration is that the bypassing be done as close to the actual elements as possible, which means the condenser must be close to the tube terminals. Ribbon conductors to the clips that attach to the tube elements may be used as the plates of condensers, since small capacities are effective for bypassing as these high frequencies. Mica spacers are convenient to prevent shorting of the ribbons.

Grounding should be done through separate channels to a common point, and not through a common large conductor, e.g., chassis, as interaction might be set up. Each stage of amplification or detection, using this tube, should be shielded, and it is practical to secure the tube to a shield wall, this constituting the

(Continued on page 39)

PRACTICAL FACTS ON ACORN PENTODE

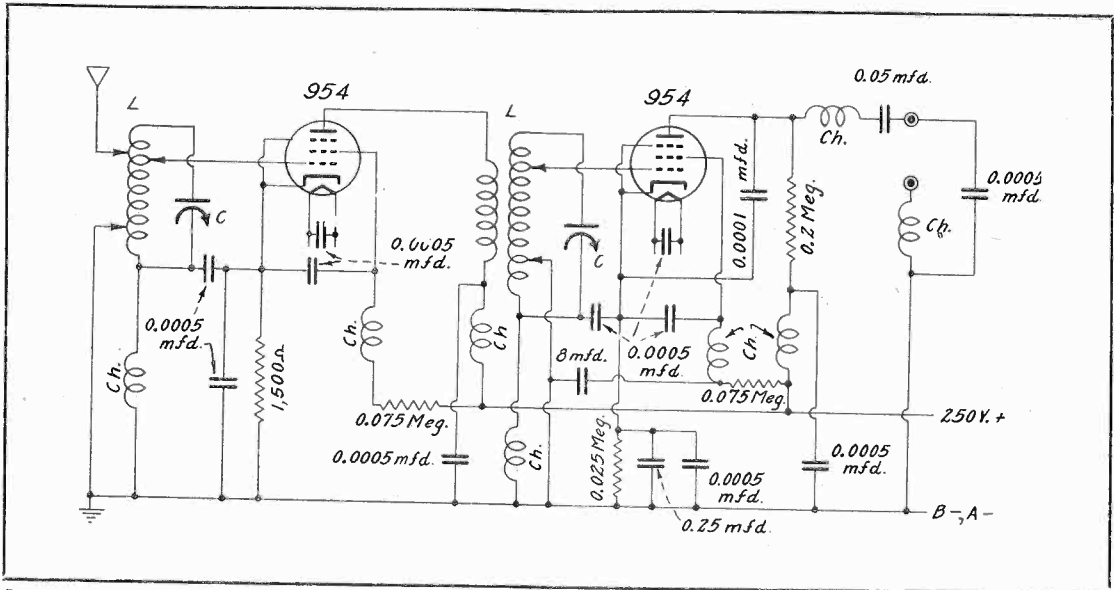

Receiving circuit design for use of the 954 acorn pentode tube. There are a stage of tuned r.f., gain of 4 or so, and a detector. Operation on wavelengths from 0.7 to 5 meters is intended, depending on the capacity of the two condensers, C_1 and the inductances. Winding data for the coils are given in the text. Tuning condenser shafts should be united to dial with insulated coupling rods, as the rotors are not at ground potential.

The radio frequency amplifier is shown biased as the result of plate-screen-suppressor current through 600 ohms. This resistance value may be reduced safely, if resultant gain warrants the change. In fact, some circuit designs show this stage without any bias at all, grid returned through the choke directly to grounded cathode. Such method is presumably based on the small necessity for bias when the input is a voltage extremely minute, as it would be in practice.

The antenna dimensions will depend on the frequency or wavelength range on which one works, and while it is true that reception is obtained even with long antennas, it is advisable to use an antenna system more closely suited to the wavelength of operation. A given antenna may be adapted to satisfactory service in this respect by the use of a small capacity between antenna and the slider shown connected to antenna. Even for the highest wavelength, 5 meters, a capacity of a few micromicrofarads would be sufficient, whereas below 1 meter the required capacity is smaller than that of the minimum capacity of commercially obtainable condensers. Therefore a condenser may be improvised, consisting of 1 inch square copper or aluminum pieces separated by the thickness of the insulating material used, which may be $\frac{3}{8}$ inch. The plate area may be reduced experimentally.

Pentodes for audio or detecting uses are subject to experiment until the tube circuiting, voltageing and loading have been standardized in practice. There has always been a disagreement as to the screen voltageing of a pentode for detecting or audio amplification. One school states that the screen voltage should be lower than the plate voltage from the viewpoint of effective values. The other side regards the applied voltages as controlling. The circuit follows the applied voltage method of reasoning, due to higher sensitivity developed from other pentodes when the effective screen voltage exceeded the effective plane voltage. This condition naturally obtains in the present instance because the effective plate voltage is dropped through a load of 0.2 meg., while the screen limiting resistor is only 75,000 ohms, with the current about one-third that of the plate circuit.

The actual plate circuit loading is reduced by the earphones intended to be connected to the two posts at right. Taking phones as found, their impedance could not be too high. Crystal phones are of high impedance and more nearly suit the requirements. They should have an 0.05 mfd. condenser in series, but this is included in the circuit diagram.

A test of the phone suitability may be provided by using the tube as a triode instead of as a pentode. Then the suppressor, screen and plate would be united. There would be more volume if the matching is better.

Lest the phones acquire a sensitivity to body capacity, the two chokes are used in series with the leads to the phone posts, and also any remaining radio frequencies are bypassed around the phones by the 0.0005 mfd. condenser at right.

Coil Data for Ultra Frequencies

2³/₄ to 5¹/₄ Meters

Inductance

L = 10 turns No. 16 bare copper solid wire wound on ³/₈ inch outside diameter, winding length ³/₄ inch.

Ch = 15 turns No. 30 insulated copper wire, wound on ¹/₄ inch outside diameter.

Capacity

C = variable condenser, 25 mmfd. maximum, extremely low minimum (about 3 mmfd.)

1 to 3 Meters

Inductance

L = 4 turns No. 16 bare copper solid wire wound on ³/₈ inch outside diameter, winding length ⁵/₁₆ inch.

Ch = same as for 2³/₄ to 5¹/₄ meters.

Capacity

C = Same as for 2³/₄ to 5¹/₄ meters.

0.8 Meter Range

Inductance

L = 5 turns No. 30 bare copper solid wire wound on ³/₈ inch outside diameter, winding length ¹/₈ inch.

Ch = same as for 2³/₄ to 5¹/₄ meters.

Capacity

C = 3 to 4 mmfd.

The coils all are single layer wound solenoids.

(Continued from page 37)

shield baffle mentioned in the listing of the interelectrode capacities.

Because of its small physical size, the small capacities of its elements, the short leads possible and the ease with which the tube may be applied to locations in a set not accessible to larger apparatus, the 954 may be used as a short probe vacuum tube voltmeter.

The 954, as well as the 955, should not be worked under conditions that exceed the plate current specifications for the stated application of positive voltages.

In the generation of oscillations, since either tube may be used as oscillator, a certain condition will develop an increase of plate current with the starting and rising of oscillation, with a temptation to make the output as large as possible, and thus run up the plate current. Such operation very seriously shortens the life of the tube.

How to Make Triode Connections

The use of a leak biased oscillator results in a reduction of plate current as the oscillation amplitude rises, but during the inoperative part of the alternation, or before oscillation starts, or rises sufficiently, the bias is from zero to some negative amount that may be too small for safety, which may account for absence of official data on use of the grid leak with this tube. As an oscillator the triode connection is practical, whereby the plate, suppressor and screen are tied together.

The presence of a high load resistor, as in a detector circuit with audio output, limits the plate current, but in oscillators for transmission

purposes there is no such high limiting device, and the plate current precautions should be observed strictly.

Eighth and Ninth Metal Tubes

Of the metal shell tubes, six were announced at once, the seventh about a month later, and now two more are announced, totalling nine of the originally intended complement of ten. So data on one more such tube are to be expected soon.

This tenth tube will be the 6F5, a high mu triode amplifier. Rating and characteristics will be: heater voltage, 6.3 volts, a.c. or d.c.; heater current, 0.3 ampere; plate voltage, 250 volts maximum; grid voltage, minus 2; plate current, 0.9 milliamperes, amplification factor,

(Continued on next page)

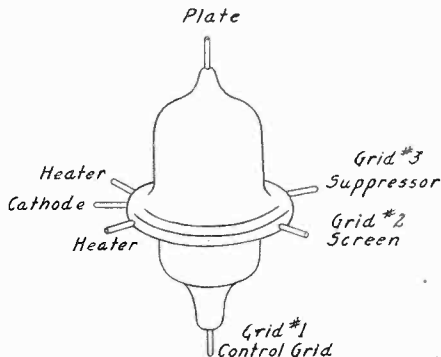

The location of the terminals of the 954. The tube is shown actual size.

(Continued from preceding page)
66,000; and the mutual conductance, 1,500 micromhos.

The six tubes were 6C5 detector amplifier triode; 6D5 power amplifier triode; 6H6 twin diode; 6J7 triple grid detector amplifier; 6K7 triple grid super control amplifier and 6A8 pentagrid converter. The data appeared in the May issue. The seventh tube was the 6L7 pentagrid mixer amplifier, described in the June issue.

The question will arise what is the difference between the 6A8 pentagrid converter and the 6L7 pentagrid mixer amplifier. The 6A8 is along the lines of the familiar pentagrid converter tubes, as represented by the 6A7 and 2A7, whereas the 6L7 is designed with two separate control grids shielded from each other; this design permits each control grid to act

Tentative Ratings and Characteristics of the 954

Heater voltage (a.c. or d.c.)..... 6.3 volts
Heater current0.15 ampere

Interelectrode Capacities

Control grid-plate (with shield baffle)0.007 mmfd. maximum
Control grid-cathode....3 mmfd.
Plate-cathode3 mmfd.

Amplifier, Class A

D.c. plate voltage.....250 volts maximum
D.c. suppressor voltage....100 volts maximum
D.c. screen voltage.....100 volts maximum

Typical Operation

90 Volt Supply

D.c. plate voltage.....90
D.c. screen voltage.....90
D.c. control grid voltage.....minus 3
Suppressor to cathode
Amplification factor.....1,100
Plate resistance.....1 meg.
Mutual conductance.....1,100 micromhos
Plate current.....1.2 milliamperes
Screen current.....0.5 milliampere

250 Volt Supply

D.c. plate voltage.....250 volts
D.c. screen voltage.....100 volts
D.c. control grid voltage.....minus 3
Suppressor to cathode
Amplification factor.....plus 2,000
Plate resistance.....plus 1.5 meg.
Mutual conductance.....1,400 micromhos
Plate current.....2 milliamperes
Screen current.....0.7 milliampere

Detector

D.c. plate voltage.....250 volts maximum
D.c. suppressor voltage....100 volts maximum
D.c. screen voltage.....100 volts maximum
D.c. control grid voltage.....minus 6 volts
Suppressor to cathode
Plate load....0.25 meg. or equivalent impedance
Plate current adjusted to 0.1 milliampere with no input signal.

independently on the electron stream. Thus the tube may be used as a mixer in superheterodyne circuits having a separate oscillator tube, as well as in other applications of dual control in a single stage. Such another application would be as a phase inverter, to introduce push pull without transformer.

The eighth and ninth tubes are the 6F6 power amplifier pentode and the 5Z4 rectifier. Since the 6F6 has characteristics of the 42 it also has the same characteristics as the 2A5, except that the heater voltage is 6.3 volts, whereas the 2A5 takes only 2.5 volts, though the heater current of the 2A5 is larger.

The metal shell tubes all take the same socket, called an octal socket because of the eight holes, but only so many tube pins are brought out of the tube base as are required. In this way the universal socket is applicable. The pin numbering system has been rearranged, as stated in the June issue, so that the numbers 1, 2, 3, 5, 7 and 8 always appear. Considering bottom view of socket, with key toward you, No. 1 is to the left of the key and always represents the shell. The rotation is clockwise in ascending order. No. 2 is a heater, No. 3 is a plate, No. 5 is a grid (excepting for rectifiers), No. 7 is a heater, No. 8 is a cathode. Thus the 8 pin tube uses all the numbers, the 7 pin omits number 6 and the six omits 4 and 6. It should be remembered that No. 1 is not an element but the metal shell.

Metal Type Tubes in Glass Envelopes

One tube manufacturer has developed and marketed a new line of tubes, designated as the "G" series, which is identical in electrical characteristics and pin connections to the all-metal tubes but is of the glass envelope type. It is stated that several of the larger set manufacturers and many smaller ones have already developed circuits employing these new "G" tubes. Early announcement of some of these radio receivers is expected.

Carrying the same type numbers as do the all-metal tubes, the letter "G" is suffixed to denote the glass envelope type. The "G" line follows conventional tube manufacturing processes.

As announced to date "G" line comprises the following types:

6A8G—pentagrid converter
6C5G—detector-amplifier triode
6D5G—power output triode
6F5G—high-mu triode
6F6G—power output pentode
6H6G—double diode
6J7G—detector-amplifier triple grid
6K7G—super control-amplifier triple grid
6L7G—pentagrid-mixer-amplifier
5Y3 —full wave rectifier (Interchangeable with 5Z4)

These tubes are directly interchangeable with corresponding type numbers of metal tubes.

An Experimenter's Super

Changes in Four Years Brought Circuit to Form Shown

By S. G. Bradley

THE subsequent diagrams represent the present form of a ten-tube set, originally built along different lines four years ago, and changed from time to time, as new tubes came out and new facts were ascertained. The main object of showing the circuit now is that others who may have experienced some of the troubles to be mentioned might apply the remedies.

There are three tuned stages at the radio frequency level and a tuned oscillator, accounting for the four-gang condenser. Some trouble was experienced as to oscillation at the r. f. level, remedied by using shielded wire from coils to overhead grids of the r. f. amplifier tubes and control grid of the mixer (pentagrid converter). The sheath was grounded to a metal lug held to the can by a short self-tapping screw. Raising the cathode bypass condensers from their previous value of 0.006 to 0.1 mfd. aided this. If after the same remedies are applied there is still some oscillation, say from 1,300 kc up, then increasing the screen series resistors from 0.075 meg. to 0.1 or 0.15 meg. will stop the trouble.

Removal of Undesired Oscillation

Also, since there are two intermediate frequency amplifiers in this superheterodyne, three i. f. coils, oscillation was plentiful at this level until screen and plate leads were filtered with high inductance chokes and relatively large condensers (10 millihenries and 0.05 mfd.), but these took up a lot of room, which had not been provided for, so the appearance was messy. It was easier and just as effective to use large condensers across the cathode biasing resistors, 2 mfd. paper type, and introduce a series resistor in the B feed common to the r. f. and i. f. tubes. The r. f. chokes and condensers effectively across them were omitted under the new circumstances. The series resistance is shown as 5,000 ohms, 3 watts, but normally 5 watts is a more readily procurable rating, and of course may be used to advantage. Any remnant of oscillation, as recurrence of the nuisance only occasionally, perhaps dependent on the line voltage, may be removed by increasing the cathode biasing resistors to 500 or 600 ohms, for the two i. f. tubes shown as having 300 ohms. The whole receiver is stable, built according to the diagram, and although the layout of parts is not critical, some attempts to build such a set may cause oscillation to arise, and the extra remedies are mentioned for that reason only.

The intermediate frequency is 175 kc, as that

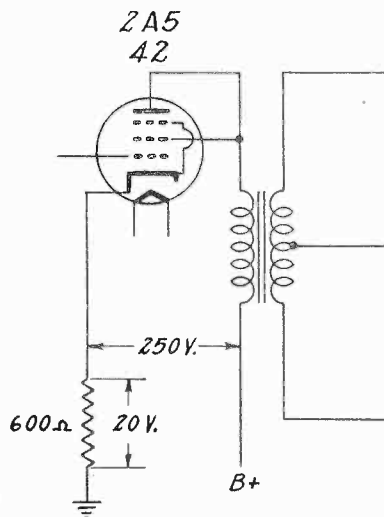

For supply of sufficient power to the grids of the output tubes for maximum realization of output the driver may be a 2A5 or 42 used as a triode as shown. The B plus designation represents the left-hand side of the 5,000 ohm series B resistor in the large diagram. The bias should be sufficient to limit the plate current to 33 milliamperes or a bit less.

is preferable to 456 or 465 kc or any frequency higher than 175 kc, for standard broadcast band use. The selectivity is greater, so is the gain. So great was the gain that the diode biased triode of the combination first audio tube could not be used that way, the signal would be cut off by the excessive bias, so cathode bias was introduced, with about 10 volts drop across the biasing resistor.

Two Diode Plates Used Separately

One of the diode plates of the 2B7 was used for detection proper, the other for automatic volume control voltage supply. The resistor load for a. v. c. gets its a. c. signal voltage from the plate of the second i. f. tube, representing a compromise between too much and too little a. v. c. The circuit is referred back to the modulator tube and the two intermediate frequency amplifier tubes for a. v. c. action.

It was not found of any particular advantage to supply a. v. c. to the first and second r. f.

(Continued on next page)

(Continued from preceding page)

tubes, there being evidence of reduced sensitivity without anything like comparable control. However, inclusion of a v. c. on the control grid of the pentagrid converter is a distinct advantage, assuring quieter and smoother reception, and giving a good ratio of control to sensitivity reduction.

It must be realized that all a. v. c. is at the expense of sensitivity, but that there would be more sensitivity than one could use with pleasure if a. v. c. were omitted, and besides a. v. c. has distinct advantages.

The second detector tube was at first a 55, and this worked well. The 2.5 volt series tubes were used throughout, but the 6.3 volt series may be substituted if the correct secondary voltage is fed to their heaters. A 2B7 was tried in its conventional form, the amplifier as a pentode, but the circuit was too powerful for the pentode section or first audio amplifier, and a triode obviously was needed, for the higher negative bias that could be wisely introduced. Perhaps it was sheer laziness that prompted one not to change the socket and wiring again, to permit reintroduction of the 55, so the screen of the 2B7 was tied to the plate to form the triode. Without making any measurements the author came to the conclusion that this setup worked better, especially with 0.5 meg. plate load, than any combination that had been tried with the 55. This might have been imagination, but imagination contributes to enjoyment no less than does reality.

T Pad Used for Volume Control

Of no technical consequence was the confinement of the volume control to a single unit. Sometimes gain is controlled at two levels, and for wide bands of frequencies covered this has advantages. For the broadcast band alone the single unit serves the present purpose. In reality, a five and a half year old son had difficulty with the controls when there were two for volume, to one of which we had the on-off switch attached. It so happened one turned one way to increase volume and the other turned the

opposite way to the same effect, wiring affecting these having been done late one night when the author was tired and sleepy. So unified control of volume and line switching was instituted.

It had been noticed, though not by the junior member of the family, that at low volume settings the low notes were attenuated when the usual potentiometer was used. It made small difference what was the value of the potentiometer, 0.1 meg. to 2 meg., the result was the same. So a T pad was substituted. This presents what is called a constant impedance to the grid circuit, no matter what the setting, although of course the volume is different, depending on how much of the detected voltage is taken off. The two resistors have equal curves with opposite signs, the amount of resistance actually in use being the same independent of setting. Since it is the lowering of the resistance in the grid circuit that removes the sufficiency of impedance to low frequencies, the reason why the remedy worked is apparent. The pad may be of 0.5 meg., but should not be higher than 1 meg. The self-capacity is sufficient to warrant the omission of a bypass condenser here.

Driving the Output Stage

The second detector feeds the driver, and the driver, as its name implies, drives the output tubes. It is practical to use instead of the 76 or 56 a 42 or 2A5 as triode driver. The smaller tube will swing the output, especially as the negative bias is only around 30 volts on the output tubes. The power output above usual Class AB arises from an increased B voltage. Instead of 350 volts between cathode and B plus, 370 volts were used, the extra 30 to constitute the 400 noted on the diagram being devoted to bias. The output is about 18 watts, which is more than sufficient even for proudest demonstrations.

Originally 2A3 push pull output was used, the B voltage a bit less than now specified, and the output rating 12 watts under these conditions, with self-bias. Now, self-bias is used on the 2A5's as triodes, and the input transformer has only little better than 1 to 1.3 ratio, primary to half of secondary.

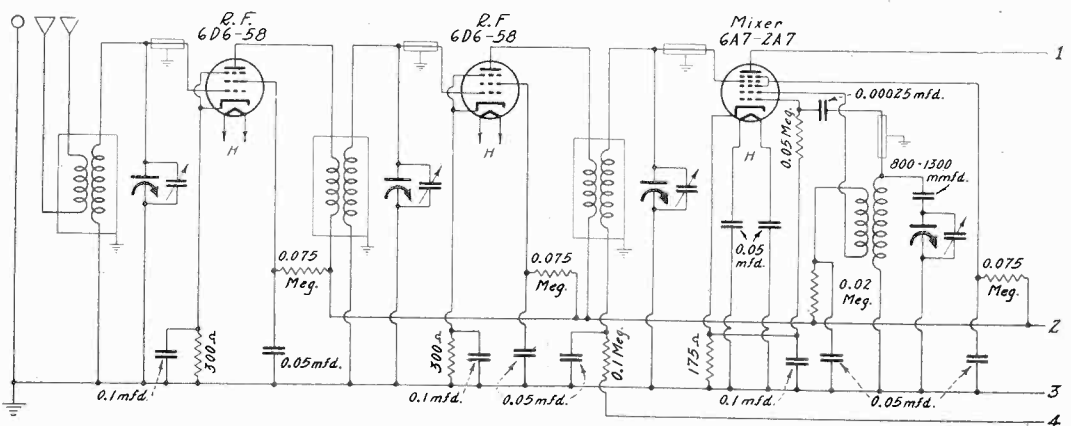

The selector circuit, through the mixer. A four gang condenser is used, so there are two stages of t. r. f. tuned input to the modulator, and tuned oscillator. In this way the image suppression is of a very high order.

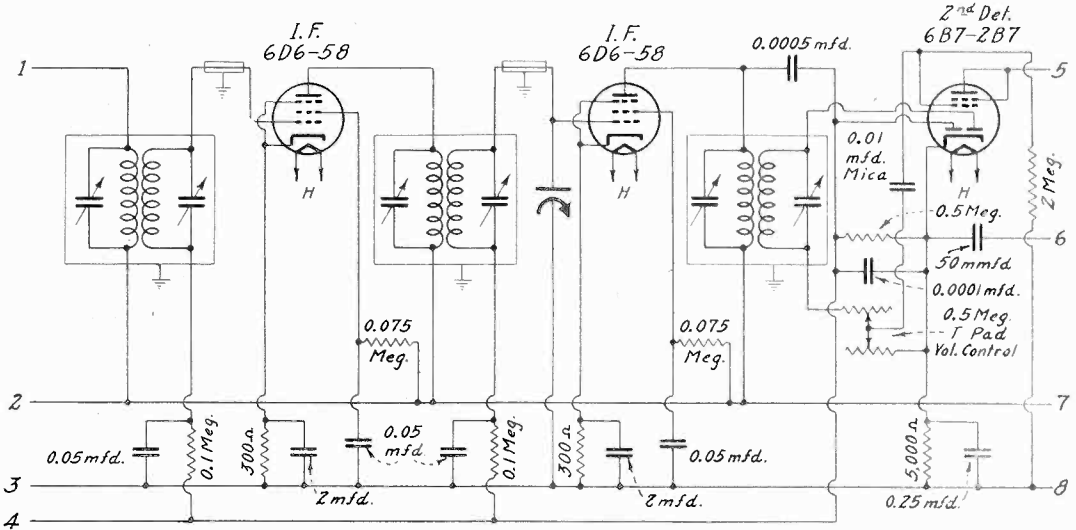

This is the intermediate amplifier, through the second detector, and part of the first audio stage, since the pentode of the 2B7 or 6B7, used as a triode, is in the same envelope as the diode detector. Separation rectification is used for a.v.c. and for second detection, hence each diode plate is used independently.

There may be a little grid current on strong passages, and even when the effective bias (self-bias compared to signal amplitude) is negative. This grid current may be due to suppressor space charge. The ratio of the transformer is therefore kept low because it is not required that voltage be built up considerably, but preferable to have a low d.c. resistance in the power tube grid circuit. The driver will supply some power for the final grid when there is direct current flowing in that circuit.

Any power demands made on the driver by the grid circuit of the push-pull stage must be small for the diagrammed condition, due to the resistor in the driver plate leg. However, there is no sense in 18 watt operation, or anything like it, in a home, except for dancing, and then

in a much larger room than found in most homes. For full attainment the 2A5 or 42 as triode then may serve as driver without the plate load resistor.

The speaker field used had a resistance of 1,200 ohms, but fields of other resistance values may be used. The load resistance of the speaker (to a.c. voltages) was 8,000 ohms, plate to plate.

The input to the set provides for use of a doublet antenna, suggested in the diagram, or a Marconi antenna, by connecting one of the primary posts to the ground post that adjoins it. Actually, the doublet was used because it happened to be there, and the pickup was not nearly as great as from a Marconi aerial, also available.

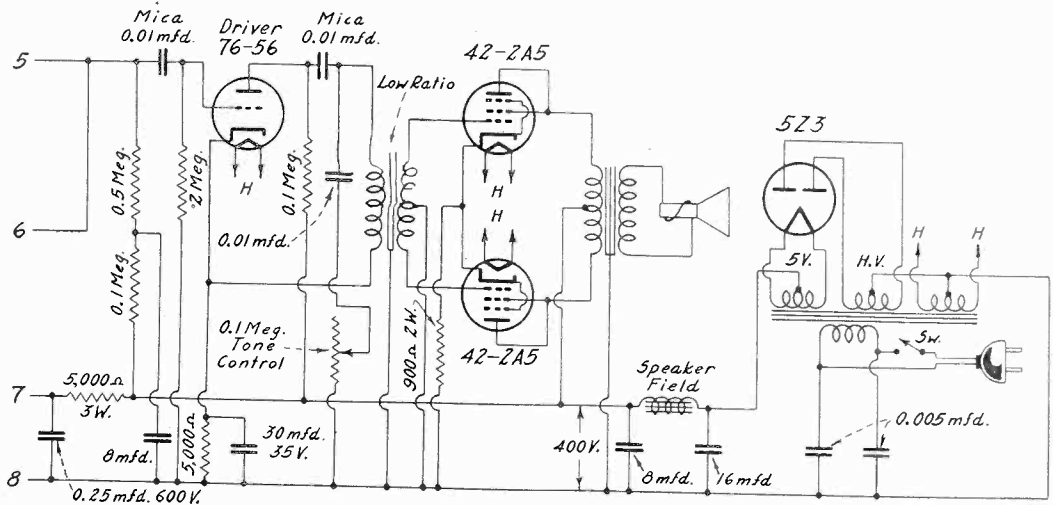

Second audio, which is the driver, push pull output and the rectifier of the stepped up line voltage. The numbers at left correspond to those at right in the previous diagram, and the same correspondence of numbers to connections prevailed between mixer output and i.f. input.

(Continued from preceding page)

tubes, there being evidence of reduced sensitivity without anything like comparable control. However, inclusion of a v. c. on the control grid of the pentagrid converter is a distinct advantage, assuring quieter and smoother reception, and giving a good ratio of control to sensitivity reduction.

It must be realized that all a. v. c. is at the expense of sensitivity, but that there would be more sensitivity than one could use with pleasure if a. v. c. were omitted, and besides a. v. c. has distinct advantages.

The second detector tube was at first a 55, and this worked well. The 2.5 volt series tubes were used throughout, but the 6.3 volt series may be substituted if the correct secondary voltage is fed to their heaters. A 2B7 was tried in its conventional form, the amplifier as a pentode, but the circuit was too powerful for the pentode section or first audio amplifier, and a triode obviously was needed, for the higher negative bias that could be wisely introduced. Perhaps it was sheer laziness that prompted one not to change the socket and wiring again, to permit reintroduction of the 55, so the screen of the 2B7 was tied to the plate to form the triode. Without making any measurements the author came to the conclusion that this setup worked better, especially with 0.5 meg. plate load, than any combination that had been tried with the 55. This might have been imagination, but imagination contributes to enjoyment no less than does reality.

T Pad Used for Volume Control

Of no technical consequence was the confinement of the volume control to a single unit. Sometimes gain is controlled at two levels, and for wide bands of frequencies covered this has advantages. For the broadcast band alone the single unit serves the present purpose. In reality, a five and a half year old son had difficulty with the controls when there were two for volume, to one of which we had the on-off switch attached. It so happened one turned one way to increase volume and the other turned the

opposite way to the same effect, wiring affecting these having been done late one night when the author was tired and sleepy. So unified control of volume and line switching was instituted.

It had been noticed, though not by the junior member of the family, that at low volume settings the low notes were attenuated when the usual potentiometer was used. It made small difference what was the value of the potentiometer, 0.1 meg. to 2 meg., the result was the same. So a T pad was substituted. This presents what is called a constant impedance to the grid circuit, no matter what the setting, although of course the volume is different, depending on how much of the detected voltage is taken off. The two resistors have equal curves with opposite signs, the amount of resistance actually in use being the same independent of setting. Since it is the lowering of the resistance in the grid circuit that removes the sufficiency of impedance to low frequencies, the reason why the remedy worked is apparent. The pad may be of 0.5 meg., but should not be higher than 1 meg. The self-capacity is sufficient to warrant the omission of a bypass condenser here.

Driving the Output Stage

The second detector feeds the driver, and the driver, as its name implies, drives the output tubes. It is practical to use instead of the 76 or 56 a 42 or 2A5 as triode driver. The smaller tube will swing the output, especially as the negative bias is only around 30 volts on the output tubes. The power output above usual Class AB arises from an increased B voltage. Instead of 350 volts between cathode and B plus, 370 volts were used, the extra 30 to constitute the 400 noted on the diagram being devoted to bias. The output is about 18 watts, which is more than sufficient even for proudest demonstrations.

Originally 2A3 push pull output was used, the B voltage a bit less than now specified, and the output rating 12 watts under these conditions, with self-bias. Now, self-bias is used on the 2A5's as triodes, and the input transformer has only little better than 1 to 1.3 ratio, primary to half of secondary.

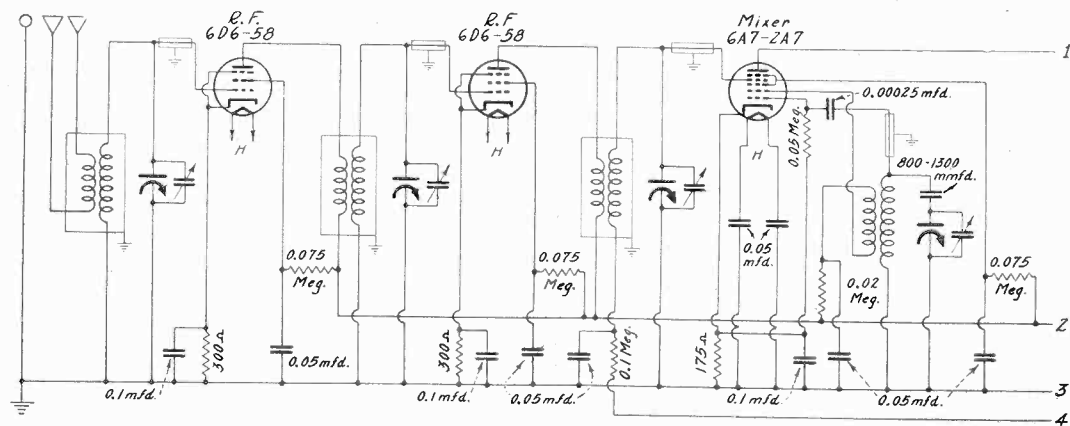

The selector circuit, through the mixer. A four gang condenser is used, so there are two stages of t. r. f. tuned input to the modulator, and tuned oscillator. In this way the image suppression is of a very high order.

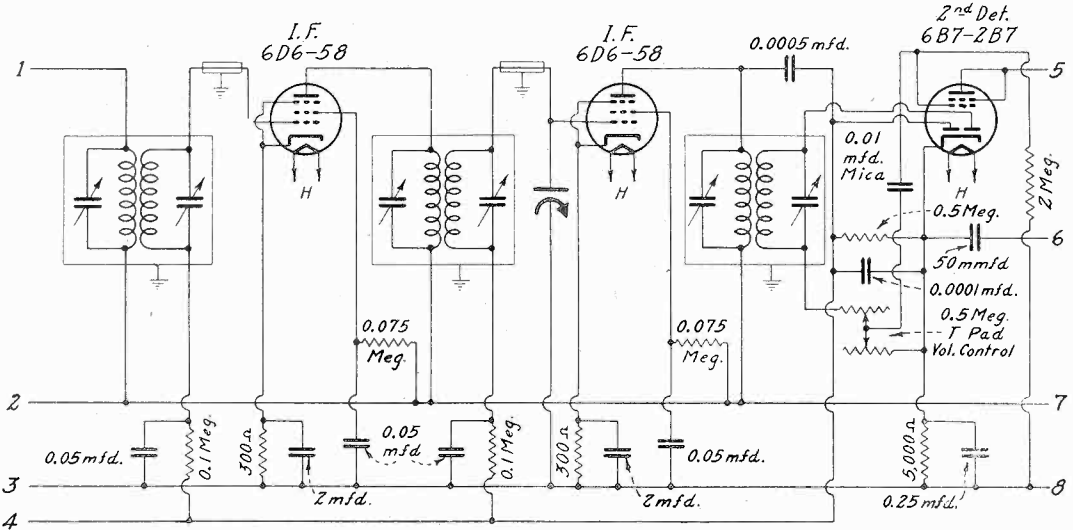

This is the intermediate amplifier, through the second detector, and part of the first audio stage, since the pentode of the 2B7 or 6B7, used as a triode, is in the same envelope as the diode detector. Separation rectification is used for a.v.c. and for second detection, hence each diode plate is used independently.

There may be a little grid current on strong passages, and even when the effective bias (self-bias compared to signal amplitude) is negative. This grid current may be due to suppressor space charge. The ratio of the transformer is therefore kept low because it is not required that voltage be built up considerably, but preferable to have a low d. c. resistance in the power tube grid circuit. The driver will supply some power for the final grid when there is direct current flowing in that circuit.

Any power demands made on the driver by the grid circuit of the push-pull stage must be small for the diagrammed condition, due to the resistor in the driver plate leg. However, there is no sense in 18 watt operation, or anything like it, in a home, except for dancing, and then

in a much larger room than found in most homes. For full attainment the 2A5 or 42 as triode then may serve as driver without the plate load resistor.

The speaker field used had a resistance of 1,200 ohms, but fields of other resistance values may be used. The load resistance of the speaker (to a.c. voltages) was 8,000 ohms, plate to plate.

The input to the set provides for use of a doublet antenna, suggested in the diagram, or a Marconi antenna, by connecting one of the primary posts to the ground post that adjoins it. Actually, the doublet was used because it happened to be there, and the pickup was not nearly as great as from a Marconi aerial, also available.

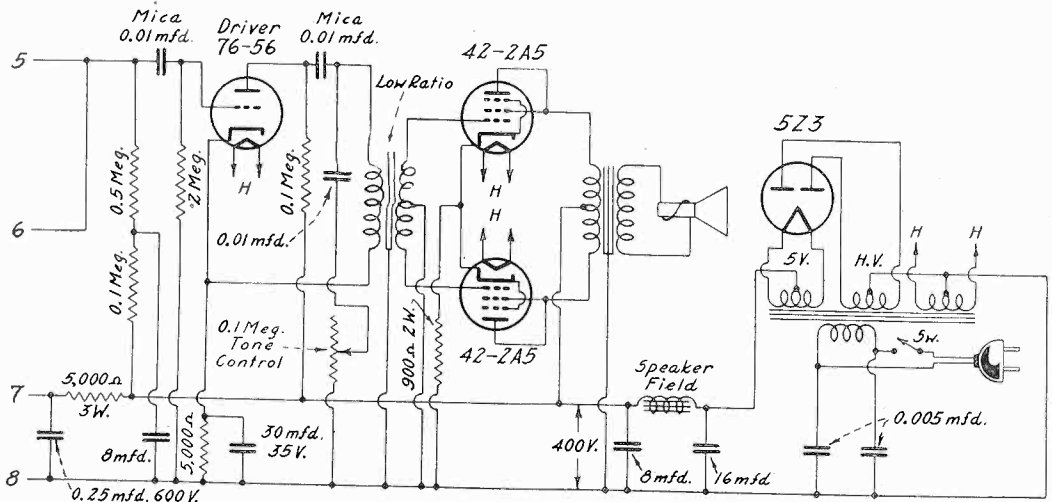

Second audio, which is the driver, push pull output and the rectifier of the stepped up line voltage. The numbers at left correspond to those at right in the previous diagram, and the same correspondence of numbers to connections prevailed between mixer output and i. f. input.

HIGH FIDELITY R. F. TUNER

*By
Sylvan
Webb*

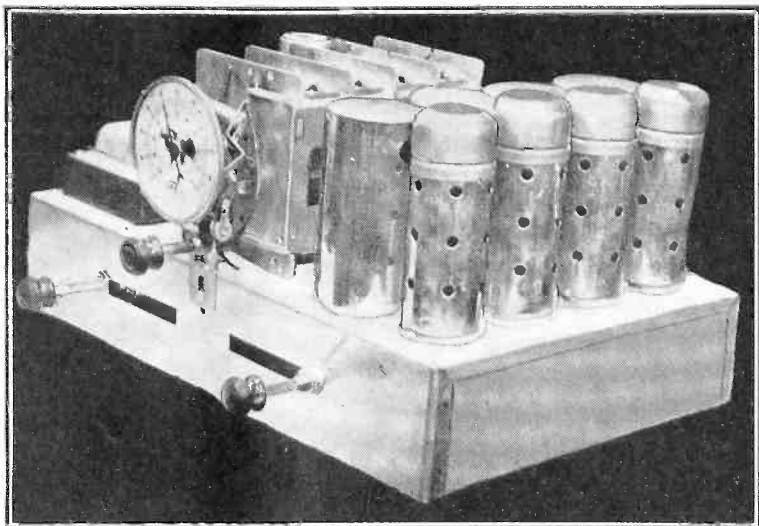

THE simplest way to safeguard against too much selectivity is to use a tuned radio frequency set, whereupon the full modulation band width is readily passed, and amplified signal should be fed to a linear detector. Then one has the password to high fidelity with minimum of effort and expense. Of course the audio amplifier, the power output and the speaker have to be in line with high fidelity requirements, for it is, if anything, easier to sacrifice the tonal value at the audio level than at the radio frequency level in a t.r.f. set, because the r.f. is protected.

The tuning considerations prompted the selection of the circuit shown in the diagram for use with a splendid audio amplifier and power output system. It will be noted that the line feed to the power amplifier is to be plugged into a receptacle, so that the on-off switch that controls the receiver proper also actuates the amplifier the same way.

Nonoverloadable Detector

There is practically no possibility of overloading the detector, and that is an important consideration. The 56 or 76 tube is used, depending on whether 2.5 volt or 6.3 volt heater supply is at hand, but the grid is tied to the plate, and the tube is thus used as a diode. It will stand an input up to 100 volts, though nothing like this voltage will be attained. Conservatism prompts one to be on the ultra-safe side. Putting the load resistor of 250,000 ohms in the negative leg permits grounding of the tuning condenser.

The two posts marked "phono" should have a shorting strap across them if no phonograph pickup is being used, and when the pickup is to be put in service the strap is removed and the pickup terminal plugs connected to the posts.

Coils used are of the high gain type. The antenna winding is a spaced primary, the plate loads are high impedance choke coils, built into

the coil unit, while a turn or so of wire over the secondary, put on somewhat as an ordinary primary would be, is used for the capacity effect to produce coupling. The choke coils in the plate circuit are so placed as not to be inductively related to the secondary.

In this way the selectivity is upheld, although the gain is high. The chokes as used provide a better result than if they were inductively coupled to the secondaries.

Gain Safeguarded by Filters

It can be seen that the r.f. filtration has been carried out in good style. The reason is that in the desire to press the gain to as great a height as practical, especially so that the high wavelength stations come in strong, the voltages are used at standard maximum, from which, with high gain, instability arises if proper filtration is omitted.

Nevertheless it was found advisable in using a bias-adjusting type of volume control to add the feature of cutting down the input at the same time that the amplification is reduced. The diagram shows this in connection with the 10,000 ohm potentiometer.

Even though one has a high fidelity tuner, he may want to use a tone control, for instance if there is a static, the tone control reduces the interference more than it does the signal. Also, many persons like to have the low notes accentuated when an orchestra is playing, and this the tone control accomplishes, as it is of the type that reduces the high audio frequencies.

How B Voltage Is Reduced

The B voltage from the usual transformer would be too high, so the 3,500 ohms resistor is used in series. It may be 2 watts rating or more. With the capacities shown on the diagram the voltage will be just about right, 230 to 250 volts, the small condenser next to the

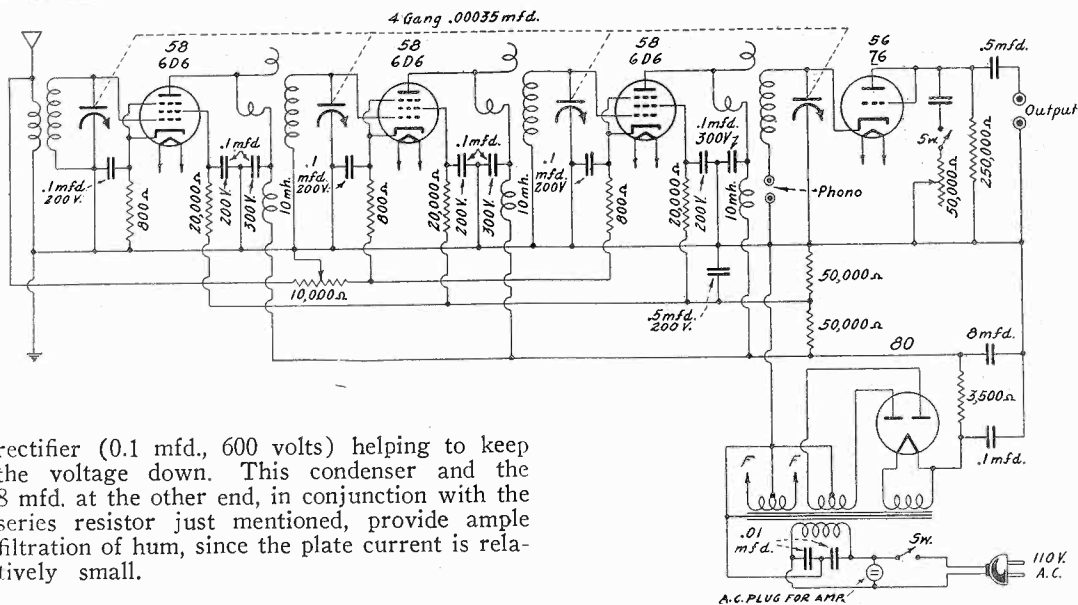

rectifier (0.1 mfd., 600 volts) helping to keep the voltage down. This condenser and the 8 mfd. at the other end, in conjunction with the series resistor just mentioned, provide ample filtration of hum, since the plate current is relatively small.

LIST OF PARTS

Coils

- One antenna coil and three high gain r.f. coils for 350 mmfd. tuning condenser (all in aluminum shields).
- Three 10 millihenry r.f. chokes.
- One power transformer.

Condensers

- One four gang 350 mmfd. tuning, with trimmers attached.
- Six 0.1 mfd. 200 volt.
- Three 0.1 mfd. 300 volt.
- One 0.1 mfd. 600 volt (next to rectifier).
- One 8 mfd. electrolytic.
- Two 0.5 mfd., 200 volt.
- Three 0.01 mfd. (one of them is in tone control circuit, value not imprinted in diagram).

Resistors

- Three 800 ohm.
- One 10,000 ohm potentiometer with switch.
- One 3,500 ohm, 2 watts.
- Three 20,000 ohm.
- Two 50,000 ohm.
- One 50,000 ohm potentiometer (used as rheostat), with switch.
- One 250,000 ohm.

Other Requirements

- One chassis.
- Antenna-ground, Phono and Output posts.
- Three grid clips.
- One dial.
- A.c. cable and plug.
- One a.c. socket for amplifier plug.
- Three six-hole sockets, one five-hole socket and one four-hole socket.
- Five tubes: either three 58's, one 56 and one 80, or three 6D6, one 76 and one 80.
- Three knobs.

TUNER SIMPLIFIED

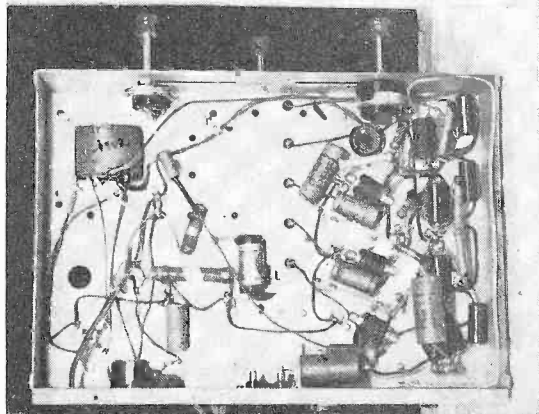
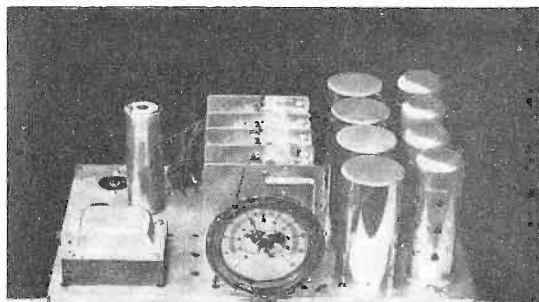

The circuit diagram shows both input and r.f. gain controlled by the volume adjuster. The condenser in the tone control circuit, above Sw, may be 0.01 mfd. The front and bottom views are at left.

Television on 6 Meters

More Power Means More Distance—Wave Angles Shift En Route and Rod Aerials are Tilted for Phasing

By Montgomery J. Arden

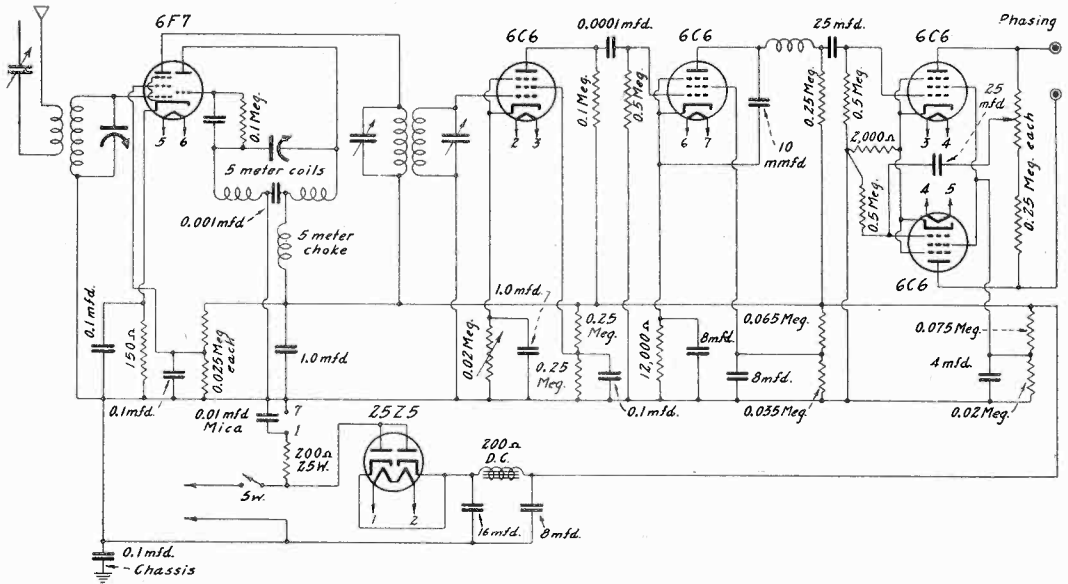

A television receiving circuit, even a superheterodyne for 6 meters, is not such a complicated affair as many would expect. The recommended order of connecting the heaters in this a.c.-d.c. set is given by following the numbers on heaters. No. 1 heater refers back to the 200 ohm resistor next to the rectifier, No. 7 to B minus, directly above No. 1.

AFTER having investigated the six-meter experiments conducted by the field force of VE9AK, the new television station at Montreal, P. Q., Canada, it is apparent that book learning aids some, but practical experience provides most of the solution of laying down a strong signal over a long route.

The station has been operating experimentally on 100 watts and has been laying down a good signal up to 50 miles. There is a receiver in the studios in the Dominion Square Building, of which set the diagram herewith is a modified pattern, while the usual type of superregenerative hookup is used at present in field work, along the lines of the "taking" circuit of the transceivers used by amateurs. While the studio receiver is undoubtedly better, it being a special television superheterodyne, with intermediate frequency around 20 meters, the results obtained over the air are better than those obtained over special wires that feed the studio set.

Amateurs Enjoy Themselves

Amateurs have been listening to the signal and have been getting a great deal of fun out

of it, although all they hear is the typical buzz saw sound, and do not convert the video impulses into vision. This is due to lack of suitable reconversion system, but the amateurs' reports have been found helpful as a basis of judging distance covered and intensity of the signal over definite periods.

Power Stepped Up

The power has been used at various levels up to 100 watts and each time it was noted that the penetration was better as the power was increased appreciably. The engineers, headed by William Hoyt Peck, inventor of the mechanical-optical system used in transmission and reception, have put to a test the theory that the line of sight horizon limits the distance that may be covered, and also the theory that waves of that frequency spectrum are obstructed by steel buildings that act as "shadows." More power has been found to be the solution in each instance, so that, speaking approximately, the distance may be increased perhaps to 150 miles with still more power, and any tendency of a

steel structure to detour or absorb the wave is readily overcome by the same simple remedy.

Power to Be 600 Watts

To get maximum power in a given direction, and have wave amplitude conditions uniform for proper antenna tilts over the full distance, beaming has been used extensively. In fact, one of the chief points of the entire experimental work at Montreal has been the accomplishment of most satisfactory beaming. This was done at first on 20 watts, with which the station started, and continued to the present 100 watts.

The power is to be increased soon to 600 watts. The result of that stepup will be checked carefully, as such power at 6 meters is unusual, and the outcome, under the conditions of careful study that prevail, may have wide scientific value.

By moving the condensing lens, C, nearer to the light source, X, the angle between X and the lens is made wider, and for a given size screen the illumination is increased. The upper example is that of more illumination. The dotted extension shows the increased size the picture could have by working at the greater angle, if the illumination on the screen were to be the same.

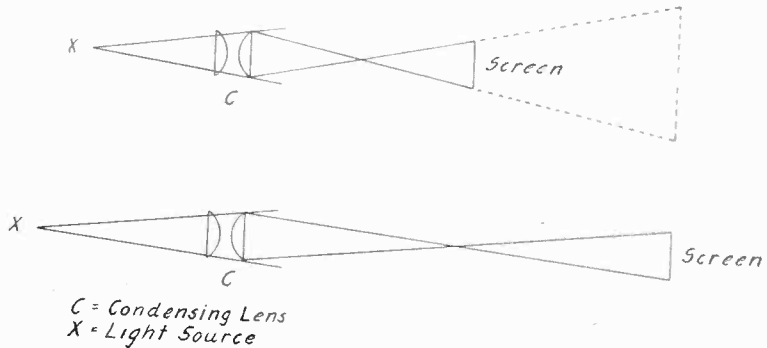

A Yogi antenna is used, which includes a transmission line of the Zepp type. The Zepp is a two-wire feed system with an ungrounded antenna, one of the wires being connected as lead-in from aerial to one side of antenna coupler's primary, the other wire to other coil terminal as a neutralizing agency, accomplished by setting the series condenser at a critical semi-critical value. The upper end of the neutralizing lead is simply stopped at an insulator near the lead-in feed of other wire at antenna.

No value for the series condenser is given in the diagram, as it would have to be determined experimentally anyway, but 50 mmfd. would be top, and since the condenser is adjustable, the correct value may be found experimentally. It is that value that makes the phase in one leg opposite to that in the other leg, so that there is no pickup by the two downcoming wires, in a receiving sense, or no radiation from them, in a transmitting sense.

Beamed Carrier

The polarization of the beam is vertical about the sending antenna, beaming being accomplished by spaced antennas of critical lengths, placed at critical distances from the half wave transmitting antenna.

As the wave progresses the plane of polar-

ization shifts, and for this reason the rod antennas used for receiving purposes should be tilted until the maximum signal strength is attained. The difference between an indifferent angulation of the receiving antenna and the correct angulation is exceedingly pronounced, something of the order of 10 to 1.

Some freaks are encountered, also, as when some losses exist in an antenna on the ground floor, but none of magnitude if antenna is moved to the second story.

Hence a rotatable type of antenna is used at key receiving points and it is believed that this type will be supplied when television sets are offered to the Canadian public.

Working on Television in Colors

The 60-line system is being retained during present experimental work. However, by the Peck system, while the number of reflecting lenses or lines limit the height to that of a 60-

line system, the optical coverage is such as to give a width to the spot equal to that of 120 lines. So the system as used may be regarded as a cross between 60 and 120 lines.

The next step to advance the scanning will be to 180 lines, expected to be on the air next year, with television in colors to follow. The color system is being worked up on the principle of rotating a beam of polarized light and bringing colored results "as easily as black and white," as one of the engineers expressed it.

Only one carrier would be used and there would be no change in the disc whatever, the color being reproduced as found in nature. It is probable that a bank of photo cells, of various sensitivities to different colors, would be used, although no official details of the system have been released yet. One point raised, however, is that the practicality of television in colors is known to exist for the mechanical scanning system with Kerr cell light modulation, whereas television in colors, using cathode ray tube for scanning, has no present known possibilities whatever. It is around the Kerr cell and particularly the capitalization of one of its vices, that the natural color possibilities exist, and there is no such device in the cathode ray system.

There is some feeling against cathode ray
(Continued on next page)

(Continued from preceding page)
television in circles where a mechanical system is being developed.

High Percentage Modulation

The modulation is now 85 to 90 per cent. and the total band width transmittable is 200 kc, of which 150 kc is being used now. Receivers of course are gaited to pass this band. It is reported that there is no distortion even up to 100 per cent. modulation, a fact attributable to a specially designed push pull transformer.

Stability of Frequency Achieved

A special type of long line oscillator has been developed and this is being used extensively, since it contributes frequency stability, and indeed its performance has been compared to that of crystal control (assuming lower frequency practice with crystals could be extended to the 6 meter band).

In this connection possibilities are seen for improvement of receivers, since many in use today for 5 and 6 meters pass not only a few hundred kilocycles but thousands of kilocycles, a necessary evil because the transmitters wob-

that some dealers complained that hints of impending practical television would hurt the sale of regular receivers. Plans have gone forward for the production of a set by a standard manufacturer in Canada that will tune in all waves, as usual, and be equipped for television, scanning device and all. Around Christmas it is expected that some department stores in Canada will have such demonstration television receivers.

Compares Picture to Home Movies

Mr. Peck is an outstanding optical expert, with wide experience on optical problems as consultant to the United States Government during the war, and later in connection with the movie industry, to which industry he contributed a colored movie system. He has devoted much attention to the aspects of light in television and lays down a picture that is regarded as having more illumination than others. The light source has been a 30 candlepower automobile lamp at the receiving end, but the light efficiency of the system has been improved, so that the 32 candlepower lamp, obtainable anywhere, may be used instead.

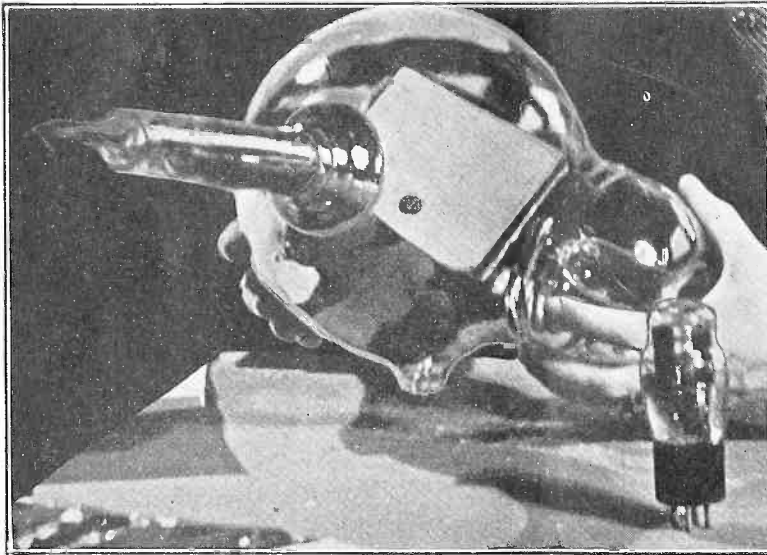

The electrical scanning system, using no moving parts, is the one on which RCA is working. The illustration shows the tube used for scanning the image at the transmitter. The tube is called the iconoscope, and it operates on the cathode ray oscilloscope principle, but instead of a fluorescent viewing screen it has a screen of millions of tiny photo cells. At the receiving end a large cathode ray tube of the more familiar type is used.

ble so much. With greater receiver selectivity the signal, set tuned to ordinary transmitter's wave, would come in and go out, due to the inconstancy of the oscillator tube at the transmitter.

With better stability at the transmitter, band widths for television are limitable to 200 kc outside, and there would be less congestion for a given number of stations on equally spaced frequencies, or no more congestion were the number of such stations increased and their carrier frequencies separated by 500 kc.

Move Made to Supply Sets

Peck Television of Canada, owner and operator of the station, reports 100 per cent. cooperation from the Canadian Government, but found

"We shall exhibit a 16-inch picture projected on a screen with as much definition as home movies," said Mr. Peck, "and so bright that it will be necessary to turn down the control, to reduce the illumination to a quantity comfortable to the eye."

More Light is Obtained

Mr. Peck then gave a private demonstration where the light on the screen showing the picture was so bright that the eye really was left without comfort, and then he turned a knob and the illumination was just right.

"In other words, this is the result that will be offered to the public?" he was asked.

But his only answer was a twinkle of the eye.

It was learned that the increased illumination, which observers who say they are impartial call surpassing, arises from working at a greater angle. The condensing lens is used closer to the light source, the illumination saved being according to the inverse square law of light. In the preceding diagram this principle is illustrated. Let X be the light source and C the condensing lens. The upper illustration shows the wider angle between the light source and the lens, compared to the lower illustration. For a given size screen, solid upright line in both instances, the illumination would be about four times as great in the upper example than in the lower, as the distance between screen and light source is about twice as great in one instance as in the other. Actually, Mr. Peck states that his present improvement yields three times as much light on the screen as he had before, the source being constant. For a given size picture, therefore, the illustration shows how the screen may be so much nearer the light source. If the same distance obtained, X to screen in both instances, as the elongation by the dotted lines suggests, the illumination would be the same for the upper example as for the lower, although the upper screen would be about four times the size of the lower, for the literal diagram, or three times the size of the lower by Mr. Peck's empirical case.

The Eye's Resolving Power

A 16-inch picture is generally regarded as acceptable, and the light values are established on the basis of such a standard. If the size were doubled the illumination would be reduced by 75 per cent. This is one factor holding down the size, another being the distance from the screen that the observer would have to sit, for a given number of lines or elements in a system, so that the picture lines would be within the resolving power of the eye. Mr. Peck does not believe there is any necessity for more than 180 lines, the comparisons between reproductions of 140 and 180 and 60 lines being made by most readers on the basis of a page held about 10 inches from the eye.

The 180-line picture, 18x24 inches, he points out, causes the lines to disappear at 9 feet 2 inches, and everybody could be at least that far from the screen.

Confidence Voiced In Final Television

By **W. R. G. Baker**

Vice President and General Manager, RCA-Victor Division, RCA Manufacturing Co., Inc.

Nobody knows how long it will take to iron out some of the deep wrinkles in television as we know it today. We have made a great deal of progress in our research laboratories during the past three years and we hope that the experience gained in field tests will enable us to determine more definitely the possibilities of television service with standards that will be acceptable to the American public. In the meantime there are innumerable problems, both technical and non-technical, that can only be solved through the operation of a controlled field test. We must study transmission and reception factors, we must design and redesign, build and rebuild apparatus, and we must evolve an entirely new broadcasting technique. While the difficulties are many, we are confident of the ultimate results.

WHEN IS A GROUND WAVE?

On low radio frequencies the ground wave is fairly strong, and for some broadcast transmissions there have been examples of suppressed sky wave resulting in reception in England of signals from America. This leads to the belief that the ground wave must have crossed the ocean. At ultra frequencies no attention is paid to the weak ground wave. The reflectors and directors are all for sky wave purposes, although the wave, if as close to ground at broadcast frequencies, might be referred to as ground wave. At the ultra frequencies there is no ionospheric reflection at all, and at no frequencies reflection of ground wave alonge, so maybe the term Heaviside-layerproof wave may come into use.

CORRECTION OF LEOTONE PRICE

The advertisement of Leotone Radio Company, 63 Dey Street, New York City, in the June issue, page 2, gave the prices of the kit for a short wave portable at \$9.25 including batteries. This was an error, as the batteries are not included at that price.

Surge Safeguard in Auto Rectifier

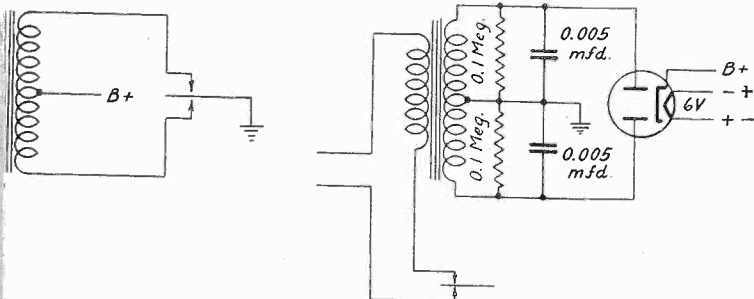

When a tube rectifier is substituted in an automobile set for a vibrator type, care must be taken that the surge voltage be controlled, and this is done by using condensers and resistors across each half of the secondary. The values imprinted on the diagram are typical.

A Small 3 Band Set

A.C. Model Covers 530 to 22,000 Kc

(Below 15 Meters) by Switching

By Maxwell M. Hauben

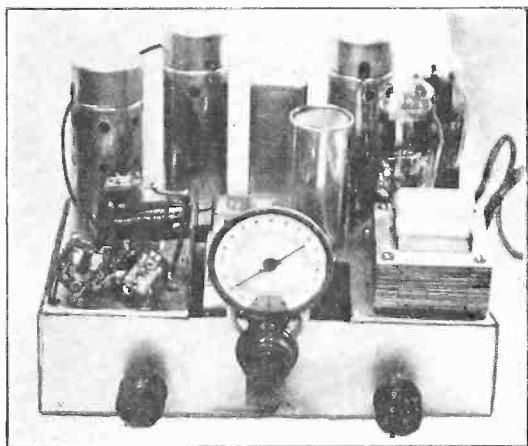

Some of the coils are atop the chassis, as front view shows.

THOSE desiring a small all wave a.c. set may build one according to the diagram, and if the intermediate channel is closely aligned, and the padding of the oscillator is done well, the performance will be satisfactory. For simplification of the coil switching problem, the modulator tuning is all that is done at the station carrier level. The performance on the broadcast and the intermediate short wave bands is improved in direction of extra selectivity by the presence of the antenna series condenser, while the unquestioned advisability of preselection for higher frequencies will be missed only occasionally. With tuning starting at 530 kc, and a frequency ratio of 3.5, the windup is well above 20 mc., or below 15 meters.

The mixer and the single intermediate amplifier are subjected to automatic volume control.

Why High Mu Tube Is Used

One object is to obtain as great gain as practical, consistent with other requirements. Automatic volume control has its now undisputed advantages, but these are at the expense of sensitivity. Therefore in a small set like this something has to be done in an attempt to atone for the sensitivity devoted to a.v.c.. In this instance the difference is made up by the use of a high mu amplifier, fed by the rectified voltage from the diode. The two diode plates, here used as one, and the high mu triode are in the same envelope. The tube is the 2A6.

As users of high mu tubes well know, the input is limited, because the bias can not be very high, therefore only so much of the rectified voltage in the diode load circuit is used as proved safe against overload of the audio system, as tested carefully on the workbench. Only 8.3 per cent. of the rectified voltage in the diode load is kept out of the audio amplifier this way, but it proved enough. The amount of a.v.c. used is subject to this reduction, too.

The high mu triode could be diode biased because the cathode is grounded, but it was found advisable to use semi-fixed bias, so that the plate current of the triode would not be cut off prematurely. There is no delay introduced, because the common circuit for a.v.c. therefore, ratification starts at once, there being no potential difference between cathode and its return, for the rectifier. The negative bias for the amplifier part of this tube, as explained, is obtained from the bleeder. The 50 ohm resistor to the lower right in the diagram furnishes this bias.

How to Line Up I. F. Channel

The output tube is a pentode for the enhanced sensitivity, and the power output is about 3 watts at 7 per cent. total harmonic distortion. Actually the total harmonic distortion present will be less in use, as receivers are worked in the home at nearer 1 watt output.

Lining up the intermediate amplifier must be done at exactly the specified frequency for the commercial coils that are to be used. The ones in the set as built were of commercial manufacture, and intended for an i.f. of 456 kc. This is a type of coil used generally by set manufacturers, and 456 kc is practically standard for them, the 465 kc i.f. being outstanding choice for construction from kits in the build-it-yourself market. The present instance is one of build-it-yourself, but using set manufacturers' type coils.

Lining up of the i.f. channel is best done with an accurate signal generator. The output of the generator is connected to the plate of the 58 i.f. tube and the grid tuning condenser adjusted first, the plate condenser next, in the coil feeding the diode.

Alignment Made Easier This Way

This procedure is suggested only because the i.f. coils may be so much out of line (not having been adjusted at all at the factory) that a signal generator of mild output might not give

a good indication if connected at first to plate of the 2A7. After the plate condenser of the second coil is adjusted it is not to be molested, not even later, when a final readjustment may be made of the grid tuning condenser in the same can. The one may be distinguished from the other because the plate condenser usually has accessible to a voltmeter the B voltage between this condenser and coil shield.

Where to Connect Meters

Next move the signal generator output to the plate of the 2A7 tube and tune the condenser across the grid winding of that coil. Next tune the plate condenser. This plate condenser also is not to be molested after once set for maximum response.

I.f. coils intended for 465 kc may be tuned to 456 kc.

Judgment of response may be on the aural basis (listening to speaker) if the signal generator is modulated. On the same basis an output meter may be used across the primary of the output transformer in the 2A5 circuit. A very low voltage a.c. meter may be used as output meter across the voice coil of the dynamic speaker. A neon tube may be put across primary of output transformer.

If the signal generator is unmodulated, a d.c. current meter may be placed in series with the return of the diode circuit, requiring a 0-1 milliammeter or sometimes even a more sensitive instrument. For this service the 500,000 ohm potentiometer's connection to ground is (Continued on next page)

LIST OF PARTS

Coils

- Three modulator coils and three oscillator coils.
- Two intermediate transformers (to be peaked at 456 kc).
- One power transformer.
- One dynamic speaker, output transformer built in, for 2A5 single tube, field 2,200 or 2,500 ohms.

Condensers

- One two gang 350 mmfd. condenser with trimmers built in.
- Two 100 mmfd. fixed, mica.
- Two 260-500 mmfd. padding.
- One 500 mmfd. fixed, mica.
- One 0.001 fixed, mica.
- One 0.002 fixed, mica.

- One 0.003 mfd. fixed.
- Two 0.02 mfd., 600 v.
- Two 8 mfd. electrolytic 450-600 v.
- Four 0.1 mfd., 200 v.
- One 0.1 mfd., 300 v.

Resistors

- One 50 ohm, 1 watt.
- Two 50,000 ohm.
- One 200 ohm.
- One 400 ohm, 2 watts.
- One 100,000 ohm.
- One 200,000 ohm.
- Two 500,000 ohm.
- One 500,000 ohm potentiometer, with switch.
- One 1 meg.
- [Half watt unless otherwise noted.]

Other Requirements

- One chassis.
- One dial with pilot lamp bracket.
- Two grid clips.
- Three knobs.
- One four pole, three throw coil switch.
- Antenna, ground binding post assembly.
- One phono output assembly (for pickup or phones).
- Sockets: one two four hole, two six hole, two seven hole. Extra four hole is for speaker plug.
- One pilot lamp, 2.5 v.
- Three tube shields (for 2A7, 58 and 2A6).
- Tubes: One 2A7, one 58, one 2A6, one 2A5, one 80.

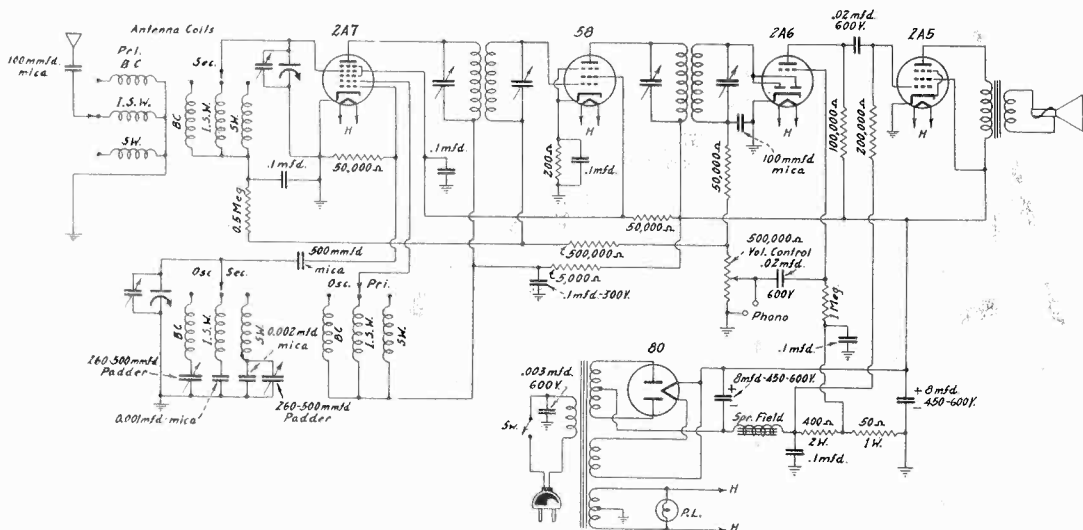

An economical, small three band set.

Coil Winding Directions for Three Band Set

The following directions are given for those who desire to wind their own coils. They do not follow the commercial type coils actually used in the set, which had some special types of winding not duplicatable except by machine. The oscillator secondary inductance is made larger than the modulator inductance for the intermediate short wave band and the short wave band, and therefore less trimmer capacity is to be used on the oscillator, when the lining up is originally made on the broadcast band, compared to the oscillator.

For the modulator Pri. designates primary, Sec. designates secondary, while for the oscillator Pri. is the feedback winding and Sec. is the grid circuit winding. All wire is put on tightly, no separation between turns, except that the short wave tickler is interwound with the secondary of the oscillator only, and as fine wire is used in the tickler, the actual length of the axial length of the secondary winding is increased very little. Allowance is made for this extra length by a half turn added to calculated inductance (included in table).

The tuning condenser sections are of commercial rating 350 mmfd., but, including the distributed capacities and the fact that 350 is nominal, and 365 usually more nearly literal, the maximum capacity is taken as 400 mmfd. Cp designates the value of the series capacity to be established in the padding circuit of the oscillator, Ceff designates the effective capacity, when account is taken of the series capacity. The inductance values of the unshielded coils are given only as a side consideration, and may be neglected, except if one desires to check by calculation the winding data given. Carefully note that the coils are not shielded. All tubing is 1 inch outside diameter.

530 to 1,850 Kc. 565.7 to 162.1 Meters

Pri. 22 turns No. 32 enamel wound over secondary, near bottom (ground) end.
Sec. 110 turns No. 32 enamel. (210 mh).

Pri. 28 turns No. 32 enamel separated 1/16 inch from Sec.
Sec. 80 turns No. 32 enamel (140 mh).
Cp = 400 mmfd; Ceff = 400 mmfd.

1,800 to 6,300 Kc. 166.6 to 47.59 Meters

Pri. 8 turns No. 18 enamel separated 1/16 inch from Sec.
Sec. 33 turns No. 18 enamel. (17.1 mh).

Pri. 12 turns No. 32 enamel separated 1/16 inch from Sec.
Sec. 40 turns No. 18 enamel (18 mh).
Cp = 1,000 mmfd.; Ceff = 285 mmfd.

6,300-22,200 Kc. 47.59 to 13.51 Meters

Pri. 5 turns No. 18 enamel separated 1/8 inch from secondary.
Sec. 6.5 turns No. 18 enamel (1.4 mh).

Pri. interwound with Sec. and consists of 6 turns of No. 32 enamel wire.
Sec. 7.5 turns No. 18 enamel wire (1.6 mh).
Cp = 2,400 mmfd; Ceff = 336 mmfd.

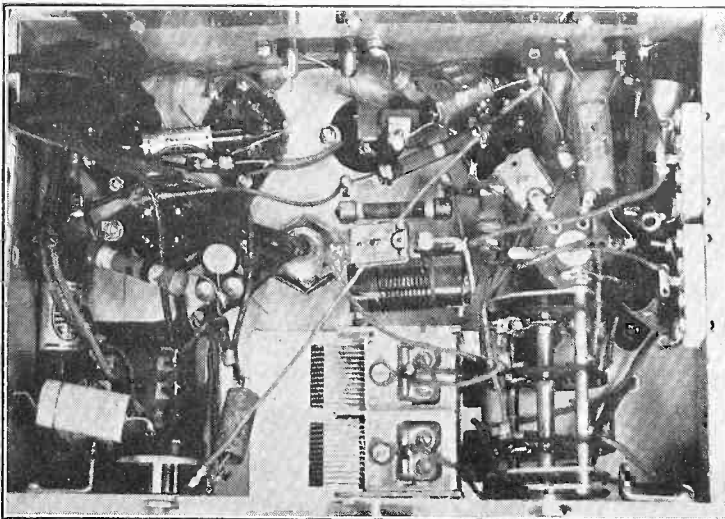

In a compact receiver for all wave coverage it is necessary to put parts fairly close together. The illustration shows the way the parts were disposed under the chassis to obtain most satisfactory results, and the layout should be copied as nearly as practical, so that the same high results will be duplicated.

(Continued from preceding page)
opened and the meter inserted between the resistor and ground. That is, grounding is complete through the meter.

If not enough deflection is obtained (meter not sensitive enough) the instrument may be placed in the plate circuit of the 2A6, but this is not a rectifier circuit and the currents will

not be changed so much, although the plate current is higher (0.8 milliampere at no signal input). The signal raises the plate current, and that is the reason why the circuit is suggested if one does not have an instrument as sensitive as 0-1 milliampere.

The diagram and the illustrations give practically all the other information necessary, except as to winding coils and padding the oscillator.

Padding Condenser Placement

The lower frequency coils in the oscillator circuit (lower left) are at left, so broadcast band is shown at outside position, intermediate short wave coil next, and short wave coil at right. It will be noticed that as the frequency is increased so is the padding capacity. For the broadcast band a compression type of condenser, 260-500 mmfd., is used. It is in series with the coil, a condition true of the other padding condensers. This series method results in less input to the modulator, since the oscillator voltage drop for any input is that derived from the inductance.

The voltage drop across the padding condenser is greatest in the broadcast band and the method is used so as to avoid overloading the modulator with oscillation voltage, there being no practical way of externally regulating this conveniently.

Tiedown Frequency Not at End

As the padding capacity is increased the movement is in the direction of a short circuit between coil return and ground, therefore the voltage drop is less. The capacity of the intermediate short wave padding is 0.001 mfd. fixed. This is not critical. For the highest frequency band the same sort of adjustable padder as used in the broadcast band is connected across a fixed condenser of 0.002 mfd.

Whenever an adjustment of the padding condenser is made it should be on the basis of a frequency close to the low terminal of the tuning of the band, but not at the low end exactly. For the broadcast band, 600 kc is a popular tiedown frequency. After adjusting parallel trimmer on both tuning condensers for maximum response around 1,450 kc of the broadcast band, less capacity in oscillator than in modulator, use 600 kc from a signal generator, fed to set antenna post, and turn the set dial until this is picked up, adjusting the padding condenser until response is maximum, while slightly rocking the tuning condenser (to and fro movement of a few degrees). When the most satisfactory response is tentatively obtained this way, leave the tuning condenser in that position and adjust the padder for maximum response, using aural or visual tests.

Padding Method Repeated

The intermediate short wave band is padded the same way, using a frequency between around 200 to 2,500 kc, and the short wave band, using a frequency around 7,000 to 8,000 kc.

LITERATURE WANTED

Readers whose name and addresses are printed herewith desire trade literature on parts and apparatus for use in radio construction. Readers desiring their names and addresses listed should send their request on postcard or in letter to Literature Editor, Radio World, 145 West Forty-fifth Street, New York, N. Y.

- S. A. Wixson, 485 E. 21st St., Brooklyn, N. Y.
 W. E. Quinlan, 302 Tully St., Syracuse, N. Y.
 Clarence C. Haas, R.D. No. 1, Andersonburg, Penna.
 Howard Evans, 2115 Madera St., Dallas, Texas.
 L. M. Mynard, Service Manager, Delco-Reemy & Hyatt Ltd. 111, Grosvenor Road, London, S.W.1, England.
 Ropson Radio Service, Algoma, Wis.
 J. H. Vinson, 701 Ely St., Carrollton, Mo.
 Harry A. Stout, P.O. Box 395, Westwood, Calif.
 Chas. Hutter, 464 - 10th St., Brooklyn, N. Y.
 G. F. Buckner, Lyman, Wash.
 Martin V. Dickmann, 4385 Ely Ave., New York City.
 Interessengemeinschaft für Rundfunk Schuterechte e.V., Berlin, S.W. 68, Zimmerstr. 3-4, Germany.
 M. Mickelson, P.O. Box 2754, Bloomington Sta., Minneapolis, Minn.
 W. L. Grieve, 47 Chancery Lane, Singapore, Straits Settlement.
 I. Pekarsky, 587 Prospect Ave., Bronx, N. Y. City
 Charmer C. Zande, 1611 - 61st St., Kenosha, Wis.
 H. W. Fricke, 296 Knox Ave., Cliffside Park, N. J.
 Paul Grauer, c/o Grauer's Hardware Store, Campbell, Nebraska.
 Joseph R. Mello, 3 Omega St., Stonington, Conn.
 Virgil Darnell, Emerson, Ga.
 L. S. Grant, 2807 E. 27th St., Brooklyn, N. Y.
 P. E. Partridge, 687 Euclid Ave., Toronto 4, Ont., Canada.
 Robert Albrecht's Radio Shop, 509 Lott St., Yoakum, Texas.
 William Stepien, 2318 Rice Str., Chicago, Ill.
 Fred J. Winkler, 32 Bergen Ave., Clifton, N. J.
 R. Mores, Tewksbury, Mass.
 Fred J. Meckelburg, 3412 No. 26th St., Milwaukee, Wis.
 John Puvogel, 1506 Grand Ave., Apt. 10, St. Paul, Minn.
 Joseph Marshall Krechniak, Ozone, Tenn.
 D. H. Saunders, 13 Addison St., Gloucester, Mass.
 Alfred De Santes, 1271 - 55th St., Brooklyn, N. Y.
 Rudolph E. Blomstrom, 19 Rolfe St., Cranston, R. I.
 Felix J. Nizza, 35 Wildwood Ave., Providence, R. I.
 Fred O. Janotta, 38 Freeman Terr., Springfield, Mass.
 C. E. Monroe, 2566 Bainbridge Ave., New York City.
 Marcellus Douglass, 638 E. 13th St., Oklahoma City, Oklahoma.
 Ben Benson, Inwood, Man., Canada.
 M. Reich, III, Hetzgasse 20, Vienna, Austria.
 Ben Meckelprang, 1822 Euclid Ave., Salt Lake City, Utah.
 Don Chase, Hartdale, St. John, Barbadoes, B.W.I.
 Headquarters Battery, 19th Field, Fort Benj. Harrison, Indianapolis, Ind.
 John Capaul, 21799 Rio Vista St., Hayward, Calif.
 M. DeGraaf, Jr., Klappa Kampit, Billiton, Netherland Indies.
 W. R. England, 226 State St., New Bedford, Mass.
 Chas. F. Hewitt, R. D. 4, Box 311, Morgantown, West Va.
 Dr. Wm. Theo. Haussmann, 3533 Old York Road, Philadelphia, Pa.
 O. E. Mowrer, 1013 W. Micheltorena St., Santa Barbara, Calif.
 P. Santos, 15 Moore St., New York City.
 W. D. Anderson, 2500 Noble Ave., Alameda, Calif.
 Irving Schneider, c/o Morris Thau Co., 515 Mission St., San Francisco, Calif.
 Frank Bartkoff, 536 E. 136th St., Bronx, New York City.
 High S. Marshall, 19 Wroxeter Ave., Toronto, Ont., Canada.
 Joseph Letasi, 1317 Mulberry St., Scranton, Pa.
 Henry D. Rolfe, 188 Cliff St., Burlington, Vt.
 Dowrad, Inc., 555 Knickerbocker Ave., Brooklyn, N. Y.

The Thyatron Tube

And How Its Inert Gas Works

By Morris N. Beitman

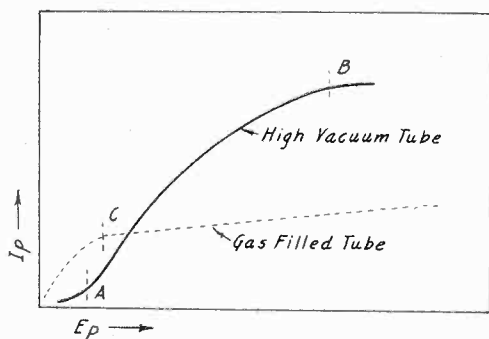

Current variations with increasing plate potential in high vacuum and gas filled tubes. Up to point A current is limited by space-charge, after point B by limited emission. After a voltage corresponding to C, the current of a gas filled tube is almost constant.

ESSENTIALLY, a Thyatron* is a vacuum tube possessing a hot cathode as a source of electrons and is filled with some inert gas or mercury vapor. Very much like the high vacuum triode, it possesses a grid control element. However, because of the presence of the gas or vapor, the plate current, plate voltage characteristics are entirely different and are utilized for application where the high-vacuum tube would not do.

In an ordinary vacuum tube the plate current is limited at low plate voltages by the presence of the space charge. Once the plate voltage is raised to remove the influence of the space charge, the plate current will vary with the voltage as some function of $3/2$ power, until the current will be limited by the emission.

The Different Action in the Thyatron

In the Thyatron the action of the plate current is entirely different and is due primarily to the formation of positive ions from neutral gas atoms. These ions are very heavy by comparison to electrons (thousands of times heavier) and do not move rapidly. However, the presence of these ions permits the flow of large electron currents by altering the space potential. In other words this makes a small cathode to anode voltage difference.

In a high vacuum tube electrons travel in a continuous path from cathode to the plate. In a gas filled tube, however, the average length

of an uninterrupted path is very much shortened by the continued collision of electrons with gas molecules. These collisions result in the creation of positive ions and additional free electrons. The positive ions so formed raise the space potential and, thereby, permit more electrons to escape from the cathode. If the rate of ion generation is large, the voltage change is negligible in the space between the anode and cathode, except in the region near the cathode and the anode themselves. These regions adjacent to the two elements of the tube are subject to large potential change and are called the *sheaths*, and the region of little change is called the *plasma*. The plasma has about an equal number of ions and electrons.

Grid as a Current Preventive

Such a two electrode gas filled tube finds application as a rectifier of relative high current capacity and possesses a small constant voltage drop. The commercial mercury vapor tubes and mercury rectifiers of the radio type such as the 83 are examples.

In the Thyatron, as mentioned previously, a third element, the grid, is incorporated as a means of a control. The starting of the current flow between the cathode and the plate of a gas filled tube depends on the formation of positive ions in the interelectrode space. The rate of this ion formation to form the plasma is dependent on the geometrical construction of the electrodes and the applied positive potential to the plate. In a two element gas filled tube the anode (plate) current is started by making the anode voltage sufficiently positive to form the plasma. In the Thyatron the grid may be used to prevent the formation of the plasma and, thereby, the starting of the current. A grid potential of a few volts may prevent the starting of an arc in a Thyatron with the plate at a thousand volt potential in respect to the cathode. A change past a certain value of the grid voltage will cause the arc to start.

Use of A.C. Input

Once the current flow is started, however, the grid has no further effect on the current. It can neither limit the current, nor stop it in practical application. In practice the grid is used either to start or prevent the starting of the discharge. The current may be stopped by sufficiently lowering the plate voltage. The discharge starting grid voltage is somewhat dependent on the temperature; the current will start at a relative algebraically lower grid potential at a higher temperature.

In alternating current application of the Thy-

*The Thyatron is a trade name of General Electric Company through whose courtesy much of this information has been obtained.

atron, the current can only flow during the positive half of the cycle and, thereby, is interrupted as many times as the frequency of the supply voltage. Each interruption serves to restore to the grid its ability to stop the current flow. For example, if the grid should become algebraically less than its trigger control value during the positive half of the cycle of the plate voltage, the current would continue to pass through the Thyatron during the remaining period of the positive lobe of the cycle. On the appearance of the next positive lobe, however, the plasma would not be able to form because of the new value assumed by the grid, and no current would flow.

The trigger point has been used in the sense as the minimum value of the grid voltage that

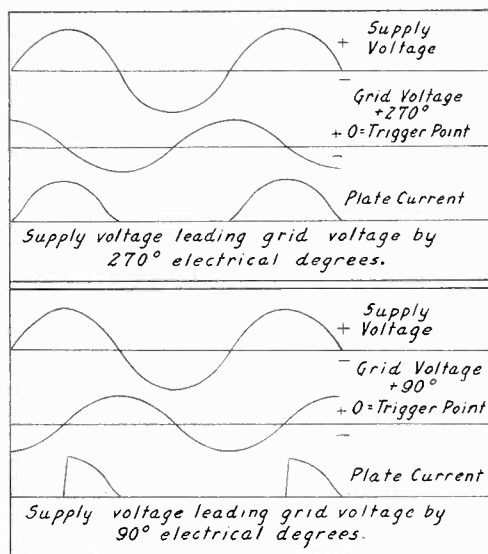

Supply voltage, grid voltage, and resulting plate current wave shapes with 0 voltage trigger point, at two different phase differences between supply and grid voltages.

will prevent the starting of the arc. An increase in the positive direction of the grid voltage will allow the formation of the plasma if sufficient anode voltage is present. The trigger values are either in the positive or negative range of grid voltage and depend on the tube construction; each type is especially suited for certain applications.

Can Invert D.C. to A.C.

The average output from a Thyatron may be varied by making the grid pass its trigger point during some period of the positive plate voltage cycle other than the very beginning. By operating the grid with alternating current voltage of the same frequency as the plate supply voltage and proper magnitude, the power output may be varied from the maximum to zero by changing the phase difference between grid and plate voltages. Fig. 2 illustrates this procedure for two different phases.

Thyatron tubes may be used as inverters of

Britain Working Remote Controlled 'Planes 10 Miles

The leading countries of the world experiment from time to time with bombing planes that soar through the air without occupants. The planes are remote controlled by radio. Various wavelengths are transmitted, one for each operation, so that all the operations that a pilot could perform in the plane are performed in the plane as the result of pressing buttons up to 10 miles away. The service area, considering the transmission power used, is in general 10 miles, although with greater power greater distance could be covered.

The United States Army has been experimenting with such planes but at present has called a halt on the tests, as they are not deemed to be of any real military value now. A connecting link is necessary, so that targets could be selected, and bombs dropped to a definite objective. At present this means is lacking, but it is believed that in time a system could be worked out that would accomplish the desired result, although it is expected that such time is a long way off, as television of a high order of definition would be necessary.

The planes at present are equipped with tuned circuits that actuate as relays when the frequencies to which the circuits are sensitized are transmitted from the ground station. Enough voltage is developed by amplification at a particular frequency to cause a switch to open or close, and thus control the desired movement. In fact, all the operations of a human pilot aboard are duplicated by remote control, and even stunting is accomplished, including tailspins, rolls and dives. Where degrees of control are to be accomplished graduated relays are sometimes used, so that the full sweep is segregated into steps of operation.

At present the British Government is using seven such pilotless planes in gunnery (artillery) practice, with land and sea objectives, but nothing is said as to how the terrain or water is explored by remote control, to prompt the remote control operation in the discharge of the shells. It is commonly regarded that the discharge is aimless.

d.c. to a.c. without any mechanical moving parts and with little loss of voltage.

In television work, where synchronous motors are utilized, it is possible to obtain alternating current of sufficient magnitude from a d.c. source with the aid of a Thyatron controlled with a small tuning fork.

A new type of an electric motor that has the characteristics of a series type d.c. motor, but which operates from an alternating current source, has been developed by E. F. W. Alexander. The direct current is supplied by means of a group of Thyatron rectifiers.

RADIO CONSTRUCTION UNIVERSITY

Answers to Questions by Readers on the Building of Radio and Allied Devices. Readers Should Address Questions to Radio Construction University, Radio World, 145 West 45th Street, New York, N. Y.

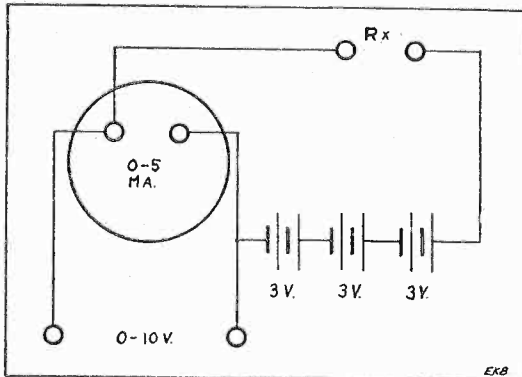

An inexpensive 0.5 milliammeter which has such internal resistance that it is also a 0-10 voltmeter of fair accuracy, may be used also for resistance measurements. With 9 volts applied, no limiting resistor is needed.

Medium Resistance Meter

I HAVE a 0.5 milliammeter which has a fairly high internal resistance, around 2,000 ohms, I should say. Would it be practical to use this as a resistance meter?—W. D. C.

A voltage may be impressed on the meter, based on the meter resistance, to attain full scale deflection, and then the resistance values for given current readings may be computed or determined experimentally from known values of resistance. The meter we believe you have in mind has a resistance of 2,000 ohms, and is sometimes also calibrated as a 0-10 voltmeter. If only six cells are used you will have 9 volts, and it is practical to base your calculations on this, too, although full scale deflection is preferable, so 12 volts are suggested, with series resistance added, about 200 ohms, to bring the needle only to full scale when the circuit is closed by a short. When an unknown resistor, Rx in the diagram, is inserted, the meter will show smaller current reading. Ohm's law applies: resistance in ohms equals voltage in volts divided by current in amperes. The "amperes" here consist of 0.01 maximum. Rx, be careful to observe, does not equal the result of this computation, but 2,000 ohms less, since each time the meter resistance must be deducted, when the calibration is made. Also, if more resistance is added, as for the 12 volt example, be sure to subtract the total resistance, meter

plus limiter, or around 1,200 ohms, from the computed value.

* * *

Why This Super Is Noisy

MY superheterodyne becomes too sensitive on occasions, hence noisy, and at those times there are squeals of various pitches and intensities as one tunes through a band. Can you give me the cause and remedy?—C. H. G.

The trouble is oscillation at the intermediate level. This may be cured in several ways. When the trouble arises, touch wetted finger to grid of the first intermediate amplifier tube, then to the grid of the second intermediate amplifier, if there are two. A plop will denote that oscillation is present, as it may be in both stages. Each stage then should be treated separately. If the biasing resistor is common to both, use two separate resistors. Across each such resistor put a 2 mfd. condenser and the trouble most likely will disappear. If not (though trouble will be less) put a resistor or a few thousand ohms in series with the plate return of each i. f. stage and bypass this resistor to ground, or preferably to cathode, with 0.05 mfd. The wires connecting to overhead grids may not be shielded. Wrap some wire around these leads, avoiding conductive contact with the grid, and ground the wire at a lug on the coil form. The reason why the trouble is intermittent probably is that the regulation of the line voltage is not good. When the line voltage is high the heater and B voltages are high, and the trouble occurs. The squeals are due to heterodynes, in other words the intermediate amplifier becomes a beat oscillator.

* * *

Two Tube Terms Distinguished

DO not the terms "conversion conductance" and "translation gain" as applied to a pentagrid converter tube mean practically the same thing, and if not, what is the difference?—L. W. C.

The two terms mean different things. The conductance is in any instance a reciprocal of resistance, and so the situation pertinent to resistance is applicable. This is that current and voltage are related by the resistance. Thus, applying Ohm's law, the resistance in ohms is equal to the voltage in volts divided by the current in amperes. Hence in connection with "conversion conductance" it is necessary to consider the factors of *current* and *voltage*. The

conversion conductance is the ratio of the intermediate frequency component of the plate current to the radio frequency component of the signal voltage applied to the control grid, both values very small. It is comparable to the mutual conductance or grid-plate trans-conductance in a triode. The translation gain deals only with voltages. It is the ratio of the intermediate frequency voltage developed across the plate load to the radio frequency voltage applied to the control grid, both values very small. It is thus comparable to voltage gain, except that voltage gain applies generally to

since this energy is mostly heat, and there is an exact relationship between heat dissipation and time rate of energy, the wattage rating obtains. The wattage is that which the resistor would be called upon to dissipate in the open air, or at least with a foot of free air space all around the resistor, and with free circulation of air. This normal wattage rating applies to resistors under the circumstances just stated. The standards of the Electrical Manufacturers Association prescribe such mounting for dissipation of about 7 watts per square inch of outside surface area of the resistor with a

When 2A3 tubes are used in push pull it is not always easy to establish the required nicety of balance, using the tubes as found. One expediency is to measure the tubes, so that for equal static conditions the plate current is the same. If separate filament excitation is at hand, then a separate biasing resistor may be used for each tube, the adjustment made with a.c. signal input (steady tone) until the biasing voltage on one tube is exactly the same as that on the other, within the absolute boundaries. Question and answer to which this illustration applies are on next page.

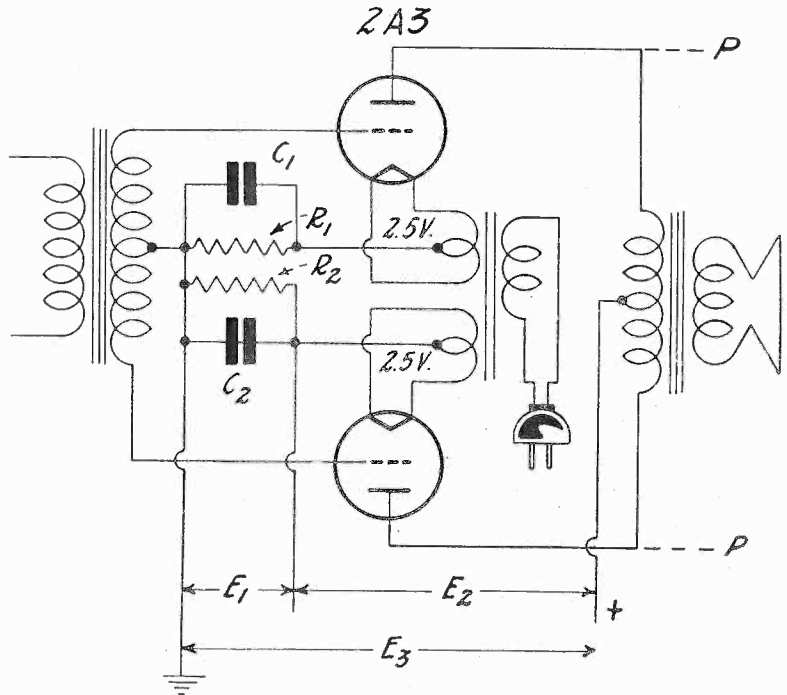

voltages of a single frequency, and represents the ratio of a small a.c. voltage developed across the plate load impedance to the small a.c. control grid voltage necessary to produce that small a.c. plate voltage.

The Metal Used as Shells

THE samples of metal shell tubes that I have seen have a strong metal shell. Is this iron?—L. B.

An alloy of iron, cobalt and nickel is used.

Standard of Wattage Rating

HOW is it that different types of resistors have the same wattage rating, or the same types of resistors have different wattage ratings? Is there not a standard for such rating?—L. S. E.

There is a standard but perhaps not all of the manufacturers follow it closely. The resistors are rated in wattage, which is strictly the rate at which energy may be dissipated, but

temperature rise of not more than 250 degrees Centigrade, air surrounding the unit not more than 40 degrees Centigrade. Taking normal room temperature at 70 degrees Fahrenheit, the permitted rise of temperature in the resistor is 450 degrees Fahrenheit under these conditions. The method of mounting and surroundings of the resistor affect the wattage rating to be given, and if it is practically assured a resistor is to be confined to "close quarters," the wattage rating should be lowered, which is within the manufacturer's discretion.

What Percentage Modulation Is

I AM a bit mixed up as to percentage modulation. Sometimes I see something to the effect that half the difference between the maximum and minimum amplitudes has to be considered, other times only that the carrier amplitude is considered as base, the ratio of rise of that amplitude expressing the percentage modulation.—W. D. C.

(Continued on next page)

transformer might well be used, and the biasing adjustment made then. This gives some attention to dynamic balance. The condition due to d. c. voltages is called static, and that due to the a. c. (signal) voltage is called dynamic. Diagram is on page 57.

Battery Operated Signal Generator

A CIRCUIT diagram of a signal generator for battery operation would be appreciated. One r. f. oscillator tube and a separate a. f. modulator tube are desired, electron coupling of output, and freedom of molestation of audio and radio frequency oscillations by attenuator settings. The modulation and r. f. output should be both subject to attenuation.—W. S. F.

Here is such a diagram. The 34 tube is the

backwards, as it were, large winding in the primary, small winding in the secondary or output. This is one of the two precautions against molestation of the d. c. voltages. The other is the use of two 0.05 mfd., one between modulator grid and 0.05 meg. audio attenuator, other from a. f. to formal plate. Any small audio transformer may be used for the 30 audio oscillator. One 1.5 volt No. 6 dry cell is sufficient to sustain oscillations in both tubes to the intended 5 mgc. limit, and much beyond, in fact, if you desire to add a fourth coil. Besides the r. f. output there is another output, and an external input. This input is such as would be supplied by a microphone, phonograph pickup or steady test tone. The audio oscillation of the 30 tube may be taken off separately, from A posts marked "A. F. Output." The 0.1 meg. resistor

Special precautions have been taken to leave the radio frequency and audio frequency oscillators free from instability due to attenuators. The general principle applied has been to avoid interference with d. c. potentials. Modulated or unmodulated r. f. output, also audio tone output alone for audio channel tests, are provided. Moreover, external audio input may be used for modulation of the r. f. oscillator, thus enabling use of this device as a phonograph oscillator or microphone oscillator. The last named use suggests the possibility of this device even as a small transmitter.

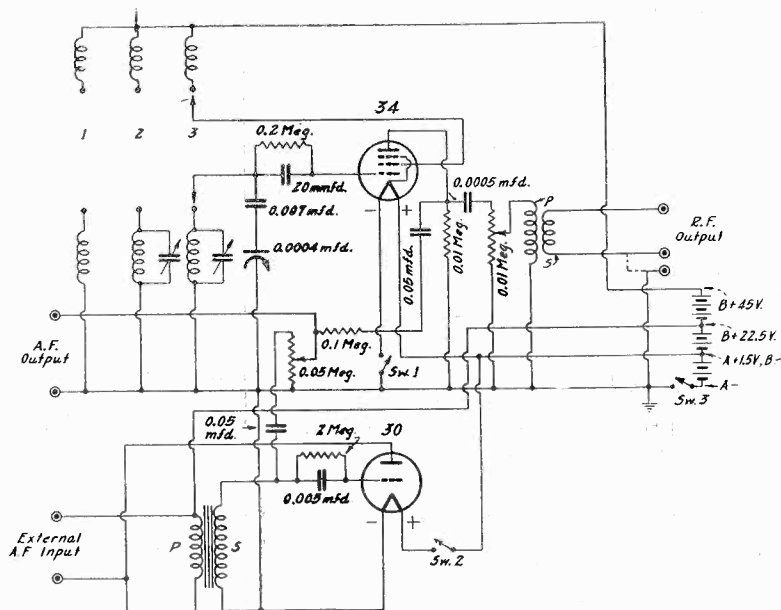

r. f. oscillator. The screen is used for the feedback, the formal plate for developing only an output voltage. Hence there is electron coupling of output, because the coupling depends on the emission, or on what goes on inside the tube. The 0.007 series condenser in the tuned circuit is not necessary except to follow a particular frequency calibrated scale. The small grid condenser is made by twisting two 6-inch-long leads of hookup wire, using terminals at one end for connection to the two sides of the 0.2 meg. grid leak, other terminals of wire free. Three bands are covered: intermediate, broadcast and intermediate short waves. Coil switch position 1 is for intermediate frequencies. The coil will be a honeycomb with larger distributed capacity than the two other coils, so to track a precalibrated dial a small capacity is added to make up the shortage. This is the same general nature as the improvised grid condenser. The r. f. output is taken from a broadcast coil used

leading to formal plate of 34 through a condenser limits the amount of modulation, so it will not be more than 100 per cent. If there is overmodulation there will be r. f. response in an unmolested receiver at two settings of the generator condenser, a degree or so apart on the dial. Increase this resistance if the trouble is present. To get louder modulation, decrease this resistance to 0.05 meg., but no lower, and check for double response. Switch No. 3 is the master. Switch No. 2 turns the r. f. oscillator on or off. Switch No. 2 actuates the audio oscillator. For modulated service, using the 30 modulator, turn on all three switches. For unmodulated r. f. service turn on Switches 3 and 1. For audio tone alone turn on Switches 3 and 2 and turn Switch 1 off. Switch 3 should be a toggle, to arrest attention by its difference, the other switches being on the potentiometers. There is always danger of leaving the genera-

(Continued on next page)

Parts That Always Win Your Admiration

For over thirty years Hammarlund has been developing and producing distinctive radio parts—the parts that you always admired for their hundreds of original features which always meant perfect performance!

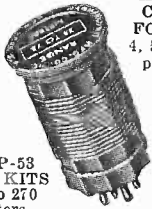

"XP-53"
COIL KITS
17 to 270
meters

"XP-53"
COIL
FORMS
4, 5 and 6
prongs.

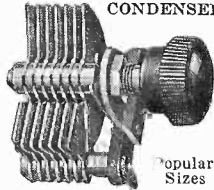

Low-Priced
"STAR" Midget
CONDENSER

Popular
Sizes

by HAMMARLUND

HAMMARLUND MANUFACTURING CO.
424-438 W. 33rd St., New York.

Check here and attach 10c for new 32-page Hammarlund 1935 Short-Wave Manual, illustrating and describing most popular S-W circuits of past year, with schematic and picture diagrams and parts lists.

Check here for FREE General Catalog.

Name

Address

RW-8

SIGNAL GENERATOR FOUNDATION KIT \$4.89

HERE is an opportunity to get the foundation parts for a swell signal generator, for "universal" or battery operation, with room for self-containment of batteries. Switch control of wave bands is intended. The bands are: Position 1 = 1400 to 5000 kc; Position 2 = 540 to 1800 kc; Position 3 = 140 to 500 kc. Frequencies are direct reading.

The foundation consists of black crinkle finished shield cabinet and chassis for two tubes; precision tuning condenser; three precision coils; precision frequency calibrated dial; two escutcheons; two chromium-etched face plates for attenuator and modulation indication; diagrams for universal and battery operation.

For "universal" use the tubes should be 6D6 and 37 (or 76); for battery operation, 34 and 30.

Order Cat. 3335 (shipping weight 8 lbs), net price, \$4.89.

Honeycomb coils on Isolantite forms are supplied for the generators. These coils are very precise and match the dial. They are obtainable separately for use with your own condenser and straight numerical dial. You would have to calibrate your generator then.

Intermediate Frequency Coil (Cat. L-140) 65c
Broadcast Coil (Cat. L-540) 60c
Intermediate S.W. Coil (Cat. L-1400) 55c

PRECISION — QUALITY

Custom Set Builders Supply Co.

135 Liberty Street, New York, N. Y.
Telephone: REctor 2-6650

(Continued from preceding page)

tor turned on after finished with a particular use, thus using up the batteries. New types of batteries make for smaller space, the small 45 volt type with 22.5 volt tap, and the new No. 6.

* * *

Coils for Ultra Frequencies

WHY do directions for winding coils for very high frequencies sometimes call for smaller diameter tubing and finer wire than used at lower frequencies where the diameter of the tubing is larger? For instance, for 5 meter work even 3 inch diameter may be used, whereas for work around 1 meter the diameter is smaller and the wire finer, e.g., No. 24 as compared to No. 16 previously.—J. V. McL.

As the frequencies become extremely high, or wavelengths extremely low, it becomes progressively more difficult to present a sufficient inductance to the tuned circuit. To achieve a particular frequency, if the capacity is relatively high to start with, the inductance will be lower than desired, in fact needed. Holding up the sensitivity depends on attaining a good value of inductance. Since the distributed capacity of a solenoid is not directly related to the number of turns, but is to the diameter of the winding, the smaller diameter is used for keeping this distributed capacity down as low as practical, thus enabling the introduction of greater inductance. A few micromicrofarads make quite a difference at these frequencies as to what the inductance must be. At the very high frequencies the stouter wire may introduce losses, due to eddy currents, etc., so that finer wire might yield better results. Usually the difference in wire sizes noted are due to experimental findings.

* * *

Surge Impedance Explained

WHAT is the surge impedance of a transmission line and how may it be computed? —I. H.

The surge impedance of a transmission line, in ohms, is equal to the pure resistance that would have to be used at the free ends of a two-wire system to prevent reflections. When the transmission line is fed by a generator there are set up wave trains, and as these have no

UNIVERSAL COMBINATION FLOOR STAND

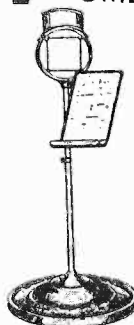

A rugged, three-piece, telescoping combination banquet and floor stand—Compact—light weight—smooth in operation—finished in fully polished nickel plate—equipped with cadmium plated, adjustable and detachable copy holder, mounted on a flexible steel arm—A clean, workmanlike job, designed and manufactured to Universal standards of quality.

List Price,
complete with 8 springs, \$10.00

Universal Microphone Co., Ltd.
424 Warren Lane, Inglewood, Calif., U.S.A.

other place to go, due to free ends, they travel back and forth along the line, and because not radiated are called standing waves. The surge impedance depends almost exclusively on the inductance and capacity of the line. For the high frequencies at which such lines are predominantly used in present-day radio practice the inductance and capacity are hard to measure, and therefore are calculated. The formulas are obtainable in any standard reference or text book. In fact, the values can be more accurately computed than measured. Other factors than inductance and capacity are not only very small, in affecting the surge impedance, but scarcely possible to determine accurately in the technique as it now stands. Therefore the inductance is divided by the capacity, and the square root of this quotient is the surge impedance. The pure resistance put between the free terminals of the line, when of the same value exactly as the surge impedance, provides the correct dissipation to prevent standing waves. The transmission line itself prevents, or should prevent, radiation from itself, as it is a means of conduction by minimum loss, and any radiation would be a loss. So, for reception, any pickup by the transmission line would be rated as a loss, too, although the effect is usually measured in terms of loss of selectivity, since undesired frequencies could be picked up.

* * *

Converter Coil Winding Data

PLEASE give data on coils for a short wave converter, i.f. at 550 kc, to tune in the principal bands with a 0.00014 mfd. tuning condenser (two gang). A coil switching device is to be used.—N.W.D.

Assuming the antenna connected to grid of the modulator tube through a series capacity, as shown in the coverter article in this issue, three tubings, $1\frac{1}{8}$ inches o.d., for 11 to 22 meters. The modulator grid winding has 6 $5/6$ turns No. 20 enamel wire wound 8 turns to the inch. Use 1 inch space, wind $5\frac{1}{2}$ turns No. 24 enamel for feedback. The $\frac{1}{8}$ inch away wind $7\frac{1}{2}$ turns of the same wire for the tuned circuit to 1 inch. Distances between coils are the same throughout. Next band, $13\frac{1}{2}$ turns No. 24 enamel for modulator, 18 turns to inch; $10\frac{1}{2}$ turns No. 24 enamel for feedback, $17\frac{1}{2}$ turns No. 24 enamel for oscillator tuned circuit, to 1 inch.

QUICK-ACTION CLASSIFIED ADVERTISEMENTS

7 cents a word. \$1.00 minimum.

ADDRESSING, MAILING CIRCULARS AT HOME for mail dealers. Earn \$15 weekly. Stamp brings particulars. Buda, Dept. C, P. O. Box 74, Brooklyn, New York.

CAPACITY RELAY. Made in various degrees of sensitivity. Performs a great variety of operations, due to body capacity effect. Approach of a person actuates the relay. Can be made so sensitive a person six feet away causes it to work. Can control starting, stopping, change of direction of rotations, etc. Write for particulars. Shore Road Radio Labs., 9120 Fourth Avenue, Brooklyn, N. Y.

PROFITABLE HOME BUSINESS. No canvassing. Buda, Dept. A, P. O. Box 74, Brooklyn, New York.

START PROFITABLE HOME MANUFACTURING! Mail Order Business. Duffy-Co., Covington, Ky.

WIRING DIAGRAMS FURNISHED for any make of set or power supply, 50c. 2-4-5 tube long or short waves schematic and picture diagrams, 25c. Winmas Sales, 1541 Vyse Ave., Bronx, N. Y.

LIMITED QUANTITY TELEPHONE RELAYS—\$1.00 postpaid. (No C.O.D.'s.) C. Weant. Respeburg, Baltimore, Md.

H U - T R A N - A T O N

Reg. U. S. Pat. Office

AMAZING! Plays radio through body. Scientific, healthful, energizing. Agent's sample, \$1.55. H.U.-TRAN-ATON CO., 20 W. 22nd St., N. Y. C.

WANTED: ORIGINAL POEMS, SONGS for immediate consideration. MMM Publishers, Studio Bldg., Portland, Ore.

"WILLCOX AUTO ELECTRICIAN'S WIRING MANUAL"—Complete wiring diagrams for all U. S. cars made in 1928-1929-1930-1931-1932. Complete data on ignition systems, generators, starting motors, batteries and lighting. Printed on tough, wear-resisting paper that can be washed with gasoline without injury to print or paper. Loose-leaf style in sturdy covers. Size 11 x 12". 300 wiring diagrams. Price \$10.00. RADIO WORLD, 145 W. 45th St., New York City.

SENSATIONAL OPPORTUNITY! \$100 weekly possible selling life and accident protection combined with merchandising privileges. Experience unnecessary. Not insurance. United Helping Hand Association, Torrington, Conn.

P. A.

PRINCIPLES of PUBLIC ADDRESS SYSTEMS

A practical handbook, full of useful information, fully illustrated, written by M. N. Beltman, an engineer and noted authority on audio amplifiers.

Considers in detail two-button and condenser, microphones, radio and phono input, acoustic feed back, mixing and volume controls, use of vacuum tubes, interstage coupling, power amplifiers, output coupling, loud speaker placement, the decibel, P. A. measurements, power level, and other points of importance including actual circuit diagrams of P. A. systems. (Size $8\frac{1}{2}$ " x 11".)

The New Money-Making Field!

Everywhere, in summer, in winter, P.A. equipment is being installed, rented, repaired. For movies, in parks, auditoriums, advertising, call systems . . . there is a demand for more P.A. The thinking man can see the possibilities. Servicemen, experimenters, this is your chance to get this book with real facts.

Price only 50c, post free.

SUPREME PUBLICATIONS

3727 WEST 13TH STREET
CHICAGO, ILLINOIS

A Good S. W. Converter Kit • Self Powered Fidelity Tuner Kit

A THOR converter used with your broadcast receiver will receive short waves 20 to 50 meters and 64-200 meters. This frequency range, obtained by switch selection of specially accurate coils, covers the principal foreign stations, and permits reception also of a wide assortment of amateur police relay ship - to - shore, airplane and other domestic transmissions. The converter is simple in operation. Self - powered for a.c. Diagram supplied. The 2A7 tube is used as mixer and 80 as rectifier. A single switch does all band selection, antenna switching and on-off operation of line voltage. Complete kit, including chassis, sockets, dial, coils, switch, power transformer, condensers (less cabinet and tubes)..... **\$6.95**
Cabinet (extra).....49c

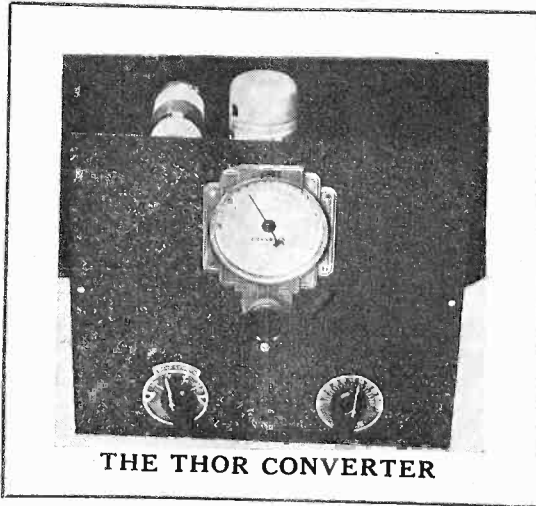

THE THOR CONVERTER

GOOD quality can be obtained from the Thor Fidelity T.R.F. Tuner, with non-overloadable diode detector. By a unique arrangement the rotor of the final section of the 4-gang condenser is maintained at ground potential. High gain r.f. coils are used in this 5-tube tuner, with built in B rectifier. Entirely self-powered and self-contained. Diagram supplied. The Tuner is self-powered for a.c. and is stable and humless. Tubes required are three 58's, one 56 and one 80, or, for 6.3 volt operation, three 6D6, one 76 and one 80. Transformer supplied for either option. Complete kit, including chassis, sockets, dial, coils, shields, power transformer, condensers (less tubes).

\$12.95

Send 10c for Assortment of Six Large Pictorial Diagrams of Receivers and Amplifier.



167 GREENWICH ST.

NEW YORK CITY

We Carry One of the Most Complete Stocks of Radio Parts and Apparatus. Write Us Your Needs. Mail Orders Filled Promptly.

RACO LEADS AGAIN!

The new R.C.A. licensed metal tubes everyone is talking about, for Broadcast, Short Wave, Portable P.A. Systems and custom set building. These tubes are brand-new and guaranteed by us. Complete data sent with each purchase of tubes.

TYPE	PURPOSE	TO REPLACE
6K7	Triple grid super control amp.	like 6D6
6A8	Pentagrid converterlike 6A7
6J7	Triple grid, detector and amp.like 6C6
6C5	Detector-amp. triodelike 75
6H6	Twin diode	
5Z4	Full wave rectifierlike 80
6F6	Output pentodelike 42
6L7	Pentagrid mixer amp.	
6F5	Triode amp.	
25Z5-MG	Rectifierlike 25Z5
43-MG	Output pentodelike 43

Your choice of any type tube, \$1.50 each.

RADIO CONSTRUCTORS LABS.

136 LIBERTY STREET

NEW YORK CITY, N. Y.

A New Book — Second Edition of FUNDAMENTALS OF RADIO

(426 pages 6" x 9", 430 figures)
By Professor R. H. RAMSEY, Ind. Univ.
Revised, enlarged, repaged, reprinted, New cover.



New subjects Multi-electrode Tubes; A, B and C amplifiers; and Cathode Ray Television. Radio theory and practice brought up to May 1935. Problems and questions on each chapter. It still can be said that "Ramsey manages to provide that missing fact which seems to be hidden in other books." Everything new and enlarged but the price. You can not afford to miss this book.

EXPERIMENTAL RADIO

By the same author. You have heard of the original radio manual of experiments. Get it. Prices: Fundamentals \$3.50; Experimental \$2.75 post paid.
Your check, postal order or C.O.D. brings 'em
RAMSEY PUBLISHING CO. Bloomington, Indiana

FEATURES OF

RADIO WORLD (May No.)

(WITH 90 ILLUSTRATIONS)

- Metal Shell Tubes—By Conrad L. Morrow.
- More Gain from New Tubes—By Harry Miller.
- Try a Whisk Broom on Your Soldering Iron—By Jack Tully.
- Plain Talk on Aerials—By Connie Andover.
- Boondoggling.
- Alignment, All Levels—By Martin A. Gobin.
- Getting the Harmonic Habit—By Albert J. Pierce.
- Armchair Portable—By J. C. Wall.
- Tuned Radio Frequency Set with Pentode or Triode Output—By Henry L. Maks.
- Portable for All Waves—By Tom Bidwell.
- What Air Condensers Do—By John Braden.
- What Pep—By Jack Sullivan.
- Neon Gadgets—By Will Ellington.
- B-u-z-z-e-r—By Leon Wolf.
- Organizing A Meter—By B. M. L. Ferris.
- Fundamentals Most Useful—By Herman Bernard.
- A Filter for High Fidelity—By Sidney Wald, E.E. Radio University.

MANY OTHER FEATURES

JUNE NO., 1935

- Illus. features in that issue: Coil Switch Assembly—Ultra Frequency Measure with Photocell and Lamp—Seventh Metal Shell Tube—Pin Numbering on Octal Bases—Finding CX Easily—Equal Gain on T.R.F.—A Beat Oscillator—High Fidelity Tuning—It's the Set, not the Car—New Police Radio—Car Sets on Peak Road—False Alarms with Universal Sets—Dual Range Super—Wave Trap Does the Trick—Measuring Low Resistance—Three Tube S.W. Set—An Effective Transceiver—A Battery Signal Generator—War on Static Succeeding—Circuits We Print Readily Duplicated—Straight Frequency Liner—The Velocity Microphone, etc., etc.

JULY NO., 1935

- Illus. features in that issue: Television in Natural Colors—Technique for 'Phone Tip Soldering—T.R.F. Tuner Made High Grain—A 5 Meter Sending Aerial—Getting Things Into Places Where They Don't Fit—A Four Tube Portable—A Transmitter Class \$750—The Saturated Pentode—A Service Wand for Light—A Marine Radio Compass—VTVM Capacity Meter—Pretuned I. F. Amplifiers—Compact Four Tube Set—Neon Tube's Average Current, etc. Radio University Dept.—Harmonic Practice for Calibrating or Checking a Generator—Articles by Capt. V. O'Rourke, Herman Bernard, J. E. Anderson, Louis Pouy, Jack Goldstein, Harvey E. Sampson, B. Herbert Russ, Earle Branker, etc., etc.

25c A COPY. \$2.50 YEARLY IN U. S. Include as part of New Subscription if you wish.

RADIO WORLD

145 West 45th Street

New York City

GENERAL SHORT-WAVE AND PUBLIC ADDRESS MANUAL

Bound in cardinal red leatherette, this manual includes articles on the construction of short-wave receivers from one to nine tubes, inclusive, and all values between, supers and t-r-f, with the clearest imaginable illustrations, both photographic and draughting. Besides the usual plain circuit diagram there is a pictorial diagram for each circuit. And all the photographs are informative. Portable short-wave sets, design and winding of coils for short waves and broadcasts (intimately illustrated).

List of short-wave stations, with meters and kilocycles and hours on the air; trouble-shooting, and forty other topics, all done well.

The public address section contains data on different systems, how to use them, and offers opportunities to turn public address work to profit. Besides, there are articles on testing and servicing not encompassed by the title of the manual—signal generators, broadcast home and portable sets, analyzers, formulas, capacity data. Everything plainly told, simple language, from microphones to speakers.

PARTIAL LIST OF CONTENTS

Amplification Factors	95
Amplifiers	115
Analyzer Unit, How to Make	129
Antenna Design	80
Antenna Lead-in Cable	86
Antenna Wire	85
Antenna, 5-Meter	71
Broadcast Receivers	88
Coil Design	23, 24, 25
Construction of Short-Wave Receivers	22
Condenser Data Sheet	13
Condensers, Proper Replacement	12
Converting Meters to Kilocycles	19
Condenser Microphone	110
Crystal Microphone	114
Converters:	
"Regent" Two Tube A.C.-D.C.	64
"Paramount" Two Tube A.C.-D.C.	65
"Adam's Four Tube A.C. Superhet.	66
Curves, Explanation	100
Hum Elimination	98
Interference Elimination	79
Morse Code	75
Modern Microphone Trends	109
Oscillator, Battery-Operated	134
Oscillator, A.C.-D.C.	138
Phonograph Combination	128
Power Transformer Design	105
Public Address Installation	94
Servicing Formulae and Data	103
Short-Wave Tuning Instructions and Data	20, 21
Short-Wave Station Log	14 to 18
Short-Wave Receivers starting	page 26
Short-Wave Power Pack	46
Transceiver, Federal	70
Transceiver, Powertone	68
Transmitter	141
Tuner, Three Tube T.R.F.	125
Tuner, Four Tube T.R.F.	126
Tuner, Superhet	127
Velocity Microphones	111
Volume Controls, Electrad Replacement	132

PRICE 50 CENTS

Book Department

RADIO WORLD

145 WEST 45th ST
NEW YORK CITY

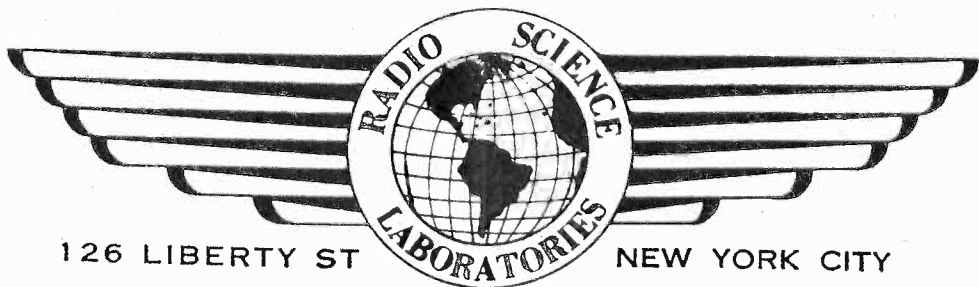

126 LIBERTY ST

NEW YORK CITY

3-A AMPLIFIER

A midget

with a GIGANTIC wallop

Just the right job for Store-Window advertising, inter-communication, small halls, classrooms, the home, and one-hundred and one other uses.

This amplifier can be used with a radio tuner, phonograph pick-up, or microphone in-put stage.

FREE
CIRCUIT
DIAGRAM

Send 3 cents
to
Cover
Mailing
Costs.

3-A AMPLIFIER

Complete Kit

WITHOUT TUBES

\$4.95

8-inch
DYNAMIC
SPEAKER
to match

\$2.69

WE CARRY A LARGE STOCK OF NEW AND USED
METERS

THE TRUTH
THE WHOLE TRUTH and
NOTHING BUT THE TRUTH

BETTER RECEPTION

with Noise-Reduction on ALL Waves

MOST AERIALS

DO NOT CUT OUT ANY NOISE

ON THE REGULAR BROADCAST BAND

**WHEN BETTER AERIALS ARE MADE
LYNCH WILL MAKE THEM ...
AND OTHERS WILL TRY TO COPY THEM**
Write for Free Bulletin on **LYNCH
PATENTED and GUARANTEED
Noise-Reducing Antennas for Home Auto Use.**
**ARTHUR H. LYNCH, INC., 227 Fulton St., N. Y.
PIONEER OF NOISE-REDUCING AERIALS**

METAL CHASSIS

We make Chassis and Metal Cabinets for any make receiver. Experimenters and others who want neat metal bases or housings for assembled apparatus, will find our workmanship superb. Inquiries should be accompanied with clear drawings, blue prints and other details concerning size and bends in metal if any, enabling us to give quick service as to prices and delivery.

Dealers and Jobbers: Write for special prices.

KORROL MFG. CO., Inc., Dept. R. W.
232 GREENWICH ST. NEW YORK CITY

**A COMBINATION OFFER!
RADIO WORLD and
"RADIO NEWS"
\$3.50**

Canadian and Foreign, \$1.50 extra on this offer.

You can obtain the two leading radio technical magazines that cater to experimenters, service men and students, for one year each, at a saving of \$1.50. The regular mail subscription rate for RADIO WORLD for one year is \$2.50. Send in \$1.00 extra, get "Radio News" also for a year—a new issue each month for twelve months. Total 24 issues for \$3.50.

RADIO WORLD, 145 West 45th Street, N. Y. City

A SMASH HIT! RADIO WORLD

The How-To-Make-It Magazine.
In Its New Monthly Form.

Radio World is \$2.50 a year (12 issues), 25c a copy. Offers of Radio World and other worthwhile publications for one full year on each. (NET):

- RADIO WORLD and SHORT-WAVE CRAFT, \$3.50.
- RADIO WORLD and POPULAR SCIENCE MONTHLY, \$3.50.
- RADIO WORLD and RADIO-CRAFT (12 issues) \$3.50.
- RADIO WORLD and RADIO INDEX (monthly, 10 issues) stations, programs, etc., \$3.50.
- RADIO WORLD and SERVICE (monthly) \$3.50.
- RADIO WORLD and EVERYDAY SCIENCE AND MECHANICS (monthly) \$3.50.
- RADIO WORLD and BOYS' LIFE (monthly, 12 issues) \$3.50.
- RADIO WORLD and MOTION PICTURE MAGAZINE (monthly) \$3.50.
- RADIO WORLD and MOVIE CLASSIC (monthly) \$3.50.
- RADIO WORLD and SCREENLAND (monthly) \$3.50.
- RADIO WORLD and SILVER SCREEN (monthly) \$3.00.
- RADIO WORLD and OUTDOOR LIFE (monthly) \$3.50.
- RADIO WORLD and TRUE STORY (monthly) \$3.00.
- RADIO WORLD and LIBERTY (weekly) \$3.00 U. S. only.

Select any one of these magazines and get for an entire year by sending in a year's subscription for RADIO WORLD at the regular price, \$2.50, plus a small additional amount, per quotations above. (Add \$1.50 for extra foreign or Canadian postage for both publications.)

Name

Address

City and State.....

- If renewing an existing or expiring subscription for RADIO WORLD, put cross in square.
- If renewing an existing or expiring subscription for other magazines, put cross in square.

Special Trial Offer for Radio World only: \$1.00 for 5 months, postpaid. Mail order with remittance to Radio World Office. NET.

RADIO WORLD, 145 W. 45th St., New York

R-F COIL WINDING

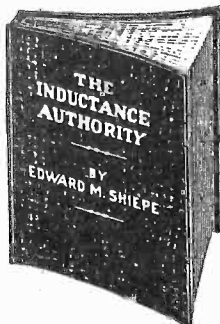

ALL you need are any standard wire and coil form and you can wind a radio-frequency solenoid to any requirement from information contained in "The Inductance Authority." No calculation is needed.

Sent prepaid anywhere on earth on receipt of \$2.00. Or send \$5.00 for a two-year sub. for Radio World and this valuable book will be sent free as a premium.

RADIO WORLD
145 W. 45th St., N. Y. C.

The Outstanding All-Wave SIGNAL GENERATOR

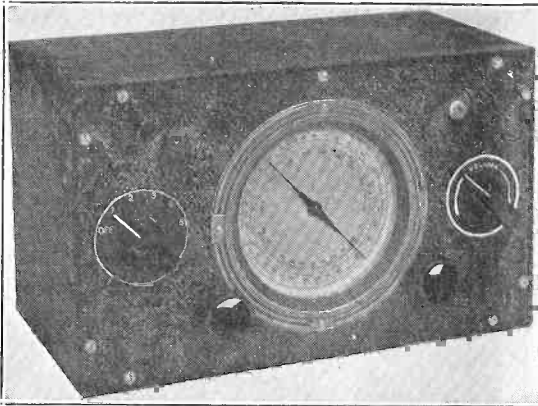

MODEL 339. A 5-band Signal Generator, 54 to 17,000 kc, all on fundamentals, switch operated, direct reading in frequency and wavelength; universal operation. Modulation on-off switch and attenuation, Electron coupled. Wired, tested, calibrated, with three tubes (6D6, 37 and neon). Shipping weight, 8 lbs. **\$16.00**

THE three low frequency coils of the generator are honeycombs, wound in quantity with special accuracy from the same spool of wire to insure uniform wire diameter hence uniform inductance. The tuning condenser is of the precision ball bearing type. The switch for band changing has a capacity of less than 1 mmfd. and a contact resistance of 0.004 ohm (four thousandths of one ohm). Everything is of the best, including black crinkle finish shield cabinet and finished chassis. Sylvania tubes are supplied.

THE highest requirements of precision and convenience for all-around work are met in the Model 339 Signal Generator, that works on a.c. or d.c. of 90-125 volts, to measure frequencies from 54 to 17,000 kc and line up channels. It also serves for determining the frequency of a station that is being received. Model 339 is outstanding because though all-wave, switch type, with airplane dial, attenuator and removable modulation, it is priced at only \$16.00 net.

- The frequencies are in five bands:
 (1)—5,400 to 17,000 kc. (2)—1,700 to 5,400 kc.
 (3)—540 to 1,700 kc. (4)—170 to 540 kc.
 (5)—54 to 170 kc.

It can be seen from the above that the calibration is decimal repeating, by noting left-hand column alone, then right-hand columns alone. Thus two calibrations afford maximum spreadout, each at outside of dial scale.

The two inside scales are for reading wavelengths, 18 to 5,500 meters.

Coincidence of generated frequency and scale reading is 1 per cent. This high order of accuracy obtains in no other instrument selling at less than twice the cost of the 339.

Many, no doubt, have been somewhat confused by the numerous type of signal generators, but will note that the best of them cover wide ranges on fundamentals, have an attenuator, and permit of pressure or absence of modulation. Also they have a vernier dial and are direct-reading in frequencies, accurate to at least 3 per cent. The 339 has all these advantages, besides affording wavelength determinations as well, and operation on 90-125 volts a.c. (any commercial frequency) or d.c. And the accuracy is three times as great. Moreover, the 339 is well built, for lifetime use, and covers all waves fundamentally, besides permitting measurements of frequencies up to 100 mcg (down to 3 meters) by resort to a slight calculation method, applying a simplified harmonic system to the 5,400 to 17,000 kc fundamental band.

The 339 has a 6D6 r.f. oscillator, a 37 rectifier tube, so that d.c. is used on the plate, while modulation is provided by a neon tube relaxation oscillator at a frequency of about 1,000 cycles.

Model 339, wired, calibrated, adjusted, complete with three tubes, ready to operate; instructions (shipping weight, 8 lbs.) **\$16.00**

Model 339K, complete kit, instructions, less only tubes\$12.50

ALL WAVE 1 TUBE A.C. & D.C. 15-2000 METERS

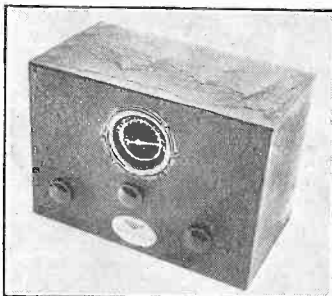

ABSOLUTELY NEW
Racoc Multi (7) Band 1 tube A.C. - D.C. Receiver

12-2000 meter
 Long - awaited thrills which cannot be had with similar S.W. receivers are now made possible for fans. This receiver will not

fit in the palm of your hand, but is guaranteed to bring in foreign reception. The only All-Wave Receiver at such a low price, guaranteed by the Racoc trade-mark. Uses the new multi-purpose 12A7 tube. A custom-built job, this set features a friction type drive airplane dial, generally found only in more expensive receivers. Dimensions: 5" x 6½" x 9".

- Complete kit (12-200 meters).....\$3.95
- Shield cab. 1.00
- No. 5 coil, 200-550 meters..... .39
- No. 6 coil, 550-1150 meters..... .39
- No. 7 coil, 1100-2100 meters..... .69
- R.C.A. license 12A7 tube..... 1.00
- Wired and tested..... 1.00
- Simple wiring diagrams and complete instructions included in every kit.

1 TUBE TRANSCEIVER

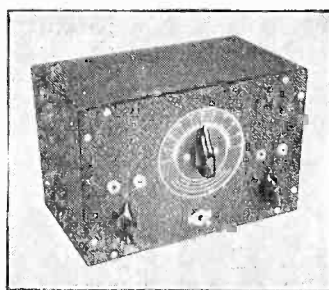

AT LAST !!!

An inexpensive 1 tube 5 and 10 meter Transceiver.

This extremely efficient transceiver is recommended for the short wave enthusiast who is interested in exploring the fascinating 5 and 10 meter bands.

The circuit utilizes the type 19 two-volt twin

tube, and is exceedingly sensitive since the super-regenerative principle is employed when the receiving position is switched on. A double pole single throw switch is the means by which the instrument may be switched to either receiving or transmitting. Dimensions: 5" x 6" x 9".

- Complete Kit with 5 meter Coils\$4.75
- Shielded Cabinet75
- 10-Meter Coils50
- R.C.A. Licensed tube65
- Wired and tested 1.00
- Wiring diagram and complete instructions included in every kit.

FEATURES

- Will operate on 5 or 10 meters by simply changing plug-in coils ● Utilizes the multi-purpose 19 tube.
- Highest Quality Parts. ● Weight only 4 lbs.

RADIO CONSTRUCTORS LABORATORIES 136 LIBERTY STREET

All Shipments in 24 Hours After Receipt of Order.

Dept. W-208, N. Y. City

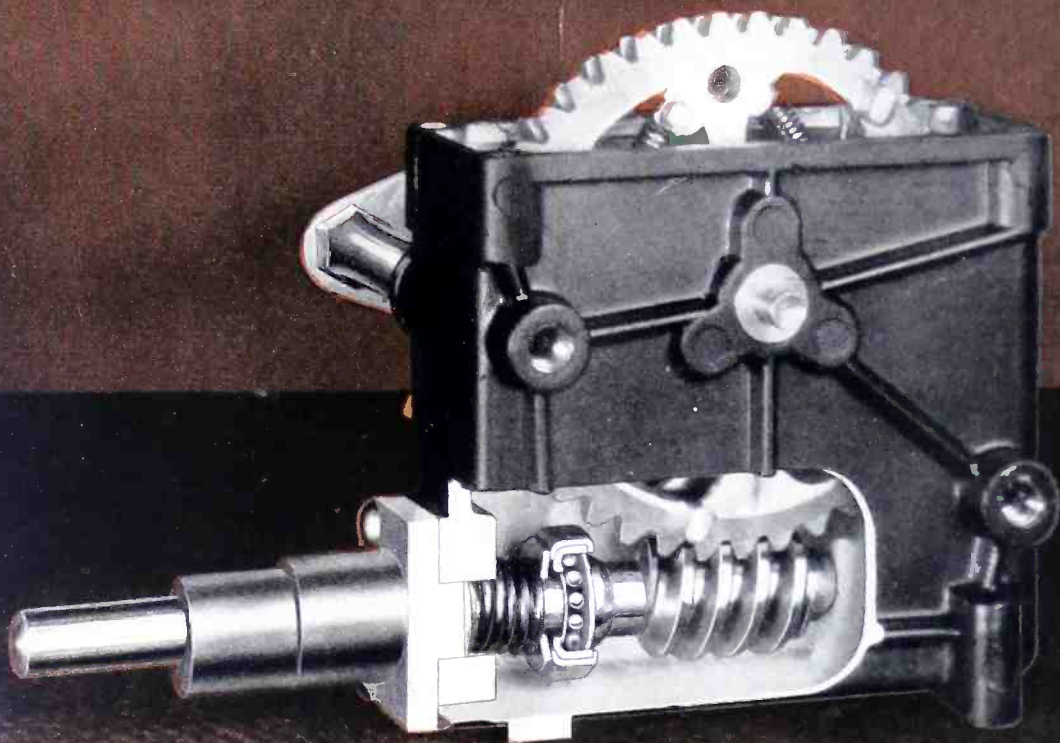

TYPE PW PRECISION VARIABLE CONDENSERS

This new National Worm-drive Condenser is ideal for use with the finest High Frequency Receivers, Signal Generators, Wavemeters and laboratory instruments. The plates are accurate Straight-line Frequency, and calibration is permanent.

The heart of this remarkable condenser is the preloaded worm-drive unit pictured above. The drive is smooth and positive, through a steel worm and accurately hobbled worm gear, preloaded with springs to eliminate backlash and wear. The worm bearing is conical with a ball bearing thrust, springloaded to take up wear. The entire drive is enclosed, the ratio being 20 to 1. The rotor shaft is $\frac{3}{8}$ " in diameter, grounded in the center, and rotating in insulated bronze bearings at the ends. There are four radial bearings, and two ball thrust bearings. Each rotor is individually insulated, contact being made through a four-leaved brush. Plate shape is straight-line frequency, and Stator insulation is Steatite. It is made with one, two, three or four sections. The dial, illustrated below, is of a new micrometer type having an effective scale length of twelve feet, and reading to one part in five hundred. As the dial and condenser sections are floating, the condenser is immune to distortion from warping of the panel or chassis.

The PW condenser and many other quality products are described in detail in the National general catalog. A copy may be obtained from your dealer, or by writing direct to the National Company, enclosing 6 cents in stamps to cover mailing costs.

NATIONAL COMPANY, INC., MALDEN, MASS.

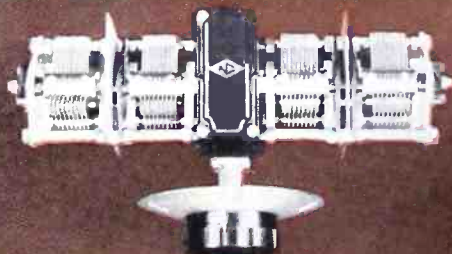
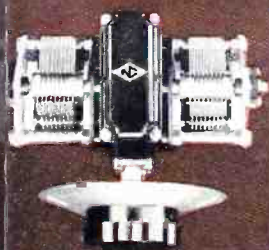

DENOTE LEADERSHIP!

New
IDEAS

MASTER
TUBE
TESTER

1210-A*

TRIPLETT

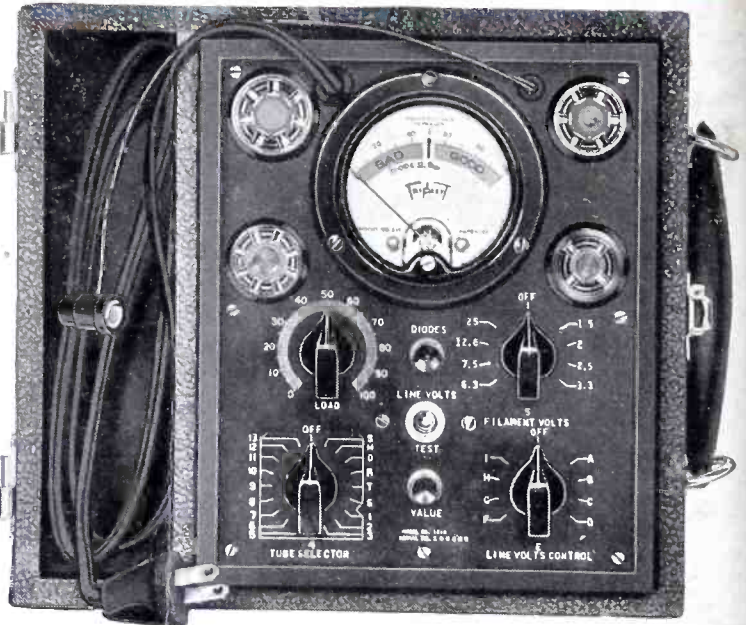

NEW creative IDEAS are the life-blood of any progressive business. IDEAS are conceived in the radio testing field because of the needs that arise among servicemen for faster, more efficient, and more accurate servicing. Triplet engineers know the requirements of the serviceman . . . and, because of the vast store of scientific knowledge that they have at their command, they are able to incorporate sound and workable IDEAS into Triplet Testing equipment.

The Triplet Electrical Instrument Company is an IDEA concern. They have pioneered many outstanding improvements in the testing field . . . their engineers are constantly working on new IDEAS. That is why Triplet testers are widely regarded as the finest, most up-to-date testers on the market today . . . and will be for years to come.

One of the outstanding IDEAS of Triplet engineers was to provide the 1210-A* Master Tube Tester with the PROPER LOAD for each tube. This new improvement, combined with the other outstanding features, such as: LARGE METER, with DIRECT

READING and TWO COLOR SCALE . . . which DENOTES "GOOD" or "BAD" CONDITION OF THE TUBES; LINE VOLTAGE REGULATION; CATHODE LEAKAGE TEST and INDIVIDUAL TESTS on DIODES and FULL WAVE RECTIFIERS, makes the Triplet 1210-A* tester the most modern and reliable tester available.

This tester makes all short tests, and is easily equipped for future requirements.

Write for information about adapting previous models to test the new Octal tubes.

*"A" tests both metal and glass tubes without adaption.

SEE THE NEW 1210-A* ON DISPLAY AT YOUR JOBBER'S

THE TRIPPLETT ELECTRICAL INSTRUMENT CO.
176 MAIN STREET BLUFFTON, OHIO, U. S. A.

RUSH COUPON FOR DETAILS!

TRIPPLETT ELECTRICAL INSTRUMENT CO.
176 Main Street, Bluffton, Ohio

Gentlemen: Please send me complete information about the improved 1210-A* and other Triplet testers.

Name.....
Street.....
Town..... State.....