

RADIO WORLD

REG. U.S. PAT. OFF.

THE HOW-TO-MAKE-IT MONTHLY—*14th Year*

JULY

1935

SOLDERING
as a SCIENCE

4 TUBE
PORTABLE

125
ILLUSTRATIONS

TELEVISION IN NATURAL COLORS

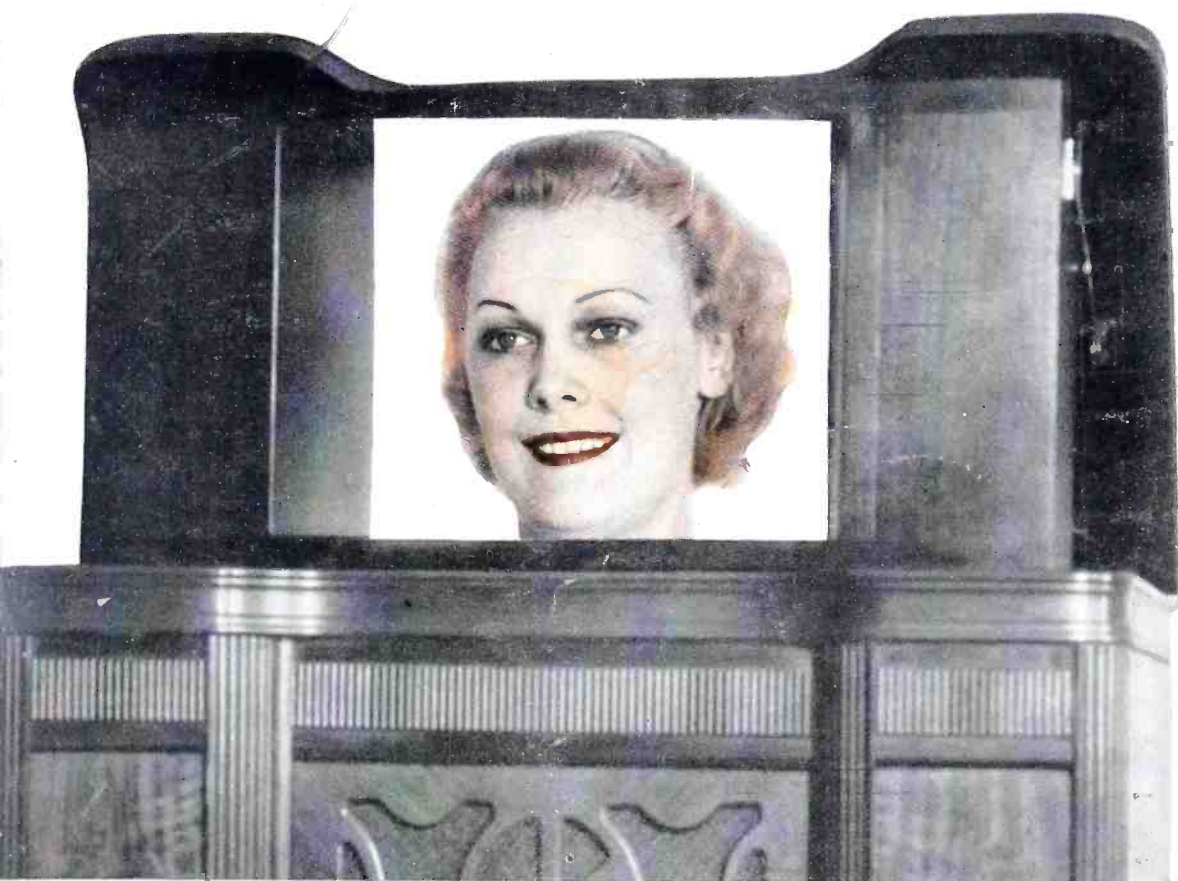

This is an actual photograph of a television receiver in which a mechanical method of scanning is used, producing black and white images. A method has been devised, based on the action of a Kerr cell on plane polarized light, for the production of images in natural colors. It is expected that this method will be perfected before the end of 1936. A girl's picture was superimposed on the screen in colors to represent the result expected to be achieved. See article on page 34

SHORT WAVE HEADQUARTERS

An Entire Floor Devoted to

Custom Built SHORT WAVE Receivers

Metropolitan Distributor for Latest Models

New Midwest 16 and 10 Tube Sets

Hallicrafters TRF and Super Skyriders

McMurdo Silver's Famous Masterpiece, World Wide Nine
and 5C Communications Receivers

Silver Marshall World Wide DeLuxe

Hammarlund Pro's All Models

RCA ACR-136 Amateur Receiver

Peak Preselectors All Types

Write for full information and catalogues. Radios in stock.
We guarantee immediate delivery to customers visiting our
Cortlandt Street Store, 24 hour service on mail orders.

EASY TERMS ARRANGED

or Special Cash Prices

DAVEGA CITY RADIO

63 CORTLANDT STREET STORE, Dept. RW, BArcly 7-1948

SIGNAL GENERATOR PARTS

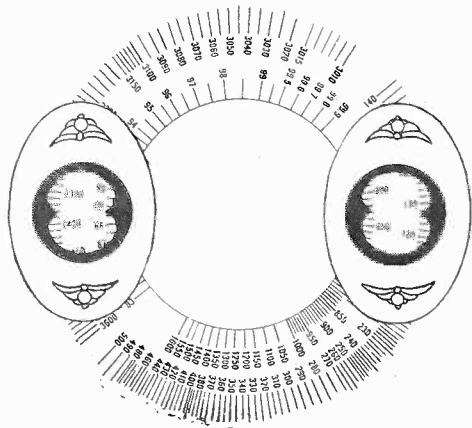

3.5 inch diameter dial scale, sturdy metal, silver finish, with black etched numbers and bars, for intermediate and broadcast frequencies, and a lower frequency band.

MOST purposes of lining up intermediate channels and broadcast levels are served by a signal generator that covers 140-500 kc and 540-1600 kc. A precision dial scale with $\frac{3}{4}$ inch hub, calibrated by Herman Bernard, offers the vast advantage of direct reading of frequencies.

With two coils and a double pole, double throw switch, and a particular tuning condenser, the intermediate and broadcast frequencies are covered. By a special harmonic method frequencies to 30 mc. can be determined. The signal generator foundation parts are suitable for battery, a.c.-d.c. or a.c. operation. The oscillator tube for battery operation should be a 34, for a.c.-d.c. operation a 6C6, and for a.c. operation a 58.

For two-band operation, sufficient for all practical purposes, only one escutcheon is needed. The low frequency coverage, 83 to 99.9 kc, is for lining up old sets that used frequencies in this range (Victoreen, Magnaformer, etc.). This band is established by using a triple throw switch, no extra coil, as the intermediate coil is shunted by a fixed 0.0008 mfd. precision condenser to provide the result. This band is also calibrated in wavelengths, 3010 to 3600 meters.

1 Per Cent. Accuracy Attained

WITH the precision coils and precision tuning condenser, the precision dial scale enables accuracy of 1 per cent., or three times the usual accuracy attained even in high priced generators. The intermediate frequency band has indicating bars spaced 5 kc minimum, the broadcast band can be read to 10 kc, the lower frequency band 0.5 kc and 10 meter differences. Thus all needs are excellently accommodated, especially as the lower frequency part of the broadcast band may be used for its second harmonics to read to 10 kc the frequencies between 1100 and 1600 kc, where the bars are 50 kc apart.

The scale is nonwarping and therefore the generator is useful in exacting climates. Circuits are supplied with each order for all three types of operation—battery, universal and a.c.—whereby the operating stability will be remarkably high, approximately that of crystal control.

FOUNDATION KIT 3332—Consists of dial scale, escutcheon, two coils for intermediate and broadcast band, and tuning condenser. Trimmer on condenser should be removed. Shipping weight, 2 lbs. Net price **\$1.95**

FOUNDATION KIT 3333—Consists of dial scale, two escutcheons, two coils, tuning condenser, 0.0008 mfd. fixed condenser. For three band coverage; low frequency, intermediate and broadcast frequencies. Shipping weight, 2 lbs. Net price..... **\$2.45**

FOUNDATION KIT 3334—Same as above. except that coil for 1400-5000 kc is added. Shipping weight, 2 lbs. Net price **\$2.85**

Precision Condenser

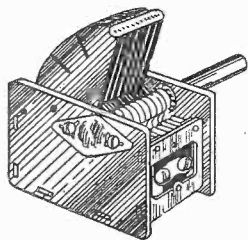

When mounting the condenser be sure that the dial scale is affixed, as otherwise it would be necessary to remove the mounted condenser to put on the scale.

A specially attractive shield cabinet, of superior workmanship and durability, has been prepared, wherein any model of the generator may be built, the battery model with batteries self contained (1.5 volts and 45 volts), the universal model with heater resistance of 350 ohms in the line cord, and the a.c. model with midget power transformer. The case alone (illustrated) is Cat. 333-CA. Shipping weight 4 lbs. Net price..... **\$1.79**

Since the dial scale's imprinted frequencies principally reflect the rate of capacity change, only a particular tuning condenser may be used. This is its appearance.

Shield Cabinet

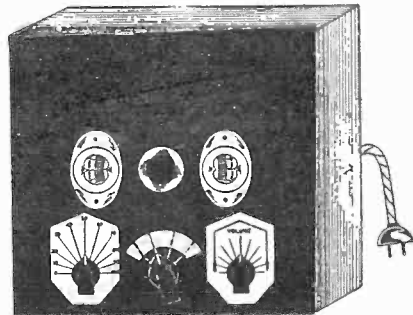

Two chrome finished face plates for the signal generator, to give a professional appearance to the front view, may be obtained, 0-100 for percentage modulation, and ungraded bars under a "volume" caption, for output attenuation, Cat. 333-FP (price of both, net) **.25c**

CUSTOM SET BUILDERS SUPPLY CO.

135 LIBERTY STREET

Telephone: REctor 2-6650.

NEW YORK, N. Y.

Shipments in 24 hours.

RADIO WORLD

The How-to-Make-It Monthly—Fourteenth Year

ROLAND BURKE HENNESSY
Editor

HERMAN BERNARD
Managing Editor

HERBERT E. HAYDEN
Advertising Manager

Table of Contents for JULY, 1935

The Science of Soldering 5 <i>Radio's Paramount Task</i> By Capt. Peter V. O'Rourke	Splendid Output for Signal Generator 33 <i>No Detuning Effect on Receiver</i>
A Short Wave Tuner-Amplifier .. 10 <i>Three Audio Stages Used</i> By Louis Pouy	Television in Natural Colors 34 <i>Selective Distortion of Kerr Cell Used</i> By J. E. Anderson
T.R.F. Tuner Made High Gain ... 12 <i>First Audio Has 27's in Parallel</i> By Jack Goldstein	A VTVM Capacity Meter 38 <i>High Resistance Also Measured</i> By J. E. Anderson
A 5 Meter Antenna 15 <i>Hollow Brass Rod Secured to Insulator</i> By Earle Branker	Pretuned I. F. Amplifiers 41 <i>The Rest of a Super May Be Built Around Them</i> By Carter G. Ralstead
Aerial Deeds and Misdeeds 16 <i>Two Pages of Photographs</i>	A Compact Four Tube Set 46 <i>Short Wave Receiver with T.R.F. Stage</i> By Robert G. Herzog
Higher Grid Leak Aids Stability . 18 <i>Helps Cure Drifting Above 10 Mc.</i>	Neon Tube's Average Current ... 47 <i>How This Value Is Determined</i> By Louis Kranz
How to Fit Things in Tight Places 19 <i>Three "Highly Scientific" Methods</i> By I. Nelson Butterworth	A Preselector 48 <i>Gives More Gain and Selectivity</i> By B. Herbert Russ
A Four Tube Portable 20 <i>Upside Down Construction Used</i> By Herbert E. Hayden	Harmonic Practice 50 <i>Its Use Calibrating Generators</i> By Herman Bernard
A 50-Watt De Luxe Transmitter 22 <i>\$750 Well Spent by Expert</i> By Harvey E. Sampson	Circuits for Rack Use 52 <i>All Wave Super and Powerful Amplifier</i>
The Saturated Pentode 28 <i>It Offers Stability Possibilities</i> By Leonard R. Woolsey	What to Do with Car Sets 54 <i>Aerial, Ground, B Supply Discussed</i> By Sol Merles
A Service Wand for Light 29 <i>Illuminates Places Hard to Reach</i> By Michael Blan	Servicing Small Sets 56 <i>Electrolytic Condensers Should Be Checked First</i> By Earle Branker
A Marine Radio Compass 30 <i>Visual Indication Achieved Ingeniously</i> By W. L. Webb	Radio Construction University .. 58

Vol. XXVII, July, 1935. No. 6. Whole No. 682. RADIO WORLD, published monthly by Hennessy Radio Publications Corporation, 145 West 45th Street, New York, N. Y. Editorial and executive offices, 145 West 45th Street, New York, N. Y. Executives of RADIO WORLD: Roland Burke Hennessy, editor and business manager; Herman Bernard, managing editor; Herbert E. Hayden, advertising manager. Officers of corporation: Roland Burke Hennessy, president and treasurer; Herbert E. Hayden, vice-president; Herman Bernard, secretary. Entered as second-class matter March, 1922, at the Post Office at New York, N. Y., under Act of March 3d, 1879.

SUBSCRIPTION RATE

Price 25 cents per copy. Subscription \$2.50 per year (12 issues), postpaid in United States and Possessions; \$3.00 per year postpaid in all other countries. Remittance for foreign subscription should be by International money-order (postal or express) or draft against or discountable at New York bank.

RADIO WORLD is distributed by the American News Company and its Branches

Radio's Paramount Task

Soldering Stands First in Importance —How to Perform Work

By Capt. Peter V. O'Rourke

Technique for 'Phone Tip Soldering

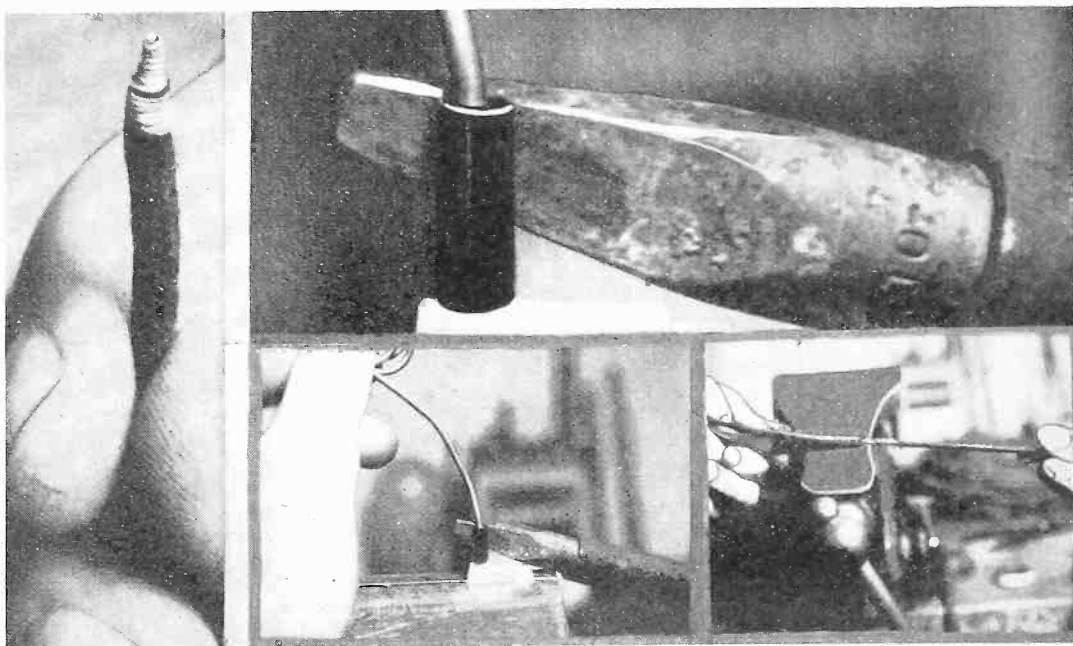

Neatly soldering tinsel cord of 'phone leads to tip plug is accomplished by twisting bare copper wire conically (left), putting a little cut solder into the plug, plus wee bit of flux, then heating the side of the plug with absolutely clean iron tip (upper right). Plug is held in vise and when point cools it will resist a little pulling.

IT isn't the cathode ray or television or the ultra wave that is the most important concern. Instead it is the soldering iron. Yes, it is with the iron that all the sets are made, and without the connections of proper identity and integrity the tubes, coils, voltages and filters matter nothing. That is why the soldering iron is commander in chief in the radio construction field.

With soldering, as with other things, some individuality of method is naturally applied. Being something of a science, soldering has its rules, and if the individuality or mannerism of method is contrary to the rules, one is likely not to be doing as good work as he should. It is only fair to state, however, that probably nobody follows all the rules, especially as some

minor infractions increase speed of work, and many desire this economy of time.

Just as you buy shoes to fit your feet, a hat to fit your head, and gloves to fit your hands, you should buy a soldering iron to fit your work. The iron, if of the electric type, will be rated in wattage, which expresses the power consumption. What one is really concerned with is the heat, but the heat is exactly proportionate to the wattage.

Select Iron of Proper Rating

For the usual radio wiring an iron of a rating of from 50 to 85 watts is sufficient. This will produce even more than the required
(Continued on next page)

(Continued from preceding page)

heat, at the end of a short tip. For heavier work a heavier iron is needed, or, in wattage, one from, say, 100 to 400 watts. Thus if soldering is to be done to large metal pieces,



A coarse file should not be used for removing pits from a soldering iron (top illustration) because it tends to remove the flatness of the tip faces and tempts one to file to a lower depth than actually necessary. Use a fine, flat file (second from top). Pits should not be cleaned with a pointed instrument, as the indentation remains as a constant source of such trouble (third from top). If the tip gets too hot, use a longer one. The one and three-quarter-inch projection shown is usually too short.

such as thick chasses, the more powerful iron is preferable.

The tip of the iron is copper, because this is the best conductor among the inexpensive metals. But the tip does not remain exclusively copper, especially if subjected to abuse, when it acquires a coating of black, the injurious carbon that really acts as a heat insulator. It has been the experience of many, no doubt, that though the iron has been on for an hour or more, solder will not melt when applied to the hot tip, because of the layer of carbon, in addition to an invisible film that in the reaction it causes upon solder somewhat suggests oil.

Rapid carbonization of the tip suggests that the heat is too great for the total dissipation of the tip, therefore a longer tip would be preferable. In this way the carbonization is retarded, so much so that practically no trouble of this kind is experienced, provided other precautions are taken. One of them is to wipe the tip clean, using steel wool, asbestos or a rag, several times during an evening's work, while another is to refrain from sticking the hot tip into a can of soldering paste.

Don't Carry Over Molten Solder

If the tip is blackened and thus partly or nearly wholly useless, it will be found that plunging the hot tip into the paste can will yield some useful small areas of the facets of the tip. Thus at least one spot is found to which the solder may be applied for melting, and the solder then may be carried over to the work, otherwise the solder would roll off the tip. This is a little speedier than the approved method of not carrying over the solder, but heating the joint and melting the solder there against the joint. The violation is widespread. Probably many of those who recommend that the rule be followed honor it more in the breach than in the observance.

The preparation of the iron for a soldering job is probably well known by every radio experimenter. Assuming the tip has unpitted surface, appears clean, the iron is heated, some soldering paste is applied to the hot tip, and then the tip is plunged into molten solder, or solder is permitted to melt all around the tip, to the very ends of the facets, the usual two or four faces, and even some short distance up the cylindrical part. Then the iron is wiped clean, using steel wool or rag, or rubbing on asbestos. Immediately the iron will glisten as if plated, but soon the shine will disappear, and a dull silver coating remain. This is the normal appearance of the tinned tip during use.

It may happen that instead of a shiny surface throughout, there are black spots. Usually these denote small indentations in the tip, known as pits. Besides, there may be flat parts of the surface that do not accept the solder, usually presenting a black appearance. Unless the solder will hold all over the working surface the tip is not in proper condition for use and should be repaired.

How to Remove Pits

To remove a pit it is advisable to file the

iron, not using a coarse file, however, as that tempts one to be too lusty about the work, file down much more than needed, and destroy the symmetry of the tip. A fine file is preferable, or one may use fine sandpaper or emery paper, although these are not so handy. Better to secure the tip in a vise and file carefully, keeping the file in a plane with the facet being worked. Remember that the file files going away from you but lifts coming back, and you want to perform a filing, not a lifting operation.

defective cord or other contact, as in the plug.

If the heat is too little, always pay some attention to the wall socket. If a three-way plug or other such device is used, that is an ever dubious convenience. The 10c type of three-way plug so commonly used is practically worthless, develops loose contacts, and has insufficient tension to hold in the wall socket, especially due to weighing if the three adapter provisions are used, and even if only one is used. Also, the wall socket itself may be worn, as evidenced by the iron's plug tending

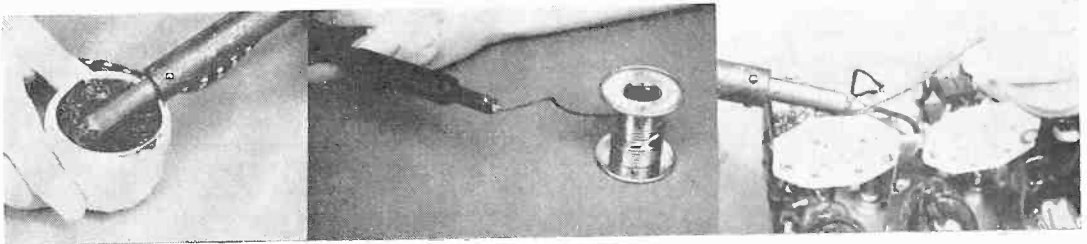

Impatient experimenters find that a dirty iron tip, which practically rejects solder, will become momentarily useful if the hot tip is plunged into soldering paste (left). However, thick cakes of carbon collect on the rest of the tip, and corrosion spreads. The iron should not be applied to the solder for "carryover" (center), but the joint should be heated and solder melted at the joint (right).

Also, filing is the remedy for removal of the foreign coating that resists solder.

Under no circumstances drill out the deposit from the pit, or attempt to pick it out with scribe, because the object is to have the tip faces flat and smooth.

Naturally, the tip is cold when this work is done, so a new test is made now, the tinning process renewed, and if the solder adheres all over the work surface, then the tip is in condition.

While the tip should be able to hold solder, and solder "rolling off" is always a warning signal, it is not good practice to apply the iron to the solder, carry the solder over to the joint, and then heat the joint principally with the solder. That method does not conduct as much heat to the joint as is desired. While holding the iron at the joint will make up for this difference, nevertheless some sort of a joint might be formed, and considered sufficient, whereas the heat was not quite as much as it should have been. Also, if flux-cored solder is used, the flux spreads away and may cause incipient carbonization. If the solder is applied, as it should be, to the preheated joint, the flux will run into the joint, where it belongs. The iron should not be removed from the joint until the solder has flowed freely.

Seeking Other Trouble Sources

If the joint does not get hot enough one should look to the iron. That is, if repeated use suggests that the heat is slow in appearing, although the iron may be rated at 50 to 85 watts and therefore seem to be correct, a defect in the iron may be causing heat minimization. Such a defect could be a poor connection inside the iron, a defective heating element, or a

to make an angle with the plug other than a right angle wall other than a right angle.

Make a Mechanical Joint First

Assuming that the heat is sufficient, the iron and accoutrements in good condition, and joints are to be soldered, the first consideration is to establish a mechanical joint before making an electrical one. That is, the solder alone should not be relied on to hold the wires in place, but the wires should be mechanically fastened so that a pretty good joint exists without soldering. No doubt this rule arises from the possibility that a poor solder joint may be made, and then at least a mechanical joint exists, and there will be good conductivity. There should be no stresses and strains that the solder is expected to take up, especially as these might cause movement after the solder has started to harden, and thus imperil the joint.

If there is not enough heat it is possible there will be a soldered joint, but it will not be a good job. Usually this type of joint, called a cold solder joint, meaning that the heat was insufficient rather than the place was cold, is evidenced by the "fingerprints" of the iron. If the point was used, the impression of the point is left. Such a joint may appear scaly, also. If the solder was joint was properly heated, and the solder flowed freely, as it should, there would be a natural contour of solidification, as determined by the surfaces to which the solder was applied, while there will be no "fingerprints" of the instrument of application. The fault with a cold solder joint is that it is not a good joint. You can pull away the wire. After making any joint, exert quite some

(Continued on next page)

(Continued from preceding page)

tension on it, to be sure that the joint is strong and stays intact. Even if pliers are used on a wire, with tension within the breaking point of the wire itself, the solder should not yield to the effect of a key opening a sardine can, but should hold.

Solder Types and Fluxes

One may use whatever type solder he prefers, cored or uncored. For radio work a solder of the 50-50 type, being quick to flow satisfactory in tension, may be used, or 60-40, another common combination. For small irons of the type generally used in home radio work, thin circular or flat solder of, both of the cored type, are popular, while uncured strip solder also finds a favor. The cored solder for radio uses must have resin core, not acid core, while

It may prove difficult to develop that much heat, in which instances a hotter iron will have to be used. A shorter tip may be inserted and the heat applicable to the chassis will be greater. It is well worth while going to this trouble, and assuring proper heat, as service men find that more than half the intended joints to chassis may be pulled off easily, as they were either cold solder joints or there was some cementing by flux but no soldered joint at all. So if soldering to a chassis, when you consider the job finished, tug on the joint with greater strength than you ever thought reasonable to such a purpose, and don't be surprised if the supposed joint turns out to be a wire in your hand and a glob of solder than rolled off the intended position of the joint.

Aside from the advertisement of one's slovenliness, a reason for not soldering to the chassis is that the practice leads to joints of this kind

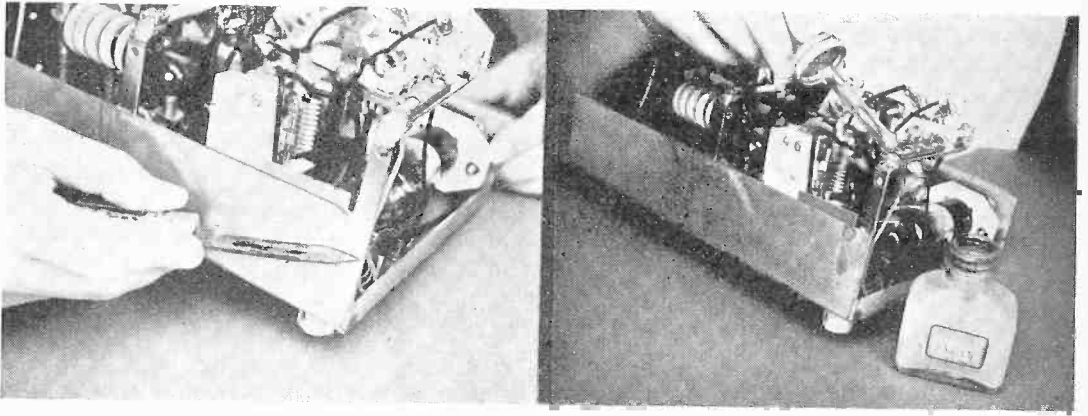

Soldering to chassis is not good practice, but if it is to be done the plating should be scraped off the chassis with a jackknife (left) and a large amount of flux used. Acid flux (right) is not recommended for radio work, but may be used for soldering if only a mechanical joint and no conduction of radio frequency currents, is desired.

if the uncured solder is used, the flux may be resin, soldering salts, or, for work on parts not to carry radio frequency currents, acid or other preparation. It is not likely that in soldering radio work one changes from one type of flux to another. Resin core serves all radio, audio and mechanical purposes on sets, although for soldering to a chassis a much greater amount of flux is needed because of the greater quantity of impurities.

It is not good practice to solder to a chassis, not only because that practice tends to make a job look measly, or suggests that the workman was of the hurried and careless type, but also because the joint may not be good. Chassis usually are plated, and especially the popular cadmium plating has to be coped with. Therefore use a chisel or jackknife to scrape off the chassis plating, apply an extraordinarily large amount of flux (though the solder being used is of the cored type with flux "built in" use external flux), and heat the chassis about the joint to be made, allowing the solder to be melted by the heat of the chassis and not directly by the iron.

being used in radio frequency return circuits. Because such soldering is generally poorly done, even the joint passing for one in a mechanical sense, especially since attempted to the purpose, the joint even if it passes for one in a mechanical sense, is not one electrically, as it should be a short circuit and turns out often to be a high resistance to r.f. Moreover, numerous return circuits begin to set up sizable currents in the chassis, and the radio frequency ground as may be considered to exist at the ground post does not pertain stall points on the chassis. Hence there is a current flowing in the chassis, a potential difference between different chassis points, and oscillations may be set up this way, besides the chassis becoming a sensitive to hand capacity at the front, where tuning and control generally are performed. Especially if there is an oscillator in the circuit on being built on the chassis, the return connection to chassis is a poor inadvisable.

Connection to Chassis

If for any special reason a connection has to be made to chassis, it is better in most in-

stances to drill a hole to pass a machine screw, and, after scraping about this hole to get rid of plating, etc., fastened down a lug, solder the intended connection to the lug. For audio frequency returns this would be passable, but for radio frequency returns it is hard to find any condition that spells necessity of using the nearest chassis pot for anchorage.

Whenever any soldering is being done, the iron should be held still. Impatience sometimes tempts one to rock the iron handle, as if one supposed he was thus delivering more heat by distributing the heat over greater surface, but of course that is the way to communicate less heat. Hold the iron still and firm against the work, and present as much of the tip areas to the intended joint as is practical, since that increases the communication of heat. Since the solder strip is to be applied to the preheated joint, it follows that no soldering is done with the point of the tip of a four-sided faced tip, and even the two faced tip should be used on either side rather than at end.

The tip is renewable. Either it screws into the base or it is pressed in and a setscrew holds it tight. Under all circumstances the tip should be held rigidly in place while the soldering work is being done. When the tip is loose heat is lost, because the conduction of heat from element to iron is reduced. Moreover, the handle should be tight, in the interest of ship-shape tooling and careful procedure.

While the practice scarcely ever is followed, it is not a bad idea to unscrew the tip, or to otherwise loosen it, after the soldering operations are completed, and tightened it again when soldering time comes 'round again. The reason is that any tendency for oxidation to take place between the tip and its bed will be avoided, as the loosening is in itself a cleaning operation, and each time it is performed will get rid of any small. If no attention is paid to the carbonization at this point, the tip may become so firmly embedded that it will be necessary to put the tip in a vise and hammer the tip to obtain some freedom from adherence, and then using heavy pliers to remove the tip. During this work, on many occasions, the iron becomes ruined.

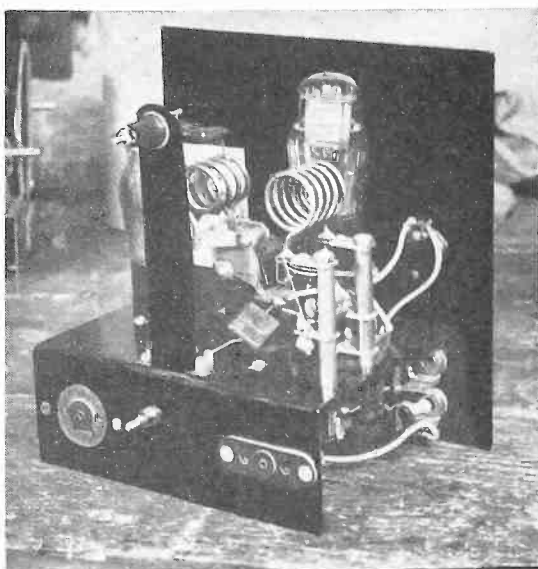

The upper picture shows the interior of a 5-10 meter transceiver. Note how the coils have been mounted on stilts in order to keep them away from the subpanel and also to keep the leads short. The lower picture shows the panel. Careful soldering is most vital for ultra frequency sets.

Transmission Lines Are Ready

Transmission lines are coming into use more and more. Recently the American Telephone and Telegraph Company announced a concentric cable capable of sending a frequency band of 1,000,000 cycles and 200 simultaneous telephone channels simultaneously. This is really not the limit, but the statement will do. This cable is a true transmission line. Similar lines are now being used in cables across the ocean, and they have an almost unlimited capacity for handling cable messages.

Transmission lines are also used in radio, for conducting the signal without loss of power,

from the transmitting tubes to the radiating antennas or from the antennas to the receiving tubes. The well known transposed leadin is a transmission line. This could also be of the concentric type, that is, a central live conductor surrounded by a grounded cylindrical sheath. Another application of the transmission line is to oscillators. A uniform transmission line is connected between the plate and the grid of the tube, with suitable blocking condensers and chokes for the supply leads. The characteristics of the line determine the frequency, the frequency constancy is high.

(Continued from preceding page)

tension on it, to be sure that the joint is strong and stays intact. Even if pliers are used on a wire, with tension within the breaking point of the wire itself, the solder should not yield to the effect of a key opening a sardine can, but should hold.

Solder Types and Fluxes

One may use whatever type solder he prefers, cored or uncored. For radio work a solder of the 50-50 type, being quick to flow satisfactory in tension, may be used, or 60-40, another common combination. For small irons of the type generally used in home radio work, thin circular or flat solder of, both of the cored type, are popular, while uncured strip solder also finds a favor. The cored solder for radio uses must have resin core, not acid core, while

It may prove difficult to develop that much heat, in which instances a hotter iron will have to be used. A shorter tip may be inserted and the heat applicable to the chassis will be greater. It is well worth while going to this trouble, and assuring proper heat, as service men find that more than half the intended joints to chassis may be pulled off easily, as they were either cold solder joints or there was some cementing by flux but no soldered joint at all. So if soldering to a chassis, when you consider the job finished, tug on the joint with greater strength than you ever thought reasonable to such a purpose, and don't be surprised if the supposed joint turns out to be a wire in your hand and a glob of solder than rolled off the intended position of the joint.

Aside from the advertisement of one's slovenliness, a reason for not soldering to the chassis is that the practice leads to joints of this kind

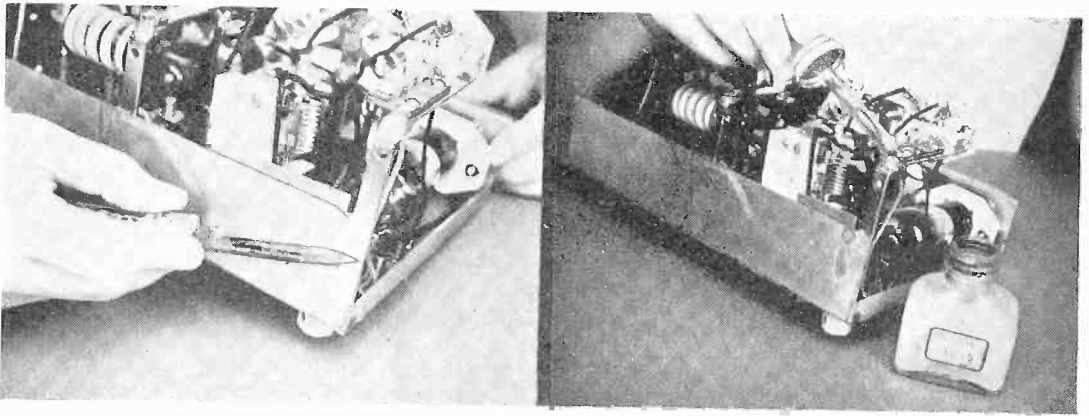

Soldering to chassis is not good practice, but if it is to be done the plating should be scraped off the chassis with a jackknife (left) and a large amount of flux used. Acid flux (right) is not recommended for radio work, but may be used for soldering if only a mechanical joint and no conduction of radio frequency currents, is desired.

if the uncured solder is used, the flux may be resin, soldering salts, or, for work on parts not to carry radio frequency currents, acid or other preparation. It is not likely that in soldering radio work one changes from one type of flux to another. Resin core serves all radio, audio and mechanical purposes on sets, although for soldering to a chassis a much greater amount of flux is needed because of the greater quantity of impurities.

It is not good practice to solder to a chassis, not only because that practice tends to make a job look measly, or suggests that the workman was of the hurried and careless type, but also because the joint may not be good. Chassis usually are plated, and especially the popular cadmium plating has to be coped with. Therefore use a chisel or jackknife to scrape off the chassis plating, apply an extraordinarily large amount of flux (though the solder being used is of the cored type with flux "built in" use external flux), and heat the chassis about the joint to be made, allowing the solder to be melted by the heat of the chassis and not directly by the iron.

being used in radio frequency return circuits. Because such soldering is generally poorly done, even the joint passing for one in a mechanical sense, especially since attempted to the purpose, the joint even if it passes for one in a mechanical sense, is not one electrically, as it should be a short circuit and turns out often to be a high resistance to r.f. Moreover, numerous return circuits begin to set up sizable currents in the chassis, and the radio frequency ground as may be considered to exist at the ground post does not pertain stall points on the chassis. Hence there is a current flowing in the chassis, a potential difference between different chassis points, and oscillations may be set up this way, besides the chassis becoming a sensitive to hand capacity at the front, where tuning and control generally are performed. Especially if there is an oscillator in the circuit on being built on the chassis, the return connection to chassis is a poor inadvisable.

Connection to Chassis

If for any special reason a connection has to be made to chassis, it is better in most in-

stances to drill a hole to pass a machine screw, and, after scraping about this hole to get rid of plating, etc., fastened down a lug, solder the intended connection to the lug. For audio frequency returns this would be passable, but for radio frequency returns it is hard to find any condition that spells necessity of using the nearest chassis pot for anchorage.

Whenever any soldering is being done, the iron should be held still. Impatience sometimes tempts one to rock the iron handle, as if one supposed he was thus delivering more heat by distributing the heat over greater surface, but of course that is the way to communicate less heat. Hold the iron still and firm against the work, and present as much of the tip areas to the intended joint as is practical, since that increases the communication of heat. Since the solder strip is to be applied to the preheated joint, it follows that no soldering is done with the point of the tip of a four-sided faced tip, and even the two faced tip should be used on either side rather than at end.

The tip is renewable. Either it screws into the base or it is pressed in and a setscrew holds it tight. Under all circumstances the tip should be held rigidly in place while the soldering work is being done. When the tip is loose heat is lost, because the conduction of heat from element to iron is reduced. Moreover, the handle should be tight, in the interest of ship-shape tooling and careful procedure.

While the practice scarcely ever is followed, it is not a bad idea to unscrew the tip, or to otherwise loosen it, after the soldering operations are completed, and tightened it again when soldering time comes 'round again. The reason is that any tendency for oxidation to take place between the tip and its bed will be avoided, as the loosening is in itself a cleaning operation, and each time it is performed will get rid of any small. If no attention is paid to the carbonization at this point, the tip may become so firmly embedded that it will be necessary to put the tip in a vise and hammer the tip to obtain some freedom from adherence, and then using heavy pliers to remove the tip. During this work, on many occasions, the iron becomes ruined.

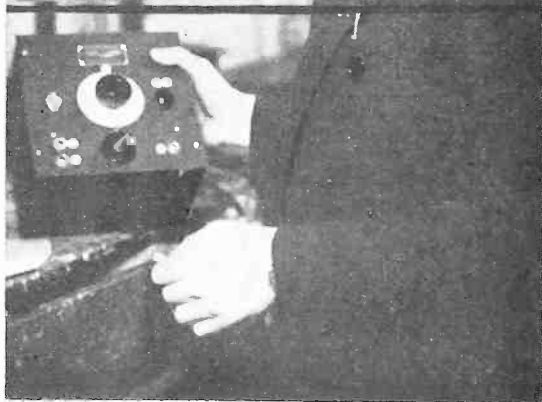
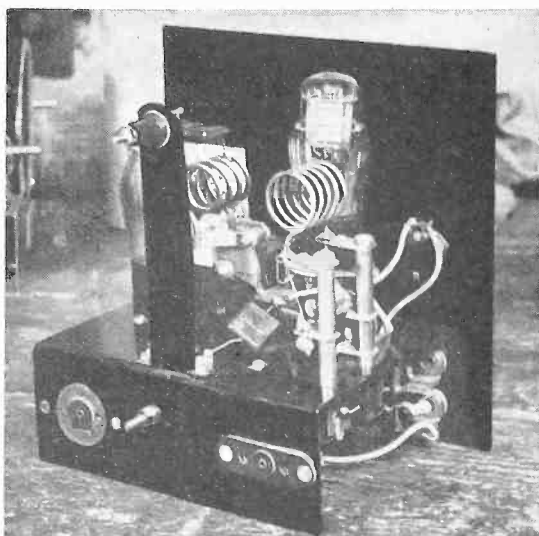

The upper picture shows the interior of a 5-10 meter transceiver. Note how the coils have been mounted on stilts in order to keep them away from the subpanel and also to keep the leads short. The lower picture shows the panel. Careful soldering is most vital for ultra frequency sets.

Transmission Lines Are Ready

Transmission lines are coming into use more and more. Recently the American Telephone and Telegraph Company announced a concentric cable capable of sending a frequency band of 1,000,000 cycles and 200 simultaneous telephone channels simultaneously. This is really not the limit, but the statement will do. This cable is a true transmission line. Similar lines are now being used in cables across the ocean, and they have an almost unlimited capacity for handling cable messages.

Transmission lines are also used in radio, for conducting the signal without loss of power,

from the transmitting tubes to the radiating antennas or from the antennas to the receiving tubes. The well known transposed leadin is a transmission line. This could also be of the concentric type, that is, a central live conductor surrounded by a grounded cylindrical sheath. Another application of the transmission line is to oscillators. A uniform transmission line is connected between the plate and the grid of the tube, with suitable blocking condensers and chokes for the supply leads. The characteristics of the line determine the frequency, the frequency constancy is high.

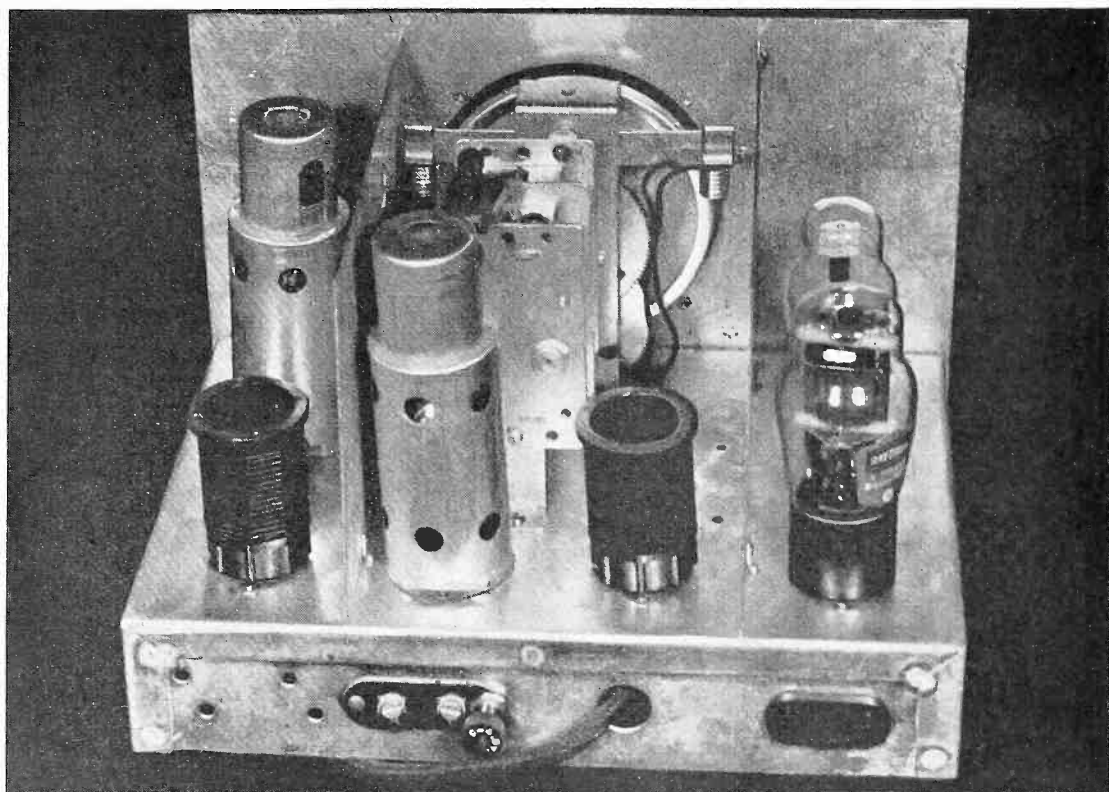

Interior view of the short wave set shows leak-condenser in shortest route to grid.

the eye, denotes the separation between the integral construction and the external apparatus.

There is of course added peril of hum when there are three audio stages, but improvement of the filtration, already taken care of in the diagram, provides the solution. The designer tried very hard to be satisfied with two audio stages, but the third one was deemed imperative, to give that extra wallop that is needed on weak, foreign stations, to justify the boast of real speaker operation.

The compartment method of construction has been followed in this short wave receiver. The coils are especially well shielded from each other because of the intervention not only of the metal

separator but also of the metal shield on the second tube. The second tube, in the middle compartment, is the 6F7, which not only works as a regenerative detector but also as a stage of audio. When a single tube is used as a diode rectifier (grid leak), diode biased audio amplifier, regenerator and once more as a straight audio amplifier, as is done in this circuit, about all that can be expected from a single tube is obtained from it. Despite the many functions performed by this tube, each is done properly.

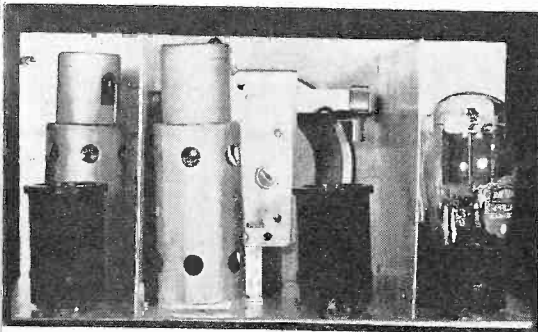

Rear view of the chassis of the tuner-amplifier.

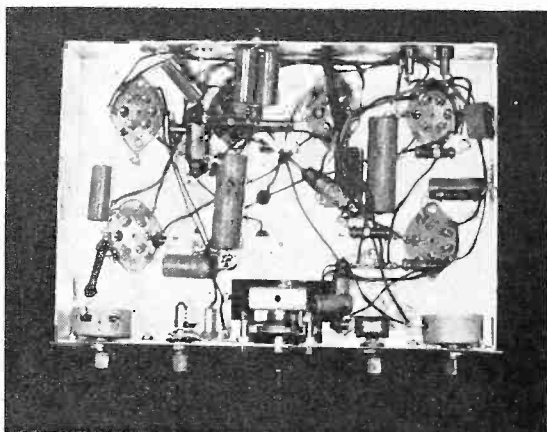

Wiring as seen from the bottom.

T. R. F. Tuner Made High Gain

By
Jack Goldstein

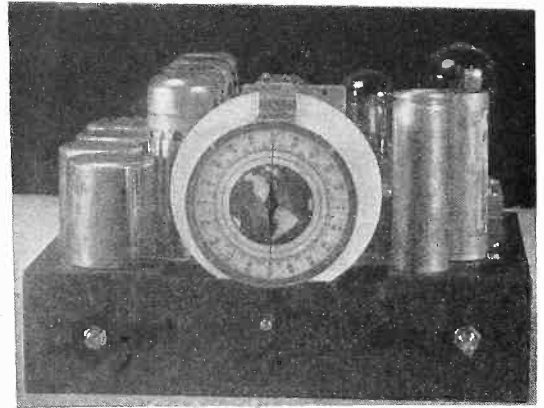

ONLY in selectivity does the superheterodyne surpass the tuned radio frequency receiver, if one may forget for a moment the ease of wiring one compared to the complexity of the other. It is practical to make a t. r. f. set just as sensitive as any useful condition would permit; that is, get down to the noise level. Farther than that it is of no consequence to go, because pressing farther simply reduces reception. However, the sensitivity of the t. r. f. hookup is not so uniform over a band as is that of the super, because the super has a fixed degree of amplification in the one or two stages of the intermediate amplifier.

On the simplicity score, of course, the t. r. f. circuit wins. Moreover, it is difficult for any one to start building a super as his first set. It is a far cry from a crystal receiver to a super. Perhaps the crystal set, almost useless today, would be experimentally preferable, than a tuned radio frequency set. Supers may come later.

Quality Obtained from Tuner

It is easy to get good quality out of the tuning portion of a t. r. f. set. Some persons like to use a t. r. f. tuner ahead of their amplifier, and for such use the circuit shown is splendid. There are four tuned stages and parallel first

audio tubes, shown as 27's, but may be 56's.

Only the essentials are included in the circuit. There is a tone control, besides the volume control, as the only concession to anything extra, if one may consider the paralleled audio tubes as valuable because more output can be withstood readily.

The coils consist of four equal solenoids on 1 inch diameter tubing, the secondaries comprising 127 turns of No. 32 enamel wire, close wound, the primaries consisting of 22 turns of any convenient sized wire, same as the secondary wire, if desired. Between primary and secondary is insulating fabric, 0.01 inch thickness, which may be approximated by two turns of wrapping paper. The primary is near the bottom.

How to Establish High Gain

These coils are contained in aluminum shields 2 1/16 inch outside diameter. It is quite within keeping to use a larger, but not smaller, diameter shield. The distance between coil and upright wall of the shield should be equalled or exceeded between coil and can bottom, and coil and can top. The standard aluminum shields therefore are satisfactory. Larger shields take more room than usual chasses afford.

To get the most results it is necessary some-

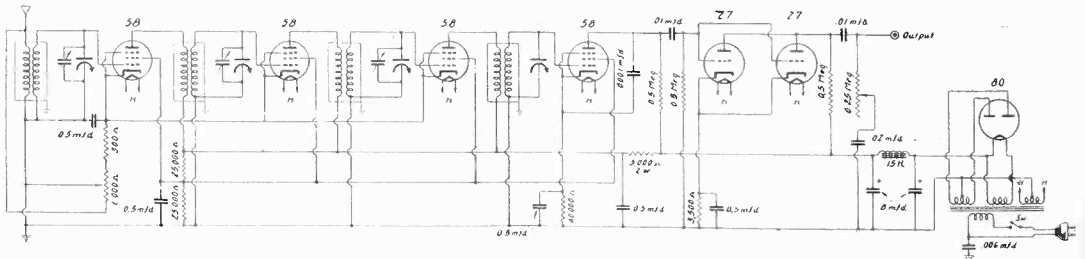

Instead of using just some specified value of fixed limiting resistor in the r. f. cathodes' leg, which proved satisfactory in one location and with a particular aerial, it is advisable to experiment with this value, for a remarkable improvement in gain is bound to result if the 300 ohms are a bit too high for a particular condition.

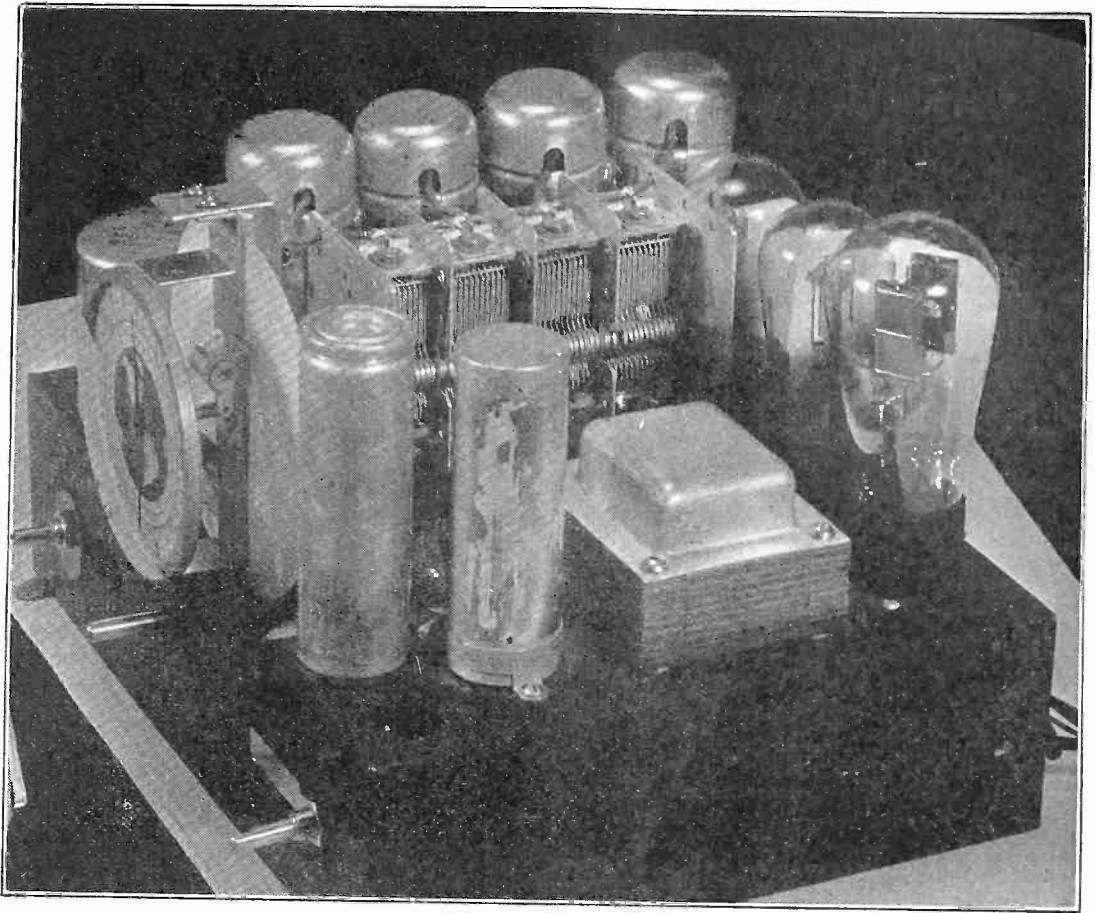

Two 8 mfd. condensers, with a 15 henry choke, provide adequate filtration, because the total current flowing is small. Because of this low value, it may happen that the B voltage will be higher than expected, since the power transformer was intended for a complete set with power tube. The 5,000 ohm resistor, however, takes care of reducing the voltage where it should be reduced. The higher voltage on the detector and audio tubes is advantageous.

what to suit the tuner to the location and aerial. Therefore assume that the aerial is connected and the set turned on. Press the volume as high as possible, by lining up the circuits and at 1,400 to 1,500 kc and turning the volume control all the way up. Tune through the broadcast band. If there is no squealing of any kind, anywhere in the span, it is permissible to lower the resistance between volume control and cathodes, shown as 300 ohms. The lowering permitted may be slight, but the small ohmage difference may make a great volume difference. An easy practical way is to shunt the 300 ohms with various medium resistors, say, a few thousand ohms to a few hundred ohms, until the one is found that makes for stability consistent with maximum intensity of program response.

There is another way of establishing this critical value of resistance; that is, instead of 300 ohms fixed, put in a 400 ohm variable. Then turn to lower resistance values until there is feedback at some high frequency of the band (1,400 to 1,500 kc) and gradually come back to higher resistance until that critical point is reached where the squeal disappears. Now it is advisable to reline the circuits, because the

different bias has changed matters a little. After realignment if there is no squealing, the set is matched to the antenna and location conditions, and will give far superior performance than by the hit or miss method.

Constants Have Been Verified

The resistance actually in circuit between volume control and cathodes now may be measured, and replaced with a fixed resistor of that value. It is not intended that this limiting resistance be varied from the front panel.

The tuner is self powered, even though it is practical to take the B voltage from the amplifier's power supply, and possibly also take the heater voltage from the transformer in the amplifier. However, the present method is economical enough, and enables earphone reception, without resort to the power amplifier or its voltaging at all.

The views of the wired and tested tuner give sufficient further assistance to enable the construction of the tuner even if one's knowledge of radio technique is extremely limited. The

(Continued on next page)

(Continued from preceding page)
 tube connections may be obtained from any tube manual, and a radio experimenter always should have such a manual at his elbow.

The values of constants, other than the experimental resistance dealt with intimately in preceding paragraphs, may be followed with cer-

tainty of wise choice. The bypass condenser from cathodes to ground is 0.5 mfd., the 27's grid resistor is 0.5 meg. and the tone control is 0.25 meg. These are specially mentioned because the decimal points are not clear from the diagram. Moreover, the 80 filament wiring "hops over" the adjacent ground lead.

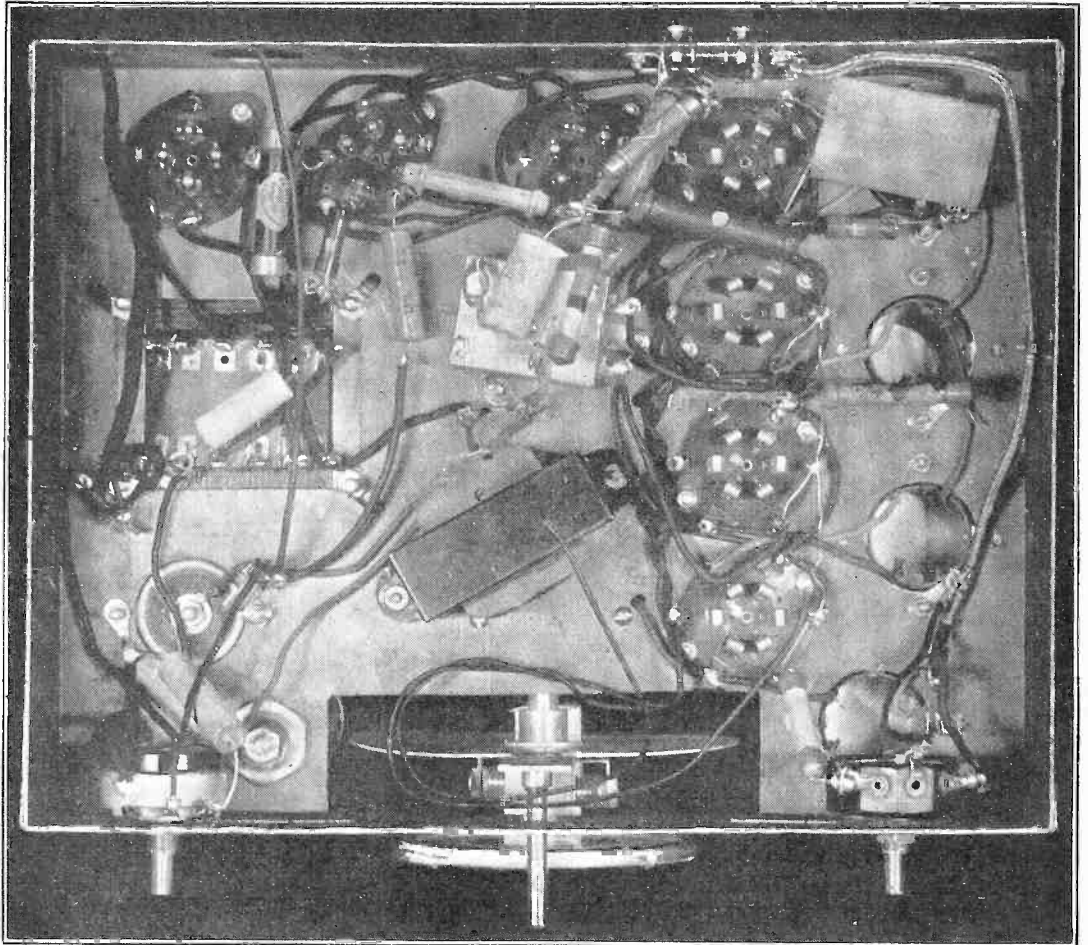

The B choke is directly in line with and near the drum dial in this underneath view of the wired tuner.

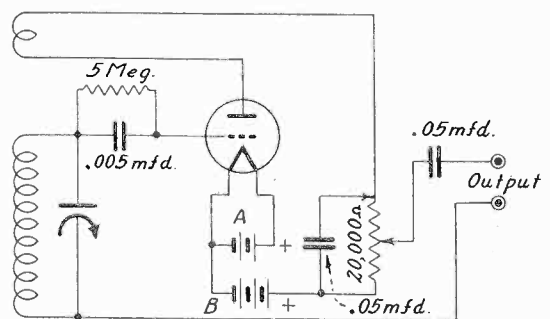
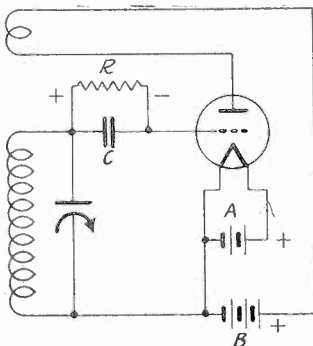

Oscillator at left strictly r. f. High leak and condenser produce also a. f. modulation at right

A 5 Meter Sending Aerial

Hollow Brass Rod Used for Half Wave

By Earle Branker

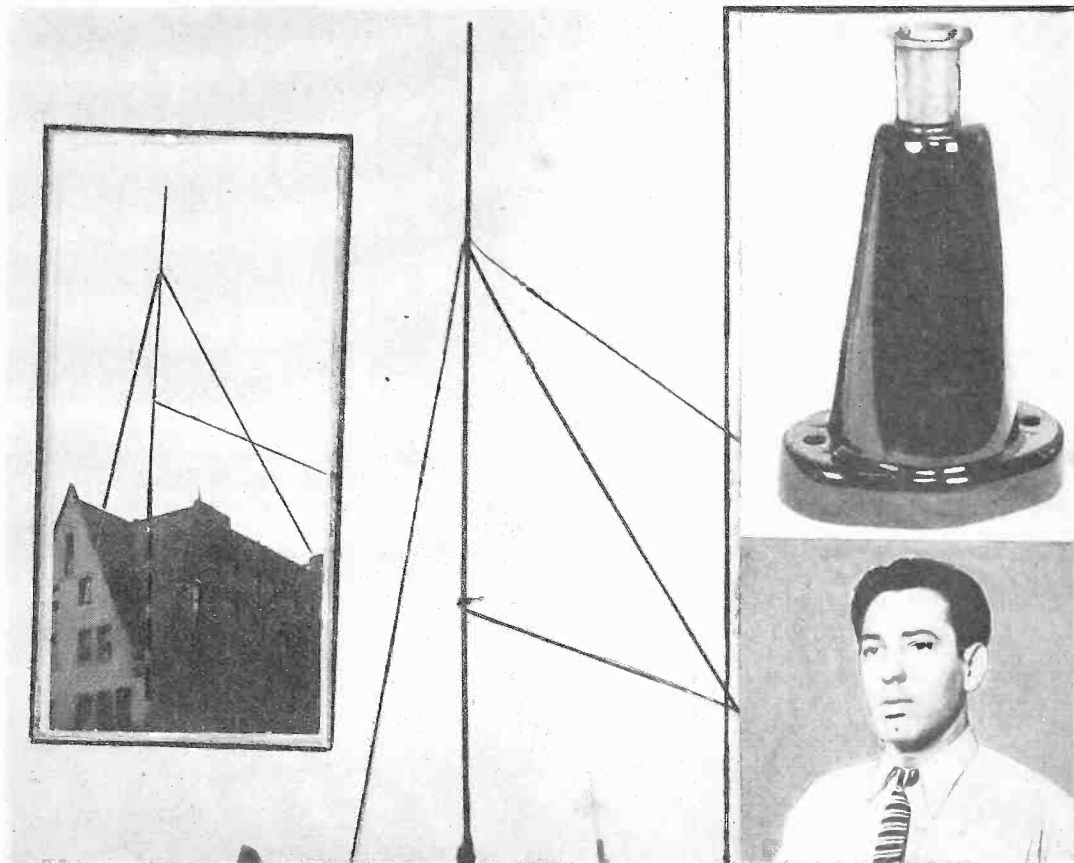

Details of the 5 meter transmitting antenna. The vertical rod at the left is a brass rod $\frac{3}{4}$ inch in diameter and constitutes a half wave radiator. The middle picture gives a closer view of the same antenna, after another guy wire has been added. The upper right picture is a photograph of the bottom insulator and anchor. Lower right picture is a likeness of the author.

FOR long and intermediate radio waves the radiating antenna is tall and has one end grounded. When short waves are to be radiated, the antenna is usually not grounded at all but is carefully insulated at the lower end as well as at the upper. On the roof of the building at the left above is shown erected a 5 meter transmitting antenna. Only the vertical rod, which is of brass tubing $\frac{3}{4}$ inches in diameter, is the antenna. It is called a half wave vertical antenna because it has voltage maxima at the ends and voltage minimum at the center.

At the upper right is shown the bottom insulator, a special porcelain device that screws down on the roof and into which the bottom of the antenna is inserted. It has all the appearance of an ink bottle but it is made of much

better material, electrically, than any bottle was made. After the bottom of the vertical half-wave rod has been inserted it is tightened by a special arrangement.

The two wires attached to the vertical rod near the top—three in case of the middle picture—are guys for holding the rod in place and to keep it from swaying in the wind. The single wire attached to the rod nearer the bottom is the transmission line that conducts the radio signal from the transmission tubes to the rod. The point at which this line is connected is critical for it determines the impedance the antenna presents to the line, and that impedance must be exactly the same as that of the line. The total length of the rod is 8 feet and the critical point is 14 per cent of the entire length, measured from the center of the rod.

Aerial Deeds and Misdeeds



The aerial photographs on this page and the next one were taken in two locations, the Times Square district near RADIO WORLD'S executive offices, and in a residential district of Brooklyn. At left is shown a far flung aerial with downlead from a standoff insulator on the side of the building at left. In the background, the Empire State Building. On the roof where the photographer stood in taking the previous picture is a so-called antenna mast supported by a shoestring tied to a pair of nails driven loosely into chimney mortar. Holley Cowerd is pointing to shoestring. At right, transposed leadin amid difficult surroundings, the Hippodrome's sign in background. At extreme right, a closeup of part of this transposed leadin.

High Wire and Hay Wire Commingle

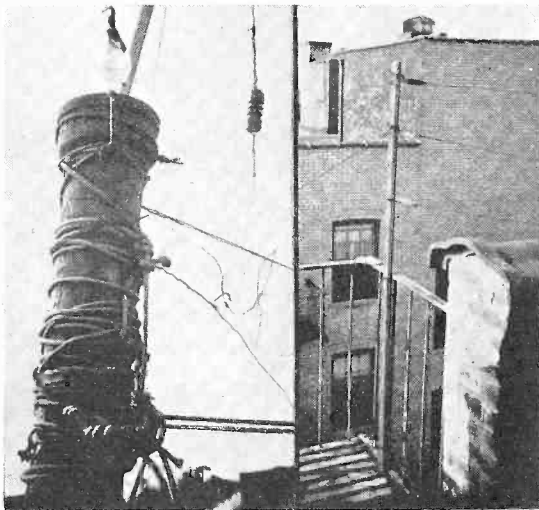

At left is a typical view on the roof of any city apartment house. It is a striking illustration of what should not be done with aerials. At right is a view taken on a fire escape. Three aerials are attached to a wooden stake fastened to the fire escape landing. It is bad radio practice and contrary to fire regulation.

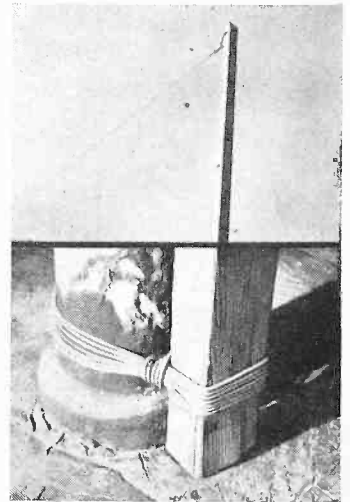

Bottom picture shows a neat way a wood pole can be attached to a ventilator on top of a roof. Near the top the pole is similarly secured. Upper picture shows the top of the pole. It is held firm by guy wires, which pull against the antenna wire. Only one antenna should be attached unless two are run at right angles.

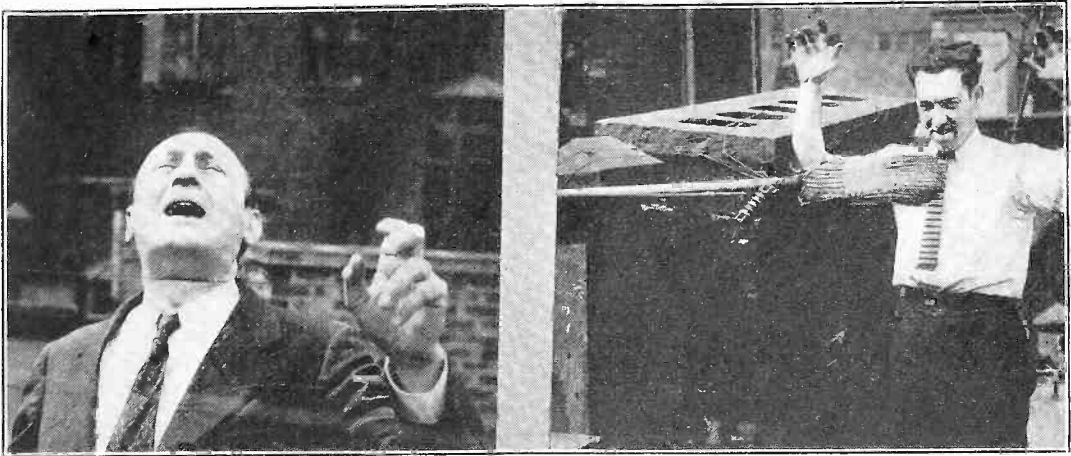

Not only should an antenna be erected and supported in the best manner for practical radio results, but also consideration should be given to others, for instance, an antenna wire should be high enough to avoid obstructing any one walking, or particularly running, on the roof, as a fireman might be doing in a dark emergency. At left a man is posing as one caught in the neck by an actual antenna wire, on the same roof where an antenna mast was supported on a shoestring. At right, also on the same roof, a broom handle was used as insulator for one aerial while a regular insulator, on the handle, was used by another radioist for his aerial. The broom dangerously obstructed roof passage.

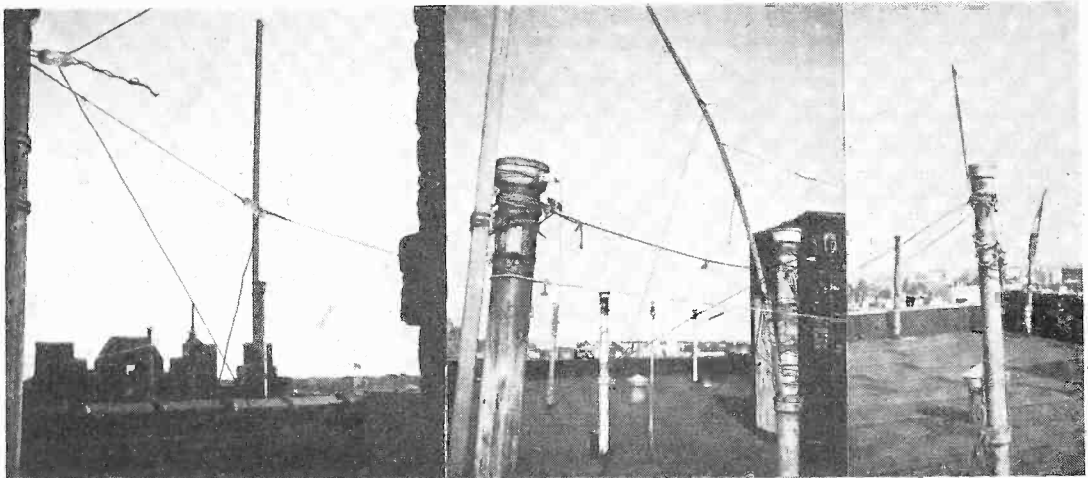

At left a splendid pole is shown in background, in line with the central porcelain insulator. The larger insulator at left is connected to a metal standpipe, with loose wire blowing in the wind and causing scratchy reception when striking either aerial. Poles loosely tied to standpipes (center and right) are unsatisfactory.



For ultra frequency work coiled pig-tail connection between rotor and condenser frame introduces transients and trouble, and constant impedance type of connection (illustrated) is preferable.

To apply coil dope, dip the brush lightly into the fluid, then quickly put back the cover on the container, and apply dope to the coil.

Preferred types of forms for transmitting purposes are usually somewhat brittle, so to avoid breaking the form when mounting it, put fibre spacer between form and chassis.

HIGHER LEAK FOR STABILITY

The choice of grid leak value in oscillators depends on the average grid current, hence also on the plate voltage, and the feedback coupling, and may range from a few hundred ohms in a transmitter (because the current is large there) to several megohms in a signal generator or a receiver, hundreds of thousands of ohms being popular.

In the use of the pentagrid converter tubes, for instance, the grid resistor is specified as 10,000 ohms for 100 volt effective plate (potential on Grid No. 2) and 50,000 ohms for 250 volts. Incidentally, when 250 volts are applied a resistor of 20,000 ohms should be used, bypassed by a condenser of 0.05 mfd. or so, to limit the effective voltage. The series resistor also acts as a stabilizing agency, because the resistor may be considered as a pure resistance to the oscillation frequencies, and the nearer the whole circuit comes to

being a pure resistance, the better the stability.

From the viewpoint of stability, which is freedom from drift, a leak of 100,000 ohms may be used, with a series B plus resistor of 20,000 to 50,000 ohms. Drift shows up beyond 10 mc and is much reduced by the method indicated. However, the higher the grid leak, and the higher the series resistor in the circuit of Grid No. 2, the lower the oscillation intensity, or the greater the danger that the tube will stop oscillating before the highest desired frequency is reached. Therefore any particular solution may have to be a compromise between these two considerations.

For signal generators, 2 meg. for the leak and 100 mmfd. to 500 mmfd. for the condenser across it usually produce excellent results. However, to match a pre-calibrated scale, the values specified by the designer should be followed.

The leak and condenser should be held firmly in place. Any likelihood of shaking introduces peril of frequency change, hence instability.

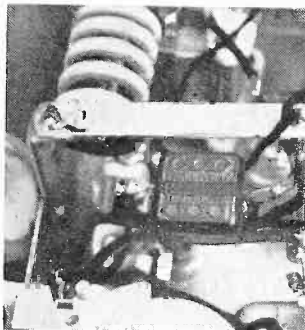

The leak may be across the grid condenser or from grid to ground or to cathode. The more positive the grid the greater the grid current.

MEASURING SMALL CAPACITIES

The oscillating tube can be held fairly constant at some selected frequency. Put a variable condenser across the oscillation transformer's secondary, and note that the plate current changes least for the higher capacity settings in tuning. This indicates that large capacity makes for stability, which it does.

Use a fixed condenser of a value within the proven stable range of the oscillator, with an accurate grid leak, which may be of the wirewound, noninductive type. This suggestion tends to keep the resistance low, because high resistances become costly, but up to 1 meg. may be used.

Now, since the plate current will change very little with substitution of different grid condenser values, the frequency is used instead, and with another device, of the

detecting type, the frequencies generated, the change due to the different values of grid condenser, are measured. Thus by the substitution method very small capacities may be measured, assuming the detector is tunable over a narrow frequency range, say, 50 kc in the broadcast band, for full dial displacement. Also, by enlarging the detector frequency span, higher capacities may be measured. Two suggested ranges are 5 to 50 mmfd. and 50 to 500 mmfd. Pursuing the same method further, increasing the span of the detector, values from 500 to 5,000 mmfd. (0.005 mfd.) may be measured.

Before using a particular tube it should be tested for leakage. If the grid to cathode leakage is too great the system becomes defective proportionately.

How to Get Things Into Places Where They Won't Fit

By I. Nelson Butterworth

WHILE other fellows may have to worry about the parallax between the moon and the sun, or the spectral analysis of Martian atmosphere, some of us have to think up ways of getting a screw or a nut into a tight place on a chassis. It often happens that some constructional idea seizes one after he had a receiver completed, or nearly completed, and there is scarcely any room left for access to anchor anything. Getting a nut to a screw then becomes a problem of major, if not terrifying, importance.

For the delectation of scientists we present three methods that have worked successfully. At left a screwdriver is shown being held against the armature of a dynamic speaker. Of course the speaker is energized; that is, operating. The magnetic field is quite strong, indeed strong enough to pull the driver over to the armature. The usual small counter pressure or inertia can be overcome by the electromagnet.

This Would Be News

The screwdriver is iron, or close to it, and therefore becomes magnetized. Then if one is working with iron screws or nuts he may lift them so that they dangle at the end of the driver. Hence the small parts are carried to their destination. Either screw or nut will yield to this technique. If you have any luck picking up a brass screw or nut, or copper rivet, this way, write a letter to the Bureau of Standards, for that will be news.

Continuing our thesis on terrestrial mechanics, we come to the thin piece of wire, which may be No. 34 or thereabouts, the end of which may be wrapped around a screw for a few turns, or even one turn (the coefficient of coupling is im-

material here), to give one leverage on the screw. Then it is practical to make the screw go places, wherever one desires, within reason, and after the screw is dropped into the prepared hole, the tail end of the screw may be held with pliers and the wire pulled right off. Thus the screw remains where intended. When doing this work, pull up the sleeves and affect an air of legerdemain, in keeping with the magic of the performance. It is O. K. to call in the neighbors, or preferably their children, to view the demonstration. The children will linger to look at more wizardry like this, particularly if one passes out lollipops.

Don't Overlook This One

Lest this laboratory experiment is not quite clear, we will go over it again. Oh, all right, not now.

A point not to be overlooked is that if the screw, after being passed into its intended resting place, is turned slightly askance, the thread will catch the side of the metal where the hole was drilled, and pliers, etc., will not be needed to hold the screw as the wire is pulled off. The thread's engagement of the periphery of the hole will dispense with the necessity of the extra exertion.

Continuing further in our research of the lofty sphere of manipulative science we come to that branch of the science known as stickem. Now, stickem is the property of matter by virtue of which the adhesiveness is beyond dispute even by the dean of the school of doubters. It is applied generously to coil dope in radio practice, but by slight extension may also be applied to soldering paste. Naturally, whatever is paste

(Continued on next page)

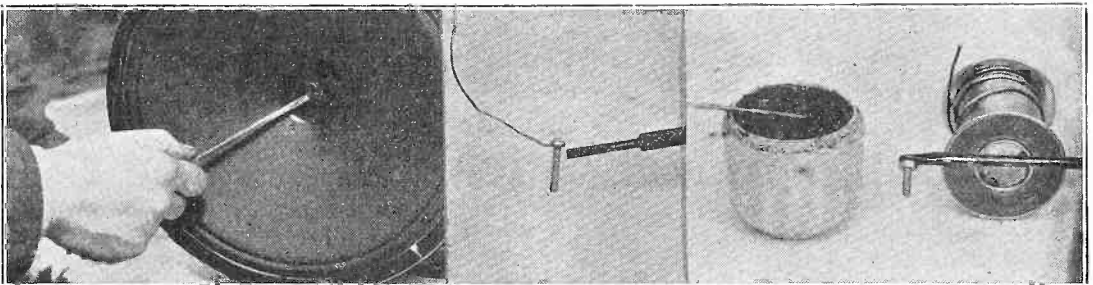

Magnetize a screwdriver at operating dynamic speaker armature. Driver will pick up iron screws. Thin wire will permit getting screw into right place, then pull wire off. Or use some stickem to hold screw, e.g., as solder paste.

A Four Tube Portable

Most of Broadcasting Band Tuned In—Short Wave Option by Plugging in Other Coils

By Herbert E. Hayden

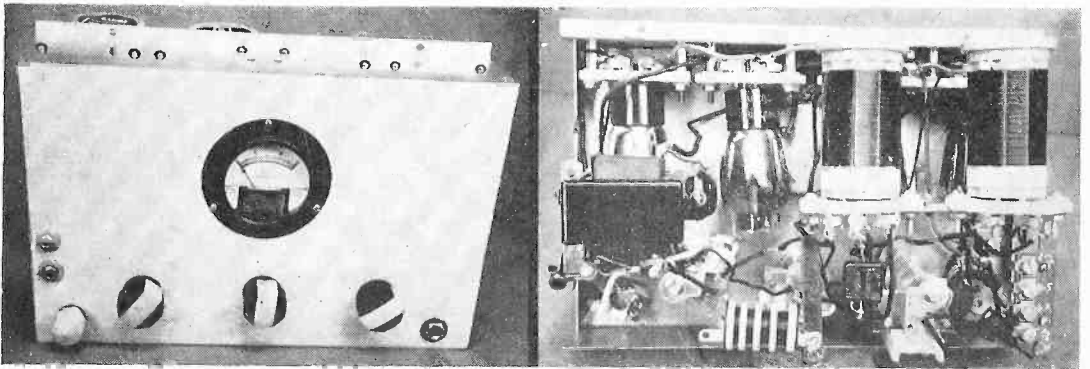

Front view of the portable receiver. The meter serves the purpose measuring filament voltage. The loudspeaker is placed in the position shown at right.

CONSIDERING the method of tube mounting, this four tube portable might also be called "the upside-down portable," since a glance at the accompanying photograph will show the four tube sockets mounted on a line, but so placed with respect to the other mounted parts as to cause the tubes to be hanging downward from the top of the chassis.

A standard metal chassis 7x10x2½ was used to anchor all of the parts, the idea being to place the completed unit in a suitable housing of fine wood, such as a figured walnut. A second idea was to have a contrasting wooden front panel of some tropical wood such as Prima Vera wood, and yet, for mechanical reasons at least, to retain the metal structure.

A compromise was affected by first scratching the surface of the metal panel with sharp lines, criss-crossed, and coating this surface with DuPont household cement, and allowing it to dry.

Next the mechanical layout of the tuning condensers, posts, etc., was accomplished, and the necessary holes drilled through the metal surface. This made use of the normally horizontal surface of the standard metal chassis, but now vertical and forming the front panel of the set, as shown.

There has appeared in the open market a product composed of a canvas surface to which is cemented a thin veneer of real wood, so that the sandwich resulting from such a combination, forms a perfectly flexible material that can be cut to almost any desired shape, much the same as a heavy paper, and yet when cemented down flat gives the outward appearance of real wood, which it is, but as explained, only the top surface. It is available in several kinds of fine wood, such as mahogany, walnut lace wood, Prima Vera, etc.

A square of this wood veneer is now given a coat of cement, spreading it evenly over the

Making Things Stick That Won't

(Continued from preceding page)
is stickem. Therefore if you are in a hurry, and at your wit's end, and desire to transport on the end of a screwdriver or other object any such tender morsel of mechanics as a nut or screw, stick the driver or other intended conveyor into the soldering paste, and if enough

goo is present, the transportee (as the object to be carried over is known in technical parlance) will obey the laws of nature without restraint or reservation. Should the screw fall off prematurely, of course use more stickem.

Some of these expositions may be a bit deep; therefore the situation is clarified pictorially.

canvas side with a flat knife. This is quickly placed in contact with the previously prepared surface of the metal chassis, and with pressure applied for a few minutes, a firm bond made with the metal surface, not easily removed.

The treated panel is next trimmed with scissors cutting off the surplus veneer, turned over, and holes neatly cut through the previously drilled ones in the metal, trimming all edges neatly to preserve the final appearance.

It is a good idea at this point to coat the

consisting of one stage of r.f., detector one straight transformer and one resistance coupled audio, giving a result that is entirely satisfactory with a fair amount of selectivity, the tuning condenser is a 2 gang .00014 mfd. with an extra 3 plate trimmer on the detector side for balancing purposes.

A meter is used in connection with a 3 volt "A" battery source and 30 ohm rheostat, since experience seemed to prove that operating the type 30 tubes (4 in this instance) at the manu-

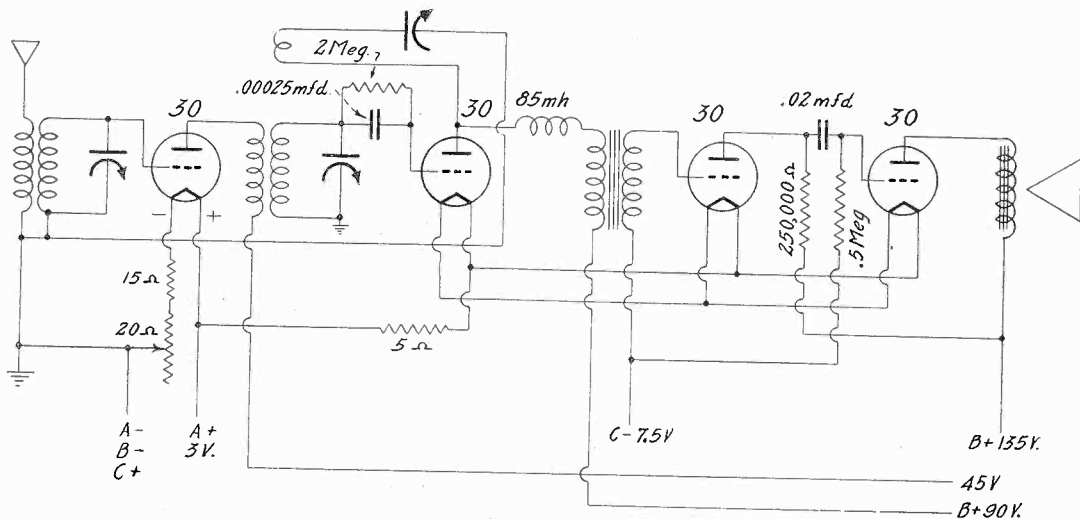

the circuit of a small, four-tube portable using a magnetic speaker. All the tubes are of the 30 type. Total filament drain is only 0.24 ampere, well within the limits of a pair of No. 6 dry cells.

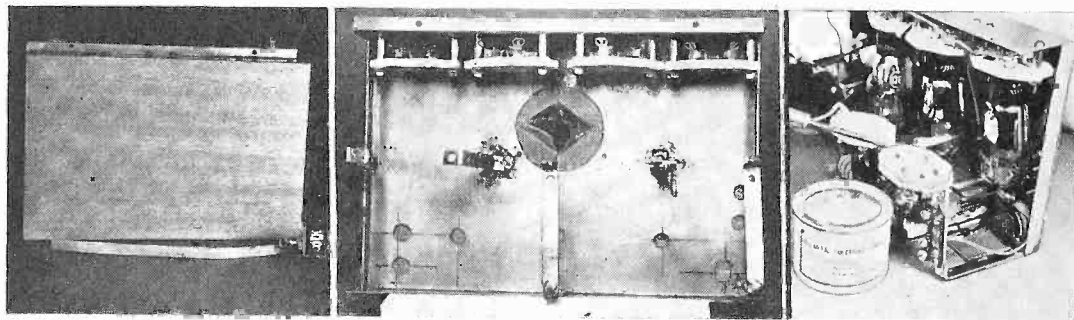

Front view of the portable with the wood veneer in place.

Back view of the portable with the wood cover removed, showing meter opening.

If brackets are aluminum they may be tinned and soldered by new process.

veneer with a plain clear lacquer, which will make it impervious to moisture, and easy to clean off later on. The parts are now inserted in their proper places the meter occupying the large opening in center panel.

A glance at the photos will show a completed rig or platform elevation for holding the 2 RF coils and sockets as in this position they are clear of the metal work from the standpoint of energy absorption. Likewise, the audio transformer is similarly treated, being mounted at the extreme left of the back panel assembly.

The circuit is no departure from the standard

factors warning of 2 volts, produces the longest tube life.

The audio output is sufficient to operate a small magnetic speaker with very good tone quality, although one of the power output tubes may be substituted if desired, but the idea was to get a total current drain of not more than .25 amperes as 2 standard little six dry cells in series would provide without overload.

As to a final housing for the completed unit, a matching case of fine wood, or a small suit case depending on the ideas of the builder, is all that is required. Mount A and B sources in a separate case.

A Transmitter Painstaking Application of

By Harvey E

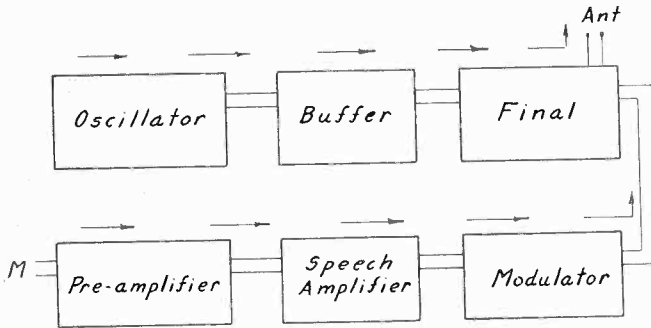

FIG. 1
Block diagram of the functions of the transmitter.

A 50-WATT transmitter has been erected with the sole object of attaining maximum results. The duplication of such an installation would cost about \$750. Standard circuiting has been followed.

For the benefit of those unfamiliar with transmitting practice and terminology, Fig. 1 shows the component units. The block formations in the top row represent in the electrical order the oscillator and buffer, really constructed on one chassis, and the final stage. The arrows point to the direction of amplification progress, or carrier course to the antenna. The oscillator amplified form, is to be transmitted. The buffer affords high conduction toward the "final," while isolating the antenna from direct influence on the oscillator.

In the lower row the microphone M feeds an audio amplifier called the preamplifier, the output of which goes to a more powerful audio amplifier, called the speech amplifier, the audio channel terminating in the tube that supplies the audio frequencies to the final stage radio frequency amplifier. This audio supply tube is the modulator. The arrows show the direction of the audio frequency progression. The amplitude of the carrier is varied by the modulator. The mixing thus takes place in the final r. f. stage, from which the antenna is fed.

Five Parts Are Considered

Let us look to see what is immediately behind the microphone into which the performer speaks or plays. Kindly refer to Fig. 2. This is the circuit of a rather complex speech amplifier, designed with the object of doing full justice to performers, listeners, and the radio

engineers. The circuit may be divided into five parts, the crystal microphone, the preamplifier, the speech amplifier, the modulator, and the power supply. Since all the specifications are given on the drawing, we shall devote our attention to the functions of those parts which are not familiar to those who are conversant with ordinary radio reception practice.

The crystal microphone, at the extreme left just ahead of the preamplifier, converts sound energy into electrical energy. Just as soon as the sound waves strike this device the signal becomes electrical. This particular microphone has a very high impedance and generates a minute voltage at a very small current. For this reason a 10 megohm resistance is connected across it. It will be noticed that both the microphone and the resistance are grounded. No polarizing potential is needed for this type of microphone, which is different from the condenser type of instrument, nor polarizing current, as is the case of the magnetic type. The crystal microphone has one desirable characteristic, and that is it does full justice to the sound that reaches it.

Since the voltage generated by the microphone is very small, it must be amplified, and that is the purpose of the preamplifier. There are two stages in this amplifier so that there is much gain in the signal strength in it. In regards to quality, anyone familiar with audio amplifiers can tell from the specifications that all audio frequencies are amplified without discrimination. Yet there is a tone control in the plate circuit of the second tube, the function of which is to lower the general tone by removing some of the higher and unessential frequencies to some extent. Sometimes a preponderance of low

r, Class \$750

Standard Circuit Practice

Sampson (W2IJL)

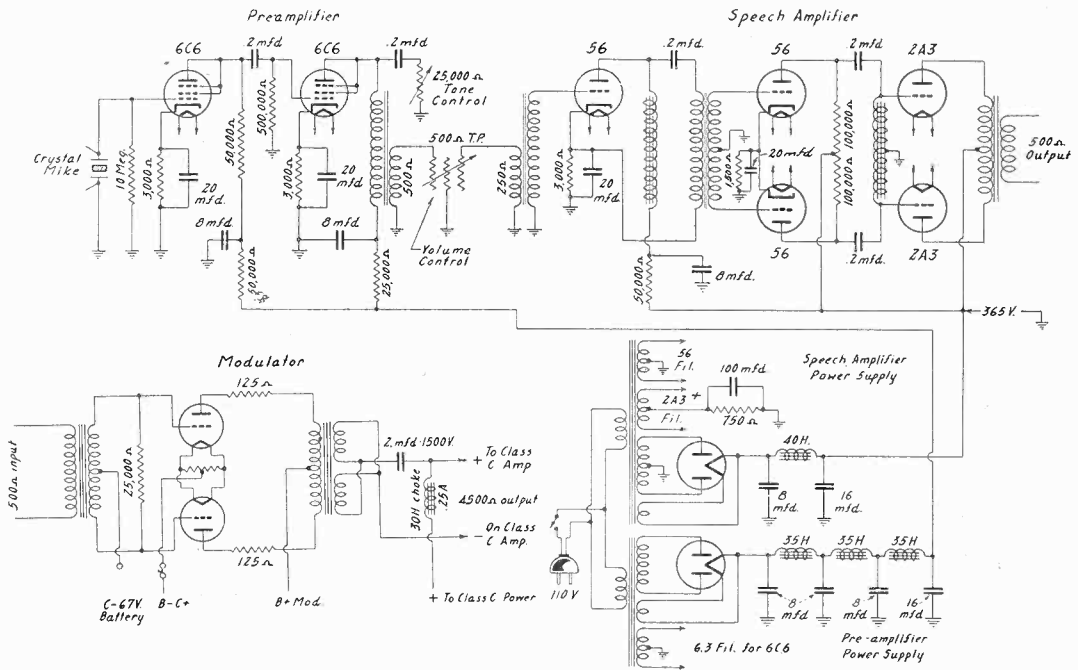

FIG. 2

The crystal microphone is connected to the input of the pre-amplifier, the output of which is fed to a 250 ohm primary input of the speech amplifier. The output winding of the pre-amplifier has 500 ohms impedance, across which is a 500 ohm T pad, thus constituting a 250 ohm match for the speech amplifier input. At lower left is the modulator circuit, at right the separate power supplies for the speech amplifier and pre-amplifier.

tones is preferable to having the tone sound more nearly natural.

The Volume Control

Following the preamplifier is a network comprising a tube-to-line transformer, a T-pad, and a line-to-tube transformer. The line may be less than a foot long or it may be a mile or more. Naturally, in this circuit it is somewhere between. The two transformers are designed to work in conjunction with a 500-ohm line. In the line, or shall we say across it, is the T-pad, and this too is rated at 500 ohms. This means that, regardless of the setting of the pad, the resistance is 500 ohms. It serves to vary the volume, or the transfer of energy from the pre-amplifier to the speech amplified, without chang-

ing the matching of the transformers. Mismatching would result in inefficient operation and considerable distortion. This type of volume control is seldom used in receiving amplifiers, but are always used in first grade transmitters and public address systems.

Now we have arrived at the speech amplifier. This is a three stage circuit, the first being single sided and the next two push pull. The customary term "speech amplifier" is really a misnomer, for if the preamplifier handles speech so does the rest, which is really a high level amplifier, for the signal intensity is comparatively very large. It should be noted that the direct current in the plate circuit of the single sided stage is not allowed to flow through the output transformer. This indicates that a

(Continued on next page)

lator tube. The crystal is not the oscillator; it merely controls the frequency of oscillation to a high degree of precision. The circuit would not oscillate without the tank circuit consisting of the coil L1 and the 250 mmfd. condenser across it.

The output of the crystal controlled oscillator is delivered by direct coupling to the grid of a buffer amplifier, in which a 210 tube is used. The buffer serves to amplify the radio frequency signal, but it also serves to prevent changes in the load from affecting the oscillator circuit.

Since the 210 tube operates at very high frequency, the circuit might readily oscillate of its own accord, due to capacity between the plate and the grid, if the feedback were not neutralized. The neutralization is effected by a 50 mmfd. condenser connected between the grid

former has the same inductance as L2 and it is tuned by the same size condenser. The link circuit, therefore, operates between equal impedances. The object of having the link circuit is to permit the transmission of power without loss over the distance necessary between the buffer amplifier and the Class C amplifier. This distance may be a few feet or much greater.

Heising Modulation Used

The coil L4 and the 250 mmfd. condenser across it are in the grid circuit of the 242A tube, which is used as power tube in the high frequency chain. It should be noticed that this tube is biased by a 90 volt battery, which is the most economical way to obtain a hum free bias.

The output of this power amplifier is modu-

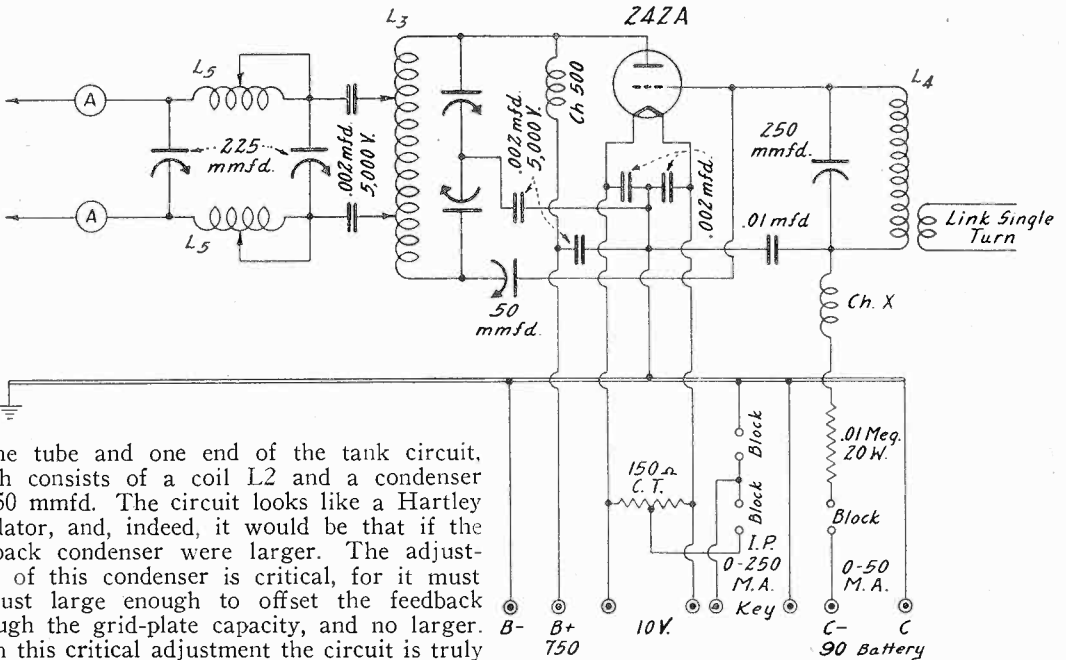

FIG. 4

The Class C amplifier or final stage.

of the tube and one end of the tank circuit, which consists of a coil L2 and a condenser of 250 mmfd. The circuit looks like a Hartley oscillator, and, indeed, it would be that if the feedback condenser were larger. The adjustment of this condenser is critical, for it must be just large enough to offset the feedback through the grid-plate capacity, and no larger. With this critical adjustment the circuit is truly a buffer amplifier, for it is strictly unidirectional.

Single Twin Links Used

The thorough filtering and bypassing should be noted. There is a radio frequency choke in the grid circuit of the oscillator. This is necessary because the crystal has a high impedance, and it is not practical to obtain this high impedance by means of a high value grid leak resistance. The oscillator tube would choke up completely or would oscillate in spurts, giving rise to the characteristic squealing heard in many oscillators when the grid leak resistance is too high.

The output of the buffer amplifier is delivered to a link circuit, which in effect is a line. The secondary of L2 is a single turn.

We are now up to the Class C amplifier, or final stage, Fig. 3. In that circuit we pick up the radio frequency line at the extreme right, where we see a single turn primary of transformer L4. Now the secondary of this trans-

lated by the modulator stage shown at left in Fig. 2. To effect the modulation the output of the modulator is applied in series with the plate supply, between B minus and plus 750 volts. The Heising method of modulation is therefore used. The radio frequency choke Ch 500 prevents the radio frequency currents from escaping through the supply to ground, but forcing it through the tuned circuit, which consists of coil L3 and two equal condensers connected in series across the coil. Notice that the common rotor of these condensers is connected to the cathode, or rather to the electrical midpoint of the filament. This point is also grounded. Therefore the output coil of the 242A is balanced with respect to ground and to the cathode. The same method of neutralization as was used

(Continued on next page)

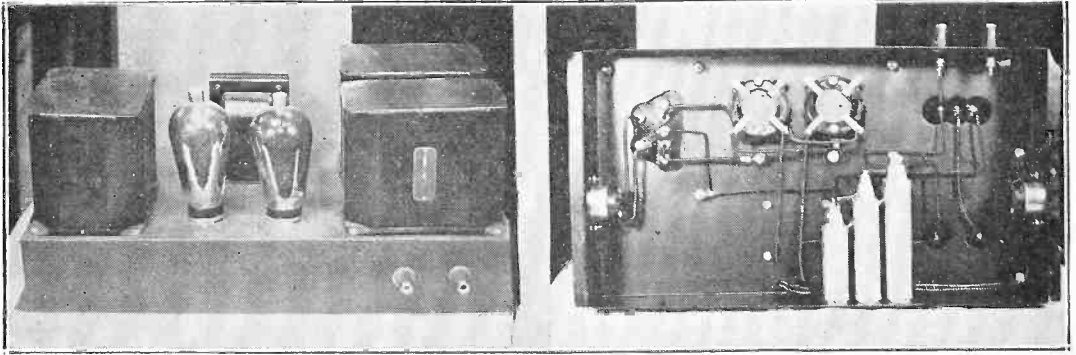

FIG. 5

FIG. 6

These are two views of the power supply for the last stage in the transmitter. In Fig. 5 the two 866 mercury vapor rectifier tubes can be seen in the middle of the picture. Behind them is the filament transformer. Fig. 6 is the bottom view of the same supply. The devices that look like white candles are three oil condensers which are rated at 1,500 volts. The power plug receptacle can be seen mounted on the left end of the chassis.

(Continued from preceding page)

for the buffer is also used in this power amplifier.

Power from the 242A tube is transferred to the transmission line feeding the antenna through two equal condensers, each of 0.002 mfd. capacity. These are connected to taps on the coil, and these taps may be moved so as to get most efficient transfer of energy. Somewhere between the taps is a point on the coil that is at ground potential. This point should be half way between if the two leads of the transmission line are to be at the same potential in respect to ground.

Inductances Adjustable By Taps

Interposed between the taps on L3 is a network of two equal coils L5 in series with the

line and two equal condensers of 225 mmfd. each across it. The inductances are adjustable by taps. The network serves to filter out harmonics generated in the amplifier and also to match the impedance of the transmission line to that of the tank circuit containing L3. Adjustments of the taps and the variable condensers are made until the line ammeters A show the greatest current.

Transmission of Test Records

The output is intended for use with a doublet antenna, which is a balanced horizontal antenna. No power is radiated from the vertical transmission line, for this line serves only to conduct the power from the tank circuit to the horizontal portion of the antenna. If the sides of

(Continued on page 28)

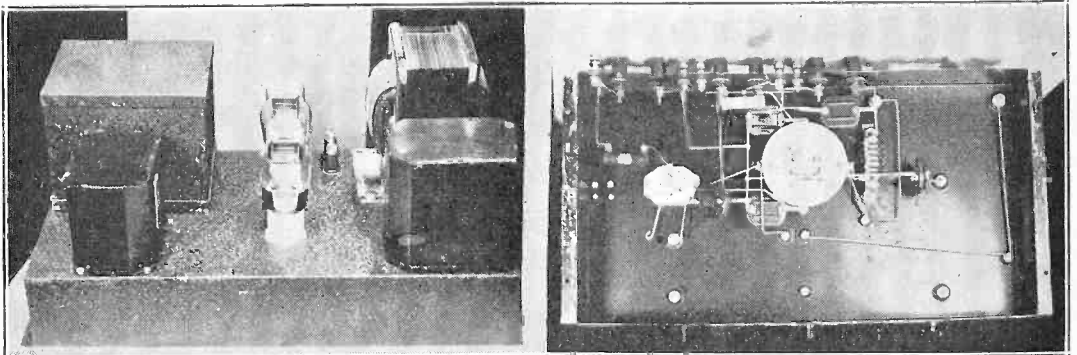

FIG. 7

FIG. 8

This is a rear view of the modulator. The parts are two 801 amplifier tubes, a push-pull input transformer, a push-pull output transformer, a filament transformer, and a choke coil.

This shows the wiring under the panel of the final radio frequency stage in the oscillator. The central white circle is the socket for the power tube, the 242A. The small stopping condensers are clearly seen.

This Is Positively "Final"

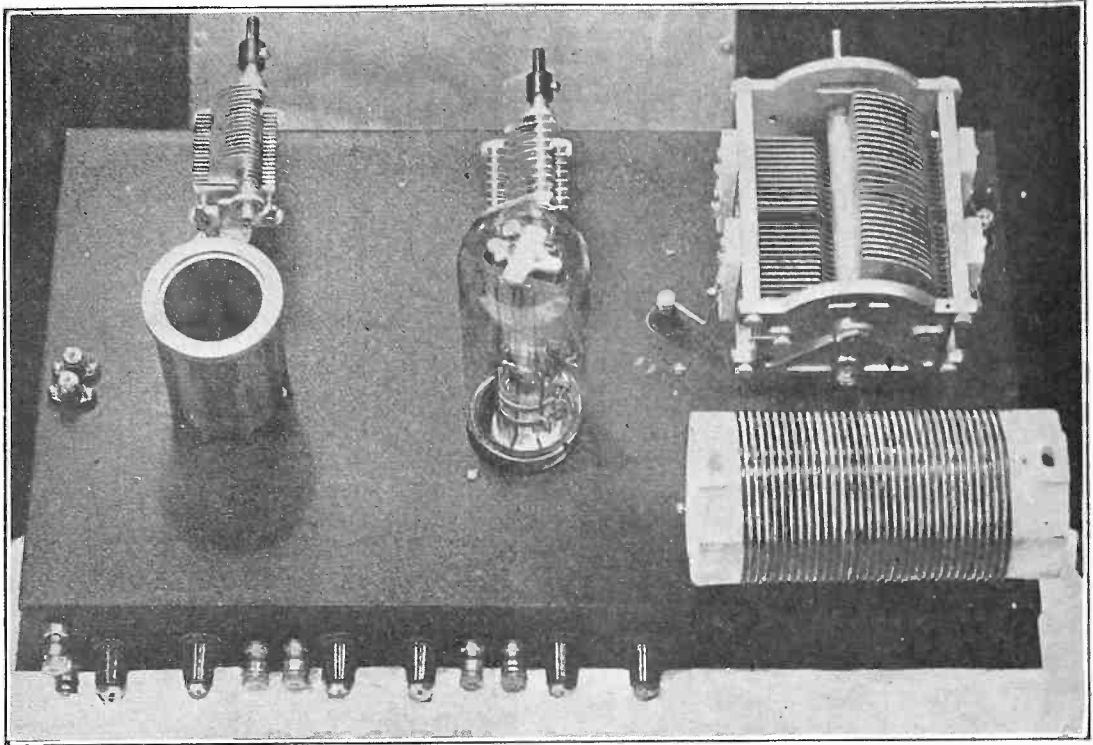

FIG. 9
Top view of the Class C final stage.

OB Stands for Oscillator-Buffer

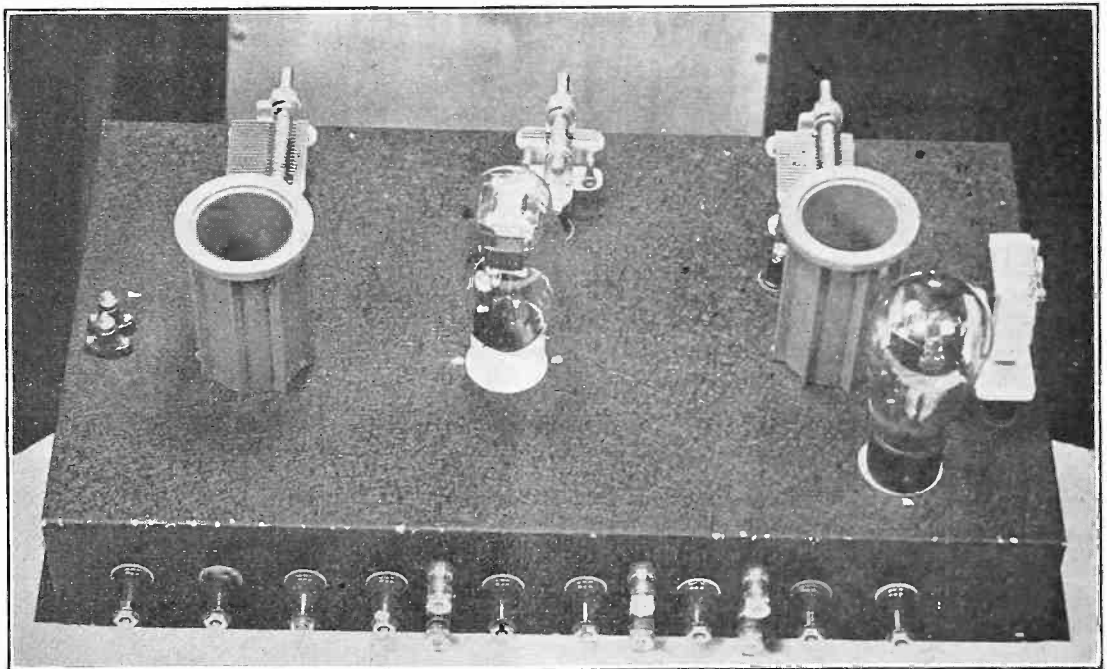

FIG. 10
Top view of the oscillator and buffer. Neutralizing condenser is at center.

The Saturated Pentode Stabilizes Oscillator Circuits in Crystal Fashion

By Leonard R. Woolsey

WHEN a vacuum tube is operated so that increase in the plate voltage does not increase the plate current saturation is said to exist. Then all possible electrons, or the full emission, are drawn to the plate. Hence the plate current is equal to the emission current, or simply the emission. Unless the negative bias is maintained extraordinarily high it is dangerous to the tube to operate it in a saturated condition.

However, with proper precautions, saturation has advantages. For instance, a saturated pentode is used frequently as a limiting resistor in series with a sweep oscillator.

Sweep Oscillator's Purpose

The purpose of the sweep oscillator is to maintain a control alternating voltage in conjunction with a voltage (or current) to be analyzed by an oscilloscope. It is desired that the timing axis be linear, so that the analyzed wave form will appear on the fluorescent screen of the oscilloscope with even distance between

crests. The use of the saturated pentode, in conjunction with a saw tooth sweep frequency oscillator, achieves this. The saw tooth wave form is one with crests that come to a point, or nearly so, and is useful because of the slow ascension and quick recovery, thus wiping out from visibility the return alternation, which, if observed, would appear as a superimposition on the wave form desired to be seen exclusively.

The Current Is Steadied

The saturated pentode steadies the current, and as such steadiness is a measure of frequency stability, it is suggested that the saturated pentode has advantages in the establishment of a regular oscillator on a stable basis. There is still considerable trouble due to instability in the local oscillators of superheterodynes and also to oscillators in signal generators, and the saturated pentode holds promise of one solution enabling approximation of the steadiness of crystal control.

The ultra frequency field applies particularly.

How to Couple Transmitter Output

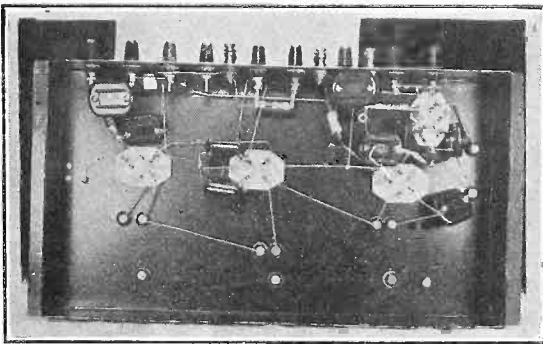

FIG. 11

Wiring of the oscillator and buffer. Bypass condensers are placed right at the nearest contact point to prevent stray coupling or feedback. Radio frequency chokes likewise are located as close to "home" as possible.

(Continued from page 26)

the line are not balanced with respect to ground there will be some radiation from the transmission line, and this is to be avoided by adjustment of the taps on L3.

The horizontal doublet antenna is a half wave structure. Each end is insulated, and therefore there is a maximum of potential at these points. For this reason the insulation must be of the best kind. The center of the horizontal portion has a current maximum, and it is here that the feed line is connected.

Horizontal Radiation

Since there is no radiation from the vertical portion, or the feed line, all radiation taking place from the horizontal portion, the electric field about the antenna is horizontal. This does not necessarily mean that signals from such an antenna cannot be received with vertical antennas, which are intended for vertical fields. No, the horizontal polarization does not remain, but at some distance away there will be a strong vertical component.

Expectations Realized

The transmitter is equipped for transmission from key, crystal microphone, or phonograph pick-up. So far splendid results have been obtained with using all of these methods of modulation. Each of the several components of which the transmitter is composed has performed up to expectations.

A Service Wand for Light

Made of Tubing, Heater Cord and Flashlight Bulb

By Michael Blan

A SMALL light for dark and otherwise inaccessible places is readily made with a heater cord, pilot lamp or flashlight bulb, and a hard rubber tubing. The reason for selecting hard rubber for home construction of such a device is that the rubber may be heated at one end so that a socket for the tube by press twisted pressure of the tube base into the softened area may be improvised.

If the rod is short the use for radio repair and construction purposes is complete. However, if one desires a long wand, such as might be used by an orchestra leader as baton, then it must be expected that some slight warmth will attach to the tube because of the greater enclosure of the heater cord, or less heat dissipation beyond the tubing.

Fits That Dreamy Waltz in Dark

The long tubing of course comes in handy in connection with amplifier installations, when one has an opportunity to interview an orchestra leader as to whether he ever "leads the band in the dark," as for one of those romantic waltzes. There are such romantic surroundings on dance floors, some may recall, that an orchestra leader will be prompted to encourage the purchase of the wand.

For radio work of a constructional nature the smaller type is satisfactory and valuable.

By using this device it was possible actually

Connections for the wand. The a.c. cable is of the type with about 350 ohms resistance built in. Only two leads of the three present are used, and one of these should read a short to one of the plug prongs, the other read an open to this same prong and 350 ohms to the other prong.

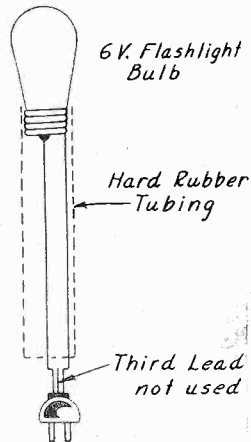

to see where a coil was open, the darkness at that particular location being practically prohibitive otherwise. The picture at left shows that use. The one at right is supposed to represent the way an orchestra leader would use the baton. The stuff in the background that suggests perhaps a vise, some Bakelite tubing, and maybe a drill press, may suggest to some the fact that the photograph was taken in a radio laboratory as indeed it was.

The devices also constitute a continuity tester.

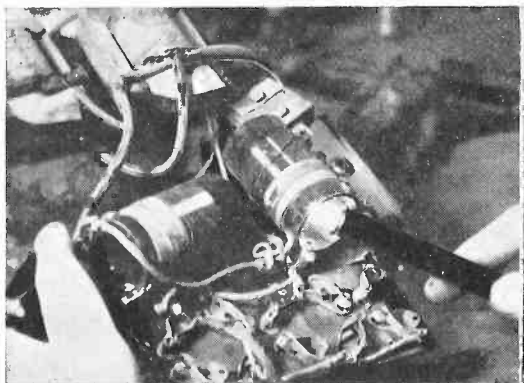

Flashlight bulb fitted onto a short hard rubber tubing, and energized from the 110 volt lighting main, a heater cord used for voltage reduction, enables one to see things when he should, whereas otherwise perhaps he couldn't. Light is highly concentrated here.



With longer tubing, the device is useful as a baton for an orchestra leader, and salable in connection with a power amplifier installation in a hall or night club. The hard rubber tubing will acquire some warmth, but the user should be advised this does not imply any danger whatever.

A Marine Radio Compass

Visual Indication Achieved Ingeniously

By W. L. Webb

Radio Development, Bell Telephone Laboratories

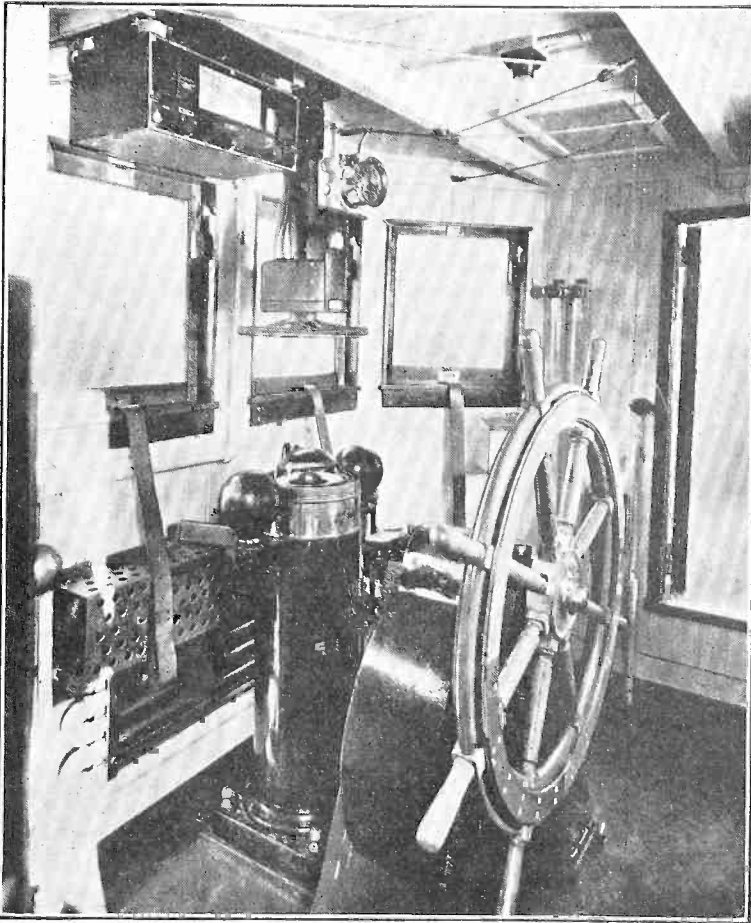

View of wheel house with housed direction finding receiver, to the right of which is the loop base with dial just above the top drive wheel and indicating meter against the column.

RADIO direction finding has been used by the Navy and many large merchant vessels for some time, and has proved to be of immense value under a variety of situations. Existing apparatus, however, is expensive and has not been employed to an appreciable extent by smaller vessels.

With the development of the Western Electric radio telephone, and its installation in fishing vessels sailing from New England ports, it became apparent that the addition of an easily operated radio compass would greatly increase the value of the radio equipment. With this in view Bell Laboratories developed a marine radio compass to be used as an adjunct to the radio telephone. It is very simple to operate and utilizes the same power supplies as the radio telephone. The design adopted avoids some of the uncertainties of direction occasionally existing with previous types of compasses.

Radio direction finders utilize the directional properties of a loop antenna. This characteristic shows that the loop will receive maximum signal when its plane is pointed toward a transmitting station, and little or no signal when its plane is perpendicular to the direction of the station.

How the "Sense" is Determined

It is evident that the position of zero signal can be determined with greater accuracy than the position of maximum signal because the rate of change of signal strength is greatest where the response of the loop is zero. This position of minimum signal is therefore used to determine the direction of the transmitting station. Since there are two positions of minimum signal, however, the loop when used alone will determine only the line of direction, but

not the direction proper, or, as it is commonly called, the "sense" of the direction. To determine the "sense" of the direction, a non-directional antenna is employed in conjunction with the loop. In the usual radio direction finder this "sense" determination requires an extra operation on the part of the operator and its determination may be rather uncertain.

In using a direction finder of the conventional type, the position of minimum or zero signal is usually determined by listening to the receiver output with head telephones, and considerable skill is often required, since there are effects tending to obscure this "null" position. Because of circuit unbalance or the effect of metallic objects on board the vessel, there is usually some signal received in all positions of the loop, and it is necessary for the operator to balance out this extraneous signal with an additional control known as the "balance" adjustment. With a weak signal, the operator must frequently interpolate between two signal amplitudes of equal value—one on each side of the null position—and in this way determine the null position as that half-way between two positions of approximately equal signal.

Visual Indication of Direction

From these rather complicated operations that must be carried out to obtain an accurate bearing, it is evident that skillful operation is usually required to obtain dependable results.

In the development of the new Western Electric radio compass, the objective has been to obtain a device that could be readily operated by any of the officers, and that would give accurate results in which they would have the utmost confidence. The new compass gives a positive visual indication of direction, rather than depending on a difficult aural balance, and the usual operations for "sense" determination and "balance" have been eliminated.

In a typical installation the loop is secured to the roof of the wheel house directly above the steering compass, and is operated by a hand-wheel on the lower end of the loop shaft, which is located in the wheel house directly above the steering compass.

In taking a bearing, the receiver is tuned by rotating the signal tuning knob, which sets the dial, marked in kilocycles, to the desired frequency. A right or left deflection of an indicating meter is at once noted, and the hand wheel is turned in a direction opposite to the direction of deflection of the meter until the meter pointer comes to zero. The bearing of the radio beacon with respect to the vessel's heading is then read directly from the azimuth scale just above the hand wheel. The direction of the ship's heading at the time is determined from the steering compass, and by combining the two, the bearing of the radio beacon is determined.

Why the Speaker is Included

A loudspeaker is provided for identification of the station and to facilitate tuning. It would

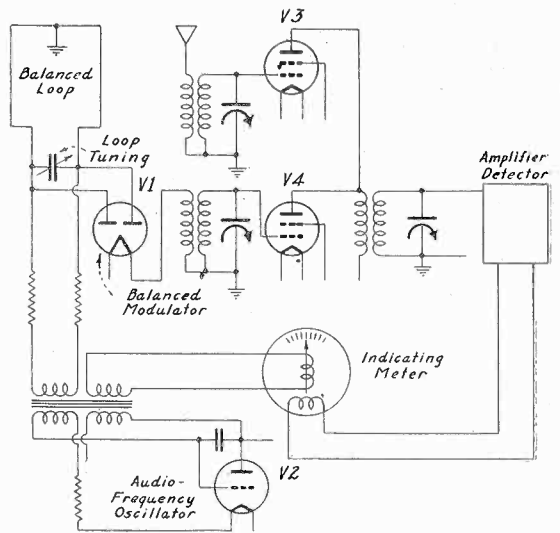

Simplified diagram of the receiver. Visual indication of the "sense" of the direction, or removal of the 180 degree ambiguity, results from comparison of the loop-fed modulator output with the output of the non-directional antenna.

not ordinarily be needed for taking the bearing except as a check to identify the station, but under conditions of severe static it is possible to eliminate a good deal of the effect of the static on the indicating meter by neglecting deflections that coincide with crashes heard in the loudspeaker. In this way it is often possible to obtain a good bearing under unfavorable conditions. Provision is also made for plugging in a headset to aid in installation adjustments, although normal service does not contemplate its use.

Besides the on-off switch there are only two major controls on the front panel: a tuning control and a sensitivity control. There is a volume control for adjusting the volume from the loudspeaker, but this will usually be adjusted to a given setting to suit the operator and left there. The sensitivity control is used to set the receiver gain at the proper value to obtain the required sensitivity at any given location. Small rectangular plates along the bottom of the receiver provide access to the required installation adjustments and the telephone jack.

The receiver may be removed from its cabinet by turning the two knobs on the ends of the front panel and withdrawing it with the two handles. External connections are made through a plug at the rear of the chassis which disengages when the receiver is removed.

Superheterodyne Circuit Used

The coils, variable condensers, and vacuum tubes are mounted on the upper side of the chassis, while the wiring, resistances, and fixed

(Continued on next page)

A Marine Radio Compass

Visual Indication Achieved Ingeniously

By W. L. Webb

Radio Development, Bell Telephone Laboratories

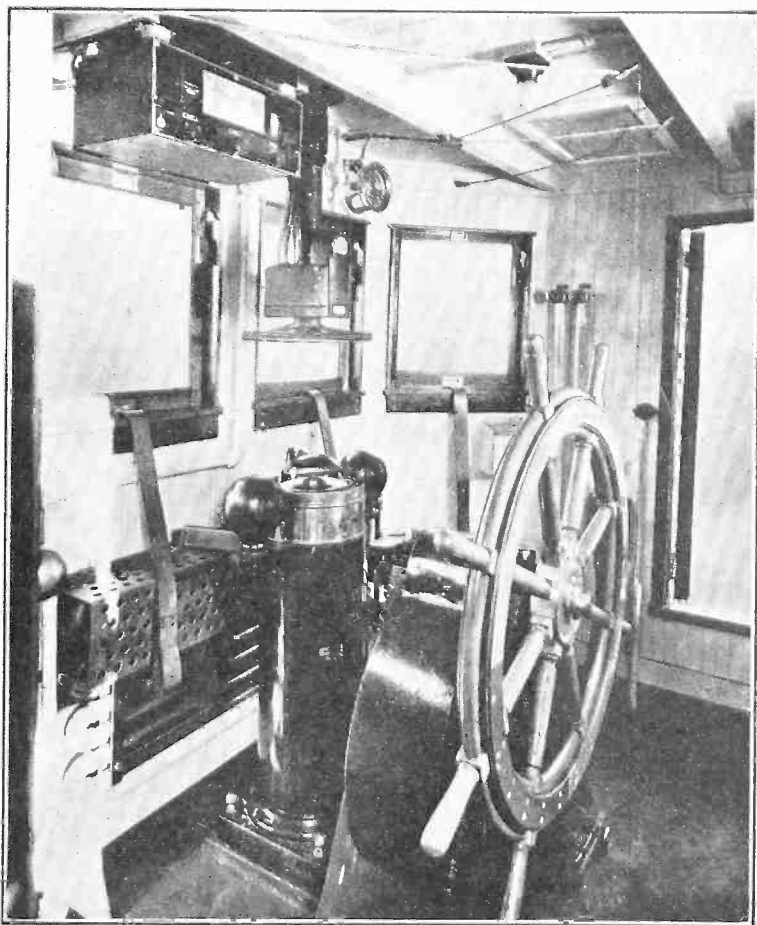

View of wheel house with housed direction finding receiver, to the right of which is the loop base with dial just above the top drive wheel and indicating meter against the column.

RADIO direction finding has been used by the Navy and many large merchant vessels for some time, and has proved to be of immense value under a variety of situations. Existing apparatus, however, is expensive and has not been employed to an appreciable extent by smaller vessels.

With the development of the Western Electric radio telephone, and its installation in fishing vessels sailing from New England ports, it became apparent that the addition of an easily operated radio compass would greatly increase the value of the radio equipment. With this in view Bell Laboratories developed a marine radio compass to be used as an adjunct to the radio telephone. It is very simple to operate and utilizes the same power supplies as the radio telephone. The design adopted avoids some of the uncertainties of direction occasionally existing with previous types of compasses.

Radio direction finders utilize the directional properties of a loop antenna. This characteristic shows that the loop will receive maximum signal when its plane is pointed toward a transmitting station, and little or no signal when its plane is perpendicular to the direction of the station.

How the "Sense" is Determined

It is evident that the position of zero signal can be determined with greater accuracy than the position of maximum signal because the rate of change of signal strength is greatest where the response of the loop is zero. This position of minimum signal is therefore used to determine the direction of the transmitting station. Since there are two positions of minimum signal, however, the loop when used alone will determine only the line of direction, but

not the direction proper, or, as it is commonly called, the "sense" of the direction. To determine the "sense" of the direction, a non-directional antenna is employed in conjunction with the loop. In the usual radio direction finder this "sense" determination requires an extra operation on the part of the operator and its determination may be rather uncertain.

In using a direction finder of the conventional type, the position of minimum or zero signal is usually determined by listening to the receiver output with head telephones, and considerable skill is often required, since there are effects tending to obscure this "null" position. Because of circuit unbalance or the effect of metallic objects on board the vessel, there is usually some signal received in all positions of the loop, and it is necessary for the operator to balance out this extraneous signal with an additional control known as the "balance" adjustment. With a weak signal, the operator must frequently interpolate between two signal amplitudes of equal value—one on each side of the null position—and in this way determine the null position as that half-way between two positions of approximately equal signal.

Visual Indication of Direction

From these rather complicated operations that must be carried out to obtain an accurate bearing, it is evident that skillful operation is usually required to obtain dependable results.

In the development of the new Western Electric radio compass, the objective has been to obtain a device that could be readily operated by any of the officers, and that would give accurate results in which they would have the utmost confidence. The new compass gives a positive visual indication of direction, rather than depending on a difficult aural balance, and the usual operations for "sense" determination and "balance" have been eliminated.

In a typical installation the loop is secured to the roof of the wheel house directly above the steering compass, and is operated by a hand-wheel on the lower end of the loop shaft, which is located in the wheel house directly above the steering compass.

In taking a bearing, the receiver is tuned by rotating the signal tuning knob, which sets the dial, marked in kilocycles, to the desired frequency. A right or left deflection of an indicating meter is at once noted, and the hand wheel is turned in a direction opposite to the direction of deflection of the meter until the meter pointer comes to zero. The bearing of the radio beacon with respect to the vessel's heading is then read directly from the azimuth scale just above the hand wheel. The direction of the ship's heading at the time is determined from the steering compass, and by combining the two, the bearing of the radio beacon is determined.

Why the Speaker is Included

A loudspeaker is provided for identification of the station and to facilitate tuning. It would

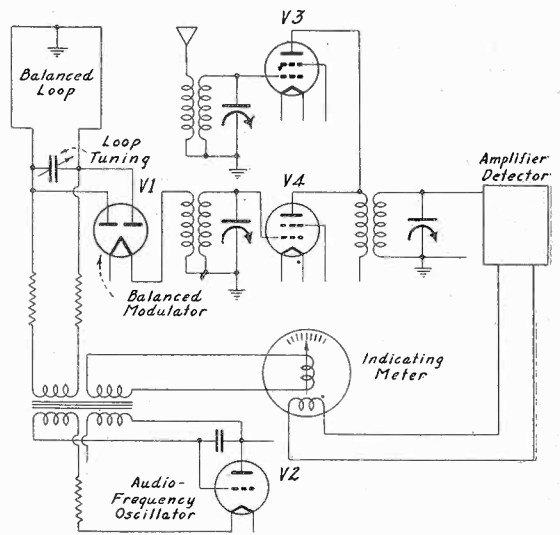

Simplified diagram of the receiver. Visual indication of the "sense" of the direction, or removal of the 180 degree ambiguity, results from comparison of the loop-fed modulator output with the output of the non-directional antenna.

not ordinarily be needed for taking the bearing except as a check to identify the station, but under conditions of severe static it is possible to eliminate a good deal of the effect of the static on the indicating meter by neglecting deflections that coincide with crashes heard in the loudspeaker. In this way it is often possible to obtain a good bearing under unfavorable conditions. Provision is also made for plugging in a headset to aid in installation adjustments, although normal service does not contemplate its use.

Besides the on-off switch there are only two major controls on the front panel: a tuning control and a sensitivity control. There is a volume control for adjusting the volume from the loudspeaker, but this will usually be adjusted to a given setting to suit the operator and left there. The sensitivity control is used to set the receiver gain at the proper value to obtain the required sensitivity at any given location. Small rectangular plates along the bottom of the receiver provide access to the required installation adjustments and the telephone jack.

The receiver may be removed from its cabinet by turning the two knobs on the ends of the front panel and withdrawing it with the two handles. External connections are made through a plug at the rear of the chassis which disengages when the receiver is removed.

Superheterodyne Circuit Used

The coils, variable condensers, and vacuum tubes are mounted on the upper side of the chassis, while the wiring, resistances, and fixed

(Continued on next page)

Direction Finder's Indicator Explained

condensers are on the under side. This arrangement, the design of which is due to G. Matejka and C. E. Cervený, brings all parts into full view for servicing and maintenance tests. A chart is provided on the front panel for recording any data needed concerning the marine radio beacons used in obtaining bearings.

Frequency Range, 242 to 515 kc

The receiver is of the superheterodyne type, especially designed for use as a radio compass, and covers the frequency range from 242 to 515 kilocycles in one continuous range. This includes all of the marine radio beacons, most of the airway beacons, and all of the ship telegraph frequencies. It has adequate selectivity to receive radio beacons separated by only from two to four kilocycles, since the attenuation four kilocycles off tune is over 50 decibels. The sensitivity is sufficient to obtain full scale deflection of the indicating meter with a signal strength of five microvolts per meter when the loop is rotated twenty degrees from the position of zero signal. Bearings accurate to one degree can be obtained even at distances of 200 miles, and at greater distances under favorable conditions.

How Visual Indication is Obtained

The loop assembly consists of a statistically shielded loop winding, a supporting pedestal with shaft, and the lower assembly. This latter assembly contains the compensator, slip rings and brushes, and the necessary terminals. The compensator functions to apply a predetermined correction to the scale pointer automatically and thus to compensate for the deviation of the direction of the radio waves due to the influence of conducting parts of the ship's structure.

The method by which the positive visual indication is obtained can be understood by reference to the simplified schematic. The side frequencies produced from the loop output by the balanced modulator are compared as to their

relative phase and intensity with the output of the non-directional antenna. The phase and intensity of the antenna output for a given signal are fixed, but the phase and intensity of the modulator output depends upon the position of the loop with respect to the direction of arrival of the signal. As the loop is rotated to the right of either of the positions of zero signal, its output will increase, and when rotated to the left, its output will increase also, but it will be 180° out of phase from the voltage produced by the right hand rotation. The output of the balanced modulator thus reverses its phase as the loop is rotated through either zero signal position.

How Direction of Deflection is Reversed

By energizing the two windings of the dynamotor type meter separately from the detected output of the receiver and the audio frequency oscillator, it is possible to reverse the direction of deflection of the meter by reversing the phase of the receiver output. This makes it possible to obtain the positive visual indication by means of the meter, the deflection of which directly follows the position of the loop with respect to the direction of the received signal. By connecting the loop so that for the correct bearing a right hand rotation of the loop reflects the meter to the right and a left hand rotation causes a left hand deflection, the correct bearing can immediately be obtained by following the rule previously mentioned; namely, "Rotate the loop in a direction opposite the direction of meter deflection until its pointer is at zero."

Any one operating a radio compass of this type is greatly impressed with the simplicity of its operation. The ease with which bearings may be obtained and the ruggedness of design of the new radio compass make it very suitable for use on any sea-going vessel.

Improvising Scriber

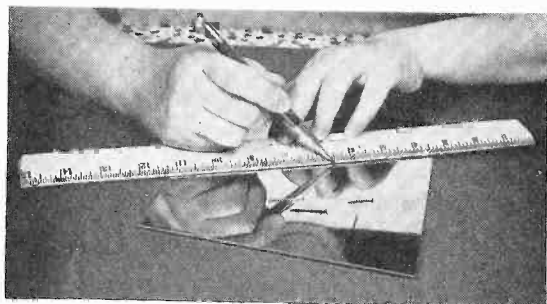

A propension pencil may be improvised as a scriber by removing the lead and replacing with a brad of the same diameter as the lead. The scriber rules lines on metal.

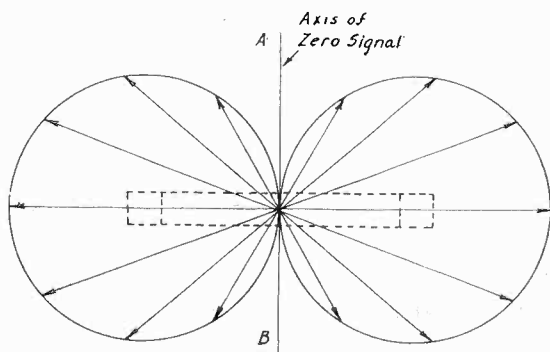

Loop antenna of direction finder is indicated by dashed lines. The vectors show the sensitivity in the various directions.

SLICK OUTPUT FOR SIGNAL GENERATOR

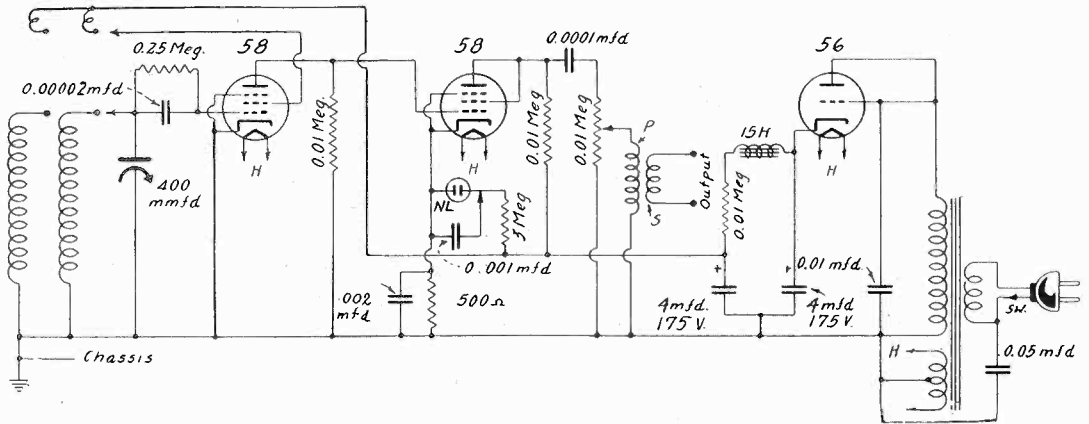

This generator for intermediate and standard broadcast frequencies, has r.f. oscillator, amplifier and rectifier. The coil PS completes freedom of the generator's attenuator from affecting set under test.

LIST OF PARTS

Coils

Two oscillation transformers for intermediate frequency and broadcast bands (third coil may be added, if desired, for intermediate short waves).

One output r.f. transformer, consisting of a honeycomb with primary about 1 inch total diameter on 3/8-inch hub, secondary from half to quarter that physical size, separation around 3/8 inch.

One small power transformer: primary, heater secondary and 1-to-1 secondary.

Condensers

One 400 mmfd. tuning condenser (if trimmer is present, remove it).

One 20 mmfd. (.00002 mfd.)

One 0.001 mfd.

One 0.002 mfd.

One 0.0001 mfd.

One 0.01 mfd.

One 0.05 mfd.

One block of two 4 mfd. 175 volt cardboard-container electrolytic condensers (black, common, to ground; two reds, plus).

Resistors

One 500 ohm.

Three 0.01 meg. (10,000 ohms).

One 10,000 ohm potentiometer with a. c. switch attached.

One 0.25 meg.

One 3 meg.

Other Requirements

One shield for 58 oscillator tube.

Two grid clips.

One dial and escutcheon.

Three knobs.

One neon lamp without limiting resistor.

One switch for modulated-unmodulated service.

One a. c. cable and plug.

One cabinet.

Two six-hole, one five-hole sockets.

Here is the wired sample of the generator, the oscillator tube alone shielded.

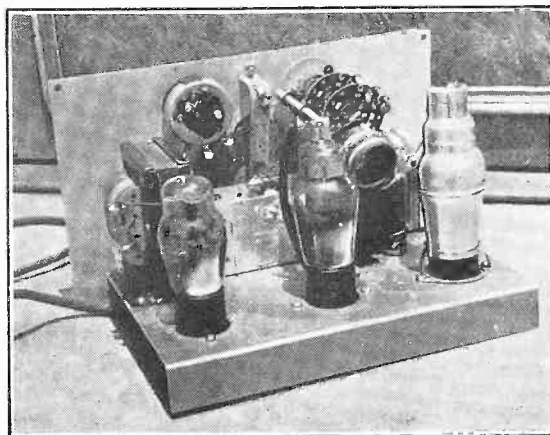

The coil switch is at right, the broadcast coil being in view below it.

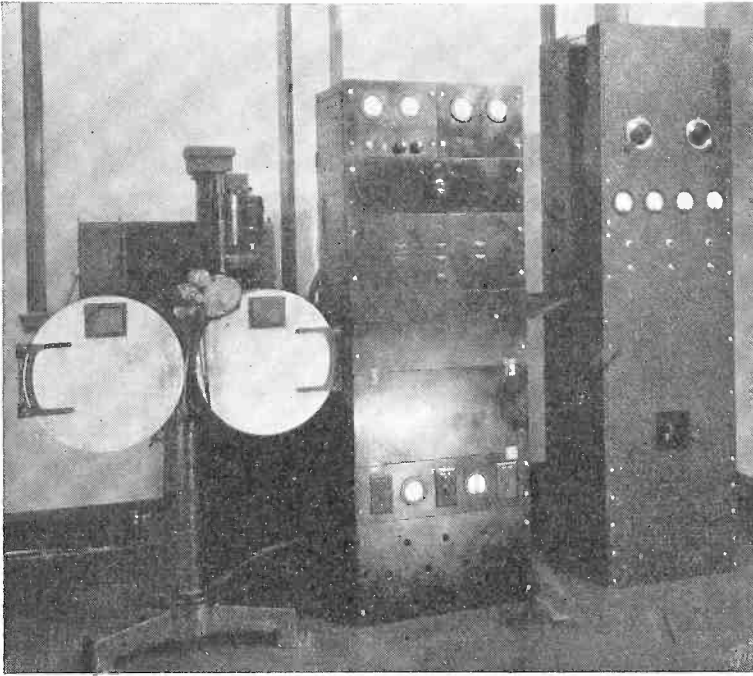

Tele in N C Selective Kerr

By

TELEVISION in natural colors! Yes, indeed. It is possible, and it may not be long before it is realized. Heretofore we have had colored television, neon orange-red television, cathode ray green television, and we have even had white television. But not television in natural colors. When Dr. A. F. W. Alexanderson first demonstrated his method of television several years ago, a gentleman in the audience asked about the possibility of having television in colors, whereupon Dr. Alexanderson excited the risibilities of the listeners by saying it was time to think of that when they had mastered television in white and black. At that time it was the concensus that it would be possible by making use of the three primary colors, just as colored pictures are made, but there was no thought of television in natural colors.

If television in natural colors comes, it will undoubtedly be as the result of the application of a defect in the Kerr cell, a device now used for modulating the light at the receiver. Before we can speculate about the possibility of recreating television images in natural colors by means of this defect in the cell, let us describe briefly that cell.

The Kerr Cell

The Kerr cell is a small condenser immersed in one of several liquids having certain electro-optical properties. The most common liquid is nitrobenzene, because this liquid has the special property in a vastly greater degree than any other generally known. Let AA, Fig. 1, represent the plates of this condenser. The two metal plates and the nitrobenzene are not sufficient to make a Kerr cell modulator. There

Movie reels, left, amplifier and, right, transmitter for television in colors.

must also be a high potential difference, E , between the plates, so that there exists a strong electric field between the plates. The intensity of this field is $F = E/a$, where a is the distance between the plates. The field is usually expressed in electrostatic units of potential per centimeter. (One electrostatic unit equals 300 volts.)

Now suppose a beam of plane polarized light

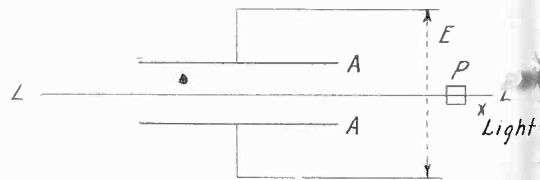

FIG. 1.

The principle of the Kerr cell. Two metal plates AA, immersed in a bath of nitrobenzene, are kept at a high potential difference E , and a beam of light, plane polarized by crystal P is sent between the plates.

Television Natural Colors

Distortion of Cell Used

E. Anderson

passed between the plates AA. The plane of polarization of that beam will twist as the beam passes through. That is the effect that is utilized in modulating the beam of light, that is in making it stronger or weaker.

We ought to say something about polarization. Light consists of vibrations in the ether, and they are electro-magnetic in nature. The electric force vibrates in one direction and the

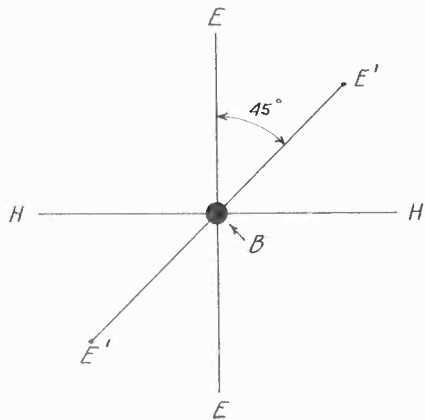
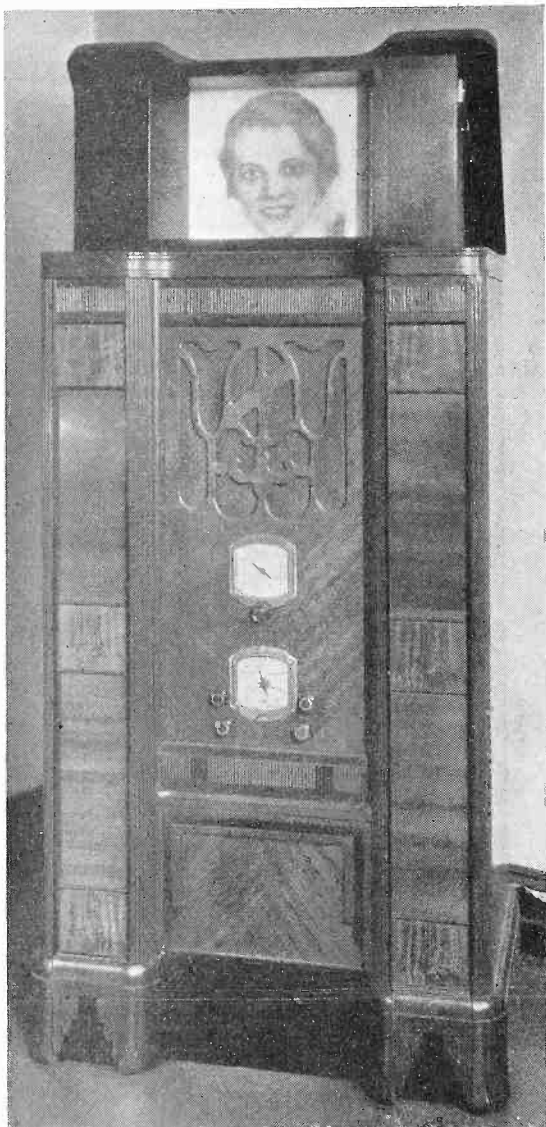

FIG. 2.

Looking head on into the beam of light as it emerges from the second crystal. EE is the electric axis of the second crystal and E'E' the plane of polarization of the light beam B. Direction of E'E' is changed by the signal.



Appearance of the all-wave receiver developed for introduction to the Canadian market early next year, with provision for television. A wash drawing of a girl's head has been inserted on in the screen space to show where the picture will appear. The top cover is collapsible and may be kept down when the set is not being used for television.

magnetic in a direction at right angles to that of the electric. Both are at right angles to the direction in which the wave moves.

The Electric Component Is Important

We are concerned now only with the electric part and the direction of propagation. When the light is unpolarized, the electric force does not vibrate in one plane only, but in all con-

(Continued on next page)

(Continued from preceding page)

ceivable planes, that is, in all planes that can be passed through the line LL. Such light is not suitable, and therefore the light beam from the source must be polarized.

Before we go on to say how this is done let us attempt to clarify the idea of polarization. Suppose we have a circular metal rod. It is the same in all directions and if we twisted that rod a little there would be no way of finding it out, especially if we could not see the rod. This rod is somewhat like a beam of unpolarized light. Now take a metal strip, thin and wide. If we twist that we can immediately notice it. It will become like a cork screw. This is somewhat like a beam of plane polarized light. The plane of polarization is the plane determined by the edges. We could describe a sine curve on one side of that strip, and that curve would represent the electric vibrations. We could not describe such a curve on the edge, if the strip were thin enough.

The light is polarized by passing the beam through a crystal of Iceland spar. The light that enters that crystal vibrates in all directions

ence is that the polarizing crystal has cut out one half of the light. Also, the crystal and the liquid absorb some of the light. Hence as far as the eye can see nothing has happened to the light except that a little more than half of it has been removed. Maybe the eye can't observe that either, for the eye has the property of accommodation to different light intensities.

But suppose we put another crystal of the same kind in the path of the beam before we look at it. If this crystal is arranged optically the same way as the other, all the light that reaches it comes through. But if the second crystal is turned through a right angle, it cuts out all the remainder of the light. That is, as the second crystal is turned, the light grows weaker until it completely goes out. If the second crystal is turned still more, the light returns. This is the principle of the Kerr cell modulator. The amount of turning of the plane of polarization can be measured by first adjusting the two crystals so that no light comes through when there is no electric force between the plates, and then noting the amount of turning of the second crystal is necessary

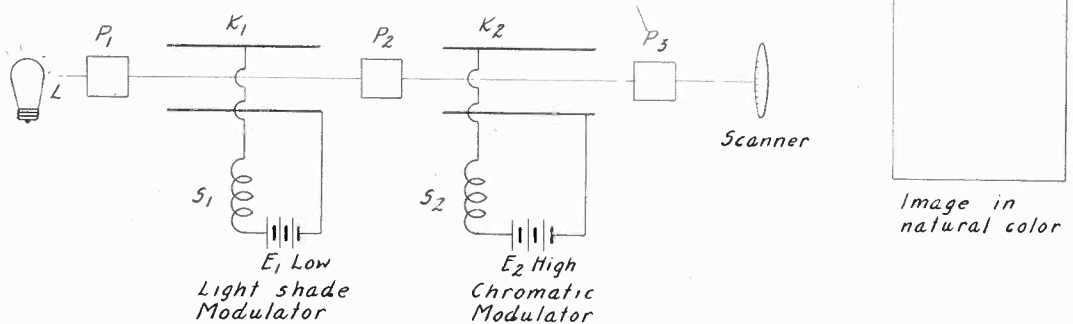

FIG. 3.

A suggested set-up for obtaining television images in natural color. P_1 , P_2 , and P_3 are polarizing crystals. K_1 and K_2 Kerr cells, and S_1 and S_2 are coils by means of which the signals are superposed on the biasing voltages E_1 and E_2 .

at right angles to the line of propagation, but the light that comes out vibrates in only one plane. It is about like passing a round rod through rollers, which make it flat.

Twisting the Plane

The light beam LL, Fig. 1, then is polarized. It has to pass through the strong electric field between AA, and as it passes the plane turns. When the liquid is nitrobenzene it twists a great deal, for a given field intensity. It twists more the stronger the field. In fact it twists in proportion to the square of the field, and that also means that it twists in proportion to the square of E , the voltage between the plates. Further, the twist is also directly proportional to the length of the condenser plates, that is, to the distance the light beam has to pass through the field.

We cannot tell by looking at the light whether it is polarized. Neither can we tell by looking that the plane of polarization has turned. To the eye the emergent light looks like ordinary light. The only apparent differ-

again to extinguish the light. Clearly, the amount by which the second crystal was turned is the same as the angle through which the plane of polarization was turned by the electric force.

The Light Modulator

Let B, Fig. 2, be a beam of plane polarized light. (It is shown round because the spot of light may be round despite its plane polarization.) Let EE be the plane in the second crystal in which the electric force vibrates. HH would then be the plane in which the magnetic force vibrates. Light coming up to the second crystal polarized so that its plane coincided with EE would pass through the second crystal without loss. Light coming up to it polarized so that the plane coincided with HH would be cut out entirely. Now let $E'E'$ represent the plane of polarization of the light for a given biasing force E across the Kerr cell. The second crystal can be adjusted so that this is the case. It is usual to adjust the crystal so that the plane of polarization of the light, $E'E'$,

Image in natural color

makes an angle of 45 degrees with the polarizing plane of the second crystal. With this adjustment the crystal lets through one half of the light that reaches it, which is only one fourth of the original light.

Now let a signal voltage be superposed on E. If this is an increase, the plane of polarization turns more, in the direction EE. Then more than one half of the light comes through. If the superposed voltage is a decrease, the plane of polarization turns less, and E'E' lies closer to HH. Less light comes through. If the decrease is so large that E'E' coincides with HH, no light comes through and there is complete darkness. If the increase, on the other hand, is so great that E'E' coincides with EE, the emergent light beam has full brilliancy. The variation between full brilliancy, for the strongest contrasts in the image, can be adjusted by

in a lens or a mirror. If we are to have television in natural color, not only must a red turn out a red, a blue a blue, and so on, but the relative shades in each color must be retained.

Turning Affects Dispersion

The chromatic dispersion becomes greater the more the plane—the mean plane—is turned. If it is turned less than a quadrant, there is little difference, but if it is turned two or more quadrants, the effect becomes very marked. The total turning of the mean plane is controlled by adjusting the field strength in the Kerr cell that is, of E/a , and also by varying the length of the cell. It is proportional to the square of the field strength and directly proportional to the length of the cell. The field is limited by

Light varies inversely as the square of the distance. That is why the light intercepted by the small screen in the upper figure is greater than the same screen when placed in the lower figure. More light is intercepted by the condensing lens when it is close to the light.

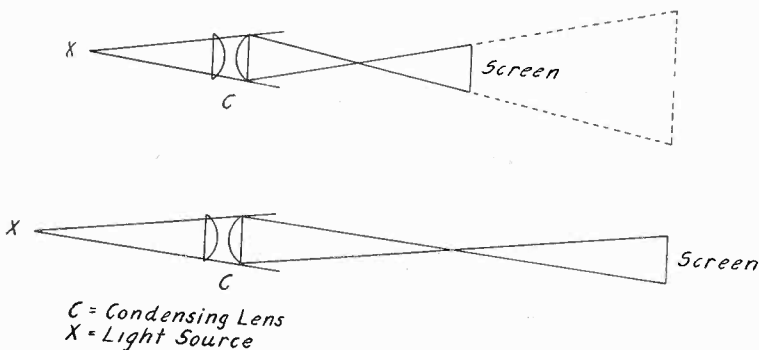

varying the amplitude of the signal superposed on the biasing voltage.

Bringing Out the Color

The amount of turning of the plane of polarization is different for different colors. Thus the Kerr constant, which is a measure of the amount of turning, is inversely proportional to the wavelength of the light. When the liquid in the cell is nitrobenzene, the Kerr constant for a length of 6390 Angstrom units is 20.2 millionths and for 4670 Angstroms it is 31.1 millionths.

Thus for the same voltage the plane of polarization for the blue light turns more than that for the red. In a sense the light is broken up into a rainbow. However, this cannot be observed directly any more than the difference between polarized light can be told from ordinary light. But after the light that has been broken up in this manner has passed through the second crystal, it will contain a predominating color.

One color might come through with full brilliancy whereas other colors, higher and lower in wavelength than the favored color, will be partly blotted out. This predominating color has no relation to the color of the original image, but only to the values of lights and shades. As an example of what might happen, a light shade of blue might turn out to be a brilliant red, whereas a bright blue might turn out a pale orange. This color effect is obviously a defect, just as chromatic aberration is a defect

the electrical strength of the nitrobenzene but the length of the cell can be varied over wide limits. It is quite feasible to turn the mean plane so that the planes for the different visible colors are spread out over a whole quadrant.

This seems to offer a chance for television in natural colors but it is a problem for inventors to worry about.

It would seem that two cells in series would be necessary. There would first be a polarizing crystal. This would be followed by a Kerr cell in which the electric field was just sufficient to produce light and shade for all colors. This modulator would be operated in the first quadrant. This cell would be followed by a second in which the polarizing voltage was high so that the planes of polarization for the different colors would be spread out over a whole quadrant.

Amplitudes Used as Color Selectors

The light reaching the second cell would be polarized and modulated as to light and shade only. Terminating the series arrangement would be a third crystal which would let through only one color at a time, this color being determined by the intensity of the signal voltage superposed on the biasing voltage on the second cell.

There would have to be a correlation between the color of the original picture and the intensity of the signal voltage on the second cell. A weak signal would turn the blue sufficiently to let all the blue light through, but it would

(Continued on next page)

(Continued from preceding page)

ceivable planes, that is, in all planes that can be passed through the line LL. Such light is not suitable, and therefore the light beam from the source must be polarized.

Before we go on to say how this is done let us attempt to clarify the idea of polarization. Suppose we have a circular metal rod. It is the same in all directions and if we twisted that rod a little there would be no way of finding it out, especially if we could not see the rod. This rod is somewhat like a beam of unpolarized light. Now take a metal strip, thin and wide. If we twist that we can immediately notice it. It will become like a cork screw. This is somewhat like a beam of plane polarized light. The plane of polarization is the plane determined by the edges. We could describe a sine curve on one side of that strip, and that curve would represent the electric vibrations. We could not describe such a curve on the edge, if the strip were thin enough.

The light is polarized by passing the beam through a crystal of Iceland spar. The light that enters that crystal vibrates in all directions

ence is that the polarizing crystal has cut out one half of the light. Also, the crystal and the liquid absorb some of the light. Hence as far as the eye can see nothing has happened to the light except that a little more than half of it has been removed. Maybe the eye can't observe that either, for the eye has the property of accommodation to different light intensities.

But suppose we put another crystal of the same kind in the path of the beam before we look at it. If this crystal is arranged optically the same way as the other, all the light that reaches it comes through. But if the second crystal is turned through a right angle, it cuts out all the remainder of the light. That is, as the second crystal is turned, the light grows weaker until it completely goes out. If the second crystal is turned still more, the light returns. This is the principle of the Kerr cell modulator. The amount of turning of the plane of polarization can be measured by first adjusting the two crystals so that no light comes through when there is no electric force between the plates, and then noting the amount of turning of the second crystal is necessary

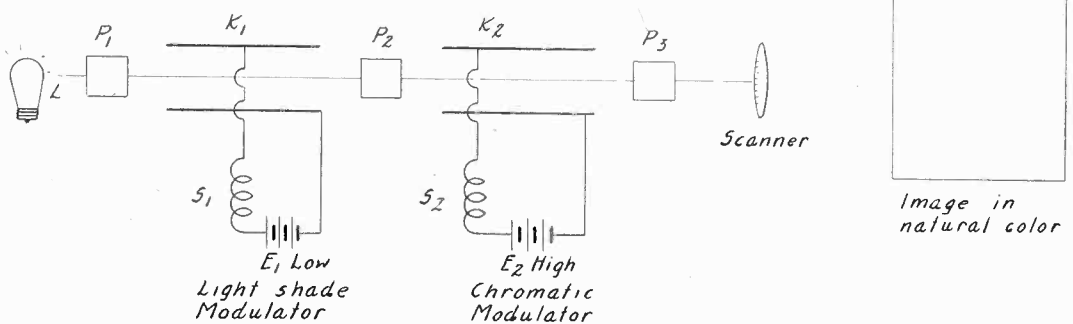

FIG. 3.

A suggested set-up for obtaining television images in natural color. P1, P2, and P3 are polarizing crystals. K1 and K2 Kerr cells, and S1 and S2 are coils by means of which the signals are superposed on the biasing voltages E1 and E2.

at right angles to the line of propagation, but the light that comes out vibrates in only one plane. It is about like passing a round rod through rollers, which make it flat.

Twisting the Plane

The light beam LL, Fig. 1, then is polarized. It has to pass through the strong electric field between AA, and as it passes the plane turns. When the liquid is nitrobenzene it twists a great deal, for a given field intensity. It twists more the stronger the field. In fact it twists in proportion to the square of the field, and that also means that it twists in proportion to the square of E, the voltage between the plates. Further, the twist is also directly proportional to the length of the condenser plates, that is, to the distance the light beam has to pass through the field.

We cannot tell by looking at the light whether it is polarized. Neither can we tell by looking that the plane of polarization has turned. To the eye the emergent light looks like ordinary light. The only apparent differ-

again to extinguish the light. Clearly, the amount by which the second crystal was turned is the same as the angle through which the plane of polarization was turned by the electric force.

The Light Modulator

Let B, Fig. 2, be a beam of plane polarized light. (It is shown round because the spot of light may be round despite its plane polarization.) Let EE be the plane in the second crystal in which the electric force vibrates. HH would then be the plane in which the magnetic force vibrates. Light coming up to the second crystal polarized so that its plane coincided with EE would pass through the second crystal without loss. Light coming up to it polarized so that the plane coincided with HH would be cut out entirely. Now let E'E' represent the plane of polarization of the light for a given biasing force E across the Kerr cell. The second crystal can be adjusted so that this is the case. It is usual to adjust the crystal so that the plane of polarization of the light, E'E',

makes an angle of 45 degrees with the polarization plane of the second crystal. With this adjustment the crystal lets through one half of the light that reaches it, which is only one fourth of the original light.

Now let a signal voltage be superposed on E. If this is an increase, the plane of polarization turns more, in the direction EE. Then more than one half of the light comes through. If the superposed voltage is a decrease, the plane of polarization turns less, and E'E' lies closer to HH. Less light comes through. If the decrease is so large that E'E' coincides with HH, no light comes through and there is complete darkness. If the increase, on the other hand, is so great that E'E' coincides with EE, the emergent light beam has full brilliancy. The variation between full brilliancy, for the strongest contrasts in the image, can be adjusted by

in a lens or a mirror. If we are to have television in natural color, not only must a red turn out a red, a blue a blue, and so on, but the relative shades in each color must be retained.

Turning Affects Dispersion

The chromatic dispersion becomes greater the more the plane—the mean plane—is turned. If it is turned less than a quadrant, there is little difference, but if it is turned two or more quadrants, the effect becomes very marked. The total turning of the mean plane is controlled by adjusting the field strength in the Kerr cell that is, of E/a , and also by varying the length of the cell. It is proportional to the square of the field strength and directly proportional to the length of the cell. The field is limited by

Light varies inversely as the square of the distance. That is why the light intercepted by the small screen in the upper figure is greater than the same screen when placed in the lower figure. More light is intercepted by the condensing lens when it is close to the light.

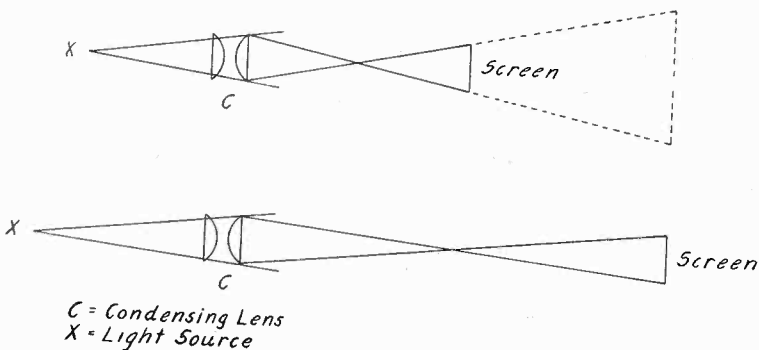

varying the amplitude of the signal superposed on the biasing voltage.

Bringing Out the Color

The amount of turning of the plane of polarization is different for different colors. Thus the Kerr constant, which is a measure of the amount of turning, is inversely proportional to the wavelength of the light. When the liquid in the cell is nitrobenzene, the Kerr constant for a length of 6390 Angstrom units is 20.2 millionths and for 4670 Angstroms it is 31.1 millionths.

Thus for the same voltage the plane of polarization for the blue light turns more than that for the red. In a sense the light is broken up into a rainbow. However, this cannot be observed directly any more than the difference between polarized light can be told from ordinary light. But after the light that has been broken up in this manner has passed through the second crystal, it will contain a predominating color.

One color might come through with full brilliancy whereas other colors, higher and lower in wavelength than the favored color, will be partly blotted out. This predominating color has no relation to the color of the original image, but only to the values of lights and shades. As an example of what might happen, a light shade of blue might turn out to be a brilliant red, whereas a bright blue might turn out a pale orange. This color effect is obviously a defect, just as chromatic aberration is a defect

the electrical strength of the nitrobenzene but the length of the cell can be varied over wide limits. It is quite feasible to turn the mean plane so that the planes for the different visible colors are spread out over a whole quadrant.

This seems to offer a chance for television in natural colors but it is a problem for inventors to worry about.

It would seem that two cells in series would be necessary. There would first be a polarizing crystal. This would be followed by a Kerr cell in which the electric field was just sufficient to produce light and shade for all colors. This modulator would be operated in the first quadrant. This cell would be followed by a second in which the polarizing voltage was high so that the planes of polarization for the different colors would be spread out over a whole quadrant.

Amplitudes Used as Color Selectors

The light reaching the second cell would be polarized and modulated as to light and shade only. Terminating the series arrangement would be a third crystal which would let through only one color at a time, this color being determined by the intensity of the signal voltage superposed on the biasing voltage on the second cell.

There would have to be a correlation between the color of the original picture and the intensity of the signal voltage on the second cell. A weak signal would turn the blue sufficiently to let all the blue light through, but it would

(Continued on next page)

VTVM Capacity Meter

High Resistance Also Measured

By J. E. Anderson

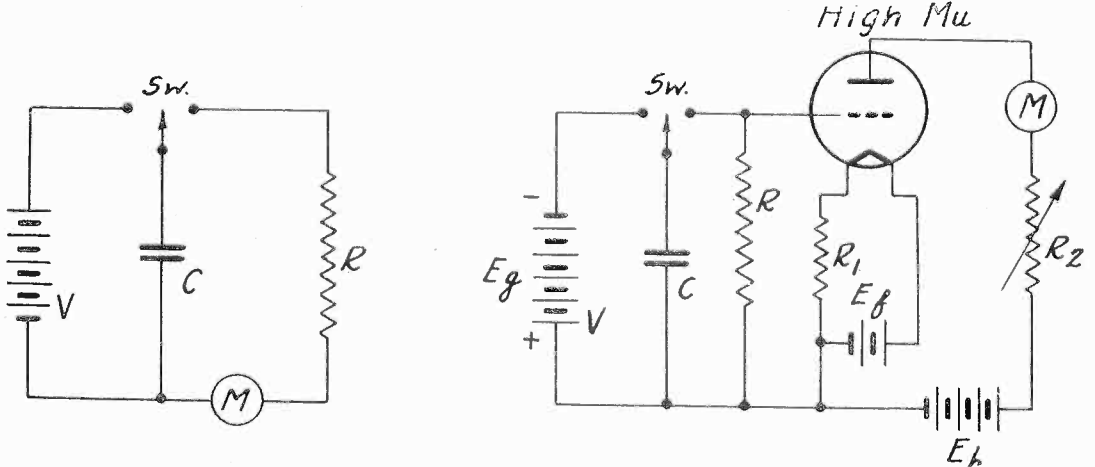

Here a meter, M, is used so that one may observe the time elapsing between the charging and the discharging of the condenser, C, which is under test. The duration is a measure of the capacity of the condenser. This principle is used for capacity measurement.

Here the stop watch principle is applied more closely, the circuit being in effect a vacuum tube voltmeter, where Eg is the grid biasing battery, C the condenser under test, R the grid load resistor, R1 the filament limiting resistor, Ef the filament voltage supply, R2 the rheostat to adjust the current to an observable and handy value operating, M the milliammeter, and Eb the B voltage supply.

If a condenser of large capacity be charged to a moderately high voltage and then connected quickly across a neon tube, that tube will glow for a brief time. The period of glow will be longer the higher the capacity and also the higher the voltage to which the condenser was charged. It is clear, therefore, that there exists a relation among the voltage, the capacity, and the time of discharge. This relation affords a means of measuring the capacity with d.c. instruments and a watch, preferably a stop-watch.

In a practical set-up the neon tube is replaced by a milliammeter and a high resistance in a circuit such as that shown in Fig. 1. Let V be the voltage of the charging battery, C the capacity of the condenser, M the milliammeter,

and R the resistance. First the condenser is charged by touching its free terminal to the battery for a second or so and then it is discharged by switching quickly to the resistance. At first the current is high but it gradually subsides to zero. The time that elapses from the instant the discharge begins until the current has reached a low, easily read value should be observed carefully. The relation from which the capacity can be obtained is,

$$C = 0.4343t/R \log (V/Ri),$$

the capacity being in farads, the resistance in ohms, time in seconds, V in volts, and the current in amperes. The logarithm is to the base 10. If R is expressed in megohms, the capacity will be given in microfarads. (See next page)

Color Difficulty in Television Wanes

(Continued from preceding page)

require a stronger signal to turn the plane of the red enough to let that through full strength. There would be comparatively little additional light loss as a result of the second cell, on any given color. There would be a little absorption

in the second cell and in the third crystal. As an electro-optical feat, the reproduction of the original color seems to be much easier of accomplishment than the more complex electro-optical-mechanical feat of producing any kind of acceptable television images.

(Continued from preceding page)

As an illustration of the capacity that may be measured let us assume that R is one megohm, t is five seconds, V is 135 volts, and i is 10 microamperes. This is about the lowest current that can be read accurately on a 0-1 milliammeter for on a 100-division scale it is just one division short of zero. We have to look up the common logarithm of 13.5, for that is the value of V/Ri . The logarithm is 1.13. The capacity therefore is 1.92 microfarads. A time of 5 seconds can be measured on an ordinary watch, but of course more accurate results would be obtained with a stop-watch. To make the time longer, and hence more accurately measurable, the value of R could be increased.

It should be observed that the leakage resistance in the condenser is in parallel with R . This fact will introduce an error unless the leakage is taken into account. Unfortunately, the leakage current does not flow through the milliammeter. It is clear that very leaky condensers cannot be tested by this means. This is especially true of electrolytic condensers.

A much more accurate method based on the same principle involves the use of a vacuum tube voltmeter calibrated for d.c. voltage. If the tube has a high μ , the determination is more accurate than if it has a low μ . When the vacuum tube voltmeter is used, it is the voltage that remains across the condenser, or across the resistance, after a certain time has elapsed, that is measured. Fig. 2 shows a suitable set-up. In this case the milliammeter has been transferred to the plate circuit of the vacuum tube. R_2 is a high variable resistance for the purpose of limiting the current and for adjusting it to a suitable value. It may be nearly full scale. R_1 is not only a filament ballast but also a grid bias resistor. The bias on the tube should be high enough to insure that no grid current flows at any time, for grid current will lower the effective value of R .

An Important Connection Explained

Let us assume that the vacuum tube voltmeter has been calibrated so that we know the actual voltage on the grid for every reading on the milliammeter. If R_2 is adjusted so that M reads exactly full scale when the grid is shorted, that is, when the only voltage on the grid is that given by R_1 , we should know from the calibration the additional voltage on the grid when the meter reads 0.9 of full scale. If the tube has a high μ , this might represent an additional bias of 0.1 volt. We know then that when the condenser is connected, in parallel with R , the voltage across the condenser is 0.1 volt when the meter reads 0.9 full scale.

It is important to connect the charging battery so that the grid side of the condenser is negative when it is charged. If it is not, grid current will flow most of the time and this would completely vitiate the result. Besides, the milliammeter would very likely be ruined.

The condenser is first charged as it was before. Then it is quickly switched over to the grid. The plate current will immediately drop to zero, and it will remain zero for some time. After a while it will begin to flow and will gradually increase to full scale. Measure the

time from the instant the condenser is connected to the grid until the plate current reads 0.9 of full scale, or some other easily read value previously decided upon. Just for the sake of illustration we'll assume that when the current is 0.9 full scale the calibration curve of the vacuum tube voltmeter shows that the voltage remaining on the condenser is 0.1 volt. That is a reason-

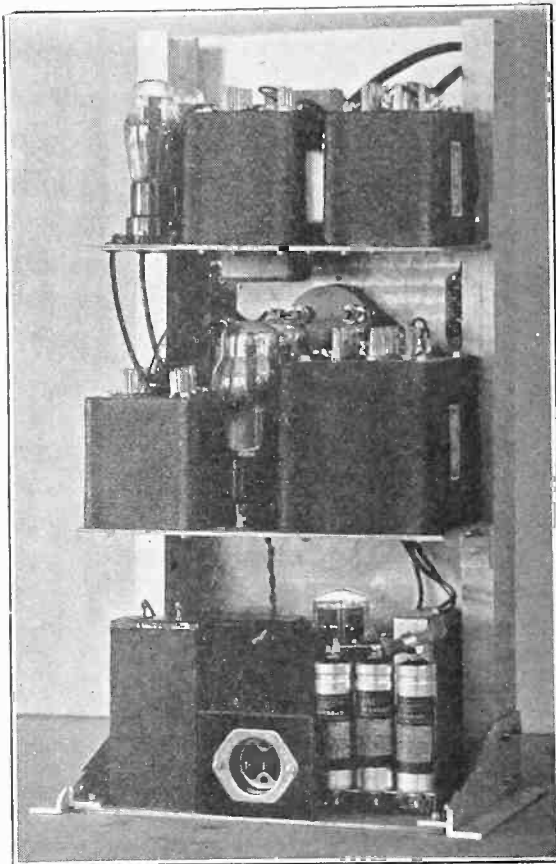

The electrolytic condensers in this power supply and amplifier may be measured with a voltmeter and a source of low 60-cycle voltage supply. Use the lowest range voltmeter available that will measure the voltage applied. The capacity value obtained will be too large because of the leakage through the condenser. An electrolytic condenser cannot be measured by the time-of-discharge method because of the leakage.

able value. In a one megohm resistance this would represent a current of 0.1 microampere. In the previous example the lowest current that could be read was assumed to be 10 microamperes. In other words, the vacuum tube voltmeter method is approximately 100 times more accurate than the current-reading method.

The same formula as given above applies to this case also, but since we measure the remanent voltage on the condenser it is better to put it in the form,

$$C = 0.4343t/R \log (V/v),$$

in which $v = Ri$, the voltage that remains on the condenser when the final time is taken.

(Continued on next page)

(Continued from preceding page)

Let us substitute the same values as before in this formula, except that v is now 0.1 volt. Now $V/v = 1,350$, the common log of which is 3.13. The capacity now becomes $C = 0.694$ mfd. If we had used the same capacity as before, namely, 1.92 mfd., the time of discharge would have been nearly 14 seconds, which can be measured more accurately than 5 seconds. Therein lies the main advantage of the vacuum tube voltmeter method.

When smaller condensers are to be measured, the resistance R should be increased so as to give a longer time of discharge.

By interchanging R and C in the second formula, an unknown resistance of high value can be measured, provided we know accurately the capacity of some condenser around one microfarad. This might be used to test the insulation of the grid of the vacuum tube voltmeter. The resistance R is removed and the charged condenser alone is connected across the input of the tube. Then the time is noted between the beginning of the leakage discharge and instant the milliammeter reads 0.9 full scale. If the insulation is very good, this will be a long time. Of course, the condenser used should itself be leak proof, for any condenser leakage will be added to that of the tube, and the resistance obtained will be that of the tube and that of the condenser connected in parallel. More leakage will be found on a moist day than on a dry day.

There may be some who would like to use this method of measuring capacities or high resistances but who will throw up their hands when they see the logarithm. In practice the logarithm need not be used at all. Suppose we always use the same charging voltage V , say 135 volts. Also suppose we use the same remanent voltage v , which we can do by adjusting the vacuum tube voltmeter. Then we only have to look up the logarithm once. Thereafter it simply becomes an instrument constant.

Standardized Values Simplify Use

Above we selected a value of 0.1 volt for v , and found that the log of V/v was 3.13. In this

special case the second formula becomes simply $C = 0.1384t/R$ farads. If further we always use one megohm when measuring capacities, the formula is simply $C = 0.1384t$ mfd. That is the equation of a straight line between C and t , which can be plotted, thus eliminating all figuring. Likewise, if we always use one microfarad for measuring resistance, the formula is $R = 0.1384t$ megohms. The same line can be used.

Of course, the most convenient remanent voltage may not be 0.1 volt, but in that case it is only necessary to look up the value of $\log(V/v)$ once. It is better to take the time when the plate current reaches a division line and find the corresponding remanent voltage than to have an even remanent voltage. It is possible, though, to have both by manipulating the fixed bias on the tube and the value of the plate resistance. It is desirable to select a bias such that when the final time reading is made, the plate current changes rapidly. This means that the lowest bias for which there is no grid current should be used.

Conversion Factors for Length Measurements

The following table gives conversion factors for measurements of length:

To Convert	Multiplier
Inches to Mils.....	1,000.
Mils to Inches.....	.001
Inches to Millimeters.....	25.4
Millimeters to Inches.....	.03937
Mils to Millimeters.....	.0254
Millimeters to Mils.....	39.3701
Inches to Centimeters.....	2.54
Centimeters to Inches.....	.3937
Inches to Meters.....	.0254
Meters to Inches.....	39.3701
Feet to Centimeters.....	30.48
Centimeters to Feet.....	.03281
Feet to Meters.....	.3048
Meters to Feet.....	3.2808

Countersink

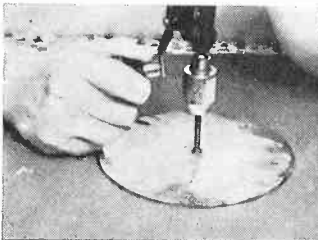

Put a machine screw into drill chuck and head will substitute for a countersink.

Identification

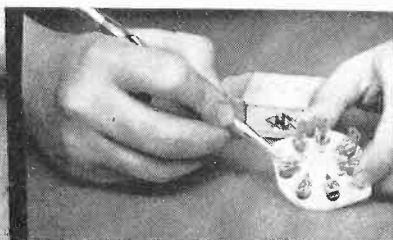

Novices will make it easier to find connections rightly if they will number the socket springs in standard order.

Vernier Knob

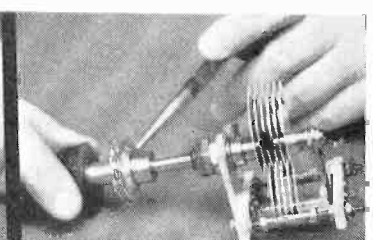

Planetary gear devices serve as vernier knobs. It is necessary to anchor one gear.

Pretuned I.F. Amplifiers

The Rest of a Super May Be Built Around Them

By Carter G. Ralstead

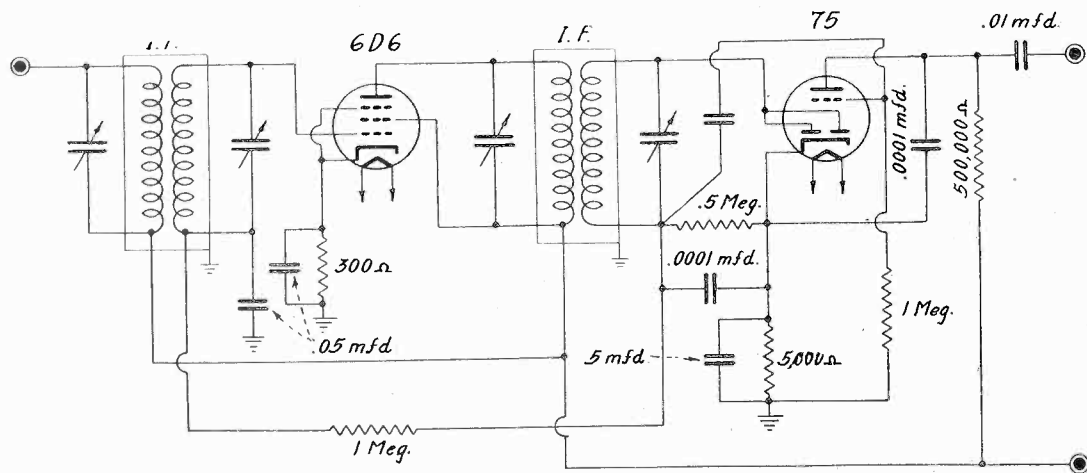

FIG. 1

A two tube pretuned intermediate frequency amplifier and first audio amplifier, intended for parallel connection of heaters.

THE difficult part of building a super-heterodyne and adjusting it into top-notch working condition is the tuning of the intermediate frequency amplifier. To make this adjustment right so as to get the maximum gain, highest selectivity, and least cross modulation, it is necessary to tune all the intermediate frequency circuits to one frequency and that the one for which the local oscillator has been designed. The work requires a signal generator which may be set at the intermediate frequency desired. If no such generator is available, the tuning must necessarily be by guess. While this may hit the right frequency very closely at times, the chances are greatly against this happy result. That guessing seldom leads to the right frequency is attested by the large number of grossly mistuned intermediate frequency amplifiers that are brought to service men for adjustment.

Intermediate frequency transformers are rated at certain frequencies, such as 175 kc, 230 kc, 456 kc, and many others. This rating does not mean that they are tuned to the rated frequency. It simply means that they can be tuned to that frequency. They can also be tuned to other frequencies, both higher and lower than the rated frequency, and in most instances far enough on either side to make it possible, and likely, that the final adjustment, arrived at by guess, will be far off the mark. Even as much as 10 kilocycles off the correct frequency is

too much if the radio frequency circuits and the oscillator are designed correctly.

Pretuning the Amplifier

Now, the intermediate frequency circuits could be tuned before they are put into the receiver by tuning them in a receiver similar to that in which they are to be used. This, however, is not entirely satisfactory because even if the receiver circuits are identical as far as the schematic and the tubes are concerned, the exact wiring cannot be duplicated, and differences in the running of connecting leads will be sufficient to upset the tuning. The reason the distributed capacities have this effect is that the capacities across the coils are very small, in order to make the gain high, and therefore small differences in distributed capacities will have a large effect on the tuning. It is a matter of percentages. If the coils were tuned with large condensers, the distributed capacities would not matter, but then the coils would not be as effective when accurately tuned.

There is only one practical way of providing accurately tuned intermediate circuits for those who do not have access to a precision signal generator, and that is to make the intermediate frequency amplifier as a unit. This has been done, and the circuit of such an amplifier is shown in Fig. 1. This circuit includes the detector and first audio amplifier for several

(Continued on next page)

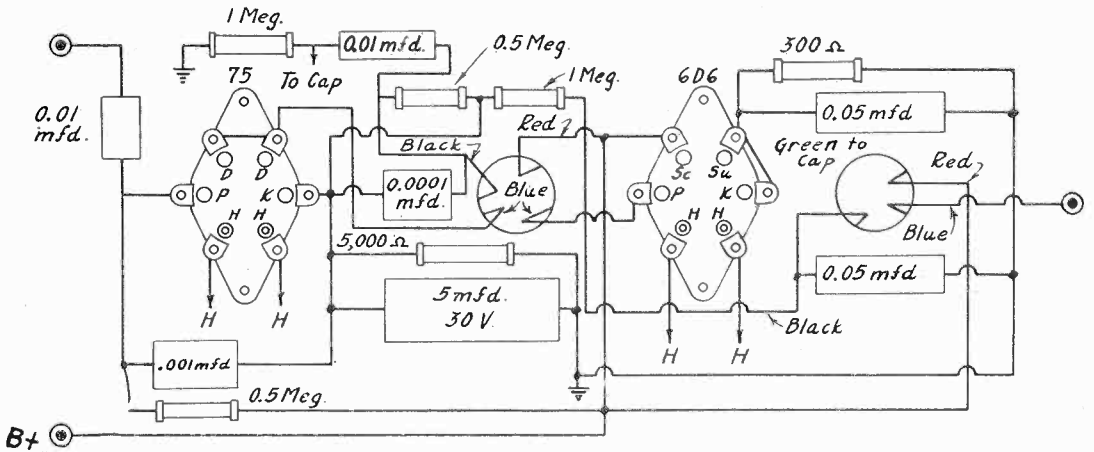

FIG. 2
Pictorial diagram of the circuit for parallel heaters.

(Continued from preceding page)
reasons. The main one is that if it is not included, the pretuning would be defeated, for one detector tube and circuit would require one setting of the tuning condenser in the final intermediate frequency circuit and another would require a different setting.

Only One Circuit to Tune

A similar situation exists at the beginning of the amplifier, but it is not practical also to supply the mixer tube. Neither is it necessary, because condenser C1 across the first tuned circuit is tuned in a typical set-up, making it practically in tune when connected to any other similar mixer. While there may be differences in wiring at this point also, one circuit can always be adjusted by trial, provided only one circuit is out of tune. To tune the amplifier, then, in any case it is only necessary to turn

the condenser on the first coil for loudest signal, after having tuned the radio frequency circuit for loudest signal on some station. The adjustment of this condenser is so close that, even in the worst cases, it should not require more than a fraction of a complete turn.

The i. f. amplifier tube is provided with a fixed bias, which is obtained from a 300-ohm resistance in the cathode lead of the 6D6. This resistance is shunted with a 0.05 mfd. condenser, which is ample capacity. This tube is also provided with automatic volume control in that the grid return is made to the negative end of the diode load resistance, through a 0.5 megohm resistor. This resistor is also shunted by a 0.05 mfd. condenser. A larger value than this is not desirable at this point because it would slow down the response of the automatic volume control.

The load resistance on the diode detector is also 0.5 megohm, and this is shunted by a

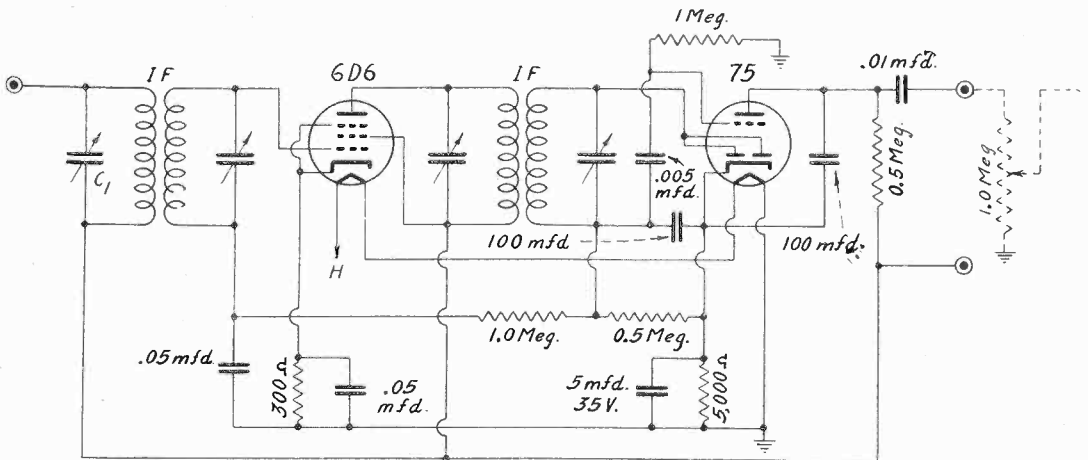

FIG. 3

The schematic of a similar circuit, adapted to series heaters, 6.3 volt type tubes, the external volume control being shown as a potentiometer the full resistance of which constitutes the grid leak for the audio stage following the 75 amplifier,

condenser of 100 mmfd. The resistance is high enough to insure good detection and also so high that it does not drag down the selectivity of the last tuned circuit. The condenser across it is large enough to remove the intermediate frequency ripple, yet not so large that it removes any of the high audio frequencies.

The grid of the 75 triode is connected to the load resistance through a 0.005 mfd. condenser (value not imprinted on diagram). Therefore fixed bias is used on the triode. This bias is provided by a 5,000-ohm resistor in the cathode circuit, which is the optimum value for this particular tube. A 5 mfd., 35-volt electrolytic condenser is connected across the bias resistor as a means of preventing degeneration of the low audio frequencies. There is no lack of low notes when this amplifier is used, assuming that they are not suppressed later on in the audio amplifier.

As there will be some ripple of intermediate frequency left at the grid of the 75, and as this will be amplified by the triode, a 100 mmfd. condenser is connected between the plate and the cathode of the 75. This is an aid in preventing trouble in the power stage due to the presence of high frequencies. The plate coupling resistance following the 75 triode is 0.5 megohm. This value goes with the 5,000-ohm bias resistance, and it is so high that a very large percentage of the μ of the 75 is utilized. A 0.01 mfd. stopping condenser completes the unit. This condenser is made large in order that it may pass the lowest audio notes for any reasonable grid leak that may be connected in the next tube. It should be pointed out that certain amplifier tubes require low values of grid leak, and the lower the leak resistance the larger the stopping condenser must be if it is to transmit the low notes.

Construction of Unit

The amplifier is built on a long and narrow chassis of such height that the unit may be mounted on any receiver chassis. All dimensions have been kept to a minimum. At each end are $\frac{3}{8}$ inch flanges with holes for mounting.

On each end of the unit is a two-contact terminal strip. Each may be marked A and G. The left end of the unit, the one beginning with

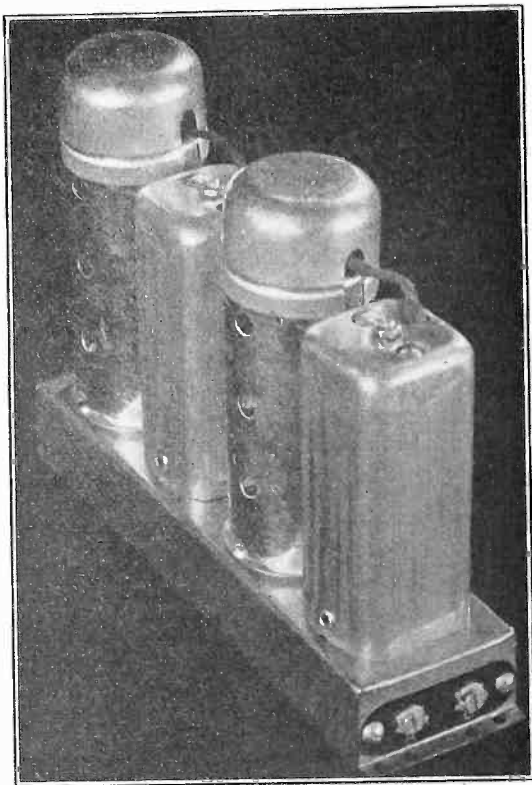

FIG. 4

General view of the top, representing the layout of the amplifiers diagramed in the preceding schematics and one pictorial circuit.

a coil, is the input end. The left hand ringed dot in parallel heater diagram represents the only utilized one of these posts, to be connected to the plate of the mixer tube. At the right end, the one with the 75 tube, the upper ringed dot represents a post to be connected to the grid of the succeeding audio frequency amplifier, and to the grid leak for that tube. The lower right hand ringed dot should be connected to B plus. The mounting of the i. f. amplifier chassis on the set chassis establishes the preceding. The cap on the 75 tube may be connected to a long lead
(Continued on next page)

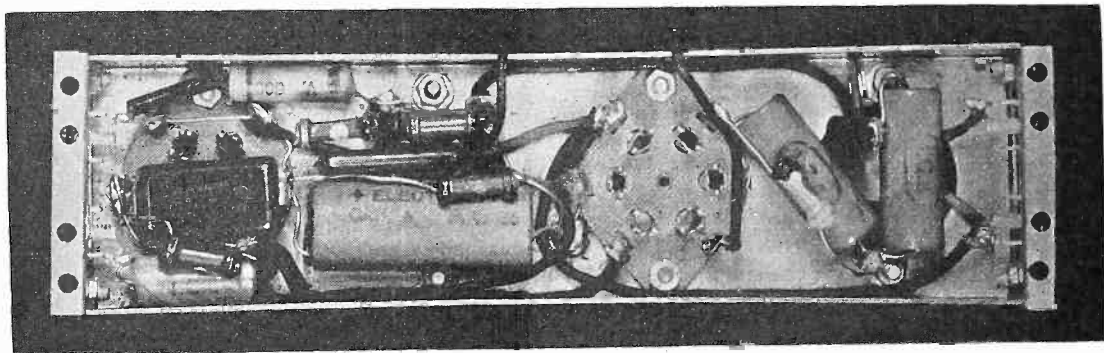

FIG. 5

Bottom view of the same amplifiers.

(Continued from preceding page)

which runs through the second intermediate frequency transformer and left free below the unit, to be connected to the slider of a manual volume control potentiometer, which may replace the 0.5 meg. fixed load on the diode, or the 75 grid leak may be a potentiometer. The third terminal of this potentiometer, of course, is connected to the 75 cathode.

The heaters may be in parallel or in series. For series connection, one end of the heater of the 75 is grounded, i. e., connected to the chassis. The other is run to one side of the 6D6 heater. The second heater terminal of the 6D6 would be connected to a long wire, to be connected to the heater of the mixer tube.

Adjusting the Tuning

While the amplifier with series heaters is for 6.3-volt tubes, the same arrangement can be used with any suitable tubes, and the heaters may be connected either in series or parallel. Sometimes they are connected in parallel for the 6.3-volt tubes, but usually in series. When 2.5-volt tubes are used, they are connected in parallel.

The intermediate frequency has not been indicated, because the amplifier may be for any particular standard frequency. The most popular frequency right now for broadcast reception is 456 kc. For shortwave reception 465 kc is more common.

Variable Coupling Introduced

At the bottom of this page is a special high gain intermediate frequency amplifier in which the coupling between the coils is variable. It may be varied continuously to suit the requirements of the moment, or it may be adjusted to a desired value and then locked in place. The advantage of variable coupling is appreciated by those who receive both code and voice modu-

lated signals. For code the selectivity must be high in order to separate one signal from all the rest, and they are spaced closely, but for broadcast reception it must not be as high if good quality is to be expected. Now, loose coupling results in high selectivity and tight coupling in rather broad tuning. By increasing the coupling sufficiently, the amplifier may even be made broad enough to accommodate television signals, which at this time require a band of about 110,000 cycles. If the amplifier is to be adjusted for this purpose it may be necessary to adjust one of the transformers for very loose coupling, another for moderately tight coupling, and the third for very tight. This can be done with this amplifier because each transformer can be adjusted independently of the others.

Several views of the variable coupling amplifier are shown on page 45. In the upper left is a bottom view, showing clearly the cams by which the coupling is varied. The other three pictures, especially the lower right, show the plungers to which one of the coils in each case is attached. These pictures also show the lock collar at the top of each plunger by means of which any given coupling is fixed.

T Pad Used as Detector Load

The circuit of the amplifier is given at the bottom of page 44. It will be observed that automatic volume control is employed, the two 58's being controlled by it. This is essential where an amplifier is to be used for the reception of far-away stations, the signals from which are subject to violent fading. It is also advantageous for the reception of local stations in that while tuning through strong stations the signals will not become unpleasantly loud.

A 55 type detector is employed in it. The load on the diode part of this tube is a T-pad attenuator. The total resistance on the diode remains 0.5 megohm regardless of the setting. Likewise the resistance between the grid of the

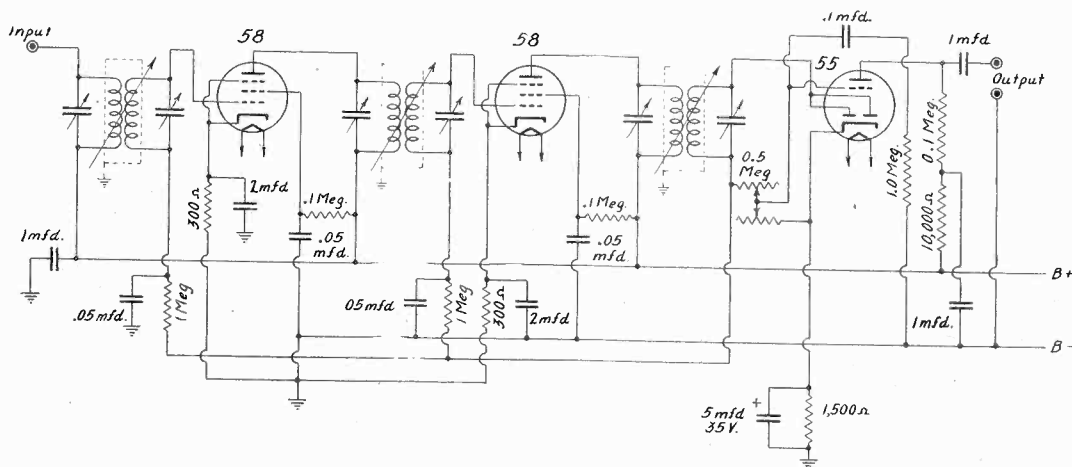

Adjustable coupling between the windings in the intermediate transformers is the special feature in this circuit. By adjusting the coupling the selector may be made more or less selective. Code signals require high selectivity; broadcast signals less.

triode and ground remains 0.5 megohm. When an ordinary potentiometer is used the load on the diode remains constant but the resistance between the grid of the triode and ground varies between zero and 0.5 megohm, if that is the maximum value of the load resistance.

This amplifier with variable coupling is capable of enormous gain because it has two 58 amplifiers and three high grade transformers. It really has more than is required for broadcast reception, except of foreign stations. This high gain is not at all a detriment even for receiving strong local stations because of the automatic volume control. But it is very convenient when picking the weak stations out of space.

When receiving code stations the selectivity must be reduced, and this is done at the expense of gain. The coupling should be much looser

than critical coupling. It is for this purpose that the high gain in the tubes is of advantage. If the amplifier is built into a circuit in which there is a beat note oscillator, there is hardly a code station within the tuning range that can not be received, assuming that the mixer and radio frequency amplifier are at least of average efficiency. When the amplifier is used for television signals the coupling would have to be increased very much, and this reduction would decrease the gain. Still there is enough gain because television signals would be rather strong if they are to be free from static crashes.

This intermediate frequency amplifier, like the one first described, can be pretuned to any desired frequency. The transformers used are for a frequency of 465 kilocycles, which is highly popular today.

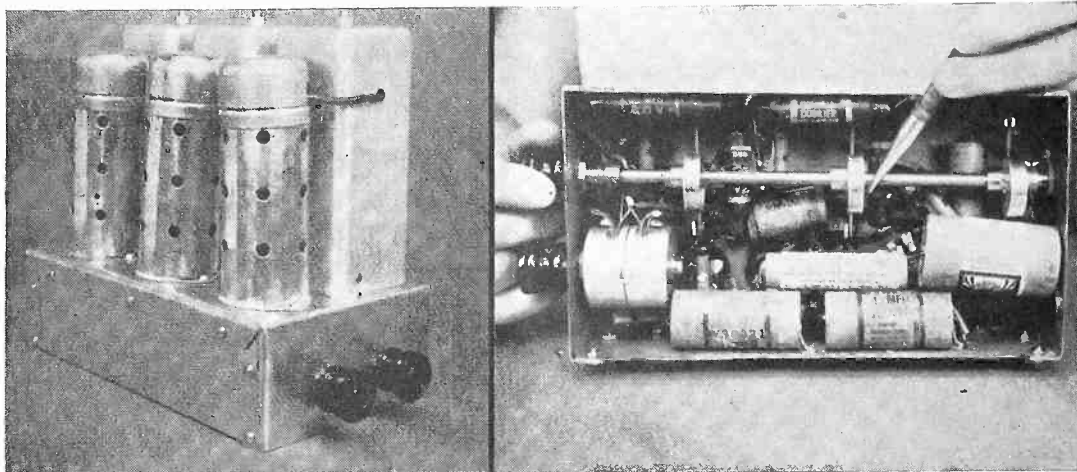

Top front view of the intermediate frequency amplifier shown in previous circuit diagram. The special coils are lined up in the rear, back of the tubes.

The coupling is varied by means of cams turned with a knob on the panel. The pencil is pointed to the middle cam. The cams control plungers. Below the cam shaft are the by-pass condensers and the T pad.

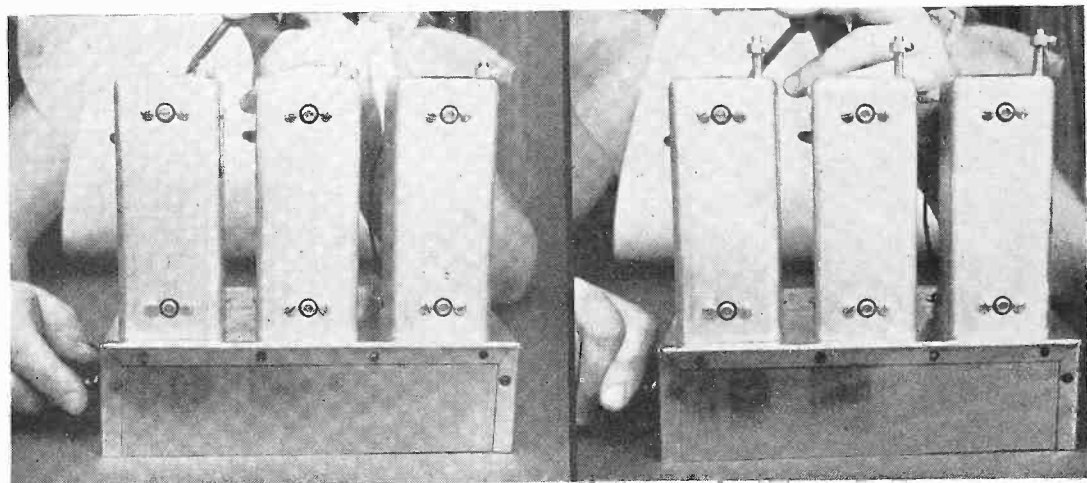

Adjusting the coupling. The cams are turned lifting the plungers on top of the cans. A lock collar is then set at the desired place, fixing the coupling.

If fixed coupling is not desired, the lock collars are left at the top of the plungers as in this case. The coupling is then varied with the cam, which stops where set.

Compact Four Tube Set For Short Waves, Using T. R. F. Stage

By Robert G. Herzog

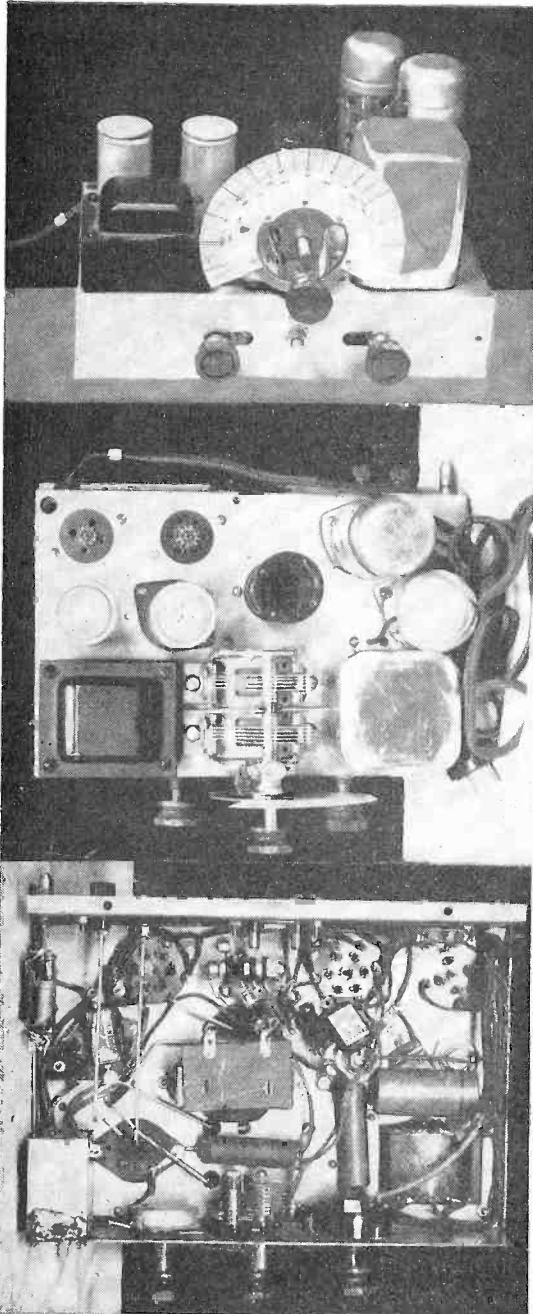

Three views of the four-tube regenerative short wave receiver. The r.f. plug in coil is in the oblong shield at right in the two views at top and second from top.

HERE is a peppy all-wave receiver. It has plenty of gain, or sensitivity, and all the selectivity that is required even in the short wave bands. The reasons are that it has two accurately tuned circuits, which is not often attempted and regeneration besides. Although there are two tuned circuits, the tuning is very easy. The two main condensers are put on one control. Signals can be brought in with this alone. However, it is very difficult to line up the tuned circuits in a multi-range receiver so accurately that they will be exactly in tune at the same time.

But they must be if the greatest sensitivity and selectivity are to be obtained. To compensate for unavoidable differences, a 50 mmfd. trimmer is put across the first section of the gang.

The tickler is fixed and the regeneration is controlled by means of screen voltage variation on the detector, or regenerative tube. This is recognized as a very good way of controlling regeneration.

Must Not Wander and Don't

Plug-in coils are used in the set to cover the various bands. This feature makes it an all-wave set because coils can be obtained for any frequency band.

Observe that thorough by-passing has been employed to eliminate wandering around of the short wave currents in channels where they don't belong. This by-passing extends to the very last tube, the audio power amplifier.

Audio power has not been neglected either. The output tube is a 2A5, which has both gain and power handling capacity. And there is enough radio frequency gain ahead of it to give it something to do.

High Capacity Used Here

A feature in it that is conducive to high sensitivity is the direct impedance coupling between the first and the second tubes. The plate of the first tube is fed through a $2\frac{1}{2}$ milihenry choke and the signal is delivered to the tuned circuit through a 30 mmfd. condenser. One reason for using this type of coupling, aside from its high gain property, is that it avoids an extra winding on the plug-in coil.

Neatness in under wiring in this set is as important as in any other. It is suggested where possible, the leads from plates be run around the inside wall of the chassis, care being used of course to keep them from the grids, thus reserving the center space for the other necessary wiring.

Neon Tube's Average Current

By Louis Kranz

NEON lamps are used more and more for various purposes. One reason is that they give a light with an extremely small current from the line or the battery. Suppose the lamp has been designed to operate on 115 volts. There is usually a 30,000 ohm resistance in series with it ($\frac{1}{4}$ -watt size). If there is no other resistance in the circuit, the current will be slightly less than 4 milliamperes. Another and smaller lamp has a resistance of 100,000 ohms and is intended for 110 volts. If the voltage actually is 115, the current is 1.15 milliamperes.

This is for the case when the lamp is continuously on the voltage. When the tube is used in an oscillator for generating an audio frequency there is always a high resistance in series with the voltage, and this must be high compared with any resistance that is connected. It might well be one million ohms.

Glow Stops But Seems to Continue

In that case the current cannot be more than one microampere per volt applied, and this even if there is no resistance in series with the lamp. But most of the time less than one milliampere per volt applied flows.

The average current in such a case might not be more than half the maximum current.

Thus if the voltage is 115 volts, the average current may not be greater than 75 microamperes. Yet the lamp appears to glow all the time, assuming that the frequency of the oscillation is greater than about 16 per second. The continuous luminosity is the result of persistence of vision.

Of course, the current that flows depends on the wattage of the lamp. A one-watt lamp would not be operated with such high resistances, although they could be.

The Change is Computed

Every time a condenser of C farads is charged to a voltage V, a quantity $CV^2/2$ coulombs is put into it. If this is done once a second the mean current is $CV^2/2$ amperes. If it is charged N times per second the average current is also N times. Thus if the voltage is 80 volts, the approximate striking voltage of some neon lamps, and the capacity is 1 mfd., the mean current is $3.2N$ milliampere. But in the neon oscillator not all the charge leaves the condenser. The lamp goes out when the voltage is about 50 volts. Thus the charge that remains is 0.00125 coulomb, and the charge that is put on every time is 0.00195. The average current therefore, would be about $2N$ milliamperes through the tube.

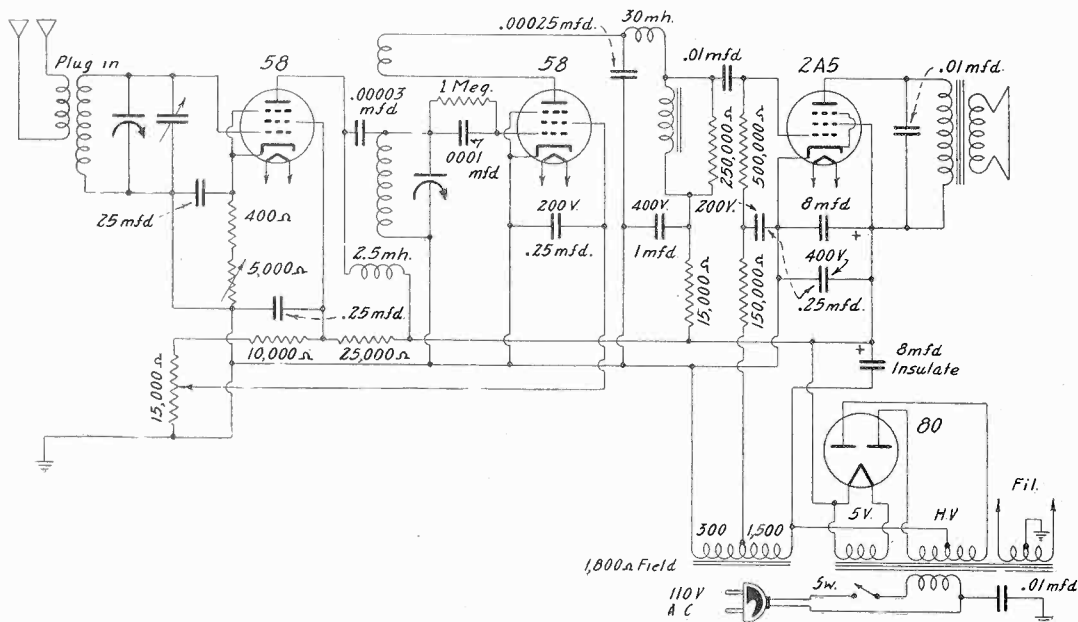

Both the r.f. and detector tubes must have shields around them. Article is on opposite page.

More Hop with Controls Wide Open

Two Stage Regenerative Preselector Does the Trick

By B. Herbert Russ (WQ2Z)

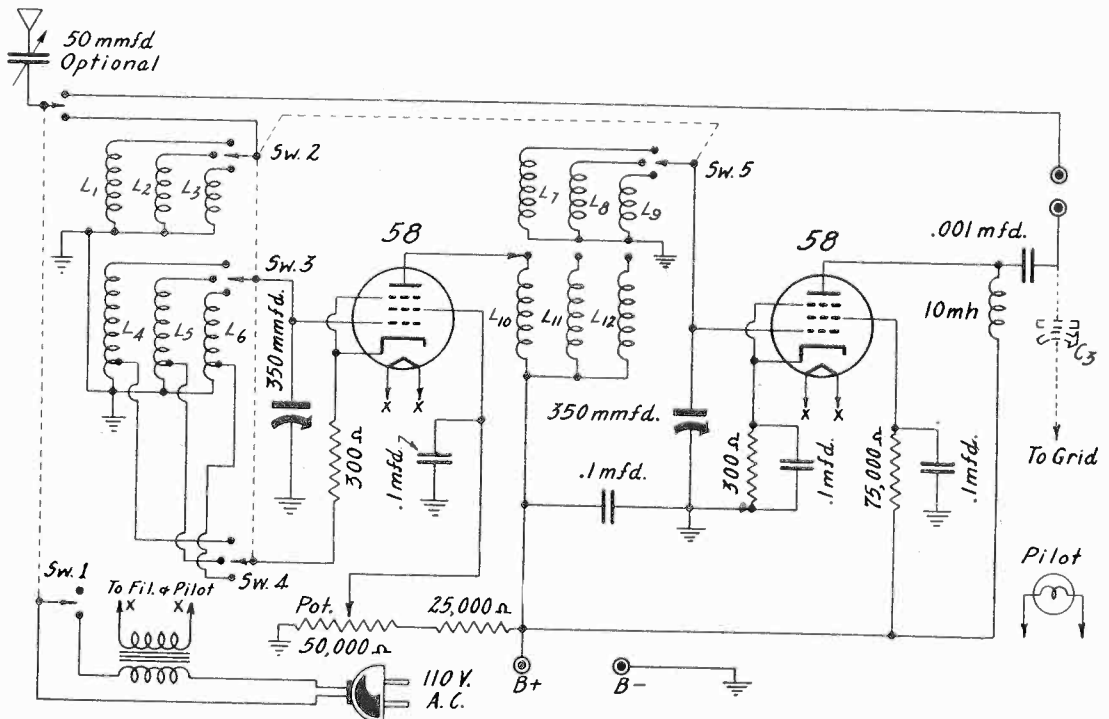

Circuit diagram of the preselector.

THE greater the signal input to a receiver the greater the signal output. No matter what the amplitude of the signal at the input of the receiver, its resultant output is determined by the overall efficiency of the receiver proper. However, for a given signal, we may vary its output over a wide range by the controls on the receiver, i. e., r. f. or i. f. control, input or output controls, but how about increasing the "hop" after all the controls are wide open?

Pre-amplification, with its inherent preselection, is the only known method today of accomplishing our desired result. It does this to the extent of a very marked increase in overall gain. The word "pre-amplification" is almost self-explanatory. Pre-amplification is that process whereby a feeble radio frequency current (picked up from the antenna) is increased in magnitude, by virtue of the associated circuits, in the pre-amplifier.

Preselection, which is a characteristic produced by pre-amplification due to highly resonant circuits, is that characteristic of selecting a signal of a particular frequency, and discriminating against all other signals. Thus, by pre-amplification and pre-selection we have at once accomplished several important and desirable results:

1. Very substantial increase in signal gain.
2. Consequent increase in sensitivity.
3. Rejection of image or repeat spots.
4. Considerable increase in selectivity.
5. Reduction of noise-to-signal ratio.

There are two tuned stages. Now, with the same number of stages, if we could increase effectiveness to the extent of another one or two stages, making the overall preselector an equivalent of three or four stages, then we would have raised the performance of the combination to a new level. This can be accomplished by the

careful and proper use of regenerative action. The unit utilizes two tuned stages of high gain type 58 tubes, the first stage being electron-coupled and regenerative. Electron coupling lends greatly to stability in operation. The regeneration control is variable.

Spillover Must Be Avoided

This control, if advanced past the point of maximum regeneration, will allow the first stage to oscillate; it is used at the point just before oscillation occurs, never in the oscillatory position. The gain is very high at the point of maximum regeneration, but falls off after oscillation sets in.

There is the double-pole, double-throw quarter turn on-off switch to throw the antenna from the preselector to the receiver proper. The unit contains its own filament supply and it is only necessary to tap the positive plate supply from the receiver with which the prefix is used for operation. The B plus may be obtained from any point at the filtered side of the plate supply. The negative connection can be obtained from the chassis or ground terminal on the receiver. Any B voltage between 150 to 300 volts may be used. A separate plate supply may be used, but is not necessary.

Plug in type coils are used for covering with ample overlap from 14 to 200 meters with three sets of coils, but these inductances are selected by front panel switching and are therefore to be classed really as of the switch type. The obvious convenience of this switching system brings itself to the fore when one is DX-ing over a wide range of frequencies.

Examples of More Volume

Aside from the technical details, the short wave listener and amateur will be interested in knowing what actual results are obtained. The short table below will give an effective and comprehensive idea of the improvement to be expected in a signal. The R system of audibility indicates the strength of signals as emanating from the speaker. An R4 to R5 signal on 'phone is just about audible, but ordinarily for loudspeaker reception, not clear or strong enough. R9 indicates full speaker strength and clarity.

Here are some actual figures of signal strength as read on the meter:

Station	Receiver With Pre-selector	
	Alone	selector
W3XAL	R5	R9 plus 3
W8XK	R6	R9 plus 4
VE9GW	R7	R9 plus 4
HVJ	R4	R9 plus 2
EAQ	R6	R9 plus 4
VK3ME	R4	R9 plus 2
W9USA	R5	R9 plus 3
W4CJ	R3	R9
W6CNE	R6	R9 plus 4

As we can readily understand, by adding audio amplification to any signal, that signal may be raised to any level, but all the background and inherent set noise will likewise be increased so that the net result will be an un-

intelligible uproar. However, by using a pre-selector, and thereby amplifying the desired carrier, the volume control in the receiver itself may be backed off until a minimum of noise is heard. At the same time the gain in the pre-

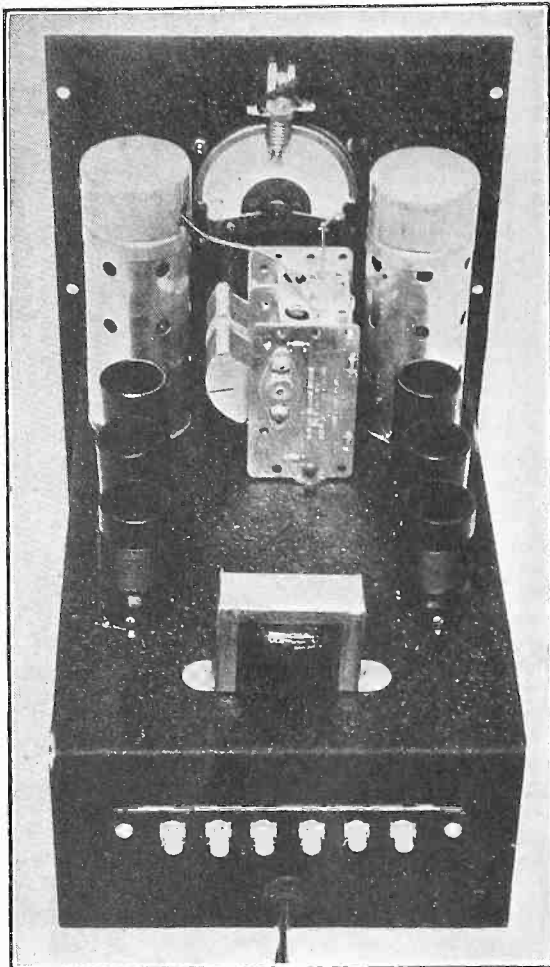

Rear view of the chassis of the finished preselector.

selector is brought to maximum, thus creating a level of signal to noise ratio that is far in excess of what the receiver by itself is capable of doing.

The image nuisance of superheterodyne type short wave receivers with inadequate or no pre-selector is eliminated by the auxiliary pre-selector. Where a short wave station program is obliterated by some c. w. signal, the preselector is brought into play, and the offending image will drop entirely out of the picture, and at the same time the station will be greatly amplified.

The preselector also actually brings in stations that ordinarily cannot be heard with the receiver alone. This is quite understandable on account of the tremendous amplification afforded by the two stages of tuned radio frequency amplification together with electron coupled regeneration. Two such stages actually have the effectiveness of 4 to 5 tubes, in addition to the line-up in the receiver used.

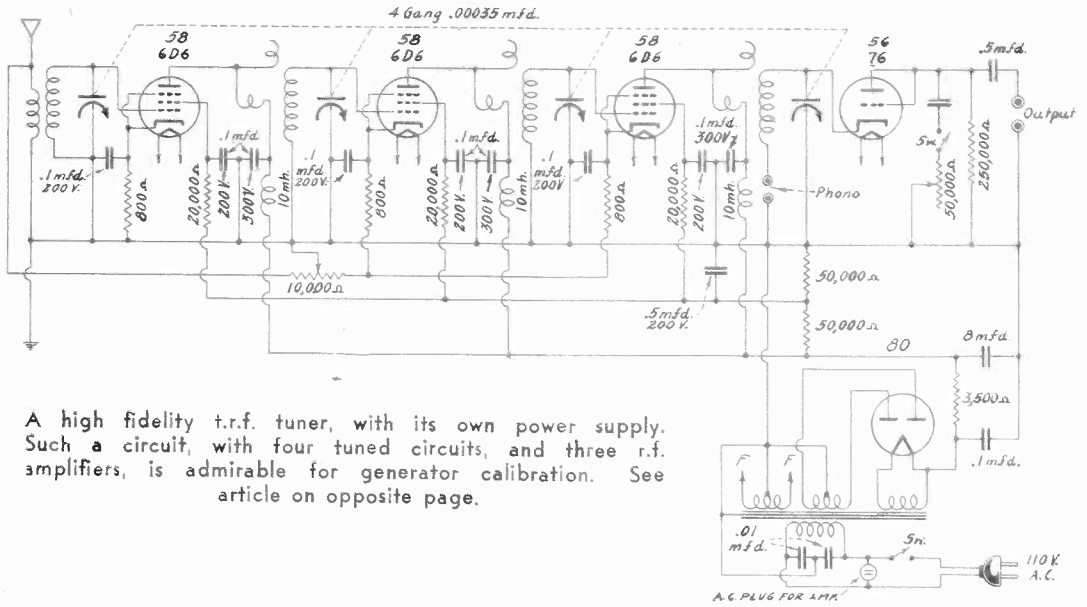

A high fidelity t.r.f. tuner, with its own power supply. Such a circuit, with four tuned circuits, and three r.f. amplifiers, is admirable for generator calibration. See article on opposite page.

For signal generator calibration a tuned radio frequency set is preferable because of absence of confusion due to multiple radio frequency levels and objectionable responses. The selectivity should be good, so that responses will be exclusive, for with broadness the responses may be due to beats with off-resonant frequencies. Always the beating method is used,

for it is the most accurate. Get as close to zero beat as practical. The receiver shown above is a tuner, self-powered, however, and earphones may be used at output, thus sparing the family a program of squeals. The beats are very irritating to persons not working with them. Even patient wives become frantic.

SUBHARMONICS OF 10 NEW YORK CITY STATIONS

H										
1	570	660	710	760	810	860	940	1180	1250	1450
2	285	330	355	380	405	430	470	590	625	725
3	190	220	236.666	255	270	286.666	313.333	393.333	416.666	483.333
4	142.500	165	177.500	190	202.500	215	235	295	312.500	362.500
5	114	132	142	152	162	172	188	236	250	290
6	95	110	118.333	126.666	135	143.333	156.666	196.666	208.333	241.666
7	81.428	94.286	101.428	108.571	115.714	122.857	134.286	168.555	178.555	207.143
8	71.250	82.500	88.750	95	101.250	107.500	117.500	147.500	156.250	181.25
9	63.333	73.333	78.888	84.444	90	95.555	104.444	131.111	138.888	161.111
10	57	66	71	76	81	86	94	118	125	145
11	51.818	60	64.545	69.091	73.636	78.182	85.454	107.273	113.636	131.888
12	47.500	55	59.166	63.333	67.500	71.666	78.333	98.333	104.166	120.833
13	43.846	50.761	54.615	58.462	62.308	66.154	72.308	90.769	96.154	111.539
14	40.714	47.143	50.714	54.285	57.857	61.428	67.143	74.277	89.277	103.571
15	38	44	47.333	50.666	54	57.333	62.666	78.666	83.333	96.666
16	35.625	41.250	44.375	47.500	50.625	53.750	58.750	73.750	78.125	90.625
17	33.529	38.823	41.765	44.706	47.647	50.588	55.294	69.412	73.529	85.294
18	31.666	36.666	39.444	42.222	45	47.777	52.222	65.555	69.444	80.555
19	30	34.737	37.368	40	42.631	45.263	49.474	62.105	65.789	76.315
20	28.5	33	29.588	38	40.5	43	47	59	62.500	72.500

H, vertical column, represents the harmonic orders of low frequencies to the right that produce zero beat with station fundamentals on the top numerical line.

Harmonic Practice

For Calibrating or Checking a Generator

By Herman Bernard

WHEN one desires to calibrate or check a signal generator at low frequencies he may use a broadcast receiver. Harmonics of the generator will beat with station frequencies. If the broadcast receiver is calibrated in frequencies, even without using beats, it is practical to get the approximate frequency of any setting of the generator by getting a response at one setting of the receiver and then at the next consecutive setting of the receiver, generator not molested. The unknown is the difference between the two frequencies read on the receiver.

This method is approximate because it is hard to get the exact frequency from the receiver, due perhaps to slight inaccuracy of its calibration, and also to the necessity of working without zero beats, which represent the closest possible method. However, when these good approximations are obtained for several positions of the generator dial, the receiver being tuned to the successive response frequencies each time for check, the calibration may be verified by zero beating for such frequencies as are submultiples of frequencies of stations readily receivable.

USE OF TABLE

The table herewith shows how the method was applied to ten New York stations. The station frequencies are divided by 2, 3, 4, etc., these being the harmonic orders of the low frequencies that zero beat with the station frequencies. The top horizontal line then represents the station frequencies, all subsequent lines lower frequencies. The harmonic orders are in the vertical column (H) at left. For any other location a table may be worked out the same way.

However, in using stations, prefer those that come in strongest, especially if the receiver being used is not very selective, for enough off-resonant energy may get by the tuner of a set to produce a response when the generator is coupled to the receiver, the receiver set at some other intended response frequency. Thus, in New York City, in some locations, if an attempt is made to use WEAJ, 660 kc, for this purpose, WOR, 710 kc, comes in so strong that harmonics of some generator fundamentals will beat with 660 kc and harmonics of other fundamental generator frequencies will beat with 710 kc and there will be confusion.

When one station is used for checking or calibrating, the resultant curve one may draw will give close values for the whole span, but this may be verified now, even using a "confusing" station, because the off resonance points will be recognized, and those coming within a degree or two of the record will be set down as

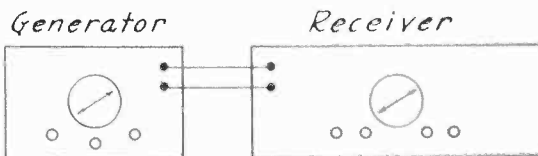

Receiver left intact, generator dial turned, the receiver must be at a frequency equal to or higher than the generator frequency, to gain a response. By dividing into the receiver frequency, various generator frequencies may be obtained. If generator is intact, receiver dial turned, the difference in frequencies read on the receiver is equal to the generator frequency.

final. Using three or four stations, enough work is done to call the work complete.

CHECKING COIL

If coils and condensers are not precision matched, but one has to pick up one or the other in a hit-or-miss manner, the coil may be checked as to whether the inductance is too high or too low by using the condenser at maximum capacity, and ascertaining the frequency then generated. This, it will be remembered, is the difference between two consecutive response frequencies read on a broadcast receiver. If the frequency is too low the inductance is too high, so remove turns until the desired low frequency results. If the frequency is too high the inductance is too low and more turns are required.

All Circuits We Print Can Be Readily Duplicated

ALL parts for circuits described in RADIO WORLD constructionally are obtainable, most of them stocked by regular supply sources. However, anybody unable to obtain desired parts may obtain information as to where to procure them by writing to Trade Editor, RADIO WORLD, 145 West Forty-fifth Street, New York, and enclosing stamped, addressed envelope.

Moreover, all of the circuits have been constructed and tested, and the photographic illustrations should be followed as closely as possible, as location of parts sometimes plays an important role in determining results, especially on short waves.

—EDITOR.

Circuits for Rack Use

All Wave Super and Power Amplifier Included

By Harry Miller

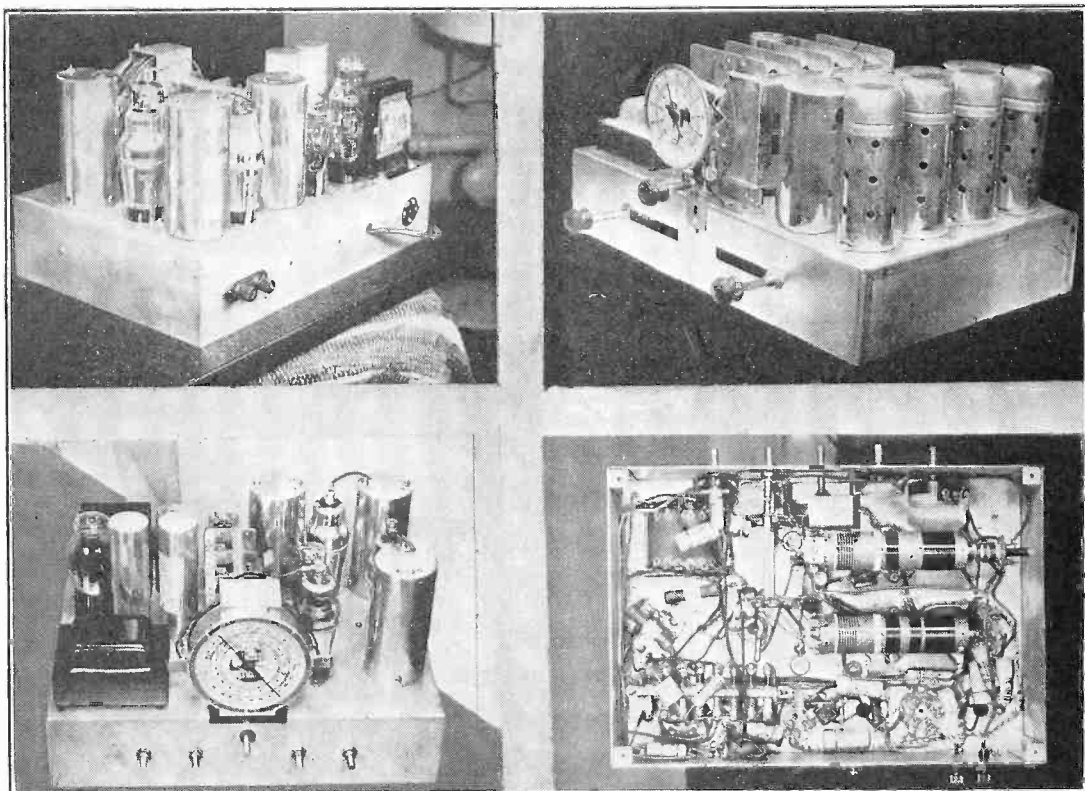

Three of these pictures, upper left and two at bottom, are the superheterodyne shown diagrammatically below. Upper left is a rear view of the completed chassis and lower left is the front view. Lower right shows the wiring under the panel, including the placement of the coils. The upper right picture is that of a tuned radio frequency receiver of corresponding sensitivity. Four r-f tuners are used, all on a gang condenser. Either one may be put on a panel on a rack.

THE high-quality speech amplifier diagrammed below has many interesting features. First of all it is provided for four different inputs, with the proper amplification for each. At the top is input from a crystal microphone. This signal is fed to one of the grids of a 53. This tube amplifies the signal and delivers it to one of the grids of the second 53, in which it is still further amplified and then is delivered to one of the grids of the third 53.

Input No. 2 is that of a crystal phonograph pick-up. This signal is delivered to the second grid of the first 53. The side of the tube amplifies it and then delivers it to the first grid of the second 53. That is, signals Nos. 1 and 2 are handled by separate tubes in the first

stage and are then combined in the second stage. Of course, only one signal at a time is used.

Signals from Nos. 3 and 4 are combined after their individual T-pad volume controls. Both, but one at a time, are delivered to the second grid of the second 53. The plates of the two parts of the second 53 are tied together, and therefore the signals from all the sources are handled by the rest of the circuit.

The first side of the third 53 acts as an ordinary audio amplifier and delivers its signal directly to the primary of an interstage push-pull transformer. However, part of the output voltage is delivered to the second grid of the last 53. This return is done solely for the purpose of inverting the voltage. The output of

the second part of the last 53 is in opposite phase to the output of the other side. If the input to the second side, and the amplification in that side, have been correctly adjusted, the signal in the lower half of the primary of the

interstage transformer is equal to that in the other half, but in opposite phase. Although the signal input to the last 53 is single sided, the output is two-phased, and the last stage is a true push-pull, power amplifier.

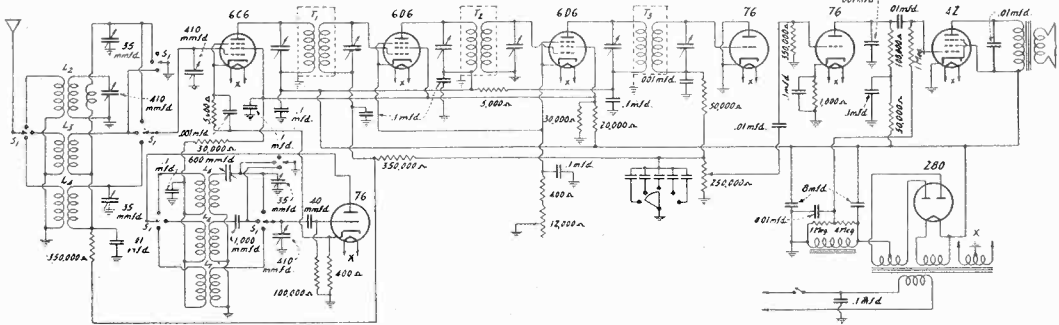

The complete circuit of an eight-tube superheterodyne covering three tuning ranges. The different tuning bands are selected by means of a 3 stop, five deck switch. The latest tubes are used.

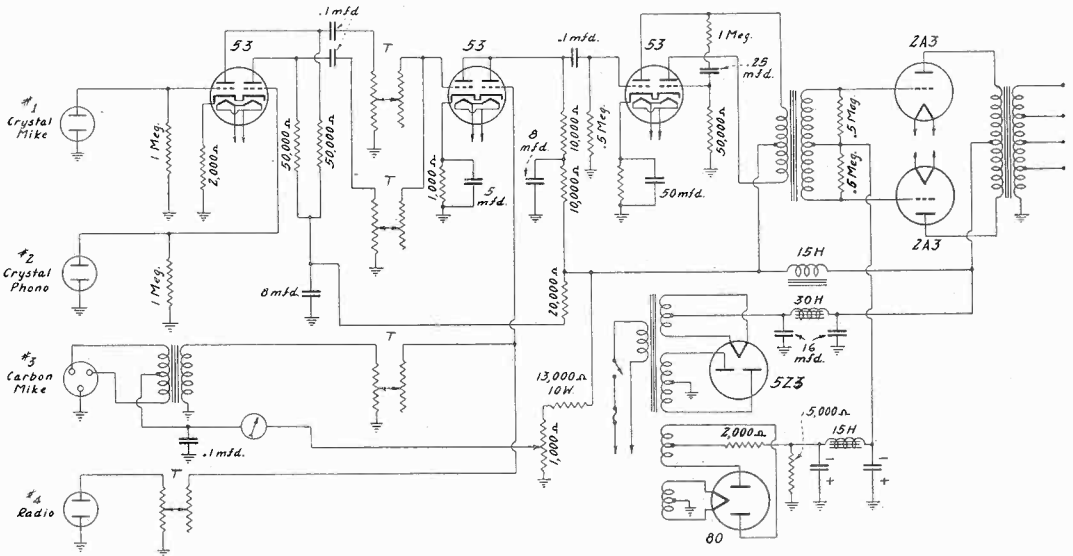

The circuit of a high quality speech amplifier and power supply. Provision is made for signal input from radio, carbon microphone, crystal microphone, and crystal phonograph pick-up. In each case a T-pad is used for controlling the signal output. This was put on another panel on the same rack as holds the all wave super.

2A3 Tubes in Push Pull

WILL you please set forth the advantages of separate filament excitation of 2A3 push pull tubes? How is it that I get no voltage reading between plate and plate with a d. c. meter? Between one plate and tap the voltage is 32 volts, between other plate and tap the same, between plate and plate nothing. I should imagine there would be summation voltage, 64 volts.—L. W. C.

The only reason for separate filament excitation is to facilitate equal biases on the respective tubes. In this way provisional match-

ing may be established, on the basis of equal bias during each alternation. The 2A3 tubes have multifilimentary structure rather difficult to produce and uniformity of emission, tube for tube, is sometimes lacking. That is one reason that hum develops, although cures are applicable, as the one under discussion. The tubes yield a powerful output and therefore are found in the best amplifiers and receivers. When you attempt to measure the d. c. voltage from plate to plate, recall that both plates are at same d.c. potential.

What to Do with Car Sets

Aerial, Ground, Noise, B Supply Discussed

By Sol Merles

RESISTORS are used in series with spark plugs to the distributor, for suppressing motor noise in a car set, but radio frequency choke coils also are used. The suppressors of the resistance type deaden the ignition, so that the car does not have quite as much pep as formerly, although the sacrifice may be salutary.

The choke system is good until the car attains high speeds. Then the choke blocks the ignition much the same way that the resistor suppressor does.

Suppressors Become Imperative

For reduction of motor noise the practice is sometimes followed of grounding the wire from the distributor to the ignition coil. If the coil is in the driver's compartment, this is not good practice, and the set had better be more closely shielded. The voltage becomes very large in this lead to the ignition coil, and so it is perhaps the better practice to avoid grounding the lead at all, if motor troubles can be circumvented some other way.

The latest automobile receivers have fully shielded chasses. If the antenna is removed, and motor noise is still picked up, then the seat of the trouble is the chassis and, it is called chassis pickup. The better shielded sets do not suffer from ignition noise through the A circuit. If the noise is present only when the antenna is connected, then suppressor systems are imperative, and generous grounding of dubious parts of the car may be practiced.

Some of the parts to be grounded in a car when there is noise in a set due to the motor are the temperature gauge, the choke rod, the accelerator control, the steering column (particularly of new cars) and the antenna leadin,

which should consist of sheathed wire, sheath grounded. The sensitivity of the sets today permits the use of thin serving of insulation or loom, whereas in other days very fat serving was used, for keeping the grounded sheath well away from the antenna leadin proper.

Best Aerial is Roof Type

The question of an aerial for an automobile set is important. The sets nowadays are very sensitive, yet much better results are attained when the aerial is just right.

Expert auto set service men consider that the roof antenna is superior. All dome lights have to be filtered if a roof antenna is used. Care must be exercised that there is no contact between antenna aerial and any metal part of the framework.

On the roof copper screen wire may be used, and in some instances chicken wire, already there, is cut free from metal framework to serve as roof aerial.

The ground lead should be as short as possible. The dash is a good ground. The motor usually has 1 inch braid bonds to the chassis, and therefore grounding is sufficient between car chassis and motor. Even in the rubber-mounted car chassis, there are enough bolts between body and chassis to accomplish the desired conductivity, and body noises from this source are rare.

An antenna above the car, erected on squat poles, is not used any more.

Double Grounding Recommended

The running board aerial is considered the best substitute. The running board aerial may consist of tin foil in a weatherproof mat. There

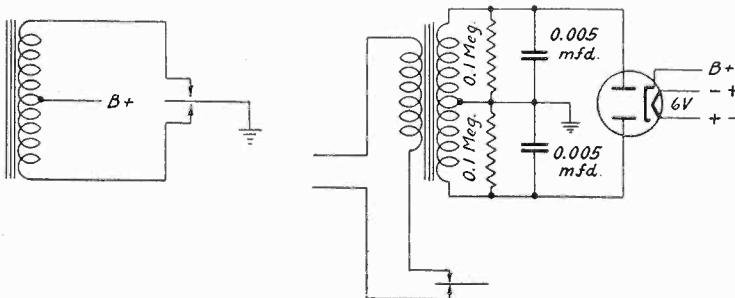

The vibrator arrangement as it exists before the tube is used is shown at left. Note that center of coil is B plus. When the tube is used, center is grounded. Also, a resistance of 0.1 meg. and a condenser of 0.005 mfd. are put across each half of the secondary. The reversible polarity signs on the rectifier heater indicate that the polarity of connection to the car A battery is immaterial.

are metal supports at each end for tension. The running board aerial is put below the board, 4 to 8 inches, the farther away from the board the better. The leadin should be shielded and grounded both at the set and at the running board. If either ground position just mentioned is left off there is danger of considerable noise coming in.

Of the six most popular car sets, all are superheterodynes.

The car sets are single units, with speaker built in, or have sets separate, with a remote control arrangement which may be mounted on steering column or panel.

The circuits are pretty much standard. A three gang condenser is used. There is one intermediate stage. The only difference seems to be in the audio channel. The more powerful sets have push pull output. The audio and the type of output account for the difference be-

three years in a car. Their normal life is the same as that of a tube, about 1,000 hours use. There is a trend toward the use of primary vibrators and rectification, instead of synchronous reeds.

One of the reasons amplifier tubes used in a

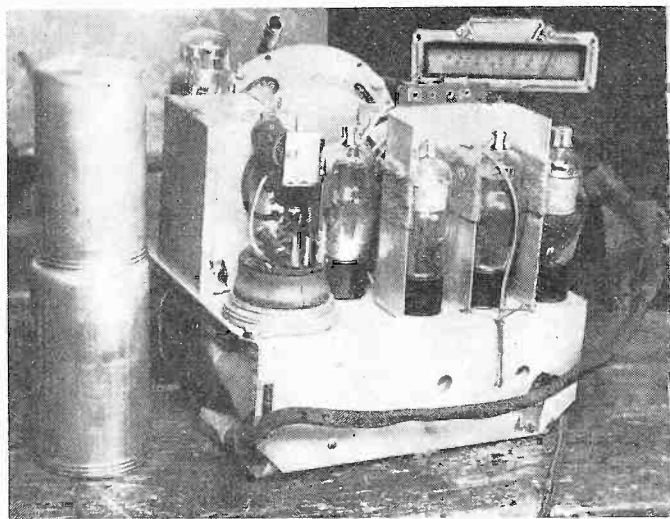
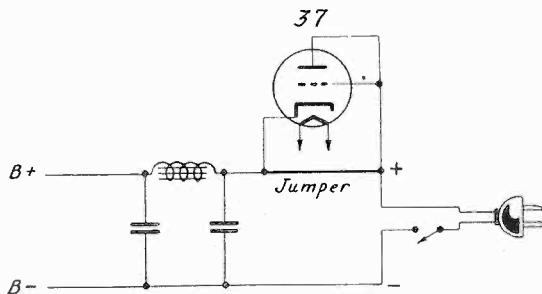

The auto set is at left, with vibrator covers removed. At right, location of new socket, and dent in block to pass tube used for replacing vibrator. At top, diagram of jumper (heavy line), for d.c. purposes only.

tween the five or six tube and the eight tube sets, as a rule.

All the car sets have automatic volume control now.

Tubes Stand Up Well

Tubes stand up very well in automobiles. It seems they have longer life in a car than in the home. This would indicate that the road shocks do not injure the tubes, but that as the car set is not played as much as is the home sets, the tubes last longer in the car.

Vibrators are used a great deal. These are devices for obtaining a. c. as the result of introducing current from the car's A battery. The a. c. is rectified and used as B voltage for the tubes of the set. Vibrators are practically standard equipment, although a few manufacturers lean to the use of rectifier tubes. Vibrators are of pretty high efficiency and are much better now than when first introduced, a few years ago. Some vibrators last two or

car receiver are not damaged by vibration is that there are never any sharp shocks. The shocks may seem sharp to the riders but that is because they are bulky, comparatively speaking. Sharp road shocks are absorbed by the rubber tires, by the air cushions inside, and by the springs on which the body is riding. Shocks from the engine are also reduced in intensity by the rubber biscuits or by similar devices. To damage such a little device as a tube by shock, the shocks would have to be very sharp, and there is practically no chance that such will occur in a car, not even in a minor collision. More damage is likely to occur as a result of overloading of the tubes, and that too is not very likely. Anyway, tubes designed for automobile use are very rugged and conservatively rated in respect to voltages. It is somewhat surprising, though, that there is no more microphonic disturbances in the output of the sets. But this, too, is no doubt explained by the ruggedness of the tubes and the many provisions made for making riding a pleasure.

Servicing Small Sets

Electrolytic Condensers Should Be Checked First

By Earle Branker

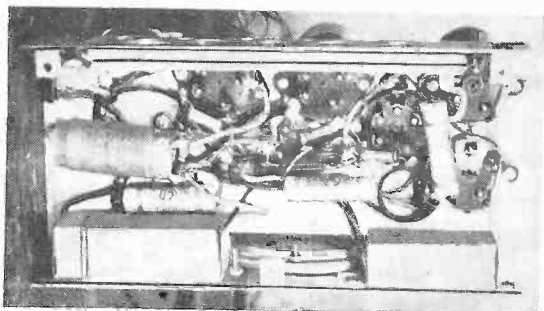

The oblong objects in the foreground are the cardboard container electrolytic condensers mentioned by the author as bearing watching as likely sources of trouble in small sets.

THE types of troubles encountered naturally change as the circuits are somewhat different from year to year. Just at present it seems that electrolytic condensers bear watching, when they are used for bypassing the biasing resistors of detector and power tubes. Certainly in universal sets they are the first things to go, as a rule. The capacity is usually rated at 5 mfd.

When the condenser becomes defective the sensitivity of the receiver is greatly reduced, and if there is by any chance a short, reception will stop altogether, and if the short is across the power tube biasing resistor, that tube is left without any bias, and almost anything may happen. The power tube may go west, the resistors serving other branches may become opened by overloading, and even speaker windings become open.

The high resistance that drops the maximum rectified B voltage to the value that the screen requires is often a source of trouble.

The B Supply Filter Condensers

The electrolytic filter condensers in the B supply leg have their movements, also. If the condensers are of good manufacture, and conservatively rated, perhaps no trouble will be encountered, but evidently a good deal of compromising is done, and the B filter condensers may be ranked as next likely to become useless. The filter condensers, both of them, go when the rectifier tube goes, so it is well to use good rectifier tubes.

When there is trouble with the cardboard container electrolytics they usually swell up, so a casual glance may spot trouble otherwise more difficult to locate.

With variable condensers there is scarcely any trouble. The plates will get dirty, but may be cleaned by using pipe cleaners, while the wiper may become corroded. A rag saturated with carbon tetrachloride will clean off the corrosion. The wiper referred to is a sort of long lug contactor, used for grounding the frame, especially if frame and chassis are at different potentials.

In certain types of sets using ball race with 3 to 1 ratio there will be slippage and loss of friction, remedied by hammering back the rear endplate, and pushing the shaft forward for realignment of the condenser plates.

Some Sets Oscillate

With r.f. coils there is little trouble, perhaps one in a thousand goes bad, and this trouble usually is an open. Sometimes the primary leadout wire on the coil is close to the secondary, and the insulation on one of the windings is punctured by the high potential difference. This trouble easily is checked by the continuity method, and the coil repaired by soldering together the open.

Oscillation at the radio frequency level is common in the low grade receivers. Oscillation at the intermediate level is rare, as the run of sets has only one intermediate stage. In any event, to cure oscillation trouble, put a shorted turn of wire around the coil and move the short toward and from the grid terminal of the coil until that point is reached when oscillation disappears. Do not ground this shorted turn.

Tubes stand up well, too well, in fact, from the viewpoint of those who sell tubes to consumers.

Making Use Strictly D.C.

Speaking of tubes, when one has a set using the 37 as rectifier, whereby the set is of the universal type, should it be desired to use the set on d. c. only, a jumper may be placed across the terminals, leaving the heater intact, however. Thus if the formal grid and plate are tied together to constitute the plate, this is one terminal of the jumper, and cathode is the other. Volume will increase considerably, due to the removal of the resistance of the rectifier tube, especially true if the rectifier has become a poor emitter or practically paralyzed. Every one concerned should be notified then that the set is no longer universal, but applicable strictly to d. c., although of course by removal of the

(Continued on next page)

jumper the former universal service may be restored.

Coupling condensers sometimes get leaky, moreover break and heal. This applies even to paper condensers. Using 100 volts, and a 0-30 microammeter, if the current is 0.5 microampere the condenser may be rated as satisfactory from the viewpoint of low leakage. This is rather a high standard. The average current is perhaps 1 to 2 microamperes. The same test may be made of course with a neon tube leakage tester,

such as the one described in the June issue of RADIO WORLD. With such a tester the condenser may be passed if the flashes are 1 per second or less.

Fading is sometimes an annoying trouble. In one particular make of set this may be traced repeatedly to the contacts breaking away from the condenser in a bakelite mould. It is cheaper to replace the whole set of condensers than to attempt to repair one of them. And new ones will improve the receiver.

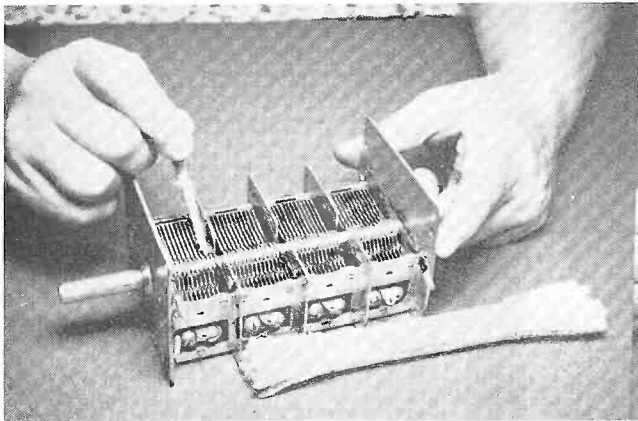

A dry pipe cleaner removes dust and grime from condenser plates. The pipe cleaner may be bent into the shape of a U for this purpose. The remedy often constitutes a cure for noisy reception. Whenever fixing up a tuning condenser, check for mechanical contact between rotor and stator plates also, and this may occur at some positions of the rotor.

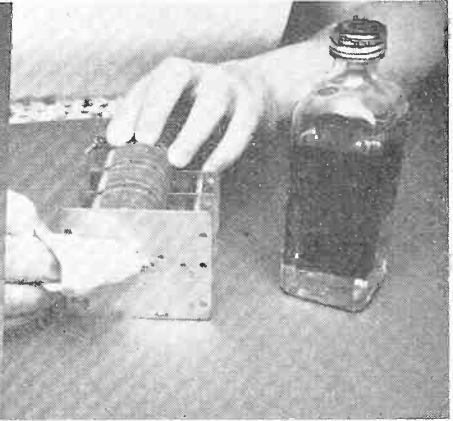

The wiper may need cleaning. For this purpose use carbon tetrachloride. Sometimes a frame is insulated from a chassis, with a long lug inside for wiping contact with the shaft at one extreme and for soldered connection to the set wiring at the other extreme. Clean this, too.

Electric and Magnetic Units

When electro-magnetic problems are approached from the electric point of view, one system of centimeter-gram-second (cgs) units is obtained, and when they are approached from the magnetic point of view another system of cgs units results. These systems of units are called the electrostatic (e. s. u.) and the electro-magnetic (e. m. u.). There is always a definite relation between the units, or between a given quantity when expressed in the two units. This relation always involves the velocity of light. Sometimes the velocity enters as a multiplier, sometimes as a divisor, and sometimes it is the square of the velocity that enters in one of these two ways. One e. s. u. of potential equals 300 volts. A volt is not an e. m. u. but a multiple of it, for the velocity of light is 30 billion centimeters per second. The e. m. u. of inductance is the centimeter. It takes one billion centimeters to make one henry. Thus a henry is a unit of length. It takes four henries to go around through the poles.

Circuit for Testing Leakage

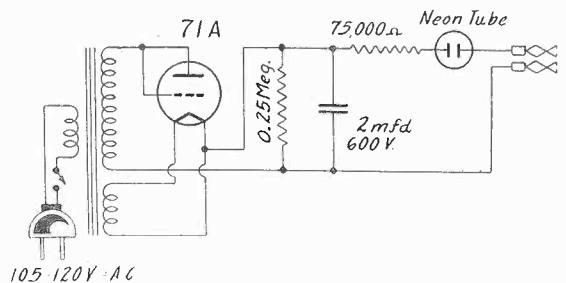

Leakage tester, using neon tube. This was described in last month's issue. The resistor across the rectifier output should be 0.25 meg. (250,000 ohms), preferably. The data published last month called for 50,000 ohms.

RADIO CONSTRUCTION UNIVERSITY

Answers to Questions by Readers on the Building of Radio and Allied Devices. Readers Should Address Questions to Radio Construction University, Radio World, 145 West 45th Street, New York, N. Y.

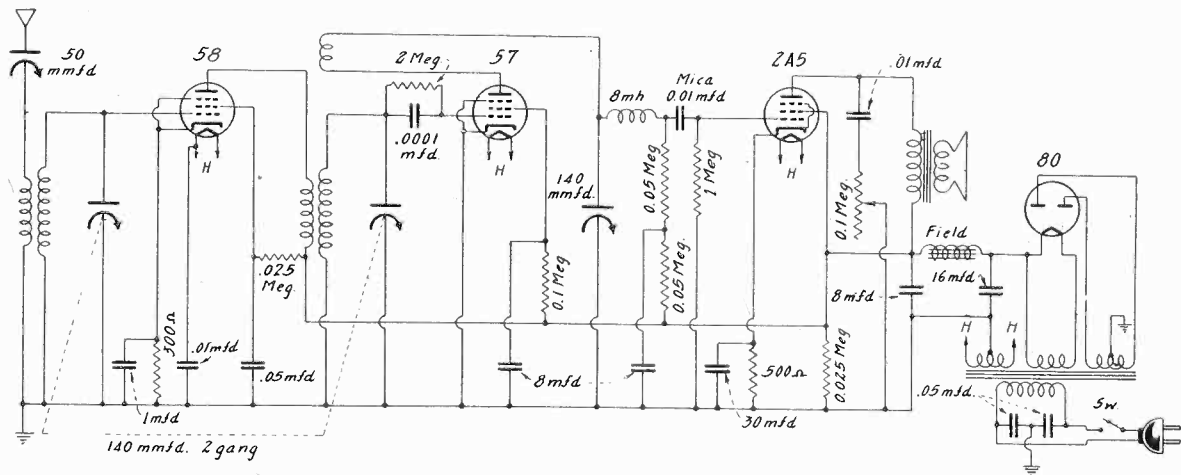

Hum is kept exceptionally low in this four tube a.c. operated short wave receiver, using plugin coils. The 0.01 mfd. condenser from one side of heater to ground, shown at the r.f. tube, but of course applicable as well to the others, removes back coupling through the heater, a seldom mentioned cause of instability.

Plugin Coil Short Wave Set

PLEASE show a circuit for a regenerative set for short waves, using plugin coils, and having r.f. tuning, if you deem it necessary. The set is for a.c. operation and care should be taken to minimize or obliterate hum.—L. W.

A four tube circuit is shown herewith. The plugin coils are commercially standard, the two gang tuning condenser is 140 mmfd. per section, and the throttle feedback condenser (8 mh choke coil to ground) is marked 140 mmfd., but if you have 200 or 250 mmfd. you may use that. The 58 radio frequency amplifier should be included, as shown, for the improved selectivity. The two chief causes of hum in short wave sets are considered. The filtration capacity should be 16 mfd. on both sides of the field, which field may have 1,200 to 2,500 ohms d.c. resistance, and be built into the dynamic speaker. The resistor-capacity filter in the 57 detector plate leg takes care of the rest of the hum reduction, as the detector is especially sensitive to such pickup and should be treated as shown. The 8 mfd. bypassing the 0.1 meg. in the detector screen circuit is there principally for tonal considerations, but as the low frequency

response is thus made keen in the audio realm, due to audio frequency regeneration, naturally the amplification at 120 cycles, the frequency resulting from full wave rectification, is pronounced, so that this particular capacity may be reduced to whatever value is desired as a compromise between hum and tone. The circuit is adaptable to the 6.3 volt tubes, requiring no change except 6D6 for the 58, 6C6 for the 57 and 42 for the 2A5, with 6.3 volt filament winding on the transformer. The hum would be a bit higher, but not sufficiently so to justify an objection.

* * *

Decimal Repeating Generator

AS I desire to construct a signal generator and even do my own dial, as I am a draftsman, will you please give me directions for coverage about 100 kc to 30,000 kc, preferably using Herman Bernard's decimal repeating system, to avoid numerous tiers on the scale? I live in New York City and would prefer to use locals for low frequency calibration by harmonics of generator.—L. M. D.

For the decimal repeating method, use a mini-

imum frequency ratio of 3.17. That means that the highest frequency of any one band is at least 3.17 times the lowest frequency of that band. The usual commercial single tuning condenser, 350 to 400 mmfd., will yield this ratio

easily. To improve spreadout do not use a much higher ratio, so an air dielectric trimmer may be put across the tuning condenser, or a sufficiently large mica condenser across the grid leak, to reduce the ratio to the desired amount. For 100 kc check against some station on a multiple of 100, i. e., WEVD, WFAB, 1300; WLWL, 1100; WPG (Camden, N. J.), 1100. The other extreme is 317 kc and can not produce a beat zero with a station you will get in the broadcast band but WAAT (Jersey City, N. J.), 940, will zero beat with 313 1/3, with WHBI and WNEW (Newark, N. J.), 1250 kc, will zero beat with 312.5, and by extrapolating the curve the termination can be determined. The second tier would be 315 to 1017 kc, WEA, 660, determining 330, lower frequencies by extrapolation, while WHN, 1010 kc, will serve for the other extreme. Then the remaining three bands will be decimal repetitions, i. e., 1000 to 3180 kc, 3150 to 10,000, and 10,000 to 31,800 kc, and become simply a matter of inductance selection.

LIST OF PARTS

For the Short Wave Set Four Tube

- One set of four two winding plus short wave plugin coils.
- One set of four three winding short wave plugin coils.
- One 8 millihenry radio frequency choke coil.
- One power transformer.
- One two gang 140 mmfd. tuning.
- One 150 mmfd. single for feedback. (May use 200 or 250 mmfd. instead.)
- One 50 mmfd. antenna tuning (insulate from a metal panel).
- One 30 mfd. 35 volt electrolytic.
- One 16 mfd. electrolytic condenser, 500 volts d. c. rating.
- Two 8 mfd. electrolytic, 500 volts d. c. rating.
- One 1 mfd. paper dielectric.
- Three 0.01 mfd. mica.
- Three 0.05 mfd. tubular.
- One 0.0001 mfd. (100 mmfd.) mica.
- One 300 ohm.
- Two 0.25 meg. (25,000 ohm).
- One 2 meg.
- Two 0.05 meg. (50,000 ohm).
- One 1 meg.
- One 500 ohm.
- One 0.1 meg. (100,000 ohm) rheostat, or potentiometer used as rheostat, one terminal and the center lug.
- Dynamic speaker with output transformer for single pentode, and field coil built in (1,200 to 2,500 ohms).
- Four six hole sockets and three four hole sockets (include uses for speaker plug and the coils).
- One a. c. cable and plug.
- One dial.
- Two knobs.
- Two grid clips.
- Antenna-ground binding posts.
- Four tubes.
- One baseboard or chassis.
- One front panel.

* * *

Microphone Mixer

CAN you supply diagram and parts layout for a microphone mixer, using a T pad? Thank you.—C. G. E.

The arrangement of the parts of a mixer, with carbon microphone exciting battery, is shown at bottom of this page in three views, the diagram herewith.

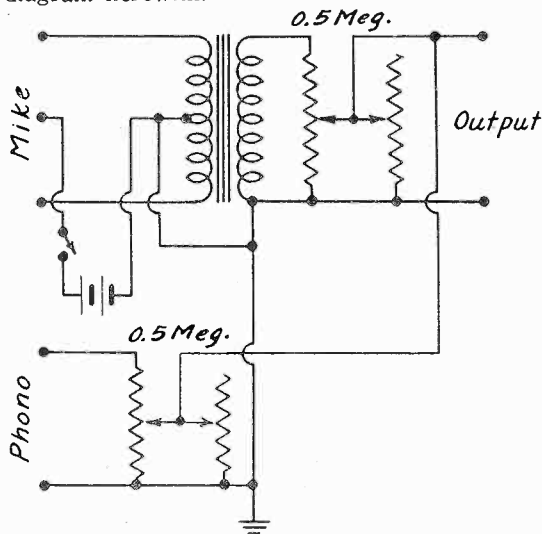

Circuit of microphone mixer.

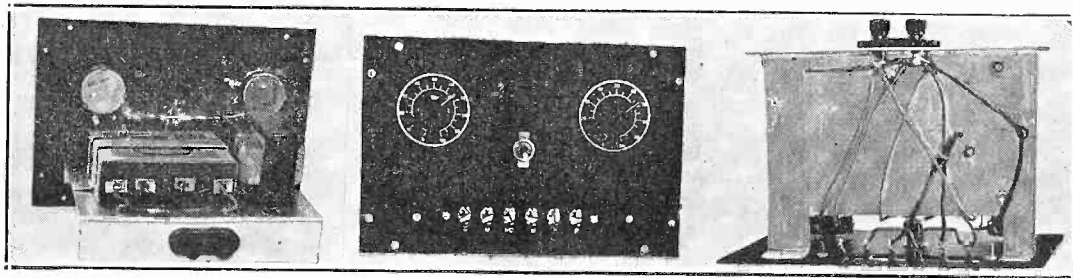

Three views of the microphone mixer.

TUNE IN ON 2140 METERS

The new H. B. long wave-plug-in coil and its two fixed capacitors will enable you to reach from 450 meters to 1640 or 1740 or even up to 2140 meters according to the size tuning condenser you use in your set. Listen to the ships on 600 or 715 meters and Radio Compass stations on 800 meters. Airlines on 900 and Beacons on 1,000 meters.

4 prong H. B. Long Wave Coil and 2 capacitors,

\$2.50

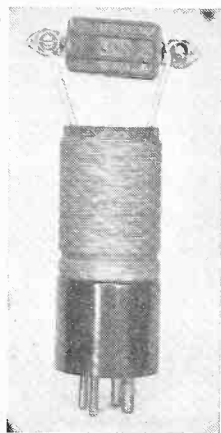

ALUMINUM PANELS

7 x 10, 14 gauge, 29c

Panels and special, longer and wider at correspondingly low prices. Add postage on 2 lbs. for each. We do not publish a catalogue. Estimates gladly furnished on request.

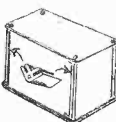

Something New! Your call letters or any markings for your panel, on black aluminum ribbon. Looks like engraving on bakelite. 5c up to 2 inches, 5c each additional inch. Sample 8c.



ALUMINUM BOX SHIELDS

"Genuine Alcoa Stock" **95c**

Special 6" x 5 1/2" x 6" Pawood Circle Cutter (not illustrated) \$1.79. Adjustable 1" to 5 1/2".

BLAN THE RADIO MAN, Inc.

177 GREENWICH ST., NEW YORK, N. Y.
Dept. R.W. — 24-Hour Shipment Guaranteed.

METAL CHASSIS

We make Chassis and Metal Cabinets for any make receiver. Experimenters and others who want neat metal bases or housings for assembled apparatus, will find our workmanship superb. Inquiries should be accompanied with clear drawings, blue prints and other details concerning size and bends in metal if any, enabling us to give quick service as to prices and delivery.

Dealers and Jobbers: Write for special prices.

KORROL MFG. CO., Inc., Dept. R.W.
232 GREENWICH ST. NEW YORK CITY

A COMBINATION OFFER!

RADIO WORLD and "RADIO NEWS"

\$3.50

Canadian and Foreign, \$1.50 extra on this offer.

You can obtain the two leading radio technical magazines that cater to experimenters, service men and students, for one year each, at a saving of \$1.50. The regular mail subscription rate for RADIO WORLD for one year is \$2.50. Send in \$1.00 extra, get "Radio News" also for a year—a new issue each month for twelve months. Total 24 issues for \$3.50.

RADIO WORLD, 145 West 45th Street, N. Y. City

FEATURES OF RADIO WORLD (May No.)

(WITH 90 ILLUSTRATIONS)

- Metal Shell Tubes—By Conrad L. Morrow.
- More Gain from New Tubes—By Harry Miller.
- Try a Whisk Broom on Your Soldering Iron—By Jack Tully.
- Plain Talk on Aerials—By Connie Andover.
- Boondoggling
- Alignment, All Levels—By Martin A. Gobin.
- Getting the Harmonic Habit—By Albert J. Pierce.
- Armchair Portable—By J. C. Wall.
- Tuned Radio Frequency Set with Pentode or Triode Output—By Henry L. Maks.
- Portable for All Waves—By Tom Bidwell.
- What Air Condensers Do—By John Braden.
- What Pep—By Jack Sullivan.
- Neon Gadgets—By Will Ellington.
- B-u-z-z-e-r—By Leon Wolf.
- Organizing A Meter—By B. M. L. Ferris.
- Fundamentals Most Useful—By Herman Bernard.
- A Filter for High Fidelity—By Sidney Wald, E.E. Radio University.

MANY OTHER FEATURES

JUNE NO., 1935

Illus. features in that issue: Coil Switch Assembly—Ultra Frequency Measure with Photocell and Lamp—Seventh Metal Shell Tube—Pin Numbering on Octal Bases—Finding CX Easily—Equal Gain on T.R.F.—A Beat Oscillator—High Fidelity Tuning—It's the Set, not the Car—New Police Radio—Car Sets on Peak Road—False Alarms with Universal Sets—Dual Range Super—Wave Trap Does the Trick—Measuring Low Resistance—Three Tube S.W. Set—An Effective Transceiver—A Battery Signal Generator—War on Static Succeeding—Circuits We Print Readily Duplicated—Straight Frequency Liner—The Velocity Microphone, etc., etc.

25c A COPY. \$2.50 YEARLY IN U. S.
Include as part of New Subscription if you wish.

RADIO WORLD

145 West 45th Street New York City

SUBSCRIBE NOW!

RADIO WORLD, 145 West 45th St., New York City. Enclosed please find my remittance for subscription for RADIO WORLD, one copy each month for specified period.

- Two years, 24 issues, \$4.50.
- One year, 12 issues, \$2.50.
- Trial sub., 5 issues, \$1.00.
(50c extra per year for Canadian and foreign postage.)
- This is a renewal of an existing mail subscription (Check off if true).

Name

Address

City

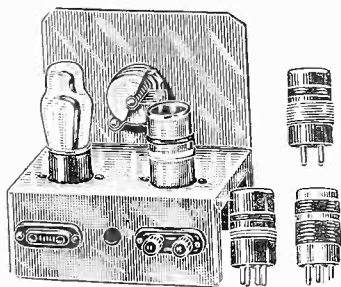

Master One Tube Short Wave Battery Operated Receiver

An inexpensive short wave receiver kit that can be assembled and wired in just a few moments. Reaches out and pulls in short wave signals with regularity. Uses the efficient type 30 tube. Requires 1-45 volt and 2-1½ volt batteries. Supplied with one coil which tunes from 90 to 210 meters. Uses highest quality parts throughout. Kit is accompanied by a full set of instructions and blueprints.

Complete Kits of Parts. Net Price	\$1.95	R.C.A. Licensed Matched 30 tube. Net Price.....	35c
Wired and Tested. Net price (extra)	50c	Set of coils for tuning from 15 to 100 meters. Net Price..	50c

To Our New York Customers
We have just opened a new store for your convenience. Every standard item is carried in stock. It will pay you to pay us a visit.

PROMPT RADIO SERVICE

79½ Cortlandt Street

New York, N. Y.

QUICK-ACTION CLASSIFIED ADVERTISEMENTS

7 cents a word. \$1.00 minimum.

SENSATIONAL OPPORTUNITY! \$100 weekly possible selling life and accident protection combined with merchandising privileges. Experience unnecessary. Not insurance. United Helping Hand Association, Torrington, Conn.

UP TO \$3.00 DAY checking radio programs for advertisers. Get paid for listening to your radio! Send \$1.00 for complete instructions, today, before your locality is filled. RADIO ADVT. GUILD, Box 493, Queensboro Station, Shreveport, La.

WANTED: ORIGINAL POEMS, SONGS for immediate consideration. MMM Publishers, Studio Bldg., Portland, Ore.

INDIAN AND LINCOLN HEAD PENNIES WANTED. Will pay up to \$2 each if over ten years old. Certain pennies worth \$53. Latest listing, 10c. American Coin Co., Box 219, Grand Rapids, Mich.

HAVE YOU A SOUND, PRACTICAL INVENTION FOR SALE, patented or unpatented? If so, write Chartered Institute, Dept. 70, Barrister Building, Washington, D. C.

PHOTO POSTCARDS. Perfect copies from any photo. \$3 per 100. Sample 3c stamp. Wm. Filline, 37027 N. Kostner Ave., Chicago, Ill.

NEW AUTO AERIAL! Fits any car; amazing volume! Build it yourself at small cost. Quickly installed; a money-maker for any radiotrician. Full details, 50c. Radio-Trician, Box 865, Glendive, Mont.

"RADIO TROUBLE SHOOTING," Second Edition, by E. R. Haan. Contains the latest on A.C. receivers, dynamic speakers and television. A practical book for practical men. Contains a special chart showing all possible radio troubles and the way to detect them. Size, 6 x 9 inches, 361 pages, 300 illustrations. Flexible binding. Price, \$3.00. RADIO WORLD, 145 W. 45th St., New York City.

ALL-WAVE OSCILLATOR KITS

3430-B—FOUNDATION KIT.

This all-wave battery operated oscillator kit comprises the following frequency determining parameters 132-3800 kc.

- 3 accurate coils.
 - 1 special variable condenser.
 - 1 3½" chrome-etched black dial directly calibrated in KC.
 - 1 double pointer escutcheon.
- Shipping weight 1½ lbs. **ONLY \$3.95**

3430-B—COMPLETE KIT.

Besides the parts in the foundation kit this complete kit gives all parts—crackled metal cabinet and chassis ready drilled—all lab. knobs, switches, volume controls, mounting brackets, resistors, condensers, etc., etc., but less tubes and batteries.

Shipping weight 6 lbs. **SPECIAL AT \$14.50**

3430-B—Completely wired signal generator with batteries, less tubes.
Shipping weight 7 lbs. **ONLY \$19.50**

37-ACK—FOUNDATION KIT. Same kit as model 3430-B except for 110 v. AC operation. 132-3800 kc.
Shipping weight 1½ lbs. **ONLY \$3.95**

37-ACK—COMPLETE KIT. This kit includes all parts for the AC operated model; no batteries necessary. 3 coils, tuning condenser, crackle-finished cabinet, bakelite panel and brackets, resistors, condensers, etc., etc. 132-3800 kc.
Shipping weight 4 lbs. **ONLY \$6.95**

37AC—Completely wired and lined-up model, with tube. 132-3800 kc. switch-type oscillator for AC operation, ready to operate.
Shipping weight 5 lbs. **ONLY \$9.50**

Immediate Deliveries Guaranteed

DELTA RADIO CO.

135 Liberty Street
New York, N. Y.

SERVICEMEN, EXPERIMENTERS, and SET BUILDERS

Make better new receivers and old receivers better with new coils of the latest and most advanced types. They make sets more selective, more sensitive, and quieter in operation.

I-F TRANSFORMERS, 465, 456, and 175 kc, doubly tuned by high grade mica trimmers—3-pie winding with Litz wire—High Q—The latest development. List price, **\$2.50**. Our price, **\$1.00**.

TWO-BAND RECEIVER TUNING KIT for B.C. and foreign short-wave bands (530-1600 kc. and 16-53 meters). Complete with coil switch and circuit diagram. Price, **\$3.00**.

These coils were used in sets designed by Jack Goldstein.

PRETUNED I-F AMPLIFIER. Two tubes, intermediate amplifier and detector-audio amplifier. Highest grade parts used. Accurately tuned to desired frequency. Any of the common intermediate frequencies, series or parallel wiring of heaters, and any type suitable tubes. Complete with tubes and shields. Designed by J. E. Anderson.

Price, **\$4.50**. Postage extra.

RADIO DESIGN COMPANY

98 Park Place, New York, N. Y.

Free technical advice given by J. E. Anderson, if self-addressed and stamped envelope is included with questions.

1 TUBE TRANSCEIVER

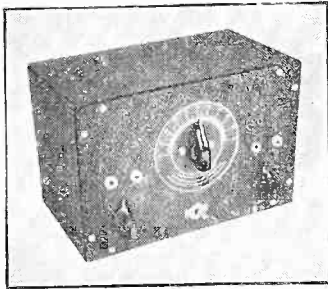

AT LAST !!!

An inexpensive 1 tube 5 and 10 meter Transceiver.

This extremely efficient transceiver is recommended for the short wave enthusiast who is interested in exploring the fascinating 5 and 10 meter bands.

The circuit utilizes the type 19 two-volt twin

tube, and is exceedingly sensitive since the super-regenerative principle is employed when the receiving position is switched on. A double pole single throw switch is the means by which the instrument may be switched to either receiving or transmitting. Dimensions: 5" x 6" x 9".

- Complete Kit with 5 meter Coils\$4.75
- Shielded Cabinet75
- 10-Meter Coils50
- R.C.A. Licensed tube65
- Wired and tested 1.00
- Wiring diagram and complete instructions included in every kit.

FEATURES

- Will operate on 5 or 10 meters by simply changing plug-in coils • Utilizes the multi-purpose 19 tube.
- Highest Quality Parts. • Weight only 4 lbs.

RADIO CONSTRUCTION LABORATORIES

136 LIBERTY STREET
Dept. RW 209
NEW YORK, N. Y.

Bandspread Receiver

Our Engineering Dept. has now perfected our short wave receiver to provide 100% bandspreading on all bands from 15-200 meters. This has been accomplished with the new dual ratio airplane dial with its 125-1 ratio bandspread pointer.

Phone jacks with speaker cutout switch are mounted on front panel for easy accessibility. Complete shielding of all stages to eliminate R.F. and audio feedback. A highly sensitive regenerative circuit using a tuned R.F. stage with a newly perfected system for equalizing both stages, makes this an ideal short wave receiver for both ham and short wave fan.

Tubes employed are the newly developed 6.3 volt types: 6D6, 6F7, 76, 42 and 80. Set is mounted on a black wrinkled heavy steel chassis. Chassis wired and tested with coils.....

\$11.75

- Cabinet for above \$ 1.75
- Five Sylvania set tested tubes..... 3.50
- 6" short wave dynamic speaker..... 2.00
- Short wave hum free power supply... 4.95
- Complete kit of parts for set and power supply 14.75

Supertone Products Corp.

Dept. RW-7
35 Hooper Street Brooklyn, N. Y.
We guarantee 24 Hour Service

RGH Super A. C.

Complete kit for 5 tube Superheterodyne, with eight plug-in coils, for 11 to 200 meters. Parts are of high quality and circuit is fully satisfactory. Requires one each 2A7, 58, 57, 2A5 and 80 tubes. Close vernier bandspread tuning for reception of maximum number of stations. Hum level below average tolerance. A highly sensitive circuit that invites short waves with added zest and interest.

24-Hour Delivery Guaranteed

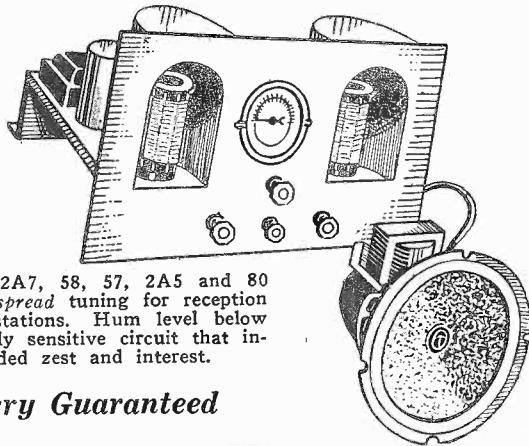

Complete Kit

\$14.95

STOCK NO. 9016

The complete kit does not include dynamic speaker, which for 6" cone is \$2.50 extra, tubes or cabinet, but does include all other requirements, even chassis.

Full instructions supplied with each kit order.



CORP.

167 GREENWICH STREET

NEW YORK CITY

Something Doubly New!

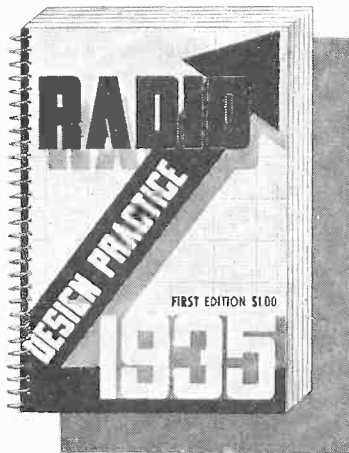

NEW Because the Book Has Just Been Published—New Because There Is Nothing Else Just Like It.

"Radio Design Practice," first edition, edited by James Millen, with drawings by M. B. Sleeper. More than 200 pages of ideas for experimenters, engineers and designers of radio and associated equipment, including a self-contained full manual on vacuum tubes and their characteristics as part of the beautiful and exhaustive presentation.

Radio companies of the highest rank and importance have co-operated to supply the data contained in this original and handsomely produced volume. The leaders in design practice lay bare the important details of construction, covering mostly mechanical and some electrical features.

Among the co-operators are A. T. & T. Company, Western Electric Company, General Electric Company, General Radio Company, Westinghouse Electric & Mfg. Company, Hygrade Sylvania Company, the Raytheon Company and National Company.

There are six sections of profusely illustrated text on (1) Assembly Practice, including relay racks and depressed panel racks; (2) Receiver Tuning Condensers, Padding Condensers, Frequency Meter Condensers and Transmitter Tuning and Neutralizing Condensers; Fixed Condensers, Mica, Paper and Electrolytic; Vernier Dials. Inductances, Coil Forms; R.F. Chokes, Shields, Sockets, Crystal Holders, Insulators, Fixed and Adjustable Resistors; Switches; Small Parts and Fittings; Plugs and Jacks; Meters; Transformers, Chokes; (3) Radio Receivers, including communication receiver, police radio receiver; broadcast receiver; short wave receiver; aircraft receiver; (4) Transmitters; (5) Speech Input Equipment; (6) Technical Manual on Radio Tubes.

Stiff paper cover printed in three colors. Page size, 6¼ x 9¼. Inside paper stock, heavy coated. A de luxe product throughout.

Sent postpaid on receipt of \$1.00

Hennessy Radio Publications Corp.

145 West 45th Street New York, N. Y.

All shipments made within 48 hours of receipt of order.

GENERAL SHORT-WAVE AND PUBLIC ADDRESS MANUAL

Bound in cardinal red leatherette, this manual includes articles on the construction of short-wave receivers from one to nine tubes, inclusive, and all values between, supers and t-r-f, with the clearest imaginable illustrations, both photographic and draughting. Besides the usual plain circuit diagram there is a pictorial diagram for each circuit. And all the photographs are informative. Portable short-wave sets, design and winding of coils for short waves and broadcasts (intimately illustrated).

List of short-wave stations, with meters and kilocycles and hours on the air; troubleshooting, and forty other topics, all done well.

The public address section contains data on different systems, how to use them, and offers opportunities to turn public address work to profit. Besides, there are articles on testing and servicing not encompassed by the title of the manual—signal generators, broadcast home and portable sets, analyzers, formulas, capacity data. Everything plainly told, simple language, from microphones to speakers.

PARTIAL LIST OF CONTENTS

Amplification Factors	95
Amplifiers	115
Analyzer Unit, How to Make	129
Antenna Design	80
Antenna Lead-in Cable	86
Antenna Wire	85
Antenna, 5-Meter	71
Broadcast Receivers	88
Coil Design	23, 24, 25
Construction of Short-Wave Receivers	22
Condenser Data Sheet	13
Condensers, Proper Replacement	12
Converting Meters to Kilocycles	19
Condenser Microphone	110
Crystal Microphone	114
Converters:	
"Regent" Two Tube A.C.-D.C.	64
"Paramount" Two Tube A.C.-D.C.	65
"Adam's Four Tube A.C. Superhet.	66
Curves, Explanation	100
Hum Elimination	98
Interference Elimination	79
Morse Code	75
Modern Microphone Trends	109
Oscillator, Battery-Operated	134
Oscillator, A.C.-D.C.	138
Phonograph Combination	128
Power Transformer Design	105
Public Address Installation	94
Servicing Formulae and Data	103
Short-Wave Tuning Instructions and Data	20, 21
Short-Wave Station Log	14 to 18
Short-Wave Receivers starting	page 26
Short-Wave Power Pack	46
Transceiver, Federal	70
Transceiver, Powertone	68
Transmitter	141
Tuner, Three Tube T.R.F.	125
Tuner, Four Tube T.R.F.	126
Tuner, Superhet	127
Velocity Microphones	111
Volume Controls, Electrad Replacement	132

PRICE 50 CENTS

Book Department

RADIO WORLD 145 WEST 45th ST
NEW YORK CITY

Powertone Portable Transceiver

For five, eight, and ten meters.

The Powertone Transceiver is a small compact unit which can be used alternately as a receiver or transmitter. Operates efficiently on either batteries or power supply. Has a distance range up to 100 miles. Uses the new multi-purpose 42 type tubes. Equipped with variable antenna coupling condenser to provide maximum efficiency with respect to different antenna lengths. Complete with five meter coils. Additional eight and ten meter coils at 45c ea.



Model X12
Powertone Portable transceiver kit less batteries and tubes. Net price **\$11.50**

Model X12W
Powertone Portable transceiver wired and tested, less batteries and tubes **\$14.50**

X12P Power Pack
Supplies proper filament and plate voltage for X12W transceiver. Net Price **\$4.25**

Powertone 20 WATT Portable Amplifier

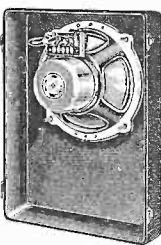
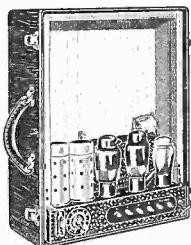

A compact portable amplifier of the most recent design. Makes use of the latest 6B5 Power amplifier tubes which produce an undistorted output of 15 watts and a peak output of 20 watts. Amplifier is provided with output terminals at 4-8-15 and 500 ohms for quick attachment of additional speakers. Makes use of oversized Hi-Fidelity dynamic speaker, which more than capably handles the output. Supplied complete with 25 feet of speaker cable, and 25 feet of shielded microphone cable. Cover can be quickly detached for remote installation of speaker.

An ideal system for auditoriums, ballroom purposes, window demonstrators, etc. Measures only 17½" x 13" x 10" overall. Net carrying weight, 27 lbs.

Complete system including five tubes, three stage 6B5 amplifier, and full sized dynamic speaker. Net Price **\$32.50**

Special double button microphone. Can be used for reproduction of voice or music. Complete with desk mike stand. Net Price **\$5.00**

TRY-MO RADIO CO., Inc. 85 Cortlandt Street, New York
179 Greenwich Street, New York

R-F COIL WINDING MADE EASY

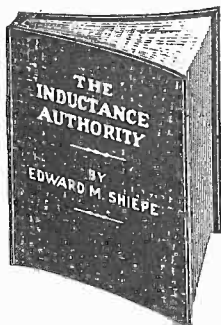

Sent prepaid anywhere on earth on receipt of \$2.00. Or send \$5.00 for a two-year sub. for Radio World and this valuable book will be sent free as a premium.

ALL you need are any standard wire and coil form and you can wind a radio-frequency solenoid to any requirement from information contained in "The Inductance Authority." No calculation is needed. Quick consultation of simple charts gives the answer in number of turns and gives it with high accuracy. This is the indispensable book for those who wind their own coils.

RADIO WORLD
145 W. 45th St., N. Y. C.

HAMMARLUND

Radio Equipment

Receiving and Transmitting Condensers, Chokes, Coils, Coil Forms, I. F. Transformers, Sockets, Shields and the Low-Priced "STAR" CONDENSER.

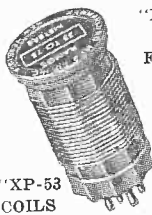

"XP-53" COILS

"XP-68" COIL FORMS

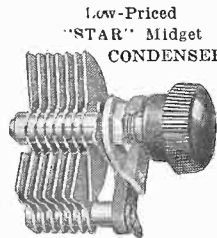

Low-Priced "STAR" Midget CONDENSER

HAMMARLUND MANUFACTURING CO.
424-438 W. 33rd St., New York.

Check here and attach 10c for new 32-page Hammarlund 1935 Short-Wave Manual, illustrating and describing most popular S-W circuits of past year, with schematic and picture diagrams and parts lists.

Check here for FREE General Catalog.

Name

Address

RW-7

HAND SOAP Guaranteed Formula

Complete directions—\$1.00

PROFITABLE. WRITE.

PELLERIN, 254 Main, Indian Orchard, Mass.

Now—High-powered Radio Books

*to help you in the solution of engineering,
practical and experimental problems*

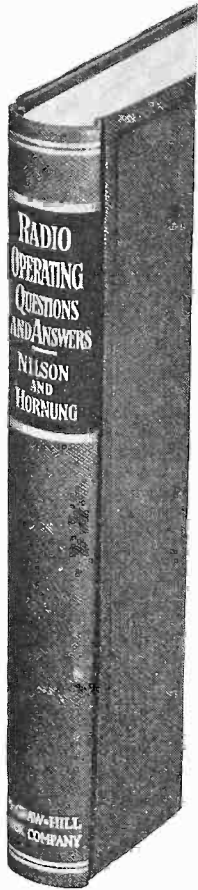

1. PRACTICAL RADIO COMMUNICATION.

By Nilson and Hornung. New book prepares you to pass examinations for *all classes* of radio operator licenses. Covers radio principles, radio equipment, power apparatus, station operating, as applied to broadcasting, marine, police, aeronautical and amateur radio. Includes entire spectrum of radio wave lengths, from ultra-short to long-wave. Especially suited for home study. 744 pages, \$5.00.

2. RADIO OPERATING QUESTIONS AND ANSWERS.

By Nilson and Hornung. Helps you to pass operator license examinations by giving hundreds of questions typical of those used on tests, together with full, clear, correct answers. Covers all phases of tests—apparatus, laws, etc.—and applies to broadcasting, marine, police, aeronautical and amateur radio. 350 pages, \$2.50.

3. ELECTRON TUBES IN INDUSTRY.

By Keith Henney. How the electron tube is used in manufacturing processes. Gives descriptions, circuits diagrams, performance charts, etc., for amplifier, rectifier, and other tubes and photocells, and comparison with other types of apparatus. 490 pages, \$5.00.

4. THEORY OF THERMIONIC VACUUM TUBES.

By E. L. Chaffee. Comprehensive treatment of fundamentals of thermionic emission and the vacuum tube. Covers use of tube as amplifier and detector as well as its general properties. 652 pages, \$6.00.

5. RADIO ENGINEERING.

By F. E. Terman. Engineering treatment of important vacuum-tube and radio phenomena. Analyzes circuits and tubes and reduces them to quantitative relations predicting performance of tubes and radio apparatus with accuracy and certainty. 750 pages, \$5.00.

6. HIGH-FREQUENCY MEASUREMENTS.

By August Hund. Presents theory and practice of measuring all manner of electrical quantities as well as present-day radio apparatus, in manner practical enough to meet needs of anyone interested in increasingly important high frequency art. 491 pages, \$5.00.

7. ELECTRONS AT WORK.

By C. R. Underhill. Tells, in everyday language as far as is possible, what electrons are, how the various tubes and cells function, and how these devices are applied in industry and biology. 354 pages, \$3.00.

8. THE PHYSICS OF ELECTRON TUBES

By L. R. Koller. Thorough explanation of the fundamental physical phenomena involved in the operation of electron tubes. Covers what takes place inside the tube, rather than circuits or applications. 205 pages, \$3.00.

9. COMMUNICATION ENGINEERING

By W. L. Everitt. Covers fundamentals of communication by wire and wireless networks, providing balanced treatment stressing broad principles rather than specific applications. 567 pages, \$5.00.

10. RADIO HANDBOOK.

By Moyer and Wostrel. Complete digest of authoritative radio data, both theoretical and practical, covering whole field, from fundamentals of electricity, to television and sound motion pictures. 886 pages, \$5.00.

HENNESSY RADIO PUBLICATIONS CORP.

145 WEST 45th STREET, NEW YORK, N. Y.

Quoted Prices are Postpaid—48-Hour Shipment Guaranteed.

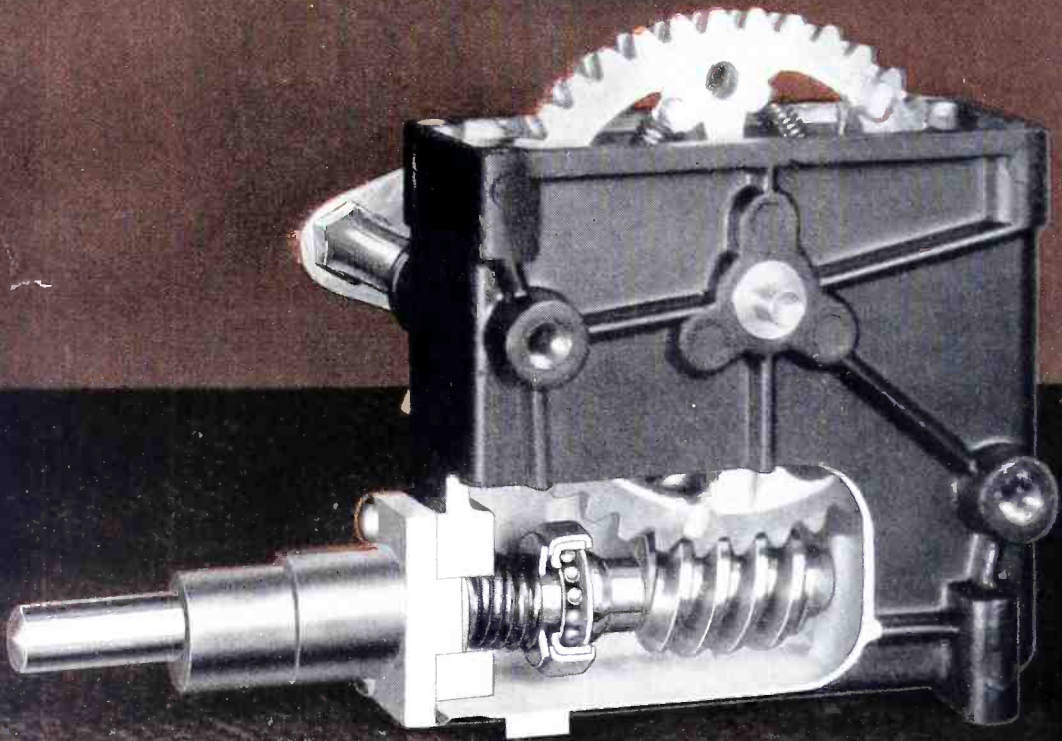

TYPE PW PRECISION VARIABLE CONDENSERS

This new National Worm-drive Condenser is ideal for use with the finest High Frequency Receivers, Signal Generators, Wavemeters and laboratory instruments. The plates are accurate Straight-line Frequency, and calibration is permanent.

The heart of this remarkable condenser is the preloaded worm-drive unit pictured above. The drive is smooth and positive, through a steel worm and accurately hobbled worm gear, preloaded with springs to eliminate backlash and wear. The worm bearing is conical with a ball bearing thrust, springloaded to take up wear. The entire drive is enclosed, the ratio being 20 to 1. The rotor shaft is $\frac{3}{8}$ " in diameter, grounded in the center, and rotating in insulated bronze bearings at the ends. There are four radial bearings, and two ball thrust bearings. Each rotor is individually insulated, contact being made through a four-leaved brush. Plate shape is straight-line frequency, and Stator insulation is Steatite. It is made with one, two, three or four sections. The dial, illustrated below, is of a new micrometer type having an effective scale length of twelve feet, and reading to one part in five hundred. As the dial and condenser sections are floating, the condenser is immune to distortion from warping of the panel or chassis.

The PW condenser and many other quality products are described in detail in the National general catalog. A copy may be obtained from your dealer, or by writing direct to the National Company, enclosing 6 cents in stamps to cover mailing costs.

NATIONAL COMPANY, INC., MALDEN, MASS.

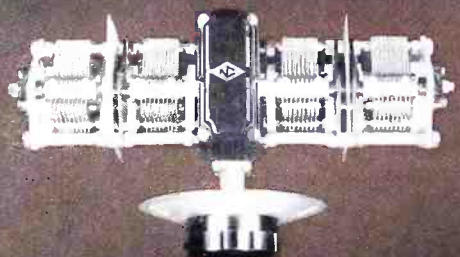

3.00

Here it is!



Readrite

No. 430

F. E. Wenger, Radio Engineer of the Readrite Meter Works, says:

"The question of servicing the new type Octal metal tube is important to every serviceman.

"Readrite Tube Testers, now in service, can easily be adapted for the new Octal tubes."

Simply get in touch with your jobber, or communicate directly with the Readrite Meter Works for full information about this newest testing equipment.

No. 430 TESTS METAL TUBES!

THE tube situation has changed. Metal tubes are here! If you are not prepared to test the new metal Octal tubes, see the Readrite 430 Tube Tester at your jobber's. Especially designed to handle any type of tube, in either metal or glass envelope . . . accurately and speedily. Constructed with sloping panel and removable cover for either counter or portable use in the one model.

The Model No. 430 has five sockets that are flush with the panel. One socket is equipped to test the new 8-Prong Octal metal tube. Another feature of this new tester is the shadow-type line voltage meter . . . located directly above the moving-coil type instrument used for testing Good and Bad tube values. Direct reading. Controls are simple and positive in action. This new all-type tube tester makes every inter-element short and leakage test, which is instantly convincing to the customer.

READRITE METER WORKS

170 COLLEGE AVENUE
BLUFFTON, OHIO

Readrite

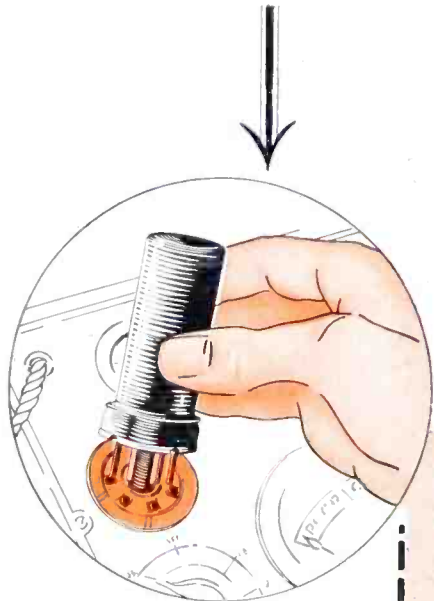

Readrite Meter Works
170 College Avenue,
Bluffton, Ohio

Name

Street

Gentlemen: Send me literature on your new Readrite Tube Tester No. 430.

City .. State