

JUNE 20
1931

LIST OF TELEVISION STATIONS

Price
15 Cents
per Copy

RADIO

REG. U.S. PAT. OFF.

WORLD

The First and Only National Radio Weekly

482nd Consecutive Issue—TENTH YEAR

**NEW AUDIO
CIRCUIT**

**One-Tube
All-Wave Adapter**

ALL-WAVE MIDGET AC SET

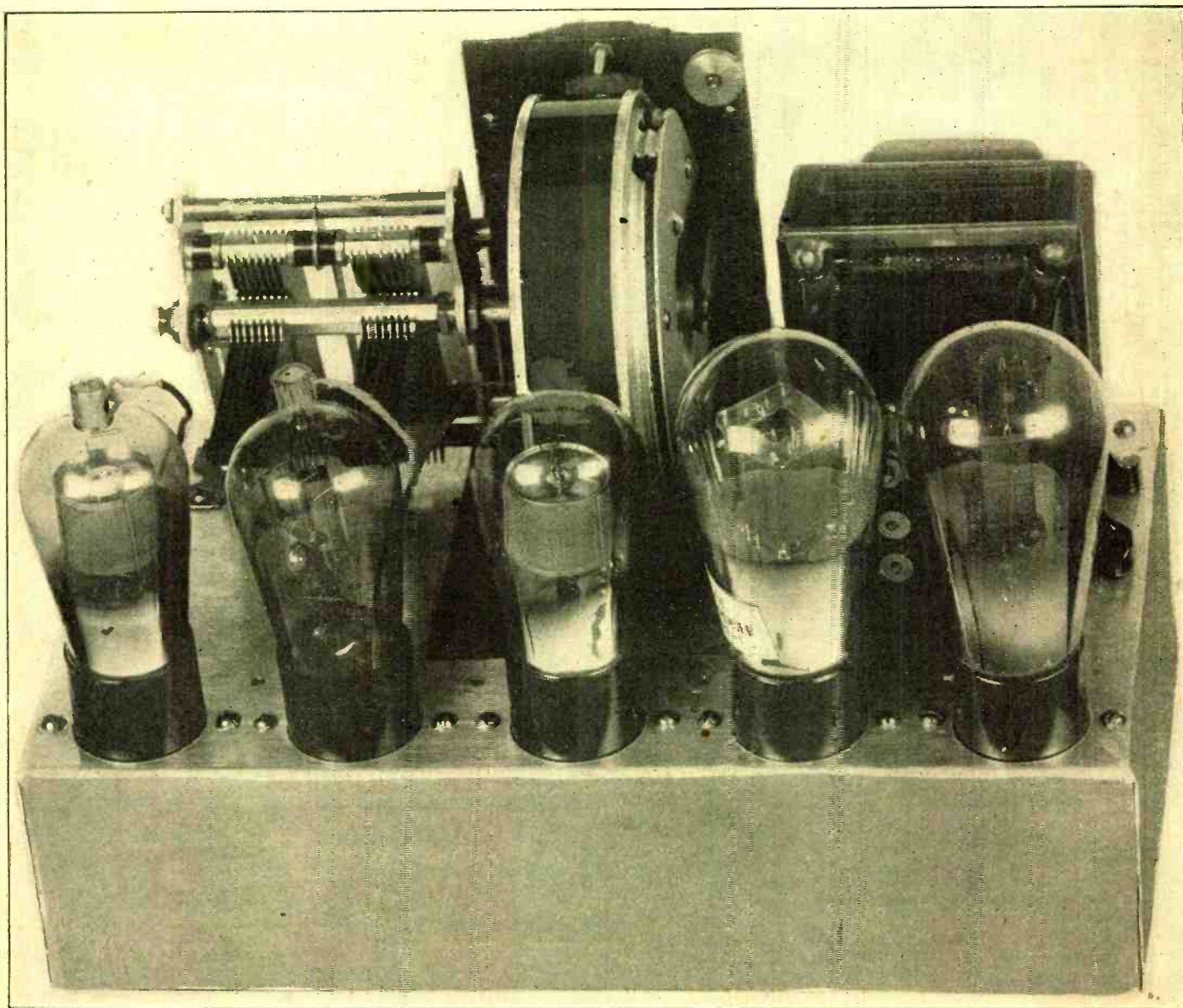

A Flip of a Switch changes the Wave Band. See pages 6, 7 and 8

Complete Parts for the All-Wave

AW-5

VARIABLE MU-PENTODE
AC RECEIVER

Order Any or All Parts

Coils

One antenna coil for .00035 mfd. tuning, 70-turn secondary, tapped at the 47th, 62d and 67th turns (AW-5-AL) \$1.10

One interstage coil for .00035 mfd. tuning, 70-turn secondary, tapped at the 47th, 62d and 67th turns (AW-5-IL) 1.25

One power transformer (2.5-volt winding, two 5-volt windings, and high voltage secondary to afford 300 volts DC output) 4.95

One 30 henry B supply choke coil 1.75

Condensers

One two-gang .00035 mfd. tuning condenser with straight frequency line plates 1.95

One block of three 0.1 mfd. condensers in one case57

One 60 mmfd. manual trimming condenser79

One equalizing condenser, 20-100 mmfd. (E)29

One .00025 mfd. grid condenser with clips40

Two .01 mfd. mica fixed condensers40

One .00035 mfd. fixed condenser10

One 1.0 mfd. bypass condenser39

One 8 mfd. and two 4 mfd. electrolytic condensers, with brackets 3.20

Resistors

One 300 ohm flexible biasing resistor20

One 25,000 ohm potentiometer with AC switch attached 1.10

One 20,000 ohm pigtail resistor20

One 10,000 ohm pigtail resistor20

One 50,000 ohm pigtail resistor20

One 5.0 meg. cartridge type grid leak (not pigtail)20

One 0.25 meg. pigtail resistor20

One 0.1 meg. pigtail resistor20

Two 5.0 meg. pigtail resistors40

One 400 ohm 5-watt biasing resistor85

One 5,000 ohm pigtail resistor25

One 30 ohm center tapped resistor20

One 0.5 meg. pigtail resistor20

Other Parts

One antenna binding post09

One ground binding post09

One twin jack speaker assembly25

One twin jack phonograph assembly25

One National modernistic dial, with pilot light and socket 2.95

One dual switch, double pole, four point, with insulated shafts 1.87

Two insulators for potentiometer, if metal chassis is used05

Two extra knobs, 3/4 inch shaft30

One metal chassis, with one UX (four prong) and four UY (five-prong) sockets 6.50

Two dozen 6/32 nickel plated machine screws and two dozen nuts20

One roll of slideback hookup wire22

Two grid clips04

Four right angle brass brackets, 3/8 inch, for mounting coil forms10

One phonograph switch25

Polo Engineering Laboratories
125 West 45th Street New York, N. Y.
Telephone: BR-yant 9-8093

SERVICE MEN'S NEW ADAPTER



Here is a new adapter that does the very trick you've wanted done—enables interruption of the connections to a tube, so current can be read, at the same time affording direct access to the prongs for voltage tests. Remove tube from socket, insert adapter in socket, put tube in adapter, and you're all set. Removable links, supplied with adapter, permit access to current.

For 5-prong tubes, Cat. B-1 @ \$1.05.
For 4-prong tubes, Cat. B-2 @ \$1.05.
Connecting cables, 2 ft. long, jack pins at both ends, Cat. 2067 (two leads), @ 36c.
Connecting cables, 2 ft. long, jack pins one end, forked lug at other, Cat. 2066 (two leads), @ 48c.

DIRECT RADIO CO.
143 West 45th Street,
New York, N. Y.

NATIONAL DRUM DIAL



National Velvet Vernier drum dial, type H, for 3/4" shaft. An automatic spring take-up assures positive drive at all times. Numbers are projected on a ground glass. Rainbow wheel changes colors in tuning. Modernistic es-cutcheon. Order Cat. ND-H @ \$3.13.

GUARANTEE RADIO GOODS CO.
143 West 45th Street, New York, N. Y.

Lowest Prices!
on thousands of **NATIONALLY ADVERTISED RADIO ITEMS**

EXTRA EXTRA
American
SALES COMPANY
WHOLESALE RADIO DISTRIB.
W-44 W. 18th St.
New York City

FREE WHOLESALE RADIO CATALOG

LEARN AT HOME TO BE A RADIO EXPERT

Many \$50 to \$100 a week jobs opening in Radio industry every year. I'll show you how to make \$200 to \$1,000 in spare time servicing sets while you're learning. Home Laboratory Outfit makes learning easy, practical. Write for "Rich Rewards in Radio". It gives the facts on jobs opening regularly and how you can learn at home to be a Radio Expert. No obligation.

J. E. SMITH, Pres., Dept. 10M4
National Radio Institute Washington, D. C.



"Kill" That Static

And Enjoy Many New Stations

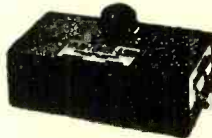

Vari-tuner in Aerial, "traps" crashing. Brings new stations, clear and strong. Write to 20th Century Co., 9520 Coca Cola Bldg., Kansas City, Mo. for 15-Day Trial Offer and latest 16-page Radio Log.

DEALERS and SERVICEMEN
STANDARDIZE ON METALLIZED



Write for Special Offer of \$3.50
Official Radio Service Manual (352 pp.) **FREE**
LYNCH MFG. CO., Inc., Dept. W, 1775 B'way, New York

"A" BATTERY SWITCH

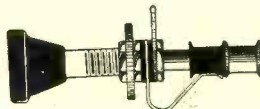

A push-pull switch for battery-operated sets. Made by Benjamin Firm, sure contact, extremely long life. Price, 25c.

GUARANTY RADIO GOODS CO.
143 West 45th St., New York, N. Y.

Subscribers! Important!

Note subscription expiration date on wrapper containing your copy of RADIO WORLD. If nearing expiration date, please send in renewal so that you will not miss any copies. Subscription Dept., RADIO WORLD, 145 W. 45th St., New York City.

115 DIAGRAMS FREE!

115 Circuit Diagrams of Commercial Receivers and Power Supplies supplementing the diagrams in John F. Rider's "Trouble Shooter's Manual." These schematic diagrams of factory-made receivers, giving the manufacturer's name and model number on each diagram, include the MOST IMPORTANT SCREEN GRID RECEIVERS.

The 115 diagrams, each in black and white, on sheets 8 1/2 x 11 inches, punched with three standard holes for loose-leaf binding, constitute a supplement that must be obtained by all possessors of "Trouble Shooter's Manual," to make the manual complete. We guarantee no duplication of the diagrams that appear in the "Manual."

Circuits include Bosch 54 D. C. screen grid; Balkite Model E. Crosley 20, 21, 22 screen grid; Eveready series 50 screen grid; Eria 224 A. C. screen grid; Peerless Electrostatic series; Philco 76 screen grid.

Subscribe for Radio World for 3 months at the regular subscription rate of \$1.50, and have these diagrams delivered to you FREE!

Present subscribers may take advantage of this offer. Please put a cross here to expedite extending your expiration date.
Radio World, 145 West 45th St., N. Y. C.

Get Greater Distance with **WELLSTON GOLD TEST AERIAL**

Reduces Static and Hum

NEW-IMPROVED WELLSTON GOLD TEST AERIAL

RADIO RECEPTION IMPROVED

The World's Smallest Aerial 2 1/2 by 3 inches in Size

THIS NEW—IMPROVED WELLSTON GOLD TEST AERIAL eliminates both outside and inside aerials. One of the greatest innovations since radio itself, this new improved model follows closely upon the success attained by the original WELLSTON GOLD TEST AERIAL which at present is giving satisfactory service to thousands of radio owners throughout the world. It brings in distant stations with crystal clear tone quality and greater volume—gives selectivity without distortion and helps to eliminate overlapping of stations, noise and electrical interference. It is absolutely non-directional, non-corrosive and guaranteed never to wear out. It does away with all lightning hazards and because it does not connect into a light socket, all AC hum and line noise is eliminated.

IT WILL NEVER WEAR OUT

Made of attractive brown genuine Durez, with binding post to match, this NEW AND IMPROVED WELLSTON GOLD TEST AERIAL is of the filtered type endorsed by radio engineers, and will last a lifetime. Although small enough to fit the palm of your hand, it has a capacity equivalent to 54 ft. of best grade aerial wire strung 50 ft. high in the air.

DEALERS WANTED

We have an unusual money-making proposition to offer dealers on our GOLD TEST AERIAL and REPLACEMENT PARTS. Exclusive territory open. Write at once for full information including SPECIAL LARGE DISCOUNTS, Price Lists, etc.

EASY TO INSTALL

It is a simple matter to install the WELLSTON GOLD TEST AERIAL—even a child can do it in a few minutes time. No extra tools are needed. Place it anywhere—inside or on the back of the radio cabinet. Once installed no further attention is required.

IF YOUR DEALER CAN'T SUPPLY, ORDER DIRECT.

Price **\$250** (Retail)

WELLSTON RADIO CORP.
Dept. 118, St. Louis, Mo.

"MATHEMATICS OF RADIO."—A great help to everybody interested in radio. \$2 postpaid. Radio World, 145 W. 45th St., N. Y. City.

SUBSCRIBE NOW!

RADIO WORLD, 145 West 45th St., New York City. Enclosed please find my remittance for subscription for RADIO WORLD, one copy each week for specified period:

- \$10.00 for two years, 104 issues.
- \$6 for one year, 52 issues.
- \$3 for six months, 26 issues.
- This is a renewal of an existing mail subscription (Check off if true).
- \$1.50 for three months, 13 issues.

Your name
Address
City



Vol. XIX No. 14 Whole No. 482
 June 20th, 1931
 [Entered as second-class matter, March, 1922, at the Post Office at New York, N. Y., under act of March, 1879]
 15c per Copy. \$6 per Year

TENTH YEAR
 Technical Accuracy Second to None
 Latest Circuits and News

A weekly Paper Published by Hennessy Radio Publications Corporation, from Publication Office, 145 West 45th Street, New York, N. Y. (Just East of Broadway)
 Telephone, BRyant 9-0558 and 9-0559

RADIO WORLD, owned and published by Hennessy Radio Publications Corporation, 145 West 45th Street, New York, N. Y. Roland Burke Hennessy, president and treasurer, 145 West 45th Street, New York, N. Y.; M. B. Hennessy, vice-president, 145 West 45th Street, New York, N. Y.; Herman Bernard, secretary, 145 West 45th Street, New York, N. Y.; Roland Burke Hennessy, editor; Herman Bernard, managing editor; J. E. Anderson, technical editor; L. C. Tobin, Advertising Manager

The Cathode Coupler

New Non-Reactive Circuit for Quality Audio

By Herman Bernard

[Herewith is presented for the first time anywhere a non-reactive audio circuit, designed and invented by the author. Its frequency characteristics are particularly fine. It is one of the most interesting of recent contributions to audio literature.—EDITOR.]

GRADUALLY the audio amplification is being reduced in receivers, while the radio frequency amplification is being increased. Five years ago three-stage audio channels were not uncommon. The two-stage transformer-coupled audio amplifier reigned for several years. The first popular shift was to push-pull, which did not increase the number of stages, but did increase by one the number of tubes, and approximately doubled the maximum undistorted power output. Then, the year before last, many switched to a resistance-coupled first stage of audio, particularly with a screen grid tube used as detector, since it most fittingly takes a resistive load. Push-pull output was retained. Now, with the advent of pentode tubes, and the demand for small-sized and inexpensive receivers, a return to the single-sided stage of output is noticed. Indeed, in some instances there is only one stage of audio, a resistive coupler joining the detector output to the power tube input.

The single stage of audio, as constituting the total audio amplification, is a step toward the total elimination of the audio channel. However, there are no tubes generally applicable to the combined functions of detection and power handling. The detector is rated by its voltage output, the power tube by its power output, so the dissimilarity of functions makes the total elimination of audio amplification not wholly practical. To be sure, signals can be heard on the speaker, from the detector output of sensitive sets, but the power requirements are lacking, and the bare performance can not be rated as an accomplishment.

New Cathode Coupler System

A system that does no more than feed the detector's output voltage to the grid of an output tube in effect produces an amplification equal to the amplification factor of the output tube. Since some audio amplification is necessary with present tuners, if only one stage is used the output tube would be preferably a pentode, because it has highest sensitivity among the power tubes. The 247 pentode, for instance, has an amplification factor of 95. This is small gain for the total in the audio amplifier, but it is not difficult to build a tuner that will produce a detector output sufficient to load up the pentode.

A new system of delivering the detector output to the power tube's grid circuit is shown in Fig. 1. The detector is a 227 tube, used as a diode, by tying together the grid and the plate.

Rectification takes place because of the tube's limitation to the passage of current in only one direction and the absence of a control element (grid). The grid-plate element may be called the anode.

Pulsating Direct Current

When a radio frequency wave is impressed on the grid circuit, consisting of coil and condenser E, from grid to B minus, there is an alternating voltage in that circuit. Since the tube can pass current in only one direction, the current flowing from anode to cathode is direct current. By putting a load between cathode and the grid return of the coil (grounded B minus), the

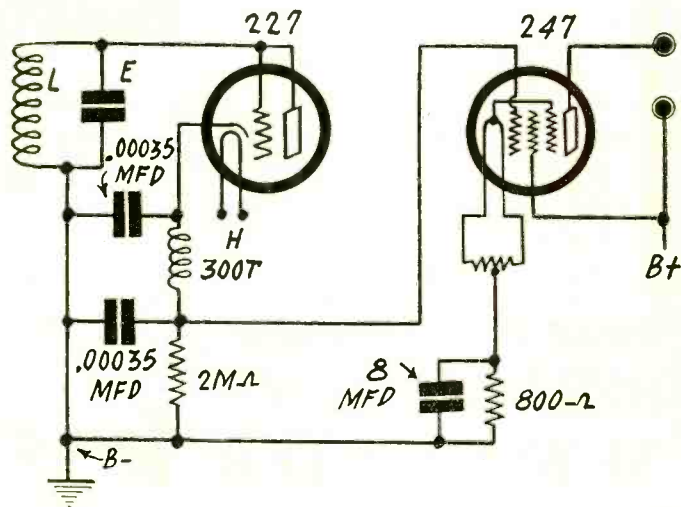

FIG. 1

The essential circuit of the Bernard cathode coupled audio amplifier. This is a non-reactive circuit of outstanding fidelity.

direct current flows through this load, and up through the coil to anode, and around again, always in the same direction. The direct current path is therefore complete.

Since there is a radio frequency input, the direct current is not a steady or pure direct current. It varies at the radio frequency just as the plate current of a radio frequency amplifying tube is direct current varying at radio frequency. This current is pulsating but it is direct, nevertheless, because it flows in only one direction.

There is no desire to pass on any radio frequency for amplification, so a pi filter is placed from cathode to the resistor to detour the radio frequencies from the power tube circuit. The requirement is for a filter that will suppress the radio frequencies substantially, yet it is not desired to suppress any of the audio frequencies, as these are what we desire to transfer. The values should be selected for their frequency characteristic. The coil therefore may be a 300-turn duolateral wound r.f. choke and the two condensers may be .00035 mfd. each.

The presence of audio frequencies is due, of course, to the fact that the radio frequency wave is modulated. At the transmitting point the carrier is varied at an audio frequency. The function of the detector is to get rid of the carrier, which it does, since it eliminates an alternating current wave. That much elimination is not sufficient, because, as previously stated, there are still the pulsations at radio frequencies in the detector's direct current output.

The load on the rectifier output is a 2 meg. resistor, but any value above 1 meg., up to the point where the last tube

(Continued on next page)

New Audio System for Non-Reactive Circuit Uses Cathode Resistor

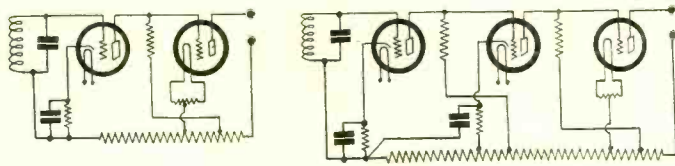

FIG. 2

A Loftin-White detector-amplifier, in two-tube and three-tube skeleton form.

(Continued from preceding page)

"blocks," may be used. Blocking is due to insufficient leakage path for the electronic accumulation on the grid.

Connections For 247 Pentode

The cathode side of the resistor is connected to the grid of the output tube. Therefore the resistor is common to both circuits, and the output of the detector exactly equals the input to the power tube. There can be no distortion of wave form or frequency due to coupling, as the coupling is non-reactive, that is, it has neither inductance nor capacity.

The output tube uses a five-prong (UY) socket, to which the usual connections are made for control grid, plate and filament. The fifth prong, which would be used for cathode in the case of the 227, 224, 235 and similar tubes, is here the special screen that greatly reduces the secondary emission and thus makes possible a power tube of larger sensitivity than any previously made for broadcast receivers. This fifth prong is connected to the same potential as the plate. If the load on the plate circuit has a relatively high direct current resistance, say, more than 500 ohms, a resistor should be introduced, without bypassing, in the screen lead (from fifth prong to B plus), so that the voltage from plate to center tap of the filament, and from screen to center tap of the filament, will read the same.

Different Situation Here

The secondary of a power transformer feeding the filament of the 247 may be center-tapped, and if so, the biasing resistor is placed from center tap to B minus. If there is no center tap one may be provided by inserting a center-tapped resistor of not more than 30 ohms total and not less than 10 ohms total.

The negative bias voltage for the 247 should be 16.5 volts. In general practice a 400-ohm resistor is used, from filament center to B minus, bypassed by a large condenser. In such a case the grid is independent of any bias control except through the biasing resistor. Here, however, we have a different situation.

The amplitude of the carrier is strongly controlling and the problem is to avoid having the control operate in the wrong direction, that is, the stronger signals must not result in seriously weaker bias. In fact, the cathode coupling system works as a steady amplifier, or in the right direction, as will be shown.

How Bias is Affected

Suppose that the voltage across the output of the detector is 15 volts. The grid prong of the power tube must be connected, as diagrammed, to the end of the load resistor nearer the cathode, and this is positive in respect to B minus by the 15 volts. So the power tube's grid would be 15 volts positive, were not the correction introduced in the biasing resistor, by doubling its value. So 800 ohms is the value specified on the diagram. It is not the adamant value, however, since what shall be the absolute value of the voltage drop across the biasing resistor will depend on the peak value of the voltage across the load resistor.

The check-up can be made quite readily when the circuit is in operation, because the voltage from plate to center tap of the pentode can be measured, and the bias adjusted on a strong station until the plate current in that tube has the recommended value of 32.5 milliamperes.

Intensity Effects

The effects of the carrier intensity and the modulation intensity are of the usual resultant order as encountered in non-reactive coupled circuits, although by a different route. It will be remembered that the Loftin-White non-reactive coupled circuit has a plate load resistor on a negative bias screen grid detector, and that the voltage drop in this resistor constitutes the negative bias on the following tube. Therefore increase in the intensity of a carrier, due to larger voltage difference

between aerial and ground, or the greater field strength in the antenna-ground circuit, causes an increase in the plate current of the detector, hence a large voltage drop, hence a larger negative bias on the next tube. Thus the plate current in the next tube decreases, and since this current controls the bias voltage, the negative bias decreases. The greater the intensity or amplitude of the carrier, the less the bias on the tube following the detector. If the second tube is not the output tube, and the same system is applied, then the decreased bias results in larger plate current in the second tube, or higher negative bias on the third tube, which means higher bias with higher carrier amplitude.

To correct the tendency of bias in the first instance to become less when the need is that it should be greater, the biases for the tube or tubes following the detector usually are taken from a voltage divider in which there is a bleeder current to help current stability. So the system is an entirely practical one and can be worked with a current and voltage stability.

The same principles applying to carrier intensity apply to modulation. As the modulation increases, the plate current increases in the detector, and the biases decrease. But the modulation and the carrier may be regarded as one, particularly with so many stations using 100 per cent. modulation.

Steadiness Achieved

The cathode coupling method arrives at a practical and steady result through a different process. As the carrier intensity increases, the voltage drop increases in the cathode load resistor. It will be remembered this drop, as it increases, moves the grid potential of the output tube in a positive direction, so up to this point increased carrier intensity makes for decreased bias. This, too, would be the opposite of what is desired. However, the decreased bias increases the plate and screen currents in the output tube, and these currents flow through the biasing resistor (800 ohms), the increase in current increases the voltage drop, hence increases the negative bias, thus effecting stability.

The various stages and effects have been treated theoretically, and an arbitrarily definite separation in time accorded to the actions. However, the rapidity is so great that the action must be taken as simultaneous, and the final effect be considered free from the intermediate results, especially as the reproducer is only in the output tube circuit.

The cathode coupling system is shown in Fig. 3 as a part of an all-wave set. The first stage of radio frequency amplification

Short-Wave Club

ARE you interested in short waves? Receivers, transmitters, converters, station lists, trouble shooting, logging, circuits, calibration, coil winding—what not? If so become a member of Radio World's Short-Wave Club, which you can do simply by filling in and mailing attached coupon. As many names and addresses as practical will be published in this department, so that short-wave fans can correspond with one another. Also letters of general interest on short-wave work will be published. Besides, manufacturers of short wave apparatus will let you know the latest commercial developments. Included under the scope of this department is television, which is spurting forward nicely. Fill out the coupon and mail at once.

If you prefer, send in your enrolment on a separate sheet or postal card.

Short-Wave Editor, Radio World, 145 West 45th Street, New York, N. Y. Please enroll me as a member of Radio World's Short-Wave Club. This does not commit me to any obligation whatever.

Name

Address

City State

I am a subscriber for Radio World.

I am not a subscriber, but buy copies at news-stands.

Purity of Tone or Vision

in Detector Circuit and Next Tube's Grid

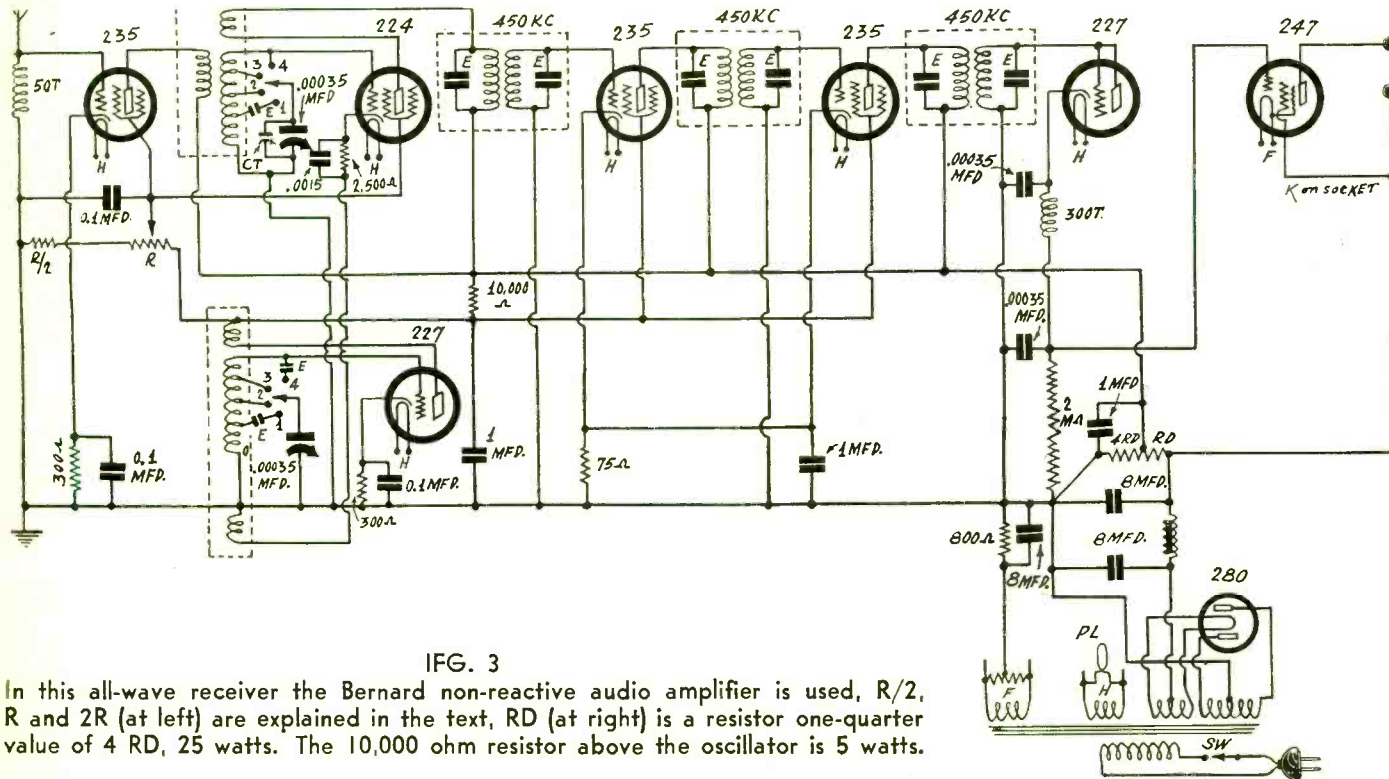

FIG. 3

In this all-wave receiver the Bernard non-reactive audio amplifier is used, R/2, R and 2R (at left) are explained in the text, RD (at right) is a resistor one-quarter value of 4 RD, 25 watts. The 10,000 ohm resistor above the oscillator is 5 watts.

consists of a blocking tube, to prevent radiation. There is no crosstalk trouble, as would be experienced were this tube a 224 instead of a 235 variable mu or exponential tube. The control of the grid bias voltage as a volume and sensitivity check eliminates crosstalk trouble.

The screen voltage of the modulator, second tube from left,

is also controlled by this potentiometer (R). The choice of values for R is not critical, but the resistance should be no less than 3,000 ohms. As implied, R/2 should be half the value of R, while 2R should be twice the value of R. These multiple and quotient values may be changed as much as 50 per cent., as their principal purpose is to enable use of the full scope of the volume control, rather than confining adjustments to a small portion of the displacement of the pointer.

Here is a list of new members of the Short-Wave Club:

- Everett Ewing, 908 Court Street, Lynchburg, Va.
- R. W. Marquardt, 3801 San Pedro St., Tampa, Fla.
- Alfred H. Haner, 3163 Jefferson Ave., Cincinnati, Ohio.
- Mr. W. H. Ribble, Radio Research Laboratories, 1638 Glynn Court, Detroit, Mich.
- Richard Otto, 1871 N. Halstead St., Chicago, Ill.
- H. G. Schaeffer, 2532 Lyle Lane, Norwood, Ohio.
- Walter Jenkins, Kimball Bros. Co., 9th St. & 11th Ave., Council Bluffs, Ia.
- Francis W. Dwyer, 131 Bastedo Ave., Toronto, Canada, c/o Dyereydio.
- E. F. Schmidt, 2916 Arthur Ave., Chicago, Ill.
- H. Grundy, 139 E. 1st St., Long Beach, Calif.
- Edmond J. Cleary, 1 Lummus Ave., Danvers, Mass.
- Josef von Baudissin, 457 West 47th St., New York City.
- Al Franklin, 286-16th Ave., Newark, N. J.
- Alf. O. Carlson, 202 Tamarack St., Liverpool, N. Y.
- Robert Brenner, 4033 Spring Grove Ave., Cincinnati, Ohio.
- John Burns, 1323 Inwood Ave., Bronx, N. Y. City.
- Eugene J. Byrne, 1827 Ditmars Ave., Astoria, L. I., N. Y.
- C. Ostachowski, 49 Sayre St., Buffalo, N. Y.
- J. C. Stanley, 1132 McKenstry, Detroit, Mich.
- Hugh Kane, 820 Fifth Ave., Williamsport, Pa.
- Dwight Craig, 3359 N. Illinois St., Indianapolis, Ind.
- Joseph Connolly, 4969 N. Kilpatrick Ave., Chicago, Ill.
- Smyrl Poyner, c/o Co-Ed Theatre, Arkadelphia, Ark.
- W. R. Van Sickle, 4904 Harger Ave., Dearborn, Mich.
- John J. Werbinski, 17130 Bloom St., Detroit, Mich.
- Howard Noling, 1536 Tremont Ave., S. W. Massillon, Ohio.
- George R. Bluhm, 36 Headley Ter., Irvington, N. J.
- Maurice Cantin, 335 Gordon Ave., Verdun, Que., Canada.
- Max Blam, 4010 Highland Ave., Sea Gate, C. I., Brooklyn, N. Y.
- J. M. Sewell, 712 N. Ridgewood, Daytona Beach, Fla.
- Simon H. Sasser, Jr., Route 1, Box 54, Summerfield, Fla.
- C. W. Woodworth, P. O. Box 364, Lockney, Texas.
- James Burdett, 527 Hood St., Waco, Tex.
- Edwin A. Gamman, R. F. D. No. 5, Auburn, Maine.
- Alger Johnson, 2807 Bay Ave., Hoquiam, Wash.
- Richard Dresselhaus, Galesville, Wis.
- George E. Russell, 2722 N. W. 23rd Court, Miami, Fla.
- Master Harold I. Brown, 538-44th St., Union City, N. J.
- Claude Albietz, 1012 S. Illinois St., Decatur, Ill.
- A. E. Peterson, Box 703, Deerlodge, Mont.
- Manert Hansen, 461-46th St., Aptm. 12, Brooklyn, N. Y.
- Wm. B. Taylor, 302 Harrison Ave., Harrison, N. J.
- Gus Seiple, Jr., 858 McQuillen St., Mobile, Ala.
- Oscar Renshaw, 1128 N. La Salle St., Chicago, Ill.
- J. L. Prather, 511 Tremont St., Chattanooga, Tenn.
- S. Douglas Eccles, 1951 So. New England Ave., Los Angeles, Calif.
- Santos Pastor, 167 W. 71st St., New York City.
- L. Schindler, 1405 Townsend Ave., New York City.
- W. H. Thorpe, 17 Park Ave., Mount Vernon, N. Y.
- Mr. Katz, 11716 Kinsman Road, Cleveland, Ohio.

Foundatinn Unit Used in Mixer

The mixer uses a foundation unit for all-wave coverage, with selection of the wave band by a front panel switch. One knob controls both modulator and oscillator inductance in the tuned circuits, as the switch is of the insulated dual type, having two poles and four throws to each pole. Pairs of points are engaged at a time, hence the switch is called a double pole four-point switch.

If .00035 mfd. condensers are used, with large copper shields for the coils, the broadcast wave band can be covered without switching more than once. In the broadcast band the difference in frequencies between the two tuned circuits is greatest, so the oscillator frequency range is cut down by a series condenser. E, for point (4), this being two 20-100 mmfd. condensers in parallel, set once, when the circuit is tested at some low broadcast frequency, say, 600 kc. or lower.

At the opposite end, points (1) on both coils, a series condenser of the same kind is used, the object being to avoid overcrowding the dial, because the frequency change is so great for a given capacity change, compared to the broadcast band, for instance. Two equalizers are again in parallel for each of the condensers E. Elsewhere E represents only one such equalizer.

Number of Turns on Coils

For those who desire to wind their own coils, the following suggestions are made: Since the tuned secondaries have the same inductance, they may consist of 100 turns of No. 28 enamel wire. The taps, from the grid end, may be at the 70th turns, the 90th turn, and the 98th turn. The number of turns between taps is as follows, which is only a restatement of the preceding: (4) to (3), 70 turns; (3) to (2), 20 turns; (2) to (1), 8 turns; (1) to (0), 2 turns. The condensers E at taps (1) are used at or near full capacity.

The detector primary has 12 turns, the detector and oscillator ticklers have 30 turns, any five wire, while the oscillator pickup coil has 4 turns. The diameter is 1.75 inch bakelite. A copper shield, 3 inch diameter, 4 1/2 inches high, is used.

An All-Screen G

By J. E

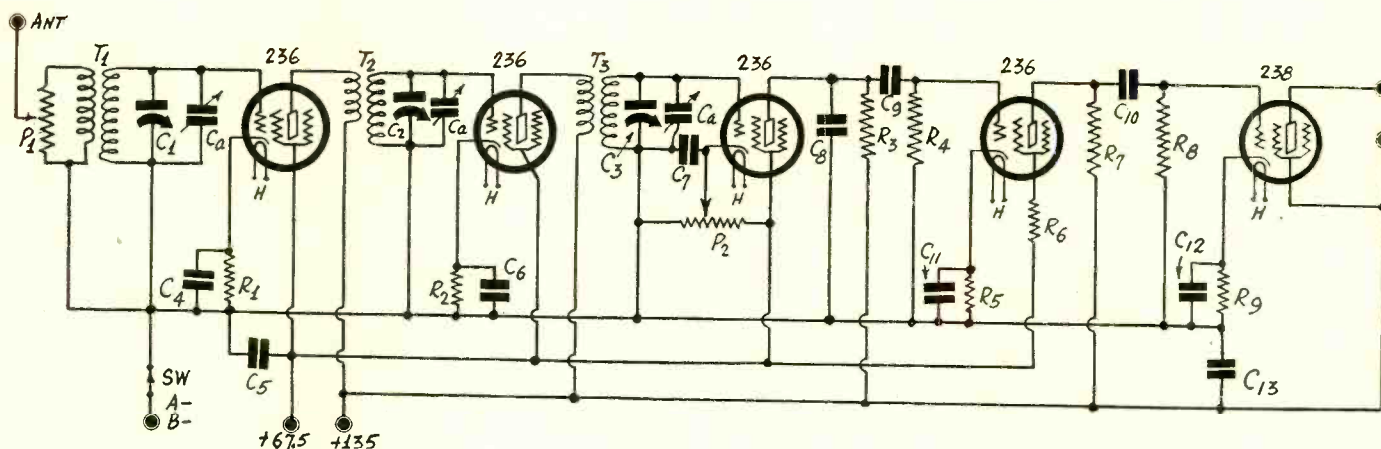

FIG. 1

The circuit of a five tube automobile receiver with screen grid and pentode tubes. It operates from the car storage battery and dry cell B batteries.

THE vacation season is on and it seems everybody wants a receiver to go in the car to be operated from the car batteries. There is a general idea that a set of this type should be small and consist of only a few tubes. While it is desirable that it should be small and compact it will not be satisfactory if it is not very sensitive, and sensitivity can only be obtained by using many tubes, for only tubes amplify. Of course sensitivity can be increased by proper tuning, by choice of proper tubes, and by proper co-ordination of the parts that go into the circuit. But it is a mistake to impose all the necessary conditions that must be met by a portable set when the set is to be carried in an automobile or when it is to be carried for only short distances.

Using Screen Grid Tubes

There are two reasons why an automobile receiver should be sensitive. The first is that the antenna and ground equipment possible in a car is very poor and its lack of efficiency must be offset by sensitivity in the set. The second is that the set may be taken to places remote from broadcast stations where signals are very weak, or to places shielded from broadcast stations by hills, mountains and woods, where the signals may be weak even when the location is geographically close to a broadcast station.

The use of screen grid tubes increases sensitivity a great deal, for these tubes amplify more than any other, provided that they are operated with the proper voltages and the proper impedances. It is quite practical to use this type of tube throughout the receiver with the exception of the output tube. And this tube can be a pentode, which also has a high gain and a high power sensitivity. In a sense this tube is also a screen grid tube and so the receiver may be built around screen grid tubes throughout.

To eliminate some weight and to save space we can use resistance coupled audio, and this we can do without sacrificing gain. Indeed, if we want to use screen grid tubes throughout, we have practically no other choice than resistance coupled audio. Resistance coupled audio also insures first rate quality, since there is no better method of amplification when quality is to be paramount.

A great deal of selectivity is needed, although this is not so important as sensitivity, because if the signals are weak even a set of moderate selectivity is keen enough to separate stations. Still the set may be used near broadcast stations and it must be selective enough to pick out any one station to the exclusion of all others. The selectivity possible with three tuned circuits should be enough. It is for almost any set, so it ought to be good enough for a portable, or more properly, a transportable set.

The Tuner

The three tuned circuits are tuned with a gang condenser containing three equal sections, C1, C2 and C3, each one of which is shunted with a trimmer condenser Ca. The success of such a tuner depends on the adjustment of the coils and condensers to equality. It may be that three coils are made exactly alike as to turns and dimensions, but they may not be quite equal when they are put in the circuit, due to the effects of tubes and shielding. It may also be that the condenser sections are exactly equal outside the circuit, but as soon as they are put in they will be unequal. These inequalities arise from differences in the tubes and the shielding.

It is a simple matter to adjust the condensers to equality by means of the trimmer condensers, but this does not necessarily insure line-up of the circuit, for the coils may be slightly different. However, if the coils are equal outside the circuit, and if they are placed similarly with respect to shields and other parts, they will be enough alike to make ganging successful by merely adjusting the trimmer condensers. No more of the trimmer capacity than necessary should be used, because large trimmer capacity may prevent covering of the broadcast band.

This means that at first the trimmer condensers should be set at minimum. Then a station should be tuned in near the 550 kc limit of the tuning band and the trimmers should be adjusted until that station comes in loudest. If no maximum is found on one of the trimmers, readjust the main gang a little, that is, detune a little, and then try adjusting the trimmers.

Coil Windings

When this adjustment has been made it might be repeated at the high frequency end of the tuner. If any appreciable change is

LIST OF PARTS

Coils

T1, T2, T3—Three shielded radio frequency transformers as described.

Condensers

C1, C2, C3—One three-gang, 0.0005 mfd. tuning condenser.
Ca—Three trimmer condensers, one for each tuning condenser.
C4, C6—Two 0.1 mfd. by-pass condensers.
C5, C7, C11, C12, C13—Five 2 mfd., or larger, by-pass condensers.
C8—One 0.00025 mfd. by-pass condenser.
C9, C10—Two 0.01 mfd. stopping condensers, mica dielectric.

Resistors

R1, R2—Two 300 ohm grid bias resistors.
R3, R7—Two 250,000 ohm coupling resistors.
R4—One 2 megohm grid leak.
R5—One 2,000 ohm grid bias resistor.
R6—One 50,000 ohm resistance.
R8—One 1 megohm grid leak.
R9—One 1,250 ohm resistor.
P1, P2—Two 30,000 ohm potentiometers.

Other Parts

Two knobs, one for each potentiometer.
One dial for gang condenser.
Five UY sockets.
Five grid clips
One 7 x 12 panel.
One 8 x 12 subpanel.

Grid Auto Receiver

Anderson

needed in the trimmer condensers, the line-up is not as good as it should be, but it will be typical of ganged-tuned receivers. If the discrepancy is very large it may be necessary to add a turn, or subtract one, from one of the coils, or else to move a coil slightly in its shields. This is entirely a matter of cut and try. If the trimming is fair the final adjustment of the trimmers should be made at mid-band, say a 900 kc. If the circuit is trimmed there there will not be much detuning at the ends.

The secondaries of the three radio frequency transformers T1, T2 and T3, contain 70 turns each of No. 28 enameled wire wound on 1.75 inch bakelite tubing, with the turns spaced so that the winding is 1.567 inches long. These coils with .0005 mfd. condensers cover the broadcast band. The primaries of T2 and T3 contain 25 turns each of No. 34 silk-enamel covered wire wound in a slot $\frac{1}{8}$ inch wide, separated from the secondary by a space of $\frac{1}{8}$ inch. The primary of T1 is the same as those of the other coils except that it has only 15 turns.

The coils should be mounted in metal shield cans not less than 3 inches in diameter and 3.5 inches high. The windings should be centered in these shields as nearly as possible so that the loss will be least and equal for all the coils and also so that the change in inductance and capacity will be the same for all the coils. If the shields are smaller than those specified the tuners may not cover the broadcast band even if the trimmer condensers are wide open.

Operation of Detector

The detector is a screen grid tube and operates on the grid bias principle. The adjustment of the detector tube for best detection is best accomplished by means of a potentiometer P2 connected between the screen return and ground, the cathode of the tube going to the slider. By sliding the contact the best combination of grid bias and screen voltage can be found instantly by simply listening for greatest output. While two fixed resistors could be used in place of the potentiometer, they would not provide the adjustment feature which is very desirable for the purpose of controlling the volume. As the cathode contact on the potentiometer is moved toward the screen the grid bias is increased and the screen voltage is decreased, reducing the output of the tube. As the slider is moved toward the ground a point will be found where the detecting efficiency is greatest, as evidenced by greatest output. As the slider is moved nearer the ground the detecting efficiency decreases slowly and even when the cathode is connected to ground there is still some detection.

The detector is coupled to the next tube by means of a 250,000 ohm resistance R3, a .01 mfd. condenser C9, and a grid leak resistance R4 of 2 megohms. This combination presents a high impedance to the tube and transfers a high detected voltage to the first audio frequency amplifier.

Screen Audio

The first audio stage contains a screen grid tube and it is coupled to the output tube by means of a resistance-capacity coupler consisting of a 250,000 ohm resistor R7, a .01 mfd. condenser C10, and a grid leak resistance R8 of one megohm. These values insure a high amplification at all frequencies down to 50 cycles per second or less. Since the screen voltage on a screen grid tube in a resistance coupled circuit must be much less than the voltage required when the load impedance to direct current is low, a 50,000 ohm resistance R6 is connected in screen circuit. The method of reducing the effective screen voltage is preferable to returning the screen lead to a lower voltage on the battery because an extra supply lead is avoided.

A low voltage on the screen, whether it is produced directly or indirectly, as in this circuit, reduces the amplification, but this is unavoidable, for without the low voltage on the screen the tube would not give distortionless amplification. It would only amplify part of the voltage cycle. The resistance R6 must be high enough, or the applied voltage low enough, to insure distortionless amplification, for otherwise the screen grid tube cannot be used in an audio stage. The reduction in the amplification is not great and the tube with the resistance coupler after it gives just as much gain as a three-element tube with a high ratio audio transformer would give. The voltage amplification is of the order of 40 times for this stage.

Output Power

If the signal voltage, peak value, is equal to 13.5 volts the output power will be 375 milliwatts, which is plenty for an automobile set. A magnetic type loudspeaker is recommended, or else a small dynamic speaker provided with a step-down transformer

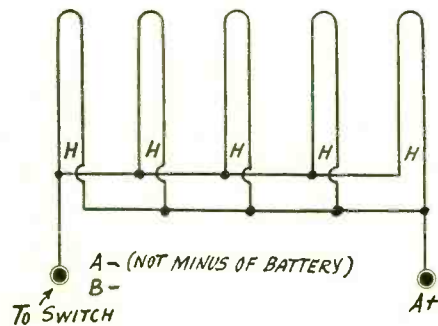

FIG. 2

Sketch of the heater circuit of the receiver in Fig. 1, showing the position of the switch with respect to the heaters and the B battery.

which will match the impedance of the tube and that of the speaker. The load impedance for greatest undistorted output should be 15,000 ohms.

The grid bias resistors in the circuit must be carefully selected so as to give the correct grid voltages on the tubes. For the radio frequency screen grid tubes bias resistance of 300 ohms are correct and hence R1 and R2 should have this value. The bias on the detector is adequately taken care of by the potentiometer P2 previously discussed. The value of R5 was determined experimentally by taking a curve on the tube as adjusted, that is, with a 50,000 ohm resistance in series with the screen lead, a 250,000 ohm resistance in the plate circuit, a voltage of 67.5 volts in the screen circuit and a voltage of 135 volts in the plate circuit. The curve showed that 2,000 ohms for R5 was satisfactory. A curve was also taken on the pentode output tube to determine the proper grid bias resistance, and it was found that R9 could be 1,250 ohms, although any value between 1,000 and 1,500 ohms gave satisfactory operation.

Values of Condensers

Each of condensers C4 and C6 should be a 0.1 mfd. by-pass. This value reduces the effective impedance of the bias resistor to less than 3 ohms at the lowest broadcast frequency and to about one ohm at 1,500 kc. Therefore there is practically no reduction in the amplification due to feedback through the bias resistance. C7 works at audio frequency and should therefore be as large as practical. A value of 2 mfd. is suitable, although a larger one is desirable. The same applies to C5, C11, C12 and C13. A value of .00025 mfd. is large enough for C8, since this practically short-circuits the out of the detector for the radio frequencies while it produces very little loss at the highest audio frequency.

P2 controls the input to the audio frequency amplifier very well by controlling the detecting efficiency of the tube, but it does not control the amplification ahead of the detector tube. It is desirable to have another control, and this should be placed as far forward in the circuit as possible. For this reason another potentiometer P1 of 30,000 ohms is put across the first primary, that is, across the antenna coil. The 236 screen grid tubes are not suitable for amplification control by varying the grid bias, for they are not of the exponential or variable mu type. Hence the first volume control should be placed in the antenna circuit. If it is not desired to have knobs for both P1 and P2 on the panel, one should be there for P1, the P2 knob then being placed on the subpanel.

All the tubes are of the so-called automotive type requiring a filament voltage of 6.3 volts. Therefore all the heaters should be brought out to a pair of leads which in turn should be connected across the car battery, or across any other 6 volt storage battery. The total filament current is 1.5 amperes so that the drain on the battery is relatively small.

The plate voltage should be supplied by a 135 volt dry cell battery which may be tapped at 67.5 and 90 volts. Sometimes the common screen lead may be connected to 90 volts instead of 67.5 volts as this may give better amplification. When the set is not in use the negative lead to the battery should be opened for otherwise the potentiometer P2 would continue to draw current when the set is turned off. If the heater circuit is arranged as in Fig. 2 with B minus connected to the negative side of the heaters, the filament switch sw will break both the heater and the potentiometer circuits at the same time. The negative of the car battery is usually grounded to the chassis of the car so no other ground is needed, provided the connection indicated in Fig. 2 is used.

Here It Is! The All-Wave AC

Variable Mu and Pentode Tubes and Front Panel Wave Band

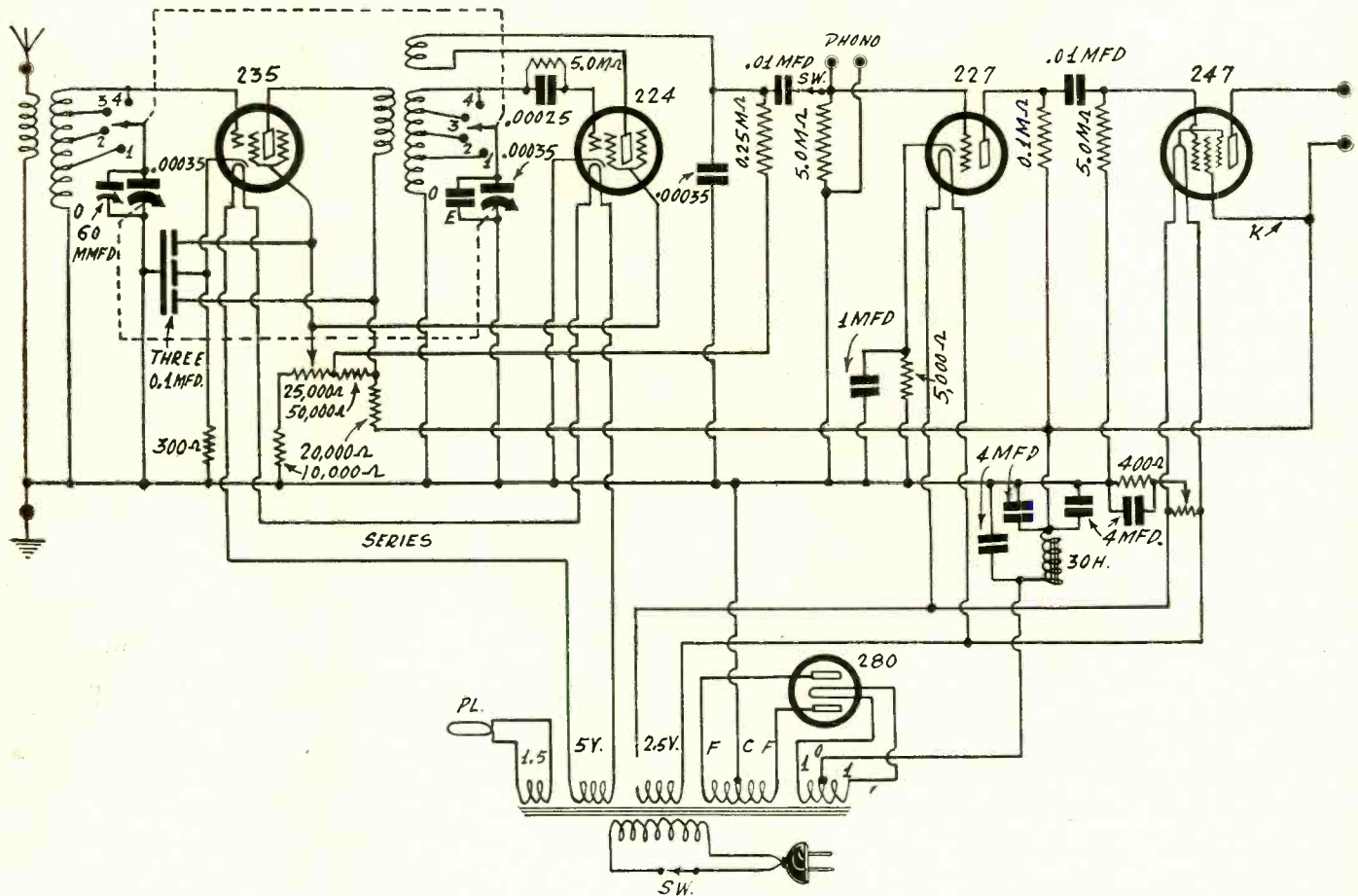

FIG. 1

The AC-operated all-wave set, AW-5, with 235 r.f. amplifier and 247 output. The broadcast band is tuned in completely, without disturbing the switch setting. An 0.5 meg. is suggested from detector screen to pointer.

AN all-wave AC-operated set, with pentode output, the quality of the output achieving the television requirement, all assembled with speaker in a midget mantel clock type Gothic cabinet! Range, 15 to 550 meters.

Here it is, the AW-5!

The fun of it is that it works very well indeed, thank you. The circuit was given to a trained service man to build, to be sure, but there is nothing tricky about the construction, and it is no doubt true every reader of these lines could reproduce the result.

The expert service man who built it was Walter J. McCord, as part of his work for Polo Engineering Laboratories.

"What I liked about it," said he, "was that after it was built all I had to do was to flip the switch and tune in stations with ease. Usually when one builds a set, I don't care how much experience he has had, there is some trouble with it, and it takes time to locate and get rid of it. The time that might have been spent in trouble-shooting was spent instead in tuning in foreign stations, which the boys must admit is better sport."

High-Class Audio

Trouble in midget sets would be particularly distressing, as there is seldom any remedy except to build the cussed thing all over again. There is no room to insert remedies. In fact, one can't see much of the wiring, as it is hidden by parts and by superimposed wiring. Having built something, it is decidedly disheartening to have to tear it down. If someone else had built it the destruction would not be annoying, because there would go along with it a feeling of superiority.

Well, it was good to have a trouble-free circuit so compactly built, and using inexpensive parts.

Simplicity attends the circuit. There is the familiar pattern of a stage of tuned radio frequency amplification and a regenerative detector, followed with audio amplification. In this case the audio amplifier is a two-stage resistance coupled channel, the volume being sufficient for speaker operation because a pentode tube (247) is used in the output. This tube has an amplification about 25 times greater than that of the 245, so where a two-stage resistance coupled audio amplifier is not enough to bring out peppy signals, using a 245 output, it is enough with the new tube.

Panel Switch Changes Wave Band

The now accepted switch method of changing the wave band is used. The switch is a double throw four-point device, with the shaft insulated from all sections. The broadcast band is tuned in without moving the switch. The succeeding bands are tuned in, down to 15 meters, simply by turning the knob.

The 235 tube is used as radio frequency amplifier, the 224 as detector, because of its high output possibilities, while the first audio tube is a 227, preferred on account of its sure-fire stability as compared to the 224 as an audio amplifier. The 227 feeds the pentode. The plate current is not so large to require an output filter for any of the good magnetic speakers, such as the Rola.

The resistance coupled audio amplifier can not be beat for quality amplification, if it is properly circuited and bypassed, although if the gain is too great there is audio frequency feedback and the quality is 100 per cent. absent.

(Continued on second column of next page)

Set!

Switching

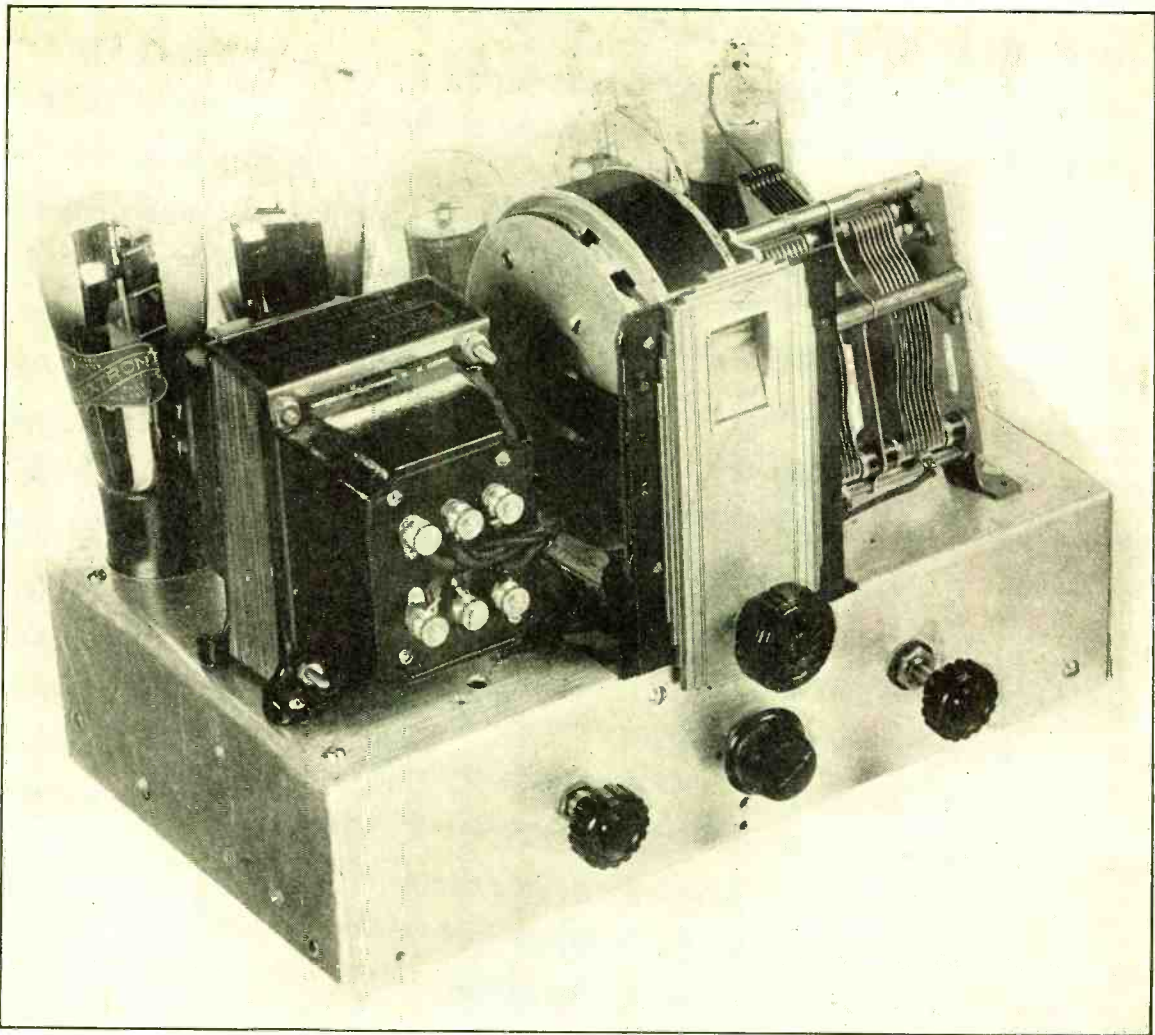

FIG. 2

A side view of the AW-5. The tubes, right to left, are 235, 224, 227, 247 and 280. The potentiometer knob is at left.

LIST OF PARTS

Coils

- One antenna coil for .00035 mfd. tuning, 70-turn secondary tapped at the 47th, 62nd and 67th turns (AW-5-AL).
- One interstage coil for .00035 mfd. tuning, 70-turn secondary tapped at the 47th, 62nd and 67th turns (AW-5-IL).
- One type K power transformer (2.5 volt winding, two 5 volt windings, and high voltage secondary to afford 300 volts DC output).

One 30 henry B supply choke coil.

Condensers

- One two-gang .00035 mfd. tuning condenser with straight frequency line plates.
- One block of three 0.1 mfd. condensers in one case (common black lead to grounded B minus).
- One 60 mmfd. manual trimming condenser.
- One equalizing condenser, 20-100 mmfd. (E).
- One .00025 mfd. grid condenser with clips.
- Two .01 mfd. mica fixed condensers.
- One .00035 mfd. fixed condenser.
- One 1.0 mfd. bypass condenser.
- Four 4 mfd. electrolytic condensers, with brackets (two condensers used in parallel after rectifier may be single 8 mfd).

Resistors

- One 300 ohm Electrad flexible biasing resistor.
- One 25,000 ohm potentiometer with AC switch attached.
- One 20,000 ohm pigtail resistor.
- One 10,000 ohm pigtail resistor.
- One 50,000 ohm pigtail resistor.
- One 5.0 meg. cartridge type grid leak (not pigtail).
- One 0.25 meg. pigtail resistor.
- One 0.1 meg. pigtail resistor.
- Two 5.0 meg. pigtail resistors.
- One 400 ohm Electrad type B biasing resistor.
- One 5,000 ohm pigtail resistor.
- One 0.5 meg. pigtail (detector screen to pointer).
- One 30 ohm center tapped resistor.

Other Parts

- One antenna binding post. One ground binding post.
- One twin Jack speaker assembly
- One twin Jack phonograph assembly.
- One National type H drum dial, with pilot light and socket.
- One dual switch, double pole, four point, with insulated shaft.
- Two insulators for potentiometer, if metal chassis is used.
- Two extra knobs for manual trimmed and potentiometer 1/4-inch shaft (switch and dial have own knobs).
- One metal chassis, with one UX (four-prong), and four UY (five-prong) sockets.
- Two dozen 6/32 nickel plated machine screws and two dozen nuts.
- One roll of slideback hookup wire. Two grid clips.
- Four right angle brass brackets, 5/8-inch, for mounting coil forms.
- One phonograph switch.

(Continued from preceding page)

The author has not been so keen about screen grid tubes as audio amplifiers just because they can be gaited to a tremendous gain—altogether too tremendous. So there might be instability, which is disastrous. A way out, used by several designers who like the advertising value of the screen grid tube even in the audio channel, is to lower the amplification, usually by having low value plate resistor, and the net gain then approximates the gain that would be obtainable from a stable 227 worked at its limit.

Remedy Readily Applied

Television receivers subscribe to this low plate resistor method. It is obvious that low values for plate resistors destroy the function of the tube as a screen grid tube and cast it into the realm of the three element tube. Another way of looking at it is that the plate is partly short-circuited by the low resistor, and the operation is that resembling a screen grid tube with screen and plate tied together, which equals a 227.

The only qualification in respect to the audio amplifier is that the recommended values of grid leaks may be too high for some installations. It is well to have as high a value as practical. The tonal response at the low frequencies is better and the amplification all along the line is higher. But if low-frequency instability arises (motorboating), then the value of either audio grid resistor may be reduced to what will bring about operation without any trouble, because put-putting means there is too much low-frequency audio amplification.

In fact, no such instability was encountered, but the situation is discussed for the benefit of those who may have the misfortune of running into motorboating. Simply connect another 5 meg. leak or smaller value in parallel with an existing one (either grid circuit) if you want to introduce the remedy with least effort.

The Pentode Connections

The audio circuit is simple, and is a familiar one, except perhaps for the pentode tube. The grid, plate and filament connections are standard for this tube, which takes a UY (five-prong) socket. The fifth connection, to what would be the cathode in the case of a 227 or similar tube, is here a screen, which is connected to the maximum B voltage.

The pentode really has two screens, but one of these is tied to the filament center, inside the tube, hence requires no additional external connection. The screen lead that does require the external connection to maximum B plus is marked K in the diagram because of its correspondence to what would be the cathode connection in other type tubes.

(Continued on next page)

AW-5 Circuit Analyzed

How Current Flows Through the Resistor Network

Coils for Circuit Different for Metal and Non-Conductive Chassis

(Continued from preceding page)

If the speaker is of the magnetic type it may have a high direct current, and this can be determined by measuring the voltage between the K screen (B plus maximum) and the center of the filament, and comparing the reading with that obtained from plate to center of the filament. If the difference is more than 15 volts it should be taken up, that is, an unbypassed resistor connected between K screen and maximum B plus. The resistance value will be about 150 ohms per volt to be dropped.

Attention to R. F. End

The radio frequency end needs the most constructional attention. The coils are placed at magnetic right angles to each other, so they may be physically close together at the right hand side, underneath, when one regards the set with front panel towards him. One coil is bracketed to the front flap of the chassis, the other to the right side flap.

The coils are wound on 1.75 inch diameter natural bakelite.

The antenna coil consists of two windings. The primary has 14 turns, the secondary, which is begun one $\frac{1}{8}$ inch away, has 70 turns. The taps on the secondary, counting from the grid end, are at the 47th, 62d and 67th turns. Therefore the number of turns between taps is 47 turns between (4) and (3), 15 turns between (3) and (2), 5 turns between (2) and (1), and 3 turns between (1) and (0). The wire is No. 28 enamel covered. Larger wire may be used on the primary, if desired, as there will be enough room on a form 3 inches long.

The interstage coil has three windings. The primary consists of 20 turns, the secondary is exactly the same as the other secondary, and the separation between primary and secondary, and between tickler and secondary is $\frac{1}{8}$ inch also. The tickler, at the opposite end, consists of 20 turns of No. 28, or, if preferred, finer wire, wound in the same direction as the secondary, which method then requires that the B plus and the ground terminals of these windings physically adjoin on the coil form. In any event, if oscillation fails, reverse the connections to the tickler.

The above directions for winding the coils apply only if a non-metallic chassis is used. If the chassis is metal, then the closeness of the coils thereto produces the same inductance reduction as if the coils were totally shielded. Therefore for metal add $\frac{1}{2}$ to the number of turns specified in the immediately preceding paragraphs.

The Resistance Network

Oscillation is controlled by the potentiometer. The resistance circuit at the screen grid and plate returns, at left in the diagram

shows that the potentiometer is worked at a relatively high voltage in respect to B minus, so that in no case can you dip down to zero.

The circuit is unstable when low values of screen voltage are applied, therefore a limiting resistor, 10,000 ohms confines the potentiometer to a certain minimum positive voltage. No infallible resistance value can be given, although 10,000 ohms is suggested. So if you hear a gurgling or rumbling sound, take it as a cue to increase the value of this resistor, from B minus to one side of the potentiometer.

The value of one resistance depends on that of another in this part of the circuit. It is assumed that the potentiometer is 25,000 ohms, but if it is of greater resistance value, then the limiting resistor should have a higher value, too. In general, the two should be somewhere nearly equal for this circuit.

100 Volts on Potentiometer

It will be seen that a 20,000 ohm resistor is in series with the plate winding at the output of the 235. This reduces the maximum B voltage to a satisfactory value, around 200 volts. It is all right to use up to 200 volts on the plate of this tube.

The resistor that drops the applied plate voltage on the 235 tube to 100 volts maximum for the potentiometer is 50,000 ohms. It should be observed, therefore, that the plate current of the 235 flows through the right-hand 20,000 ohm resistor in Fig. 1, and this resistor is in series with the potentiometer and two resistor adjuncts.

The plate current flows from B plus through 20,000 ohms to the plate of the 235, the bleeder current of the series chain of four resistors (in which the potentiometer total is as a fixed resistor) flows through this 20,000 ohm unit as well as through the three other resistors, while the screen current flows from the screens of the two tubes to the pointer connection to the potentiometer through the 20,000 ohm limiting resistor on the low side to grounded B minus.

Watch Switch Connections

The taps on the coils are connected to switch points. The switch is of the dual type, whereby one motion changes two circuits. There are four points on each of the two layers or sections, and two moving contactors, so the switch is of the double pole, four point type. The connection to the moving arms (which of course are insulated from each other) is made through two switch points that are exactly like the points to be connected to the coil, so the switch will have to be inspected. Long lugs reaching to the moving arms will be seen on the inside. These connect to stator or the tuning condensers. The switch shaft is insulated from everything.

[Other Illustration on Front Cover]

U. S. is Far in Lead with 14 of Total 35 Short-Wave Stations

The United States leads the world in short-wave broadcasting, fourteen of an international total of thirty-five stations being located in this country, according to a survey made by the foreign department of the Pilot Radio & Tube Corporation.

Of twenty-nine other countries with short-wave facilities, none has more than two stations. Great Britain has only one, as have Germany, Austria, Holland, Rumania, Russia, Czechoslovakia and Norway.

France opened her first station only last month, while Italy has two very successful transmitters in Rome. Honduras, Costa Rica, Colombia and Brazil each has small but efficient stations. Canada has two transmitters. Mexico a single powerful outfit in Mexico City. Australia, New Zealand and Siam have two apiece, the Dutch East Indies, the Philippine Islands and Japan one each. There are two small stations in India and a very large one in French Indo-China.

The most widely known stations, according to the survey, are W2XAF-W2XAD in Schenectady, N. Y.; W8XK in Pittsburgh, Pa., and PCJ in Eindhoven, Holland. The Dutch station is regarded as having the largest international audience, as it is continually broadcasting special programs timed for the most convenient reception in different countries of the world. Announcements from PCJ are made regularly in six languages—Dutch, German, French, English, Spanish and Portuguese—and all by the same man!

Many announcers are poly-lingual.

Current List Prices On Receiving Tubes

The following table gives the prevailing price lists of the various tubes:

Tube	Price	Tube	Price	Tube	Price
227	@ \$1.25	551*	@ \$2.20	WD-11	@ \$3.00
201A	@ \$1.10	171A	@ \$1.40	WX-12	@ \$3.00
245	@ \$1.40	112A	@ \$1.50	200A	@ \$4.00
280	@ \$1.40	232	@ \$2.30	222	@ \$4.50
230	@ \$1.60	199	@ \$2.50	BH	@ \$4.50
231	@ \$1.60	199	@ \$2.75	281	@ \$5.00
226	@ \$1.25	233	@ \$2.75	250	@ \$6.00
237	@ \$1.75	236	@ \$2.75	210	@ \$7.00
247	@ \$1.90	238	@ \$2.75	BA	@ \$7.50
223	@ \$2.00	120	@ \$3.00	Kino	
235	@ \$2.20	240	@ \$3.00	Lamp	@ \$7.50

* This is comparable to the 235.

Short-Wave Time-Table

A time table of principal short-wave transmissions will be published in the Special Short-Wave Number of RADIO WORLD, dated July 11th. No matter in what time zone you reside, you can tell what important stations are on the air the world over. Be certain to get a copy of this special number.

Curves on the 247 and 238

By Brunsten Brunn

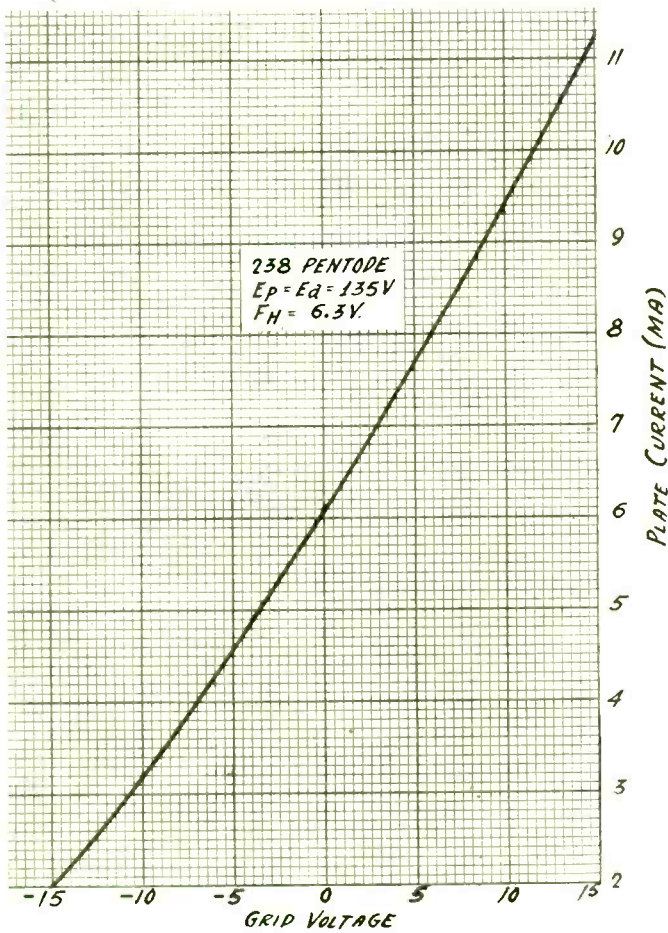

FIG. 1

A grid voltage, plate current curve of a 238 pentode tube taken with a grid bias resistor in the circuit. Signal voltages of 15 volts, plus and minus, are represented.

WHEN a grid bias resistor is used for self-biasing the grid of a tube, the grid voltage plate current curve should be taken with both positive and negative voltages in the grid circuit, superposed on the bias supplied by the resistor, for the signal voltage varies in both directions about the bias maintained by the resistance when no signal is impressed.

This does not mean that current readings are taken with a positive bias. The observations should be stopped when the applied positive bias is equal to the negative bias maintained by the resistor, for then the effective bias on the grid is just zero.

In Fig. 1 is a grid voltage plate current curves of a 238 pentode with 135 volts on both the screen and the plate, the current being only the plate current. The voltage at the zero point on the grid voltage axis is equal to the operating grid bias as maintained by the bias resistor, and voltages to the left of this point are voltages less or more negative than the operating bias, and voltages to the right are higher, of less negative, than the operating bias.

Linear Characteristics

The resulting curve taken between 15 volts, plus and minus, is gratifyingly linear, indicating a very low order of distortion. The voltages indicated on the grid voltage axis are not the actual voltages on the grid, for the drop in the bias resistance varies with the current, but the curve gives a true indication of what happens to the signal voltage, and that is the important thing. For example, when the indicated voltage is minus 15 volts the actual grid voltage is slightly more than this, and the excess is the product of the total screen and plate current multiplied by the grid bias resistance. This happened to be in this instance 1,385 ohms. The plate current at 15 volts minus is 2 milliamperes and the total current through the resistance is approximately 2.6 milliamperes. Hence the actual grid voltage is 3.6 volts more than 15 volts, or 18.6 volts.

When the indicated voltage is 15 volts, positive, the actual grid voltage is less than this by the amount of drop in the bias resistance. The plate current is 11.3 milliamperes and the total current through the resistance is approximately 14.85 milliam-

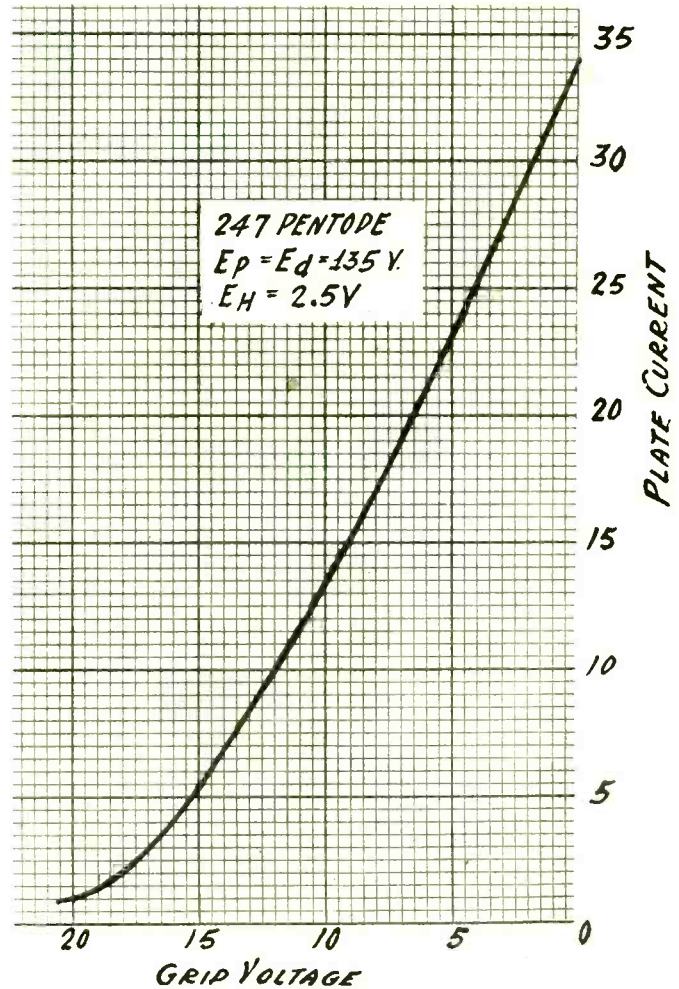

FIG. 2

A grid voltage, plate current curve on a 247 pentode with 135 volts on the plate and the screen. No bias resistance was in the circuit and the grid voltages indicated are actual.

peres. Hence the drop in the bias resistance is 20.6 volts negative. Therefore the actual voltage on the grid is 5.6 volts negative. The signal voltage could have been increased by about 6 volts without driving the grid positive. At the point where the signal voltage is zero the operating bias is about 11 volts negative.

Effect of Self Bias

Self bias reduces the amplification of the tube if there is no by-pass condenser across the resistance, and for very low frequencies a condenser does not do much good, even though it be quite large. But apparently there is an advantage in self bias in that the distortion is reduced. As the signal voltage increases in the negative direction the plate and screen currents decrease and the actual grid voltage does not go negative as rapidly as the signal. Thus the curvature at this end is reduced, minimizing distortion. On the other hand, when the signal voltage goes positive the plate and screen currents increase and the drop in the bias resistance increases. Thus the actual grid voltage does not increase, that is, approaches zero, as rapidly as the signal. Since the plate current curve increases as the grid voltage approaches zero the rise is not as rapid as it would be without the self bias. Again distortion is reduced. It is for these reasons that the curve in Fig. 1 so nearly approaches a straight line. While the curve in Fig. 1 does not indicate the plate current for the actual grid voltage it does truly represent the amplification of the signal.

Curve of 247 Pentode

In Fig. 2 is a grid voltage, plate current curve of the 247 pentode with 135 volts on the plate and the screen and 2.5 volts on the filament. The curve gives the plate current alone, without self bias. The curve indicates that a suitable operating bias for these applied voltages is 8 volts, when the plate current will vary between 34 and 4 milliamperes when the signal peak voltage is equal to the bias. The plate current at 8 volts bias is 17.1 milliamperes.

A One Tube A. C.

By Her

A ONE tube all-wave adapter was built on a top panel $6\frac{1}{2}$ by 5 inches, so as to pick up all the voltages from an AC-operated broadcast receiver that uses 224, 235, 227 or other UY tubes in the radio frequency amplifier.

The method of obtaining the voltages in this way requires interconnection of ground posts of adapter and set, and use of a five-prong plug from which five corresponding leads emerge, but only three of these are utilized: two for the heater and one for the plate of the broadcast set. Which lead is which can be determined by a continuity test, using a dry cell and a flashlight bulb, or a dry cell and a voltmeter. It is assumed the builder is familiar with the identity of the prongs of a UY socket and plug.

The 2.5 volts for the heater are communicated directly, but the plate lead from the set to the adapter is bypassed by a 0.1 mfd. or larger capacity condenser to remove the radio frequency from any winding in the broadcast set's plate circuit. This method puts a choke-condenser bypass circuit in the plate portion of a tube's hookup.

Wide Latitude for 2R

The heater and plate voltages are the only ones required for the adapter from the broadcast set, since even if a screen grid tube is used in the adapter, the screen voltage is dropped from the plate voltage by suitable resistors. Thus whatever is the value of the potentiometer R, the limiting resistor on the high voltage side of the resistor network is at least twice as great (2R), and may be several times greater, the only precaution necessary being that the limiting resistor must not be too high to permit oscillation.

This of course relates directly to the number of turns on the tickler coil. Experimentally 25 turns were used, R, the potentiometer, was 250,000 ohms, and oscillation was present all over the band, 20 to 550 meters, when 2R was 2.5 meg., or ten times as large as R. This was because the current was so small through the limiting resistor that the voltage drop was small.

Another relationship to the feedback is the number of turns on the primary in the antenna circuit. The smaller this winding, the lower the resistance in the antenna-ground circuit and in the tuned secondary.

Any kind of a substantial primary in the antenna circuit results in poor separation of broadcast frequencies, therefore only a single turn of heavy wire (No. 18 enamel) was used, being placed inside the 1.75 inch diameter natural bakelite form on the outside of which the two other windings were put. This single turn is easily made by putting your index and middle fingers straight out together, winding the turn around them and bending the wire at right angles to permit long outleads, say, 3 inches each. Then one outlead is attached to one end of the form, after the one turn coil is inserted, and the other outlead at the other end of the form.

Coil Data

The form should be 3 inches long. A $6/32$ hole is drilled (No. 28 drill) $\frac{1}{2}$ inch from one end of the form. This will be used for mounting the form after the coil is wound. Only four other holes are necessary, one each for the terminals of the secondary and the tickler. If outleads are left 4 inches long they may be used for connecting purposes when cut down and cleaned of insulation at the extremities.

About $\frac{1}{4}$ inch away from the mounting hole drill smaller hole for the beginning (plate connection) of the tickler coil, using any kind of insulated wire, and it may be as fine as desired. Put on 15 turns and terminate. This terminal will be for plate return. Leave $\frac{1}{8}$ inch and start winding the secondary, which consists of 110 turns of No. 28 enamel wire. The three intermediate taps, which by switch control permit wave band selection from the panel, are loops on the outside of the winding. For instance, five turns are put on the secondary, and a tap taken. This requires making a small loop and twisting the parallel wire around and around, about eight or ten times. Put on 20 more turns, tap, twenty more turns, tap, and then wind 65 turns. The total is 110 turns. Now the loops are scraped with a dull knife, so that the enamel insulation is removed, and the taps are ready for soldering. Likewise when the true length of the outlead wires is determined, after the coil is mounted, the excess will be cut off and the wire scraped clean at the tips.

There are three binding posts at rear. As you look at the top of the panel, in the position occupied when you are tuning, the

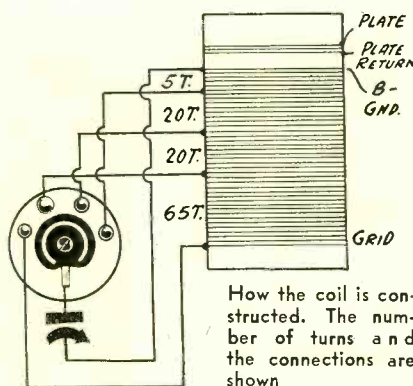

How the coil is constructed. The number of turns and the connections are shown

left-hand post is for connection to the grid circuit of the first audio tube of the broadcast set, the middle post is ground and the right-hand post is for aerial. Put on the ground post, with a lug at bottom, and screw a threaded $6/32$ brass bushing, $\frac{3}{8}$ inch long, onto the protruding screw of the binding post, at bottom of the panel. The free end of the threaded bushing therefore is ready to receive a $6/32$ screw, so get one with $\frac{1}{4}$ inch length or cut a larger one down to size with snippers, and the screw may be put through the coil form mounting hole, from the inside, to pierce the form and enter the bushing. Tighten down the screw.

Connections to the coil switch are facilitated if you put all the taps on one side.

A guiding tip is to hold the form up in front of you, with mounting hole toward you, and see that the taps are in line on the right-hand side. As the coil will be mounted with that hole away from you (as you look at the bottom of the total assembly), the taps will be on the left-hand side, adjoining the switch.

The grid condenser is soldered to the fourth switch tap, which is the lead that goes to grid of the 224 through this condenser. The grid is the control grid in this instance, and is represented by the cap of the tube. The wire thereto is passed through a hole in the panel and then a grid clip is soldered to this wire at the top of side of the panel.

A brass bushing of the same threaded type as used previously serves instead of a nut to engage the lower screw of the vernier dial. Then the three 0.1 mfd. condensers in one case may be turned down on the bushing, since there is an extruded screw on the case of this compound condenser unit.

The other parts are mounted in familiar fashion.

Connections to Be Made

It can be seen from the foregoing that the purpose of the adapter is to permit particularly short-wave reception on the speaker of a broadcast set by plugging into the first audio tube circuit of that set, and to permit reception of broadcast locals without disturbing the set-up. The connection to the first audio grid is made by removing the first audio tube and placing thereunder a looped bared wire end or a lug over the grid prong, if the first a.f. tube is a 227, or by removing the grid clip and using a new clip on the extra wire lead for connection to the cap, if the first audio tube is a 224. The circuit is completed by the grid load on the tube, in the set. The connection is made at the adapter end to the left-hand binding post (top view).

A switch plate has the numbers 1, 2, 3 and 4 on it, and 4 may be used for the full inductance, 3 for the next tap (65 turns from grid), 2 for the next (85 turns from grid) etc. In this way the higher numbers will represent bands of higher wavelengths.

The tuning condenser is a Hammarlund junior midline, .0002 mfd., and the plates move in a diameter of only 2 inches. The capacity is not large enough for full coverage of the broadcast band without switching, so the range of position 4 is about 550 meters to 260 meters. The next tap brings you down to 70 meters, and so on, until the fewest number of turns in the tuned circuit, with tuning condenser near minimum, brings you down to 15 meters.

It is preferable although not imperative to remove all the radio frequency tubes and the detector as well from the broadcast set when working the adapter, and then there is less chance of a very strong local coming through even faintly when the adapter is worked. The plug is inserted in a radio frequency socket, preferably the first r.f. stage, and the tube in the adapter will light.

Works on Any AC Set

The load on the detector plate circuit of the adapter is constant, so the troubles incident to more usual forms of adapters are removed. You do get an adequate plate load, the voltage will be sufficient to insure oscillation (since at least 100 volts always will be obtainable from AC-operated r.f. channels) and while the voltage never will be too low it may, on occasion, be too high.

When squawking sounds are heard in using regeneration on the higher frequencies (principally taps 1 and 2), is a sign that the plate voltage is too high. A grid leak of 5 meg. is specified. This makes for best sensitivity, as compared with lower values, but the resistance should be lower to correct any possible squawking, so 2 meg. may be tried, or a smaller value, until the trouble disappears. It is never present on the broadcast band, and will not show up at all until you are at least as far down as the 80-meter

All-Wave Adapter

by B. Herman

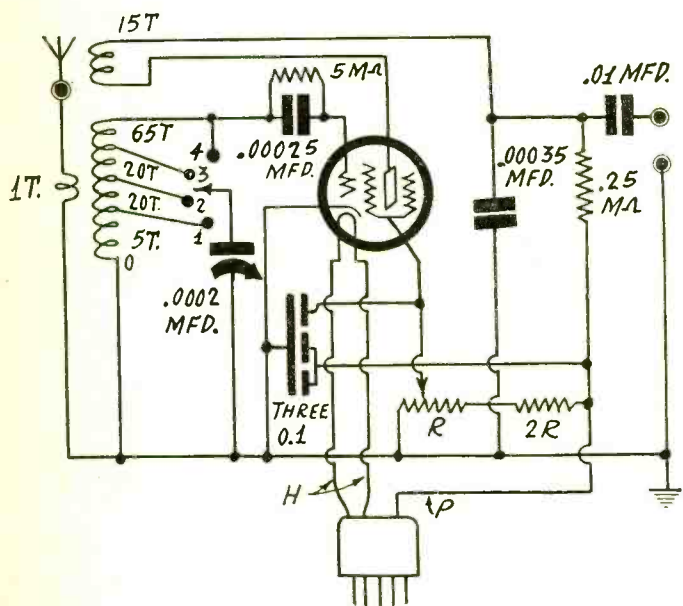

FIG. 2

The circuit of the all-wave switch-controlled adapter, using a screen grid tube, 224. Ground post of the adapter must be connected to ground post of a broadcast set to enable voltage pickup.

band. There are plenty of stations on this band, so your tests will be easy. The amateurs abound there.

By omitting the connection to grid of the first audio tube, ear-phone reception can be enjoyed. Simply connect phones from the middle binding post to the right-hand binding post (between ground and output of the adapter).

The coil data have been worked out experimentally, and there will be abundant overlap. The lower wavelength end of the broad-

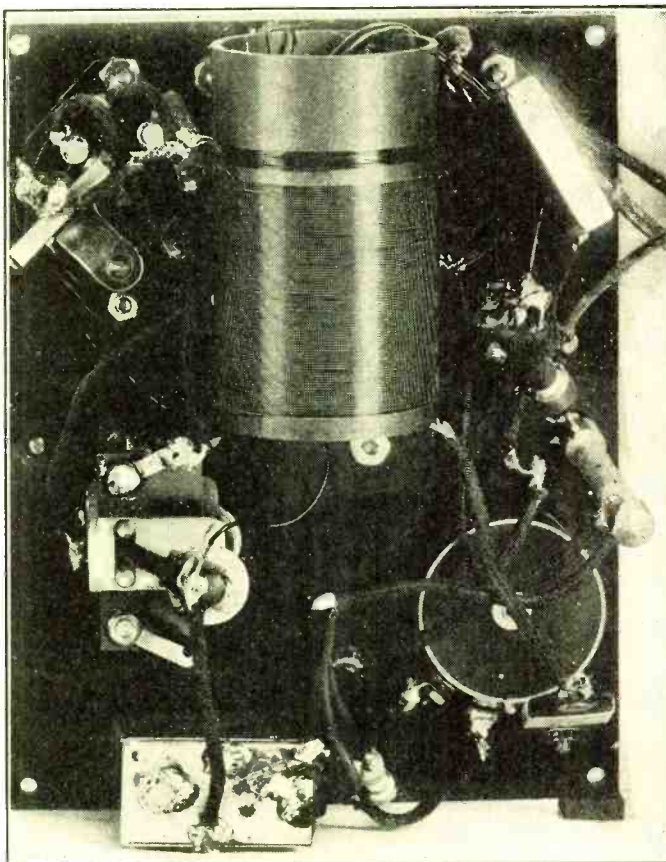

FIG. 3

View of the bottom of the panel of the all-wave adapter.

LIST OF PARTS

Coils

One 15-550 meter three winding coil for .0002 mfd.

Condensers

One .0002 mfd. Hammarlund junior midline tuning condenser.

One .00025 mfd. grid condenser with clips.

One .00035 mfd. fixed condenser.

One .01 mfd. fixed condenser.

One block of three 0.1 mfd. condensers in one case (black is common and goes to grounded B minus).

Resistors

One 0.25 meg. Lynch metallized pigtail resistor.

One potentiometer, at least 3,000 ohms. (R)

One Lynch metallized (2R) pigtail resistor, at least twice the value of the potentiometer.

Other Parts

Three binding posts.

Two 6/32 threaded brass bushings, 5/8 inch high.

One single throw four-point inductance switch with numerical plate.

One bakelite disc for mounting coil switch.

One UY (five-prong) socket.

One 5 x 6.5 inch drilled bakelite panel.

One walnut finish wooden cabinet to match.

One grid clip.

One vernier dial.

One lug.

One roll of hookup wire.

One dozen 6/32 machine screws and one dozen nuts to match.

Four wood screws for attaching panel to cabinet.

One cable (five leads) with UY plug attached.

Two pointer knobs for 1/4 inch shaft.

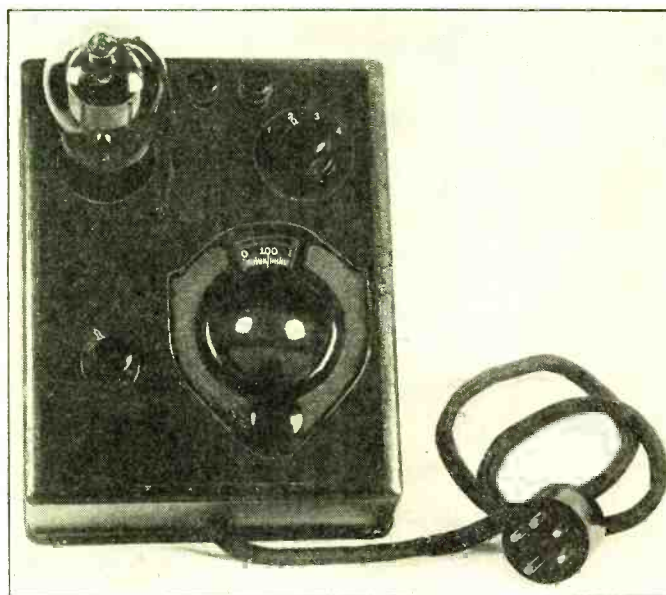

Fig. 4

The inductance switch is at the right of the tube, while the volume control is at the left of the vernier dial

cast band dovetails nicely into the tuning of the next smallest part of the inductance, while the overlap between points lower down in
(Continued on next page)

Television-Engineering

Radio, Optics and Physics Lay the Foundation

By Hollis Baird

Chief Engineer, Shortwave and Television Corporation

"What should a young man study to prepare himself for television work?"

This question has been asked very often lately and its answer shows that there is much for the embryonic visual radio engineer to absorb and digest in order to succeed.

In the first place, mere radio training doesn't mean that a man is at all qualified for television. A man can be a crack radio engineer and have as much difficulty approaching television as the former electrical engineer did when he tried to tackle radio.

Radio Is the Connecting Link

Yet it is absolutely essential that a television engineer be exceptionally well-versed in radio, for radio is the connecting means which brings television from the pickup to the television receiver output device.

But once radio is mastered, the question of television itself comes up and the point long neglected by radio engineers trying to work on television is that television is primarily an optical device and that therefore a thorough knowledge of optics is essential for the television research worker.

There are very few radio men who know anything about optics and I strongly advise study on this subject. Incidentally, the best known text book on this subject is "Physical Optics" by Woods.

Problems in Physics Arise

Having a knowledge of radio and optics, the television engineer has a third subject which should be mastered, physics, since much of the television transmission and reception work is based on physical laws and particularly on that branch of physics known as mechanical engineering. A television pickup and projector offers many delicate mechanical problems.

It is quite obvious from the foregoing that television engineering is a distinct and high art in itself, one demanding engineering talent of diversified character and high efficiency. Television also demands a good practical sense, as the purely theoretical engineer will not get very far in this subject.

While one is studying the three subjects—radio, optics and physics—their apparent relation in the art of television will be realized by a good deal of practical work on actual television apparatus and I advise prospective television engineers to get equipped with a first-class television short-wave receiver and television picture reproducing machine and start making observations on the present television broadcasting.

Advise Practical Experiments

The radio side of television reception can best be appreciated by studying the latest type of short-wave receiver which gives sufficient tuned radio frequency amplification, without regeneration. Why regeneration is taboo is easily answered on a good television receiver with two stages of tuned r. f., giving sufficient sensitivity for good television reception. A throw of a switch may introduce regeneration and the young television engineer then can easily study the effects of varying amounts of regeneration on a picture, assuming, of course, that a modern television picture reproducer is used with the set.

With television possibly going into the real short waves, a receiver should permit the reception of such waves, and may cover the short-wave band from 15 meters up to 200 and also gives broadcast coverage.

Wide Audio Range

A further requirement is that the receiver be equipped with resistance coupled audio. This is essential since the audio end of a television receiver must respond to a band of frequencies eight times as wide as that for the broadcast band, bringing into the picture audio problems not present in broadcast reception.

Intelligent analysis of such points as these, combined with a thorough study of radio, optics and physics will prove a great help to any one who hopes to embark on a television career, doubtless the next great step in popular scientific progress.

How to Connect Adapter to Set

wavelength is considerable. There is no danger of any missout.

The diagrams and photographs give a clear picture of the connections and layout. The panel is drilled, the cabinet is made to fit.

Installation Directions

The installation directions are:

- (1)—Remove aerial from the broadcast set and connect it instead to the antenna binding post (extreme right) of the adapter.
- (2)—Leave the ground connected to the broadcast set and run

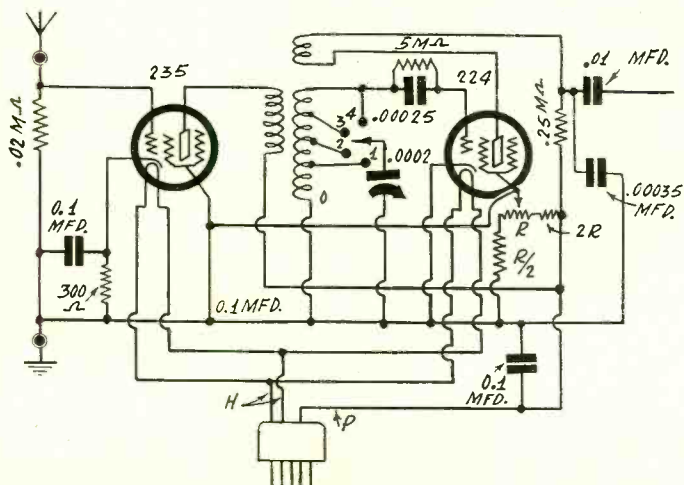

FIG. 5

Those desiring to build a two-tube all-wave adapter may follow this diagram.

a wire from the adapter's ground post (middle post) to the ground post of the broadcast set.

(3)—Run a wire from the output post of the converter to the grid of the first audio tube. Remove this tube (rf a 227) and put the grid prong into a bared noose at the end of this lead from the adapter, or use a lug, bent at right angles at the tube base bottom. If the first audio tube is a 224, the end of the output lead takes a grid clip that replaces the present connection to cap of that tube in the set.

(4)—Remove r.f. and detector tubes from the set.

(5)—Plug the adapter plug into one of the r.f. sockets or the broadcast set.

RADIO WORLD

	1 Inset	4 consec. Inset (each)	13 consec. Inset.	26 consec. Inset.	52 consec. Inset.
	10%	12 1/2%	15%	20%	
1 page	\$150.00	\$135.00	\$131.25	\$127.50	\$120.00
1/2 page	75.00	67.50	65.62	63.75	60.00
1/4 page	50.00	45.00	43.75	42.50	40.00
1/8 page	37.50	33.75	32.81	31.87	30.00
1/16 page	25.00	22.50	21.87	21.25	20.00
1 inch	18.75	16.87	16.41	15.94	15.00
	5.00	4.50	4.37	4.25	4.00

Classified advertisements, 7 cents a word; \$1.00 minimum; must be paid in advance.

Advertising Department

Radio World, 145 West 45th St., New York, N. Y.

Battery Short-Waver

By Einar Andrews

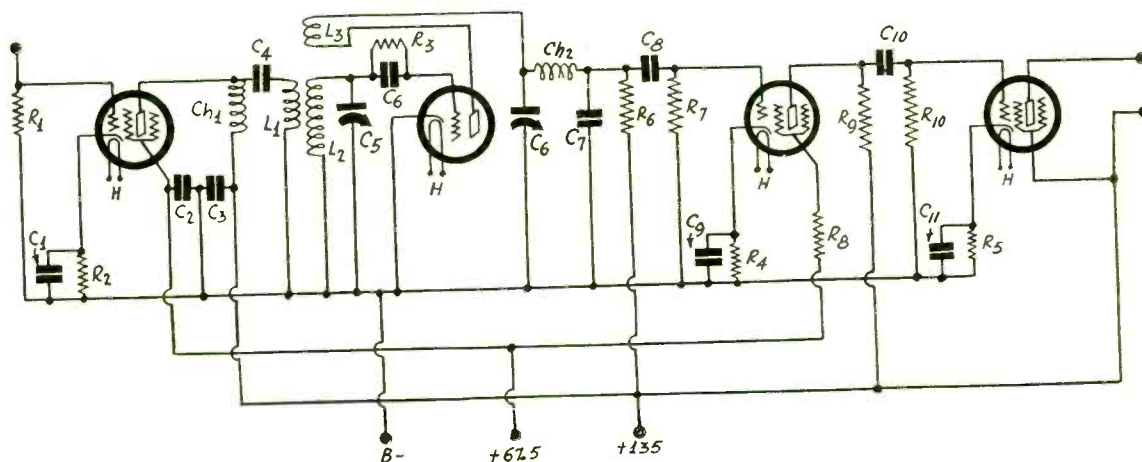

FIG. 1

In this short-wave receiver resistance coupled audio is used for high gain and good quality. A stage of untuned radio frequency boosts the amplification and increases selectivity.

HERE is a four-tube short-wave receiver with resistance coupling in the audio amplifier, but in other respects is practically identical with the four-tube short-wave receiver published last week. The question immediately arises as to which of the two is the better. A long tale is necessary to answer that question and after the tale has been told the answer would not be conclusive because both have advantages and both disadvantages.

At the outset we might say that the resistance coupled circuit is less expensive to build and also less expensive to operate, although in respect to maintenance there is not enough difference to worry about. One advantage of the resistance coupled circuit is that it takes less room to build, which is worth while.

In respect to selectivity there is no difference because the tuner is not affected by the change, that is, by the substitution of the resistance-capacity coupler for the transformer after the detector tube. In respect to sensitivity there may be a slight advantage in the transformer coupled circuit, provided a high ratio transformer is used between the detector and the next tube. In comparing the two circuits on a station 1,000 miles away there was no appreciable difference between the two as far as volume was concerned but the practical advantage was all in favor of the resistance coupled circuit. It brought in the station with less noise and with a steadier volume. The difference is to be found in the control of the regeneration rather than in the coupler between the two tubes.

It will be observed that the detector plate return in the resistance coupled circuit goes to the highest voltage available, that is, 135 volts. This was necessary in order to get regeneration

over the entire scale of the tuning condenser. Moreover, it was necessary to reduce the coupling resistance R_6 to 50,000 ohms. In the circuit the resistance R_6 was first a 200,000 ohm variable resistor. The tuning condenser C_5 was set at maximum and then the regeneration control condenser C_7 was turned and the point noted where the circuit broke into oscillation, as determined by the characteristic click. When R_6 was too large this click was not observed and it was only when it had been reduced to 50,000 ohms that click appeared. A fixed resistance of value was then substituted. This yielded oscillation all over the dial of C_5 and it could be controlled by C_7 . Incidentally, the 200,000 ohm variable resistance left in the circuit in series with the fixed 50,000 ohm resistance provided not only a good regeneration control but also a good volume control. However, it is not necessary to use both C_7 and the variable resistance.

When the circuit had been adjusted in this manner there was no squealing of the blocking type at any setting of the tuning or regeneration control condenser and the control of volume was very smooth. This accounted for the steadiness of the signals from the distant station.

The oscillation does not depend alone on the setting of C_6 and on the effective voltage on the plate, but also on the efficiency of the tuning coil L_2 and on the number of turns on the tickler L_3 . After the adjustment had been made for the tickler which had worked well with transformer coupling and also with the 50,000 ohm resistance in the plate circuit, the number of turns was doubled. This made the circuit uncontrollable and increasing the resistance in the plate circuit did not stop the oscillation satisfactorily.

Grid voltage plate current curves were taken on the screen grid and pentode tubes in the audio amplifier to check the grid bias resistor requirements. It was found this way that a resistance of 2,000 ohms was satisfactory for R_4 and a resistance of 1,300 ohms for R_5 . If a 1,250 ohm resistor is available that is just as good, but higher values than 1,300 or lower than 1,000 are not recommended.

The design of the coils for this circuit is the same as that of the coils for the circuit published on page 4, June 13th issue, the coil design appearing on page 5. The other parts required are given in the list herewith.

Condensers C_2 and C_3 are made one microfarad each so that they will serve as by-pass condensers across the B supply as well as by-pass condensers for the radio frequency currents.

The circuit must be grounded when in use, for otherwise it will be unstable. The ground should be connected to B minus.

In order to eliminate body capacity effects the front panel should either be of metal and connected to ground or else there should be a grounded metal plate back of the dials. Some dials are so constructed that this is automatically taken care of.

It is essential that a vernier dial, that is, slow motion dial, be provided for the tuning condenser C_5 for otherwise it may be that some weak stations will be passed over entirely. On the regeneration control condenser it is desirable to have a similar slow motion dial but in case it is necessary to maintain symmetry in the layout a simple knob can be used.

The first and third tubes are 236s, the second a 237, and the fourth a 238 pentode. The heater voltage H may be supplied either by a battery or a transformer provided the voltage is 6.3 or slightly more.

LIST OF PARTS

Coils

- Ch1, Ch2—Two 800-turn duolateral choke coils
- L1L2L3—One set of plug-in coils according to design cited

Condensers

- C1—One 0.1 mfd. by-pass condenser
- C2, C3—Two 1 mfd. by-pass condensers
- C4—One 0.0005 mfd. condenser
- C5, C6—Two Hammarlund 125 mmfd. tuning condensers
- C6 (grid condenser)—One 0.00025 mfd. condenser with resistance clips
- C7—One 0.00025 mfd. fixed condenser
- C8, C10—Two 0.01 mfd. condensers
- C9, C11—Two 2 mfd. by-pass condensers

Resistors

- R1, R9—Two 250,000 ohm resistors
- R2—One 300 ohm resistor
- R3, R7—Two 2 megohm grid leaks
- R4—One 2,000 ohm resistor
- R5—One 1,250 or 1,300 ohm resistor
- R6, R8—Two 50,000 ohm resistors
- R10—One 1 megohm grid leak
- Rh—Optional 200,000 ohm variable resistance in series with R6

Other Parts

- Six binding posts
- Five UY sockets
- Two dials

A Question and Answer Department conducted by Radio World's Technical Staff. Only Questions sent in by University Club Members are answered. Answers printed herewith have been mailed to University Members.

Radio University

To obtain a membership in Radio World's University Club, for one year, send \$6 for one year's subscription (52 issues of Radio World) and you will get a University number. Put this number at top of letter (not envelope) containing questions. Address, Radio World, 145 West 45th Street, New York, N. Y.

Annual subscriptions are accepted at \$6 for 52 numbers, with the privilege of obtaining answers to radio questions for the period of the subscription, but not if any other premium is obtained with the subscription.

FIG. 928
The diagram of a supersensitive superheterodyne tuner in which the grid bias for the detectors is obtained from a drop in a voltage divider. The detecting efficiency depends on the proper adjustment of the bias.

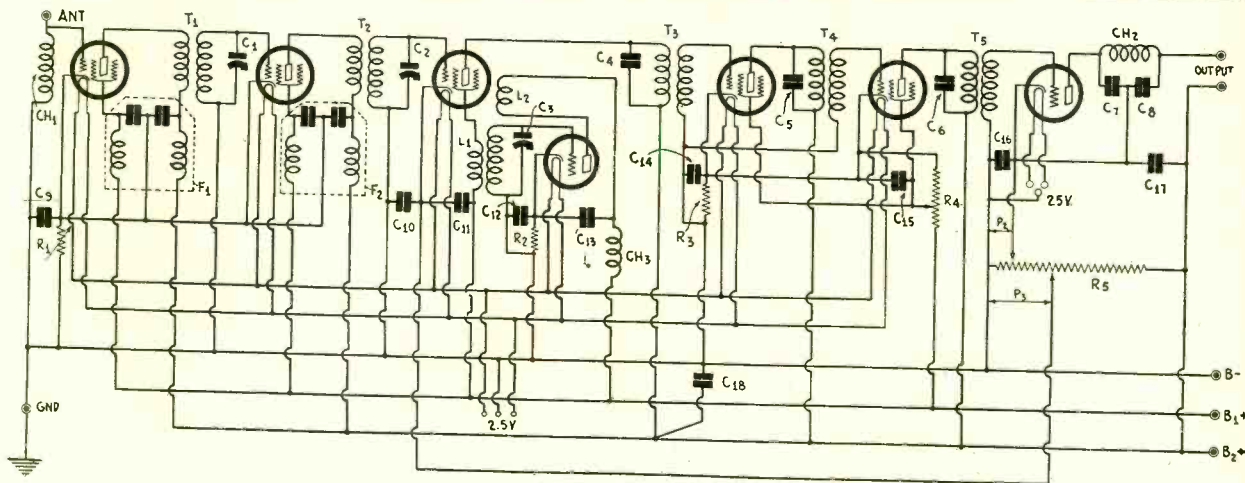

Securing High Detecting Efficiency

I HAVE built one of your superheterodynes in which grid bias detection is used in both detectors. The bias is obtained by returning the cathodes to different points on a voltage divider connected between B minus and B plus. Apparently I am not getting the correct bias because I am not getting much out of the set unless I bias the two detectors with batteries. Is not the potentiometer method as effective as the battery method of getting bias? I would appreciate a suggestion for improving the circuit in this respect.—F.W.R.

Possibly you are getting too much bias on the tubes when you use the potentiometer method. Instead of connecting the positive end of the voltage divider to the high voltage point you can connect it to the screen voltage tap. This will lower the current through the voltage divider and also the voltage drop across any portion of it. If the highest voltage in Fig. 928 is 180 volts and the potentiometer resistance R_3 is 30,000 ohms, the current through it is 6 milliamperes. If you connect the positive end of the voltage divider to the 67.5 volt point the current through the 30,000-ohm resistance will only be 2.25 milliamperes. This change may be enough to bring the bias within the operating range. For a 224 you might need a bias of 4.5 volts for good detection, which means a bias resistance 2,000 ohms, which should be the resistance between ground and the cathode connection. This does not take into account the current in the tube itself, which will increase the bias a little. If this does not bring about effective detection, a 20,000 ohm resistance may be connected in the cathode lead of each tube, dispensing with the potentiometer. In each case this 20,000 ohm resistance should be by-passed thoroughly for the lower frequency involved, that is to say, for the intermediate frequency in the first detector and for the lowest audio frequency in the second detector. A condenser of 0.1 mfd. across the first and one of 4 mfd. across the second should be enough.

* * *

House Antenna Does Not Function

I LIVE in a house in which built-in antennas are provided, as well as built-in grounds. When I connect to the ground there is an effect as would be expected, but there is no effect when the antenna is connected. That is, it makes no difference whether the antenna post on the set is connected to the house antenna or not. The antenna wire runs to the roof of the house and should be very good considering its height. I cannot understand why it does not work. Do you suppose that there is a short to ground somewhere?—F.W.R.

A long wire alone does not make an antenna. It is very likely there is a ground, though not necessarily an actual metallic connection between the ground and the antenna wire. The short is capacitive and is due to the high capacity between the antenna wire and grounded objects all around it. There are grounded conductors all around, below, on the sides and above the antenna wire. If there is a water tank on top of the building this is grounded and it may be that the top of the antenna is lower than the top of the ground. In that case you have no antenna, only a wire called an antenna by courtesy. This does not apply to the case when there is a common amplifier which feeds into the wires run to the various apartments, that is to say, the antennaplex system. While there may be much loss in the feed line there is so much amplification in the common amplifier, and there is also so much pick-up by the common antenna, that the

signal is strong as it comes to the radio receivers connected to the system.

* * *

Coil for 250 Mfd. Condenser

I HAVE a 250 mmfd. tuning condenser which I wish to use in an oscillator to cover the broadcast band. I wish to wind a coil on a 1.25 inch plug-in coil. How many turns should I use if the wire is No. 28 enamel covered?—T.C.R.

Put 148 turns of the wire on the form for the tuned winding. This will require 2 inches of the axial length of the form. It may be that the inductance will be slightly higher than necessary, due to the distributed capacity in the circuit, which cannot be taken into account beforehand. Hence remove a turn at a time until 550 kc is generated when the tuning condenser is set close to maximum. For the other winding half as many turns will be sufficient.

* * *

Receivers for Television

IT is said that regenerative and superheterodyne receivers cannot be used for the reception of television signals. If this is true, what is the reason?—F.W.R.

They can be used all right, but they have disadvantages. The main one is that they are too selective. A television radio receiver must be able to receive a wide band of frequencies so that it must not be so selective as broadcast receivers to separate stations. If the television receiver is too selective the detail of the picture will be tuned out. The set must not only receive frequencies above the audible range but also frequencies down to and below the lower audible limit. Hence not only must the radio tuner be broad but the audio frequency amplifier must have a flat characteristic over a band from about 16 cycles per second to 30,000 cycles per second. This is a very great order. The regenerative and superheterodyne receivers may also lack the stability required and they may bring in too much noise. Noise will show up more on the picture than in the audible signal.

* * *

Pentode Screen Gets Hot

I HAVE hooked up a receiver with a 238 pentode tube in the last stage. The quality is not good and it seems as if the tube is badly overloaded. I notice that the spiral representing the screen gets red hot during operation. Does this indicate that the voltage on the screen is too high? Kindly suggest the reason for the distortion and the cause of the heating of the screen.—H. G. J.

Both the heating of the screen and the distortion indicate that the grid bias is not right. Since the screen gets hot the bias is evidently not high enough. Perhaps you don't have any grid bias at all.

* * *

Sound in Solid Substances

CAN sound travel in solid substances such as iron, stone, and in liquids such as water and oil? If so, why is it that one cannot hear through solid and liquid substances?—N.J.

It depends what is meant by sound. Ordinarily, sound is only a wave motion in air or other gases. This wave motion is characterized by the fact that the motion of the individual particles of the gas is in the same direction as the direction of travel of the wave. That is, sound is a longitudinal wave motion. There is also longitudinal wave motion in solids and liquids, and

physicists refer to this as sound. The speed of sound waves of this type in solids and liquids is much greater than the speed of sound in air, about five times as great. The actual speed in any substance depends on the density and elasticity of the substance. The reason sound will not go through liquids and solids is not that it will not travel in them once it is in but that it will not transfer from air to these substances, nor from these substances to air. In striking the surface of such a substance the waves are reflected either back into the air or back into the substance, depending on which way they are approaching the surface.

Q of Circuit From Resonance Curve

IN one of your issues you derived the Q of a tuned circuit from the frequency difference between the peak and the point where the current is one-half. Will you kindly explain how this is done?—F.C.R.

The ratio of the current at any frequency to the current at resonance is the square root of $[1 + Q^2(1-r^2)^2]$, in which Q is the selectivity, or the ratio of the inductive reactance to the resistance, and r is the ratio of the resonant frequency to the other frequency. If the off-resonance frequency is taken where the current is half as great as at resonance, this ratio should be equal to 2. Hence the square of the ratio is equal to 4. That is, we have $[1 + Q^2(1-r^2)^2] = 4$. Subtracting one from each side and extracting the square root, we have $Q(1-r^2) = 1.733$. Knowing r we can get Q. Suppose it is found that the frequency of resonance is 450 kc and that frequency above resonance where the current is one-half is 470 kc. Therefore Q equals 20.8. A slightly different value is obtained on the low side of the peak.

Band Spanning Condenser

THERE is a type of condenser known as band spanning condenser which has some circular plates and some cut in the ordinary fashion. What is the object of the circular plates? They do not contribute anything to the tuning and could just as well be left out. Will you kindly explain what a band spanning condenser does and why the circular plates are used?—B.W.R.

Band spanning condensers do just what the name implies, cover a certain band of frequencies as the dial is turned from one end to the other. The circular plates contribute a fixed capacity while those plates that are cut contribute to the tuning. The smaller the variable portion of the condenser is in comparison with the fixed, or circular plate, portion, the narrower is the band covered and the easier it is to separate stations within the band covered. In place of the circular plates a fixed condenser of other type could be used, but the circular plates make an air dielectric condenser which is more efficient than any other type. Only amateurs use the band spanning condensers and they are therefore so made that they cover one of the amateur bands.

Simple Coil Winding Rule

WILL you kindly give a simple rule for winding short-wave coils to cover certain frequency ranges? For example, suppose one coil with a given condenser covers from 1,500 to 3,000 kc and this coil has 15 turns, how many turns should a coil that covers 3,000 to 6,000 kc have? I believe there is such a rule.—W.H.J.

There is such a rule, but it holds only approximately for certain types of coil, that is, for coils in which the inductance is proportional to the square of the number of turns. It holds approximately for short, compact coils and for solenoids that are very short compared with the diameter. The rule is that the product of the turns and frequency for the two coils should be equal. This assumes that the condenser is the same in the two cases and also that the diameter of the coils is the same. If a 16-turn coil tunes to 1,500 kc a coil that would tune to 3,000 kc should contain N turns when N is determined by the equation $16 \times 1,500 = N \times 3,000$. N equals 8 turns. Actually, if the 16 turn coil tunes the 1,500 kc, the 8-turn coil will tune little lower than 3,000 unless the axial lengths of the two coils are the same. When the axial lengths are the same the inductances are proportional to the square of the turns and the frequencies, for a given condenser, are inversely proportional to the turns. The above equation, which is the rule, then holds for very compact coils and for coils having the same shape factor as well as the same diameter. Stating the rule in symbols, we have $N_1 F_1 = N_2 F_2$.

Using Harmonics in Calibrating Oscillator

IHAVE tried to calibrate an intermediate frequency oscillator against an oscillator covering the broadcast band, which I have very carefully calibrated against broadcast stations. No matter where I set the broadcast frequency oscillator, there are squeals everywhere on the lower frequency oscillator, or vice versa. Is there any simple relationship between the frequencies and the points where the squeals occur that can be used in determining the frequencies of the unknown oscillator? Suppose, for example, that I set the low frequency oscillator at the lowest frequency and find that as I turn the broadcast frequency oscillator condenser there are squeals everywhere. How can I tell what the frequency of the IF oscillator is?—B.W.T.

The frequency of the IF oscillator must be found by deduction from the evidence at hand. In the first place, some squeals are very much louder than others. These come from beats

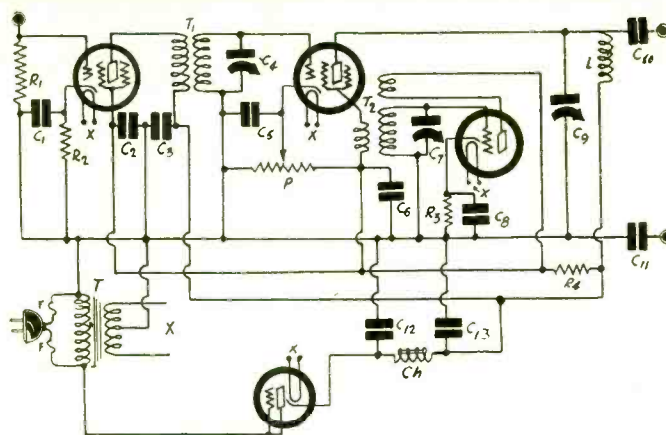

FIG. 929

A diagram of a short-wave converter with built-in B supply. This circuit is exceptionally sensitive but the sensitivity depends on the proper coupling between the detector and the first tube in the broadcast set.

between the fundamentals and the lower order harmonics. The frequency difference between two adjacent beats of the first order, that is, the loud ones, is equal to the frequency of the IF oscillator. Suppose, for example, that a loud squeal is found at 560 kc, another at 700 kc, and still another at 840 kc. There may be squeals between any two of these but these squeals are weak. We then have reason to believe that the frequency of the IF oscillator is 140 kc because the difference between any two adjacent major squeals is 140 kc. We can strengthen our belief by dividing each frequency by 140. If in each case we get a whole number we are sure that our intermediate frequency is 140 kc. Dividing 560 by 140 we get 4, and therefore 560 is the fourth harmonic of 140. Dividing 700 and 840 by 140 we get 5 and 6 respectively. These came out exact because they were assumed. In practical cases the number may not come out exact because of errors in reading the broadcast frequency oscillator. But they will come out close enough to tell which harmonic is being dealt with. Having found what we believe to be the fundamental of the low frequency oscillator, we can check it up by means of the lesser squeals. There should be squeals at 3/2, 5/2, 7/2, 9/2, etc., times the 140 kc. The first of these that falls within the broadcast range is 9/2, which is 630 kc. A squeal should be found there on the broadcast oscillator, provided that we have selected the right value for the low frequency. And there should be another at 11/2, or 770 kc, and another at 13/2, and so on. But most of these will be very weak, so it is necessary to listen very carefully for them.

Converter With B Supply

WILL you kindly show the circuit of a short-wave converter in which the B supply is built in and which contains a stage untuned radio frequency amplification ahead of the detector and a circuit after it tuned to the intermediate or broadcast frequency?—W. H. L.

Fig. 929 contains such a converter. The rectifier for the power supply is a 2Z7. The volume control potentiometer P should have a resistance of 30,000 ohms. The other parts are typical and may be found in almost any converter. The circuit LC9 should be tuned to a broadcast frequency and therefore these parts are the same as those used in ordinary broadcast tuners.

Pentode as Power Detector

CAN the 238 pentode tube be used as a power detector working into a stage of push-pull using the same type tubes? If so, what should the grid bias be?—F.W.B.

Surely, the tube can be used as power detector. It is only necessary to provide the correct bias on the control grid. In a typical circuit with 135 volts on the plate and screen grid, it was found that the plate current was practically reduced to zero at 35 volts on the control grid. Hence, if the bias is between this value and 30 volts the detection should be good. Of course, if the tube is to be followed by push-pull it is necessary to use a push-pull transformer between the detector and the next stage.

Sub-Harmonics

WHAT is the meaning of sub-harmonics? I can understand harmonics, which are integral multiples of the fundamental, but I cannot see what sub-harmonics can be. Certainly there can be nothing lower than the fundamental or the frequency called fundamental would not be that. I can also see how a vibrating body, such as a string, can vibrate at harmonic frequencies, but I cannot see how it could vibrate at frequencies less than the fundamental.—R.V.N.

The term sub-harmonic is used only for convenience when discussing a given frequency used as fundamental. The harmonics of this frequency are the integral multiples of it. Sub-harmonics are other frequencies, generated some other way, which bears a 1/2, 1/3, 1/4, etc., relationship to the fundamental.

A THOUGHT FOR THE WEEK

THE conquest of static by the resourcefully retiring sun spots, which have nearly won a complete victory over theimps of the air, has done more to make the Summer less dreaded by radioists than has any other single feature—not even excepting the bettering of Summer air programs generally. Ol' Man Static was the most unwelcome visitor that ever entered the homes of the nation and now that he has been pretty well covered up in his grave let fans, dealers and manufacturers throw on another spadeful or two of earth and in mighty chorus join in singing "Happy Days are Here Again!"

RADIO WORLD

The First and Only National Radio Weekly
Tenth Year

Owned and published by Hennessy Radio Publications Corporation, 145 West 45th Street, New York, N. Y.
Roland Burke Hennessy, president and treasurer, 145 West 45th Street, New York, N. Y.; M. B. Hennessy, vice-president, 145 West 45th Street, New York, N. Y.; Herman Bernard, secretary, 145 West 45th Street, New York, N. Y.

Roland Burke Hennessy, editor; Herman Bernard, managing editor and business manager; J. E. Anderson, technical editor; L. C. Tobin, advertising manager.

Electrical Interests

Establish Own Code

Chicago.

How the radio industry can effect considerable savings in the cost of telegraphic communication after September 1st through the use of the telegraphic code, prepared by the radio and electrical industries, is outlined in a statement just issued by a joint industry committee.

The new telegraph code, both for radio and electrical uses, has been developed after months of work by the Radio Manufacturers Association, National Electric Lamp Association, National Electric Manufacturers Association, Radio Wholesalers Association, Society for Electrical Development, and other interests. It has been compiled under expert supervision from within the radio industry by a committee headed by R. F. Pierson, of Ft. Wayne, Indiana. It provides for economy in communication and also for cheaper, more frequent, more accurate and more comprehensive exchange of information of immediate necessity.

The new code is the first instance of the entire industries uniting on a general code and its success, of course, depends upon the scope of its adoption.

Television is Used in

Health Chief's Talk

The first public health television broadcast was made recently by Shirley W. Wynne, Health Commissioner of New York City, over W2XCR and WGBS. The broadcast was the first of a series of addresses on weight control to be given every Monday afternoon during June and July. Dr. Wynne will explain safe weight reduction methods and give scientific and medical information on the subject.

RADIO ADVERTISING

The American public, I hear it said, objects to so much radio advertising. I am not so sure of this; it does not seem to object to advertising elsewhere—in the magazines and newspapers, for instance. It is preposterous to put the blame for blatant advertising on the broadcasters.

—Henry A. Bellows.

11 OF 19 USE 60 LINE BASIS IN TELEVISION

Television transmission is gradually getting on a standardized basis, so that the early difficulty of disc changing is disappearing.

The present predominating basis is 60 lines per frame, 20 frames per second, calling for disc rotation at 1,200 revolutions per minute. Thus a standard motor speed is being established, as well as a method of dissecting the picture.

The Radio Manufacturers' Association has never adopted any standard, but the practices of 48 lines per frame, 15 frames per second (900 r.p.m.) and 60 lines per frame, 20 frames per second (1,200 r.p.m.) have been recommended.

Great Progress in Few Months

The standardized basis that is eventuating is due largely to the recognition by the stations themselves of the advisability of uniform practice.

D. E. Replogle, chairman of the committee on television of the general standards committee of the R.M.A., said:

"During the past few months great progress has been made so that to date all the active broadcasting interests are using the 60-20 recommended practice. Practically every station capable of being received throughout the East is operating on 60-20 and instead of there being great television differences, there is a large degree of uniformity in our experimental broadcasting.

"Television will be the next great step in science."

List of Stations

Following is a list of active television transmitting stations, showing that of the 19 listed, 11 definitely subscribe to the 60-line method:

Call Letters	Company	Location	Power (watts)	Lines per Frame
2000-2100 KC.				
W3XK	Jenkins Laboratories,	Wheaton, Md.	5,000	60
W2XCR	Jenkins Television Corp.,	New York, N. Y.	5,000	60
W2XAP	Jenkins Television Corp.,	portable	250	60
W2XCD	DeForest Radio Co.,	Passaic, N. J.	5,000	60
W2XBU	Harold E. Smith,	Near Beacon, N. Y.	100	48
W9XAO	Western Television Corp.,	Chicago, Ill.	500	45
2100-2200 KC.				
W3XAD	RCA Victor Co.,	Camden, N. J.	500	60
W2XBS	National Broadcasting Co.,	New York, N. Y.	5,000	60
W2XCW	General Electric Co.,	Schenectady, N. Y.	20,000	—
W8XAV	Westinghouse Elec. & Mfg. Co.,	E. Pittsburgh, Pa.	20,000	60
W2XR	Radio Pictures, Inc.,	Long Island City, N. Y.	500	60
W9XAP	Chicago Daily News,	Chicago, Ill.	1,000	45
W3XAK	National Broadcasting Co.,	Bound Brook, N. J.	5,000	60
2750-2850 KC.				
W9XAA	Chicago Federation of Labor,	Chicago, Ill.	1,000	48
W9XG	Purdue University,	W. Lafayette, Ind.	1,500	—
W2XBO	United Research Corp.,	Long Island City, N. Y.	500	—
2850-2950 KC.				
W1XAV	Shortwave & Television Lab., Inc.,	Boston, Mass.	500	60
W9XR	Great Lakes Broadcasting Co.,	Downer's Grove, Ill.	5,000	24
W2XR	Radio Pictures, Inc.,	Long Island City, N. Y.	500	60

Television's First Merger Announced

Chicago

The world's first merger of television was concluded in the affiliation of the laboratory of U. A. Sanabria, Chicago experimenter, with the Shortwave and Television Corporation which has visual and sound broadcasting stations in Boston and television headquarters in New York.

Mr. Sanabria gave a demonstration of his ten-foot images before experts from the East and also showed for the first time pictures in definite black and white as contrasted with the usual red-tinged glow of Neon tubes.

Sanabria startled the scientific world a few months ago by exhibiting the large-sized television reproductions which experimenters have been seeking for years.

Sanabria, twenty-four years old, has been conducting research into television since his attendance at Oak Park High School, in 1923.

VISION FORUM DEMONSTRATED

Washington.

Linking radio and teletype to report progress of scheduled aircraft and to describe weather along airways is a possibility, if experiments now in progress are successful, according to information issued by the Aeronautics Branch of the Department of Commerce. Investigation into coordination of these systems is under way on part of the New York-Cleveland airway and preliminary results have been encouraging, it was stated.

The system employs the regular teletype ground circuit from New York to Cleveland by way of Bellefonte, Pa., and another circuit through Buffalo, N. Y. Messages transmitted along the Bellefonte circuit are sent to Buffalo by radio before being transmitted over the second network. At Bellefonte are apparatus to convert teletype signals into code for transmission to Buffalo, where other apparatus reconverts the signals into teletype, which go over the second ground circuit. Possible application of the system include bridging terrain over which it would be difficult to install land circuits and for use in case the land circuit becomes disrupted.

Kent Personally Sued on Hazeltine Patent

Philadelphia.

Suit to hold A. Atwater Kent personally liable for infringement of the neutralization patent was begun by the Hazeltine Corporation, of Jersey City, N. J.

The Hazeltine Corporation won a decision in the Federal Court against the Atwater Kent Manufacturing Company, and a special master is computing the damages. The new suit is based on the contention that Kent, largest stockholder and guiding genius of the company, is personally responsible for infringements.

RADIO DIRECTOR ABOLISHED

Montreal—Announcement was made by W. S. Thompson, director of publicity, Canadian National Railways, of the abolition of the office of director of radio and the appointment of E. A. Weir, hitherto director of radio as assistant director of publicity.

DINERS ENJOY 2-FOOT IMAGE BY TELEVISION

Chicago

Recently at the annual dinner of the Chicago branch of the American Society of Mechanical Engineers a group of about 250 saw and heard their principal speaker by radio.

Just as the national president of the society was being introduced, curtains were drawn aside and the lights lowered in the huge ballroom. There on a screen upon the platform appeared the speaker's head and shoulders, life size, and clearly reproduced. Presently, without delay, his voice filled the room.

While the speaker was going to the television studios of W9XAO about two miles away, a brief talk on television was given by W. N. Parker, engineer for the Western Television Corporation, whose cooperation made the demonstration possible. The audience was given an explanation of what they were about to witness.

Lenses Used in Scanning

As the speaker stood before the microphone, in the dimly lighted studio, a tiny spot of light was rapidly playing over his face in a series of parallel lines. The light came through a small window from one of the several scanners in the control room which employ 45 hole three spiral discs running at 900 revolutions per minute. A group of eight photo-electric cells arranged about the window served to pick up the light fluctuations reflected from his face. A special amplifier in the control room amplified the feeble photo-electric currents and caused the 2,050 kc. carrier wave of W9XAO to be modulated with the Television signals.

At the Edgewater Beach Hotel, where the dinner was held, a television radio receiver was set up and its output connected to the special projector on the ballroom stage. This projector differed from the usual television receiver scanner in that it used 45 lenses instead of the tiny pin holes, to utilize more efficiently the light from the neon lamp.

The forerunner of the modern camera used a pin hole for the lens. High speed snapshots are possible today with lenses while several minutes' exposure was required for a pin hole camera.

Lamp Drew 15 Milliamperes

Since the scanner's lenses were about an inch in diameter, the 45 lenses required a disc about two feet across. The distance to the screen was several feet and was adjusted to focus an image of the special point source neon lamp. As the disc revolved, this image spot swept across the screen in a series of parallel lines which blended into a smooth pinkish field about two feet square.

When the receiver was tuned to W9XAO, the television signals caused the brightness of the spot to vary as it travelled across the screen and a new picture of the speaker was painted every fifteenth of a second. This was too fast for the human eye so that the audience seemed to see the speaker in every motion and facial expression.

Although the brightness of the picture was sufficient to enable the speaker to be recognized the entire length of the 150 foot ballroom, the energy supplied to the neon lamp was exceedingly small, the direct current through the lamp being about 15 milliamperes.

Literature Wanted

Readers desiring radio literature from manufacturers and jobbers concerning standard parts and accessories, new products and new circuits, should send a request for publication of their name and address. Send request to Literature Editor, RADIO WORLD, 145 West 45th Street, New York, N. Y.

- LeRoy D. Brown, Radios, 83 Mills St., Morristown, N. J.
- Collins Radio Service, 1230 W. 4th St., Santa Ana, Calif.
- O. Bernard, 110 Cross St., Lawrence, Mass.
- J. Powers, 413 E. 140th St., N. Y. City.
- T. James Barnes, 323 Woodland Ave., Grove City, Pa.
- Arthur Abrahamson, 3819 Tyler St., N. E., Minneapolis, Minn.
- Pemberton McRae, 2119 Spring St., Little Rock, Ark.
- DuWell Stores, Radio & Auto Accessories, 231 Main St., Hartford, Conn.
- J. D. Henry, Radiotrician, 921 E. Franklin St., P. O. Box 603, Ocala, Fla.
- Charles A. Vitter, 27 Fitchett Ave., Poughkeepsie, N. Y.
- Edgar Dolber, 4531 Fountain Ave., Hollywood, Calif.
- Geo. Henry Dufour, 51 Fourth St., Limoilu, P. Q., Canada.
- W. C. Clinchard, Europa No. 2, Santurce, P. R. Tire Service Co., Central at 8th Ave., St. Petersburg, Fla.
- Chas. W. Engel, 28 Main St., Souderton, Pa.
- Niles Stevenson, 165 Buckingham St., Hartford, Conn.
- Pleasant H. Rucker, 1804 Neww Jersey Ave., N. W., Washington, D. C.
- K. F. Brush, 1716 State St., Schenectady, N. Y.
- L. Schmidt, P. O. Box 600, Great Falls, Mont.
- Dr. R. C. Hefebower, 22 W. 7th St., Cincinnati, Ohio.
- W. B. Floyd, Box 22, Monroe, Va.
- J. E. McCright, 442 Quincy Ave., Ottumwa, Iowa.
- Beanson Radio Service, 226 Commercial St., E. Braintree, Mass.
- Ward and Walker, Box 42, Collins, Miss.
- J. R. Smith, 7909 Aurora Ave., Seattle, Wash.
- Bernard J. Preusser, 7317 Schley Ave., Swissvale, Pa.
- Hugo V. Gruen, 40-09-95th St., Elmhurst, L. I., N. Y.
- Otto L. Neal, Radios and Tubes, 101 S. Main St., Wetumka, Okla.
- B. N. Harrington, Box 223, Washougal, Wash.
- Louis Beyer, Donahue, Iowa.
- Frank W. Ainsworth, Columbus, Kans.
- Dr. H. T. Royce, Pine Bluff, No. Car.
- John Brennan, 20 Herkimer St., Buffalo, N. Y.
- S. H. Sheib, c/o Froehling & Robertson, Richmond, Va.
- John Bartholomew, 134 Monck Ave., Norwood Grove, Man., Can.
- Melvin D. Getchell, 14 Fulton St., Woburn, Mass.
- C. C. Fields, Fields & Fields, Spencer, W. Va.
- Fred W. Spencer, 341 Wyoming Ave., Buffalo, N. Y.
- R. A. Phillipson, Dahlonega, Ga.
- L. D. Dedini, 729 Jones St., San Francisco, Calif.
- R. H. Koch, Prestonburg, Ky.
- Allen H. Schooley, Box V, Sta. A, Ames, Iowa.
- Maurice R. Thomas, 511-12 Liles Bldg., Amiston, Ala.
- J. J. Foster, Napoleon, Ohio.
- Howard S. Noling, Standard Home Utilities, 209 Lincolnway, W., Masillon, Ohio.
- Walter Helbig, 5861 N. Tolman Ave., Chicago, Ill.
- Frank F. Bodine, 7 Fayette St., Palmyra N. Y.
- Jos. Stephanski, P. O. Box 272, Niagara Falls, N. Y.
- G. K. Harrington, Manette, Wash.
- R. H. Dunn, 32 W. Bulcorn St., Buffalo, N. Y.
- H. L. Williams, R. D. No. 5, Horseheads, N. Y.

SUN AND MOON EFFECT ON SW TO BE TESTED

Influence of the sun and moon on shortwave reception is to be studied by scientists. The Perkins Observatory of Ohio Wesleyan University, which has made extensive studies on broadcast reception, will have the co-operation in the new work of the Warner and Swasey Observatory of the Case School of Applied Science in Cleveland.

Prof. Harlan T. Stetson, director of the Perkins Observatory, in a communication to the Shortwave and Television Corporation, said:

"In regard to our present research on radio reception as affecting high frequency signals, we are preparing apparatus this Summer for an extensive study. In this case the broadcasting as well as the receiving will be under our control.

"We shall send signals at different hours of the day and night on 20, 40 and 80 meter bands.

"These will be automatically recorded here at the Perkins Observatory and should furnish valuable information in the course of time on the influence of the sun and moon on short-wave reception.

"All that has been published so far has been pertinent to the broadcasting band. As there are unquestionably critical heights in the Heavyside layer for various distances in reception, it is a little difficult to predict short-wave transmission on the basis of broadcast data.

Life-Size Television Promised by Company

The Western Television Corporation, of Chicago, announces that development work is nearly completed on a home television receiver which projects a bright picture onto a two-foot square. A specially constructed lens disc combined with a newly developed neon lamp reduces the bulk and power requirements to a fraction of that demanded by present home television receivers.

Life-sized pictures, already shown experimentally, soon will be available for the home at a reasonable cost, the company states.

Special SHORT WAVE Number of RADIO WORLD

Will Be Published July 8. Dated July 11.

Nobody has to be told that the Short Wave angle of radio is a mighty important factor at the present time. It has gone so far ahead of the merely experimental stage that there no longer is the slightest doubt as to its fixed and ever-increasing importance and value.

Radio World has done its share in informing the public of the important developments in Short Wave theory and practice. Its columns have reflected from week to week the knowledge of our experts who have written on the subject. Many interesting and informative diagrams and other illustrations have been used with the text matter, and the trade aspects have been given careful attention. An army of Short Wave enthusiasts has flocked to our banner as subscribers and purchasers at the news-stands.

Now Radio World announces a special Short Wave number to be published July 8 and dated July 11. This issue will reflect the latest word in Short Wave developments.

If you have anything to sell in the Short Wave field, be sure to use this number and reach the many thousands who will buy it and eagerly read it.

Radio World's rates of \$150.00 a page and \$5.00 an inch are exceedingly low for the service it gives.

Last form closes June 30.

RADIO WORLD, 145 West 45th St., New York City

+ RADIO BOOKS +

SERVICE MANUAL RAMSAY HAAN RADIO MANUAL



"Official Service Manual," by Gernsback and Fitch, 1,000 illustrations; diagrams of commercial receivers and power amplifiers; 352 pages; includes course on servicing. Weight, 3 1/2 lbs. Complete 5-page index. Flexible leatherette cover, loose-leaf binding. Order Cat. ORSM @ \$3.50



The index to the commercial wiring diagrams takes up five pages alone. The index is an alphabetical array of the manufacturers' names, with model names and numbers stated.

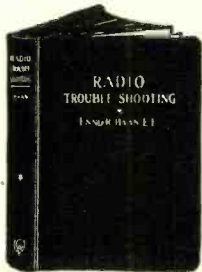

"Radio Trouble Shooting," by E. R. Haan, passes over theory, tells what to do to cure troubles. 300 illustrations, flexible binding 81 pages 6 1/2". Order Cat. HAAN... @ \$2.00

"Experimental Radio" by R. A. Ramsay, Ph.D., Prof. Physics, Indiana University. 255 pages, 168 illustrations. Cloth cover. Order Cat. REX..... @ \$2.75

"Fundamentals of Radio," by Ramsey, 374 pages, 403 illustrations. Order Cat. RFX @ \$3.50



The new edition of "The Radio Manual" answers questions about the principles, methods, or apparatus of radio transmitting and receiving. A complete course in radio operation in a single volume 30 big chapters include: Elementary Electricity and Magnetism; Motors and Generators; Storage Batteries and Charging Circuits; The Vacuum Tube; Circuits Employed in Vacuum Tube Transmitters; Modulating Systems and 100% Modulation; Wave-meters; Piezo-Electric Oscillators; Wave Traps. Nearly 900 pages, 369 illustrations; flexible fabricoid cover. Order Cat. MAN @ \$6.00

BOOKS BY JOHN F. RIDER

Two new books by Rider are:

(1) "Practical Radio Repairing Hints," a handbook for the radio worker. Replete with facts and figures, hints and kinks. No Theory. No Formulae. In it you will find explanations of the modern radio systems, automatic volume control circuits, new forms of voltage distribution... automobile radio sets, public address systems, etc. Order Cat. PRRH @ \$2.00

(2) "Practical Testing Systems," the first complete collection of accurate and practical testing circuits of interest to the service man, professional se builder and experimenter. Among the many testing systems described in this book are tube testers, capacity measuring systems, signal generators, radio frequency oscillators, audio oscillators, vacuum tube voltmeters, resistance testers, continuity testers, etc. Material for the man who wants a simple test unit or desires a laboratory arrangement. Order Cat. PTS @ \$1.00

Other books by Rider are: "Trouble Shooter's Manual," the first comprehensive volume devoted exclusively to the topic. It is not only a treatise for service men, telling them how to overcome their most serious problems, and diagramming the solutions, but it is a course in how to become a service man. It gives details of servicing and includes more than 100 actual factory-drawn diagrams of commercial receivers. 240 pages, 8 x 11". 360 illustrations. Order Cat. TSM @ \$3.50

"Supplement No. 1," containing 115 diagrams of commercial receivers, supplementing the diagrams in "Trouble Shooter's Manual," but not duplicating any. These 115 diagrams are supplied loose. They are a necessary adjunct to those in "Trouble Shooter's Manual." Order Cat. SUPP-1 @ \$1.20

"Mathematics of Radio," by Rider, 128 pages, 8 1/2 x 11", 119 illustrations, bridges the gap between the novice and the college professor. It gives a theoretical background so necessary for a proper understanding of radio and audio circuits and their servicing. Formulas for capacity, inductance, impedance, resistance, etc., are explained. Flexible cover. Order Cat. MOB..... @ \$2.00

TWO MASTERPIECES BY PROF. MORECROFT

"Principles of Radio Communication," by Prof. John H. Morecroft, second edition. Prof. Morecroft, of the Electrical Engineering Department of Columbia University and past president of the Institute of Radio Engineers, is a noted authority. Prior electrical and mathematical knowledge required. 1,001 pages and 831 illustrations. Cloth-bound. Order Cat. M-PRIN. @ \$7.50

"Elements of Radio Communication," written in plain language, requiring little foundation knowledge of radio, is another fine Morecroft book. The book is a complete course on the elements of radio, containing much material never before published. 236 pages, 170 illustrations and a complete index. Cloth bound. This is one book you must have in your library. Order Cat. M-ELEM. @ \$3.00

THREE BOOKS BY MOYER AND WOSTREL

The need for an up-to-date book on radio tubes that answers all the important questions has been filled by James A. Moyer, Director of University Extension, and John F. Wostrel, instructor in radio engineering. Division of University Extension, Massachusetts Department of Education. This book is a complete discussion of tube principles, functions and uses. The essential principles underlying the operation of vacuum tubes are explained in a non-technical manner as is consistent with accuracy. The book covers the construction, action, reactivation testing and use of vacuum tubes as well as specifications for vacuum tubes and applications for distant control of industrial processes and precision measurements. 297 pages, cloth bound. Order Cat. MWT. @ \$2.50

"Practical Radio," including the testing of radio receiving sets. 378 pages, 233 illustrations. Cloth bound. Order Cat. MWP. @ \$2.50

"Practical Radio Construction and Repairing," 319 pages, a companion volume to the above. New # edition. New price. Order Cat. MWC. @ \$2.50

Radio World, 145 West 45th Street, New York, N. Y.

Enclosed please find \$..... for which please send at once, postpaid, books indicated by my cross-

<input type="checkbox"/> Cat. ORSM @ \$3.50	<input type="checkbox"/> Cat. TSM @ \$3.50
<input type="checkbox"/> Cat. HAAN @ 3.00	<input type="checkbox"/> Cat. SUP-1 @ 1.20
<input type="checkbox"/> Cat. REX @ 2.75	<input type="checkbox"/> Cat. MOR @ 2.00
<input type="checkbox"/> Cat. RFM @ 3.50	<input type="checkbox"/> Cat. M-PRIN @ 7.50
<input type="checkbox"/> Cat. MAN @ 6.00	<input type="checkbox"/> Cat. M-ELEM @ 3.00
<input type="checkbox"/> Cat. DRB @ 6.00	<input type="checkbox"/> Cat. MWT @ 2.50
<input type="checkbox"/> Cat. PRK @ 1.50	<input type="checkbox"/> Cat. MWP @ 2.50
<input type="checkbox"/> Cat. PRRH @ \$2.00	<input type="checkbox"/> Cat. MWC @ 2.50
<input type="checkbox"/> Cat. PTS @ 1.00	<input type="checkbox"/> Cat. RTT @ 7.50

Name

Address

City State

Check here if C. O. D. is desired.

Remit with
Order for
Books and
We Pay Postage

FULL - SIZE PICTURE DIAGRAM SERIES

SIX ISSUES OF RADIO WORLD CONTAINED FULL-SIZE PICTURE DIAGRAMS OF THE FOLLOWING CIRCUITS:

Dec. 6, 1930—8A short-wave converter, 30 to 150 meters, using three 227 tubes, coil switch instead of plug-in coils. Filament transformer, 24v, and B voltage, 50 to 180 volts, required externally. One tuned circuit.

Dec. 20, 1930—3FS short-wave converter, 20 to 150 meters, using two plug-in coils, filament transformer built in, requiring only 50 to 180 volts of B voltage externally. One tuned circuit.

Jan. 31, 1931—1A de luxe all-wave converter, 15 to 600 meters, with filament supply built in. Uses three 224 tubes. B voltage 50 to 180 volts required externally. Two tuned circuits.

Feb. 14, 1931—RC27, two-tube converter, 30 to 150 meters, using two 227 tubes, coil switch instead of plug-in coils, filament transformer built in, B voltage of 50 to 180 volts required externally. One tuned circuit.

April 18, 1931—Short-wave midset set, using three 227 tubes, for one stage RF detector and one audio. Uses plug-in coils, 15 to 200 meters. Filament transformer built in. B voltage of 50 to 180 volts required externally. Plugs into detector of a broadcast set, or connects to power amplifier or earphones. Two tuned circuits.

Also, a one-tube set for broadcast and optional short-wave use and as calibrated oscillator.

April 25, 1931—DX-4 de luxe all-wave converter with complete power supply built in. Uses four plug-in coils, 10 to 600 meters. Three 224's, one 227. AC operated. One tuned circuit.

Send 75c for the Dec. 6, 20, Jan. 31, Feb. 14 and April 18 and 25 issues, or send 15c for copy of any one of these.

RADIO WORLD
45 WEST 45TH STREET
NEW YORK, N. Y.

PENTODE, \$1.00 VARI-MU, \$1.00

We carry the full line of Rextron tubes, at smashing prices for first-class, A-1 tubes with 10-day money-back guarantee. The 247 pentode @ \$1 and the 235 exponential or vari-mu tube @ \$1, as well as the 2-volt battery tubes @ \$1, afford a genuine opportunity to get the new type tubes at new low prices for "firsts."

List of Tubes and Prices

247 (pentode).....	\$1.00	120	1.00
235 (vari-mu).....	1.00	200A	1.00
230	1.00	WD-12	1.00
231	1.00	224	1.00
222	1.00	227	1.00
171A	2.10	245	1.00
171 (for AC)	1.00	210	2.95
112A	1.00	250	2.95
112 (for AC)	1.00	226	1.00
201A	1.00	280	1.00
247	1.00	281	2.95
UX-199	1.00	UV-199	1.00

RELIABLE RADIO CO.

143 West 45th Street, New York, N. Y.

- SPECIALS -

Five-lead cable, 2 ft. long, with plug to fit a five-prong (UY) socket. The cable is connected at the factory so that following wires represent the respective prongs of the socket: Blue with white marker—G post of socket; Red—plate of socket; Green—cathode of socket; Yellow—heater adjoining cathode; Black with yellow marker—heater adjoining plate.Net 65c

MARCO black bakelite vernier dials. Read 0-100 with a supplementary scale reading 0-10 between figures on large scale. Takes a 1/4" shaft...Net 50c

Parts for "A" battery eliminator: Dry rectifier, \$2.10; 0-10 ammeter, 75c; 20-volt filament transformer, \$2.50. Will handle up to 2 amperes filament current.

GUARANTY RADIO GOODS CO.
143 West 45th St. New York, N. Y.

RADIO WORLD and "RADIO NEWS"

BOTH FOR \$7.00
ONE YEAR

You can obtain the two leading radio technical magazines that cater to experimenters, service men and students, the first and only national radio weekly and the leading monthly, for one year each, at a saving of \$1.50. The regular mail subscription rate for Radio World for one year, a new and fascinating copy each week for 52 weeks, is \$6.00. Send in \$1.00 extra, get "Radio News" also for a year—a new issue each month for twelve months. Total, 64 issues for \$7.00.

RADIO WORLD, 145 West 45th Street, New York, N. Y.

Coils for Screen Grid RF and Sensitive Detector

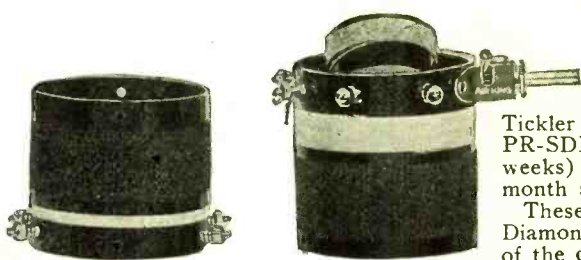

The Diamond of the Air is a popular circuit using an antenna coil and a three-circuit tuner. For this circuit the standard Diamond pair of coils consists of two, wound on 2½-inch diameters, except for rotor on smaller form. The standard pair may be obtained for .0005 or .00035 mfd. tuning. Tickler coil has single hole panel mount. For .0005 mfd. order PR-SDP-5, with blueprint, free with a six-months subscription (26 weeks) at \$3.00. For .00035 mfd. order PR-SDP-35, free with a six-month subscription at \$3.00.

These coils will give extreme satisfaction and are excellent for the Diamond of the Air, being specified by Herman Bernard, the designer of the circuit. Shipping weight, 2 lbs.

High Impedance TRF Coils for Screen Grid Circuits

These shielded coils are especially suitable for screen grid circuits, but are adaptable also to other circuits.

They consist of a secondary wound on a 1¼" diameter bakelite tubing, a layer of moisture-proof insulating fabric, and primary wound over the secondary. The bakelite tubing is firmly embedded in a veneered base, to which an aluminum plate is attached at bottom, punctured to pass outleads and to coincide with mounting holes of the aluminum shield. The shield size is 2-11/16" x 2-11/16" x 3/4". The mounting method keeps the walls of the shield equi-distant from the coil. The outleads are: shielded wire lead to plate, red lead to B plus, dark blue lead to grid and yellow to ground. When the coil is used as antenna coupler a fixed condenser of .00025 mfd. should be in series with the aerial. The connections should be: shielded wire to fixed condenser, red and yellow both to ground and dark blue to grid.

The coils are packed in matched sets of four. Thus they are of precision type, necessary for full effectiveness from gang tuning.

The primaries are of high impedance and the coupling to the secondary is very tight. The primary was made so high (40 turns) so that turns could be removed as desired, for proper proportion of stability and amplification, plus full-wave coverage.

For circuits using other tubes, the primary turns may be easily reduced by the user even to 10 turns, by cutting the primary wire near where it enters the insulating cloth, and unwinding all but 10 turns, cutting and then soldering the two wires together. Primary is on outside.

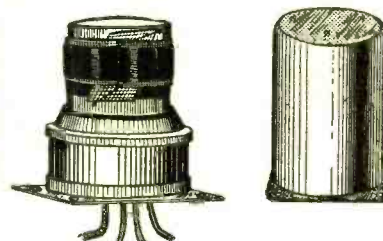

Small primaries are necessary for general purpose tubes, somewhat larger ones for screen grid tube plate circuits. Coil and shield sent free with \$2 subscription for 16 weeks. Order PR-40-70 for .0005 mfd. or PR-40-80 for .00035 mfd. Matched fours, order PR-40-70 MF or PR-40-80 MF, free with \$8 subscription, 68 weeks.

DYNAMIC TUNER ASSEMBLY—OTHER COILS

A tuning condenser with a dynamic coil to match, mounted on an aluminum base that has socket built in. The condenser shaft goes in a dial (not furnished). The tuned circuit includes a fixed and a movable winding (rotor coil) in series. The moving coil is used as a trimmer, set once and left thus, so two separate tuning dials are made to read alike, or gang tuning is made practical. No equalizing condensers needed. Do not couple the adjoining shafts.

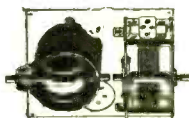

For antenna circuit input to any tube fitting four-prong UX socket, or for interstage coupling for 226, 201A, 199, 240 or 230, but NOT interstage for 232 or 222, order PR-BT-L-DC.

For interstage coupling for 232 and 222, order PR-BT-R-DC.

For antenna circuit, as RF input to any five-prong tube, order PR-BT-L-AC.

For interstage coupling for 224, order PR-BT-R-AC.

The assembly will be sent free with a \$4 subscription, 35 weeks (7 mos., 1 week). Shipping weight, 2 lbs.

The dynamic coil alone, for either .0005 mfd. or .00035 mfd. tuning. The same coil serves either capacity, as the series rotor may be set in position to increase or reduce the total secondary inductance.

For antenna coil, all circuits, and interstage coupling for all tubes except screen grid, order PR-BT-3A, free with \$2.00 subscription, 16 weeks.

For interstage coupling from plate circuit of screen grid tube, order PR-BT-3B, free with \$2.00 subscription, 16 weeks.

ANY ONE OF THESE FREE WITH \$2 SUBSCRIPTION

(PR-5-HT)—Special three-circuit tuner for .0005 mfd. tuned

primary in plate circuit of a screen grid tube; untuned secondary.

(PR-3-HT)—Same as Cat. 5-HT, except that it is for .00035 mfd.

tuning.

(PR-T-5)—Standard 3-circuit tuner for .0005 mfd. where primary is for any type of tube other than plate circuit of screen grid tube.

(PR-T-3)—Same as T-5, except for .00035 mfd. condenser instead of for .0005.

(PR-2-R5)—Radio frequency transformer for .0005 mfd. condenser where high impedance untuned primary is in plate circuit of a screen grid tube, and secondary is tuned by .0005 mfd.

(PR-2-R3)—Same as 2-R5, except that it is for .00035 mfd. tuning.

(PR-5-TP)—Radio frequency transformer for use where primary is tuned and placed in plate circuit of screen grid tube, while secondary is not tuned. For .0005 mfd.

(PR-3-TP)—Same as Cat. 5-TP, except that it is for .00035 mfd. tuning.

(PR-RF-5)—Radio frequency transformer for .0005 mfd. tuning, where untuned primary is in plate circuit of any type tube except screen grid. Useful also as antenna coupler.

(PR-RF-3)—Same as Cat. RF-5, except that it is for .00035 mfd. tuning.

Send \$2 for 16 weeks' subscription and select any ONE of above

ten coils as premium. Shipping weight, 1 lb.

DOLLAR SPECIALS!

Send \$1 for 8 weeks' trial subscription and get any one of the following premiums free:

- \$1** Klear Tuner, interference reducer, for minimizing or preventing cross-talk and cross-modulation. Makes a set more selective. Works with any receiver. Order PR-KLT. Shipping weight, 1 lb.
- \$1** Marco Vernier Dial, flat type, with scale suitable for either direction of rotation; auxiliary scale reads finer than main one; both work together. Order PR-MCD. Shipping weight, 1 lb.
- \$1** 1 mfd. Polymet bypass condenser, 250 volts DC continuous duty rating. Lug connects to positive, case to negative. A sturdy and dependable product. Order PR-POY-1. Shipping weight, 1 lb.
- \$1** 20-volt transformer; primary, 110 v., 50-60 cycles; secondary will serve as dynamic speaker rectifier transformer or A eliminator transformer, or for six heater tubes with series heaters. Order PR-20-VT. Shipping weight, 4 lbs.
- \$1** 30-ohm rheostat with switch attached. Useful in battery-operated receivers. One motion actuates both switch and rheostat. Eliminates one panel control. Order PR-30-SR. Shipping weight, ½ lb.

RADIO WORLD, 145 West 45th Street, New York, N. Y.

Enclosed please find \$..... for subscription for Radio

World for..... weeks. Please send me the premium as indicated below:

- PR-40-80 \$2 for 16 weeks; shipping weight, 1 lb.
- PR-40-80 MF \$8 for 68 weeks (1 yr., 16 wks.); shipping weight, 2 lbs.
- PR-40-70 \$2 for 16 weeks; shipping weight, 1 lb.
- PR-40-70 MF \$8 for 68 weeks (1 yr., 16 wks.); shipping weight, 2 lbs.
- PR-BT-L-DC \$4 for 35 weeks (8 mos. and 1 week); shipping weight, 1 lb.
- PR-BT-3A \$2 for 16 weeks; shipping weight, 1 lb.
- PR-BT-3B \$2 for 16 weeks; shipping weight, 1 lb.
- PR-5-HT \$2 for 16 weeks; shipping weight, 1 lb.
- PR-3-HT \$2 for 16 weeks; shipping weight, 1 lb.
- PR-T-5 \$2 for 16 weeks; shipping weight, 1 lb.
- PR-T-3 \$2 for 16 weeks; shipping weight, 1 lb.
- PR-2-R5 \$2 for 16 weeks; shipping weight, 1 lb.
- PR-2-R3 \$2 for 16 weeks; shipping weight, 1 lb.
- PR-5-TP \$2 for 16 weeks; shipping weight, 1 lb.
- PR-3-TP \$2 for 16 weeks; shipping weight, 1 lb.
- PR-RF-5 \$2 for 16 weeks; shipping weight, 1 lb.
- PR-RF-3 \$2 for 16 weeks; shipping weight, 1 lb.
- PR-KLT \$1 for 8 weeks; shipping weight, 1 lb.
- PR-MCD \$1 for 8 weeks; shipping weight, 1 lb.
- PR-POY-1 \$1 for 8 weeks; shipping weight, 1 lb.
- PR-20-VT \$1 for 8 weeks; shipping weight, 4 lbs.
- PR-30-SR \$1 for 8 weeks; shipping weight, ½ lb.

Name

Address

City, State

If renewing an existing subscription for Radio World, please put a cross in square.

15 to 550 Meters Guaranteed on Any Set!

Tune in on any AC set that uses heater type tubes in the radio frequency amplifier and bring in stations from 15 to 550 meters, obtaining the voltages from the receiver. One 224 tube used. Wave band changed by panel switch.

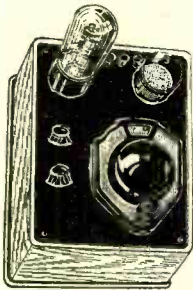

You can tune in all the short waves and the broadcast band as well on the speaker, using the Cat. SW-B Adapter. See parts list.

This splendid circuit repeatedly has brought in European, Asiatic, Canadian and South and Central American stations, and of course tunes in the domestic relay stations, amateurs, ship phone and police alarms. The receiver is built in a walnut finish cabinet, 7 x 5 1/2 x 2 7/8" overall, and has a bakelite top panel on which are the vernier dial, tube socket, vol. control and wave-switch. The illustration gives only a general idea, as the band switch is located where a coil is shown.

- One 15-550 meter three-winding coil for .0002 mfd. (Cat. L-SWB) @ \$1.10
- One .0002 mfd. Hammarlund junior midline tuning condenser (Cat. H-2) @ 1.35
- One .00025 mfd. grid condenser with clips (Cat. MCN-25) @ .20
- One .00035 mfd. fixed condenser (Cat. MCN-35) @ .10
- One .01 mfd. fixed condenser (Cat. MCN-01) @ .20
- One block of three 0.1 mfd. condensers in one case (Cat. SPB-1) @ .57
- One 0.25 meg. digital resistor @ .25
- One potentiometer, 5,000 ohms (R) @ .25
- One digital resistor (2R), 20,000 ohms @ .25
- Three binding posts (Cat. BP) @ .09 ea. @ .27
- Two milled 6/32 threaded brass bushings, 1/8 inch high (Cat. MLB) @ .05 ea. @ .10
- One single throw four-point inductance switch with numerical plate (Cat. ST-3P) @ 1.10
- One bakelite disc for mounting coil switch (Cat. BKLD) @ .12
- One UY (five-prong) socket (Cat. Y-S) @ .20
- One 5 x 6.5 inch drilled bakelite panel (Cat. PN-SWB) @ .69
- One walnut finish wooden cabinet to match (Cat. FLCB) @ .72
- One grid clip (Cat. SGC) @ .02
- One vernier dial (Cat. VD) @ 1.00
- One lug (Cat. LUG) @ .01
- One roll of hookup wire (Cat. HKW) @ .22
- One dozen 6/32 machine screws and one dozen nuts to match (Cat. DSN) @ total @ .12
- Four wood screws for attaching panel to cabinet (Cat. 4WS) @ total @ .04
- One UY cable (five leads) with UY plug attached (Cat. Y-CAB) @ .69
- Two pointer knobs for 1/4 inch shaft (Cat. PNTK) @ .15 ea. @ .30

TOTAL, ALL PARTS
(Cat. AP-SW-B) @ \$10.47



ALL-WAVE SWITCH

Double pole, four point; insulated shaft; for two tuned circuits, to switch condensers to coil taps for all-wave coverage. Switch can't slip on panel nor can knob slip on shaft.

Cat. DP-4-P @ \$1.87

OTHER PARTS

- 1 1/4-inch natural bakelite tubing, 36-inch length. Cat. NB-36 @ .33
- .00035 mfd. Ameco two-range straight frequency line condenser, specified for all-wave and short-wave circuits. Brass plates, 1/4 inch shaft. Cat. AM-35 @ \$1.95
- Allen-Hough phonograph motor, 60 cycle synchronous, 79 rev. per min., with turntable. Cat. AHM @ 4.25
- Kelford B eliminator choke coil, 100 ma. 30 henrys. In polished black shield case; mounting holes; two binding post connections. Cat. KELB @ 1.75
- Kelford 300-volt B supply, for 280 rectifier, etc. Cat. KEB @ 4.95
- 2 1/2 v. center tapped filament transformer, 8 amps. Cat. FT @ 1.62
- Hammarlund .0002 mfd. junior midline, brass plates; for short waves. Cat. H-2 @ 1.35
- Polymet 8 mfd. electrolytic, bracket. Cat. PE-8 @ 1.09
- Steel cabinet to build a power amplifier in, 8x6x6 inches. Cat. SCB @ .99

ROLAND RADIO CO.
137 Hewes Street
Brooklyn, N. Y.

853 PAGES, 1,800 DIAGRAMS IN RIDER'S NEW 6-LB. MANUAL

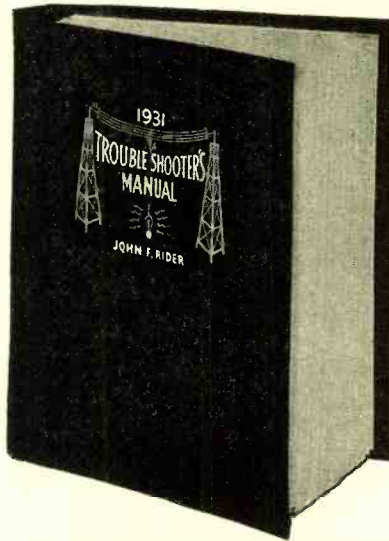

THE most complete service man's manual is the 1931 edition of "Trouble Shooter's Manual," by John F. Rider, published April, 1931, and ready for immediate delivery. Wiring diagrams of ALL popular commercial receivers and kit sets from 1922 to 1931, inclusive. Also contains a course in trouble shooting. Loose leaf pages, 8 1/2 x 11", bound. 853 pages; index and advertisements on additional pages. Order Cat. RM-31, and remit \$4.50. We will then pay postage. (Shipping weight, 6 lbs.) Ten-day money-back guarantee.

RADIO WORLD

145 West 45th Street, New York, N. Y.

THREE-IN-ONE TESTER FREE!

EVERYBODY who does any radio work whatsoever, whether for fun or for pay or for both, needs a continuity tester, so he can discover opens or shorts when testing.

A mere continuity tester is all right, but—

Often it is desired to determine the resistance value of a unit, to determine if it is correct, or to measure a low voltage, and then a continuity tester that is also a direct-reading ohmmeter and a DC voltmeter comes in triply handy.



So here is the combination of all three:

A 0-4 1/2-volt DC voltmeter, a 0-10,000-ohm ohmmeter and a continuity tester. A rheostat is built in for correct zero resistance adjustment or maximum voltage adjustment. The unit contains a three-cell flashlight battery. Supplied with two 5-foot-long wire leads with tip plugs. Case is 4-inch diameter baked enamel. Weight, 1 lb. Sent free with an order for one year's subscription for RADIO WORLD (52 weeks) at the regular rate of \$6. Order Cat. PR-500.

Radio World, 145 W. 45th Street, New York, N. Y.

Enclosed please find \$6 for one year's subscription for Radio World (one copy a week, 52 issues). Send Cat. PR-500 as premium.

Name

Address

City..... State.....

"RADIO TROUBLE SHOOTING," E. R. Haan. 328 pages, 300 illustrations, \$3. Guaranty Radio Goods Co., 143 W. 45th St., New York.

The New Jiffy Tester

Chromium-Plated Case and Accurate Meters

A NEW and improved Jiffy Tester, improved in both performance and appearance, is Model JT-N. The meters are of the moving iron type. Tested on precise batteries, they show errors not exceeding 2%. As for appearance, the case is first copper plated, then chromium plated, giving a lustrous, permanent, non-peeling non-rusting finish. It is the same finish found on hardware in fine automobiles. The handle and lock strap are genuine leather.

Jiffy Tester, Model JT-N, consists of three double-reading meters, with cable plug, 4-prong adapter, test cords and screen grid cable, enabling simultaneous reading of plate voltage, plate current and filament or heater voltage (DC or AC), when plugged into the socket of any set. The ranges are filament, heater or other AC or DC; 0-10 v., 0-140 v.; plate current; 0-20, 0-100 ma.; plate voltage; 0-60, 0-300 v. It makes all tests former models made. Each meter is also independently accessible for each range. The entire device is built in a chromium-plated case with chromium-plated slip-cover. Instruction sheet will be found inside. Order Cat. JT-N.

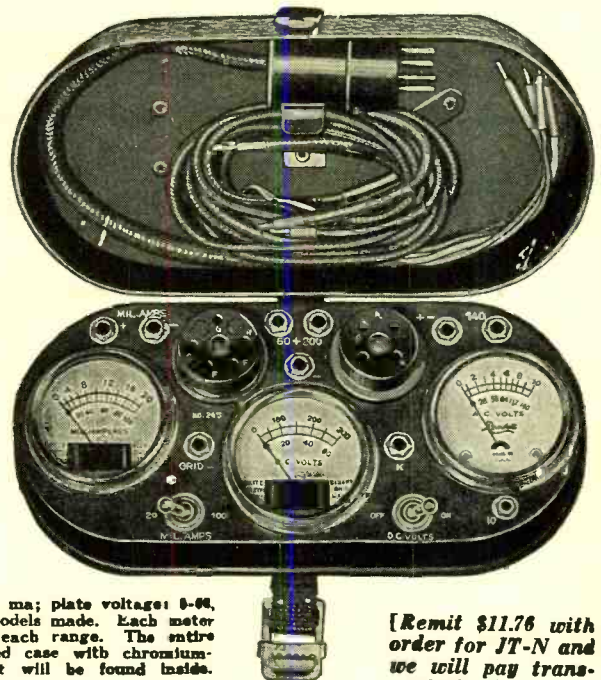

[Remit \$11.76 with order for JT-N and we will pay transportation.]

GUARANTY RADIO GOODS CO.
143 WEST 45th STREET (Just East of Broadway) NEW YORK, N. Y.

EVEREADY RAYTHEON 4-PILLAR RADIO TUBES

TRADE MARKS

ALL THE NEW TUBES—

235, the new sensational variable mu radio frequency amplifier tube for great reduction or elimination of crosstalk, direct inter-station interference and hissing background noises. It has a high mu for low bias and a low mu for high bias. Net price, \$1.54.
 551, variable mu, substantially the same operation. Net price, \$2.20.
 247, power pentode for use in the last stage, either alone or in push-pull. It has a greater power sensitivity than any other tube available. Net price, \$1.26.
 233, a 2-volt power pentode tube for use as output tube in circuits utilizing the 231 and the 232. Net price, \$1.83.
 237, a 8.3-volt general purpose tube of the heater type, suitable for use in automobile receivers. It may be used as detector, oscillator or amplifier. It may be heated with either direct or alternating current. Net price, \$1.23.
 236, a 6.3-volt screen grid tube of the heater type which may be used for amplification in receivers utilizing the 237. Net price, \$1.83.
 238, a 8.3-volt power pentode tube for use as output tube, singly or in push-pull, in receivers utilizing the 238 and 237. Net price, \$1.93.

ALSO THE STANDBYS—

227 @ \$0.88 V-199 @ 1.93 222 @ 3.15
 224 @ 1.40 X-199 @ 1.75 230 @ 1.12
 226 @ .88 120 @ 2.10 231 @ 1.12
 171A @ .98 201A @ .77 232 @ 1.61
 210 @ 4.90 200A @ 2.80 280 @ \$0.98
 245 @ .98 240 @ 2.10 281 @ 3.50
 250 @ 4.50 112A @ 1.05 BH @ 3.10
 Kino Lamp @ \$4.75 BA @ 5.20

**Every Tube Guaranteed
Electrically and
Mechanically Perfect**

EVEREADY RAYTHEON 4-pillar radio tubes are built to give consistently good service over long periods of time. Their performance is uniform day after day and they can be depended on to give maximum results.

These highly desirable qualities are obtained through the use of the unique "Four Pillar Construction" (see illustration) in which the elements are cross anchored at top and bottom. In this way, support is obtained at 8 points instead of 4 as in ordinary tubes.

This rugged trouble-proof feature enables Eveready Raytheon tubes to "stand up" under the most severe conditions and insures the same high degree of performance in the set of the consumer as they exhibit on factory tests.

These tubes have gained recognition for their precision workmanship and long life and are guaranteed to be electrically and mechanically perfect. Also, they are especially well packed in sturdy boxes.



DIRECT RADIO COMPANY
 143 WEST 45th STREET, NEW YORK, N. Y.

In the Next Issue
 of Radio World
 (Dated June 27th)
 Polo Engineering Laboratories
 Have Reserved the Back
 Cover to Announce Their
ALL-WAVE SET
 and
**Improved Short-Wave
 Converter**
 Polo Engineering Laboratories
 125 West 45th Street
 New York, N. Y.
 Telephone BR-yant 9-8093

**Tubes at
50¢ Each**

280 200A
 226 245
 171

**Tubes at
75¢ Each**

250 222
 Sold on basis of remittance with order. We will pay the postage.
RELIABLE RADIO CO.
 143 West 45th Street New York, N. Y.

BRACH RELAY—List price \$4.50; our price 99c. Guaranty Radio Goods Co., 143 W. 45th St., N. Y. C.

PHONOGRAPH PICK-UP—Made by Allen-Hough, \$3.32. Guaranty Radio Goods Co., 143 W. 45th St.

Quick Action Classified Ads

Radio World's Speedy Medium for Enterprise and Sales

7 cents a word—\$1.00 minimum—Cash with Order

FOR SALE: Two Pilot Super Wasp S.W. Receivers, complete, wired, never used. Eighteen dollars each. Cash or money order. Robert Thompson, Graceton, Penn.

FILAMENT TRANSFORMERS, 1½, 2½, 5, 7½ volt, center tapped. State voltage wanted. \$1.15 each. V. C. Cook, 3406 Frederick, Detroit, Mich.

PHONOGRAPH PICK-UP—Made by Allen-Hough, \$3.32. Guaranty Radio Goods Co., 143 W. 45th St., N. Y. C.

"RADIO TROUBLE SHOOTING," E. R. Haan. 328 pages, 300 illustrations, \$3. Guaranty Radio Goods Co., 143 W. 45th St., New York.

"FORD MODEL 'A' CAR AND 'AA' TRUCK," by Victor W. Page, M.E. Revised and Enlarged Edition. \$2.50. Radio World, 145 W. 45th St., N. Y. City

"HANDBOOK OF REFRIGERATING ENGINEERING," by Woolrich—Of great use to everybody dealing in refrigerators. \$4. Book Dept., Radio World, 145 W. 45th St., N. Y. City.

BARGAINS in first-class, highest grade merchandise. Phono-link pick-up with vol. control and adapter, \$3.32; four-gang .00035 mfd. with trimmers built in, \$1.95; .00025 mfd. Dubilier grid condenser with clips, 18c. P. Cohen, Room 1214, at 143 West 45th Street, N. Y. City.

BALKITE A-5 RECEIVER, eight-tube, three stages of Neutrodyne RF and two stages audio with push-pull output. Good distance-getter and very sensitive. Has post for external B voltage for short-wave converters. Brand new in factory case. Berkey-Gay walnut table model cabinet. Price \$35 (less tubes). Direct Radio Co., 143 West 45th St., New York.

BIG BARGAIN—500 fine Vellum, neatly printed Business Cards, including strong Card Case, \$1.50, postpaid. Handprint your copy. Mail with remittance to Roth Press, 846 Sutter Ave., Brooklyn, N. Y.

25,000 OHM POTENTIOMETER, wire wound, in shield case; takes ¼" shaft. Will stand 20 ma. easily. Excellent as a volume control. Price, 90c. Direct Radio Co., 143 West 45th Street, New York, N. Y.

STREAK BARGAIN OF 1931—Set tester, made by the famous Readrite Company, accurate to 98%, contained in a convenient small chromium-plated case measuring 8 x 3 inches, net weight 2½ lbs. Consists of three double reading meters, with cable plug, 4-prong adapter, test cords and screen grid cable, enabling simultaneous reading of plate voltage, plate current and filament or heater voltage (DC or AC), when plugged into the socket of any set. The ranges are filament, heater or other AC or DC: 0-10 v, 0-140 v; plate current: 0-20, 0-100 ma; plate voltage: 0-60, 0-300 v. INSTRUCTION SHEET INSIDE. Made to sell for \$20.00, we offer you the big opportunity of obtaining it for \$8.25 remittance with order, plus \$3.51 to be paid in 90 days. Direct Radio Co., 143 W. 45th St., N. Y. C.

U. S. BROADCASTING STATIONS BY FREQUENCY.—The April 11th issue contained a complete and carefully corrected list of all the broadcasting stations in the United States. This list was complete as to all details, including frequency, call, owner, location, power and time sharers. No such list was ever published more completely. It occupied nine full pages. Two extra pages in the April 11th issue were devoted to a conversion table, frequency to meters, or meters to frequency, 10 to 30,000, entirely reversible. 15c a copy. RADIO WORLD, 145 West 45th Street, New York, N. Y.

MOUNTED STEER HORNS: For sale, over six feet spread, mounted on panel. Rare opportunity, Texas longhorn cattle now extinct. Lee Bertillion, Mineola, Texas.

PRINTING: 1000 BUSINESS CARDS \$2.75 POSTPAID. Other printing reasonable. Samples free. Miller, (RW), Printer, Narberth, Pa.

HAMMARLUND SFL—Hammarlund's precision .0005 mid. condenser, with removable shaft; single hole panel mount. Lowest loss construction; rigidity; Hammarlund's perfection throughout. Order Cat. HAM-SFL @ \$3.00 net price. Guaranty Radio Goods Co., 143 W. 45th St., New York.

"RADIO FREQUENCY MEASUREMENTS," by E. B. Moullin, M.A., A.M.I.E., M.I.Rad. Eng. Second Edition entirely reset and greatly enlarged. Illustrated. 487 pages, plus 12-page index. Indispensable for radio experts and engineers. \$12.50. Radio World, 145 W. 45th St., N. Y. City.

"SHORT WAVES," by Charles R. Leutz and Robert B. Gable. Fully bound, 384 pages, 250 illustrations. Size 6 x 9. All new subjects. \$3.00. Radio World, 145 W. 45th St., N. Y. City.

SHORT-WAVE NUMBERS OF RADIO WORLD. Copies of Radio World from Nov. 8, 1930 to Jan. 3, 1931, covering the various short-wave angles, sent on receipt of \$1.00. Radio World, 145 W. 45th St., N. Y. City.

"SOUND PICTURES TROUBLE SHOOTER'S MANUAL," by Cameron and Rider, an authority on this new science and art. Price \$7.50. Book Dept., Radio World, 145 W. 45th St., N. Y. City.

"A B C OF TELEVISION" by Yates—A comprehensive book on the subject that is attracting attention of radioists and scientists all over the world. \$3.00, postpaid. Radio World, 145 West 45th St., N. Y. City.

STOP SHOPPING!!

HERE'S A NEW plan, which saves you money. Stop shopping—the lowest prices are right on this page. Yes, lower than in our own catalog. Why? Because no house can get out a new catalog every month, but by advertising in this magazine we can bring

you the latest and lowest prices up to the time this ad is printed. We watch our competitors and do not allow anyone to undersell us. We meet ANY price on NEW merchandise. Order direct from this page and save money. 100% satisfaction on every transaction.

Dry Electrolytic Condensers

Mount in any position! Guaranteed never to blow out! Remarkably compact and very inexpensive, permitting generous use of filtering systems. The greater the mfd. capacity employed, the less A.C. hum remains. 500 volt peak rating. Ideal for all 171A - 245 power packs—use two of each capacity desired for 250 power packs (1,000 volt peak thereby assured).



No.	Mfd.	Diameter	Length	YOUR PRICE
1801	1	3/4 in.	2 1/4 in.	\$0.27
1802	2	1 in.	2 1/2 in.	.44
1804	4	1 1/2 in.	2 7/8 in.	.83
1808	8	1 3/4 in.	3 1/2 in.	1.20
1816	16	2 in.	4 1/2 in.	2.10
1824	24	3 in.	4 1/2 in.	2.70
1832	32	3 in.	4 1/2 in.	3.30
1854	54	3 in.	4 1/2 in.	4.73

THORDARSON

"245" Power Transformer

A Miniature Power Plant — Supplies All ABC Voltages — 80 Watts

In addition to supplying a full 250 volts to the plates, and 50 volts to the grids of two type '45 tubes in push-pull, this transformer may be used to light the filaments of seven or eight 2.5-volt filament tubes; and by connecting in series two of the three 2.5-volt filament secondaries it is possible to light 5-volt filaments too. Five secondaries: S1—5 V., 2 Amp.; S2—340 V. Cent. T.; S3—2 1/2 V., 3 Amp. Cent. T.; S4—2 1/2 V., 10 1/2 Amp.; S5—2 1/2 V., 3 Amp. Cent. T. Just the power transformer for building up a high-grade audio address amplifier to use a screen-grid A.F. amplifier to boost the output of a microphone or phonograph pick-up; following this with two stages of push-pull amplification consisting of two '27's in the first stage and two '45's in the second. Bottom of transformer has bakelite panel on which are mounted all taps. It outperforms ANY similar transformer. Many Service Men keep this model transformer on hand for emergency replacements in hundreds of makes of radio sets. For 110-120 volts, 50-60 cycles. Size: 5 in. high x 4 x 3 1/2 in. Shipping weight, 8 lbs. List Price, \$15.00.

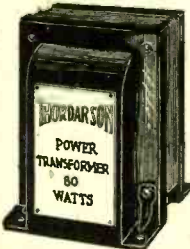

No. 1450—Thordarson Power Transformer. YOUR PRICE..... **\$3.85**

Television Receiving Lamps

These Television Receiving Tubes have been designed to avoid high space charges, and at the same time confine the light to the most useful portion of the cathode. Brilliant light spots usually found on the cathode and caused by high frequency current vibrations have been entirely eliminated by a special process which minimizes "sputtering" under the influence of the discharge. Rigid support of the elements is obtained by the use of sturdy glass rods, 1 1/4 in. x 3/4 in. with circle 1 in. square. Shipping weight, 1/2 lb. No. 775—Television Lamp. List \$1.98 Price, \$1.00. YOUR PRICE..... **\$1.98**

A.C. Short Wave Converter

The thrill of tuning in short waves is yours, because you can connect this short-wave converter to your broadcast receiver, no matter what type receiver you have. Tunes from 10 to 200 meters, using only two plug-in coils. Coils, already wound, are supplied with outfit. Converter has built-in filament transformer to heat three 2Z7's. All you need obtain from your receiver is a positive "B" voltage, anything from 45 to 180 volts. Voltage not critical. No molestation of the receiver. No tricky regeneration control, only a single, smooth-operating dial to manipulate. No squeals, no crumpling, no body capacity. All parts for 3-tube short-wave converter, including cabinet, with filament transformer, complete instructions and pictorial diagram. Shipping weight 8 lbs. List Price \$20.00.

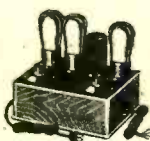

No. 1617—YOUR PRICE, less tubes **\$9.45**

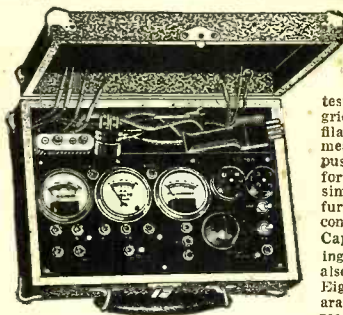

700 A.C. volts and 0-20-120 milliamperes, A.C. and D.C. filament voltages are accurately measured on the one meter. Strong case with leatherette covering. Attractive. Compact Size 10 3/4 x 3 1/2 x 8 inches. Shipping weight 15 lbs. List Price \$25.00.

No. 700—READRITE ANALYZER. YOUR PRICE..... **\$14.70**

Flewelling-Dayton SW Adapter

This wonderful instrument connects to any A.C. radio set by putting into tube socket in place of the tube (which must be a type '27, or "heater" tube) the plug which is on the end of its 2-ft. cable; then put tube into tube-socket of adapter. Remove aerial from broadcast set and connect to antenna post on adapter. Special plug-in coil No. 1 covers a wavelength band of 17 to 29 meters; coil No. 2, 27-28 meters; coil No. 3, 47-84 meters. Plug-in coil inductances come with the adapter. 5 1/2 x 7 1/4 x 4 1/2 high, overall. Ship. weight 4 lbs.



No. 1613—Dayton Flewelling Short-Wave Adapter. List Price, \$15.00. YOUR PRICE (without tube)..... **\$4.93**

Baldwin D.C. Dynamic Speaker

A brand new addition to the famous Baldwin line of speakers. Never before has a speaker of such small size offered such fidelity of response. 9 in. diaphragm, 2500-ohm field winding with 15-ohm voice coil. For use across D.C. line or with field coil acting as filter choke in power supply circuit. Furnished without coupling transformer. Shipping weight, 10 lbs. List Price, \$12.00.

No. 1513—Baldwin D.C. Dynamic Speaker. YOUR PRICE..... **\$4.73**



NEW READRITE Analyzer

This three-meter analyzer has selector switch for checking all parts of tube circuits by connecting to the set sockets. Selection for testing voltages of plate, grid, cathode and screen-grid done quickly and accurately. Plate current, filament volts, line and power supply volts are measured. Grid swing test for tubes used. Just push one button for screen-grid and other buttons for other tubes. Makes testing of all type tubes simple and thorough. 4 1/2-volt grid battery is furnished. Battery is used for grid test and continuity testing of transformers, chokes, etc. Capacity and resistance charts furnished showing use of instruments for testing condensers, also measuring resistances up to 100,000 ohms. Eight scale readings of meters may be used separately with the jack terminals provided. Scale readings are 0-60-300-600 D.C. volts. 0-10-100. Compact Size 10 3/4 x 3 1/2 x 8 inches. Shipping weight 15 lbs. List Price \$25.00.

Earl Power Transformers

Make money retamping the old battery set. This power transformer used in Earl Model 22 receiver supplies "A," "B" and "C" potentials for: two '27's (or screen-grid '24's), three '26's, two '1A's and one '80 rectifier, total current output of high-voltage winding at maximum output (about 200 volts) is 80 ma. High-voltage secondary, filament winding for '27's and for '1A's are centered-tapped. Size, 3 3/4 x 3 3/4 x 2 1/2 inches. 16 long leads, all with wiring directions. Shipping weight 5 lbs. List Price, \$7.50.

No. 1410—Earl Transformer (with-out brackets). YOUR PRICE..... **\$1.73**

No. 411—Earl Transformer, the same but with mounting brackets.. **\$1.98**

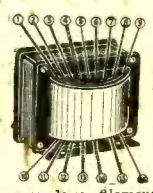

Utah Dynamic A.C. Power Speaker—Model 33A

110-volt, 60-cycle A.C. light socket supply for field excitation with Westinghouse dry rectifier. 9 in. high, 9 1/2 in. wide, 7 1/2 in. deep. Speaker comes packed in wooden crate. Weight 19 lbs. It is one of the most powerful as well as best reproducers in the market. 9-inch cone. List Price \$50.00. No. 1506—YOUR SPECIAL PRICE **\$7.45**



NEW! NEW!! Superheterodyne S-W Converter

At last a short-wave converter that converts any broadcast set into a superheterodyne short-wave receiver. Employs three 2Z7 tubes and covers from 20 to 115 meters. No plug-in coils! Coil switch is used to cover all wavelengths. Single dial control, no body capacity, no squeals. This converter has built-in filament transformer to heat the three 2Z7's.

All you need to obtain from your receiver is a positive B voltage anywhere from 45 to 180 volts. Voltage is not critical; no molestation of the receiver. So simple a child can operate it. Size 7 x 10 x 5 inches. Shipping weight, 8 lbs. List Price, \$25.00. No. 1614—Super Converter (less tubes). YOUR PRICE..... **\$15.93**

High-Voltage Condenser Units

We guarantee these condensers unconditionally. They are ideal for general replacement purposes and can be installed in any new power-pack. All condensers are furnished with 8-inch lengths of tinned "push-back" wire.

600 VOLTS				800 VOLTS			
Cat. No.	Mfd. Capac.	Your Price	Cat. No.	Mfd. Capac.	Your Price		
1702	1/2	\$0.25	1706	1	\$0.40		
1703	1	.30	1707	2	.70		
1704	2	.40	1708	4	1.05		
1705	4	.60					

Pacnet "250"

Power Auditorium Amplifier

One of the Most Powerful Super Power Amplifiers ever made.



CONTAINS 2 STAGES SUPER POWER A.F. AMPLIFICATION

This famous amplifier is provided with input and output transformers for working from a phonograph pick-up into a 2000-ohm transmission line or into the coupling transformer furnished with most dynamic reproducers. The tubes required are one '26, one '50 and one '81 rectifier. Where maximum output is not required, a '10 may be substituted for the '50 in the output. Automatic adjustment takes care of the discrepancy in voltages. The undistorted power output is 2.5 watts—enough for four small dynamic reproducers. This degree of power output provides satisfactory coverage for auditoriums having a volume of 25,000 cubic feet. The input voltage necessary to provide maximum output is but .025 volts. Ideal for theatres seating approximately 3,000 people, dance halls, schools, lectures, hospitals, auditoriums, outdoor gatherings, etc., etc. The gigantic power is at all times within control—for that matter, it can be used in any home, as the volume can be regulated down to a whisper! A PHONOGRAPH AMPLIFIER—PUBLIC ADDRESS AMPLIFIER SYSTEM. ETC. Use of the '26 tube in the input stage makes the long "warming up" period unnecessary. Shipping weight, 30 lbs. Overall size, 16 x 9 1/2 x 6 1/2" high. List Price, \$90.00. No. 1925—Pacnet Model 250 Power Amplifier (less tubes). Your Price **\$14.20**

FREE! New Summer Edition

The new Summer Edition of our greatly enlarged RADIO SERVICE TREATISE has just come off the press. If you liked the Winter Issue, you will like this one a hundred-fold. It contains some 75 new hook-ups, circuit diagrams; and some 350 illustrations. POSITIVELY THE GREATEST BOOK EVER PUT OUT BY ANYONE. Among the new matters listed are: VACUUM TUBE TREATISE, with many illustrations; full page Vacuum Tube Average Characteristics Chart for Take Care of Your Tubes; How to Connect Phonograph Pick-ups; Improving the Tone Quality of Old Sets; Connecting Additional Loud Speakers; all fully illustrated with diagrams. Other articles: Modernizing Old Radio Sets; How to Convert Battery to Power Sets; Selection of Tubes; Push-Pull Amplifiers; Replacing Audio Transformers; Phone Attachments; How to Choose Power Transformers; Voltage Dividers; Wattage of Power Transformers; Selecting and Installing Replacement Parts in Radio Sets; Filter Condensers; Repairing Eliminators. WRITE TODAY. Enclose 2 cents for postage. Treatise sent by return mail.

RADIO SERVICE TREATISE
AND
RADIO BARGAIN CATALOG
FOR RADIO SERVICE MEN, RADIO TECHNICIANS, RADIO DEALERS
RADIO TRADING CO.
25 WEST BROADWAY
NEW YORK CITY

6 MONTHS GUARANTEED NEONTRON TUBES

Sold on a 6 MONTHS FREE REPLACEMENT GUARANTEE BASIS, PROVIDING TUBE LIGHTS! All tubes are carefully meter-tested before shipment, and carefully packed. Do not confuse these HIGH QUALITY tubes with any other "low priced" tubes—our low prices are possible because we do a VOLUME business!



NEW					
Choice	Choice of	Choice	Choice	Choice	Choice
226	112A	245	222	210	235
227	200A-199X	280	210	231	247
171A	199UV-120	171	250	231	
201A	224		281	232	
63c ea.	69c ea.	79c ea.	1.58 ea.	1.08 ea.	1.50 ea.



WE ARE A WHOLESALE HOUSE AND CANNOT ACCEPT ORDERS FOR LESS THAN \$3.00.

If C. O. D. shipment is desired, please remit 20% remittance, which must accompany all orders.

If full cash accompanies order, deduct 2% discount. Send money order—certified check—U. S. stamps.

Radio Trading Co.
25R West Broadway
New York, N. Y.

ORDER FROM THIS PAGE. You will find special prices from time to time in this magazine. Get our big FREE catalog for the greatest Radio Bargains.

Should you wish goods shipped by parcel post, be sure to include sufficient extra remittance for same. Any excess will be refunded.