

March 15th
1930

Short Wave Adapter for Any Set!

15 Cents
Per Copy

RADIO

REG. U.S. PAT. OFF.

WORLD

416th Consecutive Issue—EIGHTH YEAR

Debate on Pentode

Theory of Dynamics

A Battery-Operated
Super-Heterodyne

Uses for Loftin-White
Power Amplifier

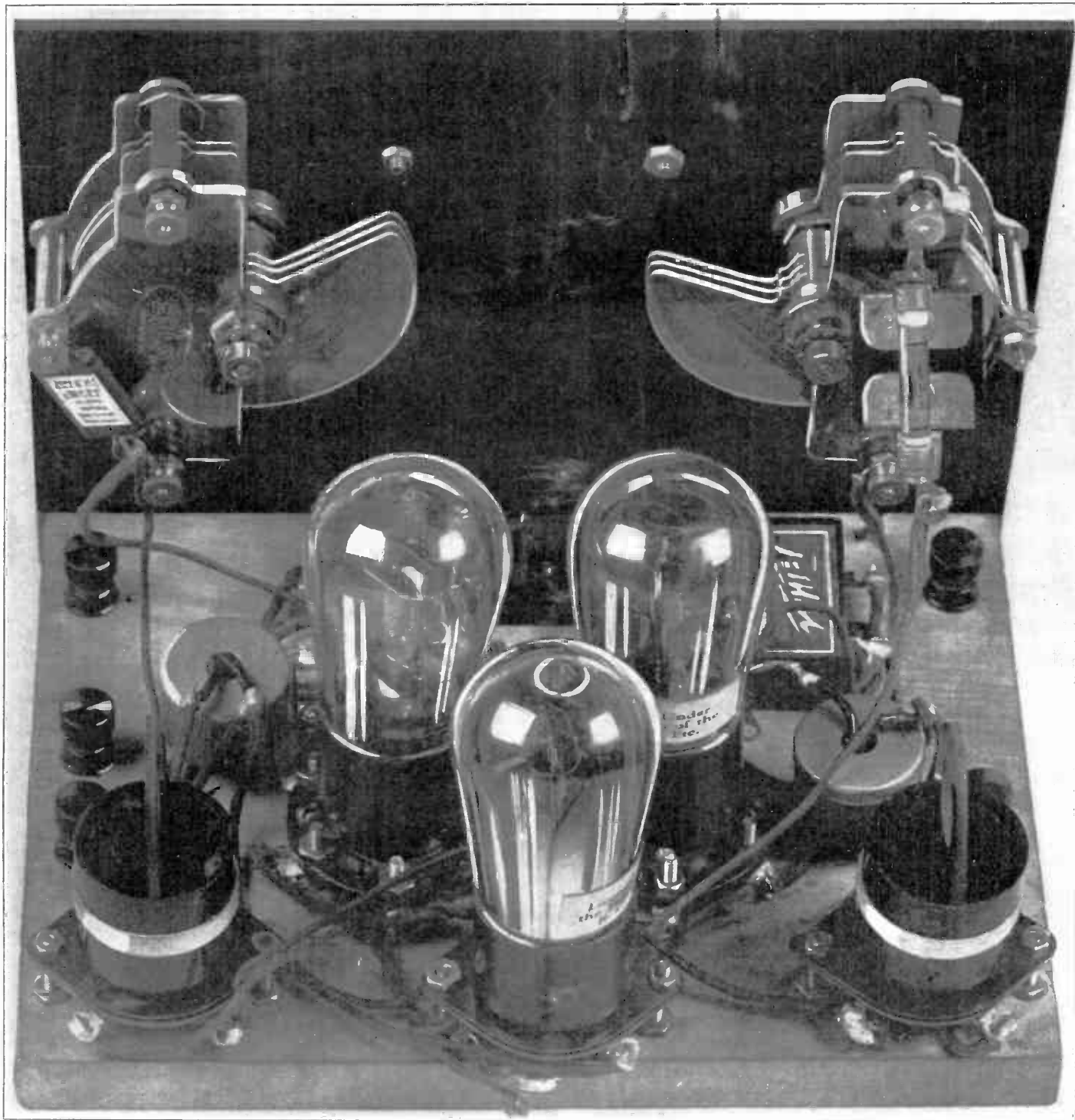

See Page 5 for Article on This Short-Wave Adapter for Any Circuit.

High Gain at Low Cost HB44 - - - \$45.35

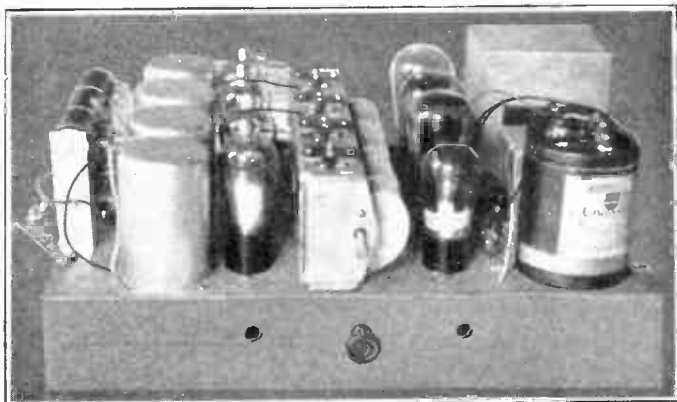

The HB44, assembled, presents in compact form, on a 17½ x 11½" steel chassis, a completely AC operated shielded receiver, using four 224 screen grid tubes, one 227, two 245s in push-pull, and a 280 rectifier, eight tubes all told. Here is the circuit that will bring 'em in from all over the country—and at a price you can afford—\$45.59. This price includes EVERYTHING except speaker, cabinet and tubes.

It's the Real Thing!

- (a) Three stages of tuned R.F., using 224 screen grid tubes.
- (b) Tuned input to 224 power detector.
- (c) Audio, consisting of first stage resistance coupled, second stage 245s in push-pull
- (d) Four totally shielded R.F. coils.
- (e) A chassis all drilled for necessary parts.
- (f) A four gang condenser, guaranteed accurate, with equalizing condensers built in.
- (g) 61 mfd. of filter and bypass capacity.
- (h) Thirteen different fixed voltages available from the output.
- (i) Single dial control.

LIST OF PARTS FOR THE HB44

<input type="checkbox"/> SL1, SL2, SL3, SL4—Four stage individually shielded coil cascade for .00035 mfd. (Four Cat. SH-3 of Screen Grid Coil Co.).....	\$ 3.80
<input type="checkbox"/> C1, C2, C3, C4—One four gang .00035 mfd. condenser with equalizers E1, E2, E3, E4 built in.....	3.95
<input type="checkbox"/> C5—One .01 mfd. mica condenser.....	.35
<input type="checkbox"/> C6, C7, C13, C14—Four 1 mfd. 200 volt DC bypass condensers....	2.00
<input type="checkbox"/> C8—One 1 mfd. 550 volt AC filter condenser.....	.85
<input type="checkbox"/> C9, C10, C11, C12—One Mershon, consisting of four condensers, two of 8 mfd. and two of 18 mfd. with bracket (Cat. Q-2-8, 2-18-B).....	5.15
<input type="checkbox"/> R1—One Electrad 25,000 ohm potentiometer with knob and two insulators	1.60
<input type="checkbox"/> R2—One 50,000 ohm Lynch metallized resistor (.05 meg.), with mounting45
<input type="checkbox"/> R3—One Lynch 5.0 meg. metallized grid leak, with mounting.....	.40
<input type="checkbox"/> R4—One 5,000 ohm resistor with mounting.....	.50
<input type="checkbox"/> VD—One Multi-Tap Voltage Divider, 13,850 ohms, 14 taps.....	3.95
<input type="checkbox"/> T1—One push-pull input transformer.....	2.50
<input type="checkbox"/> OPC—One center-tapped output choke.....	2.50
<input type="checkbox"/> T2—One Polo filament-plate supply (Cat. PFPS).....	7.50
<input type="checkbox"/> Ch—One double filter choke coil, 30 henrys each section, 100 ma.....	3.71
<input type="checkbox"/> SW—One pendant AC switch with 12 ft. cable.....	.80
<input type="checkbox"/> PL—One 2.5 volt pilot lamp and bracket.....	.70
<input type="checkbox"/> Speaker (+), (-), Ant., Gnd.—Four binding posts with insulators.....	.40
<input type="checkbox"/> One Clarostat Humdinger, 30 ohms.....	.50
<input type="checkbox"/> One subpanel 17½" x 11½", with five UY and three UX sockets..	3.00
<input type="checkbox"/> One vernier dial50
<input type="checkbox"/> Four National grid clips.....	.24
<input type="checkbox"/> All parts (less cabinet, tubes and speaker).....	\$45.35
<input type="checkbox"/> Tubes: four 224, one 227, two 245, one 280.....	9.51

GUARANTY RADIO GOODS CO.,
143 West 45th Street, New York, N. Y.
(Just East of Broadway.)

- Please ship all parts for HB44 @..... \$45.59
- Eight tubes for HB44..... 9.51
- Please ship C. O. D.
- Enclosed find \$..... remittance.
(Canadian must be P. O. or Express M. O.)

NAME

ADDRESS

CITY..... STATE.....

FIVE DAY MONEY-BACK GUARANTY

USE LYNCH RESISTORS

for new Loftin-White Set and Amplifier, auto-mobile radio sets, and new 245 resistance-coupled amplifier. Write for catalog and 40-page booklet.

LYNCH MFG. CO., Inc., 1775 B'way, N. Y.

AERIAL TUNER

Improves Your Reception

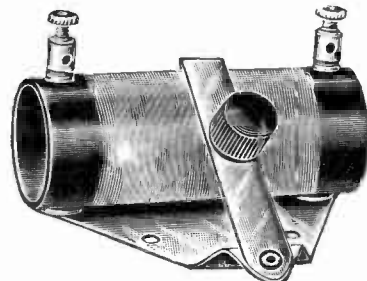

Remove aerial lead from set. Connect aerial instead to one of the binding posts of the Aerial Tuner. Connect the other binding post of the Aerial Tuner to antenna post of your set. Then move the lever of the Aerial Tuner until any weak station comes in loudest. The lever need not be moved for every different frequency tuned in. The Aerial Tuner acts as an antenna loading coil and puts the antenna's frequency at any frequency in the broadcast band that you desire to build up. Price, 85c.

GUARANTY RADIO GOODS CO.
143 West 45th Street
New York City
(Just East of Broadway)

WHAT

A BARGAIN
AT ONLY



\$4.89!!

Ansonia Gothic Speaker, a tremendous bargain at.....\$4.89!

A loudspeaker that gives you real performance, that stands up to a 171 or 171A tube without requiring an output filter, and that works splendidly from output filters in sets using 210, 245 or 250, single or push-pull, in a genuine walnut cabinet, all at less than the price of a good magnetic unit alone! And the magnetic unit in this Ansonia Speaker is of the very best Ansonia type.

The cabinet is of the popular Gothic type, and is a beauty indeed. Why, the cabinet alone cost the manufacturer in thousand lots more than the price now asked for the complete speaker.

Use this speaker on any set, battery-operated or AC, and you'll be delighted.

GUARANTY RADIO GOODS CO.
143 West 45th Street, New York, N. Y.
Just East of Broadway

Please ship C. O. D. one Ansonia Gothic magnetic speaker, in genuine walnut cabinet, @ \$1.89 plus post office charges, on 5-day guaranty of quick refund of purchase price if I am not satisfied with speaker for any reason.

Please send me a square model (not Gothic), but same unit in square walnut cabinet @ \$4.24.

Name

Address

City.....State.....

5-day Money-Back Guaranty.

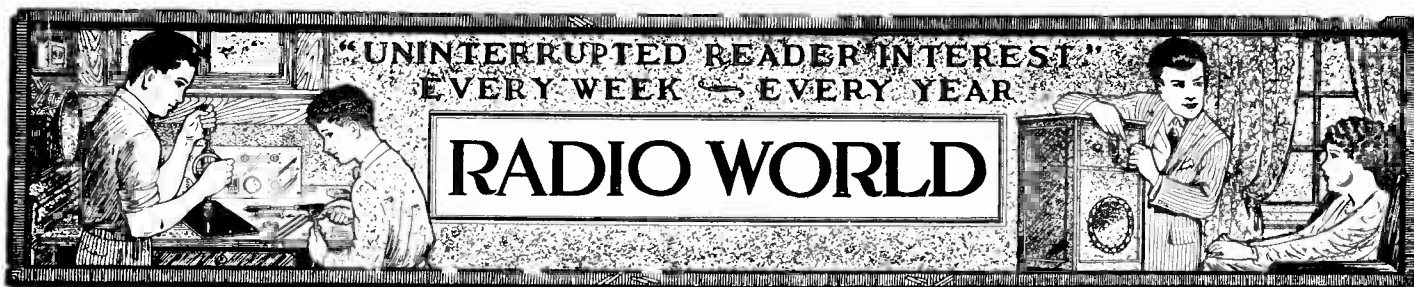

Vol. XVI, No. 26 Whole No. 416
 March 15th, 1930
 15c per Copy, \$6.00 per Year
 [Entered as second-class matter, March, 1922, at the Post Office at New York, N. Y., under act of March, 1879.]

Latest Circuits and News
 Technical Accuracy Second to None
EIGHTH YEAR

A Weekly Paper published by Hennessy Radio Publications Corporation, from Publication Office, 145 West 45th Street, New York, N. Y. (Just East of Broadway)
 Telephone, BRyant 0558 and 0559

RADIO WORLD, owned and published by Hennessy Radio Publications Corporation, 145 West 45th Street, New York, N. Y. Roland Burke Hennessy, president and treasurer, 145 West 45th Street, New York, N. Y.; M. B. Hennessy, vice-president, 145 West 45th Street, New York, N. Y.; Herman Bernard, secretary, 145 West 45th Street, New York, N. Y. Roland Burke Hennessy, editor; Herman Bernard, business manager and managing editor; J. E. Anderson, technical editor.

A Universal Adapter

That Works Short Waves With Any Receiver

By Capt. Peter V. O'Rourke

Contributing Editor

[Here is an AC short-wave adapter that requires a filament transformer, and three 227 tubes, but steps out for fair.—Editor.]

THE problem of having a dependable short-wave adapter that works on any receiver, short of a crystal set, is solved by the method illustrated in Fig. 1.

This adapter has an untuned RF stage preceding a modulator. The third tube is the oscillator. The pickup coil is permanent, being located over the oscillator socket.

The writer has operated this adapter on a short indoor antenna with good results. The circuit operates sufficiently well to warrant the assertion of utter dependability, which does not go for all adapters.

The short wave set up was made, experimentally, on a bread board 7x9 inches, of the 18-cent variety, with the handle cut off. The various parts were mounted on the board with 6-32 brass machine screws and hexagon nuts.

As you face the picture on the front cover the tube nearest you is the modulator, the tube directly behind to the right is the untuned stage, and the other to the left is the oscillator.

Where Tuning Condensers Go

The variable condenser to the left is in the oscillator circuit, the other variable condenser is in the modulator circuit, and the grid leak and grid condenser are mounted near the back of the front panel.

Almost directly under the right-hand variable condenser and mounted on the board is the 1 mfd. by pass condenser. While directly in front of this the Antenna RF choke is found, similarly on the left side. The other RF choke is slightly forward by the oscillator Variable condenser and directly in line with the other RF choke.

The sockets at the extreme left and right are respectively the oscillator short wave coil and the modulator short wave coil. These are 4-prong or UX sockets. A third coil (a winding for coupling purposes in series with the grid leak assembly and the grid of the modulator tube) is loosely coupled to the oscillator coil.

The heaters of the three tubes are connected in parallel and a single pair of leads of convenient length is connected to a source of heater current—a transformer, as indicated, with its mid taps grounded. The transformer should maintain the heater voltage drop at the tube terminals at not more than 2.5 volts.

Connections Necessary

The B voltage supply as indicated is approximately 50 volts and is derived from the B voltage supply of the radio receiver, to which the adapter is connected. This may be done directly to the receiver's B source, or to a G post of a screen grid tube. The connections to make the adapter operative (exclusive of wiring connections) are: antenna connects to adapter antenna post, ground to adapter ground post. Set connections are: run wire from one side of the modulator plate condenser to antenna post on the receiver, and run a wire from ground post on adapter to ground post of receiver.

One terminal on the adapter is the B+ 50 volts, more or less, which is connected into the B voltage network of the set, or a

HIGHLY SENSITIVE ADAPTER

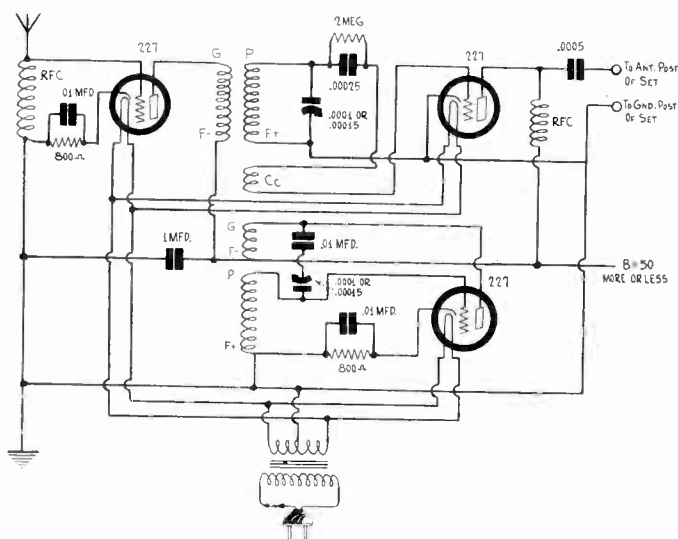

FIG. 1

A SHORT-WAVE ADAPTER THAT WORKS ON ANY CIRCUIT, CONSISTING ESSENTIALLY OF A MIXER POWERED BY A FILAMENT TRANSFORMER, WITH UNTUNED RF AHEAD. THE B VOLTAGE IS DERIVED FROM THE RECEIVER TO WHICH THE ADAPTER IS CONNECTED

thin piece of wire may be curled around the screen grid prong of a tube taken from the receiver, and when the tube is put back, a clip is attached to the overhang. The plate output of the receiver tube cannot be used this way.

If the builder wishes to take extra precautions in the matter of reducing possible inter circuit leakage, or in other words improve insulation resistance, the use of bakelite sockets and insulators is recommended.

Also the base, if of wood, could be thoroughly dried and shellacked.

Gives Excellent Results

The adapter is not experimental, in the sense that theory alone prompts this presentation, but it has been working for ten days now, and giving unflinching performance. It certainly does the trick—brings in short waves from all over—and with a simple setup. The only power needed is a small filament transformer's 2½ volt secondary. The B voltage comes from the receiver, and the radio frequency voltage from the ether.

The chief advantages are: (1), dependability; (2), high gain,
 (Continued on next page)

High Gain in Short-Wave Entire Rece

Only the Plate Potential, Around 50 Volts,

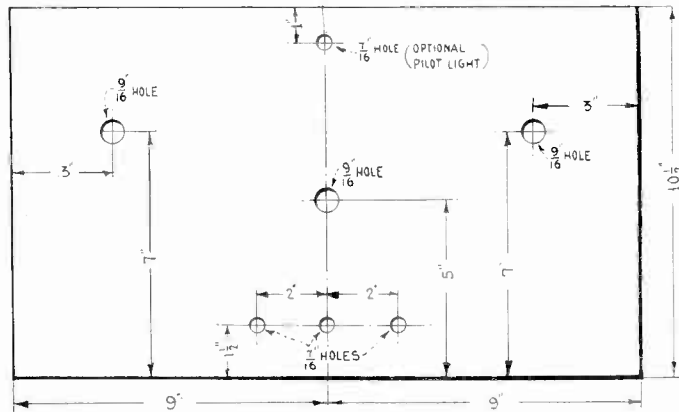

FIG. 2
DIRECTIONS FOR DUPLICATING THE FRONT PANEL
USED BY THE AUTHOR.

by an untuned RF stage and utilization of the entire broadcast receiver; (3), universal application to any and all receivers, no matter what tubes the receiver uses.

DC and AC Adapters

It is possible to power the adapter with either AC or DC on the filaments, and either type will work with either type of broadcast receiver. The accompanying drawing of a three-tube adapter is designed for alternating-current supply as far as the heaters go. This is the most convenient type where AC is available.

The heater current for the three tubes in this adapter is derived from a separate filament transformer built into the adapter. Since all the tubes in the circuit require 2.5 volts the transformer need have only one secondary winding, which should be able to deliver 5.25 amperes or more. While it would be possible to take the filament current from one of the sockets in an AC set this could not be done without eliminating part of the broadcast receiver, which is not practical. Moreover, the current required by the adapter would be greater than that required by the tube eliminated and this would upset certain adjustments in the receiver. Again, if the filament current were obtained in this manner the adapter would not be suitable for so many different broadcast receivers.

Let us examine the circuit diagram of the adapter. We note first that there is an untuned radio frequency amplifier ahead of the modulator. This is used to increase the intensity of the short-wave signals before they are impressed on the modulator and thus to widen the reception range of the circuit. The first stage is untuned because the use of more than one radio frequency tuner on short waves is not practical. Neither is it necessary to use more than one tuner.

Plug-in Coils Used

Plug-in coils, of course, are used both in the amplifier and between the RF amplifier and the modulator, because there is no other practical way of covering the wide band of short waves which is ordinarily desired. Such coils may be had in small sizes fitting into regular tube sockets.

The pick-up coil, which is loosely coupled to the oscillator, is connected in the grid lead of the modulator. This is generally regarded as an excellent way of mixing the frequencies. The oscillator is of the type in which both the grid and the plate coils are tuned with the same condenser. This type has been found to be reliable over wide ranges of frequency.

The two coupling chokes used in the circuit must have as low distributed capacity as possible since the circuit primarily works at very high frequencies. This is particularly true of the first, or antenna, coil, which must be for all frequencies between 20,000 and about 2,000 kilocycles. Distributed capacity in the winding of this coil would tend to make the coil a condenser in effect at the higher frequencies, and this would prevent reception on these frequencies. There are commercial coils which

LIST OF PARTS

- Two short-wave tuning condensers (.0001 or .00015 mfd.)
- One .00025 mfd. fixed condenser with clips
- Three .01 mfd. mica fixed condensers
- One 1 mfd. by-pass condenser
- One 80 mfd. equalizing condenser
- Coupling winding
- Two 800 ohm. wire-wound biasing resistors
- Ant., Gnd., Output—Four binding posts
- Two sets of short-wave plug-in coils, three coils to a set, total six coils
- Two four-prong sockets (for coils)
- Three five-prong sockets (for tubes)
- Two 50 to 65 millihenry RF chokes
- One .0005 mfd. fixed condenser
- Two vernier dials
- One panel and cabinet
- Six extending washers
- Three 227 tubes
- One filament transformer, 2.5-volt, 6 amp. secondary

have such low distributed capacity that no trouble will be experienced when they are used.

The second choke in the plate circuit of the modulator tube works at a much higher frequency than the first and no difficulty from the short-circuiting effect of the distributed capacity will be encountered with the ordinary chokes available.

The use of the second choke and the .0005 mfd. coupling condenser in the output is for the purpose of adapting the circuit to any receiver, no matter what type of input there is in that receiver. If the broadcast receiver normally works with a loop, this should be left in position, or else a small coil of equivalent inductance should be substituted.

Multi-Tube, Short-Wave Receiver

It is realized that when the adapter has been added to the broadcast receiver it becomes a multi-tube short-wave receiver. For example, if it is put ahead of a 5-tube neutrodyne the circuit becomes an 8-tube short-wave Superheterodyne, and if it is put before an 8-tube Superheterodyne the receiver becomes an 11-tube receiver, twice over a Superheterodyne.

Attention must be called to the method of obtaining plate voltage for the tubes in the adapter. It may be obtained from a 45-volt battery connected between B plus and ground, or it may be obtained from the B supply for the broadcast receiver. Undoubtedly most will want to use this B supply in preference to using a battery. Well, it is only necessary to run two leads from the voltage divider to the adapter. One lead is run from the negative end of the voltage divider to the ground in the adapter and the other from a suitable positive point to the terminal on the adapter labeled B plus 50. It is not necessary to use 50 volts exactly but the nearest available without providing an extra tap on the voltage divider.

In some receivers the voltage divider may not be accessible because of shielding and because of the absence of binding posts. It is, however, always possible to get at a conductor which is at the required positive potential, for example, the B plus terminal of the first audio transformer. The negative side of the voltage divider can in most instances be reached by simply connecting a wire to the metal framework of the receiver, or to the rotors of the variable condensers.

Operating Hints

The type of oscillator used is such that there may be some trouble from hand capacity effects. This difficulty, should it occur, can be avoided by placing a grounded shield made of heavy tin foil or thin sheet metal back of the panel between the oscillator control dial and the condenser. If tin foil is used it can be glued to the panel. The shield must not touch any part of the oscillator condenser because both sets of plates of this are "hot."

The present popularity of short-wave reception is bound to

SHORT WAVES DEPENDABLY RECEIVED

Adapter That Uses Your iver "As Is"

is Derived From the Broadcast Set Itself

result in great improvements in the design of short-wave receivers and it is the general rule that where most interest is concentrated there will progress be most rapid. At this time interest is centered in the Superheterodyne type adapter for short waves, and since this type is ideally suited there should be a rapid development both in the technique and in the popular interest.

One phase that should be studied thoroughly is modulation of mixing. What is the best mixer for a short-wave adapter of the type discussed herein? Should the oscillation current be introduced into the modulator tube by way of a coil connected in the grid lead, by a coil connected in the grid return lead? If a screen grid tube is used for modulation is it better to connect the pick-up coil somewhere in the grid circuit or in the screen grid circuit? If it found that coupling to the screen grid gives better results, what should the steady voltage be to give the best possible modulation and greatest sensitivity? Some of these points have been answered by experimentation already at certain frequencies but not over the entire frequency range which such an adapter is expected to cover.

Possibilities of Pentodes

We know that the screen grid tube has possibilities in short waves, both for amplification and modulation which the three-element tube does not have. But what are the possibilities of the pentode in this respect? It would seem that it has great possibilities both as a high frequency voltage amplifier and as a modulator. It has another element into which the local oscillator voltage may be impressed. There are almost limitless combinations of voltages that may be applied to the elements, and every combination will give a different result. Some of the combinations should give superior results. The possibilities of the pentode should be explored with a view of finding the best combination of voltages and modes of coupling the pick-up coil, with special reference to the high frequencies that are of greatest interest to broadcast listeners. This range is from about 20,000 kc to 3,000 kc.

There is another field for investigation in the type of detector that will give the best results on the high frequencies. For example, is grid bias detection more sensitive than grid condenser and grid leak method? We cannot answer this question off-hand just because we happen to know the answer when broadcast frequencies are involved. If grid condenser and leak detection is the more effective, what should be the values of these elements? Almost certainly they should be different at 20,000 kc than at 550 kc. There are many points to learn about short waves, and right now most of the research going on in radio deals with this phase.

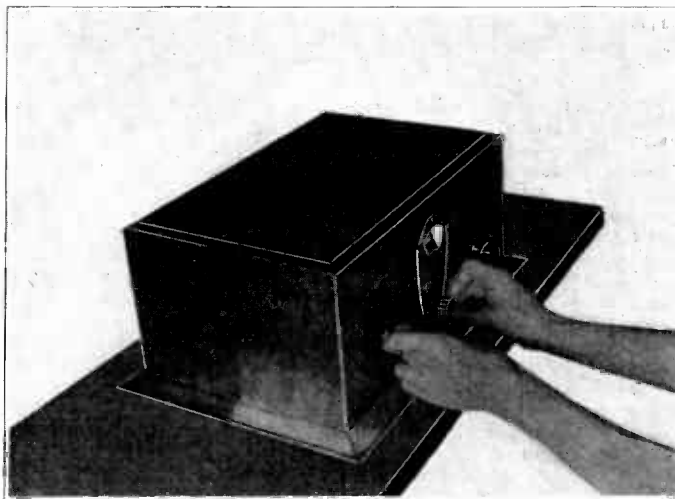

Fig. 3

When tuning in short-wave stations it is sometimes necessary to steady the hands by resting them on the table while the vernier dials are turned.

LITERATURE WANTED

- Wm. G. Smith, c/o The Vaughan Lumber Company, 2nd Nat'l Bank Bldg., Houston, Tex.
- R. W. Lineberry, 312 No. Forbis St., Greensboro, N. C.
- F. W. Allen, North East, Penna.
- Ray C. Hubler, 1417 Mentor Ave., Cleveland, Ohio.
- Allan C. Bernstein, 501 River St., Hoboken, N. J.
- Albert Dorn, 3337 N. Waterloo St., Phila., Pa.
- L. K. Swan, Box 318, New Glasgow, N. S., Can.
- A. W. Lamb, 1530 No. Clarence, Wichita, Kans.
- J. T. McLain, 1707 Kirk Ave., S. E., Roanoke, Va.
- Wm. Murto, 1408 N. 7th St., Superior, Wis.
- C. L. Stein, 4424 Pen, Kansas City, Mo.
- Pierce T. McCarthy, 185 W. 88th St., N. Y. City.
- Nathan Etelstein, 946 Forest Ave., Ridgewood, B'klyn, N. Y.
- R. W. Jamison, Box 62, Idyllwild, Calif.

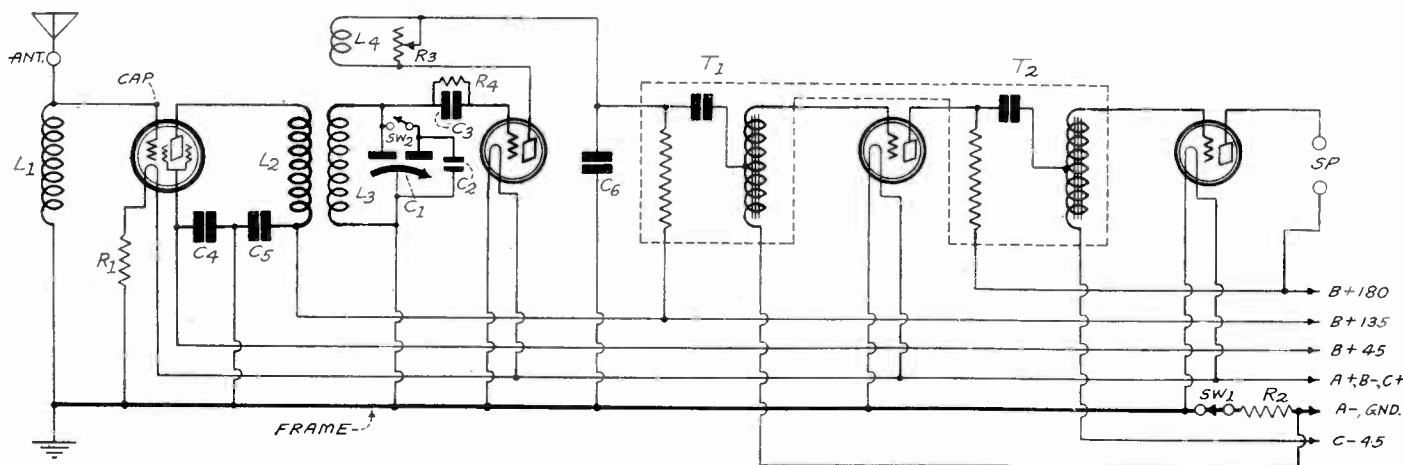

DIAGRAM OF THE NATIONAL SHORT-WAVE RECEIVER WITH WHICH HIGH FREQUENCY SIGNALS CAN BE RECEIVED DIRECTLY.

ON SPEAKER BY USE OF NEW ADAPTER

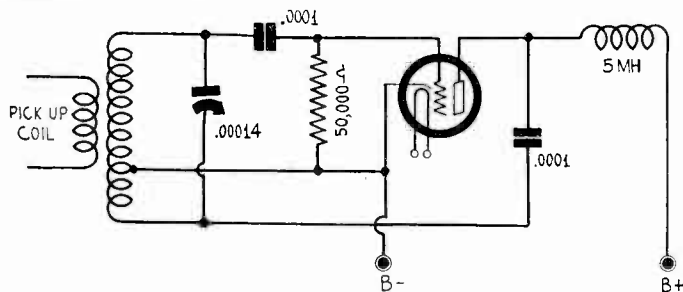

FIG. 1.

A GOOD OSCILLATOR FOR A SHORT-WAVE SUPERHETERODYNE ADAPTER. THE PICK-UP COILS CAN BE PUT IN THE GRID LEAD OF THE FIRST DETECTOR OF THE ADAPTER CIRCUIT.

SHORT-WAVE adapters based on the Superheterodyne principle have been described in several recent issues of *RADIO WORLD* and they have aroused much interest. It is confidently believed that this interest will be sustained indefinitely because this type of adapter is the only one that is based on a sound and reasonable principle. Many other types of adapters have been described from time to time, but they have never gained much popularity for the reason that they did not work unflinchingly. If they did give results these were sometimes indifferent. Interest in adapters is higher than ever, and it is imperative to supply substantial designs.

There are many reasons why the Superheterodyne type adapter should gain in popularity and in widespread distribution. They will work with any standard receiver of whatever type. They are sensitive and really are capable of results claimed for other adapters and short-wave receivers. They are simple to build and to use.

Discussion of Principle

An explanation of the principle of the Superheterodyne type adapter is identical with an explanation of the principle of the broadcast Superheterodyne. The difference is only one of frequency.

It is well known to Superheterodyne enthusiasts that when the intermediate frequency is low, there is danger of failure because the oscillator and the radio frequency circuits will not act independently. For example, suppose that the intermediate frequency is 30 kc and it is desired to tune in a broadcast station of 1,500 kc. The oscillator might be set at 1,530 kc. These two frequencies, namely, 1,500 and 1,530 kc, are so close together that the oscillator may not oscillate at the required 1,530 kc, but at a frequency which is near 1,500 kc, or exactly 1,500 kc. When this occurs the 1,500 kc signal will not be received because the 30 kc beat frequency is not produced and the intermediate frequency tuner will not pass any other.

Whether the oscillator can be set so that it will oscillate at a frequency 30 kc different from the signal frequency depends on the selectivity of the radio frequency tuner, on the selectivity of the oscillator circuit, on the degree of coupling between the two circuits, and on the ratio between the two frequencies. If the radio frequency tuner is very selective compared with the oscillator circuit, then for a given degree of coupling the radio frequency tuner will be the more effective in determining the frequency at which the oscillator works. If the oscillator circuit behaves more selectively, then for the same degree of coupling the oscillator tuned circuit will have the greater influence in determining the frequency, as it should have.

Also, for given selectivities of the two circuits, the looser the coupling between the two circuits, the less will be the mutual influence on the frequency. In other words, if the coupling is sufficiently loose the oscillator will not be appreciably affected by the presence of the radio frequency tuned circuit. Again, if the ratio of the two frequencies differs considerably from unity the mutual influence will be small. Thus a Superheterodyne with a 30 kc intermediate may work satisfactorily at 550 kc and not at all at 1,500 kc.

Making Ratio Higher

One method of minimizing the effect of one circuit upon the other is to increase the intermediate frequency. This automatically makes the ratio of one frequency to the other differ more from unity, and therefore it makes possible a closer coupling between the oscillator and the modulator circuits. The arguments against the use of a high intermediate frequency have been that the amplification and the selectivity were lower and that the instability was greater. These objections are more academic than practical in view of the present state of the art. Also, the permissible closer coupling between the oscillator and the modulator partly offsets the lower amplification on the higher intermediate frequencies.

We said this by way of introduction to the Superheterodyne type adapter because the principles of both are the same, and any difference is due to frequency.

Suppose we wish an adapter of this type capable of reaching down to 15 meter (20,000 kc). What should the intermediate frequency be? In the first place it must fall within the tuning

The New S

How Mixer Works in Conjunction

By Knollys

range of the broadcast receiver, because the tuner in this is to act as intermediate frequency tuner. In the second place it must be as high as practical in order that the ratio between the frequency of the oscillator and that of the signal shall differ as much as possible from unity. This imposes a choice of an intermediate frequency near the upper frequency end of the broadcast tuner range, preferably above the broadcast frequencies if the tuner is such as to permit it.

2,000 kc Intermediate

Assume for simplicity that the broadcast receiver can be tuned to 2,000 kc, and that we use this for the intermediate frequency. If we wish to receive a signal of 20,000 kc we can set the oscillator at 22,000 kc. Then the ratio of the oscillator frequency to that of the signal is 1.1. This is sufficiently different from unity to make the oscillator work independently of the RF tuner provided that the coupling is loose.

We might wish to tune in signals having frequencies as low as 3,000 kc. To get a signal of this frequency we would have to set the oscillator at 5,000 kc. Now the ratio of the oscillator frequency to that of the signal is 1.67.

It is necessary, of course, to have plug-in coils for both the oscillator and the radio frequency tuner in order to cover this wide range, that is, from 3,000 to 20,000 kc.

Few broadcast receivers will reach up to 2,000 kc, or down to 150 meters, but nearly all will reach to 1,500 kc, or 200 meters. The 1,500 kc frequency can be used whenever it is necessary and the results will not be much different. Should interference, due to repeats, occur, this may be avoided by changing the setting of the broadcast receiver to some other frequency. In this respect the Superheterodyne type adapter is superior to the "Superheterodyne broadcast receiver, in which the intermediate frequency is fixed, for when image interference occurs there is nothing much that can be done about it. Tuning out the interfering station in the radio frequency level is about the only remedy, but this requires radical changes in most instances. This is not necessary when the interference can be avoided by changing the intermediate frequency.

Repeats on Adapter

One way of minimizing repeats on the broadcast Superheterodyne is to make the intermediate frequency high, so that the radio frequency tuner is set far away from the oscillator frequency. This is not practical in the adapter even if the intermediate frequency is of the order of 2,000 kc. The reason for this is that the ratio of the oscillator frequency to that of the signal is closer to unity. A 2,000 kc intermediate frequency is to 20,000 kc signal frequency what a 55 kc intermediate is to a 550 kc signal. Hence troubles from image interference would be about the same in both instances if the signals at the higher frequency were as close together as at the lower. Fortunately they are not, that is, in absolute values, though they may be closer relatively.

Repeat tuning, therefore, may be expected to some extent in the Superheterodyne adapter, at least for the higher frequencies. However, as was pointed out, this should not cause any trouble since it is only a moment's work to change the intermediate frequency.

At the higher frequency end of the adapter range the repeats will be very close together. We found out before that to bring in a signal of 20,000 kc the oscillator could be set at 22,000 kc, when the intermediate is 2,000 kc. But it can also be brought in by setting the oscillator at 18,000 kc. These settings are only 4,000 kc apart, which put them very close together on the dials. At the other end of the short wave tuning scale they will be a little farther apart on the dials.

Since there are several coils in a set covering the range from 20,000 to 3,000 kc there will also be several points in the frequency scale at which the repeats will come in close and several where they come farther apart.

In most receivers it will undoubtedly be necessary to use a lower intermediate frequency than 2,000 kc. Possibly 1,700 kc is the highest that can be used in the majority of the sets. The limit, of course, is determined by the minimum setting of the tuning control of the receiver.

Possible Troubles

In some instances it may be desirable to tune the broadcast receiver to the 550 kc frequency. This would have the advantage of making the receiver somewhat more selective than it is when the receiver is tuned to the upper frequency. But considerable sensitivity is lost, as TRF amplifies more at higher frequencies. Again it may be desirable to tune it to some special

W Adapters

tion With Broadcast Receiver

Satterwhite

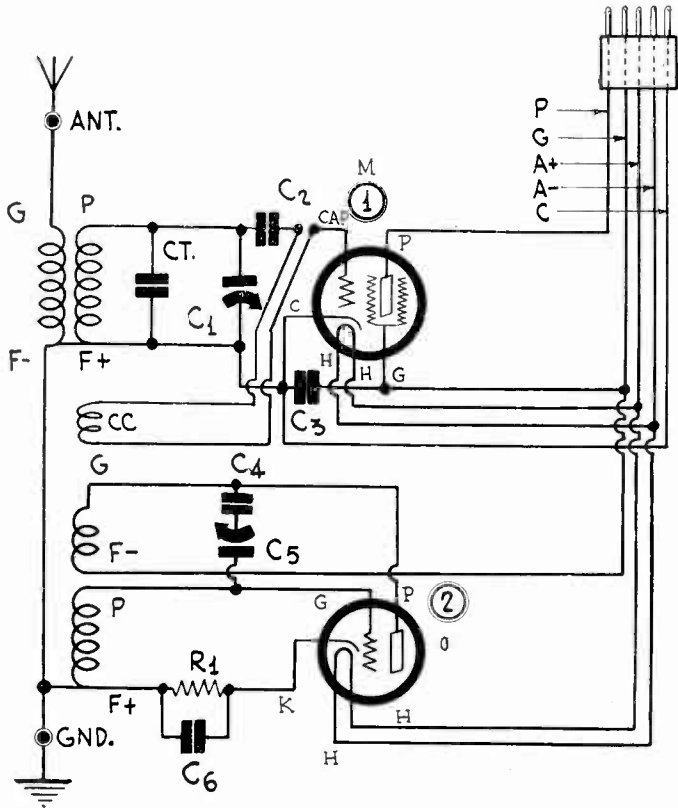

FIG. 2

A MODIFIED HARTLEY OSCILLATOR IS USED IN THIS SHORT-WAVE ADAPTER FOR AC SCREEN GRID BROADCAST RECEIVERS. IT IS "MODIFIED" TO THE EXTENT THAT A TUNED PLATE-GRID CIRCUIT IS USED.

frequency at which the intermediate is most sensitive, if this should be different from the highest frequency, due to trimmers adjusted for such other sensitivity.

It may be that an adapter built on the Superheterodyne principle will not work even though the wiring has been done correctly. This trouble is almost certain to be in the oscillator. Possibly the oscillator is not functioning because the radio frequency tuned circuit is too close and tuned too closely to the same frequency as the oscillator. It may also be that the intentional coupling between the two circuits or the two tubes is too close to permit oscillation. Another possibility is that the oscillator coil is in close proximity to a metal in which absorption occurs. Again, it may be that the voltages on the various elements are not high enough. A high frequency oscillator has to be nursed carefully at times.

Very often a short-wave adapter will oscillate on all but the smallest coil. The oscillator in the Superheterodyne adapter must function on all the coils in the set as well as on all the settings of the condenser for each coil. If it does not oscillate the adapter is dead.

The commonest cause of non-oscillation is incorrect coil polarities. The two windings, plate and grid, should be aiding each other, not bucking.

When the experienced radio fan reads the assertion that the Superheterodyne type short-wave adapter can be used successfully in conjunction with any broadcast receiver his mental reaction is one of skepticism. His experience with short-wave adapters has been such that doubt is natural and apparently logical. But has he had any experience with the Superheterodyne type of adapter? He has not, for if he had he would undoubtedly say: "Of course it works."

Strong Appeal

Even if he has not tried one of these adapters and if he studies the principle and the circuit diagram of one he will reach the conclusion that it is worth giving a thorough trial. It is so simple to build and to try and the principle appears sound. And it is. The idea of receiving short-wave stations on the existing



FIG. 3

THE COUPLING OR PICKUP COIL, CC IN FIG. 2, IS SHOWN HERE PERMANENTLY IN PLACE AT THE SOCKET THAT HOLDS THE OSCILLATOR COIL. THIS PICKUP COIL IS NOT ALWAYS NECESSARY, BUT IT IS A GOOD IDEA TO INCLUDE IT. ABOUT 6 TURNS ON 1/4 IN. OR 1/2 IN. DIAMETER WILL SUFFICE.

broadcast receiver with the aid of a simple attachment is very enticing and many who have had mediocre results with other adapters are strongly tempted to try again.

The strong appeal of the Superheterodyne type adapter is that nothing of the broadcast receiver is thrown away while the adaptation is made. If the broadcast receiver is a magnificent Superheterodyne all of that receiver is used for the short waves.

This is true whether that broadcast receiver is operated with alternating or direct current. If the broadcast receiver is a neutrodyne, AC or DC operated, the Superheterodyne type adapter works just as well. That is to say, the short-wave results are comparable provided that the neutrodyne and the broadcast Superheterodyne receivers are comparable in sensitivity and selectivity. Naturally, the Superheterodyne would be the superior circuit and consequently would give better short-wave reception.

Use With Any Receiver

This, however, does not mean that if the circuit is a neutrodyne distant short-wave stations cannot be received. They surely can, for the neutrodyne is one of the most sensitive broadcast receivers ever devised.

It can be used equally well with modern tuned radio frequency receivers, such as the HiQ30, the MB-29, HB-44 and similar sensitive receivers. Can it be used with different commercial receivers? Surely. The Superheterodyne type adapter is not a respecter of receivers. It is the most democratic of adapters.

Now some receivers are built for AC supply, others for DC supply, still others for a combination of DC and AC supply. This makes no difference whatsoever to the Superheterodyne type adapter. The only condition is that the broadcast receiver is good as such.

These statements are very comprehensive and it may be that some one will ask whether it can be used with a crystal set. It is admitted that the results will not be anything to boast about because there is no amplification in the crystal set, and it is the amplification in the broadcast receiver of which advantage is taken. There are also a few simple one-tube receivers still in use which are no better than a crystal set. But when we make claims for the Superheterodyne adapter we talk about good broadcast receivers, not those which should only be found in radio museums.

The diagram, Fig. 2, shows a short-wave adapter described in last week's issue, March 8th. This uses a modified Hartley oscillator. It is of the tuned grid-plate variety. This particular adapter is useful only with receivers that have a 224 tube as the first radio frequency amplifier. The number of intermediate stages of amplification is one fewer than the number of TRF steps in your receiver.

The adapter is as good as your receiver permits it to be. It is preferable to turn the receiver dial to tune in a frequency above the broadcast band (below the lowest broadcast wavelength). To assure utmost sensitivity here it may be advisable to readjust the trimming condensers on your receiver to this utmost high frequency to which the receiver will respond.

Trend in Design of

The intermediate frequency has been

By J. E.

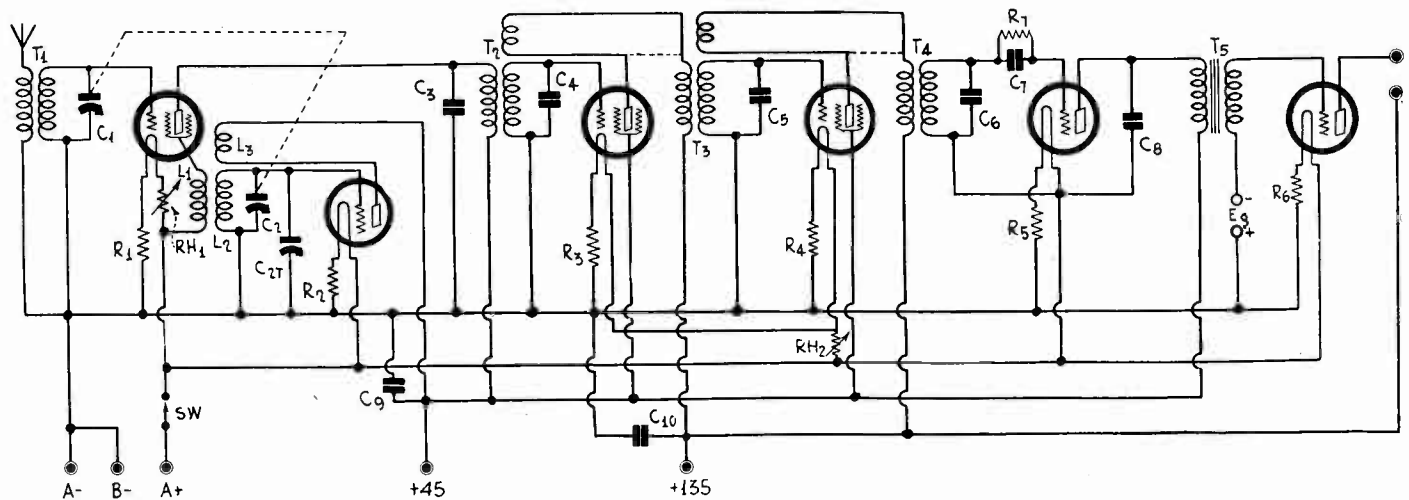

FIG. 1

A FIVE-TUBE SCREEN GRID SUPERHETERODYNE IN WHICH THE INTERMEDIATE FREQUENCY IS 500 KC. IT IS FOR DC SUPPLY AND CONTAINS ONE STAGE OF AUDIO FREQUENCY AMPLIFICATION.

THE trend in the development of Superheterodynes has always been to increase the intermediate frequency. At first the frequency used was usually 30 kc, but when certain difficulties arose because of the use of this frequency it was raised to 45 kc. Later it was raised to 60 kc, 90 kc and so on up to 400 kc, or even higher. This increase in the intermediate frequency was made largely to avoid image interference, or cross talk between two stations separated in frequency by twice the intermediate frequency. Some designers increased the frequency for the purpose of making the Superheterodyne so-called "one spot," but this was merely another way of expressing the desire to get rid of the cross talk and the resulting squealing.

The higher the intermediate frequency the less is the trouble from image interference because when the frequency is high the frequency of the interfering carrier is so far removed from the frequency of the desired carrier that it is effectively suppressed by the radio frequency tuner, even if its selectivity is only moderate. When the intermediate frequency is low it requires a high order of selectivity usually not obtainable with less than two or three tuners. Such circuits are complex and do not meet with general popular approval.

Going to Extremes

It is only natural when it is discovered that a certain course of change results in improvement that this course should be followed to extremes. This happened in the Superheterodyne, intermediate frequencies, so-called, as high as 3,000 kc being used. Such frequencies defeat the principal virtue of the superheterodyne method, the increased amplification efficiency of tubes at low frequencies. The introduction of screen grid tubes has changed this to a large extent but still there is little reason for using intermediate frequencies higher than the lowest broadcast frequency, or higher than the lowest frequency for which the receiver is designed.

Avoidance of image interference is not entirely achieved by simply increasing the intermediate frequency no matter how high it may be chosen. It is achieved only by sufficient selectivity in the tuned circuit ahead of the modulator. But one ordinary tuned circuit may be sufficient when the intermediate frequency is of the order of 500 kc while three similar tuned circuits would be required at 50 kc. Neither is it achieved by selecting an intermediate frequency so high that no broadcast station can be received at more than one setting of the oscillator dial. This would be true if there were no transmitting stations operating outside the broadcast band, but there are many more outside that band than inside.

Advantage of 500 Kc Intermediate

Nevertheless certain advantages accrue from the use of a frequency of the order of 500 kc. In the first place, the amplification of tubes is good at this frequency. That many broadcast receivers are relatively ineffective at 550 kc is beside the point, for this lack of efficiency is not due to the tubes but to the coupling transformers. In the second place, when the intermediate frequency is 500 kc no broadcast station can be received at more than one point of the oscillator dial, provided that the

oscillator is designed to cover the proper range of frequencies.

The broadcast band covers the frequencies between 550 and 1,500 kc. To receive the 550 kc carrier with a 500 kc Superheterodyne we must set the oscillator at 1,050 kc or at 50 kc. Obviously it is not practical to set it at 50 kc so we design the oscillator so that its lowest frequency of oscillation is 1,050 kc. To receive the 1,500 kc carrier we can set the oscillator either at 2,000 or at 1,000 kc. But since the oscillator has been designed so that its lowest possible frequency is 1,050 kc it is not possible to receive the 1,500 kc carrier on the lower setting. Therefore the oscillator should be designed so as to cover a frequency range of 1,050 to 2,000 kc. If we choose an intermediate frequency as low as 450 kc the oscillator must be designed so that there will be some overlapping at the higher frequency end of the broadcast band.

When the intermediate frequency is 500 kc any two stations separated by 1,000 kc will be subject to image interference. But this frequency is so high that almost any tuner for which any claim of selectivity can be made will be able to suppress the one not desired when the tuner is adjusted to the frequency wanted.

Simple Intermediate Coils

One advantage of a 500 kc intermediate is that ordinary broadcast receiver tuning coils can be used in the intermediate frequency selector. Suppose such a coil has been wound for a .0005 tuning condenser. Usually when a condenser of this capacity is connected across the winding supposed to be tuned the circuit will really be tuned to a frequency less than 550 kc. It may not reach down to 500 kc but if a trimmer condenser is connected in shunt with the main condenser it will reach down easily. Of course it is not necessary to use variable condensers. Mica dielectric condensers of the same capacity can be used, and these have the advantage of requiring very little room. The selectivity of the circuits so formed will be practically the same as if air dielectric condensers were used.

Regeneration in the intermediate frequency amplifier is feasible when the intermediate frequency is as high as 500 kc. There is no reason why it should not be used at 500 kc if it is desirable at 550 kc. One of the objections against regeneration in the intermediate frequency amplifier has been that the circuit becomes too selective in that frequency level. This objection is valid when the frequency is low but loses its validity when the frequency becomes of the same order of magnitude as broadcast frequencies. In fact the increased selectivity obtained by regeneration is desirable because at 500 kc the circuit will not be nearly as selective as at 50 kc without regeneration.

A DC 500 Kc Superheterodyne

In Fig. 1 we show the circuit diagram of a 500 kc Superheterodyne for direct current tubes. We shall give the various values involved for 222 type screen grid tubes and five-volt three-element tubes. It can easily be changed to 99 type three-element tubes by changing the ballast resistors.

The ballast resistors R1, R3 and R4, which serve screen grid tubes, should be 25-ohm units. Resistors R2, R5 and R6, which serve five-volt, .25-ampere tubes, should be 4-ohm units. Two rheostats are used for volume control purposes. Rh1 in the

Super-heterodynes

increased to avoid image interference

Anderson

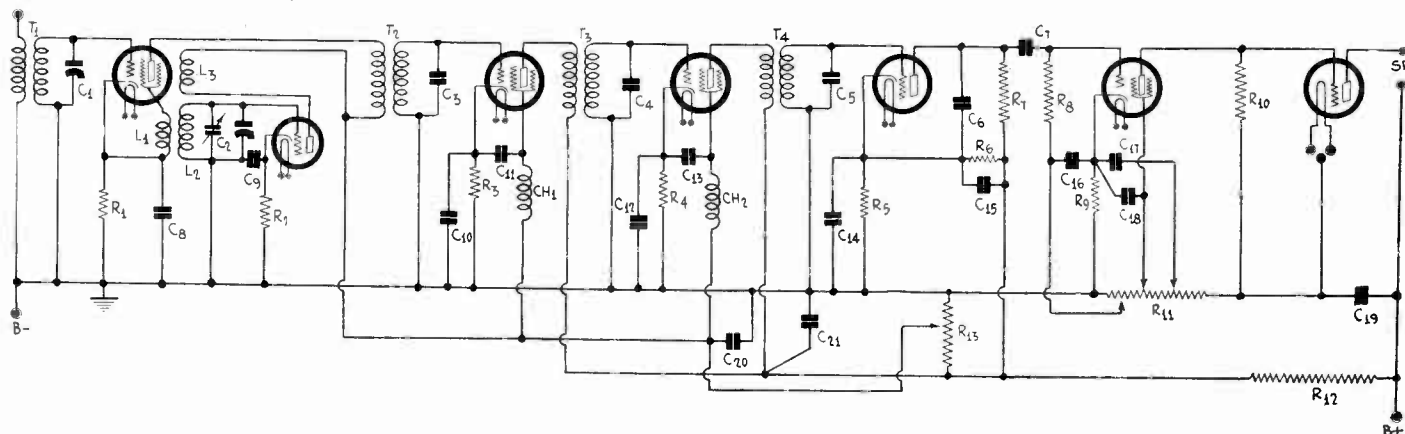

FIG. 2
THIS SEVEN-TUBE CIRCUIT IS THE AC VERSION OF THE CIRCUIT IN FIG. 1 AS FAR AS THE RADIO AND INTERMEDIATE FREQUENCY PORTIONS ARE CONCERNED. THE AUDIO AMPLIFIER IS THE LOFTIN-WHITE.

positive leg of the modulator tube should be 30 ohms and Rh2 in the positive filament lead to the two intermediate tubes should be 10 ohms or more.

T1 is an ordinary input transformer the secondary of which is wound for a .0005 mfd. condenser C1. The primary of this transformer should be rather small in order to make the circuit selective. The size of the transformer would depend largely on the room that is available for it. The receiver assembled had a coil wound on 1.25 tubing with No. 28 enameled wire and the coil was inclosed in an aluminum shield. The number of turns on the secondary was 84 and that on the primary 15 turns. However, a few more turns could have been used to advantage on the primary. In winding the secondary it is well to put on more turns than it is thought may be needed in order that there may be some leeway. Turns can always be removed if it is found condenser C1 does not cover the desired frequency range.

Adjustment of the Oscillator Coil

The oscillator coil was wound on the same size form as the antenna coil, namely, 1.25 inch diameter, and it was provided with prongs to fit into a tube socket. The pick-up winding L1 was wound on the socket and cemented in place. The socket used had a suitable shape for this. In case a socket of a different shape is used the pick-up coil can be wound on a suitable piece of tubing and placed around the socket in a similar manner. Of course, if the oscillator coil is wound on a piece of tubing which is not provided with the plug-in feature it is just as well to wind the pick-up coil on the same form. The pick-up coil used had 15 turns of No. 24 double cotton covered wire.

As indicated in the drawing, the tuning condensers C1 and C2 were put on the same shaft. This necessitated the use of the trimmer C2T. If this arrangement is used C2 may have a capacity of .000250 mfd. and C2T a capacity of .0001 mfd. That is, the total capacity, not counting stray capacity, may be .00035 mfd. If the two condensers are mounted on separate controls, which is recommended, only C2 is needed in the oscillator and it may have a capacity of .00035 mfd. This calls for 45 turns of No. 28 enameled wire on the 1.25 inch form for L2. L3 should then have 36 turns of the same wire.

If the condensers are not ganged it is also possible to use a .00025 mfd. condenser for C2, omitting C2T. In this case the secondary winding L2 should have 56 turns and L3 45. The turns on L2 in either case might be changed in specific cases to allow for variations in the condensers and in the distributed capacity, and also to allow for variations in the intermediate frequency. But it is not necessary to change provided all the broadcast stations can be tuned in.

The pick-up coil is coupled to the modulator tube through the screen grid. It will be noted that the screen voltage employed is only the drop in the rheostat Rh1. It is for this reason that the plate voltage on the screen grid tube modulator is only 45 volts. If it is desired, the pick-up coil can be connected in series with the control grid lead. If that is done the screen grid should be run directly to the 45-volt tap on the B battery and the plate return should be connected to the 135-volt tap.

Intermediate Transformers

Condenser C3 may be omitted if desired. If it is used it should not be larger than .0001 mfd. When testing whether or

not it is advantageous in any specific case the test should be made at the highest broadcast frequency, that is, at 1,500 kc.

One of the objects of using a 500 kc intermediate frequency is to take advantage of the supply of tuned radio frequency coils, either of the three-circuit type or the ordinary two-winding transformer. There are many sizes and makes available. Regeneration may be omitted if desired, and if it is, the dotted lines in the plate circuits of the third and the fourth tubes show the connections.

If it is desired to use intermediate coils of the same type as that used for T1, the secondaries should have about 100 turns for a fixed condenser of .0005 mfd. This is the total capacity including that distributed. The primary turns in this case should not be less than 50 and they should be closely coupled to the primary. That is, the primary turns should be wound over the secondary, with several layers of waxed paper between.

Special coils are being prepared for all the coils in this circuit and these coils will soon be available. When they are ready they will be described in detail for those who prefer to wind their own.

When regeneration is used it is necessary to adjust the tickler turns to fit each specific case. There should be enough to increase the sensitivity by a considerable amount, yet there should not be so many that the regeneration cannot be controlled with the rheostat Rh2. In order to get as high sensitivity as possible with perfect control of the regeneration, the tickler turns should be adjusted to such a value that the circuit just oscillates when the rheostat is set at minimum. There is no way of specifying the number needed because it depends on the tubes, the applied voltages and on the thoroughness of the shielding.

It should not be assumed that a high sensitivity cannot be obtained without regeneration. Two screen grid tubes properly loaded up amplify enormously. However, in order to take advantage of the high amplification it is necessary that all the intermediate circuits be tuned exactly to the same frequency. The tuning can be accomplished by adjusting the turns on the secondaries or by putting trimming condensers across C4, C5 and C6, or by using both these methods. The use of trimmers, although it complicates the circuit, is probably the best, for they can be placed so that they are accessible after the shields have been placed around the coils.

Type of Detection

The usual small-signal detection is used because this is the most sensitive. However, grid bias or power detection can be used if desired. For small-signal detection R7 might have a resistance of one megohm and C7 a capacity of .00025 mfd. The by-pass condenser C8 in the plate circuit may be .0005 mfd.

Only one stage of audio frequency is used because this as a rule is sufficient in a Superheterodyne. Any high grade transformer may be used for T5. If the last tube shown in the circuit is to feed the speaker it should be a 112A because this will give fair volume without requiring overloading of the detector. This tube will also serve if another stage is to be added, such as a push-pull stage of two 171A tubes. The 112A requires a bias E_g of 9 volts when the plate voltage is 135 volts.

While condensers C9 and C10 are shown in the circuit they are not needed when a B battery eliminator is used to power

(Continued on page 15)

The Design of Dynamics

Pot Magnet, Voice Coil and Baffle, Are Vital

By John C. Williams

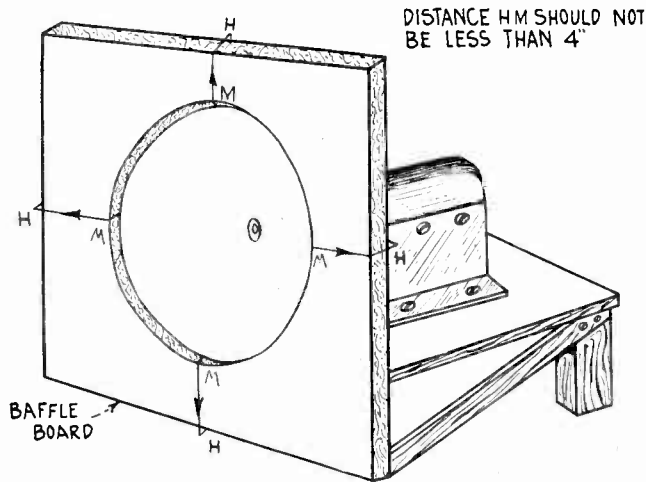

FIG. 1.
THE SHORTEST PATH TAKEN BY LEAKAGE
WAVE HM AROUND BAFFLE.

THE subject of dynamic speaker design is one with ramifications that extend into many fields. It is preferable to begin with the magnetizing coil and the dimensions of the magnetizing coil core structure (often referred to as the "pot," perhaps on account of the general shape). The magnetizing coil is one of the most important intermediaries because by taking advantage of changes in its size and shape you can produce a field magnet that will provide the maximum amount of magnetic flux with a given exciting power. The next important item relative to the magnetizing core is the core structure (the pot). It must do two things: provide an operating flux and at the same time provide a minimum of "transformer effect" loss for the comparatively weak fluxes developed in the structure by the voice coil current (which is alternating in character).

There are several combinations from which to choose design circuits and since most of these are dictated by economical considerations we must take that fact under consideration also. In speakers for domestic use (that is, in radio set combinations for home use) some good designs are possible for pot magnet coils with as little as $1\frac{1}{2}$ lbs. of copper wire. These are not intended to compete with large units such as some of our heavy theatre or public address models, but to provide ample volume for general home use. The economical consideration above referred to are designing a coil that in combination with a given "pot" and airgap will provide the maximum operating flux.

Texture and Natural Period

The acoustical properties of any sound source depend on a great many things and a few of them are:

The texture of the sounding body—its mass and (where not waterproofed) its moisture absorption coefficient.

The natural period of vibration of the air-column in front of the source, and the period of the sounding cone with its voice-coil and spring and coordinated parts, all clamped or otherwise in operating position.

The characteristics of the voice-coil operating transformer, i. e., the acoustical intensity—frequency "curve" which experiment shows not to be uniformly similar when used with different speakers.

So much for a condensed statement regarding acoustical properties. The subject is capable of exhaustive experiment and much that we know to-day is due to the many new raw and synthetic materials which enter into the design of the modern loudspeaker.

The magnetizing coil or "pot coil" has to be energized in order that the speaker when operated at sufficient volume is interesting to listen to and therefore we find at least three distinct ways of achieving the same thing! One is by pure direct current from a battery, another is by using the dry rectifier which furnishes direct current and the last is by using the electron-emitting rectifier tube or the gaseous type. Available operating conditions dictate which shall be used, and these conditions usually boil down to the type of power available. (I have omitted DC generators as a source in above since they

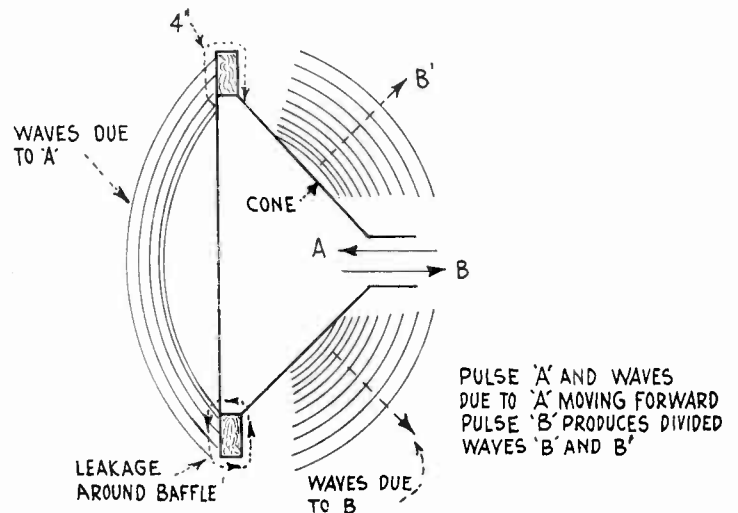

FIG. 2.
THE DIRECTION OF TRAVEL OF SOUND
WAVES FROM MOVING CONE.

are not prime sources in the sense that the devices that I've noted are.)

How Original Ones Worked

I have stated in a previous paragraph that a voice coil transformer is used. At this point it is well to recall that the original dynamic speaker operated directly from an amplifying tube (without any transformer). The steady pull due to the plate current if the tube, flowing through the voice coil, was balanced out either by a suitable opposing tension on the diaphragm or by the use of a stiff supporting member which kept the "voice-coil" reasonably well centered in the field of the operating flux.

These voice-coils were wound with many turns of very fine wire—and though they were successfully operative were not adopted commercially because of the disadvantage of the constant tendency of the voice coil to move out of the field, plus the low high frequency cutoff. The low frequency cutoff on the other hand is much "lower" than that obtained with most transformer operated voice-coil types and this is due to the impedance being higher at this point for the former speaker. But again, this excellent response of the direct coupled voice-coil on the "lows" is not especially desirable because it is obtained at a sacrifice of efficiency of reproduction on the "highs"—that is, for frequencies above 1,000 cycles. So since the direct coupled type of speaker coil has obvious defects we must leave it and return to the transformer operated type.

Impedance Value

In order that a dynamic speaker (or any other type, too, for that matter) may begin to operate as nearly as possible to its full efficiency (which is not very great at any time) it is desirable that the coupling transformer have a value of impedance that will result in the greatest possible current flow in the voice-coil windings connected to the secondary of the transformer, for all the audio frequencies involved. The usual practice consists in making sound pressure measurements and simultaneously read the voice-coil current and voltage and making direct comparisons (to save time and eliminate error as far as possible) with another transformer operating the same speaker-coil-cone assembly. Similarly, cones of different materials supplied with similar voice-coils, and operating under similar or different tensions, may be compared and measured, and observations thus gained are highly useful to the engineer and designer.

Next in order comes the baffle. Now, why do we need a baffle for this speaker, when years ago no one (at least, the average man building a radio for his own use) ever thought of using a baffle? The simplest explanation devoid of any technicality is that any sounding body or cone that is free to move on its axis will "send out two waves," one in a direction away from the front surface and another in the opposite direction. Now, these two sets of waves (produced when any cone type of speaker is operating) are equal and OPPOSITE and hence

(Continued on page 12)

How Much DX on 4 Tubes?

Overseas on Broadcast Waves, is What Some Report!

By Adam J. Arlington

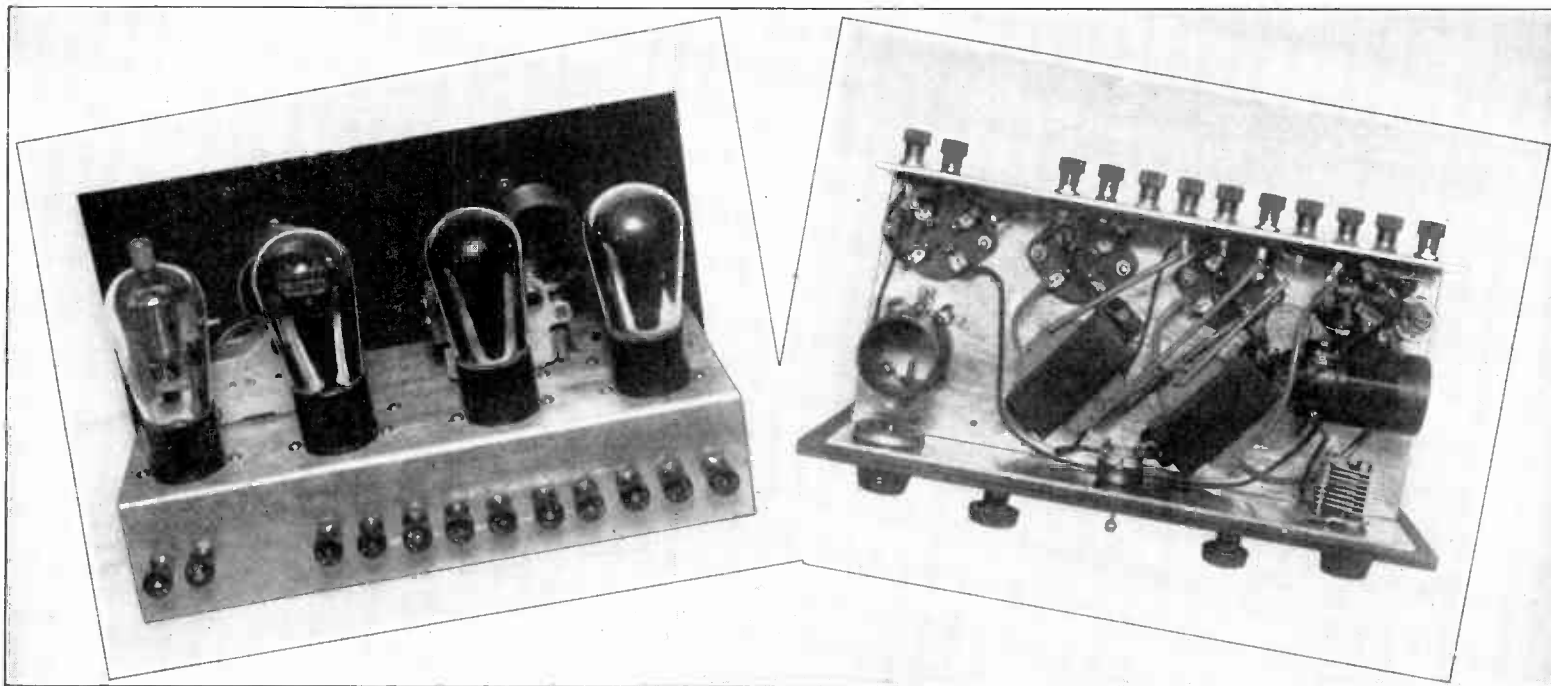

FIGS. 1 AND 2.

REAR AND BOTTOM VIEWS OF A FOUR-TUBE RECEIVER THAT BUILT UP ALMOST INCREDIBLE DX RECORDS.

A CIRCUIT known as the Screen Grid Find-All Four, popular for a year or more, is presented herewith in a slightly improved form, so that it will get even more DX. Although it uses only four tubes it has stepped out as hardly any other receiver, regardless of the number of tubes, has done. That's a broad statement, but when a circuit that works regular broadcast waves brings in an overseas station once in a while, it must be a wonder. Letters from builders attest to this overseas result.

While it would have been possible to build the Screen Grid Find-All Four as a single dial control receiver, two dial tuning has been retained, since this condition permits more accurate tuning and hence insures greater distance reception. Both the RF stage and the detector are tuned by .00035 mfd. variable condensers. The antenna coupler is specially wound, having unique

(Continued on next page)

LIST OF PARTS

- Antenna coupler (2). Screen grid coil with fixed tickler (10).
- Two .0035 mfd. variable tuning condensers (3,8).
- Two audio frequency transformers (17,19).
- Two 10-ohm fixed resistors (6,7).
- Regeneration control (12) with filament switch.
- .00025 mfd. grid condenser (11). Small by-pass condenser (16).
- One-ohm fixed resistor (15). Screen grid clip (5A).
- Two meg. grid leak (13). Two dials.
- Fixed by-pass condenser (9). Panel.
- Twelve binding posts mounted on bakelite strip.
- Aluminum chassis with four sockets (5, 14, 18, 20).

FIG. 3.
DIAGRAM OF THE CIRCUIT USED FOR PHENOMENAL DISTANCE RECEPTION. A FEATURE IS THE IMPEDANCE TYPE COUPLING. THIS DIAGRAM SHOULD BE FOLLOWED, ALTHOUGH IT SLIGHTLY CONTRADICTS THE UNDER VIEW OF THE OLDER MODEL ABOVE.

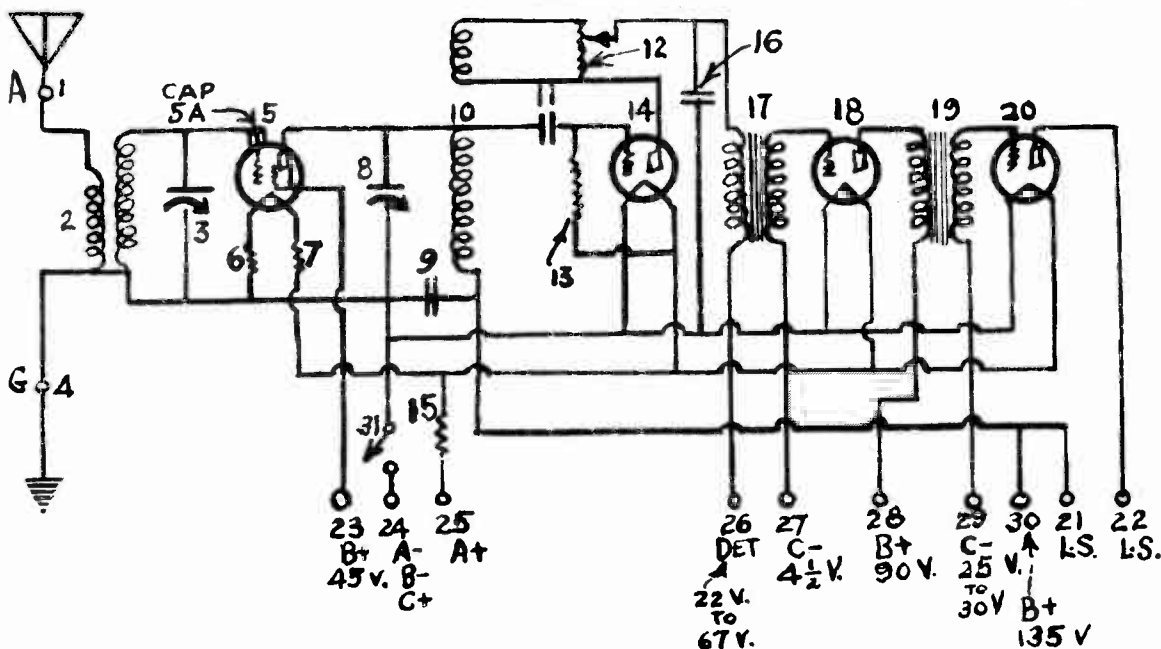

Amplifier Uses one Input Highly Suitable

I. Lester

Company

audio frequency used for broadcast reproduction. The screen grid tube is used for high amplification, and the low note response is strong due to audio regenerative effects.

There are three distinct purposes to which the average man can employ an audio frequency amplifier such as the one to be described.

First, there is the use as a phonograph record amplifier, with an electrical pick-up which can connect with the amplifier to reproduce the records electrically. The benefits which accrue from this use are abundant. There is such a vast difference in the quality and realism of the reproduction that those who have used this system to play their records have been thrilled.

Secondly, the amplifier is suitable for use in conjunction with a microphone, to amplify speech. In large halls or assemblies,

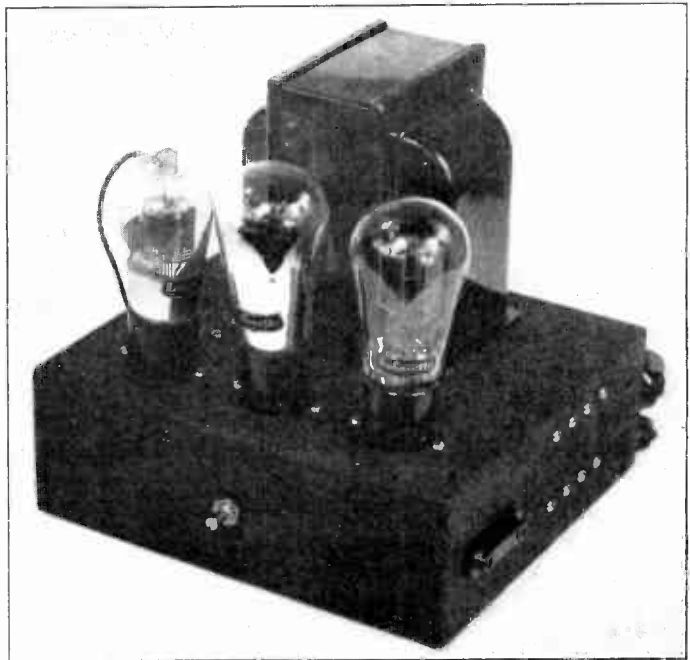

FIG. 3
VIEW OF THE ASSEMBLED POWER AMPLIFIER.

Great on DX



FIG. 3
THE COMPACTNESS OF THE FIND-ALL FOUR IS SHOWN EMPHATICALLY BY CONTRAST WITH A TABLE LAMP.

of from 50 to 75 feet long, not including lead-in, should be sufficient. The lead-in wire should be about 35 feet or more. It is suggested that the set be tried on several different lengths of antenna. Where only local stations are wanted, an indoor aerial will suffice.

It is essential that the antenna be perfectly insulated. It should be kept away from large metallic bodies. The joint which fastens lead-in to antenna should be soldered and then taped.

where crowds upwards of 500 persons are assembled, this amplifier will readily convey the voice and spoken words with plenty of volume and audibility. Again, there are many other uses, such as in stores for demonstration, at home to amplify the baby's cries and warn mother who is in another room.

Thirdly, for use as the amplifier in connection with a tuning system. This last use is in itself very important.

The type of chassis is not important, but one may be used that is already drilled, so that it is a very simple matter to mount and fasten all the parts. To complete the amplifier, including the wiring and testing, requires less than two hours.

Data on Connections

It is a very easy matter to install the amplifier. If to be used with an electrical phonograph pick-up there are but two connections to be made, after the cord and plug have been attached to the light socket (110 v 50-60 cycle AC). The input posts, marked "phono," go to the pick-up terminals, which may or may not include a volume control. The output terminals, marked "speaker," go to a dynamic speaker, provided it has an output transformer. If it hasn't, it will be absolutely necessary to get one.

If a cone, or magnetic type speaker is to be used, the same data apply.

The reason for leaving the output transformer out of the diagram is that most of the dynamic speakers have output transformers built in.

There is only one variable control in the amplifier circuit, and that is the potentiometer which controls the hum. Once that is set, it need not be altered again, unless the 224 tube is changed.

An important item is the pick-up and its volume control. Unless the pick-up is a good one, and the volume control an effective one, the results will not come up to expectations. A high-grade pick-up is recommended.

Pointers on Needles

Also, an important point, is the needle used. If it is too hard the reproduction may sound harsh. If too soft the reproduction may be too deep and possibly too low-pitched. Again, much depends upon the records themselves. Do not expect to get the best possible sound effects from old and worn records or those that are not electrically cut. A good investment in the right kind of a record will well repay the user.

Then, too, the dynamic must be suitable for the purpose. Remember that all dynamics are not good merely because they are dynamics. They may be entirely too high-pitched or too low-pitched, neither of which is desirable. The choice of a dynamic depends upon one's personal taste.

Use as Microphone Amplifier

All that is necessary to pick up the voice or music by microphone is a good microphone input transformer; a 400-ohm potentiometer to control the "button" current; and a high resistance potentiometer-type volume control. Of course, a high-grade microphone is essential for best results. To actuate the microphone, a small battery of low voltage is required. A 4½ volt C battery will answer this purpose provided that the amplifier will not be used for immoderately long periods.

The 2½-volt high current winding of the power transformer may be used to heat RF tubes, and B voltage for them may be obtained from the B supply, but it is advisable not to use more than three such tubes, i. e., three RF stages. For phonographs use the 50,000-ohm bracing resistor may be changed to 2,000 ohms or so.

ffle Is Double Asset

around the edge to the rear as is shown in the illustration on page 10. The magnetic cone speaker may be mounted in a suitable baffle, where mechanical arrangements permit, as many experimenters know, and will sound much more realistic.

I mounted a well-known "motor" in a large box made of very heavy wood—and arranged the cone on a tight leather suspension. The box measured inside 18x22x14 inches and the lumber was 1½-inch white pine almost clear of knots. The cone was an oval, 7 inches deep, and made of a clothlike texture paper about .008 thick. This made a speaker the equal of most dynamics.

Safety First! Is Demand

Fire Underwriters 1930 Rules Stress This Point

By Herbert E. Hayden

[In last week's issue, dated March 8th, the two sections of the 1930 Electrical Code of the National Board of Fire Underwriters, pertaining to receiver installations, were published in full.—Editor.]

THERE is a list of rules compiled and enforced by a constituted authority which is called the National Electrical Code.

This code devised to guide those who install and inspect installations of electrical equipment is respected wherever recognized commercial electrical work is done.

The interests of the Underwriters board are two-fold—one for the safety of the user, and the other the protection of the electrician who does the work, etc.

Now with regard to radio apparatus, at a point where the power line consideration cease, we find some facts of sufficient interest to the builder of "his own" and the service-man to warrant special attention:

In B, Eliminators or "power packs" we find that we are handling "power line" voltages, in our high-voltage output transformers, while condensers handle these same voltages, modified by rectification. The windings and insulation of all components are governed by the usual voltage breakdown tests, usually the application for a short period of three times the intended operating voltages.

There is no sense in taking any chances on the assembly or combinations of any parts for high voltage work.

The high tension portions of the winding the first thing that happens is continuous arcing and then finally voltage failure. Other causes are shorts in associated, externally-connected apparatus and wiring.

One occasional cause of voltage failure on the high potential windings of a power transformer, that has been repaired, is erosion of a part of the outer edge of the winding where an acid content soldering paste has been used too freely.

Most leads whether flexible or not are connected without the necessity of soldering, as the above trouble is almost incurable once the flux begins to "creep."

Most good power packs are designed so that there is plenty of ventilation but in some all-electrical sets that are being sold the power pack is built so closely into the set that overheating causes pack troubles. Some of this heat is due to the tubes in the set.

The writer not so very long ago witnessed something of a fire hazard in connection with the case of improper combination of a receiving set and a 110-volt DC power pack. Speaking of breakdowns, this one took the prize.

The owner in this case had a one-time popular 5-tube, battery-

operated Neutrodyne, and a good friend suggested operation by a combination 110-volt A, B and C eliminators.

The arrangement follows: four 201A controlled in parallel by a series volume filament control, and the detector filament, controlled by a 30-ohm series volume control. So, with all the adjustable resistance cut in, the device furnished approximately .21 amp to each tube at a voltage drop of 5 volts or thereabouts. Then the owner in due time signed off for the night but he cut down the volume control. He did that on the original set disregarding advice previously given. Pop! goes one tube. And then he hastily turned on the volume control again. Pop! goes one more tube! And what an arc! where the switch was broken too! The resistor, a series one on 110 volts, got very warm indeed.

And so it is always in perfectly good taste to tell radio enthusiasts to avoid using 110 volt lightningline resistors to light parallel 201A or similar filaments. There is a close parallel to this warning and the rules embodied in the Fire Underwriters recommendation.

Another suggestion to those who would seek to operate their AC electric receivers at the lowest temperature consistent with good reception is to check up on the filament or heater voltage of their tubes, or else have a competent service man do this for them. Excess heat, whatever the cause, is always harmful, and if the filament and tubes in your electric set are over-voltaged (see Manufactureres rating on tube cartons) the result is excess heat and incidentally shorter tube life.

Make sure that parts used will bear the voltage impressed on them by a comfortable margin, and also don't forget that there is a difference between the AC voltage a condenser will stand operating continuously and the safe continuous DC working voltage. The AC rating is lower, that is, .636 of the DC rating, or the AC voltage rating may be multiplied by 1.57 to obtain the DC rating. Always exceed the minimum.

These figures give average values instead of the usual but not wholly authentic root mean square values (.707 and 1.414).

All condensers operating at or near those rated AC working voltage will heat after a while, and this heating generally lowers the resistance to breakdown, therefore again test your circuit under operating conditions and find out about your condensers.

Transformers are subject to breakdown, too, due to a variety of causes, of which rectifier tube internal shorts are the least frequent.

The most prevalent cause is overheating and this in turn is due to a continuous overload. The overheating causes the insulation to become charred inside the winding assembly, and where this occurs shorts develop.

Servicing Offers Best Opportunity for Experts

Radio servicing, beyond doubt, offers the best opportunity today for the trained, practical radio man. Every radio manufacturer realizes that his present and future business depends largely on getting his radio sets into homes and keeping them there. The service man is in position to recommend any radio set. He comes into the average home as an expert. His word is final. Likewise, he can discredit any radio set or manufacturer. Little wonder, therefore, that the radio industry is making a Lindbergh out of the service man.

There are service men and service men. Many so-called service men still at large are nothing more than tinkers, or hang-overs from the days of battery radio sets when a couple of tubes, a pair of pliers and a soldering iron constituted the necessary knowledge and equipment of the service man. Today, with the all-electric radio set, there is little to tinker with. The vital parts are enclosed in metal. Only the sockets are accessible. Therefore, the service man must know how to go about finding trouble, working from the sockets in obtaining the diagnosis, just as the doctor, looking for trouble in a patient, cannot proceed to cut open his patient and look around for the trouble.

It is in the practical end of radio that there is the greatest demand for men today. Radio schools, without high-sounding fraternities, proms, sports and other collegiate adornments, do not attract flaming youth on pleasure bent. It is the more serious minded who are attracted to the cold-blooded, calculating, hard-working atmosphere of the radio school. Hence there are almost certain to be a greater supply of engineers than of practical men.

Automatic Volume Control Recommended for Portables

By RAY H. MANSON
Chief Engineer, Stromberg-Carlson

Radio entertainment, now an established factor in home life, is rapidly extending its scope, for travelers on high class boats and trains now insist that miles of travel be lightened by listening to radio. Dozens of the best passenger trains in the country are equipped with receivers of one make or another and radio sets are part of nearly every ocean liner's comfort.

The particular conditions of radio reception on moving vehicles makes one principle of reception virtually a necessity and that is automatic volume control.

The "field strength" or intensity of signal of a station varies widely at different points and a set on a train, for example, which passes from one area to another so rapidly, would give very uneven results unless compensation is made. In addition to the normal variations in "field strength" there is a natural increase and decrease of signal as the vehicle approaches or recedes from the broadcast station.

Automatic volume control, which tends to maintain a signal at substantially uniform volume, reduces these variations and gives a uniformity similar to that one gets when the receiver remains stationary in his home. So it can readily be seen why trains, boats, yachts and other vehicles are coming to insist that their radio sets be equipped with automatic volume control. Automobile receivers, which are becoming increasingly popular, will probably also demand this type of volume control in the perfected design of automobile receiver.

LIST OF CANADIAN STATIONS

By Call Letters, With Wave, Frequency and Power

Station	Location	Meters	kc	Power	Station	Location	Meters	kc	Power	Station	Location	Meters	kc	Power
CFAC	Calgary, Alta.	434.8	690	500	CJBC	Toronto, Ont.	517.2	580	500	CKIC	Wolfville, N. S.	322.6	930	50
CFBO	St. John, N. B.	337.1	890	50			357.1	840	500	CKLC	Red Deed, Alta.	357.1	840	1000
CFCA	Toronto, Can.	357.1	840	500			312.5	960	4000	CKMC	Cobalt, Ont. (East Side)	247.9	1210	15
CFCF	Montreal, Que.	291.3	1030	1650	CJBR	Regina, Sask.	312.5	960	500	CKMO	Vancouver, B. C.	411.0	730	50
CFCH	Iroquois Falls, Ont.	500.0	600	250	CJCA	Edmonton, Alta.	517.2	580	500	CKNC	Toronto, Ont.	517.2	580	500
CFCN	Calgary, Alta.	434.8	690	500	CJCB	Sydney, N. S.	340.9	880	50	CKOC	Hamilton, Ont.	340.9	880	50
CFCO	Chatham, Ontario	247.9	1210	100	CJCC	Calgary, Alta.	434.8	690	500	CKOW	Toronto, Ont.	357.1	840	500
CFCR	Regina, Sask.	312.5	960	500	CJCC	Calgary, Alta.	434.8	690	500	CKPC	Preston, Ont.	247.9	1210	25
CFCT	Victoria, B. C.	476.2	630	500	CJGC	London, Ont.	329.7	910	500	CKPR	Midland, Ont.	322.6	930	50
CFCY	Charlottetown, P. E. I.	312.5	960	250	CJGX	Yorkton, Sask.	476.2	630	500	CKSH	St. Hyacinthe, Que.	297.0	1010	50
CFJC	Kamloops, B. C.	267.9	1120	15	CJHS	Saskatoon, Sask.	329.7	910	250	CKUA	Edmonton, Alta.	517.2	580	500
CFLC	Prescott, Ont.	297.0	1010	50	CJOC	Lethbridge, Alta.	267.9	1120	50	CKWX	Vancouver, B. C.	411.0	730	100
CFNB	Queen St., Fredericton, N. B.	247.9	1210	50	CJOR	Sea Island, B. C.	291.3	1030	50	CKX	Brandon, Man.	555.6	540	500
CFQC	Saskatoon, Sask.	329.7	910	500	CJRM	Moose Jaw, Sask.	500.0	600	500	CKY	Winnipeg, Man.	384.6	780	5000
CFRB	York County, Ont.	312.5	960	4000	CJRW	Fleming, Sask.	500.0	600	500	CNRA	Moncton, N. B.	476.2	630	500
CFRC	Kingston, Ont.	322.6	930	500	CJRX	Middlechurch, Man.	25.6	11720	2000	CNRC	Calgary, Alta.	434.8	690	500
CHCA	Calgary, Alta.	434.8	690	500	CJSC	Toronto, Ont.	517.2	580	500	CNRD	Red Deer, Alta.	357.1	840	1000
CHCK	Charlottetown, P. E. I.	312.5	960	30	CKAC	St. Hyacinthe, Que.	411.0	730	5000	CNRE	Edmonton, Alta.	517.2	580	500
CHCS	Hamilton, Ont.	340.9	880	10	CKCD	Vancouver, B. C.	411.0	730	50	CNRL	London, Ont.	329.7	910	500
CHCT	Red Deer, Alta.	357.1	840	1000	CKCI	Quebec, Que.	340.9	880	22½	CNRM	Montreal, Que.	411.0	730	5000
CHGS	Summerside, P. E. I.	267.9	1120	25	CKCL	Toronto, Ont.	517.2	580	500	CNRO	Ottawa, Ont.	500.0	600	500
CHLS	Vancouver, B. C.	411.0	730	50	CKCO	Ottawa, Ont.	337.1	890	100	CNRQ	Quebec, Que.	340.9	880	50
CHMA	Edmonton, Alta.	517.2	580	250	CKCR	Waterloo, Ont.	297.0	1010	50	CNRR	Regina, Sask.	312.5	960	500
CHML	Hamilton, Ont.	340.9	880	50	CKCV	Quebec, Que.	340.9	880	50	CNRS	Saskatoon, Sask.	329.7	910	500
CHNS	Halifax, N. S.	322.6	930	500	CKFC	Vancouver, B. C.	411.0	730	50	CNRT	Toronto, Ont.	357.1	840	500
CHRC	Quebec, Que.	340.9	880	100	CKGW	Bowermanville, Ont.	434.8	690	5000	CNRV	Lulu Island, B. C.	291.3	1030	500
CHWC	Near Pilot Butte, Sask.	312.5	960	500						CNRW	Winnipeg, Man.	384.6	780	5000
CHWK	Chilliwack, B. C.	247.9	1210	5						CNRX	Bowmanville, Ont.	434.8	690	5000
CHYC	Near St. Hyacinthe, Que.	411.0	730	5000										

*Call of CFCL used by CKCL during Sunday broadcasts only.

New Super-Heterodyne Trend

(Continued from page 9)

the circuit because they are already a part of this supply. When batteries are used they are advantageous and should be one microfarad unit.

The circuit, of course, is designed for a 6-volt storage battery or an equivalent filament supply.

Circuit for AC Supply

The 500 kc Superheterodyne is equally well suited for AC tubes. In Fig. 2 is shown such a circuit. It is somewhat more elaborate than that in Fig. 1, as AC circuits usually are, but fundamentally it is the same as far as the RF and IF portions of the circuit are concerned. The audio amplifier is a combination of ordinary resistance coupling and the Loftin-White.

The transformers T1 to T4, inclusive, and the oscillator are exactly the same as the corresponding components of the DC circuit. Regeneration has been omitted because the AC tubes amplify more than the DC tubes. Moreover, there is considerably more amplification in the AF portion of the circuit.

The tuning condensers in the RF level and in the oscillator are also the same as in the DC circuit, as are the fixed condensers in the intermediate frequency circuits.

Resistors R1, R3 and R4 should be 300 ohms each. The bypass condensers C8, C9, C10, C11, C12 and C13 need not be larger than .01 mfd. The chokes Ch1 and Ch2 in the IF screen grid leads need not be larger than 5 millihenries, although ordinary 85 millihenry chokes can be used.

Power Detection Used

The detector in this circuit follows the lines developed by James Millen and Glenn H. Browning and is a form of power detector. R5, the bias resistor, should have a value of 2,000 ohms and R6 a value of approximately 20,000 ohms. C14 across R5 should be 2 mfd. and C15 across R6 need not be larger than one microfarad.

For C6 a .00025 mfd. condenser is recommended. A larger value than this would reduce the amplification on the higher audio frequencies considerably because it is connected across a high resistance, the sum of R6 and R7. For R7 a .1 megohm resistor is suggested. C7 should be not smaller than .01 mfd. and R8 not less than one megohm.

We are now up to the Loftin-White portion of the circuit. In this the following condensers are recommended: C16, C18, 2 mfd. each; C17, 0.1 mfd.; C19, 1 mfd.

R9 should be 50,000 ohms and R10 one-half megohm. R11 should be a voltage divider with sliding taps, such as an Electrad, with a total resistance of approximately 6,000 ohms. At least three sliding contacts should be provided for this resistor, not counting the end contacts. The screen grid should be connected to one of these which is about 400 ohms from the negative end of R11. The return of R8 to this resistor strip

should be made so that the plate current in the output tube indicates that the total current flowing is 32 milliamperes, and the return of C17 should be made where the hum is least.

The selection of the 6,000-ohm value for R11 was based on the assumption that the total available voltage is 450 volts, to be divided so that the power tube gets about 250 volts and the preceding tube about 200 volts.

Avoiding Complications

In order to avoid upsetting the voltage adjustments in the Loftin-White amplifier, a separate voltage divider is used for the five tubes ahead of the non-reactive amplifier. This divider consists of R12 and R13. The current passing through R12 is about 15 milliamperes normally. Since the voltage across the B terminals is supposed to be 450 volts and a voltage of 180 volts is to be applied to the plates of the screen grid tubes, the drop in R12 should be 270 volts. Thus R12 should be 18,000 ohms and capable of carrying 15 milliamperes or more.

Now we must also provide a voltage of about 75 volts for the screens of the IF tubes and the plates of the first two tubes. This voltage we get by tapping R13. The current in the positive end of R13 will be about 9 milliamperes and the drop in this resistance will be 105 volts. Hence that portion should be nearly 12,000 ohms. The current in the negative end of the resistor will be 3 milliamperes and the drop in that will be 75 volts. Thus this portion of the resistance should be 25,000 ohms.

In order to get a resistance of 37,000 ohms that will carry the current it is best to make it up by connecting three resistances in series, first a 10,000-ohm resistance at the positive end. This may be fixed. Then in the middle a potentiometer of 25,000 ohms should be used, followed by a fixed resistance of 2,000 ohms. The potentiometer is put in the middle in order that the voltage range that may be covered for the screen will be such that the potentiometer may be used effectively as a volume control. The voltage range will be roughly from 6 to 81 volts.

All the heater type tubes in Fig. 2 may be operated on one 2.5-volt winding. This should either be center-tapped or provided with a center-tapped resistor of about 20 ohms. The center-tap should be grounded. The filament of the last tube must be separate from the other, and this too should be center-tapped, either directly or through a resistance of 10 or 20 ohms.

If there is a third 2.5-volt winding which is not needed for anything else it is advisable to use it for the detector tube in the present circuit. It is not necessary, however.

Either of these Super-heterodynes can be used for receiving short-wave stations by plugging in suitable coils in the oscillator and modulator coil sockets, or else by the Super-heterodyne type short-wave adapter described elsewhere in this issue. But in view of the fact that the intermediate frequency used in the present circuits is 500 kc, that is, a third as large as that recommended in the adapter, practically the same results will be obtained by substituting short wave coils in the broadcast receiver for converting it to a short-wave receiver.

Resolved, That the F

AFFIRMATIVE

By Adam J. Broder

THE pentode tube has stirred up a heated controversy in radio circles. Some maintain that the tube will not do any more than the tubes previously available, while others maintain that vastly better results can be achieved with it. Tube and receiver manufacturers generally have taken an antagonistic stand on the pentode, while experimenters and some set manufacturers have welcomed its possibilities and are testing receivers incorporating the pentode.

Each has a reason for his stand. The manufacturers of tubes objected to the pentode on economic grounds, but the experimenters hailed it because it opens up new fields for research.

Many of the objections that have been raised against the tube have been based on the European pentode, and these objections were framed before the characteristics of the American pentode were known to the objectors. For example, they raised the points that only fair quality could be obtained from the tube and the tube was primarily for audio frequency amplification. This is largely true of the European pentode, because this was mainly intended for use as output tube in the audio amplifier.

Barking Up the Wrong Tree

Arguments based on this supposition are entirely beside the point, in so far as the American tube is concerned, because this tube was primarily intended for radio frequency amplification, or for voltage amplification in the audio amplifier. It is not at all suited for output tube and it was never intended that it should be used for this purpose.

Accordingly we must limit any discussion of relative merits of the new and previously existing tubes to voltage amplification in the radio and audio frequency amplifiers. Can more be done with a given number of pentodes than can be done with the same number of other types of tubes? That, essentially, is the question, provided we consider amplification, selectivity, cost of tubes, ease of operation of circuit, and sensitivity.

There can be no doubt in the unprejudiced mind that the pentode is a real contribution to radio, just as the screen grid tube, or the heater type tube, was a contribution. The pentode is a screen grid tube and will perform all that the screen grid tube does. All who have been converted to the screen grid tube should therefore have no objection to the pentode tube on that ground. But the pentode is more than a screen grid tube. It has an extra element which makes the tube more versatile than the four-element screen grid tube. From this viewpoint the pentode is a welcome contribution to the long list of special purpose tubes.

Special Virtues

Few will deny that the four-element tube was capable of superior results when compared with the three-element tube. And possibly there are fewer still who will not assert or admit that this tube has many shortcomings. It has a very high amplification factor under normal operating conditions. That is a point in its favor. But it has a high internal plate resistance. That is against it. Also, it has a relatively low mutual conductance. That, too, is against it. Because of these two adverse characteristics it is practically impossible to take advantage of the high amplification factor. Hence one of its principal virtues is nullified to some extent. In practice it is exceedingly difficult to extract from the tube a voltage amplification considerably higher than is possible to extract from a three-element tube having a theoretical amplification factor much lower.

The characteristic of the pentode are more favorable in this respect. The amplification factor, for one thing, is higher than that of the four-element tube. Then, again, the mutual conductance is higher and the internal plate resistance is lower. This makes it possible to extract a much higher proportion of the theoretical amplification than is possible with the four-element tube, using practical coupling devices between tubes.

The 224 tube has an amplification factor of 420 and an internal resistance of 400,000 ohms. Suppose the load resistance is 100,000 ohms, which it may be if the load is a parallel-tuned circuit of fairly high selectivity. The voltage amplification in that case would be 84. This is really a higher gain than can reasonably be expected, but it will do for comparison purposes. The pentode tube, under certain operating conditions, has an amplification factor of 540 and an internal resistance of 100,000 ohms. Suppose we load this tube up with a resistance of 100,000 ohms. The voltage amplification in that case would be 270

times. Under another set of operating conditions the pentode has an amplification factor of 750 and an internal resistance of 300,000 ohms. If the load in this case is 100,000 ohms the voltage amplification will be 188. In both cases the gains favor the pentode by a large margin.

Other Operating Conditions

The particular operating conditions selected for the pentode in the above cases are wasteful of space current and would shorten the life of the tube considerably. There are more economical combinations of voltages possible. Versatility, as was said, is a special feature of the tube. In one combination the gain factor is 575 and the internal resistance is 285,000 ohms. This with a load resistance of 100,000 ohms leads to a voltage gain of 149. Another combination gives a gain factor of 740 and an internal resistance of 380,000 ohms. This leads to a voltage gain of 154. In every case the amplification favors the pentode tube by a factor of about 100 per cent. In a practical case the actual amplification may be considerably less than those obtained above, but the reduction will be proportional, so that the pentode remains ahead.

Objections have been raised against the pentode on the ground that it requires high voltages on the plate and the screen grid. Such an objection would have been serious five years ago, but now it is entirely untenable. It is even puerile in view of the high voltages now being used in all radio receivers.

The pentode requires a little more current for its operation than the screen grid tube, and this fact apparently is a valid objection. This however, is not so serious, as it first seems, because the amplification per tube is so high that fewer tubes may be used in the receiver for the same sensitivity. When the pentodes have been reduced in number until the sensitivity is the same as that of the screen grid tube circuit having a larger number of tubes the plate current will be no greater. The saving in this case will be in filament or heater current.

Foolish Design Not Against Tube

It has been argued that as many pentode tubes will be used in a receiver as screen grid or three-element tubes. This may be true, but foolishness in design cannot be held against the pentode. The screen grid tube was supposed to have made it practical to reduce the number of tubes for a given sensitivity, but when these tubes came out the receivers had more tubes than ever. This was not a point against the screen grid tubes, but rather against advertising clamor or acts of the designers of the receivers. The same holds true for the pentode.

Usually receivers are designed with many tubes to make it appear that their sensitivity is enormous, but losses are incorporated to keep the amplification down to manageable values. This is done with screen grid tubes and will be done with pentodes.

The only objection that has some degree of validity is that a receiver built with pentodes of a reasonable number is likely not to be selective enough to separate stations. A certain number of tuners must be used to secure this selectivity. Since tuners are usually placed between adjacent tubes there are about as many tuners as tubes. Adequate amplification, it is said, will be obtained with three-element tubes and that there is no justification for tubes having a high amplification capability. This conclusion is predicated on the supposition that tubes and tuners must alternate. Tuners need not necessarily be separated by tubes. There are many methods of coupling tuners in tandem without interposing tubes.

Cost of Tubes

The cost of a tube increases rapidly with the number of elements. Therefore the pentode will cost more than the four-element tube, just as the screen grid tube cost more than the three-element tube. The same argument was raised against the screen grid tube, but the radio public "took to" the screen grid tube, nevertheless. It will also accept the pentode if it proves desirable otherwise.

The increase in the cost of the tubes does not necessarily increase the cost of the receiver as a whole, because, if the pentode is used reasonably, fewer tubes should be sufficient. Moreover, as soon as the pentodes are made in large quantities the price will be lowered to a level comparable with that of the screen grid tubes. Cost will not be a deterrent to the use of these tubes.

Another point raised against these tubes is that it is difficult to exhaust the gases and thus to make them "hard" enough. This objection had its birth in the days of the hand pump when "getters" were unknown. With the present vacuum technique there will be no great difficulty on this score.

Pentode is Desirable

NEGATIVE

By Quinlan Ross

THE pentode has already been hailed as a revolutionary contribution to radio. As the term "revolutionary" is used in radio and in many other fields where ballyhoo has been developed to a fine art, it must be admitted that the claims for the tube are correct.

But the revolution that the tube will create in the radio field cannot amount to more than a momentary tempest in a teapot. What are the phenomenal characteristics of the new tube which justifies any other conclusions? Is it devoid of the defects of the three-element tube? It is not. The defects are only reduced a bit. Is it free from the defects of the four-element screen grid tube? It is not. It only has them in a slightly less degree.

Does the new tube cost less to produce than previous tubes. It costs much more. Does it cost less to maintain in operation? No. It costs more, both directly and indirectly. Will it ultimately lead to the use of fewer tubes in a receiver? Not at all. As many tubes will be used in receivers built around the pentode as in those built around tubes having fewer elements. Will the overall amplification in the new receiver be greater than that in other receivers? Perhaps. But of what use is an amplification that is many times as great as that which can be used? Many receivers are already more sensitive than is necessary to bring entertainment to the home. Will the new receivers be more selective? Not more selective, but most likely less.

Troubles in Receiver

Will there be less trouble in a receiver built around the pentodes than in a receiver built around simpler tubes? Less! The amount of trouble is at least proportional to the number of elements. There is one more element in which troubles may occur. There is one more circuit in which defects may develop. And troubles will appear just as they appeared in the screen grid circuit of the four-element tube and in the grid circuit of the three-element tube.

In the pentode there are more leads entering the vacuous space and hence more chances for leaks to develop. There is more metal inside the glass envelope for occluded gases to hide during the evacuation process, only to come out in the open as soon as the tube has been sealed and put in operation. These occluded gases will ruin many tubes, make them "soft" after a short time of operation. A gassy tube never did give satisfactory service and it will not do so under the name of pentode.

Another difficulty that will undoubtedly develop is lack of uniformity of tubes. Modern receivers depend largely on the uniformity of the tubes of a type employed in that receiver. The pentode, due to the many elements, will be much harder to keep to a standard than other tubes of fewer elements. One receiver may therefore be excellent while another may be worse than mediocre just because tubes are not alike. It might be argued against this that matched tubes can be selected. True, if every broadcast listener having pentode tube circuits has an unlimited supply of tubes to draw from. If the average fan has one tube extra he will be doing well.

Matched Sets

If the fan cannot select a set of matched tubes why cannot the dealer or the manufacturer sell matched sets of tubes? He could, if somebody were willing to pay the bill. Matched sets of this and that have been offered for sale from time to time, the matching consisting of taking the required number from stock and attaching a sticker marked "matched." Of course, all would not do this but many would be forced to, because the purchaser would not pay the costing of matching. Even at that, the set would be "matched" in price.

The successful use of the pentode in Europe is pointed to as an argument in favor of these tubes in this country. The European tube, especially the English, is an output tube of a different design from the American and therefore is no comparison. If we were discussing that tube we could easily show why even that would not be "revolutionary" in the American market. Our three-element power tubes are much more suitable to our conditions than the European pentode would be.

Greater amplification is the ace in the hand of the protagonists of the pentode. But is the practical amplification attainable with these tubes any greater than the amplification obtainable with the four-element screen grid tube, or even with the three-

element tube? The limit of amplification is either set by the noise level or by the stray feedback in the circuit. The noise level will be the same for the pentode as for any other type of tube, because it has nothing to do with the number of elements in a tube. There is an exception, and that is against the pentode. Gassy tubes are noisier than "hard" vacuum tubes, and since the pentode is likely to be more gassy than simpler tubes it is also more likely to be noisier.

Feedback Troubles

Feedback troubles will be greater with the pentode than with other tubes. Troubles of this kind largely depend on the amplification. If the pentode amplifies more than other tubes—and that has been admitted—there will be more feedback. The resulting oscillation will limit the amplification that can be used practically.

One of the causes of oscillation is the feedback through the capacity between the control grid and the plate. This is about twice as great in the pentode as in the four-element screen grid tube. Therefore troubles should be twice as frequent, twice as serious, twice as annoying. The feedback through this capacity will limit the amplification that can be utilized to a value about the same as the practical amplification that can be obtained with the four-element tube.

If the number of tubes in the receiver is reduced so that the amplification is about the same as when triodes or screen grid tubes are used, there will be fewer tuners in the circuit and the selectivity will be less. Moreover, the selectivity per tuned circuit is likely to be less because of the closer effective coupling between the plate circuit of a tube and the tuned circuit.

Fallacy of Pre-Tuning

In answer to this argument it may be pointed out that it is not necessary to have all the tuners in the circuit between adjacent tubes. Pre-tuners can be used, it is asserted. Of course, they can be used. But what for? Have they been such a great success in practice that they may be lined up in tandem ahead of the amplifier and still get good selectivity? Of course, they have not. One of the patents on which most manufacturers pay royalties is the tuned radio frequency receiver, with tubes and tuners alternating. Would practical business men pay tribute to a patent owner if a pre-tuner were successful? They don't, and that is an admission that they have not had any success with pre-tuners. The use of pentode tubes would not change this situation at all.

If the pentode had given promise that manufacturers could have avoided paying royalties on the tuned radio frequency patent they would have hailed the arrival of the new tubes with enthusiasm. But what did they do? They issued a statement vigorously attacking the new tube. This they did through the Radio Manufacturers Association, an organization including nearly all American makers of receivers and parts.

An Old Tube

The pentode tube is really older than broadcasting. Several experimenters worked with it as long ago as fifteen years. If the idea back of the tube had been so wonderful as to justify a "revolution" now, why did not the early workers with the vacuum tube devote their energies to this tube rather than waste them on such elementary tubes as the triode and the screen grid tube? They must have been a bunch of "dubs," those fellows who developed broadcasting stations, radio receivers, public address systems, and talking movies, those things which really have revolutionized communication and entertainment!

Looking it all over, it seems that they were not so dumb, that in sidetracking the pentode and other multi-element tubes they really did the practical and the intelligent thing.

The pentode found a practical use in England where radio receivers are taxed according to the number of tubes in the set. For economic reasons the pentode was put into receivers to keep the tax down. If a similar situation should arise in this country there will be an excuse for the pentode, but not until then. While the advertisers pay for broadcasting, there is little peril of taxes on the radio set.

Government Broadcasting

It may come to the point in this country when advertisers so completely lose their sense of propriety that the public no longer will tolerate their free offerings. The Government will then take over the broadcasting function and put a tax on receivers. Then there may be a demand for pentodes, just as there is in England. However, this is not likely. It is more likely that the simple tubes will be retained, because the tax will be small.

DEFOREST CO. SUES PILOT ON REGENERATION

The DeForest Radio Company of Passaic, N. J., has instituted a suit against the Pilot Radio & Tube Corp., of Brooklyn, N. Y., manufacturers of radio parts, knock-down kits and completely assembled radio receivers, principal among these offerings being the Pilot Wasp short-wave and broadcast receivers.

The DeForest Radio Company seeks an injunction to restrain the Pilot Corporation from the alleged infringement of the DeForest patents Nos. 1507016 and 1507017, covering the use of regeneration in a radio receiving circuit.

One of a Series of Suits

The present action is one of a series of similar suits which Darby & Darby, patent counsel for the DeForest Radio Company, are instituting in a nationwide effort to protect the patent properties owned and controlled by the DeForest organization.

James W. Garside, President of the De Forest Radio Company, in commenting on these proceedings, states:

"A number of concerns who have entered the radio set manufacturing field are violating the rights invested in the DeForest Company.

Public Property Idea a Mistake

"As a result, we have instituted the present patent infringement suit against the Pilot Corporation. Other suits will follow. There is a mistaken idea at large that the regenerative patent is public property, instead of the private and presumably valuable property of the De Forest Radio Company."

Hearst News Agency Gains Delay in Appeal

The Court of Appeals of the District of Columbia has postponed for 30 days, on motion of the Universal Service Wireless, Inc., oral arguments on the company's appeal from the decision of the Federal Radio Commission allocating 20 continental short-wave channels to the nation's press. Austin F. Canfield, counsel for Universal Wireless, owned by William Randolph Hearst, said that he was not prepared because the attorneys who had appeared before the Commission in 1928 were on the Pacific Coast, but would be able to handle the case when it comes up next month.

Paul D. P. Spearman, assistant general counsel, appearing for the Commission, said that he had no objections but that the Commission did not want to be a party to the motion. The Commission, he said, was prepared to proceed.

The Press Wireless, Inc., the public utility corporation created by five newspapers to comply with the Commission's stipulation that all papers should be served alike, had been assigned twenty transoceanic channels with which to establish an international news collection system. The Universal appealed on the ground that the Commission previously had authorized the distribution of particular channels among the individual newspapers and news associations who were applicants for the frequencies.

**EIGHTH ANNIVERSARY NUMBER
OF RADIO WORLD, MARCH 29th!
READ IT!**

ADDRESSES AMATEURS



(Underwood & Underwood)

DR. LEE DEFOREST GIVING A TALK
OVER A 187-METER WAVE

DEFOREST TALK HEARD ON 187M

Veteran DX fans throughout the country have been surprised and then delighted with a new and powerful broadcaster located at the very bottom of the usual tuning dial. The broadcaster is Station W2XCD, owned and operated by the DeForest Radio Company of Passaic, N. J., which operates on a wavelength of 187 meters.

The present station is engaged in experimental transmission, mainly in conjunction with the development of DeForest transmitting audions. Although the engineers did not expect the signals to be intercepted by the usual broadcast receivers which supposedly tune down to 200 meters only, the huge volume of correspondence received from many parts of the country reveals the fact that dozens of standard broadcast receivers bring in the 187 meter signals between zero and 5 on their tuning dials.

The latest feature of this unique broadcasting station is a series of talks to be delivered by Dr. Lee DeForest, inventor of the three-element vacuum tube. The talks are primarily intended for amateurs, and will deal with early radio efforts and subsequent developments. While the radio chats are aimed at radio amateurs in particular, it is expected that many program fans will get a thrill out of hearing this pioneer broadcaster reminiscing to his many "sons."

NEW WIRE BY CORWICO

The Cornish Wire Company, 30 Church Street, New York City, announce a new hook-up wire known as Corwico Super Braidite. It can be stripped back with any automatic stripper, and the neat appearing, glossy, flame-proof insulation does not bunch up nor fray when pushed back. Corwico Super Braidite is made with a solid or stranded core in 15 different color combinations.

RADIOTRON PUBLISHES ORGAN

The RCA Radiotron Company of Harrison, N. J., manufacturer of vacuum tubes, will provide for the radio dealer and jobber a monthly publication on RCA Radiotrons. The title of this publication is "Good News." The first issue was out March 1.

DEALERS BACK STRONG POWER, CLEAR CHANNEL

The elimination of cleared channels for radio broadcasting stations, sometimes advocated by members of the Federal Radio Commission, would deprive 75 per cent. of rural listeners of even fair broadcasting service, according to Martin P. Rice, manager of broadcasting for the General Electric Company.

In a statistical report based on the observation of an engineer, and a large number of reports by radio dealers and observers throughout the country, a very decided preference for cleared channel stations was indicated, he said. This report was filed with Radio Commission by Mr. Rice.

Cleared Channels Favored

An engineer-observer distributed questionnaires in the country sections, small cities and in villages as he traveled from New York State to California and return via the Southern and Atlantic States.

Ninety-five per cent. of those reporting stated that best service is received from cleared channels; 2½ per cent. favored regional channels and 2½ per cent. endorsed local channels.

One hundred per cent. voted for more cleared channels, and no one advocated fewer cleared channels. Not a single observer favored more regional or local channels.

Most Favor More Power

Of those signing questionnaires, 80½ per cent. favored increased power and 19½ per cent. were opposed to increases.

Observers, asked to list favorite stations, indicated a decided preference for those on cleared channels.

Of the first twenty-five stations favored, all were cleared channel stations and in the next twenty-five in order of preference. The first eleven stations on the list included all the 50 kilowatt stations in the country, one 30 kilowatt station, one 25 kilowatt station, and one 12½ kilowatt station.

Called a Necessity

This verifies the opinion held by many engineers that, while moderate powers on regional and local channels can give good service within city limits, stations of substantial power operating on cleared channels are necessary to give reliable service to the millions of people living in the smaller cities, villages and rural areas, said Mr. Rice.

Robinson Opposed

Ira E. Robinson, former chairman of the Federal Radio Commission, strongly opposed cleared channels and high power. Commissioner Sykes was sympathetic to the former chairman's position on cleared channels. Robinson is still a member of the Commission, but Charles Salzman is chairman. He is said to favor high power and cleared channels.

SHORT WAVES ALLOTTED

Washington.

The Federal Radio Commission has granted permits for 41 short-wave stations. Of these permits Press Wireless, Inc., got 24, the Radio Corporation of America 10, and the Robert Dollar Steamship Company 7.

Board Names Saltzman As Its Chairman

General Charles McKinley Saltzman, member of the Federal Radio Commission from the Fourth Zone and formerly chief signal officer of the Army has been elected unanimously as chairman of the Commission, succeeding Ira E. Robinson, of the Second Zone, who had been chairman for the past two years.



Chairman Saltzman

General Saltzman will now handle administrative activities of the Commission, while supervision of the engineering division, which he had previously handled, will be taken over by Commissioner Starbuck, of the First Zone. Mr. Robinson will act as liaison officer between the Commission and departments of the government which are interested in radio.

All of the old commissioners were re-appointed by President Hoover and were confirmed by the Senate. Commissioner Judge Eugene O. Sykes of the Fourth Zone continues to be head of the legal division of the Commission while Commissioner Harold A. Lafount handles publicity and public relations.

Judge Robinson announced that he was not a candidate for the chairmanship of the Commission and expressed the opinion that it should rotate among the members.

General Saltzman is regarded as the choice of President Hoover as he is believed to share his views. Mr. Robinson was opposed to high power and clear channels and was particularly thought to be opposed to certain petitions of the Radio Corporation of America. General Saltzman's views are believed to be directly opposed to the views of Mr. Robinson on these points.

One of the most important problems before the Board, and one in which the new chairman is expected to take a directing hand, is the reassignment of frequencies to about forty stations, or as many more as is necessary to put clear-channel stations on a better footing from the public viewpoint.

It is generally conceded that the reallocation of November 11th, 1928, improved conditions, on the whole, although it made matters worse in some instances, and efforts have been made to remedy these bad spots. There still remain some troubles to cure, to avoid crosstalk and give stations a wider area of effective operation. Therefore clear-channel stations are to be shaken up a bit, as to frequency assignment, and forty have received letters asking their quick assent.

It is the Commission's intention to effectuate changes.

CAR IS DRIVEN BY MAN'S VOICE 400 MILES OFF

A demonstration of the "electric eye," or light sensitive photo-electric cell, was given recently by the Westinghouse Electric and Manufacturing Company in the show rooms of the Willys-Overland Company, New York, when H. P. Davis, vice-president of the Westinghouse Company, from his office in his company's administration building in East Pittsburgh, Pa., directed the movements of an unattended automobile in New York.

As Mr. Davis told the car to "go ahead," it moved forward. Similarly, on orders from the distant operator, the car stopped and moved backward. The lights were turned on in response to a request from the voice in East Pittsburgh.

This was the first time in history that an automobile in one city was controlled and moved at will by the voice of a person in a distant city. It was made possible by the "electric eye," or photo-electrical cell of the Westinghouse Company.

This cell was placed in the trunk in the rear of the car. A telephone connection was then established between Mr. Davis' office in East Pittsburgh and the Willys-Overland quarters on Broadway. When Mr. Davis spoke, sound impulses were set up and transferred into light waves which were picked up by the "electric eye," which in turn operated relays and gave the automobile its backward and forward movement.

The demonstration of this most modern form of remote control was witnessed by a large group of automotive experts, technical men and scientists from the Westinghouse Company, as well as by the general public and a group of newspaper men.

INTEREST IN "INHUMANS"

Great interest has been aroused in the last two years by mechanical and electrical contrivances that, to some extent, do the work that men formerly did. For instance, the word robot has found a place in the dictionary, while the feats of the machine, built to look something like a man, strutting the streets of London have amused and enthralled the world. The Televox, that answers sound instructions, and now the Telelux, that answers light instructions, are among the most interesting of recent inventions.

RCA Tube Case Is Suspended

Washington.

The Federal Trade Commission has transferred its complaint against the Radio Corporation of America to the "suspense docket," which virtually closes the case against the corporation growing out of the attempt to force RCA licensees initially to install RCA tubes in receivers.

A short time ago John W. Davis, as counsel for the Radio Corporation, filed a petition with the Commission asking that the case be dismissed, as the Federal Courts have enjoined the corporation from putting into effect the clause in the old contract. The Commission refused to dismiss the case outright. Transfer of the case to the "suspense docket" enables the Commission take it up again should future developments demand it.

JOLLIFFE GETS ENGINEER POST

Washington.

Dr. C. B. Jolliffe, formerly assistant chief of the radio laboratory of the Bureau of Standards, took office as chief engineer of the Federal Radio Commission. This is the first time in the three years the Commission has functioned that this position has been filled by a regular employe.

Dr. Jolliffe took over the duties of Captain Guy Hill, Signal Corps, who has been acting chief engineer for the Commission for a year. Captain Hill had been detailed to the Commission by the Signal Corps, but has been recalled to duty with the troops and is to sail for the Philippines on May 7. He plans to remain with the Commission until early in April to complete his work, and then go on leave before taking up his Signal Corps duties.

Dr. Jolliffe is well known in radio circles, having taken a prominent part in the activities of the Institute of Radio Engineers. He is a member of the Institute's Committee on Meetings and Papers, having charge of Measurements and Standards; a member of the Committee on Bibliography, and of the Committee on Standardization. Moreover, he is chairman of the Washington section of the Institute.

"WHOLE WORLD" IS AT CEREMONY ON SHORT WAVE

A world-wide receiving and rebroadcasting program on short-waves was conducted recently in conjunction with the cornerstone laying ceremony of the new Color-Craft Laboratory, Long Island City, New York City, by WABC's network and its associated short-wave station, W2XE. Preparation for the event had been going on for several days previously among wireless amateurs, members of the American Radio Relay League, in the United States and in foreign countries. It was thought that as many as 160 receiving stations in more than fifty countries tuned in on the 58.5 meter wave of W2XE.

Ted Ostman, owner of amateur station W2OM, at Ridgewood, N. J., and other wireless operators of the New York area, effected arrangements with amateurs in Africa, South America, India, Asia, Europe, Australia and New Zealand. Speaking of the preparations for the experiment Mr. Ostman said:

"In our daily contacts with other amateurs word of any news event or happening can be spread rapidly from point to point around the world. The original message transmitted asks all who hear to retransmit the message, and if they wish to participate in the listening scheme to notify the sender. Thus the 160 receiving stations were quickly mobilized for this event."

Evelyn Laye, English actress, of "Bitter Sweet" fame, spoke at the ceremony and her words were picked up distinctly in many countries.

Reports Diamond Results

Joseph S. Goral, Latrobe, Pa., a radio enthusiast of many years experience and a successful builder of many different types of circuits, has built the AC screen grid Diamond of the Air. He reports the following results, with stations, locations, and dial settings:

WPXCR, New Jersey, 2; WLAC, Tenn., 5; WJAS, Pa., 17½; WHAM, N. Y., 25; WOC, Iowa, 39; KHJ, Calif., 46; WWL, La., 51½; KGO, Calif., 60; WLW, Ohio, 72; WOBF, Ind., 82½; KFI, Calif., 81; and CMC, Cuba, 53.

TELELUX, NEW ELECTRIC 'MAN,' OBEYS LIGHTS

Attendantless airports which are illuminated at the approach of an airplane may become common in the future. S. M. Kintner, manager of the research department of the Westinghouse Electric and Manufacturing Company, recently showed a model of such a field to members of the New York Railroad Club, and told of its possibilities.

This marked the first display in New York of this device for making night air travel safer.

The lights of the port are turned on by a sound sensitive device which is attuned to the signal of a siren carried by the airplane. This device will act only when its microphone picks up a noise of the proper pitch.

Can Be Tuned to Motor

If it is desired to have the electric ear respond to the sound of the plane's motor, that also can be done. In this way airports that are not important enough to keep an attendant on duty at all times will become available for emergency use. The aviator wishing to land has merely to fly over the field and the landing lights will illuminate the runway.

In the model shown by Mr. Kintner a phonograph record was played which made a noise like a siren. This sound was heard by the electric ear which flashed on the lights of the miniature field.

Assisted by Dr. Phillips Thomas, research engineer, Mr. Kintner demonstrated several other recent tube-operated scientific developments which he characterized as by-products of radio. Mr. Kintner stated that it is his belief that some of the most important developments of radio in the future will come from the radio by-product field.

Telelux or Mechanical Dragon

One of the inventions demonstrated was Telelux, the mechanical dragon. Unlike his relative, Mr. Televox, Telelux answers commands issued by a flash of light. Armed with a gun which projected light, Mr. Kintner "shot" the dragon in the eye to give it orders. Under his influence Telelux turned on lights, turned them off and otherwise demonstrated his docility under the guidance of the light gun.

Mr. Kintner showed another beam of light which had the property of carrying music. A phonograph record was played and the beam carried the music to a loudspeaker across the room where it was reproduced.

In this demonstration the vibrations of the phonograph needle were turned into electrical impulses.

How Music Was Played

The light beam fluctuated with the impulses and thus impressed impulses upon a photo-electric cell which sent them on to the loudspeaker where the music was reproduced.

The radio by-products also aid in controlling vehicular traffic. An automatic model system of traffic control was shown which permitted cars on a through street to pass until a car appeared on a side street. The appearance of this car was the cue for the light to change to "go" on the side street. This feat, in model form, was accomplished by an electric eye which "saw" the car on the side street.

Selective Horns For Phonographs

One of the most impressive exhibits at the Railroad Club in New York City was a huge phonograph or radio horn higher than a tall man. Equipped with three different sections it reproduced various types of music with great fidelity.

It was explained by Westinghouse engineers that each section of the horn had a separate section of the scale to recreate which aided in the attainment of faithful reproduction.

STATES FIGHT SETS IN AUTOS

Boston.

Radios may not be operated on automobiles driven in Massachusetts, according to a ruling by the register of motor vehicles. This ruling followed a conference with the Governor's committee on street and highway safety, which recommended that the use of radios on automobiles be discontinued.

Automobile and radio manufacturers have joined in a protest to the department of public works, of which the registry of automobiles is a part, under the law providing that any ruling by the registrar is subject to appeal by the department.

Trenton, N. J.

Autos equipped with radio receivers are viewed as a menace to safety by William L. Dill, State Motor Commissioner, and he hopes that the manufacturers will realize the danger and give up the idea before it becomes necessary for the State Legislature to take action.

"The States of Massachusetts and New Hampshire," said Mr. Dill, "have already taken action to prevent the registration of automobiles equipped with radios. In this connection it may be necessary to invoke the provisions of the motor vehicle act in the matter of registering cars in this State with radio equipment."

"Preoccupation of mind is one of the greatest contributing factors in automobile accidents. To encourage the preoccupation by allowing the concentration of thought of the operator to be distracted by radio will, we believe, invite disaster, and we express the hope that the car builders themselves will sense this danger and abandon the idea of making the radio a part of the car equipment."

Jansky Testifies for WGBS on Tests

Washington.

Professor C. M. Jansky, Jr., appeared before the Radio Commission in connection with the protests against the assignment of the 600 kc channel to WGBS, New York City. He testified that he had made many tests from listeners' homes in New York and that with a modern receiver WGBS will not produce objectionable interference with stations WNYC and WMCA.

Unless the listener was within 300 or 400 yards of the WGBS transmitter there would be no blanketing, provided the listener had a modern set, he reported.

NEW 50-STORY OFFICE EDIFICE FOR RCA-VICTOR

The R. C. A.-Victor company have recently announced the preparation of plans for a new skyscraper. The building is to be located at Lexington Avenue and Fifty-first Street, New York City, in the Grand Central Zone.

The building is to be 50 stories high and will be distinguished from others, in that on the tower structure, there will be four symbolic stone figures, each bearing a crown of forked electricity, which will be illuminated at night and will represent symbolically the spirit of radio.

The R. C. A.-Victor company will use at least half the planned floor space of 310,000 square feet, according to present estimates. The balance of the space will be leased.

Ready May 1st, 1931

The plans now under preparation call for completion and occupancy on or near May 1st, 1931. The building when completed will harmonize well with surrounding structures.

Its external design is to be modified gothic and the tower portion will begin at the 20th story and continue upward for 30 stories tapering off to its top where the stone symbolic figures will be seen—these stone figures will be 50 feet in height.

The R. C. A.-Victor company are also conducting an expansion and building program at Camden, N. J. of considerable extent and it is said the cost will be close to \$7,500,000.

This expansion is of course to be expected and very likely is due to the company's anticipating large orders for its talking movie sound equipment as well as radio, and victrola-radio combinations.

Adds to Employment

The additional employment that this project will furnish will be very welcome and will doubtless be operative in absorbing the slack before very long.

The new R. C. A.-Victor building will rank tenth among New York's tall buildings. It will not be quite as high as the Metropolitan Life building, but will be taller than the new Waldorf Astoria Hotel now under construction just one block to the south.

The building expansion of New York City is still slowly moving uptown.

Amateurs' Parley Called by Board

Washington.

A conference for the consideration of amateur radio regulations has been called for March 21st by the Federal Radio Commission. It will be limited to representatives of the American Radio Relay League, the legal and engineering divisions of the Commission, and the radio division of the Department of Commerce.

In a memorandum to the Commission, Thad H. Brown, its general counsel, said that at present the general orders 24 and 76 of the Commission merely define amateurs and designate bands of frequencies set aside for amateur purposes.

"These orders should be made more comprehensive," he said, "so as to obviate the many questions of policy which are constantly arising in the radio division's administration of the amateur service."

AIR EDUCATION HOTLY DEBATED TO U. S. BOARD

Washington.

"There are certain objections to and strong points in favor of the use of radios in the classroom," according to the findings of the advisory committee of education by radio, appointed by Secretary of Interior Wilbur with the approval of the President. The findings of that committee are now being analyzed by the Federal Office of Education.

The favorable and unfavorable opinions of the use of the radio in the schoolroom are summarized as follows:

"Among those in opposition is the view that broadcasting to schools constitutes an additional sales pressure put on school officials; that it is a dangerous vehicle of commercial propaganda; that it is both expensive and experimental; that it admits jazz and cheap entertainment to the schoolroom; that it subordinates teaching to dial twisting; that it disrupts, interrupts and overcrowds the schedule; that it encourages teacher laziness; that good programs are not available; that available programs are not properly correlated with the curriculum; that there is insufficient advance information on programs; that radio is of no more advantage than a phonograph record, since the teacher must supply instruction before and after; that too many teachers are incompetent to select radio programs wisely and use them skilfully; that it threatens to bring in more mass education and standardized thinking.

Arguments in Favor

Among the arguments advanced in favor of the use of radio in the schoolroom is the theory that it enriches the curriculum; that it vitalizes instruction; that it adds variety; that it stimulates more attentive listening; that it fires the imagination; that it awakens intelligent curiosity; that it stirs ambition; that it broadens horizons; that it increases appreciation of the subjects studied; that it wholesomely stirs emotions; that it supplies personality and authenticity not felt in textbooks; that it results in increased voluntary research and study; that its demonstration lessons bring the teacher new ideas, new lesson plans, new methods, and new exercises; that it relieves the strain of continual direction of class work; that it enables the teacher to study her class and observe individual differences more effectively than is possible when she is doing the actual teaching; that it awakens adults to a new understanding and appreciation of school work; that most of the objections to it are like all objections to new methods—inspired by inertia or uncertainty—and will vanish as the art is learned; that opponents are chiefly among those who have not given it a fair trial.

Adult Education

Advantages and disadvantages also have been advanced in considering the radio as a means of getting education to the adult population, according to another statement, which follows:

"Among the objections that have been raised, it is urged that the average person does not want education, and resents the implication that he needs it; that educational talks need to be so sugarcoated that they lose most of their educational value; that the effect which they produce is largely passive and adds little stimulus to logical thought; that talks by radio encourage the fallacy that listening signifies

Braver of Arctic Covered by Mike

Winnipeg, Man., Canada.

Emile St. Goddard, youthful world champion dog musher of The Pas, Manitoba, would rather face a northern blizzard than the microphone.

He faced the microphone for the first time in a broadcast from the CNRW studio of the Canadian National Railways, Winnipeg. It took three hours of persuasion to get him there and he admitted afterwards the task "had him beaten"—but for the time being only. Now his mettle is up, and he is just waiting for another chance to prove that he isn't afraid of it.

Both he and Earle Brydges will be competitors in The Pas 200-mile non-stop Dog Derby which features the winter carnival which starts on March 4, and continues for four days.

the acquisition of education; that such broadcasts are likely to be sandwiched in between sales talks on cigarettes and lipsticks; that no proven technique has been developed; that no accurate check on results is possible; that the listener loses the advantage of diagrams, maps, or other visual aids; that he loses the value of group discussion and stimulus; that he loses the wholesome compulsion and stimulus of the teacher's presence; that the radio bars all teachers except those who have good delivery; that shortness of talks make it difficult for the teacher to say much or the student to get much.

List of Advantages

The advantages of the use of the radio for adult education are set out as follows:

It democratizes higher learning by removing obstacles that now make it available to a small percentage of Americans, and removes obstacles of age, sex, color, race, creed, special academic prerequisites, social status, or economic conditions. It makes it possible for the able teacher to reach multitudes of listeners and multiplies incalculably the beneficent influence of those teachers. It multiplies incalculably the effective reach of the endowment dollar by eliminating the need of expensive halls and dormitories in the use of this medium. It provides the swiftest means yet known for the spread of ideas; opens the treasures of the universities to all on the same conditions; increases the public appreciation of education, thereby raising the educational and cultural standards of the Nation.

The radio compels essential brevity and point, a long lost art among college lecturers. It forces the teacher to visualize his instruction to the highest degree of interest and value. Such visualized teaching at the microphone influences favorably all other teaching. The radio advances the whole educational attitude toward the goal of self-education by ridding it of experimental discipline and evasions. It makes room for the amateur teacher who has no place in the formal academic plan but who finds in himself a love, an aptitude for teaching and an accumulated wisdom worth sharing. Far from injuring any established institutions of good quality, it is urged, it so stimulates intellectual ambition among parents and young people as to increase enrollments.

THE EIGHTH ANNIVERSARY NUMBER of RADIO WORLD will be published March 29th and will be an especially attractive issue, crammed with constructional articles, and with a fine display of news. Be sure to get a copy of this issue, in two weeks, and thus treat yourself to something especially worth while. An up-to-date list of United States broadcasting stations will be published also.

STUDIO LIGHTS COLORED AS AID TO INSPIRATION

Genius, we are told, must have its inspiration. While creative geniuses must rely entirely upon the inner urge, the audience and the applause are valuable stimuli to interpretive geniuses—when they can have them.

With motion pictures and radio, performers were attacked in the most tender spot of their spiritual anatomy. Their audience was whisked from sight. The applause was removed from their eager ears. Fan letters and popularity contests alone gave them any inkling of how they were getting over.

The problem as it presented itself, first in the movies and then in radio, was treated as one of great importance. What would happen to the "divine spark of inspiration" when the current flowing from the audience to the performer and back again had been definitely and abruptly severed? The movies sought an answer in music and began installing violinists on the lots.

Radio Selected Visual Aid

Conversely, and quite logically, officials of the National Broadcasting Company determined upon a visual stimulus for those who must address their talents to the microphone.

When the company decided to construct its new quarters at 711 Fifth avenue, New York City, the studios were planned to give maximum "lift" to the artists. On the technical side there could be no discussion. The studios would have to be made eighty per cent. sound-proof and as nearly acoustically perfect as possible.

But in the decoration there was an opportunity to create an effect of color and design that would act as a stimulus to the performer. The walls, draperies, lights and furnishings must be made, if possible, to fill the gaps; the one-time orchestra that played in front of them, the sea of faces across the footlights, the applause and even the occasional encouragement from the wings.

Sorel's Debacle

The importance of such a plan is perhaps a little more apparent when it is pointed out that such a seasoned artist as Cecile Sorel of the Comedie Francaise in Paris, on the occasion of her first encounter with the microphone, was so overcome by the atmosphere, or rather the lack of it, that she could not talk and had to be excused. And today the uninitiated, watching a performance in the studio, must marvel at the manner in which the performer must lift himself by his boot-straps to project his personality. Through habit and necessity he has endowed the microphone with life. He talks to it, sings to it and gestures before it as if it were a co-performer, made of flesh and blood.

Obviously such a performance demands a very fertile imagination. The NBC studios are designed as aids to the imagination—Studio H in particular, which is said to have the largest system of lights in any room in the world.

FEWER SHORTED FILAMENTS

Now that the AC indirect heater type of tube is used so generally, e.g., the 227 and 224, the number of tubes lost to civilization by reason of filament or heater burnout is less, since the heater is not directly affected by B voltage applied to it.

A THOUGHT FOR THE WEEK

IT was feared during the early years of radio that broadcastings would diminish the interest in religion and the attendance in churches. Now, if we are to judge by the number of divines that use the microphone as a medium of expression, radio is being relied upon to bring back the prodigal sons.

RADIO WORLD

The First and Only National Radio Weekly
Eighth Year

Owned and published by Hennessy Radio Publications Corporation, 145 West 45th Street, New York, N. Y. Roland Burke Hennessy, president and treasurer, 145 West 45th Street, New York, N. Y.; M. B. Hennessy, vice-president, 145 West 45th Street, New York, N. Y.; Herman Bernard, secretary, 145 West 45th Street, New York, N. Y. Roland Burke Hennessy, editor; Herman Bernard, business manager and managing editor; J. E. Anderson, technical editor.

Amateurs and Short Waves

YEARS ago, when radio broadcasting was beginning to take on a semblance of its present-day scope, radio amateurs were beginning their first experiments with short waves. In fact, the present interest in short wave transmission and reception is firmly founded in the truly outstanding records of achievement of our amateur experiments. Now the big commercial interests are claiming their just share of glory, since by expensive experiments they reduced valuable data to commercial practice.

Not the least among the early experiments was the bridging of enormous distances with the UV-201A tube. For instance, a Bronx amateur worked an Australian station with a UV-201A tube, and while radiation never was of the order of one watt.

Now these so-called "freak transmissions" aroused the interest of engineers and scientists eventually, and resulted in the formulation of a number of interesting theories, all of which are of great importance in the study and research now being conducted by big business interests on both sides of the Atlantic.

We are likely to forget that much credit is due to the efforts of our amateurs and their organization, the American Radio Relay League, composed for the greater part of scientifically-minded men, young men and even boys, who can be trusted to maintain in the future the degree of progress, initiative and achievement that has been characteristic of their earlier days.

World-wide transmission tests, consisting of rebroadcasts by W2XE, cornerstone laying ceremonies in New York, was achieved recently. The tests provided many interested listeners with commercial and scientific data which should light the way to better short-wave transmission and reception.

Frequency Checking

Washington

CONGRESS has authorized the Secretary of Commerce to erect a constant frequency monitoring station, with all necessary facilities, to cost not more than \$80,000. It is very gratifying to see evidence of the right kind of governmental supervision and doubtless this station will do much to put some of our broadcasters in the right frame of mind on the subject of channels of separation.

Adapting B Supplies to the Loftin-White

Most of those who are interested in Loftin-White amplifiers already have B supply units designed for lower voltages than those required for this circuit, say around 300 volts. Nearly all of these will ask themselves or somebody else whether it will be all right to use one of these for the Loftin-White. The answer is an emphatic NO. As far as the filtering is concerned the B supply is all right. It may also be all right with respect to current carrying capacity, because the Loftin-White circuit of two tubes does not take much current. It fails because the voltage is not high enough.

Fortunately there is a simple way of making use of all the components in that B supply, or at least in most of the ready-made B supplies, in such manner that it will handle the Loftin-White circuit.

Now for the connections necessary. Suppose the voltage across each half of the secondary of the power transformer is about 300 volts. The voltage across the entire secondary is therefore 600 volts. Therefore it is only necessary to convert the B supply into a half wave rectifier. If the 280 rectifier is retained the two plates should be connected together and joined to one side of the high voltage winding. The other terminal of this winding is then used for B minus. The center tap on the winding is not used.

Changing the B supply to a half wave rectifier increases the hum and also makes the principal component 60 cycles. Hence there will be a greater hum component in the output. The decrease in the current requirements will make condensers and chokes more effective so this should in part offset the lower filtering efficiency at 60 cycles than at 120.

If the available B supply has an output voltage divider, which is usually the case, this should be removed if the supply is to be used only for a Loftin-White. The filtering will be better when the voltage divider is omitted.

Many readers have asked for the very best constants to use in a Loftin-White using a 250 tube following the 224. The same answer must be given to these questions, namely, "As you like it." To expatiate on that answer is merely a repetition of what was said concerning the 245 tube, using higher voltages and greater currents.

The very first thing that must be answered is whether or not the voltage available is high enough to make it worth while to substitute a 250 for a 245. The larger tube requires a plate voltage of 450 on the plate. This does not mean, however, that the total voltage should be 650 volts. If 450 volts are allowed for the plate it is necessary to allow a greater voltage than 200 volt for the plate of the 224 tube. If this is not done the first tube will not deliver enough undistorted signal voltage to the 250 to make the use of the larger tube worth while. Of course, we can use a lower voltage on the plate of the 250 so that the 200 volts will be high enough. But again a condition is met which makes the use of a 250 unwarranted.

If a 250 tube is to be used advantageously the plate voltage on that tube should be at least 400 volts and the voltage in the plate circuit of the 224 should be at least 300 volts. When we do use such a high plate voltage on the screen grid tube we encounter the difficulty of providing a coupling resistor of high value which will carry the plate current without burning up. It may be necessary to use resistors of comparatively low values in series to obtain the required resistance and current-carrying capacity.

Mexico Completes Biggest Station

Washington.

The largest broadcasting station in Mexico is practically completed at Reynosa, according to the general manager of the large broadcasting chain in charge of its building, the Department of Commerce was informed by its district office at Dallas, Tex.

The station which will start broadcasting soon will have a power of 500 watts and will have the call letters XIBC. Studios will be maintained in six cities of the Rio Grande Valley

Announcements will be made in English and Spanish as the programs are to be designed for audiences in the United States as well as for Latin-America. Speakers on the inaugural program will include Mexican government officials.

It is expected many localities in the United States will be able to receive the station. A permanent wavelength has not yet been assigned.

Listens 120 Hours And Still At It

Nutley, N. J.

When Joseph Buel, a plumber, fell asleep in the shop of Silver Tone Radio Company, of this city, at 7 o'clock in the morning, Michael Petillo, 24, a builder, won the local radio listening championship and a cash prize of \$150.

Mr. Petillo was the only one of twelve starters still awake after more than four days of continuous listening to a radio receiver. At 9 o'clock in the evening he won an additional \$50 for having remained awake 120 hours. His goal was to exceed 152 hours, the present world's championship, established by Elva Mae Richards recently at Dayton, Ohio. If he beats this record he gets another \$50.

No doubt if he beats the record there will be others of greater listening endurance who will raise the record still higher. Those who are chronic sufferers from insomnia should have a good chance of establishing a record that no normal person can touch.

In Support of Distant Reception

THE article in the February 22d issue, by Charles Norton Salmon, taking the negative in the debate, "Resolved, That Distant Reception is Worth While," is ridiculous. Mr. Salmon must be a fish indeed if he really believes what he has printed.

Of course it is true that most people do not care a great deal about distance reception as an exclusive pastime, but try to sell a radio that does not bring in distant stations. I am in the business and I know. Mr. Salmon says he does not know of any radio that will frequently bring in stations over 1,000 miles range, and that he would not know how to build one.

Not knowing the gentleman, I cannot say how little he knows about building a set that will give this performance, but his knowledge of radio must be minute indeed, as any of the kit sets on the market, using two or three or more screen grid tubes in the RF stages, will do better than this, such as Silver-Marshall Hammarlund, National, or others, and these sets can be built by anyone who has the least knowledge of operation of screw-driver, pliers and soldering iron.

I find the factory-built sets of the better quality to be distinctly superior not especially in sensitivity but rather in all-around performance to the custom built brand at anywhere near same price range. There are a number of commercial receivers with a sensitivity of 1 microvolt per meter.

Now in regard to our own experience, and distance results, all made with a set not especially sensitive, a factory-built set of the 1928 variety. We can pull in KFI, Los Angeles, 1,400 miles, probably 200 nights a year. I kept a record on this station last Winter and Spring, and on one occasion had it seventeen nights in a row before 11 o'clock. The string was broken only because one of my friends died, and I was away from home several days and did not get a chance to operate my radio. I started again on returning and got the station fourteen nights in a row before I came to a night I could not bring it in. Of course not every night was reception satisfactory.

Last week I happened to be out rather late and switched on the radio in my store and brought in fifteen Pacific Coast stations, at least twelve loud enough to fill the room, about fifty feet square, on a seven-tube set, using heater tubes, not screen grid. All Pacific states were heard at good volume, from San Diego to Tacoma and Seattle, and also had Oakland, San Francisco, Portland, Spokane, Culver City, Los Angeles, and others, all at good volume. But the remarkable part of this is, I do not consider this extraordinary, and while I mentioned the fact to a few people none of them was impressed, as such performance is rather commonplace.

I know of three instances where KFI, 1,400 miles, has been heard in daytime, and authentically. Often receive Texas stations, about 800 miles away, in daytime, and in the country can get WLW, Cincinnati, 800 miles, any afternoon during the Winter, or say twenty-five out of thirty days each month, and often get it in daytime in the Summer. Also have received WEA, WJZ, WGY, KDKA, WSB, and other stations in the daytime, also located at least 1,000 miles from here. This is daytime reception. At night we often receive seventy-five or more stations in a single evening.

Understand, I am not saying this should be the only reason for listening to a radio, but it is necessary to have a set that will get distance, and in fact almost any good radio will do it nowadays. We depend absolutely on such performance in this locality, as we have no stations of value nearby. Our "locals" are WOW, 150 miles; WCCO, 200 miles, and WLW, 700 miles. The other favorite stations are WBAP, 800 miles, WOAI, 1,000 miles; KOA, 600 miles, and several Chicago stations, 500 miles. Another thing, a set to

Forum

be selective enough for present-day operation does not ruin tone. That old bogey is the bunk.
J. P. KEARNS,
Rock Valley, Iowa.

* * *
Registers His "First Choice"

HAVING noted the various critics of your magazine I am taking the liberty of writing you to remark that RADIO WORLD is one of the two radio magazines that I continue to purchase. RADIO WORLD ranks first. Have dropped others for the reason they ceased to impart radio information. Your magazine is the only one that has stood the test and while at times there are articles of little or no interest to the writer I am quite sure there are a large number of others interested. Everybody cannot be pleased with the same article.

The same writers that object to your advertising most diligently wrestle with their Sunday papers (and daily papers, for that matter), through an overwhelming mass of advertising matter to be informed as to latest on bootleggers or corrupt officials.

The same critics who are so adverse to a page or two of advertising in your magazine will sit for hours enjoying themselves by listening to a radio announcer's ballyhoo concerning some article advertised and paid for over the numerous broadcasting stations.

Your February 22d issue was so full of advance information and good things that I am going to read it the second time.

J. E. Anderson has some rather long-winded articles. Nevertheless his articles are 100 per cent. o. k. I also would like to compliment Herman Bernard for his excellent article on distance reception. (By the way, Mr. Bernard, I have been a distance hound for ten years. Am now 50 years old and if I could not build a set that would get distance I would throw the thing out in the alley. My set is a twelve-tube and you might guess that I get KFI louder than a squeak.)

Your news items are very interesting and up-to-date.

Your advertising is in the right place and interests the writer when something is wanted.

Your magazine is just what is wanted. I buy it every week.

W. R. VAN SICKLE,

Fordson, Mich.

* * *
Appreciates Clarity

I AM a regular reader of your magazine, the only radio paper left, to my way of thinking. You make all your explanations so clear.

I noticed an article from Joseph Henkin in the February 1st issue. He wants you to cut out all the real "technical stuff," that is, radio improvements and the why and wherefore.

I have been in radio now for about eight years and as yet have never had a factory-made set.

His statement, no amateur-built radio can compare with the factory article, is bunk. How about Sergeant Rayment, S. M. 712, M. B.-29, Browning Drake Diamond of the Air? My daughter has a Browning Drake, one of originals, still in the best of order, and I'll venture to say no factory-made set in this district can show a list of stations she has, as she crosses from coast to coast from December to April, getting as many as three New York City stations on the speaker in one evening.
W. T. MCGIBBON,
Victoria, B. C., Canada.

Compliments Anderson

I HAVE been reading your publication for the last two months.

It is the only magazine that gives us real fine technical articles, written in an easily understandable manner. I specially wish to compliment J. E. Anderson for his fine articles, especially:

(a) "A Complete History of Non-Reactive Circuits," issue of February 1st.

(b) "The Pentode," issue of February 22nd.

I regard these articles as masterpieces, and I have filed them away for future reference. I mustn't forget Herman Bernard, especially his affirmative to the subject, "Resolved, That Distance Reception Is Worth While." He gave a masterly argument in support of the subject.

I consider your short articles on latest news worth the price of the magazine alone.

By the way, where has "Radio University" gone to?
ED ANDERSON,
Bronx, New York City.

* * *

Interested in Speakers

WHY all this furor about tubes for more volume? There is too much volume already with standard tubes. As for quality, well, that now rests with the loudspeaker. Ninety per cent. of commercial speakers have no quality. If you want the best obtainable you must make your own. Why is it that this important part of radio is shoved aside to make room for tubes and circuits? Great Scott! Is nobody working on loudspeakers these days?
JOHN DOUGLAS,
Elizabeth, N. J.

* * *

The Weekly Annual

THEY don't print many such magazines any better than RADIO WORLD once a year, let alone every week. The articles are concise and complete in every way, covering points not done so by any others. Keep it up, even if a few of your readers cannot understand why you should print articles of technical and theoretical value.

NORMAN O'LOANE,
Windsor, Ont., Canada.

Untuned RF Device Uses SG Tubes

A fixed or untuned radio-frequency transformer is announced by Dubilier Condenser Corporation for use with screen grid tubes. The transformer is known as the screen grid duratron.

It is an iron-core transformer and comprises two L-shaped members built up of special iron laminations .002 inch thick, arranged to form a closed magnetic circuit through two minute gaps. Each leg carries a winding of extra fine enameled wire and the energy is magnetically transferred from one winding to the other. As many as four stages of screen grid untuned RF amplification may be employed. Each stage has an amplification of over 10 and the curve can be made practically flat from 550 to 1500 kc. One stage of this untuned RF amplification has approximately one-half the gain of the best tuned RF circuit.

REDUCES RESONANCE HUM

Many persons complain that their AC receivers hum, not continuously, but when the receivers are at resonance, or when some particular stations are tuned in. An easy way to remedy this condition considerably is to improve the filtration in the B supply. A much larger capacity condenser across the DC output of the B supply, at maximum voltage drop, will help immensely.

Eighth Anniversary Number

of RADIO WORLD Issue of March 29th

THE first national radio weekly, and for the last several years the only one, RADIO WORLD will be eight years old soon, and will publish an especially attractive and interesting number in celebration of the event. Contributors, editors and national advertisers, because of the special significance of this issue, and the extra-large distribution it will enjoy, have selected this issue as one worthy of their very best. The result will be something of predominating value to reader and advertiser alike.

One of the principal technical articles will deal with short-wave adapters for all types of AC and battery-operated sets, for one to three tubes, including some new ones of remarkable performance. There will be ten circuit diagrams on this article alone.

"Shielded Coil Design for Screen Grid Receivers" is the topic of another article.

"Answers to Questions That Can't Be Answered" will deal with familiar questions that defy a definite, accurate answer, but which are asked time and again, and the

interesting reasons for their unanswerability are set forth.

"A Four Tube Receiver You Can Put in Your Pocket" will be set forth constructionally, as a complete answer to the demand for compactness.

"Audio Coupling Methods" will be another of the technical articles, of which there will be a fascinating profusion.

Besides, there will be the weekly debate, this one entitled, "Resolved, That Commercial Receivers Are Superior to Home-Built Receivers."

There will be pages of up-to-the-minute radio news from all over the world, plenty of illustrations, a lively assortment of letters from readers in Forum, and much else to absorb your attention.

Readers—Be sure to get the Eighth Anniversary Issue.

Advertisers—Capitalize on the extra "edge" at no extra cost to you. Advertising forms for the March 29th issue close at noon, Wednesday, March 19th.

Subscription Rates

**15c per copy. \$6.00 per year (52 issues). \$3.00 for 6 mos. (26 issues).
\$1.50 for 3 mos. (13 issues). \$1.00 for 8 weeks.**

ADVERTISING RATES

1 Page 7 1/4" x 11", 462 lines.....	\$300.00
1/2 Page, 7 1/4" x 5 1/2", 231 lines.....	150.00
1 Column, 2 1/4" x 11", 154 lines.....	100.00
1/4 Page, 4 1/2" D. C., 115 lines.....	75.00
1/8 Page, 4 1/8" S. C., 57 lines.....	37.50
1 Inch.....	10.00
Per Agate Line.....	.73

TIMES DISCOUNTS

52 consecutive issues.....	20%
26 times consecutively or every other week, one year.....	15%

13 times consecutively or every other week, one-half year.....	12 1/2%
4 consecutive issues.....	10%

Minimum Space, One Inch

CASH DISCOUNTS

5% off net for prepayment (cash with order)
2% off net 10 days

CLASSIFIED

Under Heading, "Radio World's Quick Action Classified Ads." Ten cents per word, minimum 10 words. No discounts at all. Cash Must Accompany Order.

RADIO WORLD

145 West 45th Street, New York, N. Y.

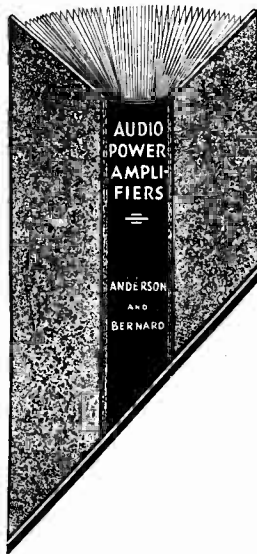

"Audio Power Amplifiers," 193 pages, 147 Illustrations; Maroon Cloth Bound Cover, Lettering in gold. Price, \$3.50.

"AUDIO POWER AMPLIFIERS"

By J. E. ANDERSON and HERMAN BERNARD

The First and Only Book on This Important Subject—Just Out

IN radio receivers, separate audio amplifiers, talking movies, public address systems and the like, the power amplifier stands out as of predominating importance, therefore a full and authentic knowledge of these systems is imperative to every technician. "Audio Power Amplifiers" is the book that presents this subject thoroughly. The authors are

J. E. Anderson, M.A., former instructor in physics, University of Wisconsin, former Western Electric engineer, and for the last three years technical editor of "Radio World."
Herman Bernard, LL.B., managing editor of "Radio World."

They have gathered together the far-flung branches of their chosen subject, treated them judiciously and authoritatively, and produced a volume that will clear up the mysteries that have perplexed many.

What are the essentials to the reproduction of true tone values? What coupling media should be used? What tubes? How should voltages be adjusted? These are only four out of 1,400 questions raised and solved in "Audio Power Amplifiers."
The book begins with an elementary exposition of the historical development and circuit constitution of audio amplifiers and sources of powering them. From this simple start it quickly proceeds to a well-considered exposition of circuit laws, including Ohm's laws and Kirchhoff's laws. The determination of resistance values to produce required voltages is carefully expounded. All types of power amplifiers are used as examples: AC, DC, battery operated and composite. But the book treats of AC power amplifiers most generously, due to the superior importance of such power amplifiers commercially.
Rectification theory and practice in all the applied branches, grid bias methods and effects, push-pull principles, power detection, reproduction of recordings and methods of measurements and testing are set forth. And besides there is a chapter on the subject of motorboating, with which one of the authors is probably better familiar than any other textbook author. Then, too, there is a chapter on tubes, with essential curves and a full list of tables of tube data. Every tube that will be used in an audio amplifier—therefore virtually all tubes—is clearly diagnosed, classified and tabulated! These data on tubes should be at every radio engineer's hand.

"Audio Power Amplifiers" is a book for those who know something about radio. It is not for novices—not by a mile. But the engineers of manufacturers of radio receivers, power amplifiers, sound installations in theatres, public address systems and phonograph pickups will welcome this book. Engineers—even chief engineers—of the Bell Telephone Laboratories, Radio Corporation of America, Westinghouse Electric & Mfg. Co., Western Electric, Phonophone, Vitaphone and the like needn't be afraid they won't learn something from this little book.

Send in This Coupon Now!

Heeney Radio Publications Corporation,
145 West 45th Street, New York, N. Y.
(Just East of Broadway).

Please send at once C. O. D. one copy of "Audio Power Amplifiers," \$3.50 plus postage.

Name

Address

City..... State.....

You may safely order "Audio Power Amplifiers," either enclosing your remittance or ordering the book mailed C.O.D. Examine it for five days. If you are not completely satisfied with it for any reason, or for no reason, send it back in five days with a letter asking for a refund. A check refunding the purchase price will be sent to you immediately. We can not send the book on approval, without payment before receipt, so please do not ask us to do so.

RADIO WORLD BOOK SERVICE

AS the first and only national radio weekly, now in its eighth year, RADIO WORLD publishes the most timely, up-to-date news of radio circuits and events in the set-building and broadcasting fields. Technical accuracy second to none. Get a copy at your news-stand today, 15c. RADIO WORLD advises impartially on all radio topics, including what text books to buy, and helps you to read the books properly. Every book advertised on this page is essential to your radio library.

Five New Volumes Offer Short-Cut to Knowledge!

MORECROFT

"Elements of Radio Communication"



The latest book by Prof. John H. Morecroft, of the Engineering Department of Columbia University, and past president of the Institute of Radio Engineers, is his "Elements of Radio Communication," a book for the novice to enjoy. We regard this as the best elementary book to inform you authoritatively on the technical phases of radio in plain language, without requirement of mathematical knowledge. The book is a complete course on the elements of radio, containing much material never before published. It has 226 pages, 170 illustrations and a complete index. Just out, it is the book of the year in radio. Cloth bound. Order Cat. ME @.....\$3.00

By the same author: "Principles of Radio Communication," second (new) edition. This book is for advanced students. It is the standard of excellence in its field. It covers much the same ground as the later book, only much more fully and more technically. Contains 1,001 pages, 831 illustrations. Cloth bound. Order Cat. MP @.....\$7.50

covers much the same ground as the later book, only much more fully and more technically. Contains 1,001 pages, 831 illustrations. Cloth bound. Order Cat. MP @.....\$7.50

MOYER and WOSTREL

"Radio Receiving Tubes"

The need for an elementary book on radio tubes that answers all the important questions has been filled by James A. Moyer, Director of University Extension, Massachusetts Department of Education, and John F. Wostrel, Instructor in Radio Engineering, Division of University Extension, Massachusetts Department of Education.

This new book is a complete discussion of tube principles, functions and uses, thoroughly up-to-date. In this book the essential principles underlying the operation of vacuum tubes are explained in as non-technical a manner as is consistent with accuracy. The book covers the construction, action, reactivation, testing and use of vacuum tubes as well as specifications for vacuum tubes and applications for distant control of industrial processes and precision measurements. 297 pages, cloth bound. Order Cat. MWT @.....\$2.50

By the same authors: "Practical Radio," including the testing of radio receiving sets, 378 pages, 223 illustrations. Cloth bound. Order Cat. MWPR @.....\$2.50

"Practical Radio Construction and Repairing," 319 pages, a companion volume. Order Cat. MVPRC @.....\$2.00 [NOTE: The standard book on tubes for advanced students is "The Thermionic Vacuum Tube," by Hendrik Van der Bijl. Order Cat. VDB @.....\$5.00]

ANDERSON and BERNARD

"Power Amplifiers"

Here is the first book to be published on the subject of "Power Amplifiers." Now printing, it is certain to fill a void in radio literature. The whole subject is fully covered in a masterful theoretical discussion of audio amplifiers and power supplies, supplemented by constructional chapters, with complete wiring diagrams and specification of parts. Learn while you build! J. E. Anderson, M. A., technical editor of RADIO WORLD, and Herman Bernard, I. L. B., managing editor of RADIO WORLD, both of the Institute of Radio Engineers, have explained fully the phenomena of power amplifiers. Learn all about motorboating and its cures, push-pull theory and practice, grid bias methods and effects, vacuum tubes in audio circuits, AC and battery type AF amplifiers, phase relationships, common impedance, filter systems, by-pass condenser effects, necessities for tone quality, values of coupling constants, and a host of other topics associated with power amplification, including speech amplifiers and "talkie" installations.

More than 200 pages and more than 100 illustrations are devoted to an analysis of this outstanding radio subject. "Power Amplifiers" is authoritative, original and comprehensive. It is free from the traditional errors that have crept into this subject. The theoretical part of the book can be understood by most novices, while the constructional part, that capitalizes the previously imparted knowledge, is thoroughly understandable by anybody. There is virtually no mathematics in the book. Cloth bound. Order Cat. PAM @.....\$3.50

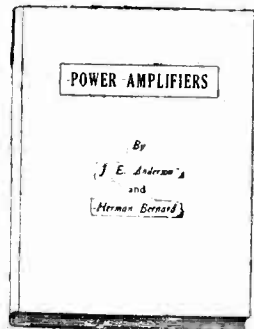

RIDER

"Service Man's Manual"

Two new books by John F. Rider, R. E. Member, Institute of Radio Engineers, constitute the series grouped by him under the heading "Service Man's Manual." Part I is "Mathematics of Radio," Part II is "Trouble Shooter's Manual."

The value of one of these books is more than doubled by the possession of the other.

"The Mathematics of Radio," 128 pages, 8 1/2 x 11", 119 illustrations, bridges the gap between the novice and the college professor. It gives a theoretical background so necessary for a proper understanding of radio and audio circuits and their servicing. Flexible cover. Order Cat. MOR @.....\$2.00

The first comprehensive volume devoted exclusively to the topic uppermost in every service man's mind is "Trouble Shooter's Manual," just published. It is not only a treatise for service men, telling them how to overcome their most serious problems, and fully diagramming the solutions, but it is a course in how to become a service man. It gives all the details of servicing as they have never been given before. Finding the right mode of attack, applying the remedy promptly and obtaining the actual factory-drawn diagrams of receivers always have been a big load on the service man's chest. But no more. Rider, expert on trouble shooting, has produced the outstanding volume on servicing, and has taken the load off the service man's chest!

This book is worth hundreds of dollars to any one who shoots trouble in receivers—whether they be factory-made, custom-built or home-made receivers. The home experimenter, the radio engineer, the custom set-builder, the teacher, the student—all will find this new book immensely informative and absolutely authoritative.

MORE THAN 100 WIRING DIAGRAMS OF RECEIVERS MADE BY MORE THAN FORTY DIFFERENT SET MANUFACTURERS ARE PUBLISHED IN THIS BOOK, INCLUDING OLO MODELS AND LATEST MODELS! RCA, ATWATER KENT, CROSBLEY, MAJESTIC, ZENITH, STROMBERG CARLSON, KOLSTER, FEDERAL, FADA, Etc. 240 pages, size 8 1/2 x 11", 200 illustrations. Imitation leather cover. Order Cat. TSM @.....\$3.50



Read Radio World Every Week

RADIO WORLD will help you in your radio work, so you will be able to use meters most valuably. Keep abreast of new circuits, intimate details on perfecting existing sets, get inside track on sensitivity, distance reception, tone quality, and news of radio, technical and non-technical. Enjoy the writings of McMurdo Silver, J. E. Anderson, Herman Bernard, John F. Rider and a host of other radio engineers in RADIO WORLD. You can find no magazine that better caters to your needs than RADIO WORLD. Short waves? RADIO WORLD will tell you all about them. Extremely sensitive broadcast receivers? Their construction and operation are fully discussed with confident regularity. Power supplies—push-pull or otherwise? AC receivers? Screen grid tubes? Large receivers that give a super-abundance of performance—small, economical receivers that give performance out of all comparison to their size? Are you interested in these? Then you're interested in RADIO WORLD.

See the list of nine meters at left. Obtain one or more of these meters free, by sending in \$1 for 8-weeks' subscription, entitling you to one meter; \$2 for 16 weeks, entitling you to two meters; \$3 for 26 weeks, entitling you to three meters; \$4 for 35 weeks, entitling you to four meters; \$5 for 44 weeks, entitling you to 5 meters; \$6 for 52 weeks, entitling you to six meters.

Present RADIO WORLD mail subscribers may renew their subscription under this remarkably generous offer. Put a cross in square. □

RADIO WORLD

145 W. 45th St., N. Y. City—Published Weekly.
All Newsstands, 15c per copy—\$3, six months—\$6 a year

Gentlemen: Enclosed find \$..... for which please send items checked on coupon. (R -10)

- 0-6 Voltmeter D.C.....Cat. 326
- 0-50 Voltmeter D.C.....Cat. 337
- 6-Volt Charge Tester D.C.....Cat. 23
- 0-10 Amperes D.C.....Cat. 338
- 0-25 Milliamperes D.C.....Cat. 325
- 0-50 Milliamperes D.C.....Cat. 350
- 0-100 Milliamperes D.C.....Cat. 390
- 0-300 Milliamperes D.C.....Cat. 399
- 0-400 Milliamperes D.C.....Cat. 394

- CAT. ME @.....\$3.00
- CAT. MP @.....\$7.50
- CAT. PAM @.....\$3.50
- CAT. MWT @.....\$2.50
- CAT. MWPR @.....\$2.50
- CAT. MVPRC @.....\$2.00
- CAT. MOR @.....\$2.00
- CAT. TSM @.....\$3.50
- CAT. VDB @.....\$5.00
- CAT.....326 Name
- CAT.....337
- CAT.....23
- CAT.....338
- CAT.....325
- CAT.....350
- CAT.....390
- CAT.....399
- CAT.....394 City..... State.....

Long Distance Reception

Guaranteed!



The Balkite A5 neutrodyne. In real walnut table model cabinet by Berkey & Gay. Volume control at left, AC switch at right, drum dial at center, with space to mark in call letters.

You want DX—the more DX the merrier! But why take any chances? We positively guarantee that the Balkite Neutrodyne, made by Gilfillan, will get you all the DX you could desire! Try the set for five days. If not completely satisfied, return it in that time for prompt refund of purchase price!

Three stages of tuned RF, neutralized, so there's no squealing; easy tuning; operation on short piece of wire indoors perfectly satisfactory; no repeat tuning points; no hum; phonograph pickup jack built in; excellent tone quality; good selectivity. These are outstanding points of the receiver, ONE OF THE MOST SENSITIVE BROADCAST RECEIVERS EVER DEVELOPED. The receiver alone lists for \$135. Here you get the set, speaker and tubes at \$9.50 less than half the list price of the receiver alone!

8-Tube Push-Pull AC Balkite Neutrodyne with Matched Speaker and All Tubes, Complete \$57.50

A good many bargains in radio receivers are available today, because set manufacturers overproduced, and had to let their stock go at sacrifice prices. It does not follow that all sacrificed receivers are worth even the cut price. We turned down many "opportunities" to obtain large quantities of "sacrificed" receivers. When the Balkite was offered to us we tested its performance for five days and were delighted. We took the set apart completely to see what calibre of parts was used and how the wiring was done. When we tell you all the parts were ace-high and the wiring the best we've seen, you will know this is an extraordinary receiver. The tubes used are five 2Z7, two 112A and one 280. The undistorted maximum power output is 780 milliwatts.

The line input must be 50-60 cycles, 105 to 120 volts. There is a voltage adjuster built in. The magnetic speaker has a matched impedance for the output of the receiver, and is itself housed in a real walnut cabinet with marqueterie inlay.

FIVE-DAY MONEY-BACK GUARANTEE ON RECEIVER, TUBES AND SPEAKER!

Guaranty Radio Goods Co., 143 West 45th Street, New York, N. Y.

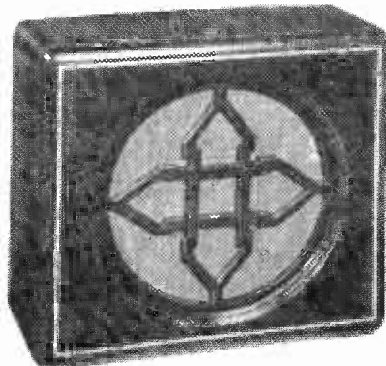

The speaker is of hand-rubbed genuine walnut and its list price alone is \$35.00.

High Impedance Audio Transformers (Four Thousand Turns on the Primary)

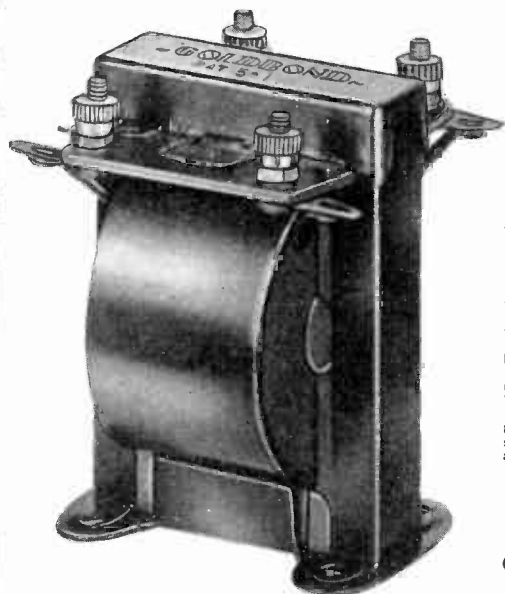

Gold Bond audio frequency transformer is shielded

Gold Bond shielded type audio frequency coupling transformers with high impedance primaries and secondaries are made in two ratios. These are 1-to-3 and 1-to-5, primary to secondary.

A single stretch of copper wire without soldered connections of in-between joints is used for each winding. 4,000 turns on the primary, so the 1-to-3 model has 12,000 secondary turns and the 1-to-5 model 20,000 secondary turns. The overall height is 3 inches and the surface occupied is 2 1/4 inches square. There are four mounting holes on the base. Extreme compactness and neatness prevail.

Laminations are of best silicon steel in a strong steel frame. The coils are vacuum impregnated and therefore moisture-proof.

Each transformer has the name "Gold Bond" stamped on it, also the ratio, and has the primary and secondary designated as such, as well as the binding posts marked P, B+, G and F-. Connect the F- post to a C- voltage. For best tonal results at adequate volume, use the 1-to-3 ratio in the first stage and the 1-to-5 in the second stage. If three stages of audio are used, each should have the 1-to-3 ratio.

High plate voltages may be used, with consequent high plate currents, due to the relatively large diameter of wire used.

These transformers are precisely wound, ruggedly made and represent the finest type of workmanship. They are sold on a 5-day money-back guaranty. Order C.O.D.

Order Cat. GB-1-3 for 1-to-3 ratio \$1.50 each
Order Cat. GB-1-5 for 1-to-5 ratio

GUARANTY RADIO GOODS CO.
143 WEST 45TH STREET
(Just East of Broadway)
NEW YORK, N. Y.

NEW Morecroft

"Elements of Radio Communication," by Prof. John E. Morecroft, of the Engineering Department of Columbia University, is the latest book on radio by this outstanding authority.

This book is entirely new and contains matter which never before has been published. It is written in plain language so that every radio novice can understand it, yet it is a complete course in the elements of radio.

It contains 266 pages, 170 illustrations and a complete index. Price \$3.00.

RADIO WORLD
145 West 45th St., New York, N. Y.

0-1 MA, \$5.95

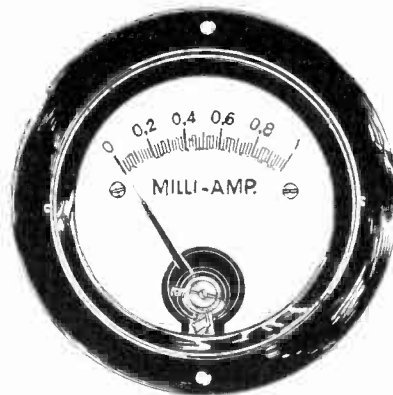

Here is a 0-1 milliammeter, accurate to plus or minus 1%, clearly legible to two-one hundredths of a milliamperere at any reading (20 microamperes). This expertly made precision instrument is offered at the lowest price so far for a 0-1 ma. Order Cat. FO-1 at \$5.95. C. O. D.

Guaranty Radio Goods Co.
143 West 45th Street,
New York City

RADIO WORLD and "RADIO NEWS"

BOTH FOR ONE YEAR @ **\$7.00**

You can obtain the two leading radio technical magazines that cater to experimenters, service men and students, the first and only national radio weekly and the leading monthly, for one year each, at a saving of \$1.50. The regular mail subscription rate for Radio World for one year, a new and fascinating copy each week for 52 weeks, is \$6.00. Send in \$1.00 extra, get "Radio News" also for a year—a new issue each month for twelve months. Total, 64 issues for \$7.00.

- If renewing Radio World subscription, put cross in square at beginning of this sentence.
- If renewing Radio News subscription, put cross in square at beginning of this sentence.

RADIO WORLD, 145 West 45th Street, New York, N. Y.

1/4" Extension Shaft

Here is a handy aid to salvaging condensers and coils that have 1/4" diameter shafts not long enough for your purpose. Fits on 1/4" shaft and provides 1/2" extension, still at 1/4". Price 1¢ net.

RADIO WORLD
145 W. 45 St., N. Y. City

PLEASE GIVE US TWO WEEKS for changing your address, showing new renewal expiration date, etc. Subscription orders are arriving in such large numbers that it takes two weeks to effectuate the change. **RADIO WORLD**, 145 West 45th St., N. Y. City.

Short Wave Circuit



National Thrill Box, 4-tube short wave circuit, 15 to 535 meters, battery-operation of filaments; B supply, either batteries or eliminator.

Get a real kick out of listening to foreign stations on a real short-wave circuit, the National Thrill Box. Uses one 222 screen grid RF amplifier, one 200A detector, one 240 first audio and one 171A or 112A output. Single control. Buy the parts and build the circuit in two hours. Data sheet shows dial settings where foreign stations come in. Cat. SW4EF, all parts, including decorative brown steel cabinet, all six plug-in coils, list price \$51.90 (less tubes). Write for wholesale prices.

Guaranty Radio Goods Co.

143 West 45th Street New York City

MORECROFT

New second edition of "Principles of Radio Communication," by Prof. John H. Morecroft, of the Electrical Engineering Department of Columbia University and past president of the Institute of Electrical Engineers. This is an outstanding and authoritative book on the subject.

This large book on radio principles and practice is something that you must not be without. Every set builder, every designer, every engineer, every service man, simply must have this book. Ready reference to all intricate problems makes this volume invaluable. Set builders, experimenters, distributors, dealers, salesmen and teachers, students and operators, all find Morecroft their standby, and now the new second edition awaits you. 1,001 pages and 87 illustrations in this cloth-bound volume.

Price \$7.50

RADIO WORLD

145 West 45th Street
New York City
(Just East of Broadway)

CONE ASSEMBLY WITH DOUBLE MAGNET UNIT

\$4.95



All assembled, with long cord, ready to play, Shipping weight 8 lbs \$4.95 (Cat. CAS) Net

Guaranty Radio Goods Co.

145 West 45th St., New York City

Attention... Radio Service Men



is compiling an international list of names of qualified service men throughout the United States and Canada, as well as in foreign countries.

This list, which RADIO-CRAFT is trying to make the most complete one in the world, will be a connecting link between the radio manufacturer and the radio service man.

RADIO-CRAFT is continuously being solicited by radio manufacturers for the names of competent service men; and it is for this purpose only that this list is being compiled. There is no charge for this service to either radio service men or radio manufacturers.

We are asking every reader of this magazine who is a professional service man to fill out the blank printed below or (if he prefers not to cut the page of this magazine) to put the same information on his letterhead or that of his firm, and send it in to RADIO-CRAFT. The data thus obtained will be arranged in systematic form and will constitute an official list of radio service men, throughout the United States and foreign countries, available to radio manufacturers. This list makes possible increased cooperation for the benefit of the industry and all concerned in the betterment of the radio trade.

NATIONAL LIST OF SERVICE MEN,
c/o RADIO-CRAFT, 98 Park Place, New York, N. Y.

Please enter the undersigned in the files of your National List of Radio Service Men. My qualifications are as set forth below:

Name (please print) (City) (State)

Address

Firm Name and Address (If in business for self, please so state)

Age Years' Experience in Radio Construction?

Years in Professional Servicing?

Have You Agency for Commercial Sets? (What Makes?)

What Tubes Do You Recommend?

Custom Builder (What Specialties?)

Study Courses Taken in Radio Work from Following Institutions

Specialized in Servicing Following Makes

What Testing Equipment Do You Own?

What Other Trades or Professions?

Educational and Other Qualifications?

Comments (Signed)

(RW. 315)

SEPARATE TESTER COMBINATION

Consists of two-meter assembly in neat black metal case, with an external high resistance meter. The two meters in the case read (a) 0-20, 0-100 milliamperes; (b) 0-10 volts, AC or DC, same meter reads both. The external high resistance meter reads 0-600 volts, AC or DC (same meter reads both). Thus you can test any plate current up to 100 ma., any filament voltage, AC or DC, up to 10 V., and any plate voltage, or line voltage or other AC or DC voltage, up to 600 volts. Five-prong plug, screen grid cable, and 4-prong adapter included. Order Cat. ST-COMB @.....\$11.00 2-meter assembly, cable plugs, Cat. 215 @ \$7.00 1-600 AC-DC meter alone, Cat. M600 @ \$4.95

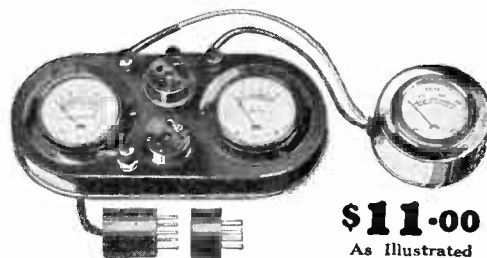

\$11.00
As Illustrated

Guaranty Radio Goods Co., 143 West 45th St., N. Y. City

Aristocrat Floor Speaker

With Molded Wood Horn of 8 ft. tone travel (exponential type) with baffle and horn motor built in. Extraordinary bargain. **\$12.00**

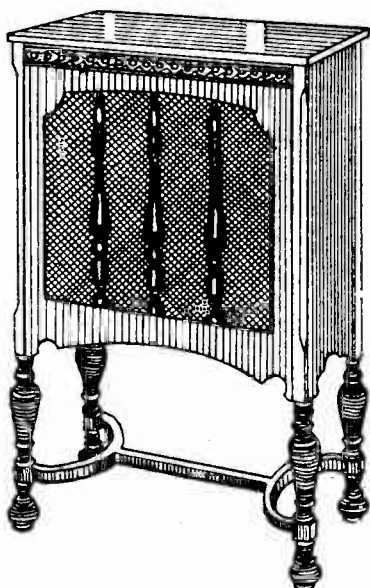

The speaker cabinet is walnut finish, 33" high, 26 1/2" wide, 17 1/2" deep, with carved legs. Golden cloth grille covers front opening. Built inside is No. 595 molded wood horn with baffle and No. 203 driving motor unit that stands 250 volts without filtration. Horn and motor removable. Table alone is worth price asked.

Shipped C.O.D. if desired.

Acoustical Engineering Associates
143 WEST 45th STREET NEW YORK CITY

SUBSCRIBERS!

Look at the Expiration Date on Your Wrapper

Please look at the subscription date stamped on your last wrapper, and if that date indicates that your subscription is about to expire, please send remittance to cover your renewal.

In this way you will get your copies without interruption and keep your file complete.

SUBSCRIPTION DEPARTMENT
RADIO WORLD
145 WEST 45TH ST., N. Y. CITY

BRILLIANT, NEW NATIONAL MODERNISTIC PROJECTION DIAL WITH RAINBOW FEATURE



Modernize the appearance of your receiver by installing the brilliant new National dial, with color wheel built in, so that as you turn the dial knob one color after another floods the screen on which the dial numbers are read. On this screen the numbers are projected, so that you get the same dial reading from any position of the eye. This is just what DX hunters want—laboratory precision of dial reading.

The escutcheon is of modernistic design. The Veivel Vernier mechanism drives the drum superbly.

Order today. Remit with order and we pay cartage. Shipments day following receipt of order

GUARANTY RADIO GOODS CO.

143 W. 45th St., N. Y. City (Just E. of B'way)

Enclosed please find \$3.13 for which please send me dial marked below:

- Cat. HC6, National modernistic drum dial, with color wheel built in, pilot bracket, 6-volt pilot lamp for storage battery or A eliminator sets; hardware; instructions \$3.13
- Cat. HC2 1/2, same as above, but with 2 1/2-volt AC pilot lamp \$1.13
- Order C.O.D. and I pay cartage.

NAME

ADDRESS

CITY STATE

LOOK AT YOUR WRAPPER

You will see by the date thereon when your subscription for Radio World expires. If the subscription is about to run out, please send us renewal so that you will not miss any copies. Subscription Department, RADIO WORLD, 145 West 45th St., N. Y. City.

Portable Type VOLTMETERS for Measuring High Voltages, Including Those of B Supplies.

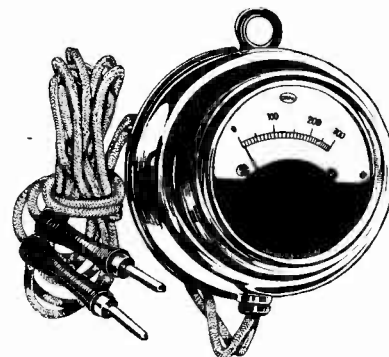

0-300 volts, at 200 ohms resistance per volt, 5 ma. drain at full-scale deflection. Accuracy, 2%. Case is full nickel finish. Long connecting cords have especially ornamental tip holders. Meter should be read in perpendicular position. Five-day money-back guaranty. Order Cat. F-300 @ \$2.59.

0-500 volts, same as above in appearance, but the range is greater and the resistance per volt is 233 ohms., 4 1/2 ma. drain at full-scale deflection. Accuracy, 2%. Five-day money-back guarantee. Order Cat. F-500 @ \$3.75.

0-600 volts, AC and DC (same meter reads both types). DC readings accurate to 2%, also AC readings 2% at 50-60 cycles but accuracy is less on AC at substantially different frequencies.

Resistance 100 ohms. per volt, 10 ma. drain at full-scale deflection. Same general appearance as illustrated meter. Five-day money-back guarantee. Order Cat. M-600 @ \$4.95.

GUARANTY RADIO GOODS CO.
143 West 45th St., New York, N. Y.
(Just East of Broadway)

Please ship C.O.D. the following makes, as advertised, on 5-day money-back guaranty:

- Cat. F-300 at \$2.59
- Cat. F-500 at 3.75
- Cat. M-600 at 4.95

Name

Address

City State

Spring Action Diagonal Nipper



A DIAGONAL cutting nipper is the second most useful tool for radio work, next to the soldering iron. Non-friction spring action adds convenience of use, as the handles are sprung back just far enough for a comfortable grip, and the jaws are closed by easy pressure on the handles.

For cutting wire, a constant operation in your work, this tool is most serviceable, as it makes a clean cut, right through fuzzy insulation as well as through metal. The cut is far more incisive than with the common diagonal cutting pliers. With the diagonal nipper you can cut wire not only along its length, but wherever it may be attached, since accessibility is perfect. A cut can be made any place where the diagonal nipper can enter, since the cutting can be done at the tip. Pliers with diagonal cutters can only pry, not cut, at the extremity.

With the diagonal nipper insulation can be bared from wire ends for soldering. Also screws up to 3/32 machine screw used in radio can be nipped off at any point with one firm application of pressure with one hand.

The device is used extensively in radio set factories and by custom set builders and radio experimenters.

Size 5 1/2" long; weight 1 1/2 lbs.; material, drop forged steel; finish, nickel plated.

Send \$3.00 for 6 months' subscription for Radio World and ask for No. 177 Nipper, free. RADIO WORLD, 145 West 45th Street, New York, N. Y.

If renewing, put cross here.

FILL OUT AND MAIL NOW

SUBSCRIPTION BLANK

RADIO WORLD

RADIO WORLD

145 West 45th Street, New York City

Please send me RADIO WORLD for months, for which

SUBSCRIPTION RATES:

- Single Copy.....\$.15
- Three Months..... 1.50
- Six Months..... 3.00
- One Year, 52 Issues..... 6.00
- Add \$1.00 a Year for Foreign Postage; 50c for Canadian Postage

If this is a renewal, put cross in square at left.

please find enclosed

Highest Grade Speakers at Lowest Prices!

T - E - M - P - L - E F - A - R - R - A - N - D



Temple AC Dynamic Model 10, in a beautiful cabinet. The speaker chassis is one of the finest made. There are an output transformer and dry rectifier built in. The cabinet has decorated walnut front and back, with carved grille ornament. An AC switch is accessible underneath cabinet. Rear is removable for adjustment of resistor knob to match the impedance of your receiver's output tube. Connect plugged AC cable to 110 volts AC, 50 to 60 cycles, and connect tipped cords to speaker post of receiver. This remarkable speaker Cat. TEM-10 at only.....

\$15.34

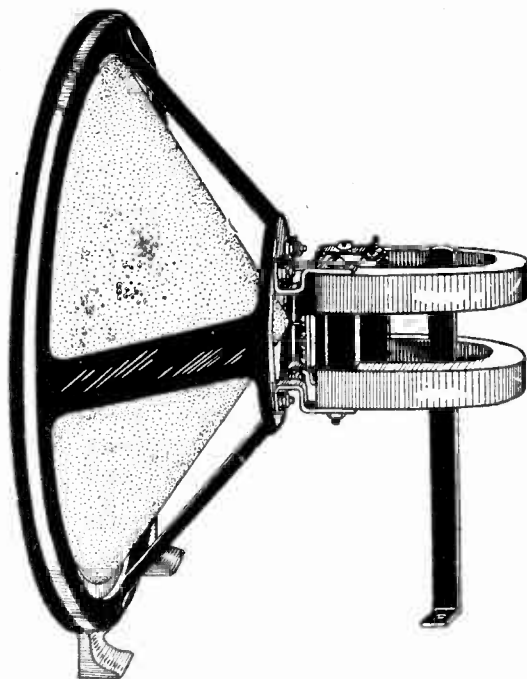

Farrand Inductor Chassis, consisting of the unit, cone, spider, bracket, assembled, but not in a cabinet.

Model 10-G, 12" extreme diameter of cone front rim **\$10.00**

Model 10-G-PP for connection to push-pull, requiring no output device, because unit is constructed as a center tapped output impedance. Center tap is yellow and goes to B+. Tipped cords go direct to plates. Outside diameter 12"..... **\$11.00**

Send No Money! Order C.O.D. from

Accoustical Engineering Associates
143 WEST 45th ST. NEW YORK CITY

NATIONAL

Velvet B Eliminator \$16.13
156 Volts (250 Tube Free)



Latest Model National Velvet-B, Type 8580, in handsome crackle finish black metal casing, for use with sets up to and including six tubes. Input 105-120 volts AC, 50 to 60 cycles. Output, 180 volts maximum at 35 milliamperes. Three variable output intermediate voltages. (Det., RF, AF) Eliminator has excellent filter system to eliminate hum, including 50 heavy choke and 15 mfd. Marshen condenser. No motorboating! (Eliminator Licensed under patents of the Radio Corporation of America and associated companies.)

Guaranty Radio Goods Co.
143 W. 45TH STREET
(Just East of Broadway)
NEW YORK CITY

TELEVISION and all about it in "A B C of Television," by Raymond Francis Yates. \$3 post-paid. Radio World, 145 W. 45th St., N. Y. City.

LACAULT'S BOOK, "Superheterodyne Construction and Operation," and Radio World for 8 weeks for \$1. Radio World, 145 W. 45th St., N. Y. City.

Two for the price of One

Get a FREE one-year subscription for any ONE of these magazines:

- CITIZENS RADIO CALL BOOK AND SCIENTIFIC DIGEST (quarterly, four issues).
- RADIO (monthly, 12 issues; exclusively trade magazine).
- RADIO ENGINEERING (monthly, 12 issues; technical and trade magazine).
- SCIENCE & INVENTION (monthly, 12 issues; scientific magazine, with some radio technical articles).
- AMERICAN BOY—YOUTH'S COMPANION (monthly, 12 issues; popular magazine).
- BOYS' LIFE (monthly, 12 issues; popular magazine).

Select any one of these magazines and get it FREE for an entire year by sending in a year's subscription for RADIO WORLD at the regular price, \$6.00. Cash in now on this opportunity to get RADIO WORLD WEEKLY, 52 weeks, at the standard price for such subscription, plus a full year's subscription for any ONE of the other enumerated magazines FREE! Put a cross in the square next to the magazine of your choice, in the above list, fill out the coupon below, and mail \$6 check, money order or stamps to RADIO WORLD, 145 West 45th Street, New York, N. Y. (Just East of Broadway).

Your Name **DOUBLE**
Your Street Address **VALUE!**
City State.....
 If renewing an existing or expiring subscription for RADIO WORLD, please put a cross in square at beginning of this sentence.
 If renewing an existing or expiring subscription for other magazine, please put a cross in square at the beginning of this sentence.

RADIO WORLD, 145 West 45th Street, New York, N. Y. (Just East of Broadway)

Hi-Q 30 Wholesale Prices!

Write or wire!

Guaranty Radio Goods Co.
143 West 45th St.,
New York City

New AC Screen Grid Short-Wave Adapter

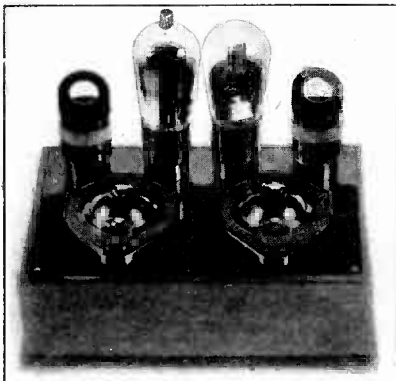

For use with AC screen grid sets only.

Order what parts you want.

- C1, C5—Two short-wave tuning condensers @ \$1.50.....\$ 3.00
- C2—One .00025 mfd. fixed condenser..... .25
- C3, C6—Two 1 mfd. bypass condensers @ \$.50..... 1.00
- C4—One .01 mfd. mica fixed condenser... .35
- CT—One Hammarlund 80 mmfd. equalizing condenser..... .35
- R1—One Electrad 800 ohm. wire-wound biasing resistor..... .20
- Ant., Gnd.—Two Eby binding posts..... .20
- Two sets of short-wave plug-in coils, three coils to a set, @ \$1.50 a set, total six coils..... 3.00
- One AC short-wave adapter cable, 5-prong..... 1.50
- Two four-prong sockets..... .40
- Two five-prong sockets..... .40
- One grid clip..... .06
- Two dials @ \$.50..... 1.00
- One panel and cabinet..... 3.00
- All parts.....\$14.71
- 227 tube..... .90

GUARANTY RADIO GOODS CO.

143 West 45th St. New York, N. Y.

- Please ship C.O.D. all parts for AC screen grid short wave adapter @ \$14.71.
- If 227 tube is desired also, put check here.
- Please ship C.O.D. only those parts noted separately.

Name

Address

City State

MICROPHONE LIGHTERS

For cigars or cigarettes, with button switch at top. Press switch, and lighter acts instantaneously. \$1.00. Model B lighter on tray, \$1.50. Radio World, 145 W. 45th St., N. Y. C.

High Efficiency Tuning Coils

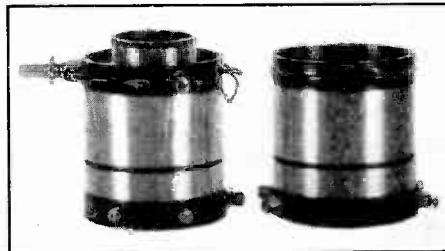

Wound with non-insulated wire plated with genuine silver, on grooved forms, these coils afford high efficiency because of the low resistance that silver has to radio frequencies. The grooves in the moulded bakelite forms insure accurate space winding, thus reducing the distributed capacity, and keep the number of turns and separation constant. Hence the secondary reactances are identical and ideal for gang tuning.

The radio frequency transformer may be perpendicularly or horizontally mounted, and has braced holes for that purpose. It has a center-tapped primary, so that it may be used as antenna coil with half or all the primary in circuit, or as interstage coupler, with all the primary on a screen grid plate circuit, or half the primary for any other type tubes, including pentodes.

The three-circuit tuner has a center-tapped primary, also. This tuner is of the single hole panel mount, but may be mounted on a chassis, if preferred, by using the braced holes.

The secondaries are for .0005 mfd. tuning only. There are no models for .00035 mfd.

These coils are excellent indeed for popular circuits like the Diamond of the Air and tuned radio frequency.

Diameters of form, 3 inches.
Two-winding coil, order Cat. GRF @ 99c.
Three-winding coil, order Cat. G-3 CT @ \$1.49.

GUARANTY RADIO GOODS CO.
145 West 45th St., N. Y. City
(Just East of Broadway)

Please mail me C.O.D. at stated prices, plus few cents extra for postage, the following coils on 5-day money-back guaranty:

- GRF at 99c.
- G3eT at \$1.49

Name

Address

City State

FULL EXPOSITION OF

HB COMPACT, BATTERY MODEL

Complete details on the theory and construction of the HB Compact were published in a four-part article in Radio World, written by Herman Bernard, designer of the circuit and inventor of the Bernard Dynamic Tuners used in the circuit. Full details on how to wind your own coils. Full-sized pictorial diagram of the wiring. Order the August 24th, 31st, September 7th and 14th Issues. 60c—

RADIO WORLD, 145 West 45th Street, New York, N. Y.

LOOK AT YOUR WRAPPER

You will see by the date thereon when your subscription for Radio World expires. If the subscription is about to run out, please send us renewal so that you will not miss any copies. Subscription Department, RADIO WORLD, 145 West 45th St., N. Y. City.

DX!!!

FIND-ALL
Screen Grid
FOUR!

Supreme in DX for a 4-tube receiver using storage battery type tubes.

Some builders have tuned in European stations, on broadcast waves, with this screen grid receiver.

Here is a big opportunity for DX hounds to build a really outstanding circuit.

All parts, as specified by Adam J. Arlington in this issue! Price \$25.00. Cabinet, \$5.00 extra.

FIND-ALL RADIO CO., Dept. W-115

Suite 707, 285 Madison Ave.

New York, N. Y.

DX!!!

RADIO AND OTHER TECHNICAL BOOKS At a Glance

RADIO

- 'Audio Power Amplifiers,' by Anderson and Bernard.....\$3.50
- 'Elements of Radio Communication,' by Morecroft..... 1.00
- 'Foothold on Radio, A,' by Anderson and Bernard..... 1.00
- 'Mathematics of Radio,' by Rider..... 2.00
- 'Practical Radio,' by Moyer & Westrel..... 2.50
- 'Practical Radio Construction and Repairing,' by Moyer & Westrel..... 2.00
- 'Principles of Radio Communication,' by Morecroft..... 1.50
- 'Radio Blueprint Library'—AC Hook-ups.... .35
- 'Radio Cyclopedia,' by Drake..... 6.00
- 'Radio Receiving Tubes,' by Moyer & Westrel..... 2.50
- 'Superheterodyne Construction and Operation,' by Lacault..... .25
- 'Thermionic Vacuum Tube, The,' by Van der Bijl..... 5.00
- 'Trouble Shooter's Manual,' by Rider..... 3.50

TELEVISION

- 'A B C of Television,' by Yates..... 3.00

AVIATION

- 'A B C of Aviation,' by Maj. Page..... 1.00
- 'Aerial Navigation and Meteorology,' by Capt. Yancy..... 4.00
- 'Everybody's Aviation Guide,' by Maj. Page..... 4.00
- 'Ford Model 'A' Car,' Its Construction, Operation and Repair—by Maj. Page..... 2.00
- 'Modern Aircraft,' by Maj. Page..... 5.00
- 'Modern Aviation Engines,' by Maj. Page..... 9.00

RADIO WORLD

145 West 45th Street

New York, N. Y.

(Just East of Broadway)

ARISTOCRAT FLOOR SPEAKER

With Molded Wood Horn and Horn Motor built in. Good value. \$12.00. Acoustical Engineering Associates, 143 W. 45th St., N. Y. C.

Quick Action Classified Ads

Radio World's Speedy Medium for Enterprise and Sales

10 cents a word — 10 words minimum — Cash with Order

ARISTOCRAT FLOOR SPEAKER—With Molded Wood Horn and Horn Motor built in. Great value. \$14.00. Acoustical Engineering Associates, 143 W. 45th St., N. Y. C.

POLO 245 POWER SUPPLY. Read all about it on another page of this issue. Polo Engineering Laboratories, 57 Dey St., N. Y. City.

"EVERYBODY'S AVIATION GUIDE." By Maj. Page. \$2 postpaid. Also "Modern Aircraft" by same author. \$5. postpaid. Radio World, 145 W. 45th St., N. Y. City.

BE SURE TO READ the advertisement on another page of this issue about the HB Compact Guaranty Radio Goods Co., 143 W. 45th St. N. Y. City.

"MATHEMATICS OF RADIO."—A great help to everybody interested in radio. \$2 postpaid. Radio World, 145 W. 45th St., N. Y. City.

RADIO EXPERIMENTAL AND DEVELOPMENTAL WORK, manufacturing; coils, transformers, chokes or any scientific apparatus. Walter Muench, 942 St. Marks Ave., Brooklyn, N. Y.

BERNARD Tuning Equipments. Star, 111 W. 28th St., Indianapolis, Ind.

TWO FOR ONE. Radio World for 52 weeks and Radio News twelve months at the combination rate of \$7. Radio World, 145 W. 45th St., N. Y.

"AUDIO POWER AMPLIFIERS," by J. E. Anderson and Herman Bernard, the first and only book on the subject. \$3.50. Hennessy Radio Publications Corporation, 145 West 45th St., N. Y. City.

RADIOMEN: TRY FURMHOLD liquid soldering flux for cleanest joints you ever saw. Noncorrosive. Solder sticks instantly. No coxing. Big bottle \$1. Sample, 50c. Guaranteed. Furmhold Co., 109-24 208th St., Bellerose, N. Y.

SETS CUSTOM BUILT

Hi-Q 30 \$145. All makes. Write for list. J. T. Boyer, Jr., Winston-Salem, N. C.

WORLD'S BEST AVIATION BOOKS: "A B C of Aviation," \$1.00; "Modern Aviation Engines," \$9.00 postpaid. Both by Maj. Page. "Aerial Navigation and Meteorology," by Capt. Yancey. \$4.00 postpaid. Radio World, 145 W. 45th St., N. Y. City.

NEW J-245-X TROUBLE-SHOOTING JIFFY TESTER

Illumination Continuity and Polarity Tester FREE with Each Outfit!



Your Price
\$15.82

Complete



Illumination Tester, Vest Pocket Size, Shows Shorts and Opens Visually, also polarity of DC line. A Neon lamp is built in.

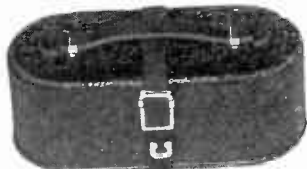

The three-meter assembly, in the crackle-brown finish carrying case, with slip-on cover in place. The handle is genuine leather. The buckled strap holds the cover on.

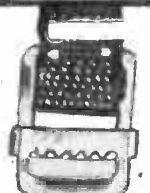
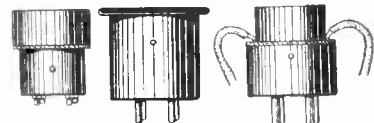

Illustration above is 2/3 scale.



J-111 Multiplier, upper left, with tip; below it, J-108 Multiplier with tip; plugs, left to right, J-19, conforms UV socket to UX plug; J-20, conforms UX tester socket to UV199 tube; J-24, to test Kellogg and old style Arcturus tubes.



Makes All Necessary Tests in a Jiffy and Simplifies Service Work!

WHEN servicing a radio set, power amplifier, speech amplifier or sound reproduction or recording equipment, the circuits and voltages are almost inaccessible, unless a plug-in tester is used.

The Jiffy 245-X plugs in and does everything you want done. It consists of:

- (1)—The enclosed three-meter assembly, with 4-prong (UX) and 5-prong (UY) sockets built in; changeover switch built in, from 0-20 to 0-100 ma.; ten vari-colored jacks, five of them to receive the vari-colored tipped ends of the plug cable; grid push-button, that when pushed in connects grid direct to the cathode for 224 and 227 tubes, to note change in plate current, and thus shorts the signal input.
- (2)—4-prong adapter for 5-prong plug of cable.
- (3)—Screen grid cable for testing screen grid tubes.
- (4)—Pair of Test Leads for individual use of meters.
- (5)—J-106 Multiplier, to make 0-300 DC read 0-600.
- (6)—J-111 Multiplier, to make 0-140 AC read 0-560.
- (7)—Two jack tips to facilitate connection of multipliers to jacks in tester.
- (8), (9), (10)—Three adapters so UV199 and Kellogg tubes may be tested.
- (11)—Illumination Tester.

The illumination tester will disclose continuities and opens and also the polarity of DC house mains. It is as handy as a pencil and fits in your vest pocket. It works on voltages from 100 to 400. There are two electrodes in a Neon lamp in the top of the instrument. On AC both electrodes light. On DC only one lights, and that one is negative of the line, the light being on the same side as the lead. Hence the illuminator shows whether tested source is AC or DC, and if DC, which side is negative.

Even the output of the speaker cord will show a light.

Also, the device will test which fuses are blown in fused house lines, AC or DC. Besides it tests ignition of spark plugs of automobiles, boats and airplanes, also faulty or weak spark plugs.

Just flash on the illumination tester momentarily. It will last about 4,000 flashes.

THE new Jiffy Tester, J-245-X, is a complete servicing outfit. It consists of a three-meter assembly in a metal case, with slip-on cover and a cable plug. There are ten adapters. It is vital to have the complete outfit so you can meet any emergency.

With this outfit you plug the cable into a vacated socket of a receiver, putting the removed tube in the tester, and using the receiver's power for making these tests: plate current, up to 100 milliamperes; plate voltage up to 300 volts; filament or heater voltage (AC or DC), up to 10 volts.

Each meter may be used independently. One of the adapters—a pair of test leads, one red, the other black, with tip jack terminals—serves this purpose. Multiplier J-108 extends the range of the DC voltmeter to 600 volts, but this reading must be obtained independently, as must readings on the 0-60 scale of the DC voltmeter. Independent reading of the AC voltmeter for line of voltage is necessary; also to use 0-140 scale while Multiplier J-111 extends the AC scale to 560 volts for reading power transformer secondaries.

The other adapters permit the testing of special receiver tubes, so that tests may be made, in all, of 22 different tubes: 201A, 200A, UX199, UV199, 120, 240, 171, 171A, 112, 113A, 245, 224, 223, 328, 280, 281, 227, 226, 210, 250, Kellogg tubes and old style Arcturus tubes.

GUARANTY RADIO GOODS CO.

143 West 45th Street, Just East of Broadway, N. Y. City.

Please send me on 5-day money-back guaranty your J-245-X Jiffy Tester, complete, with all 10 adapters, and with illuminated Tester FREE with each order. Also send instruction sheet, tube data sheet and rectifier tube testing information.

Please ship C. O. D. @ \$15.82 plus cartage and P.O. fee.

NAME

ADDRESS

CITY STATE

5-DAY MONEY-BACK GUARANTY

The Latest in Tuning Equipment

SHIELDED COIL

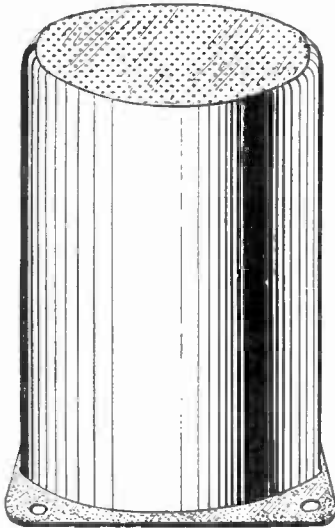

RF transformer in aluminum shield 2 1/2" square at bottom, 3 1/2" high. If metal sub-panel is used no extra base is needed. Coils have brackets on. You must assemble in shield yourself and solder winding terminals to built-in lugs. For all circuits and stages, including screen grid tubes.
 Cat. No. SH3 for .00035 mfd.\$0.95
 Cat. No. SH5 for .0005 mfd.\$1.00
 Cat. SHB (extra base)\$0.10

BERNARD TWO-TUBE TUNER ASSEMBLY

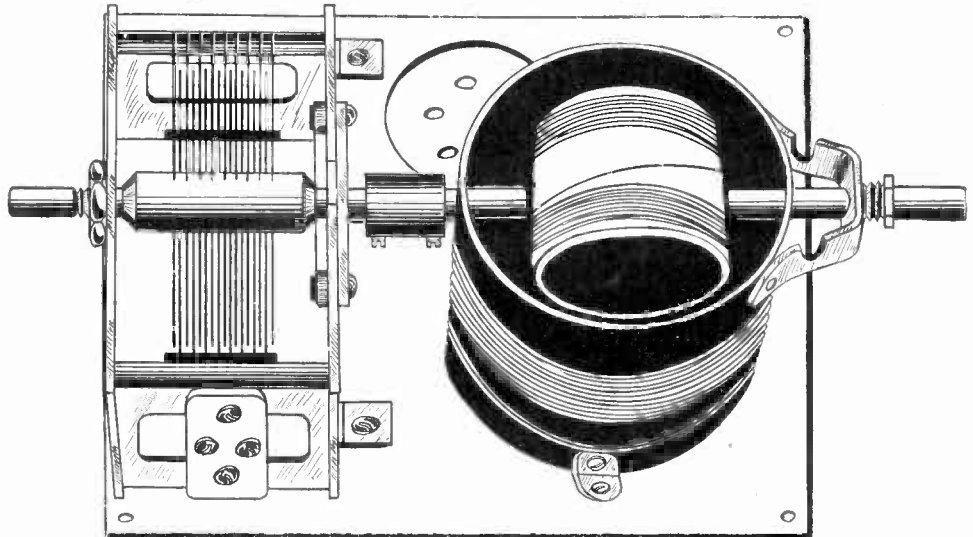

For building a tuner consisting of a stage of screen grid radio frequency amplification and a detector, AC or battery-operated, use the Bernard two-tube tuner assembly. Suitable for single control with one drum dial or separately tuned stages with two flat-type dials. The assembly consists of antenna stage (BTL-AC or BTL-DC), having Bernard Tuner BTSA, a .00035 mfd. condenser, socket, link and aluminum base. The Detector input stage (BTR-AC or BTR-DC) consists of the same parts, but the coil has a tuned primary with untuned input to detector. Assemblies are unwired but are erected. The condenser has shaft protruding at rear, so if two dials are used coil is put at front panel in either instance and condenser at front panel for the other.
 For AC operation, 224 RF and 224, 227 or 228 detector, order Cat. No. BTL-AC and BTR-AC at \$6.00 for both.
 For battery operation of filaments, 223 RF and 223, 240, 201A or 112A detector, order Cat. No. BTL-DC and BTR-DC at \$6.00 for both.
 [Note: for drum dial single control an 80 mmfd. equalizing condenser is necessary. This is extra at \$0.35. Order Cat. EQ-80.]

ANTENNA COUPLER

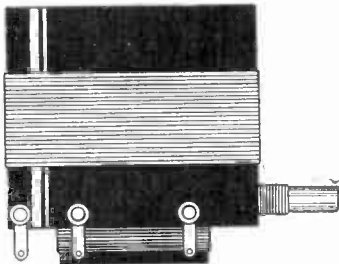

Cat. No. VA5—\$0.85
FOR .0005 MFD. CONDENSER
 Moving primary and fixed secondary, for antenna coupling. Serves as volume control.
 Cat. No. VAB for .00035 mfd.\$0.90

BERNARD TUNERS

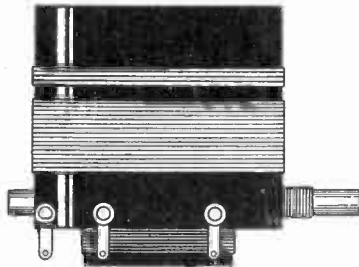

Cat. No. BT5A—\$1.35
FOR .0005 MFD. CONDENSERS

Bernard Tuner BT5A for .0005 mfd. for antenna coupling, the primary being fixed and the secondary tuned. This coil is used as input to the first screen grid radio frequency tube. Secondary has moving coil.
 Cat. No. BT3A for .00035 mfd. ..\$1.35
 Bernard Tuner BT5B for .0005 mfd. for working out of a screen grid tube, tuned primary, untuned secondary. Primary has moving coil.
 Cat. No. BT3B for .00035 mfd. ..\$1.35

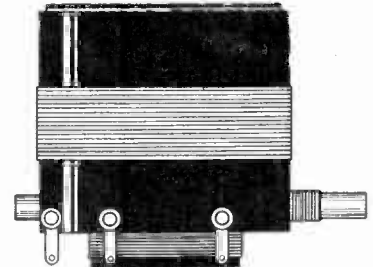

Cat. No. BT5B—\$1.35
FOR .0005 MFD. CONDENSER

SG TRANSFORMER

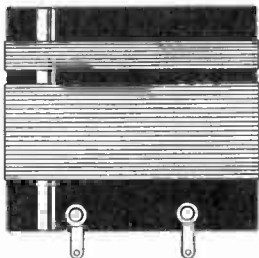

Cat. No. SGS5—\$0.60
FOR .0005 MFD. CONDENSER
 Interstage radio frequency transformer, to work out of a screen grid tube, primary untuned.
 Cat. No. SGSS for .00035 mfd.\$0.65

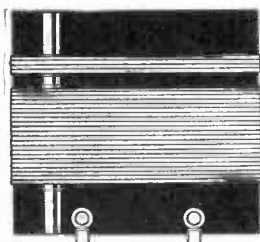

Cat. No. RF5—\$0.60
FOR .0005 MFD. CONDENSER

DIAMOND PAIR

Cat. No. RF5—\$0.60
FOR .0005 MFD. CONDENSER
 Antenna coil for any standard circuit, and one of the two coils constituting the Diamond Pair.
 Cat. No. RF3 for .00035 mfd.\$0.65
 Cat. No. SGT5—\$0.85
FOR .0005 MFD. CONDENSER
 Interstage 3-circuit coil for any hookup where an untuned primary is in the plate circuit of a screen grid tube.
 SGT3 for .00035 mfd.\$0.90

Order the Diamond Pair, Cat. DP5 for .0005 mfd. at\$1.45
 Order the Diamond Pair, Cat. DP3 for .00035 mfd. at\$1.55
 [Note: These same coils are for AC or battery circuit.]

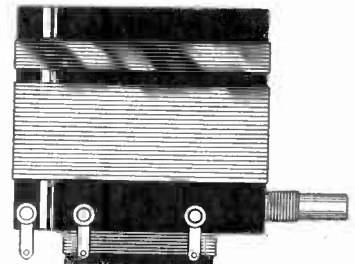

Cat. No. SGT5—\$0.85
FOR .0005 MFD. CONDENSER

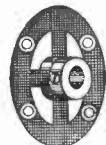

FL4 \$0.30
 Flexible insulated coupler for uniting coil or condenser shafts.
 Order Cat. FL4 at\$0.30
 Equalizing condenser, 80 mmfd., for connection across any tuning condenser where ganging is resorted to, or for equalizing independently tuned circuits to make dials track.
 Order Cat. EQ80 at\$0.35

The standard three-circuit tuner is used with primary in the plate circuit of any RF tube, AC or battery type, excepting only screen grid tube. For .0005 mfd. order T5 at\$0.85
 For .00035 mfd. order Cat. T3 at\$0.90
 All coils have 2 1/2" diameter, except the shielded coil, which is wound on 1 1/2".
 The coils are wound by machine on a bakelite form, and the tuned windings have identical inductance for a given capacity condenser, i. e., .0005 mfd. or .00035 mfd. Full coverage of the wave band is assured.

All coils with a moving coil have single hole panel mounting fixture. All others have base mounting provision. The coils should be used with connection lugs at bottom, to shorten leads.

Only the Bernard Tuners have a shaft extending from rear. This feature is necessary so that physical coupling to tuning condenser shaft may be accomplished by the insulated link.

STANDARD TUNER

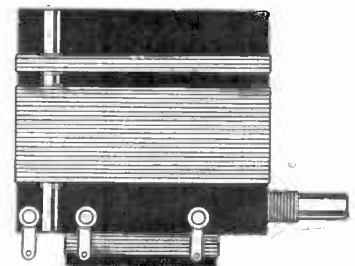

Screen Grid Coil Company,
 143 West 45th Street,
 New York, N. Y. (Just East of Broadway.)

Please ship at once C. O. D.:

- Cat. No. at \$
- Cat. No. at \$
- Cat. No. at \$

Name

Address

City State