

U. S. and CANADIAN STATIONS BY CALL LETTERS

With Location of Transmitter and Studio, Power, Wavelength and Frequency

DECEMBER 14th, 1929 CHRISTMAS NUMBER 15c

RADIO

REG. U.S. PAT. OFF.

WORLD

403rd Consecutive Issue—EIGHTH YEAR

HB 33 and HB 44

BEAT NOTE DETECTION

NEW SCREEN GRID TUBE IN MAKING

HI-Q 30 FOR AC OPERATION

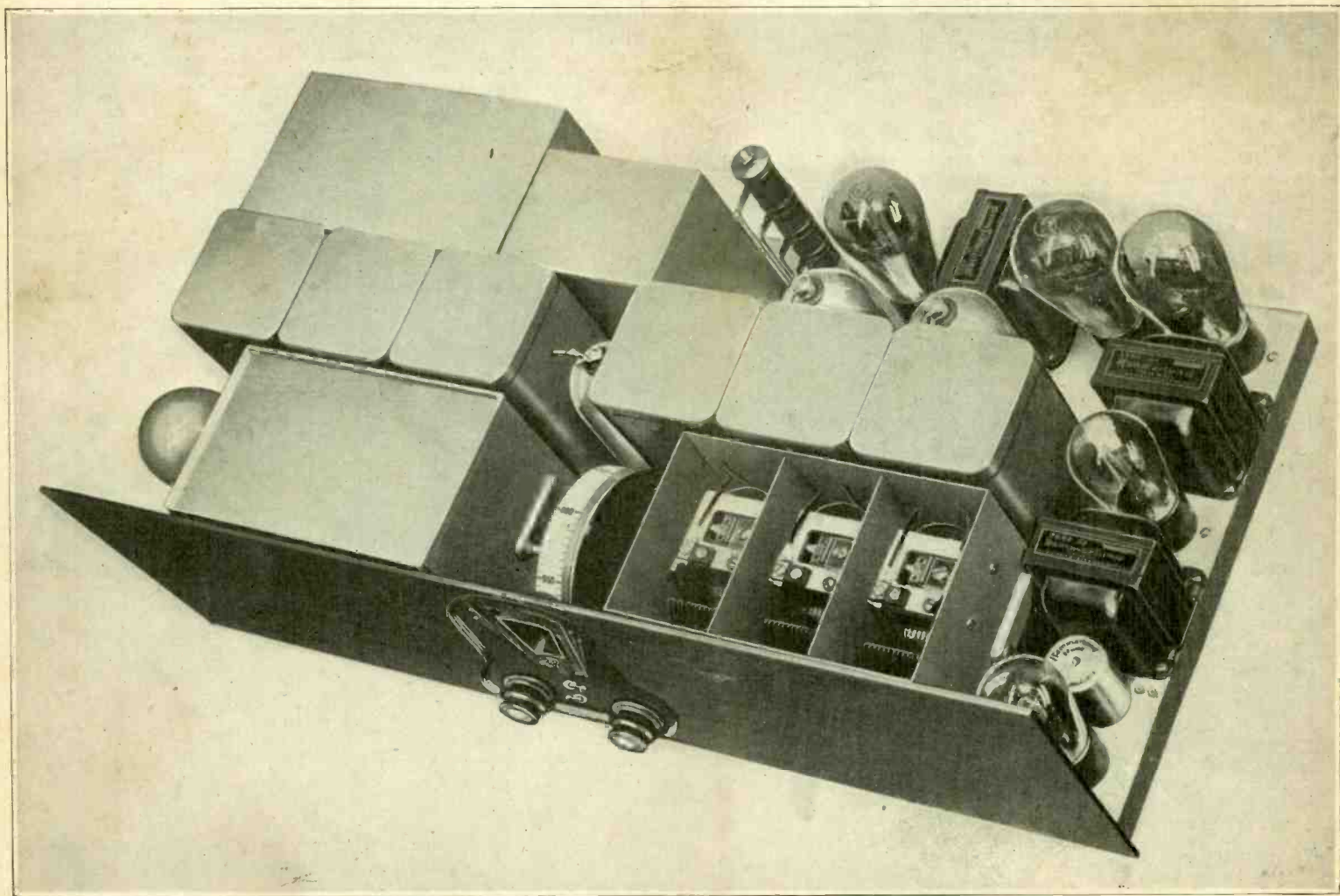

See pages 5, 6 and 7 for constructional article on this circuit

Surpassing Results from HB Compact!

Screen Grid Circuit for AC or Battery Operation Is a Knockout!

THE screen grid tubes, both AC and battery types, 222 and 224, promised much. They could be used to provide actual amplification of 150 per stage, as compared with 8 per stage for a general purpose tube. If only the screen grid tube could be used at full practical amplification! Then a few tubes would do the work of many! At radio frequencies it was found that tuning the plate circuit put the mule kick into the set. But the whole wave band could not be tuned in. So Herman Bernard invented a coil—the Bernard dynamic tuner—that accomplished the trick. Full amplification plus full wave-band coverage! That's why his HB Compacts, only four tubes (plus a 280 in the AC model) perform like eight-tube sets! The sensitivity is incredibly high.

Sensitivity

It would be far short of an accomplishment to hook indifferent audio onto a grid leak-condenser detector. So in both models he used a power detector, two resistance audio stages producing undistorted volume exceeding that of any ordinary two-stage audio amplifier, amplification sufficient to load up the power tube in each instance. And in the case of the AC model HB Compact it is a 245, with 1,600 milliwatts maximum undistorted power output, standing enough gaff for a small hall! And what tone realism! Breath-taking! Nothing in radio ever excelled this tone quality! Nothing! Absolutely nothing!

Realism

As the prices quoted in the list of component parts show, these advantages may be obtained economically. The battery model draws only 21 milliamperes of plate current, .664 amperes of filament current. Large B batteries would last a year at that rate, for average use, and a small A battery require recharging only every two months to ten weeks!

Economy

And this amazingly sensitive, most thrilling and utterly economical circuit gives you all the selectivity you will require, unless you live close to a powerful broadcasting station. So you get a super-abundance of results, in an unusual but thoroughly tried and tested, positively proven circuit!

Selectivity

HB Compact, battery model, uses a 222 RF amplifier, a 240 (high mu) power detector, a 222 first audio and a 112A or 171A power tube. The RF tube's plate circuit is tuned by a new type coil that has a moving segment as part of the tuned inductance, with step-up ratio to untuned detector grid. The audio is resistance-coupled. A 7x14" front panel may be used, with baseboard, but the HB Compact Steel Cabinet, decorated brown, with satin aluminum subpanel, sockets affixed, is recommended.

HB Compact, AC model, uses a 224 RF amplifier, a 224 space charge power detector, a 224 first audio and a 245 output tube, with 280 rectifier. Except for the space charge feature, not suitable in the battery model, and the larger power tube, not economically powered by batteries, the two models are fundamentally the same. The AC model is still more sensitive, however.

The same steel cabinet is recommended for the AC model, while the aluminum subpanel has the five sockets affixed and the type of each tube (except detector) printed on each socket.

Order what individual parts you want.

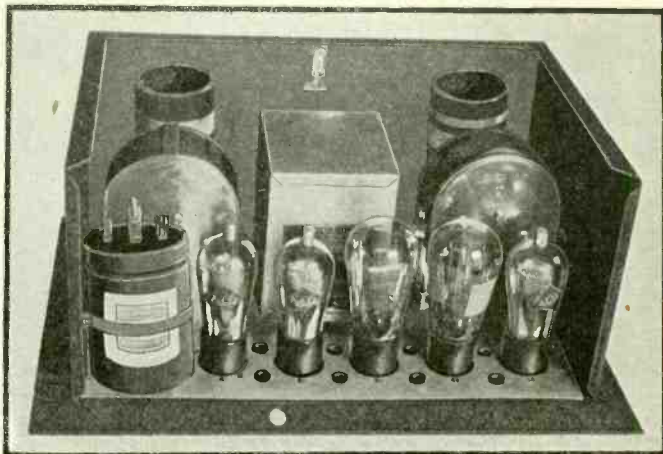

View of the HB Compact AC Model, the tubes being, left to right: 224 detector, 224 first AF, 245 power tube, 280 rectifier and 224 BF. The subpanel is only 9 1/2 x 14 1/4", yet everything save the speaker is in this small space!

Component Parts for HB Compacts

AC MODEL

L1L2L3—Bernard Antenna Tuner BTSA.....	\$2.50
L4L5L6—Bernard Interstage Tuner BT5B	2.50
CT—One 80 mmfd. equalizer35
C1, C2—Two .0005 Dustproof @ \$2.50.....	5.00
C, C3, C4, C5—Four .01 mfd. @ .35.....	1.40
C7—One 1 mfd. 500V AC85
C8, C9, C10, C11—Mershon Q2-8, 2-18B	5.15
C12, C13—Two 1 mfd. 200 V. DC @ .50.....	1.00
R—One 25,000 ohm wire-wound pot.....	1.50
R1, R2, R3, R4—5, 1.0, .05 5.0 meg. @ .35.....	1.40
T1—Polo 245 Power Supply Cat. P245PS.....	10.00
2500, 4400, 774, 50, 8 (20 watt) Voltage Divider.....	1.75
PL—Bracket and 2.5 v. AC lamp.....	.70
OC, C6—Output choke, 2 mfd. 500 v. AC cond.....	3.85
SP—, SP+—Two binding posts @ .10.....	.20
Three National clip clips @ .06.....	.18
F—One 1 amp. cart. fuse with base.....	.50
Aluminum socketed subpanel, 9 1/2 x 14 1/4", 8 brackets.....	3.25
Steel cabinet, cracked brown finish, 7x15x9 1/2.....	4.00
3 Insulating washers @ .0309
Two full-vision dials with pointers @ 75c.....	1.50
One AC pendant switch, double opening.....	.40
One 12 ft. length AC cable72
Two rolls Corwico braidite @ .3570
Two flexible couplers (links) @ .35.....	.70
\$50.19	
Kelly tubes: Three 224 @ \$3, one 245 @ \$2.25, one 280 @ \$1.75.....	\$13.00

BATTERY MODEL

L1L2L3—One Bernard Tuner for antenna circuit, for .0005 mfd. tuning (BTSB of Screen Grid Coil Co.)	\$2.50
L4L5L6—One Bernard Tuner for screen grid interstage coupling, for .0005 mfd. tuning (BTSB of Screen Grid Coil Co.).....	2.50
C1, C2—Two .0005 mfd. Dustproof tuning condensers @ \$2.50.....	5.00
CT—One Hammarlund 80 mmfd. equalizing condenser.....	.35
C3, C4, C5—Three .01 mfd. mica fixed condensers @ .35.....	1.05
R1—One .25 meg. metallized resistors.....	.30
R2, R4—Two 5.0 meg. metallized resistors @ .30.....	.60
R3—One .075 meg. metallized resistor.....	.40
R5, SW—One 75-ohm rheostat with switch attached.....	.80
R6—Two resistors, one 1.3 ohms, the other 6.5 ohms (both).....	.45
Ant., Gnd., Sp—, Sp+. Four binding posts (all).....	.40
One drilled steel cabinet 7" high, 9 1/2" front to back, 15" wide.....	4.00
Two dials with pointers (both).....	1.50
One pilot light bracket with 6-volt DC lamp.....	.70
One 9 1/2 x 14 1/4" satin finish aluminum subpanel with sockets affixed, and supplied with insulated bushings, supporting brackets, and resistor clips	2.00
Two insulated links (flexible couplers) (both).....	.70
One 7-lead battery cable50
\$23.75	
Kelly tubes: Two 222, one 240, one 112A or 171A, total, \$9.20.	

[The HB Compacts were designed and built by Herman Bernard. The battery model was described in the August 24th, 31st, September 7th and 14th issues of Radio World.]

Please Use This Coupon

GUARANTY RADIO GOODS CO.
143 West 45th St., N. Y. City, Just E. of B'way.
Enclosed please find \$..... for which please send me component parts for the HB Compact as checked off above.

NAME

ADDRESS

CITY..... STATE.....

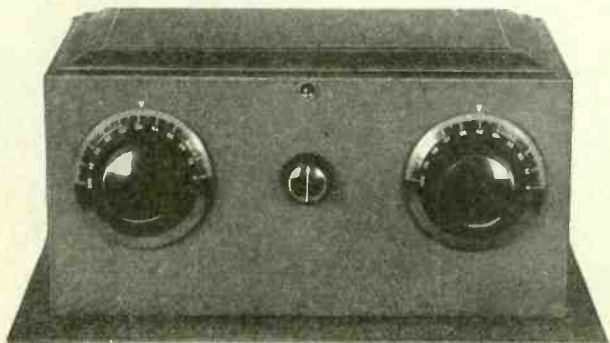

Front view of the HB Compact. The view is the same for AC or battery model. For batteries the switch is built in the rheostat. For AC a pendant switch is used at rear, in the AC cable.

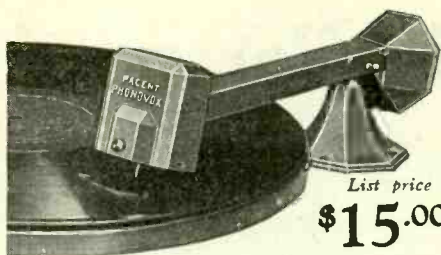

PHONOGRAPH MUSIC

List price **\$15.00** is at its best

Slightly higher west of the Rockies

with the

Super Phonovox

Plays records electrically through your radio with amazing tone realism and volume. New combination switch and volume control (with special adapter for screen grid tubes) switches instantly from radio to records without changing any connection. **English 36% Cobalt Magnets** provide extreme sensitivity. Hear it at your dealers. Two new low impedance models now available.

PACENT ELECTRIC CO., INC., 91 SEVENTH AVE., N. Y.

Pioneers in Radio and Electric Reproduction for over 20 years

Manufacturing Licensee for Great Britain and Ireland: Igranic Electric Co., Ltd., Bedford, Eng. Licensee for Canada: White Radio Limited, Hamilton, Ont.

LYNCH

TUBADAPTA For Better TONE

List Price, \$2.50
Improves reception and prolongs life of expensive power tubes. Used in last audio stage. Write for descriptive circular and complete catalogue Lynch Guaranteed Radio Products. LYNCH MFG. CO., Inc., 1775 B'way, N. Y.

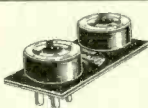

No matter what your resistance problem may be—whether an unknown high resistance value for a critical receiving circuit or a heavy duty low resistance value for grid-biasing the largest audio power tube or even transmitting tube—

Remember **CLAROSTAT** for Every Purpose
here's a

Clarostat Mfg. Co., 291 N. 6th St., B'klyn, N. Y.

No. 9

\$21 NET

to Dealer



Tests Screen-Grid

Readrite

Set and Tube Tester

The simplest of all testers to use. Not a switch or binding post to manipulate. The meters are all instantly interchangeable. Only one push button for grid condition. The three A.C. voltmeters are repulsion type 0-8, 0-15, 0-150. The three D.C. voltmeters have high resistance, 0-8, 0-50, 0-500. The three D. C. Milliammeters are 0-10, 0-50, 0-300. A.C. Voltmeters may be used as milliammeters for

testing rectifier tubes, thereby obtaining more accurate readings.

Case is light in weight, covered with grained leatherette, size 10 1/2" x 7 1/2" x 3 3/4". A most flexible tester, complete for present day testing and immediately adapting itself to future needs. Every service man should have the READRITE No. 9—A truly remarkable tester.—An investment usually paid for in the first few calls.

LIST PRICE NO. 9 — \$35.00 COMPLETE

Send for catalog of Readrite instruments, resistors, etc.

Readrite Meter Works,

12 College Ave.
ESTABLISHED 1904

Bluffton, Ohio

A COMPLETE CATALOG

containing detailed information on condensers and resistors may be had free on request.



74 1/2 Washington St., Bklyn., N. Y.

THE RESEARCH WORKER

will keep you abreast of developments in radio. It may be had free on request.

A GREAT ADVERTISING MEDIUM!

That describes Radio World. Rates on application. Radio World, 145 W. 45th St., N. Y. City.

By An *Amperite* for every tube. Dr. Radio Engineer

The Prescription for Better Radio Reception

AMPERITE automatically maintains the most efficient tube voltage. Improves tone, sensitivity, volume. For every tube. \$1.10 with mounting (in U.S.A.). At all dealers.

AMPERITE Corporation
661 BROADWAY, NEW YORK
FREE—Amperite Tube Chart. Write Dept. RW-25

This symbol in a radio diagram means—



AMPERITE
The "SELF-ADJUSTING" Rheostat

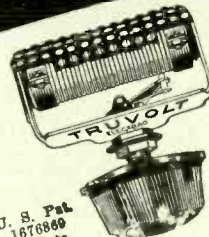

U. S. Pat. 1676869 & Pat. Pend.

Build a BETTER B-Eliminator with TRUVOLTS

TRUVOLT is the safe resistance for eliminators and power packs. Heavy nichrome wire air-cooling insures greater accuracy and durability.

TRUVOLT Variable (Illustrated) has knob variation and panel mounting. Just the thing for the experimental power bank. Lasts longer due to endwise travel of contact over wire. 22 sizes, \$2.50 ea.

TRUVOLT FIXED has exclusive sliding clip for adjustment of resistance value. All usual sizes.

TONATROL — The Wearproof Volume Control

Indirect contact between the variable arm and the resistance element insures longer life and smooth operation. Made with or without filament switch. \$1.50 to \$3.00.

ELECTRAD, INC., Dept. RW1214,
175 Varick Street, New York, N. Y.
Send TRUVOLT TONATROL descriptive literature.

Name _____

Address _____

175 Varick St., New York, N.Y. ELECTRAD INC.

A NEW IDEA IN COILS!

The Bernard Tuner Works Screen Grid Tubes Up to the Hilt!

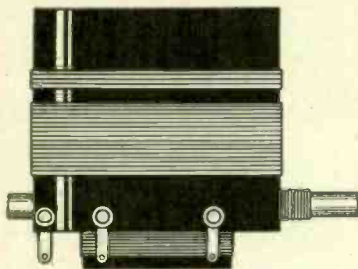

Cat. No. BT5A—\$2.50
FOR .0005 MFD. CONDENSERS
 Bernard Tuner for antenna couplings, the primary being fixed and the secondary tuned. This coil is used as input to the first screen grid radio frequency tube. The double-action tuning method invented by Herman Bernard is employed. Adjust an equalizing condenser across the tuning condenser so that exactly the same dial settings prevail through all circuits. This equalizer, 90 mmfd., once set, is left thus.
 Cat. No. BT3A for .00035 mfd.\$2.25

FOR the first time in radio a coil has been designed that permits working the screen grid tube up to the enormous amplification level that theory long promised but practice long denied.

The secret lies in tuning the plate circuit of the screen grid tube, and still covering the entire broadcast band. Herman Bernard, noted radio engineer, invented the solution—a tuned coil consisting of a fixed and a rotating winding in series, the moving coil turned by the same dial that turns the tuning condenser. An insulated link physically unites condenser shaft and moving coil. Thus when the condenser plates are entirely in mesh the moving coil is set for maximum inductance, that is, it aids the other part of the tuned winding. As the condenser is turned to lower capacity setting the moving coil aids less and less, until at the middle of the dial it acts as if fixed. From then on the moving coil bucks the fixed winding, greatly reducing the total effective inductance, and thus nullifying the effect of the high starting capacity.

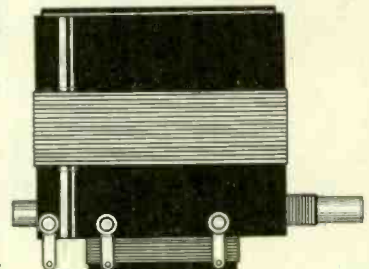

Cat. No. BT5B—\$2.50
FOR .0005 MFD. CONDENSERS
 Bernard Tuner for working out of a screen grid tube, consists of a rotary coil in series with a fixed coil, the two constituting a tuned primary, for tuning the combined rotary and fixed windings to exceed the broadcast band of wavelengths. The condenser shaft and rotary coil shaft are physically coupled so one motion turns both. Develops the highest possible amplification from the screen grid tube.
 Cat. BT3B for .00035 mfd.\$2.55

The Bernard Tuner is a two-winding coil for interstage coupling, working out of a screen grid tube, 222 or 224, and into any type tube. The tuned primary has coupled to it a still larger inductance, on separate inside form, for step-up, thus greatly increasing an already enormous amplification! This is Cat. No. BT5B for .0005 mfd., BT3B for .00035 mfd. Use BT5A or BT3A for antenna coupler, tuning the secondary, with an equalizing condenser across the antenna tuning condenser, so that the high minimum capacity of the tube's output will be duplicated at the input.

The Diamond Pair

Since 1925 the Diamond of the Air has been an outstanding circuit. It has undergone few changes. When power tubes and screen grid tubes appeared these were included. When AC operation became practical, the model was described for such use. Whether battery-operated or AC-operated, the Diamond of the Air is a dependable and satisfactory circuit. It uses a screen grid RF stage, tickled detector and two stages of transformer coupled audio. The same coils are used for both models, battery or AC. The secondaries are tuned. They are matched with fine precision, to permit ganged tuning.

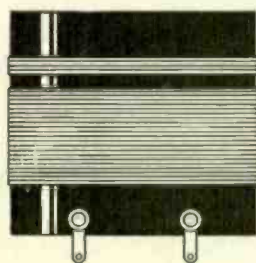

Cat. No. RF5—\$0.75
FOR .0005 MFD. CONDENSER
 Antenna coil for any standard circuit, and one of the two coils constituting the Diamond Pair. The secondary is carefully wound to match the inductance of the companion coil's secondary, so equality of tuning prevails.
 Cat. No. RF3 for .00035...\$0.80

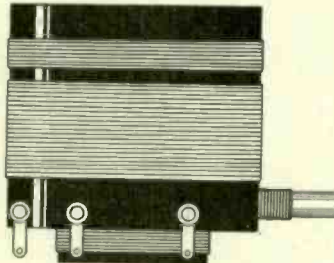

Cat. No. SGT5—\$1.25
FOR .0005 MFD. CONDENSER
 Interstage 3-circuit coil for any hook-up where an untuned primary is in the plate circuit of a screen grid tube. This primary has a large impedance (generous number of turns), so as to afford good amplification. Used in the Diamond of the Air.
 SGT3 for .00035 mfd.\$1.30

The Diamond Pair of coils for .0005 mfd. tuning are Cat. Nos. RF5 and SGT5. A circuit of excellent stability, extremely high selectivity and good sensitivity, the Diamond of the Air should be built with coils that permit full capitalization of the virtues of the circuit. Not only is the number of turns correct for this circuit on each coil, but the spacing between aperiodic primary and tuned secondary is exactly right. Note that the 3-circuit coil SGT5 (or SGT3) has a high impedance primary. This means good amplification from the screen grid tube, obtained in a manner that guarantees selectivity attainment.

ANTENNA COUPLER

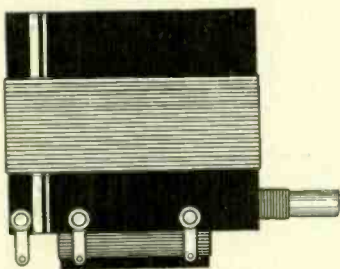

Cat. No. VA5—\$1.10
FOR .0005 MFD. CONDENSER
 Moving primary and fixed secondary, for antenna coupling, adjustable from a knob at the front panel, thus providing volume control.
 Cat. No. VA3 for .00035 mfd.\$1.15

SG TRANSFORMER

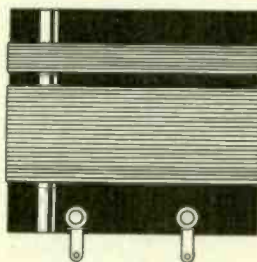

Cat. No. SGT5—\$1.25
FOR .0005 MFD. CONDENSER
 Interstage radio frequency transformer, to work out of a screen grid tube, where the generous-sized primary is in the untuned plate circuit.
 Cat. No. SGT3 for .00035 mfd.\$0.80

STANDARD TUNER

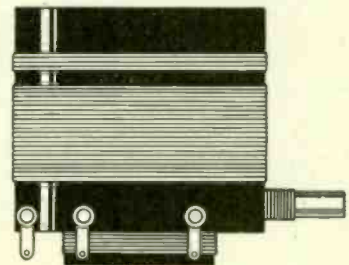

Cat. No. T5—\$1.25
FOR .0005 MFD. CONDENSER
 Standard three-circuit tuner, for antenna stage, or interstage coupling where primary is in the plate circuit of any tube except a screen grid. Provides abundant selectivity and gives smooth tickler action.
 Cat. T3 for .00035 mfd.\$1.30

SCREEN GRID COIL COMPANY, 143 West 45th St., New York, N. Y.
 Just East of Broadway

Enclosed please find \$..... for which please ship at once, parcel post prepaid, the following coils:

Quantity	Cat. No.	Price	Quantity	Cat. No.	Price	Quantity	Cat. No.	Price	Quantity	Cat. No.	Price
<input type="checkbox"/>	BT5A	@\$2.50	<input type="checkbox"/>	RF5	@\$0.75	<input type="checkbox"/>	VA5	@\$1.10	<input type="checkbox"/>	SGSP	@\$0.75
<input type="checkbox"/>	BT3A	@\$2.55	<input type="checkbox"/>	RF3	@\$0.80	<input type="checkbox"/>	VA3	@\$1.15	<input type="checkbox"/>	SGS3	@\$0.80
<input type="checkbox"/>	BT5B	@\$2.50	<input type="checkbox"/>	SGT5	@\$1.25	<input type="checkbox"/>	T5	@\$1.25	<input type="checkbox"/>	FT.1	@\$0.35
<input type="checkbox"/>	BT3B	@\$2.55	<input type="checkbox"/>	SGT3	@\$1.30	<input type="checkbox"/>	T3	@\$1.30	<input type="checkbox"/>	EQ80	@\$0.35

NAME

ADDRESS

CITY..... STATE.....

5-DAY MONEY-BACK GUARANTEE!

Insulated Link

A flexible coupling device to unite two independent shafts for single dial operation of a tuning condenser and a Bernard Tuner. If the condenser has shaft protruding from the rear, then the condenser may be panel-mounted and the coil shaft coupled by the link to either extension shaft of the condenser. If the condenser has no shaft protruding at rear, mount the Bernard Tuner on the front panel. It has shaft protruding at rear for coupling by the link to the condenser's front shaft. To make sure of insulated protection do not force the receptacles of the link together when mounting.



FLA..\$0.35

Data on Construction

The coils are wound by machine on a bakelite form 2 1/4" wide, and the tuned windings have identical inductance for a given capacity condenser, i. e., .0005 mfd. or .00035 mfd. Full coverage of the wave band is assured. The wire is silk insulated.

All coils with a moving coil have single hole panel mounting fixture. All others have plate mounting provision. The coils should be used with connection lugs at bottom, to shorten leads.

Only the Bernard Tuners have a shaft extending from rear. This feature is necessary so that physical coupling to tuning condenser shaft may be accomplished by the Insulated Link.

[Note: Those desiring the 90 mmfd. equalizing condenser for use with the antenna model Bernard Tuner, BT5A or BT3A, should order EQ80 at \$0.35.]

SCREEN GRID COIL COMPANY
 143 West 45th Street, New York City



Vol. XVI, No. 13 Whole No. 403
 December 14th, 1929
 15c per Copy, \$6.00 per Year
 [Entered as second-class matter, March, 1922, at the Post Office at New York, N. Y., under act of March, 1879.]

Technical Accuracy Second to None
 Latest Circuits and News
EIGHTH YEAR

A Weekly Paper published by Hennessy Radio Publications Corporation, from Publication Office, 145 West 45th Street, New York, N. Y. (Just East of Broadway) Telephone, BRyant 0558 and 0559

RADIO WORLD, owned and published by Hennessy Radio Publications Corporation, 145 West 45th Street, New York, N. Y. Roland Burke Hennessy, president and treasurer, 145 West 45th Street, New York, N. Y.; M. B. Hennessy, vice-president, 145 West 45th Street, New York, N. Y.; Herman Bernard, secretary, 145 West 45th Street, New York, N. Y. Roland Burke Hennessy, editor; Herman Bernard, business manager and managing editor; J. E. Anderson, technical editor.

The Hi-Q 30 for AC

Band Pass Filter Is Used as a Pre-Selector

By James H. Carroll

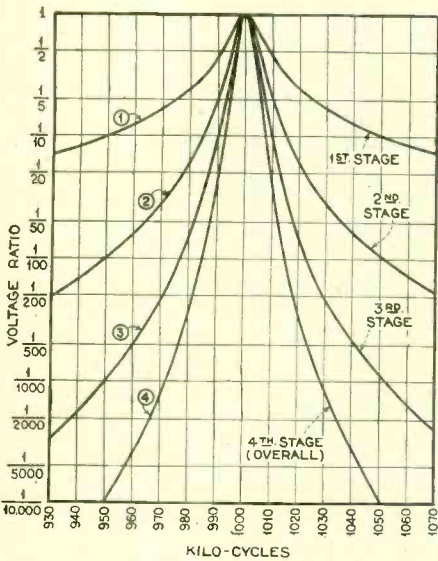

FIG. 1. CURVES ILLUSTRATING THE CUMULATIVE SELECTIVITY OF THE TUNED CIRCUITS IN THE HI-Q 30 RECEIVER, WHICH IS CAPABLE OF 10-KC SEPARATION.

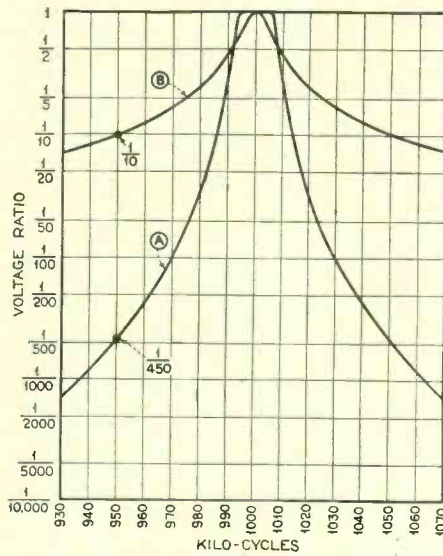

FIG. 2. CURVES SHOWING THE CONTRIBUTION TO THE SELECTIVITY OF THE HI-Q 30 OF THE BAND PASS FILTER AHEAD OF THE FIRST AMPLIFIER.

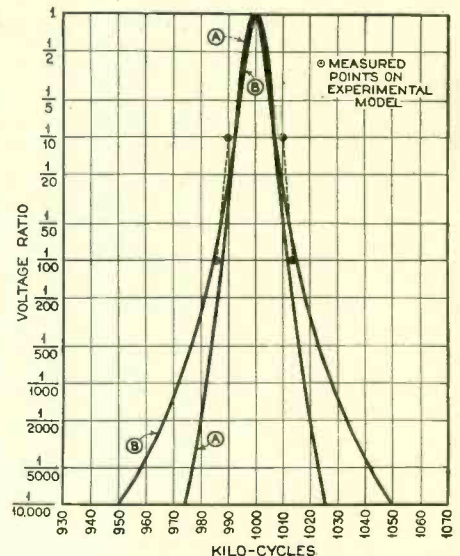

FIG. 3. CURVES ILLUSTRATING THE OVERALL SELECTIVITY OF THE HI-Q 30 RECEIVER, OR THE SELECTIVITY CONTRIBUTED BY ALL THE TUNED CIRCUITS.

EVERYBODY recognizes that the ideal receiver possesses so-called 10 kilocycle selectivity and no sideband suppression. The tuning characteristic of this ideal receiver has a square top with vertical sides, and the top is a long distance up from the line representing no signal. That such a receiver is regarded as the ideal by fans as well as engineers is evidenced by the fact that fans demand 10 kilocycle selectivity without the slightest sideband cutting and that engineers have been striving for several years to attain it.

It is not possible to attain the ideal, for every selector must work with tuned circuits and these do not have properties which permit the attainment of the absolute. The best that can be done is to approach the ideal so closely that for all practical purposes the tuned circuits admit all frequencies within a given 10 kilocycle band with extremely low attenuation, and reject all frequencies lying outside that band with a very high degree of attenuation.

Recently circuits have been developed in which the tuning characteristics are very satisfactory from the viewpoints of selectivity and sideband admission. These circuits employ band pass filters in which the transmission band is 10 kilocycles wide near the peak, or near the carrier frequency, and deviates very little from that width for small frequency changes above or below the transmission band.

The practical advantage of such receivers is that they are

capable of exceptionally high selectivity without sacrificing any of the brilliancy of quality which results when all the side frequencies are amplified in their true proportion. They approach the ideal so closely that for practical purposes they are identical with it.

THE HI-Q 30

The band pass feature has been incorporated in the Hammarlund Hi-Q 30 receiver. The principal band pass filter in this circuit is used as a pre-tuner, consisting of three tuning condensers, together with appropriate coils and equalizing condensers. There is one outstanding advantage in using such a highly selective filter ahead of the first amplifier tube, and that is the elimination of interfering signals before they reach the amplifier tube, where they could result in double frequency response.

However, this pre-tuner is not the only selector in the receiver. There are three additional tuned circuits placed between the tubes of the radio frequency amplifier. These tuners are adjusted with three condensers, each with its equalizing condenser, and all are controlled by a single knob. That is to say, all six tuner condensers are controlled by a single knob. This unified tuning is made possible by accurately proportioned coils and identical tuning condenser sections. The final touch in the equalization is accomplished by setting the

10kc Selectivity, High Atten

Audio Amplifier Has 227 First

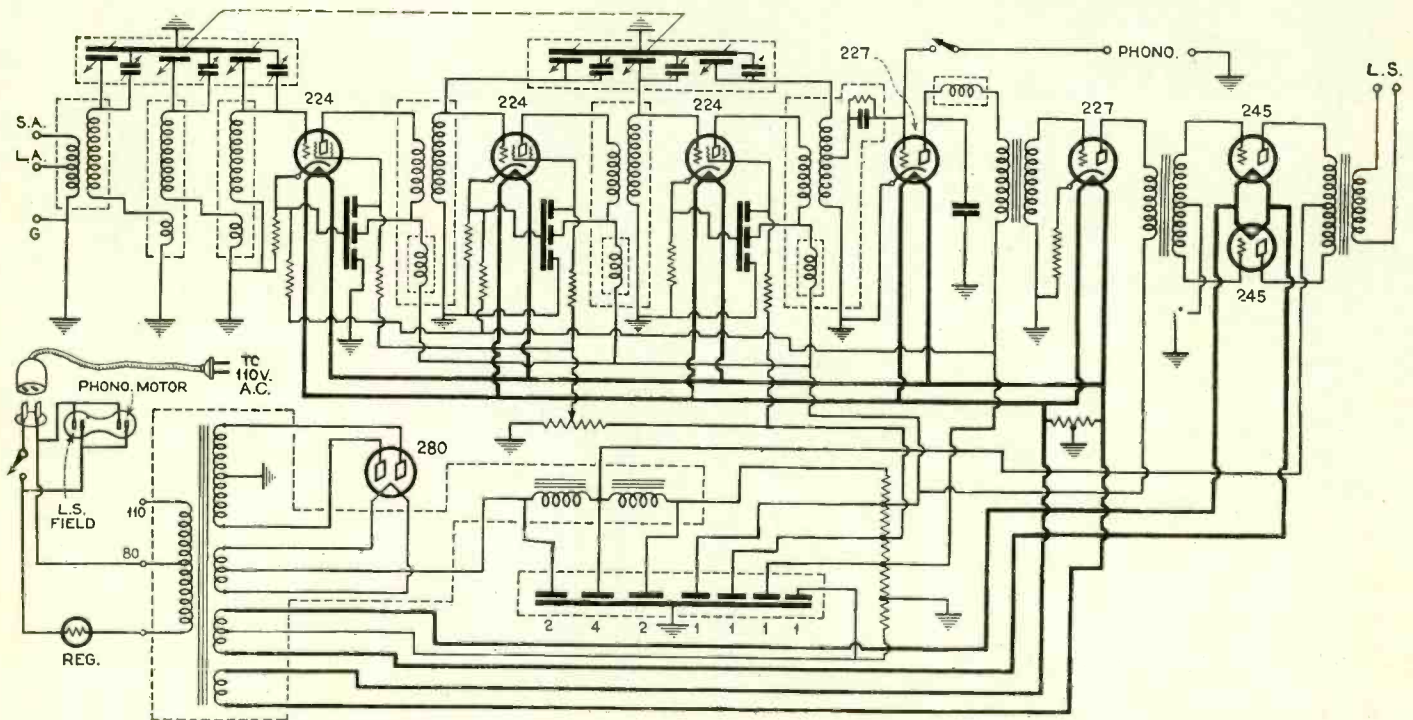

FIG. 4.
THE CIRCUIT DIAGRAM OF THE COMPLETE HI-Q 30 RECEIVER, INCLUDING POWER SUPPLY AND ACCESSORY CONVENIENCES.

(Continued from preceding page)

six compensating condensers which are attached to the main condensers in the well-known Hammarlund manner.

OVERALL TUNING CURVE

A circuit having six tuned circuits might seem entirely too selective to justify the claim of no sideband cutting. That indeed would be the case if all the tuned circuits were the same and each excessively selective. But the fact is that the experimental tuning curves of the entire selector show the desired broadness at the top necessary to bring out the sidebands and the necessary steepness to eliminate interference on channels as close as 10 kilocycles either side of the carrier to which the circuit may be adjusted. A skilled engineer, such as is responsible for the Hi-Q 30 design, can design and execute six tuned circuits so that almost any desired tuning characteristic results. To see more clearly just what the overall characteristic is, and how it was derived, let us investigate the curves.

Fig. 1 shows the progressive selectivity of the selector beginning with the tuned circuit immediately ahead of the first tube and ending up with the circuit just ahead of the detector. The fourth curve is the result of the cumulative selection and shows that at 10 kilocycles above the resonant frequency, in this case 1,000 kc. the transmission is less than 1-20 as great as at the resonant frequency. At 50 kc above or below the transmission is only 1-10,000 as great.

But this curve does not take into account the contribution of the entire pre-tuner. The effect of this is shown in Fig. 2, curve A. This curve shows distinctly the band pass filter effect in that the curve is flat at the top over a region slightly greater than 10 kc. That is to say, the relative transmission in this region is unity. At 50 kc above and below the resonant frequency the transmission is only 1-450 of the maximum.

COMBINED EFFECT

The combined effects of curve A in Fig. 2 and the fourth curve in Fig. 1 is shown by curve A in Fig. 3. All these curves are theoretical, computed from circuit constants measured separately. As a check on the computation four measured points are shown on Fig. 3 and connected by dotted lines. While the overall curve A in Fig. 3 is in itself satisfactory, it is noteworthy that the measured curve is considerably better. While the selectivity of the actual curve is slightly less for frequencies near the resonant frequency, it is much better for frequencies more than about 13 kilocycles. Both these effects are desirable because the lower selectivity at the top

LIST OF PARTS

- One Hammarlund "Hi-Q-30" Foundation Unit, QFU-30.
- One Hammarlund Three Stage Band Filter Unit, BS-3.
- One Hammarlund Three Stage Screen Grid Amplifier Unit, RF-3.
- One Hammarlund Knob Control Drum Dial, SD.
- One Hammarlund Shield Polarized RF Choke, SPC.
- One Hammarlund First Stage Audio Transformer, AF-2.
- One Hammarlund Push Pull Input Audio Transformer, AF-4.
- One Hammarlund Push Pull Output Audio Transformer, AF-M or AF-D.
- (AF-M is for magnetic speakers, while AF-D is for dynamic speakers).
- One Hammarlund Power Supply Unit for Push Pull '45s, PS-45.
- Three Hammarlund Screen Grid Tube Shields, TS.
- *One Aerovox Filter Condenser Block, CHQ-30.
- *Three Aerovox Triple By-Pass Condensers, BP-3.
- *One Yaxley Center Tapped 10 ohm Fixed Resistor, No. 810-C.
- One Pair Yaxley Insulated Phone Tip Jacks, No. 422.
- One Yaxley Speaker Twin Tip Jack, No. 401-S.
- *One Electrad Voltage Divider, RHQ-30.
- *One Electrad 1500 ohm Flexible Grid Resistor, No. 3.
- *Three Electrad 400 ohm Flexible Grid Resistors, No. 3.
- *Three Electrad 5000 ohm Flexible Filter Resistor, No. 3.
- *One Electrad 25,000 ohm special Taper Royalty Volume Control Potentiometer.
- *One Eby Two Prong Tube Socket marked "Amperite," No. 6-11 (Voltage Regulator).
- *One Eby Four Prong Tube Socket marked 280, No. 6-11.
- *Two Eby Four Prong Tube Sockets marked 245, No. 6-11.
- *Two Eby Five Prong Sockets marked 227, No. 6-11.
- *Three Eby Five Prong Sockets marked 224, No. 6-11.
- *One Eby Triple Binding Post Strip.
- *One Hart and Hegeman Phono-Toggle Switch, No. 20510.
- *One Hart and Hegeman Line Toggle Switch, No. 20510.
- *One Sangamo .001mfd. "Illini" Mica Fixed Condenser.
- *One Beaver-Arrow Handle Cap, Cord Connector and Silk Cord.
- One Beaver Duplex Receptacle, No. L-14.
- One Arrow Plug Type Midget Receptacle, No. 8339.
- One Foundation Unit, containing metal chassis, panel, wire, screws, nuts, bolts, etc.
- *Specially designed for the "Hi-Q 30." These parts are not stocked by radio distributors and are available only on special order.

uation Beyond, in Hi-Q 30

Stage and Push-Pull 245 Output

insures good quality and the higher selectivity above 13 kc insures the elimination of all interfering signals.

Although the experimental curve is not complete the four points given clearly show the trend of the curve and that is all that is necessary for a practical interpretation of the capability of the circuit.

It will be noted that curve B in Fig. 3 is not nearly as good as curve A. Curve B is the same as the fourth curve in Fig. 1. Hence the difference between A and B in Fig. 3 is due to the pre-selector and the superiority is mainly due to the band pass filter.

PRECAUTIONS AGAINST OSCILLATION

The amplification in this circuit can justly be called enormous. Three AC type screen grid tubes will give a very high order of amplification in almost any circuit, and they will make it truly enormous when the coupling coils are specially designed for use with these tubes so as to capitalize the amplification possibilities.

A high degree of amplification in a circuit demands exceptional precautions against oscillation. It is not sufficient to depend on the fact that a screen grid tube will not oscillate by virtue of feedback through the capacity between the plate and the control grid. There are many other chances for feedback, and even if the total amount is minute it may be sufficient to cause oscillation when such high amplification is used.

Shielding of the coils is one remedy for feedback, and this has been done thoroughly, as can be seen from the circuit diagram, Fig. 4, and the pictures. A special point in this connection are the short grid leads to the caps of the screen grid tubes. These are made as short as possible outside the shielding cans where they are mutually exposed. Thorough shielding is the crux of successful operation of several screen grid tubes adjusted to give a high degree of amplification.

Further measures against oscillation are filters in the plate and screen circuits of the screen grid tubes. In each plate circuit is a shielded radio frequency choke coil, which is bypassed with a condenser directly to the cathode, and in each screen circuit is a resistance, also bypassed to the cathode. Moreover, each tube has an individual grid bias resistor, also bypassed with a condenser to the cathode.

As a means of reducing the necessary size of the grid bias resistor additional current is sent through it from a point on the voltage divider, through a suitable resistance for each tube. This method of isolating the circuits and preventing reverse feedback was recently discovered and is now used in several good circuits.

THE VOLUME CONTROL

No circuit can be satisfactory without an adequate volume control, and a sensitive receiver like the Hi-Q 30 requires a control of exceptionally wide range, for it must be sufficient to turn the volume from a high power local station down to bare audibility and that from a weak distant station up to the point of overloading the loud speaker. The method adopted in this receiver is that of varying the screen grid voltage on the first two screen grid tubes, a method found exceptionally suited for this type of tube. The variation is accomplished by means of a potentiometer.

The circuit diagram in Fig. 4 is complete from the antenna binding post to the loudspeaker binding post, and from the power input plug to the voltage divider. There are several noteworthy features in the receiver indicating careful thought to meet any contingency. The input plug is of the male variety. This is a feature not found often but is included to satisfy the fire underwriters and to protect the house against dangerous short-circuits.

Provision also has been made for a phonograph motor of the electrical type. It is not necessary to run a separate line from an outlet for the motor for it is available right in the set. Another outlet in the set is provided for the loudspeaker field when a dynamic is used.

A voltage regulator, manufactured by Amperite, is put in the primary to the transformer to insure steadiness of the heater and plate voltage and a tap is provided on the primary to adjust for large differences in voltage of the line.

PHONOGRAPH PICK-UP

Provision is also made for a phonograph pick-up unit, so that the unit is connected between the grid of the detector tube and ground. This connection automatically converts the detector tube to an amplifier. Due to the fact that the grid leak and condenser method of detection is used it is not necessary to disconnect the radio frequency input when the phonograph is switched in because the impedance of the grid leak and the condenser across it is so high for audio frequencies

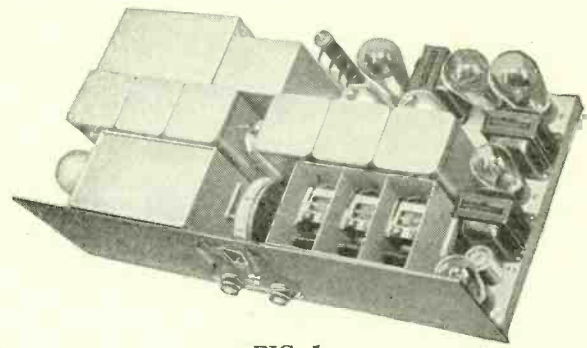

FIG. 5.
TOP VIEW OF THE ASSEMBLED HI-Q 30 RECEIVER.

that no appreciable part of the phonograph input is lost. However, a single pole, single throw switch is put in series with the phonograph pick-up so that the pick-up can be cut out when the circuit is to be used for radio reception.

When the phonograph is connected in this manner the detector circuit constitutes an automatic scratch filter. There is a radio frequency choke in the plate circuit through which the signal must pass. This chokes out some of the incidental and undesired noises. The customary by-pass condenser in the plate circuit performs a similar function by by-passing some of the noise. Likewise the grid condenser aids in this filtering.

CONSTRUCTION OF RECEIVER

Although the circuit diagram looks complex, the parts are easily wired. They are available in kit form so co-ordinated that it is hardly possible to make a mistake. Builders with only small knowledge of radio technique, using the official kit, will turn out an excellent receiver in only a few hours of pleasant work. No changes should be attempted, as a change at one place will upset the balance elsewhere, requiring additional changes to bring the circuit back to operating condition. Hence it is recommended that in building the receiver the official list of parts and blueprint be followed scrupulously. The pictorial wiring diagram is furnished with the parts.

[Part II, conclusion, next week, issue of December 21st.]

Killer of Crackles "Wanted"

by Fan

WILL YOU kindly suggest a filter to be placed in the power supply line to take out line noises such as sparking from thermostats, motors, bells, and so on. I have heard that such devices are practical. What are the necessary elements and what should be their values?—L. E. W.

Sometimes these filters are very effective in eliminating noises and at other times they serve practically no useful purpose. They are most effective when they are placed near the source of the disturbance, but in order to remove all causes of noise in this manner many filters, would have to be used in some instances hundreds in the same building. The ideal, of course, would be one to be placed near the receiver which would take out all the noise coming in on the line. Unfortunately, these are often not effective. The elements of such a filter are the same as the elements in a filter used in a B supply, except that the elements have different values. There should be a choke coil in series with the live side of the line and one by-pass condenser across the line at each side of the choke coil. The choke must have low resistance and as high inductance as practical. The size of the coil is limited by the voltage drop permissible in it. Suppose we allow a voltage drop of 5 volts at 60 cycles, and further suppose that the alternating current through it is .5 ampere, a reasonable value on the average AC receiver. On these assumptions the inductance of the choke should not be greater than 2.65 millihenries. The condensers across the line will also take some current which must be kept down. Hence the shunt condensers must not be too large. Suppose we allow a current of .5 ampere through the two condensers. Then the sum of the condensers should be 1.2 microfarads. Since the current taken by one of these condensers also flows through the choke this current will cause an additional voltage drop. Hence the first condenser might be made considerably larger than the second. For example, the first may be 1 mfd. and the second .2 mfd.

Scientific Minds Turn To

Human Ear Itself, or a Reproducer or the

By J. E.

Technical

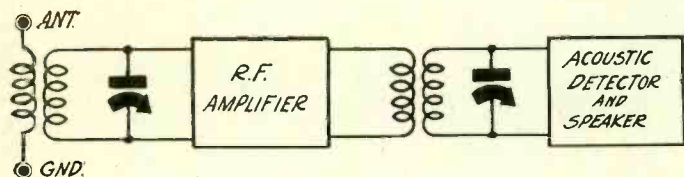

FIG. 1.
FORMAL SCHEMATIC OF A DETECTORLESS RADIO RECEIVER IN WHICH THE MODULATED RADIO FREQUENCY SIGNAL IS FED DIRECTLY TO THE REPRODUCER, WHICH MAY BE OF THE SPEAKING ARC TYPE.

NOT LONG ago a bold radio engineer suggested the abolition of the audio amplifier from the radio receiver and the possibility of connecting the loudspeaker directly to the detector. At the time such a receiver seemed to be the ultimate, the realization of which was a long, long time in the future. But even now we are rapidly approaching that state of radio development.

Whether or not we shall reach it is a question. It is not that it is unattainable but that we may skip that stage entirely and eliminate the detector as well. It may even come to the point where the loudspeaker is eliminated, without at the same time eliminating the loudspeaker volume.

These surmises seem far-fetched and visionary but they are founded on scientific facts. However, the assertion that the detector may be eliminated entirely must be taken with a certain amount of reserve. Some kind of detection is needed, but the detector need not be in any of the well-known forms. The human ear has properties similar to a crystal or grid bias detector, so if there is no mechanical or electrical detector externally the ear can be made to perform the function of detection.

THE UNDERLYING IDEA

The theory underlying the detectorless receiver is explained in the Ramsay patents, 1,651,150 dated November 29th, 1927, and 1,680,694 dated August 14th, 1928. It is based on the perception of beats produced in a superaudible frequency modulated by audio frequencies.

Suppose there are air vibrations at a frequency of 50,000 cycles per second, which are far above the upper audible limit, and that these are modulated by a tone frequency of 1,000 cycles per second. The ear cannot perceive the 50,000 cycle frequency but it can perceive, due to its detecting ability, the variation in amplitude which occurs at the rate of 1,000 cycles per second.

If the superaudible frequency amplitude is great enough, and if the percentage modulation is high, the ear will perceive the beat, or the fluctuating amplitude, with an intensity sufficient to make it appear as if it came from a loudspeaker in the ordinary manner.

At this point it is well to state a possible danger to health in such a system. It is known that fish subjected to high frequency water vibration of high intensity will die. It is also known that rats and mice subjected to intense sound vibrations will suffer injury. It would seem then that if the human ear is subjected to air vibration of superaudible frequency of sufficient intensity to make the beat or amplitude variation appear as a loud sound, injurious physiological effects would follow.

DETECTORLESS RECEIVER

One of the Ramsay drawings in the patent specifications is reproduced in Fig. 1. It consists of a radio frequency tuner and amplifier and a special kind of speaker. The radio frequency signal is modulated and the special loudspeaker responds to the variation in the amplitude, which occurs at an audio rate. Hence sound is reproduced by the speaker. While this is called "detectorless" it is really the speaker which is the detector, or if the speaker is of such construction that it can follow faithfully, without any amplitude distortion, the extremely high radio frequency vibrations, the ear becomes the detector, or possibly the air itself. Helmholtz showed mathematically that if the amplitude of air vibrations are large enough, distortion will occur. This is equivalent to detection. Hence in this "detectorless" receiver there are at least three

chances for detection: the speaker which may not be able to follow the radio frequency vibrations, the air which cannot follow faithfully intense vibrations, and the human ear which is a good detector.

Dr. C. J. Thatcher, a recognized authority on acoustics, who has investigated the Ramsay theory, in speaking of the detectorless receiver said:

"The early use of a detector came when damped waves were used for telegraphic radio signals. In this type of communication one train of waves followed another. Each wave train consisted of a group of cycles at high frequency such that the diaphragm of the headphone could not follow them. Each succeeding alternation came so quickly that the positive half of the wave trying to pull the diaphragm in was almost instantly opposed by the negative half trying to push the diaphragm out. Hence the diaphragm, because of sluggishness, didn't move.

"This same arrangement of detector or rectifier followed over into the continuous wave system of telephony we now call radio, and for the same reason. The carrier wave frequency is so great that the diaphragm can't follow.

"Because of this history the radio art is obsessed with the totally absurd idea that rectification is somehow essential to reception, and yet it should be obvious on a moment's consideration that if the speaker diaphragm could follow the frequency of the carrier wave we would hear the changes in amplitude that occur at speech frequency."

ABSURD IDEA OF DETECTION

On reflection it would seem that the idea of rectification is not so absurd after all. If the loud speaker could follow faithfully the rapid fluctuations and communicate them to the air, and if in turn the air could follow the rapid variations without distortion of the wave form, and then finally if the ear could follow the variation in sound pressure exactly, we would not be able to hear anything, even if the amplitude varied periodically at an audible frequency rate. Audibility has been eliminated by the assumptions, all of which preclude detection.

If, however, there is part or complete rectification anywhere in the chain there will be an audible component in the disturbance, which can be heard.

If we limit ourselves to one particular kind of detector and call all others something else, only then is there such a thing as a detectorless receiver.

One scheme suggested for receiving without a "detector" is to use a frequency changer such as is used in a Superheterodyne. This is formally indicated in Fig. 2. The intermediate frequency is, of course, above audibility and it is amplified to a much higher intensity than if the signal were to be amplified further at audio frequency. This highly intensified signal is impressed on a condenser type speaker. This speaker must detect in some manner even if it can follow the high frequency signal faithfully. Or if it does not detect, detection must occur in the air, or in the ear of the listener.

QUALITY CAPABILITY

One of the enticing possibilities of an arrangement of this type, that is, one without a so-called detector, is that there is supposed to be no frequency distortion. All the frequency distortion introduced by the detector and the audio amplifier, as well as by feedback in the B supply, will be eliminated. Where there is no tuning involved there is no quarrel with that statement.

But one of the suggestions in connection with the scheme in Fig. 2 is that the speaker is to be tuned to the intermediate frequency so that it will respond with the greatest amplitude. The argument is that since this operates at only one frequency, and that is far above audibility, there can be no frequency distortion. That is a patent fallacy. It used to be entertained for a long time about radio frequency tuned circuits but gradually the idea of sideband cutting grew. And as this effect was fully understood it was realized there is a great deal of frequency distortion in selective circuits.

Sideband cutting would not be limited to the radio frequency tuner but it would occur in the tuned speaker. Indeed, it would be greater in the tuned speaker for two reasons. First, the carrier frequency, to which the speaker would be tuned, would not be greatly in excess of the higher audio frequencies. Hence the effective selectivity of the speaker would be relatively high and the side band suppression great. Second, the loudspeaker would have a high inherent selectivity because mechanical devices usually do have high selectivities. It is

ward Beat Note Detection

Air May Supplant Established Methods

Anderson

Editor

true that the selectivity could be made low by loading and damping to overcome this effect, but then the increase in the amplitude would be decreased in proportion, and there would be little gained by using a resonant speaker. A highly resonant speaker of this kind would be very boomy and bassy.

CRYSTAL CIRCUIT SELECTIVITY

No doubt some increase in sensitivity could be obtained by tuning the speaker without sacrificing fidelity, just as it was possible to increase the sensitivity of the old crystal set by tuning. But in the tuned speaker the frequency ratio between the carrier and the side band would be much more unfavorable than in the case of the crystal working between broadcast and audio frequencies.

NOVEL APPLICATIONS

Superaudible vibrations in the air, which have been called supersonics and anacysms, have properties somewhat different from those vibrations in the speech and audible range. These differences are due mainly to the difference in wavelengths. They differ in the same manner as light waves differ from heat waves or radio waves.

All waves of whatever kind and wavelength can be subjected to certain changes. Take light for example. It can be reflected by mirrors, plane, cylindrical, parabolic, and spherical. It can be refracted or bent when passing from one medium to another. Light is refracted when passing from air to water, or from air to glass, or from any transparent substance to any other. Prisms and lenses are the most common refracting devices. Light can also be diffracted, bent around a sharp edge.

These properties also belong to other waves, such as water and sound waves. They bend around sharp corners, they reflect at surfaces, they bend on passing from one medium to another. The fact that we can hear a sound originating on the opposite side of a sound-proof plane of limited extent proves that sound is diffracted. The fact that we hear echoes proves that sound is reflected. However, we have no ready proof of the fact that sound is refracted or that it bends when passing from one medium to another. Yet it is true.

FOCUSING SOUND

We can send out a beam of light as in the case of a searchlight or an automobile headlight. We can do the same with sound waves by using a parabolic reflector, provided that we use a reflector of sufficiently large dimensions. The shorter the wavelength of the sound, that is, the higher the frequency the more easily we can form a beam of sound. This is done to some extent with a megaphone. It is well known that the longer the megaphone the more concentrated will be the beam of sound. When superaudible sound waves are used the megaphone, or the parabolic reflector if that is used, need not be so long to produce the same directional effect. However, the director should be long and narrow compared with one-quarter of the wavelength of the sound involved.

This possibility of focusing and directing sound waves or short length opens up a wide field of application, especially when such a sound beam is modulated with an audio frequency. We can, for example, use a system of sound carrier telephony, or simply carrier telephony. This would be similar to the beam system of radio which is used from one continent to another. There may be, for example, a ship many miles at sea. A sound beam, modulated with speech, may be directed to that ship from some lighthouse, and the lighthouse keeper could speak with the captain of the ship. The receiver in this instance might be a parabolic reflector which gathered as much of the sound as possible and directed it to a receiver which would detect the carrier sound wave.

Another possible application suggested is to talking movies. The operator would send an intense beam of speech-and music-modulated superaudible sound to the screen, just as he now sends the light to the screen. The screen would reflect the high frequency sound to all the hearers and each individual would detect the sound with his own ears.

In such a system the sound would seem to come from the actors on the screen. The screen, of course, would have to reflect diffusely, or only some of the audience would get the benefit. A screen that reflects light diffusely would not necessarily reflect short sound wave in the same manner. It would have to be very rough in order to do it, and if it were rough

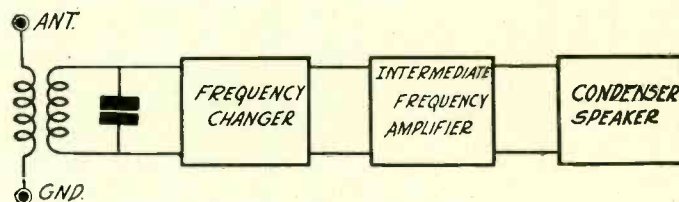

FIG. 2.

A SCHEMATIC OF A DETECTORLESS RECEIVING SYSTEM IN WHICH THE RADIO FREQUENCY IS STEPPED DOWN TO AN INTERMEDIATE FREQUENCY AND AMPLIFIED TO A HIGH INTENSITY AND THEN APPLIED WITHOUT DETECTION TO A CONDENSER TYPE SPEAKER.

enough to reflect the sound in that manner it would undoubtedly be too rough for visual purposes. But the idea has been suggested. A possible way out of this dilemma is to make the screen the detector so that superaudible waves would come to the screen in a beam and audible waves only would be reflected.

GENERATORS OF ANACYSMS

There are several generators of superaudible waves already available. One is the piezo oscillator. Rochelle salt crystals have been constructed which oscillate well down in the audible range and at least as high as 150,000 cycles. Quartz crystals are made which oscillate at all radio frequencies used at present.

Another oscillator which has come into use recently is the magnetostriction oscillator. This is possibly the simplest, for it requires only a short length of metal having high magnetostrictive properties, and a couple of coils connected suitably to a vacuum tube. Monel metal is one of the better materials for this purpose.

Tuning forks which oscillate at superaudible frequencies can be constructed easily and these too can be maintained in vibration by a vacuum tube amplifier. Another possible oscillator is a headset unit driven by a vacuum tube oscillator adjusted to the natural frequency of the diaphragm of the unit. This diaphragm would have to be stiff, small and light in order to have its natural frequency above audibility.

Some of these oscillators can readily be placed in the focus of a long and narrow parabolic reflector to create an intense beam. The headset unit, particularly lends itself well to the transmission of a modulated beam of sound. The modulation could take place in the oscillator so that the energy driving the diaphragm would be modulated.

UPPER SOUND FREQUENCY LIMIT

We have suggested sound frequencies of the order to radio frequencies. Are such sound vibrations possible? Koenig, the great German authority on acoustics, made measurements thirty years ago on frequencies up to 90,000 cycles. Recently frequencies as high as 150,000 have been used. No doubt in the near future frequencies up in the millions will be experimented with. Why should there be a limit to the frequency? Perhaps in the no distant future we shall supplement the available radio channels with high frequency sound channels and use them for broadcast as well as for point to point communication. The idea seems feasible if we could only find a sensitive detector to take the place of the vacuum tube. There is one thing in favor of high sound frequencies, and that is their great penetration.

Would such high sound vibrations be a menace to health? If they are intense enough, and fall in the frequency range between 20,000 and 100,000 cycles per second, they may be. But if they are of higher frequency it would seem that they would do more harm than high frequency alternating current passed through the body.

One of the suggested speakers working directly from a modulated radio frequency is the speaking arc. This would, for example, be connected in place of the acoustic detector-speaker in Fig. 1, and coupled inductively.

* * *

[See next week's issue, dated December 21st, for interesting methods, graphically shown, for achieving beat note detection.]

Ready Means of Elim

High Capacity Across B Voltage or Reduction

By Capt. Peter

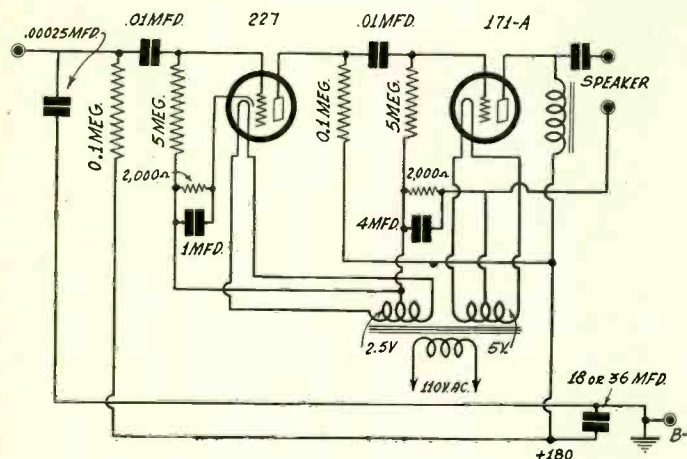

FIG. 1

A LARGE CAPACITY ACROSS THE OUTPUT IS A SUITABLE REMEDY FOR MOTORBOATING. WHAT CONSTITUTES "LARGE" DEPENDS ON THE FREQUENCY AND THE INTENSITY OF THE OSCILLATION. USUALLY 18 MFD. OR 36 MFD. WILL EFFECT A CURE WITHOUT NECESSITY OF RESORTING TO REDUCTION OF AMPLIFICATION. AN ELECTROLYTIC CONDENSER READILY AFFORDS THIS CAPACITY. GROUND CENTER-TAP OF 2.5-VOLT WINDING.

[The subject of motorboating is one of the most important ones in connection with audio amplifiers in modern receivers. While one remedy is to introduce a filter system that suppresses low notes, hence stifles motorboating, the preservation of even amplification of audio frequencies is achieved by the large capacity method. Capacity-resistor filters in the B plus lead constitute simply another method of reducing plate voltage and amplification, the other amplification reduction ways outlined herein being more economical.—Editor.]

ONE of the most common troubles in audio amplifiers nowadays, since the amplifiers are much better than their predecessors in faithfulness of response, is motorboating. The main remedies to apply to this nuisance are:

- (1)—Incorporation of a large capacity across the B supply, from minus to maximum B voltage.
- (2)—Reduction of the amplification.

A sufficiently large capacity will cure any condition of motorboating, the only trouble being that the frequency of motorboating may be so low, or the intensity of motorboating may be so severe, even if the frequency is not so low, that a prohibitively enormous capacity would have to be introduced, e. g., several hundred microfarads, a most unusual case.

Any audio amplifier that is sensitive in the low-note region may motorboat at the familiar frequencies associated with the vice. Just what motorboating is needs some explanation. It generally evidences itself as a put-put-put sound, similar to that of a motorboat engine, but this particular sound is due simply to the frequency of audio oscillation caused by the circuit constants and B voltage supply. Motorboating may be of any audio frequency, including a howl of medium frequency or a squeal of high audio frequency of oscillation. Although the sound no longer resembles that of a motorboat engine, the term motorboating is applied. The squeal is easily eradicated by a relatively small capacity, often as low as 4 mfd.

MAY MOTORBOAT AT ANY FREQUENCY

Since any circuit may motorboat at any frequency, let us take as an example a simple single stage of resistance coupled audio. This is chosen because of the well-known virtues of this type of coupling, particularly in reference to low notes. Even a single stage of resistance audio, feeding out of a detector, may produce motorboating, even of a low frequency. This will happen only when a very sensitive type of detector is used, for a detector tube is an amplifier, too. Usually this amplification is small in a detector, but if detector sensitivity is high the amplification is relatively large, so motorboating may arise. This is especially true in AC circuits, where the negative bias or power form of detection is used, and the bias is obtained through the potential difference in a resistor carrying plate current. The detector and first audio stage currents may be in phase, and thus be coupled through the resistance in the B supply, or even in B batteries, which resistance is common to both and, since the behavior of the signal current corresponds to that of alternating current, the term used for this stray coupling is common impedance.

If the bias voltage for the detector is taken from some other resistor, for instance part of the drop in a resistor biasing the last audio stage, the common coupling right in this resistor is plain, indeed. Where two stages of resistance, high quality transformer or impedance coupling are used, and the power tube biasing resistor serves in part for detector biasing, motorboating is almost assured.

CAPACITY VALUES COMPARED TO FREQUENCY

The use of a high capacity across the total output of the B supply is a safe and easy remedy, providing the trouble is not too enormous or the frequency not too low. A frequency of five, for instance, usually will disappear when 18 mfd. are connected across the output, especially since this capacity is additional to the reservoir capacity at that point in a B supply. A frequency of two or three usually will disappear before the magic of 36 mfd. As these capacities are obtainable in one unit for instance the Mershon Q 2-8, 2-18, with the two 8 mfd. sections to spare, this device may be used successfully to stop many instances of motorboating. Frequencies as low as 1/10 have been encountered in audio amplifiers.

Reduction of the amplification is another method, perhaps better considered as an auxiliary method. The proneness to motorboating, or the severity of the case, is proportional to the height of the amplification, called the amplitude. This refers to the amplification per stage.

Suppose that two stages of resistance coupling produce an amplification of 128, considering 8 per stage and including a mu of 2 for the detector since some value of amplification must be ascribed to the detector. If by introducing a high mu tube in the first audio stage, the amplification is made 30, instead of 8, then the total amplification is 240, or almost twice as great. Motorboating might be expected under such circumstances. But if an extra stage of resistance coupling is introduced, instead of heightening the amplification by use of a high mu tube, then the amplification with the extra tube is 1,021, with a smaller danger of motorboating than in the previous example of 240 amplification, although the amplitude is more than four times as great.

PHASES OF THE VOLTAGES

A condition is imposed by the phase of the voltage. In audio amplification we are concerned principally with the voltage, so will regard that only. If the number of plate circuits is odd, the tendency to motorboating is increased. The detector being also an amplifier should be included in the computation of odds and evens. So a two-stage audio amplifier has three plate circuits, detector and two audio, while a three-stage amplifier has four plate circuits, detector and three audio. Hence the condition operates in the right direction, in connection with the example of a three-stage amplifier, with four times the amplification of a two-stage amplifier, motorboating still less, if at all.

Reduction of the amplification may be obtained from any one of a variety of means, or combinations thereof. One way, if transformers are used, is to put a leak of a comparatively low value, say 0.5 to 0.25 meg., across the secondary of either audio transformer or both audio transformers, if necessary. Again, the connections to either primary or secondary may be reversed. Another way is to reduce the plate voltages on the first audio amplifier. Still another is to increase the negative bias.

However, reduced amplification need not be resorted to, if the impedance-reducing capacity is introduced, as previously described.

In a resistance coupled amplifier the higher the value of the plate resistor, the higher the amplification, until saturation is reached. After that higher values will produce lower amplification. If the plate resistor value is reduced beyond a reasonable amount, the amplification is reduced, and motorboating in many instances may be stopped in this way, or the grid leaks of lower value may be inserted in the audio channel, for instance .5 or even .25 meg.

RETENTION OF HIGH AMPLIFICATION

Every one likes to maintain for his own use as high an amplification per stage as is practical. The efficiency of the audio amplifier as an amplifier depends on that. Also in many instances the loudspeaker requires a certain minimum signal value before it responds satisfactorily to low notes. So it is by far better, although more expensive, not only to leave in the relatively high values of plate resistors and grid leaks in the audio channel of a resistance coupled amplifier, but even to raise these values to as high a degree as practical, consistent with the capacity used across the total output of the B supply. Thus, if motorboating exists, not only may it be cured, but the

inating Motorboating

of Amplification Usually Will Turn Trick

V. O'Rourke

amplifier will remain stable at even higher amplification obtained by the use of higher values of plate resistors and grid leaks. For plate resistors, unless screen grid detector or audio tubes are used, 0.1 meg. is considered a fair minimum, although for a 240 or 228 tube one may use .25 meg. to advantage. With a screen grid tube the values of plate resistors should be lower. Around .05 meg. (50,000 ohms) is usually satisfactory, but in some instances, where the 222 tube is used, 10,000 ohms may produce more volume than 50,000 ohms. If so, use the value that produces the most volume.

With any other form of audio coupling the same high amplification thus may be retained.

As for the leaks, supposing a capacity of .01 mfd. for the isolating condenser connected between plate of one tube and grid of the next, the resistor should be at least 2 meg., 5 meg. being much more suitable, because of its better sustenance of the low-note response.

LOWERED DETECTOR EFFICIENCY

On the score of efficiency, the detector itself may be operated at a lower efficiency to cure motorboating, but this is simply another way of reducing the amplification in that stage. For a grid-leak-condenser detector, usually returned to A positive for battery tubes, a return to negative filament will effect such reduction in detecting efficiency, or a much lower value of grid leak than the one used will work in the same direction.

If an AC tube is used, e. g. 227 as leak-condenser detector, the return is usually made to cathode, so the reduction in detecting efficiency may be accomplished by changing to negative bias detection, with a larger value of bias than usual. If the 227 is biased by an individual resistor, between cathode and ground, then 50,000 ohms is a good value for medium detecting efficiency, while 20,000 may provide too much efficiency, but 100,000 ohms will do better service in helping get rid of motorboating.

If any receiver motorboats it is not because of the radio channel, nor because of the B supply or the audio channel, but because of the conjunctive use of the audio channel with the B supply. If any set motorboats it is in general a good sign, since amplification is good on low notes, although one finds it hard to convince an unversed sufferer of this fact.

It is true, indeed, that something must be done to eliminate motorboating, therefore any service man confronted with this problem will find himself thankfully tipped if he effects a cure, while the set owner not only will not complain of reduced amplification but will not even notice it. Good reception will replace furious sounds. And reducing the amplification as a service man's cure for a tough problem is no crime whatever. For his own circuit for home use he would prefer to leave the amplification high and spend the extra money for the required large capacity, but a set owner confronted with the nuisance of

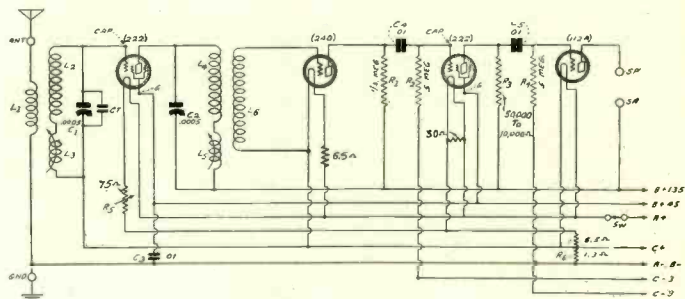

FIG. 2

MOTORBOATING IN A SIMPLE RECEIVER LIKE THIS, WHICH IS THE BATTERY MODEL HB COMPACT WITH THREE SMALL CHANGES MADE IN THE ORIGINAL DESIGN, MAY BE STOPPED BY INSERTING A SUITABLE VALUE OF PLATE LOAD REGISTER FOR R3.

motorboating would prefer the resultant cure at less expense, and the low value resistors, reduced plate voltage and altered bias are cheap remedies.

Another form of motorboating may be classed as incipient motorboating. This takes place in an AC circuit while the heater type tubes are warming up. Due to the low emission the voltage is high on the plates, beginning with no drop at all in the load, and slowly arriving at the normal value of effective plate voltage. As long as the applied voltage is the same as or nearly the same as the effective voltage, due to no drop or small drop in the load, a drumming sound is heard. This disappears as soon as the cathode starts emitting enough electrons to support required plate current. If any one objects to this small disadvantage a capacity of suitable value across the total B voltage will provide the remedy. In general, this preliminary drumming is a good sign: the amplifier is effective in a region where amplifiers usually are weak.

In battery operated receiver, such as the HB Compact, shown in Fig. 2, motorboating may be stopped by using a suitable value of plate load resistor for R3. The value may be 10,000 to 50,000 ohms. In some instances amplification will increase when 10,000 ohms is used instead of 50,000 ohms, and still the motorboating present when 50,000 ohms was used may disappear. This condition is due to reduction of negative feedback.

In connection with the HB Compact three changes are shown from the original diagram, and possessors of this receiver should try these changes. One is to put a 6.5 ohm resistor in series with the positive leg of the detector filament, another to put a 30 ohm resistor across the filament of first audio tube (effective on the other screen grid tube as well), and the last is to make the detector grid return to negative filament of the detector tube, leaving the first audio bias at 3 volts negative.

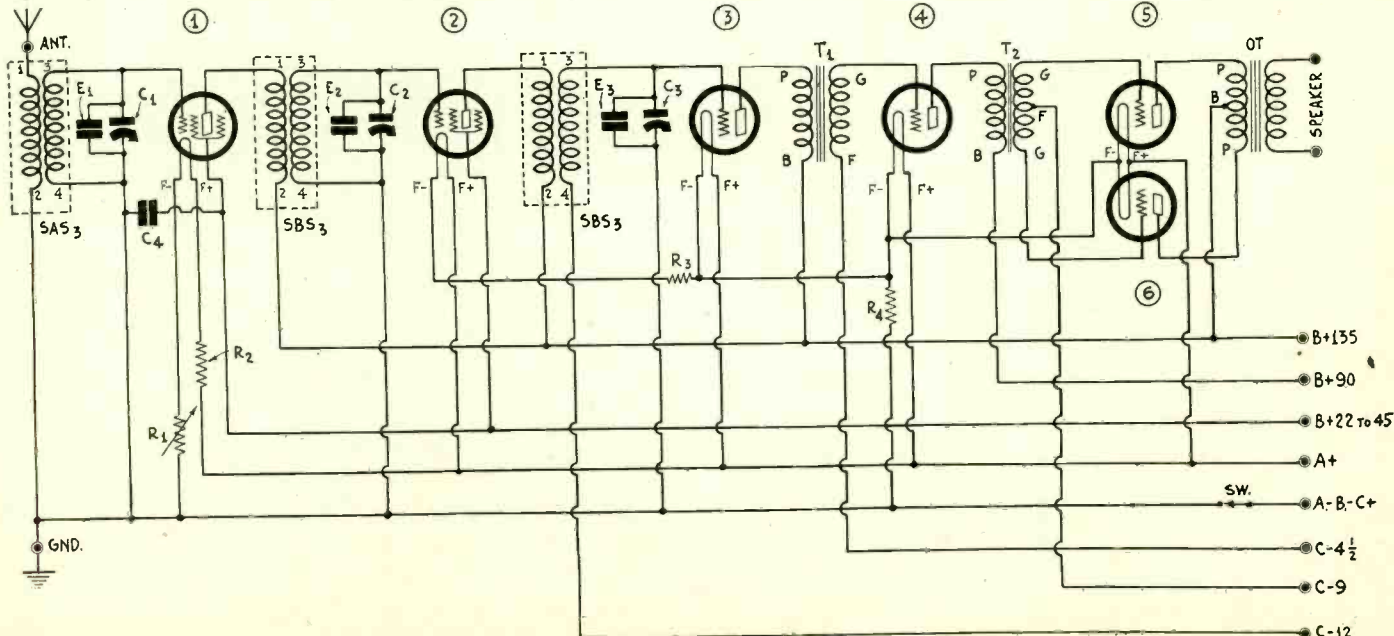

MOTORBOATING MAY APPEAR EVEN IN A TRANSFORMER COUPLED AUDIO CHANNEL LIKE THE ONE DIAGRAMMED

Direct Current Flow

Arbitrary Designation of Direction Used as

By J. E. Anderson and

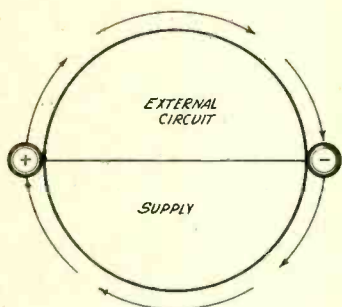

FIG. 28

If a circle be bisected with diameter terminating at (+) and (-) as shown, the direction of current flow in an external circuit may be represented by the arrows at the upper semi-circle, and the direction of flow in the supply circuit (battery or eliminator) may be represented by the arrows at the lower semi-circle. In fact all direct current flows in one direction only, and the circular course emphasizes this. The designations (+) and (-) are arbitrary.

[This article is one of a series entitled "Radio for Schoolboys." Another article will be published next week, issue of December 21st.—Editor.]

THE traditional error that direct current flows from positive to negative is preserved in standard practice to-day, because of convenience, and in fact this situation is not fraught with any harm or difficulty, since a great body of technique has been built up on the earlier misassumption, instruments predicated on it and valuable books written on that basis. We must bear in mind, however, that direct current actually always flows from negative to positive, always did and probably always will!

Knowing that, we may proceed to accept the standard practice of rating the current direction as just the opposite, and for the same purpose of convenience split the current into two opposite directions, that is, opposite in point of view, or relatively opposite, although actually the same, as shown by the example of the bisected circle.

Nobody would say that the hands of the clock for half a revolution go in one direction and for the other half in the opposite direction, yet if we assigned polarity signs to the points where the diameter meets the circumference we would indeed have to adopt the theory of opposite direction even for the hands of the clock! That would be simply adopting certain signs for reference points, as is done in radio, the signs being positive and negative.

When we consider the source of supply we are really contemplating an elevating device, the object that is elevated being the voltage, and the course of current of a circuit attached to the supply could be considered independent of the source of supply. But it is more usual to regard the current as flowing through the supply, from negative to positive.

Taking this condition, and applying it to a rectifier circuit, as in a B supply, with only a voltage divider as the load, it is plain that current will flow through the divider, and that the direction of flow will be from positive to negative, on the basis of the well-preserved traditional error. The divider is a load on the supply. To account for the presence of the positive voltage at the top the current may be assumed to flow in the

supply from negative to positive. Hence we have a complete representation of a circuit, and if we know what is the resistance connected from plus to minus, and the voltage drop across this resistance, hence the potential difference between plus and minus, we can compute the current. If the voltage from (+) to (-) is 300 volts and the resistance of the strip between them is 10,000 ohms, the current is the voltage divided by the resistance, or, 300-10,000, equally .03 ampere, usually mentioned as 30 milliamperes. In a B supply this current flowing independently through the entirety of the resistor is called the bleeder current.

PLATE CURRENT SKIPS

If a tube is connected to an intermediate voltage, as at point X in Fig. 29B, then the current in the supply courses from minus through the rectifier to the positive and down the resistor from (+) to (X), where it is diverted from further travel through the resistor because of connection of the plate of the tube to the point X through the plate load PL. Hence the current moves upward toward the plate, through the grid to the filament. Actually it courses unequally down the two legs of the filament, mostly through the negative leg. Since some point of the filament is "tied" to minus of the B supply, this is the common return point, and the circuit of plate current is thus completed. It should be observed that not only does filament current flow in the filament but plate current as well—in fact, all the plate current and all the filament current flows.

Right or

[The following questions are based on technical articles published in last week's issue. Read this week's issue carefully and know the answers to next week's questions before those questions are put.]

(1)—The selectivity of a receiver is greater at the low end of the broadcast band than at the other extreme because the frequency ratio between desired carrier and any interfering carrier differs more from unity at the low end.

(2)—The selectivity of a receiver, the resistance in each tuned circuit remaining constant, depends directly on the ratio between the desired carrier and any interfering carrier.

(3)—The greater the selectivity of a receiver the worse the quality.

(4)—It is not possible to measure voltages with a 0-1 millimeter and an external resistor unless the resistor is a multiple of 1,000 ohms, that is, unless it is 1,000, 10,000, and so on.

(5)—An inductor loudspeaker cannot chatter because there is nothing against which the armature can strike.

(6)—An inductor dynamic loudspeaker can be connected in push-pull by bringing out a lead from the wire joining the two equal coils.

(7)—The detector tube in a receiver usually works better when the filament voltage is slightly less than the rated voltage. For example, a tube with a rated voltage of 5 volts works better when the voltage is 4.5 volts.

(8)—In a grid bias resistor the plate current flows from the B minus point to the cathode.

(9)—An extra stage of amplification always increases the output of a receiver.

(10)—In a receiver in which the grid bias is taken from the B battery eliminator the voltage required for the bias is always taken from the voltage which otherwise could be used on the plate. This is true whether the bias taken from a drop in the voltage divider or taken from a drop in an individual plate circuit.

Questions

[Answers on Page 13]

- (1)—State the three sources of power supplied to a receiver.
- (2)—If a 201A tube has its filament heated from a 6 volt storage battery, state how to determine the value of a series filament resistor to drop the 6 volts to 5 volts.
- (3)—What is the resistance of the 201A filament?
- (4)—What is the voltage reference point of a tube with filament heated by a storage battery?
- (5)—How is current assumed to flow? If this contradictory to the fact? If so, why?
- (6)—How does current flow in a source of supply, as distinguished from an external circuit? If there is any discrepancy please explain.
- (7)—State the course of plate current.
- (8)—Is negative of the B supply ever C minus? Can the same lead be both B minus and C minus?
- (9)—What is the purpose of a filter in a B supply?
- (10)—Has a rectifier tube resistance? If so, is it always the same resistance? If not, how does the resistance change?

ANSWERS

- (1)—Right. This is true because at the lower end of the broadcast band two stations differing by 10 kilocycles differ relatively much more than two frequencies at the upper end differing by 10 kilocycles.

Analyzed for Schoolboys

Standard Practice to Simplify Delineation

d Herman Bernard

The only current flowing from (X) to minus is bleeder current, since the plate current avoids this path. So when multiple tubes are connected to assorted taps on a voltage divider, frequently with the plates of more than one tube connected to one tap, the computation of the voltages, assuming the resistance to be unchanged, depends on the values of current and where this current flows.

If it were desired to obtain a negative bias from the B supply, A minus would be tied to point Y, the grid return connected to minus of the B supply, and then this minus would be C minus for this particular tube, and the plate current instead of going through the filament to B minus would go from filament to Y to B minus, so consideration would have to be given to the fact that the plate current does flow from Y to minus, in determining a resistance value for this section to afford a stated bias.

WHY DIFFERENT VOLTAGES PREVAIL

Hence the design of a voltage divider to afford particular voltages depends on the number of tubes and their B and C voltages. Then the resistor is constructed to meet these voltage and current requirements.

Sometimes a voltage divider has, say, three taps to provide 180, 90 and 45 volts (four, including the terminal for negative). One may connect more tubes to the 90 volt tap than was intended. Then the voltage at this tap is less than 90, because the higher current produces a higher drop in the resistor between maximum positive and the intended 90 volt

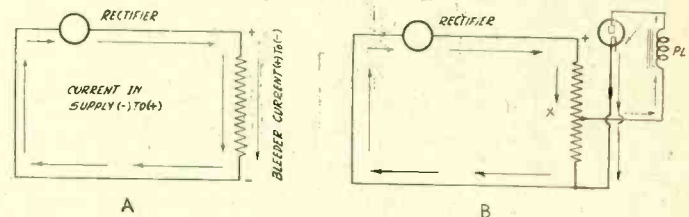

FIG. 29.

(A)—CURRENT IN A SOURCE OF SUPPLY MAY BE ASSUMED TO COURSE FROM NEGATIVE TO POSITIVE, B SUPPLY BEING REPRESENTED. BLEEDER CURRENT MAY BE CONSIDERED AS IN AN EXTERNAL CIRCUIT.

(B)—PLATE CURRENT FLOW IS REPRESENTED. THE CURRENT IN THE SOURCE OF SUPPLY IS IN THE SAME DIRECTION AS IN (A). IT THEN GOES THROUGH THAT PORTION OF THE RESISTOR FROM (+) TO TAP (X), AND SKIPS THE ROUTE FROM (X) TO (—) BECAUSE IT GOES THROUGH THE TUBE TO (—).

tap. Another factor is that the current may be so much higher as to cause an appreciable reduction in voltage due to the drop in the resistance of the rectifier.

With several taps and an assortment of tubes and different biases it becomes more than a few moments' work to determine what the resistance values should be for sections of a voltage divider. Hence adjustable resistors or a multi-tap divider is favored for universal use, while a few particular taps on a resistor are serviceable only for a given circuit or another circuit requiring the same plate voltages and currents.

While a B supply has been represented, any other supply source would serve as well. If B batteries are used the same conditions prevail as to current flow as if an AC supply were hooked up, but the B batteries do not suffer immediate voltage reduction as in a rectifier when current is increased. Even if a single dry cell were used as the supply circuit, the same situation regarding current flow would prevail. Indeed, a B battery is simply a number of series-connected dry cells of small size and small individual voltage.

Wrong?

(2)—Right. This is essentially the same as the statement above but modifies so as to keep the resistance in the tuned circuits constant. It is the relative values of the frequencies that count, or the percentage difference.

(3)—Right. It is always so and talk about 10 kilocycle selectivity and perfect quality does not alter the fact.

(4)—Wrong. The only advantage of using resistors of these values with a 0-1 millimeter is that the current scale can be converted to a voltage scale by simple mental computation. Any resistor whatsoever can be used provided that the scale is read in volts suitably.

(5)—Wrong. No matter how a speaker is constructed there must be some mechanical limits to it. If enough signal voltage is impressed across the terminals of the speaker it will chatter just as any other speaker. The advantage of the speaker is that the armature can move a considerable distance without striking and without reducing the sensitivity.

(6)—Right. These speakers are built that way now. They are furnished with three leads, two for the plates of the push-pull tubes and one for the B supply.

(7)—Right. This is particularly the case when grid condenser and leak method of detection is used.

(8)—Wrong. The conventional current flow in the opposite direction. If it did not the grid would not be negative with respect to the cathode, but positive by the amount of drop in the resistance. It is true that the electron drift through the resistance is from the B minus to the cathode, but this is only of theoretic interest.

(9)—Wrong. There are conditions under which an added stage actually reduces the amplification. This is due to reverse feed-back through the B supply. Of course, it takes a great deal of reverse feed-back to make the amplification less so that condition is not often met in practice.

(10)—Right. No matter what is done to the circuit the sum of the grid and plate voltages cannot be greater than the voltage across the voltage divider. If part of used for grid bias this part necessarily must be taken from the plate voltage. This is so easy to see when the grid bias is taken from a drop in the voltage divider but not so easy to see when it is taken from a drop in a grid bias resistor used for a single tube. Such a resistor, however, is only in parallel with a portion of the voltage divider and itself becomes a voltage divider.

Answers

[Questions on Page 12]

(1)—The three sources of power are the signal power, the A power for the filament or heater, and the B power for plate.

(2)—Since a 201A tube at 5 volts across the filament draws .25 ampere and the desired voltage drop (from 6 to 5) is 1 volt, the series filament resistor should be $1/.25$ or 4 ohms.

(3)—The resistance of the 201A filament is 20 ohms, because the resistance equals the voltage (5) divided by the current (.25).

(4)—The voltage reference point of a battery type tube is the negative filament (F) minus post of socket.

(5)—Current is said to flow from positive to negative. In fact it flows from negative to positive, but electrical technique had used the other system of reference, so when the error was discovered the earlier assumptions were retained nevertheless.

(6)—In a source of supply current flows in the same direction as anywhere else, but for convenience of graphical representation it is assumed to flow in the opposite direction to the current in an external circuit.

(7)—Plate current courses from B plus through the plate load to the plate itself, then through the grid to the two filament legs and then through the source of supply to the starting point.

(8)—Yes. The same lead may be both C minus and B minus as to different tubes, but never in reference to the same tubes.

(9)—To eliminate objectionable hum.

(10)—A rectifier tube has varying resistance depending on the current drawn, but the same resistance for the same current. The higher the current the lower the resistance of the rectifier tube.

Superheterodyne Coils

Winding Data for Tuner and Intermediate

By Knollys Satterwhite

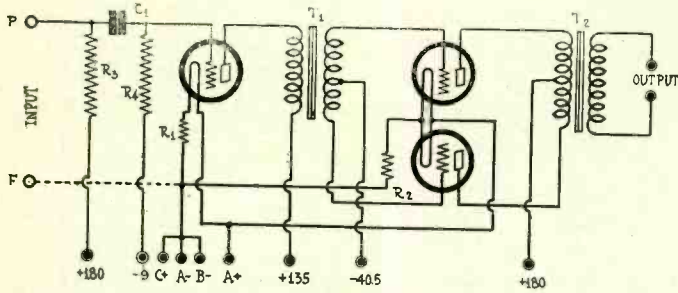

FIG. 44.

A BATTERY OPERATED AMPLIFIER COMPRISING ONE STAGE OF RESISTANCE COUPLING AND ONE STAGE OF PUSH-PULL AMPLIFICATION SUITABLE FOR USE WITH THE CIRCUIT IN FIG. 36.

[Here is another installment of the serial article entitled "The Super-Heterodyne." Next week, issue of December 21st, another installment will be published.—Editor.]

IN modern circuits the inductance coils are usually wound with fine wire on small forms. Such coils are used because of the necessity of compactness and of shielding. While they are not quite so selective as coils wound on larger diameters and with heavier wire while dissociated from shields and other metal bodies, they usually result in more satisfactory tuners in super-sensitive circuits, such as Superheterodynes and multistage screen grid radio frequency amplifiers.

There is much demand for winding data for coils of different diameters, size of wire, capacity of tuning condensers, and types of insulation, but to give a complete list would require an entire book on the subject. We shall here give the winding data for only a few coils suitable for .00035 and .0005 mfd. tuning condensers and for receivers in which several shielded stages are used. The first column in Table I. gives the outside diameter of the coil form, the second and fifth columns give the number of primary turns when the coil is used after screen grid tubes and when the secondary is tuned, the third and the sixth columns give the number of turns on the tuned secondary, and the remaining columns give the number of enameled copper wire that should be used to give the proper inductance.

COIL CHANGES

If tubes other than screen grid tubes are used the untuned primary in any case should have about one-fourth as many turns as the corresponding secondary. If the coil is used with screen grid tubes and the primary is tuned, the coil should be reversed without changing the turns on the present secondary, but the turns on the primary, which will become the secondary, should be increased to slightly more than the turns on the tuned winding.

The coils in Table I have been determined on the assumptions that the tuning range is from 550 to 1,500 kc and that the distributed capacity in the circuit is 25 mmfd. In some instances the capacity will be larger than this and in other instances it may be less. To allow for such variations two or three more turns than specified should be put on the form. If this results in an inductance which is too high it is a simple matter to remove turns until the tuner covers the desired range of frequencies.

TABLE I
Winding Data for RF Transformers

Diam.	.00035			.0005		
	Pr.	Sec.	Wire	Pr.	Sec.	Wire
1.5	54	72	32	43	58	32
1.75	50	67	30	40	54	30
2.0	46	62	28	38	50	28
2.25	45	60	26	36	48	26
2.5	44	59	24	34	46	24

TABLE II
Data for Intermediate Frequency Transformers on 1.5-inch diameter

IF kc	L mh	C mfd	Layers	Wire	Turns
50	10.12	.001	4	32 en.	447
75	4.5	.001	4	32	258
100	2.53	.001	3	32	197
125	3.24	.0005	3	32	228
150	2.25	.0005	2	32	198
175	1.664	.0005	2	32	168
200	1.266	.0005	2	32	140
225	1.000	.0005	2	32	119
250	.810	.0005	1	32	182

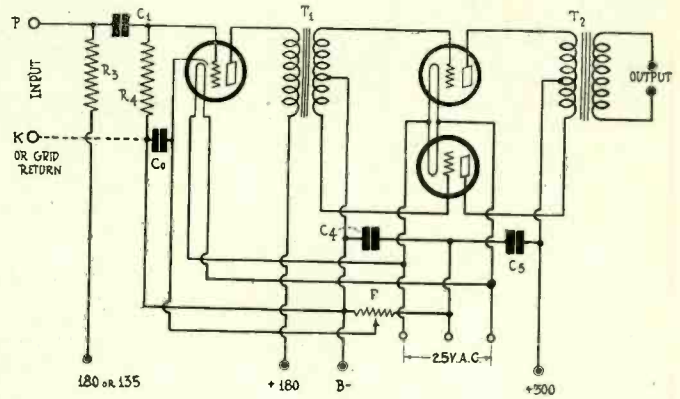

FIG. 45.

A CIRCUIT LIKE THAT IN FIG. 44 BUT DESIGNED FOR ALTERNATING CURRENT OPERATION AND SUITABLE FOR USE WITH THE SUPERHETERODYNE IN FIG. 37.

Table II gives winding data for intermediate frequency inductance coils for the usual frequencies employed in Superheterodynes. All the coils are wound with No. 32 enameled copper wire on a diameter of 1.5 inches. Due to this small diameter it is necessary to use multiple-layer winding, except in one instance. If this method were not used the coils would be too long to be practical. The wire specified winds on an average 112 turns to the inch. This makes the smallest coil, which contains a single layer, 1.625 inch long. The next coil, which contains two layers, is .532 inch long, since that in effect contains 224 turns to the inch. The largest coil, having four layers and 447 turns, will be practically one inch long.

The data given in Table II are only for the tuned winding of the transformer, whether that be used as secondary or primary. The untuned winding should be wound on a form which fits snugly inside the 1.5-inch winding and it should contain a larger or smaller number of turns than the tuned winding according to whether it is used as secondary or primary. It may also be wound with finer wire, say No. 36 enameled. Since the untuned winding will have a smaller diameter than the tuned allowance must be made for the lower inductance for a given number of turns. Hence when the primary is untuned it should have nearly the same number of turns as the secondary and when the primary is tuned the secondary should have at least 50 per cent more turns than the tuned winding.

SPACE LAYERS

The layers of the multi-layer coils should be spaced with two

(Continued on next page)

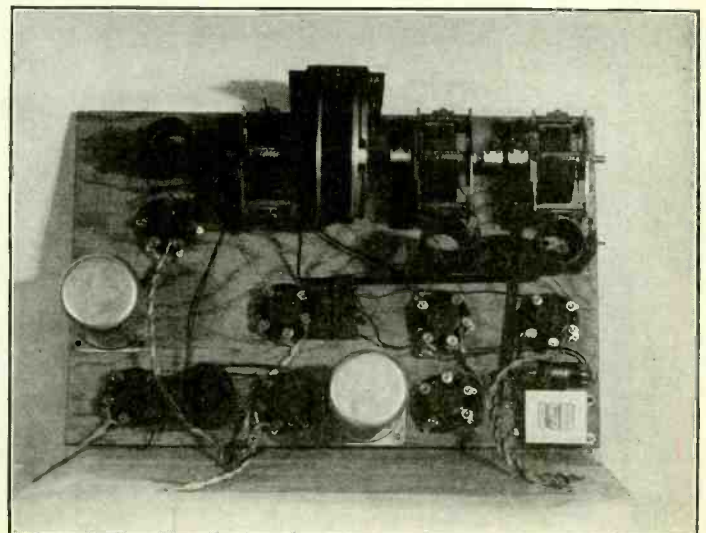

LAYOUT OF AN EXPERIMENTAL SUPERHETERODYNE USED IN TESTING SOME OF THE PRINCIPLES DISCUSSED.

A Filament Transformer

How It Is Used for Experimental Circuits

By H. J. W. Brooks

A CONSERVATIVELY rated filament transformer provided with the usual voltages is a great convenience to the radio experimenter who wishes to try out new AC circuits. He can use it for almost any radio receiver which he may decide to try out, either for experimental purposes or permanent use.

Such a transformer should have a 2.5 volt winding rated conservatively at 12 amperes. This will heat about 7 tubes of the 224, 227, and 228 types. While seven tubes normally require 12.25 amperes if the heavy duty 2.5 volt winding is conservatively rated it will easily deliver 12.25 amperes, and even more, without any appreciable drop in the voltage or excessive heating of the transformer. Seven tubes, it will be recalled, are more tubes than most modern receivers use in the radio frequency and first audio stages.

One might ask what will happen to the tubes if only two or three of them be put on such a heavy duty winding. If the transformer can supply current for seven tubes will it not supply too much for two or three? It will not. A high current capability implies excellent regulation of the voltage in the winding, that is, a negligible voltage change as the current changes. Hence the winding will supply rated current to any number of tubes from one up to the rated limit of seven.

FLEXIBILITY DESIRABLE

But a transformer which is to be used for experimental purposes as well as for permanent receivers should be flexible. For example, it is frequently necessary, or at least highly desirable, to put the AF tubes on a separate transformer winding from the radio frequency tubes. Hence the transformer should have a second 2.5 volt winding which may be used for these tubes when the circuit calls for such construction. This winding need not be of such high current rating because when all the radio frequency tubes and the detector have been provided for there are only a few tubes remaining. A customary rating for the second 2.5-volt winding is 3 amperes. This will easily take care of two 245 tubes or, if it is conservatively rated, two of the heater type tubes. The extra current requirement is only one half ampere, or 17 per cent of the rated value. The transformer winding can be overloaded to this extent without any undesirable results. Then, also, the tubes can be operated very well with a current slightly less than the rated value.

The transformer should also be provided with a winding which will accommodate such tubes as the 112A and the 171A. That is, it should have a 5-volt winding capable of supplying about two amperes. Since tubes of this type require a current only of .25 ampere, if the transformer can supply 2 amperes it will handle eight tubes of the type. Of course, this will never be required since only the last stage can use such tubes, or at most only the last two stages. As in the case of the lower voltage windings, only one or two tubes can be put on this winding without any appreciable increase in the voltage due to regulation. Another use for the 5-volt winding is to heat the filament of the pilot light or lights. Usually, one of these takes the same current as a tube.

CENTER-TAPPED WINDINGS

It is a virtual necessity that each winding on the transformer

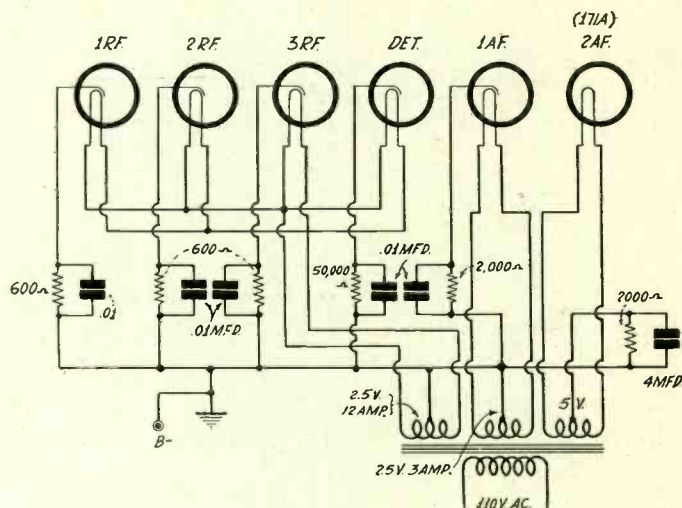

FIG. 1

USE OF A FILAMENT TRANSFORMER TO HEAT 227, 224 OR 228 RF, DETECTOR AND FIRST AUDIO TUBES, AND 171A, 112A, 171 OR 112 OUTPUT, SINGLE OR PUSH-PULL.

be center-tapped. If there is not a center-tap already it must be provided externally by means of a center-tapped resistor, and this costs more than a tap on the winding and it works no better, except in rare cases. Therefore when purchasing a filament transformer, either for experimental purposes or for use in a permanent receiver, it should have at least three windings, two 2.5-volt and one 5-volt, each of which should be accurately center-tapped and be conservatively rated.

It is not obvious why a 2.5-volt windings should be center-tapped since they are used for heating heater type tubes. But such tubes usually hum a good deal unless the center of the heater circuit is connected to ground or to some part of the cathode or B supply circuit. Making a single connection to the heater center is such a simple way of eliminating much hum that it is well worth while to secure a transformer which has the provision.

NEW DRAKE'S ENCYCLOPEDIA
 1,680 Alphabetical Headings from A-battery to Zero Beat; 1,025 Illustrations, 920 Pages, 240 Combinations for Receiver Layouts. Price, \$6.00. Radio World, 124 W. 45th St., N. Y. C.

How to Wind Superheterodyne Coils

(Continued from preceding page)

or three layers of strips of bond paper dipped in paraffin or wax. This spacing will not only reduce the distributed capacity of the winding but will also aid in keeping the layers smooth and even.

In our previous discussion of the intermediate frequency amplifier we have emphasized the desirability of a high intermediate frequency, and we have particularly recommended a frequency of 2000 kilocycles. In Table II the coil for 200 kc calls for two layers and a total of 1400 turns. The winding of this coil will be only 3/8 inch long. It also can be wound in a single layer still keeping it at a reasonable length. About 205 turns of wire will be required.

Again the reader is reminded of the fact that the exact number of turns used is not important, just so all the tuned coils in the intermediate frequency amplifier be alike and so that they be tuned with equal condensers, because it is seldom that the intermediate frequency must be adjusted accurately to any particular value. It is important, however, that all the tuning coils in the intermediate frequency filter be adjusted to the same frequency whatever that may be.

When the intermediate frequency transformers have been constructed as nearly alike as practicable, when equal fixed

condensers have been connected across them, and when the coils have been put in the circuit in equal settings, there will be only small differences among them and these differences can be adjusted by either changing the turns or by connecting and adjusting variable midget condensers across the fixed condensers. The final adjustment of the intermediate frequency filter should be left until the circuit is otherwise completed because every change, however small, will change the distributed capacity in the tuned circuits.

ENAMELED WIRE USED

Enameled wire has been specified in both Table I and Table II because such wire permits the most compact construction. When small diameters are used it is almost necessary to employ this type of insulation in order that the coils be of reasonable length. For the same reason No. 32 wire is specified. Of course, the selectivity of each tuned circuit will be less with this insulation and with this fine wire, but that is an advantage rather than a disadvantage for there will be no lack of overall selectivity. As has been stated, proper design of a Superheterodyne requires that the selectivity be kept within reasonable limits if the circuit is to do something besides select.

No Side-band-Cutting

Strong Amplification on High Waves A

By *Herm*

Managi

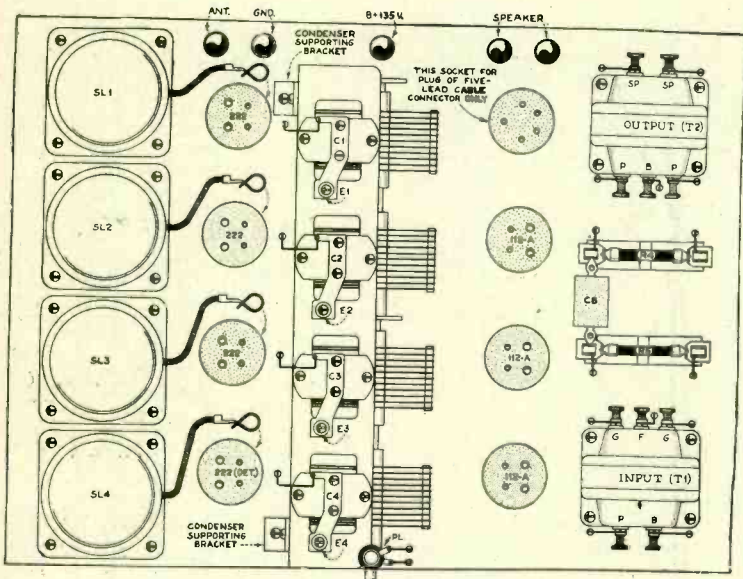

FIG. 1

LAYOUT OF PARTS FOR THE HB33. THIS REPRODUCTION WAS MADE FROM THE OFFICIAL BLUE-PRINT. THE CONDENSER SUPPORTING BRACKETS ARE OPTIONAL, AS THE CONDENSER MOUNTS DIRECTLY ON THE SUBPANEL.

THE design of the tuner in the HB33 and HB44 is such that the frequency separation is 10.3 kc at 1,500 kc, and increases slightly as the frequency decreases.

This statement seems contradictory of the fact that the selectivity of a tuned circuit is greatest at the lowest frequency and least at the highest frequency. It is a fact that the relationship just expressed prevails in any simple tuned circuit, with the single proviso that there is no regeneration. But in all multiple stages of tuned radio frequency amplification there is regeneration, although it may never amount to squealing.

One may recall the fact that in operating a regenerative receiver of the tickler coil type that, while regeneration is used, oscillation is avoided, or squealing, by operation just under the oscillation point, which gives greatest sensitivity. So automatic regeneration that arises in so-called non-regenerative receivers, like the HB33 and HB44, may be gainfully used. This regeneration is greatest at the highest broadcast frequency, hence the circuit devoid of feedback. The effect of regeneration thus effect operates in the opposite direction to that of a single tuned obtained is to overcome almost completely the selectivity drop otherwise suffered at higher frequencies.

The reason why the conquest is not actually complete is the fact that shielded stages are used. It is absolutely necessary to resort to shielding, because three stages of screen grid radio frequency amplification and a screen grid power detector otherwise would be uncontrollable. The resistance effect of the shields is greatest at the highest frequency tuned in, so the shields and the general rule of a tuned circuit work together, while regeneration works in the opposite direction.

WHERE A KICK IS BADLY NEEDED

It is certainly desirable that high amplification should prevail at the low broadcast frequencies (high wavelengths), and the absence of good amplification in this region is one of the serious shortcomings of many commercial receivers. Such circuits are gaited to afford no possibility of oscillating, hence damping devices are introduced, and while these are most effective at the highest frequencies, in this region their negating effect can be tolerated, as offsetting regenerative gain, but when stations above 400 meters are tuned in, where no regeneration is present, the drop in amplification becomes marked. Whereas many persons complain that their receivers do not tune in stations of wavelengths higher than 500 meters, the fact often

is that the sensitivity is so low at these wavelengths that the stations are not heard though the circuit can tune to those waves.

That is an appalling situation to any one particularly interested in the work of a high wavelength station, when that station is not a powerful local that may be heard despite the handicap, but may be a hundred miles or so away. Then indeed does the longing set in for a receiver that has high gain at high wavelengths.

HIGH GAIN AT HIGH WAVES ASSURED

The HB33 and HB44 are assuredly of the high-gain-at-high-wave type of circuits, and that situation is brought about by the adequacy of the inductance of the primaries connected in the plate circuits of the screen grid tubes. Then in addition the volume control is used as a radio frequency gain control, so that for the high wavelengths the resistance in the volume control circuit is low, while for the low wavelengths it should be high. A double purpose is served: the gain control in supporting high amplification at high wavelengths, and enabling use of the same amplification at low wavelengths by adjustment of the control from the front panel, makes the receiver in point of operation one that has an even amplification at broadcast frequencies. In this way one gets rid of the nuisance of a rising characteristic.

If the amplification must be high at the low wavelengths and low at the high wavelengths, any one interested in high wavelengths where the receiving antenna's field strength for a particular station is weak, one would need two receivers to obtain desired service. Now, fancy having two sets simply because some one did not think it worth while to support the amplification in an adequate circuit design throughout the entire spectrum of broadcast wavelengths!

SELECTIVITY VARIES SLIGHTLY

The selectivity curve of the HB33 and the HB44 therefore is not of itself the same for all frequencies, but the selectivity decreases slightly, to 11.8 kc from 240 to 310 meters, and thereafter runs about evenly at 10.7 kc. These minor differences are of no importance, and besides there is no known circuit that has the same selectivity at all frequencies tuned in, but only relatively the same selectivity can prevail. All band pass filters are relative in their effect, and serve an excellent purpose, the same general goal being obtained in the present instance by somewhat different means.

From what has been stated, therefore, it is plain that in the HB33 and HB44 there is no sideband attention, but the full modulation of the broadcast carrier is passed right through the radio frequency channel. Once the signal is detected in the high-negative-bias detector, which has a high plate voltage, the quality depends on the audio amplifier. A stage of resistance coupling is used for the first audio step, since a screen grid tube most naturally requires a resistor in the plate circuit. The next stage is push-pull, hence transformer coupling is used.

BATTERY AND AC TYPES

The HB33 is a battery operated receiver, although a B eliminator may be used for plate supply, if desired.

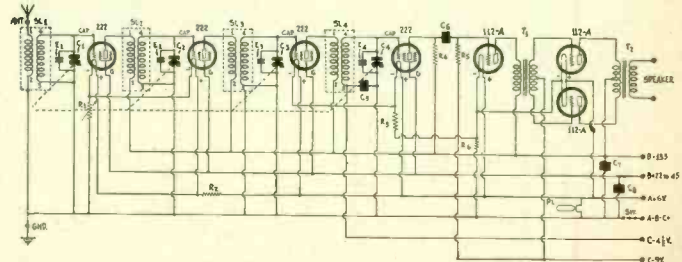

FIG. 2

THE HB33 WIRING DIAGRAM IN SCHEMATIC FORM. THIS WAS PUBLISHED LARGE SIZE, WITH LIST OF PARTS, IN THE NOVEMBER 30TH ISSUE.

in HB 33 and HB 44

Assures Distant Reception There as Well

By Bernard

Chief Editor

The HB44 is an AC receiver. The types of tubes therefore differ, and the outputs in undistorted milliwatts differ also. The AC receiver will stand a heavier signal input to the push-pull stage without overloading. Any overload in the battery or AC-model can be corrected by adjustment of the volume control.

All receivers should be overloadable, with a front panel check available. If this is not a sound assumption, then the need or desire for ultra-sensitive receivers such as these is a fallacy, and all of us are wasting our time writing, and reading about such circuits, not to say building them.

These two circuits give maximum performance, since it is virtually impractical to use more than three stages of screen grid tuned radio frequency amplification, due to reaching the noise level, where static becomes often louder than the signal itself on distant stations.

Since the selectivity has been discussed, a word about the sensitivity. So long as stability is maintainable, accurately wound coils used, and an accurately made four gang condenser, only misadjustment of the equalizing condensers would deprive you of high sensitivity.

TRIMMER ADJUSTMENT

The correct adjustment should be made in the usual way:

Tune in a low wavelength station of moderate signal intensity, adjust the equalizing condensers (which are built into the gang condenser) so that without using much of their capacity you obtain loudest response. An exception exists in the case of the trimmer across the detector input. You may have to use nearly all the capacity of the equalizing condenser for perfection of resonance there. Now tune accurately with the front panel dial, to determine if the signal is loud in one point, then at another point on the dial. If so, adjust until the maximum response is obtained at one setting only, with sharp attenuation on both sides. That finishes the adjustment for the entire scale.

No matter how much capacity trimmer capacity is used, you will still tune in the lowest broadcast wavelength. Full coverage of the broadcast band is absolutely assured. The circuit tunes from 189 meters to 567 meters, which is in goodly excess of the extremes of United States wavelengths and even the highest Canadian wavelength. Roughly, the circuit tunes 11 meters below the lowest broadcast wavelength on the Western Hemisphere, and 12 meters above the highest broadcast wavelength. Canada has a channel of 550 meters, or 5 meters above our own highest wavelength. (See page 23.)

PARTS VERY INEXPENSIVE

All these results are obtainable at no great outlay for parts. The entire list of parts for the HB33, the battery model, costs less than \$30, while the entire parts for the HB44 cost less than \$50, these prices including a good-looking steel cabinet, finished in crackled dark brown, and drilled for the full-vision vernier dial and volume control.

It has been found more satisfactory as a feedback preventive to use individual shields, and the coils are placed inside these shields, which are tubular with a flat flange at bottom, pierced for mounting holes. The subpanel, which is steel, is drilled to receive these shields, so there is no need for bases for the shields. The subpanel is the base.

To erect the coils, simply attach them to the subpanel. Each coil has two brackets built in. These brackets are toed-in, toward the center of the coil, so as not to interfere with the shield. Screws that hold the brackets protrude far enough toward the shield to prevent the coil ever from being closer to the shield than intended, and the subpanel mounting holes perfect this safeguard. The leads for primary and secondary have distinctive color markings, so wire according to these markings, and when finished, drill a hole in the side wall of the shield, near the top, to bring out the lead that goes to cap of the screen grid tube. The other leads go through a subpanel hole, in the case of each coil, to their socket and other destinations. The socket lugs are at bottom, likewise. The shields are then put in place with machine screws and nuts.

GOOD-LOOKING LAYOUT

The shields are lined up front to back, when one considers the front elevation of the cabinet before him. The four gang

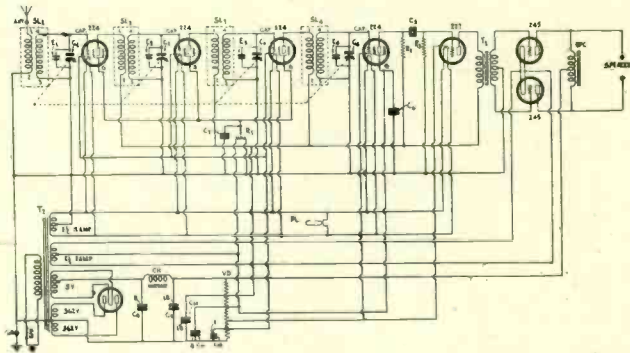

FIG. 3

THE HB44. THE VOLUME CONTROL R1 IS CONNECTED WITH ONE SIDE TO GROUND INSTEAD OF TO CATHODE, OTHERWISE THIS IS THE SAME AS THE LARGE DIAGRAM PUBLISHED NOVEMBER 30TH. EITHER METHOD MAY BE USED.

condenser is mounted in the same direction. No brackets are needed for this, as a later method provides for mounting the condenser directly on the subpanel, large holes permitting the stator screws to clear the subpanel as preventive of short circuiting. The sockets are arranged in the same direction, the four for screen grid tubes being between the shields and the condenser. Photographs of this assembly have been made and are due to be published next week.

On the right-hand side the arrangement used for the battery model is different from that used for the AC model. There are seven tubes in the battery model, eight all told in the other. In the November 30th issue, due to a typographical error, the filament current drain of the HB33 was misstated. The current drawn by the four 222 tubes, and the three 112A, is only 1.278 amperes at rated voltages. This is a low, hence economical, drain and any who use storage batteries need have no hesitancy in building the receiver, as the filament current drain is about the same as that of a set using five 201A tubes—the traditional five-tube set!

USE OF B BATTERIES

Large-sized B batteries, given average use of 4½ hours daily, should last four months, with the HB33, but a B supply is more economical, and an eliminator may be used that provides 180 volts. Under the circumstances the 180 volt tap may be connected to the push-pull output, even if 112As are used, but the negative bias should be made 12 volts.

When either receiver is constructed, besides having an installation that is good-looking in its arrangement and wiring (most of the wiring being underneath, in fact nearly all), one can treat one's self and company to distant stations in abundance. From New York City, Chicago stations are tuned in while locals are going, also stations in Canada, the Southwest and the Northwest, and the performance is altogether in the same class as that of other well-designed receivers using the same number of tubes.

The AC model uses 245s in push-pull and a special built-in ABC supply.

[Read next week's issue and find out still more particulars about the HB33 and HB44.—Editor]

ADVANTAGE OF HIGH MODULATION

WHAT ARE the main advantages of high modulation of the carrier wave of a broadcasting station? Whatever they are they must be worth while since so many modern broadcasting stations are adopting high degree modulations. —W. H. W.

One advantage is that less power is required to reach a given distance because less power, proportionately, goes into the carrier wave. Perhaps the main advantage is that there will be a smaller interference area around the station, that is, a range where the signal is too weak to be heard but where the carrier will be strong enough to cause heterodyne interference with other carriers. Either one of these would be sufficient reason for adopting the system. But high percentage modulation requires straight line detection for good quality. Receivers will be constructed in the future so that they will be adapted for such modulation, and even now the modern sets are so constructed.

A Question and Answer Department conducted by Radio World's Technical Staff. Only Questions sent in by University Club Members are answered. The reply is mailed to the member. Join now!

RADIO UNIVERSITY

Annual subscriptions are accepted at \$6 for 52 numbers, with the privilege of obtaining answers to radio questions for the period of the subscription, but not if any other premium is obtained with the subscription.

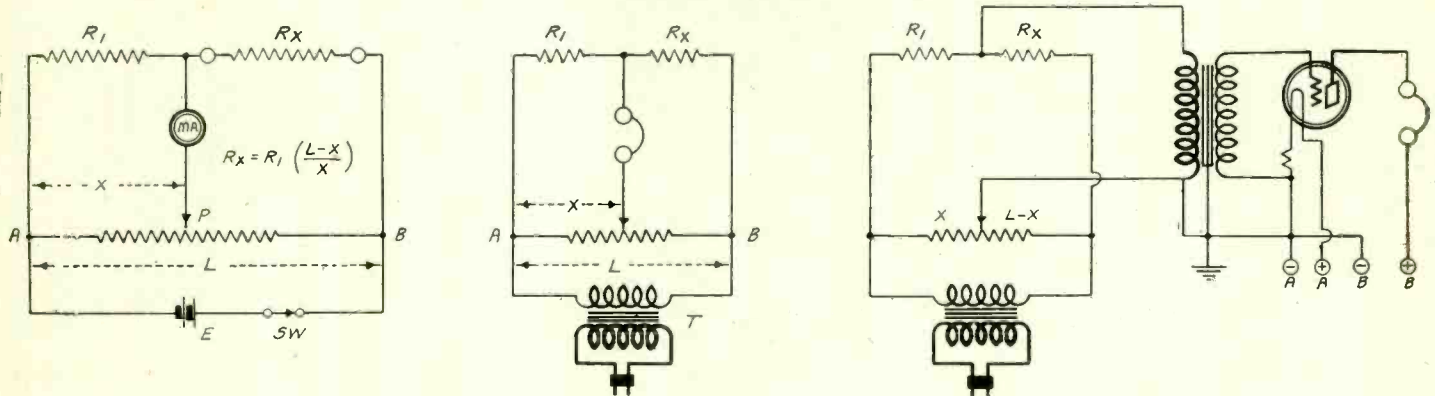

FIG. 812
THREE SLIDE-WIRE WHEATSTONE BRIDGES. THE FIRST, AT LEFT, IS FOR DC AND THE OTHER TWO FOR AC. A MILLIAMMETER MA IS USED IN THE FIRST AS BALANCE INDICATOR, AND A HEADSET AND AN AMPLIFIER IN THE OTHER TWO.

VIBRATION IN SETS

IS IT a good practice to build the loudspeaker in with the audio amplifier or does the vibration make such construction inadvisable?—J. D.

Most radio receivers on the market are constructed in this manner so the vibration cannot be serious, provided precautions are taken to prevent the vibrations from reaching the amplifier and particularly the detector. There is no doubt that it is better practice to remove the speaker a considerable distance from the amplifier because no matter how well the speaker is isolated from the amplifier there will be some vibration carried over, both mechanically and acoustically. It would be practically impossible to isolate the speaker from the amplifier acoustically.

* * *

DETRIMENT OF LONG LINES

IHAVE A powerful radio receiver which can handle several loudspeakers when they are in the same room, but I wish to run a line from the amplifier to a room upstairs and I am wondering if this is permissible. The line would be of considerable length because it will have to be run around corners so that it will be put out of sight. If it is practical to run such a line what would the effect be on the quality?—A. W. S.

The high audio notes would be by-passed to some extent due to the capacity between the two long wires. This by-passing effect, however, would not be so great as to render the arrangement unpractical. It is done frequently.

* * *

NEITHER SENSITIVE NOR SELECTIVE

MY LATEST receiver is a complete failure, and I had been led to believe that it was exceptionally good. It lacks sensitivity and it tunes in all the local stations at the same time. The quality, however, is very good. What can be wrong with it?—P. P. H.

Any number of things could be wrong with it. Presumably one of the tuners is not functioning. Possibly it is not even completed, that is, the coil may not be across the condenser at all or it may be connected only on one side. If your condensers are on one control it may be that the condensers are not lined up well. Make sure that the condensers are equal and that the coils likewise are equal.

* * *

HEATER TUBES ON DC

IS IT possible to operate heater type tubes on direct current by connecting all the heaters in series. It seems to me that this is possible since the cathodes can be run independently to any desired points. If I am wrong please put me straight—H. Q.

It is entirely feasible to do so provided you have a voltage source high enough to take care of the number of tubes you want to put in series and also provided that it can deliver a current of 1.75 amperes. Such an arrangement, however, would be rather expensive when used on a 110 volt DC line. In fact the set will take about 200 watts for the heaters alone. Since each tube requires a voltage of 2.5 volts it is possible to connect 44 of these tubes in series, and it will cost no more to heat all of these than to heat a single one, if all are in series.

RESISTANCE VERSUS IMPEDANCE COUPLING

WHICH IS better, resistance or dual impedance coupled audio? I have tried both but I cannot make up my mind which of the two gives me the less trouble. Either type gives plenty. And that brings up my real question: How can I operate either with stability?—J. B. K.

One fan will swear by resistance coupling and another by dual impedance, and one has as much right to swear as the other. The fact is that both are capable of excellent quality. But the capability is not by any means identical with actuality. If it were, you would not have had any trouble. Another fact is that both give a great deal of trouble. One is that the stopping condensers choke up by leakage from the plates. Dual impedance is not subject to this trouble so much as resistance coupling because the grid choke is a better leak than a resistance grid leak. The other trouble is that much-talked-about motorboating. Both types of amplifiers are subject to this nuisance and the cure is the same for both. By-pass the B supply leads with large condensers, preferably electrolytic.

* * *

SMALL COILS REQUESTED

INOTICED with interest, on cover of issue Nov. 23rd, "Coil Designs for Supers," and on reading find the specifications to be the same old 2.5-inch tubes for winding base.

The modern compact receiver "works" but does not have these bunglesome parts. I believe it would be extremely interesting to your readers to see some articles and specifications on the smaller forms of coil and IF transformers. Cabinets with 30-inch openings can't be bought any more. What can you do for us who are about to "go cold" on the "roll your own" idea?—C. W. S.

Criticism and suggestions of this kind are always welcome. Our answer to this particular letter is that in the very near future we shall once more give a list of winding data and coil forms. We shall also give designs for intermediate frequency transformers for different frequencies and winding forms. While most fans prefer to "roll their own" on forms and with wire large enough to handle with the bare hands, there are a few who desire to use smaller stuff. One drawback with giving tables is that it will keep us busy the rest of our radio life answering fans which coil in the table is really the best.

* * *

SLIDE WIRE BRIDGE

WILL YOU kindly publish circuit diagrams of slide-wire Wheatstone bridges for both direct current and alternating?—L. M.

You will find three different Wheatstone bridge circuits in Fig. 812. The first to the left is for direct current, operated by a battery E. Balance is indicated by the milliammeter MA. For accurate balance this meter should be very sensitive. The resistance AB is the slide-wire and the point P indicates the slider. R1 is a known resistor and RX the one to be measured. The circuit in the middle is for alternating current and is operated by current supplied by transformer T. The balance indicator is a headset. The circuit at the right is also for alternating current but the indicator in this instance is an amplifier. This is far more sensitive than the circuit in the middle.

SPEAKER RATTLES ON LOW NOTES

MY INDUCTOR dynamic speaker frequently rattles on the low notes, yet the low notes are not reproduced strongly. The amplifier is all right, for it is resistance coupled and is supposed to amplify down to 30 cycles. What is wrong with the speaker?—W. H. C.

There is nothing the matter with the speaker. Any speaker will rattle if enough is put into it, and it will rattle first on the low notes. The trouble in your case is that you have not baffled it enough. The armature can move without much resistance on the low notes and so moves far enough to strike the buffers. Load it up with a baffle and it will not only stop rattling, but it will bring out the low notes.

WHY A MULTITUDE OF CONDENSERS?

I HAVE noticed that in AC circuits many more by-pass condensers are used than in equivalent DC circuits. What is the reason for this difference?—B. J. E.

It is true that there are more by-pass condensers in an AC circuit than in an equivalent DC circuit, but not so many more as appears. In the AC circuit they are placed so that they logically go with the circuit diagram, while in the DC they are placed in the power supply. When more condensers are used in the AC circuit it is usually because bias resistors are used and that they must be by-passed more than a bias battery.

TICKLER MAKES CIRCUIT SQUAWK

WHY IS IT that a squawk starts whenever I turn up the tickler to secure a greater sensitivity? Do you think that the grid of the detector is blocking, or do you think there is something else that is wrong?—A. H.

It may be that the grid blocks when you turn the tickler up, but it is even more probable that the plate resistance of the detector tube changes so that motorboating starts in the audio amplifier. Much depends on the nature of the squawk. In the absence of details on this point we can only suggest those things that frequently do cause squawking without being specific.

DOUBTFUL ABOUT MATCHING

HOW IS IT that a transformer can be used to match the resistances of a tube and a speaker? Does not the primary of an output transformer have the same resistance all the time? I suspect that this matching business is just one more way of selling parts.—T. D. J.

If your suspicion were founded on fact all the telephone, telegraph, and electrical power companies would be wasting millions on transformers. There is no doubt about the value of a coupling transformer in matching impedances and making transmission more efficient, or more effective. The resistance of a primary of a transformer does not remain the same all the time, but depends on what resistance is connected across the secondary. If the secondary is short-circuited, the primary is also short-circuited, or nearly so.

PLAYING WITH SCREEN GRID AUDIO

RECENTLY I have been experimenting with audio amplification with screen grid tubes, especially in resistance coupled circuits. However, I have not been signally successful. There seems to be a type of distortion which I cannot account for. If there are any special tricks I wish you would point them out to me so that I can make the circuits work as well as they should. I have been assured by various articles and by experimenters that both a high degree of amplification and good quality can be secured from these tubes used in resistance coupling.—A. B.

There is no particular trick in making screen grid tubes operate satisfactorily in resistance coupled circuits. It is only necessary to insure that the voltages applied to the plate, screen, and grid are consistent among themselves and with the resistance in the plate circuit. Certain voltages are specified as normal, for example; for the 224 tube the grid voltage should be minus 1.5 volts, the screen voltage plus 75 volts, and the plate voltage plus 180 volts. This plate voltage is not the voltage applied at the low potential end of the coupling resistance, but is the effective voltage on the plate. This distinction is necessary for the screen grid tube, but not for three-element tubes. Now, if the screen grid tube is to amplify considerably more than a high mu. three-element tube the resistance load must be high, say 250,000 ohms or more. But the voltage drop in such high resistance is very high; in fact, it is the greater part of the total voltage in the plate circuit. Hence, it is necessary to make the total voltage in the plate circuit considerably higher than would be necessary for a three-element tube. There is one alternative, and that is to lower the voltage applied on the screen. The lower this voltage is the more nearly does the tube behave like a three-element tube, and, of course, the lower is the amplification. But it is better to have reasonably high amplification without distortion than extremely high amplification, theoretically, and nothing but distortion. Practically, it would be better to use the highest applied voltage available in the circuit and then reduce the screen grid voltage to the value necessary to retain a high degree of amplification without distortion. A good combination is 300 volts in the plate circuit and 30 volts on the screen, the plate resistance being about 250,000 ohms. It is also possible to increase the

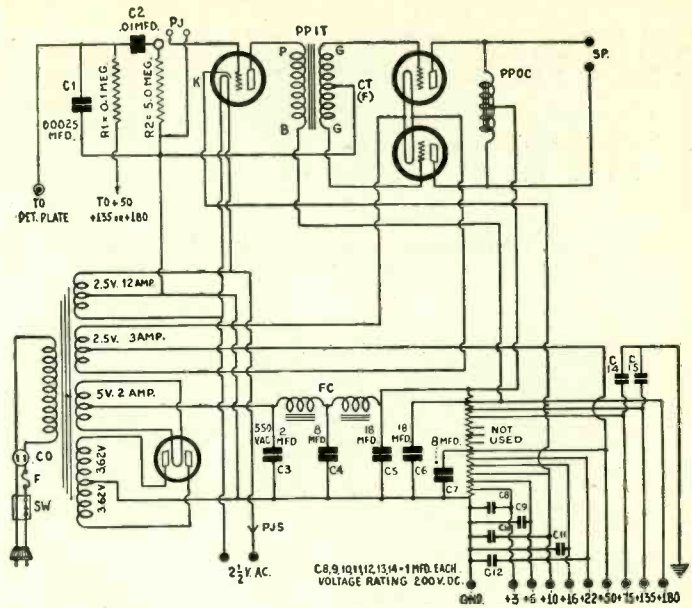

FIG. 813
A TWO-STAGE, PUSH-PULL AMPLIFIER WITH POWER SUPPLY BUILT AROUND THE POLO BLOCK. THE VOLTAGE DIVIDER CONTAINS MANY TAPS FOR A LARGE SELECTION OF PLATE VOLTAGES.

bias on the control grid, but this is not so good as to increase the plate voltage and decrease the screen voltage. Still another possibility is to reduce the plate load resistance, but this lowers the amplification considerably. The secret, then, of operating the screen grid tube in a resistance coupled circuit is to make the effective voltage on the elements right.

POWER SUPPLY AND AMPLIFIER

I SHOULD like to have a circuit diagram of an amplifier and a power supply suitable for the Polo block. I prefer an amplifier in which the last stage is push-pull.—D. D. O.
Fig. 813 shows a circuit which has been built around the Polo block. A feature of this circuit is that many different voltages are available on the voltage divider. The larger condensers in the filter are of the electrolytic type. Arrangement is made for connecting a phonograph pick-up unit in the grid circuit of the first amplifier tube.

Join
Radio World's
UNIVERSITY CLUB

And Get Free Question and Answer Service for the Coming 52 Weeks. This Service for University Subscribers Only

Subscribe for RADIO WORLD for one year (52 numbers) Use the coupon below. Your name will be entered on our subscription and University Club lists by special number. When sending questions, put this number on the outside of the forwarding envelope (not the enclosed return envelope) and also put it at the head of your queries. If already a subscriber, send \$6 for renewal from close of present subscription and your name will be entered in Radio University.

NO OTHER PREMIUM GIVEN WITH THIS OFFER

[In sending in your queries to the University Department please paragraph and number them. Write on one side of sheet only. Always give your University Club Number.]

RADIO WORLD, 145 West 45th Street, New York City.

Enclosed find \$6.00 for RADIO WORLD for one year (52 nos.) and also enter my name on the list of members of RADIO WORLD'S UNIVERSITY CLUB, which gives me free answers to radio queries for 52 ensuing weeks, and send me my number indicating membership.

Name

Street

City and State

If renewing subscription, put cross here.

HOOVER FAVORS A PERMANENT COMMISSION

Washington.

In his recent message to the Senate and the House of Representatives President Hoover said:

"I recommend the reorganization of the Radio Commission into a permanent body from its present temporary status. The requirement of the present law that the Commissioners shall be appointed from specified zones should be abolished and a general provision made for their equitable selection from different parts of the country. Despite the effort of the Commissioners, the present method develops a public insistence that the Commissioners are specially charged with supervision of radio affairs in the zone from which each is appointed. As a result there is danger that the system will degenerate from a national system into five regional agencies, with varying practices, varying policies, competitive tendencies, and consequent failure to attain its utmost capacity for service to the people as a whole."

The life of the Commission as an executive body is soon to expire, unless Congress enacts legislation to extend that life.

Representative White (Rep.), of Lewiston, Me., chairman of the House Committee on Merchant Marine and Fisheries, introduced a bill to provide for the indefinite continuance of all power vested in the Federal Radio Commission under the radio act of 1927.

Senator Dill (Dem.), of Washington, introduced a bill to extend the life of the Radio Commission.

The Interstate Commerce Committee met at the call of the chairman, Senator Couzens (Rep.), of Michigan, to map out a program for further hearings on the control of communications and power.

Germany Plans Powerful Chain

A dispatch from Berlin states that due to blanketing by London's new powerful transmitter and other high power stations surrounding Germany, the German Ministry has decided to start the construction of the planned power station near Stuttgart with a capacity of 50 to 100 kilowatts. At the same time the construction of a huge net of stations, with the same wavelengths, such as already are used in Berlin, Magdeburg, Stettin and Danzig, will be started.

RADIO HOLDS ITS OWN

In a survey of industries' yearly sales compared with a year ago, recently compiled, only five big industries had sales better than their sales in 1928. Radio, however, held its own with sales equal to a year ago and since the compilation has shown a slight gain. Radio in this respect ranked with forty-nine other leading industries, covering chiefly necessities, fundamentals and luxuries.

DOING THE BEST WE CAN

Radio World has been receiving so many subscriptions of late that the Subscription Department is somewhat behind in its work. Please give us time to enter your subscription. We will enter all subscriptions as fast as we possibly can.

Double Screen Grid Tube Due

A new tube is reported to be in the finishing process in developmental laboratories. It is described as a double screen-grid tube, intended to be ready for the public next season.

Only one additional wire would be necessary in the receiver and this would provide the bias for the second screen, the tap for which would come from the base of the tube.

This bias may be $7\frac{1}{2}$ to 12 volts positive. The intended circuits used will be similar to those now in vogue for the present screen grid tube.

The new five-element tube would have a screen for the grid, as well as the present screen for the plate. The new screen is said to lower the internal resistance, resulting in greater amplification.

Tube engineers say that the new tube will require no special radio frequency transformers.

In experiments with the new tube, coils designed for general purpose three-element tubes have been found to work efficiently. It has been found that primaries of from 6 to 10 turns gave the rated voltage amplification of 200 per stage. It is expected that the new tube will be easily interchangeable in sets using the present screen grid tube, as the only requirement will be the wire for the auxiliary grid bias.

Police Quiz Seer On Broadcasts

ROCHESTER, N. Y.

Wilbert W. Holley, of Los Amigos, Cal., who had become one of the most popular features over WHEC, was queried by the police on alleged fortune telling. He had been peering into the future for radio fans and is said to have received from 500 to 700 letters daily, as the result of broadcasts. It is alleged that his predictions were somewhat misleading, had caused domestic strife and that his activities included sale of astrological charts, guides to love, marriage, business success, etc.

WABC Answers Jersey's Complaint

Washington.

A reply has been made by WABC of the Columbia Broadcasting System to the protest instituted by the State of New Jersey against the installation of the station's proposed giant broadcasting plant at Columbia Bridge, in Morris County, N. J. The company frankly declared that it had no intention of completing the station if it should prove a nuisance to listeners in New Jersey.

"We are quite as anxious as the State of New Jersey that this station shall not become a nuisance, because the citizens of New Jersey form a part of our listening public," Sam Pickard, vice-president of the Columbia Broadcasting Company told the Federal Radio Commission.

"We do not want the station to 'blanket out' other stations. We believe, however, that the site selected is the best available in the New York-New Jersey district."

Meanwhile the transmitter remains in Queens County, N. Y.

WRIT AGAINST RCA ON TUBES IS MADE FINAL

Wilmington, Del.

The temporary injunction against the Radio Corporation of America restraining it from enforcing clause 9 of its contract with licensor set manufacturers for use of only RCA or Cunningham tubes as initial equipment has been made permanent. The decree was signed by Judge Morris of the Federal District Court. The plaintiff was Arthur D. Lord, receiver for the De Forest Radio Company. The receivership has been terminated since the inception of the suit.

The court in its new opinion said: "The defendant (RCA) now asserts, and the plaintiff denies, that the evidence adduced at the final hearing discloses that the licensees of the defendant are indispensable parties to the cause and that clause 9 of the license is not a contract or agreement whose effect may be to substantially lessen competition or tend to create a monopoly in any line of commerce.

"I think neither of these contentions of the defendant can be sustained. With respect to parties, the present record is not substantially different from that heretofore passed upon.

Sales Increased

"The new evidence touching the second contention consists mainly of the fact that clause 9, which went into practical effect about July 1, 1927, was suspended or abandoned by defendant about July 1, 1928, the number of tubes sold by defendant during this and the contiguous periods, and the estimated sales of tubes by independent manufacturers during the same periods. These figures show a relative increase in the sales made by the independent manufacturers during the time clause 9 was in effect.

"The period during which clause 9 was in effect was a short one. That period was likewise abnormal in that it was a period of changing conditions. It was during that time that the industry practically abandoned the battery or direct-current operated sets for alternating-current operated sets.

"Moreover, during that period some of the independent manufacturers, including the DeForest Radio Company, were compelled to sell tubes substantially below cost in order to continue their business.

"Moreover, the relative sales made during the period the clause was in actual operation do not negative the crucial fact that the tying clause effectually prevented the independent tube manufacturers from manufacturing tubes for defendant's licensees which, but for clause 9, the independent manufacturers would have been at liberty to do.

Injunction Granted

"Consequently, since these licensees were among the largest manufacturers of radio receiving sets, and, during the year 1927, occupied with defendant, according to defendant's own showing, 62 per centum of the entire tube field, it is obvious, I think, that clause 9 not only had the effect of substantially lessening competition, but was, as well, of a character to enable the defendant, by increasing the number of its licenses containing that clause, to destroy practically all competition in the manufacture and sale of tubes. Such agreements section 3 of the Clayton Act reaches in their incipency. An injunction must be granted."

U. S. STATIONS BY CALL LETTERS

With Location, Power, Frequency and Wavelength

FROM FEDERAL RADIO COMMISSION, AS CORRECTED TO DECEMBER 2d

[The transmitter location of each station is given, but where the studio is located in some other city or town, the studio location is given also, designated by the letter "S." Where two different powers are given, the larger is usually for daylight use only. "Kc" stands for frequency in kilocycles, "kw" for power in kilowatts, "M" for wavelength in meters.]

Station	Transmitter	Power	Kc.	M.
WAAF	Chicago, Ill.	500	920	325.9
WAAM	Newark, N. J.	1&2kw	1250	239.9
WAAT	Jersey City, N. J.	300	1070	280.2
WAAW	Omaha, Neb.	500	660	454.3
WABC	WBOQ—Queens Co. N. Y.	5,000	860	348.6
WABI	Bangor, Me.	100	1200	249.9
WABO	WHEC—See WHEC-WABO			
WABZ	New Orleans, La.	100	1200	249.9
WADZ	Akron, Ohio	1kw	1320	227.1
WAGM	Royal Oak, Mich.	50	1310	228.3
WAIU	Columbus, Ohio	500	640	468.5
WAPI	Birmingham, Ala.	5kw	1140	263
WASH	Grand Rapids Twp., Mich.	500	1270	236.1
WBAW	Lafayette, Ind.	500	1400	214.2
WBAA	Harrisburg, Pa.	500	1430	209.7
WBAL	Glen Morris, Md.			
WBAP	Fort Worth, Texas	10kw	1060	258.5
WBAX	Wilkes-Barre, Pa.	500	1210	247.8
WBBC	Brooklyn, N. Y.	500	1400	214.2
WBBL	Richmond, Va.	100	1370	218.8
WBMM	WJBT—Glenview, Ill.			
WBMS	Chicago, Ill.	25kw	770	389.4
WBRR	Rossville, N. Y.	1kw	1300	230.6
WBBY	Charleston, S. C.	75	1200	249.9
WBBZ	Ponca City, Okla.	100	1200	249.9
WBCM	Hampton Twp., Mich.			
WBIS	WNAAC—See WNAAC-WBIS			
WBLY	Bay City, Mich.	500	1410	212.6
WBNA	Fort Lee, N. J.	250	1450	206.8
WBNY	New York, N. Y.	250	1350	221.1
WBOQ	WABC—See WABC-WBOQ			
WBOW	Terre Haute, Ind.	100	1310	228.3
WBRC	Birmingham, Ala.	1kw & 500w	930	322.4
WBRE	Wilkes-Barre, Pa.	100	1310	228.3
WBRL	Tilton, N. H.	500	1430	209.7
WBRS	Wellesley Hills, Mass.	250	920	325.9
WBT	Charlotte, N. C.	5kw	1080	277.6
WBZ	E. Springfield, Mass.			
WBZA	Boston, Mass.	15kw	990	302.8
WBZ	Springfield, Mass.	500	990	302.8
WCAC	Storrs, Conn.	250	600	499.7
WCAD	Canton, N. Y.	500	1220	245.8
WCAG	Pittsburgh, Pa.	500	1220	245.8
WCAH	Columbus, Ohio	500	1430	209.7
WCAJ	Lincoln, Neb.	500	590	508.2
WCAL	Northfield, Minn.	1kw	1250	239.9
WCAM	Camden, N. J.	500	1280	234.2
WCAO	Baltimore, Md.	250	600	499.7
WCAP	Asbury Park, N. J.	500	1280	234.2
WCAT	Rapid City, S. D.	100	1200	249.9
WCAU	Byberry, Pa.			
WCAV	Philadelphia, Pa.	10kw	1170	256.3
WCAW	Burlington, Vt.	100	1200	249.9
WCAZ	Carthage, Ill.	50	1070	280.2
WCBA	Allentown, Pa.	250	1440	208.2
WCBD	Zion, Ill.	5kw	1080	277.6
WCBM	Baltimore, Md.	100	1370	218.8
WCBS	Springfield, Ill.	100	1210	247.8
WCCO	Anoka, Minn.			
WCCP	Minneapolis, Minn.	7&1/2kw	810	370.2
WCDA	Cliffside Park, N. J.			
WCDF	New York City, N. Y.	250	1350	221.1
WCFL	Chicago, Ill.	1&1/2kw	1290	232.4
WCGU	Coney Island, N. Y.	500	1400	214.2
WCKY	Crescent Springs, Ky.			
WCLC	Covington, Ky.	5kw	1480	202.6
WCLO	Kenosha, Wis.	100	1200	249.9
WCLS	Joliet, Ill.	100	1310	228.3
WCMA	Culver, Ind.	500	1400	214.2
WCOA	Pensacola, Fla.	500	1120	267.7
WCOC	Meridian, Miss.	1kw & 500	880	340.7
WCOB	Harrisburg, Pa.			
WCOH	Greenville, N. Y.			
WCRW	Chicago, Ill.	100	1210	247.8
WCSH	Portland, Maine	500	940	319.0
WCSO	Springfield, Ohio	500	1450	206.8
WDAA	Tampa, Fla.	1kw	620	483.6
WDAF	Kansas City, Mo.	1kw	610	491.5
WDAG	Amarillo, Texas	250	1410	212.6
WDAH	El Paso, Texas	100	1310	228.3
WDAY	W. Fargo, N. D.	1kw	940	319
WDBJ	Roanoke, Va.	250&500	930	322.4
WDBO	Orlando, Fla.	1kw	620	483.6
WDEL	Wilmington, Del.	250&350	1120	267.7
WDGY	Minneapolis, Minn.	1kw	1180	254.1
WDDO	Chattanooga, Tenn.	2&1/2kw	1280	234.2
WDRS	New Haven, Conn.	500	1330	225.4
WDSU	New Orleans, La.	1kw	1250	239.9
WDWF	WLSI—Cranston, R. I.	100	1210	247.8
WDZ	Tuscola, Ill.	100	1070	280.2
WEAF	Bellmore, N. Y.			
WEAI	New York, N. Y.	50kw	660	454.3
WEAL	Ithaca, N. Y.	500	1270	236.1
WEAN	Providence, R. I.	250&500	780	384.4
WEAO	Columbus, Ohio	750	570	526
WEAR	Cleveland, Ohio	1kw	1070	280.2
WEBC	Superior, Wis.			
WEBC	Duluth, Minn.	1kw	1290	232.4
WEBS	Cambridge, Ohio	100	1210	247.8
WEDQ	Harrisburg, Pa.	100	1210	247.8
WEDR	Buffalo, N. Y.	200&100	1310	228.3
WEDW	Beloit, Wis.	350	560	535.4
WEDC	Chicago, Ill.	100	1210	247.8
WEDH	Erie, Pa.	30	1420	211.1
WEHI	Weymouth, Mass.			
WEI	Boston, Mass.	10kw	590	508.2

Station	Transmitter	Power	Kc.	M.
WEHC	Emory, Va.	100	1370	218.8
WEHS	Evanson, Ill.	100	1500	199.9
WELK	Phila., Pa.	100	1370	218.8
WEMC	Berrien Springs, Mich.	1kw	590	508.2
WENR	WBCN—Chicago, Ill.	50kw	870	344.6
WEVD	Forest Hills, N. Y.			
WEW	New York City	500	1300	230.6
WEW	St. Louis, Mo.	1kw	760	394.5
WFAA	Dallas, Texas	10kw	800	374.5
WFAN	Philadelphia, Pa.	500	610	491.5
WFBC	Knoxville, Tenn.	500	1200	249.9
WFBB	Atona, Pa.	100	1310	228.3
WFBJ	Collegeville, Minn.	100	1370	218.8
WFBL	Syracuse, N. Y.	750	900	331.1
WFBM	Indianapolis, Ind.	1kw	1230	243.8
WFBR	Baltimore, Md.	250	1270	236.7
WFDL	Flint, Mich.	100	1310	228.3
WFI	Philadelphia, Pa.	500	560	535.4
WFIW	Hopkinsville, Ky.	1kw	940	319
WFKC	Akron, Ohio	500	1450	206.8
WFKD	Wissinoming, Pa.			
WFLA	WSUN—Clearwater, Fla.	1-2 1/2kw	900	331.1
WGLA	Lancaster, Pa.	15	1310	228.3
WGBB	Freeport, N. Y.	100	1210	247.8
WGBS	Memphis, Tenn.	500	1430	209.7
WGBF	Evansville, Ind.	500	630	475.9
WGBI	Scranton, Pa.	250	880	340.7
WGBS	Astoria, L. I., N. Y.			
WGCM	New York City	500	1180	254.1
WGCP	Gulport, Miss.	100	1210	247.8
WGPE	Newark, N. J.	250	1250	239.9
WGES	Chicago, Ill.	500	1360	220.4
WGH	Newport News, Va.	100	1310	228.3
WGHP	Fraser, Mich.			
WGL	Fort Wayne, Ind.	750	1240	241.8
WGN	WLB—See WLB-WGMS			
WGN	WLIB—Elgin, Ill.			
WGN	Chicago, Ill.	25kw	720	413
WGR	Amherst, N. Y.			
WGR	Buffalo, N. Y.	1kw	550	545.1
WGST	Atlanta, Ga.	250	890	336.9
WGY	Schenectady, N. Y.	50kw	790	373.5
WHA	Madison, Wis.	750	940	319
WHAD	Milwaukee, Wis.	250	1120	267.7
WHAM	Victor Twp., N. Y.			
WHAR	Rochester, N. Y.	5kw	1150	260.7
WHAS	Carlstadt, N. J.			
WHAS	New York City	1kw	1300	230.6
WHAS	Jeffersontown, Ky.			
WHAS	Louisville, Ky.	10kw	820	365.6
WHAZ	Troy, N. Y.	500	1300	230.6
WHB	Kansas City, Mo.	500	950	315.6
WHBC	Canton, Ohio	10	1200	249.9
WHBD	Mt. Orab, Ohio	100	1370	218.8
WHBF	Rock Island, Ill.	100	1210	247.8
WHBL	Sheboygan, Wis.	500	1410	212.6
WHBO	Memphis, Tenn.	100	1370	218.8
WHBU	Anderson, Ind.	100	1210	247.8
WHBY	West De Pere, Wis.			
WHBY	Green Bay Wis.	100	1200	249.9
WHDF	Calumet, Mich.	100	1370	218.8
WHDH	Gloucester, Mass.	1kw	830	361.2
WHDI	Minneapolis, Minn.	500	1180	254.1
WHEC	WABO—Rochester, N. Y.	500	1440	208.2
WHFC	Cicero, Ill.	100	1500	199.9
WHIS	Bluefield, W. Va.	100	1420	211.1
WHK	Cleveland, Ohio	1kw	1390	215.7
WHN	New York, N. Y.	250	1010	296.9
WHO	Des Moines, Iowa	5kw	1000	299.8
WHP	Le Moyne, Pa.			
WHPS	Harrisburg, Pa.	500	1440	209.7
WIAS	Ottumwa, Iowa	100	1420	211.1
WIBA	Madison, Wis.	100	1210	247.8
WIBG	Elkins Park, Pa.	50	930	322.4
WIBM	Jackson, Mich.	100	1370	218.8
WIBO	Desplaines, Ill.			
WIBO	Chicago, Ill.	1&1/2kw	560	535.4
WIBR	Steuenville, Ohio	500	1420	211.1
WIBS	Jersey City, N. J.	250	1450	206.8
WIBU	Poynett, Wis.	100	1310	228.3
WIBW	(near) Topeka, Kan.	1kw-500w	580	516.9
WIBX	Utica, N. Y.	100-300	1200	249.9
WICC	Easton, Conn.			
WICC	Bridgeport, Conn.	500	1190	252
WIL	St. Louis, Mo.	100-250	1200	249.9
WILL	Urbana, Ill.	250-500	890	336.9
WILM	Wilmington, Del.	100	1420	211.1
WIOD	WMBF—Miami Beach, Fla.	1kw	560	535.4
WIP	Philadelphia, Pa.	500	610	491.5
WISN	Milwaukee, Wis.	250	1120	267.7
WJAC	Johnstown, Pa.	100	1310	228.3
WJAD	Waco, Texas	1kw	1240	241.8
WJAG	Norfolk, Neb.	1kw	1060	282.8
WJAK	Marion, Ind.	50	1310	228.3
WJAR	Providence, R. I.	250-400	890	336.9
WJAS	North Fayette Twp.			
WJAS	Pittsburgh, Pa.	1kw	1290	232.4
WJAX	Jacksonville, Fla.	1kw	1260	238
WJAY	Cleveland, Ohio	500	620	483.6
WJAZ	Mt. Prospect, Ill.			
WJAZ	Chicago, Ill.	5kw	1480	202.6
WJBC	La Salle, Ill.	100	1200	249.9
WJBI	Red Bank, N. J.	100	1210	247.8
WJBK	Ypsilanti, Mich.	50	1370	218.8
WJBL	Decatur, Ill.	100	1200	249.9
WJBO	New Orleans, La.	100	1370	218.8
WJBT	WBBM—See WBBM-WJBT			
WJBU	Lewisburg, Pa.	100	1210	247.8
WJBW	New Orleans, La.	30	1200	249.9
WJBY	Gadsden, Ala.	50	1210	247.8
WJDX	Jackson, Miss.	500-1kw	1270	236.1
WJJD	Moosheart, Ill.	20kw	1130	265.3
WJKS	Gary, Ind.	500-1 1/2kw	1360	220.4
WJR	Sylvan Lake Village, Mich.			

Station	Transmitter	Power	kc.	M.
WOR	Kearny, N. J.			
	S-Newark, N. J.	5kw.	710	422.3
WORC	Auburn, Mass.			
	S-Worcester, Mass.	100	1200	249.9
	(formerly WKBE)			
WORD	Batavia, Ill.			
	S-Chicago, Ill.	5kw.	1480	202.6
WOS	Jefferson City, Mo.	500-1kw.	630	475.9
WOV	Secaucus, N. J.			
	S-New York City	1kw.	1130	265.3
WOW	Omaha, Neb.	1kw.	590	508.2
WOWO	Ft. Wayne, Ind.	10kw.	1160	258.5
WPAP	WQAO-See WQAO-WPAP			
WPAP	Pawtucket, R. I.	100	1210	247.8
WPCC	Chicago, Ill.	500	560	535.4
WPCB	Hoboken, N. J.			
	S-New York City	500	810	370.2
WPEN	Philadelphia, Pa.	100-250	1500	199.9
	(formerly WP5W)			
WPG	Atlantic City, N. J.	5kw.	1100	272.6
WPOE	Patchogue, N. Y.	30-100	1420	211.1
WPOR	WTAR-See WTAR-WPOR			
WPSC	State College, Pa.	500	1230	243.8
WPTF	Raleigh, N. C.	1kw.	680	440.9
WQAM	Miami, Fla.	1kw.	1240	241.8
WQAN	Scranton, Pa.	250	880	340.7
WQAO	WPAP-Cliffside, N. J.			
	S-New York City, N. Y.	250	1010	296.9
WQBC	Utica, Miss.	300	1360	220.4
WQBZ	Weirton, W. Va.	60	1420	211.1
WRAP	LaPorte, Ind.	100	1200	249.9
WRAK	Erie, Pa.	50	1370	218.8
WRAP	Reading, Pa.	100	1310	228.3
WRAX	Philadelphia, Pa.	250	1020	293.9
WRBI	Tifton, Ga.	20	1310	228.3
WRBJ	Hatiesburg, Miss.	10	1500	199.9
WRBL	Columbus, Ga.	50	1200	249.9
WRBQ	Greenville, Miss.	100	1210	247.8
WRBT	Wilmington, N. C.	100	1370	218.8
WRBU	Gastonia, N. C.	100	1210	247.8
WRC	Washington, D. C.	500	950	315.6
WREC	Whitehaven, Tenn.			
	S-Memphis, Tenn.	500&1kw.	600	499.7
WREN	Lawrence, Kans.	1kw.	1220	245.8
WRHM	Fridley, Minn.			
	S-Minneapolis, Minn.	1kw.	1250	239.9
WRJN	Racine, Wis.	100	1370	218.8
WRK	Hamilton, Ohio	100	1310	228.3
WRNY	Coytesville, N. J.			
	S-New York City, N. Y.	250	1010	296.9
WRR	Dallas, Texas	500	1280	234.2
WRUF	Gainesville, Fla.	5kw.	1470	204
WRVA	Mechanicsville, Va.			
	S-Richmond, Va.	5kw.	1110	270.1
WSAI	Mason, Ohio			
	S-Cincinnati, Ohio	500	1330	225.4
WSAJ	Grove City, Pa.	100	1310	228.3
WSAN	Allentown, Pa.	250	1440	208.2
WSAR	Fall River, Mass.	250	1450	208.2
WSAZ	Huntington, W. Va.	250	580	516.9
WSB	Atlanta, Ga.	1kw.	740	405.2
WSBC	Chicago, Ill.	100	1210	247.8
WSBT	South Bend, Ind.	500	1230	243.8
WSDA	WSGH-See WSGH-WSDA			
WSFA	Montgomery, Ala.	500	1410	212.6
WSGH	WSDA-Brooklyn, N. Y.	500	1400	214.2
WSIX	Springfield, Tenn.	100	1210	247.8
WSJS	Winston-Salem, N. C.	100	1310	228.3
WSM	Nashville, Tenn.	5kw.	650	461.3
WSMB	New Orleans, La.	500	1320	227.1
WSMK	Dayton, Ohio	200	1380	217.3
WSOA	Deerfield, Ill.			
	S-Chicago, Ill.	5kw.	1480	202.6
WSPD	Toledo, Ohio	500&1kw.	1340	223.7
WSSH	Boston, Mass.	100&250	1420	211.1
WSUI	Iowa City, Iowa	500	600	499.7
WSUN	WFLA-See WFLA-WSUN			
WSVS	Buffalo, N. Y.	50	1370	218.8
WSYR	Syracuse, N. Y.	250	570	526
WTAD	Quincy, Ill.	500	1440	208.2
WTAG	Worcester, Mass.	250	580	516.9
WTAM	Brecksville Village, Ohio			
	S-Cleveland, Ohio	50kw.	1070	280.2
WTAQ	Township of Washington, Wis.			
	S-Eau Claire, Wis.	1kw.	1330	225.4
WTAR	WPOR-Norfolk, Va.	500	780	384.4
WTAW	College Station, Texas	500	1120	267.7
WTAX	Streator, Ill.	50	1210	247.8
WTBO	Cumberland, Md.	50	1420	211.1
WTFL	Toccoa, Ga.	250	1450	206.8
WTIC	Avon, Conn.			
	S-Hartford, Conn.	50kw.	1060	282.8
WTMJ	Brookfield, Wis.			
	S-Milwaukee, Wis.	1kw.&2 1/2kw.	620	483.6
WTNT	Nashville, Tenn.	5kw.	1490	201.2
	(formerly WBAW)			
WTOC	Savannah, Ga.	500	1260	238
WWAE	Hammond, Ind.	100	1200	249.9
WWJ	Detroit, Mich.	1kw.	920	325.9
WWL	New Orleans, La.	5kw.	850	352.7
WWNC	Asheville, N. C.	1kw.	570	526
WWRL	Woodside, N. Y.	100	1500	199.9
WWVA	Wheeling, W. Va.	5kw.	1160	258.5
KCRC	Enid, Okla.	100&250	1370	218.8
KDB	Santa Barbara, Calif.	100	1500	199.9
KDFN	Casper, Wyo.	100	1210	247.8
KDKA	Wilkins Township, Pa.			
	S-Pittsburgh, Pa.	50kw.	980	306.9
KDLR	Deviils Lake, N. D.	100	1210	247.8
KDYL	Salt Lake City, Utah	1kw.	1290	232.4
KECA	Los Angeles, Calif.	1kw.	1000	299.8
	(formerly KPJA)			
KEJL	Beverly Hills, Calif.	500	1170	256.3
KELW	Burbank, Calif.	500	780	384.4
KEX	Portland, Ore.	5kw.	1180	254.1
KFAB	Lincoln, Neb.	5kw.	770	389.4
KFBK	Great Falls, Mont.	500	1360	220.4
KFBK	Sacramento, Calif.	100	1310	228.3
KFBL	Everett, Wash.	50	1370	218.8
KFDM	Beaumont, Texas	500	560	535.4
KFDY	Brookings, S. D.	500&1kw.	545	415.1
KFEL	Denver, Colo.	250	640	475.9
KFEO	St. Joseph, Mo.	2 1/2kw.	560	535.4
KFGO	Boone, Iowa	100	1310	228.3
KFH	Wichita, Kans.	500	1300	230.6
KFHA	Gunnison, Colo.	50	1200	249.9
KFI	Los Angeles, Calif.	5kw.	640	468.5

Station	Transmitter	Power	kc.	M.
KFIF	Portland, Ore.	100	1420	211.1
KFIO	Spokane, Wash.	100	1230	243.6
KFIZ	Fond du Lac, Wis.	100	1420	211.1
KFJB	Marshalltown, Iowa	100	1200	249.9
KFJB	Oklahoma City, Okla.	5kw.	1470	204
KFJJ	Astoria, Ore.	100	1370	218.8
KFJM	Grand Forks, N. D.	100	1370	218.8
KFJR	Portland, Ore.	500	1300	230.6
KFJY	Fort Dodge, Iowa	100	1310	228.3
KFJZ	Fort Worth, Texas	100	1370	218.8
KFKA	Greeley, Colo.	500&1kw.	880	340.7
KFKB	Millford, Kans.	5kw.	1050	285.5
KFKU	Lawrence, Kans.	1kw.	1220	245.8
KFKX	KYW-See KYW-KFKX			
KFLV	Rockford, Ill.	500	1410	212.6
KFLX	Galveston, Texas	100	1370	218.8
KFMX	Northfield, Minn.	1kw.	1250	239.9
KFNF	Shenandoah, Iowa	500&1kw.	890	336.9
KFOR	Lincoln, Neb.	100&250	1210	247.8
KFOX	Long Beach, Calif.	1kw.	1250	239.9
KFPL	Dublin, Texas	15	1310	228.3
KFPM	Greenville, Texas	15	1310	228.3
KFPW	Siloam Springs, Ark.	50	1340	223.7
KFPY	Spokane, Wash.	500	1340	223.7
KFOA	KMOX-See KMOX-KFOA			
KFOA	Anchorage, Alaska	100	1230	243.8
KFOU	Holy City, Calif.	100	1420	211.1
KFOW	Seattle, Wash.	100	1420	211.1
KFQZ	Hollywood, Calif.			
	S-Los Angeles, Calif.	250	860	348.6
KFRS	San Francisco, Calif.	1kw.	610	491.5
KFRU	Columbia, Mo.	500	630	475.9
KFSB	San Diego, Calif.	500&1kw.	600	499.7
KFSG	Los Angeles, Calif.	500	1120	267.7
KFUL	Galveston, Texas	500	1290	232.4
KFUM	Colorado Springs, Colo.	1kw.	1270	236.1
KFUO	Clayton, Mo.	500&1kw.	550	545.1
KFUP	Denver, Colo.	100	1310	228.3
KFVU	Culver City, Calif.	250	710	422.3
KFVS	Cape Girardeau, Mo.	100	1210	247.8
KFWB	Hollywood, Calif.	1kw.	950	315.6
KFWF	St. Louis, Mo.	100	1200	249.9
KFWI	San Francisco, Calif.	500	930	322.4
KFWM	Richmond, Calif.	500&1kw.	930	322.4
KFXD	Jerome, Idaho	50	1420	211.1
KFKX	Denver, Colo.	250	630	475.9
KFKJ	Edgewater, Colo.	50	1310	228.3
KFKM	San Bernardino, Calif.	100	1200	249.9
	(formerly KFWC)			
KFKR	Oklahoma City, Okla.	100	1310	228.3
KFFXY	Flagstaff, Ariz.	100	1420	211.1
KFYO	Abilene, Texas	100&250	1420	211.1
KFYR	Bismarck, N. D.	500	550	545.1
KGA	Spokane, Wash.	5kw.	1470	204
KGAR	Tucson, Ariz.	100	1370	218.8
KGBC	San Diego, Calif.	250	1360	220.4
KGBU	Ketchikan, Alaska	500	900	331.1
KGBC	St. Joseph, Mo.	100	1370	218.8
KGCB	York, Neb.	500&1kw.	930	322.4
KGCA	Decorah, Iowa	50	1270	236.1
KGCI	San Antonio, Texas	100	1370	218.8
KGCR	Wartown, S. D.	100	1210	247.8
KGCU	Mandan, N. D.	100	1200	249.9
KGCV	Wolf Point, Mont.	100&250	1310	228.3
KGDA	Dell Rapids, S. D.	50	1370	218.8
KGDE	Fergus Falls, Minn.	50	1200	249.9
KGDM	Stockton, Calif.	50	1100	272.6
KGDY	Oldham, S. D.	15	1200	249.9
KGEE	Los Angeles, Calif.	1kw.	1300	230.6
KGEK	Yuma, Colo.	50	1200	249.9
KGER	Long Beach, Calif.	100	1370	218.8
KGEW	Fort Morgan, Colo.	100	1200	249.9
KGEZ	Kalispell, Mont.	100	1310	228.3
KGFA	Alva, Okla.	100	1420	211.1
KGFG	Oklahoma City, Okla.	100	1370	218.8
KGFI	Corpus Christi, Texas	100	1500	199.9
KGFI	Los Angeles, Calif.	100	1420	211.1
KGFL	Hallcock, Minn.	50	1200	249.9
KGFL	Raton, N. Mex.	50	1370	218.8
KGFW	Ravenna, Neb.	50	1310	228.3
KGFX	Pierre, S. D.	200	580	516.9
KGGA	San Francisco, Calif.	50	1420	211.1
KGGF	Picher, Okla.	500	1010	296.9
KGGM	Albuquerque, N. Mex.	250&500	1230	243.8
KGHN	Pueblo, Colo.	250	1320	227.1
KGHI	Little Rock, Ark.	100	1200	249.9
KGHL	Billings, Mont.	500	950	315.6
KGHR	Richmond, Texas	50	1500	199.9
KGIO	Twin Falls, Idaho	250	1320	227.1
KGIR	Butte, Mont.	250	1360	220.4
KGIV	Trinidad, Colo.	100	1420	211.1
KGIX	Las Vegas, Nev.	100	1420	211.1
KGIF	Little Rock, Ark.	250	890	336.9
KGKB	Brownwood, Texas	100	1500	199.9
KGKI	San Angelo, Texas	100	1370	218.8
KGKO	Wichita Falls, Texas	250&500	570	526
KGKX	Sandpoint, Idaho	15	1420	211.1
KGO	Oakland, Calif.	7 1/2kw.	70	379.5
KGRS	San Antonio, Texas	100	1370	218.8
KGRS	Amarillo, Texas	1kw.	141	

TALLY REVEALS MIDWEST HAS MOST STATIONS

Washington.

Information on the distribution of radio facilities among the five zones, that will upset the long-held beliefs of the majority of radio fans has been disclosed in a report prepared for the Senate to be used in analysis of the Davis equalization amendment to the radio law. This law provides for the equal distribution of radio broadcasting facilities among the five radio zones, based on population.

It is shown that the Middle Western, or Fourth Radio Zone, is far in advance of the other zones as to number of stations. The Fourth Zone also surpasses, by substantial amounts, three of the five zones in broadcasting power. The figures, given below, comparing the number of broadcasting station licenses and power as of September 20th, 1928 to November 20th, 1929, were prepared by Commissioner Harold A. Lafount.

Fourth Zone's Rating

They show also the channel assignments to each of the zones. Here are some of the disclosures:

The Fourth Zone has 155 broadcasting stations, utilizing 325,265 watts of power. On September 20th, 1928, or prior to the nation-wide reallocation of broadcasting facilities effected pursuant to the Davis amendment, it had 152 stations using 156,015 watts.

The First, or Eastern Zone, ranks next to the Fourth in point of broadcasting power, with 307,225 watts, but has an aggregate of only 117 stations. On September 20th, 1928, it had 117 stations, using 197,425 watts.

The Second, or East Central Zone, has 104 stations with 226,855 watts, as against 96 stations with 109,680 watts; the Third, or Southern Zone, 117 stations with 188,070 watts as compared to 117 stations with 60,580 watts, and the Fifth, or Western Zone, 127 stations with 107,925 watts as against 124 stations with 67,850 watts.

New York State, with 55 broadcasting stations, leads all other States in point of total stations.

In respect to power, Illinois is far in the lead with 213,250 watts.

How Zones Fare Told in Table

Table of Zones, Showing Number of Stations and Power in Watts as of November 20th, 1929.

State	First Zone	Stations	Power
Connecticut	4	51,250
Delaware	2	350
Dist. of Columbia	3	850
Maine	3	1,100
Maryland	5	10,650
Massachusetts	15	20,300
New Hampshire	2	600
New Jersey	23	53,900
New York	52	166,815
Porto Rico	1	500
Rhode Island	5	800
Vermont	2	110
Virgin Islands		
		117	307,225
Second Zone			
Kentucky	4	16,030
Michigan	17	10,950
Ohio	23	108,960
Pennsylvania	37	68,755
Virginia	9	16,250
West Virginia	6	5,910
		96	226,855
Third Zone			
Alabama	7	7,650
Arkansas	7	12,450
Florida	10	14,100
Georgia	7	2,320
Louisiana	11	17,980
Mississippi	6	1,510
North Carolina	7	7,550
Oklahoma	11	12,750
South Carolina	1	75
Tennessee	17	26,000
Texas	33	85,685
		117	188,070
Fourth Zone			
Illinois	39	213,250
Indiana	16	14,700
Iowa	19	25,000
Kansas	7	9,100
Minnesota	11	22,700
Missouri	19	15,700
Nebraska	9	9,650
North Dakota	6	1,900
South Dakota	9	4,465
Wisconsin	17	8,800
		152	325,265
Fifth Zone			
Alaska	2	600
Arizona	6	1,800
California	45	40,250
Colorado	14	16,700
Hawaii	1	500
Idaho	6	1,815
Montana	5	1,450
Nevada	1	100
New Mexico	3	10,300
Oregon	14	10,015
Utah	3	6,100
Washington	23	17,795
Wyoming	1	500
		124	107,925
Grand totals		606	1,155,340
Channel Assignments to Zones			
Zones	Cleared	Regional	Local
First	8	27	6
Second	8	26 1/2	6
Third	8	28	6
Fourth	8	25 1/2	6
Fifth	8	27	6

209 ARE ON AIR AT SAME TIME DURING NIGHT

BY HAROLD A. LAFOUNT
Federal Radio Commission

Records of the Federal Radio Commission show that under the present allocation only 209 broadcasting stations are now operating at night simultaneously on 84 of the 90 available channels, exclusive of the 100 watt or less stations operating on six channels assigned to them.

There are 39 stations operating simultaneously on 39 channels and 170 operating on 45 regional channels. There is an average of less than four stations on each regional channel.

These figures conflict with the popular impression that the 600 stations now licensed operate simultaneously on the 90 available channels. If that were so intolerable interference would prevail in nearly all sections of the country.

732 At Once in 1927

Such a condition practically existed when the Commission took office on March 15, 1927. At that time 732 stations were in effect broadcasting day and night.

Many reports indicate that the present set-up has materially improved radio reception in most sections of the country and little improvement can be expected under any allocation plan unless the number of stations is materially reduced.

Occasionally the Commission finds it advantageous to shift the frequencies of stations because of some unusual condition. However, since to change one station affects the assignment of many other stations—often as high as 20—the problem of granting local relief often assumes gigantic proportions.

Why Many Are Turned Down

Since nearly all sections of the country are now provided with fair, if not good, radio reception, and because the channels are now groaning under the heavy load, the Commission has been forced to act adversely on many applications for new stations, which continue to be presented from all sections of the country.

CANADIAN STATIONS BY CALL LETTERS

WITH LOCATION, POWER, FREQUENCY AND WAVELENGTH

Station	Transmitter	Power	KC.	M.	Station	Transmitter	Power	KC.	M.	Station	Transmitter	Power	KC.	M.
CFAC	Calgary, Alta.	500	690	434.5	CHWC	Pilot Butte, Sask.	500	960	312.3	CJCA	Edmonton, Alta.	500	580	516.9
CFBO	St. John, N. B.	50	890	336.9	CHWK	Chilliwack, B. C.	5	1210	247.8	CJCB	Sydney, N. S.	50	880	340.7
CFCA	Toronto, Ont.	500	840	356.9	CKWJ	Toronto, Ont.	500	840	356.9	CJGJ	Calgary, Alta.	500	690	434.5
CFCF	Montreal, Que.	1650	1030	291.2	CKPC	Preston, Ont.	50	1210	247.8	CJGC	London, Ont.	500	910	329.5
CFCH	Iroquois Falls, Ont.	250	600	499.7	CKPR	Midland, Ont.	50	1120	267.7	CJGX	Yorkton, Sask.	500	630	475.9
CFCL	Toronto, Ont.	500	580	516.9	CKSH	St. H'cinthe, Que.	50	1010	296.9	CJHS	Saskatoon, Sask.	250	910	329.5
CFCN	Calgary, Alta.	500	690	434.5	CKUA	Edmonton, Alta.	500	580	516.9	CJOC	Lethbridge, Alta.	50	1120	267.7
CFCO	Chatham, Ont.	50	1210	247.8	CKWX	Vancouver, B. C.	100	730	513.0	CJOR	Sea Island, B. C.	50	1030	265.3
CFCT	Victoria, B. C.	500	630	475.9	CKX	Brandon, Man.	500	540	555.0	CJRM	Moose Jaw, Sask.	500	600	499.7
CFCY	Ch'lottet'n, P.E.I.	250	960	312.3	CKY	Winnipeg, Man.	5000	780	384.4	CJRW	Fleming, Sask.	500	600	499.7
CFJC	Kamloops, B. C.	15	1120	267.7	CNRA	Moncton, N. B.	500	630	475.9	CJSC	Toronto, Ont.	500	580	516.9
CFJG	Prescott, Ont.	50	1010	296.9	CNRC	Calgary, Alta.	500	690	434.5	CKAC	Montreal, Que.	5000	730	413.0
CFJH	Fredericton, N. B.	50	1210	247.8	CNRE	Edmonton, Alta.	500	580	516.9	CKAD	Vancouver, B. C.	50	730	413.0
CFJN	Saskatoon, Sask.	500	910	329.5	CNRL	London, Ont.	500	910	329.5	CKCI	Quebec, Que.	22	880	340.7
CFJQ	Toronto, Ont.	4000	960	312.3	CNRM	Montreal, Que.	1650	730	413.0	CKCK	Regina, Sask.	500	960	312.3
CFJR	Kingston, Ont.	500	1120	267.7	CNRO	Ottawa, Ont.	500	600	499.7	CKCL	Toronto, Ont.	500	580	516.9
CFJRC	Calgary, Alta.	500	690	434.5	CNRQ	Quebec, Que.	50	880	340.7	CKCO	Ottawa, Ont.	100	690	434.5
CHCA	Ch'lottet'n, P.E.I.	30	960	312.3	CNRR	Regina, Sask.	500	960	312.3	CKCR	Brantford, Ont.	50	1010	296.9
CHCK	Ch'lottet'n, P.E.I.	10	880	340.7	CNRS	Saskatoon, Sask.	500	910	329.5	CKCV	Quebec, Que.	50	880	340.7
CHCS	Hamilton, Ont.	1000	840	356.9	CNRT	Toronto, Ont.	500	840	356.9	CKCF	Vancouver, B. C.	50	730	413.0
CHCT	Red Deer, Alta.	25	1120	267.7	CNRV	Vancouver, B. C.	500	1030	291.2	CKGW	Toronto, Ont.	5000	690	434.5
CHGS	Summerside, P.E.I.	30	730	413.0	CNRW	Winnipeg, Man.	5000	780	384.4	CKIK	Wolfville, N. S.	50	930	322.4
CHIS	Vancouver, B. C.	50	730	413.0	CHYC	Montreal, Que.	500	730	413.0	CKIC	Red Deer, Alta.	1000	840	356.9
CHMA	Edmonton, Alta.	250	850	516.9	CJBC	Toronto, Ont.	500	840	356.9	CKMC	Cobalt, Ont.	15	1210	247.8
CHML	Hamilton, Ont.	50	880	340.7	CJBR	Regina, Sask.	500	960	312.3	CKMO	Vancouver, B. C.	50	730	413.0
CHNS	Halifax, N. S.	500	930	322.4				960	516.9	CKNC	Toronto, Ont.	500	580	516.9
CHRC	Quebec, Que.	25	880	340.7				960	312.3	CKOC	Hamilton, Ont.	50	880	340.7

0-60,0-300 HIGH RESISTANCE DC VOLTMETER

With three 28" tipped leads built in



A portable type, high resistance meter, 2 1/4" outside diameter, for close reading of direct current voltages up to 60 volts, and for reading DC voltages up to 300 volts. Three vari-colored 28" insulated leads, with jack tips, are built in. Black is minus, yellow is 60 volts maximum and red is 300 volts maximum. These voltages are marked at the meter outlets. Cat. J-246. Net price, \$2.28.

J-246 Voltmeter, for measuring all direct current voltages, including B eliminators. 0-60, 0-300 (double range).

Multiplier, with jack terminals, to increase range 0-300 range to 0-600. Cat. J-106JT (with jack terminals), net price, \$1.18.

GUARANTY RADIO GOODS CO.
143 West 45th St., N. Y. City

MORECROFT

New second edition of "Principles of Radio Communication," by Prof. John H. Morecroft, of the Electrical Engineering Department of Columbia University and past president of the Institute of Electrical Engineers. This is an outstanding and authoritative book on the subject.

This large book on radio principles and practice is something that you must not be without. Every set builder, every designer, every engineer, every service man, simply must have this book. Ready reference to all intricate problems makes this volume invaluable. Set builders, experimenters, distributors, dealers, salesmen and teachers, students and operators, all find Morecroft their standby, and now the new second edition awaits you. 1,001 pages and 837 illustrations in this cloth-bound volume.

Price \$7.50

RADIO WORLD
145 West 45th Street
New York City
(Just East of Broadway)

RADIO WORLD'S BOOK SERVICE has been found of great value not only by radio fans, constructors, etc., but also by radio and other technical schools throughout the country. See the radio books advertisements in this issue.

All Parts for

HB33-\$28.33

HB44-\$46.44

THE HB33 is a three-stage screen grid radio frequency amplifier, with screen grid power detector, all shielded, 112A first audio and 112A push-pull output. Single dial control, seven-tube circuit. Price includes all parts and crackle brown finish drilled cabinet. Order Cat. HB33 at \$28.33 (less tubes).

THE HB44 is the same fundamental circuit as the HB33 but is for AC operation. Three stages of screen grid RF, with screen grid power detector, all shielded, 227 first audio and 245 push-pull output. Single dial control 7-tube circuit and 280 rectifier, 8 all told. Price includes all parts, including power equipment, socketed subpanel (8 sockets, including one for 280 rectifier) and crackle brown finish drilled cabinet. Order Cat. HB44 at \$46.44 (less tubes).

GUARANTY RADIO GOODS CO.
143 West 45th Street
New York, N. Y.

(Just East of Broadway)

- Remittance with order.
- Ship C. O. D.

RADIO WORLD, 145 W. 45th St., N. Y. City.
(Just East of Broadway)

Enclosed please find \$3.00 for which please send one aluminum subpanel 10x20" for the new battery model 4-tube 8G Diamond of the Air, with sockets built in, and with self-bracketing front and side and rear supports; also send hardware and insulating washers.

Enclosed please find \$2.35 for which please send 7x21" drilled Bakelite front panel for the new battery model Diamond.

Enclosed please find \$3.25 for the 10x20" aluminum subpanel, etc., for the new AC Screen Grid Diamond.

Enclosed please find \$2.35 for the 7x21" drilled Bakelite front panel for the new AC Screen Grid Diamond.

Enclosed please find \$5.00 for both the aluminum subpanel, etc., and the drilled Bakelite front panel of the battery model.

Enclosed please find \$5.25 for both the aluminum subpanel, etc., and the drilled Bakelite front panel of the AC model.

Name

Address

City..... State.....

For That Boy at Christmas Time

Why not have us send him **RADIO WORLD** for the coming year and keep him abreast of all that is going on in radio? Besides, every week **RADIO WORLD** will carry him a message that suggests your thoughtfulness.

Also, on receipt of your \$6, we shall take pleasure in sending him a special letter to the effect that you have requested us to put his name on our subscription list for 52 issues.

Subscription Dept., **RADIO WORLD**, 145 W. 45th St., N. Y. C.

BROADWAY-HOLLYWOOD

World's most intriguing places. Where famous stage, screen, radio stars live their lives. Intimate stories of their stage and personal doings in

NEW STAR National Illustrated Amusement Weekly

Edited by Roland Burke Hennessy. Clever writers cover comedy, tragedy, fascination of professional life. Portraits and unusual pictures of favorites. 10c copy, \$5 year (52 issues). **SPECIAL: 12 issues \$1 and experts answer your questions. FREE. STAR, 1562 Broadway, New York.**

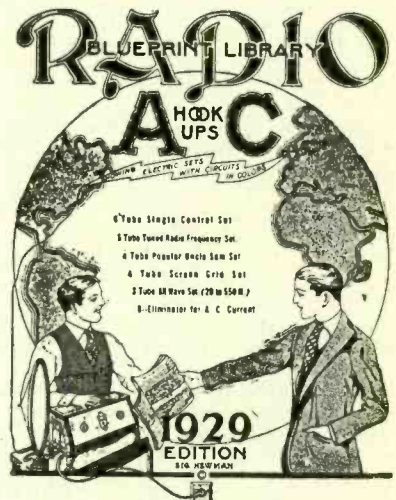

Fourteen Circuits

Each Shown in Colored Picture Diagram, Colored Schematic Diagram and Front Panel Layout

Get This **FREE** Book!

Complete AC electric receivers, with B eliminators included, also AC receivers without B eliminators, also battery operated models, all easy-to-build circuits, using your own parts.

RADIO WORLD, 145 W. 45th St., N. Y. City.
(Just East of Broadway)

Gentlemen: Enclosed please find \$1.00 for which please send me **Radio World** each week for eight weeks (regular price, \$1.20) and besides send me a **FREE** copy of the 1929 edition of **The Radio Blueprint Library of AC and Battery Hookups.**

Name

Address

City..... State.....

Note: Present mail subscribers may take advantage of this offer by putting a cross in this square. Your subscription will be extended eight weeks.

[Canadian remittance must be by postal or express money order, due to high discount rate on cashing Canadian checks in New York.]

PUBLISHERS CAN SUPPLY ALL 1929 SUMMER COPIES OF RADIO WORLD

If you have missed any copies of **Radio World** for the summer of 1929 and want to complete your file, let us know what issues you are short and we will mail them to you at 15c a copy, or any seven issues for \$1.00, mailed postpaid.

Circulation Dept., **Radio World**, 145 W. 45th St., N. Y. City.

FILL OUT AND MAIL NOW

SUBSCRIPTION BLANK

RADIO WORLD

RADIO WORLD

145 West 45th Street, New York City

Please send me **RADIO WORLD** for months, for which

SUBSCRIPTION RATES:

- Single Copy.....\$.15
- Three Months..... 1.50
- Six Months..... 3.00
- One Year, 52 Issues..... 6.00
- Add \$1.00 a Year for Foreign Postage; 50c for Canadian Postage.

please find enclosed

.....
.....
.....

Short Wave Circuit

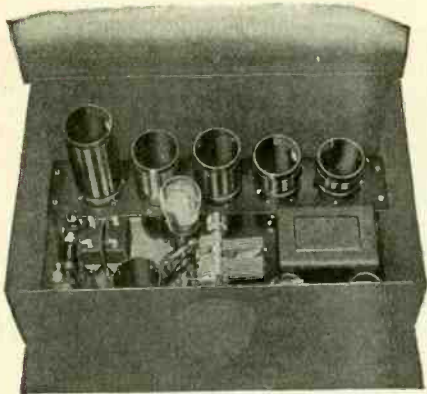

National Thrill Box, 4-tube short wave circuit. 15 to 535 meters, battery-operation of filaments; B supply, either batteries or eliminator.

Get a real kick out of listening to foreign stations on a real short-wave circuit, the National Thrill Box. Uses one 222 screen grid RF amplifier, one 200A detector, one 240 first audio and one 171A or 112A output. Single control. Buy the parts and build the circuit in two hours. Data sheet shows dial settings where foreign stations come in. Cat. SW4EF, all parts, including decorative brown steel cabinet, all six plug-in coils, list price \$51.90 (less tubes). Your price \$31.00.

Guaranty Radio Goods Co.
143 West 45th Street New York City

Horn Unit \$2.25

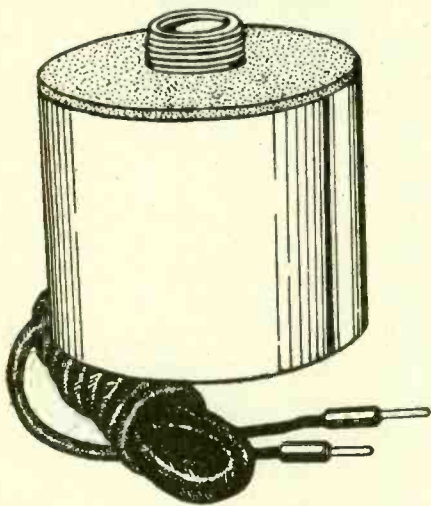

This unit is pre-eminent for horn-type speakers such as the exponential horns or other long tone-travel horns. The faintest word from a "whispering tenor" or the tumultuous shout of the crowd or highest crescendo of the band is brought out clearly, distinctly. Stands up to 450 volts without filtering. Works right out of your set's power tube, requiring no extra voltage source. Standard size nozzle and cap are die-cast aluminum, one piece, with milled platinum-like finish. The casing is full nickel, of highest possible polish. Works great from AC set, battery set or any other set, push-pull or otherwise.

For Portable Use

This unit can be used in a portable without any horn attached and will give loud reproduction. Order Cat. 225, with 4 1/2 ft. cord attached (Shipping weight, 2 lbs.) \$2.25

Air-Column Horn

8-ft. tone travel molded wood horn (less unit No. 225) is obtainable already mounted in a baffle box. Outside overall dimensions of baffle box, 21 1/4" high, 18" wide, 15" front to back. Shipping weight, 27 lbs. Order Cat. 596 @ \$8.00.

Acoustical Engineering Associates, 145 W 45th St., N. Y. City (Just E. of Bway).

Please ship C. O. D.
 Cat. No. 225 @ \$2.25 Cat. No. 596 @ \$8.00

Name

Address

City State

FIVE-DAY MONEY-BACK GUARANTEE

Every Latest Feature for Performance and Quality

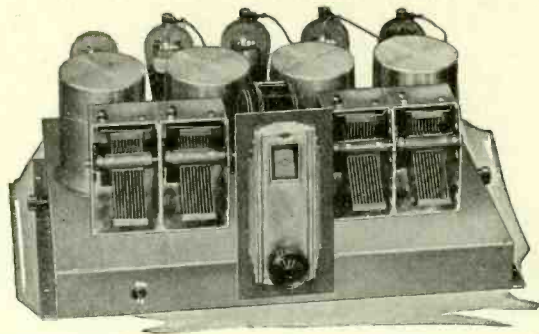

This new National MB-29 has every latest feature for performance and quality. *Four Screen Grid Tubes* for maximum sensitiveness—*Band Filter Tuning* for selectivity without cutting of side-bands—*Power Detection* is for securing maximum results from the new type high percentage broadcast modulation—*Power Audio Amplification*, 245's in push-pull recommended. Beautifully finished—rugged, shielded aluminum chassis with precision matched coils and condensers—*New National Projector Dial*. These are just the high spots. The new National MB-29 is simply full of new and ingenious features for your convenience and pleasure.

Now in stock for immediate delivery.

NATIONAL CO., Inc., Malden, Mass.

Write us today for full particulars and prices, mentioning Radio World.

NATIONAL SCREEN-GRID—MB-29

NEW Morecroft

"Elements of Radio Communication," by Prof. John H. Morecroft, of the Engineering Department of Columbia University, is the latest book on radio by this outstanding authority.

This book is entirely new and contains matter which never before has been published. It is written in plain language so that every radio novice can understand it, yet it is a complete course in the elements of radio.

It contains 266 pages, 170 illustrations and a complete index. Price \$3.00.

RADIO WORLD

145 West 45th St., New York, N. Y.

NEW DRAKE'S ENCYCLOPEDIA—1,680. Alphabetical Headings from A-battery to Zero Beat, 1,025 Illustrations, 920 Pages, 240 Combinations for Receiver Layouts. Price, \$6.00. Radio World, 124 W. 45th St., N. Y. C.

ARISTOCRAT FLOOR SPEAKER—With Molded Wood Horn and Horn Motor built in. Great value. \$14.00. Acoustical Engineering Associates, 143 W. 45th St., N. Y. C.

MICROPHONE LIGHTERS—For cigars or cigarettes, with button switch at top. Press switch, and lighter acts instantaneously. \$1.00. Model B lighter on tray, \$1.50. Radio World, 145 W. 45th St., N. Y. C.

HIGHEST RESISTANCE PHONES, \$1.65—You can't beat them at the price. Send now. Guaranty Radio Goods Co., 143 W. 45th St., N. Y. C.

LOOK AT YOUR WRAPPER

You will see by the date thereon when your subscription for Radio World expires. If the subscription is about to run out, please send us renewal so that you will not miss any copies. Subscription Department, RADIO WORLD, 145 West 45th St., N. Y. City.

Aristocrat Floor Speaker

With Molded Wood Horn of 8 ft. tone travel (exponential type) with baffle and horn motor built in. Extraordinary bargain. **\$14.00**

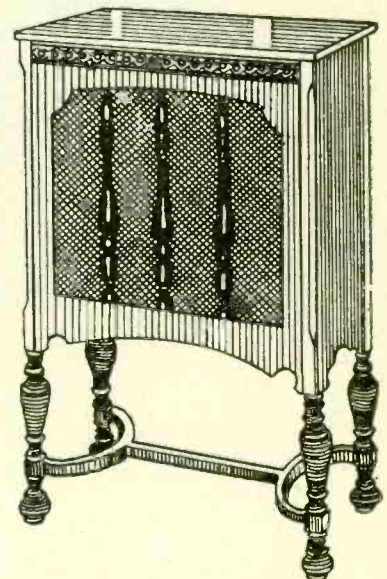

The speaker cabinet is walnut finish, 33" high, 24 1/2" wide, 17 1/2" deep, with carved legs. Golden cloth grille covers front opening. Built inside is No. 595 molded wood horn with baffle and No. 203 driving motor unit that stands 250 volts without filtration. Horn and motor removable. Table alone is worth price asked.

Shipped C.O.D. if desired.

Acoustical Engineering Associates
143 WEST 45TH STREET NEW YORK CITY

SUBSCRIBERS! Look at the Expiration Date on Your Wrapper

Please look at the subscription date stamped on your last wrapper, and if that date indicates that your subscription is about to expire, please send remittance to cover your renewal. Please give our subscription department two weeks to make changes in expiration dates, street addresses, etc.

In this way you will get your copies without interruption, and keep your file complete.

SUBSCRIPTION DEPARTMENT
RADIO WORLD, 145 West 45th St., N. Y. City

CONE ASSEMBLY WITH DOUBLE MAGNET UNIT

\$4.95



An excellent magnetic type speaker for installation in any cabinet. The unit is a double-magnet Paratone, with two magnet coils, for utmost sensitivity. Each horseshoe magnet is 3/4" thick. The magnet coils are forever protected against dust and other foreign, injurious substances, by special bakelite housings. The pin is reverse drive. The cone frame is metal. The 9" cone is specially treated buckram.

All assembled, with long cord, ready to play, Shipping weight 6 lbs. (Cat. CAS) Net **\$4.95**

The unit alone (cord included). It will operate any type sounding surface, including paper, cloth, wood, etc. Shipping weight 4 lbs. (Cat. UA) Net **\$2.95**

Guaranty Radio Goods Co.
145 West 45th St., New York City

NEWEST BOOK ON VACUUM TUBES

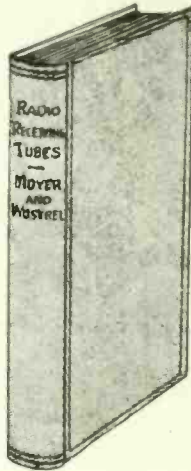

"RADIO RECEIVING TUBES," by James A. Moyer and John F. Westrel, first edition just off the press. No radio service man, experimenter or student of radio should be without this authoritative book on the principles and applications of vacuum tubes. It answers all your questions relating to receiving, amplifying and rectifying tubes. It is a complete discussion of tube principles, functions and uses, thoroughly up-to-date.

In this book the essential principles underlying the operation of vacuum tubes are explained in as non-technical a manner as is consistent with accuracy. The book covers the construction, action, reactivation, testing and use of vacuum tubes as well as specifications for vacuum tubes and applications for distant control of industrial processes and precision measurements.

Price \$2.50

RADIO WORLD

145 West 45th Street, New York City
(Just East of Broadway)

PLEASE GIVE US TWO WEEKS

for changing your address, showing new renewal expiration date, etc. Subscription orders are arriving in such large numbers that it takes two weeks to effectuate the change. **RADIO WORLD**, 145 West 45th St., N. Y. City.

PEERLESS Super Dynamic Console Speaker



Peerless Super Dynamic 12" AC-operated speaker, built into a Sonora console, with 2,000 mfd. filter condenser to kill hum; equipped with special rectifier and switch. Speaker by United Rep. Corp. List, \$155.00. Your price..... **\$37.50**

The famous Peerless AC dynamic speaker, with Kuprox rectifier and 2,000 mfd hum-killing condenser built-in, all housed in this 40" high Sonora cabinet of fascinating ply-walnut. The cabinet is all one piece—carved legs, marqueterie panel and grille pillars. Sliding back is made of caned steel, acoustically open to present boominess. This imposing floor model speaker, exactly as illustrated, in original factory packing case, shipping weight 100 lbs. Never in your life did you hear of such an amazing bargain—highest class, perfect, guaranteed merchandise at more than 75% off list price! Look at that beautiful console cabinet, its graceful legs, with archer's bow tiepiece; its rosetted side panels at front, its shapely grille pillars, all in two-tone effect, with high-polish surface of ply-walnut. The speaker sets against a golden grille, with ample baffle board concealed. Order catalog PSHB @ \$37.50. The console, which has removable back, is 40" high, 19" wide, 16" front to back. Speaker only, with 2,000 mfd. and Kuprox rectifier, all built up at factory. Order Cat. SO @ \$23.50. Cabinet only, Order Cat. CO @ \$15.00.

Guaranty Radio Goods Co.

143 West 45th Street New York City

Two for the price of One

Get a FREE one-year subscription for any ONE of these magazines:

- CITIZENS RADIO CALL BOOK AND SCIENTIFIC DIGEST (quarterly, four issues).
- RADIO (monthly, 12 issues; exclusively trade magazine).
- RADIO ENGINEERING (monthly, 12 issues; technical and trade magazine).
- SCIENCE & INVENTION (monthly, 12 issues; scientific magazine, with some radio technical articles).
- AMERICAN BOY—YOUTH'S COMPANION (monthly, 12 issues; popular magazine).
- BOYS' LIFE (monthly, 12 issues; popular magazine).

Select any one of these magazines and get it FREE for an entire year by sending in a year's subscription for RADIO WORLD at the regular price, \$6.00. Cash in now on this opportunity to get RADIO WORLD WEEKLY, 52 weeks, at the standard price for such subscription, plus a full year's subscription for any ONE of the other enumerated magazines FREE! Put a cross in the square next to the magazine of your choice, in the above list, fill out the coupon below, and mail \$6 check, money order or stamps to RADIO WORLD, 145 West 45th Street, New York, N. Y. (Just East of Broadway).

Your Name

Your Street Address

City State.....

If renewing an existing or expiring subscription for RADIO WORLD, please put a cross in square at beginning of this sentence.

RADIO WORLD, 145 West 45th Street, New York, N. Y. (Just East of Broadway)

DOUBLE VALUE!

SEPARATE TESTER COMBINATION

Consists of two-meter assembly in neat black metal case, with an external high resistance meter. The two meters in the case read (a) 0-20, 0-100 milliamperes; (b) 0-10 volts, AC or DC, same meter reads both. The external high resistance meter reads 0-600 volts, AC or DC (same meter reads both). Thus you can test any plate current up to 100 ma., any filament voltage, AC or DC, up to 10 V., and any plate voltage, or line voltage or other AC or DC voltage, up to 600 volts. Five-prong plug, screen grid cable, and 4-prong adapter included. Order Cat. ST-COMB @ \$11.00 2-meter assembly, cable plugs, Cat. 215 @ \$7.06 0-600 AC-DC meter alone, Cat. M600 @ \$4.95

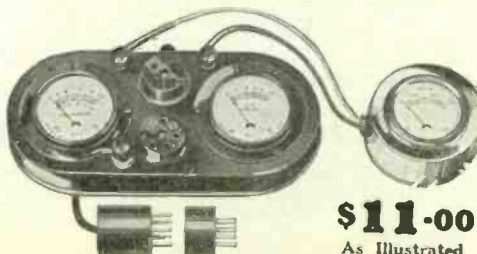

\$11.00
As Illustrated

Guaranty Radio Goods Co., 143 West 45th St., N. Y. City

Blueprint FREE!

Get a free blueprint of either circuit listed on the coupon below, by sending \$1.00 for eight weeks' subscription for RADIO WORLD, or send \$1.50 for 13 weeks' (quarter of a year) and get both blueprints free!
RADIO WORLD, 145 W. 45th St., N. Y. City
Enclosed please find:

- \$1 for which send RADIO WORLD for 8 weeks and send free blueprint of the battery model 4-tube Screen Grid Diamond of the Air.
- \$1 for which send RADIO WORLD for 8 weeks and send free blueprint of the 4-tube AC Screen Grid Diamond of the Air.
- \$1.50 for which send RADIO WORLD for 13 weeks and send both blueprints free. (If renewing a subscription put cross here.)

NAME
ADDRESS
CITY STATE.....

MICROPHONE LIGHTERS

For cigars or cigarettes, with button switch at top. Press switch, and lighter acts instantaneously. \$1.00. Model B lighter on tray, \$1.50. Radio World, 145 W. 45th St., N. Y. C.

O-1 MA, \$5.95

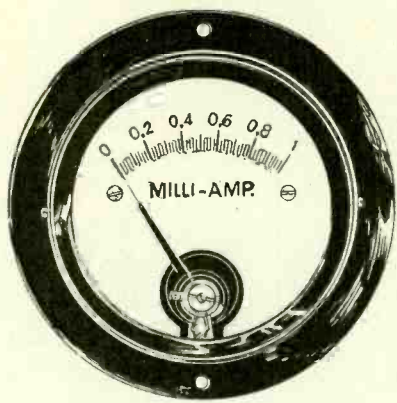

Here is a 0-1 milliammeter, accurate to plus or minus 1% clearly legible to two-one hundredths of a milliampere at any reading (20 microamperes). This expertly made precision instrument is offered at the lowest price so far for a 0-1 ma. Order Cat. FO-1 at \$5.95. C. O. D. orders accepted.

Guaranty Radio Goods Co.
143 West 45th Street,
New York City

AERIAL TUNER

Improves Your Reception

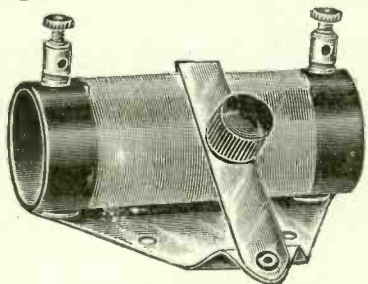

Remove aerial lead from set. Connect aerial instead to one of the binding posts of the Aerial Tuner. Connect the other binding post of the Aerial Tuner to antenna post of your set. Then move the lever of the Aerial Tuner until any weak station comes in loudest. The lever need not be moved for every different frequency tuned in. The Aerial Tuner acts as an antenna loading coil and puts the antenna's frequency at any frequency in the broadcast band that you desire to build up. Price, 85c.

GUARANTY RADIO GOODS CO.
143 West 45th Street
New York City
(Just East of Broadway)

BRILLIANT, NEW NATIONAL MODERNISTIC PROJECTION DIAL WITH RAINBOW FEATURE

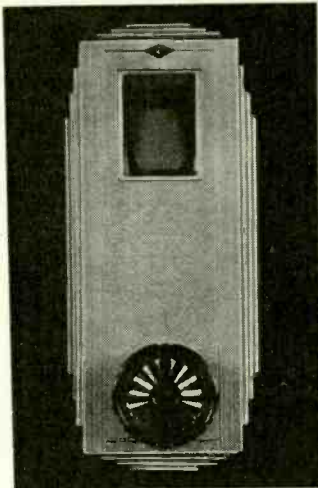

Modernize the appearance of your receiver by installing the brilliant new National dial, with color wheel built in, so that as you turn the dial knob one color after another floods the screen on which the dial numbers are read. On this screen the numbers are projected, so that you get the same dial reading from any position of the eye. This is just what DX hunters want—laboratory precision of dial reading.

The escutcheon is of modernistic design. The Velvet Vernier mechanism drives the drum superbly. Order today. Remit with order and we pay cartage. Shipments day following receipt of order.

GUARANTY RADIO GOODS CO.
143 W. 45th St., N. Y. City (Just E. of B'way)
Enclosed please find \$3.13 for which please send me dial marked below:
 Cat. HC8, National modernistic drum dial, with color wheel built in, pilot bracket, 6-volt pilot lamp for storage battery or A eliminator sets; hardware; instructions \$3.13
 Cat. HC2½, same as above, but with 2½-volt AC pilot lamp 8.13
 Order C.O.D. and I pay cartage.

NAME

ADDRESS

CITY STATE

RADIO WORLD'S BOOK SERVICE has been found of great value not only by radio fans, constructors, etc., but also by radio and other technical schools throughout the country. See the radio books advertisements in this issue.

LACAULT'S BOOK

"Super-Heterodyne Construction and Operation," giving the master's most masterful exposition of the theory, performance and construction of this fascinating type of circuit, is a necessity to every serious radio experimenter. More than 100 pages and more than 50 illustrations. Buckram cover. This book by R. E. Lacault, FREE if you send \$1.00 for an 8-weeks subscription for Radio World. Present subscribers may accept this offer. Subscription will be extended.

RADIO WORLD 145 W. 45th St., N.Y. City
Just East of B'way

NATIONAL

Velvet B Eliminator \$16.13
180 Volts (250 Tube Free)



Latest Model National Velvet-B, Type 5550, in handsome crackle finish black metal casing, for use with sets up to and including six tubes. Input 105-120 volts AC, 50 to 60 cycles. Output 180 volts maximum at 35 milliamperes. Three variable output intermediate voltages. (Det., RF, AF) Eliminator has excellent filter system to eliminate hum, including 30 Henry choke and 18 mfd Merson condenser. No motorboating! (Eliminator Licensed under patents of the Radio Corporation of America and associated companies.)

Guaranty Radio Goods Co.
143 W. 45TH STREET
(Just East of Broadway)
NEW YORK CITY

New Junior Model

POLO UNIT \$4

The famous twin magnet principle for double sensitivity, large magnets for great flux, permanently adjusted armature, all are in the new junior model Polo Unit. Weight, 2¾ lbs. Stands 150 volts unfiltered. Stands up to 250 push-pull filtered. Works any output tube, power or otherwise. Supplied with 10-ft. cord. Order unit now. Five-day money-back guarantee. Shipped C. O. D. if desired.

Acoustical Engineering Associates

143 West 45th Street
New York City
(Just East of Broadway)

RADIO WORLD and "RADIO NEWS"

BOTH FOR **\$7.00**
ONE YEAR @.

You can obtain the two leading radio technical magazines that cater to experimenters, service men and students, the first and only national radio weekly and the leading monthly, for one year each, at a saving of \$1.50. The regular mail subscription rate for Radio World for one year, a new and fascinating copy each week for 52 weeks, is \$6.00. Send in \$1.00 extra, get "Radio News" also for a year—a new issue each month for twelve months. Total, 64 issues for \$7.00.
 If renewing Radio World subscription, put cross square.
RADIO WORLD, 145 West 45th Street, New York, N. Y.

Quick Action Classified Ads

Radio World's Speedy Medium for Enterprise and Sales

10 cents a word — 10 words minimum — Cash with Order

EDISON STORAGE BATTERIES—100 volts \$6.50; ¼ Horsepower Alternating Motors \$7.00. Hoffmann Electrical Shops, 904 North Fifth, Philadelphia, Pa.

"**MATHEMATICS OF RADIO.**"—A great help to everybody interested in radio. \$2 postpaid. Radio World, 145 W. 45th St., N. Y. City.

RECENT NUMBERS OF RADIO WORLD, for 1929, 15c per copy. Any 7 copies for \$1. Radio World, 145 W. 45th St., N. Y. City.

TELEVISION and all about it in "A B C of Television," by Raymond Francis Yates. \$3 postpaid. Radio World, 145 W. 45th St., N. Y. City.

"**EVERYBODY'S AVIATION GUIDE.**" By Maj. Pagé. \$2 postpaid. Also "Modern Aircraft" by same author. \$5. postpaid. Radio World, 145 W. 45th St., N. Y. City.

"**A B C OF AVIATION.**" By Maj. Pagé. \$1.00 postpaid. Radio World, 145 W. 45th St., N. Y. City.

WORLD'S BEST AVIATION BOOKS: "A B C of Aviation," \$1.00; "Modern Aviation Engines," \$9.00 postpaid. Both by Maj. Pagé. "Aerial Navigation and Meteorology," By Capt. Yancey. \$4.00 postpaid. Radio World, 145 W. 45th St., N. Y. City.

"**AERIAL NAVIGATION and METEOROLOGY.**" By Capt. Yancey. \$4.00 postpaid. Radio World, 145 W. 45th St., N. Y. City.

TRIAL SUBSCRIPTION, 8 WEEKS, \$1.00. Send \$1 and we will send you Radio World for 8 weeks, postpaid. **RADIO WORLD**, 145 West 45th St., N. Y. City.

EVERYTHING IN RADIO At attractive Prices Sets or parts Orders shipped exactly as ordered. Prompt service. Write for prices. Inquiries invited. Send your address. **ALL RADIO CO.**, 417 North Clark St., Chicago

BE SURE TO READ the advertisement on another page of this issue about the HB Compact. Guaranty Radio Goods Co., 143 W. 45th St., N. Y. City.

TWO FOR ONE. Radio World for 52 weeks and Radio News twelve months at the combination rate of \$7. Radio World, 145 W. 45th St., N. Y.

"**MODERN AIRCRAFT.**" By Maj. Pagé. \$5. postpaid; and "Everybody's Aviation Guide." By Maj. Pagé, price \$2. postpaid. Latest and best up-to-date aviation books. Radio World, 145 W. 45th St., N. Y. City.

Power Amplifier Equipment

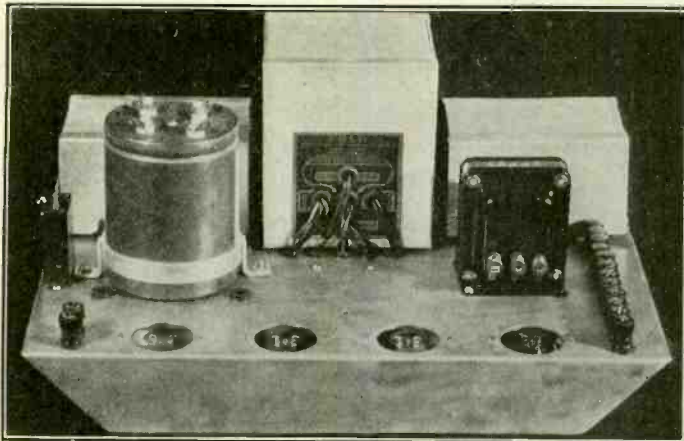

At left is illustrated a push-pull power amplifier, using a first stage of resistance coupled audio, 280 rectifier and two 245s in push-pull, as described in the November 2d issue of Radio World. Abounding volume and faithful tone reproduction are assured. The Polo Filament-Plate Supply, two Polo center-tapped audio chokes and a Multi-Tap Voltage Divider are used, with a Q 2-8, 2-18 Mershon condenser, an input push-pull audio transformer and auxiliary equipment. The total parts, including cadmium-plated steel sub-panel, come to \$43.57 net, the best power amplifier for that modest amount. Provision is made for phonograph pickup plug insertion. Thirteen output voltages are provided, including 300, 180, 75, 50 and an assortment of nine different voltages under 50 available for bias. All A, B and C voltages are provided for the power amplifier and for a tuner to be used with it employing 227, 224 or 228 tubes. Order Cat. PO-245-PA @ \$43.57 net, for 50-60 cycles, 110 volts. [For 25 cycles order PO-245-PA-25 @ \$48.57. For 40 cycles order PO-245-PA-40 @ \$46.07.]



Polo 245 Filament Plate Supply (less chokes) has four windings, all save primary center-tapped (red), is 4 1/2" wide, 8" high, 4" front to back. Weight, 9 lbs. Filament windings, 2.5 v. at 12 amps., 2.5 v. at 3 amps. (for 245 filaments), 5 v. at 2 amps. for 280 rectifier, and 724 v. @ 100 m.a., center-tapped. Order Cat. PFFS @ \$7.50. [For 25 cycles order Cat. PFFS-25 @ \$12.00.] [For 40 cycles order Cat. PFFS-40 @ \$10.00.]

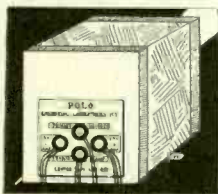

Polo Filament Transformer Only. four windings, consists of 50-60 cycles 110 v. winding, 2 1/2 v. at 12 amps., 2 1/2 v. at 3 amps., 5 v. at 2 amps. All windings, save primary, are center-tapped (red). Size, 4 1/2" high x 3 3/4" wide x 3" front to back. Weight, 6 lbs. Order Cat. PFT @ \$4.25. [For 25 cycles order PFT-25 @ \$7.00; for 40 cycles order PFT-40 @ \$6.25.]

By-pass Condensers
For by-passing B+ leads to ground or C minus from 200 v. post or less, where current is less than 10 m.a., 1 mfd. paper dielectric condensers are useful. Order LV-1 @ \$0.50 ea.

Filter Condensers
For high voltage filtration next to the rectifier, use 1 or 2 mfd. The 2 mfd. makes the output voltage a little higher.
Order Cat. HV-1 (1,000 v. DC, 850 v. AC).....\$1.76
Order Cat. HV-2 (1,000 v. DC, 550 v. AC).....\$3.52

Filament-Plate-Choke Block
Same as Filament-Plate Supply, except that two 50 henry chokes are built in. Six windings: primary, 110 v., 50-60 cycles; 2.5 v. at 12 amps.; 2.5 v. at 3 amps.; 5 v. at 2 amps.; 724 v. at 100 m.a.; chokes All AC windings center-tapped (red), except primary. Connect either end of a choke to one end of other choke for midsection. Order Cat. P-245-FPCH @ \$10.00. [For 40 cycles order P-245-FPCH-40 @ \$13.50.] [For 25 cycles order P-245-FPCH-25 @ \$14.50.]

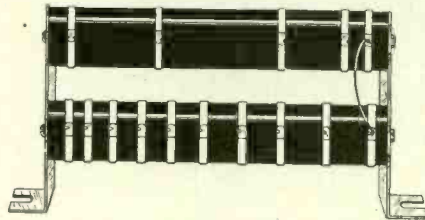

Two rugged, expertly engineered wire-wound, enamelled resistors, mounted in series, one atop the other, with fourteen useful lugs, providing all necessary choice of voltages without the uncertainty of adjustable variable resistance.

The Multi-Tap Voltage Divider has a total resistance value of 13,850 ohms, in the following steps: 3,000, 4,500, 2,000, 800, 700, 600, 550, 500, 450, 400, 200, 100 and 50 ohms. With the zero voltage lug (at lower left) the total number of useful lugs is fourteen. The resistance stated are those between respective lugs and are to be added together to constitute 13,850 ohms total.

A conservative rating of the Multi-Tap Voltage Divider is 50 watts, continuous use. The unit is serviceable in all installations where the total current drain does not exceed 125 milliamperes.

Extreme care has been exercised in the manufacture of the Multi-Tap Voltage Divider. It is mounted on brackets insulated from the resistance wire that afford horizontal mounting of the unit on baseboards and subpanels.

There long has been a need for obtaining any necessary intermediate voltage, including all biasing voltages, from a Multi-Tap Voltage Divider, but each lug has to be put on individually by hand, and soldered, so that manufacturing difficulties have left the market barren of such a device until now.

The Multi-Tap Voltage Divider is useful in all circuits, including push-pull and single-sided ones, where the current rating of 125 milliamperes is not seriously exceeded and the maximum voltage is not more than 400 volts. If good ventilation is provided, this rating may be exceeded 15 per cent.

The expertness of design and construction will be appreciated by those whose knowledge teaches them to appreciate parts finely made.

When the Multi-Tap Voltage Divider is placed across the filtered output of a B supply which serves a receiver, the voltages are in proportion to the current flowing through the various resistances. If a B supply feeds a receiver with two-stage audio amplifier, the last stage a single-sided 245, then the voltages would be 250 maximum for the power tube, 180, 135, 75, 50, 40, 35, 30, 25, 18, 10, 6 and 3. By making suitable connection of grid returns the lower voltages may be used for negative bias or even for positive voltage on the plates.

If push-pull is used, the current in the biasing section is almost doubled, so the midtap of the power tubes' filament winding would go to a lug about half way down. Order Cat. MTVD at \$3.95.

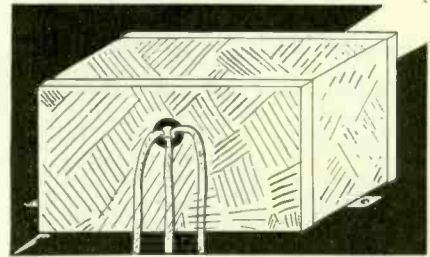

Center-tapped double choke, 125 m.a. rating, 30 henrys in each section. Used for filtering B supply or for a push-pull output impedance, where speaker cords go directly to plates of tubes. Center tap is red. Order Cat. PDC @ \$3.71.

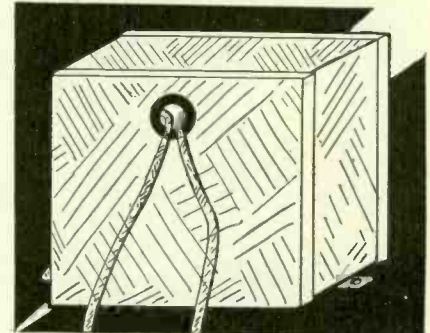

Single 30 henry 100 m.a. choke for filtered output (where condenser is used additionally) or for added filtration of a B supply. Order Cat. PSC @ \$3.56.

The Mershon electrolytic condenser, 415 volts DC, for filtering circuits of B supplies. Q 2-8, 2-18 has four capacities in one copper casing: two of 8 mfd. and two of 18 mfd. The copper case is negative. The smaller capacities are nearer the edge of the case. The vent cap should not be disturbed, and the electrolyte needs no refilling or replacement.

Mershon electrolytic condensers are instantly self-healing. Momentary voltages as high as 1,000 volts will cause no particular harm to the condenser unless the current is high enough to cause heating, or the high voltage is applied constantly over a long period.

High capacity is valuable especially for the last condenser of a filter section, and in by-passing, from intermediate B+ to ground or C+ to C-, for enabling a good audio amplifier to deliver true reproduction of low notes. Suitably large capacities also stop motor-boating.

Recent improvements in Mershons have reduced the leakage current to only 1.5 to 2 mils total per 10 mfd. at 300 volts, and less at lower voltages. This indicates a life of 20 years or more, barring heavy abuse.

In B supplies Mershons are always used "after" the rectifier tube or tubes, hence where the current is direct. They cannot be used on alternating current.

The Mershon comes supplied with special mounting bracket. Order **\$5.15** Q 2-8, 2-18 B @

ACOUSTICAL ENGINEERING ASSOCIATES,
143 West 45th St., N. Y. City.
(Just East of Broadway.)

Please ship at once the following:

Quantity	Cat. No.	Product	Price
<input type="checkbox"/>	PO-245-PA	Power amp. parts, 50-60 c.	\$43.57
<input type="checkbox"/>	PO-245-PA-40	Same, 40 cycles	46.07
<input type="checkbox"/>	PO-245-PA-25	Same, 25 cycles	48.57
<input type="checkbox"/>	PFFS	Fil. plate supply, 50-60 c.	7.50
<input type="checkbox"/>	PFFS-40	Same, 40 cycles	10.00
<input type="checkbox"/>	PFFS-25	Same, 25 cycles	12.00
<input type="checkbox"/>	PFT	Fil. trans., 50-60 e.	4.25
<input type="checkbox"/>	PFT-40	Same, 40 cycles	6.25
<input type="checkbox"/>	PFT-25	Same, 25 cycles	7.00
<input type="checkbox"/>	P-245-FPCH	Power-filter block	10.00
<input type="checkbox"/>	P-245-FPCH-40	Same for 40 cycles	13.50
<input type="checkbox"/>	P-245-FPCH-25	Same for 25 cycles	14.50
<input type="checkbox"/>	PDC	Double c.-t. choke	3.71
<input type="checkbox"/>	PSC	Single choke	3.56
<input type="checkbox"/>	MTVD	Multi-tap volt. div.	3.95
<input type="checkbox"/>	Q2-8, 2-18B	Mershon with bracket	5.15
<input type="checkbox"/>	LV-1	200 v., 1 mfd. by-pass cond.	.50
<input type="checkbox"/>	HV-1	1,000 v., 1 mfd. filter cond.	1.76
<input type="checkbox"/>	HV-2	1,000 v., 2 mfd. filter cond.	3.52

Enclosed please find check—money order—for the above. [Note: Canadian remittance must be by postal or express money order.]

Please ship C.O.D.

NAME.....

ADDRESS.....

CITY..... STATE.....

5-DAY MONEY-BACK GUARANTEE!

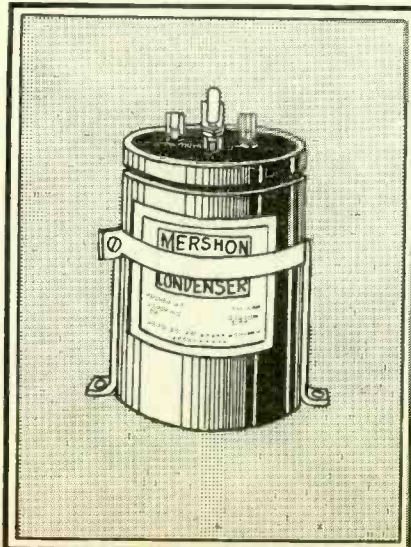

THREE CHRISTMAS GIFT BOOKS FOR SERVICE MEN!

"Trouble Shooter's Manual" *The most popular and fastest-selling book in radio today. Wiring diagrams of commercial receivers are contained in this outstanding book.*

"Mathematics of Radio" *A sure route to a good grasp on radio technique. Radio theory outlined so that anybody can understand it.*

"Testing Units for Service Men" *Circuits and Methods of Testing Equipment, particularly use of individual meters and of meters united in combination testers.*

These Three Books by John F. Rider Constitute an Outstanding Asset to All Possessors!

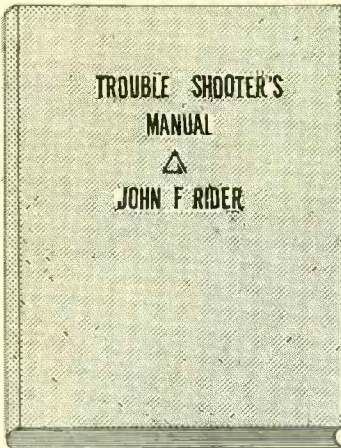

"Trouble Shooter's Manual"

is the first comprehensive volume devoted exclusively to the topic. The 240 pages include 200 illustrations devoted to wiring diagrams of factory-made receivers, besides other illustrations. It is not only a treatise for service men, telling them how to overcome their most serious problems, and fully diagramming the solutions, but is a course in how to become a service man.

This book is worth hundreds of dollars to any one who shoots trouble in receivers—whether they be factory-made, custom-built or home-made receivers.

Besides 22 chapters covering thoroughly the field of trouble shooting, this volume contains the wiring diagrams of models, as obtained directly from the factory, a wealth of hitherto confidential wiring information released for the first time in the interest of producing better results from receivers. You will find these

diagrams alone well worth the price of the book. The wiring diagrams are of new and old models, of receivers and accessories and as to some of the set manufacturers, all the models they ever produced are shown in wiring diagrams! Here is the list of receivers, etc., diagrams of which are published in this important and valuable book:

- R. C. A. 60, 62, 20, 64, 80, 105, 51, 16, 32, 50, 25 A.C., 28 A.C., 41, Receptor S.P.U., 17, 18, 33.
- FEDERAL Type E series filament, Type E series filament, Type D series filament, Model K, Model H.
- ATWATER-KENT 10B, 12, 20, 30, 35, 48, 32, 33, 40, 38, 36, 37, 40, 42, 52, 50, 44, 43, 41 power units for 37, 38, 44, 43, 41.
- CROSLY XJ, Trirdyn 3R3, 601, 401, 401A, 608, 704, B and C supply for 704, 704A, 704B, 705, 706.
- STEWART-WARNER 300, 305, 310, 315, 320, 325, 500, 520, 525, 700, 705, 710, 715, 720, 530, 535, 750, 801, 802, 806.
- GREBE MUL, MU2, synchrophase 5, synchrophase AC6, synchrophase ACT, Deluxe 428.
- PHILCO Philco-electric, 82, 86.
- KJLSTER 4-tube chassis used in 6 tube sets, tuning chassis for 7 tube sets, power amplifier, 7 tube power pack and amplifier, 6 tube power pack and amplifier, 6 tube power pack and amplifier, rectifier unit K-23.

- ZENITH 39, 39A, 392, 392A, 40A, 35PX, 35APX, 352X, 352APX, 37A, 35P, 35AP, 352P, 362AP, 34P, 342P, 33, 34, 35, 35A, 42, 352, 352A, 362, 31, 333, 353A, power supply ZE17, power supply ZE12.
- MAJESTIC 70, 70B, 180, power pack 7BP3, TP6, 7P3 (old wiring) 8P3, 8P6, 7BP6.
- FRESHMAN Masterpiece, equaphase, G, G-60-S power supply, L and LS, Q15, Q, K60-S power supply.
- STROMBERG-CARLSON 1A, 2B, 501, 502, 523, 524, 635, 638, 403AA power plant, 404 RA power plant.
- ALL-AMERICAN 6 tube electric, 8 tube 80, 83, 84, 85, 86, 88, 6 tube 60, 61, 62, 65, 66, u and 8 tube A.C. power pack.
- DAY FAN OEM, 4 tube, 5-5 tube 1925 model, Day Fan 8 A.C. power supply for 6 tube A.C., B power supply 5524 and 5525, motor generator and filter, 6 tube motor generator set, 6 tube 110 volt D.C. set, 6 tube 32 volt D.C. set.

- FADA 50/80A receivers, 460A, Fada 10, 11, 30, 31, 10Z, 11Z, 30Z, 31Z, 18, 17, 32, 10Z, 32Z, 18, 18, special 192A-192S and 192BS units, BR0A, 480A, and SF 50/80A receivers, 460A receiver and R60 unit, 7 A.C. receiver, 475 UA or CA and SP45-75 UA or CA, 50, 70, 71, 72, C electric unit for special and 7 A.C. receivers, ABC 6 volt tube supply, 86V and 82W, E180Z power plant and E 420 power plant.
- FREED EISEMANN NR5, FE18, NR70, 470, NR57, 457, NR11, NR80 D.C.
- COLONIAL 26, 31 A.C., 31 D.C.
- WORKRITE 8 tube chassis, 6 tube chassis.
- AMRAD 70, 7100, 7191 power unit.
- SPARTAN AC 39.
- MISCELLANEOUS DeForest F5, D10, D17. Super Zenith Magnavox dial, Thermodyne, Grimes 41L, Inverse duplex, Garod neutrodyne, Garod EA, Waro 7 tube, Waro 13D T, Federal 102 special, Federal 59, Kennedy 220, Operadio portable, Sleeper RX1, Amrad inductrol.

Wiring Diagrams of All These Receivers

HERE ARE THE 22 CHAPTER HEADINGS

- Servive Procedure
- Practical Application of Analysis
- Vacuum Tubes
- Operating Systems
- Aerial Systems
- "A" Battery Eliminators
- Troubles in "A" Eliminators
- Trouble Shooting in "A" Eliminators
- "B" Battery Eliminators
- Troubles in "B" Battery Eliminators

- Trouble Shooting in "B" Battery Eliminators
- Speakers and Types
- Audio Amplifiers
- Trouble Shooting in Audio Amplifiers
- Troubles in Detector Systems
- Radio Frequency Amplifiers
- Trouble Shooting in RF Amplifiers
- Series Filament Receivers
- Testing, and Testing Devices
- Troubles in DC Sets
- Troubles in AC Sets

"Testing Units for Service Men."

A 43-page, liberally illustrated book on testing units and circuits. Tells what equipment a service man should have and how to use it most effectively and quickly. Rapidity of operation is one of the points stressed throughout this valuable book, as a service man's time is his chief stock in trade.

CONTENTS

- Tube Reactivator and Voltages
- Calibrated Vacuum Tube Bridge
- General Utility Tube Tester
- AC-DC Receiver Tester
- Eliminator Testers
- Signal Generator for Receiver Testing
- Oscillators
- Cathode Ray Oscillograph
- Indicating Systems
- Tube Voltmeters
- Measurement of Inductance, Impedance, Capacity, DC Resistance
- Multi-Range Meters
- Service Station Test Bench

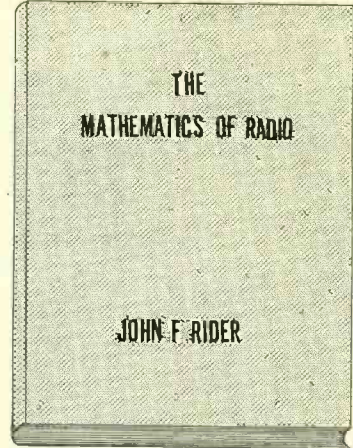
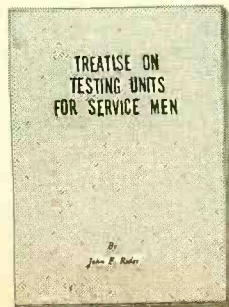

"Mathematics of Radio"

TABLE OF CONTENTS:

- OHM'S LAW.
- RESISTANCES: Basis for resistance variation, atomic structure, temperature coefficient, calculation of resistance variation, expression of amperes, volt and Ohm fractions, application of voltage drop, plate circuits, filament circuits, filament resistances, grid bias resistances.
- DC FILAMENT CIRCUITS: Calculation of resistances.
- AC FILAMENT CIRCUITS: Transformers, wattage rating, distribution of output voltages, voltage reducing resistances, line voltage reduction.
- CAPACITIES: Calculation of capacity, dielectric constant condensers in parallel, condensers in series, voltage of condensers in parallel, in series, utility of parallel condensers, series condensers.
- VOLTAGE DIVIDER SYSTEMS FOR B ELIMINATORS: Calculation of voltage divider resistances, types of voltage dividers, selection of resistances, wattage rating of resistances.
- INDUCTANCES: Air core and iron core, types of air core inductances, unit of inductances, calculation of inductance.
- INDUCTANCE REQUIRED IN RADIO CIRCUITS: Relation of wavelength and product of inductance and capacity, short wave coils, coils for broadcast band, coupling and mutual inductance, calculation of mutual inductance and coupling.
- REACTANCE AND IMPEDANCE: Capacity reactance, inductance reactance, impedance.
- RESONANT CIRCUITS: Series resonance, parallel resonance, coupled circuits, bandpass filters for radio frequency circuits.
- IRON CORE CHOKERS AND TRANSFORMERS: Design of chokes, core, airgap, inductance, reactance, impedance, transformers, half wave, full wave windings.
- VACUUM TUBES: Two element filament type, electronic emission, limitations, classifications of filaments, structure, two element rectifying tubes, process of rectification, tungar bulb.
- THREE ELEMENT TUBES: Structure of tube, detector, grid bias, grid leak and condenser, amplifiers, tube constants, voltage amplification, resistance coupling, reactance coupling, transformer coupling, variation of impedance of load with frequency, tuned plate circuit.
- POWER AMPLIFICATION: Square law, effect of load, calculation of output power, undistorted output power, parallel tubes, push-pull systems, plate resistance.
- GRAPHS AND RESPONSE CURVES: Types of paper, utility of curves, types of curves, significance of curves, voltage amplification, power amplification, power output, radio frequency amplification.
- MULTIPLE STAGE AMPLIFIERS: Resistance coupling, reactance coupling, tuned double impedance amplification, underlying principles, transformer coupling, turns ratio, voltage ratio, types of cores, late current limitation, grid current limitation.
- ALTERNATING CURRENT TUBES: Temperature variation hum, voltage variation hum, relation between grid and filament, filament circuit center tap, types of AC tubes.
- SCREEN GRID TUBE: Structural design, application, amplification, associated tuned circuits, radio frequency amplification, audio frequency amplification.

RADIO WORLD, 145 West 45th St., New York, N. Y. (Just East of Broadway)

Enclosed please find:

- \$3.50 for which please send me postpaid "Trouble Shooter's Manual" (Cat. TSM), by John F. Rider, 240 pages, 8 1/2 x 11", more than 200 illustrations, including wiring diagrams of commercial receivers as advertised; imitation leather cover, gold lettering.
- \$2.00 for which please send me postpaid "Mathematics of Radio" (Cat. MOR), by John F. Rider, 128 pages, 8 1/2 x 11", 119 illustrations, flexible cover.
- \$1.00 for which please send me postpaid "Treatise on Testing Units for Service Men" (Cat. TU), by John F. Rider, 43 pages, 6 1/2 x 9 1/2".
- If ordering C.O.D., put cross in this square.

NAME.....

ADDRESS.....

CITY..... STATE.....

[Canadian remittances must be made by postal or express money order.]

New 228, High Gain Detector for AC Sets

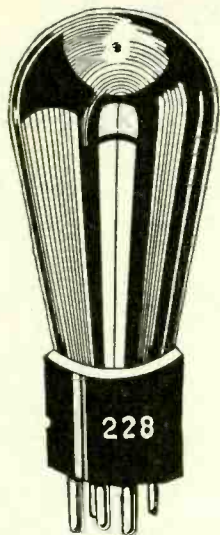

Kelly 228 Special Detector for AC circuits has a high mu. (Amplification factor) and increases sensitivity.

INCREASE the sensitivity of modern AC-operated circuits by substituting the new Kelly 228 AC detector, a high mu tube (large amplification), for the 227 tube otherwise used. The result is immediately obvious in the greatly increased volume. Otherwise weak, distant stations come in stronger and tone quality is improved. Simply substitute the 228 for the 227. No wiring change of any kind is required.

If an AC receiver uses resistance-coupled or impedance-coupled first audio stage, where the resistor or coil is in the plate circuit of the first audio tube, the 228 may be used as audio amplifier, too. It is not suitable as a radio frequency amplifier.

CHARACTERISTICS OF THE KELLY 228

Heater voltage 2.5 volts AC.
Heater current 1.75 amperes.
Amplification factor 45.
Mutual conductance 1,000.
Plate voltage 180 volts.

Grid bias, detector -6 volts.
Grid bias, amplifier -2.5 volts.
Load resistance, 0.1 to 0.5 meg.
Internal plate resistance 45,000 ohms.

\$2.50 NET PRICE

Screen Grid Tubes

THE Kelly screen grid tubes are of two types: the 222 for storage-battery operation of the filament, and the 224 for AC operation of the filament. The tubes are similar but not identical. Either type may be used as radio frequency amplifier, detector or, with resistor plate load, as audio amplifier.

The 222 has four prongs and fits into the regular UX socket. The 224 has five prongs and requires the special five-spring UY socket. The control grid is the cap of the tube.

The filament voltage of the 222 is 3.3 volts, the plate voltage 135, the screen grid voltage 45 volts or less. The heater voltage of the 224 is 2.5 volts AC, the plate voltage 180, the screen grid voltage 75 volts or less.

The net price of the 222 is \$3.50, while the net price of the 224 is \$3.00.

Other Tubes

The line of Kelly tubes includes, besides the 228, 222 and 224, the following types: 245, 226, 227, 171A, 280, 240, 112A, 201A and UX199. The 240 is a high mu tube for battery operation of the filament. It is suitable as detector or audio amplifier where a resistor of .25 meg. or an impedance coil is in the plate circuit.

You run no risk whatever when you purchase Kelly tubes. Not only are they expertly made but they are sold on a 5-day money-back guarantee. This exclusive form of protection enables you to be the ultimate judge in your own laboratory or your own home, with no appeal from your decision on our part. If you are not delighted with the performance of Kelly tubes your money will be promptly refunded on the foregoing 5-day basis.

GUARANTY RADIO GOODS CO., 143 West 45th St., N. Y. City.

Enclosed please find \$..... for which ship at once Kelly tubes marked below:

- | | |
|---|--|
| <input type="checkbox"/> 228 AC high mu.\$2.50 | <input type="checkbox"/> 171A power tube\$0.95 |
| <input type="checkbox"/> 224 AC screen grid\$3.00 | <input type="checkbox"/> 201A battery tube\$0.65 |
| <input type="checkbox"/> 245 AC power tube\$2.25 | <input type="checkbox"/> UX199 battery tube\$1.25 |
| <input type="checkbox"/> 226 AC amplifier\$4.00 | <input type="checkbox"/> Matched pair of 245s for push-pull (for both).....\$4.50 |
| <input type="checkbox"/> 227 AC det.-amp.\$1.50 | <input type="checkbox"/> Matched pair 171As for AC push-pull (for both).....\$1.90 |
| <input type="checkbox"/> 280 AC rectifier\$1.75 | <input type="checkbox"/> Matched pair of 112As for push-pull (for both).....\$1.90 |
| <input type="checkbox"/> 222 battery screen grid.....\$3.50 | |
| <input type="checkbox"/> 240 battery high mu.\$1.25 | |
| <input type="checkbox"/> 112A power tube\$0.95 | |

ALL PRICES QUOTED ARE SELLING PRICES AND ARE NET.

Name.....

Address.....

City..... State.....

Put cross here if C. O. D. shipment is desired.
Canadian remittance must be by postal or express money order.

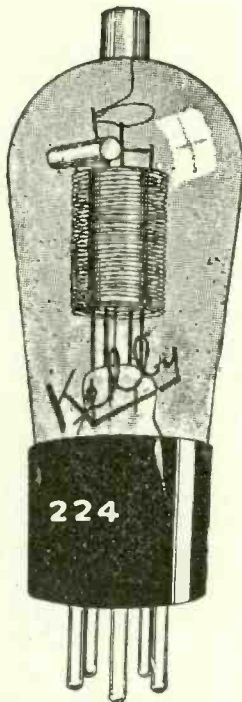

Kelly 224 Screen Grid Tube assures best tube performance in the most up-to-date AC circuits using screen grid tubes.

MICROPHONE LIGHTERS

for cigars or cigarettes, with button switch at top. Press the switch and light up!

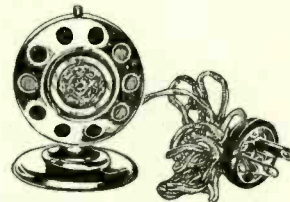

Model A lighter, microphone design, with 5-ft. AC cable and plug. Works on 110 volts, AC any frequency and on direct current. Price \$1.00



Model B lighter, microphone design, on tray, with 5-ft AC cable and plug. Works on 110 volt AC, any frequency, and on direct current. Exactly the same lighter as the other, only tray is added. Price.....\$1.50

This lighter is instantaneous. Hold button down only long enough to light a cigar or cigarette. The two models are furnished in attractive sprayed finish. Both are very compact! For instance, the tray is only 4 1/4" in diameter. Use these lighters in your home and for holiday gifts.

The heater element is renewable.

- RADIO WORLD, 145 West 45th St., N. Y. City
- Please send me Model A Microphone Lighter at \$1.00.
 - Please send me Model B at \$1.50.
 - Enclosed is remittance [Canadian must be P.O. or express money order.]
 - Ship C. O. D.

Name.....

Address.....

City..... State.....

New DRAKE'S ENCYCLOPEDIA

A reference work that has subjects classified in alphabetical order.

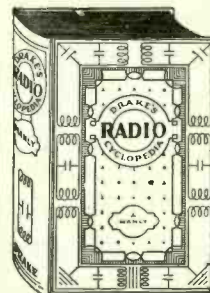

Each rule, fact, method, plan, layout and diagram is instantly picked out and separated from everything else by placing all subjects in alphabetical order with cross references for every imaginable name under which the information might be classed.

This alphabetical arrangement lets the experienced worker refer directly to the one thing in which he is interested at the moment without hunting through non-essentials. The needs of the beginner are cared for.

The important articles deal primarily with receivers and reception. They do not stop with the electrical end, but go also into the mechanics of construction.

- BOOK IS 2 1/4" THICK.
WEIGHS 3 1/2 LBS., 1,025 ILLUSTRATIONS.
- 1,680 Alphabetical Headings from A-battery to Zero Beat
 - 1,025 Illustrations, Diagrams, Layouts and Graphs
 - 920 Pages, Each 6 by 9 inches
 - 240 Combinations for Receiver Layouts
- OF THE PRINCIPAL ARTICLES**
- 159 Concern service men, 129 help the set builder.
 - 102 help the experimenter, 155 interest the student.
 - 75 assist in sales work, 73 interest set owners.

PRICE, \$6.00

Remit with order and we pay cartage. Canadian remittance must be by postal or express money order. Order C. O. D. and you pay cartage.

RADIO WORLD, 145 W. 45th St., N. Y. City

SUBSCRIBERS!

Look at the Expiration Date on Your Wrapper

Please look at the subscription date stamped on your last wrapper, and if that date indicates that your subscription is about to expire, please send remittance to cover your renewal.

In this way you will get your copies without interruption and keep your file complete.

SUBSCRIPTION DEPARTMENT
RADIO WORLD
145 WEST 45TH ST., N. Y. CITY

4-GANG CONDENSER

With Trimmers Built in **\$3.95**

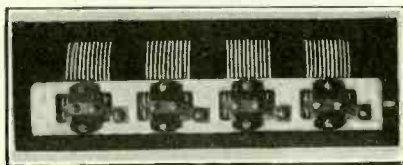

Capacity of each of the four sections is .00035 mfd. Overall length 1 1/2". Accurate capacity and precise alignment. Used in HB33 and HB44.

Guaranty Radio Goods Co.
143 West 45th Street,
New York City
[Just East of Broadway.]



Your Choice of
These Nine Meters FREE!

- 0-8 Voltmeter D.C. No. 328
- 0-50 Voltmeter D.C. No. 337
- 6-Volt Charge Tester D.C. No. 23
- 0-10 Amperes D.C. No. 338
- 0-25 Milliamperes D.C. No. 325
- 0-50 Milliamperes D.C. No. 330
- 0-100 Milliamperes D.C. No. 339
- 0-300 Milliamperes D.C. No. 390
- 0-400 Milliamperes D.C. No. 394

Equip Yourself Now
With Necessary Meters!

To do your radio work properly you need meters. Here is your opportunity to get them at no extra cost. See the list of nine meters at left. Heretofore we have offered the choice of any one of these meters free with an 8-weeks subscription for RADIO WORLD, at \$1. the regular price for such subscription. Now we extend this offer. For the first time you are permitted to obtain any one or more of all of these meters free, by sending in \$1 for 8-weeks' subscription, entitling you to one meter; \$2 for 16 weeks, entitling you to two meters; \$3 for 26 weeks, entitling you to three meters; \$4 for 35 weeks, entitling you to four meters; \$5 for 44 weeks, entitling you to 5 meters; \$6 for 52 weeks, entitling you to six meters. Return this offer with remittance, and check off desired meters in squares at left.

RADIO WORLD will help you in your radio work, so you will be able to use the meters most valuably. Keep abreast of all the new circuits, intimate details on perfecting existing sets, and get inside track on sensitivity, distance reception, tonal quality, and news of radio, technical and non-technical. Enjoy the writings of Dr. Lee De Forest, McMurdo Silver, J. E. Anderson, Harman Bernard and a host of other radio engineers who contribute their knowledge to you through the medium of RADIO WORLD, the first and only illustrated national radio weekly. You can find no magazine that better caters to your needs than RADIO WORLD. Short waves? RADIO WORLD will tell you all about them. Extremely sensitive broadcast receivers? Their construction and operation are fully discussed with confident regularity. Power supplies --push-pull or otherwise? AC receivers? Screen grid tubes? Large receivers that give a super-abundance of performance--small, economical receivers that give performance out of all comparison to their size? Are you interested in these? Then you're interested in RADIO WORLD.

Present mail subscribers may renew their subscription under this remarkably generous offer. Put a cross in square.

RADIO WORLD

145 W. 45th St., N. Y. City--Published Weekly.
All Newsstands. 15c per copy--\$3. six months--\$6 a year



GUARANTY RADIO GOODS CO.
143 West 45th Street, New York, N. Y.

One Tube?
Two Tubes?
Three Tubes?
Four Tubes?

Circuits for Schoolboys--Easy to Build, Very, Very Inexpensive!

- A One Tube Receiver, parts costing \$4.28!
- A Two Tube Audio Amplifier, parts costing \$5.23!
- A Three Tube Speaker--Operating Circuit, parts costing \$11.10!
- A Four Tube Speaker--Operating Circuit, parts costing \$12.72!

The construction of these circuits, with a pictorial diagram as one of the illustrations, was described by Jack Tully, himself a schoolboy, in RADIO WORLD. See list below.

- Sept. 21st and 28th issues, One-Tube DX Set, by Jack Tully; two-part article.
- Oct. 5th, Three-Tube Single Dial Speaker Set, by Jack Tully.
- Oct. 12th, Two Stage Transformer, Coupled Audio Amplifier, by Jack Tully.
- Oct. 19th, Four-Tube DX Speaker Set, by Jack Tully. 15 cents a copy. Order at once while these copies are available.

RADIO WORLD, 145 W. 45th St., New York

LACAULT'S BOOK

GIVES YOU A FINE UNDERSTANDING OF the SUPER-HETERODYNE

R. E. LACAULT, E.E., I.R.E., who died recently, was one of the outstanding authorities on the Super-Heterodyne. He wrote a book, "Super-Heterodyne Construction and Operation," that explains in a non-technical manner the phenomena associated with a Super-Heterodyne. More, it gives a clear outline of the way such a receiver functions, and naturally gives the clues to solving virtually all the troubles that may arise in a Super.

So thoroughly did Lacault do his work that he covered associated topics, thus making his book a sidelight on radio in general, including advice on trouble-shooting.

Therefore the service man, the home experimenter, the custom set builder and the student will welcome this book.

It consists of 103 pages and includes 68 illustrations. It is bound in maroon buckram.

There are three valuable tables in the book, also. One classifies harmonics into groups, e.g., sound, radio, short waves, heat, light, chemical rays, X-rays and "unknown." Another is a trouble-shooting chart, classifying "trouble experienced" and "causes" and referring to the text for specific solutions. The third is a table for converting broadcast frequencies to wavelengths (accurate to .1 of a meter) or for converting the wavelength into frequency.

THE book begins with a comparison of alternating and direct current and proceeds to a discussion of the relation of wavelength to frequency. Then tuning is explained.

Condensers, coils, induction, vacuum tube operation and testing, earphones and speakers, rectification, oscillation, grid condenser action, modulation, grid bias detection, regeneration, beat notes, frequency changing, audio amplification, batteries, aerials, loops, wiring, sockets, and shielding are only some of the other important topics covered.

Besides, there is an entire chapter on the construction of a Super-Heterodyne receiver, with list of parts, front, top and rear views of set, front panel layout, shield dimensional drawings, schematic diagram of wiring and picture diagrams of the top and bottom views of the subpanel.

You Can Get This Book At Once!

You will want this book not only for present reading but also for future reference. It is authoritative and highly informative. Send for it now! It's free with each order for an eight weeks' subscription for RADIO WORLD. Present subscribers may renew under this offer. Their subscriptions will be extended eight weeks. Please use coupon.

RADIO WORLD, 145 W. 45th St., N. Y. City
(Just East of Broadway)

Gentlemen: Enclosed find \$1.00. Please enter my subscription for RADIO WORLD for eight weeks at \$1.00 and send me at once one copy of R. E. Lacault's "Super-Heterodyne Construction and Operation." FREE!

I am a subscriber at present. (Check off if true.)

Name

Address

City State

5-DAY MONEY-BACK GUARANTEE

If C. O. D. desired, put cross here.

Component Parts

for

ONE-DIAL

PUSH-PULL BATTERY DIAMOND

[Check off parts you want. Each part is sold separately.]

- L1L2--Antenna coil RF3 @\$ 0.80
- L3L4L5--3-circuit SG coil SGT3 @ 1.30
- L6--Push-pull output transformer 2.83
- T1--Push-pull input transformer 3.41
- CT--80 mfd. equalizer35
- C1, C2--Two .00035 mfd. ext. shafts @ 98c 1.96
- C3, C5--Two .01 mfd. mica condensers..... .70
- R--One 6.5 ohm filament resistor..... .25
- R1, Sw--One 75 ohm switched rheostat... .80
- R2, C4--2 meg. Lynch leak, grid clip condenser51
- R3--One .25 meg.30
- R4--One 5.0 meg.30
- R5--One 1.3 ohm filament resistor..... .20
- Ant., Gnd., Sp. (+) Sp. (-)--Four posts @ .1040
- One drilled front panel 7x18" 1.85
- One socketed, self-bracketing metal subpanel, all holes drilled..... 3.50
- One National new modernistic drum dial with color wheel, pilot bracket, 6v. lamp, hardware, knob 3.13
- Two matched knobs for rheo. and tickler @ .1836
- Five vari-colored cable leads @ .07..... .35
- Flexible link and insulated shaft..... .55
- One screen grid clip..... .06
- All parts\$23.91

GUARANTY RADIO GOODS CO., 143 W. 45th St., N.Y.C.
(Just East of Broadway)

Enclosed please find \$..... for which please mail at once the parts for the Push-Pull Battery Model Diamond of the Air as checked off above.

If ordering C.O.D. put check mark here.

Name

Address

City State

TRIAL SUBSCRIPTION, 8 WEEKS, \$1.00. Send \$1 and we will send you Radio World for 8 weeks, postpaid. RADIO WORLD, 145 West 45th St., N. Y. City.

"AERIAL NAVIGATION and METEOROLOGY." By Capt. Yancey. \$4.00 postpaid. Radio World, 145 W. 45th St., N. Y. City.

Blueprint of the
New One-Dial
Push-Pull Battery Model
SG DIAMOND

Full-sized picture diagram of the wiring, with list of parts. This 5-tube receiver is really superlative. It gives you screen grid radio frequency amplification and push-pull output, most economically.

Send \$1.00 today for this blueprint or order it shipped C. O. D.

RADIO WORLD

145 West 45th Street
Just East of Broadway New York City

EVERY WEEK in RADIO WORLD appears a feature article of intense interest to schoolboys. Parents and other relatives will bring great delight to youngsters by sending \$3 for a 6 months' subscription for RADIO WORLD (26 issues) in the youngster's name--RADIO WORLD, 145 West 45th Street, New York City.

SUBSCRIBE NOW!

RADIO WORLD, 145 West 45th St., New York City. Enclosed please find my remittance for subscription for RADIO WORLD, one copy each week for specified period:

- \$6 for one year, 52 issues.
- \$3 for six months, 26 issues.
- \$1.50 for three months, 13 issues.
- This is a renewal of an existing mail subscription (Check off if true).

Your name

Address

City

NEW J-245-X TROUBLE-SHOOTING JIFFY TESTER

Illumination Continuity and Polarity Tester FREE with Each Outfit!

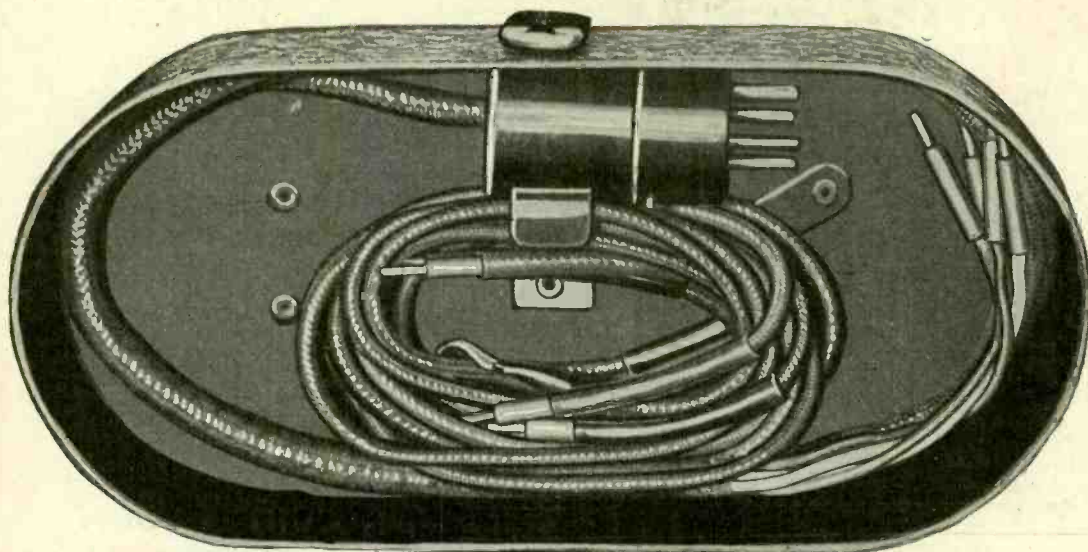

Your Price
\$15.82

Complete

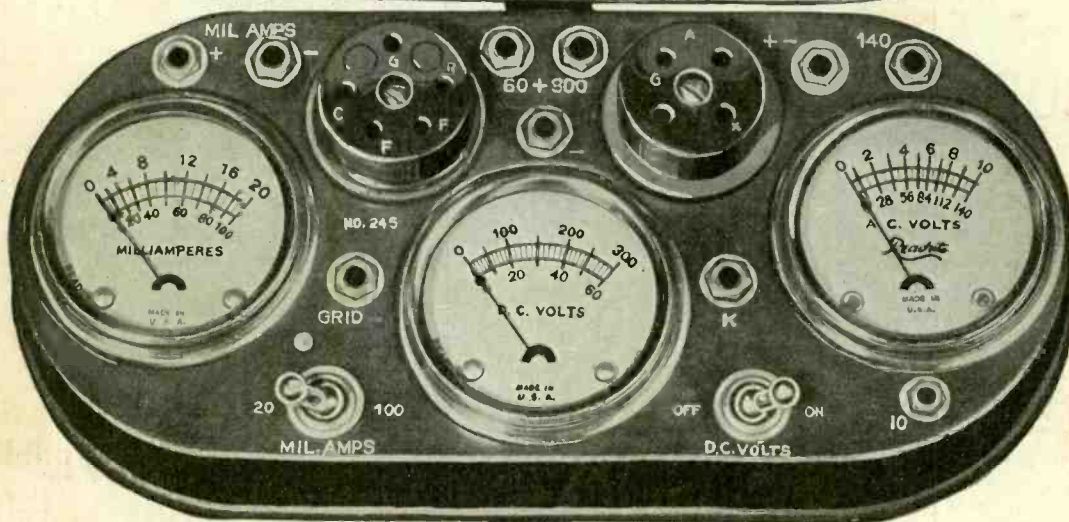

Illumination Tester, Vest Pocket Size, Shows Shorts and Opens Visually, also polarity of DC line. A Neon lamp is built in.



The three-meter assembly, in the crackle-brown finish carrying case, with slip-on cover and a cable plug. There are ten adapters. It is vital to have the complete outfit so you can meet any emergency.



Illustration above is 2/3 scale.

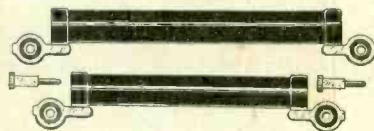

J-111 Multiplier, upper left, with tip; below it, J-106 Multiplier with tip; plugs, left to right, J-19, conforms UV socket to UX plug; J-20, conforms UX tester socket to UV199 tube; J-24, to test Kellogg and old style Arcturus tubes.

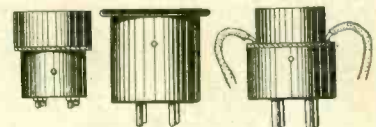

Makes All Necessary Tests in a Jiffy and Simplifies Service Work!

THE new Jiffy Tester, J-245-X, is a complete servicing outfit. It consists of a three-meter assembly in a metal case, with slip-on cover and a cable plug. There are ten adapters. It is vital to have the complete outfit so you can meet any emergency.

With this outfit you plug the cable into a vacated socket of a receiver, putting the removed tube in the tester, and using the receiver's power for making these tests: plate current, up to 100 milliamperes; plate voltage up to 300 volts; filament or heater voltage (AC or DC), up to 10 volts.

Each meter may be used independently. One of the adapters—a pair of test leads, one red, the other black, with tip jack terminals—serves this purpose. Multiplier J-106 extends the range of the DC voltmeter to 600 volts, but this reading must be obtained independently, as must readings on the 0-60 scale of the DC voltmeter. Independent reading of the AC voltmeter for line of voltage is necessary; also to use 0-140 scale while Multiplier J-111 extends the AC scale to 560 volts for reading power transformer secondaries.

The other adapters permit the testing of special receiver tubes, so that tests may be made, in all, of 22 different tubes: 201A, 200A, UX199, UV199, 120, 240, 171, 171A, 112A, 112A, 245, 224, 222, 228, 280, 281, 227, 226, 210, 250, Kellogg tubes and old style Arcturus tubes.

WHEN servicing a radio set, power amplifier, speech amplifier or sound reproduction or recording equipment, the circuits and voltages are almost inaccessible, unless a plug-in tester is used.

The Jiffy 245-X plugs in and does everything you want done. It consists of:

- (1)—The enclosed three-meter assembly, with 4-prong (UX) and 5-prong (UY) sockets built in; changeover switch built in, from 0-20 to 0-100 ma.; ten vari-colored jacks, five of them to receive the vari-colored tipped ends of the plug cable; grid push-button, that when pushed in connects grid direct to the cathode for 224 and 227 tubes, to note change in plate current, and thus shorts the signal input.
- (2)—4-prong adapter for 5-prong plug of cable.
- (3)—Screen grid cable for testing screen grid tubes.
- (4)—Pair of Test Leads for individual use of meters.
- (5)—J-106 Multiplier, to make 0-300 DC read 0-600.
- (6)—J-111 Multiplier, to make 0-140 AC read 0-560.
- (7)—Two jack tips to facilitate connection of multipliers to jacks in tester.
- (8), (9), (10)—Three adapters so UV199 and Kellogg tubes may be tested.
- (11)—Illumination Tester.

The illumination tester will disclose continuities and opens and also the polarity of DC house mains. It is as handy as a pencil and fits in your vest pocket. It works on voltages from 100 to 400. There are two electrodes in a Neon lamp in the top of the instrument. On AC both electrodes light. On DC only one lights, and that one is negative of the line, the light being on the same side as the lead. Hence the illuminator shows whether tested source is AC or DC, and if DC, which side is negative.

Even the output of the speaker cord will show a light. Also, the device will test which fuses are blown in fused house lines, AC or DC. Besides it tests ignition of spark plugs of automobiles, boats and airplanes, also faulty or weak spark plugs.

Just flash on the illumination tester momentarily. It will last about 4,000 flashes.

GUARANTY RADIO GOODS CO.
143 West 45th Street, Just East of Broadway,
N. Y. City.

- Please send me on 5-day money-back guaranty your J-245-X Jiffy Tester, complete, with all 10 adapters, and with illuminated Tester FREE with each order. Also send instruction sheet, tube data sheet and rectifier tube testing information.
- Enclosed please find \$15.82 remittance. Ship at your expense. [Canadian must be P.O. or Express M.O.]
- Please ship C. O. D. @ \$15.82 plus cartage and P.O. fee.

NAME

ADDRESS

CITY STATE

5-DAY MONEY-BACK GUARANTY