

NOV. 12 1927

15c.

RADIO

REG. U.S. PAT. OFF.

WORLD

America's First and Only National Radio Weekly

The Building Directions
for the Fenway Concertrola

Some Unbiased Facts on
Underbiased Grids

Vol-12
No-8
294

A Sweet-Toned 5-Tuber
Engineers as Mind Readers

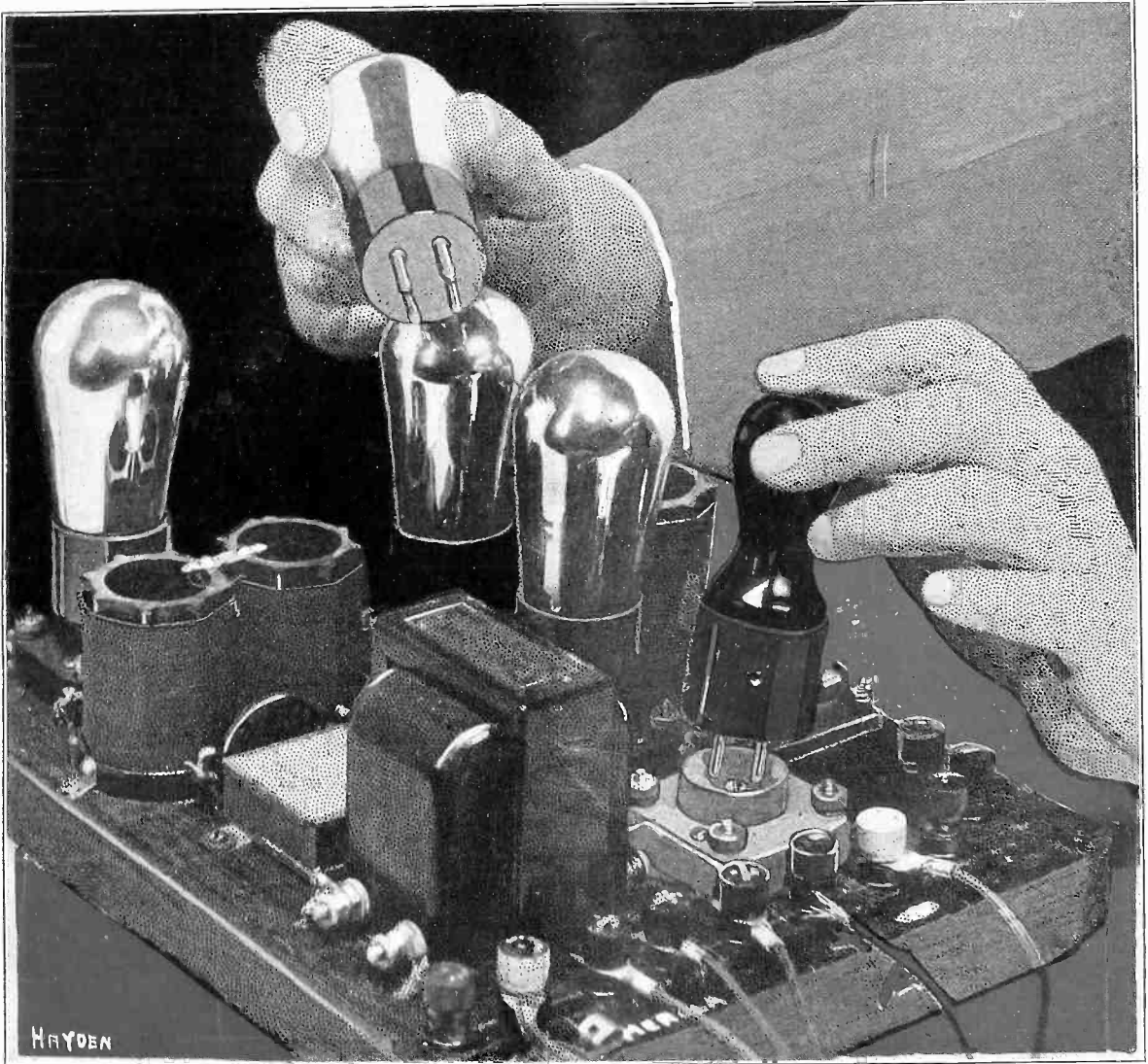

HRYDEN

HOW to Use a Phonograph Pickup and WHAT It is See page 19.

The Laboratory Electric—Filter vs. Bypass Condensers
How Marconi Beam Works—The Nine-in-Line

**BUILD YOUR OWN
POWER AMPLIFIER**

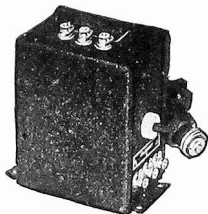

**THORDARSON
POWER COMPACT**

Convert your radio set into a real musical instrument. With a pair of pliers, a screwdriver and a soldering iron you can build a Thordarson power amplifier in two hours.

Write today for free booklet, "Power Amplification Simplified"

Power Compact R-171

Contains power supply transformer, buffer condensers, two chokes for Raytheon B-H Rectifier and UX-171 power tube, \$15.00.

Power Compact R-210

Contains power supply transformer and two chokes for UX-216-B rectifier and UX-210 power tube, \$20.00.

3569

Thordarson Electric Mfg. Co.
500 W. Huron St. Chicago, Ill.

**THE FENWAY
"WORLD SERIES"**

Consists of Five Articles Discussing All Phases of the Fenway Electric Concertrola. The one in this issue is the second. Send 50 cents for those that you need, or start your subscription with the November 5 issue.

RADIO WORLD, 145 W. 45th St., N. Y. C.

**For Best Results
with the
"FENWAY ELECTRIC
CONCERTROLA"
RECEIVER**

Featured in
RADIO WORLD
Use Only the
**HAMMARLUND
CONDENSERS AND CHOKE**

Specified by the Designer
HAMMARLUND MFG. CO.

424-438 West 33d Street, New York

For Better Radio
Hammarlund
PRECISION
PRODUCTS

**ACME
WIRE CO.
CELATSITE**

for RADIO WIRING

Flexible stranded Celatsite is composed of fine, tinned copper wires with non-inflammable Celatsite covering in 9 bright colors. Strips clean, solders readily. Sold only in 25' coils, in cartons colored to match contents. Solid Celatsite has same colored covering, but over bus bar wire. Write for folder to The Acme Wire Co., Dept. Y, New Haven, Conn.

EVERY FRIDAY evening, beginning at 6:40 P. M., a ten-minute talk on radio topics is delivered by Herman Bernard, managing editor of *Radio World*, from WGBS, the Gimbel Bros. station, New York City. Wavelength 348.6 meters; frequency 860 kilocycles. Listen in.



Trade Mark Reg'd U. S. Pat. Office
CONDENSERS



are exclusively specified by Leo Fenway for the Fenway Electric Concertrola. It is the constant report from leading laboratories as well as radio editors and authors that Tobe condensers are superior to all others tested. For the Fenway be sure of matchless performance by using Tobe condensers. Your dealer has them in stock.

"It's got to be Tobe"
Send for Price Catalogue

TOBE DEUTSCHMANN CO.
Engineers and Manufacturers of Technical Apparatus
CAMBRIDGE, MASS.

Again Chosen!

Another prominent engineer has chosen an Electrad control

TRUVOLT
Type 50

This type of TRUVOLT—the new all wire variable voltage control—is specified in the Fenway Electric Concertrola. Also Full Line of Wire Fixed Resistances.

WRITE FOR FREE RESISTANCE CIRCULAR
"This is an Eliminator Year"
Dept. 28-A, 175 Varick St., New York

ELECTRAD

\$12.50

Complete

**The Pacent
PHONOVOX
gives new enjoyment
to your favorite records**

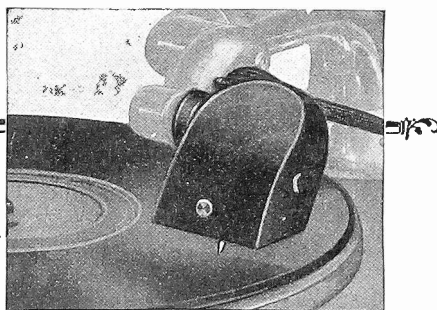

ATTACH the Pacent Phonovox, the better phonograph pick-up device, to your radio and phonograph! Play one of your favorite records! The wonderful tone quality of reproduction will amaze and delight you, giving you, at a small cost of \$12.50, the equivalent in reproduction of

the costly electric phonograph.

Your dealer will gladly demonstrate the Phonovox and show you how easily and quickly it is attached without tools or changes in wiring. All good radio and phonograph dealers handle the Phonovox. Ask for it by name and accept no substitute.

Sold and demonstrated by dealers everywhere

PACENT RADIO CORPORATION
156 West 16th Street New York

Makers of the famous Pacent Balanced Cone

**The New Morecroft Opens
Wide Field to You**

The great Morecroft has a new message for you. The second edition of his masterpiece, "Principles of Radio Communication," just off the press, is offered to you by Professor John H. Morecroft of the Electrical Engineering Department of Columbia University and past president of the Institute of Electrical Engineers.

The outstanding book on radio principles and practice is something that you must not be without. Every set builder, every designer, every engineer, every service man, simply must have this book. Ready reference to all intricate problems makes this volume invaluable. Distributors and dealers, salesmen and teachers, students and operators, all find Morecroft their standby, and now the new second edition awaits you. 1,001 pages and 831 illustrations in this cloth-bound volume.

SEND NO MONEY

Fill out and mail in the attached coupon

GUARANTY RADIO GOODS CO.,
145 West 45th St., New York City.

Gentlemen: Please send me at once and without cost to me full analytical exposition of brand-new edition of Professor Morecroft's famous "Principles of Radio Communication," consisting of 1,001 pages and 831 illustrations, constituting the second edition, which is brought right up to date, and constituting the most complete and authoritative book.

NAME
ADDRESS
CITY STATE

When You Build Fenway's Concertrola Build it Just This Way

By Leo Fenway

Associate, Institute of Radio Engineers

Copyright 1927

[An outstanding four tube circuit, operating from the AC house line, is another achievement of Leo Fenway, circuit designer extraordinary. His circuits are few and far between because he spends months, aye, years developing them. An outline of the circuit was published last week. Constructional information is published herewith.]

PART II

SOME say that when a fellow springs a new radio circuit upon a long suffering public, he ought to lead off with an apology. Others say that there hasn't been anything really new in radio since the days of the three-circuit tuner. Fancy! Look over the schematic diagram in Fig. 6. There's a circuit that didn't come by accident. Rather, it's the final outcome of burning the radio candle at both ends, during which time the writer experimented with every known type, make, brand, style and design of radio instrument.

Oh, yes, he also tried series filaments, push-pull audio, push-pull radio; and a bevy of tubes. Moreover, every known type, make and design of manufactured electric set was available, and its peculiarities and characteristics were observed, charted and filed. This research work began in the fall of 1925; it ended—rather it hasn't ended, but is still going on. During the interim, however, the Electric Concertrola was born.

"It Works" Is Not Enough

Everybody knows that nothing is so easy as to get some kind of results with radio apparatus of one sort or another. A set made of the most indifferent parts, wired in the most casual way, with proper tubes in the wrong places, with semi-rundown batteries, and various other shortcomings, still will contrive to make a noise, which noise can readily be recognized as originally emanating from the human throat, or from a musical instrument. But such results are not good. They satisfy some people, but they are not agreeable to the majority. The great pity of nearly all home-constructed sets has been that they just got themselves built somehow.

So the "old days" of home set building have changed; the prevalent idea that almost anything would do so long as it worked is "out." And the supposition that making radio sets is the easiest thing in the world is a false one. Nevertheless it is true, and must be reiterated, that receivers which give some kind of results have been successfully made by people whose lack of mechanical adaptability has rendered them incapable of constructing anything else. But their sets, mostly, have been merely an agglomeration of instru-

ments, and not a thing with a definite guiding principle through it from start to finish.

Anyone who doubts this statement is invited to visit the writer's laboratory and inspect a few of the sets which are in for repairing.

The Answer

"What, then," you ask, "is the lesson from this analogy?"

The answer is very simple: while the old way of building a radio set was a good way, but slow and uncertain, it was too slow when there is a quicker way.

Fig. 6, aside of outlining the circuit, has a designating letter on each instrument. There's a reason for this; the average set builder, when he gets on new ground, likes to have things explained simply.

Take for example, the letter A in the schematic; this is the aerial or antenna or pick-up device. It can be from 30 feet to 200 feet long, with a lead in, or lead down, of about the same length, it can be from 10 feet to 200 feet above the ground, and can be located either indoors or outdoors. If this aerial is shorter than 30 feet, the set will be critical in tuning,

it will be super-selective, and there will be a loss of volume; if the aerial is over 100 feet long, and rather high, the set will tune broadly, that is, a station may come in over several degrees of the dials, and the volume of signal will be very great. The exact length of aerial to use with the Concertrola depends upon (1) whether you live on the ground floor or on the top floor of an apartment house, and (2) whether your location is classified as a good one for radio reception. The aerial is connected with No. 1 of the 368A coil, while No. 2 of the same coil is connected with "B"—the ground.

Good Ground Advised

The ground connection is usually made to a water pipe, a steam radiator, a fire-escape, a light socket, or to rods driven into moist earth. With every form of aerial the ground lead is an essential part of the tuned circuit. If it has a high resistance, the signals reaching the detector will be weak, and the Concertrola cannot produce the results of which it is capable. While one side of the AC line furnishes a sort of grounded connection, it is wise to connect a heavy ground lead to a cold water pipe, taking care to have

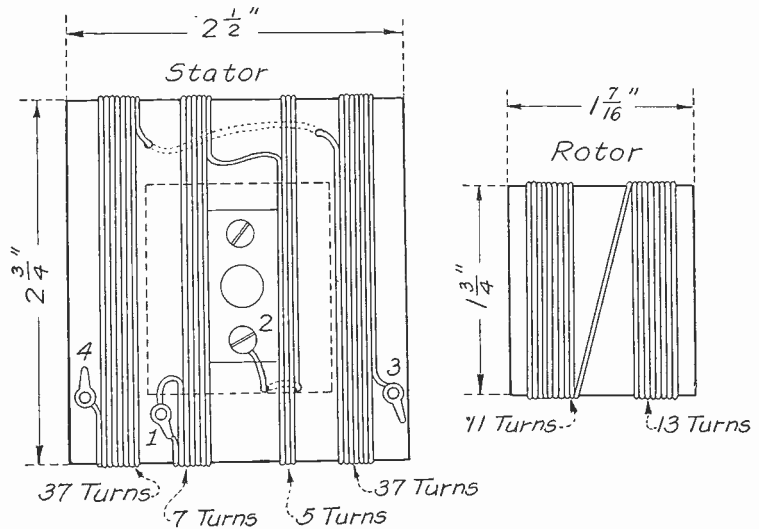
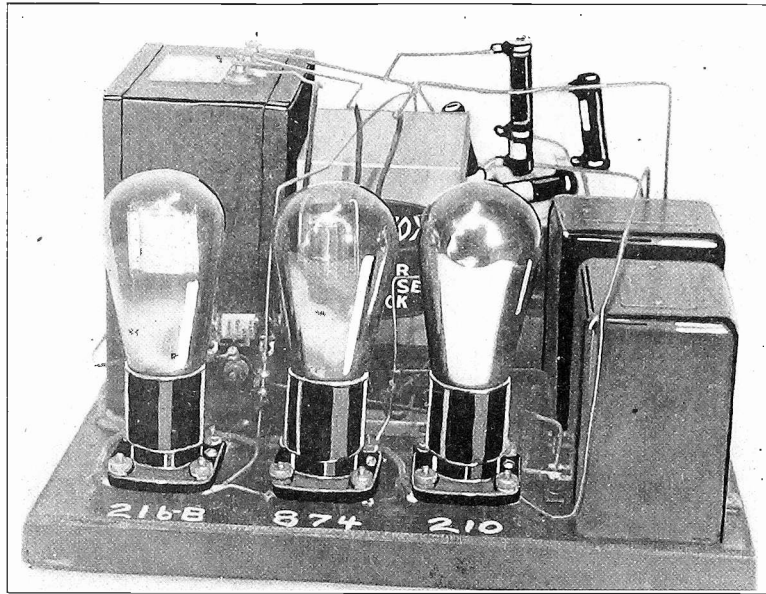

FIG. 4
GRAPHIC REPRESENTATION OF SIZE OF COILS AND NUMBER OF TURNS. THE DIRECTIONS ABOVE ARE FOR THE SPECIAL FENWAY VARIOCOUPLER 368-B. THE OTHER COIL, 368-A, IS WOUND IN THE SAME FASHION, BUT THE NO. 1 WINDING IS TAPPED EVERY SECOND TURN.

Some Unbiased Facts

By Roger



THE RESISTORS IN THE BACKGROUND OF THIS B ELIMINATOR ARE USED TO AFFORD THREE DIFFERENT FIXED BIAS VOLTAGES.

THE question as to what negative bias to use in various circuits with different tubes often comes up. What are the factors on which the value of the grid bias is determined?

In the first place the grid bias depends on the amplification constant of the tube. The larger the μ of the tube the smaller should the grid bias be, everything else being constant.

Also the grid bias depends on the plate voltage applied to the tube. The higher the plate voltage applied, the higher the grid bias should be with any given tube. The applied plate voltage is what counts, not the effective voltage on the plate, contrary to common opinion. *It is the voltage in the circuit which determines the flow of current in the plate circuit, and not the net voltage at the plate.* Hence the bias should be adjusted for the applied voltage.

Now, in certain cases it is possible to operate a tube with zero bias, or even with a positive bias, without serious effects on the amplification. Also it is possible to operate the tube with a negative bias which is more nearly zero than the bias usually recommended. Whether such deviations are possible depends on the grid circuit and on the amplitude of the signal. We can dismiss the cases of positive bias at once as being impractical. We are no more interested in a zero bias for similar reasons. In nearly all practical circuits a negative bias is required at all times. It remains to consider how much is necessary.

Amplitude and Impedance

The amount of bias necessary for any given tube and given plate battery voltage depends on the amplitude of the signal which is to be impressed on the tube. And it also depends on the type of grid circuit that is used. If the grid current, if any, encounters a high impedance on its way to the filament, it is necessary to make the negative bias so great that at

no time does the grid go positive, or even within half a volt of the zero line. This means that the grid bias must be at least half a volt greater than the amplitude of the greatest signal which will be impressed on the tube.

If the amplitude which may be impressed on the grid of the tube may reach one volt, the bias should be at least $1\frac{1}{2}$ volts. This is irrespective of the μ of the tube or the plate voltage applied, and it refers particularly to resistance coupling where the grid current would have to flow through the grid leak.

If the impedance in the grid circuit is not high, a small amount of grid current can flow without causing any reduction in the amplification. But even in this case the grid should not swing positive on the peaks of the signal voltage. It may touch zero this time. Hence the grid bias should be at least equal to the amplitude of the greatest signal voltage that is likely to be impressed on the tube. Impedance and transformer coupling come under this ruling. Few are the cases in which the regulation of the grid circuit is so good that a zero or a positive grid is allowable.

The Reconciliation

It was stated previously that the grid bias depends on the plate voltage applied and on the μ of the tube and now it is stated that the bias depends on the amplitude of the signal voltage. How are these apparently contradictory statements reconciled?

The signal amplitude determines the minimum grid bias that should be used but not necessarily the optimum bias under all conditions. The optimum bias in any given case may be smaller than the amplitude of the signal voltage. In that case the tube will be overloaded, and to avoid distortion it is necessary to increase the plate voltage applied, increase the power of the tube or lower the μ of the tube used. That is, it is necessary to use a larger and more

powerful tube. If the optimum grid bias is much larger than the greatest signal voltage amplitude, all is well. The bias may be changed to the optimum value or it may be left just a little in excess of the signal amplitude.

What determines the optimum grid bias? That is not a very definite thing and many factors must be considered. In some cases the optimum grid bias is that which gives the greatest voltage amplification and at the same time the least distortion. In other cases there is no such point, unless it be the zero bias point, which can rarely be used.

In the case of resistance coupling the plate current grid voltage curve is steepest and most nearly straight a volt or two to the left of the zero line. Hence in that type of coupling the bias should be that if other factors do not enter to demand a different adjustment. The other factors usually are the amplitude of the signal voltage and the means available for obtaining a bias.

Too Much Better Than Too Little

In resistance coupling it is also well to take the plate current through the coupling resistor into consideration. This resistor burns out at times and the cause is usually insufficient bias. For all-around satisfactory operation of circuits of either resistive or inductive coupling it is usually better to have a little too much bias than not enough. A slight loss in amplification may be the result, but this effect is so small in comparison with the many advantages that it may be dismissed without consideration.

The signal amplitude which will be impressed on various tubes in an amplifier depends on the type of tubes used in the amplifier and the total output. Suppose that the amplifier is resistance coupled with two μ 30 tubes and one μ 3 tube. The maximum voltage that may be impressed on the μ 3 tube is 40 volts, assuming a grid bias of $40\frac{1}{2}$ volts.

Suppose that the high μ tubes are so coupled that the amplification per stage is 18. The signal amplitude on the second tube from the speaker may then be $40/18$, or 2.2 volts. Let us add .3 of a volt to that in case the amplification is not quite 18. Then the signal amplitude may be 2.5 volts. But the swing of the grid should never come closer than $\frac{1}{2}$ volt of the zero bias line. Hence the bias on the second tube must be 3 volts to take care of the swing on the last tube.

Fixing First AF Bias

The amplification of the first high μ tube is also 18. Hence the amplitude of the signal on the tube may be $1/6$ volt. Call this .2 volt for good measure and add $\frac{1}{2}$ volt safety bias, and we have a bias of .7 volt. The bias on the first high μ tube in the amplifier should be that or more.

If the amplifier is served with a 6-volt storage battery there will be a one-volt bias available in the filament rheostat or ballast resistor. This is enough for the first tube but not for the second. At least 2 more volts must be provided. A 3-volt dry cell is about right, since its voltage is enough and not too much. Now if the applied voltage on the plate is 180 volts both of the high μ tubes can be biased with the 3-volt battery in that simplifies the wiring.

Now let us assume a 112-tube in the last stage with an applied plate voltage of

About Underbiased Grids

C. Brooks

157½ volts. The permissible grid swing is 11 volts with a bias of 11½ volts. This bias is obtained from a 10½-volt battery and a one-volt drop in the ballast resistor.

Second and Third AF

The amplification of the high mu tube is the same as it was when the 71 power tube was used. Hence the voltage swing on the middle tube in the amplifier will be 11/18, or .61 volt. Adding the ½ volt safety voltage to this gives a necessary bias of 1.11 volts. This is more than will be obtained from the filament ballast resistor. Hence a single dry cell should be used to supply the additional voltage. The signal amplitude on the first high mu tube will only be .0333 volt. The drop in the ballast more than takes care of the

voltage swing and the ½ volt safety voltage.

Since many tubes have the same input requirements as the 112 the results for that tube will also apply to these tubes when operating with two mu 30 tubes.

Suppose the last tube takes a voltage swing of 40 volts and the two preceding tubes are of the mu 8 type. What should be the various grid bias voltages? It depends on the voltage step-up per stage and that depends on the coupling resistors. Suppose the coupler is such that the step-up is 6 per stage, which is a reasonable value. The signal amplitude on the middle tube will then be 40/6, or nearly 7 volts. Adding ½ volts for safety the total bias on the middle tube should be 7½ volts. This can be obtained from

dry cell battery of that voltage. The one volt drop in the ballast can be added without making the bias too great.

What More Than IR Drop

The signal amplitude on the first mu 8 tube in the amplifier will be one-sixth of 7, or about 1.2 volts. Thus the total bias must be at least 1.7 volts. Since this exceeds the drop in the ballast it will be necessary to use at least one dry cell to supply all the bias that is necessary.

A signal swing of 1.2 on the first amplifier is probably more than the detector tube will deliver, so that in this series that detector will limit the volume rather than the last tube.

It is manifest how important biases are.

Six Things to Remember When Buying Resistors

When you are getting ready the parts list for a new set, power supply unit, or power amplifier, don't pass lightly over the fixed resistors. Compared to some of the larger and more pretentious apparatus in the circuit, two or three small resistors may seem relatively unimportant. But they're not!

Remember that in equipment such as an eliminator or power amplifier, the resistors determine in the final analysis the performance of units of this type. A resistor is the gate to control the flow of current. Inaccurate, poorly made resistors mean at best results not so good as those to be had with permanent, well made accurate resistors.

Keep these six buying points in mind when you purchase fixed resistors. If a resistor meets them all you can be sure of permanent performance.

1. A resistor should be unchanging in value, regardless of temperature or of load imposed on it within its watts dissipation rating.

2. Purchase permanent value. That is, buy a resistor you know will not depreciate and affect the value of radio apparatus which may represent an investment of hundreds of dollars.

3. Buy an accurate resistor.

4. Look at the joints of the resistor. Oxidization of the resistance wire will occur unless joints are carefully sealed and permanently protected from all atmospheric action.

5. Buy resistors that are free from capacity and inductance characteristics. A resistor should be a resistance, not a condenser or a coil. If it has capacity or inductance, it may affect your circuit.

6. Get resistors which won't crack or deteriorate under long usage.

Fixed resistors are important—and it's no harder to find the type you want that conforms to the requirements above than it is to get one that's half as good.

Broadcasting At Home

"Homekaster," a new and scientific radio device, brings a fresh angle to radio entertainment and instruction besides opening a new field of amusement to owners of radio receivers. With the aid of this apparatus it is possible to hold auditions at home and give a thorough test to aspiring radio entertainers, both vocal and instrumental, in one's parlor.

Broadcasting parties may be held, whereat the entire bill may be provided by home talent and received over the loudspeaker for the entertainment of guests just as if received from a radio station. Many other novel and unusual uses may be had to amuse and mystify the listeners. By a reverse process, listeners in another room may hear every sound that is made in the room containing the radio set and loudspeaker. Full details are available from the Aplin Radio Laboratories, suite 429, 30 Church street, New York City.—J. H. C.

KDKA Seven Years Old

Pittsburgh.—The seventh anniversary of KDKA was celebrated recently. Many of the artists who took part in the early days of broadcasting were featured on this program.

The Westinghouse Band under the direction of T. J. Vastine, which began its radio career when the station was first put into operation, played a prominent part in the program as well as the Little Symphony Orchestra under the direction of Victor Saudek.

GOOD VOLUME CONTROL FOR AC SET

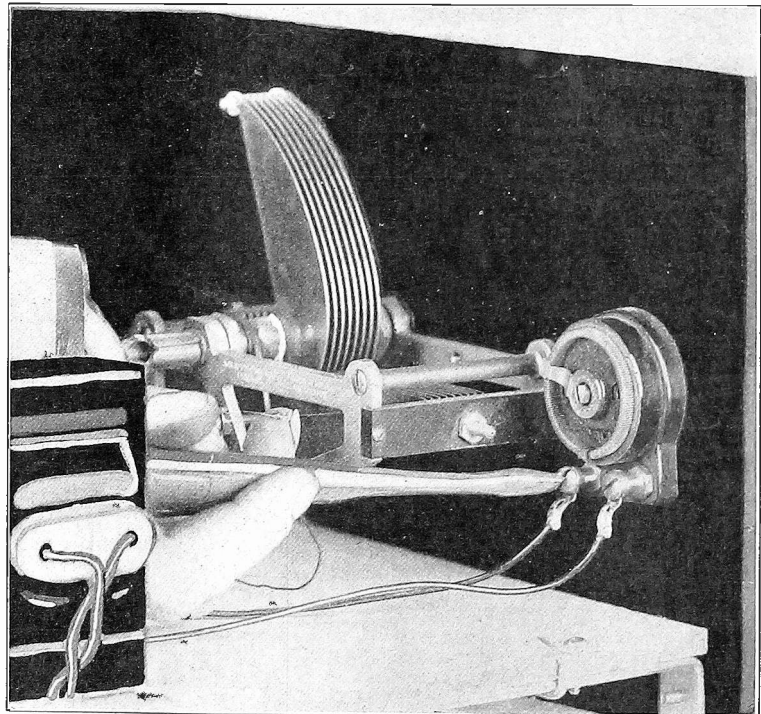

NOT ONLY NOVEL, BUT ELECTRICALLY EXCELLENT, IS THE VOLUME CONTROL SYSTEM EMPLOYED IN A VERY SIMPLE ELECTRIC SET USING 4-TUBES, TO BE DESCRIBED IN NEXT WEEK'S ISSUE OF RADIO WORLD, DATED NOVEMBER 19. AN ELECTRAD TONATROL IS INSERTED ACROSS THE ANTENNA AND GROUND. THE VOLUME CAN THEN BE CONTROLLED UNTIL IT IS DOWN TO A WHISPER. CECO N-27 TUBES ARE USED IN ELECTRIFYING THE SET. THE OUTPUT IS A UX-210 TUBE.

Some Unbiased Facts

By Roger

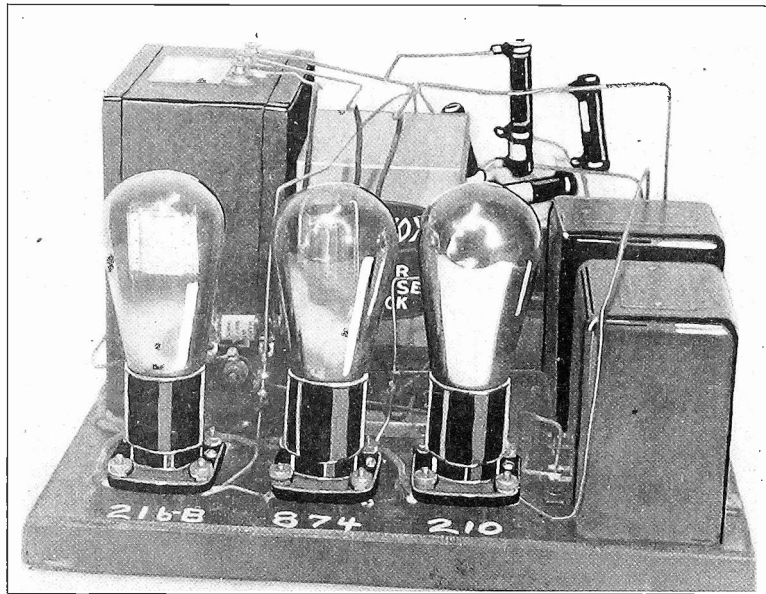

THE RESISTORS IN THE BACKGROUND OF THIS B ELIMINATOR ARE USED TO AFFORD THREE DIFFERENT FIXED BIAS VOLTAGES.

THE question as to what negative bias to use in various circuits with different tubes often comes up. What are the factors on which the value of the grid bias is determined?

In the first place the grid bias depends on the amplification constant of the tube. The larger the μ of the tube the smaller should the grid bias be, everything else being constant.

Also the grid bias depends on the plate voltage applied to the tube. The higher the plate voltage applied, the higher the grid bias should be with any given tube. The applied plate voltage is what counts, not the effective voltage on the plate, contrary to common opinion. *It is the voltage in the circuit which determines the flow of current in the plate circuit, and not the net voltage at the plate.* Hence the bias should be adjusted for the applied voltage.

Now, in certain cases it is possible to operate a tube with zero bias, or even with a positive bias, without serious effects on the amplification. Also it is possible to operate the tube with a negative bias which is more nearly zero than the bias usually recommended. Whether such deviations are possible depends on the grid circuit and on the amplitude of the signal. We can dismiss the cases of positive bias at once as being impractical. We are no more interested in a zero bias for similar reasons. In nearly all practical circuits a negative bias is required at all times. It remains to consider how much is necessary.

Amplitude and Impedance

The amount of bias necessary for any given tube and given plate battery voltage depends on the amplitude of the signal which is to be impressed on the tube. And it also depends on the type of grid circuit that is used. If the grid current, if any, encounters a high impedance on its way to the filament, it is necessary to make the negative bias so great that at

no time does the grid go positive, or even within half a volt of the zero line. This means that the grid bias must be at least half a volt greater than the amplitude of the greatest signal which will be impressed on the tube.

If the amplitude which may be impressed on the grid of the tube may reach one volt, the bias should be at least $1\frac{1}{2}$ volts. This is irrespective of the μ of the tube or the plate voltage applied, and it refers particularly to resistance coupling where the grid current would have to flow through the grid leak.

If the impedance in the grid circuit is not high, a small amount of grid current can flow without causing any reduction in the amplification. But even in this case the grid should not swing positive on the peaks of the signal voltage. It may touch zero this time. Hence the grid bias should be at least equal to the amplitude of the greatest signal voltage that is likely to be impressed on the tube. Impedance and transformer coupling come under this ruling. Few are the cases in which the regulation of the grid circuit is so good that a zero or a positive grid is allowable.

The Reconciliation

It was stated previously that the grid bias depends on the plate voltage applied and on the μ of the tube and now it is stated that the bias depends on the amplitude of the signal voltage. How are these apparently contradictory statements reconciled?

The signal amplitude determines the minimum grid bias that should be used but not necessarily the optimum bias under all conditions. The optimum bias in any given case may be smaller than the amplitude of the signal voltage. In that case the tube will be overloaded, and to avoid distortion it is necessary to increase the plate voltage applied, increase the power of the tube or lower the μ of the tube used. That is, it is necessary to use a larger and more

powerful tube. If the optimum grid bias is much larger than the greatest signal voltage amplitude, all is well. The bias may be changed to the optimum value or it may be left just a little in excess of the signal amplitude.

What determines the optimum grid bias? That is not a very definite thing and many factors must be considered. In some cases the optimum grid bias is that which gives the greatest voltage amplification and at the same time the least distortion. In other cases there is no such point, unless it be the zero bias point, which can rarely be used.

In the case of resistance coupling the plate current grid voltage curve is steepest and most nearly straight a volt or two to the left of the zero line. Hence in that type of coupling the bias should be that if other factors do not enter to demand a different adjustment. The other factors usually are the amplitude of the signal voltage and the means available for obtaining a bias.

Too Much Better Than Too Little

In resistance coupling it is also well to take the plate current through the coupling resistor into consideration. This resistor burns out at times and the cause is usually insufficient bias. For all-around satisfactory operation of circuits of either resistive or inductive coupling it is usually better to have a little too much bias than not enough. A slight loss in amplification may be the result, but this effect is so small in comparison with the many advantages that it may be dismissed without consideration.

The signal amplitude which will be impressed on various tubes in an amplifier depends on the type of tubes used in the amplifier and the total output. Suppose that the amplifier is resistance coupled with two μ 30 tubes and one μ 3 tube. The maximum voltage that may be impressed on the μ 3 tube is 40 volts, assuming a grid bias of $40\frac{1}{2}$ volts.

Suppose that the high μ tubes are so coupled that the amplification per stage is 18. The signal amplitude on the second tube from the speaker may then be $40/18$, or 2.2 volts. Let us add .3 of a volt to that in case the amplification is not quite 18. Then the signal amplitude may be 2.5 volts. But the swing of the grid should never come closer than $\frac{1}{2}$ volt of the zero bias line. Hence the bias on the second tube must be 3 volts to take care of the swing on the last tube.

Fixing First AF Bias

The amplification of the first high μ tube is also 18. Hence the amplitude of the signal on the tube may be $1/6$ volt. Call this .2 volt for good measure and add $\frac{1}{2}$ volt safety bias, and we have a bias of .7 volt. The bias on the first high μ tube in the amplifier should be that or more.

If the amplifier is served with a 6-volt storage battery there will be a one-volt bias available in the filament rheostat or ballast resistor. This is enough for the first tube but not for the second. At least 2 more volts must be provided. A 3-volt dry cell is about right, since its voltage is enough and not too much. Now if the applied voltage on the plate is 180 volts both of the high μ tubes can be biased with the 3-volt battery in that simplifies the wiring.

Now let us assume a 112-tube in the last stage with an applied plate voltage of

About Underbiased Grids

C. Brooks

157½ volts. The permissible grid swing is 11 volts with a bias of 11½ volts. This bias is obtained from a 10½-volt battery and a one-volt drop in the ballast resistor.

Second and Third AF

The amplification of the high mu tube is the same as it was when the 71 power tube was used. Hence the voltage swing on the middle tube in the amplifier will be 11/18, or .61 volt. Adding the ½ volt safety voltage to this gives a necessary bias of 1.11 volts. This is more than will be obtained from the filament ballast resistor. Hence a single dry cell should be used to supply the additional voltage. The signal amplitude on the first high mu tube will only be .0333 volt. The drop in the ballast more than takes care of the

voltage swing and the ½ volt safety voltage.

Since many tubes have the same input requirements as the 112 the results for that tube will also apply to these tubes when operating with two mu 30 tubes.

Suppose the last tube takes a voltage swing of 40 volts and the two preceding tubes are of the mu 8 type. What should be the various grid bias voltages? It depends on the voltage step-up per stage and that depends on the coupling resistors. Suppose the coupler is such that the step-up is 6 per stage, which is a reasonable value. The signal amplitude on the middle tube will then be 40/6, or nearly 7 volts. Adding ½ volts for safety the total bias on the middle tube should be 7½ volts. This can be obtained from

dry cell battery of that voltage. The one volt drop in the ballast can be added without making the bias too great.

What More Than IR Drop

The signal amplitude on the first mu 8 tube in the amplifier will be one-sixth of 7, or about 1.2 volts. Thus the total bias must be at least 1.7 volts. Since this exceeds the drop in the ballast it will be necessary to use at least one dry cell to supply all the bias that is necessary.

A signal swing of 1.2 on the first amplifier is probably more than the detector tube will deliver, so that in this series that detector will limit the volume rather than the last tube.

It is manifest how important biases are.

Six Things to Remember When Buying Resistors

When you are getting ready the parts list for a new set, power supply unit, or power amplifier, don't pass lightly over the fixed resistors. Compared to some of the larger and more pretentious apparatus in the circuit, two or three small resistors may seem relatively unimportant. But they're not!

Remember that in equipment such as an eliminator or power amplifier, the resistors determine in the final analysis the performance of units of this type. A resistor is the gate to control the flow of current. Inaccurate, poorly made resistors mean at best results not so good as those to be had with permanent, well made accurate resistors.

Keep these six buying points in mind when you purchase fixed resistors. If a resistor meets them all you can be sure of permanent performance.

1. A resistor should be unchanging in value, regardless of temperature or of load imposed on it within its watts dissipation rating.

2. Purchase permanent value. That is, buy a resistor you know will not depreciate and affect the value of radio apparatus which may represent an investment of hundreds of dollars.

3. Buy an accurate resistor.

4. Look at the joints of the resistor. Oxidization of the resistance wire will occur unless joints are carefully sealed and permanently protected from all atmospheric action.

5. Buy resistors that are free from capacity and inductance characteristics. A resistor should be a resistance, not a condenser or a coil. If it has capacity or inductance, it may affect your circuit.

6. Get resistors which won't crack or deteriorate under long usage.

Fixed resistors are important—and it's no harder to find the type you want that conforms to the requirements above than it is to get one that's half as good.

Broadcasting At Home

"Homekaster," a new and scientific radio device, brings a fresh angle to radio entertainment and instruction besides opening a new field of amusement to owners of radio receivers. With the aid of this apparatus it is possible to hold auditions at home and give a thorough test to aspiring radio entertainers, both vocal and instrumental, in one's parlor.

Broadcasting parties may be held, whereat the entire bill may be provided by home talent and received over the loudspeaker for the entertainment of guests just as if received from a radio station. Many other novel and unusual uses may be had to amuse and mystify the listeners. By a reverse process, listeners in another room may hear every sound that is made in the room containing the radio set and loudspeaker. Full details are available from the Aplin Radio Laboratories, suite 429, 30 Church street, New York City.—J. H. C.

KDKA Seven Years Old

Pittsburgh.—The seventh anniversary of KDKA was celebrated recently. Many of the artists who took part in the early days of broadcasting were featured on this program.

The Westinghouse Band under the direction of T. J. Vastine, which began its radio career when the station was first put into operation, played a prominent part in the program as well as the Little Symphony Orchestra under the direction of Victor Saudek.

GOOD VOLUME CONTROL FOR AC SET

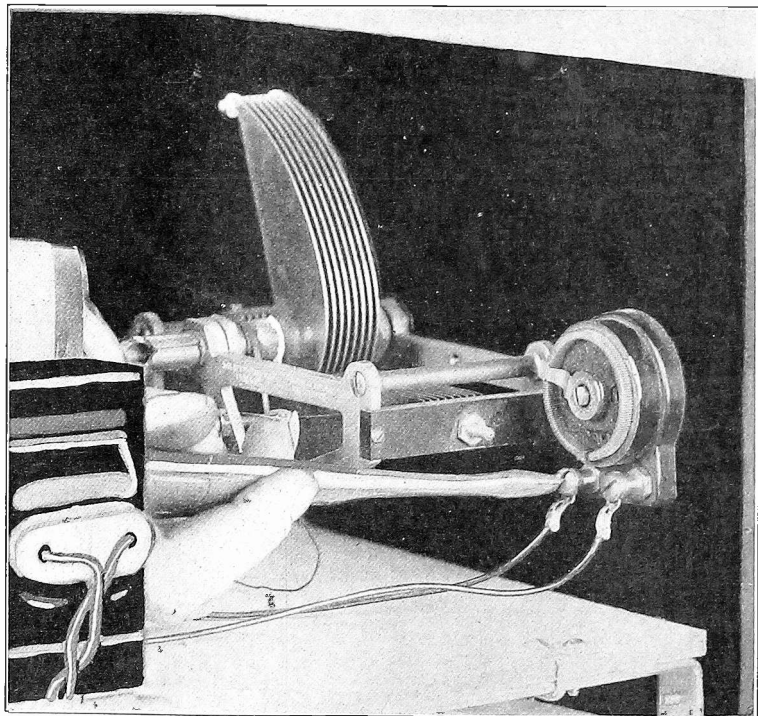

NOT ONLY NOVEL, BUT ELECTRICALLY EXCELLENT, IS THE VOLUME CONTROL SYSTEM EMPLOYED IN A VERY SIMPLE ELECTRIC SET USING 4-TUBES, TO BE DESCRIBED IN NEXT WEEK'S ISSUE OF RADIO WORLD, DATED NOVEMBER 19. AN ELECTRAD TONATROL IS INSERTED ACROSS THE ANTENNA AND GROUND. THE VOLUME CAN THEN BE CONTROLLED UNTIL IT IS DOWN TO A WHISPER. CECO N-27 TUBES ARE USED IN ELECTRIFYING THE SET. THE OUTPUT IS A UX-210 TUBE.

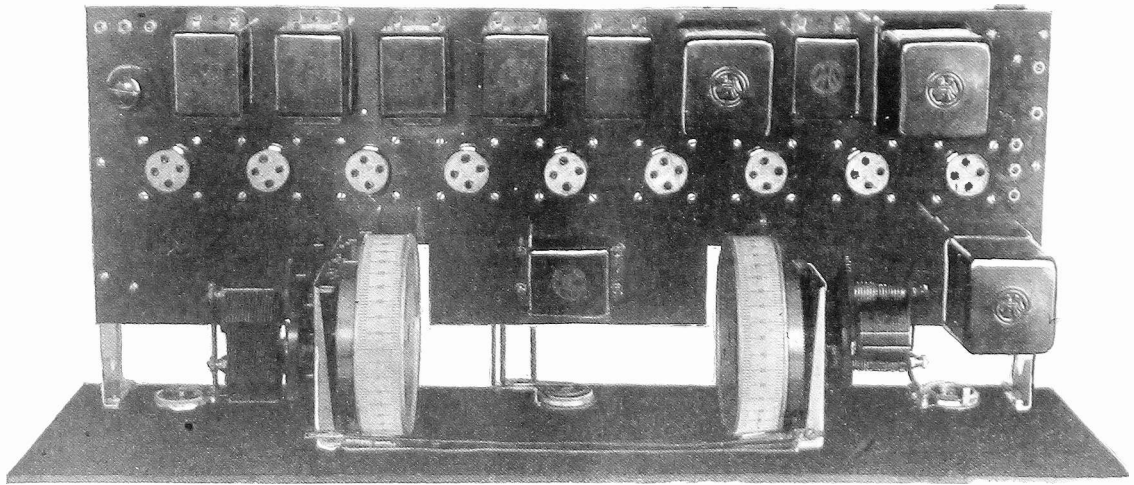

JUDGING BY THE APPEARANCE OF THIS PHOTOGRAPH OF THE BASEBOARD OF THE NINE-IN-LINE SUPER-HETERODYNE IT IS TRULY A WIRELESS SET. THERE IS AN ALMOST COMPLETE ABSENCE OF VISIBLE WIRING, AND THIS ADDS GREATLY TO THE ATTRACTIVENESS OF THE RECEIVER.

The New Nine-

By John Murray Barron

Contributing Editor

"A N improved Nine-in-Line! How can a receiver that consistently brings in stations north of the Canal Zone be improved? If the new model can do any better than mine it must be a world beater."

A Nine-in-Line enthusiast, after a year's experience with this well-known Super-Heterodyne, thus expressed his admiration for the circuit.

No sooner had he given this tribute to the great performance of the Nine-in-Line than he felt the pangs of jealousy. If one of his friends should get the new model and beat his own performance record he would know the novel experience of second place. That would not do. To forestall any such possibility he sold his old set to a friend who had admired the set and built one of the new models. What did he gain by this trade? He gained a little in consistency of performance, he gained somewhat more in tone quality, and he gained immeasurably more in the appearance of the set.

New One Outreaches

The new set outreached the old, it outplayed it, it outdid it in selectivity, and it overwhelmed it in appearance. The new set had volume aplenty, selectivity that needed no whetting, sensitivity that

needed no tickling, and an appearance that lent dignity to the drawing room. The proud owner of the new set felt sure that his radio supremacy would not be threatened for a long time, if ever.

There are no essential changes in the circuit diagram. On this score the old model rated as high as the new. When a top-notch circuit has been found and used in an earlier model, it is no improvement to make alterations just to be able to shout "improved." We note one small change in the removal of a .002 mfd. condenser from across the secondary of the first audio transformer to a similar position on the second. The net result on the quality is the same in both cases, but the wiring is simplified by the change.

A very great improvement is the provision made for the use of a power tube in the output. Instead of connecting the loud speaker directly in the plate circuit an output transformer is interposed between the tube and the speaker. A tube large enough to handle all the volume required without overloading is thus made possible without endangering the loud speaker windings.

Tuning Improvement

The greatest improvement effected is in the manner of tuning the circuit. Drum

dials are used with a very fine vernier adjustment which makes it possible to tune in the distant stations with utmost precision and ease. DX of the remotest origin follows as a matter of course. Exact tuning and high sensitivity are in-

LIST OF PARTS

- IF3, IF4, IF5,—Three H.F.L. H 210 transformers.
- IF1, IF2—Two H.F.L. H 215 transformers.
- AF1, AF2—Two H.F.L. C 16 transformers.
- RFF—One H.F.L. L 425 R.F. choke.
- L1, L2—One H.F.L. L 430 R.F. transformer.
- OT—One H.F.L. C 25 output transformer.
- C1, C2—Two Remler .0005 mfd. tuning condensers.
- C3—One General Radio 50 mmfd. mid-gate condenser.
- C4—One Carter .00025 mfd. fixed condenser.
- C6, C7, C8—Three Carter .002 mfd. fixed condensers.
- C5—One Polymet .5 mfd. by-pass condenser.
- R1—One Carter 10 ohm rheostat.
- R2—One Carter 6 ohm rheostat.
- R3—One Carter 500,000 ohm variable resistor.
- R4—One Carter $\frac{3}{4}$ ampere ballast resistor.
- DL1—Two dial lights.
- S—One Carter filament switch.
- Two Remler drum dials.
- Nine Benjamin sockets.
- Two Benjamin sub-panel brackets.
- One Formica panel 7x26 inches.
- One Formica sub-panel 8x24 inches.
- One Yaxley complete cable connector.
- Five Carter imp jacks.
- Three Eveready 45 volt batteries, heavy duty.
- Three Eveready 4.5 volt C batteries.
- One Corbett 7x26 inch cabinet.
- Eight CX-301-A tubes.
- One CX-112 tube.
- One cone type loud speaker.
- One Qualitone loop.
- One six volt storage battery.

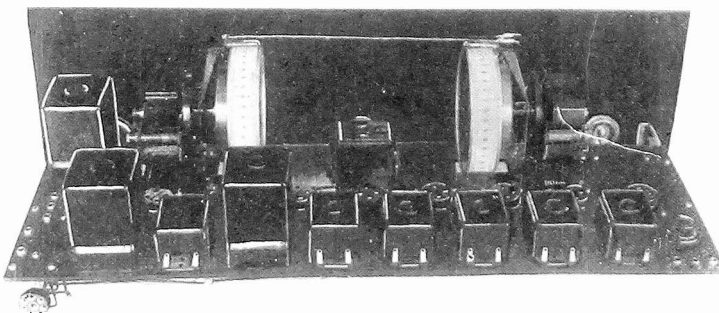

THIS VIEW GIVES ANOTHER SLANT OF THE NINE-IN-LINE SUPER-HETERODYNE. NOTE THE TERMINAL JACK IN THE LOWER LEFT CORNER.

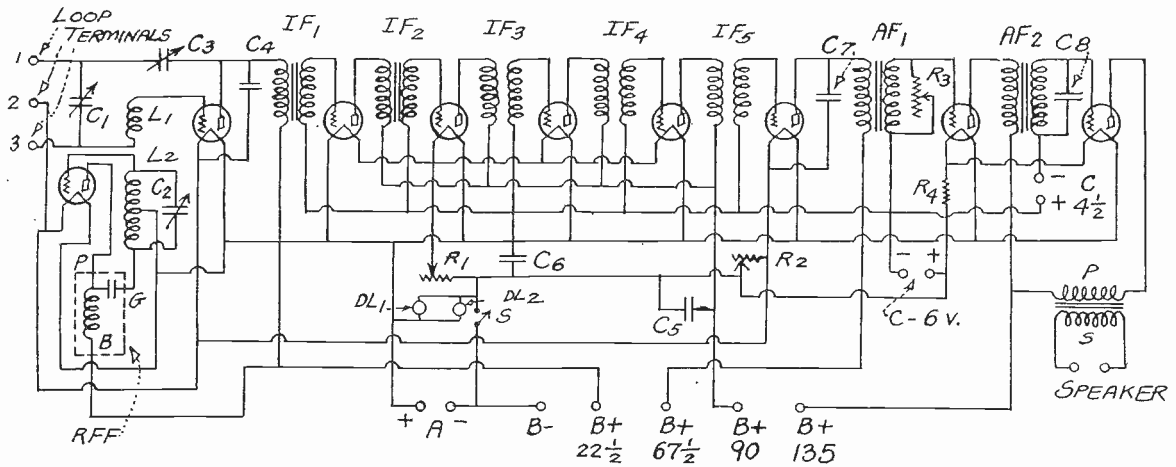

THE CIRCUIT DIAGRAM OF THE NINE-IN-LINE SET

in-Line Receiver

separable, and in that lies one of the secrets of the record-breaking performances of the Nine-in-Line.

But mere precise tuning would not avail much if the tuned circuits were not highly efficient. In this the Nine-in-Line scores heavily because it employs condensers of highest quality and coils of truly—low loss characteristics.

In speaking of tuning of a Super-Heterodyne one often forgets where the selectivity as well as the sensitivity really reside. One is apt to attribute the performance to the oscillator coil and the oscillator condenser. While these must be of high quality they are not so important as certain other parts. Yet the oscillator is given credit for unusual performances where the credit really belongs to the intermediate frequency amplifier, and to the I.F. transformers in particular.

Needs Amply Fulfilled

The main requirement of the oscillator condenser is that it can be turned easily and smoothly, and the requirement of the oscillating circuit as whole is that it oscillates uniformly over the entire broadcast band. When these are met, the rest devolves on the intermediate channel, with a small part detailed to the radio frequency tuner. A super usually stands or falls on the intermediate circuit provided that a reasonable selectivity has been introduced in the radio frequency level. When an experienced radio enthusiast buys an improved model of a certain Super-Heterodyne on the performance record of the first, one cannot logically say that the receiver has not stood the test. When others who have used the old model recommend to their friends to get one of the improved models, one is forced to admit that the circuit delivers the quality and the DX.

High Amplification in IF

The high sensitivity of the Nine-in-Line is due to the high amplification in the IF level. The low intermediate frequency employed, the iron core IF transformers used, and the four stages, account for the high gain. Two of the IF transformers are air core but adjusted to have their peaks at the same value as the iron core transformers. These two account for the selectivity of the circuit, and that select-

ivity is ample for all reasonable demands. One difficulty experienced in many Super-Heterodynes is what has been called image interference. No amount of selectivity in the IF level will help to alleviate this trouble. The problem must be attacked in the radio frequency level, by making this more selective. How has this been handled in the Nine-in-Line? A highly efficient loop is used for one thing. That eliminates most interference from certain directions due to its directional qualities. Then again this is more selective so that it minimizes interference by actually suppressing all undesirable signals. But that is not enough in this receiver. Regeneration is employed, and that intelligently applied is one of the best means of suppressing image interference. The regeneration is effected by tapping the loop in the center and by

feeding energy back through a variable midget condenser C3. This coupled with highly efficient and smooth running condenser across the loop makes for high sensitivity and a minimum of interference.

The panel view of the receiver shows the great improvement effected in the exterior appearance of the set. Small knobs for turning the drums, small illuminated windows for reading the scales, and appropriate color effects make for attractiveness and dignity. The small volume control knobs drawn up in a row near the base of the panel do not detract for the pleasing effect.

The photograph of the interior of the set shows that attractiveness is more than skin deep. It extends clear to the back wall of the set. A look inside is as pleasing an experience as to listen to the set perform.

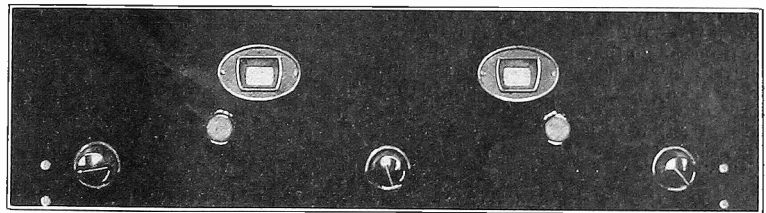

THE PANEL ARRANGEMENT OF THE NINE-IN-LINE IS SIMPLE AND DIGNIFIED, AS THIS PHOTO SHOWS.

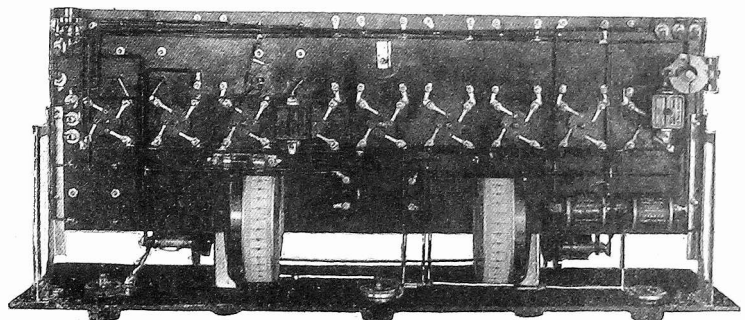

THIS VIEW OF THE UNDER SIDE OF THE SUB-PANEL OF THE NINE-IN-LINE SHOWS NEATNESS OF THE WIRING OF THE SET.

Not Much DX But

By H. B. Herman

A GREAT many persons are so enthralled at hearing real quality reproduction of a radio receiver that they ask for nothing else from it. Not a word about distance, or, if the subject is broached, it is done in a most unobtrusive and politely inquiring manner. And the answer would have to be, concerning a circuit like the one in Fig. 1, that no distance is guaranteed. Surely, one has a chance to get some, but, if it comes in, it should be considered as a windfall rather than accepted as a birthright.

Now, you scarcely could ask for greater simplicity of tuning than what such a cir-

resistance values of 100,000 to 250,000 ohms but in this circuit 2 meg. plate resistors were used with 4 meg. grid leaks. All tubes were -01A except the last a 112. With condensers of suitably large capacity, say .01 mfd., for C6 and C7, the leak-condenser combination works splendidly in favor of low note amplification.

It is the common shortcoming of loudspeakers that they cut off the lower audio frequencies, and few receivers are able to move the sluggish diaphragm to respond to low notes. Harmonics of low notes do move the speaker to action, and the ear is supposed to rectify the shortcoming by

the more enjoyable the reproduced results.

On the other hand, some speakers are not so sluggish as others. For instance, the Western Electric 540AW and the Lata Balsa Wood Reproducer account for themselves well in the neither audible regions as do the Timmons Concert Grand and the B. B. S.

Still, if one will use 400 or more volts on the plate of the last tube, preferably around 475 or 500 volts on a 210, he can make even the most reluctant speaker evoke low notes and render them well. Even a small cone then will do the trick, yes, even one eight

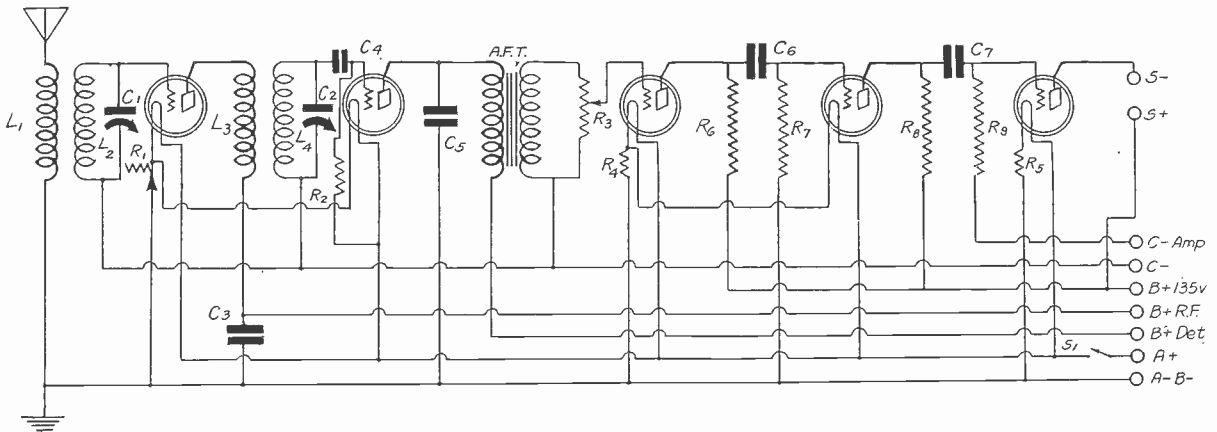

THE CIRCUIT DIAGRAM OF THE RECEIVER WITH WHICH TREMENDOUS VOLUME MAY BE OBTAINED. THE REPRODUCTION IS FLAWLESS THOUGH.

cuit as this affords. True, there are two tuned circuits, but did you ever stop to ponder the fact that a single dial may tune both without sacrifice? Ordinarily you can not get as great sensitivity out of a simple receiver like the one shown if the controls are localized. It is fine and dandy to have a single control receiver, but it is usually accepted as relatively true that one radio tube is included in the circuit to bring the sensitivity up to what it would be were an extra tuning control present. Not so in this case, and one reason is that the condenser rotors may be set at a permanent difference to compensate.

Use of the Rheostat

With the rheostat R1 controlling both the radio frequency amplifier tube and the detector tube not only is volume kept down to any desired level but also any tendency toward self-oscillation at radio frequencies is overcome by rheostat adjustment.

It is quite possible that a receiver overloads not at the radio frequency level but at the audio frequency level, and this can be corrected nicely at the input to the first AF stage. That is one reason why the 500,000-ohm potentiometer is used across the secondary of the audio transformer. Another reason is that if a phonograph pickup is used a volume control exists within the receiver itself.

The audio channel is an old-time favorite. The first stage is transformer coupled and the next two steps are resistance coupled, with one unusual feature in the resistance part, and that is the values of resistance. It is usual to recommend plate

hearing the harmonics and restoring the original frequency by intuitive reflex. But the scrambled and heterogeneous harmonics usually leave no tangible trace of the original either in the speaker or in the ear, so the better amplification the audio channel itself affords to low notes,

inches in outside diameter.

This particular squint at the problem might seem at first blush to be awry, but it is absolutely and positively the truth, and has been confirmed by aural tests and laboratory measurements time and time again.

With a transformer of satisfactorily high primary impedance and good core one can get excellent amplification in even fashion throughout the audio range of useful frequencies. The curve need not be an absolutely flat line. It never is. It must be better than the curve of a speaker, which looks like the graph of a series of nose dives and spiritual ascensions.

The circuit therefore subscribes to the best standards and is offered as something tried and tested and free from trouble, save only motorboating, a nuisance which may be encountered in any circuit if B eliminator be used, particularly a resistance coupled circuit.

Transformer No Help Here

The fact that one transformer is present makes little difference. Some designers who like resistance coupling say that one transformer gets rid of the possibility of motorboating, but like most easy-flowing pronouncements on the subject of motorboating panaceas, it has little more substantial behind it than a wish or a guess, and is easily refutable by calculation or experiment.

The thing that motorboats is the circuit established when the eliminator is hooked up to the receiver. The motorboating is merely resultant oscillation. It is not the set that motorboats nor is it the eliminator that motorboats, but it is the circuit resulting from the combination of the

LIST OF PARTS

- L1 L2—One Aero antenna coupler.
- L3 L4—One Aero wave trap unit.
- R1—One Frost 10-ohm metal frame rheostat with switch
- R2—One Polymet 2 meg. grid leak with mounting
- R3—One Frost 500,000-ohm potentiometer
- R4 R5—Two 112 Amperites with mountings
- C1 C2—One Continental .00035 mfd. die-cast double condenser
- C3—One Tube 1 mfd. 300 volt filter condenser
- C4—One .00025 mfd. grid condenser
- C5—One Sangamo .001 mfd. moulded mica condenser
- C6 C7—Two Sangamo moulded .01 mfd. mica condensers
- AFT—One Halldorson overtone audio transformer
- S-, S+—Two Yaxley pup jacks
- One Tyrman single drum
- Five Frost sockets
- One eight-lead battery cable (eighth one for second AF bias)
- Eight Eby binding posts
- One 7x21 inch front panel
- One 7x20 inch subpanel.
- One Meter Antenna Kit

Plenty of Everything Else

Acoustical Expert

two. An exception is that some particularly atrocious B eliminators designed for extreme economy, and lacking even a semblance of adequate filtration capacities, and having the cumulative vice of high resistance choke coils, motorboat of themselves, even without connection to a receiver. This brand of viciousness need not be considered in stating a general principle, as the vice was found in only two factory-made eliminators and they have been removed from the market with popular approval.

I may as well confess here and now my own theory about motorboating and that is that each and every direct-coupled audio circuit, particularly resistance coupled, when used with a B eliminator, motorboats.

Harmless Cases

Usually the motorboating does no harm. Nobody notices it. The frequency and the intensity are both too low, far below audibility, far below possibility of amplification in the audio system.

If it is slow enough and mild enough this motorboating scarcely will affect even a plate circuit milliammeter. But as the frequency rises, or more particularly as the periodic variation of current flow become more intense, the motorboating will show up on the needle. By the wiggle you can count the frequency. This happens long before the human ear can detect presence of motorboating. Hence one must recognize the existence of silent motorboating and that kind does no harm.

The frequency is likely to be one-half or one, or it may be even as low as one twenty-fifth. When the frequency is higher than these or when the motorboating is stronger, the nuisance becomes noticeable to the ear. If the severity is great enough the signal itself is stopped regularly every fraction of a second or every second or so. If the frequency is much faster, say five per second or higher, we are in the region of the commonest variety of motorboating, the kind that really sounds like the put-put-put of the engine after which the vice was named. And still the frequency may mount.

High Oscillation May Be Inaudible

It may get so high than it can't be heard, just as it may be too low to be heard, if weak enough. In the high regions the motorboating may be a whistle or scream, steady and baffling, and uncommonly associated with its true identity—motorboating.

But in the present instance only the medium sort of motorboating may be

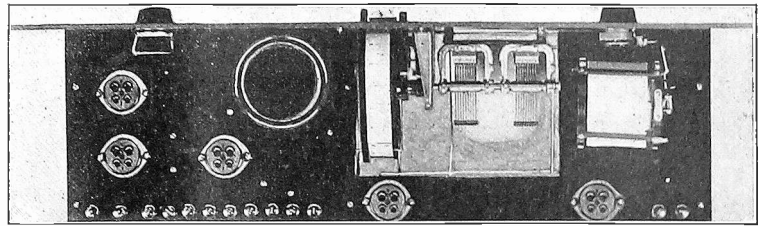

FRONT PANEL AND TOP VIEWS OF THE FIVE TUBE RECEIVER THAT WILL SATISFY ALL HANDS EXCEPT THAT IT WILL NOT BRING IN THE PACIFIC COAST NIGHT AFTER NIGHT FROM NEW YORK CITY.

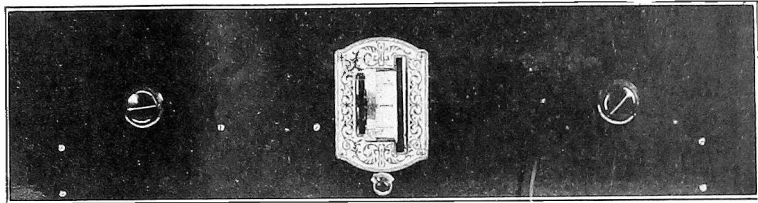

BOTTOM VIEW OF THE QUALITY-VOLUME RECEIVER. NOTE THE NEATNESS OF THE WIRING.

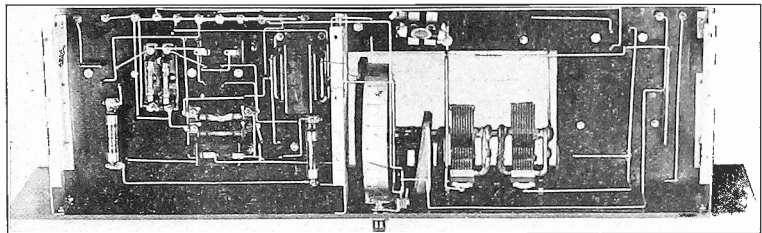

expected, and then only rarely. It is suggested that other tubes be tried. If high mu tubes bring about motorboating, and I have never come across a single instance where they did not produce a pretty bad case of it, then supplant these with type A tubes. If a special detector tube is used, and motorboating exists, try a type A tube instead, for as detectors go the special detector is a high amplifier, hence high mu.

Biasing Important

One of the best remedies is to give sufficient negative bias where it is needed, and using as much as required to attain the objective. That is why biasing batteries are particularly shown in the diagram. The radio amplifier is shown connected to the same C minus lead as is the first audio tube, and this is good practice.

But the second audio tube should have

considerably greater negative bias, and as a remedy for motorboating no fixed degree of bias can be suggested, so the lead is shown connected to minus A, and a separate battery may be inserted here, preferably one running up to 7½ volts, so that choice may be made anywhere along the line. The maximum bias thus permitted is not specifically recommended, but the wisdom of having quite a range to choose from certainly is past debate.

The speaker output should be taken through some output device, such as the Muter Clarifier, with the side marked "Input" connected to S minus and S plus, while the speaker itself is connected to the "Output" terminals of the device. In that way it becomes safe to use even more than the 135 volts shown. But if voltages around 180 are to be used, a 71 tube is safer than a 112.

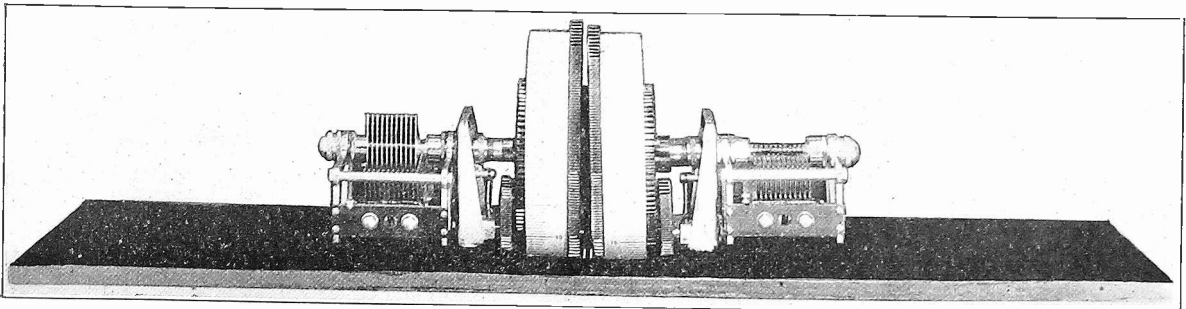

WHEN MOUNTING DRUM DIALS, BE SURE TO ALIGN THEM PROPERLY, OTHERWISE, THEY WILL NOT TURN SMOOTHLY.

The Laboratory Electric,

By the

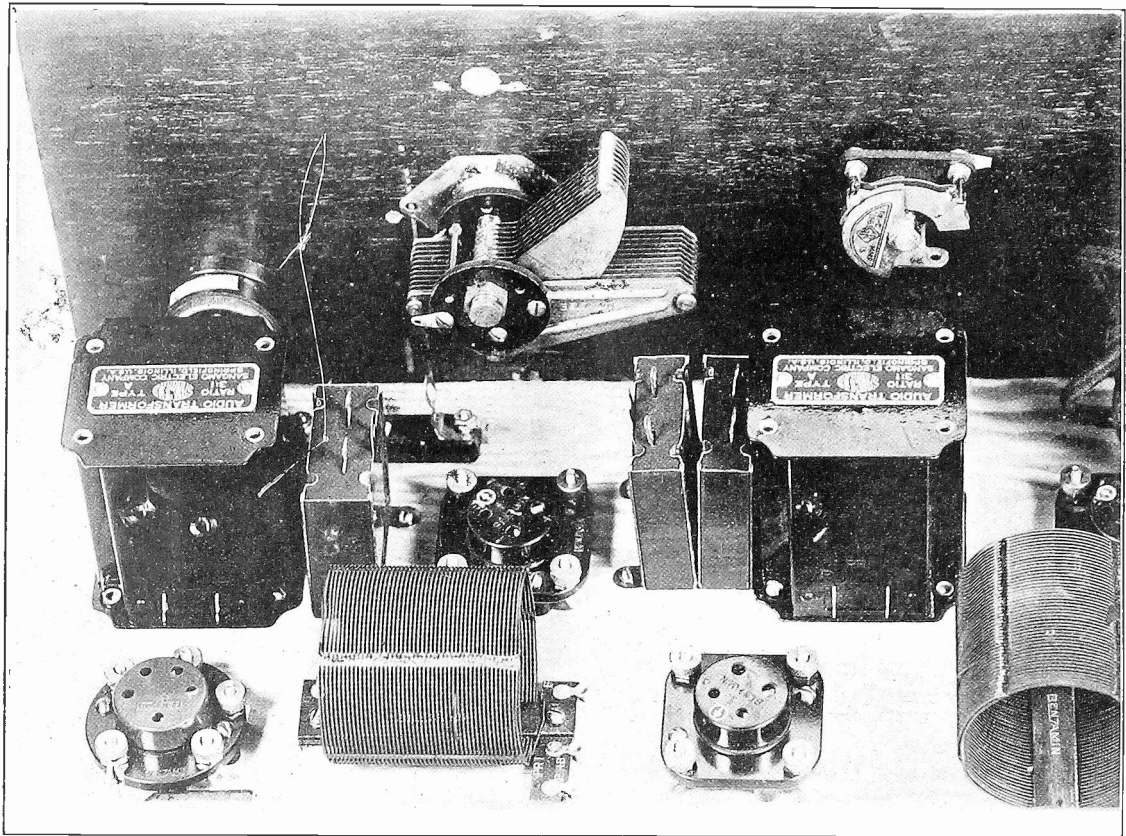

A CLOSEUP OF THE AUDIO END OF THE SET WITH THE SANGAMO AFT.

Sangamo's Audio Transformers, Brand New Products, Used in Audio Channel, Prove of Exceptional Merit — Benjamin Parts Predominate in Rest of Circuit

THOSE who work continually with radio receivers, testing, measuring, comparing, appraising them, are not easily carried away by the performance of any set. It has to be a top-notch receiver even to elicit their favorable comment. They have heard real reproduction and are not fooled by counterfeits. When many of these hard-boiled judges of receivers are unanimous in their praise of a certain receiver, and when they express it in intensified superlatives, that receiver must have characteristics always looked for but seldom found.

It must be away ahead of all others not only in tone quality but in the simplicity of operation and in the utilization of power. It must have irreproachable quality of tone. It must have volume in rich measure. It must have a high de-

gree of exclusiveness that admits only one station at a time. It must have a high sensitivity and wide range of sensitivity control. It must not be subject to battery troubles.

The Laboratory Electric was developed in Radio World's laboratory, and the development was not considered complete until every member of the staff had put his enthusiastic approval on the receiver. Each one had to be satisfied with its performance in every detail. And no one gave his approval until he could feel justified in being enthusiastic about the circuit as soon as he had given his approval. As a result, a receiver of outstanding performance emerged.

The Hum Problem

It is an electric set, which means that the filaments of the tubes are heated with alternating current and that it can be used satisfactorily with a standard B battery eliminator.

In building an electric receiver, the greatest problem is the elimination of hum. How is that accomplished in the Laboratory Electric? The first radio frequency tube in the circuit is of the —26 type. Across the filament of this tube is a low resistance potentiometer R by means of which the effective midpoint of the filament may be tapped for connection to the grid return. When the grid is returned to the midpoint the hum in-

troduced by that tube is negligible.

To reduce the hum to the vanishing point, by-pass condensers are connected across each half of the potentiometer resistance and the midpoint is connected to ground. With these precautions the residual hum is nil as far as any one can tell with ear or sensitive instrument. Hence when the signal reaches the detector input it is almost as free from hum as it was when it reached the antenna.

The detector tube is of the heater type. That tube admits no hum in the signal even when the associated circuit is regenerative. Since it does not receive a signal from the preceding tube that contains any hum, and since it does not admit any itself, the output of the detector is hum-free.

Balanced Circuit

Therefore the input to the first audio tube, which is also of the —26 type, is free from hum. This tube is connected in the same manner as the RF tube. Hence it passes on to the last tube in the circuit a signal which is uncontaminated with hum.

The last tube in the circuit is a power tube. It is heated from a special 5 volt winding on the supply transformer. A low resistance potentiometer R, is connected across the filament, and the grid return goes to the electric center of the filament.

Using AC Tubes

Laboratory Staff

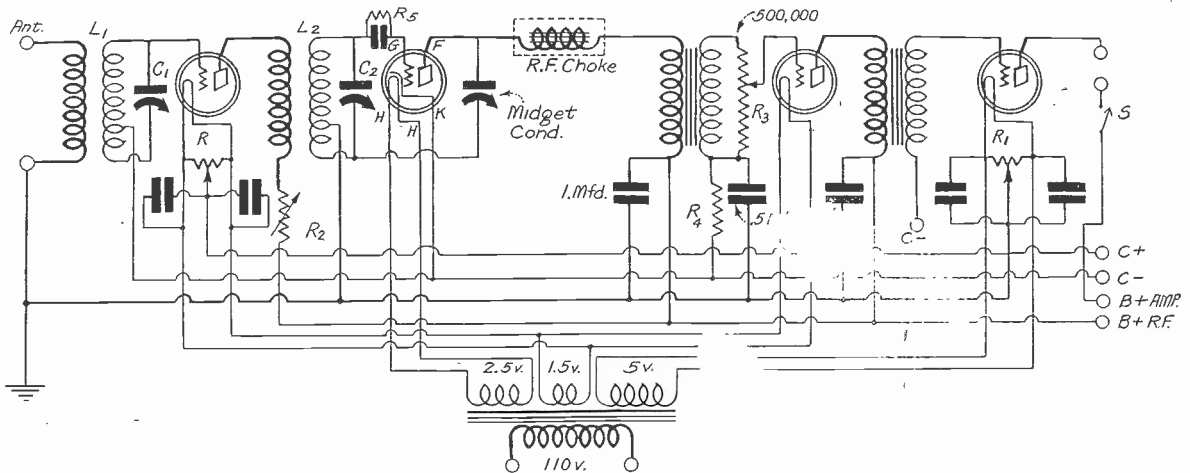

THIS IS THE CIRCUIT DIAGRAM OF THE LABORATORY ELECTRIC WHICH RESULTED IN A HIGH QUALITY RECEIVER.

A large by-pass condenser is connected across each half of the potentiometer resistance and as in the case of the two preceding amplifier tubes, the midpoint is grounded.

Every tube in the set is heated with raw AC but the circuit is so balanced that hum does not enter the signal through the filament circuits. For the filament circuit a National transformer having one 1.5 volt, one 2.5 volt, and one 5 volt winding, each capable of delivering more current than required for this receiver, is used.

Use of the Taps

The tuned circuits are composed of Benjamin RF transformers and Benjamin tuning condensers. Both of the circuits are so adjusted as to just cover the broadcast range of frequencies. Each of the secondaries contains a tap. In the first stage the tap is used for the grid return while the condenser is connected across the entire coil. This use of part of the secondary voltage is to increase the selectivity of the circuit. In the second coil the tap is used for connection to the cathode in a Hartley type of oscillator circuit. The regeneration is controlled with a throttling condenser of 15 mmfd. maximum capacity.

The sockets used in the receiver are also of Benjamin manufacture. All are of the baseboard mounting type, three of the four spring type and one of the five spring type.

The quality of the output of the receiver, which is of a high order, is due largely to the Sangamo audio frequency transformers employed in the audio amplifier. These brand-new products have an equal effectiveness of high degree over the entire audio scale, from the top note of the piccolo down to the bass of the organ. They do not discriminate against any frequencies, neither do they exaggerate.

Safeguard Against Feedback

But several precautions must be taken

in the design of a quality circuit of this nature, as was forcefully brought out during tests. A high-class transformer will not perform in a high-class manner if its work is burdened with an inefficient design. All impedances through which back coupling can take place must be adequately by-passed. For this reason a

LIST OF PARTS

- Two Benjamin straight line frequency .0035 mfd. variable condensers (9081).
- Two Benjamin tuned radio frequency transformers to match condensers (9011).
- Three Benjamin "push" type sockets for baseboard mounting (9040).
- One Benjamin five-prong "Y" type socket for baseboard mounting (9036).
- Two Sangamo audio frequency transformers (type A).
- One Sangamo moulded .00025 mfd. mica grid condenser with clips.
- Two Centralab 400 ohm potentiometers (type P-110).
- One Electrad Tonatrol.
- One Electrad 500,000 ohm potentiometer (Royalty type E).
- Six Polymet .5 mfd. 300 volt filter condensers (type A).
- One Polymet 1 mfd. 300 volt filter condenser (type A).
- One Daven resistor mounting.
- One Daven .1 megohm resistor.
- One Daven 3 megohm resistor.
- One General Radio 15 mmfd. midget condenser (type 368).
- One National filament transformer (type F 226).
- Two National vernier dials (type C).
- One 7x21 inch Lignole panel.
- One 7x20 inch wooden bassboard.
- Two Frost pan-tab jacks (253-B).

1 mfd. condenser is connected between the B terminal of the primary of the first transformer and ground. Likewise a .5 mfd. condenser is connected between the F terminal of the same transformer and ground. Another .5 mfd. condenser is connected between B of the second transformer and ground. The condensers are ample to minimize stray coupling through the plate voltage source and to give the transformers a chance to show up their excellent quality.

The first volume control in the circuit is the high resistance rheostat R2 in the plate lead of the first tube. This 50,000 ohm Electrad resistance is a very effective control. The second control is the midget condenser which controls the regeneration. This should not be used so much as the others but is included to vary the selectivity as well as to furnish increased sensitivity.

Volume and Bias

The third control is the .5 megohm potentiometer R3, connected across the secondary of the first audio transformer. This can be used without impairment of quality over its whole range.

If the signals are so great at the antenna that the first volume control R2 cannot cut down the volume to a suitable level, the third control should be used. It should be remarked here that R2 cannot be used over as wide a range in this circuit as in DC circuits because the percentage of hum increases very rapidly when the plate current is decreased below a certain value.

The grid bias for the circuit is obtained through batteries, contrary to ordinary AC practice. It is much easier to remove hum when batteries are used and therefore they are employed. A negative bias of 4.5 volts is put on the grid of the first tube, being adjusted for a normal plate potential of 90 volts. This bias is also impressed on the grid of the first audio amplifier since that is the same type of tube operated on the same plate voltage.

(Continued on page 14)

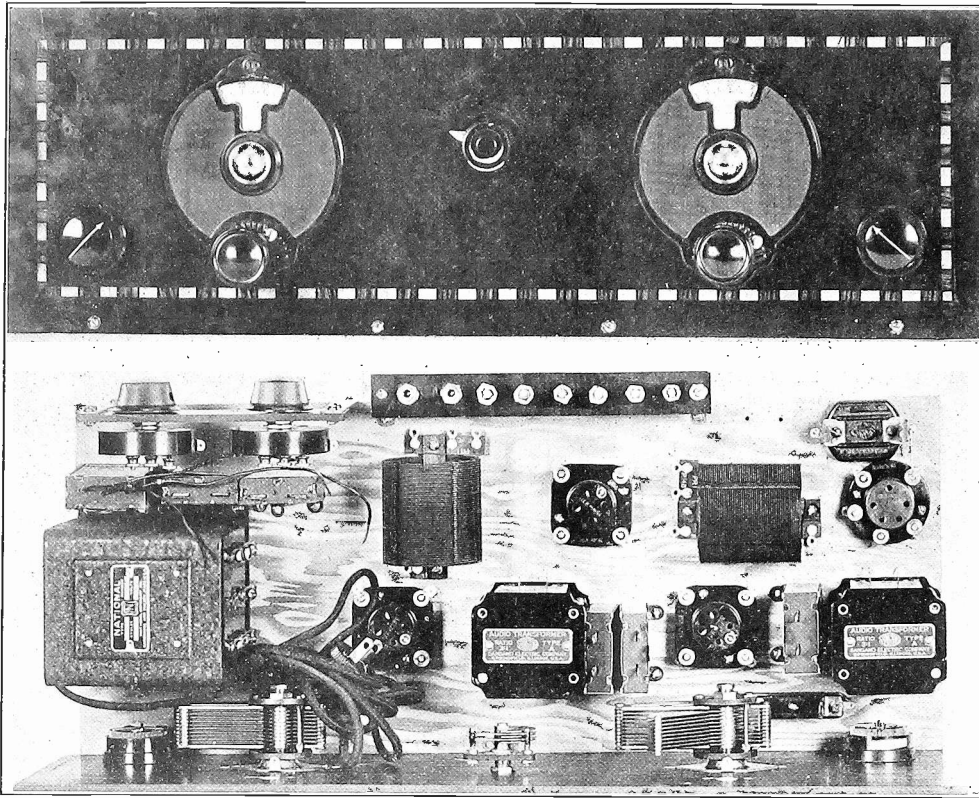

A decorative front panel view is an attractive feature of the Laboratory Electric. The bottom view shows the location of the parts if no RF choke coil is used. Otherwise the right hand AF transformer is moved back a trifle (toward socket) to make room for the choke.

(Concluded from page 13)

The bias on the grid of the detector is positive with respect to the cathode. This is obtained from the same battery that gives a negative bias to the amplifier tubes. This is made possible by the use of separate heating windings, or rather by the independence of the cathodes in the detector and the amplifiers. To give the detector grid a positive bias the cathode of the heater tube is connected to the negative terminal of the grid battery and the grid return lead is grounded, as is also the positive terminal of the grid battery.

A Special Switch Objective

On the Benjamin five-prong socket two

posts are marked H. These are the heater terminals and they should be connected to the 2.5 winding on the transformer. The grid and plate terminals are marked as usual with G and P. The cathode terminal is marked K. It is this terminal which is connected to the negative of the grid bias battery.

The grid bias for the power tube is obtained from a separate grid battery. This is consistent with a minimum of hum and the optimum in quality. If the power tube is a -71 type the bias should be 40.5 and the plate voltage should be 180 volts. The positive of this grid battery should be connected to ground and to the midpoint on the balancing potentiometer R1.

The grid condenser is a Sangamo and

moulded in Bakelite. It is supplied with resistor clips to hold a 3 megohm Glastor. Its capacity is .00025 mfd.

It will be observed that there is a switch S in series with the loudspeaker, or in the plate circuit of the last tube. Its use is not necessary, since the master switch in the power supply lines serves, but it is desirable. The heater type detector take about a minute to heat up and become operative after the power has been turned on. The other tubes become operative at once. The wait for a signal is annoying, as is its gradual increase in intensity when it does come in. If switch S is open while the detector tube is heating up, and is closed about one minute after the power was turned on, the signal will come in with full strength.

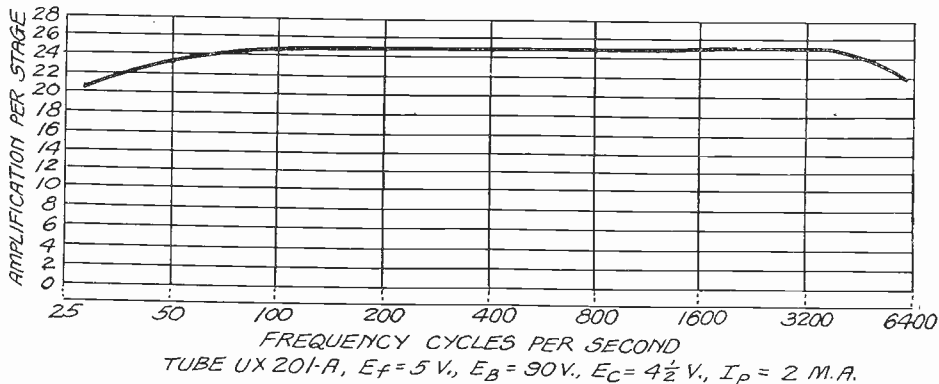

A HIGH DEGREE OF FIDELITY IS INDICATED BY THIS AMPLIFICATION CHARACTERISTIC OF A SANGAMO AUDIO TRANSFORMER AND A UX-201-A TUBE. THE CURVE WAS RUN IN RADIO WORLD'S LABORATORIES. THERE IS NO APPRECIABLE VARIATION FROM UNIFORMITY OF AMPLIFICATION OVER THE ENTIRE MUSICAL SCALE, SHOWING THAT TONE QUALITY IS UNIMPAIRED. THE TRANSFORMER, A NEW PRODUCT, IS ONE OF THE OUTSTANDING ADDITIONS TO HIGH-CLASS AUDIO AMPLIFYING DEVICES.

N. B. C. TO OPEN LARGE QUARTERS IN WASHINGTON

New studios and offices of the National Broadcasting Company in Washington, D. C., will be opened in the National Press Building, Fourteenth and F Streets, Northwest, WRC, the Radio Corporation station, is located in that city.

For six months, engineers have been working on plans for the new studios. Work is under way.

Programs originating from the National Broadcasting Company's studios in Washington, or from Government halls or buildings in the capital city will be carried through WRC and other stations associated with the N. B. C. All new and modern equipment will be installed in the new studios, although the two duplicate transmitters of WRC, located in the Riggs Bank-Tompkins Building, Fourteenth and Park Road, Northwest, will remain in their present location.

One feature of the new equipment will be additional apparatus which will enable the Washington staff of the National Broadcasting Company to handle three programs at one time, which is not now possible. Under the new arrangement, three "channels" are provided. Thus one program can be in progress in one studio and broadcast through WRC; another program can be presented in the second studio and be transmitted to the NBC's New York terminus for distribution to associated stations; and still a third program can be received in the control room from an outside point.

Twenty-one rooms on the twelfth and thirteenth floors of the National Press Building have been leased for studios and offices. There will be two studios, the largest occupying both the twelfth and thirteenth floors, utilizing six rooms of the new building. This studio will be 20 feet wide, 33 feet long and 20 feet high. The small studio occupies two rooms and is 20 feet long, 20 feet wide and 10 feet high.

INTERESTING QUERY

I HAVE built the Winner receiver described in the October 1, 8, 15, 22 and 29 issues of RADIO WORLD and am well satisfied with it. I would like, however, to be set straight on the dial readings. I get WFAF at 15. Is that O. K.? WOR comes in at 31. Is this also all right?

(2)—I notice that the set is quite broad. I live quite a distance from any broadcasting station and cannot understand this action. What would you suggest doing?

RAYMOND KELLEY, Portland, Me.

(1)—Your readings are all right.

(2)—You must have used the larger primary in the antenna coil. There are three taps in the primary. In your case, you should use the center and the end terminal of the winding.

NAVY ORGANIZES RESERVE RADIO OPERATOR FORCE

A Volunteer Communication Reserve force has been established in the Third Naval District, with headquarters in New York City, by authority of the United States Navy.

It is the purpose of this organization to tutor men so that they will become skilled radio operators, with a complete knowledge of radio theory and practice as required by the United States Navy, so that they may be called upon in case of national emergency.

Any one desiring to enroll, should communicate with the Communications Officer, Third Naval District, South and Whitehall Streets, New York.

A PEEK INTO AN EXPERT'S LABORATORY

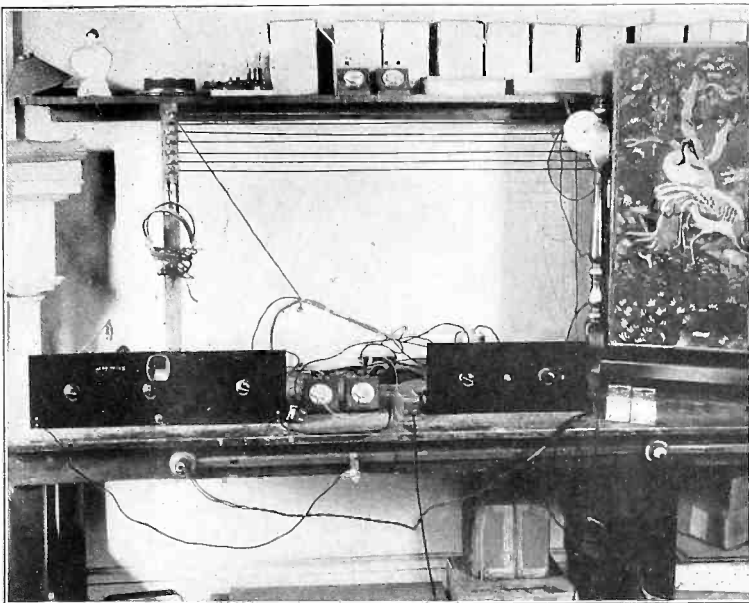

A SECTION OF ZEH BOUCK'S LABORATORY. THE AERO-7 IN ITS ELECTRIFIED FORM FOR USE WITH ARCTURUS TUBES AS DESCRIBED IN THE OCTOBER 22 AND NOVEMBER 5 ISSUES OF RADIO WORLD IS SEEN AT THE LEFT ON THE TABLE. THE B ELIMINATOR (OCTOBER 22 ISSUE) USING SILVER-MARSHALL CHOKES AND TRANSFORMER, AND THE RAYTHEON BH RECTIFIER AND R VOLTAGE REGULATOR TUBES, IS SEEN AT RIGHT. ATTACHED TO THE OUTPUT IS THE LATEST MODEL LATA Balsa WOOD SPEAKER WITH ITS BEAUTIFULLY ORNAMENTED FRONT, WHICH CAN BE SEEN TO THE EXTREME RIGHT.

KEEP HIGH VOLTAGE POSTS INSIDE

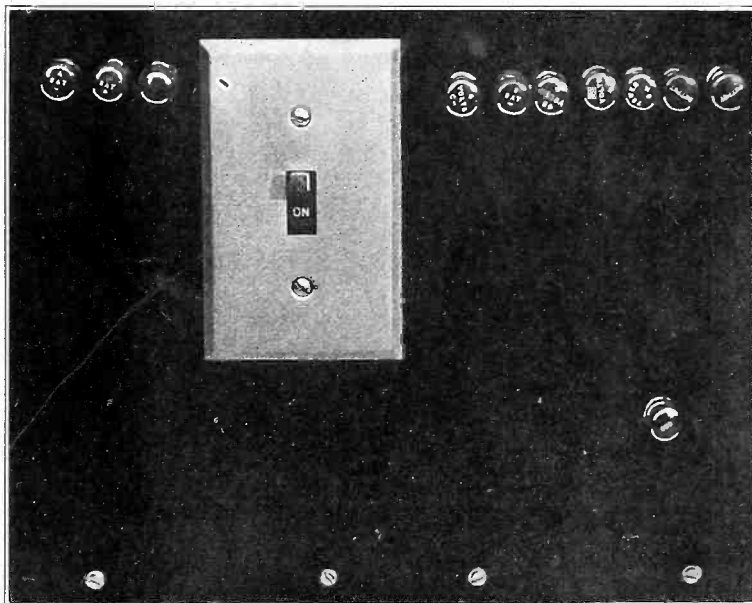

A POOR WAY TO MOUNT BINDING POSTS ON A HIGH VOLTAGE ELIMINATOR. LUGS MAY CAUSE A SHORT OR FINGERS MAY TOUCH THEM. PUT THE POSTS INSIDE AND HAVE THEM SPACED FARTHER APART.

WHAT A BATTERY MAN SAYS OF THE FUTURE IN RADIO

W. C. BROOKS, Hartford Battery Co.: "We may expect the ultimate radio receiver to be a compact, well-designed piece of furniture which, after attachment to a wall receptacle, will be instantly

ready for operation. This naturally eliminates the outside antenna and the ground connection. Both of these details are adequately furnished by the standard lighting circuit of every apartment and residence."

Willing Hands Help Round



VELVET, chintzes, tapestries and the like can be decorated in fancy fashion, so that the aesthetic product may constitute the enlivening screen of a large reproducer, either of the cone or flat type. Tropical birds are favorite subjects for such decorative use. See the result in the illustration at right.

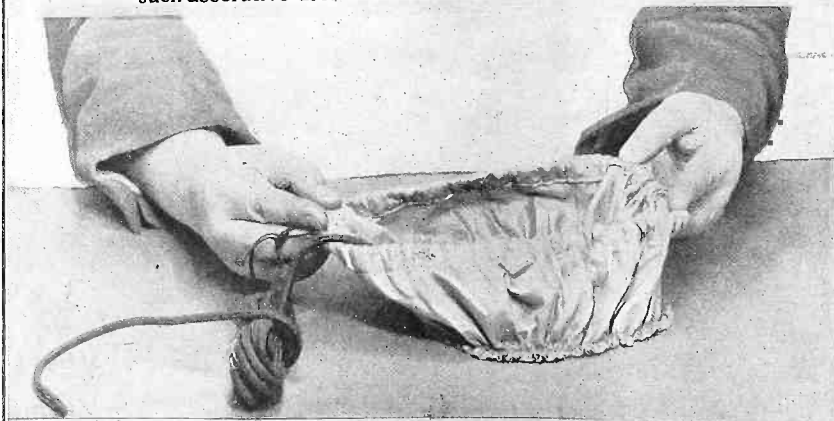

THE ADVISABILITY of protecting the unit fastened to the frame of a large cone or flat type speaker has occurred to many. A figured lamp shade dust protector, with its elastic ridges, serves the purpose well.

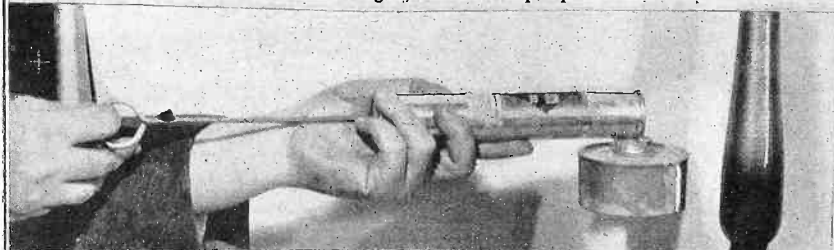

A SQUIRT GUN used in war on insects gives excellent results when you want to change the color of your radio console from ebony to cherry in a most delicate manner.

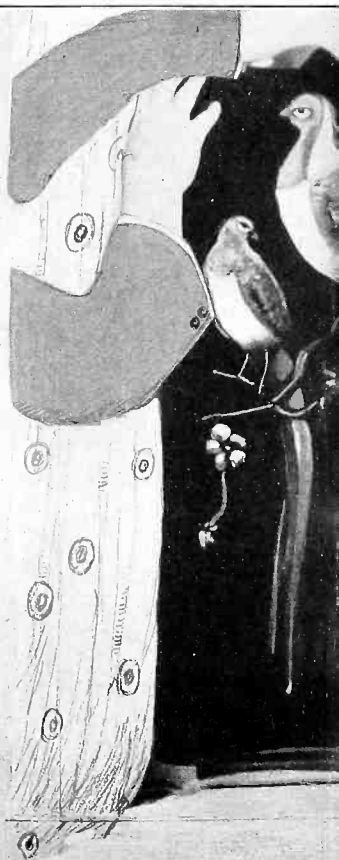

THE ARTISTICALLY finished a reproducer, so that a really impo

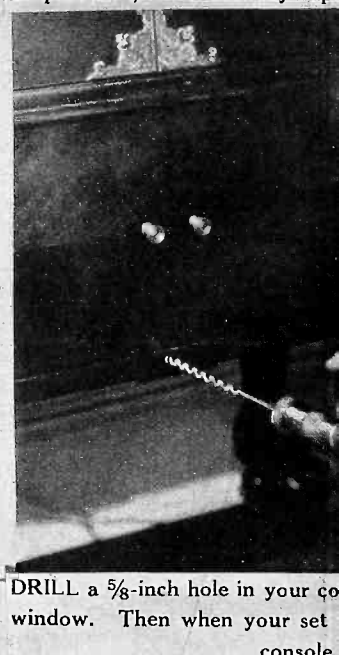

DRILL a 5/8-inch hole in your co window. Then when your set console

Out and Beautify the Home



Decorative covering is used for shrouding
g sight as well as sound greets the eye.



At this point and insert a pilot light
on, you will see the light, even when
doors are closed.

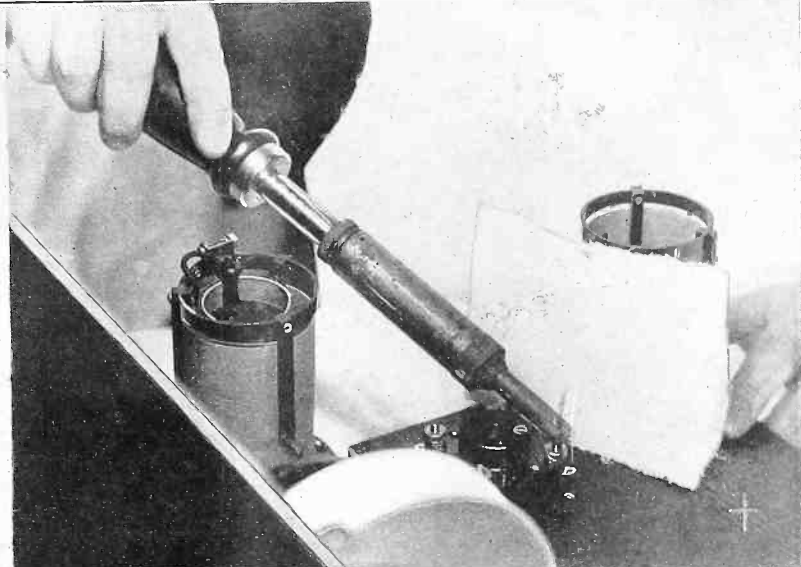

PROTECT coils and other parts from soldering iron heat by putting a piece of asbestos as shown. This bit of advice will save you many a dollar and many an ugly sight.



IF YOU HAVE no soldering iron and must make a quick joint like this you may use atropin tablets. Put one in a teaspoon and pour a few drops of water in the spoon. A steady flame will result. Renew until satisfied.

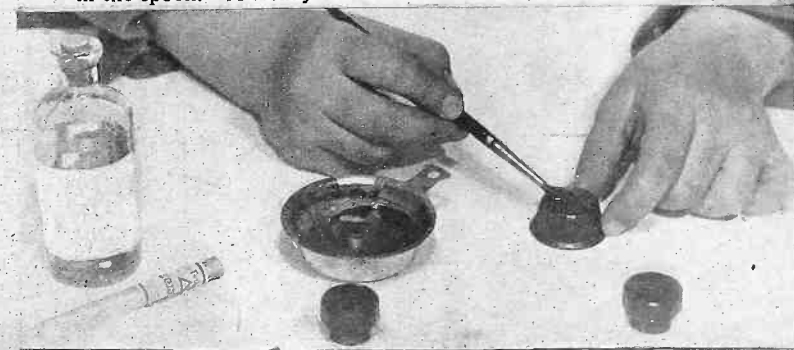

IF KNOBS on your set do not match the bronzed effects of panel escutcheons, you may bronze all the knobs and even give the panel plates the same hue,

(All photographs by Herbert E. Hayden)

Novelty In Audio

By J. Basco

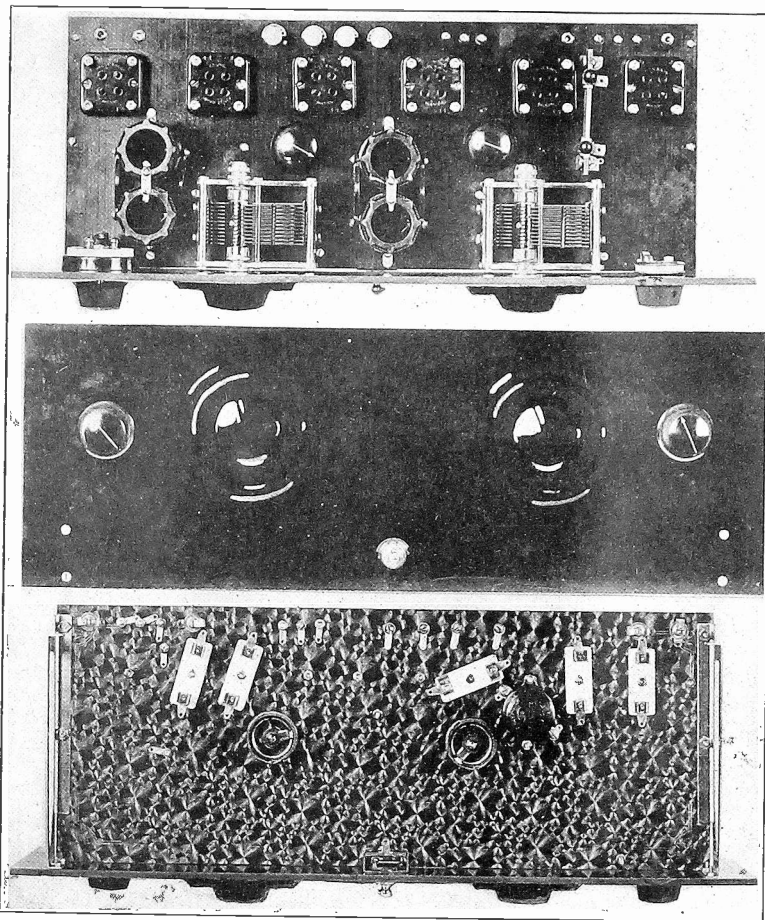

FIGS. 1, 2 AND 3
THIS SHOWS THE INTERIOR LAY-OUT OF THE HENDERSON SIX, WITH
PANEL VIEW IN CENTER AND BOTTOM VIEW BELOW.

"MY wife," said a friend of mine the other day, "has decided that we want a radio set. But I don't want to have one around the house unless it does as well as our phonograph. If you can design such a receiver I am your customer."

Their phonograph was one of the best made, and they had a large collection of the choicest records. His order was a big one, but I thought it could be filled.

While ferreting out the desired details it was found that they had no objection to a storage battery, provided it was not too large, and that it could be left on trickle charge when it was not actually used for liberating electrons.

The question of C bias was left to the judgment of the designer. In volume the proposed set had to beat the phonograph, just had to. In fidelity they would accept equality, but would prefer superiority. As to single or multiple tuning control they expressed no preference. Other details were also left to the decision of the writer.

The receiver sketched in Fig. 1 resulted. It comprised one stage of TRF, a non-regenerative detector, two stages of resistance coupled audio, and one stage of transformer coupled push-pull. The tubes used in the last stage were of the -71 type and capable of handling a high output without overloading.

The tuning coils L1, L2 and L3, were

Camfield Duoformers. These were selected to minimize direct coupling from a transmitting station in the locality where the receiver would be installed and also to eliminate stray magnetic coupling between stages. The choice proved highly satisfactory during later tests.

The tuning condensers C1 and C2 were also Camfield's. These were chosen because of their high electrical efficiency and beautiful appearance, as well as for their perfect matching with the coils selected. Both coils and condensers are so far apart in the receiver that the capacity between them is vanishingly small. Hence the circuit is stable and free from oscillation troubles.

The antenna is connected to a tap on the first Duoformer through a Electrad Royalty Tonatrol, namely Ro, which is used for controlling the volume. Carter Imp jacks are used for the antenna and the ground connections. Another volume control is R2, a Carter 20 ohm rheostat. This is in series with a 4 ohm Carter fixed resistor R, so that it is impossible to give the filament more than normal current. These two volume controls are placed on the panel for easy access.

Another variable R4, which is a Carter wire-wound 25,000 ohm resistor, is put in the plate circuit of the first tube. This may be used to a certain extent to control the volume, but its chief purpose is to limit the plate current in the tube. It is

placed on the sub-panel where it can be adjusted when necessary, but where it is inconvenient to use for routine adjustments. This resistor is by-passed by condenser C2 to allow the high frequency currents to pass to ground without high impedance. This is a .001 mfd. Carter moulded condenser.

R3 is a common ballast tube for three of the tubes in the circuit, the first of which is the detector. Since two of these tubes are 340 high mu tubes and the third is a 112 power tube, the total current in R3 is 1 ampere. Hence the resistance of it should be one ohm. It is a Carter one ohm ballast.

The grid condenser C4 is a .00025 mfd., the grid condensers C6 and C7 are .01 mfd., C5 is a .0005 mfd. All these condensers are Bakelite moulded Carter. C8 is a 1 mfd. Polymet.

The grid leak is an Amsco 3 megohm resistor. R5, R7, R9 and R10 are 25 megohm Amsco fixed resistors. R6 and R8 are 2 megohm Amsco resistors. R5 may be increased to .5 megohm if desired. The object of R9 and R10 is to divide the output voltage of the transformer equally between the two power. The 25,000 ohm Carter potentiometer R11 is interposed between two to effect a more equable division case there may be appreciable differences in the two fixed resistors, or in case the tubes should have different characteristics.

Uses Tyrman AF Transformer

The total resistance of R11 is 10% of the resistance of either of the side resistors. Since all of R11 can be thrown in either branch, an unbalance of nearly 20% can be taken care of with R11. This is a wider variation than is ever likely to be required.

The audio transformer used is not a push-pull but a regular interstage transformer, made by Tyrman.

The grid bias on the RF tube is only the drop in the resistor R1 and the rheostat R2. This bias may be one volt or more according to the setting of the rheostat. The bias on the first audio tube is the drop in resistor R3. This is one volt. This is enough for a high mu tube in that position. The bias on the second audio tube, which is a 112, must be higher since the mu of that tube is lower. It should be approximately 12 volts for the plate voltage used. The bias is obtained from the drop in resistor R12, a 1,000 ohm Carter PB two-slider potentiometer. The drop in this resistor is also used to give the necessary 40.5 volt bias on the last two tubes.

1R Drop as Grid Bias

Ordinarily it is not a good policy to obtain the grid bias from resistance drops through which the plate current flows. The resistor constitutes a coupler between the input and the output. In one stage this cuts down the amplification; in many stages it may increase the amplification at some frequency and cause distortion. In this circuit this effect is minimized because the last stage is balanced.

When the balance is perfect there is no AC component in the plate current from the last stage flowing in the resistor, and hence there is no feed-back to cause either an increase or a decrease in the amplification. There is a component of AC in R12 from the preceding stage, but the effect of this is greatly reduced by condenser C8. That is, this condenser cuts the AC component down to a small

Sustains Quality Design

Anderson

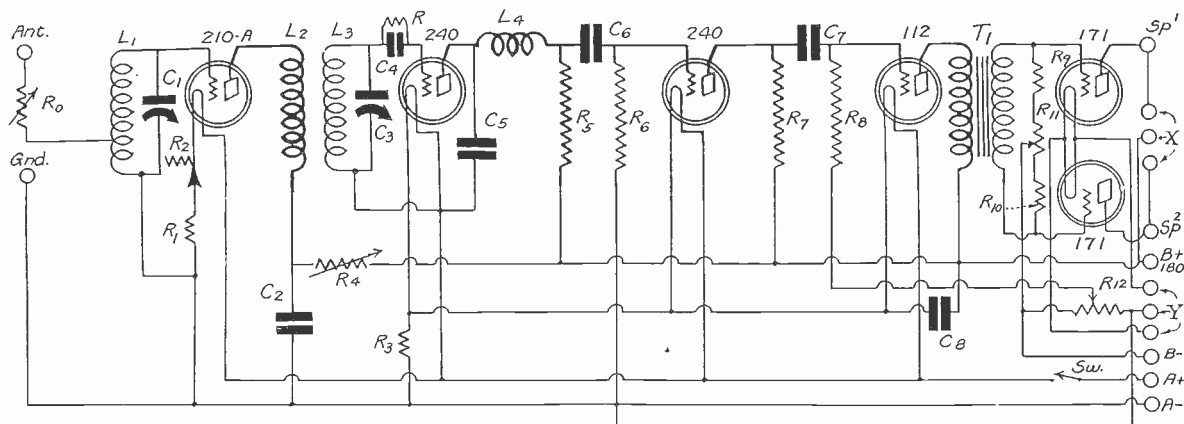

HERE IS A SET THAT ANYBODY WHO ENJOYS QUALITY WILL BE GLAD TO OWN, FOR IT IS SIMPLE AS A B C TO TUNE. THE ELECTRAD ROYALTY TONATROL RO, IS REALLY IN PARALLEL TO THE ANTENNA AND GROUND AND IN THIS CAPACITY, SERVES AS AN EXCELLENT VOLUME CONTROL.

value, except for the lowest frequencies.

Since the drop in R12 must be 40.5 volts, and since the current through it will be about 40 milliamperes, the value of R12 should be about 1,000 ohms. The total current is somewhat uncertain because the plate currents of other tubes also flows through it. Hence a slider is provided for the bias on the last tube so that the resistance used can be adjusted as required. Another slider is provided for the bias on the preceding tube. Since this will always require a lower bias than the last stage, the slider for it will always be set below that for the power tubes.

RF Choke Included

A Hammarlund 85 millihenry choke coil L4 is placed between the plate of the detector and the top of the first coupling resistor to prevent radio frequency current from entering the audio amplifier.

A small but highly important feature of the circuit is the Carter filament switch. It is of the new type which opens and closes with a lousy snap and which is provided with wiping, self-cleaning contacts. XL push posts are used for the power supply terminals. Amsco resistor mountings, Frost sockets, Karas micrometric dials, Benjamin sub-panel brackets, Formica panel and hard rubber subpanel are also used. The panel is 7x21 inches and the sub-panel is 7x20 inches.

The panel arrangement is shown in Fig. 2, except for the Karas dials which are not shown on this photograph. The two knobs are for the two essential volume controls. The Carter filament switch is shown in the center near the bottom. Fig. 1 shows the plan of the set. The position of nearly every part is distinctly shown.

There are two sets of three machine screws shown at the rear of the sub-panel. One set of these is for connection to either a push-pull output transformer or a tapped output choke. The loudspeaker jacks are connected to the outside two of this set and the high voltage to the middle. The other set is for connection to a heating transformer having a 5 volt tapped secondary. The audio transformer is not shown in the photo but space is reserved for it at the extreme right of the sub-panel. Fig. 3 shows the sub-panel arrangement on the under side. Five Amsco resistor mountings, two Carter high resistors, and the Hammarlund RF choke are shown.

The Phonograph Pick-up And How to Employ It

By Herbert E. Hayden

A phonograph pick-up is not greatly different from a microphone. As far as the outputs of the two are concerned

they are identical. Both develop a voltage which varies according to some sound. The manner in which the two pick-up the sound is different in the two instruments. The microphone picks up the sound vibrations directly from the air; the phonograph pick-up, as the name indicates, picks up the sound from the phonograph record. The microphone is dealing in "firsts"; the phonograph pick-up in "seconds."

The record contains a spiral groove which meanders its way in accordance with the sound which impinged on the recording machine. The needle on the pick-up unit is constrained to follow the groove in minutest detail and is set into a vibration which corresponds with the original sound vibration. This vibration is communicated to the magnetic circuit associated with the pick-up, which converts the vibrations to voltage variations. The voltage, which is an audio frequency signal to the amplifier in the radio receiver, is amplified just as any other signal and delivered to the loud speaker.

Practically all phonograph pick-ups operate electro-magnetically. That is, the vibrating needle causes a variation in the magnetic flux through a coil, which in turn induces a voltage in that coil. This voltage is impressed on the audio frequency amplifier in the receiver.

There are many methods of connecting the pick-up to the radio set. The particular method to use depends somewhat on the type of radio receiver that is used. In a transformer coupled receiver the pick-up coil can be put in series with the primary of the first transformer. This is the usual method because of the prevalence of transformer coupled amplifiers, and because with this method the pick-up coil can be terminated in a plug similar to a vacuum tube base and plugged into the detector socket for proper connection. The RF tubes must be turned out. (Illustration on front cover.)

LIST OF PARTS

- R—One Turn-it variable grid leak
- R0—One Electrad Royalty Tonatrol
- R1—One Carter 4 ohm fixed resistor, H-4
- R2—One Carter 20 ohm rheostat, IR-20
- R3—One Carter 1 ohm fixed resistor, H-1
- R4—One Carter 25,000 ohm variable resistor, MW
- R5, 7, 9, 10—Four Amsco .25 megohm resistors
- R6, 8—Two Amsco 2 megohm resistors
- R11—One Carter 25,000 ohm potentiometer, MW
- R12—One Carter 1,000 ohm P.B. resistor
- C1, 3—Two Camfield .0005 mfd. variable condensers
- C2—One Carter moulded .001 mfd. condenser.
- C4—One Carter moulded .00025 mfd. condenser
- C5—One Carter moulded .005 mfd. condenser.
- C6, 7—Two Carter moulded .01 mfd. condensers
- C8—One Polymet 1 mfd. condenser, 300 volt type
- L1—One Camfield antenna coupler
- L2, 3—One Camfield R.F. transformer
- L4—One Hammarlund 85 millihenry choke coil
- T1—One Tyrman AFT
- Sw—One Carter filament switch, 110 volt, new type
- Four Carter tip jacks
- Four XL push posts
- Five Amsco resistor mountings
- Six Frost UX sockets
- Two Karas Micrometric dials
- Two Benjamin brackets, 2 inches high
- Formica panel 7x21 inches
- Formica sub-panel 7x20 inches.

Even You Never Knew All This About Meters

By Frank De Rose

Voltmeters of the ordinarily purchased variety are not to be taken at their face value. When they are either brazen liars or good fiction tellers they are not to be blamed for their falsehoods. They cannot help that they are called on to tell facts where they are only able to tell fiction. The operator is the culprit.

A voltmeter which has been designed for measuring the voltages of storage and fresh dry cell batteries and generators cannot be expected to tell a true story when it is called on to measure the voltage output of a B battery eliminator, the voltage drop across a high resistance, the voltage of an old dry cell battery. It simply will not respond to the truth.

And how far from the truth is the story an ordinary voltmeter tells when it is given a chance to tell a falsehood?

Anywhere from zero to 100% off. Sometimes the story it tells is so obviously off that nobody can believe it; at other times it is off just far enough to give a semblance of truth.

Tells Truth About Self

One thing that any voltmeter in good adjustment tells all the time and under all conditions is the voltage across its own terminals. It is not the fault of the meter if the operator takes that voltage and calls it the value of the voltage he wanted.

When the meter is put across a storage battery, the voltage across the terminals of the meter differs so little from the voltage of the battery that the two can be called the same.

Similarly, when the meter is put across the terminals of a fresh dry cell battery the two voltages are the same for all practical purposes. When the meter is put across the terminals of a DC generator of low resistance the two voltages are again very nearly the same.

But suppose the meter is put across a dry cell battery in a run-down condition. The meter will give one voltage and the voltage of the battery will be something else. But the voltage given by the meter will be the voltage across its terminals.

Let There Be No Misunderstanding!

A misunderstanding may arise here unless it is added that at the time the meter is connected across the run-down battery the voltage across the battery is the same as the voltage across the meter, except for the minute voltage drop in the leads between the two.

What, then, is all the shouting about, if the voltages are the same? There is no reason at all to shout if the battery were used with the meter left connected across it. But it never is. The meter is connected across the battery momentarily to obtain a value of the voltage and then it is removed again. As soon as the meter is removed the voltage across the battery terminals changes, and may assume a value radically different from the reading obtained. The same holds when the meter is connected across the output terminals of a B battery eliminator to measure its voltage. Often the reading obtained is less than half of the true voltage existing across the eliminator output terminals when no meter is connected across them.

Radio enthusiasts are always cautioned to use a high resistance voltmeter to measure the voltages in a B battery elimi-

nator if they would have the correct values.

The higher the resistance of the voltmeter used, the less is the change in the voltage when the meter is connected. If the resistance of the meter used is 1,000 ohms per volt, the voltage change when the meter is connected to the average eliminator is less than one per cent. That is negligible in practical work.

But there are many cases when even a high resistance voltmeter will not do. A simple case may be mentioned because of its importance and because of the high probability of its recurrence. A certain set did not give the quality nor the volume that it should. All the voltages were measured with a good voltmeter, but one which took some current to operate. All the voltages in the set appeared to be as they should. But on inspection of the batteries it proved that the C battery was composed of dry cells which when new would have given a voltage of about 35 volts. The tube served by this battery needed only about 12 volts bias. Measured with the voltmeter that was what it got. Measured indirectly by observing the plate current, the bias was more nearly 30 volts. Where was the discrepancy?

Could Not Drive Current

One of the units in the C battery was practically dead. It had a very high internal resistance. When the current-drawing voltmeter was put across it there was only a faint flicker of the needle. The electromotive force left in the battery could drive practically no current through the internal resistance. When the voltmeter was put across the entire battery the electromotive force was increased many times but the battery resistance was not increased in proportion. Hence the voltage drop in the battery was proportionately less and there was about 12 volts across the terminals.

Although the run-down cells showed no life when the current-drawing voltmeter was connected across them, they were not necessarily dead when connected in the grid circuit. In that position they did not deliver any current and there was no voltage drop in the internal resistance.

The effective grid bias furnished by any cell is the electromotive force of that cell, and that was not much different from what it was when the cell was new. Thus when a grid battery which shows no life to a voltmeter is connected in the grid circuit, it is almost as effective in biasing the grid as a new battery. The plate current with definite plate and filament voltages gives a nearly correct indication of the grid bias, whereas a voltmeter connected directly across the battery lies and lies.

Not Easy to Ascertain

In some circuits it does no great harm to use a grid battery after it has ceased to show life to a current-drawing meter. But it is not a simple matter to learn just what is the bias it contributes. A high resistance voltmeter is usually not good enough for finding the value of a grid battery. It is necessary to use a vacuum tube voltmeter. This is first calibrated against grid bias voltages furnished with new batteries, or measured and used while the meter is across them. The plate current for various grid voltages is mea-

ON AND OFF INDICATOR

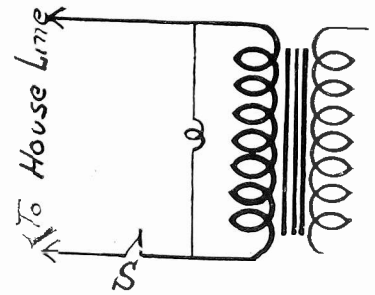

A 110 VOLT LAMP OF A SMALL WATTAGE SHUNTED ACROSS THE PRIMARY WINDING OF A POWER TRANSFORMER, WHICH IS USED IN ANY TYPE OF AN ELIMINATOR AND A SWITCH INSERTED IN SERIES WITH THIS PRIMARY, MAKE A DANDY "ON" AND "OFF" INDICATOR. A FROSTED COLORED BULB MAY BE USED. THIS INSERTED BEHIND A SMALL HOLE IN THE ELIMINATOR MAKE A PRETTY SIGHT, WHEN THE TUBE GLOWS IN ITS "ON" POSITION.

sured and plotted. Subsequently this plot can be used for determining unknown grid voltages when the plate current is known.

It may be argued that it is cheaper to throw suspected grid batteries away than to go to the expense and trouble of building and calibrating a vacuum tube voltmeter. So it is. They may be discarded as soon as the voltage as indicated by an ordinary voltmeter is 63% of rated voltage. If it is left longer it may introduce noises in the output of the receiver.

Tube Voltmeter Useful

But this fact does not eliminate the usefulness of a vacuum tube voltmeter. In most modern sets the plate and grid voltages are obtained from eliminators. In all cases this means that voltage drops are used for the various voltages. The resistances involved may be as large as or larger than the internal resistance of the meter. When they are, the meter will not give a true indication. As soon as the meter is connected more current is drawn from the source and as a result all the voltages drop. The current taken by the meter also diverts current from resistors so that the voltages are changed in this manner.

If a vacuum tube voltmeter is used no current is drawn. The voltages throughout remain exactly the same as before connecting the meter. Hence true values are obtained.

One of the simplest ways to determine whether there is a considerable change in the voltage when the meter is connected across the battery is to connect a milliammeter of suitable range in the plate circuit of the tube and to observe its behavior. If the reading on the milliammeter increases when the voltmeter is connected, the grid battery is not in good condition. The more the plate current increases when the voltmeter is connected the worse is the condition of the grid battery.

ELSA ALSEN WITH COLUMBIA

Elsa Alsen, Chicago Opera Company's distinguished Wagnerian soprano, has been engaged for an appearance over the Columbia chain during December.

AEROVOX ACQUIRES GLOBE ART

S. I. Cole, president of the Aerovox Wireless Corporation, announced that the condenser equipment of the Globe Art Manufacturing Company, of Newark, New Jersey, has been acquired by his corporation.

Radio University

A FREE Question and Answer Department conducted by RADIO WORLD for its yearly subscribers only, by its staff of Experts. Address Radio University, RADIO WORLD, 145 West 45th St., New York City.

When writing for information give your Radio University subscription number.

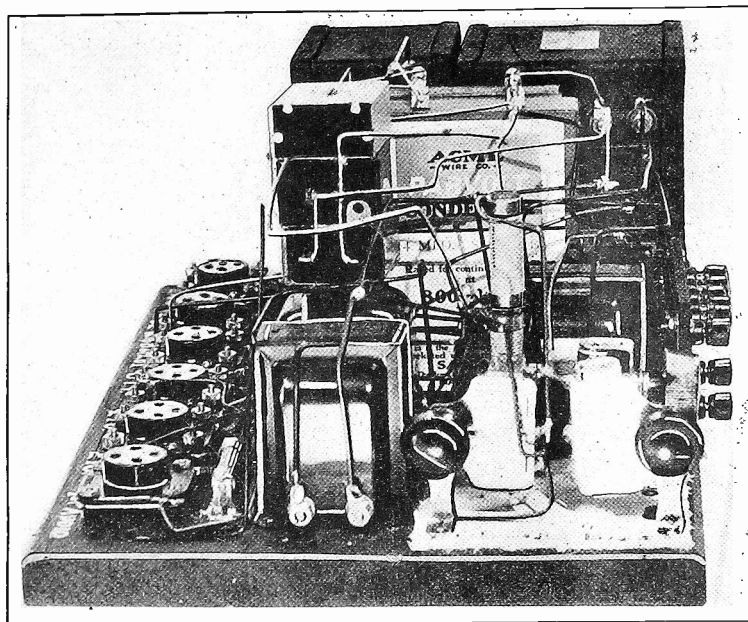

At top, we have a view of the combination eliminator and power amplifier as built by Samuel Jurmonowitz, showing the special precaution he took in mounting his resistors, asbestos sheeting being used, to prevent heat from attacking the wood. At the bottom we have another view of this power device, showing the lineup of the sockets, each one being marked for its special tube.

I HAVE read with interest the description of the Tyrman Ten receiver, which appeared in the October 22 and 29 issues of RADIO WORLD. I would like to build this set, but desire to have the honest opinion of your staff, before going ahead.

JAMES V. ELLIS,
Tannersville, New York.

This receiver is an excellent one to build. The quality of reproduction of the Tyrman Ten is free from the ordinary defects. That it is simple to manipulate becomes evident even before that. Even a blindfolded novice can tune in DX on the set. That it has all the undistorted volume that will ever be required of it in any home is plain as soon as the volume controls are turned up. That the set has all the sensitivity and all the selectivity that will be needed becomes apparent after a large number of distance stations has been brought in while all the local stations are going. And it will not take long to bring them in. Just turn the dials with the volume controls turned up and in they come, one after another. Some from afar, some from near. The Tyrman Ten is a great set.

* * *

IN AN impedance coupled amplifier is the voltage drop across the impedance in the plate circuit, applied through the stopping condenser to the grid of the next tube?

(2)—Does the grid leak or impedance in the grid circuit act as a leak to rid the

grid of its surplus negative charges?
FRANK WILLIAMS,
Los Angeles, Calif.

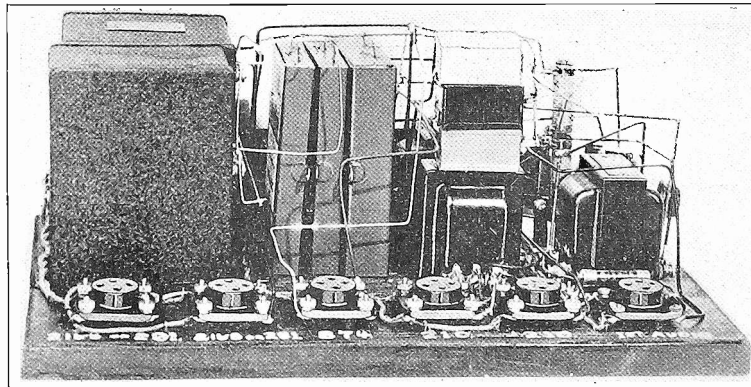

(1 and 2)—Yes.

* * *
I RECENTLY built a B eliminator and power amplifier. In it I used two 216 B rectifier tubes and two 210 power tubes. The device worked great, until one of the rectifier tubes went west. I went out and purchased a new 216B. Upon putting it in, I noticed that the other rectifier tube turned blue and the eliminator did not work. I can't imagine what could have happened. I did not touch anything in the eliminator. I tried the new 216 B tube in another eliminator and it worked great. The old one, however, refused to function. I enclose photographs of my power device so that you can see exactly what my eliminator is like. The two 210 tubes are hooked up in push pull style. Instead of incorporating the first audio tube in the set, you will note I put in right in the eliminator. This gives me a real separate audio amplifier, which I use in testing out the different radio frequency amplifier and detector portions of many different types of receivers. Not only is this a time saver, but it also simplifies matters a great deal. So as to be absolutely sure that I would get the maximum of results, that is as far as eliminating a hum was concerned, and also eliminating any chance of being troubled with burned out condensers, I used 1,000 volt condensers in the filter, one of which was a 2 mfd., the other, two 2 mfd. in parallel and the last, a 4 mfd.

SAMUEL JURMONOWITZ,
Altoona, Pa.

When you put the new tube in, it probably did not begin to function immediately and the whole load was thrown on the old tube. It is also possible that the contact between the tube prongs and the socket terminals were poor, so that only the single tube was carrying the load, the other tube being really out of the circuit.

Join RADIO WORLD'S University Club

And Get Free Question and Answer Service for the Coming 52 Weeks
This Service for Yearly Subscribers Only

Have your name entered on our subscription and University lists by special number. Put this number on the outside of the forwarding envelope (not the enclosed return envelope) and also put at the head of your queries. If already a subscriber, send \$4 for renewal from close of present subscription and your name will be entered in Radio University. No other premium given with this offer.

[In sending in your queries to the University Department please paragraph them so that the reply can be written under or alongside of each query. Write on one side of sheet only. Always give your university number.]

RADIO WORLD, 145 West 45th Street, New York City.

Enclosed find \$6.00 for RADIO WORLD for one year (52 nos.) and also enter my name on the list of members of RADIO WORLD'S University Club, which gives me free information in your Radio University Department for 52 ensuing weeks, and send me my number indicating membership.

Name

Street

City and State

A THOUGHT FOR THE WEEK

RADIO is surely the great leveller. It is democracy with a voice. It is the thing that makes the rich and poor, the young and old, the stern and the fatuous, sit and listen to the things that are well nigh as free as the air itself. It exalts as it amuses—and even the pessimist must admit that it is the one most legitimate excuse in the world for going to bed early in the morning without exciting the suspicions of snooping neighbors.

SIXTH YEAR

RADIO WORLD

The First and Only National Radio Weekly

Member, Radio Publishers Association

Radio World's Slogan: "A radio set for every home."

TELEPHONES: BRYANT 0558, 0559
PUBLISHED EVERY WEDNESDAY
(Dated Saturday of same week)

FROM PUBLICATION OFFICE
HENNESSY RADIO PUBLICATIONS CORPORATION
145 WEST 45th STREET, NEW YORK, N. Y.
(Just East of Broadway)

ROLAND BURKE HENNESSY, President
M. B. HENNESSY, Vice-President
HERMAN BERNARD, Secretary
European Representatives: The International News Co.
Breems Bldgs., Chancery Lane, London, Eng
Paris, France: Brentano's, 8 Avenue de l'Opera

EDITOR, Roland Burke Hennessy
MANAGING EDITOR, Herman Bernard
TECHNICAL EDITOR, Lewis Winner

CONTRIBUTING EDITORS:
J. E. Anderson, James H. Carroll, and
Capt. Peter V. O'Rourke

SUBSCRIPTION RATES

Fifteen cents a copy, \$6.00 a year, \$8.00 for six months, \$1.50 for three months Add \$1.00 a year extra for foreign postage, Canada, 50 cents.

Receipt by new subscribers of the first copy of RADIO WORLD mailed to them after sending in their order is automatic acknowledgment of their subscription order. Changes of address should be received at this office two weeks before date of publication. Always give old address; also state whether subscription is new or a renewal.

ADVERTISING RATES

General Advertising

| | | |
|---------------------------|----------------|----------|
| 1 Page, 7 1/2" x 11" | 462 lines..... | \$300.00 |
| 1/2 Page, 7 1/2" x 5 1/2" | 231 lines..... | 150.00 |
| 1/2 Page, 8 1/2" x 5 1/2" | 231 lines..... | 150.00 |
| 1/2 Page, 4 1/2" x 11" | 115 lines..... | 75.00 |
| 1/4 Page, 4 1/2" x 5 1/2" | 57 lines..... | 37.50 |
| 1 Column, 2 1/2" x 11" | 154 lines..... | 100.00 |
| 1 Inch..... | | 10.00 |
| Per Agate Line..... | | .75 |

Time Discount

| | |
|--|---------|
| 52 consecutive issues..... | 20% |
| 26 times consecutively or 13 O. W. one year..... | 15% |
| 13 times consecutively or E. O. W..... | 12 1/2% |
| 4 consecutive issues..... | 10% |

WEEKLY, dated each Saturday, published Wednesday. Advertising forms close Tuesday, eleven days in advance of date of issue.

CLASSIFIED ADVERTISEMENTS

Ten cents per word. Minimum 10 words. Cash with order. Business Opportunities ten cents per word. \$1.00 minimum.

Entered as second-class matter March 23, 1922, at the Post Office at New York, N. Y., under the Act of March 3, 1879.

THEY SAY

JESSICA DRAGONETTE, lyric soprano; N. B. C. musical comedy star: "I believe radio's advancement will be just as rapid as was the moving picture and I think its technique will be equal to the pictures in a shorter time. I hope to arrange my career so that I may develop with the new art and in time become outstanding in the field."

Officials In Limelight Risk Lingo-Analysis

By Herman Bernard

Broadcast From WGBS and WIP, Gimbel Bros. Stations

Celebrities are constantly appearing before the microphone. Sometimes the same celebrity is heard time and time again, sometimes a great man returns to the air after an absence of four months, I might add modestly. At all hazards, as we turn our dials we may bump into President Coolidge, or the Prince of Wales; Governor Alfred E. Smith or Senator William Marconi; Mayor James J. Walker or Mayor Will Rogers; and for that matter even Judge Rutherford.

It is interesting to study the air personalities of famous men and women. Most of us live our whole lives through, without ever seeing a President, or even a past or future President of the United States. Of our grandfathers, on the other hand, scarcely one in ten thousand ever heard the voice of a President of the United States. But to-day there is hardly an American over 10 years old who cannot recognize the voice of President Coolidge.

And when men compete for great public offices we hear their voices right in our home; many of us cast our vote on the basis of the impression made upon us by those broadcast speeches.

Some Lucky, Some Not

It is fortunate for some that this is true, unfortunate for others. Ability as a speaker is not the best criterion of ability in administration of an office, great or small. A man may have a nasal monotone as Coolidge has, yet may have a great mind for penetration and understanding of tremendous problems, as Coolidge has, and a capacity for fairness and truth that is in itself a virtue loftier than oratory.

Contrasting merely two types, one finds President Coolidge is logical, convincing, exclusively intellectual and somewhat professorial. We find Alfred E. Smith always interesting, always forceful, ready with wit and flaming indignation alike, whichever the moment demands, and as resourceful in his methods of appeal as one who had spent years in histrionic

training. One always feels that Governor Smith is one of us folk reporting back to the fireside what's been going on at Albany. Not everybody agrees with Governor Smith, but everybody is interested in what he says over the radio, and few are the programs on other waves attractive enough to compete with him. Governor Smith as a personality, even if he were not in any public office nor running for any, would outclass as a radio attraction many a man whose voice has sweeter cadences.

Hoover Crisp, Effective

Secretary of Commerce Herbert Hoover is an effective speaker, a master of clear thought and conquering logic. His is the voice that the banker, the industrialist, the economist, the captain of industry, will listen to thoughtfully, no less than will the general run of men and women, and the older children, of the land. Brilliant in intellect, Secretary Hoover bristles this outstanding keenness in his radio speeches.

Foreigners of note, arriving at these shores, scarcely ever deny us the privilege of hearing them before the microphone. The latest instance was the talk given by Senator Marconi, one of the men whose inventions contributed largely to the present success of broadcasting and of radio message service. A few months ago we heard the voice of the Prince of Wales, and were able to tell from listening to him that he is a rather nervous man, but one who knows what he wants to say or do, and says or does it accordingly.

The Prince's Accent

It was interesting to hear his mild English accent, thus showing that much travel has made his English little more that of England than that of Australia, where English is spoken much as it is in America.

These and other delightful vocal visits help make radio important and interesting and afford us privileged moments that the previous generation knew not, and add enormously to our store of knowledge and to the joy of living.

British Expert Struck By Our Chain Systems

By Captain Peter P. Eckersley

Chief Engineer, British Broadcasting Co.

I have been particularly struck in my study of the technical side with the excellence of the American system of linking stations together in what is called chain broadcasting. Technically this system is better arranged in America than in Great Britain, although we, on our side, have for some years developed a system of linking stations together so that several transmit the same program simultaneously.

I think, however, that the technique of actual radio transmitting stations in Britain is not inferior to similar technique over here. I can say this with confidence because very much the same sort of circuits and arrangements are used in both countries. Furthermore, I myself have

kept in continuous close touch with Dr. Alfred N. Goldsmith, chief broadcast engineer of the R. C. A., and to a large extent we have swapped results and compared experiences.

There is a considerable scheme developing in Britain at present so that everybody on the most simple set can be assured a choice of programs, and a choice not regulated by chance but directed by one brain with a conscious public service standpoint. Thus, for example, if there is an evening of jazz for those who would like to dance to loudspeakers, there would be on the air simultaneously a program of symphony music for the more serious-minded.

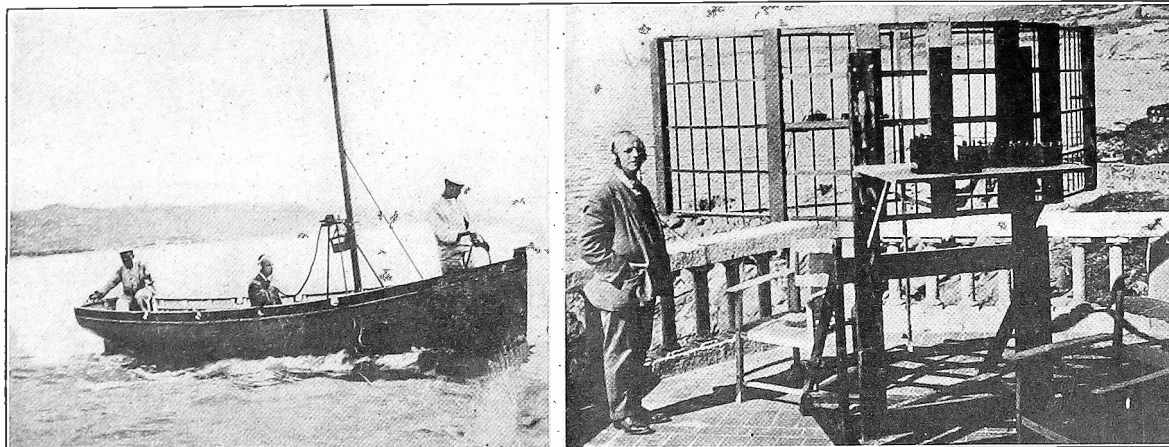

(Herbert Photos) TESTING A SHORT WAVE RADIO RECEIVER ON SIGNALS TRANSMITTED FROM THE PARABOLIC REFLECTOR.

Beam Well Developed But Over Public's Head

By Brewster Lee

During the last five years a great deal of development has been done on radio communication with short wave beams, particularly by William Marconi, the originator of the system. While this phase of radio development has been closely followed by radio engineers everywhere, it has attracted little public attention. Now and then attention has been called to the work by newspapers when they have announced the opening of a new beam circuit.

Senator Marconi's recent visit to the United States and his lecture on the beam system before the Institute of Radio Engineers stimulated public interest and forcefully called attention to the importance of the work that is being done along this line.

What is this beam system that now occupies a leading place in the art and that claims the attention of the foremost radio engineers? Let us try briefly to describe it.

The Parabolic Reflector

Of course, there can be no misunderstanding as to what a short wave beam is. As the name states, it is a beam of short radio waves. The main questions are how the beam is produced, how it is controlled, how received, what its properties are?

In connection with short wave beam radio telegraphy we always meet the term parabolic reflector. What is such a reflector and what purpose does it serve in the beam system? The parabolic reflector is a large mirror which throws all the radio waves that fall on it in one direction instead of permitting them to be broadcast equally in all directions. It thus produces the beam.

Everybody is more or less familiar with parabolic reflectors. They are used in flashlights, automobile headlights, searchlights and in many other applications. The reflectors used in these are usually paraboloids of revolutions, that is, paraboloids made by the rotation of a parabola about its axis.

A mirror of this nature has the property that if light from a very remote source, as the sun, falls on it, all this is converged at a single point called the focus.

Also if a small source of light is placed at the focus, all the light from this source

that strikes the reflecting surface is reflected out in straight lines parallel to the axis. Therein lies the value of the parabolic reflector.

Concentrated Effect

A very tiny source of light placed at the focus will appear as a very intense source because all the light is gathered together and sent out in a narrow beam.

As most radio fans know, radio waves are only overgrown light waves. It is not reasonable then to suppose that if radio waves be subjected to the same treatment as light waves they will respond in the same manner?

But it is not possible to subject them to the same treatment, because of the great difference in wavelength. A short radio wave may be 50 meters long. A light wave is so short that it would take 100,000,000 of them to make one wavelength of the short radio wave.

It is obviously impossible to make a searchlight reflector 100,000,000 larger than those used at present. Since this cannot be done radio waves cannot be subjected to the same treatment as light waves. But they can be subjected to

similar treatment. And when they are, they respond about the same way as light waves.

In radio beam work the parabolic reflectors used are not paraboloids but parabolic cylinders with the sides vertical. The reflecting surface is not silvered glass or polished metal, but it is made of tuned electric circuits. These circuits are placed vertically just like vertical antennas and they are arranged so that they trace a parabola on the ground.

Each circuit is tuned carefully to the wavelength to be sent out in a beam. The transmitting antenna is put in the focus of this parabolic cylinder, and it, too, is tuned to the wave to be sent out. The transmitting antenna is thus the source of the long wave "light."

The antenna sends out radio waves in all directions. Those that travel away from the tuned reflector pass out in a narrow beam the width of which is determined by the width of the parabola across the open side, A. B., Fig. 1, on the distance from the focus to the open end F, C, and on the length of the wave. The waves which strike the reflector are sent out in a parallel beam the width of which is equal to the distance across the reflector at the open end. Fig 1 shows the projection on the ground of a parabolic reflector as used in radio beam transmission.

It is thus seen that the narrower and deeper the reflector is, the more sharply defined will the beam be.

If something could be placed in the wave of the radio wave beam which would outline it, just as fog or dust outlines a light beam, then the beam would appear as a gigantic wall of thickness equal to the width of the opening of the reflector. It would spread out a little as the distance from the reflector increased. The wall would rest on the ground and would extend indefinitely upward. However, very close to the reflector it would not be much higher than the reflector itself.

There is no "dust" available which can be thrown in the way of the radio beam to make it visible, but that does not prevent a study of the shape of the beam, or the distribution of the electric radiation. A special form of radio receiver known as a field strength set can be used to study both the direction and the intensity of the electric field at any point around the beam transmitter.

It will be found that along the axis of the parabola the field strength will be very strong and that it will decrease very rapidly as the distance from the axis increases. Near the reflector the beam will be very clearly defined, but as the distance increases the definition will be less sharp and the beam will be wider.

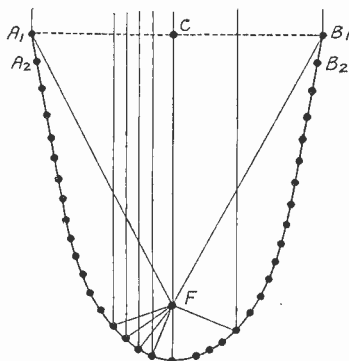
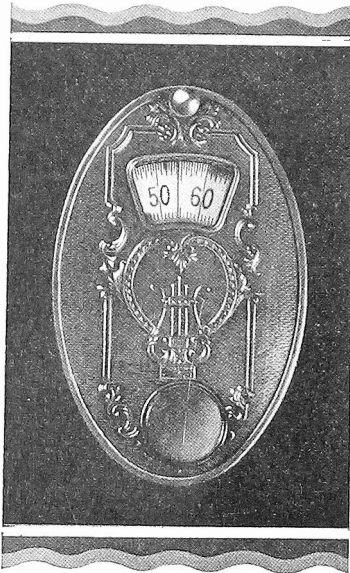

FIG. 1

A diagram of a parabolic reflector showing how a radio wave, originating at the focus F, is transmitted as a beam in one direction only. The dots A and B represent vertical circuits tuned to the wave transmitted.

Now for the
FENWAY
ELECTRIC
Concertrola



*T*HIS splendidly-designed new receiver... typical of the most advanced engineering thought for 1928... is distinguished also for its handsome, decorative panel design.

Leo Fenway, for years partial to MAR-CO's celebrated "friction-drive" dial action... has specified the new 1928 MAR-CO controls to give supreme tuning accuracy and rich beauty to his latest creation.

MAR-CO

Illuminated
CONTROLS

... with the new
decorative face plates

add the sparkle... the style touch... that modern custom-built receivers deserve. Complete with the metal faceplate that clamps flat to the panel... —with MAZDA bulb to illuminate the scale... —and with the template that makes panel-drilling so easy you *can't* go wrong...

they list at \$3.50, at all good stores, or direct from

MARTIN-COPELAND COMPANY
Providence Rhode Island

Overseas Broadcasters Confronted by Puzzles

Two of the most perplexing of problems which the National Broadcasting Company and the British Broadcasting Company will face in their trans-Atlantic broadcasts are the time and language differences.

"I think we have the technical problems of our international system pretty well in hand," said Dr. Alfred N. Goldsmith, in charge of the engineering work on this side of the Atlantic, "but now we are facing puzzles regarding time and lan-

guage. It begins to look as if we will have to make all announcements in Esperanto or bilingual. For example, if the program originates in France the announcements will be made in English and French, and if we send a program to Germany our announcements will be made in English and German. It may be a case of 'English spoken and American understood.'

"We will probably be forced to compromise on time. Some nights Americans may have to stay up a little later to hear

Glorifying the Four-Tube Set!

The FENWAY Electric Concertrola An Engineering Achievement in Electric Radio Receivers

TRULY the most remarkable Radio "buy" in America! Truly an achievement which must immediately change all existing ideas as to what the buyer of a kit of radio parts has a right to expect for his money!

The Electric Concertrola separates locals in a city the size of New York —and there are some locals in New York to separate! It serves volume with quality, not only on one station, but on all stations, program after program. It brings in DX stations on the same dial settings, evening after evening. Tunes 'em in easily, too. Only two dials—one volume control—operates with indoor or outdoor aerial.

**Easy to build with the
Concertrola Blueprints
(\$1.50 a set), PLUS the
help of a Personal
Instructor.**

**NOW, THEN, If you Don't Build the Electric Concertrola,
If You Don't Take Advantage of the Fenway Deferred
Payment Plan—Then the "LOSS IS DISTINCTLY YOURS!"**

**Read what the Editor of
Radio World says of the
Concertrola:—**

"Leo Fenway, brilliant radio author and designer extraordinary, has developed and perfected an AC receiver, the Concertrola, described herewith for the first time anywhere. The man whose nine-tube Fenway startled and delighted the enthusiasts for home-built radios, comes forward now with an out-performing four-tube set, grandly done, yet inexpensive. Originality abounds, all tempered with good sense and splendid judgment. The thing is done in the Fenway way. If you don't read every word of it the loss is distinctly yours."—Editor.

**We Urge You to
Sign This Coupon
Today. It Places
the Complete Kit
of Parts Within
Reach of Your
Purse.**

Leo FENWAY for DX! INC.,
249 W. 53rd St., New York, N. Y.

Gentlemen: Tell me more about how I can purchase a complete kit of Concertrola parts and pay for it on the deferred payment plan. No obligation, of course.

Quote your lowest cash price for the same kit.

NAME

ADDRESS

..... (R.W.)

the foreign broadcasts, while the Europeans must lose sleep if they want to hear our broadcasts. We may have to send our concerts to England around 4 or 5 o'clock in the afternoon so that they can get them at a reasonable time. If we wait until 7 P. M. to send programs to Europe it will be midnight there and the audience would not be as large as it might earlier in the night. On the other hand, the British may have to stay up later than usual to send programs to us early in our evening. When Big Ben strikes midnight in London it will be 7 P. M. in New York.

"Actual construction of the apparatus is going ahead. I doubt, however, that we will be able to broadcast the foreign concerts before Dec. 1. We will use a 40-kilowatt transmitter at Bound Brook, N. J., operating on two wave lengths. The wave utilized will be suitable for the weather and time of day. A longer wave must be employed in cold than in warm weather and the shortest wave usually serves best in daylight. Two directional aerials pointing toward England will be employed. Receiving will probably be done at Riverhead, L. I., and sent over land wires to the WJZ transmitter, also located at Bound Brook, whence the program will be amplified and rebroadcast on the 455-meter wave."

\$150,000 in Fiddles to Be Heard At Once

Violins valued at \$150,000 will be used in an hour's program to be broadcast over the Columbia Broadcasting Systems network during this Winter, when the Musical Art Quartet, which includes Sascha Jacobsen appears before the microphone. These violins are all Strads which were purchased by Felix Warburg.

The Ever-Popular **IMPROVED DIAMOND of the AIR KIT \$37.50**
GET OUR PRICES! SAVE ON THESE!
 Karas Equamatic, Karas Kinkorbecker 4, Silver-Marshall Shielded Six, New Hammarlund-Roberts H1-2, Everman 4, Aera-7, Powerfame, 4-Tube Diamond of the Air, Lynch Five and all New Kits.
 Send for New Free Catalog, Just Out
B.C.L. RADIO SERVICE CO., Inc.
 220 FULTON ST., NEW YORK CITY

IMPROVED TURN-IT



Variable Grid Leak (Non-Evaporating) 12.6 megohms **\$1.00**
 If your dealer can't supply you write direct.
GARDINER & HEPBURN, Inc., 611 Widener Bldg., Philadelphia, Pa.

MUTER Clarifier and Tone Filter

Improves Tone Quality and Volume Protects Speaker

Specified by H. B. Herman, acoustical expert, and endorsed by leading engineers and other experts everywhere.

Stock No. 2700.....Price \$30.00
 STANDARD COMPLETE AERIAL KIT
 Stock No. 250.....Price \$35.00
 CONSISTS OF
 100 feet 7-strand No. 22 aerial wire
 40 feet No. 14 gauge insulated lead-in wire
 25 feet No. 18 gauge hook-up wire
 1 No. 1000 Guardian Approved Arrester
 1 No. 1200 Adjustable Ground Clamp
 1 No. 1250 Antenna Lead-In Insulator
 2 Rainproof Porcelain Antenna Insulators
 2 Screw Eyes
 3 Porcelain Extension Knobs
 12 Insulated Staples
 1 Complete Instruction Sheet

LESLIE F. MUTER CO.
 76th and Greenwood Ave. Chicago, Ill.

REMLER

Drum Dials and Twin Rotor Condensers Specified for 9-in-Line





The Remler Twin Rotor condensers, that turn like a canoe on a calm lake, are the everlasting delight of their proud owners. The same gliding smoothness characterizes the Remler drums, new this season. For 9-in-line, two No. 649 or 639 (.0005) condensers\$5.00 ea. One left-hand and one right-hand turning drum dial (No. 110) 4.50 ea.

Remler Division of Gray & Danielson Mfg. Co.
 260 First Street Chicago San Francisco New York

HERMAN BERNARD, managing editor of *Radio World*, discusses radio topics of popular interest every Friday at 6:40 P. M. from WGBS, 348.6 meters, the Gimbel Bros. station in New York City. Listen in.

"Double R"

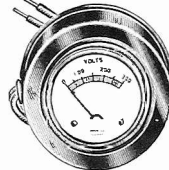
PANEL METERS RUGGED AND RELIABLE ASSETS FOR YOUR SETS



Tubes last longer when the voltages are right. The panel meter is just the thing you want for that. If you are discriminating you want the finest tone quality. A 0-50 milliammeter in the plate circuit of the last tube serves that object admirably. Mount the meter on the panel. You will be delighted at the enjoyment that will be afforded by the use of a panel meter. The DOUBLE R meters are sturdily built and accurate, yet priced very modestly. You send us nothing yet we send the meters. All you have to do is to let us know what meters you want. Order by catalog number, which appears on the left in the list printed herewith. When the postman delivers the meter you pay him the price listed below, plus a few cents postage. Then you will put your meter into action and enjoy the fruits of your wise buy. Note AC meters for new AC tubes.

| DC PANEL MILLIAMMETERS | | DC PANEL VOLTMETERS | |
|---------------------------|-------|---|--------|
| No. | Price | No. | Price |
| No. 311—0-10 mil-iamperes | \$.95 | No. 326—0-6 volts | \$.65 |
| No. 325—0-25 mil-iamperes | 1.85 | No. 335—0-8 volts | 1.65 |
| No. 350—0-50 mil-iamperes | 1.65 | No. 337—0-50 volts | 1.65 |
| | | No. 339—0-100 volts | 1.75 |
| | | | |
| | | AC PANEL VOLTMETERS | |
| | | No. 306—0-6 volts for No. 25, 28 Radiolas | \$2.50 |
| | | No. 308—0-6 volts for No. 20 Radiolas | 2.50 |
| | | No. 307—0-6 volts, desk type with cord | 2.50 |
| | | DC PIN JACK VOLTMETERS | |
| | | No. 351—0-15 volts | \$1.75 |
| | | No. 352—0-10 volts | 1.75 |
| | | No. 353—0-6 volts | 1.75 |

GUARANTY RADIO GOODS CO.
 145 West 45th St., New York City.
 Please send me Double R meters catalogue numbers
, for which I will pay the postman on receipt of meters, plus a few cents extra for postage. These meters are to be received by me on a 5-day money-back guaranty.

Name

Address

City State.....

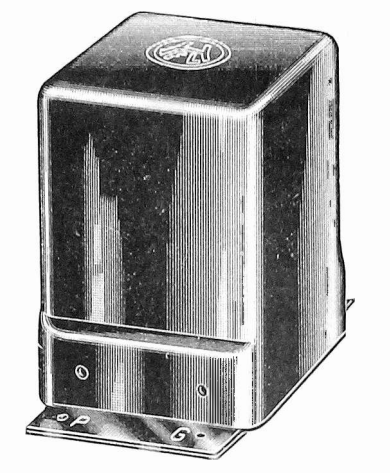

H.F.L. Transformers

H.F.L. C-16 and C-26 Audio Transformers and C-25 Output Transformer—New Companions of a Great Circuit

H.F.L. C-16 and C-26 are the most efficient Audio Transformers built. They carry signals at highest volume and lowest amplitude without blasting or developing harmonics. Operates with all power tubes as well as standard tubes. H.F.L. C-25 Output Transformer handles the voltage output of power amplifying tubes, at the same time matches the impedance of the average speaker to the tubes. Protects loud speaker unit without reducing plate voltage.

Mechanical features of these three transformers are: A coil designed and treated to exclude moisture and withstand heavy electrical surges without breaking down—complete magnetic shielding to avoid interstage coupling—terminals brought out so as to insure short leads.

Endorsed by America's Leading Engineers—Guaranteed by the Manufacturers

The new C-16, C-26 and C-25 Transformers will work in any circuit and will improve any Radio Set.

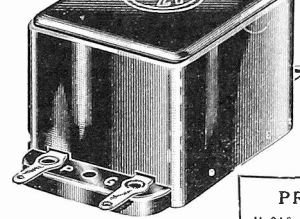

| PRICES | |
|-------------------------|--------|
| H-210 Tran. | \$8.00 |
| H-215 Tran. | 8.00 |
| L-425 R. F. Choke | 5.50 |
| L-430 R. F. Transformer | 5.50 |
| C-16 Transf. | 8.00 |
| C-26 Transf. | 8.00 |
| C-25 Output Transformer | 8.00 |
| Push Pull | 9.00 |

Set Builders and Dealers

If your jobber cannot supply you with H. F. L. Transformers, write us for name of nearest jobber.

High Frequency Laboratories

133N NORTH WELLS STREET CHICAGO, ILL.



"The House of Many Wires"
 DISTRIBUTORS OF
VICTOREEN POWER SUPPLY
 KARAS TYRMAN TEN
 ENSCO KITS
 ACME CELATSITE
 Ask for our Catalog and Prices
WEBER DISTRIBUTING CO., Inc.
 90 West Broadway New York City

**Unified
 DIAMOND**

Your heart will beat pitter-patter with joy when you turn on the switch after completing the Unified Diamond of the Air. This design consists of a balanced two-stage RF amplifier and detector, constituting the Radio Frequency Fountain, and a three stage resistance coupled channel constituting the Audio Frequency Basin. Any other form of audio may be used. Send 50c for complete description of construction (issues of Sept. 17, 24, Oct. 1, 8, 15).

Radio World, 145 W. 45th St., N. Y. C.

**Unified
 DIAMOND**

**Interesting Issues of
 Radio World**

MAY 7.—Part I of the Six-Tube Adams-Griffin Shielded Set, by Dana Adams-Griffin.

APRIL 30.—The Equamatic mixer which can be used with almost any "super" coils, by Herman Bernard.

APRIL 23.—How to measure the cut-off in the resistance AF, by J. E. Anderson. Constructional data on the Melo-Heald, an eleven-tube Super-Heterodyne, by Herbert E. Hayden. (Part II). Part IV of the four-part article on how to obtain best results with the Nine-in-Line Super-Heterodyne, by Lewis Rand.

APRIL 16.—Part I of the description of the Melo-Heald Super-Heterodyne, by Herbert E. Hayden. Part II of discussion on the Nine-in-Line Super-Heterodyne, by Lewis Rand.

APRIL 9.—A five-tube shielded set employing transformer AF, by Herbert E. Hayden. Part II of constructional data on Power Compact, by Lewis Winner. Part II of the four-part article on the Nine-in-Line Super-Heterodyne, by Lewis Rand.

APRIL 2.—(Fifth Anniversary Number) Part I of the four-part article on the super-sensitive Nine-in-Line Super-Heterodyne, by Lewis Rand. The three-tube compact, a simple one-dial, three-tube regenerative set by Jasper Henry. Part I of the two-part article on a Power Compact, the B eliminator with a stage of power audio frequency amplification by Lewis Winner.

15 cents a copy—all seven issues for 80 cents
 Radio World, 145 W. 45th St., N. Y. City

Say, Mawruss, What Is A Ge-Filter Condenser?

By Abe Katzenheimer

What is the difference between a filter condenser and a by-pass condenser? This question has been asked thousands of times. The answer is that there is no difference. A filter condenser is a by-pass and a by-pass is a filter condenser. A condenser called a by-pass furnishes a shortcut for high frequency currents across a line or across a high impedance device. That is exactly what a low pass filter condenser does.

In radio frequency circuits the high impedance around which the by-pass is connected may be a choke coil, the primary of a transformer, or a high resistance. In a filter, the high impedance across which the bypass condenser is connected is the resistance of the load and the inductive impedance of the choke coils. There is no difference in principle or operation. The difference is confined to the names.

What is the action of a by-pass or filter condenser? The condenser acts as a storage tank of electricity. It can be filled and emptied by the alternating current wave, or its electric content can be increased and decreased by a fluctuating electric wave.

The action of a filter can readily be explained with the aid of a water an-

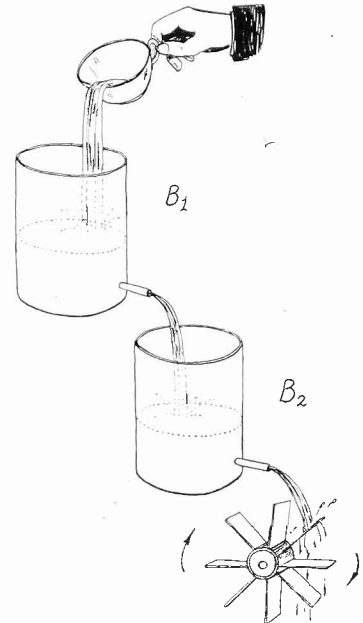

HOMEKAST!!!

The wonderful new HOMEKASTER enables you to furnish your own radio entertainments. It plugs into the radio set. Just like a tube. With the HOMEKASTER, anyone can announce, sing, etc., before the transmitter in another room, and the sounds will be greatly amplified, coming out of the loud speaker, just as if the performer were at the broadcasting studio. Mystify visitors and friends. Entertain the children.

Reverse the process and the HOMEKASTER becomes an extremely sensitive detective device. The slightest sound in the room where the innocent-looking loud-speaker stands, will be loudly reproduced in the parlors, which may be located in any other part of the home.

HOMEKASTER comes complete and ready to use Fully guaranteed. Orders filled in rotation. Send check, money order, or pay postman \$5.00 upon delivery.

Approved by RADIO WORLD Laboratories
APLIN RADIO LABORATORIES
 Suite 429, 30 Church St., New York, N. Y.

NEW RECEIVER! First to Use New Shielded Grid Tubes!

Write for Detailed Information

Camfield Radio Mfg. Co.
 35 E. Wacker Drive, Dept. R.W.3, Chicago

EVERY FRIDAY evening, beginning at 6:40 P. M., a ten-minute talk on radio topics is delivered by Herman Bernard, managing editor of Radio World, from WGBS, the Gimbel Bros. station, New York City. Wavelength 348.6 meters; frequency 860 kilocycles. Listen in.

Better by Far

Than any fixed leak in the detector circuit is the

BRETWOOD VARIABLE GRID LEAK



Because it allows adjustment of grid voltage to maximum sensitivity for reception of far-distant signals, while permitting faster discharge of electrons when receiving strong local stations, thus preventing distortion from this cause. Therefore a Bretwood Variable Grid Leak means more miles plus best possible tone quality, without any extra tubes. A patented plastic and foolproof plunger insure permanence in holding any desired resistance setting from 25 to 10 megohms, as well as very long life of the leak itself. As no grid leak can function any better than its grid condenser, be sure that you use a leak-proof Bretwood Bullet Condenser, of mica dielectric, and of .00025 mfd. capacity (another precision product, accurate to plus or minus one per cent.). Get these two parts and also get our

FREE

The New Bretwood with Condenser Attached. (Less than half actual size.) hookups, supplied with each purchase. Just fill out and mail the (Less than half actual size.)

Don't Send a Solitary Cent!

The Bretwood Leak may be baseboard or panel mounted. Works the same in any position. No fluid used.

North American Bretwood Co.,
 145 West 45th Street, N. Y. City.

Please mail me at once one New and Improved 1928 Model De Luxe Bretwood Variable Grid Leak (price, \$1.75) and attach one Bretwood Bullet Condenser (50 cents extra) for which I will pay the postman \$2.25 on receipt. Both must be the genuine Bretwood articles, imported from England.

NAME

STREET ADDRESS

CITY STATE

RW-917

FILL OUT AND MAIL NOW SUBSCRIPTION BLANK RADIO WORLD

RADIO WORLD

145 West 45th Street, New York City
 (Just East of Broadway)

Please send me RADIO WORLD for months, for which

please find enclosed

SUBSCRIPTION RATES:
 Single Copy \$.15
 Three Months 1.50
 Six Months 3.00
 One Year, 52 Issues 6.00
 Add \$1.00 a Year for Foreign Postage; 50c for Canadian Postage.

alogy. In this, electric quantity becomes amount of water; voltage, the height of the water in a vessel; current, the rate of flow of water; capacity of the condenser, the capacity of the vessel. The resistance that the load on the filter offers is represented by the resistance a nozzle offers to the flow of water.

Just as the electric current is proportional to the voltage, so the rate of flow of water is proportional to the height of the water level above the emergence point of the nozzle. The electric current is inversely proportional to the load resistance and the water current is inversely proportional to the resistance the nozzle offers.

Suppose we are dealing with a rectifier which injects electric current pulses or "squirts" into the condenser. This may be likened to regular squirts of water into a vessel, such as a water beaker. Each squirt might be a cupful of water. As a cupful of water is emptied into beaker B1, Fig. 1, the water level rises.

Regular Outflow

While the cup is carried away to be filled again the water leaks out through the nozzle and the level (voltage) falls. The rate of flow (current) also falls as the level drops.

The flow of water into the upper beaker is by cupful, but the outflow is fairly regular. The fluctuations have been greatly decreased by the upper beaker (condenser). Had the beaker been larger, that is, had it presented a greater surface, the fluctuations in the emergent stream would have been still smaller.

Just as the upper beaker smoothed out the wide fluctuations in the flow of water, so does the lower beaker B2 and the greater the surface of the lower beaker the smaller will be the fluctuations in the rate of the emergent flow. Therefore the water goes into the upper beaker in intermittent cupfuls but it emerges from the nozzle in the lower beaker as a very nearly steady stream. Another beaker in the series would have leveled out the fluctuations still more.

While the two beakers are in series with the line of flow the capacities of the beakers are really in shunt with the line, just as in the electrical filter.

In the electrical filter there is a choke coil in series with the line. This coil opposes changes in the rate of flow of current. The opposition is electric inertia.

The "Inductance" of Water

In the water analogy there is no apparent counterpart. But the water itself possesses inertia and thus supplies the necessary "inductance." This inertia is in series with the line of flow. The amount of inertia cannot be changed in the water analogy, because the density of the water remains the same. But instead of water we could use mercury. This is heavy and its "inductance" would be extremely high. The fluctuations would be smaller if mercury were used.

It is apparent from the water analogy that the wider the nozzles the greater the flow of water will be, and it is also evident that the greater will be the fluctuations in the stream and in the level of the water in the two beakers. Exactly the same is true in the electrical filter. If much current is drawn, that is, if the load resistance is low, the voltage fluctuation across any condenser, or the fluctuations in the current, will be great.

It is also clear that if the nozzle is

small the level will rise to a higher value. The same holds true in the electrical case. The less the current that is drawn the higher the voltage, as is well known from the regulation curves.

It is much easier to remove fluctuations from a line when the drain is small. The reason for this can be seen from the water analogy. It is also clear that if small cupfuls at rapid intervals are poured into the upper beaker the fluctuations in the output will be smaller than if large cupfuls at longer intervals are poured in. This shows why it is easier to filter out variations of high frequency than of low, and also why it is easier to filter the product of full wave rectification than of half wave rectification. In the water analogy full wave rectification may be represented by the use of two cups of half the size, one in each hand of the operator. While the operator emptied one cup into the beaker he would be filling the other.

The analogy will not be complete without mentioning the limitations of the flow of water or of electric current. In the rectifier the influx is regulated by the efflux.

No more can flow in than flows out, as current cannot continue to flow after the condensers across the line have been charged up to maximum voltage. In the water analogy there is no limitation on the amount of water that is put into the top beaker, or rather that is poured at it.

The operator of the cups is supposed to guide the amount of water in each cup to just fill the upper beaker each time a cup is emptied into it.

If the beakers were closed and the water forced in with a pump, the analogy would be more accurate, because a condenser is really a closed electric vessel into which electric quantity is forced with a pump. The pump in this case is the rectifier.

The Big Thrill of DX, and at very Small Cost to You

Everybody who owns a radio set likes to tune in far-distant stations now and then because not only is there a thrill in hearing a voice or instrument thousands of miles away but one verifies the fact that he has a powerful receiver and that it is in good condition, if it is able to pick up these weak signals. Now that the broadcasting stations are more suitably distributed as to wavelength or frequency, fans are in a better position to tune in distance. Besides, the weather is in their favor these days. But what kind of a set shall be used? You know very well that if the set can tune in distance once in a while, you can develop sufficient skill to make it tune in far-distant stations very often, virtually every night. Then when you have visitors you need not boast about the DX qualities of your set but simply tune the receiver and let them listen to stations thousands of miles away. You must be sure to have a receiver capable of responding to your distance-getting desires. You also want this set to have delightful tone quality, so that your own critical ears cannot detect even a single flaw in the reproduction. Indeed, even music lovers who may be guests at your home will comment admiringly upon the bewitching tone of your receiver. Then you know you have something real. The ability to get distance and to reproduce the original music without distortion depends largely on the circuit design, and you will find that the Diamond of the Air, either the 4-tube or the 5-tube model, will live up to your highest expectations. How are you going to know which to build? Carefully inspect the textual data as well as the blueprints that fully expound the theory, operation, characteristics and amplification of these two outstanding receivers that differ principally in the type of audio amplification.

The 5-Tube Diamond

Can be constructed in a couple of hours. The authorized blueprints that make this speed and efficiency possible are just off the press and will be shipped at once, together with the new booklet of full textual exposition of construction, including the winding of coils, how to connect terminals, what values of condensers and resistors to use, etc. The receiver consists of a stage of tuned radio frequency amplification, a specially sensitized detector, first stage of transformer audio and next two stages of resistance audio. It is easily adapted to playing phonograph records through the set and on your speaker. Get acquainted with this new delight.

The 4-Tube Diamond

represents the most that is obtainable from four tubes. A stage of tuned radio frequency amplification, a specially sensitized detector and two stages of transformer coupled audio. Follow the blueprint to amazing success. Build the set from parts you have. Full instructions cover utilization of such apparatus. Thousands are eager to build an economical set of surpassing performance and amazing achievement and this one is the most economical, the most scientific, and the least expensive in cost of parts and upkeep. Works splendidly from batteries, either type 99 or type 1A tubes, and can be used with A and B eliminators, power packs, etc., with great success.

Look over both of these

blueprints and read the text in both cases before choosing the receiver you are to build.

SEND NO MONEY

Just fill out the coupon below and note what you get FREE.

Guaranty Radio Goods Co.

145 West 45th Street, New York City

Please send me one newly-printed official blueprint of the 5-tube Diamond of the Air, one newly printed official blueprint of the 4-tube Diamond, and the textual data giving full directions for constructing these sets. I agree to pay the postman 75 cents on delivery. Also, you are to send me, without extra cost, one Auto Strop Safety Razor, one blade and one automatic razor strap.

Name
Address
City..... State.....

The "LYNCH 5"

was built around

SICKLES COILS

You can expect to duplicate the exceptional results only with the same

SICKLES COILS

These are the same standard high quality accurately calibrated coils which have had no superior during the past five years.

Specially designed for the

"LYNCH 5" DECK

Coil Set No. 28.....\$4.50

There are Sickles Diamond-Weave Coils for all leading circuits.

THE F. W. SICKLES CO.

142 UNION STREET

Springfield, Mass.

| No. | Coil Prices |
|------------------------------|-------------|
| 30 Shielded Transformer..... | \$2.00 each |
| 24 Browning-Drake | 7.50 set |
| 18A Roberts Circuit | 8.00 set |
| 25 Aristocrat Circuit | 8.00 set |
| 28 Lynch 5 | 4.50 set |

Everybody's Talking About It

There's a wealth of reliable, bottled-down, and interesting information in "Resistance the 'Control Valve' of Radio." Simply written — clearly illustrated. This valuable hand-book on resistance in radio is worth dollars—send only 25 cents for your copy.

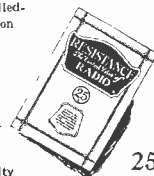

ARTHUR H. LYNCH, Inc.
1775 Broadway, New York City

25c

World "A" Power Unit--\$12.75

Automatically provides even, unvarying "A" current from your light socket. Absolutely noiseless. Assures full tone quality from your set and wider D. X. range. Famous WORLD quality—at less than half of the cost of any similar equipment. Shipped complete, subject to inspection on receipt of price, or C. O. D., if you wish. 25 amp. unit for sets of 4 tubes or less—\$12.75. 60 amp. unit for sets of 5 tubes or more, \$15.75. 5% discount if cash in full is sent with order. Send order today. World Battery Co., 1219 So. Wabash Ave., Dept. 82, Chicago, Ill.

Literature Wanted

THE names and addresses of readers of RADIO WORLD who desire literature on parts and sets from radio manufacturers, jobbers, dealers and mail order houses are published in RADIO WORLD on request of the reader. The blank below may be used, or a post card or letter will do instead.

RADIO WORLD,
145 West 43rd St., N. Y. City.

I desire to receive radio literature.

Name

Address

City or town

State

- Samuel T. Freeth, 264 Burmont Ave., Drexel Hill, Delaware County, Pa.
- Charles Cronin, 2920 N. Camai St., Philadelphia, Pa.
- Irvin Pittman, 162 Broadway, Pitman, New Jersey.
- Joseph D'Agostino, care WJZ, Bound Brook, N. J.
- Meyer Chertock, 52 Barrett St., Brooklyn, N. Y.
- H. R. Staley, 803-805 Market St., Wheeling, W. Va.
- O. W. Ross, Calydor Sanatorium, Gravenhurst, Ontario, Canada.
- P. S. Geisinger, 705 Estep St., S. W., Canton, O.
- Cecil R. Tibbetts, 168 Allen St., Buffalo, N. Y.
- H. D. McKleroy, 909 N. 11 St., Mattoon, Ill.
- Albert Riemenschneider, 1830 East Huntingdon St., Philadelphia, Pa.
- Roy Wendt, Box 844, Marshfield, Oregon.
- F. Bremon, Route 1, Box 153, Beaumont, Texas.
- John Payer, 122 Columbia St., Youngstown, O.
- J. W. Barbee, 805 Pontiac Bank, Pontiac, Mich.
- H. W. Newstead, 233 1/2 Hillside Ave., Syracuse, N. Y.
- H. Hughes, 429 Lake Avenue, Worcester, Mass.
- E. B. Kelly, 252 Watio St., Quincy, Mass.
- D. Mann, 117 Hull St., Brooklyn, N. Y.
- Edward C. Konig, 121 Lambert St., Philadelphia, Pa.
- Villers Electric Shop, P. O. Box 95, Steubenville, O.
- Morris Lev, 233 Haddon Ave., Westmont, N. J.
- Trigve Nordhogen, Stanley, N. D.
- Frank St. John, 315 North Snelling Ave., St. Paul, Minn.
- R. J. Bliss, R. 2, Box 39, Ashtabula, O.
- Russell Spafford, 399 Park St., 2 West Springfield, Mass.
- I. A. Bradley, 324 Sumatra Ave., Akron, O.

- Frank Braitner, 265 Albany Ave., Brooklyn, N. Y.
- Jack Wettstein, 5531 Howe St., Pittsburgh, Pa.
- Ray Robinson, Box 14293, Repress, Calif.
- George W. Little, Box 243, Central City, Nebr.
- F. E. Long, 2843 Washington, Dubuque, Ia.
- W. G. Perret, 1929 Chapman St., Sharpsburg, Pa.
- E. J. Butler, 5701 Callowhill St., Pittsburgh, Pa.
- B. H. Williams, 530 East Broadway, Alliance, O.
- Owen L. Saddler, 548 Taylor St., Wilmington, Del.
- Thomas Bennett, 254 South 10th St., Lebanon, Pa.
- Sam Cololough, 567 36th Ave., San Francisco, Calif.
- G. O. Worswick, 1141 Cherry Ave., San Jose, Calif.
- Frank J. Ross, 220 Fremont Ave., North, Minneapolis, Minn.
- James R. Hulton, 359 Willow St., Lockport, N. Y.

Pickup to Grid Input For Best Results

It is much better to connect the pickup to the grid of the detector tube, or to one of the audio amplifier tubes. No current will be delivered by the pick-up unit and there will be no voltage drop. Much louder response will result. Furthermore, the tube amplifies the pick-up when the voltage is impressed on the grid which it does not do when it is connected to the plate circuit.

If the circuit is resistance coupled the pick-up cannot be connected to the plate terminals of the detector with any degree of efficiency. The internal resistance of the pick-up is too small in comparison with the plate load resistance. Then when this connection is employed a stable circuit will usually start motorboating.

BENJAMIN

Cle-Ra-Tone Sockets

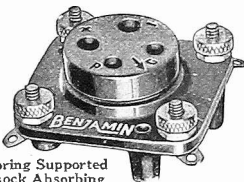

Spring Supported Shock Absorbing

The choice for practically every prominent circuit for several years. Among the most recent hook-ups for which it has been specified are:

Fenway Electric Concertrola, New Laboratory AC Receiver, Thompson Super 7, H. F. L. Nine-in-Line, Camfield Super Selective 9, Thompson A. C. Super, Magnaformer 9-8, L. C. 28, Lynch Suppressor Circuit, World's Record Super 10, Strobodine 8, Melo Heald Fourteen, St. James Super, Two-Dial Equamatic, Qualitone 6, Knickerbocker 4, Hilograd Receiver, International One-Spot, Hot Spot Fourteen.

Push Type, on Mounting Base:
Benjamin Cle-Ra-Tone Sockets...75c each
Without Mounting Base.....50c each

New Y Type Socket
Specially designed, for use with 5-pronged A. C. Radio Detector Tubes.
For direct attachment to panel... 90c each
For mounting on top of panel...\$1.20 each

At all Radio Jobbers and Dealers

Made by
Benjamin Electric Mfg. Co.
120-128 S. Sangamon St., Chicago

New York San Francisco
247 W. 17th St. 448 Bryant St.
Manufactured in Canada by the Benjamin Electric Mfg. Co. of Canada, Ltd., Toronto, Ontario

EVERY FRIDAY evening, beginning at 6:40 P. M., a ten-minute talk on radio topics is delivered by Herman Bernard, managing editor of Radio World, from WGBS, the Gimbel Bros. station, New York City. Wavelength 348.6 meters; frequency 860 kilocycles. Listen in.

WHY VOLTAGE RUNS TUBE

The vacuum tube is referred to as a voltage operated device. This is due to the fact that a varying voltage applied to the grid of a tube causes a current change in the plate circuit of the tube. In other words, the voltage which is applied to the grid of a tube acts as a control valve of the current and power in the plate circuit.

NEW CORPORATIONS

- Wireless Printing Co, New York City, \$20,000. (Attys. Rothman and Katz, 51 Chambers St., New York City.)
- Price Radio Corp., New York City, \$25,000. (Attys. Reit and Kaminisky, 305 Broadway, New York City.)
- Leo Fenway For Radio, broadcasting equipment, New York City, \$25,000 pf., 100 shares common. (Attys. Breed, Abbott and Morgan, 32 Liberty St., New York City.)



As a powerful battleship plows its way through a stormy sea, Polymet Condensers take on the mighty power requirements of modern radio and deliver steady and continuous service at their rated working voltages. Polymet Condensers do not melt down or blow up — they stand up, giving the utmost value for the money in working voltage, durability and dependability.

Polymet Block Condensers

The working voltage under which these condensers are to operate has been carefully studied and only the proper condenser sections incorporated in these blocks.

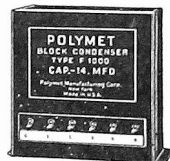

Polymet High-Volt Filter Condensers
Polymet Condensers are Non-inductive and our special process of impregnating makes them superior. Made in all popular capacities.

Write for complete information regarding Polymet parts and catalog of all Polymet Radio Essentials.

POLYMET
MANUFACTURING CORPORATION
597 Broadway, New York City

POLYMET CONDENSERS



Play Safe!

Wherever a variable resistance is specified use CLAROSTAT, the greatest variable resistor.

"THE GATEWAY TO BETTER RADIO," 82 pages covering the latest angles in radio. Send 25c to Dept. R. W. American Mechanical Labs., Inc., 285 N. 6th St., B'klyn.

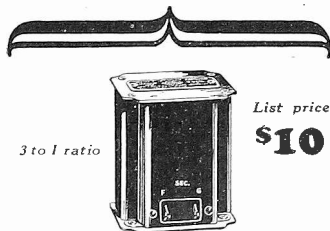

3 to 1 ratio

List price
\$10

SANGAMO

AUDIO TRANSFORMERS

COMPLETELY shielded. Tested at equivalent of 1,000 volts d. c. between windings and between each winding and case. For use with power tube in last stage. Uniform amplification over entire musical range

Sangamo Mica Condensers are accurate and STAY accurate Used in the Laboratory Electric, described in this issue

Sangamo Electric Company
Springfield, Ill. 7236-5

Designers of Receivers Must Be Mind Readers

By Dawson Frawleigh

A great deal has been written about the quality of the reproduced radio signals. The low notes have been stressed. They must be brought out with full and rich volume. The high notes also have been stressed. They must not be suppressed.

Much violent language has been hurled at the notes in the middle register. They must not be permitted to dominate.

And all this has been based on the definition of fidelity, that the reproduced signal should be an exact copy of the transmitted signal, with all the notes of high and low degree brought out in exact proportion to the same notes in the original, and with the same time relationship between the funda-

mental and its harmonics. The reproduced signal should be such that it would transport the listener, in spirit, to the transmitting studio in the presence of the performers.

Slips and Slaps

But there are many slips between the listener and the performer and sometimes the "perfect" set does not give a copy of the original. The other day I was present in a broadcasting studio when a dance orchestra was performing. The most striking feature of the performance was the lack of natural balance. One instrument that is ordinarily very loud was barely audible, another that is ordinarily very retiring was blaring forth lustily. A tenor sang a song, but so softly did he sing that it was almost inaudible to me. Surely the radio audience heard the words better than those present in the studio, or there would have been no reason for the song.

The bass drum had been removed as far as possible from the microphone. The studio was square and the microphone and the drum were diagonally opposite each other. Even with all that distance separating the drum and the microphone, the drummer had to restrain himself. The

drum did not sound too loud to the writer though he sat next to it.

"Soft Pedal"

Yet the announcer signalled the drummer to "soft pedal" the drum. In the monitoring room the boom of the drum was out of proportion to the rest of the orchestral sounds. At least so thought the announcer when he listened to the reproduction as it came through a good cone type speaker.

The boom of the drum had to be "downed"! The boom of the bass drum which 99 receivers out of every 100 did not reproduce at all had to be squelched. The boom which radio designers have striven hard for several years to put into the reproduced music was suppressed at the studio because it seemed too loud to the monitor.

In view of this manipulation of the original signal to suit the announcer's idea of what sounds natural, as reproduced by one particular speaker, the fan cannot hope to get natural reproduction even with a perfect set. He can get no better reception than the announcer or studio director is willing to hand him.

Psychological Design

When a designer strives to make a receiver which produces perfect quality, he bases his work on laboratory facts. The psychology of the announcer does not enter into his design. Hence he produces a set which would deliver excellent quality if it could only get it. When the purchaser of that set tunes in a given program with it, he gets only the whims of the announcer and the peculiarities of the monitoring system.

Both the radio designer and the listening fan are at the mercy of the announcer.

But even so, the fan is usually the gainer. The monitoring set is always a good set which enables the monitor to judge what is out and what is going into the various receiving sets. The monitoring receiver has certain characteristics which are common to all receivers.

Hence if the monitor corrects the transmitted signal so that it sounds best on the monitoring set, he also corrects for defects in all other receivers.

Difficult Reconcile

But it is difficult to reconcile the suppression of the boom of the bass drum with the characteristics of receivers. As nearly all receivers suppress the deeper tones, it would have been more logical so to place the drum that it would have come out disproportionately strong, and urge the drummer to step hard on it. But if the drum had to be muted to bring its boom down to normal in the monitoring set, and if the boom could not be heard in other sets as a result, an inducement would be given set designers to design sets at least as good as monitor set.

One reason the boom of the bass drum is almost never plainly heard in receiver is that the announcer thinks reception by the audience is an authentic reproduction of what he hears on a speaker in the studio, which speaker is actuated by the microphone and amplifier, with no radio intervening. Many announcers do not "get" that point.

6 TUBE RADIO
ONE DIAL Latest advanced circuit. All steel chassis totally shielded. Balanced parts of best quality. Marvellous power and selectivity. Gets the long range stations as clear as a bell. One dial simple control. An unsurpassed value—just one of our many radio bargains.

Only \$32.50

FREE Log and Call Book and Big New Catalog—Just off the press. Full of Radio Bargains. Send for your free copy now!

American Auto & Radio Mfg. Co.
HARRY SCHWARTZBERG, Pres.
Dept. 192 American Radio Bldg., Kansas City, Mo.



BUSINESS CARDS, PERSONAL CARDS,
BLOTTERS, ETC.

Printed the NEW Way

**3 Hundred
Colors
Dollars**

Professional Set Builders, Business Men, Executives, all find that our de luxe 3-color printing, at the price of ordinary one-color printing, makes a lasting impression.

FREE Samples Sent on Request
CARD SPECIALTIES CO.

Suite 708 63 Park Row, New York, N. Y.

A Case of Necessity

Without Morecroft at their hand radio experimenters and set builders feel lost. Morecroft is the outstanding book on the technique of radio. It tells you how to do a thing and why it is done. "Principles of Radio Communication" is the title of the book, the second edition of which has just come off the press. Everything brought right up to date. An authoritative book for designers, engineers, service men, distributors, dealers, salesmen, teachers, students and set owners. John H. Morecroft has gained world-wide fame for this masterful volume. Professor Morecroft, of the Electrical Engineering Department of Columbia University, and past president of the Institute of Radio Engineers, offers his latest and greatest product with strong binding and on good paper, 1,001 pages and 831 illustrations. Immediate shipment. Price, \$7.50.

Guaranty Radio Goods Co.
145 West 45th St.
New York City

Take Your Choice of 7 Other Publications For NEW RADIO WORLD Subscribers Ordering NOW

Radio World has made arrangements

—To offer a year's subscription for any one of the following publications with one year's subscription for RADIO WORLD—

RADIO NEWS or POPULAR RADIO or SCIENCE AND INVENTION or BOYS' LIFE or RADIO DEALER or RADIO (San Francisco) or RADIO AGE.

This is the way to get two publications

- for the price of one;
- Send \$4.00 today for RADIO WORLD
- for one year (regular price)
- for 52 numbers)
- and select any one of the other
- nine publications for twelve months.
- Add \$1.00 a year extra for
- Canadian or Foreign Postage
- Present RADIO WORLD subscribers
- can take advantage of this offer by
- extending subscriptions one year
- if they send renewals NOW!

Radio World's Special Two-for-Price-of-One Subscription Blank

RADIO WORLD, 145 West 45th Street, New York City.

Enclosed find \$4.00 for which send me RADIO WORLD for twelve months (52 numbers), beginning and also without additional cost, Popular Radio, or Radio News, or Science and Invention, or Radio Dealer, or Radio (San Francisco), or Radio Age, or Boys' Life (or \$10.00 for a two-year subscription to one address). No other premium with this offer.

Indicate if renewal. Name
Offer Good Until Dec. 10, 1927. Street Address
City and State

Why is the Karas Equamatic the Most
Efficient Receiver Ever Designed?

Write us for Full Information

KARAS ELECTRIC CO.

4039-KB, No. Rockwell St., Chicago, Ill.

COMPLETE AND LATEST LIST OF
STATIONS appeared in Radio World,
dated Oct. 29. Sent on receipt of 15c, or
start your subscription with that number.
RADIO WORLD, 145 West 45th St., New
York City.

THE R IS MADE STRAIGHT LINE!

IN electricity in all its forms, including radio, "R" stands for resistance. Any resistor that is variable should vary directly in proportion to the adjustment. In variable grid leaks this asset of "straight line R" has been missing. But now it is supplied—efficiently, perfectly—in

The New De Luxe Model **BRETWOOD** Variable Grid Leak

The improvements made in the new model—imported from England and released for the first time—are:

(1) Constant readings, (2) even distribution of the resistance element, (3) support provided for optional base-board mountings.

By using the Bretwood Variable Grid Leak you improve tone quality, by avoiding detector tube overloading, achieved by correct leak setting. Thereafter the leak may be varied for extremely distant stations, or may be left at the original setting.

North American Bretwood Co., 145 West 45th St., N. Y. City.

Gentlemen: Enclosed find \$1.75. Send me at once one De Luxe Model Bretwood Variable Grid Leak on 5-day money-back guarantee. (Or \$2.25 for leak with grid condenser attached.)

NAME

ADDRESS

CITY..... STATE.....

Inquiries Solicited from the Trade

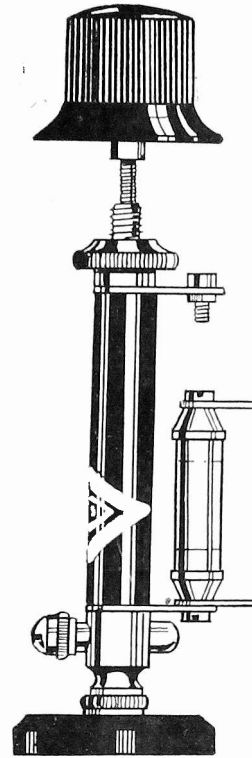

The DE LUXE MODEL with Condenser Attached

The De Luxe Model Bretwood Variable Grid Leak specified by Herman Bernard for Radio World's Four-Tube Universal Receiver.

1. The knob is hard rubber.
2. The shaft is durable brass, and can not jam or stick.
3. The brass lock nut, with milled edge, enables single hole panel mount.
4. The barrel is of hard rubber and houses the resistance element and plunger.
5. The lugs are adjustable to any position within the sweep of a circle.
6. The grid condenser is securely fastened to the lower lug and requires no extra room, as it is within the projection of the lugs.
7. The syphon container distributes a constant supply of resistance element, making the reading straight line resistance, and preventing uneven distribution of the resistance element.
8. The hard rubber pedestal affords the option of perpendicular mounting, as on a base-board.

Each Bretwood Variable Grid Leak and Bretwood Bullet Condenser is guaranteed against mechanical or electrical imperfections and is sold on an absolute five-day money-back guarantee.

If you're not delighted with results, then we're not even satisfied!

... Modern

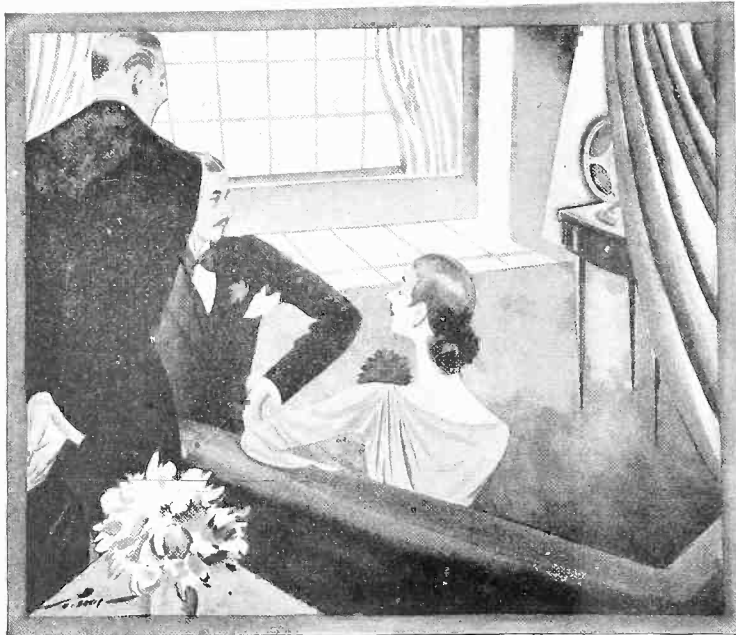

Here is the Eveready Layerbilt "B" battery No. 486, Eveready's longest-lasting provider of Battery Power.

Radio is better with *Battery* Power

NOT because they are new in themselves, but because they make possible modern perfection of radio reception, batteries are the modern source of radio power.

Today's radio sets were produced not merely to make something new, but to give you new enjoyment. That they will do. New pleasures await you; more especially if you use Battery Power. Never were receivers so sensitive, loud-speakers so faithful; never has the need been so imperative for pure DC, Direct Current, that batteries provide. You must operate your set with

current that is smooth, uniform, steady. Only such current is noiseless, free from disturbing sounds and false tonal effects. And only from batteries can such current be had.

So batteries are needful if you would bring to your home the best that radio has to offer. Choose the Eveready Layerbilt "B" Battery No. 486, modern in construction, developed exclusively by Eveready to bring new life and vigor to an old principle—actually the best and longest-lasting Eveready Battery ever built. It gives you Battery Power

for such a long time that you will find the cost and effort of infrequent replacement small indeed beside the modern perfection of reception that Battery Power makes possible.

NATIONAL CARBON CO., INC.
New York  San Francisco
Unit of Union Carbide and Carbon Corporation

Tuesday night is Eveready Hour Night
—9 P. M., Eastern Standard Time

- | | |
|------------------|--------------------|
| WEAF—New York | WOC—Davenport |
| WJAR—Providence | WCCO—(Minneapolis) |
| WEEL—Boston | WSD—(St. Paul) |
| WFI—Philadelphia | KSD—St. Louis |
| WGR—Buffalo | WDAF—Kansas City |
| WCAE—Pittsburgh | WRC—Washington |
| WSAI—Cincinnati | WGY—Schenectady |
| WTAM—Cleveland | WHAS—Louisville |
| WWJ—Detroit | WSB—Atlanta |
| WGN—Chicago | WSM—Nashville |
| | WMC—Memphis |

- Pacific Coast Stations—
9 P. M., Pacific Standard Time
KPO—KGO—San Francisco KFI—Los Angeles
KFOA—KOMO—Seattle KGW—Portland

EVEREADY
Radio Batteries
—they last longer

The air is full of things you shouldn't miss