

NOV.

7

1925

HOOKUP NUMBER!

15
CENTS

RADIO WORLD

Trade Reg. U.S. Pat. Off.

Vol. 8. No. 7 ILLUSTRATED Every Week

155-189



A Real Long Range Crosley Receiving Set, \$9.75

Do not assume from its very interesting price that this very unusual Crosley set is a toy. Its impressive performance alone entitles it to serious consideration.

Heretofore, the \$10 radio was designed only for local reception. Now the Crosley Pup extends the entertainment radius to 1500 miles under ordinary conditions. Place it beside some costly multiple-tube set and operate the dials. Both tune through local stations sharply. Both get the same programs with equal ease and clarity. Both let you tap the infinite enjoyment coming through the air. There is only one difference—the Pup operates with head phones instead of a loud speaker.

The Pup is the newest Crosley set with a price that reflects the volume-production economies of the world's largest builder of radios. It is substantially constructed and permanent in every regard. Its design is an improvement of the famous Crosley one tube set with which Leonard Weeks, of Minot, N. D., heard the MacMillan Polar Expedition while the rest of America listened in vain.

Almost overnight the Pup has become the most popular Crosley set ever offered. It is being bought for youngsters whose curious fingers cannot resist the lure of dials and switches; for the cook, the maid, the old folks back home, and for shut-ins. Traveling men are selecting it because of its easy portability, and radio enthusiasts to have an inexpensive check on their larger sets. Hear it once—and you will own one, too!

In addition to the Pup, there is a Crosley for every price and preference. Operating 1, 2 and 3 tubes, these are encased in handsome Crosley-built cabinets and range in price up to the Super-Trirdyn Special which retails for \$60. Each will deliver the superlative performance that has made the word "Crosley" a hall mark of radio perfection in millions of homes throughout the world.

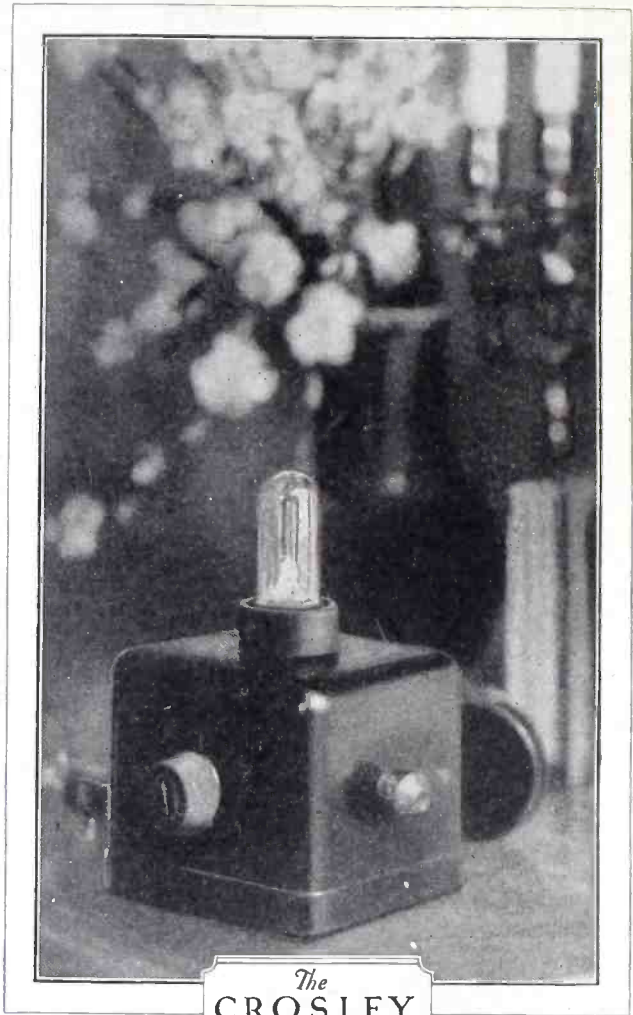

The
CROSLLEY
Pup - \$9.75

Crosley manufactures receiving sets which are licensed under Armstrong, U. S. patent No. 1,113,149 and priced from \$9.75 to \$60.00 without accessories. None of the prices quoted include batteries, tubes, headphones, etc. Add 10% to all prices west of the Rocky Mountains.

THE CROSLLEY RADIO CORPORATION CINCINNATI, OHIO

Owning and operating W L W, first remote control super-power broadcasting station

Crosley De Luxe Combination

- Musicone De Luxe - \$27.50
- Super-Trirdyn Special - 60.00
- Console Table - 25.00
- Complete - 112.50



Crosley 3 Tube
52 S. D.

Mahogany finished cabinet, sloping panel. Holds all batteries. \$32.50.



Crosley Super-Trirdyn
Regular

More compact than the Special Model—but exactly the same superb performance - \$50.00



Crosley Super-Trirdyn Special

Matchless performance and exquisite beauty combined. Solid mahogany cabinet with popular sloping panel \$60.00

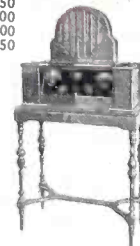

Crosley 2 Tube
51 S. D.

A true long range set, easy to tune and handsome in appearance. \$23.50.

CROSLLEY · RADIO

B E T T E R · C O S T S L E S S

Coast to Coast

The North American Bretwood Co.,
New York City

Gentlemen:

I have purchased the Bretwood
Variable Grid Leak and it brings in
all the West Coast Stations on my
Pressley. No other leak has made
this accomplishment possible.

(Signed) J. C. Salzgeber
Harrisburg, Penna.



For Bretwood Variable
Grid Leak

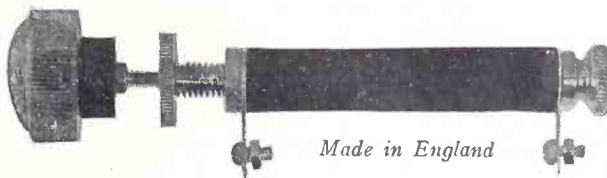

Made in England
Guaranteed Precision Range, 1/4 to 10 megohms.

"Fit for a King"

IF distance is your goal the Bretwood
Variable Grid Leak is the Magic
Means of Achieving it.

North American Bretwood Co.

Telephone: Bryant 0558

145 West 45th Street New York City

Members of the Trade, Write for Particulars.

CANADIAN DISTRIBUTOR, RADIO, LTD.
PHILLIPS SQUARE, MONTREAL

North American Bretwood Co., 145 W. 45th
St., New York City:—Enclosed find \$1.50.
Send one Bretwood Variable Grid Leak on
10-day money-back guarantee.

Name

Street

City State

Bruno

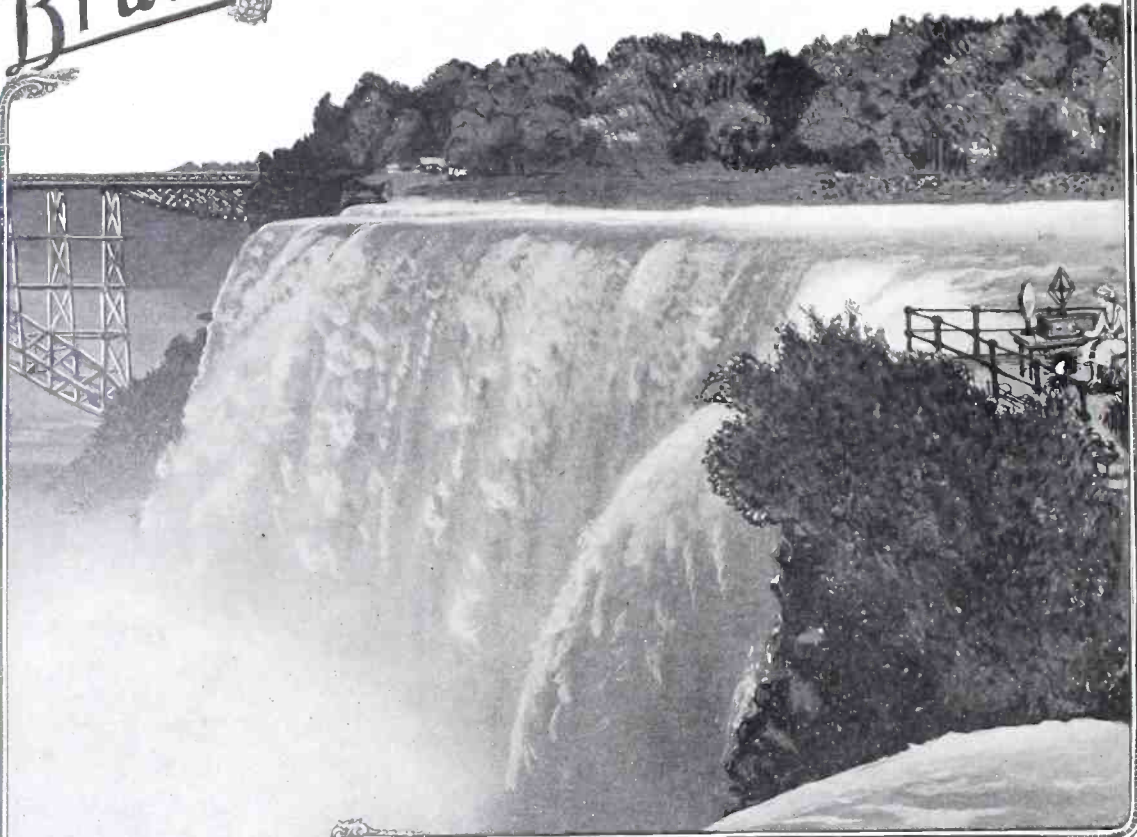

Beauty

Power

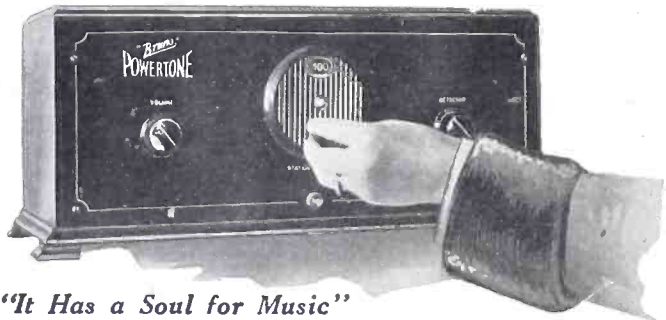

"It Has a Soul for Music"

THE public demands a set that—(1) has only one tuning control; (2) tunes on straight-line frequency; (3) reproduces with superb tone quality; (4) is inexpensively priced.

The 5-tube Bruno Powertone meets every one of these demands.

Build the Powertone and Know What Real Radio Is!
Quality—Simplicity—Volume—Distance

Complete boxed kit, with drilled, engraved panel and wiring diagram **\$29.50**
 Factory-made set, in cabinet... \$39.50

BRUNO RADIO CORPORATION
 223 FULTON STREET Dept W. NEW YORK CITY

RADIO WORLD

[Entered as second-class matter, March, 1922, at the post office at New York, N. Y., under the Act of March 3, 1879]

A Weekly Paper Published by Hennessy Radio Publications Corporation from Publication Office, 145 West 45th Street, New York, N. Y. Telephones: BRYant 0558, 0559

Vol. VIII, No. 7. Whole No. 188. 189

November 7, 1925

15c per copy, \$6.00 a year

A 3-Tube Dry-Cell Circuit

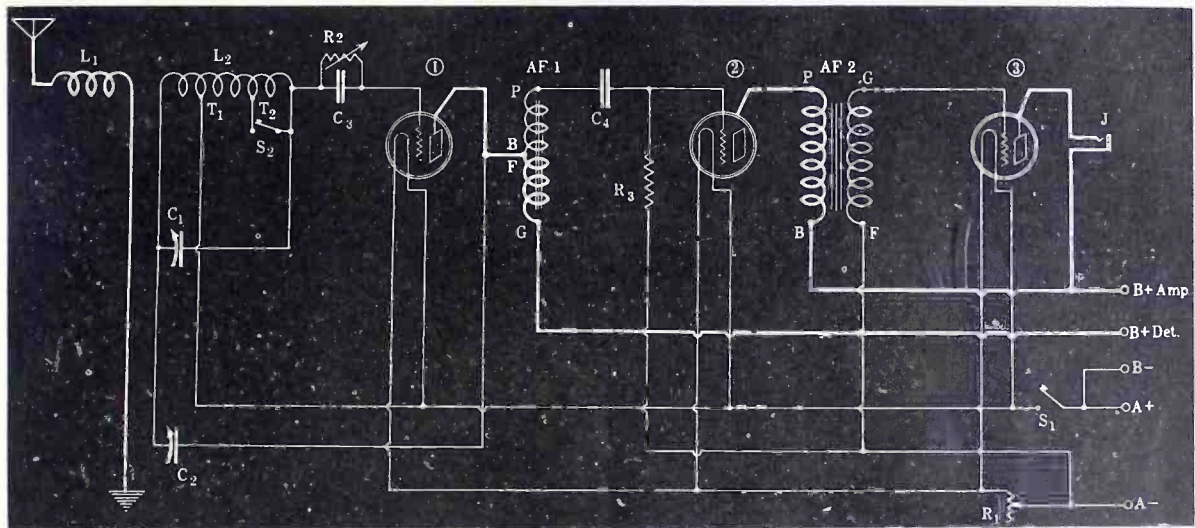

FIG. 1, the schematic diagram of the wiring. The coil L1L2 is shown horizontally so that the correct polarities are obvious. Aerial goes to beginning of L1, ground to end, rotors of C1 and C2 to beginning of L2, A+ to 14th turn tap, T1, and end of L2 to grid condenser and C1 stator. T2 is the short-wave tap, S2 being used to cut out the excess turns on L2 when short-wave reception is desired.

By Capt. P. V. O'Rourke

THE most economical expenditure on a speaker set is for one operating on dry-cell tubes, because you thus avoid the cost of a storage battery and charger, or getting the battery recharged outside. In the long run a storage battery is cheaper, even when you have to buy a charger, but the extra \$30 or so may be something a fan wants to spend at a later date and meanwhile he would be content to replenish dry cells.

The 99 type of tube affords best all-around results in the dry-cell class, as it is a good detector and a much better amplifier than the other dry-cell bulbs.

The volume is almost as good as if the 201A type tube were used, these latter requiring a 6-volt storage battery for economical operation.

Two standard transformer stages as the audio coupling will do very well, but if some volume may be sacrificed quality may be increased by using the auto-transformer method of coupling in one of the audio stages. This is shown in Fig. 1. The auto-transformer is simply a regulation audio-transformer, even a poor one you may have rejected for the other coupling method. The primary and secondary are connected so that they are in series aiding. This means that the magnetic flux is flowing in the same direction. It

is not easy to determine this, only because the experimenter may not have the necessary apparatus at hand. It is perhaps enough to know that most audio-transformers will be connected in series aiding when the P2 and S2 terminals are joined. These are otherwise identified as B and F or B and A. In any case a sort of roughness in signals heard, and also otherwise unaccountably low volume, will be experienced when the coils are connected mistakenly in the series-opposing fashion. The wrong method of connection results in low amplification.

The auto-transformer is placed in the first audio stage, AF1, and the regulation audio-transformer hookup couples the first AF to the second AF step.

Uses Hartley Oscillator

The tuner is regenerative, as that is necessary in any 1-tube set if it is to be serviceable. The Hartley oscillator method of obtaining regeneration is employed. This develops a very sensitive receiver and enables you to hear some weak stations that the regulation variable tickler coil type of regenerative receiver may not bring in. In the particular location where this set was tested WHN and WGBS are hard to get under any circumstances, but they were brought in by this receiver with low speaker volume and with fine earphone volume. Other regenerative circuits failed to bring them in at all.

The set is intended for reception of broadcast signals on the regular wavelengths, but by using an anti-capacity switch S2 and short-circuiting part of the secondary one may tune in some short-wave stations. These include WGY and KDKA, operating on their X-call short wavelengths. The short-wave adaptation

is purely a makeshift, one possible difficulty being in obtaining regeneration. In general the circuit operates on the principle of the higher the capacity setting of C2 the less the regeneration, and the difficulty might lie exclusively in the failure of C2 to reach sufficiently high capacity for short-wave regeneration. This might be cured by placing a small fixed condenser across the C1, one side of the fixed condenser to the stator plates, the other to the rotor plates, when short-wave work is contemplated. The value of this fixed condenser can be best determined only by experiment, but .0001 and .00025 are suggested.

This reversed order of regeneration is due to the reversely feedback plate current encountering a high impedance path in the plate part of L2.

The set was hooked up as shown in Fig. 1 and the tap T2 located in the middle of the secondary. The switch S2 was cut in. The result was that WMCA's second harmonic, 170 meters, came in at a setting of 90 on C1, hence the highest wave receivable would be about 200 meters, and the lowest wave would be about 75 meters. However, while regeneration was splendid on WMCA's second harmonic (at 90 on C1), it failed at a setting of about 50 on the wavelength condenser. Regeneration was present when C2 was set at 94 and C1 at 90 for 171 meters.

The dial settings as given are to be considered as applying to straight-line frequency condensers.

The short-wave part of the hookup is one which the experimenter will be glad to incorporate, since it means merely tapping the secondary and adding a switch to short-circuit the undesired turns.

The primary L1 consists of 12 turns of No. 24 silk over cotton wire on a 3 1/2"

Directions for Coil Winding

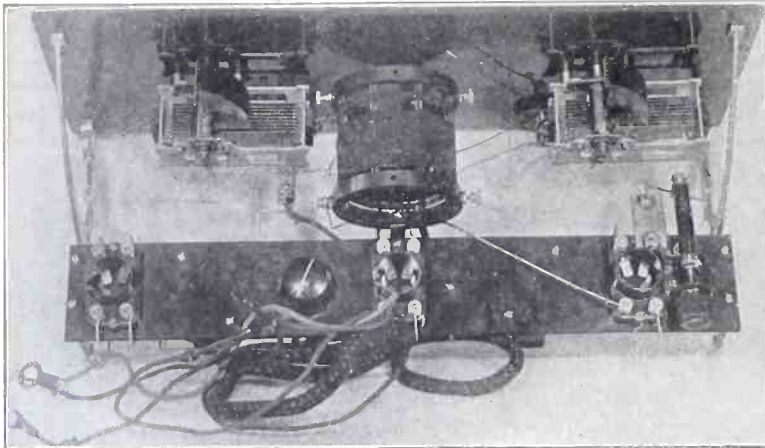

REAR VIEW. Note where the rheostat is mounted.

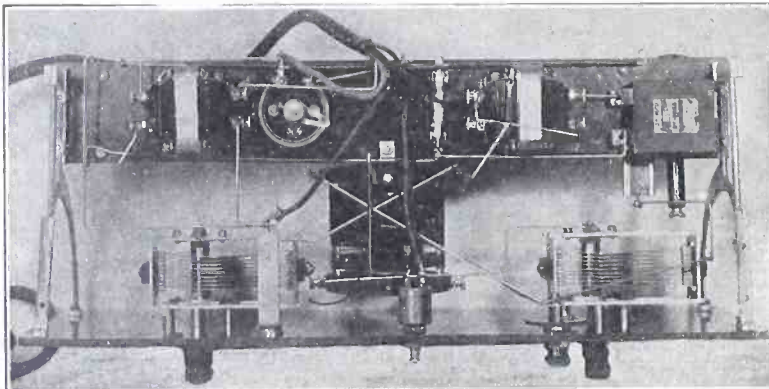

BOTTOM VIEW of the receiver. Note the difference between the A battery switch, at left, and the anti-capacity short-wave switch at right. The method of mounting the coil is shown. The rheostat is mounted on the socket shelf and need be adjusted only once, then left that way.

outside diameter skeleton form, 4" or 4½" high. A space of ⅜" is left, then the secondary is wound, consisting of 67 turns of the same kind of wire, wound in the same direction. However, the secondary is tapped as follows: first at the 14th turn, T1 in Fig. 1, and again at the 37th turn, T2 in Fig. 1. These taps are not identified that way in the picture diagram, but are shown in consecutive position. The winding of the secondary, therefore, in sequence, is done by putting on 14 turns, slightly looping the wire and twisting it around for security, then continuing by winding 23 turns more, making another provision for a tap, and then putting on a final 30 turns. This gives the necessary total of 67, made up of 14+ 23+ 30.

The insulation is scraped off the wire at the two tap points so that a piece of flexible wire about 5" long can be soldered to each, making two flexible leads. These will be soldered to their proper connections at the open end later, and any excess cut off.

If the fan is keen for short waves it would be advisable to include an extra tap (not shown in diagrams) at the 7th turn on the secondary, i.e., half way between the beginning and the otherwise first tap, T1, to cut down the impedance and aid short-wave regeneration.

The form used consisted of quartzite rods, supporting two insulated end rings in which the rods are embedded for security. If a different form is used, then use a 3" outside diameter tubing would be easiest to procure. If it is only cardboard, then immerse the cardboard in

molten beeswax and allow to harden before winding the coil. This rids the cardboard of its normal vice of susceptibility to moisture.

If No. 24 silk over cotton wire is not handy, use No. 22 single cotton and be sure to have the tubing 4½" high.

Two elements of novelty in the hookup may tend to confuse one in the wiring. These are the Hartley oscillator and the auto-transformer. Hence a few words on these:

Notice that the rotor plates of C1 and C2 go to a common lead, the beginning of the secondary L2. Remember that and, if you prefer, after the panel parts are mounted, join the two rotors with a busbar or bell wire lead, and solder the connection to the beginning of L2 at

LIST OF PARTS

- One fixed antenna coupler, L1L2.
- Two .00035 mfd. Streamline SLF condensers, C1, C2.
- One Bretwood Variable Grid Leak, R2.
- One .00025 mfd. fixed grid condenser, C3.
- One anti-capacity switch, S2.
- One A battery switch, S1.
- One 10 or 15-ohm rheostat, R1.
- One .25 mfd. Aerovox fixed condenser, C4.
- One .5 Veby meg. grid leak, R3.
- One socket shelf, 17x2".
- One pair of brackets.
- Three 99 sockets.
- Two Preferred venier dials.
- One single-circuit jack, J.
- One 7x18" panel.
- Two audio-frequency transformers, AF1, AF2.

Accessories: One cabinet, one speaker, two 45-volt B batteries; three 4½-volt C batteries for use as the A battery; lightning arrester; ground clamp; aerial wire; leadin wire; wire for internal set connections, such as busbar or No. 18 bell wire; lugs, screws, hardware.

the nearest point. This will depend on how you mount the coil, which, in this set is largely a matter of personal taste. Notice, also, that the stator plates of the feedback condenser C2 are joined to the plate of the detector tube and that this same lead goes to the joint of the primary and secondary of the audio-transformer, AF1, normally P and B. The beginning of the secondary L2 does NOT go to filament or A battery, but the grid return is made to A+ at the first tap, C1 in Fig. 1, i.e., the 14th turn tap. The reason is that the winding between the beginning of L2 and the tap at the 14th turn is in the plate circuit.

The end of L2 goes to the grid, and this is the outside wire terminal of the secondary. Locate this with a certainty. The polarities must not be mixed up, otherwise you may get no regeneration whatsoever. If you use a commercial coil that has binding posts on it, see where the wire comes from. You may find that a binding post at one end of the form really is used for connecting a wire terminal that is at the other end of the form, to give the coil greater security.

As for the auto-transformer, AF1, the plate of the detector tube, as explained, goes to the common joint of primary and secondary. The P post, i.e., the free end of the former primary, goes to one side of the fixed condenser, C4, which should be .25 mfd. The free end of the erstwhile secondary, normally G, goes to B+ detector voltage. This should be about 45, but do not hesitate to try higher and lower voltages, particularly lower. The pernicious regenerative "plop" will be smoothed out by reducing the B+ detector voltage.

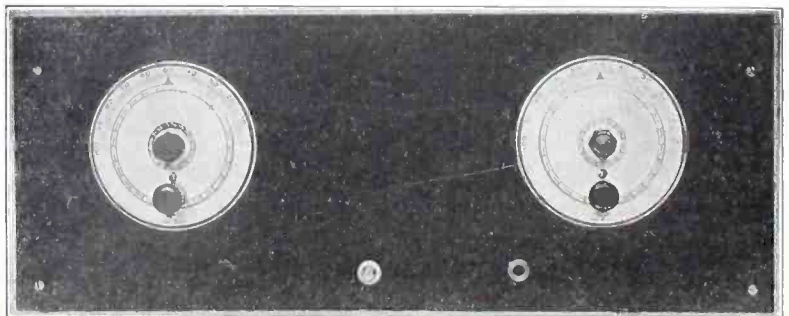

THE PANEL view of the receiver. Although SLF condensers are used, vernier dials are included, too, as they were found advantageous.

Picture Diagram of the 3-Tube Dry-Cell Receiver

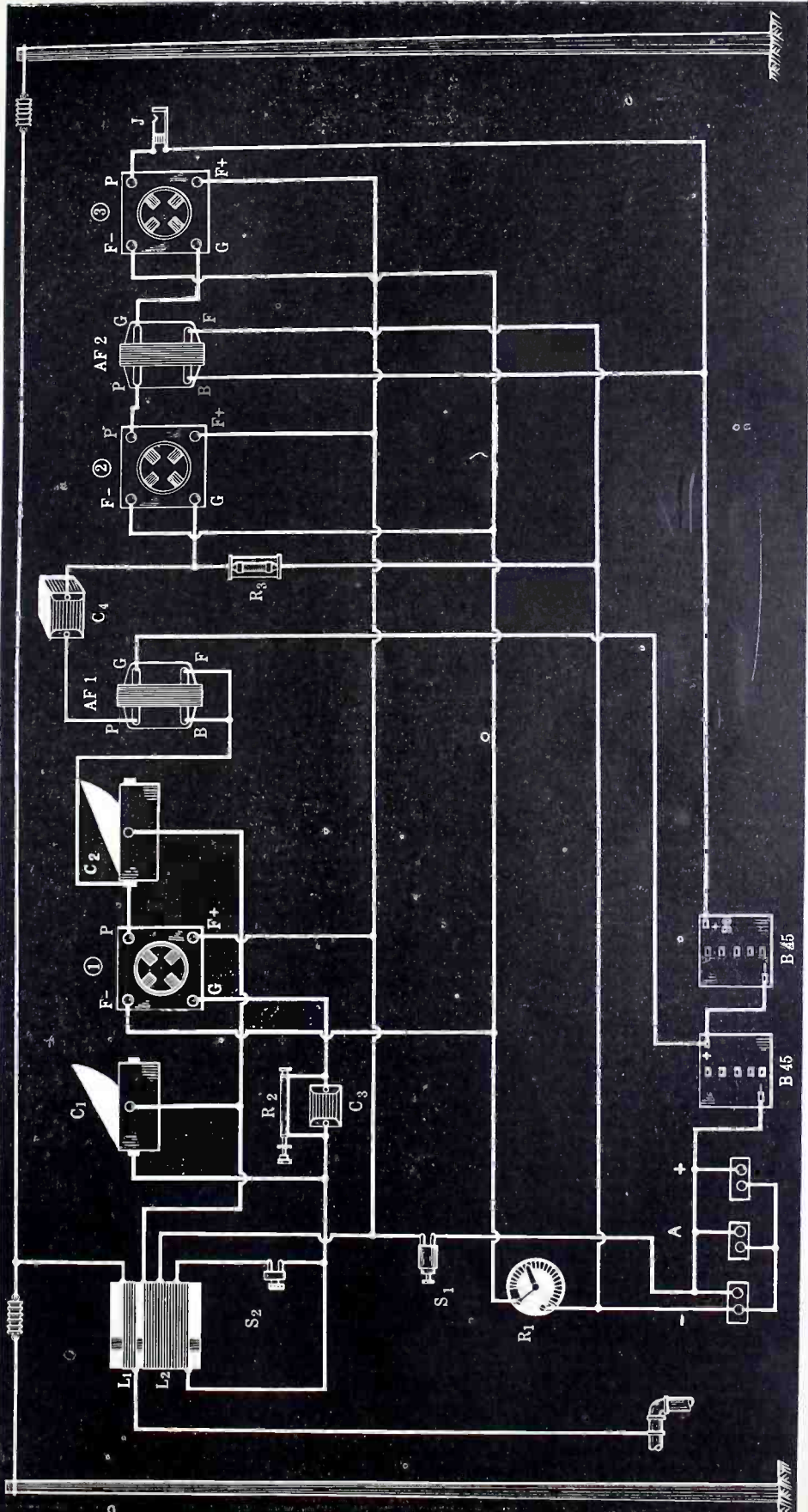

THE WIRING of the 3-Tube Set, Showing the Connections in Picture Form

Measuring Inter-Frequency

By J. E. Anderson

Consulting Engineer

EXPERIMENTERS and fans who build Super-Heterodyne receivers often want to know the frequency of their intermediate filter circuit, or of particular coils in that circuit, for the purpose of checking the adjustment of the various coils. This may be done very simply by the application of a means always at hand. It involves the use of a formula connecting the intermediate frequency, the frequency of the radio signal received, and the dial settings



J. E. ANDERSON

of the oscillator condenser in the receiver. The radio-frequency of the signal must be known and in addition three different dial settings must be observed, the two settings at which the given signal tunes in on the oscillator and the setting corresponding to zero beat between the signal frequency and the local oscillator.

Capacity Value Important

The formula is given by equation No. 1 in Fig. 1. In this f is the intermediate frequency desired, F is the radio frequency of the signal received, C is the total capacity in the oscillating circuit when this is tuned to zero beat with the signal, C_2 is the total capacity in the oscillating circuit when this is tuned to F minus f , and C_1 is the total capacity in the circuit when it is tuned to F plus f . C_1 represents the capacity for the lower setting on the dial at which the signal comes in and C_2 the capacity for the higher setting on the dial at which the same signal comes in. In place of the total capacity the corresponding dial settings may be substituted provided a straight line capacity condenser is used in the oscillating circuit and provided further that the zero setting capacity is converted into equivalent dial divisions and added to the reading. If dial settings are used the formula takes the form shown in equation No. 2 in Fig. 1.

Equation No. 1 is an exact formula, and the accuracy of a determination of the intermediate frequency mainly depends on the accuracy with which the capacity difference C_2 minus C_1 can be determined. With a precision condenser like the General Radio calibrated laboratory condenser, which can be read to about .06 micromicrofarad, the capacity difference may be determined very accurately; and a frequency determination with it may be obtained to an accuracy of better than one part in a thousand for ordinary intermediate frequencies used in Super-Heterodynes and for signal frequencies ranging from 500 to 1000 kc.

Accurate Determination

With an ordinary straight-line capacity condenser used in a receiver the accuracy may be as good as one part in a hundred, or even better. The three capacities entering into equation No. 1 are total capacities, that is, they include the zero setting capacity of the oscillating circuit as well as the capacities indicated on the dial. The zero capacity is, of course, the same for all three readings. For precision measurements the zero setting capacity should be determined by a separate measurement, but for approximate work it may be obtained by a simpler method which will be given below.

As an illustration of how the formula

$$f = \frac{FC(C_2 - C_1)}{4C_1C_2} \quad (1)$$

$$f = \frac{F(D_2 + D_0)(D_2 - D_0)}{4(D_2 + D_0)(D_2 + D_0)} \quad (2)$$

$$C = \sqrt{C_1C_2} = C_m \quad (3)$$

$$f_0 = \frac{F(C_2 - C_1)}{4C_m} \quad (4)$$

$$f_a = \frac{F(D_2 - D_0)}{4\sqrt{(D_2 + D_0)(D_2 + D_0)}} \quad (5)$$

$$K = 1 - \left(\frac{f}{F}\right)^2 = \frac{C}{\sqrt{C_1C_2}} \quad (6)$$

$$f = \left[1 - \left(\frac{f}{F}\right)^2\right] f_0 \quad (7)$$

FIG. 1, the table of formulae.

may be used for precision determination of the intermediate frequency, assume that the G. R. condenser be used and that the circuit be tuned to a station operating on 610 kilocycles. The total number of divisions on the dial is 2,500 and the total capacity of the condenser is 1,500 mmfd., so that each division represents .6 mmfd. The signal is found to come in at 777.0 and 565.5 and the zero beat position is found to be at 658.4. These readings represent capacities of 466.2, 339.30, and 395.04 mmfd., respectively. A separate experiment has shown that the zero setting capacity is 30 mmfd., so that the total capacities are $C_2=496.2$, $C=425.04$, and $C_1=369.3$. Putting these values in formula No. 1 together with $F=610$, gives $f=45$ kilocycles. Dial settings could have been used directly in the formula provided the zero setting capacity had been converted into dial divisions before adding to the readings. For this condenser 30 mmfd. is equal to 50 divisions.

Approximate Results

If only approximate results are required any ordinary straight line capacity condenser provided with a dial of equidistant graduations may be used, and the unit of capacity may be taken as a division on the dial. If the Super-Heterodyne is equipped with such a condenser the problem is very simple. Observe accurately and record the two points on the oscillator dial at which a given station comes in, and also the point at which the beat between the oscillator and the signal frequency is zero. To each of these add the number of dial divisions to which the zero setting capacity is equivalent. Insert in formula No. 2 and evaluate to get the intermediate frequency.

The zero setting equivalent reading may first be estimated. It usually lies between 5 and 6 divisions on a 100-degree scale for a 500 mmfd. condenser. Suppose six be used first. Determine f for several stations between about 550 and 950 kc. If six is correct all the calculated values for f will be about the same. If it is too large the calculated value of f will change in a regular manner as F is increased. If 6 is too small the calculated f will change in the opposite direction. It only requires a few applications with trial values of $D-O$ to find the right value. In a recent test the writer used 6 and found this to be too large. Then 5, and this seemed to be about right, and further trials in the neighborhood of 5 showed that this was the right value to use. The average value of f as obtained from six different calculations was 40.7 kilocycles, and no value differed from the mean by

more than one half of one per cent. Calculations from observations on the lower end of the dial were unreliable owing to the difficulty of determining the frequency difference with any degree of certainty.

The Elusive Zero Beat

Sometimes it is difficult to determine the zero beat position because the squeal on either side will not pass through the filter. If the head set be inserted in series with the B battery, however, the beats may be heard and the location of zero beat may be determined. It may also be found by the click method. If the loop or other tuned circuit be accurately tuned to the given station, and then the oscillator dial be swung back and forth, there will be a click at the point desired.

If the zero beat point cannot be found by either method it may be assumed to be at the capacity value obtained by taking the square root of C_2 times C_1 as shown in equation No. 3. This equation means that C is only approximately equal to the square root of the side capacities, but that the latter is exactly equal to $C-m$. With this approximation formula No. 1 becomes formula No. 4 and formula No. 2 becomes formula No. 5. The latter formula is very convenient of application. The intermediate frequency obtained with it is only approximately correct. It is slightly too large, and to obtain the right value it must be multiplied by the factor K defined by formula No. 6, as indicated by equation No. 7. The value of f in the right hand member of equation No. 7 may be one obtained by the use of the approximate formula No. 5. If f is less than one-tenth as great as F , the result obtained with equation No. 5 differs from the true value by less than one percent; and since this is more accurate than the accuracy of the capacity difference as obtained by reading an ordinary dial, it is usually not necessary to correct for the error.

A Practical Case

As an example of the use of formula No. 5 take the following problem. WEAJ operating on 610 kilocycles was tuned in on a Super-Heterodyne and the two dial readings were 89.2 and 67.9. The zero capacity equivalent was found to be 5 divisions. Hence the total capacities were 94.2 and 72.9. The difference is 21.3 divisions. The square root of the product of 94.2 and 72.9 is 82.8. Hence $f=610 \times 21.3 / 4 \times 82.8 = 39.2$ kilocycles. K as defined by equation No. 6 is in this case equal to .995, so that a closer value is 39.0 kilocycles.

If the condenser used in the oscillator of the Super-Heterodyne is a straight-line wavelength instrument the application of formula No. 1 is not easy. The capacity is no longer proportional to the dial reading. Formula No. 2 is no longer applicable. Neither is formula No. 5.

If the condenser in the oscillator is a straight-line frequency, not in name only, but actually and accurately, over the major portion of the dial, then no formula is needed for the determination of the intermediate frequency. All that is necessary is to observe the two positions at which a station of known frequency comes in, record the number of divisions between the two points and divide by two. The number thus obtained is the intermediate frequency in terms of dial divisions, and must be converted to cycles per second. This is easily done if only two stations of known frequency can be tuned in. Suppose that the dial is divided into one hundred divisions and that a 610 kilocycle station tunes in at 85 and 75 and that a 740 kilocycle tunes in at 72 and 62. The difference between the frequencies of the

(Continued on page 25)

The 5-Tube Phonograph Set

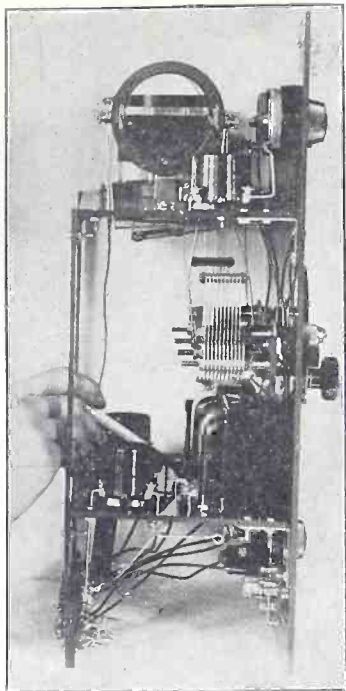

A CLEAR SIDE VIEW of the set. The pencil points to an Autoformer.

FOUR views of the 5-tube, 2-control receiver built to fit in a phonograph and to be used with an external speaker, are shown herewith. Note that there are two tiers, the one on top supporting the coils and two sockets, the lower shelf accommodating the two Autoformers and the audio-frequency transformer. The variable condensers are straight-line frequency.

The construction of this receiver was described by Lewis Winner in the October 24 and 31 issues of RADIO WORLD. The set as shown departs slightly from the descriptive text in some mechanical points.

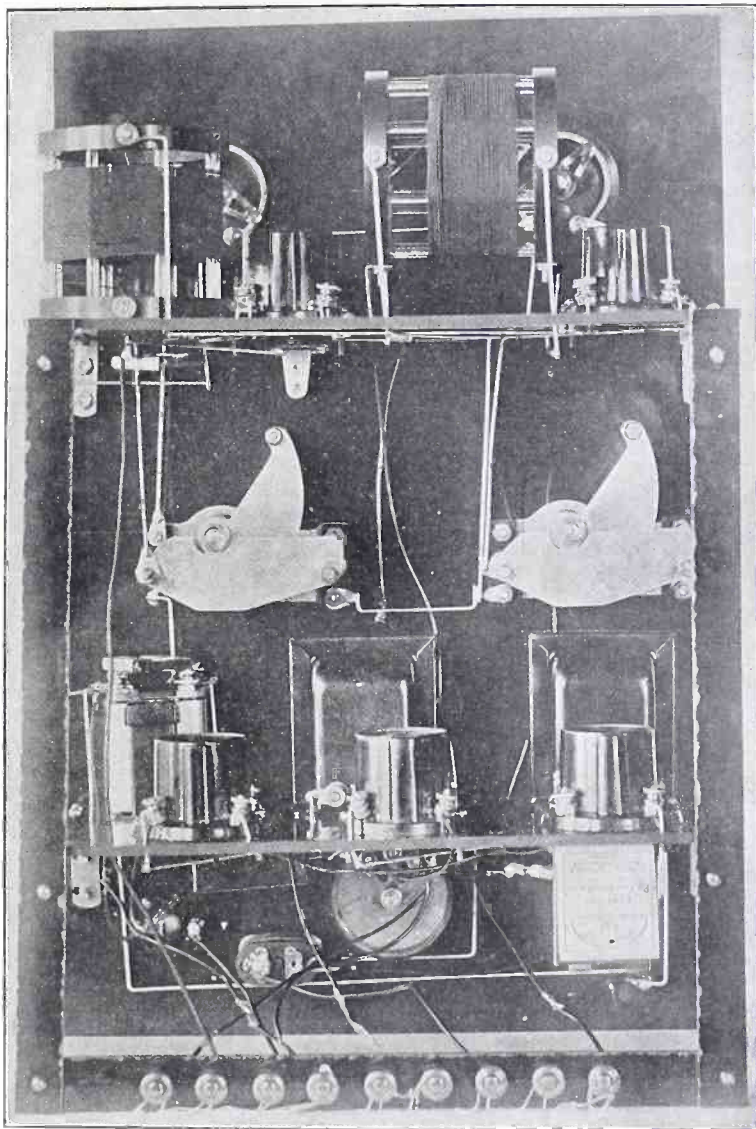

THE BACK VIEW of the receiver.

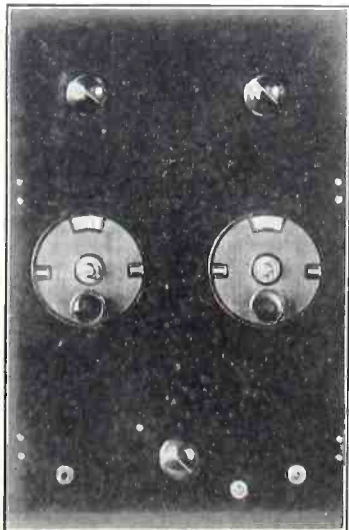

THE PANEL VIEW.

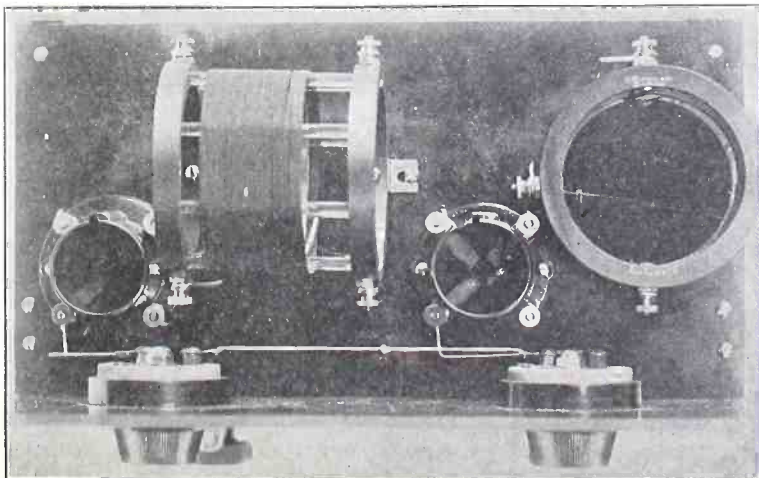

HOW the top panel is laid out.

One of the Best Crystal Sets

By Herbert E. Hayden

PROCURE a cardboard, bakelite or hard rubber form, $3\frac{1}{2}$ " in diameter and 4" in height. Now get $\frac{1}{2}$ lb. of No. 22 double cotton-covered wire. If you have No. 20 or 18 around the house it may be used.



HERBERT E. HAYDEN

Now exactly in the center of the form, 2" from the top and the bottom, and some place in the circumference make a dot. Drill a $3/16$ " hole there. Take a needle or some other sharp substance, which is $3\frac{1}{2}$ " in length. Put it through the center hole. Make a dot with this needle, where the end of the needle hits. Now place the form in a vise. This can be bought for about \$1. Get a punch, which has a very sharp point. Place it right on the point where the mark was made. Now take your hammer and hit the head of the punch until you have made a small hole on the opposite side. Take the punch out and drill a $3/16$ " hole. If these holes were drilled properly, one should be directly opposite the other.

At some point near the end of some circumference, punch two small holes. Do the same thing at the other end. Now take the wires and run the beginning of the wire through the hole and out the other. Leave enough wire out for connecting. Now wind 2 turns and take a tap. This means that a loop is made with the wire. It is not broken or discontinued. This loop is 3" in length. It is made long enough so that you will have plenty of room for soldering it to the tap. If it is not long enough there will be plenty of room for soldering on another piece of wire. Wind 2 more turns and take another tap. Wind 2 more turns and take another tap. Wind still 2 more turns, and take another tap. Wind 2 more turns and take the last tap. Now continue the winding over the hole. That is, the end of this winding is passed over the center hole, and the winding is continued, not broken and a new winding made. Do the same with this winding as was done with the one previous. That is, make taps, one at each second turn. This means that there will be 10 turns made here and 10 turns made at the other half, or all together 20 turns. The end of the latter winding is brought through one hole and out the other, in the same manner that was done for the beginning winding. When this winding is completed, it means that you have made the primary, or the antenna coil of the coupler. The secondary winding shall now be discussed.

Take a form which is 2" in diameter

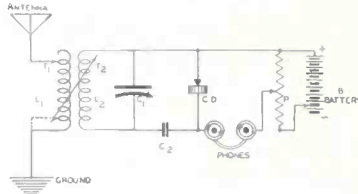

FIG. 1, showing the electrical diagram of the receiver.

and 2" high. Place in the vise. Exactly in the center drill a hole, which is $3/16$ " in diameter. Take the needle, run it through the hole, and make a mark at a point opposite the end of the form. Now take the punch and hammer out the hole. The hole is not circular enough yet, so take the drill and make a $3/16$ " hole. We will now have two holes one opposite the other, both having the same dimensions. Make a pair of dots at one end of the form, and punch two holes. Do the same at the other end. Put the beginning of the wire through one hole and out the other, leaving enough wire out for connecting purposes. Now wind 30 turns, very close together. You will probably find that the end of this winding will hit the center hole. If this is the case (due to some slack in the wire, which will not happen if wound with a machine, etc.) wind the wire over the wire. In other words, get 30 turns of wire on one-half of the form, even though you have to resort to a sort of bank winding. Continue the ending of this 30 turn coil onto the other half, (half is indicated by the center hole). Now wind 30 more turns. Connect the end of this winding through one hole and out the other. Leave enough wire for connecting purposes, and then cut the wire off. We now have 60 turns on the secondary and 20 turns on the primary.

To fit the rotor into the stator shaft, you will need a piece of stock brass $3/16$ " in diameter and 5" in length. This is passed first through the primary on one side. The rotor is then inserted. The hole of the rotor will have to come in line with the shaft. Then the shaft will pass through the rotor (both holes). The shaft is pushed through the center hole of the stator form. This means that the brass shaft is passed through the center holes of both these coils. Now in order to hold the shaft, and also the rotor some small mechanical makeshifts will have to be resorted to. At any end, push the stock brass all the way in, until only about $1/4$ " remains. Get a lock nut, the same size as the diameter of the brass, and fit it on. Now get your soldering iron, and solder the nut on securely. Make it hold tight. Now take the soldering iron, with a large piece of solder, and drop it on the shaft, just after it entered the stator, where the lock nut was soldered on. This

solder should be placed near the form proper, taking care that you do not burn the form. Now place the rotor in the center of the shaft, that is, an equal amount of inches from each side of the inner walls of the stator form. Drop solder on the outside of the rotor form, (before the shaft entered rotor form on the same side as the lock nut is). Drop solder on the other outside of the rotor form, or after the shaft leaves the rotor, which is near to the inner wall of the stator, or just opposite to the lock nut outside wall. This is all the soldering and mechanics that will have to be done. When all of this is concluded, you should have a perfect vario-coupler. The rotor should turn with ease inside the stator, unless the solder is hitting the walls, which will cause the rotor to stick. It will be a good idea if a small spring $1/8$ " long, and $1/8$ " in diameter, is dropped on the shaft in the place where the soldering was done, before the shaft was pushed through the rotor and the stator. (Drop spring on shaft after it enters the stator, etc.) If this is done, then the spring will hit the side of the walls, which will allow the rotor to move more smoothly. Now on the long end of the shaft, place a $1/2$ " piece of bushing. This should be slightly larger in size than the shaft proper, so that it will slide on smoothly. At the end of this bushing is a good idea to solder a nut on, so that when it rests up against the panel there will be a smooth surface as well as large surface to rest up against it.

How to Drill the Panel

There are four controls on the panel which is 7x12". The coupling coil dial is placed at the left and the variable condenser dial is placed at the right. In the center is the potentiometer. Right above this is the tap switch arm, T1. The coupling dial is $3\frac{1}{2}$ " in diameter. The shaft of the coupler is placed $1\frac{3}{4}$ " from the left hand edge of the panel. It is also $3\frac{1}{2}$ " from the top and the bottom. The shaft of the condenser, is placed $1\frac{3}{4}$ " from the right hand edge of the panel. It is $3\frac{1}{2}$ " from the top and the bottom. The coupling shaft and the condenser shaft are on one line. The potentiometer shaft is exactly in the center or 6" from both the right and the left hand edge. It is $1\frac{1}{2}$ " from the bottom. The tap switch arm is directly above the potentiometer, 6" from each edge, and 2" from the top. The only other large holes that have to be drilled are for the phone terminals. The first one is $1\frac{1}{2}$ " from the left hand edge and 1" from the bottom. The other one is $3\frac{1}{4}$ " from the one just mentioned. Three holes for the baseboard will have to be drilled also. These all should be $1/2$ " from the bottom of the panel. One should be placed in the center, 6" from the right and the left hand edge. One other should be 3" from the left hand edge, and the last one 3" from the right hand edge. These holes should be $1/8$ " in diameter.

Laying the Parts Out

After you have drilled the panel, you will naturally mount the parts, where those parts for which the holes were drilled. The coupler you will find will not hold. Therefore you will have to place angle irons on each end of the circumference. These should be $1\frac{3}{4}$ " long. The only parts that will have to be mounted on the panel will be the crystal detector, and the ant., gnd., + and - battery posts. This means that the board can be only 4" wide.

Wiring Up the Set

The first portion that will be attended to in the wiring up of the set will be the antenna coil, with all the taps, as this

Terrell Buys Pipe for Song In Paris to Make Wife Happy

WASHINGTON

Chief Radio Supervisor W. D. Terrell is a financial wizard as well as a shark on radio matters. Mr. Terrell has just returned from Paris where he represented this country at the International Radio Telegraph Conference. While in Paris he showed skill at bargaining.

Mr. Terrell wanted a pipe in a French shop window to replace the Missouri meerschaut which his wife finds so objection-

able. The price of the pipe was 20 francs. The shop keeper could not speak English nor could Mr. Terrell parley-vo, but after wig-wagging for awhile Mr. Terrell got the price down to 12 francs. Then followed more violent signaling about the change for an American dollar.

Figuring up his change after leaving the shop, Mr. Terrell discovered he had paid exactly one franc for the pipe. This he considered a good bargain for a foreigner.

Wiring the Crystal Receiver

is the most difficult. The first portion of the winding (where the beginning of the wire was put through the hole is the antenna winding while the portion over the center hole, or where the end winding was connected is the ground portion). The taps for the ground portion go the switch points. The tap arm, T1 goes to the antenna binding post. Now as to the ground taps. This portion is tapped, but they do not have to be used. They should only be used when you find the set tunes very broad. If the latter be the case, then the taps go to the 5 points and the arm goes to the ground post. If you do not wish to use them, then connect the end of the winding to the ground post, and forget the taps. In order to prevent losses, connect the end of the antenna winding to the antenna arm, and the end of the ground winding to the ground arm. If you are going to use the ground switch arm, then the antenna switch arm will have to be pushed over. That is instead of the antenna arm being 6" from the center, it should be placed 3" from the left hand edge, while the ground arm should be placed 3" from the right hand edge.

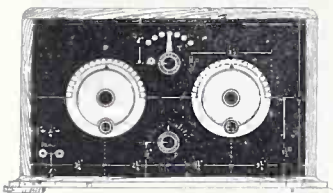

FIG. 2, showing the panel view.

Connecting the Crystal

The beginning of the rotor winding goes to the stator plates of the variable condenser, C1. It also goes to the catwhisker of the crystal detector. It also goes to the resistance wire of the potentiometer and to the plus post of the battery. Now to summarize things. The beginning of the rotor winding goes to the stator plates of condenser, the catwhisker of crystal, to resistance wire, and to + post of battery. The end of this same winding goes to the rotary plates of the variable condenser, C1. It also goes to one terminal of the fixed condenser, C2. Then it goes to the base of the crystal detector. The next connection is made to the phone post. The other phone post goes to the arm of the potentiometer which can easily be identified because it is in the center of the 3 posts. The only other post left, and which contains the resistance wire, goes to the - post of the battery. That is all there is to the wiring which is very simple.

Making the Set Work

The batteries should be made up out of a bank of 6 dry cells, each of which are of the 1½-volt type. This means that there will be 9 volts in the bank. The potentiometer has a resistance value of 400 ohms. The capacity of the fixed condenser, C2 is .001 mfd. The capacity of the variable condenser, C1 is .0005 mfd. The phones should have a resistance of 3000 ohms, and no lower. The higher resistance phones will give no better results, as far as volume is concerned.

Type of Antenna Used

The aerial for this set should be considerably long, about 125 feet, excluding the lead-in. This is just the opposite to the antenna used with the tube sets. This is done because a long antenna means volume. There will be broad tuning, but that is something you will have to put up with, if you wish to use the crystal set. This set is the most selective of all the crystal sets, and therefore the broad tuning will not be so bad as with some of the directly coupled type. The ground should be made to the water pipe, and no where else, even if the lead is 35 feet. Only in certain places, which places are very extinct, will the steam pipe prove to be better than the water pipe. Be sure to solder the wire on the clamp, and if possible solder the clamp on to the pipe proper. If you cannot do this, put some tin foil underneath the pipe, and make a very tight connection. Keep the antenna lead-in wire away from the wall,

and also do not let it run parallel to the ground pipe.

When wiring up the set, use only bell wire. Keep the wires well spaced and screw down tight, or solder all connections. Make sure that they are all solid, by testing them with a battery and phones.

Now as to the tuning of the set. Set the antenna switch to point 3. If you are using the ground points turn it to point 3 also. Turn the coupler dial to 60. Turn the condenser dial to 50. Now turn the potentiometer arm. You will note that when you come to a certain point, the volume will be great. There will only be one point that the arm can be brought to, that the set will be at it's loudest. The crystal may be of the fixed or of the variable type. If you are going to use the variable type, use a piece of Carborundum for a crystal and a steel needle for a catwhisker. Just jam the needle in the crystal, and let it alone.

If the signals are not loud, reverse the leads of the crystal. This set will work right off the bat, if all the connections are made properly. When using it in the city, the signals will be wonderfully loud. The selectivity will not be too great to rave about, but as selective as most one and 2-circuit tuners. This receiver will receive all wavelengths from 200 to 550 meters, without any trouble. The girl on the front cover is holding the completed set.

LIST OF PARTS

- One vario-coupler (L1L2).
- One variable condenser, .0005 mfd. (C1).
- One crystal detector, fixed or variable, (CD).
- One small fixed condenser .001 mfd. (C2).
- One potentiometer, 400 ohms (P).
- One 7x12" panel.
- Two 3½" dials.
- Ten switch points.
- Two switch arms.
- Six binding posts.

Accessories: One pair of phones, antenna, ground and lead-in wire, 6 dry-cell batteries (1½ volts apiece), and ground clamp, etc.

RANGE STUDY COMPLETED BY THE BUREAU OF STANDARDS WASHINGTON

The Bureau of Standards has just completed a two-year study of the distance range of broadcasting stations. The results of the study will be made public soon.

One hundred observers located at various distances up to 400 miles from East Pittsburgh, Pa., cooperated with the Bureau by making observations on the signals of KDKA. These observers were furnished with forms which were used by them to record their observations. These forms were so arranged that the data which they obtained could be transferred to cards and analyzed by automatic machines of the type regularly employed by the Census Bureau. The data will show the variation of strength of atmospheric, variation of fading, relative magnitude of obstacles to reception, variation of interference from receiving sets, relative magnitude of obstacles to reception grouped in bimonthly periods, and mean reliability of reception as a function of distance.

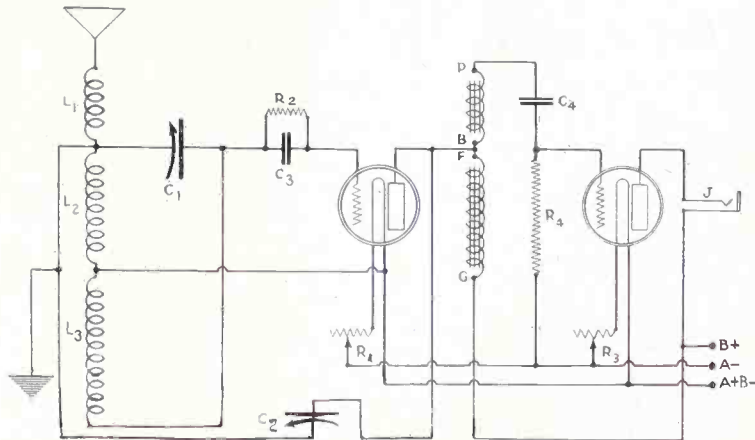

DIAGRAM of a short-wave receiver, using the Hartley oscillating system in the detector, with one stage of autoformer audio frequency amplification.

Canada to Be Represented At the National Conference

WASHINGTON

The Canadian Government has accepted the invitation to the National Radio Conference, and Mr. C. P. Edwards, director of Radio of the Department of Marine and Fisheries, has been appointed its representative, according to

a cable to the Department of Commerce from the Consulate General at Ottawa. Mr. Edwards will be accompanied by one of his assistants, probably W. A. Rush, Division Superintendent of the Radio branch, who is a noted expert in his line and has had long experience.

Nine Good 1-Tube Hookups

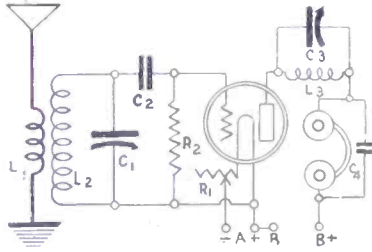
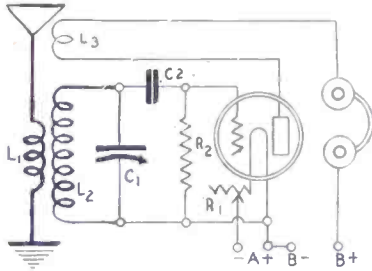

TOP DIAGRAM shows the 3-circuit tuner, using a rotary tickler coil for regeneration. The grid leak may be connected as shown if too much oscillation is present, otherwise may be placed in conventional fashion across the grid condenser C2. The same fundamental circuit is shown in the lower diagram, but regeneration is obtained by incorporating a fixed coil and tuning it with a variable capacitor. If C3 is of the same capacity as C1 in the lower diagram, then L3 would have the same number of turns as has the secondary, L1. Note that the rheostat in each instance is in the negative leg.

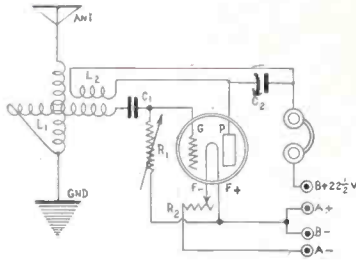

ANOTHER ingenious method of constructing a 1-tube DX set. The tap (L1) is made at the point where the stator joins the rotor. The coil, L2, is placed on the stator coil of L1, either on top, or where the stator winding ends.

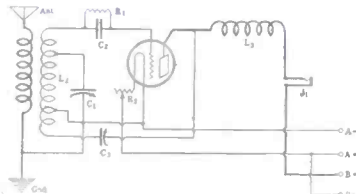

A HOOKUP for short-wave work. L3 is an RF choke coil. This hookup may be used also for general broadcast reception, the condenser capacities and the coil inductances determining the wave range. Data on coil winding for short waves were published in the October 31 issue of RADIO WORLD.

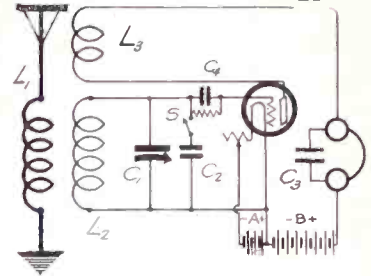

THE 3-CIRCUIT TUNER, with an auxiliary fixed condenser, C2, to enable the use of C1 alone in tuning in the lower wave stations with wide separation, by cutting out C2, which is used only for the higher waves. C2, when in the circuit, is in parallel with C1, hence boosts the wavelength.

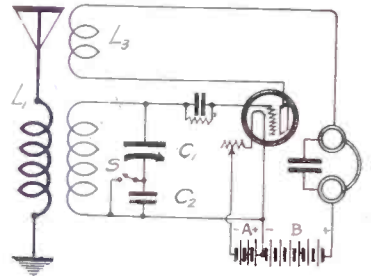

C2 IN THE above instance is in series with C1 and cuts down the wavelength. Whether to use one system or the other depends mostly on the capacity of C1. For .0001 or .00025 for C1 the parallel method would be used, C2 being about .00025 mfd. also. If C1 is .0005 or .00035, .0005 or .001, then the series method should be used, and C2 would be about .0001 mfd.

The Bernard 1-Tube DX Set for Tuning Ease and Simplicity

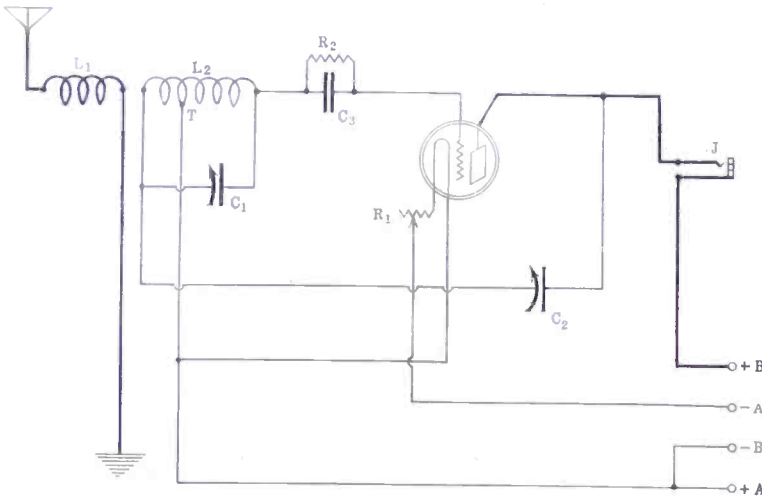

THE BERNARD 1-TUBE SET shown above uses the Hartley system of obtaining regeneration. This is like the set Capt. Peter V. O'Rourke describes in this issue, only the Captain has added two audio stages. The receiver is a sensitive one indeed. Two of the outstanding features of this set are the simplicity of the coil construction and the ease of tuning. The approach to the regenerative state is very smooth indeed. For reception of local stations it is possible to set C2 for proper feedback for a low-wave station, keep that same setting and turn only C1 to tune in stations on the higher waves. The phenomenon of tuning out a station by tickler variation alone, present in the rotary tickler coil regenerative set, is generally absent in this hookup. Any oscillatory type of tube may be used to excellent advantage. The location of the tap T depends to a considerable extent on the capacity of the feedback condenser, C2.

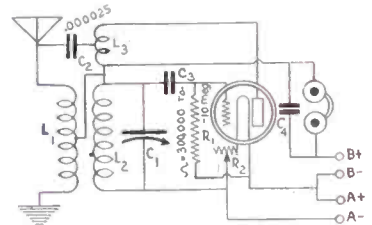

A UNIQUE method of coupling in a regenerative receiver. A 3-circuit tuner is used. L1L2 are wound on a form 3 1/2" in diameter. L1 contains 10 turns. L2 contains 45 turns. There are 35 turns on L3.

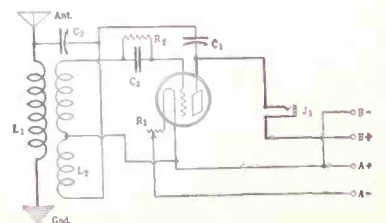

ANOTHER method of obtaining regeneration, wherein inductive and capacity feedback are both employed.

1926 Diamond and Thordarson

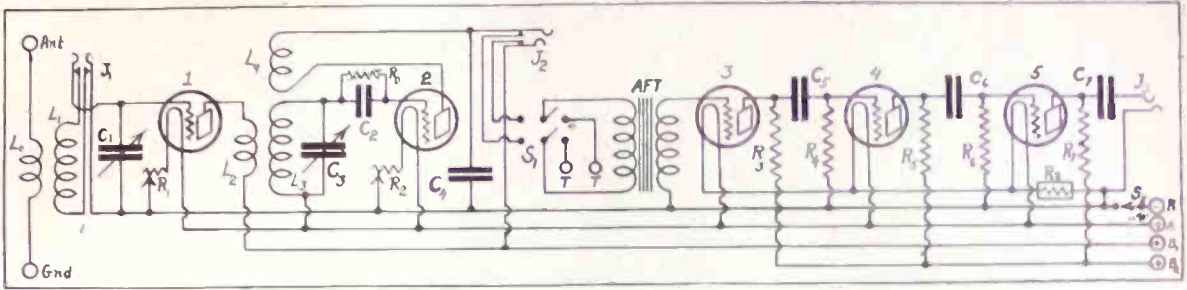

THE 1926 MODEL DIAMOND OF THE AIR, RADIO WORLD'S leading hookup. The radio side is the same as that in the 1925 model, but the audio hookup has been improved. There is a slight sacrifice in volume by including the extra resistor, R7, but quality is improved. If the extra volume is preferred, R7 may be omitted, the jack J3 being connected to plate of the last tube and to B plus No. 2, normally 135 volts. C7 would be put across the speaker connections. Another method would be to connect an audio choke coil where R7 is shown. This might be an old audio transformer, with B and F posts joined, the P and G posts being connected to plate and B plus respectively. Then C7 would be retained in its position as shown. These minor items should be the subject of individual experiment, so that the set will be made to suit the builder's preference for volume and quality. The set works well whether hooked up one way or another. Anybody building this set and desiring a free nameplate may obtain one by addressing Nameplate Editor, RADIO WORLD, 145 West 45th Street, New York City. The circuit was described by Herman Bernard in the September 12, 19 and 26 issues of RADIO WORLD, with trouble-shooting in the October 3 issue.

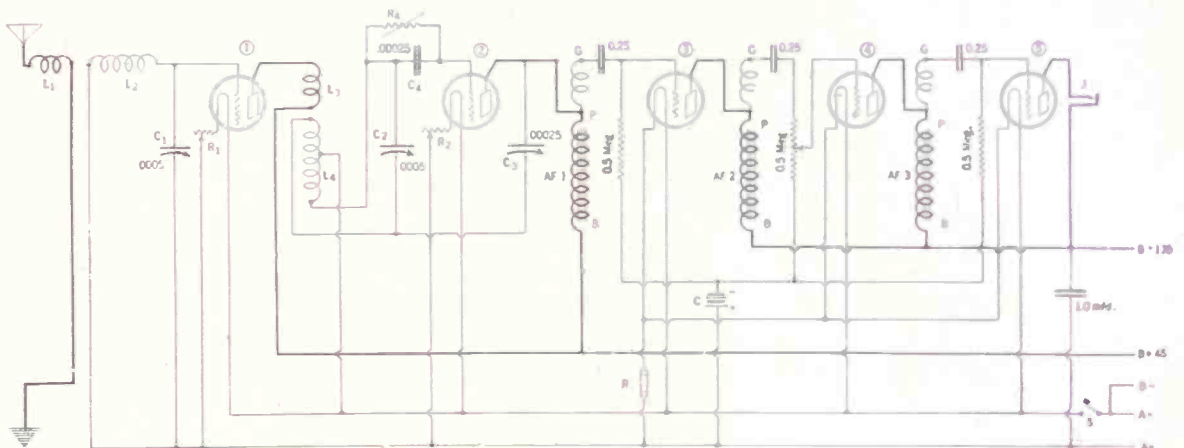

THE THORDARSON-WADE SET, which uses the Hartley regenerative system and three stages of auto-transformer-coupled audio.

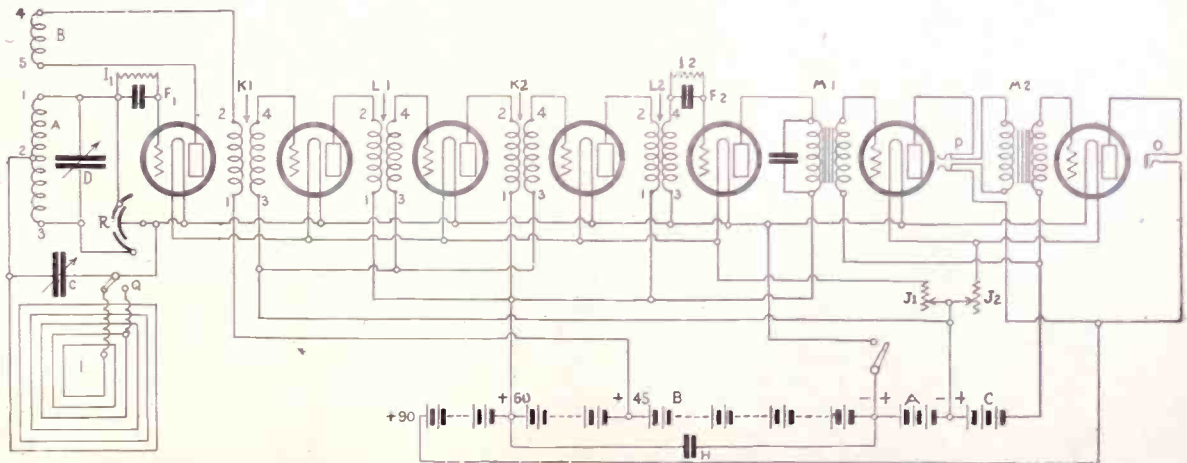

THE PRESSLEY SUPER-HETERODYNE. This is one of the best Super-Heterodynes so far developed. The Sangamo Kit was used in its construction. The mid-tapped grid coil with balancing condenser functioning on the Wheatstone bridge principle effect neutralization. A tapped loop is used, one setting being for lower waves, the other for higher waves.

Rofpatkin and Inverse Reflexes

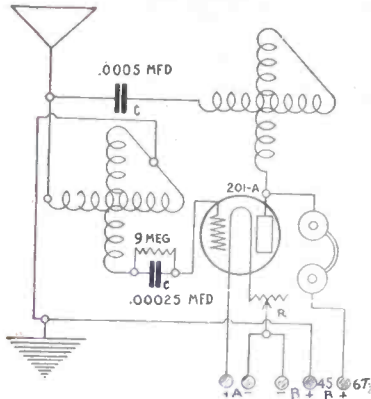

IN THIS CIRCUIT one variometer is used to tune the antenna and the grid of the tube, while the other is used as a tuner of the plate of the tube. The difficulty in this set lies in the placing of the variometers. They should be placed no more than 2 3/4" apart. Note that the B+ 45 goes to the ground binding post. The complete constructional data on this circuit was published in the April 25 issue of RADIO WORLD, and described by Lewis Winner. Although the value of the grid leak here is 9 megohms, a lower value leak may be found to work more satisfactorily. The resistance of the rheostat is 10 ohms when using 6 volts.

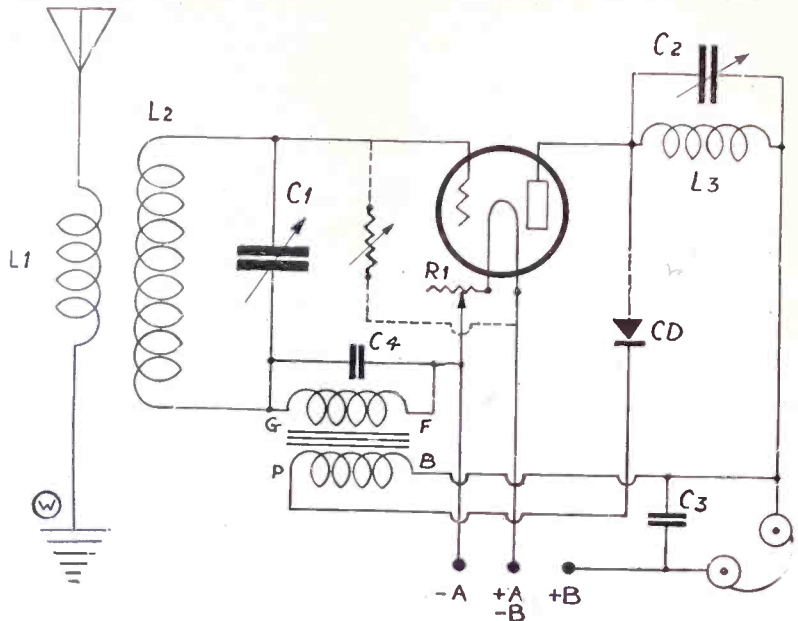

THE SET THAT CAUSED A TURMOIL. Feodor Rofpatkin in the February 21 issue of RADIO WORLD described the construction of the above circuit. One fan wrote in that it could not possibly work and that it was "a

sin and a shame" to publish such hook-ups. Hundreds of others told of their splendid success with this circuit. Although a reflex it is simple to build and not troublesome in operation. The UV201A tube is used here.

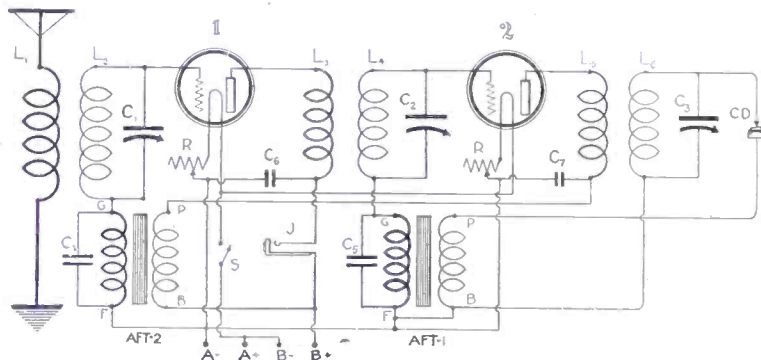

THE INVERSE DUPLEX, using two tubes for speaker operation, a crystal detector being employed. Capt. Peter V. O'Rourke described this set in the August 8 issue of RADIO WORLD.

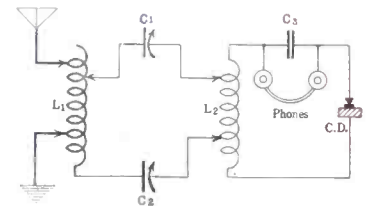

THERE is still some interest in crystal sets and this interest may increase, now that stations are usually linked in a chain when anything really important is being broadcast. This set has two tuning condensers and two tap-switches. The capacitive method of coupling is employed. C1 and C2 are .0005 mfd. condensers. L1 is a 20-turn coil tapped every two turns. L2 is a 60-turn coil tapped every 5 turns.

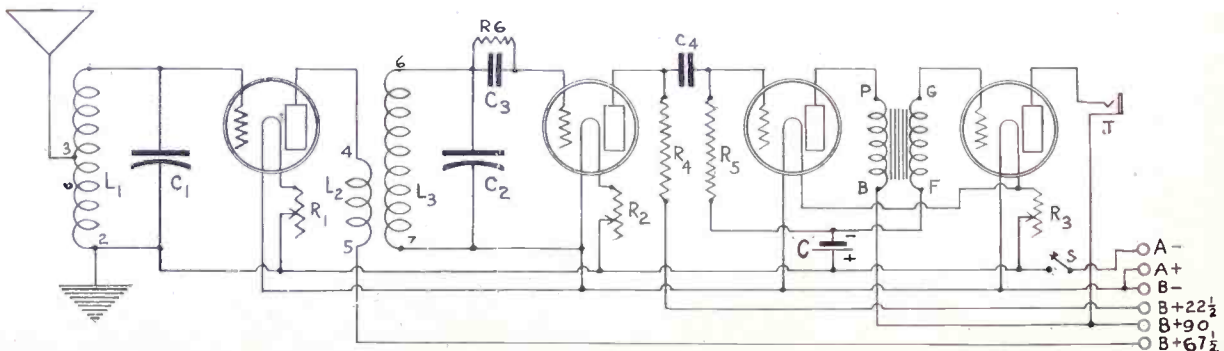

THE RX-1, a quality receiver, which M. B. Sleeper developed. J. C. Hight described the set in the October 17 issue of RADIO WORLD.

Two Popular Audio Circuits

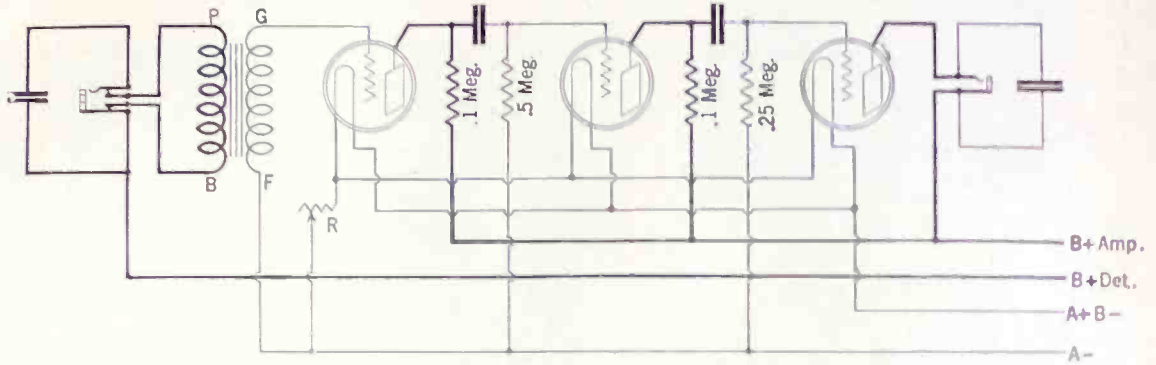

ONE TRANSFORMER stage of audio, followed by two resistance stages. This gives good quality and volume... It is a considerable improvement over two transformer AF stages. The bypass condensers at input and output may be .001 or .002 mfd., but the two other fixed condensers should be no smaller than .1 mfd., preferably .25 mfd. The rheostat R is 10 or 15 ohms for 201A or equal tubes. Hi-Mu tubes in sockets 1 and 2 (left to right) are preferable.

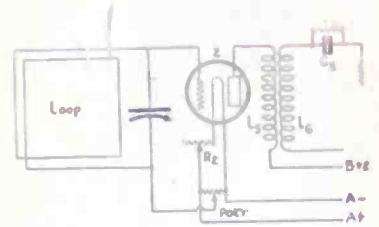
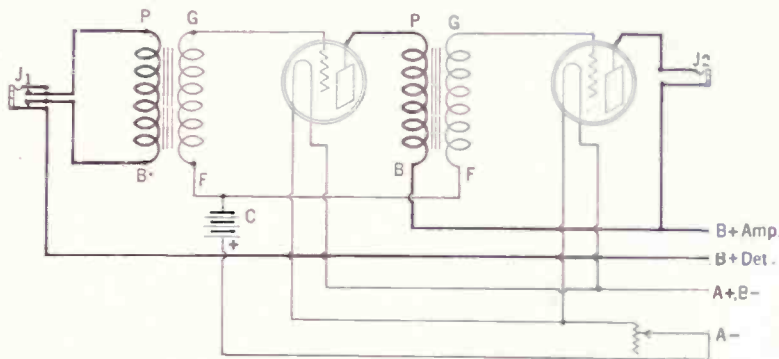

MANY desire to have a loop instead of an antenna, but do not know how to disconnect the serial and the ground from the coil, etc. The above diagram simplifies matters. The primary and the secondary of the first radio-frequency transformer are entirely eliminated. The variable condenser which originally shunted the secondary of this RFT shunts the loop terminals. In other words, the RFT is taken out, and where the secondary went, the loop is placed.

THE WAY to obtain the maximum of volume from a 2-stage amplifier is by using the above hookup, wherein two transformers are employed. There are many other methods of coupling the grid to the plate in an AF amplifier, but this is the best as far as volume is concerned. All the notes (high, low and middle) are not amplified equally, however.

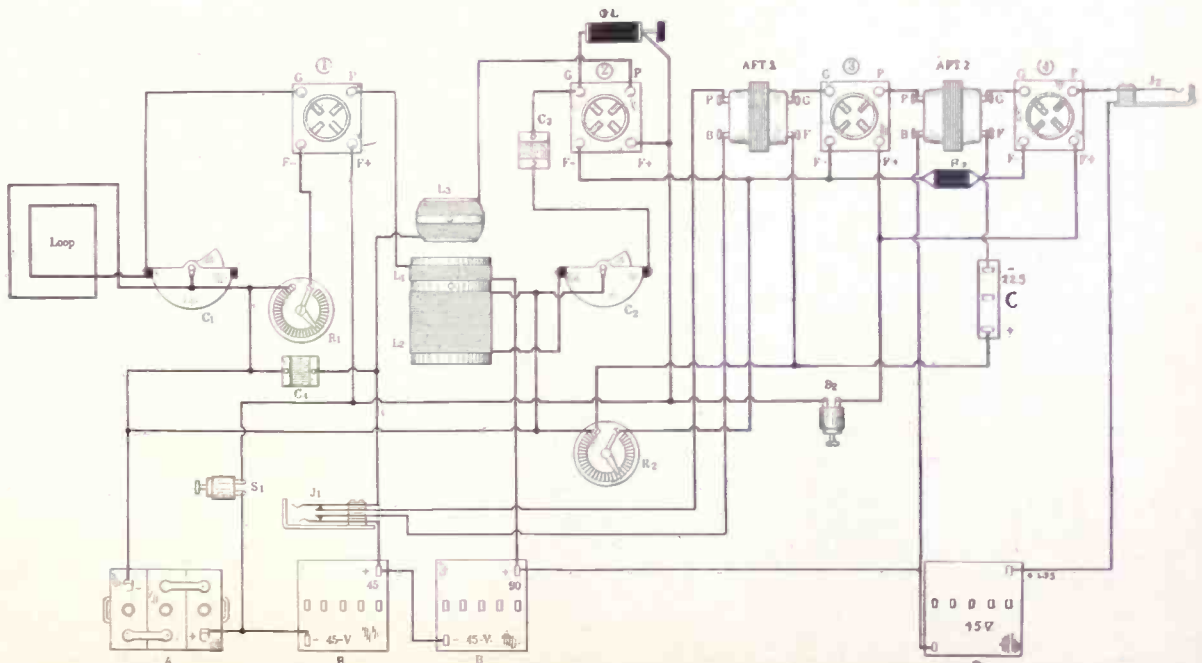
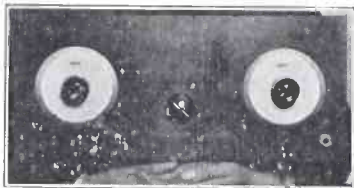

FIG. 229, showing the 4-tube Diamond, using the UX tube in the last stage.

A Flexible Short-Wave Set



THE PANEL VIEW of the short-wave receiver.

By Percy Warren

TO the real devotees of the radio art there is more to radio enjoyment than mere broadcasting. To those who seek further thrills in this king of sports, the short waves provide a field in which they can repeat in a new way all of the experiences and joys they have had in the broadcasting range.



PERCY WARREN

Ordinary broadcast receiving instruments are not built to tune in on stations that operate much below 200 meters. Because of the need for more space in the ether it is possible that the future broadcast sets will have to have a larger tuning range than at present, and fans may be picking up their entertainment on waves in the neighborhood of below 200 meters.

Now is the time to enjoy what the "wild waves" are saying in that region which is a closed book to most of the broadcast listeners but which is as active with signals as any other wave band in the radio realm.

The first step is naturally to obtain a receiving outfit that will enable you to tune in the short waves, those below 200 meters, and reach to near zero. Your present radio set probably could be converted into a short wave receiver, but it is much better and efficient to build a separate outfit specially for this kind of work.

Not only is the construction of such a receiver simple, perhaps simpler even than that of a broadcast receiver, but its cost is very moderate, and in proportion to the enjoyment to be derived, very small indeed.

To build a short-wave receiver like the one which I have been using with great success at my home, the apparatus cited in the list of parts is necessary. This listing shows merely what was used in the set, but other parts of equivalent quality, and approximate size could be used just as well with equally good results. But be sure that the substitute parts that you introduce in the circuit are good, and from reliable manufacturers. In short-wave work, it is essential to use the best, as the greatest possible efficiency is sought for the apparatus employed.

The coils may be made by the builder or bought already wound. Lorenz coils, as these low-loss windings are called, require skill for proper winding for short-waves and the B.C.L. is advised to buy the coils already wound, with the proper number of turns, and correctly tapped.

A 13-peg support, on a diameter of 3", will serve as the winding rig for home-made coils. The fixed tickler coil should have at least five or six turns of No. 16 DCC wire. Coils are made also for the

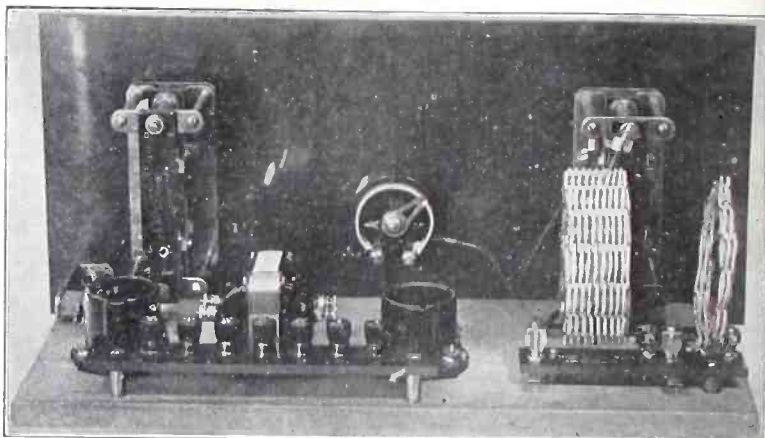

REAR VIEW of the receiver. Note the loosely coupled tickler coil, which is fixed. The mount may be turned about, so that the fixed tickler coil is at left to shorten the plate lead.

secondary, antenna and grid, circuits, these being one unit. The first of the series of secondary coils, to tune in from about 10 to 30 meters, consists of about nine turns, the taps for the grid and plate coils being determined by experiment. A larger coil for the next range is wound with 18 turns, and tapped also for the grid and plate circuits. A last coil, with about 36 turns will afford variety so you can cover pretty well the short-wave band. This should be tapped also.

On the low wavelengths tuning is extremely sharp, and the use of good condensers in connection with well-designed coils makes it possible for the 20,000 amateurs to operate nightly without noticeable interference to one another.

In the list there are mentioned variable condensers. These should be of the low-loss type, and if a higher capacity than that indicated is used, the tuning will become difficult, if not impossible for the novice.

For the optional radio frequency choke coil, which is located in the plate circuit, 120 turns of wire wound on a form 1" in diameter may be used. No. 30 DCC wire is suggested.

The method of mounting the coils should be of interest. Either a special mounting can be devised, using clips to make connections as the various size coils are hooked into circuit to cover the various wave bands, or the simpler plug-in system may be adopted. In the latter case, quick change over from one coil to the other may be affected, the coils simply being placed in a sort of socket-strip which automatically connects them in the circuit.

The connecting plugs may be bought separately and mounted individually, or secured with the coils. In either case they are recommended over the clip method. The plug method gives a sure and positive contact and permits of extensive experimentation without trouble.

When assembling the receiving set, after you have obtained all of the parts, be careful about the spacing of the various units. Do not place anything within 2" of the coils, and get the best sockets procurable, and if you can't, don't use any socket at all in the detector circuit. This can be done by removing the base of your tube, and soldering the grid, plate, and filament leads directly to the leads going to various parts of the circuit. Mount the tube on

a cushion, and eliminate possible microphonic noises which are very annoying.

Lay out the panel so that a condenser will be located on the right and left-hand sides, and the filament rheostat in the center. Then, on the baseboard, locate the coil mountings starting at the left, and place the detector socket, the amplifying transformer, and the first stage audio frequency socket in that order. The connecting strip can be screwed down directly in back of this socket, and the choke coil if any is used, is placed in back of the first socket.

Use busbar in wiring, making the lead as short as practicable. Every connection that is permanent should be soldered. Have wires running at right angles where possible.

When the set has been assembled, test and check the circuits, and connect to an aerial about 40 feet high, and 40 to 60 feet long. If you prefer, use your regular aerial.

When the tubes are lit the set will oscillate when the plate condenser is turned. While the set is oscillating, turn the tuning condenser until a signal is heard. Then bring the plate condenser

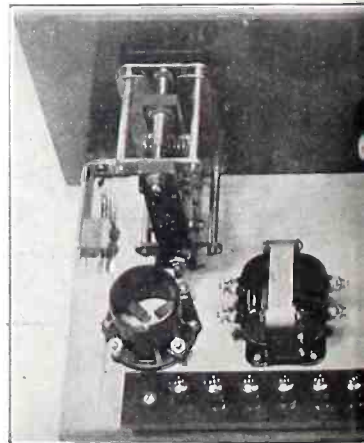

THE FLEXIBLE LEADS are shown on the secondary and also on at least one other tap connection which works best

Wonder Tube



V. K. ZWORYKIN (above), of the Westinghouse Electric Research Laboratories, East Pittsburgh, Pa., with his thermionic photo-electric tube which utilizes the mechanical power of light. The tube is one of the most sensitive known to physicists and will send out electric currents and radio impulses whenever a ray of light falls upon it. It is applied for steering ships, controlling railroad trains automatically, recording the light from variable stars, and may aid transmission of moving pictures by radio. (Wide World)

JOIN THE A. B. C.

A. B. C. stands for American Broadcast Club, an organization of fans banded together to promote the welfare of radio. There are no dues, no obligations. Address A. B. C. Editor, RADIO WORLD, 145 West 45th St., N. Y. City. The names and addresses of new members follow:
 R. E. Polzin, 24 Freund St., Buffalo, N. Y.
 Walter L. Suitala, 94 Squachan St., Selfridge Field, Mt. Clemens, Mich.
 H. E. Ferree, 2921 Lipscomb St., Ft. Worth, Tex.
 F. E. Ferree, Burkburnett Bldg., Ft. Worth, Tex.
 C. R. Ferree, 1211 Sixth Ave., Ft. Worth, Tex.
 Lyman E. Rinker, 1245 East Oak St., Portland, Ore.
 Arthur Soderstrum, Studio Orpheum Bldg., Topeka, Kan.
 Edward Hassell, 513 Superior St., Grove City, Pa.
 Paul J. Belso, 342 Lawrence St., Perth Amboy, N. J.

EXPORTS UP \$2,951,204

The total of foreign sales of American radio apparatus for eight months of this year show an advance of \$2,951,204 of shipments over the corresponding period of last year. The exports to date amount to \$5,556,284. An idea of the increase may be gained from the fact that in August of last year our radio exports were valued at \$641,238, whereas in August of this year they amounted to \$844,379.

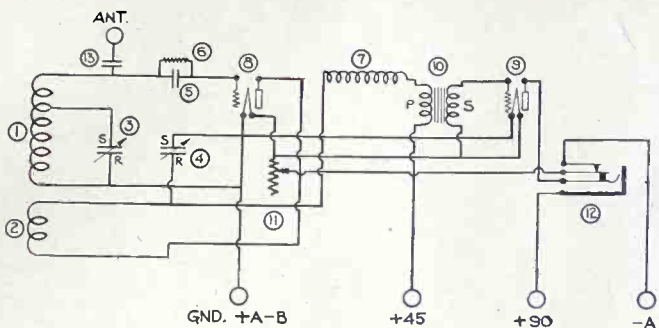

THE INDUCTIVE FEEDBACK short-wave set, in which plug-in coils are used for covering the various ranges and for highest efficiency.

LIST OF PARTS

- One set of REL low-loss short-wave coils.
- One panel, 16"x17"x3/16".
- One baseboard, 14 3/4"x9"x1/2".
- One radio frequency choke coil (optional).
- One fixed antenna coupling condenser.
- Two Wade or Hamnerlund .0001 mfd. variable condensers.
- Two sockets.
- One 10 ohm rheostat.
- One audio-transformer.
- Two 4' vernier dials.
- One Dubilier .0005 mfd. grid condenser.
- One Daven 5 meg. grid leak.
- One jack.
- One rear binding post strip (4 posts).
- One rear binding post strip (2 posts) complete, with binding posts, lugs, baseboard bushings and wood screws.

setting back until just before the circuit "spills over." Maximum signal strength will be obtained.

On the extreme low waves adjustments must be made very, very slowly, otherwise signals will be passed over. Verniers are useful in tuning low waves.

There are several broadcasting stations on the low waves now. KDKA, WGY and others can be heard. Tune them in some night and notice the difference between the low wave and their regular broadcast. In addition, some foreign stations are now broadcasting in the short-wave region.

These may be picked up too with care. For the reception of broadcasting, it is best to tune the circuit just below the point of oscillation. This will obviate a distorted signal.

Key to Numerals

- 1.—Auto-transformer—It is advisable to experiment with the tapped connections when employing the capacity feed-back circuit. Use the smallest coil for the 20 meter band, the next for the 40 and the largest for the 80. All these particular coils have taps.
- 2.—Tickler Coil—The small one to be used for the 20 and 40 meter band and the large one for the 80. There are only two.
- 3.—.0001 mfd. wavelength control variable condenser.
- 4.—.0001 mfd. regeneration control variable condenser.
- 5.—.0005 mfd. fixed grid condenser.
- 6.—5 Meg. Grid Leak—It is advisable to try various sizes. A defective grid leak will cause considerable noise.
- 7.—Radio Frequency Choke—Wind 120 turns, No. 30 DCC on 1" diameter tubing. May be omitted.
- 8.—Hard Detector Tube, preferably 201A.
- 9.—Amplifier tube.
- 10.—Audio Frequency Transformer—High ratio preferred.
- 11.—10 Ohm Rheostat.
- 12.—Single Circuit Filament Control Jack—Plain single circuit jack may be used instead and connections changed accordingly.
- 13.—Fixed Antenna Coupling Condenser—Two pieces of brass 1/2"x1/2" spaced 1/2" apart.

Don't Use Panel Like This for SW



BY PLACING the dials so close together the variable condensers used for tuning a short-wave set would lack the requisite separation.

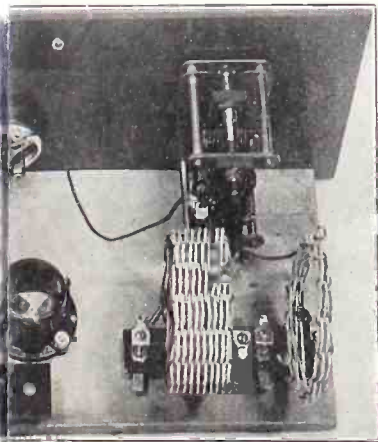

early in this photograph. There are taps one of the plug-in fixed tickler coils, but be determined only by experiment.

Radio University

A QUESTION and Answer Department
 conducted by **RADIO WORLD** for
 its Readers by its staff of Experts. Address
 Letters to The Radio University, **RADIO**
WORLD, 145 West 45th St., New York City.

WILL YOU please give me a diagram of a 5-tube inductively coupled set?—T. Harms, Claypool, Okla.

Fig. 226 shows the electrical diagram that you request. The tubing is 3 1/2" in diameter. Close to the edge wind 16 turns, (L1). Leave out two terminals, (beginning and the end of the winding), for connecting purposes. Leave 1/8" space. Wind 45 turns tapped at every fifth turn, (L2). Tap the 45th turn, too, and put on three more turns, this being a continuation of the secondary winding, and anchor the last turn in the form. Be sure that when you wind this secondary there is plenty of wire left, because the secondary winding is continued on the rotor form. Procure the two other 3 1/2" diameter forms. The primary winding (L3) contains 26

dyne coils differ from a regular 3-circuit tuner? (2) Are the RFT in both these sets the same? (3) How many turns and what size wire should I use to wind on a form 2 1/2" in diameter and the tickler, 1 1/4" in diameter for Capt. P. V. O'Rourke's "Most Efficient 4-Tube, 3-Control Set," published in the March 21 issue of RADIO WORLD? (4) Are the primary and the secondary of the standard RFT (tuned by a .005 mfd. variable condenser) good for this set, utilizing this special 3-circuit tuner?—W. H. Sevita, Mount Vernon, O.

(1) They are both the same. (2) Yes. (3) There are 10 turns wound for the primary, and 53 wound for the secondary. No. 24 silk over cotton or 22 SC wire is used. The tickler contains 36 turns

—Frank Barger, 615 South Edwards Ave., Eastwood, N. Y.

Reverse the tickler leads. Take off 5 turns from the plate coil. Take out the fixed condenser (if any) which goes from the A+ lead to the plate. Reduce the B battery current on the plate of the detector tube.

I WOULD like to have some information regarding the DX Set That Thrilled Jack, as described by Lewis Winner in the Oct. 10 issue of RADIO WORLD. (1) Is this set sensitive, clear and non-distorting on DX stations? (2) What wavelengths will this set receive? (3) Can the coils be wound on a solid bakelite tubing with equal results? (4) If the latter prevails, does the size of the tubing change? (5) How long an antenna should I have to get best results on the set?—Calvin Martin, 518 24th St., Oakland, Cal.

(1) Yes. (2) From 200 to 550 meters. (3) Yes. (4) There is no change in the diameter of the tubing. (5) The antenna should be 100 feet long.

I WOULD like to make some balloon coils, and therefore would like to have the following information regarding the same. (1) How many turns shall I wind for the primary of the coil. (2) How

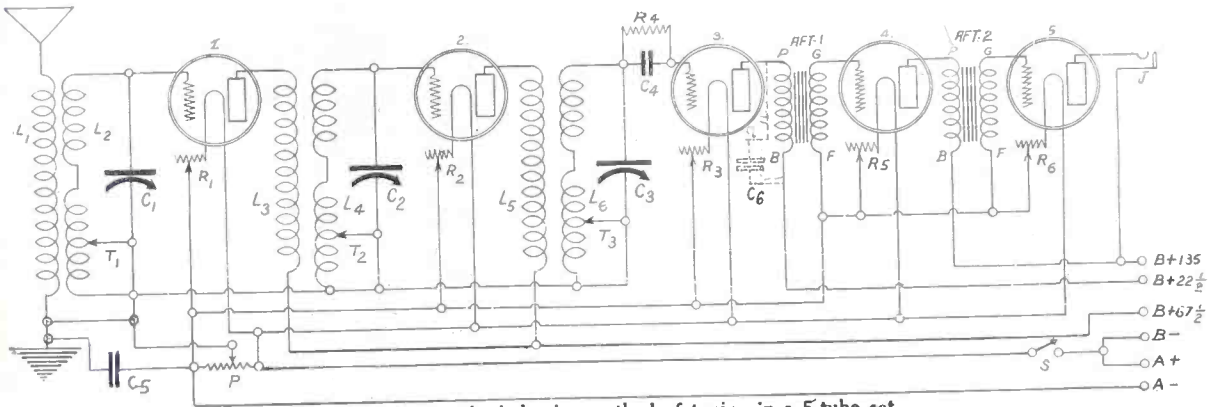

FIG. 226, shows the inductive method of tuning in a 5-tube set.

turns for L3, but 16 for L5. Wind the secondaries without taps.

Procure forms 2 1/2" in diameter. Wind 13 turns. Leave about 5" of wire out before beginning to wind the coil. Connect the long lead from the end of L2 to the beginning of this rotary winding. In the same way the other rotary coils are wound and connected. The condensers C1, C2 and C3 are variable condensers of .0005 mfd. C5 is a .001 mfd. fixed condenser. P is a 400 ohm potentiometer. R1 is a 20 ohm rheostat. R2 is a 20 ohm rheostat. R3, R5 and R6 are all 10 ohm rheostats. C4 is a .00025 mfd. grid condenser. R4 is a 2 megohm grid leak. C6 is a .001 mfd. fixed condenser. AFT1 and 2 are both of the low ratio type. The UV201A type tube is used.

I HAVE built the Diamond and find that I cannot cut through local stations. I can cut the local stations out. Could you help me?—Chas. F. Bake, 1808 W. Wyandotte, Kansas City, Mo.

Use a fairly long antenna, about 100 feet with a water pipe as a ground. The fact that you get locals proves that the set is functioning. Perhaps you skip over the stations while cruising the air. When tuning in a station, bring the carrier wave in. Then immediately vary the tickler, so that it will not squeal enough to annoy your neighbors. Now tune your condenser dials in step, slowly. If the station is there you ought to get it, with careful tuning.

IN A general way how do the Super-

of No. 28 single silk covered wire. (4) Yes.

WILL YOU please tell me if dry cell tubes will work in the 2-tube reflex, described in the Feb. 7 issue of RADIO WORLD by Capt. P. V. O'Rourke? (2) Will a fixed crystal detector work in this set?—H. M. Horton, 36 Division St., Providence, R. I.

(1) Yes, but not with much volume. (2) Yes.

PLEASE TELL me the number of turns to put on a form 2 1/2" in diameter of a 3-circuit tuner. The diameter of the rotor is 1 1/4" in diameter. I wish to use No. 26 double silk covered wire. The secondary is to be tuned by a .0005 mfd. variable condenser.—A. F. Gilbert, 184 Glebeholme Boulevard, Toronto, Ont.

There are 10 turns placed on this for the purpose of making the primary. The secondary consists of 52 turns of the same wire wound on the same tubing, with no separation. The tickler consists of 36 turns of wire.

WHERE CAN I get information on the short wave receivers?—Emanuel Ugge, care Zeuresch and Co., Pocatca u Jindr, Hradce, Czecho-Slovakia.

See the Oct. 10 and 17 issues of RADIO WORLD, also Mr. Warren's article in this issue.

I HAVE a 3-tube regenerative set which is very hard to control. It oscillates too much. Have you any suggestion?

many for the secondary? (3) What size wire should I use? (4) What is the diameter of the coil? (5) Are the primary and the secondaries of all the coils alike? (6) Should the winding be in the same direction? (7) Should there be any separation between the windings? All these coils are to be tuned by a .0005 mfd. variable condenser.—W. G. Freind, 83 Lang St., Newark, N. J.

(1) There are 48 turns wound for the primary. (2) The secondary consists of 195 turns. (3) Use No. 24 double cotton covered wire. (4) The diameter of the coil is 1 1/4". (5) Yes, all the RFT are wound in the same style. (6) Yes. (7) No.

I AM going to build the 1926 Diamond and would like to know if I could use the 180° Twin Coupler Co., 3-circuit tuner, two SLF variable condensers of .00035 mfd. capacity. The primary has 12 turns and the secondary has 43 turns. This is wound on a tubing 3 1/4" in diameter. No. 22 silk over cotton covered wire is used. The space between the primary and the secondary is 1/8". (2) If I use these coils can I obtain maximum volume and selectivity? (3) The tickler is wound on a tubing 2 1/4" in diameter and contains 33 turns. (4) Is the 1926 Diamond more selective than the 1925 Diamond?—J. G. Thomas, 5623 Hawthorne Ave., New Orleans, La.

(1) You will have to increase the windings on the secondary to 63 turns. (2) Yes. (3) Increase the windings to 43 turns. (4) No; both the same.

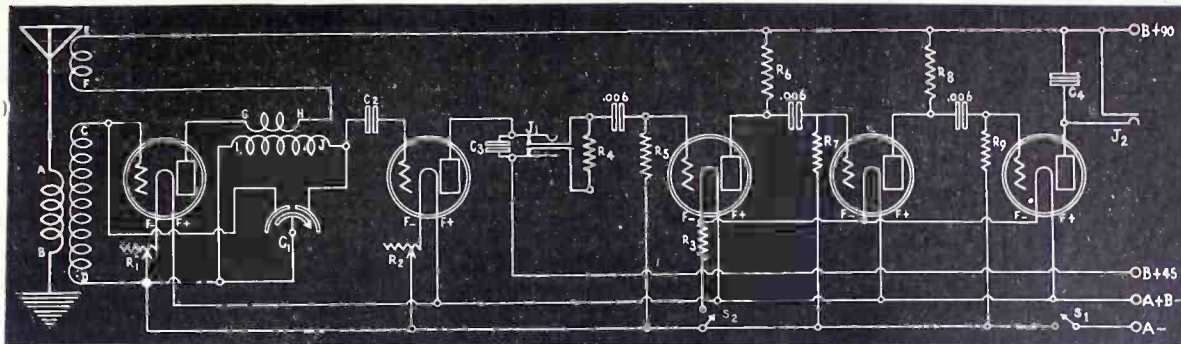

FIG. 227, showing the diagram Mr. Homins required.

WILL YOU please give me a diagram of a 5-tube loud speaker set.—T. H. Homins, Danville, N. H.

See Fig. 227. The data for winding follows: Using a 4" outside diameter tubing, 2" high, wind eight turns of No. 20 DCC for the primary of the variocoupler, AB, terminate; then leaving the least space possible, wind 31 turns of the same kind of wire in the same direction for the secondary, CD, terminate. The tickler EF, should consist of 20 turns of No. 26 SSC on a 3" diameter, 2 1/4" high. The RFT, GHIJ, consists of the same kind of winding as the primary of the coupler, except that the secondary, IJ, has one turn less, or 30 turns. C1 is a .0005 mfd. double condenser. R4, R6, R8 are 1 megohm in value. R5 is 1 megohm, R7 is 1/2 megohm, R9 is a 1/4 megohm. C4 is a .001 mfd. condenser. C3 is a .002 mfd. fixed condenser. C2 is a .001 mfd. fixed condenser. R3 is a 6-ohm Amperite resistance. R1, R2 are 6-ohm rheostats. Five UV201A tubes are used or a Sodian D21 will serve as a detector. Other detectors require a grid leak.

WILL YOU please give me a diagram of a 2-tube loud speaker reflex, with 1-control?—C. Lamons, Colfax, N. M.

Fig. 228, shows the electrical diagram of such a receiver. L1, the primary is wound on a form 3 1/2" in diameter and 4" high. There are 10 turns made. The secondary is wound on the same form and consists of 45 turns. The primary L3 is wound on a tubing 3 1/2" in diameter and 4" high. There are 10 turns made. The secondary is wound on the same tubing. There are 45 turns made. Use No. 22 double cotton covered wire for winding these coils. C2 is a .001 mfd. fixed condenser. C3 is a .001 mfd. fixed condenser. CD is a crystal detector of either the fixed or variable type. C1 is a double condenser. Each section has a capacity of .0005 mfd. AFT1 is of the high ratio type. AFT2 is of the low ratio type. R1 and R2 are both 10 ohm rheostats. The UV201A type tubes are used. The jack is of the double circuit type.

I AM contemplating building the 2-control Diamond of the Air as described in the May 23 issue of RADIO WORLD. (1) Will the Amsco .0005 mfd. SLF double condenser work well in this hook-up? (2) Why are the primary and the secondary of the RFT connected together here and not in the 3-control Diamond?—Walter A. Sorg, 7 Clay St., Dansville, N. Y.

(1) Yes. (2) This is done so that the volume of the set might be increased. Local conditions control this point, so try the hookup both ways.

I BUILT the Diamond and am having some difficulty. This lies in the crowding of the low-wave stations. I am led to understand that a SLF condenser will cure this. Is this true? (2) I also have

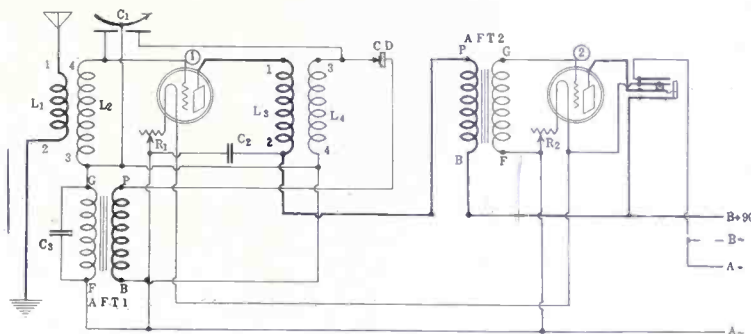

FIG. 228, showing the diagram Mr. Lamons requested.

some trouble with the high waves. Is there any way that I can get them easier?—Dr. E. H. Taylor, Pittsfield, Mass.

(1) Yes, or just slip SLF dials on your present condensers. (2) Place a .0005 mfd. fixed or variable condenser across the antenna and the ground. A small switch may be placed in series with one of the leads of this condenser. You then will be able to switch in and out without any trouble. Another way is to lengthen your antenna.

I HAVE built the Diamond and find that regeneration is uncontrollable. How can I cure this? I cannot rewind the tickler coil as it is too tricky.—E. J. Shockey, 2930 W. 1st, Engine 32, Los Angeles Fire Department, Los Angeles, Cal.

Take off the fixed condenser which goes from the plate post of the detector tube to the A battery. Use a variable grid leak. Use less B voltage. Reverse the secondary of the 3-circuit tuner.

WILL YOU kindly let me have the following information as regards the Diamond and the Powertone: (1) Which one of the two circuits is the more selective? (2) Which one is the best as to quality

and volume? (3) Are they both loggable? (4) How do they compare with the Neutrodyne? (5) Would the Powertone as a 2-control have any advantage over the Powertone as a 1-control? (6) In regards to the Percy Warren "Simple 1-Tube DX Set" described in the May 23 issue of RADIO WORLD, I would like to know if I can use a .00025 mfd. variable condenser across the grid coil instead of the .0005 mfd. variable condenser. If I can, would you please give me the number of turns.—James Laing, 59 Watchung Ave., West Orange, N. J.

(1) Selectivity equal. (2) The Diamond is louder, quality equal. (3) Yes. (4) very favorably. (5) No. (6) You can use the .00025 mfd. The number of turns on the coil is increased to 65.

I HAVE built the Diamond and until recently have had wonderful results. During the last week or so trouble has developed. The signals are now distorted. I have traced it to the first two tubes. In other words, the trouble does not lie in the AF stages. Can you help me?—Frank N. Freuch, 95 South St., Boston, Mass.

The probable trouble lies in either run (Continued on page 28)

Join RADIO WORLD'S University Club

And Get Free Question and Answer Service for the Coming 52 Weeks.

Have your name entered on our subscription and University lists by special number. Put this number on the outside of the forwarding envelope (not the enclosed return envelope) and also put it in your queries and the questions will be answered the same days as received.

RADIO WORLD, 145 West 45th Street, New York City.

Enclosed find \$6.00 for RADIO WORLD for one year (52 nos.) and also enter my name on the list of members of RADIO WORLD'S University Club, which gives me free information in your Radio University Department for 52 ensuing weeks, and send me my number indicating membership.

Name

Street

City and State

A THOUGHT FOR THE WEEK

The reputed rattle-brained radio inventor of today, with the light of zeal in his eyes and fringe on his trousers, may be the millionaire of tomorrow. You never can tell in radio.

RADIO WORLD



Radio World's Slogan: "A radio set for every home."

TELEPHONES, BRYANT 0558, 0559
 PUBLISHED EVERY WEDNESDAY
 (Dated Saturday of each week)
 FROM PUBLICATION OFFICE
HENNESSY RADIO PUBLICATIONS CORPORATION
 145 WEST 45th STREET, NEW YORK, N. Y.
 (Between Broadway and 5th Ave.)
ROLAND BURKE HENNESSY, President
M. B. HENNESSY, Vice-President
FRED S. CLARK, Secretary and Manager
 European Representatives: **The International News Co.**
 Breains Bldg., Chancery Lane, London, Eng.
 Paris, France: **Brentano's** 28 Avenue de l'Opera.
 Chicago: **A. T. Sears & Son**, Peoples Gas Bldg.
 Cincinnati Office: **Radio World**, 847 Provident Bk. Bldg.,
 7th and Vine Sts. Telephone, Canal 753 and 879.
 San Francisco: **Lloyd B. Chappell**, 656 O'Farrell St.

EDITOR, Roland Burke Hennessy
 MANAGING EDITOR, Herman Bernard

SUBSCRIPTION RATES

Fifteen cents a copy. \$6.00 a year. \$3.00 for six months. \$1.50 for three months. Add \$1.00 a year extra for foreign postage. Canada, 50 cents.
 Receipt by new subscribers of the first copy of RADIO WORLD mailed to them after sending in their order is automatic acknowledgment of their subscription order. Changes of address should be received at this office two weeks before date of publication. Always give old address also. State whether subscription is new or a renewal.

ADVERTISING RATES

General Advertising	
1 Page, 7 1/2"x11"	462 lines..... \$300.00
1/2 Page, 7 1/2"x5 1/2"	231 lines..... 150.00
1/4 Page, 4 1/2"x7 1/2"	115 lines..... 75.00
1 Column, 3 1/2"x11"	154 lines..... 100.00
1 Inch 10.00
Per Agate Line75
Times Discount	
52 consecutive issues	20%
26 times consecutively or E. O. W. one year	15%
4 consecutive issues	10%

WEEKLY, dated each Saturday, published Wednesday.
 Advertising forms close Tuesday, eleven days in advance of date of issue.

CLASSIFIED ADVERTISEMENTS

Ten cents per word. Minimum, 10 words. Cash with order. Business Opportunities ten cents per word, \$1.00 minimum.

Entered as second-class matter, March 28, 1923, at the Post Office at New York, N. Y., under the act of March 3, 1879.

NOVEMBER 7, 1925

The Weekly Rebus



WHAT tube function does this represent?

Send your answers to Rebus Editor, RADIO WORLD, 145 West 45th Street, N. Y. City.

RECENT BACK NUMBERS of RADIO WORLD, 15c each. RADIO WORLD, 145 West 45th Street, New York City.

Injunction Against Squealers Cited As Legally Sound

By Thomas Stevenson

WASHINGTON

Regenerative receivers or other electrical devices which sometimes spoil radio reception in an entire neighborhood may be banned at some future time by Court action.

This is the opinion of legal experts who have made a thorough study of the subject. Such a case has never been tried in the Courts, but it is believed there are sufficient precedents in law for an injunction preventing the operation of a "squealing" set.

Here is how the case appears to a leading legal authority:

"Any disturbance or sound in a receiving set which prevents or impairs the reception of desired matter may come from many different sources, be the result of negligence, or be wholly innocent. But whatever the source or the motive, its effects are equally serious.

"The disturbing effects may come from non-radio sources, such as X-ray or violet ray machines, leaky insulators, elevator switches, trolley wheels, contact shoes, poorly bound joints and other sparking electrical contacts, high voltage testing apparatus, motor and generator commutators and electrical precipitation plants.

Principle Well Founded

"It may come from apparatus used directly for radio communication. Receiving sets of certain types, when unskillfully used, emit disturbing emanations. Harmonics from transmitting stations are of the same class. Instances are known of disturbances so continuous and far-reaching as to make reception absolutely impossible in entire communities during all of the usual broadcasting periods.

"The situation is not novel in principle. It has risen before and has given rise to the maxim—'so use your property as not to injure the rights of another.' The apparatus which causes the difficulty is itself legitimate and ordinarily is useful and necessary. One who operates a radio transmitter or receiver, whether for commercial purpose or merely for his own instruction, or amusement, is likewise within his absolutely personal rights.

"A radio receiver is merely an artificial aid to hearing. By its use the scope of audition is extended far beyond natural range, just as the telescope increases the distance of vision. Man without artificial aid can hear the voice of another only within a few hundred yards. By radio, he hears it a thousand miles or more away, but the principle is the same so far as the fundamental right is concerned. A receiving set bears a relation to his ears similar to that of spectacles to his eyes.

Which Must Yield?

"We have then a conflict between users of radio and of other electrical apparatus, both equally lawful, but one interfering with and disturbing the other, and the question is as to the rights and legal relationships between them. If both cannot stand, which must yield?

"Every person shall so use and enjoy his own property as not to impair the enjoyment of others having an equal right to theirs. It is the first and most important obligation entering into the social compact, although it involves restrictions upon the so-called natural rights of individuals.

"Perhaps the most general application of the maxim has been in the law of nuisance, one branch of which covers

disturbing noise. Every property owner is entitled to reasonable quiet in the enjoyment of his premises, and a noise may of itself amount to a nuisance if it is harmful to the health or comfort of ordinary persons.

"Damages cannot be recovered merely for discomfort and inconvenience but a noise nuisance may be enjoined. Noise preventing comfortable living may be enjoined as a nuisance on the ground of inadequacy of legal remedy and to prevent a multiplicity of suits.

"The doctrine is equally applicable to transmitting apparatus which itself causes undue disturbance to those within hearing, certain types of spark for instance, and to the use of a loud speaker for radio reception at improper times and places, to the discomfort of others, similar to the unreasonable playing of the phonograph.

"But when we come to apply the rule to interference with radio reception we must deal with entirely new elements. There is a material dissimilarity between ordinary noise and vibration cases and those which arise from radio interference. The usual noise nuisance cannot be avoided by the person disturbed, but interference attends the radio listener only when he deliberately puts himself in a position to receive it. When not operating a receiving set he experiences no annoyance. Yet he has the legal right to operate his apparatus to the same extent that the person creating the disturbance has to operate the instrumentality which causes the harm. Both are using electrical contrivances for proper purposes, one in a legitimate business enterprise, the other as an artificial extension of natural power to hear.

"The Courts have said that the test is as to whether the noise causes annoyance, inconvenience or discomfort. Does that necessarily mean that the annoyance must come to him in one condition rather than another? The courts may well say that the rule stands as a protection whenever he is in the lawful enjoyment of his property, whether by natural or artificial means.

Neutralization Hinted

"Consistent with the rule that a person may make a reasonable use of his own property, without subjecting himself to damages for injuring the property of others, the courts scrutinize the circumstances under which the adverse parties are operating and endeavor to do complete equity between them. Thus where the interference can be obviated by comparatively inexpensive devices the courts seem to impose their installation. The courts require cooperation between the two adverse parties in order to eliminate injury, on the theory that one must mitigate his damage if he can.

"Certainly, the fair inference is that if the injury can be lessened or prevented by practicable devices, the party creating the disturbance must adopt them, particularly when the injured party cannot prevent or lessen it. The Court will not dictate how the interference shall be prevented or lessened, but will restrain the injurious operation, leaving it to the responsible party to apply such means as it elects to accomplish the required result.

"Radio disturbance is actually an annoyance—a discomfort to persons of average habits and tastes, making an ordinary use of property. That it is new is of no importance. Time and advancement of the social state demand and create progress."
 (Copyright, 1925, by Stevenson Radio Syndicate)

The 4-Tube Roberts Receiver

CIRCUIT DIAGRAM OF THE ROBERTS SET, un-reflexed and using two audio transformers. Regeneration is controlled by a variable resistor connected across the fixed tickler. (Fig. 1).

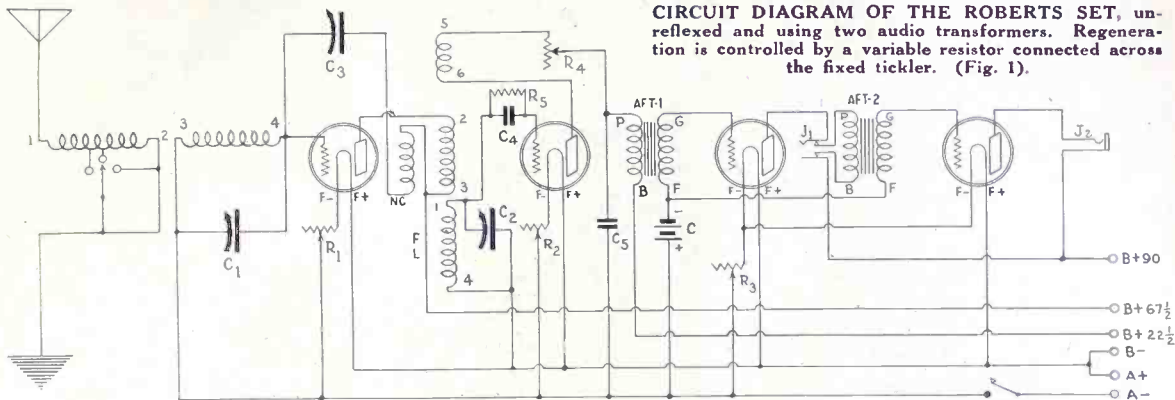

By Neal Fitzalan

ONE stage of tuned RF, followed by a regenerative detector, the RF tube being neutralized, is shown above, this being known as the Roberts set. In the present instance four tubes are used, as the audio circuit consists of two transformer stages. A fixed tickler is used in the detector plate circuit, the regeneration being regulated by a variable resistor. This is one of the forms of obtaining regeneration with fine ease of control. The actual operation of the variable resistor is as shown in the diagram, although the physical connections to the instrument would lead one to believe that the resistor was always across the coil. This is not true, of course, because it is possible to turn the knob until there is zero resistance, hence no connection between the tickler and P of AFT1.

Eliminating a Control

The circuit as shown uses the antenna coupling and interstage inductances of the American Mechanical Laboratories. The condensers that match these coils are .0005 mfd. each, shown as C1 and C2. Normally the set would have three controls—one for tuning the RF stage, one for tuning the detector input, and one for regeneration control. These may be reduced to two either by using a double condenser, two sections of .0005 mfd. each, such as Bruno No. 21, National DX or General Radio, or by employing a mechanical method, whereby one knob turns a gear that moves the rotors of the two condensers. This is known as an S-C unit.

Numerals Explained

The numerals on the coils are the same as those that appear on the commercial product. The variable resistor, made by the same firm, is known as the Clarostat and is incorporated in the coil unit.

The odd RF plate coil connection simply represents the usual primary, followed by an extra few turns wound in the opposite direction. The point at which the reversal of winding takes place is connected to B plus 67½ volts, while the other end of the reversed winding goes to the stator plates of the neutralizing condenser, C3.

C5 is .001 mfd. The rheostat values depend on the type of tubes used. The other constants are standard.

WLS TO BE AT CRETE

WASHINGTON

WLS, Chicago, will increase its power to 5,000 watts within the next few weeks, according to reports. The new 5,000 watt station will be located at Crete, Ill., with land wires connecting it to the Chicago studio.

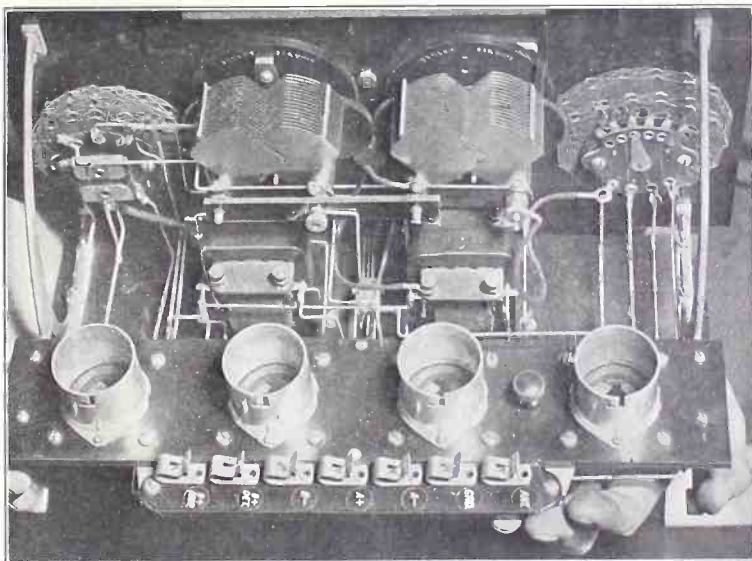

REAR VIEW of the set. Ordinarily there would be three controls—the two tuning condensers and the variable resistor—but these may be reduced to two by using the Hanscom S-C unit, as did the constructor of the above set, Charles Golenpaul. (Kadel & Herbert.)

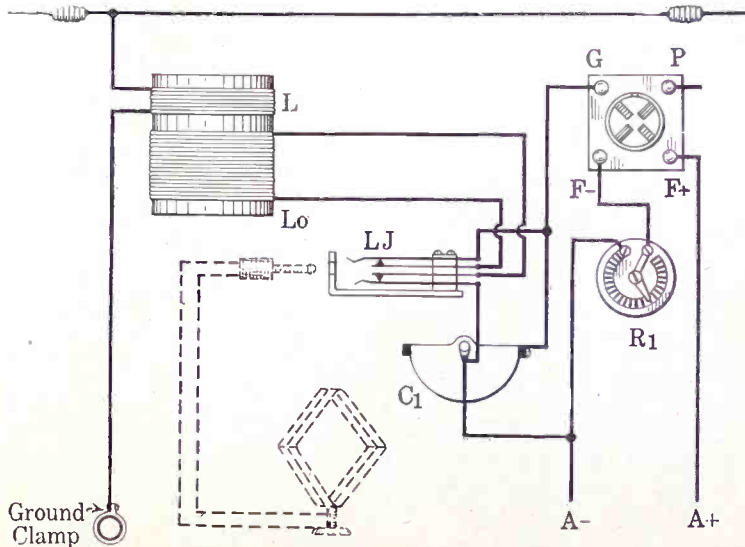

HOW to connect a loop jack. The insertion of the plug opens the circuit connected to Lo (secondary), leaving only the loop tuned by C1.

THE RADIO TRADE

CRESCENT LAVITES POPULAR
Morton W. Stearns, C. E. of Crescent Radio Supply Co., who for twenty years has been active in Radio Research is meeting with great favor with their Crescent Lavite Resistances among set builders and manufacturers, and many of the large broadcasting stations as no special mountings are necessary and very little space is required. These amplifiers can be easily added to any set after the detector.



**CONDENSERS
VERNIERS
RHEOSTATS**

AMSCO PRODUCTS, Inc. New York City

A Laboratory Product



**CRESCENT
LAVITE
RESISTANCES**

for Distortionless Amplification

13,000, 18,000, 50,000, 100,000 Ohms. List \$1.50 each. Special Sizes to Order \$2.50 each. Dealers write for discounts. When Better Resistances are made they will be Crescents. Crescent Radio Supply Co., 9 Liberty St., Jamaica, N. Y.

AMBASSADOR

4-TUBE, \$25.95; 3-TUBE, \$17.95

With tubes, cabinet; 1-tube sets, \$2.95 up. Edzin Radio, 675 6th Ave. Chick. 10385. Open evens., Sundays.

RADIO AGENTS WANTED

5 Tube Demonstrator FREE!

Earn \$25 to \$100 a week, part or full time. Everyone a prospect. Complete line standard sets and accessories, \$5 to \$80. Write today for illustrated catalog and exclusive selling plan for live dealers and community agents. 207th CENTURY RADIO CO., 1101 Coca Cola Bldg., Kansas City, Mo.



THE Antennaphone
REPLACES THE AERIAL
IMPROVES RECEPTION
NO AERIAL
NO LOOP

Gives wonderful results with any radio set. Not attached to, but merely placed under the telephone. Price One Dollar. Complete with insulated wire and simple instructions. At Your Dealer or Mailed C.O.D. on 3 days approval. ANTENNAPHONE CO., 90 West St., New York City



A. I. R. SETS
Are Guaranteed For
Tone-DX-Clarity

- 5 Tube Tuned Radio Frequency..... \$34
- 8 Tube Resistance Amplification..... 50
- 6 Tube Rambler Portable..... 90
- 6 Tube Console..... 125

If your dealer cannot make immediate delivery we will ship direct from factory.

American Interstate Radio Service
183 Greenwich Street, New York City
Distributors, Jobbers, Dealers, write for special trade terms.

S. HAMMER RADIO CO.
303 Atkins Avenue, Brooklyn, N. Y.
Please send me FREE Your NEW
RADIO CATALOG

Name
Address
City State

FILL OUT AND MAIL

SUPERTRON IN NEW HOME

The Supertron Mfg. Co., manufacturers of the guaranteed Supertron tube, are now established in their new factory at 228 Washington Street, Hoboken, N. J., and are running under full production. Henry Bobker, sales manager, predicts one of the greatest radio seasons in history, judging by the demand for Supertron tubes. They are now running the factory night and day. Another extension of factory space, with additional machinery, is being planned to take care of the expansion. Supertron tubes can be had in all types, 1½ volt, 3 volt with small base, 3 volt with large base fit standard sockets, and the regulation 6 volt ¼-amp. tube.
(Tested and Approved by RADIO WORLD Laboratories.)

New Corporations

David Grimes, Wilmington, Del., wireless sets, \$10,000. (Corp. Trust Co. of America, Del.)
Mort-Smith Corp., Paterson, N. J., radio supplies, \$100,000; Mortimer O. Smith, Hawthorne; George A. Jacob, Paterson; Louis J. Wassel, Brooklyn. (Atty., William F. Delaney, Newark, N. J.)
H. & D. Radio Co., Jersey City, N. J., \$50,000; Richard Harris, Louis Demeter, Mary Demeter, Jersey City. (Atty., Ernest B. Biro, Newark, N. J.)

Literature Wanted

THE names of readers of RADIO WORLD who desire literature from radio jobbers and dealers are published in RADIO WORLD on request of the reader. The blank below may be used, or a post card or letter will do instead.
Trade Service Editor,
RADIO WORLD,
145 West 45th St., N. Y. City.

I desire to receive radio literature.

Name

City or Town

State

Are you a dealer?
If not who is your dealer?
His Name

His Address

- Martin T. Clayton, 180 E. Dwight St., Holyoke, Mass.
- E. Cecil Tabor, R.F.D. No. 5, Winchester, Ky.
- J. F. Shaughnessy, 307½ Bissel Ave., Oil City, Pa.
- Forest Neighbors, Sedalia, Mo.
- Walter Moore, 3 Dove Court, Roxbury, Mass.
- R. D. Briggs, St. Louis, Mo.
- G. T. Finch, 110 Dorchester St., South Boston, Mass.
- James Michael, Box 107, Canonsburg, Pa.
- J. D. Nichols, 24 Anable St., E. I. City, N. Y.
- E. C. Slicer, 5637 S. Loomis St., Chicago, Ill. (Dealer.)
- R. J. Brooks, Cadiz, O. (Dealer.)
- Peter J. Pierce, Box 521, Hartford, Wis.
- M. W. Purcell, 2325 Ingersoll St., Des Moines, Ia. (Dealer.)
- F. W. Durn, Holland, Mich. (Dealer.)
- A. Herbert, 54½ Richmond St., Newark, N. J.
- J. N. Fennelly, 35 N. Burnett St., East Orange, N. J.
- L. A. Patrick, Box 153, Torrance, Pa.
- Lawrence Lamb, Mount Vernon, Liverpool, England. (Importer.)
- Robert Steidley, Lewistown, Pa. Agent.)
- Wallace E. Rushing, Millhaven, Ga. (Dealer.)
- R. T. Bragg, 2120 Emmet St., Omaha, Neb.

DEALERS

Write us for the name of the jobber who will sell you

Double Toroid Coils
NO-NOISE VARIABLE GRID LEAK
RADIO FOUNDATION, INC.

25 W. Broadway New York, N. Y.

"Bruno" Magic Dial



Makes any semi-circular plate condenser tune like the straight-line frequency type. No gears, no backlash.

\$250

BRUNO RADIO CORPORATION
Dept. W103 221 Fulton St. New York City
Inquiries Solicited from the Trade

Steinite LOW LOSS Interference Eliminator

No Radio Set Complete Without It
Now you can select stations at will, cut out interference and undesired stations—tune in loud and clear. Wonderful results with any tube or crystal set using any kind of aerial except loop antenna. Partially absorbs static.
\$1 Amazing Results, Better Reception Guaranteed or We Refund Your Post-Dollar. Send paid. Order Today

Select Stations At Will

Try this Interference Eliminator on your set—no tools—nothing to add—attached in 2 minutes to aerial. Doesn't disturb present log. Directions easy to follow. Two big banks testify to our reliability. Order today—dollar bill will do—we take the risk—money back if you say so.
STEINITE LABORATORIES
144 Radio Building, ATCHISON, KANSAS
Write for complete Steinite Radio literature—it's FREE. Most beautiful and least expensive radio sets in America.

Old boy
KESTER
Rosin Core
Radio SOLDER
Sure! is Safe and Simple
APPROVED BY
RADIO ENGINEERS
A GENUINE SOLDER
CHICAGO SOLDER COMPANY
4242 Wrigwood Ave., Chicago, U.S.A.
Originators and World's Largest Manufacturers of Self Fluxing Solder
YOUR DEALER CAN SUPPLY YOU

Two of the best sets yet designed!

Herman Bernard's
Diamond of the Air



LIST OF PARTS

One Bruno No. 55 R.F. Transformer, L0L1.
One Bruno No. 99 3-circuit tuner, L2L3L4.
Two Bruno 20-ohm rheostats, R1, R2.
Two General Instrument low loss pyrex condensers, C1, C3.
One Bretwood variable grid leak, R0.
Two double-circuit jacks, J1, J2.
One single-circuit jack, J3.
One Federal No. 65 AFT.
One 3/4 ampere ballast resistor, R5.
Fixed condensers: One .00025 mfd. grid condenser, without clips, C2; one .001 mfd., C4; three 0.25 mfd., C5, C6, C7.
One double-throw, double-pole switch, S1.
One A battery switch, S2.
Two Vebly leaks, R4, 1.0 meg.; R6, 0.5 meg.
Three 1/2 meg. Vebly resistors, R3, R5, R7.
One Bruno 5-gang socket shelf.
Five sockets.
One pair of Bruno brackets.
Three vernier dials.
One 7" x 24" drilled and engraved panel.
One set of binding posts.

\$37.50

with Bruno
Condensers **\$39.50**

NEVER BEFORE
AT THIS PRICE!



The B.C.L. Special
Metal Vernier Dial

with a ratio of 20-1.
Only 5 to a customer.

59c

Capt. Peter V. O'Rourke's
Dry Cell Set



REAR VIEW OF O'Rourke's 3-tube set.

LIST OF PARTS

One fixed antenna coupler, L1L2.
Two .00035 mfd. Streamline SLF condensers, C1, C2.
One Bretwood variable grid leak, R2.
One .00025 mfd. fixed grid condenser, C3.
One anti-capacity switch, S2.
One A battery switch, S1.
One 10 or 15-ohm rheostat, R1.
One .25 mfd. Aerovca fixed condenser; C4.
One .5 meg. Vebly grid leak, R3.
One socket shell, 1 1/2" x 2".
One pair of brackets.
Three 39 sockets.
Two Preferred vernier dials.
One single-circuit jack, J.
One 7" x 18" panel.
Two audio-frequency transformers, AF1, AF2.
One battery cable.

\$18.50



"Bruno 99" 3-circuit tuner wound on quartzite glass and specified in the Diamond of the Air.....\$5.50



"Bruno 55" matched Radio frequency coil for 99 and used in the Diamond of the Air.....\$3.00

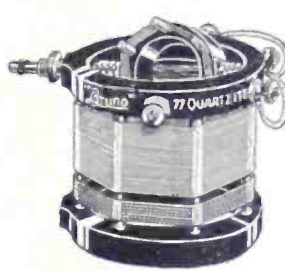

"Bruno 77" 3-circuit tuner wound on quartzite glass with special tickler for smooth regeneration control.....\$5.50



"Bruno" short wave coil. Tunes from 25-110 meters with .00025 condenser. Wound with flat ribbon wire.....\$5.50

Bruno 3 Section Condenser for Sidney E. Finkelstein's 3 in 1 receiver—\$6.95

Complete Kits for Hookups Shown in this Issue

Bernard's 1-Tube DX Set, Using SLF Condensers, Complete Kit **\$7.75**

Winner's 1-Tube Variometer Set, Complete Kit **\$7.75**

2-Tube Inverse Duplex, Complete Kit **\$14.95**

RX-1, Using Bruno Coils and Streamline SLF .00035 Condensers, Complete Kit **\$22.85**

Rofpatkin's Reflex, with Carborundum Crystal Detector and SLF Condensers **\$10.25**

Thordarson-Wade, Complete Kit **\$41.50**

Winner's Phonograph Receiver, Complete Kit **\$40.50**

8-Tube Pressley (Coils and Interfrequency Transformers) **\$22.50**

General Instrument Condensers, all capacities, Pyrex or iso-lantite in original cartons, fully guaranteed. **\$2.95**

BRETWOOD GRID LEAKS IN STOCK **\$1.50**

Bruno Brackets for the Diamond of the Air or other sets. Make a neat job facilitating the wiring, per pair. **\$1.00**

Write for Free Catalogue

B-C-L RADIO SERVICE COMPANY

223 FULTON STREET, N. Y. CITY

Standards Bureau Advises Ways to Cut "Human Static"

WASHINGTON.

Cooperative effort on the part of radio fans and the owners of electrical sources of disturbance is the most effective remedy for man-made interference, according to the Radio Laboratory of the U. S. Bureau of Standards.

"Much of the work in mitigation of electrical interference results in an improvement in the operation of the electrical devices or supply lines and is thus a double gain," the Standards Radio Laboratory asserts. "There are, however, some electrical devices which, even when in perfect working order cause disturbances which result in interference with radio reception. In many cases it is possible to provide filters, shields, chokes, etc., either at the source of disturbance or at the receiving set, which do much to relieve the difficulties.

Some of it Inevitable

"Part of the disturbance from electrical devices is practically inevitable and must be regarded, like atmospheric disturbances, as part of the inherent limitation of radio reception. In other words, the limitation of radio reception is not only the distance and the power of the transmitting stations and the sensitiveness of the receiving set, but also the omnipresent background of slight electrical disturbances which drown out signals below a certain intensity. This background of electrical disturbances is the underlying reason why reception from local stations is inherently superior to reception from distant stations."

Here are a few suggestions offered by the Bureau of Standards Radio Laboratory towards decreasing interference:

"The first thing to do in tracing the source of trouble, is to make sure that it is not in the receiving set itself. The next thing is to open the electrical switch at the house meter; if the interfering noise is still heard, the source is then known to be outside the house. It is then desirable to report the situation to the electrical power company. Many of the companies have apparatus for the purpose of following up complaints of this kind.

Usually a sensitive receiving set with a coil antenna is used to determine the direction from which the interfering noise comes, and this outfit is taken from place to place until the source is found.

Hard to Locate

"The location of such sources is often a very difficult and baffling undertaking. The trouble sometimes comes from a spark discharge over an insulator to

(Continued on page 27)

A far better Inductance for any Circuit

AERO COIL

Low Loss Inductance

AERO PRODUCTS, INC. CHICAGO
1772 WILSON AVENUE.

HOOK-UPS!—A lot of them, some of which are sure to suit your purpose, appeared in RADIO WORLD dated August 15. 15c a copy, or start your subscription with that number. RADIO WORLD, 145 West 45th St., N. Y. City.

COMPLETE LIST OF BROADCASTING STATIONS appeared in RADIO WORLD dated Oct. 3, 1925. 15c per copy, or start your subscription with that number. RADIO WORLD, 145 W. 45th St., N. Y. C.

CLAROTUNER

BERNARD of Radio World specifies Clarotuner. So does Hayden and a host of other experts. They all recommend Clarotuner because no other tuner has such perfect control over regeneration, such freedom from interference. Model 2RK (two units) consists of a tuner and a coupler that mounts with one hole and eliminates separate switches **\$7.50**

AMERICAN MECHANICAL LABORATORIES, Inc.
285-7 N. Sixth Street, Brooklyn, N. Y.



Ask about the Clarostat, heart of the Clarotuner.

If your dealer cannot supply you, write to American Mechanical Labs., 285-7 N. Sixth St., Brooklyn, N. Y.

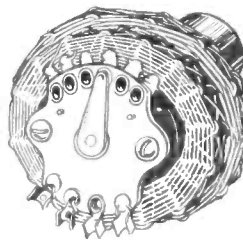

KESTER Radio SOLDER
(Rosin-Core)

If your dealer cannot supply you send us 25c in postage -

CHICAGO SOLDER COMPANY
CHICAGO, U. S. A.

22½ volt un-acid everlasting rechargeable "B" Storage Battery

\$2.95

Includes chemical



45 volts, \$5.25; 90 volts, \$10.00; 112½ volts, \$12.50; 135 volts, \$14.75; 157½ volts, \$18.50. Truly, the biggest buy today. Easily charged on any current, including 32-volt systems. Any special detector plate voltage had. Tested and approved by leading authorities such as Popular Radio Laboratories. Over 3 years sold on a non-red tape, 30-day trial offer with complete refund if not thoroughly satisfied. Further guaranteed 2 years. Knock-down kits at great savings. Complete "Hawley" "B" battery charger, \$2.75. Sample cell, 35c. Order direct—send no money—simply pay the expressman cost on delivery. Or write for my free literature, testimonials and guarantee. Same day shipments. E. Hawley Smith, 318 Washington Ave., Danbury, Conn.

THE TUBE WITH A SENSIBLE GUARANTEE **REG. U.S. PAT. OFF. SUPERTRON A GOOD TUBE**



Made with Precision!

Right from the start at our factory each SUPERTRON is produced with PRECISION as the dominating factor. The material each possesses, the triple test, and the final inspection, are all guided by the most exacting PRECISION. The unit of PRECISION called SUPERTRON is serial numbered and wrapped in a certificate bearing a corresponding number.

Thus giving you a means of identification to assure full satisfaction.

Precision Made for Your Satisfaction
Serial Numbered for Your Protection

SUPERTRON MFG. CO., Inc.
HOBOKEN, NEW JERSEY
Export Department, 220 Broadway, N. Y. City

BRANCH OFFICES IN PRINCIPAL CITIES THRUOUT THE UNITED STATES

SUPERTRON

A SERIAL NUMBER GUARANTEE

ALL TYPES

\$2.00

Canada, \$2.75



The 4-Tube Erla Pathfinder

After you have completed the wiring of this set the most important event takes place and that is the testing of the set. After tinkering around with the tools you will certainly want to know how the set really works, and will want to make it work as well as the laboratory would.

Before connecting up any batteries, antenna, ground or phones, it is a good policy to test all the parts individually for complete circuits, even though you should have done this before you started to build the set. During the wiring you might have accidentally shorted an instrument or made an open circuit on one of the instruments. The testing is done with a small dry cell and a pair of phones. After you have tested all the parts and found them to be in perfect shape, attach the A battery. Pull the switch out. If the tubes light, attach the B battery, at the same time turning off the A battery switch. If possible, put in a paralyzed tube which still has a good filament. If the tube does not blow out, when placed in the various sockets, then it is safe to put the good tubes in. This

is one place where a poor tube plays an important part. Finding the A and B battery circuits O.K., attach the antenna and the ground to their respective posts. Now plug in the phones, not the loud speaker. If you hear a distinct click, which is accompanied by some rushing noise, then you may be certain that you will hear music, and you can prepare to call in your friends to listen to the set. Tune both the variable condensers in step.

Frequency Calculation

(Concluded from page 8.)

two stations is 130 kilocycles and the difference between the corresponding readings is 13 divisions. Hence each division on the dial represents 10 kilocycles. The difference between the two readings for the 610 kilocycle station is 10 divisions, and this represents a frequency difference of 100 kilocycles. But this is twice the value of the intermediate frequency, which is, therefore, equal to 50 kilocycles. The same result is obtained from the two readings for the 740 kilocycle station.

This method of determining the intermediate frequency may be used for the purpose of matching the transformers in the intermediate frequency filter. It is possible to measure the natural frequency of each coil separately by means of this method. Thus out of a large number available those coils which have very nearly the same frequency can be selected for a super-heterodyne kit. Or if the transformers are made at home, the method may be used for adjusting all to match some coil used for a standard, say the first one made. The adjusting may either be made by varying the number of turns or by varying the capacity across the secondary winding.

FLINT AUDIO Transformers \$3.50

Ask Your Dealer or Order Direct.

FLINT RADIO CO.
1826 Wilson Ave., Chicago



LOUD SPEAKER RECEPTION

from either coast on three tubes.

Blueprint and instructions.....\$1.00
Necessary low loss coil.....\$2.50
Beautiful finished instrument.....\$35.00

S. A. TWITCHELL CO.

1930 Western Avenue Minneapolis, Minn.

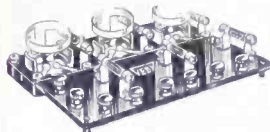

The New VEBY AMPLIFIER

A Resistance Coupled Amplifier that will truly fit within the cabinet of any commercial receiver. Just seven inches long and five inches deep. It is fully assembled and ready to attach. The price is.....\$12.00

VEBY Hi Mu Tubes A. F. 2 for R. C. Amplifiers.....\$3.00
VEBY Power Tubes A. F. 6 for the last stage.....\$4.50



47-51 MORRIS AVENUE. NEWARK, N. J.

NEW IMPROVED

FRESHMAN MASTERPIECE

AT AUTHORIZED FRESHMAN DEALERS ONLY

LESTRON

THE REAL 110 VOLT TUBE

Works Without Batteries FOR A. C. or D. C. NO REWIRING
LESTEIN CORPORATION
2 BROADWAY N. Y. CITY

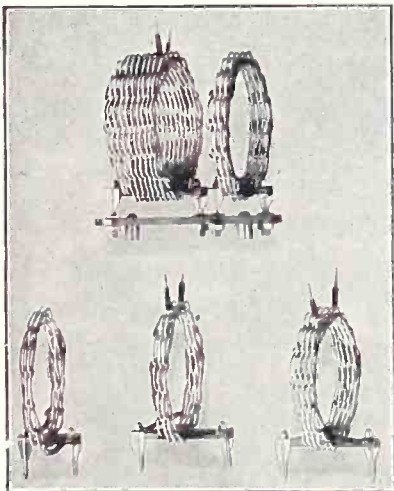

LOW REL LOSS LOW WAVE COILS

Build with "REL" Basket Weave Coils for efficiency—For any Low Loss Low Wave circuit—Wound with chocolate color, triple cotton-covered paraffined wire—Fire interchangeable units with each outfit—Tunes from 10 to 110 meter range efficiently—New models equipped with plug-in mountings—Inexpensive—Rugged.

Price \$4.50 including mounting—at your dealers or order direct.
Send for Coil Chart which tells you how to use "REL" coils in any circuit—Up to 1000 meters—It is free.

Radio Engineering Laboratories
27 Thames Street New York, N. Y.
"THE LOW LOSS COIL PIONEERS"

5 Tube Radio Set



\$29.50



The Biggest 5 Tube Value on the Market

Positively the world's greatest 5 TUBE SET 5-tube radio bargain. Regular \$75.00 value, fully built and wired in beautiful mahogany cabinet of latest design, sloping Bakelite panel, Satin finish, handsomely etched and engraved. Constructed of the finest low-loss condensers, coils and sockets. Bakelite baseboard panel and dials. \$29.50 for set only. Transportation charges extra, shipping weight 25 lbs. This set with all accessories, including the famous American Bell loud speaker with adjustable unit, 2-45 volt "B" batteries, one guaranteed 100 Ampere Hour, storage "A" battery, cable for battery connection, 5-201A tubes, aerial and ground equipment, and everything complete ready to set up and operate. Nothing else to buy. Price \$59.75. Transportation charges extra. Shipping weight 100 lbs.

Send For This Radio Book FREE

Contains thousands of bargains in radio sets, semi-finished sets and radio kits of all styles, sizes and approved circuits. Beautiful models of latest designs and types. Elaborate console models with loud speakers built right in cabinets of genuine mahogany and walnut. All sets guaranteed. Coast to coast receiving range. Also contains everything in radio supplies: including batteries, chargers, loud speakers, transformers, condensers, rheostats and any other parts you may want for improving your set or building a new one. Guaranteed saving to you of 1-3 to 1-2. We are the world's largest exclusive radio mail order house.

RANDOLPH RADIO CORPORATION
159 North Union Ave., Dept. 113 CHICAGO



1926 Catalog Containing 64 Illustrated Pages of Radio Bargains Write for it Today



EUREKA DIAL POINTER

10c EACH—NICKEL FINISH

DEALER'S DISPLAY CARD, \$3.25 NET

Obtain at your dealer's or sample mailed upon receipt of stamps.

C. W. BUTTS, INC., 42 Hedden Place, East Orange, N. J.

WGY Tests Transmission on Horizontal and Vertical Waves

Tests to establish the value of horizontal radiation on broadcast wavelengths were made from the radio developmental laboratory of the General Electric Company, near Schenectady, on two succeeding nights recently. C. J. Young, of the radio engineering department, was in charge.

Both tests were conducted on super-power, 50 kilowatts, through WGY, using the normal wavelength, 379.5 meters. The

listener had an opportunity to compare reception on both horizontal and vertical radiation on each night. The schedule provided for a half hour period of broadcast entertainment on the horizontal antenna and from 12:45 to 1:15 on the vertical antenna, regularly used for super-power transmission. A period of fifteen minutes was required to change connections from one antenna system to the other.

Nearly All SW Work

There has been considerable speculation as to the advantages of horizontal transmission. Practically all experimental work with horizontal waves has been carried on with the very high frequencies and much valuable data have been collected. Reports on short wavelength demonstrations were necessarily few because of the comparatively small number of short-wave sets in use. It is also pointed out that results on higher wavelengths may be directly opposed to the observations made on wavelengths from 50 to 150 meters.

Instituting these tests, Mr. Young requested that all radio listeners report on the quality, volume, comparative signal strength and the fading characteristics of both forms of transmission. Work in transmission development necessarily depends upon the co-operation of all those who are interested in improved broadcast transmission. Receiver development can be carried on in the laboratory but transmitter work makes the entire country a laboratory and every listener an experimenter. The reports received will be digested and expertly analyzed and it is hoped by this procedure to collect a vast fund of information which must ultimately advance the art of broadcasting.

A New Development

Sending out radio power which vibrates parallel to the earth's surface is a comparatively new development. In earlier days it was assumed that an antenna which lay parallel to the earth's surface would neither transmit nor receive signals, and that is largely true of the long wavelengths which were used before broadcasting.

However recent experiments made by E. F. W. Alexanderson, consulting engineer of the General Electric Company, and by others, have shown that short waves horizontal radiation may be more

effective than the vertical radiation obtained from the usual upright type of antenna.

Alexanderson's Theory

Mr. Alexanderson's work showed that the short, horizontally polarized waves do not follow the surface of the earth like the low waves but are launched into space as though fired by a high angle gun and that they travel in a curved trajectory through the upper atmosphere. It is Mr. Alexanderson's theory that the wave on returning to earth is vertically polarized.

GEM TUBE

A Guaranteed Radio Tube Within Reach of All

Every tube guaranteed. A tube for a dollar at \$2 value. A trial order will convince you. It has thousands of others. Send your orders at once.

Orders sent C.O.D. parcel post.

Type . 199A
Type . 199
Type . 200
Type . 201A

\$1.00 EACH
(with standard base)
Dealers. Write for Discounts

GEM TUBE CO.

Dept. W. 200 B'way, N. Y. C.
220 So. State St., Chicago, Ill.
Lafayette Bldg., Detroit, Mich.



THOUSANDS OF BARGAINS

FACTORY GUARANTEED MOSE, BY MAIL

Genuine New Radiotron or Cunningham Tubes

UV-199-200-201A-WD-11-12 **\$1.98**

C299-300-301A-C11-12

Fresh Burgess or Eveready "B" Batteries

22 1/2 Volt large size \$1.30-15 Volt large size \$2.80

Write for Free New Complete Catalog on Sets and Parts

STONE ELECTRIC CO., 714 Pine St., St. Louis, Mo. Dept. W.

All Aids. F.O.B. St. Louis, Mo.

WAAGE "B" ELIMINATOR

solves the "B" Battery problem. Use 201-A Type tube; old tube that lights will do—A.C. (Without Tube) 201-A Type \$26.00 For New U. X. Tube \$38.00

A. H. WAAGE
8 Reade Street, New York
Guarantee money back if not satisfactory.



Make Soldering a Pleasure

USE THE Newest in Radio Radio Soldering Fluid

Makes the Amateur a Professional. No scraping. Solders any metal. No corroding. Just apply Fluid with any solder. Recommended by leading Mfrs. 25c per bottle; 30c mailed.

Imperial Soldering Fluid Co.
81 Cortlandt Street New York



RADIO STUDY AT HOME

Radio, the wonder of all ages, has grown with gigantic strides. Radio experts are needed to keep pace with its growth. Thousands of you, having positions are open to you. Earn money—traveling—into the home. Thousands of you, having positions are open to you. Earn money—traveling—into the home. Thousands of you, having positions are open to you. Earn money—traveling—into the home.

YOU EARN WHILE YOU LEARN

Our home-study course in practical radio can be mastered by you in 3 months. Become a radio engineer. Write for free booklet, "Millions Unemployed." **FREE TRIP** if you enroll now. Send letter or postal to **RADIO STUDY AT HOME** Dept. W. 200 B'way, N. Y. C.

AMERICAN RADIO ENGINEERS
Dept. 23 Herald Bldg., Chicago, U. S. A.

MOUNTFORD

FITS ANY MOUNTING **50¢**

PLUNGER TYPE VARIABLE GRID LEAK

Perfect graduation obtains all fractions of a megohm from 1/4 to 20 inclusive. Increases selectivity and sensitivity. Unaffected by heat or cold and when properly adjusted is guaranteed to maintain accuracy of range and consistency of resistance. An asset to any set. At your dealers or sent post-paid upon receipt of price. Satisfaction guaranteed or money refunded.

C. E. Mountford
468-67 Greenwich St.
New York City



Save 20 to 50% FREE RADIO CATALOG

LATEST IN HOOK-UPS AND RADIO

Get the lowest rock-bottom prices on radio parts, sets, kits. New free Radio Catalog and Guide by mail of standard, reliable, guaranteed goods. Over 100 latest hook-ups and illustrations. Be sure to get this thrifty book before you buy. It puts money in your pocket. Saves you as much as half on a set. Also please include name of radio fan. Send letter or postal NOW.

THE BARAWIK COMPANY
10-10 S. Canal St., Chicago, U. S. A.

OUR NEW CATALOGUE

Just completed—listing hundreds of BARGAINS, will be mailed to you upon receipt of name and address.

GET YOUR NAME ON OUR MAILING LIST

SIMPLEX RADIO SUPPLY CO.
1806 LAFAYETTE AVE. DEPT. D ST. LOUIS, MO.



PANELS

THORDARSON-WADE-BERNARD
1 TUBE-DIAMOND OF THE AIR,
1925-1926 MODELS
O'ROURKE'S 3 TUBE DRY CELL
PRESSLEY, ETC.

CUT, DRILLED ENGRAVED

CORTLANDT PANEL ENGRAVING CO.

79 Cortlandt Street New York City

RADIO WORLD'S QUICK-ACTION CLASSIFIED ADS.

10 CENTS A WORD. 10 WORDS MINIMUM.

GET A NICE RADIO TABLE for Xmas for \$6.00. From this advertisement, or send stamp for circular. Purcell Radio Dept., 2325 Ingersoll, Des Moines, Iowa.

PULLMAN CONDUCTORS, PORTERS. Men wishing such positions can easily qualify, information free. Supt. 123C, Railway Exchange, Kansas City.

LISTEN in every Friday at 7 P. M. and hear Herman Bernard, managing editor of RADIO WORLD, discuss "Your Radio Problem," from WGBS, Gimbel Bros., New York City, 315.6 meters.

RECENT BACK NUMBERS of RADIO WORLD, 15c each. RADIO WORLD, 145 West 45th Street, New York City.

HOOK-UPS!—A lot of them, some of which are sure to suit your purpose, appeared in RADIO WORLD dated Aug. 15. 15c a copy, or start your subscription with that number. RADIO WORLD, 145 West 45th St., N. Y. C.

HOW TO BECOME AN AMATEUR OPERATOR—A comprehensive, illustrated article appeared in issue of June 27, 1925. 15c per copy, or start your subscription with this number. RADIO WORLD, 145 West 45th St., N. Y. C.

HAVE YOU ANYTHING TO SELL OR EXCHANGE? Use RADIO WORLD'S Classified Department and get great results. 10c a word. RADIO WORLD, 145 West 45th St., N. Y.

HOW TO BUILD THE POWERTONE, 1 dial, 5 tubes, described in RADIO WORLD, issues of Aug. 29 and Sept. 5. Powertone Trouble-shooting, Sept. 12. Send 45c for all three. Special diagrams and "blueprint in black" included among the many illustrations. RADIO WORLD, 145 West 45th St., N. Y. C.

"LIBERTY AFLAME" and other patriotic verses. By Roland Burke Hennessy in cloth, \$1.00. Columbia Print, 145 West 45th St., N. Y. C.

(Continued from page 24)

ground, or between a pair of wires, or it may be that the wire is touching some object such as a tree, pole, guy wire, etc. Such a spark discharge is a loss of power to the operating company and a potential source of serious trouble and for these reasons the company is probably more interested in finding and eliminating this type of trouble than the radio listener. Large leaks and sparks may often be observed at night, especially in hot

weather. However, sparks which are too small to be readily noticed, may cause serious interference to radio reception.

"A frequent cause of interference is power line inducted which is due to the presence of power wires near the antenna or receiving set. A humming sound in the telephone receivers will usually identify this source of interference. A method of eliminating, or at least reducing the magnitude of this interference, is to place the antenna as far as possible from the wire lines and at right angles to them.

"Sparks are produced in the normal operation of many types electrical apparatus (such as motors, doorbells, buzzers, gasoline engines, X-ray apparatus, violet-ray machines, some forms of battery chargers, rural telephone ringers, heating pad thermostats). Sparks are also sometimes produced at defective insulators, transformers, etc., of electric wire lines. Sparks usually give rise to electric waves which travel along the electric power wires and by them are radiated out and are then picked up by radio receiving sets. The noise thus produced in a radio set may come from a disturbance which has traveled several miles along the electric power wires.

"One remedy for such types of interference is to eliminate the spark. This is possible if the spark is an electrical leak and not necessary to the operation of the machine in which it occurs. Many very useful electrical machines, however, require, for their operation, the making and breaking of electrical circuits while they are carrying current and whenever this happens a spark is produced. It is impossible to eliminate these machines so that it is necessary to make the spark of such nature or so arrange the circuits that the radio-frequency current is reduced or prevented from radiating.

"To prevent the radio-frequency current produced by a spark from getting on to the lines connecting the sparking apparatus, some form of filter circuit is necessary. A condenser (1 microfarad, more or less) connected across the sparking points will short circuit a considerable amount of the radio-frequency current, or, a condenser connected from each side of the line to ground will serve the same purpose. A choke coil in each side of the line in addition to the condensers connected to ground forms a simple filter circuit which should prevent frequencies

in the broadcast range from getting on the line. A high inductance (choke cell) or high resistance connected in each side of the line changes the characteristics of the circuit so as to reduce the amount of power radiated."

FREE BOOKLET FOR INVENTORS

IF YOUR INVENTION is new and useful it is patentable. Send me your sketch.

Z. H. POLACHEK, 70 West St., New York

Reg. Patent Attorney-Engineer

THE NUNEY BACK STORE OF CORTLAND ST.

CITY RADIO

79 CORTLAND ST.

PHONE BR 6700

Dept. RW, New York City, N. Y.

Immediate service on Mail Orders. Orders shipped same day received. Every purchase guaranteed by the oldest radio store in New York.

Thordarson-Wade **\$42.50**
Kit,
Endorsed by Herman Bernard

- Daven Super Amplifier Kits (new).....\$11.45
 - Exide Sto. Bat., 100 amp., rubber case \$12.95
 - Sterling 100 rubber case, 2-yr. guar. 10.25
 - Freshman Eliminators—D.C., \$17.50
 - Freshman Eliminators—A.C., 20.00
 - Clarostat 1.70
 - Freshman Kit, Regular \$17.50..... 8.95
 - Complete Bremer Tully Kit, including Drilled and Engraved Bakelite Panel 39.50
 - Amperites 3.79
 - Erla Balloon Coils, set of three..... 8.95
 - Erla Kits, complete coils and condensers 16.50
 - Amsco Cond., str. line fre., .0005..... 3.95
 - Morrison Units adj. 3.25
 - Sterling double reading meter, 0-3 and 0-120 2.75
 - Magnavox Horn M4 12.25
 - Federal Trans. 65 and 65A 3.15
 - Bremer-Tully Nameless Kit..... 16.95
- Send name and address for our latest Radio Catalogue and radio map of the world.

ULTRA-VERNIER TUNING CONTROL

A VERNIER DIAL ON WHICH YOU CAN PENCIL RECORD THE STATIONS. GEARED 20 TO 1. SILVER FINISH \$2.50—GOLD FINISH \$3.50

PHENIX RADIO CORP., 116-F East 25 St., N.Y.C.

Depend on ROSSITER

& COMPANY INC.

136 Liberty Street, N.Y.

Sangamo Condensers
for accuracy that endures. Heat proof, moisture proof, fume proof.

Vitalitone Speakers
for tones that are true. All musical notes reproduced faithfully.

Doubletroid Coils
for efficiency in radio frequency construction. No external magnetic field.

LABORATORY TESTED RADIO Products

Passed by the Engineering Laboratory of Rossiter, Tyler & McDonell, Inc.

A RADIO CABINET OF BEAUTY AND ELEGANCE DIRECT TO YOU AT LOWEST COST

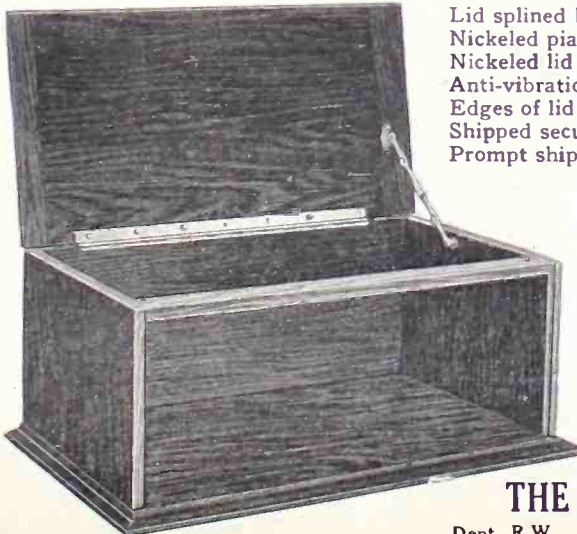

- Lid splined both ends to prevent warping.
- Nickel piano hinge.
- Nickel lid support of artistic design.
- Anti-vibration cushion feet (not visible in cut).
- Edges of lid moulded to match bottom.
- Shipped securely packed in strong carton.
- Prompt shipment.

	Hardwood, Rubbed Mahogany Finish	Solid Black American Walnut
7 x 18 x 7 1/2 or 10 in. deep.....	\$3.50	\$5.00
7 x 24 x 7 1/2 or 10 in. deep.....	4.00	5.50
7 x 26 x 7 1/2 or 10 in. deep.....	4.75	6.25
7 x 28 x 7 1/2 or 10 in. deep.....	5.50	7.00
7 x 30 x 7 1/2 or 10 in. deep.....	6.00	8.00
7 x 21 x 10 in. deep.....	3.75	5.25

CASH WITH ORDER or C. O. D. if 1/4 of price is sent with order.
Prices F. O. B. Hickory, N. C.
Order express shipment, often cheaper than mail and much safer from damage.
FREE WITH EACH CABINET a glued-up stock non-warping 1/4-inch BASEBOARD.

THE SOUTHERN TOY COMPANY, INC.

Dept. R.W.

HICKORY, NORTH CAROLINA

(Continued from page 19)
 down A or B battery. If you are using a batch of batteries, there might be a run-down battery among them. There might also be a broken cell in one of the B batteries. * * *

I HAVE a Neutrodyne set and would like to find out the number of turns to



FOR "FANS"

OUR new 64-page Radio Catalog including all the best and latest Kits, Parts and Accessories for broadcast receiving sets. Lowest prices in the country.

More than 1,000,000 fans and hams make our store their headquarters—get these books and find out why.

Write for either or both

FOR "HAMS"

NEW 32-page booklet of Army and navy transmitting apparatus and miscellaneous specialties for "hams" such as W. P. Choke Colls, Generators, Resistance Boxes, etc.

509 South State Street



Dept. R. W. 8 Chicago Ill.



Resistance Coupled Amplification?

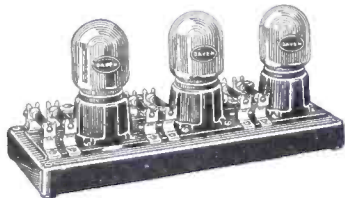

BECAUSE this method of amplification is the only way to procure quality of tone without the slightest distortion. The Daven Super-Amplifier can be conveniently put into any existing set. Use it also in the new set you are going to build.

To increase volume 50% and have no distortion use Daven High Mu Tubes in Resistance Coupled Amplifiers. Prices—High Mu-20, \$4.00. Mu-6 (for last or output stage), \$5.00.

Mail the coupon for complete information.

The Star of World

DAVEN RADIO CORPORATION
 Resistor Specialists

Newark

New Jersey



DAVEN RADIO CORPORATION R-11-25.
 128 Summit Street, Newark, N. J.
 Please send me the following:
 ...Resistor Manual. 50c is enclosed.
 ...Complete Catalogue (free).

Name _____
 Address _____

Get the Handbook of Resistance Coupled Amplification, 48 Pages, 25c. By mail 30c.

FOR DEALERS: Send your letter-head and we will have our nearest distributor communicate with you.

THE BIG LITTLE THINGS OF RADIO

place on a form 2 3/4" in diameter, using No. 24 double cotton covered wire. The secondaries will be shunted by .000375 mfd. variable condensers.—George D. Sullivan, 803 West 180th St., N. Y. City.
 The primaries contain 15 turns. The secondaries contain 60 turns. The tap on the first and the second secondary of the RFT is brought from the 15th turn from the beginning of the coil. In other words, the tap number of turns is equal to the primary number of turns. The primaries are the same on all three coils.

IN LOOKING over the RX1 radio receiver, described in the Oct. 17 issue of RADIO WORLD I find all the parts to build this set, but am in doubt about the condensers. (1) Can any type be utilized? I ask this because I have a pair. (2) What is the capacity? (3) What type of tubes should be used in the various stages?

(1) Yes, any type. (2) The capacity of these condensers are .0005 mfd. (3) 201A throughout are efficient. Magnavox for AF and detector were used by the author.

WOULD LIKE to ask a few questions regarding the Thordarson-Wade Set as described by Herman Bernard, in the Oct. 3 issue of RADIO WORLD. (1) Would a coil and variable condenser inserted in the plate circuit of the detector tube be any advantage? (2) Would tapped primary of the first coil improve the reception of higher wavelength stations, thereby raising the normal aerial wavelength? (3) Mr. Bernard suggested improvement by using Hi-Mu tubes in the 1st and 2nd audio stages; is the Hi-Mu 20 correct? (4) Is there any change of wiring or parts to be made?—L. D. Phillips, 323 North State Street, Dover, Delaware.

(1) No. (2) Not enough to warrant inclusion. The set regenerates even beyond 600 meters. (3) Yes. (4) No.

I AM contemplating building the 4-tube DX receiver which appeared in the October issue of "Radio Review," the one republished from the Aug. 1, issue of RADIO WORLD. I would appreciate it very much if you would tell me if I could use the 199

tube instead of the 201A type such as used by Herbert E. Hayden. (2) Will the volume of the set depreciate very much? —Harry G. Sashks, 4712 Behrwald Ave., Cleveland, O.

You could use these tubes successfully. The volume may be a little less, but only



NO BACKLASH

The Best Dial for the Finest Tuning

Equip your set with Fynur Vernier Controls.

They operate by traction (no gears) so there isn't the slightest backlash or lost motion. It's a new dial—beautifully and perfectly made, and so simple in construction that a child can take it apart and reassemble it. The dual control, moreover, permits of a quick, general setting as well as the infinitely fine vernier adjustment.

The Fynur is a quality dial for those who want the very best. Ask to see one at your dealer's, or write to us.

Price \$3.50

August Goertz & Co., Inc.
 270-286 Morris Ave., Newark, N. J.

FYNUR VERNIER CONTROL

You Save 50%
 Approved! Listed as Standard by Leading Authorities including Radio News Laboratories, Popular Science, Institute of Standards, Popular Radio Laboratories, Radio Broadcast Laboratories, Radio in the Home and La. Inc.



World Radio Batteries are famous for their guaranteed quality and service. Backed by years of successful manufacture and thousands of satisfied users, acid and leakage. You save 50 per cent.
Radio Station WSBC
 Set your Radio Dial at 210 meters for the new 1000 watt World Storage Battery
 6-volt, 100 Amperes \$11.25
 6-volt, 120 Amperes 13.25
 6-volt, 140 Amperes 14.00
Solid Rubber Case Auto Batteries
 6-volt, 11-Plate \$11.25
 6-volt, 15-Plate 13.25
 12-volt, 7-Plate 16.00

SEND NO MONEY

Just state battery wanted and we will ship-day order received, by Express, C. O. D., subject to your examination on arrival. Extra Offer: 5 per cent discount for cash in full with order.

Buy now and get a guaranteed battery at 60 per cent saving to you.

WORLD BATTERY COMPANY
 Dept. 27
 1219 So. Wabash Ave., Chicago, Ill.

World

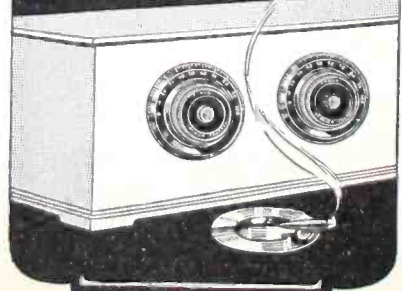

a little. You will have to change the resistance of the rheostats to suit the tubes.

I HAVE wired up the Roberts circuit, but am having some trouble with it. (1) The trouble does not lie in the detector and RF stage, but in the AF stage. When I plug in on the last two tubes I get a high-pitched whistle in the speaker.—Russell Julien, Arcanum, O.

Put a .002 mfd. fixed condenser across the output (speaker tips). Test your stopping condensers for a short, also the resistors. Run-down A or B batteries will cause such a whistle.

AS TO the RX1 receiver, published in the Oct. 17 issue of RADIO WORLD. (1) Could I use the AmSCO or Streamline straight-line frequency condenser with basket weave coils? (2) Could I use a 199 tube with an Amperite to control the filament of the tube, using a 6-volt storage battery. (3) Is it necessary to use a Hi-Mu tube for the resistance coupler? (4) If this is the case will a Daven do? (5) Could I use a 201A tube for a detector, and a 301A for the last stage of audio?—A. W. Green, N. Y. City.

(1) Yes. (2) Yes, the 6V199 type. (3) No, but volume is increased. (4) The Daven is a good one indeed. (5) Yes.

I AM building the 1926 Diamond from the parts supplied by the B-C-L Radio Service Co. As I am situated several hundred miles from the nearest broadcasting station, it is therefore necessary that the set give me good DX. (1) I would like to know if I can use the UX tube in the last stage of AF. (2) Would it be better to use Hi-Mu tubes?—Oscar Bast, Wenatchee, Wash.

(1) The UX tube will not be of much advantage in the last stage, due to the

resistor, which would require too high B voltage. (2) The Hi-Mu tubes may be used in the AF stages.

I WOULD like to know if a stage of AF amplification can be added to a crystal detector. (2) If it can, will you please tell me how?—W. Moore, 2150 7th Ave., N. Y. City.

(1) Yes. (2) Connect one of the terminals which went to the phones to the P post of the AFT. Connect the other phone post to the B post of the AFT. Apply no B battery to the B terminal.

The P post usually goes to the base, while the B post goes to the return of the secondary, which comes from the cat-whisker of the crystal. The G of the APT goes to G of the socket, the P to A minus.



Long Distance Radio \$2.95

Leak's most exact crystal set. No tubes. No batteries. No grid. AF-1000 range. Works 100 miles. Fully guaranteed. We are anxious to give you the best of Long Distance Radio. Write, please.



Vigilance

Constant vigilance is the price of uniformity and constant vigilance is maintained over Magnatrons. That is why Magnatrons are uniform, and uniformly good.

The Magnatron DC-201A, DC-199, and DC-197 (large base) now list for only \$2.50 each

Conway Electric Laboratories, Magnatron Bldg., Hoboken, N. J. West Coast supplied from complete stocks carried by Pacific Radio Laboratories, 256 South Los Angeles St., Los Angeles, California.

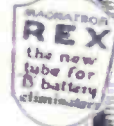

ARE YOU THE MAN

to be first in your town to sell and demonstrate POWEROLA, the famous 5-tube, battery operated light socket radio receiver (not an attachment), universal for D.C. or A.C. (105-115 v., 44-60 cycle), now sold and demonstrated by the New York Edison Co., public utility companies and radio, electric and music dealers everywhere. Absolutely dependable, fully guaranteed, powerful, practical, perfect in performance.

Are You the Man Who Sees Opportunity Ahead for Real Money Making? Write for literature, terms and prices at once.

POWEROLA RADIO CORP. 145 BROADWAY NEW YORK CITY

HOW TO BUILD THE POWERTONE, 1 dial, 5 tubes, described in RADIO WORLD, issues of Aug. 29 and Sept. 5. Powertone Trouble-shooting, Sept. 12. Send 4c for all three. Special diagrams and "blueprint in black" included among the many illustrations. RADIO WORLD, 145 West 45th St.,

MAGNATRONS

RADIO WORLD'S 2-For-Price-of-1 Subscription Offer For NEW RADIO WORLD Subscribers Ordering NOW

Radio World has made arrangements

- To offer a year's subscription FREE for any one of the following publications with one year's subscription for RADIO WORLD
- RADIO NEWS or -RADIO DEALER or
- POPULAR RADIO or -RADIO JOURNAL or
- RADIO BROADCAST or -RADIO (San Francisco) or
- SCIENCE AND INVENTION or -THE EXPERIMENTER or
- RADIO AGE

This is the way to get two publications

- for the price of one;
- Send \$4.99 today for RADIO WORLD
- for one year (regular price
- for 52 numbers)
- and select any one of the other
- nine publications for twelve months.
- Add \$1.00 a year extra for
- Canadian or Foreign Postage.
- Present RADIO WORLD subscribers
- can take advantage of this offer by
- extending subscriptions one year
- if they send renewals NOW.

RADIO WORLD'S SPECIAL TWO-FOR-PRICE-OF-ONE SUBSCRIPTION BLANK

RADIO WORLD, 145 West 45th Street, New York City.

Enclosed find \$6.00 for which send me RADIO WORLD for twelve months (52 numbers), beginning..... and also without additional cost, Radio News, or Popular Radio, or Radio Broadcast, or Science and Invention, or Radio Dealer, or Radio (San Francisco), or The Experimenter, or Radio Journal, or Radio Age (or \$10.00 for two yearly subscriptions).

Indicate if renewal. Name
 Offer Good Until November 20, 1925. Street Address.....
 City and State.....

RESULTS EDITOR:

I have built The Midget 3-Tube set described by Herbert E. Hayden in the August 8 issue of RADIO WORLD, and it certainly works great. I don't think any more could be expected from three tubes. The first night that I completed the set the following stations were received by me, all on the loud speaker: WSB, WCCO, WOK, WBBM, WIBO, WAFD, WFAM, WTAM, WENR, WCEE, WCBM, KDKA, WBZ, WBAP, WEAR, WEBB, WGN and WGY. If this is not considered a good record I would like to know what is. Anybody wishing to build a good set, take my ad-

RESULTS

Readers report on their experiences with sets built from hookups published in RADIO WORLD. Address Results Editor, Radio World, 145 West 45th Street, New York City, and send photographs of sets, if possible.

vise and build this one. They will never be sorry, once they get it working right. Thanks to Herbert E. Hayden and RADIO WORLD for this circuit.

LAZARUS HARRIS, 258 East Market St., Wilkesbarre, Pa.

RESULTS EDITOR:

I have tried five hook-ups from RADIO WORLD and they all worked fine. I now have the Transcontinental Reflex, published in the January 10 issue of RADIO WORLD, and it is great. It tunes very sharply.

JAMES W. FARR, c/o H. T. Shannon, Cary Station, Ill.

RESULTS EDITOR:

I have just built The Diamond as a portable, using the 199 tubes. The set was built on a 7x18" panel. The set was wired with bell wire. At first the results were poor, due to the uncontrollable oscillations. I then reversed the tickler connections and the following stations came rolling in with speaker volume: WMAK, WBBM, WOK, WSAI, WMBF, WEBB, KYW, WLW, WHT, WCBF, WTAS, WCAU, WJJD, WGBU, WCEE, WHO, KDKA, WBZ and WKAQ. It is really a DX hound, and if handled properly, will bring in the stations without any whistling.

Any set published in RADIO WORLD will work if properly wired. I say this from experience, as I have wired several sets which were built from RADIO WORLD's diagrams and they all worked after the diagrams were followed.

THOMAS D. SUTTON, 1450 Chapel St., Norfolk, W. Va.

Jones MULTI-PLUG THE STANDARD SET CONNECTOR

HOWARD B. JONES 618 S. CANAL STREET CHICAGO

LISTEN IN every Friday at 7 P. M. and hear Herman Bernard, managing editor of RADIO WORLD, discuss "Your Radio Problem," from WGBS, Gimbel Bros., New York City, 315.6 meters.

RESULTS EDITOR:

I have built three of the sets "A Baby Can Build" as described in the August 29 issue of RADIO WORLD by Herbert Hayden and they are all O. K. I can bring in DX right through the locals. Pittsburgh, Chicago, New York and Atlantic City are among the cities that are received.

I have also built the 2-Tube Speaker Reflex, described by Brewster Lee in the August 15 issue. It sure is a wonder for two tubes. I can hear it all over the house.

ROBERT KEMY, 85 Magnolia St., Dorchester 25, Mass.

PANELS

RADION and HARD RUBBER RETAIL ANY SIZE WHOLESALE PRICE LIST MAILED ON REQUEST

HARD RUBBER SHEETS-RODS-TUBING

Special Hard Rubber Parts Made to Order. Send Sample or Sketch for Quotation. NEW YORK HARD RUBBER TURNING CO. 212 CENTRE ST. NEW YORK

"EAGLE" ALL-METAL

RADIO TOWERS

Adjustable to Fit Any Type of Mast

Get better reception with a good outside Aerial Long distance sets, including ability to use the best possible Aerial. Eagle Radio Towers are handsome and sturdy or write us for literature.

J. R. Burrell Co., 714 N. Cambridge Ave., Milwaukee, Wis. Dept. 15



Ask an Owner He Knows

RADIO CATALOG



also LOG

FREE SAVE

on all the latest standard radio sets. No exceptions. Our 1926 Beautifully Illustrated Catalog. JUST OFF THE PRESS! Everything now in Radio AT BLOWN PRICES. Write for it today, before you buy anything. Delay means losing exceptional chance to participate in this great BARGAIN SALE. Rush your name and address of once and get also a

LOG BOOK FREE ECONOMY RADIO SALES COMPANY 248 6th Ave., Dept. E New York Deal Direct and Save Real Money (No Dealers)

Mailing Lists

Will help you increase sales. Send for FREE catalog giving names and prices on classified notices of your best prospective customers - National, State, Local - Individuals, Professions, Business Firms. 99% Guaranteed to refund at



ROSS-Gould Co. 33rd St. St. Louis

NAMEPLATES

FOR RADIO WORLD'S 1926

Diamond of the Air

NOW READY FOR DELIVERY

Those who have already ordered these nameplates will receive them in the course of a few days.

If you are building the Diamond of the Air, and have not already requested a nameplate, send us your name and address and we will send you one

RADIO WORLD

145 W. 45th St. New York City

A Satisfied Radio Dealer

The Seal of



Satisfaction

THE BOWER RADIO SHOP READING, MICHIGAN

Gets quantity discounts, quick shipments, guaranteed products, reliable repairs, personal attention and real SERVICE. All of these things are represented by "THE SEAL OF SATISFACTION." Look for it! It appears on all radio supplies sold by us. It is your guarantee of satisfaction. Write us a card today. Just say, I am interested in The Seal of Satisfaction or send three two-cent stamps for our new Loose Leaf Catalog.

EVERY SET BUILDER NEEDS THIS



"Morising Bus-Bar Union"

Makes for quick assembling. Repairs can be made by using Morising Bus-Bar Union without taking set apart.

Assemble round or square Bus-Bar and solder three wires at a time. Order No. 1 for No. 14, No. 2 for 12 wire. Send 25 cents for enough for building one set, or ten dozen for \$1.00.

Newark Watch Case Material Co. 15 Ward Street Newark, N. J. DISTRIBUTORS WANTED

EASTERN

PICKLE BOTTLE COILS

are exclusively licensed by M. B. Sleeper for his new, revolutionary, non-regenerative four-tube RX-1 circuit described in Radio World. Per set. \$6.00

Eastern Pickle Bottle Coils are also designed for perfect performance in the following circuits:

SUPERDYNE (\$8.00 per set) BROWNING-DRAKE (\$8.00 per set) ROBERTS (\$8.50 per set), TUNED R. F. CIRCUITS (\$2.00 per set).

Certified by Norman Bernard. At your dealers or direct, postpaid. EASTERN COIL CORPORATION 22 WARREN ST. NEW YORK

FILL OUT AND MAIL NOW

SUBSCRIPTION BLANK

RADIO WORLD

RADIO WORLD

145 West 45th St., New York City

Please send me RADIO WORLD for months, for which

please find enclosed \$.....

SUBSCRIPTION RATES:

Table with subscription rates: Single Copy \$.15, Three Months \$.45, Six Months \$.80, One Year \$ 1.50. Add \$1.00 a Year for Foreign Postage; 50c for Canadian Postage.

Hammond's 8-on-1 Invention Rejected for Broadcasting

WASHINGTON

Application of the new invention of John Hays Hammond, Jr., by which it is possible to transmit eight separate radio signals simultaneously on one wavelength, is not considered by experts of the Navy Department as of practical application to broadcasting.

The invention was examined by the Navy experts. An official report is being prepared which soon will be forwarded to Mr. Hammond. Although it is considered impractical for broadcasting purposes, Mr. Hammond's invention is regarded as having enormous commercial possibilities.

Operation of the Hammond device on wavelengths between 200 and 600 meters would complicate rather than solve the present congestion, the experts say. The first objection is that none of the 5,000,000 receivers now in operation would

be capable of receiving the multiple signals. The only thing they could get would be a heterodyne squeal. A second objection is the creation of a greater number of harmonics by the device. If eight signals are being transmitted on a 500 meter wavelength, eight harmonics are created at 250 meters, causing just eight times the present interference.

The Hammond machine makes pos-

sible the transmission of eight signals simultaneously through the use of a distinct net of "sub-frequencies." The device operates with a single carrier wave, but with eight sub-frequencies superimposed on the original wave.

NEW STATION FOR BALTIMORE WASHINGTON

A new class B station will take the air in Baltimore within a week or two. The station, which is just being completed by the Gas and Electric Company, will have a call of WBAL and, it is understood, will operate on 256 meters with 1,500 watts power.

TROUBLE-PROOF!

Once a variable condenser is in a set, if anything goes wrong with the condenser, you have to rip the set apart just to enable you to hunt for the trouble.

Therefore, use a condenser that is not as fragile as peanut-brittle, but as sturdy as an oak—one that gives the best possible service, and gives it unflinchingly!

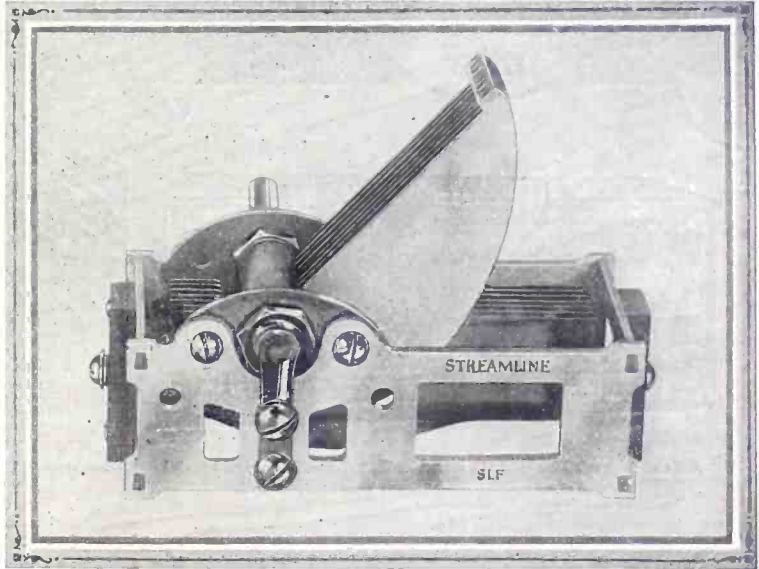

"Built to Last a Lifetime"

The Streamline Straight-Line Frequency Condenser assures you of the greatest possible tuning ease, with wide separation between stations otherwise crowded together on the dial. The rotor plates turn gently and are safeguarded against touching the stator plates. Rigid mechanically, low-loss electrically, the Streamline is also a thing of beauty and a joy forever!

.0005 (23 plates) \$2.50 .00035 (17 plates) \$2.25 .0003 (13 plates) \$2.00

Immediate Delivery—Absolute guarantee on every box.

STREAMLINE RADIO CO.

223 FULTON STREET
New York City

Enclosed find \$..... for which send me by return mail Streamline SLF condensers, capacity

NAME CITY

ADDRESS STATE

\$4.75

POLLO

A loud speaker of surprising musical quality and volume. In the class with high-priced speakers. Artistically designed. Swan neck type. Adjustable unit where volume and tone are at all times under perfect control. Send no money. Just pay the postman.

RIX RADIO
SUPPLY HOUSE, INC.
5365 4th Ave. Dept. 43 Brooklyn, N. Y.

EVEREADY
Radio Batteries
—they last longer

**Get Your Coil
Connections Right**

When You Build

**The
Powertone**



Construction of this 1-dial, 5-tube quality receiver fully described and illustrated, with "blue print in black" included, in Aug. 29 and Sept. 5 issues. Special discussion of how to connect the coil terminals. Trouble-shooting in this set, Sept. 12 issue. Send 45c. Get all three.

RADIO WORLD
145 West 45th St., N. Y. City

The New WAVE MASTER a Radio Set Worthy to Bear the KELLOGG Name



The Wave Master Console Model
 A handsome genuine mahogany design with battery compartments and inbuilt horn. Price, **\$275.00**
 Without battery table, price **\$225.00**
 Also made in the beautiful Console model, genuine mahogany, price, **\$235.00**

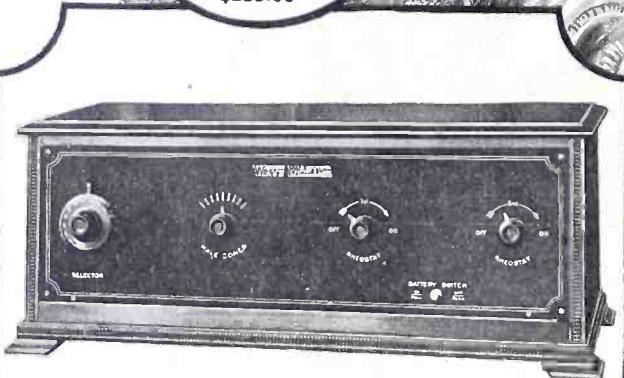

A Year Ahead! The WAVE MASTER, 5-Tube Standard Model
 Cabinet of solid, Genuine Mahogany, beautifully finished, 28 inches long, 11 inches high. Price, **\$125.00**

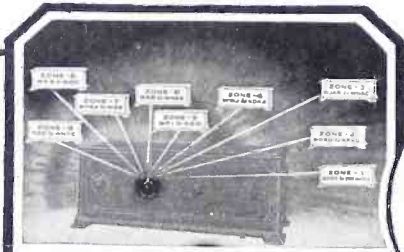

A Separate Circuit for Each 40 Meter Wavelength
 One-Dial Control, Yet Greater Selectivity.



Kellogg Symphony Reproducer
 \$25.00

"I never dreamed it was such fun"

"I used to be content to enjoy radio merely as a listener, never realizing how much greater pleasure I was missing. I had no idea of the fascinations of radio tuning—the fun of going after any station and getting it."

WHEN you make a telephone call, the operator connects you first with the "exchange" and then with the desired number of that group or division.

To "connect" the WAVE MASTER instantly with any desired broadcasting station, you first set the pointer for the "Exchange" or wave zone group to which the station belongs and then merely turn the Station Selector dial. "Expert" tuning becomes child's play. To separate stations very close together in their wavelengths, is astonishingly easy. When buying any radio set, protect yourself by learning something about the firm that produced it—their reliability and experience. For 28 years Kellogg has produced the finest of telephone apparatus. Since radio began Kellogg has built the highest quality parts.

If you do not know where you can see, try and hear the WAVE MASTER in your neighborhood, write us. We'll give you the name of your nearest dealer, and, if you wish it, a full technical explanation of the Wave Master Circuit. Ask for Folder No. 7-K.

Radio Dealers and Jobbers

The WAVE MASTER franchise backed by Kellogg resources and our powerful advertising campaign, is most valuable. Open territories are being rapidly taken up. If interested, wire or call on us promptly for our money-making proposition.

Kellogg Switchboard & Supply Company
 1066 West Adams Street, Chicago, Illinois

KELLOGG WAVE MASTER SWITCHBOARD & SUPPLY CO.