

APRIL 12

ILLUSTRATED

EVERY WEEK

56.00 A YEAR

KBP

# RADIO WORLD

Title Reg. U. S. Pat. Off.



FRONTIER DAYS were being screened in Wadsworth, Nev., the other day. Madge Bellamy, featured in the Fox Film Corporation's production of a Rex Beach novel, got lonesome for a set and one was rushed to her. Hence the pest got a taste of its sweet future.

**ADVANCE PROGRAMS FROM ALL OVER**



# ANNOUNCING—The Bestone V-60 Super-Toned Receiver

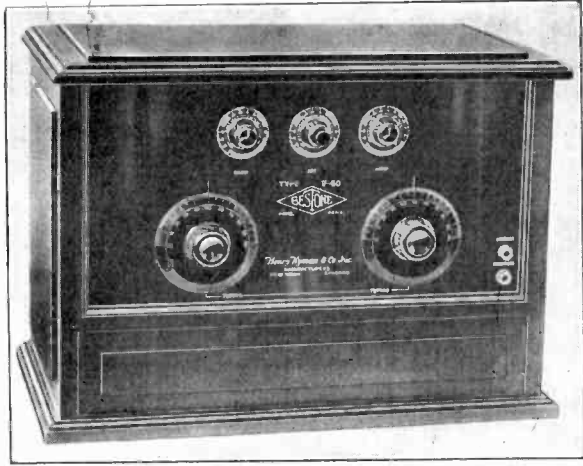

*Incorporates*  
*All the Essential Qualities*  
*for Ideal Radio Reception*

- |                     |                  |                 |
|---------------------|------------------|-----------------|
| Tone                | Distance         | Volume          |
| Economy             | Sensitivity      | Selectivity     |
| Ruggedness          | Two Controls     | Simple Tuning   |
| No Regeneration     | No Distortion    | No Reradiation  |
| No Howls or Squeals | No Body Capacity | Only Four Tubes |

Parts May Be Had by the Experimenter  
Write for Particulars

## HENRY HYMAN & COMPANY, Inc.

476 BROADWAY  
NEW YORK

Manufacturers

212 W. AUSTIN AVE.  
CHICAGO

"The 'Bestone' Receiver under tests conducted by the Radio Editor has proven superior in tonal quality to any set, commercial or home-made, tested under similar conditions. It was noteworthy that volume was not sacrificed for clarity as is commonly the case."

*New York Telegram-Mail.*

"It is easy to tune and it certainly does work—has the selectivity which is essential where the ether is congested as it is here."

*New York Herald-Tribune.*

"The 'BESTONE' Circuit combines the essentials of the ideal radio Receiver in an economical, practical combination. The outstanding features are its quietness of operation without distortion, its extreme sensitivity, simplicity of operation, faithful reproduction and distance-getting qualities."

*New York World.*

Complete Parts  
for 1 and 3 Tube

REINARTZ

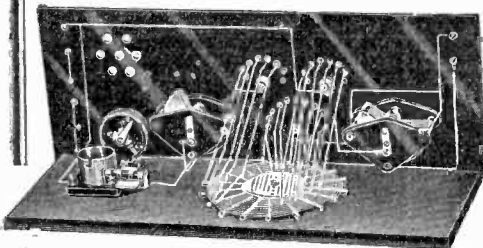

Consisting of	Our Price
7x18 Formica Panel.....	\$1.70
Bakelite Socket.....	.45
Howard Ver. Rheo.....	1.35
23-Plate Var. Condenser.....	1.45
11-Plate Var. Condenser.....	1.35
1 Reinartz Coil.....	1.95
Freshman Var. Grid Leak and Condenser comb.....	.75
3 Switch Levers.....	.75
8 Binding Posts.....	.40
2 Doz. Switch Pts.....	.40
25 ft. Tinned Wire.....	.15
Baseboard for Mtd.....	.25
Blueprint with complete instruction for assembling and wiring.....	.50

Reg. Price, \$21.69  
Our Price **\$11.45**

**Panels Drilled FREE**  
Specially drilled panels are included with each of the sets illustrated and described above. We give this free service only on panels included with complete sets.

VARIABLE CONDENSERS	
\$7.00 value, 43 Plate Vernier	\$3.95
6.50 value, 23 Plate Vernier	3.45
6.00 value, 11 Plate Vernier	2.95
1.75 value, 3 Plate Vernier	1.18
4.30 value, 43 Plate NOW	1.75
3.70 value, 23 Plate NOW	1.45
3.30 value, 11 Plate NOW	1.35
2.25 value, 5 Plate NOW	1.25
Complete Parts for ALL Receivers	
1-Tube Eria	\$20.90
2-Stage Amplifier	12.95
Honeycomb Receiver	17.95
Ultra Audion	8.95
Overland Circuit	8.25
Haves DX	10.95
Superdync Receiver	15.85
Long-45 Circuit	16.25
Cockaday	11.95
Super Heterodyne	92.50



Mail Orders Address Dept. W-6, Chicago, Ill.

### SALVAGE MEANS

Save, Service, Satisfaction

When you buy that radio apparatus from the Chicago Salvage Stock Store, the world's greatest radio store, you can be certain of these three things:

1. You have saved money through the hundreds of radio bargains made possible by our enormous buying power.
2. You have been served intelligently by men who are qualified radio experts.
3. You have bought quality apparatus because we handle nothing but brand-new merchandise GUARANTEED to give complete satisfaction.



Western Electric  
VT-2 Tubes  
**\$7.45**

### Save On Specials Here!

COCKADAY COILS at.....	<b>\$1.95</b>	Fisher SPLIT VARIOMETER.....	<b>\$2.75</b>
Columbia TUNED AIR-CORE TRANSFORMERS, set.....	<b>\$12.50</b>	Tri-Coil R. F. TRANSFORMER.....	<b>\$1.85</b>
Freshman GRID LEAK and CON-DENSER.....	<b>65c</b>	Genuine 3 in. and 4 in. BAKELITE DIALS.....	<b>25c</b>
100-ft. RIBBON AERIAL.....	<b>\$1.45</b>	Moulded VARIOMETERS and COUPLERS, values up to \$7.00, at.....	<b>\$3.65</b>
Double PHONOGRAPH ATTACHMENTS.....	<b>65c</b>	West. Electric VT-2 TUBES, ea.....	<b>\$7.45</b>

Complete Parts  
for 3 4 and 5 Tube

NEUTRODYNE

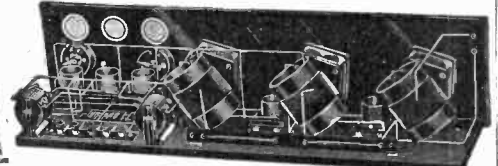

With FREED-EISMAN OR FADA LICENSED PARTS for 5-Tube Set as follows: 7x28x3-18 drilled and engraved panel, with baseboard.



Automatic  
Electric Headset  
**\$3.65**

- 2 Audio Frequency Trans.
- 3 Eria Bezels.
- 1,001 Mica Condensr.
- 1 I. M. F. D. By-Pass Concl.
- 3 Filament Control Jaska.
- 3 4-Inch Dials.
- 1 Howard Vernier Rheostat.
- 1 Howard Plain Rheostat Strip of Bakelite.
- 8 Binding Posts.
- 2 Firth Sockets.
- 1 3 Gang Firth Socket with mountings and screws.
- 20 Feet Bus Bar Wire.
- Screws, Nuts and Miscellaneous set.
- Construction Book and Schematic Print.
- Grid Leak and Mica Condensr.

3-Tube Set **\$28.60**      5-Tube Set **\$46.25**

New Catalog Ready!

Send 10c for copy today!

### FORMICA PANEL sq. in. 1 1/2 TUBING in. 10c

HONEYCOMB COILS	
1,500 Turns.....	\$1.50
1,250 Turns.....	1.50
1,000 Turns.....	1.25
750 Turns.....	1.00
250 Turns.....	.75
150 Turns.....	.60
100 Turns.....	.50
75 Turns.....	.40
50 Turns.....	.40
35 and 25 Turns.....	.40

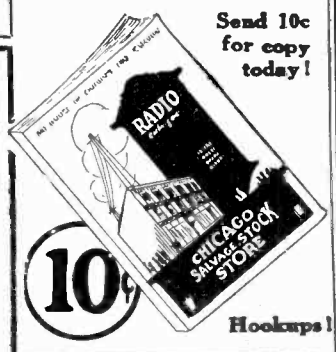

# RADIO WORLD

[Entered as second-class matter, March 28, 1922, at the Post Office at New York, N. Y., under the Act of March 3, 1879]

A Weekly Journal Published Every Wednesday and Dated Saturday, by Hennessy Radio Publications Corporation from Publication Office, 1493 Broadway, New York, N. Y. Phones: Lackawanna 6976 & 2063.

Vol. V, No. 3. Whole No. 107

April 12, 1924

15c. per copy, \$6.00 a year

## Spider-Web Coils Improve Neutrodyne

By Byrt C. Caldwell

**M**ANY of the thousands who own Neutrodyne receivers have difficulty in neutralizing the set. In most cases this is due to poorly designed sets, or poor wiring. A radio set of any kind, and one using radio frequency amplification in particular, must be designed and wired with the greatest amount of care for best results.

In any radio frequency set there is a feed back action, and if the set is poorly designed or wired, this feed back action is strong enough completely to prevent good results. In a good Neutrodyne receiver there is very little feedback, and this is neutralized by the opposite feedback of the neutralizing condensers. A properly made Neutrodyne set brings wonderful results.

There have been many attempts to reduce the back coupling in the receiver. When UV199 or C299 tubes are used in place of the standard tubes, a great improvement is noted.

The coils in the Neutrodyne are so placed as to have as little inductive relation between them as possible. However, the fields about these coils are so large that there is enough to cause trouble. New coil designs have been tried, with varying success.

One of the most successful is the D-coil transformer designed by Kenneth Harkness, wound on a tubing in the form of two Ds with the flat sides facing each other.

The writer designed a set using D-coil transformers wound on spider web forms. This set gave wonderful results (Fig. 1). There were no neutralizing con-

densers and the set in spite of this, did not oscillate. But when others tried this circuit out, there was a fair percentage who could not get the set to function for the first evening, or several evenings, and they then gave it up as "too hard." The set is hard to work

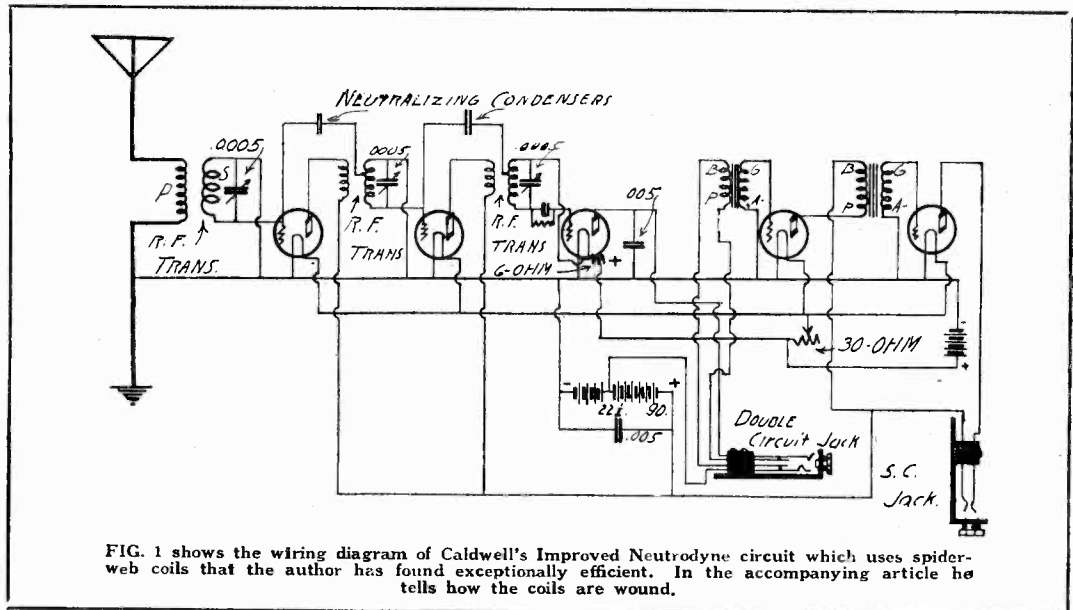

FIG. 1 shows the wiring diagram of Caldwell's Improved Neutrodyne circuit which uses spider-web coils that the author has found exceptionally efficient. In the accompanying article he tells how the coils are wound.

properly at first, because the primaries and the secondaries should be placed together by actual trial in the receiver.

Since the publication of the article on the Ultradyne, the writer has experimented a great deal with spider web coils in this type of circuit. It is well known that spider web coils are much more efficient than those wound on tubing. This is due to their low distributed capacity, and their small stray fields. Why then, if their fields are so small, could they not all be placed at right angles to each other, as in the Ultradyne, so as to reduce the back coupling to a negligible amount. On actual trial, it was found that neutralizing

(Concluded on page 7)

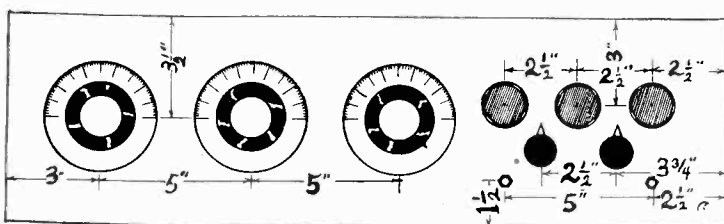

FIG. 2—Panel layout, showing position of the dials, bezels and rheostat knobs, with measurements given for distances.

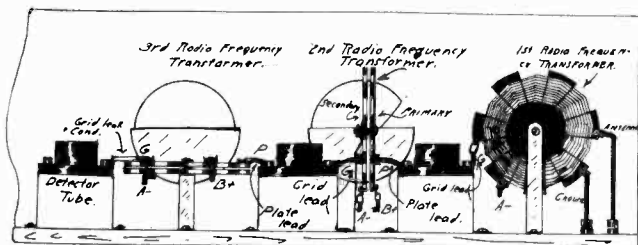

FIG. 3—The author stresses the correct placing of the radio frequency transformers as one of the most important considerations in constructing the Improved Neutrodyne. The rear panel sketch clearly shows their relative positions.

# Splendid Results Obtained With Crystal

By Solon Crane

**T**HE crystal detector has been neglected by the average radio fan as not being sensitive enough and as being impractical. This conclusion, however, usually is reached after not having given the crystal a fair chance to show its worth. The crystal detector is an excellent instrument for use in its place and if a little experimental work is done on the part of the operator, results which formerly were thought impossible will be obtained.

Very often we hear reports of 1,000 mile reception with a crystal detector and by the average reader these results are thought to be impossible. They are, however, as has often been proven, absolutely possible although they are usually accomplished under extraordinarily favorable conditions. Under average conditions, however, the crystal detector, when properly handled, is capable of receiving over a distance of 100 miles with quite fair reproduction in the head phones. Of course, the reproduced signals will not be as loud as when a regenerative vacuum tube detector is used, but they will have an advantage and that is, that they will be much clearer and the tones of various musical instruments and of speakers will be more natural than when a regenerative vacuum tube circuit is used. The crystal detector furthermore gets away from any possibility of radiation and since C. W. reception is impossible, no interference will be obtained from that source.

In *RADIO WORLD* for February 9, 1924, was described a radio receiving set using a crystal detector and a balanced tuner which gave exceptional results. The tuner is, of course, an important part of the receiving set and, therefore, the reader is urged to look up the above mentioned article for collateral reading in connection with this one.

The purpose of this article is to bring forth the good and bad points of the various kinds of minerals and crystals which are available for radio work and sum them up in such a manner that they will give the reader a working basis for crystal experimentation which may in time and undoubtedly will, if he pursues the correct course, make him a faithful follower of the crystal detector.

We will omit consideration of various types of synthetic and artificial detector elements which have been put upon the market of late and will mention only one or two ideas for the constructor regarding the making of synthetic minerals at home.

First and foremost on our list of available and practical minerals is galena. This material is a metallic ore being sulphite of lead or as is expressed in chemistry, PbS. This mineral comes in a cubical form and the crystals can be easily split. It is not advisable to purchase one or two small pieces at a time as the material can be purchased quite cheaply in half pound or pound lots. These lots can then be broken up into pieces of the correct size and hundreds of the smaller pieces will be found to be very sensitive. This mineral is to be used with a very light contact and the writer found a piece of 14 karat gold wire about the same diameter as No. 30 copper wire to be about the best. Gold has the advantage of not oxidizing readily and, therefore, the point in contact with the crystal is always good. Even at that, it is advisable to run a piece of fine emery paper over the point occasionally in order to clean it off. This crystal is easily knocked out of adjustment by jars and should, therefore, be so

**T**HIS special auto was designed and built by Scotland Yard. With small antenna, it establishes communication even while moving forty miles an hour.

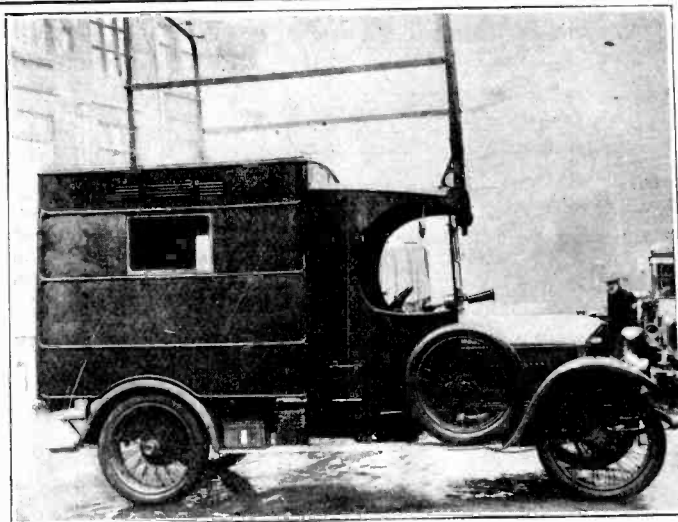

(Wide World)

mounted as to be as free from vibration as possible. The contact between the crystal and its holder or cup is extremely important. Spring clips with very strong springs are quite good and make a firm contact. Even better than this is the method of placing the crystal in a cup and surrounding it with a soft metal capable of melting at a very low point. Solder should never be used for this as the sensitiveness of galena is almost invariably spoiled by the great heat necessary to melt the solder. A suitable soft metal may be prepared by dissolving in mercury as much tin foil as possible. Knead the mass thoroughly, continuing to add tin foil until an excess is present which cannot be worked into the mass. Be sure that you use tin foil for this work as lead foil is not satisfactory. After finishing the kneading process, melt the material over an alcohol flame, pour out and let it harden. The metal can be remelted and used again at any time desired. This metal melts quite a little below the boiling point of water and, therefore, does not get hot enough to render the crystal useless.

The writer some time ago made experiments in the production of synthetic galena and some interesting results were noticed. The process was as follows: A small quantity of lead was melted in a crucible and when it reached the melting point, an equal quantity of flowers of sulphur were poured into the crucible and at the same time the flame was removed. Upon hardening, a greyish substance was found, which could be broken up and placed in a suitable mounting. Various degrees of sensitivity were obtained by varying the amounts of lead and sulphur used. Due to incomplete notes made at the time, the writer cannot give any definite quantities and, therefore, it will be necessary to experiment to discover them. A word of caution here. Do not conduct the above experiment unless good ventilation is available as the fumes of the melting sulphur are extremely obnoxious and if breathed in quantities are injurious. They cause a very unpleasant choking sensation.

The writer found that a test detector which gave very good results could be made as follows: Connect a wire to a sheet of brass about 6" square, connecting

(Concluded on next page)

# Radio Offers New Basis of Reckoning

SOME well informed radio engineers and many blasé radio fans were electrified and even astounded to observe the radio time and speed experiments of Captain R. H. Ranger, of the Radio Corporation, conducted at the Cosmos Club in Washington a few days ago before a section of the Association of Electrical Engineers. He not only transmitted a radio message 4,250 miles to Warsaw, Poland, and got a reply in approximately three minutes, but he measured the time required for a single radio impulse to make the round trip as .046 seconds. The latter experiment was to show that contrary to a popular conception, radio is not instantaneous.

Captain Ranger stated:

"The fact that a radio impulse traveling over a given distance, negotiates this space in a definite and fixed time, may set a new standard against which time and distance may be measured, giving a degree of accuracy and reliability surpassing even the accepted methods of astronomical observations."

"What does he mean?" some of the uninitiated immediately inquired. He meant that since it takes appreciable and measurable time for a radio signal, a dot in this instance, to travel a given distance, we have a new standard measuring instrument which will remain the same for centuries, and, with continued use, our ability to measure even small lapses of time will increase. Practical applications include aids to the mariner, until recently dependent upon dead reckoning when the sun was invisible and no radio beacons were available. "Radio," Captain Ranger said, "will be the answer to civilization's demand for greater accuracy." Already this system makes it possible to check the accuracy of automatic relays and in the future we may expect more useful applications, for example, checking time differences between two distant points. With a globe-encircling chain of powerful stations the world time could be carefully calibrated. The radio "dot" can eventually be made to act as a very accurate check on longitude determinations.

By way of exposition, Captain Ranger said: "Suppose clocks at Warsaw and New York were geared accurately to the sun's time at each locality. Then transmit Warsaw's sun time to New York. The difference in the two clocks, in New York, gives the portion of the day or revolution of the world between the two, which is the difference in the longitudes. With the present advance in radio, the least accurate part of such measurements comes in the solar observations, but in spite of this," he said, "accuracies below fifteen feet in the 4,250 miles covered are in order. When the round-the-world radio (robin) has checked the speed of radio waves to the final degree, radio alone will give the actual distances between any two points, according to this engineer."

## Interference Imported

INTEREST in amateur radio is just beginning in Italy. The broadcast bug is biting and conditions as regards reception of programs are about the same as they were in the United States two years ago.

Everyone wants radio sets, but the ready-made apparatus is far from being standardized. The fan who is starting in radio is in doubt as to what kind of a set he should get.

Strange to say, most interference on short waves comes from Holland, France, England, Switzerland, Belgium and other foreign stations.

**FIVE-TUBE LOOP SET** of Walter S. Lemmon uses 2 stages of tuned radio frequency, special coils, mounted at an angle on the condensers; detector and two stages of audio. The coil mounts assure stability.



(K. & H.)

## Results from Crystal

(Concluded from preceding page)

the other end of the wire to one of the detector posts on the receiving set. Connect a flexible wire to the other detector post and scrape one end of the flexible wire clean. Tune in a signal with the regular detector, which is contained in the set, in operation. Remove the cat-whisker from the crystal which is mounted in the detector stand and place a quantity of broken up mineral on the brass plate. Every piece of mineral can then be run over carefully with the pointed end of the flexible wire and tests readily made. It will very often be found that when a fairly large piece of crystal is tested, no sensitive spots will be found. However, by breaking it up into smaller pieces, sensitive spots are often found on the newly made faces. This applies to all types of minerals.

The next important mineral on our list is silicon, a product of the electric furnace. The majority of the fused silicon used in radio work is made in the gigantic furnaces at Niagara Falls. This material is of a greyish black hue and is extremely hard and brittle. It should be mounted the same as galena, observing similar precautions in regard to heating. In operation, it is very stable and is not easily knocked out of adjustment, but usually, it is not so sensitive as galena.

Of late, combination detectors have come quite into favor. One of the most popular and probably the only one worth considering is Perikon, a combination developed by G. W. Pickard. This consists of crystals of copper pyrites and zincite held in firm contact with each other. Usually when such a combination as this is used, five or six crystals of zincite are mounted in a large cup and placed in opposition to a small cup, which contains a piece of sharply pointed copper pyrites. The point of the pyrites crystal is then adjusted over the surface of the zincite until the most sensitive spot is found.

# Meet the Neutrad, Two Tube Wonder

[**H**EREWITH RADIO WORLD publishes an article by Walt S. Thompson, Jr., E. E., revealing the one-tube Neutrad Unit, which, incorporated in any regenerative set, adds to its volume and distance. Tuned R. F. and the neutralizing principle are employed. The regenerative set also is thus prevented from radiating.]

By Walt S. Thompson

**T**HE curse of radiating receivers is still with us and is getting more menacing every day. Is there no way by which regenerative and other radiating sets can be made fool proof? Can they be muffled as we muffle the exhaust from an automobile engine? Yes. There are several methods by which one can muffle a radiating set. One of these methods is described in this article.

Let us first find out just what types of receivers radiate these annoying whistles and squeals.

Probably the worst offender is the single circuit regenerative receiver when allowed to oscillate. The question this arises: Do all such sets radiate at all times? No.

A single circuit regenerative receiver radiates only when the detector tube is oscillating.

An experienced operator will never allow his tube to break over into the oscillating state but will tune in a broadcasting station by keeping the tube circuits so adjusted as to get maximum amplification. This condition is reached just before the point at which the tube starts oscillating. A considerate operator will never tune in a station by the beat note or whistle method. The practice of turning up the filament rheostat and adjusting the regeneration control until whistles are heard as one turns the tuning condenser, may make it easier to find a station, but it prevents one's neighbors from enjoying a concert.

Be considerate and keep the regeneration control at the point just before whistles begin to be heard.

The writer has seen several advertisements which state that by changing a single circuit tuner to a three circuit tuner, radiation can be prevented. This statement is a fallacy. The three circuit regenerative sets will radiate just as easily as the single circuit sets, perhaps not as energetically but for longer periods. If one's detector is sufficiently coupled to the antenna for signals to be received, any oscillatory currents in the tube circuits will be radiated. The same rule then applies to the three circuit regenerative receiver.

The radio fans in general seem to think that by using a reflex circuit or a set incorporating radio frequency amplification they have a receiver which will not radiate. Such an idea is far from the truth.

Any reflex circuit or radio frequency amplifier which makes use of a potentiometer or a rheostat for stabilizing will radiate if any of the tubes are oscillating.

The practice when tuning such sets seems to be the same as that when tuning regenerative receivers, that is, tuning by the whistle. When so tuned, these sets are radiating. If one possesses such a receiver he should see to it that the stabilizer has stopped all oscillations before he begins to tune.

The next type of circuit to be considered is the neutrodyne. This set when properly neutralized will not radiate, but if a whistle is heard when the set is being tuned, it is an indication that proper neutralization has not been effected.

question has arisen as to whether this set radiates.

With the publicity given to the super-heterodyne, the

**CIRCUIT DIAGRAM** of Thompson's Neutrad unit, which, when used with any one-tube regenerative set, prevents radiation and at the same time increases distance. The parts designated within the dotted lines can be built into a small cabinet, and coil L3 connected to binding posts on the cabinet. The lower right-hand symbols are at the detector coupler.

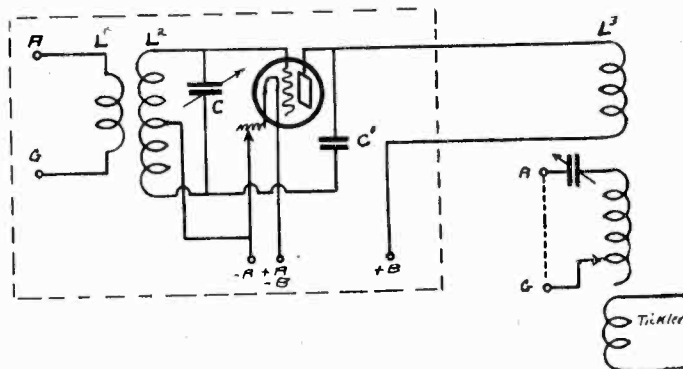

Of all the super-heterodyne sets described in the recent issues of various magazines and newspaper weeklies there is probably not one out of ten which is not a very vicious radiator.

The majority of super-heterodynes have an oscillator coupled indirectly to the receiving aerial or loop and hence although no whistles are heard, the set is radiating at all times when it is in operation. In a commercial super-heterodyne which has come on the market recently, radiation is prevented by placing one stage of permanently stabilized radio frequency amplification between the oscillator and the receiving loop.

Such a method as this makes a super-heterodyne non-radiating and fool-proof and is the only way known to the writer by which radiation can be prevented.

To summarize briefly: There are very few sets which do not radiate at some time or other, although any set can be so tuned or so modified as to prevent radiation. The Golden Rule of Radio is:

"Do not allow your set to oscillate at any time."

Assuming that we already have a set which radiates, let us find a means by which such radiation can be prevented, even if the set is in the hands of an inexperienced operator. Such a means is illustrated by the accompanying sketch of the neutrad unit. This diagram gives a hook-up for a Golden Rule unit which may be added to a variety of sets and which is very inexpensive.

From the sketch it is evident that the Golden Rule unit forms part of a stage of tuned radio frequency amplification when used in conjunction with any of the popular regenerative sets. All the apparatus enclosed within the dashed lines may be mounted in a small cabinet or box. The only part external to the cabinet is the inductance L3 which should be connected to the unit by means of a pair of leads long enough to allow it to be placed on top of the receiving set with which the unit is to be used.

The apparatus necessary to build this unit follows:

- L1—L2, tuning unit.
- C, variable air condenser, .0005 mfd. capacitance.
- L3, a 75-turn honeycomb coil.
- C1, a small centralizing condenser.
- Rheostat, tube, socket, binding posts, wire, etc.

The neutralizing condenser was described by the writer in the December 29, 1923, issue of the RADIO WORLD, although any of the commercial types of neu-

(Concluded on next page)



# Neutralized R. F. Added to Detector

(Concluded from preceding page)

tralizing or compensating condensers will be found to be satisfactory for use in this unit.

To allow the use of a separate A and B battery without great expense, the 199 tube is recommended. The leads from the unit to the honeycomb coil L3 may be a twisted two-wire flexible cord, but to add a refinement to the unit these leads should be kept about three-quarters of an inch apart. This can be done by taping the leads to form a flat, flexible cord with the wires at the outer edges.

The tuning unit L1-L2 should be constructed by the builder. Two pieces of composition tubing are required, one having a diameter of three inches and the other a diameter of two and three-quarters of an inch. Both pieces of tubing should be about three and one-half inches long. On the smaller tube wind ten turns of No. 22 D.C.C. wire, midway between the two ends, for the primary L1.

For the secondary L2, wind fifty-six turns of the same size wire on the larger piece of tubing, making a tap at the mid point. These two windings should be mounted one inside the other, bringing the ends of the primary winding out through the inside of the smaller tube and terminating all the ends and the middle tap of the secondary soldering lugs or binding posts.

After the unit has been completely constructed and assembled it can be put into operation by placing it next to the receiving set and then placing the honeycomb coil directly over the coupler of the set as indicated by the sketch. Next connect both batteries to the proper binding posts and connect the antenna and the ground to the primary of the tuner. Then insert the vacuum tube into its socket.

In case the receiver with which the unit is to be used is a single circuit set, the antenna and ground binding posts should be connected as indicated by the dotted

When the filament is again turned on, the signals will reappear, but the amplifier tube will not oscillate and no oscillatory current from the detector unit will be able to reach the air. Thus the receiving set has been made non-radiating, even in the hands of a novice. It will be found that less turns will then be required for the receiver tuning inductance.

Having thus prepared the unit for operation, the filaments of all tubes should be turned up and an attempt be made to tune in a station. The tuning of the receiver will not be materially changed with the exception that the tap switch will be set to include less turns. The condenser C will be an added tuning unit and must be adjusted to get the greatest signal volume.

As the neutralizing condenser C1 has not been adjusted, the radio frequency amplifier tube will prob-

ably oscillate during this first tuning. However, after having located a strong signal, the neutralizing condenser may be set as follows: Turn out the filament of the radio frequency amplifier tube. The signals will decrease in volume, but will not disappear. Next adjust the condenser C1 until the signals fade out entirely. This is the proper setting and the condenser should be fixed permanently in this position.

## An Improved Neutrodyne

By Byrt C. Caldwell

(Concluded from page 3)

condensers could be dispensed with entirely with such transformers. The coils are extremely easy to wind, and the primaries and secondaries may be placed together properly by mere inspection.

These transformers may be replaced for the regular transformers in the Neutrodyne, or the set may be made directly.

The transformers are wound on standard spider web forms, which may be obtained in almost any radio store. The inside diameters of these coils are  $2\frac{1}{4}$  inches. The outside diameter is unimportant. They may be cut down so as to take as little room as possible, after they are wound.

The winding of the secondary is done with No. 24 D.S. wire. There are 60 turns on each secondary. The primaries are wound with No. 22 or 20 D.S. wire. The form is first wound partly full of string, and is then wound with the wire, so as to bring the primary winding in the center of the secondary winding. There are six turns on each primary. The outside of each primary is connected to the plate, (antenna in the first coil) and the inside to the B-positive (ground in the first coil). The outsides of the secondaries are connected to the grids of their respective tubes, and the insides to the negative of the filament battery. The secondaries of the second and third transformers are tapped after fifty turns are wound.

The panel layout is shown (Fig. 2) and should be followed in detail.

The most important thing in the construction of a radio frequency amplifier, provided good apparatus is had, is the arrangement of the parts. For this reason, the radio frequency part of the receiver is shown (Fig. 3). It is important that the arrangement be followed carefully. The leads to the grid and plates must be very short, and at right angles when possible. If the arrangement shown is followed, these leads will be very short. It will be noticed that the coils are all placed at right angles to each other. The tubes are placed on mountings of strip brass.

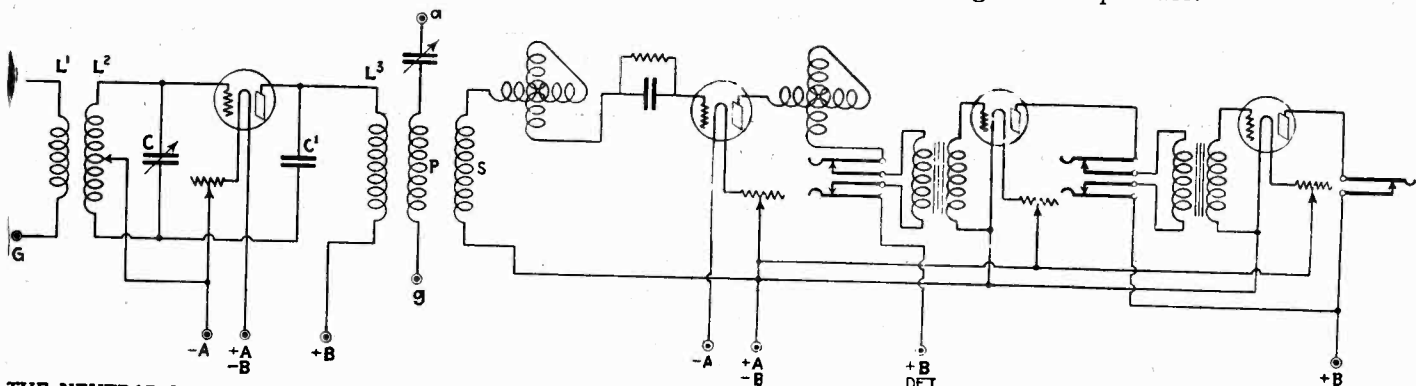

THE NEUTRAD UNIT, used in conjunction with a standard Armstrong regenerative set, is shown in the above diagram. Binding posts A and G should be connected and coil L3 should be placed as close as possible to primary, directly above or below it, never at right angles.

# How to Care for Your Storage Battery

By Leonard West

**T**HE number of lead storage batteries being ruined by neglect is appalling when one stops to think that a little care would eliminate this trouble. The lead type of storage battery, contrary to all other types of batteries must be constantly looked after and cared for or it will be irreparably ruined. If dry cells or zinc and carbon wet cells or Edison storage batteries are used, they can be put away in a corner and left for almost any length of time. The only result will be that they will be run down and in the case of the wet cells and the Edison storage batteries they can be repaired immediately, while in the case of the latter it only being necessary to recharge again. However, if such a procedure is attempted with the lead battery, sulphation of the plates takes place and if the electrolyte is allowed to evaporate too far, it will be necessary to take the battery apart in order to repair the damage. The lead battery, however, even with its faults has a firm position in radio because of its many good points.

We will first go over several of the important points that should be watched in connection with a new or nearly new storage battery. In the first place, the battery should always be kept fully charged or as nearly so as possible. The best method of testing a storage battery is by means of a standard hydrometer such as can be purchased in any radio or electrical supply shop for one dollar or thereabouts. This hydrometer consists of a cylindrical container with a rubber bulb at one end and a rubber tube at the other and has within it a glass tube with a bulb blown on one end, in which is contained a small quantity of lead so that when the outside container is full of liquid, the glass tube will float upright. This rod is calibrated and the scale usually reads from 1.300 to 1.100. This is the specific gravity scale and indicates the condition of the electrolyte within the battery. To test a battery, remove the vent caps, introduce the rubber tube into a cell and by compressing and releasing the rubber bulb, draw a quantity of the electrolyte up into the container. A reading is taken at the top of the solution and enough of the latter must be drawn into the outside container to float the glass tube. In a fully charged battery, the rod will float with a given portion of itself above the level of the electrolyte and the scale reading should be between 1.275 and 1.300. A battery half charged will read 1.210, while when it is fully discharged it will read about 1.120. The specific gravity of the electrolyte of a radio battery should never be allowed to go below 1.200 or at the very lowest 1.175. When it gets this low, the battery should be immediately recharged as otherwise the battery will be damaged. After all three cells of the battery are tested in this manner, add pure distilled water so that the electrolyte level will be at least 5/16 of an inch above the tops of the plates. This is essential in order to prevent sulphating of the plates, the remedy of which will be discussed below.

Where house current is available, it is very desirable to charge a battery every two or three days. Do not overcharge. Thus it can be kept up to full strength and the battery is benefited by such use. After each charging, check the specific gravity and the height of the electrolyte. In cases where such current is not available, the battery should be used sparingly, not operating any more tubes than are absolutely necessary. Even at that, the battery should be charged every two weeks.

If for any reason whatsoever the battery has been lying idle for several months without being charged

## Even the Horse Laughs

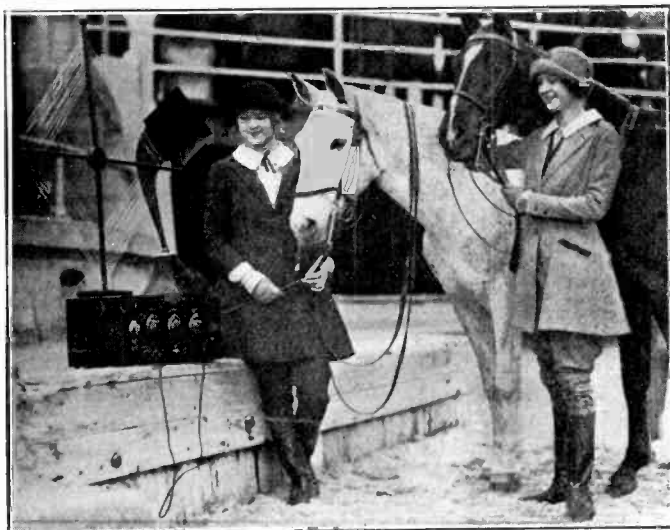

(Atlantic Fotos)

SMILES AND LAUGHTER were the order of the day when Beatrice and Marcella Swanson, musical comedienne, halted a canter at Atlantic City long enough to let their noble steeds listen in. In the upper photo, so a discerning student of horseflesh said, the brown horse wears an actual grin, plus a twinkle of mirth, while sister horse next to him is indulging in a horse laugh. In lower photo, Marcella is shown putting earphones on her mount.

or the electrolyte level has been allowed to fall below the tops of the plates, sulphation almost invariably sets in and renders the battery low in efficiency. If one or two charges and discharges fail to bring it up to the required condition, it will in all probability be necessary to dismantle the battery. This can be accomplished by the amateur if he is careful, although it is advisable to take the battery to a service station. The inexperienced man should not try to dismantle a storage battery.

## Don't Abuse Battery

**W**OULD you go without eating for a few weeks? No. Neither does your storage battery like to be starved. In other words, never let your battery remain in a discharged state. Whenever the specific gravity goes down to about 1.180, put it right on the line to be charged. And don't forget, when you go away on your vacation this summer, give the battery a good charge, fill it with distilled water and give it a short respite from its labors.



# Ship Speeds to Rescue After SOS

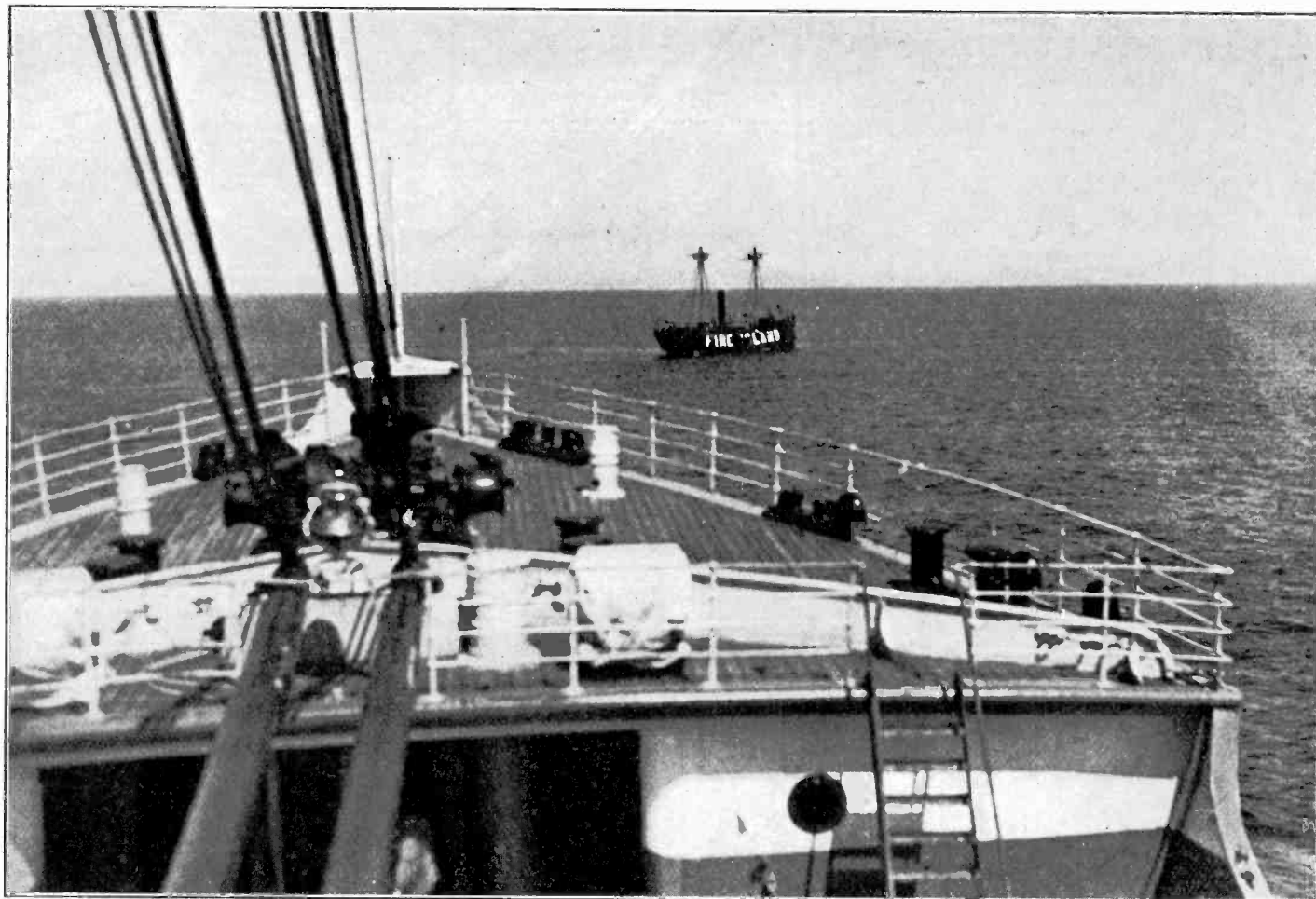

(K. & H.)

SOS—The thrilling call comes through the air. A ship is in distress. All ears are strained to catch the call for help. Sister ships rush to the rescue. Everyone breathes a sigh of relief when the news is flashed that all is safe. The Lightship Fire Island, off New York, was rammed in a fog by the freighter, Castillian. Immediately the call for help was broadcast, and rescuers rushed to the aid. Rescue ship shown in foreground. The lightship was saved from sinking by the captain and the crew who stuck through danger threatened.

## The Rules of the Game

By Rogers H. Bryant, Radio Engineer

EVERYBODY is familiar with the expression "the rules of the game." It refers to that great accumulation of unwritten laws governing the conduct of a gentleman in any branch of sport. A man who lives up to these laws is known as "a good sport" and enjoys the respect of all who know him. Such a man would never take an unfair advantage over his opponent even when to do so might make the difference between winning and losing the game. In other words, it is the practical application of the "golden rule."

Now let us see how "the rules of the game" apply to radio reception. Every night several hundred broadcasting stations send out the best concert available. This entertainment is free to all who possess a radio receiving set. That it is free does not alter our obligation to the other members of the audience who have just as much right to an uninterrupted enjoyment of any program they may select as we have. Unfortunately such is not the case at the present time. There are many people who are just as much annoyance to their radio neighbors as the man who keeps time with his feet is to those around him at the movies. And most of these people do not realize that they are creating a disturbance. Any one who listens in will agree with me that the radio disturbance is many times worse

than we would tolerate in a music hall. The question is, what can we do about it?

It seems to me that there are three ways in which the interference can be greatly decreased. One way is to legislate against the use of any receiving set that is capable of interfering when improperly operated. A second and more desirable way is to educate the operators of receiving sets likely to cause interference. The third way is to gradually eliminate all receiving sets, capable of interfering, by a process of development rendering them obsolete.

I am decidedly against the first method mentioned, namely, legislation. I believe in laws, and every other right-minded person does, too. I divide laws into two great classes, the laws of Nature and the laws of man. I have great respect for the laws of nature, because to my mind they are perfection. A certain cause always produces the same effect no matter how hard man may try to make it otherwise. There is a paragraph in the laws governing radio communication where a penalty is provided for anyone who wilfully or maliciously interferes with the reception of signals from outside the State. So far this has not been invoked against the owners of oscillating receiving sets and we hope that it will not be necessary. Our friends in the British Isles began broadcast reception under strict regulations governing the type of apparatus which they might use. It has been interesting to us who are engaged in the radio business to note recently that these regulations have been gradually suspended.

# BROADCAST PROGRAMS FROM FAR AND NEAR

## Station WJZ, New York City

455 Meters (660 Kcys.) E. S. T. Apr. 10.—1:00 P. M.—Pennsylvania Concert Orchestra. 2:00 P. M.—New York Board of Education program. 3:00 P. M.—Afternoon Auditorium Concert. 4:10 P. M. Mary Gleason, recitations. 4:45 P. M.—“That Street Called Broadway,” by Rosalie Armisted Higgins. 5:00 P. M.—Chester Frost's Bostonian Orchestra. 5:30 P. M.—Federal and State Agricultural Reports. 7:00 P. M.—Uncle Dave Cory's “Jack Rabbit Stories.” 7:45 P. M.—Lettie Bythorn, soprano. 8:30 P. M.—Wanamaker Organ Recital. 9:15 P. M.—American Legion Night. 10:30 P. M.—Dance Program by Theodore's Hotel Majestic Orchestra.

Apr. 12.—3:00 P. M.—Metropolitan Music Company. 3:15 P. M.—Ethel Ross Burckhardt, soprano. 4:00 P. M.—Tea Concert by the Hotel Belmont Stringed Ensemble. 5:15 P. M.—Philip E. Svigals, pianist. 5:30 P. M.—Federal and State Agricultural Reports. 7:00 P. M.—Howard Garis' “Uncle Wiggily Stories.” 7:30 P. M.—Katherine Jaggi Wier, pianist. 8:15 P. M.—Leon Gilbert Simon, baritone. 8:45 P. M.—“The Wedding of Harp and Spark,” by Dr. Alfred N. Goldsmith.

## Station KDKA, Pittsburgh, Pa.

326 Meters (920 Kcys.) E. S. T. Apr. 10.—12:00 Noon—Weather forecast, United States Bureau of Market Reports from the studio of the National Stockman and Farmer. 12:20 P. M.—Lenten Services of the Trinity Church, Pittsburgh, Pa. 6:15 P. M.—Dinner concert by the KDKA Little Symphony Orchestra. 7:30 P. M.—Farm feature. 8:00 P. M.—Music and addresses from the Kiwanis Club dinner. 9:00 P. M.—Concert by the KDKA Little Symphony Orchestra.

Apr. 11.—6:15 P. M.—Organ recital by Lucile Hale. 7:15 P. M.—Sunday School Lesson for April 12. 7:40 P. M.—National Stockman and Farmer market reports. 8:00 P. M.—Radio Boy Scout meeting. 8:30 P. M.—Concert by the King-Haw Entertainers. 9:55 P. M.—Arlington time signals. Weather forecast.

Apr. 12.—11:55 A. M.—Arlington time signals. 12:00 Noon—Weather forecast, United States Bureau of Market Reports. 12:20 P. M.—Lenten Services of the Trinity Church, Pittsburgh, Pa. 1:30 P. M.—Concert by Daugherty's Orchestra. 6:15 P. M.—Dinner concert by the Westinghouse Employees Band. 7:45 P. M.—Last Minute Helps to Teachers of Adult and Secondary Classes. 8:15 P. M.—“More Fish and Better Fishermen,” Dr. Charles Reitell of the University of Pittsburgh. 8:30 P. M.—Concert by the Westinghouse Band.

## Station KSD, St. Louis, Mo.

546 Meters (550 Kcys.) C. S. T. Apr. 9.—6:30 P. M.—Program of Abergh's Concert Ensemble, broadcast direct from Hotel Statler. 9:00 P. M.—Studio recital by Grace and Melba Hise, May O'Brien, sopranos; Bernice Carr and Ione Gardner, pianists; Joe A. Saracini, violinist. 11:30 P. M.—Broadcasting direct from Hotel Statler dance music played by Rodemich's Orchestra.

Apr. 10.—8:00 P. M.—Studio recital by Ida Quernheim, soprano; Hartzell Lyon, baritone; Adele Quernheim, pianist.

Apr. 12.—8:30 P. M.—Missouri Theatre Orchestra concert and specialties broadcast direct from the theatre.

## Station WGY, Schenectady, N. Y.

380 Meters (790 Kcys.) E. S. T. Apr. 10.—11:55 A. M.—Time signals. 12:30 P. M.—Stock market report. 12:40 P. M.—Produce market report. 2:00 P. M.—Music and household talk. 6:00 P. M.—Produce and stock market quotations; news bulletins. 6:30 P. M.—Dinner music by Romano's Orchestra. 7:45 P. M.—Musical program.

Apr. 11.—11:55 A. M.—Time signals. 12:30 P. M.—Stock market report. 12:40 P. M.—Produce market report. 12:45 P. M.—Weather forecast. 2:00 P. M.—Music and talk. 6:30 P. M.—Children's program. 7:45 P. M.—Radio drama, “Pierre of the Plains,” presented by WGY Players.

Apr. 12.—11:55 A. M.—U. S. Naval Observatory time signals. 12:30 P. M.—Stock market report. 12:40 P. M.—Produce market report. 9:30 P. M.—Dance music by Romano's Orchestra.

## Station WBAP, Fort Worth, Texas

476 Meters (620 Kcys.) C. S. T. Apr. 13.—11:00 A. M.—12:15 P. M.—Complete services of the First Methodist Church; Rev. J. W. Bergin, pastor. 4:00-5:00 P. M.—Organ concert by Miss Margaret Agnew White of the Rialto Theatre. 11:00-12:00 P. M.—Popular concert by Fred Cahoon's WBAP Southern Serenaders Orchestra.

Apr. 14.—7:30-8:30 P. M.—Concert by the White Shoe Company Male Quartet. 9:30-10:45 P. M.—Concert by artists of the Butcher School of Hawaiian Music.

Apr. 15.—7:30-8:30 P. M.—Concert by E. Clyde Whitlock, violinist, and a group of his pupils. 9:30-10:45 P. M.—Concert offered by Mrs. Louis Morris, vocalist, and a group of assisting artists.

YOU get everything but the motions when Fanny Brice broadcasts through WEAF. In the photo Fanny is seen doing her stuff without the makeup. She is one of the lights of the Ziegfeld “Follies.”



(Foto Topica)

## Station WJY, New York City

405 Meters (740 Kcys.) E. S. T. Apr. 10.—7:30 P. M.—Breaux and Tobias, popular songs. 7:45 P. M.—Stockbridge Stocks, one-act play. 8:05 P. M.—“Gold” by Innis Brown. 10:15 P. M.—Messner Brothers' Jazz Orchestra. 10:45 P. M.—Olga Warren, soprano, accompanied by Mme. Bertha Vandenberg.

Apr. 11.—7:30 P. M.—Ellsworth B. Morse, baritone; Herbert E. Rector, tenor; H. Fred Hildbrandt, accompanist. 8:15 P. M.—Francis Kirsch, soprano, accompanied by Keith McLeod. 10:30 P. M.—John Doherty, baritone.

## Station WLW, Cincinnati, Ohio

309 Meters (970 Kcys.) C. S. T. Apr. 13.—9:30 A. M.—School conducted by the Editorial Staff of Sunday School Publications of the Methodist Book Concern. 11:00 A. M.—Services of the Church of the Covenant. 7:30 P. M.—Church Services. 8:15 P. M.—Concert by the Western and Southern Orchestra.

Apr. 14.—10:30 A. M.—Weather Forecast and Business Reports. 3:00 P. M.—Market Reports. 4:00 P. M.—Babson Reports. 8:00 P. M.—College of Music presents “An Hour With Schubert.”

## Station WOC, Davenport, Iowa

484 Meters (620 Kcys.) C. S. T. Apr. 10.—10:00 A. M.—Opening Market Quotations. 10:55 A. M.—Time Signals. 11:00 A. M.—Weather and River Forecast. 12:00 Noon—Chimes Concert. 2:00 P. M.—Closing Stocks and Markets. 3:30 P. M.—Educational Program. 6:30 P. M.—Sandman's Visit. 6:50 P. M.—Sport News and Weather Forecast. 9:00 P. M.—Orchestra Program.

Apr. 11.—10:00 A. M.—Opening Market Quotations. 10:55 A. M.—Time Signals. 11:00 A. M.—Weather and River Forecast. 12:00 Noon—Chimes Concert. 2:00 P. M.—Closing Stocks and Markets. 3:30 P. M.—Educational Program. 6:30 P. M.—Sandman's Visit. 6:50 P. M.—Sport News. 7:20 P. M.—Sunday School Lesson. 8:00 P. M.—Musical Program.

Apr. 12.—10:00 A. M.—Opening Market Quotations, Garden and Household Hints. 10:55 A. M.—Time Signals. 11:00 A. M.—Weather and River Forecast. 11:05 A. M.—Market Quotations. 12:30 P. M.—Closing Stocks and Markets. 3:30 P. M.—Educational Program. 6:30 P. M.—Sandman's Visit. 6:50 P. M.—Sport News and Weather Forecast. 9:00 P. M.—Orchestra Program.

## Station WOO, Philadelphia, Pa.

509 Meters (590 Kcys.) E. S. T. Apr. 11.—11:30 A. M.—United States weather forecast. 11:55 A. M.—United States Naval Observatory time signal. 12:00 Noon—Luncheon Music by the Tea Room Orchestra. 7:30 P. M.—Dinner Music from the Hotel Adelphia Concert Orchestra. 8:30 P. M.—Special Program from the Fox Theatre Studio. 10:03 P. M.—Dance Program by the Kentucky Kernels from the Hotel Adelphia.

Apr. 12.—11:00 A. M.—Grand Organ. 11:30 A. M.—United States weather forecast. 11:55 A. M.—United States Naval Observatory time signal. 12:00 Noon—Luncheon Music by the Tea Room Orchestra. 5:00 P. M.—Sports Results and Police Reports. 9:55 P. M.—United States Naval Observatory time signal. 10:02 P. M.—United States weather forecast.

## Station KFI, Los Angeles, Cal.

469 Meters (640 Kcys.) P. T. Apr. 10.—4:45 P. M.—Evening Herald News Bulletins. 5:15 P. M.—Examiner News Bulletins. 6:45 P. M.—Y. M. C. A. concert, sales lecture and bedtime story. 8:00-9:00 P. M.—Ambassador Hotel concert. 9:00 P. M.—Examiner concert. 10:00 P. M.—Vocal and instrumental concert.

Apr. 11.—4:45 P. M.—Evening Herald News Bulletins. 5:15 P. M.—Examiner News Bulletins. 6:45-7:30 P. M.—Vocal and instrumental concert by Myral Belle Vickers. 8:00 P. M.—Evening Herald concert. 9:00 P. M.—Examiner concert. 10:00 P. M.—Lillian Hasserles Novelty Orchestra. 11:00 P. M.—Ambassador-Max Fischer's Coconut Grove Orchestra.

Apr. 12.—4:45 P. M.—Evening Herald News Bulletins. 5:15 P. M.—Examiner News Bulletins. 6:45 P. M.—Instrumental program. 8:00 P. M.—Vocal and instrumental concert. 9:00 P. M.—Examiner concert. 10:00 P. M.—Vocal and instrumental concert. 11:00-12:00 P. M.—Ambassador-Max Fischer's Coconut Grove Orchestra.

## Station WDAF, Kansas City, Mo.

411 Meters (730 Kcys.) C. S. T. Apr. 10.—3:30 P. M.—D. Ambert Haley's Dance and Concert Orchestra. 6:00 P. M.—Piano tuning-in number on the Duo Art. Marketgram, weather forecast, time signal and road reports. The children's story and information period. Music—Fritz Hanlein's Trianon Ensemble, Hotel Muehlebach. 11:45 P. M.—1:00 A. M.—(Nighthawk Frolic) The “Merry Old Chief” and the Coon-Sanders Novelty-Singing Orchestra.

Apr. 11.—3:30 P. M.—Musical Matinee. 6:00 P. M.—Marketgram, weather forecast, time signal and road report. The children's story and information period. Music—Fritz Hanlein's Trianon Ensemble, Hotel Muehlebach. 8:00 P. M.—Novelty Night, program by the WDAF minstrels, and Jack Riley's Plantation Serenaders.

Apr. 12.—3:30 P. M.—Musical Matinee, the Riley Ehrhart Orchestra. 6:00 P. M.—Marketgram, weather forecast, time signal and road report. The children's story and information period. 11:45 P. M.—1:00 A. M.—The “Merry Old Chief” and the Coon-Sanders Novelty Singing Orchestra.

## Station WDAF, Philadelphia, Pa.

395 Meters (760 Kcys.) E. S. T. Apr. 10.—11:45 A. M.—Daily Almanac. 12:02 P. M.—Organ recital from the Stanley Theatre. 2:00 P. M.—Arcadia Concert Orchestra. 4:30 P. M.—Women's Club Hour. 7:30 P. M.—Dream Daddy with the Boys and Girls.

Apr. 11.—11:45 A. M.—Daily Almanac. 12:02 P. M.—Organ recital from the studio. 2:00 P. M.—Arcadia Concert Orchestra. 4:30 P. M.—Program of Dance Music by Sal Zaleb and his orchestra. 7:30 P. M.—Dream Daddy with the Boys and Girls. 10:10 P. M.—Howard Lanin's Dance Orchestra.

Apr. 12.—11:45 A. M.—Daily Almanac. 12:02 P. M.—Organ recital from the Stanley Theatre. 2:00 P. M.—Arcadia Concert Orchestra. 4:30 P. M.—The Cotton Pickers, under the direction of Wilbur De Paris, playing at the Palais De Amour. 7:30 P. M.—Dream Daddy with the Boys and Girls.

## Station WSB, Atlanta, Georgia

429 Meters (700 Kcys.) C. S. T. Apr. 10.—12 M.—Entertainment. 3:30 P. M.—Howard Theatre overture nad prologue. 5:00 P. M.—Miss Bonnie Barnhardt's songs and bedtime story. 10:45 P. M.—“The Evolution of Dixie,” an original musical fantasia.

Apr. 11.—3:30 P. M.—Howard Theatre overture and prologue. 5 P. M.—Vick Myers' Melody Orchestra. 8:00 P. M.—“The Seven Adairs,” Atlanta family of entertainers, including the “Kid Quartet.” 10:45 P. M.—Bob Hardin's Orchestra.

Apr. 12.—3:30 P. M.—Howard Theatre overture and prologue. 8:00 P. M.—United States post-office staff entertainment. 10:45 P. M.—Week-end revue featuring Mrs. Kathleen Rogers Pape, international pianist.

Apr. 13.—11:00 A. M.—First Presbyterian Church service. 5:00 P. M.—Central Baptist Church choir. 7:30 P. M.—Wesley Memorial Church service.

**Station WOAW, Omaha, Neb.**

526 Meters (570 Kcys.) C. S. T. Apr. 10.—6:00 P. M.—Every Child's Story Hour. 6:30 P. M.—Dinner program by Goldenrod Orchestra. 9:00 P. M.—Program by Hotel Fontenelle Concert Orchestra. 10:00 P. M.—WOAW Dance Program by Frank Hodek's Orchestra.  
 Apr. 11.—6:30 P. M.—Dinner program by Harmo Jazz Orchestra. 9:00 P. M.—Concert program by Oakland (Iowa) Band.  
 Apr. 12.—6:30 P. M.—Dinner program by Lenn Kelly's Harmonians. 9:00 P. M.—Program by colored artists.

**Station WWJ, Detroit, Mich.**

517 Meters (580 Kcys.) E. S. T. Apr. 10.—8:00 A. M.—Setting-up exercises by R. J. Horton, physical director of the Detroit Y. M. C. A. 10:25 A. M.—Official weather forecast. 11:55 A. M.—Arlington time relayed by the Western Union. 12:00 Noon—Edward Barnes, baritone; LeRoy De Turk, tenor. 3:00 P. M.—The Detroit News Orchestra. 7:00 P. M.—The Detroit News Orchestra. 10:00 P. M.—Dance music by Jean Goldkette's Orchestra.  
 Apr. 11.—8:00 A. M.—Setting-up exercises. 9:45 A. M.—Public Health Service bulletins and talks on subjects of general interest. 10:25 A. M.—Official weather forecast. 11:55 A. M.—Arlington time relayed by the Western Union. 12:00 Noon—Dance music by Jean Goldkette's Orchestra. 3:00 P. M.—The Detroit News Orchestra. 8:30 P. M.—Anne Campbell, Detroit News Poet.  
 Apr. 12.—8:00 A. M.—Setting-up exercises. 9:45 A. M.—Public Health Service bulletins and talks on subjects of general interest. 10:25 A. M.—Official weather forecast. 12:00 Noon—Edward Barnes, baritone; LeRoy De Turk, tenor. 3:00 P. M.—The Detroit News Orchestra. 3:30 P. M.—Official weather forecast.

**Station WGI, Medford, Mass.**

360 Meters (830 Kcys.) E. S. T. Apr. 10.—12:40 P. M.—New England Weather Forecast. 12:45 P. M.—Closing Report on Farmers Produce Market Report. 5:30 P. M.—Closing Stock Market Reports, Live Stock Markets Reports. 6:15 P. M.—Boston Police Reports, Boston Police Headquarters. 7:00 P. M.—Evening Program. 8:00 P. M.—Radio Drama by the Boston Stage Society.  
 Apr. 11.—12:40 P. M.—New England Weather Forecast. 12:45 P. M.—Closing Report on Farmers' Produce Market Report. 5:30 P. M.—Closing Stock Market Reports. 6:15 P. M.—Code Practice. 7:00 P. M.—Boston Police Reports, Boston Police Headquarters. 7:30 P. M.—Evening Program.  
 Apr. 12.—6:45 P. M.—Code Practice. 7:05 P. M.—New England Weather Forecast. 7:30 P. M.—Talk on Current Events. 8:00 P. M.—Evening Program.

**Station WRC, Washington, D. C.**

489 Meters (640 Kcys.) E. S. T. Apr. 10.—5:15 P. M.—Instruction in International Code. 6:00 P. M.—Children's Hour by Peggy Albion. 6:15 P. M.—A Talk on Cancer Prevention. 8:00 P. M.—Dance Program by the Better Ole Orchestra. 9:00 P. M.—Song Recital by Marguerite Todhunter, contralto. 9:15 P. M.—Concert by the Lee House Trio. 9:55 P. M.—Retransmission of Time Signals and Weather Reports. 10:00 P. M.—"Amending the Volstead Act" by Senator Arthur Capper.  
 Apr. 11.—3:10 P. M.—Song Recital by Arthur McCormick, baritone. 3:25 P. M.—Current Topics by the Editor of "The Review of Reviews." 3:35 P. M.—Piano Recital by Ethel Grant. 4:00 P. M.—Song Recital to be announced. 5:15 P. M.—Retransmission of Time Signals and Weather Forecasts. 6:00 P. M.—Stories and Songs for Children.  
 Apr. 12.—5:15 P. M.—Instruction in International Code. 6:00 P. M.—Children's Hour by Peggy Albion. 7:45 P. M.—Bible Talk. 8:00 P. M.—Song Recital by A. Harlen Castle, tenor. 8:15 P. M.—Piano Recital by Katherine Offerdinger. 8:30 P. M.—A Talk on the U. S. Coast Guard. 9:00 P. M.—Song Recital to be announced. 9:15 P. M.—A Talk on Amending the Volstead Act. 9:30 P. M.—Dance program by the United States Army Band.

**Station WHAZ, Troy, N. Y.**

380 Meters (790 Kcys.) E. S. T. Apr. 14.—9:00 P. M.—The Masque of Troy presenting the four act comedy "The County Chairman," by personal permission of the author, George Ade. 12:00 P. M.—Monthly transcidental program by Campus Serenaders and Rensselaer Polytechnic Institute Glee Club.  
 Apr. 21.—9:00 P. M.—Concert by Beman Park Neighborhood Association, women's quartet, vocal and instrumental soloists. 9:45 P. M.—Garden Talk by John Jeannin, Jr., former extension lecturer, New York State Department of Agriculture. 10:00 P. M.—Concert by Troy Salvation Army Silver Band.  
 Apr. 28.—9:00 P. M.—Concert by Rensselaer Polytechnic Institute Students' Symphony Orchestra, with assisting artists. Lecture on chemical engineering by member of the faculty of the Troy Tech.

**Station WKAQ, San Juan, P. R.**

360 Meters (830 Kcys.) Broadcasts two concerts weekly as follows: Wednesdays, 7 to 9 P. M.; Fridays, 7 to 9 P. M. Porto Rico time is one hour earlier than Eastern Standard time. The time given (7 to 9 P. M.) is E. S. T.

**JOSEPHINE ROYLE**, who recently was heard from WJZ, with her father, Edwin Milton Royle, the dramatist, and her sister, Selena. They presented a scene from Mr. Royle's play, "Launcelot and Elaine." The play is based on Tennyson's romantic poem.



**Station KGW, Portland, Ore.**

492 Meters (610 Kcys.) P. T. Apr. 13.—6:00 P. M.—Church Services. 7:00 P. M.—George Olsen's Concert Orchestra in Dinner Program.  
 Apr. 14.—11:30 A. M.—Weather Forecast. 3:30 P. M.—Literary Program by Portland Library Association. 8:00 P. M.—Recital by Joseph P. Mulder, tenor. 9:30 P. M.—Musical Program.  
 Apr. 15.—11:15 A. M.—Market Basket. 11:30 A. M.—Weather Forecast. 12:30 P. M.—Concert by Civic Music Club of Portland. 3:30 P. M.—Talk by Jeanette P. Cramer, home economics editor of The Oregonian. 7:45 P. M.—Talk for Farmers, Oregon Agricultural College Extension Service.

**Station WOS, Jefferson City, Mo.**

441 Meters (680 Kcys.) C. S. T. Apr. 11.—8:00 P. M.—Address: "Some Interesting Facts About Wool," by Daniel C. Rogers, State Marketing Bureau. 8:20 P. M.—Varied musical program presented by the faculty and students of Hardin College.  
 Apr. 13.—7:30 P. M.—Complete religious service of the First Presbyterian Church of Jefferson City. The Rev. W. Hooper Adams, Pastor; Mrs. Mary Armstrong, Organist; Mrs. John V. Jobe, Director of Vested Choir.

**Station KHJ, Los Angeles, Cal.**

395 Meters (760 Kcys.) P. T. Apr. 10.—12:30 P. M.—News Items, Weather Report, Music. 2:30 P. M.—Program presented through the courtesy of Barker Brothers. 6:45 P. M.—Children's program. 8:00-10:00 P. M.—Program presented through the courtesy of Mu Phi Epsilon. Dr. Chain Weizman, president of the World Zionist organization.  
 Apr. 11.—12:30 P. M.—News Items, Weather Report and Music. 2:30-3:30 P. M.—Program presented through the courtesy of Barker Brothers. 6:45 P. M.—Children's program. 7:00 P. M.—Organ recital. 8:00 P. M.—Program presenting the Studebaker Radio Orchestra.  
 Apr. 12.—12:30 P. M.—News Items, Weather Report and Music. 6:45 P. M.—Children's program. 8:00 P. M.—Program presenting Mrs. Norman Hassler, soprano; Mr. Norman Hassler, baritone; Eleanor Sleeth, violin; Clarence Kellogg, pianist.

**Station CKAC, Montreal, Canada**

430 Meters (700 Kcys.) E. S. T. Apr. 12.—7:00 P. M.—Kiddies' stories in French and English. 7:30 P. M.—Rex Battle and his Mt. Royal Hotel Concert Orchestra. 8:30 P. M.—Frontenac Breweries Band and Artists direct from the brewery. 10:30 P. M.—Jos. C. Smith and his Mt. Royal Hotel Dance Orchestra.

**Station WAAW, Omaha, Neb.**

630 Meters (830 Kcys.) C. S. T. Apr. 9.—8:00 P. M.—Marketgrams.  
 Apr. 10.—8:00 P. M.—Educational program, talks, agriculture topics.  
 Apr. 11.—8:00 P. M.—Bridge talks by Mrs. Guy U. Purdy, of Omaha, Neb., Omaha's most noted bridge teacher.  
 Apr. 12.—8:00 P. M.—Marketgrams.

**Station WFAA, Dallas, Texas**

476 Meters (630 Kcys.) C. S. T. Apr. 10.—6:45 P. M.—Boy Scout program, H. W. Wester, scout executive, directing. 8:30 P. M.—Old fiddlers and varied entertainment. 11:00 P. M.—Ernst Emmett and his orchestra.  
 Apr. 11.—12:30 P. M.—Address, Dr. Robert Stewart Hyer, president emeritus Southern Methodist University. 8:30 P. M.—Varied program by entertainers from Palmer, Texas.  
 Apr. 12.—8:30 P. M.—Piano recital, Mrs. Joseph B. Rucker, teacher. 11:00 P. M.—Dance music.  
 Apr. 13.—6:00 P. M.—Radio Bible Class. 9:00 P. M.—The Singers, twenty voices from Corsicana, Texas. 10:00 P. M.—Jack Gardner's Honey-boys' Orchestra.

**Station KGO, Oakland, Calif.**

312 Meters (960 Kcys.) P. T. Apr. 9.—1:30 P. M.—New York stock exchange quotations and weather report. 3:00 P. M.—Short musical program. 6:45 P. M.—Final stock exchange quotations and weather report, news items.  
 Apr. 10.—1:30 P. M.—New York stock exchange quotations and weather report. 6:45 P. M.—Final stock exchange quotations, weather report and news items. 8:00 P. M.—Three act drama, "Kindling," by KGO Players; music by Sweet Briar Trio.  
 Apr. 11.—1:30 P. M.—New York stock exchange quotations and weather report. 3:00 P. M.—Short musical program. 6:45 P. M.—Closing stock exchange quotations, weather report and news items.  
 Apr. 12.—12:30 P. M.—New York stock exchange and U. S. weather report. 8:00 P. M.—Program by Soroptimist Club of Oakland, Cal. 10:00 P. M.—Dance music by Orchestra in St. Francis Hotel Ballroom, San Francisco, Cal.

(Continued on page 25)

A List Showing the Votes Cast Will Be Published in an Early Issue

# Who Is America's Most Popular Radio Entertainer?

Everybody is interested in this query: Who is America's most popular radio entertainer? You have your favorite. Who is she or he? Let us know your choice, whether a comedian, an opera singer, a jazz band, or a story-teller.

RADIO WORLD wants to be able to tell the world the name of the entertainer who stands highest in the regard of listeners-in.

Use the accompanying blank and mail to Broadcasting Manager, RADIO WORLD.

Cut off. Fill out. Mail today.

BROADCASTING MANAGER, RADIO WORLD,  
 1493 Broadway, New York City.

Dear Sir:

My favorite entertainer is.....Station.....  
 Name.....  
 Street Address.....  
 City and State.....

[A COMPLETE LIST OF BROADCAST STATIONS was published in RADIO WORLD, issue of April 5. Another list, revised to date of going to press, will be published soon.]



# How Acorn of Radio Grew to Great Oak

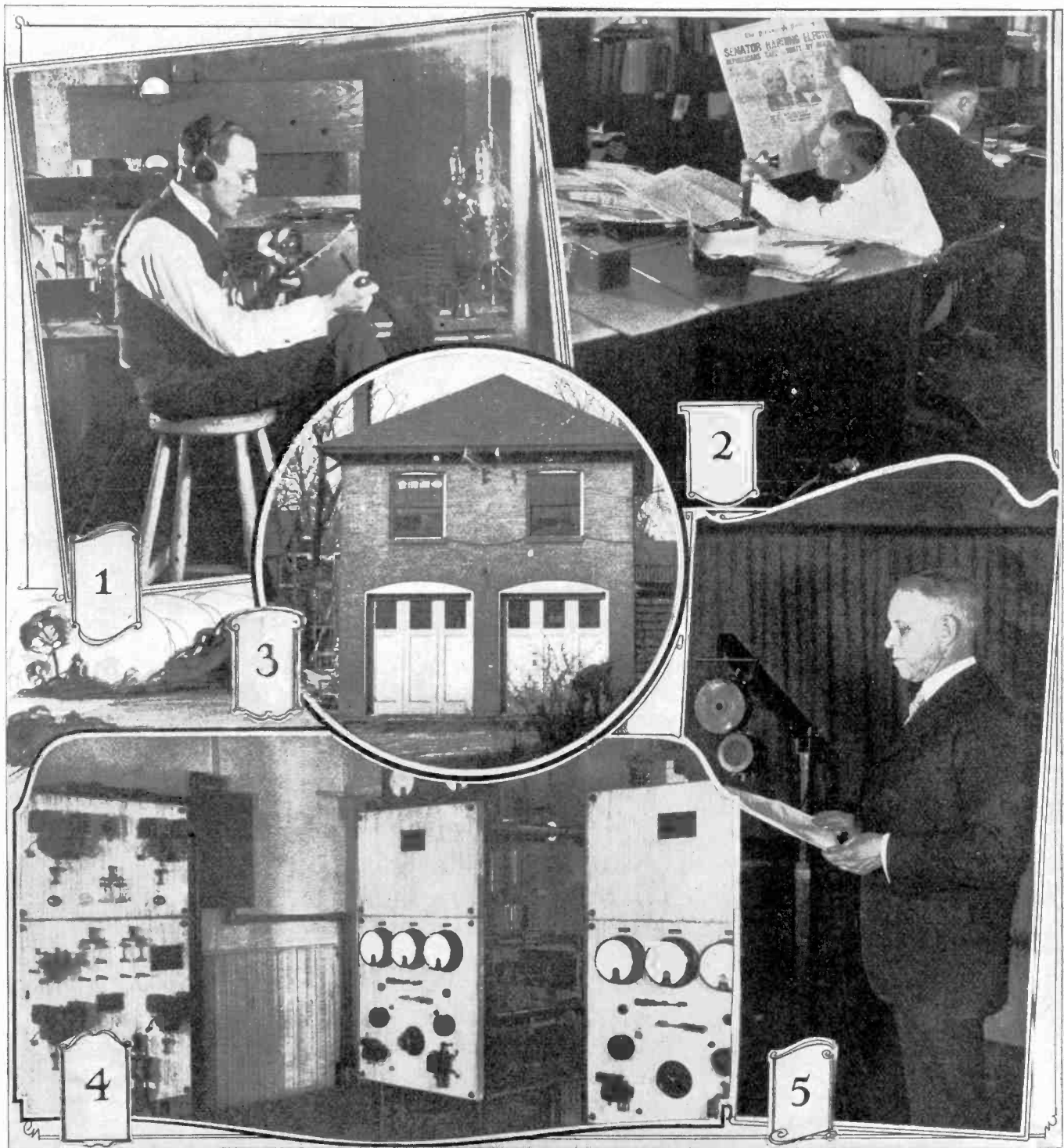

KDKA! The magic letters that were first heard over the air in the fall of 1920. Little did the pioneers in radio who experimented with real broadcasting then think to what extent their work would be carried. Radio now has a firm hold all over the globe. The "fad" of a few years ago is today a hard and fast necessity—and rapidly becoming one of the biggest industries in the country. Fig. 1 portrays the lowly garage in which the pioneer radiophone was hooked-up and tested. Fig. 2 shows the office of the Pittsburgh Post, from where the election returns were telephoned to KDKA for broadcasting. Fig. 3—Does this look like a broadcasting station of to-day? Well, it's where the practical application of the idea originated. Frank Conrad's garage near East Pittsburgh has the high honor of having been the first station. Fig. 4—Now this is something different. KDKA's control room is the very latest thing in radio. Fig. 5—The first to talk to England. H. P. Davis, credited with being the father of broadcasting, is shown talking into the ultra-audible microphone.

## Inspectors Find Autos and Loops Essential

By Carl H. Butman

**P**ORTABLE receiving sets with directional loops, mounted in automobiles, are coming to be an essential part of the equipment of the nine radio supervisory districts, according to officials of the Department of Commerce. Recently, through the operation of a direction-finding set mounted in an automobile in Oak-

land, a long offending unlicensed station was located and dismantled. This station, operating at all hours of the day and night, sometimes under the fictitious call "6LL," was causing great interference, and was breaking the radio regulations as to fake "SOS" calls, improper messages, and what is constituted as proper language of the air.

# A 10-Watt C. W. and Phone Transmitter

By Leroy Western

**S**AY, fellows, if you want to put in a *real* combination C. W. and radiophone transmitter, just glance over the circuit diagram shown in Fig. 1 and note the simplicity of it. This set is a wonderful distance annihilator both for C. W. and phone and uses

rent supplied should be at least .09 amperes. The milliammeter should preferably read from zero to 500 milliamperes over a large scale. This will enable you to use it in many other experiments and it is particularly helpful in receiving sets employing UV199 tubes for operating them at a constant current.

The transformer indicated may be similar to that

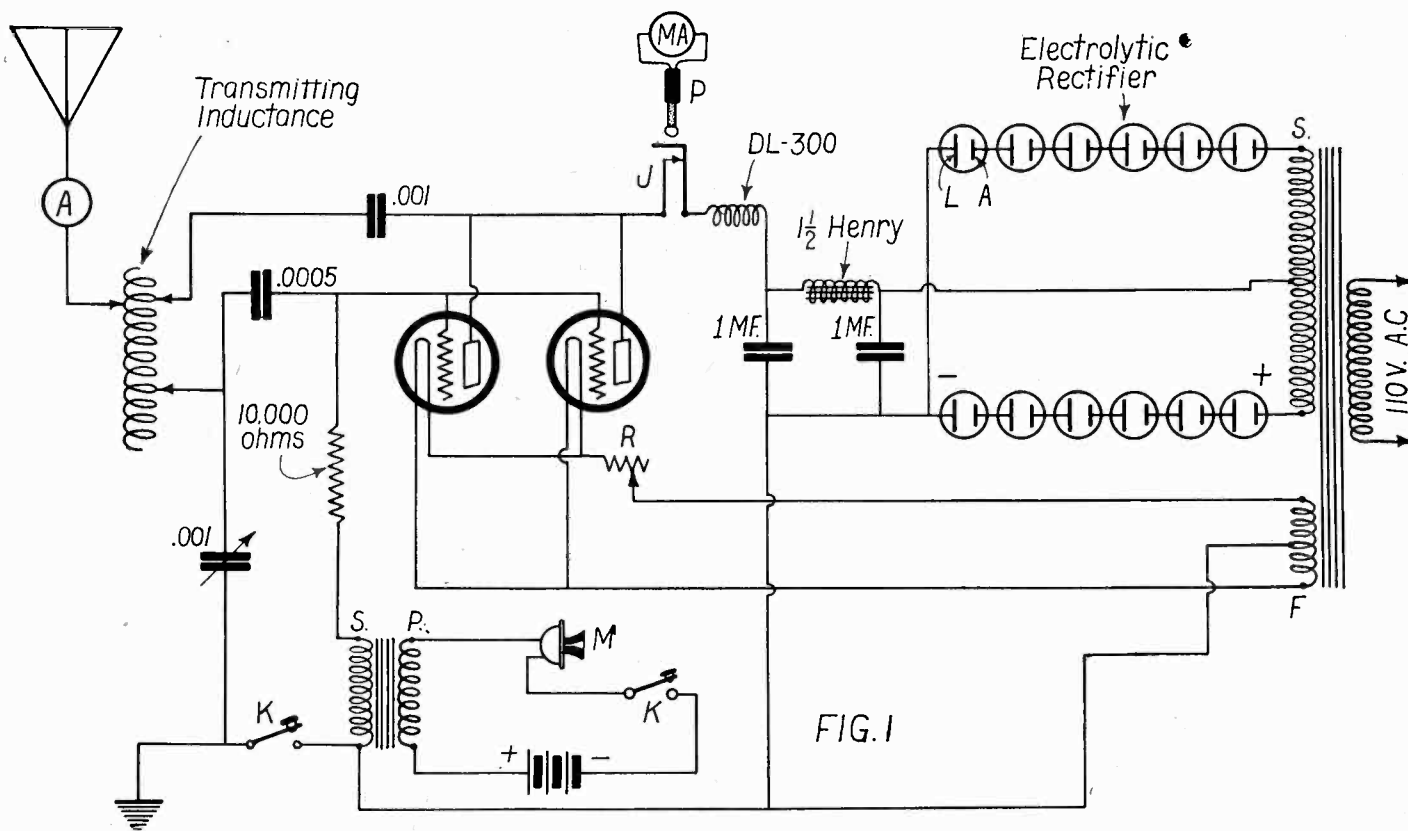

Circuit diagram of CW transmitter. Key in modulator circuit remains open when straight CW is used. Key in grid circuit is closed when voice is used.

rectified A. C. for supplying the plate current in both instances. A well known oscillating circuit is used in connection with this set and two 5-watt power tubes in parallel act as oscillators. The grid method of modulation is used when radiophone transmission is desired.

The transmitting inductance may be similar to that described by the author in several articles which have appeared in this magazine, or if one desires something better, a standard type may be purchased from any company dealing in transmitting apparatus. It should, however, contain at least 20 turns of either very heavy copper wire or better still copper ribbon, wound edgewise. Three clips must be provided which are to be used for tuning. By the way, in connection with the antenna circuit it is well to mention that a hot wire ammeter or radio frequency current indicator should be obtained.

Get the best possible type, even if it costs a little more, because you can always use it in connection with any transmitting set.

A well-made instrument is a decided asset, while a cheaply constructed one is very often more of a hindrance than a help.

While on the subject of meters, it may be well to mention the milliammeter, shown in the plate circuit. This should also be of a good grade and will show you just how much current is being supplied to the plates of the two tubes. In the case of two 5-watt power tubes, which are connected as shown, the cur-

described by the writer in one of the past issues of RADIO WORLD. This is provided with a center tap on both secondaries. The center tap on the large secondary is used to supply the positive potential to the plates of the tubes through the radio and audio frequency choke coil. The latter consists of a honeycomb coil with 300 turns of wire wound thereon.

The radio frequency iron core choke coil may have an inductance from 1½ to 5 henrys and rather than try to make one, the amateur should purchase one from a recognized supply house.

The reason for this is that the construction is rather complicated and involves the winding of many hundreds of turns of very fine wire. Furthermore, better results will undoubtedly be obtained from a manufactured instrument. The filter system consists of this iron core choke coil used in connection with two 1 mf. condensers. They should be of a very good type capable of standing up to 1,000 volts. Either mica or a fine quality paraffin paper may be used as a dielectric, but it is advisable to purchase them rather than make them as the capacity will undoubtedly vary quite a lot if the condensers are home-made. The same applies to the microphone or transmitter induction coil or transformer. They are comparatively inexpensive and it is hardly worth while to devote the time to constructing one.

The microphone should be of a type designed for radio telephony use and should be operated at the  
(Concluded on next page)

# A Fine CW Transmitter

(Concluded from preceding page)

potential recommended by the manufacturers. In series with the microphone and battery there should be connected a switch indicated by K in the diagram so that the microphone circuit can be opened when you are not transmitting. This makes possible a considerable saving in batteries.

In order to make the set more stable in operation and keep the grid of the oscillator tubes at an even potential, it is necessary to take a tap off from the center of the winding, which provides the necessary low voltage for the filaments. The key may be of the type usually used in telephony and should be provided with a circuit closer. This circuit closer is to be closed when transmission is to be by radiophone. When you are going to transmit with C. W., open the switch in the microphone circuit, see that the tubes are oscillating and manipulate the key.

The .001 mf. condenser in series with the plates and the .0005 mf. in series with the grids should be of the mica type specially designed for transmission. The same applies to the .001 mf. variable condenser, which is in series with the inductance and the ground. The grid leak may be made by soaking a strip of paper in India ink, and clamping the ends between binding posts and then measuring the resistance by any of the well-known methods or a standard grid leak of the type enclosed in a glass tube may be obtained. The latter method is recommended as being the most efficient and in the most likely way to obtain maximum results.

## The Rectifier

In order to supply a fairly constant direct current to the plates of the two vacuum tubes used in this circuit, it is necessary to use some sort of a rectifying device. The type known as the electrolytic rectifier is probably the most frequently used and is very simple to build. This device makes use of a peculiar action found between two certain dissimilar metals when immersed in conductive solution. It has been found that when this is done, an electrical current can pass through the solution in one direction only and will be retarded when it attempts to pass in the other direction. By making use of this principle and a certain connection of elements it is possible to rectify or change both halves of the cycle of the A. C. to a single polarity which of course gives us a direct pulsating current. Even yet, this current would be unsuitable for telephony, but by the introduction of the choke coils and condensers shown in the diagram in Fig. 1, it is possible to so smooth out the current that it is suitable for radiophone use.

The actual construction details of the electrolytic rectifier are shown in Fig. 2. A shows an assembly of three jars. Twelve of these are necessary and are connected as shown in Fig. 2A and Fig. 1.

In order to make this rectifier, first obtain a quantity of lead and aluminum sheets about 1/32nd to 1/16th of an inch thick, the thickness being practically immaterial.

Next lay out on the two sheets the outline of the plates as shown in Fig. 2B. By careful manipulation of the laying out it will be possible to get quite a good number of plates out of a comparatively small sheet of metal. Cut up twelve aluminum and twelve lead plates of the size and shape shown and assemble them in the jars, connected together with bolts and nuts drawn up tightly on the joints as shown in Fig. 2A. The jars used are made of glass and the size need not be exact. The only necessity is that they be

large enough to contain the plates and leave a space of about one inch between them. In order to prevent creeping of the solution, the tops of the jars should be immersed in molten paraffin to a depth of about one inch.

There are many solutions which can be used for electrolytic rectifiers, but the most common and probably the best is a saturated solution of borax. To make this, heat sufficient water to fill the twelve jars to almost boiling. Keeping the water hot, pour in a quantity of ordinary 20 Mule Team borax, stirring constantly until no more can be dissolved. Allow the solution to cool and you will notice that a certain amount of the solid matter will be precipitated. Decant the clear liquid and fill the jars with it.

Some authorities on the subject claim that it is necessary to form the plates of the electrolytic rectifier before using them in a receiving set. However, this is not always necessary and the writer found that if the rectifier was connected up as shown in Fig. 1 and the set used, that the plates formed themselves with no trouble whatsoever.

## Tuning the Set

After everything is collected together, tested and hooked up as shown in Fig. 1, the set must be adjusted and tuned. To do this, close the key, light the tubes and adjust the three clips on the transmitting inductance as well as the .001 mf. variable condenser in series with the ground. Adjust these until the hot wire meter shows the highest radiation. Now obtain a wave meter and readjust the set until it is on the proper transmitting wavelength. It may be necessary to go through this process two or three times until the greatest radiation for a given wavelength is obtained. A further check on the operation of the set may be obtained by means of the milliammeter shown connected to the plug, P. Insert the plug in the closed circuit jack, J, and you will be able to determine how much current is being supplied to the plates of the two vacuum tubes.

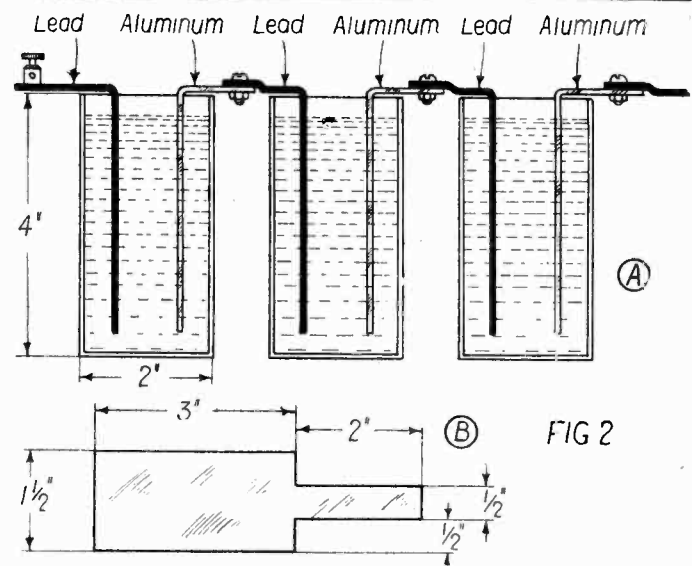

FIG. 2.—Schematic diagram of Electrolytic Rectifier, giving dimensions and location of lead and aluminum electrodes.

## Join in Silent Chorus!

THE entire population of radio these days is condemning the fellow with the squeak box. Join in the chorus and cut out the howls and noise in the air. The air should be full of music and pretty talk but not noises.



# Who Owns These Feet?

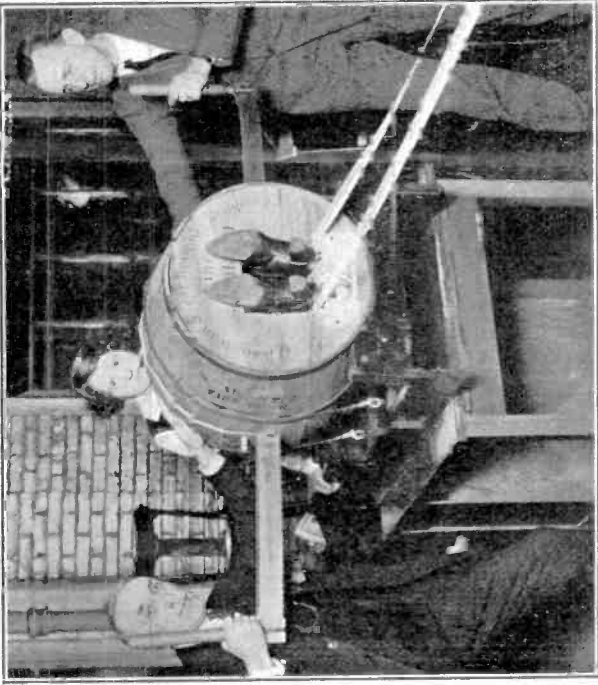

THE GIRL above doesn't look worried in stunt for broadcasting from WTW on April 16. Are her feet the ones protruding from the barrel, or are the shoes empty?



(International Newsreel)  
**TIME SIGNALS FROM A TIMEPIECE**  
—That's usual, but the unusual thing here is that the old alarm clock had its insides taken out, and a receiving set built in. The time comes from Big Ben alright, but via Arlington Radio. Miss Jane Gagnon now goes to sleep by the clock instead of arising by it.



THIS invalid woman may not be able to go to the opera, but she hears it just the same. Radio is universal, you can't be too young or too old to dodge the germ.

# He Builds 12-Tube Super-Heterodyne in Tiers

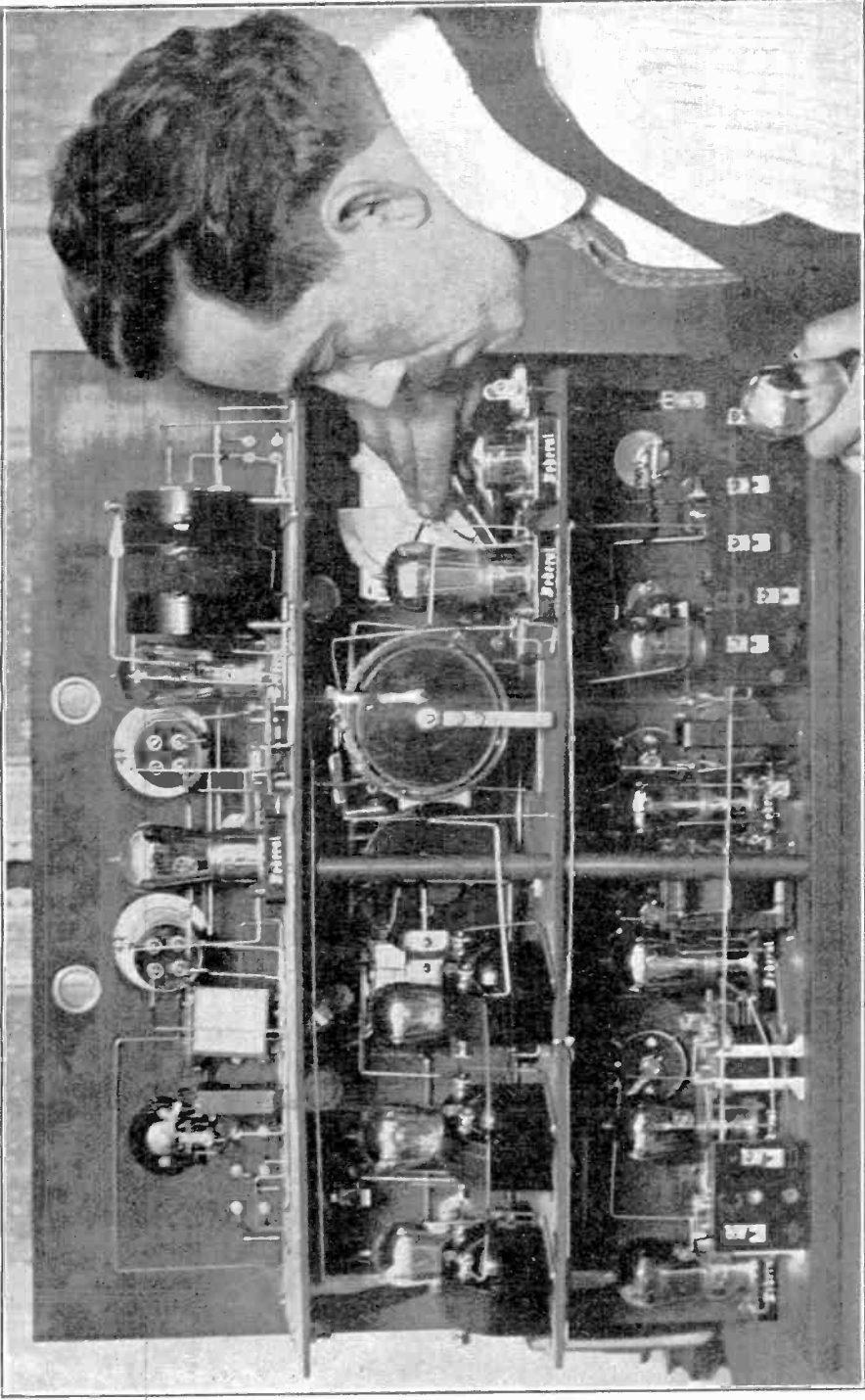

(K & H)  
**HENRY BRINKHAM**, of Pelham, N. Y., wanted something unique and original. This 12-tube convertible tuned radio-frequency, super-heterodyne is the result of his labors. It is built in tiers. He got London and Mexico City on a loop. Note batteries in the rear of the panel.



(International Newsreel)  
**RABBI SILVERMAN** of Temple Emanuel-Eli, New York, campaigning for the Palestine Upbuilding Fund through Station WEAJ. Rabbi Silverman recently returned from a trip to the Holy Land. He is known as the dean of American rabbis.

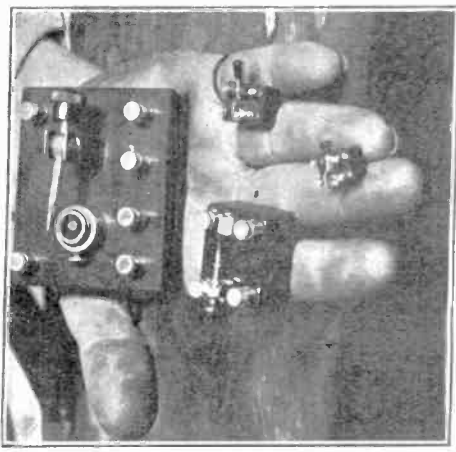

(International Newsreel)  
**A HANDY HANDFUL**—Now, it's finger ring size receivers, instead of only vest-pocket editions. B. Michelson certainly is attacking the cost of listening-in.

# Radio Helps Her Class

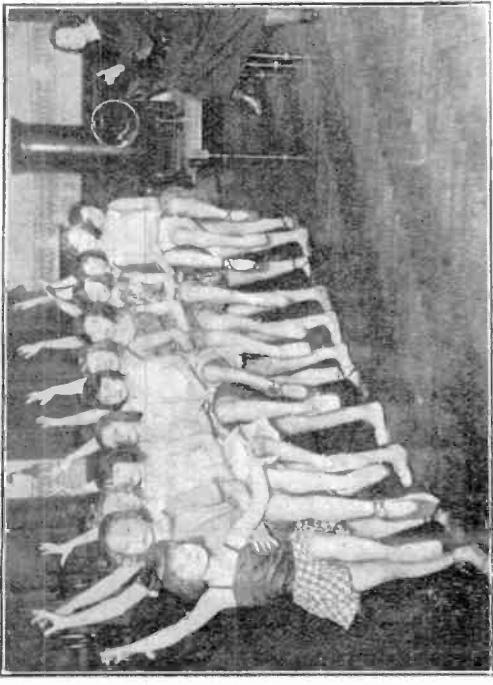

(Keystone View)  
**A CLASS OF GIRLS** in Berlin is taught dancing to music by radio. Just goes to show how really universal radio has become. You can soon expect to see pictures of Cannibal Chiefs doing setting up exercises in the wilds of the jungle from instructions sent out by radio from some health center up in South Podunk.



(Wide World)  
**HIRAM PERCY MAXIM**, famed in amateur radio, and President of the American Radio Relay League, arrived home recently from a trip abroad, where he made a three-months' study of radio conditions.



(Williams)  
**WHILE THEIR HUSBANDS**, famous opera singers, broadcast from a Berlin station, Senora Pasquale Amato (left) and Mme. Leo Slezak, take in the performance via the ether.

# Radio Helps Her Class

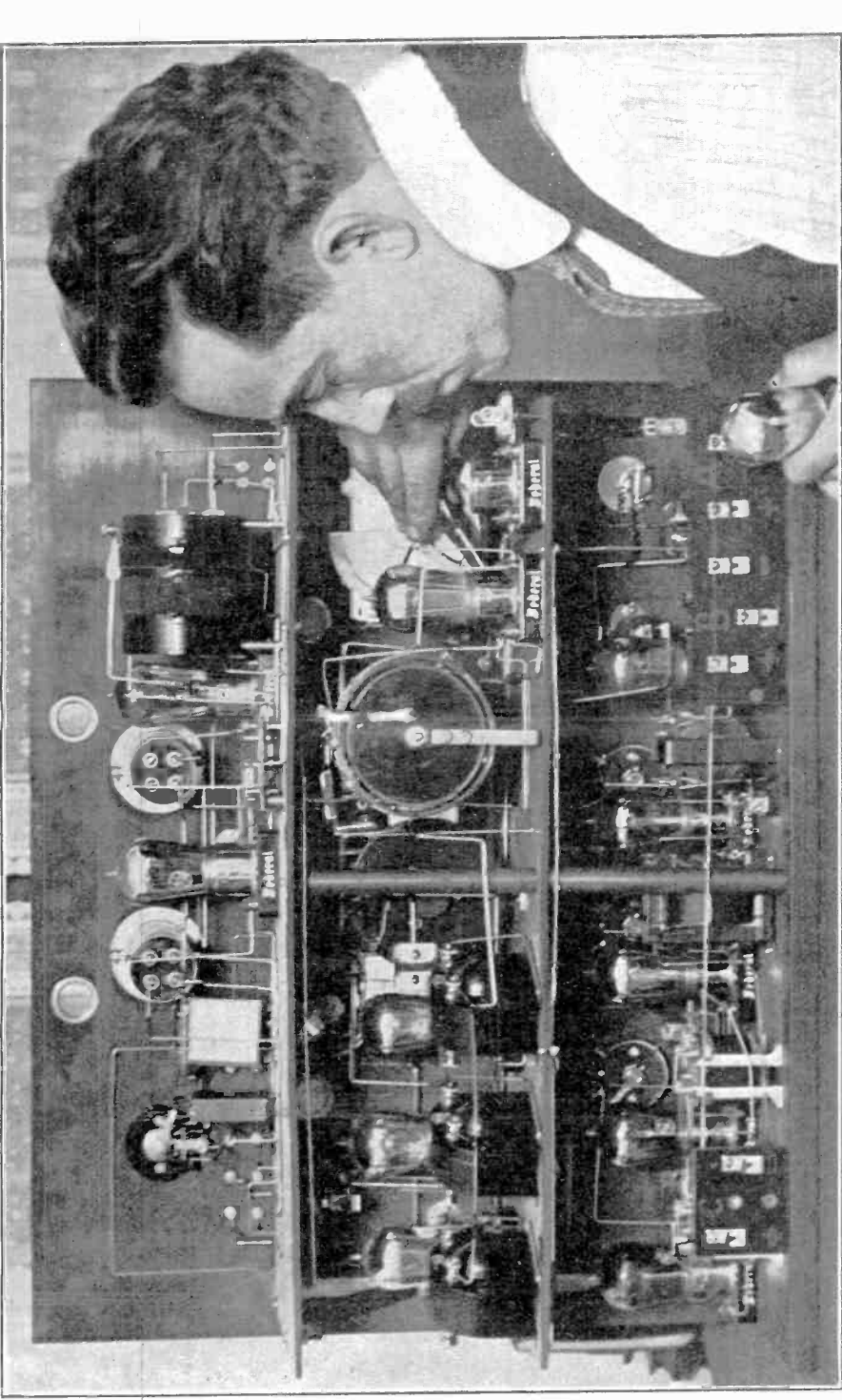

(International Newsreel)  
**SENATOR HOWELL** of Nebraska is talking over the possibilities of installing a radio receiving and broadcasting station in Washington. R. A. Ford, attorney for the Radio Corporation of America, and F. P. Guthrie, Washington manager of the company, are giving their expert advice to the senator.



(Keystone View)  
**HAS IT COME TO THIS?** Yes, now the bakers don't care to walk out or go on strike. The amusing thing is, however, someone has just started to broadcast a talk on "How to Bake."



(Keystone View)  
**HAS IT COME TO THIS?** Yes, now the bakers don't care to walk out or go on strike. The amusing thing is, however, someone has just started to broadcast a talk on "How to Bake."

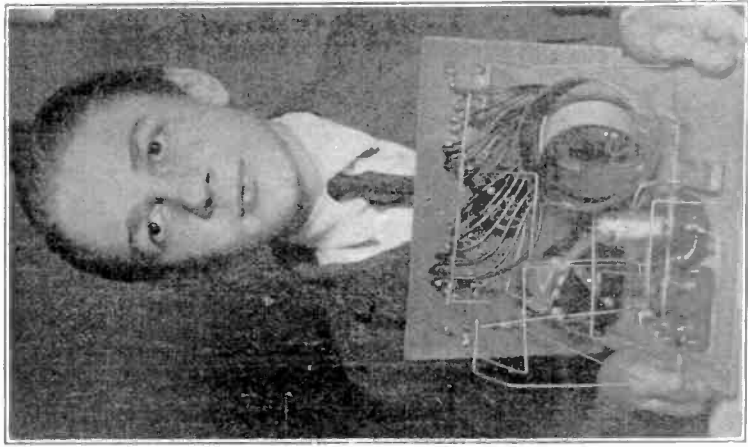

(Foto Topics)  
**CHARLES WOLF** designed and built this efficient set all by himself. On one tube he hears Kansas City and Hastings, Nebraska, with surprising volume, using a 75-foot antenna.



# The Radio University

## A Question and Answer Department conducted by RADIO WORLD for its Subscribers by its Staff of Experts.

Address Letters to Radio University Department  
RADIO WORLD, 1493 Broadway, New York City

**I HAVE a three-tube Reinartz receiver which I am not very much satisfied with. I am using two CV2012 audio transformer coupled condenser tuned circuits. I use a 250 ohm 23-plate variable condenser and one 11-plate condenser with variometer. Can these be used also? Geo. Metcalfe, 1655 Gray Avenue, Detroit, Mich.**

The transformers you have can be used with good results in the neutrodyne circuit. Would suggest the use of 11-plate condensers throughout, although the two 23-plate condensers may be used.

**I have built a tuned radio-frequency set according to the hook-up in Radio World for Dec. 8. Many stations come in, but I cannot hear them. I use a 250 ohm 23-plate variable condenser and one 11-plate condenser with variometer. Can these be used also? Geo. Metcalfe, 1655 Gray Avenue, Detroit, Mich.**

Test your B batteries to make sure that they are not run down. If you are using a soft tube for the detector, try cutting down on the detector plate voltage, also increase the plate voltage for the amplifier tube. See that the tube socket contacts are clean, also the prongs of the tubes. So over the circuit carefully, making sure that the plate leads are not shorted. Test all the condensers for shorts and see that the plates of the variable condensers have no dirt accumulated on them. Examine and test your jacks for shorts and clean up all the flux on the leads. Creeping soldering flux causes many of the internal troubles of home made sets.

**I have a 43 plate condenser. Would the one on page 12 receive as well with this condenser as one of 23 plates?—G. G. Stewart, Jr., 238 Mount St., Montreal, Can.**

Your 43 plate condenser can be used in this set, but the tuning will be much finer. Would suggest that you use some sort of a vernier with it.

**Please give me a description of the coil L used in the set using radio-frequency with a Reinartz tuner described in the Radio World of Feb. 23. Should the coils be at right-angles to one another?—L. B. McDonald, 63 Lockwood Ave., Stamford, Conn.**

Coil L in this circuit is 65 turns of number 22 DSC wire wound on a 3 1/2 inch Radio tube. Make 6 taps of ten turns each and five inch apart. Mount the coils about six inches apart. It does not make much difference if they are at right angles or not if they are kept apart.

**I recently installed a radio in a house about 350 feet from a telephone central and they use an interchanger (or electric ringing device) which gives them a ringing current of 110 volts. They have this interchanger turned on, it puts up a clatter in the radio receiving set, but when central closes at night this clatter stops. What can be done to stop this interference?—O. L. Brandt, Penokee, Kansas.**

You are located in a rather unfortunate position, being so close to the source of trouble. If it is possible to use a loop wound suggest that you do so, as this is the best to overcome the interference. Ordinary copper screening is no good for this purpose, and can be tacked to a frame and placed near the loop. You can also try the following method of eliminating the interference. Connect a one henry iron-core choke in series with a one-half mfd. condenser and place them across the antenna and ground terminals of the set. This gives good results in some cases, but it can probably be cut down to such an extent that it won't be annoying.

**Kindly inform me where Bryt C. Caldwell can be reached?—W. Kockwell, 24 Worcester Square, Boston, Mass.**

Mr. Bryt C. Caldwell can be reached at 235 Lamartine Street, Boston 30, Mass.

**Would you please tell me where I could purchase a VT1 tube to be used in a Reinartz circuit as described in the Radio World of February 27?—Edwin H. Fellner, 314 Grant Street, Litchfield, Ill.**

We do not recommend any apparatus sold in the competitive field, for further information as to parts see the advertising columns in this issue.

**Can UV201A tubes be used in the superdyne instead of UV199 with equal results? Can a but-**

**I am a beginner in radio and would like to know the answers to the following questions: 1—What is meant by "best" or "optimum" tuning? 2—How can I tell if my tuning is correct? 3—What is the very best wire to use for the ground? 4—What is the best wire to use for the lead-in? 5—What is the best way to connect the antenna to the set? 6—What is the difference in 200, 300 or 400 ohms in head phones? Which is the best to use? 7—When three or four sets of phones are connected in series, can they be of different resistances? Would there be any difference in the sound? 8—What is the best way to connect the antenna to the set? 9—What is the best way to connect the antenna to the set? 10—What is the best way to connect the antenna to the set?—C. E. Krueger, Lebanon, Pa.**

1—Screened wire is best for the aerial. Thin coated wire prevents E. M. F. leakage. 2—The best wire to use is No. 14 or 16. 3—Use a 250 ohm 23-plate variable condenser. 4—Use a 250 ohm 23-plate variable condenser. 5—Use a 250 ohm 23-plate variable condenser. 6—Use a 250 ohm 23-plate variable condenser. 7—Use a 250 ohm 23-plate variable condenser. 8—Use a 250 ohm 23-plate variable condenser. 9—Use a 250 ohm 23-plate variable condenser. 10—Use a 250 ohm 23-plate variable condenser.

**Kindly advise me if the Haynes Griffin air core 3,000 meter radio-frequency transformers can be used with success in the Ultradyne set?—E. O. Hillis, 347 Madison Avenue, New York City.**

No. The ultradyne transformers are differently constructed. In RADIO WORLD for March 1 Mr. Brothard Foot's article requires one 1-4 and one 1-5 with condenser. Can you tell me where they may be obtained, or if the condenser in a Ford coil would be used?—H. A. Crohn, 1207 Eighth Street, Coffeyville, Kan.

These condensers are handled by houses selling transmitting equipment, and you can surely get them there. Do not know just what capacity the Ford coil is, but suggest you try two of them. They may be all right for the purpose.

**Will you kindly send me a table for determining the wave length of transmitters? Is a two-element tube practical for use on a small set?—Cary Byron, Milano, Texas.**

A table such as you ask for will be printed in an early issue of RADIO WORLD. Do not advise the use of the two-element tube. Use a good crystal or a regular three-element tube.

**I have made the White unit for regenerative sets and am using it with a single circuit set which is a 250 ohm 23-plate variable condenser. Would it be better to use a 250 ohm 23-plate variable condenser?—W. Z. Clifton, 136 Broad Street, Easton, Ala.**

You should have the negative A grounded.

**In RADIO WORLD for February 23 I note that the two coils of the White radiation killer are separate. How should they be mounted?—William Turner, Carl Donaldson & Co., Minneapolis, Minn.**

The coils may be mounted one on each side of the panel as convenient. Preferably they should be kept at least 5 inches apart.

**My friend has an antenna running right near mine, and when we both operate our sets we cause howling and squeaking which is very annoying and interferes with reception. Is there any way in which this can be overcome?—J. Schwartz, 1438 Sterling Place, Brooklyn, N. Y.**

In order to do this, if both sets are regenerative, it will be necessary for both of you to incorporate some form of radio frequency choke circuit, similar to that outlined in RADIO WORLD for February 23. If only one of you incorporates a radio frequency choke circuit, the other will still interfere, therefore both must have radio frequency chokes. This additional not only prevents re-radiation, but acts as one step of tuned radio-frequency amplification and will bring the stations in louder. In addition, greater selectivity will be had. See article by Walt S. Thompson, in this issue.

**I intended building a three-tube E-circuit receiver, but since reading about the superdyne, I would like to know which of the two are the best. Will the book type condenser work in this circuit?—E. M. Mann, R. 2, Mt. Clemens, Mich.**

The superdyne circuit should not be constructed by an inexperienced man unless you want to experience a "white noise" which is a result of a permanent winding being put in the set on a board for testing will help you when you put it in a cabinet. If care is taken, and good apparatus used, you can expect good results from any circuit of worth. The book type of condenser will work in this circuit.

**Enclosed find \$6.00 for RADIO WORLD for one year (52 Nos.) and also consider this as an application to join RADIO WORLD'S University Club, which gives me free information in your Radio University Department for the coming year.**

Name .....  
Street .....  
City and State.....

## Girl Economizes With Table Idea

### Has Set Built Under Top, So Ordinary Uses of Furniture Are Preserved

#### By the Hostess

**A CONSTRUCTIVE suggestion made by a Los Angeles girl who had her eye on radio economics was that a set be built under the top of a small living room table, thereby permitting the table to be used for all its ordinary purposes while still serving its uses for the set. Using a table solely to put a set on top of it struck her as being extravagant.**

The table is three feet high and is of grained oak. It sets off prettily a space of blank wall near the china closet. A top stands a fruit bowl and next to that a relic of another day. An artistic effect is produced that raises no protest even from an interior decorator.

The set may be tuned while one is seated at the table. That, however, proves slightly uncomfortable, because of the acute angle at which the dial calibrations must be read, unless the tuning is done two feet away, when perhaps there's a muscular strain.

A preferable, though much more informal method, is to sit on the floor. That manner can not obtain when one has Lord and Lady Cholmondeley as her dinner guests, but it serves well when just "us folks" are around the house. A cotton-stuffed lounge pillow makes tuning easier.

## Runs a Radio Piano

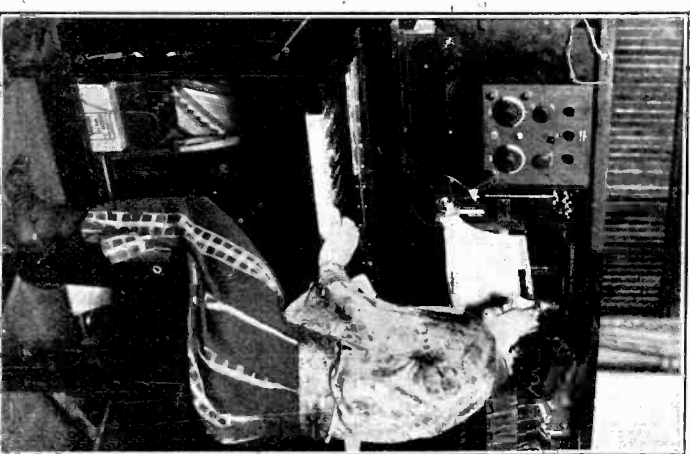

(K. & H) MISS BERT SEGEL

**A RADIO piano, invented by Maurice A. K. Bretzfelder, provides considerable enjoyment for Miss Bert Segel. The device is yet to make its commercial debut.**

The antenna, loop fashion, is secreted between the boards of the piano top. The amplifier and loud speaker fit into the space occupied by the music roll holders. The set and batteries are concealed by sliding doors.

The amplifier and horn in the photo are shown taken from their original place. The batteries and set can also be seen.

## The Radio Woman



(International Newsreel) A RADIO TABLE as devised by a Los Angeles girl with the idea of household economy in view, without artistic effect being sacrificed.

## The Radio Primer

### Information and Instruction for the Novice

#### What the words Mean; Functions of Various Parts

### Beginners' Dictionary

By N. N. Bernstein

**Binding Post**—This is composed of a machine screw, washer and two nuts. The screw is put through a hole in the panel, and fastened with one nut. Connection is made by winding the wire around the screw, and fastening it by tightening the second nut.

**Ground Clamp**—A strip of metal, usually copper or lead alloy in which suitable holes are made to conform with the standard sizes of piping. Connection is made by means of a screw, passing through the proper holes and fastened by a nut.

**Amateur**—Many a beginner in radio thinks that an "amateur" is a novice. Really, the beginner is a "novice." An "amateur" in radio is a person of experience in the art, and is an amateur only in the sense that he does not work at radio for his livelihood.

**Brasspounder**—A word designating a commercial operator, radio or telegraph. The key the operator uses is made of brass and he "pounds" it to produce the signals.

**DX** is an expression or, rather, the radio amateur's abbreviation for distance. CW is the abbreviation for "continuous wave transmission," a method generally used by amateurs in radio transmission. This system is used exclusively for broadcasting.

# RADIOGRAMS

WORLD NEWS HAPPENINGS BRIEFLY PHRASED FOR OUR BUSY READERS

**Net income** of the General Electric Company in 1923 was \$38,001,528. This compares with \$30,749,966 in 1922, after maintenance and depreciation charges, reserves, provision for Federal taxes, etc. Allowing for interest and discount on debentures, other interest payments, addition to general reserve and 6 per cent. cash dividends on special stock, earnings were equivalent to \$18.25 a share on the \$180,089,246 of common stock outstanding, against \$14.86 earned on the \$175,624,746 of common outstanding at the end of 1922. Surplus in excess of cash dividends was \$18,579,423, compared with \$12,157,391 in 1922.

\* \* \*

**Musicians** over the country have been asking higher rates for playing at concerts which are broadcast than for playing at dances and other functions, said Joseph Weber, President of the American Federation of Musicians. Mr. Weber denied reports that the musicians were opposed to the development of the radio, but he said that in some instances dance orchestras had been eliminated and radio sets substituted. In some cities, he said, rules were being made by local unions making specific charges for broadcasting.

\* \* \*

**A boomerang** imported from the wilds of Australia where this weapon was at one time used by the natives to kill game and annoying neighbors will be presented by the American Radio Relay League to the first radio amateur in this country or Canada who establishes two way communication with an amateur in Australia or New Zealand.

\* \* \*

**King George of England** put a radio set in the palace, using a loop. Pope Pius

had a set installed, but uses an outdoor aerial. The Pope often listens in on the program from 2LO.

\* \* \*

**King George** will open the British Empire Radio Exhibition at Wembley on April 23 and his words may be broadcast. The hour for the speech is 11.30 a. m., Greenwich time.

\* \* \*

**Donald B. MacMillan** and his party of Arctic explorers are safe, according to reports received at headquarters of the American Radio Relay League at Hartford, Conn. An amateur radio operator in Lancaster, Cal., talked with Donald H. Mix, radio operator of the MacMillan expedition, on Sunday and, in reply, received faint signals, which he was unable to understand. MacMillan's radio has not been picked up since February 16 and friends of the explorer have become anxious.

\* \* \*

**A bill** by Senator Howell, Republican, of Nebraska, was approved by the Senate Interstate Commerce Committee in Washington. Radio licenses and other "privileges for the use of ether" would be restricted to two years' duration, with power vested in the President to annul them in time of war or other emergency.

\* \* \*

**A law** adopted by the Boston Musicians Protective Association requires that players be paid extra for all concerts where the programs are sent out by radio. This is expected to result in double pay for such musicians and in some cases treble pay.

\* \* \*

**Representative Emanuel Celler**, of New York, said in Washington that a Federal law prohibiting advertising via the ether

should be adopted now, as conditions are a menace to the art.

\* \* \*

**Ten radio broadcasting firms** in New York City are accepting fees from advertisers illegally, W. E. Harkness, vice-president of the American Telephone & Telegraph Company, charged yesterday, in discussing the company's suit against Station WHN for the alleged infringement of basic patents on instruments of telephony, a branch of which, the company says, is radio.

\* \* \*

**The Salvation Army** is seeking to raise \$512,500 for its work in New York City during 1924. E. B. Pillsbury, No. 66 Broad street, has accepted the chairmanship of the radio division group.

\* \* \*

**The American Telephone and Telegraph Company** in a statement signed by President H. B. Trayer, said a monopoly of the air is not desired or desirable, and favored Federal control.

\* \* \*

**The Bergen County Masonic Institutional Association** at Hackensack, N. J., offered to build an entrance arch to the County Tuberculosis Hospital grounds, to give radio equipment to the hospital and to wire and equip the 100 rooms in the proposed new addition, so that each patient can plug in and get the radio entertainments while in bed. The hospital managers accepted the offer.

\* \* \*

**Guy E. Tripp**, president and chairman of the board, Westinghouse Electric and Manufacturing Company, in a speech to the Maine Society in New York, prophesied that radio would make English the world tongue.

## Four-Tube Set Uses No Regeneration

**I**N the Bestone circuit, designed by Henry Hyman & Co., Inc., tuned radio frequency is used in one stage. Then there are the detector and the two stages of audio frequency amplification, or four tubes in all.

As will be seen from the diagram, standard practice is followed in the wiring of this receiver. The tuning unit merely feeds the grid of the first tube and from that point on, the wiring is exactly the same as other sets employing one stage of radio frequency, detector and two stages of audio frequency.

In the construction of the receiver, great care must be taken that only quality apparatus is used throughout, that the condensers, both fixed and variable, are the proper capacity, while it is very important that efficient transformers be used to obtain maximum results.

For this circuit the following is claimed: Tone, volume, distance, sensitivity, selectivity, no distortion, no regeneration, only four tubes, no body capacity, simple tuning, only two controls, no head phones needed, no howls, squeals or whistles, and stations always on same reading.

The "Bestone" receiver is non-regenerative and non-radiating. Stations are brought in quickly as there are no squeals, howls, whistles or other distortions and the only interference will be caused by other reradiating receivers which, of course, will affect any circuit.

The parts required:

- |  |                                   |
|--|-----------------------------------|
| 1 Cabinet  | 2 4-inch Dials                    |
| 1 Panel  | 2 .001 Fixed Condensers           |
| 1 Hard Rubber Shelf  | 1 .00025 Fixed Condenser          |
| 2 Brackets for attaching Shelf                             | 1 .006 Fixed Condenser            |
| 1 "Bestone" V-60 Tuning Unit                               | 4 Standard V. T. Sockets          |
| 1 "Bestone" V-60 Amplifying Inductance (R. F. Transformer) | 1 6 Ohm Vernier Rheostat          |
| 2 .00036 (15 plate) Variable Condensers coupled together   | 2 20-inch Rheostats               |
| 1 .00036 (15 plate) Variable Condenser                     | 2 Audio Amplifying Transformers   |
| 1 .0005 Fixed Condenser                                    | 1 Open Circuit Jack               |
|  | 1 Two Circuit Jack                |
|  | 6 Rubber Binding Posts            |
|  | Screws, Copper Lugs and Bus Wire. |

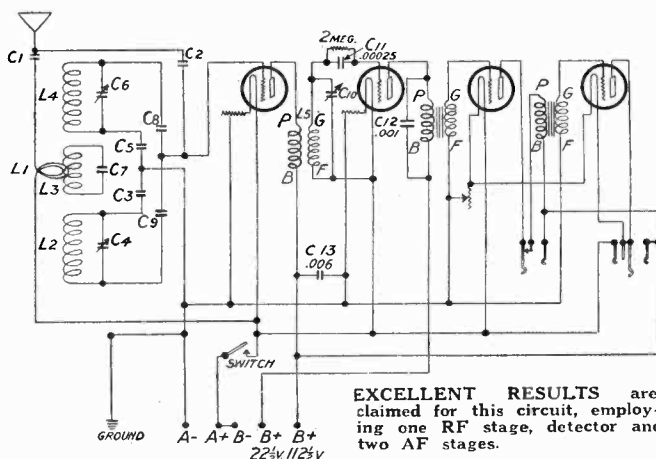

EXCELLENT RESULTS are claimed for this circuit, employing one RF stage, detector and two AF stages.

## New Broadcasting Stations

Three broadcasting stations in Class A were licensed last week:

Call	Station	Frequency Kcys.	Wave Length Meters	Power Watts
KFFP	First Baptist Church, Moberly, Mo.	1130	266	50
WCBQ	First Baptist Church, Nashville, Tenn.	1270	236	100
WDBF	Robert G. Phillips, Youngstown, Ohio	1220	246	50



# RADIO WORLD

TELEPHONES:  
LACKAWANNA 6976 and LACKAWANNA 2083  
PUBLISHED EVERY WEDNESDAY (Dated

SATURDAY OF SAME WEEK)  
FROM PUBLICATION OFFICE,  
1493 BROADWAY, NEW YORK, N. Y.  
BY HENNESSY RADIO PUBLICATIONS  
CORPORATION

ROLAND BURKE HENNESSY, President  
M. B. HENNESSY, Vice-President  
FRED S. CLARK, Secretary and Manager  
1493 BROADWAY, NEW YORK, N. Y.  
Boston Representative: Chas. H. M. White, 1267 Com-  
monwealth Avenue, Allston, Mass.  
Chicago Representative: Mat H. Friedman, 519 East 60th  
Street, Chicago, Ill.  
San Francisco Representative: Conger & Johnston, Hol-  
brook Building.  
Los Angeles Representative: Conger & Johnston, Higgins  
Building.  
European Representatives: The International News Co.,  
Brooms Bldgs., Chancery Lane, London, Eng. Paris,  
France: Brentano's 28 Avenue de l'Opera.

Roland Burke Hennessy

Editor

Herman Bernard  
Managing Editor

N. N. Bernstein  
Technical Editor

## SUBSCRIPTION RATES

Fifteen cents a copy. \$6.00 a year. \$2.00 for six  
months. \$1.50 for three months. Add \$1.00 a year  
extra for foreign postage. Canada, 50 cents.

Receipt by new subscribers of the first copy of RADIO  
WORLD mailed to them after sending in their order, is  
automatic acknowledgement of their subscription order.  
Changes of address should be received at this office two  
weeks before date of publication. State whether sub-  
scription is new or a renewal.

## ADVERTISING RATES

One page: One time—\$150.00.  
Half, Quarter, Third and Two-thirds pages at propor-  
tionate rates.

One inch, one time—\$5.00. Per space line \$9.40.  
On four consecutive issues, 10% discount.  
On thirteen consecutive issues, 15% discount.  
Cover and preferred-position rates made known on  
application.

Terms: 30 days net. 3% 10 days.

## CLASSIFIED ADVERTISEMENTS

Five cents per word. Minimum, 10 words. Discount  
of 10% on 4 consecutive issues—15% on thirteen consecu-  
tive issues. Cash with order.

Entered as second-class matter, March 28, 1922, at  
the Post Office at New York, New York, under the act  
of March 3, 1879.

## IMPORTANT NOTICE

While every possible care is taken to state correctly  
matters of fact and opinion in technical and general writ-  
ings covering the radio field, and every line printed is  
gone over with a scrupulous regard for the facts, the  
publisher disclaims any responsibility for statements re-  
garding questions of patents, priority of claims, the proper  
working out of technical problems, or other matters that  
may be printed in good faith and on information furnished  
by those supposed to be trustworthy. This statement is  
made in good faith and to save time and controversy in  
matters over which the publisher cannot possibly have  
control.

APRIL 12, 1924

## Advertising Via the Air

IT must be obvious to everybody that the radio authorities at Washington never contemplated any promiscuous use of the air for advertising purposes any more than they intended that only one broadcaster, no matter how strong or well equipped, should have a monopoly of this form of spreading propaganda at so much per minute.

Censorship is generally regarded as a pretty bad thing in a country boasting of its independence of thought and expression. And yet the very ones who are most likely to be affected by censorship in any form are almost invariably the ones who commit breaches that lead to censorship.

Take the motion picture business as an example.

There never would have been any picture censors if certain makers and exploiters of motion pictures had not overstepped the line of good

## Squeal Warns User of Set

By M. C. Batsel,  
Westinghouse Electric &  
Manufacturing Co.

THERE has been considerable written recently in regard to interference caused by receiving outfits. As a result of this discussion the radio public may be confused in regard to the real situation, its causes and possible means of improving conditions.

We are sure that legislation making it illegal to operate a receiver that can radiate, if it is improperly operated, will not prevent the use of such receivers.

The cheapest and most efficient receiver that can be made is of the regenerative type, so that the person of limited means desiring to listen to the broadcasted entertainment can obtain more for his expenditure of money if he chooses a regenerative set. This is true whether he constructs his own outfit or buys a manufactured set. The maintenance cost of the regenerative receiver is small. The receiver when properly operated will not interfere with other receivers nearby.

It is not difficult for the user of a regenerative receiver to know that his receiver may be interfering with reception by other people. When the regenerative amplification is increased to more than the useful amount the operator hears a squeal in his own receiver and should immediately reduce the regeneration.

If every operator of a regenerative receiver who desires to enjoy the broadcast transmission realizes that every time he permits his receiver to squeal that his neighbors who may be listening in to the same station must endure listening to the same squeal, we are sure that there will be little trouble from careless handling of regenerative receivers.

Should the education of users of regenerative receivers fail to pro-

taste and often of downright decency in their effort to attract public attention and shekels.

And so it will be with broadcasting, if care is not taken to see that neither the patience nor the preferences of the public is forgotten in the effort to capitalize broadcasting privileges.

Already there are signs at Washington that our legislators will not hesitate at censorship should there be a general attempt to abuse those

duce results then it will be necessary for manufacturers and dealers to discourage the manufacture and sale of all apparatus capable of producing interference and to discourage the use of such receivers, thereby denying the public the privilege of obtaining the cheapest and most simple efficient apparatus now known for receiving. It is possible for those who can or care to pay for them, to obtain efficient receivers that are not capable of causing interference.

## Harbord's Greeting

GENERAL JAMES G. HARBORD, president of the Radio Corporation of America, on the second anniversary of RADIO WORLD, several days ago sent the following greeting:

Editor, RADIO WORLD:

IN this generation of tremendous scientific progress, hardly any development has held forth greater possibilities or promise for the peoples of the world than the art of radio broadcasting.

This new medium to happy and contented living has taken the world by storm and with it has come an insatiable thirst for knowledge and more knowledge about it.

The radio press has played a paramount part in disseminating this knowledge. Without our radio papers, development would have been seriously hindered, and the present high state of broadcast reception impossible.

On this, your second anniversary, I greet you and compliment you on the great work you are doing. May each succeeding year disclose to you bigger and broader opportunities to serve the public in your phase of a wonderful industry.

JAMES G. HARBORD.

fairly well-defined rights that go with a broadcasting license.

There must be no indiscriminate attempt to foist advertising on listeners-in under the guise of entertainment.

This is the time to hush all the mutterings that have been heard of late. Stop censorship and other objectionable legislation by putting a quietus on the trouble makers. There is no smoke where there is no fire.

# Hoover Cup Winner Gives Tips On Transmitter Work

Donald C. Wallace Owns Best All-Around Amateur Station, Home Designed and Constructed

THE Hoover Cup has this year been awarded Donald C. Wallace of Minneapolis, Minn., operator of amateur station 9ZT. The award known as the "Department of Commerce Cup" is presented annually by Herbert Hoover to the owner of the best all-around amateur station, home designed and constructed.

Announcement of the winner has just been made here following decision of the special committee of judges appointed by Charles Stewart, vice-president of the American Radio Relay League and manager of the Atlantic division. The judges were Charles A. Service, assistant secretary of the ARRL; Howard

F. Mason, department editor "QST," and Arthur L. Dudlong, editor "Current Radio" Dept.

Aside from its value as a relay station for handling message traffic, this station, 9ZT, is regarded as an exceptionally valuable unit for emergency communication and has frequently been of aid while telephone and telegraph wires were out of commission.

The transmitter utilizes one 250 watt radiotron tube. The Hartley circuit is used, and simplicity exists throughout the entire layout. A chest of drawers houses the surplus material.

"It has been found poor policy to change waves, and except in rare instances, only two waves have been used—215 meters and 115 meters. All variation from these waves have been slight or rare—so that those who wish to communicate with 9ZT can count on finding it on the same wave," said Mr. Wallace.



(Foto Topics)

THE DEPARTMENT OF COMMERCE CUP, Won by Donald C. Wallace.

## Funoflex Circuit

By Loud Speaker

### One Act Radio Comedy

SCENE: Anywhere.  
Time: Anytime.

Characters: Mike—Newcomer in radio, who thinks broadcasting was invented last week when he got his first set. Ike—An old-timer (married). Discussion is taking place as to how old radio is.

Mike—Well, you gotta prove it to me. I say radio is still in its infancy. Why, it was only invented recently.

Ike—All right, I'll prove that radio is as old as man. Didn't Adam have one of his ribs taken out and have a loud-speaker made of it!

\* \* \*

A NOVICE in radio entered a store to buy a set.

"What kind would you prefer?" asked the salesman.

"I don't know," replied the novice. "I'm in the dark when it comes to radio, but I've been told I'd better buy a Page and Shaw."

Yes, the novice was a woman.



(Foto Topics)

AT LEFT, Donald C. Wallace, at his station, 9-ZT, showing the layout that won him the title of champion. He gives some advice on receiving and sending on low wave lengths. He uses 215 meters and 115 meters, with slight and rare variation. Almost any night 9-ZT can be heard working WNP, the exploring ship of the MacMillan expedition, which is now near the North Pole.

## MAGNAVOX Radio Products



A1-R—\$59.00

THIS combination of electro-dynamic Reproducer and one-stage Power Amplifier gives the user the utmost in adaptability, convenience and efficiency.

### Magnavox Reproducers

R2 with 18-inch curvex horn \$50.00  
R3 with 14-inch curvex horn \$35.00  
M1 with 14-in. curvex horn. Requires no battery for the field \$35.00

### Magnavox Combination Sets

A1-R consisting of electro-dynamic Reproducer with 14-inch curvex horn and 1 stage of amplification \$59.00

A2-R consisting of electro-dynamic Reproducer with 14-inch curvex horn and 2 stages of amplification \$85.00

### Magnavox Power Amplifiers

A1—new 1-stage Power Amplifier \$27.50  
AC-2-C—2-stage Power Amplifier \$55.00  
AC-3-C—3-stage Power Amplifier \$75.00

Magnavox products can be had at Registered Magnavox Dealers everywhere. Write for new 32-page catalogue.

The Magnavox Company  
Oakland, California

New York Office: 370 Seventh Avenue

Canadian Distributors

Perkins Electric Limited, Montreal

# United Warfare Begins on Broadcast Advertising

"Action Necessary," Says President Caddell, "to Head Off Handicap to Industry"

THE American Radio Association, 50 Union Square, New York, has begun a campaign against advertising in radio broadcasting.

"Some action is necessary at this time," said Executive Secretary Alfred M. Caddell, "to head off what threatens to become a great handicap to the radio industry.

Numerous complaints are being received from the radio public, which is objecting in increasing numbers to having its news, music and entertainments interspersed with advertising which properly belongs in the columns of newspapers and magazines."

Stuart Rogers has been appointed Chairman of the Anti-Advertising Committee, which states it will ask the Associated Advertising Clubs of America, the American Newspaper Publishers' Association, the Associated Advertising Agencies and similar organizations to cooperate with the American Radio Association "for the protection of the public."

## Business Troubles

Scholes Radio & Manufacturing Corporation, 32 West 18th street, New York, was petitioned in bankruptcy by Alfred E. Taylor for \$350; Elizabeth A. West, \$354; Sally Messinger, \$250.



(Chicago Evening Post)

## PREPAREDNESS

Uncle Hi puts up an aerial and intends to drill holes in his earmuffs so he can use earphones.

# The Radio Trade

## Withholding of Tubes Is Denied by the R. C. A.

ANSWERING a charge made in the trade that the Radio Corporation of America had withheld the sale of vacuum tubes and thus restrained the sale of rivals' sets, E. E. Bucher, manager of the sales department, denied it, saying:

"Only 10 to 15 per cent. of our total monthly tube production is required for our merchandise, the remainder going to purchasers using sets and parts manufactured by others.

"We maintained a day-by-day inventory of from 450,000 to 600,000 tubes of five different types, up to January 1.

"768,816 Radiotrons were delivered to the trade in January, this year; 825,936 in February, and March deliveries exceed 900,000.

"70 per cent of our monthly production schedule is composed of Radiotrons UV-200 and 201-A.

"Stocks of dry battery tubes have been in excess of the trade demands from May, 1923, to date and current production is keeping apace of the demand.

"Current production on the storage battery types of tubes is actually in excess of new orders booked for these particular types, but present production schedules should produce an excess.

"There is no desire on the part of the Radio Corporation to do anything other than produce tubes in sufficient quantities to meet every possible requirement of the trade. We are in the business to sell and not to withhold."

The Radio Corporation states that within a comparatively short time relief from the present tube shortage will be had.

## N. Y. Local Explains National Affiliation

THE New York local of the Radio Trade Association is sending out an announcement to clear up some misunderstandings as to the relationship of the Local Branch and the National Association.

Every member in good standing of the Local is a member in good standing in the National Organization with a full vote on all matters, enjoying exactly the same advantages that are held by members who have no local association affiliations, the letter sets forth.

## COMING EVENTS

**April 16 and 17.**—First National Radio Conference, Hotel Waldorf-Astoria, New York, sponsored by American Radio Association. Who shall pay for broadcasting? will be discussed.

\* \* \*

**April 26 to May 3.**—Third Annual Better Homes and Building Exposition, Fifth Regiment Armory, Baltimore, including section set aside for a radio show. Home installations from the viewpoint of interior decoration will be featured.

\* \* \*

**April 28.**—Conference at Bureau of Standards, Washington, to standardize dry cell battery types and specifications.

\* \* \*

**September 22 to 28.**—First Annual International Radio Show, Madison Square Garden, New York.

## New Corporations

Polydine Corp., New York, radio, 1,000 shares common stock, no par value; A. J. Egan, H. L. O'Brien, T. F. Frawley. (Attorneys, Fruecuff, Robinson & Sloan, 67 Wall St.)  
Ritz Radio Co., New York, \$10,000; N. J. Jacobs, C. Wolf, H. J. Tasch. (Attorney, U. S. Tasch, 1,270 Broadway.)

### Delaware Corporations

Radio Service, Inc., Wilmington, \$100,000. (Corporation Trust Co. of America.)  
Uptegraf Electric Manufacturing Co., Pittsburgh, New York, manufacture transformers, \$10,000. (U. S. Corporation Co.)  
Labelle Co., Wilmington, radio equipment, \$100,000. (William Prickett, Wilmington.)  
Sousan Pharmaceutical Co., Philadelphia, \$100,000. (Corporation Guarantee and Trust Co.)  
Syco Radio Products, manufacture apparatus, \$100,000; Emerson K. Young, C. Austin Beck, Wm. S. Silverman, Philadelphia. (U. S. Corporation Co.)

### Cosmopolitan Amends Name

The Cosmopolitan Radio Co., New York, has changed its name to Cosmopolitan Phusiformer Corp.

## Business Opportunities Radio and Electrical

Rates: 40c a line; minimum 3 lines  
**ALL WE PRINT IS RADIO STATION CARDS**  
at lowest prices obtainable. Dismukes, Printer, Mariannam, Ark.

### RADIO BUYER AVAILABLE

Has extensive radio merchandising experience, knowledge of every phase of radio industry and department store methods; recently buyer and manager for one of New York's largest radio retailers; seeks reliable connection, where his experience could be utilized to improve and enlarge your radio business. Box X, Radio World.

**RADIO STORE FOR SALE—EXCELLENT**  
location and reasons for selling; not a junk shop; \$2,500 necessary. Box W, Radio World.

**MACHINE & ELECTRICAL WORK WANTED**  
Special machines completely constructed; light assembling on contract; service of designing electrical and mechanical engineers. Leo F. Robertson, Inc., 540 West 22d street, New York City. Watkins 6371-8563.

**INVENTERS ATTENTION!**—Are you looking for first-class equipped machine shop? We develop inventions, make models, dies, tools, build special machinery, do metal stamping, estimates given on quantity production. Wilson Manufacturing Co., 137 Grand St., New York City. Telephone Canal 8147.

**RADIO—LARGE CORPORATION**, with factory fully equipped to manufacture complete sets or radio parts; will manufacture and market; ideas wanted. Box 123, Radio World.

**RADIO ENGINEER**—Thoroughly experienced on Superheterodyne, particularly latest six-tube half-harmonic arrangement, seeks connection with interested party. Box 456, Radio World.

# RADIO WORLD

The National Illustrated  
Weekly

On April 15 Goes to a

**FLAT RATE**  
**\$5 Inch; \$150 Page**

On yearly contracts made before April 15th the rate is \$4 an inch, or \$120 a page.

Radio World, 1493 Bway, New York

**RADIUMITE**

A New Ultra-Sensitive Reflex Crystal. Can be used in all reflex circuits and crystal sets. Fully guaranteed. Sent prepaid to any part of United States or Canada upon receipt of Money Order.  
 PRICE 60c EACH MOUNTED DEALERS! Write for Discounts.  
**MAURICE SCHWARTZ & SON**  
 710-712 BROADWAY, SCHENECTADY, N. Y.

**Have You a Neutrodyne?**



Does it howl? Is it hard to control? Do you wish to eliminate neutralizing condensers and double the efficiency of your receiver?  
**TECHNIFORMERS** are so extremely efficient that the sensitiveness of a receiver incorporating them is unsurpassed. There is no inductive coupling between them, and as a result, neutralizing condensers and potentiometers are not required to stop oscillation.  
 Try them out. We assure you of satisfaction.  
 Price. Set of 3. For substitution in your neutrodyne. \$8.00.  
**TECHNIFORMER KIT.** 3 Techniformers with variable condensers. \$18.00.  
 Dealers: Write for our prices.  
**Technical Radio Laboratories**  
 Jamaica Plain Boston, Mass.

Fans who are considerate of the comfort and pleasure of their neighbors and other radio fans in the vicinity should get **RADIO WORLD** for Dec. 8, Feb. 9, and Feb. 23, and see how they can conquer the squeals in their receivers that are causing so much trouble. 15c. per copy, the three issues for 45c., or start your year's subscription with any one of them. **RADIO WORLD**, 1493 Broadway, New York City.

**MAIL US YOUR DISCARDED JEWELRY.** Gold Crowns and Bridges, Watches, Diamonds, Silver, Platinum and Old False Teeth. Money promptly mailed. Goods returned if offer refused. **UNITED STATES SMELTING WORKS**, (The Old Reliable), Dept. 55A, Chicago, Ill.

**SUPERTRAN**

Reg. U. S. Patent Office

**THE IDEAL AUDIO FOR NEUTRODYNES**

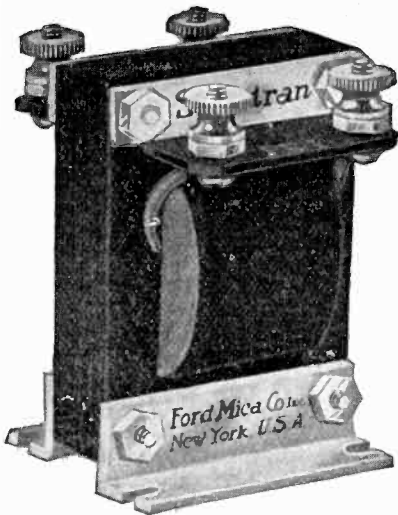

Every Neutrodyne Receiver requires audio transformers which are especially built for this circuit. Build right by selecting **SUPERTRANS** first! Greatest volume. Least distortion.

Works equally well with all types of modern tubes.

**Price \$6.00**

At your dealers or by mail postpaid on receipt of purchase price. Write for our free literature.

**Ford Mica Co., Inc.**

14 Christopher St., New York  
 Western and Southern Distributors  
 Beckley-Ralston Company

**Our Queer Law**

By C. B. Cooper

Chairman on Broadcasting Co-Operation, Radio Trade Association

**T**HE radio world fears a monopoly of broadcasting and although assurances have come from the American Telephone and Telegraph Company that they do not intend to establish such a monopoly, radio broadcasting is too precious and important a thing to become the prey of a large corporation, should the opportunity present itself.

People commonly believe that the government controls the air, but it does not under the present law.

The two laws governing radio in the United States have outgrown their usefulness, because neither deals specifically with the most important branch of radio and that is broadcasting. Neither gives the Secretary of Commerce the right to refuse licenses. If I wanted to, I could put in a station in New York, demand a license, put on a business, phonograph, or other kind of programme for twenty-four hours a day. Under the present laws, I don't believe I could be stopped, as long as I attended to business and did not cause malicious interference.

On the other hand, there is nothing in the present laws to prevent a radio monopoly, and as long as we leave radio open to a possible monopoly, there will always be some person or group trying to find a way to do it.

Right now, if the American Telephone and Telegraph Company succeeds in putting forward a license that stops at 500 watts and does not provide for the use of wires

**RADIO RECORD**

Keep a permanently bound record of all stations you have received and how you received them. Radio Record 5 1/2" x 14"—500 lines. All broadcasting stations listed, and indexed with space for new stations—\$1.00 Postpaid.  
**THE BEADLE PRINTING CO.**  
 MITCHELL SOUTH DAKOTA  
 Applause Cards 60 for \$1.00 Postpaid.

**THE ROBERTS "B" BATTERY**

Everlasting, rechargeable "B" BATTERY made of Edison elements.  
 Best for Neutrodynes, Superdynes, Superheterodynes and all high powered circuits. Superior in quality, durability, workmanship and finish. Satisfaction absolutely guaranteed. Insist on your dealer showing you **ROBERTS "B" BATTERY** before buying any other.  
 Dealers write for terms.  
**ROBERTS "B" BATTERY COMPANY**  
 1120 Myrtle Avenue Brooklyn, N. Y.

**THORIO**  
 RADIO TUBES  
 1 1/2-3-6-8-6V 1/4 AMP. DETECTOR  
 FIT STANDARD SOCKET - WORK ON ANY CIRCUIT - MAIL YOUR ORDER TO  
**HAYDEN-SALESCO.**  
 JERSEY CITY - N. J.

**No Set, Just Tube Alone Used, to Hear Locals**

**U**NIQUE reception of a radio concert has been accomplished by Professors E. E. Witmer and C. B. Bazzoni at Morgan Laboratory, University of Pennsylvania. They used a specially designed two-element nitrogen-filled tube to study the spectrum of the blue light emitted by it.

"I knew," said Dr. Witmer, "that this tube could oscillate like tubes used to detect radio signals. By inserting a special transformer and head phones in the plate circuit we were delighted to hear a broadcast from a local station."

The remarkable thing about the reception of radio concerts with the nitrogen tube is that no special apparatus of any kind was used to tune in a station. The nitrogen tube and its circuits acted as a rectifier. No aerial or ground was employed, the long leads encased in conduit and coming from a storage battery in an adjoining building serving as a loop antenna and also supplying the necessary inductance.

outside the studio, they have all stations "sewed up."

In other words, no other broadcasting stations will be able to relay programmes. And by the exclusive use of high power, they could blanket every station in existence and lease outside wires only to their own stations.

Apparently some law must be passed to prevent such eventualities. There was a time when there were so few in radio that the public had to swallow many things, but today, with millions of persons and dollars interested, we have the power to control this new public utility.

Wallace H. White, Jr., Congressman from Maine, has introduced a bill for the third successive year, for proper radio regulation, and this year it certainly should be passed.

**Cyclone**



**WORLD'S BEST**

"A" and "B" BATTERIES specially built for your Radio Set in all types. Highest quality GUARANTEED for DISTANCE, CLEARNESS, and LONG LIFE.  
**Standard Electric Novelty Co.**  
 NEW YORK CITY  
 Best proposition for Jobbers and Dealers. Some territory still available for New Distributors. Write for details at once.

**SEE SUNBEAM FOR SERVICE**



**SUNBEAM**

13 Years in the Same Spot  
**From Wholesaler Direct to You!**

**A**LL parts for Neutrodyne Circuits. Knockdown Neutrodyne Set with drilled Bakelite Panel and Cabinet, \$39.50. Same set built to order, \$50.00. All (good) parts for the famous One-Knob set with drilled Bakelite Panel (Guaranteed 1500 Mile Range), \$5.95. **SUPER-SEVEN-TUBE SET**, from Coast-to-Coast Circuit. Price and information on request. Super-Heterodyne Sets Built to order. Prices on request.

"ANYTHING IN RADIO"

EVERYTHING ELECTRICAL

**SUNBEAM ELECTRIC CO., 71 Third Avenue, New York City**

"Write to Third Avenue and Save a Third"



**PATENTS**

promptly processed. Trade Marks designed & registered. INVENTION RE-  
**FREE** CODING BLANK  
Phone Vanderbilt 7212

**FREE** MANUFACTURERS  
**PATENT CO., INC.**  
BOOK 520 FIFTH AVE  
NEW YORK

**Nath. Baldwin Phones with**

**SHELTONE**  
**LOUD SPEAKER**  
COMPLETE \$10.00  
Postpaid. Use your headset for 3 purposes—Exceptional combination value—Every pair of phones tested—Guaranteed to give results.  
**WALTER SCOTT**  
1187 S. Broad St.  
Newark, N. J.



**New Army Station  
Opens at Leavenworth**

THE Army Message Center in Washington was in direct touch recently with its new radio station at Fort Leavenworth, Kansas. The new circuit of about 1,000 miles was opened for tests, and mechanical transmission was tried out experimentally. WBC, the call of Leavenworth was heard for the first time by oper-

ators at WVA, which is the call of the Army Message Center in the Munitions Building.

The set at Leavenworth is a duplicate of the 10-KW tube set, recently installed at Fort Douglas, Salt Lake City and completes the Army's transcontinental circuit, in three jumps; eliminating five relays. Messages now go from Washington to Leavenworth, to Salt Lake City and then to San Francisco. The new set may be used for broadcasting also.

**VACUUM TUBES  
REPAIRED**

WD-11, WD-12,  
UV-201A, UV-199 **\$2.50**  
and others for

Quick service. All tubes repaired by us guaranteed to work as good as new. Send your dead tubes. All you pay is \$2.50 plus postage to postman.

**THOMAS BROWN CO.**  
511-519 ORANGE ST. NEWARK, N. J.

**Chorus of Loud Speakers  
Winds Up Edison Show**

A MIGHTY radio chorus, with all the receiving sets tuned in on one broadcasting station and all the loud speakers turned in one direction marked the close of the Edison Radio Show in New York. More than fifty different sets were exhibited.

**A SENSATION  
HIRSCH**



Radio World  
The Radio News.  
The Sun-Globe.  
The Telegram-Mall.  
The Tribune.  
The World.  
In fact all radio writers are unanimous in their praise of the

**HIRSCH  
\$2.50 VACUUM  
CRYSTAL  
TUBE**

**WHAT IT IS**  
A fixed crystal mounted inside an ordinary small bulb. The vacuum tube then is simply an unusual method of mounting a fixed crystal.

**WHAT IT DOES**  
Makes it impossible to tamper with adjustment. The rod electrodes provide a spring mounting to protect it from shocks.  
The vacuum prevents any contamination of the crystal surface.  
For Better Sets—Nothing Better

Manufacturer's Agents  
**ELLESS RADIO EXCHANGE, INC.**  
48 Vesey St., N.Y. Certificates 6495-6788

**Lattice Coil Specialties**



Variometers  
Variocouplers  
R.F. Transformers  
Micro-Mike  
Condensers  
Plate Cells  
Tapped Coils

**ESTRU LATTICE COIL PRODUCTS** have been designed so as to produce as nearly as possible **IDEAL INDUCTANCE** in various forms. It was not the intention in designing, to produce Miniature Apparatus, the small size being the result of careful electrical design with no **UNNECESSARY** Mechanical parts which would detract from the electrical efficiency.

**YOU** will appreciate these facts as set forth in our **COMPLETE DESCRIPTIVE LITERATURE**, which will be sent on request and in reading our **GUARANTEE** which goes with all **ESTRU PRODUCTS**.



2965 WEST MADISON STREET

**Double Adjustable  
FRESHMAN  
Crystal Detector**

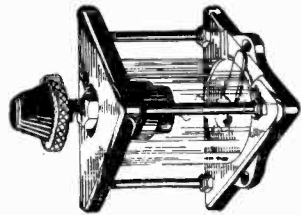

for base or panel mounting. When mounted on panel only the knob shows on the front. No more searching for the sensitive spot. Merely turn the knob as you would a dial thus adjusting the crystal instead of the cat's whisker. Best for both Reflex and Crystal sets.

**PRICE \$1.50**

Freshman Super Crystal—Sensitive in every spot, mounted on a special non-metallic housing, eliminating howls and squeals .....50c

At your dealer's, otherwise send purchase price and you will be supplied postpaid.

Ask your dealer or write for our free diagrams of Neutrodyne Tri-Flex, Polydyne, Super-Heterodyne and other good circuits.

**Chas. Freshman Co. Inc.**  
**Radio Condenser Products**  
106 Seventh Ave. New York City

**BILTMORE REFLEX**

Three thousand miles on the loud speaker, without outdoor antenna, or even a loop! This is what the **BILTMORE REFLEX RECEIVER** is capable of. But a ground, and a few feet of concealed wire are all that is required. It is undoubtedly the most sensitive receiver made. Actually, the results usually surpass those obtained on the eight tube super-heterodyne.

The quality of the tone is pure, clear and full. Reproduction is perfect, due in large measure to the Erla fixed rectifier which is employed.

In appearance, the receiver is unsurpassed—beautiful Radion Mahogany panel, heavy hand rubbed mahogany cabinet, heavily nickel-plated metal parts. All connectoins are made to the rear of the cabinet.

The most efficient circuit is used—four tubes, yet equivalent to eight.

The apparatus employed is of the very best—Radion Mahogany panel, bakelite reflex variocoupler, moulded bakelite sockets and dials, Frost jacks, Erla rectifier, Dubilier Micadons, Acme Radio Frequency Transformers, and Acme Audio Frequency transformers. We



can obtain no better apparatus.

Extremely selective, it is, nevertheless, easy to tune. You have but to snap the switch to listen to the world. A child can operate it without previous experience.

It is but slightly affected by static. Ideal for summer reception.

It may be operated entirely on dry cells.

And—the price. But \$100. Anyone can afford this wonderful receiver. Should you operate it, see it, and hear it, you would have no other.

And—we assure you of and guarantee you complete satisfaction.

**DEALERS!** You should handle this most popular receiver.  
Write us.



**BILTMORE RADIO COMPANY**  
Dept. W BOSTON 30, MASS.

**REVISED EDITION JUST OUT  
THE RADIO DEALER  
YEAR BOOK**

listing manufacturers of radio apparatus by their products, showing list prices and trade marks.

The Most Complete Book of Its Kind Ever Published.

Single Copies, ONE DOLLAR postpaid. Or Free with year's Subscription to The Radio Dealer at \$2.00 domestic, \$3.00 foreign.

Send all orders to

**THE RADIO DEALER**  
1133 Broadway New York, N. Y.

### Broadcast Programs

(Continued from page 11)

#### Station WBZ, Springfield, Mass.

337 Meters (890 Kcys.). E. S. T. Apr. 10.—11:55 A. M.—Arlington time signals; weather reports; Boston and Springfield market reports. 7:00 P. M.—Music talk. 7:30 P. M.—Bedtime story for the kiddies. 7:40 P. M.—Concert. 9:30 P. M.—Boston Choral Society from Jordan Hall. 9:55 P. M.—Arlington time signals.

Apr. 11.—11:55 A. M.—Arlington time signals; weather reports; Boston and Springfield market reports. 6:00 P. M.—Dinner concert by the WBZ Orchestra. 7:00 P. M.—Dramatized story prepared by the Youth's Companion. 7:30 P. M.—Bedtime story for the kiddies. 9:55 P. M.—Arlington time signals. 10:00 P. M.—Recital by Harriet C. Jenny.

Apr. 12.—11:55 A. M.—Arlington time signals; weather reports; Boston market reports. 7:00 P. M.—Dinner concert. 7:30 P. M.—Concert by Norman Dash, baritone. 8:30 P. M.—Recital by Majorie Posselt, violinist. 9:00 P. M.—Concert by Highland Glee Club. 9:55 P. M.—Arlington time signals.

#### Station KYW, Chicago, Ill.

536 Meters (560 Kcys.). C. S. T. Apr. 11.—9:30 A. M.—Late news and comment of the financial and commercial markets. 6:00 P. M.—Spanish lesson by Prof. A. A. Braschi. 6:45 P. M.—Children's bedtime story told by Walter Wilson, better known as "Uncle Bob." 7:00 P. M.—Dinner concert broadcast from the Congress Hotel, Chicago. 7:00 P. M.—Joska DeBabary's Orchestra. 7:10 P. M.—Clyde Doerr's Orchestra, playing in the Pompeian Room. 10:00 P. M.—Midnight Revue.

Apr. 12.—9:30 A. M.—Late news and comment of the financial and commercial markets. (This

service is broadcast every half hour during the twenty-four.) 10:30 A. M.—Farm and Home Service. 6:45 P. M.—Bedtime story told by Walter Wilson. 7:00 P. M.—Dinner concert broadcast from the Congress Hotel. 7:00 P. M.—Joska DeBabary's Orchestra. 7:10 P. M.—Clyde Doerr's Orchestra. 8:00 P. M.—Musical program. 10:00 P. M.—Late show.

#### Station WIP, Philadelphia, Pa.

509 Meters (590 Kcys.). E. S. T. Apr. 11.—1:00 P. M.—Luncheon music. 1:30 and 6:00 P. M.—Official weather forecast. 6:05 P. M.—Dordan-Lewis Dance Orchestra. 7:00 P. M.—Uncle Wip's bedtime stories.

(Concluded on page 29)

### KENNEDY TUNER

Takes the place of—  
3 Honeycomb Coils at \$1.40 ..... \$4.20  
1 Honeycomb Coil Mounting ..... 5.00  
1 23-Plate Vernier Condenser ..... 5.00

\$14.20

INCLUDING GLOBE TROTTER DIAGRAM **\$5.00**

### T. J. KENNEDY

RADIO GLOBE TROTTER

470 W. 159th St. NEW YORK, N. Y.



**The STANDARD SPEAKER SUPREME**

FULL, Rich, Mellow Tone,  
Absolutely No Distortion,  
Beautiful in Appearance. No  
Extra Batteries Necessary.  
Full Guaranteed

12" bell 19" high  
Sent Prepaid on Receipt of Price,  
or C.O.D. **\$7.50**

**STANDARD RADIO CO.**  
Dept. G. 611 Market St., Philadelphia, Pa.  
Send for Complete Catalog

### TUBE INSURANCE

91½% of all tubes are needlessly destroyed.  
**RADECO SAFETY FUSES**

offer complete protection.

Price, 50 cts. each

**RADIO EQUIPMENT COMPANY**  
20 Stuart St. Boston, Mass.

### Complete Parts for Pfanstiehl 1 Tube Receiver—Only

**\$11.85**

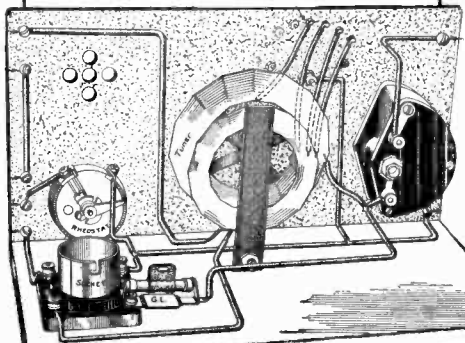

### FREE Complete Soldering Outfit with each Set

Great news for the home radio builder! You can now buy parts for the set you want to build in the form of a Complete Knock Down Set. You save money buying this way. You save a world of trouble picking up parts here and there. Everything fits. Drilled panel and a big clear blue print like the above illustration is included with each set. It shows the proper location of each part—shows exactly how each connection should be made. No chance to go wrong.

Every Knock-Down circuit we sell is first built and tested in our laboratories. No "freak" circuits offered. Only standard designs that have been thoroughly tested and proved efficient. You can positively depend on Marshall Knock-Down Sets.

Look at the money you save! Only \$11.85 for everything needed to build the great Pfanstiehl Receiver illustrated above. Every part, every piece of wire, every lug and screw is included. Send money order for \$11.85 and we will deliver this complete outfit to your home, postage paid.

**Licensed Neutrodyne Knock-Down \$39.50 Set—only . . .**

If you prefer an Ultra-Audion, a 3-tube regenerative, a Neutrodyne, send for our new catalog. All are described and offered at sensational price reductions. Write today.

**Marshall Radio Products, Inc.**  
Marshall Blvd. and 19th St., Dept. 56-14 Chicago



### "The Loveliest Thing I've Ever Heard Over the Radio"—Mary Garden

Only the most flawless reproduction, free from distortion and parasitic noises, could earn a tribute so unreserved from America's queen of song.

The exquisite tone quality and purity of Duo-Reflex reception that appealed so irresistibly to Miss Garden is finding equally enthusiastic appreciation in the homes of super-critical radio lovers everywhere.

Not only in sheer tonal perfection, but in range and volume, have Erla Duo-Reflex receivers demonstrated decisive superiority. Tube for tube, they are the most powerful receivers known.

Complete Erla parts, including celebrated synchronizing radio and audio transformers that enable vacuum tubes to do triple duty, guarantee success to the amateur who "rolls his own." Easily understood blueprints guide every step of construction and assembly.

Ask your dealer for free Erla bulletin No. 20, giving latest Erla one, two and three-tube diagrams; or write direct, mentioning your dealer's name.



Increased range and volume, as well as elimination of distortion, follow installation of Erla transformers. Reflex and Cascades types. \$5



Exclusive ability of Erla audio transformers to amplify three stages without distortion assures improvement in any receiving set. List, \$5

Dealers and Jobbers—Erla products turn over rapidly, reducing capital invested and increasing profit. Send for liberal scale of discounts

Electrical Research Laboratories  
Dept. W 2515 Michigan Ave., Chicago

**ERLA**

**\$ 34.49**

5 Tube Genuine Hazeltine Neutrodyne

THE DE LUXE  
 LICENSED BY  
 INDEPENDENT RADIO MANUFACTURERS INC.  
**NEUTRODYNE**  
 UNDER HAZELTINE PATENT NO. 1450080  
 OTHER PATENTS PENDING  
 REG. U.S. PAT. OFF.

**\$ 34.49**

Complete Assembly Kit Ready to Build

**All Parts MATCHED**  
**All Parts LICENSED**

**Fine Workmanship**

- 1 DRILLED Radion Mahoganite Panel, engraved in gold.
- 3 Four-inch Radion Mahoganite Dials, gold engraved.
- 2 Gold Plated Jacks.
- 3 Genuine Hazeltine Neuroformers mounted on the famous Comsco Bakelite End Condensers. Positively the only Neutrodyne Kit including these famous Comsco Condensers.
- 2 Hazeltine Neurodons.
- 5 Bakelite Sockets.
- 1 6-ohm Rheostat with gold plated knob to match panel.
- 1 30-ohm Rheostat with gold plated knob to match panel.
- 2 Genuine Killark Shielded Audio Transformers
- 1 Baseboard.
- 20 Feet Tinned Bus-bar.
- 1 .00025 Freshman Grid Condenser.
- 1 Tubular Glass Grid Leak.
- 1 Set Engraved Binding Posts.
- 1 .002 Micon Condenser.
- 1 .006 Micon Condenser.
- Exact size special panel and base blueprint.
- All packed in attractive box.

**Complete Outfit of Additional Accessories**

- 5 Tested Matched Tubes (201-A Type) for Neutrodyne.....\$19.25
- 2 45-volt "B" Batteries..... 6.00
- 1 "A" 60 ampere Storage Battery..... 10.95
- Phones (3000 ohms)..... 3.75
- Complete Antenna Equipment 1.50
- Cabinet, Piano Finish..... 4.95

\$46.40

ALSO SOLD SEPARATELY

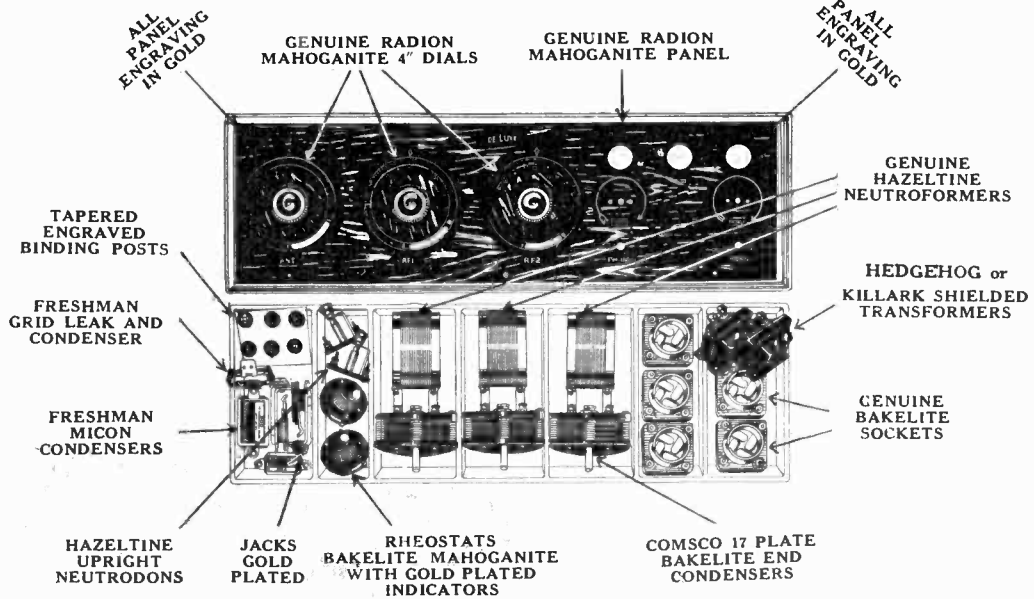

**The RADIO-SHACK**

EXECUTIVE OFFICE:

55 Vesey Street Dept. RW-12 New York City

Goods Shipped C. O. D. Just pay the Postman. Every article sold on WRITTEN Money-Back Guarantee.

We ANSWER every letter we get—and same day we get it.

**SEND NO MONEY**

**Radio Used as Aid in White Plague Fight**

PHYSICIANS in charge of the Mountain Sanatorium at Hamilton, Ontario, have accepted radio broadcasting as a valuable ally in their fight against tuberculosis. Probably in no hospital has a more complete radio receiving equipment been installed than that which is in daily use at the Hamilton Institution, where the buildings housing the patients are scattered over a large area. It is possible to get broadcast entertainment from all parts of the United States and Canada and when static

is bad or when local interference prevents good reception, the hospital "broadcasts" its own program to the patients. This affords no end of enjoyment.

**THE VICTORY**

A Socket Built on Merit Electrically and Mechanically Perfect



Genuine Phosphor Bronze Contacts Used for Panel Mounting

List Price Triple, \$2.75; Single, \$1.00.

Insist that your dealer supply you with the genuine VICTORY SOCKET. Triple, \$2.75; single, \$1.00. Expert Drillers and Cutters of Genuine Fernium Panels and Tubing. Estimates Cheerfully Given.

UNITED RADIO MFG. CO. 191 Greenwich Street New York City

**The Twitchell Auxiliary Tuner**

Patents Pending. Name Registered.

**MORE THAN A WAVE TRAP**

A TWITCHELL AUXILIARY TUNER connected to any make of tube receiving set will positively cut out any local broadcasting or code stations so you may tune in all long distance stations any time regardless of local conditions.

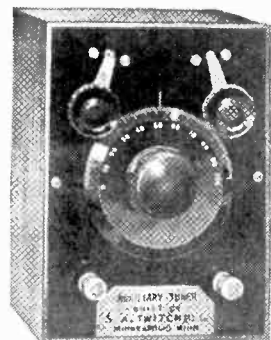

Unlike any wave trap, THE TWITCHELL AUXILIARY TUNER does not ever decrease but in many cases increases the volume from distant stations.

These TUNERS are in daily use within 400 feet of large broadcasting stations and enable their owners to easily and completely cut out the local station and bring in distant stations at any time on a loud speaker.

This instrument will also enable you to bring in programs sent out on longer waves than you can tune in without it, thus bringing all the broadcasting stations within the wave length range of the many sets of limited range now in use.

Copyrighted diagram of this tuner, 50c, or with all parts, \$9.00. Complete instrument in walnut cabinet, ready to use, \$15.00.

A New and Wonderfully Efficient Coil for the Reinartz circuit for those who want the best. Price \$4.00, or with blueprint for either one or three tubes, \$4.50.

This circuit brings in both coasts loud and clear and is the most successful Reinartz modification yet produced.

All goods prepaid. These instruments are easy to build, easy to operate. Everything clearly shown

1930 WESTERN AVENUE

**S. A. TWITCHELL**

MINNEAPOLIS, MINN.

**SENSATIONAL OFFER**



**FADA NEUTRODYNE**

For a limited time we are offering complete parts for 5-tube Neutrodyne set ..... **\$69.45**

**FREE:** We will make up this remarkable set absolutely FREE for you and guarantee the best results. A genuine MAHOGANY CABINET will also be given FREE.

Our guarantee is unconditional. If the set does not work to your satisfaction or for any reason you are not satisfied, return within two weeks, and money will be refunded.

**FADA KIT, \$54.75**

Sealed and Original

**Perfection Radio Corp.**

119 W. 23rd St. 118 Nassau St.

59 Cortlandt St. 78 Cortlandt St.

New York City



# In Hawaii, Hears U. S.

WITH "Aloha," greetings from Hawaii, the Paradise of the Pacific, Mrs. C. H. Judd of Waikane, P. O. Oahu, Hawaii, expresses "many thanks for the thrill of hearing WHAZ." She reports that two steps of audio amplification brought the program in clearly with the phones and if NPM, the naval station twelve miles away had been off the air "I would have had you clearly through

the magnavox." She continued, "Can you imagine how my husband felt when he heard from the Rensselaer Polytechnic Institute? He went to the Institute in Troy from Hawaii when a young man in 1884. We heard WHAZ through all the high power so near to us which very nearly makes radio impossible for us here. We are 23 miles from Honolulu on the windward side of Oahu with the grand Pacific before us and a high mountain back of us. Hope we can hear you often."

## Ackerman

**LOUD SPEAKER, \$9.50**  
Complete—Ready for Immediate Use  
Delivered Anywhere in the U. S. A. A Marvelous Speaker for the price of a headset.  
Dealers and Jobbers Write for Discounts  
**ACKERMAN BROS. CO., Inc.**  
301 W. 4th St. (Dept. "RW") New York, N. Y.

Supremacy Proven by Every Test

# FILKO-STAT

THE SCIENTIFICALLY CORRECT  
RADIO RHEOSTAT

**\$25 for \$10**

FAMOUS BEL-CANTO  
LOUD SPEAKER

PRICE **\$10**  
DELIVERED FREE  
TO YOUR DOOR

Money Back Any Time Within Ten Days  
If Dissatisfied

BEL-CANTO MFG. CO.  
BENSEL-BONIS CO., Inc.  
417-421 East 34th Street New York City

## Intercollegiate League Is Formed Down East

Springfield, Mass.

**T**HIRTEEN New England colleges and universities are represented in the New England Intercollegiate Radio Relay League, organized here at the convention of the New England division of the American Radio Relay League. J. O. Glennie of Dartmouth College was elected President.

The seven colleges represented at the organization conference are: University of Maine, Worcester Polytechnic, University of Vermont, Norwich University, M. I. T., Dartmouth and Clark University. Others that have assented to becoming members are Tufts, Amherst, Boston College, Brown, Harvard and Wesleyan. All these are code stations.

The purpose of the organization is to handle radio traffic between colleges, play-by-play results of football and athletic contests, reports of debates and reports of general collegiate interest.



## ULTRADYNE

the Improved Super-Heterodyne.  
Send 50c for book giving complete details of drilling, assembling, wiring and tuning 8 and 8 tube ULTRADYNE Receivers.

50c  
Phenix Radio Corp., 5-9 Beekman St., N. Y. C.

Thank Your Favorite Stations—Request Your Favorite Selection

THANK YOU  
92c  
Apr. 1, 1924  
307  
The orchestra was wonderful  
Rene Longan  
sing the Rosary

YOUR OWN Name and Address Printed FREE On Every Card

"Thank You" cards are all the rage. Stations appreciate them. A pleasure to use. Be in style. Low introductory price. 100—\$1.65; 200—\$2.60; 300—\$3.50 POSTPAID. Order today.

MONEY REFUNDED if Not Satisfied

Good quality cards—High grade printing. You will be DELIGHTED.  
Send order with check or money order today — NOW  
**RADIO PRINTERS, Dept. 47** Mendota, Illinois

## FAHNESTOCK CLIPS

"Popular Wherever Radio Is Used"

14 Sizes in Beautiful Display Case.

Dealers write for big money-making proposition.

**FAHNESTOCK ELECTRIC CO.**  
Long Island City, L. I.

## Coast to Coast Reception

with a

# Star Coupler Coil

Write for Illustrated Literature

**STAR**  
**RADIO PRODUCTS CO.**

711 So. Dearborn St. Chicago, Ill.

## \$15 Set Gets 2,000 Miles

The Essex Radio Special, the receiving set with a conscience, gets you more distant stations clearer and sweeter than sets costing ten times its price.

**\$15** SET COMPLETE WITH CABINET WITHOUT TUBE OR BATTERIES

**\$20** SET COMPLETE WITH CABINET TUBE AND BATTERIES

# Essex Radio Service

617 West 125th St. New York  
Detailed information on request.

**BOYS—DANDY RADIO SET**—Only \$1.50. Includes coil, detector and crystal or free for a little work. Write quick. John W. Shaw, 221 A. Northeast, Room 6, Washington, D. C.

**FOR SALE**—First \$75 buys an A No. 1 three tube DX Radio outfit, with tubes and B Batteries. Free particulars. Frank Baertich, Troy, Indiana.

# THIS SPECIAL SUBSCRIPTION OFFER FOR NEW SUBSCRIBERS ONLY

RADIO WORLD AND OTHER POPULAR RADIO PUBLICATIONS FOR THE PRICE OF SUBSCRIPTION FOR RADIO WORLD ALONE

Radio World has made arrangements —by which it is possible —to offer a year's subscription for —any one of the following publications —with one year's subscription for —**RADIO WORLD:** —**RADIO NEWS** or —**POPULAR RADIO** or —**RADIO BROADCAST** or —**WIRELESS AGE** or —**RADIO DEALER** or —**RADIO (San Francisco).**

This is the way to get two publications —for the price of one: —Send \$4.00 today for **RADIO WORLD** —for one year (regular price —for 52 numbers) —and select any one of the other —six publications for twelve months— —Add \$1.00 a year extra for —Canadian or Foreign postage. —This offer good only up to and —including April 1, 1924. —Present **RADIO WORLD** subscribers —can take advantage of this offer by —extending subscriptions one year NOW. —Or order thru your newsdealer.

## RADIO WORLD'S SPECIAL TWO-FOR-PRICE-OF-ONE SUBSCRIPTION BLANK

**RADIO WORLD, 1493 Broadway, New York City.**

Enclosed find \$6.00, for which send me **RADIO WORLD** for twelve months (52 numbers), beginning ..... and also, without additional cost, Radio News, or Popular Radio, or Radio Broadcast, or Wireless Age, or Radio Dealer, or Radio for twelve months, beginning .....

This Offer Good Only Between March 19 and April 20

Name .....  
Street Address .....  
City and State .....

**DO NOT ASK FOR A GRID LEAK**

Ask for a  
**DAVEN RESISTOR**



It Is Just as Easy and Means a Lot More.

**DAVEN RADIO CO.**

"Radio Resistor Specialists"  
10-12 Campbell Street Newark, N. J.

**FOR RELIABLE UP-TO-DATE RADIO MAILING LISTS**

Use Our Card Catalog Directory In Use Now With Over 200 Radio Manufacturers and Jobbers Your ENVELOPES ADDRESSED At \$2.50 per 1,000

Write for Particulars Sydell's Radio Trade Directory 610 W. 31st St., New York. Chickering 9640

**"KILLS REFLEX TROUBLES"**

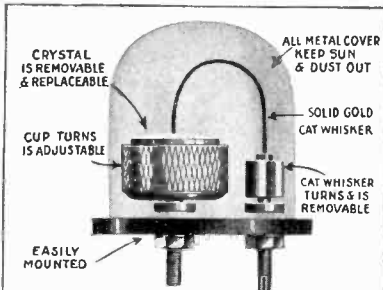

SPECIALLY ADAPTED FOR REFLEX WORK

**"LINCOLN" DETECTOR**

Creating tremendous sensation. Enclosed, fixed, adjustable. New. Brings in distant stations loud and clear. You need it. Ask your dealer or write—today. Price only \$2.00. Absolutely guaranteed for one year.

Jobbers, Dealers: Wire or write. Mention this ad.

**LINCOLN MFG. COMPANY**  
Dept. S-1 Los Angeles, Calif.

**World Show Won by N. Y.**

THE First Annual International Radio Show will open at Madison Square Garden on Monday, September 22 and continue until Sunday night, September 28.

The exposition will be held under the auspices of the newly organized Radio Manufacturers' Show Association, composed of sixty American radio manufacturers. U. J. Herrmann and James F. Kerr, who managed the annual Chicago Radio Show, will be Managing Director and General Manager respectively.

There will also be an Advisory Board, made up of E. B. Mallory, Chairman of the Radio Division of the Associated Manu-

facturers of Electrical Supplies. Paul B. Klugh, Executive Secretary of the National Association of Broadcasters, and Calvin Harris, publicity man.

The Radio Manufacturers' Show Association is the moving spirit of the garden show. They will hold a show also in Chicago, at the Coliseum, November 18 to 23 and one on the Pacific Coast early in 1925.

The Board of Directors has taken an exclusive ten-year lease on Madison Square Garden for a week each year for its Annual International Radio Show. The Association has also taken over the Chicago Coliseum for a like period and another ten-year lease is being negotiated on a Western exposition building.



For best reception you need

**The Goodman**

The niftiest short wave tuner on the market. Great for present broadcasts, local and DX. Used in all parts of the world. Certificates of merit from testing laboratories. Pamphlet on request.

L. W. GOODMAN, Mfr., Drexel Hill, Pa.



**ACH**

Sharp Tuner Dial

3-inch size ..... \$2.50  
4-inch size ..... \$5.00  
1/4 3/16 bushings, 5c. ea.

Rough or Fine Tuning  
Mail Orders Prepaid USA

Why the ACH is different  
3 in. DIAL ..... (30-100)  
4 in. DIAL ..... (50-100)

A. C. Hayden Radio & Research Co.  
Brockton, Mass., U. S. A.

**NEUTRODYNE PARTS**

Full set of Neutroformers, Variable Condensers with dials, and Neutrodens \$13.25

Above parts are Genuine Workrite Neutroformers, made under Hazeltine patents.

Complete parts for three tube Neutrodyne tuner, (tubes, batteries, or phones not included), drilled panel, tube sockets, rheostats, fixed condensers, jack, binding posts, wires, spaghetti, and blue prints.

**COMPLETE FOR \$19.95**

Postage additional on all shipments. Ask for our price list.

Send no money, Order by postcard, Pay the Postman.

**RADIO SURPLUS STORES**  
HELENA, MONTANA

**Federal Radio Products**  
Standard of the Radio World, 130 separate units, fully Guaranteed. Write for Catalog. Federal Telephone and Telegraph Co. BUFFALO, N. Y.

For Maximum Amplification Without Distortion and Tube Noises use the well known **Como Duplex Transformers** Push-Pull Send for literature **COMO APPARATUS COMPANY** 446 Tremont St. Boston, Mass.

The Ultimate Radio Receiver **THE FLEX-O-DYNE CO.** 1674 Broadway (At 52nd St.) New York, N. Y. Circle 4549

WE REPAIR **RADIO TUBES**

WD-11 ... \$3.00	DV-2 ... \$3.00
WD-12 ... 3.00	DV-6A ... 3.00
UV-200 ... 2.75	UV-199 ... 3.00
UV-201 ... 3.00	C-299 ... 3.00
C-300 ... 2.75	UV-201A ... 3.00
C-301 ... 3.00	C-301A ... 3.00
DV-6 ... 3.00	Marconi ... 3.00
DV-1 ... 3.00	Moorhead ... 3.00
6 v. Plain Detector ... 2.75	
6 v. Plain Amplifier ... 3.00	

Mail orders solicited and promptly attended to. Dealers and agents write for special discounts. **H. & H. RADIO CO.** P. O. Box 22-B Clinton-Hill Station Newark, N. J.

**2500 Miles with One Myers Tube!**

Remarkable radio reception is an every-day result with MYERS TUBES. Mr. W. E. Gerard, 73 Pine Avenue, St. Lambert, Montreal, Canada, using only one MYERS TUBE, hears KDZB, Bakersfield, California.

Get distance with clarity. MYERS are the only tubes correctly designed for radio without bunched leads. Two types—for dry or storage battery. Insist on MYERS at your dealer's—otherwise send purchase price and be supplied post-paid. Write for free circuit diagrams.

**\$5** EACH, complete with mounting clips ready to mount on your set; no sockets or extra equipment required.

**F. B. Myers Co. Ltd.**  
Radio Vacuum Tubes  
240 CRAIG ST. W. MONTREAL CANADA

(Actual Size)

**That Superdyne Receiver!**

The receiver every fan has been looking for. The Four-Tube Receiver that is more powerful than a six-tube Naval Receiver. The Receiver which does not require a laboratory expert to build or operate. The Receiver that accomplishes anything any other will—and then more.

**SEE RADIO WORLD**

for Dec. 15, 22 and 29, and get all the details which will enable you to build this marvelous four-tube wonder. The 3 copies for 45c, or sent free if you send \$6.00 for yearly subscription. NOW!

**BUILD a "S-U-P-E-R-D-Y-N-E" RADIO WORLD, 1493 Broadway, N. Y. C.**

(Concluded from page 25)

Apr. 12.—1:00 P. M.—Recital by Karl Bonawitz on the Germantown Theatre organ. 1:30 and 6:00 P. M.—Official weather forecast. 6:05 P. M.—Harold Leonard's Red Jackets. 7:00 P. M.—Uncle Wip's bedtime stories. 8:15 P. M.—An Evening with the Matinee Musical Club. 10:15 P. M.—Harold Leonard's Red Jackets.

Apr. 13.—7:30 P. M.—Evening service from Holly Trinity Church. 9:30 P. M.—Concert.

**Station WHAS, Louisville, Ky.**

400 Meters (750 Kcys.). C. S. T. Apr. 10.—4:00 P. M.—Concert under the direction of Miss Rose Henley. 4:50 P. M.—Local livestock, produce and grain markets. 7:30 P. M.—Concert under the auspices of Miss Carolin Chrisman of the Louisville Conservatory of Music.

Apr. 11.—4:00 P. M.—Selections by the Walnut Theatre Orchestra. 5:00 P. M.—Official central standard time announced. 7:30 P. M.—Concert by the Hoosier Male Quartette.

Apr. 12.—4:00 P. M.—Concert by Child pupils from the Academy of Our Lady of Mercy. 4:50 P. M.—Local livestock, produce and grain market reports. 5:00 P. M.—Official central standard time announced. 7:30 P. M.—Concert.

**Station WNAC, Boston, Mass.**

278 Meters (1080 Kcys.). E. S. T. Apr. 10.—10:30 A. M.—WNAC Women's Club talks. 12:15 P. M.—King's Chapel service. 1:00 P. M.—Shepard Colonial Orchestra. 6:30 P. M.—WNAC Dinner Dance. 9:00 P. M.—Everett City Band.

**FRESHMAN  
VERNIER DIAL**

A Bakelite dial with Vernier adjustment. A small rubber tired wheel through the slot in the dial permits you to set the dial to the exact point and obtain the same dial setting every time. Just the thing for Neutrodyne, Polydyne and Super-Heterodyne.

Price, 3 in., \$1.00  
Price, 4 in., \$1.50

At your dealer's, otherwise, send purchase price and you will be supplied postpaid. Ask your dealer or write direct for free diagrams of Neutrodyne, Polydyne and Super-Heterodyne Circuits.

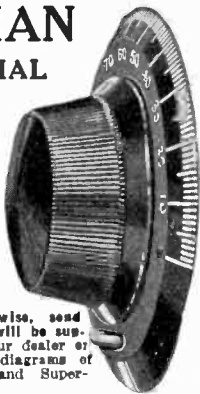

**Chas. Freshman Co. Inc.**  
*Radio Condenser Products*

106 Seventh Ave., New York, N. Y.

**RADIO TUBES**

that have been rebuilt. Also a limited number of new tubes released every month for advertising purposes.

Our written GUARANTEE of full satisfaction is enclosed with every tube we send out. This protects you.

Type 201a.....\$3.00  
Type 12.....3.00  
Type DVI.....3.00

Special prices to dealers.

**A. & T. RADIO CO.**

Dept. A DANVERS, MASS.

**RADIO**

SEND FOR OUR COMPLETE MONEY SAVING CATALOG  
**TIMES SQ. AUTO SUPPLY CO. INC.**  
MAIL ORDER DEPT.  
1745 BROADWAY AT 54th STREET  
NEW YORK, N. Y.

**Big Money and Fast Sales**

EVERY OWNER Buys Gold Initials for His Auto—You charge \$1.50, make \$1.44. 10 Orders Daily Easy.

Samples and information Free!

**WORLD MONOGRAM COMPANY**  
Dept. 92 NEWARK, N. J.

Apr. 11.—12:15 P. M.—King's Chapel service. 1:00 P. M.—Shepard Colonial Orchestra. 4:00 P. M.—Shubert Trio. 6:30 P. M.—WNAC Dinner Dance. 7:30 P. M.—Speech by President A. L. Lowell of Harvard College. 10:00 P. M.—Wit and music.

Apr. 12.—1:00 P. M.—Miss Gile, pianist; trombone quartet. 4:00 P. M.—Tea Dance. 6:30 P. M.—WNAC Dinner Dance. 8:00 P. M.—Highland Glee Club. 9:00 P. M.—Dance music.

**Station WAAM, Newark, N. J.**

263 Meters (1140 Kcys.). E. S. T. Apr. 10.—7:00 P. M.—Times Square Entertainers, popular songs. 8:30 P. M.—Margulies Trio, instrumental program. Russian folk-dance music. 10:00 P. M.—Charles J. Saunders' Sterling Dance Orchestra.

**Tubes Repaired \$2.50**

GUARANTEED

All Standard Types W. D. 11 and 12 U. V. 100 - 200 - 201A

24-hour service. Mail orders sent Parcel Post C.O.D.

**RADIO TUBE SERVICE CO.**  
239 Centre St., near Grand St. New York City

Save  
**1/2 Price**  
of  
**New Tubes**

Burned out or broken tubes repaired and guaranteed equal to new.

**Harvard Radio Laboratories**  
200 Old Colony Ave.  
South Boston, Mass.

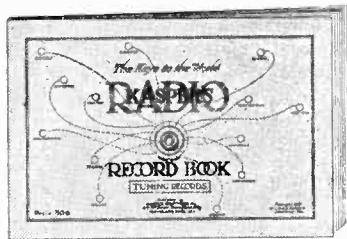

**"SPIKE"**

THE STATIONS YOU RECEIVE  
IN A  
**KASPER RADIO RECORD BOOK**

Then you will know where to set the Dials, Switches and Rheostats to bring them back. This book is endorsed by thousands of professional Radio Fans in all parts of the country because it covers everything on the panel. (Copyrighted.) Can be used with any set. Contains up-to-date list of 1,100 Broadcasting Stations, Time of Principal Cities and instructions How to Record Stations. 24 Pages, Valuable Information. No set complete without one. 50c per Copy, Postpaid. For your convenience send a one dollar bill for two copies, otherwise send Money Order for one or more. No checks nor stamps.

We also furnish Kasper's "APPLAUSE CARDS," printed on stamped Postal Cards—25 mailed anywhere upon receipt of 50c.

**KASPER BROTHERS COMPANY**

317 Lorain Street Bank Building

Cleveland, Ohio, U. S. A.

**RADION PRODUCTS**

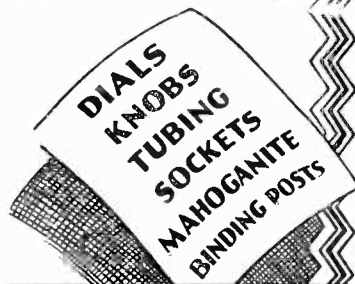

**Mahoganite and Black RADIO PANELS**

All stock sizes.  
Cut to any special size.

Are you having trouble getting a panel out to your special size? Write the N. Y. Hard Rubber Turning Co. at once,—they are being retained by the biggest hard rubber users in the radio industry, and they can supply you quickly and at low cost. Mail orders promptly filled.

Various sizes of Rods; Special parts made to order.

*Inquire Now!*

**N. Y. HARD RUBBER TURNING CO.**  
212 Centre Street, New York City

**FILL OUT AND MAIL NOW**

SUBSCRIPTION BLANK

**RADIO WORLD**

RADIO WORLD

1493 Broadway, New York City

Please send me RADIO WORLD for.....months, for which

please find enclosed \$.....

SUBSCRIPTION RATES:

Single Copy .....\$ .15.....  
Three Months ..... 1.50  
Six Months ..... 3.00  
One Year, 52 Issues..... 6.00\*  
Add \$1.00 a Year to Foreign Postage; 50c for Canadian Postage.



**Genuine Ken-Rad Radio Tubes**  
**\$3.49**

Type 200 or 201A  
Every tube absolutely guaranteed.  
Write for list of other radio bargains.  
Cash or C.O.D.  
**MARTIN HARDWARE CO.**  
105 N. Main Street Hamilton, Mo.

**SOMETHING REALLY FREE**



Here is something actually given away. In an effort to introduce the qualities of the YELLOWTIP Crystal and Crystal Detector to a great number of radio fans, we offer for a limited time to give away the regular 50c YELLOWTIP Crystal with each order for a YELLOWTIP Crystal Detector. Price \$2. In a two-dollar bill for this advertisement and mail it today together with your dealers name.  
**Yellowtip Detector Sales Co., 48 First St., Carlstadt, N. J.**  
**FIXED - ADJUSTABLE - DUST-PROOF**

**GLOBE**  
**UNIQUE**  
TRADE MARK

**WATCH FOR IT!**  
**Globe Radio Equipment Co.**  
217 WEST 125TH STREET, NEW YORK

**The Popular Neutrodyne!**

This receiver is rapidly becoming the "Old Reliable." A five-tube tuned radio-frequency set that any inexperienced fan can operate.

SEE RADIO WORLD for March 8, 15, and 22 and get all the details which will enable you to build this reliable and powerful five-tube neutrodyne outfit. The three copies for 45c, or sent free if you send \$6.00 for yearly subscription. NOW!

**RADIO WORLD, 1493 Broadway, N. Y. C.**

When you see it in RADIO WORLD you know it's news—not a month old.

**DO YOU WANT TO BUY, SELL OR EXCHANGE RADIO OR OTHER GOODS? TRY THIS DEPARTMENT AT 5c A WORD**

**RADIO WORLD'S QUICK-ACTION CLASSIFIED ADS**

**15%-20% (per cent) DISCOUNT** on all Standard Receivers. Freed-Eisemann Neutrodyne, \$125.00; New Radiolas, Crosley XJ, \$47.00. Write, Thomas Radio Co., 111 Dix Street, Muncie, Ind.

**PATENTS PROCURED.** Send sketch or model today for examination, prompt report and advice. No charge for preliminary advice. Write for free Booklet and blank form on which to disclose your idea. Highest references. Promptness assured. Clarence A. O'Brien, Registered Patent Lawyer, 201-B, Security Bank Building. Directly across the street from Patent Office, Washington, D. C.

**MAGNAVOX R3.** Latest nationally advertised reproducers; concert modulator. List, \$35.00. Introductory, \$25.00. The factory sealed carton is your guarantee. Radio Central, Dept. W, Abilene, Kansas.

**STATEMENT OF THE OWNERSHIP, MANAGEMENT, CIRCULATION, ETC., REQUIRED BY THE ACT OF CONGRESS OF AUGUST 24, 1912.**

Of Radio World, published weekly at New York, N. Y., for April 1, 1924.

State of New York,  
County of New York, ss: \_\_\_\_\_

Before me, a Notary Public, in and for the State and County aforesaid, personally appeared Roland Burke Hennessy, who, having been duly sworn according to law, deposes and says that he is the Editor of the Radio World, and that the following is, to the best of his knowledge and belief a true statement of the ownership, management (and if a daily paper, the circulation), etc., of the aforesaid publication for the date shown in the above caption, required by the Act of August 24, 1912, embodied in section 443, Postal Laws and Regulations, printed on the reverse of this form, to-wit:

1. That the names and addresses of the publisher, editor, managing editor, and business managers are: Publisher, Hennessy Radio Publications Corporation, 1493 Broadway, N. Y. C.; editor, Roland Burke Hennessy, 1493 Broadway, N. Y. C.; managing editor, Herman Bernard,

**Tips on Tube Replacements**

Bring Defective Bulb Back to Dealer; Do Not Send It to the Manufacturer

**DIFFICULTIES ARE MET**

**T**HE Radio Corporation of America guarantees their tubes against mechanical defects. The public is asked to return defective tubes to their dealer.

The dealer is asked to accept the returned tube and immediately paste a sticker on the glass indicating the customer's name, date, etc.

The dealer then returns the tubes to his jobber, who in turn sends them to the Radio Corporation, where they are tested, and new ones sent in place, if replacement is found justified. No charge is to be made for handling of defective tubes when they are returned by the customer to the dealer who sold it.

Some concerns in New York City make a charge of ten cents for tubes returned by customers who did not originally purchase the tubes from them.

Some difficulties have been encountered in working out details to satisfy all. Dealers treat tube replacement as a big problem.

**Federal Dry Battery Conference This Month**

**T**HE Bureau of Standards has called a dry-cell conference for April 28th to standardize battery types and specifications. The Government purchases about 135,000 dry batteries a year. They include over a dozen types and sizes to fulfill many requirements, including radio A and B batteries, but the exact distribution for telephone, bell-ringing, flashlight, ignition and radio use is not available.

Manufacturers and users, including government representatives will attend.

**Radio Reception Record**

Eliminate that slipshod method of receiving. Know where to find a station when you want it. This book keeps a complete record of each station heard—one station to a page. Printed on high grade bond paper. Only 35 cents each. Three for a dollar bill.

**JOS. M. EDWARDS**  
Box 8X AUBURN, ALABAMA

**PATENTS** Domestic and Foreign, Trade Marks and Copyrights, Infringement Suits and Interference Cases

Booklet "More Light on Patents" Sent Free  
**MAX D. ORDMANN**  
Reg. Pat. Lawyer  
Mech. and Elect. Engineer  
Specializing in Radio  
1503 Woolworth Bldg., N. Y. City Tel. Whitehall 7040-1

**COMPLETE RADIO**

RECEIVING OUTFIT  
Tube, Phones, Batteries, Aerial, Lead-in Wire, Insulators All included. 1000 Miles Guaranteed.  
**\$17.50**  
SEND NO MONEY. PAY THE POSTMAN.  
Money Back if You Want It.  
**NATIONAL RESERVE RADIO CO.**  
17-19 BRIDGE STREET NEW YORK CITY

**RADIO WORLD FOR 1923 FOR YOUR LIBRARY**

RADIO WORLD from January 6, 1923, to December 29 complete, with the exception of January 13, January 20, January 27, February 24 and March 12, will be sent postpaid for \$5.00.

Many of these issues are nearly out of print, and we suggest, therefore, that orders be sent in early. Any single number, 15c; or any seven numbers for \$1.00.

Circulation Department,  
**RADIO WORLD,**  
1493 Broadway, New York City.

RADIO WORLD, the only radio paper that keeps right up to the minute on all radio news—it's NEWS when you see it in RADIO WORLD.

**PATENTS—SEND DRAWING OR MODEL FOR EXAMINATION AND OPINION.** Booklet free. Watson E. Coleman, Patent Lawyer, 644 G St., Washington, D. C.

**PATENTS—Write for free Guide Books and Record of Invention Blank before disclosing inventions.** Send model or sketch of your invention for our prompt Examination and Instructions. No charge for the above information. Radio, Electrical, Chemical, Mechanical and Trademark experts. Victor J. Evans & Co., 924 Ninth, Washington, D. C.

**MODEL "C" Super-heterodyne and model "J" Two stage tuned radio frequency amplifier unit for sale cheap to quick buyer.** These are complete units built up by expert radio engineers. A real ten tube DX receiver. E. E. GIBBONEY, Everett, Pa.

**BARGAIN—Cockaday set, \$25.00; Harkness two tube "Knock-Out" set, \$35.00; Autoplex with one step, \$45.00; Superdyne, \$75.00.** Prices include cabinet, phones, tubes. Send money order or certified check. Walbridge, 2246 14th st., Troy, New York.

**WORLD-ROMIC System, masterkey to all languages.** Primers, \$1.94, each language: Arabic, Chinese, Danish, Dutch, English, French, German, Italian, Latin, Panjabi, Polish, Portuguese, Russian, Spanish, Swedish. Pronunciation-tables, 30c. Dictionaries, grammars, 4,000 languages: Afrosemitic, Amerindic, Eurindic, Indopacific, Siberic, Sinindic. LANGUAGES, 8 W. 40th St., New York City.

**LEARN REAL ESTATE—The best business.** Start without capital; splendid opportunities everywhere. Free synopsis. Nat'l Co-operative Realty Co., R5 Marden Bldg., Washington, D. C.

1493 Broadway, N. Y. C.; business manager, Fred S. Clark, 1493 Broadway, N. Y. C.

2. That the owners are: (Give names and addresses of individual owners, or, if a corporation, give its name and the names and addresses of stockholders owning or holding 1 per cent, or more of the total amount of stock): Hennessy Radio Publications Corp., 1493 Broadway, N. Y. C.; Roland Burke Hennessy, 1493 Broadway, N. Y. C.; M. J. McArthur, Statler Hotel, Cleveland, Ohio.

3. That the known bondholders, mortgagees, and other security holders owning or holding 1 per cent, or more of total amount of bonds, mortgages, or other securities are: (If there are none, so state.) None.

4. That the two paragraphs next above, giving the names of the owners, stockholders, and security holders, if any, contain not only the list of stockholders and security holders as they appear on the books of the company but also, in cases where the stockholder or security holder appears upon the books of the company as trustee or in any other fiduciary relation, the name of the person or corporation for whom such trustee is acting, is given; also that the said two paragraphs contain statements embracing affiant's full knowledge and belief as to the circumstances and conditions under which stockholders and security holders who do not appear on the books of the com-

pany as trustees, hold stock and securities in a capacity other than that of a bona fide owner, and this affiant has no reason to believe that any other person, association, or corporation has any interest direct or indirect in the said stock, bond or other securities than as so stated by him.

5. That the average number of copies of each issue of this publication sold or distributed, through the mails or otherwise, to paid subscribers during the six months preceding the date above shown is \_\_\_\_\_ weekly. (This information is required from daily publications only.)  
**ROLAND BURKE HENNESSY**  
Editor.

(Sworn to and subscribed before me this 1st day of April, 1924.

**KARL E. GOTTFRIED,**  
Notary Public, New York County, New York County Clerk's No. 304, New York Registers No. 4228, Commission expires March 30, 1926.

Note.—This statement must be made in duplicate and both copies delivered by the publisher to the postmaster, who shall send one copy to the Third Assistant Postmaster General (Division of Classification), Washington, D. C., and retain the other in the files of the post office. The publisher must publish a copy of this statement in the second issue printed next after its filing.

# Set on Desert Cheers Star

MADGE BELLAMY, movie star of Fox Film Corporation, was pining with ennui near Wadsworth, Nevada. She wired to Oakville, California, to have a set sent to Wadsworth, where a novel by Rex Beach was being filmed. On the way out the set was used in the Pullman, and the loud speaker was clearly heard all the way along the road.

In the morning the set was used at a side track near Wadsworth. The Monotrol brought in excellently a varied evening entertainment. Said one of those present:

"We started testing at 5:30 P. M., and picked up a few Coast stations and a few

Eastern stations. As we were all interested in receiving KFI, Los Angeles, broadcasting station of the Western Electric Company, we kept pretty close to their wave length.

"A special program was arranged by a trade association and the Southern Pacific Co. for the Fox Film Co. and Miss Bellamy. The reception was so clear that we could hear the announcer and entertainers breathing."

**CROSLEY**  
RADIO CATALOG FREE

Describes fully the complete line of radio frequency sets, regenerative sets (licensed under Armstrong U. S. Patent No. 1,113,149) and parts.

Write for Catalog Today

**THE CROSLEY RADIO CORPORATION**  
POWEL CROSLEY Jr., President  
2402 Alfred Street Cincinnati, Ohio

**RADIO HORN**

Has clear, natural tone and an exceptionally fine appearance. Your receiver fits in base. Mail a dollar bill for horn like picture, knocked down, prepaid. Easily assembled by anyone.

**\$1.00**

FOX MFG. COMPANY, DEPT. C  
247 So. Broadway, Los Angeles, Cal.

**Radio Supplies Factories**

Please send offers for first class Radio apparatus and supplies. Sole agency wanted for Finland.

**FIRMAN J. V. TOIVANEN**  
FINLAND, KUOPIO

Mahogany finish cabinets, with hinged tops and rabbeted front, permitting panel to fit flush. Substantial and handsome. Sent C. O. D.

Panel Size	Price	Panel Size	Price
6x7	\$1.75	7x10	\$2.30
6x10 1/2	2.00	7x12	2.50
6x14	2.25	7x14	2.75

**R. M. HINSON** NEW HARMONY INDIANA

**GUARANTEED "B" BATTERIES**

Large	45	Volt	\$3.60
"	22 1/2	"	1.80
Medium	45	"	2.75
"	22 1/2	"	1.60
Small	22 1/2	"	1.00

**All Variable—POSTAGE FREE**  
anywhere in U. S.

*Satisfaction Absolutely Guaranteed*

**S. & H. BATTERY SUPPLY CO.**  
41 Nevins Street Brooklyn, N. Y.

**SHAMROCK**  
FOR SELECTIVE TUNING  
TUNED RADIO FREQUENCY KIT

Can be used in any Tuned Radio Frequency circuit.

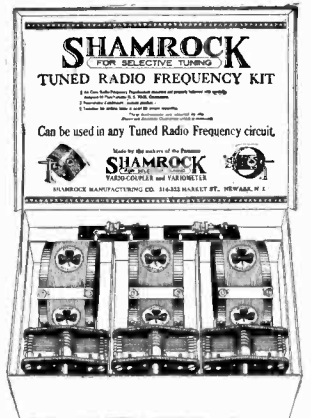

**YOU DON'T NEED TUBES**

to hear programs from stations 400 to 1000 Miles Away. I can show you how to get them on YOUR CRYSTAL SET. Changes often cost Less Than One Dollar. Send self-addressed envelope for picture of my set.

**LEON LAMBERT**  
562 So. Volusia, Wichita, Kansas

**BRISTOL AUDIOPHONE**  
MORE THAN A LOUD SPEAKER

Bristol Audiophone, Sr., 15-in. Horn. \$30.00  
Bristol Audiophone, Jr., 11-in. Horn. \$22.50  
Bristol Single Stage Power Amplifier. \$25.00

Write for Bulletin 3006-W  
**The Bristol Company**  
Waterbury, Conn.

Radio Department of  
**The Eclipse Electric Co.**  
414 West 42nd Street  
In the Heart of New York

We issue monthly a list of standard apparatus at below average price. Send your name and address to receive same.

Agents for Westinghouse A. & B. Storage Batteries. Prices upon request.

Acme Audio A-2 Transformer	\$3.90
Acme Audio A-2 Transformer, unmounted	1.95
Angle Bracket to Mount Transformers	.10
Signal 23 Plate .0005 Condenser	1.85
Pacnet Plugs	.38
Ackerman Loud Speaker, complete	6.75
Ambassador Phones	3.25
Federal Phones	4.75
Complete Parts for Ambassador Set	17.00
Complete Parts for Basia Reflex Set	24.50
Complete Parts for 5-Tube Neutrodyne	32.00

Include money order for prompt shipment.

**There's a Shamrock for every circuit**

*Shamrock Kit, list \$20*

"... Using two of your variometers and one coupler in my standard regenerative circuit, I am sure of getting at least fifteen DX stations every night."

"... I am using a Shamrock coupler with a—condenser to tune the secondary in my one-tube reflex, and am getting fine selectivity and wonderful volume."

We are receiving letters every day from fans telling of the unusual results they are getting with Shamrock products. No matter what circuit you want to build, Shamrock parts will increase their efficiency. Shamrock Kits, Variometers and Variocouplers incorporate the finest workmanship possible today. Before you build your set—ask your dealer to show you Shamrock parts.

**SHAMROCK MANUFACTURING CO.**  
Dept. 5, Market Street, Newark, N. J.

## SHAMROCK MANUFACTURING COMPANY

COUPON

Shamrock Mfg. Co., Dept. 5, Market St., Newark, N. J.

Gentlemen: Please send me information on the Shamrock parts which may be used for the following circuits.

Regenerative  
 Reflex  
 Balanced tuned radio frequency

Name .....

Address .....

Dealer's Name .....



**Does Your Aerial Keep?  
You in Hot Water**

## Replace It With— FREIDAG AERIAL FITTINGS

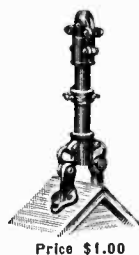

Price \$1.00 Per Set

**N**EAT Secure Fittings which allow the erection of a slightly Aerial in from 15 to 30 minutes. No pipe threading required, made to fit standard 1/2 and 1 inch pipe. FREIDAG FIXTURES spell Save, Secure and Slightly Aerials. Write for description giving the name of your Radio Dealer.



No. 60—Price \$3.50 Per Set

**Dealers-Jobbers:** The Fan has learned the importance of a perfect aerial. Sell them Perfect Aerial Fittings. Write today for discounts and descriptive booklets.

**THE DIRECT SALES COMPANY**  
431 So. Dearborn Street CHICAGO, ILL.

"THE AIR IS FULL OF THINGS YOU SHOULDN'T MISS"



## Why Big Cells Count in Radio "B" Batteries

THIS handsome metal case Eveready "B" Battery No. 766 costs only two-thirds more than the smallest Eveready "B" Battery, but it contains seven times the electricity! This makes the No. 766 over four times as economical as its baby brother. That is why most people buy it.

Its fifteen large cells give 22½ volts of strong, steady energy day after day. Cells that pour out power the moment you turn on your tubes. Cells that rest well when idle, renewing their vigor for your next demands.

No cells have a bluer-blooded ancestry than these. They are the product of thirty years of dry battery research and development of the

world's foremost electro-chemical laboratories. We think that No. 766 is the handsomest battery ever made. But that is a matter of opinion. It is a matter of engineering record, however, that this great standard "B" Battery has proved itself as perfect in performance as we are convinced it is superfine in appearance.

The 45-volt Eveready No. 767 contains the same large powerful cells as the No. 766. For maximum "B" Battery economy, therefore, buy the 22½-volt Eveready No. 766 or the 45-volt Eveready No. 767, as you prefer. Here is the "B" Battery at its best.



**Eveready "B" Battery No. 766**  
22½ volts. Six Fahnestock Spring Clip Terminals, giving variable voltage from 16½ to 22½ volts, in 1½-volt steps. Length, 6¾ in.; width, 4¾ in.; height, 3 3/16 in. Weight, 5 lbs.

NATIONAL CARBON COMPANY, INC.  
Headquarters for Radio Battery Information  
New York San Francisco  
Canadian National Carbon Company, Limited  
Toronto, Ontario

If you have any radio battery problem, write to G. C. Furness, Manager, Radio Division, National Carbon Company, Inc., 200 Orton Street, Long Island City, N. Y. Informative and money-saving booklets on "A," "B" and "C" Batteries sent free on request.



**Eveready 6-volt Storage Battery**

**No. 764 The Space Saver Vertical 22½-volt "B" Battery**

**Eveready Radio "A" Dry Cell**  
Specially manufactured for use with dry cell tubes

**No. 767 "B" Battery, 45 volts**  
Variable taps Fahnestock Clips

**No. 771 "C" Battery**  
Clarifies tone and increases "B" Battery life

# EVEREADY

## Radio Batteries

—they last longer