

CORRECTED LIST OF BROADCASTERS—(Continued in This Issue)

15c. a Copy

October 27

\$6.00 a Year

RADIO WORLD

Title Reg. U. S. Pat. Off.

ILLUSTRATED

EVERY WEEK

HEARS WORLD'S SERIES BROADCAST, BUT DOES HIS STINT

Vol-4 No-23 Oct 27 1933

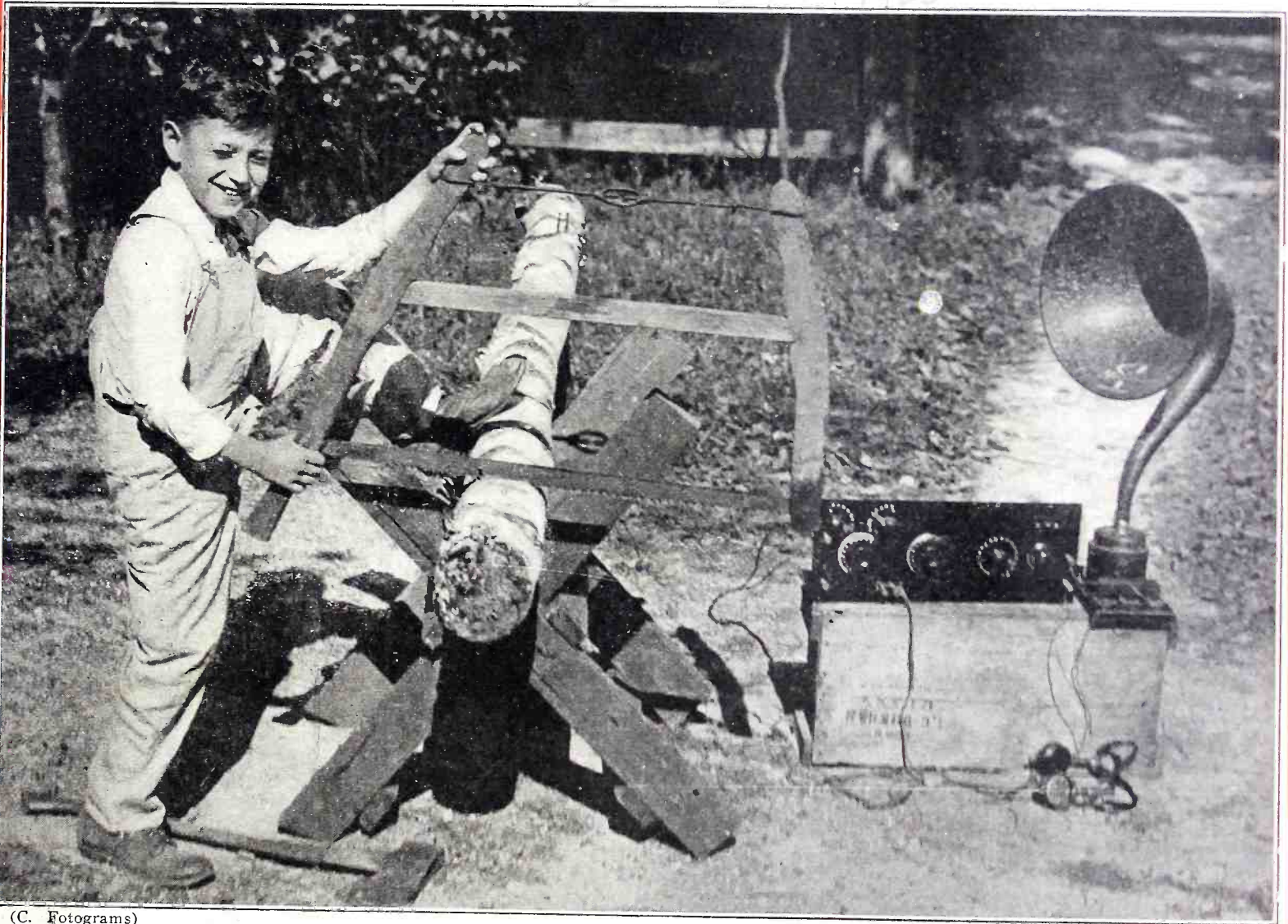

(C. Fotograms)

Young Louis Scharf, who lives up New York State way, has his regular stints to do, as every boy should have. But he's a live baseball fan, too. So when the World's Series came along he solved his problem by setting up his receiver and loud speaker out back of the wood shed. He sawed softly, and perhaps not as fast as usual, but he got the ball games play by play.

TUNED PLATE REFLEX CIRCUITS (See Inside)

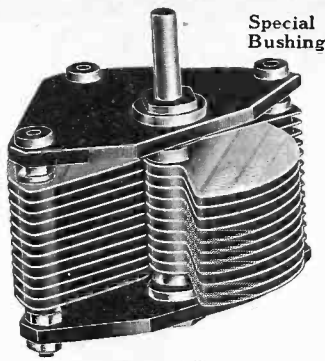

**THE FAMOUS
Aetaco Condensers**

Aluminum Plates stamped and pressed to insure precision in operation. All spacers are machined brass, nickered finish, "Special Bushing."

CONDENSERS

43 Plate Condenser	\$1.75
23 Plate Condenser	1.50
17 Plate Condenser	1.35
11 Plate Condenser	1.10
5 Plate Condenser	.90
3 Plate Condenser	.80

SWITCHES

12 Point Back Panel Mounting Inductance Switch, Special Bushing	\$0.75
12 Point Inductance	.65
Indoor Spring Wire Aerial	1.00
Standard 4-Prong Socket	.50

WHOLESALE AND RETAIL

American Radio Stores

235 Fulton Street New York City

**G. W. 5 Circuit
Radio Plug**

PATENT APPLIED FOR



PHONES
LOUD SPEAKER
SERIES
PARALLEL
SHUNT

Accommodates Head Set and Loud Speaker or Two Head Sets — permitting *instant* choice of Five Circuits without removing plug or changing tips.

Price \$1.50

At Your Dealer or Direct From Us
MADE OF GENUINE BAKELITE
Jobbers Write for Quantity Discounts

Manufactured by
G. E. WALKER CO., Inc.

1926 CHESTNUT ST. ST. LOUIS, MO.

Baseball, the Ticker and Radio

ONE of the Wall Street ticker services, which ordinarily carries market reports and brief news bulletins, claims it beat the world in getting out the World Series baseball returns play by play, through the aid of radio. Incidentally by this method it beat its rival service, which is its chief aim in life on the Street.

When the batteries were announced each day, an experienced typist sat at his typewriter with the head phones of a newly installed radio receiving set clamped on. As the news came in from WEA, he wrote it on small slips of paper and as fast as a sentence was completed, handed the sheet to the ticker operator sitting beside him. This operator wrote it on his machine and it was reproduced word for word on every ticker on the circuit.

In practically all the stock brokers offices, it is reported, crowds surrounded the little tickers, eagerly reading the returns from the tape. Stocks and bonds, wheat and sugar were forgotten for the time as the news of the Giants and Yankees came in.

This is probably the first time radio has served the ticker service but it is not the last, as there are several uses to which it can be put; for example, copying the weekly weather report from NAA at Washington thus saving telephone or telegraph tolls and considerable time. Another instance would be the sending of standard time, as well as important items broadcast from the Capital.

How to Make Inductance Coils

A CIRCULAR descriptive of how to make a series of single-layer inductance coils suitable for radio-frequency standards has been prepared by J. L. Preston and M. S. Strock of the Bureau of Standards, Washington, D. C. Owing to the increased interest in radio-frequency measurements, the illustrated circular should be of considerable value to those technically inclined and in laboratories where a fixed inductor of known inductance and having a small radio-frequency is desired. This type of coil in conjunction with a high-grade variable air condenser, such as the Bureau of Standards type, forms a very dependable and accurate wavemeter. The pamphlet is known as Letter Circular LC-103.

Naval Station to Send Standard Signals

STANDARD radio-frequency signals will be transmitted from NPG, the naval radio station at San Francisco on the third Monday of each month at 8 A. M. Pacific time. All transmission will be on continuous waves from both a medium and a high-powered arc set, no voice announcements being made. The six frequencies to be transmitted will range from 28.5 to 125 kilocycles, all long wave lengths.

Announcing

"The Latest Creation in Radio"

The

"SUPERTRAN"

F. M. C. Audio
Frequency Transformer

Has no equal on the market for

**EFFICIENCY
QUALITY
PRICE**

Report of laboratory test made by the well-known New York Radio Engineer and Inventor, LESTER L. JONES, sent upon request.

Jobbers, Dealers and Manufacturers write for our proposition and prices.

Manufactured by

FORD MICA CO., Inc.

14 Christopher Street New York City, N. Y.



For All Round Radio Work the Welsh Peanut Tube Is Demonstrating Its High Efficiency

Voltage 4 to 6; Amp. 1/4 Price
Manufactured by
Welsh Electric Lamp Corp. \$2

Sockets 40c
Adaptors 75c
69 Boylan St.,
Newark, N. J.

Improved Reinartz Circuit



By eliminating Electro Static effects between Tubes non-magnetic

Patent "VAC-SHIELDS" Pending

Prevent Interstage Coupling. Make it easy to tune in DX. Your set should have them. By Mail Post Paid direct from our Laboratories, \$1.00.

ORANGE RESEARCH LABORATORIES
41 North 16th East Orange, N. J.

WD-11 and WD-12

TUBES REPAIRED

WD-11 or WD-12	\$3.50
C-300 or UV-200	2.75
C-301 or UV-201	3.00
C-302 or UV-202	3.50
C-301A or UV-201A	3.50
DV-6 or DV-6A	3.00
C-299 or UV-199	3.50

All tubes guaranteed to work like new.

Mail Orders Given Prompt Attention
"24 Hour Service"

RADIO TUBE CORP.

70 Halsey Street Newark, N. J.
TUBES SENT PARCEL POST, C. O. D.

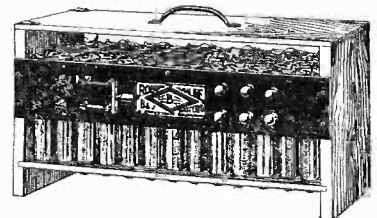

Rechargeable Storage "B" Battery

Build Yourself a Rechargeable Storage "B" Battery From Edison Elements That Will Last You a Lifetime!

Complete units for making a 110 volts, 1500 Milliampere battery consisting of cabinet, switch, elements, glass tubes, separators, wire, electrolyte and blueprints for assembling, \$12.50. Battery assembled and charged, \$17.50. Drilled elements, 6c. per pair; glass tubes, 2c. each; separators, 1c. each; nickel wire, 1c. per length; rubber covered switch wire, 2c. per foot. Mail Orders Filled.

W. ROBERTS STORAGE "B" BAT. CO.
41 JEFFERSON STREET BROOKLYN, N. Y.
Near Broadway and Myrtle Avenue
Tel. Pulaski 2023



Bristol Audiophone

LOUD SPEAKERS

No Battery Required.

Senior	\$32.50
Junior, 15 in.	25.00
Junior, 11 in.	22.50
Baby, 15 in.	15.00
Adjustable	19.00
Baby, 11 in.	12.50
Adjustable	16.50

Sent Postpaid on receipt of price.

The Bristol Audiophone Loud Speaker is the most satisfactory in all respects. Good, clear reproduction without distortion. Made in dull gold, bronze finish.

TRADE MARK
AUDIOPHONE
REG. U. S. PAT. OFFICE

A REAL AUDIOPHONE FOR \$12.50

NATIONAL "B" BATTERIES

	Large	Medium	Small
22 1/2 V. Plain	\$1.35	\$1.10	\$0.75
22 1/2 V. Variable	1.45	1.20	.80
45 V. Plain	2.60	1.85	..
45 V. Variable	2.90	2.15	..

All new goods. Not one a week old. Made by competent workmen of the best materials.

COMBINATION OFFER

BABY BRISTOL AUDIOPHONE	\$12.50
Three 22 1/2 Large Variable B Batteries	4.35
	\$16.85

Sent Postpaid for \$15.00.

National Reserve Radio Co.
Suite 702 2 STONE STREET, NEW YORK

RADIO WORLD

[Entered as second-class matter, March 28, 1922, at the Post Office at New York, N. Y., under the Act of March 3, 1879]

A Weekly Journal Published Every Wednesday and Dated Saturday, by Hennessy Radio Publications Corporation from Publication Office, 1493 Broadway, New York, N. Y. Phones: Lackawanna 6976 & 2063.

Vol. IV, No. 5. Whole No. 83

October 27, 1923

15c. per copy, \$6.00 a year

Tuned Plate Reflex Circuits With Improved Range and Volume

By H. S. Potter

THE predominant question among radio fans at the present time is: "Have you tried a reflex set yet?" Anyone who has not devoted some of his attention to one of the various reflex circuits has missed a great deal of real radio pleasure.

What is a reflex circuit? It is a circuit in which the received energy is passed through one or more tubes, amplified at radio-frequency, rectified by a detector of either the tube or crystal variety and then passed through the same amplifier tubes again and amplified at audio-frequency.

The multi-tube sets are critical as regards adjustment, require very careful and skilful construction, and are therefore not adapted to construction or use by a novice.

The one-tube reflex seems to be the real solution to the problem. While experimenting with reflex circuits I hit on the scheme of tuning the plate circuit of the amplifier tube. I improved the range and volume of my set fully fifty per cent. by this method.

This circuit will work either on antenna and ground, loop and ground, or loop only. When used with antenna and ground a variocoupler should be used. The tuning will be very broad if a single circuit tuner is used. If used on loop and ground, as shown in the hook-up herewith, very good results are obtained, and the tuning is sharp. When the ground is disconnected there is some loss of signal strength, but the directional qualities of the loop are more noticeable. The tuning, also, is very sharp, making a vernier adjustment of the tuning condenser necessary.

Using a loop 15" square and a ground connection, I have heard repeatedly, in the headphones from Mt. Vernon, N. Y., Detroit, Chicago, Buffalo, Boston and Atlanta, as well as many other distant stations. I have had the local stations audible all over the room on a

loud speaker, or with the phones lying on the table. These results were obtained during the unfavorable months of August and September.

Using only the loop antenna, I have picked up all the above named stations with the exception of Atlanta, but with less volume. Reception was absolutely free of any annoying sounds, such as static, and clicks caused by induction. Tuning was sharp, and the loop was extremely directional even on nearby local stations.

Fig. 1 shows the connection of the set to an antenna and ground, while Fig. 2 shows the connection to a loop and ground. To use only the loop, as in cases of severe static or interference, the ground is simply disconnected at point X.

Reference to the figures will show that a separate inductance, L₂, is connected in the plate circuit, and tuned by means of the variable condenser, C₂. This is not in accordance with the usual practice in tuned radio-frequency amplification, as the coupling coil is then tuned. This was first tried, but the circuit was unstable and hard to control, while plate tuning alone was very broad. The coil L₂ was then added, and everything was

fine and dandy, tuning being as sharp as could be desired. In mounting the apparatus for this set, great care should be taken to keep L₁ and L₂ apart, and at right angles. Otherwise an uncontrollable feedback will result, which will cause howling and difficult tuning.

If an antenna is to be used a variocoupler will be required. Although no taps are shown in the drawing, it is well to use a coupler with taps on the primary. An instrument giving 180° variation from zero to maximum coupling is desirable. The coupler should be wound with wire not smaller than No. 24. Do not purchase one of the ultra-compact type wound with

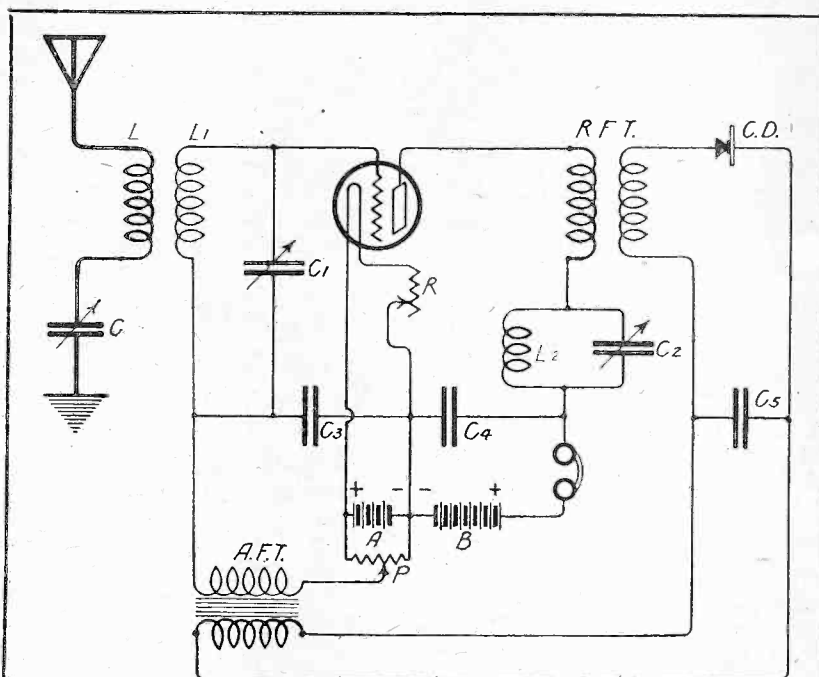

Fig. 1. Circuit diagram for a one tube reflex receiver using tuned plate or impedance coupling for the radio-frequency amplification. A set of this type furnishes enough power to operate a loud speaker, and the crystal detector makes faithfulness of reproduction possible.

No. 30 wire as these have high resistance, giving broad tuning.

If a loop antenna is used, the coil L1, Fig. 2, is necessary. It is made by winding a cardboard tube, 3½" in diameter, for a distance of 2½" with No. 22 SCC wire. Tap this coil at ¾" and 1½", in order to cover the amateur and experimental wave bands. No taps are required if only the broadcast band is to be covered.

The plate inductance, L2 in each figure, is made in the same manner. Slight changes in the dimensions of either coil will not greatly impair the efficiency of the set, but those given have been found to work best. Unless the person building this set fully understands the design of inductances in high frequency circuits it is best to adhere to the figures given.

The loop antenna shown in Fig. 2, just above the

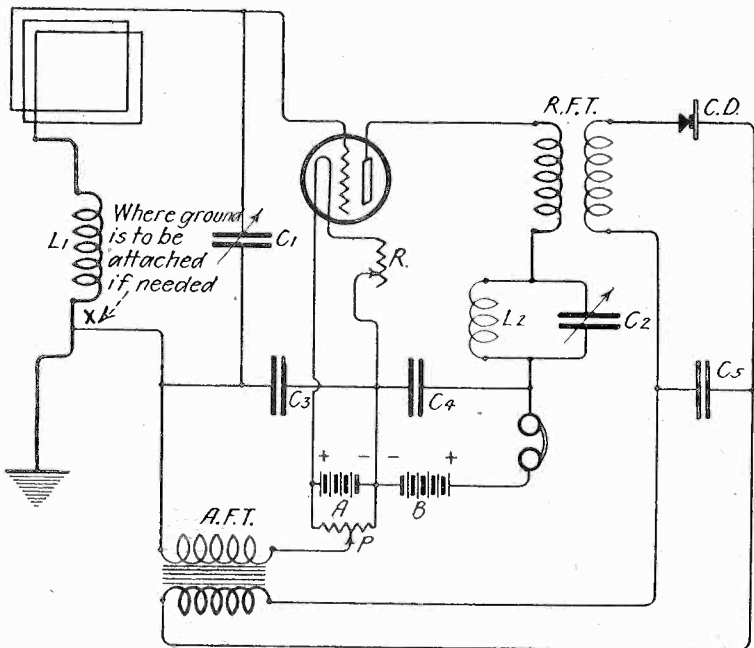

Fig. 2. A single tube reflex for use with a loop. This circuit embodies the same principles as Fig. 1 with the exception of using a loop or loop and ground instead of the regular antenna and ground.

tuning inductance, is of the flat type, and measures 15" on a side for the outside wire. It is wound with seven turns of No. 18 bare or stranded copper wire, spaced 1" apart.

The condensers, C1 and C2, are both 23 plate variables. C1 should be a vernier, if fine tuning is desired. No vernier is required on C2, as the plate circuit tuning is not so critical.

The fixed condensers are of the mica dielectric type.

Under no circumstances should the cheap paper ones be used. C3 has a capacity of from .001 mfd. to as low as .0008 mfd. C4 is not critical and is about .001 or .002 mfd. The condenser C5 is not always necessary but helps with some transformers.

In my set I use a UV199 tube, and obtain excellent results, as this tube is a fine radio-frequency amplifier, is non-critical in adjustment, and quiet in operation. If greater volume is desired, a UV201A may be used, with 135 volts on the plate, but under this arrangement great distance will be impossible as this method would give mainly audio-frequency amplification. A 30 ohm rheostat, shown at R, is used to regulate the filament current when UV199 tubes are used.

A potentiometer, P, with a resistance of 300 or 400 ohms, is connected across the A battery. This serves as a stabilizer, and cuts out howling. On distant stations its adjustment is quite critical.

The radio-frequency transformer, R. F. T., may be of almost any make which covers a band of 150 to 500 meters.

For an audio-frequency transformer I have found that a Federal, type 226-W, is about the best. It has a low ratio, only 3½ to 1, but gives good amplification. Other makes may be used with very good results, although it will be necessary to ground the core and casing of some of them.

The best crystal to use is one of the synthetic type, as they are uniformly sensitive, and therefore easier to adjust.

No dimensions for panel layout are given, as every amateur has on hand some apparatus which he wishes to incorporate in the set, thus making it necessary to alter the panel layout slightly. As a suggestion, however, a standard 7"x18"x3-16" panel, cabinet to fit, is well adapted to the purpose. Keep L1 and L2 at right angles, and as far apart as possible. Be sure to keep leads, especially in the grid circuit, very short.

A few hints on operation will not be out of place at this point. Let us consider the process of tuning in a station on the circuit in Fig. 2:

Turn up rheostat R and set the potentiometer arm about 45° from the negative battery connection end. Set condenser C2 at zero, and slowly rotate condenser C1. If no signals are heard, or if there is a long drawn howl, the crystal detector is out of adjustment. When this is adjusted correctly, a station may be tuned in with C1. Now adjust C2 and the potentiometer P, as well as the rheostat R, until the desired signal-strength and clarity are obtained.

All this is not as difficult as it reads. You soon get to know the meaning of little sounds which indicate the need of some particular adjustment.

Phone Amateurs Attention!

IT is a notable fact that there has recently been licensed a great number of amateur 'phone stations. This is a commendable fact inasmuch as it shows that the "mere novices" are becoming educated, and instead of just listening, are now station owners and operators. The only thing to watch out for is this. A great number of these sets are fairly powerful, so when you are tuning them you have to take into consideration the fact that harmonics can be created on waves much higher than your main carrier. Just for the fun of it, listen in some time when one of these is on and you will note three or four very high harmonics up around the experimental and commercial wave bands. Correct tuning and operation of the station and correct antenna design will eliminate this.

DX Weather Is Here

THE little cold snap which recently visited the Eastern States gave proof to many who had reconstructed their sets, or bought new ones, that they will perform well on DX. It showed that distance reception needs cold weather for real DX work. Now that you have tested it out and found that what the magazines say about the warm weather is true, buck up and show us how you can handle the set. Send your distance records in to the DX Editor, RADIO WORLD, 1493 Broadway, New York. Write on one side of the sheet; do not crowd your letter, but space it out. If you submit a diagram, draw it plainly on a separate sheet, and place a foot-note showing just what each piece of apparatus is, using names or make if you think it necessary.

A Good Example of Amateur Construction

THE prize for real careful construction in designing and making a multi-tube set which works marvelously, should go to M. W. Obermiller, if it has not done so already.

Mr. Obermiller, who is a very particular fan, and who furthermore is a faddist who includes the word "neatness" as one of the most important two syllable words in his vocabulary has completed a receiver, which for careful workmanship and actual working ability will stand as a model for a long time.

The receiver itself, which is a three-stage radio-frequency amplifier detector, and two-stage audio-frequency amplifier combines the best apparatus possible, with the most careful planning, wiring and work, and that combination, when shaken well always means a "real set."

You enthusiasts who throw a receiver together take a peek at the two illustrations on this page. The one shows the rear view of the receiver with the cabinet removed and the tubes in place. Note the shipshapeness of everything. Each thing in its place, and a place for each thing. The wiring neatly and well done. Every joint soldered to copper lugs. Each wire running straight, either horizontal or vertical and not scrambling all over the place.

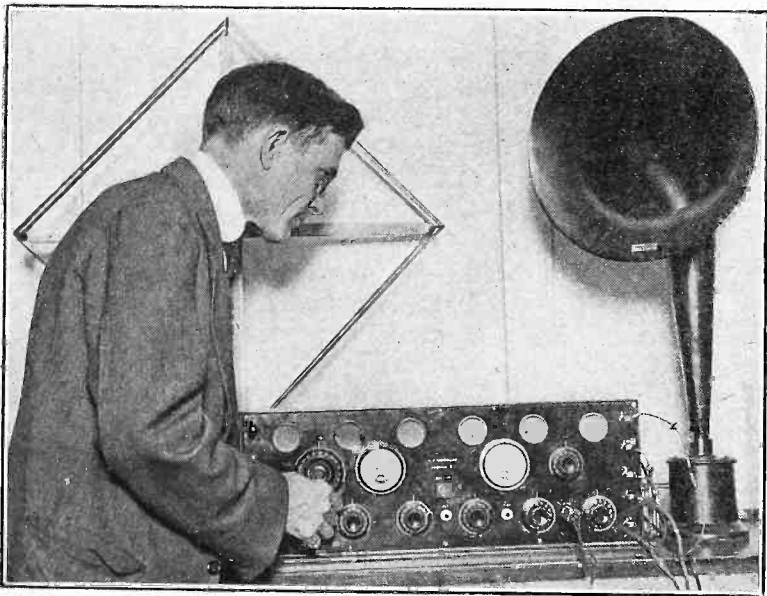

(C. Kadel and Herbert)

Front view of the set in operation, with Mr. Obermiller tuning in. Loud speaker reception of extremely distant stations is an every-day occurrence with this receiver.

Viewing the set from the other side, note the fact that Mr. Obermiller takes such pride in his work that he even has it engraved with his name. The two meters are for indicating the filament current and the plate voltage in milliamps. The only tuning control is the condenser and the turning of the loop, which is shown, the rest of the controls being the rheostats and potentiometer.

It might be of interest to state that Mr. Obermiller has built quite a few receivers and any which did not come up to the final test for good work were either completely rebuilt, or else found refuge in the nearest scrap heap. With the receiver shown, with the loop antenna, stations all over the United States and Canada have been clearly and loudly received, from Lynbrook, N. Y., the home of the builder. No expense has been spared in getting the very best of parts, and plenty of time has been taken in the construction, which are the basic factors of a well designed and worked out receiver.

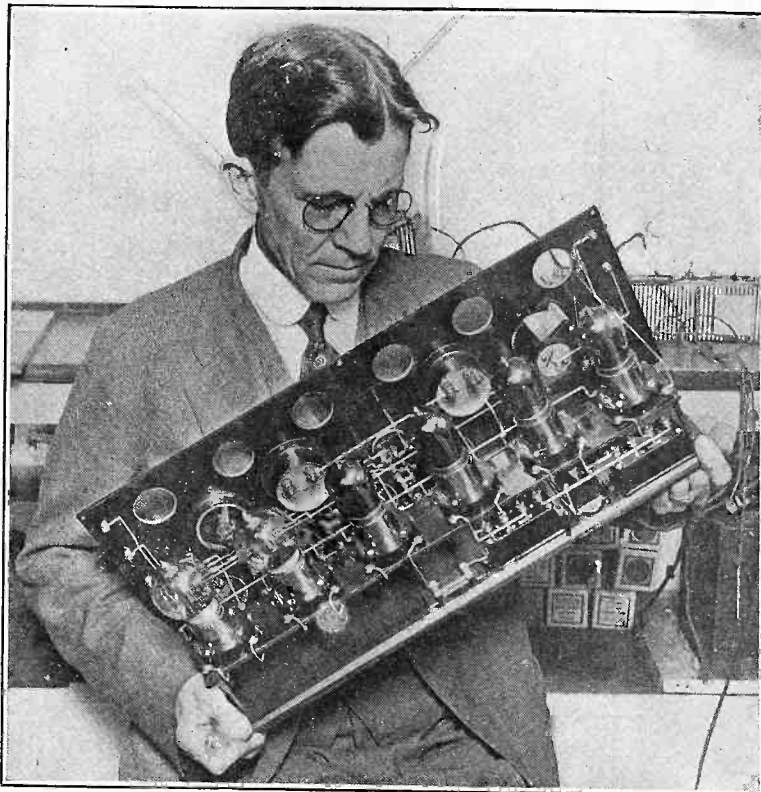

(C. Kadel and Herbert)

Mr. Obermiller and his six-tube receiver. Note the extreme neatness and well planned appearance of this receiver. Such construction always pays in the end.

An Aid to the Small Town Amateur *By Anna Leo*

WHILE constructing a set, dial pointers were needed and the local dealer met the question with the usual answer:

"Just out, buddy. Something else I can do for you?" It brought this impatient retort: "Yes, get out and get a live dealer in your place."

No dial pointers. So to the ten-cent store he went and there purchased a box of aluminum thumb tacks. He placed the tack end into the mighty grasp of the small table vise

and proceeded to file the round head of that tack until it took on the shape of an arrow. Three more were needed and three more were filed with just the same ease. The tack end was also an advantage over glue. He tacked them above the middle of the dial and the tack end projected beyond the bakelite panel in the back. A pair of plyers soon finished that. Thus a five-cent box of thumb tacks will make a can of arrows for local amateurs and serve the purpose, too.

Guarantees

GUARANTEES look big when lettered on window cards or stated orally by the man selling goods, but the courts do not consider oral guarantees as binding. No man who has any common sense

will take another's word for anything if it is too strongly stated. The best way of assuring success in the building of receivers is to use apparatus that is national in its scope, well known and advertised and with a good name back of it—the best guarantee possible. When a dealer makes a guarantee and the device fails he should be called on to make good.

New Applications of the Sodion Detector

AN interesting paper on "New Applications of the Sodion Detector" was presented by Harold P. Donle, Chief Engineer of the Connecticut Telephone & Electric Co., at the October meeting of the Institution of Radio Engineers held in New York City. He demonstrated the operation of his vacuum tube, pointing out that the form shown differed from the type exhibited last winter. The new model draws less than $\frac{1}{4}$ ampere filament current (designed for dry-cell use) and has no liquid sodium electrode. Like the previously described type, however the Sodion tube

used at exceedingly loose couplings and gives not only good selectivity between broadcasting stations but great freedom from spark interference.

Among the characteristic curves of the tube Fig. 2 is of interest. Four curves are shown, the first (marked I_a) giving the increase of anode current, at 24 volts plate potential, as the voltage applied to the collector is varied by means of the potentiometer. The second curve to be considered is that marked I'_c , which shows how the collector-circuit current increases as the applied potential is decreased. This curve was taken with the anode circuit open to prevent ionization between the anode and filament. As soon as the anode circuit is closed through the B battery the collector-circuit current increases to the values shown by the curve I_c , the difference representing one effect of the ionization between plate and filament. This difference is plotted for each potential as the fourth curve $I_c - I'_c$. A most interesting point is that the detection of current flow in the collector circuit is against the potential applied to the collector; the current is greatest when this e.m.f. is least, and it is therefore often called the "neutralizing potential."

Fig. 3 shows the tube arrangement, the glass shell S containing the anode or plate A, the filament F and the collector or control electrode C. A heater H is wrapped non-magnetically around the outside of the tube, a second external glass shell S_1 , being provided to protect the tube shown and to conserve heat. The internal electrodes are supported through a glass bead B. The tube is pumped to the highest possible vacuum and internally treated with an alkali metal such as sodium, to provide the stable ionizing material that plays an important part in its sensitiveness.

Fig. 4 shows one of the most interesting characteristics of any detector, i.e., the relation of input radio-frequency and output audio-frequency power. For the Sodion this characteristic is a straight line, which is a desirable relation for the reproduction of high quality speech and music by radio.

The Sodion tube was shown in simple circuits such as that above and also in combination with radio and audio frequency amplifiers. Its outstanding features are pure quality of tone reproduction, stability in operation, and absence of interference-producing squeals and whistles, as the tube cannot be made to oscillate,

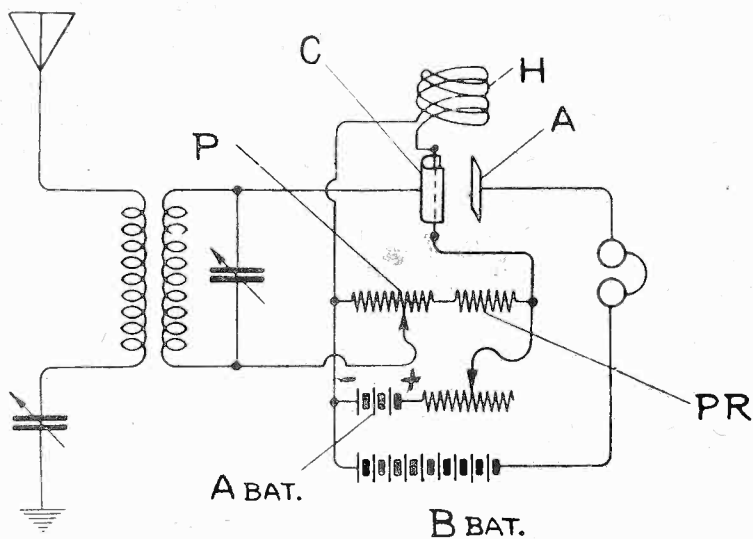

Fig. 1. Circuit in which the new sodion detector tube performs best. It is the straight audion non-regenerative circuit. This tube cannot be used in a regenerative circuit as it cannot be made to oscillate.

has no grid but utilizes a trough-shaped piece of nickel, partially surrounding the filament and open toward the anode, as its control electrode.

Fig. 1 shows a good circuit for the Sodion detector. The heater H is permanently connected in series with the filament, the entire tube assembly fitting a four-prong base. The A battery may be three dry cells in series and the B battery a single 22½ volt block. A standard rheostat of 4 to 6 ohms is satisfactory, and the potentiometer P may be of 30 to 50 ohms with its fixed resistor of 75 to 150 ohms. The heater terminal is connected to the common negative of the A and B batteries. The inductively-coupled tuner is

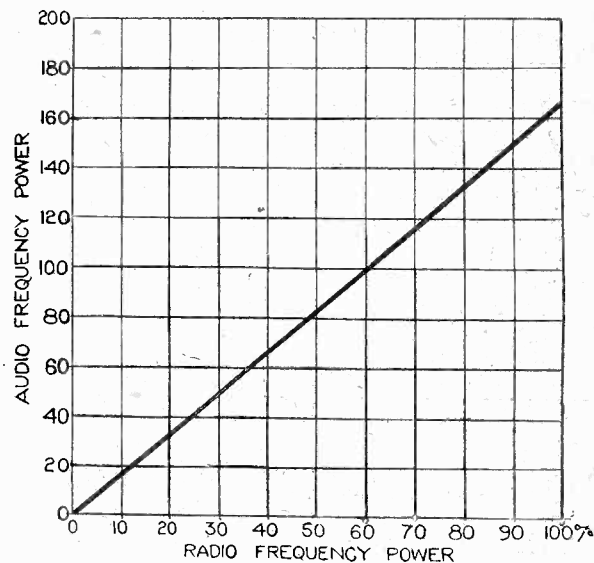
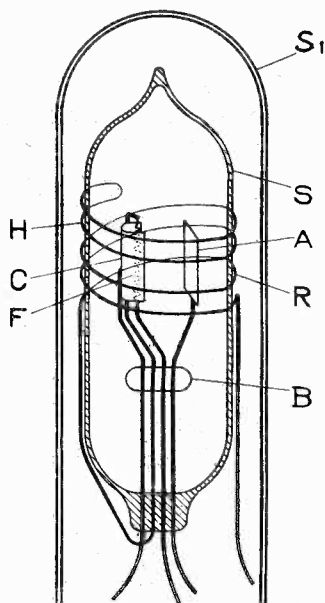
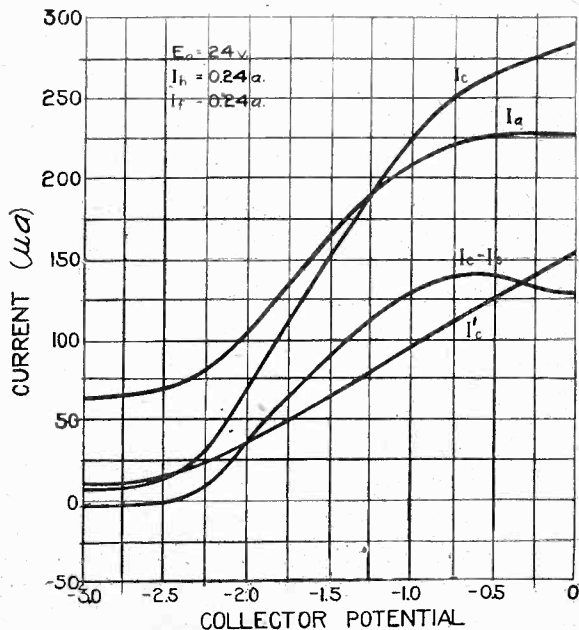

Fig. 2. Four characteristic curves of the new sodion tube showing its action under various current-collector potential values. Fig. 3. Tube arrangement, showing the inside small tube with elements and the outer protective tube. Fig. 4. Characteristic curve showing the relation of input radio-frequency and output audible frequency power as a straight line throughout its range.

Resonance Wave Coil Reduces Static

By S. R. Winters

THE resonance wave coil has been recently adapted to reducing or suppressing atmospheric disturbances in the reception of signals by radio telegraphy or telephony. This development is responsible for the introduction of a new type of radio apparatus, namely, the "resonance wave coil receiver."

The first type of resonance wave coil, which was developed by the Signal Corps of the army, consisted of a hollow cardboard tube, 38" long and $2\frac{3}{4}$ " in diameter, around which was threaded a single layer of No. 32 insulated wire. Terminal binding posts were

resonance wave coil. The radio research laboratories of the Signal Corps have varied the designs of cardboard tube with respect to the size of the wire and the manner of winding—from a simple layer of wire to a double-banked coil. Also, two metal bands have been used on one coil, thus enabling two operators to receive wireless signals of different wave-lengths simultaneously, each operator connecting the grid element of a vacuum tube to the metal band or "collector ring."

So much for a description of the resonance wave coil and its principle of operation. In its new role of

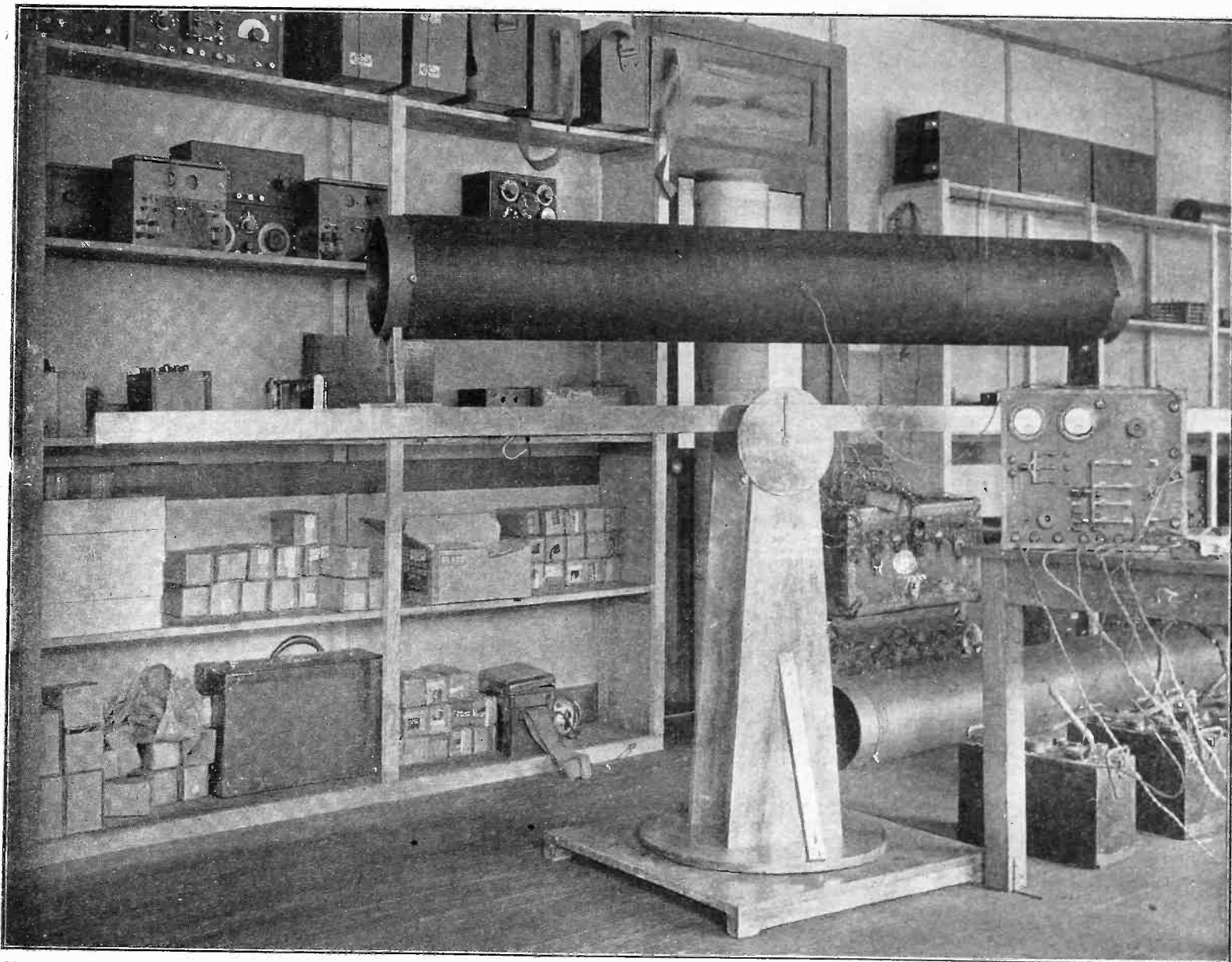

Fig. 1. A form of resonance coil as used by the Signal Corps of the army in their experiments. In this coil the collector ring is permanently fastened to the center of the coil, the wire being wound over it. This ring is connected to the antenna side of the receiver as shown in Fig. 2 on page 10.

placed at each end of this wire-wound cardboard tube. The principle of the resonance wave coil as a device for receiving wireless signals is explained when we are told that a brass band or ring forms a capacity connection to this cardboard tube, but is otherwise insulated therefrom. This band or ring gathers up the radio voltage at the particular point where it is located on the coil and conveys the electric energy to the grid element of the electron tube. This metal band or "collector ring," may be slid along the cardboard tube and collects the wireless signals of varying wave-lengths.

The above description fits the simplest design of

eliminating or reducing "static" or atmospheric disturbances, notable modifications are introduced before the "resonance wave coil receiver" is developed. First, a so-called "guard tube" is introduced in the electric circuit of the resonance wave coil. The former, which may or may not be slit, is from one-third to one-half the length of the resonance wave coil. The metal band or "collector ring" is placed at the opposite end of the coil. The "guard tube" is grounded, with the result that the latter obtains all of the radio voltages reaching the coil and none of them are collected by the metal band. That is to say, the

(Concluded on page 10)

An Ideal Radio-Frequency Amplifier for Concert Receiving

By Walt. S. Thompson, Jr., E. E.

THE ideal receiver for the broadcast listener should be selective, sensitive and should give distortionless reproduction. If these qualities are present in a receiving set, the owner will have at his command concerts from all the powerful stations of the country and each program will be enjoyed by the most discriminating music lover due to its perfect reproduction. The writer in designing the set herein described has tried to meet the above specifications and presents a "quality" rather than a "quantity" concert receiver.

The circuit used, as can be seen by referring to Fig. 1, makes use of two stages of radio-frequency amplification. The effect of radio-frequency amplification is to increase the sensitivity and hence the receiving range of a set, a fact well known to the average fan today. It is to the use of radio-frequency amplification that this set owes its remarkable receiving range,

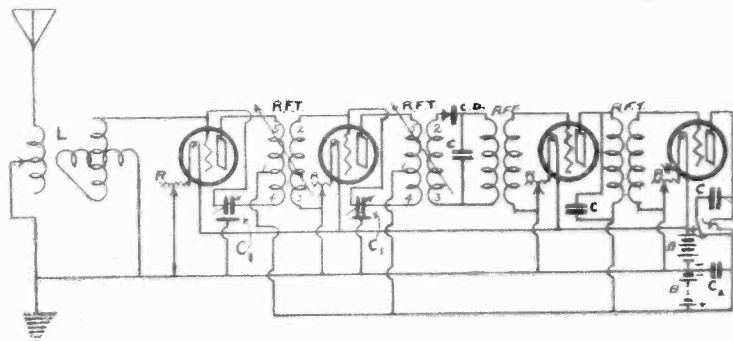

Fig. 1. Radio-frequency receiver utilizing special radio-frequency transformers and tuner. A crystal detector makes possible clear reproduction and the neutralizing or compensating condensers C_1 allow the neutralization of each separate tube and transformer giving maximum radio-frequency amplification.

it being capable of receiving from stations one thousand miles away, using an indoor antenna.

The selectivity of a receiving set should increase for every increase in receiving range, due to the fact that there are more stations which can be heard and hence sharper tuning is required to separate them. The use of "tuned" radio-frequency amplification and a loosely coupled primary circuit gain this increase of selectivity in this circuit. The tuning of the plate and the grid circuits to the incoming wave in both stages of radio-frequency amplification provides a wave trap effect so that interfering stations are completely filtered out before reaching the detector.

The great difficulty previously met with in using tuned radio-frequency amplification, was the elimination of the feed-back action from the plate to the grid circuit of each amplifier tube and also from the plate circuit of one tube to the grid circuit of a preceding tube. This feed-back action causes regeneration when the filaments are low and oscillations when the filaments are of normal brilliancy.

The principal paths for this feed back of energy are: (1) Resistance coupling between tubes due to the use of a common plate battery having a high internal resistance. (2) Inductive coupling between transformers and tuner. (3) Capacitive coupling within each tube and between wires. Of these paths, the worst offender is the electrostatic coupling within the tube, although the others must be taken care of in the design and construction of the set. The resistance

coupling is neutralized by shunting the B battery with a condenser having a capacitance of about 0.5 mfd. shown as C_2 in Fig. 1. The construction and placing of the radio-frequency transformers and the tuner neutralizes the inductive coupling and the compensating condensers neutralize the capacitive coupling after care has been taken to keep all grid and plate circuit wires separated as much as possible.

The theory involved in the use of the compensating condensers shown as C_1 in Fig. 1 will not be taken up in detail. Suffice it to say that the additional winding of the radio-frequency transformer in conjunction with the condenser, builds up a charge on the grid of the tube equal to and of opposite polarity to the charge built up by the feed-back action and hence prevents any transfer of energy from the plate to the grid circuit.

The tuner shown as "L" in Fig. 1 consists of a variometer having the primary coil coupled to it as shown by Fig. 2. A 3" bakelite or cardboard tube about 2" long is fastened to the variometer by means of two small brass or copper braces, the dimensions of which are given. Two brass machine bolts should be used to fasten the braces to the tube and two brass wood screws should be used to fasten the braces to the variometer. The builder must select a screw short enough so that the end will not touch the winding of the variometer. In assembling the tuner the primary winding should be placed on the tube first, winding on it 10 turns of No. 22 D.C.C. wire, tapped at the third, sixth and ninth turns. The primary circuit is of the so-called semi-aperiodic type, meaning that it is not sharply tuned to the incoming wave but responds equally well to most all of the broadcasting wave lengths. The reason for bringing off taps is to change the degree of coupling between the primary and secondary circuits and not to tune the primary. The loudest signals will be received when all 10 turns are in the circuit, although the set will be most selective when only three turns are included. This adjustment will be made to suit the tuner and the degree of interference he is troubled with when receiving.

The radio-frequency transformers are of a special type designed by Lester L. Jones, formerly Radio Aide, U. S. N., to be used in conjunction with the compensating condensers to eliminate feed-back in tuned radio-frequency amplification. By using this ingenious device as a coupling between amplifier tubes, the experimenter can tune the grid circuit of one tube, the plate circuit of the preceding tube and change the coupling between the two by the manipulation of one dial. The vario-transformers, as they are called, are capacitatively shielded from the tuner's hand and from each other, eliminating body capacity effects and the above-mentioned inductive coupling. Fig. 3 shows the terminal strip of the vario-transformer, the numbering corresponding to that given on Fig. 1, so that the builder can make no mistakes in wiring the set. The entire frame of each vario-transformer should be grounded as indicated.

The compensating condenser is a three-electrode condenser with a capacitance variable between 3 mmf. and 7.5 mmf. As the purpose of this condenser is to

neutralize the tube capacitance, it is made variable so that it may be adjusted for any tube which the builder may use, this being necessary because different type tubes do not have the same grid-plate capacitance. Another feature of the condenser is that it is shielded so that there will be no body capacity effect when it is being adjusted. The condenser may be adjusted to suit the operator's fancy; that is, the tube capacitance may be entirely balanced, giving clear and distortionless reproduction, which is a revelation; the condenser may be slightly unbalanced to give a small amount of regeneration, or the condenser may be completely unbalanced to make one of the tubes oscillate for C. W. reception or for picking up stations. A distinctive advantage of this three-electrode condenser is that the balancing may be done without detuning the set and that after being balanced the tuning of each individual circuit is entirely independent and will cause no howling. After the set has been balanced there will be no radiation and no oscillations, these two facts being big advantages of this balanced radio-frequency amplifier.

In selecting a crystal detector the experimenter would do well to purchase a synthetic rectifier due to its stability and sensitivity.

The rheostats "R" should be selected to match the tubes used, the writer recommending the UV201A or the C201A, although other hard tubes will be found satisfactory.

The pieces of apparatus used by the writer in constructing this set are given below with the necessary values for each:

One variometer (200 to 600 meters), one Bakelite tube (3" dia. x 2"), 2 brass braces, 2 vario-transformers (180 to 610 meters), 2 Amsco compensating condensers (C₁), 2 Amertran audio frequency transformers, 1 crystal detector (synthetic), 3 by-pass condensers (.001 mfd.) (C), 1 by-pass condenser (.5 mfd.) (C₂) 4 rheostats (30 ohms) (R), 4 tubes (UV201A or C201A), 4 tube sockets, 1 single circuit jack, 1 composition panel, 3 four-inch dials, 1 four-point switch, connecting wire, wire for primary coil, binding posts, etc.

After the set has been carefully constructed, the experimenter is ready to try it out. The first step, of course, is the connection of batteries, antenna, ground, and the head set and the placing of the tubes in their

sockets. Next turn up the tube filaments to their proper brilliancy, setting the compensating condensers to read about 50 for their initial adjustment. Placing the tap switch to include all 10 turns of the primary, some station is tuned in with the other three dials. After a station has been picked up, the compensating condensers can be balanced until there is no tendency for any tube to oscillate and the reproduction is clear. When this has been done the variometer and the vario-transformers can be given their final setting. If the experimenter is troubled with interference, the tap switch can be set to include fewer primary turns and the other dials reset slightly.

The slight unbalance of the compensating condenser on the second tube will increase the signal strength, although the reproduction will be slightly distorted as in a regenerative set which employs too much regeneration.

A method of determining when the set is completely balanced is to turn out the filament of the first tube when receiving some signal. If the signal drops out entirely, the correct setting for the compensating condenser has been found. This can be repeated with the other tube after turning the first filament on again.

This set will function well with an indoor or outdoor antenna, a loop or a lighting socket plug to pick up the signal, although the maximum signal strength will be obtained using an outdoor antenna.

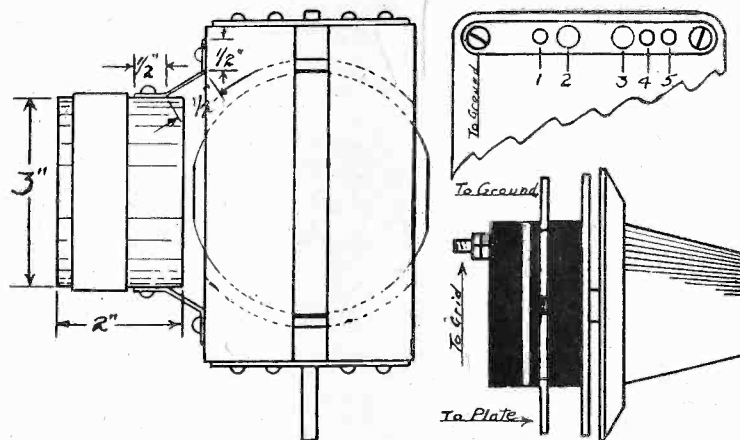

Figs. 2, 3, 4. Manner of constructing the tuner shown as L in Fig. 1. Terminal strip of the vario-transformer or radio-frequency transformer, with numbers to correspond to connections shown in Fig. 1. The compensating condenser is of special make. Note that there are three terminals in this condenser.

The Radio Woman

I WAS mightily interested to read a letter shown to me by our circulation manager from a woman reader who ordered a renewal of her subscription to RADIO WORLD. It was from Miss May Clough, Greenwich, N. Y., and concludes as follows: "We shall soon be having radio weather again, although once in a while even now we get distance. With my single circuit regenerative, which I built, using the UV199 tubes, on Sept. 22 I had PWX, Havana, Cuba, for about an hour, and the evening of Sept. 25, the Atlanta Journal station came in with great clearness."

* * *

"Kady" our maid, whom I told you about some time ago, gave her own version of a radio party last week while F. H. and myself were visiting. She invited two of the girls from next door and turned on the loud speaker and all the tubes, and then when she was finished she couldn't turn them off, and so sat up nervously until after 1 A. M. twisting and turning the dials trying to turn the tubes off. They happen to be controlled by means of the jacks and she didn't know how

to pull them out because they seemed to stick and she was fearful of hurting the set. She happened to hear F. H. one night after he had blown three tubes. "Hones' I wouldn't touch him no more" she started in weeping as soon as I entered the door, and it took us all of thirty minutes to quiet her and assure her that she hadn't hurt anything.

* * *

Well, friend husband has finally bitten off the piece that I have expected for some time. Last Saturday afternoon a nice little Ford truck, embellished with gold letters indicating a radio store in New York backed into the street, friend husband got off the front seat and started in to unload a bunch of heavy bundles and boxes. Ever since that time he has been converting the spare maid's bedroom closet up-stairs into a remote control station. More wiring and switches and relays and converters and 50 watt tubes I never did see. He believes in doing things right anyway, so he even brought an electrician along to lay the wires in conduits. Now I see where I finally get some use out of the code that I have been studying for the past eight or nine months.

Resonance Wave Coil Reduces Static

(Concluded from page 7)

radio-frequency alternating currents entering this system are cut out by this "guard tube."

Upon the assumption that "static" or atmospheric disturbances are impulses of extremely low frequency, ranging from 200 to 300 cycles a second, this "guard tube" drains off this form of interference. The theory is that when the "atmospherics" strikes the antenna

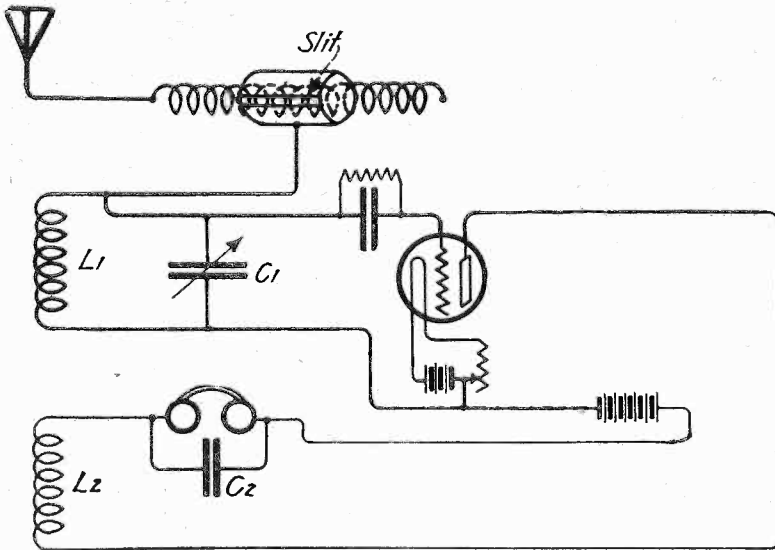

Fig. 2. Single circuit receiver using resonance coil as described. The slit ring is slid back and forth over the coil until the best place is located. Another ring called the guard tube may be fitted over the lower end of the tube and grounded.

it produces the effect of abruptly injecting a high voltage on the left end of the resonance wave coil. The voltage is absorbed by the latter and unless interrupted in its course the coil will oscillate at its own wave-length. The use of the "guard tube" averts this os-

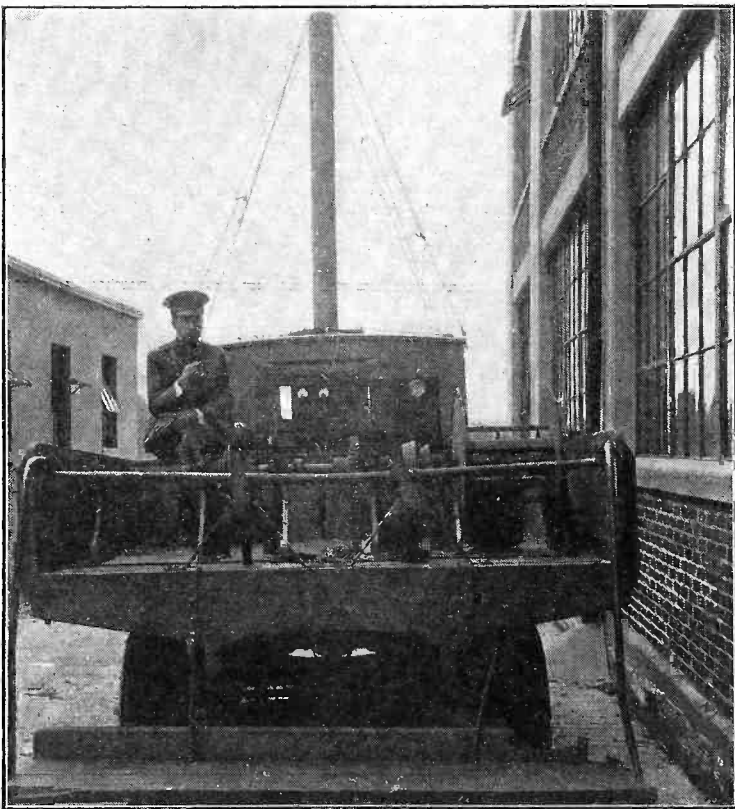

Fig. 3. The resonance coil used on one of the signal corps trucks in their experiments, both as to receiving and transmitting. In this particular case no additional antenna was used.

cillation, however, and the "static" is relayed to the ground.

In the removal of the atmospheric disturbances the orderly wireless signals are drained off as well.

This condition may be compromised, however, by grounding the "guard tube" in such a way that the connection will function as a solid ground on all wave-lengths except one. The Signal Corps describes this essential proviso as a "rejector circuit." For instance, if the latter is in resonance with a wave-length of 400 meters, all other frequencies are rejected or, more properly speaking, are arrested and drained off to the ground. The signals borne on the 400-meter wave-length are admitted through the resonance wave coil to the metal band or "collector ring."

In devising a "rejector circuit," the amateur or novice should use heavy wire for the windings on the cardboard tube and also employ a variable condenser with low losses. The Signal Corps suggests for such an electric circuit, the use of a variable condenser of .001 microfarads capacity. The latter should be shunted across a resonance wave coil comprised of 55 turns of double cotton-covered wire, No. 14 B. & S. gauge, threaded around a cardboard tube $3\frac{3}{4}$ inches in diameter. The condenser, preferably, should be insulated with hard rubber. Such a circuit will afford an inductance of 0.1 millihenry.

Structurally, the metal band for assembling the radio signals and the "guard tube" for draining off the impulses of "static" may be made of brass. They should fit snugly on the wire-threaded cardboard tube. A convenient arrangement, according to the Signal Corps, is to cover the winding with a layer of thin paper and then employ tubes that will barely slide smoothly over this paper. The "guard tube" is not necessarily split but the metal band for collecting the waves must be.

Dr. Louis Cohen, consulting engineer of the Signal Corps and who is largely responsible for the application of resonance wave coils as a means of suppressing atmospheric disturbances, indicates that regeneration may be employed in the "resonance wave coil receiver" by the use of a tickler in the conventional manner or by employing of a plate-circuit variometer. In either instance a tuned secondary circuit is necessary. Regeneration may be accomplished in the absence of additional windings of wire on the cardboard tube.

The experiments in the laboratories of the Signal Corps have included the splitting of the "guard tube" into two parts and the adding of a second resonance wave coil on which the metal ring functions in assembling the wireless waves. The two cardboard tubes used in this way are wound in the same manner. Such an electric circuit permits of the use of receiving instruments of practically any design.

As indicated in a preceding paragraph, the resonance wave coils may differ widely in the size of wire and the manner of winding. However, the Signal Corps ventures certain suggestions in this particular that may prove of value in charting the course of experiments in making these coils as "static eliminators." For the purpose of receiving music and speech, on wave-lengths ranging from 200 to 600 meters, a single layer of No. 30 wire 18" long on a cardboard tube 3" or 4" in diameter, is suggested.

Are You a Real Fan?

THIS is a very pertinent question to ask the many thousands of enthusiasts who pride themselves on their ability to pick music and programs out of the ether. The real question is, do you help your neighbor out of his troubles if you are able?

How to Charge Storage Batteries

By Leroy Western

AFTER having constructed a storage B battery such as described in last week's issue of RADIO WORLD by the writer, it becomes necessary to "form" the plates, since they are not of the "pasted" type. This is necessary in order that the battery may function properly, for if the plates are not formed to the necessary degree, the action of the battery will be far from satisfactory as it will not hold its charge for any appreciable length of time.

When considering the problem of charging batteries, it is necessary to regard two different sources of current, in order to cover the average installation. These currents are alternating and direct.

The amateur who has D. C. supplied to his home is indeed lucky when it comes to charging storage bat-

teries, as the very simplest apparatus will suffice. Consider that a storage B battery is to be charged from a D. C. source. We will find the simplest circuit in Fig. 1. You must be careful to get your polarities correct in using this method of charging for otherwise your battery will be ruined. As will be seen, the storage battery is connected directly across the 110 volt D. C. line with a 50 watt lamp in series so that only a fraction of an ampere of current will be delivered to the battery. When using this method of charging, a B battery having a voltage of anywhere from 22½ to 90 volts may be charged at one time.

method is illustrated in Fig. 2. Here a single jar electrolytic rectifier is used and a 50 or 75 watt lamp regulates the amount of current delivered to the battery. Using such a device, you should never attempt to charge a battery for a value of more than 65 volts.

Regarding the construction of the electrolytic rectifier, it will be found that an ordinary fruit jar will suffice for the container. The electrodes may consist of a strip of lead and a strip of aluminum, each 2" wide by 5" long by ⅛" thick. These should be separated by wooden blocks and suspended within the jar.

The container may then be filled with any one of the following solutions. Several are given so that the material that is easiest to obtain may be used:

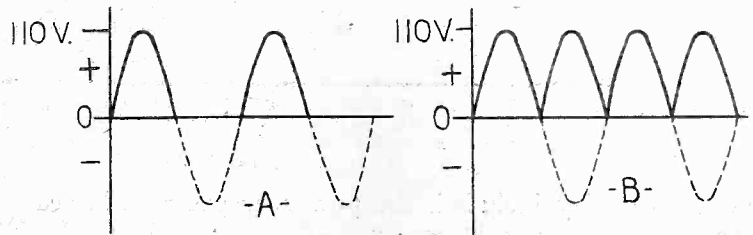
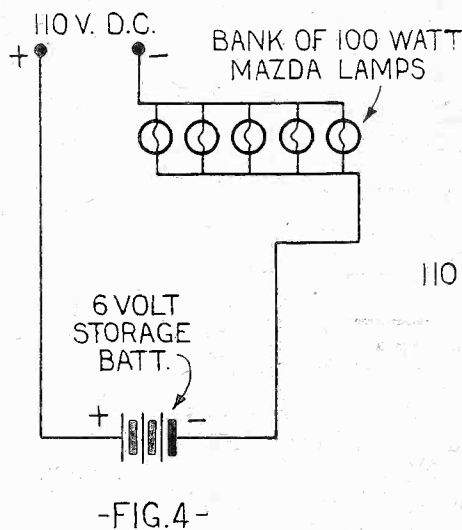
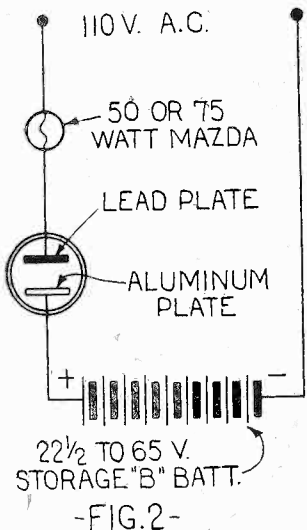
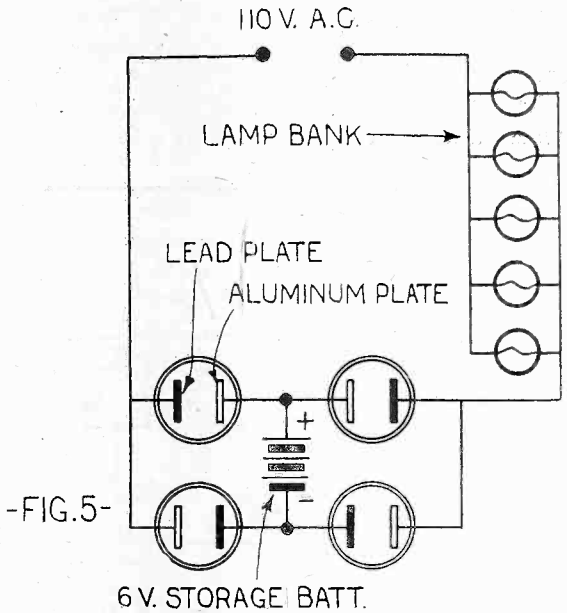
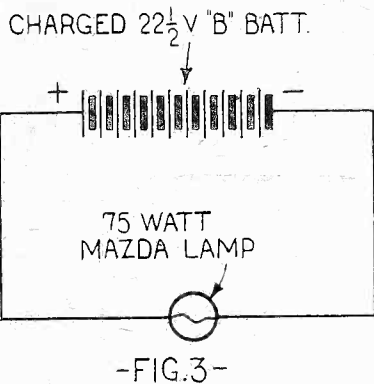
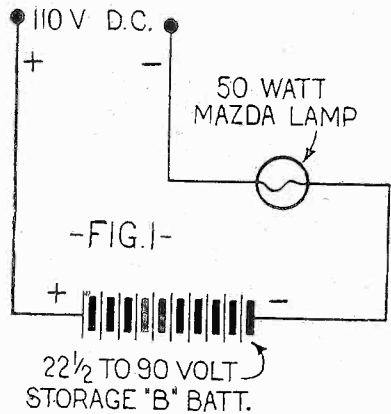

Figs. 1-6. Methods of charging both A and B storage batteries as described in the accompanying article. The storage B battery described in RADIO WORLD for October 20 may be charged by the methods explained here.

teries, as the very simplest apparatus will suffice. Consider that a storage B battery is to be charged from a D. C. source. We will find the simplest circuit in Fig. 1. You must be careful to get your polarities correct in using this method of charging for otherwise your battery will be ruined. As will be seen, the storage battery is connected directly across the 110 volt D. C. line with a 50 watt lamp in series so that only a fraction of an ampere of current will be delivered to the battery. When using this method of charging, a B battery having a voltage of anywhere from 22½ to 90 volts may be charged at one time.

If, however, alternating current only is available, it is necessary to use some form of rectifier in the circuit in order to deliver a direct or pulsating direct current to the battery. For charging storage B batteries which require only a small current, the easiest

Saturated solution of sodium phosphate, saturated solution of bicarbonate of soda, 10% solution sulphuric acid, 10% solution of hydrochloric acid, or saturated solution of salt.

After the rectifier jar has been set up, the leads which are to be connected to the battery should be connected together. In other words, the rectifier is to be placed across the mains with the electric light bulb in series. This is allowed to remain this way for a period of eight to ten minutes, whereupon it will be found that a film will have formed on the aluminum plate which gives the apparatus its rectifying powers. During this charging process the solution may boil, but it should be allowed to do so and any deficiency made up after forming of the plate by the addition of distilled water. After the plates are formed, and

(Concluded on page 22)

A DX Continuous Wave and Phone Set

By Byrt C. Caldwell

THIS winter the ranks of the amateurs are going to be enormously increased, due to the conversion of hundreds of broadcast listeners into enthusiastic "brass pounders." There is some mysterious attraction in code work that keeps the operator interested far into the morning, long after the most ambitious "fans" have retired.

For the good of radio, the amateurs are to be encouraged. If amateur radio had been suppressed years ago, broadcasting would as yet be a thing of the uncertain future. Most of the great radio engineers and inventors of today received their training as amateurs, and the great radio men of the future are now lowly amateurs and broadcast listeners.

The fan who is going in for transmission work this winter desires a set which will give maximum results with a given outlay of money, and a set which is fairly easy to construct and operate. The set described in this article is ideal. It employs the circuit used by the British engineers in their war sets. It is the best short wave circuit yet devised, and in comparison with other circuits, the Colpitts

so it is apparent that with this circuit they are under a considerable load. For safety with this load a gap should be connected between the grid and filament of the tube. This should consist of two points separated a distance of about the thickness of post card. A hot wire meter should be used in the antenna lead and, although it is not absolutely necessary, a filament voltmeter should be used so that the tube may be operated with a constant voltage on the filament, instead of a constant current. The most critical adjustment in this circuit is the condenser C_1 . When the tap T_1 is changed, the setting of this condenser is changed also.

All parts of the set should be placed as close together as possible, and short straight connections should be used. The wiring should be done with bus wire, and every connection should be carefully soldered. The constants for the circuit are as follows:

L_1 —Inductance. 25 turns of ribbon or large wire, wound on form of bakelite or formica strips, 6" in diameter and 6" long, bare wire. L_2 —Tickler. 15 turns annunciator wire on same kind of form, 4" in diameter, and placed inside of the antenna inductance at the ground end. The

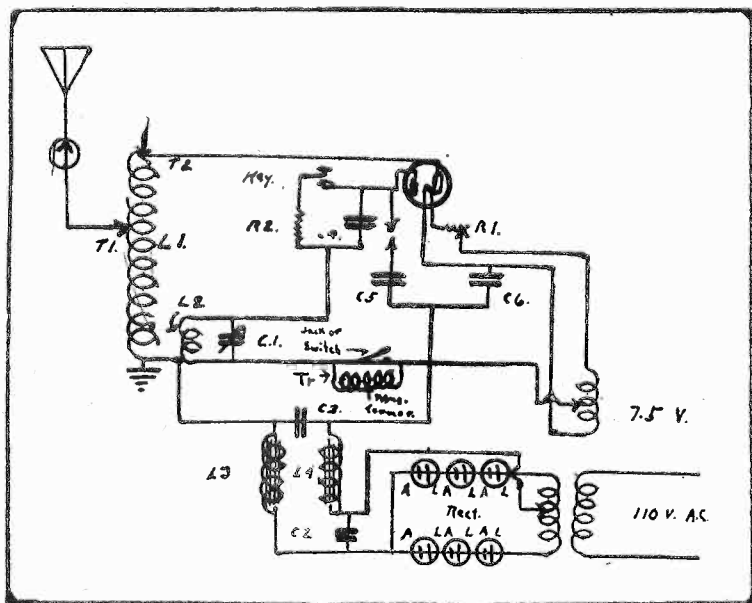

Fig. 1. Diagram of a single tube CW transmitter or phone set. The high plate voltage is supplied by rectified AC through the transformer and rectifier bank with the chokes and eliminates the necessity of a generator.

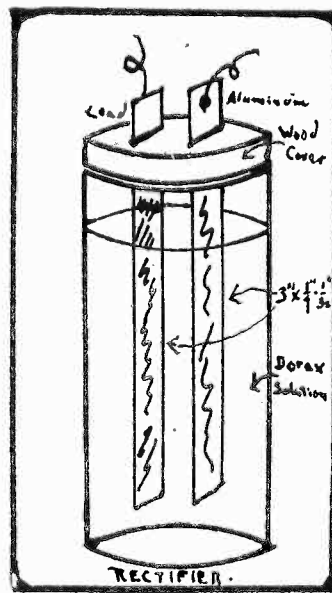

Fig. 2. Constructional details of an easily made liquid rectifier for use with the transmitter shown.

and the Hartley included, the power output was increased by at least one hundred per cent. The set may be used with one UV202, as shown, or with two connected in parallel, or the 50 watt tubes may be used.

We will start with the antenna. A good antenna is as important as a good set. The single wire which is used for receiving would never do for transmission work. The ideal antenna for the amateur is the cage type. Six or eight wires, soldered around several metal hoops about 3' in diameter and 60' long, is about right. This should be erected about 40' to 50' from the ground. A counterpoise should be used if possible. This should be about 6' from the ground and should consist of six or eight wires spread out in a fan shape under the antenna. It should project several feet on all sides of the antenna. Keep the antenna system as far as possible from all objects such as trees, houses, etc., as all these absorb energy and increase the resistance of the aerial. Use only one insulator at each end of the cage.

The high tension supply consists of a 200 watt C. W. transformer. The output, which is at a potential of 550 to 600 volts, is rectified by means of an electrolytic rectifier. The normal plate voltage of the UV202 tubes is 350 volts,

wire on this should be wound in the opposite direction to the wire on the antenna inductance. L_3 , L_4 — $1\frac{1}{2}$ henry iron core chokes, 150 M. A. capacity. C_1 —.0005 variable condenser. C_2 —2 mfd. condenser. With 50 watt tubes they must withstand 2000 volts. C_3 —1 mfd. condenser. C_4 —.002 mfd. mica fixed condenser. C_5 , C_6 —.001 fixed condensers. R_1 —5 ampere rheostat. Not absolutely necessary if filament voltage is exactly 7.5 volts. R_2 —20,000 to 30,000 ohm grid leak. With two tubes, 10,000 to 15,000, and with 50 watt tubes, using 1000 volts on the plate, 50 ohms with one tube, and 250 with two. If the normal plate voltage of the tubes is used, the grid leak may be omitted. T_1 —Tap. Vary wave length. T_2 —Tap. Vary power to plates of the tubes. Tr. Secondary of modulation transformer. This should be short-circuited when straight C. W. is being used. Rect. 12 jar rectifier. The size of the plates should be 3" by $\frac{1}{4}$ ", cut out of $\frac{1}{32}$ " sheet aluminum and lead. To make the solution, dissolve as much borax as possible in a quantity of hot water. When the solution cools, pour off the clear liquid from the undissolved borax, and use this solution for the rectifier. For the 50 watt tubes, a 20 jar rectifier should be used, with larger plates.

When using this set, keep down to about 150 meters. The short waves eat up the distance far better than do the longer waves, and it is a pity that amateurs are restricted from using a wave length lower than 150 meters.

This set is the easiest to operate of the standard circuits, and it is by far the best for short wave transmission. For the broadcast listener who is going to join the ranks of the amateurs this winter, it is undoubtedly the best set.

When tuning, remember that best transmission is not always accomplished with maximum antenna current. When tuning the set at first, it is well to work with another sta-

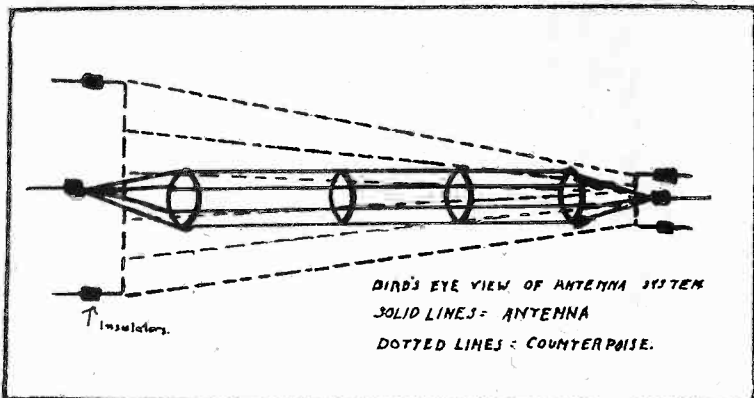

Fig. 3. Schematic diagram of a suitable cage antenna and counterpoise arranged for the efficient transmission of CW signals.

tion, and have him report when your signals are best. And when you have it tuned, for the sake of all amateurs within your range, and for the sake of your own reputation, leave the tuning alone except when it is necessary to change it, and when you are transmitting, say what you have to say in as few words as possible. When calling a station, call him once or twice, and if he does not answer, do not attempt to get him again, for a while at least.

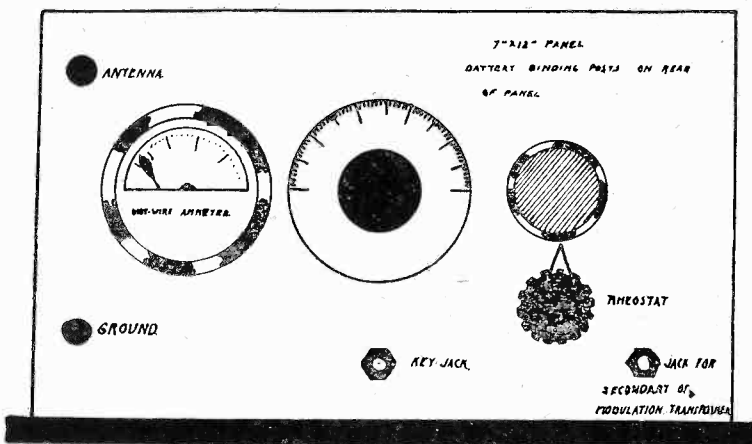

Fig. 4. Suggested panel layout for the CW transmitter as described. Note that it has but one control, that being the condenser.

This set with a good antenna system, has a reliable working range of 1,000 miles with C. W., and about 100 miles with phone, and with extra good conditions, its range is several times this.

Send Radio Pictures To "Radio World"

RADIO WORLD is constantly on the lookout for real live amateur photographs of intimate amateur events. If you are an amateur photographer and run across any good subjects, or have any radio pictures that are good and sharp, with clear shadows and nice whites, send them in to us. Those that are available will be paid for at our usual rates.

Use of Radio Signals in Navigation Growing

WASHINGTON, D. C.—Public attention was recently directed forcibly to the use of radio as an aid to navigation, when seven naval destroyers cruising in a thick fog went on the rocks off Point Arguello, California. The squadron commander did not accept as correct the radio compass bearings sent him from a naval compass station on shore. The radio compass service is fairly new and some skippers have not heretofore placed enough confidence in the bearings furnished them. To be sure, the bearings are not always exact, varying some two degrees and being subject to local conditions, but after the Point Arguello disaster, when twenty-three lives were lost and over nine million dollars' worth of naval property destroyed, much more confidence will undoubtedly be placed in radio bearings.

Naval commanders and navigators will certainly proceed with more caution in the future when the bearings furnished by radio stations do not agree with their own reckonings. They will undoubtedly ask for further bearings, especially when a single station only is available. Secretary of the Navy Denby has ordered a special study made of radio communication between ships and shore stations, with particular regard to the use of radio compass bearings. Already U. S. Fleet regulations provide that ships on a coastwise run communicate with available radio compass stations every four hours for checking and testing purposes, except in bad fog when other ships might need assistance or directional aid.

There are two methods of securing radio bearings. The system followed at the 52 naval radio compass stations is for ships to call the station asking for their bearings, which are then given in relation to the station. Usually two or three stations are called and the lines representing their directions from the vessel are plotted on a chart. The point of intersection indicates the position of the ship, subject to certain corrections.

The other method, used in the American lighthouse service and by many merchant vessels requires that a radio compass be located on each ship, the skipper ascertaining his own bearing from the stations called and plotting his own position. The shore stations simply emit a radio wave for him to observe and to measure its direction with his radio compass.

Favorable comment is given on both methods, as each is of extreme value to navigators off their courses, lost in fog or proceeding in unfamiliar channels. The ship compass system is quite expensive but the operation is strictly up to the skipper and any errors are naturally his own. Having his own compass enables him to pick up any ship or station carrying radio and get its bearing regardless of whether or not that ship or station has a radio compass. The naval system held as an essential war service and believed more reliable by many, is useful only to ships when a radio compass station on shore can be picked up and communication established. Skippers whose vessels are not provided with radio compasses find the naval stations of especial value and will undoubtedly continue to call them unless they install compasses of their own.

During the fiscal year 1923, the navy's shore system supplied 120,523 radio bearings to 57,836 vessels. The average time to serve each ship for the entire naval service was 3 min. 1½ sec. per bearing.

An RF Sharp Tuning Loop Receiver

A tuner slightly critical approaches the ideal

*By C. White
Consulting Engineer*

WHEN radio broadcast reception first became popular a broad tuning receiver was considered as a very good receiver for general use by all except those living where extraneous noises and interference were exceptionally strong. The reason for this false or unearned popularity of a broad tuning receiver was due to the fact that it was easy to tune. Today the same receiver would be cast aside in disgust by many who are now forced to use the better circuits to get good results. A broad tuner picks up and amplifies a wide band of radio frequencies. The station you desire to receive from sends out a very sharp wave; in other words, its carrier wave is free from broadness due to improper filtering. Now if your set picks up quite a large band of radio-frequencies, some a little higher than this desired frequency and some a little lower in frequency, it is plain to see that the ratio of interfering signal strength to that of desired signal strength is made much greater

because it is extremely selective and you must take time to catalogue the direction of the loop and the setting of the set controls for each station. A good way to control or determine the right direction to point the loop is to get a broadcasting map of the United States, with most of the stations shown. From this map you can easily find out what direction lines up a station with you, and by using a compass to find out just where north is you can soon point your loop the right way. There are times and places, however, when a loop is not so directional. This may be due to Northern Light conditions, or a large amount of steel nearby, or the presence of extremely strong interference, such as high-tension electric lines.

Because a loop only picks up a small amount of energy something must be arranged in the receiver to compensate for this lack of energy. The general method is to employ one or more stages of radio-frequency or super-regeneration. The loop itself should be well insulated at the wire supports with bakelite or formica strips if the loop wire be uninsulated. Copper ribbon in a stranded form, or especially stranded radio-frequency wire is the best to use for loops. The loop for this outfit should measure about 3' on the diagonal of the square, and should have 10 turns of wire in all. An 11-plate condenser with another small vernier condenser placed in parallel with C-1, or, better still, if you do not wish to add another condenser to the receiver, a type of sharp tuning dial to allow minute adjustment of the condenser C-1. The condenser C-2 is exactly similar in size to C-1 but is not quite as critical on tuning adjustment. Any form of variocoupler (V. C.) that is wound on good insulating material with well-insulated wire will do. It will not be necessary to go to the trouble to buy expensive moulded couplers unless you so desire. A grid condenser of .00025 mfd. (H) and a variable grid leak being variable up to 5 megohms or more will greatly aid in getting clear detection of music. A potentiometer P with a resistance of 300 ohms or more is quite necessary to control the oscillation of tube No. 1, which is the radio-frequency amplifier. The condenser C-4 is a telephone size condenser with a capacity of 1.0 microfarads. This condenser is now quite easily procurable from most any radio dealer, since it is largely used at present in radio-frequency amplifiers. The unit C-4 is the ordinary .0025 mfd. bypass condenser for the phones. The inductance choke coils X help to keep the high and low frequency currents where they belong. This unit (X) has an inductance of .1 henry and has an iron core. These inductances are made by Federal Tel. & Tel. Co.

There is no reason why any of the modern tubes that are made for radio-frequency amplification and detection will not work satisfactorily in this circuit. But on tryout excellent results were obtained from UV201A and UV199 types of tubes. Do not neglect to apply full "B" battery potential to the plate of the amplifying tube (No. 1), and not more than 40 volts to the plate of the detector (No. 2) if the last mentioned types of tubes are employed. In actually connecting in C-1 and C-2 be sure to see that the fixed plates of these condensers are next to the grids of their respective tubes. It will not be necessary to shield either of these condensers. All joints must be well soldered and all wires insulated.

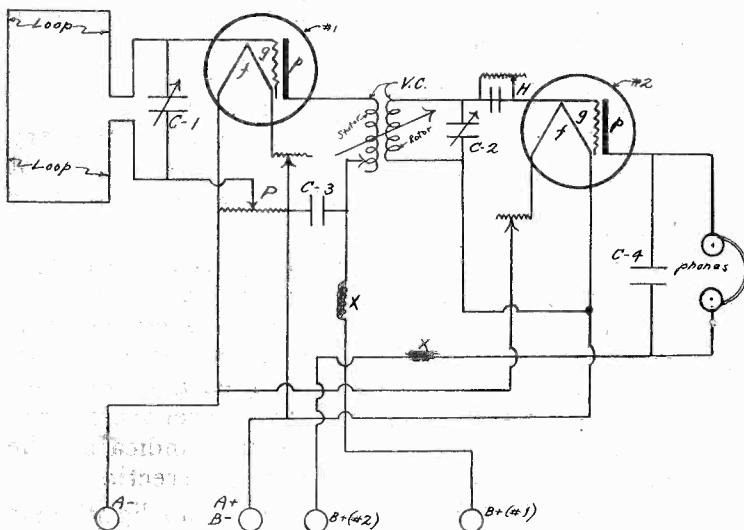

Radio-frequency receiver using two tubes on a loop and capable of very sharp tuning. Note that a coupler is used as a radio-frequency transformer.

than if the receiver tuned only to the frequency desired and rejected all other interfering frequencies adjacent to it but not exactly the same.

While it is very true that an outside aerial picks up a greater amount of signal energy than the best type of indoor loop, still at the same time an outside aerial picks up a greater amount of small interference that a loop would fail to pick up to any great amount. This small interference comes from all directions, and while no one interfering frequency may be great, still the sum total or combined effects of them all is very large and generally produces a serious interference in all. Since a loop aerial is the most directional type of aerial you do not pick up interference from all directions, but only from the direction in which the loop is pointing. It is obvious that the directional feature alone in a loop greatly increases the selectivity of a receiving outfit.

A loop added to any receiver will always improve selectivity and clarity of received signal. But the best possible combination is a sharp tuning receiver and a loop. Of course, you can not expect to get very good results from such an outfit on the first try-out,

National Association of Broadcasters Holds First Annual Convention in New York

THE first annual convention of the National Association of Broadcasters took place at the Commodore Hotel, New York City, October 11 and 12, 1923. Prominent broadcasters from all parts of the country were in attendance and for two days exchanged ideas on the theoretical, mechanical and practical phases of broadcasting.

The Thursday morning session, with Mr. Paul B. Klugh, executive chairman, presiding, received the reports of the Executive Committee, an address by the executive chairman, the Finance Committee, the report of the manager of the Bureau of Music Release, and the Legislative Committee.

The following officers were elected for the ensuing year: President, Eugene MacDonald, Jr., Station WJAZ, Zenith Edgewater Beach Hotel, Chicago; vice-president, Frank W. Elliott, Station WOC, Palmer School of Chiropractic, Davenport, Iowa; vice-president, John Shepard, III., Station WNAC, The Shepard Stores, Boston, Mass.; secretary, J. Elliott Jenkins, Station WDAP, Board of Trade of the City of Chi-

tion to broadcast bulletins of late news first. Record manufacturing company—Action postponed. Referred to committee. Bureau of Music Release activities reviewed. Over 100 numbers released in three months. Less than 10% of music submitted has been released. Authorization given to expand agencies for collecting MSS to include Europe and South America. Vote of appreciation to radio press for loyal support in broadcasting problems.

The Thursday afternoon meeting was an open meeting, to which non-members were invited. Paul B. Klugh, executive chairman, gave a summary of the morning session for the benefit of those who did not attend. The following addresses were made:

"The Future of Broadcasting," by Eugene MacDonald, WJAZ, Chicago; "Radio and Good Will," by Frank W. Elliott, WOC, Davenport; "Department Store Broadcasting," by John Shepard III., WNAC, Boston; "My View of the Future of Wave Lengths, Tubes and Output," by J. Elliott Jenkins, WDAP, Chicago; "Government Regulation," by Harold Power, WGI, Medford



An interesting test was conducted by the Association of Broadcasters from the Hotel Commodore, New York. By arrangement a test was sent from a Chicago broadcasting station requesting each one who received the message to reply by wire to the association in New York. The telegraph companies installed special instruments and in four hours 4,182 responses were received, the public spending more than \$3,000 to send these wires. It is estimated that one in one hundred would spend a minimum of seventy-five cents to send these wires and this places the number of listeners at 400,000. In the photo, left to right, are: Raymond Walker, New York; C. H. Anderson, Cleveland; Senator Frank Elliott, Davenport, Iowa; E. F. McDonald, Chicago; Paul Klugh, chairman of the Broadcasters Association; Wm. S. Hedges, Chicago; J. E. Jenkins, Chicago; A. B. Cooper, John Shepard 3rd, Boston; Powel Crosley, Cincinnati.

ago, Chicago, Ill.; treasurer, Powel Crosley, Jr., Station WLW, Crosley Manufacturing Company, Cincinnati, Ohio; board of directors, Harold J. Power, William S. Hedges, Henry A. Rumsey, W. S. Harris, Robert Shepard, Bowden Washington, G. Brown Hill.

Mr. MacDonald was escorted to the chair, and thereupon took charge of the meeting. Action was taken upon the following subjects as indicated:

Amendment of the by-laws to provide for a Listeners' Membership. Full debate on this matter. Referred to committee to develop and complete plans to be submitted at next meeting. Organization of music publishing company. Full debate. Referred to executive committee for immediate attention. Extension of tax free music service to hotels, theatres and moving picture shows. Favorable action and plan of procedure authorized. Legislative requirements debated and procedure determined upon, with full authority to proceed. News service for members referred to Executive Committee, with authority to provide best service obtainable so that members may be placed in the posi-

Hillside, Mass.; "What Broadcasting Does for a Newspaper," by Wm. S. Hedges, WMAQ, Chicago; "A Manufacturer's View of Broadcasting," by Powel Crosley, WLW, Cincinnati; "Banking and Broadcasting," by C. H. Handerson, WJAX, Cleveland; "The Art of Popularizing a Station," by N. T. Granlund, WHN, New York.

At 6:30 the meeting adjourned to parlor "K," where President MacDonald had provided refreshments, and informal discussions were carried on on the subjects presented during the convention. At 7:30 the annual banquet was held at the Belmont Hotel. President MacDonald acted as toastmaster and addresses were made by the following gentlemen: Paul B. Klugh, executive chairman, spoke on "Why Are We Here?"; D. Rigley spoke on "Why Manufacturers Should Support Broadcasting," and short addresses were made by a number of others. The banquet adjourned at 11:30, many members accepting an invitation from N. H. Granlund of station WHN, to visit his studio. Friday was spent in Executive Committee meetings.



(C. Photonews)

It seems to be the style to build apparatus of gargantuan aspect and then compare it with its normal brothers. Well, here is an amplifying horn that to say the least is "some horn." Looking into the business end of this baby was something like looking down the elevator shaft of the tallest building in the world. And didn't it make some racket when it was switched on!

Captions by Robert L. Dougherty

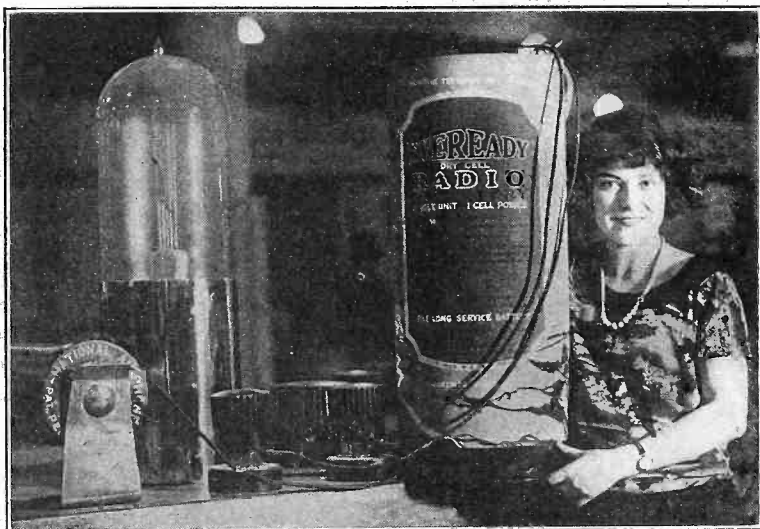

(C. International Newsreel Photo) -

Here is some more nice apparatus. Imagine using a portable set of these dimensions and having to cart around a battery of the size shown. The young lady, Agnes Leonard, is standing beside the largest one tube set in the exposition with the largest real dry cell ever made. The cell stands over three feet high and is 15 inches in diameter which really makes it just the thing for the portable set on your next hike—if you take a moving van along.

Some Exhibits at the

THIS year's radio exposition in New York showed without a doubt that radio and the radio business are rapidly establishing themselves on a firm footing. Even the amateur builder exhibits showed improvement. While some makers relied upon the uniqueness of their receivers to attract attention, the greatest number relied upon really fine commercial appearing work, with standard circuits and careful construction. The prizes for these sets were awarded to the following: O. B. Parker, 85 Fourth Avenue Brooklyn, N. Y., won the first prize of \$50. His set was a three-tube portable receiver. Joseph Dorothy, 517 West 148th Street, New York City, received second

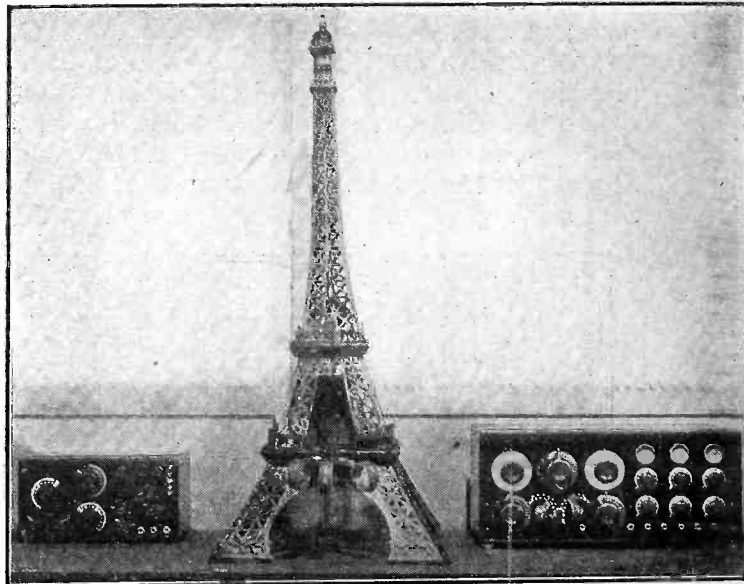

(C. Keystone View)

Three fine exhibitions of amateur construction. The most interesting one of course was the Eiffel Tower design. It is a three-circuit receiver with all the tubes and condensers in the center of the tower, and only the three coils showing. Those on either side of it are examples of the work of regular fans whose fancy did not stray so far afield.



(C. Photonews)

An exhibit that attracted a lot of attention at the show was this set which was captured from the Germans. It was exhibited at the Army Booth, where also were shown quite a few other interesting exhibits. The set is a complete tube receiver and transmitter and is one of the type that the Germans used for work in the trenches. It is battery operated and self-contained in every particular. Captain W. E. Seamon is operating it. This set created great interest among the visitors.

New York Radio Show

ize, and Frank Adams, of 67 Gold Street, Brooklyn, Y., won third prize.

More people attended this year's exhibition than any past year. If manufacturers can judge from the crowds and the interest and enthusiasm they show this should be a banner radio year and good manufacturers should make fortunes. Over 60,000 people attended the show which proved that the interest in radio is most assuredly growing faster than ever. Radio is no longer the mysterious thing that it has been in the past. People realize that there is no trickery attached to it, and growing confidence in it are adopting it as a regular means of entertainment and obtaining knowledge.



(C. Underwood and Underwood)

Somebody walked out of the exposition and left his phones lying around, so Miss Agnes Leonard decided to adopt them, but found that it would take a truck to move them. The phone shown is one of the numerous exhibits that attracted attention because of its immense size. It is the largest real working model of a phone ever made. The diaphragm is made of sheet steel, and the magnets are wound with No. 14 bell wire.

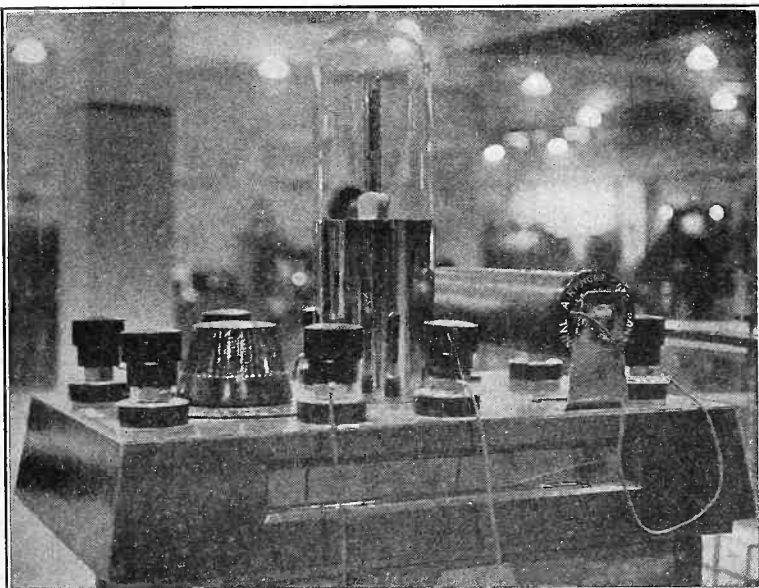

(C. Kadel and Herbert)

The largest one tube set made was always sure to attract attention. The set is a model of the one tube National Airphone Receiver and is complete in every detail, even to the dimensions of the tube as compared with a real set. The side was open to show spectators the interior working of the two-plate condenser and to prove to the folks that the set was a working model and not just a clay enlargement. The tube of course was a dummy, but realistic even at that.

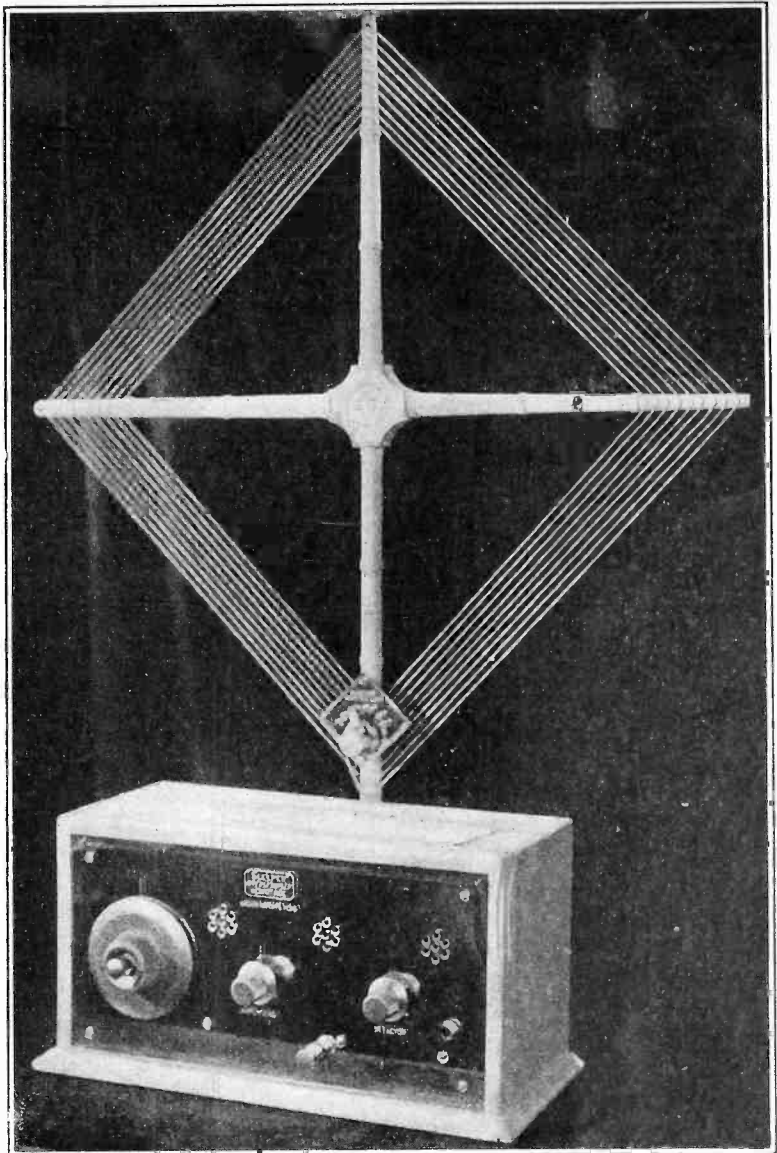

(C. Kadel and Herbert)

One of the outstanding exhibits of the show was this ivory and gold Sleeper monotrol receiver, with plate glass mirror panel. The controls were gold plated and the cabinet was of ivory composition. The set was built for Miss Marguerite Clarke, the screen star who very kindly loaned it while the show was on. The Grimes inverse duplex reflex circuit is used in this receiver which works on a tuned loop as shown.



(C. Foto Topics from KV)

John H. Morecroft, vice-president of the Radio Engineers Club, presenting Harold H. Beverage, inventor of the Beverage wire antenna, with a check for \$500 as a reward for the most noted improvement made in radio during the year. Each year the club presents cash awards to the inventors of the most noted improvements and it was unanimously judged that Mr. Beverage's invention had done most to increase distant reception and decrease static and unwanted signals.

Corrected Official List of Broadcasting Stations in the United States

FOLLOWING is the third installment of a corrected list of commercial broadcasting stations in the United States as issued by the Department of Commerce. The list will be continued in next week's RADIO WORLD.

Call	Station	Frequency Kcys.	Wave Length Meters	Power Watts
WPA	Fort Worth Record, Fort Worth Texas	833	360	100
WIAJ	Fox River Valley Radio Supply Co., Neenah, Wis.	1,340	224	100
WSAL	Franklin Electrical Co., Brookville, Ind.	1,220	246	20
WOAD	Friday Battery & Elect. Co., Sigourney, Ia.	833	360	50
WABC	Fulwider-Grimes Battery Co., Anderson, Ind.	1,310	229	10
WTAF	Gallo, Louis J., New Orleans, La.	1,240	242	20
WIAC	Galveston Tribune, Galveston, Texas	833	360	100
WGAJ	Gass, W. H., Shenandoah, Ia.	833	360	20
WQAY	Gaston Music & Furniture Co., Hastings, Neb.	833	360	20
WGY	General Electric Co., Schenectady, N. Y.	790	380	1,000
WPAQ	General Sales & Engr. Co., Frostburg, Md.	833	360	10
WMAH	General Supply Co., Lincoln, Neb.	1,180	254	15
WAAS	Georgia Radio Co., Inc., Decatur, Ga.	833	360	20
KFDV	Gilbrech & Stinson, Fayetteville, Ark.	833	360	100
WAAK	Gimbel Bros., Milwaukee, Wis.	1,070	280	100
WIP	Gimbel Bros., Philadelphia, Pa.	590	509	500
WQAC	Gish, E. B., Amarillo, Texas	833	360	100
KFGY	Gjelhaug's Radio Shop, Baudette, Minn.	1,340	224	20
KFIK	Gladbrook Electric Co., Gladbrook, Ia.	1,280	234	20
WRAW	Good, Horace D., Reading, Pa.	1,260	238	10
KJQ	Gould, C. O., Stockton, Cal.	833	360	5
KFFV	Graceland College, Lamoni, Ia.	833	360	250
KNT	Grays Harbor Radio Co., Aberdeen, Wash.	1,140	263	250
KFEJ	Greason, Guy, Tacoma, Wash.	833	360	10
WLAX	Greencastle Community Broadcasting Station, Greencastle, Ind.	1,300	231	5
WQAZ	Greensboro Daily News, Greensboro, N. C.	833	360	30
WSAJ	Grove City College, Grove City, Pa.	833	360	100
WABN	Grover, Waldo C., La Crosse, Wis.	1,280	234	100
WHAH	Hafner Supply Co., Joplin, Mo.	833	360	20
WCBA	Haimbach, Chas. W., Allentown, Pa.	1,070	280	5
KPO	Hale Bros., Inc., San Francisco, Cal.	710	423	500
KGG	Hallock & Watson Radio Service, Portland, Ore.	833	360	100
WOAT	Hamp, Boyd Martell, Wilmington, Del.	833	360	250
WOAA	Hardy, Dr. Walter, Ardmore, Okla.	833	360	20
WDAK	Hartford Courant, Hartford, Conn.	1,150	261	100
KFDP	Hawkeye Radio Supply Co., Des Moines, Ia.	1,080	278	100
WEAS	Hecht Co., Washington, D. C.	833	360	50
WIAI	Heers Stores Co., Springfield, Mo.	1,190	252	20
KFGV	Heidbreder Radio Supply Co., Utica, Neb.	1,340	224	10
KXD	Herald Publishing Co., Modesto, Calif.	1,190	252	10
KQW	Herrold, Charles D., San Jose, Cal.	833	360	50
WFAJ	Hi Grade Wireless Inst. Co., Asheville, N. C.	833	360	50
WHAO	Hill, F. A., Savannah, Ga.	833	360	50
WAAZ	Hollister Miller Motor Co., Emporia, Kan.	833	360	50
KFBE	Horn, Reuben H., San Luis Obispo, Cal.	833	360	10
WJD	Howe, Richard Harris, Granville, Ohio	1,310	229	50
WGL	Howlett, Thomas F. J., Philadelphia, Pa.	833	360	250
WDAI	Hughes Radio Corp., Syracuse, N. Y.	1,220	246	100
WQAV	Huntington & Guerry, Inc., Greenville, S. C.	1,160	258	15
WHAY	Huntington Press, Huntington, Ind.	833	360	10
WEV	Hurlburt-Still Electrical Co., Houston, Texas	833	360	250
WJAG	Huse Publishing Co., Norfolk, Neb.	833	360	100
WFAN	Hutchinson Elect. Service Co., Hutchinson, Minn.	833	360	100
WLAZ	Hutton & Jones Elect. Co., Warren, Ohio	1,210	248	10
WNAM	Ideal Apparatus Co., Evansville, Ind.	833	360	100
KFAU	Independent School Dist. of Boise City, Boise, Idaho	1,110	270	10
WGV	Interstate Electric Co., New Orleans, La.	833	360	100
WOI	Iowa State College, Ames, Ia.	833	360	500
KFJX	Iowa State Teachers, College, Cedar Falls, Iowa	1,310	229	50
WEAY	Iris Theatre, Houston, Texas	833	360	1,000
KFDZ	Harry O. Iverson	833	360	5
WJAD	Jackson's Radio Eng. Lab., Waco, Texas	833	360	150
WBAO	James Milliken Univ., Decatur, Ill.	833	360	50
WSL	J. & M. Elect. Co., Utica, N. Y.	1,100	273	100
KFIB	Jenkins, Franklin W., St. Louis, Missouri	1,230	244	10
KFFB	Jenkins Furniture Co., Boise, Idaho	1,250	240	10
WAAB	Jensen, Valdemar, New Orleans, La.	1,120	268	100
WLAP	Jordon, W. V., Louisville, Ky.	833	360	15
WIAB	Joslyn Automobile Co., Rockford, Ill.	1,190	252	50
WIAK	Journal Stockman Co., Omaha, Neb.	1,080	278	200
WOAP	Kalamazoo College, Kalamazoo, Michigan	833	360	100
WCBB	K. & K. Radio Supply Co., Greenville, Ohio	1,250	240	100
WIK	K. & L. Electric Co., McKeesport, Pa.	1,280	234	500
WDAF	Kansas City Star, Kansas City, Mo.	730	411	500
WTG	Kansas State Agricultural College, Manhattan, Kan.	833	360	1,000
WCAE	Kaufmann & Baer Co., Pittsburgh, Pennsylvania	650	462	500
WJAT	Kelley-Vawter Jewelry Co., Marshall, Mo.	833	360	25
WTAG	Kern Music Co., Providence, R. I.	1,160	258	10
WCAY	Kesselman O'Driscoll Music House, Milwaukee, Wis.	1,150	261	500
KFBK	Kimball Upson Co., Sacramento, Cal.	1,060	283	100
WMAY	Kingshighway Presby. Church, St. Louis, Mo.	1,070	280	10
KFFR	Kirk, Jim, Sparks, Nev.	1,330	226	10
WDBC	Kirk Johnson & Co., Inc., Lancaster, Pa.	1,160	258	50

(To be continued. Readers who preserve these installments as they appear in RADIO WORLD will have a complete and up-to-date list of broadcasters in the United States. The publication of this corrected list began in RADIO WORLD for October 13, 1923.)

Here Are Good Broadcast Programs

Station KDKA, East Pittsburgh

326 Meters. Eastern Standard Time. October 27.—10:00 A. M.—Music. Union Live Stock Market Report from the National Stockman and Farmer. 11:55 A. M.—Arlington Time Signals. 12:30 P. M.—Music. Weather Forecast. 12:50 P. M.—United States Bureau of Market Reports furnished through the National Stockman and Farmer. 1:30 P. M.—Concert by Dougherty's Orchestra from McCreery's Dining Room, Pittsburgh, Pa. 3:00 P. M.—Pitt-Tech football game from Forbes Field, Pittsburgh, Pa. 6:15 P. M.—Dinner Concert by the Westinghouse Band under the direction of T. J. Vastine. Program March, "Our National Heritage," Wood; Overture "King of the Night," Bainard; "A Sleighbell Party," Michalis; Fantasia "My Old Kentucky Home," Dalby (solo for all instruments); Intermezzo "After Sunset," Author-Pryor; Ballet Music from "Faust," Gounod—No. 1 "Waltz for the Corpe De Ballet"; No. 3—Entre of the Nubian Slaves"; No. 4—"Pas Seul of Cleopatra"; No. 5—"Entry of the Trojan Maidens." 7:30 P. M.—Concert by Richard Murphy, piano, and Frank Sykes, reader; especially for the children. Program—Recitations, "The Robin," Anon; "The Cricket," Anon; "The Night Wind," Field; "Seein' Things," Field; "Vocation," Tagore; "Little Willie's Hearing," Anon; "Our Hired Girl," Riley; "The Flag Goes By," Bennett. Musical numbers, "Dance of the Bajaderes," Heins; "Tarantelle," Virgil; "La Secret," Gautier; "Mill Song," Ringuet; "Minuet," Paderewski. 8:00 P. M.—"Bringing the World to America," prepared by "Our World." 8:15 P. M.—"Navy Day" program celebrating the birthday of the late Col. Roosevelt. 8:30 P. M.—Concert by the Westinghouse Band under the direction of T. J. Vastine assisted by Jack Smalley, baritone soloist First Presbyterian Church, Crafton, Pa.; Ruth Clark, pianist and accompanist. Program—Band selections—Selection "The Bartered Bride," Smetana; Patrol "Knights of Old," Keifer; Excerpts from the opera "Mafistofel," Boite; "Hungarian Dance No. 5," Brahms; "The Swan," Saint-Saens; Caprice, "Hearts Message," Santelmann; "Album Leaf," Wagner; Intermezzo "Flirtation," Helmund; Overture "Poet and Peasant," Suppi. Baritone solos—a. "To You," Speaks; b. "Little Mother of Mine," Burleigh; a. "Tears of God," Mowrey; b. "When," Benhaw; a. "Marchita"; b. "Less Than the Dust," Finden. 9:55 P. M.—Arlington Time Signals. Weather Forecast.

Station KYW, Chicago

536 Meters. Central Standard Time. October 27.—9:30 A. M.—Late news and comment of the financial and commercial market. (This service is broadcast every half hour thereafter until 1 P. M.) 10:58 A. M.—Naval Observatory Time Signals. 11:05 A. M.—Weather Report. 11:35 A. M.—Table talk by Mrs. Anna J. Peterson of Peoples Gas Co. 1:20 P. M.—Closing market quotations. 2:15 P. M.—Late financial comment and news bulletins. 2:30 P. M.—Closing stock quotations, Chicago Stock Exchange. 3:00 P. M.—Late news and sport bulletins. (This service is broadcast also at 4:00, 4:30 and 5:00 P. M.) 3:30 P. M.—News and sports. 4:00 P. M.—Late news and sport bulletins. 4:30 P. M.—News and sports. 5:00 P. M.—Latest news of the day. 6:30 P. M.—News, financial and final market and sport summary. Financial summary furnished by the Union Trust Co. and Chicago Journal of Commerce. 6:50 P. M.—Children's bedtime story. 8:00 to 8:58 P. M.—Musical program: Herbit Mintz and Harry Giese, pianists. Mary Lee, soprano. Sallie Menkes, accompanist. A. W. "Sen" Kaney, specialty act. Other artists and program will be announced by radiophone. 8:58 P. M.—Naval observatory time signals. 9:00 P. M.—News and weather reports. 9:05 P. M.—"Under the Evening Lamp" service including stories, articles and humorous sketches furnished by the Youth's Companion. News, sports and children's bedtime story furnished by the Chicago Evening American. Sunday, October 28.—11:00 A. M.—Central Church service broadcast from Orchestra Hall, Chicago. Dr. F. F. Shannon, pastor. Musical program under the direction of Daniel Protheros. 7:00 P. M.—Sunday Evening Club service broadcast from Orchestra Hall, Chicago. Special musical program will be given by the choir of one hundred under the direction of Edgar Nelson. Speakers will be announced by radiophone.

Station WFAA, Dallas, Texas

476 Meters. Central Standard Time. Friday, October 26.—12:30-1:00—Address, Dr. Robert Stewart Hyer, Southern Methodist University, department of physics, on the Sunday school lesson, "Some Missionary Teachings of the Prophets." 8:30-9:30—Paul Skinner's Orchestra, high school musicians. Saturday, October 27.—12:30-1:00—Address, Prof. J. D. Boon, Southern Methodist University, department of physics, chair of astronomy, on "November Heavens." 8:30-9:30—Old fiddlers from Renner, Texas. 11:00-12:00—MacDowell Sisters in special request program of Hawaiian music. Sunday, October 28.—2:30-3:30—Radio Chapel Bible Class, 5,200 members enrolled, Dr. William M. Anderson, Jr., pastor First Presbyterian Church, teacher; with half-hour of Gospel song. 9:30-10:00—Sacred music recital by choristers from Oak Lawn Methodist Church, E. W. Pfaffenberger, director. 10:00-11:00—Dizzy Four Orchestra.

Station WLW, Cincinnati

309 Meters. Central Standard Time. October 29.—10:30 A. M.—Weather Forecast. Business Reports. 1:30 P. M.—Business Reports. 3:00 P. M.—Special Music by Jennie Kehrt. Babson Reports. 8:00 P. M.—Program under the auspices of the Editorial Staff of Sunday School Publications, Methodist Book Concern: Serenade, Napravnik, the Cincinnati String Quartet; General Announcements; Present Opportunities for Co-operative Service. The Rev. Henry Pearce Atkins, Executive Secretary, Cincinnati Federation of Churches; The Cincinnati String Quartet—a. Sally In Our Alley, b. Cherry Ripe, Frank Bridge; "Sons of the Earth," a poem by Robert H. Schaeffer, Read by the Rev. A. D. Moors; The Cincinnati String Quartet—a. Negro Spiritual, arranged by Pochon, b. Nocturne, Borodine, c. Scherzo, Tschaiokowsky; Gladys Woers, soprano; the Crosley Theatrical Reviews, and the Roger Hill Dance Orchestra.

October 30.—10:30 A. M.—Weather Forecast. Business Reports. 1:30 P. M.—Business Reports. 3:00 P. M.—Special Music by Jennie Kehrt. 10:00 P. M.—Violin solo: Cletus Mecklenburg, with Flora Metz, accompanist. Prelude to the Deluge, Saint-Saens; Duet: Cecilia Schulte, soprano, and John Twerck, tenor; Tenor solos by John Twerck: a. Lassie O'Mine, Walt; b. Spring's Yesterday, Strickland; Soprano solos by Cecilia Schulte: a. O Come with Me in the Summer Night, Vanderstucken; b. Lullaby from Jocelyn, Goddard (with violin obligato); Piano solo by Claire Harkness and inspirational talk on "Life and Happiness" by Mary Cornell Stoiber, leader of the New Thought Temple of Cincinnati; Violin solo by Cecilia Mecklenburg, "Romance," Elman; Soprano solo by Cecilia Schulte, A. Swedish Folk Song, "Seventeen"; Violin solo by Cletus Mecklenburg, Adagio movement from the Viotti Concerto; Tenor solo: John Twerck, "Honey Chile," Strickland; Entertainment by the Circle Orchestra.

Station WOC, Davenport, Iowa

484 Meters. Central Standard Time. October 26.—10:00 A. M.—Opening Market Quotations. 10:55 A. M.—Time signals. 11:00 A. M.—Weather and River Forecast. 11:05 A. M.—Market Quotations. 12:00 Noon—Chimes Concert. 2:00 P. M.—Closing Stocks and Markets. 3:30 P. M.—Educational Program—Lecture by C. C. Flanagan (Musical numbers to be announced). 5:45 P. M.—Chimes Concert. 6:30 P. M.—Sandman's Visit. 6:50 P. M.—Baseball Scores and Weather Forecast. 8:00 P. M.—Musical Program (1 hour)—Erwin Swindell, Musical Director. Allouez Council, K. of C., Quartette, of Rock Island, Illinois. Herman Snell, tenor; Geo. Canfield, baritone; Maurice DePaepe, bass; John Naab, tenor.

October 27.—10:00 A. M.—Opening Market Quotations. 10:55 A. M.—Time Signals. 11:00 A. M.—Weather and River Forecast. 11:05 A. M.—Market Quotations. 12:00 Noon—Chimes Concert. 12:30 P. M.—Closing Stocks and Markets. 3:30 P. M.—Educational Program—Lecture by C. C. Hall. (Musical numbers to be announced). 5:45 P. M.—Chimes Concert. 6:30 P. M.—Sandman's Visit. 6:50 P. M.—Baseball Scores and Weather Forecast. 7:00 P. M.—Lecture—"Life and Character of Theodore Roosevelt," by Chas. Grilk, attorney, of Davenport, Iowa, a personal friend of the late President Roosevelt. 9:00 P. M.—Dance Program (1 hour). P. S. C. Orchestra, with V. B. Rochte, baritone soloist. Popular music released through the National Association of Broadcasters, of which WOC is a member.

Station KHJ, Los Angeles, Cal.

395 Meters. Pacific Time. Thursday, October 25.—12:30-1:15, 2:30-3:30, 6:45-7:30 P. M.—Program presented through the courtesy of the Chamber of Commerce of Redlands. 8:00-10:00 P. M.—Program arranged by Redlands. 10:00-12:00 P. M.—Broadcasting by line telephony of Art Hickman's Orchestra, from Biltmore Hotel.

Friday, October 26.—12:30-1:15 P. M.—Musical Program. News Item. 2:30-3:30 P. M.—Matinee Musicale. 6:45-7:00 P. M.—Children's Program. Bedtime Story by "Uncle John." 7:00 to 7:30 P. M.—Organ recital from First Methodist Episcopal Church, Arthur Blakeley, organist. 8:00-10:00 P. M.—De Luxe Program. Lecture by Walter F. McEntire. 10:00-12:00 P. M.—Broadcasting by line telephony of Art Hickman's Orchestra, from Biltmore Hotel.

Saturday, October 27.—12:30-1:15 P. M.—Musical Program. News Items. 2:30-3:30 P. M.—Matinee Musicale. 6:45-7:30 P. M.—Children's Program. Bedtime Story by "Uncle John." 8:00-10:00 P. M.—De Luxe Program. 10:00-12:00 P. M.—Broadcasting by line telephony of Art Hickman's Orchestra, from Biltmore Hotel.

Station WBZ, Springfield, Mass.

337 Meters. Eastern Standard Time. October 27.—11:55 A. M.—Arlington time signals; weather reports; Boston and Springfield Market reports. 7:00 P. M.—Dinner concert by the Hotel Kimball Trio, under the direction of Jan Geerts, direct from the Hotel Kimball dining room. 7:30 P. M.—Twilight tales for the kiddies. "Bringing the World to America," prepared by "Our World" Magazine. "This week's Judge." 8:00 P. M.—Concert by Gertrude Clifford, soprano; Mrs. Eleanor Turner LaZazzera, accompanist; Mrs. Miriam M. Thomson, pianist. 9:00 P. M.—Bedtime story for grownups, by Orison S. Marden. 9:55 P. M.—Arlington time signals.

Station WGI, Medford, Mass.

360 Meters. Eastern Standard Time. October 26.—12:00 Noon—Program of selections on the Edison, Brunswick and Chickering-Ampico. 3:00 P. M.—Amrad Women's Club: 1. Talks by Mrs. D. H. Goodwin. 2. Especially arranged Edison Program, arranged by Vocalion Hall, Boston. The records played on the Edison Laboratory Phonograph. 5:00 P. M.—"Twilight Tales" read by Miss Eunice L. Randall. 5:30 P. M.—New England Weather Forecast furnished by the U. S. Weather Bureau. Closing Report on Farmers Produce Market Report. Live Stock Market Reports. Closing Stock Market Reports furnished by Elmer H. Bright & Company, Members of the New York and Boston Stock Exchange. 6:00 P. M.—Late News Flashes—Early Sports News—Boston American. 6:15 P. M.—Code Practice. Lesson Number 146. 6:30 P. M.—Boston Police Reports, Boston Police Headquarters. 6:45 P. M.—Condition of Massachusetts Highways furnished by the Automobile Legal Asso. 7:30 P. M.—Evening Program: 1. Selected verses by Mr. Charles L. H. Wagner, radio poet. 2. The AMRAD Concert Company will entertain with duo, trios and quartet numbers.

October 27.—6:00 P. M.—New England Weather Forecast furnished by the U. S. Weather Bureau. New England Crop Notes furnished by V. A. Saunders, Statistician. Late News Flashes—Early Sports News—Boston American. 6:15 P. M.—Code Practice, Lesson Number No. 147. 6:30 P. M.—Boston Police Reports, Boston Police Headquarters. 7:30 P. M.—Evening Program: 1. Thirtieth of a series of talks on New England Business Problems by Arthur R. Curnick of the New England Business Magazine. 2. Musical Program to be announced.

October 28.—4:00 P. M.—Twilight Program: 1. "Adventure Hour," conducted by the Youth's Companion. 2. Musical Program arranged by Kenneth W. Houghton, baritone. 8:30 P. M.—Evening Program: 1. Talk on "World Unity" under the auspices of Mass. Federation of Churches. 2. Evening Musicale arranged by Leo Fenway and Friends.

Station WGY, Schenectady, N. Y.

380 Meters. Eastern Standard Time. October 26.—10:30 P. M.—Program of Jewish melody. Orchestra selections: a. "Wengerka," Folk Dance; b. "Kozatski," Folk Dance, WGY Orchestra. Mezzo-soprano solo, "Hatikvo," Traditional, Rose Cohn. Violin solo, "Hebrew Lullaby," Achron-Auer, Edward A. Rice. Orchestra selection, "Hebrew Love Song," Rimsky-Korsakow, Orchestra. Address, "Yourself and Forest Devastation," by Hon. Gifford Pinchot, Governor of Pennsylvania (Courtesy "Field and Stream" Magazine). Violin solo, "Eili, Eili," Traditional, Edward A. Rice. Mezzo-soprano solo, "Aheim, Aheim," Folk Song, Rose Cohn. Orchestra selection, "Lamentation," Moussorgsky, Orchestra. Mezzo-soprano solo, "Ofen Tripichneck," Folk Song, Rose Cohn. Orchestra selections, "Hebrew Dance," Karganow.

October 27.—11:55 A. M.—U. S. Naval Observatory time signals. 12:30 P. M.—Stock market report. 12:40 P. M.—Produce market report. 9:00 P. M.—Kenmore Hotel (Albany, N. Y.) Orchestra.

Station WIP, Philadelphia

509 Meters. Eastern Standard Time. October 27.—1:00 P. M.—Organ Recital by Karl Bonewitz on the Germantown Theatre Organ. 1:30 P. M.—Official Weather Forecast. 3:00-4:30 P. M.—Play by play report of the Football Games at Franklin Field. 6:00 P. M.—Official Weather Forecast. 7:00 P. M.—Uncle Wip's Bedtime Stories and Roll Call for the Children. 8:00-8:15 P. M.—"Our Bacterial Friends and Enemies," by Louis Gershenfeld, Professor of Bacteriology, Philadelphia College of Pharmacy and Science. 8:15 P. M.—Artist Recital by Florence Haeule, Violinist, and Herbert Howells, Baritone. 9:00 P. M.—A Tabloid Performance of Rigoletto. Hilda Reiter, Soprano; Adele Pack Kende, Contralto; Frank Oglesby, Tenor; Doctor L. H. Lipschutz, Baritone; WIP Opera Orchestra, and Chorus. 10:15 P. M.—Charlie Kerr and his Orchestra from the St. James Hotel.

Station WRC, Washington, D. C.

469 Meters. Eastern Standard Time. October 27.—10:00 A. M.—Foreign Exchange Quotations furnished by the Washington Loan and Trust Co. 3:00 P. M.—Fashion Developments of the Minute prepared by Harper's Bazar. 3:10 P. M.—A Talk on Colonel Roosevelt and the Navy League. 3:20 P. M.—Violin Recital by Selina Dowling. 3:30 P. M.—Farm Home Reports. 3:40 P. M.—Current Events prepared by The Review of Reviews. 3:50 P. M.—Song Recital by Hazel Winston. 4:00 P. M.—The Magazine of Wall Street. 4:10 P. M.—Piano Recital by Albert Gaunt. 6:00 P. M.—Children's Hour by Marietta Stockard Albion.

Station KSD, St. Louis

546 Meters. Central Standard Time. October 26.—8:00 P. M.—Program by choir of Central Presbyterian Church, Mrs. Katherine Cowan, soprano; Mrs. Charles H. Austin, contralto; Waldo Finke, tenor; Frank Ingalls, basso; Mrs. Frank A. Neal, accompanist.

October 27.—8:00 P. M.—Orchestra concert, organ recital, vocal and instrumental specialties broadcast direct from the Missouri Theatre.

Answers to Readers of Radio World

What is the ratio of the audio-frequency transformer used in the neutrodyne receiver? Are the three air core transformers used in the radio-frequency circuit identical for the three and four-tube receivers? What type of tube do you recommend for these receivers, the six volt or the dry cell tubes?—John J. Martell, Gladstone, Mich., Route No. 1.

There is no set ratio for the audio-frequency transformers in this circuit. Use a good standard make. The radio-frequency transformers or "neutroformers" are identical. Use the six volt tubes. You may use either a loop or a small antenna.

* * *

What is the address of B. C. Caldwell? C. H. Poppe, Room 1305, 15 Dey Street, New York City.

The address of Byrt C. Caldwell is 235 Lamartine Street, Boston 30, Mass.

* * *

Is the Model "C" super-heterodyne receiver as designed by the Experimenters Information Service a good set? I am new at the game, and would like to get a set that will give me satisfaction?—H. J. Shaffer, 616 Lyons Avenue, Irvington, N. J.

This receiver is well known and gives satisfaction when operated correctly.

* * *

I have trouble tuning out WEAJ in order to hear WJZ or any of the other stations that are not as powerful as WEAJ. Can I use a variometer in place of the fixed coil in the wave trap shown in RADIO WORLD for April 28? Has any better method of making a wave trap been evolved since that time? If so, where may I find it?—R. C. Hopkins, 5205 Fourteenth Avenue, Brooklyn, N. Y.

You may use a variometer with better results. It would complicate the controls slightly but would be worth the trouble. A double tuned wave trap of high selectivity was described in RADIO WORLD for Oct. 20. You may use the wave trap described on your own receiver.

* * *

Can the WD12 tubes be used in the super-regenerative receiver described by C. White, in RADIO WORLD for Dec. 23rd, 1922? He specifically stated that WE-VT1 should be used, but I cannot obtain them.—J. H. Norman, Victoria, B. C., Canada.

While this tube may be used, the results will be very poor. If you cannot use or obtain the tube recommended, suggest that you use one of the small size transmitting tubes, C302 or UV202.

* * *

Can you suggest any manner in which I may connect one rheostat to control my five tubes? I do not want to use separate rheostats for each tube. Is it advisable to do so? I have been told that each tube should have a separate control.—M. R. Shelley, Detroit, Mich.

This can be accomplished by placing the filament leads of all the tubes in parallel, and placing the rheostat in series with the battery lead of all tubes. It is not advisable. While it is not necessary for each tube to have its own rheostat, the detector should be capable of adjustment. If you are using radio-frequency, we suggest that you use three controls—one for the radio-frequency tubes, one for the detector, and one for the audio-frequency tubes.

* * *

I have been told that placing a variable condenser in the phone circuit will aid in

selectivity. On my set (3 tube regenerative) it does little more than make the signals muffled at times, and at other times it seems to do nothing. Should the condenser be in series or in parallel? I have it the latter way.—Charles Clarke, 3790 Broadway, New York City.

The placing of the condenser across the phones sometimes aids in clearing up the signals in the phones. It will not add to the selectivity of the circuit because it is in the audio side of the receiver. The condenser should be in parallel as you have it. If your receiver is correctly designed, the correct plate voltage used, and the phones of good make designed for radio there is no need for capacity across the phone leads except, in certain cases, where it is used to by-pass current as in reflex circuits.

* * *

Which would be more efficient in a three circuit receiver (tickler coupling in the plate circuit) bank wound coils, spider web coils, honeycomb coils, helical wound pancake coils, or solenoid coils? Is it advisable to make apparatus such as variable condensers and coils or is the efficiency lowered by using home-made apparatus?—Julius Montague, Portland, Ore.

In the circuit you mention, the spiderweb or honeycomb coils are considered most efficient. Solenoid coils should not be used as their distributed capacity is high. It is not advisable to make variable condensers unless you have ample tool-making machinery. The average variable (sliding vane plate type) condenser calls for very accurate machine work and is a rather hard job. The coils may be wound at home very easily, if care is taken.

* * *

Can the Grimes inverse duplex circuit as shown in RADIO WORLD for October 6, page 19, be used with detector only? That is, without the A. F. amplification?—F. X. Miko, 134 Witte St., Schenectady, N. Y.

If you remove the A. F. amplification from this circuit you are simply using radio-frequency amplification and detector, and there is no sense in building the receiver. If you simply want radio-frequency and detector, build it. The advantage of reflex circuits is combining radio-frequency and audio-frequency amplification in the same tubes.

* * *

What is the meaning of the expression "DX" and "DXrs" and "QRM"? Are these expressions colloquialisms or are they standard abbreviations?—Fred Vickers, 71 Coxwell Ave., Toronto, Canada.

The meaning of "DX" is distance and it is the telegrapher's abbreviation. A "DXr" is one who has the hobby of trying to get distance reception. "QRM" is the International abbreviation for spark or phone interference. It is one of the signals included in the International Radio Telegraph abbreviations.

* * *

I am interested in the triple circuit variometer receiver described by C. C. Hermann and appearing in RADIO WORLD for June 30. Can I use radio-frequency transformers in place of the audio-frequency transformers mentioned in his article? I have radio-frequency transformers on hand. What is the capacity of the condenser mentioned in the article?—J. Jones, 442 10th Ave., N. Y. City.

You cannot use a radio-frequency transformer in place of the audio. They per-

form different functions in the circuit and where a diagram calls for audio-frequency transformers, use them. The condenser should be .001 mfd (43 plate).

* * *

I desire a receiver whereby I might have a combination of three types of circuits on one panel. I wish to experiment with them. They are a regenerative, a reflex, and a plain crystal receiver. Can such a panel be arranged?—J. S. Alexander, 5 High Street Place, Brookline, Mass.

Do not ask for unusual panel arrangements or combination circuits, as we cannot spare space to print them. Such an arrangement as you contemplate possibly could be worked out but it would be so intricate and complicated and the wiring necessarily so arranged that you would not be able to work the circuits after you had them hooked up due to inter-coupling. Build each circuit separately, which is the only method that can be relied upon.

* * *

I have recently built a set known as the three circuit regenerative. It worked fine for a period of about two months, using the loud speaker on two or three tubes. The volume has recently fallen off to such an extent that I have to use two tubes to hear anything in my earphones, and loud speaker operation on anything less than local stations on all three tubes is impossible. It daily gets weaker and weaker, and I have looked all over and yet find nothing wrong. The tubes are new and the storage battery fully charged all the time. What can my trouble be?—Jacob Kuhleman, Port Jefferson, N. Y.

From your description we think that your B batteries are at fault. Get a voltmeter and test each one. If the 22½ volt batteries are below 17 volts and the 45 volt battery is below 35, throw them out and get new, fresh ones. This is probably your only trouble.

* * *

Who is 2LO? Where is he located? I recently heard him one morning on my three tube reflex receiver when I used an outside antenna and ground, and cannot find his call in the call letter book.—Lee Mason, 434 4th Ave., Brooklyn, N. Y.

2LO is the London broadcasting station of the British Broadcasting Corporation, located in London, England. See RADIO WORLD for Sept 29, for a complete list of all the foreign broadcasting stations, calls, and their location.

* * *

Can you furnish me with a two-stage amplifier hook-up for the circuit published in RADIO WORLD for May 26th, by A. D. Turnbull? Can you furnish me with a panel diagram of this, with the stages controlled by three jacks? What make of transformers would you recommend? I find that a condenser in the ground lead helps in the tuning. Would it be wise to include this in the finished set?—B. W. Hill, 12 Maple Drive, Great Neck, N. Y.

In RADIO WORLD for August 18, page 20, you will find a suitable two-stage audio-frequency amplifier diagram. We cannot furnish panel layouts or plans. We cannot recommend any specific makes of competitive apparatus through these columns. Buy the best you can get. If you find the condenser improves the set, include it. We suggest that you provide a shunting switch around it, however, so that you may short it at times to lengthen the wave of the receiver.

Latest Radio Patents

Wireless Recording and Transcribing Apparatus

No. 1,469,561: Patented Oct. 2, 1923. Patentee: M. R. Hutchison, West Orange, N. J.

My present invention relates more particularly to the recording and transcribing of wireless telegraph messages, although it may be usefully employed for other signals sent by other methods.

According to present day practice, it is common to have the wireless transmitting apparatus generate oscillations and radiate waves of high frequency, say 36,000 cycles

in reproducing and transcribing from such record at a considerably lower speed.

It has been found, however, that if the messages are sent at a very high rate say 100 words per minute, which is possible with the improved sending apparatus now available, the speed of the reproducing phonograph would have to be reduced to say 30 revolutions per minute in order to reach the desired transcribing speed of 25 words per minute. The result is not satisfactory because such reduction in speed reduces the pitch of the note to 80 vibrations per second with the result that the signal sounds as a guttural grunt, easily confused with the inherent phonograph "scratches" and with the noises due to "static" or "atmospheric" disturbances which are recorded with the signals.

In order to meet these conditions and to enable the phonographic method of recording and transcribing to be practiced at such high rates of signaling as the sending station may be capable of transmitting, my invention contemplates employing means at the receiving station to break up each of the received wave trains into much smaller lengths, so that the note in the receiving instrument will be of much higher pitch. This pitch will be proportioned to the speed of sending and to the desired rate of transcribing so that, after recording at a speed not too high for good recording and after the pitch of the note has been reduced by the slow speed required for effective reproducing and transcribing, the note in the reproducer will still be of a frequency giving good audibility, say two to three hundred per second. For instance, if 100 words per minute are being sent and if the operator can transcribe at 25 words per minute, the interruptions may be such as to produce in the recorder, a note of say 1000 or 1500 per second, so that when reproduced at say one-quarter the recording speed the reproduced note will be of 250 or 375 pitch.

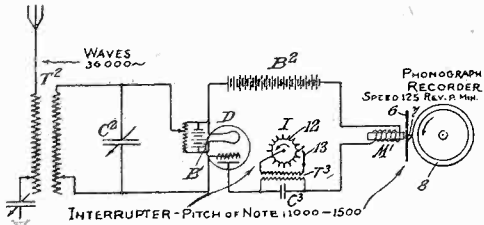

Apparatus whereby high speed signals may be impressed on a wax record, and later transcribed at a much lower rate without materially lowering the pitch of the signals to the point where they are indistinguishable.

per second. Such frequencies are above the limit of practical audibility and it is common to have the waves generated intermittently in rapidly succeeding groups of wave trains. One means of doing this is to have a rotary electrode for the spark gap so that discharge of the oscillatory circuit is precipitated at the desired rate, say 320 times per second. Each oscillatory discharge gives rise to a train of say 75 or 80 waves of the 36,000 frequency, so that each wave train lasts about two-thirds of the interval between discharges. These trains following each other at the rate of 320 per second are

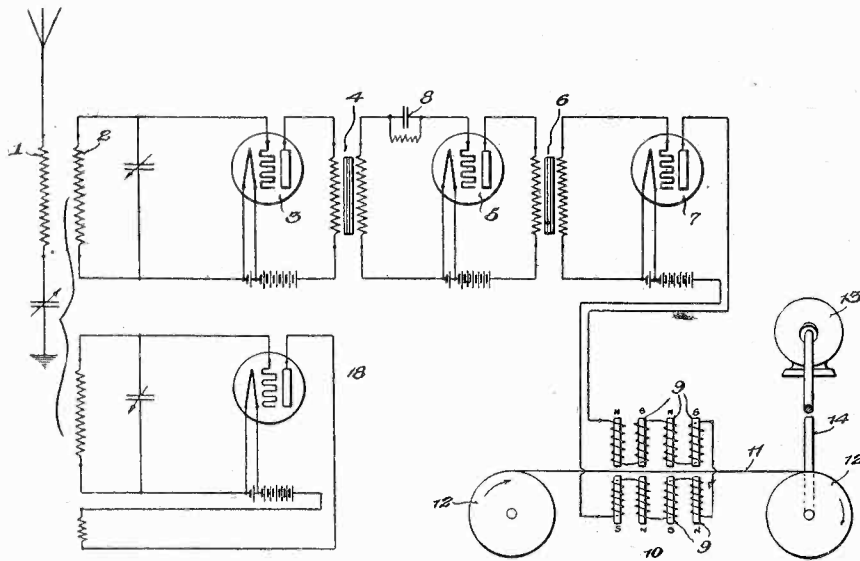

Method of recording on a moving wire high speed telegraphic signals to be later transcribed at a lower rate.

translated in the receiving apparatus in such manner that they are heard as notes having a pitch of 320 per second, continuing a short time for the dots and a longer time for the dashes.

There is no particular difficulty in such phonographic recording. The incoming circuit that ordinarily connects with the head set of the operator is merely connected to a magnet which actuates the recording jewel of a cylinder phonograph which is revolving at a rate of say 125 revolutions per minute, thereby recording the intermittent 320 pitch note which represents the dots and dashes. Nor is there any great difficulty

Radiotelegraph System

No. 1,463,386: Patented July 31, 1923. Patentees: W. L. Carlson and E. C. Hanson, Washington, D. C.

This invention relates to the reception of radio or wireless signals and more particularly to those systems employing sustained wave reception.

The primary object of our invention is to provide an electric circuit for selectively receiving electric signals.

A further object is to provide an electric circuit for selectively recording electric signals on a permanent recording device.

MAGNAVOX Radio Products

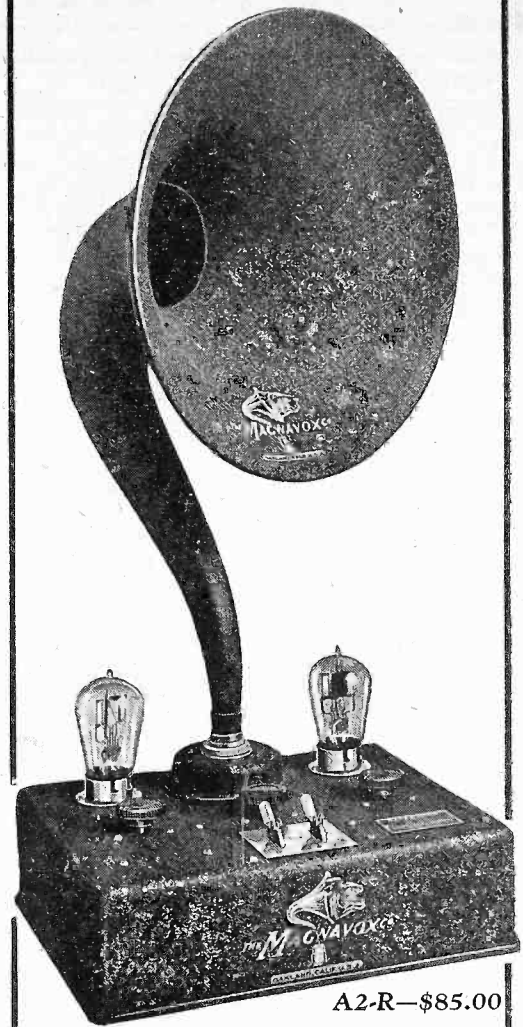

A2-R—\$85.00

MAGNAVOX Radio Combination Set A2-R consists of electro-dynamic reproducer and 2-stage Power Amplifier, as illustrated. This instrument insures the utmost in convenient, perfect reproduction with any good receiving set.

Magnavox Reproducers

- R2 with 18-inch curvex horn \$60.00
- R3 with 14-inch curvex horn \$35.00
- M1 with 14-in. curvex horn. Requires no battery for the field \$35.00

Magnavox Combination Sets

- A1-R consisting of electro-dynamic Reproducer with 14-inch curvex horn and 1 stage of amplification \$59.00
- A2-R consisting of electro-dynamic Reproducer with 14-inch curvex horn and 2 stages of amplification \$85.00

Magnavox Power Amplifiers

- A1—new 1-stage Power Amplifier \$27.50
- AC-2-C—2-stage Power Amplifier \$55.00
- AC-3-C—3-stage Power Amplifier \$75.00

Magnavox products can be had at Registered Magnavox Dealers everywhere. Write for new 32-page catalogue.

The Magnavox Company
Oakland, California

New York Office: 370 Seventh Avenue
Canadian Distributors
Perkins Electric Co., Ltd., Montreal

RADIOGRAMS

WORLD NEWS HAPPENINGS BRIEFLY
PHRASED FOR OUR BUSY READERS

A new 1,000-watt Class B broadcasting station will soon be put on the air by the Citizens Radio Service Bureau, of Chicago. It is stated that the programs will be of special interest to "hams."

* * *

An all British wireless exhibition and convention will be held from November 8 to 21 at White City, Shepherd's Bush, London. It is organized in conjunction with the National Association of Radio Manufacturers. One of the features will be demonstrations by the British Broadcasting Co., Ltd.

* * *

The Prince of Wales on his recent visit to Montreal refrained from going to the theatre and instead had a special apparatus built by the Westinghouse Company installed in the Royal Suite at his hotel to listen to the thrilling horror play being broadcast by La Presse, the largest daily newspaper in the Dominion of Canada.

* * *

The import duty on apparatus for wireless telegraphs imported into British India has been reduced to not more than 2½ per cent. ad valorem. The former rates of import duty on telegraph instruments and apparatus and parts thereof was 15 per cent. ad valorem except if imported by, or under the orders of, a railway company, when they were subject to a duty of 10 per cent. ad valorem.

* * *

A New York man advertises for capital to finance a plan, "with opportunity for enormous profits," whereby a fleet of 100 traveling automobile grocery stores may be put in operation. The scheme at least furnishes an idea for radio dealers who are after, or ought to be after, the farmer trade and possible buyers in isolated communities. Remember the "tin peddler" of the old days who drove up to the farmhouse with his rattling cargo to trade for "garden truck"? Why not run an automobile up the farmer's lane spouting music or a market talk from the loud speaker?

(Concluded from page 11)

the electrolyte has been replenished, a layer of mineral oil or paraffin oil may be placed on top of the electrolyte. This will effectually prevent evaporation and the solution need not be replenished.

We will now go back to the forming of the storage battery plates. After having given the battery an initial charge by one of the two methods described above, the polarity of the electrodes should be marked so that no mistake will be made in future chargings and the battery should be connected across a 75 watt Mazda lamp as shown in Fig. 3 until almost completely discharged. It is then recharged, having the polarities connected in the same manner as before and then discharged. This process is gone through ten or twelve times, or until the plates are sufficiently formed so that the battery will hold its charge for the desired length of time. Great care must be taken that at no time during the charging and discharging processes, does the electrolyte boil over. If such seems to be about to take place, the battery should be disconnected from the circuit and allowed to cool.

In charging six-volt storage batteries, considerably more current must be supplied to the batteries than could be obtained from the circuits in Fig. 1 or Fig. 2. For this work it is necessary to use a bank of lamps in series, with one side of the main supply as shown in Figs. 4 and 5. The number of lamps will depend entirely upon the size of the battery to be charged and it is usual to consider a 100 watt Mazda lamp as capable of passing one ampere. The charging rate of any battery should be approximately 1½ times the normal discharge rate which can be ascertained from the manufacturer, or in some cases may be found on the little lead plate nailed to the side of the battery container. Fig. 4 shows the charging of a six-volt storage battery

"Father is Scotch and takes the headphones off when the minister announces the offering," wrote eight-year-old Harold Midgley, of Galt, Ontario, Canada, to WGY, the Schenectady, N. Y. broadcasting station.

* * *

Police Commissioner Richard E. Enright, of New York City, who is making a series of addresses on Tuesday nights through Station WJZ, reports that his recent talk on street traffic was heard in England and that he had been asked a number of questions by English correspondents.

* * *

Ratification has been made of the contract between the French Compagnie General de Telegraphie Sans Fils and the Russian Radio Electric Trust, according to cable advices from Trade Commissioner Butler, at Paris. The agreement provides for the installation of wireless stations and manufacture of apparatus in Russia.

* * *

Mrs. Jacob Riis, widow of the late philanthropist, who wrote "Theodore Roosevelt the Citizen," will talk from Station WOR on the afternoon of October 27th, in the series of interesting appearances which are being made at the popular New Jersey station under the general title, "Half Hours With Successful Women." Mrs. Riis' observations will be of national scope and should interest the afternoon radio audience.

* * *

Thomas Alva Edison, the eminent inventor, was present at the opening of the Electrical Show in New York City last week and granted interviews to reporters. "Radio," he said, in reply to a question, "is one of the greatest things for the boys and young men of this country. It teaches them to experiment more and to think. The more of that sort of thing they do the better off the country will be." Mr. Edison also expressed the opinion that Secretary Herbert Hoover, of the Department of Commerce, "is one of the few men in this country who has a dead level head."

from a 110-volt D. C. supply, while Fig. 5 shows how A. C. may be utilized for this purpose. Here a four-jar rectifier is used in order to facilitate the charging of the battery and if desired this same scheme may be used for the charging of B batteries. Of course, in any case the size of the lamp bank must be varied to suit the purpose to which the rectifier is to be put. In connecting up the apparatus, always be sure of your polarities so that they will not get reversed and ruin the battery.

The difference between the current delivered by a single jar and a four-jar rectifier is illustrated graphically in Fig. 6. As is well known, alternating current reverses its polarity several times per second, the exact number of times being termed cycles. The average house current is 60 cycle. By referring to A in Fig. 6 we see the action of a single jar rectifier. It will be noticed that a pulsating direct current is delivered, as graphically depicted by the solid curve on the positive side of the line. It will also be seen that no current is delivered for a space equivalent to one-half a cycle. Therefore, it will be realized that it will take twice as long to charge a battery by this method as by the four-jar method. The curve of the current delivered by the latter is illustrated at B in Fig. 6. Here we see that the lower half of the cycle is rectified so that its curve appears above the line and a continuously pulsating direct current will be found in the D. C. circuit. No gaps are seen in the curve of the direct current; it merely pulsates from zero to 110 and back to zero again. Then there is no space as it starts up toward 110 immediately.

Bearing the above outlined facts in mind, the amateur will have no trouble at all in constructing and operating any of the simplest types of rectifiers to his satisfaction.

Radio Merchandising

Advertising Rates: Display, \$5.00 an inch, \$150.00 a page. Classified Quick-Action Advertising, 5 cents a word.

Telephone Lackawanna 6076

Talking Machine Company in Receivers Hands—Radio Too Stiff a Competitor

JUDGE LEARNED HAND in the Federal Court at New York City has appointed two receivers for the Columbia Graphophone Manufacturing Company, a pioneer in the talking machine industry, following the filing of an involuntary petition in bankruptcy by three creditors. James R. Sheffield and H. L. Wilson, President and General Manager of the corporation, were appointed receivers to carry on the business.

Counsel for the company announced the appointment of a reorganization committee, with which has been deposited substantially all of the company's issues of stocks and bonds. Liabilities, according to a balance sheet of Aug. 31, then amounted to \$21,317,266, with assets of \$19,205,000.

More than 6,000 dealers have been handling the products of the company, which has a main plant in Bridgeport, Conn., and branches in most of the large

cities of the United States and Canada. The Columbia Graphophone Company is the selling department of the company now in bankruptcy.

In a statement the receivers said they would work together to safeguard the interests of the creditors and the stockholders and would map out a plan whereby the company could continue in business.

The financial distress of the company has been public information for some time past and the news of the receivership therefore was not unexpected.

It has been rumored for several months that the phenomenal success attained in popularizing radio receiving sets has seriously affected the phonograph and record business. It also was rumored that the Columbia people intended to get into the radio business in order to balance the inroads on their trade. This report, however, never was confirmed.

Radio Literature Wanted

Manufacturers of and dealers in radio apparatus and accessories are notified that literature and catalogues describing their products have been requested, through the Service Editor of RADIO WORLD, by the following:

Leslie Irvine, 411 Sixth st., Altoona, Pa.
 Fred P. Masteller, 2416 North Waco, Wichita, Kansas.
 Harold S. Norris, 745 North Main st., Greenville, S. C.
 E. T. Rowland, P. O. Box 93, Lewistown, Pa.
 E. Van Hoesen, 40 Fountain st., Rochester, N. Y.
 John H. Cochran, 207 East Adams st., Fairfield, Iowa.
 Thos. F. Leahy, 26 East Centre st., Mahanoy City, Pa.
 R. E. Decker, 555 Halifax st., Petersburg, Pa.
 H. V. Petrie, Box 357, Hazelton, Kansas.
 Sgt. D. S. Catchim, U. S. M. C., 3423 Brown st., N. W. Washington, D. C.
 A. A. Woods, 209 Mercantile Library Bldg., Cincinnati, Ohio.
 R. R. Brady, Westinghouse Lamp Co., Bloomfield, N. J.
 Chas. L. Will, Vinton, Iowa.
 H. J. Engel, New Braunfels, Texas. (Retailer.)
 L. Wahl, 110 St. Louis ave., Buffalo, N. Y.
 The Ashland Radio Equipment Co., Room 405, Second National Bank Bldg., Ashland, Ky.
 Central Tel. Institute, Dott-Swan Bldg., Sioux City, Iowa.
 Edgar M. Jackson, 1644 L st., Lincoln, Neb. (Dealer.)
 John A. Sloat, 241 Broadway, Monticello, N. Y. (Radio doctor.)

Additional Phone Service for Radio World

Due to increase in business activities, it has been found necessary to install two telephone trunk lines in the offices of RADIO WORLD. These two trunk line numbers are Lackawanna 2063 and Lackawanna 6976. If one is busy, try the other.

Radio Trade Notes

B. P. Scott, of the Central Tel. Institute, Dott-Swan Bldg., Sioux City, Iowa, writes that he is in the market for radio equipment suitable for his school and also is interested in any proposition that will give the school a profit in handling radio equipment for amateurs and experimenters.

* * *

Fred P. Mostetter, 1416 North Waco St., Wichita, Kansas, would like to receive radio information from reliable firms. He is considering becoming a distributor and retailer.

* * *

New Radio and Electric Firms

Federal Telegraph Company of Delaware, New York, has increased its capital from \$2,000,000 to \$3,500,000.

General Instrument Corporation, New York City, radio instruments, \$5,000; W. Scandron, L. Isaacs, I. Sickle. (Attorney L. Scandron, 150 Broadway.)

J. De Milta, Manhattan, electrical supplies and autos, \$20,000; J. De Milta, E. A. Esposito, L. Brondi. (Attorney, C. Ladd Davis, 45 Cedar St.)

Upper Bay Electric Marine Co., Brooklyn, N. Y., \$3,500; D. and T. Johnson, T. Kuhnapel. (Attorney, H. O. Oobson, 189 Montague St., Brooklyn.)

Burrows Electric Co., Buffalo, N. Y., has increased its capital stock from \$15,000 to \$40,000.

Major J. Andrew White Joins Radio Firm

MAJOR J. ANDREW WHITE, well-known to all broadcast fans as the sports announcer par excellence, has accepted a vice-presidency with the Haynes-Griffin Radio Service, Inc., of New York City. Let it be stated at once that Major White will continue to describe sporting events for Station WJZ.

For many years Major White was associated with the Marconi Company and the Radio Corporation of America. He was also editor of the Wireless Age. He is a pioneer announcer in a difficult field wherein he stands almost alone and has thousands of friends among the broadcast listeners.

Coming Events

NATIONAL RADIO WEEK, November 25 to December 1, 1923.

SECOND ANNUAL RADIO SHOW, Coliseum, Chicago, November 20-25.

ELECTRICAL AND INDUSTRIAL EXPOSITION, Grand Central Palace, New York City, October 17 to 27.

MERRIMAC VALLEY RADIO SHOW, Lawrence, Mass., November 8, 9 and 10, under the auspices of the Lawrence Radio Club. For particulars address J. C. Cowd, 353 Essex Street, Lawrence, Mass.

Radio and Electrical Business Opportunities

Rate: 40c a line. Minimum, 3 lines.

NEW DISCOVERY IN RADIO

Distributors wanted, territory given; \$750 required; enormous demand. Box 1, Radio World.

ELECTRICAL jobbing and importing business, established 7 years, can be purchased as a going concern, for the actual cost of the present high-class stock, which amounts to about \$5,000; the firm makes good profits, is rated and trades with the very best houses; accounts, good will and rating go free with the stock; has such an opportunity been offered to you before? Don't let it pass by. Rich, 706 Knickerbocker Building, 42d St., N. Y. C.

CANADIAN SALES AGENT—Manufacturers' agent, handling mechanical and electrical specialties and auto accessories, is open for additional lines, commission or otherwise; well established; only first-class lines considered. Address Manufacturers' Sales Company, 556 Aylmer St., Montreal.

OPPORTUNITY offered man with executive ability and \$15,000 in cash to manage an electric battery service business in Greater New York (main establishment and two branches); sole agency for the world's greatest and best-known battery.

To the man who qualifies, this is an opportunity seldom offered.

Will bear strictest investigation. Address O. M., Box 2, Radio World.

\$2,000 WITH services in established electrical concern by engineering graduate, with business experience. Box 3, Radio World.

SOLICITING your orders for manufacturing of metal goods, radio, auto accessories and special hardware in any quantity. P. SORENSEN, 18 Dunham Place, Brooklyn, N. Y.

EXPERIMENTAL ENGINEER, unusual ability in developing inventions, designing machinery, desires permanent connection. Box 4, Radio World.

MAYS makes metal specialties raw, assembled or finished; quotation from blueprint or model. Mays Mfg. Co., Box 671, Providence, R. I.

The Most Important Radio Event of the Year!
National Radio Week, November 25 to December 1, 1923

Cockaday Coil Set \$2.50

Including full size blue prints of panel layout, complete picture hookup, and fully illustrated instructions for construction and operation.
 Coils are fully assembled, made exactly as specified by Mr. Cockaday, D coil bank wound. Far more efficient than any home made coils.
 Standard parts for this sensational circuit—panel, coils, condensers, verniers, variable resistance, vernier rheostat, socket, double jack, dials, switch, contact points, posts, busbar, wire, spaghetti, etc. (no tubes or phones).

Complete for \$11.65
 Postage additional on all shipments.
Send no Money. PAY THE POSTMAN.
 All Goods Shipped Parcel Post C. O. D.
RADIO SURPLUS STORES
 HELENA, MONTANA

RADION PANELS BLACK AND DIALS—KNOBS MAHOGANITE

20 Stock Size Panels and Also
CUT TO ANY SIZE
 "Radion" Tubing: 2", 2½", 3", 3¼", 3½", 4", 5"
 Cut to Any Length
 Special Parts Experimental Work
 Made to Order
N. Y. Hard Rubber Turning Co.
 212 CENTRE STREET NEW YORK

IT HAS HAPPENED TO ALL OF YOU IN A FRACTION OF A SECOND!

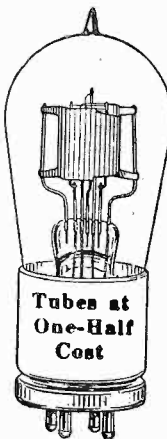

WHEN the filament burns out, at least \$5.00 goes with it to put the set in operation again.

WHY not save nearly one-half the cost of a new tube by sending us your burned out or broken tube to be repaired?

WE REPAIR EVERY TYPE OF tungsten wire filament receiving tube. All our tubes are TESTED and GUARANTEED to function as well as when new. All tubes returned P. P., C. O. D.

HARVARD RADIO LABORATORIES
 P. O. Box 1781
 BOSTON MASS.

Head Set
\$4.50



Loud Speaker
\$12.00

"ROYALFONE" KING OF ALL



A head set far superior to the average and just as good as the best. Equally good for all distances.



A loud speaker of superior qualities. Reproduces signals with no distortion at high amplification. A home instrument at a very moderate price.

Royal Electrical Laboratories
 207 Market Street Newark, N. J.

Royalfone

Measurements of Frequencies of Stations

IN order to assist the Radio Inspection Service in maintaining stations on their licensed frequencies, the Bureau of Standards of Washington, D. C., makes daily measurements of the emitted waves from various stations. The measurements to date have been mainly on Class B broadcasting stations and on the low-frequency high-power transoceanic stations. The measurements show in general a gratifying degree of adherence to the assigned frequencies. In a few cases where the observation showed stations to be seriously off their assigned frequency, the Supervisors of Radio have readjusted them so as to bring them within the required tolerance.

In only a few cases are the stations maintaining without exception the assigned frequencies so closely that the wave can be used as a frequency standard. Special attention is being given by the bureau to the stations which do maintain such standards, and an announcement will be made later stating the degree of constancy that has been observed, so that persons may utilize the transmissions from these stations as a standard for the calibration of apparatus.

The method used by the bureau in measuring the frequency of distant stations involves the use of a local radio-frequency generator. This is adjusted to the same frequency as the received wave from the transmitting station, this adjustment being determined by receiving both frequencies in a receiving set and varying the local generator until a zero beat note is obtained. The frequency of the local generator is then measured with a wave meter.

Further details of the method are given in Bureau of Standards Letter Circular 92, "Radio Signals of Standard Frequency and Their Utilization." A limited number of copies is available at the bureau and can be obtained by those having actual use for this information.

The Outline of Radio

LITTLE, BROWN & COMPANY, Boston, have just published the latest radio book, under the title "The Outline of Radio: What Radio Is and How It Works." It is a cloth-bound volume of 256 pages, profusely illustrated with half-tones and well prepared diagrams.

The author is John V. L. Hogan, one of the best known radio engineers in the United States. He is a fellow and a past president of the Institute of Radio Engineers and is a member of the American Institute of Electrical Engineers.

To the reviewer it seems that here at last is a book which the skilled and experienced radio man conscientiously can recommend to his novice friends. It contains answers to the questions novices nearly always ask and its statements are authoritative. The fundamentals are treated competently and the historical resume is accurate and interesting. In its scope and method the present volume differs from any other yet published on radio and should make an exceptionally wide and general appeal.

Whether the inquirer after radio information be a "fan" or a layman he will find a great deal of instruction and well expressed information in "The Outline of Radio."

Radio World is \$6.00 (52 issues), \$3.00 six months, \$1.50 three months, 15c. single copy. Radio World, 1493 Broadway, New York City.

Don't Ask for Rheostat—Say

FIL-KO-STAT FOR REAL FILAMENT CONTROL

Federal Standard Radio Products

Standard of the Radio World, 130 separate units, each fully Guaranteed.

Write for Catalog.
Federal Telephone and Telegraph Co.
 BUFFALO, N. Y.

DO YOU WANT PLANS FOR MAKING THE SLEEPER DUOTOL RECEIVER, USING THE SLEEPER TWINS. — Two Variometers and the fixed Coupler? SEND 10c for the June issue of RADIO AND MODEL ENGINEERING.

SLEEPER RADIO CORPORATION
 88 W. Park Place New York City

SEND NO MONEY **Guaranteed!** **\$3.98** **Money back if they do not satisfy after 5 DAYS TRIAL**

SEND no money! Order by postcard and pay postman on arrival. If they do not excel any other phones you ever used regardless of price, return them and your money will be refunded at once.

AMBASSADOR
 LONG RANGE PHONES
 TOWER MFG. CORP., 98 BROOKLINE AVE., BOSTON, MASS., DEPT. A

IMPROVED GROUND CLAMP

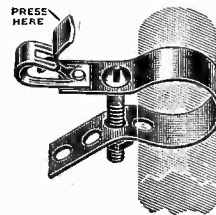

Equipped with FAHNSTOCK PATENT Wire Connectors Easily Attached

No Soldering—For Radio Use Only
 AT YOUR DEALERS

FAHNSTOCK ELEC. CO.
 LONG ISLAND CITY, N. Y.

HUNT'S UNIVERSAL HAIR-LINE RADIO TUNING DEVICE

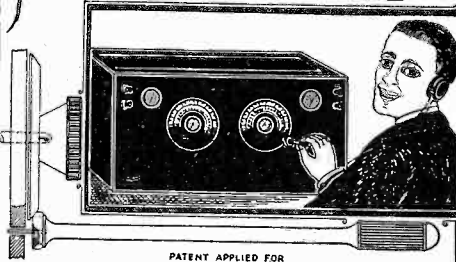

OVERCOMES BODY CAPACITY

Gives micrometric adjustment outside the field of inductivity.

Tested and approved by amateurs and experts. Enables you to tune distant stations easier and more clearly. Simple as A B C. Installed from outside, no dismantling of your set necessary. Audibility made more natural or less distorted by the fine adjustments obtained. One Hunt's Device handles all dials on set or several sets. Costs only one dollar on guarantee of money refunded if not satisfied. Ask your dealer or order direct from Hunt Co., 486 Shrine Bldg., Memphis, Tenn.

It Costs You No More
to Buy

Columbia Bakelite Moulded Apparatus

The All-Circuit Variometer

The Columbia Variometer is fully bakelite moulded, green silk, pigtailed, and provides for all circuits of today and tomorrow; the stators may be split. You cannot obtain a finer tuning variometer. Body capacity minimized. Regenerative, Ultra-Audion, Flewelling, Reinartz and Reflex Circuits all provided for. Diagrams with each instrument.

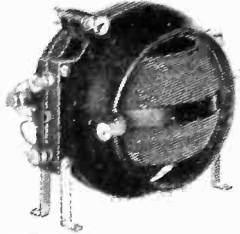

Type C109A, Price\$5.50

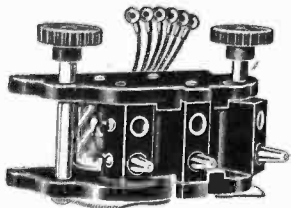

The Geared Coil Mounting you have been looking for. Moulded of genuine bakelite; geared 5 to 1 reduction; 6 inch silk leads. A True Columbia Product.

Type C401, Price\$5.00

- A Few More Columbia Products:
- Bakelite Moulded Variocoupler, Type C120 \$6.00
 - Bakelite 180° Variocoupler, Type C105 5.00
 - Bakelite 3 Coil Geared Mounting, Type C401 5.00
 - Bakelite 2 Coil Geared Mounting, Type C402 3.50
 - Inside Coil Mount Geared and "Vernier" Type C403 6.00
 - Coil Plug50
 - All Meter 180° Couplers 7.00
- and complete line of mounted coils.

All good dealers have Columbia Products.
Insist on them.

Columbia Radio Corp.
155 N. Union St. Chicago

**"VERILOUD"
SYNTHETIC
RADIO CRYSTAL**

ON APPROVAL FOR 30 ¢
ZOBEL-STEIN LABORATORIES
322 9TH ST. BROOKLYN, N.Y. SOUTH 2650

**RADIO TUBE SPECIALISTS
WE SAVE YOU MONEY**

RADIO DEALERS

If you are looking for real repair service write us. Also, wonderful line of new tubes.

RADIO PRODUCTS CO.
115 W. Broadway, Dept. R., N. Y.

**FRESHMAN
NOISELESS
TESTED MICA
CONDENSER**

MFG. BY
CHAS. FRESHMAN CO. Inc.
NEW YORK CITY

ALL CAPACITIES—WRITE FOR LEAFLET

RADIO WORLD

TELEPHONES:
LACKAWANNA 6976 and LACKAWANNA 2063
PUBLISHED EVERY WEDNESDAY (Dated
SATURDAY OF SAME WEEK)
FROM PUBLICATION OFFICE,
1493 BROADWAY, NEW YORK, N. Y.
BY HENNESSY RADIO PUBLICATIONS
CORPORATION

BOLAND BURKE HENNESSY,
President and Editor
M. B. HENNESSY, Vice-President
FRED S. CLARK, Secretary and Manager
1493 BROADWAY, NEW YORK, N. Y.
Boston Representative: Chas. H. M. White, 1367
Commonwealth Avenue, Allston, Mass.
Chicago Representative: Mat. E. Friedman, 519
East 60th St., Chicago, Ill.
European Representatives: The International News
Co., Breems Bldgs., Chancery Lane, London, Eng.
Paris, France: Brentano's, 37 Avenue de l'Opera.

Managing Editor: Stephen L. Coles
Technical Editor: Robert L. Dougherty

SUBSCRIPTION RATES

Fifteen cents a copy. \$6.00 a year. \$3.00 for
six months. \$1.50 for three months.
Add \$1.00 a year extra for foreign postage.
Canada 50 cents.
Receipt by new subscribers of the first copy of
RADIO WORLD mailed to them after sending in
their order, is automatic acknowledgment of their
subscription order.

ADVERTISING RATES

One page: One time—\$150.00.
Half, Quarter, Third and Two-thirds pages at
proportionate rates.
One inch, one time—\$5.00. Per agate line
\$0.40.
On four consecutive issues, 10% discount.
On thirteen consecutive issues, 15% discount.
Cover and preferred-position rates made known
on application.
Terms: 30 days net. 2% 10 days.

CLASSIFIED ADVERTISEMENTS

Five cents per word. Minimum, 10 words.
Discount of 10% on 4 consecutive issues—15%
on thirteen consecutive issues. Cash with order.

Entered as second-class matter, March 28, 1922,
at the Post Office at New York, New York, under
the act of March 3, 1879.

IMPORTANT NOTICE

While every possible care is taken to state
correctly matters of fact and opinion in technical
and general writings covering the radio field, and
every line printed is gone over with a scrupulous
regard for the facts, the publisher disclaims any
responsibility for statements regarding questions
of patents, priority of claims, the proper working
out of technical problems, or other matters that
may be printed in good faith and on information
furnished by those supposed to be trustworthy.
This statement is made in good faith and to save
time and controversy in matters over which the
publisher cannot possibly have control.

Government Radio Head Plans Trip

CHIEF SUPERVISOR OF RADIO
C. W. D. TERRELL of the Department of Commerce will make a swing around the country, eventually visiting each of the nine radio districts. Recently he made a trip to Detroit and Chicago, the eighth and ninth district headquarters. Within a month's time he hopes to start west to visit Seattle and San Francisco and inspect the district headquarters there. Returning via New Orleans he will stop off there and in Atlanta, where the new fourth district offices were recently established. En route to Washington he hopes to stop at Norfolk. Later in the season he will go to Baltimore, New York and Boston, thus completing a circuit of all nine district headquarters.

Since the advent of broadcasting it has become necessary for the Chief Supervisor to keep in closer touch with his district supervisors and their inspectors, and it is for this reason, and in an effort to adjust some local difficulties, that Mr. Terrell is making the extensive trip. No exact schedule has as yet been announced other than that he will start about November 1.

Mr. Terrell will also sound out the sentiment of several sections of the country as to broadcasting, amateur activity and other phases of radio communication as a part of a general study he is making of operation under the regulations and new wave lengths laid down last spring.

Full of Opportunities
Radio World's Classified Dept.

PATENTS

promptly procured. Trade
Marks designed & registered
**FREE INVENTION RE-
CORDING BLANK**
Phone Vanderbilt 7312

**FREE MANUFACTURERS
PATENT CO. INC.**
BOOK 520 FIFTH AVE.
NEW YORK



10 Initialed Binding Posts
Beauties—Sent anywhere by mail on receipt of price, 20c. each. Fine panel design and wiring advice free. Panels drilled. Wood for Beautiful Cabinets cut to size, with instructions for assembling and finishing like rosewood or mahogany. Will secure anything you want in the Radio Line and ship by parcel post, C. O. D., anywhere in the U. S. Satisfaction Guaranteed.
Maitland and Spencer Roach
2905 Columbia Ave., Phila., Pa.

DUPONT MAKES PYRALIN SHELSTONE

Loud Speaker

With Complete

**Nath.
Baldwin
Head Set**
Type C
Perfect
Results



Shelstone is made of Dupont's Pyralin, is transparent and one of the most attractive Loud Speakers on the market.

It is built differently to take advantage of the most correct acoustic principles and reproduces music and speech with a clear tone.

Loud Speaker with phones..\$15.00
Loud Speaker postpaid..... 3.00

Satisfaction guaranteed. C. O. D. or cash with order. Dealers write for discounts.

Distributors for Nathaniel Baldwin, Inc.

THE SHELSTONE COMPANY
187 Clinton Ave. NEWARK, N. J.

USE A C H SHARP TUNER DIALS

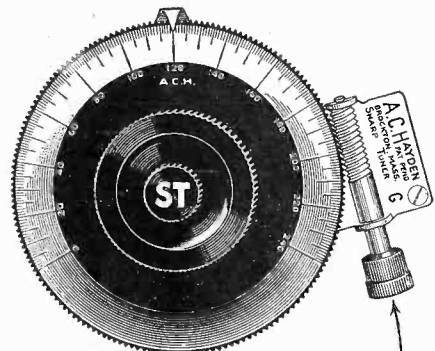

Why the A.C.H. is different

3 in. DIAL (150-T0-1)
4 in. DIAL (215-T0-1)

Rough tuning with dial or one thousandth of an inch in either direction.

MONEY BACK GUARANTEE

Price ACH 3" Dial Complete.....\$2.50
Price ACH 4" Dial Complete.....\$5.00
Regular fitting 5-16" hole, 3/4" and 3-16".
Bushings, 5c. each extra. 10c. for all.

ASK YOURSELF THIS

Would W. S. Brooker, Alberta, Canada, write, "Held Ft. Worth, Texas, one hour steady," and purchase another if he were not satisfied? * Would L. M. Cope, Connellsville, Pa., send check, saying, "Send another of those wonderful Dials," if he were not satisfied?

Would J. E. Byron, Loveland, Colo., say, "I heard WMAF, S. Dartmouth, Mass., and picked up five new stations," and recommend same to his friend, Dr. B. E. Wright, who purchased one, if he were not satisfied?

To retain your good will you must be satisfied or money back.

The ACH will improve any set.

Send for circular No. 3 on RV Loud Talker and Detector Set. A truly wonderful set.

All ready for you to put together.

A. C. HAYDEN RADIO & RESEARCH CO.

Brockton, Mass., U. S. A.
Mail Orders sent prepaid in U. S. A.

DO YOU WANT TO BUY, SELL OR EXCHANGE RADIO OR OTHER GOODS? TRY THIS DEPARTMENT AT 5c A WORD

RADIO WORLD'S QUICK-ACTION CLASSIFIED ADS

This department is intended for everybody who wants quick action on short announcements covering the buying, selling, exchanging or general merchandising in the radio and other fields. Readers of RADIO WORLD will find that it pays to read these columns every week. Advertisers will get an eight-day service here—that is, copy received for this department will appear in RADIO WORLD on the news-stands eight days after copy reaches us.

The rate for this RADIO WORLD QUICK-ACTION CLASSIFIED AD. DEPT. is 5c. per word (minimum of 10 words, including address), 10% discount for 4 consecutive insertions, 15% for 13 consecutive insertions (3 months). Changes will be made in standing classified ads. if copy is received at this office eight days before publication. RADIO WORLD, 1493 Broadway, N. Y. C. (Phone, Bryant 4796).

ONE-TUBE STANDARD CIRCUIT set complete with bulb, batteries, phones and cabinet. Will sacrifice at \$35.00. William O'Brien, 133 West 79th Street, New York City.

HYPNOTISM—mesmerism, astounds, controls self and others, wants gratified, mind reading (any distance). Wonderful, fascinating 205-page illustrated book. \$1.00 postpaid. R. W. Collins Co., 197 Fulton St., Brooklyn, N. Y.

SACRIFICE SALE of condensers, 23 plate, \$1.59. Vernier, \$2.59; 43 plate, \$1.79. Vernior, \$2.98; 11 plate, \$1.25. Guaranteed head phones, \$2.90. Satisfaction or money refunded. Dept. B., Spies Radio, Bank and Ann, Baltimore, Md.

PATENTS—SEND DRAWING OR MODEL FOR EXAMINATION AND OPINION. Booklet free. Watson E. Coleman, Patent Lawyer, 624 F Street, Washington, D. C.

SPIDER-WEB INDUCTANCES wound with double covered green silk wire and void of all compounds. Type C for Reinartz circuit, \$1.50. Type D for modified Reinartz circuit, \$1.25. Type M wave trap filter coil, \$1.25. Directions free with all coils. NOLTE MFG. CO., 61 Gautier Ave., Jersey City, N. J.

MAGNAVOX TYPE R3. Latest nationally advertised reproducers. List \$35. Introductory offer, \$25. The factory sealed carton is your guarantee. Radio Central, Dept. W, Abilene, Kansas.

15c. LETTERED BINDING POSTS, complete set eight, 60c; two sets, \$1.00. Prepaid, same day. Stamps accepted. Everything in radio. Ask for quotations. List for stamp. Kladag Radio Laboratories, Kent, Ohio.

GENUINE EDISON ELEMENTS (new) for making "B" Batteries. Obtained from U. S. Government. A positive and negative element—6c.; glass tube—3c.; all other parts at reasonable prices. Postage, etc., 50c. extra per order. Free instructions. TODD ELECTRIC COMPANY, 103 West 23rd Street, New York.

WANTED—Second-hand omnigraph. Good condition. Theodore Lucke, Le Mars, Iowa.

FOR SALE—\$100.00 powerful 10-tube loop set, unassembled. \$45.00 worth of 201-A tubes. Combs the sky from coast to coast. Ten transformers. Lewis Rogers, Genesee Apartments, Lockport, New York.

TWO NEW DE FOREST DV-6 TUBES, \$3.50 each. Butler, 1915 Herbert Street, Baltimore, Md.

"REXO" RADIO RECEIVER—75-mile range—\$1.00 postpaid. Central Radio, 9413 Holton, Cleveland, Ohio, Dept. 120.

BUILD yourself a Storage "B" Battery from Edison elements that will last you a life time. Complete units for making 100 volt 1500 milliamperes battery, consisting of a cabinet, switch, elements, glass tubes, separators, nickle wire, electrolyte and blue print for assembly, \$12.50. Assembled battery, \$17.50. Drilled elements, 6c a pair; glass tubes, 2c each; separators, 1c each; nickle wire, 1c each; rubber covered wire, 2c foot. Mail orders filled. W. Roberts Storage "B" Battery, 41 Jefferson St., Brooklyn, N. Y.

EDISON STORAGE BATTERIES, \$2.50. Worth \$48. 824 North Fifth, Philadelphia, Pa.

VACUUM TUBE RESULTS FROM A CRYSTAL SET! A "PT" Ultra-Sensitive Contact will increase the range and audibility of your crystal receiver. The most sensitive catwhisker in the world. It will not jar out. Thousands in use. Record, 1,000 miles on phone; 3,300 miles on spark. Price twenty-five cents in coin. "PT" CRYSTAL CONTACT COMPANY, Box 1641, Boston.

EXCHANGE JOLLY, INTERESTING LETTERS THROUGH OUR CLUB. Betty Lee, Inc., 4254 Broadway, New York City. Stamp appreciated.

DRACO Tube Protectors, 15 cents each, postpaid. DUANE RADIO APPLIANCE CO., 31 Liberty Street, San Francisco, Cal.

CRAM'S RADIO BROADCASTING MAP of the UNITED STATES AND CANADA. Scale 100 miles to the inch. In two colors, size 34x28. Printed on high-grade map paper, up-to-the-minute information, indicating all amateur and standard broadcasting stations, with complete index to stations. 35c postpaid. The Columbia Print, 1493 Broadway, New York City.

ELEMENTS OF RADIO TELEPHONY, by Wm. C. Ballard, Jr. A standard book on radio telephony, the work of a recognized authority. Accurate, simple, clear, reliable and strictly up-to-date. For the technical man who wants to post himself on radio and for the radio enthusiast who wants the fundamental principles of radio and their application tersely and entertainingly presented. Price, postpaid, \$1.50. The Columbia Print, 1493 Broadway, New York.

WHILE THEY LAST—Crosley No. V1 Receivers, \$19.50; De Forest Reflex Receiver, \$75.00; UV-200 Detector Tubes, \$3.90; UV-201 Tubes, \$5.00; WD-11 Tubes, \$5.25; Airway Variometers, \$3.00; Moulded Variometers, \$5.75; Atwater-Kent Coupler on Panel, \$9.50; Atwater-Kent Two Step Amplifiers, \$9.50; Marshall-Gerken Amplifiers, \$7.50; Detroit Amplifier Horn, \$7.50; R-3 Magnavox, \$20.00; Dictograph Loud Speaker, \$14.50; Dictograph Headsets, \$5.75; Frost Phones, \$3.75; Rheostats, 75c; Moulded Dials, 40c. N. E. RISTEY, Spring Grove, Minn.

LONESOME! MAKE NEW AND TRUE FRIENDS. Confidential. Write DOLLY GRAY AGENCY, Box 186B, Denver, Colo.

DOES TUNED RADIO FREQUENCY PUZZLE YOU?—If so, and you want to build a set incorporating this very efficient means of getting long distance volume on either crystal or tubes, send 15c for issue of July 14, 1923, or start your subscription with that number. RADIO WORLD, 1493 Broadway, New York City.

DO YOU WANT A POWER AMPLIFIER?—You can build one from complete details given on page 6 of Radio World, dated June 9, 1923. Send 15c., or start your subscription with that issue. RADIO WORLD, 1493 Broadway, New York City.

WEIGHS ONLY 8 OZ.

The Scientific

SEND NO MONEY!

20,000 TURNS EQUIVALENT TO 3,000 OHMS

2.95

POST-PAID

LOUD SPEAKER UNIT \$1.95

Order TODAY and Pay Postman on arrival

THE SCIENTIFIC ELECTRIC WORKS

98 Brookline Ave. Dept. D BOSTON, MASS.

We Guarantee The Scientific Headset to be the greatest value on the market. Try it for five days. If not satisfactory send it back and your money will be refunded immediately. Circular on request. Dealers wanted.

WJZ Football Season Opens

LAST Saturday Station WJZ opened its radio football season with a play-by-play description of the Princeton-Notre Dame game direct from the Palmer Stadium at Princeton. The radio schedule contains some of the fastest and biggest games of the entire football season, and this fall will be one of joyous Saturdays for the listeners-in. October 27th WJZ will broadcast the game between Penn State and the University of West Virginia from the Yankee Stadium, and on November 3 the invisible audience will hear the game between Washington-Jefferson and Lafayette College from the Polo Grounds.

The next two games are big ones in every sense of football. November 10 the Harvard-Princeton game will monopolize the interest of the listeners and on November 24 WJZ will broadcast the Army-Navy game from the Polo Grounds. November 29 and the Dartmouth-Columbia game wind up one of the best radio schedules in the past three years. All the games will be described minutely by a noted football player and authority, in the same manner which has proved so popular in the broadcasting of such fights as the Dempsey-Firpo contest, and in the World Series games, from WJZ.

FOR RELIABLE UP-TO-DATE RADIO MAILING LISTS

Use Our Card Catalog Directory in use now with over 200 Radio Manufacturers and Jobbers

Your ENVELOPES ADDRESSED At \$2.00 per 1,000

Write for Particulars

Sydell's Radio Trade Directory
406 W. 31st St., New York. Watkins 5987

\$1.25

Loop Antenna

Post Paid in U. S. A.

A highly efficient complete indoor aerial.

Write for literature describing Radio Cabinets and other products.

Robbins Woodworking Co.
502 SECOND ST. LIBERTYVILLE, ILL.

THE GOODMAN

THE GOODMAN

PAIEN T PENDING

The Niftiest Short Wave Tuner on the Market Only \$6.00 & PP on 1 lb. Send for pamphlet.

L. W. GOODMAN
DREXEL HILL, PA.

Mr. C. H. Jenkins, Audubon, N. J., writes:—"On July 13th, tuned in WBAP, Fort Worth, Texas, (476 meters), with the GOODMAN

RADIO WORLD As a Birthday or Holiday Gift

Why not send him RADIO WORLD as a gift for the coming fifty-two issues—a birthday or a holiday gift? Send us \$6.00 with the name and address for one year and we will enter the order and in addition will send out an acknowledgment to the name and address, saying that RADIO WORLD is sent with your compliments. This will be an every-seven-day reminder of your generosity.

SUBSCRIPTION DEPARTMENT RADIO WORLD, 1493 BROADWAY, N. Y. C.

TECHNICAL BOOKS FOR RADIOISTS, ELECTRICIANS, AND OTHERS

Construction of Radio Phone and Telegraph Receivers for Beginners—By M. B. Sleeper.....	50.75
Ideas for the Radio Experimenter's Laboratory—By M. B. Sleeper.....	.75
The Radio Experimenter's Hand Book—By M. B. Sleeper.....	1.00
Radio Hook-Ups—By M. B. Sleeper.....	.75
Radio Design Data for Radio Transmitters and Receivers—By M. B. Sleeper.....	.75
Construction of New Type Transatlantic Receiving Sets—By M. B. Sleeper.....	.75
How to Make Commercial Type Radio Apparatus—By M. B. Sleeper.....	.75
A B C of Vacuum Tubes Used in Radio Reception—By E. H. Lewis.....	1.00
Wireless Telegraphy and Telephony Simply Explained—By Alfred P. Morgan.....	1.50
Experimental Wireless Stations—By P. E. Edelman.....	3.00
Six Successful Radio Sets—By M. B. Sleeper.....	.50
101 Receiving Circuits—By M. B. Sleeper.....	.50
Arithmetic of Electricity—By Prof. T. O'Connor Sloane.....	1.50
Commutator Construction—By William Baxter, Jr.....	.35
Dynamos and Electric Motors and All About Them—Dynamo Building for Amateurs, or How to Construct a Fifty Watt Dynamo—By Arthur J. Weed.....	1.00
Electric Bells—By M. B. Sleeper.....	.75
Experimental High Frequency Apparatus, How to Make and Use It—By Thos. S. Curtis.....	.50
Electricity Simplified—By Prof. T. O'Connor Sloane.....	1.50
Electrician's Handy Book—By Prof. T. O'Connor Sloane.....	4.00
Electric Toy Making, Dynamo Building and Electric Motor Construction—By Prof. T. O'Connor Sloane.....	1.50
House Wiring—By Thos. W. Poppe.....	1.00
How to Become a Successful Electrician—By Prof. T. O'Connor Sloane.....	1.50
Standard Electrical Dictionary—By Prof. T. O'Connor Sloane.....	5.00
Storage Batteries Simplified—By Victor W. Page, M.S.A.E.....	2.00
Telephone Construction, Installation, Wiring, Operation and Maintenance—By W. H. Radcliffe and H. C. Cushing.....	1.50
Wiring a House—By Herbert Pratt.....	.35
The Modern Gasoline Automobile, Its Design, Construction, Operation—By Victor W. Page, M.S.A.E.....	4.00
Hints and Tips for Automobilists—By Victor W. Page.....	.75
Questions and Answers Relating to Modern Automobile Construction, Driving and Repair—By Victor W. Page.....	2.50
Automobile Starting, Lighting and Ignition Systems—By Victor W. Page.....	2.00
Automobile Repairing Made Easy—By Victor W. Page.....	4.00
The Model T Ford Car, Its Construction, Operation, etc.—By Victor W. Page.....	4.00
Automobilist's Pocket Companion and Expense Record—By Victor W. Page.....	1.50
Location of Gasoline Engine Troubles Made Easy—By Victor W. Page.....	.35
Location of Carburetion Troubles Made Easy—By Victor W. Page.....	.35
Location of Ignition System Troubles Made Easy—By Victor W. Page.....	.35
Location of Cooling and Lubricating Troubles—By Victor W. Page.....	.35
Lubrication of the Motor Car Chassis—By Victor W. Page.....	.35
Location of Starting and Lighting System Faults—By Victor W. Page.....	.35
Location of Ford Engine Troubles Made Easy—By Victor W. Page.....	.35
Location of Motorcycle Troubles Made Easy—By Victor W. Page.....	.35
A B C of Aviation—By Capt. Victor W. Page.....	2.50
Aviation Chart—By Lieut. Victor W. Page.....	.35
Glossary of Aviation Terms—English-French; French-English—By Victor W. Page and Paul Montarlot.....	1.00
Westinghouse E-T Air Brake Instruction Pocket Book—By Wm. W. Wood.....	2.50
Machine Shop Arithmetic—By Colvin-Cheney.....	.75
Practical Instructor and Reference Book for Locomotive Firemen and Engineers—By Chas. F. Lockhart.....	2.50
Gas, Gasoline and Oil Engines—By Gardner D. Hiscox.....	3.00
The Gasoline Engine on the Farm: Its Operation, Repair and Uses—By Xenon W. Putnam.....	3.00
Lathe Work for Beginners—By Raymond F. Yates.....	2.00
The Lathe—Its Design, Construction and Operation With Practical Examples of Lathe Work—By Oscar E. Perrigo.....	3.00
Complete Practical Machinist—By Joshua Rose.....	3.00
Shop Kinks—By Robt. Grimshaw.....	.75
Home Mechanic's Workshop Companion—By Andrew Jackson, Jr.....	4.50
Machine Shop Tools and Shop Practice—By W. H. Vandervoort.....	6.00
The Naval Architect's and Shipbuilder's Pocket Book—By Clement Mackrow & Lloyd Wollard.....	3.00
Prospector's Field-Book and Guide—By H. S. Osborn.....	3.00
Model Making—By Raymond Francis Yates.....	4.00
Motor Boats and Boat Motors—By V. W. Page and A. C. Letch.....	3.00
Popular Handbook for Cement and Concrete Users—By Myron H. Lewis.....	4.50
Punches, Dies and Tools for Manufacturing in Presses—By J. V. Woodworth.....	5.00
Standard Electrical Dictionary—By Prof. T. O'Connor Sloane.....	1.50
A Course in Mechanical Drawing—By Louis Rouillon.....	2.50
Self-Taught Mechanical Drawing and Elementary Machine Design—By F. L. Sylvester, M.E.....	2.50
Practical Pattern Making—By F. W. Barrows.....	2.50
American Stationary Engineering—By W. E. Crane.....	.75
Steam Engineer's Arithmetic—By Colvin-Cheney.....	2.50
500 Plain Answers to Direct Questions on Steam, Hot-Water, Vapor and Vacuum Heating—By A. G. King.....	2.50
Standard Practical Plumbing—By R. M. Starbuck.....	3.50
Mechanical Drawing for Plumbers—By R. M. Starbuck.....	2.00

Any of these books sent prepaid to any part of the world on receipt of order in cash, check, stamps, express or postal order.

THE COLUMBIA PRINT
1493 BROADWAY NEW YORK CITY

A. C. Tube Transmitters

Editor, RADIO WORLD:—In RADIO WORLD for October 6, 1923, on page 10, an article "Standardizing Radio Nomenclature," by Carl Butman, appears.

In this article it is stated that there is no such thing as a spark tube transmitter. This is incorrect. What is now known as a spark tube transmitter is one in which the output of a DC-operated spark coil with its high voltage reduced by a shunt condenser, not A. C., is used for plate supply, and is distinct from the usual straight or rectified A. C. supply. Yours, truly,

A. P. GOWAN,
Chief Operator, Forest Hill Radio Station,
(3TY-9BC), 120 West King Street,
Kitchener, Ontario.

[Mr. Butman was simply quoting in his article the conclusions on proper nomenclature reached by officials of the Navy Department. The reference was to A. C. tube transmitters only.—EDITOR.]

Station WEAF's Football Plans

IN order to supply the demand for running accounts of important football games, WEAF is arranging to broadcast two games simultaneously when two important games are scheduled. For this purpose, WBAY, operating on a wave length of 316 meters, will probably be used. Arrangements are now under way to broadcast the following games: Yale-Army, at New Haven, November 3; Rutgers-West Virginia, at Polo Grounds, November 6; Columbia-Cornell, November 10, Polo Grounds; Princeton-Harvard game, November 10, Princeton; Yale-Princeton, at New Haven, November 17; Yale-Harvard, at Cambridge, November 24; Army-Navy game, at Polo Grounds, November 24, Pennsylvania-Cornell, Philadelphia, November 29.

Construction of New Type Transatlantic Receiving Sets

By M. B. SLEEPER
Fully Illustrated. Price 75 Cents
IN addition to the listening to ships and broadcasting stations on short wave lengths there is a peculiar fascination about listening to the high-power telegraph stations of England, France, Germany, Russia and Italy as well as those located in the Pacific Ocean and the Oriental Countries. It is much easier to do this than most people imagine. The sending is very slow, a feature of assistance to the beginner in telegraphy. Several types of receiving sets for this task are described. Detectors, amplifiers, oscillators, etc., for long distance reception are also described. Suggestions for the operation of relays by the signals and the reproduction of them on a phonograph are given. In addition there is some valuable data on home made wavemeters for testing and experimenting.
Sent P. P. prepaid, on receipt of price, by
THE COLUMBIA PRINT
1493 BROADWAY, NEW YORK CITY

Mr. Manufacturer:

Do you realize that when you send your literature to a prospect that you are actually sending your SILENT SALESMAN on the road? It is up to this SILENT SALESMAN to convincingly sell your goods.

Many a sale is lost just because your literature may fail to INSTRUCT the prospect to appreciate the very good and distinctive features found only in your goods.

Let me show you how your catalogs or booklets can be made interesting as well as profitable.

CHARLES H. M. WHITE

Consulting Engineer
1367 Commonwealth Ave., Boston, Mass.

ALL LINES OF RADIO MERCHANDISE

ARE IN OUR STOCK
New York Prices Direct to You
Just Tell Us What You Want
GLOBE RADIO SHOP
115 West 23rd Street New York

Send \$6.00 for RADIO WORLD and get 52 issues without a break.

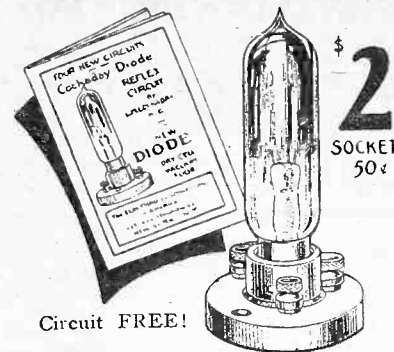

New Cockaday Circuit —and the DIODE

A revelation in reflex work. The Diode replaces the crystal and overcomes all former difficulties with reflex circuits. Requires no adjustments for change of wave lengths. Gives you the clear reproductions of a crystal with the sturdiness and reliability of a tube. No "B" batteries required. Operates on less than 1/2 ampere from single dry cell. Easily adapted to Erla circuits.

At your dealers or send purchase price and you will be supplied direct.

ELECTRAD, Inc.

428 Broadway, New York



PURETONE RADIO CRYSTAL E

— SYNTHETIC GALENA —
UNEXCELLED IN QUALITY
FOR REFLEX AND CRYSTAL SETS
Awarded Certificates of Excellence by Leading Radio Laboratories.
THOUSANDS OF SATISFIED USERS.
PRICE 25 CENTS MOUNTED
Every Crystal Carefully Tested and Guaranteed.
LARGE CYLINDRICAL CRYSTALS
Mounted with Special Cat-Whisker
PRICE 50 CENTS
Excellent Proposition for Dealers.
OSCAR F. NILSSON
6 WEST 127TH STREET NEW YORK

AMATEURS! FANS! ATTENTION!

ALL BROADCASTING STATIONS—Complete with the call, location, wave length, frequency of the station, and power used started in Radio World of Oct. 13.

This list is most complete, and no amateur or fan should be without it. It will be completed in following issues, and as revisions or changes are made the list will be kept up-to-date, so that you will always have an up-to-date list to which you can refer. Don't miss any issue. Send 15c to

RADIO WORLD, 1493 BROADWAY
New York City, or start your subscription with that number.

DO IT NOW—DON'T DELAY!

Books For The Trade

Manufacturers, distributors, dealers and others should make use of the following books:
Radio Dealer Year Book, complete....\$1.00
Radio Dealer Jobbers' Directory.....50c
Radio Dealer Trade Mark Directory....35c
Any of the three sent postpaid on receipt of price. The three books sent for \$1.50.

THE COLUMBIA PRINT

1493 Broadway New York

MARTIAN BIG FOUR
\$7.50 Crystal Receiving Set.
 LIST Something Entirely New
 in Crystal Sets.
WHITE MANUFACTURING CO.
 93-107 Lafayette Street Newark, N. J.

The Wireless Oracle

By Hirsch M. Kaplan

GAMBLING?

YOU ARE IF YOUR RADIO TUBES ARE UNPROTECTED



Your Vacuum Tubes are the most delicate parts of your Radio Set. They are easily blown out—you have probably already had this exasperating experience—it is apt to happen at any time.

'B' Battery wires accidentally crossed for only an instant with the filament leads or sudden excess current from the 'A' Battery will do it.

You can prevent this and save yourself money and inconveniences and relieve your mind at a trifling cost.

INSTALL RADECO SAFETY FUSES

on all your tubes. Applied in an instant to one at the filament terminal. Will fit any standard tube going in any standard socket.

Price 50 cents each, sent postpaid and fully guaranteed. Do not delay. Order now. Specify type of tube used.

Dept. 5
RADIO EQUIPMENT CO.
 Manufacturers and Distributors of Standard Radio Equipment
 630 Washington Street Boston, Mass.
 New England's Oldest Exclusive Radio House
 Dealers:—Write for our proposition

WBZ, in co-operation with the Massachusetts Division of University Extension has begun broadcasting a series of courses on "Radio Reception and Transmission." These talks are delivered by Edward H. Goodrich. Those interested are reminded to tune in WBZ, which operates on a wave length of 337 meters, every Wednesday night at 7 p. m. until further notice.

WJAX offered an excellent program. They were assisted by Roy A. Lewis, pianist, and Gyp Girs, violinist.

Fred Fisher's Entertainers delighted us with offerings of popular hits, rendered both vocally and instrumentally. They were from our Newark neighbor, WAAM.

The Bedford Y. M. C. A. of Brooklyn has returned to the air with its regular Men's Conference with the noted Rev. Dr. S. Parkes Cadman. This service is to be broadcast as a regular Sunday afternoon feature from station WEAJ.

Our old friend, Betsy Ayres, was with us again and sang many of her songs which had made her famous when a member of "Roxy's" troupe. She rendered her recital through station WEAJ.

WFI verniered its way through with a program by the Boy Scout Radio Corps.

WJZ offered some lively entertainment by broadcasting the popular hit, "Little Jessie James," direct from the Longacre Theatre. Now that I've heard this wonderful comedy I am going to see it. Are you?

WGR broadcast the banquet of the National Safety Congress in the ballroom of the Hotel Statler. Entertainment was furnished by the Buffalo Players who presented a one-act playlet entitled, "Finders Keepers."

A tip! Followers of the stage and screen can obtain the latest about their star or stars by tuning in station WDT any Wednesday evening at 7 P. M. and listen to a talk on "Stage and Screen," as delivered by Charles Reed Jones.

The past week sure was a gala one for both radio and WHN. The other afternoon, Miriam Battista, child movie star, appeared at Mr. Loew's station and gave several recitals. The same evening, the famous comedian of the screen, Charles Chaplin, appeared and gave the B. C. L.'s some first class impersonations and humorous talks. The following evening Benny Leonard, world's lightweight champion, appeared at the studio and rendered a program of recitations and stories.

The WGY Players celebrated their return to the air, after an absence of three months, by offering the famous comedy-drama, "Three Live Ghosts." The music between acts was greatly appreciated.

The Madrigal Male Quartet, from station

The Cincinnati Conservatory of Music through WLW offered "Spanish Night," a program of Spanish music rendered both vocally and instrumentally. The one-act radario "A Sunny Morning" was presented by the Crosley Radarians.

Gerardo Cetrulo, well-known foils expert, who is shortly to meet Giacinto Sanges in a bout for the American championship, delighted us with a talk on "Fencing."

Would suggest that all those interested in detective stories listen in for the broadcasting of "The Waddington Cipher," by William Johnstown, through Station WJZ every Wednesday at 8 P. M.

Natural Re-PRODUCTION



Atlas AMPLITONE LOUD SPEAKER

Re-PRODUCTION so natural that even experts exclaim "indeed a revelation," "nothing short of remarkable." Every voice inflection is faithfully re-born. Distortion made impossible by the marvelous, patented "double diaphragm." Ask your dealer for the final proof—a demonstration. Write for Booklet.

COMPLETE WITH CONNECTING CORD

\$25

What have you accomplished with your Atlas Loud Speaker? Tell us about it.

Multiple Electric Products Co. Inc.
 ORANGE ST. RADIO DIVISION NEWARK, N. J.

WE REPAIR RADIO TUBES

WO-11... \$3.50	UV-199... \$3.50
WD-12... 3.50	C-299... 3.50
UV-200... 2.75	UV-201A... 2.50
UV-201... 3.00	C-301A... 3.50
C-300... 2.75	UV-202... 4.00
C-301... 3.00	C-302... 4.00
	DV-6A... 3.50

Mail orders solicited and promptly attended to.
 Dealers and agents write for special discounts.

H. & H. RADIO CO.
 P. O. Box 22-B
 Clinton-Hill Station Newark, N. J.

ARMSTRONG, FLEWELLING, REINARTZ, GRIMES, COCKADAY, HAZELTINE, SATTERLEE AND OTHER POPULAR STANDARDIZED CIRCUITS DESCRIBED AND ILLUSTRATED IN RADIO WORLD'S FALL BUYERS' NUMBER, DATED OCTOBER 6, 1923. SENT ON RECEIPT OF 15c. OR START YOUR SUBSCRIPTION WITH THAT NUMBER.

American Broadcasters Heard in England

TWENTY-ONE English radio fans have written WGY, the General Electric Company broadcasting station, announcing successful reception of the Schenectady station's program during the first week in September. WGY and other American stations have been heard frequently by the English fans but trans-Atlantic transmission is rather unusual at that period of the year.

Many of the writers compare WGY with the transmitting stations in England and on the continent and a majority of them refer to programs broadcast September 6 and 8. W. E. Philpott, of Rye, Sussex, England, picked up WGY in the early morning of September 1. He writes: "I was rather 'bucked' up with the results. Congratulations on the fine modulation. You were quite equal to Birmingham and Manchester."

Henry Myers, of Low Fell, Durham, England, heard WGY and writes: "For consistent strength and clarity the concert came through much better than I get the London transmission."

J. Rhodes, writing from Leeds, Yorkshire, England, said WGY was as "clear as Manchester, 40 miles away."

The report of H. L. Holt, of Manchester, England, is especially interesting inasmuch as he received WGY on an indoor aerial. He writes: "The apparatus I was using consists of an indoor aerial across the kiddies' bedroom and the ordinary detector and one stage of low frequency. The aerial is just a length of bell wire stretched backwards and forwards across the room in the form of a W and a V and then through the floor to the living room below the set. The tuner is just an ordinary single circuit regenerative one."

Reception on a loud speaker strong enough to wake a person sleeping upstairs with bedroom door shut, is reported by T. Hall Felton, of Grimsby, England. Mr. Felton was listening in with his father, Dr. E. H. Felton, who is vice-president of the Grimsby District Radio Society. He has a five valve (tube) experimental set. "On two high frequency valves," he writes, "you are as loud as the English stations on three valves. In operating the loud speaker five valves were used." Mr. Felton picked up WGY on September 4, 6 and 8.

Radio Progress in Chile

ANOTHER step was taken in the development of radio-telephony in Chile recently when for the first time a conversation was held between a private broadcasting station belonging to a Chilean amateur in Vina del Mar, on the Pacific Coast, and Tucuman, Argentina. The Vina del Mar station was distinctly heard in a radio club in the latter city at midnight, whereupon conversation was kept up for over an hour.

BRISTOL AUDIOPHONE
MORE THAN A LOUD SPEAKER
 Bristol Audiophone, Sr., 15-in. Horn...\$32.50
 Bristol Audiophone, Jr., 11-in. Horn...\$22.50
 Bristol Single Stage Power Amplifier...\$25.00
 Write for Bulletin 3006-W
The Bristol Company
 Waterbury, Conn.

10c
 Brings you our new catalogue and radio information booklet illustrating and describing the Super-Regenerative and other latest and popular circuits. Our technical staff is at the disposal of our customers. Make use of their knowledge. Merchandise shipped immediately on receipt of order.
 U. S. Bureau of Standards "Radio Book."
 Special65c.
FREMONT RADIO SALES CO.
 227 FULTON STREET, NEW YORK CITY



SPECIAL SET

CONSISTING OF

\$35.00

Guaranteed For 1500 Miles

SUNBEAM

- | Bank Wound Coupler, silk wire, 600 meters...
- | Bakelite Panel, 7x12
- | Mahogany Cabinet
- | Pr. Potter Precision Phones (2200 ohms)
- | E. R. 22 1/2 V. Battery
- | Red Seal Battery
- | W.D. 12 Tube
- | 100 ft. Antennae
- | 2 Insulators—SET COMPLETE

ALSO SPECIALS ON

- COCKADAY COILS, with Hook-up for 3 bulb set...\$2.50
- V COUPLERS, Cotton Covered (600 meters)...\$1.00
- With Silk Winding
- Limited Quantity BAKELITE SOCKETS.....\$3.50

All Standard Merchandise, Fully Guaranteed. Take advantage of these low prices, as prices are going up. Send in for Our Weekly Specials.

SUNBEAM ELECTRIC COMPANY
 71 THIRD AVENUE NEW YORK CITY

THE TRINITY LOUD SPEAKER



TYPE "A1"
 21" FIBER HORN
 \$25.00



TYPE "B"
 (For Phonographs)
 \$12.50

INTERIOR CONSTRUCTION

An ear phone is an ear phone no matter how fancy the horn that covers it may be, and, due to the delicate construction of an ear phone it is utterly incapable of giving true tone reproduction, especially, when relatively large currents are passed thru its coils, such as the output of a two-stage or power amplifier.

The Trinity Loud Speaker element embodies the well-proven and tested principles of the phonograph reproducer with the soundest principles of electromagnetic design best adapted for loud speaker operation. It is not an ear phone when placed on a head band and a loud speaker when covered with a horn. It is a sturdy loud-speaking element ALWAYS.

Send for Literature.

TRINITY RADIO CORPORATION
 446 TREMONT STREET, BOSTON, MASS.

THESE BACK NUMBERS OF RADIO WORLD ARE OUT OF PRINT

April 22, 1922	October 28, 1922
April 29, 1922	January 13, 1923
May 26, 1922	January 20, 1923
June 24, 1922	January 27, 1923
August 5, 1922	February 24, 1923
October 21, 1922	May 12, 1923

If you can supply these back numbers, mail them to this office and we will send you current issues for them.

RADIO WORLD
 1493 Broadway New York City

FILL OUT AND MAIL NOW
 SUBSCRIPTION BLANK

RADIO WORLD

RADIO WORLD 1493 Broadway, New York City

Please send me RADIO WORLD for months, for which please find enclosed \$.....

SUBSCRIPTION RATES:

Single Copy	\$.15
Three Months	1.50
Six Months	3.00
One Year, 52 Issues.....	6.00
Add \$1.00 a Year to Foreign Postage; 50c for Canadian Postage.	

For Maximum Amplification Without Distortion and Tube Noises use the well known
Como Duplex Transformers
 Send for literature immediately.
COMO APPARATUS COMPANY
 446 Tremont St. Boston, Mass.

Latest Discovery!
SCHICKERLING
 LATEST TYPE
SUPER DX. TUBES
 ELIMINATE DISTORTION, CLEAR AS A BELL
 DETECTORS AND AMPLIFIERS 1 1/2-3-6V.
 LOW AMPERAGE - FULLY GUARANTEED
 \$ 6.50 LIST. AT AUTHORIZED DEALERS ONLY
 OR MAILED PROMPTLY UPON RECEIPT OF MONEY.
 SCHICKERLING 313 HALSEY ST. NEWARK, N.J.

For Clear and Loud Reception
 INSIST ON
Defiance Mica Condensers



Whose Quality is Guaranteed.
 Made in the full capacity. Mail orders filled.
 .001 25c. .0005 20c.
 .002 30c. .00025 20c.
 .0005, .00025, made with 1/2, 1 and 2
 Megs G. L. 25c.
 Dealers write for discounts.
DEFIANCE LABORATORY
 65-67 West Broadway New York City

SPECIAL
 Direct from Manufacturer to Consumer
 Improved Model
LOUD SPEAKER
 With Unit and Cord
 Price **\$8.00**
 (For a limited time only.)
 Genuine Wood Fibre Horn
 Entirely eliminates that annoying metallic sound. Positively the only WOOD FIBER HORN on the market today.
 10-inch Bell with Standard Attachment; Complete. Height 24 inches. Colors, Black, Mahogany and Olive Green.
 Delivered to any part of the United States and Canada.
EMIL DeCLYNE
 15 Park Row, Room 2525, NEW YORK CITY
 Send M.O. or C.O.D. Dept. M.M., Tel. Barolay 6298

Ventriloquism by Radio



(C. Underwood and Underwood)
 The radio audience recently had a rare treat in being allowed to hear over the air Marshall Montgomery, famous ventriloquist, and his silent side partner, "Jerry." It is a difficult feat for the unseen audience to visualize such entertainment, but by simply recalling to mind a ventriloquist performance they can distinguish the actions the talker wishes to bring before them. Of course, the "kick" in a ventriloquist act lies in the motions of the dummy, so it called for quite a bit of explaining and ingenuity on the part of both the announcer and the principal of the performance to impress the unseen and unseeing audience with the novelty of the entire thing. This was the first time such a performance has been attempted over the radio and Marshall Montgomery prepared a special act for this particular performance.

John Bassett Moore Speaks Through WGY
 JOHN BASSETT MOORE, judge of the Permanent Court of International Justice at The Hague, addressed the radio audience of WGY, the General Electric Company broadcasting station at Schenectady, N. Y., on the evening of October 19 on the subject of the international court and some illusions concerning it. The program previously scheduled, the production of the

Compare the Bel-Canto Adjustable Loud-Speaker with all other makes at any price. It will be a Bel-Canto. List, \$22.50.
BEL-CANTO MFG. CO.
 Bensel-Bonis Co., Inc.
 417 E. 34th St. New York City

HOOK-UP AND CIRCUIT HOUNDS
 Did you miss it? Do you want it? If you do you can get it by writing in to Radio World for any one of these back numbers, as per dates:

- Satterlee Circuit Feb. 8
 - G. W. May's Wonder Circuit..... Feb. 17
 - Multi-tube Reflex Circuits..... March 8
 - One tube Superregenerative..... March 8
 - Lewis Three Tube Circuit March 10
 - Regenerative Radio Frequency Circuit for 5 tubes March 24
 - Hazeltine Neutrodyne Receiver..... March 31
 - 2VK'S Transmitter circuit..... April 21
 - Compact Universal Receiver..... April 28
 - Stockelburg Pup receiver..... May 5
 - Improved Grimes Circuit, A. D. Turnbull's Long Distance Circuit, Combined Receiver and Transmitter, Improved 1 tube Rienartz May 19
- Any number for 15c. Any 7 numbers for \$1.00. All 12 numbers for \$1.50. Or start subscription with any number. Radio World, 1493 Broadway, New York City.

DX Nite Owls, Attention!
 THE DX season is nearly upon us. All faithful DXers are requested to get ready for the fray and prepare themselves for the night vigil.
 Send your records to the Editor of RADIO WORLD.
 Write only on one side of the paper and write clearly.
 Give full particulars of your location, your set, your aeriels and other items of interest.

play, "The Hottentot," was delayed until the conclusion of Judge Moore's address, which was delivered at a session of the 59th convocation of the University of the State of New York, held at Chancellor's Hall, Albany, N. Y.

EXTRAORDINARY DOUBLE SUBSCRIPTION OFFER

RADIO WORLD AND OTHER POPULAR RADIO PUBLICATIONS FOR THE PRICE OF SUBSCRIPTION FOR RADIO WORLD ALONE

- Radio World has made arrangements
- by which it is possible
- to offer a year's subscription for
- any one of the following publications
- with one year's subscription for
- RADIO WORLD:
- RADIO NEWS or
- POPULAR RADIO or
- RADIO BROADCAST or
- WIRELESS AGE or
- RADIO DEALER or
- RADIO (San Francisco).

- This is the way to get two publications
- for the price of one:
- Send \$6.00 today for RADIO WORLD
- for one year (regular price
- for 52 numbers)
- and select any one of the other
- six publications for twelve months-
- Add \$1.00 a year extra for
- Canadian or Foreign postage.
- This offer good only up to and
- including November 1, 1923.
- Present RADIO WORLD subscribers
- can take advantage of this offer by
- extending subscriptions one year NOW.
- Or order thru your newsdealer.

RADIO WORLD'S SPECIAL TWO-FOR-PRICE-OF-ONE SUBSCRIPTION BLANK

RADIO WORLD, 1493 Broadway, New York City.

Enclosed find \$6.00, for which send me RADIO WORLD for twelve months (52 numbers), beginning months, beginning months, beginning

This Offer Good Only Until November 1, 1923.

Name

Street Address

City and State

LATEST BROADCASTING MAP IN COLORS FREE to NEW RADIO WORLD SUBSCRIBERS

The latest radio broadcasting map of the United States and Canada, containing all the new allocations and changes, is offered *free* to subscribers for Radio World who send in their subscriptions within the coming four weeks. This map is printed on fine map paper stock and has just the information you want regarding broadcasting stations throughout the continent, including army and navy stations.

If you are already a subscriber you can get this map by renewing your present subscription now.

Send direct to this office or you may subscribe thru your newsdealer who can send your subscription direct to us.

Use the coupon attached. Offer open until Nov. 1, 1923.

RADIO WORLD FREE MAP SUBSCRIPTION BLANK

Radio World,
1493 Broadway, New York.

For the accompanying \$3.00 please send me Radio World for six months (26 numbers) beginning with issue datedand also, without any expense to me whatsoever, the latest radio map as advertised.

Name

Address

City and State.....

If you wish two maps, one for yourself and one for a friend, send \$6.00 for a yearly subscription and the two maps will be sent to different addresses if you wish.

WJAZ Will Attempt Radio Talk with WNP

CHICAGO, ILL.—His ship hemmed in by ice at winter quarters, Refuge Harbor, and surrounded by the gloom of the long Arctic night that is now approaching, Donald B. MacMillan will listen to a voice from civilization, addressed to him personally for the first time since he embarked from the Maine coast, if the management plans of station WJAZ, Zenith broadcast station at the Edgewater Beach Hotel here, are successful.

Until the present time all communication with the explorer's radio station, Wireless North Pole, has been in code through various amateur stations operated by members of the American Radio Relay League. Though broadcast stations all over the country have been heard by those on board the Arctic vessel "Bowdoin" no effort has been made to talk direct with the explorer by voice.

Owing to its inability to carry long distances on low power there is no radiophone equipment on the "Bowdoin," all communication being carried on by means of an amateur type code transmitter. In order to test the sending range of the Edgewater Beach station and at the same time cheer the ice-bound explorers by word from home, enhanced by the quality that only the human voice can give, this station will call WNP at midnight C. S. T., Wednesday weekly.

All amateurs who are trying to communicate nightly with WNP by code are asked by the management of the Zenith broadcast station to advise MacMillan of this schedule in order that he may listen for the first radio voice ever to call an explorer in the far North. For this purpose WJAZ will operate under the license 9XN. If MacMillan hears these messages he can reply with his code transmitter.

The equipment of 9XN is located in the old shack at 5525 Sheridan road, formerly occupied by the famous amateur station 9ZN, operated by R. H. G. Mathews, A. R. R. L. central division manager. One of the first speakers scheduled to talk is a cousin of Captain MacMillan.

2650 MILES

with ONE TUBE. Broadcasting from Atlantic Coast and Cuba heard in California by users of the CROSS COUNTRY CIRCUIT. This range is due to simplicity of set and operation as only one control is used for tuning. Easily and cheaply built. Dry cell tubes may be used. Complete instructions with panel layout, assembly views, etc., postpaid for 25c. Or further information for red stamp. VESCO RADIO SHOP, Bx. RW-117, Oakland, Cal.

WHAT'S IN A "B" BATTERY

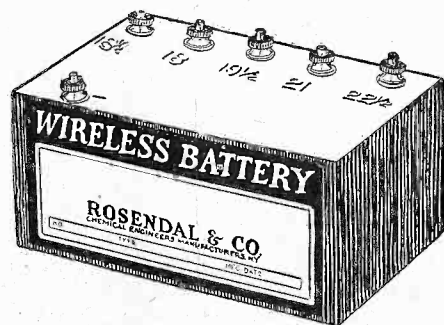

	Large	Med.	Small
22 1/2 V. Plain...	\$1.25	\$1.00	\$0.70
22 1/2 V. Variable	1.38	1.13	0.75
45 V. Plain...	2.50	1.75
45 V. Variable	2.75	2.00

Ask for Circular on other radio parts

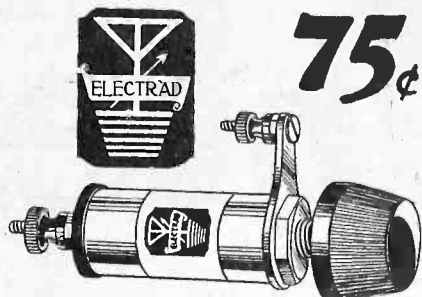

Pressure Resistance

The latest invention in pressure grid leaks. Each movement gives a definite new resistance. Positively does the work where others fail. A gradual resistance over entire range of 1/4 to 10 megohms. Eliminates circuit noises, is moisture proof, and non-microphonic. Ideal for use in Miloplex circuits. Guaranteed.

At your dealers or send purchase price and you will be supplied direct.

ELECTRAD, Inc.
428 BROADWAY, NEW YORK



FADA

Complete markdown parts for the 5-tube Fada Neutrodyne Receiver, including drilled engraved Bakelite Panel and Base Board\$65.00
Absolutely guaranteed on our money-back basis.

Amperite—Automatic Filament Control.
Unmounted \$0.70. Mounted.....\$1.10
Langbein and Kaufman Varlometers.....\$6.00
Langbein and Kaufman Variocouplers.....\$6.00



23 Warren St.
New York City

Our stock consists of a most complete line of all standard radio apparatus. Just let us know what you want and we will ship it to you immediately at regular manufacturers' prices.

NOTHING more than a number of small cells, wired together in series, each cell being composed of a zinc cup with a mixture of chemicals inside.

It took Rosendal years of painstaking analytical work to get that mixture just right—and it is RIGHT TO-DAY.

That's why a "Rosendal" is a good battery. Guaranteed money back if you're not satisfied.

Send M. O. or order for C. O. D.

ROSENDAL & CO.

Chemical and Radio Engineers
2 and 4 Stone Street New York

Interference

THIS IS HI HI STATION DAH de dah QRM - QTA dah de dah de dah I hear you calling in

BANISHED!

THAT set of yours can be made so selective you'll think it's a land-line telephone instead of a radio receiver! Absolutely! If you want to listen to Chicago you'll hear Chicago. Not half a dozen other stations at the same time. Not ONE other station. Just Chicago, alone and uninterrupted!

It doesn't make a bit of difference how selective your receiver is now; it doesn't matter whether your set is regenerative or whether it's a radio frequency amplifying set—it can positively be made 100 per cent more selective! Yes, sir, today—right now you can have a perfectly selective receiver!

How? Kenneth Harkness, famous engineer of the Radio Guild, tells you how in his amazing new book, "Radio Frequency Amplification." In this book Kenneth Harkness tells you exactly what *causes* interference. He explains why some sets are selective and others non-selective. Then he tells you all about his latest invention—the marvelous Harkness Coupler—which positively *banishes* interference! This remarkable yet simple piece of apparatus will change that nightly fight of yours against interrupted receiving into an evening of real fun. It will make tuning as easy as falling off a log. Kenneth Harkness tells you *why* this astonishing device cuts out interference and shows you how to use it in *your* receiver and make *your* set super-selective.

Many Other Startling Revelations

This one feature of Mr. Harkness' new book is alone worth the small price of the book to you. Yet this is only one of the many new and startling revelations which are made in this extraordinary book.

Kenneth Harkness—the Edison of Radio—also reveals in this book all the details of his astounding new 1-tube set which actually operates a loudspeaker! He opens right up and gives you all the dope on this miracle receiver of modern radio—this inexpensive, easy-to-operate 1-tube set which does the work of receivers costing two and three times as much.

Then he takes you behind the scenes and shows you how different types of hyper-sensitive receivers are made. He gives away

professional engineering secrets of manufacture never before revealed to the amateur radio constructor!

He shows you how to build a radio frequency amplifier which you can add to your receiver to enormously increase its receiving range.

With 175 diagrams, drawings and action photographs each step in the construction of different types of receivers and amplifiers is unfolded for you with the graphic clearness of a talking-moving picture. Under the expert guidance of Mr. Harkness you will be able to build any or all of these sets. More . . .

Advanced Radio Made Easy for You

In this comprehensive book Mr. Harkness not only tells you how to banish interference from your receiver; he not only tells you how to build new and remarkable receivers—he also explains the whole theory of radio reception for you. In the first 8 chapters of his book, with scores and scores of illustrations, he leads you step by step from the elementary laws of electricity to the advanced principles of radio reception. His arguments are so skillfully worded; his explanations are so simple and understandable that you will quickly and easily learn advanced radio.

What This Book Means to YOU

When you read this book you will learn advanced radio. There's no question about it. It wasn't written for the other fellow—it was written for

YOU. It was written to show *you* how to banish interference from your receiver; to teach *you* the advanced principles of radio reception; to show *you* how to build luxurious modern receivers at low cost. After a few days with this book there won't be a thing that will stump you—not a question you can't answer. Those little breakdowns that happen every now and then, those mysterious whistles and scratches that destroy good reception—you will know how to avoid them. You will know how to make your set receive stations thousands of miles away!

SPECIAL 5-DAY EXAMINATION OFFER

You've always wanted a real, live, practical radio book like this. You can have it for the asking—without paying a cent in advance. In fact, we are so confident that you will be *delighted* with Mr. Harkness' book that we will send it to you for five days' examination and let you judge for yourself! Just fill in and mail the coupon below. Don't send any money—pay nothing until the book is actually in your hands. When the postman arrives deposit with him the full price of the book—only \$1.25 plus a few cents postage. Examine the book for 5 days. Read it from beginning to end. See for yourself how it expands your knowledge of radio. Learn all about the remarkable receivers Mr. Harkness describes. Find out all about the interference-banishing Harkness Coupler. If you are not absolutely satisfied, if you do not feel that the book is all that we claim and more—send it back and we will promptly refund your money. That's fair enough, isn't it? You take no risk—you have nothing to lose and everything to gain, so mail the coupon today and get your copy by return. Don't delay—you may forget or misplace this advertisement and thereby miss this unusual opportunity. Do it now, while you're thinking about it.

Do it now
**SEND NO MONEY
JUST MAIL THIS
COUPON**

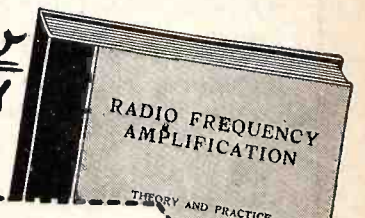

THE RADIO GUILD, INC.,
256 West 34th Street, New York, N. Y.

Please send me—immediately—the new Kenneth Harkness book "Radio Frequency Amplification" which will tell me how to banish interference from my receiver and which explains the theory and practice of radio in simple language. I will deposit \$1.25 plus a few cents postage with the postman. It is understood that if I am not absolutely satisfied I may return the book within 5 days after receipt for a prompt refund of my money.

Name.....
Full Address.....

(Orders from Canada and other countries outside U. S. are payable \$1.50 cash with order subject to same money back guarantee.)