

CHRISTMAS NUMBER

DECEMBER 9—15c.

1922

# RADIO (Trade Mark) WORLD

ILLUSTRATED

WEEKLY

This Is a Radio Christmas!



Santa Claus Tunes In Millions of American Homes!

Why Radio-Frequency  
Amplifies Signals

More Records by the  
DX Night-Owls

**There Is NO OTHER—**

WITH

**A large map, size 2 feet by 3 feet  
printed in two colors**

*showing location of every Broadcasting Station in  
United States and Canada; change of time area  
and location of each of the nine districts.*

THE

**THIRD EDITION**



ALL UNDER ONE COVER

An Official List of all Amateurs, Special Amateurs and  
Broadcasting Stations of

**UNITED STATES AND CANADA**

ALSO

How to Construct and Operate a Honeycomb Coil Set,  
Detector and Two Step Amplifier

**PRICE, \$1.00 COMPLETE**

(DO NOT SEND STAMPS)

Order from your dealer—If your dealer hasn't them, send direct.

**DEALERS WRITE FOR PROPOSITION**

**RADIO DIRECTORY & PUBLISHING CO.**

45-K VESEY STREET

NEW YORK, N. Y.

**STANDARD PARTS**

The Best Xmas Buy

Special Price for Month of December



Western Electric, illustrated..... \$8.50  
Federal, 2000 ohm..... 4.50  
Kellogg, 2400 ohm..... 7.00  
Auth..... 4.00

All in original sealed boxes. The efficient result depends on a good head-set.



Paragon Rheostat, for Panel or Table..... \$0.70  
Klosner, Vernier, Special Type for Detector.. .60

If you want good tuning and a long life for your tubes, select either rheostat above. Greatest satisfaction.

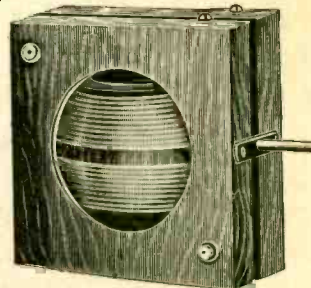

Large Size Variometer, illustrated, a Baldwin  
win..... \$3.25  
Queens Make, Coupler or Variometer..... 2.50

**RADIO MAP**

LATEST EDITION

Featuring:—District Divisions, Time Divisions  
and All U. S. and Canada Broadcasting Calls  
35 Cents

Above Map Given FREE  
with \$5.00 purchase until Xmas.

All sales prices in November issues of RADIO  
WORLD are good until Xmas. Postage must be  
included with order. Checks must include 10c.  
exchange and please have them certified. All  
goods are shipped P. P. insured.

**RADIO DISTRIBUTING &  
AUTO SUPPLY COMPANY**

64 West 66th Street, New York City  
Phone Columbus 8584

Broadway-7th Avenue Subway  
6th or 9th Avenue L.

**What Shall I Give HER For Christmas?**

*The biggest treat any woman of refinement, who is  
most particular about her appearance, can have is*

Les Etoils Skin Food.....	\$1.25
L - Arc - En - Ciel ideal cleanser .....	\$1.25
Kanti Face Powder (four shades) .....	\$1.50
Rouge Superlative .....	\$1.00
Jeunesse astringent .....	\$1.50
Marvelous wrinkle remover and cleanser.	
Amber Royal Perfume.....	\$4.00
Eye Lash Grower.....	\$1.00
	<b>\$11.50</b>

This entire assortment in  
beautiful Christmas Box will  
be delivered prepaid upon  
receipt of .....

**\$10**

**Mme. Anita Kanti's  
Christmas Beauty Box**

Mme. Kanti's wonderful preparations have been  
the favorite for years and used by the famous  
beauties of both Paris and New York.

Among Mme. Kanti's personal clients can be  
named the reigning stage and screen stars.

ABSOLUTE SATISFACTION GUARANTEED

Address

**MME. ANITA KANTI**

47 West 42nd Street, New York City

VOLUME TWO OF

# RADIO WORLD

[Entered as second-class matter, March 28, 1922, at the Post Office at New York, N. Y., under the act of March 3, 1879.]

A Weekly Journal, Published Every Wednesday and Dated Saturday, by Hennessy Radio Publications Corporation from Publication Office, 1493 Broadway, New York, N. Y. Telephone: Bryant 4796.

Vol. II, No. 11. Whole No. 37

December 9, 1922

15c. per copy, \$6.00 a year

## Radio Now Used in the United States Congress

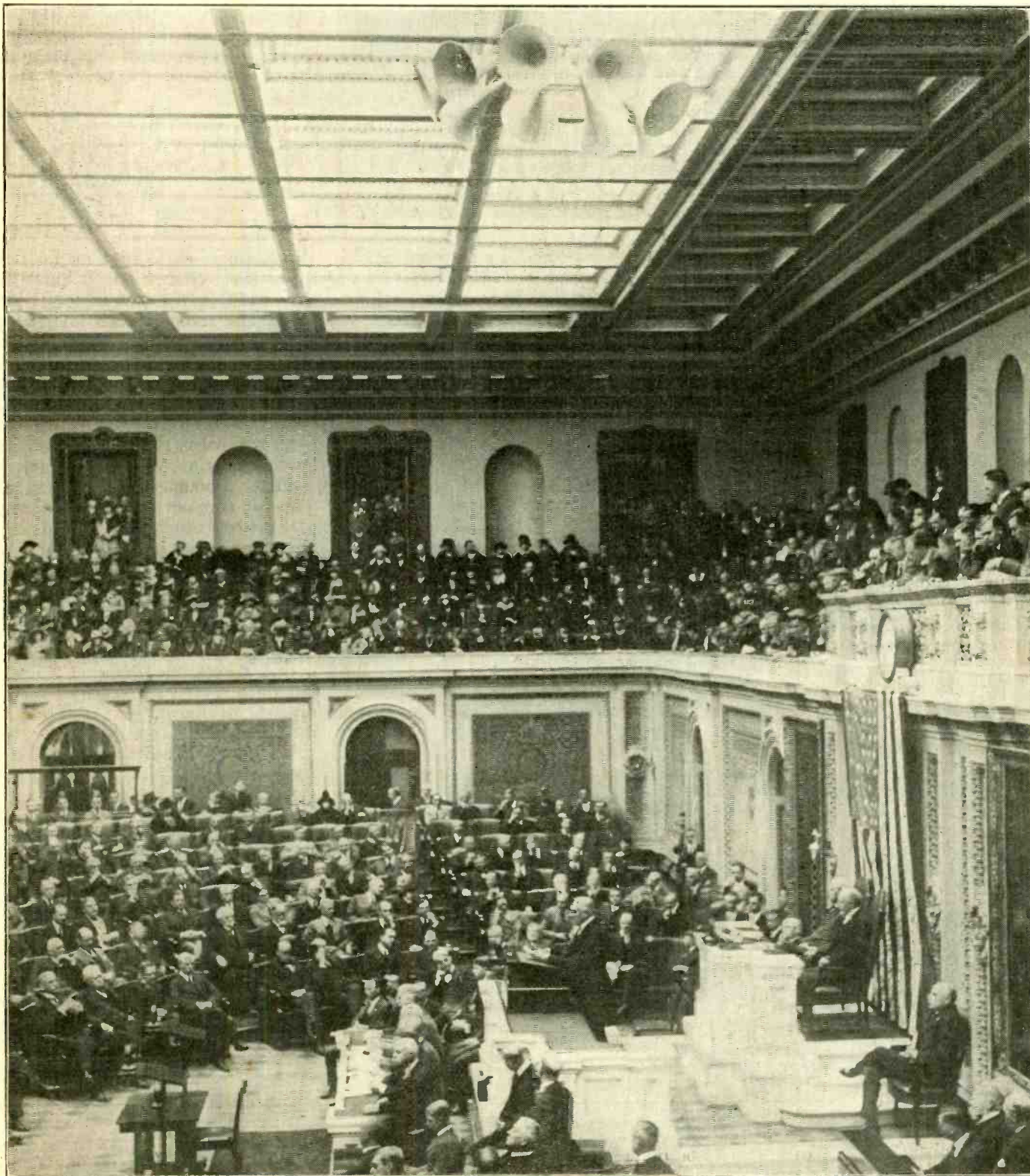

(C. International News Reel)

President Harding delivering his recent message to Congress. The bell-like apparatus suspended from the ceiling are microphones which catch his words for broadcasting. The square discs in front of the reporters are also microphones to catch their orders.

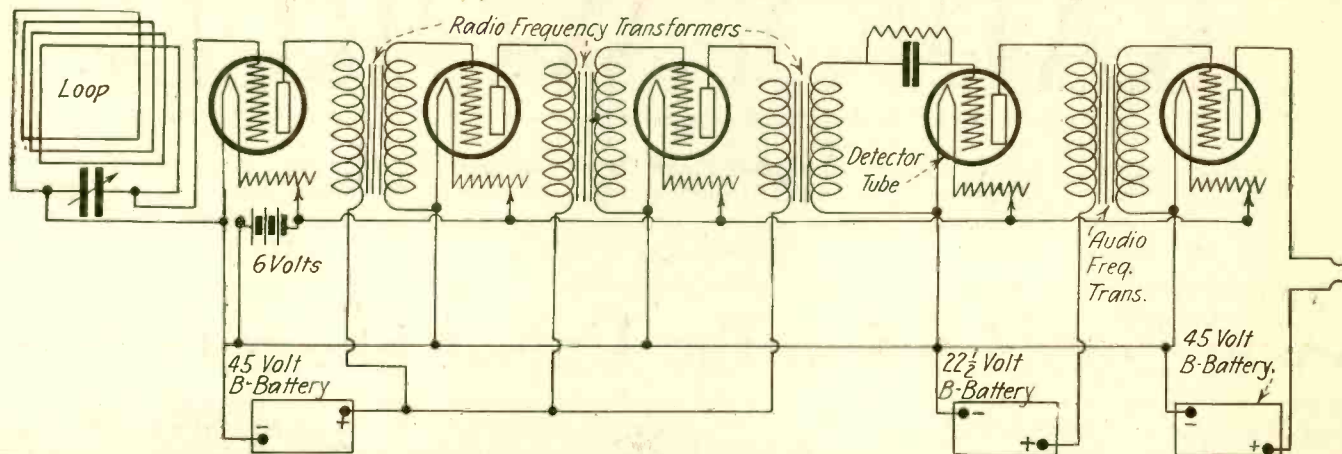

Figure 1—Schematic diagram of a five-tube radio-frequency receiver. The first three tubes and transformers are the radio-frequency amplifiers, the next tube is the detector, and the last tube is a one-stage of audio-frequency amplification. A loop aerial is used. Suggested by George W. May. Drawn by S. Newman.

# Why Radio-Frequency Amplifies Signals

By Donald Van Wyck

**R**ADIO-FREQUENCY amplifiers are attracting considerable attention. Radio fans who are unable to erect a satisfactory antenna may improve the strength of incoming concert music, or increase hearing range, by means of radio-frequency amplification, audio-frequency amplification, or a combination of both. In cases where the receiving station is near the transmitting station, the energy received is usually sufficient to reproduce sounds without radio-frequency amplification. When the receiving station is more remote, the signal must be built up, or amplified, before it passes through the detector and the stages of audio-amplification. If radio amplification is not used, audio-frequency amplification in such cases is frequently of little use. In the first place, the fundamental difference between radio-frequency and audio-frequency amplification is far from clear to many of the amateur operators of to-day. As the names imply, both instruments amplify the signals received from distant broadcasting stations; but they do it in a widely different manner. The audio-

frequency method, for instance, amplifies whatever the detector delivers to it and, therefore, increases the volume of sound in the head telephones. It is obvious that if a certain signal is too weak, by the time it reaches the receiving antenna to operate on the detector, no amount of audio-frequency amplification will make it audible in the head phones. Radio-frequency amplification, on the other hand, goes straight to the root of the trouble. The radio-frequency tubes precede the detector in the circuit and confine their work to the radio impulses in their original form. In accordance with the natural action of the vacuum tube, these impulses are successively strengthened by as many tubes as desired. When they are deemed sufficiently strong they are passed to the vacuum-tube detector for conversion into currents of audible frequency. Once audible sounds are produced, audio-frequency amplification may be relied on to obtain the desired volume.

The connection between the amplifying vacuum-tubes may be merely a wire or, possibly, a very high resistance; or it may be some form of a

transformer. The first method, that of a direct connection, is unsatisfactory and is never used in actual practice. The second is fair and has received more or less recognition. The third method of using transformers is the most satisfactory and is most generally used. The transformers may be of the air-core type or of the iron-core type, which has two independent coils known as primary and secondary, respectively, mounted on laminated legs. The iron-core amplifying transformers give the best results and, paradoxically, also give most trouble to the uninitiated.

The amount of iron in any transformer is dependent on the frequency of the current which is passed through the windings, and the higher the frequency the less the iron used. Since the iron must reverse its polarity with each reversal of the current, this indirect ratio may be explained easily.

With audio frequencies, such as are encountered in signals after they leave the detector, the design of the transformer is not difficult. But when it is remembered that the radio-frequency of a 200-meter wave runs into the millions of cycles per second, the complexity of the task which confronts the designer of radio-frequency amplifying transformers is realized at a glance.

The design of the radio-frequency amplifying transformer would not prove a thorn in the sides of the manufacturers if the commercial phase of the question could be side-stepped. It is not much of a problem to construct a transformer which will function very well in a narrow band of wave lengths; say from 200 to 300 meters. But such a device would not meet the sanction of most amateurs because they do not wish to be put to the task of changing transformers for the various wave lengths. Beware of all-wave radio-

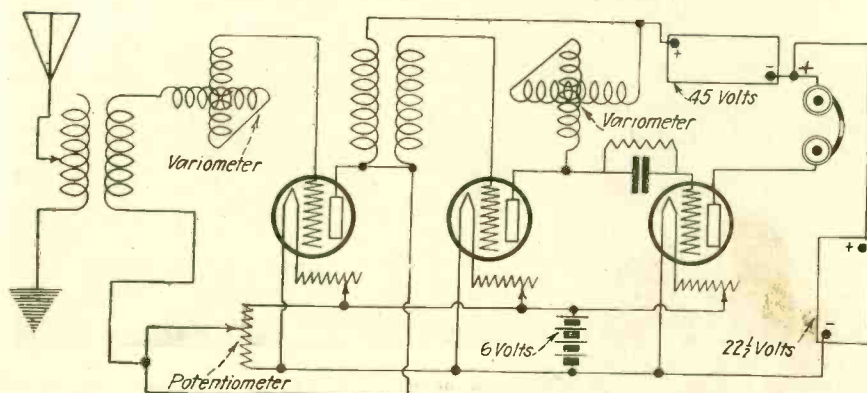

Figure 2—Another schematic sketch of a radio-frequency receiver. This diagram shows two radio-frequency tubes and one detector-tube in operation. This circuit should produce unusual results on DX work. Suggested by George W. May. Drawn by S. Newman.

# Capacitively Coupled Receiver for DX Work

By Arthur O. Curtis

**C**APACITIVELY coupled circuits are those in which condensers are used to connect primary and secondary circuits. By varying their values, a set may be placed in tune with a transmitting station. This type of coupling is said to be electrostatic, since condensers function only by reason of their electrostatic field. A simple circuit shown accompanies this article. This diagram, when used with such a receiver, will operate successfully on short waves. It is seen that the primary circuit is essentially a parallel resonant circuit, as distinguished from the series of resonant circuits that are common to the direct and inductively coupled

circuits. Sharp tuning is accomplished more successfully with this type coupled affair than with any other, and it is somewhat more efficient than other types. Adjustments may be said to be more critical and, generally, there are more adjustments to be made with this type set than with any other. The

three variable condensers C, C1, and C2 are of .0005 micro-farad capacity. L1 is the primary inductance coil and L2 is the secondary inductance coil. The tuning is controlled by C2, while C and C1 act as the coupling control. The primary (which is L) consists of forty turns of No. 24 cotton-covered wire wound on a tube 3½ inches in diameter. L1 has 30 turns of No. 22 cotton-covered magnet wire wound on a tube 3½ inches in diameter. The coils, when in operation, should be placed at least four inches apart. The degree of coupling is determined by the amount of capacity of C and C1. Broad tuning can be had by increasing the capacity. Small capacity affords sharper tuning and minimizes interferences. The secondary coil in the detector circuit is of standard type and is used to obtain satisfactory results. Changing the capacity settings for these coupling condensers does not change the resonant frequency of the circuit, but merely changes the amount of energy transmitted from the primary to the secondary through the condensers.

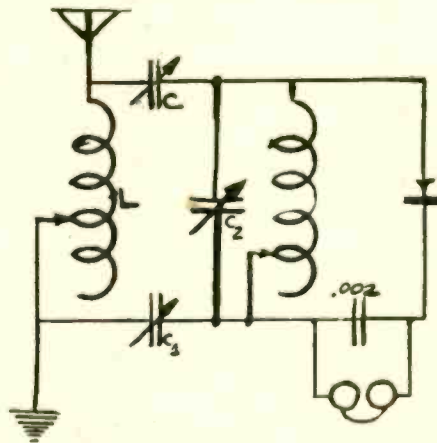

Condensers may be used to a great advantage by employing a capacitively coupled receiver. The above schematic diagram shows such a circuit. The condensers act in this circuit as a coupling between the two coils. Drawn by Arthur O. Curtis.

(Continued from preceding page) frequency transformers. They will not function. Several schemes have been tried for circumventing the natural limitations of the radio-frequency transformer. One has the division of the windings in sections with suitable taps brought to the surface. By means of either binding posts, or a movable contact-arm, the transformer is tuned to the particular band of wave lengths to be received, and, therefore, the loss incident to using a transformer designed for one frequency on a vastly different one is partially avoided. The other scheme provides a series of transformer units to be plugged in and out in accordance with the tuning.

The most common radio-frequency transformer on market resembles the audio-frequency type and is designed to function on a band of wave lengths from 200 meters to 450 meters.

Accompanying this article are two schematic diagrams of practical radio-frequency circuits which consist of three stages of radio-frequency and detector; also, one stage of audio amplification. For the antenna with this particular set, I used the loop aerial as explained by me in RADIO WORLD, No. 33, dated November 11. The loop aerial (Figure 1) gives the marked advantage of eliminating interference and practically makes a directive antenna a compass loop. The loop aerial will function satisfactorily if used with this three-stage amplifier. Figure 2 shows a two-stage amplifier of the radio-frequency type with vacuum-tube detector. Any one contemplating the building of this set will find that it works far better than some others.

## Take Care of Your Storage Battery



(C. Kadel & Herbert, N. Y.)

The storage battery—these cells of electrical energy are of vast importance. Most of the receiving outfits, t-day, using vacuum tubes need such a storage battery. The storage battery is rather a delicate affair, even if it does weigh a lot. Care must be taken that it does not deteriorate quickly. With good care a battery for radio work should last several years. The above photograph shows how to keep a battery clean. A clean battery will prevent short circuits.

# The Aerial Press of America

By Washington R. Service

**P**ERHAPS, at last, there is something new under the sun. Whoever thought of an aerial newspaper before a few pioneer mentors of public opinion began broadcasting their news items that all who "listened in" might hear—free?

Among 582 radio stations broadcasting in the United States, today, there are 83 representing publications—most of them daily newspapers. Nine of these etherial news sheets are super, or Class B, stations especially licensed to broadcast on a 400-meter wave. All told, these news broadcasts of the air reach millions who do not subscribe to the publications but who are most enthusiastic aerial "hearers" none the less loyal to their favorite papers because they are unknown to the editors. There is an "Aerial Press of America" even though there are no aerial subscription lists and no advertising accounts.

It is certainly something new, this broadcasting of the news and sports of the world, gratis. It is a service highly valued by the hearers. Many predict that it has come to stay. Some Canadian newspapers have also taken up the scheme of news broadcasting, as well as publications in Porto Rico and Hawaii.

George Schubel, secretary of the Radio Broadcasting Society of

America, a publisher, has made a study of aerial news distributing, with the result that he advocates the broadcasting of news matter by publishers. Paralleling the printed news, he claims, broadcasted news serves both national and local fields and provides for a versatility of free expression of public opinion. Radio can be used in the gathering of news as well as in its dissemination, especially in country districts, and tends to broaden the scope and circulation of a newspaper. There are several known instances where radio carried daily news reports when other lines of communication failed, and, in some instances, amateurs aided. An SOS story has been covered by wireless and aid rendered by means of radio as well on land as at sea. Instances where the wires and regular channels were beaten are recorded.

Government weather, crop and market reports are now carried by radio in advance of press releases. The only way by which a newspaper can hope to compete is through the same medium.

"Why give away material?" may be asked. This is answered by citing the case of the Boston "American's" experiments in broadcasting bulletins from its news before they were printed. The news is transmitted from WGI,

Medford Hillside, and the service to thousands is reported to have brought most valuable publicity to the Boston sheet. All who listen in to brief news items want to know more of the details and, naturally, purchase a copy of the "mother" sheet as soon as it is available. Out of over eighty papers licensed to broadcast, only about half a dozen have stopped this service. A few have combined with other organizations in the use of a single broadcasting-station.

The following United States newspapers operate broadcasting services:

KDYU—"Herald," Klamath Falls, Oregon.

KDYX—"Star-Bulletin," Honolulu, Hawaii.

KDZA—"Daily Star," Tucson, Arizona.

KDZH—"Evening Herald," Fresno, California.

KDZR—Bellingham Publishing Company, Bellingham, Washington.

KFAC—"Daily Press," Glendale, California.

KGW—Oregonian Publishing Company, Portland, Oregon.

KLX—"The Tribune," Oakland, California.

KSD—"Post-Dispatch," St. Louis, California.

KUO—"The Examiner," San Francisco, California.

KWH—"The Examiner," Los Angeles, California.

KXD—"The Herald," Modesto, California.

KZN—"Salt Lake Deseret News," Salt Lake City, Utah.

WAAF—Chicago Daily Drivers Journal, Chicago.

WAAL—"Tribune," Minneapolis.

WBAD—"Journal," Minneapolis.

WBAD—"Star-Telegram," Fort Worth, Texas.

WBAU—"The Republican," Hamilton, Ohio.

WCAB—"The News," Newburgh, New York.

WCAG—"The States," New Orleans, Louisiana.

WCAW—"The Herald," Quincy, Massachusetts.

WCX—"Free Press," Detroit, Michigan.

WDAE—"The Times," Tampa, Florida.

WDAF—"Kansas City Star," Kansas City, Missouri.

WDAK—"The Courant," Hartford, Connecticut.

WDAL—"Times-Union," Jacksonville, Florida.

WDAV—"Muskogee Daily Phoenix," Phoenix, Arizona.

WEAR—"Baltimore American," Baltimore, Maryland.

WFL—"The Chronicle," Houston, Texas.

WFAM—"The Times," St. Cloud, Minnesota.

WFAT—"Sioux Falls Daily," Sioux Falls, South Dakota.

WFAW—"Daily Metropolis," Miami, Florida.

WGAR—"Fort Smith American," Fort Smith, Arkansas.

WGAZ—"The Tribune," South Bend, Indiana.

(Continued on the following page)

## The Latest Vamp!

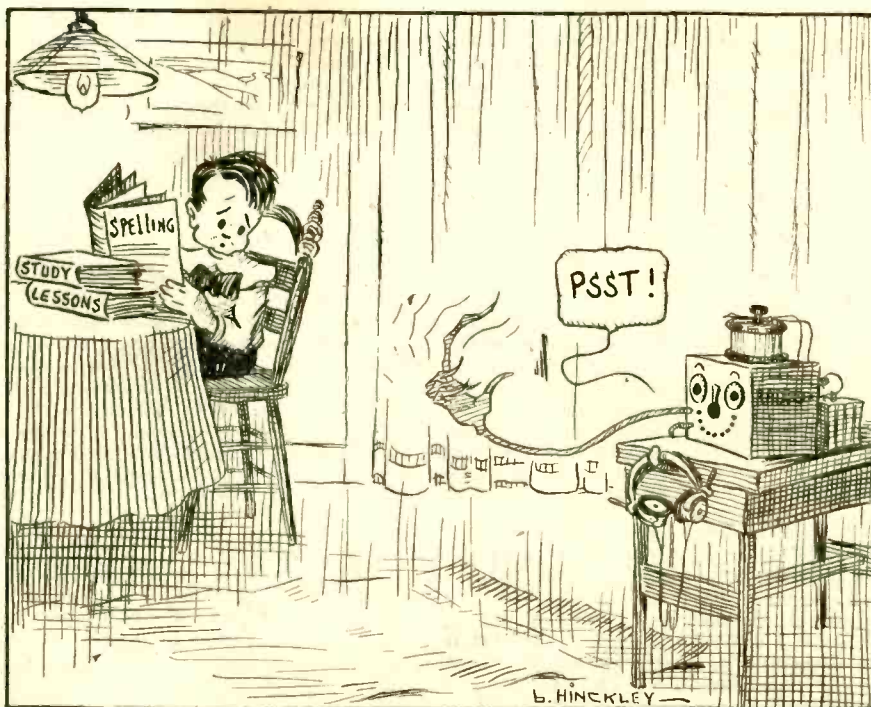

(Cartoon by Lawrence B. Hinckley)

# How to Prepare Hard Sheet-Rubber for Your Radio Apparatus

By *W. S. Standiford*

**T**HE experimenter in all kinds of electrical apparatus finds it necessary to cut hard sheet-rubber into round discs for making Wimshurst machines, or for parts of wireless-telegraph and telephone sets now used extensively. The amateur radio-telephone-maker uses wood for his panels and large diameter cardboard tubes for his vario-coupler, tuner and other parts.

While wood may be used for a panel, it is not nearly as effective as hard

rubber. Factory-made appliances are constructed of the latter or of an insulator equally as good. Cardboard is a fragile substance and does not give continuous service as a vario-coupler. On account of hard rubber, in its dry state, being difficult to cut and bend into cylinders for radio parts, amateurs use wood and cardboard. The writer, after some experimenting, found an easy way to cut and bend hard sheet-rubber 5/16 inch thick. Mark an outline on the place to be

cut, using a scribe or knife. Then plunge the sheet into very hot water until it is of the pliability of leather. Cut along the mark with scissors, or tinsmiths snips, according to the thickness of the material. As it becomes cooler it will be more difficult to cut. If any further cutting is to be done, place the sheet-rubber in hot water again and continue as I have described. Next place a sheet of glass on a newspaper on your work-table. Dip the rubber in hot water again, place it on the glass, put another sheet of glass on top of the rubber and weight it down. When cold, the piece will be found to be straight, the cutting having thrown it out of shape.

To bend the hard sheet-rubber into cylinders for tuning coils and other parts, make a wooden mandrel of the desired diameter, measure its surface with a tape measure, and cut the material the desired length. Heat the rubber in hot water. Place two wooden blocks on a smooth surface sufficiently far apart to be even with the edges of the rubber to be bent. Put the hot sheet in position on the blocks and press down the mandrel on its center, gradually curling it into cylindrical shape to fit the mandrel. With thick plates, reheating them several times may be necessary to produce the desired shape. When cold, fill the crack between the two edges with automobile-tire cement. There is a rubber putty-composition for mending tire cuts which is excellent for joining edges. It is best to tie the cylinder tight, with string, until either the cement, or putty, has set.

Polishing hard rubber is a poser for electrical experimenters, as they do not understand how to make the edges of the sheets as smooth as their sides. Therefore, they generally smooth the edges with a file and let it go at that. This mars the appearance of the instruments. By the following process an even polish will result: Fasten a piece of fine-grained sandpaper to the top of your work-table and run the piece of rubber across the sandpaper in a series of smooth strokes, taking care to keep the grain straight. Continue this operation on a second sheet of the finest sandpaper that can be obtained. Wipe off all dust and give the edge a coat of shellac in order to fill the pores. When dry, rub with a piece of felt tacked to a wooden block—the felt to be dampened with oil and FF grade of powdered pumice-stone as an abrasive.

(Continued from preceding page)

WGF—"Register and Tribune," Des Moines, Iowa.

WHN—"Ridgewood Times," Ridgewood, Long Island, New York.

WOZ—"The Palladium," Richmond, Indiana.

WPA—"The Record," Forth Worth, Texas.

WSB—"The Journal," Atlanta, Georgia.

WWB—"Daily News," Canton, Ohio.

WWJ—"The News," Detroit, Michigan.

KFAP—"Standard," Butte, Montana.

WHAS—"Courier Journal and Times," Louisville, Kentucky.

WHAT—"Democrat," Yale, Oklahoma.

WHAY—"The Press," Huntington, Indiana.

WIAC—"The Tribune," Galveston, Texas.

WIAK—Journal-Stockmen Company, Omaha, Nebraska.

WIAN—"Chronicle and News," Allentown, Pennsylvania.

WIAQ—"The Chronicle," Marion, Indiana.

WIAS—"The Hawkeye," Burlington, Iowa.

WJAF—"The Press," Munsey, Indiana.

WJAG—"Daily News," Norfolk, Nebraska.

WKAA—"Republican-Times," Cedar Rapids, Michigan.

WKAC—"The Star," Lincoln, Nebraska.

WJAN—"Peoria Star," Peoria, Illinois.

WJAQ—"Capper Publications," Topeka, Kansas.

WKAK—"Okfuskee County News," Okemah, Oklahoma.

WKAM—"Daily Tribune," Hastings, Nebraska.

WKAT—"Morning Times," Frankfort, Indiana.

WMAJ—"Kansas Drivers Telegram," Kansas, Missouri.

WMAQ—"Daily News," Chicago.

WNAB—"Park City Daily News," Boiling Green, Kentucky.

WRAU—"Daily News," Amarillo, Texas.

KFBS—"Chronicle News," Trinidad, Colorado.

WGM—"Constitution," Atlanta, Georgia.

WNAS—"The Statesman," Austin, Texas.

WHAL—"Capitol News," Lansing, Michigan.

KHJ—"Times-Mirror," Los Angeles, California.

KYI—"Bakersfield-Californian," Bakersfield, California.

WFAA—"Dallas News," Dallas, Texas.

KVQ—"The Bee," Sacramento, California.

There are students of the problem who believe that press broadcasting stations should handle all news, since the news is really owned by members of the press and is received, first, by them; besides which, the publishers know how to handle the news better than any other agency. Newspapers, usually in the lead of progressive developments, are apt to find it necessary to follow the lead of the aerial pioneers and, in future, carry radio-news bulletins for their clients. Radio is a household contact with the world.

Of the newspaper broadcasters, nine have secured the Class B license permitting them to broadcast on 400-meter wave; they follow: Atlanta "Journal," Atlanta "Constitution," Dallas "News," Detroit "News," Detroit "Free Press," St. Louis "Post-Dispatch," Kansas City "Star," Fort Worth "Star-Telegram," and Los Angeles "Times-Mirror."

The Seattle "Post Intelligencer" now uses the broadcasting station KFC; the Philadelphia "Record" broadcasts through WCAU; "The Ensenada News," Yauco, Porto Rico, uses WGAD; the Indianapolis "Star's" news is released through WOH; the Tacoma "Times" co-operates with KMO; the "Oklahoman" "speaks" its news over station WKY; the Boston "American" uses WGI, and the Memphis "News-Scimitar" announces over WPO. In Canada, two news broadcasters are the Toronto "Daily Star," operating CFCA, and the Winnipeg "Tribune," CJNC.

Among other daily papers said to be planning to use news broadcasting are "The Courier," Grant's Pass, Oregon; "The Gazette," Billings, Montana; "Raleigh Register," Beckley, West Virginia; "Daily Telegram," Adrian, Michigan; "News Herald," Litchfield, Illinois, and the "Pilot," San Pedro, California.

# The Radio Primer

For Thousands of Beginners Who  
Are Coming into Radio Circles

## Weekly A B C of Radio Facts and Principles Fully and Tersely Explained

By Lynn Brooks

**H**OW are electrons moved about? The chemical action of electrons we have described, although it is not called by that name. You light a cigarette—chemical action changes the tobacco into smoke. An apple decays—chemical action has caused this change. Light a fire—chemical action creates the heat. So it has been found that, under certain conditions, chemical action will feed electrons on one hand and destroy them on the other.

\* \* \*

*How can chemical action be started?*

Fill a glass jar with an acid. Put into this acid a piece of copper and a piece of zinc, allowing both copper and zinc to stick out of the acid. We have made then what is called a voltaic cell. Usually we just call it a cell. A group of cells together is called a battery. The accompanying sketch shows what we have done. Chemical action will remove electrons from the copper and give electrons to the zinc, so that B has more than the usual number of electrons and A has less than its usual number. B is called the negative terminal; A the positive terminal. Connect A and B by a wire and the electrons will flow through a wire from B to A. They will flow continuously because the chemical action keeps the zinc supplied with them. Connect the two terminals by a wire and show the direction in which the electrons flow and the direction of the current.

\* \* \*

*Now that we have electrons flowing, what have we accomplished?*

We have produced all the conditions necessary for an electric current. An electric current will result if we keep a voltage between two terminals, as with the voltaic cell, and connect these terminals by a conductor. To study electricity further, we must study the electric current.

\* \* \*

*What makes a current?*

A flow of electrons makes a current. If we measure the number of electrons flowing, we must state a definite time in which to count them. The definite time is a second. Then, also, we must confine our

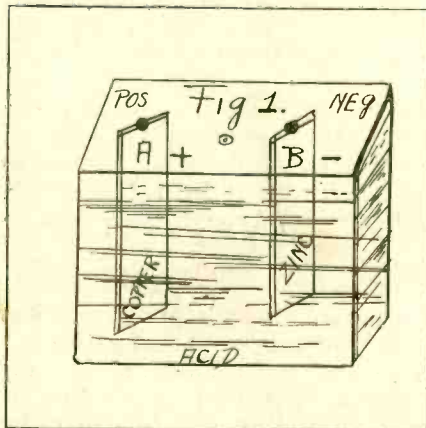

Figure 1—Showing the battery where chemical action takes place to produce electricity.

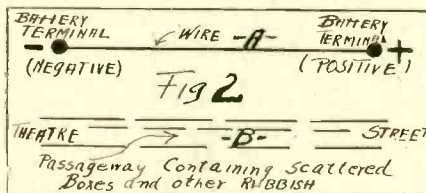

Figure 2—Showing how the electrons travel from the negative to the positive terminals.

measurement to one place in the path of electrons so that we measure current by counting the number of electrons which pass a given point in a second of time.

\* \* \*

*What is unity of measurement?*

The unit of measurement of electric current is the ampere, just as the measurement of weight is the pound. We say that an object weighs 13 pounds. In the same ratio, we say that a wire carries a current of 15 amperes. Thus you see an ampere means a definite number of electrons passing a point in a second of time. There is an instrument known as an ammeter. It is used to measure the number of amperes. In electricity you will find the word "meter" affixed to various words.

\* \* \*

*How can we secure as many amperes as we want? In other words, how can we control the number of electrons passing a given point in a second?*

In Figure 2, electrons are shown trying to journey from the negative to the positive terminal. They act like a crowd of people trying to rush out of a building the entrance to which is blocked.

## Radio Facts

By Charles H. Plath

**O**NE thing we must guard against in radio-receiving sets is dust and dampness. The set should be kept, preferably, in a dry room, otherwise moisture will gather in the interior of the works and, probably, form contacts which may lead to the short circuit of the set or give leakage of current. The B batteries should be kept in a dry place, preferably a box, otherwise they will get weak and become "dead." A handy thing around a station is a small long-handled brush. This is used to keep the dust away from switches and parts. Care should be taken to keep the switches and condenser terminals clean, also any other place where dust may collect. It would be a good scheme to clean and dust the set once an evening. This would prevent the dust from collecting in quantity, thereby preventing any leakage to the set. Care and attention should be given to the set as it is delicate. If this is accomplished the set will function.

\* \* \*

**A**NTEENNA insulators should be kept in good condition and wiped off occasionally; because they collect a certain amount of dirt and carbon, especially when near any smokestacks. A film of carbon or dirt over the surface of the antenna insulator will cause leakage and an improperly poor-range set will be the answer. Sometimes other developments happen in the aerial, so it is best to be certain that the aerial is well insulated from the lead-in to the set. The lead-in may be touching some metal near the house, or in the room where it connects with the instruments.

\* \* \*

**W**HEN a dry cell is run down a very good way to get some extra life out of the battery is to work as follows: Remove the wrapper from the cell and place it in a can 5 or 6 inches high and about an inch wider in diameter than the cell. Fill the can with vinegar and a little salt. The salt should be shaken into the can and stirred well. Let this mixture stand overnight. Next morning, on inspecting the old battery, you will find that it has as much pep as if it were a new one. The battery should be left in this solution until it becomes exhausted. It has given many hours of life beyond the period when it was thought "dead" by the amateur. This is quite an experiment, and every radioman who uses dry cells should give it a trial and watch the results. The scheme comes in handy when in a pinch for some voltage.



# Some of the Leading Daily-Newspaper Radio Editors of the United States



(Reading from left to right) Top Row—Raymond Francis Yates, "The Mail," New York City; S. F. Owen, "The Atlanta Journal," Atlanta, Georgia; Everett A. Rudloff, "Asbury Park Press," Asbury Park, New Jersey, Second Row—G. C. Condon, Jr., "The Atlanta Constitution," Atlanta, Georgia; Frank J. Moles, "The Gazette," Schenectady, New York; Raymond C. E. Pryde, "The Enquirer," Buffalo, New York; E. L. Bragdon, "The Globe," New York City; John H. Clymer "Jacksonville Journal," Jacksonville, Florida.

Directly under Mr. Clymer's photograph—Jack Binns, "The Tribune," New York City.

Bottom Row—Charles D. Kelley, editor and supervisor Detroit "News" Broadcasting Department, Detroit, Michigan; John E. Hersam, "New Canaan Advertiser," New Canaan, Connecticut; Arthur F. Hardwick, "The Republican," Springfield, Massachusetts; Jack Turner, "The Age-Herald," Birmingham, Alabama; Miss Marion Stowe, "Hartford Times," Hartford, Connecticut.

# Receiving and Denoting Direction of Radio Signals with a Coil of Wire

By S. R. Winters



A fine photograph of a "loop," or "coil," antenna, or vertical conductor of electricity. The antenna is shown in place with a complete receiving-set. When supported by a six-stage amplifier, signals are received from France and Germany.

**W**HEN one or more turns of wire form a square, or rectangular frame it constitutes a coil. A rope, not in use, when forming a series of rings, or a snake gathering itself preparatory to springing toward an object, are common illustrations of a coil. Speaking in electrical terms, however, copper wire wound around a wooden frame—the strands of which wire are spaced one-half of an inch, or one inch, apart—constitutes an antenna for the reception of wireless communications. The "coil," or "loop," antenna and the "overhead," or vertical conductor of electricity are well-nigh household terms emblazoned on the crest of popularity of radiotelephone broadcasting.

#### Experiments That Lead to Success

A coil of wire as an electrical inductance, other than being the most compact form of antenna, is as versatile as the proverbial Jack-of-all-trades. It may be enclosed completely in a suit-case—or, when rigged-up in a wilderness for the reception of wireless signals, it may determine the direction of the transmitting station from which the communications are coming in. The photograph illustrates a portable radio-direction finder employed by the United States. The coil of wire, forming an antenna, is mounted on a vertical axis on which the frame supporting the strands of wire may revolve freely. Meanwhile, as the coil is rotated about its axis,

a curve is plotted indicating the variations in the strength of the electric current received for the electromagnetic wave approaching from a particular direction. The coil of wire, when employed in this capacity, may be dubbed correctly a direction finder or radio compass.

The electron-tube amplifier, with its score of other triumphs, has been a boon in the use of coils of wire as antennae. In the absence of substantial amplification of the feeble electric-current received in the coil antenna, the few turns of wire on a square wooden frame would be as powerless to produce audible signals as a pyramid. The Radiocommunication Section of the Bureau of Standards, United States Department of Commerce, has conducted extensive experiments with strands of wire wound about a frame as an antenna, and recommends the use of six stages of amplification for satisfactory results. However, with two stages of audio-frequency amplification, wireless signals may be received from nearby stations.

#### Versatility of the Coil Antenna

If supported by six stages of amplifications, a coil antenna located in Washington, D. C., may record wireless signals from the high-power radiotelegraph stations in France and Germany. An exceptional instance of the capacity of a coil antenna is noted where all the big European stations were received in France by use of a frame containing 200 turns of wire, only eighteen centimeters square. The radiotelegraph signals emanating from the high-power station of the United States Navy Department at Annapolis or Greenbury Point, Maryland, have been recorded in Paris, France, by the use of a coil only ten inches in diameter. The versatility of the coil antenna is suggested by the development of a complete radiotelephone receiving set in an ordinary suit-case with the form of antenna snugly encased in the covers of the traveling bag. It was developed by the Bureau of Standards, the coil antenna and half a dozen audion bulbs encased in a container only 7 by 11 by 18 inches in dimensions.

The coil antenna, other than serving as a direction-finder afield, lends itself to use in locating the direction of wireless signals when installed on seafaring vessels. A system of radio direction-finding for navigation purposes in fog and thick weather has been developed by F. A. Kolster, formerly in the service of the federal government, and F. W. Dunmore, of the Bureau of Standards. The striking directional characteristics of the coil antenna suggest its fitting application on radio-equipped airplanes, especially when flying is to be done in foggy weather or at night. Such a form of antenna is of a discriminating caliber. Its directional tendencies are such that strong signals may be recorded from a particular point of the compass and feeble wireless signals from other directions. Thus, by capitalizing the directional qualities of the coil antenna, interference from transmitting stations whose offerings are not desired, may be curtailed.

Radio amateurs have reported their experiences receiving signals by use of a sensitive receiving-set even when their antennae were altogether discontinued. This phenomenon is explained by the fact that the wiring of the radiotelephone receiving outfit assumed the form of a coil antenna.

## New Chief of Radio Corporation Chosen from United States Army

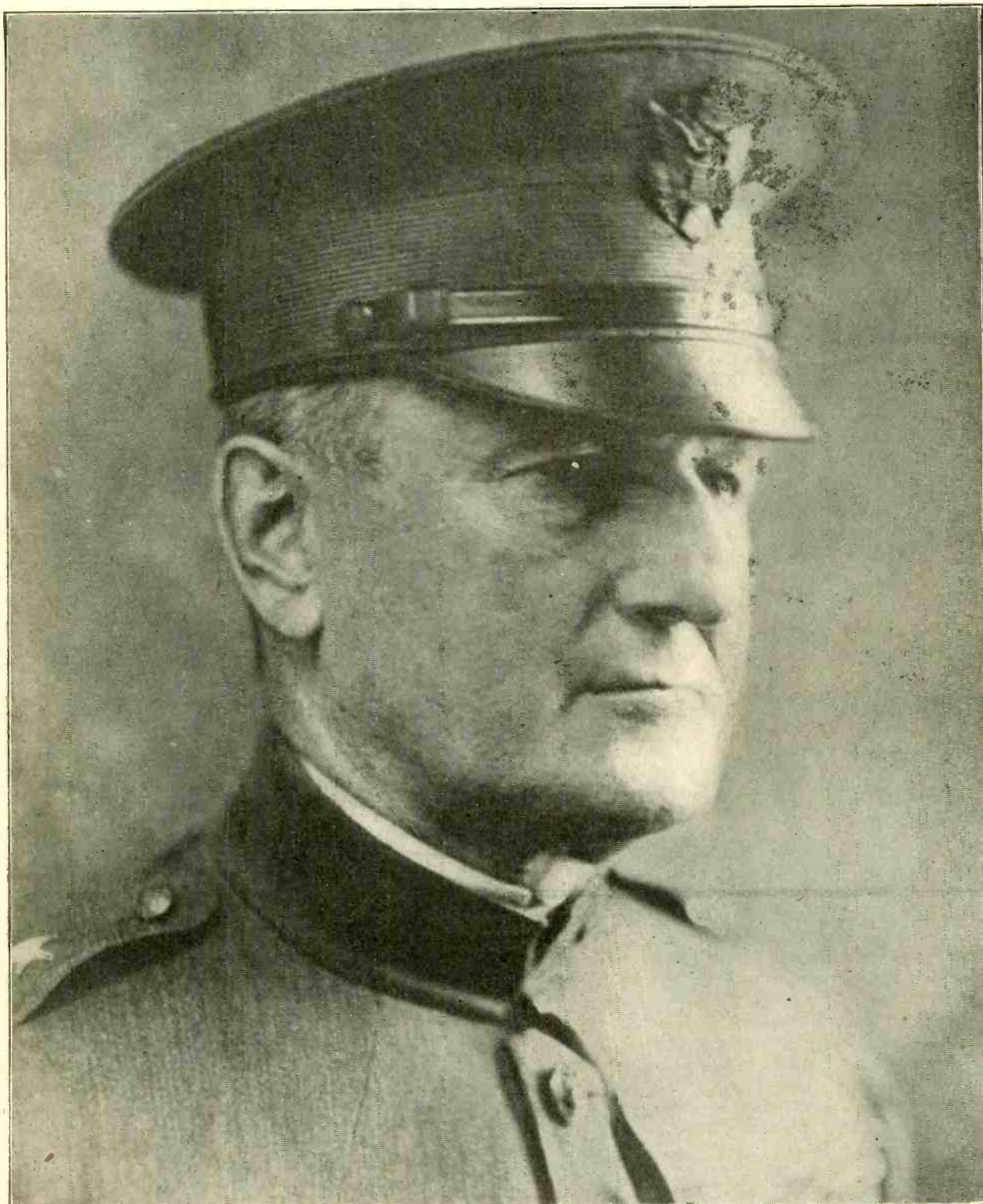

(Courtesy of Radio Corporation of America)

### Major-General John C. Harbord, U. S. A.

**MAJOR-GENERAL JOHN C. HARBORD**, one of the distinguished officers of the United States Army, ranking only below General Pershing, as Deputy Chief of Staff, will retire, on December 28, to become president of the Radio Corporation of America. The Secretary of War approved his application for retirement. Both Mr. Weeks and General Pershing stated publicly that General Harbord had served in the Army in a highly distinguished and loyal manner, and that his unusual experience as an organizer and executive would insure his success in the business world. The post for which General Harbord has been chosen is regarded of vital importance to the Government as well as the public, since the Radio Corporation of America was formed at the suggestion of representatives of the United States Navy in order that powerful world-wide radio communication, free from foreign domination, might be built up.

# Radiograms

## The Latest Christmas Radio News Briefly Told for the Growing Army of Radio Fans

**T**HE plan, recently adopted by the police of the country of broadcasting fingerprints of captured criminals to ascertain if they are wanted elsewhere, resulted in the return to New York from Los Angeles of Harold J. Burns, of New York City. Burns, who is said to have used the alias "Darcey," is wanted here in connection with an alleged homicide and two burglaries. He jumped a bail bond of \$12,500 to avoid standing trial on the former charge. The broadcasting of his fingerprints and his apprehension chalk up a new record for radio as a crime deterrent.

\* \* \*

An epidemic of influenza occurred among the officers and crew of the American steamer, "President Roosevelt." The chief officer of the vessel and the purser were among those ill. Supplies of brandy were ordered by radio for the invalids. These were sent on board on the arrival of the steamer at Plymouth and quickly administered. The Volstead act may mean one thing, but radio is ever ready in time of need not only to uphold American liberty, but to protect the sick and forestall epidemics.

\* \* \*

Reports from Croydon, Surrey, England, that a radio engineer had heard parts of the musical concert broadcast from WJZ, of the Westinghouse Electric Company, proved the success of an experiment they were making in increased power. J. H.

Ridley, of Croydon, said he heard the WJZ call and then the strains of a familiar overture. He stated the time was 1.15 o'clock Monday morning, November 27 (8.15 o'clock Sunday night, New York time). Westinghouse radio engineers said they had doubled the power of the broadcasting plant two weeks ago and that on Sunday night atmospheric conditions were at best.

\* \* \*

A system of pilotless airplane control in France has passed a two-day test satisfactorily, according to experts who supervised the trials with a 300 horse-power passenger carrying government biplane that flew over Etampes aviation field. The plane, going aloft with no one aboard, responded to control by radio from the ground, performed all the customary evolutions, and then landed safely. During the tests the machine was frequently lost from sight in haze and clouds, but it was always under radio control.

\* \* \*

Construction of a huge radio transmitting and receiving station in Miami, Florida, for handling South American, Central American and West Indian business to be relayed direct to New York, will be undertaken by the Tropical Radio Telegraph Company, of Boston, a subsidiary of the United Fruit Company, it was announced by George S. Davis, general manager of the radio company. The towers of the sending station will be 437 feet high, higher than any in America, except those at the Arlington Naval Station.

\* \* \*

The Capitol Theatre, New York, musical program, broadcast direct from the theatre, proved another big radio success. This radio-engineering feat, by the American Telephone & Telegraph Company, was accomplished by means of a highly sensitized microphone suspended twenty feet from the roof and thirty feet from the stage. The sounds of the music were caught by the amplifiers and then carried over specially equalized telephone wires to station WEAJ and broadcast from there. This is the first time in radio and musical history that symphonic music by a large orchestra was broadcast direct from the theatre during a performance. It is estimated that over 600,000 radio sets caught the concert, reaching a probable audience of over a million persons. Telegrams and letters from stations reporting the success of the concert were received from points in Ohio, Michigan, Minnesota, Nebraska, Ontario, Toronto, the New England States, Kentucky, Virginia, Georgia, and one thousand miles out at sea.

\* \* \*

The great improvement in the power, clarity, and brilliancy of WJZ, Newark, New Jersey, has startled many who have been accustomed to receive this station at the full power of their sets. Listeners in have been compelled to reduce their amplification materially to prevent the signals from being intolerably loud. The explanation of this improvement is that WJZ has a new transmitter. Though the old one was generally regarded as one of the finest in the country, recent developments by the Westinghouse engineers rendered it obsolete, and that it was removed and a new one, up to date in every respect, installed in its place. This new transmitter is rated at double the power of its predecessor. It has 1,000 watts and is greatly superior in the details of its transmitting, modulating, and generating system. It is about three times more effective than the old transmitter. While listeners with electron-tube receivers all over the country have been quick to notice the change, it has been especially pleasing to local owners of either crystal detectors or loud speakers, who are now able to get highly satisfactory results from their instruments.

\* \* \*

Millions have enjoyed the Chicago operas, broadcast by radio. A large audience in and around New York listened to the music of "Aida," played in Chicago and broadcast on the 400-meter wave length of station KYW. The voice of Rosa Raisa was heard as clearly in New York as in the Middle West. Since the opening of Chicago's opera season the radio audiences have heard "Carmen," with Mary Garden singing the leading role, "La Boheme" and "Parsifal." Two operas will be broadcast each week from 8 p. m. to 11 p. m., central standard time.

## For the First Time Santa Claus is Delayed



(Cartoon by Harry B. Stilman)

Santa Claus:—How do they expect me to make my rounds with this radio music to detain me,

**Be a National Radio Week Booster**

# Radio and the Woman

## Crystal D. Tector Sends a Goodly Radio Measure of Christmas Cheer and Some Pertinent Advice

**D**URING the past few weeks, I have received an unusual number of technical questions to answer—and, singular as it may seem, all but a very few sent to me by men. If I should attempt to answer so many questions in my department, I wouldn't have space for half the necessary replies; so I have turned over all these communications to the technical editor of RADIO WORLD and he will answer them in the regular department, "Answers to Readers," from week to week. I deeply appreciate the confidence that so many men place in my ability to help them; but, and I am sure they will agree with me, I have so much else to write about that devoting my allotted space to answers of a technical nature would deprive me of my customary weekly chatter.

**T**HIS is the Christmas Number of RADIO WORLD—a number that goes forth to all of you with a hearty message of gladness and cheer. In a way, it is the forerunner of the National Radio Week Number which will be published the week before Christmas—dated December 23, to be exact—as on that evening the festivities that will mark the celebration of the first big week set aside for radio and the first Radio Christmas, will begin. I believe that every radioist at heart will do something during this week to increase the interest in radio—to bring at least one new fan into the fold. While the great army of radioists is growing faster than the most sanguine of us anticipated, there are millions who, as yet, are uninitiated. And the larger the radio family, the more healthy it will be. The more people enrolled as radio enthusiasts, the faster will perfection in radio development be attained. We pioneers are looking to a day when radio will be declared the most vital, necessary, and important family element in this country.

**I** SUPPOSE that I have written over a hundred letters to as many women, in the past week, giving all sorts of information regarding the formation of committees, menus for suppers, suggestions for window decorating, banners, signs and what not. I hustled these answers by post because by the time the replies would reach you through this page, the information would be too late for practical use. From the letters received, I feel that the spirit of radio week has become deep-rooted in the heart of the feminine radioist. I felt all along that we women would do our part. And, why not? Radio will interest women just as keenly as it will interest men. I was not at all surprised at the many letters that I have received from mothers whose sons are begging them for sets for Christmas.

**T**HESE mothers have besieged me with all sorts of queries as to what is the best set to buy, what is needed to comprise a set, how will they know that the apparatus will work after it has been purchased—and all that sort of thing. Now, you cannot blame a mother when her young hopeful demands such an outlay for Christmas. She wants to know that her money will not be wasted; she wants to be sure that she is going to be advised correctly. It has been the greatest pleasure to me to devote my time to these mothers—and it will be a greater pleasure if they will write me when their boys' sets are in operation. If any mistakes occur, I will feel duty bound to help set them right.

**"W**HEN my little boy came to me the other day," writes one dear mother in Texas, "and told me, so plaintively, that this is to be 'a radio Christmas,' and he didn't want to be

behind the times, I simply couldn't refuse him. We live far from a town of any size—and I must ask you to help me. Tell me what to do and what to buy." Only a stony-hearted woman could refuse an appeal like that—and I am not, My heart goes out to the little ones—especially at Christmas.

**D**O you know that one of the most wonderful bits of broadcasting was the services of the St. Thomas Church, Fifth avenue, several Sundays ago, and so well described by Peter Gray in RADIO WORLD. I had invited a score of neighbors to my house to hear it. The solemnity of it all, the sacred music, the sermon by Dr. Stires, possessed all the wonderful potentiality and had more effect, if I do say it, than if we had been seated in the great edifice. There was Friend Husband, who hasn't seen the inside of a church since—oh, I'm ashamed to tell—and others equally as guilty, listening in with all the eagerness and interest of the most devoted parishioners. One man who hadn't heard a sermon preached since he was a little boy, remarked that Dr. Stires's words filled him with real inspiration. Others were equally as impressed. It was a soul-satisfying, impressive service. And, let me add, radio is going to bring about the long-looked-for return to religious devotion. I don't say it may, I repeat that it will.

**F**OR many years, and the ministers have admitted it from time to time, the great majority of us have not taken kindly to religion and we have not attended divine worship as did our forebears. Radio will bring religion to the masses as no other element can or will. Some have scoffed that it is not a thing to be broadcast, that nobody wants to hear a sermon. Well, I can truthfully state here that my friends who have asked when they may hear another St. Thomas service will more than fill my radio-reception room. Dr. Stires has done a big thing. He and other ministers who have made the microphone as important as any other phase of divine worship deserve our thanks.

**P**ERHAPS The Saviour himself might have foreseen—in his great human vision—just this present-day occurrence when he said that he could destroy the temple and rebuild it in three days. Perhaps He meant that one did not have to go to church to hear the word of God. Perhaps He foresaw that this mighty and mysterious power of the air would carry His thoughts and teachings to all parts of the earth even unto the remotest hamlet and the humblest home. Don't miss hearing such a service as I have described oh, ye of little faith, for some mysterious element that surrounds it all will awaken in you the belief that a Greater Power is giving unto all mankind the things that mankind is inclined to receive with clouded vision.

**A**ND so it is fitting at this time of the year that we realize at least one great good to the credit of radio. This is the first Radio Christmas. Radio will spread the gospel of Peace and Good Will this Christmas as it has never been spread before—and, in years to come, we will look for our Christmas service by radio just as we will look for every other gladsome feature of this happy time.

So, here's to a Happy, Joyous, Radio Christmas for 1922.

May we have a bigger one in 1923!

—CRYSTAL D. TECTOR.

## Radio Don'ts

**D**ON'T place your battery on charge without making the correct polarity connections.

Don't charge your battery without knowing the density of the acid.

Don't allow the storage battery to get low, due to neglect of attention.

Don't let the water get low in your battery. Always add distilled water from time to time.

Don't fill your batteries on carpet. The acid will eat holes in it.

Don't try to hear signals when the polarities of the B battery are wrong.

Don't light your tubes up to brilliancy. It is not necessary.

Don't try to look for all-wave radio-frequency transformers. There are none.

Don't try to use WD-11 vacuum tubes for radio-frequency work.

Don't try to use WD-11 tubes for super-regeneration. They will not hold out.

Don't try to tune a set by guessing at it. Have someone teach you. You will see a vast difference.

Don't load up the primary of your vario-coupler without loading the secondary.

Don't expect to know how to tune a regenerative receiver the first time you get one.

Don't forget that with a two-variometer type receiver the wave length cannot be had over 800 meters. 2500 mters is not obtainable.

Don't try to hear long-distance stations with a crystal detector.

Don't try to employ 1½-volt tubes in a radio-frequency or superregenerative set. They cannot be used.

# Radio's First Big O'er with Gl



(C. Kadel & Herbert)



(C. Kadel & Herbert)

(Above) One important element of a vacuum tube receiving set is the storage battery. The only test one can give this battery to insure life is the hydrometer test. This instrument may be purchased for a reasonable sum. It comprises a rubber bulb at one end. The end of the tube is placed in the liquid and inside the battery containing the acid.



(Left) This is KHJ, "The Times," Los Angeles, California, in operation. Input panel, transmitter panel, power panel, and reading room from left to right. KHJ, on 500 watts, has done a great deal for radio in the Southwest since November 1. One can almost see the millimeter readings. The antenna ammeter reads "8 5/10 amps." "Uncle John," the bedtime story-telling genius, and "Cousin Bill," the humorous-news reader, are "on the job" in the studio, a handsomely furnished room with correct broadcast acoustics. The photograph shows only the instrument room.



(C. Kadel & Herbert)

(Left) That radio broadcasting is useful as well as entertaining is proved by Miss Emily Exner, who keeps a typewritten record of all lectures on cooking and other branches of housekeeping that come to her by radio. She is an ardent radio fan and spent so much time experimenting with her radio set that her mother admonished her and told her it would be more to her credit if she would "learn something about cooking instead of fooling around that old radio machine." Then Miss Exner, unknown to her mother, started to keep a record of the domestic science lectures, and, after a time, presented this valuable radiold information to her mother. Now her mother thinks radio "just wonderful."

(Right) William M. Priess, of Belmont, Massachusetts, for many years a resident of New York City, former Army officer, inventor of front-line radio communication sets and other apparatus used by both the Army and Navy during the World War, is fighting in the courts of Massachusetts to retain control of his inventions, for which patents are pending. The battle promises to become one of the bitterest ever fought over radio patents. The courts have just issued an injunction restraining others from revealing the secret principles and processes of manufacture, from experimenting or otherwise operating with certain inventions which Mr. Priess claims. All the radio manufacturing corporations in the United States are marking time pending the decision of this important suit.

(C. Keystone View)

# Christmas Brims adsome News



(Left) The storage battery used with vacuum-tube receivers, today, becomes a problem to many radio fans who break into the game with such apparatus. Due to their size, weight, and the care required, some means must be adopted to keep them near the set yet where they may easily be reached. The accompanying photograph shows a suitable shelf which makes a convenient place on which to keep A and B batteries. By following this plan, the batteries are out of sight and the spilling of acid and water on the carpet is avoided.

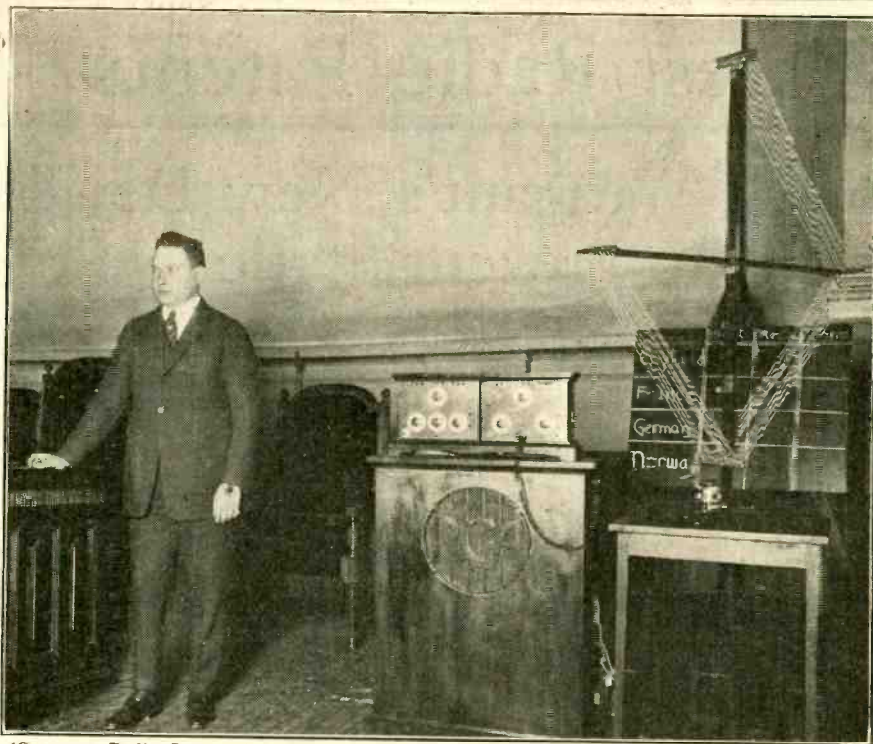

(Courtesy, Radio Corporation of America)

(Above) David Saranoff, vice-president of the Radio Corporation of America, delivering his famous address on radio before the New York Electrical Engineers Society, which he supplemented by demonstrating to the audience actual radio transmission and reception with England, France, Germany, and Norway.

(Right) Lord and Lady Mountbatten, distinguished British visitors, inspecting the apparatus room of Station WEAJ, of the American Telegraph and Telephone Co., New York City. Lord Mountbatten is partly hidden, at right, by Mr. L. S. Ross, music director of WEAJ.



(C. Central News Photo Service)



(Co.)

# Why I'm Proud of My Home-Made Set

By A. J. Weis

373 East 204th Street, New York, N. Y.

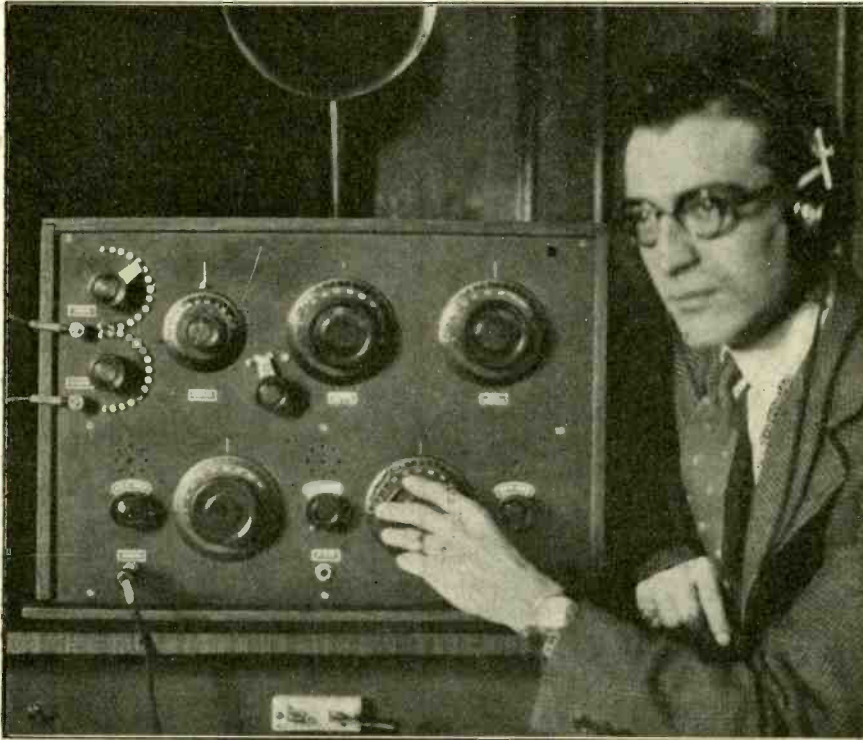

"Close-up" of Mr. A. J. Weis and his home-made receiving set.

**I**N response to the request in RADIO WORLD for pictured information, I am enclosing a photograph of the receiver which I built and with which I am getting what I consider remarkable results.

I regret that I have nothing to offer in the way of new wrinkles or phenomenal hook-ups, but I feel that I have succeeded in finding a better way of doing one thing at least, and that is obtaining a well-balanced panel lay-out. This, I find, has been sadly overlooked in most home-made sets and in many commercial sets as well.

I have also, I think, succeeded in arranging the accessories that make up a

receiver, in an orderly and convenient manner.

The table on which my set appears, in the picture, is home-made. It contains a compartment in the rear for the B batteries, four in number. The cover of the table is hinged, permitting ready access to the batteries at any time while the set is in operation. On the lower part of the table is a shelf, placed at a convenient height, which holds the A battery. The leads are brought out at the top, through holes drilled in the cover.

The battery binding-posts are all in the rear of the cabinet. This gives the panel a neat appearance and keeps the

## Over the Top!

(Radio Version)



(Cartoon by Lawrence B. Hinckley)

conglomeration of wires away from one's hands when manipulating the dials.

The loud-speaker is placed in the rear, on a small shelf. This keeps it out of the way and at the proper height.

Notice that the amplifier is built into one cabinet with the receiver proper. This cuts down the length of the cabinet by one half.

The receiver is an ordinary regenerative one, using a coupler with a condenser tuned secondary, and a plate variometer for regeneration.

V-T 1 and V-T 2 tubes are used exclusively and respectively for detection and amplification. Other parts of the set are as follows: home-made 180 coupler, Mignon condenser, Atwater Kent variometer, Paragon rheostats, Radio Corporation transformers, General Radio Corporation dials, switch points and levers, also a Radio Corporation potentiometer.

The following is a list of stations I have copied to date: WJZ, WWZ, WHN, WOR, WEA, WAAM, WBS, WLAW, WGY, WHAZ, WBZ, WNAC, NOF, WOO, WHAS, KDKA, WOC, WFI, WMAK, WRW, WNAQ, WSB, WIP, WWJ, KYW, WGM, WHB.

I have letters from most of the above stations, proving that I have actually received their programs.

While this may not seem such a remarkable record to many radio fans who have covered a still greater distance with their outfits, it does mean a great deal to me, since I built the set myself.

## Uses Miniature Resistances in Plate of Single-Circuit

**E**DITOR, RADIO WORLD:—Enclosed is a wiring diagram for a single-circuit receiving set with which I have derived exceptional results. With this circuit and a one-step amplifier, I have heard the following stations: KDKA, WWJ, WSB, PWX, WGY, KFAF, NOF, WHB, WOC, WBAP, and others too numerous to mention. If you will notice the diagram, I am using non-inductive resistances in my plate circuit which seem to hold my tube steady and prevent it from going into oscillations, for which the single circuit set is noted. On several occasions, I have adjusted my set to such a fine degree that I could hear violin music from the lowest to the highest notes without the bulbs going into oscillations. This also makes it very selective. When you adjust your set you do not seem to have other high-power stations breaking through.—Fred Gretsch, 1311 East Condit Street, Decatur, Illinois.

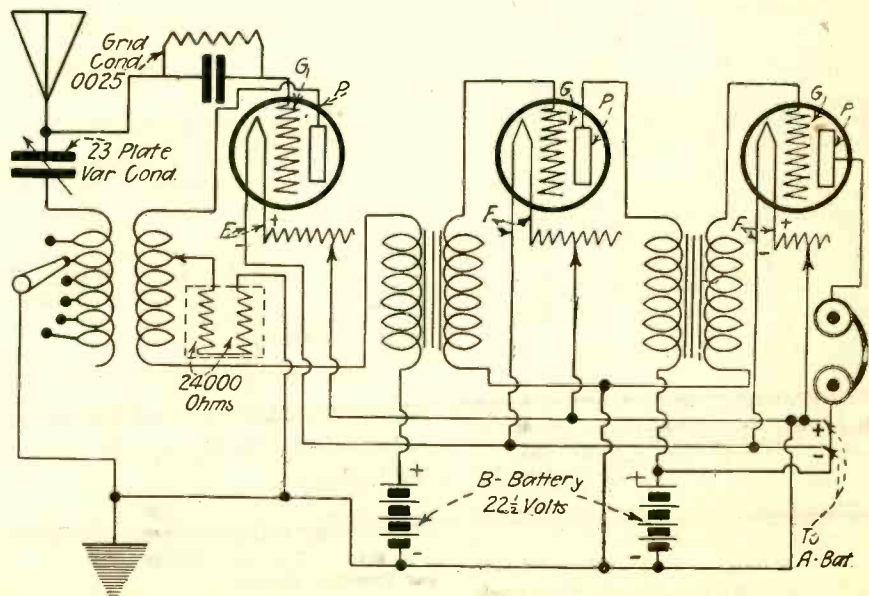

Hook-up of Mr. Gretsch's set as described in his letter to Radio World.



### Inductance and Resistance

I DON'T quite know what this title means, but for all of that it seems to me rather good. I came upon it in the radio section of a metropolitan newspaper with which I happen to be familiar, says Robert L. Duffus in "The Globe," New York. It was part of a discussion of Oscillations, The Damping Constant, Filter Tuning, Microhenries, Microfarads, and other subjects connected with the miracle of sending a jazz concert or a bed-time story through the air from Newark to Oyster Bay. The miracle was impressive, but it seemed that no one without a passionate affection for logarithms and diagrams could have made head or tail of the explanations.

I pointed this out to a representative of the circulation department. The man in the street wouldn't read such stuff, I said, and if he did read it he wouldn't understand it. What he wanted was simplicity. He couldn't digest anything complex, or—as Noah Webster would say—esoteric.

The circulation man listened to me patiently. He had but one answer. He didn't know what the man in the street thought about these technical subjects, but he did know that he liked to read about them. There was no doubt about this, for he had figures to prove it.

Who read the radio section? Boys and young men very largely. Most boys liked to tinker with scientific toys and many of them knew a lot more about electricity than college professors had known a few years ago. Logarithms and technical jargon were as easy as baseball to these young people.

But the boys didn't have it all to themselves. Every one who was interested in the wireless telephone learned about it, just as they had previously learned about automobiles. Age wasn't a barrier. Men who would have regarded a technical discussion of the economic cycle or European politics as clear beyond them easily got a grasp on the just as difficult subject of electricity.

The explanation is one long known to educators. We all learn more easily when we are interested than when we are not. A boy may go to school for years and make practically no progress. Then he discovers that he has a personal need for mathematics or science, and he soaks it up almost overnight. It was interest that was lacking, not intelligence.

Probably this is true of multitudes whom it pleases the intellectual snobs to regard as hopelessly stupid. Somehow or other, life has failed to engage their interest except at a few points. There is no reason why the schools, and later the newspapers, magazines, and theatres, should not get them excited about a wide variety of subjects. The trouble is that scientists, artistic persons, and others, who regard themselves as out of the ordinary, usually won't take the trouble to tell the man in the street about the thrilling things they know and feel.

Yet it can be done. If "inductance and reactance" can be made comprehensible to the man in the street so can anything else that it is valuable for him to know.

#### Another Radio Club

THE Highway Radio Club was organized November 23. Applications for membership may be filed with William C. Burns, corresponding secretary, 2655 Mansfield

Any single copy of Radio World, beginning with No. 1, mailed on receipt of 15 cents postpaid. Any seven issues for \$1.00. The full 20 numbers sent for \$2.90. Or send \$3.00 for 6 months (26 numbers) or \$6.00 for 1 year (52 numbers) and have your subscription start from No. 1. Radio World, 1493 Broadway, New York.

Place, Brooklyn, New York; or, Joseph F. Doherty, chairman of the committee on membership, 1117 Quentine Road, Brooklyn, New York. The object of this organization is to promote good fellowship among amateurs and fans, and to promote instruction and experimenting.



### Agents

LARGE MANUFACTURER OF SHIRTS wants Agents to sell complete line of shirts direct to wearer. Exclusive patterns. Big values. No capital or experience required. Write for free samples. MADISON SHIRT MILLS 557 Broadway New York, N. Y.



Made for All Phones Ask Your Dealer

**THEY ARE GOOD PUT THEM ON YOUR PHONES**

Ship out the metal disc and slip in the MICA-PHONE. Result—Clearer, better tone, all noises eliminated. Write for circular. Discounts to dealers and jobbers. MICA PHONES sell fast. Radio Mica Products Co., 156 E. 43d St., New York

### RADIO FINDS A BETTER CONDENSER

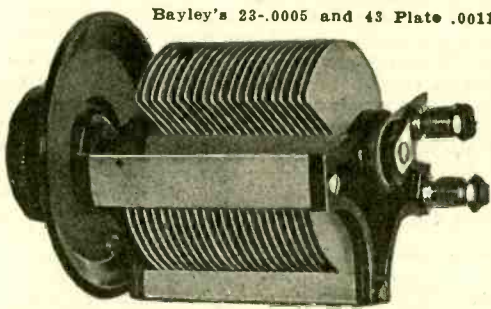

Bayley's 23-.0005 and 43 Plate .0011.

Its plates spaced close give it the finest tuning qualities. It is a die-cast product; the stationary plates are cast solid, accurately and permanently spaced, on three upright supports, while the movable plates are cast on the center revolving spindle. Plates cannot loosen, which eliminates shorting. Each condenser has our money-back guarantee.

Price, 23 Plates \$3.25 each  
43 Plates \$3.75 each

TO JOBBERS AND DEALERS  
A SPLENDID PROPOSITION  
**Bayley Condenser Co.**  
105-109 Vanderveer St., Brooklyn, N. Y.

## "BECO" RADIO FREQUENCY SETS A REAL DX SET TUNED TRANSFORMER TYPE

200 TO 500 METERS

2 RADIO FREQUENCY

2 AUDIO FREQUENCY

1 VACUUM TUBE DETECTOR

ALL ON 3 TUBES

**BISSELL ENGINEERING COMPANY**

161-167 WEST 64TH STREET

NEW YORK

FILL OUT AND MAIL NOW

SUBSCRIPTION BLANK

## RADIO WORLD

RADIO WORLD

1493 Broadway, New York City.

Please send me RADIO WORLD for ..... months, for which

please find enclosed \$ .....

**SUBSCRIPTION RATES:**

Single Copy ..... \$ .15  
Three Months ..... \$ 1.50  
Six Months ..... \$ 3.00  
One Year (52 Issues) ..... \$ 6.00  
Add \$1.00 a Year for Foreign and Canadian Postage.

**The best SOCKET for the DRY CELL TUBE**

60c.

**LINCOLN RADIO CORPORATION**  
118 W. 58th St. Manufacturers New York City

**INCREASE YOUR CRYSTAL RANGE**  
BY USING A "PT" ULTRA-SENSITIVE CONTACT IN YOUR CRYSTAL DETECTOR

1. It locates a sensitive spot instantly.
2. Brings music and code in louder.
3. Withstands hammer jolts without jarring out.

Price, with instructions, twenty-five cents.

"PT" CRYSTAL CONTACT COMPANY  
Box 1641 BOSTON 8, MASS.

**SPECIAL OFFER**

For a limited time only

Paragon RA-10.....\$65 Grebe CR-5.....\$70  
Paragon DA-2 .....\$5 Grebe ROK..... \$5

Prices F.O.B. Red Bank, N. J.

**A. V. GREGORY**

42 Broad Street Red Bank, N. J.

**PHANTOM-CIRCUIT**

**BUILD YOUR OWN.** This marvel of mystery, using no aerial, no loop, no ground, brings in music instead of static showers. We consistently hear concerts on Magnavox, from stations 550 miles distant, audible 100 feet from horn. The simplicity of this set will surprise you. No radio frequency. Complete instructions with photo of circuit sent prepaid for \$9c.  
VESCO RADIO SHOP, Box W-704, Visalia, Calif.

Variometers with dial, \$2.38

Variocouplers with dial, \$1.88

Post Paid

Money Back if not Satisfactory

**OSLAND, INC.**

Manufacturers

122 FIFTH AV. NEW YORK

**RADIO MAILING LISTS**

9276 Retail Radio Dealers, United States .....per M, \$7.50  
1184 Radio Manufacturers .....per list, 10.00  
1880 Radio Supply Jobbers .....per list, 12.50  
257 Radio manufacturers of complete sets .....per list, 4.00  
260 Radio Stations .....per list, 4.00  
14000 Radio Amateurs and Managers of Radio Stations .....per M, 7.50

Neatly typewritten and ready to send you on receipt of remittance covering the amount.  
**TRADE CIRCULAR ADDRESSING CO.**  
166 W. ADAMS STREET CHICAGO, ILL.

**SAVE MONEY**

ON HIGH GRADE

**Variable Condensers**

Direct from Manufacturers

Take the middleman's profit and selling costs for yourself. We sell you direct. These extremely accurate instruments made by experienced condenser people are minus the decorative frills that add to cost. Price reduced to rock bottom without sacrificing quality in the least. Satisfaction or your money back. Write today for very interesting circular.

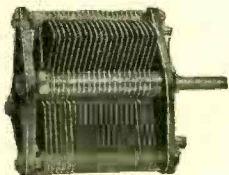

PRICES:

21 Plate

**\$2.55**

43 Plate

**\$2.95**

Complete with Mounting Screws

Your Order Filled by Return Mail

No checks or money orders needed. Pay postman. Send the order TODAY, enclosing 5 two-cent stamps to cover mailing cost and receive your condenser in a day or two.

**MANUFACTURERS' RADIO ASSOCIATION**

90 East Kinney St. Newark, N. J.

Subscribe for RADIO WORLD. \$6.00 a year, \$3.00 six months, \$1.50 three months.

**Answers to Readers**

**I** INTENDED to construct a cabinet 8 x 15 x 30 inches. I will divide this into four compartments so as to hold. 1. a honeycomb coil regenerative receiver; 2. A telephone head set; 3. Battery; 4. My 6-volt A battery. My A battery will be about 12 inches from the receiver. Do you think this will interfere with satisfactory reception?—John Mullenbauer, Poughkeepsie, N. Y.

The length of the A-battery leads make very little difference in the efficiency of a set. The length you mention is all right.

\* \* \*

Can I use Westinghouse type WD-11 tubes for amplifiers? If so, what kind of amplifying transformers must I use? Also, what kind of grid condenser and leak will I need for the detector tube?—W. E. Gilbert, Jr., Box 1282, Alliance, Neb.

WD-11 tubes may be used as amplifiers. The regular standard transformers may be used, but the Sleeper transformers work best with this type tube. It is not essential that a grid condenser, or leak be used with this type tube, but we advise you to try it out as an experiment. A .00025 mfd., condenser will answer the purpose and a 1-megohm leak.

\* \* \*

I have a two-stage honeycomb outfit with 100 feet of aerial. I was receiving WJZ and WOR wonderfully. I disconnected my tuner and replaced it again exactly the way it was before I removed it. Now my receiving is reduced fifty per cent. in loudness. I have tested my batteries, both A and B, and find them fully charged.—Paul Haffner, Woodcliffe, N. J.

Undoubtedly the trouble is caused by what is known to radiomen as "fading." This is a condition over which we have no control. It sometimes happens during reception, and frequently becomes so loud that the vacuum tubes are paralyzed and reception ceases. Then it is a good plan to disconnect the B battery, let the tubes recover, then replace the B battery with the amount of voltage somewhat reduced during the period of the maximum reception. Try smaller coils on the secondary and the tickler.

\* \* \*

I would appreciate a diagram with complete directions regarding the construction of a radio outfit.—Herman Brush, Mt. Carmel, Ill.

RADIO WORLD, No. 33, dated November 11, page 4, will give you a complete diagram and all the necessary data you need.

\* \* \*

How can I make a charger for alternating current?—C. E. Chamberlain, Jaffrey, N. H.

Purchase a battery charger from some reputable concern. These chargers are more efficient and compact than most troublesome, noisy, home-made affairs.

\* \* \*

I have a regenerative set with one step of radio-frequency amplification. I cannot receive long-distance stuff except the local stations. Will you please publish a good hook-up?—Reader 319, Louisville, Ky.  
(Continued on following page)

Quality, Design + Workmanship + Material = **RELIABILITY**

**RADIO-A RE-CHARGER**

**Simple to Use**

Just plug in at any 110 v. A. C. lamp socket—attach clips to battery—turn on current and you have your own charging plant.

A compact portable Recharging unit that will fully charge a 100 AH battery overnight for 5c. to 10c.

At your dealers or write  
**King Electric Mfg. Co., Inc.**  
1661 Fillmore Avenue Buffalo, N. Y.

**PATENT**  
Your Radio Ideas.  
Call or Write  
**FREE ADVICE**

ASK MANUFACTURER...  
**PATENT CO.**  
FOR 520 FIFTH AVE  
NEW YORK

**STANDARD HEADSET**  
2,500 OHM

Guaranteed to be equal of any phone on the market listing at \$6.00 **\$5.75**

Dealers and jobbers write.

**Standard Electric Sales Co.**  
848 Broad Street Newark, N. J.

**FOR CHRISTMAS**

"The Little Wonder"  
**CRYSTAL SET \$4**

\$2.50 UNMOUNTED

Just the gift for your boy or girl. Sent prepaid. Free catalog on request.

**GUARANTEED.** Galena and Radiocite... **20c.**  
TESTED CRYSTALS

Radi-O-Plate Panels. All sizes cut to order.

**Holloway Electric Supply Co., Inc.**  
238 Third Avenue New York City

Do You Like Clear Tone—Sharp and Distinct? If so try

**MARSH'S**  
**Vernier Variable Condenser**  
**AT LAST**

Made in Three Styles. Dial Knob and Screws Complete. Fully Guaranteed.

27-Plate ..... @ \$5.50  
28-Plate ..... @ \$4.75  
11-Plate ..... @ \$4.25

Mail orders promptly filled.

**F. P. Marsh, 145 Nicoll St.**  
NEW HAVEN, CONN.

**RADIO SALESMEN!**

**A Rare Selling Opportunity**  
**For Live Wire Men**

Handle Grewol Detectors in territories not opened.

Write for full particulars.

**RANDEL COMPANY**  
9 Central Ave. Newark, N. J.

Do Your Buying At

**PERMANENT RADIO FAIR**

Hotel Imperial  
32nd Street and Broadway  
New York City

Buyers — Dealers — Radio Department Managers, Demonstrations of Any of the Products of the Exhibitors. Only Products of Representative Manufacturers Are on Display.

Nearly 100 Manufacturers  
Now Exhibiting

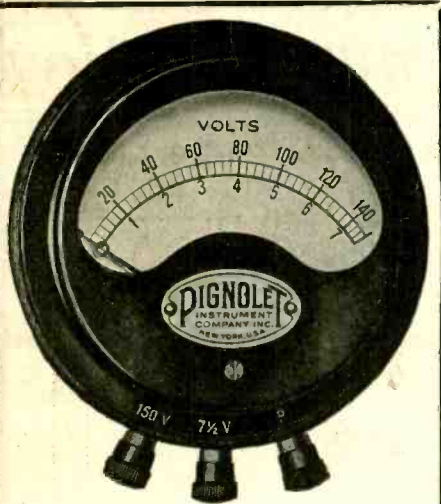

**Pignolet  
RADIO  
VOLT-METER  
ONE INSTRUMENT  
MAKES ALL TESTS**

Write for booklet with suggestions for testing and adjusting Radio Sets.

Thousands now in use give absolute satisfaction.

**Pignolet Instrument Co., Inc.**  
114 Liberty Street, New York, N. Y.

**Answers to Readers**  
(Continued from preceding page)

In this issue there are two good hook-ups of radio-frequency. We advise you to see RADIO WORLD No. 19, dated August 5, in which appeared article on radio-frequency by George W. May. This should set you right in fixing up your set.

\*\*\*

Please publish a hook-up with a variometer in series with the primary of the loose coupler?—Harry Homer, Glen Cove, L. I.

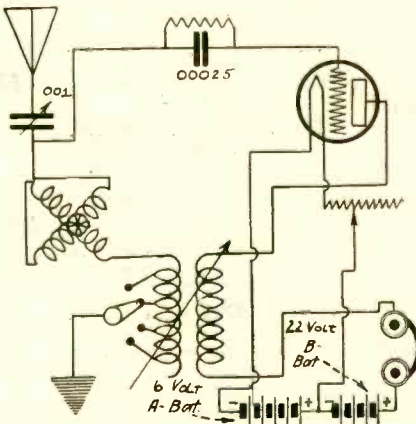

Hook-up requested by Mr. Harry Homer, Glen Cove, Long Island.

The above sketch shows the correct hook-up for such an arrangement. Care should be taken in checking up all connections and battery polarities.

\*\*\*

I am planning a 1-tube hookup as illustrated in RADIO WORLD, No. 30, dated October 21, page 7, and would like to add one step of amplification. Please send me a wiring diagram.—Richard Burgess, Burlington, Vt.

There appeared in RADIO WORLD, No. 22, dated August 26 an article by Fred. Chas. Ehlert, "My Detector and One-Step Amplifier." This describes the exact receiver you have in mind. A complete diagram is also published.

\*\*\*

I am building a honeycomb coil regenerative set. I am told that if I short circuit the tickler coil I will get efficient spark reception. Would there be any advantage in using loading condensers to load the primary and secondary of my set to larger capacities?—Maxwell Murphy, Eastport, Maine.

Do not short circuit the tickler coil or the signals will be very weak. See RADIO WORLD, No. 24, dated September 9, page 9.

**American  
RADIO  
Exposition**

**The Official Exposition for  
American Manufacturers**

with the endorsement of the

**NATIONAL RADIO  
CHAMBER of COMMERCE**

and sanction of the Radio  
Apparatus Section of the

**ASSOCIATED  
MANUFACTURERS of  
ELECTRICAL SUPPLIES**

**Grand Central Palace  
New York**

**December 21st to 30th**

(Sunday excepted but Christmas Day included)

This first really comprehensive Exposition to be staged in a manner worthy of a great industry includes such representative exhibitors as:

- Western Electric Company, Inc.
- Radio Corporation of America
- National Carbon Company
- C. Brandes, Inc.
- Sleeper Radio Company
- General Insulate Company
- Executive Radio Council
- Coto-Coil Company
- Weston Electrical Instrument Co.
- American Radio Relay League
- Stromberg-Carlson Mfg. Co.
- Holtzer-Cabot Company
- Clapp-Eastham Company
- Dublier Condenser Company
- DeForest Radio Telephone & Telegraph Co.

All of the above and other leading manufacturers have contracted for space and many more are at present negotiating for representation. The opportunity to display Radio products to thousands of buyers during the holiday season is an unusual one. The exposition will be one of New York's big features in connection with National Radio Week.

For further particulars write or wire

**AMERICAN RADIO  
EXPOSITION COMPANY**  
120 BROADWAY, NEW YORK  
TELEPHONE JOHN 0000

**PRICES SMASHED**

Each sale has created new friends and customers with the result that we now announce drastic reductions in our quality lines. All goods prepaid. Send card for complete price list. You'll be surprised. You'll tell your friends. A sample saving follows:

REGENERATIVE VACUUM TUBE SET		
Approximate range—1,000 miles.		
	Our Price	Others
Panel—Bakelite—7"x12" drilled.	\$1.75	\$2.50
Cabinet of 3-ply wood to fit panel.	1.50	2.50
Two dials—each 35c.	.70	1.40
16 switch points with nut. Ea. 1c.	.16	.48
4 switch stops with nut. Ea. 1c.	.04	.12
8 binding posts. Nickel plated @ 3c	.24	.48
2 switch levers @ 25c.	.50	.90
1 filament rheostat. Highest grade.	.65	1.10
1 vario coupler. Fourteen taps.	2.25	4.00
1 23 plate variable condenser.	1.95	3.50
1 tube socket—Shielded.	.45	.85
1 grid condenser and leak.	.10	.25
1 phone condenser.	.10	.25
1 tube socket support.	.15	.25
12 feet spaghetti tubing @ 4c.	.48	.84
15 feet copper connecting wire.	.30	.45
Blueprint showing details to assemble	.10	.25
	\$11.42	\$20.12

Other articles taken at random from our late price list are—

Detector tubes—Cunningham—NOT rebuilt	\$3.95	\$5.00
Transformer—Audio frequency.	2.95	4.00
Variometer—Hardwood stators 4 1/2".	2.25	4.00
Frost Fono—2000 ohms.	3.95	5.00
Kellor—2400 ohms.	8.75	12.00
Western Electric 2200 ohms.	8.25	12.00
Blueprints giving detail of 3 step amplifier or regenerative receiving set.	.10	.25
Two step amplifier—knocked down	12.95	23.50
Panel drilled	18.95	35.00
Two step amplifier assembled. In cabinet	17.95	35.00
Vacuum tube set in cabinet 7"x12" Wired	17.95	35.00

Send for list today or order direct from above. Goods sold subject to return for rebate or exchange. YOU MUST BE PLEASED.

**Radio Parts Manufacturing Co.**  
16 Park Place West Detroit, Mich.

Latest broadcasting map 15c. That is, a complete broadcasting map appeared in Radio World, No. 8, dated May 20. Mailed on receipt of 15c. Radio World Company, 1493 Broadway, N. Y. C. (Adv\*)

**VARIO COUPLERS**

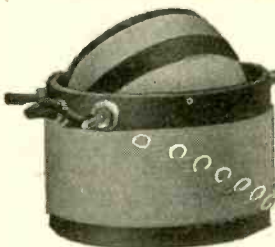

**GEM  
\$1.25  
List**

We also make 6 other styles  
That List \$2.50 up

**Jobbers—Dealers—Agents**

Write for Discounts

**Jewell Radio Sales Co.**

90 West St. New York City  
Phone Rector 1835

**R-C CABINETS**

Mahogany Phenograph Quality Finish. No Drilling of panels for attaching required. Hinged top.

**RETAIL PRICES**

7x6 .....\$2.50      7x14 .....\$3.00  
 7x10 .....\$2.75      7x18 .....\$3.50  
 7x21 .....\$4.00

If your dealer cannot supply you, order direct.

**THE R-C MILLS**

Executive Offices, 30 E. 23d St., New York, N. Y.  
 (Mention RADIO WORLD)

**TOBACCO HABIT BANISHED**  
**QUICK, SURE, LASTING RESULTS**

**Tobacco Redeemer** banishes the habit completely, almost before you know it. An absolutely scientific, thoroughly reliable treatment. No matter how long the habit, or in what form used, you will have no craving for tobacco after you take this pleasant, inexpensive treatment. This we positively guarantee. Your money returned without argument or question if not satisfied. Write for free explanatory booklet and proof of what Tobacco Redeemer has done for men addicted to the tobacco habit. Send post card or letter today.

Newell Pharnacal Co., Dept. 971, St. Louis, Mo.

**GITHENS TRUTONE RADIO HORN—LOUD SPEAKER**

First one to sell on ten day trial Money back Guarantee



Retail Price \$21.00 Includes Loud Speaker

Trutone has been pronounced the best on the market by experts. It has a clear, true tone. Every radio fan should try Trutone and compare it with others. If YOU don't find Trutone the best, your money will be refunded. It is sold on a ten-day trial money-back guarantee. If not carried by your dealer write us.

Distributors and Dealers, write!

**AUTO PARTS MFG. CO.**  
 1815 Trombly Ave., Detroit, Mich.

**FRS**

ALL MOLDED UNIVERSAL COMBINATIONS  
 5 Units in 3

F. R. S. Molded Variometers..... \$6.00  
 F. R. S. Molded Variocouplers..... \$5.00  
 F. R. S. Molded Bank Windings... \$5.00  
 Bank Windings are interchangeable for direct mounting on either Variometer or Variocoupler.

Universal—Accurate—Interchangeable  
 A Complete Two-Stage Long Range Receiver

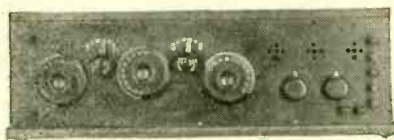

Set includes two Federal Transformers, Condenser, two-molded variometers, molded variocoupler, three V. T. sockets, filament rheostats, dials. Read 'Em binding posts, switch points; in attractive cabinet and drilled panel: complete, ready to hook up. \$40  
 A \$125 Radio for.....

**F. R. S. Radio Corporation**

409-D East Fort St. Detroit, Mich.

**RADIO WORLD**

TELEPHONE, BRYANT 4796  
 PUBLISHED EVERY WEDNESDAY (Dated SATURDAY OF SAME WEEK) FROM PUBLICATION OFFICE, 1493 BROADWAY, NEW YORK, N. Y. BY HENNESSY RADIO PUBLICATIONS CORPORATION

ROLAND BURKE HENNESSY, President and Editor  
 M. B. HENNESSY, Vice-President  
 FRED S. CLARK, Secretary and Manager  
 1493 BROADWAY, NEW YORK, N. Y.

**ASSOCIATE EDITORS**

Robert Mackay      Fred. Chas. Ehlert

**SUBSCRIPTION RATES:**

Fifteen cents a copy. \$6.00 a year. \$3.00 for six months. \$1.50 for three months. Add \$1.00 a year extra for postage to Canada and foreign countries.

Receipt by new subscribers of the first copy of RADIO WORLD mailed to them after sending in their order, is automatic acknowledgment of their proportional rates.

Advertising rates on request.

**ADVERTISING RATES:**

One page: One time—\$150.00.  
 Half, Quarter, Third and Two-thirds pages at proportionate rates.  
 One inch, one time—\$5.00. Per agate line, \$0.40.

On four consecutive issues, 10% discount.  
 On thirteen consecutive issues, 15% discount.  
 Cover and preferred-position rates made known on application.  
 Terms: 30 days Net. 2% 10 days.

**CLASSIFIED ADVERTISEMENTS:**

Five cents per word. Minimum, 10 words. Discount of 10% on 4 consecutive issues—15% on thirteen consecutive issues. Cash with order.

Entered as second-class matter, March 28, 1932, at the Post Office at New York, New York, under the act of March 3, 1879.

**IMPORTANT NOTICE:**

While every possible care is taken to state correctly matters of fact and opinion in technical and general writings covering the radio field, and every line printed is gone over with a scrupulous regard for the facts, the publisher disclaims any responsibility for statements regarding questions of patents, priority of claims, the proper working out of technical problems, or other matters that may be printed in good faith and on information furnished by those supposed to be trustworthy. This statement is made in good faith and to save time and controversy in matters over which the publisher cannot possibly have control.

**10 More Broadcasters**

THE list of commercial broadcasting stations operating on 360 meters was increased by the following ten during the week ending November 25:

WOAK—Collins Hardware Co., Frankfort, Kentucky.

WPAC—Donaldson Radio Co., Okmulgee, Oklahoma.

KFGH—Leland Stanford Junior University, Stanford University, California.

WOAH—Palmetto Radio Corporation, Charleston, South Carolina.

WTAC—Penn Traffic Company, Johnstown, Pennsylvania.

KFDC—Radio Supply Company, Spokane, Washington.

WRAA—Rice Institute, Houston, Texas.

WTAU—Ruegy Battery & Elect. Company, Tecumseh, Nebraska.

WOAN—James D. Vaughn, Lawrenceburg, Tennessee.

WOAL—William E. Woods, Webster Grove, Montana.

**Radiophone in Each Room**

ACCORDING to Michael Emmett, the Palace Hip Theatre, in Seattle, Washington, holds out a novel inducement to the artist in the way of a radiophone in each dressing room. Here the artist can sit while making up, or between shows, says "Vaudeville News," and hear lectures, sermons, music, etc. Its effects are marvellous, for the artist keeps out of the wings, being interested in the radio, and happily forgets that evil tendency of "talking shop." This seems to be a new blessing to the theatrical world. Mr. Joseph Muller, manager, and the stage hands do all in their power to bring happiness to the artists while playing in Seattle, according to Mr. Emmett.



**The HOMCHARGER**

charges your AUTO or RADIO BATTERY for a Nickel. Price, \$18.50 Send for FREE Bulletin DEALERS—WRITE NOW! The Automatic Electrical Devices Co. West Third St., Cin., O.

**INSU-LITE**

PANELS

1/8" —.01 per sq. in.  
 3/16" —.015 per sq. in.  
 1/4" —.02 per sq. in.

DEALERS: Write for discount.

General Merchandise Co.  
 140 Market Street, Newark, N. J.

**IS YOUR TELEPHONE HEAD SET WEAK?**

Let meremagnetize it. Guaranteed, in one day good as new. \$1.50 Per Set

I rewind for higher ohmage. All radio telephone repairing at moderate prices. Mail orders attended to. Dealers write.

ROYS, 101 West 42nd St., N. Y.

**THE GOODMAN**

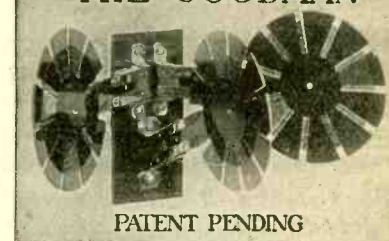

PATENT PENDING

The Niftiest Short Wave Tuner on the Market Only \$6.00 & PP on 1 lb. Send for pamphlet.

**L. W. GOODMAN**  
 DREXEL HILL, PA.

Major ———, Halifax, N. S., writes: Delighted. Received Schenectady clearly on one tube first time I tried the GOODMAN. Would have saved trouble and money by buying months ago.

**NOVO "B" BATTERIES FOR RADIO**

22½-45 & 105 VOLTS

**NOISELESS DEPENDABLE GUARANTEED**

ASK YOUR DEALER

NOVO MANUFACTURING CO.  
 424-438 W. 33rd ST. NEW YORK

531 SO. DEARBORN ST., CHICAGO.

# Pruden Reliable Radio Specialties

## For Good Results!

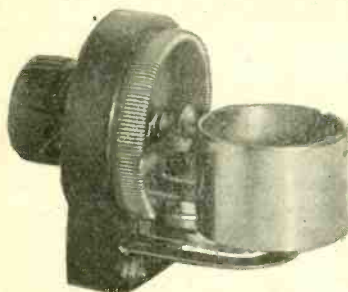

**Ajax Socket Rheostat**  
A device for which amateurs and professionals have long been waiting. Eliminates wiring between socket and rheostat. List..... **\$2.00**

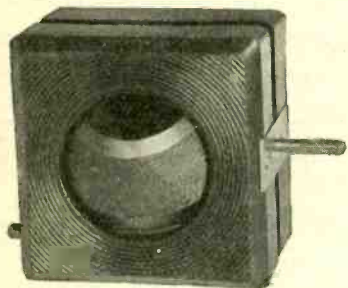

**Keystone Moulded Variometer**  
Made of a special composition—extremely light in weight and durable. Wave length ranges from 150 to 580 Meters. Terminals conveniently arranged to afford easy connections and avoid crossing terminal wires. Rotor and Stator windings guaranteed not to loosen. Brush type contacts. List each. **\$5.00**

THE name "Pruden" back of standard Radio Equipment is a guarantee of mechanical excellence, perfection of workmanship and scientific correctness of design.

Now, more than ever, when the market is flooded with inferior goods, it pays to buy standard trade marked products.

You can pin your faith to "Pruden." Money-back unconditionally if you do not get complete satisfaction.

Just a few leaders of Pruden Reliable Products shown here that will give you better radio results at no greater cost.

Dealers write today for our interesting proposition.

**FREDERICK H. PRUDEN INC.**

993 Bergen Ave. Jersey City, N. J.



**Phono-Phane Permanent Radio Detector**

The only fixed radio detector requiring no adjustment. Used in place of crystal or vacuum tube detector. Gives excellent quality of sound without distortion, battery or tube noises. Detects telegraph signals at several thousand miles. Detects broadcast music more clearly than vacuum tube detector, and requires no amplification where the incoming signal has sufficient strength to actuate the sensitive phones. Ideal for use in regenerative circuits. Handsome, substantial, suitable for assembly in the finest radio equipment. Guaranteed against imperfection \$3.50 or faulty operation. List each.



**Saturn Automatic Plug**

The only perfect automatic plug, no need to take apart to make connections. First insert the terminals into the "Saturn" and a perfect connection is made. So constructed that pulling of the cords makes the connection more positive. **\$1.50** List each

## W. J. Burns to Speak on Police Radio

HOW radio is employed, and may be employed, by police and other agencies for the detection of crime will be demonstrated in an intensely interesting manner at the American Radio Exposition, Grand Central Palace, New York City, December 21 to 30, inclusive. William J. Burns, chief of the United States Secret Service, is much interested in radio and is using it in his department. He will speak at the exposition. In accepting the invitation to speak, Mr. Burns said: "It will be interesting to compare the archaic methods of criminal investigation of the past with the methods of the present; also, what we hope to do in the future with radio—which is the last word. I will explain also how we expect to use radio in the next Bureau of Identification which we are at present organizing in my department."

Several demonstrations will be made to show how radio has been employed by police chiefs of European cities.

A concentrated effort is being made by the management and the numerous exhibitors participating in this exposition to make it thoroughly representative of what is best in the radio industry. Many unusual "stunts" and demonstrations are planned.

Additional contracts for space were signed by the following concerns: Jewett Manufacturing Corporation, American Radio & Research Corporation, Electric Storage Battery Co., Ackerman Bros. Co., Inc., Electric Record, Feri Radio Manufacturing Co., General Lead Batteries Co., Copper Clad Steel Co.

### Point It East!

A MILLION-WATT vacuum tube has been built in Schenectady which is expected to carry radio-telephone conversation across the Atlantic. We sha'n't mind, as long as they keep it pointed east.—"The Plain-Dealer," Cleveland.

Complete Your File of **RADIO WORLD**  
52 Weeks for **\$8.00**

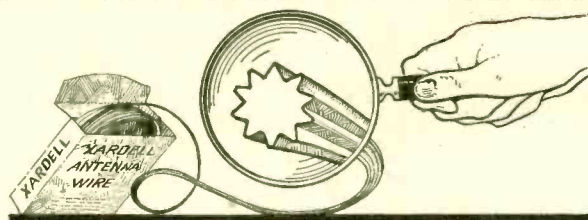

## Something Brand New in Antenna Wire

**Jobbers and Dealers—Stock this now for Fall Trade**

Here is an Antenna Wire that will at once appeal to the radio enthusiast. It has a real selling argument in that it is different and better than any makeshifts to date.

This new wire, hard drawn from the finest copper, has a corrugated surface with 10 collecting points on its circumference. This gives a greater collective surface and the points give a greater gathering surface.

The result is extreme sensitiveness, and an increase in the range and clearness of any set, from the simplest crystal type to the finest V. T. Receiver.

Packed in neat cartons of 100 feet, 200 feet and 500 feet.

Price **\$2.00 per hundred prepaid**  
Order direct or from your dealer



### YOUR NEWSDEALER

will deliver **RADIO WORLD** to your home. In order to be sure of getting **RADIO WORLD** regularly, and of not missing a single issue, we suggest that you either subscribe direct or through your newsdealer at \$6.00 a year (52 issues), \$3.00 six months, and \$1.50 three months. Or instruct your newsdealer to deliver **RADIO WORLD** regularly to your home each week. Dealers will take standing orders and make deliveries of paper whenever requested. Radio World, 1493 Broadway, New York.

### SEND US THE NAME OF YOUR RADIO CLUB

Also the names of your president and other officers. We want to add these to a list of radio clubs and officers we are preparing for publication in an early issue. **RADIO WORLD**, 1493 Broadway, New York.

DO YOU WANT TO BUY, SELL OR EXCHANGE RADIO OR OTHER GOODS? TRY THIS  
DEPARTMENT AT 5c A WORD

# RADIO WORLD'S QUICK-ACTION CLASSIFIED ADS

This department is intended for everybody who wants quick action on short announcements covering the buying, selling, exchanging or general merchandising in the radio field. Readers of RADIO WORLD will find that it pays to read these columns every week. Advertisers will get a ten-day service here—that is, copy received for this department will appear in RADIO WORLD on the news-stands ten days after copy reaches us.

The rate for this RADIO WORLD QUICK-ACTION CLASSIFIED AD. DEPT. is 5c. per word (minimum of 10 words, including address), 10% discount for 4 consecutive insertions, 15% for 13 consecutive insertions (3 months). Changes will be made in standing classified ads., if copy is received at this office ten days before publication. RADIO WORLD CO., 1493 Broadway, N. Y. C. (Phone, Bryant 4794.)

**ATTENTION!** You invent it. Let us make it. Models, dies, manufacturing. Sheldon Tool Co., Rosedale Station, Kansas City.

**EDISON B. BATTERY UNITS**—One positive and one negative plate for 10c. 18 sets will make a 24-volt battery. Wilkinsburg Wireless Shop, 711 Penn Avenue, Wilkinsburg, Pa.

**LOUD SPEAKER FOR ANY CRYSTAL SET.** Hear music over entire house. Easily constructed by amateurs. Eliminates Battery. Instructions complete. 25c. Catalogue Free. Representatives wanted. **STEINMETZ WIRELESS MFG. CO., EASTEND, PITTSBURGH, PA.**

**OLD MONEY WANTED**—\$2.00 to \$500.00 EACH paid for hundreds of Old and Odd Coins. Keep all old money. Send 10 cents for New Illustrated Coin Value Book, 4x6. You may have valuable coins. Get posted. We pay CASH. Clarke Coin Company, Ave. 83, Le Roy, N. Y.

**HAVE YOU SEEN IT?** My unusual, fully illustrated radio catalog is complete. Saves you money. N. E. Ristey, Spring Grove, Minn.

**YOUR HOROSCOPE**, business, changes, social, matrimonial prospects. Send birthdate and Ten Cents (stamps) for remarkable test reading. ZANYA, 202-J, West 105th St., N. Y.

**EXCHANGE JOLLY, INTERESTING LETTERS** through our club. Stamp appreciated. Betty Lee, Inc., 4254 Broadway, New York City.

**RADIO FANS:** Have you read of the wonderful new all-wave Radio Frequency Amplifier invented by Doctor Miller of the Naval Radio Research Laboratory, Bureau of Standards, Washington, D. C.? We manufacture this device under license. May be added to your present set, giving wonderful results on distant stations, or may be made up into loop receiver sets with extreme range and beautifully clear reception, for home or automobile use. Besides being the best amplifier on the market, the Miller covers all waves at equal efficiency. Price, \$6.50 per unit. Details free. Coast Radio, Inc., El Monte, Los Angeles, Calif.

**"MUSIC composed"** to words. Bauer Bros. (formerly of Sousa's Band), Oshkosh, Wis.

**RADIO MAN** with two years' experience desires position. Herbert, Listerville. New Brunswick, Canada.

## PATENTS

Protect your invention today. Write for 1922 Illustrated Book Free. Radio, Electrical, Chemical and Mechanical experts. Over 30 years' experience. A. M. Wilson, Inc. (Radio 3 ARH), 310-18 Victor Building, Washington, D. C. (Successors to business established 1891 by A. M. Wilson.)

**Manufacturers of Rogers Radio Receivers and Rogers Receiving Radiometers.** Rogers Radio Company, 5133 Woodworth Street, Pittsburgh, Pa.

**EXCHANGE LETTERS** with friends everywhere. Pleasant pastime. Information for stamp. Smith, Box 3125, M. Portland, Ore.

**NEWS AND GOSSIP OF THE STAGE**—Send 10c. for specimen copy of **NEW YORK STAR**, the great illustrated theatrical weekly. \$4.00 year, \$2.00 six months, \$1.00 three months. New York Star Co., 1493 Broadway, N. Y.

**PATENTS**—Electrical cases a specialty. Pre-war charges. B. P. Fishburne, Registered Patent Lawyer, 386 McGill Bldg., Washington, D. C.

**FREE APPARATUS FOR SECURING SUBSCRIPTIONS FOR "RADIO."** Write today for complete list of premiums and our special subscription offer. "RADIO," Pacific Bldg., San Francisco, Cal.

**50% MORE RECEIVING POWER** with the Harsha 6 volt, 80 ampere hour radio "A" special storage battery, which is guaranteed for two years. \$18.00. Vernier Variable Condensers. 43 plate, \$6.00; 21 plate, \$5.50; 11 plate, \$5.00. Grid leak mounting, 35c. Send money order, but do not add postage or express charge. J. MASCUCH, 74 North 19th St., East Orange, N. J.

**BOOST RADIO.** Wear a pin or button. It shows you are progressive. Designs and estimates furnished by official club jewelers. The Rankin Co., Radio Dept., 1118-20 Chestnut St., Philadelphia, Pa.

**LOOK! ALL NECESSARY PARTS** to make V. T. Detector Control, including drilled panel and wire. Price \$3.75. Karnes Radio Shop, Chico, Texas.

**LOW RADIO PRICES**—Write now for free MONTHLY BULLETIN. Gives up-to-date prices on new merchandise. HQLMES ELECTRIC CO., Libertyville, Illinois.

**EISEN Supersensitive tested Crystal.** No buzzer test necessary. If not satisfactory, return crystal and money will be refunded with mailing charges. Mounted, 50c.; unmounted, 45c. Special Prices to dealers. Wm. Hafner, 726 New St., Camden, New Jersey.

**DIALS**, 3-inch, genuine hard rubber, raised or depressed scale, white or gilt lettering. Drilled for 1/4 and 3/8 inch shafts. 60c. each, 3 for \$1.50, postpaid. No stamps. RADIO SALES CO., Box 1144, Bethlehem, Pa.

**MILLER AUDIO FREQUENCY transformer** eliminates howling. Entirely satisfactory on three stages. Price \$5.00 postpaid anywhere in U. S. RADIO SALES CO., Box 1144, Bethlehem, Pa.

**MEN WANTED for detective work.** Experience unnecessary. Write for details explaining guaranteed position. J. GANOR, former Gov't Detective, St. Louis, Mo.

**EDISON storage "B" Battery Elements**, 5c. per pair. 18 will make one 22.5 volt battery. Gilman's Battery Shop, Chelsea Square, Chelsea, Mass.

**GET A 1000 MILE RANGE RADIO XMAS PRESENT FOR \$32.50** complete with tube, phones, "B" Battery. \$16.50 down, balance monthly. D. & R. Radio Supply Co., Fort Dodge, Iowa.

**INSTANT BATTERY CHARGER!** Radio sets demand it. Manufacture at home on royalty. Big Profits. Gold Seal Chemical Company, Syracuse, New York.

**ISSUES OF RADIO WORLD** from April 1 to Oct. 7 (7 numbers) for 15c a copy, or the whole lot for \$3.15. Or send us \$6.00 for one year and start with the first number. RADIO WORLD, 1493 Broadway, New York.

**WE PASS samples or circulars**, 1c. each, to houses direct. Lady Canvassers. We mail your circulars, 25c. a hundred. Guaranteed names of our mail order customers. 75,000 up-to-date lists, \$2.00 thousand; 7,000, \$10.00. C. H. Davis & Son News Agency and Mail Order Distributors, 614 W. Jefferson, Greenfield, Ohio.

**VACUUM TUBES** repaired reasonably. Satisfaction guaranteed or cost nothing. Vacuum Elect., 103, 1621 Derr, Toledo, O.

## Radio Club Activities in West Virginia

THE Delta Radio Club has been organized with the following officers: Neil S. Forman, president; Joseph D'Agostino, secretary; Randolph Liston, treasurer. It is located at Morgantown, West Virginia, and its call is 8-BQG.

The West Virginia University Radio Club is another new one. It is authorized by the University College of Engineering. Call, WHD. The officers are: Arthur Price, E.E., president; Joseph D'Agostino, associate member, I. R. E., secretary.

## Blessings on 'Em

MAY blessings be upon the heads of the gentlemen who invented:

Phonographs,  
Player pianos,  
Radios,  
Slide-trombones,  
Clarionets,  
Fiddles,  
Singing exercises,

And may they always have to lie awake and listen to them.—Roy K. Moulton in "The Mail," New York.

## ARNOLD NAVY MODEL LOOSE COUPLER Back to Pre-War Price

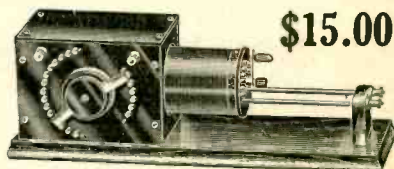

The most consistent piece of apparatus on which to hear the Radio Telephone (Broadcasting) range from 200 to 3,000 meters "WITHOUT DISTORTION." It is a COMPLETE TUNER. Only a mineral detector or Audion Detector required. Send in your order today. Immediate shipment promised or call and hear one and take it away with you.

A 3c stamp will bring my literature showing my complete line.

**SPECIAL**  
Sets built to Order, Repaired or Rewired. Accessories for Sale. Baldwin Phones Repaired. New Diaphragms Put On.

**J. F. ARNOLD**

2289 THIRD AVE. N. Y. CITY  
Established 1910 (Near 125th Street)

**WE NEED RADIO WORLD**, dated April 22 and August 5. If you have copies you don't require, mail to this office and current issues will be sent you for them. RADIO WORLD, 1493 Broadway, New York.

**Spirola**

## GIVE A SPIROLA CHRISTMAS!

and let the whole family listen to REAL MUSIC all the year through! Nothing adds so much to a two-stage set as a high-grade SPIROLA speaker.

## BETTER LOUD SPEAKERS

**REAL CABINET TYPE**—not just the usual horn enclosed in a cabinet. Powerful, beautiful, with an **INCOMPARABLE TONE**. We make a complete line of the highest class construction throughout, with fine hand rubbed finishes. SPIROLAS are and have always been sold under money-back guarantee to equal in volume and far surpass in beauty and tone any other up to twice their price.

**SPIROLA CONCERT**—Complete with built-in unit and cord, ready to attach in place of phones. Finish: oak (CO) or mahogany (CM), bronzed throat. \$12.50

**SPIROLA DUPLEX**—For use with any headset. Separate tone chamber for each phone, eliminating interference. Finish: oak (DO) or mahogany (DM), bronzed throat. \$4.85

Satin black finish all over, nickeled fittings. (DB) \$3.85

**SPIROLA SIMPLEX**—For use with Baldwin or other unit. Oak (SO), mahogany (SM) and black (SB) finishes, same prices as DUPLEX.

At dealers or postpaid (C. O. D. if preferred). If desired we will send in holiday packing direct to recipient, carefully following your instructions. DEALERS' We can fill holiday rush orders!

L. H. DONNELL MFG. CO., DEPT. B, BOX 70, ANN ARBOR, MICH.

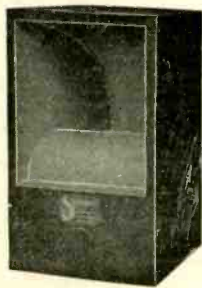

### Remote Control a Future Use of Radio

AS we listen in on our little receiving sets we think that radio is a great thing, and one deserving of much attention. But yet, do we ever consider the many other uses that radio waves may be put to beside that of broadcasting intelligence and music? Remote control of mechanism is also possible with these very same waves, says "The Globe," New York.

With the development of amplifiers there has come the increasing possibility of using radio to control the operation of any machinery or motion at a distance, by use of a relay or switch connected to special radio receiving apparatus. In order to accomplish this, signals are transmitted by radio, and are received by a receiving station employing a very sensitive amplifier and specially designed relay device. This relay is then connected to such mechanism as it is desired to operate at the receiving station. Such mechanism can be an electric light, an electric bell, the control lever of an airplane, the switch of an electric power line, or, in fact, most any mechanical or electrical device. A disadvantage of radio control is that the receiving apparatus must be in continuous operation, with consequent consumption of power from the batteries or generator which supplies current to the receiving set. For certain purposes, however, this is not too great an expense to keep the use of distant control by radio from being feasible. The use of radio in this way is being considered by a number of electric power companies for operating switches at distant power plants or stations.

At one of the recent manoeuvres of our fleet a battleship without a soul aboard, equipped entirely for radio control, was sent out to sea, and acted as an effective moving target for our gunners on other ships.

### The Voice Amplifier

AS it is becoming popular to broadcast events which take place miles away from the broadcasting station proper, it has become necessary to make use of a "voice amplifier." This device enables the reproduction at the station of sounds picked up a great distance away, without the loss of clearness or intensity at the broadcasting transmitter.

Subscribe for RADIO WORLD. \$6.00 a year, \$3.00 six months, \$1.50 three months.

### Attention, Newsdealers

You should keep a good supply of back numbers of RADIO WORLD on hand all the time. It has been the experience of many dealers that a purchaser of RADIO WORLD for the first time will almost immediately want the back numbers, some of which are already out of print and some of which are difficult to get. THE PUBLISHER WILL FURNISH BACK NUMBERS TO DEALERS DIRECT OR THROUGH THE AMERICAN NEWS CO. AND ITS BRANCHES. Dealers should hold their unsold copies for a reasonable length of time. RADIO WORLD of October 23 contained a full page of contents of back numbers to that date. 15 cents per copy; any seven numbers for \$1.00. RADIO WORLD, 1493 Broadway, New York.

### COMPLETE YOUR FILE OF RADIO WORLD

Copies of Radio World No. 1

If you did not get a copy of Radio World No. 1 send us \$6.00 and we will send you the paper for one year, and start it with our first issue, which will be mailed you as soon as possible after receipt of order. (Adv.)

# Those Broken and Burned-Out VACUUM TUBES CAN BE REPAIRED



and Guaranteed Too!

If your dealer does not know, send direct to us.

## Harvard Radio Laboratories

165 HIGH STREET

BOSTON, MASS.

Tubes returned Parcel Post, C.O.D.

# AMERICAN RADIO-STORES

SPECIAL

SPECIAL

### TUBE SET

- | Rheostat
- | W. D. II Socket
- | W. D. II Tube
- | Grid Leak Condenser
- | "B" Battery, 22 1/2 volts
- | "A" Battery, dry cell
- | Variocoupler
- | "23" Plate Condenser
- Wire for Hook Up Free

**\$10.95**

Complete

### CRYSTAL SET

- \$4.50 Double Slide Tuning
- Coil, \$2.25 Crystal Detector

**\$4.80**

100 feet Stranded Aerial Wire, 2 Insulators (complete).

### THE "SKINDERVICKEN" BUTTON

Has taken the town by storm. Every Radio Fan wants one. Amplifies your signals and brings in long distance. We have them. You will want one right away. **95c**

## DEPENDABLE MERCHANDISE AT REDUCED PRICES

### SETS

- \$225.00 Wireless Specialty—Crystal and Audion, 150 to 3,000 meters. Our price today
- \$25.00 Baby Lawson Crystal Sets—Complete
- Aerial Wire Insulators and Phone
- \$25.00 Polak-Green, complete

### PHONES

- \$8.00 Federal Phones
- 15.00 Western Electric No. 509-W
- 12.00 Kellogg Phones
- 8.00 Auth

### RHEOSTATS

- 1.50 Paragon Rheostat
- 1.50 Klossner Vernier
- .95 Reeps Vernier
- 1.00 Regal
- 1.00 Roberts
- 1.25 Boston Porcelain Base

### VARIOMETERS

- \$5.00 Queens Variometers
- 5.00 Polak-Green Variometers
- 5.00 Baldwin Variometers

Others as Low as One Dollar

### AMPLIFYING TRANSFORMERS

- \$3.50 Baldwin Coupler Super Type
- 6.50 Emco Varlo-Coupler
- 5.00 Queens Varlo-Coupler

### LOUD SPEAKERS

- \$5.00 General Radio
- 7.00 Jefferson
- 6.50 Murad Radio Frequency
- 3.00 Baldwin Radio Frequency

### SPECIAL

- Formica, pound
- Panels drilled to specifications.
- \$2.50 Beginners' Practice Keys.
- W. D. II Sockets.

Also Hundreds of Other Radio Bargains Too Numerous to List  
THESE PRICES DO NOT INCLUDE POSTAGE.

## AMERICAN ELECTRO TECH.

(Established 1913)

235 FULTON ST. and 1987 BROADWAY (near 67th St.)

Be a National Radio Week Booster

“The wise man looks into space,  
and knows there is no limit to dimension.”

said **Chuang Tzu**.

The wise Radioist bridges the greatest  
distances with a

# Grebe Receiver.

*Doctor Mu.*



A LONG RECORD of unequalled  
performance has won for the  
Grebe Receiver the unqualified en-  
dorsement of all good dealers.

“Musings of Doctor Mu” — the  
story of the development of the Per-  
fect Receiver, free upon request.

## GREBE RADIO

A. H. GREBE & CO.  
INCORPORATED  
RICHMOND HILL, N. Y.



Licensed under  
Armstrong U. S.  
Pat. No. 1113149

