

JANUARY, 1954

Radio-Television
**SERVICE
DEALER**

TV - AM - FM - SOUND

Includes: **"VIDEO SPEED SERVICING"**
& **"TV FIELD SERVICE"** *Data Sheet Sections*



The Professional Radio-TVman's Magazine
Reaching Every Radio TV Service Firm Owner in the U.S.A.



N2B A 2K-952 MAR 57

ROBERT G WALRAVEN
134 BADER ST
GREEN BAY WISC

NO. 1 CHOICE

of **ALL** Fixed Composition Resistors by almost

3 to 1*

**Not Claims! Not Predictions! But Plain Facts!
Unbiased, authoritative, independent surveys (made
regularly since 1930) show IRC BT RESISTORS to
be the Service Technicians' choice by a continually
increasing margin. Today, BT RESISTORS are
preferred over the total of all other brands combined!*

**Ask for IRC BT's...
Most Service Technicians Do!**

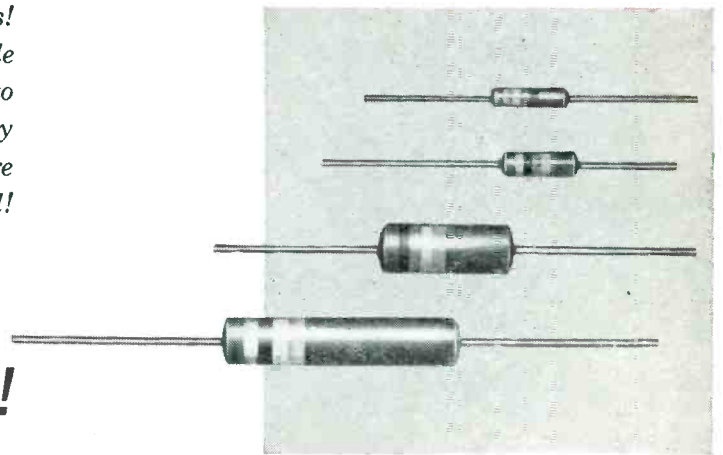

INTERNATIONAL RESISTANCE COMPANY

413 N. Broad Street, Philadelphia 8, Pa.

Wherever the Circuit Says ~~~

In Canada: International Resistance Co., Ltd., Toronto, Licensee

For
Your Exact
Fuse Needs
there's
A BUSS
FUSE

BUSS is the one source for any fuse you need: — standard type, dual-element (slow blowing), renewable and one-time types . . . in sizes from 1/500 ampere up.

BUSS Fuses can be relied upon for dependable electrical protection, elimination of needless blows, and top quality in every detail because — EVERY BUSS and FUSETRON FUSE USED IN THE ELECTRONIC TRADE IS ELECTRONICALLY TESTED. The sensitive testing device rejects any fuse that is not correctly calibrated, properly constructed and right in all physical dimensions.

That's why manufacturers and service organizations for over 38 years have turned to BUSS for their fuse needs — no matter how exacting.

And a customer instantly recognizes quality when he sees BUSS Fuses. Millions of fuses for home, farm, commercial and industrial use have established BUSS as the known brand — sales are easier and never a "come back" on your service.

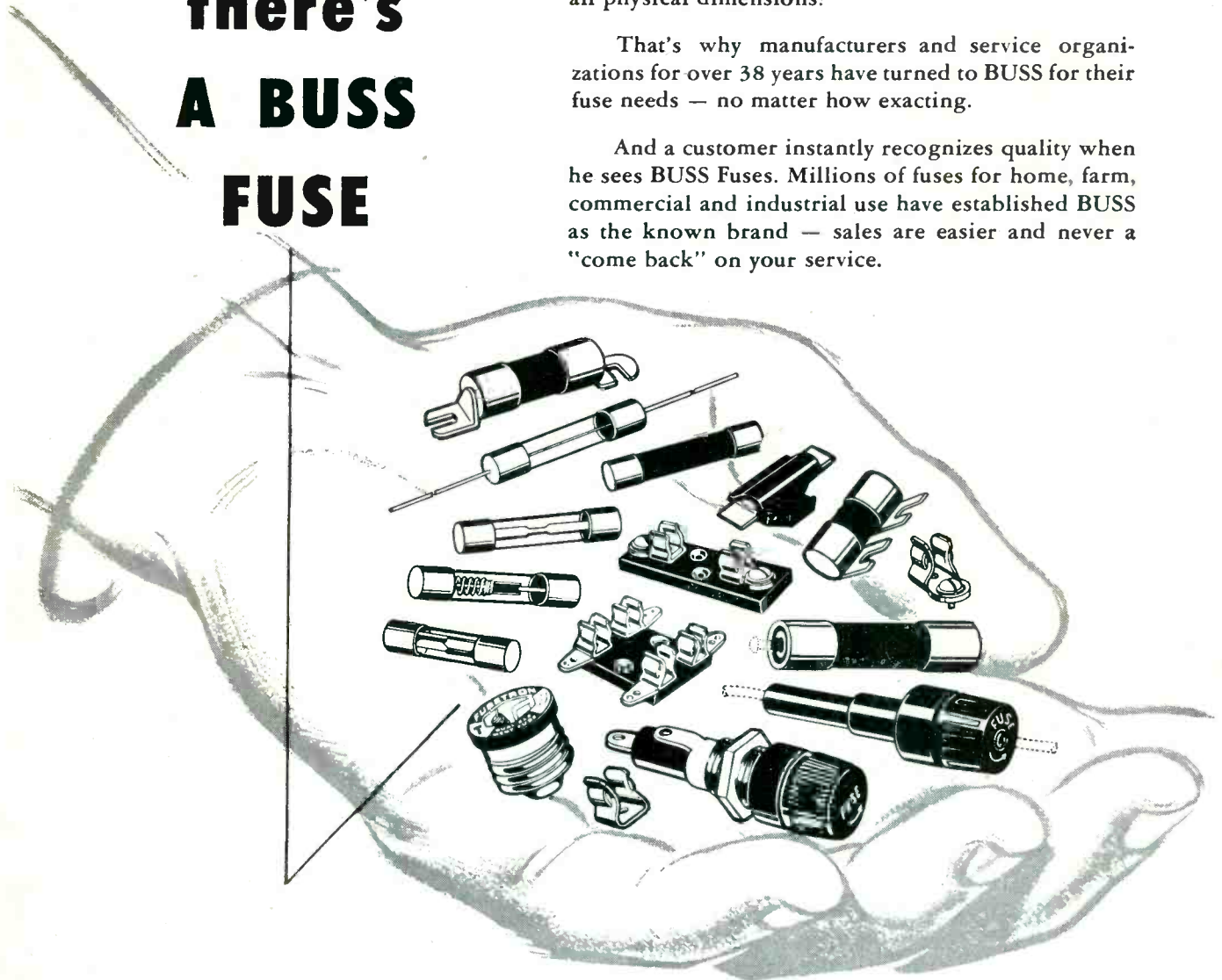

For
Full
Information
Mail
this
Coupon

BUSSMANN Mfg. Co. (Division of McGraw Electric Co.)
University at Jefferson, St. Louis 7, Mo. SD-154

Please send me bulletin SFB containing facts on
BUSS small dimension fuses and fuse holders.

Name _____

Title _____

Company _____

Address _____

City & Zone _____ State _____ 154

JFD JeTOMIC

Produces brilliant deep fringe UHF performance—plus.
 Produces heretofore unachieved gain of:
 Stacked* UHF Rhombic on Channels 14 to 83
 Stacked JeT conical on every VHF Channel 2 to 13.
 Featuring exclusive no-loss isolation network—Only 1 lead to set.

Model JeT 454 Single \$16.50 list
 Model JeT 454 S* Stacked 32.50 list

* complete with stacking transformers

Guaranteed to out-perform any other VHF or UHF-VHF antenna. Both units factory pre-assembled with renowned Jet-action all-aluminum construction. Write for Forms 230 and 241.

the most powerful **1.2** *punch*

Channels	14	21	28	35	42	49	56	63	70	77	83	DB GAIN
Competitor A Conical with Bowtie (2 stack)	4.0	3.25	2.0	1.0	1.0	0.75	0.5	0.7	0.9	0.75	0.3	
Competitor B Bedspring with UHF	0.75	0.75	0.9	1.0	0.8	1.0	1.5	1.6	1.25	2.5	1.0	
Competitor C Conical with V (2 stack)	3.0	3.3	4.0	4.6	4.9	5.0	4.8	4.5	4.25	4.0	3.75	
Competitor D Filter type with attached "V"	2.0	2.0	2.5	2.75	2.9	2.9	2.4	2.2	2.0	3	1.0	
JFD JeT 454 S	7.0	7.25	7.4	8.5	9.0	9.5	10.25	10.25	10.25	10.0	9.75	

JFD SUPER-JeT

Delivers Spectacular Deep fringe VHF performance—plus.
 Packs Unprecedented gain of:
 Single 10-Element VHF Yagi on each channel from 2 to 13.
 Stacked UHF Bowtie-Reflector off side lobes on Channels 14 to 83.

Model JeT 213 Single \$20.75 list
 Model JeT 213 S* Stacked 42.50 list

* complete with stacking transformers



Burton Browne Advertising

JFD Manufacturing Company
 Brooklyn 4, N. Y.

in antenna history!

CHANNELS	2	3	4	5	6	7	8	9	10	11	12	13	DB GAIN
Competitor A Mattress (4 Stack)	4.0	5.0	7.0	6.25	5.0	5.25	6.0	5.25	7.25	9.25	8.5	7.0	
Competitor B Radar Screen Type A	0.0	3.0	4.0	3.25	3.0	4.5	7.0	7.0	8.0	10.0	10.0	9.0	
Competitor C Radar Screen Type B	0.75	3.25	4.5	3.5	3.5	6.0	7.0	6.5	7.75	8.0	7.5	6.0	
Competitor D CHS 2-13 YAGI	4.50	5.00	5.75	3.00	2.50	3.50	1.00	0.0	.875	.875	.50	.75	
JFD JeT 213 S	6.0	7.5	8.75	7.75	6.75	10.0	9.0	7.0	9.0	10.0	11.0	9.75	

	1" Square Crossarm	Completely Preassembled	LIST PRICE
Competitor A	NO	YES	\$55.00
Competitor B	NO	NO	\$34.95
Competitor C	NO	NO	\$47.50
Competitor D (2 STACK)	NO	NO	\$65.90
JFD JeT 213 S	YES	YES	\$42.50

World's largest manufacturers of TV antennas and accessories.



Every Service Firm Owner in the U. S. A.
Receives SERVICE DEALER Monthly
DISTRIBUTION THIS ISSUE OVER 63,000

COWAN PUBLISHING CORP., 67 West 44th Street, New York 36, N. Y.

VOL. 15, NO. 1

JANUARY, 1954

EDITORIAL STAFF

Publisher

SANFORD R. COWAN

Editor

SAMUEL L. MARSHALL

Assistant Editor

NORMAN EISENBERG

Contributing Editors

LEONARD LIEBERMAN

ROBERT T. DARGAN

RUDOLF F. GRAF

MARVIN KLEIN

SAN D'ARCY

• •

BUSINESS STAFF

Advertising Director

SANFORD L. CAHN

Advertising Manager

HARRY N. REIZES

Eastern Adv. Sales

JACK N. SCHNEIDER

Production Manager

DAVID SALTMAN

Circulation Manager

HAROLD WEISNER

Assistant Circulation Manager

EDWARD J. HARMAN

• •

BRANCH OFFICES

CHICAGO

HAROLD F. MANN
 333 No. Michigan Ave.
 Franklin 2-7100

LOS ANGELES

TED E. SCHELL
 2700 West Third Street
 Dunkirk 2-4889

CLEVELAND

RICHARD E. CLEARY
 Commercial Bank Bldg.
 Berea, Ohio
 BErea 4-7719

FEATURE ARTICLES

Color TV, Part 3, by <i>Leonard Lieberman</i>	23
More detailed information and explanation of color receiver operation.	
Key Test Points, Part 2, by <i>Bob Dargan</i>	26
Servicing video if and detector sections.	
Stand-Off Insulators and U.H.F., by <i>Douglas H. Carpenter</i> and <i>David B. Tolins, Jr.</i>	40
Greater signal strength possible with new type stand-off insulator.	
Waveform Analysis in Sync Circuits, by <i>George Holmes</i>	45
How waveforms are developed in sync circuits.	

CIRCUIT & SERVICE DATA

Video Speed Servicing Systems Data Sheets (VSSS)	
G. E. 830, "R" version	35
Tele-King 812	37
Rider TV Field Service Manual Data Sheets	
RCA KCS74 and KCS74M1	41

DEPARTMENTS

Trade Flashes	6	The Workbench	33
Editorial	10	Circuit Court	39
Trade Literature	14	New Products	46
Guest Editorial	16	Association News	48
The Answer Man	31	Advertising Index	54
Annual Index	55		

RADIO-TELEVISION SERVICE DEALER is published monthly by Cowan Pub. Corp., 67 West 44th St., New York 36, N. Y. Subscription price: \$1 for 2 years in the United States, & U.S. Poss. Elsewhere \$1 per year additional. Single Copies 25c. Reentered as second class matter Sept. 25, 1950 at the Post Office at New York, N. Y. under the Act of Mar. 3, 1879. Copyright 1954, Cowan Pub. Corp.

POSTMASTER: SEND FORM 3579 TO RADIO-TELEVISION SERVICE DEALER,
 67 WEST 44TH ST., NEW YORK 36, N. Y.



CHANNEL MASTER

introduces a

basically *new type*
of VHF antenna

the **CHAMPION***

the highest gain
all-channel VHF antenna
ever developed!

Featuring the unique new "Tri-Pole"

TRIPLE-POWERED DIPOLE

The "Tri-Pole" is a new antenna system in which the Low Band folded dipole also functions as three folded dipoles tied together in phase on the High Band. This is the heart of the Champion, the secret of its phenomenal performance on all 12 VHF channels.

the **CHAMPION** is the most sensitive all-channel VHF antenna ever designed!

Stacked **CHAMPION** provides:
11-13 D B High Band gain
6½-7½ D B Low Band gain

Here is a totally NEW kind of antenna, completely different — in principal and performance — from any VHF antenna you've ever seen! Since the lifting of the TV freeze means a gradual disappearance of the single-channel VHF area, the VHF antenna of the future will be a multi-channel antenna. Prepare now for outstanding reception on all VHF channels — present and future — with Channel Master's super-sensitive **CHAMPION**! Outperforms every all-channel VHF antenna made today — and many Yagis, too!

COMPARE these features with the antenna you are now using:

- Folded dipoles throughout — give close to 300 ohms impedance across the entire band.
- Screen-type reflector provides high uniform gain on every channel, 2 through 13. Not frequency sensitive — this reflector provides more than twice as much extra gain as straight bar reflectors.
- Phase-correcting harness is built-in and fully assembled; the only wiring you do is to attach the lead-in.
- All-aluminum construction . . . lightweight, durable, non-corrosive.

MARVEL OF PRE-ASSEMBLY

assembles faster than a
5-element yagi!

Collapsed "Pop-Up" screen opens instantly — no loose rods, elements or hardware. "Tri-Pole" assembly features automatic Spring Lock Action — all dipoles snap permanently into place without wing nuts or any other hardware.

It's a **CHAMPION** in any area!

- 1-bay—local areas
- 2-bay—secondary and fringe areas
- 4-bay—super-fringe areas

Copyright 1953, Channel Master Corp.

THIS ANTENNA...

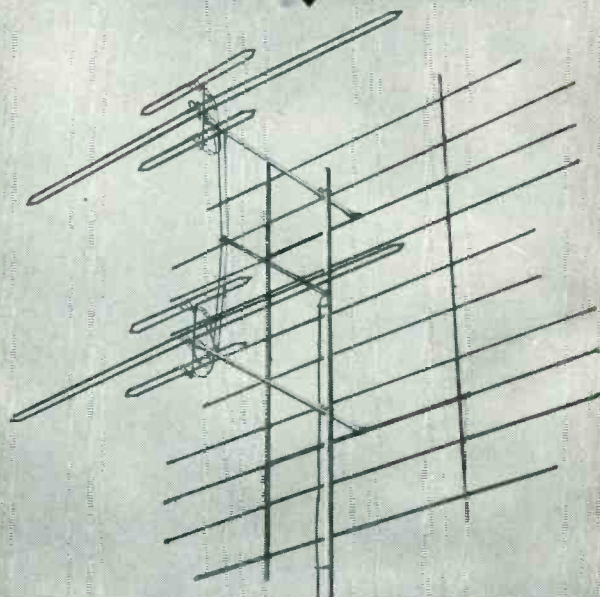

OUT-PERFORMS:

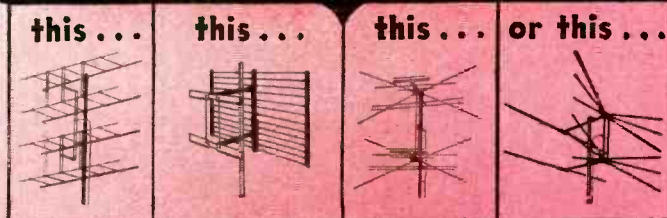

The 2-Bay **CHAMPION** actually
gives you the performance of:

- Separate 5-element Yagis for every Low Band channel!
- Separate 10-element Yagis for every High Band channel!

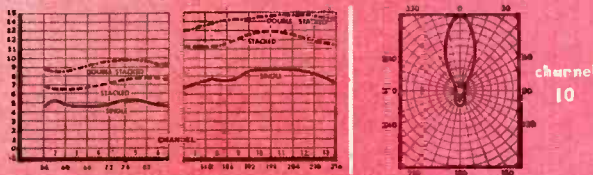

Model No		List Price
325	Single Bay	\$20.83
325-2	2-Bay	\$42.36
325-4	4-Bay	\$88.89
Separate Stacking Harness		
325-3	2-Bay Harness	\$ 2.08
325-5	4-Bay Harness	\$ 4.15

Send for complete technical literature.

CHANNEL MASTER CORP.

B - LENEVILLE, N. Y.





you're on **easy street**
with **PHOTOFACT**
SCHEMATICS

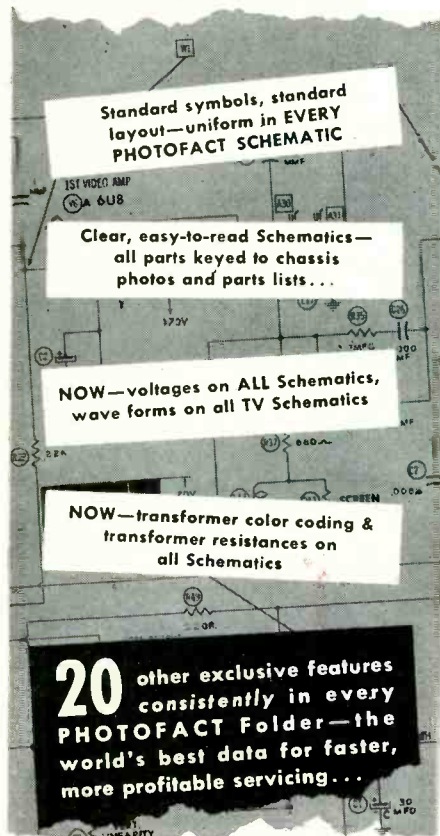

Standard symbols, standard layout—uniform in EVERY PHOTOFACT SCHEMATIC

Clear, easy-to-read Schematics— all parts keyed to chassis photos and parts lists...

NOW—voltages on ALL Schematics, wave forms on all TV Schematics

NOW—transformer color coding & transformer resistances on all Schematics

20 other exclusive features consistently in every PHOTOFACT Folder—the world's best data for faster, more profitable servicing...

NOW! GET THE PROOF FOR YOURSELF!

FREE

We'll send you a Free Photofact TV Folder— just ask us for it!

Learn for yourself how PHOTOFACT pays for itself by earning bigger profits for you! We'll send you the proof—a FREE specimen PHOTOFACT TV Folder that shows all the features found consistently and exclusively ONLY in PHOTOFACT. Send for your FREE specimen TV Folder now. Examine it. Compare it. You'll see why PHOTOFACT belongs in your shop! And you'll want to ask your parts distributor about the pay-as-you-earn-plan. Only \$25 down brings you the entire PHOTOFACT Library. Write for FREE specimen TV Folder—learn now how to earn more!

HOWARD W. SAMS & CO., INC.
2209 E. 46th St., Indianapolis 5, Ind.

HOWARD W. SAMS & CO., INC.

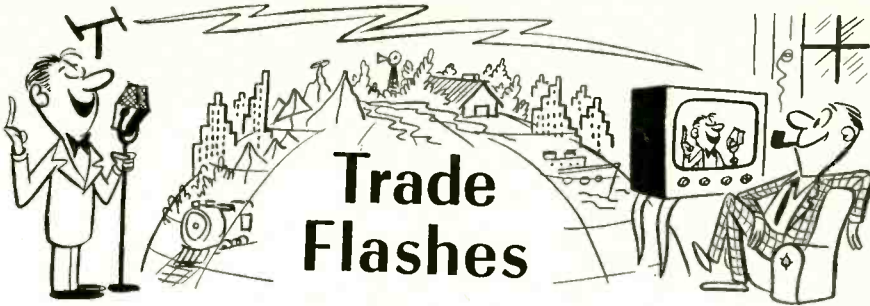

Industry Leaders Differ on Number Of Color TV Sets for 1954

The Radio - Electronics - Television Manufacturers Association (RETMA) estimates about 192,600 color TV sets will be produced in 1954, it is reported. This figure is an average estimate; high guess was 650,000 sets and low guess was 50,000 sets.

The low guess is more in keeping with the estimate released by J. B. Elliott, RCA's vice-president in charge of consumer products. Mr. Elliott figures between 50,000 and 75,000 color TV sets will be produced in 1954.

An even lower estimate is offered by Edward S. White, Chief Engineer of the Advanced Development Department of CBS-Columbia. Mr. White has stated that the first color TV receivers would cost about \$1,000 and that the industry could conceivably make 30,000 to 50,000 sets in the first year following FCC approval. Mr. White counsels the public not to expect too many marvels overnight. He said: "It is true that television and electronics have made tremendous strides but behind the startling announcements were always years of research... We are engaged in making better use of electronics, not newspaper headlines."

Despite difference of opinion on color TV, there is widespread agreement on the promise of 1954 for black-and-white TV. Mr. White has emphasized that this form of programming would continue to be the backbone of the nation's video system for many years to come. RCA's Mr. Elliott has asserted that many millions of black-and-white TV receivers may be sold in 1954. The RETMA estimates close to 5,000,000 black-and-white TV sets will be made and sold in the U. S. A. in 1954.

NEDA Numbers to Appear On Burgess Battery Cartons

Burgess Battery Company announces that their unit and master shipping cartons for Burgess portable radio batteries will carry NEDA numbers as well as their own. Copies of the index

are available on request. Write to National Electronic Distributors Association, 228 North LaSalle Street, Chicago 1, Illinois.

Service Dealers Attend Raytheon Meetings

Over 1,000 service dealers attended Raytheon "Service Saver" meetings in Springfield, Mass; Manchester, N. H.; and Boston Mass. recently. Sponsoring the New England meetings were the following Raytheon distributors: L. L. Del Padre Associates, De Mambro Radio Supply Company, Electrical Supply Corporation, Graybar Electric Company, Hatry and Young of Mass. Inc., Lincoln Electronic Supply Corporation, A. W. Mayer Company and Willett Radio Supply, Inc.

Largest attendance was registered at the Boston meeting where 850 service dealers were on hand to hear Bill Ashby's presentation of the Raytheon "Service Saver" plan at the John Hancock Hall, Wednesday evening, October 28th.

At the meetings conducted by Mr. Ashby, a slide-illustrated talk reviewing U.H.F. installations and servicing problems was given. He further developed the Raytheon "Service Saver" plan, also illustrated with slides, built around the T.V. Owner's Guide and the dealer's Service Saver Manual and wall chart (described in the November issue of RTSD). Attending service dealers were most enthusiastic in their response to the informative and educational talks.

Hi Fi Expected To Stimulate Sales

The tremendous upsurge of public interest in high fidelity music reproduction for the home may lead to increased phonograph and equipment sales of between 200 and 300 million dollars in 1954, it is estimated by Henry G. Baker, vice president of R.C.A.

"If our industry is alert to this great demand for enjoyment of the finest musical reception I think it will be able, by the end of next year, to put high fidelity equipment in from five to ten times as many American homes

3 great, new UHF antennas

by **CHANNEL MASTER**

STACKED TWIN CORNER REFLECTOR model no. 406-2

The most powerful UHF fringe area installation you can make today!

- Broad Band coverage — yet out-performs most stacked Yagis.
- Covers every UHF channel, not just segments of the band.
- New impedance-matching, two-stage stacking system.

Another original Channel Master development!

Model No.	Description	List Price
406	Twin Corner Reflector	\$18.06
406-2	2-Bay Twin Corner Reflector. Stacking harness furnished free.	36.10
406-3	Stacking harness only, furnished separately.	2.08

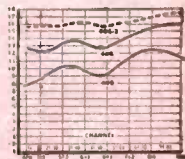
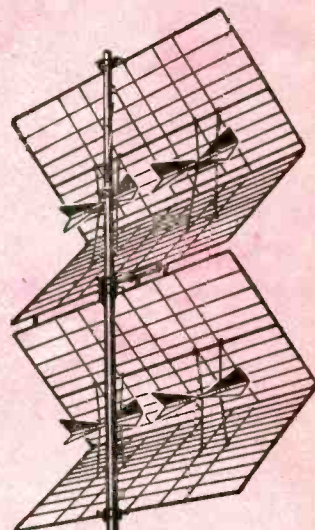

*powerful
new
antennas
span
vast
distances*

the first UHF CORNER REFLECTOR with optional "2-way" mounting!

model no. 409



mounts
this way . . . or this way

Only CHANNEL MASTER'S CORNER REFLECTOR can be adapted to any kind of UHF installation — with or without VHF — at no extra cost. Every antenna contains all necessary hardware and braces for BOTH popular types of mounting. Sharp directivity and unusually high gain across entire UHF band.

only
\$903
list

Installs instantly! Original Channel Master assembly feature: Screen swings open like a book — dipole assembly snaps into place.

"SWEET 16" The World's First 16-Element UHF Yagi!

- Custom-designed for your particular area.
- Super-power! Sensational fringe area reception.
- Delta-Weld design. Elements WELDED to crossarm. Delta-matched dipole gives uniform impedance.
- Wide band coverage, up to 21 channels.
- Average gain: 13 DB single
16 DB stacked

model no. 420

\$820



Send for technical

CHANNEL MASTER CORP.
LITTLEVILLE, N. Y.

The master

of television signal generators

- more sweep
- greater RF output
- better stability
- increased accuracy
- unlimited flexibility
- lower cost

model TVG-2

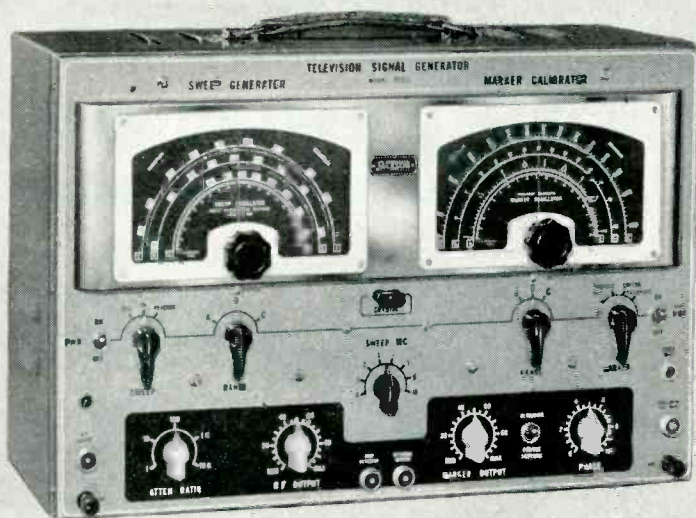

See your electronics distributor or write.

JACKSON

"service engineered" test equipment

JACKSON ELECTRICAL INSTRUMENT CO.
DAYTON 2, OHIO

IN CANADA:
THE CANADIAN MARCONI CO.

as now have it," Mr. Baker said at a recent high fidelity symposium.

George R. Marek, director of the artists and repertoire division of RCA Victor records, predicted that the record industry's sales volume would increase from its present \$225 million annually to more than \$300 million within the next five years. The bulk of the increase, he stated, would come from sales of classical records stimulated by the expanding high fidelity market.

Finney Wins

"Unfair Competition" Lawsuit

The Finney Company, Cleveland, Ohio, manufacturers of a fringe area antenna line, have obtained a court judgment for damages and a permanent injunction against a Canton, Ohio service company that had been selling an unnamed antenna which they represented as being a genuine Finco antenna.

The following quotation is reproduced from a decision of the Court of Common Pleas, Stark County, Ohio, November 6, 1953:

"being fully advised in the premises and by agreement of the parties hereto, the Court finds that the defendant has engaged in unfair competition, as in said petition complained of, by passing off unto its customers, as "Finco" antenna, other antennas of similar appearance which were not genuine and which were not products of the plaintiff, and that plaintiff is entitled to an award of damages and a final and permanent order restraining defendant from further unfair competition with the plaintiff."

Mr. M. L. Finneburgh, Vice President of The Finney Company, stated in a general release to the trade press, "I believe we are the first manufacturer ever to carry a case of misrepresentation by a service company into the courts of the United States."

RMS Gains Control Of Ames and JEB

Sidney Pariser, President of Radio Merchandise Sales, Inc., 2016 Bronxdale Avenue, N. Y. 62, announces that RMS has now acquired the controlling interests in the Ames Mfg. Corp., manufacturers of a complete line of wire products, and in the JEB Sales Corporation, producers of the JEB rotator.

The sales program for all three companies will be handled by Martin Bettan, present Sales Manager of RMS, and in almost every instance Mr. Bettan reports that the present RMS representatives have arranged to handle all three lines. RMS, Ames and JEB

[Continued on page 47]

**You can't
do without...**

SYLVANIA'S SEE-WELL TOOL KIT

A NEW, TIME-SAVING TOOL-SENSATION!



Tough, compact styrene case with clip lock.

Flash-light handle for interchangeable tips.

**YOUR 3 MOST NEEDED TOOLS
IN 1 KIT-MAGNETIC PHILLIPS AND
FLATHEAD SCREWDRIVERS, NYLON
ALIGNMENT TOOL - PLUS
POWERFUL FLASHLIGHT!**

Break-resistant lucite spotlights work.

Stainless steel handle with built-in flash-light. Uses 2 pencil light batteries of any size (not included in kit).

Magnetized tempered steel Phillips screwdriver head embedded in clear lucite shaft.

Flat screwdriver, magnetized tempered steel, clear lucite shaft for tight fitting handle.

Nylon, non-conductive alignment tool on lucite rod, to reach and see what you're doing.

This
\$ 795
VALUE
for only 15
Sylvania Premium Tokens.

NO MORE FUMBLING inside dark radio and TV cabinets. At the flick of a switch, a bright light automatically focuses right at the spot you're seeking. Saves your time . . . improves your work.

3 Handy Tools in 1. Magnetized Phillips and Flathead screwdrivers, nylon alignment tool - all 3 built into break-resistant lucite shafts perfectly fitted to flashlight handle.

Without doubt, this SEE-WELL Tool Kit is one of the slickest, quickest service tools ever built!

See your Sylvania Distributor Today! He has this remarkable tool kit for you now - you need only 15 Sylvania Premium Tokens. The time to get this valuable Sylvania See-Well Tool Kit is NOW - so don't delay, order high quality Sylvania tubes TODAY.

Remember, you get 1 token with every 25 Sylvania Receiving Tubes or every Sylvania TV Picture Tube you buy.

SYLVANIA

Sylvania Electric Products Inc. Dept. 4R-3901, 1740 Broadway, New York 19, N. Y.

In Canada: Sylvania Electric (Canada) Ltd.
University Tower Bldg., St. Catherine Street, Montreal, P. Q.

LIGHTING • RADIO • ELECTRONICS • TELEVISION

RADIO-TELEVISION SERVICE DEALER • JANUARY, 1954





EDITORIAL...

by S. R. COWAN
PUBLISHER

COLOR TV MERCHANDISING

SOME Service Dealers feel that the slight slow-down of TVset buying in major cities has been occasioned by the publicity given to the imminence of color TV, and our own survey in this regard bears them out. However, we still believe that the sale of color TVsets in any appreciable volume is a matter for very late 1954 or early 1955 at best. We doubt that there will be over 50 thousand color TVsets produced within the next 12-month period, or up until March 1955.

Several "bright" Service Dealers have started to use a clever merchandising "angle" in order to keep black & white TVset sales volume up. They are offering present b & w model TVsets for sale now with a guarantee that the full purchase price will be allowed against the purchase of a color TVset when they first become available. Knowing that color TVsets, when initially offered, will sell in the \$800 to \$1,000 price range, the Service Dealers who are using this gimmick figure that on a subsequent trade-in-deal the presently-sold TVset, (in the \$200-\$300 price range), represents no more than a "normal" discount or allowance against the new color TVset. They can't lose, dollarwise, and they keep the present b & w buyer in a complacent frame of mind during the interim. We like the idea, but soon the public may get wise to it. Meanwhile, anyone who fails to buy a b & w TVset now just because he would rather wait for color is only cheating himself of good entertainment, worth far more than he pays for.

Just before closing out this discussion about color TV, let us reiterate what has been said in these columns before concerning technical text material on color TVsets. At this moment the very biggest TVset manufacturers, RCA, Sylvania, G. E., Philco, Emerson, Raytheon, Zenith and others are working night and day trying to compile worthwhile data that would help TV servicemen learn all the why's and wherefore's about servicing color TVsets—and not one of these firms has as yet released such service data to their own service departments because the material they have on hand is still not complete or practicable. We will NOT kid you in our editorial columns about such a vital subject nor will we attempt to "window-dress" articles to delude you that we are covering color TV service problems now. The time is not ripe, and that is that! It's better that we give you no information about the technical aspects of color TV rather than give you false information, or data that is not worthwhile.

THE CUSTOMERS WRITE

OUR circulation department has been on the verge of going "batty" these past few weeks. Thousands of owners of legitimate service shops have sent in their Free Subscription Order Forms, clipped from this magazine, and properly filled in—but they failed to enclose one of the three types of supporting proof that we asked for, such as: 1)—the page from the Tel. Co. Classified Directory showing their service firm's listing under either "Radio Service" or "Television Service"; or 2)—a letterhead or business card; or 3)—an old invoice showing that the firm does business with a Parts Jobber. Fellows, please take care of this little detail hereafter to save us a lot of unnecessary correspondence and to expedite correcting your stencil if it is wrong.

Also, despite the fact that we state clearly that "Under our new policy any legitimate service shop owner whose name is not already on our list who sends us the proper proof of his status (as outlined in the above paragraph) need not pay for his subscription"—hundreds of such shop owners have sent us money along with notes saying that they like *Service Dealer* so much they insist that we accept their dollar and consider them as paid subscribers rather than as free qualifiers. No finer compliment could be paid us and we are very appreciative.

OPINIONS—PRO AND CON

WE have asked service shop owners in all parts of the country the simple question, "How's Business?" In new TV areas they report, "Wonderful!" In major cities like New York, Chicago, Los Angeles, etc., where TV has become somewhat commonplace, they report with less enthusiasm the consensus: "It could be much worse."

In major cities most old, small-screen TVset owners who have purchased new big-screen models during the past two years have kept their old sets as the 2nd or 3rd set in the home. And these old sets, despite the fact that they get less use than heretofore, because of aging, are providing a comfortable volume of service business.

In this connection, statistics about the number of homes having TVsets in them are a factor worth considering. Although over 27 million TV sets have been sold to date, only 15 million homes have TV sets in them. Some homes have two, and others have three sets. Thus the fear, that TV might soon reach a saturation point causing new set sales to drop off sharply, is unjustified. Remember that upwards of 35 million homes still did NOT have a TVset as of January 1st, 1954.

This is to certify that

Frank's Radio

has

BOND

and this

- 1. GUARANTEE FOR NEW REPLACEMENT DATE
- 2. Use only
- 3. Notch
- 4. Test



EXTRA The Daily News

EXTRA

RAYTHEON BONDED PROGRAM ENTERS TENTH YEAR

RAYTHEON PROGRAM CONTINUES TO BE SERVICE DEALERS' MOST EFFECTIVE SALES AID

...the most effective sales aid...
 ...service dealers' most effective sales aid...
 ...Raytheon Bonded Program...
 ...continues to be service dealers' most effective sales aid...



...the most effective sales aid...
 ...service dealers' most effective sales aid...
 ...Raytheon Bonded Program...
 ...continues to be service dealers' most effective sales aid...

COMPANY

Raytheon
 by BOY TUBEDISTERS, President

No. _____ A

It was way back in 1945 that Raytheon, the first tube manufacturer to recognize the Service Dealers' need for help in combating public mistrust, provided that help through the *Raytheon Bonded Electronic Technician Program*. For the past nine years this Raytheon support has helped many thousands of Service Dealers gain customer confidence and good will — substantially in-

crease their volume and profit. Today, with the addition of television, the Raytheon Bond is more important than ever. And today, as always, if you can qualify for it, your status as a Raytheon Bonded Electronic Technician *costs you not one cent*. It is *Raytheon's* investment in *your* future.

If you're interested in making more money, ask your Raytheon Tube Distributor to tell you about the Raytheon Bonded Program. He'll be pleased to tell you how this powerful sales stimulator can help you.



RAYTHEON MANUFACTURING COMPANY

Receiving Tube Division
 Newton, Mass., Chicago, Ill., Atlanta, Ga., Los Angeles, Cal.

Excellence in Electronics

RAYTHEON MAKES ALL THESE: RELIABLE SUBMINIATURE AND MINIATURE TUBES • SEMICONDUCTOR DIODES AND TRANSISTORS • NUCLEONIC TUBES • MICROWAVE TUBES • RECEIVING AND PICTURE TUBES

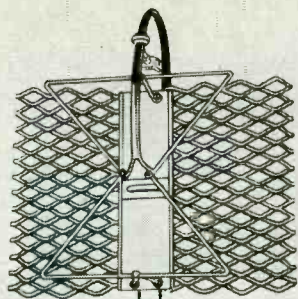

Model UW-2

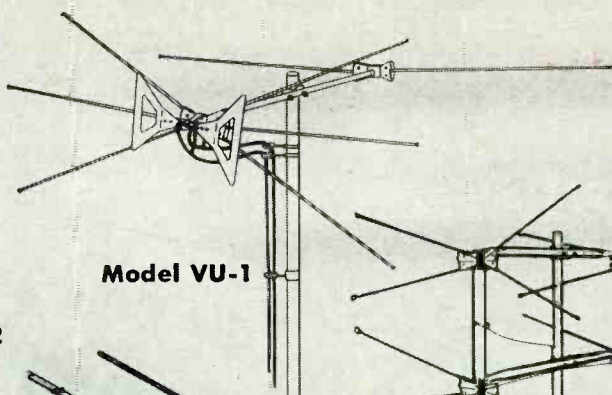

Model VU-1

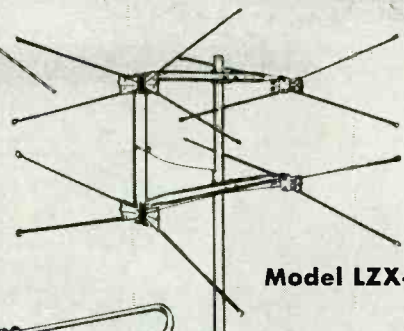

Model LZX-2L



Model 4YG-45

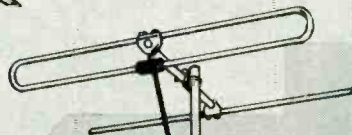

Model 92-FM

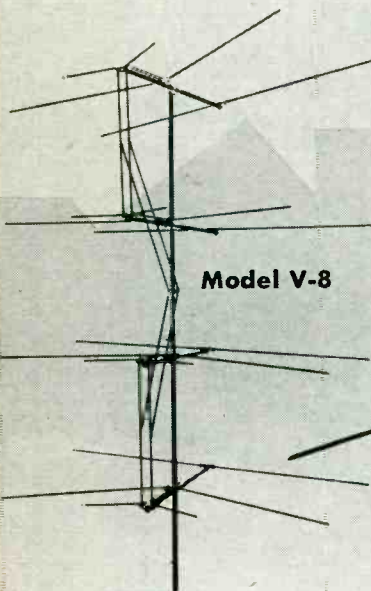

Model V-8

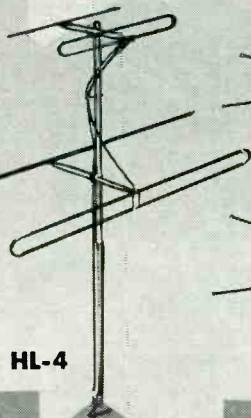

Model HL-4

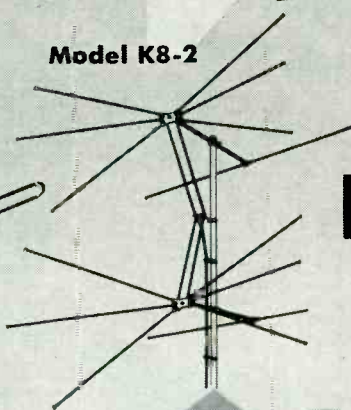

Model K8-2

RADIART

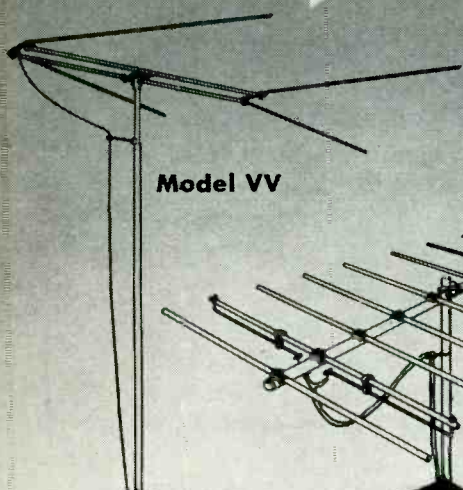

Model VV

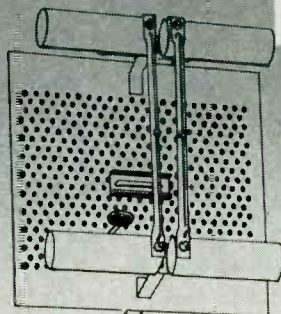

Model U-4

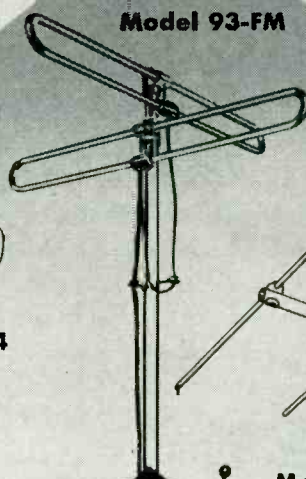

Model 93-FM

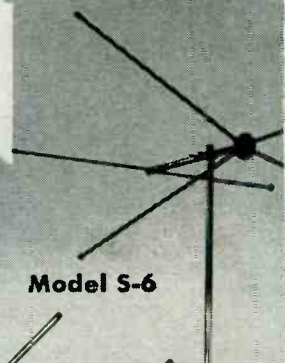

Model S-6

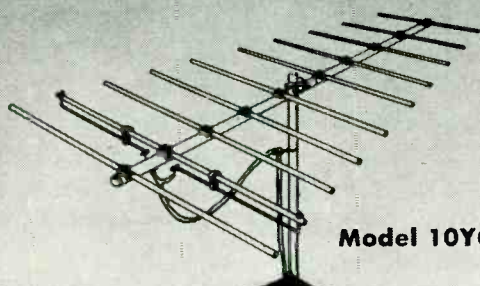

Model 10YG

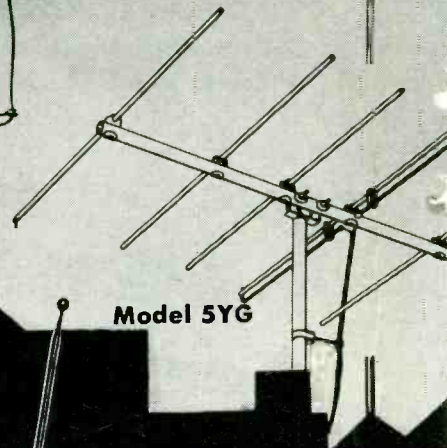

Model 5YG

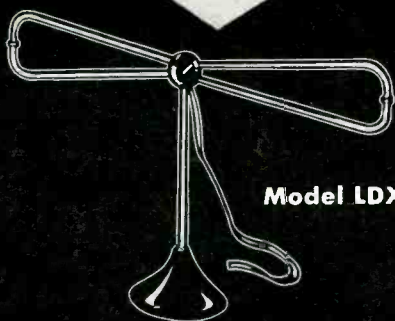

Model LDX-1



Model CT-231

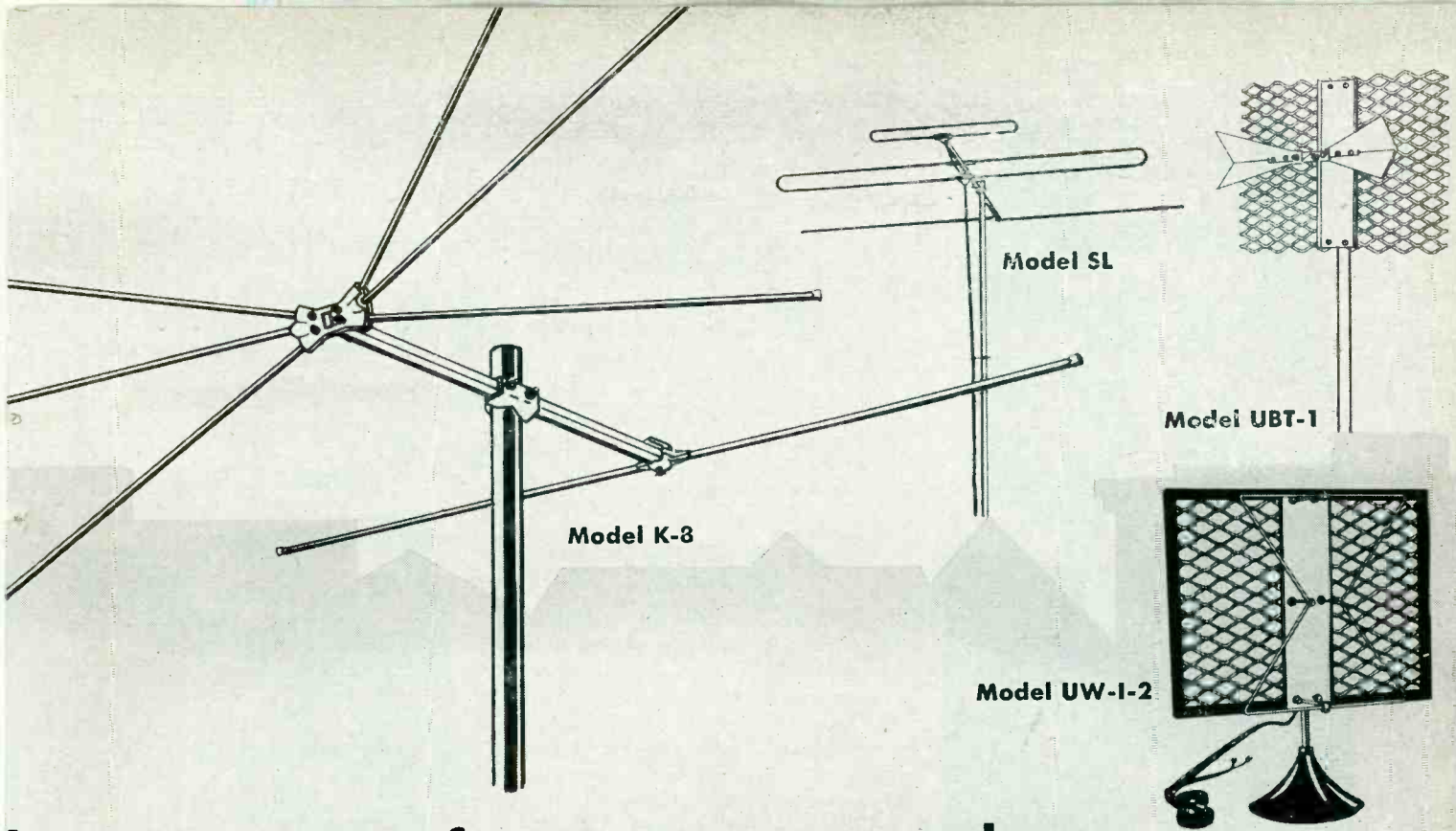

has a type for every need ...
 a design for every application

UHF and VHF ANTENNAS

Ready For Immediate Delivery

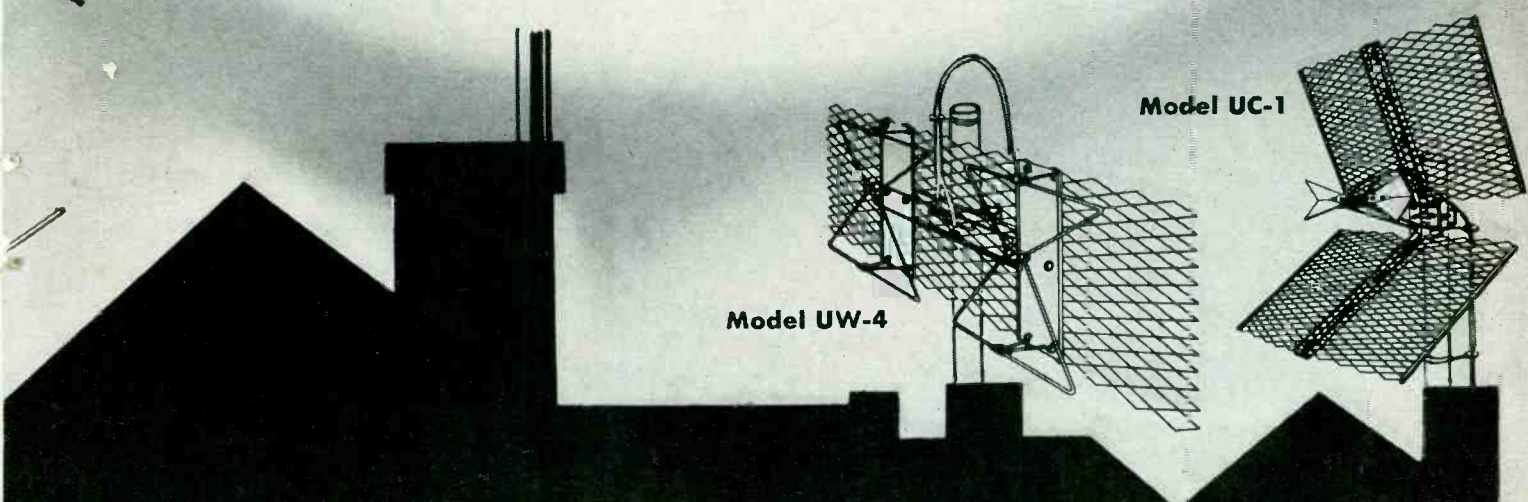
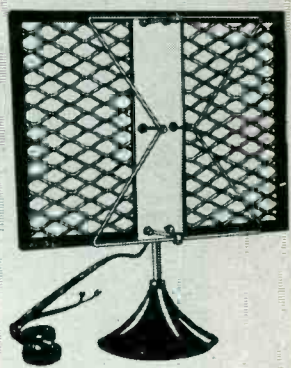

THE RADIART CORPORATION
 CLEVELAND 13, OHIO

TV ANTENNAS * AUTO AERIALS * VIBRATORS * ROTORS * POWER SUPPLIES

RIDER TEK-FILE*

**NOW...
ONLY \$1.50
PER PACK!**

packaged tv service information

(Schematics on all production runs. Voltage data. Waveforms. Alignment. Chassis views. Installation. Chassis removal, etc.)

factory- authorized

factory- approved

for easy TV
servicing...

tailor-made
for more than
3000
receiver models.

**NOW ONLY
\$1.50 per pack**

(at your jobbers)

Try a pack. If you're not satisfied,
return the pack within 7 days and
your money will be refunded.

*Dependable TV replacement
parts listings starting
with pack 57

JOHN F. RIDER

Publisher, Inc.

480 Canal Street
New York 13, N. Y.

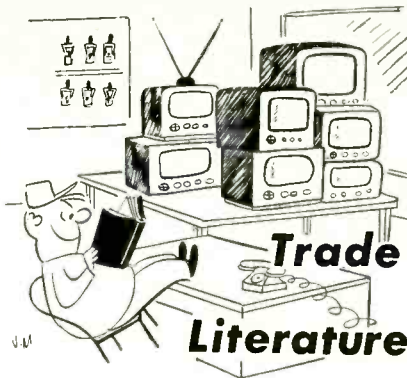

New Books

(J. Richard Johnson, *How To Troubleshoot a TV Receiver*, John F. Rider Publisher, Inc., N.Y., 128 pp., \$1.80.)

Aimed at the servicing technician, this attractive volume presents certain basic lines of approach to repairing sets. The book re-defines standard procedures such as the use of schematics and test-patterns. In addition, the author provides some interesting new twists on common problems that plague servicing work. The book is replete with examples of real troubleshooting problems. Amply illustrated and indexed, *How To Troubleshoot a TV Receiver* should be a welcome addition to any man's tech library.

The *Radio Designers Handbook*, fourth edition [reproduced and distributed by Radio Corporation of America; price, \$7.00] is a result of the combined efforts of thirty-three authors-engineers. This virtual encyclopedia contains 1,500 pages of information pertaining to circuit design and applications of most every circuit used in radio receivers.

For those who must refer occasionally to authoritative sources on circuitry, this book is a must. For the practicing technician, a world of information is available on circuit operation and adjustment. In addition, many valuable charts and reference sources are included.

The reviewer believes this book to be the most complete compilation to date on the subject of radio receiver circuitry.

Special monographs dealing with various aspects of television engineering are being published by Philips' Technical Library of Holland. Available so far is volume 1, "I.F. Stages" which deals with the application of the pentode in TV receivers, and volume 2, "Flywheel Synchronization of Saw-Tooth Generators" which analyzes the flywheel action of resonant circuits, discusses automatic phase control and practical flywheel circuits for TV receivers. The general title for the series

there's always
something
new
being developed
by *Perma-Power*

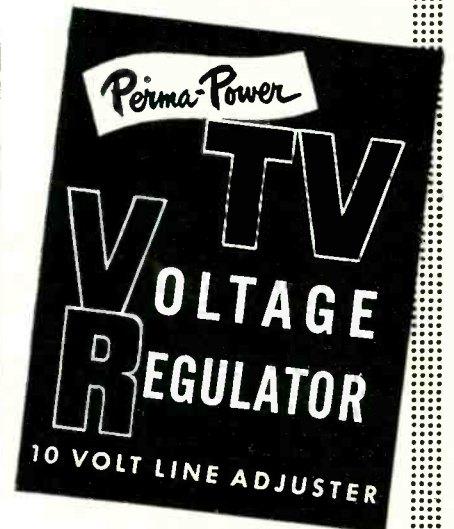

- NORMAL LINE VOLTS
 - 10 VOLTS INCREASE
 - 10 VOLTS DECREASE
- 300 WATTS**

List Price
\$6.75

Sold Through
Better Jobbers

manufactured by
Perma-Power COMPANY
Chicago 25, Ill.
Manufacturers of Electronic Equipment Since 1928

is *Television Receiver Design*. For further information, write the American distributor, Elsevier Press, Inc., at 402 Lovett Blvd, Houston 6, Texas, or at 155 East 82nd Street, New York 28, N. Y.

Catalogs, Bulletins, and Guides

J. W. Miller Company's Catalog No. 154, titled *TV Technician's Coil Replacement Guide*, is available from the manufacturer. 20 pages profusely illustrated, the catalog contains valuable data on such Miller products as pix if transformers, sound transformers, horizontal oscillator and sync control coils, adjustable ion trap, video peaking coils, and adjustable linearity and width controls.

A catalog describing *Plastic Capacitors* can be obtained by writing to Plastic Capacitors, Inc., 2511 W. Moffatt St., Chicago 47, Ill. The catalog describes the background of plastic capacitor and lists specifications for various types available.

Comprehensive data on characteristics, applications, tolerance, windings, terminations, dimensions, insulation, charts and graphs, etc, is contained in *Catalog Bulletin B-8*. For your copy, write International Resistance Company, 401 North Broad Street, Philadelphia 8, Pennsylvania, for Catalog Bulletin B-8.

Just off the press is new *Bud Catalog of Sheet Metal Products and Electronic Components*. This 52 page catalog illustrates and describes the complete Bud line. Copies may be obtained by writing to Bud Radio, Inc., Dept. C9, 2118 East 55th Street, Cleveland 3, Ohio.

LaPointe Electronics Inc., Rockville, Connecticut, has released to its national distributors a completely new and revised twenty-page catalog. All pages are punched and bound into a handsome cover featuring the new VEE-D-X mobile point-of-sale display piece. Catalog sheets follow N.E.D.A. recommendations for specification data and include gain charts as well as shipping weights and other detailed information on antennas and accessories.

Ten new bulletins issued by the General Electric Commercial Equipment Department in Syracuse, N. Y., describe latest improvements in many of the company's radio communication equipments for industrial and civil defense applications, taxicabs, utilities, police and fire departments.

The new bulletins cover six base

TOWN

Simpson

MODEL 488 FIELD STRENGTH METER

Saves service time in TV antenna installation—makes service profits longer...Whether installation is fringe in the hills or in the bounce-filled canyons of the city, Model 488 gives you the best location quickly, accurately...Location of maximum signal areas, antenna orientation, comparison of antenna systems, adjustment of boosters and checking antenna and lead-in installations are only a few of the many functions of Model 488.

You're losing profits without one...Dealer's net price including operating instructions and shoulder strap, \$115.00

See your jobber for full information or write Simpson Electric Company, 5200 West Kinzie Street, Chicago 44, Illinois. Phone ESTebrook 9-1121.

In Canada: Bach-Simpson, Ltd., London, Ont.

Another reason why Simpson is the world's largest manufacturer of test equipment

Country

burton brayne advertising

station combinations and four mobile combinations.

The new bulletins are available from the Inquiry Section, G-E Electronics Division, Electronics Park, Syracuse, N. Y.

Snyder Manufacturing Company of Philadelphia has issued its new 1954 *Catalog* containing the company line of television antennas and accessories. Completely revised in content and appearance, the catalog is brightly printed in three colors and has been edited for simplicity and easy reference. Contained within a separate cover, the pages of the new Snyder catalog

describe and illustrate the company's line of television antennas including the outdoor and indoor Directronics, the Head-Line and Redi-Mount conicals, UHF antennas, Yagis, folded and line-up antennas and the indoor antenna series. Also included is a catalog page on Snyder television antenna masts, accessories and 2-set coupler, plus a page on Snyder sales aids.

A new feature of the Snyder catalog this year is an attractive cover for executives' desks. Copies of the catalog may be obtained by writing to sales manager Dick Morris at Snyder Manufacturing Company, Philadelphia 40, Pa.

AMPHENOL

EMPHASIS ON

QUALITY

makes antennas 4 ways

Better

Better

PICTURE

VHF or UHF, any television set will present its finest picture with an AMPHENOL antenna. There is an AMPHENOL antenna for every location, and AMPHENOL precision engineering has designed each antenna type to satisfy the most stringent electrical requirements.

Better

PERFORMANCE

AMPHENOL antennas will outlast ordinary antennas in every installation. The use of premium materials and craftsmanship antenna assembly assures set owners of long trouble-free years of efficient performance. Ice storms or high winds are easily weathered by sturdy AMPHENOL antennas.

Better

BUSINESS

The combination of better tv pictures and longer-lasting antenna installations adds up to better business for every dealer or serviceman that sells the quality AMPHENOL line. Customer satisfaction is one sure result of selling AMPHENOL—and is a dealer's best advertisement for future business.

Better

PROFITS

Selling up to quality with AMPHENOL instead of down to price with other antennas means higher profits for every merchandiser. The slightly higher price of an AMPHENOL antenna to the customer gives him the best antenna on the market—and gives you a larger gross and a higher net profit.

Guest

Editorial



EDWARD F. MORGAN

Service Manager,
CBS-Columbia, Inc.

IT has always been a television manufacturer's Service Manager's function to supply the service dealers, agencies and servicemen with schematics and service manuals. Since the start of television, elaborate manuals were available from manufacturers which contained schematics, parts lists, detailed circuit description and analysis, alignment procedures, service hints and latest circuit changes, in addition to such basic installation information as ion trap adjustments, antenna connections and information on procedures for replacing the picture tube.

When all this information was printed, it would often result in a booklet of considerable size which was expensive to publish in limited quantity and therefore had to be sold at a price. A technician who merely needed a schematic was forced to buy literature in excess of his needs. When a circuit change came along, supplementary manuals had to be printed, which only added to the confusion of the service man.

CBS-Columbia Inc., in recognizing this problem, has condensed all service manuals to a point where they contain only data peculiar to any one particular chassis. This deletes information which, in the past, comprised the bulk of a service manual and which today is considered "standard operating procedure" by the trained technician.

Our service manuals now consist of the following essential items:

1. Schematic of the chassis in question.
2. Voltage and wave form charts. (Often included as part of the schematic.)
3. Alignment procedure.
4. Parts lists, including cabinet hardware.
5. Top and bottom view of chassis.
6. Special service notes pertaining to the particular chassis.

This reduced the manual to such small proportions that the cost of printing became negligible. Now it became possible to provide this information to every set owner by inserting it with the instruction book in each television carton. As a result, it is no longer necessary for individual servicemen to write to the factory for service data, which process always resulted in service delay and customers' dissatisfaction.

When circuit changes become necessary, they are printed first in a service bulletin which is made available to the trade. When the improved version of the chassis appears as a production run, immediately a new condensed manual will accompany it on its way to the consumer. This eliminates the necessity of explaining the circuit changes (which were necessary to accomplish the improvements) in a supplementary manual.

AMPHENOL

AMERICAN PHENOLIC CORPORATION

Chicago 50, Illinois

Service Men!

**THE GUARDIAN
SERIES 200
RELAY...**

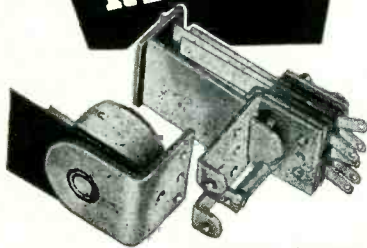

Interchangeable
**COIL and CONTACT
SWITCH ASSEMBLIES**
Save Time—Cut Costs!

★ Coil assembly includes coil and field piece. Contact assembly consists of switch blades, armature, return spring and mounting bracket. Standard and Midget contact assemblies in either S.P.D.T. or D.P.D.T. are *interchangeable* and can be used with any of 13 coils described below.

CONTACT SWITCH ASSEMBLIES

CAT. NO.	TYPE	AMPS	COMBINATION	THROW
200-1	Standard	8 amps	Single Pole	Double Throw
200-2	Standard	8 amps	Double Pole	Double Throw
200-3	Standard Contact Switch Parts Kit with complete assembly and wiring details			
200-4	Standard	12.5 amps	Double Pole	Double Throw
200-5	Standard	8 amps	Four Pole	Double Throw
200-M1	Midget	8 amps	Single Pole	Double Throw
200-M2	Midget	8 amps	Double Pole	Double Throw
200-M3	Midget Contact Switch Parts Kit with complete assembly and wiring details.			

13 COILS ASSEMBLIES

A.C. COILS*		D.C. COILS	
CAT. NO.	VOLTS	CAT. NO.	VOLTS
200-6A	6 A.C.	200-6D	6 D.C.
200-12A	12 A.C.	200-12D	12 D.C.
200-24A	24 A.C.	200-24D	24 D.C.
200-115A	115 A.C.	200-32D	32 D.C.
		200-110D	110 D.C.
		200-5000D for current type	

*All A. C. coils available in 25 and 60 cycles

GUARDIAN ELECTRIC
1606-A W. WALNUT STREET CHICAGO 12, ILLINOIS
A COMPLETE LINE OF RELAYS SERVING THE RADIO INDUSTRY

SUBSCRIBE TODAY!

All the material published in "Service Dealer" enables servicemen to do their work more efficiently, in less time, and by simpler means. The more speed and productivity a technician has—the more jobs he can do in a working day—with the end result that employed technicians will earn more for their employers, and employers in turn will be able to pay their technicians better wages out of increased profits.

-EMPLOYED TECHNICIANS - 24 ISSUES for \$1.00 -

RADIO-TV SERVICE DEALER NEW
67 W. 44 St., New York 36, N. Y. RENEWAL

Gentlemen:

Here is \$1.00 for which enter my 2-year subscription.

Name

Address

City Zone State

Employed by (Name of firm)

Firm's business address

City Zone State

Your Position or Title

Check whether firm is:

Service Organization or Dealer having Service Dept.

If some other type of company describe:

(If a group of sub. orders are being sent, simply type the list—give each man's title)

antennas by **AMPHENOL**

UHF/VHF

UHF

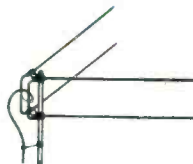

STACKED-V
114-059



YAGI
114-054

VHF

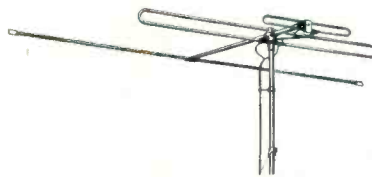

INLINE*

*REISSUE U.S.
PAT. NO. 23,273
114-005



BO-TY
114-065

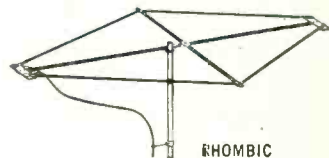

RHOMBIC
114-060

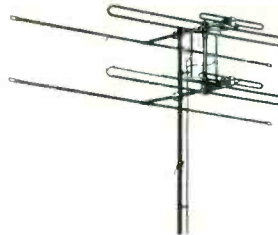

STACKED ARRAY
114-302

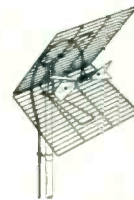

CORNER REFLECTOR
114-058

for a complete line of quality
tv antennas, look to



AMERICAN PHENOLIC CORPORATION
Chicago 50, Illinois

LITTELFUSE

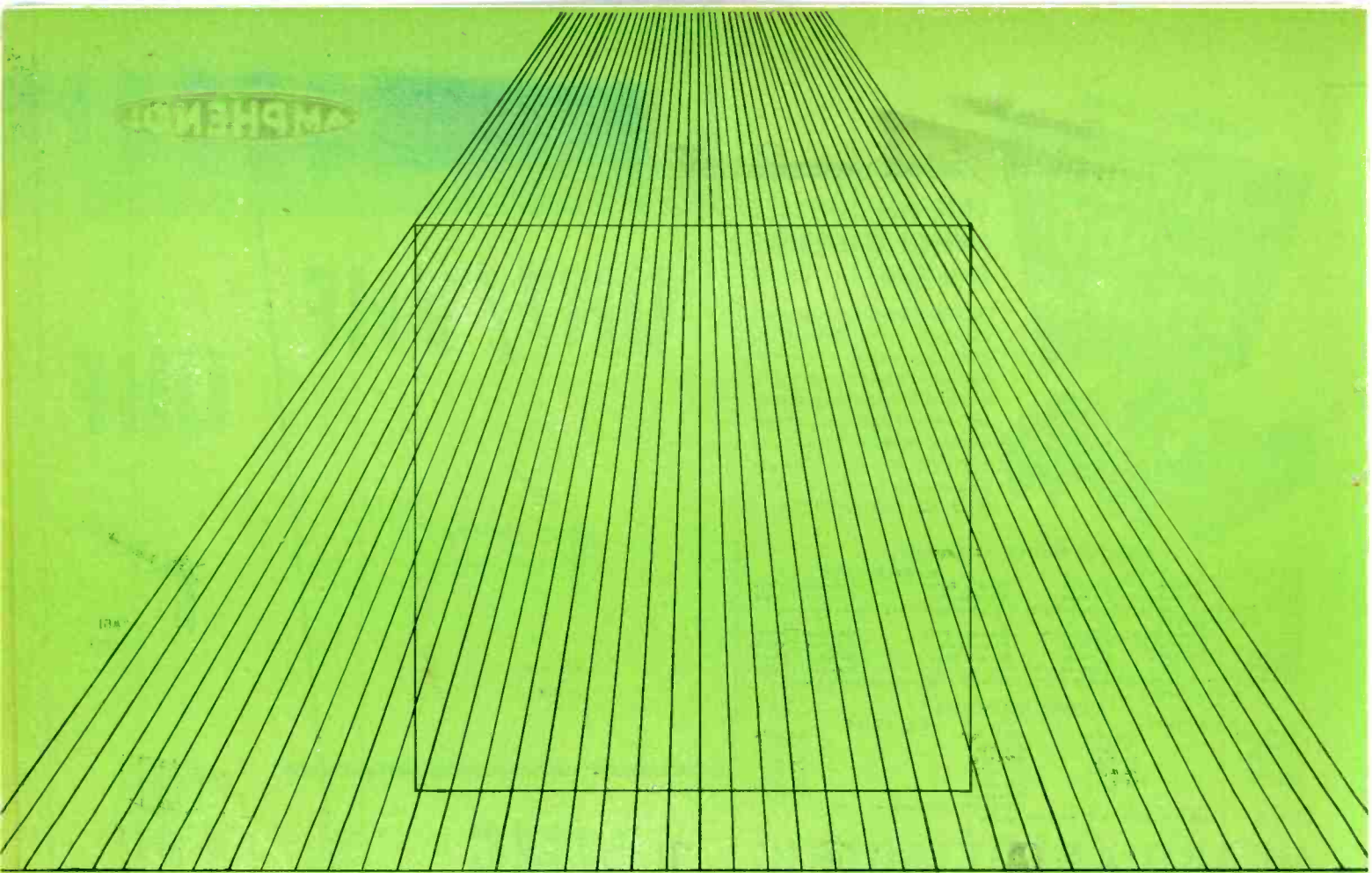

THINGS ARE **NOT** AS THEY SEEM...

This *is* a perfect square.
It is an optical illusion that the sides bend.



3 amps fuse will not blow at 3 amps.

Fuses are not rated by the current at which they blow. Fuses are rated by the maximum current they should carry indefinitely.

Each type of fuse blows according to the requirements of the equipment it was designed to protect.

Littelfuse has cooperated with NEC, Underwriters, Armed Forces MIL Specs Committees in establishing the characteristics of the various fuse types.

Littelfuse holds more design patents on fuses than all other manufacturers combined.



3 AG "SLO-BLO"



3 AB



8 AG U/L



1 AG



4 AG ANTI-VIBRATION

LITTELFUSE

DES PLAINES, ILLINOIS

Small vertical text on the left margin, possibly a signature or reference code.

BACK THE LINE THAT BACKS YOU!

ALLIANCE

New, Restyled Models + \$500,000 Ad Campaign

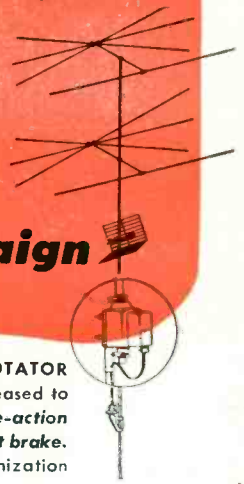

REDESIGNED ROTATOR UNIT—Speed increased to 2 rpm. *New double-action magnetic anti-drift brake.* Smoother synchronization with control units.

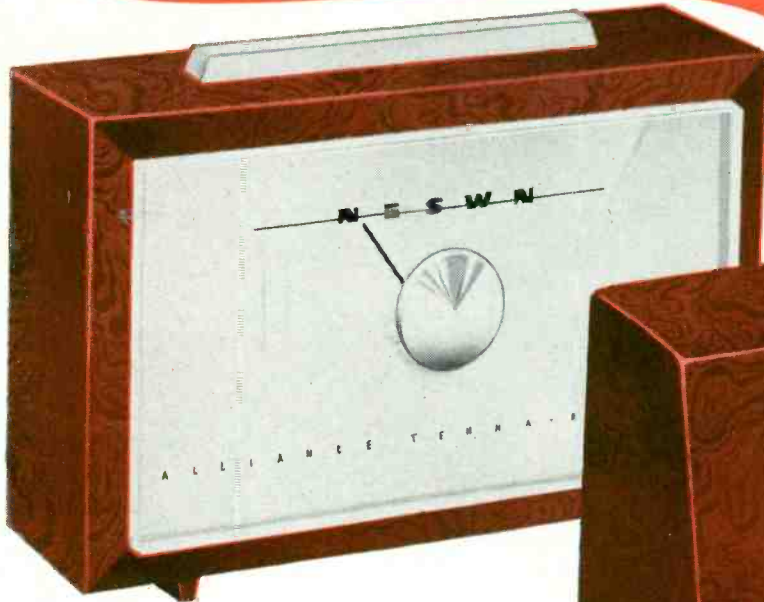

MODEL T-10, finger-tip electrically controlled Alliance Tenna-Rotor with direction indicator dial. Extremely accurate. Modern styling by Reinecke & Associates **\$44.95**

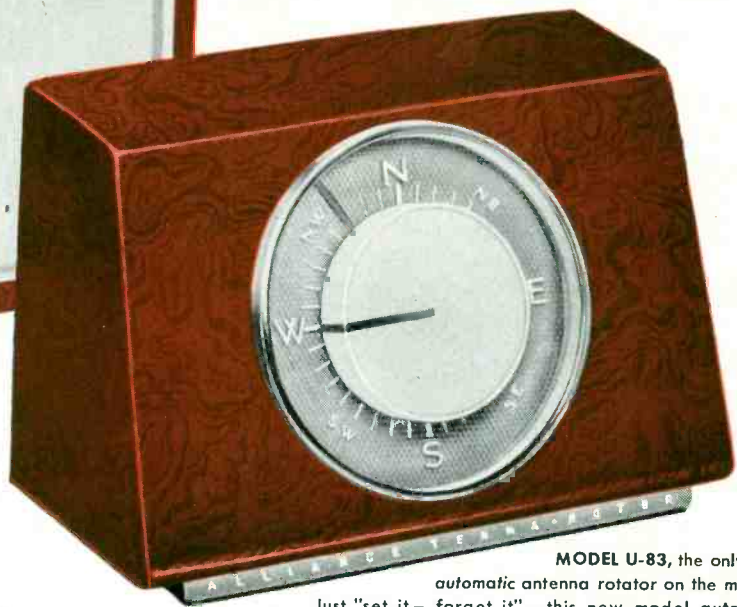

MODEL U-83, the only fully automatic antenna rotator on the market. Just "set it—forget it"—this new model automatic Alliance Tenna-Rotor. Reinecke-designed . . **\$44.95**

Here's how Alliance pre-sells for you!—

1 New styling sells on sight! Style's the thing, and Alliance has it! More eye-appeal, more buy-appeal in these smart, new Alliance Tenna-Rotors and the Alliance TV Converter! Boost your sales, boost your profits with Alliance—the line that backs you!

2 \$500,000 ad campaign sends sales your way! Alliance keeps spring promises!

TV Spots—eye-compelling "home" demonstrations—more than 16 million viewers on more than 100 stations—*this is our fifth straight year of TV advertising!*



ALLIANCE TV CONVERTER

adds all new UHF channels. Advertised on TV! The quality converter built to last! **\$42.50**



— full-page ad in this top consumer magazine! Newspapers—dominant, sales-making ads in key markets! Point-Of-Sale Displays—full-color, on-the-spot reminders!

OVER ONE AND ONE-QUARTER MILLION ALLIANCE TENNA-ROTORs NOW IN USE!

ALLIANCE MANUFACTURING CO., ALLIANCE, OHIO

FROM COAST TO COAST —

the nation has seen the Regency Remote TV Control on television. Garroway sold it for you to a fresh market. Now, 20,000,000 TV set owners can adjust the TV picture from where it is seen with the Regency Remote TV Control.

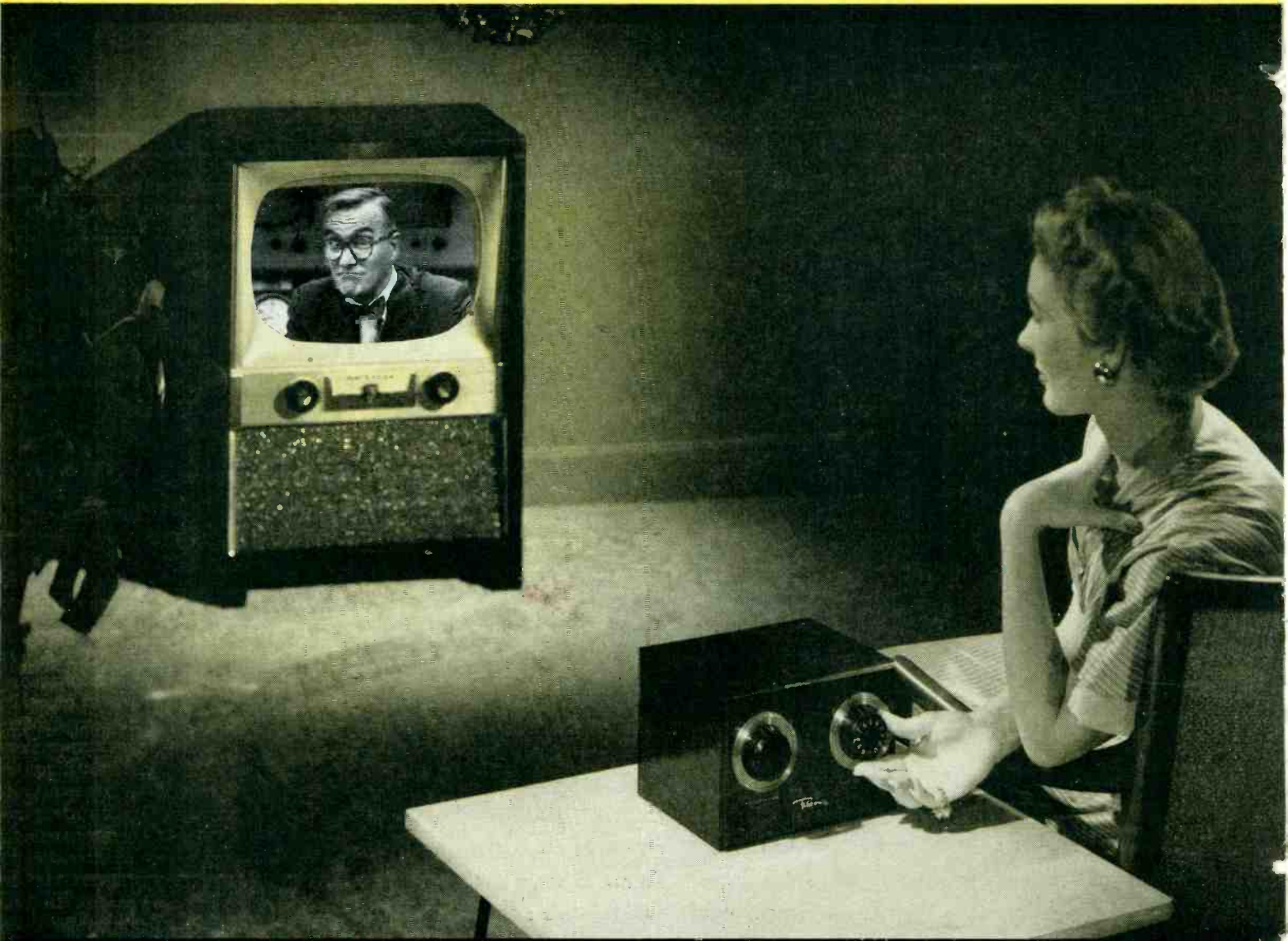

TODAY'S GREAT OPPORTUNITY IN TELEVISION ACCESSORIES —

close the sale Garroway started

A NEW PRINCIPLE in Remote Universal Control Devices!

- It works on as much as 100 feet of cable (permits running cable around room periphery!)
- Sharpens contrast!
- Brightens the picture!
- Controls volume!
- Changes channels!

MODEL RT-700 \$69.95 LIST

Regency

DIVISION OF I. D. E. A., INC.

Makers of VHF Boosters, FM Boosters, UHF Converters, Professional High Fidelity Equipment and Television Remote Control.

Admiral

ALL-CHANNEL

UHF ANTENNAS

**HIGH GAIN
LOW COST**

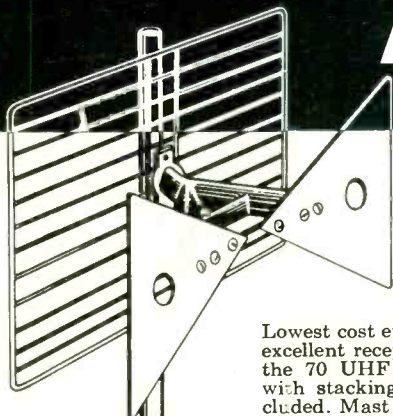

Admiral BOW TIE

Lowest cost ever for a quality UHF antenna. Gets excellent reception in good signal areas on any of the 70 UHF channels. Each antenna furnished with stacking bar. Mast mounting brackets included. Mast not included.

No. AN65A—Deluxe—Shipped completely assembled. Suggested list price..... **\$5.95**

No. AN65B—Standard—Similar to above, smaller reflector screen. Shipped knocked-down. Sug. list price... **\$3.95**

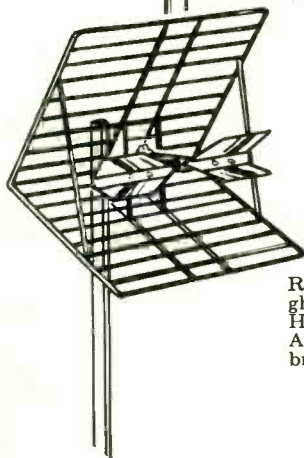

Admiral CORNER REFLECTOR

Recommended for troublesome locations where ghosts, reflections and interference are encountered. High gain, 14db. Front to back ratio 15 to 1. Assembled, ready to put up. Mast mounting bracket included. Mast not included.

No. AN56A—One bracket mounting. Suggested list price..... **\$11.25**

No. AN56B—Same as above, front mounting. Suggested list price..... **\$11.25**

INDOOR UHF ANTENNAS

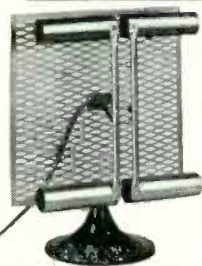

Admiral Super

Recommended for troublesome locations. Exceptionally high gain... over 7 db... excellent ghost suppression. Only 12 inches wide. Weighted and felt padded base.

Admiral Target

Smartly styled in rose-gold colored anodized aluminum with mahogany phenolic base. Stands only 10 inches high. Base is weighted and felt padded... can be placed on top of receiver... picks up all UHF channels.

No. 94A10-6—Complete with lead-in. Suggested list price... **\$12.95**

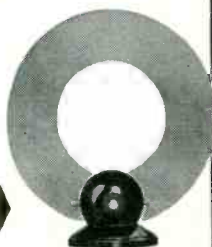

No. 94A10-7—Complete with lead-in. Suggested list price... **\$4.95**

You'll make an *extra profit* on every installation using these high gain UHF antennas. Ask your Admiral distributor about the *extra large discounts* from the list prices quoted here.

You'll be giving your customer extra value, too! All these antennas are finest quality... made with aircraft aluminum antenna elements and vibration-proof reflectors. "A-frame" insulators provide plenty of free air space around elements. The units have high mechanical strength and low resistance. They are *double plated* for extra resistance to weathering... first zinc plated, then dipped in zinc dichromate which gives them a beautiful gold finish. These antennas can be easily fastened to existing masts and towers. Order by part number from your Admiral distributor.

Ask your *Admiral distributor* for
FREE CATALOG
with complete line of *Admiral*
TV antennas and accessories

Admiral Corporation
Accessories and Equipment Division,
Chicago 47, Illinois

NEW Certified Quality Service Business Builders SIGNS...POSTALS ...AD MATS

GET THIS CATALOG

TIE IN even stronger with your *Certified Quality Service* campaign in LIFE and POST. Tell your customer again and again. *You* offer him the quality service and fair charges that spell C...Q...S. Win his confidence and you win his business. Along with your CQS tags and displays, use your new CQS illuminated indoor sign . . . flange sign . . . postals . . . and ad mats. You'll be proud of them. They are modern, dignified, economical . . . and their CQS message sells *hard*. See them at your CBS-Hytron distributor's. Or write for CQS-10 catalog. But act now!



NEED MORE CQS TAGS?

With your 3-line imprint, they are priced low: 250 for \$2.25, 500 for \$3.50, 1000 for \$6.00. Order from your distributor . . . or direct.

4 MORE CQS Sales Aids

IDENTIFY YOU AS A...
Certified
QUALITY SERVICE DEALER

NEW CQS ILLUMINATED INDOOR SIGN
Wraps your potent *Certified Quality Service* message into a dramatized play. Brilliant . . . colorful . . . Pleo-glas sign (25 1/2 by 10 by 3 1/2 inches) pulls customers to you. Hang it (comes equipped with chains and hooks) or stand it in window . . . on counter . . . on shelf. Comes ready to plug into a-c socket, with economical 30-watt fluorescent tube. Makes ideal night light and 24-hour salesman. Identified yourself. Get your CQS Illuminated Indoor Sign up right away. Only \$9.45, F.O.B. continental U. S. A.; or see your CBS-Hytron distributor.

NEW CQS METAL FLANGE SIGN
Proudly, boldly *Certified Quality Service* is seen by millions Campaign. Big, sturdy 12 inches, with mounting colors in weather-resistant sign outdoors or indoors U. S. A.; or see your distributor.

NEW CQS POSTAL CARDS
NEW CQS AD MATS

CQS-10 Catalog also features
3 direct-mail postals . . . 9 ad mats.

60-DAY OFFER!

10 SOCKET LOCATORS with 20 miniature tubes

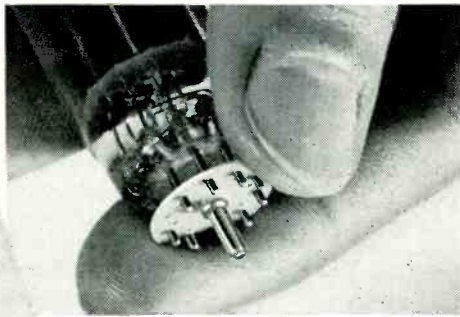

During January and February. Order 20 CBS-Hytron miniature tubes. Your distributor will give you this package of 10 new CBS-Hytron Socket Locators. With them, plugging miniatures into hard-to-locate sockets is easy. Socket Locator slips over pins of tube (7-pin or 9-pin). Key of Locator finds socket . . . guides tube into it, quickly. Save time and temper . . . take advantage of this limited offer. See your CBS-Hytron distributor.

NEW...FREE CBS-HYTRON CRYSTAL DIODE MANUAL

Complete, down-to-earth, 8-page manual on crystal diodes. Three parts: 1. Advantages and construction. 2. Complete data, 38 types. 3. Selection and application. Profusely illustrated. Ten basic circuits. Gives you *all* the crystal-diode information you have been seeking. FREE . . . from your CBS-Hytron distributor . . . or write direct.

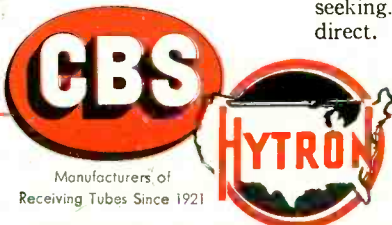

Manufacturers of
Receiving Tubes Since 1921

CBS-HYTRON Main Office: Danvers, Massachusetts

A Division of Columbia Broadcasting System, Inc.

A member of the CBS family . . . CBS Radio • CBS Television
Columbia Records, Inc. • CBS Laboratories • CBS-Columbia • and CBS-Hytron

RECEIVING . . . TRANSMITTING . . . SPECIAL-PURPOSE AND TV PICTURE TUBES • GERMANIUM DIODES AND TRANSISTORS

COLOR TV

by LEONARD LIEBERMAN

FIGURE 1 is a partial block diagram of the transmitter section. For the purpose of refreshing our memory, let us re-list the component parts of this section. These are: a three-color-sensitive camera; a system for treating the camera outputs so that they may be added; a luminance channel for modulating the video r-f carrier; a color encoding section with a two channel output (E_Q and E_I); a color sub-carrier oscillator; a system for modulating this frequency in both phase and amplitude by the outputs of the color encoder which are 90° apart; a color-phase sync signal generator (color burst generator) to provide a reference phase signal; a line and frame sync generator; a power output stage; and the radiating antenna.

Camera Tube

Figure 2 shows a camera having all the scanning tubes in one housing. The units in front of the scanner tubes are dichroic mirrors. (This mirror is one in which the back is coated so that it reflects one color while permitting all the other colors through.) The result is that the mirrors reflect only the desired color to the corresponding scanning tube.

Matrixing and Gamma Correction

The output of each camera is an electrical waveform whose amplitude represents that portion of the scanned picture output containing the particular color to which it is sensitive. The pickup tube output is gamma corrected, matrixed, so that when the reference white *Illuminant C* is being scanned, the red tube output represents 30%, the green tube output represents 59%, and the blue tube output 11% of the value of the total signal.

Matrixing can be performed in several ways. Matrixing is the transforma-

tion of several independent signals into other signals. The resultant signals have for their components predetermined percentages of the original signals. A matrixing circuit combines the outputs of two circuits. Channel 1 has a certain amount of non-linearity. By adding a certain amount of Channel 2 to the Channel 1 output in the matrixing tube, the result is a linear signal.

Chroma Signals

The outputs of this gamma correction and mixing circuit are three signals. These are the luminance (E_Y) and the two color difference (E_R-E_Y ; E_B-E_Y) channels. The latter two signals

Part 3 of this series explains more details of the color TV transmitter and begins a discussion of the receiver.

plied to a low pass filter. In the E_I are then matrixed again. The results of this matrixing are the E_Q and E_I signals previously discussed.

The two chroma signals are then a-channel, the bandpass is 0-1.5 mc. The E_Q channel has a 0-600 kc band-pass. The signals are each fed to the input of a separate modulator tube. The outputs of these tubes are 90° out of phase.

Sub-Carrier

These output signals now modulate the output of a sub-carrier 3.579545 mc oscillator. The matrixing and the phase relationships are such that if

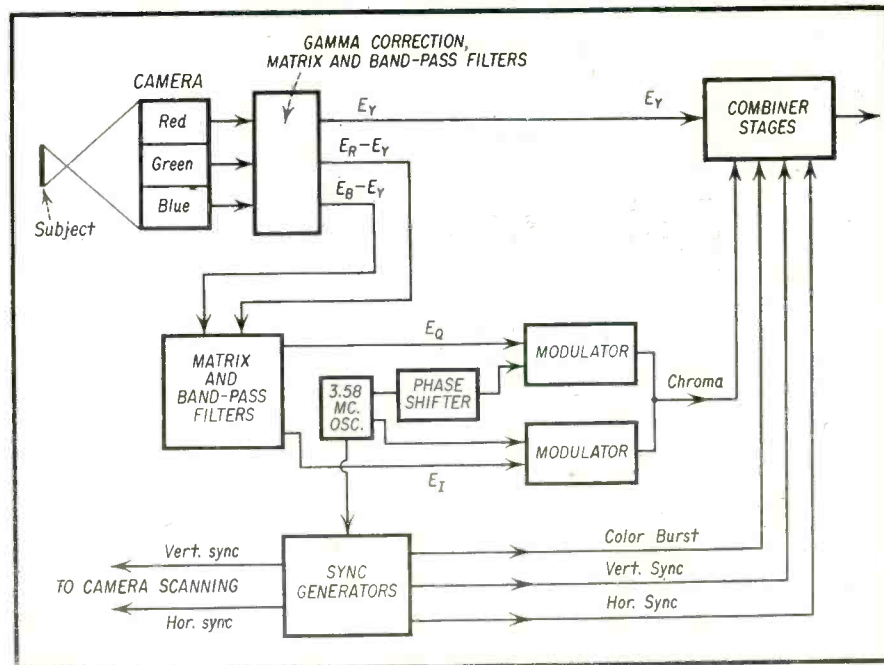

Fig. 1—Partial block diagram of color TV transmitter.

saturated blue is set in phase with the oscillator burst phase, saturated red lags the oscillator burst phase by 103.6° and, saturated green lags the oscillator burst phase by 243.5° .

Color Burst

A portion of the unmodulated oscillator signal is taken off and, by means of suitable frequency dividers, is used to generate the line and frame sync signals. Some of this unmodulated signal is also applied to a gated circuit. The output of this circuit is a sine wave at the sub-carrier frequency and locked in phase with it. This burst is added to the "back porch" of the horizontal sync pedestal. (Fig. 3)

Combing Signals

All the parts of the total signal, the luminance channel, the chroma channel and the combined sync signals are combined in a circuit similar to that shown in Fig. 4. Note that the combining is done by means of common plate impedances in the 6AH6 and 7AD7 tubes. The final combined signal is then used to modulate the video rf carrier. After this operation, the signal moves in a straightforward way to the output stage and the transmitting antenna.

The Receiver

At the color receiver, Fig. 5, the signal is received at the antenna, and fed to the rf amplifier. Then it is heterodyned with the local oscillator, goes through several stages of i-f amplification, and is rectified at the second detector in exactly the same way as in the present monochrome set. The

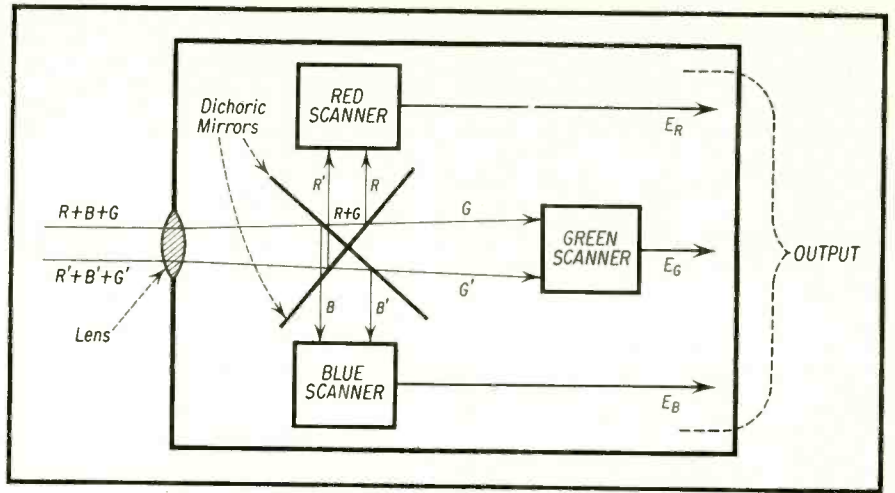

Fig. 2—Three color camera with dichroic mirrors.

audio portion of the signal is treated in a manner similar to current design.

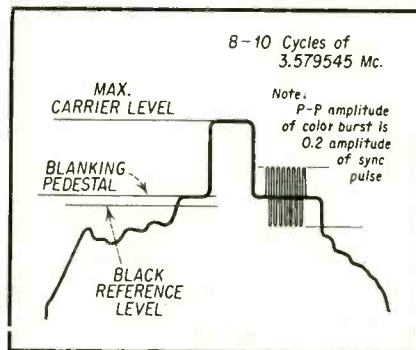

Fig. 3—Horizontal sync pulse with color burst added to "back porch."

The sweep syncs are taken off following the second detector. With some modifications, the vertical and horizontal scanning sections resemble those used now.

Color Burst

The information for the color or chroma section is taken off after the video detector. Using the output of the second detector, the color burst is separated from the composite signal. The derivation of the color burst is similar to keyed agc, as can be seen from the following. To insure that only the color burst reference pulses are used, the input of the burst amplifier is opened or made operative by a pulse from the horizontal output transformer. This pulse occurs during the retrace time so that only the 8 cycles of the reference 3.58 mc on the blanking pedestal is present in the gated output.

By means of a phase detector and a reactance tube, Fig. 6, the 3.58 mc local oscillator in the receiver can be made to lock at the reference phase from the transmitter in a very short time. There are, at present, several different types of APC (Automatic Phase Control) Systems. It has been found by the NTSC Field Test Panels that, even at this early stage of the color TV art, the different APC systems hold the oscillator in phase even when the input signal to noise ratio is as high as unity.

E_g and E_r Signals

The output of the 3.58 mc oscillator is fed directly to one synchronous demodulator. It is also applied to the second demodulator through a 90° phase shift network. The color sub-carrier modulation present in the detected video signal is fed simultaneously to the synchronous demodulators. This modulation has a low-frequency band-pass characteristic. (See RTSD, Dec. '53.) It is separated from the total video signal by means of a low pass filter.

In a synchronous demodulator, a signal containing two phases of a carrier is mixed with another signal con-

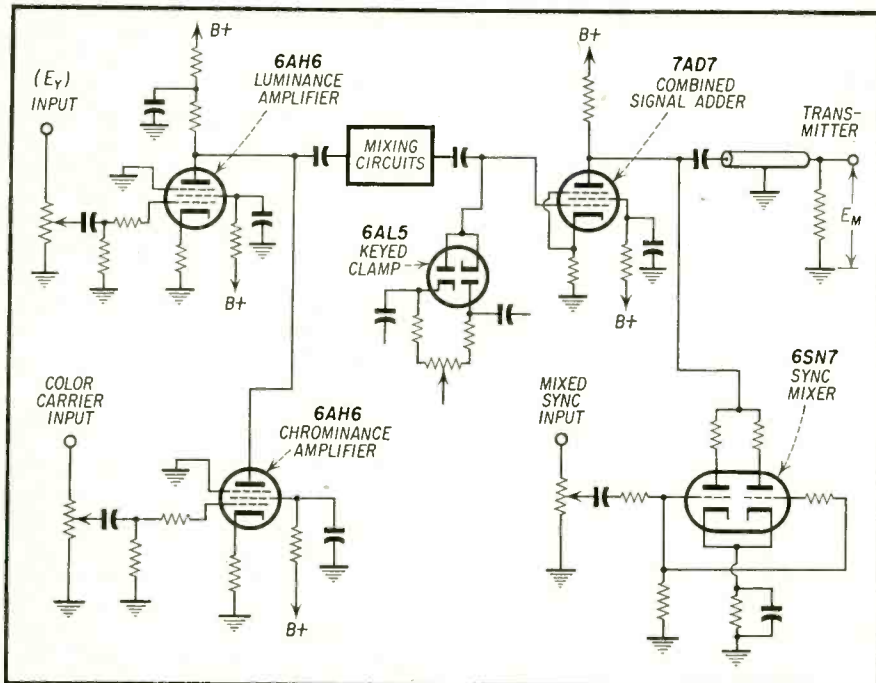

Fig. 4—Combiner circuit for color TV transmission.

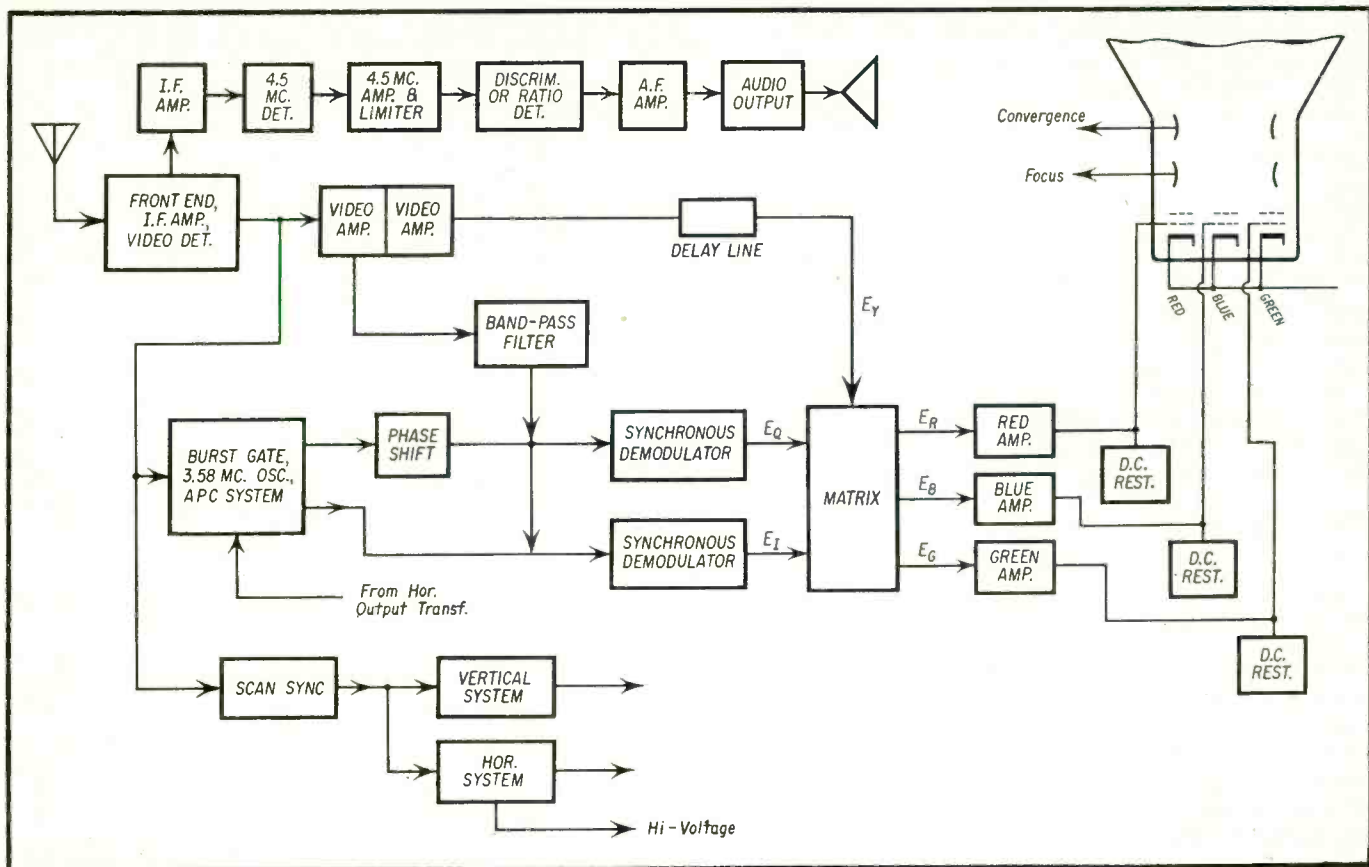

Fig. 5—Block diagram for general color television receiver.

taining only one phase of the same carrier. The output of the demodulator is that portion of the complex signal whose original phase was the same as the mixing signal. By applying the local 3.58 mc oscillator in suitable phase to each of the demodulators, the single signal from the luminance channel can be broken up into its original E_Q and E_I components.

E_R , E_B and E_G Signals

The E_Q and E_I signals are themselves composed of different proportions of the E_R - E_Y and E_B - E_Y signals. The recovered E_Q and E_I signals are, therefore, fed to a matrixing system. The output of this matrixing system, when the E_Y signal is added at the inputs of the E_R , E_B , and E_G adder tubes,

contains the original three colors. They are in the voltage ratio to each other which existed at the output of the scanning cameras.

DC Restoration

The need for accurate reproduction of the brightness level which exists at the camera has been discussed in detail previously (RTSD, Nov. '53). Because this requirement is so stringent, it is very likely that the d-c restorer tube will again appear in color TV sets.

Delay Line

Note that before the luminance signal is added to the color difference signals at the adder input, a delay line is inserted. This unit is necessary as a result of the different frequency

bandpass characteristics of the luminance and chrominance channels. If the delay were not inserted, the luminance signal, as a result of its higher frequency response, would be present at the adder input before the chrominance signals.

4.5 Mc Trap

To keep the design non-critical as far as linearity and signal compression are concerned, most of the developmental designs use two or three video amplifiers. In addition to this feature, there is another to be found in the sound system. Here again, to prevent critical operation, while keeping the advantages of intercarrier sound, an extra circuit is included. Just before the video detector, an additional *if* amplifier feeds an additional detector. The output of this detector is the familiar 4.5 mc signal, which in monochrome sets, is present at the video detector output. Because the 4.5 mc is detected at this stage rather than at the video detector, it is possible to use very sharp 4.5 mc rejection traps before, instead of after, the video amplifier. In this way sound interference can be kept out of the picture channel very effectively. The 4.5 mc sound signal is then limited and applied to a sound FM detector.

[Continued on page 52]

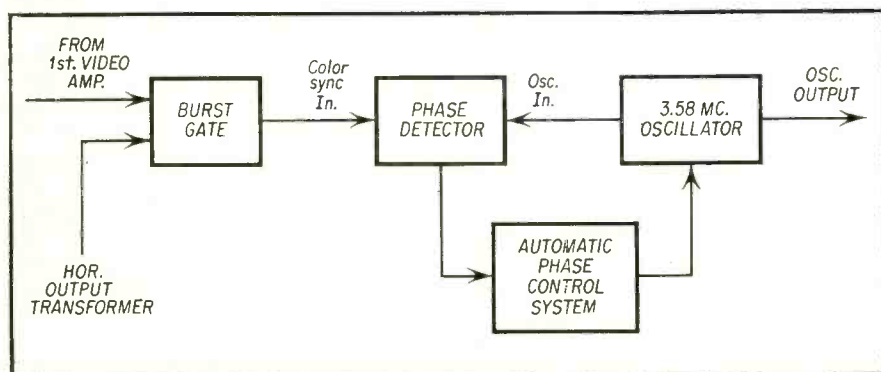
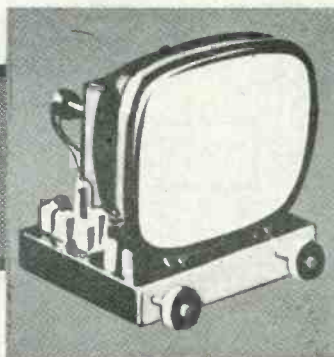

Fig. 6—Block diagram, automatic phase control loop.

TV TROUBLE SHOOTING

USING Key Test Points



by **BOB DARGAN**

PART 2

THE purpose of this section is to cover the key test points in the *if*, video detector, amplifier, and output stages of a TV receiver. The manner in which the background circuit should be checked will also be discussed. Many of these stages can be serviced with a signal generator and scope. These are important items *when necessary*, but a great deal of service work can be performed without them.

It is through the use of these checks, as will be emphasized, that the technician can achieve speed in servicing of receivers. Speed means more income. Anything that wastes the serviceman's time costs him money. More work could be performed if more speed in servicing is acquired.

Tubes

One of the most serious causes of waste of a serviceman's time and energy is neglect of checking for defective tubes before actual mechanical servicing a receiver. The first and most important check a serviceman should make on any receiver is the condition of the vacuum tubes. It is wrong to do any other checking until it has been determined that all the tubes are good.

Are all the tube filaments lit? This is an obvious question. It is also the easiest and first step in the repair operation. The next step is to determine beyond any question that the tubes in the circuits that could possibly be responsible for the trouble are in good condition. It is useless to start checking the Key Test Points until this has been done. This is of the utmost importance. It is where many technicians fall down.

The vast majority of troubles in a television receiver are usually due to one or more tubes having developed

This article discusses the key test points to be found in the *if* section and video detector. The operation and checking of germanium rectifiers is also explained.

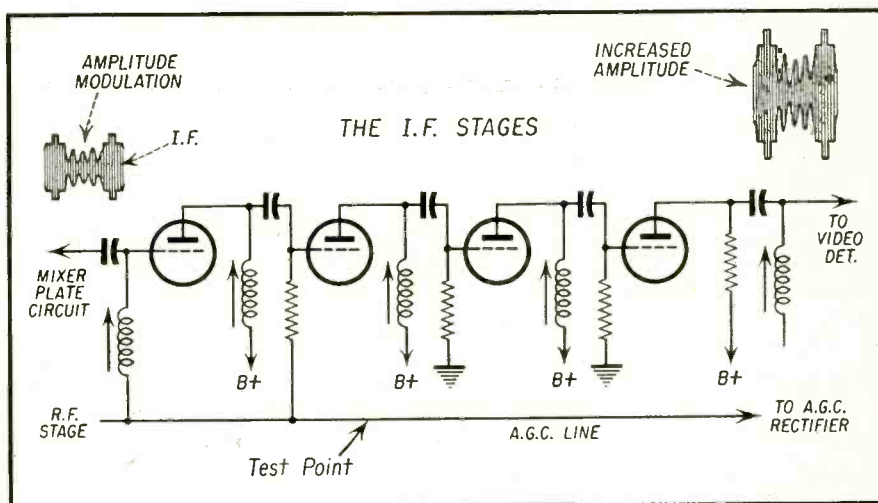

Fig. 1—In the above partial schematic the video signal is increased in peak to peak amplitude in the *if* stages.

a defect. Too many technicians immediately dig into a television chassis before making certain that the tubes are not at fault. Many technicians will smile at this because they realize they have made the same error. Probably we all have at some time or other.

Don't be caught spending several hours tearing apart circuits only to find that a tube is gassy. You will groan at your carelessness when it happens, and it happens all too often to far too many technicians.

Another point about tubes concerns the ones carried in the tube kit. Be absolutely sure that all tubes carried are good tubes. Extreme care should be exercised against letting old or defective tubes become mixed in with

the new or good tubes. This happens every day with even some of the most cautious technicians and it is another cause of a great many hours of lost labor.

In fact, it is an excellent idea to have a set of tubes in the shop which have been thoroughly checked and are therefore definitely known to be good. These tubes can be kept apart from all others and used only for checking purposes, always removing the test tubes from the set after the check has been performed. These tubes can be marked in some manner which will permit easy identification and prevent them from being mixed up with the defective or customer's tubes. A simple method is to put a label or a daub of

all-channel antenna

"17 DB gain..."

"...most sensitive all-channel antenna"

"22 DB gain"

What can you believe in Antenna Claims?

"OUTPERFORMS ALL OTHERS"

22 DB GAIN"

"Guaranteed reception"

"Guaranteed reception"

"OUTPERFORMS ALL OTHERS"

Every claim for all-channel antenna performance should be supported by facts, and not "sales talk." With facts to follow, you guard your reputation for integrity. Facts are what you get from DAVIS... indisputable proof of performance, furnished by an impartial outside authority: Microwave Engineering Company, of Los Angeles, who are recognized experts on antenna research and testing.

Write for all the data which Microwave Engineering has developed on the DAVIS antenna. You'll see performance characteristics which are actually certified... data you can count on!

Remember, it's the picture on the TV set that pays off in customer satisfaction. A DAVIS picture must please you—our antenna is guaranteed to be the best all-channel unit you can buy... guaranteed to please or your money is refunded by the factory.

Send the coupon for facts on the DAVIS antenna. Sold through your electronic distributor... THE BACKBONE OF YOUR INDUSTRY.

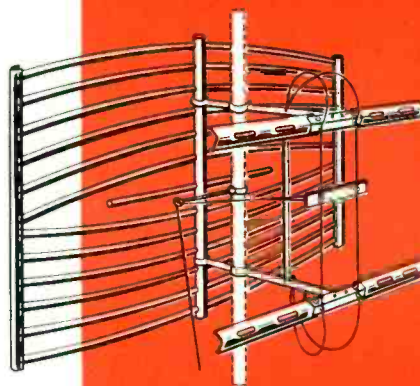

DAVIS ELECTRONICS

America's Fastest Growing Antenna Manufacturer

MAIL THIS COUPON TODAY:

DAVIS ELECTRONICS, Box 1247, Burbank, Calif.

Gentlemen... send me the following:

- Technical data and complete information on the new SUPER-VISION ANTENNA
- Name and address of NEAREST JOBBER

COMPANY NAME _____

MY NAME _____

ADDRESS _____

CITY _____ STATE _____

DAVIS ELECTRONICS • P. O. BOX 1247 • BURBANK • CALIFORNIA
Factories in; BURBANK, CALIF., CHICAGO, ILL., SILVER SPRINGS, MD.

paint on each test tube. This procedure may appear to be expensive and require a quantity of tubes to be set aside for this purpose; but consider the cost in time, which is money to the serviceman, if one defective tube is used in testing a receiver. Remember also, that *even new tubes can be defective*.

Another point about tubes: many technicians have developed the ability to determine if a tube is conducting by the amount of heat on the envelope. This means not just the amount of heat from the filament lighting the tube, but the additional heat caused by conduction in the tube and plate dissipation. If the tube is only lighted with filament voltage and is not drawing *dc*, the heat of the envelope will not be nearly as great as when current is being conducted. This can be borne out by the many technicians who have had to reinsert hot tubes.

From this point on, in this discussion, we will assume that all tubes in the circuits discussed are known to be good. The possibility of a defective tube existing in the receiver will not even be considered. The cardinal rule, which should be understood without saying for all technicians, is that all the tubes have been substituted for with known good tubes in those circuits and stages where the trouble could exist.

The IF Section

The purpose of the *if* section is to amplify the signal to a proper level for video *if* detection. The *if* signal is the result of superheterodyning the *rf* signal to a lower or intermediate frequency because it is easier to achieve amplification at the lower frequencies. Three or four tuned stages are usually employed with the gain of several of the stages governed by a negative automatic gain control (*agc*) voltage (see Fig. 1). The output of the *if* strip is rectified or detected in a diode circuit so that the video modulation or picture information is removed for further amplification in the video stages.

In checking the *if* circuits, the first test is on the picture tube. If there is snow or noise in the raster, the *if* strip is probably good and the trouble is up in the tuner. This can be confirmed if a considerable amount of noise is available from the speaker when the volume control is increased to the maximum audio position. If the picture has snow in it, the trouble is more than likely in the tuner. If the picture is weak but does not contain snow, the trouble will most likely be localized to the *if* video detector or video amplifier stages.

One of the next steps in the location of the trouble in a receiver is to ex-

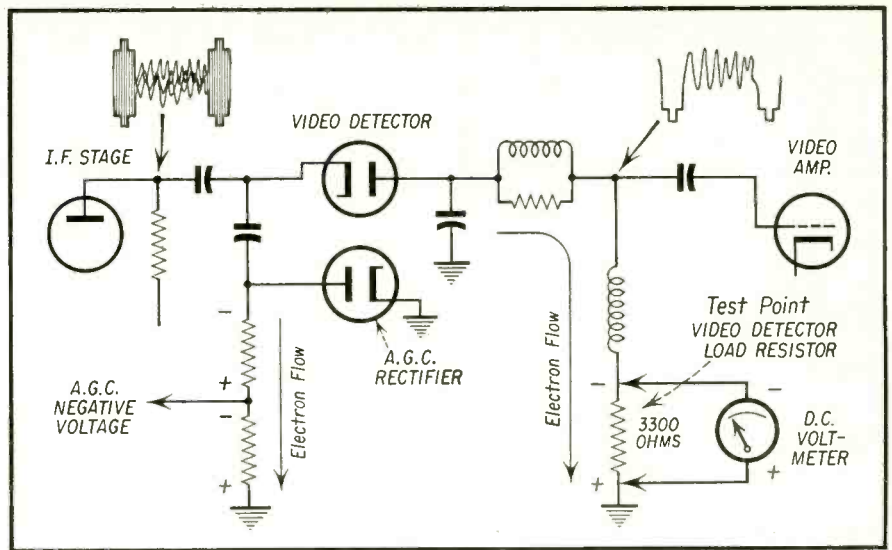

Fig. 2A—Measure the negative *dc* voltage across the 3300 ohm video detector load resistor to determine if the signal information is reaching the video detector

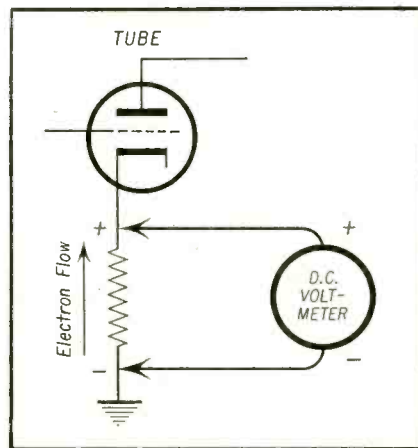

Fig. 2B—Measuring the *dc* voltage drop produced across a resistor.

amine the sound available from the receiver. If the transmitted audio is heard, there is no question about the stages from the tuner through the *if* strip to the video detector. That is, provided the receiver is of the current intercarrier vintage. Therefore,

the trouble in the receiver must lie between the sound take-off point and the picture tube. If the receiver is of the older type and sound is present, the circuits common to video and sound in the receiver are working and the difficulty is after the take-off point for the sound.

In the *if* circuits, there are a number of ways to determine whether signals can pass through the *if* stages to the video detector, picture tube and speaker. If the chassis hasn't been removed from the cabinet, the tubes can be plugged in and out of their sockets starting at the video detector and working towards the front end. This should locate a stage through which the shocked signal will not pass, and therefore no effect will be visible on the raster and heard from the speaker when the tube is clicked in and out of the socket.

If the chassis is on the bench, scratching the *if* tube grid terminals with a screwdriver or sparking the plate terminals to chassis can provide an indication as to which stage in the *if* section

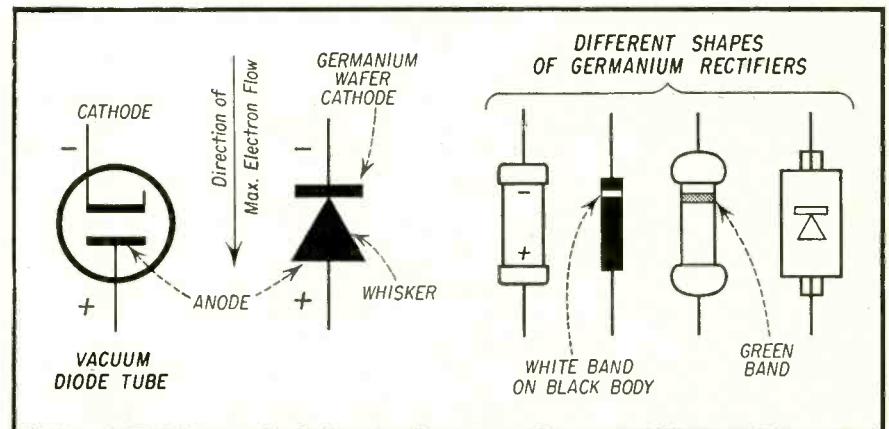

Fig. 3—The direction of maximum electron flow is shown for the vacuum tube and the germanium crystal.

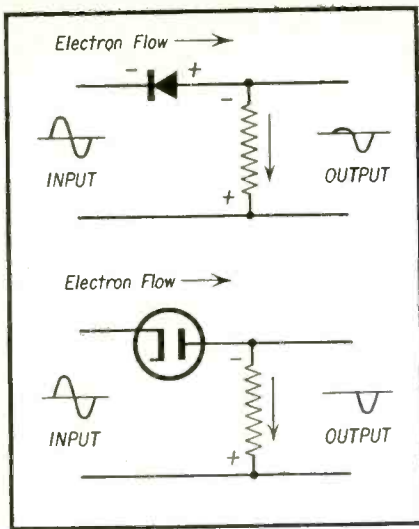

Fig. 4—Comparing the direction of electron flow in a vacuum tube diode with a germanium crystal.

is open as far as the signal path is concerned.

This same shocking of the *if* circuits can be just as easily accomplished by connecting the voltmeter lead to the plate and grid circuits. The contacting and opening of the meter leads in the circuit will cause flashes in the picture and static from the speaker as with the other methods. This type of circuit disturbance check is very useful in testing almost any electronic circuit. As with other discussions, a number of methods of checking signal continuity are provided and it is up to the individual technician to adopt and make his own the particular method he finds most suitable.

The Video Detector Load Resistor

The key check point for the *if* strip is at the video detector load resistor. Every video detector stage must have a load resistor. This resistor is low in value, about 3300 ohms, and is in series with a peaking coil. If the *if* signal is reaching the video detector circuit, the composite video signal will be developed across the load resistor. This negative *dc* voltage can be measured only when the video detection is occurring to the *if* signal. It is therefore an excellent test point (see Fig. 2A).

The negative *dc* voltage measured across the load resistor is usually about 2 volts, and the *agc* system should control the *if* and *rf* stage gains so that the voltage will be maintained at this level under strong signal conditions. The fluctuating *dc* voltage of the detected composite signal is averaged out and the voltmeter shows a steady negative *dc* voltage.

If this voltage is not present across the video detector load resistor, it indicates that the *if* signal is not reach-

ing the detector circuit. Therefore, this is the key test point or dividing point in the receiver as far as the received signal is concerned.

The video detector voltage must be measured across the resistor because in some receivers a variable delay *agc* system is employed which connects a positive voltage to the detector circuit. Concerning this, one of the least understood or remembered facts in electronic theory, is the direction in which electrons flow in a circuit or resistor. Electrons are negative in potential and always flow towards a more positive potential (or less negative). B plus voltage is a potential which attracts the negative electrons because of the deficiency in negative electrons in the B plus supply. Therefore electrons always flow to the B plus supply. Through resistors, the electron flow will be as shown in Fig. 2B. The end of the resistor towards which the electrons will flow must be positive with respect to the other end of the resistor. This is even more definitely brought out if it is considered around the circuitry of a triode tube with a resistor in the cathode circuit. It can easily be seen that the electron flow in the tube is from the cathode to the plate and the electron flow in the resistor must be in the same direction, toward the cathode, as indicated. This will be confirmed if the voltage drop across the cathode resistor is measured. Notice that the positive lead of the meter is connected to the positive potential point at the resistor and the negative lead is connected to the negative potential end. This should be applied to the video detector load resistor and it can be seen why the voltage at the resistor will be negative with respect to ground.

Germanium Rectifiers

Within the past several years germanium crystal rectifiers have replaced the vacuum tube diode as the means of accomplishing video detection. There are many advantages in the use

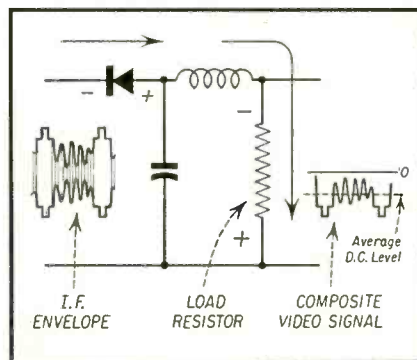

Fig. 5—A video detector circuit showing the input *if* signal and the output composite signal.

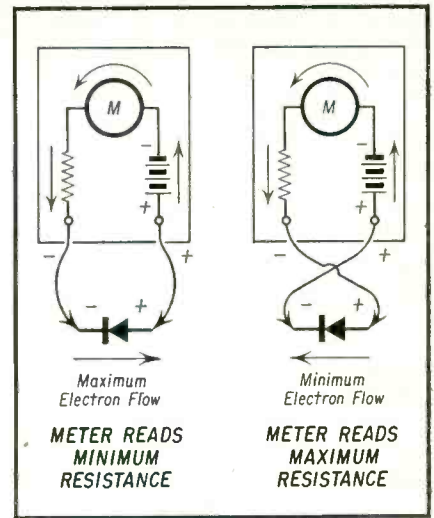

Fig. 6—Testing germanium rectifiers using an ohmmeter.

of a light, small crystal over the vacuum diode that required a socket and filament voltage.

Germanium crystal rectifiers have the ability to conduct more current in one direction than in the other. The direction of maximum current flow is shown in Fig. 3. Note that the direction of maximum current flow is opposite to that indicated by the arrow in the electrical symbol. When an alternating voltage is applied, the germanium rectifier allows electrons to flow from the germanium wafer to the whisker during one portion of the cycle and blocks the electron flow for the other portion. This action is repeated for each cycle (see Fig. 4). A small amount of current does flow in the inverse direction of the germanium rectifier as can be noted in Fig. 4. A comparison of the crystal versus the vacuum diode reveals that they are very similar in their action. Also shown in Fig. 4 are some of the different shapes of germanium rectifiers being used in television receivers.

When the *if* signal is applied to the crystal detector, it is in the form of the *rf* envelope except that the *if* frequency is lower. Fig. 5 shows the output of the video detector circuit which is the composite video signal containing the sync and picture information.

Checking Germanium Rectifiers

In checking germanium crystal rectifiers with a meter, the forward to back resistance ratio is sometimes used as an indication of their condition as shown in Fig. 6. Of course, the crystal should be disconnected from the circuit at one end so that the circuit components will not affect the test. Measuring the resistance in the forward direction or maximum conduction di-

[Continued on page 51]

FOR TOMORROW... AS WELL AS TODAY!



UHF and VHF

RCP "DO-ALL" TV SIGNAL
GENERATOR MODEL 750

3 INSTRUMENTS IN 1

- Signal Generator
- Marker Generator
- Pattern Generator

SPECIFICATIONS

BANDS: 9-11 MC, 21-47 MC, 54-220 MC,
465-670 MC, 650-900 MC.

TUNING: Special anti-backlash drive combined
with the inductuner guarantees the extreme
accuracy. Dial is continuously calibrated
through 340°.

MODULATION: 360 cycles and 141.75 Kilo-
cycles internal modulation has been pro-
vided—unmodulated carrier signal is also
available.

SIZE: 10 1/4" x 6 1/2" x 5 1/4"
WEIGHT: 9 lbs.

PRICE: \$79.50

Completely covered in one instrument—
a Signal Generator, Marker Generator
and Pattern Generator covering all the
UHF and VHF channels for every TV
and FM receiver.

There's no need to put more money in
more instruments as long as Radio City
Products puts more in one instrument.
This latest "DO-ALL" engineered by RCP
reflects the very finest in RCP design
efficiency.

Versatile in concept the RCP Model 750
can check, test and align front ends,
IF's, sound and pix traps, linearity,
syncs, sweeps, positioning, focus and

deflection. Designed for portable or
bench use, the 750 reflects the finest in
construction and appearance. It is hand-
somerly finished in an attractive brushed
aluminum panel with a steel carrying case.

- Inductuner insures accuracy of
within 1/2 of 1% over the entire
range of 9 Mc to 900 Mc.
- All VHF frequencies are on fun-
damentals.
- RF's and IF's are clearly calibrated
on a large etched aluminum dial.
- Steady horizontal bars, vertical
bars and crosshatch pattern indi-
vidually produced on all channels.

Remember... You Can Do More With A "DO-ALL"

RADIO CITY PRODUCTS CO., Inc.
152 WEST 25th STREET • NEW YORK 1, N. Y.

RCP

Dear Answer Man:

In a Crosley Model DU-21, chassis 357-1, I do not have sufficient range of the focus control to go through a clean-cut focus of the picture. Is there anything that can be done without going through an extensive modification in the chassis? Everything seems to be normal in the receiver.

J. B. E.
Philadelphia, Pa.

Dear J. B. E.:

To change the amount of current flow through the focus coil, disconnect the green lead at the focus coil as shown in Fig. 1 but do not cut the

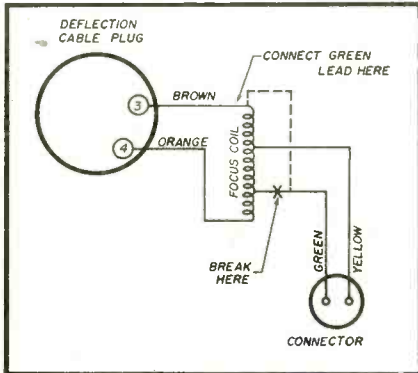

Fig. 1—Crosley DU-21, chassis 357-1, changing current through focus coil.

lead too short. Wrap a piece of electric tape over the exposed wire. It may be desirable to reconnect the lead at some future date. If the picture tube is replaced, the original connection might be desirable.

Dear Answer Man:

I have a customer who owns an R.C.A. TV Model No. 2-T-51. The set will operate O.K. for about ten minutes and then the picture narrows horizontally thus causing about one inch of black to show on each side.

I have tried new tubes which do not help in the least. I suspect that the selenium rectifiers may be getting weak but as the customer does not care to spend any amount of money for a fix I wonder if you could help me out.

Would reversing the leads on the width control give me any more width? Line voltage is 124 volts. Any information which you may be able to furnish me will be appreciated very much. P.S. Would changing the value of a resistor in this set give more width?

V.G.A.
Walworth, N. Y.

Dear V.G.A.:

In reference to the width problem on the R.C.A. Model 2-T-51, your suspicion concerning the selenium rec-

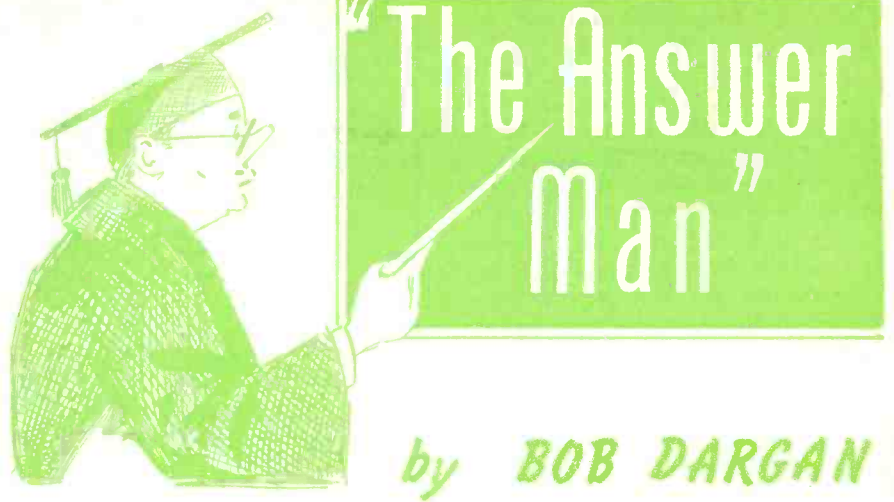

Do you have a vexing problem pertaining to the repair of some TV set? If so, send it in to the Answer Man, care of this magazine. All inquiries acknowledged and answered.

tifiers is very likely correct. If you will measure the B plus voltage when the reduction in width occurs you will undoubtedly find that the voltage had dropped lower than normal. The only correct answer to this problem is to replace the selenium rectifiers if they are at fault. Selenium rectifiers will not improve in their rectifying ability once the rectification efficiency is reduced. The width will probably become even more narrow and the height will be reduced.

If the height is unaffected, the trouble is more than likely in the horizontal output circuit. The width potentiometer is in series with the deflection yoke and the boost charging condenser that develops the boost voltage. When the resistance is introduced in this series arrangement as shown in Fig. 2 by positioning the width control away from the top point there will be a voltage drop across this resistance which will reduce the width. The boost B plus voltage fed to the 6AU5 horizontal output tube plate will be reduced. At the same time the deflection voltage will divide between the yoke and the series resistance of the width control. This arrangement permits varying the width within a designed range. However, under the circumstances you relate, the width control is probably in the position of maximum width and therefore minimum resistance.

On the basis of this understanding of the circuit it can be seen that if the .033 μ f or .027 μ f condensers develop a leak after the receiver warms up, the above symptoms will occur. But the height would be relatively unaf-

ected or, if anything, would increase with the decrease in high voltage.

The screen circuit of the 6AU5 tube should be examined to determine that the screen voltage is the proper value, 185 volts. Defects in the components of the screen circuit could cause this type of trouble. If the 6800 ohm resistor increases in value with heat, or

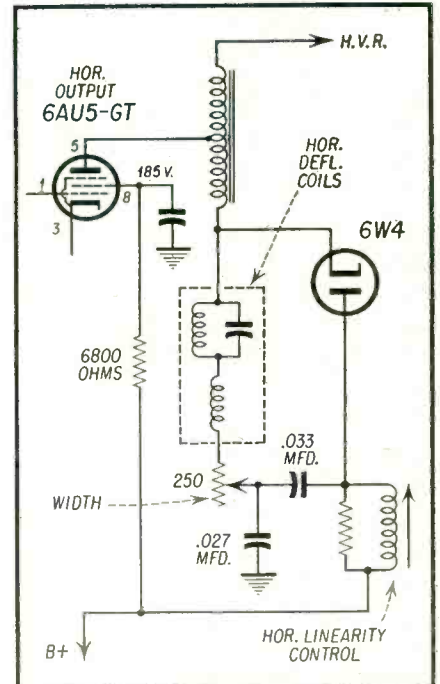

Fig. 2—RCA 2T51, KCS45, horizontal width control circuit, showing all points to be checked for trouble.

the screen bypass .047 μ f condenser develops a leak, a reduction in screen voltage would occur which would also reduce the output deflection voltage.

These two components should be thoroughly investigated.

If it is convenient to change a component value in the receiver, the screen dropping 6800 ohm resistor might be lowered in resistance. This would provide more screen voltage which in turn would give more output deflection voltage up to the point where secondary emission becomes excessive, thereby reducing the output deflection voltage. However, it would be unwise to make changes in the receiver to correct for a trouble that exists and will only have to be corrected in the long run.

Dear Answer Man:

I have a 19 inch Admiral, chassis 21J1, which has insufficient width. The width is only slightly narrow but I have been unable to find anything wrong with the receiver. All voltages are normal and all tubes have been checked.

L. S.
Brooklyn, N. Y.

Dear L. S.:

At the winding on the horizontal output transformer there is a winding for the width coil and at the junction of the winding and width coil is a take-off point for the voltage to be used in the sync discriminator, 6AL5 tube. Also, at this junction, as shown in Fig. 3, is a condenser which bypasses some of the deflection voltage to chassis. This condenser may be either a .002 μf or a .005 μf in capacitance. Increase the value of this capacitance by connecting in parallel with it another .002 or .005 μf condenser. Naturally the smallest capacitance should be used that will provide proper width as it will slightly reduce the brightness and high voltage. However, there will probably be more than enough brightness and high voltage with this change.

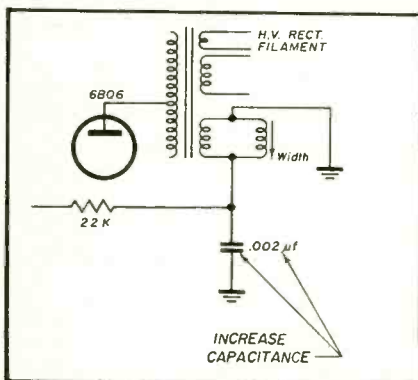

Fig. 3—Increasing value of by-pass condenser in h.o.t. circuit will improve pix width in Admiral 21J1.

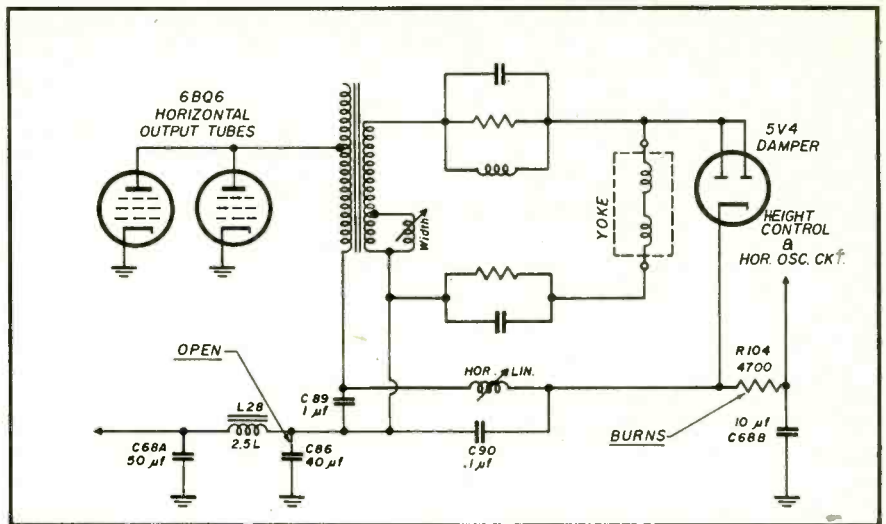

Fig. 4—Philco 1600, horizontal circuit. If C86 opens, RF currents flow via R104 to C86B where they are by-passed to chassis.

Dear Answer Man:

I have a Philco Model 1600 with which I am having a great deal of difficulty. I have no high dc voltage although I can draw a small rf arc at the high voltage rectifier plates. There is insufficient deflection field built up in the horizontal output transformer to light the high voltage rectifier filament. The horizontal output transformer, yoke and all tubes have been changed along with a number of condensers. I am at a loss as to what to do next. P. S. There is one other symptom. The 4700 ohm resistor burns but there is no short in the vertical circuits and no visible cause for the overheating of this resistor.

H. A.
Bronx, N. Y.

Dear H. A.:

From your description of the difficulty and after examining the schematic it appears that the output filter condenser in the power supply is open. This condenser is C86, 40 μf and places the B plus line at rf ground potential with respect to the horizontal deflection voltages at the bottom of the transformer and linearity. The condenser actually bypasses these voltages at the bottom of the transformer and linearity condensers to chassis ground.

If C86 opens, the rf current in the horizontal deflection system is blocked by the high reactance of the filter choke at the 15,750 cycle deflection frequency and follows the path of least resistance which is through the 4700 ohm resistor to the 10 μf condenser, C68B, where it is bypassed to chassis. This additional rf current through the 4700 ohm resistor causes it to burn.

This type of trouble has happened in a number of television receivers of

different makes and always has been a difficult problem because a condenser in the power supply is the least likely component to suspect until the full situation is realized.

Dear Answer Man:

I have a Philco TV receiver in the shop for repairs that I gave up on and I was just wondering if you had the answer for it.

The chassis is a 71 RF (run 12) and deflection chassis G1 (run 10) from a Model 52-T2252. When this receiver is turned on the picture is down from the top and up from the bottom about 2 inches, and after about 5 minutes it gives a full picture.

There is no foldover.

During this 5 minutes if the station happens to show a blank raster the raster will expand to full size then shrink again when the picture comes back on.

This happens only in the first 5 minutes after which the picture is normal as long as the receiver is on.

Also if at any time the receiver is turned off, regardless of how long it had been on, and left off for one minute and then turned on again, the small picture is there again.

So the trouble is only during the first 5 minutes of operation. There is plenty of adjustment on the rear controls to give a full picture when the set is first turned on, but after 5 minutes the picture will be too big. This is vertical trouble only. Changing tubes does not help as I tried several complete sets of new tubes. I changed the 21EP4A tube several months ago to a 21EP4B but the picture was normal

[Continued on page 51]

WHEN turning on the receiver, a loud pop was heard, and what looked like steam poured out of something beneath the set. The plug was pulled out and the set turned over. It was observed that two horizontal centering control bypass electrolytic condensers had burst at the top and that the dielectric was pouring out.

Because this had happened to other RA103D's on several occasions, some of these condensers were already in stock. The horizontal centering control was checked to see if it was open or bad in any way. It was O.K. The two condensers were replaced and the set turned on again. As it came on, the vertical spread way out and then came back to normal. However, it did not stop here; it kept on shrinking until it was about two inches from top and bottom.

A check was made on connections to the two condensers just replaced, and over the entire area for solder drippings and bad connections, but everything was found in order. Both 6SN7's were replaced, but still the vertical kept shrinking. A check was then made on the vertical output stage. The writer knew from experience on this set that occasionally vertical shrinkage occurred when C208A, the 30 μ f condenser off the vertical output transformer, was leaky. Another 30 μ f condenser was jumped across it, but with no effect. The old one was clipped out and replaced with the new one, but again no effect.

A check was then made from grid to ground off the vertical output tube V217 for the positive voltage that would be there if C258 were leaky. It was O.K. R327-3.3K was then checked for a positive voltage which would result if C257-1 μ f were leaky. (These condensers sometimes get leaky in the RA103.)

The set was then turned off, and thought was given to the possibility that the vertical output transformer might be defective; but this was very uncommon, and no replacement was made. The vertical blocking oscillator transformer is a very common source of vertical trouble in this set. When the primary opens on these transformers, it affects the vertical hold. However, in this case, the hold was O.K.

At this point a check was made on the two 10K resistors, (R217 and R218) off the vertical output transformer to see if they had increased in value. They checked on the nose. The writer

THE WORK BENCH

BY PAUL GOLDBERG

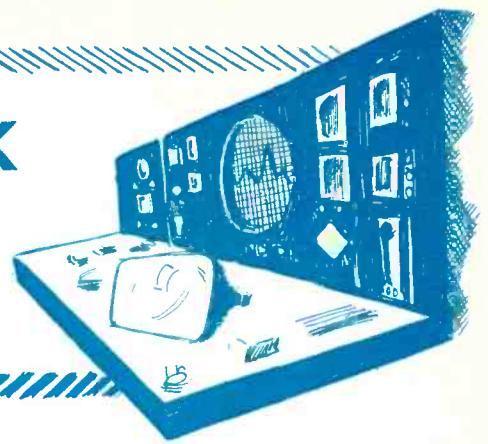

An experienced serviceman relates some of his troubleshooting experiences on typical sets in RTSD's new department.

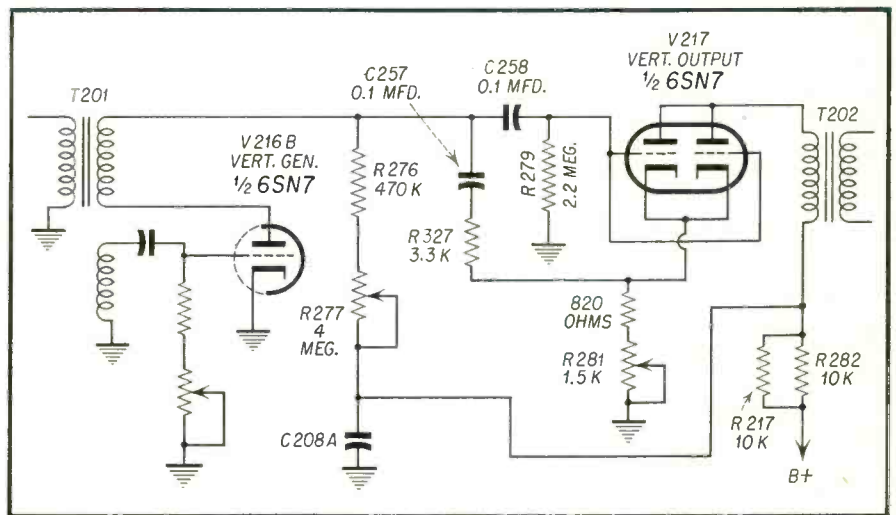

Fig. 1—Du Mont RA103D, partial schematic of vertical section. The solution to this problem was unusual (see text).

never had seen a resistor in the RA103 change value, unless some other component had shorted. Now, R276-470K, the load resistor which changes value in so many other sets, was checked and found O.K.

The vertical linearity and the height controls were then measured and found O.K. These controls have gone bad on occasions. The height control, usually because it remains in one position for too long, becomes intermittent in this particular spot; while the vertical linearity control usually goes bad because of a bad tube pulling too much current, or a shorted component causing the same thing.

At this point R279, the 2.2 meg. grid resistor off V217, was checked. The meter read 1 meg. It was thought that the cathode of V217 might still be warm, so V217 was pulled out. R279 still read 1 meg. Recalling that C258 was checked before and found not leaking, we were baffled by this

development. C258 was clipped out of the circuit anyway; and the reading from grid to ground again taken; it still read 1 meg. The 2.2 meg resistor was clipped out of the set entirely and measured on the bench. It read exactly 2.2 meg—oh!

Now the "Piece de Resistance": With the 2.2 meg out of the set, the .1 μ f clipped out of the circuit, and V217 removed, a check was made from grid to ground on the V217 socket. It measured approximately 2 meg. It was then noticed that a wire was going from the grid connection to a terminal lug to which C258 was previously soldered. This was removed and again a resistance between ground and lug was measured and found to be 2 meg (refer to Fig. 2). On further examination of the terminal lug, it was found that some of the dielectric of the condensers that had burst before had dripped down between the tiepoint lug and the ground lug. It

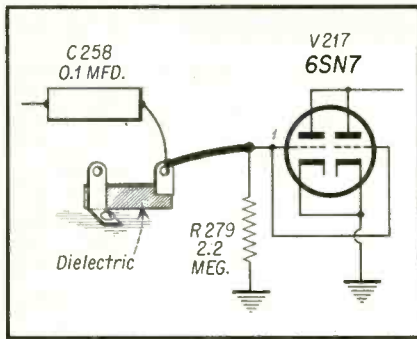

Fig. 2—Partial schematic of V217, showing dielectric trouble point.

was barely noticeable. This dripping was then scraped off, and sure enough, the reading between the tie point lug and ground was now infinity. C258 was then soldered directly to pin 1 of V217 eliminating the tie lug. The set was then turned on and observed for eight hours. No shrinkage. A bill was then made out and good riddance!

Motorola TS60—loss of two channels after replacing fine tuning shaft

The set came into the shop with a broken fine tuning shaft. This usually happens when the fine tuning knob gets worn and the customer decides to use a screwdriver by wedging it be-

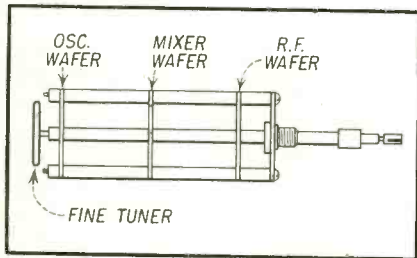

Fig. 3—Motorola TS60, station selector switch assembly TT-14, side view.

tween the split shaft of the fine tuner. In this repair you don't replace the fine tuner by itself. You replace the entire station selector switch assembly. You will notice in Fig. 3 that the station selector switch is mounted separately from the tuner tubes. By removing five or six components, wires, and the nut and lock washer, the station selector switch assembly comes out fairly easy.

An assembly was picked up from Motorola, and the repair was started. These tuners are not prealigned and sometimes there is difficulty. The new station selector switch was installed easily enough, and the set turned on. All stations came in except channels 11 and 13. All connections were gone over again and found to be okay. Spreading L7 and adjusting C-12, the

oscillator trimmer, seemed to be of no avail.

Now, this particular station selector switch was the revised type "TT-14." Therefore, there was an extra coil which affected the high frequency channels; looking at Fig. 4 you see it is L-4M. But spreading this coil didn't help either. It was then decided to resolder all the connections on the oscillator tube 12AT7, V-2B. After doing this the sound on Channel #11 barely came in, but no Channel 13.

Next the various oscillator condensers were moved slightly into different

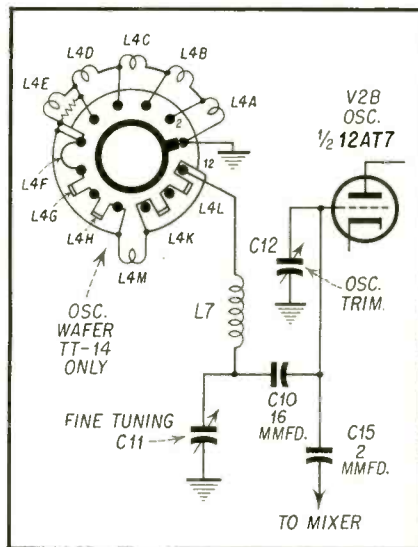

Fig. 4—Motorola TS60, schematic of oscillator wafer of selector switch.

positions. Moving C16-10 μ f. brought in Channel 11. C16 was then removed and its leads made as short as possible. It was then reconnected and run as close to the chassis as possible. The set was turned on and Channel 13 and 11 came in perfectly. C16, being the grid leak condenser for the oscillator, naturally has a tremendous effect at these

frequencies. Therefore, in the future, the writer will certainly make sure that all tuner component leads are made as short as possible. Of course the best procedure is to duplicate exactly the original lead dress.

RCA KCS47A—Intermittent H.V.

When the set was first turned on it played fine; so it was put on the cooking bench. Three-quarters of an hour later, the 6W4 began to glow red, and a sizzling noise followed by a click was heard. The H.V. fuse blew and the high voltage was gone.

The 6W4 was changed and a reading taken from ground to plate and cathode on the 6W4 socket, but no short was found. What seemed to baffle the writer was the sizzling noise heard before the H.V. went out. It seemed to come from the power transformer.

The 1/4 amp H.V. fuse was jumped, and the set turned on again. After 15 minutes, again the power transformer began to sizzle, the 6W4 glowed red, and the H.V. went out as before. However, by drawing a spark off the plate cap of the 1B3 with a screwdriver, the H.V. came on again.

It was then decided to check the 6W4 filament section of the power transformer as this was the only section of the power transformer directly related to the H.V. The filament leads going to the 6W4 were clipped and measured with respect to ground. They measured 1.5 meg.

Many RCA KCS 47's have this trouble in which the H.V. insulation around the 6W4 filament winding breaks down. RCA provides another power transformer for replacement with proper insulation. However, it is not necessary to replace the power transformer in this particular case.

[Continued on page 51]

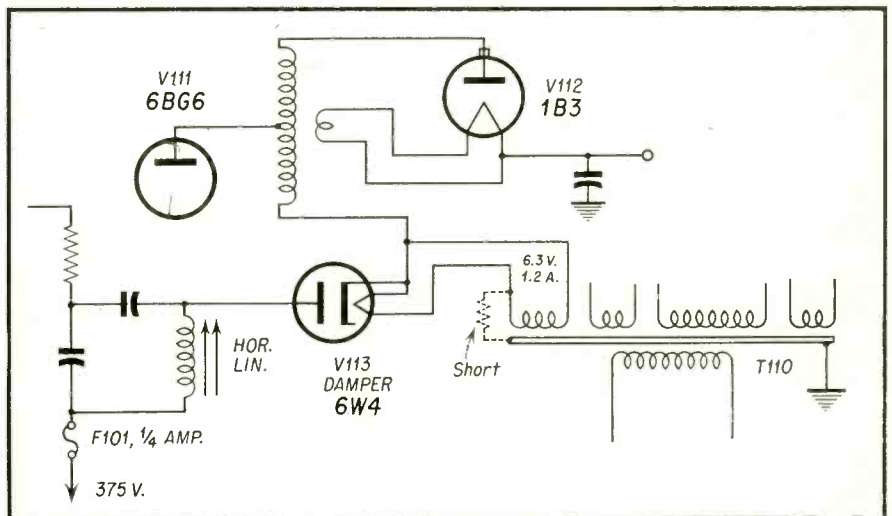

Fig. 5—RCA KCS47A, partial schematic of h. v. circuit

Mfr. G. E. Model No. 830 "R"

Card No. GE830-1

Section Affected: Sound

Symptom: No sound.

Cause: Component failure.

What To Do:

Replace: C73 (150 μ f)—shorted.

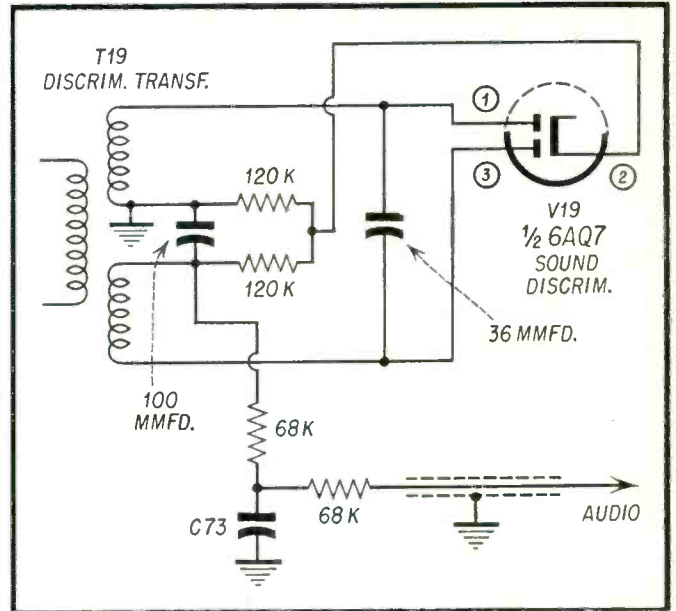

Mfr. G. E. Model No. 830 "R"

Card No. GE830-2

Section Affected: Pix

Symptom: AGC overload.

Cause: Component failure.

What To Do:

Replace: C22 (100 μ f)—shorted.
Also, R10 (1K) and R12 (47 ohms)—burned.

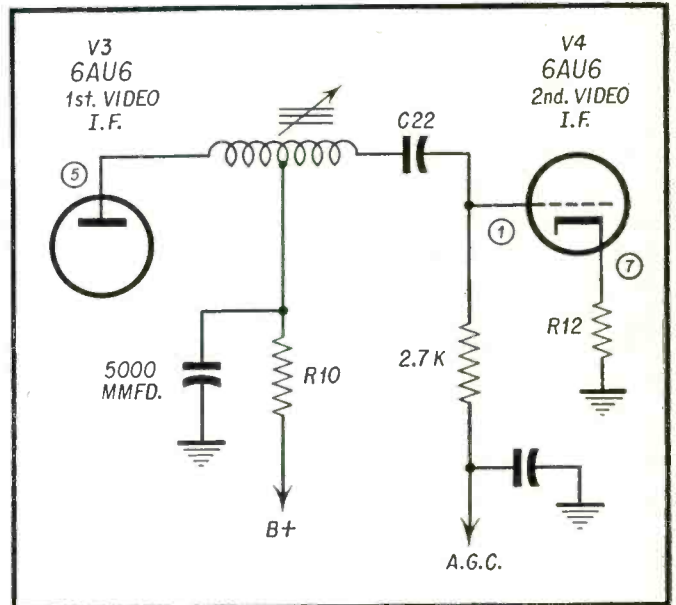

Mfr. G. E. Model No. 830 "R"

Card No. GE830-3

Section Affected: Pix

Symptom: Can't get Channels 11 and 13.

Cause: Component failure.

What To Do:

Tighten: SR1 selenium rectifier which supplies 6 volt dc filament—voltage drops when loose.

Check: SR1 output—should be at least 6 volts; if not, replace.

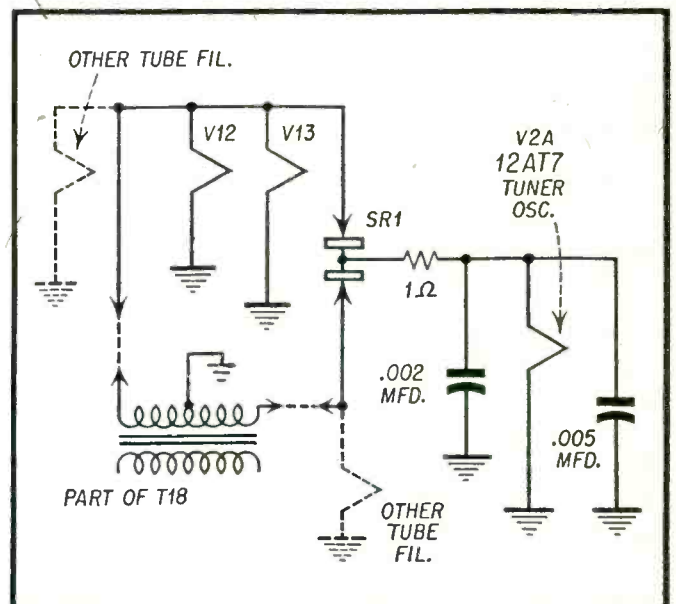

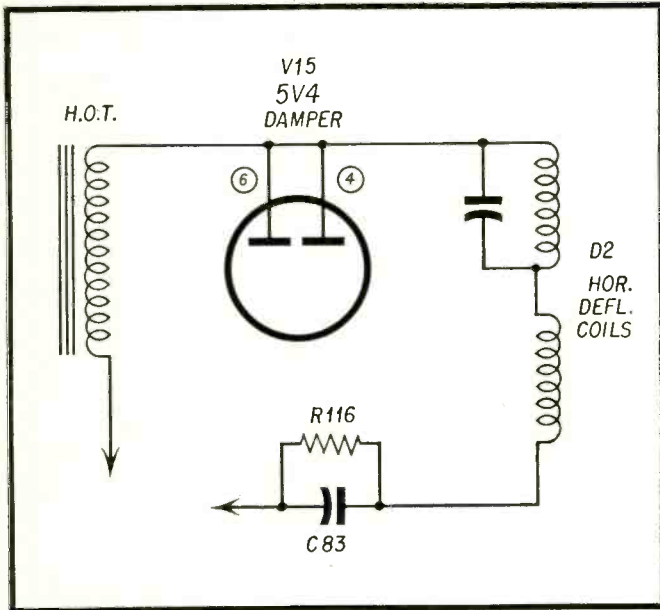

Mfr. G. E. Model No. 830 "R"

Card No. GE830-4

Section Affected: Raster

Symptom: White vertical line down center. R116 burned.

Cause: Component failure.

What To Do:

Replace: C83 (.5 μ f)—open.
Also, R116 (350)—burned.

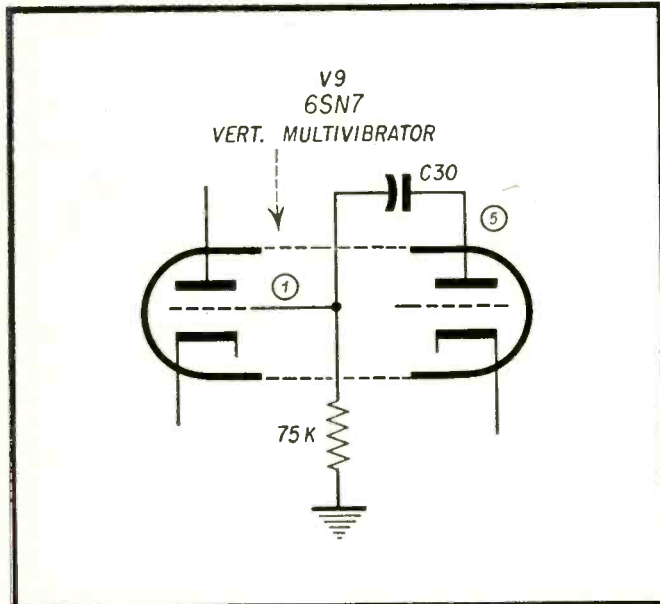

Mfr. G. E. Model No. 830 "R"

Card No. GE830-5

Section Affected: Pix

Symptom: Insufficient height.

Cause: Component failure.

What To Do:

Replace: C30 (.002 μ f)—leaky.

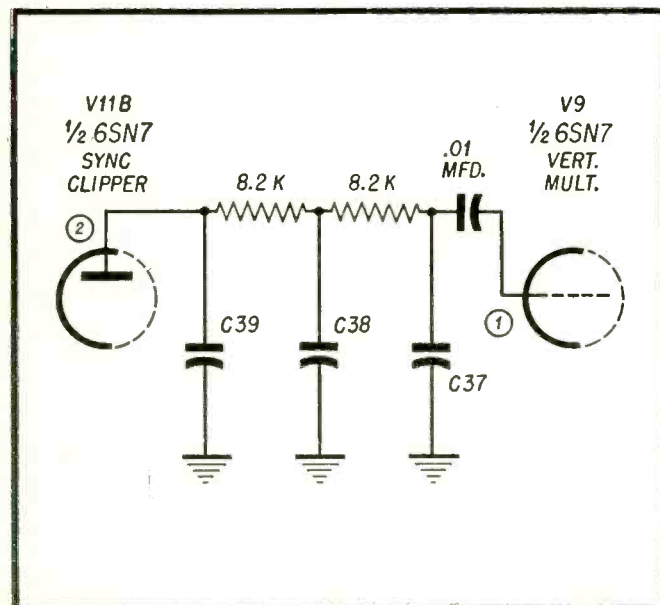

Mfr. G. E. Model No. 830 "R"

Card No. GE830-6

Section Affected: Pix

Symptom: Insufficient height.

Cause: Component failure.

What To Do:

Replace: C39 (.05 μ f), C38 (.01 μ f), and C37 (.01 μ f)—shorted or will short eventually.

Mfr. Tele-King Model No. 812

Card No. TK812-1

Section Affected: Sound

Symptom: No sound, R113 burns.

Cause: Component failure.

What To Do:

Replace: C110 (.02 μ f)—shorted.
Also, R113 (1K)—burned.

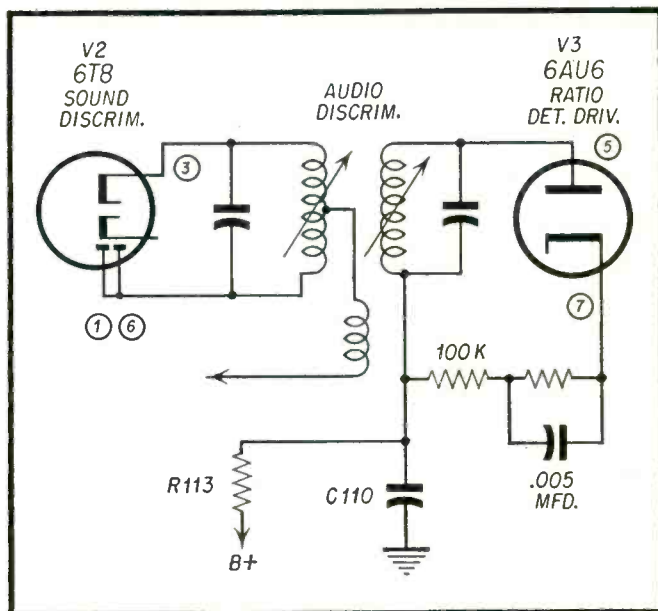

Mfr. Tele-King Model No. 812

Card No. TK812-2

Section Affected: Sync

Symptom: Vertical hold out of range.

Cause: Component failure.

What To Do:

Replace: C310 (.005 μ f)—leaky.
Also, R305 (1 Meg)—increases in value.

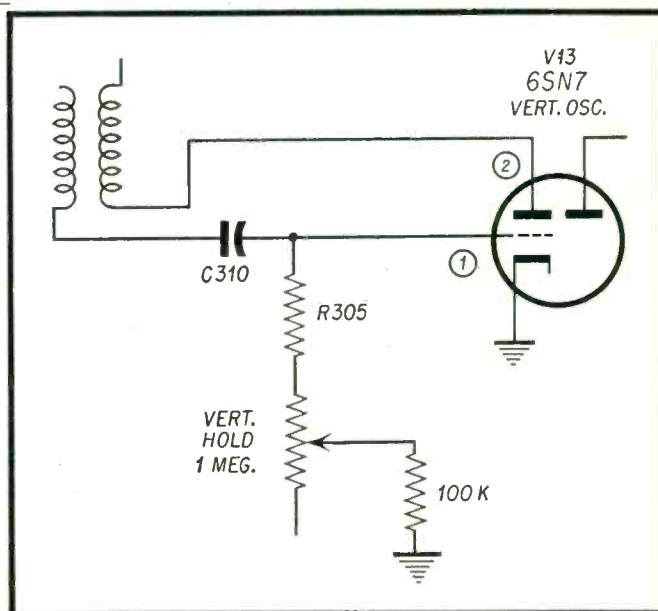

Mfr. Tele-King Model No. 812

Card No. TK812-3

Section Affected: Sync

Symptom: Critical horizontal hold-affects vertical hold slightly.

Cause: Component failure.

What To Do:

Replace: C331 (.001 μ f).

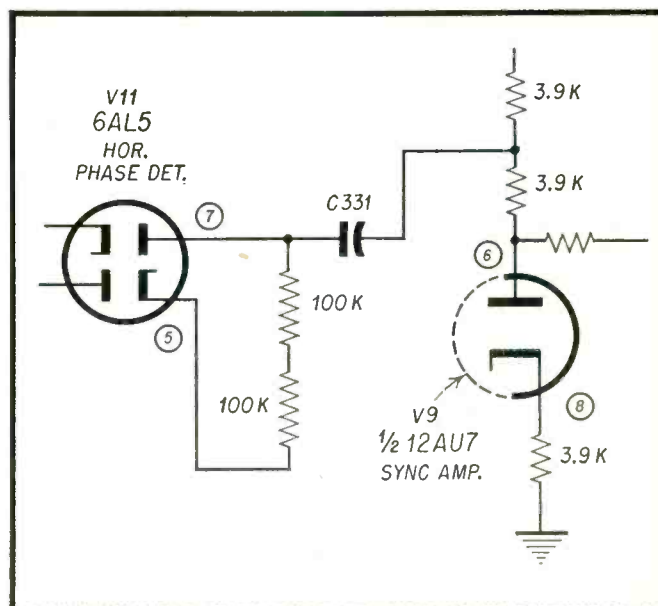

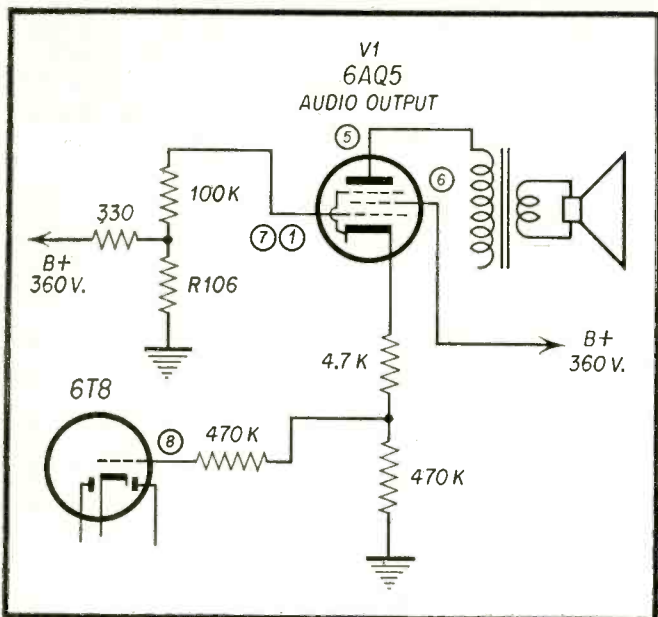

Mfr. Tele-King Model No. 812

Card No. TK812-4

Section Affected: Sound

Symptom: Sound low and nasal.

Cause: Component failure.

What To Do:

Replace: R106 (180K)—increases in value.

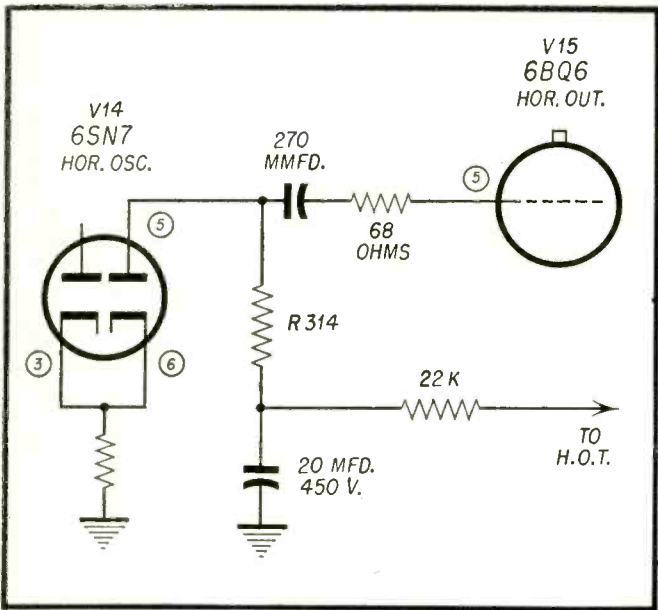

Mfr. Tele-King Model No. 812

Card No. TK812-5

Section Affected: Raster

Symptom: Insufficient width.

Cause: Component failure.

What To Do:

Replace: R314 (270K)— increases in value.

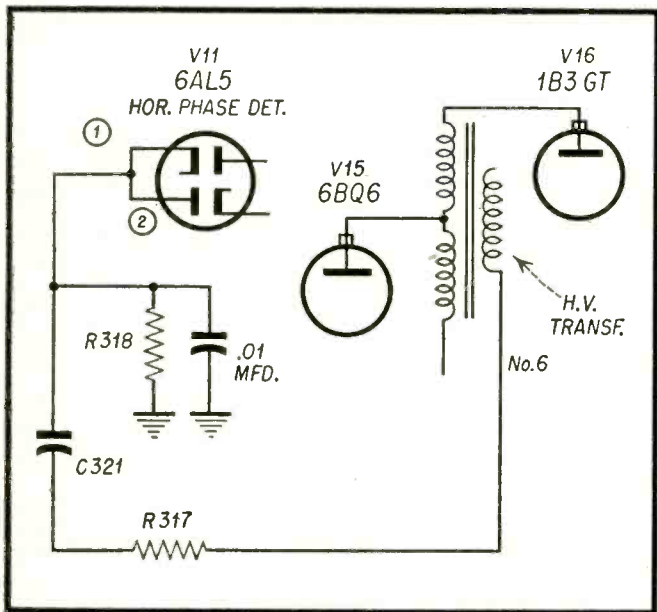

Mfr. Tele-King Model No. 812

Card No. TK812-6

Section Affected: Sync

Symptom: No raster.

Cause: Component failure.

What To Do:

Replace: C321 (.05 μ f)—shorted.
Also, R317 (4.7K)—burned.
Also, R318 (27K)—burned.

CIRCUIT COURT

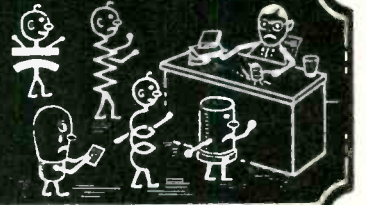

Sylvania 1-518: Video Amp., Sync, Keyed AGC

The Sylvania 1-518, while generally straightforward in design, has several variations from the usual which are worth examining. In the video amplifier circuit (Fig. 1), the grid of the amplifier is direct-coupled to the crystal second detector. The plate of the 12BY7 is direct-coupled to the CRT. The direct coupling all the way through eliminates the need for a *dc* restorer circuit and also eliminates the low frequency phase shift caused by the coupling condensers. The cathode of the 12BY7 is returned through a potentiometer to a 4.5 ohm resistor in the cathode of the 6BQ6 horizontal output amplifier. The result is that a minimum cathode bias is established on the 12BY7 for any setting of the contrast control.

In the sync and *agc* systems (Fig. 2), there are several departures from usual circuitry. We find V15a diode-connected and used as a sync input gate, two sync separators (V14A and V14B) acting in parallel, and a keyed *agc* system in which the keyer tube also acts as an *agc* amplifier.

Sync Action

Discussing first the sync action: the plate voltage of V15a is set so that any noise pulses on the sync pulse cause the diode V15a to stop conducting because the cathode will become positive with respect to the plate. The result is that only the composite video signal is passed to the sync separators. This signal is then applied to the grids of V14a and V14b in parallel. In the cathode of V14a are C201 and R202. The time constant of C201 and R202 is such that C201 charges to the average value of the sync pulse. This voltage acts as a bias for V14a so that the tube only conducts on the sync portion of the signal. In addition, the voltage on the V14a resistor, R202, is used to bias the *agc* keyer. Since the cathode of the keyer is at +60 volts and the positive voltage on the grid is lower, the grid to cathode bias is established.

V14b acts as a grid lead detector. Its sync pulse output is added to that of V14a and the added output is im-

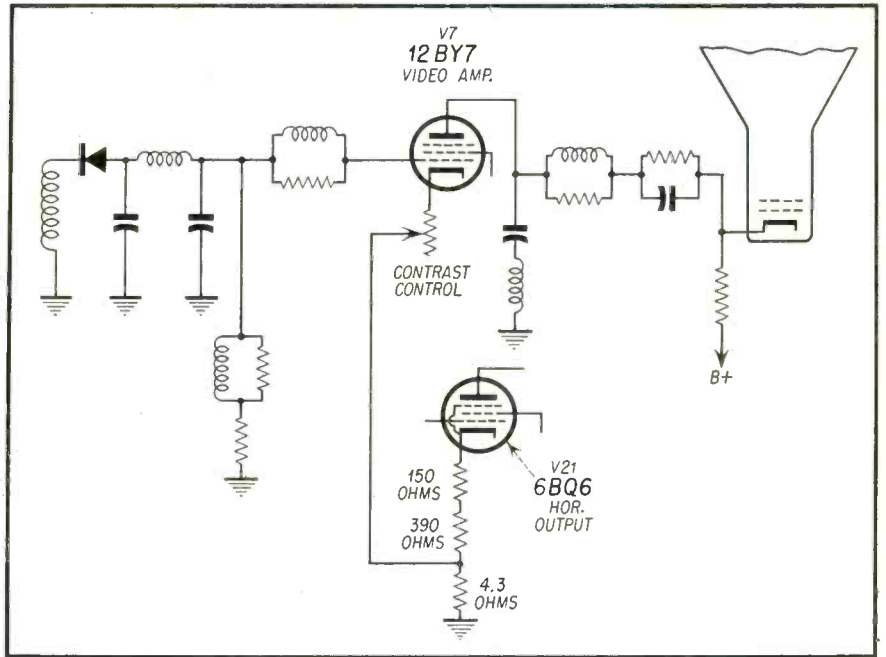

Fig. 1—Sylvania 1-518, video amplifier circuit.

pressed on the grid of V15b. V15b clips the negative going sync pulse in its grid circuit and because of its low plate voltage limits in the plate circuit, thereby removing any remaining video signal.

As far as the keyed *agc* action is concerned, V13, the 6AU6, is keyed by a

pulse from a transformer in the high voltage circuit. The tap on R202 not only sets the *dc* bias on the keyer, but also the amplitude of the sync pulse fed to the keying tube. The *agc* for the *rf* grids is taken off R137. V11 (6AV6) acts as a bias clamp. The *if* grid *agc* is taken off R143.

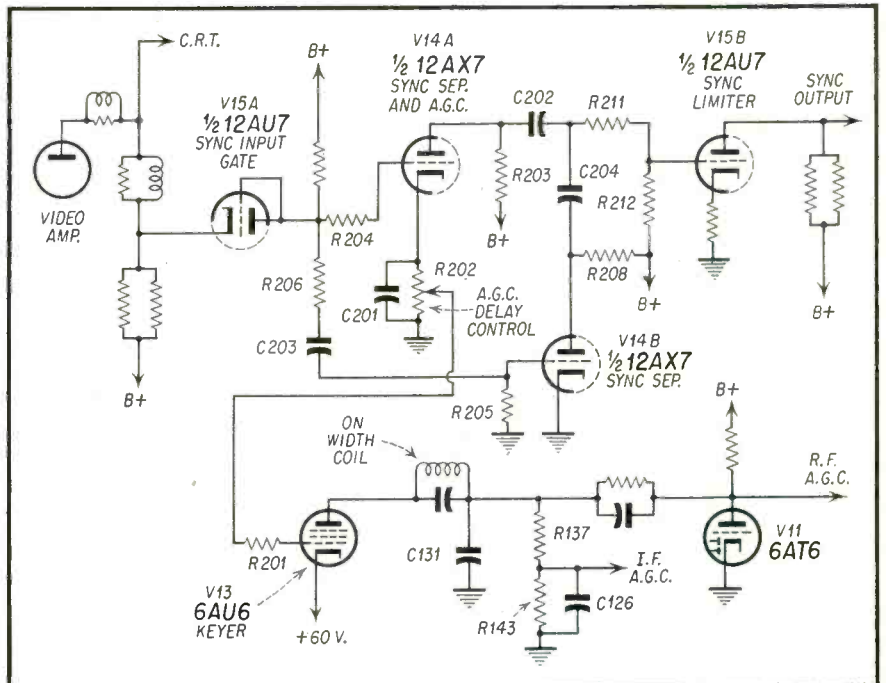
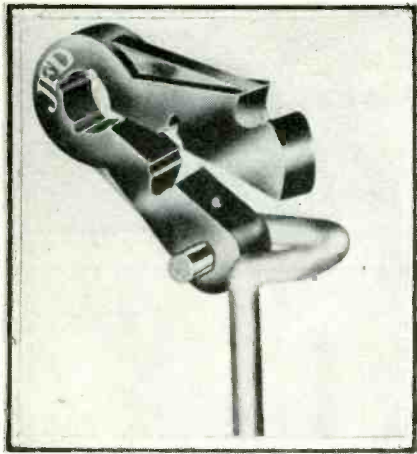

Fig. 2—Sylvania 1-518, sync and *agc* systems.



MANY television antenna installers in *uhf* areas find a substantial signal loss, even after trying higher gain antennas designed for fringe reception. A common cause for this loss in installations where location requires an inexpensive low-gain antenna, is the stand-off insulator. The standard metal-encircled polyethylene grommet causes a serious voltage loss, due mainly to violation of the proper distance between the line and the metal grommet holder. The metal ring that secures the grommet produces a capacitive short. Close proximity of metal to a conductor of voltage causes some degree of loss at any frequency, but becomes a serious problem when it comes to *uhf* reception.

A metal-encircled stand-off insulator, or a metal-free insulator too close to the stand-off anchor frame, will create a standing wave. The stand-off in Fig. 1 has been successfully used for years at *vhf* frequencies. However, when used in *uhf* installations a loss results which the installer cannot put his finger on. Although harmless in appearance with a well-molded grommet, it is a factor causing line unbalance and signal loss. When a transmission line is passed through the grommet, the impedance of the line fluctuates in a series of discontinuities directly proportional to the number of stand-off insulators used.

Increasing the frequency and increasing the number of points of impedance mis-match increases the standing wave ratio. Even the relative po-

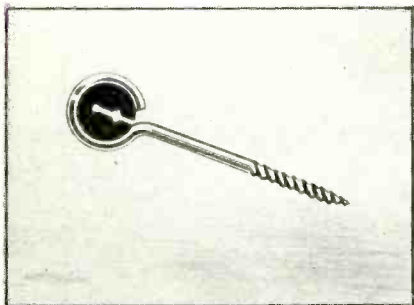

Fig. 1—VHF type insulator causes signal loss when used for UHF.

J.F.D. Engineers Explain:

Stand-off Insulators And U. H. F.

BY DOUGLAS H. CARPENTER
AND DAVID B. TOLINS, JR.

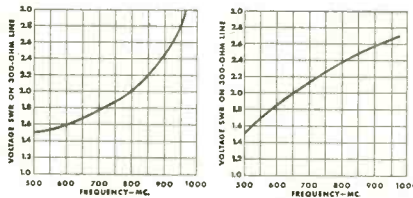

Fig. 2

Fig. 2A

Fig. 2—Standing wave ratios plotted as test results of six grommets.

sition of one stand-off insulator to another will affect the net signal loss. If the installation happens to contain two stand-offs a distance apart equal to half the wavelength of the frequency transmitted, the signal would be stifled almost entirely. If oval and flat polyethylene lines are used, half a wavelength would be 83% of half a wavelength in free air dielectric, due to the slower travel of the wave through polyethylene.

Examples of increased standing wave ratio shown in Figs. 2 and 2A are the plotted results of tests with 6 metal-encircled grommets spaced a half-wavelength apart at several test frequencies. A marked improvement was achieved by spacing the stand-offs in an exact relationship determined by many tests. This method would take too much time, however, to be worthwhile for the installer. Since the first insulator becomes a shunt capacity, the one nearest to it may be placed slightly under a quarter wave away to nullify the capacitive effect.

To assure optimum distance between conductor and metal stand-off in a mass-produced stand-off insulator, JFD's mechanical design laboratories set out to adapt mechanical construction to electrical requirements. The metal-encircled grommet, aside from its electrical shortcomings, requires the cumbersome threading of the oval line through the stand-off to the point of connection, or the grommet must be removed to insert the line and then replaced in the metal ring.

Metal-free stand-off insulators had had been developed previously. How-

ever, in one model, the grommet had a tendency to slip out of the stand-off frame. In another, the metal nail was too close to the line.

Combining electrical efficiency with mechanical convenience, the end product derived is shown in Fig. 3. The stand-off utilizes a pivot-action-lock principle from which is derived the JFD "PAL" name.

The shoulder of the molded polyethylene grommet snaps under the metal stand-off frame, compressing and holding firmly flat ribbon line in the slot, or low loss oval line in the circular end. The necessity to remove the grommet entirely from the stand-off frame or to thread the line through the stand-off is eliminated entirely. The "PAL" in wide-open position is shown at the top of this page. The line is slipped into the proper place. Then, the cam type latch slips into the metal frame. Added pressure from a polyethylene button on the anchor finger of the grommet locks the grommet latch securely in the frame.

In Fig. 3, a dimension "D" indicates the relative distance between the conductor and any metal. For *uhf* signal transfer, this is the minimum dimension that must be maintained to insure zero signal loss. As with all basic improvements, dimensions are important. The critical dimension must be maintained, or any variation will result only in loss of signal, thus defeating the entire purpose of the design.

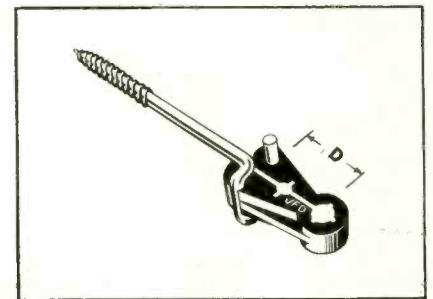

Fig. 3—New type stand-off insulator assures minimum loss in UHF.

Chassis: KCS74 and KCS71M1
 Model: 17T250DE and 17T261DE
 17T250DE "Brett"
 17T261DE "Ainsworth"

Pre-published from Rider "TV Field Service Manuals"

by Rider & Alsberg

Copyright 1953, John F. Rider Published, Inc.

TUBE COMPLEMENT

SYMBOL	TUBE	FUNCTION
V1	6X8	RF Osc. and Mixer
V2	6BQ7	RF Ampl.
V101	6AU6	1st Sound IF Ampl.
V102	6AU6	2nd Sound IF Ampl.
V103	6AL5	Ratio Detector
V104	6AV6	1st Audio Ampl.
V105	6AQ5	Audio Out.
V106	6AU6	1st Picture IF Ampl.
V107	6CB6	2nd Picture IF Ampl.
V108	6CB6	3rd Picture IF Ampl.
V109	6CB6	4th Picture IF Ampl.
V110	6CL6 (6AG7)	Video Ampl.
V111	6CB6	AGC Ampl.
V112	6SN7GT	Horiz. Sync Ampl.
V113	6SN7GT	Sync Separator
V114	6SN7GT	Vert. Sync. Ampl. and Vert. Sweep Osc.
V115	6AQ5	Vert. Sweep Out.
V116	6AN7GT	Horiz. Sweep Osc. and Control
V118	1B3/8016	High Voltage Rectifier
V119	6W4GT	Damper
V120	17QP4	Kinescope

Key Voltages

All voltages are measured with respect to chassis ground.

B+ voltage, Plate of Damper tube V119	pin 5	280VDC
Boosted B+ voltage, V120 (C.R.T.)	pin 10	560VDC
Plate voltage of Vert. Osc. V114	pin 2	70VDC
Plate voltage of Vert. Out. Ampl. V115	pin 5	267VDC
Plate voltage of Hor. Osc. V116	pin 5	197VDC
Plate voltage of Hor. Control tube V116	pin 2	228VDC
Grid voltage of Hor. Out. Ampl. V117	pin 5	-15.3VDC

ADJUSTMENTS

Ion Trap Magnet Adjustment

Set the ion trap magnet approximately in the position shown below. Starting from this position immediately adjust the magnet by moving it forward or backward at the same time rotating it slightly around the neck of the kinescope for the brightest raster on the screen. Reduce the brightness control setting until the raster is slightly above average brilliance. Turn the focus control until the line structure of the raster is clearly visible. Readjust the ion trap magnet for maximum raster brilliance. The final touches of this adjustment should be made with the brightness control at the maximum clockwise position with which good line focus can be maintained.

Deflection Yoke Adjustment

If the lines of the raster are not horizontal or squared

with the picture mask, rotate the deflection yoke until this condition is obtained. Tighten the yoke adjustment wing screw.

Picture Adjustments

It will now be necessary to obtain a test pattern picture in order to make further adjustments. Connect the antenna transmission line to the receiver.

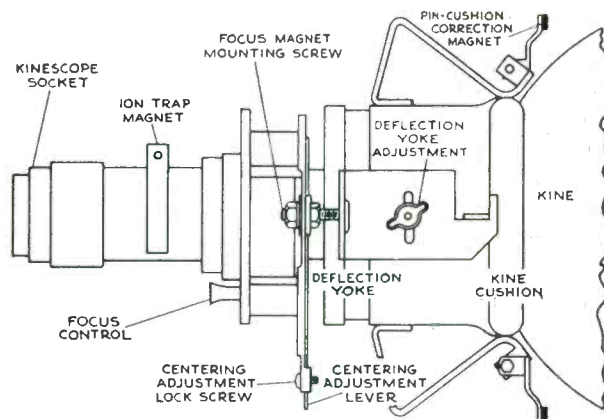

Yoke and Focus Magnet Adjustments

If the Horizontal Oscillator and AGC System are operating properly, it should be possible to sync the picture at this point. However, if the AGC control is misadjusted, and the receiver is overloading, it may be impossible to sync the picture.

If the receiver is overloading, turn AGC control on the rear apron counter-clockwise until the set operates normally and the picture can be synced.

Check Of Horizontal Oscillator Alignment

Turn the horizontal hold control to the extreme counter-clockwise position. The picture should remain in horizontal sync. Momentarily remove the signal by switching off channel then back. Normally the picture will be out of sync. Turn the control clockwise slowly. The number of diagonal black bars will be gradually reduced and when only 2 or 3 bars sloping downward to the left are obtained, the picture will pull into sync upon slight additional clockwise rotation of the control. Pull-in should occur before the control has been turned 120 degrees from the extreme counter-clockwise position. The picture should remain in sync for approximately 90 degrees of additional clockwise rotation of the control. At the extreme clockwise position, the picture should remain in sync and should not show a black bar in the picture.

If the receiver passes the above checks and the picture is normal and stable, the horizontal oscillator is properly aligned. Skip "Alignment of Horizontal Oscillator" and proceed with "Focus Magnet Adjustment."

[Continued on page 44]

RCA TROUBLESHOOTING CHART

NO SOUND—NO RASTER

Power input circuit
Check Selenium rectifiers
Check B+ Filter Network
Phono-TV Switch

NO RASTER—SOUND OK

Brightness control
Check HV Fuse F101 (0.25 Amp)
Ion trap
V110, V116, V117, V118, V119, V120
HV xformer Hor. yoke CRT connections

WEAK PIX—SOUND AND RASTER OK

Tuner fine tuning
Picture control
V1, V106, V107, V108, V109, V110, V111

POOR HOR. LIN.

Hor. Lin. and Drive controls
V117, V119
Check 0.022 and 0.027 mf caps. connected to terminal
3 of Hor. Out. Trans.
Hor. Out. Trans.

POOR VERT. LIN.

Vert. Lin. and Height controls
V114, V115
Check 0.033 mf cap. connected to pin 2 of V114
Check 0.0022 mf cap. connected through 0.033 mf
cap. to pin 2 of V114

PIX JITTER SIDEWAYS

Hor. Hold and Locking Range controls
Hor. Osc. Trans. Adj. (T113)
V116, V117
Check 0.001 mf and 68 mmf caps. connected to pin 1
of V116

SMEARED PIX

Tuner fine tuning
Picture and A.G.C. controls
V1, V106, V107, V108, V109, V110
Check Vid. Det. crystal CR101 (Part of T109)
Check Vid. Det. and Amp. peaking coils
IF and RF alignment

POOR PIX DETAIL

Tuner fine tuning
Focus control
V106, V107, V108, V109, V110
Check Vid. Det. crystal CR101 (Part of T109)
IF and RF alignment

SOUND BARS IN PIX

Tuner fine tuning
Check alignment of T110
Picture and A.G.C. controls
Check Vid. Det. crystal CR101 (Part of T109)
V1, V2, V106, V107, V108, V109
IF and RF alignment

SNOW IN PIX

A.G.C. control
V2, V106, V107, V108, V109
Antenna and transmission line

AC IN PIX (DARK HOR. BAR)

V1, V2, V106, V107, V108, V109, V110, V111

ENGRAVED EFFECT IN PIX

Tuner fine tuning

Picture and A.G.C. controls
V1, V106, V107, V108, V109, V110, V111
Check Vid. Det. crystal CR101 (Part of T109)
Check Vid. Det. and Amp. peaking coils

VERT. BARS

Hor. Drive and Width controls
V117, V119
Check damping network connected to terminals 3 and
7 of Defl. yoke
Defl. yoke ringing

PIX JITTER UP AND DOWN

A.G.C. control
Vert. Hold control
V111, V112, V113, V114, V115
Check 0.001 mf cap. connected to pin 1 of V114
through a 68K res.

PIX BENDING

Hor. Hold and Locking Range controls
Hor. Osc. Trans. (T113) Adj.
A.G.C. control
V111, V112, V116, V117
Check 0.47 and 0.1 mf caps. connected to pin 3 of V116
Check Vid. Det. crystal CR101 (Part of T109)

AUDIO HUM IN SOUND

V101, V102, V103, V104, V105

DISTORTED SOUND

Tuner fine tuning
V1, V101, V102, V103, V104, V105
Check 0.01 mf cap. connected to pins 1 and 7 of V105
Ratio Det. Balance control
Sound and Vid. IF alignment T101, T110
Det. alignment T102

NO SOUND—PIX OK

Tuner fine tuning
V101, V102, V103, V104, V105
Volume control
Speaker (open voice coil or defective connection)
Sound and Vid. IF alignment T101, T110
Det. alignment T102

WEAK SOUND—PIX OK

Tuner fine tuning
Volume and Ratio Det. Balance controls
V1, V101, V102, V103, V104, V105
Sound and Vid. IF alignment T101, T110
Det. alignment T102

NOISY SOUND—PIX OK

Volume control
V101, V102, V103, V104, V105
Check sound system for loose connections
Speaker
Sound IF and Det. alignment T101, T102, T110

SYNC. BUZZ IN SOUND

Tuner fine tuning
A.G.C. and Ratio Det. Balance controls
V101, V102, V103, V111
Check Vid. Det. crystal CR101 (Part of T109)
Sound IF and Det. alignment T101, T102, T110

INTERMITTENT SOUND—PIX OK

V101, V102, V103, V104, V105
Poor connections in sound system

**WEAK OR NO PIX—
SOUND WEAK—RASTER OK**

Tuner fine tuning
A.G.C. control
V1, V2, V106, V107, V108, V109,
V110, V111
Check Vid. Det. crystal CR101
(Part of T109)

**RF and IF alignment
INTERMITTENT RASTER—
SOUND OK**

Brightness control
V116, V117, V118, V119, V120
HV xformer

RASTER BLOOMING

Hor. Drive control
V117, V118, V119, V120
Check Selenium Rectifiers
Check 680 mmf cap. connected
to terminal "D" of T113

INSUFFICIENT BRIGHTNESS

Ion trap
Brightness and Hor. Drive controls
V117, V118, V119, V120
Check 10K ohms res. connected
to pin 4 of V117
Check Selenium Rectifiers
Low line voltage

EXCESSIVE RASTER (PIX SIZE)

Hor. Drive and Width controls
Height control
V117, V118

INSUFFICIENT RASTER WIDTH

Hor. Drive and Width controls
V116, V117, V119
Check Selenium Rectifiers
Check 0.0012 and 0.00068 mf
cap connected to terminal "D"
of T113
Low line voltage

INSUFFICIENT RASTER HEIGHT

Height and Vert. Lin. controls
V114, V115
Check 0.1 and 0.033 mf caps. con-
nected to pin 2 of V114
Low line voltage

NO VERT. DEFL.

V114, V115
Check 0.1 mf cap. connected to
pins 1 and 7 of V115
Vert. Defl. yoke
V. O. T.

NO VERT. SYNC.—

HOR. SYNC. OK

Vert. Hold control
V114, V115
Check Vert. Int. network
Check 0.001 and 0.1 mf caps. con-
nected to pin 1 of V114

NO HOR. OR VERT. SYNC.—

PIX SIGNAL OK

A.G.C. control
V11, V112, V113

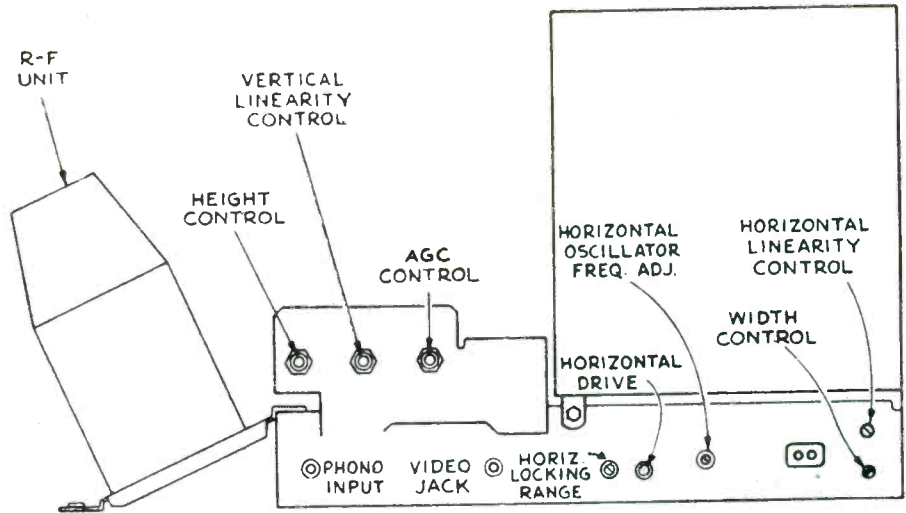

Rear Chassis Adjustments

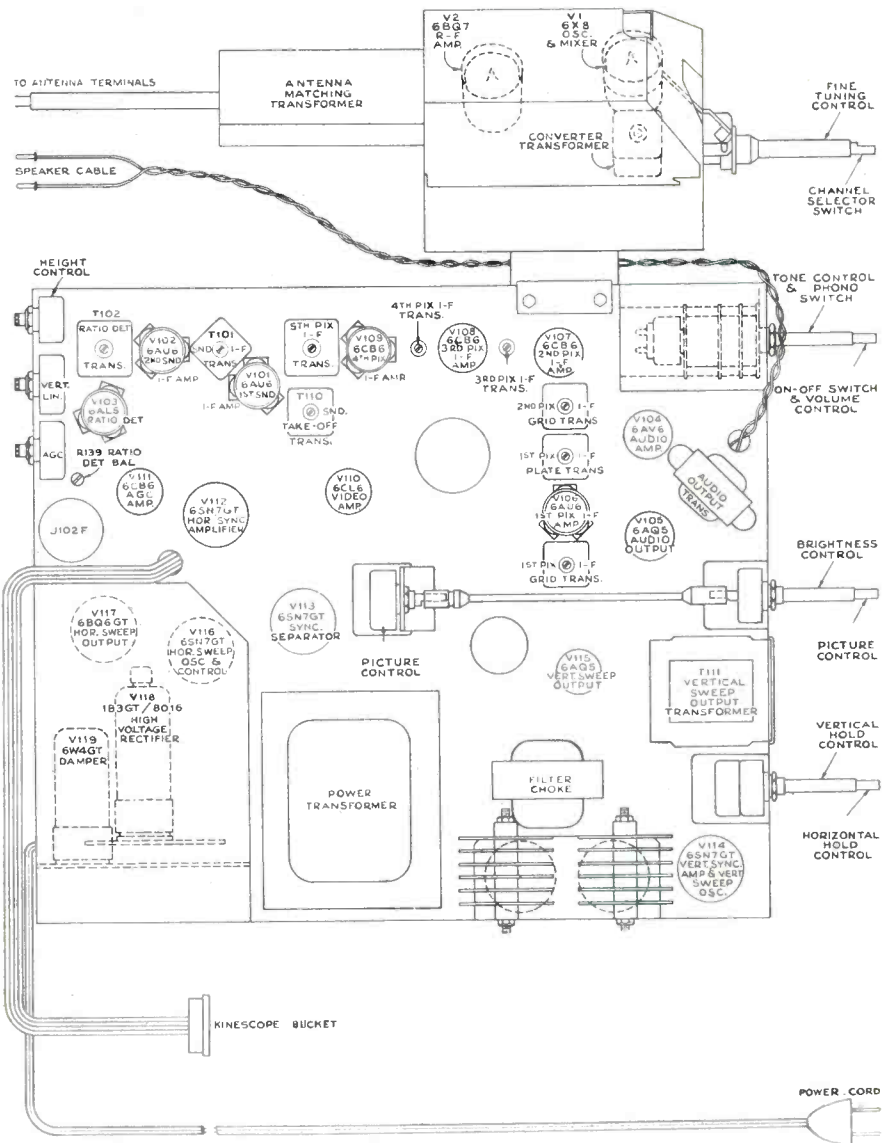

Horizontal Frequency Adjustment

Turn the horizontal hold control to the extreme clockwise position. Tune in a television station and adjust the horizontal frequency adjustment at the rear of the chassis until the picture is just out of sync and the horizontal blanking appears as a vertical or diagonal black bar in the raster. Then turn the core until the bar moves out of the picture leaving it in sync.

Horizontal Locking Range Adjustment

Set the horizontal hold control to the full counter-clockwise position. Momentarily remove the signal by switching off channel then back. The picture may remain in sync. If so turn the Hor. Osc. Transformer rear core slightly and momentarily switch off channel. Repeat until the picture falls out of sync with the diagonal lines sloping down to the left. Slowly turn the horizontal hold control clockwise and note the least number of diagonal bars obtained just before the picture pulls into sync.

If more than 3 bars are present just before the picture pulls into sync, adjust the horizontal locking range trimmer slightly clockwise. If less than 2 bars are present, adjust Hor. Locking Range Trimmer slightly counter-clockwise. Turn the horizontal hold control counter-clockwise, momentarily remove the signal and recheck the number of bars present at the pull-in point. Repeat this procedure until 2 or 3 bars are present.

Repeat the adjustments under "Horizontal Frequency Adjustment" and "Horizontal Locking Range Adjustment" until the conditions specified under each are fulfilled. When the horizontal hold operates as outlined under "Check of Horizontal Oscillator Alignment" the oscillator is properly adjusted.

AGC Threshold Control

The AGC threshold control is adjusted at the factory and normally should not require readjustment in the field.

To check the adjustment of the AGC Threshold Control, tune in a strong signal and sync the picture. Momentarily remove the signal by switching off channel and then back. If the picture reappears immediately, the receiver is not overloading due to improper setting of AGC Threshold Control. If the picture requires an appreciable portion of a second to reappear, or bends excessively AGC Threshold Control should be readjusted.

Centering Adjustment

No electrical centering controls are provided. Centering is accomplished by means of a separate plate on the focus magnet. The centering plates include a locking screw which must be loosened before centering. Up and down adjustment of the plate moves the picture side to side and sidewise adjustment moves the picture up and down.

If a corner of the raster is shadowed, check the position of the ion trap magnet. Reposition the magnet within the range of maximum raster brightness to eliminate the shadow and recenter the picture by adjustment of the focus magnet plate. In no case should the magnet be adjusted to cause any loss of brightness since such operation may cause immediate or eventual damage to the tube. In some cases it may be necessary to shift the

position of the focus magnet in order to eliminate a corner shadow.

Focus Magnet Adjustment

The focus magnet should be adjusted so that there is approximately three-eighths inch of space between the rear cardboard shell of the yoke and the flat of the front face of the focus magnet. This spacing gives best average focus over the face of the tube.

The axis of the hole through the magnet should be parallel with the axis of the kinescope neck with the kinescope neck through the center of the opening.

Pin-Cushion Correction

Two pin-cushion correction magnets are employed to correct a small amount of pin-cushion of the raster due to the lens effect of the face of the kinescope. These magnets are mounted on small arms, one on each side of the kinescope as shown. The arms hinge in one plane on self tapping screws which act both as a hinge and an adjustment locking screw. When the magnets are swung towards the tube, maximum correction is obtained. Minimum correction is obtained when the arms are swung away from the tube. To adjust the magnets, loosen the two self tapping screws and position the magnets until the sides of the raster appear straight. Tighten the screws without shifting the position of the magnets. In some cases it may be necessary to twist or bend the magnet support arms to obtain the appearance of straight raster edges.

Width, Drive And Horizontal Linearity Adjustments

Adjustment of the horizontal drive control affects the high voltage applied to the kinescope. In order to obtain the highest possible voltage hence the brightest and best focused picture, adjust horizontal drive trimmer C191B counter-clockwise until the picture begins to wrinkle" in the middle then clockwise until the "wrinkle" disappears.

Turn the horizontal linearity control L107 clockwise until the picture begins to "wrinkle" on the right and then counter-clockwise until the "wrinkle" disappears and best linearity is obtained.

Adjust the width control L106 to obtain correct picture width.

A slight readjustment of these three controls may be necessary to obtain the best linearity.

Adjustments of the horizontal drive control affect horizontal oscillator hold and locking range. If the drive control was adjusted, recheck the oscillator alignment.

Height And Vertical Linearity Adjustments

Adjust the height control (R199 on chassis rear apron) until the picture fills the mask vertically. Adjust vertical linearity (R211 on rear apron), until the test pattern is symmetrical from top to bottom. Adjustment of either control will require a readjustment of the other. Adjust centering to align the picture with the mask.

Chassis Removal

To remove the chassis from the cabinet for repair or installation of a new kinescope, remove the control knobs, the cabinet back, unplug the speaker cable, the kinescope socket, the antenna cable, the yoke and high voltage cable. Take out the chassis bolts under the cabinet. Withdraw the chassis from the back of the cabinet.

WAVEFORM ANALYSIS

in Sync Circuits

BY GEORGE HOLMES

SQUARE waves are frequently applied across RC networks in TV receivers as, for example, in vertical and horizontal blanking pulses in the sync amplifier circuit. This causes many of the peculiar waveforms frequently observed by the technician.

To understand the manner in which these waveforms are developed, we'll first apply a square wave E_A of 2000 cycles to the circuit in Fig. 1. Then we'll follow the path of charge and discharge across the condenser, examining the resultant wave shape E_R across R.

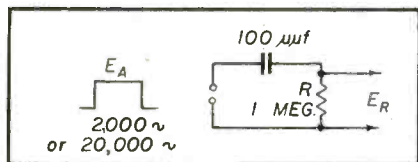

Fig. 1—Simple circuit for studying RC action on 2000 cps square wave.

The formula $T = RC$ (where R and C are in ohms and farads respectively) explains the amount of time it takes a capacitor to charge up to 62.8% of the applied voltage. In other words, if we apply 10 volts to a condenser, it would charge up to 6.28 volts in T time (refer to Fig. 2).

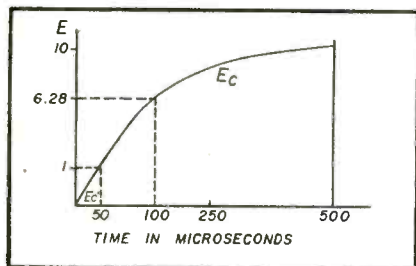

Fig. 2—Curve showing how voltage charges up condenser in Fig. 1.

The curve in Fig. 2 indicates how the voltage is developed across the condenser as it charges up. Because the curve is exponential, it will take an infinite amount of time for the condenser to become fully charged. However, for purposes of explanation

and simplicity, let us designate $5T$ as the time it takes for the condenser to become fully charged.

Now we can use our formula:

$$\begin{aligned} T &= RC \\ &= 1,000,000 \times 100 \times 10^{-12} \\ &= 100 \text{ } \mu\text{secs.} \end{aligned}$$

Therefore:

$$5T = 500 \text{ } \mu\text{secs.}$$

Observe that the 2000 cycle square wave E_A mentioned above also makes one complete cycle in $1/2000 = 500 \text{ } \mu\text{secs.}$ This is the time it takes the condenser to become fully charged. Therefore, the 2000 cycle wave will just about charge the condenser in Fig. 1 in $500 \text{ } \mu\text{sec.}$

Referring to Fig. 3, we are now going to follow E_A , the applied voltage, and E_R , the voltage across the resistor. From point G which is at zero voltage level, E_A , because of the square wave characteristic, rises instantaneously to 10 volts. This is equivalent to a voltage of infinite frequency being applied

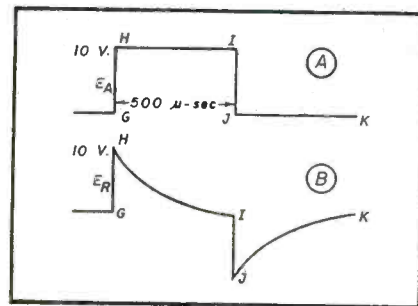

Fig. 3—Waveforms of applied voltage and for voltage across resistor.

to a condenser. The reactance, X_c , offered by the condenser to a signal of infinite frequency is zero ($X_c = -1/2\pi fc$). Therefore, the voltage across the resistor will rise instantaneously to 10 volts. This is shown as point H in Fig. 3B.

Notice that E_A stays at 10 volts for 500 micro-seconds until point I is reached. During this time, the condenser will charge to the full value of 10 volts. E_R as shown in Fig. 3B, which was at 10 volts initially will drop exponentially to zero. Now, E_A drops instantaneously to zero. This cor-

responds to points I and J. Here is where confusion usually takes place. If the applied voltage drops to zero and there is 10 volts across the condenser; and if the sum of all the voltages around a series circuit equals zero, then there must be 10 volts across the resistor at this instant to balance the 10 volts across the condenser. Referring to Fig. 4 we see that the condenser at this instant becomes the generator and applies its 10 volts instantly across the resistor at an opposite polarity. Adding up the voltages shown in Fig. 4, we observe that $+10 - 10 = 0$.

Referring again to Fig. 3A, point J corresponds to an applied voltage of zero volts. The condenser now discharges exponentially through the resistor in $5T$ or $500 \text{ } \mu\text{secs.}$ as shown in Fig. 3B, J to K.

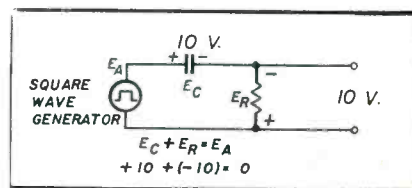

Fig. 4—For an instant, the condenser generates a 10 volt square wave.

Now let us see what happens when we apply a 20,000 cycle square wave to the circuit shown in Fig. 1. In this case:

$$\begin{aligned} T &= 1/f \\ &= 1/20,000 \\ &= 50 \text{ } \mu\text{secs.} \end{aligned}$$

Referring to Fig. 5, where E_A^1 rises to 10 volts instantaneously E_R^1 will also rise instantaneously to 10 volts for the reasons discussed previously. We are now at point L (Fig. 5B) and E_A^1 levels off at 10 volts for $50 \text{ } \mu\text{secs.}$ to point M.

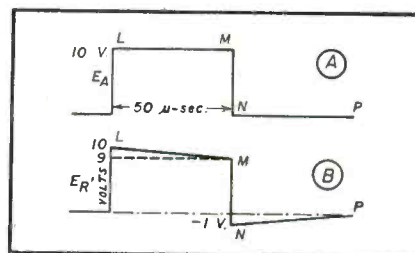

Fig. 5—Waveforms for applied voltage and for voltage across resistor.

The components used in Fig. 1 ($R = 1 \text{ meg, } C = 100 \text{ } \mu\text{f}$) will permit the condenser to charge up fully in $500 \text{ } \mu\text{secs.}$ Since the incoming wave has a duration of only $50 \text{ } \mu\text{secs}$ it will charge up the condenser to only 1 volt as shown in Fig. 2. (We use 1 volt in this case for simplicity of explanation and calculation.)

Referring to Fig. 5: since at point M the capacitor is charged up to 1 volt,

[Continued on page 53]

New

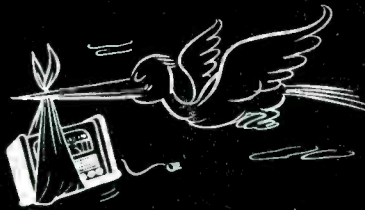

Products

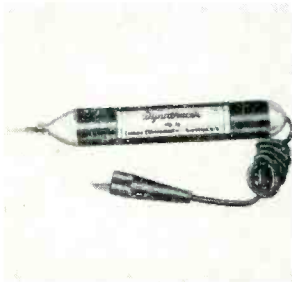

TV "Dynatracer"

The new TV "Dynatracer" (Century Electronics Co., Bklyn, N.Y.) is a portable, self-powered quality instrument designed to trace TV signals through any sound, sync, a/c, vertical or horizontal sweep circuit. It picks up its signal from one section of the receiver and feeds it to other portions of the set. It will also trace voltages and locate defective parts.



Screwdriver Illuminates Close Work

A screwdriver in the new Rosco Flash Kit features a handle with built-in light. Three interchangeable screwdriver blades are magnetized. The complete kit contains: a spring-chuck illuminated handle; #1 Crosspoint blade for Phillips-Type screws; a regular screwdriver blade; a fine works blade and a standard bulb and battery. For further information, write Rosenberg Brothers & Co., Smithtown, L.I., N.Y.

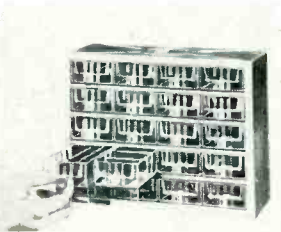

"See-Thru" Drawers

The Model J-20 "See-Thru" drawer consists of twenty plastic drawers in a welded all-steel cabinet. Overall size is 10 1/4"H x 12 1/2"W x 6"D. Adjustable drawer dividers and identification labels are included. Other models range from 8 to 128 drawers, with larger drawers, and portable models with carrying handles. General Industrial Co., 5738 N. Elston Ave., Chicago 30, Ill. will send additional information on request.

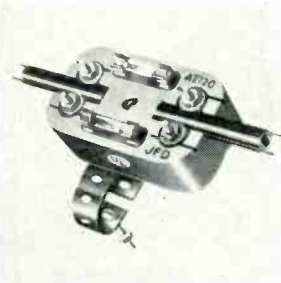

New JFD Lightning Arrester

JFD Manufacturing Co., Brooklyn, New York, has announced the new patented "Lightning Sentry" lightning arrester and static discharger, model AT120. The Lightning Sentry includes both an internal resistor network and two replaceable fuses. The resistor network will bypass all regular picture-smearing static charges to ground, as well as lightning charges.

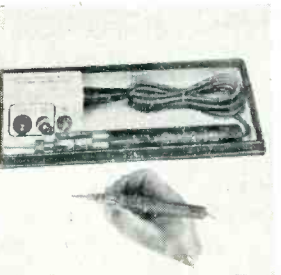

New Desco Circuitracer

The new Circuitracer, made by the Desco Mfg. Co., 605 E. Walnut Street, Pasadena, Calif., tests live circuits as low as 2 volts or as high as 600 volts. It can locate grounds, opens or shorts in dead or live circuits. A simple conversion makes the Desco a low voltage tester or a high voltage tester for live circuits, or a continuity tracer for dead circuits. Weight is 2 1/2 oz.

New Weston Tubechecker

The Model 981 Type 2 tubechecker provides for rapid measurement of proportional mutual conductances, emission characteristics of rectifiers and diodes, and the firing potential limits of voltage regulators and low power thyatrons.

Complete information including ranges, prices, etc., can be obtained directly from Weston Electrical Instrument Corp., 614 Frelinghuysen Ave., Newark 5, N.J.

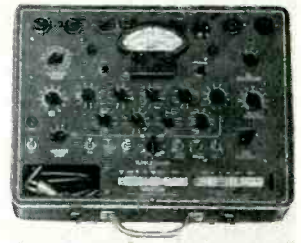

New Case For Servicemen

An all-steel case designed for servicemen features six plastic-clear boxes for small parts, a seven partition removable metal tray, four bins on one side, two extra large on the other. It is made of heavy gauge metal with full-length hinge, lock, catches, and handle. Overall size is 21 by 12 by 7 1/2 inches. For further information, write to Hardware Dept., Sears, Roebuck & Co., 403 South State St., Chicago 5, Ill.

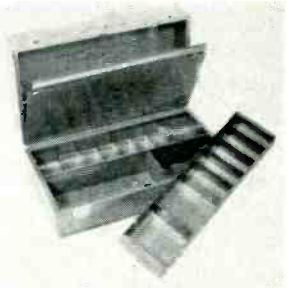

Webcor 3-Speaker Tape Recorder

Webcor's Model 2030, features three PM speakers: one 4-inch mounted in front, and two 6-inchers on the sides of the chassis. This speaker system is also used in Webcor's "Musicale" phonograph. The Model 2030 contains a four-pole shaded motor, two-speed recording, inputs for mike, phono and radio, amplifier with push-pull output, bass and treble boost and bass-compensated volume control. Distortion is said to be negligible.



Plug-In Selenium Rectifier

This item facilitates field replacement of selenium rectifiers, particularly the types commonly used in radio and TV receivers. Lugs are polarized for proper circuit connection. Vibration or shock will not cause the rectifiers to fall out of the socket. It is possible to mount in a conventional manner and solder to the lugs. Write to Cinch Manufacturing Co., Chicago for data.

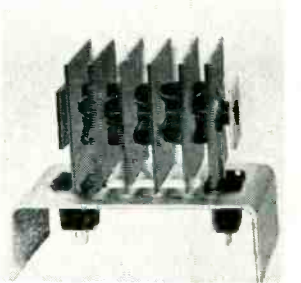

Insuline Lucite Test Leads

A new pair of Lucite Handle Test Leads, intended for use with standard voltmeters, multimeters, vacuum-tube voltmeters, etc. has been introduced by the Insuline Corporation of America, Long Island City 1, N.Y. Ends are fitted with small threaded chucks which take phonograph-needle test tips. The handles carry 45-inch lengths of leads with molded right-angle phone tip plugs.

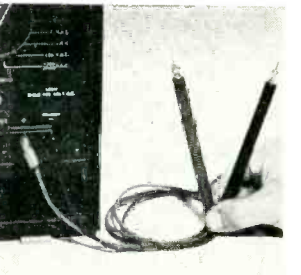

TRADE FLASHES

[from page 68]

Trailers (Mobile Homes) With Built-in TV Sets

CBS-Columbia, the television manufacturing division of the Columbia Broadcasting System, announced recently that it had completed negotiations to provide television receivers as standard built-in equipment for the Pacemaker Trailer Company of Elkhart, Ind.

The CBS-Columbia television-equipped trailers are currently on display at the 17th Annual Mobile Homes Manufacturers Association Convention in Cleveland.

Photographic Method For Pix Tube Screen

In a color television picture tube screen, three different phosphor materials may be placed in an interspersed dot pattern on a glass plate, a phosphor for each of three primary colors, red, blue, and green. Here D. J. Bracco, engineer at Sylvania Research Laboratories, uses a photographic method of forming the complex screen. Light from the point source zirconium lamp passes through an aperture plate containing more than 200,000 precisely spaced small holes. Rays of light fall in the desired dot pattern on a photographic emulsion containing the color phosphor. After controlled exposure and process-

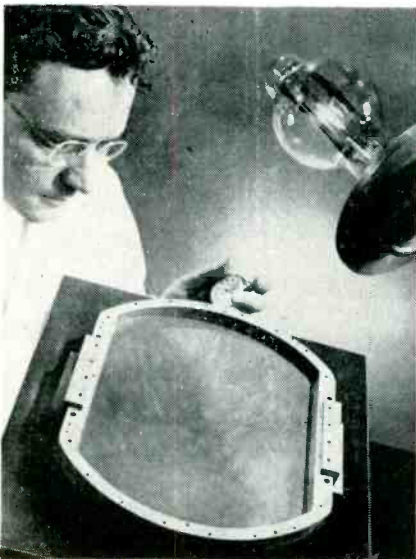

ing, only the phosphor remains in the pattern. The process is repeated for the other two phosphors with the screen and aperture plate moved slightly to permit the new dots to fall between those previously formed. A full color picture is produced by each of three electron streams being made to fall on the appropriate set of color phosphor dots.



R. H. SCHNEBERGER

NATIONAL
SERVICE
MANAGER

OF
Crosley
SAYS...

"... we are glad to see the wide distribution of our information in Rider's Radio-TV-PA Manuals, Tek-Files, TV MANUFACTURERS' RECEIVER TROUBLE CURES Series, UHF PRACTICES AND PRINCIPLES, etc. We keep all of this information in our technical library. When we hold our monthly service classes the distributors, dealers and independent service men who use these manuals and books comment on their accuracy and reliability.

"For the past 20 odd years we have observed that people in the Radio-TV Servicing Industry have always considered Rider servicing data, both Manuals and Tek-Files, to be an "encyclopedia" of our industry. We are glad to see such technical literature disseminated to the servicing fraternity."

available *Now* -
TV 12 and Radio Manual 23

MR. SERVICE SHOP OWNER:

Your integrity, reputation . . .
the "good will" you establish
. . . can only be built or
maintained by servicing your
customers with the best!

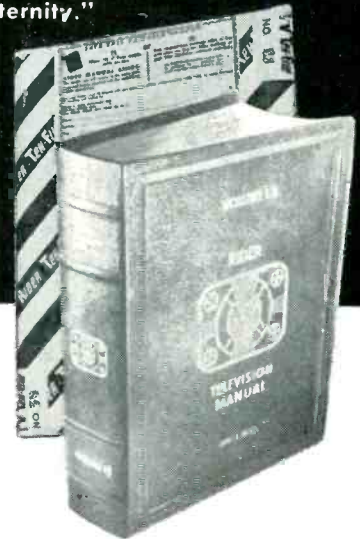

And now TEK-FILE... ONLY \$1.50 per pack

Dependable replacement parts listings
beginning with TV 10 and TEK-FILE pack 57

For easier radio servicing... use Rider's 22 AM-FM Radio Manuals

JOHN F. RIDER

PUBLISHER, INC.
480 Canal Street, New York 13, N. Y.

In Canada:
Mr. Charles W. Panton
1926 Gerrard Street, East
Toronto, Ontario

Export Agent:
Roburn Agencies, Inc.
39 Warren Street
New York 7, New York

West Coast Office:
4216-20 W. Jefferson Blvd.
Los Angeles, California

Cable Address:
Roburnage N. Y.

Stop scouting around for hard-to-find Can-Type Electrolytics!



Your Sangamo Jobber can supply all your "twist-tab" needs

Whether you need a hard-to-find capacitor for an obsolete set, or the latest size for any 1953 model, you can make just *one* stop for all electrolytic replacements—your Sangamo Jobber. He carries the most complete line of twist-tabs in the industry . . . and he has them **IN STOCK!**

Sangamo Type PL Electrolytics are used as original equipment by all major manufacturers—they are *exact* replacements—they assure long life and dependable performance at 85° C and under conditions of high surge voltages and extreme ripple currents.

Make your Sangamo Distributor your "head-quarters" for all your capacitor needs. He can help you because he stocks . . .

Sangamo . . . still the most complete line in the industry



SANGAMO ELECTRIC COMPANY

MARION, ILLINOIS

SC54-1

ASSOCIATION NEWS

Chicagoland REPS

Annual election of officers of the Chicagoland Chapter of "THE REPRESENTATIVES" will take place at the May meeting of the chapter each year instead of at the December meeting, following the passage of an amendment to the chapter's By-Laws conducted by mail here last month, according to Roy J. Magnuson, who heads the By-Laws Committee. The purpose of the change is to enable new officers to take over their duties during the summer months, giving them more time to plan the entire business year program, including the appointment of committees. Installation of duly elected officers will take place at the chapter's June meeting.

RETMA Symposium

Preliminary plans for the fifth government-industry conference designed to spur the continued improvement in quality of all electronic components indicate a new technique will be used in bringing together government and industry experts on electronics on May 4-6, 1954. The three-day technical meeting will be held in the auditorium of the U. S. Department of Interior in Washington.

The conference is sponsored by the American Institute of Electrical Engineers, the Institute of Radio Engineers, the Radio-Electronics-Television Manufacturers Association and the West Coast Electronics Manufacturers Association with the active participation of the U. S. Department of Defense and the National Bureau of Standards.

The technical committee, under Mr. Rogers, is introducing a new concept into the electronic symposium field. The program of the forthcoming meeting is designed to emphasize quality and reliability of components in electronic systems as distinguished from the former emphasis placed on the individual components. The committee is carrying the problem a step further in concerning itself with the development, fabrication and application of component parts into "black boxes" or electronic systems.

LIETA

The board of directors of the Long Island Electronic Technicians Association recently toured the David Sarnoff Experimental Labs at Princeton, N.J., as guests of RCA. Described as a "heaven for the electronic tech-

nician" the labs featured a complete color TV set-up, from transmitter and camera to receiver. Other items of interest was RCA's well-stocked tech library of over 9,000 volumes; a glass-blowing apparatus for tubes; the field sound room for mikes and speakers; the making of germanium transistors.

On December 3rd, LIETA members heard a lecture on "the latest techniques on the color synchronization channel circuits by Mr. C. E. Page, engineer from the Hazeltine License Labs.

The LIETA NEWS, monthly publication of LIETA, features an employment exchange for technicians, who can register with Dick Carey, Chairman, 179 Seventh St., Garden City, N.Y.

Missouri Valley REPS

The "Heart of America Chapter" has been chosen by members of the Missouri Valley Chapter as being more indicative of the area served by its members and, effective January 1, 1954, it will become the official name of the chapter now known as the Missouri Valley Chapter of "THE REPRESENTATIVES."

Annual election of officers took place recently. Clyde H. Schryver was elected president to succeed Zell S. Myers. Fred Somers, Jr., 1953 secretary and treasurer, rose to the vice presidency, taking over the post from Mr. Schryver. G. L. Koenig was elected secretary and treasurer for the coming year.

NEDA-Chicago

At a recent meeting of the Chicago Chapter of the National Electronic Distributors Association held in Ray Foley's Club, J. E. Bowman, J. G. Bowman & Co., and Ralph E. Walker. Walker-Jimieson, Inc., gave a resume of the accomplishments made by the Association during the past several years. They emphasized that trade organizations are definitely a part of the American business system and that the electronics industry was organized from top to bottom at every level from the manufacturer to the service dealer.

The speakers reviewed the work done by NEDA against licensing legislation as well as its support of the Broyhill bill. Stressed too was the fact that NEDA was responsible for materials being available to electronic parts distributors during World War II and during the Korean hostilities in 1951.

The co-chairmen emphasized representation of distributors in the Association before administrative bodies such as NEDA's appearance before the Interstate Commerce Commission in the case now pending to obtain cancellation of the \$1.50 surcharge on



PAMPER

YOUR TV AND RADIO SETS

WITH DEPENDABLE **OHMITE**[®] REPLACEMENTS

Little Devil[®] COMPOSITION RESISTORS



Tiny, yes . . . but what dependability, ruggedness, and stability! And they provide an extra margin of safety—being rated at 70C rather than 40C. Completely sealed and insulated by molded plastic, they meet all JAN-R-11 requirements . . . are available in 1/2, 1, and 2-watt sizes in all RTMA values.

TYPE AB NOISE-FREE POTENTIOMETERS

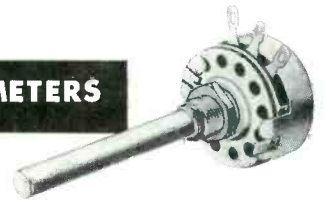

Because the resistance material in these units is solid-molded—not sprayed or painted on—continued use has practically no effect on the resistance. Often, the noise-level *decreases* with use . . . and they provide exceptionally long, trouble-free service. Rated at 2 watts, with a good safety factor.

BROWN DEVIL[®] AND DIVIDOHM[®] RESISTORS

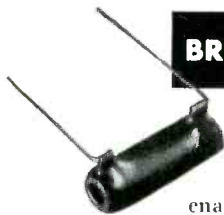

BROWN DEVIL fixed resistors and DIVIDOHM adjustable resistors are favorite vitreous-enameled units! DIVIDOHM resistors are available in 10 to 200-watt sizes; BROWN DEVILS in 5, 10, and 20-watt sizes.



**WRITE FOR
STOCK
CATALOG**



OHMITE MFG. CO.
3640 Howard St.
Skokie, Ill.
(Suburb of Chicago)

Be Right With ...
OHMITE

RHEOSTATS • RESISTORS • TAP SWITCHES

Check! these N. J. R. T. TUBE prices
70% to 90% off list . . .

Type	Price	Type	Price	Type	Price
1A7GT	.45	6AQ5	.37	6SK7GT	.39
1B3GT	.47	6AQ6	.35	6SL7GT	.46
1H5GT	.38	6AT6	.35	6SN7GT	.50
1L4	.44	6AU4GT	.69	6SQ7GT	.35
1L6	.41	6AU6	.36	6T8	.54
1LC5	.49	6AV6	.35	6U8	.59
1LN5	.49	6AX4GT	.57	6V6GT	.37
1N5GT	.44	6BA6	.41	6W4GT	.42
1R5	.37	6BA7	.57	6W6GT	.45
1S5	.43	6BC5	.42	6X4	.35
1T4	.43	6BD6	.45	6X5GT	.35
1U4	.43	6BE6	.37	7F8	.63
1U5	.37	6BG6G	.92	12AL5	.40
1X2	.52	6BH6	.44	12AT6	.35
3A4	.43	6BJ6	.41	12AT7	.54
3Q4	.46	6BK7	.65	12AU6	.38
3Q5GT	.47	6BL7GT	.60	12AU7	.41
3S4	.44	6BQ6GT	.57	12AV6	.50
3V4	.45	6BQ7	.80	12AV7	.57
5AZ4	.50	6BZ7	.89	12AX4GT	.46
5U4G	.45	6C4	.39	12AX7	.49
3Y3GT	.30	6CB6	.42	12BA6	.36
5Y4G	.33	6CD6G	1.09	12BA7	.44
5Z3	.37	6FG	.37	12BE6	.37
6A3	.57	6FGGT	.35	12BH7	.65
6A6	.49	6J5GT	.40	12SA7GT	.42
6AB4	.42	6J6	.50	12SK7GT	.46
6AF4	1.06	6K6GT	.35	12SN7GT	.50
6AF6	.75	6L6	.62	12SQ7GT	.42
6AG5	.41	6S4	.37	12SR7MET	.47
6AJ5	.88	6S8GT	.51	12V6GT	.60
6AK5	.73	6SA7GT	.41	19BQ6G	.96
6AL5	.36	6SD7GT	.39	19T8	.77

Guarantee
ALL NJRT TUBES
ARE BRAND NEW
AND FULLY GUAR-
ANTEED FOR 1
YEAR

Type	Price
25BQ6GT	.60
25L6GT	.37
25W4GT	.45
25Z6GT	.35
35A5	.50
35B5	.38
35C5	.37
35L6GT	.40
35W4	.35
35Z3	.43
35Z5GT	.35
42	.40
43	.53
45	.53
50B5	.37
50C5	.37
50L6GT	.39
70L7GT	1.07
76	.42
117Z3	.35
807	.97

T.V. PIX TUBE
BRIGHTNER \$1.59
LOTS OF 10 1.49
For T.V. sets where voltage supply
is low AC LINE BOOSTER \$5.95
with safety fuse and switch

Free Five 1L4 tubes individually cartoned list
\$11.25 with every order of \$25.00 or more.
Many 7 volt types not listed. Tubes individually boxed. Orders
under \$10 subject to \$1 handling charge. Tubes offered subject
to prior sale. Prices subject to change. Orders shipped prepaid
if check enclosed. 25% deposit required on c.o.d. shipments.

SEND FOR FREE TUBE LISTING.

ORDER NOW . . . Before new price increases go into effect Feb. 1st.



NEW JERSEY TELEVISION SUPPLY CO.
Sole Distributor of NJRT Tubes
906C WESTFIELD AVE., ELIZABETH, N. J. EL. 3-6166

THE NEW TV DYNATRACER

ONLY \$4.95
Y. Pd.
or C.O.D.
+ Chgs.

- TRACES TV SIGNALS AND VOLTAGES
- LOCATES DEFECTIVE COMPONENTS
- REQUIRES NO ADDITIONAL EQUIPMENT

This sensationally new piece of test equipment is ideal for trouble-shooting television sets in the home or in the shop. The "DYNATRACER" will out-perform more expensive testers and should pay for itself on the very first repair.

A Must for Every TV Technician

SPECIFICATIONS: The "DYNATRACER" is a self-powered quality test instrument designed to trace TV signals through any Video, Sound, Sync. AFC, Horizontal or Vertical Sweep Circuit—will isolate trouble to a stage or component.

ADDED FEATURE: The "DYNATRACER" will also trace voltages (50/700 V. AC/DC) and instantly locate open, shorted, intermittent or leaky (up to 20 MEGOHMS) condensers, resistors, coils, X-formers, etc.

Instruction and Trouble-Shooting Book Enclosed
10 DAY MONEY-BACK GUARANTEE

Cut out advertisement . . . attach name and address with \$5.00 bill, check or money order and mail to

Century ELECTRONICS CO.
8509-21st Ave., Dept. 401, Brooklyn 14, N. Y.

LTL truck shipments. Other NEDA services discussed included the reduction of rail rates on the return of defective picture tubes to manufacturers; NEDA's uniform Battery Index; study of office methods, procedures and equipment in conjunction with ten other national wholesale associations; present cooperation with the Government in the disposition of surplus government electronic materials, and the activities of the Association regarding excise tax liability on rebuilt tubes.

Annual Report—N.Y. I.R.E.
In accordance with the Section by-laws, the Annual Report for the 1952-1953 year has been made available by the Secretary of the New York section of the I.R.E. For information or copies, contact A. S. Beck, Secretary, Bell Telephone Labs., P. O. Box 107, Red Bank, N. J. If telephoning, call CH 3-1000 and ask for a Red Bank line.

Pa. State Federation Servicemen's Associations
Plans have been made for the Federation's part in the proposed Eastern Conference scheduled for April 2, 3, and 4 in Philadelphia, it is announced by L. J. Helk, Federation secretary. In conjunction with the conference will be a three-day color TV symposium which will include lectures by eminent authorities. The first 3-D TV lecture screen will be presented and used during the symposium. All servicing groups in the East are to be invited, with both the national service organizations—NATESA and NETSDA—taking part. Mr. Bert Bregenzer, of the Pittsburgh chapter, announced that the Washington, Pa. Association had voted for Federation affiliation. Mr. Joseph Zapracki, heading the Luzerne chapter, was appointed to the nominating committee.

HICKOK
Model 695

VHF SWEEP GENERATOR

- Fundamental output on all frequencies.
- All Electronic sweep.
- .5 volt fundamental output.
- Triple shielding prevents leakage.
- Continuously variable tuning.
- Write for technical details . . .

THE HICKOK ELECTRICAL INSTRUMENT CO.
10533 Dupont Ave., Cleveland 8, Ohio

EICO

KITS - WIRED INSTRUMENTS

Give you **HIGHEST QUALITY!**
SAVE OVER 50%!
World-famous performance-proved EICO Kits and instruments are designed from YOUR point of view—with the best of circuitry and the finest components. Because you do the easy assembly of EICO Kits in just one evening, you get a fine precision instrument and SAVE 50% and more!

See the complete EICO line of VTVMs, scopes, generators, V-O-Ms, tube testers, battery eliminators, decade boxes, etc., at your local jobber today. Write NOW for FREE Catalog D-1.

425K 5" PUSH-PULL SCOPE KIT \$44.95
WIRED \$79.95.

EICO ELECTRONIC INSTRUMENT CO., Inc.
84 WITHERS STREET, BROOKLYN 31, N. Y.

ANSWER MAN

[from page 32]

then and this trouble showed up a couple of months after the tube was changed. I can find nothing wrong with the receiver. I changed the two selenium rectifiers on a chance they were weak but no change in operation resulted. I then changed condenser C703 on the schematic which didn't help any so I gave up as I have no idea what is wrong and neither does any other TV man around here.

As I figure it "Heat" must be the answer but just which part or parts is it? Can you answer this sticker?

J.W.L.

Wayne, W. Va.

Dear J.W.L.

In reference to the vertical deflection troubles you are experiencing in the deflection chassis G1, it is felt that the selenium rectifiers should be rechecked. Probably the substitution was made with the same current rating selenium rectifier as are in the TV receiver, which is 350 milliamps. Try 450 milliamp selenium rectifiers before going any further.

There are a number of other possibilities for the cause of this vertical trouble. The next preliminary step that should be taken is to substitute the 6BQ6 and 6V3 tubes with tubes known to be good. This may have been already done. Naturally, it assumed that several 6AH4 vertical output tubes have been tried.

Check the following resistors.

R819—120K

R818—150K

R702—330K

R706—2.5 meg height control (by substitution)

R703—8.2K

Check the 10 μ f, 450 volt condenser, C815.

Check C702—.1 μ f & C701—.047 μ f.

Check the 17 inch piece of #24 size wire that is used for a voltage dropping resistor for a poor solder connection. In fact, all the solder connections associated with the vertical oscillator and vertical output stages should be heated and checked for a resin joint.

Finally, there is the remote possibility that the trouble may resolve itself into either the vertical output transformer or even the yoke. But since the trouble is experienced only for the first five minutes it would really not be necessary to change these items for this minor difficulty.

CBS-COLUMBIA
GENERAL ELECTRIC
PHILHARMONIC
WESTINGHOUSE
MOTOROLA
SYLVANIA
HOFFMAN
EMERSON
PHILCO
ADMIRAL
MUNTZ
RCA

**STANCOR HAS EXACT
REPLACEMENT FLYBACKS
FOR ALL THESE TV
MANUFACTURERS' SETS...and
others will be available soon**

Stancor TV replacements are listed in Sams' Photofact Index, Counterfacts, Rider Manuals and Tek-Files



**CHICAGO STANDARD
TRANSFORMER CORPORATION**
3586 ELSTON AVE., CHICAGO 18, ILL.

EXPORT SALES: Roburn Agencies, Inc.
39 Warren Street • New York 7, New York

WORKBENCH

[from page 34]

Filament transformers (6.3V) are made expressly with a 1/1 ratio for this purpose.

In many KC6 47's, it has also been noticed that the filament leads are pushed under a metal chassis wedge to hold them in place as they run from the 6W4 to the power transformer. These filament leads are through to the wedge. By simply letting the leads run loosely along the side of the chassis, a lot of trouble can be avoided.

KEY TEST POINTS

[from page 29]

rection can show resistances as low as 400 ohms. The reverse direction resistance should be 10,000 ohms or more. The ratio of the forward to back resistance ratio will therefore usually be 1 to 25 or greater. However, this does not always provide conclusive proof that the crystal is good. It does confirm whether the crystal is open or shorted. When in doubt about the crystal, substitution is the quickest and most confirming check.

MOSLEY WALL-FEED

TV LEAD-IN ENTRANCE

For Homes and Trailers

- Low Cost!
- Easy To Install!
- Attractive Appearance Wins Customer Approval!
- Weather-proof!
- For All UHF and VHF Lines!

available at Radio and Television
Parts Distributors—coast-to-coast.

MOSLEY ELECTRONICS, INC.

8622 ST. CHARLES ROCK ROAD

ST. LOUIS 14, MISSOURI



Cat. 626

MOSLEY WALL-FEED

List Price \$1.26

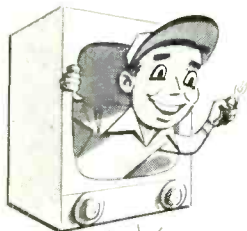

That's for Me for TV!



Available
in clear,
aluminum,
glass and
flat black

\$1.79
LIST
12 OZ.

Insulate everything in TV set except moving parts and tubes! Spray antenna and all connections. Prevent corona, arcing. Keep out moisture, rust.

Higher dielectric strength than any other insulating spray on the market . . . Proven by twenty years of use by leading component parts manufacturers . . . Now packaged in an easy-to-use Spratainer especially for you!

These are just a few of the many features that make Insl-x E-16 best for you! The extremely high dielectric strength of Insl-x assures positive insulation. Use Insl-x, the material that was designed to do one specific job—INSULATE.

See your jobber or write for complete technical data, Dept. 301

INSL-X SALES COMPANY,
26 Rittenhouse Place, • Ardmore, Pennsylvania

MOVING?

When you change your address please notify our circulation department as soon as possible. This is to your advantage, since it takes approximately 5 weeks to have your stencil changed and duplicate copies cannot be sent. Be sure to give your old as well as your new address.

RADIO-TV SERVICE DEALER

67 West 44th St.
New York 36, N. Y.

In the substitution, the correct polarity of the crystal must be observed when connecting in the crystal. Some technicians have attached a test crystal to a spring clothespin or alligator clips for quick connection in place of the suspected crystal. If the crystal is soldered into the circuit, two points are very important. Don't connect the pigtails to the terminal so that there is any tension on the crystal and apply only as much heat as is necessary to accomplish the soldering of the mechanical connection. The pigtailed of the crystal can be held with a long-nose pliers so that the heat will not travel to the crystal but will be blocked and absorbed by the long-nose pliers.

Washed out pictures or overdriven pictures can often be traced to defective germanium crystals. The key test point at the video detector load resistor should be employed to determine the condition of the crystal. If the voltage is too great or too small across the load resistor, the crystal can very well be suspected.

COLOR

[from page 25]

Scanning

The major variations from standard monochrome circuitry are in the scanning circuits. These changes are made necessary by the fact that each color beam has its own screen element. The deflection coils must, therefore, move the beam for each color in a slightly different manner. In the single gun tube, the beam must be oriented differently for each color. In the three gun tube, none of the beams moves through the direct center of the deflection or focusing fields. All three beams are being deflected at the same time. They must be kept in proper relationship to each other and to the color element mask. This requirement makes additional circuits necessary to insure uniform focusing of the beams across the entire face of the tube.

Power Supply

Variations in CRT beam current show up as changes in brightness. The high voltage must, therefore, have very good regulation. The type of "blooming and breathing," which can and does exist on monochrome sets when the brightness or contrast levels are changed, cannot be tolerated. As a result, a number of the experimental designs have a voltage regulator system incorporated. The high voltage required for color CRT's is approximately 20 to 25 kv. To get this voltage, a voltage doubler system is generally used.

[To Be Continued]

WAVEFORM ANALYSIS

[from page 45]

the voltage across the resistor is $10 - 1 = 9$ volts.

Now as before, E_{A1} drops instantaneously to point N. At point N, we have an applied voltage of zero and a condenser charged up to 1 volt. Again the condenser becomes the generator with a potential of 1 volt, and is ready to discharge across the resistor. Remember, when the applied voltage drops to zero as before, the condenser becomes the generator in the circuit and instantaneously applies its own voltage across the resistor. Again the sum of the voltages will equal zero, and E_{A1} will equal one volt negative. See Fig. 6.

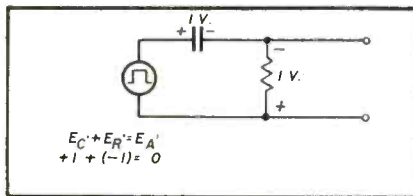

Fig. 6—Discharge of C after having been charged up with 1 volt.

If we look at Fig. 5B again, we see the negative one volt at point N in the E_{A1} wave shape. E_{A1} will remain at zero level to point P. Thus, the condenser, which has a one volt charge, can discharge itself through the resistor; it does so exponentially to point P.

Now that we have discussed the two different resultant wave shapes, let us see where this knowledge can be used. Fig. 7 shows part of the sync circuit used in an RCA 630. Let us

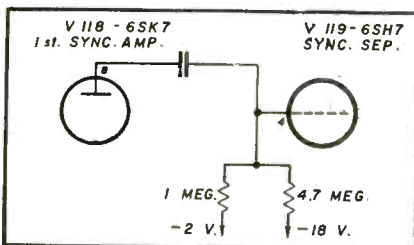

Fig. 7—RCA 630 sync circuit (partial schematic); 6SK7 acts as generator, assume that the 6SK7 is the generator, and that the total resistance in the circuit plus the capacity will give us an RC time which we can compare to the RC time of the network in our previous discussion. Thus by applying the 60 cycle vertical blanking pulse to this network, we should get approximately a resultant wave shape as in Fig. 3 where we applied 2000 cycles. Also, when we apply the 15,750 cycle horizontal blanking pulse to this network, we should get approximately the same wave shape as we did in Fig. 5, where we applied 20,000 cycles.

QUAM

the Quality line

manufacturers of

QUAM Adjust-a-Cone® Speakers for television, radio, high fidelity, public address, outdoor use, replacement and many other applications.

QUAM Focalizer Units for TV picture tube focusing... use Alnico V permanent magnets... eliminate troubles inherent to wire-wound focusing devices.

QUAM Ion Traps for any size or type of TV picture tube.

QUAM Tru-Match Output Transformers, designed to get the best performance from your speaker.

QUAM-NICHOLS CO.
Marquette Road and Prairie Avenue
Chicago 37, Illinois

PREMIER TV RADIO SUPPLY
Division of CONTINENTAL CORPORATION
3239 West North Avenue, Chicago 47, Ill.
DEPARTMENT 404 ARmitage 6-5550

RADAR TYPE TV ANTENNA
For UHF and VHF
RECEIVES ALL CHANNELS

212 miles reception recorded, 125 miles common. This unbeatable antenna has been reinforced to withstand 150 mile winds.
Satisfaction guaranteed or your money back.
Less Mast, List Price.....\$49.95
Your Cost.....**\$19.95**

5 ft. ALUMINUM MAST heavy gauge 1 1/4" diam. with interlocking end. Slip two sections together for a ten-footer. 5 sections = 25ft.
Each section.....\$1.25

Write for our BARGAIN FLYER No. 44

UHF Antenna Kit
Includes everything you need.

- 1.) UHF bow tie antenna with reflector.
- 2.) 3 mast sections.
- 3.) Jumbo 300 ohm tubular transmission line.
- 4.) Sealer cap for UHF transmission line.
- 5.) Universal mast base.
- 6.) 30 ft. top quality guy wire.
- 7.) 3 screw eye anchors for guy wire.
- 8.) Guy wire ring.
- 9.) 3 stand off insulators for 300 ohm transmission line.
- 10.) 2 mast stand off insulators for 300 ohm transmission line.
- 11.) Illustrated instructions for quick, easy assembly.

All in one carton for only \$7.65
Double bay array complete as above plus 5 mast sections and matching device for proper stacking \$11.77

TV Antennas
10 Element conical... rugged throughout... Only... **\$3.95**

Double bay array, with stacking bars.....\$7.75
4 Bay array, with harness and stacking bars.....\$14.95
6 Element Conical, Only.....\$2.95

"TIP WRENCH"

GETS NUTS, BOLTS AND SCREWS
 Into "Hard-To-Get-At" Places—
HOLDS THEM FIRMLY
WHILE TIGHTENING

Or, "TIP WRENCH" goes in and unloosens them and takes them OUT. "TIP WRENCH" is built to work in deep. Holds Nuts, Bolts and Screws where fingers can't hold them. With "TIP WRENCH" you can stop fumbling and save valuable minutes in either REPAIR or LINE PRODUCTION WORK . . . In total, it SPEEDS THE JOB—SAVES THE COST MANY TIMES OVER.

"TIP WRENCH"
SOCKET
POCKET-WRENCH

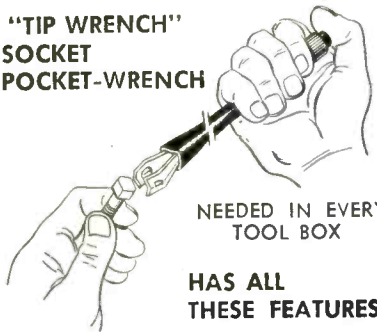

NEEDED IN EVERY
 TOOL BOX

HAS ALL
 THESE FEATURES:

1. It grips—starts—tightens (or loosens). Just one setting.
2. It GRIPS FIRMLY. A nut or bolt won't slip or turn. For screws, the screw driver blades—one in each jaw—engage the slot in the screw head.
3. By thumb pressure on the plunger head, the Jaws slide out and OPEN, the nut, bolt or screw is inserted, gripped firmly, and the user is ready to go in and complete the job.
4. "TIP WRENCH" is a TOUGH TOOL—for TOUGH JOBS. Built of finest materials and precision manufactured . . . It's RUST PROOF, too.
5. SHOCKPROOF. Has a tough Vinylite insulated shank.
6. Knurled—Hardened Steel Jaws slide in form-fitting barrel which "take the pressure" when tool is in use.
7. Capacity: No. 2 to No. 12 Nut or Screw.

**THREE
 CONVENIENT
 SIZES:**
 No. 1. Capacity:
 No. 2 to No. 8
 Nut or Screw
 8 1/2"



No. 2. Capacity:
 No. 6 to No. 12
 Nut or Screw
 8 3/4"
 No. 3. Capacity:
 No. 6 to No. 12
 Nut or Screw . . . 4 1/2"

EACH **\$1.35**



ORDER
 A SET

ORDER THROUGH YOUR JOBBER . . .
 If he cannot supply immediately, ORDER
 DIRECT—but GIVE US YOUR JOBBER'S
 NAME . . . SAVE MONEY & TIME—with
 "TIP WRENCH." Write For Literature.
Sold on A Money-Back Guaranteee
 Address: "TIP WRENCH" DIVISION
SMITH HEAT TREATING CO.
 5865 Wilmington Ave., Los Angeles 1, Cal.

Advertising Index

Admiral Corporation	21
Alliance Manufacturing Co.	19
American Phenolic Corp.	16, 17
Audel Publishers	54
Bussmann Mfg. Co.	1
CBS-Hytron	22
Century Electronics Co.	44
Channel Master Corp.	4, 5, 7
Chicago Standard Transformer Corp.	51
Davis Electronics	27
Electronic Instrument Co., Inc. (EICO)	50
Guardian Elec. Mfg. Co.	17
Hickok Electrical Instrument Co.	50
Insl-X Sales Company	52
International Resistance Co.	Cover 2
Jackson Elec. Instrument Co.	8
JFD Manufacturing Co., Inc.	2
Littelfuse, Inc.	18
Mosley Electronics	52
New Jersey TV Supply Co.	50
Ohmite Manufacturing Co.	49
Perma-Power Company	14
Premier TV Radio Supply	53
Quam-Nichols Company	53
Radiart Corporation, The	12, 13
Radio City Products Co., Inc.	30
Raytheon Manufacturing Co.	11
RCA Tube Dept.	Cover 4
Regency	20
Rider, John F. Publisher, Inc.	14, 47
Sams, Howard W. & Co., Inc.	6
Sangamo Electric Company	48
Simpson Electric Co.	15
Smith Heat Treating Co.	54
Snyder Manufacturing Co.	Cover 3
South River Metal Products Co.	54
Sylvania Electric Products, Inc.	9

South River NEWS

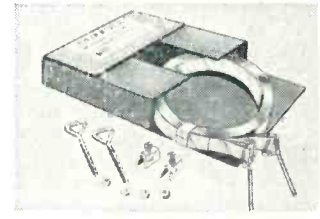

NOW! Banding Kits NEW!
 for EXTRA LARGE CHIMNEYS

KIT XL "ST": (Consists of)
 2—18' x 3/4" STAINLESS STEEL
 STRAPS with eyebolts attached
 2—Eyebolts Unattached
 4—Nuts to Fit Eyebolts
 2—KWIK KLIP Strapping Fasteners

Also available, **KIT XL "G"**, same as
 above with 18' GALVANIZED STRAPS.

Universal—may be used with any
 chimney antenna mount.

In Canada: A.T.R. Armstrong Co., Toronto

**SOUTH RIVER METAL
 PRODUCTS CO., INC.**
 SOUTH RIVER, N. J.

PIONEER AND OUTSTANDING PRODUCER
 OF FINEST LINE OF ANTENNA MOUNTS

AUDELS TV-RADIO SERVICE LIBRARY

HERE IS LATE INFORMATION IN A
 HANDY FORM FOR RADIO AND TELEVISION
 REPAIRMEN, SERVICEMEN AND STUDENTS

**2 VOLS. \$6 COMPLETE \$1 A
 PAY ONLY 1 MO.**

**AUDELS T.V.-RADIO
 SERVICE LIBRARY**—
 Highly Endorsed—1001
 Facts—Over 1552 Pages—
 625 Illustrations, Diagrams
 of Parts. Presents Important
 Subjects of Modern
 Radio, Television, Industrial
 Electronics, F.M. Public
 Address Systems, Auto,
 Marine & Aircraft Radio,
 Phonograph Pick-Ups, etc.

IT PAYS TO KNOW!
 The Basic Principles—
 Construction—Installation
 —Operation—Repairs—
 Trouble Shooting. Shows
 How to get Sharp, Clear
 T.V. Pictures. Install Aerials—
 How to Test. Explains
 Color Systems, Methods of
 Conversion, Terms, etc. In-
 cludes Ultra High Fre-
 quency (U.H.F.)—Valu-
 able for Quick Ready Ref-
 erence & Home Study. Tells How to Solve T.V.
 & Radio Troubles—Answers Your Questions.

Get this information for yourself.
7 DAY TEST—ASK TO SEE IT!

MAIL ORDER

AUDEL Publishers, 49 W. 23 St., N.Y. 10, N.Y.
 Mail AUDELS T.V. RADIO SERVICE LIBRARY 2 Vols. \$6 on 7
 days free trial. If O. K. I will remit \$1 in 7 days and \$1 monthly
 until \$6 is paid. Otherwise I will return them.

Name _____
 Address _____
 Occupation _____
 Employed by _____

R.T.S.D. ANNUAL INDEX FOR 1953



THIS INDEX is arranged alphabetically by types of articles. If you cannot find what you are looking for under one topic, we suggest you try another heading.

ANSWER MAN

Admiral 19B1—intercarrier sound system
Nov. p. 40

Air Marshall 12040 Code 26.....Oct. p. 42

Blooming raster and high voltage...Dec. p. 31

Capehart Farnsworth 3007-M,
chassis CX-30Oct. p. 42

Channel 2 GhostsDec. p. 30

Horizontal circuits and drive controls
Oct. p. 70

Philco model 49-1150, code 123.....Nov. p. 39

RCA 7T104Dec. p. 30

Replacement yokesDec. p. 66

ASSOCIATION NEWS

Associated Radio & Television Servicemen
of New York (ARTSNY).....May p. 71
Dec. p. 67

Ass'n of TV Service Companies, Cincinnati
Nov. p. 33

Ass'n of TV Service Companies of Greater
St. LouisAug. p. 60

Chicagoland Reps.Dec. p. 70

Eastern Idaho TV Servicemen's Ass'n
(EITSA)Oct. p. 55

Electronics Technicians Ass'n (ETA)
Dec. p. 67

Empire State Federation of Electronic
Technicians (ESFETA)May p. 22
Aug. p. 40

Federation of Radio Servicemen's Ass'n
of Penna. (FRSAP) Jan. p. 47; Mar. p. 54;
June p. 56; Aug. p. 58; Sept. p. 62; Nov.
p. 33

Joint Electronic and Radio Committee on
Service (JERCs).....Feb. p. 51; Mar. p. 54

Long Beach Radio Technicians Ass'n, Inc.
(Calif) (LBRTA)Apr. p. 49

Long Island Electronic Technicians Assn,
Inc. (LIETA) Aug. p. 40; Oct. p. 55; Nov.
p. 33

Nat'l Alliance of TV and Electronics Assn's
(NATESA) Jan. p. 45; Mar. p. 54; Apr.
p. 49; May p. 75; Aug. p. 40; Sept. p. 62;
Oct. p. 55; Nov. p. 33; Dec. p. 67.

Nat'l Electronics Distributors Ass'n
(NEDA)Dec. p. 68

Nat'l Electronic Technician and Service
Dealers Ass'n (NETSDA) May p. 22; June
p. 56; Aug. p. 40; Nov. p. 33; Dec. p. 68

Phila. Radio Servicemen's Ass'n (PRsMA)
Jan. p. 47; Feb. p. 50; Apr. p. 49; May
p. 72; Oct. p. 56.

Radio & TV Service Ass'n, N.C. (RTSAN)
Dec. p. 68

Radio & TV Technicians Guild (Boston)
Apr. p. 49

Radio & TV Technicians Guild of Florida, Inc.
Jan. p. 46; Feb. p. 51; May p. 75; June
p. 56; Sept. p. 62.

Radio & TV Ass'n of Springfield and Vicinity
(Ohio) (RTASVO) May p. 22; Sept. p. 62.

Radio & TV Servicemen of New Jersey, Inc.
(RTSNJ)June p. 56; Aug. p. 58

Radio Technicians Guild of Rochester
Aug. p. 40

San Antonio Radio & TV Ass'n, Inc.
(SARTA)Feb. p. 51

TV Dealers of Ft. Lauderdale.....May p. 71

TV and Radio Electronics Inst. of
WashingtonSept. p. 62

TV and Radio Technicians group of the
Electronics Ass'n of Kansas City
(TRTEAKO)Oct. p. 55

TV Installation Servicemen's Ass'n
(TISA)—IllinoisAug. p. 60

TV Servicing Dealers Ass'n, Philadelphia
(TSDAP) Apr. p. 49; June p. 56; Aug.
p. 40; Sept. p. 62; Dec. p. 68.

TV Service Engineers, Inc.Apr. p. 49

Texas Electronic Association (TEA) Sept.
p. 62; Nov. p. 33.

Texas Radio & Service Clinic & Electronics
FairOct. p. 56

Utah Ass'n of Radio and TV Servicemen
(UARTS) Aug. p. 60; Oct. p. 55; Dec. p. 67

AUDIO AND HI FI

Phono Facts, 1953, part 1, by Maximilian
WeilMay p. 38

Phono Facts, 1953, part 2, by Maximilian
WeilJune p. 48

Push-pull audio in TV receivers, by Matthew
MandlJan. p. 26

Your Hi-Fi Market, part 4, by Charles B.
GrahamJan. p. 22
part 5Feb. p. 36
part 6Apr. p. 33

CIRCUIT COURT

Admiral 21W1-contrast control action
Oct. p. 57

Capehart CT52 & CT57-heptode sync
stripperMay p. 54

Capehart CX37-ageSept. p. 52

Capehart CX37-horizontal afe.May p. 54

Capehart CX37-horizontal osc. & afe.
Sept. p. 70

CBS Columbia 817, 820-sync amplifying
systemFeb. p. 52; Apr. p. 48

Conrac model 61-multiurpose tube circuitry
Mar. p. 53

Conrac model 61 & 64-deflection and sync
stripperFeb. p. 52

Du Mont RA 164-horizontal phase detector
Nov. p. 51

Du Mont RA 164-sync separator.....Dec. p. 40

Emerson 120166-DJan. p. 39

G.E. model No. 21T4Apr. p. 48

General Industries UHF Tuner.....Dec. p. 40

Motorola TS-292-horizontal sweep circuit
June p. 55

Philco RF71 chassis-noise suppression &
sync gatingOct. p. 57

Stewart-Warner No. 21T-9211B.....Jan. p. 39

Westinghouse V2214-sync separation &
clippingAug. p. 46

Zenith 1953 K chassis-video amp. & sound
take-offJune p. 55

Zenith "K" series-age amp.Aug. p. 46

Zenith "K" series-horizontal afe circuit
July p. 38

EDITORIALS

An Unintentionally Dangerous Suggestion
May p. 3

Catalog Section Offer Withdrawn.....May p. 3

Color TV's ProblemsDec. p. 4

Controls Are OffApr. p. 3

Defining A New Policy.....Nov. p. 6

Five-City SlumpApr. p. 3

"Fix-it Yourself" BooksJune p. 10

Gyps Go To JailJan. p. 3

New Servicemen's MagazinesJuly p. 4

Non-Unity Is DangerousAug. p. 10

Our Blast on Price-Fixing.....Jan. p. 3

Our New FeaturesNov. p. 6

Our New PolicyOct. p. 14

Recognition—At Last!Oct. p. 14

Servicing as Liaison Medium.....Oct. p. 14

Servicing—The Nation's Big Business
Nov. p. 6

Teletast of ColorDec. p. 4

The Customers WriteDec. p. 4

The Elements and TVMar. p. 3

The Status of Color TVJune p. 10

This Issue Breaks RecordsFeb. p. 3

Transceivers and the Serviceman.....Mar. p. 3

Trends and New Products.....Mar. p. 3

UHF Conversion ProblemsSept. p. 10

Video Speed Service Systems Jan. p. 3; Feb.
p. 3.

FEATURE ARTICLES

A New C-R Tester, by Jesse Dines Aug. p. 24

A New Tandem I-F Amplifier.....Nov. p. 31

A Precision Transistor Oscillator.....Apr. p. 26

A Successful Control System for Service
AssociationsJune p. 52

Auto Radio Noise Elimination, by Jack
DarrMar. p. 38

Booster Standards Defined, by Harris
and SuddersMar. p. 34

CBS Colortron, part 1Nov. p. 27
part 2Dec. p. 22

Circuit & Service Data of Emerson Chassis
120165DApr. p. 36

Color TV, part 1, by Leonard Lieberman
Nov. p. 35

part 2Dec. p. 33

Design of a Sensitive VTVM.....Jan. p. 28

Field Strength Meter, by Starke and Lerner
Oct. p. 43

Fluctuating Line Voltage, by Verne Roberts
May, p. 35

Flyback Transformer Tester, by Harry
CaseySept. p. 23

Fringe Area Installations, by Rudolf F.
GrafMar. p. 28

Germanium and Radio Electronics, by
Rufus P. TurnerMay p. 41

Good Service Pays Off, by Harry J. Miller
Feb. p. 39

Horizontal Sweep and Deflection Systems
(Symposium 9), by Matthew Mandl
Nov. p. 18

Horizontal Sync and Sweep Servicing,
part 1, by Leonard Lieberman.....Apr. p. 30
part 2May p. 28
part 3June p. 32

How to Sharpen Carbide-Tipped Masonry
DrillsNov. p. 53

Impedance Measurements, by Rufus P.
TurnerFeb. p. 23

Looking for Trouble? by Cyrus Glickstein
Feb. p. 30; Sept. p. 32

Manufacturers Further Public-Serviceman
RelationsMay p. 53

Manufacturers' Service AidsNov. p. 55

Modern AGC Systems, by Matthew Mandl
Mar. p. 23

Philco UHF Tuners and Converters, by
Dan LernerAug. p. 22

Printed Electronic Circuits, by Jesse Dines
June p. 35

Q. Measurements and Meters, part 1, by
Rufus P. TurnerSept. p. 29
part 2Oct. p. 26

Radio Receiver Oscillator Troubles,
by Harry MileafJuly p. 35

RC Circuits, part 1, by Cyrus Glickstein
Nov. p. 21
part 2Dec. p. 35

Servicing Clock-Radio TimersSept. p. 48

Sound Systems in TV, part 1, by
Leonard LiebermanFeb. p. 33
part 2Mar. p. 41

Supply Your Own Test Pattern,
by Marvin KleinJune p. 30

Sync Circuits, part 1 (Symposium 7),
by Leonard LiebermanAug. p. 19
part 2Sept. p. 19

The Norfolk Story, by Sanford R. Cowan
Oct. p. 25

Three Speed Changer Conversion,
by L. C. Burdick.....Sept. p. 26

Transistor Parameters, by Rufus P.
TurnerOct. p. 38

Troubleshooting Horizontal Deflection
Circuits, by Frank De FinaJuly p. 20

Tuner Tips, by Al Kinckiner.....July p. 22

TV Interference AidsSept. p. 36

TV Sound Circuits, part 1, (Symposium 8),
by Rudolf F. GrafOct. p. 20
part 2Nov. p. 43
part 3Dec. p. 26

TV Troubleshooting Using Key Test
Points, by Bob DarganDec. p. 14

UHF Antennas, part 1, by Rudolf F. Graf
June p. 27
part 2July p. 17
part 3Aug. p. 28

UHF Converters, part 1, by Allan Lytel
Jan. p. 13
part 2Feb. p. 26

UHF Test Equipment, by Allan Lytel
July p. 24

UHF Tuners, by Leonard Lieberman
Oct. p. 17

UHF-VHF Station Listings.....Aug. p. 41

Vertical Deflection Systems, by Leonard
LiebermanJan. p. 17

Vertical Retrace Blanking, by Al Kinckiner
Aug. p. 39

Vertical Roll Troubles, by Harry Mileaf
Mar. p. 42

Vertical Sweep Circuits, by Cyrus Glickstein
May p. 25

Video Amplifier Techniques, by Edward
M. NollApr. p. 23

Yes! No! The Status of Licensing,
by Bethune JonesJuly p. 40

Your Own Life May Depend On This!
Apr. p. 47

R.T.S.D. ANNUAL INDEX FOR 1953

★
Your Complete Guide to
the Past Year's Material
★

GUEST EDITORIALS

W. L. Parkinson, General Electric
Dec. p. 10
R. H. Schneberger, Crosley.....Nov. p. 8

NEW PRODUCTS

Jan. p. 40; Feb. p. 54; Mar. p. 56; Apr. p. 54;
May p. 58; June p. 60; July p. 42; Aug.
p. 48; Sept. p. 56; Oct. p. 60; Nov. p. 85;
Dec. p. 38.

RIDER TV FIELD SERVICE

MANUAL DATA SHEETS

Rendix chassis No. T17-1; T17.....Dec. p. 51
Crosley chassis No. 402; 403; 404; 402-1;
403-1; 404-1.....Nov. p. 71
G.E. Models 17T10; 17T11; 17T12; 17T21
Dec. p. 55
Philco chassis No. D-181; R-181.....Nov. p. 75
Raytheon chassis No. 24T2.....Dec. p. 59
Zenith TV chassis 191.25, 6, 7, 8.....Nov. p. 79

SHOP NOTES

Airline 3 speed changer-slow speed
Nov. p. 57
Barkhausen oscillation.....May p. 56
Chrysler 1951 Auto Sets.....Apr. p. 50
Connecting External Antenna to Loop Set
Apr. p. 50
Ford model M1 (8A-18805A) Auto Set
Apr. p. 50
Identifying Tube Numbers.....June p. 51
Intercarrier buzz.....May p. 56
Intermittent Sound in Admiral Chassis
May p. 56
Motorola model 61K22-intermittent Apr. p. 50
Motorola Oscillator in FM Receivers June p. 51
RCA KCS66-68-pix flashing.....May p. 56
Save Some of Those Picture Tubes Nov. p. 57
Sentence Models 329, 331, 338-intermittent
if's.....June p. 51
Servicing Tuners.....May p. 56
Sharpening Bar Test Patterns.....May p. 56
Sylvania model 508-retrieving slug Nov. p. 57
TVI.....Nov. p. 57
Universal Cheater Cord.....Apr. p. 50
Westinghouse V2162-loss of horizontal sync
Apr. p. 50
Westinghouse V2172 chassis-variations in
6AL5 tubes affect bandpass of video if
June p. 51
Zenith model 29G20-oscillation.....Apr. p. 50

SYNC PULSES

Accolades are in order.....May p. 10
Antenna rotator boom.....May p. 10
A TV Joke.....May p. 11
Leading manufacturers are cooperating
May p. 10
Los Angeles TV boom.....Apr. p. 13
Madison, Wisc. lawmakers.....May p. 10
More standardization.....Apr. p. 13
New homes bonanza for TV men.....Feb. p. 12
NIESA is born.....May p. 62
Open conflict on licensing.....June p. 24
Opposition to TV.....Apr. p. 12
Possible shortages.....May p. 62
Predictions we made.....Apr. p. 13
Receiver line franchises.....Apr. p. 12
Single TV xmtr cities.....Apr. p. 12
Subscribers being questioned.....May p. 11
Television's growth.....June p. 25

TRADE FLASHES

Jan. p. 4; Feb. p. 6; Mar. p. 4; Apr. p. 6;
May p. 4; June p. 4; July p. 6; Aug. p. 4;
Sept. p. 6; Oct. p. 8; Nov. p. 84; Dec. p. 12.

TRADE LITERATURE

Aerovox bulletin on new components
May p. 68
Allied High-Fidelity Auditor.....Mar. p. 20
Allied 1954 Catalog.....Oct. p. 58
Antennas and Boosters (Channel Master)
Aug. p. 52
Annual Report 1952 (La Pointe).....Mar. p. 20
Assembly Kit brochure; (Federal).....Apr. p. 70
AVCO sales and service booklets.....Mar. p. 21
Brochure on production of components
(Insuline).....June p. 64
Bulletin GD-1 on Germanium diodes
(Intl Rectifier).....June p. 37
Bulletin No. 182 on UHF converters and
boosters (Electrovoice).....Aug. p. 52
Capacitor Catalog Supplement (Astron)
Oct. p. 58
Catalog Bulletin SR-3 on varistors (IRC)
Aug. p. 52

Catalog No. 53 on rubberized abrasives
(Cratex).....Aug. p. 52
Catalog of TV antennas and accessories
(RMS).....Aug. p. 51
Catalog PG-3, Glassal Capacitors
(Pyramid).....Aug. p. 54
CRS-Hytron Reference Guide for Miniature
Electron Tubes.....Apr. p. 18
Clarostat TV Control Replacement Manual,
2nd ed.Apr. p. 20
Color Code Calculator (Centralab).....Dec. p. 76
Condensed Price List (Sprague).....Dec. p. 39
Descriptive catalog sheets (ATR).....Oct. p. 72
Du Mont Service News.....Feb. p. 58
Electrovoice bulletins.....Feb. p. 58
Equipment catalog (Perma-Power) Dec. p. 76
ETR-641, TV service booklet (G.E.) Apr. p. 20
Federal TV Picture Tube Data Book
Oct. p. 58
Filter Design Data by John H. Mole
(Wiley, publ.).....Feb. p. 60
Form No. 33 (Merit Coil & Transformer)
Apr. p. 70
G.E. Carboly "1-a-month" kit.....Feb. p. 60
High Fidelity Simplified (Rider, publ)
Feb. p. 60
Hudson catalog.....Feb. p. 60
How to Troubleshoot a TV Receiver, by
J. Richard Johnson (Rider, publ) Dec. p. 39
How to Use the Simpson 479-180 for
UHF Alignment.....Aug. p. 52
Jensen Technical Bulletin No. 4.....Mar. p. 21
Mallory Catalog No. 553.....Aug. p. 54
NEDA Battery Index.....May p. 68
Picture Tube Data Chart (Du Mont) Aug. p. 52
Picture Tube Interchangeability Replacement
Guide (Transvision).....May p. 68
Piston capacitors brochure (JFD).....Oct. p. 58
Pix-O-Fix TV Troubfinder Guide by
Ghirardi & Middleton (Rinehart, publ.)
May p. 69
Printed Circuit I-F Components (RCA)
Apr. p. 74
Printed Electronic Circuit Guide No. 2
(Centralab).....May p. 69
Product Catalog No. 53 (Walco).....May p. 69
Quick Facts about color TV (G.E.) Oct. p. 58
Radio's Masters.....Feb. p. 58
Radiotron Designer's Handbook (RCA)
Oct. p. 58
RAM 1954 Replacements Components
Manual.....Oct. p. 58
RCA Announcement of printed-circuit
electronic inductors.....June p. 37
RCA Receiving Tubes for AM, FM &
TV Broadcast.....Apr. p. 18
Rider Television Manual, vol. 11
(Rider, publ.).....Apr. p. 20
Sound Talk bulletin No. 21 (Minnesota
Mining & Mfg. Co.).....Apr. p. 70
Sprague Replacement Catalog C-609 Aug. p. 27
Stancor Tape-Wire Recorder Replacement
Guide.....May p. 69
Stancor TV Transformer Replacement
Guide.....Oct. p. 58
Sub-miniature indicator lights brochure
L-153, (Dialight).....June p. 64
Sylvania Radio and TV Receiving Tubes
June p. 37
Sylvania TV Pix Tube and CRT
Characteristics Chart.....June p. 37
TACO Presents UHF.....Apr. p. 70
TELCO Catalog T-54.....Aug. p. 27
This Business of Radio and TV Servicing
(RCA).....May p. 68
Transformer catalog (Stancor).....Dec. p. 39
Tube Substitution Chart (CBS-Hytron)
Aug. p. 52
Transistor Manual (CBS-Hytron).....Oct. p. 58
TV and FM Receiver Servicing, by Milton
S. Kiver (D. Van Nostrand, publ.) Dec. p. 76
TV Antenna Handbook for VHF and
UHF (Channel Master).....Oct. p. 58
TV Capacitor Replacement Supplement
(Sprague).....Oct. p. 58
TV Engineering, by Donald Fink (McGraw-
Hill, publ.).....Jan. p. 48
TV Fuse Guide (Littlefuse).....Oct. p. 72
TV Manufacturers' Receiver Trouble
Cures, vol. 2 (Rider, publ.).....Mar. p. 21
TV Picture Tube Components (Sylvania)
Oct. p. 58
TV Service Data Book (Du Mont) Aug. p. 27
TV Sweep Alignment Techniques, by Art
Liebscher (Rider, publ.).....Mar. p. 21
TV Tenna Tips (Snyder) Mar. p. 20; Dec.
p. 39.
UHF Converters (Sams and Co., publ.)
Apr. p. 20

VEE-D-X Antennas (La Pointe).....Oct. p. 58
What You Should Know About Television,
by J. H. Ruiter, Jr. (Ruiter, publ.)
Jan. p. 48
Workman TV Booster Bulletin.....Oct. p. 58
Your Road to Better FM (WARD) Feb. p. 62

TUBE NEWS

CBS-Hytron type 1N133.....Nov. p. 59
CBS-Hytron type 24TP1.....Sept. p. 50
CBS-Hytron type 6216.....June p. 47
GE 6AH4-GT vert. amp.Apr. p. 52
GE 6CL6.....Aug. p. 45
GE TV 21JP4.....Sept. p. 50
Hytron 21YP4.....Apr. p. 52
Hytron type 27EP4.....Feb. p. 41
N.U. germanium diodes.....Aug. p. 45
Rauland 21YP4; 21ZP1A.....Apr. p. 52
RCA transistors.....Sept. p. 50
RCA 6BQ7A.....Feb. p. 40
RCA 12AX1-GT.....Feb. p. 40
RCA 12BF6.....June p. 47
RCA 12V6-GT.....Apr. p. 52
RCA 12X4.....Nov. p. 59
Sylvania tetrode transistor.....Nov. p. 59
Sylvania type 10B2.....Sept. p. 61
Sylvania 6T4.....Aug. p. 54
Sylvania 6U8.....Apr. p. 52
Sylvania 12BY7.....Feb. p. 40
Sylvania 21YP4.....June p. 47
Sylvania 21ZP4.....June p. 47
Sylvania 21ZP4A.....June p. 47
Workman 5TV4.....Aug. p. 45

VIDEO SPEED SERVICING SYSTEMS (VSSS) DATA SHEETS

Admiral chassis No. 19 series.....Sept. p. 39
Admiral chassis No. 20A-1.....Mar. p. 45
Admiral chassis No. 20A-1; 20B-1;
21A-1.....Jan. p. 31
Admiral chassis No. 22F2; 22M2; 22P2
Nov. p. 61
Admiral model No. 19 series.....Oct. p. 47
Airline model 841A3010.....Apr. p. 39
Arvin chassis No. TE337.....June p. 39
Arvin model No. TE290.....Apr. p. 41
Belmont Raytheon chassis No. 20AY21
July p. 27
Capehart CX-33.....Feb. p. 43; Aug. p. 33
CBS chassis No. 700-10.....Jan. p. 33
CBS-Columbia chassis No. 2000.....Aug. p. 31
Crosley chassis No. 265.....May p. 45
Crosley chassis No. 385; 386; 387; 393;
394.....Oct. p. 49
Du Mont chassis No. RA-117.....July p. 29
Du Mont chassis No. RA-161.....Dec. p. 43
Emerson chassis No. 120118.....Jan. p. 35
Emerson chassis No. 120144 and 120144B
July p. 31
G.E. model No. 17C103, etc.....Dec. p. 45
Hoffman chassis No. 180.....Nov. p. 63
Magnavox chassis No. CT219.....Apr. p. 43
Motorola chassis No. TS292.....June p. 41
Olympic chassis No. TA.....Feb. p. 45
Philco 49-1040.....Feb. p. 47
Philco 1240.....Feb. p. 47
Philco model No. 51T1433B.....Apr. p. 45
Philco chassis No. 1954 "B" line.....Nov. p. 65
Philco chassis No. Deflection D1, etc.,
code 121; 125.....Dec. p. 47
Philco chassis No. Deflection G1.....Oct. p. 51
RCA chassis KCS-34.....Aug. p. 35
Sentinel model No. 412 Mar. p. 47; Oct. p. 53
Sentinel model Nos. 412; 413; 414; 415;
422; 421.....Jan. p. 37
Sentinel model Nos. 412; 413; 415.....Feb. p. 49
Sentinel model Nos. 454; 455; 456; 457
Sept. p. 41
Silvertone chassis No. 51-178.339.....May p. 47
Stewart-Warner chassis No. 9300.....June p. 43
Stromberg-Carlson chassis No. 17 series
Aug. p. 37
Stromberg-Carlson chassis No. 116 series
Nov. p. 67
Stromberg-Carlson model No. 119 series
Mar. p. 49
Stromberg-Carlson chassis No. 317 series
May p. 49
Sylvania chassis No. 1-139.....May p. 51
Sylvania chassis No. 1-186.....Mar. p. 51
Sylvania chassis No. 1-274.....Sept. p. 43
Sylvania chassis No. 1-437.....Sept. p. 45
Sylvania chassis No. 437.....Dec. p. 49
Transvision chassis No. "A" series July p. 33
Truetone model No. 2D1235B.....June p. 45



YAGI



DELTA MATCH

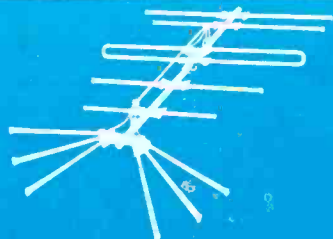

CON-YAGI COMBINATION

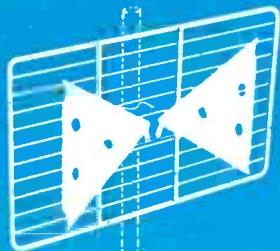

UHF

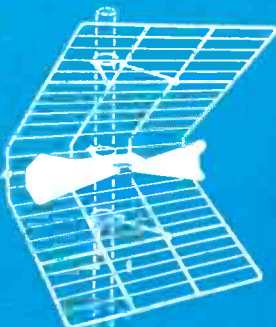

UHF

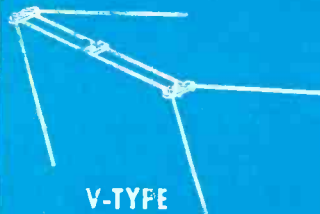

V-TYPE



*BELLEVUE TV MASTS

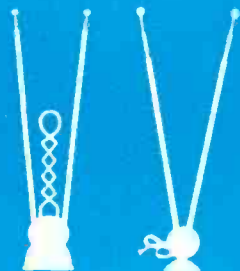

INDOORS



WINDOW

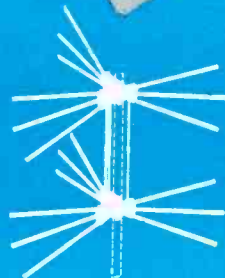

Directronic

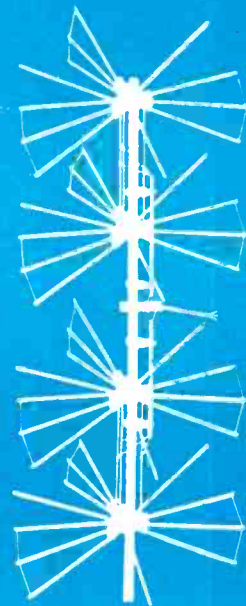

Directronic



LINE-UP

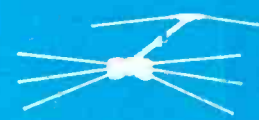

SNAP-UP

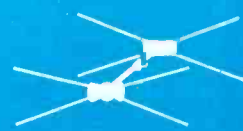

CONICAL

Snyder
PHILADELPHIA

The Only

Complete

TV ANTENNA

LINE

SNYDER MFG. CO.

ANTENN-GINEERS[®]
PHILADELPHIA, U.S.A.

*BELLEVUE TUBE MILL, INC., PHILADELPHIA, A *Snyder* AFFILIATE
SNYDER ANTENN-GINEERS LTD., TORONTO, CANADA, A *Snyder* AFFILIATE
WORLD EXPORT: ROBURN AGENCIES, INC., NEW YORK 7, N.Y.

MANUFACTURERS START TO FINISH

Now... only \$149⁵⁰

Suggested
User Price

the popular RCA WO-88A

featuring...

- ✓ Voltage-Measuring Facilities
- ✓ "Plus" and "Minus" Sync
- ✓ High-Input Resistance
- ✓ Low-Input Capacitance

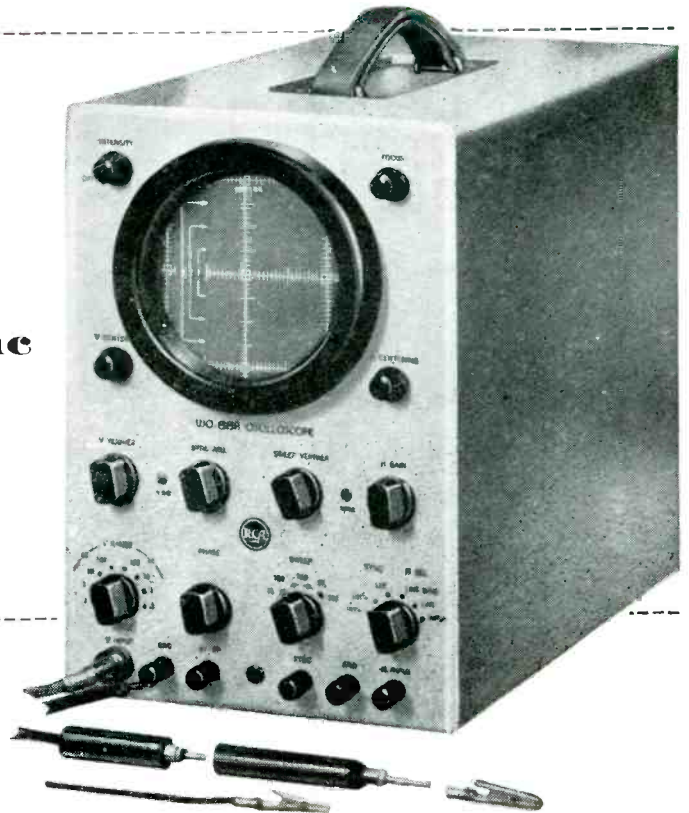

Check these "extra" features

- Direct-coupled vertical amplifier
- 5' Cathode-ray tube with magnetic shield
- 60-cycle sweep with wide-angle phasing control
- Frequency-compensated attenuators
- "Voltmeter-type" vertical attenuator
- "Voltmeter-scale" type graph screen
- 1-volt peak-to-peak calibrating voltage
- Scope is completely stable—even at maximum sensitivity of 25 millivolt-per-inch
- Quick "recovery" time, freedom from line "bounce"
- Completely shielded input cable eliminates hum and noise pickup

Specifications —

- Deflection Sensitivity: (vertical amplifier) 25 rms millivolts or better per inch.
- Vertical-Amplifier Frequency Response: Flat from dc to 100 Kc; within -3 db at 500 Kc; within -10 db at 1 Mc.
- Input Resistance and Capacitance: 10 megohms and 9.5 uuf with WG-216B Low-Capacitance Probe.
- Sweep-Circuit Frequency (four ranges): 15 cps to 30 Kc.
- Square-Wave Response: Negligible tilt and overshoot.
- Average Rise Time (Vert. Amp.): 0.5 microsec.
- Power Supply: 105-125 volts, 50-60 cycles.
- Size 13½" high, 9" wide, 16½" deep. Weight only 25 lbs. (net).

The WO-88A has built-in voltage calibrating facilities which permit simultaneous waveshape display and peak-to-peak voltage measurements. Frequently, the shape of the TV waveform under observation will be correct but its amplitude will be low and, consequently, cause improper operation. Therefore, a TV 'scope is complete only if it can measure the peak-to-peak voltage of the displayed waveform. Check this feature on the "88"!

On the WO-88A, sync polarity may be reversed instantly by simply clicking a front-panel switch. This feature is important because TV pulses may be either positive or negative, depending upon where the 'scope is connected. To avoid waveshape "jitter" or distortion, use a 'scope which will "lock in" readily on all types of TV waveforms. Check this feature on the "88"!

When you use the low-capacitance probe supplied with the WO-88A, the over-all input resistance is raised to 10

megohms! Because many TV circuits are extremely sensitive to resistive loading, normal circuit operation may be seriously disrupted by loading of the average 'scope. With the low-capacitance probe, however, loading problems are minimized. Check this feature on the "88"!

In addition, the low-capacitance probe supplied with the WO-88A decreases the over-all input capacitance to less than 10 uuf! Excessive capacitance loading can cause the horizontal oscillator to change frequency or stop oscillating. When the WO-88A is connected, the low over-all input capacitance leaves receiver operation essentially unaffected. Check this feature on the "88"!

Get full details today from your RCA Distributor or clip coupon and mail to:

RCA Commercial Engineering
Section A42W Harrison, N. J.
Please send me your new folder on the RCA
WO-88A Oscilloscope.

NAME _____

ADDRESS _____

CITY _____

STATE _____

ZONE _____



RADIO CORPORATION of AMERICA

TEST EQUIPMENT

HARRISON, N. J.