

JUNE 1953

Radio-Television
**SERVICE
DEALER**

N28
2K-922
WALKER
ROBERT G. WALKER
GREEN BAY WIS
134 BAY ST
GREEN BAY WIS
MAY 57



The Professional Radio-TVman's Magazine

IN THIS ISSUE:

- UHF Antennas, Part I
(TV Symposium Series)
- Supply Your Own Test Pattern
- Horizontal Sync & Sweep Servicing, Part 2
- Printed Electronic Circuits
- Phono Facts, Part 2
- Successful System for Service Organizations
- Video Speed Servicing Systems

AM-FM-TV-SOUND

A N O T H E R C B S - H Y T R O N F I R S T

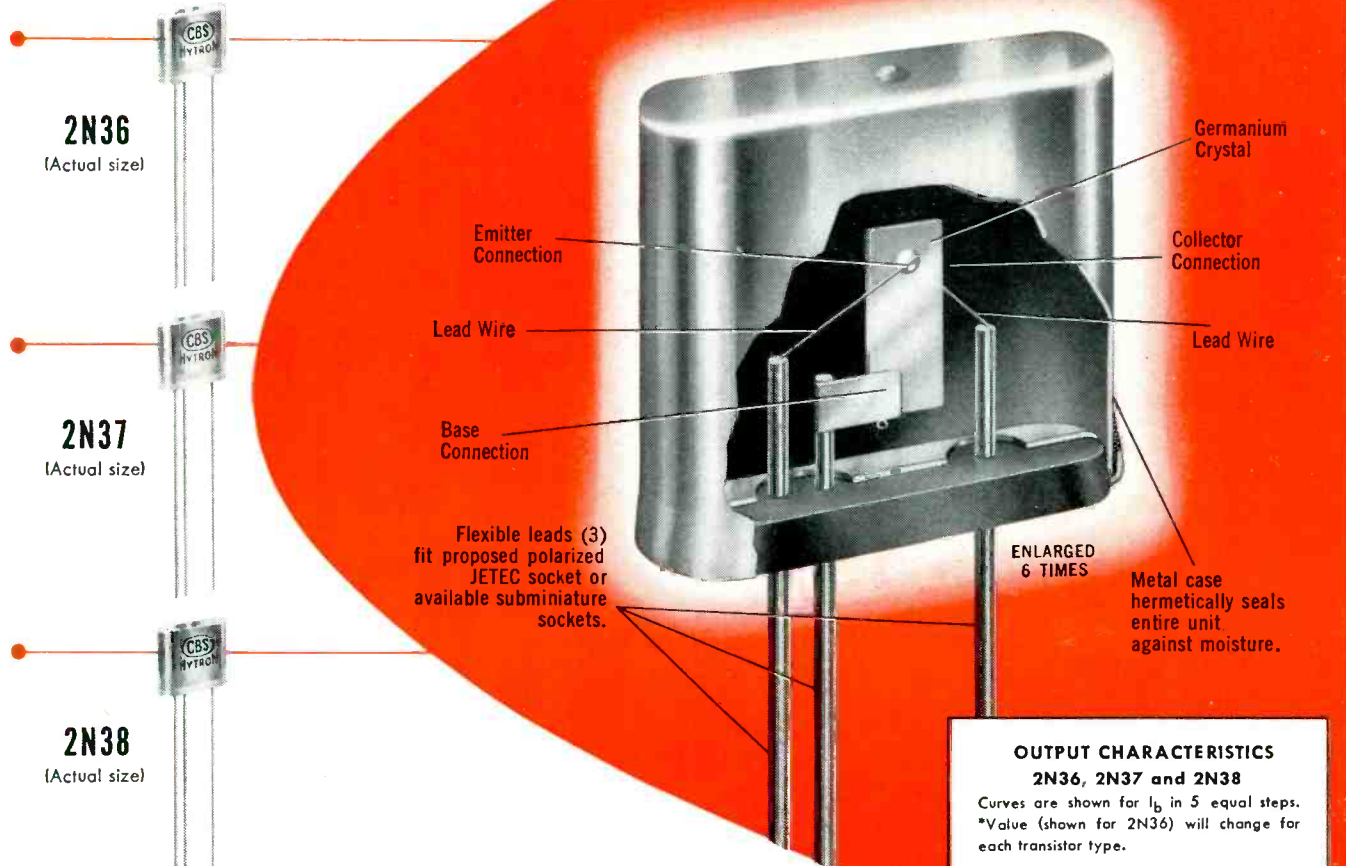

**NOW...HERMETICALLY SEALED
CBS-HYTRON
JUNCTION TRANSISTORS**

In junction transistors, the surfaces are extremely sensitive to moisture. For dependability, they must be completely moisture-proofed. CBS-Hytron, recognizing this, is the first to offer you the new *hermetically sealed* 2N36, 2N37, and 2N38 junction transistors. Each is uniquely sealed in a metal case . . . moisture-proof, contamination-proof, light-proof. (See drawing.)

You can buy these new hermetically sealed P-N-P junction types immediately. All are amplifier types. Have similar characteristics, except for current amplification and power gain. You may operate the 2N36, 2N37, 2N38 up to 55°C. Their in-line design gives you: Compact, flat mounting . . . easily identified polarity . . . solder-in or plug-in (with clipped leads) convenience.

In addition to their unique moisture-proof feature, these CBS-Hytron junction types offer: (1) High gain. (2) Low noise figure. (3) Operation at low voltages. As well as other advantages characteristic of transistors: Compactness . . . light weight . . . ruggedness . . . instantaneous operation . . . and long life.

Remember, CBS-Hytron hermetically sealed 2N36, 2N37, 2N38 transistors are available at once. Write for complete data. Or order now for prompt delivery.

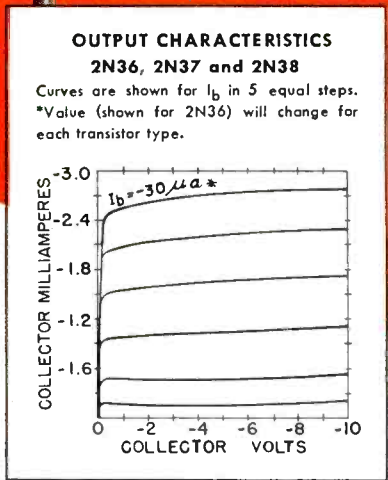

ELECTRICAL CHARACTERISTICS †
CBS-Hytron P-N-P Junction Transistors

Characteristic	2N36	2N37	2N38
Collector voltage	-6	-6	-6
Collector current	-1	-1	-1
Current amplification factor #	45	30	15
Power gain #	40	36	32

†Typical values at 25°C. #Grounded emitter connection.

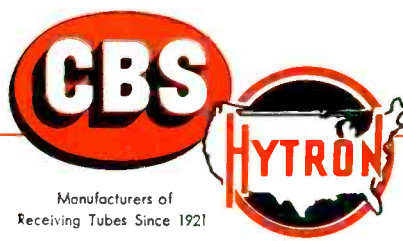

NOW 3 CBS-HYTRON TEST ADAPTERS. By popular demand. Three sizes now available at these net prices: 7-Pin Miniature, \$1.45; 8-Pin Octal, \$2.25; 9-Pin Miniature, \$1.75. Take advantage of e-a-s-y "topside" testing. Order your Test Adapters today from your CBS-Hytron jobber.

CBS-HYTRON Main Office: Danvers, Massachusetts

A Division of Columbia Broadcasting System, Inc.



The man who brought back a smile

EXCITED? Cynthia was practically bursting! Last thing Dad said was "Now you look close, Cindy.

You'll see me right there in the audience tonight, and I'll wave to you." (They always do!)

Long about three o'clock Cynthia's mother turned on the set . . . "just to make sure."

Well, there was a picture, if you could call it that . . . but so dim and fuzzy they'd never even recognize Dad that evening. And Cindy . . . disappointed? She was brokenhearted!

But, you know the happy ending . . . the serviceman's competent analysis . . . replacement of a worn-out tube with a Federal "Best-in-Sight" Picture Tube . . . and there are smiles again.



Federal's

Line of Popular-Size Picture Tubes will take care of over 90% of all TV replacements.

Write for free copy of Federal's TV Picture Tube Data Book, Dept. 11-445

THE SERVICEMAN gives his customers years of experience and expert technical ability. His business is knowing what's best . . . and giving the best. Customers rely on his judgment just as thoroughly as he relies on Federal "Best-in-Sight" Picture Tubes for the sharpest, brightest, clean-cut pictures possible. He knows that when he picks up the carton with the blue and white Federal label, he's going to make some customer a lot happier for a long, long time.



Consult your local Federal Distributor or write to

Federal Telephone and Radio Corporation

VACUUM TUBE DIVISION

100 KINGSLAND ROAD, CLIFTON, N. J.

In Canada: Federal Electric Manufacturing Company, Ltd., Montreal, P. Q.
Export Distributors: International Standard Electric Corp., 67 Broad St., N. Y.

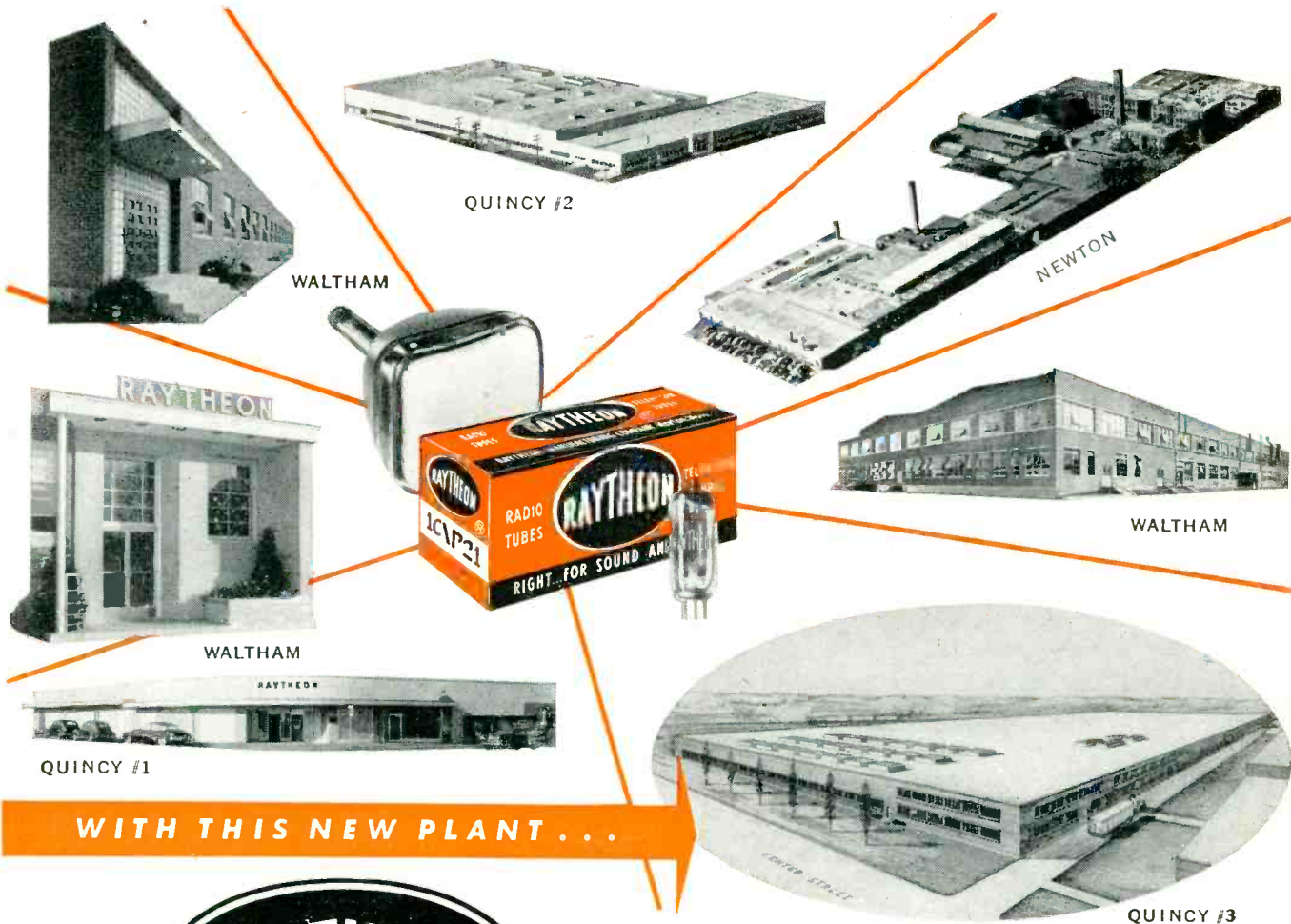

WITH THIS NEW PLANT . . .

the **RAYTHEON** resources

DEVOTED EXCLUSIVELY TO ELECTRON TUBES

- **more than 1,000,000** sq. ft. of manufacturing area
- **more than 10,000** skilled tube craftsmen
- **backed by 30 years** of tube engineering, development and production experience

Raytheon's newest plant at Quincy, Massachusetts is expressly designed to economically manufacture 24 inch and larger Raytheon Picture Tubes. It will employ the very last word in modern engineering and manufacturing techniques. It will be devoted exclusively to the making of tubes worthy of the Raytheon reputation for quality and dependability. With *Raytheon* Radio and Television Tubes you are *Right . . . for Sound and Sight.*



RAYTHEON MANUFACTURING COMPANY
 Receiving Tube Division
 Newton, Mass., Chicago, Ill., Atlanta, Ga., Los Angeles, Calif.
 RAYTHEON MAKES ALL THESE:
 RECEIVING AND PICTURE TUBES • RELIABLE SUBMINIATURE AND MINIATURE TUBES • GERMANIUM DIODES AND TRANSISTORS • NUCLEONIC TUBES • MICROWAVE TUBES

Excellence in Electronics

THESE BOOKS HELP YOU EARN MORE IN TV SERVICING

"How to Understand and Use TV Test Instruments"



Provides basic explanations of how each test instrument operates. Covers: VT Voltmeters, AM Signal Generators, Sweep Signal Generators, Oscilloscopes, Video Signal Generators, Field Intensity Meters, Voltage Calibrators. Describes each in detail; explains functions; tells proper use in actual servicing; shows how to avoid improper indications. Helps you get the most from your instruments; saves you time, helps you earn more. 148 pages, 8 1/2 x 11".

ORDER TN-1. Only \$3.00

"TV Servicing Short-Cuts"

Describes a series of actual TV service case histories, giving step-by-step explanations of how the service technician localized and tracked down each problem. Shows how these frequently recurring troubles can be tracked down and solved in any set. Explains how to apply proper time-saving servicing techniques—gives you the successful experience of experts, to make your service work easier, quicker, more profitable. 100 pages, 5 1/2 x 8 1/2".

ORDER TK-1. Only \$1.50



"Servicing TV in the Customer's Home"



Saves you time, work and chassis-hauling on outside TV service calls. Shows you how to make successful repairs on the spot using these methods: employing VTVM and capacitor probe to trace down trouble; "tube-pulling" to diagnose trouble by observing audio and picture effects; performance tests through analysis of test pattern; adjustment techniques developed for field servicing. Saves time, avoids chassis removal. 96 pages, 5 1/2 x 8 1/2".

ORDER TC-1. Only \$1.50

"Television Tube Location Guides"

VOL. 3. Shows tube positions and functions in hundreds of important TV sets. Helps save servicing time. Often, looking at the picture or listening to the sound, provides the clue to the trouble. Frequently, a tube failure is the cause. This guide, with its clear, accurate tube placement and function diagrams, makes trouble diagnosis and tube replacement quick and easy, without removing chassis. 192 pages. All new diagrams continuing coverage from Vol. 2.

ORDER TGL-3. Only \$2.00

VOL. 2. Over 200 pages of tube placement diagrams not included in Vols. 1 and 3.

ORDER TGL-2. Only \$2.00

VOL. 1. Over 200 pages of diagrams not in Vols. 2 and 3. ORDER TGL-1. Only \$1.50



"Photofact Television Course"



A full, easy-to-understand explanation of TV principles, operation and practice. Covers Cathode Beam Formations and Control, Beam Deflection Systems, Beam Mod. and Synch.; analyzes CR tubes, camera tubes, voltage supplies, saw-tooth generators, sync. circuits, control functions, antenna circuits, RF input tuning, IF systems, AGC, DC restoration, etc.; with full bibliography and glossary. 208 pages, 8 1/2 x 11".

ORDER TV-1. Only \$3.00

HOWARD W. SAMS & CO., INC.

Order from your Parts Jobber today, or write direct to Howard W. Sams & Co., Inc. 2209 East 46th Street, Indianapolis 5, Ind.

My (check) (money order) for \$..... enclosed. Send the following books:

- TN-1 TK-1 TC-1
 TGL-3 TGL-2 TGL-1 TV-1

Name.....

Address.....

City..... Zone..... State.....

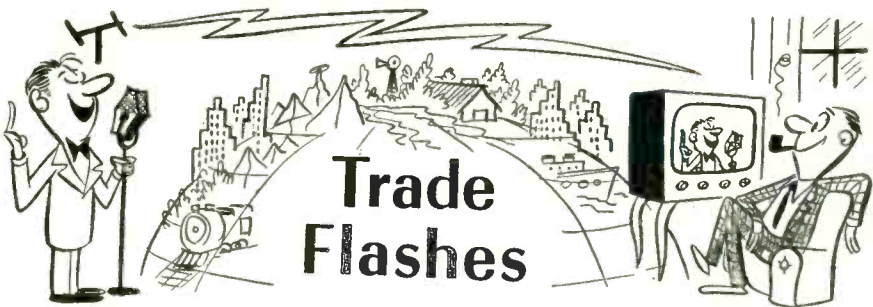

NEDA Opposes Illinois Bill No. 135

Declaring that a small clique of television servicemen who are promoting Illinois Senate Bill #185 want to create a monopoly in their business, L. B. Calamaras, NEDA executive vice president, spear-headed industry opposition to the measure in a hearing on April 22 before the Senate Committee on Municipalities. The bill would authorize Illinois cities to license, tax, and regulate television and radio servicemen.

"This legislation would greatly aggravate the already acute shortage of trained servicemen," Mr. Calamaras declared, "and could well result in an increase on the cost of repair services to be paid by the public of several hundred per cent."

Sylvania TV School Graduates

Twelve From April Service Course

Twelve more new television service and repair experts have successfully completed the intensive course given by the Sylvania Television Service School, it was announced by E. W. Merriam, Service Manager of the Buffalo organization.

The Sylvania school, offers a concentrated, comprehensive course in the latest and most efficient techniques of television repair and maintenance. Classes are limited to groups of twelve, and emphasis is placed on actual practical trouble-shooting—utilizing the most modern scientific equipment. The entire course is so devised that it can be completed in ten days spent at the Radio and Television Division of the Sylvania Electric Products plant in Buffalo.

Raytheon Co-sponsors UHF Lecture

Another "How to Interpret What You See in uhf" lecture was presented to 300 servicemen in Atlanta, Ga., on April 14, 1953. The meeting was under the co-sponsorship of Southeastern Radio Parts Co., Raytheon tube distributor and Hopkins Equipment Co., Raytheon TV set distributor, and was held in the Atlanta City Auditorium.

The main speaker of the evening was Mr. William Ashby, of Raytheon. The

lecture outlined the best methods known today to localize service problems by using the information on the face of the picture tube. Uhf antennas, installation techniques, feed lines, high speed service and all methods and means of uhf tuning were covered in detail.

RCA Trophies for Outstanding Service Performance

Managers of four RCA Service Company television branches are presented by Frank M. Folsom (center), president of the Radio Corporation of America. The managers accepted "President's Cup" trophies in behalf of TV service branch employes for outstanding achievement in providing prompt, conclusive service to television set



owners during an intensive campaign designed to promote maximum efficiency and customer satisfaction. From left are: E. C. Cahill, president of the RCA Service Co.; Ernest A. Steinkraus, Auburn, N. Y., branch; Francis X. Diamond, Baltimore branch; W. L. Rothenberger, New York regional manager for RCA; Mr. Folsom; R. N. Baggs, general sales manager, RCA Service Co.; Robert C. Scully, Bridgeton, N. J., branch; Orrin Dunlap, Jr., vice president in charge of advertising and publicity for RCA; and Stanley T. Burek, Kalamazoo, Mich., branch.

FTC Holds Video Guide Claim

False

The following news release appeared in Retailing Daily:

Washington, May 15—Claims that inexperienced persons can repair their television sets without danger if they follow the "TV owner's guide to opera-

Save by Standardizing
YOUR ELECTRICAL PROTECTION

with the Complete Line
of **BUSS FUSES**

for Television • Radio • Radar • Instruments • Controls • Avionics

You'll save time and trouble when all your fuse needs are supplied by one, dependable source. The complete BUSS line makes it easy for you to select the fuse to do the job right.

Behind every BUSS fuse is the world's largest fuse research laboratory and fuse production capacity. To assure and maintain top quality, each individual BUSS fuse is tested in a highly sensitive electronic device. Any fuse that is not correctly calibrated, properly soldered or the right dimensions, is automatically rejected.

Start now to simplify your fuse selection and save by standardizing on the complete BUSS line.

Plus a complete line of fuse clips, blocks and holders

SEND FOR THIS
HELPFUL
INFORMATION

IT'S GOOD BUSINESS to stock and use BUSS fuses. Your customers know the name BUSS . . . famous for protection in homes, on farms and in industry for 39 years. When you use BUSS, they know you've used the finest fuses available.

BUSSMANN Mfg. CO., Division of McGraw Electric Co
University at Jefferson, St. Louis 7, Missouri

BUSSMANN Mfg. Co. (Division of McGraw Electric Co.) SD-653
University at Jefferson, St. Louis 7, Mo.

Please send me bulletin SFB containing facts on BUSS small dimension fuses and fuse holders.

Name _____

Title _____

Company _____

Address _____

City & Zone _____ State _____ 653

tion and repair" were branded as false and misleading in a Federal Trade Commission complaint made public today.

The commission's complaint is directed against Cecel C. Hoge, Hamilton Hoge, John Hoge, Sidney C. Hoge and Barbara Obolensky, partners in Huber Hoge & Sons, 699 Madison Avenue, New York.

Also named in the complaint are Harry Schneiderman, doing business as Bedford Co., 799 Broadway, and Louis Linetsky, an individual also known as Louis Linett.

FTC also objects to advertisement for the guide that says: (1) Post-1947 sets, cared for according to instructions in the book will give sharp, distinct, reception up to 100 miles away from a transmitting station without special electronic equipment; (2) A television owner, through use of the guide, will be able to trace each trouble to its source, and locate and replace worn-out parts; (3) The book gives an effective method for locating burned-out tubes: (1) By following instructions, an owner can prevent major breakdowns, keep his set in perfect operating

condition, convert his set to color, save \$65 to \$100 a year on service charges and obtain a 40 per cent discount when buying a new set.

The companies and officers have 20 days to answer the complaint. A hearing is scheduled in New York on July 7 before Examiner Abner E. Lipscomb.

Tydings Hold UHF Clinic

The Tydings Company, one of Western Pennsylvania's largest distributors of electronics equipment, is creating good public relations by helping to prepare the Tri-State area (Western Pennsylvania, Eastern Ohio, Northern West Virginia) for maximum reception of ultra high frequency television.



Servicemen and Dealers listen to service lecture at Tydings UHF Clinic.

The second of a series of *uhf* clinics for dealers and servicemen was held recently at the Tydings Company Auditorium in Pittsburgh.

Congregating from many points within a 150 mile radius of Pittsburgh, more than 375 dealers and servicemen heard a lecture on *uhf* converters, their development, circuits and servicing by Richard Marsh, *uhf* specialist from the P. R. Mallory Company. A question and answer period followed.

Over Two Million TV Sets Shipped to Dealers

Over two million television sets were shipped to dealers throughout the United States during the first quarter of this year, the Radio-Television Manufacturers Association announced. Total shipments for the period were estimated at 2,060,016 sets by the association compared with 1,277,512 television receivers shipped during the same 1952 period.

In March of this year, RTMA estimates showed that 711,838 TV sets went into the hands of dealers as against 471,015 in that 1952 month.

Siragusa Claims Color TV Not Yet Ready for Market

Forcing the production of color television sets before the development of a satisfactory picture tube would be the

(Continued on page 12)

COMING SOON- Telechief!

SANGAMO'S NEW PREMIUM TUBULAR CAPACITOR — designed to give you better TV performance!



**EXTRA VALUE
at NO EXTRA COST!**

Sangamo combines an amazing new molding compound with a new impregnant to bring you a completely new paper tubular capacitor—developed by request to meet rigid specifications so tough that no previously existing paper tubular could approach them.

Thousands of Telechiefs have been tested under actual service conditions... have proved their ability to outlast and outperform all other tubulars.

The new molding compound, Sangamo Humiditite, greatly

lengthens capacitor life. It has been proved, by severe tests, to give the best seal against moisture of any molding compound in the industry.

The new Sangamo impregnant holds rated capacity under all conditions and makes the Telechief really rugged.

Because we know that service men want only the best replacement parts—the new Telechief will soon be released to the service trade. Keep in touch with your Jobber.

Those who know... choose Sangamo



SANGAMO ELECTRIC CO. MARION ILLINOIS







Belden

Aptitude-Tested



INTERCOMMUNICATIONS CABLES

Aptitude-tested Belden Intercommunications Cables are available for every type of installation and for every type of equipment. The permanence and trouble-free performance of Belden Inter-Com Cables assure you constant quality in your work. For more profitable installations, specify Belden Inter-Com Cable.

Belden Manufacturing Company
4639 W. Van Buren St.
Chicago 44, Ill.

	For Station-to-station and extension Wiring (Unshielded)		For Station-to-terminal Wiring (Unshielded)		For Station-to-station and Extension Wiring (Shielded)	
A.W.G. and No. Condrs.	22-2	22-12	22-12	22-3	22-3	22-3
Stranding	Solid	Solid	7x30	7x30	7x30	7x30
Nom. Diam (inches)	.145	.265	.310	.210	.220	.220
No. Pairs	1	6	6	Not Paired	Not Paired	Not Paired
Insulation Thickness (inches)		.010	.010	.010	.010	.010
Tinned Copper Shielding	None	None	None	Over 1 conductor	Over 3 conductors	Over 3 conductors
						
	8740	8743	8747	8734	8735	

GENERAL PURPOSE PLASTIC INSULATED CABLES.
Flexible, lightweight, and small diameter. Applications include control, annunciator, and communication circuits.

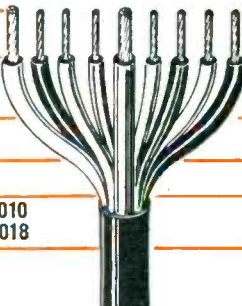
A.W.G. and No. Condrs.	22-4	22-3	22-5	22-7 18-2
Stranding	7x30	7x30	7x30	7x30 16x30
Nom. Diam (inches)	.168x.276	.140	.170	.245
No. Pairs	2			
Insulation Thickness (inches)	.015	.010	.010	.010 .018
Tinned Copper Shielding	Over 1 pair			
				
	8732	8443	8445	8449

Belden

Radio WIRE

The *Aptitude-Tested* **LINE**

TIGHT SEAL

... BONDED BLUE-POINT

TOUGH SHELL

... MOLDED PLASTIC TUBULAR

... a
in



ASTRON

BLUE-POINT

BONDED

Capacitors

**INDIVIDUALLY
TESTED AND
GUARANTEED**

To insure *still greater* dependability in the field, each and every Astron Blue-Point Capacitor is subjected to an exhaustive series of physical and electrical tests prior to final shipment. As a result, Astron proudly *guarantees* the excellence of every Blue-Point Capacitor you buy.

†Trade Mark

Export Division: Rocke International Corp., 13 E. 40th St., N.Y.C.
In Canada: Charles W. Pointon, 1926 Gerrard St., East, Toronto.

ASTRON

Major Achievement

Molded Capacitor

Construction and

Performance

Engineered and Produced Exclusively by ASTRON



PATENT
PENDING

Now—Heat and Moisture PROTECTION To a Degree Never Before Possible!

Outstanding Performance in Hot and Humid Climates!

Here at last is a capacitor that affords *absolute protection* under every condition—a capacitor you can rely on completely—ASTRON BLUE-POINT, the *bonded* capacitor.

This capacitor is produced by an exclusive new design and manufacturing process (patent pending) developed by Astron engineers.

The all-important *blue point* which distinguishes this new capacitor actually *bonds* itself to the tough, heat-resistant outer shell and leads—forming the *tightest seal against moisture* ever produced!

The Blue-Point *dry-assembly* process—as used in hermetically sealed metal encased capacitors—prevents contamination, provides still further protection against moisture, and assures uniform *quality and dependability* for every Blue-Point.

The Blue-Point is mineral oil impregnated* for continuous operation at 85°C. The blue point seal

itself makes ingenious use of a special thermo-setting, heat-resistant, non-inflammable *bonding agent* as a positive protection against moisture.

With the Astron Blue-Point, you may solder leads as close to the capacitor as you like. Leads will not pull out, nor will the heat of the soldering iron damage the lead or the connection.

Further, every Blue-Point is clearly marked with rated voltage and capacitance, and is imprinted with outside foil identification.

The Astron Blue-Point Capacitor gives you greater protection against heat and moisture at every stage—assuring long life and dependable performance from *every unit*—to a degree never before possible with molded plastic capacitors.

From now on, look for the Blue-Point—ask for exclusive Astron Blue-Point Capacitors by name ... more than ever before, *depend on, insist on* ... ASTRON!

*For bulletin AB-20A, with complete engineering data and listings, write: Astron Corporation, 255 Grant Avenue, East Newark, N.J.

Astron manufactures a complete line of dry electrolytic capacitors, metallized paper capacitors, plastic molded capacitors, standard and subminiature paper capacitors and RF interference filters for every radio, television and electronic use.

DEPEND ON—INSIST ON



CORPORATION

255 Grant Avenue

East Newark, New Jersey

by every test



ATR

AUTO RADIO VIBRATORS

Have Ceramic Stack Spacers

A COMPLETE LINE OF VIBRATORS

Designed for Use in Standard Vibrator-Operated Auto Radio Receivers. Built with Precision Construction, featuring Ceramic Stack Spacers for Longer Lasting Life. Backed by more than 22 years of experience in Vibrator Design, Development, and Manufacturing.

"A" Battery Eliminators, DC-AC Inverters, Auto Radio Vibrators

- ✓ NEW MODELS
- ✓ NEW DESIGNS
- ✓ NEW LITERATURE



See your jobber or write factory

AMERICAN TELEVISION & RADIO Co.

Quality Products Since 1931

SAINT PAUL 1, MINNESOTA—U. S. A.

EDITORIAL

by S. R. COWAN

"Fix-it Yourself" Books

Amer. News. Co., national distributors of books and magazines, reports that close to 600,000 copies of "Telefixit"—the 50c "fix-your-own-TVset book"—have been sold since 1951 and that the demand for copies continues unabated. Possibly 400,000 more copies will be sold this year.

The book's publisher claims, "Many TV repairmen bought the book in bulk for distribution to customers because legitimate repairmen dislike nuisance calls on simple troubles that can be corrected by the set owner himself." Brother, that's the best case of vivid imagination we've heard of in years. If any of the technicians ever gave these books to their customers, they did so anticipating that they'd get their 50c investment back with dividends. Try, sometime, to clean up the horrible mess that these books get their readers into.

Our original opinion of the book remains unchanged. We opined once, and do so again, that every novice who uses such a book to try to repair his own TVset, or to avoid paying a professional technician his fee, is gambling with his money, and possibly with his life. We repeat emphatically that these "fix-it yourself" books are a serviceman's best friend. But we want servicemen to maintain honest policies, so don't give the books to your customers: business is fine enough without the need of creating it artificially at the expense of the "suckers."

The Status of Color TV

In late March, newspapers were carrying the story that CBS prexy Frank Stanton had testified before the House Commerce Committee stating, "CBS has no plans, so long as the present circumstances exist, to broadcast or manufacture under the approved (incompatible) field sequential system." Thus mechanically controlled color TV died, and frankly, neither we nor any technician that we know of, mourns the passing.

In contrast, RCA officials told the same committee that their firm was "ready and willing" to start making color receivers designed in accordance with their own "compatible" system. The point not stressed by the newspapers is that the FCC has not yet been afforded an opportunity to examine and test the newly improved RCA or DuMont compatible methods, and that if such equipments were to be taken under test, a period of at least six months would be required before either approval or rejection was decided upon.

Let's get 50 million TVsets working in all parts of the country first, and then we'll have time to add color, if only as a means of making a semi-saturated market partially obsolete. Progress can't be stopped but it can stumble and be badly hurt if it tries to run before it is able to crawl.

EASIEST USING, EASIEST READING VACUUM TUBE VOLT-OHM METER



Model 709

New **TELE-VOLTER** by Jackson

The **BIGGEST** little instrument of its kind

The 7"-square meter, with hair-line pointer, provides all the voltage (AC-DC) and ohm ranges you could possibly want or need. Meter is electronically protected against overload.

Controls consist of on-off circuit switch, zero adjust, ohms adjust, besides switches built into probes for changing from DC to AC or ohms.

High voltage accessory probe gives readings to 30,000 volts DC.

Dealer net price . . . \$95.00

Ask your electronics distributor for information, or write us.

JACKSON

JACKSON ELECTRICAL INSTRUMENT CO.
DAYTON 2, OHIO

"SERVICE ENGINEERED" TEST EQUIPMENT

IN CANADA: THE CANADIAN MARCONI CO.

TRADE FLASHES

(from page 6)

most serious mistake anyone could make, Ross D. Siragusa, president of Admiral Corporation declared. "Scientific progress cannot be produced or hastened by either congressional mandate or wishful thinking. The industry has to have the right color picture tube and the right tube simply doesn't exist at present.

Siragusa claimed the present color tubes are only laboratory devices and cannot be considered ready for public use by the longest stretch of the imagination. Even if the tubes were dependable and serviceable in the field, they are still too complex for mass production at reasonable cost.

TV Set Production at Annual Rate of Nine Million

Production of television receivers attained an annual rate of more than nine million sets in the first quarter of 1953, according to statistics released by the Radio-Television Manufacturers Association.

The output of radio receivers in the first three months of 1953 was at the yearly rate of more than 15 million sets, RTMA said.

First quarter production of TV sets at 2.3 million compared with 1.3 million sets in the same 1952 period. Output of radio receivers in the first three months of 1953 totalled 3.8 million as against 2.3 million sets manufactured in the corresponding 1952 period.

RCA Promotions

Donald H. Kunsman has been elected a vice president of the RCA Service Company it was announced by E. C. Cahill, president of the company, following a meeting of the board of directors. Mr. Kunsman will be vice-president in charge of the Consumer Products Service Division.

Mr. Cahill also announced the election of Gerald W. Pfister as Treasurer and Controller of the company, the post vacated by Mr. Kunsman. Mr. Pfister was manager of field administration in the Consumer Products Service Division.

CBS-Columbia Appoints Louis Hausman

David H. Cogan, President of CBS-Columbia Inc., announces the appointment of Louis Hausman as Vice-President of CBS-Columbia.

Electronic Tube Manufacturers Meet With NPA

An estimate of increased demand in 1953 for electronic tubes, including those for radio and television sets, was

another original!

Entirely New!

The last word in

UHF

TV Antennas

the

UW-2

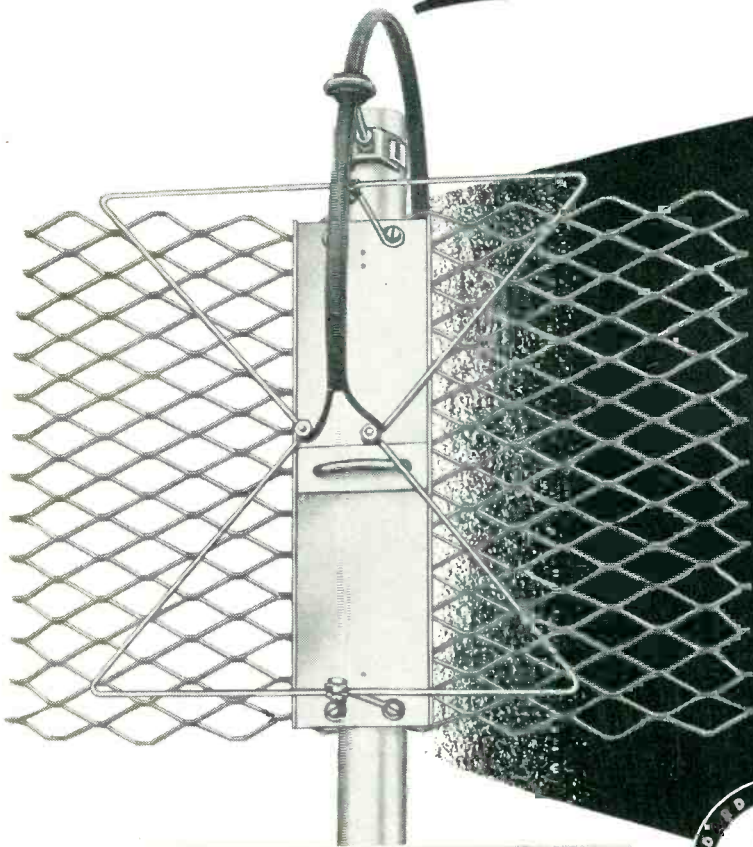

Here's The One They've All Copied!

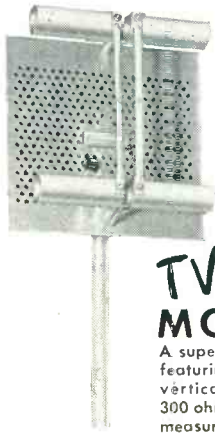

**...NOW
AT NEW
LOW PRICES**

**UHF
TV Antennas
MODEL U-4**

A superb quality UHF antenna featuring uniform gain with low vertical radiation (no ghosts). 300 ohm terminal impedance... measures 12x12x15 inches.



Here is another ORIGINAL... entirely NEW UHF TV antenna that far excels anything yet seen! It is a completely balanced broad band antenna covering ALL channels from 14 to 82 and terminating in 300 ohms with a very low voltage standing wave ratio! Some of the features include:

- Minimum wind resistance, (a double stacked UW-2 offers less wind resistance than many single bay antennas).
- The UW-2 assumes NO potential difference between itself and the mast, allowing MAXIMUM lightning protection when the mast is grounded.
- COMPLETELY FREE of insulators and their offending results.
- Excellent directivity, single lobe horizontal field pattern, 470 to 850 M.C.



SUBSIDIARY OF



THE RADIART CORPORATION CLEVELAND 13, OHIO

VIBRATORS • AUTO AERIALS • TV ANTENNAS • ROTORS • POWER SUPPLIES

RADIO-TELEVISION SERVICE DEALER • JUNE, 1953

A Quarter of a Century

... of leadership
in the design and manufacture
of quality electronic products
represents experience and
know how that means
consistently highest quality...
and more profit for you.



INSIST ON
American
Replacement
Crystal
CARTRIDGES

more profit...
more satisfied customers

Handy-5-Pak with cartridge
replacement chart on back
available now.



Send for Free Catalog 46

American

MICROPHONE CO.

370 S. FAIR OAKS AVE., PASADENA 1, CALIF.

made by electronic tube manufacturers at a joint Industry Advisory Committee meeting with the National Production Authority, Department of Commerce.

Members of two committees, one representing the Receiving Tube Industry, the other the Transmitting and Special Purpose Tube Industry, estimated 1953 production at 443,000,000 receiving tubes and 9,962,000 cathode ray picture tubes to meet military and civilian needs. This represents an increase of about 20 per cent and 30 per cent, respectively, over 1952 production.

Wescon Technical Program Takes Form

General outlines of the technical papers program for the forthcoming Wescon (Western Electronics Show and Convention) in San Francisco, August 19-21 are crystallized into 17 sessions including approximately 85 papers, according to an announcement by Bernard M. Oliver, Hewlett-Packard Company, Wescon papers chairman. Wescon is jointly sponsored by the IRE (7th region) and WCEMA (West Coast Electronic Manufacturers Association).

The program will include two sessions each on antennas, propagation, electron devices, circuit, and computers; and one session each on airborne electronics, microwave techniques, servos and telemetering, instrumentation, transistors, and nuclear-radiation measurements.

Eastern Sales Managers Club

Elects Officers

At its April meeting, the Sales Managers Club—Eastern Group held election of officers. The following slate was unanimously named:

President, Jerry Kirschbaum, Vice President of Precision Apparatus Corp.; Vice President, Bob Ferree, Distributor Sales Mgr., International Resistance Corp.; Re-elected Secretary-Treasurer, Walter Jablon, Vice President Bogen Sound Systems; Director to Executive Board—Show Corporation: (Two year term) B. L. Cahn, Vice President Insuline Corporation of America, (Continues another year). Vin Uhlrich, Renewable Tube Sales Mgr. National Union Radio Corp.

Clarostat Board Chairman John Mucher Dies

John J. Mucher, 70, prominent manufacturer of resistance devices and a pioneer in the radio-electronic parts industry, died on Thursday, April 23rd, at his home in Dover, N. H. He was Chairman of the Board of Clarostat Mfg. Co., Inc. for the past seven years. In 1921, with two brothers,

Latest Books for TV "KNOW-HOW"!



TV MANUFACTURERS' RECEIVER TROUBLE CURES VOL. 1, VOL. 2 and VOL. 3

Positive cures for TV troubles! Gives you exact directions for correcting TV receiver performance "bugs". Each cure is official, factory-authorized, direct from the receiver's manufacturer. Listings by manufacturer and model or chassis number. Helps correct the most difficult faults — picture jitter, hum, instability, buzz, tearing, etc.

Vol. 1, 115 pages (5 1/4 x 8 1/4").....\$1.80
Covers 12 brands, Admiral through Dumont.
Vol. 2, 117 pages (5 1/4 x 8 1/4").....\$1.80
Covers 11 brands, Emerson through Jackson
Vol. 3, 119 pages (5 1/4 x 8 1/4").....\$1.80
Covers 16 brands, Kaye-Halbert through Philco
VOLUMES 4 and 5 coming soon!

Prominent manufacturers not in first 3 volumes
**ONE SERVICE JOB WILL MORE THAN PAY
THE COST OF THIS SERIES OF BOOKS!**

OBTAINING AND INTERPRETING TEST SCOPE TRACES

by J. F. Rider

Over 500 actual photographs of test scope traces. Shows how to use scopes and what the traces mean.

Valuable for servicing TV receivers, FM and AM radio receivers, audio systems and test equipment. Specific test equipment set-ups shown with each application. No other book like it!

Over 140 pages.....Only \$2.40

HOW TO USE METERS

by J. F. Rider

Panel type, volt-ohm-milliammeters, vacuum tube voltmeters for servicing radio and TV receivers, audio amplifiers, power supplies; for use and repair of ham transmitters. Written for the service technician, the TV and Radio student and hams. Over 140 pages.....Only \$2.40

TV SWEEP ALIGNMENT TECHNIQUES

by Art Liebscher, Test Equipment Specialist

Never before has there been a book such as this on TV sweep alignment! An expert gives you accurate time-saving methods — and tells you how they work. Introduces the new Supermark method. Check-full of sweep curve pictures. Valuable for servicing in UHF signal areas.

123 (5 1/2 x 8 1/2") pp., illus.....\$2.10

TV TROUBLESHOOTING AND REPAIR GUIDE BOOK

by R. G. Middleton

The finest practical book to make your TV servicing easy. Spot TV receiver troubles rapidly. Includes receiver waveforms, visual alignment, test equipment kinks, etc.

204 (8 1/2 x 11") pages.....\$3.90

ENCYCLOPEDIA ON CATHODE-RAY OSCILLOSCOPES AND THEIR USES

by Rider and Uslan

Covers practically every scope manufactured during the past 10 years — and applications. 992 (8 1/2 x 11") pages, 3,000 illus. Cloth cover.....\$9.00

Write for information on all RIDER books.

Buy these books now from your jobber... bookstore... If not available from these sources, write to:

JOHN F. RIDER Publisher, Inc.
Dept. 6SD 480 Canal Street, New York 13, N. Y.

Snyder

PHILADELPHIA

ANTENN-GINEERED®

TO PERMIT USE OF 2 TV RECEIVERS
FROM 1 AERIAL INSTALLATION

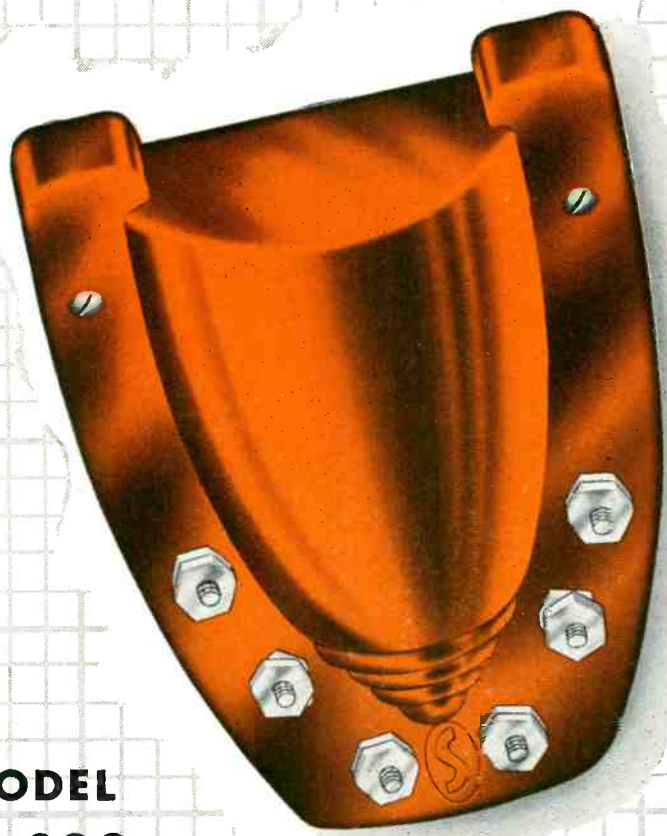

MODEL
AC-800

2-SET
TV COUPLER
\$2 45
LIST



AUTOMATIC NO ADJUSTMENTS SWITCHES

- Provides maximum gain for each receiver
- Minimizes interaction
- Utilizes specially designed Long-Lines transformer arrangement
- Genuine Bakelite Case complete with lead-in terminals for quick and easy installation

MOUNTS ANYWHERE—Permanently!

- On either receiver
- Between receivers
- In basement

SNYDER MFG. CO.

ANTENN-GINEERS®
PHILADELPHIA

WORLD EXPORT: ROBURN AGENCIES, INC., NEW YORK 7, N. Y.

CANADIAN DISTRIBUTOR: VAN DER HOUT ASSOCIATES, LTD., NEW TORONTO

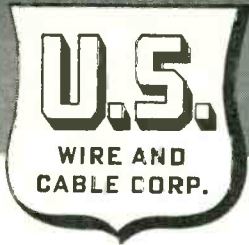

"Rotaxial" Cables

for

COMMUNITY TV SYSTEMS

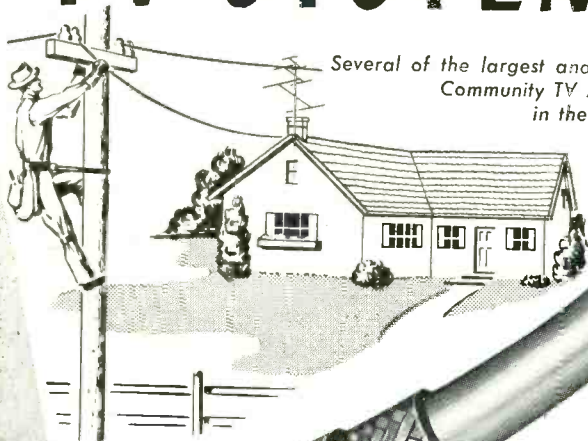

Several of the largest and most successful Community TV Antenna Systems in the country, specify U. S. Cables.

Double Braid, Single Jacket
No. LR 5-00
No. LR 1 00

Double Braid Double Jacket
No. DSCJ-55
No. DSCJ-11

U. S. High Frequency Cables give you these features:

Exceedingly LOW RADIATION LOSSES, combined with consistent peak performance over the entire VHF range.

LONG LIFE and maximum efficiency, regardless of weather conditions, are inherent in these cables.

New Catalog: Write for your copy today.

UNITED STATES WIRE & CABLE CORP.

PROGRESS AND MONROE STREETS • UNION, NEW JERSEY

Representatives in Principal Cities

Jacob and Stephen, he founded the Clarostat Mfg. Co., in Brooklyn, serving as the company's first president from 1921 to 1946.

Deeply interested in the fields of chemistry and electro-mechanics, John Mucher was successful in securing patents on a number of inventions.

Survivors include his wife; a son Walter J. Mucher of Newmarket, N. H.; a daughter, Mrs. Eugenia Burnell, Dover; five grandchildren and two great-grandchildren. Also two brothers, Frank of Skanneateles, N. Y., and Alexander, in Europe.

NEDA New Address!

After April 27, 1953, National Electronic Distributors Association headquarters offices were located at 228 North La Salle Street, Suite 1114, Chicago 1, Illinois. The telephone number remains the same.

Philco Faces Mass Transportation for Convention

Philco Corporation faces the biggest mass transportation job ever undertaken by a private company as it plans for its midsummer convention in Atlantic City from June 7th to 10th, it was reported recently by railroad and airline officials.

It involves the transport of 7,500 men from over State, Hawaii and Alaska to the shore resort center and more than 7,000,000 miles of travel by plane and train, said Ray B. George, Philco vice president in charge of merchandising. Travel plans call for direct arrival at Atlantic City's airport and train terminal for the nation's top radio, television and appliance dealers who are to attend the meeting.

Edwin I. Guthman, Coil Manufacturer, Dies Suddenly

Edwin I. Guthman, head of the Edwin I. Guthman Co., Chicago, Ill., died suddenly of a heart attack on Friday, April 24th. He was 49 years old at the time of his death.

During the war, Mr. Guthman's prominence and experience in the component industry was recognized with his appointment and diligent service on the electronics panel of the influential War Production Board. For several years, Mr. Guthman was the coil sections chairman for the Radio and Television Manufacturers Association.

Mr. Guthman is survived by his widow, Audrienne, and his two sons, Melvin, 17, and Robert, 14, who reside in Evanston, Illinois.

Du Mont Dedicates New Plant

The world is rapidly entering a period when almost every phase of human endeavor is vitally affected by

Sylvania's New 1954 Calendar for Service Dealers.... sells all through the Year!

The'll read your super-service story every month!

Filled with ideas and recipes your prospects will want to keep

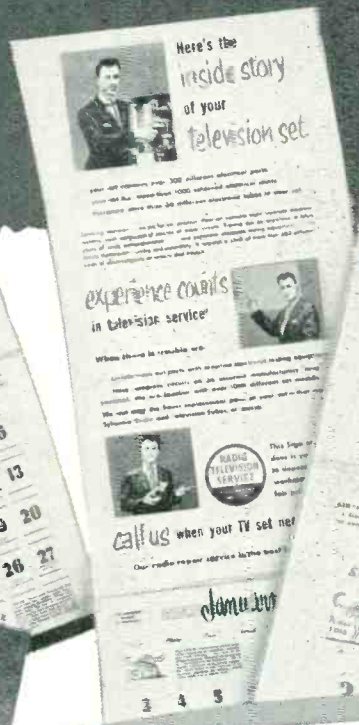
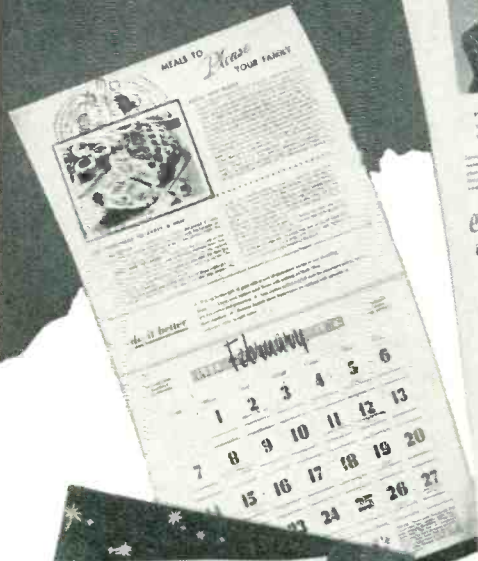

**Only 1½¢
PER MONTH PER PROSPECT...
YOUR GREATEST
ADVERTISING BUY!**



It's your personal Christmas greeting too

Don't miss this Dramatically Different Business Builder!

Here's the hardest-selling, custom-made Home Calendar ever offered to Radio-TV Service Dealers! It's tailor-made just for you! Features an appealing illustration painted exclusively for Sylvania by a famous cover artist. Reproduced in full color and imprinted with your name and address.

Your prospects simply can't overlook this calendar. It's filled with timely hints and valuable household suggestions they'll want to keep handy. And, every time they turn the page they'll be reminded of your dependable service, skill, and experience.

Order now . . . supply limited! At only 1½¢ per customer per month (in lots of one hundred or more), this calendar

is truly the smartest advertising buy ever offered. But don't delay, the supply is limited! Order a couple of hundred from your regular Sylvania distributor . . . TODAY! If he is out of stock, write to: Sylvania Electric Products Inc., Dept. 3R-2206 1740 Broadway, N. Y. 19, N. Y.

SYLVANIA



electronics and the cathode-ray instrument is providing the important key to what can be termed the Electronic Age, according to a statement issued by Allen B. Du Mont Laboratories, Inc.

The statement was made at Clifton, N.J., ceremonies, at the dedication of a new plant of the Cathode-ray Instrument Division. The new 118,000 square foot facility is the largest in the world devoted exclusively to the manufacture of cathode-ray instruments for science, industry and military applications. The audience was a representative group from the military, industry, government, civic affairs and the press.

CBS-Columbia Offices Moved to New Long Island City Plant

Administrative offices of CBS-Columbia Inc., television set manufacturing subsidiary of the Columbia Broad-

casting System, have been moved from the Brooklyn plant to its new Long Island City plant, 3400 47th Avenue, Long Island City, N. Y.

Television and radio production will continue at the Brooklyn site even after full production is begun at the Long Island location, which adds 272,500 square feet of floor space.

GE Promotes Sales Contest

Cash awards totaling \$7,125 will be distributed by General Electric's Tube Department as prizes in a sales contest designed to build business for radio and television service dealers, G. A. Bradford, manager of advertising and sales promotion for the G-E Tube Department, announced.

Top prize of \$2,500 will be presented to the contestant who makes the best 50-words-or-less explanation of how

he would spend \$2,500 to improve service business. The contest is open to all radio and television service dealers and their employees. It opens on June 15 and will close on August 31.

RCA Unveils Transistors, High-Fidelity Equipment, and "TV-Eye"

The first public showing of three new RCA product lines were highlighted at the company's participation in the Annual Electronics Parts Show, May 18 through 21, in Chicago's Conrad Hilton Hotel.

Making their first appearance were the four types of commercial RCA transistors, a full range of high-fidelity sound-reproducing equipment, and the RCA "TV-Eye," a relatively inexpensive closed-circuit television system. The RCA Victor display also featured the company's developmental tri-color kinescope and a shadow-box display which showed the color-dot structure of the color tube's faceplate.

The transistor exhibit became commercially available on May 1, together with a motion display illustrating their operation.

Webster-Chicago Corp. Opens Eastern Office

Webster-Chicago Corp. has opened an eastern division office to serve customers along the Atlantic seaboard, it was announced by Norman C. Owen, vice-president in charge of sales.

C. S. Castle, for five years a Webcor sales executive in Chicago, will direct the new office. It is located at 26 E. First St., Mount Vernon, N. Y.

The company has heretofore operated all of its sales activities from Chicago, utilizing 14 sales representatives to serve the trade in the various marketing areas. Sales representatives will continue to serve other areas.

Radio City Products Co. Inc. Elects Vice-President

Walter M. Jonas has been elected Vice-President in charge of Production of Radio City Products Company of Pennsylvania. Mr. Jonas has been with the company since 1950 and was previously Production Manager.

Davis Electronics to New and Larger Plant

Davis Electronics, manufacturers of the Davis Super-Vision All-Channel Television Antenna, have moved their offices and assembly manufacturing to their new plant in Burbank, California.

This new plant gives them approximately five times the floor area of the Burbank plant which they have just vacated, and allows them greatly increased office, assembly, storage and

(Continued on page 22)



DEALERS!

\$32.50 package for only \$12.50!!!

Here's an opportunity with a terrific knock for you dealers! Duotone offers \$25.00 worth of needles for only \$12.50! **But that's not all!** Now every dealer can have his own needle inspection clinic at no cost! With every \$12.50 order for replacement needles, Duotone gives free a kit which comprises \$7.50 in useful materials — included are a plastic carrying case... a fine 50 power large field hand microscope for examining old needles easily and efficiently... a new amazing ELECTRO-WIPE cloth... and a professional tool for quickly replacing needles. Place your order today direct with your jobber.

replacement needles —	\$25.00
one microscope —	5.00
one electro-wipe cloth —	1.50
one plastic kit —	.50
one professional tool —	.50
	\$32.50
	ONLY \$12.50



DUOTONE

KEYPORT, NEW JERSEY

Canadian Representative: CHARLES W. POINTON, TORONTO, CANADA
Export Division: AD. AURIEMA, INC., NEW YORK CITY, N. Y.

**PORTRAIT
OF
PROGRESS**



1945
9,000 square feet

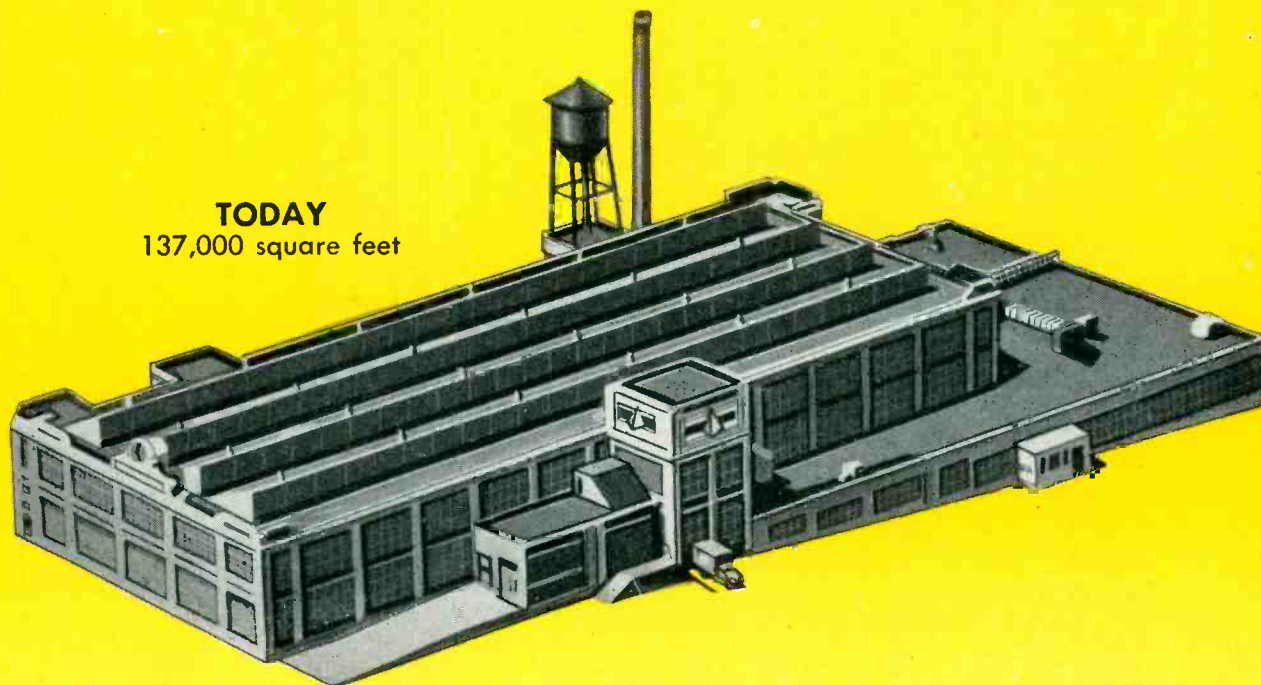

TODAY
137,000 square feet

Pyramid's unparalleled growth reflects the truth of the statement: In capacitors, your best bet, your best buy, is



PYRAMID

**PYRAMID ELECTRIC COMPANY
NORTH BERGEN, NEW JERSEY**

Free literature on request

R_x for UHF's fringe areas!

CHANNEL MASTER'S all-UHF TWIN CORNER REFLECTOR

the most sensitive fringe area antenna ever developed for UHF!

- Two dipoles—actually two antennas in one.
- Provides twice the gain of any standard-type UHF Corner Reflector.
- Instantly installed in just three steps.
- Furnishes far better picture quality — at far greater distances.
- Eliminates UHF's TWIN TERRORS. Features vibration-proof construction; and "free-space" terminals.

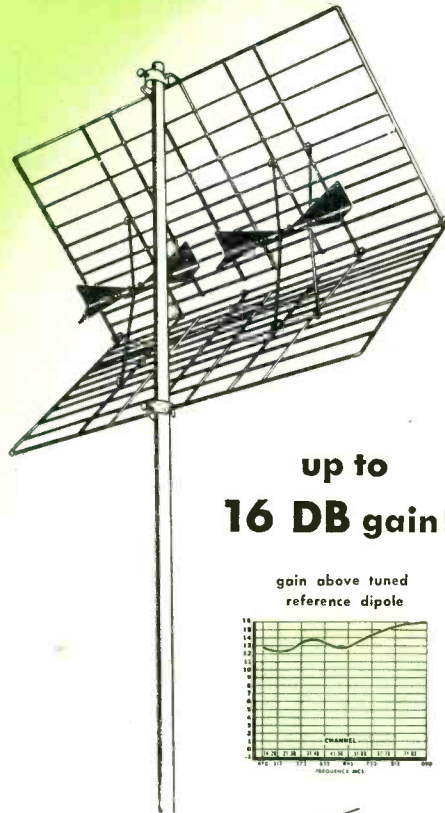

model no. 406

up to
16 DB gain!

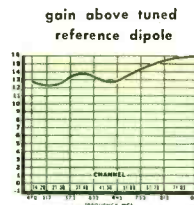

horizontal polar pattern (relative voltage)

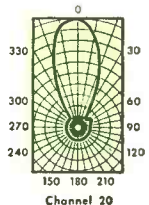

practically
no
assembly
necessary

CHANNEL MASTER'S 10-ELEMENT DELTA-WELD YAGI

custom-designed for your specific area!

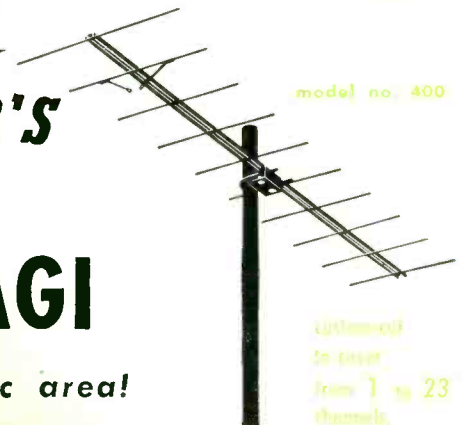

model no. 400

adjustable
to cover
from 7 to 23
channels

CHANNEL MASTER
engineering
pays off on **UHF!**

- Elements permanently WELDED IN POSITION on crossarm.
- Custom construction — designed for almost any UHF area.
- Delta-matched dipole for excellent impedance match.
- Brilliant performance. Average gain: over 11 DB, single bay; over 14 DB, stacked. Even higher on some models.
- Eliminates UHF's TWIN TERRORS.



CHANNEL MASTER CORP.
ELLENVILLE, N. Y.

Write for complete technical literature.

At Last! a YAGI for the ENTIRE LOW BAND!

CHANNEL MASTER'S Newest futuramic

Completely covers every low band channel — 2 through 6

Now the extraordinary high gain of a Yagi . . . the razor-sharp directivity of a Yagi . . . Not on just one channel — but clear across the entire Low Band!

Designed for service TODAY and TOMORROW in these 3 booming VHF markets:

Areas in which present VHF stations are changing channels (on the Low Band).

The Futuramic Yagi provides better reception than conventional Yagis on the present channels — and when the shift occurs this superior reception will continue on the new channel WITHOUT INTERRUPTION. And you can make your change-over installations NOW.

Areas in which a new VHF station is being added to the present one (on the Low Band).

The great number of single channel Yagis now in use will not bring in the new channel. If an additional Yagi is installed it will have to be tied into the present installation with separate leads and a switching system. However, one Futuramic will do the job of BOTH antennas — at lower cost — with better results on BOTH channels.

Areas served at present by two or more VHF stations on the Low Band.

You no longer have to compromise between conventional broad band antennas, and separate Yagis for each channel. The Futuramic gives you the full advantages of both. It combines highest gain and sharpest directivity with simple, economical installation.

horizontal polar pattern (relative voltage)

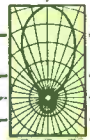

gain above tuned reference dipole

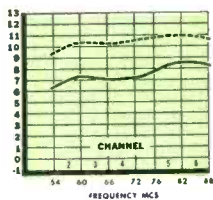

model no. 1126

A high-low Futuramic combination is the most sensitive array ever designed for all-channel VHF reception. Just combine models 1173 and 1126.

Now — 6 great Futuramic models, designed for every reception area:

model no.	channels covered	list price
1173	7 — 13	\$20 ⁸³
1124	2, 3, and 4	\$40 ⁹⁷
1125	2, 3, 4, and 5	
1136	3, 4, 5, and 6	
1146	4, 5, and 6	
1126	2, 3, 4, 5, and 6	

CHANNEL MASTER engineering pays off on **VHF!**



CHANNEL MASTER CORP. ELLENVILLE, N. Y.



Latest TV Data!

JUST OUT

RIDER'S TV II

with
dependable
replacement parts
listings

THE standard reference
for TV service technicians

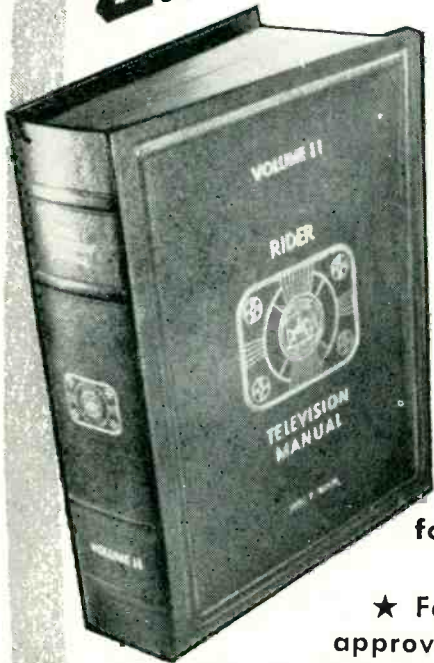

- ★ Factory-authorized! Factory-approved!
- ★ Servicing data—direct from the manufacturer!
- ★ Now sectionalized for most up-to-date coverage!
- ★ Schematics . . . waveforms . . . chassis views . . . circuit changes . . . different production runs!
- ★ Cumulative replacement parts listings include cross-reference by chassis and models!
- ★ Over 2,200 (8½ x 11") pages in a (12 x 15") durable binder! Only \$24.00!

Order from your jobber today!

TEK-FILE

TAILOR-MADE FOR EASY TV SERVICING

TV service information in 83 individual packs . . . the same data as in Rider TV Manuals . . . about 3000 models . . . new packs monthly . . . try a TEK-FILE Pack at \$2 each. Money refunded within 7 days if you're not completely satisfied.

★ Dependable replacement parts listings beginning with Pack 57

For easier radio servicing . . . use Rider's 22 AM-FM Radio Manuals



JOHN F. RIDER

PUBLISHER, INC.
480 Canal Street, New York 13, N. Y.

West Coast Office:
4216-20 W. Jefferson Blvd.
Los Angeles, California

Export Agent:
Roburn Agencies, Inc.
39 Warren Street
New York 7, New York

In Canada:
Charles W. Pointon
1926 Gerrard Street, East
Toronto, Ontario

Cable Address:
Roburnage N. Y.

TRADE FLASHES

(from page 18)

shipping facilities. This move is the second move they have made within the past year . . . Plant No. 2, the fabrication plant, is also located close by in Burbank.

Erie Resistor Builds Plant in Mississippi

The Erie Resistor Corporation, Erie, Pa., has announced plans for the construction of a new plant for the manufacture of electronic and plastic products at Holly Springs, Mississippi, 40 miles south of Memphis, Tennessee.

"The decision to secure additional facilities is due to overcrowding of present facilities and the shift in some markets of the company's products," G. Richard Fryling, president of the Erie firm explained. Plans call for a one story brick face building providing approximately 60,000 square feet on a 25 acre tract on the outskirts of Holly Springs.

IRC Opens Syracuse Sales Office

The International Resistance Company, Philadelphia, announces the opening of a Syracuse Sales Office on May 15, 1953, located at 112 Montgomery Street, Syracuse 2, New York.

The branch office will function as general liaison between IRC and its New York State area customers, with the exception of New York City, in promoting and selling the expanding IRC line, processing orders and issuing quotes.

Mr. James G. Perkins, Jr. has been appointed General Manager. Mr. Richard Johnson—Assistant Manager, and Miss Anne Florek—Customer Service Correspondent.

Stromberg-Carlson Sound Division Launches National Advertising Campaign

The Stromberg-Carlson Company's Sound Division is embarking on "the most complete national advertising campaign of any manufacturer of sound equipment," according to Mr. Frederic W. Haupt, advertising manager of the company's Sound and Telephone Divisions.

The campaign will feature all products of the Sound Division, but will give special emphasis to general sound equipment, such as intercommunication systems, paging systems, and music broadcasting systems. The advertisements will point out how industry can save money, increase production, and improve morale through the properly-planned use of these products.



The Picture Tells the Story

TV Antennas exist for one reason — to provide a clear, strong, sharp picture!

TRIO ZIG-ZAG* TV Antennas perform so well in this all important respect that they are America's most wanted.

Yes, a picture — the TV picture — tells the TRIO story more eloquently than anything else! Where all other antenna designs fail, high gain TRIO ZIG-ZAG TV Antennas consistently lock in sharp, clear pictures — from Maine to Texas, in city or country!

TRIO TV antennas look different, work different — provide a magnificent DIFFERENCE in picture quality!

*Patent Pending

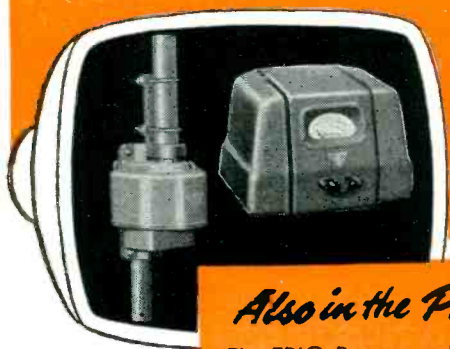

Also in the Picture

The TRIO Rotator and Direction Indicator are the most dependable ever built. Developed after \$50,000 research. Fully guaranteed for a FULL two years!

*New insulating sleeve, with longer leakage path and elimination of slit, does away with assembly errors — elements cannot short out. For maximum strength, new steel, electro-plated element clamps have been introduced.

Best Buy in UHF Antennas LOW IN COST — HIGH IN PERFORMANCE

NEW TRIO UHF BOW-TIE with reflector

Sturdy, broadband antennas of uniformly high gain that have been thoroughly field tested. Phasing strips installed, pre-assembled — a jiffy to attach reflector screen. Available in one, two and four bay models. Usual high-quality TRIO construction.

Model UBT-4
Supplied With
4 Foot Mast

Model UBT-1
Supplied With
2 Foot Mast

Model UBT-2
Supplied With
3 Foot Mast

NEW TRIO UHF MULTI-CHANNEL YAGI ANTENNAS

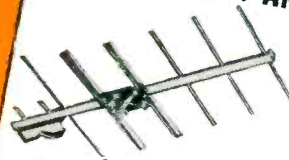

Broadband yagis developed by TRIO now successfully applied to UHF. Four models cover more than two needed for any one area.

These high gain six element yagis have sharper directivity, thereby eliminating ghosting. Thoroughly field tested. Entire antenna mounted in front of mast removes metal from field of reflectors or antenna elements. Mast clamp supplied. Completely assembled.

- Model 6-UBY 14-26 for Channels 14-26
- Model 6-UBY 27-42 for Channels 27-42
- Model 6-UBY 43-60 for Channels 43-60
- Model 6-UBY 61-83 for Channels 61-83



TRIO MANUFACTURING CO.

GRIGGSVILLE, ILLINOIS

see

the **UHF VHF**
AMPHENOL
television
antenna story

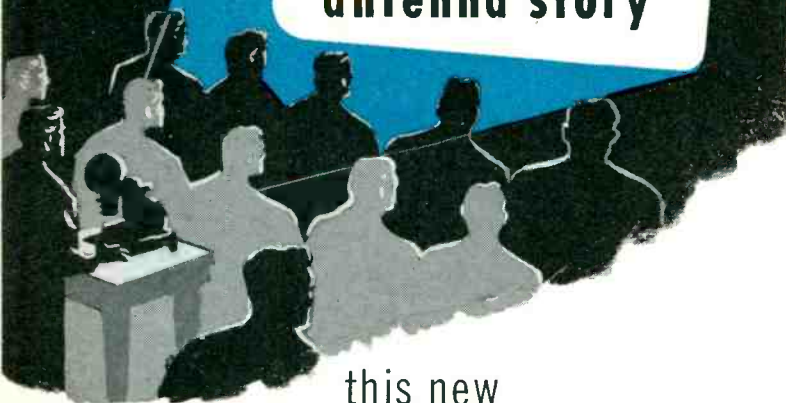

this new
AMPHENOL FILM presentation

Previewed by your distributors at the May Electronics Parts Show in Chicago, a new AMPHENOL film, "The UHF-VHF Television Antenna Story," will soon be available for showing to servicemen and dealers. Your jobbers thought it so good (they found its information on UHF particularly helpful) that AMPHENOL is making it available for wider distribution. Besides reviewing VHF transmission and antenna characteristics, the film clears up a great deal of the current confusion on UHF; answers questions that will be asked of you. Given special attention in this factual presentation are the many different UHF antenna types: Rhombic, Yagi, Corner Reflector, Bo-TY and Stacked-V. The sometimes puzzling behavior of UHF signals is illustrated and discussed.

★ For complete information on UHF as well as VHF be sure and contact your distributor and arrange to see "The UHF-VHF Television Antenna Story." ★



AMERICAN PHENOLIC CORPORATION
 chicago 50, illinois

SYNC

by

OPEN CONFLICT ON LICENSING between Associations of Servicemen and other groups such as National Electronic Distributors' Association and Radio-Television Manufacturers' Association is breaking out in several parts of the country.

For example, in certain cities the locally organized servicemen's associations have come to the conclusion that it would be to their best interests, and to the best interests of the set owners in their community, if License Laws were enacted and municipal regulations enforced. Proceeding on that presumption, the servicemen's associations in question worked with their legislators and had License Bills proposed for enactment. Then, when hearings were held, representatives of NEDA (and in some cases RTMA) came forth and opposed the Bills to the dismay and chagrin of the servicemen.

That the servicemen's associations anticipated some opposition to their license laws was to be expected; but to have that opposition come from another segment of the industry was, in the servicemen's association's opinion, completely unjustified and improper. In other words, the members of the servicemen's associations believed that they should make moves which are in their best interests and that outsiders should mind their own business.

In the strict sense of the word, NEDA members do have an interest in what servicemen's groups do, for the servicemen are in most cases their primary source of support. Questioned on the subject some NEDA executives stated, in their opinion one basic reason some servicemen's organizations favored license laws was because such laws would tend to keep down the number of service firms in their community and thus eliminate a certain amount of competition. Naturally, parts distributors were in opposition because it is their theory that the more servicemen there are the more potential customers there are for the distributor to sell to.

In rebuttal the servicemen contend that if, in any given community, there are 1,000 receivers, regardless of the number of servicemen, only a certain number of replacements can be used to repair those 1,000 receivers if they break down, no matter how many technicians there are available to service them. For example, if one service firm is there, it can buy and use 1,000 new "off-on" switches whereas if there are 100 service shops, with each having an equal share of the business, each could only buy 10 switches and the same 1,000 replacement switch total turn-over would be the end result.

Since the advent of the radio-television industry the several basic segments within it have formed national groups to represent their own interests. NEDA now represents a fair percentage of parts distributors, possibly 25%. RTMA represents almost all of the parts manufacturers. Servicemen, on the other hand, have no effective national organization, and in fact are by far the most badly organized element even in their local communities. Yet in annual dollar volume they are the most profitable segment to both the distributor and manufacturing groups.

Now, getting back to the rising conflict between servicemen groups and distributor groups, an attempt to coordinate both interests is being made before matters get completely out of hand. The publisher of this journal, S. R. (Sandy) Cowan has been asked by several servicemen's

PULSES

SAN D'ARCY

associations, to try to bring the various groups, i.e., servicemen's associations, NEDA and RTMA into line so that no one group opposes the other.

This is a delicate problem with many ramifications and Mr. Cowan has gone on record to this effect: He will support those Servicemen's Associations who favor licensing for their communities (providing he feels the proposed regulations are written to serve the best interests of both the service profession and the set owners in that community) —and he will oppose licensing in those communities where the Servicemen's Associations themselves oppose licensing. The first problem confronting him is simply this: what servicemen's groups want local licensing? . . . and what servicemen's groups oppose it? Correspondence now in his files gives him the answer to the wishes of some groups, but to date other servicemen's groups have not gone on record one way or the other, and the matter must rest there until Mr. Cowan has been "given his assignment." Now if you, the reader of this article, being a member of an established organization or association of servicemen, wish to broach the subject to your colleagues, do so. Then have the spokesman for your group write to Mr. Cowan their wishes, so that he will be enabled to follow up the proposition along the lines, pro or con, that you favor.

TELEVISION'S GROWTH IS APPARENT BY THESE STATISTICS: *As of June 1st, 1953, there were almost 27 million receivers in use in 116 different cities being serviced by 166 different stations, uhf and vhf included. In addition there were 266 other stations, located in 201 cities, that had CP's from FCC, or who were about to get the green light" and were attempting to start functioning as quickly as possible. Translated into generic terms for the serviceman's evaluation, this means that now almost 22% of the families living in the U. S. are within the range of a telecasting station; and that almost 50% of the families that do reside within reach of TV signals have a receiver. However, in fact, some communities have upwards of 89% TV family coverage and other communities still are relative "barren" with only 3% of the families now owning a TV set.*

Projected on the premise that "a certain number of new stations will become operative every six months" and using past figures divided by 6 for averages (as most major cities already have TV thus leaving only 40% coverage per family to be anticipated for future stations), one can reasonably theorize that in just one year, approximately 150 cities will be served by TV stations of their own (as against 116 now), that 204 stations will be functioning (as against 166 now), and that upwards of 34 million receivers will be operating in 33 million homes. One million homes will, by 1954, have 2 TV sets operating as against 440 thousand being dual set served now.

Projecting this subject into "potential for servicemen," we find that in theory, within a year, 40% of the servicemen who now are not able to get any share of TV installation or repair work as they are not in TV-served areas will be . . . and accordingly, their monthly income should rise from 40% to 80% monthly over what it now is. That's how much difference TV makes to the "have nots" as compared to the "haves." In the same manner, servicemen who are already situated in TV-served areas can logically anticipate an average of 10% to 40% more dollar repair volume than present averages

starred
in

AMPHENOL

the **UHF VHF**
AMPHENOL
television
antenna story

AMPHENOL UHF antennas featured in AMPHENOL's film, shown at the May Parts Show, were these:

BO-TY (with reflector) An efficient performer on all channels, 14 to 83. Signal gains of 5½ to 8 DB. An excellent major-area antenna for locations troubled with reflections.

YAGI Best for extremely high gain over a specific group of channels. Single forward lobe and high efficiency make it ideal for fringe areas. Gives high gain of 10 DB.

CORNER REFLECTOR Designed for high gain over all UHF channels. Ascending signal gain of 7.8 DB to 13 DB across UHF channels makes it especially desirable for low signal areas.

RHOMBIC Provides narrow horizontal directivity over all UHF channels. Excellent for areas of medium signal intensity because of good signal gain from 6.2 DB to 13.8 DB.

STACKED-V For all channels, VHF or UHF, 2 to 83. Seamless aluminum tubing elements can be adjusted to different angles for VHF signals, UHF signals, or both.

and shown also,
the dependable VHF performer

INLINE* Leading the field for over four years! Unique INLINE design assures constant fine reception. Maximum broadband gain over all channels and excellent impedance match.

*Reissue Pat. No. 23,273

AMPHENOL Antennas = best reception for UHF or VHF

AMPHENOL

AMERICAN PHENOLIC CORPORATION
chicago 50, illinois

don't improvise ...

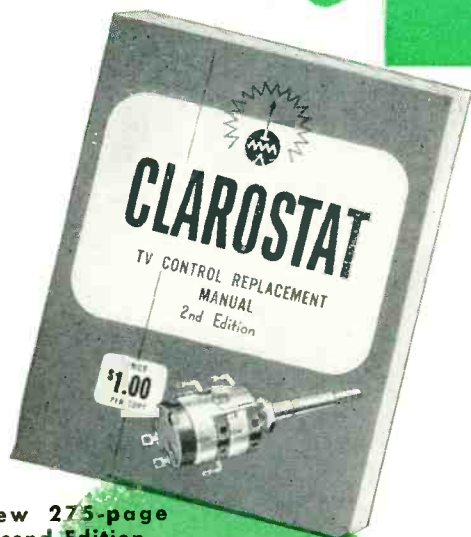

New 275-page
Second Edition —
simply indispen-
sable!

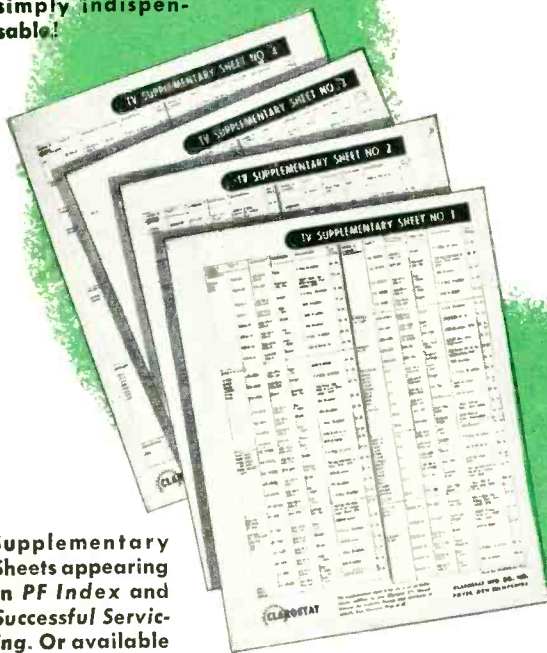

Supplementary
Sheets appearing
in PF Index and
Successful Servicing. Or available
from your jobber.

RTV-ize!

FOR FAST, SURE, ECONOMICAL CONTROL REPLACEMENTS

As easy as using the 'phone book. As sure as if you looked up the original specs of that chassis. Because Clarostat engineers, responsible for the majority of TV controls in use, have compiled the replacement data available to you in the *Clarostat TV Control Replacement Manual* and the *Supplementary Sheets*.

The listings are by set-manufacturer's model and chassis, part number, Clarostat catalog number, function and description. Cross references, too. Standard types where feasible; RTV or matched replacements, where essential.

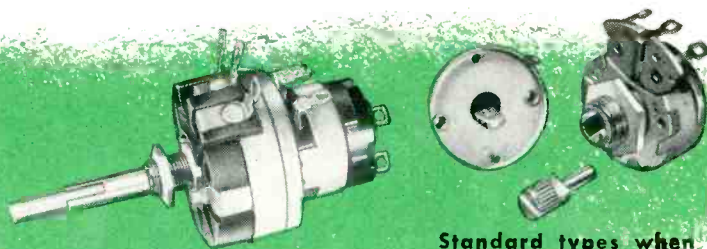

RTV or matched replacements available when Standard types won't do.

Standard types when feasible — especially field-assembled "Pick-A-Shaft" and Ad-A-Switch** combinations.

ASK YOUR JOBBER . . .

He'll gladly show you the big Second Edition of the Clarostat TV Control Replacement Manual. Also the Supplementary Sheets. And remember, he carries Clarostat Standard and RTV controls for your convenience.

STAND PAT WITH
C

CLAROSTAT Controls & Resistors

CLAROSTAT MFG. CO., INC., DOVER, NEW HAMPSHIRE
In Canada: Canadian Marconi Co., Ltd., Toronto, Ontario

*Trade-mark

UHF

ANTENNAS



PART 1

by RUDOLF F. GRAF

Beginning a two part article on ultra high frequency antennas. This installment deals with the design, construction, characteristics, and operation of the Bowtie, V-Type, Rhombic, and Yagi UHF antennas.

DURING the past years we have been concerned with the reception of only 12 television channels extending from 54 to 88 mc (Channel 2-6) and from 174 to 216 mc (Channel 7-13). During these years there have appeared some very important developments and improvements in both receiving and transmitting apparatus. Still we have not yet reached the stage where we are able to obtain good TV reception in a majority of locations without the use of an outdoor antenna installation. Antennas have been designed during this past period of time to function well in various terrains and at varying distances from the transmitting station. Now, with *uhf* stations popping up all over the country, we are faced with the problems of receiving not only 12 channels but also 70 new ones to give us a total of 82 channels.

The subject of *vlf* antennas (Channel 2-13) has been dealt with frequently and in such great detail previously, that we shall concern ourselves here only with antennas required for the reception of *uhf* signals.

Special antennas had to be designed since it was found that in all but the strongest signal areas, antennas designed for *vlf* did not perform satisfactory on the Ultra Highs. A great

variety of these *uhf* antennas has appeared on the market in a relatively short time. Most of them are familiar in their appearance in that they are based on their larger size *vlf* brothers. However, some of them are quite unfamiliar. In general, *uhf* antennas are much lighter and much smaller than what we are used to. Let us first of all see why that is so.

Since we are using antennas that are cut a half wavelength at the operation frequency we can compare the antenna length for a *vlf* and a *uhf* channel.

Let's take channel 6 and channel 57. Half a wavelength for channel 6 is 68 inches and for channel 57 it is only 8 inches. *Fig. 1* gives a chart showing all the new *uhf* channels with their corresponding frequencies and wavelengths. We are going to refer to this chart again later. The spacing of *uhf* antennas is correspondingly reduced also. Thus, we get much smaller and lighter arrays. Furthermore, those types of antennas that were too large or too expensive to be practical at *vlf*, are not quite common and effective at *uhf*. Let us now take a look at the various types of *uhf* antennas that have made their appearance on the market so far.

The Bowtie Or Fan Dipole Antenna

This antenna consists of a pair of triangular elements (*Fig. 2*). They are usually made of aluminum and mounted so that their apexes are facing each other. The transmission line is connected at these points as illustrated in *Fig. 3*. Because of its appearance this antenna is commonly referred to as the Bowtie. The two triangular elements are mounted on insulators which are connected to the antenna mast. The triangles are usually supported in such a fashion that the points at which the transmission line is connected, are in free space. They are usually referred



(Courtesy Channel Master)

Fig. 2—Bowtie or Fan Dipole Antenna.

to as free space terminals and are resorted to so as to prevent the accumulation of dirt, soot, ice or any other foreign matter at the antenna terminals.

This antenna is actually based on the conical principal and may sometimes be called a broad band dipole. Its response is quite good over the entire *uhf* spectrum and it may be used with a reflector screen for increased gain. For best match to the present day 300 ohm transmission lines, the antenna elements angles should be 70 degrees and the end-to-end spacing between the triangles should be 16 inches. Dimensions are given in Fig. 3.

The antenna, when used with a screen reflector about 18 inches wide and 15 inches high, has a gain of between 3 and 5 db over the entire *uhf* spectrum. The gain increases for the higher channels. This reflector can be constructed of any rigid screen or wire mesh and it should be mounted 3½ inches behind the Bowtie when both are mounted on the mast. The addition of the reflector makes the antenna more directional both in the horizontal as well as the vertical plane, and its performance is comparable to that of a *vhf* folded dipole with reflector used on the *vhf* band.

If higher gain is required the antennas may be stacked. Stacking bars should have a center to center length of 13½ inches for best performance. The transmission line is connected to the center of the stacking bars. When stacking two Bowties we get a gain of from 5 to over 7 db with the higher gain obtained at the higher channels. The fact that this antenna, as well as many other *uhf* antennas, has gain characteristics that increase with frequency is quite advantageous, since it helps compensate for the increased losses in the transmission lines at higher frequencies. As shown in Fig. 3 four Bowties may be stacked for gains between about 7 and 10.5 db over the entire *uhf* spectrum.

V-Type Antennas

So far there has appeared on the market three distinct types of antennas that are constructed along the same principle of operation and may be grouped under the common heading of "V" type antennas. They are the type of antennas known as the long wire antennas. That is, the antenna elements themselves are more than one wavelength long. They are essentially dipoles that are "tilted". Generally, the antennas are also suitable for *vhf* reception. The three above-mentioned types that we will discuss are the four element horizontal "V"

Channel	Freq.	Video	Audio	Full Wave (Inches)	Half Wave (Inches)	Quarter Wave (Inches)
14	470-476	471.25	475.75	25.0	12.5	6.3
15	476-482	477.25	481.75	24.7	12.4	6.2
16	482-488	483.25	487.75	24.4	12.2	6.1
17	488-494	489.25	493.75	24.0	12.0	6.0
18	494-500	495.25	499.75	23.8	11.9	6.0
19	500-506	501.25	505.75	23.5	11.8	5.9
20	506-512	507.25	511.75	23.2	11.6	5.9
21	512-518	513.25	517.75	23.0	11.5	5.9
22	518-524	519.25	523.75	22.7	11.4	5.7
23	524-530	525.25	529.75	22.4	11.2	5.6
24	530-536	531.25	535.75	22.2	11.1	5.6
25	536-542	537.25	541.75	21.9	11.0	5.5
26	542-548	543.25	547.75	21.7	10.9	5.4
27	548-554	549.25	553.75	21.4	10.7	5.4
28	554-560	555.25	559.75	21.2	10.6	5.3
29	560-566	561.25	565.75	21.0	10.5	5.3
30	566-572	567.25	571.75	20.8	10.4	5.2
31	572-578	573.25	577.75	20.6	10.3	5.2
32	578-584	579.25	583.75	20.3	10.2	5.1
33	584-590	585.25	589.75	20.1	10.1	5.0
34	590-596	591.25	595.75	19.9	10.0	5.0
35	596-602	597.25	601.75	19.7	9.9	4.9
36	602-608	603.25	607.75	19.5	9.8	4.9
37	608-614	609.25	613.75	19.3	9.7	4.8
38	614-620	615.25	619.75	19.1	9.6	4.8
39	620-626	621.25	625.75	19.0	9.5	4.8
40	626-632	627.25	631.75	18.8	9.4	4.7
41	632-638	633.25	637.75	18.6	9.3	4.7
42	638-644	639.25	643.75	18.4	9.2	4.6
43	644-650	645.25	649.75	18.3	9.2	4.6
44	650-656	651.25	655.75	18.1	9.1	4.5
45	656-662	657.25	661.75	17.9	9.0	4.5
46	662-668	663.25	667.75	17.8	8.9	4.4
47	668-674	669.25	673.75	17.6	8.8	4.4
48	674-680	675.25	679.75	17.5	8.8	4.4
49	680-686	681.25	685.75	17.3	8.7	4.3
50	686-692	687.25	691.75	17.2	8.6	4.3
51	692-698	693.25	697.75	17.0	8.5	4.3
52	698-704	699.25	703.75	16.9	8.5	4.2
53	704-710	705.25	709.75	16.7	8.4	4.2
54	710-716	711.25	715.75	16.6	8.3	4.2
55	716-722	717.25	721.75	16.5	8.3	4.1
56	722-728	723.25	727.75	16.3	8.2	4.1
57	728-734	729.25	733.75	16.2	8.1	4.1
58	734-740	735.25	739.75	16.0	8.0	4.0
59	740-746	741.25	745.75	15.9	8.0	4.0
60	746-752	747.25	751.75	15.8	7.9	4.0
61	752-758	753.25	757.75	15.7	7.9	3.9
62	758-764	759.25	763.75	15.5	7.8	3.9
63	764-770	765.25	769.75	15.4	7.7	3.9
64	770-776	771.25	775.75	15.3	7.7	3.8
65	776-782	777.25	781.75	15.2	7.6	3.8
66	782-788	783.25	787.75	15.1	7.6	3.8
67	788-794	789.25	793.75	15.0	7.5	3.8
68	794-800	795.25	799.75	14.8	7.4	3.7
69	800-806	801.25	805.75	14.7	7.4	3.7
70	806-812	807.25	811.75	14.6	7.3	3.7
71	812-818	813.25	817.75	14.5	7.3	3.6
72	818-824	819.25	823.75	14.4	7.2	3.6
73	824-830	825.25	829.75	14.3	7.2	3.6
74	830-836	831.25	835.75	14.2	7.1	3.6
75	836-842	837.25	841.75	14.1	7.1	3.5
76	842-848	843.25	847.75	14.0	7.0	3.5
77	848-854	849.25	853.75	13.9	7.0	3.5
78	854-860	855.25	859.75	13.8	6.9	3.5
79	860-866	861.25	865.75	13.7	6.9	3.4
80	866-872	867.25	871.75	13.6	6.8	3.4
81	872-878	873.25	877.75	13.5	6.8	3.4
82	878-884	879.25	883.75	13.4	6.7	3.4
83	884-890	885.25	889.75	13.3	6.7	3.3

(Courtesy Channel Master)

Fig. 1—Chart showing new *uhf* channels with corresponding frequencies and wavelengths.

array, vertical stacked "Vs", and the so-called "Trombone," produced by Ward Products.

Figure 4 shows a four element horizontal "V" antenna. Because the gain of this type of antenna increases in proportion to the length of each leg, the elements are made as long as possible without serious sacrifice of me-

chanical soundness. The longer each of the four legs of the "V" becomes in relation to the wave length of the signal being received, the narrower must be the angle between the elements in order to obtain good directivity and high gain.

In order to be able to use the antenna for *vhf* and *uhf* we have to have

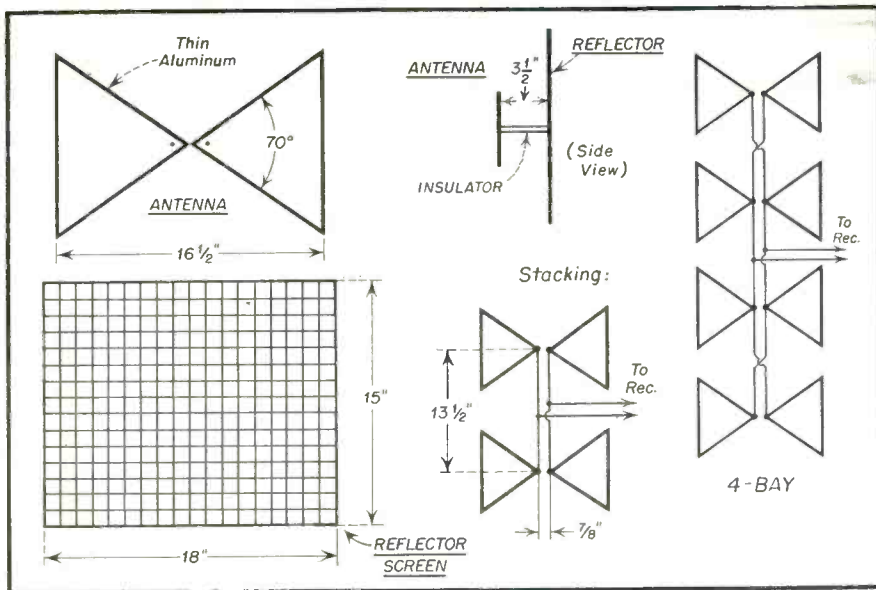

Fig. 3—Bowtie antenna characteristics and dimensions.

some means of choosing an optimum operating angle depending on what we want to receive. Therefore, most all manufacturers producing this type of antenna make provision for adjusting the angle between the elements. As shown in Fig. 4 there are three positions that these elements can take. The widest angle is 90° the next is 60° and the narrowest is 45°. These positions are recommended to be used as follows: The widest angle is recommended for *vlf* reception only, the next angle for *vlf* and *uhf* reception (Channel 2 to 83), and the narrowest angle for the upper end of the *uhf* band. As can be seen from the illustration, the antenna consists essentially of four rods of which there are two in the front and two in the back. The transmission line bringing this signal to the receiver is connected to the two back elements. The two front elements serve as directors.

Unlike all other antennas employ-

ing directors, these types of antennas have the director connected to the antenna proper by means of two rods which also served as cross-arms. These cross-arms conduct the signal picked up by the two front rods to the back rods, where the signal combines with the signal already received by the back rods. These signals are in phase. Pick up from the rear is not good because the signals picked up by the two sets of elements will combine out of phase and thus tend to cancel each other.

The second type of V antenna consists of two Vs mounted one above the other, as illustrated in Fig. 5. As before, the length of the elements as well as the included angle are both critical. This antenna however, is not made adjustable. Thus we find that these antennas are constructed with the elements 55" long, having an included angle of around 50°. The antenna arms are spaced approximately 13 1/2"

apart. Two types of construction have

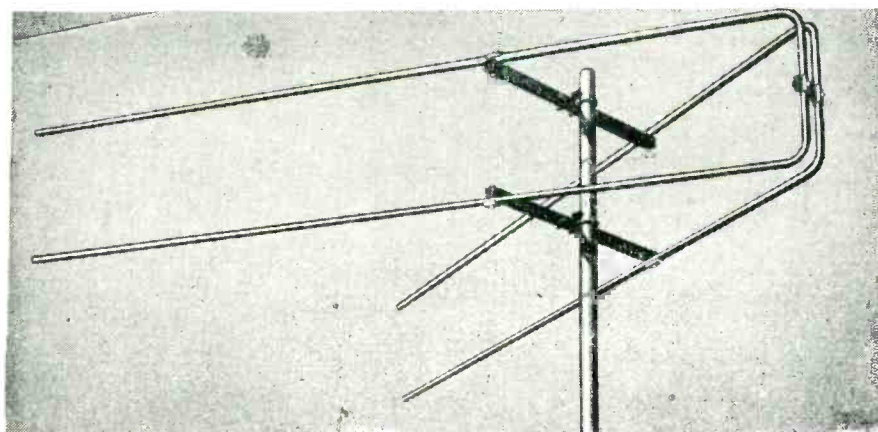

(Courtesy Radelco)

Fig. 5—Two Vs mounted one above the other.

been employed. One has the elements held at the vertex of the included angle with all of the 55" exposed to the wind. This might cause the antenna to vibrate in the wind, an undesirable property at *uhf*. A more desirable construction is one where two elements are bent in the shape of a long U and are supported in the middle somewhere near their center of gravity. Whether one of the other con-

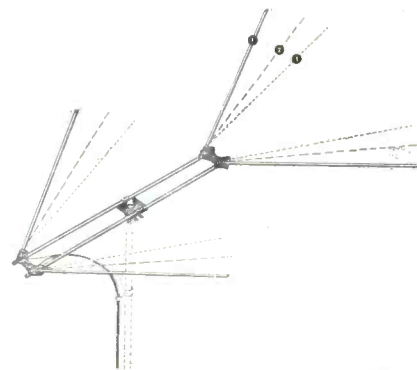

(Courtesy Ward)

Fig. 4—Four-element horizontal "V" antenna.

struction is used, the transmission line is connected to the halfway point of the 13 1/2" section joining the two "Vs".

The third type of V antenna variation is the "Trombone", illustrated in Fig. 6. This antenna consists of four Vs (8 elements) and is designed to give the highest gain of all V-type antennas.

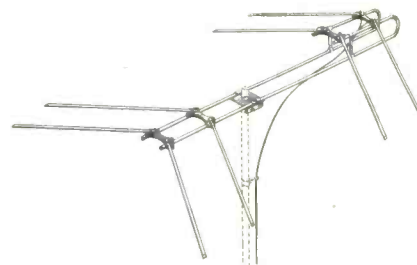

(Courtesy Ward)

Fig. 6—"Trombone" antenna.

The center connecting bars are folded back on themselves which makes the antenna look very much like what its name implies. Here again, there are three angular positions to choose from. The manufacturer recommends the widest angle, that is 90° for reception of *vlf* only. As we go up in frequency, approaching the higher end of the *uhf* band it is recommended that the angle of the forward "Vs" be decreased to 60 and 45°. There is a great variety of positions that may be achieved with this antenna, and the best one can undoubtedly be found

(Continued on page 68)

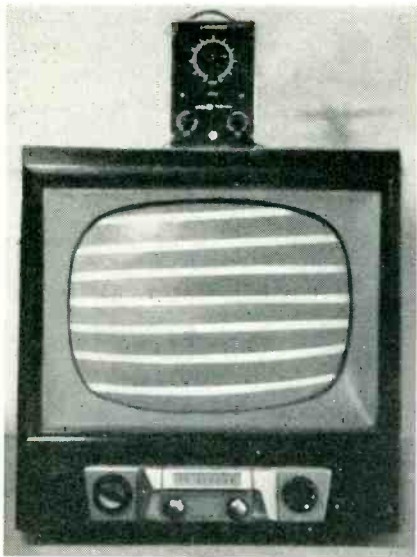

(Courtesy H. E. Prew Studios)

Fig. 1—Good horizontal linearity.

HOW many of you are longing for the good old days of television servicing (just a couple of years ago!) when some test pattern was always available for making satisfactory final adjustments of linearity, height, and width? Thinking along the same lines, how many of you are spending just about twice as long as you should in a customer's home just because each member of the customer's family has a different idea as to the proper length of Milton Berle's head? Let's face it. Those so-called "good old days" are gone forever! We are all going to have to adjust to the following situation:

(1) The increased use of telecasting as an advertising medium is going to limit the showing of test patterns to times which are, for the most part, inconvenient insofar as servicing is concerned.

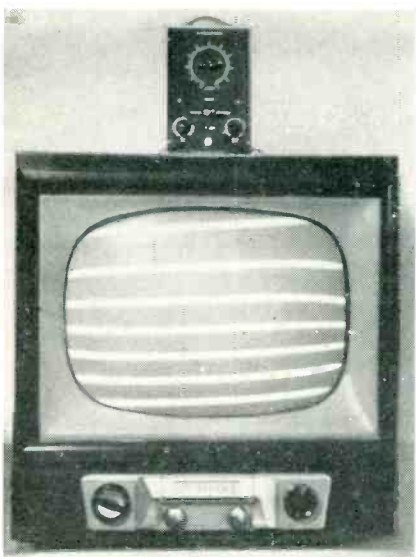

(Courtesy H. E. Prew Studios)

Fig. 2—Poor horizontal linearity.

(2) Customers' tastes are too variable and undependable to be used as criteria in proper adjustment of interdependent controls such as linearity, size, and centering.

Fortunately, an instrument has been available for some time which bids fair to perform excellent service in making good, fast adjustments that are satisfactory to both the serviceman and the customer. Furthermore, these adjustments can be made at any mutually convenient time. The "pattern generator" is not only much easier to use than the usual test pattern, but also offers other advantages. For instance, it can be used as a general service instrument to isolate troubles anywhere in the video amplifier section of a television receiver from the kinescope all the way to the second detector; in such an application the well-known techniques of "signal injection" can be employed very easily. It can also be

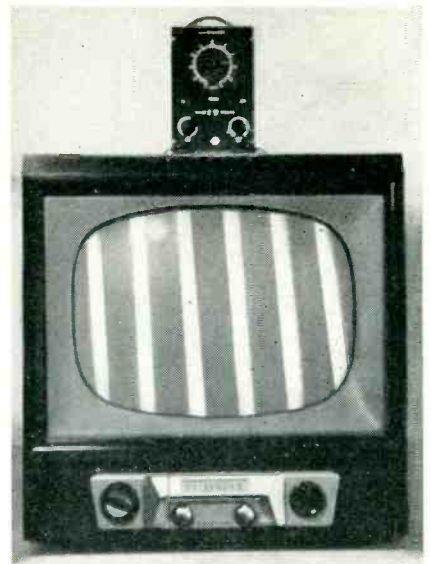

(Courtesy H. E. Prew Studios)

Fig. 3—Good vertical linearity.

Supply Your Own TEST PATTERN

by MARVIN KLEIN

This article describes the theory of operation and application of a pattern generator.

used to isolate defects in the sweep circuits which tend to give rise to non-linear pictures on the screen. Moreover, it can be used in conjunction with an *rf* signal generator to localize troublesome conditions in the *rf* and *if* stages of the receiver. These additional uses of the pattern generator will be discussed later in this article.

Theory of Operation

The theoretical background of the pattern generator is quite simple. Basically it depends upon the fact that the degree of linearity of any television picture is a measure of the uniformity of the speed at which the electron beam traverses the screen of the picture tube. If the beam does not move at a constant speed of trace, parts of the picture may, on the one hand, be either compressed or expanded—giving rise to horizontal non-linearity—or, on the other hand, parts of the pattern

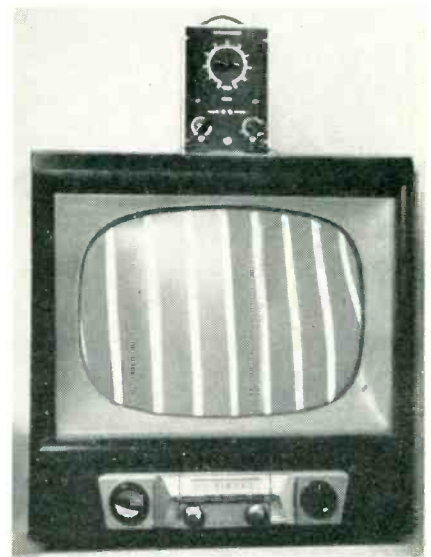

(Courtesy H. E. Prew Studios)

Fig. 4—Poor vertical linearity.

may be lengthened or shortened—giving rise to vertical non-linearity. For example, the average 17" kinescope screen has a useful width of slightly over 14"; a televised picture consisting of 7 vertical lines should maintain these lines at constant width and with equal spacings of 2" between lines when reproduced on this screen. However, if the horizontal linearity and size adjustments have not been properly made, some of the lines will be thicker than others while the spacing between lines will not be uniform. A similar distortion takes place in the case of horizontal lines if the vertical adjustments have been improperly made. Now, the pattern generator is simply a device which can generate such a pattern of uniform, parallel horizontal and vertical lines. As can be seen from Figs. 1 to 4, non-linearity is extremely easy to detect and correct by means of such patterns.

Commercial Product

A commercial instrument of this type shown in Figs 1-4 is the Model CB-101 manufactured by the United Technical Laboratories of Morristown, New Jersey. This unit employs a relaxation oscillator, the Potter amplifier—or, as it is more familiarly known, "the cathode-coupled multivibrator"—to generate the line pattern. The oscillator itself, along with the various controls, but without the details of the power supply, is shown schematically in Fig. 5. At first glance, it seems to resemble a "one-shot multivibrator." Actually, however, it oscillates continuously, since the 220 ohm resistor

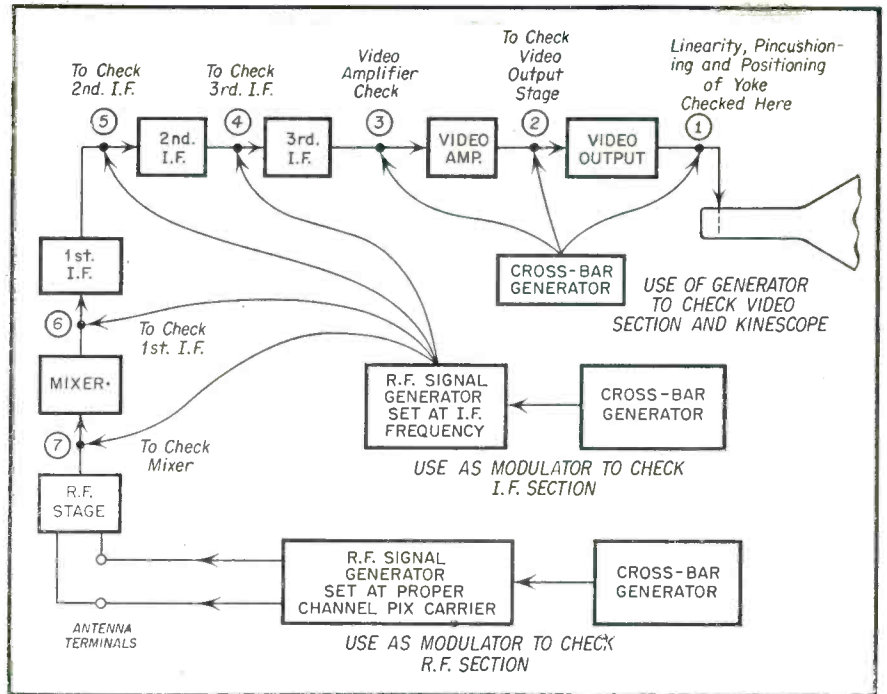

Fig. 6—Block diagram of pattern generator and its use in testing various sections of a TV receiver.

is too small to keep the 12AU7 at cut off. The 15K and 10K resistors in the plate circuits are such as to allow the production of lines of narrow width and wide spacing. The actual number of lines which can be displayed on the kinescope screen is determined by the frequency of the oscillator. This frequency is controlled chiefly by the series network consisting of the 15K resistor, the 50 μf or .002 μf capacitor, the 27K resistor and the 1 meg pot. When the 50 μf condenser is inserted, a

high frequency is generated, producing the vertical lines on the scope which are used in the adjustment of horizontal linearity. On the other hand, if the .002 μf condenser is used, low-frequency operation is obtained, and horizontal lines—which can be used for the adjustment of vertical linearity—are produced. The frequency control, permits continuous variation in the number of lines produced on the screen, and also permits locking of these lines in a stable pattern. Should it be impossible to produce such a stable pattern—by adjustment of this control together with readjustment of the "hold" controls of the television receiver—another control, the sync control, can be used. This control allows the generator to be synchronized with the sweep circuits of the receiver. The remaining output level control permits the gain of the generated bar pattern to be varied, so that overdriving of the receiver circuits can be avoided.

Operation

This method of operation of the pattern generator is extremely simple, and the instrument thus lends itself very nicely to home-servicing practice. For example, the adjustment of linearity requires only the following connections: the low or "cold" output terminal is clipped to the chassis, and the high or "hot" terminal is connected directly to the video control element of the picture tube, which could be either the cathode or the control grid, as the case may be. The instrument shown in

[Continued on page 70]

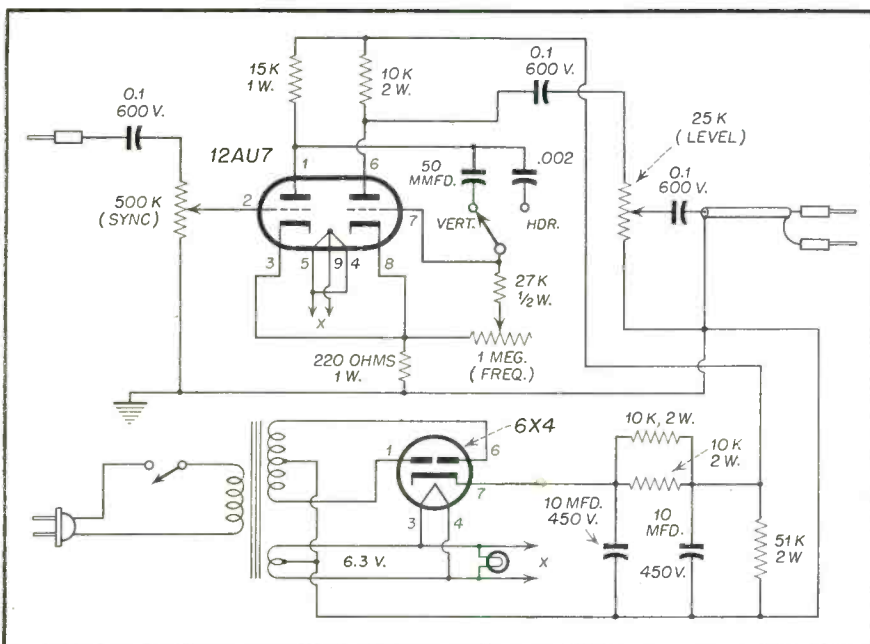

Fig. 5—Circuit diagram of Model CB-101 pattern generator.

THE purpose of the horizontal sync signal is to initiate the sweep of the electron beam across the face of the picture tube. This sweep coincides in time and space with the beam sweeping the face of the camera tube. The waveform is started in the horizontal oscillator. It is synchronized by a pulse generated at the studio. The CRT electron beam swept by this wave form is done in one of two ways: electro-statically and electro-magnetically.

Electro-static deflection as far as home receivers are concerned, is obsolete. However, for ease in explaining deflection fundamentals, it will be reviewed here briefly. If two plates of the same polarity and potential are positioned so that they face each other, electrostatic fields of force are formed around the plates in such a manner that lines of force extend from the plates into space. If the voltage on the plates is increased, these fields will extend further and further from the plates. Because the charge on the plates is the same, a narrow path is formed between the fields which offers an electron beam a low resistance path between the two fields. If the voltage on the two plates is changed an equal amount and of opposite polarity, the cleared center will shift. The electron beam will move with the cleared center. By applying a variable *ac* potential on the plates the beam may be made to traverse the face of the CRT. (Fig. 1) To achieve a linear voltage change a sawtooth voltage is applied in opposite polarity to the plates.

In the electromagnetic deflection system, use is made of the fact that electromagnetic fields of force also affect the motion of an electron beam. These fields are created by the passage of a current through a coil. This coil is of course known as the yoke, and is so designed that two uniform or two equally non-uniform fields can be created opposite each other. When a current wave is fed through the coil, the fields can be made to move uniformly or non-uniformly as desired, from side to side. Non-uniform field design is used in the so-called "cosine yoke" to correct for defocusing effects which occur when sweeping the face of tubes 16" or larger.

In addition to the deflection system, there is a need for generating a high accelerating voltage for the second anode. We will discuss the high voltage generation at the end of this article.

The Yoke

Figure 2(a) shows the voltage waveform which would generate a saw-tooth of current through a theoretically pure inductance (no resistance losses). Figure 2b shows the voltage waveform which will produce a saw-tooth of current

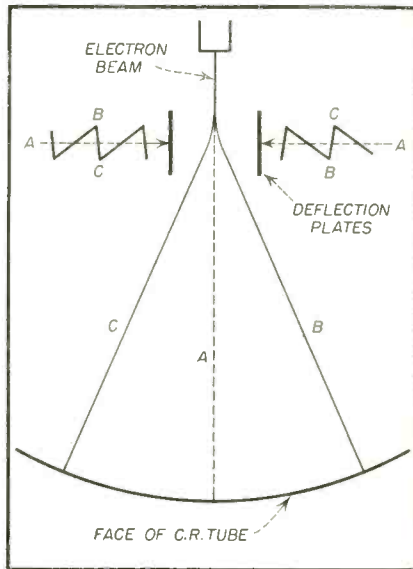

Fig. 1—Effect of saw-tooth on beam.

across a resistance. Since there is no practical coil without resistance Fig. 2c shows the waveform of voltage which will produce the required current wave in a practical coil. This waveform is produced by a combination of the pulse of Fig. 2a and the saw-tooth of Fig. 2b. The linearity of the curve from A to B is controlled by the inductance of the coil. This indicates that the linearity of the sweep is a function of this inductance. It follows, therefore, that when it becomes necessary to replace a yoke the replacement called for *must* be an exact duplicate of the defective part.

The voltage waveform required for Fig. 2c is developed by taking the output of the horizontal oscillator and shaping it. This shaping is performed by a network connected at the input circuit of the horizontal output tube (Fig. 3).

Horizontal SYNC & SWEEP Servicing

by LEONARD LIEBERMAN

PART 3

This final installment deals with various types of deflection systems used in modern TV receivers.

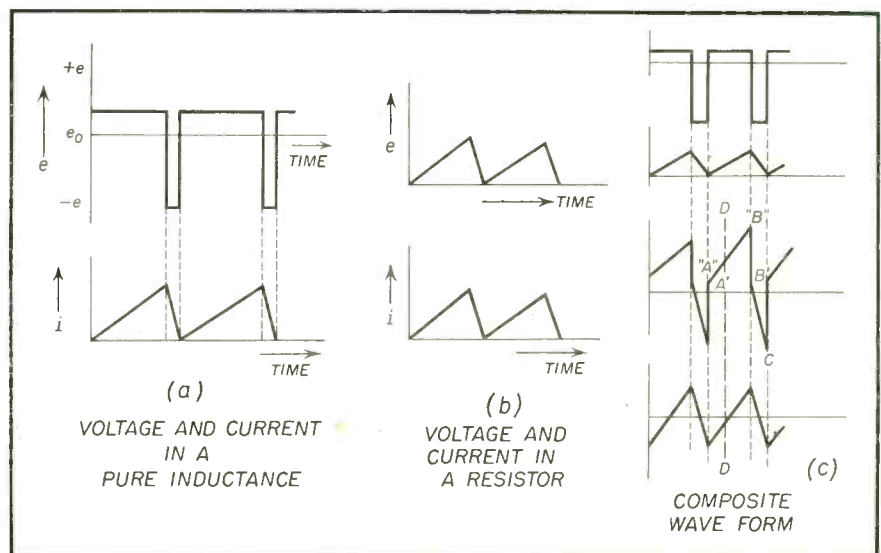

Fig. 2—Voltage and current relationships and wave forms in a pure inductance, resistor, and combination of both.

Again, it must be emphasized that exact replacements are necessary to insure operation of the set exactly as it was designed.

The Horizontal Output Tube and Transformer

The primary purpose of the horizontal transformer is to provide a match between the output impedance of the amplifier tube and the impedance of the yoke so as to derive the maximum transfer of energy between the two circuits. The core material of present day transformers, a low-loss hi-permeability ferrite, insures that the losses in the core are kept to a minimum, resulting in hi-efficiency output circuits. The impedance match is achieved by means of a step-down ratio in the primary to secondary windings.

Now let us examine a typical circuit's current and voltage relationship (Fig. 4). The shaped waveform is fed to the grid of the amplifier (6BQ6, 6CD6, etc.). This tube normally is conducting from A' to B' in Fig. 2c. The tilt A-B is exaggerated for purposes of illustration and is never more than 5%-10%. For all practical purposes the output of the amplifier can be considered constant. This causes a steady rise in yoke current. It should be noted that since in the initial state the fields are of equal strength, this rise in current causes the beam to move from the center of the screen to the right side.

Retrace Time

During the period B-C the pulse goes sharply negative. In the time B'-A' the output tube is cut-off. The output plate voltage goes up sharply. The tube remains cut-off for most of the horizontal blanking period. During this cut-off time the direction of both the voltage and current in the yoke change direction. The current must go from its previous peak to the peak in the opposite direction now in 7 μ secs as against the 50 μ secs it took to rise previously. It can easily be seen

that the rate of current change is now 7 times as great as it was before. This high rate of current change produces a high voltage across the yoke. Due to the step up action from secondary to primary of the output transformer this pulse appears at the plate of the output tube. Its potential is in the order of many kilovolts.

The Damper Circuit

The yoke coil with its distributed wiring capacities, and circuit shunt capacities, represents a tuned circuit with its own natural self resonant frequency. When this self resonant circuit is hit with a high voltage pulse during retrace, it will go into shock-excited oscillation (Fig. 5). This oscillation will cause the current saw-tooth to become distorted. That part of the distortion which occurs during retrace is of no

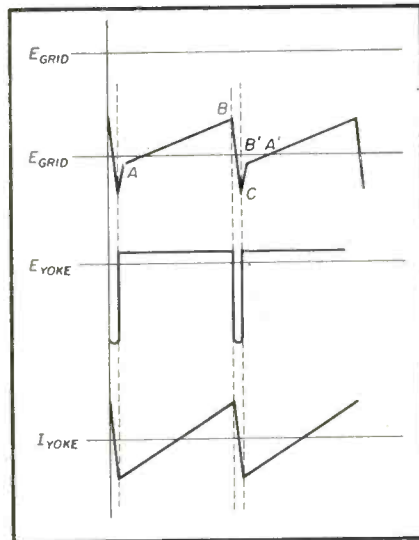

Fig. 4—Voltage and current in horizontal output transformer and yoke.

consequence since it would not be visible but the oscillations which occur during the forward trace would cause the screen to acquire a series of rippling bars until the oscillations would die out.

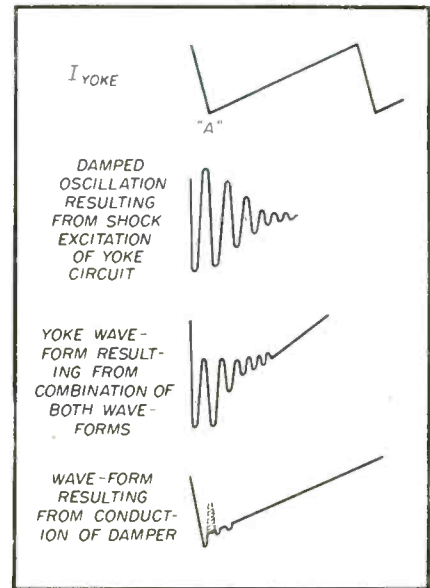

Fig. 5—Wave forms produced as a result of damping.

While this development at a first glance seems to be an extreme handicap it has actually been turned around and utilized to increase the power efficiency of the modern TV receivers. Let us see how this is accomplished. The oscillations in the yoke circuit could be damped down by putting a very low value resistor across the entire network. This, however, would require a greater power output from the amplifier tube and waste a tremendous amount of power across the damping resistor. Since damping is desired only when the voltage waveform reaches the point A in Fig. 5, it is conceivable that a diode properly biased and connected can be used as a short circuit at that point and so damp the oscillation as to extinguish them. Furthermore, the current drawn by the diode can be rectified and put to use in the set as an additional power source. Finally, since this damping action takes place while the voltage in the output amplifier is building up, this current can be used to start the rise in the yoke current—further linearizing that current rise.

One method of hooking up the damper is shown in Fig. 6. The plate is so connected that it will be positive in relation to the cathode during the positive point excursions of the damped oscillation train. At this time the diode will conduct and its forward resistance is so low that it looks like a short across the yoke. A coil is sometimes inserted into the diode circuit to help assure the linearity of its current. This coil in addition to condensers C₁ and C₂ completes a filter network to rectify the pulsed ac, with the result that a boost dc voltage is available. This boost voltage is super-imposed on the regular supply voltage. It is also

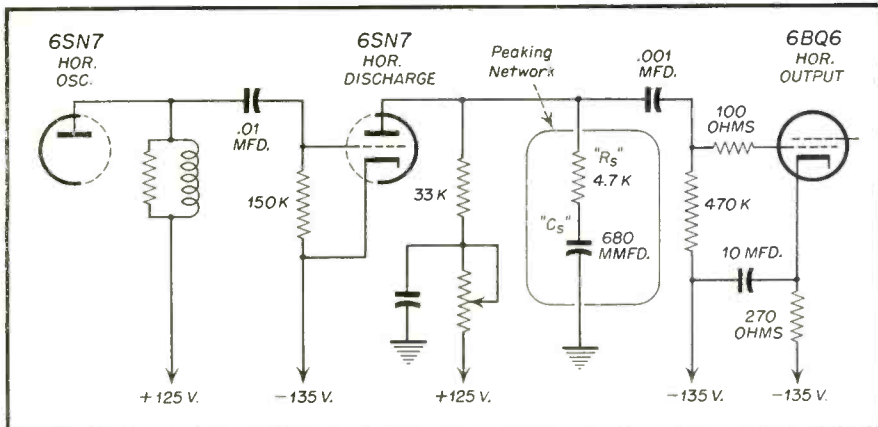

Fig. 3—Horizontal shaping using a tube.

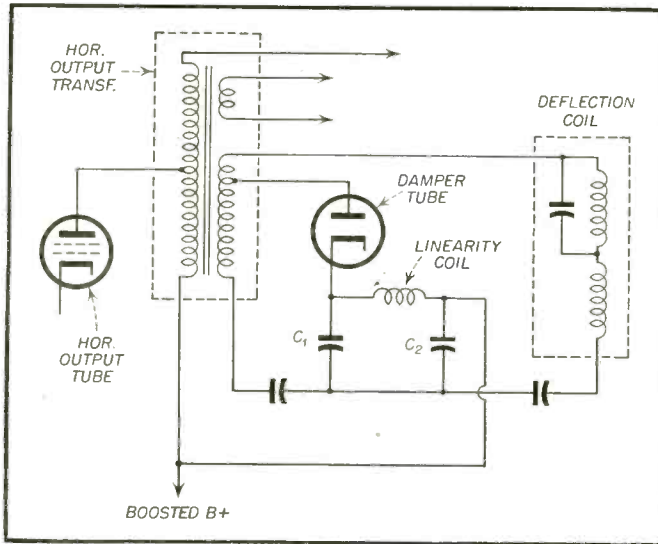

Fig. 6—Typical horizontal output circuit.

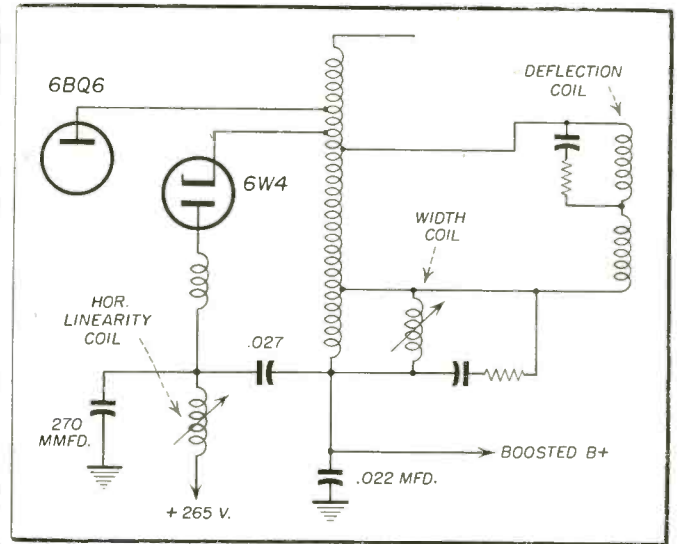

Fig. 7—Autotransformer horizontal output circuit.

often applied to the horizontal and vertical tubes to permit wider plate voltage swings.

Autotransformer and Direct Drive Systems

The autotransformer horizontal output system (Fig. 7) functions in the same manner that the conventional system does with this exception: Since there is not the phase reversal in voltage which is characteristic of conventional transformers, the wiring of the damper tube must be reversed. In the conventional transformer, the secondary is 180° out of phase with the primary. Because we want the diode to conduct whenever the positive pulse of the oscillations in the secondary bucks the positive going pulse in the primary, the damper is connected as shown in Fig. 6. In the autotransformer the voltage in the transformer and the yoke are in phase; therefore it is

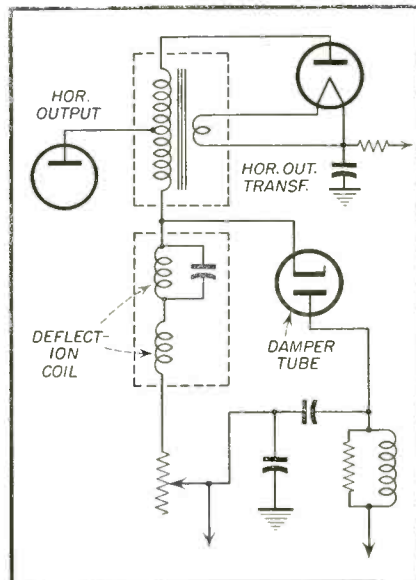

Fig. 8—Direct drive system.

necessary to cause diode conduction during the negative excursion of the oscillation. For this reason, the diode is connected so that the cathode is ordinarily more positive than the plate and it will conduct only when it is driven more negative than the plate. The only effect that this design variation has on the set is the fact that there is now a 1000-1500 volt pulse on the cathode. The cathode and filaments are tied together to prevent any possibility of a cathode to filament arc-over. If the damper filament is part of the power transformer, it must have a high dielectric insulation between it and the other windings. In many sets this problem is overcome by the use of a separate transformer for the damper filaments.

The direct drive system is similar to the autotransformer except that the yoke is in series with the output transformer. This system is not used very much (Fig. 8).

The width coil is used to increase or decrease the effective inductance transformer secondary, thereby, changing the amount of developed current and voltage. The condenser across half of the yoke winding is included to compensate for the distributed capacity of the lower half to ground. If this capacity is not balanced out the current waveform shows a slight "ringing" and this results in a ripple appearing on the left-hand side of the raster.

High Voltage

The high accelerating voltage for the second anode can be developed in several ways. The use of 60 cycles with a step-up transformer has for valid reasons fallen into disuse so a discussion of it would be academic. The two remaining systems in use are the rf high

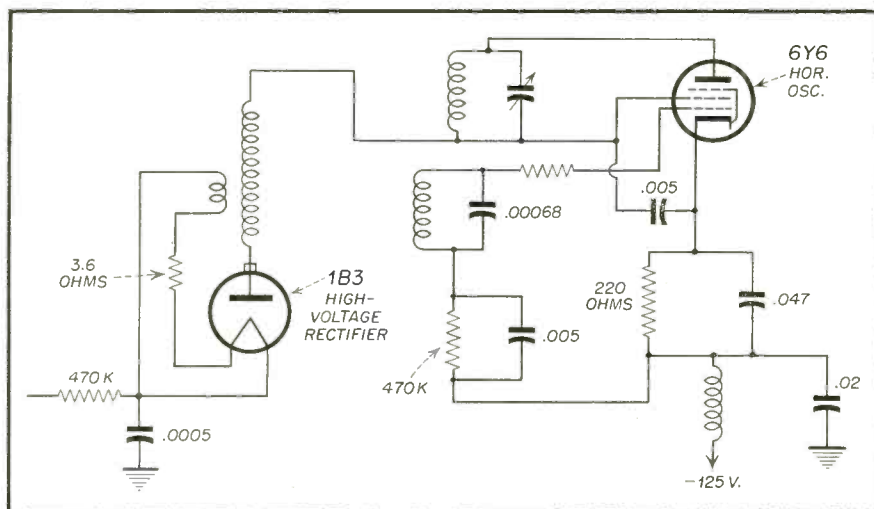
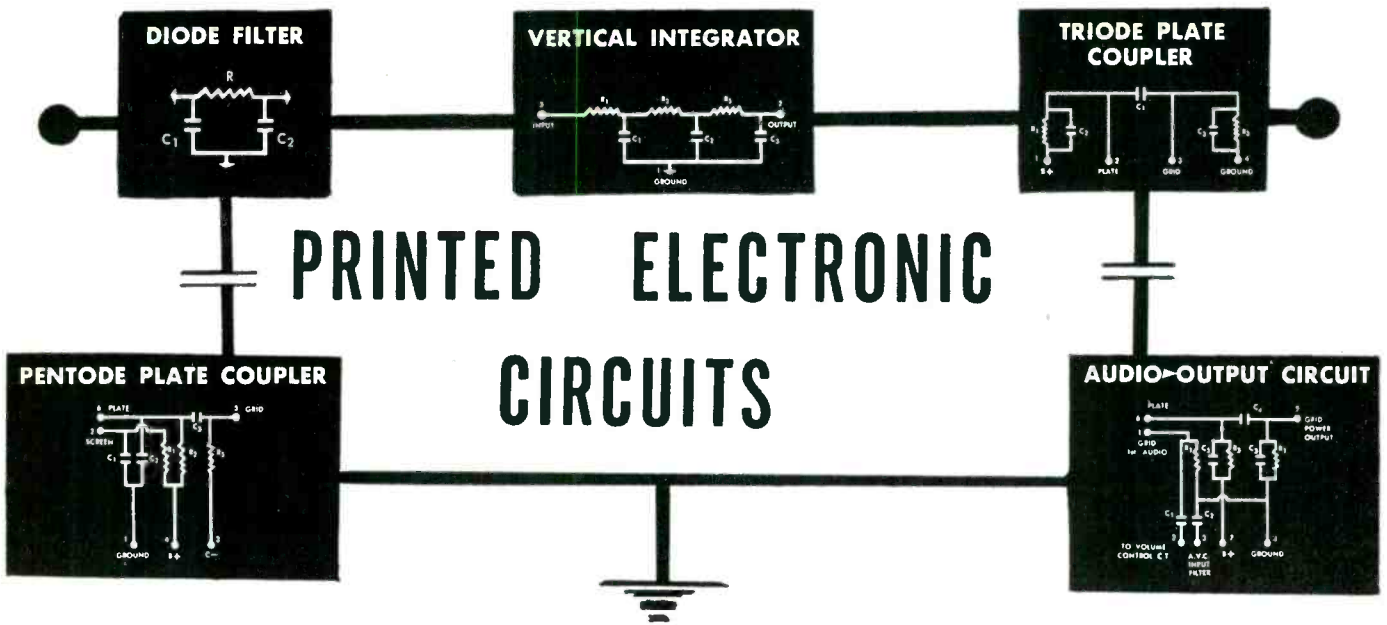

Fig. 9—R. F. high voltage system as used in Sylvania Model 1-186.

[Continued on page 67]



by **JESSE DINES**

PRI-N-T-E-D electronic circuits should strike a familiar note to many of you old-timers. Just think of how many of you have used, at one time or another, graphite pencils to doctor up a worn-out carbon resistance control. You were, in effect, making your own printed circuit. Today, the manufacture of printed circuits is a flourishing industry which has taken the electronic field by storm. Printed circuits are used in industrial and military equipment wherever it is found feasible. This is easy to understand inasmuch as they are compact, easy to install, cheaper in cost than

Presenting an informative article on the applications of printed circuits in radio and TV receivers. A chart is provided giving pertinent information on various types.

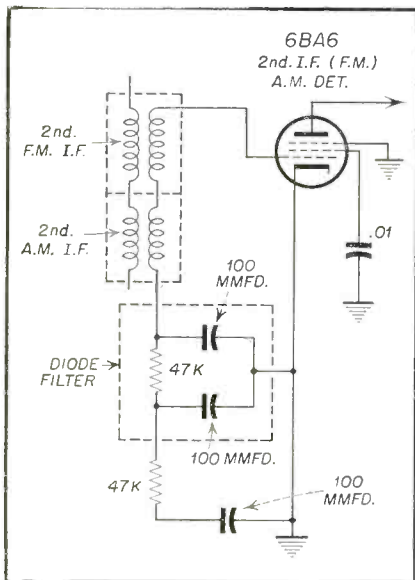

Fig. 3—A diode filter printed circuit is used in the Hallicrafter CR-322 Radio.

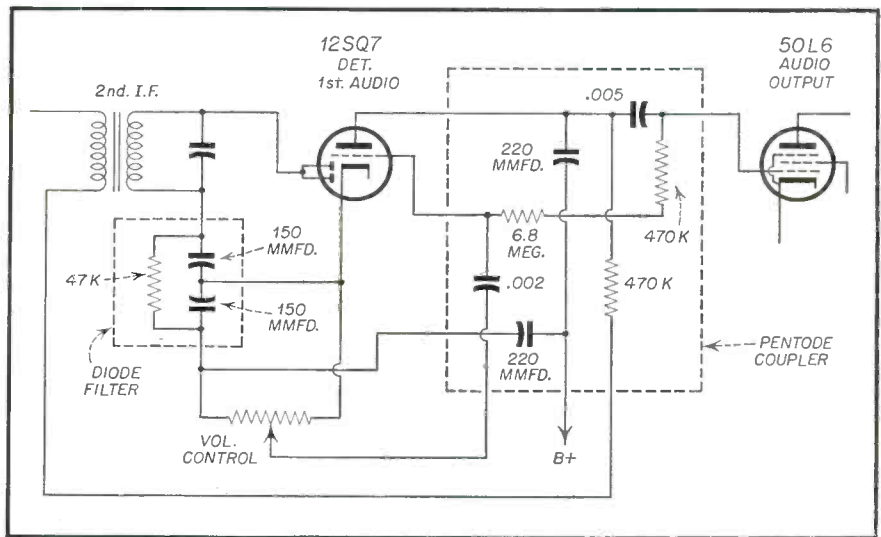

Fig. 1—A diode filter and pentode coupler are printed circuits in the Olympic Radio Model 489.

their associated parts, and, above all, they save valuable space.

The radio-television industry, although slow to start, is finally beginning to pave its own way in the printed circuit field. It was just about a year ago that printed circuits were used sporadically in radio and television circuitry. Today, a majority of the famous-make television sets em-

body at least one printed circuit while many radios, especially portables and clock-radios, utilize several of them. You can clearly see then that there is a definite trend toward the employment of as many printed circuits as possible.

Applications

Let us take a look at specific cases where printed circuits are used in

place of ordinary component parts. (Refer to Figures.) In the 100 Hallicrafter Television series, the vertical integrator, consisting of six component parts (three resistors and three capacitors) forms the printed circuit; other printed circuits show diode filters, triode and pentode couplers, as in the Olympic (Model 489), Arvin (Model 657-T) and Hallicrafters (Model CR-322) radios. Observe how a simple R-C coupling network is used in the Willys (Model 670777-Colonial Radio Corporation). These are, by no means, all the types employed. Point of information! H-attenuator pads, in the form of printed circuits, are now available to remedy overloading in strong-signal areas. They may be purchased by simply stating the amount of attenuation (db) that is needed.

The manufacture of printed circuits on a large scale has become increasingly evident; in fact, a considerable number of capacitor and resistor manufacturers are seriously contemplating entering the printed circuit manufacturing field because of the sizable demand that is beginning to unfold.

The serviceman, however, is beginning to experience difficulty in ordering printed circuits which must be replaced. The reason for this is two-fold: primarily, he finds that at present only a few parts manufacturers are making them available; secondly, he finds that their component values do not duplicate exactly what he wants. For example, even though four manufacturers make the vertical integrator for television, only one makes it with capacitor values of .002, .0047 and .0047 mf.

In order to facilitate the task of the serviceman when he orders a replacement printed circuit, the author has made available to him charts

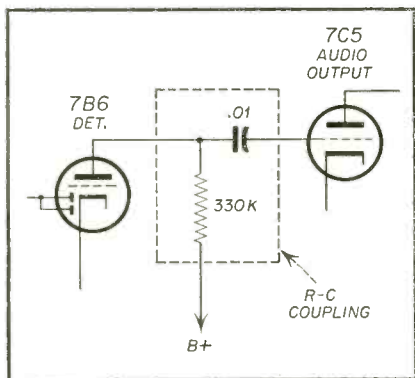

Fig. 4—The Willys Model 670777 (Colonial Radio Corp.) uses an R-C coupling printed circuit between the detector and audio output stages.

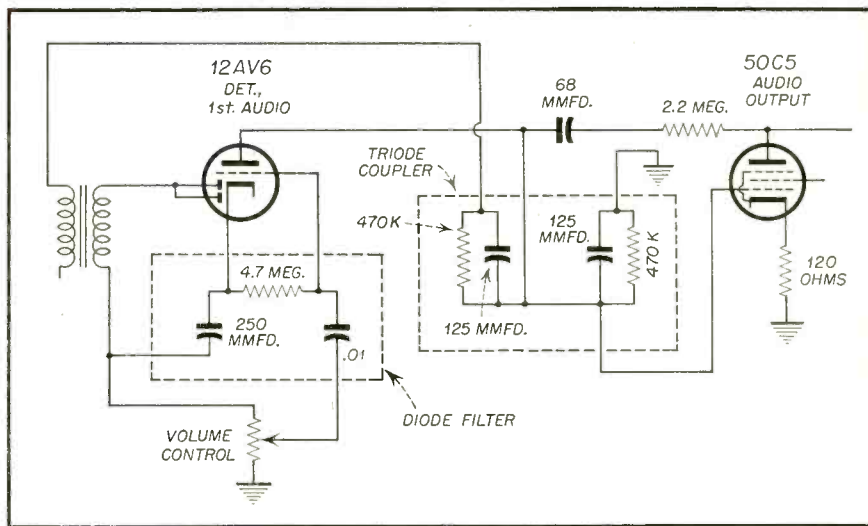

Fig. 2—The detector-1st audio and output stages of Arvin-Clock Radio Model 657-T showing a diode filter and triode coupler used as printed circuits.

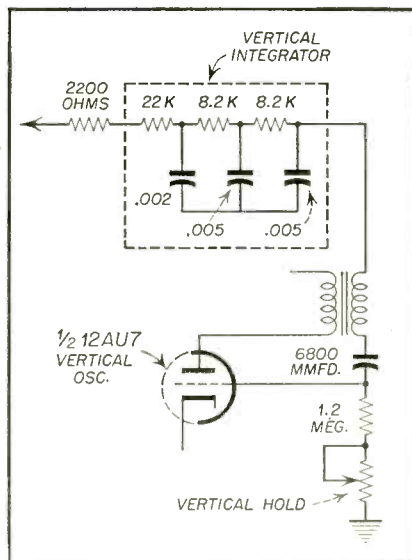

Fig. 5—In the Hallicrafter 1000 Series Television Sets, the vertical integrator is a printed circuit.

which disclose the following pertinent data regarding printed circuits:

1. The name of most of their manufacturers
2. The part numbers of their manufacturers
3. The networks of the most frequently-used ones
4. Their capacitance and resistance values
5. Their over-all dimensions

You might be interested to note that manufacturers rate the component values of printed circuits at approximately $\pm 20\%$ tolerance.

Incidentally, you will be pleased to know that a schematic is supplied with every purchase of a printed circuit. This, in turn, should avoid any con-

fusion which may arise as to where the terminal points of the printed circuit originate—a fact which must be ascertained in order to connect them properly in circuitry.

More and more, different types of printed networks are appearing on the market. This would lead us to believe that eventually all conventional circuitry will be replaced by printed circuits. If this is so, can you imagine what the television set of the future will be like, what with its small size, compactness and simplicity?

TECHNICAL ARTICLES WANTED

on

TV, AM RADIO, FM RADIO, PHONO MECHANISMS, HI-FI AUDIO, AUTO RADIO, TEST EQUIPMENT, ANTENNAS

pertaining to their

Theory, Installation, Application, Service & Maintenance

submit manuscripts to
Managing Editor

Radio-Television Service Dealer
67 West 44 Street New York 36, N. Y.

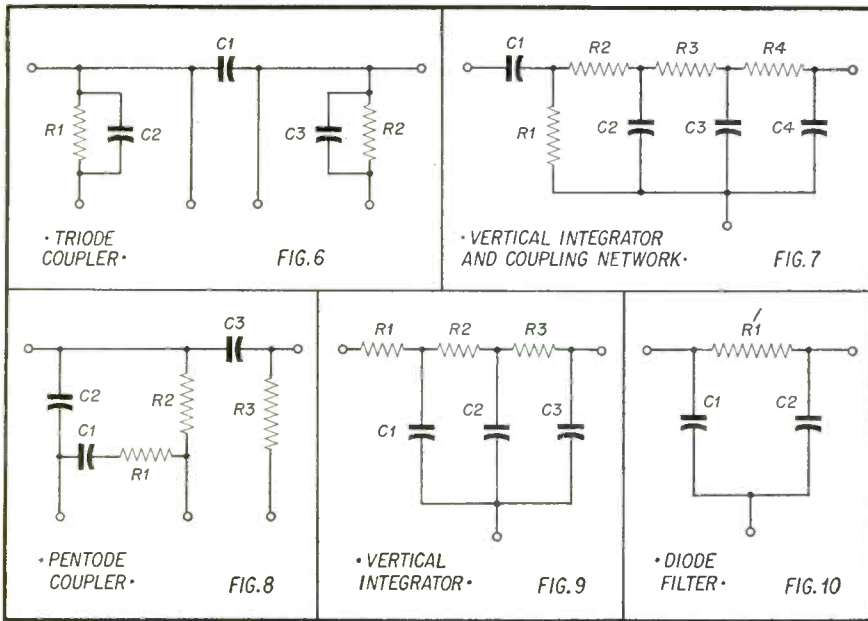

Charts below give circuit constants for various types of printed circuits shown in Figs. 6 to 10 shown above.

C1 (MMF)	C2 (MMF)	R1 (Ohms)	AEROVOX			CENTRALAB			ERIE			SPRAGUE		
			L*	TH*	Part No.	L	TH	Part No.	L	TH	Part No.	L	TH	Part No.
50	50	47K	-	-	-	-	-	-	37/64	11/64	1403-3	9/16	5/32	100C3
100	100	47K	3/4	5/32	DF-104	17/32	7/64	PC-50	37/64	11/64	1403-1	9/16	5/32	100C1
150	150	47K	-	-	-	17/32	7/64	PC-51	37/64	11/64	1403-2	9/16	5/32	100C2

*Notes: L-Length in inches
TH- Thickness in inches

Manufacturers' data on triode coupler printed circuits.

R1	R2	R3	R4	uf. C1	uf. C2	uf. C3	uf. C4	AEROVOX			CENTRALAB		
								L	TH	Part No.	L	TH	Part No.
22K	22K	8.2K	8.2K	.01	.002	.005	.005	1-1/16	5/32	PA-111	1-3/32	1/8	PC-101

Manufacturers' data corresponding to Fig. 7 above.

R1	R2	R3	C1 uf.	C2 uf.	C3 uf.	AEROVOX			CENTRALAB			ERIE			SPRAGUE		
						L	TH	Part No.	L	TH	Part No.	L	TH	Part No.	L	TH	Part No.
4.7M	1M	2.2M	.005	50	.002	1-1/16	5/32	PA-116	1-17/64	.045	PC-90	1-11/32	11/64	1407-1	1-3/8	5/32	103C2A
4.7M	1M	2.2M	.005	100	.002	-	-	-	-	-	-	1-11/32	11/64	1407-2	-	-	-
4.7M	1M	2.2M	.005	100	.005	-	-	-	1-17/64	-	PC-90	1-11/32	11/64	1407-3	1-3/8	5/32	103C3A
4.7M	1M	2.2M	.0047	47	.0022	-	-	-	-	-	-	-	-	-	1-3/8	5/32	103C2
4.7M	1M	2.2M	.0047	100	.0047	-	-	-	-	-	-	-	-	-	1-3/8	5/32	103C3

Manufacturers' data on pentode coupler printed circuits.

R1	R2	R3	C1 uf.	C2 uf.	C3 uf.	AEROVOX			CENTRALAB			ERIE			SPRAGUE		
						L	TH	Part No.	L	TH	Part No.	L	TH	Part No.	L	TH	Part No.
22K	8.2K	8.2K	.002	.005	.005	1-1/16	5/32	PA-110	1-3/32	1/8	PC-100	1-5/64	11/64	1405-1	1-1/8	5/32	101C1AB
22K	8.2K	8.2K	.002	.0047	.0047	-	-	-	-	-	-	-	-	-	1-1/8	5/32	101C1

Manufacturers' data on vertical integrator circuits.

R1	R2	C1 uf.	C2/C3 uf.	AEROVOX			CENTRALAB			ERIE			SPRAGUE		
				L	TH	Part No.	L	TH	Part No.	L	TH	Part No.	L	TH	Part No.
250K	500K	.005	250	3/4	5/32	PA-112-2	13/16	5/32	PC-71	15/16	11/64	1406-02	25/32	5/32	104-C5
250K	500K	.01	250	-	-	-	3/132	7/64	PC-81	5/164	11/64	1404-02	1/8	5/32	102-C2
500K	500K	.005	250	3/4	5/32	PA-112-1	13/16	5/32	PC-70	15/16	11/64	1406-01	25/32	5/32	104-C4
500K	500K	.01	250	3/4	5/32	PA-112-3	3/132	7/64	PC-80	5/164	11/64	1404-01	1/18	5/32	102-C1

Manufacturers' data on diode filter printed circuits.

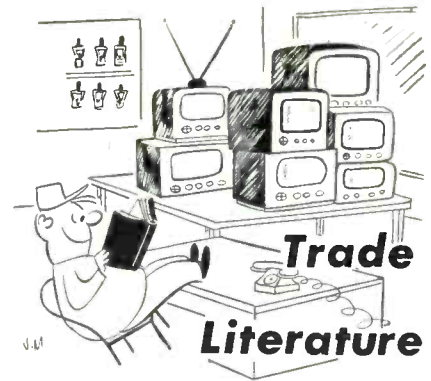

The familiar green "Sylvania Television Picture Tube and General Purpose Cathode Ray Tube" characteristic chart has been revised to include the latest modifications, type changes, etc., making the total types listed in the booklet to over 250. Sylvania has included tubes manufactured by other companies so as to make the chart as useful as possible to everyone interested in cathode ray tubes.

The revised "Sylvania Radio and Television Receiving Tubes" booklet this year includes, in addition to previously listed types, the very latest television receiver and Sylvania sub-miniature tubes. Over 750 different receiving tube types are listed in the chart—along with their basing diagrams.

The two booklets can be obtained free through Sylvania distributors or from Sylvania Advertising Distribution Department, 1100 Main Street, Buffalo, N. Y.

* * *

More compact and efficient radios, TV receivers, and communications equipment were envisioned with the RCA announcement recently of printed-circuit electronic inductors, mass-produced for general use. In such components, printed circuitry replaces conventional wire windings with uniformly made printed coils, according to the Tube Department of the RCA Victor Division, Radio Corporation of America.

These revolutionary components—six 40-megacycle *if* transformers, coils, and traps—are produced by a special photo-etching process which makes possible virtually limitless production of identical electronic circuits from a single photographic negative, according to L. S. Thees, general sales manager of the RCA Tube Department.

* * *

Bulletin GD-1 on Germanium Diodes describes fully the characteristics and

[Continued on page 64]

NOTICE TO PURCHASERS OF VSSS BOOK!

It was discovered, after the first 1,800 copies of the VSSS book was run, that the Index was printed improperly, so that the punched holes perforated some of the printed information. If you have received such a copy, you may receive a new index merely by writing to us and requesting same.

VIDEO SPEED SERVICING SYSTEMS

9th INSTALLMENT

INDEX FOR APRIL, MAY and JUNE ISSUES

<i>Mfr.</i>	<i>Chassis No.</i>	<i>Section Affected</i>	<i>Month</i>	<i>Page</i>	<i>Card No.</i>
Arvin	TE 337	Sync	June	39	AR-337-1
Arvin	TE 337	Sync	June	39	AR-337-2
Arvin	TE 337	Sync	June	39	AR-337-3
Arvin	TE 337	Pix	June	40	AR-337-4
Arvin	TE 337	Pix	June	40	AR-337-5
Arvin	TE 337	Pix	June	40	AR-337-6
Crosley	265	Sync	May	45	CR265-7
Crosley	265	Pix	May	45	CR265-8
Crosley	265	Pix	May	45	CR265-9
Crosley	265	Sound	May	46	CR265-10
Crosley	265	Pix	May	46	CR265-11
Crosley	265	Pix	May	46	CR265-12
Motorola	TS 292	Pix	June	41	MO292-1
Motorola	TS 292	Pix	June	41	MO292-2
Motorola	TS 292	Pix	June	41	MO292-3
Motorola	TS 292	Pix	June	42	MO292-4
Motorola	TS 292	Pix	June	42	MO292-5
Motorola	TS 292	Pix	June	42	MO292-6
Silvertone	51-478.339	Raster	May	47	SI478-1
Silvertone	51-478.339	Pix	May	47	SI478-2
Silvertone	51-478.339	Sync	May	47	SI478-3
Silvertone	51-478.339	Sync	May	48	SI478-4
Silvertone	51-478.339	Sync	May	48	SI478-5
Silvertone	51-478.339	Raster	May	48	SI478-6
Stewart-Warner	9300	Pix	June	43	SW9300-1
Stewart-Warner	9300	Pix	June	43	SW9300-2
Stewart-Warner	9300	Pix	June	43	SW9300-3
Stewart-Warner	9300	Pix	June	44	SW9300-4
Stewart-Warner	9300	Sound	June	44	SW9300-5
Stewart-Warner	9300	Sound	June	44	SW9300-6
Stromberg-Carlson	317 Series	Pix	May	49	SC317-1
Stromberg-Carlson	317 Series	Pix	May	49	SC317-2
Stromberg-Carlson	317 Series	Sync	May	49	SC317-3
Stromberg-Carlson	317 Series	Pix	May	50	SC317-4
Stromberg-Carlson	317 Series	Raster	May	50	SC317-5
Stromberg-Carlson	317 Series	Pix	May	50	SC317-6
Sylvania	1-139	Pix	May	51	SY139-13
Sylvania	1-139	Pix	May	51	SY139-14
Sylvania	1-139	Pix	May	51	SY139-15
Sylvania	1-139	Pix	May	52	SY139-16
Sylvania	1-139	Pix	May	52	SY139-17
Sylvania	1-139	Pix	May	52	SY139-18
Truetone	2D1235B	Raster	June	45	TU1235-1
Truetone	2D1235B	Pix	June	45	TU1235-2
Truetone	2D1235B	Pix	June	45	TU1235-3
Truetone	2D1235B	Pix	June	46	TU1235-4
Truetone	2D1235B	Pix	June	46	TU1235-5
Truetone	2D1235B	Pix	June	46	TU1235-6

Mfr. Arvin Chassis No. TE337

Card No. AR-337-1

Section Affected: Sync

Symptom: Unstable sync.

Reason For Change: Improve sync.

(This change was included in chassis No. TE337-1)

What To Do:

Change: R166 (270K) to 150K-10% (Fig. A).
Also, R167 (4.7 meg) to 2.2 meg (Fig. A).
Also, R203 (220K) to 100K (Fig. B).

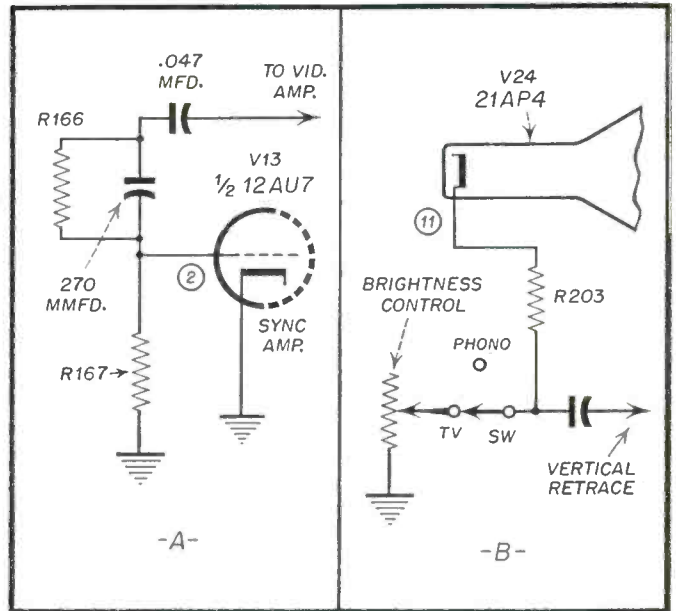

Mfr. Arvin Chassis No. TE337

Card No. AR-337-2

Section Affected: Sync

Symptom: Unstable sync.

Cause: Video modulation.

(This change was started in chassis No. TE337-1)

What To Do:

Remove: R202 (1K-10%-2W).
Connect: R202 from junction of Pin #6 of V-12, Also, R161 (4.7K) to 218VDC line. Also, C10 (5 μ f-250V) from junction of Pin #6 of V12, R161 to ground.

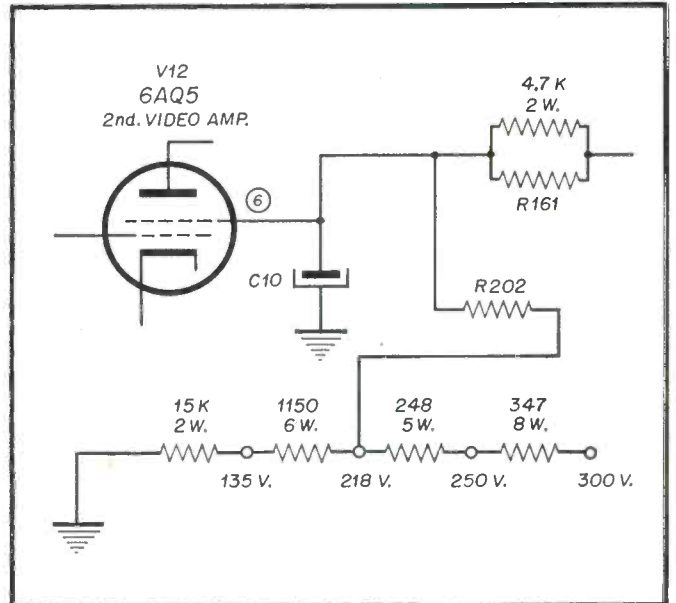

Mfr. Arvin Chassis No. TE337

Card No. AR-337-3

Section Affected: Sync

Symptom: Inadequate horizontal hold control range.

Reason For Change: Circuit improvement.

What To Do:

Change: R220 (91K) to 100K.
Also, R221 (30K) to 50K.

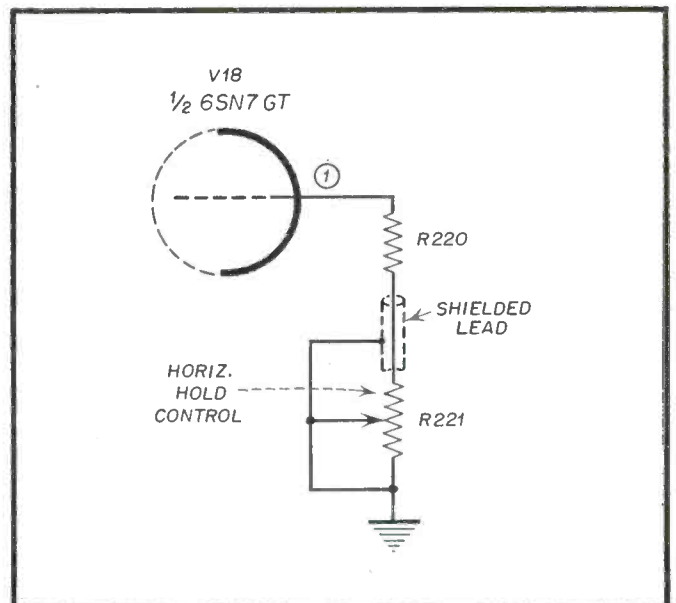

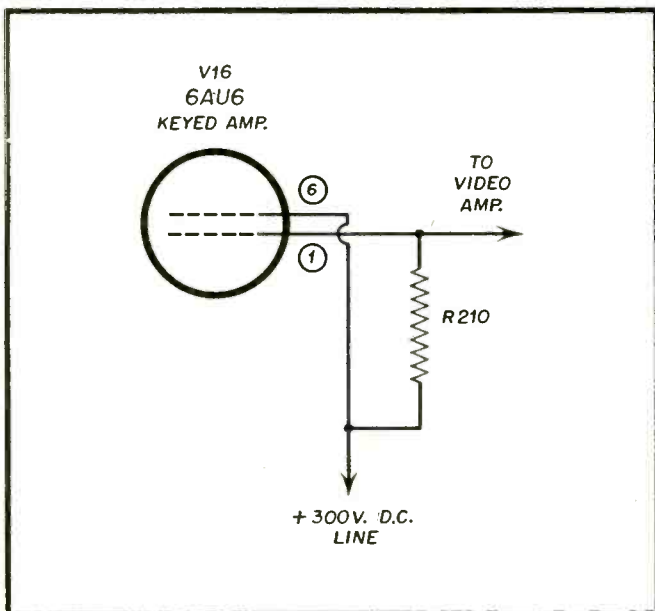

Mfr. Arvin Chassis No. TE337

Card No. AR-337-4

Section Affected: Pix

Symptom: Too much snow.

Reason For Change: Circuit improvement

What To Do:

Change: R210 (470K) to 220K.

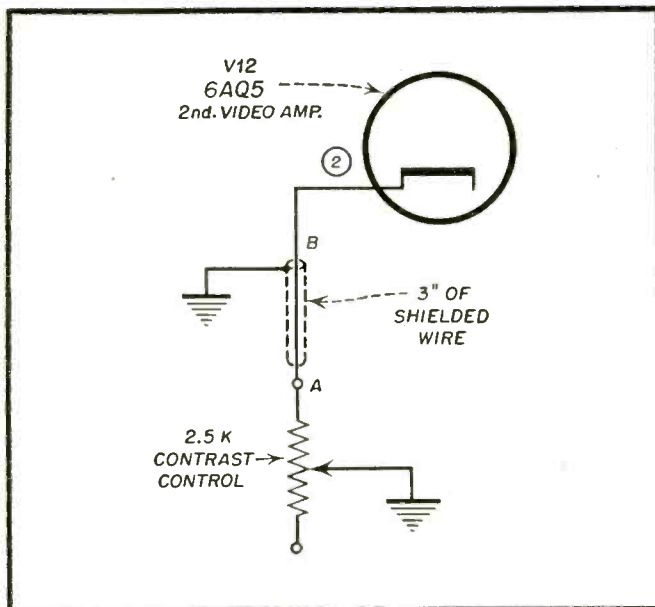

Mfr. Arvin Chassis No. TE337

Card No. AR-337-5

Section Affected: Pix

Symptom: Washed out pix in weak signal area.

Cause: Too much capacitance in cathode of 2nd video amplifier (shielded lead from cathode to contrast control).

What To Do:

Reduce: Length of shielded portion of lead between pin #2 of V12 and contrast control. Use about 3" of shielded lead at contrast control end of wire, grounding shield at "B" end of shield as shown. Purpose of shield is to isolate video from surrounding audio circuits.

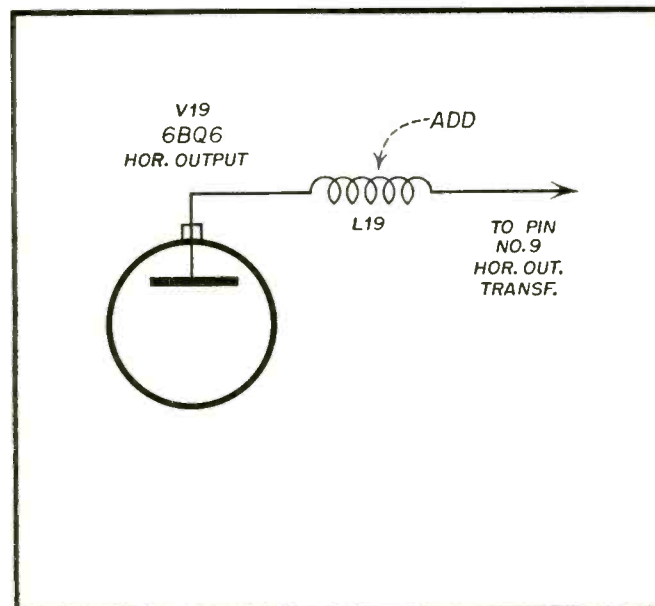

Mfr. Arvin Chassis No. TE337

Card No. AR-337-6

Section Affected: Pix

Symptom: Barkhausen oscillation (white vertical lines in pix).

Reason For Change: Reduce Barkhausen oscillation.

What To Do:

Add: L118 (93 μ h) in plate circuit of 6BQ6.

Mfr. Motorola Chassis No. TS292

Card No. MO292-1

Section Affected: Pix

Symptom: Bars at side of pix.

Cause: Horizontal output oscillation.

What To Do:

Add: 470 ohm resistor in screen of V15.

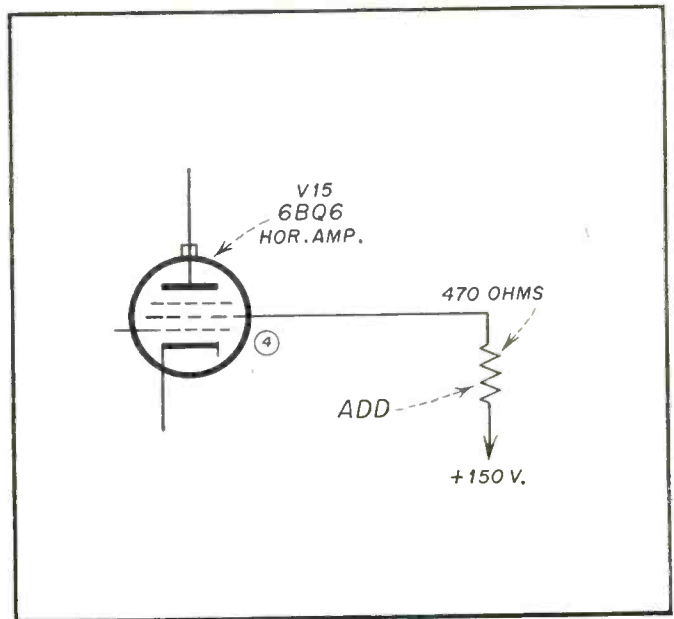

Mfr. Motorola Chassis No. TS292

Card No. MO292-2

Section Affected: Pix

Symptom: Horizontal foldover.

Cause: Horizontal overdrive.

What To Do:

Change: R82 (4.7K) to 6.8K.

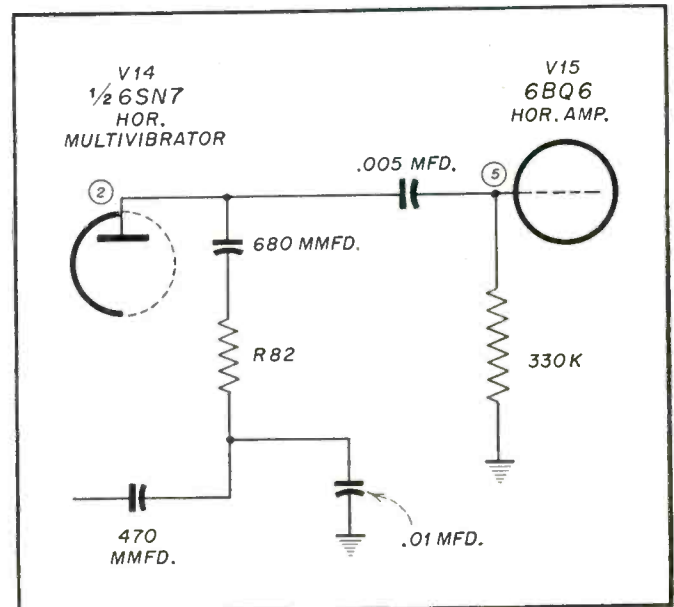

Mfr. Motorola Chassis No. TS292

Card No. MO292-3

Section Affected: Pix

Symptom: Inadequate video response.

Reason For Change: Circuit improvement.

What To Do:

Interchange L17 to L16.

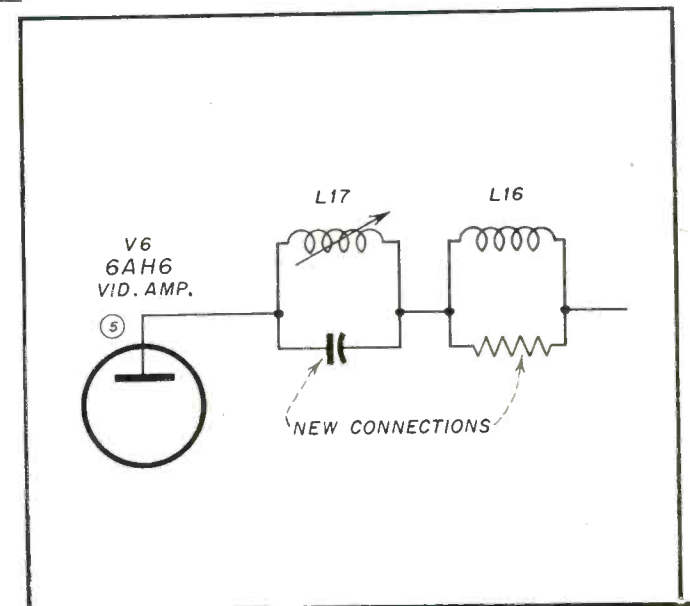

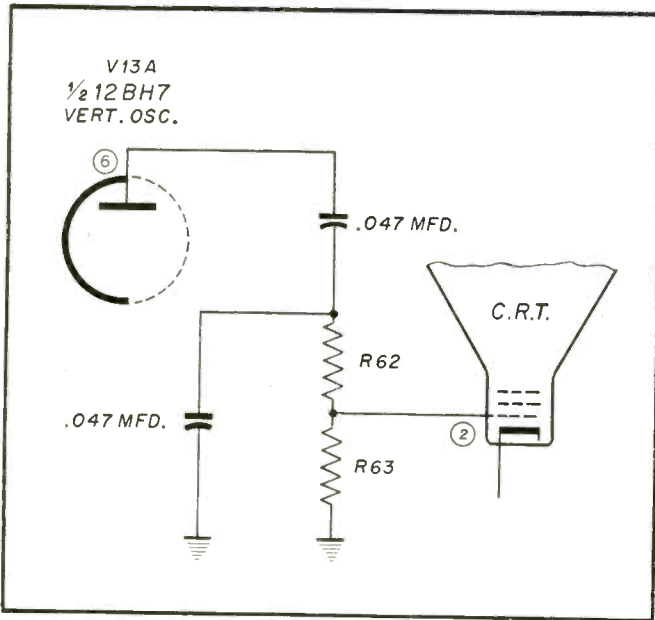

Mfr. Motorola Chassis No. TS292

Card No. MO292-4

Section Affected: Pix

Symptom: Retrace lines in pix.

Cause: Inadequate blanking pulse.

What To Do:

Change: R62 (3.3K) to 1.8K.
Also, R63 (1.8K) to 3.3K.

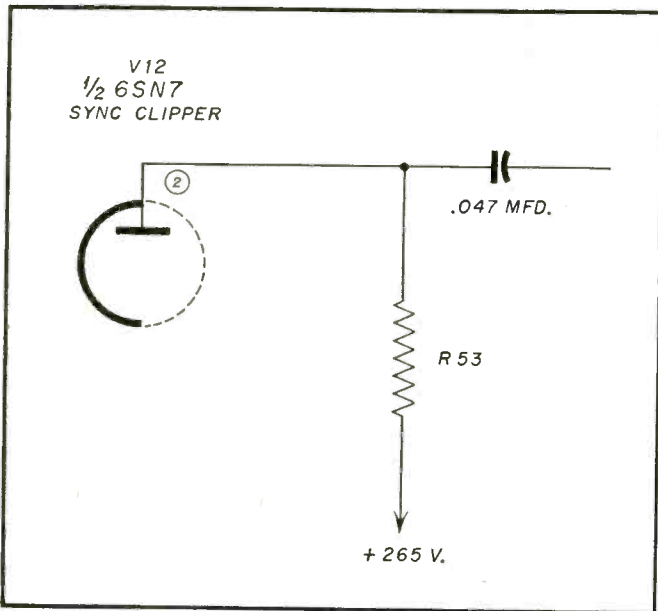

Mfr. Motorola Chassis No. TS292

Card No. MO292-5

Section Affected: Pix

Symptom: Inadequate interlace.

Reason For Change: Circuit improvement.

What To Do:

Change: R53 (680K) to 1 meg.

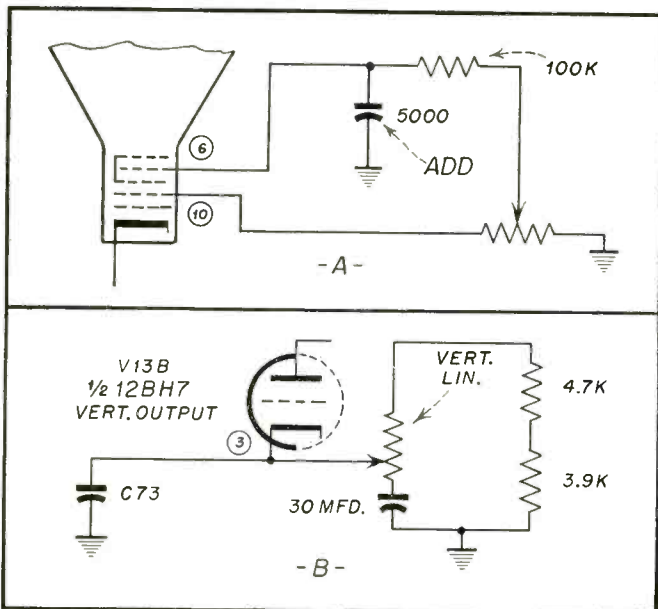

Mfr. Motorola Chassis No. TS292

Card No. MO292-6

Section Affected: Pix

Symptom: Arcover in CRT and/or vertical output.

Cause or reason: Circuit improvement.

What To Do:

Add: 500 μ f-200V condenser from Pin #6 CRT lead to ground (Fig. A).

Change: C73 (5000 μ f) to 5000 μ f-2000V (Fig. B).

Mfr. Stewart-Warner Chassis No. 9300

Card No. SW9300-1

Section Affected: Pix

Symptom: Pix goes out of horizontal sync when changing station.

Reason For Change: Circuit improvement.

What To Do:

Add: 5000 μ f condenser between R44 (47K) and R97 (820K).

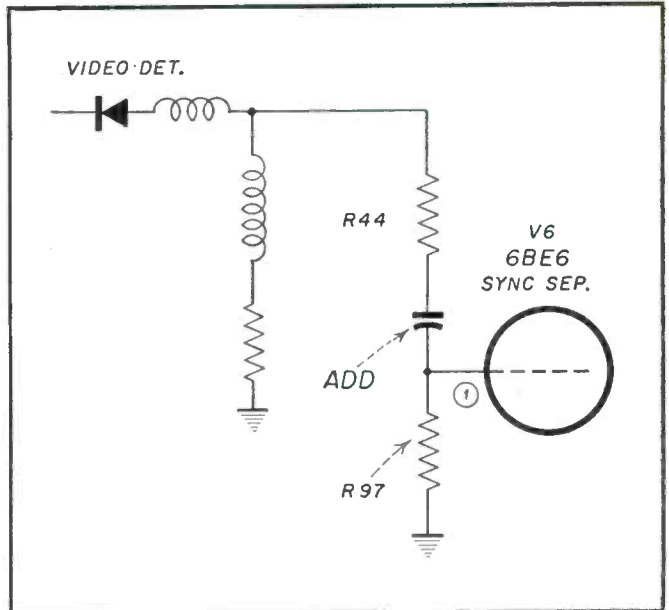

Mfr. Stewart-Warner Chassis No. 9300

Card No. SW9300-2

Section Affected: Pix

Symptom: Horizontal instability in strong signal areas.

Reason For Change: Circuit improvement.

What To Do:

Change: R124 (100K) to 120K (Fig. A). Also, R97 (1.2 meg) to 820K (Fig. B).

Reconnect: C107 (100 μ f) from junction R105 and R106 to plate of V7A (Fig. C).

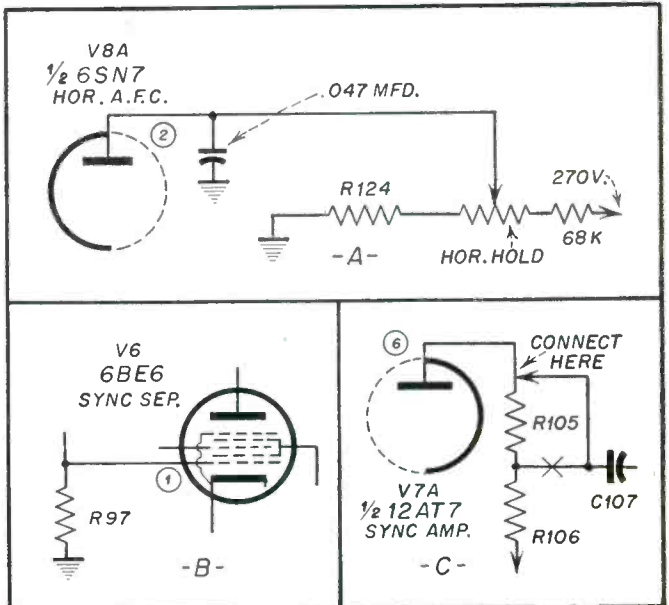

Mfr. Stewart-Warner Chassis No. 9300

Card No. SW9300-3

Section Affected: Pix

Symptom: Pix "hooking."

Cause or Reason For Change: Video in sync.

What To Do:

Change: R100 (330K) to 220K. Also, R102 (12K or 6.8K in some models) to 18K.

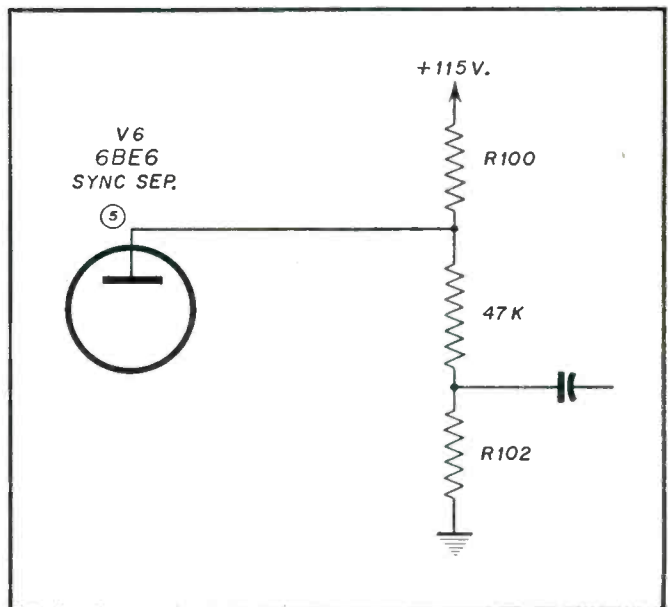

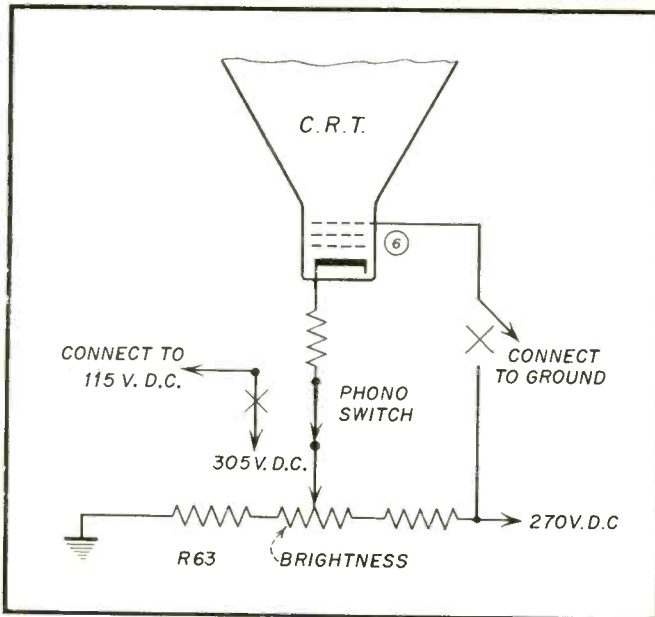

Mfr. Stewart-Warner Chassis No. 9300

Card No. SW9300-4

Section Affected: Pix

Symptom: Inadequate focus at high brightness.

Reason For Change: Circuit improvement.

What To Do:

Change: R63 (15K) to 22K.

Reconnect: Phono switch from 305 VDC to 115 VDC.
Also, Pin #6 CRT from 270 VDC to ground.

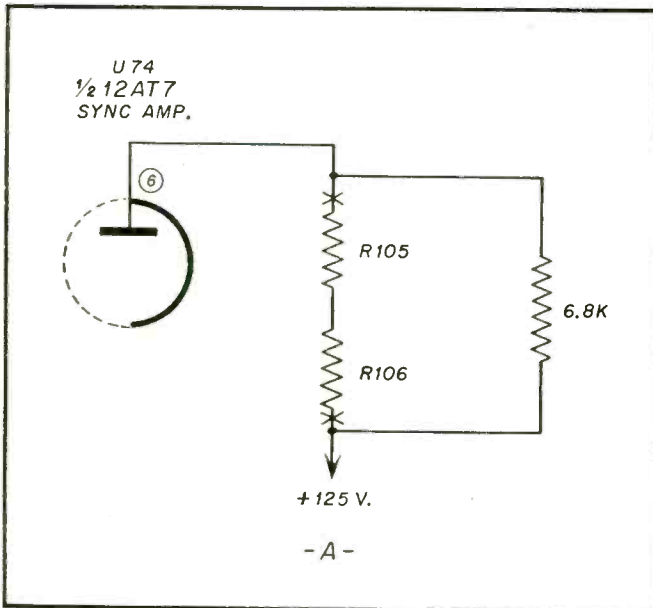

Mfr. Stewart-Warner Chassis No. 9300

Card No. SW9300-5

Section Affected: Sound

Symptom: Hum and buzz in sound.

Reason For Change: Improved circuit operation.

What To Do:

Remove: R105 (3.3K) and R106 (3.3K) (Fig. A).

Add: 6.8K in place of R105 and R106 (Fig. A).
Also, 1.5K and 15K in series as shown.
Also, 4 μ f at junction of 270 VDC and 15K (Fig. B).

Reconnect: C85C from plus 270 VDC to junction of 1.5K and 15K (Fig. B).
Also, Pin #6 of V5 from plus 270 VDC to plus 260 VDC.

(Continued on Card No. SW9300-6)

(from Card No. SW9300-5)

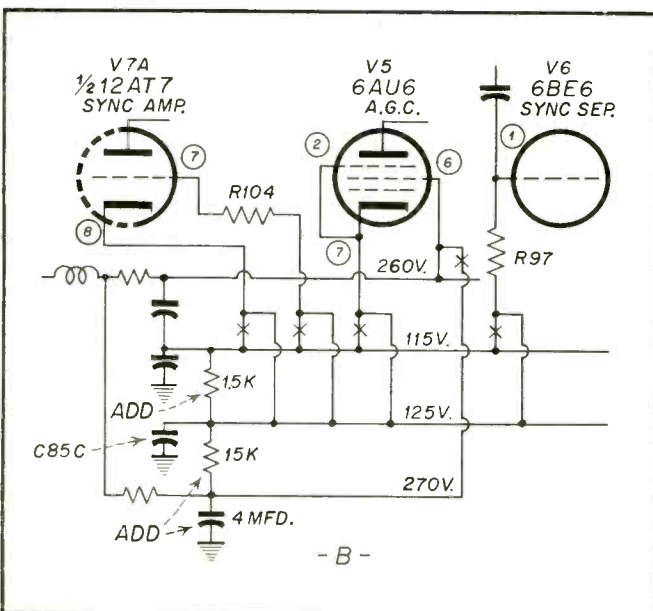

Mfr. Stewart-Warner Chassis No. 9300

Card No. SW9300-6

Section Affected: Sound

Symptom: Hum and buzz in sound.

Reason For Change: Improve circuit operation.

What To Do:

Reconnect: Pin #8 of V7A from plus 115 VDC to plus 125 VDC.
Also, Pins #2 and #7 of V5 from plus 115 VDC to plus 125 VDC.
Also, R97 (820K) from plus 115 VDC to plus 125 VDC.
Also, R104 (1 meg) from plus 115 VDC to plus 125 VDC.

Mfr. Truetone Model No. 2D1235B

Card No. TU1235-1

Section Affected: Raster

Symptom: No raster.

Cause: Defective circuit components.

What To Do:

Check: R99 (1 meg),
Also, C78 (500 μ f-20KV).
Also, T9 (horizontal output transformer).

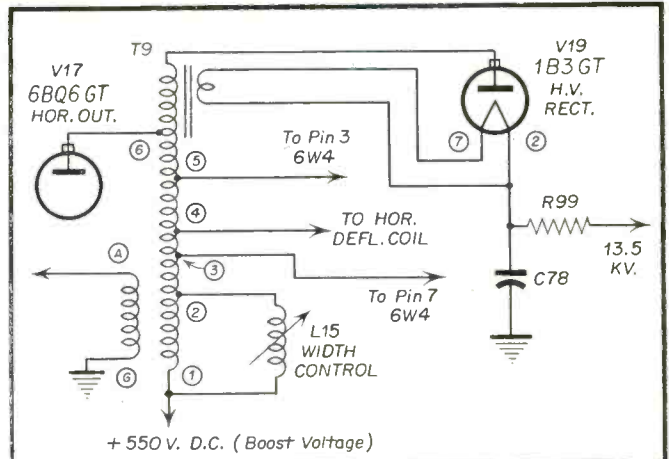

T9 RESISTANCE CHART (APP. OHMS)

TERM.	VALUE	TERM.	VALUE
A - G	10.0	1 - 5	35.0
1 - 2	0.5	1 - 6	55.0
1 - 3	2.0	1 (Top cap 1B3)	310.0
1 - 4	10.0		

Mfr. Truetone Model No. 2D1235B

Card No. TU1235-2

Section Affected: Pix

Symptom: Poor vertical linearity.

Cause: Defective circuit component.

What To Do:

Check: R49 (8K), R54 (2.5 meg), R55 (2.2 meg), R56 (10K).
Also, C35A (100 μ f-50V), C39 (.01 μ i), C70 (30 μ f-400V).
Also, C37 (.047 μ f) for leakage.

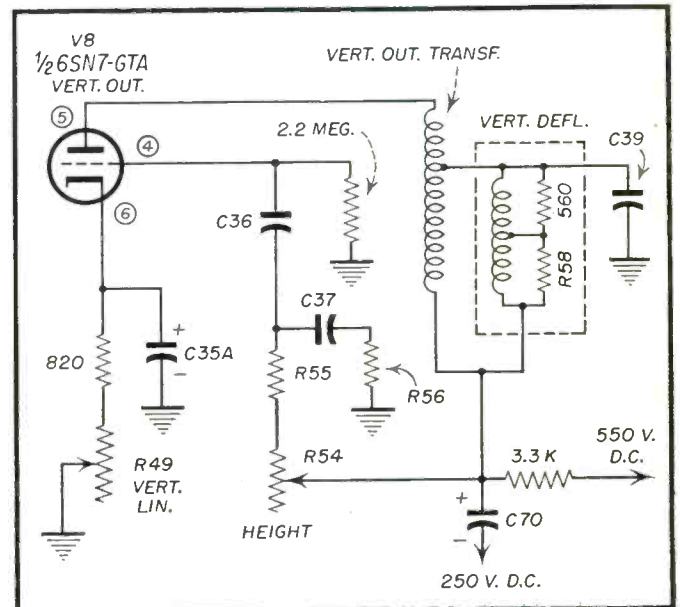

Mfr. Truetone Model No. 2D1235B

Card No. TU1235-3

Section Affected: Pix

Symptom: Poor horizontal linearity.

Cause: Defective circuit component.

What To Do:

Check: C14 (.1 μ f), C76 (.15 μ f), C77 (.15 μ f).
Also, L16 (horizontal linearity coil).
Also, L17 (horizontal deflection coil).

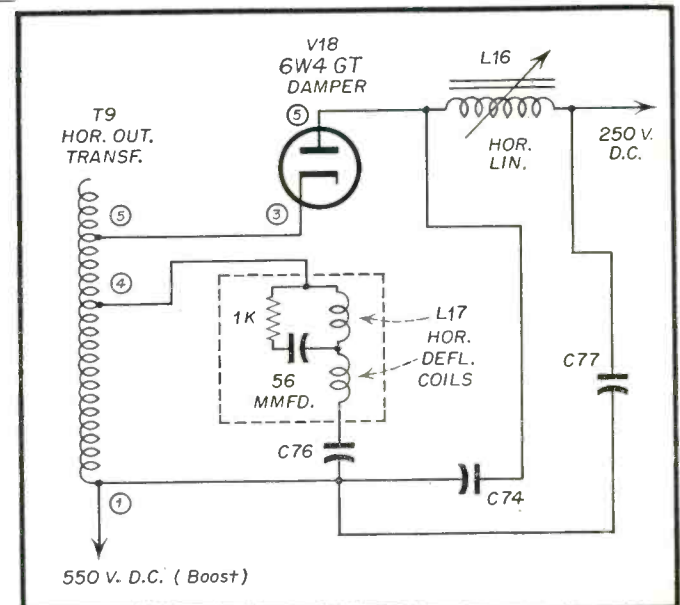

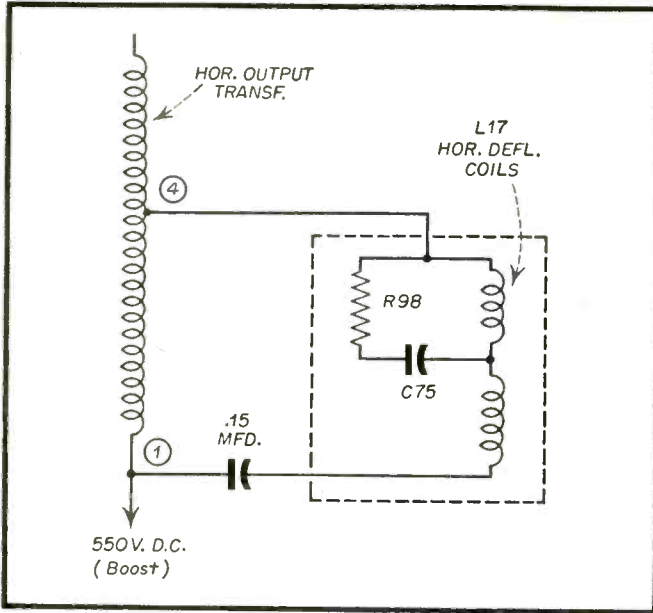

Mfr. Truetone Model No. 2D1235B

Card No. TU1235-4

Section Affected: Pix

Symptom: Wrinkles on left side of raster.

Cause: Defective circuit components.

What To Do:

Check: C-75 (56 μf) internal in yoke assembly.
Also, R-98 (1K).

Replace: V-18 (6W4-GT).

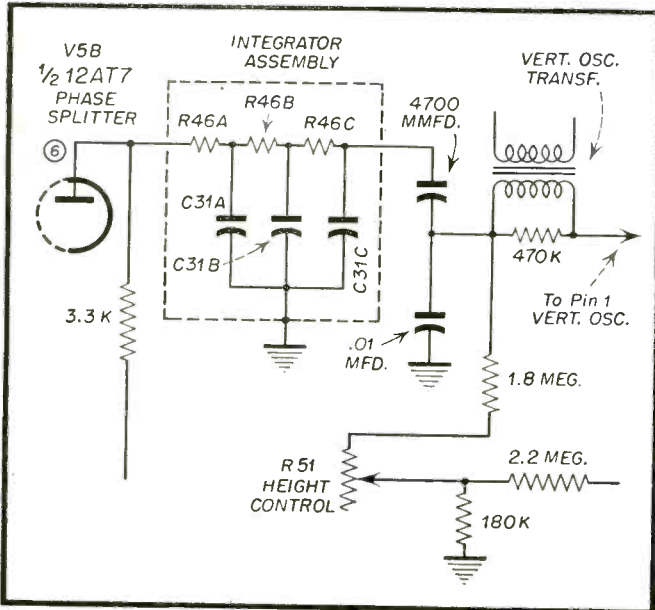

Mfr. Truetone Model No. 2D1235B

Card No. TU1235-5

Section Affected: Pix

Symptom: No vertical sync.

Cause: Defective circuit component.

What To Do:

Check: C31A (.002 μf), C31B (.005 μf), C31C (.005 μf).
Also, R46A (22K), R46B (8.2K),
Also, R46C (8.2K), R51 (1 meg).

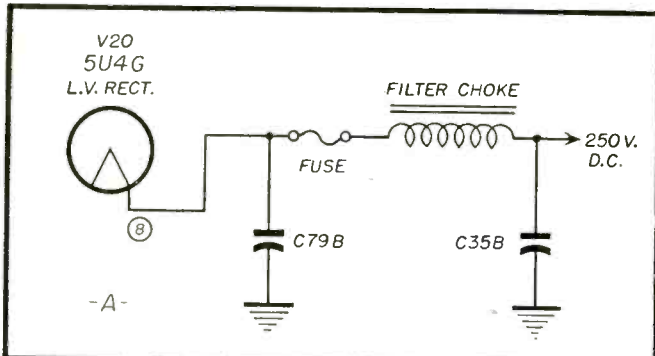

Mfr. Truetone Model No. 2D1235B

Card No. 1235-6

Section Affected: Pix

Symptom: Pix bends in "S" shape pattern.

Cause: Defective circuit components.

What To Do:

Check: C35B (80 μf -300V), C79B (80 μf -300V). Fig. A
Also, sync stability control adjustment on strong station signal (Fig. B).

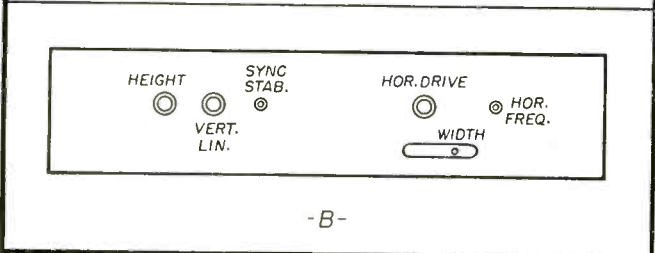

NEW TUBES

CBS-Hytron Type 6216 Filter Reactor Tube

The CBS-Hytron type 6216 is an electron tube of beam power design and has miniature 9-pin construction. When used in appropriate circuits, it replaces the iron-core filter choke, particularly in airborne and vehicular electronic equipments, thus materially reducing the weight and space normally required by the iron-core choke. It is equivalent in performance to a 12-henry filter choke of 100 ma and 350 ohm ratings.

Typical Operation — Class A Audio Amplifier

Plate voltage	200	volts
Grid #2 (screen) voltage	100	volts
Grid #1 (control grid) voltage	-6	volts
Peak AF Grid #1 voltage	6	volts
Zero signal plate current	47	ma
Max. signal plate current	51	ma
Zero signal Grid #2 current	2.0	ma
Max. signal Grid #2	4.0	ma
Plate resistance	38,800	ohms
Transconductance	8,800	umhos
Load resistance	4,500	ohms
Total harmonic	10%	
Max. signal power output	3.8	watts

Average Characteristics — Filter Reactor

Heater voltage	6.3	volts
Heater current	1.2	ampere
Plate voltage	100	volts
Grid #2 voltage	100	volts
Grid #1 voltage	-3	volts
Grid #1 resistor	1	megohm
Plate resistance (approx.)	18,500	ohms
Transconductance	12,800	umhos
Plate current	72	ma
Grid #2 current	3	ma
Grid #1 voltage (approx.) for Ib=50 ua	-25	volts

Typical Operation — Filter Reactor (See Circuit)

Heater		
Voltage ac-dc	6.3	volts
Current	1.2	amps
D.C. Plate supply voltage (input to filter)	400	volts
D.C. Plate voltage (plate to cathode)	60	volts
D.C. Grid #2 voltage	100	volts
D.C. Grid #1 voltage	-1	volts
D.C. Output voltage (output from filter)	335	volts
D.C. Cathode current (load current)	100	ma d-c
RMS Ripple voltage (in output) (Nt=1)	210	millivolts

Type 6216 characteristics.

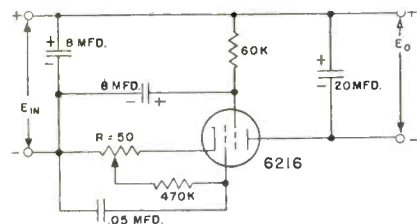

Typical applications diagram of filter reactor tube.

Terminal Connections

Pin connections

- Pin 1: Plate
- Pin 2: Grid No. 1
- Pin 3: Cathode
- Pin 4: Heater



- Pin 5: Heater
- Pin 6: Plate
- Pin 7: Grid No. 2
- Pin 8: Cathode
- Pin 9: No connection

Base connections.

The mechanical design of the 6216 is such that it can withstand shocks up to 700 g. It is also extremely resistant to the vibrations encountered in present high-speed military aircraft.

Its electrical design is such that it has an extremely low tube drop and very high plate resistance. For this reason, it outperforms such tubes as the 6W6GT, 25L6GT and 50C5 in applications where high circuit efficiencies are required. A detailed circuit and application information for the 6216 used as a typical filter reactor is included elsewhere in this bulletin.

The CBS-Hytron 6216 has many unique features among which are:

1. Ruggedized construction
2. Resistance to vibration
3. Resistance to interface formation
4. Very high perveance
5. Extreme power sensitivities

It may be used in Class A, Class B, and Class C amplifier applications, as a passing tube in electronic voltage-regulated power supplies, in wide-band video amplifiers, and in passive switching applications.

Sylvania 21ZP4, 21ZP4A, 21YP4

Three new 21-inch spherical-screen television picture tubes, are being manufactured by the Television Tube Division of Sylvania Electric Products, Inc.

Designated the 21ZP4, the 21ZP4A and the 21YP4, the new tubes have gray filter glass face plates to provide proper picture contrast. Types 21ZP4 and 21ZP4A are magnetically focused and deflected, while the 21YP4 is designed for electrostatic focus. All three require an external ion trap magnet. The 21ZP4A and 21YP4 tubes are supplied with an external conductive coating.

By using a deflection angle of 70 degrees, the overall length of the new tubes is 23 inches. Greatest bulb dimensions are: diagonal—21 7/32 inches, height—15 9/16 inches, width—20 1/4 inches. Recommended operating conditions include: anode—16,000, grid No. 2—300 volts, ion trap magnet field strength—45 gauss. Anode contact, base and base connections are conventional.

The new tubes weigh approximately 24 pounds, as compared with approximately 28 pounds for the 21-inch cylindrical tubes. The picture is approximately 19 1/2 x 14 1/4 inches.

RCA 12BF6

The 12BF6 is a multi-unit miniature tube of the heater-cathode type containing two diodes and a medium- μ triode in one envelope. It is intended primarily for use as a combined detector, amplifier, and avc tube in automobile radio receivers operating from a 12-volt storage battery.

The characteristics of the triode unit are such that it can be impedance-coupled or transformer-coupled to the output stage. In either case, the triode unit can supply more than ample output with low distortion to drive a pair of 12V6-GT's operating at maximum plate voltage in the output stage of automobile receivers.

GENERAL DATA

Electrical:

Heater, for unipotential Cathode:		
Voltage (AC or DC)	12.6	volts
Current	0.150	ampere

TRIODE UNIT AS CLASS A₁ AMPLIFIER

Maximum Ratings, Design-Center Values:

PLATE VOLTAGE	300 max.	volts
PLATE DISSIPATION	2.5 max.	watts
PEAK HEATER-CATHODE VOLTAGE:		
Heater negative with respect to cathode	90 max.	volts
Heater positive with respect to cathode	90 max.	volts

Typical Operation with Transformer Coupling:

Plate voltage	250	volts
Grid voltage	-6	volts
Amplification Factor	16	
Plate Resistance (Approx.)	8500	ohms
Transconductance	1900	umhos
Plate Current	9.5	ma
Load Resistance	10000	ohms
Total Harmonic Distortion	6.5	per cent
Power Output	300	milliwatts

Typical Operation as Resistance-Coupled Amplifier:

See Chart Below

DIODE UNITS

Maximum Ratings, Design-Center Values:

PLATE CURRENT (for each diode)	1.0 max.	ma
--------------------------------	----------	----

Diode Considerations:

Diode units No. 1 and No. 2 and the triode unit have a common cathode. Diode biasing of the triode unit of the 12BF6 is not recommended.

Type 12BF6 characteristics.

SOCKET CONNECTIONS Bottom View

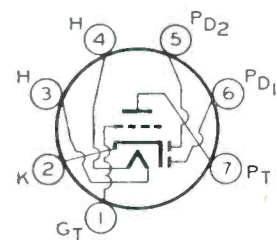

12BF6 tube.

PHONO FACTS

1953

PART 2

by **MAXIMILIAN WEIL**

(President & Chief Engineer, Audak Company)

Turntable

59. The first essential in a turntable is that it maintain a constant speed, if there is to be no pitch distortion due to the speed factor.

60. A simple and most practical method of testing the speed constancy of a turntable is by playing either a piano or a violin recording with long sustained notes. Where available, playing a disc with a constant frequency note—anything from 1,000 to 3,000 cps—is an excellent method to use. The human ear is very sensitive to changes in pitch (wow).

61. Ability of a turntable to maintain constant pitch is very important. It should be checked at all the speeds that are being used in actual playing.

62. The slower the speed, the more difficult it is to maintain constant pitch. Therefore, the slow speed, 33 1/3 r.p.m., should be checked carefully.

63. Where quality performance is sought, a quality magnetic pickup is assumed.

64. Up to a few years ago, pickups were made with heavy vibrating mass for high output. High output was necessary to make up for the lack of gain in amplifiers. It was also needed to overcome the stray fields due to poorly designed electric motors.

65. It is now generally accepted that today's amplifier must be built with sufficient gain to permit the use of a modern high-quality magnetic pickup.

66. For the same reasons, turntable motors are now engineered and built so that they will not interfere with the performance of a highly sensitized magnetic pickup. (See #83)

67. Turntables designed to satisfy the factors outlined above are now available. Satisfactory multi-speed turntables may now be had at a very modest cost.

68. A turntable should always be mounted so that the motor will be as far as possible from the reproducer head.

69. When mounted, the turntable should be as level as possible.

70. A steel turntable should be solid throughout the area traversed by the stylus. That is, there should be no perforations of any kind throughout that area. As a rule, such perforations register in the loud speaker.

71. The turntable proper should be free of wobble.

72. A good turntable should be free of rumble, both lateral and vertical.

73. A rumble not only registers in the speaker, but also increases record-wear.

74. Felt or rubber covering placed loosely on the turntable has a tendency to slip. This should be prevented if pitch variation is to be avoided.

Figure 1 shows the highest development in acoustic tone-arms, about 1926. Note the ball-bearing structure. The well in the base was filled with a viscous material which served the dual purpose of providing some damping at that end of the arm, and at the same time providing a fairly airtight junction between arm and horn. To cut down the transfer of stylus-generated exciter energy, suitable damping was applied at junction of reproducer and arm. In spite of all these precautions, however, the stiffness of

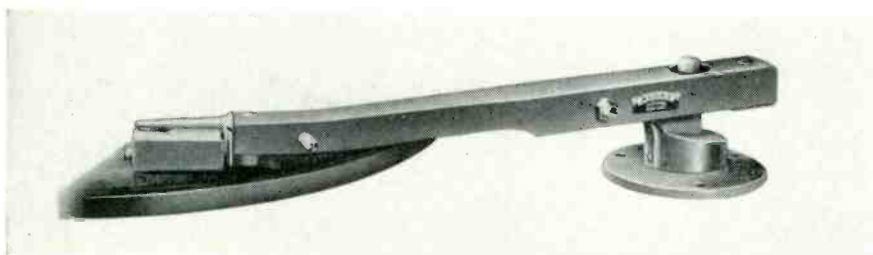

Fig. 3—Audax Polyphase Reproducer (L-6 with 12" arm—16" same style). Figures 1 and 2 appear in May issue of RTSD.

Typical Hi-Fi installation using a "Webcor Diskchanger"

(Courtesy Webster Chicago Inc., and Voice and Vision, Inc. Chicago, Ill.)



the stylus was so great that considerable vibratory energy found its way to the arm.

Figure 2 shows the first commercial electronic pickup (built by Audax), about 1926. The tone-arm of this pickup moved in ball bearings. Note the reproducer-head pivoted at the front of the arm—a carry-over from the acoustic tone-arm. This was found to be highly undesirable—especially when the 33 1/3 r.p.m. discs came in with talking pictures.

Figure 3 shows a modern tone-arm.

Addenda

75. It is practically impossible to retip a complete stylus-assembly, without destroying the performance that was built into it, originally. Careful adjustments and precision-calibration of the parts of a stylus-assembly are vital to the desired performance. Money will be saved if the stylus assembly is discarded once the jewel is worn . . . the cost of the metal parts being insignificant.

76. "Hangover" is about the worst type of distortion met with in reproduced music. It shows its ugly head in connection with mechano-electrical reproducers such as pick-ups, microphones, and speakers. It is imperative, therefore, in a high-quality disc-reproducing system, that transformation of the mechanical wave-shape into the desired electrical wave-form, take place instantaneously and simultaneously with the motion of the stylus-point. There must not be the slightest trace of phase-lag between the mechanical and the desired electrical wave forms. . . . A well designed, high quality magnetic reproducer (pick-up) is the only type capable of meeting these all-important requirements.

Furthermore, the magnetic pick-up is self-contained and direct acting, generating its own E.M.F., requiring no outside aid, such as voltage supply, ect.

77. Near-zero vibrating mass and near-infinite compliance are the basic musts for ear-quality. The compliance must be so great that the groove will have absolute control of the stylus, at all times. (See #16-17 and 18)

78. When properly built, such a reproducer makes possible the playing of records, even soft lacquer discs, indefinitely.

79. In general, the higher the quality of a pickup, the lower the output. It does *not* follow, however, that a low output makes a quality reproducer.

80. Pointer 17 directs the use of a 78 r.p.m. record when testing for compliance. A microgroove disc is made with only about half the volume, and would aid in concealing stylus stiffness.

81. Pointer 22 calls attention to the importance of proper matching, when a high-quality reproducer is used. This refers to correct electrical values and connections. Such information is always supplied by the maker of the reproducer and should be followed carefully.

82. In a reproducer, the less material needed for damping, the better. In any case, media with naturally variable damping characteristics, such as oils, etc. should be avoided.

83. Where a good turntable is not at hand, the alternative is to use a coarser, stiffer type reproducer. Such a reproducer is insensitive to minute shadings, motor-rumble, etc. . . . This, of course, would mean a sacrifice of quality musical performance as well as a sacrifice of the record itself.

84. For discs to continue in good condition, the point-pressure should not exceed 10 grams where both, LP's and 78's are played. Where only LP's are played, it should not be less than 5 grams. It is most important, therefore, that a powerful magnet in a pick-up does not exert additional pull on a steel turntable. Such a pull may mean a point-pressure several times the desired amount. A simple way to test this, is to place a full-tone steel needle on a smooth, glass-like surface, gradually approaching the steel needle with the pickup from above and see at what distance the needle will "jump" up to the pickup.

Additional Data

One of the important factors in the public acceptance of the new LP discs is the fact that, they can be played

with a total absence of surface noise, commonly referred to as "scratch," that has plagued music lovers for over 50 years. Vinyl records are highly susceptible to mechanical injury—scratch, etc. It is of vital importance, therefore, to prevent these discs from becoming scratched or marred in any way.

Extensive investigation shows that unwittingly, the owner himself inflicts mechanical injury (scratches), on his records.

It has been suggested that wiping LP (vinyl) discs with a moist cloth would keep them clean. This certainly seems very simple and attractive. The author himself used this method until one day, something happened that prompted him to investigate. Accidentally, a soft lacquer disc was left exposed to dust and grit, for several days. As a routine matter, the disc was wiped "clean" with a moist cloth and played. The results were distressing, to say the least. The exposed side of this disc had been played but a few times, and now was actually noisy; whereas the reverse side, which was not exposed to dust and grit, and was not wiped "clean," had been played over 600 times, and was still in excellent condition. A look at the moist cloth showed that a great deal of dust and grit clung to it, just as would be expected.

It was then realized just what was taking place. The resultant effect of the cloth rubbed over the disc, was very much like the action of fine sand paper. Obviously, if the cloth scratches a lacquer disc, it will do the same thing to a vinyl record, although because of the harder surface, at a somewhat slower rate. Further investigation disclosed exactly that to be the case.

1. Never use a cloth of any kind to clean your records.
2. Never use a brush of any kind on your records.
3. When in doubt about using anything on a record, other than the stylus itself, just ask yourself if you would use it on a valued, soft lacquer disc.

Tests show that anything rubbed over the record will scratch the groove walls by rubbing the dust and grit into the delicate glossy surface. Once attention is called to this, it becomes obvious that this is exactly what must happen.

In the case of a very dusty record, fluff the dust off with a soft, loosely waving handkerchief. When playing, a stylus attracts the dust, lint, etc., that is lodged in the grooves. Brush the dirt off the stylus after each play. It will help keep your records clean.

Oddly enough, no protective envelope has yet been produced that would entirely protect a disc from dust and grit.

Stylus Alignment

It is highly important that, viewed from the front, the stylus be straight, up and down, on the record and not lean at an angle against the groove wall.

The investigation extended over a period of eight months and included pickups and arms of all makes. Out of 74 installations of various makes, 39 were found to be badly out of alignment; that is, the stylus was tracking the groove at an angle, to the right or to the left.

Misalignments were found to be far more numerous in cases where the pickup head was mounted inside the arm, and therefore could not be seen. Such arms were designed back in the thirties for use with crystal pickups. Hidden by the arm, the crystal pickup head needs no finished appearance, thereby saving that cost. This was found to be a very common source of record erosion and distortion. . . . Here is a simple and effective way to check stylus-record alignment:

Place a small unframed mirror (such as may be found in a ladies' handbag)—on the turntable. Now, gently lower the stylus-point to contact the mirror in the same way as you would when placing it on a record. Standing squarely in line with the front end of the arm, so that you do not see the sides of the arm, you will be able to clearly see in the mirror just what the stylus alignment is.

This is an excellent way of checking stylus-alignment in all cases,—even where the reproducer is secured to the arm professional style, out in the open where it is in full view. With a mirror, any angular misalignment will appear twice as large.

1. Be sure to correct any stylus-record misalignment.
2. Never play a record with a stylus out of alignment.

Securing Head To Arm

This is a constant source of stylus-

record misalignment. As there must ways always be sufficient play to permit the parts to telescope together, frequent misalignment is to be expected. This necessary play, plus a certain amount of disalignment in the mounting of the connector pins, permits a slight shift of the reproducer—clockwise or anti-clockwise, causing the stylus to lean at an angle against one of the walls of the groove.

The one changer, for example, has provision for firmly securing the reproducer to the arm—*after stylus alignment.*

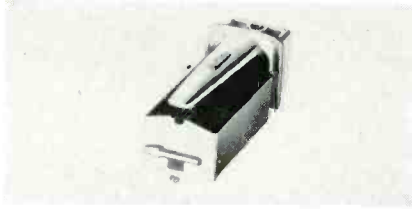

Audak Polyphase Reproducer.

So simple

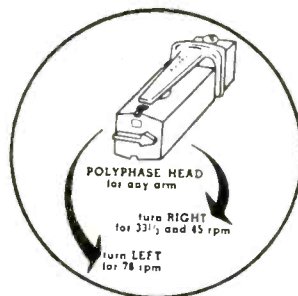

Illustration showing how pickup head may be switched to long-playing or 75 RPM.



Audak Polyphase Reproducer for Garrard.

Frequently, the arm itself is found to be out of alignment. With certain types of arms, this can be easily remedied by placing a bit of paper under the one side of the base.

1. Check stylus-record alignment carefully, it is of the utmost importance in minimizing record wear and distortion.
2. Every time the head is removed from the arm for any reason, such as repair or installation of new stylus, etc., the stylus-record alignment should be checked carefully, after the head is reinstalled.
3. Because a reproducer head is liable to become disaligned at

any time it should be checked periodically, as a routine matter.

4. Even in the professional type mounting, the head should be carefully aligned before finally securing it to the arm. This should also be checked periodically.

Brushing Records

Attaching a brush to a pickup for the purpose of carrying off a static charge on a disc, or for any other reason, is a serious matter to the record and the performance. This is especially so with a highly sensitized pickup.

The brush may carry off the static charge but, it will do the record far more harm than good. It most certainly will not improve the performance.

Brush attachments, to "clean" the record grooves, have been tried time and again for over thirty years. At one time or another, every record owner has tried to brush the dust and grit out of the grooves. Much to his dismay, however, the dirt kept going 'round and 'round like a squirrel in a cage, getting nowhere. Ignoring, for the moment, the factor of mechanical injuries, here is why it has never been possible to clean records with a brush:—

As the bristles push some of the dirt ahead of them, by the time they reach, say the tenth groove, there will be ten "groove fulls" of dirt the brush will try to push into the eleventh groove and so on. Of course, the microscopic size groove cannot possibly hold ten "groove fulls," causing some of the accumulated dirt to spill to one side and some to go under the brush. The net result is that the dirt is no longer distributed uniformly, but instead, is scattered over the record in lumps. . . . To make matters worse, the dirt under the brush is being rubbed into the delicate, glossy surface—with the usual results—scratch.

Furthermore, in the old acoustic and early electronic-pickup days, with point-pressures of 3½ to 5 oz. (100 to 150 grams), a variation of a few grams was of no consequence. With the highly sensitized pickups of today, however, with a needle-force of but a few grams, such a brush will cause serious variations in point-pressure, as the disc revolves.

Moreover, being attached to the pickup, the brush will transmit to the head some of the recorded vibrations, motor rumble, etc. Worse than that, the brush will transmit from many grooves simultaneously, depending on the number of bristles in the brush and the brush-pressure. It will set the

[Continued on page 64]

SHOP NOTES

Write up any "tricks-of-the-trade" in radio servicing that you have discovered. We pay from \$1 to \$5 for such previously unpublished "SHOP NOTES" found acceptable. Send your data to "Shop Notes Editor."

Sentence Models 329, 331, 338-Intermittent IF's

Intermittent or noisy 1st or 2nd *if* transformers have caused trouble. New types of *if* transformers having changes illustrated below can be identified by a red dot of paint on either the top or bottom of the coil can.

The reason for this is warpage of the bakelite pieces on top and bottom of the silver mica condenser plates, resulting in the condensers becoming loose and intermittent. It is not necessary to replace the *if* transformers. Special metal clips Part No. P-1010 which firmly clamp the bakelite pieces together are available. This can be done without removing the coils from the chassis.

Illustrations show the correct method of installing the special metal clips. Remove only one *if* coil can at a time—this will prevent damage to one coil while repairing the other. Remove all tubes from the chassis.

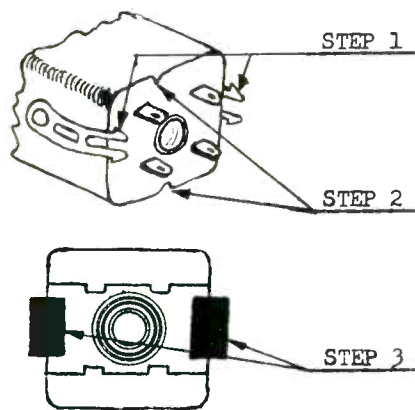

Steps in repairing IF's.

Loosen the coil can cover from the chassis by compressing the ends of the spring type mounting clips from the underside of the chassis and pushing outward until the can and coil are just free of the chassis.

With a thin screwdriver inserted from the underside of the chassis thru opening located underneath the *if* coil assembly straighten crimping on

bottom edge of coil can, and gently remove coil can.

Slide metal clips over both pieces of bakelite carefully. Hold opposite side of coil while pushing in clip.

When replacing the coil can line up the top of the coil form with the opening of the coil can before locking the coil can in place.

Sentinel Radio Corporation

Identifying Tube Numbers

A magnifying glass of good strength will save time and temper in determining the tube number of miniature tubes.



Using a magnifying glass to identify tube numbers.

A glass of the type shown may be drilled at the base and mounted permanently on the service bench for use when checking auto radios.

H. Leeper
Canton, Ohio

Westinghouse-V2172 Chassis—Variations in 6AL5 Tubes Affect Bandpass of Video I-F System

It has been found that the bandpass of the video *if* system is affected somewhat by the characteristics of the 6AL5 tube used in the video detector circuit. Tubes with an excessively high perveance cause the *if* response curve to be round-topped with narrow bandpass characteristic. This condition is especially undesirable in weak signal areas. For best results in the V-2172 chassis, it is recommended that when a replacement is required a 6AL5 tube made by

Raytheon be used in the video detector circuit. In other circuits, tubes made by other manufacturers will perform satisfactorily.

Westinghouse Service Dep't

Motorola Oscillator in FM Receivers

Excessive frequency drift in Motorola FM receivers manufactured between 1949 and 1951 may be caused by a defective or incorrect temperature compensating capacitor in the FM oscillator circuit. This capacitor, located on the FM oscillator inductor assembly, has a value of 85 mmf and a negative temperature coefficient of either .000750 mmf/mmf/°C or .001500 mmf/mmf°C. The table model receivers, which are tightly enclosed, generate more heat and require more compensation than the relatively open and cooler consoles.

If objectionable frequency drift is noticed during the warm-up period, change the compensating capacitor. It may not have the proper temperature coefficient. For example, oscillator drift requiring retuning to a lower frequency on the dial indicates that the degree of compensation is too great. Use as a replacement, a capacitor with the marking or color coding shown below. On tubular capacitors, the temperature coefficient appears as the end dot on the capacitor, and it should be either purple (for 750 parts per million) or orange (for 1500 parts per million). Disc type capacitors are marked directly in parts per million.

The following chart lists the recommended compensating capacitors

MODEL	AV-FM CHASSIS	PART NUMBER	RECOMMENDED COMPENSATING CAPACITOR	
			TEMP. COEF. (PPM)	END DOT COLOR
7XW21	HS-218	21A690688	1500	Orange
7XW22	HS-218	21A690688	1500	Orange
8F21	HS-247	21K691203	750	Purple
8F21B	HS-247	21K691203	750	Purple
9F21	HS-246	21K691203	750	Purple
9F21B	HS-246	21K691203	750	Purple
12V4				
Series	HS-190	21K691203	750	Purple
12V7C				
Series	HS-190A	21K691203	750	Purple
16F1	HS-234	21K691203	750	Purple
16F1B	HS-234	21K691203	750	Purple
16V7B	HS-211	21K691203	750	Purple
16V7B	HS-211	21K691203	750	Purple
17F1	HS-253	21K691203	750	Purple
17F1B	HS-253	21K691203	750	Purple
17F2	HS-253	21K691203	750	Purple
17F2B	HS-253	21K691203	750	Purple
17F4	HS-253	21K691203	750	Purple
17F5	HS-261	21K691203	750	Purple
17F5B	HS-261	21K691203	750	Purple
17F6	HS-253	21K691203	750	Purple
17F6B	HS-253	21K691203	750	Purple
17F7	HS-253	21K691203	750	Purple
17F7B	HS-253	21K691203	750	Purple
17F9	HS-261	21K691203	750	Purple
17F9B	HS-261	21K691203	750	Purple
18F1	HS-230	21K691203	750	Purple
19F1B	HS-230	21K691203	750	Purple
20F1	HS-230A	21K691203	750	Purple
20F1B	HS-230A	21K691203	750	Purple
20F2	HS-230A	21K691203	750	Purple
20F2B	HS-230A	21K691203	750	Purple
79F21B	HS-178_A	21K691203	750	Purple
79F21B	HS-178_A	21K691203	750	Purple
79K21	HS-165	21A690688	1500	Orange
79K21C	HS-168A	21A690688	1500	Orange
79K22	HS-168A	21A690688	1500	Orange
91F21	HS-230A	21K691203	750	Purple
99F21B	HS-170	21K691203	750	Purple

Motorola capacitor chart.

for all FM receivers manufactured during 1949, 1950, and 1951. This chart should be taken for final authority, even though it may not agree in all instances with the various Replacement Parts Lists in the Service Manuals.

Motorola Service Dep't



Fig. 1—How a typical system looks with clerk at desk.

A SUCCESSFUL

THERE is more than mere cynicism to the expression "A rich man is simply a poor man who has a lot of money." It could be paraphrased to read: "A successful service shop operator is one who probably would have failed were it not for the fact that he avoided doing the wrong things."

Most service organizations now-a-days operate profitably. Some make money because the volume of business is so large, with most jobs providing a small profit, so that frequent losses on some jobs are offset in the aggregate. But many busy shops that are not enjoying justified profits would do so if they employed a good working system whose records would quickly show up mistakes that are being made, and which should be eliminated.

For example, if the manager of a busy service organization does not quickly "spot" a job that requires call-back after call-back, with consequent mounting losses, his firm will suffer an irreparable loss. In contrast, when a "lemon" is discovered quickly and corrective steps are taken promptly, losses are kept at a minimum and customer satisfaction is maintained at a peak. Proper shop records are the key to achieving this desired status.

It takes great ingenuity and know-how to plan and put into use a really thorough bookkeeping and job-record business system. Too many "home-made" systems have faults or omissions which require extra time to make up for, and time-saving is a big factor in any successful enterprise, for seconds wasted in making records represent absolute loss, what with technicians earning upwards of \$3 per hour or 5 cents a minute. Some "home-made" systems are too complex, providing much unwanted information, or they are not comprehensive, and thus require a lot of mulling over, which defeats their basic purpose.

A "System" must consider 2 phases.

All systems dealing with services and components must take into account the needs of both the management end of the business as well as the service department end of the business. From the *management's* point-of-view, a business control system should be:

- 1)—Comprehensive and flexible. The same system should accommodate the firm's own retail customers as well as any jobs that are handled on a sub-contract basis.
- 2)—Simple to use and maintain. All waste motions and duplications must be eliminated to conserve time.
- 3)—Accurate, so billing to customers will be correct and so that delinquent accounts may be held to a minimum.
- 4)—Informative, so that nuisance calls may be quickly discerned—and so

that the shop may be guided in handling customers who require frequent service.

- 5)—Efficient so that management may obtain needed information for monthly Profit & Loss records, inventory control, etc.

While those five points are basic requirements of the management part of a service business, the operative, or service departments requirements must also be taken into account, and a proper business system must provide for the service department's benefit records which:

- 1)—Are simple to use by field technicians so they waste a minimum of time doing paper work.
- 2)—Eliminates possibility of the fieldman being unprepared to satisfy the customer on the first home call by providing as much of a "case history" as is possible.
- 3)—Forewarns the service department

The diagram illustrates how a master card is used to populate an Office Master form. The master card, labeled 'JONES', contains the following information:

- Invoice No. 12345, Date: 10/15/53
- Name: John Doe, Phone No. 123-4567
- Address: 123 Main St, City, State
- Make: Ford, Model: 1953 Ford
- Service: Tune-up, Oil Change
- Technician: J. Smith
- Time: 10:00 AM - 11:30 AM

The Office Master form has a grid for tracking service calls:

1st SERVICE CALL	DATE	BY
2nd SERVICE CALL	DATE	BY
3rd SERVICE CALL	DATE	BY
4th SERVICE CALL	DATE	BY
5th SERVICE CALL	DATE	BY

Below the grid is a section for 'REMARKS' and a 'TOTAL TIME' section with columns for 'TIME IN', 'TIME OUT', and 'TOTAL TIME'.

Fig. 2—"Office Master" form backed up by master card.

The description of a commercial system that provides complete control, simple to install and comprehensive in its use.

CONTROL SYSTEM

FOR SERVICE ASSOCIATIONS

manager what replacements probably will be required by the field technician.

- 4)—Provides a fairly accurate perpetual tube and components inventory.
- 5)—Provides necessary receipt forms for fieldmen. These forms, having carbonized backs, require but one writing to serve all purposes.
- 6)—Furnish a permanent record for the service department manager, and at the same time provides a file copy for the phone operator, and allows the bookkeeping department to have all data in cases where cash income or billing is involved.

Our search for a suitable, low-cost service system which has already proven successful in use was rewarded in the discovery of the Markem Service Systems, which is and has been used for several years by operators of large and small independent organizations, and specialty service contractors whose basic dealings are with many furniture and department stores that "farm out" all service and installation work. Herein is described the Markem System that is excellent for service shops having from 100 to 3,000 active accounts. A more elaborate system capable of handling 3,000 to over 50,000 active accounts, which merely differs in the manner in which files are setup and maintained, is also available to those whose volume requires such heavy traffic.

Description of the System's components.

The control system for the average service organization is made up of a desk posting tray for fast selection of "master cards," a job-dispensing rack with a set of combination imprinted "office master" sheets (backed up by the tabbed "master card"), and the double (backed up) receipt forms. A glance at Fig. 1 shows how a typical system looks on the desk of a young lady who is designated to accept in-

Fig. 3—Receipt form.

coming telephone service call orders.

Assuming that "a picture is equivalent to 1,000 words," we will pictorially describe the printed-forms and then show, step-by-step what happens when a service call comes in. Figure 2 shows the "office master" form which is backed up by the tab-card called the "master card." The top back portion of the "office master" is carbonized so that whatever is written on it automatically is recorded on the "master card" under it and the reverse side of the latter is also printed with job-records so that a "master card" covers 5 jobs in all, 2 on the face side and 3 on the reverse.

Figure 3 shows the two receipt forms, one backing up the other as shown in Fig. 3 B-C, one copy being for the customer and the other for the field technician.

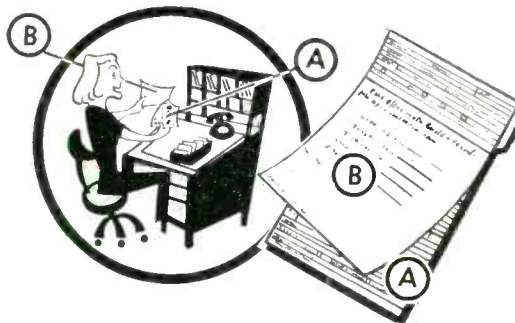

How the system is used.

The service call is received by the incoming-call operator. She records all pertinent facts on the top sheet of "office master" copy which we'll call B. The facts are recorded in indelible carbon on the "master card" A under it.

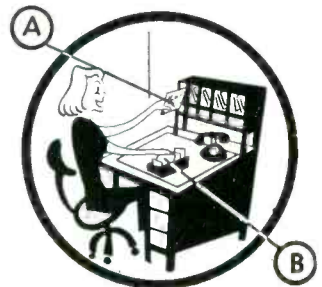

The "office master" B is refiled by the operator so she will have at hand a record of the customer's job should the customer call in before the repair is completed. The "master card" A is placed in the rack for the service department manager to pick up and is replaced by a colored outguide which indicates that a master card is out with a technician or for any other purpose.

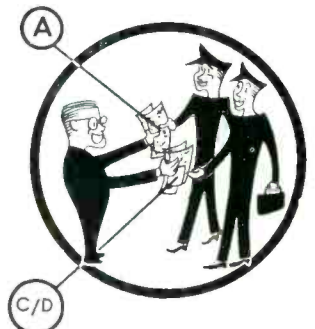

The service department manager studies his file and dispatches the crew, giving them the "master card" itself (and all necessary parts or instruments). He also gives the field crew a set of receipt forms C and D.

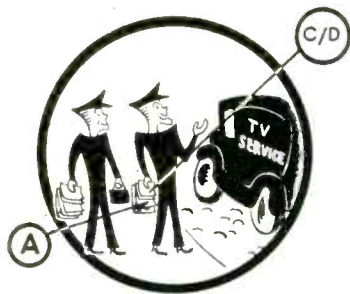

The crew of service technicians take off on their assignments.



At the customer's home, necessary work is done.

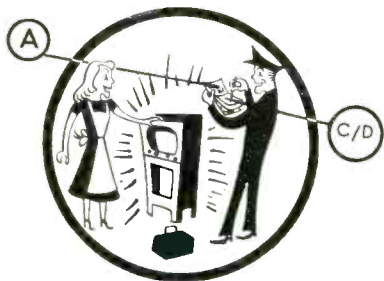

If the receiver is repaired at the customer's home the technician fills in all details on receipt-form *C* after placing it over the "master card" *A*. One writing does all the work because of the patented no-smear wax-spot on the forms *C* and *D*. If the set must be taken to the shop for repairs the technician only fills in the form *C*, which is the customer's receipt, and the carbon copy *D* is attached to form *A* and returned to the shop with the job.

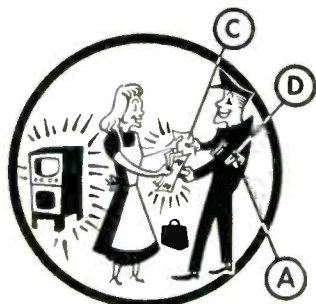

Assuming the job is repaired at the house, the customer pays for the services rendered, getting her receipt. Here again, the copies are made on forms *D* and *A* which are returned to the shop with the money received. One posting completes master card customer's receipt and cash control copy.

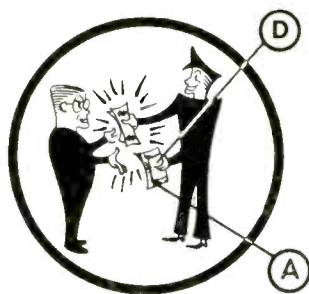

The service technician turns over to the service department manager his "master card" *A* and receipt form "*D*" and the money collected. This detail relieves the technician of responsibility for any tubes or parts that have been charged against him and which he used on the job. At the same time, the service department manager gets his information as to what used tubes or parts must be re-ordered to keep his inventory up to prescribed standards.



Having made his necessary records and "cleared" the job, the service manager turns over to the bookkeeper the receipt form *D* and the money collected, or if billing is involved, the form *D* is used for posting the invoices, or is used as the invoice. Many types of information for management can be obtained later by inspecting these receipt forms. For example, a daily record of cash income, amount of billing, etc., can be posted in the Ledger.

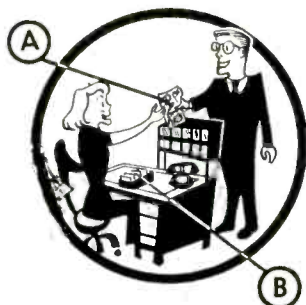

The final motion is for the service department manager to return to the telephone operator the "master card" *A* which she re-files along with the "office master" and removes the out-guide *B*. As the card *A* is used time and time again it automatically builds up a case history of any particular set.

Because many service organizations do a considerable amount of service work for department or specialty stores

which do not operate their own service departments, this system, as described, is extremely flexible. For example, the receipt forms used by a service crew when handling a "farm-out" job might bear the imprint of the Dealer who originated the service call instead of the service firm that did the actual work. When turned in this receipt form becomes the agent by which the Dealer renders his invoice to the customer, and the other receipt becomes the agent by which the service firm bills the Dealer. The service technician accomplishes this in one simple operation by merely inserting the extra receipt form under the original pair of receipt forms when making out the job record at the customer's home. This is shown as *Fig. 4*.



Fig. 4—Serviceman's receipt form.

In like manner these forms are flexible enough so a Dealer may cover a customer's contract for installation and servicing by simply inserting a pre-printed wax spotted contract form *B* of his own (*Fig. 5*) when making out his original sales copy to give to the customer. In such a case the Dealer simply turns over the basic original installation order form, which is the same combination of "office master" *B*

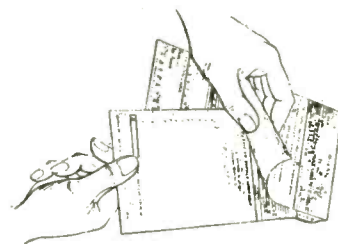
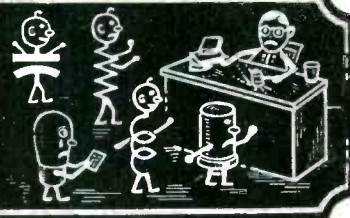

Fig. 5—Spotted contract.

and "master card" *A* to the service firm who is commissioned to do the installation. The Dealer's copy then becomes his record to show that the service firm's invoice is accurate and should be paid.

If and when a service organization's volume of business exceeds 3,000 active accounts, Markem recommends that the Revo-file, which is rotary, be used to replace the smaller desk tray. The records are inter-transferable without need for hole-punching.

CIRCUIT COURT



Zenith 1953 K Chassis-Video amplifier and sound takeoff

This Zenith chassis (Fig. 3) uses a three stage video amplifier circuit. One of the end results is that the cathode of the CRT is fed with a sync phase positive picture. Cathode drive of the CRT tends to minimize the noise streaks that occur during strong noise pulses. The tubes used are the pentode section of a 6U8 as the first video amplifier and two sections of a 12AU7 as the second and third stages. The 6U8 pentode section also acts as the first 4.5 mc sound amplifier. The sound signal is taken off the pentode plate and is fed to the triode section which operates solely as a 4.5 mc amplifier. The sound take-off is a rather unusual circuit. The primary and secondary windings of *L12* are each resonated to 4.5 mc. The secondary utilizes the 6U8 triode section input capacity to tune it to 4.5 mc. The primary and secondary are coupled by means of *C27*, a 3.3 mmf. condenser.

The 4.5 mc. signal is taken from the junction of *C27* and the secondary of *L12* through *C26* to the grid of the 6U8 triode section. By means of the feedback tap on the *L19* coil, and *C13*, the 6U8 triode section is neutralized to prevent its going into oscillation. The second and third video amplifier stages are of a conventional design.

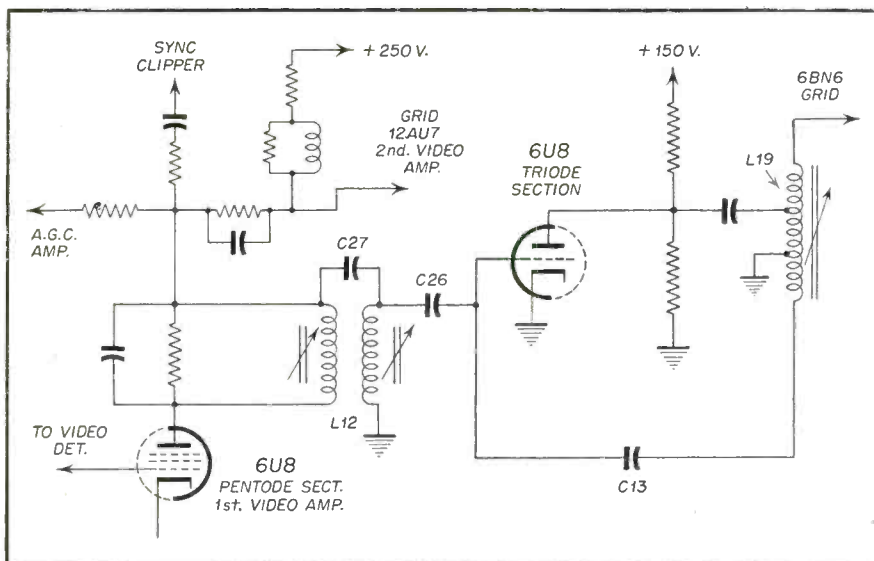

Fig. 1—Partial schematic of Zenith 1953 K chassis.

MOTOROLA TS-292-Horizontal sweep circuit

The horizontal oscillator used in the Motorola TS-292 is a multivibrator. This multivibrator applies a saw-tooth voltage waveform to the grid of the 6BQ6 which pulses the tube into and out of conduction. During conduction of this tube the current is transferred into the deflection yoke, moving the electron beam from the center of the face to the right edge of the face of the tube. The energy in the yoke is at its maximum value at this time. At the end of conduction, the 6BQ6 is quickly cut off. This action causes a collapse of the magnetic field of the yoke, and a build-up of energy in the opposite direction across the distributed capacity of the yoke, which is discharged back into the magnetic circuit. During this latter period, the electron beam quickly moves to the left side of the picture tube face. This is called the retrace of the beam.

At the end of the first half of the field collapse (which can be looked on as analogous to a damped oscillation train), the polarity of the voltage across the magnetic circuit is reversed so that the damper tube starts conducting current, beginning with a maximum value and decreasing to zero. This conduction moves the beam back to the center of the picture tube face.

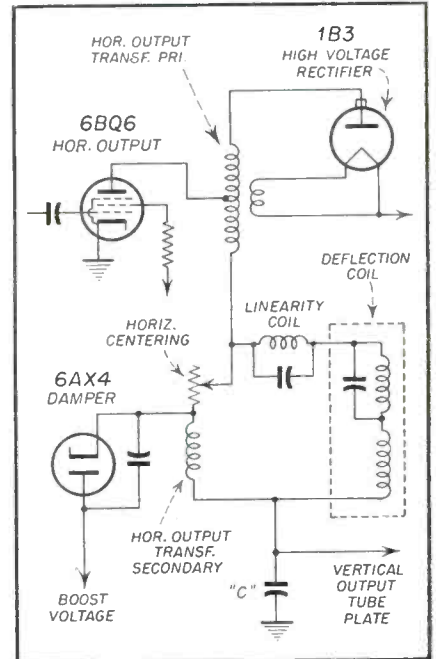

Fig. 2—Motorola TS-292 Horizontal sweep circuit.

If the damper tube were not in the circuit the oscillations set up would continue into much of the sweep and distort the picture. The damper tube current flows into condenser "C", Fig. 1. Condenser "C" originally is charged to a voltage equal to the damper plate voltage when the set is turned on. The damper current flowing into "C" adds a boost voltage to the original voltage and this sum is applied to the 6BQ6 plate. This boost voltage represents the energy the damper tube has recovered from the magnetic circuit and which is reused.

When the 6BQ6 conduction is quickly stopped, the flyback oscillation begins. The amplitude of this flyback pulse is increased by the transformer action of the high voltage secondary winding and is rectified by the 1B3 to provide the second anode voltage for the picture tube.

The horizontal transformer in this receiver uses a variable air gap in the core to adjust the horizontal width. Varying the air gap varies the inductance of the transformer just as a shunt coil, as in conventional circuits. However, the air gap method pro-

[Continued on page 67]

ASSOCIATION NEWS



Television Service Dealers Association Phila., Penna.

The Television Service Dealers Association of Philadelphia has provided its members a sales letter, with as many copies as each member may need for his mailing list. To date, over 47,000 have been printed and mailed with a balance of 100,000 which are now being printed. These letters and envelopes and booklets, entitled "Facts About TV Service" were supplied at no charge to the membership as part of a Business Builder and Public Relations Program of this Association. This first mailing has been prepared for the members by its advertising committee chairman, Mr. Marty Benoff and Public Relations Committee Chairman, Mr. Wm. Weil, Jr. It was through the cooperation of Mr. John Thompson, General Electric Co., Tube Division, and local parts distributor, Mr. Green of Almo Radio that the stationery and booklets were obtained for the organization. The membership's report on the result of the first mailing was very favorable.

Bill Weil, Jr.

Radio and Television Servicemen of New Jersey, Inc. Paterson 1, N. J.

Henry A. Williams, publisher of the Paterson Morning Call, was presented with the first annual award of the Radio and Television Servicemen of New Jersey, Inc., for his efforts to promote the public acceptance of reliable television service. The award was made at the association's second annual dinner-dance, held in the Suburban Restaurant, Paramus, N. J., on May 11. There were 155 members and guests at the dinner. The plaque cited Williams' "exceptional efforts to inform and advise television set owners, to advance better business principles, and to promote public acceptance of reliable television service."

In making the presentation, H. B. Rhodes, president of the group, pointed

out that the Morning Call had run for almost two years the weekly column "Video Views," provided by the association; had cooperated completely with the association in efforts to raise the standards of TV servicing advertising; had publicized the activities of the Association and exposed evils in the service industry. He also mentioned that Mr. Williams, as a member of the State Board of Education, had been most active in promoting educational TV channels in the state.

NETSDA

The National Electronic Technicians and Service Dealers Association will discuss licensing problems, incorporation, publicity and credentials at its next meeting, set for Sunday, June 7, at 1 p.m., at its headquarters at 165 East Broadway, New York. Group will also set up an agenda for all future meeting dates and places. All TV associations representatives, whether members of NETSDA or not, were invited to participate, according to Jack Wheaton, chairman of public relations for the group.

State Federation News Release

The Federation of Radio Servicemen's Associations (FRSAP) of Pennsylvania met in its monthly session, Sunday, May 27th, 1953, in Maurice's Restaurant, Philadelphia, Pa. President Milan Krupa, Wilkes-Barre, presided. One of the highlights of the meeting was the re-instatement of the Philadelphia Radio Servicemen's Association (PR SMA) to membership in the Federation. Representing PR SMA were Samuel Brenner, President, Al Haas and Stanley Meyers.

Committee reports were heard, and, additions to the day's agenda included: The adoption by the Federation of the Resolutions drawn at the recent Paterson Eastern Conference.

The advisement of all affiliated Chapters to forward all local questionable Radio-Television newspaper advertising to the Federation Secretary.

To name a Committee to await upon the Keystone Chapter of NEDA. Plans were furthered in promoting TV Educational Broadcasts on the local level, aimed at making a better understanding between the set owner and the local organized technician.

Chapter reports were given and a panel discussion on the proposed Pennsylvania Licensing Bills, HB-838, and HB-839 was held. The Federation is in favor of their enactment into law.

The Federation also went on record by unanimous vote, "as condemning NEDA and RTMA for alleged opposition to the will of the organized Technician and Service Dealers in Pennsylvania.

Radio & Television Technicians Guild Of Florida Inc.

After years of waiting, South Florida finally has its second television station. Channel 23 WFTL, for Lauderdale. A tentative date for channel 17 WITV, Fort Lauderdale, is Sept. 30th, 1953. These two stations are in the UHF band. This means that all television receivers manufactured from 1946 up to this date, with one exception, will have to be converted.

Whether Strip converters or over all external converters are employed, one thing is quite obvious, these converters will be of little value in years to come. They will be dirt collectors. As sets are manufactured they will contain a built-in VHF/UHF tuner. Set owners will eventually be buying new sets and current sets and converters will have no value. So a question for the future is "What will the retail dealer do with the converters and sets that he will have to accept as a trade-in, in years to come?" Well, we are radio and TV servicemen, we are not supposed to look at the future, just go along from day to day.

We seem to have let a thought ramble through this editorial. Take it for what it is worth.

Thos. M. Middleton

See YOUR ANSWER

WITH THE **PRECISION ES-500A** HIGH SENSITIVITY — WIDE RANGE **5" OSCILLOSCOPE**

PUSH-PULL VERTICAL AND HORIZONTAL AMPLIFIERS
20 MV PER INCH "V" SENSITIVITY — 150 MV PER INCH "H" SENSITIVITY

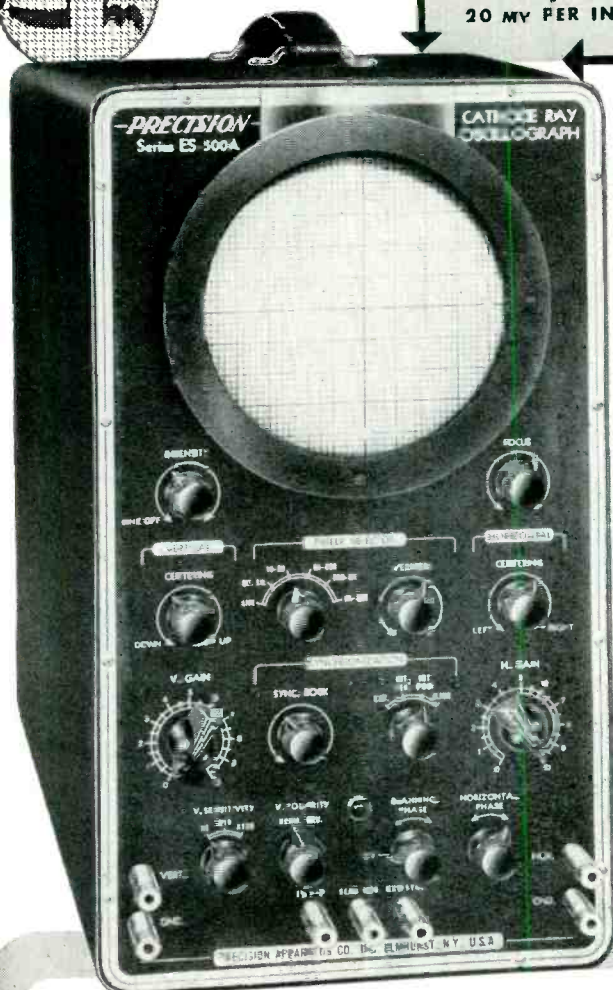

SERIES ES-500-A affords the ultimate in performance, visibility and operational flexibility at moderate cost. **PRECISION** engineers have incorporated every necessary feature which they found to be required to meet the needs of the rapidly advancing art of electronics, A.M., F.M., and TV.

SUMMARY OF IMPORTANT FEATURES

- ★ **Push-Pull Vertical Amplifier — High Sensitivity, Wide Range, Voltage Regulated.** 20 millivolts (.02v.) per inch deflection sensitivity. 10 cycles to 1 MC. response. 2 megohms input resistance. Approx. 22 mmf. input capacity.
- ★ **Compensated Vertical Input Step Attenuator—X1, X10, X100.**
- ★ **Direct Peak to Peak Voltage Checks** thru use of internal, semi-square wave, regulated voltage calibrator.
- ★ **Vertical Phase-Reversing Switch.** Non-frequency discriminating.
- ★ **Push-Pull, Extended Range, Horizontal Amplifier—150 Millivolts (.15 v) per inch deflection sensitivity.** 10 cycles to 1 MC response at full gain. 1/2 megohm, approx. 20 mmf. input.
- ★ **Linear Multi-Vibrator Sweep Circuit—10 cycles to 30 KC.**
- ★ **Amplitude Controlled, Four Way Synch. Selection:** Internal Positive, Internal Negative, External and Line.
- ★ **"Z" Axis Modulation input facility for blanking, timing, etc.**
- ★ **Internal, Phasable 60 cycle Beam Blanking** for elimination of alignment retrace; clean display of synch. pulses, etc.
- ★ **Sweep Phasing Control** for sinusoidal line sweep usage.
- ★ **Direct Horizontal and Vertical Plate Connections.**
- ★ **High Intensity CR Patterns** through use of adequate high voltage power supply with separate 2X2 rectifier.
- ★ **The Circuit and Tube Complement:** 6C4 "V" cathode follower, 6CB6 "V" amplifier, 6C4 "V" inverter, Push-Pull 6J6's "V" driver, 7N7 "H" amplifier and inverter, Push-Pull 6AU6's "H" driver, 7N7 Multi-vibrator, linear sweep oscillator, 5Y3 low voltage rectifier, 2X2 high potential rectifier, VR-150 regulator, 5CP1/A CR Tube.
- ★ **Four-Way, Lab-Type Input Terminals—**Take banana plugs, phone tips, bare wire or spade lugs. Matches SP-5 Probe Set cable connector.
- ★ **Light Shield and cross-ruled Mask,** removable and rotatable.
- ★ **Extra Heavy-Duty Construction and components.**
- ★ **Heavy Gauge, Etched-Anodized, No-Glare, Aluminum Panel.**
- ★ **Fully Licensed under Western Electric Co. patents.**

Series ES-500 A: In louvered, black-ripple, heavy gauge steel case. Size 8 1/4" x 14 1/2" x 18". Complete with light shield, calibrating mask and comprehensive instruction manual. **NET PRICE \$173.70**

Series SP-5 — OSCILLOSCOPE TEST PROBE SET

FOR TV SIGNAL TRACING, ALIGNMENT,
TROUBLE SHOOTING AND WAVEFORM ANALYSIS

- ★ Specifically engineered for use with **PRECISION** Cathode Ray Oscilloscopes, Series ES-500 and ES-500A.
- ★ Includes four of the most important test probes for general purpose, as well as specialized use
 1. HIGH IMPEDANCE—LOW CAPACITY PROBE
 2. SIGNAL TRACING—CRYSTAL PROBE
 3. RESISTIVE—ISOLATING PROBE
 4. SHIELDED—DIRECT PROBE
- ★ Each probe is specifically engineered for efficient application to the special test problems requiring its use.
- ★ Distinctively colored heads and individual labelling permit positive identification of each probe.
- ★ A single, universal, coaxial cable accommodates each probe through a quick-change, self-shielding connector.
- ★ A specially-designed, shielded plug provides for positive cable attachment to the ES-500 and ES-500A Vertical input posts.
- ★ Each probe head terminates in a patented clip-on tip which frees both hands of the operator.



Series SP-5, in custom-designed, vinyl-plastic, carrying case, complete with four probe heads, universal coaxial cable, and detailed operating instructions. **NET PRICE \$23.50**

TV • AM • FM • TV • AM • FM

See the ES-500A Oscilloscope and the Series SP-5 Test Probe Set at leading Radio Parts & Equipment Distributors.

PRECISION APPARATUS COMPANY, INC.

92-27 HORACE HARDING BLVD. • ELMHURST, L. I., N. Y.

EXPORT DIVISION: 458 BROADWAY, NEW YORK CITY U.S.A. • CABLES—MORHANEX
CANADIAN SALES DIVISION: ATLAS RADIO CORP. LTD., 360 KING ST. W. TORONTO 2B, ONTARIO

PERSONNEL NOTES

Meet the key men responsible for the manufacture and distribution of servicemen's products.

Garrett W. Davis has been appointed south central regional sales manager for General Electric Tube Department replacement sales, with headquarters in Kansas City, Mo., it was announced by Gordon E. Burns, field sales manager of G-E Tube Department replacement sales.



John Q. Adams, CBS-Hytron's Vice President in Charge of Sales, announces the appointment of Walter J. Brock as Midwest Sales Manager. Mr. Brock replaces George M. Deters who formerly held the same position at CBS-Hytron, a Division of Columbia Broadcasting System, Inc. Previously, Mr. Brock was sales representative at CBS-Hytron's Chicago sales office.



In a joint announcement, Avco Mfg. Co., disclosed that James D. Shouse one of Avco's senior vice presidents who also has been chairman of Crosley Broadcasting Corporation, will be chief executive officer of all Crosley Division operations, including radio-television and appliance activities. He will continue as chairman of Crosley Broadcasting Corporation.



Jerry Kirshbaum, Sales Manager of Precision Apparatus Company, Inc., Elmhurst, N.Y., manufacturers of radio and TV test equipment, has been elected President of the Eastern Division of the Sales Managers Club for the year ending April, 1954. In 1952, Mr. Kirshbaum was Vice-President of the organization, and for the two years prior to that he was a Director to the Show Corporation Board.



David B. Tolins, Jr., named by JFD Manufacturing Company of Brooklyn, New York, to the new position of Publicity Director. Mr. Tolins will assist in direct-mail operations, will write educational articles, press releases, general catalog and cooperative newspaper copy.

At a special meeting of the board of directors of Vaco Products Co., Harry Silverstein was elected president to fill the vacancy left by the death of C. D. Pettingell, co-founder of the Chicago screw driver concern. Alvin E. Shugarman, former vice president, was named executive vice president. James T. Pettingell was elected vice president. Other offices remain unchanged.



Mr. Max Goldfinger was appointed as house salesman for South River Metal Products Co., Inc. He will visit and sell to Parts Distributors in the areas of New York City, Long Island, Southern New York State up to Middletown and Poughkeepsie, and Northern New Jersey. Martin L. Roth, now assumes direct responsibility for all sales promotional activities throughout the United States and Canada.



Thomas Paxton, district sales manager for the Hallicrafters Company, has been named general manager of Hallicrafters-Chicago, Inc., Robert E. Russell, executive vice-president of Hallicrafters-Chicago announced. The new executive joined Hallicrafters as a district sales manager in April 1952. Paxton replaces Ernest Riehl, former general manager who resigned.

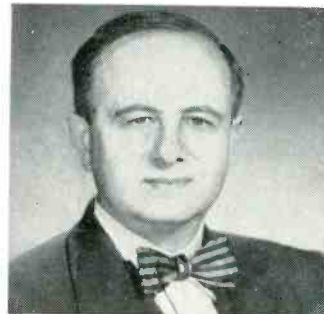

The appointment of Dr. Constantine S. Szegho as vice president in charge of research for The Rauland Corporation was announced by W. E. Phillips vice president and general manager of the Chicago tube manufacturing company. Dr. Szegho's improvements in cathode-ray tubes and other special tubes have been major contributions to the television tube industry.

Joseph J. Connolly has been appointed Resident Field Engineer responsible for the service activities of East Coast distributors of Stewart-Warner Electric, the radio and television division of Stewart-Warner Corporation, Robert W. Felber, Service Manager, has announced. A native of Philadelphia, he will make his headquarters there.



The elections of Don G. Mitchell left as Chairman of the Board of Directors and H. Ward Zimmer right as President of Sylvania Electric Products Inc. were announced by the Board of Directors. Mr. Mitchell, who has been President of Sylvania since 1946, succeeds as Chairman, Max F. Balcom, a member of the Sylvania organization and predecessor companies for 35 years.



The First and Only VHF to UHF Signal Generator Adapter

Here from
PHILCO



Now at a mere fraction of the usual cost, you can produce UHF signals for TV receiver tests. As the output from any VHF signal generator at 60 MC is fed into this Model G8000 Adapter, the VHF sweep or marker signal beats against the UHF oscillator of the unit, producing UHF signals having the same characteristics as the VHF input signal. The most economical system ever . . . and only Philco has it!

Check These Philco Features

1. No expensive attenuator required —the VHF signal generator output attenuator controls the UHF output signal level.
2. Precision Vernier Dial for accurate re-set ability.
3. Can function as an external UHF converter by connecting UHF antenna transmission line to generator's output terminal and connecting lead to TV receiver tuned to 60 MC (Channel 3).
4. High UHF levels, excellent stability, no drift.

VHF INPUT
60 MC

UHF OUTPUT
SIGNAL



5" Wide Band TV Oscilloscope
Model 7021. Finest at the price! Provides extremely wide video response for accurately viewing complex TV wave forms. Celebrated input attenuator and gain control for peak voltage readings.



Philco Appliance Tester
Model 5007. In one compact, portable unit—everything you need to make range, refrigerator, freezer and air conditioner temperature and power measurements quickly and easily.

YOURS ON NEW SPECIAL PAYMENT PLAN

Fill Out and Mail Coupon or See
Your Philco Distributor Now!

PHILCO CORPORATION, Accessory Division
Allegheny & "A" St.,
Philadelphia, Pa.

- I am interested in the Philco Test Equipment shown here. Please send me details of your SPECIAL PURCHASE PLAN for obtaining these units.
- Please send FREE copy of your new booklet on Philco Test Equipment.

NAME.....
ADDRESS.....
CITY..... STATE.....



PHILCO Test Equipment
SPECIFICALLY Designed for the Serviceman

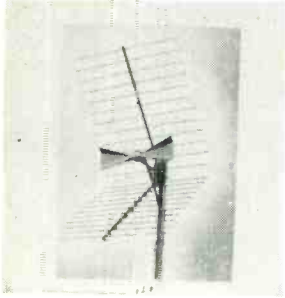
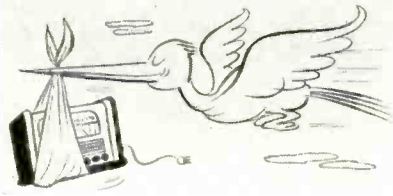

VEE-D-X Markets Corner Reflector

La Pointe Electronics Inc.—A new addition to the VEE-D-X line of uhf antennas is the new Corner Reflector, Model COR-U. It delivers high gain on all uhf channels and has excellent front to back ratio which for the most part eliminates the need for probing in difficult signal areas. Compact swing-open design which requires less than thirty seconds for assembly.

New Flyback Transformer

Ram Electronics Sales Co., Irvington-on-Hudson, New York, manufacturers of the complete RAM line of Test-Pattern Tested components for television, has just made available to the replacement market the new Model XO74 Horizontal Deflection & High Voltage Output Transformer. Rugged, anti-corona construction, edge-to-edge 70-degree deflection, compactness and high-efficiency design are among its many other features.

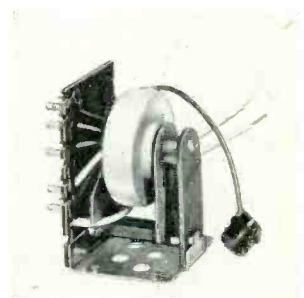

New Device Converts Battery Portables to AC

Electronic Devices, Inc., selenium rectifier manufacturer of Brooklyn, N. Y., introduces "Sav-A-Battery" new device which quickly converts battery-type portable ("personal") radios to ac operation on ordinary 110-volt house current, occupying the same space as the batteries it replaces. Sold through service dealers, list price is \$9.95.

Blue-Point Capacitor

A completely new concept in the design, construction and performance of molded plastic paper capacitors (patent pending), was announced by Astron Corporation, 255 Grant Ave., East Newark, New Jersey. Capacitors are housed in an attractive, yellow, tough, non-flammable, molded plastic case and are permanently sealed against heat and moisture by means of a special solid glass-like thermosetting bond.

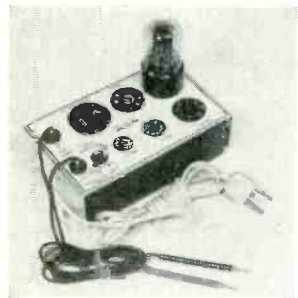
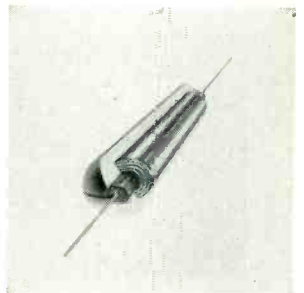

New General Purpose Tube Checker

Visulite Co., 423 Broome St., New York, N. Y. has introduced its new Tube Checker. Primarily designed for continuity and inter-element short checks on all radio, TV and picture tubes, the Visulite Tube Checker is provided with test leads for checking continuity. It is completely shockproof and guaranteed not to damage tubes or other devices under test.

RCA Coupling Device

Installation of secondary TVsets in the home is made possible by this small RCA coupling device which permits simultaneous operation of two TVsets from the same antenna. Installation of coupler requires only screwdriver and several minutes. Connections are made by attaching coupler to antenna line and running separate transmission line from top of coupler to second TVset. The three sections of the RCA TVset coupler are shown at right. Unit lists for \$1.95.

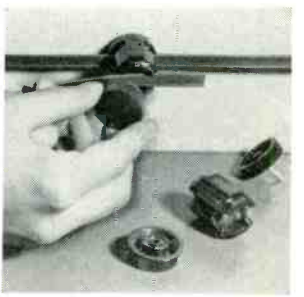

New Hush Jr. Kit Servicer

Chemical Electronic Engineering, Inc., 233 Main St., Matawan, N.J., announces the new Hush Jr. Kit Servicer that consists of a 2 ounce bottle of Hush complete with a 24 karat gold plated spray attachment, retailing at \$1.25. Cleaner sprays on, leaving a protective film which does not react to heat, cold, oil or corrosive solution. Hush will not affect inductance, capacitance or resistance.

Snap-Around Ammeter

The Amprobe Junior, a new snap-around volt-amp tester built to do a specific job at low cost, is now being introduced by the Pyramid Instrument Corp. The Amprobe measures current instantly without shutdowns or ammeter connections. It is a voltage meter which gives an accurate voltage reading without guesswork on a full-size 1.8" calibrated scale. The Junior sells for only \$19.85, including voltage test leads.

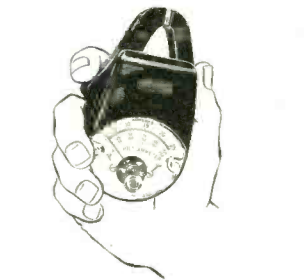

3-Tube Multi-Power vhf Television Booster

A new, improved Model 3002-A 3-tube Tune-O-Matic all channel vhf TV Booster is being produced by Electro-Voice, Inc. Buchanan, Michigan. Automatically self-tuned to all vhf channels, no separate manual tuning of booster is required. Built-in Hi-Lo Gain Switch permits reducing gain, if desired, when local station is tuned in.

New Halldorson Flyback

Answer to the need for hard-to-duplicate Philco flybacks, have been announced by Halldorson Transformer Company, 4500 Ravenswood Ave., Chicago 40, Illinois. These parts are designed to service over 135 Philco TV models for 1951-52-53. Halldorson FB407 and FB408 are tailor-made coil assemblies made to fit the core pieces, terminal panels, and mounting brackets of original Philco parts which are adaptable to quick coil changing.

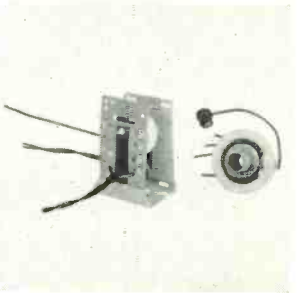

TRIPLETT 630 Volt-Ohm-Mil-Ammeter

"speaks" for itself in any company



ing to desired circuit thru a single 2½" knob flush with the face panel. The molded switch itself embodies the most advanced engineering practices. Fully enclosed, the silvered contacts are kept permanently clean. Its rugged construction means stronger performance and longer life.

These two factors are but samples of the many ways in which on-the-job needs have been anticipated and provided for in a beautiful streamlined tester. It provides A.D-D.C. Volts, D.C. Micro-amperes, Milli-amperes, Amperes, Ohms, Megohms, Decibel and Out Put readings in a no-short design embodying interior construction with all direct connections; no harness cabling. Its fool-proof unit switch construction houses precision resistors in insulated recesses in direct connection with switch contacts.

Study the following Ranges and descriptions and compare them point by point with any similar instrument for conclusive proof that Triplet 630 "speaks" for itself in any company.

Ranges

D.C. Volts: 0-3-12-60-300-1200—at 20,000 Ohms/Volt (For Greater Accuracy on TV and other High Resistance Circuits.)

A.C. Volts: 0-3-12-60-300-1200-6000—at 5,000 Ohms/Volt (For Greater Accuracy in Audio and other High Impedance A.C. Circuits.)

Decibels: -30, +4, +16, +30, +44, +56, +70.

(For Direct Reading of Output Levels.)

D.C. Microamperes: 0-60—at 250 Millivolts.

D.C. Milliamperes: 0-1.2-12-120—at 250 Millivolts.

D.C. Amperes: 0-12—at 250 Millivolts.

*Ohms: 0-1,000-10,000—(4.4-44 at center scale).

*Megohms: 0-1-100—(4,400-440,000 center scale).

Output: Condenser in series with A.C. Volt ranges.

*Resistance ranges are compensated for greatest accuracy over wide battery voltage variations. Series Ohmmeter circuits for all ranges to eliminate possibility of battery drain when leaving switch in Ohms position.

TRIPPLETT 630 Volt - Ohm - Mil - Ammeter has many significant advantages and features that make it stand distinctly apart from similar instruments in its price class. Actually in components, in engineering, in minutely accurate performance, Triplet 630 closely approaches laboratory standards.

Since the scales of any VOM comprise the means by which it makes its multiple services most valuable, the legibility and easy-read-ability are of prime importance. Triplet engineers have created in Triplet 630 the longest scales available in this size tester. (The upper arc by actual measurement is four and three-eighths inches.)

This long-scale factor accounts for the ease with which precise readings are easily made. Further legibility is gained by use of black and red scale markings. D.C. and D.B. are black and white. A.C. and Ohm markings are red on white. Ohms from one hundred million to one-tenth ohm mark the range of this amazing scale. On low ohms, center scale reading is 4.5 ohms.

The Single Switch

Further indication of the practical skill and engineering "know-how" behind Triplet 630 is the Single Switch. Its simplicity of operation assures no burn-outs thru momentary memory lapses. There is instant switch-

Get a Triplet 630 into your own hands at your distributor.
U.S.A. Dealer Net \$3950

TRIPPLETT ELECTRICAL INSTRUMENT COMPANY
BLUFFTON, OHIO

TRIPPLETT



New uhf vhf Directronic Portable TV Aerial

Snyder Manufacturing Company of Philadelphia has announced production of a new Directronic portable TV Aerial for uhf-vhf reception. Snyder GM-K adjustments take advantage of the weaker than normal signals encountered indoors. Snyder 6-position Directronic switch aids in impedance matching and ghost elimination.

TV Wall Plate Socket

A new television lead-in wall plate socket that requires no wall opening or outlet box has been announced by Mosley Electronics, Inc. Said to resemble in appearance standard electrical wall plates, the new Mosley TV Sockets mount flush on wall or baseboard and may be installed in seconds with just a screwdriver. For additional information write Mosley Electronics, Inc., 8622 St. Charles Rock Road, St. Louis 14, Missouri.



New Test-Point Jack

A new Test-Point Jack (also called Terminal Jacks), has been developed and put on the market by Cannon Electric. Titled the 45-E Series and designed to accommodate standard 0.081 inch diameter phone tips, the Jacks are used for patch boards, high-voltage disconnects, feed-thrus, stand-offs, switching range calibration and general laboratory use. The Jacks are 15/16 inch overall.

UHF "Tri-Fan" Antenna

Insuline Corporation of America, 3602-35th Avenue, Long Island City, N. Y., announced a new antenna designed for channels 14 to 83. It is of the bow-tie type and achieves very sharp directivity through the use of a rectangular reflector screen. The antenna proper measures 17 by 7 inches; the reflector 20 by 11 inches. The unit is easily assembled, and mounts on standard pipe with a single U clamp.

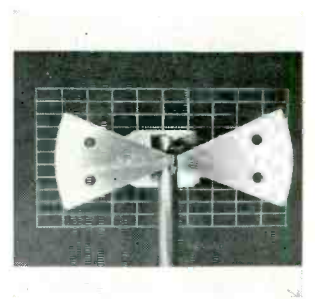

Rocketennas Give Higher

Sensitivity

Tesco, by TV Products Company of Springfield Gardens 13, New York, announces 10 element Yagi Rocketennas cut to single channels for maximum gain. Completely pre-assembled, all-aluminum Rocketennas cover channels 2 through 6 in two section units—boom-braced. Channels 7 through 13 are designed as one-piece units requiring no boom-bracing. Literature upon request.

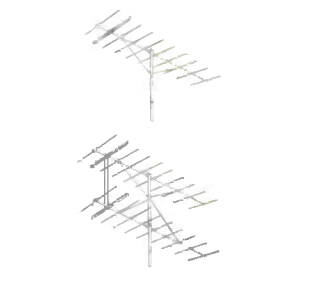

UHF611 Bowtie-Flector

JFD Manufacturing Company of Brooklyn, New York, announce production of new model uhf611 Bowtie-Flector antenna. The recent innovations in all JFD antenna manufacturing—rigid wire-frame screen reflectors that minimize vibration, and JFD's "Bronzidite" military-specified plating that prevents rust and corrosion in non-aluminum parts—are prominent features of the model uhf611.

Ultra-Tri-Interaction Filter

Channel Master Corp., Ellenville, N.Y., has announced the development of the Ultra Tie, Model No. 9034, that combines separate antennas into a single vhf-uhf antenna system. The Ultra Tie performs two valuable functions: At the mast, it joins all types of individual vhf and uhf antennas together for use with a single transmission line; and at the set or converter, it separates vhf and uhf signals where separate vhf and uhf terminals are provided.

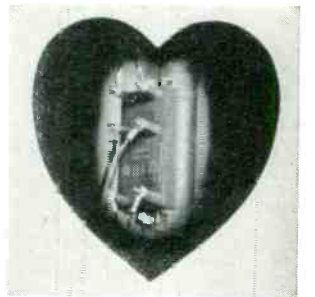

New Dynatracer

Century Electronics Co., 8509-21 Ave., Brooklyn, N.Y. has introduced an effective piece of test equipment, the Dynatracer. It is a portable self-powered quality instrument designed to trace or inject signals through video, sound, sync, AFC, vertical or horizontal sweep circuits. With a flick of a switch, it will also trace voltages and locate open, shorted or intermittent components.

Garrard Announces New Manual 3-Speed Record Player

Player

Garrard Sales Corp., 164 Duane St., N.Y. 13, introduces this new compact, high-fidelity manual record player. The new Garrard model "T", the "Crest", plays all record speeds, and guarantees the finest reproduction of recorded music where a changer is not desired. Features include: easy stylus pressure adjustment; professional-type finger lift; automatic start and stop mechanism.



New Stacked Bow Tie

Telrex, Inc., Asbury Park, N. J., introduces the Telrex Model No. 755 that provides a completely pre-assembled, unitary array comprising two vertically stacked Bow Tie "Conical-V-Beam" dipoles with stacking bars, and a single, screen reflector assembly for uhf channels 14 to 83.

"Carlco" Parts Kits and

Wire Counter Display

Carl Cordover & Co., 100 Warren St., New York 7, N.Y., has introduced five new parts kits for servicemen, and dealers. The Resistor, Tubular, Mica, Ceramic, and Electrolytic Kits contain all assortments which include the most popularly used sizes as replacements in all electronic equipment.

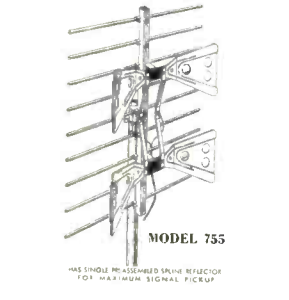
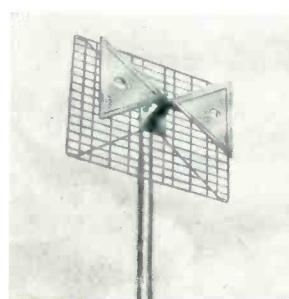
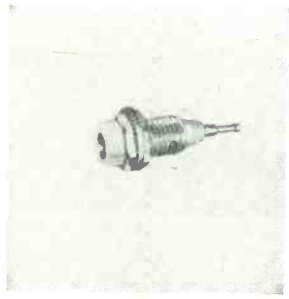

CBS-Hytron Test Adapters

CBS-Hytron, Danvers, Massachusetts, is offering, in addition to its 7-pin Test Adapter, a 9-pin Miniature Test Adapter and an 8-pin Octal Test Adapter. Now servicemen can test all sockets "topside". No more wrestling with heavy chassis. There is no need to disturb wiring or parts—just plug tubes into Test Adapters and Adapters into sockets.



NOW! EVERY CHANNEL—

**2 to 83, with one antenna
—one transmission line**

THE *Telrex*

**DUO-BAND
"CONICAL-V-BEAM"***

REGISTERED
TRADEMARK

BETTER BY DESIGN...

RAIN OR SHINE!

Telrex

UHF STACKED
"CONICAL-V-BEAM"
WITH PARABOLIC
TUNED SPLINE
REFLECTOR

Full-wave, Stacked "Conical-V-Beam" Dipoles with Parabolic Reflector. Stacked Broad-Band "Perfect Match" Conical-V-Beam Dipoles with tuned spline parabolic reflector for clean, ghost-free low angle, long distance, reception "Rain or Shine." The "Ultimate" in UHF arrays. Gain — Better than 15.9 db. Front-to-Back Ratio in excess of 28 db.

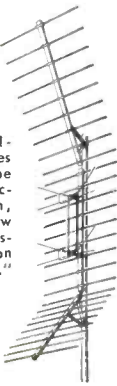

● **DUO-BAND "CONICAL-V-BEAM"** — The TELREX "DUO-BAND" extends the "Conical-V-Beam" principle with the addition of two supplementary V splines which compact and add in-phase the higher frequency signals.

● **TRANSITION FROM VHF to UHF is AUTOMATIC and PERFECT!** (No "lossy" filter or isolation networks.) VHF and UHF signals are picked up at same cone apex.

● **NOW! WITH A SINGLE TRANSMISSION LINE!** Uniformly high gain with one major lobe. Channels 2 to 83. Actually improves reception on Channels 7 to 13 over standard "Conical-V-Beam."

● **EXCELLENT DIRECTIVITY ON VHF-UHF** — A clean, unidirectional pattern, assures high signal-to-noise ratio and freedom from "ghosts." The perfect array for reception near or far. Rugged design—light weight—low wind resistance—stacked models for increased sensitivity.

● **MODIFYING EXISTING "CONICAL-V-BEAMS" WITH TELREX KITS** — Existing "Conical-V-Beams" can be modified to operate efficiently on Channels 2 to 83 by means of the new TELREX Modification Kit.

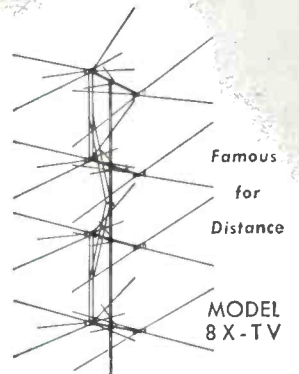

Famous
for
Distance

MODEL
8X-TV

The ultimate in long distance arrays. Guaranteed to out-perform any antenna or combination of cut-to-frequency antennas. When used with Duo-Band splines it comprises the ultimate in reception on Channels 2 to 83. If the Telrex 8X-TV does not produce a usable signal TV reception is either impossible or impractical!

"CONICAL-V-BEAMS" ARE PRODUCED UNDER RE-ISSUE PATENT NUMBER 23,346 and SOLD ONLY THRU AUTHORIZED DISTRIBUTORS



ASBURY PARK 5,
NEW JERSEY



Originators and Manufacturers of "CONICAL-V-BEAMS" — insist on the Original!



TRADE LIT

[from page 37]

advantages of the new line now being produced by International Rectifier Corporation. These Diodes are the result of two years of development and pilot production. Any of the standard units listed in Bulletin GD-1 may be shipped from stock. Larger production quantities can be scheduled to meet your requirements.

* * *

L-153 Brochure on Sub-Miniature Indicator Lights is offered by Dialight Corporation upon request. Units described fall into the following general categories: (1) For Plastic Plate Edge

Lighting, Qualified Products List Approval QPL-7806 . . . (2) Indicator Lights, non-dimming . . . (3) Dimmer Types, mechanical or polaroid . . . (4) Light Shield, for lighting dials and instruments . . . (5) Indicator Lights with patented "Press-to-test" feature and dimming or non-dimming lens caps. Diagrams and technical data facilitate procurement of units from the brochure.

Inquiries may be addressed to: Mr. E. Greene, Dialight Corporation, 58 Stewart Ave, Brooklyn 37, N. Y.

* * *

The Insuline Corporation of America, 3602 35th Avenue, Long Island City 1, N. Y., has released a 16-page brochure describing the production of

electronic components and assemblies for both civilian and military purposes. The publication is printed in two colors and is elaborately illustrated. Copies are available upon request.

PHONO FACTS

[from page 50]

pickup head in motion at the lower frequencies, particularly.

Bear in mind, as the bristles wear the brush becomes stiffer. Slivers of the bristles will be deposited in the grooves, further adding to distortion. One, single bristle may be compliant but, when reinforced by 50 to 100 or more bristles, the brush becomes a secondary stylus in its own right, producing rumble, wear, "double-talk," etc.

Then, there is the obvious action by the brush that gathers under itself a lot of the dust and grit and, like fine sandpaper, keeps rubbing it into the delicate surface of the groove walls—inflicting scratches, slowly but surely.

If you must use a brush, attach it to the arm as far to the rear as possible, to minimize transmission of vibrations to the pickup head.

Try this:—Insert a brush—such as above referred to—in place of the regular stylus in your pickup. Place it on a record and turn up the volume control. You will be astonished at the distorted sounds you will hear.

Liquids

Experience with some of the liquids now on the market, shows that they have a tendency to coat the grooves with a pasty, greasy film. Such pasty film then collects and cakes up on the stylus, causing distortion.

Before using any liquid on your records, be mighty sure of its efficacy and harmlessness to the disc and stylus.

It has been suggested that LP records be treated like photographic plates. They each have a delicate surface, so let each be washed in a similar manner, using, of course, plain water for the discs. However, as one record collector said, "this would be like having to wash dishes after each meal." Furthermore, it has been found that letting water run on the disc will not remove the dust and grit from the very short waves, unless the faucet is open full force. This is highly inadvisable, as the full force of the water stream would have a "sandblast" action, causing the grit to leave puck marks on the delicate surface of the groove. . . . By the way, this prompts the writer to ask: Would you rub a

HERE IT IS!



Complete, up-to-date listings, illustrations, and descriptions of ERIE Electronic components are contained in the new ERIE CATALOG D-53.

This catalog assembles all the new items introduced since publication of our last catalog together with the long-time standard numbers.

Ask for it at your Distributors,
or write Dept. C for your copy.

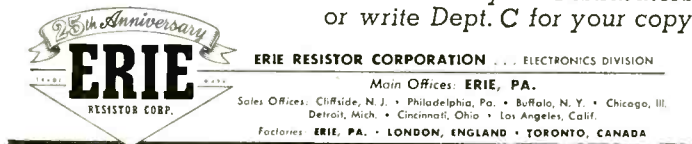

MOVING?

When you change your address, please notify our circulation department as soon as possible. This is to your advantage, since it takes approximately 5 weeks to have your stencil changed and duplicate copies cannot be sent. Be sure to give your old as well as your new address.

RADIO-TELEVISION SERVICE DEALER

67 West 44th St.
New York 36, N. Y.

Order Yours Now!

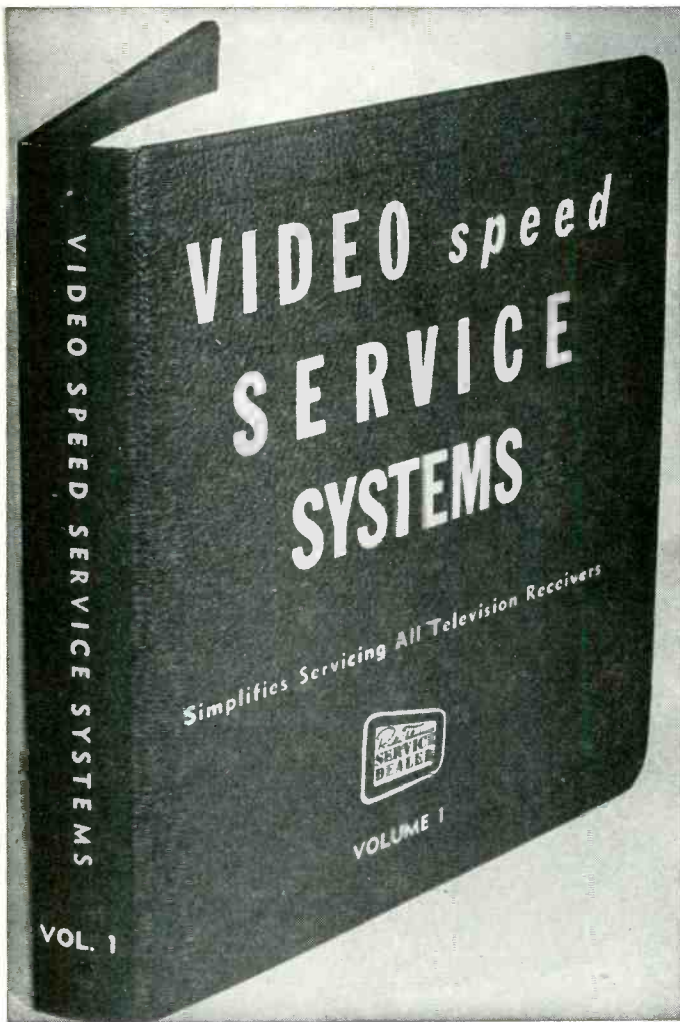

VIDEO speed SERVICING SYSTEMS

\$4.95 • (post paid)

Distributors—order your supply now!

Service Dealers—get your copy of VSSS from your Distributor. If he can't supply you, order direct by mail from us.

Contains over 600 Service Items representing over 1000 of the most-serviced Television models now in use. Over 25 different manufacturers' lines are covered.

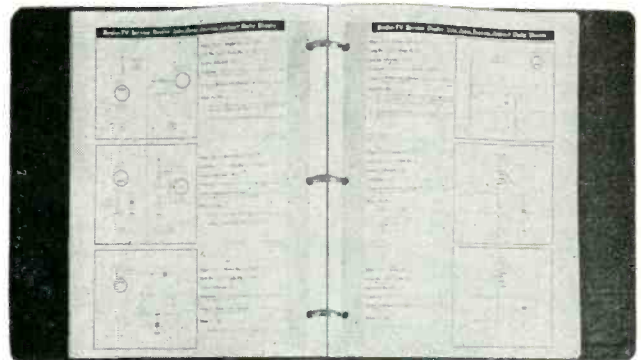

The expansion type ring binder (of finest quality) is 9 x 12 inches, holds all 224 pages of VSSS Vol. 1, and has room for another year's supply of VSSS Data Sheets. Opens flat for bench use. TVset models and chassis are cross indexed for speedy reference.

Video Speed Servicing Systems IS GUARANTEED To Simplify Servicing All TVsets. 24 (or more) new Data Items are published in every issue of "Radio-Television Service Dealer" as a regular monthly feature.

TEAR OFF AND MAIL NOW

RADIO-TELEVISION SERVICE DEALER
67 West 44th Street, New York 36, N. Y.

Please send me post-paid VIDEO SPEED SERVICING SYSTEMS Volume 1. Enclosed herewith is

my check money order for \$_____ for _____ copies at \$4.95 each.

Name

Address

City Zone State

photographic plate with a cloth, brush or any other object?

Pre-Emphasis and De-Emphasis

The average record purchaser has the mistaken idea that it is the new plastic (vinyl) material that is responsible for the scratchless reproduction of these new discs. To be sure, the new vinyl plastic is a contributing factor to the quietness of the new discs. This is true in part only. . . . Actually, however, the detested surface noise (scratch) is rendered inaudible through an ingenious technique used in the recording and playing of these records.

Because, an understanding of the workings of this technique will aid in obtaining the intended performance, an explanation is in order.

It will simplify matters if, for explanatory purposes, we take only one frequency, say 5,000 cycles. In this technique, the 5,000 cycle note would be recorded four times as loud as it should be, that is four times (+ 12db) as loud as a 1,000 cycle note. Such a pre-emphasized recording, if played the same way as the 78's that is, without any correction (equalization), would be much too shrill. Therefore, the accentuated 5,000 cycle note must be reduced (electrically) to the

level of the 1,000 cycle note, if the performance is to be as intended.

In recording, accentuating the higher frequencies, as outlined above, is referred to as pre-emphasis. The technique that must be used when such a record is played, is referred to as de-emphasis.

The usual "scratch" is not present in the soft master recording, but is brought into play with the material. When the 5,000 cycle note is electrically reduced to only 1/4 (minus 12 db) of its recorded volume, the scratch is automatically reduced by the same amount. . . . A poorly designed pickup (peaks) will nullify the advantages of this technique.

The above is of great importance, as most record buyers are unaware of this recording and playing technique and play LP's in the same way as they play the 78's—resulting in scratch, shrillness and distortion.

1. De-emphasize (reduce) the treble notes to their proper value, if you want quality performance from LP's.
2. All good amplifiers now have provision for proper LP de-emphasis.
3. If your amplifier has no provision for it, the maker of your pickup will supply the necessary

information for obtaining the proper de-emphasis.

If de-emphasis is carried out as intended, with good LP discs, no scratch should be audible—provided your records have not been abused.

In conclusion, it is hopeful that the information contained here will prove of assistance. To those not versed in the art, who may be contemplating the assembly of quality audio apparatus, the following suggestion is offered:

Assuming that, after inquiries and investigation, you have finally decided on the reproducer, as the first step in building up the chain of audio components. Write to or call on the maker of the pickup, and ask him for his recommendations for a turntable and amplifier. It is natural for the maker of the pickup to wish his reproducer to perform with a good turntable and a good amplifier. For that reason, his recommendations may be depended upon. After that, you ask the maker of the amplifier what speaker he recommends. For the same reasons, the maker will want to recommend the speaker which will perform best with his amplifier.

The writer has seen this method of selecting audio apparatus work out satisfactorily in many cases. It is simple and costs nothing. Try it out

Service Men!
THE GUARDIAN
SERIES 200
RELAY...

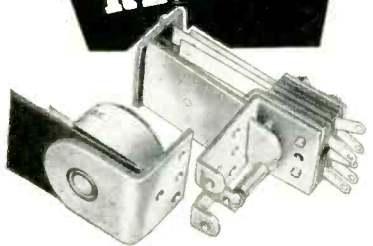

Interchangeable
COIL and CONTACT SWITCH ASSEMBLIES
Save Time—Cut Costs!

★ Coil assembly includes coil and field piece. Contact assembly consists of switch blades, armature, return spring and mounting bracket. Standard and Midget contact assemblies in either S.P.D.T. or D.P.D.T. are interchangeable and can be used with any of 13 coils described below.

CONTACT SWITCH ASSEMBLIES

CAT. NO.	TYPE	AMPS	COMBINATION
200-1	Standard	8 amps	Single Pole Double Throw
200-2	Standard	8 amps	Double Pole Double Throw
200-3	Standard Contact Switch Parts Kit with complete assembly and wiring details		
200-4	Standard	12.5 amps	Double Pole Double Throw
200-5	Standard	8 amps	Four Pole Double Throw
200-M1	Midget	8 amps	Single Pole Double Throw
200-M2	Midget	8 amps	Double Pole Double Throw
200-M3	Midget Contact Switch Parts Kit with complete assembly and wiring details.		

13 COILS ASSEMBLIES

A.C. COILS*		D.C. COILS	
CAT. NO.	VOLTS	CAT. NO.	VOLTS
200-6A	6 A.C.	200-6D	6 D.C.
200-12A	12 A.C.	200-12D	12 D.C.
200-24A	24 A.C.	200-24D	24 D.C.
200-115A	115 A.C.	200-32D	32 D.C.
		290-110D	110 D.C.
		200-5000D	for current type

*All A. C. coils available in 25 and 60 cycles

GUARDIAN ELECTRIC
1606-G W. WALNUT STREET CHICAGO 12, ILLINOIS
A COMPLETE LINE OF RELAYS SERVING THE RADIO INDUSTRY

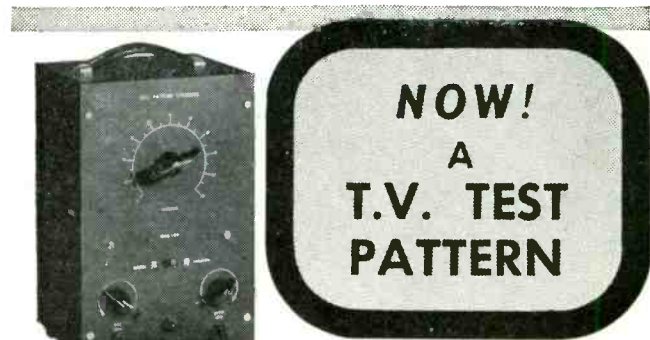

NOW!
A
T.V. TEST PATTERN

WHenever You NEED one

USE
MODEL CB-101

UTL PATTERN GENERATOR

SIMPLE • EFFICIENT • ACCURATE

for a **STEADY NON-SHIFTING**
VERTICAL or HORIZONTAL
TEST PATTERN

HERE'S WHY YOU'LL LIKE IT . . .

- ★ Makes horizontal and vertical linearity, width, height and centering tests.
- ★ Checks relative gain of video stages; isolates defects in video amplifier.
- ★ Tests performance of kinescope directly.
- ★ Checks overall image reproduction when used to modulate TV signal generator.
- ★ Uses sync impulse of receiver to insure steady line or bar pattern.
- ★ No removal of chassis necessary; special leads connect to tube pins.

— Ask your distributor about it.

Send for free folder No. 205

UNITED TECHNICAL LABORATORIES

Engineers • MORRISTOWN, N. J. • Manufacturers

the next time you have to assemble a system.

A severe and complete revolution has taken place in the field of recorded music. This fact must be kept in mind if you wish to obtain, to the fullest, the performance of which these new discs (the 78 r.p.m. discs too), are capable. . . . Results obtained with poor or old, compromise equipment, will be just as the name implies, a poor compromise—at best.

You go to a concert to satisfy your desire for good music, which is exactly what you want in music electronically reproduced. . . . In both cases, your ears are the only, the supreme judge.

—o—

CIRCUIT COURT

[from page 55]

vides a much greater variation of width.

Horizontal centering is effected by means of a bridge circuit (Fig. 2), which can vary the direction of *dc* through the deflection coils. It utilizes the primary of the transformer and the 6BQ6 as one leg, the centering

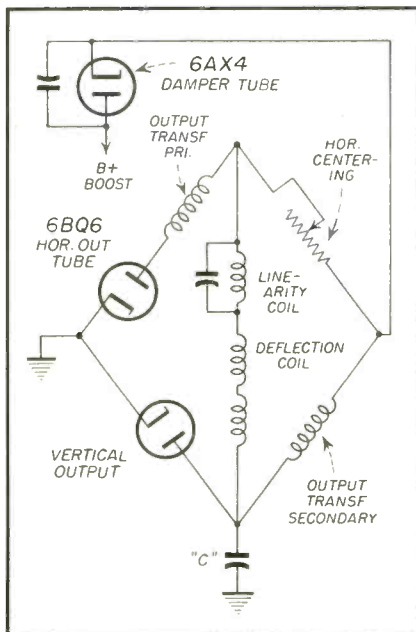

Fig. 3—Bridge circuit used for horizontal centering.

control as a second leg, the transformer secondary as a third leg and the vertical output circuit as the fourth leg. The linearity coil and horizontal deflection coils are connected across the bridge. The boosted B+ is the source of direct current for the bridge and the linearity coil and condenser serve as a correction device to effect linearity, at the same time allowing the direct current to flow.

HORIZONTAL SYNC & SWEEP

[from page 31]

voltage system (Fig. 9) and the fly-back or kick-back system (Fig. 10).

The latter is a logical extension of the deflection system which we have been discussing. In this system, during retrace time, the high rate of change of current results in a high voltage pulse. As a typical example, if this pulse appearing across the yoke coil and the output transformer secondary is 1000-1500 volts p-p, the voltage reflected back to the amplifier tube plate by means of the secondary to primary step-up may reach a value of 6,000 volts, p-p. By means of autotransformer action, this is further stepped up

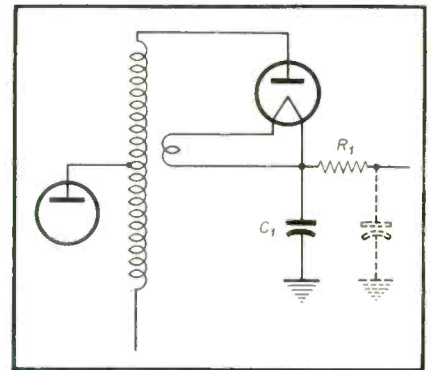

Fig. 10—Flyback high voltage.



Your reputation as a skilled Service Man depends a great deal on your choice of replacement parts. The performance of replacement speakers reflects upon your ability and knowledge. Be sure the reflection is favorable. Specify Utah* speakers—and your customers will say "That Service Man Knows His Business!"

*All Utah speakers have exclusive Utah Universal Angle Mounting.

FREE . . . WRITE TODAY FOR THE NEW UTAH REPLACEMENT SPEAKER CATALOG S201
Export Dept. Rocke International Corporation, N. Y. C.

utah

RADIO PRODUCTS CO., INC.
HUNTINGTON, INDIANA

A WHOLLY OWNED SUBSIDIARY OF NEWPORT STEEL CORPORATION

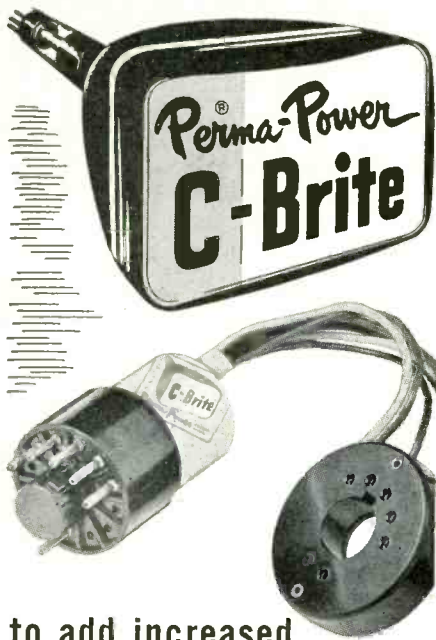

to add increased
brilliance to any
TV PICTURE TUBE

manufactured by
Perma-Power COMPANY
Chicago 25, Illinois
Manufacturers of Electronic Equipment Since 1928



double purpose for double sales!

JFD Lightning Arrester AT103
protects UHF and VHF signals

For use with UHF or VHF tubular twin lead, the AT103 is the perfect tie-in for every antenna sale. And the exclusive JFD strain-relief lips that prevent contact washers from ripping the twin lead apart give you yet another sales-making feature. Write for bulletin #139. *No. AT103 \$2.25, list.

*Complete with stainless steel strap and aluminum ground wire.
JFD Manufacturing Co., Inc., Brooklyn 4, N. Y.
World's largest manufacturer of television antennas and accessories

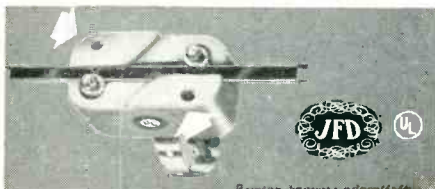

so that at the plate of the high voltage rectifier it is in the order of 12-15 KV. By means of a filament winding coupled to the transformer the diode conducts on every pulse. The rectified output is filtered by means of C_1 , R_1 and the capacity of the aquadag coating of the CRT to ground.

In the r-f high voltage system (Fig. 9) we find an oscillator with a very high-Q tank in the plate circuit. This plate tank is coupled by autotransformer action to the plate of the high-

voltage rectifier. The action is then similar to the fly-back system.

Servicing the Deflection System

In servicing the horizontal deflection system circuits, the troubles are usually obvious. The main thing to be careful about has been pointed out several times in this series. That is to replace defective parts with their exact replacement. Make sure that the replacement is exactly like the defective part in all its electrical and mechanical specifications.

UHF ANTENNAS

[from page 29]

only in the field under actual operating conditions. There are three positions near the bend of the antenna, at which the transmission line may be connected. Which of these is used, depends on the desired coverage of the antenna.

Rhombic Antennas

This antenna, (Fig. 7A) is essentially two "Vs" connected end to end. In performance however, it is a much better arrangement. This is one of the antennas, which has been found practi-

which does not have the transmission line connected to it, is pointed to the station being received. At this point, as shown in Fig. 7B, we usually connect at 470 ohm noninductive resistor. (A carbon resistor serves the purpose very nicely.) An antenna constructed in such a fashion has a uni-directional response. That is, it receive signals only from the front. If it is desirable to make the antenna bi-directional, (Fig. 7C) that is, if we want to make it received signals equally well from the

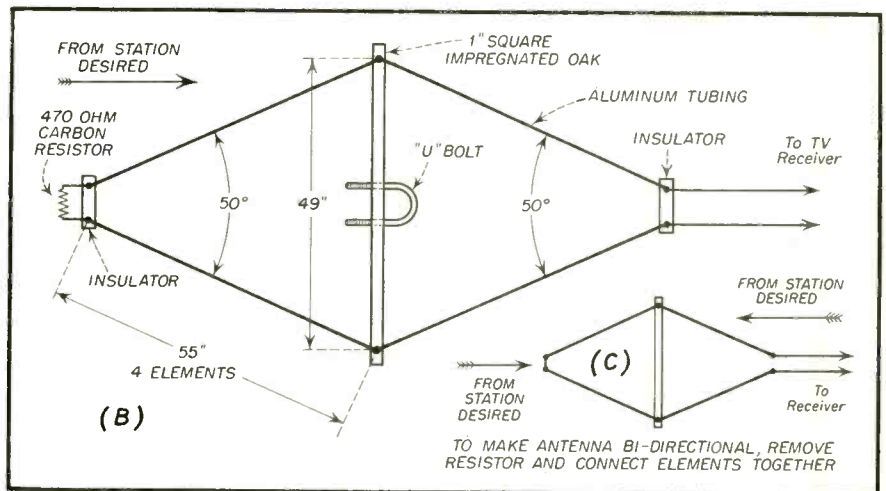

Fig. 7—Rhombic antenna dimensions and characteristics.

cal only for the *uhf* band, since its dimensions when calculated for a *vhf* channel, become prohibitively large. For *vhf* its legs would be around 21 ft. each. This antenna is illustrated in Fig. 7B. As we can see, the length of the legs for *uhf* is only 55" and the included angle is 50°. An antenna constructed this way will satisfactorily cover all *uhf* channels and it will exhibit characteristics which will show an increase in gain for the upper *uhf* channels. The antenna is quite directional and is to be recommended in installations where trees, buildings and other obstructions cause trouble due to multiple signal path reflections. The antenna is connected so that the end

front, and from the back, we simply remove the resistor, and connect the two elements. If additional gain is required, the antennas may be stacked and should be separated half a wavelength at the desired frequency.

Yagi Antennas

The Yagi is a type of narrow band high gain antenna with which we already are familiar. It has proven its value as just about the best fringe area antenna for *vhf*, and it looks like it might have the same distinction for *uhf*. Because of the much shorter wavelengths with which we are now dealing, the antennas are quite a bit more compact and certainly a whole



SAVE Up to \$1.00 each.

Form a Group,

Subscribe to "RTSD"—

"The Professional Radio-Television man's Magazine"—published monthly. All articles are exclusive and timely. Practically every issue is worth what an entire 1 year subscription costs.

The more in a group the bigger the savings. 6 men in a group save \$1.00 each; 4 men groups save 80c per man. Present "RTSD" subscribers may participate in or form a group with co-workers, or even competitors. Still active subscriptions are automatically extended 2 years. Start a Group today! The timely and exclusive technical data appearing in future issues of "RTSD" will make this the best investment you ever made. The special Group Rate offer may be withdrawn at any time—so hurry.

Use This Coupon For Convenience

(The coupon below can be used for from 1 to 6 subscription orders. Use it today!)



TEAR OUT—MAIL TODAY

RADIO-TELEVISION SERVICE DEALER
67 West 44th Street, New York 36, N. Y.

Please enter 2 years subscription orders for the names given below. Our remittance is enclosed.

NOTE: If you do not wish to tear this order blank out, just print or type the information on a single sheet of paper, following the style given. Each subscriber's occupation must be clearly described.

	AP-1
	In U.S.A.
<input type="checkbox"/> One 2-year subscription	\$3.00
<input type="checkbox"/> Two 2-year subscriptions each	2.50
<input type="checkbox"/> Three 2-year subscriptions, "	2.30
<input type="checkbox"/> Four 2-year subscriptions, "	2.20
<input type="checkbox"/> Five 2-year subscriptions, "	2.10
<input type="checkbox"/> Six 2-year subscriptions, "	2.00

Name

Address

City Zone State

Describe Title or Position and Type of Business

State whether a New Subscriber or Renewal Order

Name

Address

City Zone State

Describe Title or Position and Type of Business

State whether a New Subscriber or Renewal Order

Name

Address

City Zone State

Describe Title or Position and Type of Business

State whether a New Subscriber or Renewal Order

Name

Address

City Zone State

Describe Title or Position and Type of Business

State whether a New Subscriber or Renewal Order

Name

Address

City Zone State

Describe Title or Position and Type of Business

State whether a New Subscriber or Renewal Order

Name

Address

City Zone State

Describe Title or Position and Type of Business

State whether a New Subscriber or Renewal Order

A Full Size
LIGHTNING ARRESTER
at the Price of a Midget



LIGHTNING ARRESTER

MODEL TAS Real protection against lightning and static charges — the RADIART Lightning Arrester has all the features! Fits anywhere... inside or out... handles standard or jumbo leads... no wire stripping necessary... does not unbalance the line... low internal capacity... no loss of signal... internal resistance "leaks off" static discharges! UNDERWRITERS LABORATORIES APPROVED.

THE RADIART CORPORATION
CLEVELAND 13, OHIO

The **NEW**
JSC
Tubular
Twin Lead...



The best low loss, low cost 300 ohm lead-in for UHF and VHF television.

Rain, snow, dirt or salt deposits do not materially affect impedance and electrical efficiency.

JSC tubular construction contains and protects the concentrated field of energy and reduces to a minimum high ratio signal losses.



Manufactured under license of Amphenol Pat. 2543696.

lot smaller and lighter than their big *uhf* brothers. Nevertheless, they provide more gain than any other *uhf* antenna of comparable weight and size. Essentially, the antenna consists of a folded dipole with a reflector and a number of directors. At the present time there are *uhf* yagis on the market with four, six and eight directors. That gives us six, eight and ten element yagis respectively. Because of the small size of the antenna, it is physically possible to construct a yagi with 15 or even 20 active elements.

The yagi has an excellent front-to-back ratio, but its bandwidth is rather limited. As more and more elements are added, the bandwidth decreases and the gain will show an increase. The highest gain is obtained at that frequency for which the antenna is designed and the gain drops off rather sharply on each side of the design frequency. Commercially, these antennas are available for a group of adjacent channels. With one of these antennas it is possible to cover satisfactorily about seven adjacent channels on the low end of the *uhf* band, and on the upper end we can cover approximately ten channels with one antenna. Of course, the response will be best, and the gain will be highest only on the channel for which the antenna has been designed. Various modifications have been made in the basic yagi design, and the goal has always been to give us an antenna that has the very high gain of a yagi and yet be a "broad band" antenna. On this basis, there is now available a group of three modified yagi antennas that are designed to cover all 80 *uhf* channels satisfactorily.

All of the pertinent design data is given in Fig. 8. The antenna consists of one reflector, the antenna element and four directors. The directors and reflectors can be made of 1/4 inch diameter brass or aluminum tubing. Rods may be used instead of the tubing, but they will make the whole assembly just slightly heavier. The antenna element is made with material

having two different diameters; namely 1/4 inch and 1/8 inch. This must be done in order to increase the impedance of the antenna so as to afford a good match to a 300 ohm transmission line. The line is connected to the 1/8 inch wires as shown in the illustration. If you use brass for the antenna, the whole thing can be soldered together very nicely. Since the center-to-center spacing for the elements of the antenna is only 3/8 inch, we have to be very careful to keep the 1/8 inch rod very straight and rigid. The cross-arm should be of oak which must be im-

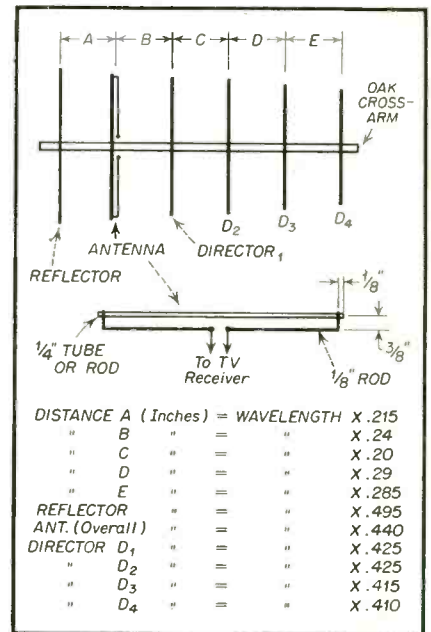

Fig. 8—Six-Element Yagi antenna dimensions and characteristics.

pregnated with wax or treated in any other manner which will make it suitable for outdoor use. The length of the cross-arm is the sum of the spacings A, B, C, D, and E plus about an inch, so as to have 1/2 inch of wood left at each end. In order to hold the elements straight and parallel to each other, the wood should either be notched or drilled. The elements are held to the cross-arm by screws.

[To be Continued]

TEST PATTERN

[from page 3]

Fig. 5 is particularly advantageous in this respect—its *Klipzon* leads permit solid connection to the control element by merely piercing the lead going to this electrode. The connection is rigid and will not fall off. Thus, the receiver chassis does not have to be disturbed. Once the connection has been made, it is a simple matter to adjust quickly the

various size, centering, and linearity controls to produce a full-size picture containing a number of parallel lines, either vertical or horizontal, all of constant width and equally spaced from each other.

For adjusting the vertical section of the receiver, the *function* switch of the instrument should be set to produce

South River

★ ★ NEWS ★ ★

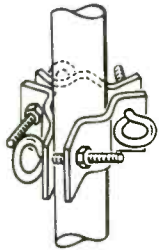

Model GC-3
GUY WIRE

CLAMP

Clamps on mast with a sure grip

accommodates masts to 2" O.D. Features 3 eyebolts for guy wire attachment. Model GC-1 . . . 12 holes for guy wire attachment. Accommodates masts to 1 1/2" O.D. Model GC-2 . . . Similar to Model GC-1 with 2 eyebolts for guy wire attachment.

South River Antenna Mounting Accessories are carried by every leading TV Parts Jobber from coast to coast.

Write for your copy of our new 1953 catalog.

SOUTH RIVER METAL PRODUCTS CO., INC.

SOUTH RIVER, N. J.

PIONEER AND OUTSTANDING PRODUCER OF FINEST LINE OF ANTENNA MOUNTS

TECHNICAL ARTICLES WANTED

on

TV, AM RADIO, FM RADIO, PHONO MECHANISMS, HI-FI AUDIO AUTO RADIO, TEST EQUIPMENT, ANTENNAS

pertaining to their

Theory, Installation, Application, Service & Maintenance

submit manuscripts to
Managing Editor

Radio-Television Service Dealer

67 West 44 Street New York 36, N. Y.

\$1.00 to \$5.00 PAID "for SHOP NOTES"

Write up any "kinks" or "tricks-of-the-trade" in radio servicing that you have discovered. We will pay from \$1 to \$5 for such previously unpublished "SHOP NOTES" found acceptable. Send your data to "Shop Notes Editor," RADIO-TELEVISION SERVICE DEALER, 67 West 44 St., New York 36, N. Y. Unused manuscripts cannot be returned unless accompanied by stamped and addressed return envelope.

horizontal lines. For most accurate work it is advisable to use a minimum of six lines. The *sync* control should be kept at a minimum position, since it is extremely easy to obtain a good, stable pattern by merely adjusting the *frequency* control of the generator and the *vertical hold* control of the receiver. If the lines are not equal in width or in spacing, the vertical centering, height, and vertical linearity controls of the receiver are readjusted until this equality is obtained.

A similar procedure is used to obtain horizontal linearity. In this case, of course, the pattern consists of vertical lines. Some modification of the method may be necessary, however, if it is impossible to obtain a sufficiently stable pattern by merely adjusting the horizontal hold control of the receiver and the frequency control of the generator. The *sync* control of the generator is used. The *sync* lead is coupled to the horizontal oscillator of the receiver; the horizontal oscillator tube is removed from its socket, and a small adapter is attached to the plate pin. The *sync* input lead is thereupon clipped to this adapter, and the oscillator tube is replaced in its socket. In most cases, sufficient *sync* voltage can be obtained by wrapping the *sync* lead around the wires leading to the yoke, thus eliminating the necessity of removing the tube. For best results, the *sync* level should first be set at a minimum. The frequency control of the generator and the horizontal hold control of the receiver are adjusted for minimum instability. The *sync* control of the generator is then advanced to the lowest position at which locking is obtained. At this point, the frequency controls may again have to be slightly readjusted. This technique results in the least amount of "over-sync," and minimum distortion is encountered.

When neither horizontal or vertical linearity is obtainable, the generator may be used to make stage-by-stage tests. For instance, horizontal sweep defects—producing non-linearity—may be located by injecting the signal, starting at the horizontal output tube and working forward to the horizontal oscillator. The pattern on the picture tube is observed at each point of the signal injection until the defective circuit is reached.

Other Applications

As mentioned earlier in this article, this type of instrument has uses other than those involved in obtaining good linearity. These auxiliary uses may be grouped generally into two main classifications:

(1) those in which the generator is coupled directly to the video portion of the receiver, and,

Columbia

The Improved Deluxe TELEVISION Service Light!



HANDIER THAN A FLASHLIGHT!

Now . . . with complete swivel for better lighting and easier servicing!

EVERY SERVICEMAN, experimenter, model-maker, needs this handy item. No need to work in the dark . . . ample light is provided by a 7 1/2 watt, 110 volt bulb that remains cool at all times.

Scientifically-designed, unbreakable aluminum reflector directs maximum light to point of work . . . A REAL TIME AND LABOR SAVER.

Carried by leading jobbers!

Have you seen our other TV service aids . . . "TV Service Cord" and "TV Picture Tube Extension Cable"?

We manufacture cord sets and cables to government and civilian specifications.

Columbia

WIRE & SUPPLY CO.

2850 Irving Park Road • Chicago 18, Ill.

"National distributors and warehouse for ANACONDA denseath television and radio wires and cables"

Compare!
PROVE
EMC
SUPERIORITY!



MODEL 106

Vacuum Tube Voltmeter
✓CHECK THESE FEATURES

Specially designed for field alignment of television and radio sets. Uses dual triode balanced bridge circuit. All functions and ranges completely electronic—meter cannot burn out. Zero center position for FM discriminator alignment. Uses 1% precision resistors for voltage multipliers. 5 DB ranges. Full scale deflection of 1½ volts for both AC-DC volts. Measures resistance in 5 ranges from .2 ohm to 1000 megohms. 1 Meg isolating resistor in probe.

SPECIFICATIONS

DC VOLTAGE: Input resistance 16.5 megohms or 1½ megohms per volt. Ranges: 0 to 1.5, 10, 100, 300, 1000 up to 30,000 volts (with accessory probe.)

AC VOLTAGE: Input resistance 2 megohms. Ranges 0 to 10, 100, 300, 1000. Frequency response flat from: 25-100,000 cycles.

OHMS: 1000 — 10,000 — 100,000 — 10 megohms, 1000 megohms. Compact, portable bakelite case measures 4¼" x 5¼" x 2½".

MODEL 106 \$35.90

In Kit form \$23.90

MODEL HVP 30,000 Volt Probe for Model 106 \$8.75

Write Dep't. 5D6 for latest FREE Catalog



MOVING?

When you change your address, please notify our circulation department as soon as possible. This is to your advantage, since it takes approximately 5 weeks to have your stencil changed and duplicate copies cannot be sent. Be sure to give your old as well as your new address.

RADIO-TELEVISION SERVICE DEALER

New York 36 N. Y.
67 WEST 44th St.

(2) those in which it is used as a modulator for an *rf* signal generator. Under the first classification may be listed its use in the detection of troubles arising in the video amplifier stages of the receiver. Signal injection is again used to isolate the trouble to a particular stage, starting with the input to the kinescope and moving forward stage by stage toward the video second detector.

Adjustment of the yoke can also be made by this method. If the horizontal lines produced by the generator appear tilted on the kinescope screen, the yoke can be rotated until the display does appear to be horizontal. If either the lines or bars on the extreme edge of the picture are bowed, or if both display this condition known as "pin-cushioning," this situation can be corrected by the use of an "anti-pin-cushion magnet." This magnet is adjusted until the lines and bars are straight and parallel.

As a modulator for an *rf* signal generator, the pattern generator can be used to check all the video synchronizing circuits, as well as the *rf* and the *if* stages. The generator is connected to the external modulation terminals of the *rf* signal generator, and the generator is set to the proper *rf* or *if* frequency. If a signal of *rf* frequency is to be injected, it can be connected to the antenna terminals of the receiver, care being taken that the selector dial is set at the proper channel. All the tests should be made while working from the picture tube toward the antenna. The correct frequency should be used for the stage being tested, and the output control of the pattern generator should be set so as to provide an optimum signal level without overloading.

The pattern generator may also be used as a signal source for checking relative gain measurements of the video amplifier stages by using an *ac* vacuum tube voltmeter as an indicator. The VTVM is connected to the output of the last stage of the video amplifier; the generator is connected to the same point, and the resulting voltage is noted. The generator is then connected to the output of this stage, and the output voltage is again read. The relative gain of the stage may be obtained by dividing the second reading by the first.

In conclusion, it can be stated that the pattern generator is a very useful instrument from many viewpoints, including cost, light weight and portability, simplicity of operation and connection, and versatility. As time goes on, there is reason to predict a bright future for this instrument in the field of television servicing.

Advertising Index

Aerovox Corporation	3
American Microphone Co.	14
American Phenolic Corp.	24, 25
American Television & Radio Co.	10
Astron Corporation	8, 9
Belden Manufacturing Co.	7
Bussmann Manufacturing Co.	5
Channel Master Corp.	20, 21
Clarostat Mfg. Co., Inc.	26
Columbia Wire & Supply Co.	71
Duotone	18
Electronic Measurements Corp.	72
Erie Resistor Corp.	64
Federal Telephone & Radio Corp.	1
General Electric Company	11
Guardian Elec. Mfg. Co.	66
Hytron Radio & Electronics Co.	Cover 2
Jackson Electrical Instrument Co.	12
Jersev Specialty Co.	70
JFD Manufacturing Co., Inc.	68
Mallory, P. R. & Co., Inc.	Cover 3
Perma-Power Company	68
Philco Corporation	59
Precision Apparatus Co., Inc.	57
Pyramid Electric Company	19
Radiart Corporation	13, 70
Raytheon Mfg. Co.	2
RCA Tube Dept.	Cover 4
Rider, John F. Publisher, Inc.	14, 22
Sams, Howard W. & Co., Inc.	4
Sangamo Electric Company	6
Snyder Manufacturing Co.	15
South River Metal Prods. Co.	71
Sylvania Electric Products Inc.	17
Telrex, Inc.	63
Trio Manufacturing Co.	23
Triplett Elec. Instrument Co.	61
United States Wire & Cable Corp.	16
United Technical Laboratories	66
Utah Radio Products Co., Inc.	67

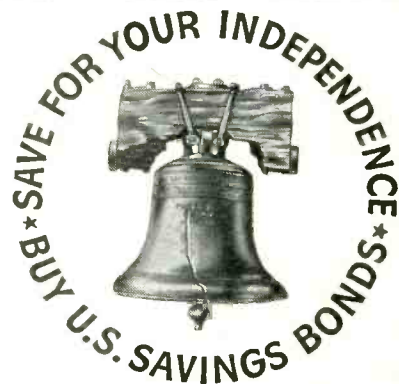

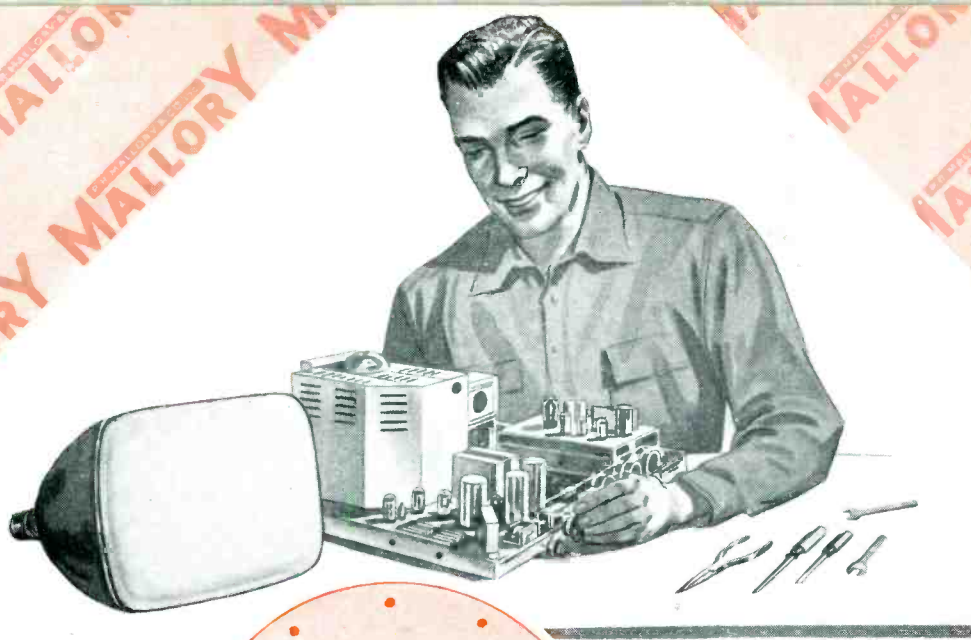

The Time YOU SAVE ...is ALL PROFIT!

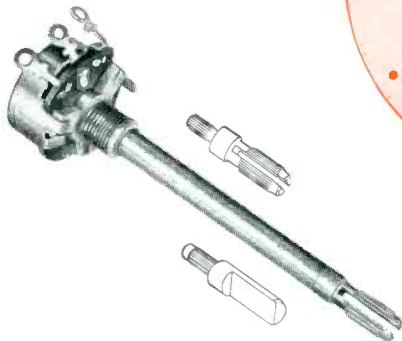

Mallory Dual Control Kits

Three kits of controls and switches, selected to meet varying requirements in different parts of the country, will serve 50 different models of radio and television sets. You pay only for the controls and switches; attractive 3-drawer metal cabinet is free of extra cost. Get details from your Mallory Distributor.

Every job is in a hurry around a busy service shop . . . and minutes saved add up to more work done and greater profits, to say nothing about satisfied customers.

When you use Mallory Midgetrols®, you'll find them fast and easy to install in any TV or radio set.

Round tubular shafts can be cut accurately and quickly . . . fit split-knurled or flattened-type knobs.

AC switches can be attached instantly without disassembling the control.

Unique design simplifies inventory problems . . . makes them quickly available from your distributor.

Midgetrols are engineered to match the electrical characteristics of the original equipment of any TV or radio set. They will give equal, and often better, performance than the original control . . . your assurance of precision quality on every job.

This will save time, too. Ask your Mallory Distributor for a copy of the Mallory Control Guide. It is a complete cross reference between set manufacturers' part numbers and the equivalent Mallory control.

P. R. MALLORY & CO. Inc.
MALLORY

CAPACITORS • CONTROLS • VIBRATORS • SWITCHES • RESISTORS
RECTIFIERS • POWER SUPPLIES • FILTERS • MERCURY BATTERIES
APPROVED PRECISION PRODUCTS

P. R. MALLORY & CO., Inc., INDIANAPOLIS 6, INDIANA

*Depend on Mallory
for
Approved Precision Quality*

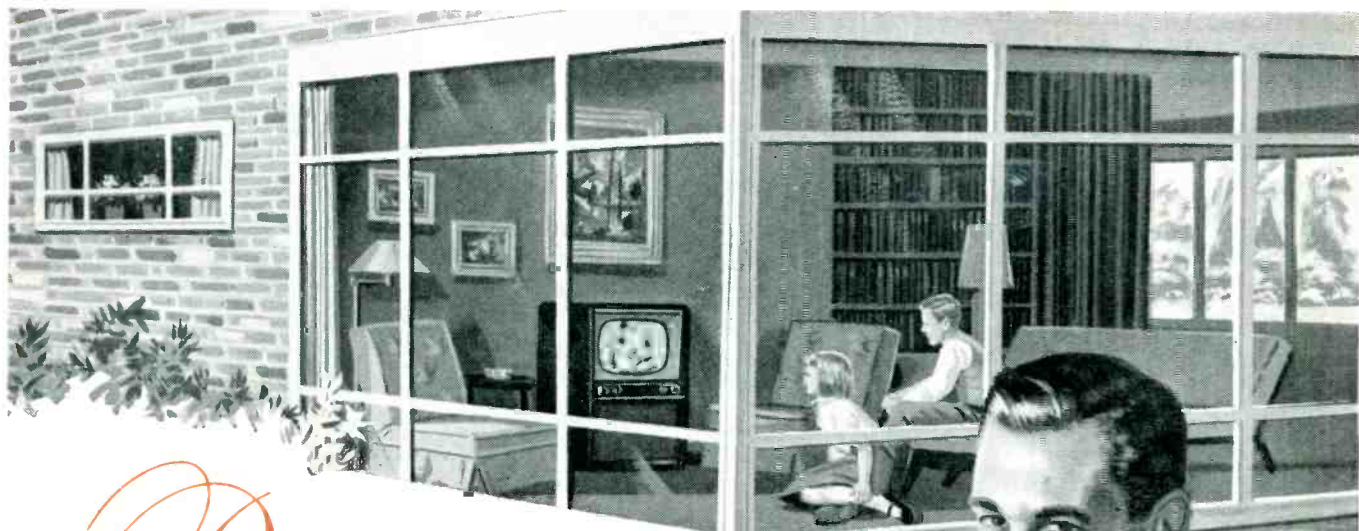

Partners

... for extra profit

EVERY successful service call automatically results in *extra profit* . . . in *dollars and cents* . . . and in increased "*customer confidence*." You can insure *both* kinds of profit by coupling your good name in partnership with another . . . *RCA*.

Wherever you go, the familiar RCA emblem serves as your silent partner, helping you to sell your service and build repeat business. And the superior quality of RCA Receiving Tubes and Kinescopes protects your profit by cutting those costly call-backs caused by premature tube failures.

Helping you to safeguard your reputation is a vital, everyday service of RCA Tubes. And that protection is yours at no extra cost.



"Sign up" for Success

Identify yourself with RCA! Ask your *RCA Tube Distributor* today how *you* can qualify for a Dealer Identification Plaque displaying your name. He'll give you full details on the big RCA Sales Promotion Program.

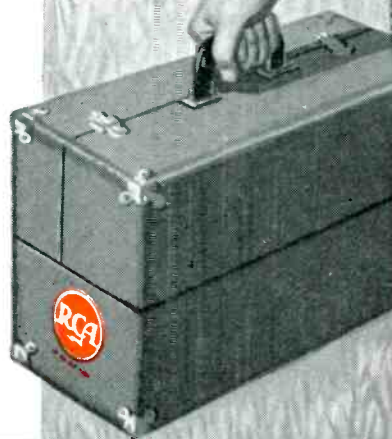

RADIO CORPORATION of AMERICA
ELECTRON TUBES

HARRISON, N. J.