

JULY, 1952

Radio-TV
**SERVICEMAN
DEALER**

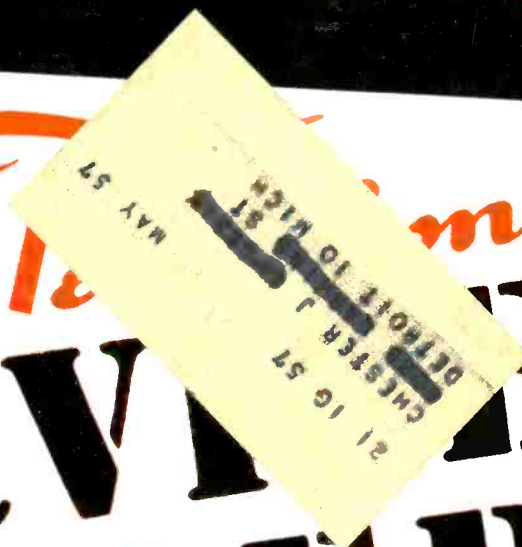

The Professional Radio-TVman's Magazine

IN THIS ISSUE:

- Video Amplifiers, Part 3
- Looking For Trouble, No. 10
- Common Troubles in Limiter,
Separator and Clipper Stages
- Indoor Directronic Antenna
- High Fidelity Goes to Towel

AM-FM-TV-SOUND

What's your unlucky day?

Bad luck—in the form of dissatisfied customers—can come your way any day in the month if you buy capacitors by rating only rather than by rating *and* brand. But . . . you can make every day a lucky day if you . . .



Make Sure! Make it Mallory!

Repair work that insures satisfied customers is yours every time if you always specify Mallory capacitors, because outstanding performance is built into *all* Mallory capacitors.



Mallory FP's are the only fabricated plate capacitors available to the replacement trade. And they are accepted as *the* top-notch capacitors by the makers of TV and radio sets. Mallory FP's give long-lasting service even at 185° F. (85° C.).



Mallory Plascaps* are the first completely engineered plastic tubular capacitors. Always use them and avoid leakage . . . premature shorting . . . unsoldered leads . . . off-center cartridges. Count on Mallory Plascap as you do on Mallory FP's.

In the past 25 years, Mallory research and engineering work has resulted in a series of developments that give you capacitors which are smaller . . . more uniform . . . longer-lasting . . . more resistant to heat. Look to Mallory for future capacitor improvements. Order Mallory capacitors today and be sure.

Depend on your Mallory Distributor for quality products at competitive prices.

P. R. MALLORY & CO. Inc.
MALLORY

CAPACITORS • CONTROLS • VIBRATORS • SWITCHES • RESISTORS
• RECTIFIERS • VIBRAPACK* POWER SUPPLIES • FILTERS
*Reg. U.S. Pat. Off.

APPROVED PRECISION PRODUCTS

P. R. MALLORY & CO., Inc., INDIANAPOLIS 6, INDIANA

Be Sure of Your Installations... Next Year

Use

Aptitude-Tested

MIKE CABLE Now!

• Now, you can be sure of your installations with Belden Microphone Cables. They are *Aptitude-Tested* and rated to give you safe and complete knowledge of their characteristics. Furthermore, Belden Mike Cables are built for maximum service. Put them to work for you now—and be sure... specify Belden.

Belden Manufacturing Co., 4639-W. Van Buren Street
Chicago 44, Illinois



To You,
Belden's Golden Anniversary
Means

—product performance that can come only from a "know-how" that has grown through actual service since the inception of Radio.

—an ability to co-operate in pioneering new wires to meet or anticipate industry's growing needs.

In the years that follow

This Belden Program Is—

— TO BE
CONTINUED



No. 8411

Nominal Capacitance 37 mmf per ft. Use particularly for lapel microphone.

No. 8401

Nominal Capacitance 25 mmf per ft. For crystal, ribbon, carbon microphones.

No. 8422

Nominal Capacitance 32 mmf per ft. Use specially for carbon microphones.

No. 8410

Nominal Capacitance 33 mmf per ft. For crystal, ribbon, carbon microphones.

No. 8412

Nominal Capacitance 68 mmf per ft. Use specially for carbon microphones.

No. 8423

Nominal Capacitance 54 mmf per ft. Use particularly for carbon microphones.

No. 8424

Use for interconnecting power cable for all electronic uses. Also microphone cable.

Belden Radio WIRE

The *Aptitude-Tested* LINE

102 BILLION

FREE SALES BOOSTS A YEAR FOR YOU!

NEW
CBS-HYTRON
BRAND
gives you:

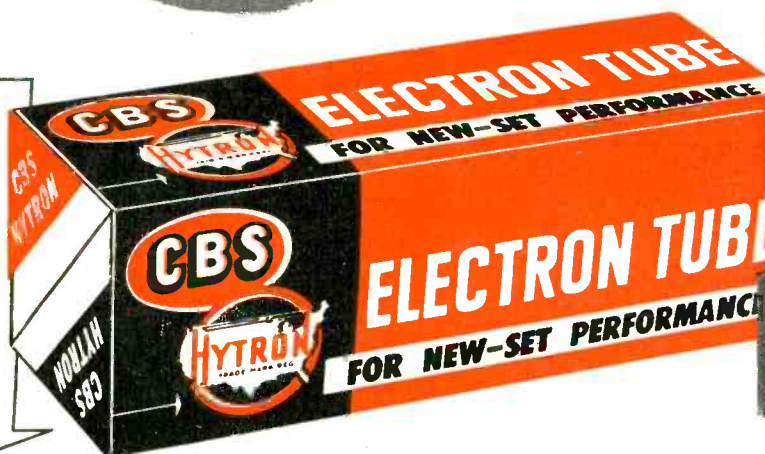

Acceptance



1,973,326,000 times a week! 102,612,952,000 times a year! The magic letters "CBS" are seen and heard on radio and TV station breaks. Impact is terrific. An average of 13 sales impressions weekly for every man, woman and child in the country. Every one of your customers knows CBS. Knows he can depend upon CBS. Consumer acceptance of your CBS-Hytron brand grows hourly.

Engineering



As a division of the Columbia Broadcasting System, Inc., CBS-Hytron commands tremendous engineering resources for you. Because CBS embraces the field of electronic entertainment: Radio broadcasting. TV broadcasting. Radio, television, and phonograph sets. Records. Electronic research laboratories. And CBS-Hytron tubes.

Leadership



For example, CBS-Hytron originated: the GT tube . . . the subminiature tube . . . the rectangular picture tube . . . specialized, low-cost TV receiving tubes. CBS-Hytron's new picture-tube and miniature-tube plants are the most modern in the world. Such aggressive leadership guarantees you the newest and best in tubes.

YOU CAN'T BUY BETTER

Demand the CBS-Hytron brand. You get the finest electron tubes that progressive engineering skill and craftsmanship can make. You get the brand known and respected by every one of your customers. You get the brand they see and hear the most . . . CBS-Hytron.



MAIN OFFICE: SALEM, MASSACHUSETTS

EDITORIAL

by S. R. COWAN

Catalog "Sections"

Over 5,000 subscribers requested copies of the "Radio's Master" 68 page catalog sections on recording, phono equipment and accessories since we announced this new free subscriber service two months ago. Now we offer the section on Test Equipment, Meters and Instruments. Each section is over 120 pages and covers the products of more than 40 manufacturers. No technician or service bench can operate at peak efficiency without a section at hand. Get your free copy, if you are a subscriber, by merely requesting same on the coupon form provided for the purpose. See page 42.

We are gratified to have heard from hundreds of subscribers who thanked us for their section on sound equipment. They liked the dispatch with which they received their copy, and more important, having had an opportunity to peruse same, they acknowledged the value and aid it provided in their daily work. That being so, the new section on test equipment, etc., will be an even greater boon.

Service Trends

An unprecedented volume of battery-operated receiver repair jobs has deluged service shops throughout the country in recent weeks. This is a sure sign that the general public is vacation-minded, and experience proves that when the trend is towards heavy vacation business, money is free and easy. That being the case, it is passing strange that radio dealers are still cutting prices on all types of radios and TVsets, working on margins much too thin for safety.

In contrast, indices show that service shop price ranges for repairs are holding steady and the dollar volume is growing along with profit margins. In times like the present, with taxes high and getting higher, one must conclude that at long last the service profession has become mature.

Low Price Appeal Service

We have always advocated free enterprise and aggressiveness in business conduct. Price cutters and chiselers, and shops that try to survive purely on the basis of low price appeal never seem to thrive or become firmly established. All businessmen must first determine how much their time, experience and investment is worth to them as a basis for establishing their minimum weekly take-home pay, and proceed from that point in fixing their minimum hourly wage. The fly-by-nights and fakers work inversely, setting up a "come-on" cut-price structure, hoping to get sufficient volume to meet their required earnings. Stated simply, a sound business is established on a concrete, predetermined foundation in contrast to the wishful thinker who builds on drifting sand.



Sanford R. Cowan

EDITOR & PUBLISHER

Samuel L. Marshall
MANAGING EDITOR

COWAN PUBLISHING CORP.

67 WEST 44TH ST.

NEW YORK 36, N. Y.



VOL. 13, NO. 7

JULY, 1952

Editorial	3
Trade Flashes	4
Personnel Notes	12
Common Troubles In Limiter, Separator, and Clipper Stages, <i>by Matthew Mandl</i>	17
Servicing information and procedures used in these stages of a TV receiver.	
Video Amplifiers, Part 3, <i>by Leonard Lieberman</i>	20
Third and final installment shows typical techniques used in servicing video amplifiers.	
Looking For Trouble, No. 10, <i>by Cyrus Glickstein</i>	23
Service jaunt through an Admiral Model 24DI receiver.	
Indoor Directronic Antenna	28
The Directronic principle is now applied to an indoor TV antenna.	
High Fidelity Goes To Town	29
A gigantic truck is furnished with a variety of Hi-Fi equipment to aid the Radio-TV Service Dealer sell Hi-Fi.	
Trade Literature	30
New catalogs, booklets, periodicals, manuals, and textbooks	
Association News	31
Association activities reported from all over the country.	
Circuit Court	32
DuMont RA119A high voltage circuit and sweep failure protection circuit.	
New Products	34
Tube News	39
A new department devoted to a technical description of new tubes.	

SANFORD L. CAHN, Advertising Director HARRY N. REIZES, Advertising Manager
DAVID SALTMAN, Production Mgr. CHARLES LO CICERO, Circulation Mgr.

TED E. SCHELL, 2700 West 3rd St., Los Angeles, Calif., Dunkirk 2-4889
RADIO-TELEVISION SERVICE DEALER is published Monthly by Cowan Pub. Corp., 67 West 44th St., New York 36, N. Y. Subscription price: \$2 per year in the United States, U.S. Poss. & Canada: elsewhere \$3. Single Copies: 25c. Reentered as second class matter Sept. 25, 1950 at the Post Office at New York, N. Y. under the Act of Mar. 3, 1879. Copyright 1952, Cowan Pub. Corp.

PHOTOFACT Users Write Our Best ADS!

Hundreds of unsolicited letters tell what the world's finest Radio & TV Data means to Service Technicians



John E. Schromm
5 Falmouth St.
Belmont, Mass.

"Finding out how good your PHOTOFACT Folder Sets are is like discovering a gold mine."



Mr. Armand Chasse
30 Ward St.
Paterson, N. J.

"I want to thank you for your help. I like PHOTOFACT very much because it makes my servicing so much easier."



Mr. Louis Pesiri
29-23 Jordan St.
Bayside West, L. I., N. Y.

"I buy Howard W. Sams' books and publications regularly because they give me the right information. I have Sams' PHOTOFACT right up to Set No. 165."

NOW! GET THE PROOF FOR YOURSELF!

FREE

We'll send you a Free Photofact Folder on any receiver listed in "PF Index & Technical Digest."

Learn for yourself—at our expense—how PHOTOFACT pays for itself by earning bigger repair profits for you! Select any Folder from the PF Index (if you haven't an Index, get a free copy from your distributor). When you write us for your Free Folder, be sure to state Photofact Set and Folder Number as shown in the Index. Get your Free Folder now. Examine, use, compare—see why you can't afford to be without PHOTOFACT!

HOWARD W. SAMs & CO., INC.
2201 East 46th Street • Indianapolis 5, Indiana

TRADE FLASHES

A "press-time" digest of production, distribution,
and merchandizing activities

Pioneers Honored By Sylvania

Thirty pioneer broadcasting personalities were honored at a luncheon in New York on May 15 attended by 209 representatives of show business, press and the radio and television industry.

Simultaneously, President Truman was presented with a plaque by Mr. Don Mitchell, president of Sylvania Electric, at a White House ceremony on the occasion of his company's production of one billion radio tubes. Mr. Truman received a gold replica of the billionth tube identical to the Pioneer Broadcasting Awards.

Awards were presented by Max F. Balcom, Sylvania's board chairman "in recognition of pioneering contributions to broadcasting."

Main speaker at the event was E. Finley Carter, vice president in charge of engineering for Sylvania. He saluted Dr. Lee De Forest, inventor of the amplifying tube, as the "father of radio and television", and presented him with the actual billionth tube.

Set Production Drops

Production of both radios and television receivers in April was substantially under the set output in the corresponding 1951 month, according to industry estimates released by the Radio-Television Manufacturers Association.

RTMA estimated the April output at 847,946 radios and 322,878 TV sets compared with 1,337,042 radios and 500,000 television receivers manufactured in April 1951. Ninety-six per cent of the April home set production which totaled 286,164 units, consisted of table model radios. TV table models over 17 inches in size represented 19 per cent of the TV output compared with eight per cent in the fourth quarter of 1951 and only one per cent in the last quarter of 1950.

A breakdown of the April radio output showed the manufacture of 286,164 home sets, 176,003 clock radios, 110,529 portables and 275,250 auto receivers. Home sets with FM facilities totaled 31,591 units in April. In addition 12,193 TV receivers with FM circuits were produced during the month.

Tube Sales Drop

Sales of television picture tubes to receiver manufacturers in April de-

creased considerably under sales in March and in April 1951, the Radio-Television Manufacturers Association reported. April sales to set manufacturers totaled 270,781 tubes valued at \$6,074,540.30 compared with 370,206 units valued at \$8,582,538.06 in March and 278,955 tubes valued at \$6,869,181 in April a year ago.

Sales of receiving tubes in April totaled 26,247,258 units valued at \$19,801,541.03, according to statistics released by the Radio-Television Manufacturers Association. This compares with 35,883,627 tubes sold in the corresponding 1951 month. Sales in the first four months aggregated 112,181,580 units valued at \$80,853,004.09.

A breakdown of the April report showed sales of 23,363,508 receiving tubes of the entertainment-type and 2,883,750 of the allied or non-entertainment type. A total of 15,334,092 tubes were sold for new equipment, 6,095,641 for renewals, 1,560,406 for export and 3,257,119 were sold to the government.

G. E. Service Promotion Contest

A nationwide contest for all radio and TV service dealers, with entries based on service promotion campaigns conducted by these dealers between June 15 and August 15 of this year, was announced on June 12 by the Tube Department of the General Electric Company.

In making the announcement John T. Thompson, G-E replacement tube sales manager, said the theme of the new contest is to promote bigger summer business for service dealers through an annual vacation-time checkup campaign for TV sets, based on a philosophy of preventive maintenance.

Three new 1952 Dodge panel trucks are the top prizes. One hundred other winners will have their choice of jewelry, a complete fishing kit, or a set of matched golf irons and nylon golf bag.

Entry blanks are available through G-E tube distributors, who will also supply service dealers with ad mats, mailers, streamers, and door knob hangers to help them promote a bigger summer business. Dealers need not rely on these sales aids, but may use

Here's How BUSS FUSE "Know How" Helps Protect Your Reputation

The BUSS Fuses you buy today are the result of the production of millions upon millions of BUSS Fuses during the past 37 years. These years of specializing have taught BUSS engineers how to make fuses of unquestioned high quality — and still maintain a competitive price.

Behind the established reputation of BUSS Fuses is the world's largest fuse research laboratory and the world's largest fuse production capacity.

To make sure that a BUSS Fuse will always operate properly under service conditions . . . each and every BUSS Fuse is tested in a highly sensitive electronic device that records: — the fuse has the right capacity, is properly constructed and right in all physical dimensions.

These important safeguards build customer goodwill. That's why you can handle BUSS Fuses with complete confidence — you know you will have no irritating and costly "come-backs". It pays to standardize on BUSS Fuses.

BUSSMANN MFG. CO.

University at Jefferson St. Louis 7, Mo.
Division of McGraw Electric Company

SEND THE COUPON FOR COMPLETE FACTS

BUSSMANN Mfg. Co. (Division of McGraw Electric Co.)
University at Jefferson, St. Louis 7, Mo.

SD-752

Please send me bulletin SFB containing complete facts on
BUSS small dimension fuses and fuse holders.

Name _____

Title _____

Company _____

Address _____

City & Zone _____ State _____ 652

BUSS offers a complete line of fuses for Radio • Television • Controls • Avionics • Radar • Instruments • PLUS a companion line of fuse clips, fuse blocks and fuse holders.

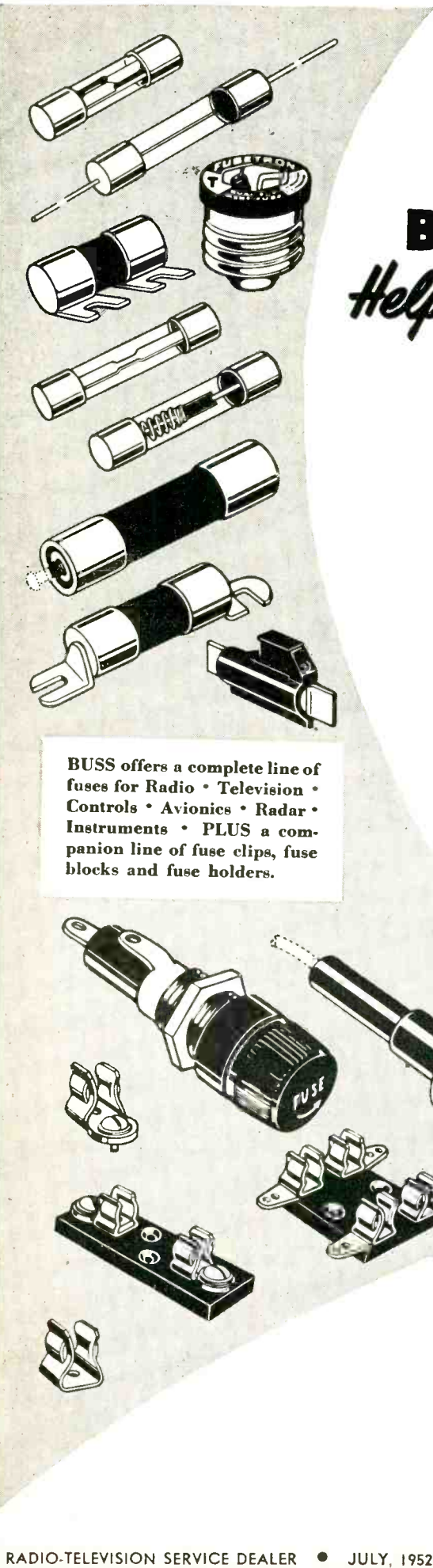

Here's why those in the know

-demand

CANNON PLUGS

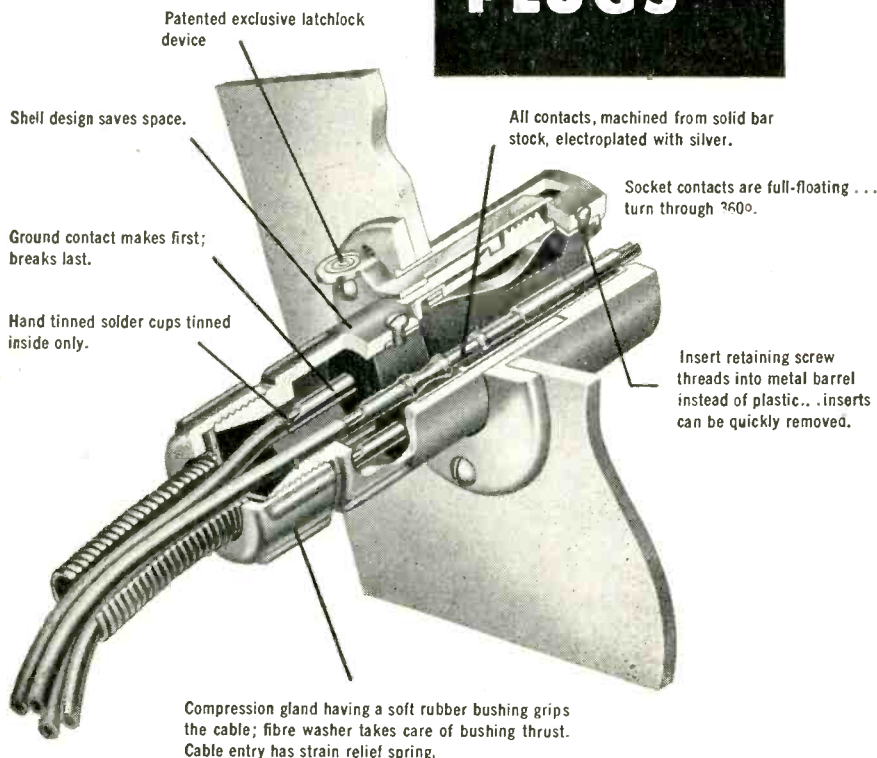

No corners are cut... nothing is overlooked to assure you outstanding performance with Cannon Plugs. So long an engineer's choice, the words "Cannon Plugs" have become part of our electrical language. Continued excellence of design... ability to meet your changing requirements... are good reasons why the Cannon line of connectors continues to excel where specifications must be met. XL Connector Series is just one of the many Cannon types—world's most complete line. Request bulletins by required type or describe your needs.

CANNON ELECTRIC

Since 1915

LOS ANGELES 31, CALIFORNIA

REPRESENTATIVES IN
PRINCIPAL CITIES

In Canada & British Empire: Cannon Electric Co., Ltd., Toronto 13, Ontario. World Export (Excepting British Empire): Frazer & Hansen, 301 Clay St., San Francisco.

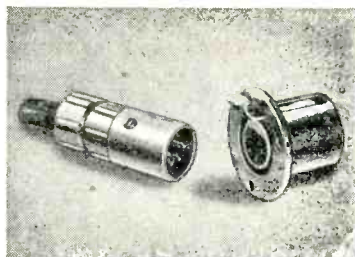

There are 12 items in the XL line. Insert arrangements available: 3-15 amp. contacts, 4-10 amp. contacts—working voltage 250 volts. Zinc and steel plugs with bright nickel finish are standard. Satin chrome finish also available on steel plugs.

any ingenious methods they are able to devise, said Thompson.

Public Regards TV Man Highly

The television service industry has the hearty endorsement of TV set owners in a nationwide public opinion poll conducted for RCA Victor and the RCA Service Company by Elmo Roper, one of the country's leading market research experts.

A large proportion, 86%, of all television owners who had had experience with television service indicated a high opinion of the quality of work performed by their TV service technician. The findings also indicate that the great majority of the television public consider TV servicemen to be courteous, prompt in responding to calls, and fair and reasonable in their charges.

"Recently published articles have reflected on the honesty and competence of television servicemen by charging that the TV public was being gouged," said E. C. Cahill, president of the RCA Service Company. "While we knew from experience that these reports were based on isolated instances, and did not, by any means, reflect the true character of the service industry, we were disturbed by the unfair and misleading impressions they were creating among the public. So we commissioned Mr. Roper to get the full facts from the people who were in the best position to judge—the television set owners."

Workshop Completes Outdoor Range

Workshop Associates, Division of The Gabriel Co., announces the completion of a new antenna pattern measuring range on the site of their new Natick laboratory.

This range will be used for measuring antenna radiation patterns over a distance of approximately 1200 feet. It consists of a transmitting tower and a receiver 1200 feet away, where the actual measuring is done. The site is located in Natick, Mass., in a country area free from outside interference that could affect accurate measurements.

This new pattern range is now in operation and supplements the 3200' range Workshop has been using for several years at its Needham, Mass. plant.

Parts Show Huge Success

Attendance of more than eleven thousand persons at the 1952 Electronic Parts Show here May 19-22nd, coupled with the fact that approximately 4,746 of that number registered as distributors, distributor personnel and sound dealers, made good the advance predictions that this year's Show

For the **clearest** picture of campaign progress...



Rauland PICTURE TUBES

Man, what a year for TV—and TV service profits! The richest menu of regular attractions ever offered to viewers... PLUS the party conventions, the campaign, the elections and inauguration! When viewers need replacement picture tubes, they'll want them fast—and good.

So remember that Rauland alone

offers these replacement profit advantages:

- The *most complete* line of replacement picture tubes... a far better supplement for your regular tube line than a second line of receiver tubes.
- The faster, *surer* installation adjustment made possible by the patented Indicator Ton Trap.

- The dependable, uniform *extra* quality that so many smart service men depend on for assured customer satisfaction.

Remember, Rauland research has developed more "firsts" in picture tube progress since the war than any other maker. And this leadership pays off... in your customers' satisfaction.

THE RAULAND CORPORATION



Perfection Through Research

4245 N. KNOX AVENUE • CHICAGO 41, ILLINOIS

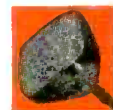

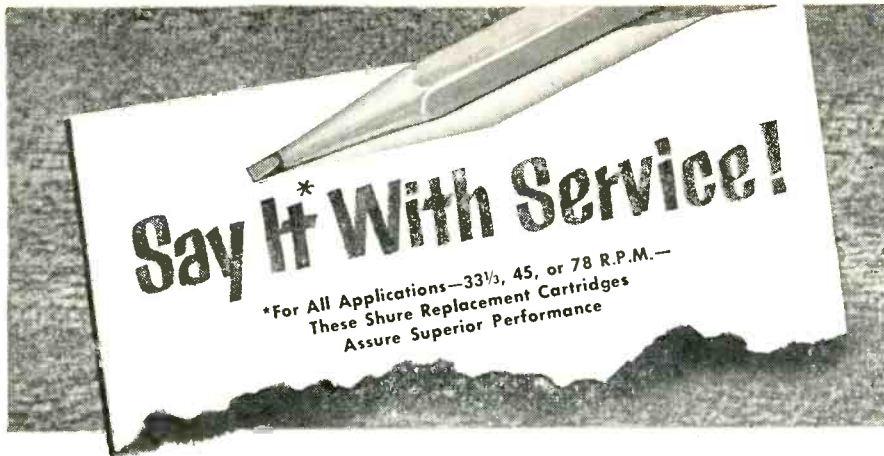

W 42 BH

78

This "Dual Voltage" cartridge is an excellent all-around replacement for old-style 78 r.p.m. cartridges. It guarantees improved performance in many cases. A unique "Slip-On" condenser harness provides choice of output voltage—1.5 with condenser harness installed and 3.75 without condenser. For fine quality at low cost your best bet is the Model W42BH at only \$4.95 list.



W 31 AR

WC 31 AR

33 1/3

45

This high output (2.1 volts!) "Direct Drive" cartridge was specifically designed for use with all fine-groove records. Universal mounting bracket provides quick, easy installation in RCA-type 45 r.p.m. changers. (Fits 1/2" and 5/8" mounting centers.) Has easy-to-replace needle. For maximum quality, highest output, and low cost, specify Model W31AR at the low list price of only \$6.50

33 1/3

45

Also available as ceramic cartridge (same price)—Model WC31AR. Highly recommended in areas where heat and humidity make use of conventional crystal cartridges impractical.



W 26 B

33 1/3

45

78

This "Vertical Drive" "all-purpose" cartridge provides superlative reproduction for all types of records. Low tracking pressure (only 6 grams) and high needle compliance guarantee faithful tracking and longer record life. Uses exclusive Shure "Unipoint" needle, scientifically designed for maximum performance and long life.



W 22 AB

33 1/3

45

78

This "Vertical Drive" "turnover-type" cartridge provides extended frequency response (50 to 10,000 c.p.s.) at extremely low needle point pressure—only 8 grams. One of the most popular, widely used cartridges in original equipment. Highly recommended as replacement in phonographs equipped with turnover mechanism. Individual needles—one for fine-groove and the other for standard records—guarantee maximum results.



W 22 AB-T

33 1/3

45

78

Offers all the advantages provided by the Model W22AB, plus a long-life turnover mechanism. Furnishes replacement of old, worn-out turnover mechanisms as well as cartridges. Also an excellent replacement for converting all-purpose phonographs into turnover type.

Patented by Shure Brothers, Inc., and Licensed under Patents of the Brush Development Co.



SHURE BROTHERS, Inc. ★
225 W. HURON ST., CHICAGO 10, ILL.

Manufacturers of Microphones
and Acoustic Devices
Cable Address: SHUREMICRO

would be an unprecedented success, Charles A. Hansen, Show President reported.

Unofficial figures indicated that a total of 11,016 persons attended the Show in the Conrad Hilton Hotel's Exhibition Hall and fifth and sixth floors. These figures compared with last year's total of 8,498. This year's distributor attendance was estimated at 4110 against 2,439 in 1951; a total of 636 sound dealers were listed (a category not tabulated last year); while 3275 persons were listed as exhibiting manufacturers and their personnel (4,107 last year); and 2293 representatives this year compared with 1,798 last year.

Clarostat Honors Two More 25-Year Men

On the eve of the opening of the Radio Parts Show in Chicago, Clarostat officials and sales reps gathered at a banquet to pay tribute to a former shipping clerk who rose to become president of this multi-million dollar corporation, and to a former science magazine editor who now heads his own advertising agency catering to the radio-electronic industry.

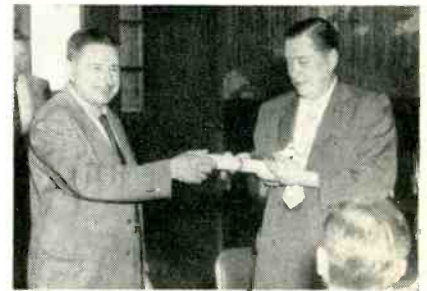

Victor Mucher and Austin Lescarbou receiving Clarostat honors.

Thus honored were Victor Mucher, president of Clarostat Mfg. Co., Dober, N. IL., and Austin C. Lescarbou, its advertising counsel who operates his own agency at Croton-on-Hudson, N. Y.

As a bit of playful irony, each man had been notified that he would present the watch and testimonial scroil to the other, but neither knew it was to be a two-way performance. Hence a real surprise to both.

DuMont Opens Chicago Factory Branch

The receiver division of Allen B. Du Mont Laboratories, Inc. has established a factory branch distributor for Du Mont television receivers in the Chicago area.

Albert C. Allen has been appointed manager of the new factory branch. Presently Du Mont's central states

THE ONLY WAY to make tv servicing easy

Here is the key to easy tv servicing... based on practical what-to-do and how-to-do-it information.

Naturally, every set manufacturer wants his receiver repaired correctly. Once he sells a receiver, he'll go to great lengths to keep it operating properly. That's why he prepares such a wealth of servicing data. Data that deals with practical facts... what-to-do and how-to-do-it. It is this data which Rider publishes in complete, unedited form - because it is this data that makes tv servicing easy!

Here's an example: On Hallicrafter receiver models 805, 806, 810 and 810C (chassis number M800S) the manufacturer issued 32, 8½" x 11", pages of servicing data. (We published all 32 pages in Rider TV Manual Vol. 8, and in Rider Tek-File Pack 6.) These models were manufactured in 7 production runs. To give you all the data you need, individual bottom views are given for runs 1, 2, 3 and for 4, 5, 6, 7. To show the difference between the receivers, the manufacturer prepared, and we reprinted, four different schematics. One of these is for run 1; another shows the receiver as produced in runs 2 and 3. Still another schematic shows the runs 4, 5, 6 and 7... but this schematic applies to the receivers using EM (electromagnetic) focus coils. The fourth schematic applies to production runs 4, 5 and 6 for receivers using PM (permanent magnetic) focus coils.

The variations introduced by different runs displayed a major effect on the tube operating voltages. In many instances they varied by as much as 100 per cent. Can you imagine yourself determining whether the operating conditions were right or wrong on these Hallicrafter models without this vital complete data!

This is only one example in thousands of how complete servicing

data makes your job easy. And it is this data which appears in Rider Servicing Data. From large, easy-to-follow schematics... circuit explanations... stage by stage alignment curves... page after page of troubleshooting test patterns... waveforms... clear, enlarged chassis views... circuit changes... to complete unpacking instructions; Rider Data is the only publishing source for complete, factory-issued, official servicing data... in accurate, organized, unedited form. NOW, WITH THESE TWO IMPORTANT FEATURES:

Manufacturers' Trouble Cures

These 3" x 5" standard index cards called Rider Handies contain vital manufacturer-issued permanent trouble cures plus production changes. Each Handy is identified with a manufacturer and a receiver model. With Rider Handies you save countless hours of diagnosis and repair time... because Handies contain the data you must have to make permanent repairs on many manufacturers' models. (Rider Handies information appears in Rider TV Tek-File packs, and Rider TV Manuals beginning with Vol. 9.)

Guaranteed Replacement Parts Listings

Beginning with Rider T.V. Manual 10 and Rider T.V. Tek-File Pack 57, replacement parts listings are included. All the replacement parts listed in Rider tv servicing data meet the physical and electrical performance ratings of the original equipment!

Rider Servicing Data available in two forms:

Rider T.V. Manuals.

Vols. 1 to 9. *Pictured Below*

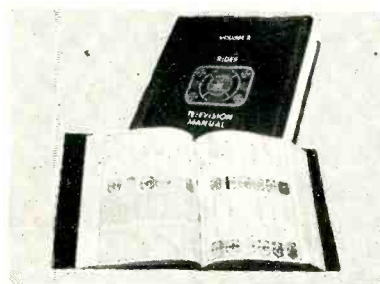

Each contains full data for manufacturers' receivers produced during a certain period. (The latest, T.V. 9, just published, covers October 1951 through February 1952.) Each manual has over 2,000 (8½" x 11") pages in permanent binder, with an index covering the contents of all manuals. Rider manuals are perfect for shop use and permanent reference. Price - \$24 each.

Rider T.V. Tek-Files. Packs 1 to 60

The contents of a typical T.V. Tek-File pack are shown below. In Rider Tek-File packs you buy complete Rider servicing data for only one, two, or a few manufacturers... according to your needs. Notice that each pack consists of handy, standard file folders for easy use. Only \$2 each pack.

FREE Rider T.V. Tek-File indexes covering the contents of all published packs are at your jobber's. If he's out, write us.

DON'T BE SWITCHED!

Rider Tek-File is DEFINITELY NOT the same as any other publisher's service. If your jobber doesn't carry them, DON'T BE SWITCHED. Write us direct... we'll sell you. (Please include your jobber's name.)

TRY A PACK.

Prove to yourself that Rider Tek-File makes tv servicing easy. Buy one pack for the next receiver you service. If you



don't agree it's better than anything you ever used, return the pack to us within seven days... we'll send you a full refund!

OUT SOON.

Rider RADIO Tek-Files! Same style as T.V. Tek-Files. Now, get your complete radio servicing data this easy economical package way. Ask your jobber.

John F. Rider Publisher, Inc., 480 Canal St., New York 13, New York.
West Coast Office: 4216-20 W. Jefferson Blvd., Los Angeles, California.

The Nationally Advertised



Bonded Electronic Technician

Program — with its cash-protected Bond, its code of Business ethics, and tremendous public appeal — builds business and profits by creating customer confidence in you . . .



*Better look into it today.
This sales stimulating program
costs you nothing if you
can qualify.*



*Ask your Raytheon Tube Distributor for complete information.

Excellence in Electronics

RIGHT... FOR SOUND AND SIGHT



RAYTHEON MANUFACTURING COMPANY

Receiving Tube Division

Newton, Mass., Chicago, Ill., Atlanta, Ga., Los Angeles, Calif.

RECEIVING AND PICTURE TUBES • RELIABLE SUBMINIATURE AND MINIATURE TUBES • GERMANIUM DIODES AND TRANSISTORS • RADIAC TUBES • MICROWAVE TUBES

DON'T GAMBLE WITH LIGHTNING

Be Sure with Vee-D-X
Lightning Arresters



A model and mount
for every type of
installation

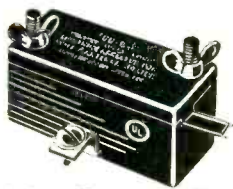

RW-200 TWO-WIRE
\$1.25 List

Most popular two-wire arrester. Exclusive saw-tooth point construction assures positive contact without wire-stripping. Highest quality thermo-setting plastic.

RW-204 FOUR-WIRE
\$1.50 List

Accommodates both standard 300 ohm transmission line and four-wire rotator line. Similar in construction to RW-200.

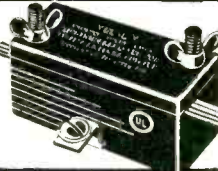

**RW-210 TWO-WIRE
SCREW-TYPE**
\$1.25 List

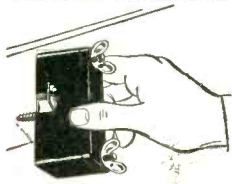

A new single screw model for fast, easy installation. Appearance and features similar to RW-200. For four-wire rotator line order Model RW-214 (\$1.50 LIST).

**RW-200-S TWO-WIRE
STRAP MOUNT**
\$1.25 List

Has specially engineered strap for non-slip mounting on all size masts or pipes. Similar in construction to RW-200. For four-wire rotator line order Model RW-204-S (\$1.50 LIST).

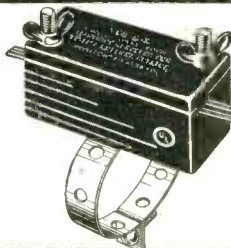

**RW-300 ORIGINAL
Heavy Duty TV
LIGHTNING ARRESTER**
\$2.00 List

First and finest arrester to be introduced to the television trade. A time-accepted standard with TV experts from coast-to-coast. The air gap plus resistors provides double protection. Case of moisture-resistant mica-fill bakelite.

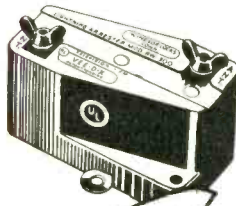

Guaranteed
FOREVER

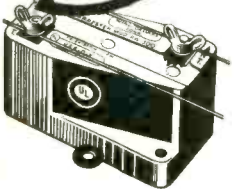

**RW-310 NEW OPEN
WIRE ARRESTER**
\$2.00 List

Similar in construction to RW-300 but designed to accommodate open wire transmission line. Newly designed clips provide positive connections and accurate wire spacing.

VEE-D-X

Makers of the world's
most powerful TV
antenna systems.

THE LAPOINTE-PLASCOMOLD CORPORATION
Rockville, Connecticut

PERSONNEL NOTES

Westinghouse Television-Radio Division announced the appointment today of *Jay M. Allen* as manager of manufacturing and *Ricardo Muniz* as superintendent of manufacturing, at the Division plant here.

Jack A. Berman, of Shure Brothers, Inc., Chicago, whose work as chairman of the Educational Program Committee of the 1952 Electronic Parts Show is credited with helping to make this year's educational program at the May Show an outstanding success, will serve as consultant to the National Electronic Distributors Association convention program committee, it was announced at NEDA headquarters.

Richard F. Goetzen, Sales Manager of the Fidelitone Division of Permo, Inc., will direct the accelerated activities of the Direct Factory Men covering sale of the Fidelitone Line. The Permo Line of Products, presently consisting of 113 Special Type Needles, Magnetic Recording Wire and Recording Tape, and Record Brushes, will be handled by Independent Manufacturers Representatives.

Astron Sales Corporation announced that Mr. M. A. De Matteo has been placed in charge of jobber sales.

J. Calvin Affleck has been appointed advertising manager of the receiver division, Allen B. Du Mont Laboratories, Inc.

John W. Lohnes has been appointed vice president of sales for the Jeffers Electronics and Speer Resistor Divisions of Speer Carbon Company.

The appointment of *Johnny Walker* as regional sales manager of the lower Ohio, Indiana, and the state of Kentucky was announced by Stewart-Warner Electric, the radio and television division of Stewart-Warner Corporation.

The appointment of *Adrian S. Price* as Director of Public Relations and Advertising for RMS, electronic and television accessory manufacturers, has been announced recently.

Gerald Light has joined CBS-Columbia Inc., as Director of Advertising and Sales Promotion, it was announced, CBS-Columbia Inc., Mr. Light recently resigned from the Emerson Radio and Phonograph Corpo-



Gerald Light

ration where he held the position of Advertising Manager and other sales executive posts for the past nine years. Also announced was the appointment of *Bernard M. Dover* as Project Engineer.

George W. Henyan of 43 Washington Avenue, Schenectady, N. Y., has resigned as chief of the components branch of the National Production Authority's Electronics Division, and returned to the General Electric Company as assistant to the general manager of the Tube Department. *Robert O. Bullard* of 1905 Union Street, Schenectady, N. Y., was also named manager of Industrial and Transmitting Tubes for the department, which post Henyan held for three years prior to his Washington appointment last November. *Newell J. Corwin* of 2040 Baker Avenue, Schenectady, has been appointed manager of the General Electric Company's Scranton, Pa., Tube Works.

The assignments of *Messrs. Edward Kantrowitz*, *Albert Leon* and *Arnold Henderson* to high departmental posts was announced by Emerson Radio and Phonograph Corporation. Mr. Kantrowitz has been assigned as Acting Manager of Advertising Department. Mr. Leon has been assigned as Acting Manager of Sales Promotion Department. Mr. Henderson is assigned to the post of Assistant National Sales Manager.

Motorola Inc. announced the election of *Edward R. Taylor* to the newly created office of assistant to the president, effective June 1.

The appointment of three new Spartan District Merchandisers in outstate New York has been announced by B. G. Hickman, General Sales Man-

HIS CHOICE IS *Regency*

LARGEST SELLING VHF BOOSTER AT ANY PRICE!

MR. EARL M. RUSH
GENERAL MANAGER, V-M CORPORATION
WORLD'S LARGEST MANUFACTURERS
OF RECORD CHANGERS
PHOTOGRAPHED IN HIS HOME

ALSO MAKERS OF THE
Regency UHF CONVERTER

ATR

Makes
it easy
to DEMONSTRATE
AND TEST
D.C. APPARATUS
FROM A.C. LINES



"A" BATTERY ELIMINATORS

For DEMONSTRATING AND TESTING
AUTO RADIOS

New Models . . . Designed for testing D.C.
Electrical Apparatus on Regular A.C. Lines.
Equipped with Full-Wave Dry Disc Type
Rectifier, Assuring Noise-less, Interfer-
ence-Free Operation and Extreme
Long Life and Reliability.

NEW MODELS
NEW DESIGNS
NEW LITERATURE

"A" BATTERY ELIMINATORS
DC-AC INVERTERS
AUTO RADIO VIBRATORS

See your jobber or write factory

AMERICAN TELEVISION & RADIO Co.

Quality Products Since 1931

SAINT PAUL 1, MINNESOTA-U. S. A.

ager of Sparton Radio-Television, Jackson, Michigan. The new moves place *Carl Boyden* as Sparton District Merchandiser of Western New York; *Herb Poad* as Sparton District Merchandiser of Central New York; and *Ed Maser* as Sparton District Merchandiser of Upstate New York.

Three veteran field sales representatives of the Tube Department of RCA Victor have been promoted to the posts of managers of newly created districts for the company's renewal sales activities, it was announced by L. S. Thees, general sales manager.

The three new district managers are *Joseph J. Kearney*, East Central district, with headquarters in Cleveland; *A. K. Mallard*, Southwestern district, with headquarters in Dallas; and *Ted Martin, Jr.*, Northeastern district, with headquarters in Boston.

The appointment of *James M. Skinner, Jr.*, as vice president-distribution for all domestic divisions of Philco Corporation was announced recently.

Mr. Richards W. Cotton has been given a temporary leave of absence from Philco Corporation to accept appointment as Chairman of Electronics Production Board of the Defense Production Administration and Director of the Electronics Division of the National Production Authority, Department of Commerce.

South River Metal Products Co., Inc., South River, New Jersey, announced the appointment of *Martin L. Roth* to the position of Sales Manager of the Company.

Transformer Corporation, Chicago, announced the appointment of *Eugene J. Flesch* as assistant to the general sales manager.

Sylvania Electric Products Inc. announced the appointment of *Samuel B. Williams* as Assistant to the President. *George W. Griffin, Jr.*, Manager of General Electric Company's News Bureau at Schenectady, N. Y., since 1945, succeeds Mr. Williams as Director of Public Relations at Sylvania.

H. Everett Smith has been appointed president of The Wilcox-Gay Corporation and Garod Radio Corporation of Charlotte, Michigan, and Brooklyn, New York.

The election of *T. M. Douglas* as a vice president and director of Federal Telephone and Radio Corporation, Clifton-Passaic, N. J. associate of the International Telephone and Telegraph Corporation, was announced. At the same time, it was announced that *S. J. Powers*, manager of Federal's Selenium-Intelin Division, has been elected a vice president.

Hudson Radio & Television Corp. of New York City, announces several

changes in management of the firm. *David H. Ormont* is now president, *Sol Baxt* is vice president and *Joseph Simons*, secretary. There will be no change in operation of the business. *Morton Schwarty*, Southwestern sales representative of Olympic Radio & Television, Inc., since October, 1951, has been promoted to the post of Midwestern regional sales manager, with headquarters in Chicago. In his new capacity, Mr. Schwarty succeeds *Nate Hast*, who recently resigned from the Olympic sales staff.

Adolph L. Gross has resigned as president of the Hudson Radio & Television Corporation, 48 West 48th Street, New York, and has disposed of his interest in the firm to David H. Ormont. He will announce plans for a new operation in the near future.

The Turner Company, has announced the appointment of *Hobert M. Murdock* as Vice President in charge of sales, and *Benno Von Mayrhauser* as Vice President in charge of production.

Jack Abel has joined the Insuline Corporation of America, electronic parts manufacturer of Long Island City, N. Y. to take charge of the mechanical engineering department.

At a meeting of the Board of Directors of P. R. Mallory & Co. Inc., Indianapolis, held May 29, *Frank B. Powers* was elected Vice President in Charge of Manufacturing.

In the first of a series of decentralization moves Alliance Manufacturing Company announced the appointment of *Albert Saunders* as District Manager, and *C. Pat Walder* as Western District Manager.

R. W. Fordyce, general sales manager of Bendix Radio, Television and Broadcast Receiver Division of Bendix Aviation Corporation, will resign from the position he has held for the past two and a half years to enter the distributing business in Miami. Mr. Fordyce will handle the Bendix Television and Radio lines for the entire southern Florida area.

The General Bronze Corporation announces the promotion of *Ira Kamen* to Vice President of their Brach Manufacturing Corporation Division.

Mr. Kamen will be responsible for organizing the expanded industrial and government sales operations of the Brach organization. In addition, Mr. Kamen will continue to handle contract negotiations for Brach's Radar Antenna, Servo, and other electronic activities.

Andrea Radio Corporation, announces the advancement of *M. J. McNicholas* to the position of Manager, Special Apparatus Division.

For Replacement and Conversion . . .

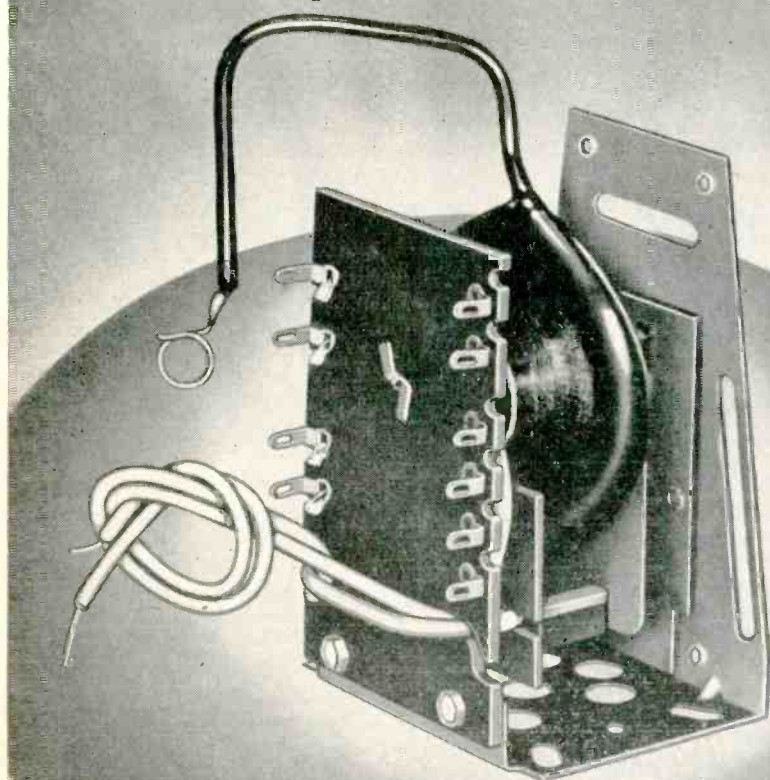

RCA-231T1 . . . Only \$9.95
Suggested List Price

✓ TAPPED PRIMARY
TO TAKE CARE OF
WIDE-RANGE OF "B" VOLTAGES

✓ FOR DEFLECTION ANGLES
FROM 50° TO 66°

✓ DELIVERS UP TO
15 KILOVOLTS

✓ MATCHES ALL YOKE
INDUCTANCES
FROM 8 TO 30 MH

NOW . . . a "universal-type" horizontal output & HV transformer

You've wanted it . . . here it is—the first "universal-type" horizontal output and HV transformer that solves virtually all replacement problems in TV receivers utilizing transformers which have isolated secondary windings. Because of its versatility, this new transformer is particularly suitable for conversion jobs.

Mechanically and electrically . . . the new RCA-231T1 meets practically every mounting and circuit requirement. With its 3 terminals on the primary winding and 7 terminals on the secondary winding, this universal-type transformer accommodates all standard driver tubes . . . assures a flexible and accurate match to an extremely wide range of yoke inductances . . . and provides excellent voltage regulation, ample width, and high voltage output. It uses a ferrite core for highest efficiency, cushioned to reduce 15-Kc acoustic radiation . . . and an arc shield to minimize corona problems. Provided with multiple mounting holes and slots, the RCA-231T1 can be quickly installed in practically all receivers.

Now, for the first time, you can simplify your stocking and servicing problems, with the new RCA-231T1 transformer for receivers using isolated-secondary-type transformers. Save yourself time and trouble . . . get a supply of 231T1's from your RCA Parts Distributor *today*.



RCA-201Y1
Converkit

Only \$19.70 Suggested List Price

Handles picture tubes up to 21 inches in size and having horizontal-deflection angles up to 66°. Contains high-quality electronic components—an RCA-211D2 "Anastigmatic" Deflecting Yoke and an RCA-231T1 Horizontal-Deflection-Output and High-Voltage Transformer.

See your local RCA Parts Distributor for "Original" RCA TV Components.

tmks. ®



RADIO CORPORATION of AMERICA

ELECTRONIC COMPONENTS

HARRISON, N. J.

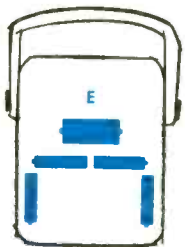
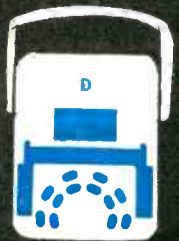
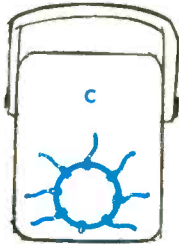

THE SIMPSON MODEL 260 VOLT-OHM-MILLIAMMETER OUTSELLS ALL OTHERS COMBINED BECAUSE

- A covers all ranges necessary for Radio and TV set testing
- B includes the Simpson 50 Microampere Meter Movement known the world over for its ruggedness
- C no bulky harness wiring, thus eliminating all intercircuit leakage at this high sensitivity
- D molded recesses for resistors, batteries, etc.
- E easy battery replacement
- F covered resistors to prevent shorts and protect against dust and moisture
- all components—including case and panels—are specially designed and completely tooled for maximum utility...not merely assembled from stock parts

ranges

20,000 Ohms per Volt DC,
1,000 Ohms per Volt AC
Volts, AC and DC: 2.5, 10, 50,
250, 1000, 5000
Output: 2.5, 10, 50, 250, 1000
Milliamperes, DC: 10, 100, 500
Microamperes, DC: 100
Amperes, DC: 10
Decibels (5 ranges):
-12 to +55 DB
Ohms: 0-2000 (12 ohms
center), 0-200,000 (1200 ohms
center), 0-20 megohms
(120,000 ohms center)

prices

Model 260 \$38.95; With Roll
Top \$46.90. Complete with
test leads and operator's
manual. 25,000 volt DC Probe
for use with Model 260, \$9.95.



Simpson Instruments That Stay Accurate Are Available From All Leading Electronic Distributors.

SIMPSON ELECTRIC COMPANY

5200 W. Kinzie St., Chicago 44, Illinois • Phone: COLUMBUS 1-1221

In Canada: Bach-Simpson, Ltd., London, Ont.

Common Troubles In LIMITER, SEPARATOR and CLIPPER STAGES

by **MATTHEW MANDL**

(Author of Mandl's Television Servicing)

IN television and frequency modulation receivers certain similarities exist among the limiter, sync separator, and clipper stages. This means that common servicing techniques can be employed for these stages. Thus, an understanding of the comparative differences between such stages and ordinary amplifier stages will be of material aid to the servicing technician when trouble shooting defects in these stages.

Methods of servicing limiter, separator, and clipper stages as employed by the practicing service dealer.

Sync Separation

As shown in *Fig. 1*, clipper or separator stages are so designed that the peak portions of the input signal are clipped from the remainder of the signal and the appearance of the clipped portion in the output circuit

affords the degree of separation required. If, for instance, this were a sync separator as shown at "A", the composite video signal would be injected into the grid circuit in a positive-going direction. During the peaks of the signal (sync pulses) the grid

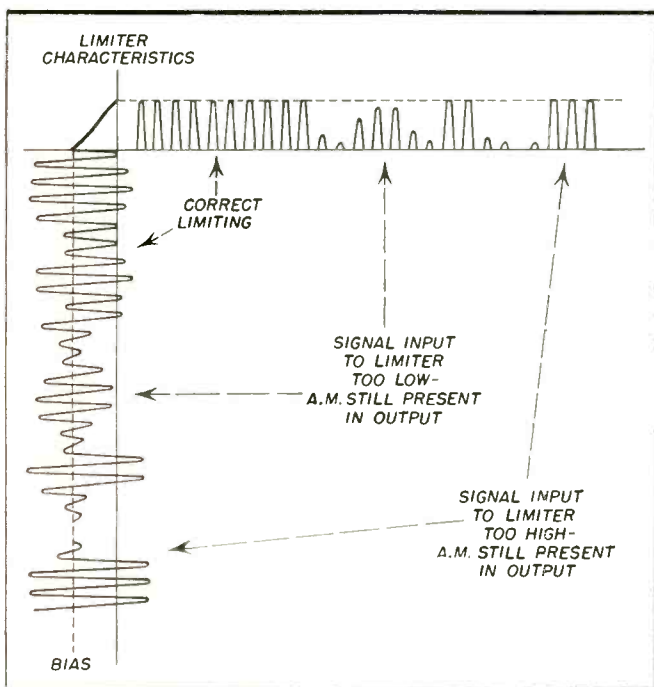

Fig. 1. Similarity of sync clipper and limiter circuit action.

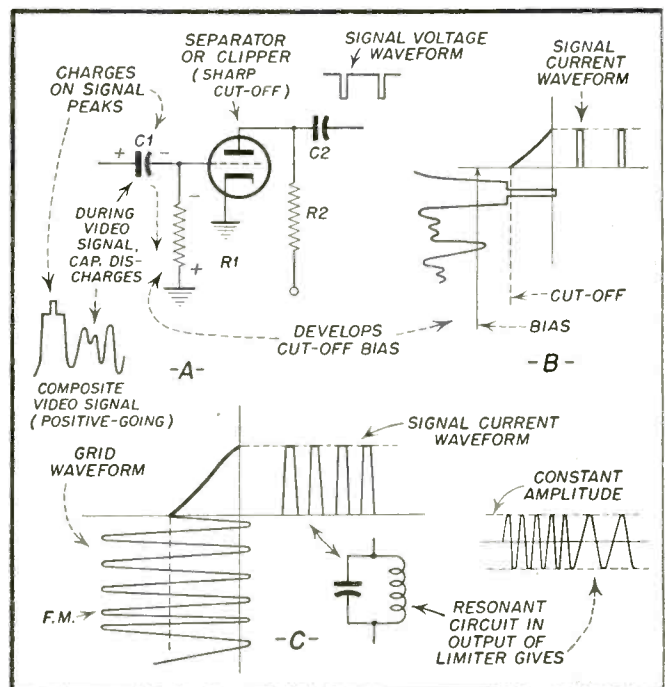

Fig. 2. Limiter characteristics for various conditions of video signal.

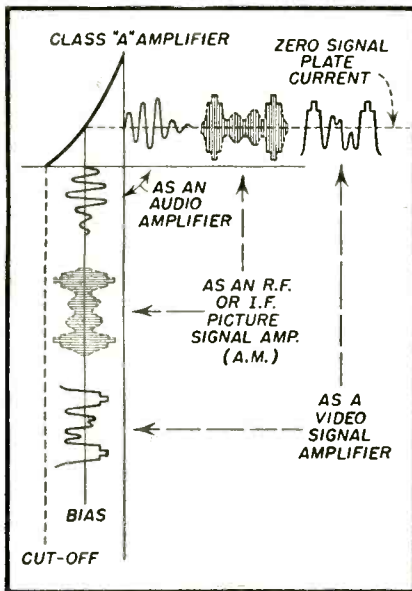

Fig. 3. Class "A" amplifier characteristics.

goes positive and current, therefore, flows from cathode to grid and toward the capacitor, *C1*. The effect here is as though the grid and cathode were acting as a rectifier and charging *C1* to the peak of the sync tip. Inasmuch as this is the highest amplitude of the signal, the capacitor will charge to virtually full value because of the low impedance of the grid input circuit during conduction. At this time the video information comes along its amplitude is lower than the sync tip and, therefore, the capacitor will discharge across the grid leak, *R1*, in the direction shown by the arrows. This develops a high bias and cuts off the tube as shown at "B" of Fig. 1. This bias establishes the point around which the composite video signal varies and brings the blanking at the cut-off point. Thus, only the sync tips will develop current flow. Thus, across *R2* of the circuit, the signal voltage waveform for the sync tips only is developed.

The time constant of *C1* and *R1* is made sufficiently long to hold a substantially full charge on the capacitor between sync tips to maintain a fairly constant bias value. Should the television receiver be switched to another station which has a lower or higher signal, the automatic function of the separator will still establish the bias so that proper clipping is maintained. On occasion, internal bias may be applied to assure that the blanking level will always be at or below the tube cut-off point.

A sharp cut-off pentode is usually used instead of the triode shown at "A" because the pentode tends to maintain the average bias at a more

constant level. This means that the output will be maintained at a fairly even level for best synchronization of vertical and horizontal sweep circuits.

Limiting

The limiter circuits used in frequency modulation receivers or in the sound sections of television receivers function in similar fashion to the separator circuits. As shown at "C", the incoming signal is applied to the grid at or slightly below the cut-off point. A low voltage is applied to the limiter stage so that the tube saturates easily. Thus, only a portion of the positive alternations of the incoming signal will appear in the plate side. All the signal below the tube cut-off point is obliterated and amplitudes in excess of tube saturation are leveled out. This, then, assures constant amplitude output from the limiter and thus eliminates amplitude variations such as static, impulses noises, and other interference in the nature of amplitude variations.

As can be seen from "C" of Fig. 1, the plate current is in the form of pulsating d.c. When this is impressed across the resonant circuit between the limiter and FM detector, the fly-wheel effect of the resonant circuit will produce an r-f sine wave as shown in Fig. 1 "C." The clipping action has not affected the frequency variations, and these are then detected by the discriminator or ratio detector for amplification by the audio stages.

Correct limiter function depends on saturation of the limiter by a well-amplified signal from the sound i-f stages. This is shown in Fig. 2 where the initial signal waveform has amplitude variations. You will note, however, that even though the signal amplitude varies, the amplitude does not drop below the tube saturation

point. If the signal input to the limiter is too low, insufficient clipping will not be realized as shown in the second portion of the waveform on the grid of the limiter (Fig. 2). This means that the limiter function has been nullified and AM variations will still be present. Besides this, the tube will now act as an amplifier rather than a limiter and hissing noises and rushing sounds will be present from the speaker. If amplitude variations of a high order are present the limiter will again be ineffective as shown in Fig. 2. Here the extreme amplitude variations increase beyond the saturation point but during the reverse swing will also drop to zero level as shown. This again will produce amplitude variations from the limiter and thus defeat its prime function.

It is for this reason that the alignment of the i-f stages preceding the limiter should be properly adjusted. Incorrect alignment will result in insufficient signal to the limiter and thus permit noise to enter the system. The same holds true if the picture i-f stages of an intercarrier receiver are not properly aligned. If amplitude variations in excess of those normally present should enter the limiter circuit, severe intercarrier buzz will be encountered.

Compare the limiter, clipper and separator circuits previously discussed with the class "A" amplifier circuit whose characteristics are shown in Fig. 3. In these circuits a fixed bias is established by a cathode resistor or some other source and no bias is developed by capacitor-grid leak function. The bias is set on the straight-line portion of the characteristic curve so that all portions of the signal are amplified without undue harmonic distortion. Such a class "A" amplifier is used in the audio amplifier circuits

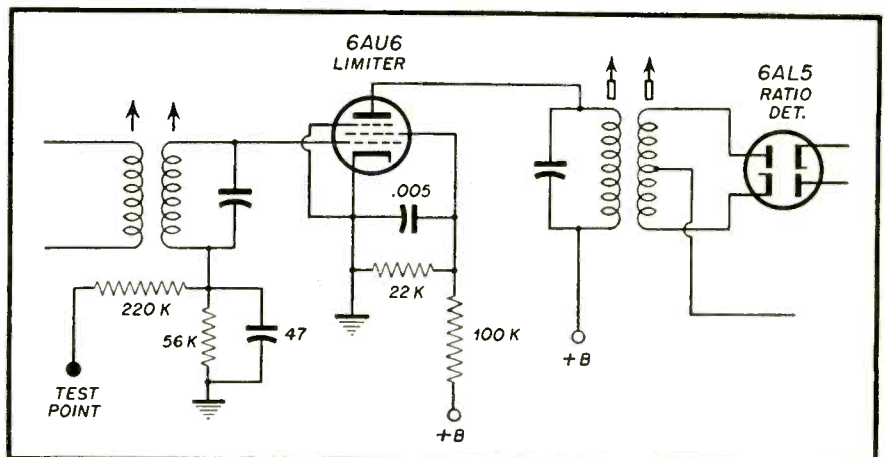

Fig. 4. Limiter preceding ratio detector in G.E. Model 20C150 series TV receivers.

of radios, FM, and television receivers as well as in the r-f and i-f stages of such receivers. Besides this, the class "A" amplifier is also used for amplifying the video signal derived from the picture detector. This difference in function means that somewhat different servicing procedures should be used for checking circuits in which the grid runs positive on occasion and draws grid current.

Servicing Factors

Inasmuch as grid current flows in limiter and clipper circuits, the self-bias which is established can be used as an indication of whether or not the limiter circuit is functioning as well as for establishing the presence of an incoming signal. Thus, in signal tracing procedures the presence of bias across the grid leak of such a circuit would definitely show that signal voltage is arriving at this stage, otherwise the grid would not be driven positive and no bias would develop. For this reason such circuits are somewhat similar to oscillators which also develop their own bias. (See "Servicing TV Oscillator Circuits" in the March issue of Radio Service Dealer.) A VTVM should be used for such d-c voltage measurements because the high input resistance will not unduly load the grid circuit when taking such measurements.

Some manufacturers provide test points for this purpose and a typical one is shown in Fig. 4. This represents the limiter used in the General Electric Model 20C150 television receiver series. The test point has a series resistor of 220,000 ohms for better isolation of the vacuum-tube voltmeter and to prevent loading effects. If no voltage is present across this test

point it would indicate that either the input signal is missing or that a short or other defect exists within the tube which prevents the rectifying action of the grid and cathode elements. In the absence of a test point, the voltmeter is placed directly across the grid resistor and a negative reading should be obtained from the top of the grid resistor to ground. In a limiter circuit the more common troubles (other than misalignment) would consist of incorrect voltages caused by power supply deficiencies or by defective component parts in the limiter circuits. Thus, the .005 μ f screen by-pass could short and thus damage the 100,000 ohm dropping resistor feeding the B plus to the screen. A voltmeter check would indicate lack of voltage at the screen because of the shorted capacitor, while an ohmmeter check with the receiver off would show the screen shorted to ground.

The 22,000 ohm resistor from the screen to ground is a bleeder for the purpose of stabilizing the voltage on the screen. Should this short, it would have the same effect as a shorted capacitor and would overheat the 100,000 ohm resistor and in all probability burn it out.

As in many other receivers, in the G.E. a limiter is used before a ratio detector, even though the ratio detector is primarily insensitive to amplitude variations. The limiter, however, assures AM clipping and minimizes noise effects which may sometimes appear from the ratio detector. Actually, however, many ratio detectors are used without the limiter, and theoretically it is only essential when the discriminator type of frequency modulation detector is used. The latter

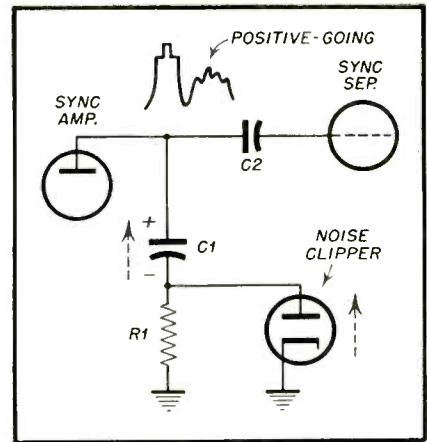

Fig. 5. Diode noise clipper.

requires AM clipping because it will detect AM as well as FM.

In the sync separator systems of television receivers, some amplification is often employed either prior to separation or after. Besides this, noise clippers are usually employed for the purpose of removing any noise pulses which may override the sync signal. Such noise clippers can be a diode tube such as shown in Fig. 5. This noise clipper diode conducts during the sync pulse and charges $C1$ with a polarity as shown inasmuch as current must flow up through the diode from cathode to plate, and thence to the capacitor. When the sync pulse leaves, $C1$ will discharge across $R1$ at a relatively slow rate because the diode no longer conducts. This places a negative potential at the top of the resistor and thence at the anode of the diode. Thus, the diode can no longer conduct (because its plate is negative) until the next sync pulse comes along and overcomes the negative potential. When a noise pulse higher than sync enters the system it would overcome the negative charge on the capacitor and cause the diode tube to conduct again.

The noise pulse is then clipped and reduced to the level of the sync pulse. This minimizes the instability effects which could be produced by noise pulses. The diode could also be a Germanium crystal such as the 1N34. Triodes are also used such as shown in Fig. 6 which represents the sync separator and amplifier system used in the Hallicrafters Model 822 receiver. Here sync amplification and separation are accomplished by a single 12AU7 tube, while sync clipping is done in another 12AU7 tube, the second portion of which forms the vertical blocking oscillator.

When servicing such circuits they

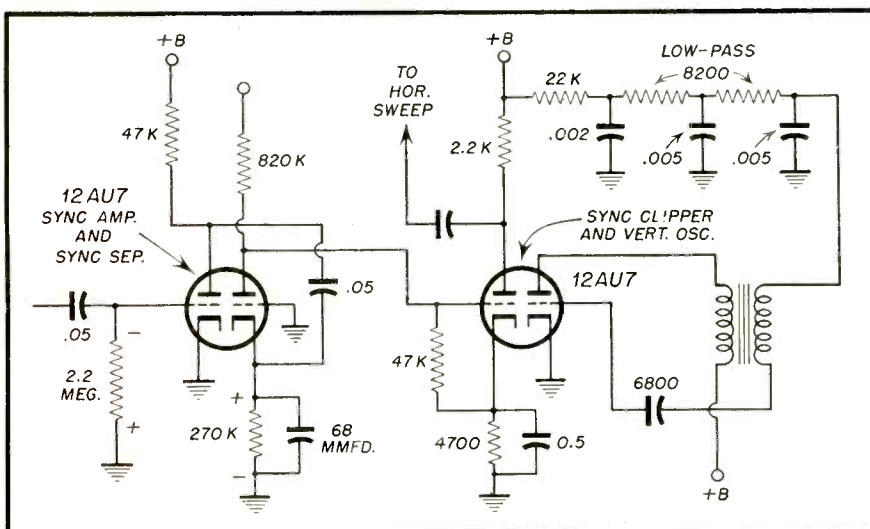

Fig. 6. Sync separator system used in Hallicrafters Model 822 TV receiver.

[Continued on page 47]

VIDEO AMPLIFIERS

PART 3

by **LEONARD LIEBERMAN**

Servicing the Video Amplifier

The main sources of trouble in the video amplifier are in the following order: the amplifier tubes, the peaking coils, the plate and cathode resistors and the screen by-pass condensers.

Tubes, even while seeming to be working properly, can cause all sorts of trouble which might seem to be in other circuits. For example: if a tube is a bit gassy, its transconductance goes up and its input and output capacities change. This, in turn, as shown previously affects the video amplifier response. The effect on the pix tube screen might be either a smeary picture or a "ghosty" ringing picture. If the plate current runs high enough, the cathode and plate resistors might overheat and change value without necessarily burning up. This would appear either as a loss in gain, or video in the sync (video in the sync symptoms were discussed previously).

If the picture is "smeary" check the peaking coils for continuity. If any one of them reads more than 5 ohms, the chances are that it is defective.

The final installment in this series discusses the various methods, test set-ups, and operations that may be employed when servicing video amplifiers of various types in TV receivers.

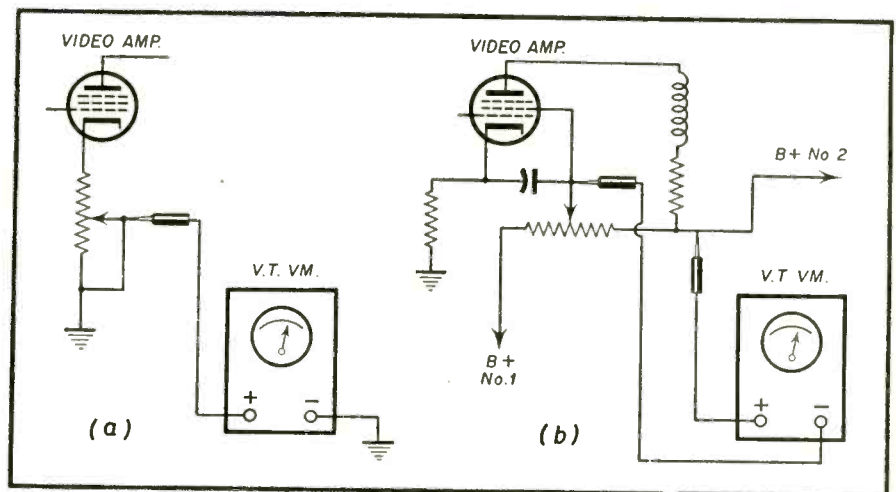

Fig. 14. VTVM connections for checking contrast controls.

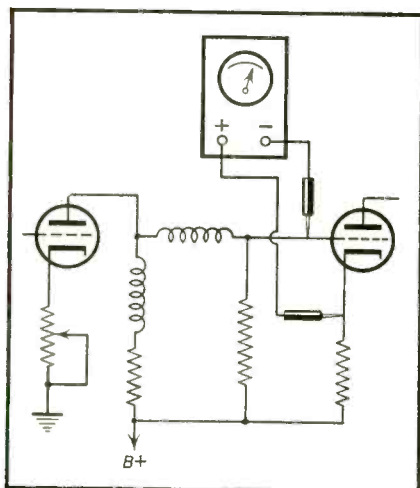

Fig. 13. VTVM connections for bias readings in direct coupled amplifiers.

There are as yet no standard jobber replacement units for these coils. It is, therefore, advisable to replace the defective unit with the manufacturer's exact replacement part.

"Hooking" or "weaving" (top of pix curved to one side) can be caused by the video amplifier operating in a critical plate current region or the sync take-off resistor having changed value. If "hooking" does occur, try replacing the sync take-off resistor with one which is either 20% or 30% higher or 20% to 30% lower in value than the resistor at present in the set. Poor picture resolution with an unstable sync in sets using a pentode video amplifier can sometimes be caused by a high resistance leak in the screen by-pass condenser.

In addition to the other sources of

trouble, misalignment of the 4.5 mc trap will create a very annoying condition on the screen. This consists of dots crawling across the screen. These dots are the result of 4.5 mc beat notes which are not filtered out due to this misalignment.

For proper servicing of the video amplifier, the minimum test equipment requirements are a good VTVM and an oscilloscope. The manufacturers' voltage and resistance ratings are also important. If in addition, you have an r-f signal generator and a good sweep generator with at least a 0-10 mc sweep, you can get all the necessary information on the action of the video amplifier which you need. The first operation after checking the tubes in servicing video amplifiers is taking voltage readings. When using

Erratum:

The captions in Figs. 10 and 11 on page 22 in the May, 1952 issue of RSD dealing with the second installment of this series should be reversed.

a good VTVM, these readings should be plus or minus 10% of the manufacturer's ratings. These readings generally are taken with respect to ground. In direct coupled video amplifiers, it is also advisable to take measurements between cathode and grid (Fig. 13). The meter is connected with the negative prod to the grid and the positive to the top of the cathode resistor.

An additional measurement which should be taken is to check the action of the contrast control. This measurement is especially advisable in sets in which the control is in the video amplifier circuit (Fig. 14). The meter needle should move smoothly from minimum to maximum and back when the control is rotated. Any sudden jumps or ragged needle action would indicate a noisy or erratic control. This sort of defect will show up as either noise blobs (like snow) or as ragged flashing as the control is varied.

In case the 4.5 mc trap is misaligned, basically the same method is used for alignment in both split sound and inter-carrier type sets. The method of alignment of the split sound system requires a single generator capable of producing 4.5 mc accurately. A VTVM and a crystal diode head (Fig. 15) are also necessities. The equipment is connected as shown in Fig. 16. If there is more than one video amplifier stage, the signal generator should be connected to the grid of the first amplifier. The meter and crystal are always connected to the CRT input point. When the equipment

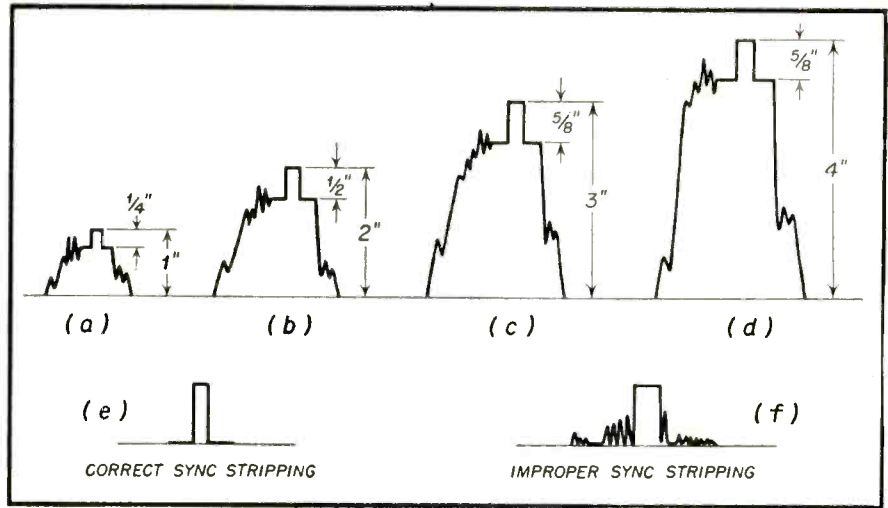

Fig. 17. Sync compression.

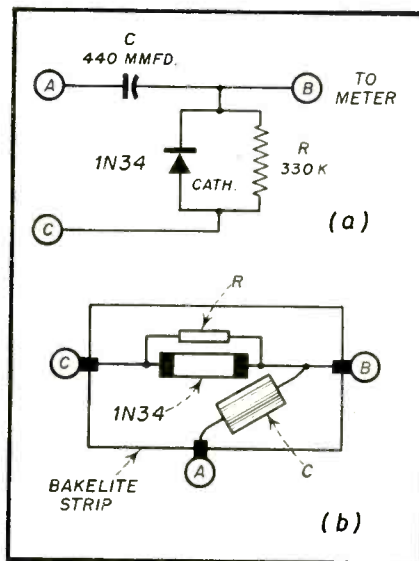

Fig. 15. Crystal diode for checking video amplifier response.

- (a) electrical
- (b) suggested physical assembly.

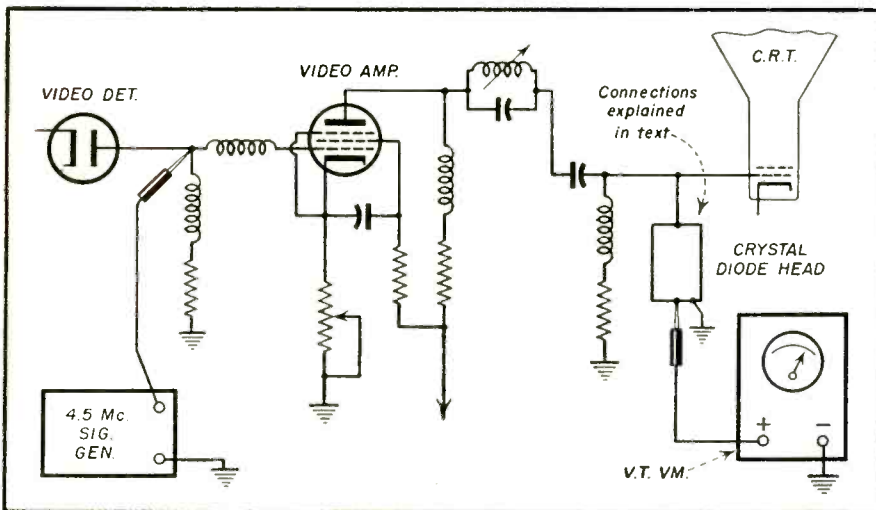

Fig. 16. Instrument hook-up for aligning 4.5 mc trap.

is connected as shown, the output of the signal generator is adjusted so that the VTVM reads on the upper portion of the lowest voltage scale. The 4.5 mc trap is then adjusted for a minimum reading on the meter.

It will sometimes be found that at maximum 4.5 mc rejection, a slight smear is introduced into the picture. When this occurs, back off on the 4.5 mc trap adjustment until the situation is corrected. There will usually still be sufficient rejection to keep the 4.5 mc beat from appearing in the picture. In inter-carrier sets, the same method is used but one or more of the video i-f tubes should be removed. This prevents the 4.5 mc signal from leaking into the video amplifier.

For detecting open video peaking coils, the only test required is a continuity check across the coil leads. If the meter reads more than a few ohms, the coil is open. Just because the meter shows a reading in the order of several thousand ohms is no indication of a good coil. The reason for this is the following: Some coils require damping resistors across them to prevent excessive peaking. It is common practice, therefore, to wind these coils around the body of an insulated resistor. Therefore, if the coil opens, it is possible to get a continuity reading through the resistor.

In addition to the above, two other kinds of information can be obtained from the video amplifier. The first is the amount of compression of the sync pulse. Some sync compression is usually designed into the amplifier in order to clip noise pulses which might be riding on the top of the sync pulses (Fig. 17). Too much compression of the sync will result in the video information not being sufficiently stripped from the sync in the sync separator stage.

This type of poor operation results in annoying (weaving) of the picture, vertically or horizontally, or both. To check for excess clipping, connect the equipment as shown in (Fig. 18). Set the contrast control at minimum. Adjust the scope height for a pattern approximately one inch or so on a 5 or 7 inch scope. When scope height is adjusted, increase the contrast control setting and observe the relative proportion of the sync pulse to the entire picture as the control is advanced. For example, assume that initially the pulse height is $\frac{1}{4}$ " when the entire signal is 1", then, as the picture increases to 2", the sync pulse should be approximately $\frac{1}{2}$ ". As the contrast control is advanced, note the point at which the relative proportion changes. This is the point of sync compression. If this point occurs, towards the maximum gain point of the control the operation is normal. If, however, it occurs at the low end of the control, check for changes in plate load resistor values, leaky coupling condensers, or a gassy video amplifier tube.

The other point of interest is the video amplifier response. This can be checked by connecting the sweep generator and scope as shown in Fig. 19. The video detector input to the grid of the amplifier is disconnected. The sweep generator is connected by means of 100—150 μf condenser to the amplifier grid. The socket of the CRT is then disconnected. This is done because of the fact that if the input capacity of the scope were added to that of the CRT it would double the capacities for which the circuit was designed. If the CRT weren't disconnected, we would get an incorrect idea of the amplifier response. A variable marker of 0-4.5 mc is then loosely

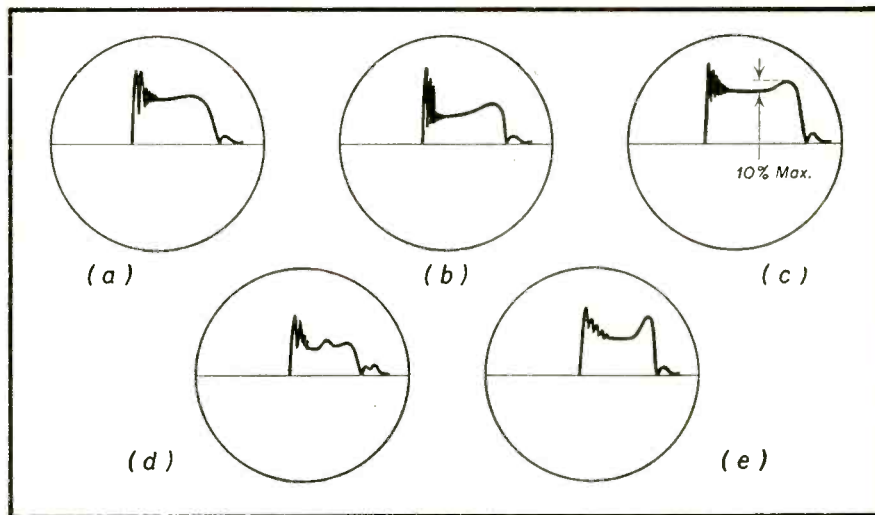

Fig. 20. Video amplifier band pass response curves on CRO screen. (a) ideal; (b) actual-minimum contrast; (c) actual-maximum contrast; (d) and (e) improper amplifier response.

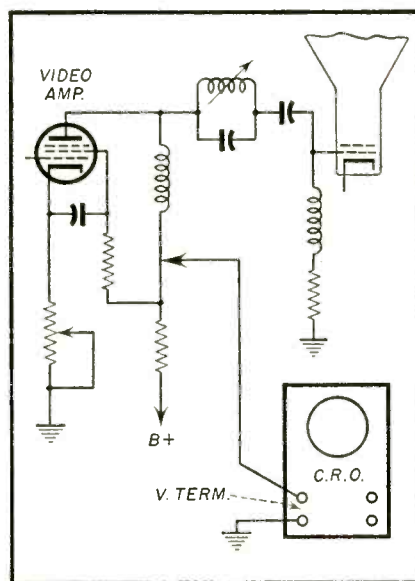

Fig. 18. Connections for checking sync clipping.

coupled into the input of the amplifier and the 3 db point can then be determined. A grid dip meter is the best marker used for this purpose. Variation of the contrast control should show no marked distortion of the wave form (Fig. 20).

Conclusion

In conclusion, the video amplifier while comparable to the audio output tube, is basically much more complex. The troubles arising from improper operation of this stage becomes usually evident on the face of the CRT. The troubles will not always be apparent by voltage checks. Use of the oscilloscope is an imperative and valuable aid in trouble-shooting. This is especially true in tracking down the cause of trouble when bothered by sync instability or pix distortion. Work in the video amplifier must be done carefully and cleanly. Lead dress should be maintained at its original position. Manufacturer's lead length on components should be duplicated. With careful observance of the above, trouble-shooting the video amplifier should be a much simpler and quicker job than it generally is.

THE END

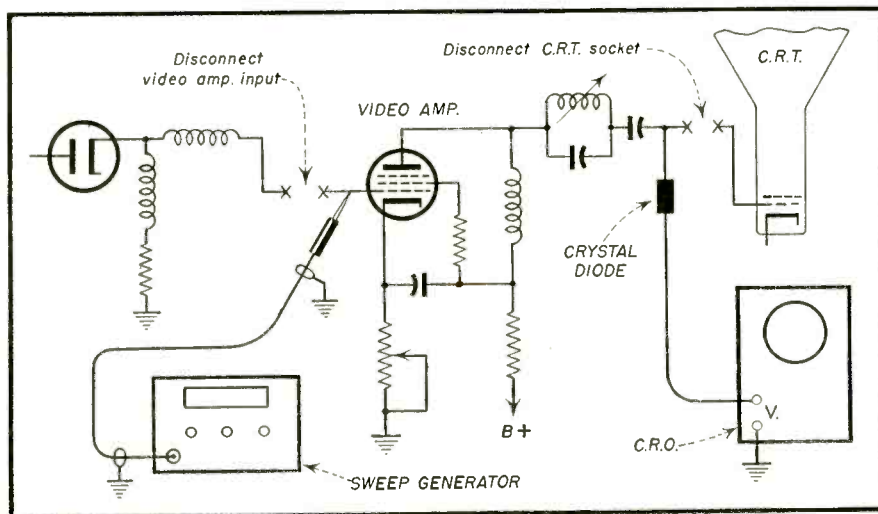

Fig. 19. Connections for checking video amplifier band-pass response.

\$1.00 to \$5.00 PAID
"for SHOP NOTES"

Write up any "kinks" or "tricks-of-the-trade" in radio servicing that you have discovered. We will pay from \$1 to \$5 for such previously unpublished "SHOP NOTES" found acceptable. Send your data to "Shop Notes Editor," RADIO-TELEVISION SERVICE DEALER, 67 West 44 St., New York 18, N. Y. Unused manuscripts cannot be returned unless accompanied by stamped and addressed return envelope.

LOOKING FOR Trouble?

No. 10

by Cyrus Glickstein

(Instructor, American Radio Institute)

CCHECK up on your servicing techniques by answering the questions in the TV trouble-shooting quiz. A defective receiver is on the bench and the quiz follows the usual servicing procedures. Answer each question before going on to the next. If there is more than one correct answer to a question, give all correct answers. Answers and discussion follow.

Receiver: Admiral 24D1, transformer low voltage power supply, kickback high voltage supply, split sound system.

Trouble: Sound and raster O.K., no pix.

1. The first step, as usual, is to try to localize the trouble to a definite section of the receiver by observing the symptoms, manipulating the appropriate controls, and noting the effects. With the contrast control all the way up, rotation of the fine tuning affects sound only in the usual way. No pix. On all channels, sound is O.K., raster is normal and no picture is seen. The brightness control varies the brightness normally. On the basis of the above, the defective section appears to be:

- Front end (r.f., oscillator, mixer)
- Sync section (Sync amplifier, sync clipper)
- Low voltage power supply
- Video strip (Video i.f., video detector, a.g.c., video amplifier)
- Horizontal sweep (Horizontal oscillator, horizontal output)

2. The video strip appears to be the defective section. All the tubes in the video strip are changed, but no improvement is noted. A scope is used to help localize the trouble to the defective stage. The scope is applied to the video detector output, pin 7, 6AL5, V304 (Fig. 1). With a channel tuned

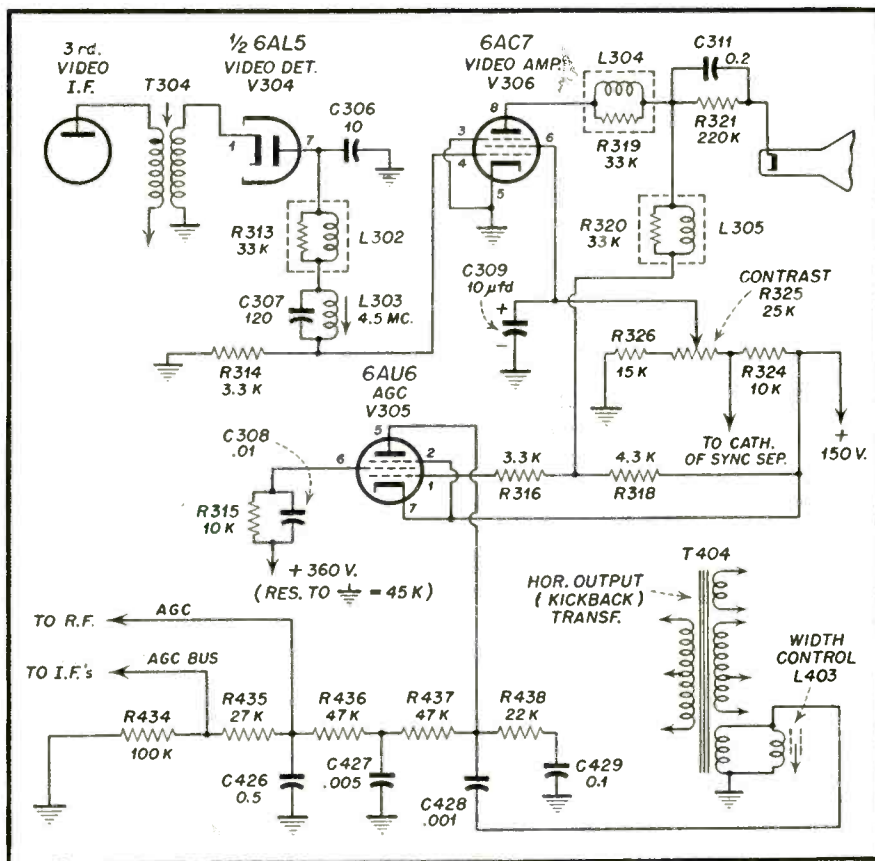

Fig. 1. Partial schematic of Admiral, Model 24D1, showing video detector, video amplifier, and keyed AGC stages.

in, a video signal is seen on the scope. This indicates the video i-f stages are functioning and the defect must be between the detector load and the CRT. The scope is used for signal tracing between these two points. The following waveforms are observed—Fig. 2.

The signal appears to be lost at the following point:

- Detector output—pin 7, 6AL5, V304.

- Grid of Video Amp.—pin 4, 6AC7, V306.
- Plate of Video Amp.—pin 8, 6AC7, V306.
- Grid of a.g.c.—pin 1, 6AU6, V305.
- Plate of a.g.c.—pin 5, 6AU6, V305.

3. Waveforms indicate the Video Amplifier stage is not operating. Voltage checks are made around the Video Amplifier, 6AC7, V306, and compared

NEW CENTRALAB

eliminates "cut and try"

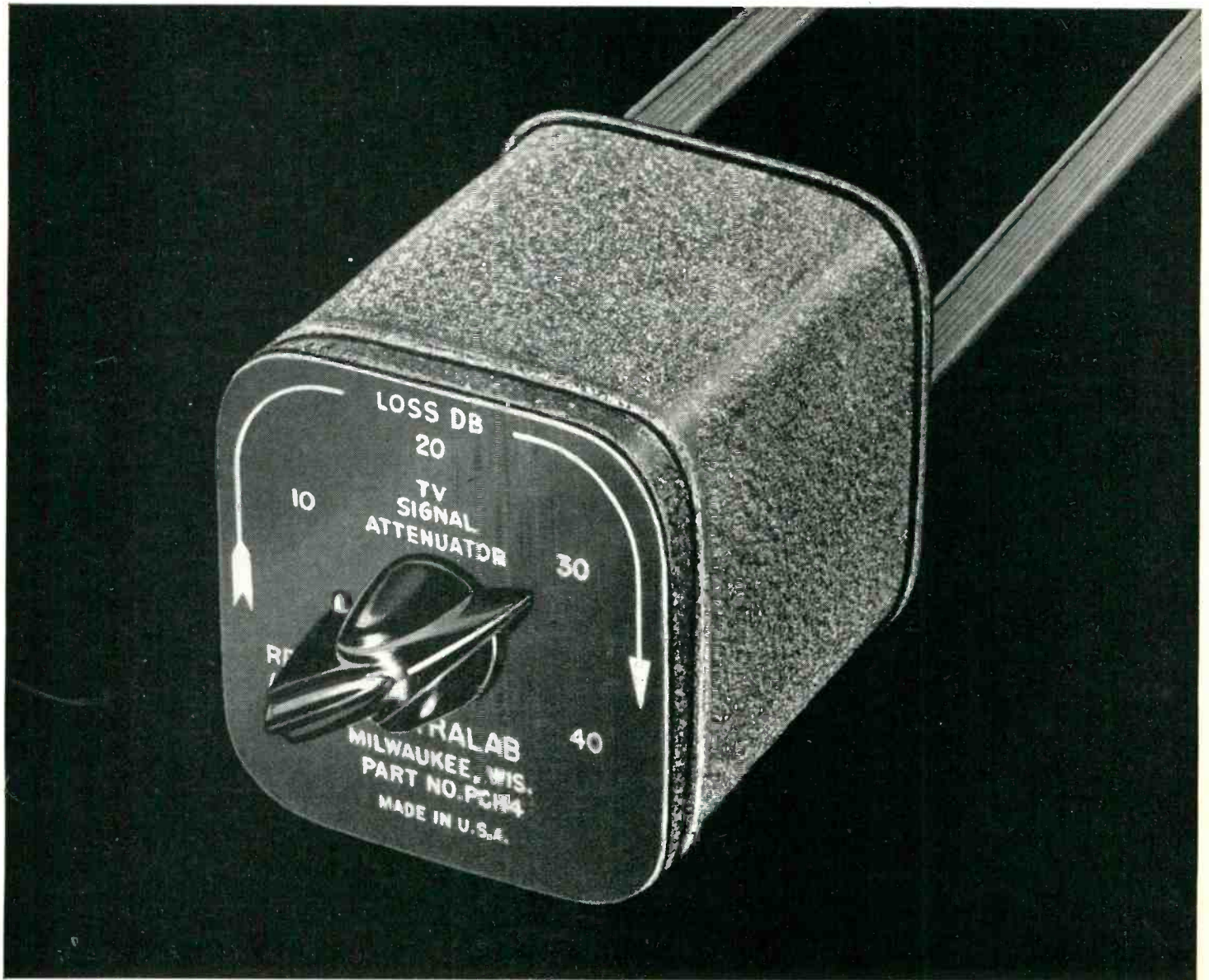

TV service men will welcome this new Centralab Attenuator Switch. It's especially useful where a television set is located too close to a broadcast station. Or if a set is in an area served by several stations, it helps correct a high-power situation—where one sig-

nal is too strong in relation to other stations.

The Centralab Attenuator Switch quickly matches the signal strength to the requirements of the receiver. You can then install an H-Pad quickly . . . achieve optimum performance.

SERVICE TOOL

methods of installing H-pads

New TV Attenuator Switch saves you testing time ... assures no overloading of sets

HERE'S a new Centralab service tool that will save you time determining the exact amount of attenuation required to get the best TV reception.

Four different H-Pads are mounted permanently in the attractive metal case of Centralab's Attenuator Switch. You simply hook up the 300 ohm antenna twin-lead . . . and turn the dial to the H-Pad that gives you the proper amount of attenuation. Then unhook the leads and install the proper H-Pad. Takes only a few minutes for the

entire installation.

More, if you have customers who want a permanent installation with selective attenuation, this switch is ideal. A convenient bracket is available to facilitate mounting the switch in back of the cabinet.

Your Centralab distributor will be glad to give you full specifications on this handy, time-saving service tool — as well as the Centralab H-Pads described below. See him today, or use the handy coupon below.

FOR BEST PERFORMANCE AND ATTENUATION, use the handy Centralab P.E.C. television H-Pads. They can prevent overloading, eliminate tearing of the image, improve both audio and video results. Also useful in matching impedance between the antenna and the receiver. Available in 10, 20, 30 and 40 db. H-Pads install in series with the standard 300 ohm antenna.

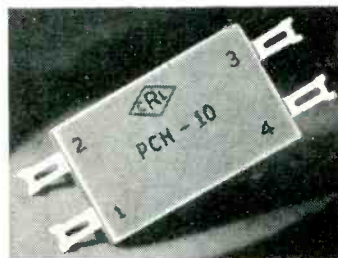

Centralab

A Division of GLOBE-UNION INC.
944 E. Keefe Avenue • Milwaukee 1, Wisconsin



CENTRALAB, A Division of Globe-Union Inc.
944 E. Keefe Avenue, Milwaukee 1, Wisconsin

- Please send me additional technical information on the new Centralab TV Attenuator Switch.
- Send information on TV H-Pads.

Name.....Position.....

Company.....

Address.....

City.....Zone.....State.....

(To ground)	Mfr's Specs	Measured
Ep (pin 8)	130 v	145 v
Esg (pin 4; contrast cont. max.)	110 v	120 v
Eg (pin 4)	-4 v	-6 v
Ek (pin 5)	0 v	0 v

to the manufacturer's specifications. The voltage readings point to the following possibility:

- Low cathode emission from the VA tube
- Leaky coupling condenser to the grid of VA tube
- Open peaking coil in plate circuit of VA
- Leaky screen bypass condenser causing excessive current through VA tube
- D-C voltage component from large detected signal is biasing the VA approximately to cut-off

4. Evidently, a large signal with its d-c component on the grid of the VA is biasing the stage to cut-off or close to it. There is practically no current through the tube and practically no signal appears on the plate of the VA. This is verified by turning the channel selector knob to a blank channel. Voltages around the VA stage become normal. Since the signal input to the VA is larger than normal, a defect is indicated in the a-g-c system. This is checked by measuring the negative AGC voltage from the a-g-c bus (Fig. 1) to ground. Instead of measuring approximately -4V with a strong signal, 0 voltage is measured.

A further check is made around the AGC stage, 6AU6, V305, by voltage and resistance readings:

(To ground)	Mfr's Specs	Measured
Ep (pin 5)	-4 v (with strong signal)	0 v
Esg (pin 6)	320 v	0 v
Eg (pin 1)	130 v	145 v
Ek (pin 7)	150 v	150 v

(To ground)	Measured
Rp (pin 5)	225 K
Rsg (pin 6)	infinity
Rg (pin 1)	42 K
Rk (pin 7)	35 K

On the basis of the voltage and resistance readings around the a-g-c stage, the trouble is:

- R315 (screen) decreased in value
- R315 open
- C308 (screen) shorted
- C308 open
- 428 (plate) shorted

Answers and Discussion

1. d

Poor or no video and normal sound in a split second receiver usually indicate trouble in the video strip. In this type of receiver, a defect in the front end generally affects both sound

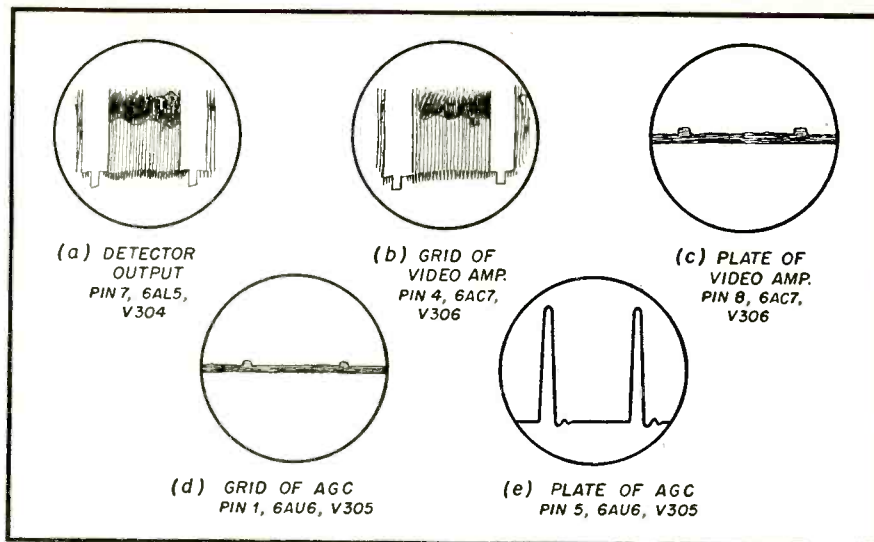

Fig. 2. Waveforms observed on oscilloscope.

and picture. Some front end defects like oscillator misalignment of one or more channels can result in the reduction or loss of sound for those channels while still allowing some picture information to go through. None of the other choices would account for the observed symptoms.

2. c

A signal is observed at the control grid of the Video Amplifier stage, while none is seen at the plate. The TV stage evidently is not operating.

3. e

The voltage readings show above normal plate and screen voltages indicating less than normal current through the tube. The large negative voltage on the control grid explains why the tube current is below normal. The signal amplitude across

the diode load, pin 7, 6AL5, V304, to ground is unusually large. The detected signal across the diode load gives a pulsating d-c voltage in a negative direction. This is direct coupled to the control grid of the VA (there is no coupling condenser). In normal operation, both an a-c video signal and the d-c component are applied to the control grid of the VA.

If the detected signal is unusually large, both the a-c signal and the d-c voltage going to the control grid of the VA are unusually large, Fig. 3. As a result of a larger-than-normal signal, the VA is biased to or almost to cut-off, with a consequent reduction or complete loss of amplification in the VA stage. If the previous scope check around this stage had been carefully made, with the scope calibrated to

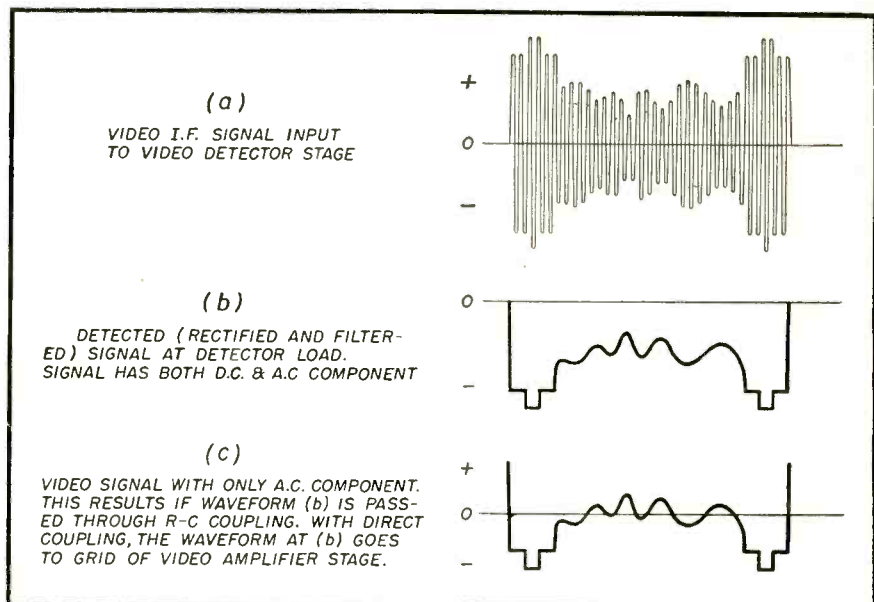

Fig. 3. Input and output of video detector.

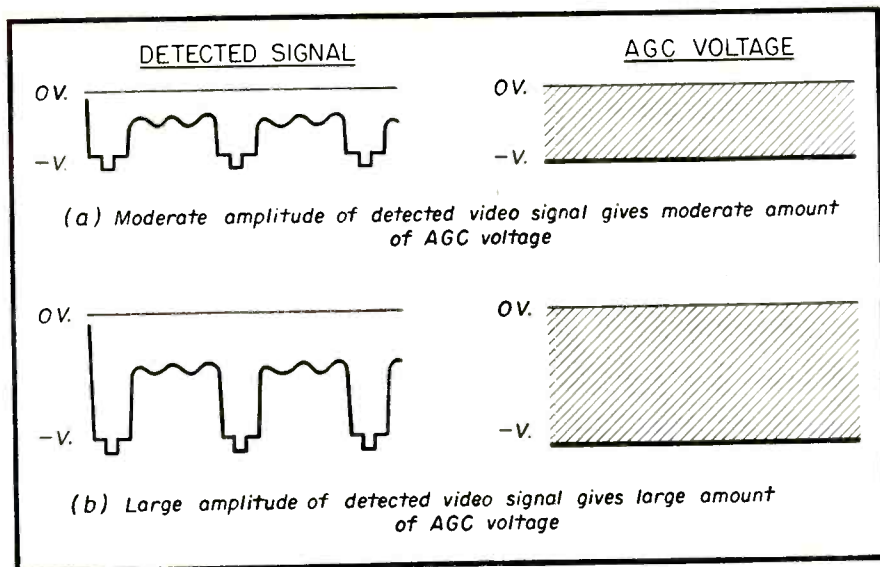

Fig. 4. Relationship of detected video signal and AGC voltage. (Note: Detected video may be either positive or negative in polarity. AGC bias is always negative.)

read the correct peak to peak signal voltage, it would have been obvious that the signal input to the VA stage was abnormally large.

The most likely possibility for the large signal is the failure of the AGC system. With no a-g-c bias voltage, there is more than usual amplification in the controlled stages. This model uses a gated a-g-c system, which operates only during the end of each horizontal line. The purpose is to provide fast-acting a.g.c. less susceptible to noise and airplane flutter. The a-g-c tube, V305, is cut off by a high bias, the cathode voltage being much more positive than the grid. A positive pulse from the horizontal sweep circuit is applied to the plate of the a-g-c tube. The pulse is capacity coupled by C428 (.001) Fig. 1, from the width control and one of the secondary windings of the horizontal output transformer. In addition, positive polarity video signals are directly coupled to the control grid of the a-g-c tube from the plate of the VA. Because of the high bias on the a-g-c tube, both the positive pulse on the plate and the positive video signals on the grid are necessary to make the tube conduct. The greater the amplitude of the video signals, the more the tube conducts.

When the tube conducts, a pulse of current flows from plate to ground through R438, 22k, and C429, .1; also the series-parallel circuit, R437, C427, R436, C426, R435, R434. A negative voltage is developed from the plate of the a-g-c tube to ground which is filtered by the R-C network. R434 and R435 form a voltage divider and a somewhat larger bias is fed to the r-f stage than the i-f stages.

Low cathode emission might explain the higher than normal plate and screen voltages but this possibility of trouble is ruled out for two reasons: a) the tube had been changed and b) the large negative voltage on the grid was a more specific reason for the plate and screen voltages. An open peaking coil would cause an abnormally low plate voltage. A leaky screen bypass condenser would cause less current rather than excessive current through the tube and the screen voltage would be lower not higher, because of the leaky condenser. However, plate voltage would then be higher.

4. b

Neither a shorted nor open C308 would result in a zero voltage reading on the screen of V305. The only defect listed which could cause this is an open R315. This is further verified by the infinite resistance reading from the screen. The other three screen defects listed would give a definite resistance reading from screen to ground. A shorted C428 would not account for either the screen voltage or resistance reading and the resistance from plate to ground would be much lower than normal—almost zero.

While there are several variations, most a-g-c systems in current receivers fall into three basic groups:

- 1) Simple a.g.c.;
- 2) Amplified a.g.c.;
- 3) Gated a.g.c.

In all systems, the object is to make the a-g-c bias voltage vary in proportion to the strength of the signal. The a-g-c bias is then fed back to the controlled r-f and i-f stages. This produces a fairly uniform signal output to compensate for variations of signal strength between stations and momen-

tary changes in signal strength from the same station. Since a-g-c bias applied to a weak signal will result in an even weaker signal, most amplified a-g-c systems and some gated a-g-c circuits incorporate an a-g-c threshold control. This permits controlling the signal level at which a-g-c comes into operation and prevents a-g-c bias from being developed when signals below that level (weak signals) are received.

A-G-C troubles may give rise to many different kinds of symptoms. One characteristic set of symptoms is the following: With the contrast control all the way up, the picture is blanked out completely on strong stations. On weak stations, or when one antenna lead is disconnected when tuned to a strong station, a picture is visible, it may or may not be synchronized, but there is excessive snow.

While the gated a-g-c circuit shown in Fig. 1 is conventional, direct coupling of the detector to the video amplifier and the video amplifier to the a-g-c stage gives rise to some unusual symptoms when trouble develops. One rather unusual result is the loss of both sound and pix if the filament of the video amplifier, V306, opens. The loss of picture information, of course, is to be expected. (Note: this is not an intercarrier set). With an open filament on the VA, plate voltage goes up. Because the control grid of the a-g-c stage is direct coupled to the plate of the VA, the control grid voltage of the a-g-c tube goes up. Bias on the a-g-c stage is reduced. Pulses from the horizontal output applied to the plate of the a-g-c tube are sufficient to make the tube conduct. A large a-g-c bias is developed and fed back, reducing the amplification of the controlled stages—including the r-f amplifier. As a result, sound is either low or cut off.

Most of the video and sound symptoms which may arise from a-g-c defects can also be caused by defects in other sections of the receiver. Such symptoms include poor sync action, weak pix or too strong pix, weak sound, etc. This, of course, is due to the fact that a.g.c. controls the r-f stage, which affects both sound and picture information, and two or more stages of video IF, which affect picture information. In intercarrier sets, the controlled i-f stages are common for both picture and sound. When the video signal amplitude is too high or too low, sync trouble is likely to develop, since the sync pulses are part of the composite video signal.

[Continued on page 48]

INDOOR DIRECTRONIC ANTENNA

The novel principles of the Directronic Antenna are utilized in this new indoor antenna for TV reception.

A newly-marketed indoor antenna is based on the Directronic principle recently described in the November 1951 issue of Radio-TV Service Dealer Magazine. This permits electronic orientation (beam shifting) without a motor. Features of this antenna are:

1. It is broad-band antenna and thus eliminates the need for changing the length of elements each time a station is tuned in.
 2. It is constructed of adhesive foil and can thus be mounted in a closet, in an attic, or on the ceiling (foil is decorative in appearance).
 3. Because it doesn't have to be near the receiver, the presence of persons near the receiver has virtually no affect on performance.
 4. The adhesive foil elements permit adapting the installation to the contour of the mounting site.
- Thus, in a closet the elements can fan out from the ceiling mounting hub

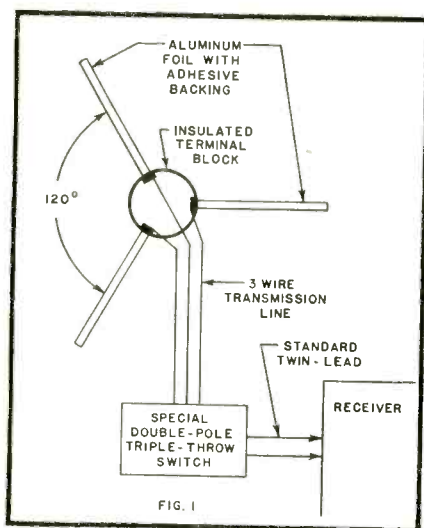

Fig. 1. The Directronic is connected to the receiver as shown.

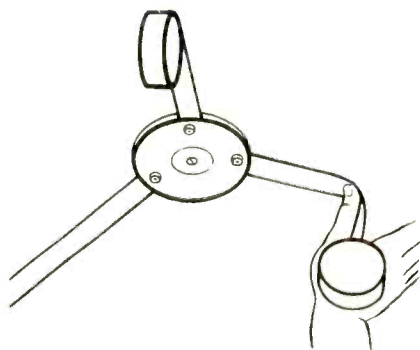

Fig. 2. Method of unravelling the elements of the Directronic antenna. One adhesive tape element is unraveled at a time and pressed into position in its desired location.

and run the length of the ceiling to the side walls. Here, they can curve down the side walls for their full length. This preserves the 46 inch length of the elements and gives maximum signal pick-up.

5. Because several switch positions are possible, troublesome room reflections can be minimized because of the beam selection features of the "Directronic" principle. This makes for a reduction in the reception of ghosts as well as giving sharper picture detail.

It must be kept in mind that the foregoing does not imply that the indoor Directronic is superior to a well-installed outdoor type. The latter, if sufficiently high and of good design, will generally outperform any indoor type.

The Indoor Directronic consists of three 46 inch elements (adhesive foil) as shown in Fig. 1. To the insulated terminal block where the antenna elements meet, a 3-wire line is connected. This runs to a three-position switch at the receiver and thus permits changing the direction of pick-up.

The terminal block has provisions for fastening it to the ceiling and the

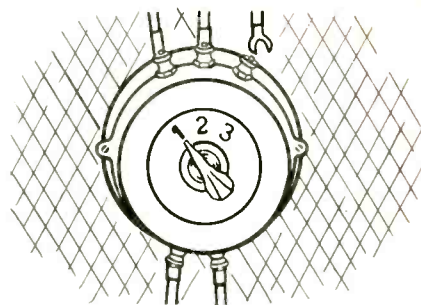

Fig. 3. Switch connections to antenna and receiver.

view shown in Fig. 1 is that seen from above. Elements are placed 120 degrees apart, though this placing can be altered during installation to suit closet or room contours.

The installation itself is simple and requires no mechanical ability or technical knowledge. The first procedure would be to select a mounting site. This should be as high as possible yet located sufficiently near the receiver to permit a short run of transmission line.

The antenna comes assembled except that the adhesive tape elements are in coiled form. One should be unraveled and pressed into the position it is to assume at the location chosen. After this has been placed, unravel the second and third tape elements and fan them out to the chosen position. (Fig. 2) It is preferable to run as much of the antenna elements along a horizontal span as possible. Thus, if the terminal unit is mounted at the center of a closet ceiling the elements should be fanned out horizontally for the entire ceiling length before curving down along the side walls.

The 3-wire transmission line is then run in the most convenient manner to the double pole-triple throw switch fastened to the rear of the receiver. The transmission line can be held in place with insulated staples, making sure not to drive such staples through the wire. A small section of conventional 2-wire twin-lead connects the switch to the television receiver.

Figure 3 illustrates the switch in its position at the rear of the receiver (or at side). Once the antenna is installed the selector switch can be utilized to take advantage of the many reflections which are present indoors. Thus, the same switch position may be the best for one or two stations, while the second or third switch position may give better performance for other stations in the vicinity. Accurate patterns cannot be plotted for this antenna because the lobe constructions are influenced to a marked degree by metallic conduits and other reflective material within the walls.

HIGH FIDELITY GOES TO TOWN!

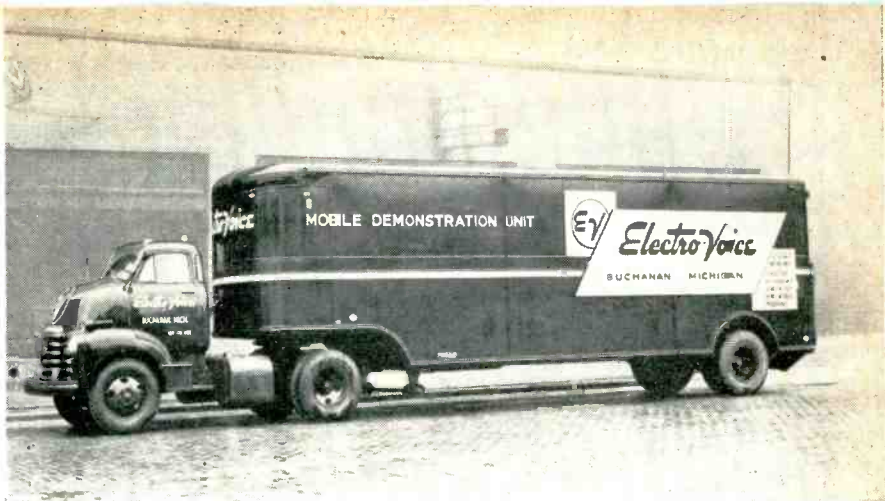

Mobile demonstration unit offers sales opportunity to Hi-Fi installers.

IMAGINE seeing and hearing an actual demonstration of high fidelity reproducing equipment in your own locality. This will soon be a reality when the Electro-Voice Mobile Demonstration Unit rolls your way.

For the first time, the audio story will be brought right to you so that you can hear for yourself and make your own listening comparison tests. Furthermore, you will be able to invite your potential customers to this same demonstration. With the vastly growing interest in high fidelity, this should mean good business for you.

Recognizing that nothing can take the place of personal listening, Electro-Voice, Inc., engineers and manufacturers of high fidelity products, has taken the initiative in creating this Audio CaraVan Mobile Demonstration Unit and bringing it to you with the cooperation of their Distributors.

The Mobile Demonstration Unit is

a high fidelity audio show on wheels. The 1850 cubic foot interior of a 12,000 pound CaraVan with a 38 foot trailer (the largest model Fruehauf furniture van made in this type) pulled by a Chevrolet cab-over-engine tractor, has been architecturally and decoratively designed to simulate rooms in a home or studio.

In this Audio CaraVan, you will see and hear the company's furniture-styled Klipsch-Licensed Folded Horn Corner Cabinets and the new Cornerless Corner Cabinets—Speakers and Speaker Systems—fed by broadcast quality recording equipment such as Ampex and Magnecord tape recordings and playback units, Rek-O-Kut turntable with E-V Phono-Cartridges, and with a console switching control system that enables you to make your own listening comparison tests. In addition, unique Columbia 7" LP records containing excerpts from actual

recording sessions will be given away free.

Here, too, you can actually test various types of the company's Microphones that are used on TV and Radio Networks, Public Address, Home Recorders, Communications Equipment, etc. You will see their automatic self-tuning Tune-O-Matic and Tenna-Top TV Boosters and TeleVider TV Distribution Systems that provide complete isolation in multiple Television installations.

The Electro-Voice Mobile Demonstration Unit is being readied for the road. Naturally, it will follow the weather. Watch for it. It marks another milestone in the history of audio and video, and should be of great interest to everyone—the high fidelitist, the music lover, the home recordist, the audio and video engineer, the radio amateur, distributors and hi-fi installers.



Interior views of the Mobile demonstration unit.

TRADE LITERATURE

A revised, up-to-date edition of its *replacement parts catalog, C-608*, is now available from the Sprague Products Company. This 20-page booklet contains complete listings of all the standard stock Sprague Capacitors and Koolohm resistors, including Sprague's newly widened line of plate and disc ceramics including ratings up to 6,000 volts, and its new "doorknob" ceramics rated at 20,000 volts. Copies are available free by writing to Sprague Products Company, 71 Marshall Street, North Adams, Mass.

A new enlarged *third edition of Sylvania's Television Receiver Tube Complement Book* has been announced by the Radio Tube Division, Sylvania Electric Products Inc., Emporium, Pa. The new third edition lists receiving and picture tube types required for nearly 4000 different models of TV sets now in home use.

TV receivers are listed alphabetically by manufacturers to provide convenient reference for TV servicemen when checking tube types required for a specific model and its chassis. The total number of tubes required for each chassis is also given.

The book is cross-indexed to associate trade names with manufacturers' names in the simplest possible way. This cross indexing was included to save servicemen time on house calls by permitting them to carry the correct replacement tubes and thereby eliminating extra trips to the shop.

The 120 page, 5½" x 8½" book is wire-o-bound, and may be carried conveniently in the TV servicemen's kit, or in the glove compartment in his truck. Copies of the new book may be obtained through Sylvania Tube Distributors or on payment of seventy-five cents direct to the advertising department, Sylvania Electric Products Inc., Emporium, Pennsylvania.

* * *

A colorful new *Condensed Catalog No. 113* has been issued by Electro-Voice, Inc., Buchanan, Michigan.

The new *Condensed Catalog* illustrates and describes the current comprehensive line of Microphones for Television, Radio, Recording, P. A.



and Communication; Phono-Cartridges for all 3 speeds; Hi-Fi Speakers, Drivers, Horns and Crossovers; Hi-Fi Folded Horn Corner Enclosures and 2-, 3- and 4-way Speaker Systems; Automatic Self-Tuning Tune-O-Matic and Tenna-Top Boosters; and the TeleVider Distribution System for multiple TV installations.

For a free copy of *Condensed Catalog No. 113*, write to Electro-Voice, Inc., Buchanan, Michigan.

* * *

Simultaneously with the release of the 1952 Silver Anniversary Line at the Parts Show, Jensen Manufacturing Company presented the trade and public with a new 20 page, 8½ x 11 *High Fidelity Catalog* in two colors. The brochure has introductory material address to Music Lovers and Audio Hobbyists and contains sections on selecting loudspeakers, how to listen to a loudspeaker demonstration, selecting enclosures and similar valuable information for the layman.

Because of the amazing growth of the high-fidelity market, Jensen is urging distributors to obtain copies of this informative booklet by requesting *Brochure 1020*, Jensen Manufacturing Company, 6601 S. Laramie, Chicago, Ill.

* * *

TV Troubleshooting And Repair Guide Book by *John F. Rider* and *Robert G. Middleton*, will be published in June by John F. Rider Publisher,

Inc. The book now on press, contains a greatly expanded contents than originally projected.

Taking into consideration the many possible problems that may arise in servicing television receivers, this book is a thorough presentation of TV receiver troubles and cures. It tells the serviceman how to recognize TV receiver trouble symptoms and remedy them. This is accomplished through the use of patterns taken from TV receiver picture tubes and waveforms from scopes. All information is practical. Much valuable data is given on troubleshooting with test equipment—special emphasis on the use of scopes. Visual troubleshooting techniques, also very important, are thoroughly covered.

Completely indexed, and containing approximately 192 8½" x 11" pages in a heavy durable cover, the book will be available at the Rider distributors in June. It is priced at \$3.90.

* * *

"The Representatives" of Radio Parts Manufacturers, Inc., announces publication of its new *1952 National Membership Roster*. Copies are available without charge to any manufacturer, distributor or other industry person by request, on his business letterhead. They may be obtained from the National office of "The Representatives", 600 South Michigan Avenue, Room 1425, Chicago 5.

* * *

The *1952 VEE-D-X TV Catalog* containing the complete line of VEE-D-X antennas and accessories has just been released. Containing 24 pages and printed in two colors, the catalog features not only standard VEE-D-X products, but also includes such outstanding new developments as the VEE-D-X "Q-Tee", the VEE-D-X "Long John", 3 new models of the RW series Lightning Arresters, the new VEE-D-X "Mighty Match", and many others.

* * *

1952 Waldom Replacement Speaker Cone Manual #52. This latest edition is the most complete replacement cone guide available. Over 5000 models of 105 set and speaker manufacturers are listed showing manufacturers model

[Continued on page 44]

ASSOCIATION NEWS

Local, State and National Associations are urgently requested to send in news of their activities so that we may print them in these columns.

Federation of Radio Servicemen's

Associations of Pennsylvania

Southern Pa. Radio & TV Technicians Association

G. W. Dean reports that Motorola gave a well planned lecture on the common faults of the Motorola television receiver. This meeting was well attended by SPRTTA members and non-members. Many Motorola dealers were also invited to attend. This meeting proved that the membership is very interested in their future. Their knowledge of television and electronic servicing has been increased as a result of such meetings. *Radio Servicemen's Assoc. of Luzerne County*

It was reported that the upstate chapter is now carrying on an extensive membership campaign even though it has 115 members actively engaged in association functions. The entertainment is completing plans for the big outing to be held at Lily Lake in August of this year. Plans are also closing on a money raising theatre production which is sponsored by the county association once each year. Interest of the membership was aroused as a result of the Television Station freeze. Information is now being gathered on the various problems that will arise in a virgin television area. The Policy Committee reported progress in its efforts to establish an ethical basis for distributor relationship. Membership certificates were distributed to members in good standing. These certificates are now serving to associate the technician with excellent work in his community. *Lackawanna County Radio Technicians Association*

The following item concerning the LCRTA annual charter night party appeared in the Scranton Tribune:

The Lackawanna County Radio Technicians Association held its annual charter night party last night in The Dietrick with John McGoldrick



Members of the Associated Radio-TV Servicemen of New York are shown gathered around a recent demonstration lecture presented by the Oak Ridge Company at the ARTSNY clubroom.

Shown from left to right (rear) are: Harry Temler, (No. 2 unknown) John Wagonny, Sid Perlin, Edward Eisen, O. Capitelli and John Bradley. Pointing his finger at the CRT is Henry Levine; and at the right is Marvin Kaplan of the Oak Ridge Company.

as toastmaster and Attorney Daniel Jenkins as the principal speaker.

Approximately 80 members, wives and friends attended the charter night celebration. Mr. McGoldrick, Chief Engineer WQAN, AM-FM Scranton, gave a brief history of the association and also discussed ultra-high frequency broadcasting as related to television.

Mr. Jenkins, an examiner for the Public Utility Commission, discussed the workings of the Commission and its influence on the Commonwealth.

A number of guests from the Luzerne County Radio Technicians Association attended the meeting, which was arranged by August Cianchetti, Ernest Courtemanche, Ray Rogers, Fay Maynard and William Slavinskis.

The association will meet at 8 p.m. next Wednesday in the Chamber of Commerce Building for a talk by

William Powell, RCA Service Co., on "Introduction to Ultra-High Frequency." The meeting will be open not only to members of the association but also to their friends.

Philadelphia Radio

Servicemen's Association

Most of the service companies doing business these days can attribute their success to direct mail advertising to the customer—and not, as so many believe, by newspaper ads. . . .

The past month was one of great activity within the PRSMA and the biggest affair was, of course, the association's Spring Party. The affair was held out in the West Philadelphia Post Home of the Irish War Vets on Friday, May 2nd. To my mind, it was most thoroughly enjoyed by all. The committee, consisting of Bill Poole and Frank Gerhard, are certainly to be commended for their work in making a success of the affair.

Department of Labor Statistics now making a job survey on the Electronics Field. They are calling on all types of operations, small shops, contractors, etc. Let's give them all the cooperation we can. The interview of 3 men in our place only took 20 minutes altogether.

Memo to anyone interested: PRSMA is not contemplating going out of business. Membership is in fact rising.

Society of Radio and TV Technicians, Inc. (Calif.)

At the present time we have a group doing research upon horizontal output transformers, their characteristics interchange ability and adaptability; with regard to conversions. This takes into consideration the amount of high voltage developed under different loading conditions and particularly the horizontal retrace time. This in-

[Continued on page 45]

CIRCUIT COURT

Dumont RA119A High Voltage Circuit

The high voltage circuit of the Dumont RA119A warrants close examination for a number of reasons. The first of these is that the high voltage and horizontal sweep circuits are not incorporated in one circuit. Although several other sets on the market have the same feature, they use an r-f oscillator for their voltage source. The Dumont uses the fly-back type of output for its high voltage with a separate oscillator circuit operating at approximately the horizontal sync pulse frequency.

Another reason for this circuit being of interest is the high voltage regula-

tion system being employed. The use of 30" CRT necessitates a very stable high voltage. Due to tube characteristics, variations of the high voltage would cause serious tube malfunctioning. Even the amount of non-regulation which can be tolerated by the eye in 14" or 17" tubes becomes very annoying in a tube like the 30BP4. In addition, there is an elaborate sweep failure protection circuit used which will be discussed separately.

V1 and V2 (6BG6's) are connected in parallel. The grids of V1 and V2 are driven by a pulse from a blocking oscillator type separate oscillator circuit. This pulse cuts V1 and V2 off. The result is a sharp rise in pulse in

the output transformer. The transformer pulse is amplified by autotransformer action and causes first V6 then V7 in a hi-voltage doubler circuit to conduct. The high voltage appears at the cathode of V7, the doubler tube.

While this operation is conventional and straightforward, let us examine how the high voltage regulation system works. Referring to the schematics, it is noted that the screen grids of V1 and V2 go back to +420 volts through R72 and the internal resistance of V3. V3 is a 6W6 which is triode connected. The grid of V3 is connected to the plate of V1.

V4 is the control amplifier tube. The cathode of V4 goes to ground

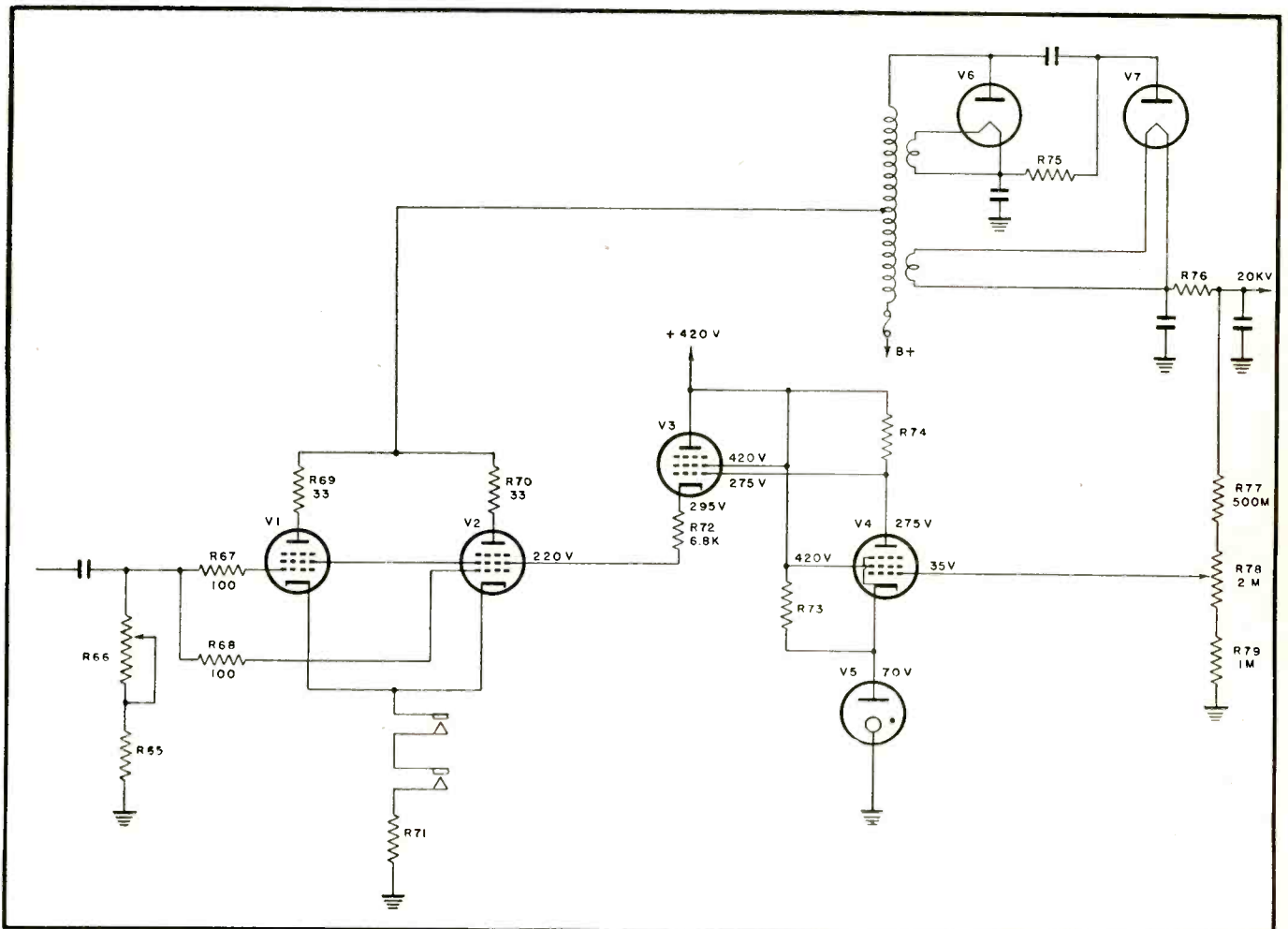

DuMont RA 119 high voltage regulation circuit.

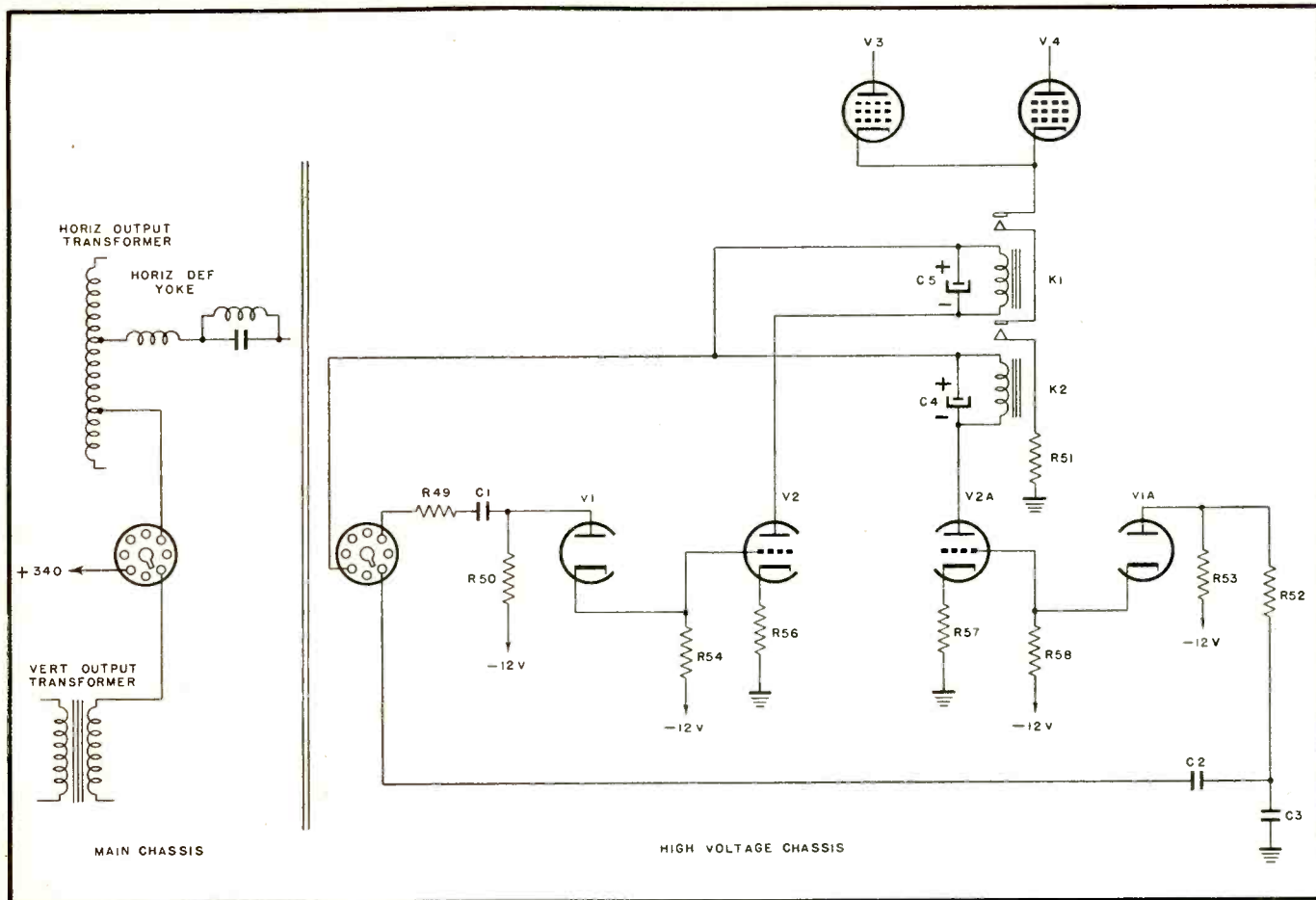

DuMont RA 119 sweep failure protection.

through V_5 a $VR75/OA3$. V_5 is a gas regulator tube which, once it fires, has a constant output voltage. The firing voltage for V_5 is supplied by the bleeder $R73$ going to +420 volts. The plate goes to +420 through $R74$ a 300K resistor. The steady state plate voltage is approximately +275V. The grid goes to a voltage divider consisting of $R77$, $R78$ and $R75$ from high voltage to ground.

It is evident from the value of this divider, 503 megohms, that there is very little current through it. There will exist a voltage across each resistor proportional to the value of each resistor as compared to the total resistance. The amplitude of this voltage is also proportional to the amount of high voltage between the top of $R77$ and ground. $R78$ is variable and the arm can tap off a voltage of between +20 and +60 volts. It is set for optimum operation of the control system.

Now, to examine the operational action of this system. We can represent V_3 as a variable resistor in the screen circuit of V_1 and V_2 . Let us assume that the high voltage is starting to decrease from that which is desired. This results in a drop in the voltage at the grid of V_4 . Since the

bias of V_4 is determined by the difference in positive voltages on the grid and cathode, a drop in grid voltage is the equivalent of an increase in bias. This increase in bias reduces the plate current with a resulting rise in plate voltage.

The grid of V_3 which is connected to the plate of V_4 then rises. This results in an increase in cathode current. This increase in cathode current is the equivalent of a reduction in the tube's dynamic resistance. Since V_3 resistance is in series with the screens of V_1 and V_2 its reduction results in the screen voltage rising. When the screen voltage rises, the output of V_1 and V_2 tends to rise resulting in a greater high voltage output. This compensates for the tendency of the high voltage to drop. The reverse action takes place when the high voltage rises. $R67$, 68 , $R69$ and $R70$ in the plate and grid circuits of V_1 and V_2 are parasitic suppressors.

DuMont RA119A

Sweep Failure Protection Circuit

A high voltage system in this chassis is not an integral part of the sweep circuits. As a result, if for any reason either of the sweep circuits fail, there is a possibility of the intensity beam

burning a line in the fluorescent screen. If both fail, a hole will definitely be burnt into the center of the screen. The likelihood of this occurring is much greater in a circuit of this type than in the conventional fly-back circuit. In the conventional circuit, if anything occurred to cause the horizontal sweep circuit to stop working, there would be no high voltage. In the chassis being discussed, this would not happen.

The operation of sweep failure protection circuit is comparatively straightforward. Both circuits work identically so that it would be simpler to consider one of them. Positive pulses from the horizontal output circuit are fed to the V_1 diode. V_2 is connected in the following manner: The cathode goes to ground through $R56$. The plate returns to +340 volts through the relay $K1$. The grid returns to -12 volts through $R54$. In the no signal state, V_2 is cut off, there is no plate current and $K1$ is de-energized. It can be noted that $K1$ and $K2$ relays are in series in the cathode of the parallel $6BG6$'s, the high voltage pulse amplifier. Therefore, as long as no horizontal pulse is applied to V_1 and

[Continued on page 45]

NEW PRODUCTS

TEST EQUIPMENT RACK

In an effort to help the radio service dealer streamline his servicing activity and conserve valuable bench space, the Tube Department of the RCA Victor Division today announced the availability of a double-tier, four-section rack especially designed to consolidate major television test instruments in a single test location.

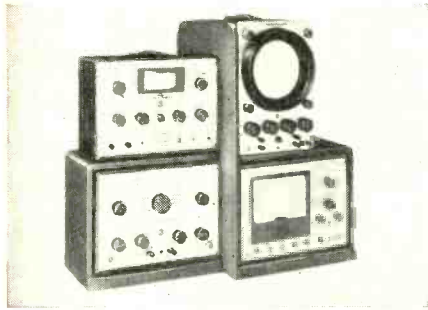

Constructed of sturdy, attractively finished wood, the new "consolidation" rack is available to radio service dealers and servicemen throughout their RCA test equipment distributors.

Consolidated equipment, the company pointed out, gives the shop a more professional and impressive appearance, conserves valuable floor and bench space, and saves the serviceman time, steps, and effort by enabling him to perform all test functions at one location.

The rack has been specifically designed to accommodate RCA's matched television test instruments, including the WR-39C calibrator, WR-59B sweep generator, WO-56A oscilloscope, and the WV-87A Master "VoltOhmyst" test instrument.

"MINIT-UP" TV ANTENNA

A new high gain dual channel yagi TV antenna, featuring one minute "on the job" assembly, has been announced recently by Trio Manufacturing Company.

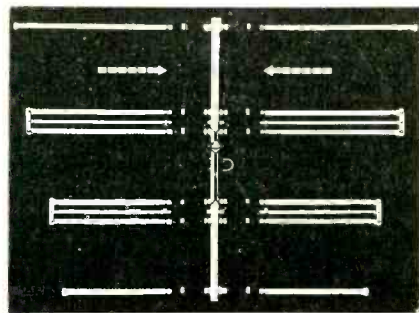

To achieve the unusual ease and speed of assembly, each element section of the new Trio "Minit-Up" Antenna is color coded and slips into an insert correspondingly coded. In speed tests at the factory, it was determined that an inexperienced man can assemble all elements to boom in just forty-five seconds!

The new "Minit-Up" construction is available in Trio model 445MU, a dual-channel yagi for channels four and five, and model 479MU, for channels seven and nine. The company expects to make this same construction available soon in a full line of five element single-channel yagis.

For complete information about the new "Minit-Up" TV Antenna, write Trio Manufacturing Company, Griggsville, Illinois.

TV MAST MOUNT

Channel Master Corporation, Ellenville, N. Y. has begun production of the "Peak-N-Base" mount, a unique new idea in mountings. The "Peak-N-Base" mount really is two mounts in one. It consists of three simple components which may be rapidly assembled either as (1) a rugged sure-footed base mount or (2) an adjustable peak mount.

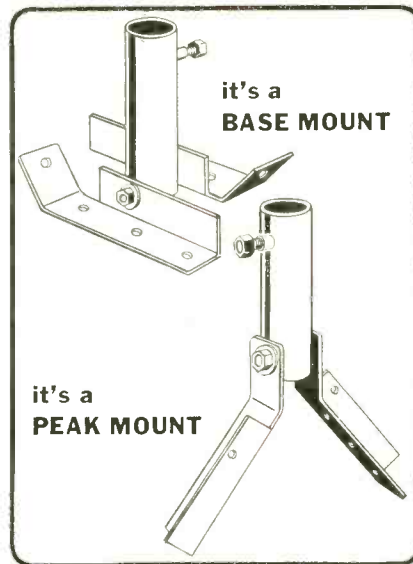

The very same hardware, just one bolt and nut, is used to assemble either type of mount. Mast is held firmly in place in a heavy gauge steel cylinder with a locking bolt to prevent mast movement. The locking device features Channel Master's exclusive "Weld-Nut," spot-welded on the inside of the cylinder, which is the neatest, strongest locking device now in use.

The "Peak-N-Base" mount may be used with all types of masts up to 2 inches OD. The entire mount is bright zinc plated to prevent corrosion.

TV ANTENNA PACKAGE

The JFD Manufacturing Co., Inc. of Brooklyn has made a thorough revision of its well-known "Tenna-Pak" line. Seven new "Tenna-Paks" have been added to the original group of five at the request of numerous distributors throughout the nation. Included in the new line of 12 are special "JeTenna-Paks", which include the renowned fan-front conical in each carton.

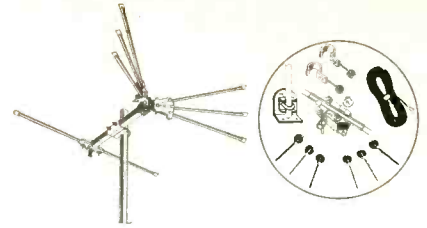

These include antennas, masts, lightning arresters, lead-in wire, stand-offs of all descriptions and base mounts. Originally, inventory control of these units can be very difficult. Each is in a different part of the distributor's shop and checking can be a long and tedious procedure. With "Tenna-Paks," however, every installation is in a single box.

More information on the "Tenna-Paks" can be obtained by writing directly to the JFD Manufacturing Company, Inc. at 6101 16th Avenue, Brooklyn 4, New York or by calling the firm at BE 6-9200, its telephone number in Brooklyn.

INDOOR "BAT WING" ANTENNA

Telrex, Inc., announces a new Top-of-Set Antenna: the "BAT WING." No fuss, bother or time-consuming adjustments. Superior



styling of modern design that enhances any living room. Rich aluminum elements are mounted on a finely finished, tip-proof base. List Price \$3.99. Write for literature, to Telrex, Inc., Asbury Park, N. J.

HARDWARE RACK

The new Walsco 50 Line of radio and TV hardware has just been introduced to the trade and is now available through most jobbers in the U. S. and Canada. This latest addition to the Walsco hardware line includes a new package, a new price, and a new display.

The main purpose of the Walsco 50 Line is to offer technicians and service men a better way to store small hardware items in



an attractive, plastic container that has unlimited uses on every busy, congested work bench. Each container is clearly marked, and the items are plainly visible, which makes it easy for the service man to select his hardware in a jiffy.

GUARANTEED

to **OUTPERFORM**
any other INDOOR TV AERIAL

INDOOR

Snyder
PHILADELPHIA

Directronic

TV AERIAL SYSTEM

DEVELOPED BY ENGINEERS

TESTED THROUGHOUT THE COUNTRY

PROVED BY REPEAT SALES

SNYDER MFG. CO.

ANTENNA-ENGINEERS®
PHILADELPHIA

WORLD EXPORT: ROBURN AGENCIES, INC., NEW YORK 7, N. Y.
CANADIAN DISTRIBUTOR: VAN DER HOUT ASSOCIATES, TORONTO



The new 50 Line eliminates the waste of loose items being misplaced, as so often happens with other types of packaging. These plastic containers can be neatly stacked . . . and the sliding lid on each container makes all hardware easily accessible.

The new 50 Line is being shown by jobbers everywhere in an attractive self-service display.

IMPROVED OSMIUM PHONO NEEDLE

Buyers of osmium-tipped phonograph needles are now assured of getting a stylus with all of the desirable wearing qualities of sapphire, according to an announcement just made by

Life . . . (and Death) OF PHONOGRAPH NEEDLES

Diagram shows how wearing qualities of Jensen Industries' new "Durosmium" Phono Needle compare with diamond, sapphire and conventional osmium points after each has been played 35-40 hours.



DIAMOND



DUROSMIUM



SAPPHIRE



OSMIUM

Jensen Industries, Inc., Chicago. An exclusive development of that veteran manufacturer of precision phono needles and other audio accessories, the recently improved needle incorporates a new alloy, "Durosmium," giving record collectors and commercial users of recordings a premium product at no increase in price.

Jensen Durosmium needles, packaged on cards or in plastic boxes complete with instructions for installation, are distributed through leading electronics distributors everywhere. Additional information on the full Jensen line may be obtained by writing direct to Jensen Industries, Inc., 329 South Wood Street, Chicago 12, Illinois.

VTVM

A new Triplett Vacuum Tube Voltmeter, Model 650, with engineering and construction features planned to meet today's diversified testing demands. Peak to Peak ACV and RF measurements are made with one probe. This eliminates troublesome change of probe when changing from ACV and RF measurement.

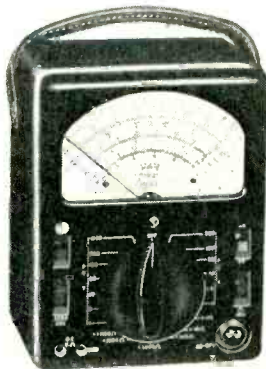

Complete frequency coverage of Model 650 is from 20 cps to well over 110-mc with one probe. One main selector switch controls all ranges. The tester has one volt full scale reading on both AC and DC. An especially designed, insulated, shielded RF probe with short leads provides for high frequency

measurements and the tester has zero center mark for FM discriminator alignment plus any other galvanometer measurements. High input impedance 11 megohms on DC allows for accurate measurements without loading the circuit under test. There are special means for making adjustment for ACV zero shift with line voltage variation. High precision composition resistors are used throughout. Separate 1 ACV and 5 ACV scales guarantee greater accuracy.

2-SET COUPLER

A new efficient, low cost two-set TV coupler has recently been announced by Mosley Electronics, Overland, Missouri. Named Dual-Match, the new Mosley TV Coupler is intended to satisfy a growing demand in metropolitan areas where many families now have an extra TV set in their playroom, den or elsewhere. The Dual-Match is compact in size and may be mounted on baseboard or on the back of most TV sets. Like other Mosley TV lead-in accessories, the Dual-Match is designed for use with standard 300 ohm flat transmission line and is installed without solder. It is designed so that one set will not interfere with the other.

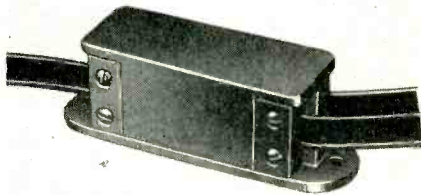

Further information can be obtained by writing Mosley Electronics, 2125 Lackland Road, Overland, Missouri. The Dual-Match is available at most Radio Parts Jobbers.

NEW CONDENSER CONSTRUCTION

Silicon rubber bushings are now used as standard terminal construction on all hermetically-sealed bathtub type and can type capacitors with rivet lug terminals manufactured by the Astron Corporation, East Newark, New Jersey.

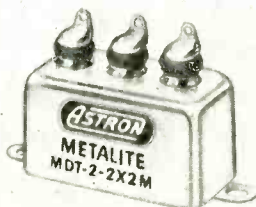

According to the announcement, silicon rubber bushings provide a more positive hermetic seal as well as bearing approval of the Armed Forces as the preferred terminal construction.

Astron also manufactures metallized paper capacitors as well as a complete line of other subminiature types, dry electrolytic capacitors and RF interference filters. For further information write the manufacturer, Astron Corporation, 255 Grant Avenue, East Newark, New Jersey.

LIGHTNING ARRESTOR

RMS Inc. announces the development of a new lightning arrester model, LA-3, designed to accommodate both twin lead and open transmission line.

Twin lead is firmly located on the arrester by placing it between the inner edges of the

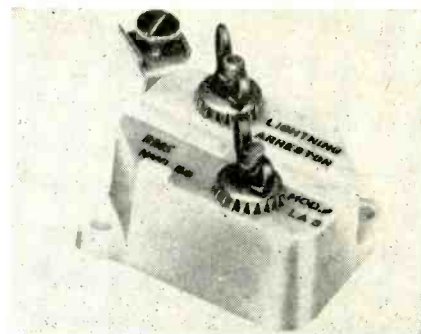

guides molded into the unit. Open line, on the other hand, is securely positioned on the outer edges of the guides. A saw-tooth washer and wing-nut pressure provide ample contact with the conductor.

In offering this new unit, RMS engineers point out its importance as a static discharge eliminator, referring to the numerous occurrences of burned-out set components attributed to static discharges. The LA-3 Arrester is available from RMS Jobbers and lists at \$1.00.

The unit is approved by Underwriters Laboratories, Inc.

HIGH-VOLTAGE

FLAT-PLATE CERAMICS

The latest development in the ceramic capacitor field—a complete line of Bulplate "flat-plate" types for high-voltage uses—has been announced by the Sprague Products Company, North Adams, Mass. The amazingly small size of these new units permits them to be used almost anywhere.

Available Sprague Bulplate types include ratings for 1000, 1500 and 6000 d-c working volts. Values range from 4.7 to 4700 mmf. for 1000-volt types; from 4.7 to 220 mmf. for

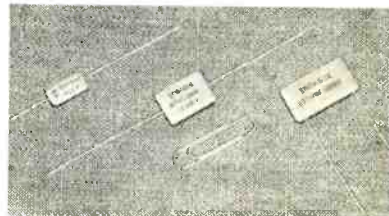

1500-volt types; and from 4.7 to 470 mmf. for 6000-volt capacitors.

A feature of Sprague BULPLATE High-Voltage Ceramics is their extra-heavy moisture-resistant insulating coating. Conservatively rated for 85°C. operation, Bulplates are ideal for use in television sets and other equipment where high temperatures so often wreak havoc with conventional capacitor types.

Bulplates are now available through Sprague parts distributors. Bulletin M-479 containing complete details will be sent on request to Sprague Products Company, 71 Marshall St., North Adams, Mass.

RACON HORNS

These new Racoon horns and loudspeakers are for use in sound systems which require

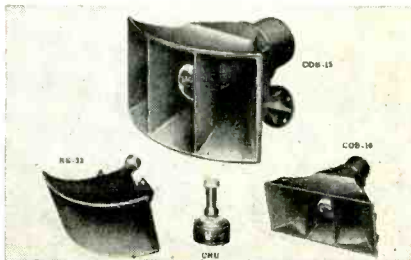

Here's Why — the CDR Rotor

**...Is the NO. 1
all-purpose Rotor!**

It has EVERYTHING!

And it does have EVERYTHING... as you can plainly see! Just check over this impressive list of features — and you'll see why... ALREADY THE NEW CDR ROTOR is acclaimed as the outstanding unit in the field! No other rotor boasts all these features... that's why it's the best ALL-PURPOSE rotor money can buy.

MODEL TR-11 Complete rotor with handsome modern design plastic cabinet and meter control dial... finger-tip lever—using 4 WIRE CABLE... \$44.95

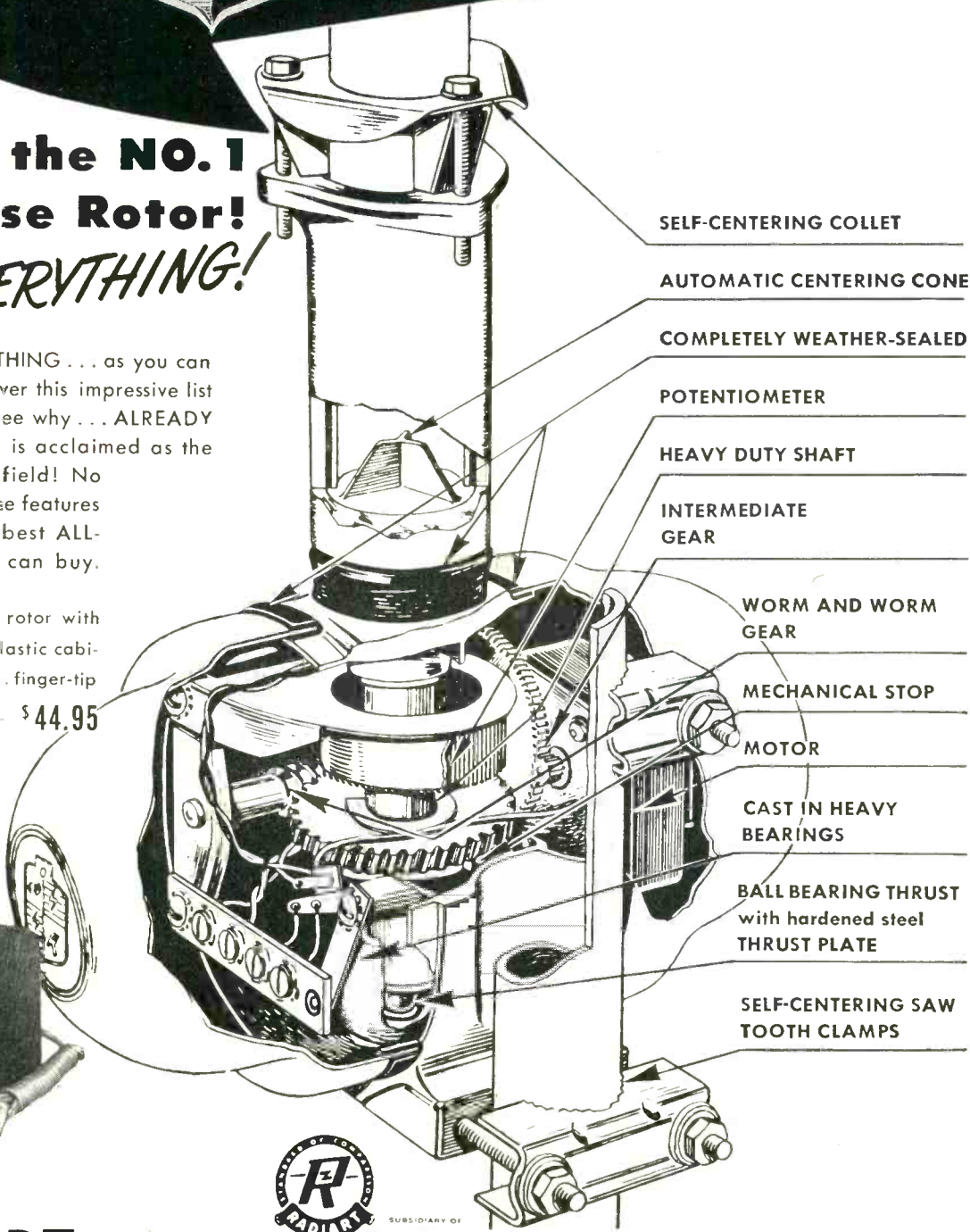

- SELF-CENTERING COLLET
- AUTOMATIC CENTERING CONE
- COMPLETELY WEATHER-SEALED
- POTENTIOMETER
- HEAVY DUTY SHAFT
- INTERMEDIATE GEAR
- WORM AND WORM GEAR
- MECHANICAL STOP
- MOTOR
- CAST IN HEAVY BEARINGS
- BALL BEARING THRUST with hardened steel THRUST PLATE
- SELF-CENTERING SAW TOOTH CLAMPS

THE **RADIART** CORPORATION

CLEVELAND 13, OHIO



SUBSIDIARY OF



CORNELL-DUBILIER

SOUTH PLAINFIELD, NEW JERSEY

high intelligibility combined with mechanical and electrical ruggedness and wide horizontal angle of coverage. All models incorporate husky, non-resonant cast aluminum bells.

The COB-15 and COB-16 are of reentrant design (350-11,000 cycles), will handle 25 watts of program material continuously and are provided with driver units enclosed in water-tight covers.

Model RE-32 is of "straight" horn design, with a nominal cutoff at 500 cycles, which results in crisp, highly articulate quality. Provided with a "U" bracket for easy positioning. Thread size is 1 3/8" -18 for any standard driver unit (1-7/16"—16 on request). Horizontal dispersion 90°, vertical dispersion 60°. Dimensions 13" D, 15 1/2" W, 9" H.

The model CHU is a 15,000 cycle driver unit for use with the RE-32 horn when the latter

is employed as a tweeter in 2 and 3 way high-fidelity systems. When coupled to the proper crossover network, 15-20 watts of program material may be easily handled.

Technical data sheets describing these and other Racon models in detail upon request.

NEW 300-OHM LINE

"Weldohm," a new 300-ohm Transmission Cable, television lead-in wire, 254% more flexible and 162% stronger than present 300-ohm transmission lead-in wire, has just been announced by Belden Manufacturing Company, Chicago, Illinois.

Belden "Weldohm" Transmission Cable is made of finely drawn copper-coated steel, closely stranded to give maximum flexibility. On a 180° flexing test, it has 254% more flex-life than a pure copper cable of the same gauge.

In a direct breakage test, Belden engineers stated that "Weldohm" has 162% more strength than its copper equivalent.

Belden's new "Weldohm" 300-ohm Transmission Cable is now available to television servicemen through leading radio jobbers and distributors. A new, improved product at a very slight increase in cost.

HIGH VOLTAGE CONDENSERS

Erie Resistor Corporation of Erie, Pennsylvania is offering two new high voltage "Ceramicon" TV by-pass capacitors which, it says, have been designed primarily to supply high voltage power supply filtering for television receivers. Style 412 is rated at 20 KV and Style 414 at 10 KV. The company states that conservative designing has been followed by months of proving-in tests.

The case insulation is of low-loss, molded thermosetting plastic, which it is claimed provides a moisture seal of thoroughly tested and proven superiority. Ring convolutions are molded into the surface of the 20 KV capacitor, to prevent surface leakages that are caused by ordinary handling and a consequent deposit of conductive materials. According to the manufacturer the convoluted design increases the effective surface creepage path by more than 14%. Write for catalog and samples.

TV "DO-ALL" GENERATOR

One compact, accurate, efficient instrument—moderately priced—which gives the performance of several combined instruments—each of which is higher priced and all of which are needed for properly servicing Television and FM receivers and equipment.

Covers every band, every channel of Television, and FH receivers—All on Fundamental Frequencies.



Range: 9 Megacycles to 220 Megacycles with skips ALL FUNDAMENTALS—Bands 9-11 Megacycles 21-47 Megacycles: 54 to 220 Megacycles. Accuracy: Better than 1/10 of 1 per cent tolerance on 9-11 Megacycles frequencies, and better than 1/2 of 1 per cent on 21 to 220 MC. This makes an excellent Marker-Generator. *Pattern Generator: Modulation can be either Horizontal Bar-Vertical Bar or Cross Match. *Tuning: Dial is continuously calibrated through 340° giving an extremely long calibration scale; enables easy reading and tuning. Each TV channel is marked specially, on the dial, facilitating alignment. *Audio Output: Both 540 Cycles and 220.5 KC are available. *Attenuation: Complete variation through 200 ohm control.

the BIG 10

fabulous
10 element
Yagi

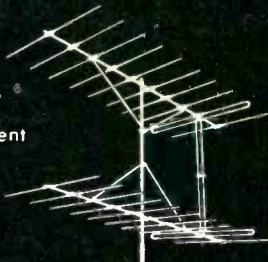

- The highest gain Yagi in TV history: 12 DB single, 14 1/2 DB stacked (78% stacking gain).
- "Boom Braced" (low band) to prevent picture flicker.

600 Series

5 element
Yagi

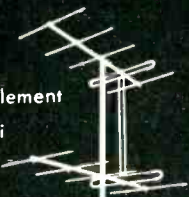

- Highest gain of any 5 element Yagi: over 9 DB single, 12 DB stacked.
- Full 100% stacking gain!

do
you
get
these

Major Benefits

in your present TV installations?

1. Adjustable impedance eliminates mismatch to 300 ohm line in single and stacked arrays.
2. Wider spaced elements, on longer cross-arms, for still higher gain.
3. Up to 100% additional gain in stacking.
4. And you don't pay for stacking bars!

4

major benefits are provided by Channel Master Z-Match Yagis which are essential to better, more profitable fringe installations. No other Yagi gives you any of them! However, in the Z-Match Yagi, you get all 4 features — at no extra cost.

Write for new catalog

List Prices

Ch.	600	BIG 10
7-13	7.65	13.89
2-3	17.65	31.94
4-5	16.67	28.47
6	16.67	25.69



CHANNEL MASTER CORP.
ELLENVILLE, N. Y.



NEW TUBES

RCA-19X8

The new 19X8—a "19-volt" version of the 6X8—is a 9-pin miniature tube containing a medium- μ triode and a sharp-cutoff pentode. It is designed especially for use as a combined oscillator and mixer tube in "transformerless" AM/FM receivers. The 150-milliamperere heater of the 19X8 permits series-string heater operation with other tubes having 150-milliamperere heaters.



SOCKET CONNECTIONS
Bottom View

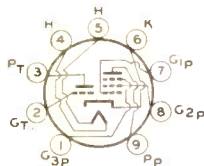

Characteristics:

Triode Unit:		
Plate Voltage	100	volts
Cathode-Bias Resistor	100	ohms
Amplification Factor	40	
Plate Resistance (Approx.)	6800	ohms
Transconductance	5800	ohms/micromhos
Grid-No. 1 Bias (Approx.)		
for Plate Current of 10 microamp.	-10	volts
Plate Current	8.5	ma
Pentode Unit:		
Plate Voltage	250	volts
Grid No. 3 (Suppressor)	Connected to Cathode at Socket	
Grid No. 2 Voltage	150	volts
Cathode-Bias Resistor	200	ohms
Plate Resistance (Approx.)	750000	ohms
Transconductance	4800	ohms/micromhos
Grid-No. 1 (Approx.)		
for Plate Current of 10 microamp.	-10	volts
Plate Current	7.7	ma
Grid-No. 2 Current	1.6	ma
Pentode Unit Connected as Triode:		
Plate Voltage	150	volts
Grid No. 3	Connected to Cathode at Socket	
Grid No. 2	Tied to Plate	
Cathode-Bias Resistor	250	ohms
Amplification Factor	42	
Plate Resistance (Approx.)	7900	ohms
Transconductance	4000	ohms/micromhos
Grid-No. 1 Bias (Approx.)		
for Plate Current of 10 microamp.	-10	volts
Plate Current	7.8	ma

19X8 Characteristics

The low grid-No. 1-to-plate capacitance of the pentode mixer unit of the 19X8 minimizes feedback problems encountered in mixer circuits operating into high-impedance plate loads. The low output capacitance of the mixer unit permits the use of a high-impedance plate circuit with resultant increase in mixer gain.

The 19X8 offers versatility to designers of AM/FM receivers. The pentode unit may be used in the AM

section as a pentode mixer to provide high gain, and in the FM section either as a pentode mixer or as a triode-connected mixer depending on signal-to-noise considerations. The triode unit of the 19X8 makes a satisfactory oscillator for either the AM section or the FM section.

Hytron 6BZ7-Tentative Data

The 6BZ7 is a medium μ , nine-pin miniature twin triode designed for use in low noise v.h.f.—amplifier application and particularly for cascade operation. It features improved cascade tuner gain and higher mutual conductance than the 6BQ7 to which it is otherwise similar.

Basing Designation

Pin 1 - Plate of Triode #2	Pin 6 - Plate of Triode #1
Pin 2 - Grid of Triode #2	Pin 7 - Grid of Triode #1
Pin 3 - Cathode of Triode #2	Pin 8 - Cathode of Triode #1
Pin 4 - Heater	Pin 9 - Internal Shield
Pin 5 - Heater	

Characteristics, Amplifier Class A (each section)

Plate Voltage	150 volts
Cathode-Bias Resistor	220 ohms
Amplification Factor	38
Plate Resistance	5600 ohms
Transconductance	5600 umhos
Plate Current	10 ma
Grid Voltage (approx) for plate current of 10 ma	11 volts

6BZ7 Characteristics

Sylvania 6AN4

A new tube (Type 6AN4) designed for economical, high efficiency television tuner service, has been developed by Sylvania Electric Products Inc., Emporium, Pennsylvania.

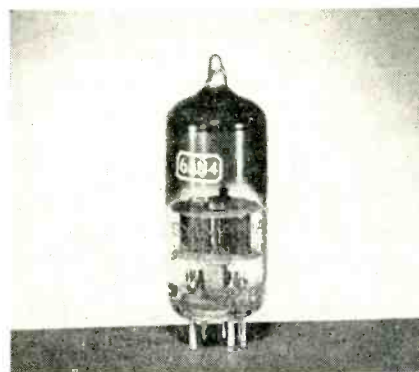

Heater Voltage	6.3 Volts
Heater Current	225 Ma
Plate Voltage	200 Volts
Cathode Resistor	100 Ohms
Plate Current	13 Ma
Transconductance	9000 umhos
Amplification Factor	70

6AN4 Characteristics

Prior to the development of this tube type, uhf-vhf television tuners

required additional tubes for each band. The Sylvania Type 6AN4 permits the use of one economical set of tubes and circuits for all television services.

The Sylvania Type 6AN4 is a T-5½ miniature triode designed for use as a grounded grid rf amplifier or mixer in the uhf-vhf television bands. The tube features high μ and μ , internal shielding between plate and cathode leads, and double plate and grid connections for reduced lead inductance. In circuits designed for its use, a gain of 10 db, 10 megacycle bandwidth, and a noise figure of 15 db, can be obtained at 900 megacycles.

In combined services, the Type 6AN4 also eliminates the necessity of a special low-noise pre- if amplifier, thus simplifying the switching from uhf to vhf. The Sylvania Type 6AN4 may be used in cascade circuits for further isolation of oscillator voltage, and for increased rf gain.

Sylvania 6BX7GT

A new high perveance double triode designed for vertical deflection and oscillator service in television receivers

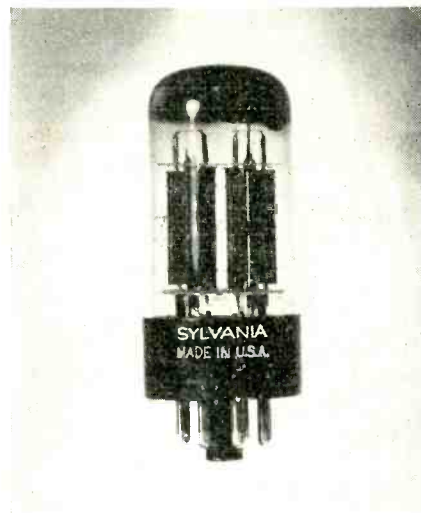

Heater volts	6.3
Heater current, amperes	1.5
Plate volts, (each section)	250.0
Plate current, ma. (each section)	42.0
Plate resistance, ohms	1300.0
Transconductance, micromhos	7600.0
Amplification factor	10.0

6BX7GT Characteristics

ers has been announced by the Radio Tube Division, Sylvania Electric Products Inc., 1740 Broadway, New York 19, New York. The new tube, type 6BX7GT, is available through authorized Sylvania tube distributors.

The 6BX7GT is particularly well suited for reduction of vertical distortion in television receivers, due
[Continued on page 44]

TRADE FLASHES

[from page 10]

of receivers includes three types of sets. (1) a 20-inch chassis without cabinet for home decorators who want to build a chassis into a wall or into their own cabinet; (2) a 20-inch model in an unfinished cabinet for customers who wish to paint, stain or antique their TV set to harmonize with the color scheme of the room; and (3) tables models in any of seven colors, for those who prefer pre-finished sets.

These "coordinated colors" were chosen by *House and Garden* fashion experts in pastel and deep basic colors as those shades which harmonize best with modern American living rooms

Permo Merchandizing Service Announced

A complete merchandizing service for Permo Special Type Replacement Needles was announced by Permo, Inc., world's oldest, largest and leading manufacturer of long life phonograph needles. Gail S. Carter, Permo's Vice-President, made the announce-

ment. "Now, for the first time, Service dealers have available a complete merchandizing service that gives them everything they need to buy and sell special type needles. There are 113 Special Type Needles in the Permo Line, and a merchandizing service has been designed to keep dealer and distributor inventory at a minimum while providing a complete selection of special type replacement needles available at all times."

Vee-D-X Develops UHF Antennas

Jerome E. Respass, President of The LaPointe Plascomold Corporation, is shown pictured with experimental line of VEE-D-X UHF antennas. He is holding a UHF con-

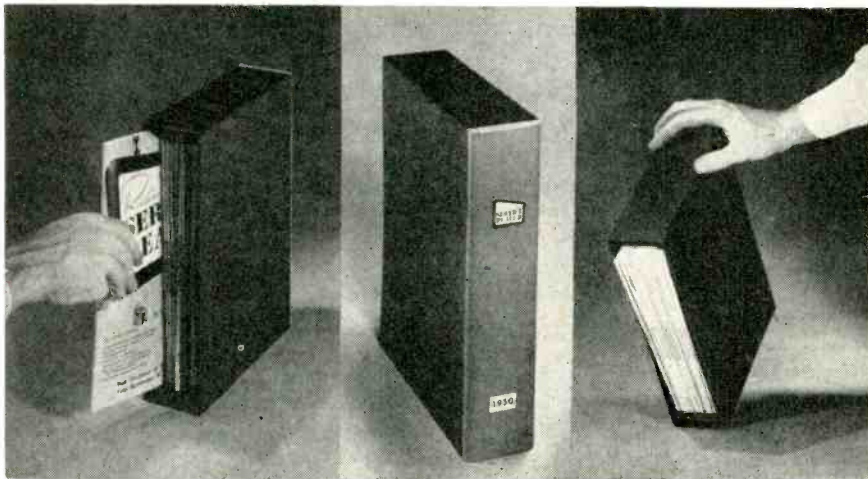

(B)

(C)

(A)

A New Magazine Holder

- (A) Side and front view reveals handsome appearance; fitting well into any library shelf.
- (B) Small crosspiece at bottom prevents magazines from falling out when SAMARTO magazine holder is turned upside down. Also eliminates books dropping out when holder is removed from shelf.
- (C) Removing or inserting magazine into holder is simplicity itself as this illustration reveals. Merely put the magazine into the opening and it will fall into position below the cross-piece thereby being kept secure in the holder. When taking out a magazine, merely raise it slightly above crosspiece as shown.

This indispensable magazine holder features:

- Sturdy wood frame construction.
- Durable and attractive simulated leather covering.
- Spacious accommodations for one year's issues of RTSD.
- All magazines are immediately visible and available for instant removal or storage.

all for only

\$1.95

POSTPAID

RADIO-TELEVISION SERVICE DEALER
67 WEST 44TH ST., NEW YORK 36, N. Y.

Sirs: Enclosed herewith is my check (or money order) for \$..... for
..... magazine holders.

Name

Address

City Zone State

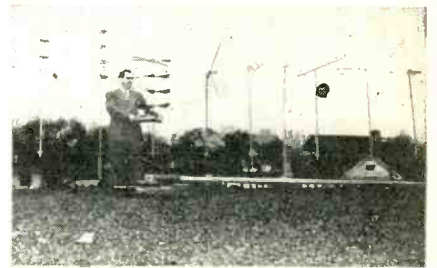

verter that will be required, in most cases, for adapting TV receivers for UHF reception. These antennas were developed at the VEE-D-X engineering laboratory in Westport, Conn., 50 air miles from the experimental UHF transmitter located in Bridgeport, Conn. From left to right: the Double Vee, Colinear Array, Stacked Bowtie, Corner Reflector, Cubicle Quad, Folded Dipole, Jagi, Rhombic and Slot.

Littelfuse Celebrates

Silver Anniversary

Littelfuse, Inc., Chicago, marked 25 years in the industry with a buffet-bar party in the south ballroom of the Conrad Hilton Hotel on May 21st.

During the party, silver cufflinks carrying a candlestick motif were presented to E. V. Sundt, President; T. N. Blake, Executive Vice President and J. D. Hughes, Vice President.

More than 200 friends of Littelfuse attended the celebration.

Raytheon Expands

The Receiving Tube Division of Raytheon Manufacturing Company, Waltham, Mass., will open a branch plant in Brockton, it was announced recently by N. B. Krim, vice president and general manager of the division.

Burgess Prize Is Chevrolet

A 1952 model Chevrolet is the grand prize being offered radio parts dealers and servicemen in the Burgess Portable Radio Battery Prize Carnival. If you haven't received your entry

[Continued on page 43]

**Select your hardware
in these new, handy, plastic,
re-usable containers**

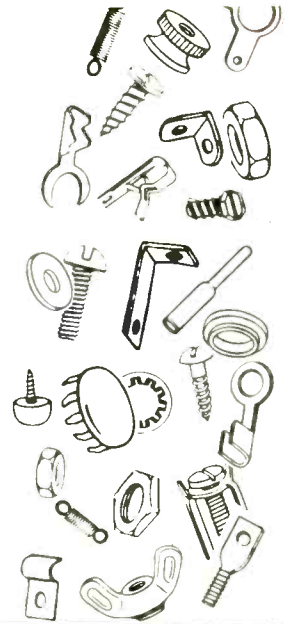

New WALSCO 50 LINE

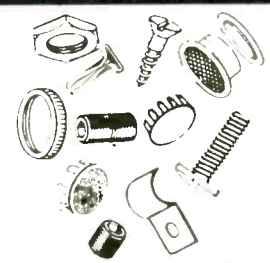

It's the smart way to buy hardware...it's the convenient way to store hardware...it's the economical way to use hardware. The new WALSCO 50 LINE is attractively packaged in transparent, plastic containers. The part number, the contents, and its uses are all plainly visible on each container, making it easy for you to select your hardware in a jiffy. The new 50 LINE eliminates the waste of small, loose hardware items being misplaced... keeps your busy work bench free from congestion. Now, all your hardware items can be neatly stacked in sturdy, re-usable containers. Available at your jobber. Select *all* your hardware from the new, self-service 50 LINE display.



Walsco quality earned its reputation



WALSCO

Walter L. Schott Co.
3225 Exposition Place
Los Angeles 18, Calif.
Branch: Chicago 6, Ill.

In Canada
Atlas Radio Corp., Ltd.
Toronto, Canada

Radio-Television SERVICE DEALER

Yours for the Asking

- **FREE!** 68 page catalog section from Radio's Master.
- Catalogs the products of 30 manufacturers of Recording, Phono Equipment and Accessories.
- Complete descriptions, specifications and illustrations of such products as: Recorders, Phono Motors, Turntables, Record Changers, Cartridges, Pickups, Discs, Tape, Needles, etc.

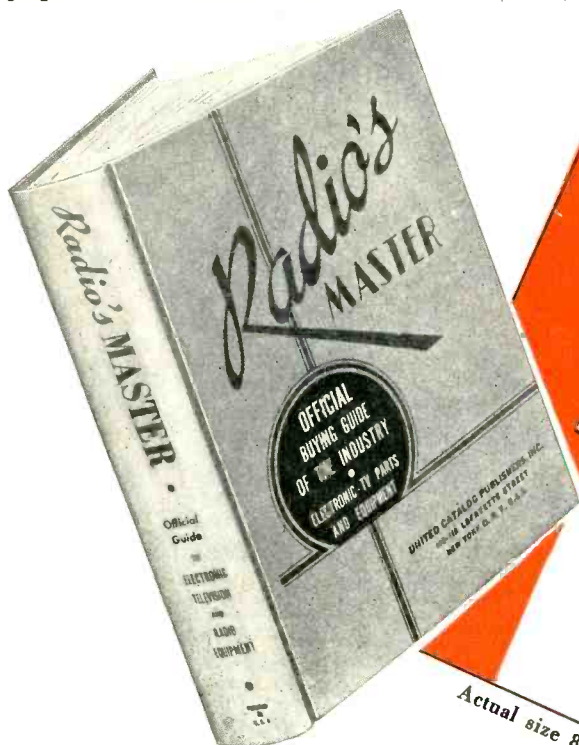

Represented in RADIO'S MASTER 68 page Recording & Phono Equipment Booklet are the products of the following manufacturers:

- ALLIANCE MANUFACTURING CO.
- AMERICAN MICROPHONE CO.
- THE ASTATIC CORP.
- AUDAK COMPANY
- AUDIO DEVICES, INC.
- BELL SOUND SYSTEMS, INC.
- BERLANT ASSOCIATES
- BOGEN CO., INC.
- CLARKSTAN CORP.
- DUOTONE CORP.
- ELECTRO-VOICE, INC.
- FAIRCHILD RECORDING EQUIPMENT CO.
- GARRARD SALES CORP.
- GENERAL ELECTRIC COMPANY
- GENERAL INDUSTRIES CO.
- JENSEN INDUSTRIES, INC.
- MAGNECORD, INC.
- MASCO ELECTRONIC SALES
- M. A. MILLER MFG. CO.
- MINNESOTA MINING & MFG. CO.
- NEWCOMB AUDIO PRODUCTS CO.
- ORRADIO INDUSTRIES, INC.
- PERMO, INC.
- PICKERING & CO., INC.
- PRESTO RECORDING CORP.
- RECORDISC CORP.
- RECOTON CORP.
- REEVES SOUNDRAFT CORP.
- REK-O-KUT COMPANY
- SHURE BROS., INC.
- V-M CORPORATION
- WALCO PRODUCTS, INC.
- WEBSTER-CHICAGO CORP.
- WEBSTER ELECTRIC CO.

Actual size 8" x 10 1/2"

Radio-Television Service Dealer subscribers will receive without cost or obligation, a complete 68 page catalog section as reprinted from the Industry's Official 1100 page Radio's Master, 16th edition.

This section catalogs in detail the products of the leading Recording and Phono Equipment manufacturers — all in 1 handy booklet. It is complete with descriptions, specifications and illustrations as written by each manufacturer. Whether you buy, sell or specify these products, you will find this booklet extremely helpful.

This offer is made possible by a special arrangement between Radio-Television Service Dealer Magazine and the publishers of Radio's Master. Be sure to get your copy now. Fill in the coupon and mail.

If you need catalog data on any other products, let us know.

RADIO-TELEVISION SERVICE DEALER 67 WEST 44th STREET, N. Y. 18, N. Y.

Please send me, without cost or obligation, the 68 page Recording & Phono Equipment and Accessories Booklet as reprinted from Radio's Master.

Name

Address

City..... Zone..... State.....

MAIL TODAY

TRADE FLASHES

[from page 40]

blanks contact your distributor. He will give you full details on how you can qualify.

It's an easy contest—one that any dealer can qualify for. It consists of writing out a statement in 25 words or less on why you like to sell Burgess Portable Radio Batteries.

Sheldon Expands On West Coast

To provide complete servicing facilities for Sheldon Television Picture Tubes to manufacturers and jobbers on the West Coast, the Los Angeles branch office and warehouse of Allied Electric Products Inc. and its Sheldon Electric division have been moved to a 21,000 square foot air-conditioned building at 2724 Leonis Boulevard in Los Angeles, according to an announcement issued today at the home office and main factory of the company in Irvington, N.J.

Ajax Condenser Co. Opens

Factory On West Coast

Bernard Polayes, president of Ajax Condenser Co., Inc., 932 Wrightwood Ave., Chicago, Ill., has announced the opening of a condenser factory on the West Coast.

J. T. Dempsey Passes Away

Mr. Joseph T. Dempsey, personnel and labor relations director for 12 years of Philco Corporation radio and television plants in Sandusky, Ohio, passed away suddenly Tuesday evening after a brief illness in Crile Clinic, Cleveland.

Speer Combines Subsidiaries

Speer Carbon Company, Saint Marys, Pennsylvania, and its subsidiaries, Jeffers Electronics, Inc., DuBois, Pennsylvania, International Graphite and Electrode Corporation, Niagara Falls, New York, and Speer Resistor Corporation, Saint Marys, Pennsylvania, have consolidated into one company, the Speer Carbon Company, with headquarters at Saint Marys. The various subsidiaries henceforth will operate as divisions of Speer Carbon Company.

Tel-O-Tube Expands

Construction has begun on a new, one-level addition to the 50,000 square foot East Paterson plant of the Tel-O-Tube Corporation of America, Mr. Sam Kagan, president of the company announced recently.

Electronic Supply Corp. Expands

After six years at their present location Electronic Supply Corporation of 40-14 Greenpoint Ave., Long Island City, is moving to its new and larger

building. The organization has grown steadily after starting in one-half of its present main store, expanding into 40-12, 40-10, 40-08, Greenpoint Ave.

Admiral Uses Trailer

For Sales Promotion

Admiral Corporation is aggressively pushing the sale of television receivers in areas 25 to 200 miles from transmitters with a special "Fringe Area Trailer Promotion," according to Raymond W. Peterson, manager of the accessories division.

Admiral's intensified promotion revolves around a small trailer with a

portable 75-foot antenna mast developed by company engineers and George Spencer, Admiral distributor in Minneapolis. Salesmen working the fringe area prospects, put on an actual free home demonstration of the television set using the antenna.

Special newspaper mats, window streamers, and radio spot announcements have been prepared for dealers. Admiral also provides complete 20, 30, 40 and 50-foot antenna kits. Distributor field engineers are available to make initial trailer demonstrations to assist dealers in setting up their fringe area department.

MATTISON SILVER ROCKET 630 CHASSIS WITH TUNEABLE BUILT-IN BOOSTER FOR BETTER DX RECEPTION

Featuring NEW CASCADE TUNER
made for UHF interchangeable
tuning strips and 70° COSINE YOKE

● Broad band single knob control pre-amplifier built in to eliminate long leads which may cause regeneration and attenuation of signal.

● ONLY THE MATTISON 630 CHASSIS HAS ALL CHANNEL TUNEABLE BUILT-IN BOOSTER THAT INCREASES SIGNAL STRENGTH UP TO 10 TIMES. THE SILVER ROCKET WILL OUTPERFORM ANY CHASSIS MADE—IS PRICED RIGHT TO SELL FAST WITH AN EXTRAORDINARY MARGIN OF PROFIT FOR YOU. WRITE FOR CONFIDENTIAL PRICE SCHEDULE.

● Mattison features a complete line of cabinets MADE IN MATTISON'S OWN CABINET FACTORY. 36 breathtaking designs that blend perfectly in any setting, traditional or modern.

Tube
Complement:
28 tubes
3 rectifiers
1 CRT
32

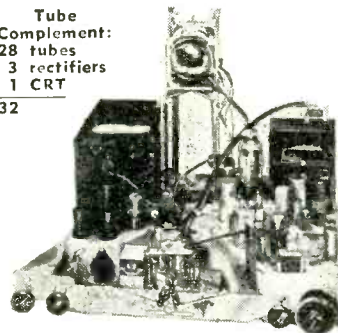

All Channel Booster

Here are some unsolicited, sincere reactions to the MATTISON TV LINE!

From Ashland, Ohio
"—only one word could describe it—TERRIFIC!" signed H. E. B.

From Tigard, Oregon
"—Yours is the best picture that I have seen of all custom sets. It brought in a picture from Seattle just like a picture from any local station that I have seen in the east last winter!" signed G. E. B.

From Peru, Illinois
"—Your Silver Rocket Chassis is one of the finest chassis on the market today!" signed G. A. B.

From Crossville, Tennessee
"—As for performance, both your chassis were outstanding. Everybody who has watched them concedes that they are the hottest things on the market. In the few days we used it in my home we got almost incredible results. They produce a remarkably good picture." signed J. M.

DEALERS! SERVICE-DEALERS! Here is YOUR opportunity to become the "important" TV Dealer in your area for THE FINEST CUSTOM-BUILT LINE OF TELEVISION RECEIVERS. FREE!! Write for Mattison's merchandising portfolio explaining "THE MATTISON UNASSEMBLED PLAN" and "THE MATTISON \$1,000,000 FLOOR PLAN". **SALESMAN — AGENTS!** Choice territories available. Become a Factory Sales Representative. Prefer men with experience selling direct to dealers. WRITE TODAY!



When you buy from Mattison you need only one source of supply! You can buy a Mattison Chassis, a Mattison Cabinet or a complete Mattison TV Set!

Mattison Television & Radio Corporation

893 Broadway, Dept. SDB New York 3, N. Y.

TRADE LIT.

[from page 30]

number, speaker size and Waldom replacement cone number. The manual includes a section showing how to easily replace a speaker cone, complete with illustrations and explanation. It also includes a listing of universal field cones. An extremely useful and time saving manual that should be on every serviceman's bench.

1952 *Waldom Electronic Components and Croname Products Catalog #502*. Complete descriptive listings and illustrations of Croname Knobs, Dial Plates, Title Plates, Croflex Tuners, Auxiliary Drives, Instrument Dials and Auto Radio Controls and Panel Kits, Waldom Knobs, Tube Sockets (JAN and Laminated), Terminal Strips and TV Components. An invaluable catalog for the engineering and purchasing departments of electronics users.

Both of the above catalogs are available at no charge to servicemen, engineers and purchasing agents. Write Waldom Electronics, Inc., 911 N. Larrabee St., Chicago 10, Illinois.

* * *

A new 16-page handbook on home construction of *electronic flash* equipment for amateur photographers has just been published by the Sprague Products Co. The new Sprague booklet gives complete circuit details for four different photoflash outfits using Sprague's new Type FF-1 low leakage capacitors rated at 525 mf, 450 volts in a can 2" in diameter by 4½" long and weighing only 11 ounces. This new Sprague capacitor is the same size as the 300 mf units which have been previously furnished for this purpose and have only a fraction of the leakage current of the older capacitors.

Copies of the Sprague Electronic Flash Handbook, form C-703, are available from all Sprague distributors for 35c or may be obtained by sending 35c in coin or stamps directly to Sprague at 71 Marshall Street, North Adams, Mass.

* * *

Andrea Sales Corp., distributors of the Andrea "sharp-focus" television receivers in the Metropolitan Area, announced the issuance of a weekly "Andrea News Bulletin" each Thursday to all Andrea dealers. The "Andrea News Bulletin" will contain in-

formation pertinent to the television industry, and will include selling and promotional hints that can be applied to any electrical or appliance items carried by the Andrea dealers.

* * *

John F. Rider Publisher, Inc., 480 Canal St., New York, announces that their *revised catalog* is available.

The 8-page 8½ x 11 inches catalog is a complete up-to-date listing of Rider Manuals, Rider Tek-file and books. Information on Rider books due to be published in early Summer, is also included.

Copies of the catalog are available from the organization's distributors or directly from the publisher.

NEW TUBES

[from page 39]

to low plate supply voltage.

The new tube is mounted in a T-9 bulb and is supplied with a short intermediate shell octal base with 8BD base connections. It may be mounted in any position. The tube is 1 9/32" in diameter; 3 5/16" long and is 2 3/4" high when seated.

THIS IS IT! THE RELAY

WITH *Interchangeable Coil*
FOR A WIDE RANGE OF RADIO APPLICATIONS

GUARDIAN Series 200

Interchangeable

COIL and CONTACT

Switch Assembly

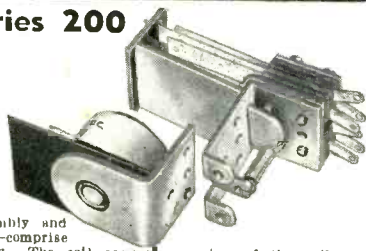

Two basic parts—a coil assembly and a contact switch assembly—comprise this simple, yet versatile relay. The coil assembly consists of the coil and field piece. The contact assembly consists of switch blades, armature, return spring and mounting bracket. The new Guardian Midget Contact Assembly which is interchangeable with the Standard Series 200 coil assembly, is also available in either single pole, double throw; or double pole, double throw.

CONTACT SWITCH ASSEMBLIES

CAT. NO.	TYPE	COMBINATION	
		Single Pole	Double Throw
200-1	Standard	Single Pole	Double Throw
200-2	Standard	Double Pole	Double Throw
200-3	Contact Switch Parts Kit		
200-4	Standard	Double Pole	Double Throw
200-M1	Midget	Single Pole	Double Throw
200-M2	Midget	Double Pole	Double Throw
200-M3	Midget Contact Switch Parts Kit		

13 COIL ASSEMBLIES

A.C. COILS*		D.C. COILS	
CAT. NO.	VOLTS	CAT. NO.	VOLTS
200-6A	6 A.C.	200-6D	6 D.C.
200-12A	12 A.C.	200-12D	12 D.C.
200-24A	24 A.C.	200-24D	24 D.C.
200-115A	115 A.C.	200-32D	32 D.C.
		200-110D	110 D.C.

*All A.C. coils available in 25 and 60 cycles

GUARDIAN ELECTRIC

1606-H W. WALNUT STREET

CHICAGO 12, ILLINOIS

A COMPLETE LINE OF RELAYS SERVING RADIO AMATEURS

BACK ISSUES

of Radio-Television Service Dealer

AVAILABLE

January	1951, 1952
February	1951, 1952
March	1951
April	1950, 1951, 1952
May	1948, 1949, 1950, 1952
June	1949, 1951
July	1950, 1951
August	1950, 1951
September	1948, 1949, 1951
October	1949, 1950, 1951
November	1948, 1949, 1950, 1951
December	1949, 1950, 1951

35c per copy

25c per copy in lots of 10 or more

RADIO-TELEVISION SERVICE DEALER

67 WEST 44th ST., NEW YORK 36, N. Y.

Please send me the Nov. 1948 July 1950 Aug. 1951
back numbers checked May 1948 Aug. 1950 Sept. 1951
here. . . . Sept. 1948 Oct. 1950 Oct. 1951
 June 1949 Nov. 1950 Nov. 1951
 Sept. 1949 Dec. 1950 Dec. 1951
The price is 35c for May 1949 January 1951 January 1952
each copy unless 10 or Oct. 1949 Feb. 1951 Feb. 1952
more are ordered. If 10 Nov. 1949 March 1951 April 1952
or more are ordered the Dec. 1949 April 1951 May 1952
price is 25c each copy. April 1950 July 1951
 May 1950 June 1951

I remit herewith \$..... for the copies ordered at c. each.

NAME

ADDRESS

CITY ZONE STATE



At your RMS Jobber

CVA-500 end-fired array — excellent reception in the fringe. Rugged — up fast, stays fast.

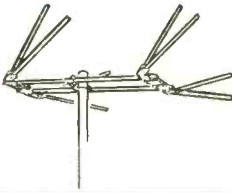

The little man

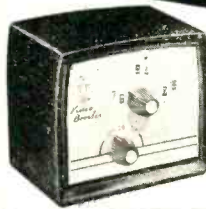

SP-6J Triode Tube Boosters — new beauty, excellent performance in semi-fringe and fringe. U/L approved

is always there

SP-6 Pentode Tube Booster with external gain control — ideal in the extreme fringe. U/L approved.



with everything

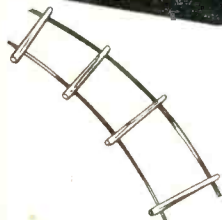

HG-450 Hi-Gain open transmission line is Copperweld far stronger!

you need for

LA-3 lightning arrester — static discharge eliminator for twin lead or open line. Mounts flat or to mast. U/L approved.



TV installation

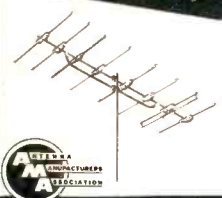

STYLE 8 and 10 element yagis — real uniquely steel-braced.



ask him for RMS products
RMS, New York 60, N. Y.

CIRCUIT COURT

[from page 33]

V2 is cut off, there is no high voltage. When the pulse is fed to V1, the tube conducts through R50 and R54. As the top of R54 goes more positive, V2 comes out of cut-off. V2 plate current through K1 causes the relay to close. When the vertical relay closes, the high voltage circuit can operate. The condenser across the relays keep them closed between pulses. It also keeps the relay from chattering.

ASSOCIATIONS

[from page 31]

formation is then demonstrated at the meeting. This is one subject upon which there is practically no information to the practicing technicians. This requires considerable equipment and a lot of extra work is set up for demonstrations.

In view of the above we are starting to try a new type of presentation. This will consist of full color slides to be projected at the meeting, the accompanying explanation to be tape recorded, how this will work remains to be seen. However, it offers the advantage of being usable many times over. With the cost of film being negligible, I personally have high hopes for this system.

Dell Davis

Radio and Television Technicians Guild of Florida, Inc.

The R&TTG in co-operation with the Florida Power & Light Co. and the local distributors, will combine their efforts and set up a display of a modern Radio & TV Service Shop.

This unit will be displayed at the main office of the Florida Power & Light, located at 25 S.E. 2nd Ave.

It will be some time in June, the exact date is yet to be determined.

The main, and most important reason for this show, is to help educate the Public in the problems confronting the Service Technician.

It will also give them some idea of the extensive amount of equipment necessary to trouble-shoot their sets.

If we can send them away from this show thinking, and with a realization that this job of ours is something more than a "screw driver mechanic" proposition, then we will have gained much to further the cause of the man in the Electronics Service Field.

The RCA meeting as sponsored by East Coast had the best turnout this writer has ever seen at any meeting

WE GREW UP WITH THEM

Ever since radio was in "knee pants," Supreme has been providing aids to help electronic technicians use their training and experience more efficiently and profitably. We know that in television today, as it was with the TRF's and neutrodynes of yesteryear, they must have high quality, dependable test equipment to save time and keep up with this progressive electronic industry. We also know that service technicians do not want Supreme to sacrifice quality by substituting unproven materials in place of those temporarily under control due to our nation's mobilization program. They will, as they have in other emergencies, give us extra time, if needed, to deliver a product that is "Supreme By Comparison" in every respect.

Supreme's mission in our defense program, just as it was during World War II, is to help the technicians in our armed forces locate that faulty part or maladjustment quickly by supplying them with well designed and reliable testing equipment. For a quarter century Supreme has been a major contributor to the efficiency of the electronic technician—we grew up with them. By continuous research, development, improvement, and production of equipment for maintenance of electronic devices—plus our close contact with the electronic technician—knowing the job he has to do—what it could mean if he fails—leads us to accept new challenges with confidence and pride. Supreme's "know-how," gained both in peace and war, is one of this nation's assets in times like these.

Our 25th Year

SUPREME

Testing Instruments

"SUPREME BY COMPARISON"
TUBE TESTERS • SIGNAL GENERATORS
PANEL METERS • MULTI-METERS
OSCILLOSCOPES

Supreme, Inc., Greenwood 1, Mississippi



SAVE Up to \$1.00 each. Form a Group, Service Dealers Subscribe to "RTSD"—

"The Professional Radio-Television man's Magazine"—published monthly. All articles are exclusive and timely. Practically every issue is worth what an entire 1 year subscription costs.

The more in a group the bigger the savings. 6 men in a group save \$1.00 each; 4 men groups save \$.75 per man. Present "RTSD" subscribers may participate in or form a group with co-workers, or even competitors. Still active subscriptions are automatically extended 1 year. Start a Group today! The timely and exclusive technical data appearing in future issues of "RTSD" will make this the best investment you ever made. The special Group Rate offer may be withdrawn at any time—so hurry.

Use This Coupon For Convenience

(The coupon below can be used for from 1 to 6 subscription orders. Use it today!)



TEAR OUT — MAIL TODAY

RADIO-TELEVISION SERVICE DEALER
67 West 44th Street, New York 36, N. Y.

Please enter 1 year subscription orders for the names given below. Our remittance is enclosed.

NOTE: If you do not wish to tear this order blank out, just print or type the information on a single sheet of paper, following the style given. Each subscriber's occupation must be clearly described.

	In U.S.A.	Foreign Rates
<input type="checkbox"/> One 1-year subscription	\$2.00	\$3.00
<input type="checkbox"/> Two 1-year subscriptions, each	1.75	2.75
<input type="checkbox"/> Three 1-year subscriptions, "	1.50	2.50
<input type="checkbox"/> Four 1-year subscriptions, "	1.25	2.25
<input type="checkbox"/> Five 1-year subscriptions, "	1.10	2.00
<input type="checkbox"/> Six 1-year subscriptions, "	1.00	1.50

Name
Address

Describe Title or Position and Type of Business

State whether a New Subscriber or Renewal Order

Name
Address

Describe Title or Position and Type of Business

State whether a New Subscriber or Renewal Order

Name
Address

Describe Title or Position and Type of Business

State whether a New Subscriber or Renewal Order

Name
Address

Describe Title or Position and Type of Business

State whether a New Subscriber or Renewal Order

Name
Address

Describe Title or Position and Type of Business

State whether a New Subscriber or Renewal Order

Name
Address

Describe Title or Position and Type of Business

State whether a New Subscriber or Renewal Order

in Miami. The meeting was excellent. Mr. John Meagher needs no introduction to the men in the TV service.

National Alliance of Television & Electronic Service Associations

From NATESA we receive this nice letter. Thanks!

Dear Sandy:

It was very nice talking to you at the Chicago Show. I am sure that each of us has come away from this meeting with a better knowledge of the other. I want to also, at this time, commend you highly for the nice coverage you gave NATESA, TISA and all the other affiliated associations.

Allow me also to congratulate you highly on the 98c Mechanic article by Houde. May I suggest that you do your damndest to get this article reprinted by Readers Digest? I am sure that it should be eminently qualified for that publication. It would thus reach the consumer who certainly needs this kind of enlightenment.

Regards!

Frank Moch, Pres.

MANDL

[from page 19]

should be studied for slight variations which might exist, because these will determine the best method for testing. In the one shown in Fig. 6, for instance, the anode of the first tube is coupled to the cathode of the second, while the grid is grounded. This cathode injection would mean that the cathode capacitor could not have a large value because it would have a shunting effect on the signal. Usually a cathode by-pass capacitor can be made larger in value during replacement because generally the higher the value of the capacitor the greater the filtering action.

In this instance, however, the 68 μf capacitor should be an exact replacement. A short in this circuit will also shunt the signal and cause sync instability. A leakage of the .05 μf coupling capacitor between the first and second tubes would apply plus B to the cathode and thus increase the relative grid bias. This would upset the operation and again cause instability of both vertical and horizontal sync systems. Horizontal sweep is derived from the sync clipper plate which also feeds the low-pass filter network to the vertical oscillator. Defects in the low-pass filter will have a primary effect on the vertical circuit, while

defects in the first 12AU7 stages will affect both vertical and horizontal sync.

When such circuits are defective, tubes should be replaced first, even though they check well in a tube checker. Often characteristics can change slightly and upset good sync separation. This could cause weaving and pulling of the picture. If the tubes are known to be all right, the next procedure would be voltage readings as well as ohmic readings of all resistors.

Defective resistors and capacitors should be replaced if off-value by more than 10% and it is best not to change the values during replacement. Signal tracing can be accomplished by measuring the grid bias established in the separator and clipper stages, or an oscilloscope can be used to ascertain the presence of signal waveforms.

The bias across the second cathode resistor (270,000) can be measured from cathode to ground or from cathode to grid since the latter is grounded. Even though the grid is



NEW EICO Instruments and KITS

gives you Laboratory Precision at Lowest Cost!

...with a complete line



221K VTVM Kit
Kit \$25.95
Wired \$49.95



625K Tube Tester
Kit \$34.95
Wired \$49.95



320K Sig. Gen. Kit
Kit \$19.95
Wired \$29.95



145K Sig. Tracer
Kit \$19.95
Wired \$28.95



425K 5" Scope Kit
Kit \$44.95
Wired \$79.95



315K Deluxe Sig. Gen. Kit
Kit \$39.95
Wired \$59.95



HV Probe \$6.95



511K VOM
Kit \$14.95
Wired \$17.95



306K Sweep Gen. Kit
Kit \$34.95
Wired \$49.95
C-5 5mc Crystal \$3.95



RF Probe Kit \$3.75
Wired \$5.95



1040K Battery Elim. Kit
Kit \$25.95
Wired \$34.95

Over 100,000 servicemen have bought one or more EICO Kits and Instruments. That's the proof of EICO's leadership in value to the serviceman!

For latest precision engineering, finest components, smart professional appearance, lifetime performance and rock-bottom economy—see and compare the EICO line at your jobber's today before you buy any higher-priced equipment! You'll agree, with over 100,000 others, that only EICO Kits and Instruments—no other—give you the industry's greatest values for the industry's lowest cost!

Read the full story on the complete EICO line. Write today for your free latest Catalog D-7.

ELECTRONIC INSTRUMENT CO., Inc.
84 WITHERS STREET, BROOKLYN 11, N. Y.
© 1957 Electronic Instrument Co., Inc.

Due to unsettled conditions, prices and specifications are subject to change without notice. Prices 5% higher on West Coast.

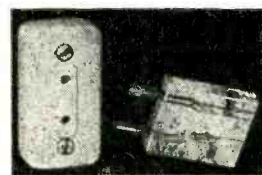

Cat. No. 343-PK

List Price \$1.05

Compact TV Lead-in terminal or tap socket. Molded polystyrene. In brown or ivory. With mating transmission line plug.

MOSLEY PLUGS and SOCKETS FOR BETTER TV INSTALLATIONS

Use these MOSLEY Low Loss Plugs and Sockets on every TV installation job for neat, efficient constant impedance connections of standard 300 ohm transmission line to set or booster. Save installation time—prevent call backs—with these solderless, sturdy MOSLEY accessories. Your customers will appreciate their convenience, too!

Cat. No. 311

List Price \$.30

Solderless Transmission Line Socket mates with Input Adapter, right, for convenient lead-in connection to set or booster.



Cat. No. 304

List Price \$.30

Input Adapter attaches to antenna terminal strip on set or booster. Mates with Line Socket, left, for quick connect—disconnect.



MOSLEY ELECTRONICS 2125 Lackland Road, Overland, Missouri

**FASTER
STURDIER**
Lower Installed Cost

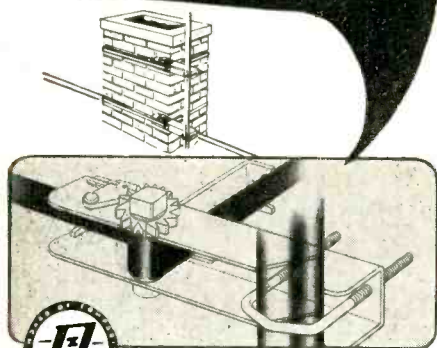

SPEE-DEE

CHIMNEY MOUNT

Model AK85 The fastest-installed chimney mount ever devised for TV antennas! Rugged in design—simple to install. Simply thread strapping through ratchet, around chimney and back through ratchet—wind up ratchet tight—and the job's done! Heavy gauge, zinc-plated steel with large "U" bolt for up to 1 1/4" O.D. mast and full length galvanized steel strapping.

THE RADIART CORPORATION
CLEVELAND 13, OHIO

it's the Nut
that counts!

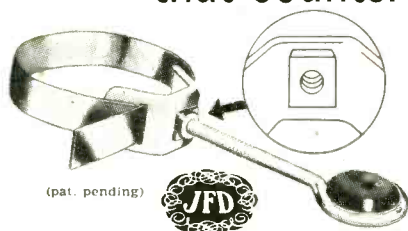

Nut universal STAND-OFF
INSULATOR

greatest improvement in
screw-eyes since TV began!

6 full, machined threads provide "bulldog" grip, anchor the screw-eye for good! No stripping of any screw-eye, no slipping of strap! Reinforced "arch-bridge" construction prevents bending or buckling of clamp no matter how much the stand-off is tightened. Ultra-low loss polyethylene insert and sturdy electro-galvanized steel strap for universal mounting on any mast up to 2 1/2" od. Available for both single and dual lead-ins in 3 1/2", 5 1/2", 7 1/2" and 12" sizes.

Write for Form No. 149
and Free Nut Stand-off Sample
... today!

JFD Mfg. Co.
Brooklyn 4,
BEnsonhurst 6-9200



world's largest manufacturer
of TV antennas & accessories

grounded, it will be negative with respect to the cathode and, therefore, the bias developed across the cathode resistor will also be the grid bias.

Other variations will be encountered, though fundamentally their function is basically the same and, therefore, common servicing procedures will hold for all such circuits.

TROUBLE?

[from page 27]

In servicing receivers with possible defects in the a-g-c system, the first point to keep in mind is that the symptoms will not generally point directly to a-g-c trouble. The symptoms may be any one or combination of the following: defective sound, defective video, defective sync. The usual servicing procedures should be followed to try to localize the trouble to a defective section and defective stage. If no other specific cause of trouble shows up, the a-g-c circuit should be checked. In all types of a-g-c systems, the a-g-c voltage should be proportional to the signal—the stronger the signal, the more a-g-c voltage should be developed. A quick check on the operation of the a-g-c system can be made by tuning in a strong station and 1) checking the d-c voltage at the video detector load resistor and 2) comparing this reading to the d-c voltage measured at the a-g-c bus. It should be noted that the voltage at the detector is pulsating d-c (rectified and filtered r.f.) and may be either positive or negative in polarity depending on the circuit hookup. The d-c voltage measured at the a-g-c bus (or at the grids negative). At both points, video detector output and a-g-c bus, the d-c voltage should be proportional to the strength of the signal, *Fig. 4*. The readings should be approximately equal. In many cases, a defect in the a-g-c system causes a larger than normal d-c voltage (and signal voltage as seen with a scope) at the detector load resistor and a lower than normal a-g-c bias.

An oscilloscope is very helpful in localizing a-g-c trouble. The scope is used to check waveforms and peak to peak voltages at the video detector and the inputs and outputs of the a-g-c system. When the trouble is localized, d-c voltage checks of the a-g-c stage and a-g-c bus, supplemented when necessary by resistance checks, should track down the defective component.

TECHNICAL ARTICLES WANTED

on

TV, AM RADIO, FM RADIO, PHONO MECHANISMS, HI-FI AUDIO, AUTO RADIO, TEST EQUIPMENT, ANTENNAS

pertaining to their

**Theory, Installation, Application,
Service & Maintenance**

submit manuscripts to
Managing Editor

Radio-Television Service Dealer
67 West 44 Street New York 36, N. Y.

AD INDEX

American Television & Radio Co.	14
Belden Manufacturing Co.	1
Bussmann Manufacturing Co.	5
Cannon Electric Company	6
Centralab	24, 25
Channel Master	38
Electronic Instrument Co. Inc.	47
Guardian Elec. Mfg. Co.	44
Hytron Radio & Electronics Co.	2
Jensen Manufacturing Co.	10
JFD Manufacturing Co. Inc.	48
LaPointe-Plascomold Corp.	12
Mallory, P. R. & Co. Inc.	Cover 2
Mattison TV & Radio Corp.	43
Mosely Electronics	47
Radiart Corporation	37, 48
Radio Merchandise Sales Inc.	45
Rauland Corporation	7
Raytheon Mfg. Co.	11
RCA Tube Dept.	15, Cover 3-4
Regency Div., I.D.E.A. Inc.	13
Rider, John F. Publisher, Inc.	9
Sams, Howard W. & Co. Inc.	4
Schott, Walter L. Co.	41
Shure Brothers Inc.	8
Simpson Electric Co.	16
Snyder Manufacturing Co.	35
Supreme, Inc.	45
Transvision, Inc.	10



You're a Radio Man...we're a Radio Company...
...so let's make money together

HERE'S HOW!

We've been telling millions of radio listeners and television viewers that you, the Radio Service-Dealer are best qualified to sell and install RCA Radio Batteries. You can capitalize on this national advertising coverage right in your own neighborhood by stocking and promoting fast-selling RCA Radio Batteries.

We help you advertise for repeat sales on the RCA Radio Battery carton itself. Volume-type RCA Batteries carry a printed message directing the portable radio owner back to *you* for replacements. And a special space is provided below this message for you to imprint your own name and address with a personalized stamp which you may obtain from your RCA Battery Distributor. You can make more money selling RCA Batteries because customers come back to *you* for battery replacements.

We create new, *ready-made* markets for *you*. The revolutionary new RCA VS236 and VS216 Batteries make possible the design of personal portables having a "Balanced Life" battery complement which will provide 10 times longer playing time without battery change than previ-

ously possible. The new RCA Victor Super "Personal" radio was designed especially for these new battery types. Here's a whole new battery replacement business open to you when you sell RCA Radio Batteries.

For the whole exciting profit-building story, call your RCA Battery Distributor *today*. Let's get started selling RCA Batteries together . . . *right now*.



Revolutionary New RCA Radio Batteries Provide 10 Times Longer Playing Time Without Battery Change in New RCA Victor Super "Personal"



RADIO CORPORATION of AMERICA
RADIO BATTERIES **HARRISON, N. J.**

tmks ®

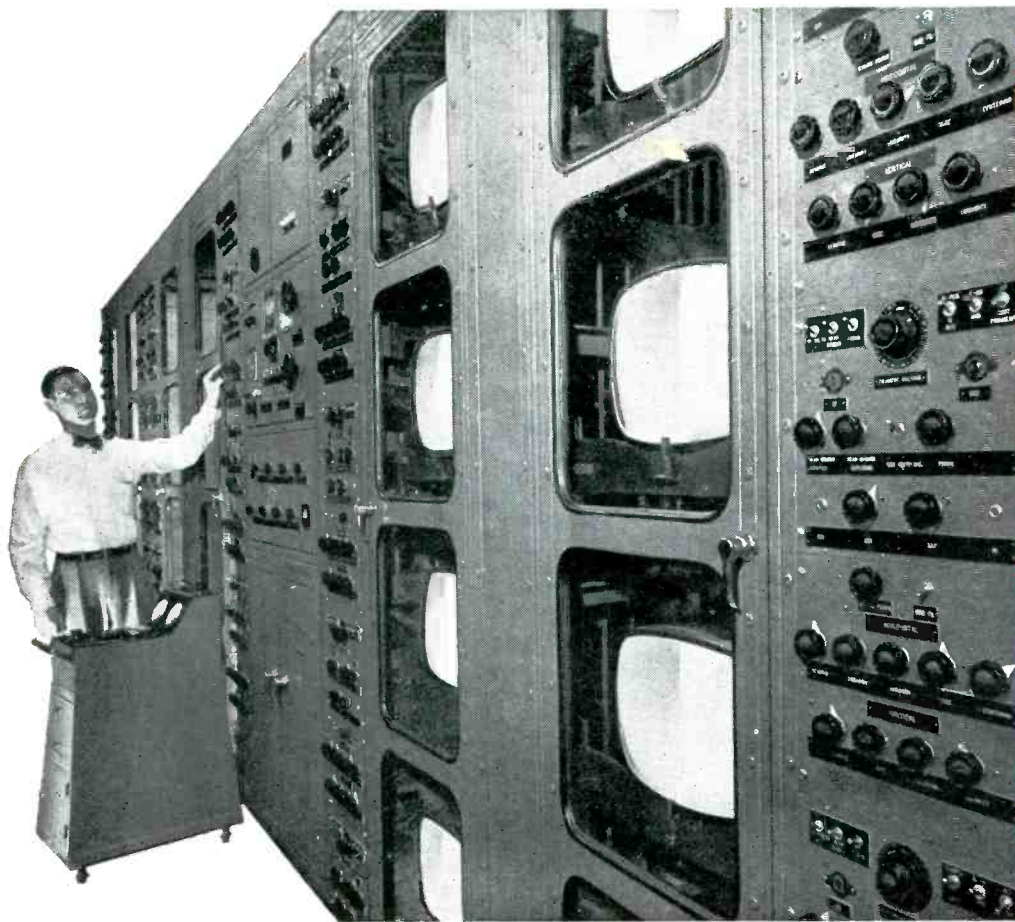

Specialized racks like these are used to life-test RCA Kinescopes.

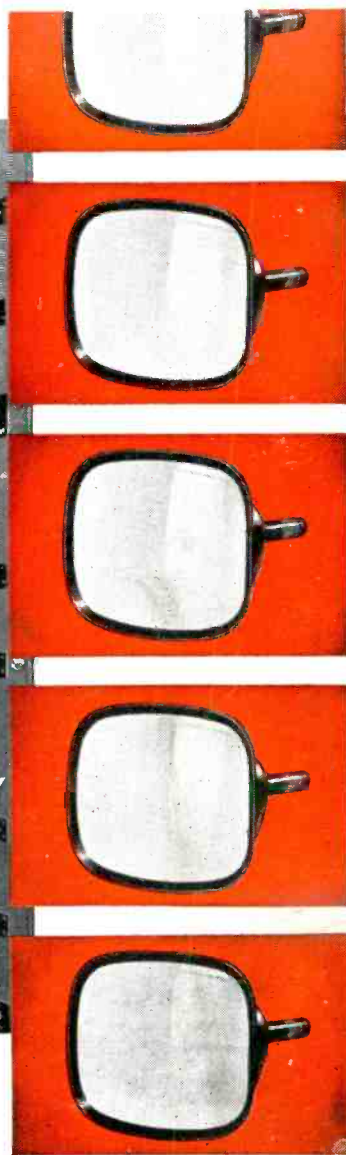

The Million-Dollar Test Equipment

... that pays off in better picture tubes

AT RCA's picture tube plants, constant vigilance over quality is maintained with specialized test equipment valued at well over one million dollars. This huge investment is one reason why RCA picture tubes are the best you and your customers can use.

In one phase of the quality-control program, random samples of picture tubes are taken directly from the pro-

duction lines and subjected to rigorous life tests in racks such as those shown. Any deviation from prescribed quality standards is promptly noted and corrected at the source. In addition, a portion of these samples is given an extended life test equivalent to *years* of actual service in the home.

RCA's constant vigilance at all stages of manufacture is your assur-

ance that only top-quality RCA Kinescopes leave the factory. In this way, RCA closely guards its own reputation . . . and yours as well.

With RCA Receiving Tubes, as well as RCA Kinescopes, TOP-QUALITY CONTROL makes the difference.



RADIO CORPORATION of AMERICA
ELECTRON TUBES

HARRISON, N. J.

TMKS. ®