

Radio
**SERVICE
DEALER**

MARCH, 1950



IN THIS ISSUE:

AFC for Local Oscillators
Improving Focus in TV Receivers
Picture Tube Characteristics Chart
The Television Waveform and
its Components, Part 3

AM-FM-TV-SOUND

The Professional Radioman's Magazine

8740

8743

8734

8735

8738

8739

8747

8433

8799

8752

INTERCOMMUNICATION AND SOUND SYSTEM CABLES

Every Type for Every Service

Sold Exclusively Through Recognized Wholesale Distributors

Belden
Radio WIRE



"MY **BIG** SALES ASSET!"

WHAT helps me sell tubes, and the radio-TV service that goes with them, is buyers' preference for the G-E brand." You hear this from pleased servicemen . . . everywhere . . . who are cashing in on the strong trend to General Electric. Good tubes and popular—available in all the types you need, including latest designs—backed by advertising and promotion aids that really pull business *your* way . . . these form a bright sales picture when you feature the G-E line. Build a fast-growing income on your public's faith in the General Electric monogram! Your G-E tube distributor will be glad to help. Phone or write him today! *Electronics Department, General Electric Co., Schenectady 5, N. Y.*

You can put your confidence in—

GENERAL  ELECTRIC

101-JA3

**ONE SOURCE FOR
ALL YOUR TUBE
REQUIREMENTS!**

TV PICTURE TUBES

METAL TUBES

GLASS TYPES

MINIATURES



—also GERMANIUM DIODES and SELENIUM RECTIFIERS. Stock G-E 100-percent, to save time and routine in ordering—to have the benefit of bulk deliveries from your distributor—to profit from General Electric tube quality and product popularity.

Field Findings

A resume of Industry happenings here, there and everywhere

IN these columns we have repeatedly and emphatically urged *all* radio service dealers and technicians, regardless of where they resided, to learn immediately all they possibly could about TV. We have even gone so far as to state as our opinion that unless the old timers in the radio servicing profession took TV seriously they might fail to survive against the influx of new men having real TV know-how. Sad to relate, too many readers failed to heed our suggestion. Consequently the mortality rate of independent radio servicemen and of old, established radio service organizations is higher than ever before. For example, the telephone company's new classified directories now being issued throughout the country in areas having TV list from 16% to 26% fewer firms under the classification "Radio Service" than were listed in the previous directories.

TV Service Potential

We who are interested in statistics and related facts bearing upon the service profession, used to gloat that our part of the overall radio industry represented about 28% of the total. For example, the radio industry hit the half billion dollar mark in 1947 and of that total approximately one hundred and forty million dollars was in the "service and replacement" classification. In 1950 over one hundred and twenty million dollars worth of TV accessories alone will be sold.

The average independent radio serviceman, two years ago, could feel that he had obtained a fair average share of business if his sales volume for the year reached \$9,000 and if his actual net earnings for the year approximated \$3,000. Now-a-days, with TV changing the picture so radically, the average technician's earnings are nearly double what they were two years ago, despite the fact that "factory service companies" have made deep inroads into the earnings of independent operators. This picture is fast changing, and now, more than ever, the future for the independent operator seems bright indeed. But, real money can only be made by businessmen with know-how, and in TV this means technical competence—the

BY S. R. COWAN



ability to do a job right the first time and in the shortest possible time and for a fair price. Figuratively speaking, it takes as long to trouble-shoot and repair 7 conventional radio sets as 1 TV receiver. So, in computing a TV repair estimate, plan accordingly.

Here and There

Between mid-December 1949 and mid-January 1950 we travelled covering the Atlantic seaboard from Salem, Mass. down to Jacksonville, Fla., and the west coast of Florida as far south as Ft. Meyers. Keeping a weather eye out, looking for TV antennas as we drove along the highways, we made some interesting observations. For example, TV is highly concentrated in but relatively few New England cities, such as Boston, Hartford and Stamford. It tapers off in most of those conservative outlying areas. Asked to explain why, most Service Dealers reported the public lacked enthusiasm for TV while only two or at most three TV outlets were receivable. This is in sharp contrast to the Delaware-Maryland-Virginia "Cape" region. Driving south down the peninsula, from Dover, Del., through Salisbury, Md. and as far as New Church, Va., one sees TV arrays in profusion. Here, in areas upwards of 140 or more air-line miles from the nearest TV stations at Philadelphia, Baltimore

and Washington a very high percentage of homes along the highway have TV sets. My eyes popped at the fine, well-guyed, high masts and varied arrays, practically all of which also had antenna rotors.

Then as one went further south TV faded completely until Jax, as Jacksonville is known. Going west and south into Florida we saw antennas in scattered sections in such remote (from TV stations) cities as Clearwater and St. Pete. Time didn't permit us to chat with anyone at Anderson Radio Co. in St. Petersburg, Porter's at Clearwater, Gates Radio in Tampa or Blocker-Turnipseed Furn. Co., Ocala, but should *anyone* in the cities mentioned want to send us a line about TV sales and service conditions thereabouts we would welcome same and report forthwith.

Radio Servicemen "Panned" Again

The radio servicing profession got another unjustified blast of bad publicity in New York City in early January when a Margaret Arlen, using the facilities of WCBS, stated in effect that one cannot trust two out of three radio repairmen. As I get the story, her broadcast, based upon figures given her by the Better Business Bureau, told how unreliable the servicing profession is and urged listeners to contact the BBB before calling in a repairman. Also, I am told that the story was based upon what the BBB had come across in the way of bad service conditions in the city of Pittsburgh, Pa. over a year ago and not in New York, but that point was not made known in the broadcast in question.

The New York City association of servicemen, ARSNY, immediately set to work to correct the damage done and is being supported in its efforts by no less authorities than the elected public officers who until recently were advocating that N. Y. servicemen be licensed, and who having found to their own satisfaction that the industry had already gone a long way towards cleaning up the bad conditions, were subsequently supporters of

[Continued on page 31]

Ask Your Jobber To Show
You The New
"BITE-GRIP"
on this New Universal
Bracket — It Locks The
Elements In Place Like
A Vise!

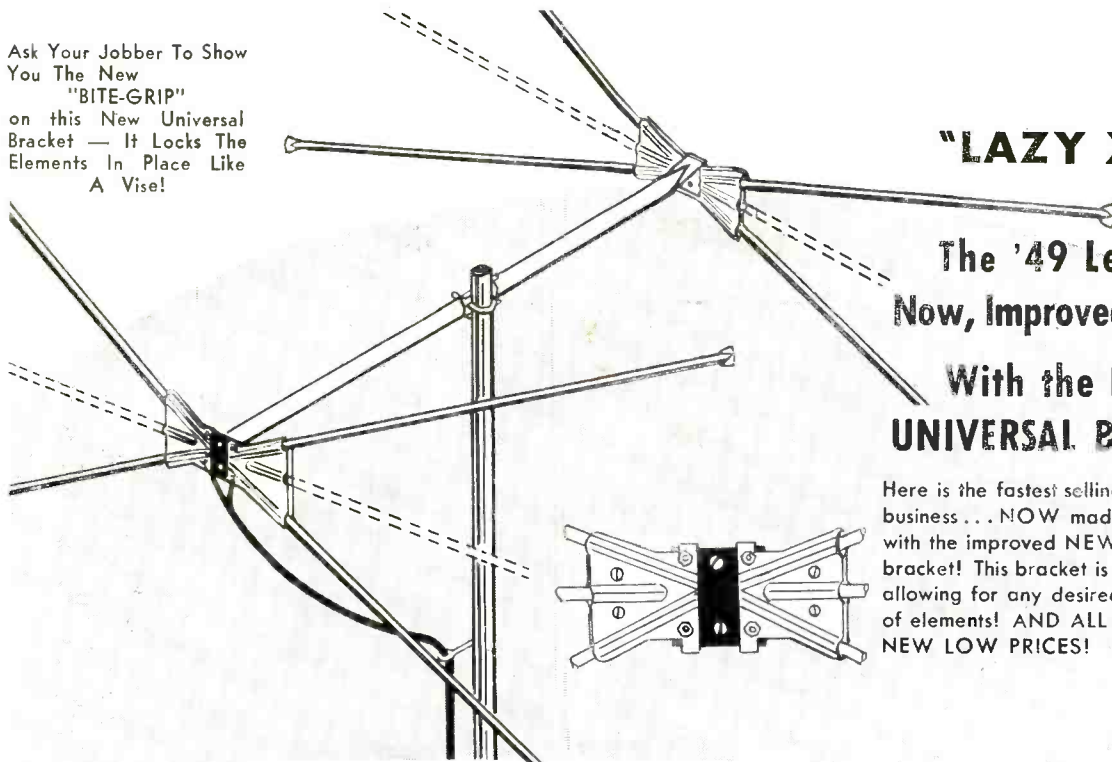

"LAZY X"

The '49 Leader -
Now, Improved for '50

With the NEW
UNIVERSAL BRACKET

Here is the fastest selling conical in the
business... NOW made even better
with the improved NEW UNIVERSAL
bracket! This bracket is truly versatile,
allowing for any desired arrangement
of elements! AND ALL THIS AT THE
NEW LOW PRICES!



RADIART Blankets the TV Antenna Field

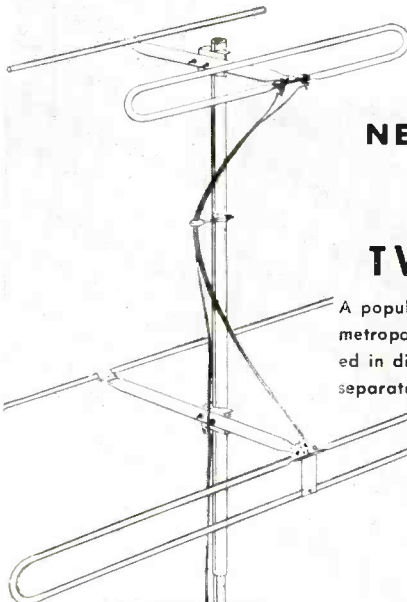

NEW SUPERIOR Hi-Lo TV ANTENNA

A popularly-priced hi-lo type... for
metropolitan areas with stations located
in different directions. Available
separately, stripped or complete.

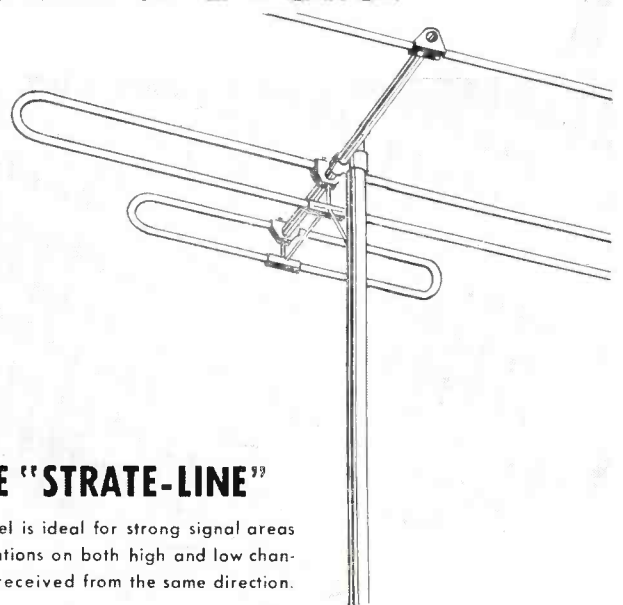

THE "STRATE-LINE"

This model is ideal for strong signal areas
where stations on both high and low chan-
nels are received from the same direction.

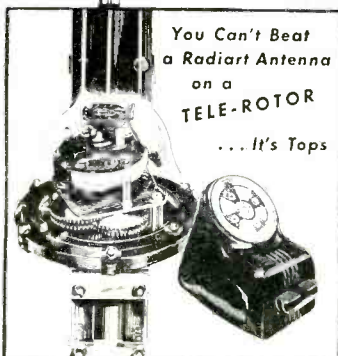

You Can't Beat
a Radiart Antenna
on a
TELE-ROTOR
... It's Tops



IT'S RIGHT WHEN IT'S RADIART

THE **RADIART** CORPORATION
CLEVELAND 2, OHIO



- VIBRATORS
- AUTO AERIALS
- ROTATORS
- TV ANTENNAS
- POWER SUPPLIES

EDITORIAL

by S. R. COWAN

Built-In TV Antennas—Ha! Ha!

Practically all TV set makers are featuring models with built-in antennas. Radio retailers, anxious for sales, stress and highlight this so-called "feature" in their advertising. The most predominant claim is that the buyer can "save the cost of an outside TV antenna installation". All of which is fine, except for the incontrovertible fact that built-in antennas, *even the best of them in the most ideal locations*, are far less efficient than the most economical and elementary outside TV antenna. Our recommendation to dealers is simply this: explain to potential TV set buyer that he should, without question, authorize and pay for a *complete* installation, including an outside antenna, unless in his particular case his landlord will not permit him to enjoy the benefits of same. A survey recently made shows that nearly 90% of all the people who bought TV sets on the premise that they would work satisfactorily with built-in antennas are disgruntled. Most of them feel that they have been "taken" by the dealer, who in practically every case happened to be one who did not operate his own service department. Until TV stations increase their signal output at least 10 times over present limits, outside TV antennas are going to be a *must*, and don't forget it.

Welcome Students

When "RSD" was launched 11 years ago we stated quite bluntly that we would only try to cater to practicing technicians and not to students. Frankly, economics were involved too, because it actually costs us more to send a copy of "RSD" to every subscriber than he pays for it. It was our belief that students should get their basic learning in schools, continue their education and progress by means of apprenticeships working under experienced technicians, and then launch themselves as independents who we *hoped* would subscribe to "RSD". Times have changed, for with the acute shortage of competent TV technicians, we have come to believe that now we should accept subscriptions from students so we may help fill the void more quickly. With that in mind not long ago we started to accept subscriptions from students enrolled in accredited radio-TV training schools. In fact, within the past 3 months we have accepted about 1,000 such subscriptions. A study of these shows that a very large percentage of the students are also engaged in radio-TV work, either part-time as employees of some TV service company, or part-time as independents who by taking courses at school during the day continue to operate their own shops at night. That these student newcomers to "RSD" like our efforts is attested by the overwhelming influx of unsolicited mail which states, in effect, "Why didn't I get "RSD" sooner? I'd be further along now if I had." Thanks fellows!



Sanford R. Cowan
EDITOR & PUBLISHER

Samuel L. Marshall
MANAGING EDITOR

COWAN PUBLISHING Corp.
342 MADISON AVENUE
NEW YORK 17, N. Y.

Vol. 11, No. 3

MARCH, 1950

Editorial	4
Field Findings, by Sanford R. Cowan	2
I Told You So, by San D'Arcy	12
Trade Flashes	6
Automatic Frequency Control for Local Oscillators, by Allan Lytell	13
An excellent opportunity to find out why and how a-f-c circuits operate.	
Improving Focus in TV Receivers, by Matthew Mandl	16
An effective resumé of commercial focus control circuits, together with a discussion of the service problems usually encountered.	
Picture Tube Characteristics Chart	18, 19, 21
This most up-to-date chart of picture tube character- istics is an amplification of the original Chart which appeared in the Jan. 1949 RSD, and contains all picture tubes, including the latest.	
Circuit Court	20
Admiral Model 19A1, Bogen Model PX10	
The Television Waveform and its Components, Part 3, by Samuel L. Marshall	22
Continuing along the same vein as in the two previous installments, that is from the point of view of what the TV signal is composed of, the author discusses the function of the d-c component and the video carrier in the composite signal.	
New Products	24

SANFORD L. CAHN
National Advertising Sales Manager

HARRY N. REIZES
Advertising Manager

NATHAN BOYCE, Circulation Manager

BRANCH: J. C. GALLOWAY 816 W. 5th St., Los Angeles 13, Calif., Mutual 8335

RADIO SERVICE DEALER is published monthly by Cowan Publishing Corp., 342 Madison Ave., N. Y. 17, N. Y. Subscription price: \$2 per year in the United States, U.S. Possessions & Canada: elsewhere \$3. Single copies: 25c. Entered as second class matter Dec. 13, 1948 at the Post Office at New York, N. Y. under the Act of Mar. 3, 1879. Copyright 1950 by Cowan Pub. Corp.

WHAT IS A FRINGE AREA?

Is it Miles? . . . Is it Limited to an Inside Antenna?

Is it Limited by an Outside Antenna?

ACTUALLY, IT'S THE PICTURE REGARDLESS OF LOCATION*



RURAL districts that are located great distances from a transmitter are more commonly thought of as fringe areas. Here "The Standard Booster" literally reduces miles to feet and brings studio clear reception to your TV receiver.

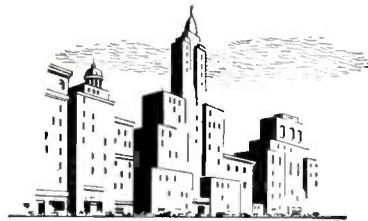

FRINGE area reception also exists within a few miles of a transmitter. Natural or unnatural obstacles found in cities frequently cause fringe area conditions. "The Standard Booster" sweeps aside obstructions and gives your set the ideal picture.

GOOD NEWS FOR SERVICE MEN

The "Standard Tuner". . .
now available as
a replacement unit
through
your local
jobber.

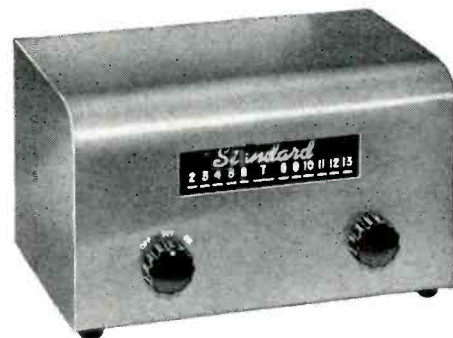

"The Standard Booster"

"The Standard Booster" provides the additional gain to improve the picture where the signal is weak. Rural or city area, "The Standard Booster" is equally effective . . . low noise factor . . . trouble free operation.

Standard COIL PRODUCTS CO., Inc.

CHICAGO • LOS ANGELES • BANGOR, MICHIGAN

* It's the signal strength at a particular location regardless of distance from the transmitter.

SPRAGUE

Molded

TELECAPS

The greatest paper tubular development in 20 years



**...premium quality
...plus performance
AT NO EXTRA
COST!**

You really get your money's worth in Sprague high-temperature phenolic molded Telecap tubular capacitors. They're the *only* molded tubulars made by the dry process—then impregnated* and solder-sealed just like expensive metal-encased oil-paper capacitors.

They're tops on ANY job —yet you buy them at ordinary tubular prices.

*Mineral oil impregnated from 600 to 10,000 volts d-c.

SPRAGUE PRODUCTS COMPANY
71 Marshall Street
North Adams, Mass.

CASH IN ON THIS!

Get the better, more profitable service calls! Send postcard for Sprague booklet "YOUR MONEY'S WORTH IN GOOD RADIO AND TELEVISION SERVICE" and details on how to put this sales-builder to work for your service business!

*Trademark

TRADE FLASHES

A "press-time" digest of production, distribution & merchandising activities

Parts Show Registration Exceeds Expectation

The rush of distributor registrations for the 1950 Parts Distributors Conference & Show to be held here May 22 and 25, Stevens Hotel has exceeded even the fondest expectations of the Show's sponsoring associations, Kenneth C. Prince, Show Manager, said this week.

First mailing of application forms to distributors brought 532 registrants by return post representing 184 distributing companies—over 60% of the

public a better insight into the intricacies of the sight and sound medium.

The Telecruiser, which contains more than \$100,000 in electronic equipment is the most advanced vehicle of its kind. Mounting a triple image orthicon camera chain, the Telecruiser virtually duplicates actual studio operating conditions in every respect and will give the public a first-hand view of the workings of television transmission and reception.

The complete schedule follows:

	TV	FM-AM and FM	AM Only	All Sets
January	121,238	147,733	561,900	830,871
February	118,938	98,969	498,631	716,538
March	182,361	71,216	607,570	861,147
April	166,536	37,563	468,906	673,005
May	163,262	28,388	449,128	640,778
June	160,736	40,512	471,342	672,590
July	79,531	23,843	318,104	421,478
August	185,706	64,179	559,076	808,961
September	224,532	70,936	461,532	757,000
October	304,773	83,013	587,267	975,053
November	414,223	122,603	787,533	1,324,359
December	292,061	86,550	620,382	998,993
TOTAL	2,413,897	875,505	6,391,371	9,680,773

Table illustrating 1949 production of all types of receivers. Postwar TV set production is estimated at near 4,000,000.

entire advance registration for the four months preceding the 1949 Show. "Such enthusiastic response indicates that distributor attendance, both for companies and individuals, will far exceed the 1949 total," he said. He added that under this year's registration system each person applying for admission must submit a list of lines carried to insure that distributors badges will go only to persons affiliated with companies which buy from exhibitors at distributor's prices.

DuMont Telecruiser Tours

East & South

Allen B. Du Mont Laboratories, Inc. announced that the Telecruiser, a completely mobile television studio, has embarked on a twenty-two city tour of the east and south in a series of special demonstrations to give the

February; 16-20—Baltimore; 21-25—Washington; 27—Richmond; 28—Norfolk; March 1—Norfolk; 2—Portsmouth; 3—Raleigh, N.C.; 4—Greensboro, N.C.; 6—Winston-Salem, N.C.; 7-8—Charlotte, N.C.; 9-13—Atlanta, Ga.; 14—Birmingham, Ala.; 15—Montgomery, Ala.; 16—Mobile, Ala.; 17-20—New Orleans, La.; 21—Baton Rouge; 22—Jackson, Miss.; 23—Memphis, Tenn.; 24—Nashville, Tenn.; 27—Huntington, W. Va.; 28—Charleston, W. Va. 29—Youngstown, Ohio; 30—Pittsburgh, Pa.

RCA High Voltage Probes

Two new high-voltage probes, designed for use with popular low-current voltmeters to provide safe, convenient, and accurate means for measuring high-voltages in high-impedance circuits such as those found in televi-

Sylvania's NEW

Tube Testers

are one jump ahead of tomorrow!



MODEL 220

Once again Sylvania has anticipated radio and television developments. Sylvania's new tube testers, both counter and portable models, are not only capable of testing every modern receiving tube . . . they are calibrated to Sylvania's latest tube production standards.

Experts in tube-testing have built this new instrument . . . but you don't have to be an expert to operate it. Counter clerks, uninitiated in radio technicalities, can use it after a few minutes'

instruction. For the benefit of the customer, the illuminated meter reads "GOOD" or "REPLACE" for all tubes, including diodes. Gas tests can be made easily. It is the first tester with both circular and linear subminiature sockets. The new fast, smooth-running roll-chart is easily removable from the front panel.

Modern styling of both models tells even the layman that your up-to-the-minute service is one jump ahead of tomorrow!

MODEL 219



A few more facts on what's NEW

In Tube Testers 219 (Counter) and 220 (Portable)

- Novel voltage controls prevent tube damage
- Switch-numbers correspond to tube pin-numbers
- Switching arranged for easiest operation
- Exclusive ohmmeter-type indicator for shorts and leakage
- Shorted tube reads "REPLACE"—no neon lamp
- Double-size power transformer

NOTE ON "KNOW-HOW"

A comprehensive explanation of tube characteristics and tube tester applications comes free in each Operating Manual.

SYLVANIA ELECTRIC

RADIO TUBES; CATHODE RAY TUBES; ELECTRONIC DEVICES; FLUORESCENT LAMPS, FIXTURES, SIGN TUBING. WIRING DEVICES; LIGHT BULBS; PHOTOLAMPS

RADIO SERVICE DEALER • MARCH, 1950

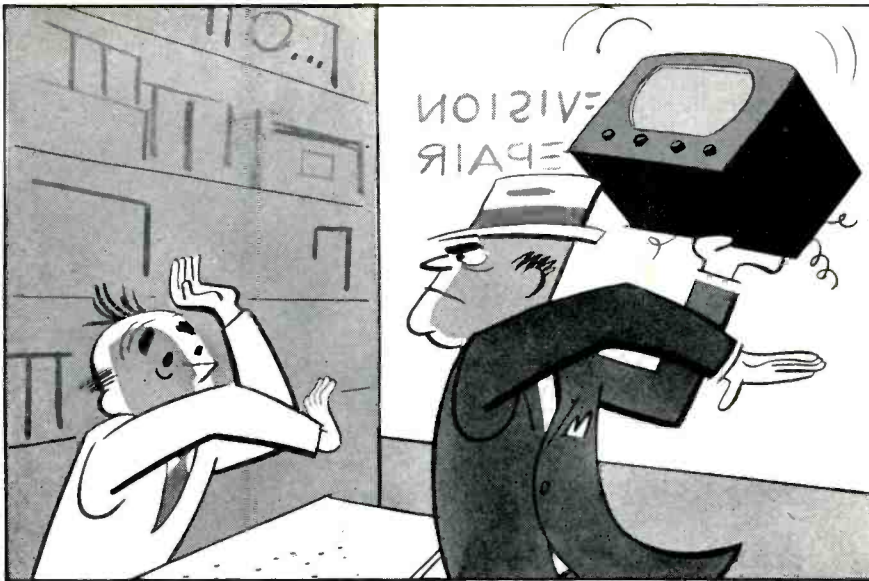

Quality Parts...



for jobs that **WON'T BOUNCE BACK!**

A TV customer can get mighty angry when your repair job doesn't hold up. The trouble might be a defective part—not your fault at all—but you can't explain that to *him*. He pays good money to have his set put into shape.

As far as he is concerned, if it breaks down again *you* are to blame.

A satisfied customer is your most valuable business asset. Don't take a chance on losing it by using second-grade, "just-as-good" replacement parts. Use OHMITE parts—known the world over as the standard for dependability—and be *sure!* Take a tip from thousands of radio servicemen and electronic engineers, who have found *through experience* that OHMITE can be depended upon for years of trouble-free service.

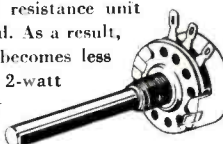

 <p>Little Devil COMPOSITION RESISTORS</p> <p>Tiny, rugged. Resistance and wattage clearly marked on every one. 1/2, 1, and 2-watt—all RMA values. Tolerance ± 5 and $\pm 10\%$.</p>	 <p>BROWN DEVIL WIRE-WOUND RESISTORS</p> <p>Vitreous-enameled. Provide utmost dependability in small size. Mount by 1 1/2" timed wire leads. Three sizes: 5, 10, and 20-watts. Tolerance $\pm 10\%$.</p>
 <p>DIVIDOHM ADJUSTABLE RESISTORS</p> <p>Vitreous-enameled, wire-wound. Odd resistance values quickly obtained. Ideal for voltage dividers. Stock wattages: 10, 25, 50, 75, 100, 160, and 200—many resistance values.</p>	 <p>TYPE AB POTENTIOMETER</p> <p>It's quiet! Has a resistance unit that's solid-molded. As a result, noise level often becomes less with use. Has a 2-watt rating, good safety factor.</p>

OHMITE MANUFACTURING CO.

4846 Flournoy St., Chicago 44, Illinois

Be Right with

WRITE FOR CATALOG 21
Lists rheostats, resistors,
chokes, etc.

OHMITE®

RHEOSTATS • RESISTORS • TAP SWITCHES

sion receivers and broadcast transmitters, have been announced by the RCA Tube Department.

The new probes, RCA Types WG-289 and WG-290, are identical except for their connectors. The WG-289, designed for use with electronic voltmeters such as the VoltOhmyst meter, has a microphone-type connector. The WG-290, for use with non-electronic voltmeters, has phone-type connectors. To adapt the probes to various popularly used makes of voltmeters, five types of multiplier resistors are separately available.

Industry Mourns Rob't. D. Hickok

The electrical industries lost a scientist with the passing of Robert D. Hickok, 70. President and founder of The Hickok Electrical Instrument Company. An active RMA member and Fellow of The American Institute of Electrical Engineers, he was regarded highly as a pillar of long standing in the electrical field.



Mr. Hickok started his career as a watchmaker in Greenville, Michigan. He moved to Atlanta, Georgia, and founded The Hickok Electrical Instrument Company in 1910. In 1913, he moved his company to Cleveland, Ohio, where the two main Hickok plants are now operating.

R. D. Hickok, Jr., and Walter Weiss are filling the vacancy due to the recent death of Mr. Hickok, Sr.

GE Tube Campaign

Further indications that the Tube Divisions of the General Electric Company intend to offer an even closer business-building support for radio and television service dealers during 1950, were revealed by John T. Thompson, receiving tube replacement sales manager. According to Thompson, a campaign especially designed for local use and based on the theme "Profits

Because

**Contact is Gentle
Yet Firm . . .**



Mallory Vibrators Give Better Service!

Slow contact impact, for minimum wear—high contact pressure, for low resistance—fast contact break, for reduced arcing and pitting! That combination of features is possible only with the patented, tuned mechanism in Mallory Vibrators. It is the secret of their longer life and greater dependability.

Mallory Vibrators are a result of Mallory's unique facilities in electronics, electro-chemistry and metallurgy. The contacts are Mallory-specified and Mallory-made. The perfect tuning is accomplished by an exclusive design and individual adjustment by skilled technicians.

Those are the reasons why more Mallory Vibrators are used in original equipment than all other makes combined. When you use Mallory Vibrators for replacements you are sure of long life, dependable starting and high output efficiency. See your Mallory distributor now!

More Mallory Vibrators are Used in Original Equipment Than All Other Makes Combined



P. R. MALLORY & CO. Inc.
MALLORY

CAPACITORS • CONTROLS • VIBRATORS • SWITCHES • RESISTORS
• RECTIFIERS • VIBRAPACK* POWER SUPPLIES • FILTERS

*Reg. U. S. Pat. Off.

APPROVED PRECISION PRODUCTS

P. R. MALLORY & CO., Inc., INDIANAPOLIS 6, INDIANA

RADIO SERVICE DEALER • MARCH, 1950

BACK NUMBERS of "RSD"

Order them now - the supply is low.

JULY 1946

Distortion—Determining the Cause, Part I
Ohmmeters, Cond-Testers, Cap.-Met. Part 2
Multivibrators

SEPTEMBER 1946

Transconductance-Reading Tube Tests
How Is Your Grid Biased, Part 2
Centralized Radio Servicing

NOVEMBER 1946

The TV Opportunity—Installing & Servicing
Don't Miss "Hidden" Profits, Part I
Service Market in Industrial Electronics

DECEMBER 1946

Modernizing Sets by Using New Rectifiers
Deflection Generators in TV
Guide for Miniature Electron Tubes
Answers to FM Servicing Problems

MAY 1947

Oscillator & Power Supply Troubles
Ion-Trap in C-R Tubes
P-A System Design & Applications, Part I

JULY 1947

Frequency Modulation, Part I, antenna fundamentals & signal shifting effects
Automatic Gain Control Circs. in TV Sets
Using Conventional Sig. Gen. for FM Align.

OCTOBER 1947

Add Record-players to Modernize Old Sets
P-A Fundamentals & Complexities
Modern TV Kits

FEBRUARY 1948

High Speed Servicing
Visual Alignment
Income Tax Deductions

MAY 1948

FM Set Alignment Procedure
Video Detectors
How Vectors Simplify Servicing
Significance of Power Factor and Q

JULY 1948

Television's Service Outlook
Video Amplifiers
Bad Acoustics Cured Electrically

SEPTEMBER 1948

De-emphasis in FM Set Circuits
Video Amplifiers, D-C Restorers
Simple Wattmeter

OCTOBER 1948

Projection TV
Distributed Capacitance
TV Picture Tubes
High Voltage Test Probes

NOVEMBER 1948

Sweep Generators
TV Picture Tubes
155 Loudspeakers, Voltage-Fed
Making Good TV Installations
FM-TV Antenna Mast Support

DECEMBER 1948

Checking Video & Synch Waveforms by CRO.
Magnetic Recording
Projection Television, Part 2

FEBRUARY 1949

Test Equip. Symposium Issue:
CROs - VTVMs - Sq. Wave Generators -
Markers - Multimeters - Kilovolts -
High Voltage Probes, etc.

JUNE 1949

Direct View Enlarging Lens
Modern Tape Recorders, Part 2
Custom Building High Fidelity Circuits,
Part 2

JULY 1949

Picture Tube High Voltage Systems
High Quality Tuner Analysis
Amateur TV Interference

SEPTEMBER 1949

Legality of TV "Policies" Clarified
A Klystron TV Sweep Generator
High Quality Analysis Series, Part I
"Aspen" — Philco's Built-In TV Antenna

OCTOBER 1949

P.A. Techniques For The Coming Elections
The Kay Megaliner
TV Quiz No. 5
Servicing Photo-Electric Equipment, Part I
Sixteen Inch TV Conversion Kit

NOVEMBER 1949

The 'Scope as a Modern Service Tool,
Part I
A Wide-Range Impedance Bridge
Tone Controls
A New Aid to Rapid Servicing
High Quality Analysis Series, Part 2
Ladders — Their Use & Care

DECEMBER 1949

Servicing Sound I-F Stages in TV & FM Sets
Modern Electronic VOM
Servicing Photo-Electric Equipment, Part 2
TV Truck Solves Installation Problems



John T. Thompson, at left, and John T. Robinson of G. E., looking over promotional material in Four-Way Plan Kit.

Plus for 1950", has been created for the exclusive use of service dealers everywhere. It is available through G.E. and Ken Rad tube distributors.

"Repeated customer-contacts offer the sure, the known way, to increase service business," Thompson said, "and our new Four-Way Plan does just that. It gives the service dealer an easy way to increase his customer contacts—to make 1950 his year for profits plus."

Philco TV Components Handbook

The Television Components Handbook" has been announced by Philco Corporation. This is a companion volume to the "Radio Components Handbook" previously published. Both books may be obtained through Philco Distributors or direct from Philco Corporation, Accessory Division, Philadelphia.

The Television Components Handbook covers the application of component parts in television receivers together with general component and television data. Cloth bound 160 pages 6 x 9 inches with index. \$2.50 postpaid.

Astatic Merchandises Booster Via TV

Plans of The Astatic Corporation, Conneaut, Ohio, to use television on a national scale for advertising its TV booster were revealed with announcement that the first one-minute commercial appeared over WNBK, Cleveland, Monday, February 13.

Six one-minute motion picture films, with sound and using live talent, have been produced to show the Astatic Television Booster in use and point up its exclusive features, according to William J. Doyle, Astatic general sales manager. The films will be alter-

[Continued on page 29]

RADIO SERVICE DEALER MAGAZINE
342 MADISON AVE., NEW YORK 17, N. Y.

Please send me the back numbers checked here . . .

The price is 35c. for each copy unless 10 or more are ordered. If 10 or more are ordered the price is 25c. each copy.

<input type="checkbox"/> July 1946	<input type="checkbox"/> July 1947	<input type="checkbox"/> Sept. 1948	<input type="checkbox"/> June 1949
<input type="checkbox"/> Sept. 1946	<input type="checkbox"/> Oct. 1947	<input type="checkbox"/> Oct. 1948	<input type="checkbox"/> July 1949
<input type="checkbox"/> Nov. 1946	<input type="checkbox"/> Feb. 1948	<input type="checkbox"/> Nov. 1948	<input type="checkbox"/> Sept. 1949
<input type="checkbox"/> Dec. 1946	<input type="checkbox"/> May 1948	<input type="checkbox"/> Dec. 1948	<input type="checkbox"/> Oct. 1949
<input type="checkbox"/> May 1947	<input type="checkbox"/> July 1948	<input type="checkbox"/> Feb. 1949	<input type="checkbox"/> Nov. 1949
			<input type="checkbox"/> Dec. 1949

I remit herewith \$..... for thecopies ordered atc. each.

NAME

ADDRESS

CITY

ZONE

STATE



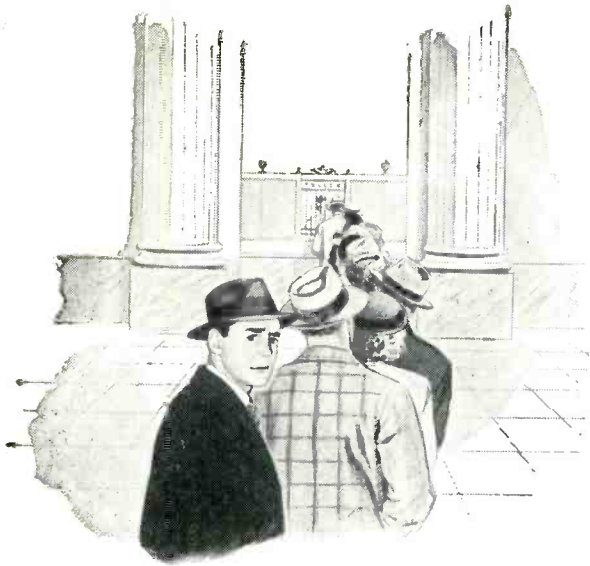

THIS IS HARD



BUT THIS IS EASY



**AND THIS IS
MIGHTY WONDERFUL**

SURE, you believe in saving.

But it's mighty hard to make yourself take cash out of your pocket, and time out of your day, to do it regularly.

The sure way, the *easy* way to do your saving is to get started on an *automatic* savings plan with U. S. Savings Bonds. Like this . . .

1. If you're on a payroll, sign up in the Payroll Savings Plan, then forget it. From then on the money saves itself—so much per week, or so much per month.

2. If you're not on a payroll, sign up at your bank for the Bond-A-Month Plan. Equally easy. You decide how much you want to put into bonds every month, your bank does the rest.

In just ten years after you start buying bonds, your money starts coming back to you—well-fattened! Every \$3 you invest today brings you back \$4 to make possible all the wonderful things you dream of doing.

And remember—any time you need your money for emergencies, you can get it back in minutes, without losing interest.

Automatic saving is sure saving—U.S. Savings Bonds

Contributed by this magazine in co-operation with the Magazine Publishers of America as a public service.



I TOLD YOU SO

by San D'Arcy

History Repeats! Just twenty-one years ago the newspaper headlines blared "Radio Leads Stock Market To New Highs!" And that's what we read in the current dailies, only now the word Video is used instead of Radio. Those who remember the boom days of 1929 recall that then the radio industry surged ahead because of the introduction of the first A. C. operated receivers. Now that video has had practically all of the "bugs" removed, and has won unquestioned public acceptance, the only factor holding the industry back is FCC's reluctance to give the Telecasters the "green light".

Unionization. No one knows the exact figure but it is a fair estimate that between eight and ten thousand technicians are now employed by various television specialty service companies throughout the country. Recently, in the Metropolitan New York area, several AFL organizers have been hard at work with the result that approximately 1,900 TV service and installation men have already become affiliated with some local of the AFL. Further, the New York organizers expect to have upward of 10,000 members in time. Does that give you any idea as to how many men are ultimately expected to be engaged in TV servicing in Gotham alone? So far the unions claim to have gotten some benefits for their members, such as shorter hours and higher wages. Prevailing union-member scales are from \$35 for a 48 hour week to \$65 and more for a 40 hour week depending upon the worker's job classification. (Editor's aside, non-union men and independents are earning much more).

Pay-To-See-TV. Zenith has for a long time advocated a method of telecasting via telephone service which because of a secret scrambling device would preclude reception of the non-commercial programs to non-subscribers for the service. FCC has granted the Chicago manufacturer a 90-day period in which to test their theories, but the industry as a whole is betting heavy odds that nothing will ever come of the experiment because the American public is quite satisfied with free programs, although they include far too high a ratio of paid commercials, many of which are truly innocuous.

Co-op Radiators. The area coverage achieved by a TV transmitter is in great part determined by the height and location of the antenna, or radiator. Radiators spaced widely apart in a congested metropolitan area are the most troublesome problem confronting installing technicians because they consume so much time wasted in orientation of antennas. Now that WABD (Chan. 5), WJZ-TV (Chan. 7) and WNBT (Chan. 4) have arranged so that all three will use the 1,200 foot high Empire State Building as their transmitting point, everyone, meaning the TV set owner, the installer and the telecaster will benefit. In time it is quite likely that every major city having 3 or more TV transmitters will enjoy the facilities of a mutually supported TV radiator, and it is rumored that some of these towers will go as high as a half-mile skyward, which will increase the effective range tremendously.

"You can't get any more out of a TV set than you put into it. And that means signal strength supplied by the antenna. That's why we always recommend the antenna accepted as standard by the whole TV industry — the Amphenol INLINE* Antenna."

* U. S. PATENT NO. 2,474,480

The booklet he is showing gives the whole TV story. Write for your copy — a postcard will do it.

AMERICAN PHENOLIC CORPORATION
1330 SO. 54TH AVENUE • CHICAGO 58, ILLINOIS

AMPHENOL

RADIO SERVICE DEALER • MARCH, 1950

AFC

for

LOCAL OSCILLATORS

by **ALLAN LYTEL**

PART 1

Frequency shift in oscillators may produce serious effects in h-f receivers, particularly in TV. In this article the author explains in great detail how a.f.c. is developed, and how it overcomes the effects of frequency drift in oscillators.

LOW frequency local oscillators such as those used in broadcast receivers have little if any difficulty in maintaining their correct operating frequency. The drift problem is negligible when the oscillator frequency is comparatively low. If the oscillator drifts 0.1%, the seriousness of this shift depends upon the operating frequency. There are various reasons why a self-excited oscillator will not maintain its exact frequency under all operating conditions. A change in the line voltage, a slight change in the value of parts, the aging of the tube itself, or the heating of the tube and its associated circuit elements, all tend to change the oscillator frequency.

Effect of Oscillator Drift

Let us suppose that there are a number of individual oscillators operating at different frequencies and that they each have a frequency drift of 0.1% in a certain specified period of time. In the AM broadcast band as well as in the FM broadcast band, this frequency change will be dependent upon the characteristic width of the broadcast band itself. The detrimental effect of a frequency drift will increase as the oscillator frequency increases. In AM and FM radio, oscillator drift will cause the receiver to go out of tune, that is, the receiver will be detuned as its local oscillator frequency drifts. In the cases of a small frequency change, the station will be slightly detuned. A very large frequency excursion could mean the complete loss of reception from a particular station. The actual circuit design problems of oscillator drifting are such as to be kept under control by careful circuit components and design.

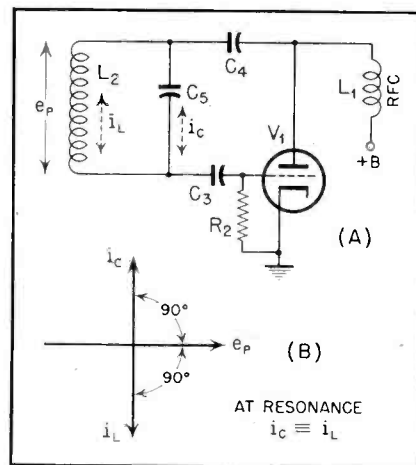

Fig. 1. Oscillator Circuit

Very high frequency radio and television are dependent upon a stable oscillator in order to produce a good quality picture and high fidelity sound. In television, for example, a drift of the local oscillator in the receiver, can and does cause a loss in picture quality or sound quality. In extreme cases, either the picture or sound, and sometimes both are completely lost. The effective drift is more pronounced in the case of television since it is a visible rather than an audible indication, of detuning. At the same time, an oscillator has a greater drift (expressed in cycles per second) at a high frequency than it does at a low frequency. The following example will show this. We will assume the oscillator drift or frequency change to be 0.1% of the operating frequency. In the following table, the frequency change is indicated. Notice that at 1000 kc it is only 1 kc. An AM radio

operating at this frequency would have a slight but not serious detuning, since the band width in general for this type of broadcast is 10 KC.

Operating Frequency	Frequency Change
1,000 KC	1 KC
10,000 KC	10 KC
100,000 KC	100 KC
1,000 MC	1 MC
10,000 MC	10 MC

An FM receiver would have a frequency excursion of 100 KC if the operating frequency were to be taken as 100,000 KC as shown in the table. This frequency change is one-half of the total band width for frequency modulation. The total FM band, including the guard bands, is plus or minus 100 KC or 200 KC. Thus this frequency change would be sufficient to seriously affect the operation of the receiver. FM receivers on the market have local oscillators the frequency drifts of which are always less than the amount used in our illustration. Increasing the operating frequency of a local oscillator to 1000 MC causes a drift of 1 MC, which is a change in frequency for the oscillator greater than the original operating frequency. In the upper limit of the table, the local oscillator operating frequency is 10,000 MC and an excursion of 10 MC would be obtained with this percentage of drift. It will be seen from these examples, that assuming a certain percentage of oscillator change due to

any one of the circuit variations, the high frequency oscillators are much more critical than low frequency circuits in relation to drift or frequency change.

Reactance Tubes

Automatic frequency control of local oscillators is usually accomplished by means of a reactance tube. This circuit provides a current output which is either inductive (current lagging voltage) or capacitive (current leading voltage). This reactive current is added to the current flow through the tank circuit of the local oscillator. There are many possible arrangements for reactance tubes but all of them work to create a reactive current flow; the exact nature of this current flow depends on the voltage and current relations of the tube output. The reactive current flows through the oscillator tank circuit and changes the oscillator frequency. If a capacitive current is added to the oscillator tank circuit, the oscillator must decrease in frequency. If an inductive current is introduced into the oscillator tank circuit, the oscillator must increase in frequency in order to keep the tank circuit at resonance.

A control voltage is used to change the bias on the reactance tube grid. This changes the amount of reactive current flowing in the reactance tube plate circuit. The nature of the circuit design determines the type of reactive current flowing, that is, whether it is capacitive or inductive. (Therefore, the control voltage may be used to change the oscillator operating frequency. This control is usually obtained from a discriminator output, the latter changing with the intermediate frequency of the signal. Thus, if the i.f. changes, because of oscillator drift, the discriminator output voltage which controls the reactance tube causes a reactive current flow from the reactance tube. This current flow introduced into the oscillator tank circuit, changes the oscillator frequency and brings it back to the point of normal operation. At this point, the intermediate frequency is now correct and the output for the discriminator decreases. A frequency sensitive circuit is used to control the reactance tube and the reactance tube changes the oscillator frequency. In this manner, automatic frequency control is accomplished.

An oscillator circuit as in Fig. 1 has a capacitive current and an inductive current in its tank circuit, which are exactly 180 degrees out of phase with each other. As shown in the phasor diagram, the r-f plate voltage is taken as 0 phase; this is e_p in the figure. Current flowing through the

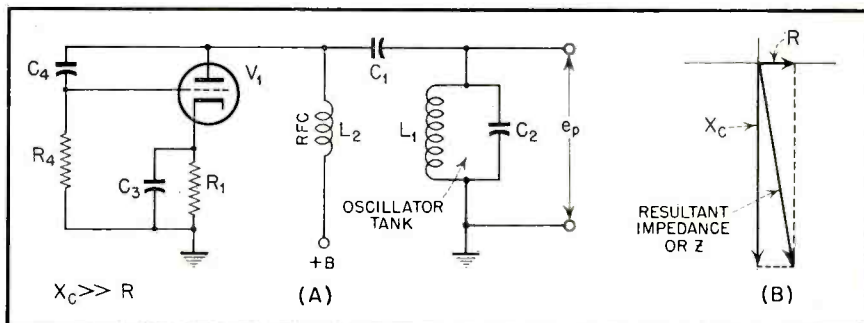

Fig. 2. Reactance tube oscillator control. V_1 produces a capacitive current through oscillator tank.

inductance L_2 is 90 degrees lagging the voltage across the tank circuit. Capacitive current flow i_c is 90 degrees leading the tank circuit voltage. The oscillator in Fig. 1A is shunt fed and L_1 is a radio frequency choke in series with the B+ lead. C_4 and C_3 isolate the applied d-c voltage from the grid and the plate. Grid bias for this oscillator is obtained from the grid leak R_2 and the capacitor C_3 .

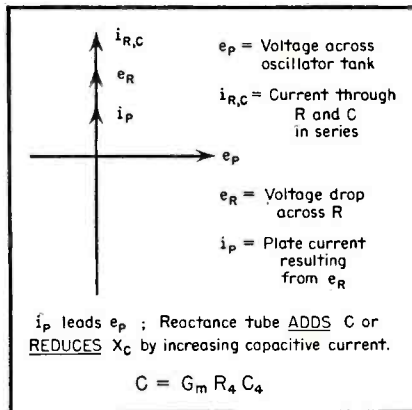

Fig. 3. Phasor analysis of series phase shifting circuit across oscillator tank circuit.

These two individual currents flowing in the oscillator tank are important to a functional understanding to reactance tubes since these currents will add to or subtract from these resonant currents. Adding an inductive current flow to the resonant circuit will force the oscillator to increase its frequency. This will reduce the capacitive reactance and increase the inductive reactance. A balance will then be maintained between the inductive current flow and the capacitive current flow; this balance being a necessary feature for and indeed a definition of resonance. Introducing an additional capacitive current will cause the oscillator to decrease its operating frequency which decreases the inductive reactance and increases the capacitive reactance thus again bringing the circuit to a condition of resonant balance.

One of the commonly used types of reactance tubes is shown in Fig. 2 where the voltage e_p is across L_1 and C_2 representing the oscillator tank circuit. The phasor relations illustrating the operation of this reactance tube are illustrated in Fig. 3. Oscillator tank voltage, e_p is impressed across the series combination of capacitor C_4 and resistor R_4 through the coupling capacitor C_1 . This series combination of capacitance and resistance is used to perform the phase shifting function. In this circuit, the capacitor reactance is much greater than the resistance. Applying these relations to a phasor diagram, part B of Fig. 2, shows the addition of a small resistance and a large capacitive reactance. This resultant impedance is predominantly capacitive reactance.

Let the applied voltage across the series phase shifting circuit which is e_p be represented by zero phase in Fig. 3, current flow through the series network must be 90 degrees out of phase with the applied voltage. In any series circuit which is predominantly capacitive (where the capacitive reactance is much greater than the resistance) the current flow will lead the applied voltage. Current flow through this series phase shifting network is i_c and must be 90 degrees leading in relation to e_p the applied voltage. However, only the drop across the grid leak R_4 is applied as a signal to the reactance tube. In any purely resistive circuit, the current and voltage are in phase hence the voltage drop across the grid resistor e_R is in phase with the current causing this voltage drop. The grid voltage is then 90 degrees ahead of the voltage applied to this phase shifter series circuit.

In a vacuum tube amplifier, the plate voltage and grid voltage are 180 degrees out of phase but the grid voltage and plate current are exactly in phase. This means the current flow in the reactance tube plate circuit is in phase with the grid signal voltage. Since the grid signal is 90 degrees leading e_p , the reactance tube plate current i_p is 90 degrees leading

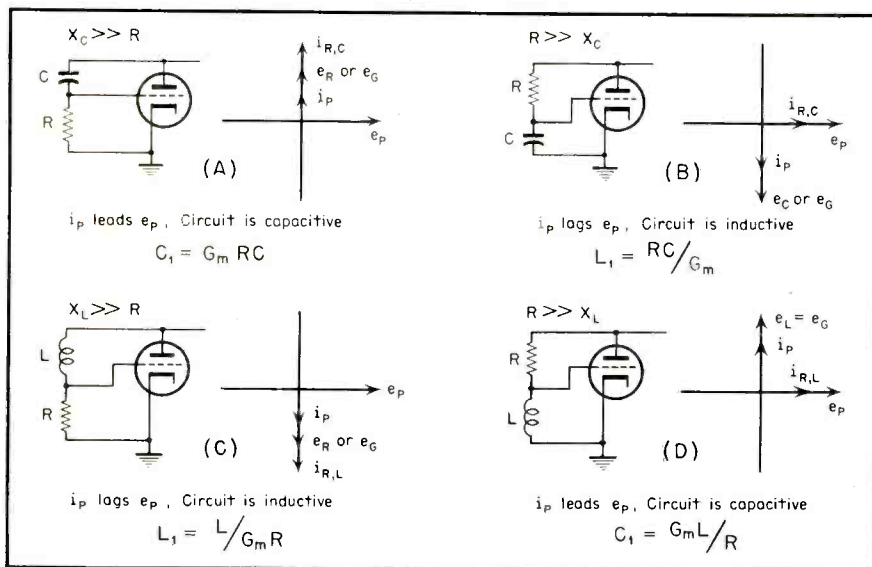

Fig. 4. Various reactance tube phase conditions.

e_p also. Thus the plate current of the reactance tube leads the voltage across the oscillator tank circuit. Radio frequency choke L_2 prevents the oscillator signal current which is also radio frequency from flowing through this plate supply lead. Reactance tube plate current thus passes through the capacitor C_1 through the oscillator tank to ground. In this particular case, we have a capacitive plate current (current leading voltage) which adds to the capacitive current in the oscillator tank and also subtracts from the inductive current flow. The reactance tube capacitive current effectively adds capacity to the oscillator tuned circuit. Increasing capacity would decrease capacitive reactance and increase the capacitive current. Since we have increased capacitive current we have effectively decreased the capacitive reactance and increased the capacity.

Mutual conductance in a vacuum tube is a measure of plate current change divided by grid voltage change. The mutual conductance is an important factor in the operation of the reactance tube circuit; a change in reactance tube bias will change the mutual conductance of the tube. A measure of the total added capacitance created by and caused by the reactance tube may be obtained from the formula

$$C = g_m R_4 C_4$$

where g_m is the mutual conductance of the reactance tube and R_4 and C_4 are the parts of the phase-splitting circuit. This formula applies only where the capacitive reactance is much greater than the series resistance and where the series resistance is used as the grid resistor.

Thus far, we have used a series combination of resistance and capacitance

to produce a capacitive output current from the reactance tube. In Fig. 4, three other possibilities are illustrated; part A of this figure being a summation of the circuit discussed above. Part B has the series resistance leg much greater than the capacitive reactance. The resistance should be at least 10 times the capacitive reactance. With the symbols having the same significance as before, the applied voltage coming from the oscillator tank circuit is e_p and has a zero reference phase. Since the phase shifting circuit now is predominantly resistive, the current flow through the circuit will be in phase with the voltage drop across it, hence $i_{R,C}$ is in phase with e_p . In this circuit, however, the capacitor voltage drop is now used as signal voltage for the tube. Voltage drop across a capacitor is 90 degrees out of phase with the current flow. The

current flow leads the voltage in a capacitive circuit, thus the voltage across this capacitor e_c is 90 degrees behind the series current.

Since the voltage across the capacitor is also the grid signal, it may have the symbol e_g . In this manner, the grid voltage is 90 degrees behind the applied voltage coming from the oscillator. Again the plate current i_p is in phase with the grid voltage e_g and this makes the reactance tube plate current 90 degrees behind the applied voltage, which originally came from the oscillator tank circuit. We now have a condition where i_p lags e_p . This defines an inductance, hence the reactance tube current is now inductive. The total added inductance produced by this reactance tube may be obtained from the formula:

$$L_1 = \frac{RC}{g_m}$$

A phase-splitting network may be obtained by using a resistor in series with an inductance as shown in parts C and D of Fig. 4. In part C the inductive reactance is much greater than the series resistance. The current through this phase shifting network is 90 degrees behind or lagging the applied voltage e_p . In any inductive circuit, the voltage leads the current or the current lags the voltage. Since a pure resistance is used to develop the grid signal, the grid voltage e_g or e_c is in phase with the series current. Again the reactance tube plate current will be in phase with the grid voltage signal and an inductive current output is produced. The value of this inductance L_1 which the reactance tube adds to the oscillator tank circuit is given by

$$L_1 = \frac{L}{g_m R}$$

[Continued on page 34]

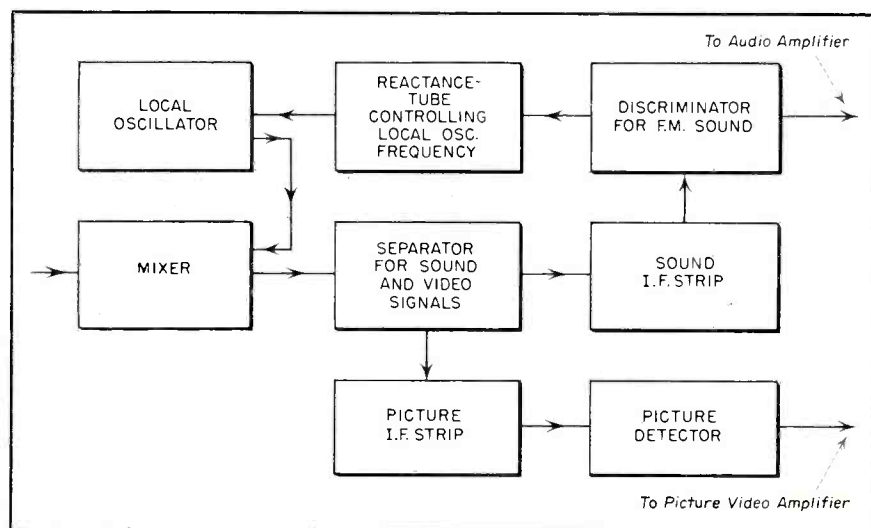

Fig. 5. Block diagram of the general a-f-c system used to prevent drift of a local oscillator circuit.

IMPROVING FOCUS

in

TV RECEIVERS

by **MATTHEW MANDL**

Technical Institute, Temple University

A good clear picture in a television receiver depends on a number of things.

1. Proper RF—Mixer—Oscillator tracking.
2. Proper IF alignment.
3. Proper Video Amplifier design.
4. Correctly adusted focus coil.
5. Correctly adjusted focus control.
6. Ability of the picture tube electron beam to be focused into a pin-point on the face of the screen.
7. Component parts in the focus circuit being within prescribed tolerances.

Checking Focus Circuits

When all of the foregoing requirements are met, the resultant picture will be sharp and clear and both the horizontal and vertical wedge lines of a station pattern will converge clearly to the center hub. If the receiver requires alignment, or if the video amplifier does not pass frequencies up to 4 mc, it will be impossible to secure clear definition of the vertical wedge of a station pattern. If, on the other hand, it is impossible to get clear and sharp horizontal wedges, the trouble will be found to be either incorrect setting of focus coil and control, a bad component part in the focus circuit, or a picture tube in which the scanning beam is not perfectly round, but has an oval shape. In the latter case good focusing will be impossible to achieve without picture tube replacement. In most cases, however, the trouble will be found to be elsewhere, inasmuch as virtually all modern tubes have the inherent ability to give a sharp focus.

Final results should always be checked by viewing several stations, because the sharpness of the transmitted picture may vary considerably between programs sent over the coaxial cable and those originating in the local studio. Pronounced reflections

A discussion of focus control circuits of various types, and focus coil adjustments for best results. Possible sources of failure in these circuits are indicated, which include electrostatic as well as electromagnetic.

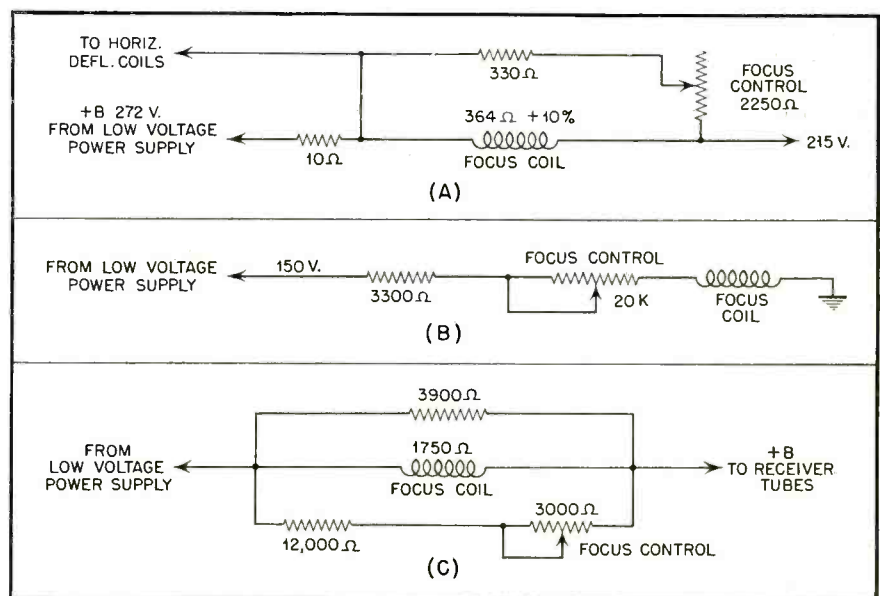

Fig. 2. Typical focus control circuits found in TV.

on the transmission line will also affect the sharpness of the picture, though this phenomena will not be the same for all stations, since frequency will alter the standing wave ratio. Stubs or tinfoil attached to the transmission line will help correct the standing wave condition for the offending frequency. The station patterns are not always uniform either, though the nonuniformity usually is encountered in positioning and linearity, and not in sharpness. *Figure 1* shows a typical station pattern in which the focus has been affected by an incorrect setting of the focus con-

rol. Note how the wedge lines become obscured as they converge toward the center.

When a television receiver has been in service for some time and suddenly develops poor focus, the likelihood of the cause being poor alignment or tracking is remote. R-F and i-f stages, once aligned, tend to remain close enough for excellent reception for several years because of the wide band-pass. A sudden change in clearness is more likely to be the result of a defective component in the focus circuit, or a defect in the focus coil assembly.

Figure 2 shows some typical focus



Fig. 1. Incorrect focusing.

control circuits, and any change in the specified values given by the manufacturer will invariably result in poorer focus. The focus circuits usually consist of a resistive network receiving power from the low voltage power supply. The intensity of the magnetic field set up around the focus coil by the current flowing through it influences the electron beam and sharpens it to proper focus.

Very few modern receivers have their focus controls mounted on the front of the cabinet. Most of them have the focus control mounted as a "pre-set" control. However, in many of the earlier models the focus control is brought to the front of the receiver; and in a few models front and rear controls are used.

Figure 2A shows the focus control circuit of the RCA 8T241 series of television receivers. It will be noted that the focus coil has a definite d-c resistance of 364 ohms, and this value should be within 10% plus or minus when read with an accurate ohmmeter. In checking the resistance of a focus coil, however, one end must be disconnected from the rest of the circuit so that the shunting resistors of the network will not give incorrect readings. The fact that the focus coil becomes warm during operation is not an indication of a defective unit, for most of them run slightly warm during normal operation.

An ohmmeter check should also be made on all the resistors associated with the focus circuit, including the focus control variable. Open controls and defective resistors are often encountered because of the relatively higher currents flowing through these units as compared with resistors and potentiometers carrying audio or r-f currents of relatively low amplitudes. Poor contact in the focus control can cause a streaky picture and poor focusing, and should be tightened or cleaned with carbon tetrachloride or contact cleaning fluid available at radio parts distributors.

Figure 2B shows the relatively simple focus circuit of the Zenith G2322 television receiver. The whole network

is a series circuit to ground and usually gives little trouble. Resistor values should again hold within 10 percent of rated values. The entire section also acts as a bleeder, but because there is less than 10 ma. of current flowing through the network, little trouble is encountered with burnouts. As carbon resistors age, however, the resistance values often increase, and any change in focusing ability will usually be traced to faulty components.

Figure 2C shows the type focus control circuit employed by Admiral in their 30A1 chassis incorporated in several models of their receivers. Here the focus network is in series with the low voltage power supply line, and the B voltage for amplifier and sweep tubes flows through it. As with other control circuits, the resistor values of the manufacturer are given and any change will result in improper focus-

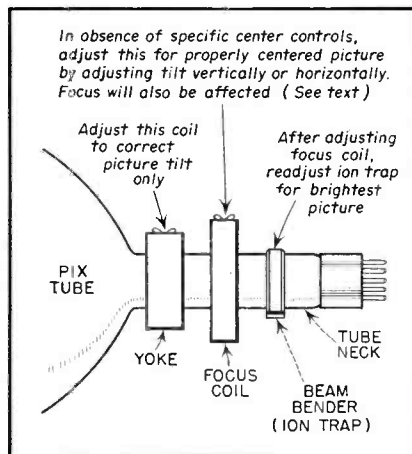

Fig. 3. Focus coil adjustment without centering controls.

ing. When values change gradually, the focus control may still be able to maintain focus, but it will be found that the focus control setting gets closer and closer to the limit of the variable resistor. Eventually the defect becomes so great that good focus can only be secured at the full setting of the focus control. Any additional increase or change in the resistive network will result in total inability of the focus control to re-focus, and in such cases where the change is gradual, final failure can be anticipated by checking the circuit when it becomes noticeable that the focus control is not at approximate center for best results.

The types of focus circuits to be found in other receivers do not differ materially from the ones shown, though values for the resistors, focus control and coil differ for the various manufacturers. It is for this reason that service notes must be consulted when taking ohmic readings—particularly in the case of the coils where the

d-c resistance may vary from a few hundred ohms to several thousand. With resistors the problem is more simple because the color code will indicate the values originally making up the network.

Focus Coil Adjustments

Poor focus can also be the result of an improperly adjusted focus coil, because there is an optimum setting of this inductance which will give the best line trace on the face of the tube. With receivers having horizontal and vertical position controls the problem of proper focus coil setting is simplified. In this case the focus coil is adjusted so that it is positioned at perfect right angles to the neck of the tube, then moved forward or back until the focus control can give sharp horizontal wedges. Another check is to watch the face of the tube at close range, and note the fine line trace of the horizontal sweep in forming the raster. Each line should be visible from one end of the tube to the other. Once the proper focus has been secured, the position controls are reset for proper picture positioning. The ion trap must also be adjusted again for the brightest position.

In the absence of positioning controls, the focus coil is the only method left for proper picture positioning. If proper focusing and also proper positioning is desired, the proper setting of the focus coil becomes a critical and somewhat painstaking procedure. The focus coil must be adjusted with relation to its vertical and horizontal angle with respect to the neck of the tube in order to position the picture within the mask of the receiver cabinet. When the proper position has been secured, focus must be checked, for this particular

[Continued on page 31]

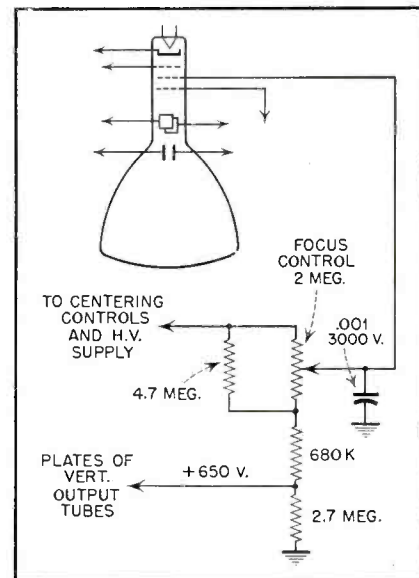

Fig. 4. Belmont focus network.

Radio Service Dealer

TV PICTURE TUBE CHART

COPYRIGHT 1950, COWAN PUBLISHING CORP.

	Dimensions (K)		Raster Size	Base	Socket Conn.	Anode Term.	Solid Defl. Angle	Type		Deflection Factor		Heater (L)		Foc. Coil Ma. (B)	Ion Trap	Ion Trap Ma. (E)	Grid Bias Cut-Off (D)	Grid No. 2 Volts	Anode No. 1 Volts	Anode No. 2 Volts
	Diam. In.	Length In.						Deflect	Focus	Hor.	Vert.	V	I							
3KP4	3 1/16	11 1/2	1 7/8 x 2 1/2	MED. SHELL MAGNAL 11 PIN	3KP4	NONE		E	E	76 TO 100 TO 104	100 TO 136	6.3	0.6				-64	2,000	450 (C)	2,000
3NP4 (A)	2 1/2	10	1.48 x 1.8	SPECIAL 5 PIN	SPEC. 3NP4	CUP	42°	M	M			6.3	0.6	(C)	METAL SCREEN		-65			24,000
TP400A	4	12 3/4	2 1/4 x 3	OCTAL	TP400A	CAV.		M	M			6.3	0.6		METAL SCREEN		-70			20,000
5BP4	5 1/4	16 3/4	3 x 4	LG. MAGNAL 11 PIN	11A	NONE		E	E	76	84	6.3	0.6				-40	450		2,000
5TP4 (P)	5	11 3/4	3 x 4	SM. SHELL DUODECAL 7 PIN	12C	REC. SM. CAV. CAP.	50°	M	E			6.3	0.6		METAL SCREEN		-70	4,900 (M)		27,000
7DP4	7 3/16	14 1/16	4 x 5 1/2	SM. SHELL DUODECAL 7 PIN	12C	CAV.	50°	M	E			6.3	0.6		DOUB. MAG.	70	-45	1,430		6,000
7EP4	7	14 1/2	4 x 5 1/2	MAGNAL 11 PIN	11D	NONE		E	E	95	110	6.3	0.6				-60	650		2,500
7CP4	7	14 1/2	4 x 5 1/2	MED. SHELL 12 DIMEPTAL PIN	14G	NONE		E	E	25 TO 34	31 TO 41	6.3	0.6				-60	1,000		3,000
7HP4	7 3/16	13	4 x 5 1/2	SM. SHELL DUODECAL 7 PIN	12D	BALL CAP	50°	M	M			6.3	0.6				-55	250		6,000
7JP4	7	14 1/2	4 x 5 1/2	DIMEPTAL 12 PIN	14G	NONE		E	E	150 TO 204	186 TO 246	6.3	0.6				-180 TO -120	1,620 TO 5,400		4,000 TO 6,000
8AP4 8AP4A (O)	8 1/2	14	5 1/4 x 7	SM. SHELL DUODECAL 7 PIN	12H	MET. CONE LIP	54°	M	M			6.3	0.6	115	DOUB. MAG.		-45			7,000
8BP4	8 1/2	16 1/2	5 1/4 x 7	MED. SHELL 12 DIMEPTAL PIN	14G	NONE		E	E	124 TO 168	146 TO 198	6.3	0.6				-120	1,600 TO 2,400 (Q)		6,000
9AP4	9	21	5 3/8 x 7 1/4	MED. 6 PIN	6AL 9-12AP4	MET. CAP.	40°	M	E			2.5	2.1				(J)	250	1,460	7,000
10BP4 10BP4A (O) (R)	10 1/2	17 5/8	6 x 8	SM. SHELL DUODECAL 7 PIN	12D	REC. SM. CAV. CAP.	50°	M	M			6.3	0.6	115	DOUB. MAG.	109	-45			9,000
10CP4	10 1/2	16 5/8	6 x 8	SM. SHELL DUODECAL 7 PIN	12D	SM. BALL CAP	52°	M	M			6.3	0.6				-55			8,000 TO 10,000
10EP4	10 1/2	17 5/8	6 x 8	SM. SHELL DUODECAL 7 PIN	12D	CAV.		M	M			6.3	0.6		MAG.		-45			8,000
10FP4 10FP4A (O) (R)	10 1/2	17 5/8	6 x 8	SM. SHELL DUODECAL 7 PIN	12C	REC. SM. CAV. CAP.	50°	M	M			6.3	0.6	115	METAL SCREEN		-45			9,000
10HP4	10	19 1/4	6 x 8	DIMEPTAL 12 MED. BASE PIN	14G	NONE		E	E	80 TO 100	104 TO 130	6.3	0.6				-100	900 TO 1,400 (S) 1,200 TO 1,800		4,000 TO 5,000
12AP4	12	25	7 3/8 x 9 3/4	MED. 6 PIN	6AL 9-12AP4	MET. CAP.	40°	M	E			2.5	2.1				-45		1,460	7,000
12CP4	12 1/16	18 5/8	7 3/4 x 10 1/4	6 PIN	4AF	MET. CAP.		M	M			2.5	2.1	115	MAG.	109	-45			9,000

Part No.	12	20 1/8	7 3/4 x 10 1/4	OCTAL	5AN	MET. CAP	55°	M	M	6.3	0.6	90	20	-45	250	7,000
12JP4	12	17 1/2	7 3/4 x 10 1/4	SM. SHELL DUODECAL 7 PIN	12D	REC. SM. CAV. CAP	50°	M	M	6.3	0.6	146		-45	250	10,000
12KP4	12	17 5/8	7 1/2 x 10	SM. SHELL DUODECAL 7 PIN	12D	REC. SM. CAV. CAP	54°	M	M	6.3	0.6	135		-45	250	9,000
12LP4	12	18 3/4	7 1/2 x 10	SM. SHELL DUODECAL 7 PIN	12D	REC. SM. CAV. CAP	54°	M	M	6.3	0.6	110		-45	250	11,000
12MP4	12	17 1/2	7 1/2 x 10	SM. SHELL DUODECAL 7 PIN	12D	REC. SM. BALL CAP	55°	M	M	6.3	0.6	135		-45	250	10,000
12NP4	12	17 1/2	7 1/2 x 10	SM. SHELL DUODECAL 7 PIN	12D	REC. SM. BALL CAP	56°	M	M	6.3	0.6	135		-45	250	10,000
12OP4	12	18 3/4	7 1/2 x 10	SM. SHELL DUODECAL 7 PIN	12D	REC. SM. CAV. CAP	54°	M	M	6.3	0.6	110		-45	200	11,000
12QP4	12	18 5/8	7 3/4 x 10 1/2	SM. SHELL DUODECAL 7 PIN	12D	METAL CONE LIP	54°	M	M	6.3	0.6	110		-45	250	11,000
12RP4	12	18	7 3/4 x 10 1/4	SM. SHELL DUODECAL 7 PIN	12H	ANGOE CAP	55°	M	M	6.3	0.6					11,000
K1003	12	23 1/2	7 3/4 x 10 1/4	12 CONTACT	K1003	METAL CAP		E	E	2.5	2.1	159		-100		5,000 (N)
15AP4	15	1/2	9 1/2 x 12 3/4	SM. SHELL DUODECAL 7 PIN	12D	SM. BALL CAP	52°	M	M	6.3	0.6	159		-45	250	12,000
15CP4	15	1/2	150 SQ. IN. AREA	SM. SHELL DUODECAL 7 PIN	12D	CAV. BUTTON	500	M	M	6.3	0.6	115 +15		-45	250	9,000 TO 15,000
15DP4	15	1/2	9 1/2 x 13 3/4	SM. SHELL DUODECAL 7 PIN	12D	REC. SM. CAV.	57°	M	M	6.3	0.6	146		-45	250	13,000
16AP4	15	7/8	10 x 13 1/4	SM. SHELL DUODECAL 7 PIN	12D	MET. CONE RIM	53°	M	M	6.3	0.6	105		-60	300	12,000
16BP4	16	1/8	10 1/4 x 13 1/2	SM. SHELL DUODECAL 7 PIN	12D	REC. SM. CAV.	62°	M	M	6.3	0.6	146		-45	250	13,000
16CP4	15	7/8	11 1/4 x 15 3/4	SM. SHELL DUODECAL 7 PIN	12D	REC. SM. CAV. CAP	52°	M	M	6.3	0.6	110		-45	250	12,000
16DP4	15	7/8	10 x 13 1/4	SM. SHELL DUODECAL 7 PIN	12D	REC. SM. CAV.	60°	M	M	6.3	0.6	110		-45	250	15,000
16EP4	15	7/8	10 x 13 1/4	SM. SHELL DUODECAL 7 PIN	12D	METAL CONE LIP	60°	M	M	6.3	0.6	105		-55	300	12,000
16FP4	16	1/8	10 1/4 x 13 1/2	SM. SHELL DUODECAL 7 PIN	12D	REC. SM. BALL CAP	62°	M	M	6.3	0.6	146		-45	250	13,000
16GP4	16	17 11/16	10 x 13	SM. SHELL DUODECAL 5 PIN	12D	METAL CONE LIP	70°	M	M	6.3	0.6	100		-55	300	12,000
16HP4	15	7/8	10 x 13 1/4	SM. SHELL DUODECAL 5 PIN	12D	REC. SM. CAV. CAP	60°	M	M	6.3	0.6	110		-55	300	12,000
16LP4	15	7/8	10 x 13 1/4	SM. SHELL DUODECAL 5 PIN	12D	REC. SM. CAV. CAP	52°	M	M	6.3	0.6	110		-55	300	12,000
16MP4	16	1/8	10 x 13 1/4	SM. SHELL DUODECAL 5 PIN	12D	REC. SM. CAV. CAP	60°	M	M	6.3	0.6	110		-55	300	12,000
16RP4	14 3/8 11 3/8	18 3/4	10 1/8 x 13 1/2	SM. SHELL DUODECAL 7 PIN	12D	REC. SM. CAV. CAP	60-70° PH-650	M	M	6.3	0.6	100		-45	300	12,000
16SP4	15	7/8	10 x 13 1/4	SM. SHELL DUODECAL 5 PIN	12D	REC. SM. CAV. CAP	70°	M	M	6.3	0.6	110		-55	300	12,000
19AP4	18	5/8	11 1/4 x 15 3/4	SM. SHELL DUODECAL 5 PIN	12D	METAL CONE LIP	66°	M	M	6.3	0.6	146		-45	250	13,000
19DP4	18	7/8	11 1/4 x 15 3/4	SM. SHELL DUODECAL 5 PIN	12D	REC. SM. CAV. CAP	66°	M	M	6.3	0.6	146		-45	250	13,000
20BP4	28	3/4	12 7/8 x 17 1/4	SM. SHELL DUODECAL 7 PIN	12D	METAL CAP	50°	M	M	6.3	0.6	135		-45	250	15,000

CIRCUIT COURT

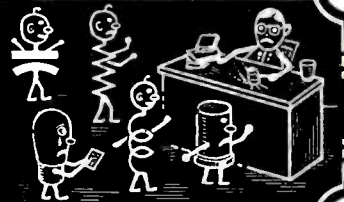

Admiral Model 19A1

This eighteen tube, seven inch direct view TV receiver uses a 7JP4 viewing tube. Electrostatic deflection tubes of this type require deflection voltages of considerable amplitude and the opposite plates must be 180 degrees out of phase. The partial schematic shown illustrates the method of obtaining the potential for the horizontal plates.

A single triode tube, in this case half of a 6SN7GT, serves as the horizontal oscillator. *T1* is the transformer providing feedback and inductance for the frequency determining circuit. Sync pulses are applied to the grid from a sync amplifier output.

The oscillator is of the self-blocking type with a large value of grid capacitor (.01 μ f) and with part of the grid leak variable to provide hold adjustment. The 15,750 cycle pulses applied via the 50 μ f capacitor lock the circuit at that frequency if it is normally running slightly slower.

The cathode circuit returns to ground through one half of the output transformer. This winding, while having low d-c resistance (200 ohms) has a high impedance at the oscillator frequency. Deflection voltage for one plate is taken off from the cathode.

The plate of the oscillator receives d-c voltage through the other coil on the output transformer. The coils are so polarized that they provide the needed phase inversion. The opposite deflection plate is fed from the oscillator plate. Both coils of the output transformer are shunted to ground by 1000 μ f capacitors. The plate voltage to the oscillator can be varied by a series resistor to set the horizontal size.

Bogen Model PX10

One of the limitations to the faithful reproduction of recorded music is that imposed by the difficulty of covering an adequate dynamic range, particularly on classical selections. A full symphony orchestra may cover a volume range of 60 to 70 db, while most recording systems are limited to something like 40 db. The limits, in the case of disc recording, are set by the noise level of the recording and reproducing equipment and the disc material structure and the area between grooves.

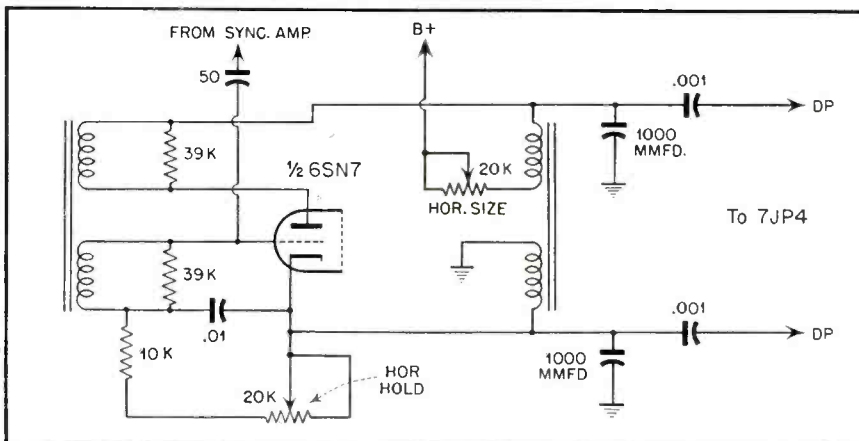

Admiral Model 19A1 - Partial schematic of hor. defl. circuit.

One method sometimes employed to overcome the shortcoming is to make the amplification of the reproducing amplifier vary as the level of the signal changes. If properly applied this can provide the required additional range and impart added life to symphonic recordings.

An amplifier containing such a feature is illustrated in partial form. A 6SC7 dual triode preamplifier precedes the stages shown. They are followed by a 6SL7 amplifier/inverter and a pair of 6V6 output tubes.

The 6SL7 shown is fed a portion of the input signal, the amount being adjusted by the control *R1*. Amplification takes place in the first section. The output of this section is rectified by the second section, connected as a

diode. A voltage, varying directly as the signal strength, and positive in polarity, is developed across the 470K load resistor.

This variable voltage is applied as bias to the #1 grid of the voltage amplifier 6SA7. The input signal is fed directly to the #3 grid from the volume control. A switch is provided in the grid of the following stage to permit switching the input directly to that stage in case the expansion feature is not desired.

A filter circuit between the diode load and the #1 grid of the 6SA7 prevents too rapid rise or decay of the gain and tends to smooth out variations in the expansion effect, due to the relatively long time constant.

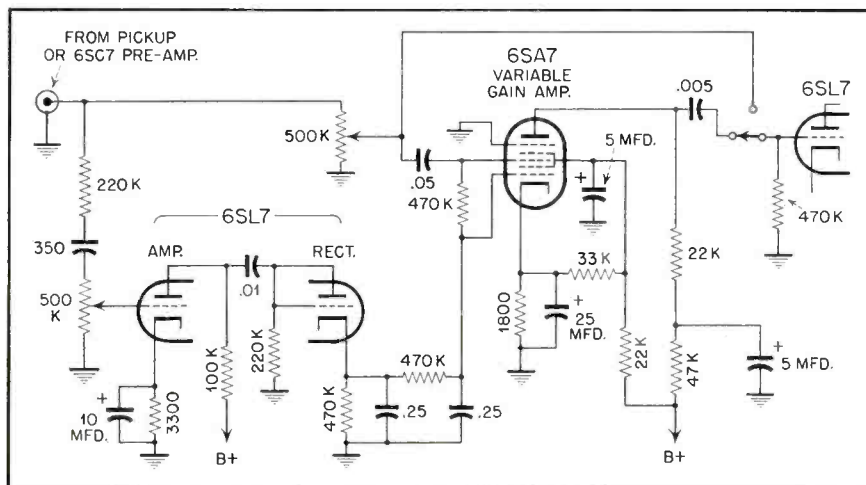

Bogen Model PX10 - Partial schematic of expansion circuit.

TV Picture Tube Manufacturers

- Allen B. DuMont Labs., Inc. Passaic, N.J.
 Allied Electronics Corp., Irvington, N.J.
 Eureka Television Tube Co., Ridgewood, N. J.
 General Electric Co., Syracuse, N.Y.
 Hytron Radio & Electronics Corp., Salem, Mass.
 North American Philips Co., Inc., N.Y.C., N.Y.
 Radio Corporation of America, Harrison, N.J.
 The Rauland Corporation, Chicago, Ill.
 Raytheon Mfg. Corp., Newton, Mass.
 Sylvania Elec. Products Inc., Emporium, Pa.
 Taylor Tubes Inc., Chicago, Ill.
 Tel-O-Tube Corp. of America, East Paterson, N. J.
 Thomas Electronics, Passaic, N.J.
 Tung-Sol Lamp Works Inc., Newark, N.J.
 Zetka Television Tubes Inc., Clifton, N.J.

- (a) Due to the extremely high light intensity produced on the tube face, protective circuits should be incorporated in the television chassis. This should be done to prevent line burns on the phosphor screen, in the case of sweep circuit failure.
 (b) For standard focus coil JAN, or equivalent.
 (c) 290 ohm coil-120 ma.; 11,000 ohm coil-20 ma.
 (d) Visual extinction of undeflected focused spot. Adjust supply to $\pm 40\%$ of indicated value.
 (e) For standard ion trap coil.
 (f) Supply should be adjusted to $\pm 40\%$ of indicated value.
 (g) With combined grid-No. 1 bias voltage and video-signal voltage adjusted for a highlight brightness of a 2 foot-lambert on a $1\frac{1}{2}'' \times 2\frac{1}{2}''$ picture area.
 (h) Diagonal of rectangle.
 (i) Approximately 35% of grid No. 2 voltage is required for current cutoff when, in some applications, it is necessary to use the maximum permissible grid-circuit resistance.
 (j) Designed to replace 11AP4 used in pre-war TV receivers.
 (k) Varies slightly with different manufacturers.
 (l) Plus or minus 10%.
 (m) For anode No. 2 current of 200.
 (n) Anode No. 3, 8,500 volts.
 (o) Tinted screen incorporates light-absorbing materials to reduce reflections.
 (p) External coating on which, when grounded, acts as a corona shield.
 (q) With the combined grid #1 bias voltage and video-signal voltage to produce a highlight brightness of 15 ft.-lamberts on a $4\frac{1}{2}'' \times 6\frac{1}{2}''$ picture area.
 (r) Outside conductive coating which, when grounded, serves as a filter capacitor and shield against external electrostatic fields.
 (s) An insulating band on the lower edge of the internal coating assuring a sharper picture by elimination of stray or spurious beams.

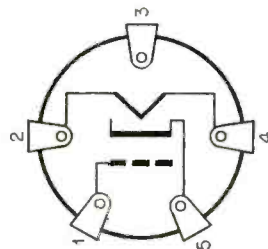

3NP4

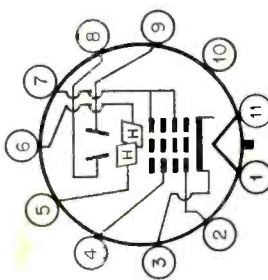

3KP4

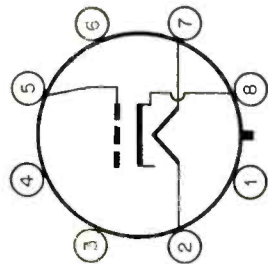

TP400A

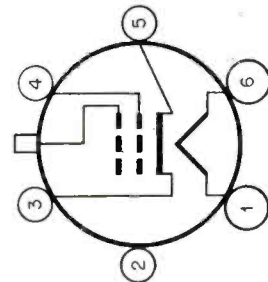

4AF

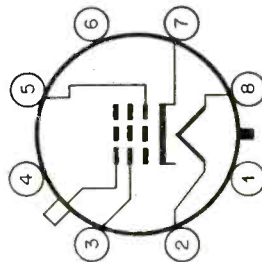

5AN

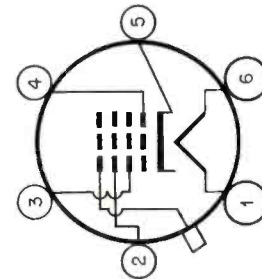

6AL (9-12AP4)

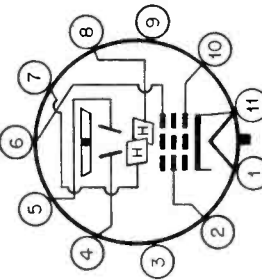

K1003

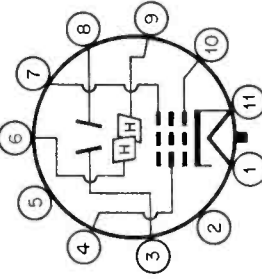

11A

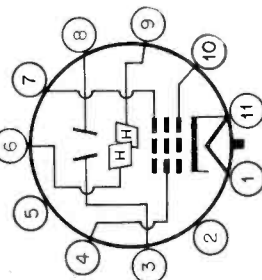

11D

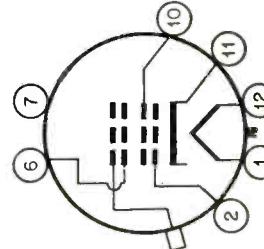

12C

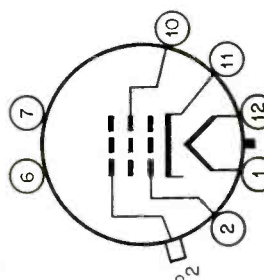

12D

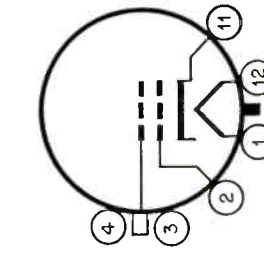

12H

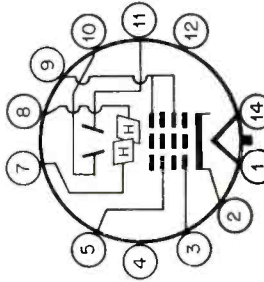

14G

TUBE
BASE

CONNECTIONS

The Television WAVEFORM and its COMPONENTS

by SAMUEL L. MARSHALL

(From a forthcoming book, "Television Service Techniques")

Part 3

THUS far we have discussed two signal components present in the transmitted signal, these being, 1) the video signal (RSD Jan. 1950), and 2) the sync signal (RSD Feb. 1950). It will be recalled that the video signal has a frequency range of from 30 cycles to 4.5 megacycles, and is composed of three basic parts, blanking, synchronizing and picture information. The blanking pulse cuts off the light on the picture tube during horizontal and vertical retrace. The horizontal sync pulse starts off the horizontal retrace. And last, the vertical sync pulse starts off the vertical retrace. All of these signals, by their presence in the transmitted signal, are designed to produce identical effects in the receiver.

In this installment we shall discuss two other signal components present in the modulated composite video signal, these being, 1) the d-c component, and 2) the video carrier.

D-C Component

In order to understand the purpose of the d-c component as applied to a video signal we must first analyze the video signals produced by a given scene under different conditions of illumination. As a practical illustration look at the side of a tall building on a dull day and observe the contrast in shading between the windows and the stone or brick wall. The wall will appear grey and the windows almost black. Observe this same building on a bright day and the wall will appear white and the windows grey.

Remembering this principle, let us now refer to *Fig. 1-18* where we observe that for a checkerboard pattern on the mosaic corresponding to a series of alternate black and grey areas as shown in *A* a corresponding video signal at the output of the picture tube as shown in *B* is produced. This signal is essentially a pulsating d.c. with the a-c component varying between grey and black. At the output terminal of the coupling condenser, *C*, shown

The author of this series is attempting to "reach" the reader by developing the whole subject of TV around a single nucleus, that is, the signals contained in the television waveform. And to make the subject matter even more understandable he constantly compares the new material to be learned with similar material in AM and FM. In this installment the elementary discussion of the basic components in the TV waveform is concluded.

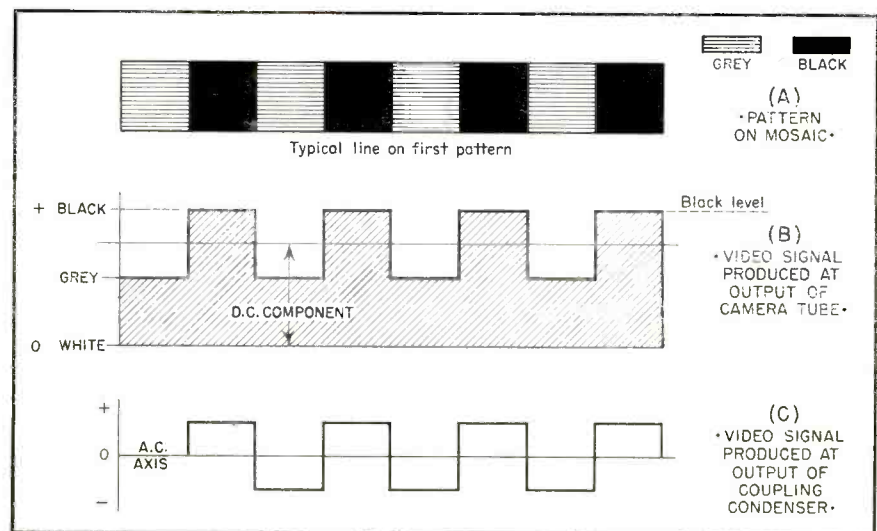

Fig. 1-18: Development of video signal as a result of alternate black and grey checkerboard pattern on the face of the mosaic.

in *Fig. 1-1*, the video signal is essentially a.c. and takes the form and amplitude shown in *Fig. 1-18C*.

Let us now employ a second checkerboard pattern, as shown in *Fig. 1-19A*, in which the areas vary alternately from white to grey. The corresponding pulsating d-c signal at the output of the coupling condenser is shown in *C*.

Notice that the waveforms of *Fig. 1-18C* and *Fig. 1-19C* are identical in amplitude and frequency. How then can we produce a video signal which is able to distinguish between a pat-

tern that varies between black and grey and one that varies between white and grey? The answer lies in *Figs. 1-18B* and *1-19B*. Notice that both signals are essentially pulsating d.c., and that the d-c component present in the signal gives it the property of enabling it to distinguish shades of light that vary between black, grey and white. If we can reinsert the lost d-c component we can reestablish the original relative values of white, grey, and black which were present in the original signals.

One method of doing this in a trans-

mitter is shown in *Fig. 1-20*. By placing a photo-electric cell in the vicinity of the scene being scanned we are able to insert, in series with the video signal, a voltage which depends on the background brightness of the scene. Thus, for a dark scene, corresponding to *Fig. 1-18A*, little light is picked up by the P.E. cell, and the voltage across the grid load resistors, R_1 and R_2 , is essentially the original video signal with little added d-c voltage due to the voltage drop across R_2 caused by the flow of electrons from the P.E. cell. However, the scene corresponding to *Fig. 1-19A* is much brighter, and the P.E. cell causes an increased number of electrons to flow through R_2 , making the grid side of the resistor, R_2 , more negative by the added d-c voltage drop across R_2 .

A grid with increased negative bias results in reduced plate current. Thus, the waveform of a bright scene is displaced nearer the zero plate current axis than a waveform corresponding to a dark scene. The highest value of plate current that flows in a totally

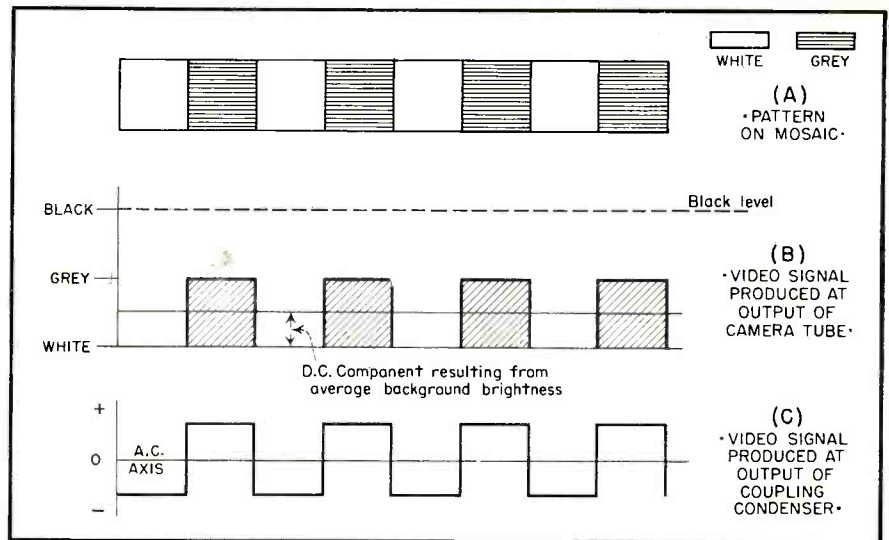

Fig. 1-19: Development of video signal as a result of alternate white and grey checkerboard pattern on the face of the mosaic.

plate current level as the scene gets brighter. Notice that the a-c component of the signal remains unchanged in either case.

Thus, the purpose of the d-c com-

ponent is to vary the average background brightness of the scene. For a given scene it enables us to distinguish varying shades of light on the scene.

Up to this point we have discussed three components present in the composite video signal, pix, sync, and the d-c component. These three components are all that are necessary to operate a wired television system, that is one which does not require broadcasting over the air waves. In fact, it is this signal that is used to operate the monitors used in broadcasting stations.

The Video Carrier

For broadcasting purposes the composite signal is made to modulate a high frequency c-w carrier as shown in *Fig. 1-1*. Unlike the system of modulation used in AM, where the average amplitude of the signal is constant and equal to the unmodulated carrier amplitude as shown in *Fig. 1-22*, in TV the average amplitude of the modulated signal is not constant.

Reference to *Fig. 1-23* will clarify this point. Notice that the carrier voltage corresponding to "no signal" is a maximum corresponding to black,

[Continued on page 27]

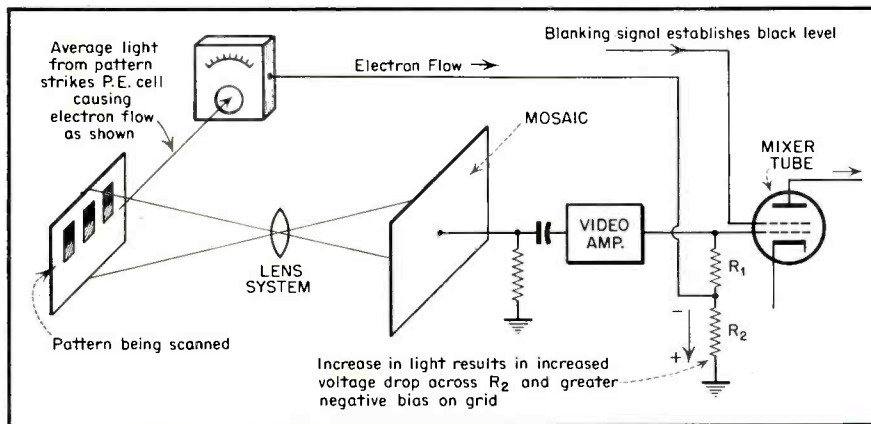

Fig. 1-20: Method of inserting average background brightness information of scene into video signal electrically. Complete video signal applied to mixer tube is voltage across $R_1 + R_2$.

black scene corresponds to the plate current established by the blanking level. Higher values of plate current flow only during the sync pulse. This is shown in *Fig. 1-21*, where a typical plate current waveform for the two patterns of *Figs. 1-18* and *1-19* are illustrated. Notice that the video signal now contains a d-c component enabling it to distinguish between signals that vary between black, grey, and white.

To summarize the preceding discussion we might observe that the d-c component is provided by the photocell current which in turn depends on the average background brightness of the scene being scanned. This d-c component actually raises the waveform of the video signal towards the blanking level (black) as the scene gets darker, and lowers it towards the zero

plate current level as the scene gets brighter. Notice that the a-c component of the signal remains unchanged in either case. Thus, the purpose of the d-c com-

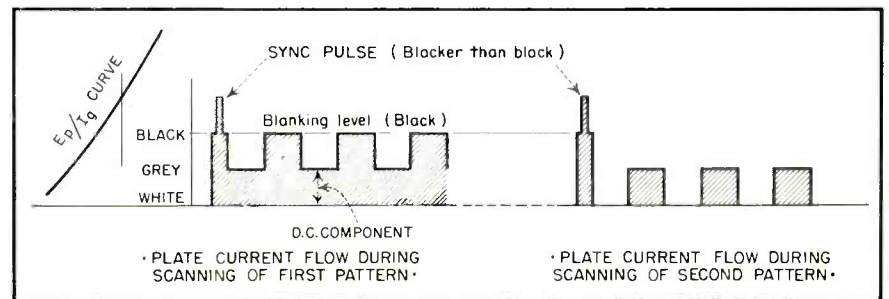

Fig. 1-21: Reestablished background brightness information enables video signal to differentiate between white-grey and black-grey scene.

NEW PRODUCTS

TUBE TESTERS

Two new tube testers Probable Type 220 and Counter Type 219, designed for accurate and thorough testing of radio, television, mobile transmitting and industrial electron tubes, have been announced by the Radio Tube Division of Sylvania Electric Products Inc., 500 Fifth Avenue, New York 18, New York, according to C. W. Shaw, General Sales Manager.

Features of the new testers, for portable and bench use include an exclusive ohmmeter-type shorts and leakage test which indicates "Replace" or "Good" directly on the instru-



ment's illuminated meter; direct meter indication for all other tests; an easy-to-operate gas test; and a combined emission and transconductance test under dynamic operating conditions which takes relative tube life into account. Twelve sockets provide for testing 4, 5, 6, 7, 8 and 9-pin tubes, octal and lock-in, miniatures, subminiature, acorn and hearing aid types, mobile and ruggedized tubes, and pilot lamps.

TWIN DRIVEN YAGI

Following the design and development of the Twin-Driven Yagi antenna, Technical Appliance Corporation, Sherburne, N. Y., now

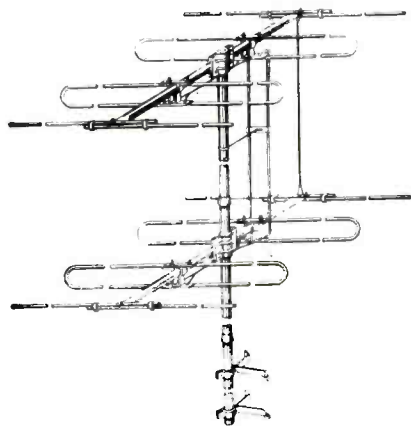

announces a new Twin-Driven Yagi, Cat. 985 - 4½, which has performance peaks at both Channel 4 and Channel 5.

This antenna is an important addition to the TACO line of fringe area antennas since many of the large metropolitan areas, such as Chicago, Cleveland, New York, Washington, Los Angeles and San Francisco, have stations operating on Channels 4 and 5.

This new antenna is constructed in the famous Jiffy-Rig method, thereby cutting installation time to a fraction of that formerly required.

RCA 16GP4

Tube Department, Radio Corporation of America, Harrison, N. J., announces the 16GP4, a short, directly viewed, 16-inch picture tube of the metal-cone type for use in television receivers designed for it. A rounded-end picture 11" x 14½" is obtained by utilizing the full-screen diameter.

Having a maximum overall length essentially 5 inches shorter than the 16AP4, the new wide-angle 16GP4 offers designers of television receivers greater flexibility in chassis design. The comparatively flat face of the 16GP4 is made of "Filter-glass" to provide increased picture contrast particularly in a lighted room.



The 16GP4 has a new design of cone-to-neck section which makes possible the design of a longer and more efficient yoke than would otherwise be practical. Other outstanding features incorporated in the 16GP4 include an ion-trap gun which requires only a single-field magnet, and a duodecal 5-pin base which permits the use of a lower-cost segment socket.

ELECTRONIC VOM

Simpson Electric Company, 5200-18 W. Kinzie St., Chicago, is producing the new Model 303 Vacuum Tube Volt-Ohmmeter, which was designed especially for television servicing. The Simpson 303 has a large, sensitive 4½ inch meter for easy readability.

With a d-c. input resistance of 10 megohms for all ranges, there is negligible circuit loading. The "303" has five d-c. voltage ranges and 5 a-c voltage ranges, five resistance ranges, three AF voltage ranges, decibels from -20 to +63 in five ranges, a zero center galvanometer for FM discriminator alignment and other galvanometer applications, and an r-f voltage range with 20 volts maximum and flat frequency measurements between 20 kc. and 100 mc.



The "303" is equipped with a d-c voltage probe, an a-c voltage-ohms probe and a ground lead. Accessory equipment includes a high frequency probe and a 30,000 volts high voltage probe.

PHONO CARTRIDGES

A new development in miniature sized crystal phonograph pickup cartridges, the "AC" Series, has been announced by The Astatic Corporation, Conneaut, Ohio. Appreciably improved performance characteristics and quality for midrange cartridges are attributed by the manufacturer to the accomplishment of a new low inertia of the AC Series' mechanical drive system.

The new Astatic units have housings of molded Bakelite and metal mounting brackets (which fit standard ½" mounting centers) and needle guards. The cartridges use Astatic's special Type "C" Taper-Lock needle, which features ease of changeability without tools.

There are four models in the AC (bottom) Series. Model AC-78 has a three-mil radius



stylus tip, either precious metal or sapphire, for standard 78 RPM records; Model AC, a one-mil stylus for narrow-groove, slow-speed records; Model AC-AG has Astatic's new All-Groove stylus tip, of special design to play 33-1/3, 45 and 78 RPM records; and Model ACD (top) is a turnover cartridge with dual needles to play narrow-groove records on one side and 78 RPM on the other.

The frequency range of all models is from 50 to 10,000 c.p.s. Needle pressure of the AC model is five grams, while that of the others is six grams. Output of all, at approximately 1,000 c.p.s., is 1.0 volt, using the Audiotone 78-1 and RCA 12-5-31V test records.

CHIMNEY MOUNTS

Two new TV and FM antenna chimney mounts have just been announced by the C & G Tool Mfg. Corp., 39 Main St., East Orange,

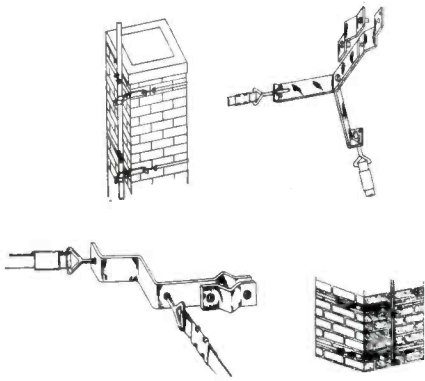

N. J. Type 3 is illustrated on top, and Type 2 on bottom in the above illustration. Made of heavy gauge steel and weather-proof plating, these mounts are designed for ease of installation and strength.

ANTENNA ROTATOR

The Radiart Corporation of Cleveland, Ohio, through Milton S. Ruth, Jobber Sales Manager, announces the expansion of their television antenna line to include a new antenna rotator unit called the Radiart "Tele-Rotor". It will handle as much as a 150-pound load with ease! Other features include a streamlined weather-proof housing that keeps out water, snow and ice. The powerful heavy-duty motor reverses instantly by the remote fingertip control switch.

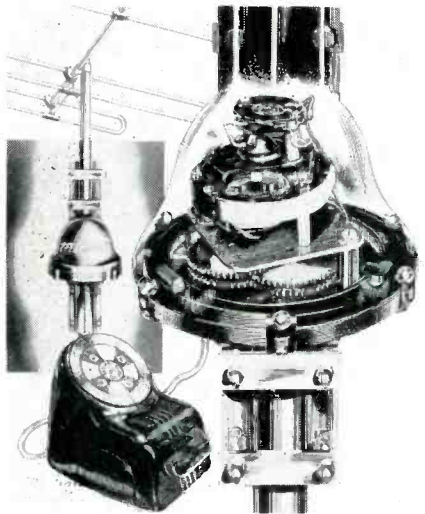

The basic design accommodates any type mounting, mast, tower or platform. Further, it will handle any size mast from 7/8 inch up to and including 2 inches in diameter. The unit is simple to install and is complete with control box in two models. Model TR-1 is the rotator with control unit having "end of rotation" light, using 4 wire cable. Model TR-2 is the compass control rotator with the illuminated "perfect pattern" dial control unit.

ELECTRONIC VOM-CAP. METER

Just announced is a new HICKOK Vol-Ohm-Capacity Milliammeter especially designed for increased speed and range in television servicing.

Designated Model 209-A, this highly accurate instrument measures any resistance, capacitance, voltage or current ever encountered in AM, FM or TV receiver servicing.

Built with an unusually large 9" meter scale for easier readings of greater accuracy.

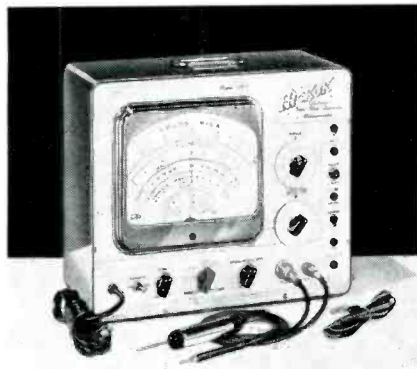

Measures resistance as low as 1/10 ohm and capacitance of 1 mmf. Permits peak-to-peak voltage measurements and contains zero-center DC scale for increased accuracy in FM-TV servicing. Has a new AC range of 1200 volts.

and featured flat frequency response to 300 megacycles. Complete with low capacity, high frequency probes and all test leads.

Attractive, portable steel carrying case. 13 1/4" x 16 1/4" x 7", 18 1/2 lbs., 115 VAC. Write today for new literature covering full technical details. The Hickok Electrical Instrument Company, 10533 Dupont Avenue, Cleveland 8, Ohio.

TV CAPACITORS

An addition of 28 values to the line of Ceramic BC Hi-Kap Capacitors to make available to service engineers capacities so widely used in late model TV sets has been announced by the Centralab Division of Globe-Union Inc.

Formerly made in 20 values, the new Centralab capacitors now come in 48 different values and four sizes, with tolerances of 20% from 10 μ f through 2,200 μ f, and guaranteed minimum values from 2,500 μ f through 10,000 μ f.

The Centralab BC Hi-Kap capacitors have a low power factor, are designed to withstand

"A jack of all trades is a master of none".

We, at Oxford, are devoting our efforts solely to making speakers and have been specializing in outstanding speaker production since 1924.

Our highly skilled engineers and technicians, our expansive volume production facilities, and our every effort are for the sole purpose of manufacturing speakers. Because we are **SPEAKER SPECIALISTS**, Oxford has met the most exacting needs, which has resulted in countless satisfied customers. Our sales policies are always fair and workable for your benefit.

The next time you need speakers, specify **OXFORD** . . . the product of men who know the speaker business . . . specialists to serve your every need.

Write for your copy of our new catalog today!

Leading jobbers carry Oxford Speakers for TV, FM, AM, AUTO and PA.



OXFORD ELECTRIC CORPORATION

3911 South Michigan Avenue • Chicago 15, Illinois
EXPORT: ROBURN AGENCIES, NEW YORK CITY



HICKOK
New Small Size
Dynamic Mutual Conductance
TUBE TESTER
World Famous

MODEL 600

THE HICKOK ELECTRICAL INSTRUMENT CO.
10533 DUPONT AVE. • CLEVELAND 8, OHIO

SEE YOUR JOBBER OR WRITE FOR COMPLETE INFORMATION TODAY

high temperatures, and are moisture proof. The capacitors have #22 tinned soft copper wire radial leads to permit easy, close coupled connections and eliminate tricky bending and fitting.

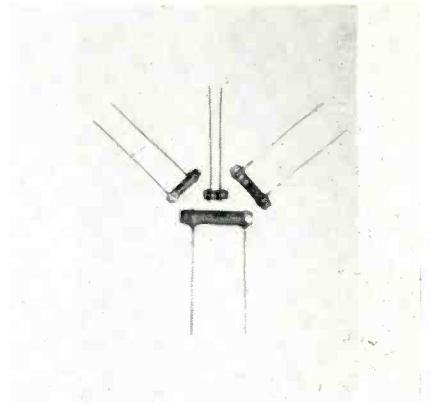

The BC Hi-Kaps are used as replacement capacitors in TV, AM and FM receivers, and will supplant the old-style tubular capacitors in much new equipment. All of the capacitors in the expanded line are rated at 600 working volts d.c.

REPLACEABLE STYLUS ASSEMBLY

The General Electric Company here has announced a modified replaceable stylus assembly for use with its variable reluctance phonograph cartridge, according to E. A. Malling, sales manager for components in the company's Receiver Division.

The new design, in which the horizontal stylus arm has been given a double twist and is double damped, has been named the "Baton" stylus.

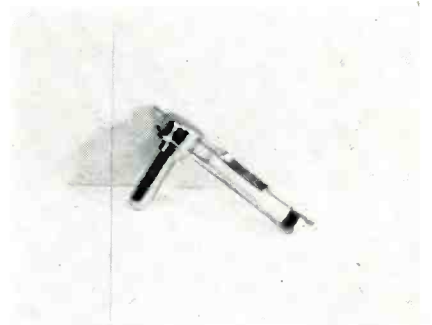

As a result of this modification, the G-E cartridge performs with much higher compliance and improved tracking ability. The double damping greatly reduces needle talk, preventing it from being induced in the tone arm.

The modified stylus assembly, which fits any G-E cartridge with the replaceable stylus feature, is currently being sold in new cartridges and as a replacement stylus.

OHM'S LAW CALCULATOR

A new pocket-size Ohm's Law Calculator, featuring separate slide rule and parallel resistance scales, has been announced by Ohmite Manufacturing Co., Chicago, manufacturers of electrical rheostats, resistors, and tap switches.

Like previous Ohmite calculators the redesigned calculator provides a simple and handy means of solving resistance problems. With one setting of the slide it gives the answer to any Ohm's Law problem—reading directly in ohms, volts, amperes and watts.

Two new scales on the back provide a standard slide rule as well as a quick, one-setting means of solving parallel resistance

STAMINA!

LONGER PERFORMING

T. E. I. television tubes, like all true champions, deliver an outstanding performance every time...and they keep on delivering!

Years of continual use* find the performance rating of these tubes practically unaffected—the tubes still capable of delivering thousands of additional hours of steady, clear, velvet-smooth pictures. For with every component, every operation, every inspection, stamina has been built in, has become an integral part of every Thomas tube.

Expect better performance, and more of it, from Thomas Electronics television tubes. They'll deliver every time!

*Life-test equivalents

See us at **BOOTH 295 I.R.E. SHOW**
Grand Central Palace March 6-9

THOMAS ELECTRONICS, Inc.
118 Ninth Street Passaic, New Jersey



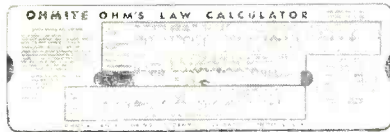

problems. The slide rule will multiply, divide, and find squares and square roots.

The calculator is made of heavily varnished cardboard, in handy pocket size (9" x 3"). It is priced at 25c, and may be obtained from Ohmite Manufacturing Co., 4937 Flournoy St., Chicago, Illinois.

COBRA TYPE LOUDSPEAKERS

Almost every sound technician has come up against that real headache of a sound installation problem—extremely large noisy crowds, very wide area to be covered, very bad acoustical conditions—where the use of conventionally designed trumpets just won't do the job. The new Racon COB wide-angle cobra loudspeakers have been designed expressly to lick these "toughest" problems.

Each Racon COB horn provides a sound field essentially uniform with respect to frequency and intensity over a horizontal angle of 120 degrees and a vertical angle of 40 degrees.

The cutoff design point of the COB models is 370 cycles to remove the lower frequencies

which interfere with the reproduction of crisp, articulate quality so essential for successful voice reproduction. Thus amplifier input requirements are also reduced considerably.

Additional specifications: 25 watts operating capacity; 50 watts peak capacity; re-

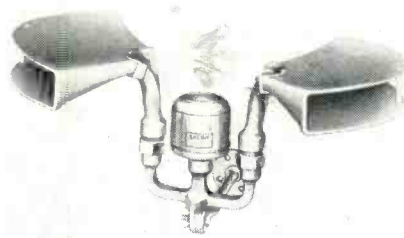

sponse 370-6500 cycles; impedance 15 ohms; sensitivity as single wide-angle speaker is 105 db at 4 feet, 1 watt input.

For your free copy of the new Racon catalog describing this unit and the complete Racon line, write directly to Racon Electric Co., Inc. 52 East 19th Street, New York 3, N.Y.

TV ANTENNA

Tricraft Products Company, manufacturers of a complete line of television, FM and AM antennas and accessories, announces the availability of their completely re-engineered model #950.

The #950 "DUO-BAND" can be assembled in a matter of seconds. Matching connecting harness is designed to correctly match high

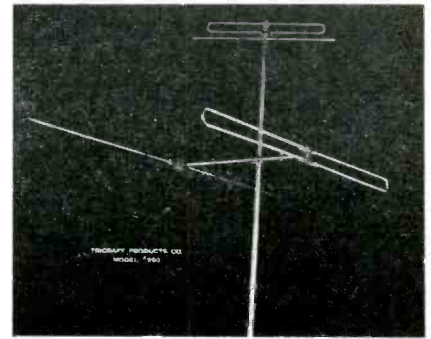

band elements with low band elements. It is constructed entirely of sturdy, weatherproof aluminum.

For further information on the new #950 and other TRICRAFT models, as well as a copy of their latest catalog, write TRICRAFT PRODUCTS COMPANY, 1535 North Ashland Avenue, Chicago 22, Illinois.

TV WAVEFORM

[from page 23]

and that as the video signal goes white the carrier amplitude is reduced to 15% of its maximum value. This value of 15% was chosen to prevent zero carrier output on white modulating signals. Such a condition would result in unstable operation of the receiver

All Conicals Look Alike, but

only OAK RIDGE Fringemaster

GIVES YOU: LOWEST COST AND HIGHEST QUALITY FOR GREATEST PROFIT!

HIGHEST GAIN FOR LOCAL AND FRINGE AREAS!

Here's why you get lowest installation costs, fewest call-backs, best performance—and highest profits—with the new Oak Ridge FRINGEMASTER Conicals:

- for Metropolitan Areas: The X-66 gives you the highest gain and lowest cost for its type on the market! 6 forward and 6 reflector elements.
- for Fringe Areas: The superb sensitivity of the XX-66 is unmatched by any other conical! Lowest-priced! 6 forward and 6 reflector elements, double-stacked.

- Highest gain conical beam
- Highest signal-to-noise ratio
- Major lobe in line of frequencies
- Highest front-to-back ratio
- Matched to 72, 150 or 300-ohm transmission lines
- Supplied with any combination of antenna or reflector elements

- Sensitivity and directivity instantly changeable by inserting different ratio of antenna to reflector elements
- Non-flattened tubular rigid support for all elements
- "U"-bolt assembly—Easy stacking
- Speedy Assembly

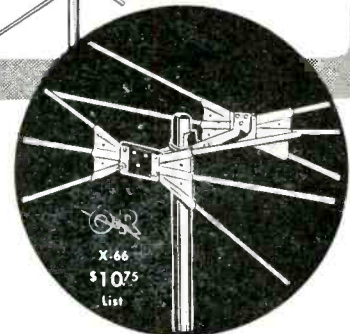
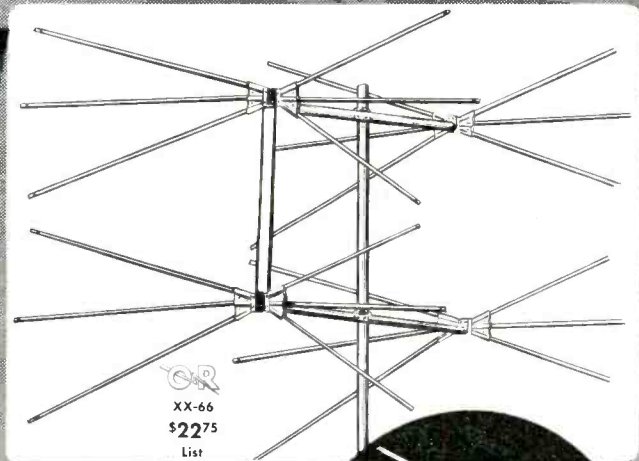

OAK RIDGE PRODUCTS
239 EAST 127 STREET, NEW YORK 35, N. Y.
Manufacturing Division of VIDEO TELEVISION, INC.
Makers of the famous SNAP-LOCK Patented TV-FM antennas and accessories and the Oak Ridge MINIATURE TV test equipment

See why the new Oak Ridge FRINGEMASTER Conical is the greatest profit-maker of them all! Place your order for it with your parts jobber NOW.
Write for your free Catalog D-2.

and will be discussed in greater detail in another installment.

Continuing further in our analysis we find that the average value of the signal is no longer constant but varies with the picture signal. The only constant components of the signal are the blanking and sync pulse levels.

This system was not chosen fortui-

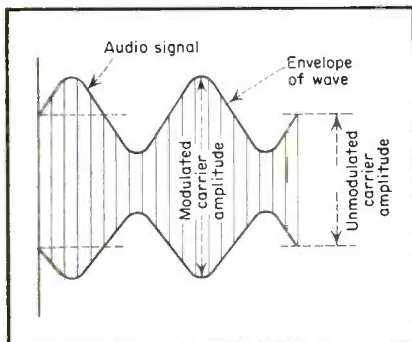

Fig. 1-22: Typical modulated carrier of AM signal. Average amplitude of signal is equal to unmodulated carrier amplitude, and is constant at any value of audio signal.

tously, but rather as a result of careful consideration on the part of planning committees. It was desired to obtain a sync pulse amplitude of constant value and sufficient amplitude

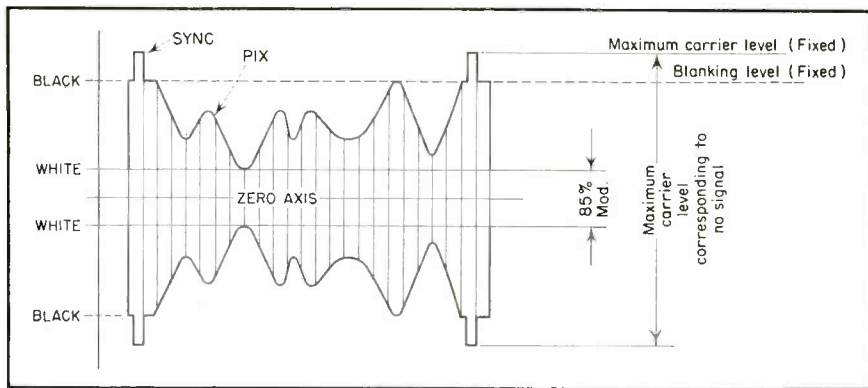

Fig. 1-23: Typical modulated carrier of TV signal. White signal drives carrier towards zero axis. Average value of modulated signal varies with pix signal, and is no longer constant as in AM. Only constant values of signal are sync and blanking.

to insure proper triggering of the receiver sweep circuits, and this system was selected. Notice that in the modulating process the white, or negative, portion of the video signal drives the carrier almost to zero amplitude. This is called "negative transmission". In Europe where "positive transmission" is used, the white portion of the signal goes positive, and the sync pulse which is negative drives the carrier towards the zero output level.

In Fig. 1-1 we illustrate how the complete system is integrated. The

composite video signal is mixed with the c-w carrier in a special type of modulator which produces a modulated carrier with negative transmission characteristics. The latter is then fed into the transmitting antenna where it is radiated into space. Of course it must be borne in mind that the sound signal is fed into the antenna together with the video signal, except that the sound is frequency modulated with a maximum deviation of 25 kc, its carrier being separated from the video carrier by 4.5 mc.

IN THE SETS OF THE BEST MANUFACTURERS FOR YEARS...

NOW!

it's **TEL-O-TUBE** for **REPLACEMENT!**

PRODUCTION 1800 PER DAY!
IMMEDIATE DELIVERY ON ALL TYPES!
PROVED SUPERIORITY!

For manufacturers, Tel-O-Tube has long meant higher picture tube quality at lower cost. The list of famous TV set makers who have specified Tel-O-Tubes for their production is a virtual who's who of the industry—Admiral, Ansley, Crosley, Emerson, Garod, Olympic, Starrett, Tele-King, Tele-Tone, Sightmaster, Video Corporation of America, etc. Again and again, Tel-O-Tubes meet the critical approval of these receiver manufacturers. Here is indisputable proof of Tel-O-Tube superiority!

Now Tel-O-Tube means more replacement sales at lower costs for more profits for you. We have stepped up our production to a new high of 1800 a day, and are pushing higher every week—to fill your replacement needs for the finest picture tubes of every type—with immediate delivery!

Tel-O-Tubes are made in our 3 new modern plants under the newest, most stringent quality controls and test tolerances, backed by the latest engineering "know-how." That's why you get more dependable performance and longer life—get more sales and more profits—with Tel-O-Tubes.



New Tel-O-Tube 16XP4 16" Rectangular

Take a tip from the quality-conscious receiver manufacturers—specify Tel-O-Tube. We have a "honey" of a sales story for every TV serviceman interested in profits in picture tubes. For full details, write NOW to Dept. D-1.

TEL-O-TUBE SALES CORPORATION

469 SEVENTH AVENUE, NEW YORK 18, N. Y.

Telephone: Pennsylvania 6-7385-6-7

TRADE FLASHES

[from page 10]

nated in appearances two or three times weekly from each station added to the company's TV advertising schedule, Doyle stated. New films will replace the original six before the latter have lost their interest through too much repetition, he declared.

Other stations to start beaming the Astatic commercials include: WPTZ, Philadelphia; KRON-TV, San Francisco; and WICU, Erie, Pennsylvania. Results during the first weeks of this schedule will be closely checked to guide selection of other stations and time availabilities. It is expected that Astatic will, within a few months, have its commercials appearing in most of the nation's television market areas.

Merit Announces TV "Replacement Guide"

The Merit Transformer Corporation is announcing its 1950 TV "Repl" Guide, listing approximately 400 popular television receiving sets, made by 60 manufacturers. This guide is intended to cut repair-bench time, by

providing a simple, quick method of determining the correct replacement parts. It's claimed to be the most complete, up-to-date listing that has as yet been made available to the trade. Merit intends to keep this guide up-to-the-minute, by turning out subsequent issues as often as new sets and parts make it advisable.

At the same time, Merit is introducing ten new "Flybacks" Focus Coils, and Deflection Yokes, and twelve new TV transformers, including powers, audios, vertical outputs, and chokes. These added products will round out the Merit line—thus establishing Merit as a single, convenient source of supply for these television components.

Free copies of the Merit TV "Repl" Guide and further information regarding their new products may be secured by writing the manufacturer direct: Merit Transformer Corp., 4425 N. Clark St., Chicago 40, Ill.

New Rider Manuals

Rider Manual Volume XX (20), the latest volume in the Perpetual Trouble Shooter series, is currently available at all Rider distributors, William J. Marcus, in charge of jobber sales of John F. Rider Publisher, Inc., 480 Canal Street, New York 13, N. Y., announced recently.

The coverage on AM-FM receivers, auto radios, record changers, and tuners is complete as of November 1949. Factory-authorized data of 74 manufacturers comprises 1776 pages—all filed in their proper places. A cumulative index for Volumes XVI through XX plus a "How It Works" book (simplified discussion of the latest circuit theory) rounds out the coverage.

Also announced is the Rider TV manual No. 4 which is in production.

Retaining the practical enlarged page size format, 12" x 15", established with TV Manual Volume 3, TV 4 will have the equivalent of 2300 pages (8½" x 11") all filed in their proper places. Giant pages have a single fold for increased longevity. The factory-authorized data of more than 70 manufacturers will be represented in this up-to-date compilation of television servicing material.

TV Service Co. Opens Branches

Abington Television Service of Garden City, L. I., opened two new branches in the Queens-B'klyn (N.Y.) area and in Washington, D. C., Sam Barriette Pres., and Charles Wigutow V. P., announced recently.

This move indicates that TV service contract companies are becoming a

Protect your profits by selling and using



TV ACCESSORIES

For speeding up installations of all TV and FM antennas

CHIMNEY MOUNTS and WALL MOUNTS

C&G-2 CHIMNEY MOUNT

Offset bracket mounting

Easy to install. Bracket is made of non-corrosive steel, 1½ in. wide. Two 12-ft. galvanized straps with eye-bolts attached to each strap. Note the method of clamping and locking strap.

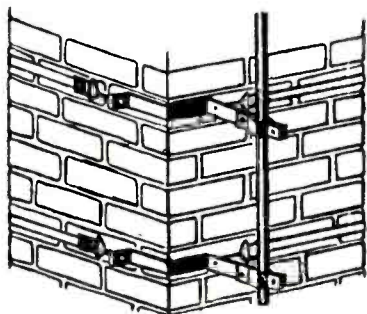

Detail of C&G-2 mounting—

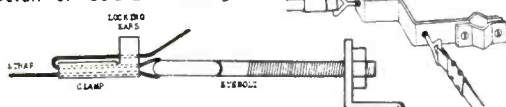

C&G GROUND ROD

4 ft., copper plated, 3/8" round rod.

C&G-3 DELUXE Y-TYPE CHIMNEY MOUNT

Made of heavy gauge steel and weather-proof plating. Two 12-ft. galvanized straps with eye-bolts attached to each strap.

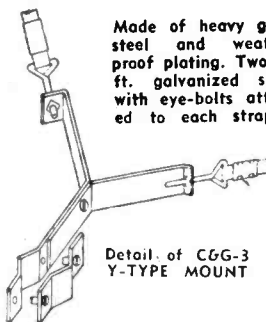

Detail of C&G-3 Y-TYPE MOUNT

C&G-1 DELUXE WALL MOUNT

For wood or masonry. Clearance, 7½ inches.

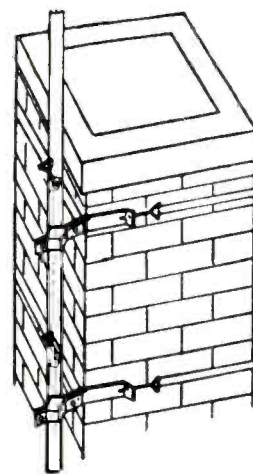
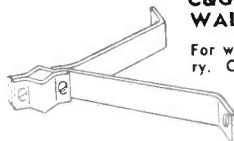

C&G-4 WALL MOUNT

Rugged, weatherproof bracket. Clearance 4 inches.

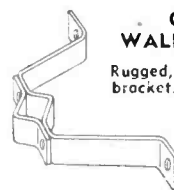

DISTRIBUTORS—Write for prices and COMPARE.

DEALERS—Contact your nearest distributor.

THE **C&G** TOOL MANUFACTURERS, INC.

39 Main St., East Orange, N. J.

"big-business" factor in the service industry, and are spreading over wide areas of operation.

"High Quality" Brochure

A new brochure entitled, "History Repeats" has been made available by Espey to counter salesmen and sound

salesmen of radio parts distributors and dealers.

On the subject of High Quality radio reception the customer may become better educated than the salespeople, and the object of this brochure is to provide a 1950 modern version

of custom building and the latest AM-FM radio receiver combinations. Copies are free. Write The Espey Mfg. Co., Inc., 528 East 72nd Street, New York 21, N.Y.

Cone Catalog

A new 24-page illustrated catalog has just become available from Waldom Electronics, Inc., Chicago, Ill. This catalog has a complete listing of replacement cone assemblies, both post-war and pre-war, including some 1948 and 1949 models.

Sylvania TV Tube Complement Book

A new 56-page television receiver tube complement book listing by make and by model the number and type of receiving and picture tubes used in more than 620 sets, has been announced by Sylvania Electric Products Inc., Radio Tube Division.

The book also contains a chart showing the percentage of each of 136 receiving tube types used in TV sets distributed by 85 manufacturers.

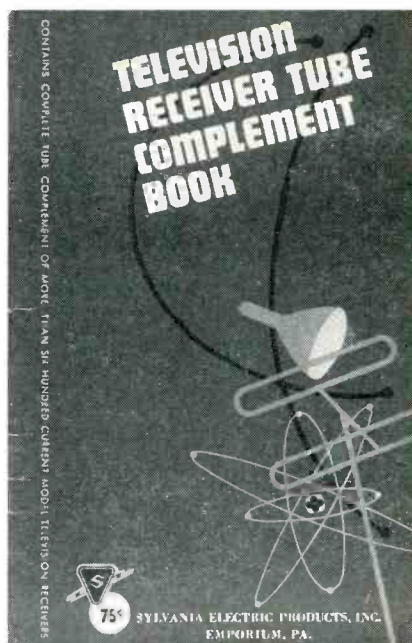

This reference list is included to aid television repairmen in stocking for future replacements. The reference material in the book also includes a list of 80 TV set manufacturers and their addresses for use in securing more service information on a particular set.

Another section of the book describes modifications required, if any, for 120 television picture tube replacement types, because of change of dimension, electrical characteristics, socketing and other specifications. Suggestions for safe handling of picture tubes is also included in the book, which measures 8" x 5½" and is available through Authorized Sylvania Distributors.

THERE'S A LEADER IN EVERY CROWD

TACO LAZY X

- Antennas may look alike from a distance. But COMPARE them side-by-side for ease of assembly, structural strength, TV performance, and you'll see why TACO is the leader.
- Taco Lazy X (illustrated) is an all-band antenna with a uniform high gain throughout both bands. FOR REAL RESULTS, INSTALL A TACO!

WRITE FOR DETAILS AND CATALOG

RADIO AND ELECTRONIC EQUIPMENT

TACO

**TECHNICAL APPLIANCE CORP.
SHERBURNE, N. Y.**

In Canada: Stromberg-Carlson Co. Ltd., Toronto 4, Ont.

Insure BETTER Television Service to Your Customers! . . . Exclusively Designed



**HIGH VOLTAGE AND ELECTROLYTIC TUBULAR
TELEVISION CAPACITORS**

**Especially Engineered for Television Circuits by
INDUSTRIAL CONDENSER CORP.**

The . . . of . . . replacement. Industrial Condenser Corp. manufactures . . . capacitors exclusively brings you highest quality for the . . . requirements of Television at exceptionally attractive prices! Specially capacitors are Pyrotron, designed for low power factor, high dielectric constant, high operating temperature—Oil, Pyrotron, Wax and Electrolytic Capacitors. Finest materials throughout.

Ask Your Jobber for our Attractive Prices Today!

Or write for Bulletin 1095 Industrial makes quality Capacitors for Television, Radio, every electronic and industrial application—all types.

Send for Complete Catalog

INDUSTRIAL CONDENSER CORP.
3243 N. CALIFORNIA AVENUE CHICAGO 18, ILLINOIS
Sales offices in all principal cities

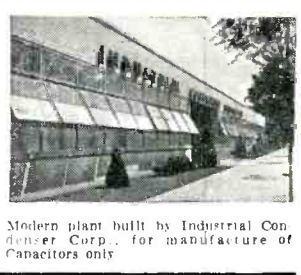

FIELD FINDINGS

[from page 2]

ARSNY and the good work it has accomplished since its inception a year and a half ago.

We have always had a high regard for the BBB and will continue to have only as long as it maintains high ethical standards of its own. Such happens not to have been the case recently, and from our observations of the BBB workings we are inclined to believe it is getting to be a publicity-seeking organization which is stepping out of bounds, releasing obsolete information as being current—and then, like Readers Digest, not doing the proper thing of qualifying its fault-finding releases when confronted with irrefutable proof of its errors. To combat such unjustified attacks the servicing profession has no choice other than to become organized into groups and associations of local bodies which can defend their respective positions and offset any harmful propaganda by having a public relations committee of their own.

In this regard, we hear that new radio-TV servicemen's associations are being organized all around the country and we urge their respective corresponding secretaries to keep in close communication with us so that through our "Association News" department we can keep you all closely apprised of happenings.

Improving Focus

[from page 17]

setting may not be the best for good focusing. If focusing is off, the coil will have to be moved slightly forward or back, noting the effect on focus and position. See Fig. 3.

For best results the focus coil position in such receivers may require considerable manipulation before line trace on the face of the tube is sharp and clear along the entire tube surface. If the positioning requires too pronounced an angle of the focus coil it will be virtually impossible to get uniform focusing over the entire tube face. In such cases most technicians make sure the center portion of the picture is in sharpest focus, because the focus control will either make the center fuzzy and the edges clear or vice-versa.

Care must also be taken that the focus and beam bender coils are not

In Fair Weather or **FOUL...**

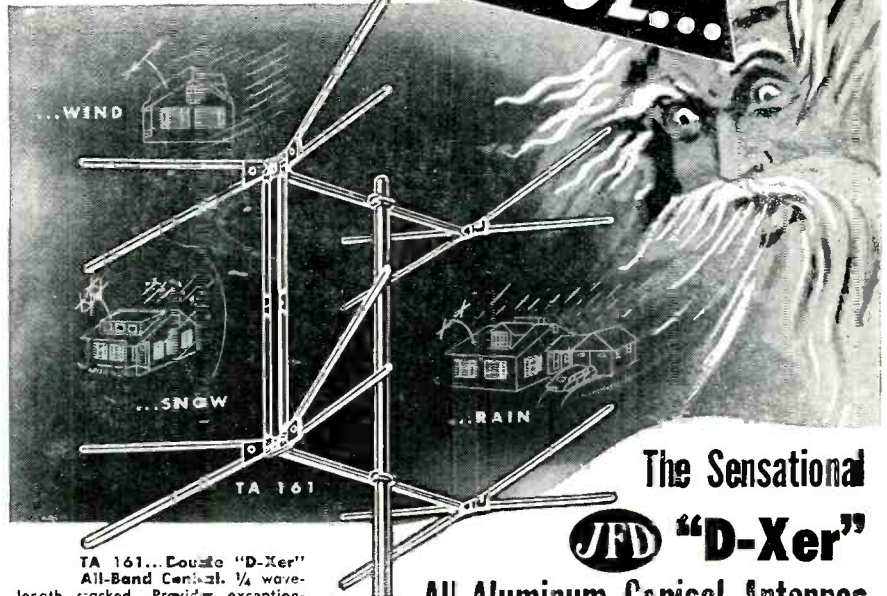

TA 161... Coupled "D-Xer"
All-Band Conical. 1/4 wave-length socked. Provides exceptionally high DB gain on both bands, Channels 2 to 13.

THEY ARE STRONGER!

Rugged construction. The only Conicals with reinforced elements. Will not bend, sag, sway or whip. Withstand all kinds of rough weather — wind, snow, rain, hail, etc.

MORE ECONOMICAL!

Feature-for-feature, quality-for-quality, performance-for-performance, JFD "D-Xer" All-aluminum Conicals give more for the money than any other antenna. The smart serviceman looks for the reinforced element.

AND MORE PROFITABLE!

"D-Xer" Conicals sell faster — more easily. They require minimum servicing. Once put up, they stay put up — and they stay sold!

Write for Free Descriptive Bulletins



JFD MANUFACTURING CO., Inc.
6125 16th Avenue, Brooklyn 4, N. Y.
FIRST in Television Antennas & Accessories

GREENOHM

★ Yes sir, POWER! These Clarostat power resistors are built to handle real power—from first to last—year after year . . . for outstanding service. Special cold-setting inorganic cement coating won't crack, peel, blister or flake. Handles heat shock of frequent on-off operation without flinching.

Standard 5 to 200 watt ratings. Fixed or adjustable. Wide selection of resistance values. Also with taps, all types of terminals and mountings, on special order. Better — yet cost no more.

★ Write for Engineering Bulletin 113. Try a Greenohm! Let us quote.

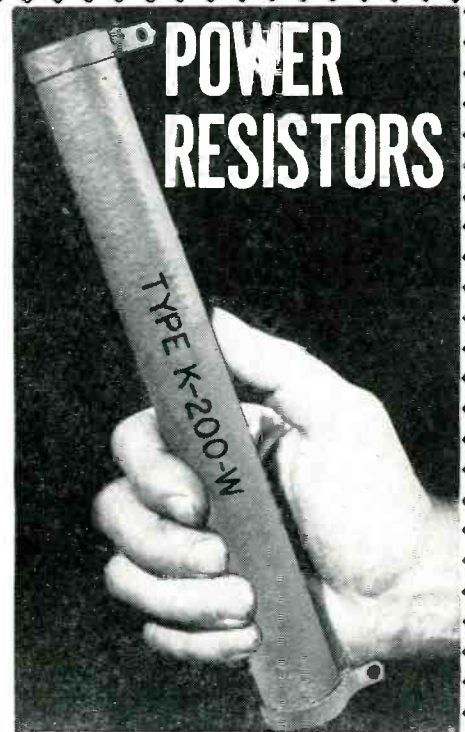

CLAROSTAT



Controls and Resistors

CLAROSTAT MFG. CO., INC. • DOVER, NEW HAMPSHIRE • In Canada: CANADIAN MARCONI CO., LTD. Montreal, P. Q., and branches



Service Dealers Form A Group,

Subscribe to "RSD"—

SAVE Up to \$1.00 each.

"The Professional Radioman's Magazine"—published monthly. All articles are exclusive and timely. Practically every issue is worth what an entire 1 year subscription costs.

★ The more in a group the bigger the savings. 6 men in a group save \$1.00 each; 4 men groups save \$.75 per man. Present "RSD" subscribers may participate in or form a group with co-workers, or even competitors. Still active subscriptions are automatically extended 1 year. Start a Group today! The timely and exclusive technical data appearing in future issues of "RSD" will make this the best investment you ever made. The special Group Rate offer may be withdrawn at any time—so hurry.

Use This Coupon For Convenience

(The coupon below can be used for from 1 to 6 subscription orders. Use it today!)



TEAR OUT ~~THE~~ MAIL TODAY!

RADIO SERVICE-DEALER MAGAZINE
342 Madison Ave., New York 17, N. Y.

Please enter 1 year subscription orders for the names given below. Our remittance is enclosed.

NOTE: If you do not wish to tear this order blank out, just print or type the information on a single sheet of paper, following the style given. Each subscriber's occupation must be clearly described.

	In U.S.A. & Canada	Foreign Rates
<input type="checkbox"/> One 1-year subscription	\$2.00	\$3.00
<input type="checkbox"/> Two 1-year subscriptions, each	1.75	2.75
<input type="checkbox"/> Three 1-year subscriptions, "	1.50	2.50
<input type="checkbox"/> Four 1-year subscriptions, "	1.25	2.25
<input type="checkbox"/> Five 1-year subscriptions, "	1.10	2.00
<input type="checkbox"/> Six 1-year subscriptions, "	1.00	1.50

Name.....
Address.....
Describe Title or Position and Type of Business.....
State whether a New Subscriber or Renewal Order

Name.....
Address.....
Describe Title or Position and Type of Business.....
State whether a New Subscriber or Renewal Order

Name.....
Address.....
Describe Title or Position and Type of Business.....
State whether a New Subscriber or Renewal Order

Name.....
Address.....
Describe Title or Position and Type of Business.....
State whether a New Subscriber or Renewal Order

Name.....
Address.....
Describe Title or Position and Type of Business.....
State whether a New Subscriber or Renewal Order

Name.....
Address.....
Describe Title or Position and Type of Business.....
State whether a New Subscriber or Renewal Order

influencing the beam too much in one direction. If the beam is pulled off center too much, one section of the picture will be blotted out because the beam hits the neck of the tube for some portion of the horizontal or vertical trace. This usually shows up in one of the corners of the picture first (assuming a 4 to 3 ratio picture) because the corners of the picture represent extremes of sweep.

With the receivers utilizing the entire picture face it will be found that an improperly set focus coil and ion trap will mask out the rim of the picture near the tube edge. Under such a condition the height and width control will be unable to blow up the picture to tube face size, because the beam is striking the tube neck at the extremes of beam trace. Proper adjustment of coils will rectify this condition.

Preliminary to focus coil and ion trap adjustments, a check on the yoke (deflection coils) should also be made. While this coil has little to do with focusing, it does affect picture tilt. Shifting the yoke around its axis will correct picture tilt. The yoke should always be as close to the end of the neck as possible.

Non-magnetic Focusing

Television receivers using 7" tubes with electro-static deflection have sim-

ilar focusing networks as the larger magnetic focusing types but do not, of course, have a focus coil. Focusing is accomplished within the tube by the focusing electrode of the electron gun structure. This means, then, that focus changes are solely a function of the potential applied to the focus electrode. Resistive networks in such sets are more elaborate, because the high voltage is divided into appropriate values for horizontal and vertical deflection plates so that proper centering can be achieved.

Some 10" receivers are also on the market utilizing electrostatic deflection, notably the Belmont Model 22A21. The focus network for this receiver is shown in Fig. 4, and consists of a focus control of 2 megohms. This potentiometer is shunted by another resistor, and the parallel branch thus secured is also a voltage feed network for the plates of the vertical output tubes, with a bleeder section of 2.7 going to ground.

The .001 μ f capacitor across the potentiometer gives smoother control, though the high voltage across this unit increases the danger of breakdown. When replacing this capacitor, not only must the same value be chosen, but the voltage rating must be observed. Defective capacitors or resistors will result in poor focus.

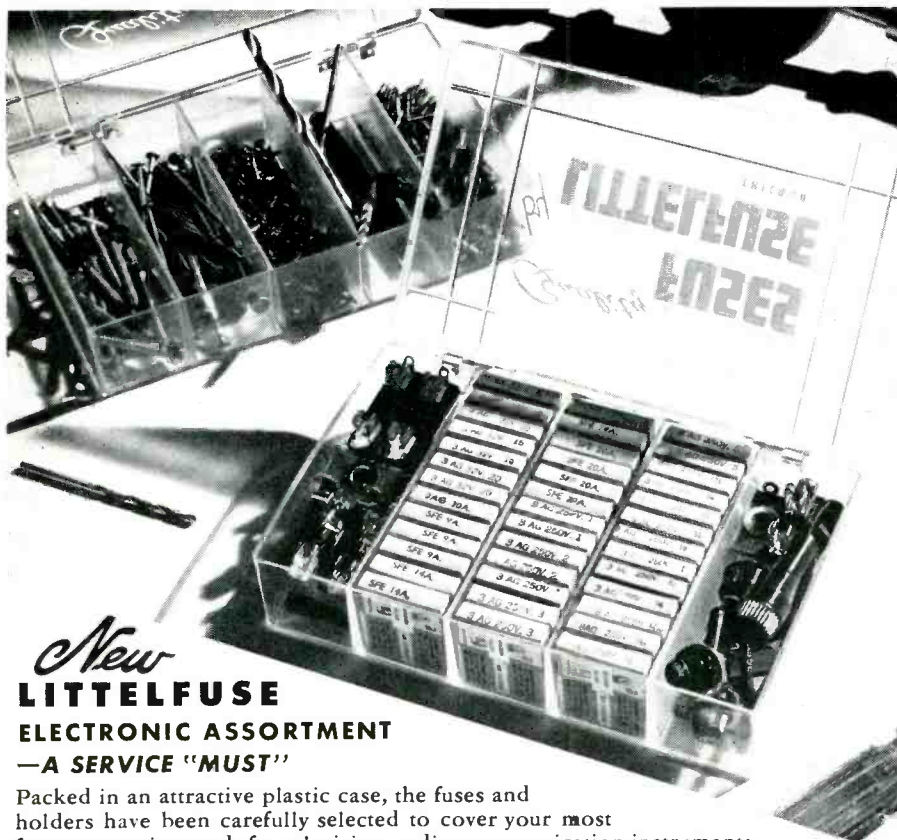

New LITTELFUSE ELECTRONIC ASSORTMENT —A SERVICE "MUST"

Packed in an attractive plastic case, the fuses and holders have been carefully selected to cover your most frequent service needs for television, radio, communication instruments, etc. . . . You will reuse the plastic case for easy-to-lose parts, fishing tackle, coins, and stamps.

Be sure to have the fuse to fit!

LITTELFUSE INCORPORATED 4787 North Ravenswood Avenue, Chicago 40, Illinois
RADIO SERVICE DEALER • MARCH, 1950



"A" BATTERY ELIMINATORS

I.R.E. Show-Booth 202, March 6-9



for DEMONSTRATING AND TESTING AUTO RADIOS

New Models . . . Designed for testing D. C. Electrical Apparatus on Regular A. C. Lines. Equipped with Full-Wave Dry Disc Type Rectifier, Assuring Noiseless, Interference-Free Operation and Extreme Long Life and Reliability.



AUTO RADIO VIBRATORS

A Complete Line of Vibrators . . . Designed for Use in Standard Vibrator-Operated Auto Radio Receivers. Built with Precision Construction, featuring Ceramic Stack Spacers for Longer Lasting Life.

NEW MODELS ✓ NEW DESIGNS ✓
NEW LITERATURE ✓
ATR "A" Battery Eliminator, DC-AC Inverters, Auto Radio Vibrators
See your jobber or write factory

AMERICAN TELEVISION & RADIO Co.
Quality Products Since 1931
SAINT PAUL 1, MINNESOTA-U. S. A.

Build YOUR OWN Heathkit TEST EQUIPMENT

Heathkits are beautiful factory engineered quality service instruments supplied unassembled. The builder not only saves the assembly labor cost but learns a great deal about the construction and features of the instrument. This knowledge aids materially in the use and maintenance of the equipment. Heathkits are ideal for and used by leading universities and schools throughout the United States. Each kit is complete with cabinet, 110V 60 cycle transformer (except Handi-Tester), all tubes, coils assembled and calibrated, panel already printed, chassis all punched; formed and plated, every part supplied. Each kit is provided with detailed instruction manual for assembly and use. Heathkits provide the perfect solution to the problem of affording complete service equipment on a limited budget. Write for complete catalog.

Heathkit AUDIO GEN KIT \$34.50

Heathkit TUBE CHECKER KIT \$29.50

Heathkit TELEVISION GENERATOR KIT \$39.50

Heathkit SIGNAL TRACER KIT \$19.50

Heathkit CONDENSER CHECKER KIT \$19.50

NEW Heathkit IMPEDANCE BRIDGE SET \$69.50

Heathkit R.F. SIGNAL GEN. KIT \$19.50

Heathkit 5" OSCILLOSCOPE KIT \$39.50

Heathkit BATTERY ELIMINATOR KIT \$22.50

Heathkit ELECTRONIC SWITCH KIT \$34.50

Heathkit VACUUM TUBE VOLTMETER KIT \$24.50

NEW Heathkit HANDITESTER KIT \$13.50

HEATH COMPANY
BENTON HARBOR, 12 MICHIGAN

EXPORT DEPARTMENT
12 EAST 40th STREET
NEW YORK 16, N.Y.
CABLE - ARLAB - N.Y.

AFC

[from page 15]

If the resistance is much greater than the inductive reactance we have the condition of part *D* of Fig. 4. The series current i_{r1} is in phase with the applied voltage since the circuit is predominantly resistive. However, the grid voltage signal e_{g1} or e_g , since it is developed across an inductance, leads the series current. The grid voltage signal leads the series current and the reactance tube plate current is in phase with the grid voltage. In this manner, because i_p leads e_p the output current from the reactance tube is capacitive. The value of this added capacitance is

$$C_1 = \frac{g_m L}{R}$$

By means of a phase-splitting network having a reactance in series with a resistor, the voltage from the oscillator tank circuit may be shifted by 90 degrees. Either a capacitive or an inductive phase shift may be obtained depending on the series circuit arrangement and values. The reactance tube output plate current is in phase with the grid voltage of this tube and either an inductive or capacitive current may be obtained. Where the output current leads the voltage, we have a capacitive circuit, and where the output current lags the oscillator tank voltage we have an inductive circuit. These reactive currents when introduced into the oscillator tank circuit cause a change in frequency. A control voltage, coming from a frequency sensitive circuit changes the amount of reactive current flow and an automatic frequency control system is produced.

Complete Frequency Control Systems

Automatic frequency control systems have many applications in the present day television system. In the receiver itself, there are two separate and individual functions which may be performed by these automatic frequency control circuits. The first of these is the stabilizing of the radio frequency local oscillator by overcoming the tendency toward frequency shift. A second use of reactance tube frequency control is found in the stabilization of synchronized oscillators used for sweeping circuits.

In Fig. 5, we have a block diagram of the general type of AFC system used to control the local oscillator. There are two inputs to the mixer tube; one of these is the radio frequency signal of the television station which is fed into the mixer tube from the r-f amplifier. The second input into this tube is the r-f output from the local oscillator. This oscillator functions either above or below the

**A
Better
Model
at an even
Better
PRICE**

Model 950

The New "Tricraft Duo-Band"

HI AND LOW BAND arrays orient individually . . . can be assembled in matter of seconds . . . here is the new outdoor antenna that is unexcelled for quality, construction and price value . . . matching connecting harness is designed to correctly match high band elements with low band elements. Factory assembled with sturdy weatherproof construction for fast installation.

**ALWAYS QUALITY-
NOW LOW PRICE!**

Tricraft Antennas are accepted for their unsurpassed quality. We have increased our production facilities in order to offer our complete line at greatly reduced prices . . . but our quality will still "lead the field."

"TRICRAFT ANTENNAS" • Jobbers: send for our are sold through jobbers • new low price list!



Tricraft Products Co.

1535 North Ashland Ave., Chicago 22, Ill.

Manufacturers of complete line of Television, FM and AM antennas and accessories

incoming r-f signal so that the mixer may heterodyne the local oscillator frequency and incoming r.f. to produce the proper intermediate frequencies. There is a single output from this mixer tube which feeds the signal separator. Both the sound and video signals are outputs from the signal separation circuit in this block diagram. The picture intermediate frequency is passed on to the picture intermediate amplifier system, then on to the video detector. This detector, feeds the video amplifier which of course presents intensity modulation for the grid of the picture tube.

The sound intermediate frequency signal goes from the signal separator to the sound i-f amplifier system. A discriminator or other type of FM detector is fed by the sound i-f strip. There are two outputs from the FM detector; the audio frequency signal after being deemphasized is passed on

the audio amplifier and then to the loud speaker. A d-c component, which is a function of the intermediate frequency signal, is taken from the discriminator circuit to control the reactance tube bias. This reactance tube presents either an inductance or a capacitance to the oscillator circuit. The control voltage coming from the discriminator changes the bias and hence the plate current of the reactance tube. If this reactance tube, for example, is supplying capacitive current to the local oscillator tank, more bias will mean less current flow and a smaller simulated added capacitance while less bias will mean more plate current and a greater value of simulated capacitance.

In this manner the discriminator functions to control the size of the capacitance or inductance which the reactance tube adds to the local oscillator tank circuit. The nature of the reactance which the tube adds, that is, whether this reactance tube output is inductive or capacitive depends on the circuit design. The frequency output for the local oscillator is a function of the reactance tube plate current which is in turn determined by the control voltage coming from the discriminator for the FM sound. Control voltage could also be obtained from the video IF strip, however, the sound channel provides a better frequency control because of the relative sharpness of the sound i-f transformers.

The operation of this circuit may be seen from the following sequences of events. If the local oscillator is on exactly the right frequency for a particular channel which is tuned in, it will feed to the mixer exactly the correct frequency to provide the proper sound and picture i-f transformers. A certain value of d-c voltage is taken from the discriminator and used for the control voltage of the reactance tube. As long as the local oscillator remains at the proper frequency, the sound i-f signal is correct and the control voltage does not change. However, when the local oscillator drifts or changes its frequency slightly, the mixer will receive a signal which when beat against the incoming r.f. will not produce the correct sound i.f. Thus the discriminator output voltage will change; this control voltage changes the plate current of the reactance tube. A change in the reactance tube plate current affects the frequency of the local oscillator by changing the amount of reactive current.

If we assume the reactance tube is arranged to provide an inductive current output and that the local oscillator decreases in frequency, we have the following conditions. A decreased



JAN. 1950 ISSUE
60 MANUFACTURERS - 400
MODELS. MOST COMPLETE,
UP-TO-DATE LISTING

Get this easy-to-use, time-saving guide to exact replacements for all popular television receivers. Simplifies servicing, cuts repair-bench time. Write us today for your free copy.



WATCH FOR Merit's future issues of the TV "Repl" Guide

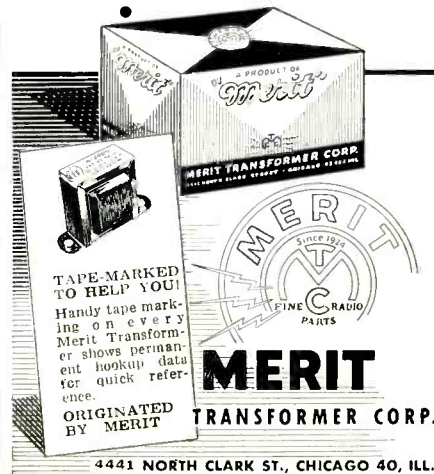

TAPE-MARKED TO HELP YOU! Handy tape marking on every Merit Transformer shows permanent hookup data for quick reference. ORIGINATED BY MERIT



MERIT TRANSFORMER CORP.

4441 NORTH CLARK ST., CHICAGO 40, ILL.

ODEGAARD ORIGINAL NAIL
POLYETHYLENE STANDOFF
JOHN ODEGAARD PAT. PEND.

for Ribbon or Coaxial Cable

Saves more labor, time and money than any other standoff! No drilling—just quick, easy hammer strokes. Easily drives into wood, mortar, iron, aluminum, etc. Excellent mast-coupler. "Step"-locked, permanent installation. Cadmium-plated hardened high-carbon steel nail. Specially punched lo-loss polyethylene.

SERVICEMEN: For free sample and nearest distributor's name, write today to Dept. D.

PARTS DISTRIBUTORS: Choice protected territories still open. For full details, write today to Dept. D.

COPYRIGHT 1950, JOHN ODEGAARD, BROOKLYN, N. Y.

ODEGAARD MFG. CO.
5416 EIGHTH AVE., BROOKLYN 20, N. Y.

C.T.I. TRAINED MEN ARE AVAILABLE!

Each month C.T.I. graduates ambitious young men who have completed an intensive course in Radio and Television maintenance and repairing. Their training has been practical. They've learned by working on modern equipment under personal, expert supervision. If you need a trained technician, we invite you to write for an outline of our course, and for a prospectus of the graduate. (No fees, of course).
Address: Placement Manager, Dept. P105-3
COMMERCIAL TRADES INSTITUTE
1400 GREENLEAF CHICAGO 26

TECHNICIANS AVAILABLE

Carefully selected group of trained men, graduates of reliable and well established trade school now available to fill positions in the Radio or Refrigeration field. Willing to travel anywhere. Why not fill that vacancy with an efficient and reliable man. Write Eastern Technical School, 888 Purchase Street, New Bedford, Mass.

Servicemen - Dealers

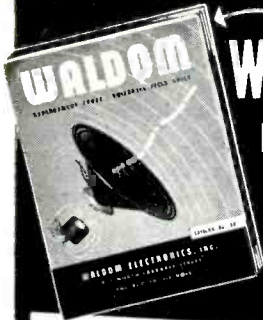

WALDOM
Replacement
Cone
Manual
Catalog No. 50

Write for your FREE copy Today!

Waldom's Free New 24-Page Replacement Cone Manual lists specific replacement data for over 75 different TV, FM, and AM Sets. This handy reference speeds-up your repair time — means more profit to You! Write today for your Free Copy. Send your name and address to Dept. D.

For Finer Tone a Waldom Cone



- Check these features:
- Hawley diaphragms — with the patented thin, tapering edge that assures maximum speaker efficiency and true low frequency response.
 - The finest voice coils and spiders made with precision craftsmanship to exacting specifications.
 - Unconditionally Guaranteed as to construction and performance.
 - Carries the full R.M.A. Warranty.

WALDOM ELECTRONICS, INC.
911 N. Larrabee St., Chicago 10, Ill.

SHOOTS TROUBLE FASTER!

MAKES MORE MONEY FOR YOU ON JOB OR AT SERVICE BENCH!



PRICE \$9.95 at Distributor or postpaid, direct No COD's please. Ohioan's add 3% State Sales Tax

Signalette

MULTI-FREQUENCY GENERATOR

In radio service work, time means money. Locate trouble faster, handle a much greater volume of work with the SIGNALETTE. As a trouble shooting tool, SIGNALETTE has no equal. Merely plug in any 110 V. AC-DC line, start at speaker end of circuit and trace back, stage by stage, listening in set's speaker. Generates RF, IF and AUDIO Frequencies, 2500 cycles to 20 Megacycles. Also used for checks on Sensitivity, Gain, Peaking, Shielding, Tube testing. Wt. 13 oz. Fits pocket or tool kit. Satisfaction, or money back! See at your dist. or order direct.

CLIPPARD INSTRUMENT LABORATORY, INC.

Dept. F, 1125 Bank Street
Cincinnati 14, Ohio

Qualified Jobbers write, wire for details.

bias on the reactance tube causes an increase in the reactive plate current which increases the inductive current flow in the oscillator plate circuit. That is, the new increment of inductive current adds to the inductive current already present since they are in phase and subtracts from the capacitive current already present, since these two are out of phase. Since resonance is a condition where the inductive current equals the capacitive current, the oscillator must increase its frequency thus increasing the inductive reactance which decreases the reactive current. Increasing the frequency also decreases the capacitive reactance which increases the capacitive current. The new higher frequency is a condition whereby the inductive current equals the capacitive current.

Any specific circuit for automatic frequency control for the local oscillator depends on three primary factors. The local oscillator may be above or below the incoming frequency and this will to a large extent determine the design of the AFC system. For example if the local oscillator is above the incoming signal and it drifts higher in frequency, the control system must be arranged to decrease its output frequency and bring it back to normal. If the local oscillator is tuned below the incoming r.f. and it has a tendency to drift, the reactance tube must also decrease the local oscillator and bring it back to its original frequency. However, with a given discriminator circuit the control voltage would not be the same in both cases. If an increasing i.f. means a plus voltage and a decreasing i.f. means a minus voltage at the detector, the local oscillator above the incoming r.f. would produce a positive control voltage as it drifted higher. The local oscillator below the r.f. would create a negative control voltage as it drifted higher. In this manner the control circuit depends upon the frequency relation between the local oscillator and the incoming r.f.

There are other important factors to be taken into consideration. First there are several points in the FM detector circuit where control voltage may be taken. Then, there are various types of FM detectors which may be used including the ratio detector and the discriminator. Finally, there are several possibilities for the reactance tube circuit itself. By choosing a combination of reactance and resistance for the phase-splitting network, the reactance tube will produce either an inductive or capacitive current output. Either type of plate current output may be used for frequency control of the local oscillator.

AD INDEX

Alliance Manufacturing Co.	Cover 3
American Phenolic Corp.	12
American Television & Radio Co.	33
Belden Manufacturing Co.	Cover 2
C & G Tool Manufacturers, Inc.	29
Clarostat Mfg. Co., Inc.	31
Clippard Instrument Laboratory	36
Commercial Trades Institute	35
Eastern Technical School	35
General Electric Company	1
Heath Company	34
Hickock Elec'l Instrument Co.	26
Industrial Condenser Corp.	30
J.F.D. Mfg. Co., Inc.	31
Littelfuse, Inc.	33
Mallory & Co. Inc., P.R.	9
Merit Coil & Trans. Corp.	35
Oak Ridge Products	27
Odegaard Mfg. Co.	35
Ohmite Mfg. Co.	8
Oxford Electric Corporation	25
Radiart Corporation, The	3
RCA (Electron Tubes)	Cover 4
Sprague Products Co.	6
Standard Coil Products Co.	5
Strand Hotel	36
Sylvania Elec. Prods., Inc.	7
Technical Appliance Corp.	30
Tel-O-Tube Sales Corp.	28
Thomas Electronics, Inc.	26
Tricraft Products Co.	34
U. S. Treas. Dept.	11
Waldom Electronics, Inc.	36



HOTEL STRAND

ATLANTIC CITY'S IDEAL CONVENTION HOTEL

Exceptional Convention Facilities adaptable to small, medium or large groups. Ample Meeting, Banquet and Exhibition Rooms. Wonderful location Boardwalk opposite Steel Pier. Write Convention Manager TODAY.

The Strand features Spacious Colorful Lounges—Open and Inclosed Solaria—Salt Water Bath in rooms—Garage on premises. Courteous Personnel.

When in Atlantic City visit

Famous Fiesta Lounge

Food for Epicures

Exclusive Penna. Avenue and Boardwalk.



TV SERVICE DEALERS! RIDE THE ALLIANCE TENNA-ROTOR

"CASH IN ON TV ADVERTISING"

Gravy Train!

NEW!
 Direction Indicator Control Model DIR Now Available!

Eye-Compelling TV Demonstrations

Sell! . . . 6,000,000 Viewers Around 50 TV Stations . . .

SEE TENNA-ROTOR IN ACTION!

There is only one Tenna-Rotor!

Dealers . . . Service Men!

. . . Climb on the gravy train now! Write for the Alliance Merchandiser — "Fastest Profit Maker in Television Today".

Ask for the new model DIR folder

- Alliance Tenna-Rotor is the **only rotator backed by TV advertising** . . . every week your customers see the Alliance films! Dealer response is terrific!
- Proved in the field by thousands of users **from coast to coast!**
- Laboratory tested to operate in rain, snow or icy weather!
- **Exclusive! Only Alliance** has special 4-conductor cable with "Zip" feature to make installations faster—easier!
- **Exclusive! Only Alliance** has Underwriters' Laboratories approval and a **ONE YEAR** Guarantee!

Alliance Manufacturing Company • Alliance, Ohio

Export Department: 401 Broadway, New York, N. Y., U. S. A.

THE QUALITY OF RCA TUBES IS UNQUESTIONED

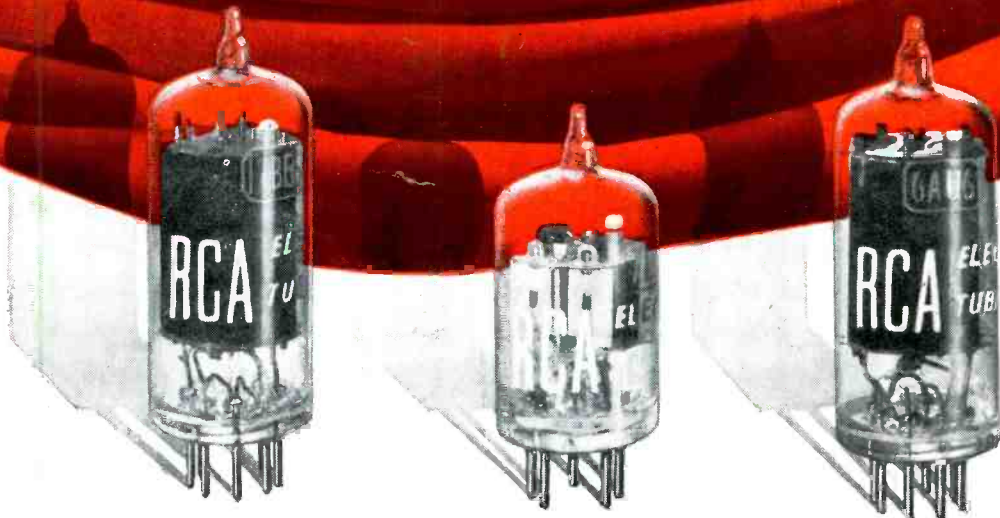

Higher Quality Standards for TV, FM and AM

THE QUALITY LEVEL of RCA miniatures has been continually advanced in step with circuit progress. Improved design . . . more rigid control over manufacture and inspection . . . and more exacting tests, including rigid re-test before shipment, are the reasons why RCA miniatures have unusually uniform characteristics, so important to tubes for television receivers in particular, and also for FM and AM receivers. Their dependability in criti-

cal circuits cuts down costly service call-backs.

And now . . . this extra quality of RCA miniatures is "packed in so it can't be shaken out." A new type "snug-fit" carton protects tubes against damage by holding them securely in place during transit.

RCA's engineering leadership adds value beyond price to the RCA tubes you sell. Your customers know about this advantage too.

Always keep in touch with your RCA Tube Distributor



RADIO CORPORATION of AMERICA
ELECTRON TUBES

HARRISON, N. J.