

*Radio*  
**SERVICE  
DEALER**

AUGUST, 1948



**IN THIS ISSUE:**

FM and TV Boosters

Appliance Repair Techniques for Radiomen

Video Amplifiers—D-C Component

**AM-FM-TV-SOUND**

*The Professional Radioman's Magazine*

# All New! Mallory Revolutionary Midgetrol



Quietest and Smoothest . . . by Test!

**THE SIZE IS . . . . . NEW**

Only  $\frac{15}{16}$ " in diameter, it easily services the increasingly popular small sets where ordinary controls will not fit.

**THE SWITCH IS . . . . . NEW**

No chance of failure—it's Mallory engineered and Mallory manufactured. Pushes on—stays on—and works.

**THE DESIGN IS . . . . . NEW**

Brand new shaft style saves valuable time in installation—reduces inventory since one shaft fits all knobs.

**THE ELEMENT IS . . . . . NEW**

More accurate over-all resistance, smoother tapers, ample power dissipation.

**THE CONSTRUCTION IS . . . . . NEW**

Extra quiet—no metal-to-metal contact between shaft and cover or bushing. Special Mallory contact material.

**THE CONTACT IS . . . . . NEW**

Laboratory tests prove that the Mallory Midgetrol is the quietest control on the market.

**THE SHAFT IS . . . . . NEW**

Unique—two simple fittings—for all type knobs. No need for extra controls for different knobs.

**THE TERMINAL IS . . . . . NEW**

Won't break—twist 'em all you want in close working space. Away from panel to avoid shorting.

**THE EXTENSION IS . . . . . NEW**

Easy to apply with self-tapping screws. Supplementary shafts available for installations which require them.

**THE SUSPENSION IS . . . . . NEW**

Two-point—insures even contact pressure at all points of rotation. Larger bushing area—added support—no wobble.

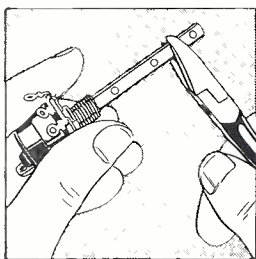

Side snips neatly cut shaft to length desired.

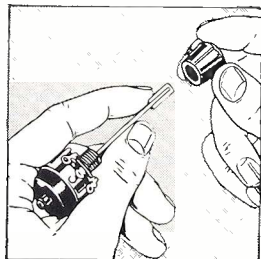

U-clip furnished to slide over end of shaft—holds set-screw knobs.

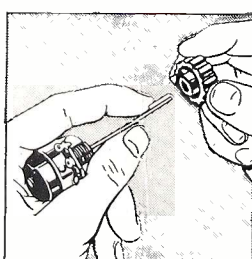

Use half the U-clip to hold push-on type knobs.

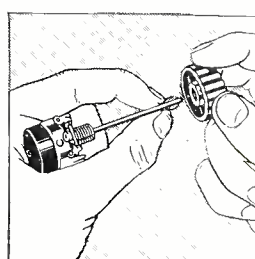

Spring steel clip included for use with knurled knobs.

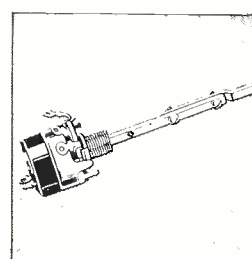

Extension shafts with two self-tapping screws available when needed.

It's the NEW Standard in Carbon Controls. See your Mallory distributor.

P. R. MALLORY & CO. Inc.  
**MALLORY**  
 CAPACITORS • CONTROLS • VIBRATORS • SWITCHES • RESISTORS  
 • RECTIFIERS • VIBRAPACK\* POWER SUPPLIES • FILTERS  
\*Reg. U. S. Pat. Off.  
**APPROVED PRECISION PRODUCTS**

**P. R. MALLORY & CO., Inc., INDIANAPOLIS 6, INDIANA**

# CROSLEY *Twice Tested*

## ★ RADIO PARTS for general replacement



**IMMEDIATE DELIVERY!**

from your nearest **CROSLEY** Distributor, listed below



LOOK FOR this emblem on the outside of every package of parts you buy. It's your guarantee of quality parts *inside*.

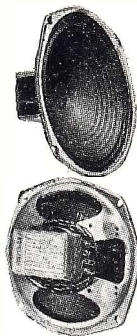

**CROSLEY TOP QUALITY SPEAKERS** P.M. types have maximum weight Alnico 5 magnets for extra stability under overload. E.M. types designed for smooth reproduction with maximum load. Install Crosley replacement speakers—and satisfied customers will *spea*k up for you!

GET EXTRA DOLLARS WITH THE MASTER TOUCH-UP KIT!



Complete with all materials and instructions for a factory-quality cabinet touch-up job. Plenty of prospects for this service—get your kit now! Your cost, only \$5.25 including metal box. Order part No. 139712 from your Crosley distributor.

Write your distributor for free Crosley Service Parts Catalog.

# CROSLEY

Division—**AVCO** Manufacturing Corporation  
Cincinnati 25, Ohio

Albany, New York. . . . . Roskin Bros.  
Amarillo, Texas

Domestic Appliance Dist.

Atlanta, Georgia. . . Georgia Appliance  
Baltimore, Maryland Legum Distributing  
Birmingham, Ala. Alabama Service Co.  
Boston, Mass. . . . . Wahn Distributors  
Buffalo, N. Y. . . . . Western Mdse. Distrs.  
Bristol, Tenn.-Va. Interstate Hardware Co.  
Carrier Mills, Ill. . . O'Keefe Distributing  
Charlotte, N. C. . Carolinas Auto Supply  
Chicago, Illinois. . . Harry Alter & Bros.  
Cincinnati, Ohio. . . Modern Distributing  
Clarksburg, W. Va. . . Utility Co., Inc.  
Cleveland, Ohio. . . Frankelite Company  
Columbus, Ohio Miami Valley Dist. Co.  
Dallas, Texas. . . Lone Star Wholesalers  
Davenport, Iowa. . . Sieg Home Supply  
Dayton, Ohio. . . . . Miami Valley Dist.  
Denver, Colo. . Graybar Electric Co., Inc.  
Des Moines, Iowa. . . H. E. Sorenson Co.  
Detroit, Mich. . . . . Peninsular Dist. Co.  
El Paso, Texas. . . . Vaughan Appliance  
 Fargo, N. D. . . . . Meyers-Taube Co.  
 Ft. Smith, Arkansas Eads Bros. Furniture  
 Ft. Wayne, Indiana. . R. M. Kaough Co.  
 Ft. Worth, Texas. United Appliance Co.  
 Grand Rapids, Mich.

Independent Distributors, Inc.

Great Falls, Mont. . . Gi. Falls Paper Co.  
Harlan, Ky. . . . . Kentucky Mine Supply  
Harrisburg, Pa. . . . Jules Alexandre, Inc.  
Hastings, Nebraska. . . Dutton-Lainson  
Hazleton, Pa. . . . . Lehigh Valley Dist.  
Houston, Texas

Reader's Wholesale Distributors

Huntington, W. Va. Huntington Wh'e Furn.  
Indianapolis, Ind. . . Capital Paper Co.  
Jackson, Miss. . . . Southern Wholesalers  
Jacksonville, Fla. Graybar Elec. Co., Inc.  
Kansas City, Mo. . . . Superior Distr. Co.  
Little Rock, Ark. . . . Wright Service Co.  
Los Angeles, Calif. . . J. N. Ceazan Co.  
Louisville, Ky. . . . . Cooper-Louisville  
Manitowoc, Wis. . . J. J. Stangel Hdwe. Co.  
Memphis, Tenn. . . . . National Rose Co.  
Miami, Fla. . . . . Graybar Electric Co., Inc.

Milwaukee, Wis. . . . Greusel Distr. Co.  
Nashville, Tenn. . . . Nashville Chair Co.  
Newark, N. J. . . . . Apollo Service, Inc.  
New Haven, Co. . . H. M. Tower Corp.  
New Orleans, La.

Woodward, Wight & Co.

New York, N. Y. . . . Crosley Distr. Corp.  
Omaha, Nebr. Electric Fixture & Supply  
Orlando, Fla. . . . Graybar Elec. Co., Inc.  
Peoria, Illinois. . . Johnston-Moody Co.  
Philadelphia, Pa. . . Judson C. Burns, Inc.  
Phoenix, Arizona Appliance Distributors  
Pittsburgh, Pa. Pittsburgh Products Co.  
Portland, Maine Graybar Elec. Co., Inc.  
Portland, Ore. . . Fields Sales Company  
Providence, R. I. Graybar Elec. Co., Inc.  
Quincy, Illinois. . . Tenk Hardware Co.  
Reno, Nev. . . Heat. & Air Cond. Supply  
Richmond, Virginia. Louis O. Bowman  
Roanoke, Va. . . . Richardson-Wayland  
Rochester, N. Y. . . O'Donnell-Dunigan  
Saginaw, Mich. . . . . J. Fischer & Sons  
Salt Lake City, Utah Western Supply Co.  
San Antonio, Texas. Alamo Distributing  
San Francisco, Calif. California Electric  
Savannah, Georgia. . . . Frank Corp.  
Seattle, Wash. . . Commercial Appliance  
Shreveport, La. . . . Electric Supply Co.  
Sioux Falls, S. D. . . Power City Radio  
South Bend, Ind. . . The Ridge Company  
Spokane, Wash. . . Standard Sales Co.  
Springfield, Ill. . Central Ill. Wholesalers  
Springfield, Mass. . . Tarbell-Watters  
Springfield, Mo. . . . Rogers & Baldwin  
Sterling, Illinois. . . Hardware Products  
St. Louis, Missouri. . . ARA Distributing  
St. Paul, Minn. . Motor Power Equip. Co.  
Syracuse, N. Y. . . O'Donnell Distributors  
Tampa, Fla. . . . Graybar Elec. Co., Inc.  
Toledo, Ohio

Walding-Kinnan & Marvin Co.

Tulsa, Oklahoma Tom P. McDermott, Inc.  
Tucson, Arizona. Appliance Distributors  
Washington, D. C. American Wholesalers  
Watertown, S. D. . . . . Lyle Meyers  
Wichita, Kansas. Steve Wise Company  
Youngstown, Ohio. . . Dorrance Supply



# How to Make **MORE WALK-IN PROFIT** per Portable

Here's the Federal Miniature Selenium Rectifier that reduces your cost and does a better job

Now this Federal Miniature Selenium Rectifier actually costs much less than any of the rectifier tubes it replaces. That's the economic reason why you will find this modern power supply in so many of the 1948 portable and personal radios. The performance reasons are that Federal Selenium Rectifiers assure instant starting . . . longer life . . . cooler operation.

It's easy to bring most small radios up to date with Federal Selenium Rectifiers. Circuit changes are minor. All you have to do is to solder a few connections.

When you use Federal Selenium Rectifiers, you're sure of the best obtainable. It was Federal that first introduced the Selenium Rectifier in this country nine years ago. And Federal has led in the research, development and manufacture of ever-better Selenium Rectifiers at less cost.

Ask your jobber about Federal Miniature Selenium Rectifiers for portable and personal radio repairs. For full information on how to increase your profits by their use, write to Department F-985.

Type 402D3150A—75 ma

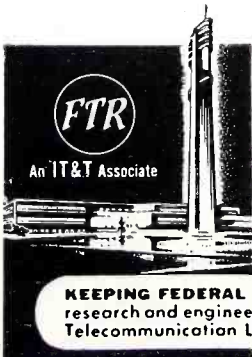
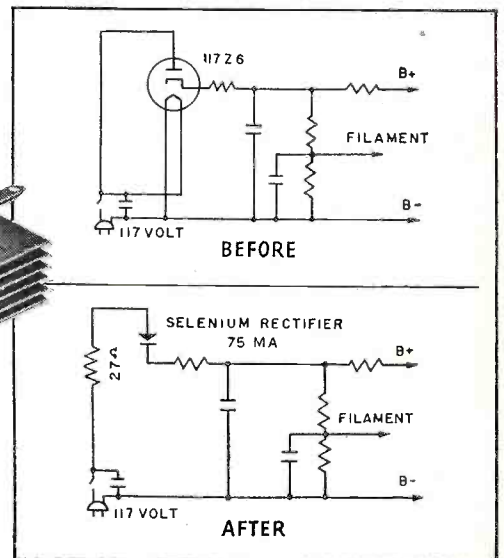
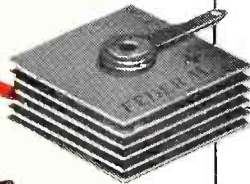

## Federal Telephone and Radio Corporation

SELENIUM and INTELIN DIVISION, 900 Passaic Ave., East Newark, New Jersey

In Canada: Federal Electric Manufacturing Company, Ltd., Montreal, P. Q.  
Export Distributors: International Standard Electric Corp. 67 Broad St., N. Y.

**TUBES ARE KNOWN BY**

**THE COMPANY THEY KEEP**

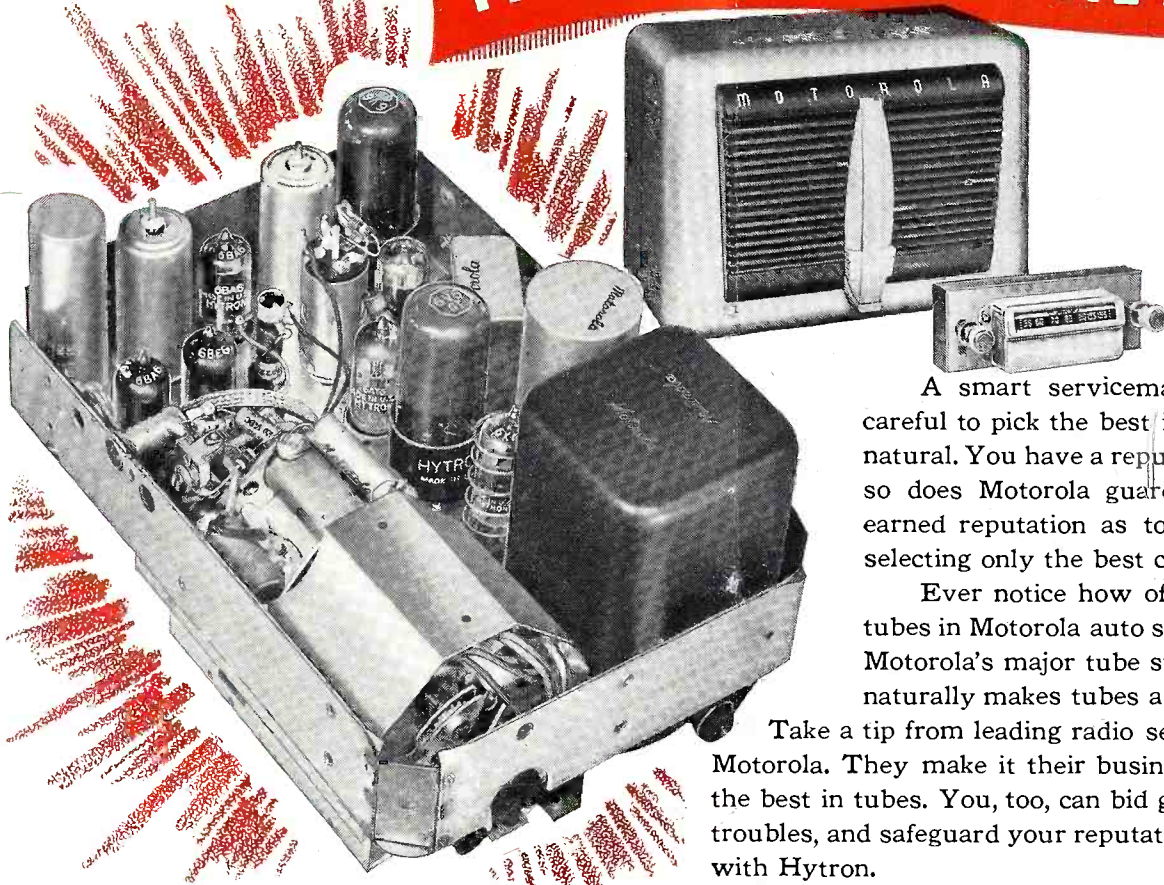

A smart serviceman, you are mighty careful to pick the best in tubes. That's only natural. You have a reputation to protect. Just so does Motorola guard jealously its well-earned reputation as tops in auto radio by selecting only the best components.

Ever notice how often you find Hytron tubes in Motorola auto sets? To rate as one of Motorola's major tube suppliers, Hytron just naturally makes tubes a lot better than good.

Take a tip from leading radio set manufacturers like Motorola. They make it their business to know and use the best in tubes. You, too, can bid goodbye to your tube troubles, and safeguard your reputation by "going steady" with Hytron.

**SERVICEMEN—Win These Monthly Prizes!**



FIRST PRIZE, AUG.

McMurdo Silver 900A "Vomax," 904 C/R Tester, and 905A "Sparx."



FIRST PRIZE, SEPT.

Jackson 641 Universal Signal Generator.



FIRST PRIZE, OCT.

Weston 769 H-F Electronic Analyzer.



Want one of these deluxe first prizes? Perhaps a \$200 U. S. Savings Bond grand prize? Or one of three \$50 and three \$25 U. S. Savings Bond second and third prizes? Try your hand at any or all of Hytron's monthly contests exclusively for radio servicemen. It's easy. Here's how. Get entry blank

with complete details from your Hytron jobber, or write us. Describe your proposal for a simple, economical shop tool like the Hytron Tube Tapper or Miniature Pin Straighteners. Mail entry to Hytron Contest Editor. Then hold your breath. The finger of the judges may point at you.

SPECIALISTS IN RADIO RECEIVING TUBES SINCE 1921



**HYTRON**  
RADIO AND ELECTRONICS CORP.

MAIN OFFICE: SALEM, MASSACHUSETTS

NEW 9-PIN  
Miniature Pin Straightener



Only 49¢ at Hytron jobbers

# EDITORIAL

by S. R. COWAN

## Statistics

The statistics that follow indicate how fast TV is moving into a dominant position. But more important, the figures should cause progressive Service Dealers and Service Organization operators to cogitate with the purpose in mind of trying to determine what type and percentage of the total business in their particular community is coming into their own shops. Finally, the portion of this editorial that follows immediately after "Statistics" outlines a positive suggestion, which if acted upon seriously, might result in a most profitable idea for Service Dealers and Servicicers.

During 1947 RMA members produced 160 thousand TV receivers. During the first six months of 1948 the same group made over 278 thousand video sets, and with ever-stepped-up production expects to make over a half-million during 1948.

Total radio set sales in 1947 were over 19.5 million units having a manufacturers' value of \$700 million. Unfortunately the industry overproduced table model AM sets and they are a glut on the market that can cause serious complications. There is a noticeable increase in \$9.95 type sets. We regret this and hope that the makers will get smart quickly and stop producing "killermerchandise".

Of the 100 million radio tubes made during the first six months of 1948, about 80% were for new sets and 20% went to jobbers for sale in the replacement market. If the country's servicicers were as aggressive as they should be replacement radio tube sales could easily and justifiably be much greater percentagewise.

## Selling More Tubes

Each year RMA sponsors in conjunction with retailers a sales promotion stunt that has proven successful. They call the stunt something like "A Radio In Every Room Week." It's a fine idea . . . but it don't help the servicing side of the industry. So, suppose the Service Dealers and Service Organizations of the country were to organize and promote a "Check Your Old Radio Week." Without doubt the public would take to such an idea . . . have many sets checked that ordinarily would not be, and in the doing, the service group would come up with a lot of replacement tube sales that would result in improved reception, and many minor faults in sets would be cleaned up with mutual profit to the servicing profession and set owning public. If the service profession likes our rough proposal about a "Check Up Week," we might submit the idea to RMA for consideration.

## Misleading Dealer TV Claims

New York's Better Business Bureau justifiably warns TV retailers to eliminate rampant ambiguous or misleading claims when advertising or making sales presentations, stressing they must define clearly: 1) exactly what channels any given set is capable of receiving; 2) what service charges will be made to assure satisfactory reception on all channels within the set's range at time of installation; and 3) whether additional charges are to be applied for adjustments made after the original installation, in cases where additional channels come into being. We urge dealers in all TV areas to keep their TV claims clean.



Member of the  
Audit Bureau of  
Circulations



VOL.  
9  
NO.  
8

SANFORD R. COWAN, Editor & Publisher

SAMUEL L. MARSHALL, Technical Editor

AUGUST, 1948

Editorial . . . . .	4
Trade Flashes . . . . .	8
FM & TV Boosters, by W. H. Buchsbaum . . . . .	11
Theory and application of commercial FM & TV Boosters.	
Appliance Repair Techniques That Radiomen Should Know, by Wm. R. Wellman . . . . .	13
Basic information regarding many electrical appliances	
Re: "Field Findings" . . . . .	15
Video Amplifiers—D-C Component, by S. J. Marshall . . . . .	16
D-C Component explained here as Part 2 in the series.	
Circuit Court . . . . .	18
Howard 472 Series; Silvertone Model 8000; Crosley Model 146CS; Motorola Model 67F.	
Shop Notes . . . . .	20
RCA 65 BR9, Radiola 65 BR9, testing power unit with dummy load; Frozen dial lamps; Webster Model 80—oscillator circuit changes; G-E Models 356-7-8-376-7-8—tube replacement caution; Silver-Marshall Model V—hum; Admiral 8B1, 9A1, 9B1—fogging dials; Transvision TV Kit—service hints.	
New Products . . . . .	21

SANFORD L. CAHN  
National Advertising Sales Manager

HARRY N. REIZES  
Advertising Manager

BRANCH: J. C. GALLOWAY, 816 W. 5th St., Los Angeles 13, Calif., Mutual 8335

Jean M. Wheeler  
Circulation Manager

David Saltman  
Adv. Production Manager

RADIO SERVICE DEALER (title registered U. S. Pat. Off.) is published monthly at 28 Renne Ave., Pittsfield, Mass. by the Cowan Publishing Corp. Executive & Editorial Offices, 342 Madison Avenue, New York City 17, New York. Subscription rates:—United States, U. S. Possessions and Canada, \$2.00 for 1 year, \$3.00 for 2 years; elsewhere \$3.00 per year. Single copies: 25c. Printed in U. S. A. Entered as Second Class Matter at the Post Office at Pittsfield, Mass., under the Act of March 3, 1879. All subscribers should allow at least three weeks for change of address. Copyright, 1948, by Cowan Publishing Corp.

# "YOU CAN'T BEAT KEN-RAD TUBES!"



"You can't beat Ken-Rad tubes—I found that out long ago!

"Ever since 1935, when I started in business, I've been using Ken-Rad tubes.

"And believe me, they hold up—never let me down!

"I found Ken-Rad tubes dependable. So I sold them to my customers. They like them, too. I never receive a complaint.

"In fact, I think a good part of the big repeat business I do is the result of Ken-Rad tubes.

"Quality pays off!"



**JOHN F. BERANICH**, 4439 West Madison St., Chicago, Ill., does a big business servicing radios, and like thousands of other servicemen he uses Ken-Rad tubes. He likes their dependable quality!

## "HERE'S WHY YOU CAN'T BEAT KEN-RAD TUBES!"

"From start to finish, Ken-Rad tubes undergo strictest inspections and tests.

"I know, because I help test them!

"They're made to stand up, satisfy customers, increase your business.

"You can depend on Ken-Rad tubes because they're tested for noise, microphonics, static, life, shorts, appearance, gas, air and hum.

"Your customers can depend on Ken-Rad tubes because they're built, throughout, to the highest standards of quality, stamina, and endurance."



**WALTER DOWNING**, Foreman, Raw Materials Inspection Department, is in charge of comprehensive testing of all materials used in making Ken-Rad tubes. Here cathode sleeves are being tested for breaking strength.



**KEN-RAD** *Radio Tubes*

PRODUCT OF GENERAL ELECTRIC COMPANY

Schenectady 5, New York

**The  
Serviceman's  
Tube**



# EDITORIAL

by S. R. COWAN

## Statistics

The statistics that follow indicate how fast TV is moving into a dominant position. But more important, the figures should cause progressive Service Dealers and Service Organization operators to cogitate with the purpose in mind of trying to determine what type and percentage of the total business in their particular community is coming into their own shops. Finally, the portion of this editorial that follows immediately after "Statistics" outlines a positive suggestion, which if acted upon seriously, might result in a most profitable idea for Service Dealers and Servicicers.

During 1947 RMA members produced 160 thousand TV receivers. During the first six months of 1948 the same group made over 278 thousand video sets, and with ever-stepped-up production expects to make over a half-million during 1948.

Total radio set sales in 1947 were over 19.5 million units having a manufacturers' value of \$700 million. Unfortunately the industry overproduced table model AM sets and they are a glut on the market that can cause serious complications. There is a noticeable increase in \$9.95 type sets. We regret this and hope that the makers will get smart quickly and stop producing "killer merchandise".

Of the 100 million radio tubes made during the first six months of 1948, about 80% were for new sets and 20% went to jobbers for sale in the replacement market. If the country's servicicers were as aggressive as they should be replacement radio tube sales could easily and justifiably be much greater percentagewise.

## Selling More Tubes

Each year RMA sponsors in conjunction with retailers a sales promotion stunt that has proven successful. They call the stunt something like "A Radio In Every Room Week." It's a fine idea . . . but it don't help the servicing side of the industry. So, suppose the Service Dealers and Service Organizations of the country were to organize and promote a "Check Your Old Radio Week." Without doubt the public would take to such an idea . . . have many sets checked that ordinarily would not be, and in the doing, the service group would come up with a lot of replacement tube sales that would result in improved reception, and many minor faults in sets would be cleaned up with mutual profit to the servicing profession and set owning public. If the service profession likes our rough proposal about a "Check Up Week," we might submit the idea to RMA for consideration.

## Misleading Dealer TV Claims

New York's Better Business Bureau justifiably warns TV retailers to eliminate rampant ambiguous or misleading claims when advertising or making sales presentations, stressing they must define clearly: 1) exactly what channels any given set is capable of receiving; 2) what service charges will be made to assure satisfactory reception on all channels within the set's range at time of installation; and 3) whether additional charges are to be applied for adjustments made after the original installation, in cases where additional channels come into being. We urge dealers in all TV areas to keep their TV claims clean.



Member of the  
Audit Bureau of  
Circulations



VOL.  
9  
NO.  
8

SANFORD R. COWAN, *Editor & Publisher*

SAMUEL L. MARSHALL, *Technical Editor*

AUGUST, 1948

Editorial . . . . .	4
Trade Flashes . . . . .	8
FM & TV Boosters, by W. H. Buchsbaum . . . . .	11
Theory and application of commercial FM & TV Boosters.	
Appliance Repair Techniques That Radiomen Should Know, by Wm. R. Wellman . . . . .	13
Basic information regarding many electrical appliances	
Re: "Field Findings" . . . . .	15
Video Amplifiers—D-C Component, by S. J. Marshall . . . . .	16
D-C Component explained here as Part 2 in the series.	
Circuit Court . . . . .	18
Howard 472 Series; Silvertone Model 8000; Crosley Model 146CS; Motorola Model 67F.	
Shop Notes . . . . .	20
RCA 65 BR9, Radiola 65 BR9, testing power unit with dummy load; Frozen dial lamps; Webster Model 80—oscillator circuit changes; G-E Models 356-7-8-376-7-8—tube replacement caution; Silver-Marshall Model V—hum; Admiral 8B1, 9A1, 9B1—fogging dials; Transvision TV Kit—service hints.	
New Products . . . . .	21

SANFORD L. CAHN  
National Advertising Sales Manager

HARRY N. REIZES  
Advertising Manager

BRANCH: J. C. GALLOWAY, 816 W. 5th St., Los Angeles 13, Calif., Mutual 8335

Jean M. Wheeler  
Circulation Manager

David Saltman  
Adv. Production Manager

RADIO SERVICE DEALER (title registered U. S. Pat. Off.) is published monthly at 28 Renne Ave., Pittsfield, Mass. by the Cowan Publishing Corp. Executive & Editorial Offices, 342 Madison Avenue, New York City 17, New York. Subscription rates:—United States, U. S. Possessions and Canada, \$2.00 for 1 year, \$3.00 for 2 years; elsewhere \$3.00 per year. Single copies: 25c. Printed in U. S. A. Entered as Second Class Matter at the Post Office at Pittsfield, Mass., under the Act of March 3, 1879. All subscribers should allow at least three weeks for change of address. Copyright, 1948, by Cowan Publishing Corp.



# "YOU CAN'T BEAT KEN-RAD TUBES!"



"You can't beat Ken-Rad tubes—I found that out long ago!

"Ever since 1935, when I started in business, I've been using Ken-Rad tubes.

"And believe me, they hold up—never let me down!

"I found Ken-Rad tubes dependable. So I sold them to my customers. They like them, too. I never receive a complaint.

"In fact, I think a good part of the big repeat business I do is the result of Ken-Rad tubes.

"Quality pays off!"



**JOHN F. BERANICH**, 4439 West Madison St., Chicago, Ill., does a big business servicing radios, and like thousands of other servicemen he uses Ken-Rad tubes. He likes their dependable quality!

## "HERE'S WHY YOU CAN'T BEAT KEN-RAD TUBES!"

"From start to finish, Ken-Rad tubes undergo strictest inspections and tests.

"I know, because I help test them!

"They're made to stand up, satisfy customers, increase your business.

"You can depend on Ken-Rad tubes because they're tested for noise, microphonics, static, life, shorts, appearance, gas, air and hum.

"Your customers can depend on Ken-Rad tubes because they're built, throughout, to the highest standards of quality, stamina, and endurance."



**WALTER DOWNING**, Foreman, Raw Materials Inspection Department, is in charge of comprehensive testing of all materials used in making Ken-Rad tubes. Here cathode sleeves are being tested for breaking strength.



**KEN-RAD** *Radio Tubes*

PRODUCT OF GENERAL ELECTRIC COMPANY

Schenectady 5, New York

*The  
Serviceman's  
Tube*



# IT'S HERE! WEBSTER-CHICAGO AUTOMATIC MICROGROOVE RECORD CHANGER

**"MICROGROOVE" IS HEADLINE NEWS—  
MODEL 133 IS "CASH REGISTER" NEWS!**

**Model 133 • the famous Webster-Chicago foolproof record-changer mechanism • New balanced tone arm and nylon knee action needle • magnificent reproduction from microgroove records • 33 RPM turntable speed — plays 10 twelve inch or 12 ten inch microgroove records *automatically* at one loading • 4 hours of continuous record play with fast change cycle.**

# THE *Matinee*

First of the Webster-Chicago line of automatic record changers for microgroove recordings • Phone your Webster-Chicago distributor for details. Don't delay! Be ready for the microgroove records. **\$38<sup>75</sup>** Retail  
\$39.95 West of the Rockies

## WEBSTER-CHICAGO

5610 West Bloomingdale Ave.  
Chicago 39, Ill.



# TRADE FLASHES

A "press-time" digest of production, distribution & merchandising activities

## Hytron Announces First Winner

The first contest winner whose serviceman's tool suggestion was voted to be the best entry was Mr. Harry L. Smith of 25-26 Steinway St., Long Island City, New York. The first prize for May was a DuMont Type 274 five-inch Oscillograph. All you have to do

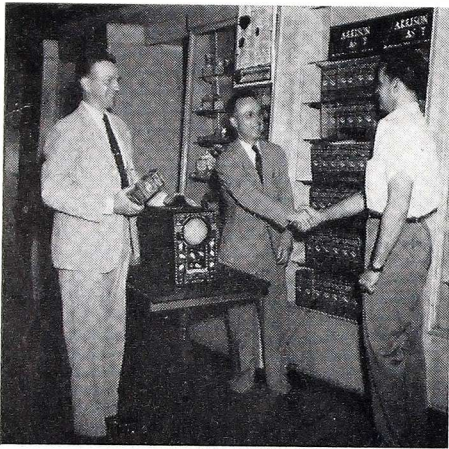

to enter this monthly contest is get an entry blank with complete details from your Hytron jobber or write Hytron direct. Describe your proposal for a simple, economical shop tool like the Hytron tube tapper or miniature pin straighteners, and you may find yourself a first prize winner.

## Zenith Announces

The completion of negotiations with Farnsworth Television & Radio Corporation by which Zenith acquires paid-up rights to build home television receivers under all of Farnsworth's patents and pending applications for the entire life of the patents concerned. A nationwide series of schools conducted by Zenith Radio Corporation to teach correct servicing of FM radio receivers which started in Milwaukee Monday, June 9. A genuine Zenith-Armstrong FM and long-distance AM table model receiver that provides the advantages of frequency modulation at a new low price. The addition of an AM console combination, Model 7R887, to the company's line. A portable that pops open and starts playing at the touch of a convenient button. The appointment of Kenneth W. Sickinger as assistant advertising manager announced.

## Magnavox Enters TV

The Magnavox Company recently marked its entrance into the television field with a premiere showing of twelve

models in a wide variety of furniture styles, priced from \$299.50 to \$1,750.00 at the convention of the National Association of Music Merchants.

## Sightmaster's New TV Screen

The "Americana" a new TV receiver was recently introduced by the Sightmaster Corporation. The "Sightmas-



ter" screen (patents pending) is a decorative mirror when the set is not in use. When the set is in operation the picture appears on the mirror itself. It is not a reflected image, but a picture actually transmitted through the mirror.

## New Components Red Book

Howard W. Sams & Co., Inc. announces publication of the RADIO INDUSTRY RED BOOK, a cooperative industry effort, representing the first and only complete radio receiver

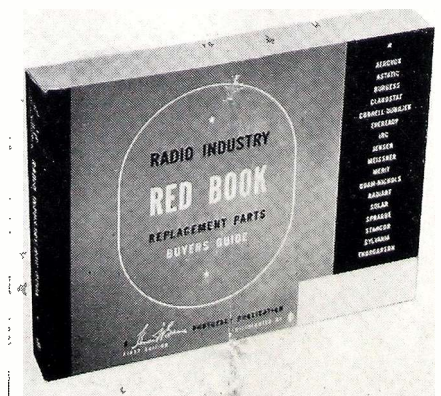

replacement parts guide ever published. This single authoritative volume provides accurate, easy to use listings on all 9 major replacement components for approximately 17,000 models made during the ten year period 1938 to 1948. It lists original parts, together with numbers for proper replacement parts.

## Crosley Ups Redden — '49 Line Shown

Appointment of Ellis L. Redden as Director of Advertising and Sales Promotion is announced by N. C. Macdonald, General Sales Manager, Crosley Division, Avco Manufacturing Corporation, Cincinnati, Ohio. He will be responsible for all advertising media, sales



promotional activities, training programs, and the Home Economics Department.

An "all new line for '49" consisting of 26 radios and a television receiver with a 12-inch picture tube, was unveiled by Crosley Division, Avco Manufacturing Corporation, at a distributor meeting in Cincinnati June 28-29-30. Presentation was made to more than 200 representatives of Crosley's national and international distributor organization in the company's auditorium by Stanley Glaser, manager, radio and television section.

## Engineers to Meet in Fall

The 1948 Rochester Fall Meeting of members of the Institute of Radio Engineers and the Radio Manufacturers Association Engineering Department will be held November 8, 9 and 10 at the Sheraton Hotel, Rochester, New York according to an announcement by Virgil M. Graham, chairman of the

(Continued on Page 22)

**Specify the**



**1201**

**DELUXE ALNICO 5  
LOUDSPEAKER**

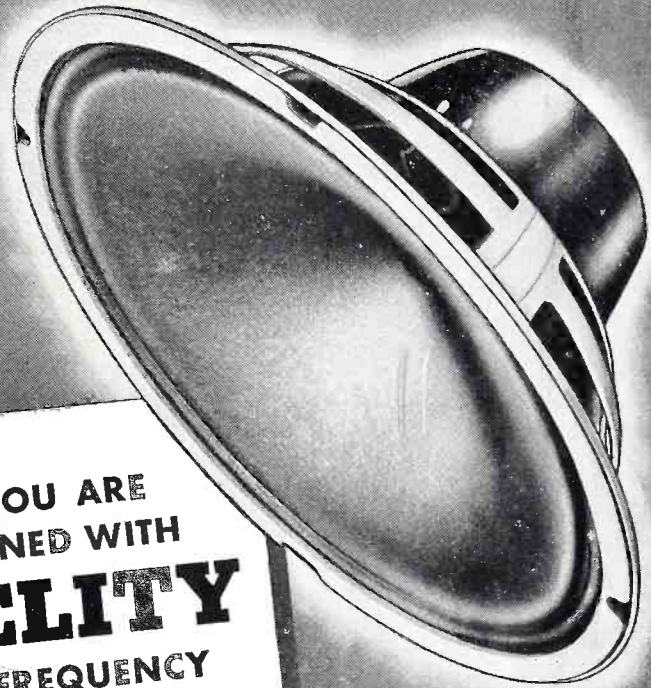

WHEN YOUR  
JOB DEMANDS  
**POWER**  
25 WATTS  
POWER HANDLING  
CAPACITY

WHEN YOU ARE  
CONCERNED WITH  
**FIDELITY**  
BROAD FREQUENCY  
CHARACTERISTIC  
50—13,000 CYCLES

EQUIPPED WITH  
THE FAMOUS  
**GENERAL ELECTRIC**  
**ALUMINUM FOIL BASE**  
**VOICE COIL**

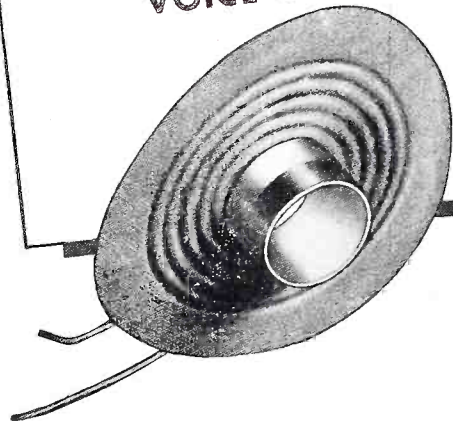

**P**OWER, fidelity and a price that will amaze you for a speaker of this exceptionally high quality—it's the G-E 1201.

It's a wide range speaker with the frequency response stretched out at both ends of the curve to give intense realism, smooth, full lows and "high fidelity." A curvilinear cone is employed to provide this extended frequency response. Alnico 5, 14½ ounces of it, gives high sensitivity and smooth response.

The moving parts in the speaker assembly are ruggedly designed to take high power without damage to the speaker in any way.

Note: Frequency response 50—13,000 cycles.

For complete information on this outstanding speaker write: *General Electric Company, Electronics Park, Syracuse, New York.*

**GENERAL**  **ELECTRIC**

HUNDREDS OF SERVICEMEN CASHED IN ON SYLVANIA'S SPRING PROMOTION

# NOW... SYLVANIA OFFERS THE RADIO SERVICEMAN ANOTHER PROFIT-BUILDING PLAN FOR THE FALL!



Shown at the left is one of Sylvania's national ads to appear in Life, The Saturday Evening Post, Collier's, Radio Best... during September, October, November and December. This series of ads is designed to sell you and your dependable radio repair service to your prospects.

HERE'S HOW YOU TIE UP WITH AND CASH IN ON THESE ADS...

...in 5 different ways!



**1. 4 POSTAL CARD MAILINGS—ONE FOR EACH MONTH**

Sylvania supplies these cards in 3 colors, imprinted with your name and address. You pay only the postage on each card. You send them to your customers and prospects!



**2. 4 WINDOW DISPLAYS—ONE FOR EACH MONTH**

Sylvania supplies you FREE 4 big, colorful displays. Each one is tied in with the national advertising using the same illustrations and copy. You put them in your window to attract customers!



**3. 4 WINDOW STREAMERS—ONE FOR EACH MONTH**

Sylvania gives you FREE these four 2-color streamers. They are also tied in with Sylvania's national advertising. You attach these to your window as another means of attracting new customers!



**4. 8 NEWSPAPER AD MATS—TWO SIZES FOR EACH MONTH**

Sylvania sends you FREE 2 ad mats for each month—one and two-column by seven inches. Use them in your local or neighborhood papers and classified telephone directory.

**5. RADIO SPOT ANNOUNCEMENTS—SEVERAL FOR EACH MONTH**

Sylvania also provides FREE several radio commercials for each month for the radio serviceman who uses radio advertising. Call or see your local radio station for rates.

**THIS 4-MONTH ADVERTISING PROGRAM PACKED IN ONE HANDY KIT**

Covering the months of September, October, November and December, this hard-hitting sales promotion program is packed in one big kit. You pay only the postage on the government postal cards you mail. Sylvania supplies everything else without charge.

**YOU CAN IDENTIFY YOURSELF WITH THIS DECAL**  
Put this decal on your door, windows and truck. It is reproduced in Sylvania's national ads and identifies you as the radio serviceman described in Sylvania's national advertising.

Learn how you can participate in this Fall advertising program. Write Sylvania Electric Products Inc., Advertising Department, Emporium, Pa., or see your Sylvania Distributor.

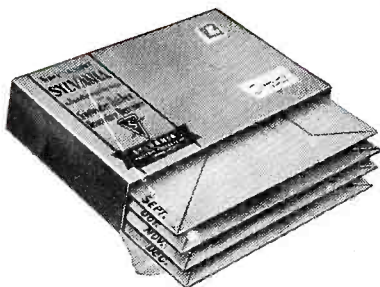

# SYLVANIA ELECTRIC

RADIO TUBES; CATHODE RAY TUBES; ELECTRONIC DEVICES; FLUORESCENT LAMPS, FIXTURES, WIRING DEVICES; PHOTOLAMPS; ELECTRIC LIGHT BULBS

# FM & TV BOOSTERS

by W. H. BUCHSBAUM

**Modern FM and TV receivers often require additional stages of preamplification in the front end in order to improve gain and selectivity. This article outlines the theory and applications of commercial boosters for this purpose.**

ONE of the characteristics of the present system of FM and television broadcasting is the existence of a relatively limited area in which reception is usually possible. Regardless of the power which a station may radiate, its range is limited by the curvature of the earth, since radio waves above 30 mc usually are not reflected by the Heavyside Layer. With FM networks soon spanning the country, this is not as great a drawback as in the television field, where stations are still few and confined to the large cities and where the cost of relays or video transmission lines is very high. The following discussion applies to both FM and television, but since the problems of bandwidth and signal strength are much greater in television broadcasting, preamplifiers and boosters are used mostly for video reception. However, most of the data given will be the same, with slight modifications, for FM reception.

## Service Areas

Using an antenna the height of the Empire State Building in New York, a television station may hope to cover adequately an area of about a 60 mile radius. That is, if the power output is sufficient and no natural or man-made obstacles obstruct the straight-line path of the radio waves. Beyond 60 miles reception becomes irregular, depending on many factors such as weather, location and special local conditions. Instances have been reported where a Chicago TV station was received clearly in New York, a phenomenon which can be explained only by assuming special conditions in some layers of the stratosphere. Many cases of such freak reception are on record, but since they only occur very rarely they have no commercial value.

There is, however, an area (see Fig. 1) around the regular 60 mile circle where

reception is still possible but requires extra sensitive receivers and special antenna installations. This so-called *fringe* area is usually comprised of the resort section of big cities, small towns and farm areas. If good reception can be made possible there, a large and valuable market will jump up overnight. City folks, used to the latest technical achievements are ready consumers when they have a chance to see the ball games or the shows while enjoying a summer vacation, and in the winter time roadhouses, taverns and even the individual farmer are eager for entertainment

some TV receivers, when properly aligned, may have an input sensitivity of down to 50 microvolts, and still provide a good picture, most sets require an antenna input signal of at least 150 microvolts and above. Therefore, if a 20 microvolt signal is available in some locality in the fringe areas, a booster having a gain of 8 will provide 160 microvolts, enough for a satisfactory picture not only on a very sensitive but also on an average TV set. We have found through experience that where the signal from the antenna is less than 10 microvolts, no amount of amplification

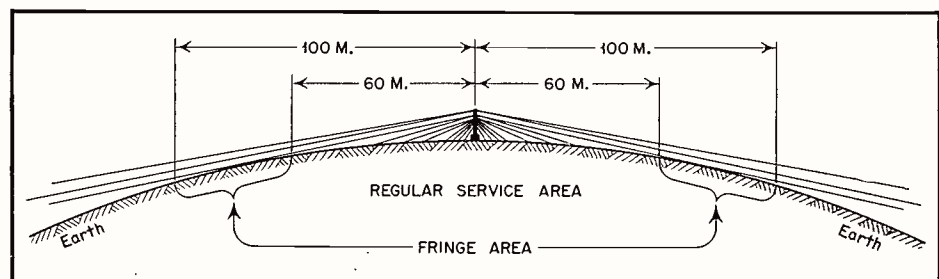

Fig. 1—FM and TV Service area that can be covered by antenna atop the Empire State Building

which can be had right at home. Many dealers in these fringe areas have found a booming business in television receivers of all price ranges, if only they can be made to work in that locality. That is where television preamplifiers or boosters come in.

## Need for Preamplifier

Since it is not economical for TV set manufacturers to make receivers with the maximum possible sensitivity, it is necessary to add a preamplifier between the antenna and the set to boost the antenna signal and improve the signal-to-noise ratio. This is especially important where the signal is so weak that it is almost in the noise level. While

will give a good picture, because the noise level usually starts at about 5 microvolts and noise is amplified along with the signal. However, instances are on record where good reception was obtained by the use of several boosters in series, with less than 10 microvolts. That is possible only in especially noise-free locations, such as might occur out in the country.

While an antenna preamplifier will not act as a wave trap for interference, it will in many cases eliminate or minimize certain types of interference. Since it usually contains several tuned circuits it provides additional selectivity and greater rejection of off-channel interference. As a matter of fact, owners of prewar TV sets who do not have an r-f stage often purchase boosters to

make up for it. Since lack of an r-f stage usually gives an appreciable amount of radiation of the local oscillator, such a set will interfere with other receivers nearby. Addition of a booster provides a stage between oscillator and antenna and, therefore, reduces greatly the radiation problem, while at the same time providing additional gain and better selectivity.

### Applications

When the first TV sets were installed in fringe areas, servicemen often built their own antenna pre-amplifiers to enable the customer to receive some station particularly far away. Today this is no longer practical, since small, self-contained and highly efficient boosters are on the market which require practically no installation and little technical knowledge. Most of these come in small cabinets, easy to match to the TV set, with just an AC plug and terminals for the antenna and a connecting lead to the receiver. The price ranges from \$25.00 to \$50.00 approximately, for various types of units. Considering the price of a TV receiver, the customer usually has no objection to the additional charge, if it will help him enjoy better reception. Or, if a set owner has moved to a new location where reception is poor he will gladly spend the extra money to protect his investment and get the maximum enjoyment out of it.

The types of boosters on the market vary considerably. Some provide continuous tuning over one or two TV bands, others feature a 13 channel selector switch, while still others come pre-tuned to just one station, providing great gain at this one frequency. Judging from sales, the most favored is an all-channel, continuous tuning type booster which, in the "off" position provides a direct connection, from antenna to receiver. This makes it possible to use it on just one weak station and turn it off when viewing another channel, without the customer having to go to the trouble of disconnecting leads each time. Continuous tuning means accuracy which is hard to obtain with channel switching arrangements, since these necessarily have to be tuned broader, to avoid realignment by the serviceman.

Figure 2 shows the diagram of the Vision Telebooster Model TVX. This unit incorporates all the features mentioned above, plus the desirable fact that there is no d-c path to the chassis and, therefore, no chance of shock in touching any terminals. The selenium rectifier assures long life and little heat. Each 6AK5 amplifies only over one of the two TV bands and has a sharply tuned input with a two-gang variable

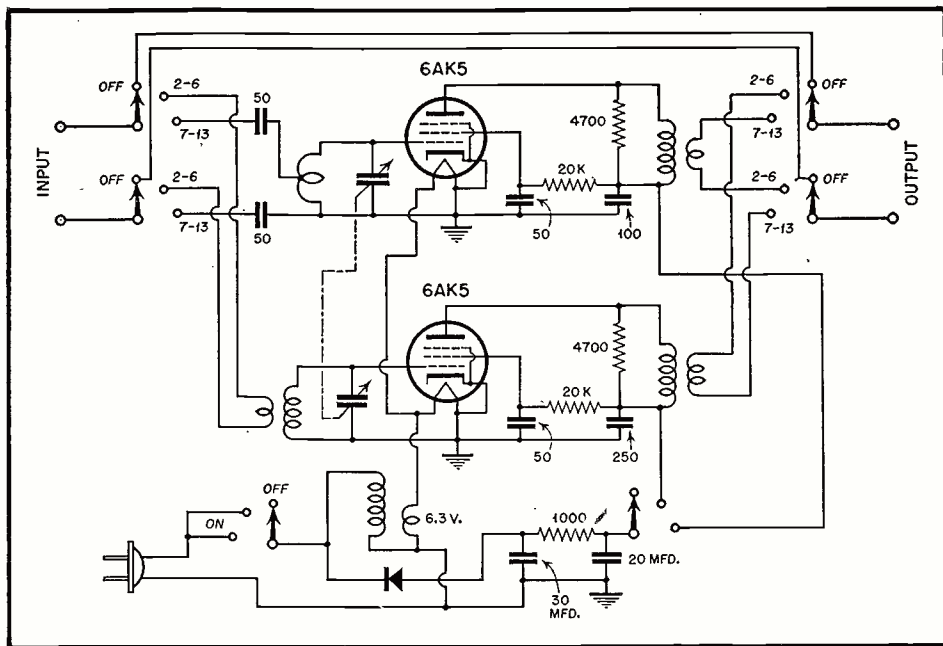
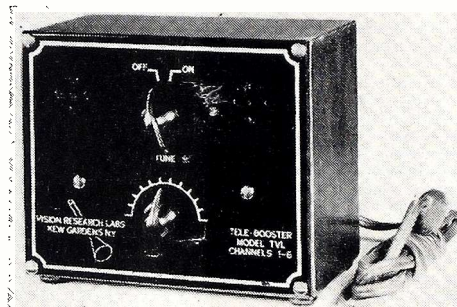

Fig. 2—Vision Telebooster Model TVX circuit diagram.



### Vision Telebooster Model TVL

condenser providing accurate tuning from channels 2 to 6 and 7 to 13. The output is loaded down with a 4700 ohm resistor to give a broad bandpass response. Since no bias is employed, the plate current has to be limited by a low screen grid potential, which is obtained through the 20,000 ohm screen grid resistor.

Although this circuit looks very fundamental, the actual construction of this unit is not so easy. As can be calculated, the grid coil for the 170 to 216 mc band has to be quite small and the actual length of the wire very accurate. It was found, for instance, that an eighth inch variation would throw it badly off-range. Another critical factor at such high frequencies is the ground path for the different r-f currents. With all factors adjusted properly, however, this unit gives very good results. On the low band it gives a gain of about 8 times with an average bandwidth of 6 mc, while on high band also it maintains about 6 mc bandwidth and gives a gain of from 4 to 6 times.

Another widely used circuit is shown in Fig. 3. This is a single stage, cathode coupled, grounded grid amplifier, using a 6J6 duo-triode. It is favored mainly for its stable operation and simplicity

of design. The inductance in the cathode lead should present an impedance of about 300 ohms at the center frequency of the desired band. While this circuit works well on the lower TV band, its application for the high band presents some difficulties. For one thing, a switching arrangement would have to switch three inductances, since otherwise the cathode impedance would be either too great or too small. The amplification obtained from this type of circuit in the lower TV band ranges from 3 to 5 times with bandwidth at the required 6 mc. Formerly some enterprising TV servicemen often installed

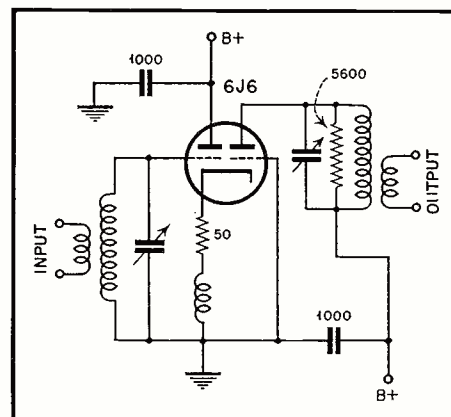

Fig. 3—Widely used booster circuit.

this type of amplifier right on the chassis of a TV receiver located in an area of weak signals. Today commercial boosters generally are found simpler and more satisfactory.

Some commercial TV boosters use a 13-channel switching arrangement instead of continuous tuning. Naturally, this means that the tuned circuit in each channel and stage must be aligned properly. Since this would require a lot more labor and equipment than can be expended at a low price, some manufac-

(Continued on page 30)



# APPLIANCE REPAIR TECHNIQUES

## that Radiomen Should Know

by WILLIAM R. WELLMAN

**Many service dealers have found that electrical appliance repairs dovetails well with radio service as far as filling in slack periods are concerned. In addition the income derived from this readily available field is not to be sneezed at. This article presents a comprehensive treatment on this subject.**

**T**HE field of appliance servicing is one which the radio serviceman is likely to find himself, sometimes unwillingly. Customers and friends often turn such work over to him (how often have you had a customer ask, during the course of a radio repair job, whether you are equipped to handle such repairs?). In many small towns and cities, there are no other repair shops specializing in this work. This being the case, suppose we consider the principles involved in the most often-used appliances and attempt to discover their basic principles and methods of effecting repairs. The more common appliances fall into four rather well-defined categories: motor-driven appliances, appliances using a heating element, fluorescent lamps, and electric clocks. We shall discuss these in the order named.

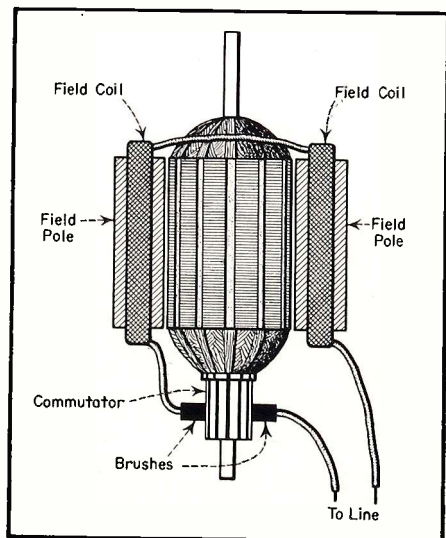

Fig. 1—Commutator type motor basic connections.

### Motor-Driven Appliances

Since almost all of the appliances you will encounter are intended for operation on alternating current, we shall limit ourselves to a consideration of a-c motors. There are two main types: those having a wound armature and a commutator, and induction motors.

The commutator type motor generally used in such appliances as vacuum cleaners, sewing machines, etc. may be operated on either a.c. or d.c.; in fact it is often called a universal motor. The basic circuit diagram of such a motor is given in *Fig. 1*, and you will note that the armature and field coils are in series. This motor operates on the principle of attraction and repulsion between the magnetic poles developed in the armature and those set up in the field. Connection to the armature coils is established through the medium of the commutator and brushes. As the commutator rotates past the brushes, the armature coils are cut into and out of the circuit in order; this maintains continuous rotation.

The so-called squirrel cage induction motor consists of a set of field poles upon which the field coils are wound. The proper name of this winding, by the way, is *stator* rather than *field*. This type of machine does not have a wound armature, but has instead, a rotor. The rotor consists of iron laminations, or punchings, which are assembled on the shaft to form a drum having slots. Copper bars are laid in these slots, and the bars are insulated from the iron core by means of insulating paper or by being coated with an insulating varnish. End rings are then placed over the bars;

these end rings have holes to accommodate the ends of the bars. Finally, the ends of the bars are soldered to the end rings. Mechanically, then, we have what appears to be a cage (see *Fig. 2*)—hence the name, squirrel cage. From an electrical viewpoint, we have a solid copper ring. Now, when a copper ring is placed within a proper alternating current field, the ring will revolve. Rotation will not result, however, unless we have a revolving field, and this is not set up on single phase supply.

The situation described above is quite similar to that encountered in some very low-priced phonograph motors made a few years ago. These were of the synchronous type, and were not self-starting; the turntable had to be brought up to running speed by hand. Obviously, it would be very undesirable to have to turn a motor over by hand every time it was placed in use, therefore, other means are used to effect self-starting.

One method of doing this is to use an auxiliary stator winding known as a starting winding. This starting winding generally has fewer turns than the main

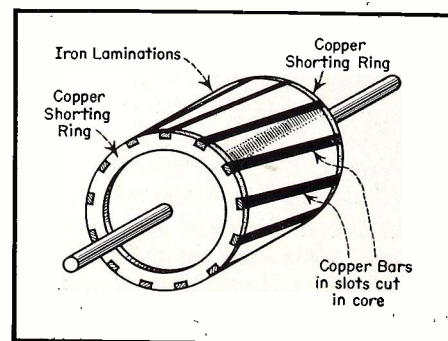

Fig. 2—Squirrel cage induction motor.

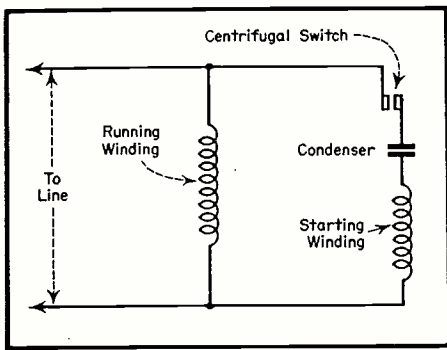

Fig. 3—Capacitor-start induction motor circuit.

stator winding, and often the wire is of smaller gauge. A voltage which is out of phase with that in the main winding is supplied to the starting winding. There are at least two methods of accomplishing the desired result, but the method most often used is to connect a high capacity condenser in series with the starting winding; this of course, causes the current to lead the voltage. Such machines are known as capacitor-start induction motors, and are very widely used in refrigerators and for many other purposes. A schematic diagram of this type of motor is shown in Fig. 3. Notice that there is a switch connected in series with the condenser and the starting winding. The operation of this switch is entirely automatic, and will be described in a moment.

When the line switch is closed, power is applied to both the starting and running windings, but the voltage across the starting winding is out of phase with that across the main winding. A torque is exerted on the rotor which causes it to turn. When the motor reaches operating speed, the starting winding is no longer necessary, and it is then cut out of the circuit by the switch shown in the diagram. On the motor shaft there are two hinged leaves which are free to move against the action of two small springs. As the motor speed increases, these leaves, due to centrifugal force, tend to move away from the shaft. As they move, they cause a small bakelite bushing to slide along the shaft, and the pressure of this bushing against one of the switch contacts causes the switch to open. Of course, when the machine is stopped, the lack of centrifugal force causes the leaves and the bushing to return to their normal positions, and the switch is again closed, ready for the next start.

A third type of motor, which is frequently used in refrigerators or other appliances requiring a motor of 1/3 horsepower or larger, is the repulsion-start motor. Briefly described, this machine has a stator similar to that used in a capacitor-start motor, but has a wound armature, equipped with a commutator. The commutator, however, has bars arranged radially to the shaft (in the form of a disc) rather than parallel to the shaft (in the form of a

drum) as in the case of the universal series motor. During starting the brushes and commutator are used in the usual manner, but when the motor reaches operating speed, a metal ring short-circuits the commutator bars, converting the armature into a squirrel cage rotor and the machine then runs as an induction motor.

If we attempt to list the troubles likely to develop in series motors, we shall probably find that the most common ones are worn brushes, worn or dirty commutators, excessive sparking at brushes, bearing wear, burned out windings. The last two mentioned are probably beyond the scope of the average radio repair shop and will not be considered here. They should not be attempted unless proper equipment is available and unless the individual has had special training.

Replacement of brushes in the average motor is a simple operation. A typical brush assembly is illustrated in Fig. 4. Note that the carbon brush A is held against the commutator by pressure of the compression spring B. Spring and brush are held in place by the threaded retainer screw C. Sometimes the spring is fitted with a small disc which bears against the under surface of the retainer screw. The brush well, D is square so that the brush is prevented from turning. In replacing brushes, it is obvious that the new brushes must have the same cross section as the original ones, otherwise they cannot be inserted in the well or will fit too loosely, but it is also important that the new brush be of the correct length. When removing a retainer screw, be sure to hold the screw during the last turn or so, otherwise the released spring may cause the entire assembly to fly out of the well. In taking a motor apart (in cases where the original brushes are in good condition) you will notice that the brush has a curvature which corresponds to that of the commutator. When reassembling, be sure that the brush is inserted correctly to insure maximum contact with the commutator. One more caution regarding brushes: if you find it necessary to take a machine apart, always remove the brushes first. When reassembling, always replace the brushes last.

Commutator troubles require measures which depend upon the particular situation existing. If the commutator is merely glazed and not badly worn, it may be cleaned with sand paper. A small piece of fine sand paper is placed around a wooden block and held against the revolving commutator. Do not use emery, carborundum or aluminum oxide abrasive cloths or papers for this purpose. Most cases of excessive sparking can be cleared up by either replacing the brushes or cleaning the commutator. If the commutator is badly worn, it

must be turned down to slightly smaller diameter, after which the level of the mica between the bars is lowered below that of the copper by "undercutting." Ordinarily, turning down a commutator is not a job for the average radio service shop, and certainly cannot be handled unless a lathe is available.

Series type motors are widely used in vacuum cleaners, sewing machines and many other appliances, and troubles will occur that are peculiar to the particular application. Some of these will now be taken up.

In the usual vacuum cleaner, the motor drives an intake fan at a relatively high speed. The air containing dust is forced into a bag or tank at the discharge side of the fan. The bag, being somewhat porous, allows the air to escape, but the dust is retained. Since the motor runs at high speed, lubrication is particularly important. Lubrication instructions accompany each new machine, but are often lost, and the service man will have to use judgment at times. Some motors, which are equipped with "sealed-for-life" ball bearings, do not require lubrication. Other types may have ball bearings which require periodic lubrication, and in such cases a satisfactory lubricant is vaseline. This may be purchased in collapsible tubes having a long spout, ideal for the purpose. If the motor uses sleeve bearings rather than ball bearings, oil is the usual lubricant. S.A.E. 10 motor oil is suitable. Oil holes will be found at both ends of the motor housing. Remember that excessive lubrication may often be as harmful as too little oil.

A common repair job on cleaners is the replacement of the cord or switch, or perhaps both. In bag type cleaners, a toggle switch is almost always used, and this is located on the handle. It is often possible to remove and replace a switch by merely removing the two screws which secure it to the handle, but sometimes it is necessary to partially disassemble the handle in order to get enough cord slack so that the switch terminals are accessible. The replacement switch should not only be of the same physical size as the original one, but must have ample current-carrying

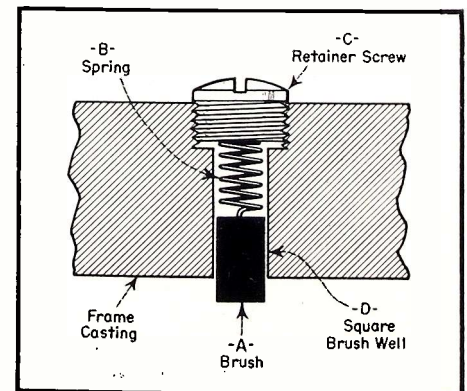

Fig. 4—Motor brush assembly.

## Re: "Field Findings"

As Mr. Cowan served as Grand Juror during the entire month of July he could not travel throughout the field, as is his customary practice, to assemble the material for his column, "Field Findings." However—that department will be back again in the next issue.

S.L.M.

capacity. If you find it necessary to replace the cord, use only heavy-duty rubber covered cord of the round type. Do not use ordinary two conductor parallel rubber or cotton covered lamp cord, as it will not stand the abuse to which the cord is subjected. The average customer will be pleased if you install a cord of ample length, since most homes do not have nearly enough convenience outlets, nor are they always located in the right places.

While most cleaners use a fixed brush in front of the cleaner nozzle, a few have a revolving belt-driven brush. Among these are Apex, Hoover, Premier, AMC and Kenmore. A rubber belt is used, and after a long period of service it will become slack or perhaps break. Display cards holding a half-dozen belts with sufficient variety to fit most popular cleaners are available at low cost.

If you encounter a complaint of lack of suction, it will probably be due to one of two causes: leaks, or a defective bag. If the pores in the bag become clogged, it is obvious that the air compressed by the fan cannot escape, and as a result the volume of air handled by the machine will be reduced. If the bag is not too old, it may be restored to usefulness by a thorough cleaning, but if it has been in service a long time it will be best to install a new one.

Leaks which allow air to escape will also reduce the efficiency of the machine. These may occur in many places, and are often difficult to detect. The best

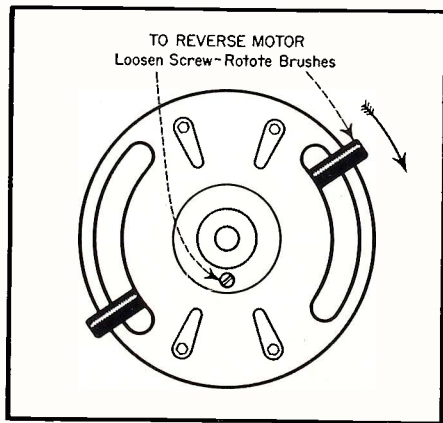

Fig. 5—Reversing direction of universal motors.

procedure is to carefully examine all joints, and if you suspect that they are not tight, go over them. As an example, an old cleaner was in such shape that it developed practically no suction. A joint between the fan housing and the motor housing was suspected. This joint was taken apart, the adjoining surfaces carefully cleaned and a film of gasket cement applied to them, after which the screws holding the two castings together were securely tightened. The improvement in efficiency was quite remarkable.

Sewing machine drives are of two types: friction wheel and rubber belt. The belts used are quite similar to those used for driving vacuum cleaner brushes—in fact, one or two belts made for cleaners will also fit some sewing machines. Many conversions to electric drive which were made years ago are still in use, and most of these employ a motor having a rubber friction wheel which bears against the sewing machine hand wheel. Wearing of the rubber wheel will, of course result in loss of power. If a new wheel cannot be obtained, a temporary repair may often be effected by "retreading" the wheel with a short section of rubber tubing of the right diameter. If the tubing is not a very tight fit on the wheel, a coat of rubber cement may be applied to the wheel before the new "tread" is put on.

Many universal motors for sewing machine and other applications are arranged so that the direction of rotation may readily be reversed. This is done by shifting the position of the brushes, see Fig. 5. To reverse the direction of rotation, first loosen the brush assembly lock screw, indicated in the drawing. This screw will usually be found immediately above or below the shaft. With this screw loosened, turn the brush assembly in one direction or the other, as indicated by the curved arrow. Incidentally, some repulsion start motors used in larger refrigerators have a similar arrangement for reversing.

The speed control is usually operated either by a foot treadle or a knee lever. Some type of rheostat is used, and this is connected in series with the motor. If a foot treadle is used, the rheostat and connecting cable are generally detachable, so that they may be stored when not in use. The usual troubles arise in regard to such cords and cables, and there seems to be no need to enlarge upon this. The rheostats used vary in design, and are a likely source of trouble. One type, not too widely used, consists of a set of carbon discs or blocks. The contact between these blocks, and consequently the resistance, is varied by pressure on the foot pedal. This type of control seems to give little trouble from an electrical standpoint, the principal cause of failure being mechanical, as a result of wear. A second type of

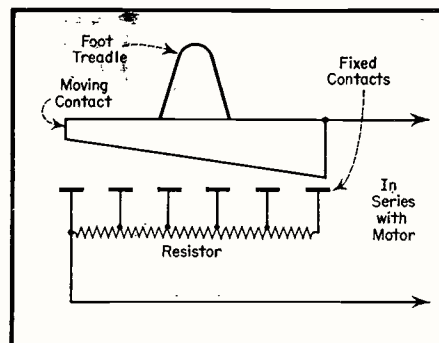

Fig. 6—Foot rheostat wiring diagram.

rheostat consists of a wire-wound resistor having a number of taps. These taps are connected to a series of spring contacts, as illustrated in Fig. 6. As pressure is exerted on the speed control lever, the wedge shaped movable contact engages one or more of the spring contacts, shorting out part of the resistance. With no pressure on the control lever, the circuit is open and the motor does not run. If you find that the motor does not run until the control lever has been moved some distance, the trouble will very likely be due to an open section in the resistance winding. The customer's complaint will be that the machine cannot be slowed down. Failure of one or more of the springs to make contact with the wedge will result in irregular speed control. The third type of speed control consists of a cast iron foot pedal which is connected to the moving arm of a rotary switch lever by means of a steel rod. The switch lever moves over a series of contact points, and these points are connected to taps on a wire wound resistor. With the pedal in the "up" position, the motor circuit is open; as the pedal is depressed resistance is cut into the circuit and this resistance is decreased as the pressure is increased. If the motor fails to run at all or if it does not start until the pedal is depressed quite far, the trouble is due to an open resistance winding or to failure of the switch lever to make contact with the points. Occasionally a control of this type will stick in the down position when pressure is removed. This is generally due to a bend or twist in the link rod which connects the pedal with the switch lever.

Before leaving the subject of appliances which are driven by series-wound motors, a few general remarks should be added. Complaints of failure of a motor to start should first be checked by determining whether the shaft of the motor is free to turn. If it is free, power should then be applied directly to the motor terminals, since this will eliminate faults which may exist in switches, speed controls, etc. If the motor then runs normally, look for trouble else-

(Continued on page 29)

# VIDEO AMPLIFIERS

**A**D-C restorer circuit, as employed in a TV receiver, enables the average brightness present in the original televised scene to be reproduced in the received image. This background brightness is an important component of the complete signal transmitted because it reveals how much light is contained in the televised scene, thereby making it possible for us to distinguish between scenes taken under different light conditions such as bright daylight, under cloudy skies, or at night.

In order for us to understand thoroughly how the d-c restorer works in a receiver, it is necessary for us to learn how this d-c intelligence is generated in a transmitter. It might be appropriate, here, to point out that the composite video signal contains *three* distinct forms of intelligence, these being: 1) the picture information as it pertains to the amount of light contained in each element of the scanned mosaic, 2) the synch pulses, and, 3) the d-c component, or average background brightness information.

Let us assume that the scene to be televised has a checkerboard pattern as shown in Fig. 1a. Each line is further assumed to be equal in width to a horizontal scanning line. The corresponding waveform appearing at the output of a camera tube has a frequency equal to the number of pairs of black and white elements scanned per second, and a peak-to-peak amplitude proportional to the contrast in light between elements. For purposes of illustration we will assume

**In this installment "Video Amplifiers" began last month continues with a discussion on what the d-c component accomplishes in the transmitted video signal. This is preparatory to the final article in this series, entitled, "D-C Restorers and Their Applications", to appear next month**

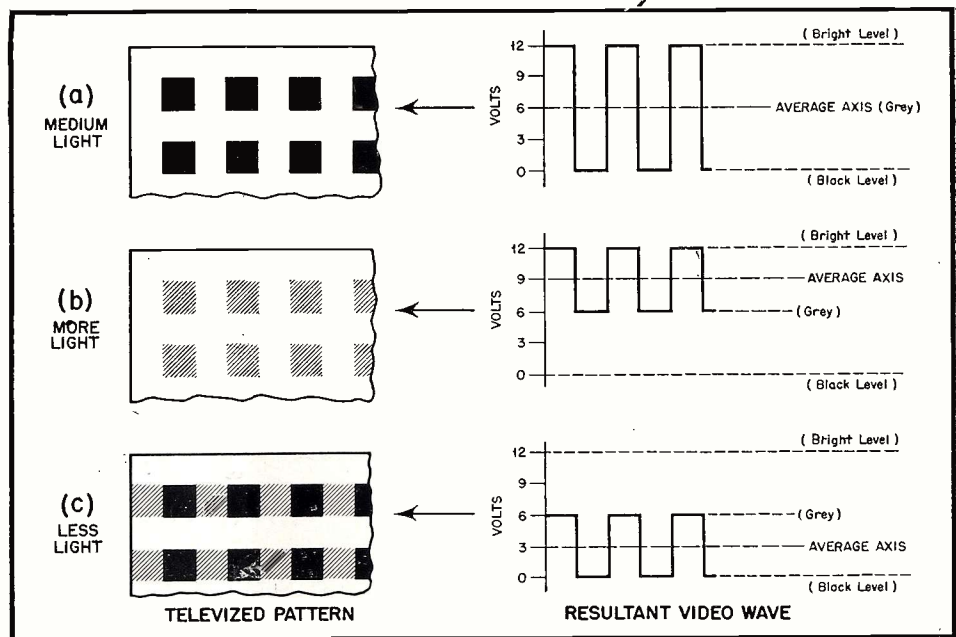

Fig. 1—Amplitude and frequency variations of video wave with variation of average light on patterns.

an exaggerated value of 12 volts for this peak to peak value.

Let us now suppose that the light on the scene is increased. This is represented in Fig. 1b where the black elements now appear grey, and the white

elements remain white (adding light to a white scene adds little to the whiteness of the scene). The corresponding waveform is shown at the right of Fig. 1b. Notice that the frequency remains the same and that the amplitude is reduced

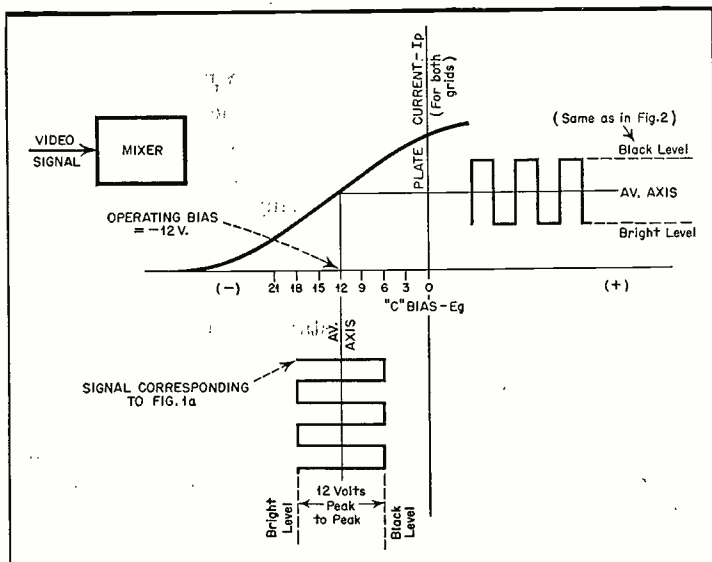

Fig. 2— $E_g/I_p$  characteristic of synch portion of mixer tube.

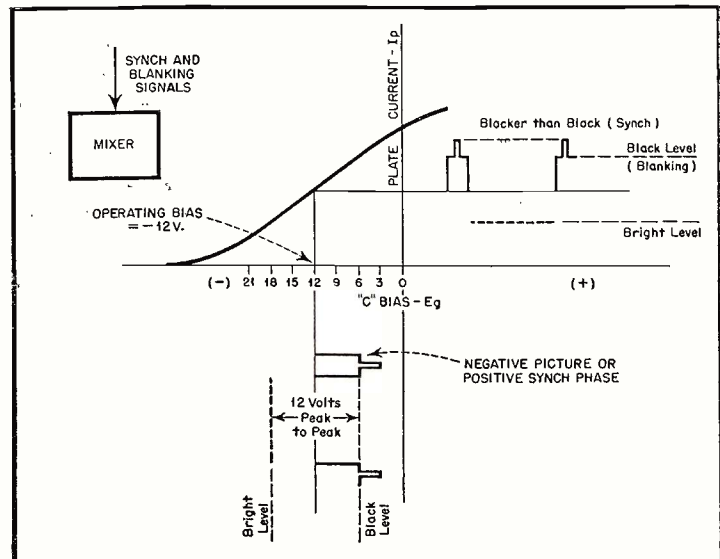

Fig. 3— $E_b/I_p$  characteristic of video signal grid of mixer tube.

# D-C COMPONENT

by SAMUEL MARSHALL

## PART 2

to an assumed value of 6 volts, peak to peak:

It would appear that this wave contains all the essential elements of intelligence that are required for transmission; first, because the frequency variations tell us how far apart the areas are spaced before any light changes occur, and second, the peak-to-peak amplitude of these waves tells us how much light is involved in each change. However, we shall shortly see that this information is inadequate and must be further supplemented by information pertaining to the average brightness of the complete scene.

We now proceed to the third case where the total amount of light on the scene is reduced to a point where the greys appear black and the whites appear grey. This is shown in *Fig. 1c*, the waveform corresponding to this scene appearing to the right.

On the assumption that just as much light was added to produce *1b* as was reduced to produce *1c*, and that the change in contrast between white and grey involves as much light as the change in contrast between grey and

\*Actually the camera signal, the blanking signal, and the synch pulses enter the transmitter at different points along the line.

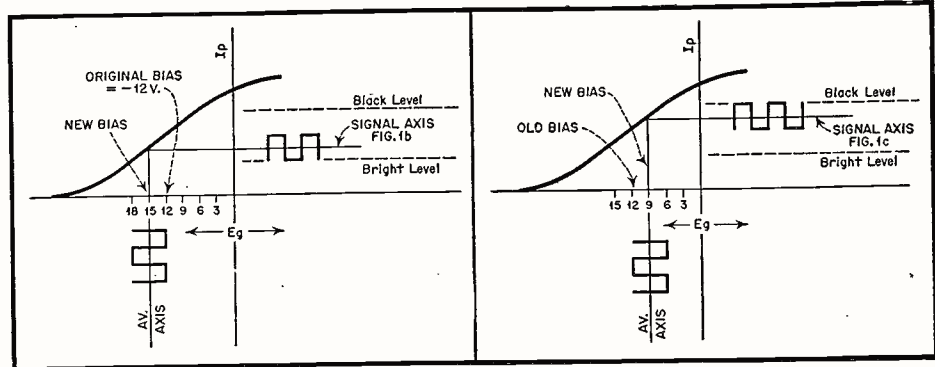

Fig. 6—Shift of operating bias due to d-c component change caused by increased brightness.

Fig. 7—Shift of operating bias due to d-c component change caused by reduced brightness.

black, the waveforms produced by *1b* and *1c* will have the same amplitude. Notice, then, that to all intents and purposes, waveform *1c* is identical in frequency and amplitude to waveform *1b*. How, then, can we differentiate between the dull scene of *Fig. 1c* and the bright scene of *Fig. 1b*?

This might be done at the transmitter in the following manner.\* First, a twin mixer tube is provided at the output of the camera tube preamplifier. This mixer is assumed to contain provisions for the injection of two signals, the first being the camera signal and the second the blanking and synch pulses, these signals entering the mixer at a negative picture phase. Each signal can be considered as entering this tube via separate grids. The outputs of both plates of this tube feed into a common load. Both sets of elements are assumed to have identical characteristics.

Second, the operating point of the synch grid bias is established so that the blanking level of the synch signal during the positive swing corresponds to black in the camera tube. We shall assume, for simplicity of explanation, that the most suitable value of this level is 6 volts. See *Fig. 2*. The camera tube output is calibrated so that if a signal from this tube were to be injected into the synch grid with a peak-to-peak value of 12 volts, the excursions represented would be from absolute black to absolute white. The positive amplitude reached by the synch pulse is thus adjusted to correspond to black in the camera tube. The synch signals which are fed into the mixer originate in an external synch signal generator.

As stated previously the output of the camera tube feeds into a separate grid of the mixer tube. Thus, referring to *Fig. 3*, we observe that the positive half of the signal corresponding to *Fig. 1a* drives the grid bias of the picture grid to the same blanking level as the synch pulse. Notice the relative positions occupied by the synch pulse and the video signal in the plate current curve. Re-

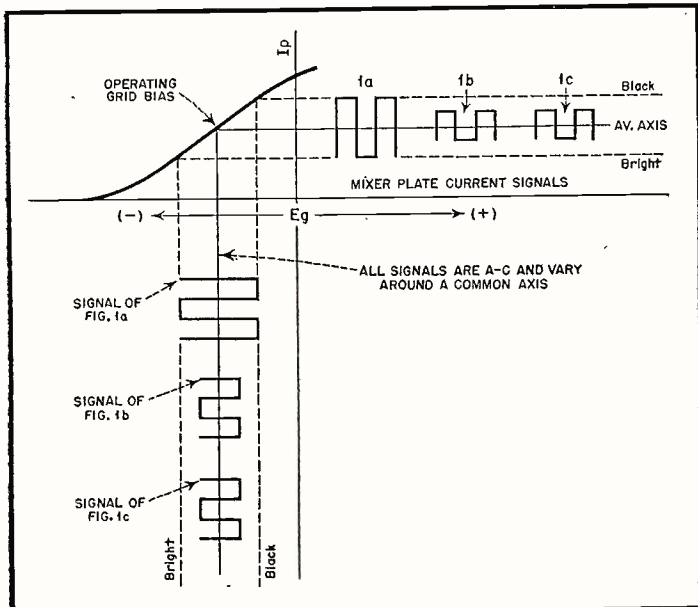

Fig. 4—How picture signals line up without d-c component added.

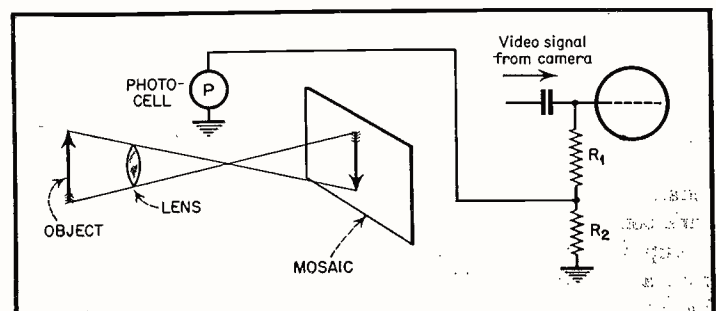

Fig. 5—How d-c component is added to video signal.

# CIRCUIT COURT

## Howard 472 series

An interesting variation in input circuits for combinations AM-FM receivers is employed in the Howard 472 series sets. The tube line-up is conventional, with miniature types in all circuits except output and rectifier. R-F stage includes a 6BA6, and the converter is a 6BE6. A dual two gang tuning condenser has high capacity sections for AM and low capacity sections for the FM band. A loop provides AM pickup, while a folded dipole is built in for FM reception.

An examination of the partial schematic will show details of the circuits in question. Coil  $L_1$  is the primary of the FM r-f transformer.  $L_2$  is the FM secondary, and is tuned to 101 mc by an adjustable core. Switch  $S$ , is in position 2 for FM, thus completing the tuned circuit to ground. The signal is coupled to the grid of the 6BA6 r-f tube by a  $100 \mu\mu\text{f}$  capacitor. AVC is applied via the 100K-ohm resistor.

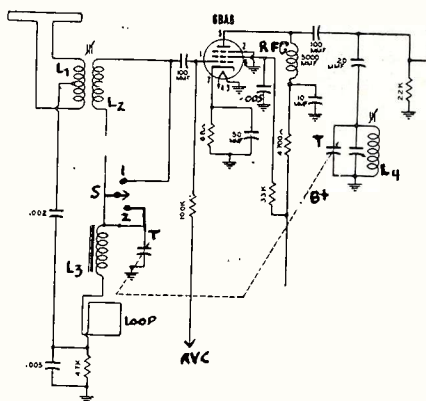

Howard 472, r-f stage

Following r-f amplification, the signal develops voltage across the FM plate load RFC. The low end of this coil is effectively at ground potential by virtue of the  $10 \mu\mu\text{f}$  by-pass. The signal is then coupled to the tuned circuit in the grid of the 6BE6 converter. The tuned circuit is coupled to the signal bus by a  $20 \mu\mu\text{f}$  capacitor.

Oscillator voltage is generated in the converter by a conventional tuned circuit with cathode tap. The second small section of the tuning gong tunes the FM oscillator coil.

In the AM position,  $S$ , moves to position 1, thus shorting the FM r-f coil.  $L_3$  constitutes the major portion of the tuned circuit, with a low impedance loop in series, and R-C network completing the circuit. An added pickup is provided by feeding energy from a tap on the FM r-f coil,  $L_1$ , to the low end of the loop via a capacity

divider. One large section of the tuning gong tunes this circuit.

Amplified voltage appears at the plate of the 6BA6, across the choke RFC and a 4700-ohm resistor in series. The  $10 \mu\mu\text{f}$  capacitor has little effect at these frequencies, as has the  $20 \mu\mu\text{f}$  component which couples the FM tuned circuit. The grid circuit of the 6BE6 is thus aperiodic.

The AM oscillator coil and second large section of the tuning gong are switched in by the band switch.

## Silvertone Model 8000

This instrument illustrates one version of the trend to simplification of receiver design in the interest of size, weight and cost reduction.

The circuit embodies the superheterodyne principle, but no i-f amplification in the usual manner. Signal pick-up occurs on a short antenna intended to be stretched out to full length. The signal appears across a high impedance primary on the r-f coil. Additional coupling to the 12SA7 converter grid obtains via a  $14 \mu\mu\text{f}$  capacitor between the high ends of the coils. The combination of inductive and capacitive coupling tends to equalize gain over the tuning range.

The usual oscillator coil is used in the cathode and oscillator grid of the 12SA7. A dual condenser tunes the r-f and oscillator circuits. An i-f of 455 kc is developed in the plate circuit of the converter.

The single i-f transformer has a tapped primary. The plate of the 12SA7 connects to one end of the coil, and the screen grid to the other end. The B plus voltage is supplied at the tap. This feature provides feedback in the converter circuit and adds to the gain of the stage. The secondary of the i-f transformer connects to one diode plate of a 12SQ7. Audio and a-v-c voltages are developed across the 2-meg. load resistor (also serving as

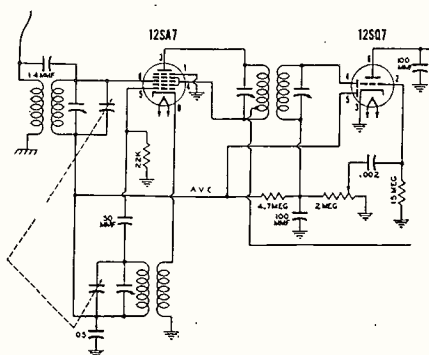

Silvertone 8000, r-f stage

volume control). The AVC is applied to the signal grid of the 12SA7.

Audio voltage is amplified in the triode section of the 12SQ7 and a 50L6 output tube. Power is supplied by a 35Z5 rectifier.

The second diode plate of the 12SQ7 is tied to the a-v-c bus and serves to prevent a positive voltage building up in the absence of a signal.

## Crosley 146CS

The advent of the new FM band in the 100 mc region has brought many new problems to designers, and even more to producers, of home receivers. Not the least of these problems is that of a high frequency oscillator with all the attributes needed in such a stage. Among the desirable features are mechanical stability, freedom from drift and uniformity of output over the tuning range.

The Crosley 146CS has a particularly interesting oscillator which should provide excellent performance. The mixer for the FM band in this set is a 6AC7 tube. While this type gives

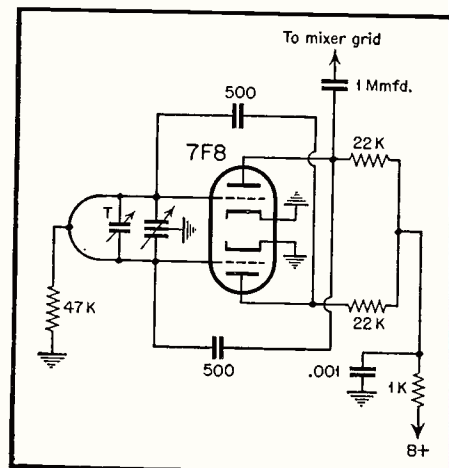

Crosley 146CS, Oscillator

high transconductance, and thus good conversion gain, it is quite critical in regard to oscillator injection voltage. The oscillator employed is capable of developing this uniformity.

A 7F8 tube, a dual triode designed for high frequency work, is used in the circuit. Low inter-electrode capacity and rigidity tend to aid in efficiency and stability. A push-pull circuit is used, with the tuning elements connected from grid to grid. As shown in the partial schematic, there is a common grid leak of 47K ohms from the center of the coil to ground.

The coil itself is a heavy conductor with very low losses. The tubing con-

(Continued on page 28)

*Howard W. Sams*

presents the amazing  
**RADIO INDUSTRY  
RED BOOK**

**REPLACEMENT PARTS  
BUYER'S GUIDE**

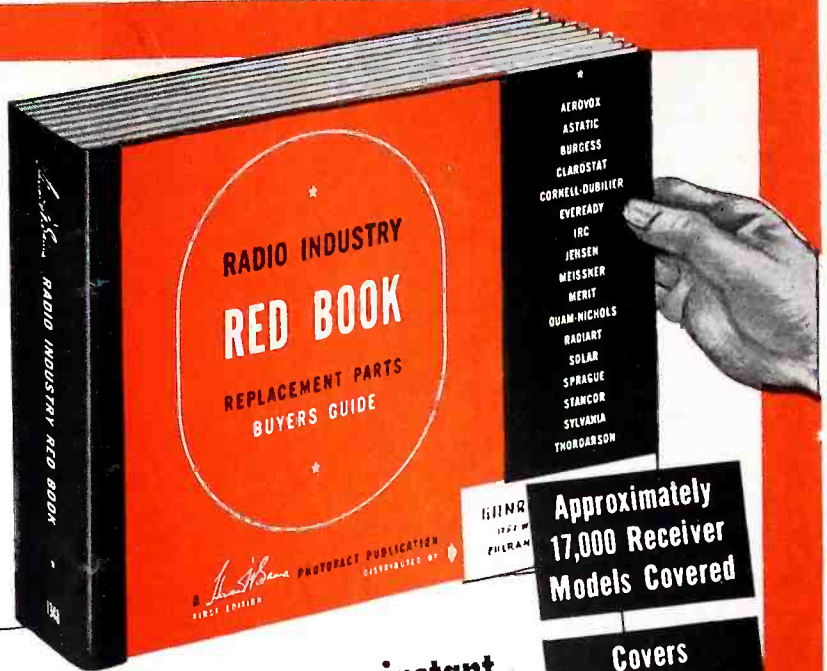

**NOW**—a SINGLE authoritative volume that gives you instant reliable data on ALL replacement parts for thousands of popular radio receivers... more useful data than in all other replacement parts guides and manuals **COMBINED**...

**COMPLETE!**

The First Cooperative Industry Effort in Behalf of the Radio Service Technician

**FOR THE FIRST TIME IN RADIO HISTORY!**

**All 9 Major Replacement Components Listed**

*(not just 1 or 2 components)*

**17 Leading Parts Manufacturers Represented**

*(not just 1 manufacturer)*

Approximately  
**17,000 Receiver  
Models Covered**

Covers  
**Ten Years:  
1938 to 1948**

Easy to Use:  
**All Data  
Quick to Find**

**440 Pages  
Smythe-bound  
Opens Flat**

**COMPLETE DATA ON ALL RECEIVER REPLACEMENT PARTS — ALL IN THIS ONE GREAT BOOK!**

Save time! Stop wasteful hunting! Get ALL the parts data you need—quickly—from this single book.

NOW—for the first time—have all the replacement parts data you need—ALL in one single, authoritative volume. No more waste of valuable time searching through dozens of incomplete manuals and catalogs. The RED BOOK, first and only complete parts guide ever produced, covers approximately 17,000 radio models made from 1938 through 1947—10 full years. Lists parts made by 17 leading manufacturers—not just one! Gives you complete, accurate data on all 9 major replacement components—not just one or two! Clear, concise, easy-to-use—over 440 pages (8½" x 11") bound in a sturdy sewed cover, arranged alphabetically by manufacturer and model number for quick reference. Does away with confused collections of separate books and manuals—gives you complete information—PLUS data that cannot be found in any other source—at a fraction of the price you'd pay for the books it replaces. There's never been anything like it—absolutely indispensable for every service shop!

Only the RED BOOK gives you ALL this invaluable data. Here's everything you need to know about the replacement parts for the receivers you service daily. The RED BOOK gives you original manufacturers' parts numbers, proper replacement parts numbers and valuable installation notes on *Capacitors, Transformers, Controls, IF Coils* (including Peak Frequencies), *Speakers, Vibrators and Phono Cartridges, Tube and Dial Light* data includes number of tubes in each chassis, with type number for each tube, plus dial light numbers. *Battery* data includes replacement numbers on A, B, and AB packs. The following leading replacement parts manufacturers are represented in the RED BOOK:

- |                  |            |
|------------------|------------|
| AEROVOX          | ASTATIC    |
| BURGESS          | CLAROSTAT  |
| CORNELL-DUBILIER | IRC        |
| EVEREADY         | JENSEN     |
| MEISSNER         | MERIT      |
| QUAM-NICHOLS     | RADIART    |
| SOLAR            | SPRAGUE    |
| STANCOR          | SYLVANIA   |
|                  | THORDARSON |

18 months in preparation—over \$90,000 to produce.

The RED BOOK is the product of thousands of man-hours spent in laboratory research and in cooperation with 17 participating manufacturers to produce the most complete, accurate, authoritative parts replacement guide ever published. Every bit of information in this amazing book has been painstakingly checked to insure maximum accuracy and usefulness. Over \$90,000 was spent to prepare the RED BOOK—the only book that brings you everything you need to know—every bit of replacement parts data you want to make your work easier and more profitable. You can't afford to be without the RED BOOK. It's the indispensable guide you'll use profitably every single day. Stop hunting for the right answers now—order your copy today.

**THE INDISPENSABLE  
RED BOOK... ONLY... \$3.95**

**BE SURE TO ORDER YOUR RED BOOK TODAY** →

**HOWARD W. SAMS & CO., INC.**  
INDIANAPOLIS 7, INDIANA

Mail This Order Form to Your Parts Jobber Today or send directly to HOWARD W. SAMS & CO., INC., 2924 E. Washington St., Indianapolis 7, Ind.

My (check) (money order) for \$..... enclosed.  
 Send.....RED BOOK(S) at \$3.95 per copy. (I understand that delivery will be made to me in September.)

Name.....  
Address.....  
City..... State.....

# SHOP NOTES

Write up any "tricks-of-the-trade" in radio servicing that you have discovered. We pay from \$1 to \$5 for such previously unpublished "SHOP NOTES" found acceptable. Send your data to "Shop Notes Editor".

## R.C.A. 65 BR9, Radiola 65 BR9. Testing Power Unit with Dummy Load

The power unit may be tested without being connected to the radio chassis. Connect an 8000 ohm 5 watt resistor between B+ and chassis ground, connect a 7 ohm 10 watt resistor between A+ and chassis ground (these connections to be made at the cable socket of the charger unit to insure testing of all connections). Under these conditions with the power switch turned to ON BATTERY the B+ voltage should be approx. 103 volts and the A+ voltage should be approx. 2.05 volts. With the unit connected to 117 volts 60 cycle A.C. and the power switch turned to ON A.C. the voltages should be slightly higher.

## Frozen Dial Lamps

When a dial lamp is frozen into the socket and cannot be removed without breaking the bulb, quite often a lighted match or a hot soldering iron held against the socket will loosen it. If the bulb is broken off in socket a 3 cornered file broken off square makes a fine wrench to turn it out of the bulb.

Submitted by James R. Limbeck, Glendale, Cal.

## Webster Model 80 Wire Recorder. Oscillator Circuit Changes

Webster Chicago Corp. releases the following circuit changes that should be made in certain of the Model 80 units that are in service, or that may be brought in for repair.

Starting approximately with production serial No. 56000 a new oscillator coil (part No. 65P024) will be used in the Model 80 Wire Recorder. It may be distinguished from the present coil (part No. 65P015) by its greater size and the method of bringing all five leads out to individual solder lugs mounted on a fibre disc.

The coil is interchangeable with past production provided that the tuning and coupling condensers are charged at the same time.

Illustration	Before/After Serial No. 56000	
Oscillator Coil		
35	65P015	65P024
Tuning Condenser C-7	.01-400V	.002-400V
Coupling Condenser C-4	.002-600V	.0001-600V
Do not change from one type of coil		

to the other without changing both condensers. The L-C ratio of the circuit must be held within limits or the oscillator will not function. The coupling condenser C-4 controls the amount of energy fed into the oscillator grid, and although not as critical as C-7, it must be of the correct approximate value.

The purpose of the new coil is to reduce the heat dissipated in the coil windings. The oscillator frequency remains at 35-40 kc and the output at approximately 5 watts.

Another circuit change to be made at the same time will reduce the screen current in the 6V6. This consists of the addition of a 22M, 1 watt resistor in the B+ lead to screen (terminal 4) of the 6V6. This dropping resistor is by-passed to ground at the grid end by a .5 mfd. 400V condenser.

## G.E. Models 356, 357, 358, 376, 377, and 378. Caution in Tube Replacement

When an old type construction G-E 6BE6 converter tube (date coded 8/17 or before) is replaced with a new type construction G-E 6BE6 (date coded 8/22 or later), it is necessary that the FM oscillator choke coil L8 be a 13 1/2-turn coil (Cat. No. RLF-012) instead of the 17-turn coil that was used in early production models. The new 13 1/2-turn coil will give proper operation of the oscillator when either new or old type G-E 6BE6 converter tubes are used, while the 17-turn coil will only operate properly with G-E 6BE6's date coded 8/17 or before.

## Silver-Marshall Model V. Hum

Hum was traced to placement of dial light leads too close to tuning meter leads. Redress leads.

Submitted by James R. Limbeck, Glendale, Cal.

## Admiral 8B1, 9A1, 9B1—Fogging Dials

From the Admiral Service Dept. comes the following:

The dial windows of the 8B1, 9A1 and 9B1 chassis build up a small electrostatic charge, thus causing the plastic to attract fine dust particles. These are so fine that the dial windows appear milky or foggy. This often occurs within a few days.

After considerable research, we found that a solution called Hexco Dust-Ded, is an effective remedy. This solution is used on television magnifying lenses

to reduce their affinity for dust. When testing this solution, we found it will materially reduce the amount of fine dust collecting on dial windows, thus preventing the foggy appearance. As far as we can determine, one application will last indefinitely. However, it is possible that reapplication may be necessary. At the present time we are treating all dial windows in production with this solution.

To properly apply the solution, the dial window will have to be removed from the cabinet. Remove the knobs and the screws holding the escutcheon to the cabinet. Clean the window by wiping off the dust thoroughly on both sides, with a damp (not wet) cloth or chamois skin. Apply the Hexco Dust-Ded according to the directions on the bottle.

A small quantity of 1/2 ounce bottles of this solution will be sent you without charge. We recommend that each of your salesmen call this to the attention of his dealers.

If you should desire additional quantities of Hexco Dust-Ded, order our part number 98A11-2. List Price .30, Distributor Cost .12.

## Transvision Receivers

Transvision makes available the following Special Notes which in many cases apply to all makes of television receivers.

### Tube Brightness

The normal life of a television picture tube is several thousand hours. However, a spot can be burned into the screen very quickly if the brightness control is set at a high level. This becomes especially true as the raster is reduced and approaches the size of a spot.

### Vertical Hold

Do not adjust the vertical hold so that the picture moves downward. The proper setting of the vertical hold is that point where the picture moves slowly upward just before locking into position. The contrast setting should be set at a normal picture setting for your particular locality.

### Interruptions

During the transmission of television programs there may occasionally be interruptions in either sound or picture. It is advisable therefore not to make any adjustments on your receiver until you are positive the station is not at fault.

### Contrast Control

The setting for the contrast control will usually be found near the upper end (right side) and normally affects the sound due to the type of circuit used.

### Hold Controls

It has been found that due to care-

(Continued on Page 29)



### New Sensitive Relay

A new relay, with a split armature, called the "24", is being manufactured by the above-named company. This New "24" Relay was developed for automatic controls, keying, antenna changeover, burglar alarms, and closed circuit applications.

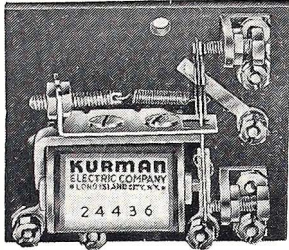

The following characteristics are incorporated in this relay: Rated Sensitivity:—.014 Watts D.C., .3 V.A. A.C. Adjusts to operate at .005 Watts, and from .01 to 115 Volts D.C. or A.C. Features included are: contact flexibility, magnetic circuit, U-shaped magnetic circuit of high permeability nickel alloy, especially heat treated. Steep curve provides dependable constant operation at low current values. Bakelite or mycalex bases are obtainable.

For further information write to the manufacturer: Kurman Electric Co., Inc., 35-18 37th St., Long Island City 1, N. Y.

### New Featherweight Iron

Transvision announces a new featherweight Soldering Iron called "Solde-tron," which weighs only 3 ozs., and contains the following features: Interchangeable tip-heads. Fingertip control. High working output, low current drain. The iron heats up within 20 seconds from a cold start; cools upon release of the button;

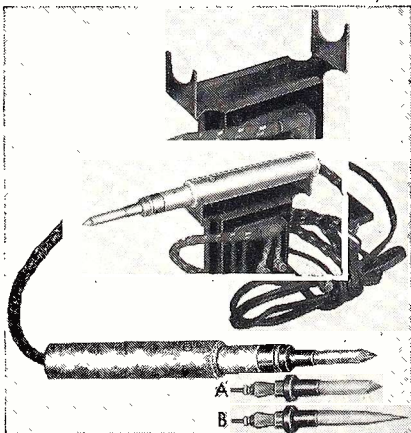

quickly reheats when button is pressed. Bakelite handle with cork covering. Long, thin tip permits soldering in inaccessible places. Heater element incorporated in each tip head. Tips heated to 1800°F in test did not burn out.

The iron comes ready for attach-

# NEW PRODUCTS

ment and operation on 110V. A.C. 50-60 cycles through transformer supplied with iron; or 6-8 volt A.C. or D.C. without transformer (from an automobile battery). Choice of 3 tip-heads—long, stubby, or medium shape heads are provided. Overall size of iron is 9 $\frac{1}{4}$ " x 15 $\frac{16}{16}$ ".

For further information write to the manufacturer: Transvision, Inc., New Rochelle, N. Y.

### New Interference Filter

What interference filter to use and how to connect it is readily and positively determined by the Aerovox Interference Filter offered by Aerovox Corporation of New Bedford, Mass.

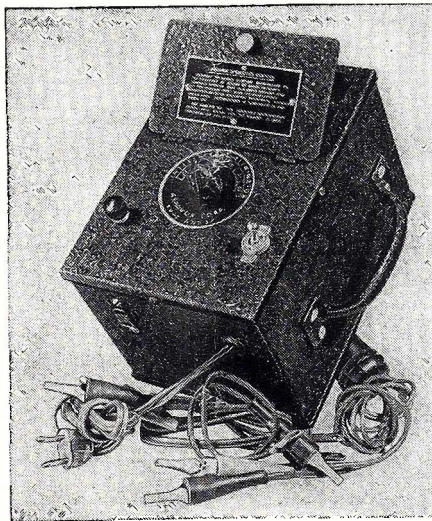

In a sturdy metal cabinet with rigid side handle and with hinged-cover compartment holding the assortment of connecting cords, plugs, receptacles and clips, the Selector goes out on the job. There it is readily connected in various ways with the noise-producing appliance or equipment. The knob is then turned through the series of different settings, each bringing into circuit the same circuit elements as found in Aerovox Interference Filters of corresponding type numbers. Thus the type filter to use, as well as the best connections, are immediately known, and the permanent installation made accordingly.

### Triplett Volt-Ohm-Mil-Ammeter

Triplett announces a new Volt-Ohm-Mil-Ammeter, Model 630, of advanced modernistic design: A new type enclosed molded switch permanently retains contact alignment, wide range scales and features completely insulating the large sensitive meter, precision resistors, etc

Six D.C. Volt ranges from 0 to 6000, at 20,000 Ohms/Volt assure greater accuracy for testing Television and

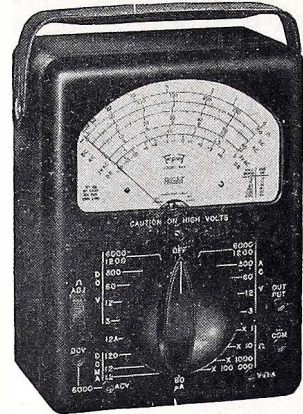

other high resistance D.C. and A.C. circuits. Six A.C. ranges to 6000, at 5000 Ohms/Volt provide greater accuracy in audio and other high impedance A.C. circuits. Five Direct Current ranges from 0-60 Microamperes to 0-12 Amps; Resistance ranges to 100 Megohms; Decibels from -30 to +70 DB and Output ranges afford complete Volt-Ohm-Mil-Ampere analysis.

Precision resistors—each rigidly mounted in its own molded compartment—are directly connected to the switch. A large 5 $\frac{1}{2}$ " meter provides easy-to-read multi-color scales, and is separately housed in a molded case. The streamlined, black molded case, 3-6 $\frac{32}{32}$ " x 5 $\frac{1}{2}$ " x 7 $\frac{1}{2}$ ", is completely insulated and has removable, black leather strap handle.

Address Triplett Elec. Inst. Co., Bluffton, Ohio.

### New Microgroove Record Changer

Webster-Chicago announces that their new Model 133 automatic microgroove Record Changer is in production now and will be ready for distribution as soon as microgroove records become available.

A new carefully-balanced tone arm which applies no lateral pressure on the thin walls carries the approved



Nylon Knee Action Needle easily and precisely along the groove. The drive

on Model 133 has been reduced to 33 rpm with the same single-speed torque characteristics and wow-less performance of the standard Webster-Chicago record changer models. The changer unit is mounted in an all metal base which may be used on table top or in radio console compartment for amplification through radio. As much as 4 hours of continuous play with a single loading of 10 twelve inch or 12 ten inch with microgroove records is possible with this changer.

The new model will carry the name "Matinee." Full description and sales literature will be available through Webster-Chicago distributors according to schedule.

#### New Volt-Ampere Wattmeter

The new Hickok Model 900B Volt-Ampere Wattmeter is designed for testing all A. C. appliances from clocks to 200 volt electric ranges. Incorporates a current transformer for additional ranges of 5000 and 10,000 watts, and 65 and 130 amperes.

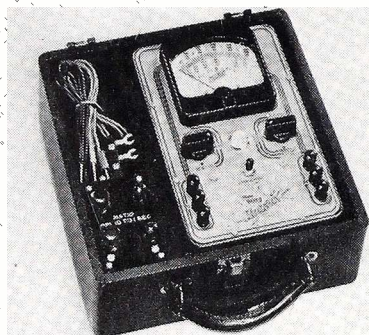

Tests appliances under actual use conditions. Shows wattage consumption, amperes and line voltage. A new continuity test consisting of a neon lamp connected between line and load binding posts provides a simple but accurate test for shorts in power circuits.

Technical characteristics are: A.C. Watts — 0-100-500-1000-200 (5000-10,000 extended range with C-105 current transformer), A.C. Amperes — 0-1.3-6.5-5-13-26-65-130, A.C. Volts — 0-130-260, A.C. Milliamperes — 0-260.

For further information write to The Hickok Electrical Instrument Company, 10533 Dupont Avenue, Cleveland 8, Ohio.

#### New Transvision Television Kit

Transvision announces their new TV kit which features new-type cabinet with built-in lens. Lens magnifies and clarifies picture. Lens also creates the effect of apparent rotation of the picture, so that when the observer moves, the picture still seems to be in focus and clearly visible from any angle. Lens also heightens picture contrast.

This product is merchandised in

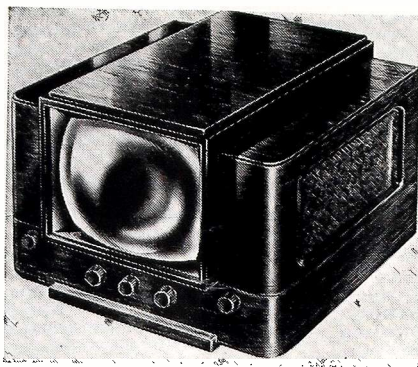

**KIT FORM**, for easy home assembly by laymen. No technical knowledge is required. Simple step-by-step instructions are included. The above mentioned lens is a precision-designed and manufactured product; made of plastic, liquid-filled; optically ground and polished. Uses 10" Electromagnetic Direct-view Picture Tube; has complete FM radio (which comes completely factory-wired); receives all channels in any area; supplied complete with antenna and lead-in wire. The lens is 15" x 11", giving a picture size of approx. 10" x 12" or 120 sq. in.; the cabinet, measures 26" wide x 17" high x 19" deep . . . available in Mahogany, Walnut, or Blonde finishes.

For further information write Transvision Inc., 385 North Ave., New Rochelle, N. Y.

#### TRADE FLASHES

(Continued from page 8)

Rochester Fall Meeting Committee and director of technical relations for Sylvania Electric Products Inc.

#### Berman-Shure Coast Rep.

Shure Brothers, Incorporated, announces the appointment of Mr. Eugene L. Berman as their representative in the northern California territory.

#### Belden Appoints Stanton

H. W. Clough, Vice-President in charge of sales, Belden Manufacturing Company, wiremakers, Chicago, announces the appointment of Edgar Stanton, Jr., as advertising manager.



Edgar Stanton, Jr.

#### Erie Appoints Poff

Organization of a Distributor Sales Department headed by J. K. Poff is announced by Erie Resistor Corporation, Erie, Pa. This newly formed department will handle sales to parts jobbers, of the Company's products.

#### Rider Opens Chi. Office—Expands Lab.

Joseph K. Rose, well-known figure in radio circles in the middle west, has been appointed to head the Chicago office of John F. Rider Publisher, Inc. With the opening of the Chicago office, the Rider organization will be in a better position to serve the radio manufacturing industry, the schools and the jobbers who are located in that area. Joe Rose can be reached at 6240 North Francisco Avenue, Chicago 45, Illinois.

Because of the great expansion of the electronic field during the past few years—especially television—the present space occupied by the Rider Labs has been found entirely inadequate. . . . Accordingly, new space totalling about 11,000 square feet, was leased by John F. Rider at 480 Canal Street, N. Y. C.

#### RMA Town Meeting in N. Y. C.

First of a series of five educational meetings for radio technicians in the next twelvemonth will be held in the Hotel Astor on September 26, 28 and 29, Harry A. Ehle, Chairman of the Town Meetings Committee of the Radio Parts Industry Coordinating Committee, announced recently. The New York meeting will be followed by one in Boston at the Hotel Bradford, November 15, 16 and 17, and by others in Atlanta (January), Los Angeles (March) and Chicago (April), Ehle said. Programs will bring the technician constantly revised, up-to-the minute information on television servicing, as well as a balanced program designed to make his life easier as an independent businessman.

Ehle announced appointment of Walter W. Jablon, Vice President In Charge of Sales of the Espey Manufacturing Company, New York, as member of his committee and his personal representative in preparation of the New York meeting. William P. Ready, Radio Parts Sales Manager of The National Company, Malden, Mass., has consented to act in the same capacity for the Boston meeting. The Associated Radio Service Men of New York, Inc., is cooperating in program development and other details of the New York meeting.

#### Sams Sponsors Lecture Tour

A. C. W. Saunders, whose Television training program is the basis for the Howard W. Sams' Photofact course in

# NOW!

## A Triplet-Made ELECTRONIC VOLT-OHM-MILLIAMMETER

**MODEL 2451**  
DEALER NET ONLY  
**\$69<sup>50</sup>**

*includes crystal Probe  
good to 125 MC.*

This new vacuum tube Volt-Ohm-Milliammeter incorporates features previously found only in the most expensive equipment.

**For the Radio Service  
Engineer who Knows**

This fine laboratory instrument has been designed to meet the needs of the radio service engineer for a high quality electronic V.O.M. at moderate price. Only the finest precision components are used including 1% resistors, sensitive 200 microampere meter, with meter isolated from input circuit for overload protection, housed in sturdy attractive metal case. Furnished complete with crystal probe that will handle all F.M. frequencies, accurate to 125 MC.

### RANGES

D.C.-A.C.-A.F. VOLTS: 0-2.5-10-50-250-500-1000  
R.F. VOLTS: 0-2.5-10-50  
D.C. MILLIAMPERES: 0-2.5-10-50-250-500-1000  
OHMS: 0-1K-10K-100K  
MEGOHMS: 0-1-10-1000

R. F. Diode Probe extra—  
(Plugs in same socket without change of connection . . . frequencies up to 400 MC.)  
High Voltage Probe also available  
(Will extend DC Volt Range to 10,000 Volts for TV requirement.)

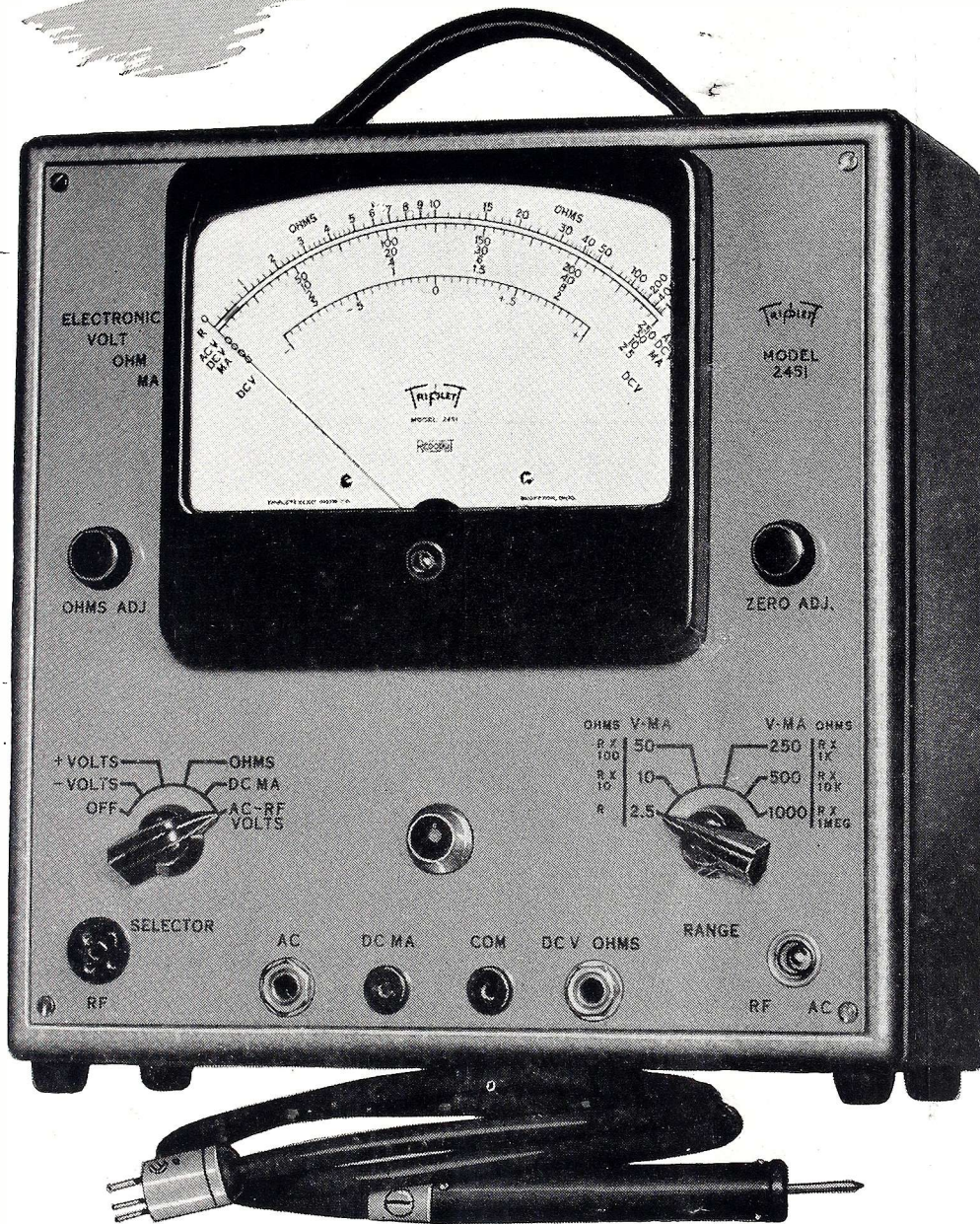

### CHECK THESE FEATURES

1. All Voltages read on single linear scale (A.C.—D.C.—R.F.)
2. Simplified balancing . . . merely zero on range to be used and proceed.
3. Large 6" 200 Microampere Red • Life-Time Meter guarantee against defective workmanship or material. 5.6 inch scale length at top arc.
4. Zero center voltage scale provided for F. M. discriminator alignment.
5. Input impedance 11 Megohms on D.C. Volts; approx. 4.8 Megohms on A.C. and R.F. Volts.

See your Radio Parts Distributor or write

**TRIPLET ELECTRICAL INSTRUMENT COMPANY • BLUFFTON, OHIO, U.S.A.**

In Canada: Triplet Instruments of Canada, Georgetown, Ontario

*Precision first...to Last.*



# 3 steps to

**GREATER DISTANCE**

**BETTER VIDEO**

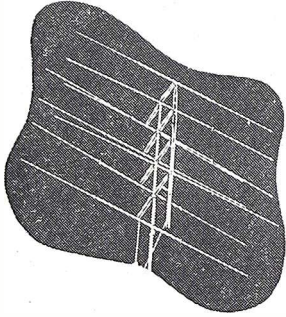

VEE-D-X,  
the long range,  
high gain  
TV antenna

Two or three stage  
TV Pre-Selectors for  
higher antenna gain  
and isolating  
interference.

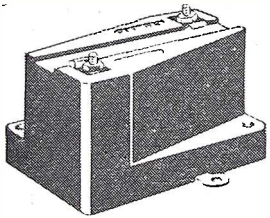
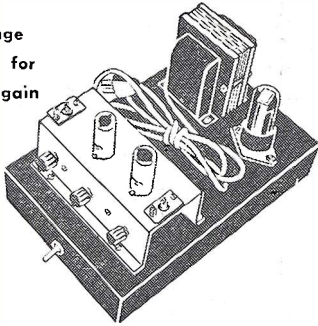

VEE-D-X  
lightning arrester,  
protection to  
TV receiver  
and equipment.

Three important steps to take to get the most out of every TV receiver. VEE-D-X developed this high quality, engineered TV equipment after extensive research and development to provide an adequate and safe antenna system for every type of installation. There is no substitute for a high gain antenna in TV, but with the addition of a VEE-D-X Pre-Selector, higher gain is achieved along with the suppression of unwanted signals. Protected with a VEE-D-X lightning arrester, you can have the finest TV antenna system available with a VEE-D-X installation. See your favorite radio jobber or write to: LaPointe Plascomold, Unionville, Connecticut.

**VEE-D-X**

Adds more vision to television

Television principles, recently addressed groups of Radio Service Technicians in Bethlehem and Philadelphia, Pa., and in New York City, on the fundamentals of Television receiver servicing. These meetings of Radio service men are the first of a series to be sponsored by Howard W. Sams & Co., Inc. to alert Radio Technicians to the opportunities in Television. Mr. Saunders' lecture schedule under Howard Sams' sponsorship will take him to every major section of the country during the balance of this year.

### Bendix New Policy and Personnel

Bendix recently announced the appointment of E. C. Bonia as General Sales Manager for Radio and Television, Bendix Radio Division of Bendix

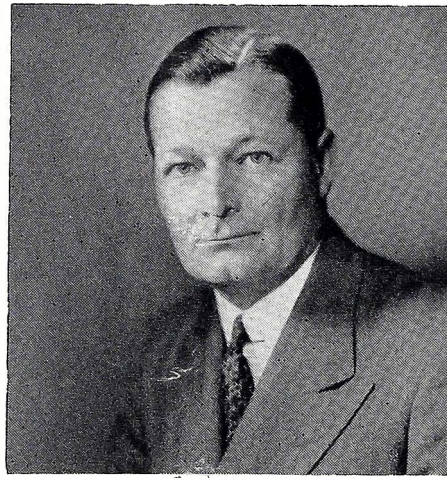

E. C. Bonia

Aviation Corp. Following his appointment, Mr. Bonia announced the appointments of F. T. Sterritt as advertising manager, and C. J. Hassard and R. W. Fordyce to his sales force. Bendix is now operating on a new "Direct to dealer sales policy."

### Hytron's "goldfish bowl" Contest

Thousands who attended the Radio Parts and Electronic Equipment Conference and Show at the Hotel Stevens during May made a guess at the num-

ber of cathode ray sleeves in the "goldfish bowl" at the exhibit of the Hytron Radio and Electronics Corporation. Guesses ran as high as one trillion. The actual number of sleeves in the bowl was 7,210. Prize for the closest guess, a \$50 U. S. Savings Bond, went to Wayne Phelps who is with Hytron distributor R. C. & L. F. Hall, Inc., of 1306 Clay Avenue, Houston, Texas, who made the remarkably close estimate of 7200—a guess within .138% of a perfect score.

### Stromberg-Carlson Pushes TV

Stromberg-Carlson's exhibit at the National Association of Music Merchants show in Chicago featured the company's new television line, showing for the first time in that city the "Rochester," 12-inch tube, table model with "console coupler" cord for attachment to larger sets.

A television survey conducted recently in New York and Philadelphia by the Federal Advertising Agency for the Stromberg-Carlson Company reveals that, although only 27 per cent of present video owners have a console type receiver, 51 per cent desire it. Seventy-five per cent of the video receivers were found to contain 10-inch tubes and 11 per cent had 7-inch tubes. The remainder were using larger sizes. Asked for preference in considering the next purchase, the majority of owners indicated that they would buy a receiver with a larger tube, with the 12 and 15-inch sizes most popular.

### RMA, IRE Form Joint Committee

Creation of a Joint Technical Advisory Committee for the purpose of advising governmental agencies, such as the Federal Communications Commission and other professional and industrial groups on technical aspects of radio, television, and electronic problems, was announced today jointly by the Radio Manufacturers Association and the Institute of Radio Engineers. The JTAC reports to the two Boards of

## Permoflux SPEAKERS



**YOUR JOBBER CAN SUPPLY YOU!**

Permoflux quality and dependability—the same as supplied to the major set manufacturers—is your assurance of complete customer satisfaction. You'll find Permoflux Speakers easy to install and readily available in both PM and Electro-dynamic types. You'll find too, that it pays to give your customers "tops in tone" with a Permoflux Replacement Speaker.

TWO COMPLETE  
FACTORIES TO SERVE YOU

**PERMOFLUX**

WRITE FOR  
FREE BULLETIN

PIONEER MANUFACTURERS OF PERMANENT MAGNET DYNAMIC TRANSDUCERS

### PERMOFLUX CORPORATION

4960 WEST GRAND AVE., CHICAGO 39, ILLINOIS  
236 SOUTH VERDUGO ROAD, GLENDALE 5, CALIFORNIA

**DANGER  
HIGH  
VOLTAGE**

# SAFE..SIMPLE

**HIGH VOLTAGE TV Tests to 30,000 VOLTS**

WITH THE NEW

## PRECISION SERIES TV

**Super High Voltage Safety Test Probes**



NOW . . . the TV high voltage test problem solved with safety and operational confidence. A super high voltage test probe, "Application Engineered" for the job . . . tested on the job . . . approved for the job. Custom designed for YOUR safety FIRST, and providing the accuracy, dependability and reliability you expect from products bearing the "Precision" name.

★ Convenient (Tool-less) means for rapid removal and interchange of the special cartridge style high voltage tubular multiplier permits a single TV probe to be employed with more than one, high sensitivity, multi-range test set, via purchase of the appropriate cartridge.

Series TV High Voltage Test Probes are now on display at all leading radio parts distributors and are available as follows:

★ **Series TVP**  
High Voltage Test Probe LESS multiplier cartridge.

Net Price \$12.35

★ **Series TV-1**  
Model TVP with cartridge for Precision Series EV-10VTVM.

Net Price \$15.45

★ **Series TV-2**  
Model TVP with cartridge for Precision (or any) 20,000 ohms per volt test sets having a built-in 6000 volt DC range.

Net Price \$15.45

★ Stock value and special value multiplier cartridges are available to match most popular high sensitivity test sets.

- ★ Extended high dielectric anti-leakage paths.
- ★ Multi-channelled guard barrier.
- ★ Full handle length internal arc-back shield directly grounded.
- ★ External arc-back barrier directly grounded.
- ★ Fully shielded instrument connecting cable.
- ★ All critical high potential and ground connections within the probe are positively accomplished via high compression contact springs.
- ★ Special helical film-type cartridge multiplier, developed specifically for very high potentials.
- ★ Custom molded polystyrene probe head, bakelite handle and barrier. Specially machined and tooled lucite internal components.
- ★ "Application Engineered" to meet the exacting requirements demanded by its intended field of usage.



Series TV High Voltage Test Probes provide direct kilovoltmeter facilities with your present high sensitivity test set, and vacuum tube voltmeter such as the "Precision" instruments illustrated below.

◆ See them on display at all leading radio equipment distributors along with the complete Precision line of modern electronic test instruments for all phases of AM-FM-TV service and maintenance. ◆



**Model 85**  
Laboratory Type 20,000 ohms per volt AC-DC test set. Full rotary range and function selection. 34 self-contained ranges to 6000 volts, 60 megohms, 12 amperes, + 70 DB. 4 1/2" full vision meter.  
Net Price \$38.75

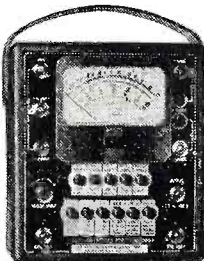

**Model 858-L**  
20,000 ohms per volt Multi-Master High Speed Wide Range push button operated AC-DC V-O-M. 54 ranges to 6000 volts, 600 megohms, 12 amperes, + 70 DB. Full vision 4 1/2" meter.  
Net Price \$54.10



**Model EV-10 MCP**  
Multi-range high sensitivity zero-center VTVM plus complete AC-DC V-O-M facilities to 6000 volts, 2000 megohms, 12 amperes, + 70 DB with extra large 7" meter.  
Net Price \$89.95

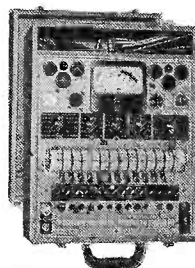

**Model 10-54-P**  
Combination Electronic Tube Tester, and 20,000 ohms per volt AC-DC V-O-M. Self-contained rotary selective ranges to 6000 volts, 12 amperes, 60 megohms, + 70 DB. 4 1/2" full vision meter.  
Net Price \$134.40

## PRECISION APPARATUS COMPANY, INC.

92-27 Horace Harding Boulevard • Elmhurst 8, New York  
Export Division: 458 Broadway, New York, U. S. A. Cables—Morhanex

RADIO SERVICE DEALER ◆ AUGUST, 1948

Directors who have delegated the responsibility to Dr. B. E. Shackelford, President of the Institute of Radio Engineers, and to Dr. W. R. G. Baker, Director of Engineering of the Radio Manufacturers Association as direct contacts.

### Microgroove Recordings

Dr. Peter Goldmark, CBS Director of Engineering Research and Development, who developed the Columbia LP Microgroove records which provides 45 minutes of playing on a single non-breakable disc of finer, noise-free tonal quality, gets a magnified view of the microgrooves in one of the new records.

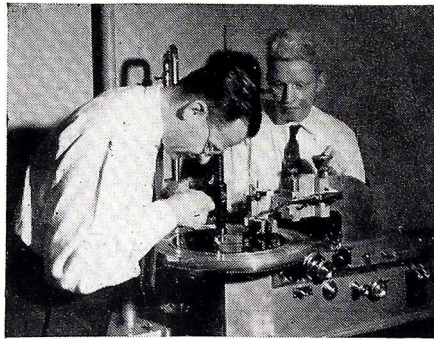

Rene Snepvangers, co-worker with Dr. Goldmark looks on while a Microgroove record is examined.

**QUALITY, FIDELITY  
FOR FM, MONITORING,  
RECORDING, AND  
OTHER SOUND USES**

**WIDE RANGE and  
PA SPEAKERS**

**GET HIGH** quality sound reproduction throughout the tonal range with Utah Wide Range Speakers. These Wide Range Speakers assure exceptionally brilliant response in the middle range plus extension of the higher frequencies to 10,000 cps. Unusual sound requirements in FM, laboratory, monitoring, or recording work, often can be met with Utah Speakers. Ask about the SP8JW and SP12LW.

**WHEN YOU** have a public address job use SP8K, SP12M, SP12P. Utah Speakers are quality built and severely tested. They are completely dust proofed and have pot covers. Write for catalog today!

## UTAH RADIO PRODUCTS

HUNTINGTON, INDIANA  
DIVISION OF INTERNATIONAL DETROLA CORPORATION  
EXPORT DIVISION: MORHAN EXPORTING CORPORATION  
NEW YORK, NEW YORK

*utah*

**BUILT STRONGER TO LAST LONGER**

### VA Limits GI Courses

Veterans Administration recently issued instructions to eliminate avocational and recreational courses under the GI Bill. Training determined by VA to be avocational or recreational in character includes certain courses in: (1) Dancing, photography, glider, bar tending and mixology personality development, entertainment, instrumental and vocal music, public speaking, sports and athletics.

### Sparton Ups Wagner

W. W. (Bill) Wagner has been appointed Assistant Sales Manager of the Sparton Radio & Appliance Division of the Sparks-Withington Company.

### Sentinel Adds to Sales Staff

Sentinel Radio Corporation of Evanston, Illinois, announces the appointment of "Larry" O'Brien and "Les" Kelsey to handle special contract sales of the company's products.

### Meck Announces New Line

A new line of FM-AM Receivers covering the entire new standard FM band 88-108 megacycles and 150-1750 kilocycles AM, has just been announced by John S. Meck, President, John Meck Industries, Incorporated, Plymouth, Indiana.

### SHOP NOTES

(from page 20)

lessness the hold controls, located on the rear skirt of the chassis, are sometimes interchanged. If your set is troubled with poor synchronization or lack of height or width, check these controls.

#### Audio Drift or Regeneration (Squeal)

In the event of sound drift or squeal, check the location of the 2.2 megohms grid resistor from pin No. 4 of the 6AC7 to ground. In the instructions this is resistor No. 2 on Diagram D, and must be placed exactly as shown and as closely as possible to the chassis.

### VIDEO AMPLIFIERS

(from page 17)

member that the plate circuit of this mixer contains both synch and camera signals.

Using the same operating grid bias the signals corresponding to Figs. 1b and 1c would ordinarily line up with signal 1a in the manner shown in Fig. 4. A study of this figure would indicate that we have no means of distinguishing between signals 1b and 1c, which occur in succeeding frames under different light conditions.

To get around this, a means is pro-

vided for at the camera tube whereby the average light in the scene is made to vary the d-c bias of the picture grid of the mixer tube so that a dark scene shifts the operating point to the right, and a bright scene shifts this point to the left. This is done by means of the system illustrated in Fig. 5.

$P$  represents a photo electric cell which registers the average light falling on the picture grid of the mixer tube. The output of this cell is then made to flow through resistor  $R_2$  to ground, causing a voltage drop across this resistor. In this manner the grid bias on the camera grid of the mixer tube is increased or decreased in accordance with the average amount of light contained in the televised scene. The time constant of the circuit enables the action to follow light variations taking place over a complete frame. The polarity of the voltage developed across  $R_2$  is such that the grid side becomes more negative as the average light increases. This corresponds to a negative picture phase.

Under these conditions the operating "C" bias on the picture grid varies with the amount of background light. Thus, the signal corresponding to Fig. 1b shifts the bias to the left as shown in Fig. 6. Notice that the plate current now flows in the region corresponding to more light.

On the other hand the signal corresponding to 1c results in a shift of the

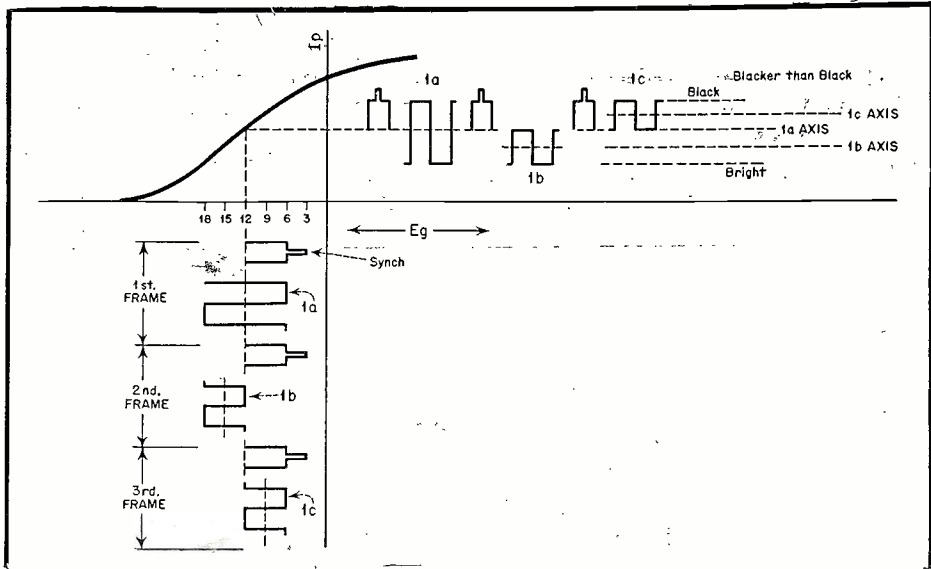

Fig. 8—Composite waveform of synch signal and picture signals, la, lb, and lc, with d-c component added.

operating point to the right, as shown in Fig. 7. This causes the signal to operate in the region corresponding to less light. As mentioned before, by proper adjustment of the circuit components, the level of the picture signal corresponding to black can be made to fall on the same line as the synch signal blanking level. This is shown in Fig. 8 where all the signals are combined into a composite video signal containing the synch pulses and the picture signal.

It is important to bear in mind that in order to obtain this signal we have to

add the average background brightness intelligence to the picture and synch signals. This intelligence is in the form of a varying d-c voltage applied to the grid of the mixer.

At this point it might be appropriate to point out that this d-c voltage is called the "d-c component." Actually, what this d-c component does is to shift the video signal axis up towards, and down away from, the blanking level, depending on the average background brightness of the scene. Thus, for the two scenes shown in Figs. 1b and 1c, where the patterns are

## FULL LOAD TESTS

... for radio and hearing aid A and B batteries with the NEW Simpson Model 379

The new Simpson Model 379 Battery Tester gives you a more accurate picture of the condition of radio and hearing aid A and B batteries than any other instrument of its type. This is possible because Model 379 has an unusual advantage—Simpson has provided it with loading resistors having an accuracy of 1%, enabling you to place these batteries under full load test. You get the picture in the terms you want—instantly and accurately.

Designed by Simpson to meet the specifications of leading battery manufacturers, Model 379 is manufactured in a size that is especially convenient for the radio serviceman. It measures only 3"x5<sup>7</sup>/<sub>8</sub>"x2<sup>1</sup>/<sub>2</sub>" and weighs but one and one-half pounds. The instrument can test all makes of batteries because, regardless of the type of terminal, positive contact is assured by the needle point prods with which Model 379 is furnished.

Other Simpson features are evidence of the fact that everything has been done to make the Model 379 simple to operate and easy to read. For instance, a single rotary switch selects the voltage of the battery under test and brings into place the correct loading resistor. The full 3" dial shows three arcs—one for all radio A batteries, another for hearing aid A batteries, and a third for all B batteries. Each arc is divided and marked in three sections, "Good," "Weak," and "Bad."

Housing of the instrument is molded black bakelite, and all figures on the case are recessed in the panel and filled in white for greatest legibility and long wear. These refinements and many more make the Model 379 a typical Simpson instrument—"an instrument that will stay accurate."

**Simpson**

INSTRUMENTS THAT STAY ACCURATE

ASK YOUR JOBBER

SIMPSON ELECTRIC COMPANY  
5200-18 Kinzie Street, Chicago 44, Ill.  
In Canada: Bach-Simpson, Ltd., London, Ont.

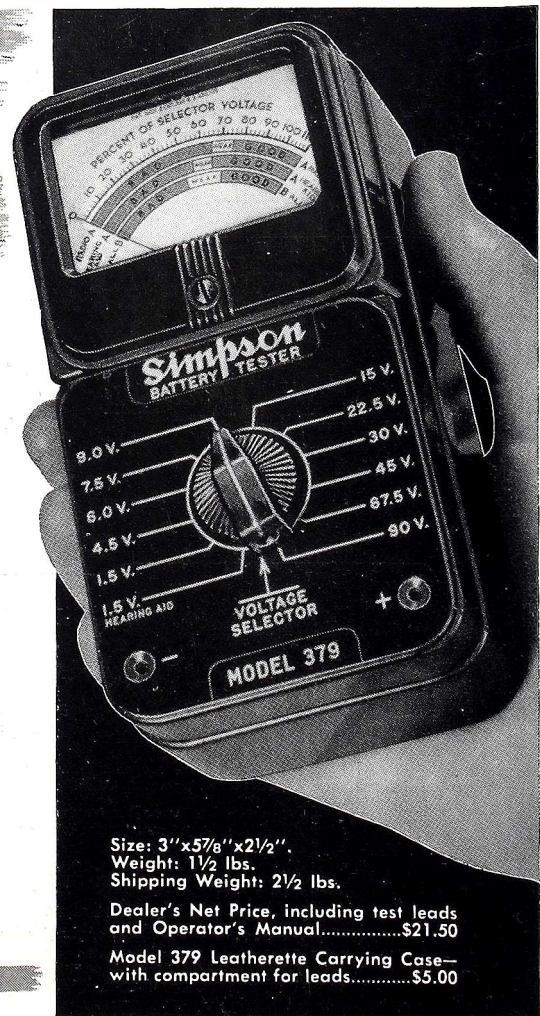

Size: 3"x5<sup>7</sup>/<sub>8</sub>"x2<sup>1</sup>/<sub>2</sub>".  
Weight: 1<sup>1</sup>/<sub>2</sub> lbs.  
Shipping Weight: 2<sup>1</sup>/<sub>2</sub> lbs.

Dealer's Net Price, including test leads and Operator's Manual.....\$21.50

Model 379 Leatherette Carrying Case—with compartment for leads.....\$5.00

identical and the light contrast is the same, but where the background levels are different, the darker scene is brought up towards the blanking level, and the brighter scene down towards the bright region of the signal.

Another important point to bear in mind is that the blanking level is always

at a constant amplitude, whereas the picture signal varies in amplitude from zero to this blanking level as it changes from white to black. This is why, in a TV receiver, the only constant component of the signal is the blanking level and its associated synch pulse.

(To be continued)

**For the Sharpest, Clearest Pictures**

INSTALL A  
WORKSHOP  
RECEIVING SYSTEM

In many locations, the ordinary television antenna does not provide enough "signal strength" for even the finest receivers. Workshop custom-designed Receiving Systems, because of their "high gain," will bring you pictures with brilliant clarity — even at places far beyond the normal range.

**Here's what users say:—**

—"My WORKSHOP 6-element high-gain antenna brings in Chicago stations 225 miles away."  
—"Ghosts and noise have completely disappeared since I installed your Television Receiving System." — New York City  
—"The tough winter brought down a lot of antennas in my neighborhood, but my rugged Workshop antenna stood up beautifully." — White Plains  
—"I get wonderful reception on baseball games 125 miles from Cleveland with your antenna system."

Many new television stations will come on the air soon. Play safe with a Workshop Receiving System — it is designed to take care of them.

Write for Free Television Catalog



**THE WORKSHOP ASSOCIATES, INCORPORATED**

69 Needham Street, Newton Highlands 61, Mass.

## REVOLUTIONARY SOLDERING IRON

# TRANSVISION

## Soldetron

Tr. Mark Reg., Pat. Pend.

For Easier, Better Soldering—on Any Job!

- Weighs only 3 ozs., yet can do the job of a 200 watt iron.
- Heats up in twenty seconds from a cold start; saves time.
- Fingertip control; permits soldering without fatigue.

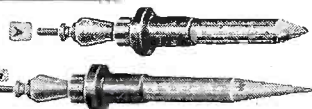

Ready for attachment and operation on 110 V. A. C., 50-60 cycles, through transformer supplied with iron, or 6-8 volt A.C. or D.C. without transformer (from an automobile battery). Overall size 9 1/4" x 3/8"; ship. wt. approx. 4 lbs.

- Ideal for fine precision work in "hard-to-reach" places.
- Readily interchangeable tip-heads; no cleaning or filing.
- Retains heat with switch off up to 1 minute; efficient.
- Bakelite handle, cork covering, for comfortable cool grip.

**PRICE, Including transformer and Tip-Head "A," \$13.95**  
5% higher west of Mississippi; fair traded.

Ask your distributor, or for further information write to

TRANSVISION, INC., Dept. RSD, NEW ROCHELLE, N. Y.

In Calif.: Transvision of Cal., 8572 Santa Monica Blvd., Hollywood 46

## CIRCUIT COURT

(from page 18)

denser is of the split-stator type. This is of particular advantage in that there are no moving contacts in the tuned circuit, the rotor being at ground potential between the opposite high potential sides of the circuit.

Feedback is established by 500  $\mu\text{f}$  condensers from each grid to the opposite plate. At 100 mc these provide essentially unity coupling. The plates are each fed voltage (about 75 volts) through 22K ohm resistors which serve as isolating impedances.

The r-f output is taken from one plate via a 1  $\mu\text{f}$  condenser to the mixer grid. This small value of coupling induces negligible unbalance to the circuit, probably less than exists in the two sections of the tuning gang. No switching is involved, a separate oscillator circuit being used for AM reception.

### Motorola 67F series

An uncommon oscillator-mixer circuit is employed in this broadcast band receiver. The set is of the a-c/d-c variety. A simplified schematic of the combination is illustrated.

The mixer stage uses a 12AU6 tube with conventional loop and i-f transformer in the grid and plate circuits. The oscillator voltage is applied to the cathode of the mixer. Note that the plate and screen are returned to the mixer cathode by a .01  $\mu\text{f}$  capacitor.

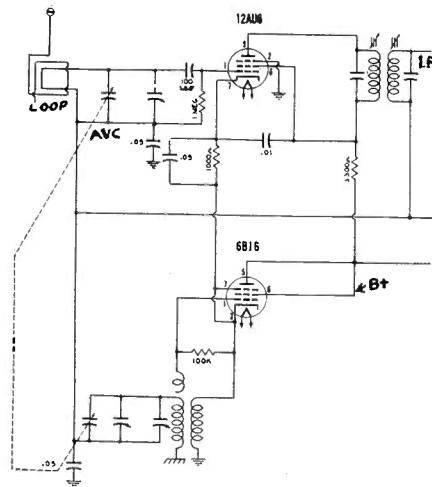

Motorola 67F, r-f and osc.

Bias for the mixer is developed across a 1000-ohm resistor (by-passed for r.f. by .05  $\mu\text{f}$ ).

The oscillator is of the grounded plate (for r-f voltage) type, with a cathode coil coupled to the tuned circuit. The grid is coupled to the tuned circuit by a small coil. Plate and screen are tied to form a triode of the



6BJ6 tube. The voltage developed across the cathode coil is fed to the mixer by direct connection between cathodes. The oscillator is self-biased by the 100K-ohm grid leak.

### Appliance Repairs

(from page 15)

where. On the other hand, if the motor still does not operate, there are four distinct possibilities: open field winding, open armature winding, a broken connection or a brush which does not make contact with the commutator. Any one of these will open the series circuit and render the motor inoperative. The condition of the field and armature windings may easily be checked with an ohmmeter. An open circuit within the field coil itself is not likely, because the wire is not of fine gauge, but of course such a condition might arise through burn-out as a result of a severe overload. A better possibility would be breaking of one of the leads at the point where it leaves the coil. This should be relatively simple to repair. Rewinding of field coils should not be attempted by the radio man except in cases where no facilities are available for having the work done by a specialist in a reasonable length of time. If the job is attempted, the wire should be gauged and the turns carefully counted as they are removed. In many machines, the coils are form wound and it may be necessary to construct some type of wooden form for this purpose.

When we consider the armature winding, we shall find that because of the smaller size wire, an open circuit is more likely than in the case of the field, but it is not likely that all of the coils will be open. It is possible, however, that a motor has been stalled and the coil which was under the brushes at that instant has been burned out. If this has happened, spinning the shaft by hand after applying power should start the machine. Whether one coil or several are open, the armature must be rewound and this is a job that you are not advised to attempt under any circumstances. If you find no sign of open field or armature coils, the trouble may be due to a broken connecting lead between windings. This may be the lead between field coils or the wire running from one end of the field to one brush or perhaps at some other point. Inspection plus the ohmmeter should indicate the fault within a short time. Finally, it is possible for a brush to be broken or so badly worn that it does not contact the armature. Do not be surprised if a machine is brought in with one or both brushes missing. And of course the customer is never able to cast any light on the matter of the missing parts.

(To be Continued)

**ASTATIC PIONEERED THE FIRST CRYSTAL DEVICES**  
*Again Astatic takes the lead*

**with MICROPHONES**  
**and PHONOGRAPH PICKUPS**  
**Employing the AMAZING PIEZOELECTRIC CERAMIC ELEMENTS**

Astatic again assumes a pioneer role . . . in making available, for the first time, the unique physical advantages of the amazing, piezoelectric ceramic element, in a microphone and phonograph pickup cartridge of advanced quality and fidelity. Unaffected by heat, moisture or dryness, they can go virtually anywhere . . . provide transcription quality reproduction, troublefree service, in tropical climates, under exposure to direct sunlight, heat from klieg lights or automotive interiors, when subjected to the many other conditions that threaten damage or impaired performance to other type instruments. These, plus other important advantages, combine to assure an immediate, enthusiastic reception for Astatic ceramic devices.

**NOW AVAILABLE** Astatic has incorporated ceramic elements in two of its most popular product designs—the convertible "Velvet Voice" Microphone and the "Quiet Talk" series pickup cartridges. Now moving through Astatic production lines, they are immediately available.

Write for prices, specifications

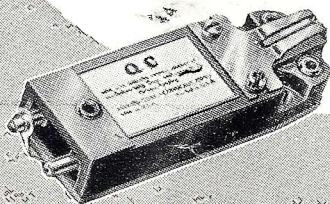

## FULL 13 CHANNEL TV-FM COVERAGE!

*New!*

### JFD Super-Beam HI-LO Duo Orienting Array

- ★ Independent orientation of upper and lower bays.
- ★ Minimized "ghost" effects.
- ★ Frequency Range 44-216 mc. — +4.2 DB gain.
- ★ All-weather polystyrene Rotolock insulator insures high frequency insulation — permits tilting of antenna.
- ★ Precision-designed element-spacing for optimum gain.

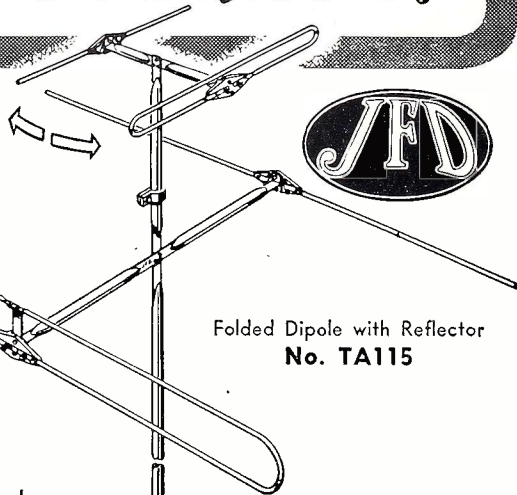

Folded Dipole with Reflector  
No. TA115

- ★ Shipped complete with special JFD Mount Master — unique All-Angle Mounting Bracket.
- ★ Lightning-fast assembly time — no hardware bag.

Write for JFD 16-page Super-Beam Catalog.



**MANUFACTURING CO. Inc.**

4113 Fort Hamilton Parkway

Brooklyn 19, N. Y.

# Presenting DURANITE

## the SUPERIOR CAPACITOR



Several sizes —  
1 1/32" to 2 1/32"  
dia. 1 1/8" to 2"  
long.

• An entirely new tubular capacitor—featuring Aerolene, the new impregnant; new processing methods; new DURANITE casing.

Such is DURANITE—the toughest tubular yet offered for use in stay-put assemblies. Therefore don't confuse DURANITES with conventional molded tubulars. DURANITES are different.

Drop, bang, scratch—no damage to the permanent, non-varying, rock-hard DURANITE casing. Unaffected by high temperatures—nothing to melt or burn. Thoroughly moistureproof. No shelf deterioration. Pigtailed won't pull out. And so on.

Order DURANITES from your Aerovox jobber. Popular capacities. 200 to 1600 v. D.C.W. Try them. You'll be amazed!



**FOR RADIO-ELECTRONIC AND  
INDUSTRIAL APPLICATIONS**

AEROVOX CORP., NEW BEDFORD, MASS., U.S.A.  
Export: 13 E. 40th St., New York 16, N.Y. • Cable: 'ARLAB'  
In Canada: AEROVOX CANADA LTD., Hamilton, Ont.

## FM & TV BOOSTERS

(from page 12)

turers load the coils down so much that tuning is no longer critical. This lowers the gain substantially and reduces the selectivity too. Generally speaking, the continuously tuned amplifier employing a single stage is usually preferred to the same type of circuit with a channel switch. The most desirable type of booster as far as gain is concerned is the one offered by a concern in the West. This unit, containing three or four stages, has fixed tuning for only one channel. It has a self-contained power supply complete with transformer and filter choke. It provides substantial gain, coupled with excellent selectivity and bandpass characteristic. It is, however, limited to areas where only one single station is operating. Otherwise the possibility of using a separate unit such as this for each channel, with the consumer having to connect and disconnect leads every time when switching stations, makes the unit too cumbersome.

### LIMITATIONS

At this point it is necessary to discuss some of the limitations of boosters, and the pitfalls encountered in their use. For one thing there are localities where the TV signal is so weak that it is below the noise level. Locating a good antenna on a nearby elevation and installing a booster directly at the antenna and one at the receiver may do the trick. Nevertheless, there are locations where reception is just not possible and where any great expenditures are just wasted. In apartment houses where the landlord prohibits roof antennas a booster may be used in conjunction with an indoor antenna. A good place for such an antenna is on the window frame if this is made of wood or just outside the window if steel frames are present. Sometimes an antenna can be made by cutting 300 ohm line to form a folded dipole of the proper length which can then be placed under a rug or behind curtains etc., If this is done in a building of steel and concrete, good signal may be present except when casement type windows are closed or steel venetian blinds are drawn. In any event, it must always be kept in mind that a minimum signal must be available to give a picture, no matter how good the booster.

Sometimes customers complain that a booster, which works wonders on one station does nothing on another. The reason is often that the second station comes in strong enough and the additional signal merely tends to give more a-v-c voltage, naturally no increase in brightness. When a booster designed for all 13 channels does not seem to work on the upper band the cause may

## SENSATIONAL BUYS!



### FAMOUS R.C.P.

Hi-Mog. Multitesters  
Model 450A Only \$20.95

Are you impressed by big names and sky-hook prices? R.C.P. is big, too—but big enough to vank down instrument prices even for shoe-string bankrolls. This No. 450 series compares with the finest precision testers on the market—yet costs you approximately half! Slashed operating costs help you compete for more service business. Order now from your jobber, or write direct.

• • • • •  
Top resistance range of 50 Megohms, no tubes or batteries required. • 24 ranges of volts-ohms-current-db. • Wide scale 4-5/8" meter, 1,000 ohms p.v. • Fine germanium crystal rectifier for AC. • Handsome panel, heavy duty oak case.

• • • • •  
MODEL 450AP, Portable @ \$24.95  
MODEL 450C, 20,000 ohms p.v. @ \$28.50  
MODEL 450CP, De Luxe Portable @ \$32.50  
SEE R.C.P. — BEST FOR EVERY TEST

**RADIO CITY PRODUCTS CO., INC.**

152 West 25th St.  New York 1, N. Y.

## Introducing CELLULAR GRAND by RACON

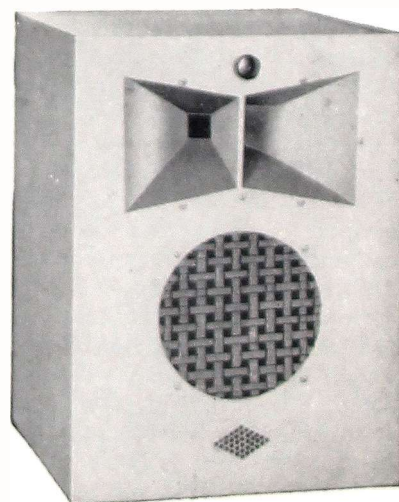

A high fidelity reproducer that sets a new standard of efficiency in electro-acoustical conversion. Size 11"x11"x15" Small enough to fit into the home console. Sound output ample for studio and industrial requirements. Has 120° horizontal sound angle. Special type cone speaker for low reproduction, and cellular speaker for wide angle coverage and high frequency response, and many other exclusive features. Frequency range 50 to 12,000 cps.

Write today for free literature

**RACON ELECTRIC CO., INC.**

52 E. 19th St., New York 3, N. Y.

RADIO SERVICE DEALER ♦ AUGUST, 1948

use...  
**OHMITE**  
Replacements

**BROWN DEVIL RESISTORS**... Wire-wound, vitreous-enameled type. Now in compact 5-watt size. Also 10 and 20-watt units.

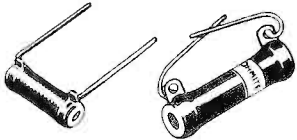

**LITTLE DEVIL RESISTORS**... Now 1/2 and 1-watt sizes in ±5% tolerances. Also 1/2, 1, and 2-watt sizes in ±10% tolerances.

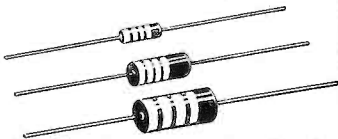

**TYPE AB POTENTIOMETER**... A new extremely high quality molded composition unit—rated 2 watts with a good margin of safety.

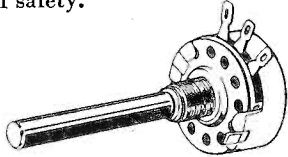

**DIVIDOHM ADJUSTABLE RESISTORS**... Wire-wound vitreous-enameled type—10 to 200 watts. Sturdy... dependable.

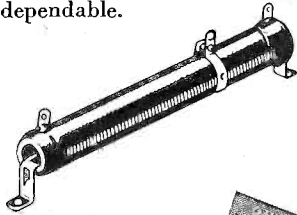

See Your Nearest  
Ohmite  
Distributor  
Send for  
Catalog 19



**OHMITE MANUFACTURING CO.**  
4846 Flournoy St., Chicago



Be Right with...

**OHMITE**  
RHEOSTATS • RESISTORS  
TAP SWITCHES

be extensive mismatch with the antenna. It is very necessary when working in the upper band that the antenna contain a proper high-frequency element.

Commercial all-wave antennas always contain a high-frequency element, but if a low band antenna is used reception in the high channels can be improved by adding a simple short dipole. The best length for such a dipole is about 14½ inches each element—total length 29 inches. This can be made of 300 ohm twin lead, giving a folded dipole or else short metal rods can be used for a plain dipole. This additional antenna is connected in parallel with the low band section. At the lower channels the short element may load the antenna down a little, but since the characteristic impedance of most antennas are no higher than 300 ohms, this will be negligible. At the high channels the long section

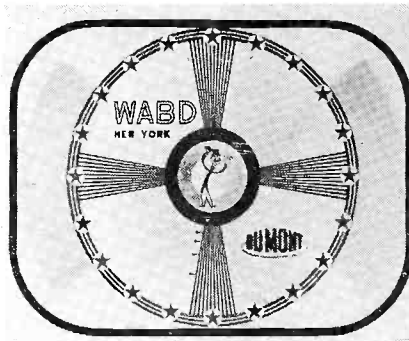

Correct pattern with booster.

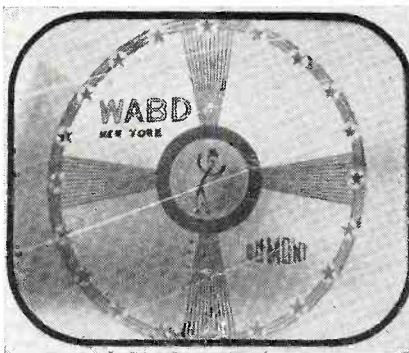

Weak signal needs booster.

represents a relatively large impedance and, therefore, gives no trouble. The need for high-frequency antennas for good reception can not be overemphasized, especially in locations where only low-channel stations were received previously.

All in all, the booster is a very useful accessory to many television installations and thousands of service dealers are already using it to the satisfaction of their customers. In some areas like New Haven, Milford, Bridgeport, all in Connecticut, television sets are already sold with a booster and some TV manufacturers furnish boosters with their sets in these fringe areas. In the vicinity of Poughkeepsie, N. Y. alone,

*New! New!*

**CHIMNEY MOUNT  
ANTENNA BASE**

- for TELEVISION
- FM • AMATEURS

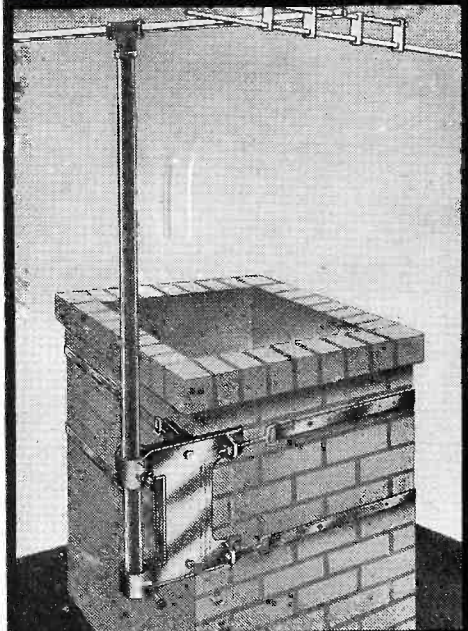

Pat. Pending

**INSTALLED IN 10 MINUTES  
PERMITS USE OF SEVERAL  
MOUNTS ON ONE CHIMNEY**

"Chimney Mount" is a brilliantly engineered new antenna base that can be installed in 10 minutes without the use of special tools or drilling of holes. Several can be strapped to one chimney—also mounts on pole, 2 x 4, side of house or to any rectangular roof extension. Fastens aerial to highest point with galvanized steel bands having a combined tensile strength of more than 3,000 pounds. Made of corrosion-resistant aircraft-type aluminum alloy. Weight: 3 lbs.

**"Chimney Mount"**  
List Price, \$7.50  
Cost to Trade, \$4.50

Available Through All Leading  
Jobbers or Write to:

**South River Metal Products Co.**  
South River, New Jersey



# Easier Antenna Installations



STAR TAMPIN



STAR DRYVIN



STAR STAZIN



STAR SPRINGIN

Star Expansion Bolts make it easy to fasten TV equipment to brick, stone, concrete or any other type of masonry. Help you to position antenna masts, cables and lines in the best possible manner... assure greater satisfaction; reduce service calls. There's a Star fastening for every masonry job. See your jobber or write for details.

**★ STAR EXPANSION BOLT CO. INC.**

147 Cedar Street, New York 6, N. Y.

# Vital Aids

**IN SERVICING  
MINIATURE TUBE RADIOS  
AND EQUIPMENT**



★ Star Miniature Socket Wiring Plugs for accurate alignment of miniature socket contacts during wiring. Precision cast of zinc base alloy—pins of stainless steel. #JE-9 (9 pin); #JE-10 (7 pin).

★ Star Miniature Tube Pin Straighteners (with stainless steel insert) to obtain a perfect fit when the tube is placed in the equipment. #JE-15 (9 pin); #JE-13 (7 pin).



Scientifically designed — Precision made  
Immediate Delivery in Any Quantities

**★ STAR EXPANSION PRODUCTS CO., INC.**

147 CEDAR STREET, NEW YORK 6, N. Y.

about 3000 boosters are in use, and there is hardly any TV receiver there working without a booster and good antenna. In the Middle West, around Chicago, a tremendous market for preamplifiers has already opened up, and in the vicinity of Boston dealers are getting ready for the big rush once the Boston TV station gets on the air, which may be by the time this article is printed. Wherever TV stations spring up and provide a new market for receivers, another market at least as big can be reached by the use of boosters and good antenna installations. The low price, compactness and easy installation of most commercial boosters make them indeed a great sales aid and a source of additional income to the alert dealer. Since they are useful not only in fringe areas, but also where regular outdoor antennas are not possible, their application is limited only by the inevitable curvature of our globe and the ingenuity of the serviceman.

## Ad Index

Aerovox Corporation.....	30
Air-King Prods. Co., Inc. Cover	3
Astatic Corporation, The.....	29
Crosley Div., Avco Mfg. Corp.	1
Delehanty Institute.....	32
Eastern Technical School.....	32
Federal Tel. & Radio Corp.....	2
General Elec. Co. (Speaker Div.)	9
Hytron Radio & Electronics Corp.	3
J. F. D. Mfg. Co., Inc.....	29
Ken-Rad Div. of G. E. Co.....	5
LaPointe Plascomold Corp.....	24
Mallory, P. R. & Co., Inc. Cover	2
Oak Ridge Antennas.....	32
Ohmite Mfg. Co.....	31
Permoflux Corp.....	24
Precision Apparatus Co.....	25
Racon Electric Co., Inc.....	30
Radio City Products Co., Inc....	30
R C A (Tube Div.).....	4
Sams, Howard W. & Co., Inc. ...	19
Simpson Elec. Co.....	27
South River Metal Prods. Co....	31
Stahl, Michael, Inc.....	32
Star Expansion Bolt Co., Inc....	32
Star Expansion Prods. Co., Inc....	32
Sylvania Elec. Prods. Inc.....	10
Transvision, Inc.....	28
Triplett Elec. Instru. Co.....	23
Utah Radio Products.....	26
Webster-Chicago Corp.....	6, 7
Workshop Associates, Inc., The	28

## Rig-Fast

### TV & FM Antennas

For clear, sharp signals—sell the Rig-Fast line. All aluminum, strong and easy to install. All models are interchangeable and are packed with complete accessories. Write for details.

**OAK RIDGE ANTENNAS**  
239 East 127th St., N. Y. 35, N. Y.  
Dept. B.

**Selected Group of Men**, desire employment in Radio Field. Will travel anywhere. Qualified radio servicing, installation, test instruments, circuit operation, etc.

**Eastern Technical School**  
888 Purchase Street, New Bedford, Mass.

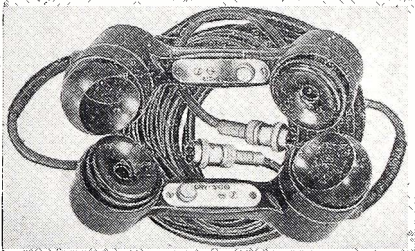

RCA-CRV-51019 Hand Sets self contained battery operated. Uses 4 pen light batteries excellent for Television Antenna installation. Sold in pairs only..... Pair \$15.  
TS-10P Sound power handsets in original export packing. Each \$15.00 2 for \$27.95

Prompt Delivery—25% deposit required on C.O.D. order. Shipped F.O.B. New York—Write Dept. RS9.

**MICHAEL STAHL, Inc.**

39 VESEY ST.

New York 7, N. Y., WO 4-2886

## \$1.00 to \$5.00 PAID for "SHOP NOTES"

Write up any "kinks" or "tricks-of-the-trade" in radio servicing that you have discovered. We will pay from \$1 to \$5 for such previously unpublished "SHOP NOTES" found acceptable. Send your data to "Shop Notes Editor," RADIO SERVICE DEALER, 342 Madison Ave., New York 17, N. Y. Unused manuscripts cannot be returned unless accompanied by stamped and addressed return envelope.

## A CAREER WITH A FUTURE! TELEVISION

SHOP WORK • SHOP TECHNIQUES • THEORY • FULLY EQUIPPED LABORATORIES  
• RADIO SERVICE & REPAIR  
• F. M. & TELEVISION  
• TRANSMITTER COURSES  
Preparing for F. C. C. LICENSES  
• RADIO TECHNOLOGY  
MORNING • AFTERNOON • EVENING CLASSES • MODERATE RATES • INSTALLMENTS  
AVAILABLE UNDER G. I. BILL

**DELEHANTY SCHOOL OF  
RADIO • ELECTRONICS • TELEVISION**  
105 EAST 13th STREET, NEW YORK 3, N. Y. • DEPT. U

LICENSED BY STATE OF NEW YORK

*When a set is beyond repair—*

**DON'T LOSE YOUR PROFIT—**

**Sell a NEW**

**AIR KING  
RADIO!**

Made by the Makers of  
the Famous  
AIR KING WIRE RECORDER



Model A-520

**AIR KING New  
3-Way Portable**

**Midget in Size—Giant in Power**

No warm-up period required, even on AC-DC...self-contained loop antenna. Polystyrene cabinet in maroon or ivory...vinylite handle. Superheterodyne...4 tubes plus selenium rectifier. Weighs 4 1/8 lbs. with batteries. Takes 3 flashlight "A" batteries and 1 67 1/2-volt "B" battery. Size: 8 3/4" long x 4 7/8" high x 4" deep.

**\$28<sup>95</sup>**

Less batteries  
Slightly higher in Zone 2

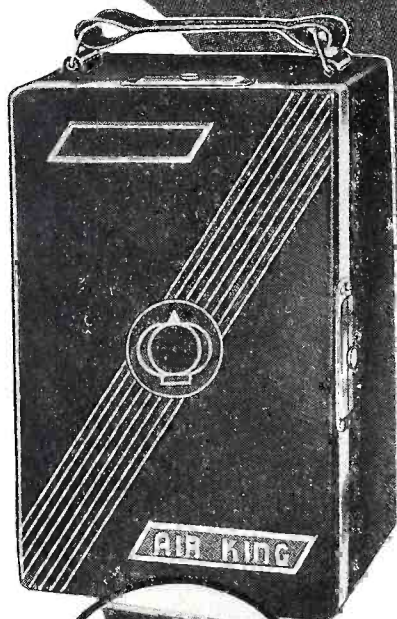

Model A-425

**AIR KING  
Pockette Personal**

Loop antenna in cover...4 miniature tubes...uses 1 standard flashlight battery and 1 standard 45-volt "B" battery. Polystyrene case. Sturdy metal grill to withstand outdoor elements. When lid's open, "Pockette" is on...close lid and it's off. Net weight: 1 lb., 11 oz. Measurements: 3"x5 3/4"x3 5/8". Ebony with nickel trim... **\$19<sup>95</sup>**

Model A-426—Ivory with Gold trim... \*\$24.95  
Model A-427—Maroon with Gold trim... \*\$22.95  
\*Less batteries. Slightly higher in Zone 2.



So tiny it fits in the palm of your hand

**AIR KING Court Jester**

High fidelity table radio-phonograph. Superheterodyne. Plenty of power! Plays 10 and 12-inch records; equipped with Fidelitone lifetime needle. Comes in hand-rubbed walnut finish. **\$29<sup>95</sup>**

Slightly higher in Zone 2

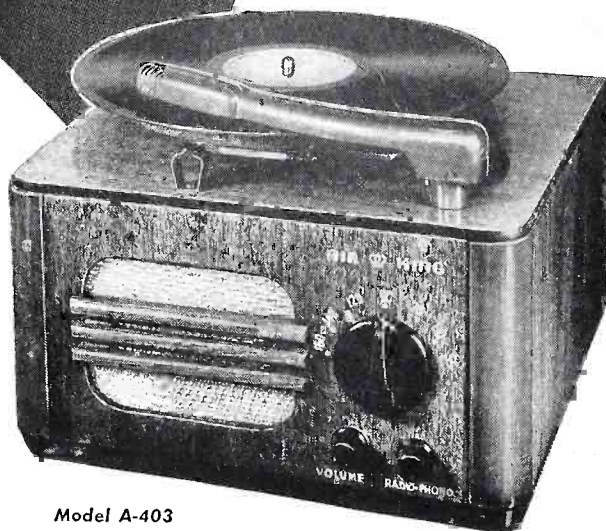

Model A-403

AIR KING PRODUCTS CO., INC., 170 53rd ST., BROOKLYN 32, N. Y. • Export Address: Air King International, 75 West St., New York 6, N. Y.

**AIR KING RADIO**  
Division of HYTRON RADIO & ELECTRONICS CORP.

*The Royalty of Radio Since 1920*





*Push RCA Tubes and Watch Your Business Grow!*



*RCA brings you the widest range of tubes . . . backs you up with the best in sales aids.*

## Cover the field with RCA tubes

AM, FM, or TV . . . practically every make and model receiver you're called upon to service can be completely re-equipped with *standard available* RCA tubes.

In power and special tubes, too . . . for broadcast, amateur, communications, and industrial equipment . . . RCA has a comprehensive line for every application.

Having the tubes your customers need . . . and the brand they prefer . . . means more business for you—from more sources!

Your RCA Distributor carries extensive stocks of RCA tubes to back you up . . . and the greatest line of sales promotion material to help you sell them. So—see him today for full details on how you can profit by pushing RCA tubes.

THE FOUNTAINHEAD OF MODERN TUBE DEVELOPMENT IS RCA

**TUBE DEPARTMENT**

**RADIO CORPORATION of AMERICA**

**HARRISON, N. J.**

