

radio service dealer

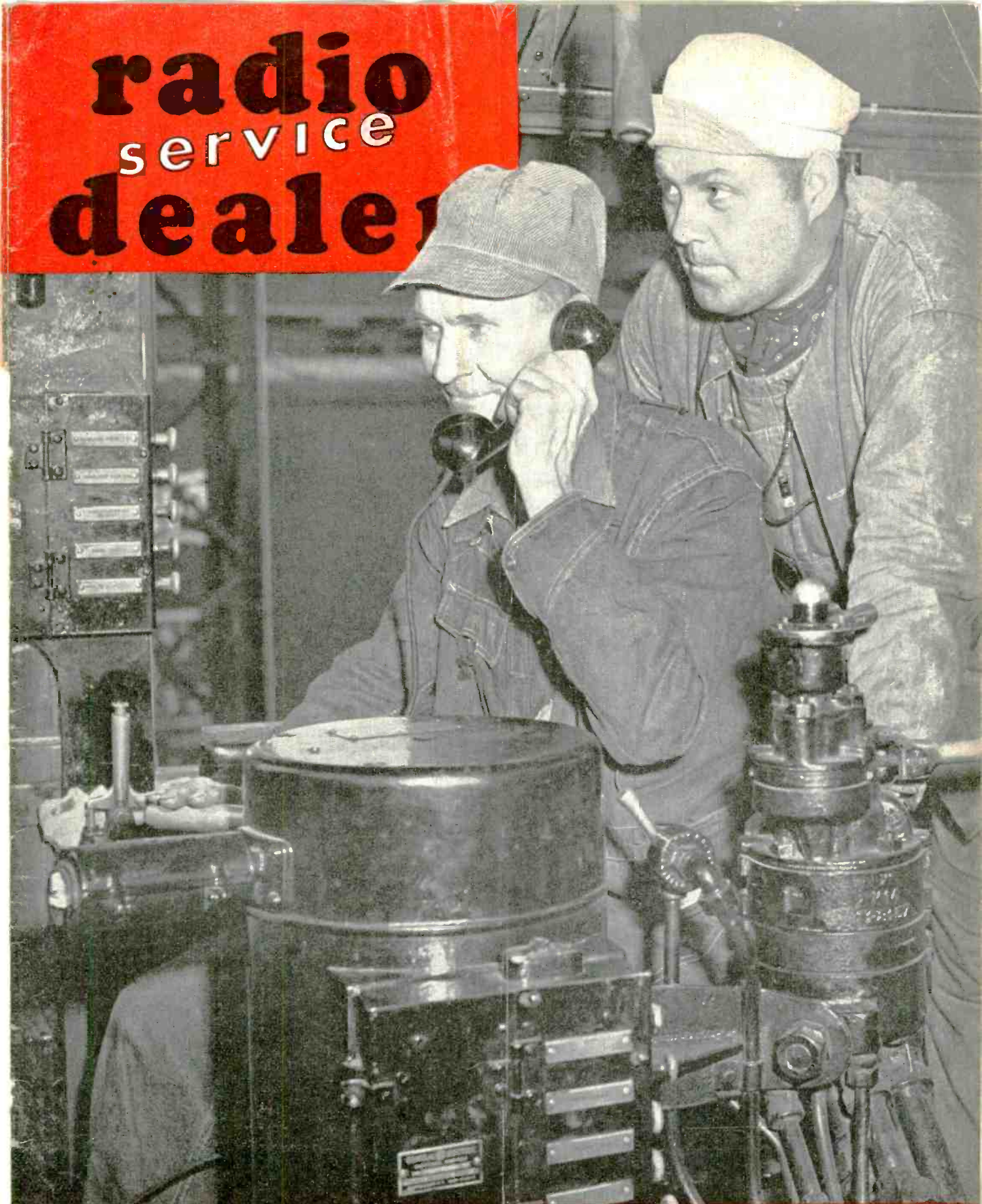

In **New Radio Opportunities — Radio Telephony**
This **★**
Issue: **A New High Speed Circuit Tester**

July, 1944
25c

P. R. MALLORY & CO. Inc.
MALLORY

Tips on Radio Service Short Cuts

Reclaiming High Leakage Electrolytic CAPACITORS

Where high leakage wet or dry electrolytic capacitors are encountered, many of them may be re-aged and put back into service.

The simple method described below requires little equipment and will prove useful in reclaiming such units where possible.

Necessary Equipment

- 1 — a rectifier power supply capable of delivering up to 500 volts DC at 100 milliamperes.
- 2 — any convenient means for varying the output voltage of the power supply to match the rated voltage of the condenser to be re-aged.
- 3 — a 10,000 ohm 10 watt resistor.
- 4 — a 0 to 500 voltmeter.
- 5 — a 0 to 50 milliammeter.

P. R. MALLORY & CO., Inc.
INDIANAPOLIS 6 INDIANA

MYE TECHNICAL MANUAL
—108 pages of complete data on capacitors, noise suppression, receiving tubes, loud speakers, vibrators, phono-radios, automatic tuning and other valuable information. Available from your Mallory distributor... Price, \$2.00.

4TH EDITION RADIO SERVICE ENCYCLOPEDIA . . . Complete information on repairing any make or model of receiver. Circuit references, original part numbers and recommended replacements. Available from your Mallory distributor . . . Price, 95 cents.



Buy More War Bonds

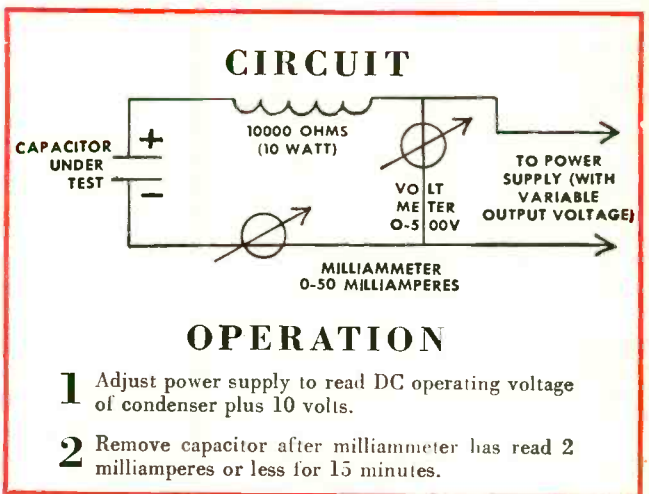

P. R. MALLORY & CO. Inc.
MALLORY
Approved Precision Products





History of Communications Number Five of a Series

NIGHT COMMUNICATIONS ON THE HIGH SEAS

In those early days when our Navy was first organized night communication was made by lantern from the masthead. This was the only communication between ships at sea during through which many times news from home was transmitted.

Today, through the use of Universal Microphones and voice communication components, vital communications of War are speedily transmitted equally as well from small sea-craft and battle cruiser to home port.

Many new types of Universal microphones shall be developed from the experience obtained from the production of military units, for the private citizens in the marine pleasure-craft in the days after Victory is ours.

< Model T-30-S, illustrated at left, is but one of several military type microphones now available to priority users through local radio jobbers.



UNIVERSAL MICROPHONE COMPANY
INGLEWOOD, CALIFORNIA





Yesterday and **TODAY**

The Army-Navy Production Award for outstanding achievement in producing vitally important materials essential to the war effort will be an added incentive to the management and employees of

WARD PRODUCTS CORPORATION to keep producing more and better equipment for the men who are doing the fighting. While yesterday WARD Antennas were accessories for pleasure, today they are implements of War.



WARD

Antennas

THE WARD PRODUCTS CORPORATION, 1523 EAST 45TH STREET, CLEVELAND, OHIO

Radio Service Dealer



UNIMETER

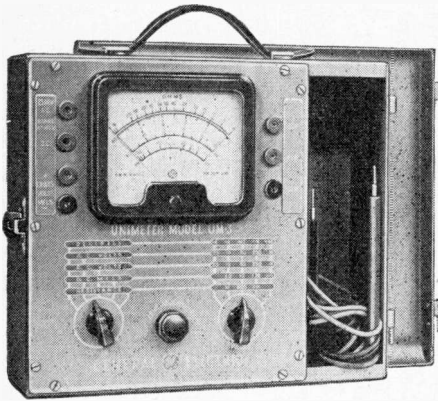

• Completely portable all-around utility instrument, ideally suited for reliable service work. Large meter calibrated to reduce the error possibility in readings makes the G-E unimeter a popular one with servicemen.

Other General Electric units available for testing electronic circuits and component parts are: audio oscillators, oscilloscopes, condenser resistance bridges, signal generators and other utility test instruments.

For complete details about the new General Electric line of SERVICE TESTING EQUIPMENT, please fill out the coupon below. . . .

FREE CATALOG



**ELECTRONICS DEPARTMENT
GENERAL ELECTRIC CO.
Schenectady, N. Y.**

Please send, without obligation to me, the General Electric Testing Instrument Catalog, **D-7** (loose-leaf), for my information and files.

Name _____
Company _____
Address _____

GENERAL ELECTRIC

Electronic Measuring Instruments

radio service dealer

Covering all phases of radio, phonograph, sound and electrical appliance merchandising and servicing.

VOLUME 5, NUMBER 7

JULY - 1944

CONTENTS

With the Editor	4
Astounding Radio-Appliance Potential; Gas for Servicemen	
In & Around the Trade	6
What goes on in the market	
Time Means Profits Eugene A. Conklin	11
There's money in clock repairs and service	
A New High Speed Circuit Tester A. Liebscher	12
A "must" article for bench and lab. men	
Know Your Oscillograph! (Part 2)	13
A complete discussion of the how and why of this instrument	
Outlook for Radio and Appliance Service Dealers R. H. Rasmussen	16
The low-down on the real selling job ahead	
Technical Service Portfolio Section XL	20
Paper Capacitors as Mica Capacitor Substitutes	
DISCUSSION	22
Latest news on records and record makers	
Our Cover: New Opportunities in Radio	23
Uses of radio-in-industry	
Letters to the Editor	24
The customers always write	

ELECTRICAL APPLIANCE RETAILING SECTION News 19

SANFORD R. COWAN...*Editor & Publisher* LEWIS C. STONE.....*Managing Editor*
CHARLES H. FARRELL .*Advertising Manager* SYLVIA BORNKOFF.....*Circulation*

Copyright, 1944
COWAN PUBLISHING CORP.

Executive & Editorial Offices: 342 Madison Ave., New York 17, New York
Member of the Audit Bureau of Circulations.

RADIO SERVICE DEALER is published monthly at 34 North Crystal Street, East Stroudsburg, Pennsylvania, by the Cowan Publishing Corp., Executive & Editorial Offices: 342 Madison Avenue, New York City 17, New York. Subscription rates:—United States and Possessions \$2.00 for 1 year, \$3.00 for 2 years; elsewhere \$3.00 per year. Single copies: 25c. Printed in U. S. A. Entered as Second Class Matter October 3, 1941 at the Post Office at East Stroudsburg, Pa., under the Act of March 3, 1879. All subscribers should allow at least three weeks for change of address. Everything concerning subscriptions should be directed to Circulation Dept., 342 Madison Ave., New York 17, N. Y. Material submitted must contain a self-addressed stamped return envelope. While every effort will be made to handle articles with care, the publisher assumes no responsibility. Material accepted is subject to any revisions, including change to, or omission in "by-line" as well as author's name, which in the opinion of the publisher may be deemed necessary or expedient. Payment will include all photographs, sketches, diagrams as well as all of the author's right, title and interest in and to the material submitted. Material submitted will be considered to have been released by the person or persons shown or mentioned therein, and the authors agree to hold this publisher harmless from any manner of suit or damage resulting from the printing of said pictures or articles.

Astounding Radio-Appliance Potential

THE MILWAUKEE JOURNAL's 1944 survey of conditions obtaining in that typical, thriving American community are worth noting by Service Dealers who can use the figures to guide them in their present and postwar planning.

Milwaukee has 226,000 homes, urban and suburban combined. A Service Dealer knowing his community's size can use proportional ratios to determine his own particular sales and service potential. To illustrate, if 10% or 22,600 Milwaukee families want fishing tackle, it is safe to assume that in a town of 2,000 population, 10% or 200 families will also want tackle. Let Milwaukee guide you.

Quoting from the survey: 27.5% (or 62,168) Milwaukee homes have radios needing repair or replacement; 19.5% (or 44,000) homes have vacuum cleaners needing re-

pair or replacement; and the figures for other appliances are: washing machines, 40,000 homes; cooking ranges, 21,250 homes; electric irons and toasters, each about 20,000 homes; refrigerators, 18,000 homes and electric mixers, 10,400 homes.

As 31.7% (71,600) Milwaukee homes want a quick-freeze unit; 44.2% want automatic washers and 35% want electric ironers, it is apparent that prospects for this country's radio and electrical appliance service dealers are exceedingly bright. It's a great, profitable business to be in. So, repair to the hilt now, keep customers happy by treating them fairly, put profits into War Bonds and be prepared for the fast-approaching V-Day and the time when radios and appliances will again be delivered to dealers and consumers eagerly awaiting them.

"B" Gas Rations For Servicemen Now Okeh!

ON JUNE 19th the OPA amended and "clarified" gasoline Ration Order 5C with the statement, "Preferred mileage may not be granted for the repair of radio receiving sets unless the sets are used by or on behalf of a government or government agency for inter-communication or for monitoring broadcasts."

At first reading of this RO amendment we got the impression that Service Dealers were now only to be allowed "A" gasoline rations. We communicated with Mr. Quentin W. Regestein, OPA Washington, D. C., who stated that such an interpretation was incorrect. Mr. Regestein further explained that "preferred mileage" means "C" rations, for which only a few Service Dealers will qualify. However, the OPA authority declared that Service Dealers may apply for and obtain "B" rations under the new amendment as it is recognized by OPA that the main-

tenance and repair of home radio sets is a valuable adjunct to the war effort.

Service Dealers in the Eastern part of the country are now eligible for sufficient "B" coupons to allow them 325 miles of occupational driving per month. Service Dealers in the Midwest section are entitled to 475 miles of occupational driving monthly and Service Dealers located out West may have 400 miles of occupational driving monthly.

Many Ration Boards, confused by the original Ration Order, have long refused Radio Service Dealers supplemental "B" rations on the grounds that repairing home radios meant repairing "entertainment devices" which of course was not the original intent of OPA. Now, at long last, the entire issue is clarified. Service Dealers, as we have maintained from the outset

(Continued on page 32)

Radio Service Dealer

FOR WANT OF A TUBE . . .

A BATTLE WAS LOST



Not in This War . . .

Thanks to the Preferred-Type Program of the Army and Navy

WHEN the radioman in a critical battle today needs replacement tubes, he knows they're ready to move up to him . . . *on the double!*

But this fortunate situation doesn't just "happen"; actually, it is the result of careful planning.

Months before Pearl Harbor, the Joint Army-Navy Committee on Vacuum Tubes recognized the desirability of keeping the number of tube types in military equipment at a minimum. A Joint Army/Navy PREFERRED LIST OF TUBES was adopted, and military equipment was designed around these tubes almost exclusively. This forward-looking policy greatly simplified military tube stocks, thus insuring speedy replacements wherever they're needed.

The Preferred Type idea works.

Today, it is saving lives . . . tomorrow it will bring you greater profits. You'll have faster turnover if the bulk of your tube business is in fewer types. Your ordering will be simpler, deliveries faster. You'll save book-keeping costs, and your customers will be sure of better

tube performance . . . for quality is more uniform as a result of longer manufacturing runs on fewer types.

You can count on RCA to keep plugging the Preferred Type Program. It makes sense . . . for the Armed Forces today, for your business tomorrow.

And speaking of tomorrow, remember, *the Magic Brain of all electronic equipment is a Tube . . . and the fountain-head of modern tube development is RCA!*

Tune in on RCA's "The Music America Loves Best" every Saturday, 7:30 P. M., E. W. T., Blue Network.



**BUY
WAR
BONDS**

RADIO CORPORATION OF AMERICA

RCA VICTOR DIVISION • CAMDEN, N. J.

LEADS THE WAY. *In Radio . . . Television . . . Tubes . . .
Phonographs . . . Records . . . Electronics*

In & Around the Trade

Being a condensed digest of some of the happenings in and around the radio trade as compiled by the Editors



Paul V. Galvin (left), president of the Galvin Manufacturing Company, Chicago, hands the gavel over to Raymond C. Cosgrove, vice president and general manager of the manufacturing division, The Crosley Corporation of Cincinnati. Mr. Cosgrove was elected president of the Radio Manufacturers Association at its Third War Production Conference in Chicago last June.

New Philco Television Link

John Ballantyne, president of the Philco Corporation, Philadelphia, predicts that over the years television should duplicate the remarkable record of growth and progress of radio.

In line with its plans to participate in and contribute to this growth, the company has just opened a New York to Philadelphia television relay transmitter link.

Astatic Appoints Cartwright

R. T. Shottenberg, Sales Manager, announces the appointment of J. M. Cartwright, 1276 Peabody Avenue, Memphis, Tenn., as representative of The Astatic Corporation, Youngstown, Ohio, in the

States of Louisiana, Mississippi, Arkansas and Western Tennessee. Mr. Cartwright, long familiar with radio and sound products, will serve Astatic's established customers to good advantage in this territory where he is so well and favorably known.

Radio Training Films Available

"Crystals Go To War," a training film of Reeves Sound Laboratories, Inc., of New York City, is the Kodachrome sound film which illustrates and narrates the manner in which vital crystal oscillators, supplied for Airborne Radio, United States Army Signals Corps, are made.

It starts with an introduction about the various types of quartz and their original uses as ornaments, decorative pieces and in jewelry, and then goes

on with a brief history of the discovery of the piezoelectric property of the quartz crystal and its development by Dr. Cady, of Wesleyan University. It then continues on with the perfection of the rough quartz for manufacture: the cutting, sawing, lapping and testing of crystal oscillators.

The film is available on application by technical organizations.

The film may be obtained by schools, colleges or civic groups upon payment only of transportation charges. Regional Department of RCA Victor Requests may be addressed to the Education, Camden, N. J.

Crosley Appoints Distributor for Portland, Ore.

Appointment of the Arthur L. Fields Chevrolet Company of Portland, Oregon, as distributor for The Crosley Corporation in the Portland, Oregon, territory, was announced by J. H. Rasmussen, commercial manager of The Crosley Corporation.



Arthur M. Fields

For the past twenty-seven years, Arthur L. Fields has been at the head of this company which has been operated as a partnership. The company occupies a modern two-story concrete building at 107 S.E. Grand Avenue in Portland, where all possible facilities in both service and parts will be available to Crosley dealers.

Plant-Broadcasting Unit

A simplified low-cost unit for voice-paging and music broadcasting in war production plants was announced last month by Operadio Mfg. Co., St. Charles, Ill.

This "Plant Broadcaster" operates 20 to 40 loudspeakers and covers an area of up to 100,000 sq. ft. The attractive cabinet requires only 22 ins. of floor space and comes ready to "plug in."

The new standardized broadcasting unit is highly versatile. In addition to broadcasting music to maintain or increase production with fewer workers or untrained personnel, it can be used

(Continued on page 9)

Keep that date with "ROSY FUTURE"

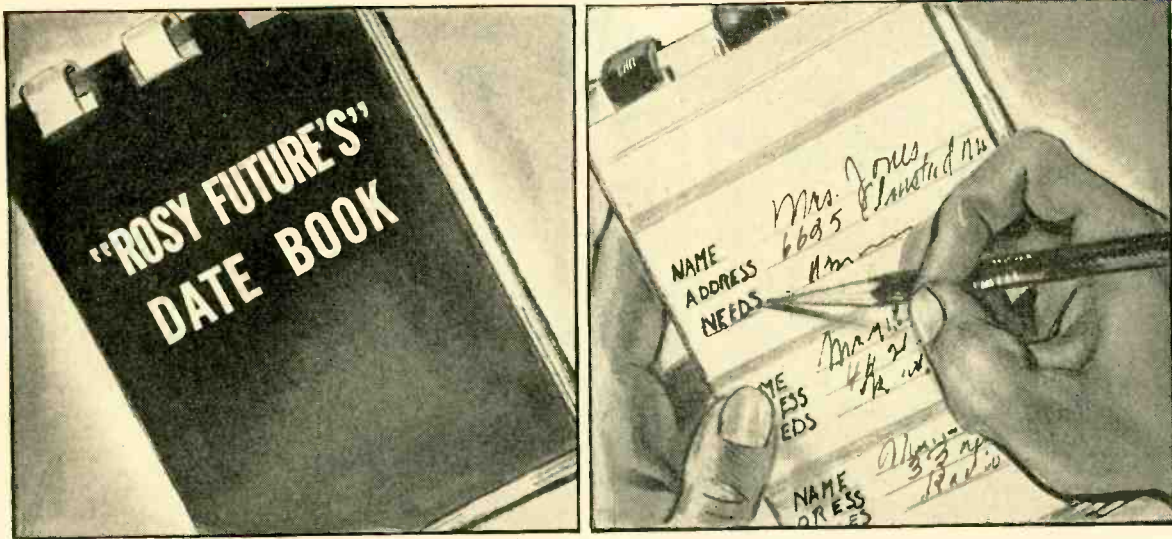

Get this Date Book FREE!

When "Delivery Day" comes many of your service customers will want—and will buy from someone—that extra radio they've been planning on, or a smart new portable phonograph. Because you will have their confidence and will be welcome in their homes—these will be sales dates that YOU should make and keep, with profits that YOU should pocket. Don't lose this opportunity. Send for your MECK "Rosy Future" Date Book today (it's FREE!)—and start making a complete list of your future sales customers NOW. Then—when "delivery day" comes—you will be prepared to meet those customers' needs with MECK Radios and Phonographs. Remember, they're *Built to Perform, Priced to Sell!*

WRITE FOR *Free*
"DATE BOOK" NOW

Pocket size, durable—get started on YOUR post-war plans now. Just write—it's free!



BUY MORE BONDS—AND KEEP THEM!

DISTRIBUTED NATIONALLY THRU RADIO PARTS JOBBERS

MECK RADIOS • PHONOGRAPHS
* * *
INDUSTRIAL SOUND

JOHN MECK INDUSTRIES, PLYMOUTH, INDIANA, U. S. A.



Are You Caught in War-Time Cobwebs? by Don Herold

I know a lot of folks who are sitting this war out. Oh, they may be hustling some, but they are giving their real brains and will-power a three or four-year vacation. No use, they figure, to hump their cerebral muscles until peace comes.

I wouldn't put any radio service men in this class, but, just the same, a popular national business magazine tells of a radio dealer in Brooklyn who hadn't changed his window display since Pearl Harbor. An irate prospect for a scarce

facturers are preparing new products and there's bound to be an upsurge in competition too. The way for established service men to get their share of the clover is



to keep informed on developments, keep a live, neat shop, and cultivate future customers. Smart dealers always cash in on the real and prestige value of using and talking about famous radio parts, such as International Resistance Units.



radio tube insisted that the dealer take a tube out of one of three sets in his window. Dealer insisted there were no sets in the window, and nearly collapsed when he saw 'em. Dealers who don't get ahead in their thinking now, are going to be behind when peace comes. Manu-

No. 6 in a series of special messages prepared by America's famous business writer, humorist and cartoonist, Don Herold. . . In sponsoring these Don Herold "broadcasts," IRC pays tribute to the thousands of Radio Service Men who, whenever possible, specify and use IRC resistance units in their work.



INTERNATIONAL RESISTANCE CO.

401 N. Broad St. • Philadelphia 8, Pa.

IRC makes more types of resistance units, in more shapes, for more applications than any other manufacturer in the world.



In & Around The Trade

(Continued from page 6)

to provide plant-protection alarm and air-raid warning. It enables management to talk directly to employees and to furnish them with news broadcasts, nutritional and safety information, War Bond programs, inspirational material and the like.

The control cabinet can be located near the telephone switchboard, or placed in any convenient location with connection to the microphone and key cabinet at the switchboard. Paging calls may be sent over the system while music is being played by means of an automatic control which decreases the music volume. This permits the paging call to be heard clearly and yet continues the thread of the music melody.

A complete summary of research in the industrial field has been issued in booklet form, by Operadio, under the title of "Music and Manpower".

Stromberg-Carlson Note

Stanley H. Manson, manager of public relations for the Stromberg Carlson Company and Lee McCanne, the company's secretary and assistant general manager, attended the annual confer-



Stanley H. Manson

ence of the National Federation of Sales Executives held recently in Chicago. Mr. McCanne was elected a director of District II of the Federation, comprising the Sales Executives Club in New York, Albany, and Rochester, N. Y., and Newark, N. J.

Dr. Power Reopens Offices

Dr. Ralph L. Power, Los Angeles radio counsellor, has returned to his own offices after termination with the San

Francisco Signal Corps Inspection Zone of the Army, which he joined in 1942.

After being in the AEF, World War I, Dr. Power became a college professor, and was one of the first radio announcers on the West Coast and radio



Ralph L. Power

editor of the Los Angeles Times, Examiner and Record. He then entered advertising.

His first client was the Universal Microphone Company, which account he still retains and he also handles trade publicity for the Hoffman Radio Corporation, Los Angeles.

Donley Heads New Westinghouse Radio Receiver Division

Walter Evans, Vice President in charge of Westinghouse radio activities, announces the appointment of Harold B. Donley as manager of the Westinghouse Radio Receiver Division. This marks the first time since 1928 that Westinghouse will develop a complete line of home radio receivers which will include standard receiving sets and frequency modulation, with and without phonograph combinations, and home television equipment. These will be manufactured and marketed as soon as possible.

Mr. Donley has been with Westinghouse 22 years and was until recently general appliance manager for the Westinghouse Electric Supply Company in New York City.

RMA Elects S. I. Cole

S. I. Cole, president, Aerovox Corporation, New Bedford, Mass., has been elected a director of the RMA Parts Division for two years beginning 1944.

Aero Appoints Burcham

Don Burcham has been appointed representative in the northwest for Aero Needle Company, Chicago, Ill.

Belmont Increases Deliveries

P. S. Billings, president, Belmont Radio Corporation of Chicago announces that deliveries of radar and other electronic equipment to the armed forces for the first five months of this year came to more than \$27,000,000. This is greater than the company's production for all of 1943.



Frank M. Folsom, RCA Victor Division head and other company officials, greet Dave Schwab and Harry Spector, of the D & H Distributing Company, which has just added Baltimore to its territory for the distribution of RCA Victor products. Left to right are Mr. Folsom, Dave Schwab, M. F. Blakeslee, RCA Victor's Eastern Regional Manager, Harry Spector and T. F. Joyce, General Manager of RCA Victor's Radio, Phonograph and Television Activities.

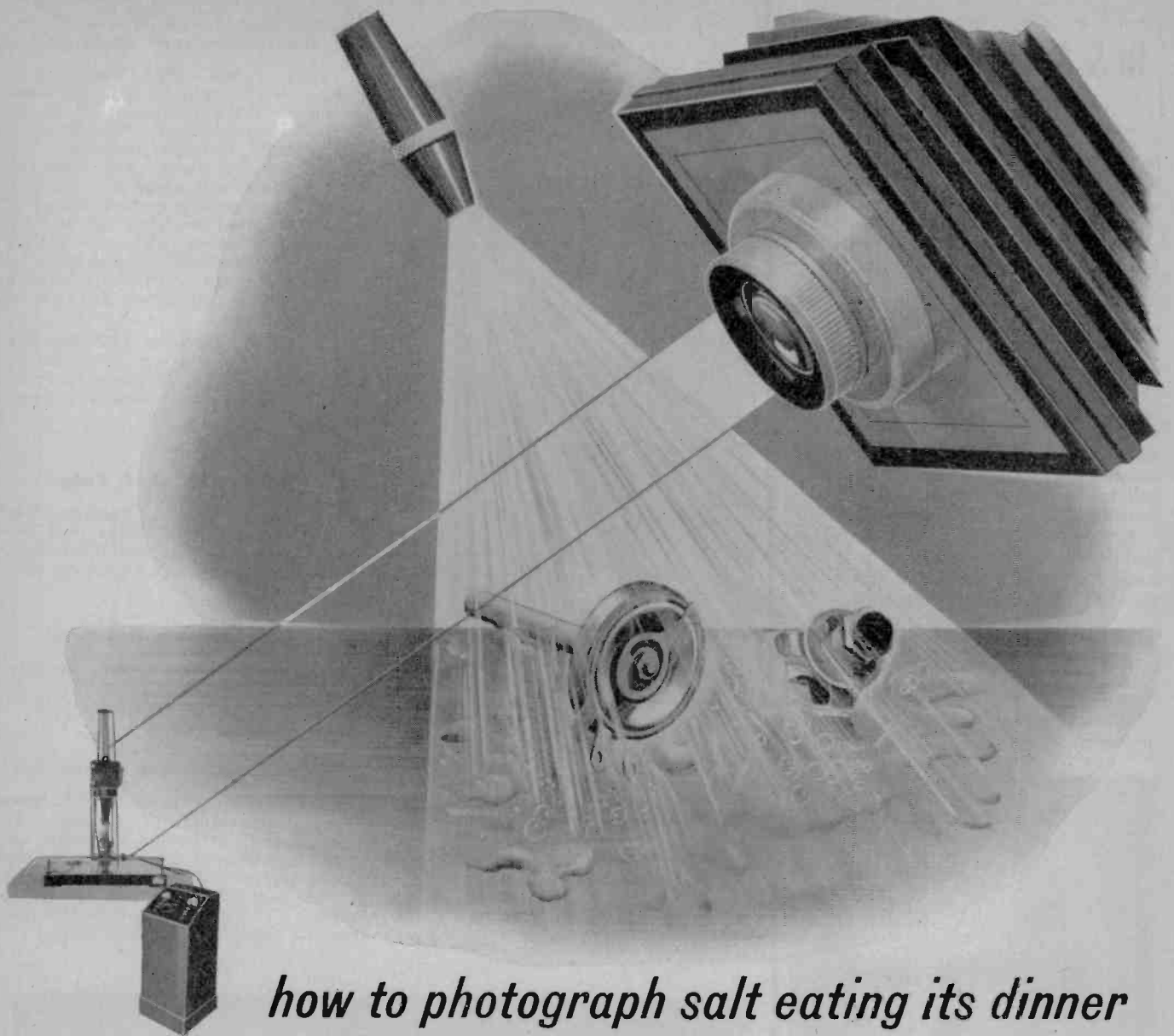

how to photograph salt eating its dinner

Salt, from the sea and air, has a tremendous appetite for many metals—eating them away unless they're protected. The exact effect of its gluttony and the success of the means used in preventing this costly damage are measured accurately by Utah's salt-spray test. One of the stages in Utah's complete circuit of radio and electronic tests.

Immediately after the parts have been subjected to the salt spray, microphoto-

graphs are taken and developed in the especially equipped Utah dark room. Thus, it is possible to make a microscopic inspection of the actual condition of the metal *before* other atmospheric changes take effect. Since metal surfaces exposed to salt-spray tests change rapidly *after tests are completed*, it is necessary and possible, by this photographic method, to determine and *accurately* record corrosion in metals.

As a result of this and other Utah tests, efficient performance of Utah parts is assured under any and all conditions normally encountered—the failures due to inadequate, inaccurate testing are avoided. ★ ★ ★

Every Product Made for the Trade, by Utah, Is Thoroughly Tested and Approved

utah

Radio Products Company,

836 Orleans Street, Chicago 10, Illinois



Keyed to "tomorrow's" demands:
Utah wirewound controls, switches, plugs,
jacks, vitreous enamel resistors, transform-
ers, vibrators, speakers.

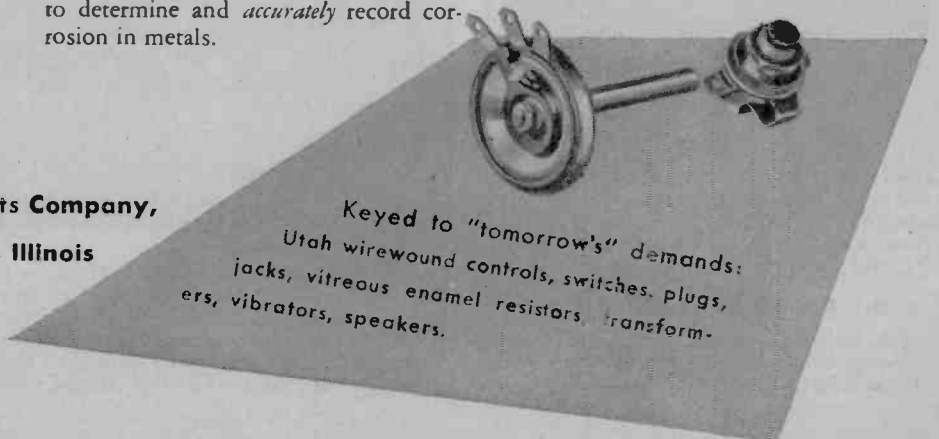

Time On My Hands is a perpetual *Hit Parade* candidate so far as Radio Serviceman Bartlett, of Syracuse, New York, is concerned. For to him an electric clock is a thing of beauty. Getting down to cases, Bartlett combines radio servicing with electric clock repair. For at present the humble electric alarm clock is kingpin in the scheme of getting defense-workers to work on time. And replacements are not always available if the family time-piece goes on a spree.

Bartlett believes that electric clock servicing is a wartime field of endeavor worth considering by the typical radioman. There is no delivery problem; clocks can be brought into the shop in person and picked up by the customer in person. Moreover, clocks present only half the replacement situation that radios do. Clock parts are fairly plentiful according to this radio-clock repairman.

Bartlett puts aside a certain section of each day for clock-servicing. He suggests it best to work for a few hours at the radio service bench then spend an hour or two on clock repair. The change in work relaxes the radioman's mind and prevents him from going stale. Bartlett advises that this procedure helps from the standpoint of customer satisfaction. All things being equal, they'll bear with and not criticize a serviceman for delays in radio repairing if they respect him as a clock-repairer and depend upon him in his dual capacity.

This enterprising Syracuse serviceman informs all radio customers about his clock activities personally when they enter and again as they exit from the shop. In addition, he uses time signals which tie in with his clock-repairing business.

Bartlett recommends a monthly "inspection" of electric clocks at a flat inspection rate of 50c. For this fee the clock is examined and minor adjustments made if necessary. Serious repairs are charged fully for and are *not* included in the monthly "time-checking" fee.

In this way Bartlett can catch the flaws in electric clocks before they generate into serious propositions. Each customer has a certain day each month he or she is to bring all household clocks into the shop. In an average family some family member has a wristwatch so that the house isn't left timeless. The inspection is completed in 24 hours flat unless trouble really rears its ugly head.

The clientele for this monthly checking service is necessarily restricted to a selected group and only so many are accommodated monthly. It is not an "advertised" service and is confined largely to radio customers. The day before a customer's clock or clocks are due in for ex-

TIME MEANS PROFITS

by Eugene A. Conklin

Clock servicing is a "natural" extra money-maker for radio servicemen during war-time. These repair customers will be post-war radio and appliance buyers.

amination, Bartlett calls the household and issues a verbal reminder. If the clock isn't in on the specified day the customer does not get the 50c rate but may pay the regular shop charge which is somewhat higher.

In this way Bartlett does not go out on a limb as regards getting too huge a number of clocks in for the monthly once-over. For good measure, customers desiring the service must make their own pickups—no house calls are even remotely considered.

Bartlett uses one full day weekly to check the clocks in theatres, restaurants, small factories and busi-

ness offices. Again this "commercial checkup" is at a flat monthly rate of 75c, the slightly higher figure being justified by the leg work involved.

Bartlett does not attempt to train apprentices in the art of clock-repairing but he has hired a house wife who accepts and disburses both radios and clocks over the shop counter.

It's this serviceman's considered opinion that the repairing of electric clocks is desirable from all standpoints. But he will not repair any other form of electrical product. Clocks is clocks, and toasters, ironers, cleaners and the like he cannot undertake to service.



A view of Bartlett's Shop

A New

HIGH-SPEED CIRCUIT TESTER

by A. Liebscher

HOW much time have you lost because you did not have a schematic diagram on hand to indicate cable connections? And how many hours have you wasted because the nomenclature of a tube was effaced and you were not sure which socket terminals had plate, filament or bias voltage? Has it been trouble to be certain of having the proper voltmeter range, polarity and choice of AC or DC indication before you dared touch a probe to questionable points in a circuit? And what about accidentally probing a high voltage contact, when you did not predetermine its presence, only to see your meter bang itself off scale once more?

Well, the *Electronic Indicator* described in the circuit in *Fig. 1B* is not designed to be a cure-all, but it will go a long way in relieving your nerves and conscience by making care-free random probing possible—and what's more, very practical. With it you can feel free to be quite "trigger happy" without endangering the life of your meter or causing damage to a bias cell.

Take any radio chassis or electronic control device, turn it upside down and start probing with this "magic" indicator. Yes, probe any point—plate, screen, bias, a.v.c., power line output, oscillator grid, power transformer secondary and all the rest—and your answers will come rolling right along; positive dc, negative dc, AC, motor-boating, negative oscillator grid voltage, audio speech or music, etc.

Of course, there are limitations. The Indicator will not show actual voltage, but it will differentiate between high, medium and low dc voltage (so you can tell plate or screen from cathode and grid); in fact, you can go a step further and identify the ac filament contacts—all without turning a knob or even changing a pin plug.

Here's how it works. First, the

This electronic indicator has time-saving features, plus safety operating factors which prevent meter burnout . . . Random probers can be "trigger-happy."

cathode bias resistor (R_c) is set to cause the indicator 6E5 tube to illuminate 2/3 of its normal unbiased shadow angle, with no input signal or external voltage applied. (See *Fig. 2*)

Then the plate resistor (R_p) is adjusted to cause the two edges of the illuminated portion of the indicator to contact each other without overlapping, with a 6.3-volt, AC, 60-cycle signal applied to the input.

After these two easy calibrations have been made the interpretations of various reflections are used to differentiate between AC (a-f) or dc, relative dc voltage values; continuous audio or interrupted audio.

The application of a negative dc voltage will close the eye within a range of approximately -4 to -1000

volts. Voltages down to a half volt or less will be indicated, although they may not be sufficient actually to close the eye.

Positive voltage applications up to 1000 volts will reverse the deflection, causing the eye to open. We see here that a quick, safe and reliable indication of polarity is obtainable even down to the smallest potential which will produce a visible indication.

Examining *Figure 1*, you will note that the resistor (R_i) and the capacitor (C_i), in series, will serve as a means of assuming a charge from an applied dc voltage. This charge will slowly leak off due to the high resistance discharging circuit through the 10 megohm input resistor (R_i), which with R_i remains to discharge C_i once the source of the applied voltage is disconnected. This discharge rate for either positive or negative voltage will be in proportion to the applied voltage, thus showing a slow return to the normal shadow angle when high voltage is applied. The lower the voltage, then, the more rapid the return to normal will be.

From the foregoing we have found how a negative voltage will cause the eye to close and how a positive voltage will cause it to open more than normal. If we then apply an AC or audio voltage composed of alternate positive and negative peaks, the indicator deflection should show a swing in both directions. This is exactly what happens and the eye shows a partial illumination over its entire deflection area with any voltage from approximately 4 volts r.m.s. to 1000 volts, r.m.s. The partial illumination is due to the "on" and "off" time of the a-c voltage

(Continued on page 34)

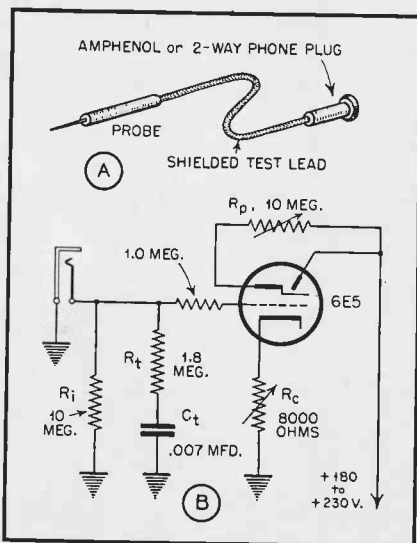

Figure 1A-1B

KNOW YOUR OSCILLOGRAPH!

Prepared by the

**ENGINEERING DEPT.
ALLEN B. DUMONT
LABORATORIES, INC.**

**The oscillograph is the most useful unit
on the test bench. It is also the least
understood. This series explains it fully**

PART 2.

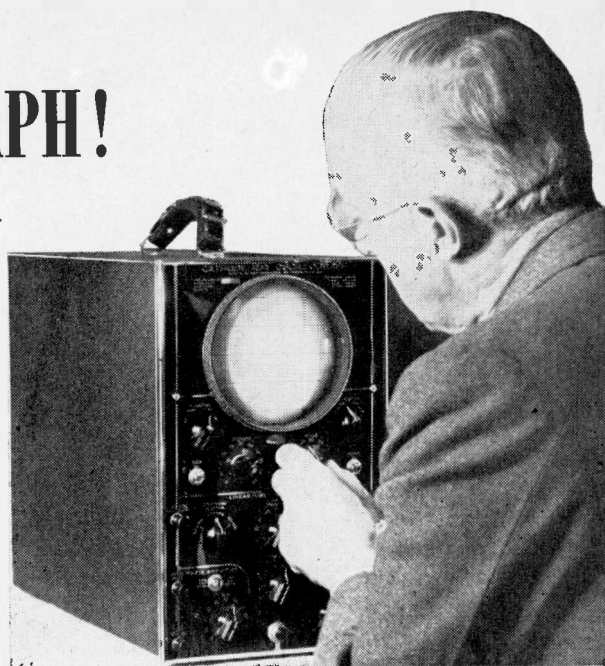

Deflection Sensitivity and Deflection Factor

It is convenient to express the gain of a given amplifier by use of the term "Deflection Sensitivity," which is the ratio of the lineal deflection produced on the cathode-ray tube screen to the r.m.s. or the direct current voltage required at the input terminals to produce this deflection. Deflection Sensitivity, therefore, gives a convenient figure for comparison of various types of oscillographs irrespective of type of cathode-ray tube used or the accelerating potential at which it is operated. An increasingly desirable term used for the sake of convenience is the term "Deflection Factor" which is the reciprocal of the "sensitivity" ratio.

In general, the useful range of a cathode-ray oscillograph extends from zero frequency to several hundred megacycles, provided sufficient voltage is available to allow a reasonable deflection with direct connection to the cathode-ray tube deflection plates. The amplifiers generally provided will extend the useful voltage

range while at the same time will restrict the useful frequency range. Since these two considerations tend to operate in opposite directions, a factor taking both into account is useful in determining the performance of a particular amplifier. Such a factor is that obtained by taking the product of the gain and the band width. Consequently, it follows that an amplifier with an extended high frequency range will have a high deflection factor or similarly a low deflection sensitivity. Obviously, a large number of amplifying stages can be used to increase the gain to any desired value, providing noise disturbances can be kept to a satisfactory minimum. For a device which provides a visual indication, however, the requirements for stability are stringent. Unless sufficient stability is provided, accurate photographic records of cathode-ray tube indications are not practical. As a result, the design of any oscillographic amplifier is necessarily a compromise.

Square Wave Response

Since a cathode-ray oscillograph is primarily a test instrument, it should give a true representation of the signal under observation. In order to investigate the characteristics of an amplifier, it is common practice to apply a square-wave signal, as shown in Figure 4, to the input circuit. The steep front of such a wave gives an indication of the high-frequency or "transient" response, and the flat top of the wave is an indication of the low frequency characteristics of

the amplifier, where the terms "high" and "low" frequency are relative to the fundamental frequency of the square wave.

Low Frequency Distortion

If a low frequency square wave signal is applied to the amplifier circuit shown in Figure 5 between point A and ground, and if the time constant of the grid top circuit, C_1R_1 , is too small, the signal at point B and therefore at the output between point C and ground, will appear as shown by the dotted line in Figure 4. This sawtooth distortion is caused by the charging and discharging of the capacitance C_1 through resistance R_1 during the flat top periods. This type of low-frequency distortion may obviously be reduced or eliminated by making the values of C_1 and R_1 sufficiently large so that the time constant of this part of the circuit becomes very large. For very good low-frequency response, i.e., with this type of distortion eliminated, the physical size of the capacitance required becomes unreasonable since the grid resistance must be limited in value by the grid current charac-

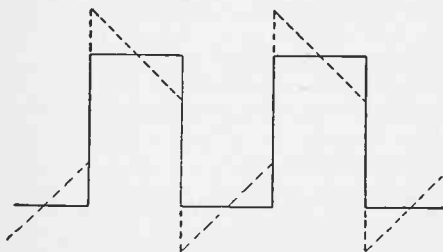

Figure 4

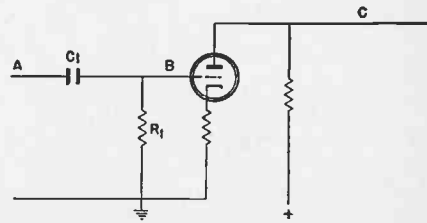

Figure 5

teristics of the vacuum tube. It is also desirable to keep the time constant of this part of the circuit as small as possible since it will determine the actual time required for the amplifier to recover from the effects of a large transient pulse. One method of obtaining good low-frequency response while still limiting the size of C_1 and R_1 is to employ plate circuit compensation as shown in *Figure 6*. By the addition of the resistance-capacitance circuit $R_2 C_2$ in the plate circuit of the amplifier as shown in *Figure 6A*, a voltage appears at point D having a form as shown in *Figure 6B*. When this potential is added to that shown by the dotted line in *Figure 4*, the resultant is the original square wave, which appears at point C in *Figure 6A*. This compensation must be carefully balanced to provide the proper amount of compensation to correct

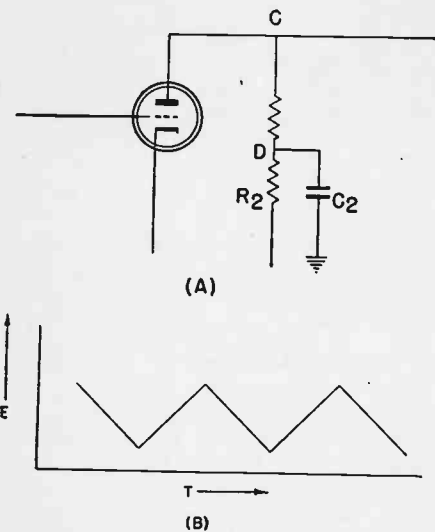

Figure 6

for the amplifier characteristics without introducing additional distortion.

Stray Circuit Capacitances

The presence of stray circuit capacitance and the inter-electrode capacitance of the vacuum tubes in the amplifier may be represented by the dotted shunt capacitance C_0 shown in *Figure 7*. These stray circuit capacitances have the effect of decreasing the plate load impedance as the signal frequency is increased. High frequencies are therefore attenuated and the frequency response curve will appear as shown by curve A of *Figure 8*.

High Frequency Compensation

By the insertion of a series inductance L_1 in the plate circuit of the amplifier, as shown in *Figure 7*, a reactance increasing with frequency is added to the vacuum tube plate load to increase its impedance at high frequencies and, consequently, to

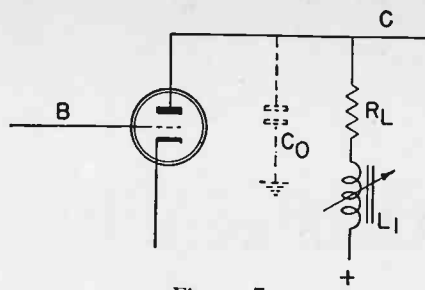

Figure 7

maintain the amplifier gain at these frequencies. If this inductance should be increased in value above the optimum, a response curve similar to curve C of *Figure 8* will be obtained. This rising characteristic is obtained by resonance between the added inductance L_1 and the stray circuit capacitance C_0 . This type of characteristic will accentuate the response to signal components over a limited frequency range, thus tending to distort the signal under observation. The effect is shown in *Figure 9*, illustrating a tendency toward oscillation at the start of each half cycle of the square wave. The inductive compensation employed should be so proportioned that the maximum increase in high-frequency response is obtained without introducing additional distortion of the signal. An example of proper compensation is shown by curve B of *Figure 8*, and a typical example of good wave response corresponding to this type of characteristic is illustrated by *Figure 10*, for a square wave of 100,000 square-wave cycles per second. It will be noted that usable deflections may be obtained at frequencies higher than the high-frequency rating of the amplifiers, provided that the amplifier characteristics are taken into consideration and the resulting pattern properly interpreted.

D-C Signals

The resistance-capacitance coupled amplifiers ordinarily employed in cathode-ray oscillographs will not pass direct current signals because of the inability of a capacitance to pass direct current. Signals which are composed of an alternating component superimposed upon a direct current are therefore established upon a new reference axis corresponding to the average level of the alternating component. Since means are already available for the meas-

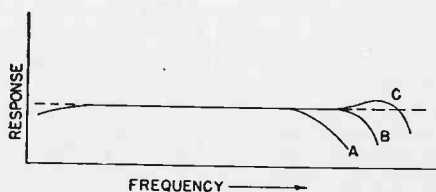

Figure 8

urement of the direct current component of the signal by meters and direct connection to deflection plates, automatically removing the d-c component results in being able to obtain full-scale deflection, or more, of the alternating component, thereby facilitating fine detail study of the pattern.

Although nearly all oscillographs do not include direct current amplifiers, special instruments have been made with them. This problem has proved difficult to solve since direct current amplifiers are in general, rather unstable, the instability increasing with the gain. Improvements have been made in their design in recent years, but they are not yet in widespread use. The use of carrier current amplifiers in obtaining a high gain for direct current use has been suggested, and future developments may include such amplifiers.

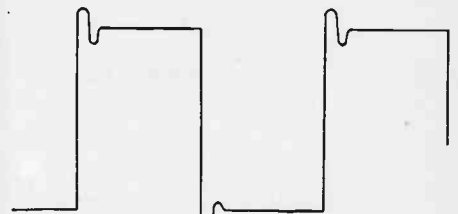

Figure 9

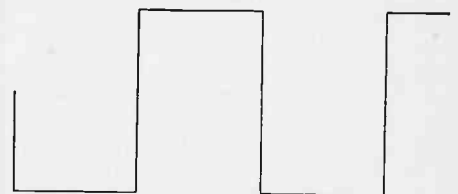

Figure 10

Noise

Noise is another factor to be considered in amplifier design. Noise includes such component factors as actual noise produced by controls, microphonics, and residual hum. It should be remembered that an oscillograph provides a visual indication and noise, as such, is not apparent except as a distortion of the pattern under observation. Consequently, care is exercised in the selection of gain controls, vacuum tube types and other components to be used. This particular consideration is becoming more important since the state of the art is indicating a trend toward higher accelerating potentials and more sensitive instrument amplifiers to extend the range of usefulness.

Z-Axis Amplifiers

Separate amplifiers are usually provided for Z-axis or intensity modulation of the cathode-ray beam. The considerations of the design of

these amplifiers are, in general, different from those employed for deflection. The output voltage requirements are considerably less severe, while the frequency range usually extends to a higher upper limit. Since these conditions are generally true, the design of an amplifier is considerably simplified, even though an extended frequency range is desired. The lowered output voltage requirement for complete modulation of the cathode-ray tube beam allows the use of low plate impedance in the final stage of this amplifier for extended high-frequency response. Since, in general, the source of signal for operation of this amplifier is an external signal generator, the input sensitivity need not be too great, thus simplifying the design of this amplifier still further by requiring fewer amplifying stages. One desirable feature which may be incorporated is a means for reversing the polarity of the modulating signal to allow selection at will of either a reduction or an increase in the intensity of the beam.

Uses

One of the principal uses of the Z-axis amplifier is to provide a means for impressing a timing signal upon the pattern. The timing signal for this purpose is supplied desirably in the form of sharp pulses of short duration and necessarily higher frequency or rate than the signal under observation in order to increase the accuracy with which the time interval between certain events can be determined and in order to prevent elimination of large section of the trace. Although the linear time-base provided is very nearly linear in time, it cannot be depended upon for highly accurate determinations. Therefore, use of the modulation amplifier for timing purposes is recommended.

In some cases this amplifier handles the signal used for elimination of the return trace or flyback of the time-base to prevent confusion of the pattern.

Attenuators

Since the oscillograph is a measuring instrument, the power drawn from the circuit under test should be a minimum. The input circuits must have provision also for attenuation of the signal to a value which may be handled by the input of the first vacuum tube without distortion or overload. This provision requires a high impedance, low capacitance, voltage divider placed across the input terminals of the oscillograph. The simplest method of obtaining such a voltage divider would be to use a high-resistance potentiometer in the grid circuit of the first vacuum tube. The use of such an attenuator however, is subject to certain limi-

tations, mainly extreme frequency discrimination at intermediate settings. As shown in *Figure 11*, the distributed capacitances C_1 and C_2 produce a voltage division at the higher frequencies. This voltage division is essentially constant and independent of the setting of the potentiometer arm. Thus, as the position of the potentiometer arm is changed, the relative voltage division across the sections of the potentiometer and capacitances will differ, producing serious frequency discrimination. Although this frequency discrimination may be by using a low-resistance potentiometer, the loading upon the circuit under test will be excessive. A solution of the difficulty is to provide an input attenuator with fixed steps and adjustable capacitance elements as illustrated in *Figure 12*. This scheme will permit individual adjustment for each attenuation ratio, maintaining uniform voltage division over a wide frequency range. Obviously, this cannot be used as the only attenuator, since to cover a wide voltage range and still maintain useful attenuation ratios, a large number of steps would be required. Consequently, an additional method of attenuation will be required for fine adjustment. Such a method is available by the use of a cathode follower stage, providing a low impedance cathode output suitable for use with a continuous attenuator, or gain control.

One type of circuit, which involves a cathode-follower stage, and which will allow a wider range of input signal than conventional amplifiers is shown in *Figure 13*. This circuit will, however, have a definite frequency limitation, but it is a definite improvement over other previous systems. For the widest possible frequency range without frequency discrimination, the circuit of *Figure 14* will be used. With R_1 and R_2 both low in value, the circuit capacitances will be ineffectual even in the megacycle region. C_1 is used as a blocking capacitance in both cases to remove the direct current from the control R_2 . Both of these circuits when used in conjunction with the fixed-step attenuator permit an extremely wide range of voltage input without frequency discrimination.

Positioning Circuits

The cathode-follower circuit illustrated in *Figure 13* may also be used for obtaining a means of providing a positioning voltage for cases where the deflection amplifier is directly connected to the deflecting plates of the tube. Such a circuit is illustrated in *Figure 15*, as well as a method for connecting the amplifier to the deflection plates at or near ground potential.

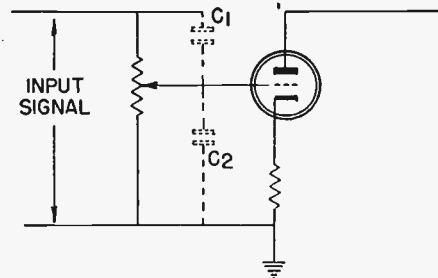

Figure 11

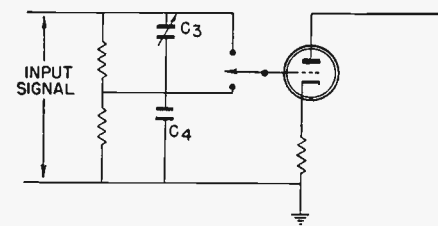

Figure 12

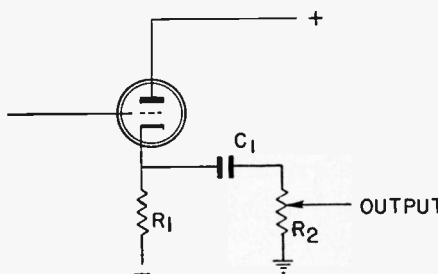

Figure 13

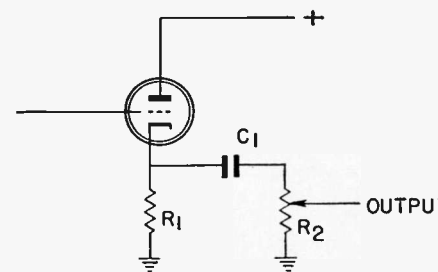

Figure 14

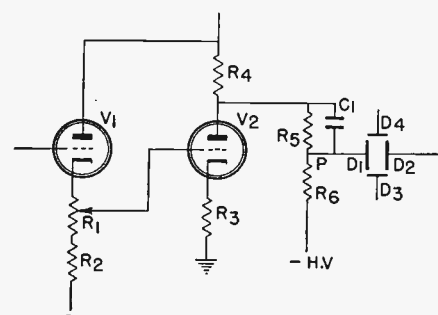

Figure 15

Since the cathode of V_1 operates at a positive potential with respect to ground, and since the return for R_2

(Continued on page 32)

THE OUTLOOK FOR RADIO and

by J. H. RASMUSSEN

Director of Sales,
Crosley Corporation

THE production picture on radio and appliances is not so simple. Last October some high officials in Washington were optimistic about refrigerator production starting in the second quarter of this year. They talked of a yearly rate of 900,000 to 1,000,000 refrigerators. Since that time, the projection has been pushed back to the 3rd or 4th quarter. Some leaders in government and industry believe that it will be 1945 before we get under way.

Approximately the same situation exists on washers and other major appliances—just last week one of the officials in the Consumers' Durable Goods Division of the WPB refused to even estimate when washer production would start. He would only state that there now are no definite plans to produce washers at any time soon.

Of course, this outlook could change overnight—depending upon war developments.

Radio Production Outlook

The Army and Navy radio equipment requirements for 1944 are even larger than in 1943. Production was increased 80% from January to November of 1943, but Major General Clay recently issued a statement that signal equipment must be expanded in 1944. Despite enormous volume at Crosley in 1943, they still have unfilled orders for more than a year's production in war material of which a substantial portion is signal equipment.

We find no one in authority who will venture a civilian radio production forecast for 1944, other than the possibility of making some small nearly standardized sets for export to Central and South America and to reconquered areas.

New Models

It is rather clearly indicated that the first refrigerator production will be from the tools and dies last used. The only changes will probably be material substitutions where critical materials were used in the last production.

This is a sensible program. We do not believe that the valuable time of engineers and toolmakers should be diverted to new model refrigerators during the emergency. Particularly so because the last models which the industry produced were very efficient and attractive refrigerators. The same rules will probably apply on other major appliances including washers, ranges, etc.

The refrigerator industry generally understood to agree that the second

models produced will have a normal year model changes. The really new models probably won't appear until the final phases of the war have been terminated for a good many months.

This model program is sound, sales-wise. Millions of families need an electric refrigerator right now. They need one from the very first production. Then later, sales stimulation will be provided by sharply-improved models. And still later, the new designs should be ready when a real sales impetus is required. In the meantime, every one who buys will have secured a sound value, a beautiful and an efficient refrigerator.

Many authorities believe that approximately the same program will be followed in radio. That the first production will be from the last tools and

dies but that the quality will be improved because of the things which have been learned in the production of the exacting specifications of war radios. Improved manufacturing processes and more rigid quality control will result in better quality and greater uniformity.

Undoubtedly, the first models produced will have new designs in wood cabinets.

What will come later will be influenced by the findings of the Radio Technical Planning Board which has been organized at the suggestion of Chairman Fly of the Federal Communications Commission. The findings of RTPB and the later decisions of the Commission will have an important bearing on both Frequency Modulation and Television.

Factory-to-independent-distributor-to-dealer trading discussed. Accumulated demand means huge sales for radio and appliance dealers. Start prospect lists now.



"Voice letters" have clicked. Sales of blanks and equipment plus maintenance will add to dealers' incomes as "voice writing" becomes commonplace for business and personal correspondence too.

APPLIANCE SERVICE DEALERS



J. H. Rasmussen

In the early days of the war, there was a great deal of discussion in and out of Washington on the revolutionary changes which would occur at war end in our system of distribution. Thinking on this subject has changed during the past six months and the consensus of opinion now seems to have rationalized.

We at *Crosley* believe that the present system of distribution in the radio and appliance industry is sound. We do not believe that a radical change is required—we do not think it would be in the public interest. We went on record to this effect on July 26, 1943. Since that time many others have done likewise.

The costs of wholesaling and retailing in radio and appliances have been

materially reduced during the past ten years. This has been possible because of improved products that give better performance and less service—because of greater efficiencies and because of highly expanded volume.

A further amplification of those same factors will provide greater efficiencies and lowered costs in the future. That is progress. I'm sure none of us, manufacturers, distributors or retailers want to attempt to stand in the way of progress.

As these things are accomplished—when the costs are reduced—then the margins of distribution can be reduced still maintaining an adequate and fair margin of profit for the services rendered. When these things become fact not theory, then another great forward step will have been made by our industry. A further contribution will have been made to the American system.

We believe in the factory-to-independent-distributor-to-dealer-type of distribution.

Future of the Radio and Appliance Industry

We are urging our distributors and dealers to prepare for big volume increases in the post war market. Why do we think the market will be so large? Let's take a quick look at some of the facts which are now available.

Many of us often lose sight of the established fact that our country is growing rapidly. In 1940, there were six million more persons employed, or seeking employment in this country than in 1929. In 1940, 46 million employed persons produced more goods and services than in any previous year. In 1941, with shorter working hours, the productivity was 25% greater than in 1929. After the war, there will be

more than 57 million workers available to produce and to consume. Millions of these will want and will buy new radios and appliances.

We all know about the great deferred demand, and people will have the money to buy with.

Individuals in this country had never saved as much as 10 billion dollars in one year prior to 1941. In 1942, they saved more than 25 billion dollars. Approximately 20 billion went into savings in currency, bank deposits and Government Bonds alone.

The savings in 1943 exceeded 30 billions and if the war lasts through 1944 the savings will be even larger. In the past three years, savings in currency, bank deposits and Government Bonds have increased more than 60 billion dollars. They will probably be in excess of 100 billion prior to war end.

And, during this period, installment sales indebtedness has been reduced from some 9 billion dollars to an estimated less than 2 billion. All other indebtedness has likewise been sharply reduced.

So today—Americans owe less and have bundles of cash.

The Domestic and Foreign Branch, WPB Radio Division, recently estimated a postwar market of 17,000,000 to 21,000,000 radio receivers.

Prominent television authorities are now forecasting that television sales in important figures will start within one to two years after the end of the Japanese war. F. M. sales forecasts are large also.

Certainly, all of this is not an impossibility if the RTPB studies and conclusions materialize as rapidly as is now forecast.

The U. S. Chamber of Commerce "Third Progress Report" of a consumer survey to measure Post War Buying Interest for the Period Immediately Following War's End indicates two things:

1. That people have the money to buy—and that
2. They expect to buy in large volume.

The survey shows that even more people were saving money in 1943 than in 1942. Sixty-one percent say they are now able to save. Thirty-four percent say they are saving over 10% of their income. Actually, more than 61% are saving because 76% are buying War Bonds and Stamps.

Eighty-four percent are investing in one or more of the following: War Bonds, life insurance, savings accounts, mortgage retirement or other investments.

Forty percent of the people feel they are better off than a year ago. And

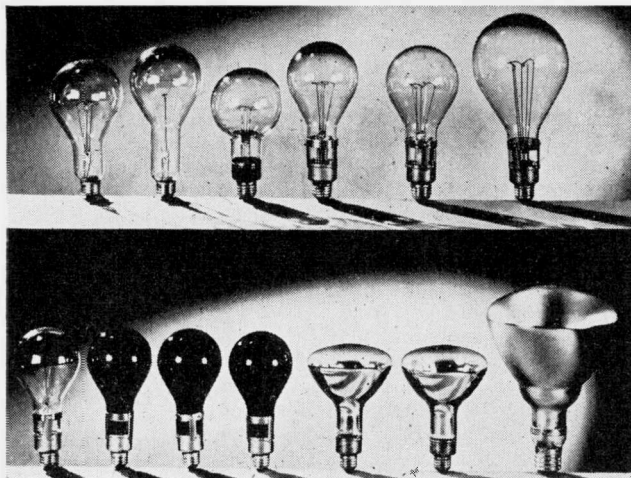

Big profits in new and replacement sales are coming to dealers who handle industrial and specialty lamps such as these, made by Sylvania Electric Products, Inc.

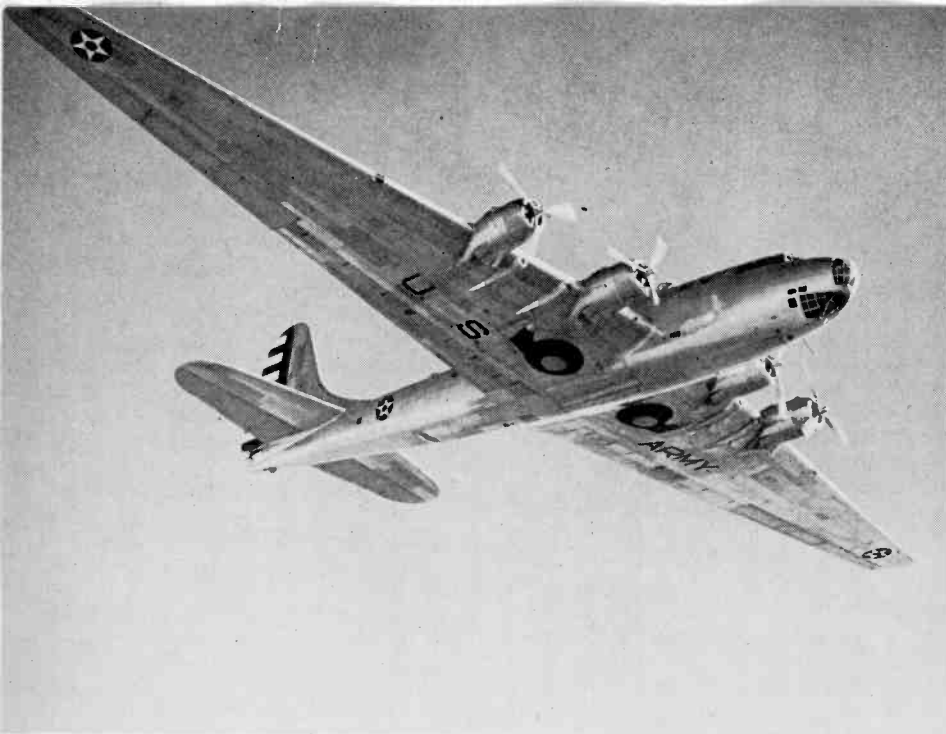

Official U. S. Signal Corps Photograph

There are servicing opportunities in the 35,000 radio-equipped planes anticipated for the first post-war year.

The personnel is courteous. When they can't give customary prompt service, a good and polite explanation is made. Customers are being created for products when they are again available.

During the past year or two, many prominent dealers have lost their identity as radio and appliance dealers. They haven't had this merchandise to display or sell. Their stores today look like anything but a radio and appliance store. This was a natural sequence to the closing of production.

But I think it is not now too early for dealers to start identifying their stores as radio and appliance dealers as soon as products are available. Appropriate signs in the windows, in the store, direct mail and prominent display in your newspaper and radio advertising will some day pay big dividends.

Certainly it's not too early to start an up-to-date prospect list.

During the past sixty days, I've talked with many distributors and dealers. There seems to be two schools of thought on post-war selling.

One school says—"There is such a terrific pent-up demand for radios and appliances—there are billions of dollars in War Bonds and other savings that are waiting to rush into the market as soon as production starts again. So we think there will be a 'Sellers Market' for several years after manufacture starts. Why should we spend money on advertising and salesmen when the demand will be bigger than the supply? We are going to wait until supply is greater than the demand before we start to build a sales organization."

The other school says—"We think there is going to be a bigger radio and appliance market after the war than has ever existed before. But, we also know that the production capacity of the radio and appliance industry will be increased many fold when war production stops. Practically every manu-

(Continued on page 32)

55% have confidence in the future. They think there will be "plenty of jobs" for everybody the first year after the war.

Sixty-four percent of the Nation's 35 million families name one or more purchases they would make within *six months*, if the war ended tomorrow.

What will they buy?

3,675,000 intend to buy new automobiles

2,625,000 intend to buy mechanical refrigerators

2,100,000 intend to buy washing machines

1,645,000 intend to buy stoves

1,400,000 intend to buy vacuum cleaners.

People plan to buy these large quantities of appliances in six months.

In addition to the appliances which were sold in volume prior to the war, there will be a greatly increased business in many that were just getting a good start.

The frozen food cabinet is a good example. Only a small quantity has been produced and sold but the demand when production is permitted has been estimated in very large figures.

We know that big meat packers are laying plans to put the old-fashioned meat industry on a production basis. They forecast savings to the consumer of 20% to 30% on 60 pound frozen meat assortments. The large food packers plan to get into the frozen food business with both feet. They forecast better quality and lower prices for frozen foods than for canned or fresh fruits and vegetables.

When these programs materialize, the purchase of a frozen food cabinet will have an appeal from an economic as well as a convenience standpoint. The food savings will result from bulk pur-

chases so a larger compartment will be required than can be contained in a two-temperature refrigerator.

The room cooler business was bigger in conversation than in fact prior to the war. It was just beginning to come into its own in 1941. Post-war forecasts vary from 100,000 to 250,000 per year. But our guess is that when we have the right unit at the right price, that sales might well be one million per year.

There are many other untapped markets including kitchen cabinets, garbage disposal units, dishwashers and so on.

So we firmly believe that the outlook for the radio and appliance manufacturer, distributor and dealer is a brilliant one.

It will be easy for you to accurately determine whether or not there will be a big radio and appliance market in your community. Ask the first 100 people who come into your store, "Do you plan to buy a radio, television, F. M. radio, refrigerator, frozen food cabinet, washer, ironer, table appliances, dishwasher, kitchen cabinet, etc. when production is resumed."

My guess is that if you do this you will have the start of a fine prospect list. Your best prospect will be the customer to whom you have given satisfactory service in the past. We know a great deal, from firsthand experience, about how difficult radio and appliance service problems are today. We have been operating three distributor service departments.

We know how difficult it is to get and to train and to replace service men. How hard it is to get replacement parts. But many distributors and dealers are actually making friends today through their service department.

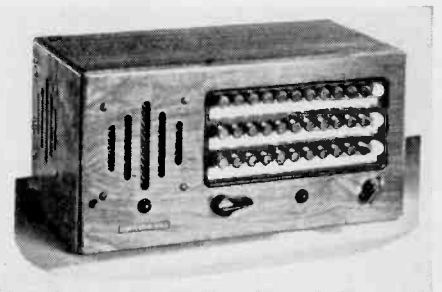

11,000,000 potential users of intercom. systems, such as this Garner Conversecall, constitute the post-war market in sales and servicing.

Radio Service Dealer

ELECTRICAL APPLIANCE

Retailing

Registered U. S.
Patent Office

Park Goes Over To Admiral

Louis M. Park, formerly Supervisor of Radio and Home Appliance Sales Statistical, and Order Department of *Stewart-Warner*, has become associated with *Admiral Corporation*, Chicago, as Executive Assistant, Sales Department.

In announcing this appointment, J. H. Clippinger, Vice-President in charge of



sales, said Mr. Park will devote his time to working on sales development in cooperation with regional managers who are now setting up national distribution of Admiral Radios and Major Appliances. When peacetime production resumes, Park will head the Sales Statistical, and Order Department.

Repair Business From Department Stores

It is reported that a chain department store in Chicago is "merchandising" the present frozen condition in domestic appliances by setting up fix-it departments. There they take orders to repair worn gimmicks, from toasters, waffle irons, washers, refrigerators, etc., to radios. The work is farmed out to various independent servicing organizations.

Though many radio services dealers are working against time, often into the small hours, to keep up with the demand for repairs, there may be some who are in a position to benefit considerably from this potential source of additional income.

What happened in Chicago can well be duplicated in any community, large or small. Say a dealer works out an arrangement with a local department store, or furniture store, to handle repair work on certain appliances in addition to radios. It might be done on a percentage or flat "trade fee" basis. The service dealer might bill the department store monthly, allow-

ing 20% or so to the store, which will collect the individual customer items. Or there may be a flat "spiff" to the store for every job turned in, depending on the amount of billing.

The announcement about the Chicago set-up says nothing about having the dealer's name displayed in the fix-it departments. But that is almost a trade obligation, anyway. There's no doubt that the department stores will have recourse to the service dealer in the case of complaints. The work will, of course, carry a guarantee, with the usual provisos regarding parts and labor. Where a proposition like that does work out, the stores can put a crown on their efforts to cater to the public by stressing the fact that they are employing reliable service dealers who join them in their guarantees. And while dealers may never learn the identity of the people whose appliances they are repairing, they can amass a vast amount of extra good will in their communities—a priceless ingredient for their post-war business planning—plus additional cash income.

Sally Silex Debut

"Sally Silex" is the pert new trade character now featuring in an extensive advertising campaign by the Silex Company, originators of the glass coffee



Sally

makers. "Sally" will appear in 180,000,000 national magazine impressions

during 1944 and will tell how to handle and take care of modern home equipment such as glass vacuum coffee makers, or Silex automatic steam irons.

Improved All-Appliance Tester

A new improved electrical appliance tester is now built to operate at an extremely low range of 0-20 watts as well as the high range to 2000 watts. It tests all electrical appliances from bell transformers and clocks to electric ironers and ranges operating on the 220-volt three-wire Edison system.

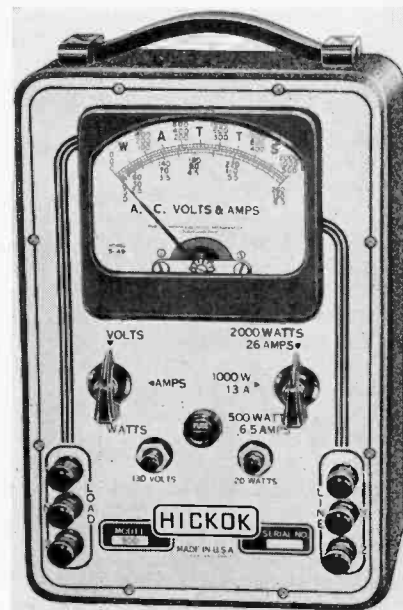

The tester measures actual load values of volts, amperes, and watts. Quickly locates trouble in A. C. appliances while they are in actual operation. It is protected from accidental overload by means of a fuse. Overall dimensions are 9½" high, 6¾" wide, 3" deep; weighs 8½ lbs., and the meter is 4" square. This is the new Model 900 manufactured by the Hickok Electrical Instrument Company, 10533 Dupont Avenue, Cleveland 8, Ohio.

Proctor Toaster Repair Hint

The utmost care in packing must be taken when returning a model No. 1430 for repair. The bakelite base is fragile and must be protected against breakage in shipment. The toaster should be packed in its original carton with sufficient inner packing to prevent the toaster from rattling in the carton. This original carton should in turn be packed in a larger carton with excelsior packed tightly around the bottom of the carton to protect the base of the toaster.

If these instructions are not followed the risk is very great that the toaster will be received with a broken base.

Technical Service Portfolio

SECTION XL

PAPER CAPACITORS AS MICA CAPACITOR SUBSTITUTES*

AS A MEANS of meeting the shortage of mica capacitors, various capacitors of other types have been proposed as alternates. Included among the suggested substitutes are the impregnated paper capacitors of both tubular and molded-bakelite construction.

Paper capacitors of several types have been tested by the capacitor manufacturers to determine their suitability as mica condenser substitutes. Among the electrical characteristics investigated are the Q , power factor, insulation resistance, temperature coefficient of capacitance, and working voltages. In determining the suitability of substitute capacitors, it has been necessary to keep in mind the particular applications in electrical circuits in which mica condensers have distinguished themselves, and to respect size requirements already set by mica capacitor dimensions.

Types

Bakelite-molded paper condensers usually resemble standard molded mica units in shape; and their sizes are not much different from those of mica capacitors. The capacitor sections may be of "stacked" construction or may be "wound" and flattened. The molded paper condenser may be impregnated with oil or wax.

Special tubular paper capacitors for mica substitution resemble standard tubular units except for their reduced size. These condensers are generally oil-impregnated and are provided with cylindrical metal containers, with or without an outer insulating sleeve.

* By the Engineering Department of Aerovox Corp., New Bedford, Mass.

War-time conditions made mica capacitors unobtainable for civilian radios. Methods for substituting available paper capacitors are discussed in this timely article.

Substitute paper condensers of both types cover a wide range of capacitance values. While it is desirable to replace as many of the mica types as possible, it is particularly important that alternates be provided for the larger condenser value units which employ the greatest amount of mica. Prominent in the latter class are units with capacitance rat-

ings of 0.002 *mfd.*, 0.005 *mfd.*, and 0.01 *mfd.*, which are employed in various coupling, blocking, and bypassing positions in radio and electronic circuits.

Sizes

Bakelite-molded paper capacitors can be found with approximately the same dimensions as corresponding

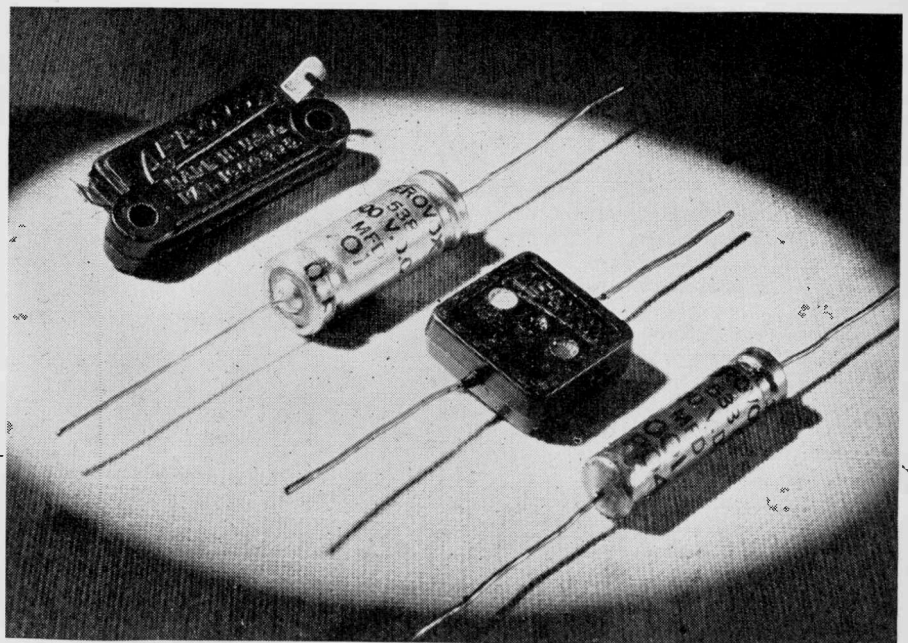

Capacitors of Mica and their Paper Equivalents.

mica condensers up to 0.01 mfd. These units are usually molded in black bakelite in accordance with tentative specifications of the American Standards Association.

Special small-sized oil-impregnated paper tubular condensers up to 0.01 mfd. capacitance are obtainable in overall lengths from 1" to 1 13/16" and diameters from 5/16" to 7/16". Outer insulating sleeves add 1/16" to length and 1/32" to the diameter. These small sizes should enable direct replacement of mica units mounted in close quarters.

Electrical Characteristics

The electrical characteristics of substitute paper condensers depend upon the material employed as a dielectric (at least as far as dielectric constant is concerned), and the properties of the oil or wax impregnant.

In general, a low Q value (10 to 30 at 10 Mc.) may be expected. Power factor will be approximately 0.5% at 1000 cps. Insulation resistance will be of the order of 8000 to 10,000 megohms at 500 volts dc. Residual inductance will depend upon the type of construction and lead length, and is usually of such magnitude that the resonant frequency of the 0.01 mfd.

unit occurs in the vicinity of 10 megacycles.

Beyond the resonant frequency, the condenser is generally considered as unsuitable for by-passing in high-frequency circuits. However, this is not entirely true. Stating the matter in engineering terms, the reactance of the capacitor does become inductive at frequencies higher than the resonant point, but an inductive reactance can be as efficient a by-pass path as a capacitive reactance, as long as the reactive path is considerably lower in ohmage at the operating frequency than is the by-passed path. This will be true except when phase angle of the feedback voltage is of importance. Thus, for instance, an inductive reactance of 1 ohm or thereabouts might by-pass effectively a tube cathode resistor of 500 ohms. At a certain high frequency beyond resonance, the inductive reactance will become equal to the resistance of the by-passed component and its by-passing ability, accordingly, will be destroyed.

Temperature coefficient of capacitance for the 0.01 mfd metal-encased tubular substitute paper unit will be positive and of a low value. Temperature coefficients of both

capacitance and power factor are governed by a number of factors which are of special concern to the manufacturers and some servicemen.

Capacitance tolerances of substitute paper units up to, but not including 0.01 mfd capacitance, are -20 to +50%; for units of 0.01 mfd capacitance, the tolerance is -10 to +40%.

Common working voltages for the substitute paper condenser are from 300 to 800 volts dc for capacitance values between 0.001 mfd. and 0.01 mfd. Some of the types have already given good account of themselves on life tests conducted by the manufacturers as well as their customers.

Ability of the substitute units to withstand water immersion according to any standard specifications is a function of the condenser casing, rather than of the type of element or impregnant. This is important in moist locations.

Applications

It has been common practice to employ mica condensers in certain critical positions in r.f. circuits where equivalent series resistance of the unit must be of a low magnitude. One such application is the (Continued on page 36)

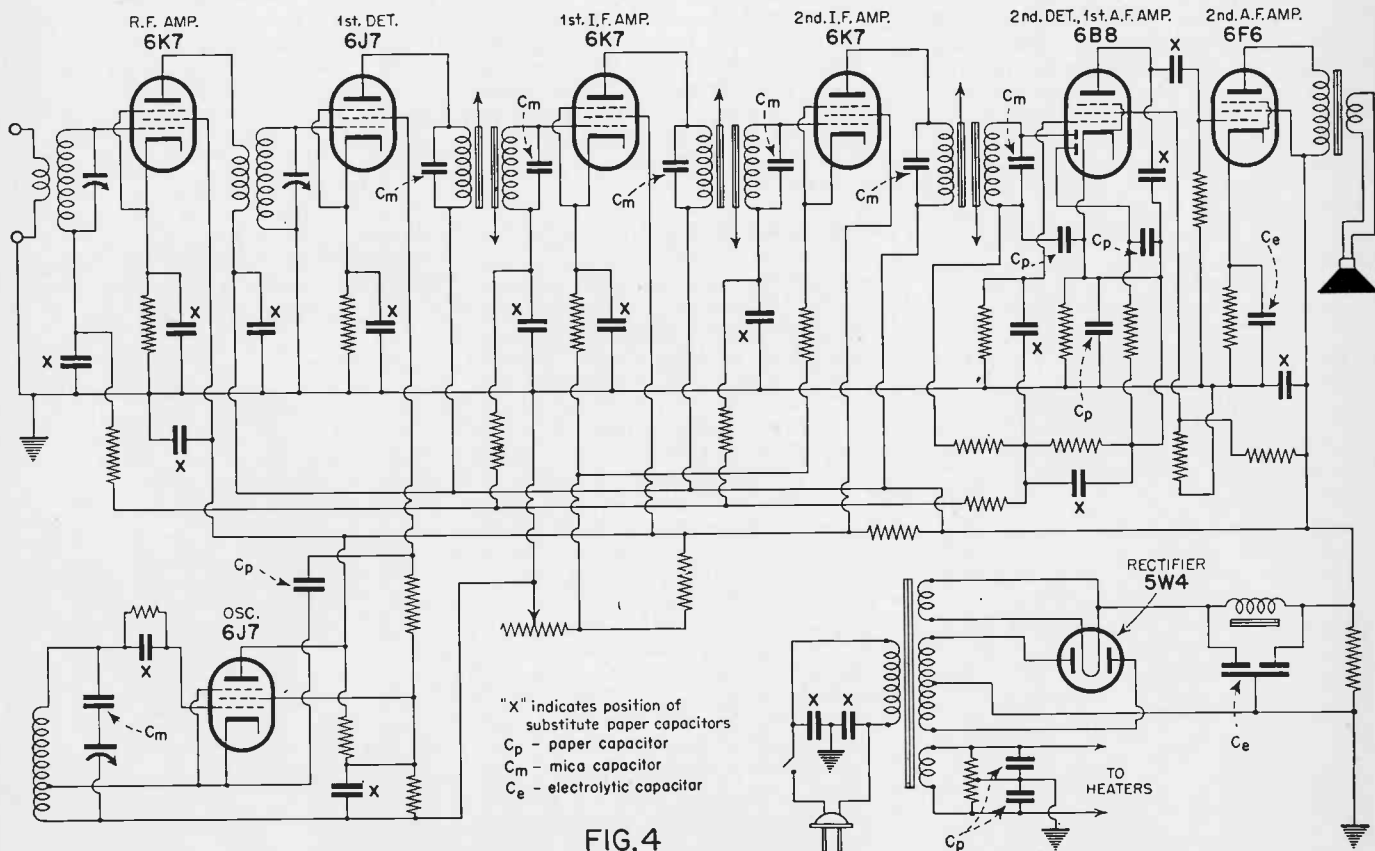

FIG. 4

Illustrating where paper capacitors may be substituted for micas in a super-het circuit.

DISCussion....

Odds 'n Ends by L.C.S.

One minute Tommy Dorsey was lined up for the "Bandwagon" summer series . . . the next had the Victor maestro booked for the "All Time Hit Parade." . . . Things whizz in music bizz! Artie Shaw fans swarm backstage to check Romeo Penque, who looks so much like Artie and plays like him that even his fans are confused. . . . Sammy (Okay) Kaye and his boys got the big hand in a couple of theater runs in Manhattan last winter . . . so now the swing and sway topper has another New York date which will keep the band in the city all summer . . . the first in three years. . . . Dinah Shore and Lena Horne are sharing in another of the army's overseas "command performance" radio programs. . . . Sings Dinah: current hit "Long Ago and Far Away." . . . Lena revives "Mad About the Boy," from her "Moanin' Low" Victor album. . . . Lena will glamor them at Chicago's swank Chez Paree nightery this summer, soon as she finishes her "overseaing." . . . The West Coast rumors Artie Shaw will debut a new dance orchestra soon, like the one he led before joining the Navy. Artie got his honorable discharge after grooving through the South Pacific with his Navy band. . . . On D-Day, workers in plants everywhere heard special programs of recorded patriotic music over internal broadcasting systems. Could be the industrial network might have polled "Good Bless America" a spot on the Hit Parade that day!



Glen Miller

Vaughn Monroe (Victor) was named "Bandleader Father of the Year" by the National Father's Day Committee. . . . "Candy," his two year old heartbreaker is dad's number 1 fan. . . . Buddy Rich is with Tommy Dorsey again, but he's set on handling his own crew and soon. . . . Alvino Rey, "name" bandleader, was the shy sailor who carried a guitar under his arm on a recent "Meet Your Navy" network broadcast . . . but he wouldn't tell until he was introduced on the program. . . . Lena Horne . . . gets orchids from the Committee for Unity in Motion Pictures as the most outstanding Negro actress of the year, sharing honors with singer Dooley Wilson. . . . Wayne King, now a Major in the Army, will debut a new army radio show over the Blue. . . . Victor has timed a new disc release with Wayne's public reappearance . . . "Amor" is the disc, soon on sale. . . .

The late Fats Waller's piano teacher, James P. Johnson, got the first copy of Victor's memorial album, "Fats Waller Favorites," on the Eddie Condon Jazz show. . . . Perry Como, Victor's baritone, is back in New York from pix-making in Hollywood. . . . Duke Ellington is touring upper United States and Canada and will start a concert series here soon. . . . Glenn Miller's Army Air Forces band is out cultivatin' for the Fifth War Loan Drive. . . .

Charlie Spivak gets the special ribbon from the Merchant Marine . . . his band cheerfests frequently at hospitals for injured seamen. . . . Duke Ellington (Victor) and poet Langston Hughes are doing a song soluting Negro members of the WACS. . . . Vaughn Monroe books Paramount New York for August . . . and will guest-spot soon on the Blue's "The Music America Loves Best." . . . Extravaganza version of "The Ziegfeld Follies" in technicolor sets up three songs for Lena Horne . . . Dinah Shore is underwater pinup girl . . . submarine (secret) skipper says the crew has two hobbies . . . hunting Japs and dallying over Dinah's discs. . . .

Spike (the) Jones is dated with a full size dance gang . . . dubbed Spike Jones and his other orchestra . . . ballrooming on the West Coast . . . come ballads or city slicker stuff, either way, the band surpleases 'em. . . . Hal McIntyre has Ruth Gaylor vocalizing with his orchestra . . . able Ruth has been "stuffin' her do" with America's finest bands, and still is. . . . With being pro-

filed by our est. contemp. "New Yorker" and all, where do Duke Ellington find the time to plan that long series of Concerts de Jazz? . . .

Record Reviews

RCA-Victor:

Piano Music of Villa-Lobos (Brazil), "The Child's Family"; final side, "Joy in the Garden" (Suite Floral Op. 97)—in Album M-970. Played by Artur Rubinstein.

This is a Victor national special release. Artur Rubinstein heard some Villa-Lobos compositions and sought out the composer in Brazil. Villa-Lobos shows a first-hand knowledge of his country's folk music and primitive rhythms. No wonder he cast aside accepted forms, showing unusual originality in his compositions, which include orchestral and solo instrumental works as well as choral music.

In spite of the title, "The Child's Family" is not children's music, but is rather a series of tone sketches about a doll family which a child accumulates. Artur Rubinstein's performance of these seemingly light pieces is a marvel of piano sorcery evoked with his flying fingers and insinuating phrasing.

"Fats" Waller Favorites (Album P-151.) "Fats" himself, Piano and Orchestra.

These have been lonely months in the music business since the death of

(Continued on page 38)



Tommy Dorsey

Radio Service Dealer



Our Cover: NEW OPPORTUNITIES IN RADIO

MANY dealers who have "come along" in the last year or two have been wondering how many army and navy-trained radio men (and pre-war radio servicemen who have been engaged since Pearl Harbor in war plants at high wages), contemplate going into the radio business as soon as they are mustered out or lose their present-day war jobs.

Dealers will be interested to learn that legislation is being contemplated to require returned war veterans and ex-radio servicemen to obtain licenses to practice as independent radio servicemen. Also, that many pre-war radio servicemen and others, now in the armed forces, have opined that when they are mustered out they do not intend to enter the radio dealer or service field as independents, but will rather seek salaried, full-time positions as installation-maintenance men for airlines, bus and taxi lines, railroads, ship lines and other industries that will use radio communication extensively in post-war days.

"Ridey-Talkies" Promise Busy Post-War Era for Radio Servicemen. Above: Motorola's 2-way FM Radiotelephone used on Locomotive to contact Train Dispatcher.

In this vein, our front cover this month shows a railroad engineer and fireman using a Motorola 2-way radiotelephone which operates between the train dispatcher's office and the locomotive cab. The apparatus is intended to facilitate the safer handling of passenger trains and tremendously speed up freights conveying war materials in train yards and on long hauls.

There is further promise for ex-service radio specialists in the announcement by the General Electric Company's Electronics Department and the taxi industry's Cab Research Bureau, Inc., that a "ridey-talkie" version of the war's walkie-talkies will be installed right after the war in taxicabs, beginning with Cleveland's fleets. Benefits claimed are: establishing contact with any cab

instantly anywhere; eliminating all present unattended call boxes and their direct lines to cab headquarters; reducing "dead" mileage and thus conserving gasoline, rubber and extending the life of the cab itself.

When it comes, radio servicemen may have this stationary apparatus to cope with, in the beginning: one main and two supplementary transmitters, each having four channels with 100 cabs assigned to each channel. In addition there will be thousands of units of cab equipment to service.

These are just a few of many new applications of radio-in-industry which will provide men released from military service with the post-war job opportunities many of them are seeking.

Letters to the Editor

OPA-TUBE CEILING

Editor:

Your June issue article, "Is The OPA Tube Ceiling Fair?" is one of the most outstanding, truthful statements of fact I have come across in any radio trade paper. The facts you put into print indicate unquestionably that you are for independent service dealers. You have chosen sides and I am certain that as more and more radio servicemen read your articles they will acknowledge your publication as the

one radio trade magazine of, by and for servicemen.

You did not try to appease either the OPA, jobbers or servicemen. Your article revealed conditions as they actually are. Let us offer a vote of gratitude to the trade magazine which has dared print the truth in the interests of America's radio servicemen.

Burt Selle
Ohio

Thanks, Mr. Selle, and the hundreds of other dealers who wrote us in like vein. Since its inception RADIO SERVICE DEALER has openly opposed and crusaded against jobbers who do retail service in direct competition with service dealers.

We'll carry on the campaign and advocate Governmental laws to correct a bad situation that is getting worse.

JOBS TURNED AWAY

Editor:

I am a full-time radio serviceman and

dealer operating a shop in a town of 9,000, eight miles south of the end of Boston's subway system, so whatever you publishers can do in helping the radio servicing industry will certainly be appreciated by all of us engaged in this headache of a business.

I am forced to turn away five to eight small sets daily for lack of 50L6, 12SA7, 12SK7, 25L6, and other types of tubes which cannot be secured from any Boston wholesaler, only in lots of two or three a month, provided you stand in with the jobber and give him plenty of business. We keep getting tips about some black market source of tubes at list, or 50c to \$1.50 above list. The same applies to wire wound resistors, power transformers, etc., and lately a serious shortage exists in even low voltage electrolytic condensers which are needed in many small set servicing jobs.

Lately Boston and New York jobbers are circularizing the trade with lists of adapters for using one tube in place of another. These combinations use a 7A8 in place of a 12SA7, a 47 to replace a 45, and so forth, when no one has any, either wholesale or retail, and the substitute tubes such as 7A8, 7B7, 47, etc., are as difficult to obtain as the tubes they are supposed to replace. The public knows nothing about these conditions, only reading daily paper bla-bla about "Eight Million Radio Tubes To Be Released," and when they are most of the numbers are slow moving types that have been in the jobbers' warehouses for the past two or three years such as types 26, 27, and other numbers that hardly anyone wants.

Probably the above is what you have heard a thousand times in the past year but it is the problem the serviceman faces today and something should be done to get a few scarce tubes into the hands of all the services who need them so badly at this time.

Arthur T. Dolan
Massachusetts

ANNUAL INDEX

Editor:

I have copies of your magazine since its first issue and I continually refer to many articles published several years ago. The Annual Index published in your 1940, 1941 and 1942 December issues were a great help but why didn't you publish an Index of 1943 text content?

Frank Polting
Idaho

WPB paper restrictions were so acute we had to decide whether to run an Index or omit two articles. Perhaps we can have a 1944 Index.

POST-WAR DEALER

Editor:

In Your May issue is an article that interested me very much. It's about the plans of radio and electrical appliance manufacturers for post-war. I am now in the Army (Signal Corps) but want to get in touch with the manufacturers so I can plan my post-war career as a dealer.

L. B.

We requested the manufacturers to send you data.

JUKES

Editor:

I would like to see you publish some articles on juke boxes, for example, Wurlitzer and Seeburg's remote control jobs. Also, I would like to have your ideas about future juke boxes and
(Continued on page 26)

Electro-Voice MICROPHONES

The extent of our line is but partially illustrated in this advertisement. Our current production is now being utilized in essential services. Soon, however, there will be Electro-Voice Microphones available for civilian use... and these will be described fully in subsequent advertisements.

In our South Bend laboratory, we have complete facilities for accurate frequency checking, harmonic wave analysis, measurement of ambient noise, etc. Electro-Voice Microphones reflect painstaking care in design and construction by superior performance in the field. They serve you better... for longer periods of time.

If your present limited quantity needs can be filled by any of our Standard Model Microphones, with or without minor modifications, we suggest that you contact your nearest radio parts distributor.

Paper Packs a War Punch . . . Save Every Scrap

ELECTRO-VOICE MANUFACTURING CO., INC. • 1239 SOUTH BEND AVENUE • SOUTH BEND, INDIANA
Export Division: 13 East 40th Street, New York 16, N. Y. — U. S. A. Cable: ARLAB

HOW CAN THE RCA ELECTRON MICROSCOPE HELP YOU?

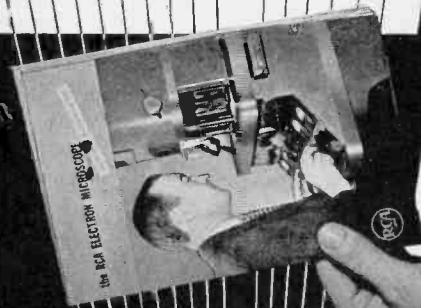

The RCA Electron Microscope, an instrument which magnifies up to 22,000 times (and makes micrographs which, enlarged photographically, make possible useful magnifications up to 200,000

times), has enabled scientists to achieve important advances in industry and research. Its tremendous magnifying power is of great value to the chemical, metallurgical, ceramic, plastic, aviation, textile, rubber and petroleum industries—or to any field where particle size, shape, structure or distribution are of interest, or where minute surface details of metals or other materials must be studied.

Two new models of the RCA Electron Microscope are now available. One is a compact desk model—the other, a new Universal type containing an electron diffraction camera. Information on these instruments, their use and applications, is offered in a new 16-page booklet "The RCA Electron Microscope." The coupon at the left will bring you this booklet by return mail.

Please Use This Coupon

Electron Microscope Section, Dept. 125
Radio Corporation of America, Camden, N. J.
Please send me the new bulletin entitled "The RCA Electron Microscope."

Name.....
Position.....
Company.....
Street..... City.....

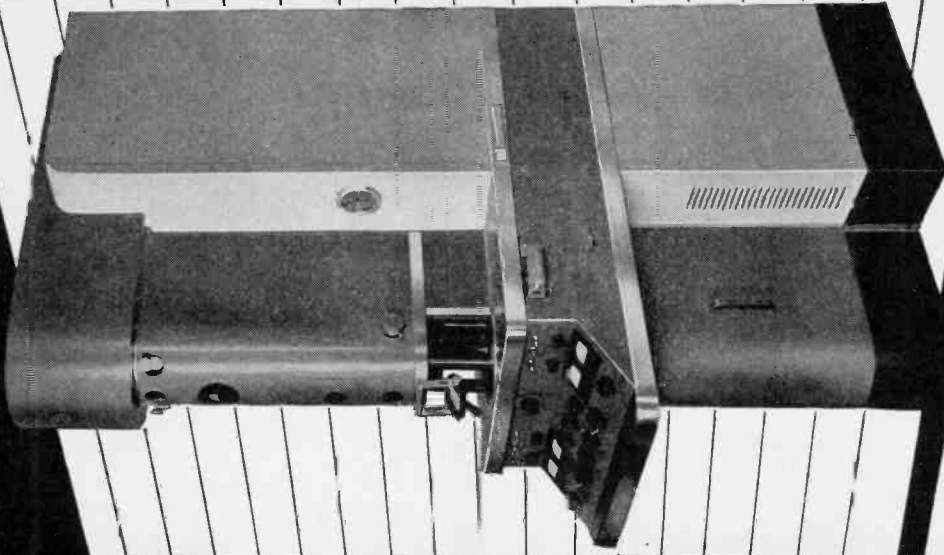

BUY MORE
WAR BONDS

RADIO CORPORATION OF AMERICA

RCA VICTOR DIVISION • CAMDEN, N. J.

LEADS THE WAY... In Radio... Television... Tubes...
Phonographs... Records... Electronics

Letters To The Editor
(Continued from page 24)

whether you believe television will tie-in with jukeboxes.

Joseph Venci
Penna.

We will try to accommodate you.

CALLING DETROIT

Editor:

What radio serviceman's organization do we have in Detroit?

Helene Putrya
Michigan

Before Pearl Harbor Detroit had an excellent Chapter of Radio Servicemen of America, Inc. The National RSA

suspended activities "for the duration." Perhaps the Detroit group still functions. Can some Detroiter answer this?

ARE DEALERS CONSUMERS?

EDITOR:

Please refer to your article on page 10 of the June, 1944, RADIO SERVICE-DEALER. In the third paragraph you mention that sales at wholesale might exclude sales to dealers. I see no need for lengthy discussion to correct the thoughts you convey.

Pick up Document 31336, Rev. SR 14, and study paragraph A: "Maximum Prices for Sales at Wholesale." Very clearly wholesale sales are mentioned as sales to dealers. Enclosed is that regulation with a few pertinent words.

In reading paragraphs A and B, we

find three classes of activity involved. In paragraph B it is the ultimate consumer (civilian) and industrial, commercial, governmental and institutional. In paragraph A we find the retailer mentioned as a person other than the ultimate user.

Although the word "dealer" is not mentioned, the deduction necessary is very slight. Eliminating those mentioned, that is industrial, commercial, governmental, institutional and ultimate consumer, we must be pointing at the dealer. It is just a matter of reading and re-reading paragraphs A and B.

The balance of the article is really good. We agree 100% that consumer service has no place in the parts distributor's activity.

We thank you for the many fine articles in your good magazine.

M. H. Kirkeby, Pur. Agent,
Lew Bonn Company, Minn.

Mr. Kirkeby is absolutely correct but as some jobbers find it "convenient" not to interpret paragraph A of GMPA, Amend. 134, as he does, we are asking for legislation that will compel jobbers to confine their activities to wholesale selling so service dealers can get the merchandise intended for their use by manufacturers without danger of reprisal.

OPA Changes

Daniel L. Jacobs, from York Automotive Distributing Co., radio distributors, becomes a head of the Radio and Miscellaneous Unit.

Ernest W. Heilmann, from A. G. Spalding & Bros., becomes section head supervising pricing actions for radios and musical instruments, sporting goods, bicycles, dry batteries, housewares, hardware, luggage, watches and other personal accessories.

O'Leary of Belmont to WPB

Appointment of Frederick A. O'Leary, of the Belmont Radio Corporation of Chicago, as chief of the radio and radar section of the production department, is announced by W. H. Wheeler, Jr., regional director of the War Production Board. This department assists New England military electronic equipment manufacturers with production, scheduling, procurement, manpower and priority problems.

Mr. O'Leary was formerly associated with Raytheon Manufacturing Company, Waltham, and the Eastern Company of Cambridge, Mass.

More Batteries, Says WPB

Radio dealers and other merchants who handle farm radio batteries are told by WPB's Director Stanley B. Adams that an increase in battery production is expected this fall. Overseas needs for batteries have increased enormously, but WPB is trying also to step up civilian production because lack of batteries may prevent people from tuning in on important radio messages and participating in vital war programs.

Synthetic Wire Insulation Coming

Large-scale, peacetime use of plastics and synthetics in place of natural rubber as insulation for electrical wires,

TODAY in WAR ... TOMORROW in PEACE

BRACH

MARINE ANTENNAS and MOUNTS



Brach Marine Antennas and Mounts are now manufactured 100% for the service of Uncle Sam's amphibian tanks, PT boats, etc. But with the dawn of Victory we shall be ready and able to utilize our enhanced experience and wartime "know how" in supplying the civilian requirements for antenna equipment for ship-to-shore communication.

L. S. BRACH MFG. CORP.

World's Oldest and Largest Manufacturers of Radio Antennas and Accessories
55-65 DICKERSON STREET • NEWARK N. J.

PICTURE PAGE of Mt. Carmel's Famed Precision-el

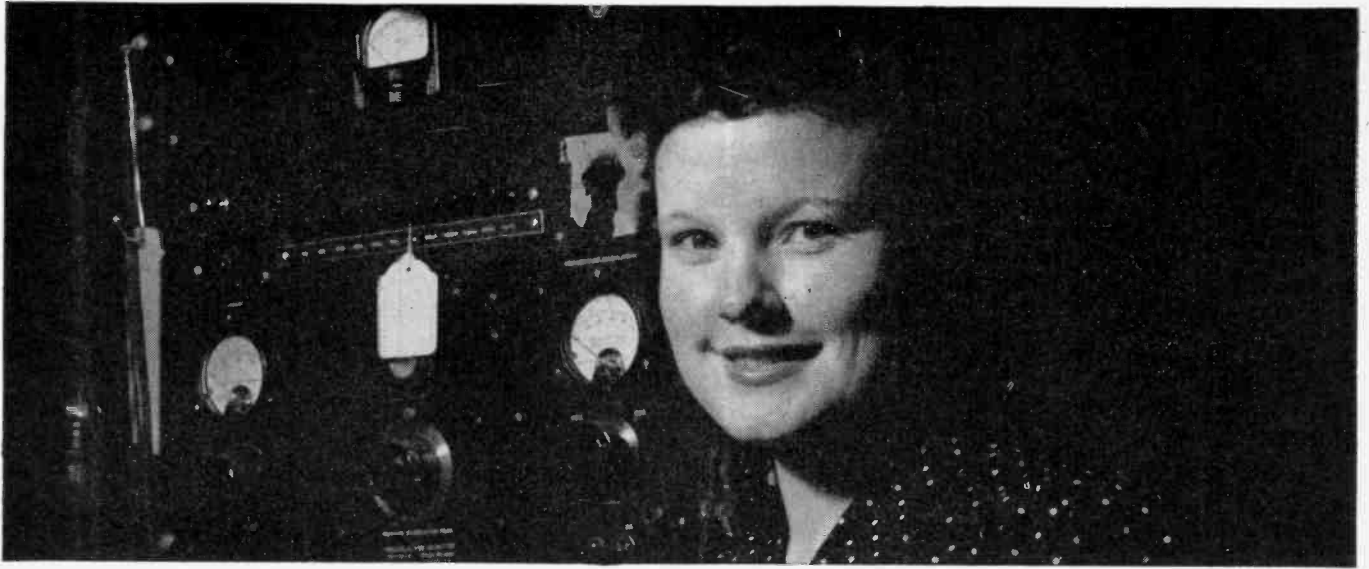

Ever hear the story of how "precision-el" originated? It was coined by a writer who visited the Meissner plant at Mt. Carmel some time ago. He had watched in amazement as hundreds of flying fingers handled intricate and delicate assignments with unerring precision. "This," he was told, "is just a small part of Meissner's personnel . . ."

"Personnel?" he exclaimed. "Well, from what I've seen today, I'd call them 'precision-el'! No wonder Meissner has such a reputation for quality!"

Specialist! Mt. Carmel, Illinois, is said to have more electronic technicians per thousand population than any other city in America. This young lady is one of many experienced workers at Meissner's Mt. Carmel plant.



Time Out! This busy worker pauses for only a fleeting second as the roving photographer snaps his picture. He does his part in making the vital and highly technical products with which Meissner supplies Allied armed forces 'round the world.



Veteran! Here is another reason for Meissner's top reputation for precision work. Meissner people rightly take pride in their job, in their own personal production.



Precision-el at Work! These young women, like many Mt. Carmel residents, have literally learned the electronic business "from the ground up." They are versatile enough to handle any one of many difficult assignments.



Now! Special 1944 Bulletin

Here's what everyone in the industry needs to know about Meissner's 1944 line of radio parts. Contains complete descriptive matter, with pictures. Now, more than ever, it pays to keep posted on what Meissner offers. Send for your copy today, because the supply is limited. Free! Write to address below.

MEISSNER

MANUFACTURING COMPANY • MT. CARMEL, ILL.

ADVANCED ELECTRONIC RESEARCH AND MANUFACTURE

cables, and cordage was forecast by H. W. Clough, vice president of the Belden Manufacturing Company, at a recent conference of the company's salesmen and engineers in Chicago.

Belden research laboratories, which adapted the materials to meet specific war needs when the natural rubber stringency developed, is continuing to develop still greater peacetime applications. In many applications the new plastics and synthetics are superior to natural rubber; in others they are equally efficient. Resistance to acids and oils, ability to withstand high and low temperatures, and extreme flexibility were listed as among their favorable characteristics. Considering these desirable qualities, costs compare favorably with natural rubber and should be no bar to use after the war.

Just as the last war gave great impetus to American development of the dye, automotive, and radio industries, the experiences in this war will give powerful impulse to the growth of plastics and synthetics, Mr. Clough stated. Television, electronics, aviation, the electrical appliances field, automotive vehicle owners, and householders will benefit in many ways from these products, including the economies from increased efficiency, longer life, and greater utility. An additional advantage is the variety of beautiful colors in which many plastic materials are available.

**A Wider Range Oscillograph
At Moderate Cost**

Allen B. Du Mont Laboratories, Inc., Passaic, N. J., announce their new Type

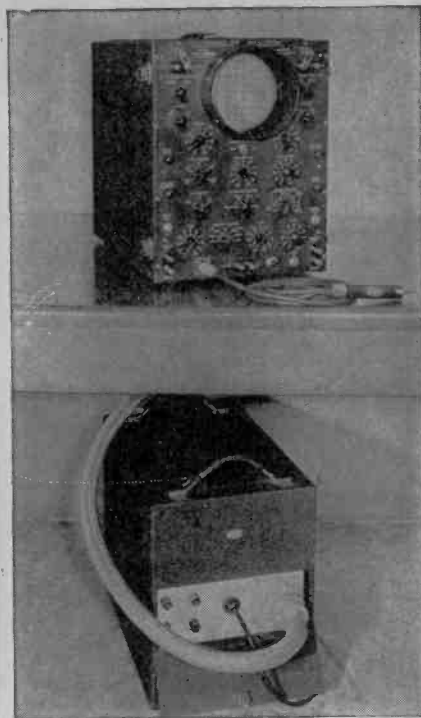

248 oscillograph, available at moderate cost. It is portable, suitable for lab, production or bench-test work. The instrument reproduces either transient or recurrent phenomena. The wide band vertical axis amplifier is usable to 10 MC. 4,000 volts.

**Big Future For Radionics
Says E. F. McDonald**

"When I left the Navy at the end of World War I, I went into radio because it was young, interesting and exciting. In 1920 many looked upon radio as an unimportant part of the electrical industry, underestimating its potentialities. In Zenith's early days many dealers, even of phonographs and musical instruments, refused to consider handling radios," writes Commander E. F. McDonald, Jr., in Zenith Radio Corp.'s house organ, Radiolog, for May, 1944. "Today radio and electronics are only two subdivisions of the vast new science called 'radionics' which with many



E. F. McDonald
Radio Service Dealer

Lend-lease did not introduce Ken-Rad to foreign service. Years before the war our export accounts were located in sixty countries on every continent and major islands in every sea. In war or peace Ken-Rad serves the world.

KEN-RAD

EXECUTIVE OFFICES
OWENSBORO · KENTUCKY
EXPORTS 15 MOORE STREET NEW YORK

- TRANSMITTING TUBES
- CATHODE RAY TUBES
- SPECIAL PURPOSE TUBES
- RECEIVING TUBES
- INCANDESCENT LAMPS
- FLUORESCENT LAMPS

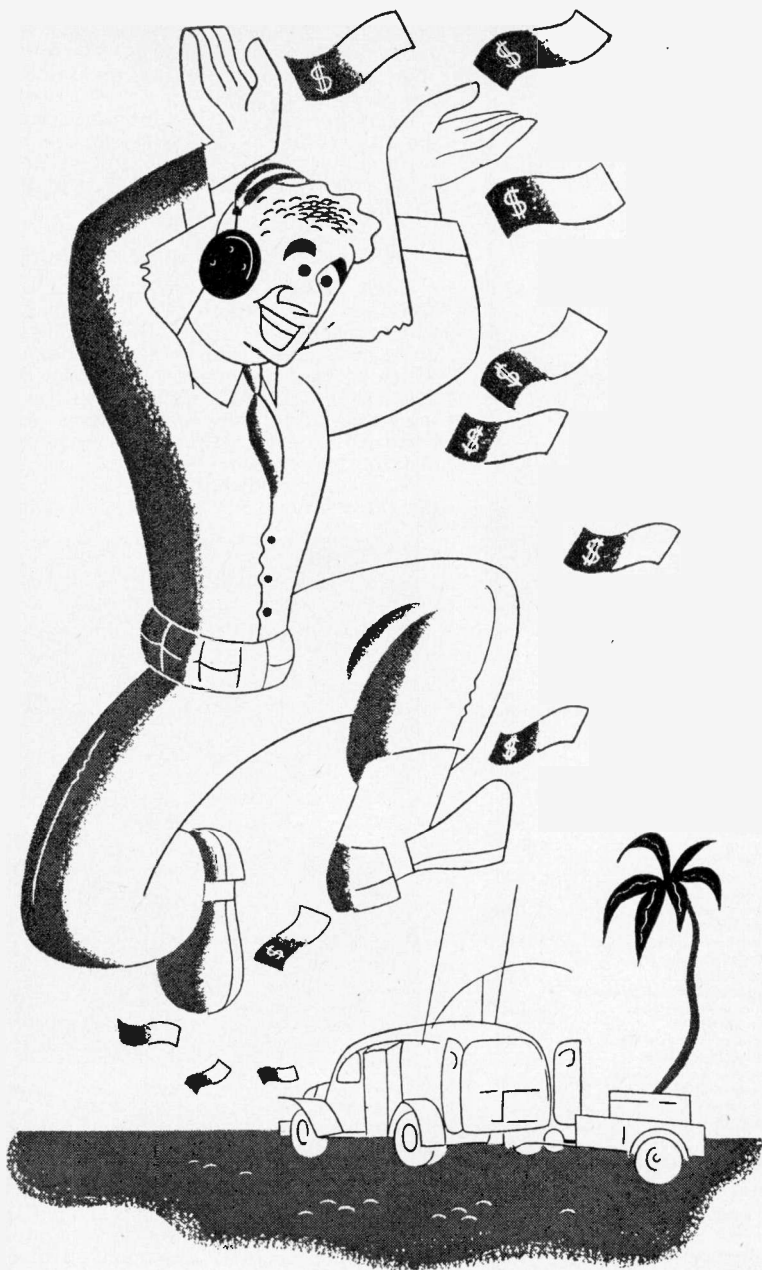

NEW LETTER CONTEST for SERVICEMEN!

**ELEVEN 1st PRIZE WINNERS
IN 5 MONTHS IN CONTEST #1!**

Yes sir, guys, the hundreds of letters received were so swell that *double* first prize winners had to be awarded each of the first four months and there were *triple* first prize winners the fifth and last month . . .

SO—HERE WE GO AGAIN!

Get in on this NEW letter contest—write and tell us your *first hand* experiences with *all* types of Radio Communications equipment built by Hallicrafters including the famous SCR-299!

RULES FOR THE CONTEST

Hallicrafters will give \$100.00 for the best letter received during each of the five months of April, May, June, July and August. (Deadline: Received by midnight, the last day of each month.) . . . For every serious letter received Hallicrafters will send \$1.00 so even if you do not win a big prize your time will not be in vain. . . . Your letter will become the property of Hallicrafters and they will have the right to reproduce it in a Hallicrafters advertisement. Write as many letters as you wish. V-mail letters will do. . . . Military regulations prohibit the publication of winners' names and photos at present . . . monthly winners will be notified immediately upon judging.



hallicrafters RADIO



THE HALLICRAFTERS CO., MANUFACTURERS OF RADIO AND ELECTRONIC EQUIPMENT, CHICAGO 16, U. S. A.

July, 1944

29

"THE HELP SITUATION" by Larlar



HERE'S HELP THAT KNOWS NO VACATION

Employees really need vacations this year. High speed effort, long hours and personal war-born worries cause fatigue that can be relieved only by a complete change.

How to maintain production during the vacation period? That is the problem of all employers today.

True, temporary, substitute help is not available, but permanent authoritative help is yours for the small effort of ordering Rider Manuals and Rider Books.

These time-savers should be by the side of your employees all year 'round, directing them to better, more efficient methods of radio servicing and providing them with the reference material they need to handle the huge volume of work coming to your shop today.

Have all thirteen volumes of Rider Manual on each of your benches and circulate the other Rider Books among your employees.

The greater their knowledge, the better their tools—the bigger their production. Place that order today!

- RIDER MANUALS (13 VOLUMES)**
 Volumes XIII to VII.....\$11.00 each volume
 Volumes VI to III..... 8.25 each volume
 Abridged Manuals I to V (1 volume).....\$12.50
 Automatic Record Changers and Recorders 6.00
- OTHER RIDER BOOKS YOU NEED**
- The Cathode Ray Tube at Work
 Accepted authority on subject..... \$3.00
 Frequency Modulation
 Gives principles of FM radio..... 1.50
 Servicing by Signal Tracing
 Basic Method of radio servicing..... 3.00
 - The Meter at Work
 An elementary text on meters..... 1.50
 - The Oscillator at Work
 How to use, test and repair..... 2.00
 - Vacuum Tube Voltmeters
 Both theory and practice..... 2.00
 - Automatic Frequency Control Systems
 — also automatic tuning systems..... 1.25
 - A-C Calculation Charts
 Two to five times as fast as slide rule..... 7.50
 - Hour-A-Day-with-Rider Series—
 On "Alternating Currents in Radio Receivers"—
 On "Resonance & Alignment"—
 On "Automatic Volume Control"—
 On "D-C Voltage Distribution"..... 90c each
- JOHN F. RIDER PUBLISHER, INC.**
 404 Fourth Avenue, New York 16, N. Y.
 Export Division: Rocke-International Corporation
 13 E. 40th Street, New York City Cable: ARLAB

new developments, most of them so secret that not a whisper of even their existence has reached the public, is proving to be our supreme weapon in this war.

"It is my opinion that radionics is at the same point today as radio was in 1920, and I believe it will open new fields equally beneficial to the industry and its dealers."

Meissner Post-War Planning

Oden F. Jester, vice president of the Meissner Manufacturing Company, Chicago and Mt. Carmel, Ill., completed an 8,400 mile tour recently during which he talked to representative radio dealers and distributors in large trading areas and surveyed conditions preparatory to organizing the company's distributing organization.

Intended for distribution to the upper-income market, the Meissner radio-



Oden F. Jester

phonograph will require a rather unique sales and distribution policy. Said Mr. Jester: "Only dealers who can demonstrably sell the upper-income market, who are themselves well established in their trading areas, and who can offer an unusual type of customer service, will be chosen. Since production will not begin for some time, we are being very careful and deliberate in establishing our general national sales policy."

The Meissner advertising campaign has been running in top-rank national magazines and radio trade publications since the beginning of this year. Dealers can learn more about Meissner sets from Mr. Jester in the company's booth at the coming convention of the National Association of Music Merchants in Chicago.

"Cliff" Estey Joins Burton Browne

F. Clifford Estey, a well known executive in both the radio and metals fields, has been appointed assistant to Burton Browne, president of Burton Browne Advertising, 150 East Superior St., Chicago.

"Cliff" is one of the real oldtimers in the amateur shortwave radio, having started his tinkering about 1906. Oldtimers will remember him as LAFV who created quite a stir in 1921 with his 70 foot vertical antenna.

Radio Service Dealer

RIDER MANUALS GIVE YOU THE HELP YOU NEED!



BE SURE... Standardize on

STANCOR Transformers

Call your nearest Stancor Jobber... or write us for his address

STANDARD TRANSFORMER CORPORATION
 1500 N. HALSTED STREET CHICAGO



SPRAGUE TRADING POST



A FREE Buy-Exchange-Sell Service for Radio Men



ASK FOR THEM BY NAME

If you appreciate the Trading Post Advertising Service—and hundreds of servicemen have told us that they do—we know we can count on you to ask for Sprague Atom midget dry electrolytic capacitors by name, and to insist on getting them whenever they are available. Atoms are smaller, less costly, and are fully as reliable as the big, old-fashioned condensers they replace. Use them universally on all of your jobs. They're more dependable—they speed up your work!

WANTED FOR CASH—RCA Voltohmyst and Philco 030 dynamic tester. Kenneth C. Sanford, c/o Smith & Phillips Co., 469 Washington St., E. Liverpool, Ohio.

WANTED—Tube checker, must test locals, etc. Also want sig. generator, prefer x-tal controlled; also small (15-20 watt) P.A. system complete. G. H. White, 449 Wellington Rd., Mineola, N. Y.

FOR SALE—Philco dynamic tester #030, \$18; Philco condenser meter #010, \$6; Superior #1280 tube and set analyzer, \$24. All in 1st class shape. Stephen G. Meyers, 1709 Hilton Ave., Ashland, Ky.

FOR SALE—Set of Rider's manuals vols. #4 to #13 incl. complete with index. Brand new, \$80. Henry L. Pershall, 509 Deer Park Ave., Babylon, L. I., N. Y.

WANTED—Good sig. generator, ohmmeter, tube tester, condenser tester. Describe fully and I'll reply. N. W. Luckey, Bancroft Hotel, Bend, Oregon.

WANTED—Communication receiver such as Echophone or equivalent of comparative size. Rush information. Sgt. Morgan L. Striling, Crew 5333, Combat Chew Headquarters, Biggs Field, Texas.

FOR SALE OR TRADE—Limited quantity Philco di-pole F-M outdoor antennas compl. with mtg. couplings & 50' transmission line, in original sealed cartons, Philco part no. 45-2926, \$8.25 list, will sell for \$4 ea. or trade for 12v and 2v type tubes, No. C.O.D.'s. Send check or M.O. A. Brindley, Radio Technical Service, 2821 W. Girard Ave., Philadelphia 30, Pa.

FOR SALE—Vol. 1 to 7 incl. of Rider's manuals, good condition, complete with index. Also Burton signal generator #11, battery operated, range 100 kc. to 70 mc. C. F. McCracken, Hughes Park, Bridgeport, Pa.

FOR SALE—Tubes, cartoned and uncartoned, all guaranteed: 6A7, 6A8; 6X7; 43; 45; 58. Otis B. Martin, Jacksonville, Ark.

FOR SALE—Overstock of power transformers, all new, boxed, 115v 60 cycle, std. makes, 1/50 mil - 3/70 mil - 4/90 mil - 4/150 mil - 2/160 mil—5 and 6.3v filaments upright mtg. 5/90 mil - 1/110 mil 2.5 & 5v filaments, upright mtg. 5/60 mil - 9/75 mil - 3/90 mil - 8/125 mil - 14/150 mil 1/120 mil with motor tuning winding—5 & 6.3v filament winding — full shell universal mounting. Cupples Radio Service, 1813 - 29th St., Galveston, Texas.

WANTED—Following tubes: 80; 45; 28; 27; 56. Advise price for immediate cash. Clarence Stinnett, 1721 Elm Ave., Lynchburg, Va.

WANTED—A complete set of Rider manuals, 1 through 13. Used copies in fair condition. Cash. H. P. Boone, 18 Riberia St., St. Augustine, Fla.

URGENTLY NEEDED—A modern tube tester, preferably Radiotechnic Lab tester but will accept other good make. Also want 70L7 GT/G and 50Y8T/G tubes. Brill Radio Service, 1920 Circle Ct., Chicago Heights, Ill.

FOR SALE—International Morse code course records. The Linguaphone course consists of 5 double-faced 10" records with inst. book & album. Used little. R. E. Hartman, Dakota, Ill.

WILL TRADE—Triplet #321 3" milliammeter 0-5 scale, practically new, for any make milliammeter with 0-1 scale in good condition & same size. Also will trade one Thordarson T54F55 2.5v c.t. filament transformer, brand new, for what have you? C. P. Young, 936 Joliet St., New Orleans 18, La.

WANTED—Echophone EC-1 or Sky Buddy for solder studying advanced communications. Cash. Sgt. Jack Rickel, Hq. Co., IRTC, Camp Robinson, Ark.

WANTED—Will buy used console (or new) cabinets in which old radios can be installed. What have you? John A. Gruenigan, Central Y.M.C.A., Harrisburg, Pa.

FOR SALE—Precision #500 tube checker in perfect condition with rotary illuminated chart. Also small lot of misc. parts such as small meters, Roller-Smith radio freq. meter, sockets, controls, transformers, etc. Write for list. Arthur W. Klein, 6708 Sixth Ave., Brooklyn, N. Y.

WANTED—Used sig. generator covering from 100 kc. to 120 mc. S. J. Bivins, City Radio Shop, Thomasville, Ala.

FOR SALE—#18 Hickok all-wave signal generator with built-in DB-level output meter. In perfect condition. \$65. Pvt. J. M. Novak, Co. I, 804th S.T.R., Camp Crowder, Mo.

WANTED—Pocket size V-O-M 0 to 5,000 volts in 6 ranges, AC-DC 0 to 1,000, D.C. milliamperes 0 to 40,000 ohms. Jack M. Malone, 525 E. Main St., Eaton, Ohio.

FOR SALE—Radio City comb. tester, multimeter, plug-in analyzer #802-A. Brand new condition. Also Radio City pocket multimeter #456, brand new condition. Also have misc. parts & tubes. A. Gilbert, 878 Bryant Ave., Bronx, New York 59, N. Y.

WANTED—A milliammeter. The Radio Shop, Ferdon Ave., Box B, Piermont, N. Y.

IMPORTANT NOTICE!

We discourage offers to buy or sell anything beyond the O.P.A. ceiling prices, and will not knowingly accept such ads for the Sprague Trading Post.

URGENTLY NEEDED—Volt-ohmmeter 0-10 megohms, 0-1000v AC-DC. Ed H. Rogers, P.O. Box 273-3, Hawthorne, Nevada.

WANTED—802 CR tube (2"), also 1 1/2 to 117 volt tube tester transformer in A-1 shape. Cash. Richard Blair, 710 Clark St., Missoula, Mont.

WANTED—New or good used mica and variable condensers, resistors, 1LE3, 1G4, 175, GT tube sockets; 500,000 ohm pot.; coils; chokes or what have you? State price. L. A. Kirk, Box 511, Colfax, Calif.

FOR SALE—12" Jensen dynamic speaker, separate excitation included; RCA 100-A magnetic speaker; Western Electric #540 carbon mike. Excellent condition. Edmund McD. Bendheim, 22-33 - 31st St., Astoria, L. I., New York.

FOR SALE—One C13 Janette rotary converter, 115v 4.2 amp. D.C.; 110v, 60 cy. AC. 300 watts, 3600 r.p.m. incl. built-in filter, \$35 f.o.b. Sven Steiner, 1 Cabrini Blvd., New York 33, N. Y.

WILL TRADE one Delco 32v superhet receiver #3210 using 6A7, 2-6D6 85, and 2-48 in A-1 condition for good AC-DC table model or what have you? Also have Rider's manual #9 for sale. D. M. Decker, Deckerville, Mich.

FOR SALE—Jackson #540 sig. generator, \$40; Jackson #560 multimeter & tube tester, \$40; Jackson #580 oscilloscope, 3", \$60; Philco dynamic audio analyzer, \$25; R.C.P. tube tester, \$30; Rider's manuals (brand new) vol. 1 thru 5 (abridged) and vols. 3 thru 13, \$125; Approx 200 tubes, 70% are new, at least 60 different types incl. 35Z5, 35L6, 3Q5's etc.—take all or none @ 50c ea. Instruments complete with tubes, instructions, and charts. Write for list. Will sell complete shop for \$525. Don Savin, 107 East E St., McCook, Neb.

WANTED FOR CASH—Jackson #642 multimeter, also signal tracer, amplifier Carron or similar with graduated scale to show exact frequency of signal. L. W. Smeltzer, 3721 Legation St., N.W., Washington, D. C.

WANTED—Volt-ohmmeter; AC-DC multimeter & tube tester; set analyzer and

tube tester combination. Fred Kreuger, 8116 Quincy Ave., Cleveland, Ohio.

WANTED—Short-wave receiver, battery or AC; 2 - I-F 1500 kc. transformers; 1 Meissner B.F.O. transformer; set of Hammarlund short-wave coils - 2-140 mmf. variable condensers and other radio parts. What have you. Joseph Harter, Sweet Corner Road, Fairport, N. Y.

FOR SALE—Two Genemotors, 350v @ 100 M. \$5 ea.; Philco wireless station setter #014, \$12; two Carter 6v units (need diaphragms), \$5 ea.; two 6v Western Electric units (need diaphragms), \$8 ea.; 200 auto radio plates compl. with fittings, \$10. Will swap 12SA7's or 12SQ7's for 35L6's or 50L6's. Al Budin, 11211 Superior Ave., Cleveland 6, Ohio.

WANTED FOR CASH—Precision #832 multimeter, Supreme #542, Superior #1220, or Simpson #235. Meter must be good. Felix Carfagno, 560 Wythe Ave., Brooklyn, N. Y.

WANTED—Volt-hmyst or volt-hmyst jr. for cash and a few hard-to-get tubes for a bonus. Walt's Radio Shop, 11449 L.B. Blvd., Lynwood, Calif.

WANTED FOR CASH—One 12SK7 or 12SK7GT, one 12A8, and one 12SQ7 or 12SR6GT. Radio Service, Box 322, Syracuse, Kansas.

WANTED—Low priced short-wave set, any make. Geo. Shafter, 2240 E. 24th St., Granite City, Ill.

WANTED—One Cetron CE-T gas filled caesium photo cell. John W. Butler, 424 Mansfield St., Belvidere, N. J.

FOR SALE—Complete tube stock, more than 60% types in heavy demand, new in sealed cartons. Also input, output & power transformers, crystal cartridges, wire-wound and carbon resistors, condenser sets, etc. All new stock. Send stamped, addressed envelope for list. Radio Electronic Co., Hudson, Wis.

WILL SWAP cathode ray tube #906 (never used) for camera and pay cash difference. Also have a Triplet 327 O-1 Ma. meter for trade. What have you? William Miller, 693 Union Ave., Providence, R. I.

WANTED—Oscillator or ohmmeter for radio work. Robert Goodlett, 1729 Duncan St., Louisville, Ky.

WANTED—Two 6V6 tubes and one 35L6. Cash. Glenn L. Thompson, 3807 1/2 Lake Park Ave., Chicago 15, Ill.

FOR SALE—Precision 832 multi-range tester with simplified rotary 31 range selection and extra large 3 1/2" meter. Used very little. L. R. Couch, Jr., 2139 Greenwood St., Savannah, Ga.

YOUR OWN AD RUN FREE!

This is Sprague's special wartime advertising service to help radio men get needed parts and equipment, or dispose of radio materials they do not need. Send your ad today. Write PLAINLY—hold it to 40 words or less. Due to the large number received, ads may be delayed a month or two, but will be published as rapidly as possible.

Different Trading Post ads appear monthly in Radio Retailing-Today, Radio Service-Dealer, Service, Radio News, and Radio-Craft. Sprague reserves the right to reject ads which do not fit in with the spirit of this service.

HARRY KALKER, Sales Manager.

Dept. RSD-74, SPRAGUE PRODUCTS CO., North Adams, Mass.

SPRAGUE CONDENSERS KOOLOHM RESISTORS

Obviously, Sprague cannot assume any responsibility, or guarantee goods, services, etc., which might be exchanged through the above advertisements

NEED A SUPPLY
OF MATCHES?

SYLVANIA SERVICEMAN SERVICE

by
FRANK FAX



Book matches, imprinted with your name, are one of the best and most economical ways to advertise your business.

Sylvania has prepared a new style of book match for your use.

Supplied to you for cost, with your name handsomely imprinted:

1,000 .. \$3.25 5,000 .. \$14.90
2,500 .. 7.50 7,500 .. 22.40

Plus 40 cents per thousand Federal Tax. Orders under 7,500 are shipped FOB Shipping Point; over 7,500, FOB your address.

Order from your local Sylvania distributor, or send your order to Frank Fax, Sylvania, Emporium, Pa.



SYLVANIA
ELECTRIC PRODUCTS INC.
RADIO DIVISION

Your Oscillograph (Continued from page 15)

is to a negative supply, some point on R_1 can be made a point of zero potential. Consequently, a direct current voltage is available when applied to the grid V_2 to cause the direct current plate voltage of V_2 to vary, and therefore, to cause direct current positioning. The resistor R_4 comprises the plate load for the deflection amplifier V_2 , while R_5 and R_6 returned to a high negative potential provide direct current voltage division to cause point P to be at zero potential with respect to ground. Capacitance C_1 is provided to reduce the attenuation of the alternating current signal component. Since R_5 is necessarily high in value, the time constant of C_1 and R_5 will not attenuate the low frequencies appreciably. The chief advantage of direct current positioning is that of eliminating the lag usually associated with alternating current positioning, when good low frequency response is maintained.

Alternating current position, as illustrated in Figure 16, is used for applications where the lag is not serious, or when direct current connection is not desirable.

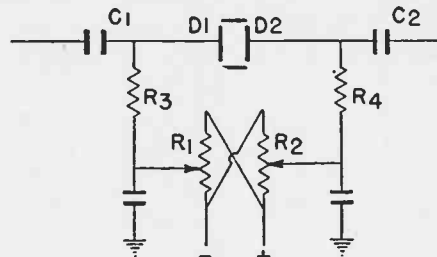

Figure 16.

The above mentioned lag or "electrical backlash" is caused by the time required for the capacitance C_1 and C_2 to establish a steady direct current potential at plates D_1 and D_2 after position control potentiometers R_1 and R_2 have been adjusted to some new value. This time is necessitated by the large time constants C_1R_3 and C_2R_4 . High values of resistance are necessary at R_3 and R_4 to maintain a high input impedance at the deflection plates and to insure good low frequency response in the deflection plate coupling circuit.

With the Editor (Continued from page 14)

of OPA gas rationing, you are entitled to "B" rations for occupational use in repairing non-portable radio sets, P-A systems, etc., and you are entitled to "C" rations if your work includes re-

pairing government owned radios or monitors.

S. R. Lowan

Post War Outlook (Continued from page 18)

facturer in the business has sharply increased his capacity during the war. Therefore, we know that the 'Sellers Market' won't last long and that we soon will have to roll-up our sleeves and do some good old-fashioned selling again."

This second school goes on to say, "We know that selling has been easy during the past few years—we haven't really had any tough selling since 1938. We think that sales will be large in the post war market, but only for those who have prepared to make them large.

"Now we know that we could save some money on advertising and salesmen expense during the early allocation of production period—but it's during that time we are going to build the nucleus of the selling organization we will later require. We are going to

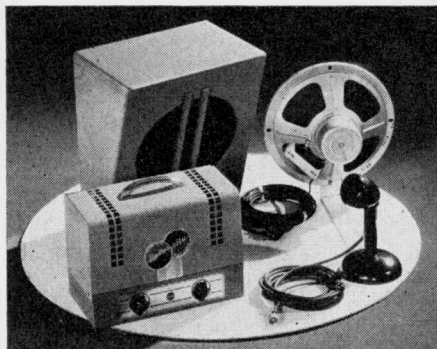

Industrial P-A Installations Are Already Booming. (Photo courtesy of Lafayette Radio Corp., Chicago).

give a little at the start to make a good return later on.

"We are going to pay out some commissions at the start which we could save—but we can pay them and still

(Continued on page 36)

FADA'S S.M. 81 SERVICE MANUAL

AN INDISPENSABLE AID TO THE SERVICE MAN

Here's the Book You've Been Waiting for!

Contains all available Service Data on all FADA Receivers \$1.00 Plus Postage

Send for it Now!

FADA OF NEW YORK
928 BROADWAY NEW YORK, N.Y.
Large Stock of Replacement Parts & Cabinets



The Famous Three!

Tinker, Evers and Chance were famous for Stamina, Efficiency and Fine Performance. So are all RACON Products!

There's a RACON speaker, horn and driving unit for every conceivable sound distribution application. Only RACON can supply, when needed, another famous three-in-one combination — Weatherproof, Stormproof, Acoustic Material which is impervious to any weather condition and prevents resonant effects.

Now that industrial war plants can obtain sound installations, remember that RACON's should be used to afford peak efficiency.

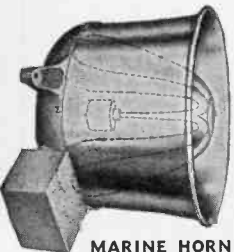

MARINE HORN



RE-ENTRANT TRUMPETS



P.M. UNITS

MARINE HORN SPEAKERS, approved by the U. S. Coast Guard, may be used as both speaker and microphone. Available in several sizes.

RE-ENTRANT TRUMPETS, compact, of the double re-entrant type, afford long air-column in small space; deliver highly concentrated sound over long distances.

P.M. HORN UNITS are available in operating capacities of 5 to 50 watts.

RACON ELECTRIC CO. 52 E. 19th ST., N. Y.

RACON

SUPREME

BY COMPARISON

★ Current Supreme Models

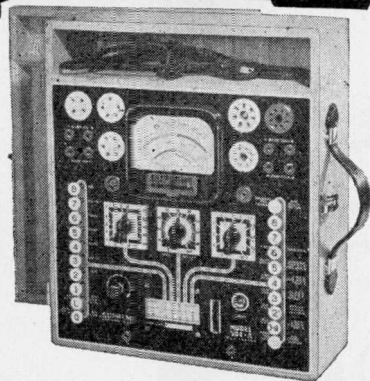

Model 504-A
Tube and Set Tester

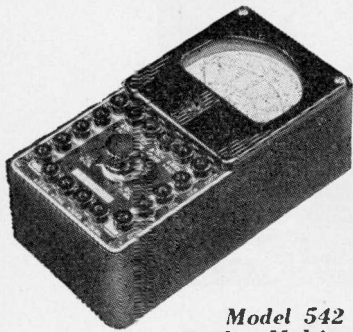

Model 542
Pocket Multimeter

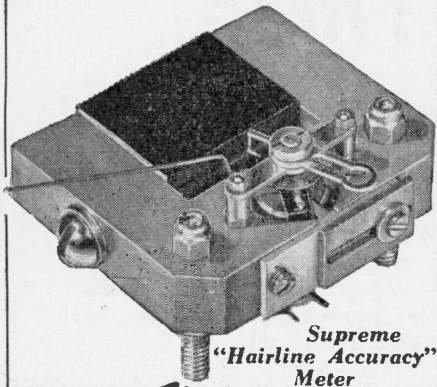

Whats New-

IN TEST EQUIPMENT?

Military secrecy precludes our answering that now. But radical new developments in testing techniques have been and are being perfected. Because of these important advances, when Victory comes your NEW Supreme Test Equipment will be, more than ever, "Supreme By Comparison."

SUPREME INSTRUMENTS CORP.
Greenwood, Miss., U. S. A.

A New High Speed Circuit Tester

(Continued from page 12)

swing in either direction. Audio frequencies between zero and 30 cycles will be indicated by their



Normal adjustment of indicator. If no d-c, a-c or a-f is present, the shadow angle will not change. It will register as low as a half-volt.



Negative d-c is indicated by partial or complete closing of shadow angle.



Positive d-c causes increased opening of shadow angle. Time to return to normal shows relative amount d-c.



A-c or a-f will produce deflection in positive and negative directions, and can be identified by medium light intensity over the deflection area.



Flickering in two directions shows irregular a-f peaks; in one direction, interrupted or pulsating d-c.

Figs. 2-A-B-C-D-E above

flickering and amplitude repetition. Speech and music can be defined by discontinuous flickering which in itself opens the way for using this indicator as an audio signal tracing device.

For high speed testing the old screw driver method can be revived, but this time the brutal part of it is overcome because of the high resistance input of the electronic indicator. You can quickly check for the presence of voltages where they belong or for the presence of undesired voltages, hum or signals where they do not belong.

In practical application it is easy to detect a leaky coupling capacitor with an internal leakage resistance around 1 or 2 megohms by observing polarity indications while probing at the grid side of the capacitor.

After the above leakage test has been made, a further check on coupling capacitors is a simple matter. By connecting a small capacitor, say of about .002 mfd. in series with the probe the d.c. plate voltage will be blocked, permitting only A.C. or audio voltage to influence the Indicator. With this adaptation the same a.f. indication should be apparent at both ends of the capacitor; if it is not, the capacitor may be open or grounded and consequently useless.

Should your problem involve intermittent output, the indicator as modified above, can be used as a high impedance monitor to test for the erratic action of a capacitor over a period of time sufficient to produce such behavior. Once connections are made for monitoring the signal through a suspicious part of any defective device it is not necessary to touch anything until the normal course of events have proven or disproven any questionable performance. Thus the problem of contact shock-curing poor internal capacitor connections is eliminated.

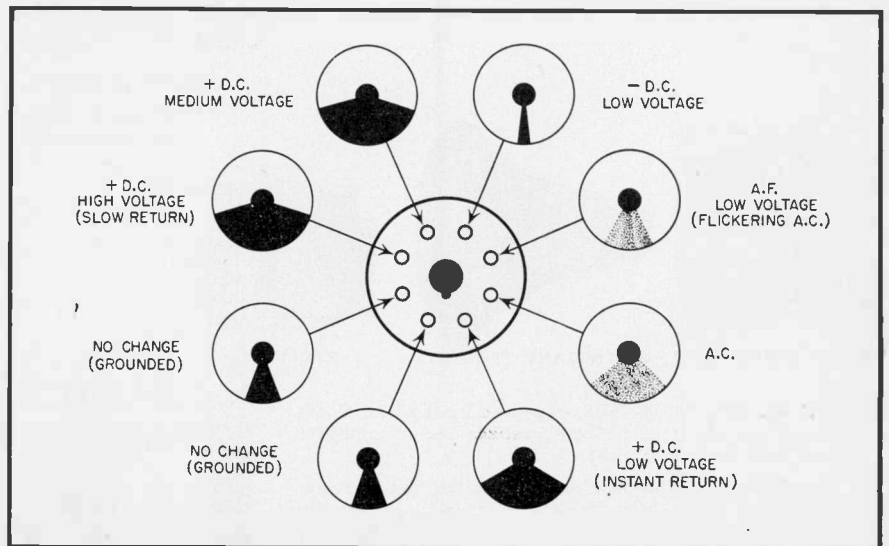
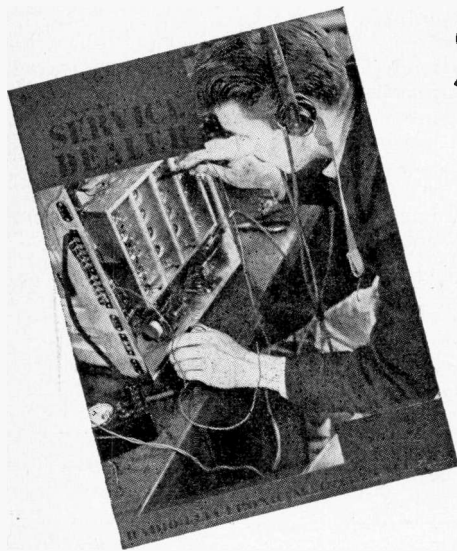

Figure 3



Subscribe NOW to radio service dealer

Approximately 1000 more new subscribers can be added to our lists under present paper restrictions. Old subscribers, extend your subscription today to make sure you don't miss out!

TEAR
OUT



AND
MAIL
NOW

RADIO SERVICE DEALER

(Remit by Check or Money Order. We cannot assume responsibility for cash sent thru mails).

COWAN PUBLISHING CORP.
342 Madison Ave., New York 17, N. Y.

Sirs: Here is my check (or money order) for \$.....Enter my subscription order for the next.....issues. The information given below is accurate. If my subscription is rejected I expect an immediate refund in full. Subscription Price: 12 issues \$2.—24 issues \$3. Canadian and Foreign subscription are \$3 annually.

Name (print carefully)

Address City State

Firm Name Year Est. 19.....

I am OWNER If some other classification or occupation, state it on the line below:
 DEP'T MGR.
 EMPLOYEE

Please check whether firm is

- | | | |
|---|--|--|
| <input type="checkbox"/> Radio Dealer | <input type="checkbox"/> Radio Wholesaler | <input type="checkbox"/> Hardware Store |
| <input type="checkbox"/> Radio Service Organization | <input type="checkbox"/> Music Store | <input type="checkbox"/> Electrical Appliance Dealer |
| <input type="checkbox"/> Automotive Store | <input type="checkbox"/> Any other classification (State it) | |

Post War Outlook
(Continued from page 32)

make a fair profit. By paying them we are going to have trained people ready who will be the foundation of the really large radio and appliance business we expect to do for the many years to come.

"We aren't going to wait and suddenly wake up some day to find that now that we can get plenty of merchandise we don't have an organization to sell it. And—to find that our competitors have all the good men and that we are many months behind in our advertising, promotion and selling campaigns. If we were to wait, it might take us years to catch up. We

prefer to have our competitors do the catching up."

Many retailers are today making complete plans for their post war radio and appliance departments. The enlarged department floor space plans are already laid out. Merchandising programs have been developed. Arrangements have been made for department heads who are to start work several months in advance of the time production will begin. Tentative arrangements have been made with salesmen—and so on.

There will be a big normal market for post war products. But it can be made bigger by creating a bigger demand. And that is what salesmen, advertising and sales promotion can accomplish.

Technical Service Portfolio
(Continued from page 21)

fixed-capacitance series padder in tuned L-C circuits in radio receivers, r.f. oscillators, and electronic test instruments (See Figure 1).

In order to prevent broadening of the selectivity curve of such a cir-

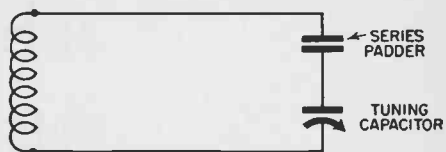

FIG. 1

cuit, it is necessary that the equivalent series resistance of the padder condenser be very low. Another manner of stating this requirement is by saying that the capacitor Q must be very high. Heretofore, mica condensers have met this requirement with no difficulty. However, the low-Q characteristic of the substitute paper condenser renders that unit totally unsuitable for use in high-frequency tuned circuits.

Certain receiver circuits in which automatic volume control is incorporated employ a fixed condenser in series with the grounded end of the inductor of a tuned circuit, as shown in Figure 2. Here, as in the first

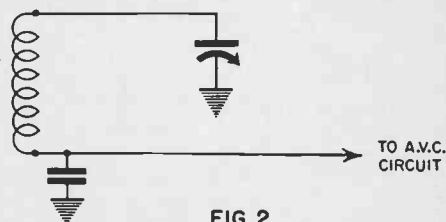
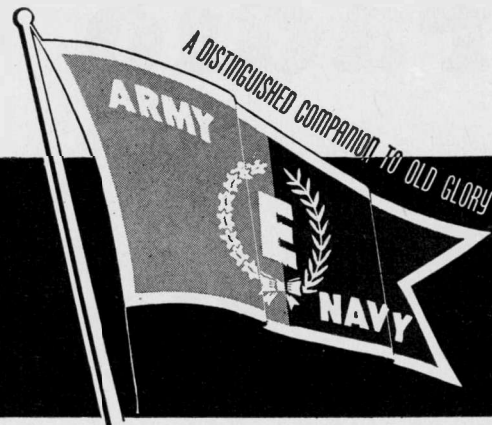

FIG. 2

case, the fixed capacitor is effectively connected in series with the coil and the variable condenser and will reduce the circuit selectivity unless the fixed unit possesses low equivalent series resistance. Present substitute paper condensers do not exhibit a sufficiently high Q to replace mica capacitors in this application.

(Continued on page 38)

Radio Service Dealer



for **EXCEPTIONAL PERFORMANCE**

INSULINE has been awarded the Army-Navy "E" for exceptional performance in the production of Radio-Electronic Products.

We are resolved that this honor shall be answered with stepped-up production . . . with new records of exceptional performance worthy of the trust placed in us by the Armed Forces.

Looking Ahead! Though engaged in vital war work, Insuline is looking ahead. We are gearing our organization for the post-war requirements of the Radio-Electronics Industry.

Write for 48-page Catalogue.



INSULINE

CORPORATION OF AMERICA

INSULINE BUILDING · LONG ISLAND CITY, N.Y.



TYPES OF
SCREW DRIVERS
and
SMALL TOOLS

Means
VACO
Amberyl

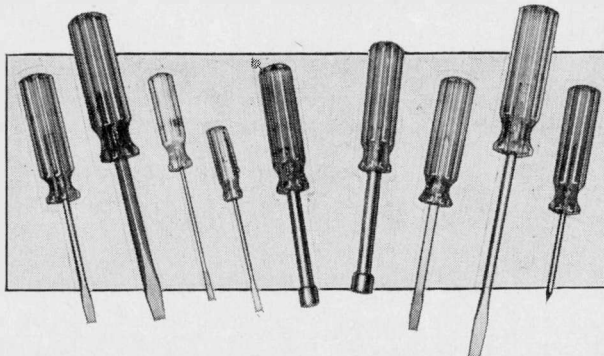

Has the Tool You
Need . . . To Suit
the Job It's
Needed For

VACO PRODUCTS CO.

309 E. ONTARIO STREET

CHICAGO 11, ILL.

Canadian Branch Warehouse: 560 King St., W., Toronto 2, Ont.

★ **He won't dodge this-** ★



Don't you dodge this!

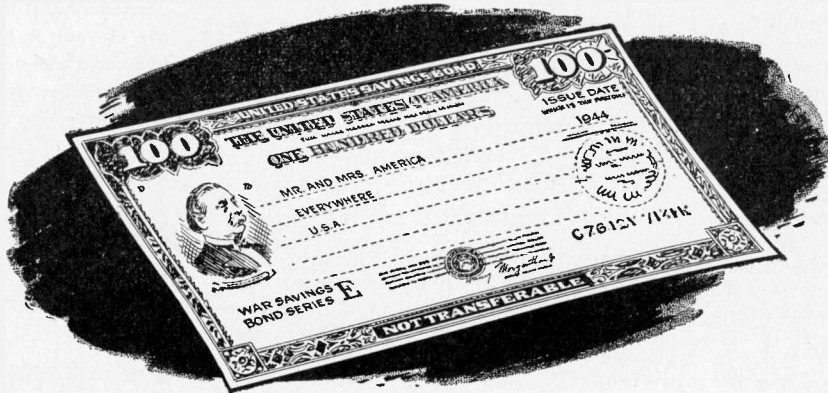

The kid'll be right there when his C. O. finally gives the signal . . .

There'll be no time to think of better things to do with his life. THE KID'S IN IT FOR KEEPS—giving all he's got, *now!*

We've got to do the same. This is the time for us to throw in everything we've got.

This is the time to dig out that extra hundred bucks and spend it for Invasion Bonds.

Or make it \$200. Or \$1000. Or \$1,000,000 if you can. There's no ceiling on this one!

The 5th War Loan is the biggest, the most vitally important financial effort of this whole War!



***Back the Attack!* - BUY MORE THAN BEFORE**

RADIO SERVICE DEALER

★

This is an official U. S. Treasury advertisement—prepared under the auspices of Treasury Department and War Advertising Council

★

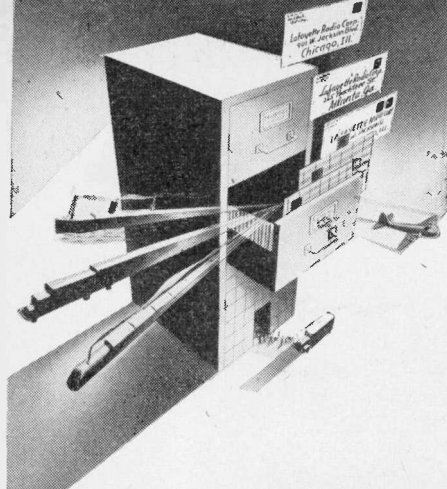

INTELLIGENTLY SPEEDILY...

The Lafayette Radio Corp. organization, built soundly over a period of 25 years, functions in two "key" shipping centers — Atlanta and Chicago. Yes, we maintain tremendous stocks of radio and electronic components and equipment. But, equally important, there are "brains" to go with them. Our men are truly appreciative of what you are up against these days... whether you're a giant of industry, the little service man around the corner, or represent a military agency or training school.

Because we are well versed in all fields utilizing electronics, your orders are handled intelligently. At our fingertips is complete data on shipping routes, priorities, effective substitutes... all things a purchasing agent wants to know. Write, wire, telephone or teletype — get to know the superior service of Lafayette Radio Corp.



NEW — 8-Page CIRCULAR, listing merchandise available for immediate delivery, will be rushed to you on request. All items are subject to prior sale. Write or wire Dept. K-7

P. S. We specialize in equipment for laboratory and experimental use. Such equipment built to your specifications if you desire.

Lafayette Radio Corp.

901 W. Jackson Blvd. 265 Peachtree Street
CHICAGO 7, ILLINOIS ATLANTA 3, GEORGIA

Technical Service Portfolio

(Continued from page 36)

Similar tuned or padded circuits containing only fixed capacitors (Figure 3) are employed occasionally at the high Q values imperative in r.f. circuits. Tuned audio amplifier plate and grid tanks, a.f. wave filters, and

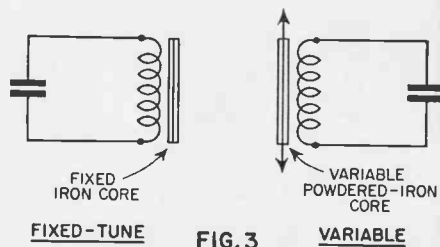

tone-control circuits are examples of this application in which the new substitute paper condensers are entirely satisfactory, provided they show low power factor at 1000 c.p.s.

The paper units can be used, also, for by-passing in r.f. circuits operating at frequencies up to the capacitor resonant point, and as far beyond as the ratio of reactance to by-passed-circuit resistance will permit. They are satisfactory for by-passing in audio-frequency circuits.

Figure 4 shows an ordinary superheterodyne receiver circuit in which permissible positions for substitute paper capacitors have been indicated.

DISCUSSION

(Continued from page 22)

"Fats," and this release is by way of a memorial to his undying music.

Eight tunes, including a new improvisational version of "Honeysuckle Rose," "Fats" most famous composition. "Your Feet's Too Big" and "Holt Tight" are humorous vocals; "Ain't Misbehavin'" is piano. "The Joint is Jumpin'" is a fast tune and "Two Sleepy People" sounds like it reads. Then there's "I Can't Give You Anything But Love, Baby" in a duet with Una Mae Carlisle, and "The Minor Drag"—one of Waller's first discs featuring "Fats" Waller and his Buddies—his original band. This album is a must for anybody's jazz department.

Wayne King and his Orchestra play both sides of record 20-1587. "Amor-Beguine" (with vocal refrain) and "I'm Gettin' Mightily Lonesome for You" (vocal by the Three Barries).

"Amor" is played with feeling, but no "schmalz." The other number is an appropriate tune for these days, and the Three Barries do a good job on it.

John Charles Thomas in Concert Favorites (Album M-966). A three-pocket, 10-inch selection of six ingenious songs which have become staples in the concert repertory: "Drink to Me Only With Thine Eyes"; "In the Gloaming"; "Your Presence"; "Fulfillment"; "Come



● Aerovox makes an exceptionally wide choice of heavy-duty and special-service capacitors, as distinguished from the usual radio capacitors in the general catalog.

Today these top-grade capacitors are virtually drafted for the requirements of our armed forces. Also, they service the aviation, police-radio, broadcasting and other high-priority requirements. However, tomorrow those heavy-duty, special-service capacitors will be available to you also, for use in your electronic and industrial assemblies and maintenance. Aerovox is already mobilized for the forthcoming Electronic Age. And Aerovox is helping you find your place in the greatly expanded opportunities of tomorrow.

See Our Jobber . . .

Ask him for a free subscription to the monthly Aerovox Research Worker. Ask for latest catalog. And order your capacitor requirements from him.

AEROVOX
Capacitors
INDIVIDUALLY TESTED

AEROVOX CORP., NEW BEDFORD, MASS., U. S. A.
In Canada: AEROVOX CANADA LTD., HAMILTON, ONT.
Export: 13 E. 40 St., New York 16, N. Y. Cable: 'ARLAB'

Radio
AND
ELECTRONIC
DEVICES

BURSTEIN-APPLEBEE CO.
1012-1014 McGee St. • Kansas City 6, Missouri

to Me In My Dreams"; "Tis the Day." Carroll Hollister is at the piano.

In all six songs, ranging as they do through every emotion, the natural and artistic qualities of this American baritone's voice are coupled with exceptionally fine diction. Each song is an entity, a miniature masterpiece of vocal artistry. . . . The man just loves to sing, and admits it: "I'm not happy unless I am about to sing, singing, or finishing a sing." . . .

Bluebird 30-0826 is shared by Charlie Barnet and his Orchestra and Alvino Rey's group. Barnet, with the capable assistance of baritone Bob Carroll, plays "I'll Remember April," while Alvino Rey and Yvonne King swing through the melody and lyrics of "Don't Take Your Love From Me."

Barnet's band is augmented by a violin section giving a smooth setting to Carroll's voice. The tune on the record flipover is tailor-made for the 'young love' department, and Alvino and Yvonne are their usual perfect match in it.

Bluebird 34-0715 gives us Yank Rachell, blues-singing "Bye Bye Blues" and "Katy Lee Blues." Original blues was "shouted" rather than sung, and Yank has clung to that first blues manner. The accompaniment is not so musical as it is rhythmical. Both sides of this Bluebird Race record are traditional blues in the twelve bar pattern, as originally played.

Sidelights on Plant Broadcasting

Psychologists note that the music programs played for war workers is creating a desire for classical music among people who never heard the works of the masters before. Various plants report employees requesting repeats of Beethoven, Bach, and Brahms. At one plant in the middle west an employee dropped a note in the request box asking the director to "play that Bronze Lullaby and Clair de Goon again."

Certain plants equipped with RCA internal broadcasting systems report that soft, sweet music is played in the company infirmary waiting rooms to soothe nervous patients. Nurses report that the music causes the patients to relax, thus aiding medical diagnosis and treatment.

A wartime substitute for the "singing messenger boy" has been devised by Fred Homer, director of plant broadcasting at the RCA Victor Camden plant. A glee club octet harmonizes "Happy Birthday" over the plant broadcasting system prior to announcing birthdays.

New Coil-Winding and RF Resonance Calculator

Allied Radio Corporation, Chicago, announces the release of a new slide-rule type rapid calculator, permitting quick and accurate determination of inductance, capacitance, and frequency components of series or parallel tuned RF circuits as well as inductance, turns - per - inch, wire type, wire size, coil diameter and coil length for single layer-wound solenoid type RF coils. All values, in either case, are found with a single setting of the slide and are extremely accurate. Price 25c.

July, 1944

IF YOU CANNOT REPLACE RADIO PARTS REPAIR THEM WITH

Walsco

PRODUCTS



Walsco RADIO CHEMICALS

- Speaker Cements
- Cements For Plastics
- Special Adhesives
- Contact Cleaning Fluids
- Noise Eliminating Compounds
- Radio Lubricants

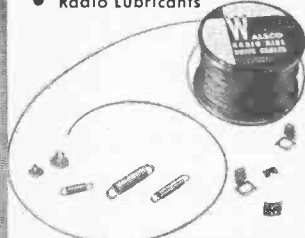

Walsco RADIO HARDWARE

- Dial and Knob Springs
- Trimounts, Set Screws

Walsco CABLES, BELTS

WALTER L. SCHOTT CO.

Manufacturers of

WALSCO PRODUCTS

For Communication Equipment Manufacturers,
Laboratories, Schools and Radio Repair Men

9306 Santa Monica Blvd., Beverly Hills, Calif.
Dept. RS-1

Of course—we are concentrating our efforts on war production—but not for a second are we neglecting the RADIO SERVICEMEN who require so many WALSCO RADIO PRODUCTS to keep the radios of their customers in perfect working order. Write today for WALSCO Catalogue No. 112, giving complete information about WALSCO PRODUCTS.

PERFORMANCE

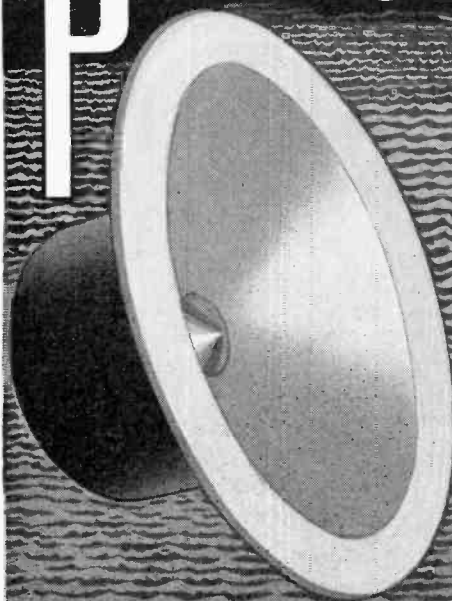

Today, front line performance that takes grueling punishment in stride — Tomorrow, the same unsurpassed performance for civilian use. In case delivery is slow, remember the armed forces get first preference. Watch Cinaudagraph Speakers After Victory!

Cinaudagraph Speakers, Inc.

3911 S. Michigan Ave., Chicago

"No Finer Speaker Made in all the World"



**YOURS
..FOR THE
ASKING**



Available from local dealers or by writing factory direct.

UNIVERSAL STROBOSCOPE

This handy phonograph turntable speed indicator, complete with instructive folder, is now available gratis to all phonograph and recorder owners through their local dealers and jobbers. As a recorder aid the Universal Stroboscope will assist in maintaining pre-war quality of recording and reproducing equipment in true pitch and tempo. Universal Microphone Co., pioneer manufacturers of microphones and home recording components as well as Professional Recording Studio Equipment, takes this means of rendering a service to the owners of phonograph and recording equipment. After victory is ours—dealer shelves will again stock the many new Universal recording components you have been waiting for.



ROLLING ON TO

Victory

★ Clarostat continues to be engaged 100% in the most important job of all—winning the war—on land, sea and in the air.

But after victory has been won, Clarostat promises the trade—servicemen, jobbers and others—that Clarostat products for initial and replacement uses alike, will once more be generally available for peacetime pursuits. Meanwhile, let's keep 'em rolling!



Permatone Needles Sell Well

Backed by an extensive promotional campaign in the trade press and featuring window displays at record dealers, the Garod Radio Corporation's campaign for its Permatone Phono Needles is at "flood-stage" now, it was announced this week by Sales Manager Lou Silver. Leading recording artists are highlighted in the series soon to be released.

In addition to full scale promotion for the three types of Permatone Phono Needles, now standard best sellers in the trade, Garod has also introduced a new recording stylus retailing for \$.50.

Definitely committed to a policy of selling direct to distributors, Garod is sparing no effort in its current advertising series to promote the best interests of the exclusive jobbers it has set up in its selling territories. This "exclusive-with-distributors" policy, long a feature of Garod merchandising, will continue into the post-war period, Silver added.

In addition, attractive packaging in three colors is proving its worth, as sales records of distributors testify. The Garod Standard Permatone Phono Needles sell for \$.50 and play 1500 recordings; the Superior Model retails at \$1.00 and plays 4000 discs, while the DeLuxe Model is priced at \$1.50 and plays 7000 records.

Featuring an exclusive "filter-trap" which absorbs shock and reduces scratches to an imperceptible degree, it has a highly polished, tempered surface. The velvet-smooth non-corrosive tip fits perfectly into the groove of the record and guarantees excellent fidelity of tone, even while protecting the surface.

Three Socket Wrenches Combined in One

Having the same approximate dimensions as a single socket wrench and with very little additional weight, the new Tesco Multi-Socket Wrench automatically accommodates #10 standard, #12 standard, 1/4" standard and light, and 5/16" light hexagon nuts. Merely by pressing the wrench over any of the three sizes of nuts automatically selects the proper nested hexagonal tube suited to that particular nut.

By no means a "gadget," the Tesco Socket Wrench is specifically designed for heavy duty service, making it unexcelled for factory production or servicing work of any kind. Its design is such that any stress incident to turning a nut is transferred to the outer hardened-steel casing. It is also designed to provide a clearance through the barrel for studs up to 5 1/2" length, thus making it ideal for turning nuts on long studs. Both handle and barrel have moulded insulation capable of withstanding a dielectric test for one minute at 5,000 volts RMS.

Descriptive literature will gladly be sent on request to the manufacturer, The Eastern Specialty Company, 3617-19 North 8th St., Philadelphia, Pa.

National Carbon Sales Setup

A new sales set-up under which all company products will be handled nationally from seven divisional offices is being installed by National Carbon Company, Inc. While the new system gives the division heads responsibility for sales of all company products, "Eveready" dealers will be served by men who give their whole time to it.

Ad Index

Aerovox Corporation	38
<i>Agency: Austin Lescarboursa & Staff</i>	
Brach Mfg. Co., L. S.	26
<i>Agency: United Adv. Co.</i>	
Burstein-Applebee Co.	38
<i>Agency: Frank E. Whalen Co.</i>	
Cinaudagraph Speakers, Inc.	39
<i>Agency: Michael F. Magyer</i>	
Clarostat Mfg. Co.	40
<i>Agency: Austin Lescarboursa & Staff</i>	
Electro-Voice Mfg. Co.	24
<i>Agency: Shappe-Wilkes, Inc.</i>	
Fada of New York	32
<i>Agency: Sternfeld-Godley, Inc.</i>	
Galvin Mfg. Corporation	3rd Cover
<i>Agency: Gourfain-Cobb, Inc.</i>	
General Electric Co.	3
<i>Agency: N. W. Ayer & Son, Inc.</i>	
Hallicrafters Co., The	29
<i>Agency: Burton Browne, Inc.</i>	
Insuline Corp. of America	36
<i>Agency: H. J. Gold, Advertising</i>	
International Resistance Co.	8
<i>Agency: The Lavenson Bureau</i>	
Ken-Rad Tube & Lamp Corp.	28
<i>Agency: Allen, Heaton & McDonald, Inc.</i>	
Lafayette Radio Corp.	38
<i>Agency: Shappe-Wilkes, Inc.</i>	
Mallory & Co., Inc., P. R.	2nd Cover
<i>Agency: Western Advertising Agency</i>	
Meck Industries, John	7
<i>Agency: The Aitkin-Kynett Co.</i>	
Meissner Mfg. Co.	27
<i>Agency: Gardner Advertising Co.</i>	
Racon Electric Co.	33
<i>Agency: Leon Allen, Advertising</i>	
Radio Corporation of America	5, 25
<i>Agency: Kenyon & Eckhardt, Inc.</i>	
Raytheon Production Corp., 4th Cover	
<i>Agency: Burton Browne, Inc.</i>	
Rider, John F.	30
<i>Agency: Lansford F. King Advertising</i>	
Schott Co., Walter L.	39
<i>Agency: Barton A. Stebbins</i>	
Sprague Products Co.	31
<i>Agency: The Harry P. Bridge Co.</i>	
Standard Transformer Corp.	30
<i>Agency: Burnet-Kuhn Adv. Co.</i>	
Supreme Instruments Corp.	34
<i>Agency: O'Callaghan Adv. Agency, Inc.</i>	
Sylvania Electric Products, Inc.	32
<i>Agency: Arthur Kudner, Inc.</i>	
United States Treas. Dept.	37
Universal Microphone Co., Ltd.	1, 40
<i>Agency: Ralph L. Power, Advtg.</i>	
Utah Radio Prods. Co.	10
<i>Agency: The Buchen Co.</i>	
Vaco Products Corp.	36
<i>Agency: Duane Wanamaker</i>	
Ward Products Corp.	2
<i>Agency: Burton Browne, Inc.</i>	

\$1.00 PAID FOR SHOP NOTES

Write up any "kinks" or "tricks-of-the-trade in radio servicing that you have discovered. We will pay \$1 in Defense Stamps for such previously unpublished "SHOP NOTES" found acceptable. Send your data to "Shop Notes Editor," RADIO SERVICE DEALER, 342 Madison Ave., New York 17, N. Y. Unused manuscripts cannot be returned unless accompanied by stamped and addressed return envelope.

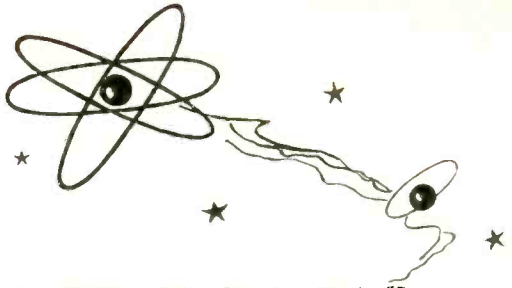

MIRACLES OF SCIENCE?



You Bet! But none that replace **SOLID SELLING**

Motorola Radio

CAVALRY GUIDON SET

Developed and built by
Motorola Engineers in co-
operation with Engineers of
the U. S. Army Signal Corps.



Scientific and technological progress have been kicked forward at a tremendously accelerated pace. To win wars there *must* be miracles of development and production. However, let us not lose sight of the somewhat slower tempo which prevails under normal competitive selling conditions.

Check the facts: 1. There *will* be a tremendously swollen consumer demand. 2. With their accumulated war savings, people will be ready,

willing, able and anxious to buy.

But, if past experience can be trusted at all, Mr. and Mrs. America will be very careful and twice as cagey about what they buy and where they buy it. They will have to be *sold*.

Manufacturers and retailers alike should take Mr. Miracleman off the payroll now. He always looks pretty in pictures, but he wilts fast when Mr. Solid Selling takes off his coat, rolls up his sleeves and goes to work.

GALVIN MFG. CORPORATION • CHICAGO 51



Motorola Radio

F-M RADIO ★ PHONOGRAPHS ★ RADAR ★ TELEVISION ★ F-M POLICE RADIO ★ MILITARY RADIO COMMUNICATIONS

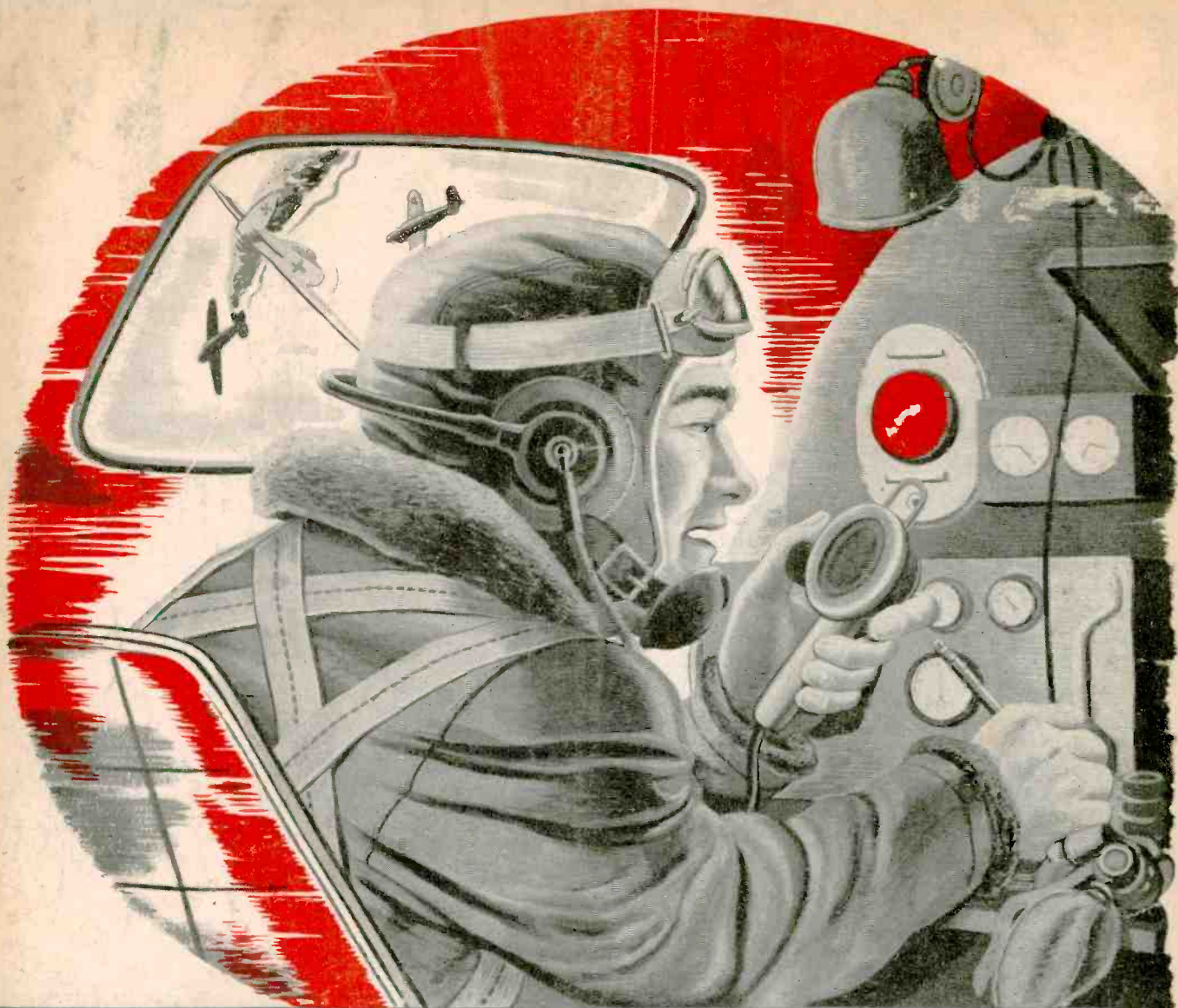

PROVING GROUND FOR EVEN BETTER
"RAYTHEONS" TOMORROW!

Electronic tube developments are being refined in the crucible of war at an amazing rate. Raytheon engineers are originating new designs—manufacturing techniques are greatly stepped up, and many new applications for electronic tubes have been found—applications that will contribute much to the postwar era of electronics.

Raytheon's research and great wartime production record will doubly protect the tube requirements of

postwar radio and industrial electronic equipment manufacturers. As before the war, the postwar Raytheon tubes will reflect the best engineering for all applications, as well as all the "Plus-Extra" performance qualities that have been synonymous with the name of Raytheon throughout the years.

Raytheon Production Corporation

Newton, Massachusetts • Los Angeles • New York
 Chicago • Atlanta



All Four Raytheon Divisions Have Been Awarded Army-Navy "E" Plus Stars

RAYTHEON

High Fidelity

RADIO AND ELECTRONIC TUBES



DEVOTED TO RESEARCH AND MANUFACTURE OF TUBES FOR THE NEW ERA OF ELECTRONICS