

ET/D

AUGUST 1981 • \$1.50

ELECTRONIC TECHNICIAN/DEALER
LEADING THE ELECTRONIC
SERVICE MARKETS

OP Amps II

Microprocessor tuning
Alarm installation

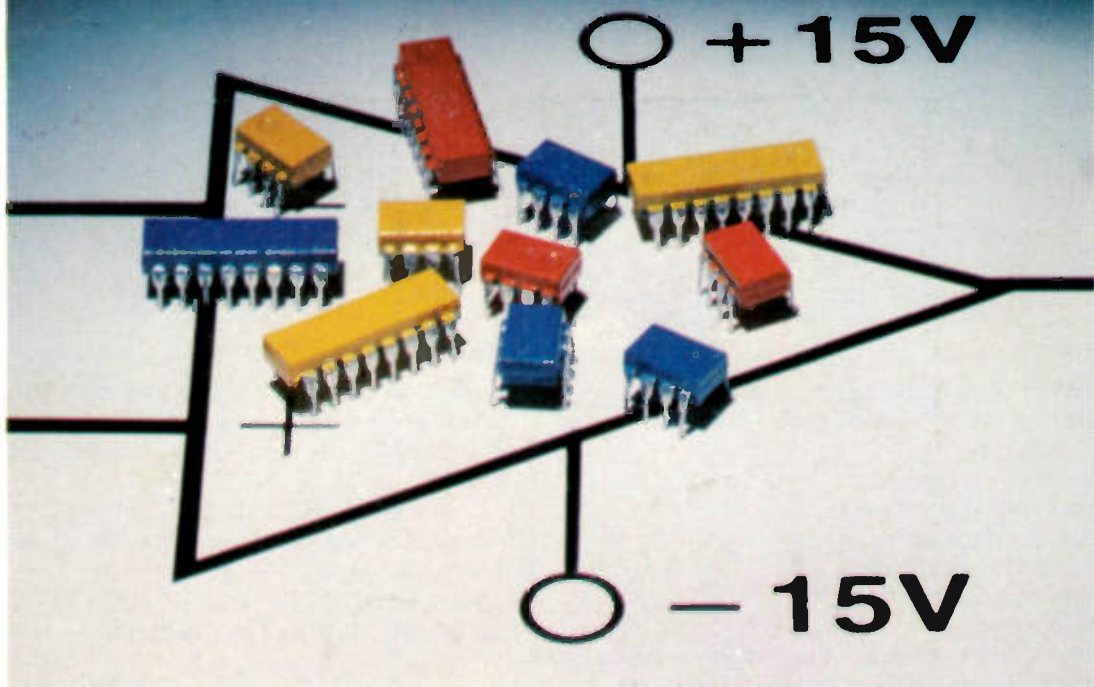

KDW 4038013-P2-
4823ADIR -379-
RAY KDWCK
27734 DENMAP
WARREN

AB

4PR82
-AS

MI 48093

Hundreds of Quality Test Accessories Under One Roof.

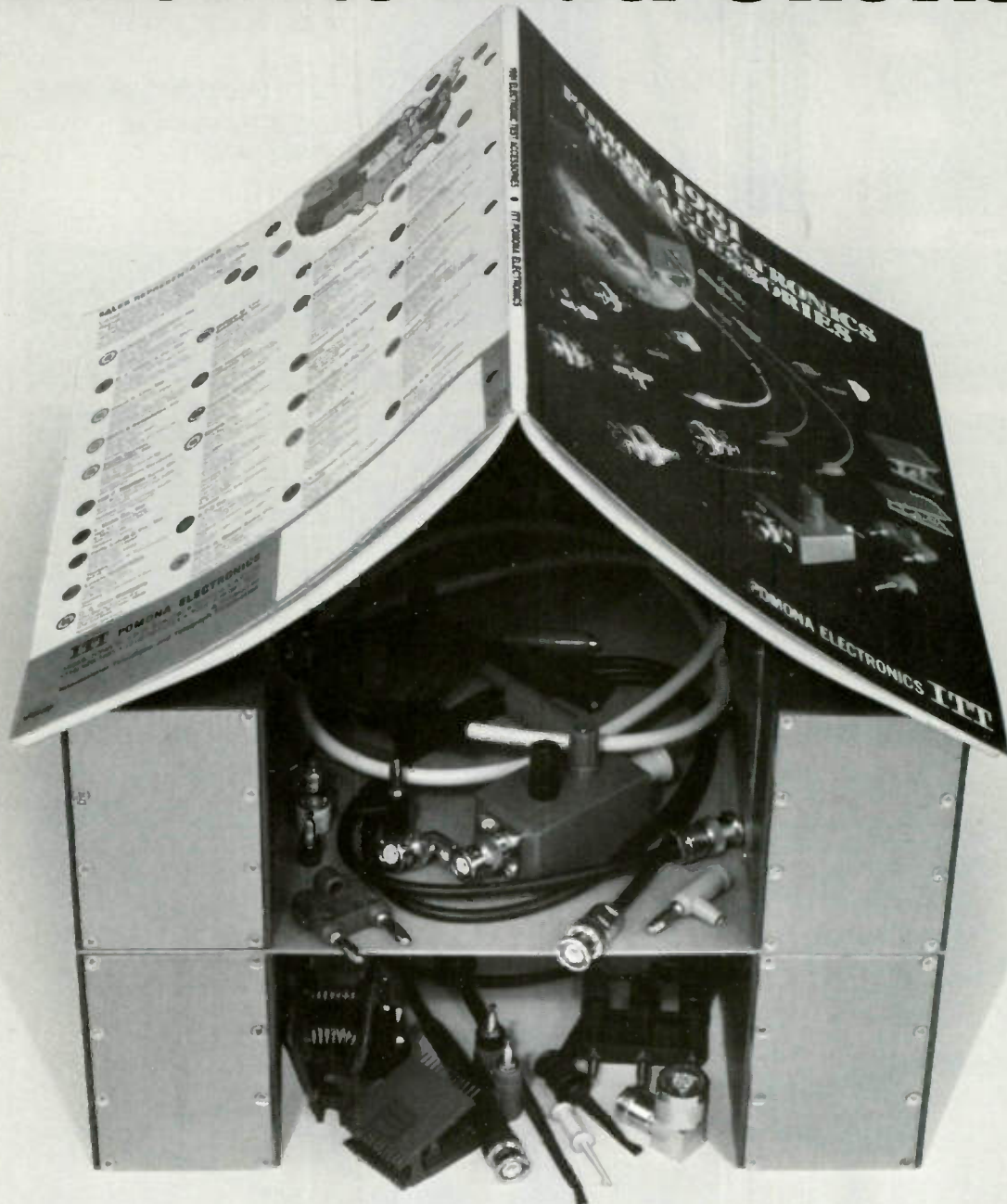

Your 1981 Pomona Electronics catalog is ready. And it covers more than 650 high-quality test accessories.

Bushels of black boxes.
Dozens of Dip Clip™ test clips.
Carloads of connectors.
Grosses of Grabber™ clips.
Armloads of adapters.
Pounds of pin tips.
Bunches of bananas. And much, much more.
Refer to your copy of the Electronic Engineers

Master (EEM) catalog for complete product in-

formation, or ask us for a free catalog today.

ITT Pomona electronics, 1500 E. Ninth St.,
P.O. Box 2767, Pomona, CA 91766. Phone (714)
623-3463.

In Europe, ITT Industries Belgium S.A., Pomona
Division, 250 Avenue Louise, Box 121, Brussels,
Belgium. Phone 02/640.34.00.

AVAILABLE THROUGH YOUR FAVORITE
ELECTRONIC PARTS DISTRIBUTOR

Consistent quality for a complex world.

Pomona Electronics **ITT**

Circle No. 109 on Reader Inquiry Card

INDUSTRY REPORT

ETA—Department of Defense Technician Certification Promotion

ETA-I (Electronics Technicians Association, International) has developed a program to offer its Certified Electronics Technician testing program to military personnel. The Department of Defense is now offering ETA exams at military installations through its DANTES program. (Defense Activity for Non-Traditional Education Support).

Under the government program, several other professions have similar DANTES contracts. Among these are the CPM (Certified Professional Managers); CQE (Certified Quality Control Engineer); CMT (Certified Medical Technologist); CET (Certified Engineering Technician) and the CAM (Certified Auto Mechanic) programs.

Ron Crow, CET, ETA's Director of Certification, said "The DANTES program should be a boost for technician certification as it provides information about the exams and registration at

each military post. It also establishes testing facilities and evaluation process by the educational unit of the defense department."

Interested technicians serving in the military should contact their education officers for testing times and dates and further information. Non-military technicians can receive more information by writing: ETA-Certification, PO Box 1258-ISU Station, Ames, IA 50010.

Admiral Electronic Parts Distribution

The Industry Report article in the April 81 issue of ET/D on Admiral parts distribution was worded incorrectly. The corrected information is: Admiral parts are handled on a factory direct basis only in those areas where distributors have been discontinued. Currently, authorized Admiral distributors are located in Los Angeles, Pittsburgh, Quincy, MA, E. Rutherford, NJ, Metairie, LA, York, PA, Philadelphia, Kingston, PA, El Paso, TX, Bluefield, WV, Lubbock, TX, Nashville, Dallas, and Honolulu. The toll-free WATS line for the Admiral dealer direct areas is 800-447-8361 (not 477), in Illinois the number is 800-322-0486.

Franchise Developments

Consumer electronics service shop franchising has made several recent advances. Tronics 2000 of Blooming-

ton, Indiana, recently announced that it has been licensed in California and Minnesota and now is authorized to solicit franchises in 39 states. Tronics 2000 recently sold the Minneapolis and St. Paul areas to Minnelex, Inc., the Cleveland area to a corporation headed by Paul Stetz, formerly associated with real estate franchising, and much of Cook County (Chicago, etc.) Illinois to an Oak Park businessman. At this time three shops fly the Tronics 2000 banner.

Two consumer electronics serveshop franchising operations have reportedly begun to operate in the Philadelphia area. One, called Tru-Vision, is said to be franchising locally, preliminary to going national.

FCC Urged To Expedite AM Stereo Proceeding

The Executive Committee of the National Association of Broadcaster unanimously voted recently to urge the Federal Communications Commission to make the resolution of the long-pending AM stereo proceedings a matter of "highest priority" and, as a means of furthering that objective, to assign sufficient engineering staff to assure expedited action. "Everyday that a decision in the AM stereo issue is delayed," the Executive Committee said, "the American public is being deprived of the benefits of this important technology."

WORKMAN & UTR

PROUDLY ANNOUNCE

THAT UTR ELECTRONICS IS NOW A DIVISION
OF WORKMAN ELECTRONIC PRODUCTS, INC.,
SARASOTA, FLORIDA



TV MODULES and TUNERS

UTR Electronics is one of the largest rebuilders
of modules and tuners in the world.

FAMOUS FOR:

- Quality Parts
- Quality Workmanship
- Same Day Service
- 1 Year Warranty

TUNER REPAIR AND REPLACEMENT

UTR Electronics

Division Of: WORKMAN ELECTRONIC PRODUCTS, INC.
801 ROSE CIRCLE, S.W. • ATLANTA, GA. 30310
Phone 404 753-5311

COMPARE OUR LOW PRICES

(EXR) SAME EXACT PARTS AS SYLVANIA ECG* LINE.

AT 50% TO 80% OFF SYLVANIA PRICES.

SYLVANIA ECG* TYPE NO.	SYLVANIA SUGG. RETAIL	OUR PRICE	SPECIAL (MIN. 5 PCS.)
ECG 165	13.50	2.95	SG 613 6.50
ECG 238	15.75	2.95	2SC867A 4.25
ECG 276	10.95	5.95	2SC1308K 2.45
ECG 500A	20.00	9.95	SE 5020 0.65
ECG 523	22.80	12.95	ECG 793 2.80
			ECG 794 2.60

COD ORDERS WELCOME (Min. Order \$25)

CALL TOLL FREE 800-526-4928

3 YEARS WARRANTY ON ALL PARTS.

DIGITRON ELECTRONIC Corporation

110 Hillside Ave. • Springfield, N.J. 07081

*ECG IS A TRADE MARK OF GTE SYLVANIA

ET/D

ELECTRONIC TECHNICIAN/DEALER

LEADING THE ELECTRONIC
SERVICE MARKETS

August 1981, Vol 103, No. 7

WALTER H. SCHWARTZ
Editor

PETER B. CREDIT
Assistant Editor

RAY ALLEGREZZA
Contributing Editor

TOM GRENEY
Publishing Director

DON FRASER
Graphic Design

MISSY JERSETT
Production Manager

LILLIE PEARSON
Circulation Fulfillment

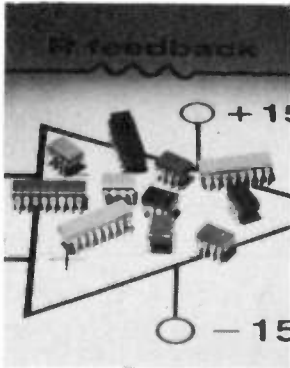

On The Cover: The operational amplifier! The concept is simple; the practical application and troubleshooting may be quite complex. But they appear in a variety of electronic equipment from test instruments to television sets and thus are featured on this month's cover to emphasize our second installment of a four part series on their application and troubleshooting.

FEATURES

Alarm installation

More basics 12

CET Quiz VIII

When are you going to take the test? 15

Op Amps, part II

What the textbooks don't tell you. 17

Magnavox Micro-Tune troubleshooting

Logically 30

DEPARTMENTS

Industry Report 3

Letters 5

From the Editor's Desk 7

Security Viewpoint 8

Newsline 10

TEKFAX 19

Test Instrument Report 36

New Products 37

Security Products 38

Classified Advertisements 40

Advertisers' Index 42

Reader Service 43



A HARCOURT BRACE JOVANOVICH PUBLICATION



ELECTRONIC TECHNICIAN/DEALER (ISSN 0192-7175) is published monthly by Harcourt Brace Jovanovich Publications. Corporate offices: 757 Third Avenue, New York, New York 10017. Advertising offices: 757 Third Avenue, New York, New York 10017 and 111 East Wacker Drive, Chicago, Illinois 60601. Accounting, Advertising Production and Circulation offices: 1 East First Street, Duluth, Minnesota 55802. Subscription rates: one year, \$12; two years, \$20; three years, \$26 in the United States and Canada; all other countries: \$40. Single copies: \$1.50 in the United States and Canada; all other countries: \$4.50. Second class postage paid at Duluth, Minnesota 55806 and additional mailing offices. Copyright © 1981 by Harcourt Brace Jovanovich, Inc. All rights reserved. No part of this publication may be reproduced or transmitted in any form or by any means, electronic or mechanical, including photocopy, recording or any information storage and retrieval system, without permission in writing from the publisher. ELECTRONIC TECHNICIAN/DEALER is a registered trademark of Harcourt Brace Jovanovich, Inc.

POSTMASTER: Send address changes to ELECTRONIC TECHNICIAN/DEALER, P.O. Box 6016, Duluth, Minnesota 55806.

LETTERS

HELP NEEDED

I am in need of an operation manual for a vacuum tube tester, distributed by the Commercial Trades Institute model no. TC-20. Will pay for copy or for a manual or information as where one may be obtained.

Brad Luttrell

General Delivery, Windsor, KY 42565

Needed: Audio output transformer, part no. 95-1698-A, for old tube type Zenith AM-FM-Stereo phonograph console, chassis no. 7G30 (amplifier). Zenith no longer manufactures or stocks this part.

William M. Suhly

456 Burritt Ave.

Stratford, CT 06497

I need a schematic for my tube tester, Model N.S. 802 Manufactured by Radio City Products Inc. New York City.

Jorge Sandi Prado

100 Cnetros Qeste Fabrica "Reyco"

Sto Tomas Calle Blancos

Guadalupe, San Jose

Costa-Rica

I can't find any info on Electric Cars-Kit Form. Would appreciate any help you can give me; companies, prices, schematics, etc.

Bruce's Electronics Shop

R. D. #2, Quince Rd.

Walnutport, PA 18088

Need two tubes ECLL800 or replacement tube 6KH8 for a Grundig table console radio. Will gladly purchase one tube if that is all that is available.

T.J. Litzow 708-18th Ave. S.W.

Rochester, Minn. 55901

Would like to hear from anyone using a R.W.S. Television Trainer, Model CL-35 for Technical Training.

Fred Happy

Acheron College P.O. Box 190

Kingston, Ontario K7L 4V9

Need a schematic for a Watch Master Model G-7 watch timing machine. Please!

Tim McCall

McCall's TV and Stereo

502 Main

Stockton, KS 67669

I need a schematic and/or service manual for a tektronix oscilloscope model 541.

Howard D. Waldren
3 Vincent Place
Oakdale, NY 11769

I would appreciate your printing this request for help in locating a vertical output transformer for a Magnavox TV receiver CH; T949. The part number is 32C004-1.

Russell Cothran

2213 T Place S.E.

Washington, D.C. 20020

OOPS:

In the March 1981 issue of ET/D an article titled 'Alarm Systems—Design and Sources of Supply' by John Sanger was presented on page 20. On page 24 of the article a chart showing the equipment and costs of a typical alarm system was shown. Near the bottom of the chart the author states that a PROFIT MARGIN of 30% is determined by multiplying the total system cost of \$697.45 by 30% yielding \$209.24 in profit. Mr. Sanger misleads the reader of his article by using the wrong term. PROFIT MARGIN, to describe the profit figure of \$209.24 that was determined. The proper term is MARK-UP. These two terms are often confused as being one in the same but in fact are not. The

term MARK-UP is used when the cost of the material is known and the retail price is unknown. PROFIT MARGIN is the term used when the retail price is known and the cost of the material unknown. In the chart on page 24 the cost of the system is known and the retail price is the unknown so MARK-UP is the correct term that should have been used. Now that we know when each term is used, we can understand why a PROFIT MARGIN of 30% is not the same as MARK-UP of 30% as implied by the chart. The following example using the figures from the chart points this out.

DEALER COST	\$697.45
MARK-UP (30%) × .30	
PROFIT	\$209.24
RETAIL PRICE	\$906.69
PROFIT MARGIN (30%) × .30	
PROFIT	\$272.01

As you can see the two profit figures are not the same. In reality, if there is \$209.24 of profit in a sale of \$906.69, the PROFIT MARGIN is not 30%, but 23%. this is 7% less profit on the sale than is implied by Mr. Sanger's chart. I hope ET/D will publish a correction to this mistake so that it's readers are not

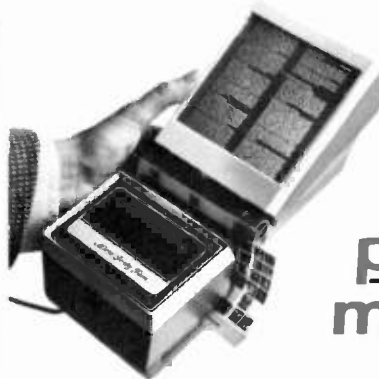

Now you've got us
where you want us...
right in the palm
of your hand!

First practical,
personal size
microfiche reader.



Installation
schematics



Customer service

Micro Forty Four. Puts a world of information at your fingertips—on service calls, in the field, outside office or in home. And, naturally, it comes from the leading manufacturer of micrographic readers. The design is a marvel of simplicity. Flip up viewing hood and our advanced optical system projects a bright, clear image on the full 5-1/2" diagonal screen. Operates on batteries, 110V or car lighter. Weighs less than 1-1/2 lbs. Fits a tool case.

Micro Forty Four is a small miracle, ideal for service personnel. Call or write now for information on the affordable new personal size **Micro Forty Four** Reader from Micro Design: the Reader Leader.

MICRO DESIGN

DIVISION OF BELL & HOWELL CO.

857 W. State Street

Hartford, Wisconsin 53027

(414) 673-3920

Circle No. 107 on Reader Inquiry Card

ET/D - August 1981 / 5

mislead into thinking that by Marking-up their merchandise by 30%, they are making a 30% profit Margin on the sale.
 David Odette
 Manager
 Marcraft Inc.
 Highway 59 No.
 Thief River Falls, MN 56701

Editor: I am afraid ET/D's editors are better Technicians than Accountants. You are quite right. As a matter of fact I think the dealer should get the 30% profit. We'll try to keep our business profitable.

AUDIO

Enjoyed our meeting at SCES and am indeed delighted that you chanced to stop by the Professional Audio Retailers Association booth.

PARA is involved in many projects of great importance to the audio specialty industry. Currently, we are making plans for a computer seminar to be held in Kansas City within the next few months, research is being undertaken toward development of a sales training course for our membership, an advertising program to be conducted in conjunction with our manufacturer associate members is getting underway, for

our second annual one-on-one, CEO conference to be held in Spring of 1982, and perhaps most important to your readers, a research project on the state of service in the audio industry is being developed by our Board members which will lead to the publication of a position paper by PARA within the next few months.

Our first one-on-one conference, held last April in Kansas City, was an enormous success. As one indication of that, PARA's membership has more than doubled since that event. We are an organization of audio specialty dealers, formed a bit more than 2 years ago, whose goal is to improve the business climate, and quality, of the audio specialty industry. President of PARA is Walt Stinson of Listen Up, Denver, Co, Vice President Wayne Puntel, Audio Craft, Cleveland, OH, and our Secretary-Treasurer is Ted Ave-Lallemant, Beatty Electronics, Kansas City, MO. PARA was founded at the suggestion of David Beatty, formerly David Beatty Stereo, Kansas City, MO, in late 1979 and has progressed, more swiftly the last few months, to where we are today: some fifty members, both regular and associate manufacturer.

We would welcome inquiries from

audio specialty dealers who may read your publication and can be reached at (816) 444-3500 or at 9140 Ward Parkway, Kansas City, MO 64114. I, or our Executive Director Ms. Rita Matthews, would be more than happy to answer any queries regarding PARA.

Look forward to visiting with you again at WCES in Las Vegas.

Jerry Fogel
 Executive Vice President

TEKFAX

I would appreciate any help in obtaining copies of the following TEKFAX numbers: 102, 109, 110, 111, 112, 113 and 114, and a copy of Howard W. Sams, Color TV Servicing Made Easy, Vols. 1 and 2, by Wayne Lemons and Carl Babcoke.

Lee Randolph
 710 Morton St. N.W.
 Washington, DC 20010

I would like to sell my complete TEKFAX collection which is in heavy ring binder books and dates back to 1965 right up to the present time. I also have in addition, TEKFAX Vol. 106, 110, 112 and 114. No reasonable offer refused.
 Robert J. Spachman
 109 S. 5th St., Souderton, PA 18964

Price Without Sacrifice.



HITACHI V-302B & V-152B

Put a proven Hitachi dual-trace oscilloscope on your bench for as little as \$735. Our V-152B 15MHz model includes unprecedented sensitivity (1 mV/div.)...10X sweep magnification...front panel XY operation...trace rotation...Z-axis input...and more. Need greater bandwidth? Our V-302B model is the only 30MHz dual-trace scope with signal delay line priced under \$1000, with all the above features, to make your testing operations fast, easy, and accurate. Reliability is exceptional, too. (As you'd expect from a manufacturer with over 20 years of experience "outscoping" the competition.) So exceptional, in fact, that Hitachi quality is backed by a 2-year warranty...the longest in the industry. Whether you use it for teaching or repairs, for video, audio, or computer testing, you can't find more scope for your dollar than at Hitachi. Write for more details.

Hitachi...The measure of quality.

- V-152B 15 MHz Dual Trace . . . \$735*
 - V-302B 30 MHz Dual Trace . . . \$995*
- *Probes included.



HITACHI
 Hitachi Denshi America, Ltd.
 175 Crossways Park West
 Woodbury, NY 11797
 (516) 921-7200

Circle No. 105 on Reader Inquiry Card



Walter H. Schwartz, *Editor (Duluth)*

Peter B. Credit,
Assistant Editor (Duluth)

Tom Greney, *Group Vice President
Publishing Director (Chicago)*

Don Fraser, *Graphic Design*

Missy Jersett, *Production Manager*

Diane Blesener, *Production Supervisor*

Lillie Pearson, *Circulation Supervisor*

Gene Bailey, *Reader Service*

Julie Laitin, *Promotion Director*

Dawn Anderson, *Classified Ad Mgr.*

Please submit editorial
manuscripts to:
Editor ET/D, 1 East First Street,
Duluth, Minn., 55802.

ADVERTISING SALES

Please send all advertising material to:
ET/D, Production Mgr.
120 West Second Street
Duluth, Minn. 55802
(218) 727-8511

East Region
Steve Del Duca
757 Third Avenue
New York, N.Y. 10017
(212) 888-4382

Midwest Region
Keith Lewis
111 East Wacker Drive
Chicago, Ill. 60601
(312) 938-2325

Southern Region
Chuck Cummings
613 N. O'Connor
Irving, TX 75061
(214) 253-8678

Western Region
Joyce Amiri
10741 Moorpark St., Suite #21
North Hollywood, CA 91602
(213) 980-7750 or (213) 760-1684



HARCOURT BRACE JOVANOVIĆ PUBLICATIONS

Robert L. Edgell, *Chairman*
Richard Moeller, *President*
Lars Fladmark, *Executive Vice President*
Arland Hirman, *Treasurer*
Thomas Greney, *Group Vice President*
Ezra Pincus, *Group Vice President*
Lawrence Witchel, *Group Vice President*
Joe Bilderbach, *Vice President*
James T. Gherna, *Vice President*
George A. Glenn, *Vice President*
Harry D. Ramaley, *Vice President*

FROM THE EDITOR'S DESK

Exciting and astonishing things are going to happen in consumer electronics in the next few years. Predictions by reputable forecasters assert that because of the expected explosion of video-based consumer electronics, the overall need for service will increase greatly in three to five years. Predictions have been made that the average household will spend about two thousand dollars per year by 1990 on consumer electronics equipment, software and service. It appears that though service per unit has declined greatly, the number of units of consumer electronic equipment is still to increase.

What are some of the factors, large and small, producing this increase? The first is the increase in video program material becoming available on tape, disc, through cable and soon direct broadcast satellite. VCR sales increase steadily, are reportedly up 139% so far this year. Video discs are apparently off to a somewhat slow start, though RCA says they are good, and as expected. With almost everyone getting into the act, the discs will catch on. I do foresee a reduction in relative cost of both players and discs as production bugs are worked out. The availability of more diverse programming via cable or satellite is imminent. Cable systems are being built with 50 to 100 channel capability. Direct broadcast satellite however may be the real source. RCA is about to apply for a direct broadcast satellite system license. According to *Television Digest*, DBS Corporation intends to file an application for the launch of three satellites each capable of 10 channels of video. Each satellite would cover an area of the U.S. Malcom Forbes, in his "Fact and Comment" column of *Forbes* magazine for June 8, 1981, says of the relationship of cable and DBS: "But putting all your bucks on one costly wire to each house? In less than 60 months, for \$300, more or less, every house and apartment will be able to stick a dish-topped mast on the roof and, with it, tune in on any one of the countless programs being beamed to and from most anywhere."

Another need for video displays is presented by teletext. About a quarter of a million teletext sets are now in use in Europe. According to the British, teletext receivers, costing about \$250 more than a standard television set have been selling at the rate of about 8000 per month. The cost premium, now about 25%, is expected to fall to 10-15% by 1982 and teletext may well be a standard feature soon thereafter—another reason for making sure of your digital electronics/microprocessor knowledge.

For those who diversify and adapt, the future is reasonably bright. If you cannot, straight television service will continue to decline, and you may soon have to look for another job or retire.

To see what you, our readers, think and do ET/D will be conducting a two part survey; a list of questions and a postage-paid return card will be the first thing you see when you open ET/D's next two issues. This survey will tell us something about you, and, what you want to see in ET/D. You will not have to identify yourselves on the return card and we will let you know the results after they are tabulated. We would like to be deluged with returns and I encourage you to take a few minutes to answer.

Sincerely

OPTIMA VALUE SALE

TO ORDER CALL TOLL FREE 1-800-327-0224

G.E. SYLVANIA, ZENITH 75% Off LIST NEW-BOXED

<input type="checkbox"/> 3A3	5 for \$11.88	<input type="checkbox"/> 6HV5	5 for \$26.19
<input type="checkbox"/> 6BK4	5 for \$22.06	<input type="checkbox"/> 6JE6	5 for \$24.75
<input type="checkbox"/> 6CJ3	5 for \$11.06	<input type="checkbox"/> 6LB6	5 for \$23.81
<input type="checkbox"/> 6FQ7	5 for \$ 9.19	<input type="checkbox"/> 6LF6	5 for \$24.75
<input type="checkbox"/> 6GF7	5 for \$16.06	<input type="checkbox"/> 17JZ8	5 for \$12.94
<input type="checkbox"/> 6GH8	5 for \$ 9.38	<input type="checkbox"/> 38HE7	5 for \$22.69

All Tubes Not Advertised, Write in at 75% off list. Sleeves Only. Singles 72% off list.

TRANSISTORS & I.C.'s . . . MIN. 5 Year Guarantee

<input type="checkbox"/> 2SC1172 Toshiba	\$2.95	<input type="checkbox"/> 1166BA521	\$1.25
<input type="checkbox"/> 2SC867A Sony	\$3.95	<input type="checkbox"/> 2SC1172B	\$1.95
<input type="checkbox"/> SG613 Sony	\$6.95	<input type="checkbox"/> 2SC1308K	\$1.95
<input type="checkbox"/> TA7222 Toshiba	\$1.50	<input type="checkbox"/> 2SC1358A	\$1.95
<input type="checkbox"/> TA7204P Toshiba	\$1.00	<input type="checkbox"/> 165	\$1.95
<input type="checkbox"/> TA7205P Toshiba	\$1.25	<input type="checkbox"/> 238	\$1.95

REPLACEMENT FOR ECG

<input type="checkbox"/> 130	\$.75	<input type="checkbox"/> 196	\$.59	<input type="checkbox"/> 791	\$1.50
<input type="checkbox"/> 152	\$.49	<input type="checkbox"/> 197	\$.59	<input type="checkbox"/> 792	\$1.50
<input type="checkbox"/> 153	\$.49	<input type="checkbox"/> 230	\$2.84	<input type="checkbox"/> 793	\$2.00
<input type="checkbox"/> 171	\$.59	<input type="checkbox"/> 291	\$.95	<input type="checkbox"/> 808	\$1.50
<input type="checkbox"/> 182	\$1.50	<input type="checkbox"/> 292	\$.95	<input type="checkbox"/> 819	\$1.50
<input type="checkbox"/> 183	\$1.50	<input type="checkbox"/> 329	\$1.60	<input type="checkbox"/> 822	\$2.00
<input type="checkbox"/> 186	\$.55	<input type="checkbox"/> 712	\$1.00	<input type="checkbox"/> 820	\$2.00
<input type="checkbox"/> 195A	\$.75	<input type="checkbox"/> 731	\$1.00	<input type="checkbox"/> 1167	\$1.95

ZENITH, RCA & SYLVANIA MODULES

<input type="checkbox"/> 9.79	\$ 2.95	<input type="checkbox"/> 145256	\$11.56
<input type="checkbox"/> 9.92	\$ 8.95	<input type="checkbox"/> 145262	\$18.95
<input type="checkbox"/> 9.147	\$10.50	<input type="checkbox"/> Rep. ECG500A	\$ 9.95
<input type="checkbox"/> 150.190	\$12.95	<input type="checkbox"/> Rep. ECG523	\$13.95
<input type="checkbox"/> 138697	\$13.23	<input type="checkbox"/> Rep. ECG526	\$14.95
<input type="checkbox"/> 139546	\$17.36	<input type="checkbox"/> 32-39202-3	\$14.95
<input type="checkbox"/> 141154	\$19.60	<input type="checkbox"/> 32-43068 1	\$14.95
<input type="checkbox"/> 141427	\$19.33	<input type="checkbox"/> 32-41658-3	\$14.95

GENERAL

<input type="checkbox"/> VEH070 & 076 VIDEO HEAD	\$49.95 @
<input type="checkbox"/> 2 1/2 Amp 1000 PIV	100 for \$ 8.00
<input type="checkbox"/> 3 Amp 1000 PIV	100 for \$15.00
<input type="checkbox"/> STEREO Y ADAPTER 1/4"	10 for \$ 4.90
<input type="checkbox"/> 9 ft. 59U F-F 99c		<input type="checkbox"/> 10ft 59U F-F \$ 1.09

Quantity Prices Available

Letters of credit and all checks placed on deposit with Bank of Hallandale, FL. VISA/Bank Americard & Master Charge accepted. Min. order \$75. FOB Dania, FL. Catalog \$3, refundable upon order.

SEND CHECK OR MONEY ORDER TO:

OPTIMA ELECTRONICS

2022 Tigertail Blvd., Dania, FL 33004

Phone (305) 920-3550

TOLL FREE 1-800-327-0224

Circle No. 108 on Reader Inquiry Card

SECURITY VIEWPOINT

By Ray Allegrezza

You may want to consider leasing as opposed to a one time installation. It builds revenues and with monies coming in every month from leased jobs you can better keep a positive cash flow going.

While your supply of cash may initially be depleted somewhat by the purchase of the leased equipment, you will be getting revenue back on equipment you own.

Be selective when you buy, but don't be afraid to buy! If the XYZ Alarm Manufacturing Co. is running a special on the type of panels you happen to use, increase your order.

One dealer I recently spoke to, Bill Cereske of North American Alarms in San Francisco, said he is currently "sitting on 60-70 control units." Seems unwise? Not at all. "I know I'll use them in the near future, and because I have them here, and I bought them at a good price, my bids on leased jobs are very hard to beat."

Whenever possible try to finance yourself. Put your money into selling new accounts and upgrading existing ones. Remember if you can see your way clear to finance yourself, the money you owe costs you 20% less than money borrowed from a lending institution.

If you are considering expanding your business and increasing your sales or installation department, now is a good time to do it. With money being tight, people are looking for work. My dealer friend in San Francisco said "we had a lot of people in my area looking for work. I got a number of suitable applicants who were willing to come in on an entry level.

Keep one thing in mind. Inflation and recession are detours to any business. This doesn't have to mean the road is permanently closed.

The prime rate. Nobody is happy about it, but it appears that it is a fact of life we are all going to have to live with for some time.

With the lending rate hovering around 20 per cent, the small business has to think twice before borrowing money for any reason.

In my opinion, the safest thing you as a security dealer/installer can do right now is to avoid 'swimming in financial waters that you know are over your head.'

By this I mean now would not be a good time to invest in sophisticated equipment. Especially if you have to borrow money to purchase (and who doesn't these days?). While the more sophisticated systems are fine in terms of capabilities, they are more expensive than your panels, bells and sirens. How often will you be called upon to install such a system? To borrow money (at about a 20% interest rate) just to have these systems sitting on your shelf can be a disaster.

Now more than ever is the time to turn towards the use of reliable distributors. By dealing with the distributor you don't have to carry a lot of equipment that you may not need. The distributor is also in a much better position to carry inventory than the small dealer.

Another thing you can do is to be more selective in your ordering of parts and materials. Keep a close watch on *what is selling, how fast it sells, how much it sells and how often it needs to be reordered.*

ATTENTION TECHNICIANS

- ★ JOB OPENINGS
- ★ MONTHLY TECHNICAL TRAINING PROGRAM
- ★ BUSINESS MANAGEMENT TRAINING
- ★ LOW COST INSURANCE
- ★ CERTIFICATION
- ★ TECHNICAL SEMINARS

All of this in a nonprofit international association for technicians

FIND OUT MORE:



7046 DORIS DR.

INDPLS., IN. 46224

Wm. B. Allen Can Help You Close More Security Sales With These Professional Demonstration Kits

For years, successful security salesmen have depended upon professional demonstration kits to dramatically show their products and services, interest and involve their prospects, keep their presentation on track and close more sales.

Now, Wm. B. Allen has available two of the security industry's most popular demonstration kits.

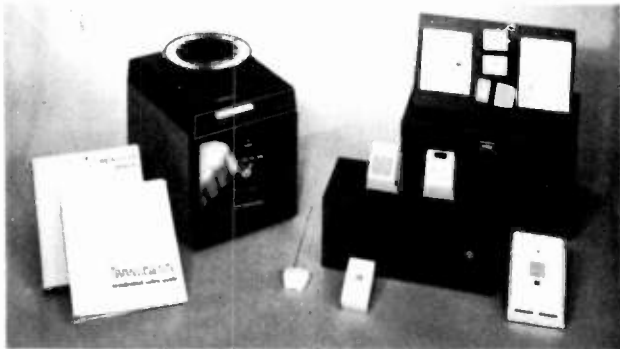

Transcience Industries RSK-1 For Wireless Systems

TRANSCIENCE INDUSTRIES RSK-1 FOR WIRELESS SYSTEMS

A complete in-home presentation, demonstration and sales package featuring labor saving wireless security systems. Includes a custom audio-visual presentation, portable forward and rear screen projector, working equipment display and sales and installation guides. Truly one of the most complete residential sales kits available.

FIRE BUGLARY INSTRUMENTS DEMO 90 FOR HARD WIRED SYSTEMS

Designed to provide an easy to use and understand demonstration of proven hard wired security systems. Its color graphics, lighted digital and led displays, working components and contemporary packaging will make any presentation simpler and more effective.



Fire Burglary Instruments Demo 90 for Hard Wired Systems

CALL TOLL FREE FOR COMPLETE INFORMATION 800 535-9593

Whether you are just beginning or have already established yourself as a security dealer, these demonstration kits can help increase your confidence, reduce your sales time and significantly increase your income.



THE 1981 WM. B. ALLEN CATALOG

Featuring America's leading manufacturers of security, fire, video, sound and intercom equipment. Hundreds of photographs, diagrams, comparison charts, specifications, new product listings and special educational sections. The \$5.00 catalog fee is refundable with your first order.

Call Toll Free To Order Your Copy

800 535-9593

NATIONWIDE

800 462-9520

LOUISIANA ONLY

WM. B. ALLEN SUPPLY COMPANY, INC.

1601 BASIN STREET, NEW ORLEANS, LA 70116

WHEN THE PROBLEM IS WHERE TO FIND IT, THE SOLUTION IS WM. B. ALLEN.

Circle No. 101 on Reader Inquiry Card

NEWSLINE

FIRST CLASS RADIO TELEPHONE (OPERATOR) LICENSE ELIMINATED. The Federal Communications Commission recently voted to eliminate First Class Radio Telephone license requirements and the license itself. A new examination, for a General Radio telephone license, roughly equivalent to the Second Class examination will be available soon. At present First Class Radio Telephone License renewals will receive a Second Class Radio Telephone license. Once the General Radio Telephone License is available all renewals will receive it. Responsibility for technical capability is now that of the station licensee.

RCA TO MAKE DBS APPLICATION. RCA American plans to file an application for a Direct Broadcast Satellite system by July 16 according to Television Digest. It is speculated that RCA, unlike Comsat, intends to become a common carrier rather than a broadcaster.

U.S. COLOR TV MARKET SHARE. Color Television market share for 1980 and projected share for 1981 figures were recently published by Television Digest.

Rank	Brand	1981 % share	1980 % share
1	Zenith.....	20.5	20.5
2	RCA.....	20.0	21.0
3	GE.....	7.7	7.5
4	Sears.....	7.2	7.5
5	Sony.....	7.0	6.5
6	Magnavox.....	6.9	7.0
7	Quasar.....	4.9	5.0
8	Sylvania.....	4.0	4.0
9	Montgomery Ward...	2.7	2.25
10	Panasonic.....	2.1	2.0
11	Sanyo.....	2.0	2.0
12	Hitachi.....	2.0	1.7
13	J.C. Penney.....	1.5	1.5
14	Sharp.....	1.5	1.5
15	Philco.....	1.2	1.2
16	MGA.....	1.2	1.0
17	Toshiba.....	1.1	1.0
18	Curtis Mathes.....	1.0	1.0
19	Gold Star.....	0.8	---
20	Sampo.....	0.5	---
21	Samsung.....	0.4	---
	All others.....	3.8	5.25

24 HOUR VIDEOCASSETTE POSSIBLE. A hybrid digital-analog scanning system, now under development by Jones VVS, Inc., could cram 24 hours of video into audio-sized cassette with 1/8 in. tape--at least theoretically--according to backers. First use of technique, however, will be more modest--theft-proof encryption of pay-TV signals. Other applications are seen as high-definition pictures in standard TV channel, two or more conventional pictures on single channel.

**PHILIPS KNOWS
HOW TO SUCCEED
IN BUSINESS.
THEY JUST BOUGHT
SYLVANIA ECG.**

SYLVANIA RECEIVING TUBES
SYLVANIA ECG® SEMICONDUCTORS

SYLVANIA PICTURE TUBES
SYLVANIA SPECIAL PRODUCTS
SYLVANIA DATA DISPLAY TUBES

Philips ECG, Inc.

A NORTH AMERICAN PHILIPS COMPANY

Alarm Installation

Basics

Alarm systems are not complex in concept; however, as a practical matter, installation may be quite difficult. Here are some of the techniques of selecting switches, running wires and installing foil tape and other hardware.

by John Sanger

Creativity is a desirable characteristic for an alarm installer. Every system that he installs presents new problems to be solved. And, just as no two systems are alike, no two installers will solve installation problems in the same manner.

Mistakes, if we can learn from them, are valuable learning experiences. Many of the following applications and techniques are based on personal experience from trial and error (with a few more errors than I sometimes care to admit); some are from veterans in the alarm industry who have shared their experiences with me over the years.

Basics

It goes without saying that an installer should read the instructions that come with the alarm equipment. Unfortunately, not all of them do and the results can be costly.

Following a few simple rules can save time, money, and needless headaches.

- (1) Use good equipment. It will cost less in the long run.
- (2) Apply the equipment properly.

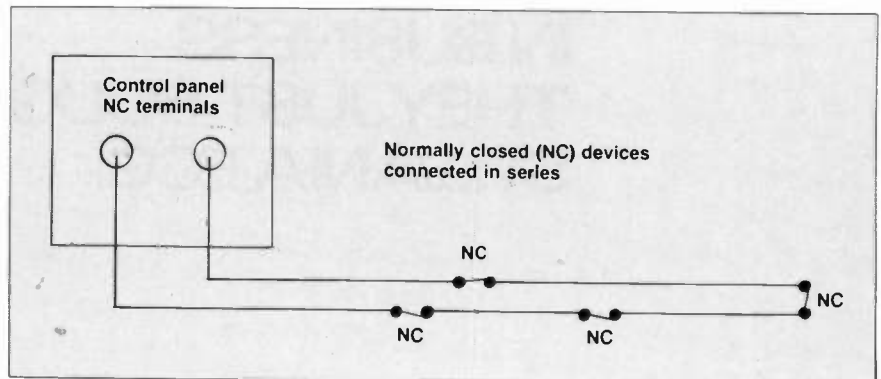

Fig. 1. Single ("Hot") Loop

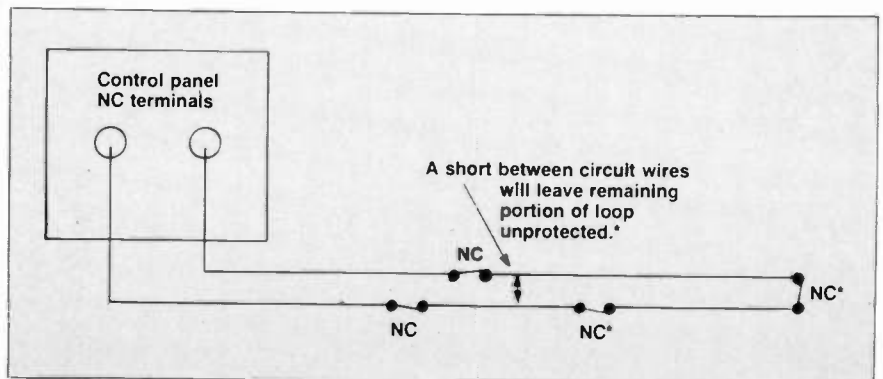

Fig. 2. A short in a single loop

Attempting to over-extend the capability of a piece of equipment will eventually cause problems.

- (3) Make all connections *before* applying power.
- (4) Double-check all connections before applying power.
- (5) Be sure that primary power is derived from a 24-hour source and not from a switched ac outlet.

Protective Circuit/Loop

Most burglar alarm circuits employ normally closed (NC) devices connected in series. Breaking (i.e., opening) the normally closed circuit will cause the control panel to go into an alarm condition.

There are three common normally closed burglary circuits:

- (1) Single-Loop (sometimes called a *Hot Loop*)
- (2) End-of-Line Power Loop
- (3) Return Loop

The single-loop design is the simplest to install because it "dead ends" at the last sensor (Figure 1) and does not require a wire run back to the control panel. It should be noted, however, that a short between the circuit wires will render the remaining portion of the loop unprotected (Figure 2).

The end-of-line power (Figure 3) and the return loop (Figure 4) circuits have true positive and negative voltage and polarity must be observed. Normally closed protective

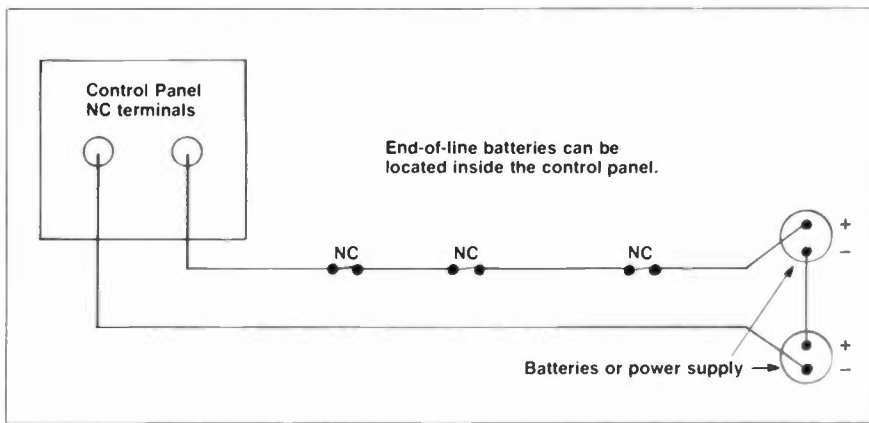

Fig. 3. An End-of-line power loop

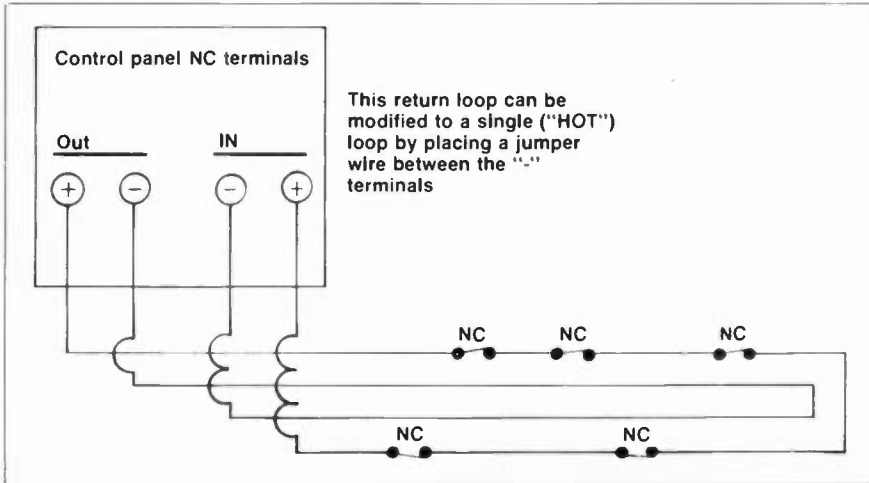

Fig. 4. The return loop

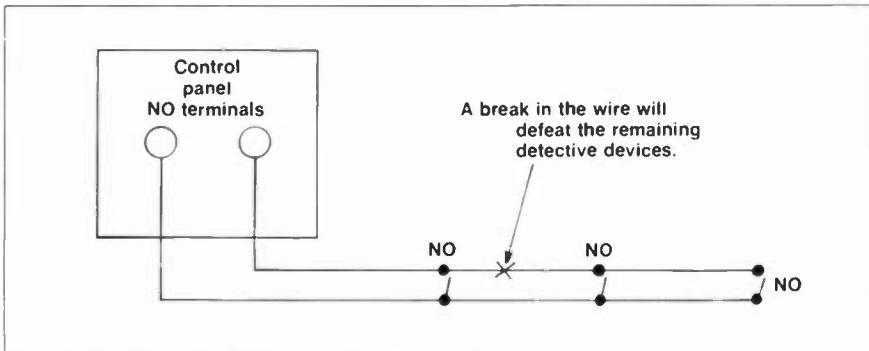

Fig. 5. The effect of an open in system using N O switches

devices should be installed on the positive leg of the circuit. The single-loop circuit generally has positive output and voltage cannot be checked because negative voltage is not present in the loop.

Some control panels offer normally open (NO) protective circuits as burglar alarm circuits—utilizing normally open devices connected in parallel. (Normally open circuits are most frequently used for fire, panic and hold-up devices.) Unless the system is designed to use an end-of-line resistor for circuit supervision, a cut or break in the protective circuit will defeat all detectors beyond that point (Figure 5).

Magnetic Contact Switches

The most common detection device in a burglar alarm system is a magnetic contact switch. They are available in a variety of sizes, shapes and colors, and are available in normally closed and normally open configurations. They are classified according to type of switch: either *reed* or *mechanical*. The reed type is glass enclosed, making it suitable for corrosive or exposed environments; it is also more fragile than the mechanical type. Most of the modern switches, of either type, are very good—with some manufacturers rating the life of their switches at 10,000,000 cycles.

Whenever possible, especially in

residential systems, recessed magnetic contact switches should be used. Not only do they enhance the appearance of the system because they are not visible, they reduce the possibility of tampering because they are not easily accessible. Long drill bits are available to facilitate drilling up through the door frame and header into the attic. While bits are available in lengths up to 72 inches, a 1/4 x 30 inch bit is usually sufficient.

If using magnetic contact switches on windows, a problem sometimes arises when the customer wants to open the windows for ventilation and have the alarm on at the same time. Figure 6 shows one possible solution to the problem. A normally open switch can be used (because it is closed when it is away from the magnet) on the window frame and the magnet can be mounted on the sash. Sliding the window past the switch will activate the alarm. A word of caution: if the window is left open past the switch when the system is armed there will be no protection.

Foil Tape

There is absolutely no substitute for experience when applying foil tape; the learning process can be frustrating.

Foil tape is one of the best protective devices available. There is nothing mechanical that can fail; either it is in one piece or it is not. Breaking the glass to which the tape is applied will break the tape as well. Foil tape, therefore, is simply a flat wire applied to glass.

Until an installer has had some experience applying foil tape, it is advisable to mark the *outside* of the glass with a felt-tipped pen or grease pencil to insure that the tape is applied in a straight line on the *inside*. The foil should be applied 3-4 inches from the window frame, making certain that the bottom portion of the glass is covered since glass usually breaks in a downward direction (Figure 7).

Make sure that the glass to which the tape is applied is *clean*. Then, if using self-adhesive foil tape, apply it using the line marked on the outside of the glass as a guide. If using regular (non-adhesive) foil tape, a coat of clear varnish 3/8" wide must be applied to the window. Once the varnish is "tacky," the tape can be applied and will adhere to the varnish.

Foil take-off blocks are applied to the glass where the foil tape ends and

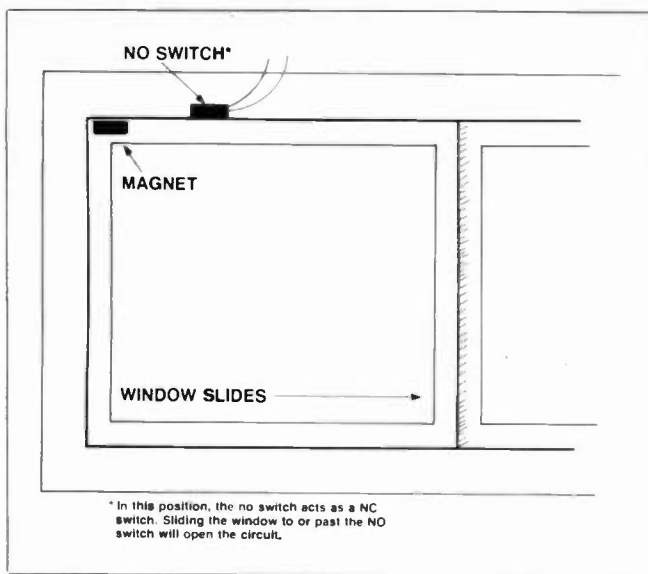

Fig. 6. A switch installed to allow partial opening of a window

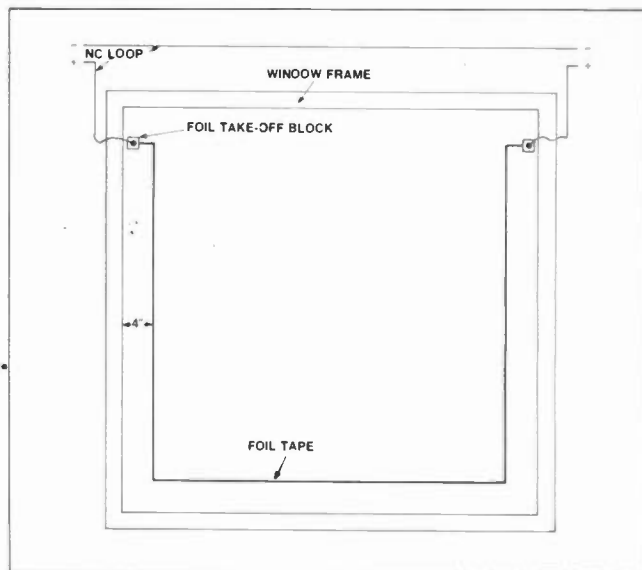

Fig. 7. Foil installation on a window glass

they are used to connect the tape to the wire loop. Several varieties of foil take-off blocks are available—and selection depends on specific application and personal preference.

Right angle turns with regular foil tape are made simply by folding the tape over itself. Square corner turns must be made with self-adhesive foil tape. To make a right angle turn with self-adhesive foil tape, make the standard turn *in the opposite direction* then fold the tape over itself in the direction that the foil tape is supposed to follow. A small amount of varnish in the fold of the tape will help hold the tape secure.

Glass Breakage Detectors

In lieu of using foil tape, glass breakage detectors may be used on windows. These detectors may be used successfully if they are adjusted properly—in strict adherence to the instructions provided by the manufacturer. Glass breakage detectors are well suited to residential applications where foil tape might not be desired from an appearance standpoint. They are more expensive than foil tape but installation labor is considerably less. (Note: *vibration* contacts should *not* be used on windows).

Zones

Even though the alarm system does not *require* zones, they can be useful if it becomes necessary to locate a problem. Toggle switches and/or terminal strips inside the control box allow the troubleshooter to quickly isolate the problem zone—instead of individually checking each sensor in the entire system.

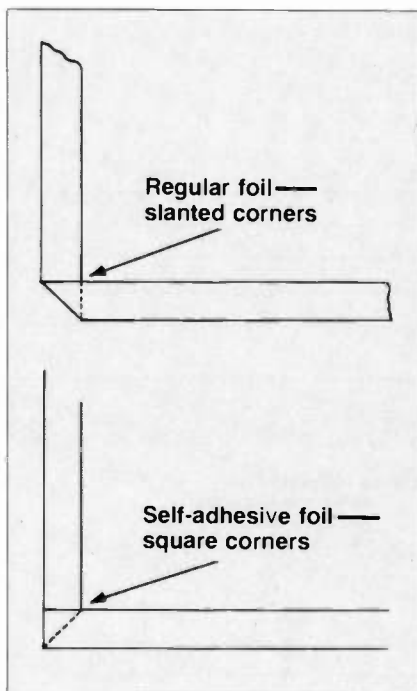

Fig. 8. Foil corners

Wiring

Marking wires with tags or labels will save time if it is ever necessary to trace a wiring problem. Long wire runs should be marked periodically along the entire length of the run. When several wires are run together they should be marked. Simple markings such as NC DELAY (normally closed delay loop), NC INT (normally closed interior loop), NO PANIC (normally open panic circuit), or 12VDC PIR (12 vdc to passive infrared detector) are all that are needed—just enough for easy identification. Moreover, marking the end of each wire as it is dropped to terminate in the control box makes final hookup a simpler task. A variety of adhesive and tie type wire markers

are available.

When running wires in an attic, staple them securely to the rafters or some out-of-the-way place. Keeping them out of harm's way will prevent accidental damage, and an unnecessary service call, because the customer snagged and broke a wire while rearranging the attic.

Periodically, along the run, leave some slack in the wire. Tapping into the loop to add sensors at a later date is easier if the wire is readily accessible and long enough to work with.

False Alarm Prevention

Entry warning devices should be used on control panels that have a pre-alarm output during the entry time delay. An entry warning beeper (such as Moose Products' MA-2) or buzzer (such as Amseco's PAL328N) will suffice. The audible warning device reminds the customer to disarm the system before the entry delay expires—thus, reducing false alarms. A side benefit is that the buzzing or beeping indicates to an intruder that *something* is about to happen. Chances are that he will not stay to find out what happens next.

Summary

The practical side of alarm system installation—that is, what happens on the job site in the real world—must be learned, for the most part, from experience. However, common sense and planning are valuable assets to an installer and will pave the way for a smoother installation. Future articles will discuss specific applications of equipment and unusual techniques for solving installation problems. **ETD**

CET test preparation quiz VIII

Semiconductors and such

Have you taken the CET test yet? If not, here is quiz number 8 to help you get ready. It is hoped that solving these quizzes is proving beneficial to you. In any case, they should indicate those areas where some review may be helpful. For the most benefit, don't look at the solution until you have made your best effort.

By Frank R. Egner, CET

- All coils have some resistance, R_s , in addition to reactance, X_L . As a general rule, R_s can be neglected during analysis when:
 - $X_L = 10 R_s$ or more.
 - $R_s = 10 X_L$ or more.
 - $X_L = 5 R_s$ or more.
 - $R_s = X_L$ or less.
- A single trace oscilloscope can be made to operate like a dual trace scope by using:
 - A paraphase amplifier.
 - A push-pull amplifier.
 - A push-push amplifier.
 - An electronic switch.
- A VOM is used to measure vacuum tube bias. For the most correct indication:
 - Use a low range for larger deflection.
 - Use a high range for minimum loading.
 - All ranges provide comparable indications.
 - Low ranges are more accurate than high ranges.
- An electronic law states that the polarity of an induced voltage is always of such polarity as to oppose the force that created it. This is known as:
 - Ohm's law.
 - Kirchhoff's law.
 - Lenz's law.
 - Thévenin's theorem.
- In general, RC coupled networks have negligible effect on the coupled signal when:
 - $R = 1/10 X_C$ or less.
 - $R = X_C$.
 - $X_C = 1/10 R$ or less.
 - C is small and R is large.
- The silicon controlled rectifier (SCR):
 - Is turned on and off by a gate pulse.
 - Is turned on but not off by a gate pulse.
 - Turns on with dc and off with a gate pulse.
 - When turned on, conducts in either direction.
- A forward biased PNP bipolar transistor conducts current by the movement of:
 - Holes from C to E.
 - Electrons from E to C.
 - Holes from E to C.
 - Majority carriers from C to E.
- When high frequency currents travel through a conductor, the wire resistance becomes appreciable. This phenomenon is called:
 - Magnetic induction.
 - Self inductance.
 - Conductor reactance.
 - Skin effect.
- The terminals of the transistor in figure 1 are named:
 - Emitter, base, collector.
 - Source, gate, drain.
 - Base 1, emitter, base 2.
 - Cathode, gate, anode.
- In figure 1, transistor Q1:
 - Must have forward bias to conduct.
 - Conducts by the movement of positive charges.
 - Is a type of unipolar device.
 - Is a type of MOSFET.
- When compared to NPN and PNP transistors, Q1 in figure 1:
 - Is voltage, rather than current operated.
 - Provides voltage instead of power gain.
 - Has a lower high cutoff frequency.
 - More than one but not all are true.

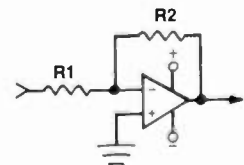

Figure 2

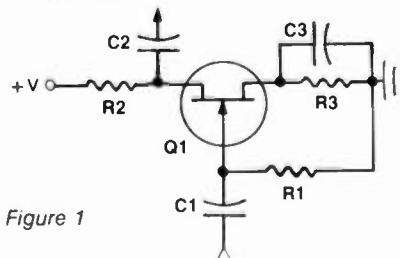

Figure 1

d. Voltage gain will decrease.

15. An NTC thermistor:

- a. Increases resistance with increased temperature.
- b. Is a type of linear resistor.
- c. Decreases resistance with decreased temperature.
- d. Decreases resistance as temperature increases.

16. In a voltage divider, a 6.8K 0.5w resistor drops 47 volts. The resistor:

- a. Will likely overheat.
- b. Will quickly burn out.

- c. Has ample power rating.
- d. Should be at least 1w.

17. A TV pentode IF amplifier blocks the signal. The tube tests good. The tube is removed and socket voltages measured. $E_b = 150v$ (B+), $E_{g2} = 150v$, $E_{g1} = 0v$, $E_k = 0v$. The trouble may be:

- a. An open cathode capacitor. *OR CATHODE*
- b. Highly increased screen resistor.
- c. A shorted cathode by-pass.
- d. IF transformer primary open.

18. Color TV signals conform to what the human eye can see. The

higher frequencies (detail) are transmitted in:

- a. Blue.
- b. Red.
- c. Green.
- d. None of these.

19. The color signal is interleaved with the luminance signal. This means the color signal is:

- a. Only transmitted on even scan lines.
- b. Spaced between the luminance signals.
- c. Only transmitted on odd scan lines.
- d. Interlaced on even fields.

20. The horizontal frequency prescribed for color TV transmission is:

- a. 15,750 Hz.
- b. 15,734.265 Hz.
- c. 15,764.264 Hz.
- d. 15,750 plus or minus 15 Hz.

21. The vertical frequency prescribed for color TV transmission is:

- a. Precisely 60 Hz.
- b. 60.94 Hz.
- c. 59.94 Hz.
- d. 60 plus or minus 1 Hz.

22. Only two color signals are transmitted on the TV signal. The third color can be recovered because the transmitted color signals are:

- a. Opposite in polarity.
- b. The same polarity.
- c. 45 degrees out of phase.
- d. In quadrature.

23. The on or off status of the color killer stage is controlled by the:

- a. AGC voltage.
- b. ACC voltage.
- c. Burst signal.
- d. Color oscillator.

24. The hue of the reproduced picture is determined by:

- a. The phase of the I and Q signals.
- b. The R-Y and B-Y signals.
- c. The phase of the color oscillator.
- d. All of these.

25. The saturation of the reproduced colors is established by the amplitude of the:

- a. R-Y, B-Y, and G-Y signals.
- b. Y signal.
- c. 3.58MHz oscillator signal.
- d. Luminance signal.

Get MORE in capacitor types and ratings at a Sprague Q-LINE™ Distributor

No matter what type of capacitor you're looking for, look for it on a Q-MART® capacitor display. You'll find exactly what you want. That's because the Sprague Q-LINE features a computer-selected inventory of most-frequently-used capacitors. And blister-pak packaging keeps the capacitors clearly visible and fully protected.

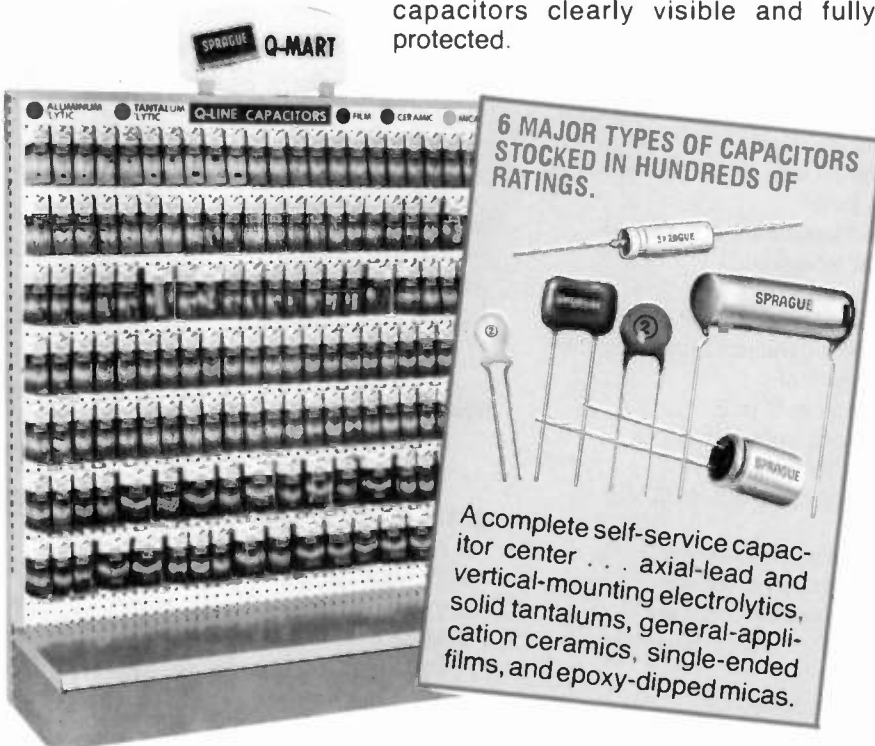

For detailed information on all Q-LINE products (capacitors, switches, chassis boxes, optoelectronic devices, DIP/SIP components, resistors, wiring components, etc.) write for 40-page Catalog C-652 to Sprague Products Co., Distributors' Division of the Sprague Electric Co., 509 Marshall St., North Adams, Mass. 01247.

Where MORE is more than a promise.



a subsidiary of GK Technologies

Answers on page 37.

Operational Amplifiers, part II

The amplifier

If you ever have wondered why an op amp circuit you were troubleshooting behaved as it did, you perhaps were not aware of some of the characteristics of the modern operational amplifiers; the text books don't always tell the whole story.

By **Bernard B. Daien**

In Part I of this article, we discussed the basic inverse feedback loop around a single input, single output amplifier, stating that feedback can change the input resistance, the output resistance, gain, distortion, and bandwidth of an amplifier. The differential amplifier was briefly mentioned, noting that diff amps have two inputs, *and the input signal is the difference between the two inputs*. Common mode rejection was described, laying the groundwork for the integrated circuit op amp.

Before going further, it is important to reiterate that the diff amp input is the difference between the two inputs, and that anything that affects both sides of the diff amp equally does not produce a significant output signal. Thus if both sides of the amplifier are subjected to power supply ripple, or if there is an unwanted signal pickup which is fed into both inputs, the output will not be affected. This characteristic is known as, "Common Mode Rejection", i.e., anything common to both sides of the diff amp

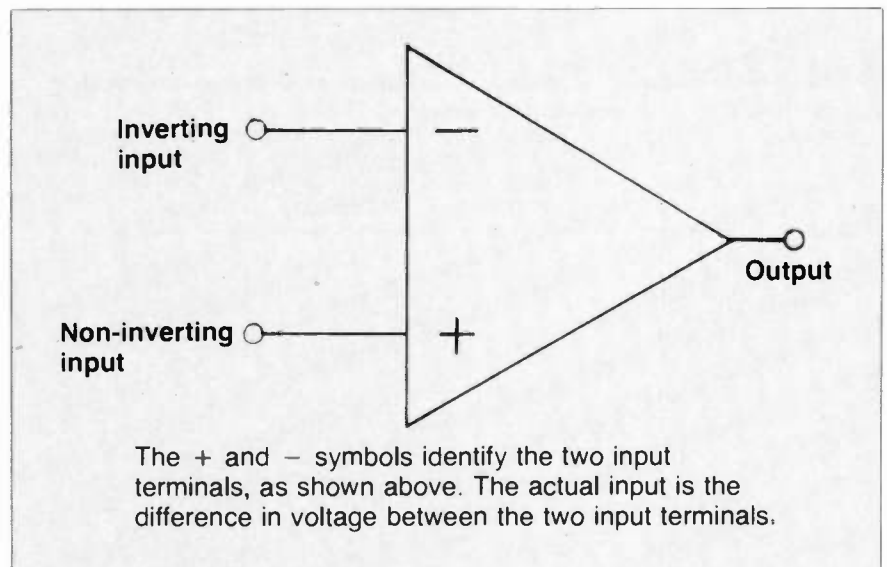

Fig. 1. The symbol for an operational amplifier.

is rejected. Now, on to the . . .

Basic Op Amp . . .

The basic op amp is a multi-stage amplifier, with a differential amplifier as the input stage, and a single output. It is so designed that one of the inputs is in phase with the output, and the other input is out of phase with the output, over the normal range of frequencies for which the op amp is specified. Usually with a high gain op amp, the open loop gain begins to drop off at 100 Hz or less! Most op amps have quite a bit of phase shift, due to the large number of stages involved, distributed capacitances, Miller Effect, etc. This phase shift prevents the output from being out of phase, or in phase, with the input, (depending upon which input is used), as the frequency is increased beyond a certain point . . . and that may occur at a very low frequency! Since many data sheets fail to show the phase

shift versus frequency, it is very easy to turn your "stable amplifier" into an oscillator, with "parasitic" oscillations at some high frequency by adding phase shift in the external feedback path.

Some amplifiers have a certain amount of compensation built into them, usually in the form of RC networks, which roll off the high frequency response in order to reduce the tendency towards self oscillation. Other op amps require that you use external components to achieve the same purpose. Stated another way, any time you close a feedback loop around a very high gain amplifier . . . look out!

The symbol for an op amp is shown in Figure 1, along with conventional terminal markings. The two inputs of the op amp offer a tremendous advantage . . . FLEXIBILITY. We can now use one for feedback, and the other for the signal, thus separating

these two essential functions. Furthermore, common mode rejection insulates these two from the influence of undesired factors, such as hum pickup, power supply voltage variations, supply ripple, etc. The op amp therefore becomes the closest thing to an ideal amplifier that we have. And, because it is flexible, its uses are limited only by our imagination! The op amp can be used in so many different ways that the next part of this article will be devoted to op amp applications . . . and that will only serve to scratch the surface.

This is a good time to clear up a little confusion about the difference between the op amp and a "comparator". The comparator uses

the comparator can change state more rapidly than the op amp. This ability to change output quickly is called, "slew rate", and is usually given in volts per microsecond. The more voltage change per microsecond, the faster the slew rate. So, if you are looking for speed, and linearity is not important, as in digital circuitry, use a comparator. If, on the other hand, you need linearity, or must use an inverse feedback loop for some reason, you will have to use an op amp, and live with a slower slew rate.

Operational amplifiers, like other amplifiers, have a large number of specifications, which must be consulted if you intend to use the

resistances so high, that for most purposes they look like an open circuit. In fact, op amps come in several families today, each with their own characteristics and advantages or disadvantages. Some are very fast, but have low input resistance, others work at very low supply voltage or current, etc. It is necessary to become familiar with, and study the specification sheets for the various op amps in common use....but be very careful, for nowhere else is "specmanship" so prevalent, (the practice of writing a spec in such a way that it appears better than it is, a la "used car dealer" style).

"Input offset voltage"....the two inputs do not exactly track each other, due to minute differences in the op amp, therefore the inputs must be offset to bring the output voltage to the center of the output swing capability. It is possible to zero the op amp by changing the input biasing on one of the inputs, or by changing the characteristics of one of the input amplifiers by means of an "offset adjust" terminal provided on the op amp. Then there is "the input offset current"....op amps draw a minute input current from the signal source, due to the input resistance. The current in each input differs slightly, and if the source is a high impedance, this will cause a difference in the input voltages.

Both the input offset voltage and current are temperature sensitive, and the better op amps are specified so that they change very little, while the less expensive op amps may not even have a published spec on input changes over the temperature range! Most good op amps have input currents in nano amperes, or, in the case of FET op amps, pico amperes, while the less expensive op amps may have input currents in microamperes.

Since the input current flows through the source resistance, and/or the bias resistors, if the two inputs are driven by different source resistances (or bias resistances), the input voltages will wind up being different due to the IR drops. Thus it is always good practice to make sure that both inputs of the op amp see closely the same resistances. Of course if the input current is very low, and the source resistances are also very low, the IR drops will be so low as to be negligible.

Finally, we come to a very important subject . . . noise! Since op amps

(2A) Basic inverting circuit

(for dual power supplies with common ground).

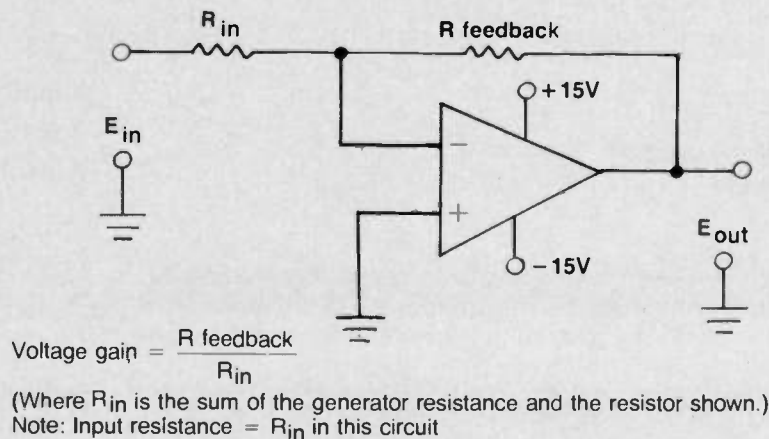

Fig. 2A. Inverting operational amplifier circuit.

the same symbol and labels as the op amp, and has two inputs and one output like an op amp . . . but the comparator is designed to be used open loop (no feedback). The reason for this is the comparator is not used as a linear amplifier . . . the output is in one of two states, high or low, much as in digital circuits. The state of the output depends upon whether the inverting, or the non-inverting input is the higher . . . i.e., it "compares" the two inputs, and changes output state in accordance with whichever is the higher input.

Since the comparator is not intended for linear applications, (no closed loop) there is no danger of oscillation, and therefore no need for compensating capacitors. Since there are no compensating capacitors to charge and discharge, the output of

amplifier for any practical purpose. Some of these specs, and their implications are: "Output resistance" . . . op amps have an open loop output resistance that can vary anywhere from less than 100 ohms to several thousand ohms. Although this will be changed when the feedback loop is closed, nevertheless it is wise to choose an amplifier with a low output resistance if you intend to drive a low load resistance, while a high load resistance can be driven from either a high or a low output resistance. "Input resistance" . . . again, if you are getting your input signal from a high impedance source it might be necessary to use a high input resistance op amp. Today we have amplifiers with Field Effect Transistors (MOSFETs) as the input stage, and these have input

have very high gain, it takes very little noise in the input stage to produce very noticeable noise output. Unfortunately, the subject of noise in op amps is usually treated with very difficult mathematical approaches. The facts are really quite simple . . . op amps are like any other kind of amplifier, and generate noise in the same manner . . . but, to sum up, there are three basic kinds of *consistent noise* in semiconductor amplifiers. The first is a noise voltage, which depends upon resistance, temperature, and bandwidth, increasing as any of these factors increase. The second is noise current, which increases as the current through a semiconductor junction is increased, and also with bandwidth. The third noise is called, "1/f" noise, (One over f noise) . . . which means "one divided by the frequency" . . . the mathematicians way of saying that the noise is inversely proportional to the frequency at which it is measured. Stated another way . . . the noise goes up as the frequency goes down! Thus, this noise is worst at very low frequencies, starting below one thousand cycles per second, and going on down to dc. This noise has never been fully understood, and is related to semiconductors.

There is another noise which is not consistent . . . it consists of bursts of noise, and as seen on an oscilloscope, looks like corn popping . . . and therefore has been dubbed "popcorn noise". This noise depends upon the processing used in making the semiconductors, and is generally lowest with the best quality processing.

Noise is very important, since in any system, the useable gain is limited by the noise. There are some simple tests for the different kinds of noise, and some things you can do to minimize noise. The noise voltage component can be determined by operating the amplifier with the input shorted. The noise current component can be found by operating the amplifier with the input fed from a very high source resistance (open circuit). Feedback does not affect the signal to noise *ratio*, since it reduces both the noise and the signal.

Also, as in other amplifiers, an impedance mismatch between the signal source and the input of the amplifier, can seriously degrade the noise performance. (This corresponds to a mismatch between the antenna and the input of a TV receiver.) The

use of a bipolar input type of op amp will result in best noise performance for a source resistance under about 10,000 ohms, while FET input type of op amps do better above 10,000 ohms, and really shine at 100 kilohms and up. The reader might do well to refer to the June 1979 issue of ETD for a more specific discussion of noise in electronic circuits, if he wishes to pursue the subject further.

Now then . . . what to do about noise. Since current noise is dependent upon current flowing through the semiconductors, reducing the current reduces the noise faster than it reduces the gain. Some op amps have a terminal which can be

are unavoidable. (This comment is often neglected in texts on op-amps).

Of course, it goes without saying that bandwidth much in excess of that required will result in more noise. It has always amused the author to note the specifications on so called "high fidelity amplifiers" which go down to a few Hertz. With semiconductors there is a lot of 1/f noise below 40 Hertz, lots of turntable rumble, etc., . . . and usually zero signal! It's like the 300 horsepower car on the city streets . . . nowhere to use it. The practical moral is, "restrict the bandwidth if you want to reduce the noise". Communications technicians have long understood this simple fact, which is one of the

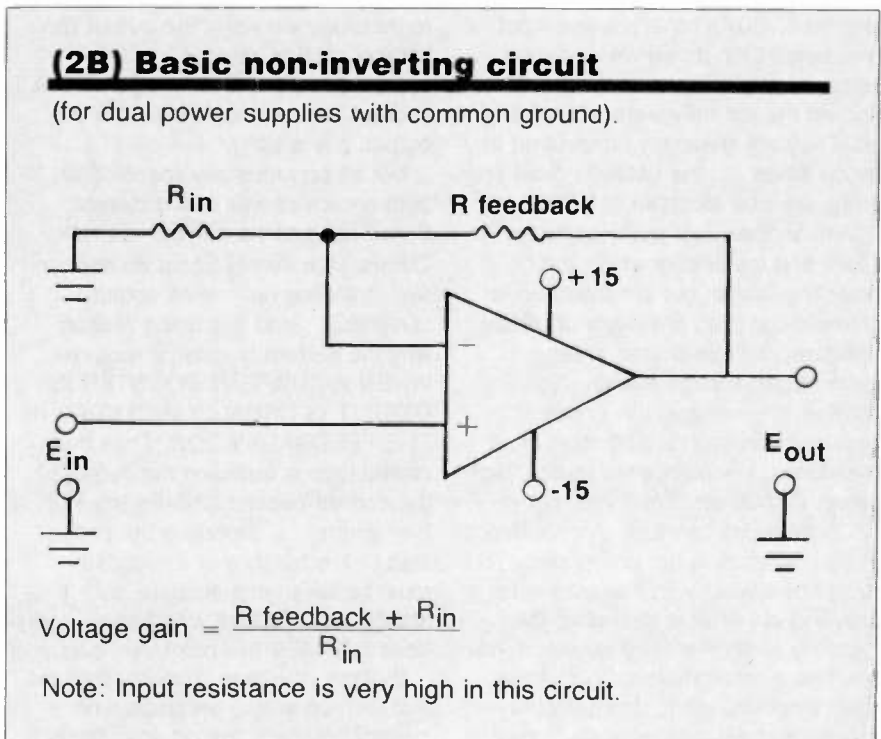

Fig. 2B. Non Inverting operational amplifier circuit.

used to control the op amp's current. Such amplifiers made by Fairchild are called "Programmable Op Amps", by RCA "Operational Transconductance Amplifiers" and similarly by National Semiconductor.

As you will see later in this article, the "non-inverting" configuration (circuit) permits the feedback network to be fed into one input terminal, while the signal goes into the other terminal. As a result, it is possible to avoid having the feedback resistor's value determined by the signal source resistance. This flexibility permits adjustment of the input resistance for optimum noise performance. Therefore the non-inverting circuit often results in superior noise performance when low signal levels

reasons why communications receivers have very narrow bandwidths.

Current Differencing Amplifiers

There is another and newer member of the op amp families, which works on a somewhat different principle, and is intended for a somewhat different use. The original op amps were designed to operate right down to dc. As a result they were intended to operate from dual supplies, usually about plus and minus 15 volts. The output of the op amp then was centered at zero volts, and could swing either positive or negative. But there was a continuing demand for an op amp that would operate from a single power supply, primarily to

amplify ac signals. The conventional op amp came in a variety of types, and while some could operate from a single supply, the output swing did not go from nearly supply voltage right down close to zero volts.

The Current Differencing Amplifier (CDA) was designed specifically to operate from a single power supply, mainly for use with ac signals; its output swing can go from close to the supply voltage, down almost to zero. There are some basic differences in the designs of the CDA and the older op amps. The op amps work on the difference in input voltage between the two input terminals, while the CDAs operate on the differences in currents fed into the two input terminals. CDAs have a lower input resistance than do conventional op amps, but they are quite inexpensive, and do the job they were intended to do. They are generally considered to be op amps . . . the LM3900 quad op amps are one example of CDAs.

Just as there are many vacuum tubes and transistors which are basically similar, but are intended for different uses, so are many op amps optimized for specialized uses . . . large output voltage swings, high voltage, low voltage, low power consumption, high speed, high input resistance, low output resistance, high power output, etc. Take your choice . . . but choose carefully. An op amp is not an op amp, is not an op amp. You must know what your requirements are, find out what is available, then carefully study the spec sheets. If you can find a recommended circuit that does what you want, use it. Home brewed circuits may oscillate, have insufficient bandwidth, slow slew rate, etc. There are many pitfalls in which you can become entangled until you acquire a little experience with op amps. Op amps are not only simple to use . . . they are deceptively simple to use! (A few resistors, and one I.C., and "away we go . . .")

Preamplifiers.

It is seldom mentioned that even a fairly inexpensive op amp can beat the performance of a very expensive op amp with the aid of a "preamplifier" specifically designed for this type of use. We are not discussing an audio type preamplifier, but rather an op-amp preamplifier. National Semiconductor makes op amp preamps . . . and I refer you to them for further literature on the subject, as it is beyond the scope of

this article . . . but you should be aware of their existence, in order to pursue the subject if you have need.

Current Boosters . . .

Just as we can use a preamplifier ahead of an op amp, so can we use an amplifier following an op amp to increase the output current handling ability. This is especially useful in driving low impedance transmission lines, etc. It should be noted that the load for the op amp can be connected between the output terminal and ground, or between the output and the power supply line. In one case the current flows out of the output terminal, in the other case it flows into the output terminal! In op amp terminology we say, "the output can source, or sink, current." (If the current flows out of the output, it is a source. If the current flows into the output, it is a sink).

Not all op amps are specified to both source or sink much current. Some can source well but not sink. Others, vice versa. Some do neither well, handling only small output currents . . . and this is the reason why the current booster is required. WHEN A CURRENT BOOSTER IS USED IT IS USUALLY INCLUDED IN THE FEEDBACK LOOP. Thus the closed loop is between the output of the current booster and the input of the op amp . . . therefore the phase shift characteristics of the booster must be taken into account, for stability calculations. Literature usually does not make this point very clear.

By now you have probably realized that with op amps, preamps, and current boosters, the op amp family can do a very wide variety of tasks, from microvolt signals up through several watts of power, over a wide range of frequencies.

Op amps are often used as a part of a system, rather than a "stand alone" device. They interface with some sort of signal source, and in turn, drive some other circuitry. Thus the use of preamps, and current boosters is a natural consequence to the way op amps are used. To consider the op amp as a stand alone device limits its usefulness in many applications. The use of an op amp as a differentiator, for example . . . no one uses a differentiator alone . . . usually it is as a "signal processor", shaping a waveform for sync use, etc. The common idea that an op amp is primarily a "gain block" is therefore not very meaningful. In the next part

of this article, dealing with applications, we will be using much of what we have discussed so far.

Basic Op Amp Circuits.

All op amp circuits fall into two main categories, "Inverting" or "Non Inverting", depending upon whether *the input signal* is fed into the inverting input, or the non inverting input. Of course the output must be fed back into the inverting input if we are to have negative feedback . . . but, with the aid of a phase inverter, it is possible for the feedback loop to be fed into the noninverting input. It is all relative . . . a matter of simple phase relationships.

Figure 2 illustrates the basic inverting, and non inverting circuits, along with the formulae for gain calculations. In these circuits the op amp is used as a straight amplifier . . . the simplest of the various circuits. These are the building blocks from which we can develop other more complex circuits later on.

Op amps have been around in integrated circuit form since the early 1960s. As a result, there are a lot of "surplus" older op amps available at very attractive prices . . . but many of these are not bargains because they have problems . . . odd power supply voltages, tendencies to "latch up", they burn up easily with overloads, can't handle a wide range of input signals or output swings, etc. It is wise to stay away from the following op amps for the above reasons: the 702 and 709 series. There are some fairly old op amps available in surplus that work well, and are easy to apply: the LM101, LM201, LM301, LM107, LM207, LM307 and the 741, 747, and 748 series, and you will find these satisfactory for most published circuits. By using cross reference lists available from Motorola, Texas Instrument, National Semiconductor etc., you can find DIRECT REPLACEMENTS for the above made by several manufacturers, with other identifying numbers.

You can buy op amps in single, dual, and quadruple packages. The dual and quads are especially convenient and economical when used for active filters, and signal processing, requiring several op amps. They also save quite a bit of space in compact equipment.

The next part in this series will discuss the practical considerations in using op amps, and several representative applications. **ETD**

Into electronics, computers, or amateur radio?
Choose 6 informative books
for only \$ 2⁹⁵

(values to \$121.65)

8434 List \$31.90
2 vol. count as 1
30 PROJECTS TO IMPROVE YOUR STEREO SYSTEM
BY DAVID R. WEEMS

Playing The Stock & Bond Markets With Your Personal Computer
by L.K. Summella
1251 List \$16.95

1066 List \$19.95
THE ILLUSTRATED DICTIONARY OF ELECTRONICS

1233 List \$14.95
AC/DC ELECTRICITY'S ELECTRONICS MADE EASY

955 List \$10.95
Modern Digital Communications

DESIGNING AND BUILDING YOUR OWN STEREO FURNITURE
BY CARL R. ...

1211 List \$14.95
THE COMPLETE HANDBOOK OF VIDEOCASSETTE RECORDERS
2ND EDITION
BY LIBERTY HYLAND

1108 List \$11.95
49 EASY-TO-BUILD ELECTRONIC PROJECTS

714 List \$8.95
Radio Astronomy for the Amateur
by Dave Heiserman

905 List \$9.95
BUILD-IT BOOK OF DIGITAL ELECTRONIC TIMPEICES

1216 List \$12.95
HOW TO TROUBLESHOOT & REPAIR ELECTRONIC CIRCUITS
It's your author's practical, problem-solving guide to common electronics.

1076 List \$12.95
Artificial Intelligence
Making machines "think"

1218 List \$16.95
Computer Graphics— with 29 ready-to-run programs
by David Chance

1278 List \$16.95
MODERN COMMUNICATIONS SYSTEMS AND APPLICATIONS
BY MERVYN ...

1339 List \$13.95
101 EASY TEST INSTRUMENT PROJECTS
BY ROBERT W. ...

1276 List \$15.95
Computer Graphics— with 29 ready-to-run programs
by David Chance

1265 List \$18.95
222 WEEKEND ELECTRONICS PROJECTS
Family fun, fun-to-do & guides to all kinds of fascinating do-it-yourself projects!

1015 List \$10.95
A BEGINNER'S GUIDE TO COMPUTER MICROPROCESSORS
with prog.

1230 List \$15.95
THE COMPLETE HANDBOOK OF AMPLIFIERS, OSCILLATORS & MULTIVIBRATORS

733 List \$12.95
DIRECTIONAL BROADCAST ANTENNAS: A Guide to Adjustment, Measurement, & Testing

1132 List \$10.95
HANDBOOK OF ELECTRICAL NOISE: MEASUREMENT & TECHNOLOGY
A complete reference for engineers & scientists.

1249 List \$15.95
103 PROJECTS FOR ELECTRONICS EXPERIMENTERS
BY FORREST M. MIMS, III

841 List \$9.95
BUILD YOUR OWN WORKING ROBOT
BY DAVID & ROSEMAR ...

1245 List \$16.95
ELECTRICAL WIRING HANDBOOK

1062 List \$12.95
THE A TO Z BOOK OF COMPUTER GAMES

1120 List \$8.95
OSCAR: The Ham Radio Satellite
by Dave Ingman, ...

7 very good reasons to try Electronics Book Club . . .

- **Reduced Member Prices.** Save up to 75% on books sure to increase your know-how
- **Satisfaction Guaranteed.** All books returnable within 10 days without obligation
- **Club News Bulletins.** All about current selections—mains, alternates, extras—plus bonus offers. Comes 14 times a year with dozens of up-to-the-minute titles you can pick from • "Automatic Order". Do nothing, and the Main selection will be shipped to you automatically! But . . . if you want an Alternate selection—or no books at all—we'll follow the instructions you give on the reply form provided with every News Bulletin
- **Continuing Benefits.** Get a Dividend Certificate with every book purchased after fulfilling Membership obligation, and qualify for discounts on many other volumes
- **Bonus Specials.** Take advantage of sales, events, and added-value promotions
- **Exceptional Quality.** All books are first-rate publisher's editions, filled with useful, up-to-the-minute info



ELECTRONICS BOOK CLUB
Blue Ridge Summit, PA 17214

Please accept my Membership in Electronics Book Club and send the 6 volumes circled below. I understand the cost of the books selected is \$2.95 (plus shipping/handling). If not satisfied, I may return the books within ten days without obligation and have my Membership cancelled. I agree to purchase 4 or more books at reduced Club prices during the next 12 months, and may resign any time thereafter.

714 733 841 905 955 1015 1062 1066 1076
 1108 1120 1132 1211 1216 1218 1222 1230 1233
 1245 1249 1251 1265 1276 1278 1337 1339 8434

Name _____ Phone _____
 Address _____
 City _____
 State _____ Zip _____

(Valid for new members only. Foreign and Canada add 20%.)

ETD-881

Troubleshooting the Magnavox Micro-Tune

Digital techniques

Digital troubleshooting techniques are becoming applicable to consumer products. Some of these may be new to you but they can save you time and simplify your troubleshooting. Here's an instance of their application.

By Joseph Sloop

As we all know, entertainment products are becoming more and more sophisticated—and digitized. So much so, in fact, that many are actually microprocessor controlled. They are in essence, miniature computers. So how does the consumer electronics technician troubleshoot such a product? This magazine, as well as other such professional journals, has published numerous articles on the theory and troubleshooting of digital circuits. Most of these have been structured around the use of the old standby for the technician—the oscilloscope. And, it cannot be disputed that the scope is the technician's right arm. But, there is another piece of equipment which can be used very effectively to pinpoint difficulties in consumer products containing digital circuits. It lends itself to quick and easy checks of the digital circuit. The instrument I refer to is the logic (or digital) probe. Its mate, the digital pulser probe, is quite helpful too. In the following paragraphs I will explain how to troubleshoot the Magnavox remote Micro-Tune microprocessor controlled tuning system. Logic and pulser probes are

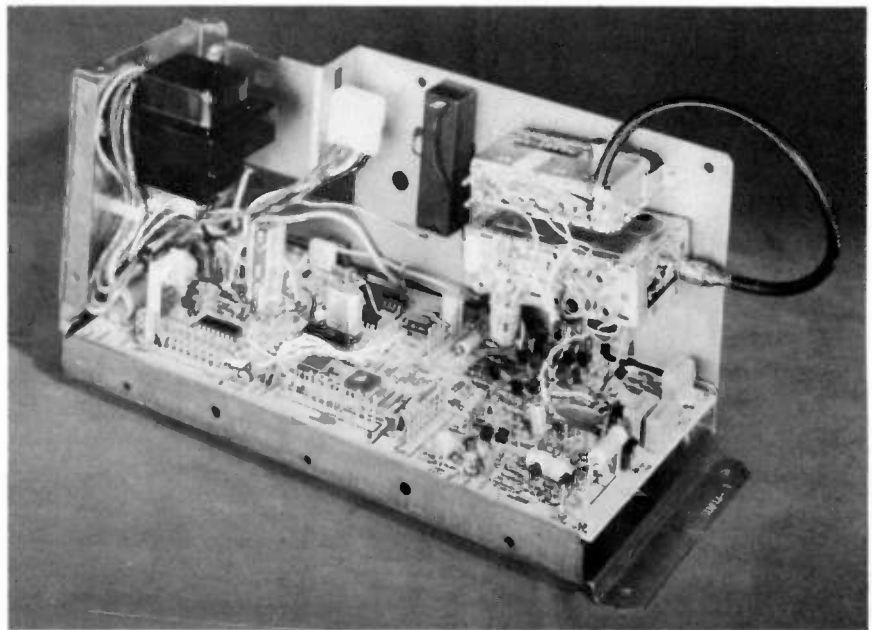

The Magnavox 703954 Micro-Tune

used in the explanation of the equipment utilized in the troubleshooting process.

Being a dyed-in-the-wool oscilloscope believing technician, I'll have to admit that using the logic probe as a troubleshooting tool in a television tuning system wasn't an attractive idea to me at first! A fellow by the name of Henry Fleming will be credited with the idea—by me at least. And, after using the logic probe in the Magnavox Micro-Tune, he convinced me. It is useful, it has its place, it works, and it saves time. Consumer electronic technicians would be well advised to think seriously about using the logic probe and the logic pulser, in troubleshooting the digital circuits they repair.

The logic probe is primarily a go-no-go tester. It attaches to ground and to the positive supply of the circuit

(usually +5v). With the supply connected, when a logic ONE or HI is applied to the probe input, the ONE LED indicator lights (see figure 1). When a logic ZERO or LO is applied, the ZERO indicator LED lights. The probe used was the B & K Dynascan DP-50 which has a third LED to indicate when the input is pulsing. It also has a memory function which will cause the pulse light to remain on even if a short-lived pulse is sensed. This is an especially good feature for some tests in the Micro-Tune.

Some of the measurements in the Micro-Tune require you to know more than if the signal is a one, a zero, or a pulse. For example, when the ONE and ZERO LEDs are equally lit, the ONE or ON time is the same as the ZERO or OFF time, and a 50% duty cycle is indicated. If the ONE LED is brighter than the ZERO LED, the duty

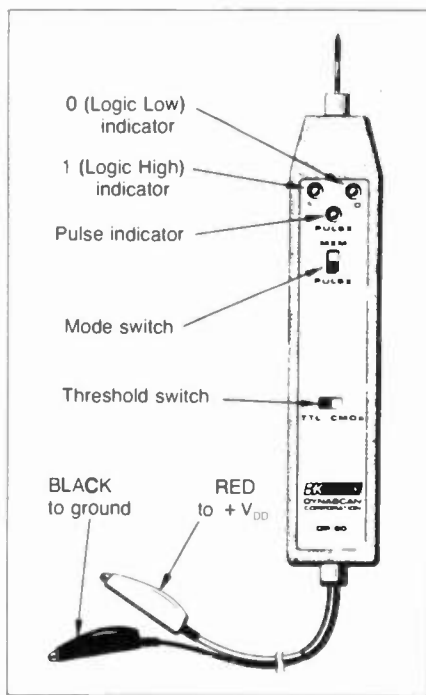

Fig. 1. A typical logic probe (courtesy B&K-Precision).

cycle is higher than 50%, and vice versa. Short duration pulses going toward the ONE level would appear as seen in figure 2, if seen on the scope. In this case the ONE LED would be dimly lit while the ZERO LED would be bright. The opposite is illustrated in figure 3. In both these examples the pulse LED would be glowing to indicate that the signal is a pulse rather than the possibility of a steady state ONE or ZERO.

There is a five-step approach to troubleshooting any digital circuit:

1. Gain an overall knowledge of the system by studying the functional block diagram and the factory explanation of its operation. The block diagram of the Micro-Tune is shown in figure 4.
2. Check for essential voltages and signals—those necessary for operation of the system. They include B+, clock operation, and any special micro-processor voltages and signals.
3. Diagnose the fault to the function that is not operating—inputs, readouts, memory, keyboard, and so on . . .
4. Determine by the schematic diagram the digital circuits used in the defective section, such as AND, OR, J-K flip flops, etc. Refer to truth tables for these devices and know what input-output signals or signal levels to expect.

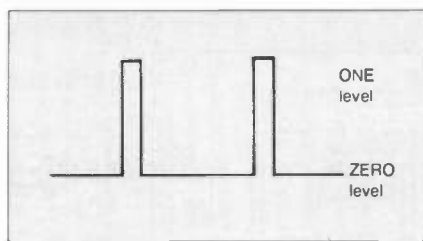

Fig. 2. A low duty cycle pulse.

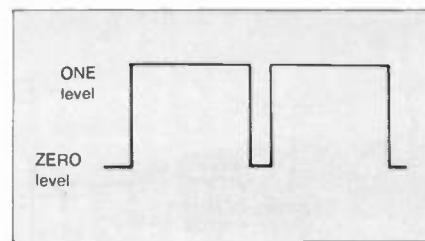

Fig. 3. A high duty cycle pulse.

5. Use the logic probe and pulser to locate the defective component.

The key to any troubleshooting is number 3 above, the initial symptom diagnosis. It is essential that a careful analysis be made of the symptoms in order to classify the problem according to one of the operating functions of the system. In the Micro-Tune, these functions are:

- Power Supply
- Keyboard Functions
- Channel Display
- Channel Tuning Function
- Remote Control

Once the diagnosis has been made to one of these functions, some rather simple checks can be made to pinpoint the defective component.

If an IC has an input but no output, check the B+ voltage and the load resistor. If the IC is direct coupled to the following IC, without resistor isolation between them, either the first IC may have a defective output or the second may have a defective input, which would cause the same symptom. Of course, the circuit can be broken between the two and signal output of the first checked. If it is good, the problem is probably with the input to the second. The best test though is to use the logic pulser. I used the B & K Dynascan DP-100. It has an automatic level sensing ability that insures that a pulse will be generated at any point the probe is used. If that point is at a logic HI, the pulser will pull it low. If the point is at a logic LO, it will be forced HI. The high current, low duty cycle signal of the pulser guarantees that the logic state at the point of injection will be changed, even if the point is stuck or shorted. The pulse output is either at a 5 Hz rate or as a single pulse when manually switched. A typical test sequence is illustrated in figure 5.

The Micro-Tune Microprocessor must be operating correctly before anything else in the system will work. And, to operate, it must have:

1. 5 volts \pm 0.5 volts at pins 40 and 39.
2. 4 MHz oscillator (clock) signal at pins 1 and 2.

3. 60 Hz 50% duty cycle square wave at pin 25 . . . 5 v p-p.

4. An external interrupt signal at pin 38 . . . 5 v p-p. These conditions **MUST** be met if the system is to operate.

In order to verify the 5 v external interrupt signal at pin 38 of the microprocessor, it is desirable to place the remote on-off switch or the factory/normal switch in the off or factory position. This depends on which model set is being worked on since some models do not have a remote defeat switch. In any event, what you're doing is defeating the external remote noise input from the system. With the switch in the on position, the logic probe indicates a duty cycle of about 50%. With it in the off position, the duty cycle is about 25%. If this interrupt signal is missing, check the pulse shaping circuit of Q2 and Q5.

Power supply

Just a word about the Micro-Tune power supply. Actually there are eight supplies. Six are produced on the Micro-Tune chassis and two on the host TV chassis. Power supply problems can cause a great variety of symptoms. Measure all voltages and insure that they are correct. Keep in mind that low power supply voltage can be caused by circuit loading, and don't forget to check for ripple content.

After all these NECESSARY conditions have been met, a lot of further troubleshooting time can be saved by allowing the microprocessor to check itself. Shorting pins 5 of P/J4 and 3 of P/J103 will cause the microprocessor to check itself and the readouts to flash the number "35". While the test is being made the screen will display snow and the set will turn off as the short is removed. If anything other than "35" is seen during this time, the microprocessor is defective.

CAUTION: THE SELF-TEST PROCEDURE IS NOT VALID FOR THE NON-REMOTE MICROTUNE. IT WILL NOT INDICATE A

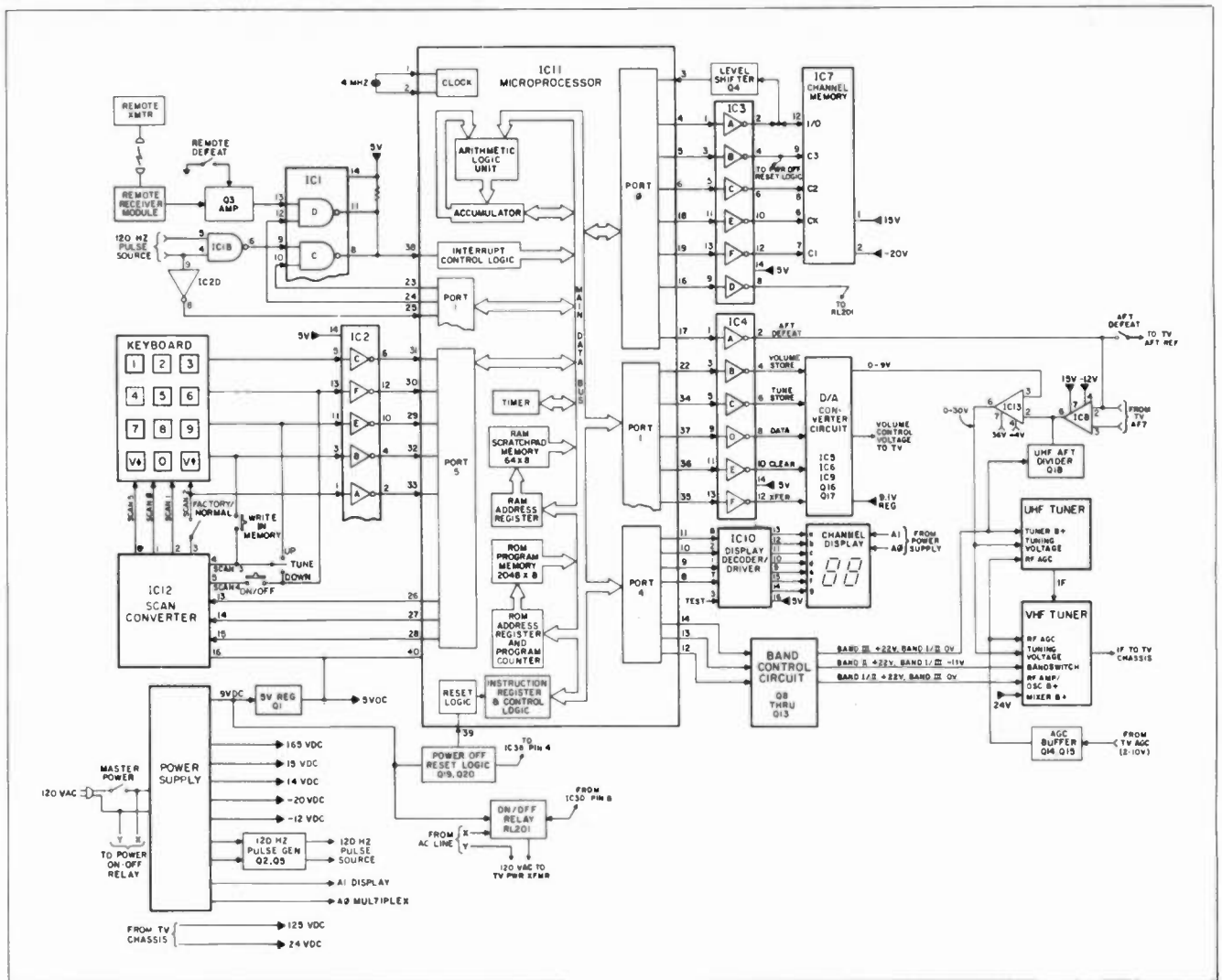

Fig. 4. The Micro-Tune block diagram (courtesy Magnavox).

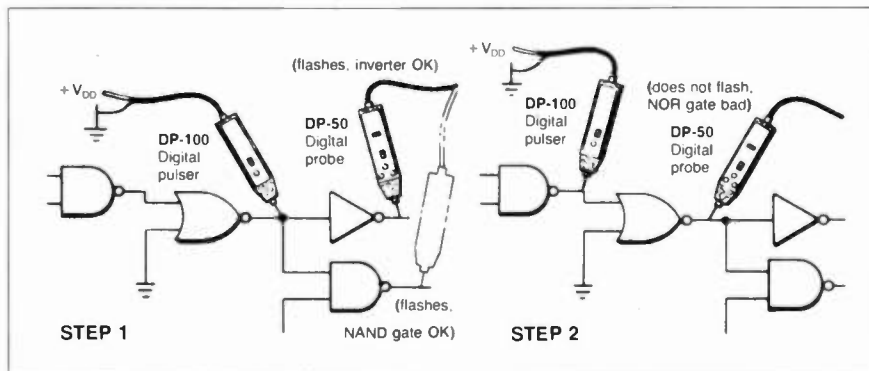

Fig. 5. Logic probe/pulser, typical testing sequence (courtesy B&K-Precision).

DEFECTIVE MICROPROCESSOR AND MAY CAUSE MEMORY LOSS IN THE SYSTEM.

Keyboard functions

If pressing the on/off button does not cause the display to light and the on/off relay to click, look for alternate HI and LO states at the output of IC3D on pin 8. Alternate states should be observed as the on/off button is

pressed. If not, check the output of pin 16 of the microprocessor. If the pulse alternates here as the on/off button is pressed, replace IC3. If not, troubleshoot the keyboard. Keep in mind that the microprocessor should already have been checked.

For whatever keyboard function is inoperative, trace the scan pulses from IC12 to the keyboard button and from there to IC2 and the microprocessor. Check the B+ to IC2

and IC12. If OK, check the HI level voltage at pins 1, 3, 5, 11, and 13 of IC2. If it is missing on any pin, check the resistor and capacitor associated with it and if good, replace IC2. If the voltage is correct, press each even numbered button in turn, while measuring the pulse level at pin 1 of IC12. It should be a low duty cycle. Check for a high duty cycle pulse at pin 2 of IC12 while pressing odd numbered buttons. Check all keyboard functions in the same manner, such as the on/off function. Check for the high duty cycle pulse at pin 5 of IC12 as the on/off button is pressed. When the corresponding function button is pressed each scan line of IC12 will have a high duty cycle pulse except for pin 1. If all pulse lines are correct, check the associated inputs to IC2. If any of the pulses at IC12 are absent, J101A, the associated pushbutton, or IC12 may be defective. Because of the special nature of IC12 as a troubleshooting aid to determine its

Fig. 6. Magnavox 704156 remote Micro-Tune schematic (courtesy Magnavox).

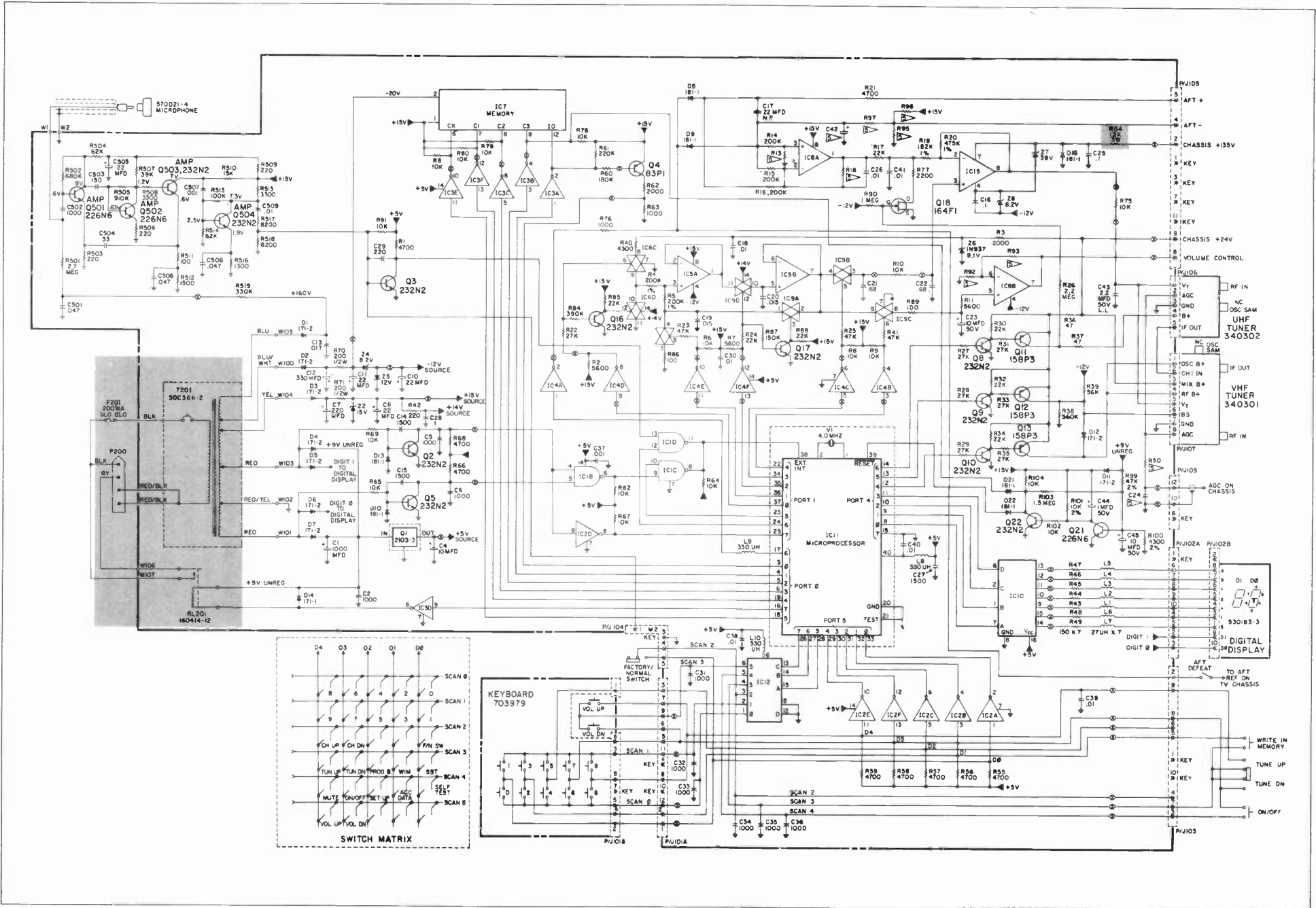

	Band I (LO VHF)	Band II (HI VHF)	Band III (UHF)
PIN 12	1	0	0
PIN 13	0	1	0
PIN 14	0	0	1

Chart 1. Microprocessor bandswitching outputs.

quality. Use the pulser and logic probes to test IC2.

Channel number display

When troubleshooting the channel display, check for proper operation of the keyboard buttons by pressing each number button twice in sequence. You should see 0, 11, 22, 33, 44, 55, 66, 77, 99 as you do. If this response is not obtained for any button, troubleshoot the keyboard input. If the numbers appear to be correct except that some segments are not lit or if the left or right digit or both do not light, ground pin 3 of IC10 and check for number 88 on display. If 88 appears, this verifies the LED display, L1 through L7, R43 through R49 and part of IC10. If either the left or right digit or both do not light at all, check the positive going half sine wave pulses at pins 2 and 3, P/J102A and pins 9 and 10, P/J2B. If present at P/J102A and absent at P/J102B, check wiring and socket connections. If absent at P/J102A, check rectifiers D5 and D6. If all segments light on either the left or the right digit but not the other, replace the LED display. If one or more segments do not light on either digit but is lit on the other, replace the LED display. If one or more segments are not lit on either digit ground the corresponding pin at IC10. Don't ground the segment at either P/J102B or P/J102A. The current limiting resistor and RF choke must be in series with the LED. If the faulty segment now lights, replace IC10. If it does not light, check continuity between pin at IC10 and the LED at P/J102B (approximately 150 ohms). If after testing all segments of both digits, the numbers are still incorrect or missing, press the 0 button twice and check for 60 Hz pulses at pins 1, 2, 6 and 7 of IC10. If present, replace IC10.

Channel tuning and audio volume control

If the symptom has been diagnosed to be a tuning fault, the first step is to set up the correct operating conditions for

the VHF and UHF tuners. This is accomplished by the bandswitch control circuits. Each channel number has a corresponding memory location in the channel memory, IC7. Two of the fourteen bits in each location are used to store the band control information. Whenever a channel is selected through the local keyboard or by remote operation, the channel memory is read for that number and the data is impressed on a scratch pad memory within IC11. The twelve bits used to store tuning data are routed to the digital to analog converter while the two bits used to store band information are decoded and used to control the bandswitch circuits.

If a channel selection is made and the channel number appears on the number display, but the channel is not tuned in, verify the correct operating conditions for the tuners.

On band I the VHF RF/OSC B+ should be 22 volts, the bandswitch should be -11 volts, and the UHF B+ should be 0 volts.

When tuned to band II the VHF RF/OSC B+ will be 22 volts, the bandswitch will be 22 volts, and the UHF, which is still off, is 0 volts.

On band III the VHF RF/OSC B+ will be 0 disabling the VHF input. The bandswitch will be -11 volts, and the UHF tuner will be turned on with 22 volts.

If any of these voltages are missing, check the sources first, then the bandswitching circuitry. For all symptoms of incorrect channel or lack of tuning, check the microprocessor, and then reprogram the bandswitch memory by shorting pins 6 and 7 of J103. When this is done the display will go blank for about 11 seconds. After the display returns, select a channel, and fine tune it. If channel selection is still inoperative, check the output of pins 12, 13 and 14 of IC11.

They should be seen as in chart 1.

If the microprocessor checked good these pins should be correct after band reprogramming. If the microprocessor outputs are good, but

Channel		Tuning voltage		
		MIN	TYP	MAX
B A N D 1	2	4.1	4.5	4.8
	3	5.5	6.8	8.0
	4	8.2	9.3	10.5
	5	13.4	14.7	16.1
	6	21.0	22.0	23.0
B A N D 11	7	8.9	11.0	13.0
	8	9.6	12.1	14.4
	9	10.5	13.1	15.5
	10	12.0	14.4	16.8
	11	14.5	15.8	17.4
	12	17.0	18.0	19.3
B A N D 111	13	21.0	22.0	23.0
	14	1.5	2.4	3.2
	20	2.9	3.8	4.6
	25	4.0	5.0	6.1
	30	5.2	6.2	7.5
	35	6.5	7.7	9.0
	40	7.5	9.0	10.5
	45	8.6	10.4	12.3
	50	9.7	11.8	14.0
	55	10.7	13.0	15.3
	60	12.0	14.2	16.5
	65	13.3	15.5	17.7
	70	15.2	17.1	19.1
	75	17.4	19.0	20.8
80	20.5	22.0	23.5	
83	23.5	25.5	27.5	

Chart 2. PC tuning voltage chart.

the tuner voltages are incorrect, check the transistor switching circuit (Q8-Q13), seen in the schematic in figure 6.

A word of caution here about tracing this signal through the transistors with the logic probe. If a 1 level is found on pin 12 for instance, a 0 will be found on the input of Q10. At first this appears to be impossible, but the logic probe will measure the base-emitter voltage of Q10 as being lower than the 1 level at about 0.7v. Therefore it is seen by the probe as being a 0. The output of Q10 will be 0 also because Q10 is a common emitter and therefore, inverts its input. This is true for all 3 bandswitching outputs of the microprocessor. If the microprocessor checked good with its self test routine, and the outputs on pins 12, 13 and 14 are still incorrect after reprogramming, IC7 must be checked. IC7 is a memory IC and cannot be tested with the pulser, but IC3 and Q4 can be. If they are good, it is a good bet that IC7 is defective. Before replacing it though, make sure the two voltage supplies are correct ... pin 1 at 15 volts and pin 2 at -20 volts. Then check for the static condition of 15 volts on pins 7, 8 and 9 of IC7. If any is low, replace IC7.

The other two inputs to the memory function must be checked and the method is the same as for the other inputs. At pin 6 of IC7 a zero level should be present. If not, trace the signal back through IC3 where the signal should be inverted. Now use

Function	Freq range (KHZ)
CH DOWN	36,345 - 36,420
CH UP	36,691 - 36,766
MUTE	37,037 - 37,112
ON/OFF	37,384 - 37,459
VOL DOWN	37,730 - 37,805
VOL UP	38,076 - 38,151
9	38,423 - 38,498
8	38,769 - 38,844

Function	Freq range (KHZ)
7	39,116 - 36,191
6	39,462 - 39,537
5	39,808 - 39,883
4	40,155 - 40,230
3	40,501 - 40,576
2	40,847 - 40,922
1	41,194 - 41,269
0	41,540 - 41,615

Chart 3. Remote transmitter frequency chart.

the same methods as before to determine if IC3 or IC7 is faulty. Do the same at pin 12 of IC7 . . . the signal level there should be LO. After the static voltages have been proven to be correct and the microprocessor has been self-checked, if incorrect channel selection persists, change IC7.

Information can be seen entering and exiting the memory when the logic probe is connected to any of the memory IC pins. As the channels are changed, the LEDs blink showing that high frequency pulse information has appeared at the probe input. By using the probe's memory function, a permanent indication is seen of the short lived information or instruction dump to or from the memory.

Now that you're sure the memory and the microprocessor are operating properly, check the operation of the tuners. At this point the bandswitching voltages should be correct because of previous troubleshooting on memory, microprocessor, and bandswitching circuits.

Tuning voltages however may still be incorrect. Refer to Chart 2 for the dc tuning voltages. Compare the measured tuning voltages with those given in the chart. If they are within the normal tuning range, make the usual checks of AGC, tuner link, and so on, and if found to be OK replace the tuner.

If all these tests have been made, and the tuner voltages are still incorrect, absent or near +30 volts, the D to A converter and the tuning voltage amplifier must be checked.

The tuner and volume both operate from the same D to A converter. IC9B and C merely switch the analog voltage between outputs—to the sound or tuning voltage amplifiers. Voltage at pin 8 of P/J105 varies from 0 to 9 volts, when the volume up and down buttons are pressed. If the D to A converter is operating check the B+ at IC9 and follow the positive pulse from pin 6 of IC4 to IC9 pin 5. Channel tuning voltage will pass thru

IC9B from pin 4 to pin 3 if the turn on pulse reached pin 5 and the switch works. This voltage should be measured as channel selection is made. If the signal is present at one point but not at the following, there must be a problem between the two points.

If the tuning voltage is still incorrect, AFT could be pulling the tuner off . . . measure the voltage for IC8 and IC13. The difference between pins 2 and 3 of IC13 should be within one volt of each other . . . if not, ground pin 1 of IC8. If the voltage is now correct, remove the ground, defeat the AFT with the AFT switch and measure the voltage at pin 1 of IC8. If it is not 0, replace IC8.

As mentioned earlier, if the sound does not change levels as the volume buttons are pressed, the D to A converter is not operating. Check the B+ at pin of IC4 and high duty cycle pulses at the inputs of IC4 at pins 3, 5, 9, 11, and 13. Now check the outputs at pins 4, 6, 8, 10 and 12. They should be low duty cycle and if any pin does not have a pulse, replace IC4.

Check for low duty cycle pulses at pins 5 and 6 and a high duty cycle pulse at pin 12 of IC6. If any pulse is absent but was at the input of IC4, there is an indication that the coupling resistor or IC6 is bad. Note that the pulse at pin 12 was inverted through Q16. If no pulse goes through Q16, check it and its associated components.

Check pulse input to IC9. There should be low duty cycle pulses at pins 5, 6, and 12 and a high duty cycle pulse at pin 3. The pulse at pin 3 is a high duty cycle because of the inversion provided by Q17. If any of these pulses are missing, but were present at the outputs of IC4, replace IC9 . . . at pin 3 if the signal is absent, check Q17. This confirms the signal to the D to A converter switches. Now, check for correct B+ at IC5, then for 0 to 9 volts at the output of the IC9 switches while holding in the volume

change and channel change buttons. If there is no output, check the output capacitors, then replace IC9. If the correct output is found at the IC9 switches but is not available from the output of either IC8 & IC13, change the op amp which does not have an output.

Remote control

If the microtune system does not respond to signals from the remote transmitter, verify that the remote defeat switch is in the correct position. If the Microtune system still does not respond substitute a known good transmitter. If there is still no response, substitute the remote receiver module and check for proper operation. If there is still no response, verify the 160 volt transducer and 5 volt Q3 supplies. If present, check Q3, R1, R91 and C29. Confirm low duty cycle pulses at pin 12, IC1. If absent, replace IC11. If the pulses at pins 12 and 13, IC1 are confirmed, the remote should operate if all other functions are normal. If not, replace IC11.

The remote transmitter contains a crystal oscillator and a keyboard encoder. Service is limited to replacing the standard 9 volt battery that powers the unit. However, the transmitter frequencies as listed in Chart 3 can be monitored with a frequency counter at the collector of Q3 to verify the transmitter frequencies are correct.

Though the logic probe is easily used (and I hope you have seen that it can be used in consumer products), it is not meant to take the place of the scope. There are many instances when the logic probe and voltmeter will be the only pieces of test equipment needed. But there are also many instances when the oscilloscope must be called upon to furnish conclusive proof of a suspected defect. It is not my intention to convince you to leave the scope on the shelf, but rather to broaden your horizons to include another most useful piece of test equipment. You will find it simple and easy to use. You do not have to look from the circuit board to the screen, chancing a probe slip and a shorted connection. The readouts are directly above the probe and easily seen, and there are practically no adjustments to be made as the probe is moved from circuit to circuit. It isn't a miracle tool nor will it do your work for you, but in the shop where efficiency is the name of the game it is worth investigating. **ETD**

TEST INSTRUMENT REPORT

Weston has met the demand for a high quality, versatile, digital multimeter with its Series 6400 and 6500 microprocessor controlled, portable, bench-type DMM's. All of the parameters, ranges, and measurement modes are the same for both the Series 6400 and 6500, but the Series 6500 has 12 additional computing functions, which makes it even

example, lead resistance may be nulled out prior to performing a series of resistance measurements), FILTER, which provides the average value of the input signal (useful when performing measurements from noisy sources), Ax + B which, when activated, multiplies measured value x by constant stored in register A, adds constant stored in register B and displays the result, (constants are entered into memory by the operator), $\Delta\%$ which compares the measured value to a preset value and displays the deviation percentage from that value, Max Min which compares measured values with stored maximum and minimum values and updates those stored values when exceeded, LIM which causes the message HI or LO to appear on the LCD when the measured value exceeds preset high or low values respectively, and the semiconductor test which measures resistance values across semiconductor junctions.

We found the Model 6504 to meet or exceed the manufacturer's specifications in every category (including accuracy). The ac and dc voltage range of the 6504 is from 200 mv to 2000v, with a dcv accuracy of 0.03% + 2 digits, an acv accuracy of 0.5% + 15 digits (100Hz to 10KHz), (0.8% + 15 digits on 2000v range), and 0.7% + 20 digits (45Hz to 20KHz), 1.0% + 25 digits on the 2000v range.

The measurement functions are dc and ac voltage, dc and ac current (200 μ A to 2A), and resistance from 200 Ω to 2M Ω .

A number of useful accessories are available with the 6504 to extend its operating capability. They are: an ac clamp-on probe, (switch-selectable to 200a with an accuracy of 1%), a temperature probe which provides a direct reading in $^{\circ}$ C or in $^{\circ}$ F of the temperature at the probe tip sensor, a hold-probe to hold the display reading, an RF voltage probe which extends the ac frequency range of the 6504 for voltage measurement (10KHz to 50 MHz), a VHF RF probe which extends the frequency range even further (50KHz to 520MHz), a high voltage probe which extends the dc voltage range to 50kv, a carrying pack, and a carrying case.

The instruction manual is impressive. It consists of a complete set of operating instructions, application notes, a thorough explanation of theory of operation, a maintenance section, drawings, and a complete list of illustrations.

The Model 6504 is solid, is compact and lightweight (1.8kg), and has all the necessary features needed in a DMM for the shop or lab. **ETD**

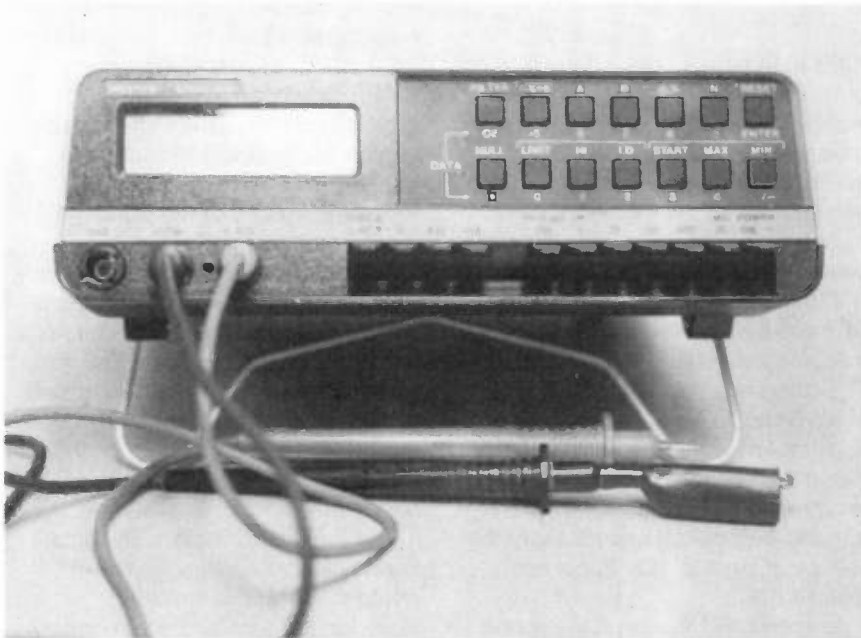

Weston's Series 6500 DMM.
For more information Circle No. 150 on the Reader Service Card.

Weston's Series 6500 DMM

For Shop or Lab

By Peter B. Credit

more useful for an industrial, manufacturing, or lab setting.

Within the 6500 Series are the Models 6502 and 6504. We tested the Model 6504 which measures true rms, while the 6502 measures average ac. All of the other features are the same.

The Model 6504 is equipped with a low power, high contrast 4½ digit LCD which provides readouts from 0 to 19999 with the appropriate decimal point. When the microprocessor detects abnormal operator use, it reconfigures the LCD segments to form special display messages such as FUNC (improper or inadequate functions selected), no AC (improper K Ω function selected), 0.rng (over-range condition), rng (improper range selected), OUCH (over-range detected in 2000 vdc or ac range), 0.FLO (calculation overflow), and a flashing display indicating a low battery condition (optional 6v battery pack available).

Paddle keys on the front panel of the 6504 are used to select function and range of desired measurements while pushbuttons are used to select six calculated functions: NULL, FILTER, Ax + B, $\Delta\%$, Max Min, and LIM.

NULL is used to null out a particular value from subsequent readings (for

NEW PRODUCTS



Satellite Video Receiver

Circle No. 115 on Reader Inquiry Card

Hustler Inc. announces its entry into the satellite TVRO earth station component market with a new 24-channel receiver, Model SVS-1000 for the private terminal. Simplified front panel layout includes controls for audio level, subcarrier frequency, fine tuning, and a 24 position rotary switch channel control for instant transponder selection. Features include a built-in regulated power supply with dc block to provide power to the L.N.A. through the coax, and switchable modulator with 75 ohm output on VHF channels 3 or 4 for feeding the signal directly to the TV antenna terminals. The Model SVS-1000 is designed to receive satellite TV transmissions in the 3.7-4.2GHz range, with audio subcarrier of either 6.2 or 6.8MHz. A wood-grained enclosure accents the brushed aluminum front panel to compliment any room decor.

Down Converter

Circle No. 116 on Reader Inquiry Card

Mitsubishi Electronics America (MELA) is marketing dual conversion down converters for satellite communication earth stations and IF filter/equalizers for INTELSAT earth stations. The down converters, series U-4536, operate in the 4 GHz (3.7 to 4.2) down-link frequency band and can receive all carriers specified in INTELSAT B.G. specifications; are compact in design that two can fit side by side on a 19-inch rack shelf; have primary AC power of 117v, 50 or 60 Hz; reportedly offer excellent residual phase noise (less than 14 dB) by combining low-noise crystal oscillators and a phase-locked frequency source; and are said to offer the ultimate in frequency selection capability, if an internally built-in or external (100 MHz to 110 MHz) frequency synthesizer is used

without need of additional tuning. Also provided is a built-in low noise frequency synthesizer which can be operated in 1 MHz steps for SCPC traffic. The down converters offer six options, including frequency synthesized HLO Type 1 (in 125 KHz steps, fully automatic and applicable for FM-FDM carriers), and Type 2 (in 1 MHz steps with mechanical cavity tuning and ultra-low noise characteristics suitable for SCPC traffic); external synthesizer input for the converter; improved frequency stability; group delay equalizer for compensation of group delay distortion produced in the first IF BPF, and up to four isolated and identical outputs. Mitsubishi's newly designed IF filter/equalizers feature sharp skirt characteristics attenuating over 35

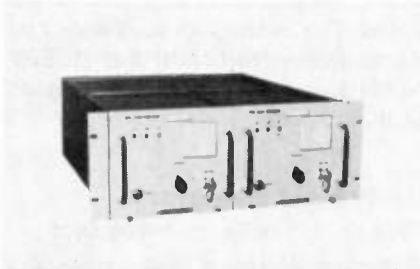

dB out of band, while keeping the in-band ripple for both gain frequency response and group delay characteristics

to a minimum to meet all INTELSAT IV and V requirements.

Tool Cases

Circle No. 117 on Reader Inquiry Card
Platt Luggage, Inc., introduces two new tool cases and one new all-purpose aluminum case. The 800T tool case is a 2 pallet injection molded polypropylene case combined with 2 molded polyurethane pallets. The model 805T is a one pallet case. For carrying small tools, Platt has a zipper tool case that weighs only 2 lbs. and measures 10 inches x 13 inches. The case has 29 pockets and is made of padded vinyl with a heavy duty nylon zipper. For general purpose use, Platt has an all aluminum case that has five adjustable rubber covered dividers with polyfoam interior and is available in two sizes, 18¼ x 13 x 5 inches and 18¼ x 13 x 7½ inches. **ET/D**

Electronic quiz answers:

- | | | | | |
|------|-------|-------|-------|-------|
| 1. a | 6. b | 11. d | 16. c | 21. c |
| 2. d | 7. c | 12. d | 17. b | 22. d |
| 3. b | 8. d | 13. a | 18. d | 23. c |
| 4. c | 9. b | 14. b | 19. b | 24. d |
| 5. c | 10. c | 15. d | 20. b | 25. a |



The Greenpar Probe

... made to last, and last, and last.

Each Greenpar probe kit is ruggedly constructed and incorporates strain relief mouldings at both ends of the coax cables. The earth lead is detachable, with screw connection for secure fixing and easy removal.

<p style="text-align: center;">88000</p> <p style="text-align: center;">Fixed Attenuation</p> <ul style="list-style-type: none"> • Attenuation 10:1 - 1% • Bandwidth 100MHz • Cable Length 1.2 meters • Capacitance 12pF • Working Voltage 600V d.c. or peak a.c. • BNC Plug <p style="text-align: center;">\$25.95</p>	<p style="text-align: center;">88100</p> <p style="text-align: center;">Switched Attenuation</p> <ul style="list-style-type: none"> • Attenuation 1:1 Reference 10:1 - 1% • Bandwidth 1:1 10MHz 10:1 100MHz • Cable Length 1.2 meters • Capacitance 12pF • Working Voltage 600V d.c. or peak a.c. • BNC Plug <p style="text-align: center;">\$29.95</p>
--	--

Just in ...

HITACHI test equipment



V-151B

V-152B

V-302B

To get the whole MCM parts story—Get the **NEW** MCM Electronic Parts Catalog!



Call us last—'cause we'll beat the price beaters!

1-800-762-4315
Ohio Watts Line

mcm
ELECTRONIC PARTS

1-800-543-4330
National Watts Line

Circle No. 106 on Reader Inquiry Card

SECURITY PRODUCTS

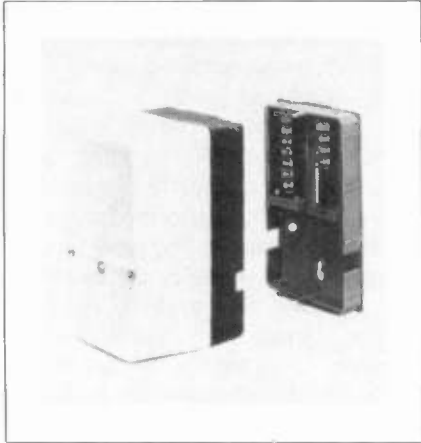

Infrared Detector

Circle No. 119 on Reader Inquiry Card

Aritech introduces its Series 550 passive infrared detectors that provide uniform detection capability throughout their pattern. By varying the focal length and effective aperture, the sensor sees a moving heat source in its true size, no matter how far away it is. It does not confuse a close-up small target with a distant man-size target. This prevents unwanted alarms caused by small targets close to the detector. The 550 has a background disturbance indicator that locates potential hazards that should be avoided when aiming the sensor. The *Aritech* 550 is available in 8 different models, allowing you to select the most appropriate detector for each installation. Stand-alone detectors can be powered by a 16 vac transformer and stand-by rechargeable battery or by an external 12 vdc power source. The 550 also is available as a sensor for the *Aritech* 230 multihead intrusion detection system (with or without No Homerun Zoning). Wide angle models protect a 40 foot by 50 foot area, long range models protect a 185 foot by 8 foot area.

Security Console

Circle No. 120 on Reader Inquiry Card

The AC100 console from *Advanced Signaling, Inc.* is designed for use in police stations where consolidation or miniaturization of receiving equipment is desired. Because the console functions as the annunciator panel and the module housing cabinet, installation can be accomplished at a reasonable price with a minimum amount of labor. Low cost and ease of installation permits use

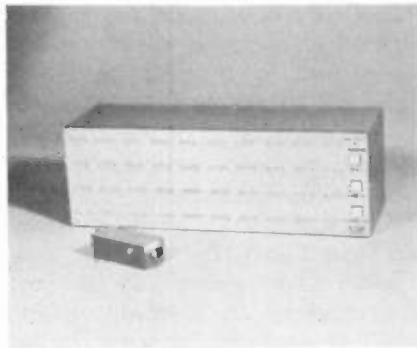

of the AC100 in P.D. locations where there is a probability of growth potential, as well as P.D. locations where space and appearance require a change in equipment. When an alarm or trouble condition exists, the indicator lens on the console will illuminate either red or amber respectively and a buzzer will sound. The buzzer can be silenced by momentarily depressing the RESET button. Lamp test buttons are provided on the console.

Body Heat Detector

Circle No. 121 on Reader Inquiry Card

Detection Systems, Inc., manufacturer of ultrasonic, photoelectric and passive infrared burglar alarm detectors recently introduced a patented body heat detector. The DS901 passive infrared detector features three separate patterns in the same enclosure as well as a multiple sensitive area approach that protects any area from a long narrow aisleway to a living room, dining room or other area requiring 'broad coverage.'

Information Display System

Circle No. 122 on Reader Inquiry Card

The *Vindicator* CM-4500 Information Display System is designed to enhance visual identification of alarm locations and accelerate security response to



emergency situations. Specifically developed to operate with *Vindicator's* SMS-2000A monitoring systems, the CM-4500 permits the user to create and store pre-planned messages and graphics. The stored information is displayed on a CRT monitor when the alarm is annunciated on the SMS-2000 system. The CM-4500 consists of the rack-mountable processor and *Vindicator* CRT-1000 video monitor. This microprocessor-based system can be easily programmed on the processor keyboard. A single 5-1/4 in. disc drive memory will store 64 graphic maps and 100 messages, and accommodate 1000 zones. The locking keyboard prevents unauthorized access.

Passive IR Intrusion Detector

Circle No. 123 on Reader Inquiry Card

Arrowhead Enterprises, Inc., introduces its new passive IR detector, the Series S8500. This Passive IR detector is designed to be recess-mounted for residential and office installations. The Series S8500 features the Pattern Locator which allows you to actually "see" where the unit is "looking," taking the "guess work" out of alignment. You will see, when standing in the zone of detection, the pattern locators red glow being emitted from the lens array. With an easily accessible adjustment you can now aim the detection zone to exactly where you want it. It reportedly avoids problem areas and gets the pro-

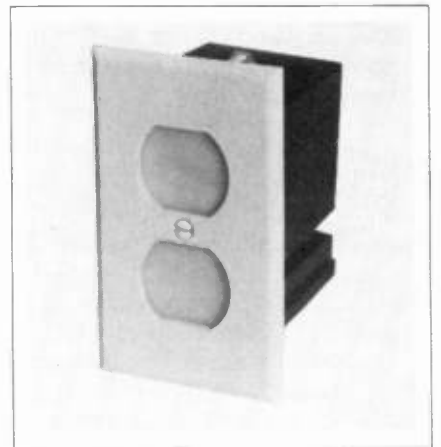

tection where it is needed with "no guess work" or lengthy time consuming walk tests. Other features of the Series S8500 are, 6vdc to 14vdc operation which makes it compatible with most controls and power supplies, a 75 ft. range, no wide "dead zone" in the middle of the detection area, and easily accessible terminal block connections and snap out circuits which will reportedly reduce installation and service costs. **ET/D**

“You fix TV’s... what brand should I get?”

You’re on the spot. Any set you tell your customer about has a chance of failing sometime.

But though we’re not saying we’re perfect, we’d like you to recommend RCA. Because we’re sure your customer will love its picture performance.

You can find the problem and repair it quickly if anything does go wrong. Because with RCA’s unitized chassis, failures are easy to handle.

RCA gives frequent hands-on workshops, as well as lectures. So when failures do occur, you’ll be ready.

RCA has more than 500 parts distributors nationwide. We have this large network because we don’t want you to have to wait too long for parts.

We also keep your inventory expenses lower by using components instead of modules, in most circuits.

We know your customers think you’re responsible for everything about their sets.

Good and bad.

And that’s why we here at RCA are doing everything possible to make sure that when you finish a service call, everybody’s smiling. Your customer’s happy with your recommendation. And you’re still the expert.

RCA

**RCA IS MAKING
TELEVISION
BETTER AND BETTER.**



For your free subscription to RCA COMMUNICATOR, our magazine of news and advice for service technicians, write RCA, Dept. 1-455, 600 North Sherman Drive, Indianapolis, IN 46201.

CLASSIFIED

RATES: 50 cents per word (minimum charge, \$15). Bold face word or words in all capital letters charged at 65 cents per word. Boxed or display ads charged at \$60 per column inch (one inch minimum). Agency commissions will be given only when camera-ready art is provided by agency. For ads using blind box number, add \$5 to total cost of ad. Send ad copy with payment to Dawn Anderson, ELECTRONIC TECHNICIAN/DEALER, 1 East First Street, Duluth, MN 55802.

BOX NUMBER REPLIES: Mail box number replies to: ELECTRONIC TECHNICIAN/DEALER, Classified Ad Department, 120 W. 2nd St., Duluth, MN 55802. Please include box number in address.

WANTED

Wanted for Cash: 7N7, 7F7, 53, 6L6 metal, 6AF6, 6HU8, 304TL, 4CX1000A, all transmitting, special purpose and Eimac tubes, etc. DCO Inc., 10 Schuyler Avenue, North Arlington, N.J. 07032, Toll Free (800) 526-1270. 8/81

WANTED: PICTURE TUBE REBUILDING EQUIPMENT working or not. Write or call Atoll Television, 6425 Irving Park, Chicago, Illinois 60634. Phone 312-545-6667. 9/81

MIRROR IN-THE-LID, SPINNING DISK, AND OTHER PRE-1946 TELEVISION SETS, parts, literature wanted for substantial cash. Also need 12AP4, 9AP4, MW-31-3 picture tubes, and any information on projection sets made by **TELICON CORP.** of N.Y. in 1947. Arnold Chase, 9 Rushleigh Rd., West Hartford, CT 06117. (203) 521-5280. 3/82

I need a flyback for a b/w Zenith TV (Zenith part #95-3298). New or used. Ray's TV, 4841 E. View Dr., New Orleans, LA 70126. 8/81

BUSINESS OPPORTUNITIES

GROUND floor opportunity with new company! Best marketing plan available in the United States today. A superior product line, better incentives and excellent bonus programs combined, offer the most success-oriented plan yet to be announced. Write or call for free information. **ENHANCE MARKETING GROUP, (E),** P.O. BOX 26563, Salt Lake City, UT 84126. (801) 467-0473. 9/81

Established TV repair good customer fully equipped shop for 2 Techs-Full SAMS from #1 to current-excellent current test equipment-Inventory only-call or write Charles Lurcott Inc., REALTORS-P.O. Box 80-Lincoln City, Oregon 97367. (503) 994-2141.

FOR SALE: TV SALES & SERVICE SHOP located in Mayville, Wisc. a growing industrial community in central Wisc. A prime Sportsmen's area as well. Includes bldg, Living quarters, truck, test equip., parts, and new merchandise. Call 1-414-387-3757 or 387-2438 for information or appointment. **TRIPLE CROWN REALTY,** 14 Tower Dr., Mayville, Wisc. 53050 9/81

MECHANICALLY INCLINED INDIVIDUALS Assemble electronic devices in your home. Knowledge or experience not necessary. Get started in spare time. Turn your spare or full time into cash. No investment-Write for free details. **ELECTRONIC DEVELOPMENT LAB,** Box 1560B, Pinellas Park, FL 33565. TF

Established TV repair. Must sell due to poor health. Just pay for my inventory. Plenty of business. Up to date test equipment. Excellent reputation. PO Box 16268, Jacksonville, FL 32216.

SOUTHERN NEW JERSEY: Established major TV-Appliance retail operation. Zenith and Whirlpool franchises. Factory authorized on Zenith but service most major brands of TV & stereos. Large and highly efficient sales and service areas. Plenty of carry in work. Growth opportunity for ambitious investor at the seashore in Wildwood, N.J. Owner retiring. For full details call 609-522-4510. 8/81

ESTABLISHED T.V. SALES, SERVICE & Antenna Business. Same location for eleven years. Untapped potential. A great opportunity for the right person. Contact Vince Brekel, Box 486, Benkelman, Nebraska 69021 or phone 308-423-2420 or 423-5359. New industry moving into area. 8/81

TV Sales Service-Est. 18 yrs. Factory Authorized Service. Owner retiring-Complete shop with equip. parts, etc. \$15,000.00. Call 516-588-4855 or write to Louis Sventora, 321 Portion Rd., Lake Ronkonkoma, L.I., N.Y. 11779. 9/81

Florida's Sun Coast. TV sales & service. New Showroom attached to modern 2 bedroom home in nice area. Plus separate rental house. \$90,000. For details call 1-813-541-2039. Or write Shop Owner: 7744 46 Ave. North, St. Petersburg, Fla. 33709

Parsippany, New Jersey, **TELEVISION STEREO Repair Shop For Sale.** Established Five Years. High Net, Good Equipment and High Quantity Parts Supply. Great Opportunity For The Right Man. 201-334-2022.

T.V. AND APPLIANCE, Sales and Service— Business for sale in small South Central Montana Community. Owner retiring and will sell building, equipment, and inventory. Call **MANDEVILLE AGENCY (406) 322-5361.**

For Sale: Zenith Sales and Service shop near major highway, complete with truck. 5 minutes to beach in Los Angeles area. \$25,000 plus inventory. Call Jim, 213-375-2233. 10/81

TV Sales and Service Shop - 16 yrs. same location - No. Calif. mountain town. Good Living. 916-628-5513.

FOR RENT

SCHEMATICS - LIBRARY SERVICE. One month rental fee \$2.25. Membership card \$10.00. **ALL RIDERS** manuals and **SAMS** available for your use. **THE TV SHOP,** 530 Minnesota Ave., Fallbrook, California 92028. (Telephone 1-714-723-1302). 1/82

FOR SALE

SCRAMBLED-TV WHAT IT IS-HOW IT WORKS. New publication explains how the two encoding/decoding systems used today work. Theory, circuits, etc. Send \$9.95 to: Workshop, Box 393ETM, Bethpage NY 11714. TF

Common VTR Problems and their causes. Video tape presentation shows you actual symptoms, then gives you the most likely causes. Covers both VHS and Beta type Video Tape Recorders. Please specify type of cassette you wish, VHS or Beta. A most valuable tool for all repair shops and technicians for only \$49.95. **B&K Audio and Video Production,** 706 South Patrick Drive, Satellite Beach, Florida 32937. 8/81

Now Only \$149.95

Columbia Video Systems Co.
2401 Bluemidge Ave., Suite 100
Silver Spring, Maryland 20902
To order phone toll-free
800-638-2000

Low Cost High Performance CCTV Camera
USE IT WITH YOUR PRESENT TV

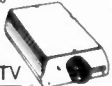

Superb quality. American made TV camera by GBC Corp. ideal for security, education, home, business etc. 10000: 1 ALC 2/3 in 600 lines, 2-1 Intl. Just plug it in. AC or DC! With 16 mm lens \$167.50. Outperforms cameras costing twice as much.

RF-Verter - SAVE 100's of \$\$ by using your present TV as a Video Monitor. This simple kit can be assembled in less than 15 min. and will convert VIDEO to RF for use with any CCTV camera, VTR, Computer, etc. No mod. to TV necessary \$17.95. For technical information call 301-933-6494.

Visa & Master Card Accepted.

Lowcost needles wholesale 12 up, Pickering V-15 \$2.75/ea., XV-15 \$3.50/ea., original magnetic cartridges V15/AT2 \$6.00/ea., Empire Mark IV \$8.00/ea., Shure M81MC \$5.95/ea., many more, free catalog, 212-897-0509. D & W, 66-19 Booth St., Rego Park, NY 11374. 9/81

PICTURE TUBE REBUILDING EQUIPMENT capable of producing four high quality tubes per day (**WILL TRAIN TO OPERATE**) Call or Write Atoll Television, 6425 Irving Park, Chicago, Illinois 60634, ph. 312-545-6667. 9/81

T.V. PICTURE TUBE REBUILDING EQUIPMENT FOR SALE. COMPLETE UNIT CAPABLE OF REBUILDING TWENTY TUBES PER DAY. ALL NECESSARY SUPPLIES AND MATERIALS INCLUDED. FOR INFORMATION CALL 218-727-2825 OR WRITE NWK, 413 EAST SUPERIOR STREET, DULUTH, MINNESOTA 55802. 8/81

"QUALITY ELECTRONIC PARTS AT WHOLESALE PRICES." ELECTRONIC DEALERS AND HOBBYISTS! Send your name and address for "free catalog" and be placed on mailing list for monthly specials. Free technical assistance available with order! R. L. Miller, Box 391 Bay Station, Dept ETD 2 Brooklyn, NY 11235 TF

TECHNICAL reports: Keep pace with technology. Stay current beyond immediate job requirements. Engineers, technicians, computer science personnel. Free brochure. **ADVANCED TECHNOLOGY EDUCATIONAL SYSTEMS,** 4615 North Park Avenue, Suite 1519, Chevy Chase, Maryland 20015. 9/81

SATELLITE television...Howard/Coleman boards to build your own receiver. For more information write: **ROBERT COLEMAN**, Rt. 3, Box 58 ETD, Travelers Rest, SC 29690.

TV TROUBLE ANALYSIS TIPS. Over 300 symptoms/remedies by circuit area. Tough ones I found in years of servicing. e.g. Poor sync-C66 shorted-Wards-GEN-12349A-SAMS 995-2. Save time and money. Due to demand, send only \$12.50 to **CHAN TV**, 8151 Grandview Rd., Chanhassen, MN 55317.

WHOLESALE TV PARTS-transistors (TM/PTC/ECG) Thordson Yokes & Flies; Resistors; Capacitors; Triplers; Tools; Tubes 72% off; Sams 6.25, Video Tapes. Video Movies bought, sold, rented. Send for free catalog. Astro Electronics, Old Grand Union Shopping Ctr., Rt. 9W, Stony Point, N.Y. 10980. 914-942-2173 8/81

Free flyer! Microwave TV Antennas, Cable TV Converters-30 and 40 channel, and Cable Inverters. CB Accessories and books including Bootleggers Bible for PLL modification above channel 40 and below channel 1, CB Repair Manual, and Linear Amplifier Planbook. Catalogue \$1.00 refundable. MC/VISA (401) 846-5627. AP Systems, PO Box 263 ED, Newport, RI 02840. 8/81

PASS FCC EXAMS

The Original FCC Tests. Answers exam manual that prepares you at home for FCC First and Second Class Radiotelephone licenses. Newly revised multiple choice exams cover all areas tested on the actual FCC exam. Plus — Self-Study Ability Test. Proven! \$12.95 postpaid. Moneyback Guarantee.



COMMAND PRODUCTIONS
Radio Engineering Division

P.O. Box 26348-W
San Francisco, CA 94126

PRINTED circuit boards with running water! Technical breakthrough. Precise reproduction. Ideal for beginners. Free info. **COVAL**, Dept. ET8, 2706 Kirby, Champaign, IL 61820. 9/81

FREE speaker catalog! Woofers, mids, tweeters, hardware, crossovers, grille cloth, plans, kits, information, much more. Discount prices. **UNIVERSAL SOUND**, Dept. ET, 2253 Ringling Blvd., Sarasota, FL 33577, (813) 953-5363. 1/82

SATELLITE parabolic antenna, including polar mount. Fiberglass and steel construction f/d—.45, 12'—41 dB—\$1,100. **SATRONICS COMMUNICATIONS**, P.O. Box 2924, St. A, Champaign, IL 61820 (217)398-2873. 9/81

TV AND RADIO TUBES 49¢ EA!! Send for free color parts catalog. Your order free if not shipped in 24 hours. Cornell Electronics 4215-17 University San Diego California 92105 TF

TUBES—Receiving, Industrial and Semi-conductors, factory boxed. Free price list. Low, low prices. **TRANSLETRONIC INC.**, 1365-39th Street, Brooklyn, N.Y. 11218E 800-221-5802, 212-633-2800.

SAMS PHOTOFACTS 33-796, 30% complete. Sell all or part. List available. R. L. Wollam, 1 Woods Ct., Huntington, NY 11743.

SONY-PANASONIC-RCA-ZENITH-EXACT REPLACEMENT PARTS—LARGE INVENTORIES—SEND PART OR MODEL NUMBERS—WILL UPS OR COD—GREEN TELE RADIO DISTRIBUTORS, 172 SUNRISE HIGHWAY, ROCKVILLE CENTRE, N.Y. 11570. TF

Satellite Television: Information on building or buying your own earth station. Six pages of what's needed, where to get it, costs, etc. \$4.00 to Satellite Television, RD #3, Box 140, Oxford, NY 13830. TF

1 BPI, 3000C, distortion analyzer. Excellent condition. **FINKLEA'S** 223 S. McQueen St., Florence, SC 29501. (803) 662-2526. 9/81

Automobile radio and tape replacement parts: Delco, Chrysler, Philco-Ford, Motorola, Panasonic and many others. Large inventory. **Laran Electronics Inc.** 3768 Boston Road, Bronx, NY 10469 (212) 881-9600 out of New York state (800) 223-8314. TF

Need a 470 mfd at 75 wv (RCA #134179)? Norfolk got a replacement 470 mfd at 80 wv, pc at the right price—\$2.00 each/10 for \$19.00—f.o.b. Garnerville, NY 10923.

MINIATURE ELECTROLYTICS. Assortment No. 56—10 ALL DIFFERENT 100 VOLT AND UP. 5 MFD @ 100 AX—20 MFD @ 100 AX—100MFD @ 100 AX—10 MFD @ 150 RAD—25 MFD @ 150 AX—50 MFD @ 150 AX—1 MFD @ 160 PC—2.2 MFD @ 250 PC—10 MFD @ 250 PC—12 MFD @ 250 AX. Norfolk Electronics, P.O. Box 91, Garnerville, NY 10923.

MINIATURE ELECTROLYTICS. Assortment No. 57 10 ALL DIFFERENT 100 VOLT AND UP. 15 MFD @ 100 AX—20 MFD @ 100 AX—22 MFD @ 100 RAD—100 MFD @ 100 AX—4 MFD @ 150 AX—8 MFD @ 150 AX—22 @ 160 RAD—47 @ 160 AX—3.3 @ 200 PC—20 @ 250 AX—\$7.95 each/2 for \$15. Norfolk Electronics, P.O. Box 91, 55 Railroad Avenue, Garnerville, NY 10923.

PALOMAR—pride—exclusive repair facility. Factory trained technicians—all work guaranteed. **PALOMAR/PRIDE ELECTRONICS**, 1320 Grand, San Marcos, CA 92069 (714) 744-0720. 9/81

LOWEST prices electronic parts. Confidential catalog free. **KNAPP**, 4750 96th St. N., St. Petersburg, FL 33708. 9/81

CABLE TV converter, low cost, easy to build, plans \$5. **L. NAHHAS**, 112 Williams Ave., Old Tappan, NJ 07675. 9/81

RF power transistors—tubes—special parts for "ham" linears. MRF454 \$17.00, MRF455A \$14.00, 8950 \$9.00, 6LF6 \$5.50, catalog and cross-reference help available. COD—Visa/MC. **WESTCOM**, 1320 Grand, San Marcos, CA 92069. (714) 744-0728.

COMPLETE line of microwave television converters and accessories to suit your needs. Converters have a one year warranty backed by a 3 year reputation. Call or write for complete specifications and pricing, **dealer inquiries invited.** **TRITON MARKETING**, 1933 Rockaway Parkway, Brooklyn, NY 11236. (212) 531-9004.

FOR SALE—Model 1474 B&K dual trace 30MH oscilloscope with probes. Good condition. \$595.00 plus shipping. CB schematics 38 through 141—\$1.50 each. Mike Tucker, 1712 Meadowview Dr., Statesville, NC 28677. (704) 876-1666.

RF spectrum analyzer, ASL model 8622, 1C to 1,000 MHz, 3-inch CRT, manual and application notes, weight 22 lbs. Excellent condition. \$895. **M.W. ROBERTS**, 3694 East Tompkins, Las Vegas, Nevada 89121. (702) 451-3517.

SIMPLE SIMON 7 + 11 PART KITS

MITSUMI UHF TUNER

PRICE
\$34.95

Freq. Range UHF 470 - 889 mHz
Channels 14-83 Output Chan 3

1 VT1-SW	Varactor UHF Tuner Model UES-A55F	\$34.95
2 CB1-SW	Printed Circuit Board Pre-Drilled	\$18.95
3 TP7-SW	P.C.B. Potentiometers, 1-20K, 1-1K & 5-10K OHMS, 7-pieces	\$5.95
4 FR35-SW	Resistor Kit 1/4 W, 5% Carbon Film, 32-pieces	\$4.95
5 PT1-SW	Power Transformer PRI-117VAC, SEC-24VAC, 250MA	\$6.95
6 PP2-SW	Panel Mount Potentiometers & Knobs 1-IKBT & 1-SKAT W/SW	\$5.95
7 SS14-SW	IC's-7 ea., Dodes 4 ea., Regulators 2 ea., Heat Sink 1 ea.	\$29.95
8 CE9-SW	Electrolytic Capacitor Kit 9 ea.	\$5.95
9 CC33-SW	Ceramic Disk Capacitor Kit 50 W.V. 33 ea.	\$7.95
10 CT-SW	Variable Ceramic Trimmer Capacitors 5-65PFD 6 ea.	\$5.95
11 L4-SW	Coil Kit 2 ea., 18 MHS, 1 ea., 22 MHS Inductances-prewound and 1 ea. T37-12 Ferrite Tond Core with 3 ft. of #26 Wire	\$5.00
12 ICS-SW	I.C. Sockets Tin Inlay 5 ea. 8 Pin, 2 ea. 14 Pin	\$1.95
13 SR-SW	Speaker Oval 4x6" & Prepunched Wood Enclosure	\$14.95
14 MISC-SW	Misc. Parts Kit Includes Hardware, 6/32 & 8/32 Nuts & Bolts, H.U. Wire, Ant. Terms, DPDT ANT. SW., Fuse Fuseholder etc.	\$9.95

*When Ordering All Items 1 Thru 14 Total Price **\$139.95**

ANTENNA & ACCESSORIES

STVA-1-STV	Yagi Antenna 13.5 DB, 75 OHM, CHN 42 Thru 54	\$9.95
STVA-2-STV	Yagi Antenna 13.5 DB, 75 OHM, CHN 20 Thru 28	\$9.95
	CO-75 Coaxial 75 OHMS Low Loss	\$12 P/FT
	F-59 Coaxial Connectors ea.	\$ 3.99
	MT-1 Special UHF 75-300 OHM Matching Transformer ea.	\$1.45
	A-1 indoor VHF-UHF Antenna Amplifier with Power Supply 300 OHM IN & Out. APT 13Db gain	\$19.95

Min. Order Amount Is \$19.95. Add 10% Shipping and Handling. Over \$40.00 Add 5% Catalog \$1.00.

Mail Orders Only

SIMPLE SIMON ELECTRONIC KITS

Call/ orders mail to:
3871 S. Valley View, Suite 12
Las Vegas, NV 89103
(702) 322-5273

Other orders mail to:
11850 S. Hawthorne Blvd., Hawthorne,
California 90250, Tel: (213) 675-3347

VISA — MASTERCHARGE ACCEPTABLE



DON'T LET INFLATION BLOW IT!



Use your "Dollars and Sense."
Send for this free booklet, and information on how to obtain bulk copies.



George W. Hayden
The Advertising Council
825 Third Avenue, New York, N.Y. 10022

Please send me a free copy of "Dollars and Sense," and information for ordering bulk copies.

NAME _____

TITLE _____

ORGANIZATION _____

STREET _____

CITY _____

STATE _____ ZIP _____

SIGNATURE _____



A public service message of The Advertising Council and The U.S. Departments of Agriculture, Commerce, Labor and Treasury. Presented by this magazine.

AD INDEX

Circle No.	Page No.
101 William B. Allen Supply Co., Inc.	9
102 Cooper Group	Cov. 4
103 Digitron Electronics Corp.	3
104 Electronic Book Club	29
105 Hitachi Denshi America, Ltd.	6
106 MCM Audio Inc.	37
107 Micro Design	5
North American Philips	11, Cov. 3
108 Optima Electronics	8
109 Pomona Electronics	Cov. 2
RCA Consumer Electronics	39
110 Sprague Products Company	16
111 Workman Electronics	3

TEST INSTR. RPT.

Circle No.	Page No.
150 Weston Instruments	36

NEW PRODUCTS

Circle No.	Page No.
115 Hustler, Inc.	37
116 Mitsubishi Electronics America	37
117 Platt Luggage, Inc.	37

SECURITY PROD.

Circle No.	Page No.
119 Aritech	38
120 Advanced Signaling, Inc.	38
121 Detection Systems, Inc.	38
122 Vindicator	38
123 Arrowhead Enterprises, Inc.	38

This Index is furnished for the readers' convenience. However, the publisher can not guarantee its accuracy due to circumstances beyond our control.

Support the
March of Dimes
BIRTH DEFECTS FOUNDATION

Lots of smart companies have high blood pressure control programs.



MASSACHUSETTS MUTUAL
LIFE INSURANCE COMPANY
SPRINGFIELD, MASSACHUSETTS

Campbell Soup Company



bloomingdales

What about yours?

Uncontrolled high blood pressure is a major health problem. About 26 million workdays and billions of dollars are lost each year because of it.

But high blood pressure can be easily detected and controlled. Proper treatment, every day, can prevent heart failure, kidney disease, stroke and premature death caused by high blood pressure.

Many companies, large and small, have successful on-the-job high blood pressure programs for their employees and management. Look into it. You can save time and money. And protect your employees' health. To find out the whole story write:

Ms. Judie LaRosa
Worksetting Programs
Coordinator
National High Blood Pressure
Education Program
Bethesda, MD 20205

**High blood pressure.
Treat it and live.**

National High Blood Pressure Education Program,
National Heart, Lung, and Blood Institute,
U.S. Department of Health and Human Services



Are you throwing away tickets to Hawaii?

**The Philips ECG sweepstakes can turn tabs into a vacation
for two, or one of 2,159 other great awards.**

Don't pass up your chances to be a winner in our "Reach for the Rainbow" Sweepstakes. The awards range from a Hawaii vacation to mopeds, workshop tools, calculators, cash, and other valuable items.

Every time you collect 5 receiving tube address tabs or 5 ECG semi-

conductor tabs or bags you're entitled to one chance to win. One color-tube serial label earns you ten entries. The more entries you get, the more chances you have to win. And there's no limit to the number of awards you can receive. We'll have winners from every state.*

See your local distributor for entry forms and details. All entries must be postmarked by midnight, August 31st, 1981.

Start collecting your stack of address tabs from Sylvania brand products today. They could pay the tab for your next vacation.

Philips ECG

A North American Philips Company

*The Philips ECG "Reach for the Rainbow" Sweepstakes is available only to dealers and service technicians. Employees of Philips ECG, Inc., its authorized distributors, or their advertising agencies are not eligible to participate. No purchase required. Reasonable facsimile accepted. Void where prohibited by law.

The Tools.



**Boker, Crescent,
Lufkin, Nicholson, Plumb,
Weller, Wiss, Xcelite.**

The right tool makes the job easier.
And Cooper makes the right tool for the job.
Whether you're making or mending, cutting or joining,
striking, measuring or stripping, there's a Cooper tool that's
just right. Don't take chances on tools. Specify Cooper
and get 'em right the first time!

from Cooper The Toolmaker. T.M.



The Cooper Group

BOKER® CRESCENT® LUFKIN® NICHOLSON® PLUMB® WELLER® WISS® XCELITE®
P.O. Box 728, Apex, North Carolina 27502, Tel: (919) 362-7510, Telex: 579497

Circle No. 102 on Reader Inquiry Card