

DECEMBER 1977 • 75 CENTS



A HARCOURT BRACE JOVANOVICH PUBLICATION

ELECTRONIC TECHNICIAN/DEALER

WORLD'S LARGEST TV-RADIO SERVICE & SALES CIRCULATION



Medical Electronics:

Is there a place for you?

Modern chroma circuits, part II

ET/D's 1977 Index

Admiral's newest chassis

GET MORE FOR YOUR DUDS!

PTS OFFERS GREATER VALUES FOR DUD TV MODULES

PTS is into module rebuilding in a big way, and we'll buy all the dud modules you can lay your hands on. Check your shop. Whether you have one or 101, PTS will give you more for your dud TV modules.

COMPARE!

A FEW EXAMPLES OF DUD MODULES PTS PAYS TOP DOLLAR FOR:

MODULE	OEM DUD VALUE	PTS DUD VALUE
Quasar 65534A82-B-If	\$13.05	\$14.20
RCA MCK001A/141224	\$10.00	\$11.40
Zenith 150-162	\$10.48	\$12.20

If you have a large quantity of dud TV modules send us a list of brand* and module numbers and we'll advise you of the value. Contact the PTS Servicenter nearest you for more information.

* Acceptable brands are Admiral, GE, Magnavox, Montgomery Ward, Philco, Quasar, RCA, Sears/Warwick, Sylvania and Zenith. Do not include ceramic encapsulated, broken or cannibalized modules. PTS reserves the right to reject any or all modules.

PTS ELECTRONICS, INC.

Check this Listing for the PTS Servicenter Nearest You.



PTS SERVICENTER LOCATIONS

MIDWEST

Home Office
BLOOMINGTON, IN 47401
5233 S. Hwy. 37, P.O. 272
812-824-9331
CLEVELAND, OH 44134
5682 State Road
216-845-4480
KANSAS CITY, KS 66106
3119A Merrilam Lane, P.O. 6149
913-831-1222
MINNEAPOLIS, MN 55408
815-W. Lake St., P.O. 8458
612-824-2333
ST. LOUIS, MO 63130
8456 Page Blvd., P.O. 24256
314-428-1299
DETROIT, MI 48235
13707 W. 8-Mile Rd.
313-862-1783
GRAND RAPIDS, MI 49501
1134 Walker Northwest
P.O. 1435
616-454-2754
CINCINNATI, OH 45216
8172 Vine St., P.O. 15491
513-821-2298
MILWAUKEE, WI 53218
7211 Fond du Lac
414-464-0789
COLUMBUS, OH 43227
4005A E. Livingston
614-237-3820
INDIANAPOLIS, IN 46202
28 E. 14th St.
317-631-1551
DAVENPORT, IA 52805
2024 E. River Dr., P.O. 187
319-323-3975
OMAHA, NE 68132
5008 Dodge Street
402-558-1800
CHICAGO
Berkeley, IL 60163
1756 S. Taft Street
312-449-2082

SOUTH

ATLANTA, GA 30311
2180 Campbellton Road
P.O. 42558
404-753-0007
JACKSONVILLE, FL 32210
1918 Blanding Blvd., P.O. 7923
904-389-9952
WASHINGTON, DC
Silver Spring, MD 20910
8880 Brookville Rd.
301-565-0025
CHARLOTTE, NC 28225
726 Seigle Ave., P.O. 5512
704-332-8007
BIRMINGHAM, AL 35201
210 N. 9th St., P.O. 1801
205-323-2657
MEMPHIS, TN 38118
3614 Lamar Ave., P.O. 18053
901-365-1918
NORFOLK, VA 23504
3118 E. Princess Anne Rd.
804-625-2030
NEW ORLEANS
Metairie, LA 70004
3920A Airline Hwy., P.O. 303
504-837-7569
TAMPA, FL 33690
2703 S. Macdill, P.O. 14301
813-839-5521
NASHVILLE, TN 37214
2426 A Lebanon Rd.
615-885-0688

NORTHEAST

SPRINGFIELD, MA 01103
191 Chestnut, P.O. 3189
413-734-2737
PHILADELPHIA
Upper Darby, PA 19082
1742-44 State Rd., P.O. 207
215-352-6609
PITTSBURGH, PA 15202
257 Riverview Ave., W. P.O. 4130
412-761-7648
E. PATERSON, NJ 07407
158 Market St., P.O. 421
201-791-6380
BUFFALO, NY 14212
993 Sycamore St., P.O. 1241
716-891-4935
BOSTON
Arlington, MA 02174
1167 Massachusetts Ave., P.O. 371
617-648-7110
SYRACUSE, NY 13204
418 Salar St., P.O. 207, Salfina Sta.
315-475-2330
BALTIMORE, MD 21215
5505 Reisterstown Rd.
301-358-1186

PACIFIC

SACRAMENTO, CA 95841
4351 D Auburn Blvd., P.O. 41354
916-482-6220
SAN DIEGO, CA 92105
5111 University Ave., P.O. 5794
714-280-7070
LOS ANGELES, CA 90023
4184 Pacific Way
213-266-3728
PORTLAND, OR 97213
5220 N.E. Sandy Blvd.
P.O. 13096
503-282-9636
SEATTLE, WA 98109
432 Yale Ave. N, P.O. 9225
206-623-2320

MOUNTAIN

DENVER
Arvada, CO 80001
4958 Allison St., P.O. 672
303-423-7080
SALT LAKE CITY, UT 84106
1233 Wilmington Ave.
P.O. 6218
801-484-1451
PHOENIX, AZ 85009
2916 West McDowell Rd.
602-278-1218

SOUTHWEST

LONGVIEW, TX 75601
110 Mopac Rd., P.O. 7332
214-753-4334
OKLAHOMA CITY, OK 73106
3007 N. May, P.O. 60566
405-947-2013
HOUSTON, TX 77207
4326 Telephone Rd., P.O. 26616
713-644-6793

NEWS OF THE INDUSTRY

Sylvania-Panasonic Join Home Video Tape Parade

Panasonic and GTE Sylvania are the latest to join the growing list of U.S. television manufacturers who will market home video cassette recorder/players in time for Christmas this year. Both have opted for Matsushita's two and four hour recording format, the same unit being marketed by RCA which caused industry waves by pricing their unit at a suggested retail of \$1,000 earlier this year.

Matsushita, of course, is Panasonic's parent company.

Panasonic's entry into the field began about two weeks ago with their unit, called Omnivision IV, going for a suggested retail of \$1,095. Sylvania, on the other hand, delayed putting their units on the market until an initial round of distributor service seminars could be conducted around the country. At press time, no decision had been reached by Sylvania on price or what they will call their version of Matsushita's machine.

Following the industry trend, both will offer optional black and white television cameras for a price in the neighborhood of \$300.

Still taking a wait and see attitude regarding VCR units are General Electric and Admiral among the major U.S. manufacturers.

Sony, the first to market VCR in this country with its Betamax two-hour maximum recording time, is also offering its \$1,300 unit through other manufacturers. Zenith Radio Corp., is thus far the only U.S. manufacturer having opted for this format, although it is also being offered through Toshiba and Hiatachi.

Among the manufacturers selecting Matsushita's VHS (Video Home System) format are JVC, RCA, Magnavox, Panasonic, and Sylvania. JVC is actually manufacturing the Matsushita designed unit.

Quasar Electronics is the only manufacturer offering a third variation of the VCR, a single head recording "Alpha Wrap" format with one or two hour record/play options. This unit, as of press time, was priced at \$995.

Radio-TV Dealer Sales Boom

Booming color television sales, judging by third quarter statistics, continue to point to 1977 as a banner year, according to EIA figures.

Color TV sales to dealers for September were 1,104,941, up 28.3 per cent from a year earlier and for the

nine-months totaled 6,208,922, up 20.5 percent over a year earlier. Total television also showed strong gains with the nine-months figure totaling 9,960,807 which amounts to an increase of 15.1 per cent over the nine months figures a year earlier.

Both RCA and Zenith report color TV sales to dealers at record or near record levels while other manufacturers report performances substantially ahead of last year.

EIA also reported soaring dealer sales in radio. For September 7,765, 263 units were sold, up 60.5 per cent over September of 1976. For the nine months, EIA said, total radio sales were 39,446,360 and this amounted to a hefty 35.6 per cent increase over figures for the comparable period a year earlier.

Tube Warranty Practices Criticized

The Chicago chapter of NATESA (National Association of Television and Electronic Servicers of America) says members are becoming increasingly concerned over the "growing practice" of circuit tube sales without warranty and it is considering notifying the Consumer Advocates office in Washington, D.C.

According to NATESA president George Weiss, "Ultimately it will be the consumer who will get burned if this trend continues."

Although manufacturers about two years ago discontinued warranties on circuit tubes, distributors were giving a 5 per cent discount to cover faulty tubes. Now, Weiss said, some distributors in the Chicago area have discontinued the practice of passing on the 5 per cent discount to service dealers and others are contemplating following suit.

"Right now I find in my own shop a 10 per cent tube failure rate, and it is not the \$3 tubes that are giving out. It's the bigger \$12 tubes.

"If one of these breaks down in the home there's the additional consideration of a \$25 service call we have to sacrifice, so it's a problem of labor costs as well," he said.

A statement released by NATESA said that an August 12 letter to tube manufacturers and marketers calling attention to the situation has gone unanswered. The non-warranty policy "is conducive to a serious drop in quality," NATESA charged, and added "it appears that such is already the case" since field reports indicate the 5 per cent allowance "definitely is not compensating for the cost of needed replacement and certainly not for the cost of calls."

In addition to the proposal that the Consumer Advocate be notified, NATESA said it was also suggested that servicers "find new sources re-



RICHARD W. LAY
Editor
43 East Ohio Street
Chicago, Ill. 60611
(312) 467-0670

DOH W. MASON
Managing Editor
1 East First Street
Duluth, Minn. 55802
(218) 727-8511

ALFRED A. MENEGUS
Publisher
757 Third Avenue
New York, N.Y. 10017
(212) 888-4382

DAVID J. HAGELIN
Associate Publisher
and General Manager

TOM GRENEY
Publishing Director

JOHN PASZAK
Graphic Design

DEBBIE PORKKONEN
Production Manager

LILLIE PEARSON
Circulation Fulfillment

GENE BAILEY
Manager, Reader Services

DAWN ANDERSON
Classified Ad Manager

ADVERTISING OFFICES

DAVID J. HAGELIN
43 East Ohio Street
Chicago, Ill. 60611
(312) 467-0670

CHUCK CUMMINGS
Ad Space South/West
613 North O'Connor
Irving, Texas 75061
(214) 253-8678

ROBERT UPTON
Tokyo, Japan
C.P.O., Box 1717

ELECTRONIC TECHNICIAN/DEALER

DECEMBER 1977 • VOLUME 99 NUMBER 12

THE COVER: Raymond Lipinski, Acting Director of Biomedical Engineering at Northwestern Memorial Hospital, Chicago, adjusts a non-fade display monitor in the hospital's Intermediate Coronary Care Unit. Telemetry signals transmitted from mobile heart patients allow the staff to monitor heart functions in real and delayed time.

18 A look at biomedical electronics servicing

What you need to know to break into this expanding field and what you can expect when you get there. By Joseph J. Carr, CET

24 Admiral color television for 1978

A new chassis—the 25M55M—is introduced and designed to handle Admiral's new 90 degree delta CRT. We take a look at the new circuits.

27 Servicing modular chroma—Part two

The conclusion of our two part series on servicing modern color circuits emphasizes proper signal tracing methods.
By Bernard B. Daien

30 The ET/D Annual subject reference index

An alphabetized subject-to-issue listing of editorial topics and servicing tips published in ET/D during 1977.

DEPARTMENTS

1 NEWS OF THE INDUSTRY	36 DEALER'S SHOWCASE
8 NEWSLINE	39 NEW PRODUCTS
12 TECHNICAL LITERATURE	46 CLASSIFIED ADS
11 FROM THE EDITOR'S DESK	48 ADVERTISING INDEX
14 SERVICE SEMINAR	49 READERS SERVICE
34 TEST INSTRUMENT REPORT	51 TEKFAQ



A HARCOURT BRACE JOVANOVIH PUBLICATION



HARCOURT BRACE JOVANOVIH PUBLICATIONS. Robert L. Edgell, Chairman, Richard Moeller, President/Treasurer, Lars Fladmark, Senior Vice President, Thomas Greney, Vice President, Ezra Pincus, Vice President, James Gherna, Vice President, Lois Sanders, Vice President, Harry Ramaley, Vice President, Joe Bilderbach, Vice President, George Glenn, Editorial Director.

ELECTRONIC TECHNICIAN/DEALER is published monthly by Harcourt Brace Jovanovich Publications. Corporate offices: 757 Third Avenue, New York, New York 10017. Advertising and editorial offices: 43 East Ohio Street, Chicago, Illinois 60611 and 757 Third Avenue, New York, New York 10017. Editorial, Accounting, Advertising Production and Circulation offices: 1 East First Street, Duluth, Minnesota 55802. Subscription rate: one year, \$8; two years, \$14; three years, \$18 in the United States and Canada. Other countries: one year, \$15; two years, \$24; three years, \$30. Single copies: 75¢ in the U.S. and Canada; all other countries: \$2. Second Class postage paid at Duluth, Minnesota 55806 and at additional mailing offices. Copyright © 1977 by Harcourt Brace Jovanovich, Inc. All rights reserved. No part of this publication may be reproduced or transmitted in any form or by any means, electronic or mechanical, including photocopy, recording, or any information storage and retrieval system, without permission in writing from the publisher.

POSTMASTER: Send Form 3579 to ELECTRONIC TECHNICIAN/DEALER, P.O. Box 6016, Duluth, Minnesota 55806.



Why fiddle with cross-references... when replacing standard Japanese original equipment semiconductors?

Buy the original Japanese number from HEP, such as 2SA495, 2SB468, etc.

Our broad line includes the Discretes, ICs and Modules most in demand by the professional service technician.

Time is money—HEP can save you both. And that's the name of *that* tune!

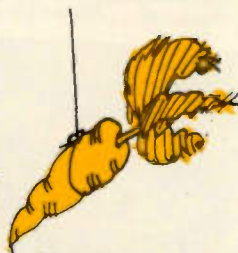

Write:
Motorola HEP
705 W. 22nd Street
Tempe, AZ 85282

Your complete semiconductor supplier.

...for more details circle 120 on Reader Service Card

Shape up can chalk



1. ZENITH'S INSTANT PARTS PROGRAM

It's the easiest, least expensive Zenith inventory control system ever devised for TV service technicians.

Organizes the most needed, most used TV replacement parts so they're where you want them, when you want them.

And ZIP keeps these parts organized thru periodic checks by your Zenith distributor salesman who personally replaces slow-moving stock numbers with new, popular parts.

As a result, your original investment is protected and your supply of Zenith parts is always current.

Call your Zenith distributor now for all the details on the ZIP program that fits your needs.

your shop so you service more sets... up more profits!

2. FINGERTIP CONTROL OF YOUR CURRENT TECHNICAL AND CROSS-REFERENCE MATERIAL

Now's the time and here's the way to end forever the costly nuisance of searching for current technical data, trying to find cross-reference material, and looking for the oldest and newest schematics.

With Zenith's new CRSP* Manual Organizer, you keep everything neat, clean, orderly...right at your fingertips.

Housed in a beautiful, durable "organizer" is a 3-ring binder with 4½ inches of catalog capacity...a "want" book... space for your most often used phone numbers...separate wells for note paper and pencils...and even a chain-attached towel to reduce catalog-page soilage.

It's just what the doctor ordered for your service shop. Comes completely assembled, ready to use.

Call your Zenith distributor now and find out how you can put the Zenith CRSP Manual Organizer to work for you!

*Cross-Reference Sales Program



For your own reputation and in your customers' best interest, always specify Zenith exact replacement parts and accessories.

ZENITH
The quality goes in before the name goes on®

Zenith Radio Corporation / Service, Parts & Accessories Division / 11000 Seymour Avenue / Franklin Park, Illinois 60131

...for more details circle 131 on Reader Service Card

ardless of point of origin" or simply tell the customer there is no warranty even though "this obviously will...nullify guarantee on the set as well."

In a letter sent to tube manufacturers, NATESA said the present situation "is not conducive to good industry or consumer relations (and) servicers being on the 'firing line' are catching most of the flak."

Zenith Seeks Supreme Court Decision; Announces Third Quarter Loss

Zenith Radio Corp., which announced in October a 25 per cent reduction in its U.S. workforce over the next year

and transfer of its module and chassis assembly operations to foreign shores, has officially asked the U.S. Supreme Court to review a lower court's ban on counter duties on Japanese consumer electronics products.

Zenith has long been seeking U.S. government intervention in what it has termed unfair competition. Specifically, Zenith cites the Japanese government's practice of rebating to Japanese manufacturers excise taxes on consumer electronics products for import to the United States.

Although Zenith won an initial U.S. Customs Court ruling defining the rebate as a Japanese government sub-

sidy to manufacturers, a federal appeals court reversed that ruling.

Opposing the Zenith position is the U.S. Treasury Department which fears a world trade debacle since many Japanese and European manufacturers are the beneficiaries of similar tax considerations by their governments on items for export in world trade. Apparently the U.S. is in a bind over the situation since the sanctioned General Agreement on Tariffs and Trade has said such counter duties would violate world trade agreements.

Joining Zenith in its bid to have the Supreme Court settle the issue are several U.S. television manufacturers and labor groups as well as the U.S. Steel Corp.

Zenith contends the effect of the Japanese government's rebate policy allows consumer electronics products sold in Japan to be sold in the United States for up to 40 per cent less in price.

If the Supreme Court decides to hear the issue, it will most likely hand down a decision sometime around the first of the year.

In another announcement Zenith said it had suffered a \$12.9 million third quarter loss, primarily through the write-off of an inactive color picture tube plant in Lansdale, Pa. The loss amounted to 69 cents per share with the plant write off accounting for 65 cents.

For the first nine months Zenith sales totaled \$724 million, compared to \$699 million in 1976 and net income totaled \$600,000, compared to \$24.8 million for the comparable period a year earlier.

CB Or Not CB

CB radios are often the whipping boy for all kinds of reported television interference, reports the Citizens Radio Section of the Electronics Industries Association, when in fact the problem may be common household appliances.

That statement came from the Citizens Radio Section as it proposed new technical standards to eliminate what it called the "occasional interference" which unwanted signals from CBs cause in TV sets. The section said in a proposal to the FCC that CB harmonic emissions be limited to 75 decibels below the station's 4 watt power limit.

"Harmonics have no communication value to the CB user, but may have the potential for interfering with certain TV channels," especially in high density residential areas. However, the CB section said, a study of American households reveals that the typical private home might contain 60 to 100 devices capable of TV and radio interference, devices such as auto ignitions, household appliances, fluorescent lights, electrical toys "and

NEW FROM LEADER One-Button Range Digital Multimeter.

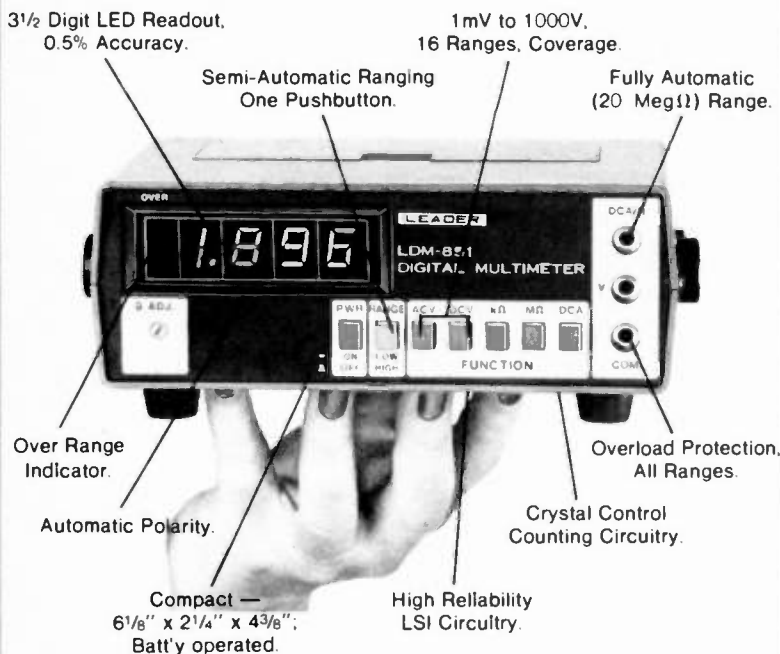

Now, Easy Pushbutton Operation Is Yours!

Model LDM-851 . . . \$199.95

See your distributor or write direct for details.

When Quality Counts . . .

151 Dupont Street, Plainview, N.Y. 11803
(516) 822-9300
In Canada: Omnitrax Ltd. Montreal, Quebec

LEADER
Instruments Corp.

...for more details circle 116 on Reader Service Card

many other sources."

In addition, "no significant decrease in reported cases of CB interference to TV reception can be expected until firm action is taken to end the use of illegal power amplifiers."

GTE Reports Earnings Increase

General Telephone and Electronics Corporation reports third quarter earnings of \$143.4 million, an increase of 26 per cent over third quarter results a year earlier.

According to a company spokesman the improvement was attributable to "substantial increases" in manufacturing earnings from the communications products and consumer electronics products groups.

Theodore F. Brophy, chairman, said the consumer electronics products group sustained a \$4.3 million third quarter loss in 1976 but this year showed a \$444,000 gain.

Briefs

EIA's 10-year forecast for the government electronics market indicates a modest real growth rate of 1.4 per cent, or 7.4 per cent when the expected 6 per cent rate of inflation is counted in—EIA's Board of Directors has voted to support Sony's position in the latter's legal battle with Universal Studios and Walt Disney Studios. Universal and Disney allege copyright infringement through the marketing of Sony's videotape recorder equipment—and, Donald R. Kronenwetter has been named vice president of GTE Sylvania's newly reorganized Distributor and Special Markets Division. It was formerly known as the Replacement Markets Operation. ■

Help.

- Our Cities.
- Our Oceans.
- Our Trees.
- Our Rivers.
- Our Air.
- Our Mountains.
- Our Fishes.
- Our Deserts.
- Our Tomorrows.

Give a hoot!
Don't pollute.



Seeking Original Japanese Replacement Parts for CB and Stereo Repair Use?

SEE US AT THE 1978 WINTER CONSUMER ELECTRONICS SHOW
IN LAS VEGAS JANUARY 5-8



CB REPAIR PACKAGE

\$63.00 value for only \$39.95

Contains 2 each. Repair almost all CB Sets

2SB 405 2SC 1014 2SC 1307
2SC 710 2SC 1173 2SC 1678
2SC 756 2SC 1226 2SD 235
2SC 828 2SC 1239 TA 7205P
2SC 945 2SC 1306 BA 511

SPECIAL PACKAGE OF MOST COMMON DRIVERS & FINALS

This kit contains 6 each of:

2SC 1678 2SC 756
2SC 1018 2SC 799
2SC 1226 2SC 1239
2SC 1306 2SC 1307

\$145.00 value for Just \$99.95

Original Japanese Transistors FET, IC, Diodes CHECK OUR LOW PRICES!

TRANSISTORS		FET		IC		DIODES	
2SA 49	59	2SA 818	1.40	2SC 403	59	2SC 871	59
2SA 70	1.10	2SA 839	2.95	2SC 430	1.10	2SC 957	2.50
2SA 101	59	2SA 841	59	2SC 454	59	2SC 1451	1.60
2SA 102	59	2SA 847	59	2SC 458	59	2SC 1475	1.40
2SA 234	59	2SA 850	.70	2SC 460	59	2SC 1478S	.70
2SA 342	.90	2SA 872A	.59	2SC 461	59	2SC 1509	1.10
2SA 353	.70	2SA 908	11.00	2SC 481	1.60	2SC 1584	8.50
2SA 377	2.00	2SB 24	59	2SC 482	1.50	2SC 1586	6.60
2SA 440	.90	2SB 55	1.10	2SC 485	1.60	2SC 1624	1.30
2SA 483	3.00	2SB 75	.59	2SC 486	1.60	2SC 1626	1.10
2SA 484	2.50	2SB 77	.59	2SC 495	1.00	2SC 1628	1.30
2SA 485	2.00	2SB 186	.59	2SC 497	1.60	2SC 1647	.59
2SA 489	1.60	2SB 187	.59	2SC 509	.90	2SC 1669	1.60
2SA 495	.70	2SB 202	1.60	2SC 517	3.95	2SC 1674	.59
2SA 496	1.10	2SB 220	.70	2SC 535	.70	2SC 1675	.59
2SA 497	1.60	2SB 303	.59	2SC 536	.59	2SC 1678	2.25
2SA 509	.70	2SB 324	.70	2SC 537	.59	2SC 1684	.45
2SA 525	2.50	2SB 337	1.60	2SC 538	.70	2SC 1684	1.10
2SA 537	2.25	2SB 367	1.50	2SC 538A	.70	2SC 1706	.59
2SA 539	2.50	2SB 368B	2.15	2SC 562	2.15	2SC 1708	2.00
2SA 561	.59	2SB 379	1.10	2SC 563	1.10	2SC 1726	2.00
2SA 562	.59	2SB 400	.59	2SC 620	.59	2SC 1730	.59
2SA 564A	.59	2SB 405	.70	2SC 627	1.60	2SC 1760	2.00
2SA 565	1.10	2SB 407	.70	2SC 632A	.70	2SC 1775	.45
2SA 566	3.40	2SB 415	1.20	2SC 644	.59	2SC 1816	4.25
2SA 606	1.90	2SB 434	1.20	2SC 645	.70	2SC 1885	2.25
2SA 624	1.10	2SB 463	1.50	2SC 650	1.30	2SC 1908	.59
2SA 627	3.60	2SB 471	1.60	2SC 668	.59	2SC 1909	4.40
2SA 628	.59	2SB 472	2.80	2SC 680	2.80	2SC 1951	1.10
2SA 634	.90	2SB 474	1.20	2SC 684	1.40	2SC 1957	1.20
2SA 640	.59	2SB 475	1.00	2SC 693B	.59	2SC 1969	4.90
2SA 643	.70	2SB 492	1.20	2SC 696	1.95	2SC 1973	1.10
2SA 659	.59	2SB 507	1.60	2SC 708A	1.90	2SC 1975	4.40
2SA 663	4.90	2SB 514	1.90	2SC 710	.59	2SC 2026	.90
2SA 666	.70	2SB 526C	1.30	2SC 711	.59	2SC 2029	3.90
2SA 672	.70	2SB 527	1.90	2SC 712	.59	2SC 2091	3.60
2SA 673	.70	2SB 528D	1.60	2SC 717	.59	2SC 2092	3.90
2SA 678	1.60	2SB 531	3.40	2SC 730	4.40	2SC 2098	3.90
2SA 683	.70	2SB 536	1.60	2SC 732	.59	2SC 2110	2.80
2SA 684	.70	2SB 537	1.60	2SC 733	.59	2SC 2128	2.00
2SA 695	.70	2SB 539	1.60	2SC 734	.59	2SC 2139	3.50
2SA 697	.70	2SB 541	4.40	2SC 735	.59	2SC 2179	.70
2SA 706	1.60	2SB 544	10.00	2SC 736	.59	2SC 2182	1.50
2SA 719	.70	2SB 553	3.40	2SC 756	2.80	2SC 2188	3.00
2SA 720	.70	2SB 561B	.70	2SC 773	.59	2SC 220	1.20
2SA 721	.70	2SB 564	.90	2SC 774	1.60	2SC 226	1.60
2SA 725	.59	2SB 569	1.90	2SC 775	1.95	2SC 227	.59
2SA 726	.59	2SB 595	7.00	2SC 776	2.65	2SC 228	1.10
2SA 733	.59	2SB 600A	7.00	2SC 777	3.50	2SC 229	1.90
2SA 740	2.65	2SC 183	.59	2SC 778	3.60	2SC 234	1.00
2SA 744	3.70	2SC 184	.59	2SC 779	2.65	2SC 238	1.00
2SA 745R	4.00	2SC 281	.59	2SC 783R	3.60	2SC 242	2.80
2SA 747	5.80	2SC 284	1.40	2SC 784	.59	2SC 248	3.70
2SA 750	.59	2SC 367	.90	2SC 785	.59	2SC 252	1.90
2SA 756	3.40	2SC 369	.70	2SC 789	1.00	2SC 254	1.60
2SA 758	5.80	2SC 371	.59	2SC 793	2.80	2SC 256	1.60
2SA 774	.59	2SC 372	.59	2SC 799	3.60	2SC 257	.59
2SA 777	1.10	2SC 373	.59	2SC 781	2.65	2SC 258	1.00
2SA 798	.70	2SC 374	.59	2SC 815	.59	2SC 259	1.00
2SA 814	1.90	2SC 380	.59	2SC 828	.59	2SC 260	1.00
2SA 816	.70	2SC 381	.59	2SC 829	.59	2SC 261	1.00
		2SC 382	.59	2SC 838	.59	2SC 262	1.00
		2SC 387	.59	2SC 839	.59	2SC 263	1.00
		2SC 394	.59	2SC 870	.59	2SC 264	1.00

PRICES MAY CHANGE WITHOUT NOTICE

COD ORDERS WELCOMED Less than \$500 no deposit required

IMMEDIATE DELIVERY WITHIN 48 HOURS ON ALL TRANSISTORS IN STOCK
Minimum order \$10.00 Ohio residents add 4% sales tax Add \$1.00 postage and handling
Quantity discount prices Ask For Our Complete Price List Manufacturer Inquiries Welcomed
ALL PARTS GUARANTEED AGAINST FACTORY DEFECT

TOLL FREE TELEPHONE:

Nationwide 800/543-1607 LOCAL 513/874-0220
Ohio 800/582-1630 874-0223
Hours: Mon.-Fri. 10-7; Sat. 11-5

FUJI-SVEA ENTERPRISE

a Division of Fuji-Svea Incorporated
Dept. ET

P.O. Box 40325 Cincinnati, Ohio 45240

...for more details circle 114 on Reader Service Card

NEWSLINE

EXTENSION OF 23-CHANNEL CB SALES IS DENIED. The FCC has turned down requests from 23 CB manufacturers, importers, distributors and retailers for an extension to Aug. 1, 1978 of the deadline for sales of 23-channel transceivers. Thus, the deadline stands at Jan. 1 at which time all 23-channel radios must be off the retailers shelves. The FCC felt that an extension would be unfair to those who have already lost money unloading their 23-channel inventories.

MEANWHILE -- CB MANUFACTURERS ARE HAVING MONEY PROBLEMS. The E. F. Johnson Co., Electronic News reports, is negotiating with its banks for a restructure of its credit agreement in accordance with the company's changed financial situation. Because of an announced third quarter loss of \$4.4 million, the firm expects to grant the banks security interest in the balance of its assets. Johnson spokesmen say year-to-date sales were hurt by cost of liquidation of 23-channel radios and oversupply of foreign imports.

DYNASCAN REPORTS LOSS FROM CB SQUEEZE. Dynascan, producer of Cobra CB products, has reported a loss of \$682,000 or 24 cents a share on sales of \$12,432,000 in three months ended Sept. 30. Dynascan's president, Carl Korn, "Excess supplies of 23-channel and 40-channel models have led to a continuation of price-cutting, and to reduced sales of 40-channel models." Korn said, however, the firm's Industrial Products group continued to show strength with sales exceeding last year's record in test equipment and radio remote controls.

SHARP SURVEY REVEALS LIKELY SALES POINTS FOR HOME VTR. A survey by Sharp Electronics reveals that the TV departments of mass merchandisers and department stores, along with appliance stores and hi fi specialty shops are the most likely places through which home VTR will be sold. Most department stores and mass merchandisers (92%) said the addition of home VTR offered a new opportunity to form "a more advanced consumer entertainment department."

COMPETITION UP -- PRICES DOWN IN VTR. Following the lead of others, Sony has dropped the list price for their Betamax from \$1,300 to \$1,095. This is still \$100 above the new price announced by Zenith for the same unit. Zenith's new price is \$995, which makes it competitive with the RCA offering.

FOUNDER OF THE TRIPLETT CORPORATION DIES. One of the few remaining pioneers of the electronic industry, Ray L. Triplett, 93, founder of the Triplett Corporation, died in Florida on October 25. His one room factory, founded in Bluffton, Ohio in 1904, has grown into one of the major test instrument manufacturers.

EICO MOVES TO NEW LONG ISLAND LOCATION. The EICO Electronic Instruments Company, producer of electronic kits and wired equipment, has moved from Brooklyn to new quarters at 108 New South Road, Hicksville, NY. The new location will permit intergration of the company's engineering, production and shipping departments into one modern building.

WINTER CES SHOW IS A SELL-OUT. The 1978 Winter Consumer Electronics Show, to be staged for the first time in Las Vegas, Jan. 5-8, is a complete sell-out with over 75 applicants on the waiting list.



Charles Varble, Jr.,
Chart Television, St. Ann, MO 63074

**“I don't compromise
the quality of my service...
or the quality of the parts I use.”**

Your reputation is our reputation

Tube Products Department · Owensboro, Kentucky 42301

GENERAL  ELECTRIC

**From blisters to
boxes to bags.**

**Mallory's got the
winning team
for your solderless
terminal needs.**

Mallory solderless terminals are available now — packaged to suit your needs. These crimp-type terminals and connectors fit virtually all popular applications and come in a complete range of sizes from 26 through 4/0 AWG.

Buy the winning team for convenience and reliability. See your Mallory Distributor. Or contact Mallory Distributor Products Company, a division of P. R. Mallory & Co. Inc., Box 1284, Indianapolis, Indiana 46206. (317) 856-3731.



MALLORY

Capacitors • Controls • Fastening Devices • Resistors • Security Products • Semiconductors • Solderless Terminals • Sonalert® Signals • Switches

...for more details circle 118 on Reader Service Card

VTR repair: yes or no?



A recent phone check with many of the television manufacturers who are bringing out one of the two basic VTR units in time for Christmas (see Industry News Page) reveals that training sessions are in full swing. If your service shop is contemplating getting into this service area as it develops, now would appear to be the time to make that decision.

However, there are several things you should keep in mind. Primarily, the considerable investment in equipment you will have to make to service these very complicated machines will have to be weighed against the limited amount of service that will be available initially. VTR service at present is not self-supporting. Whether it becomes self-supporting in the future is a judgmental decision that can be argued either way. However, for the present, it seems likely that to make your investment as economical as possible you'll have to know both the Sony Betamax and the Matsushita VHS formats.

In addition to freeing up a technician for the four or five days of schooling on VTR units, you'll need the following in the way of basic test equipment (in addition to the special jigs which each manufacturer is selling for servicing the servo-mechanical parts of these units).

- An NTSC color generator
- A dual trace, delayed sweep scope with channel 2 polarity inversion and TV sync separator capabilities.
- A quality frequency counter with at least 7 digit readout and 4 place period display.
- And, a quality digital VOM.

Most of the manufacturers have just finished first level training sessions for their distributors. Now it is up to the distributors to continue with the training cycles, sometimes with support from the manufacturer, in other cases without. To be blunt about it, the distributor level training will be geared toward locating authorized retail dealers with service centers and "serious" independent shops willing to purchase the specialized test equipment that goes with the specific VTR unit. To assess your chances of getting into this area, it would be best to contact your local distributor. Meanwhile, here's a rundown on who's doing what in the service training area on VTRs.

SONY: Began Sept. 25th in its four U.S. regions 5-day training seminars aimed at Sony Service Centers, servicing dealers, and selected independents.

GTE SYLVANIA: Began Oct. 17th special 4-day distributor training seminars at various U.S. locations. Second round of training to continue at distributor level with manufacturer support.

ZENITH: Began 5-day session in mid-August for distributors, service centers and independent dealers. Currently accepting class loads of about 30 technicians in Chicago.

RCA: Started 5-day sessions for 70 distributors in late August. Some distributors began a special 1-day introductory course open to all service dealers and centers, plus a second level 5-day program for authorized service centers.

MAGNAVOX: Began Nov. 14th, 5-day sessions for selected franchised independent service dealers.

Suffice it to say VTRs are complicated and precise electronic and mechanical products. For instance, Matsushita's VHS unit contains 9 circuit boards which serve as 13 when operated in the 2 and 4 hour modes. Video information recorded on tape is an FM square wave, the chroma signal recorded on tape is beat down to 629 KHz, drive motors are clocked by video signals. In short, it's a whole new world.

With this issue ET/D is beginning the first of a series of articles on VTRs, or VCRs, if your prefer. I hope they will give you a better insight on what to expect when you come face-to-face with them in the field.

Richard M. Lay

OPTIMA VALUE SALE

G. E., SYLVANIA, ZENITH, RCA, ETC.

75% OFF LIST NEW JOBBER-BOXED TUBES

<input type="checkbox"/> 3A3 5 for \$7.44	<input type="checkbox"/> 6J8 5 for 15.50
<input type="checkbox"/> 6GH8 5 for \$8.75	<input type="checkbox"/> 6JS8 5 for 13.75
<input type="checkbox"/> 6BK4 5 for 13.81	<input type="checkbox"/> 6LB6 5 for 14.94
<input type="checkbox"/> 6FQ7 5 for \$5.63	<input type="checkbox"/> 6FQ7 5 for \$5.63
<input type="checkbox"/> 6GH8 5 for \$5.88	<input type="checkbox"/> 12GN7 5 for 10.38
<input type="checkbox"/> 6GJ7 5 for \$5.69	<input type="checkbox"/> 17J28 5 for \$7.69
<input type="checkbox"/> 6DW4 5 for \$6.44	<input type="checkbox"/> 23Z9 5 for \$9.44
<input type="checkbox"/> 6HA5 5 for \$7.13	<input type="checkbox"/> 35HE7 5 for 13.83

*All Tubes Not Advertised, Write In at 75% off list. Sleeves Only. Singles at 72% off list. Special: 100 6GH8's G.E. \$99.00.

TRANSISTORS EQUIVALENT UP TO 90% OFF LIST

<input type="checkbox"/> SK 3018	<input type="checkbox"/> ECG 108	<input type="checkbox"/> SK 3114	<input type="checkbox"/> ECG 159
<input type="checkbox"/> 3024	<input type="checkbox"/> 128	<input type="checkbox"/> 3122	<input type="checkbox"/> 123A
<input type="checkbox"/> 3025	<input type="checkbox"/> 129	<input type="checkbox"/> 3124	<input type="checkbox"/> 123A

Minimum 5 of a Number

<input type="checkbox"/> SK 3027	<input type="checkbox"/> ECG 130	ea. 90¢
<input type="checkbox"/> 3054	<input type="checkbox"/> 184	ea. 70¢
<input type="checkbox"/> 3103	<input type="checkbox"/> 157	ea. 60¢
<input type="checkbox"/> 3041	<input type="checkbox"/> 152	ea. 70¢
<input type="checkbox"/> 3079	<input type="checkbox"/> 162	ea. \$1.50
<input type="checkbox"/> 3115	<input type="checkbox"/> 165	ea. \$2.75
<input type="checkbox"/> 3248	<input type="checkbox"/> 186A	ea. \$.70
	<input type="checkbox"/> 1155	ea. \$2.50
	<input type="checkbox"/> 1058	ea. \$2.50
<input type="checkbox"/> 3197	<input type="checkbox"/> 235	ea. \$2.00

RCA ORIGINAL TRANSISTORS

<input type="checkbox"/> SK 3040 ea. \$2.90	<input type="checkbox"/> 3501 ea. \$3.45
<input type="checkbox"/> SK 3115 ea. \$6.75	<input type="checkbox"/> 3504 ea. \$5.00

JAPANESE TRANSISTORS

<input type="checkbox"/> 25C 1878 \$2.00	<input type="checkbox"/> TA 7205P \$2.50
<input type="checkbox"/> 25C 1308 \$2.00	<input type="checkbox"/> TA 7204P \$2.50
<input type="checkbox"/> 25C 2098 \$3.00	<input type="checkbox"/> UPC 1025H \$3.25
<input type="checkbox"/> 25C 517 \$2.50	<input type="checkbox"/> AN 214 \$2.50

IC'S EQUIVALENT TO ECG

\$1.00 each Minimum 5 of a Number				
<input type="checkbox"/> 708	<input type="checkbox"/> 709	<input type="checkbox"/> 710	<input type="checkbox"/> 712	<input type="checkbox"/> 713
<input type="checkbox"/> 714	<input type="checkbox"/> 718	<input type="checkbox"/> 719	<input type="checkbox"/> 722	<input type="checkbox"/> 723
<input type="checkbox"/> 725	<input type="checkbox"/> 731	<input type="checkbox"/> 740	<input type="checkbox"/> 743	<input type="checkbox"/> 748
<input type="checkbox"/> 780	<input type="checkbox"/> 783	<input type="checkbox"/> 788	<input type="checkbox"/> 790	<input type="checkbox"/> 791
<input type="checkbox"/> 793	<input type="checkbox"/> 812	<input type="checkbox"/> 923D		

YOKES

<input type="checkbox"/> Y88	<input type="checkbox"/> Y130	<input type="checkbox"/> Y94	<input type="checkbox"/> Y105	<input type="checkbox"/> Y119
<input type="checkbox"/> 95-2779				ea. \$5.75
<input type="checkbox"/> Y153	<input type="checkbox"/> DY92C	<input type="checkbox"/> DY99AC		ea. \$8.95

DIODES, RECTIFIERS, EQUIVALENT

<input type="checkbox"/> 6500 PIV Color Focus Rect.	10 for \$4.95
<input type="checkbox"/> 2.5a 1000 PIV IR 170	100 for \$9.00
<input type="checkbox"/> B- Boost Rect.	20 for \$6.00
<input type="checkbox"/> Syl-Zen Tripler 212-139	ea. \$6.50
<input type="checkbox"/> Admrlr Tripler	ea. \$4.95

AUDIO - CARTRIDGES - NEELES EQUIV.

<input type="checkbox"/> Astatic 133 ea. \$1.95	<input type="checkbox"/> 142 ea. \$1.45			
<input type="checkbox"/> BSR SC7M2	<input type="checkbox"/> SC8H2	<input type="checkbox"/> SC12M ea. \$1.90		
<input type="checkbox"/> EV 28 ea. \$1.50	<input type="checkbox"/> EV 5015 ea. \$2.15			
<input type="checkbox"/> GE LC2 ea. \$.85	<input type="checkbox"/> GECC850			
<input type="checkbox"/> 880	ea. \$2.95			
<input type="checkbox"/> Panasonic EPC 42	ea. \$2.00			
<input type="checkbox"/> EPC70LTS	ea. \$1.00			
<input type="checkbox"/> Tolrad All Numbers SN-1 to 6	ea. \$1.95			
<input type="checkbox"/> Varco CN75	<input type="checkbox"/> TN4B ea. \$1.40			
<input type="checkbox"/> ST4X	ea. \$1.15			
<input type="checkbox"/> Zenith 142-166	<input type="checkbox"/> 167	<input type="checkbox"/> 168 ea. \$2.75		
<input type="checkbox"/> N44	<input type="checkbox"/> 77	<input type="checkbox"/> 75	<input type="checkbox"/> 91	<input type="checkbox"/> V15 ea. \$2.25
<input type="checkbox"/> BSR ST17D	10 for \$6.90			

CB HARDWARE and WIRE

<input type="checkbox"/> PL 259 10 for \$3.10	<input type="checkbox"/> PL 258 10 for \$3.90
<input type="checkbox"/> 3 ft. RG58 2PL259	10 for \$9.90
<input type="checkbox"/> 20 ft.	\$2.00
<input type="checkbox"/> 20 ft. RG58 1PL259-1 Spade Lug	\$1.70
<input type="checkbox"/> CB Lightning Arrestor	ea. \$1.95
<input type="checkbox"/> 50 ft. 59U incl. F. conn.	ea. \$1.89
<input type="checkbox"/> 100 ft.	\$3.69
<input type="checkbox"/> 50 ft. RG 8U ea. \$7.55	<input type="checkbox"/> 100 ft. \$12.95
<input type="checkbox"/> 400 ft. 300 ohm wire 40' hanks white	\$5.00

GENERAL

<input type="checkbox"/> 60 Min. Irish Cassette Tapes	24 for \$8.00
<input type="checkbox"/> \$300 Surprise Package	\$10.00
<input type="checkbox"/> 100 Asst. Caps	\$4.00
<input type="checkbox"/> 20 Asst. Belts	\$7.00
<input type="checkbox"/> 300 ohm signal splitters. (TV)	10 for \$7.90
<input type="checkbox"/> TV Lighting Arrestors	10 for \$5.00
<input type="checkbox"/> 75-300 ohm Matching Trans.	10 for \$5.90
<input type="checkbox"/> Deluxe Lock Mounts w/P1259	\$3.95
<input type="checkbox"/> Speco 2 station Intercom	\$7.95
<input type="checkbox"/> 18" & 25" Color Boosters	3 for \$10.00
<input type="checkbox"/> C Cell Batteries	24 for \$2.40
<input type="checkbox"/> Stereo "Y" Adaptors 1/4"	10 for \$6.90
<input type="checkbox"/> 8 Track Head Cleaner	10 for \$5.90
<input type="checkbox"/> Clothes Pins	100 for \$10.00

SPEAKERS

<input type="checkbox"/> 4" 4 for \$4.00	<input type="checkbox"/> 8" ea. \$2.95
<input type="checkbox"/> 3x5 4 for \$5.00	<input type="checkbox"/> 4x6 4 for \$6.00
<input type="checkbox"/> 4x10	ea. \$3.95
<input type="checkbox"/> 5x7 speaker klt incl. grill	ea. \$1.95
<input type="checkbox"/> 6x9 klt incl. grill and Swick	ea. \$3.95
<input type="checkbox"/> 6"x9" OP-69—Min. 10	ea. 55¢
<input type="checkbox"/> 1 Pr. 20" Speaker Baffles. Incl. Speakers	\$19.95
<input type="checkbox"/> 1 Pr. 12" Speaker Baffles. Incl. Speakers	\$9.95

WANTED: Electronic Merchandise.

WILL PAY CASH . . .

Letters of credit and all checks placed on deposit with Manufacturers Hanover Trust Bank, N.Y.C. Master Charge, Min. \$100. C.O.D.'s 50% dep. BankAmericard-VISA, Min. \$100. C.O.D.'s 50% dep. Min. order \$75 FOB Brooklyn, N.Y. Catalogue \$3, refundable upon order. SEND CHECK OR MONEY ORDER TO:

OPTIMA ELECTRONICS

Box 372 Ryder Street Station
Brooklyn, New York 11234
Phone (212) 439-7434

TECHNICAL LITERATURE

Indicator Lights and Lampholders are catalogued colorfully and completely in new literature available from Chicago Miniature Lamp Works. The new catalog, No. 7800, describes the company's full line of standard lenses, incandescent and neon indicators, cartridge hardware and lampholders. Each page covers a separate series, showing features, dimensional drawings, electrical and mechanical specifications. Also included are lamp types suggested for use in the various indicators. Available free from George Neeno, Chicago Miniature Lamp Works, 4433 N. Ravenswood Ave., Chicago, Illinois 60640.

Chemicals For Electronic Servicing are described and illustrated in the latest catalog from the Rawn Company. The new 12-page catalog covers such chemical servicing aids as tuner cleaners, tuner lubricants, circuit and component coolers, cements for all types of repair work, protective and insulating coatings, solvents and polishes. Prices are included. This new catalog is available free from Rawn Company, Inc., Box 9, Spooner, Wisconsin 54801.

Getting To Know OSCAR-From the Ground Up is the title of new guide book to amateur communications satellites from the American Radio Relay League. In 14 sections, the new book provides an introduction to space communications, the equipment needed, a description of the brand-new OSCAR satellite and future ones now under construction. Each copy of the book contains a four-color tracking device that makes finding the satellites an easy task. Available for \$3 from The American Radio Relay League, 225 Main Street, Newington, CT 06111.

CB Microphone Adapters for 1080 models and 153 CB transceiver brands are cross referenced and described in a new 4-page guide available from GTE Sylvania. The new guide identifies the right Sylvania Match-All adapter to use with the different CB brands and models. The guide, which is in alphabetical order, also contains a listing of those CB radios which require other Sylvania microphones. Available free from CB marketing Dept., GTE Sylvania Inc., 100 First Ave., Waltham, Mass. 02154.

Pre-packaged Electronic Components are shown in the latest catalog from Sprague Products. Catalog C-651

contains 28 pages of information on carded components ranging from all types of capacitors, including trimmers, to carbon-film and vitreous-enamel resistors, silicon and germanium transistors, rectifiers, diodes, integrated circuits, quartz crystals, optoelectronic devices, switches, wiring components, pulse transformers, and CB noise filters. Available free from distributors or from Technical Information Service, Sprague Products Co., Marshall Street, North Adams, Mass 01247.

Mobile Communications Antennas for all frequencies used for mobile-to-mobile and mobile-to-base operations are described in the latest catalog from Larsen Electronics. Both quarter wave and gain types are featured with a variety of permanent and temporary mounts included. Over 200 antenna types, frequency ranges, and mounting styles are detailed. The catalog is indexed by both number designations and description for easy finding of specific styles or models. Available free from Larsen Electronics, P.O. Box 1686, Vancouver, WA., 98663.

Sub and Microminiature Switches for many applications are covered in the most recent catalog from C & K Components. The 48-page catalog describes and illustrates brand-new offerings of the company in the first five pages ranging from actuators, bushings, terminations and interchangeable nylon lever handle caps for toggle switches. Also in the catalog are specifications for: toggle, rocker and lever handle, printed circuit mounting, snap-acting pushbutton, alternate and action and momentary pushbutton, subminiature and microminiature pushbutton, illuminated rocker, power, slide, and thumbwheel switches. Available free from C&K Components, Inc., 103 Morse St., Watertown, MA 02172.

The Proper Use & Care of Hand Tools is the subject of handy 88-page booklet available now from Klein Tools, Inc. Tools covered are pliers, screwdrivers, wrenches, striking and struck tools, vises, clamps, snips, tool boxes, chests and cabinets. The booklet contains hundreds of illustrations which show how to select the proper tool for various jobs, the care and maintenance of tools and many of the hazards which can result from misuse of tools. Cartoon characters are used to emphasize the test. This new literature is available free from Klein Tools, Inc., 7200 McCormick Road, Chicago, Illinois 60645.

Quartz Crystals Technology is covered in a new 150-page manual avail-

able from the Sentry Manufacturing Co. The new book is said to take the mystery out of understanding and using quartz crystals. It helps you specify what you need for your commercial two-way, marine, aircraft, public service, ham and monitor radios. Also, frequency charts for 23 channel sets and what crystals are need for conversion to 40-channels. Available for \$2.95 from Sentry Manufacturing Co., Chickasha, Oklahoma 73018.

AC/DC Power Supplies and Converters are described in a new 8-page booklet from Analog Devices. Full product summaries are included of the firm's 900 series AC/DC modular power supplies, available with 5 to 24 volt output and current ratings from 25 mA to 2A and modular DC/DC converters that satisfy a wide variety of floating single 5V and dual 15V power requirements. The booklet also describes the newest additions to the company's line of chassis mount supplies. Available free from Analog Devices, Inc., P.O. Box 280, Norwood, MA 02062.

Test Instruments, Assembled and in Kit Form are covered fully in the 1978 catalog from Eico. The new 38-page book features their complete line of electronic kits and factory assembled instruments, burglar/fire alarm systems, and CB accessories. Completely new test instruments for 1978 are: portable digital multimeters, function generator, portable IC color generator, digital frequency counters, a solid state triggered sweep 10 MHz oscilloscope, a self-service tube tester and a digital power supply. New CB accessories include a 100 watt in-line wattmeter, an SWR/Power meter, a mobile field strength meter and power supplies. Available free from Eico Electronic Instrument Co., Inc., 108 New South Road, Hicksville, N.Y. 11801.

New Test Instruments in 9 separate product categories and designed for use in industry, quality control, service, education and communications are featured in a newly published 12-page short form catalog from Leader Instruments. The new brochure features dual trace and single trace oscilloscopes ranging from 30 MHz bandwidth down to 4MHz; digital multimeters with single pushbutton semi-automatic operation; audio analyzer systems; color bar generators; counters, bridges and testers; signal generators for CB, audio and RF testing; wow and flutter meters; and 9 communications testers. Available free from Patrick Redko, Leader Instruments Corp., 151 Dupont St., Plainview, N.Y. 11803. ■

You can be sure

more times in more circuits in more places than with any other multimeters on the market today

Each Sencore DVM is backed with 15 Megohm input impedance for one third less circuit loading on every measurement. That means 50% higher accuracy than other DVMs.

DVM38 \$348
3½ DIGIT .1% DCV ACCURACY
AUTO-RANGING DVM

A "prime" standard at your fingertips for measurements you can trust. Auto-ranging for extended low-level range and ease of operation. 15 Megohm input impedance assures .1% reading accuracy is maintained in solid state circuits. Highly sensitive, yet fully protected to 2000 VDC overloads. Hi-Lo Power Ohms circuit simplifies in-circuit resistance measurements.

DVM37 New \$248
3½ DIGIT .1% DCV ACCURACY
PORTABLE DVM

Prime standard .1% accuracy on the bench or in the field for less than \$250. The DVM37 is the most accurate portable DVM you can buy, with 15 Megohm input impedance for 50% more accuracy. Includes automatic features—Auto Zero, Polarity, Decimal, Overrange. Fully protected inside to over 2000V on all functions, including Ohms, and protected outside with super-rugged case. Full ranges for every test. Fingertip "Push-On" switch in probe saves batteries as power is applied only when needed.

DVM32 \$198
3½ DIGIT .5% DCV ACCURACY
PORTABLE DIGITAL MULTIMETER

Bench and field master for digital accuracy measurements anywhere. 0.5% DCV accuracy, backed with 15 Megohm input impedance. Exclusive battery-saving Auto-Display turns the display on automatically when you make a measurement. 2000V input protection on all functions and ranges—including Ohms.

DVM36 \$158
3½ DIGIT .5% DCV ACCURACY
POCKET PORTABLE DVM

Pocket portable lab accurate performance that fits every budget with highest performance-to-price benefits of any meter. .5% DCV accuracy, backed with 15 Megohm input impedance for lowest circuit loading. Full protection to 1000 V on all functions and ranges—including ohms. Drop-proof case. Battery-saving "Push On" button in probe.

DVM35 \$134
3 DIGIT 1% DCV ACCURACY
POCKET PORTABLE DVM

Fast, direct reading digital accuracy for the man on the go. Same features as DVM36, except 3-digit, 1% DCV accuracy, backed by 15 Megohm input impedance that is ten times more accurate than analog meters.



New DVM37



DVM32



DVM38



DVM36

In stock at your favorite local Sencore Full Line Distributor.

...for more details circle 127 on Reader Service Card

SENCORE

DIGITAL MULTIMETER SPECIALISTS

3200 Sencore Dr., Sioux Falls, SD 57107 (605) 339-0100

SERVICE SEMINAR

The material used in this section is selected from information supplied through the cooperation of the respective manufacturers or their agencies.

ADMIRAL

Color TV Chassis K10 & K19—One or two thin, dark, vertical interference bars from left to center of picture

These bars, which are more prevalent on the low VHF channels, may only be noticeable on weak signals or when using a built-in antenna. The position of the bars changes when the horizontal dynamic controls on the convergence board are adjusted. This is not the same as 'snivets' which are caused by the horizontal output tube during UHF operation. The problem can be corrected by adding a 680pf 500V capacitor across each of the clamp diodes on the convergence assembly, as shown in drawings below. The top diagram is for the K10 chassis, and the bottom diagram for the K19 chassis. Keep the leads short.

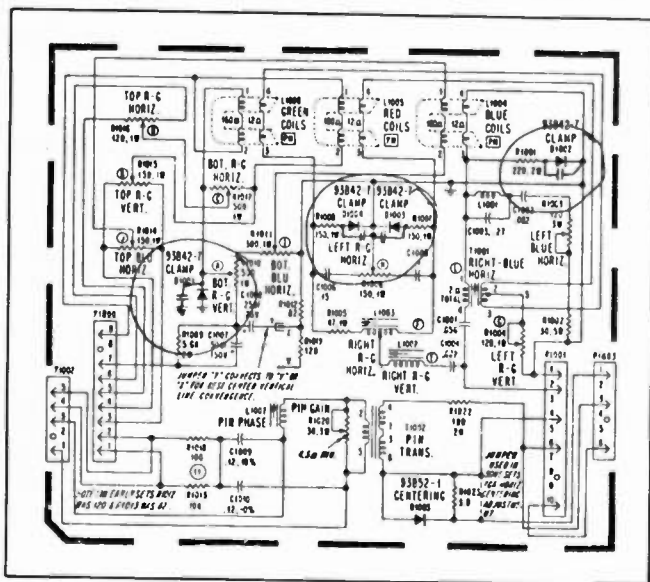
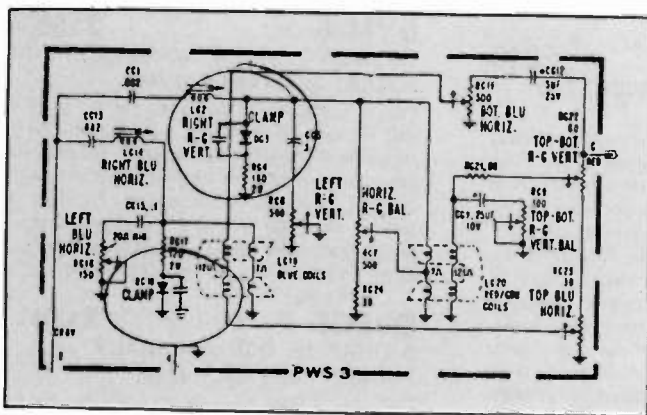

Color TV Chassis M10—Service Hint for Replacing Transistor Q101

When replacing the forward pass transistor Q101 the transistor socket may slip out of its retainer while inserting the new transistor. Improper installation could be the result with failure, then, of Q101, blown fuses, etc. To avoid this problem, insert a blunt rod or tool through the lower of the two holes in the bottom left rear of the chassis shown below, and to the left of the power supply panel. Pressure can then be applied to hold the socket in its retainer while removing and inserting the new transistor.

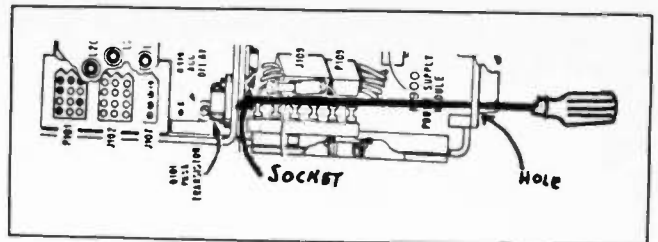

GTE SYLVANIA

Color TV Chassis E06/08/20/21—Snowy UHF picture

The cause is probably the RF AGC Delay (R276) set too high. Do not replace the UHF tuner. Instead, check the delay control.

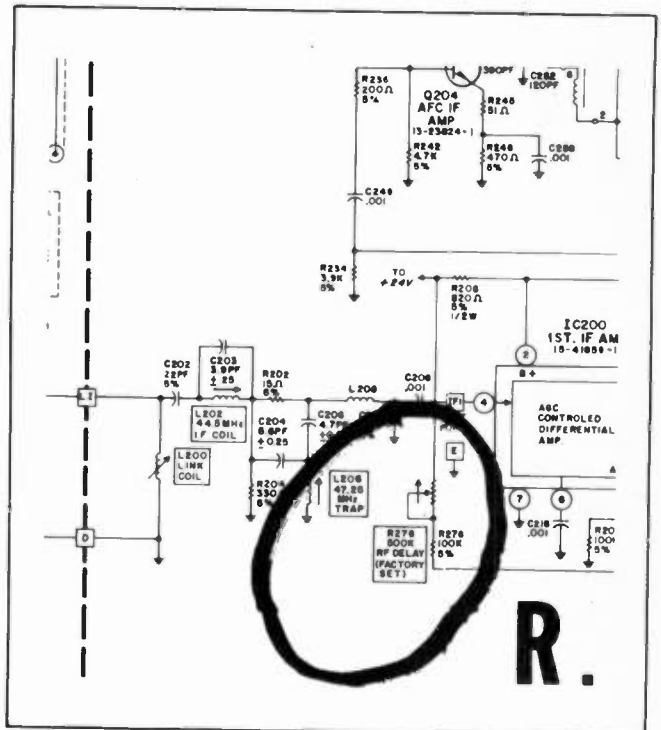

B/W Chassis B-10-7—Horizontal oscillator will not start except when set has been in 'instant on' mode. Then it is off frequency. The fault is capacitor C400 which is shorted. Replace.

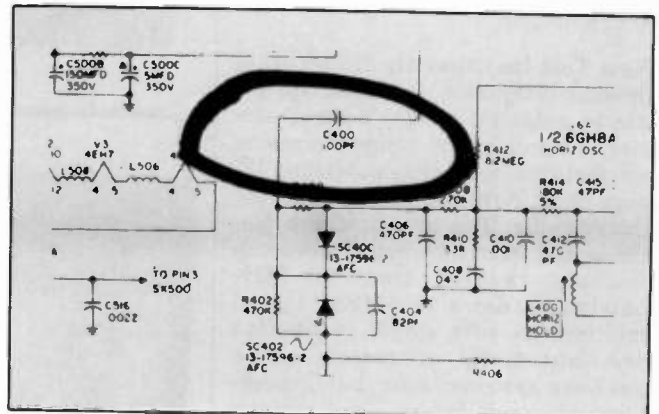

B/W Television (console)—Correction of VHF dial slippage

Properly calibrate VHF dial, and then remove complete dial and hub assembly from tuner shaft. Install soft wire staple through the plastic dial and hub as shown in dia-

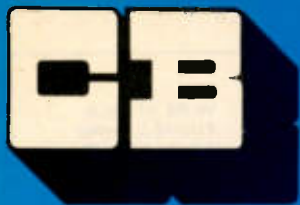

ANTENNA CENTER

THE ANTENNA ORGANIZER .. THAT DOES MORE THAN DISPLAY ANTENNAS!



COMPREHENSIVE ASSORTMENT OF ANTENNA--TOP, CENTER & BASE LOADED MODELS--ALL INDIVIDUALLY SKIN PACKED FOR PROMINENT DISPLAY.

- ▶ SINGLE ANTENNAS
- ▶ SINGLE ANTENNA KITS
- ▶ CO-PHASED ANTENNA SYSTEMS
- ▶ MOUNTS & CABLES

UNIQUE "SWING-ASIDE" FLOOR MERCHANDISER LETS YOU GET MAXIMUM RETURN FROM MINIMUM FLOOR SPACE. REQUIRES ONLY 5' x 2' AREA. LOOK WHAT YOU GET:

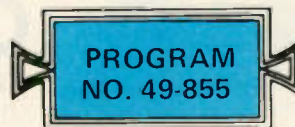

- 20 different antennas, antenna kits and co-phase systems--40 total products.
- Revolutionary "Swing-Aside" self-service floor merchandiser places entire selection at customer's finger tips.
- Colorful, descriptive header, complete with illustrations and catalog numbers, informs customer of the exact antenna or kit he desires.
- Versatility of selection allows 65 different antenna and mount combinations.



GC ELECTRONICS
DIVISION OF HYDROMETALS, INC.
ROCKFORD, ILLINOIS U.S.A. 61101



CONTACT YOUR GC DISTRIBUTOR TODAY!

WHEN IT COMES TO

Tube Sockets

Oneida's
SELECTION
IS ENDLESS!



Oneida knows how important it is to have the right parts (sockets) at the right time. That's why your Oneida distributor can probably supply you with the right socket for just about any job. 7-pin, 9-pin, 12-pin, circular, exact replacement, etc. Oneida has 'em by the hundreds.

IMMEDIATE DELIVERY FROM YOUR
ONEIDA DISTRIBUTOR

Oneida

ONEIDA ELECTRONIC MFG. INC.

P.O. Box 678, Baldwin Street Ext., Meadville, Pa. 16335
Phone (814)336-2125

...for more details circle 123 on Reader Service Card

gram. Use a low wattage soldering iron to heat staple as you push it through hub and dial. Then bend staple over on the backside.

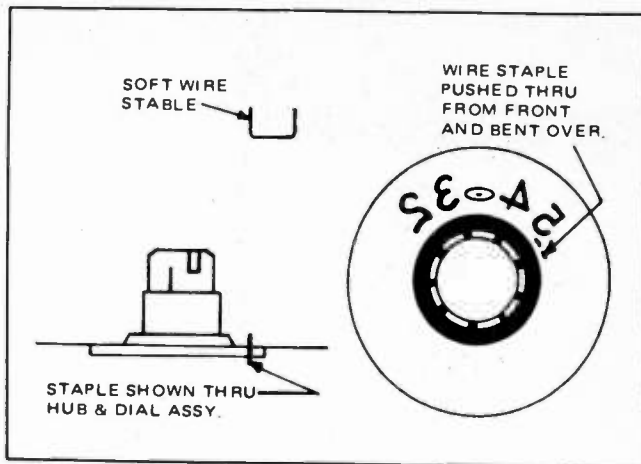

GENERAL ELECTRIC

Color TV Chassis CD—Poor horizontal sync or no horizontal sync
This refers to sets serial coded 5T3T and later sets with stick HV rectifier. The cause is a decrease in value or an open with the 39K, ½ watt resistor, R251. The solution is to replace R251 with a 39K, 1 watt 10% carbon resistor.

Color TV Chassis MC & MB-75—When the grass is not green.
To solve this 'blue grass' problem, first, set up the fleshtone properly in both the auto and manual positions with the tint control. Then turn the core of L642 on the chroma

Use this versatile frequency counter when accuracy counts.



WD-752A
\$200.00

See it at your
VIZ distributor

Exceptional accuracy and sensible features make our new wide-range frequency counter the ideal choice for checking out audio, video, CB, ham radio and other communications equipment.

- Wide range—10Hz to 60MHz
- Precise 10.000MHz crystal-controlled time base for ±0.1ppm stability
- 1KHz audible tone for SSB carrier frequency measurement
- Selectable input sensitivity (for noise rejection)—10 or 100mV
- 6-digit bright LED readout
- Indicators for signal, overflow, and range
- Small and compact; ac operated

**VIZ Test
Instruments Group**
of VIZ Mfg. Co.

335 E. Price St., Philadelphia, Pa. 19144

Formerly
RCA
Instruments

© VIZ
6644A

...for more details circle 128 on Reader Service Card

module clockwise one full turn. This reduces the demodulation angle by about 25 degrees. Next, check the tint control in the manual position to make sure that the fleshtone range is still wide enough. Then widen fleshtone range, if necessary, by turning L642 counterclockwise until the desired results are attained. This adjustment is only possible on EP93X41 modules. It is fixed on EP93X89 modules.

MAGNAVOX

Radio Chassis R344—C202 capacitor failure

A few R344 stereo console chassis were produced with a jumper at C202 installed. This jumper is intended for use only on the R342 and R343 chassis. When it has been installed wrongly in the R344, it can create distortion at high volume levels, and can eventually damage C202. If the jumper is found in an R344 chassis being serviced, remove the jumper.

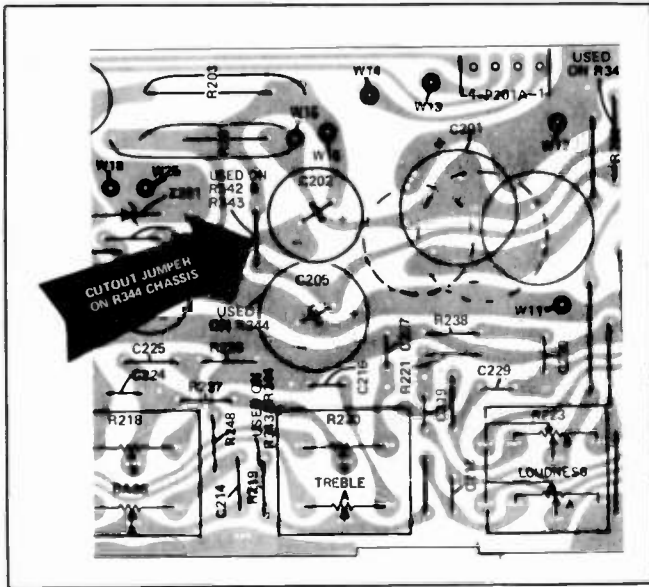

Color TV Chassis T995—Replacing the feed-thru capacitance assembly

In late production of the T995 chassis, three feed-thru capacitors and two ferrite beads have been added to the horizontal output stage. The capacitors are soldered to a mounting bracket which is attached to the heat sink alongside the horizontal output transistor, Q1, as shown in the diagram. The connecting leads to the base and collector pass through the opening in the ferrite beads.

If replacement of one of the feed-thru capacitors is necessary, you can save time by replacing the entire feed-thru assembly, which consists of the bracket and capacitors soldered in place. The ferrite beads are not provided because the originals can be re-used. Part number is 171441-1.

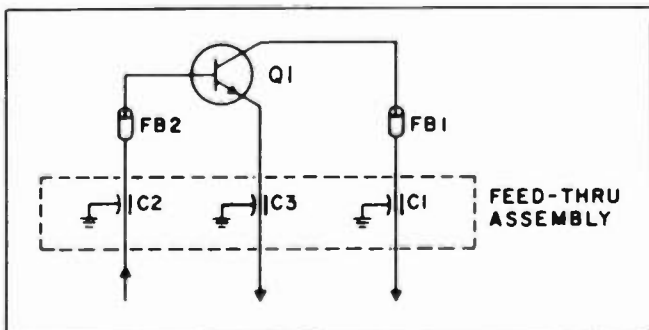

RELY ON THE MODULE REBUILDER



IT'S GETTING HARDER
TO GET IT WHEN YOU
WANT IT ... BUT M.E.S.
ALONE WILL GIVE
YOU THAT
GUARANTEED PROFIT
RETURN. PLUS, WE'LL
THROW IN THAT
WORKMANSHIP
WE'RE BECOMING
FAMOUS FOR!

WE...Specialize in all Magnavox & G.E. modules.

- Service all Magnavox remote controls.
- Final check all modules on an operating chassis.
- Use only factory specs parts for repairs.
- Have been in TV servicing for 20 years.
- Are factory trained, CET's & state licensed.
- Give you a 1 year limited guarantee.

SEND YOUR MODULES NOW
48 HOURS IN SHOP SERVICE

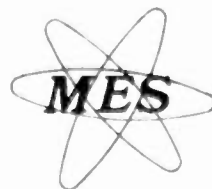

**MODULAR
ELECTRONICS
SERVICES, LTD**

4024 W. 10th St.
Indianapolis, Ind 46222
(317) 243-8347

...for more details circle 119 on Reader Service Card

DECEMBER 1977, ELECTRONIC TECHNICIAN/DEALER / 17

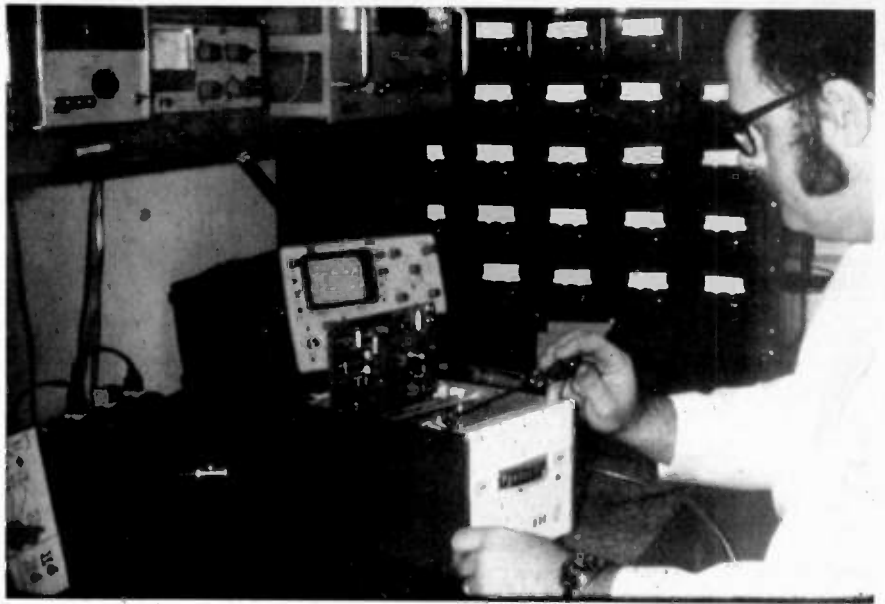

The author servicing an ECG amplifier module.

Tapping the medical electronics market

By Joseph J. Carr, C.E.T.*

■ *(Editor's Note: The sale of medical industrial electronic equipment to medical institutions within the United States now constitutes a market that surpasses \$660 million annually. It is expected that medical instrumentation sales will increase at a rate of 15 to 20 per cent through 1980. All of this equipment needs regular service and calibration. As part of ET/D's goal of keeping the consumer electronics service industry aware of expanding opportunities, we present this general overview of the medical electronics service business and how to break into it).*

Biomedical equipment servicing is one of the service industry's growth areas and potentially quite profitable for both service companies and individual technicians. Considering that some 1,300 manufacturers offer about 10,000 different models, the medical equipment industry obviously is healthy enough to structure a career around, or a business from.

I know from experience that the

*(*Mr. Carr is Senior Bioelectronics technician at the George Washington University Medical Center, Washington, D.C.)*

person who is really qualified to service a solid-state color television receiver is knowledgeable enough in basic electronics to learn medical equipment servicing. There's little that is exotic, but some specialized knowledge is required.

So how do you get this knowledge? The best is from a formal program at a college, university, or technical institute. A good background in electronics courses, plus a few courses in biomedical instrumentation or something similar would be in order. A number of community colleges now offer such programs and their popularity is growing everyday.

And don't forget to check your local library or scientific bookstore for such books as the one I have written, "Servicing Medical and Bioelectronic Equipment" (TAB Books No. 930). Medical equipment manufacturers themselves provide well written and complete service and training manuals on their own products.

WORKING IN THE HOSPITAL ENVIRONMENT

The hospital is a sensitive area,



A renal dialysis machine.

so things that might be marginally acceptable in other jobs or shops will be unacceptable in the hospital. When you enter a patient's room to repair a cardiac monitor, for example, you are expected to get in and out as quickly as possible. There's no room for the chit-chat that might be tolerated on a television service call.

Extremely high standards of craftsmanship are enforced in the hospital environment. Hospitals will give job preference to technicians who are certified by one of the existing certification groups (see accompanying list elsewhere in this article). Sloppiness in this business can be fatal. I recall the case where a defibrillator failed to operate when the doctors tried to resuscitate a heart attack victim. Subsequent examination revealed a classic case of bad craftsmanship. A technician had soldered a tubular electrolytic across the open section of a multiple-section electrolytic capacitor in the power circuit. The bad section of the electrolytic eventually shorted to ground (as they often do) and this rendered the machine inoperable. We will never know if this killed the patient, but the technician who takes such shortcuts has no business in medical electronics.

A point to remember if you contemplate getting into medical electronics is that you won't be servicing electronics alone. Many very important devices are actually electro-mechanical in nature.

Included in this list would be the renal dialysis "kidney machine."

It contains electrical as well as mechanical components and no small amount of plumbing. Other electro-mechanical devices you'll run up against are the intra-aortic balloon pump, heart lung machines, autotransfusion pumps, respirators, suction pumps and a host of other devices.

KNOW YOUR MARKET

If you are a shop owner contemplating a medical service business, an investigation of your potential market will give you a good idea of your chances. In the larger cities there will probably be others doing the same type of work. However, smaller towns often offer the best opportunities.

A reader in a small western town wrote to me about a proposal he received from the local hospital administrator. The hospital wanted local service for their coronary care unit patient monitoring system. The nearest factory service was out of San Francisco, some 600 miles away. Each service call, one every three weeks, cost not less than 8 to 10 hours in time (at \$35 an hour). Add air fare for the technician and air freight for his equipment and parts, and the hospital ended up typically paying \$500 per call—or about \$9,000 a year.

To check out your service shop's potential in this area, first determine who does the buying. Hospital departments are economic activities not unlike businesses, and you may be able to sell your services to specific departments if not the whole institution.

Service purchase decisions may be made by any of the following people, either singly or in concert with each other: administrator, assistant administrator, purchasing director, director of materials management, medical doctors, department heads, director of nursing, head nurses in intensive care units, operating rooms, emergency rooms or dialysis units, and lastly the director of plant operations. More recently, you may have to "sell" the clinical engineer, senior biomedical equipment technician (BMET), or a technical administrator.

WHAT SERVICES SHOULD YOU OFFER?

The two areas where many hos-

pitals seem to be potential customers are in repair and a regular preventive maintenance program. The repair function must be clearly defined so you will have to decide on what you can do. You should remember, too, it is virtually mandatory you offer 24-hour service seven days a week. In fact this may help you get an account if the competition in your area does not provide such service, or fails to deliver as promised. In some cases, hospitals use outside vendors only after hours so that they do not have to pay a salary differential to the in-house technician. This then could be your foot in the door.

If there are only a few hospitals in your locale, and you want their general electronic repair business, it will be wise to assemble a list, by manufacturer and model number, of their intensive care, coronary care, operating room and emergency room monitoring equipment, all of the electrosurgery equipment in the OR, and all of their ECG (electro cardiogram) machines. Contact each manufacturer to inquire about doing their service formally. If new installations are contemplated inquire about becoming a warranty station. In any event, try obtaining all service manuals and other pertinent literature, plus a list of recommended spare parts. Generally the service technician at the plant is the best source of information.

Preventive maintenance has become a major consideration in hospitals because of the requirements of the JCAH (Joint Commission on Accreditation of Hospitals) and insurance carriers. Also, it's necessary as a legal safeguard in medical malpractice suits.

This job may be performed in-house or by an outside contractor on a fee-for-service basis. The job may range from checking a piece of equipment to a complete mechanical rebuilding. But, beware of contracts that leave you open to liability for the cost of some repair parts, as they can be quite costly.

BASIC TEST EQUIPMENT

Although some specialized equipment is necessary in medical electronic service, most of the test instruments required will be of the same sort as needed in any electronic servicer operation.

Oscilloscope: It should have a

bandwidth of not less than 5-MHz (15-MHz is necessary if a lot of digital circuits are serviced). It should be dual trace and have a triggered sweep circuit.

DMM: Capable of setting a potential to 0-volts + 10-millivolts. This means at least 3½-digits of resolution, which is no longer either uncommon or expensive.

Electrosurgery apparatus are high powered R.F. generators capable of delivering upwards of one ampere of R.F. current to a 500-Ohm (non-inductive) dummy load. Therefore you will need a tester that provides a means for observing the waveform (safely!) on an oscilloscope. This capability is necessary for servicing some solid-state electrosurgery equipment.

Another required instrument is the electrical safety analyzer. Safety considerations in medical environments are far more critical than in other places, so a constant surveillance program must be followed. An addition to this is an electronic a.c. leakage current tester for more portable operation.

The ECG waveform simulator, affectionately dubbed a "chicken heart", is used to provide a reasonable waveform to ECG preamplifiers when troubleshooting or testing.

Also required will be a defibrillator analyzer, and be sure to specify a model that has an oscilloscope output jack. These devices are little more than a 50-Ohm dummy load, driving an integrating voltmeter calibrated in watt-seconds.

A leading supplier of specialized test equipment for the BMET is Med-Search Systems, Inc.; 5480 Wisconsin Avenue; Chevy Chase, MD 20015. They are in a position to make up a starting package of instruments from several manufacturers.

CERTIFYING ORGANIZATIONS

There are two non-governmental organizations offering certification for medical electronics technicians—in addition to the Veteran's Administration which has its own certification procedure.

Certified Electronic Technician

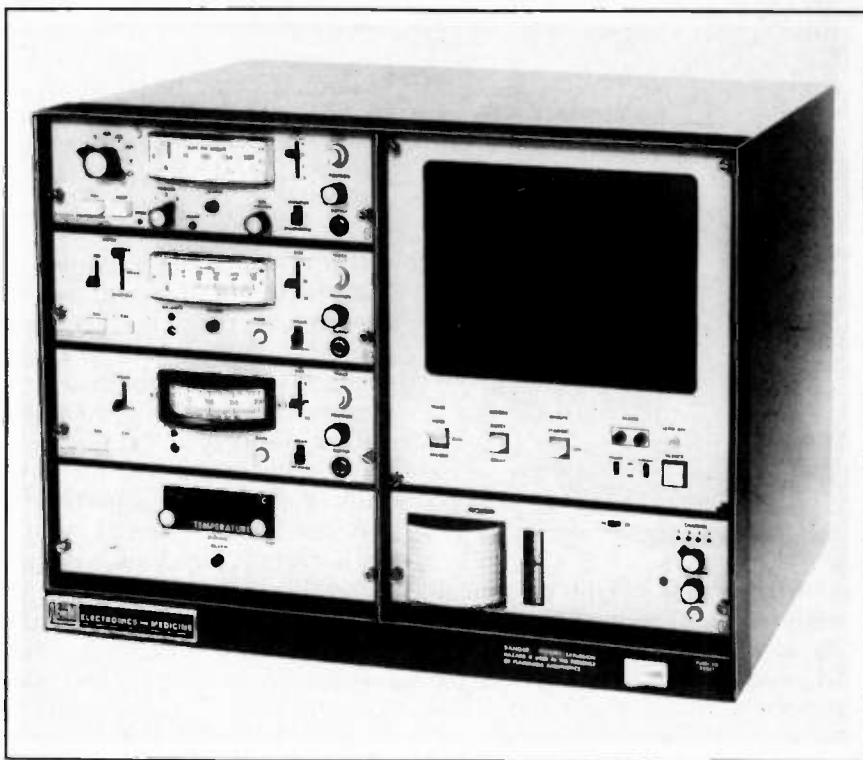

A bedside patient monitor system (courtesy of Electronics for Medicine).

(CET) program of ISCET (1715 Expo Lane; Indianapolis, IN. 46224). This organization offers a medical electronics option.

Association for the Advancement of Medical Instrumentation (AAMI—1901 Fort Myer Drive; Suite 602; Arlington, VA 22209). The AAMI also certifies clinical engineers, who are often responsible for directing the efforts of BMET's in addition to performing the functions of consultant on medical equipment purchases, design of new devices and facilities planning.

JOB ROLES IN MEDICAL ELECTRONICS

The Biomedical Equipment Technician (BMET) fills the most common job roles in medical electronics regardless of whether he works for a vendor, manufacturer, or is employed in-house by a hospital. His duties will be to troubleshoot, repair, calibrate, inspect and manage the maintenance of medical equipment as well as to instruct other hospital personnel on the proper operation of the equipment.

Below are listed the most common functions of the BMET.

The Factory BMET: Usually works out of a local field office with

company car and modest expense account. Will service his company's line of equipment and make new installations. Generally they report incomes of \$10,000 to \$22,000.

In-House BMET: Salary generally ranges from \$10,000 to \$16,000 a year. Works regular hours at the same location every day. He may be employed by the maintenance or "plant operations" section, one of the hospital's clinical departments, or a separate department of biomedical or clinical engineering.

Independent Vendors: They come in two varieties, national corporations and local service companies. The locals tend to be operated in much the same manner as consumer electronics and two-way radio shops. Pay is usually competitive but advancement may be limited due to smallness.

National Corporations, such as Honeywell, Inc., and The Stanwick Corporation, provide maintenance services. Pay and incentives are about the same as for manufacturer's technicians, but these technicians will service a much broader range of equipment than the factory servicer. ■

Here Today, Gone Tomorrow.



At General Electric we're treating every TV parts order like a rush order. Here's how it's paying off: Over 99% of the General Electric TV replacement parts ordered this year were in stock in our national computer-linked parts distribution system. And on the average better than 90% were ready for immediate shipment from the Regional Replacement Parts Centers.

This is why most parts are now shipped the same day an order's received or by the close of business the following day.

But ordering parts from us is more than fast. It's easier than ever before. In almost all areas, our toll-free ordering numbers connect you directly with GE Parts Centers. And you can charge your order to Master Charge, VISA (BankAmericard) or your approved GE Open Credit Account.

What's more, when you order several parts and one isn't immediately available, we don't leave you hanging. Instead, we ship what's in stock and include the expected shipping date for what isn't.

How did General Electric's parts distribution come so far so fast? One factor was the enlargement of stocks at many



GE Parts Centers. But the deciding factor was our determination to build a streamlined, efficient system that simplified the parts ordering process for both of us.

Now comes the easiest part of all. Clipping out and sending in the coupon below. When you do, we'll send you a list of our toll-free numbers and all the information you need to take the easy way out next time you order TV replacement parts from us. It's our business to make your business easier.

"I've got your number."

"DUTCH" MEYER/GENERAL ELECTRIC COMPANY
TELEVISION BUSINESS DEPARTMENT
COLLEGE BOULEVARD/PORTSMOUTH, VA. 23705

Dear "Dutch":

Please send me the items checked below:

- Brochure covering GE toll-free ordering numbers.
- Listing of Parts Distributors.
- Master Charge and VISA (BankAmericard) information.
- GE Open Credit Account information.

Name _____

Service Company _____

Address _____

City _____ State _____ Zip _____

THIS IS GE PERFORMANCE TELEVISION

GENERAL  **ELECTRIC**

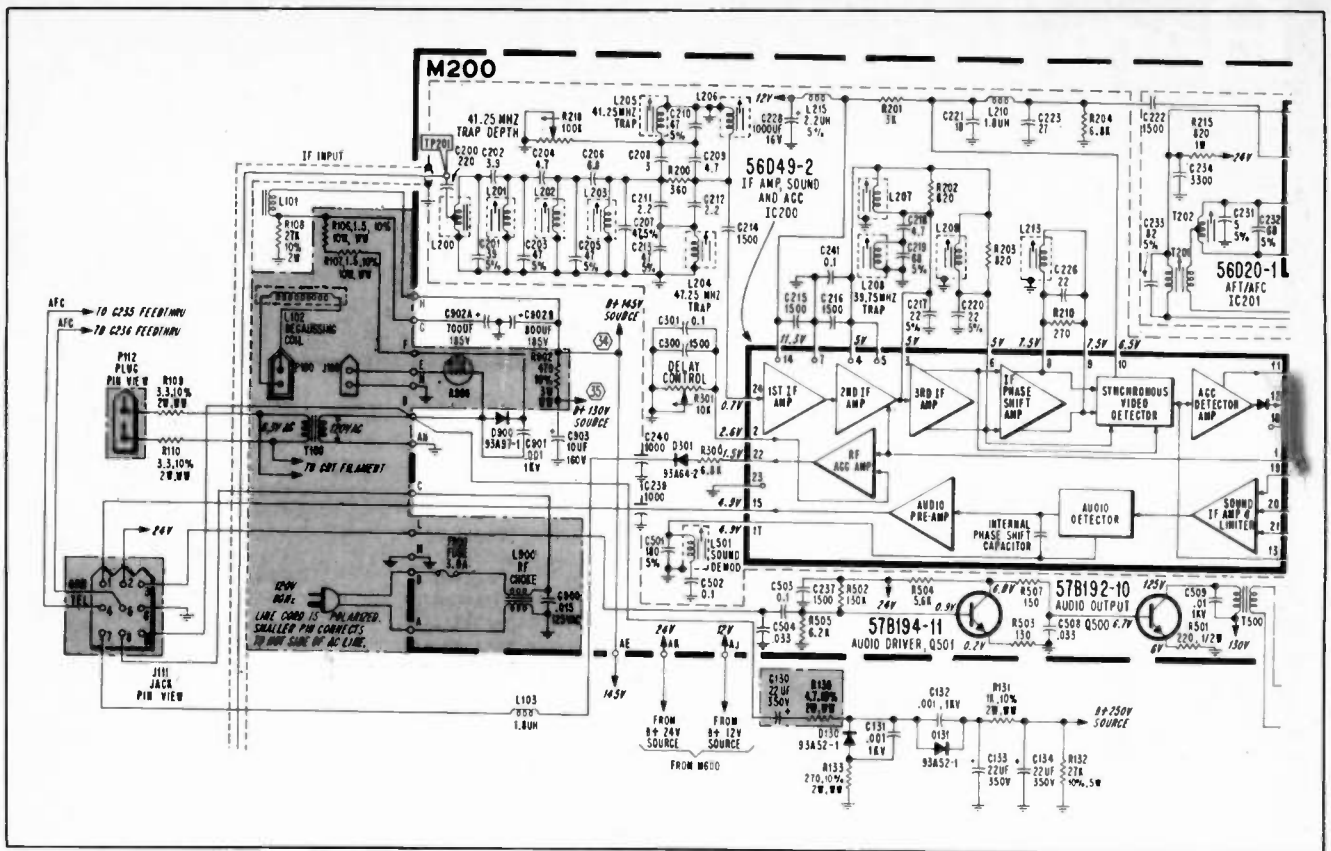

Fig. 1—A section of the schematic for Admiral chassis 25M55M showing the source of +145 and +250 B+ voltage supplies.

Admiral color television for 1978

Eight models in Admiral's 1978 color TV line feature the new 25M55M chassis which is basically an M45 chassis with modifications. We take a look at the changes.

■ A total of thirteen new models make up the 1978 color TV line for Admiral. Five of the thirteen use last year's 9M50 chassis with electronic tuning, and the remaining eight models feature the new 25M55M chassis. All models use the negative matrix 90 degree delta CRT. The new 25M55M chassis is basically an M45 chassis which has been modified for full N-S and E-W pincushioning as well as to drive the larger 23-inch and 25-inch delta CRTs. Now let's take a look at circuitry which is new with the 25M55M chassis.

POWER SUPPLIES

The 25M55M is a line-connected chassis (Fig. 1) that gets its B+

from two basic rectifier supplies. One is a +145 volt source primarily used for horizontal and vertical sweep output. This supply is then decoupled to produce +130 volts for the audio output. The other rectifier supply is a +250 volt source for the RGB output amplifiers. The +250 volt source is required in the case of delta CRTs because a 140-150 volt bias is needed between cathodes and grids for gun cut-off. Actually, 170 to 180 volts of instantaneous signal/DC is used for gun cut-off because the control grids are already operating at about 30 volts above ground.

An isolation transformer must be used during servicing as one side of the AC line is 'hot'. It's this

hot side that provides the AC source for the half wave diode, D900, used in the +145 supply, and diodes D130 and D131, as a half wave doubler to produce the +250 volt supply. The hot side of the AC line is also applied across PTC R900 and the degaussing coil, L102.

The low voltage supply (+24 and +12 volts) that operates the front end, the tuners, the low level signal and low level sweep circuits comes through Module M600 but is derived from the positive flyback pulse (Fig. 2) that appears across the horizontal output transformer, T101, secondary winding between pins 7 and 10. This is a pulse-derived supply even though it is often called 'scan-derived'. It is actually produced by the 40KHz flyback pulse oscillation.

The +250 volt supply which, as has been noted, is required by the delta CRT for gun cut-off, is produced by the doubler circuit (Fig. 1) that includes diodes D130 and D131. This doubler circuit works in the following manner: Diode D130 starts to conduct to ground through capacitor C130 and resistors R130 and R133 during that half of the AC cycle when the 'hot'

"Our son fixes digital computers for the Navy and pop-up toasters for me."

Mrs. Kenneth Johnson, Ellisville, Missouri.

"Our son is a Data Systems Technician. The Navy taught him how to remove computer circuits and repair them. But I can't wait till he comes home on leave," says Mrs. Johnson. "All that training comes in very handy."

If your son is good at fixing up his stereo or if he knows his way around the wiring in your appliances, he may be eligible for about \$17,000 worth of advanced technical training in electronics. And it won't cost you a cent.

For more information, tell him to talk to his local Navy Recruiter. Or mail the coupon below. For the fastest reply, call toll-free, 800-841-8000 anytime, day or night. **The Navy.**



TO: Capt. Robert W. Watkins
NAVY OPPORTUNITY INFORMATION CENTER
P.O. Box 2000, Pelham Manor, N.Y. 10803

PSA

Yes, I think my son is good enough to qualify for \$17,000 worth of technical training in Advanced Electronics. Please send more information.

NAME (Please Print) _____

ADDRESS _____

CITY _____ PHONE _____

STATE _____ ZIP _____

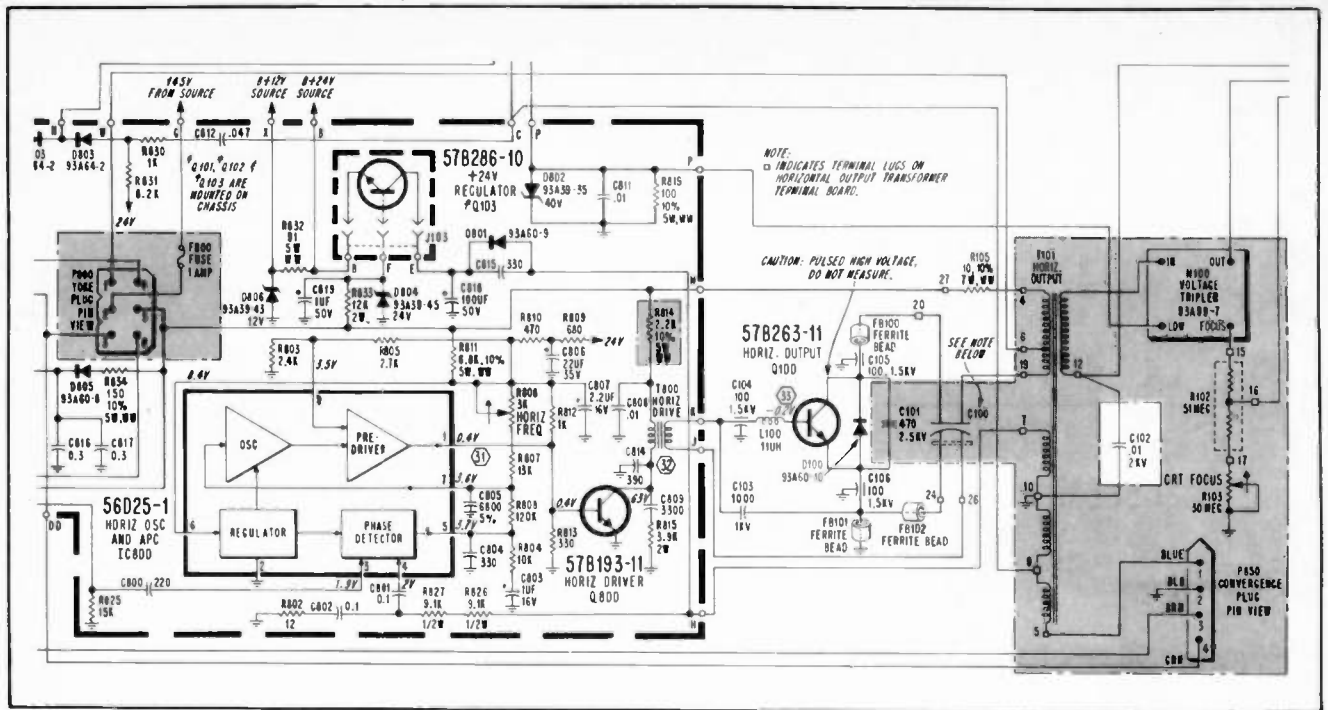

Fig. 2—The 25M55M chassis gets its low voltage supply (+24 & +12 volts) from the positive flyback pulse appearing across a secondary winding of the horizontal output transformer.

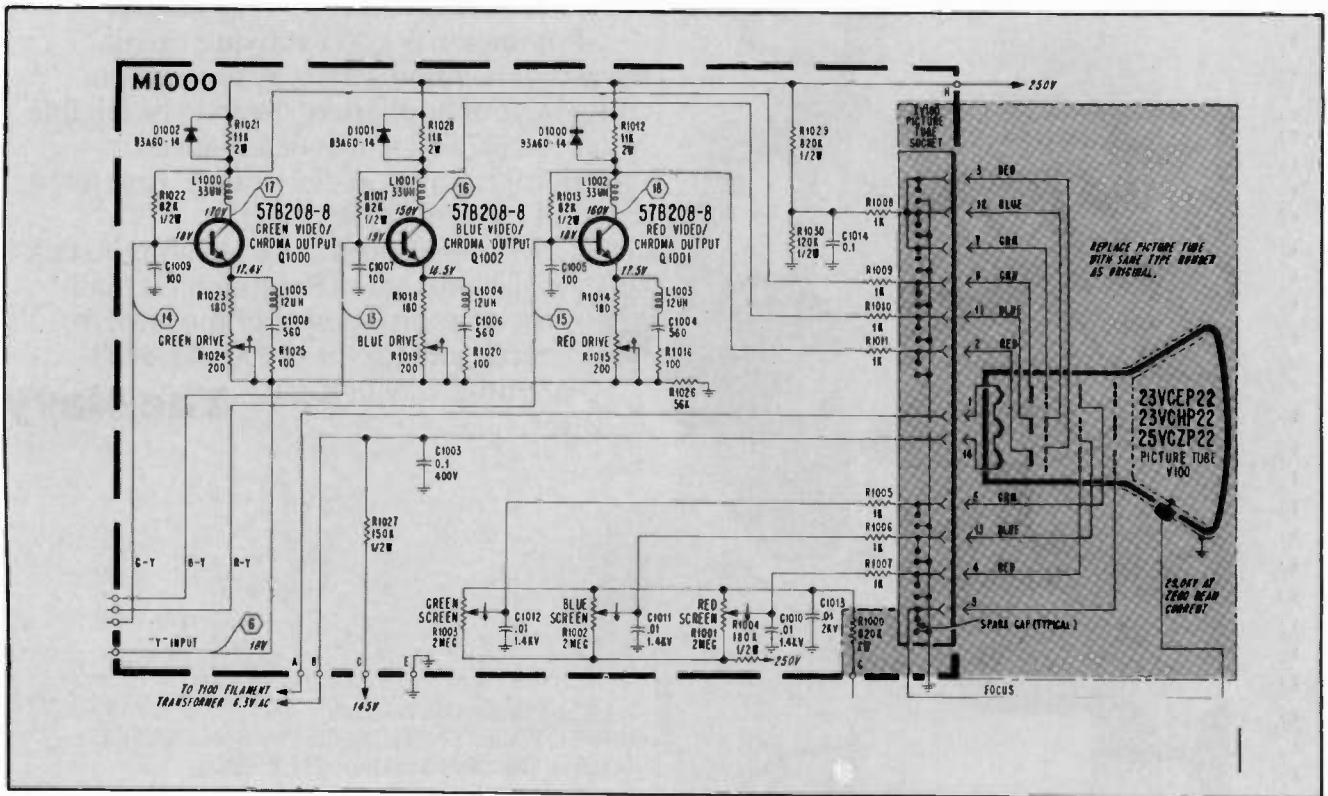

Fig. 3—Separate drive and screen controls are included for each gun in the 25M55M chassis to accommodate the new delta CRT.

side is negative with respect to chassis ground. This action charges capacitor C130 to near line voltage peak. Then, when the hot side of AC becomes positive with respect to ground during the other half cycle of AC, diode D131 starts to conduct with a path from ground through filter capacitors C133 and C134, and then through D131, R130 and C130 to the posi-

tive AC source. The two voltages produced combine to produce almost twice as high a charge across filter capacitors C133 and C134 as could be obtained from a simple half wave rectifier.

THE SIGNAL SYSTEM

The signal circuits—front end AGC loop, Y video and chroma—are almost the same as in the pre-

vious M45 chassis except for some minor modifications. The changes, mainly, have been made to accommodate the new delta CRT. For example, separate drive controls are used in the emitters of the green, blue and red amplifiers, as shown in Fig. 3. And separate G2 screen controls are included for each gun. The G2 supply voltage is produced by a separate diode in

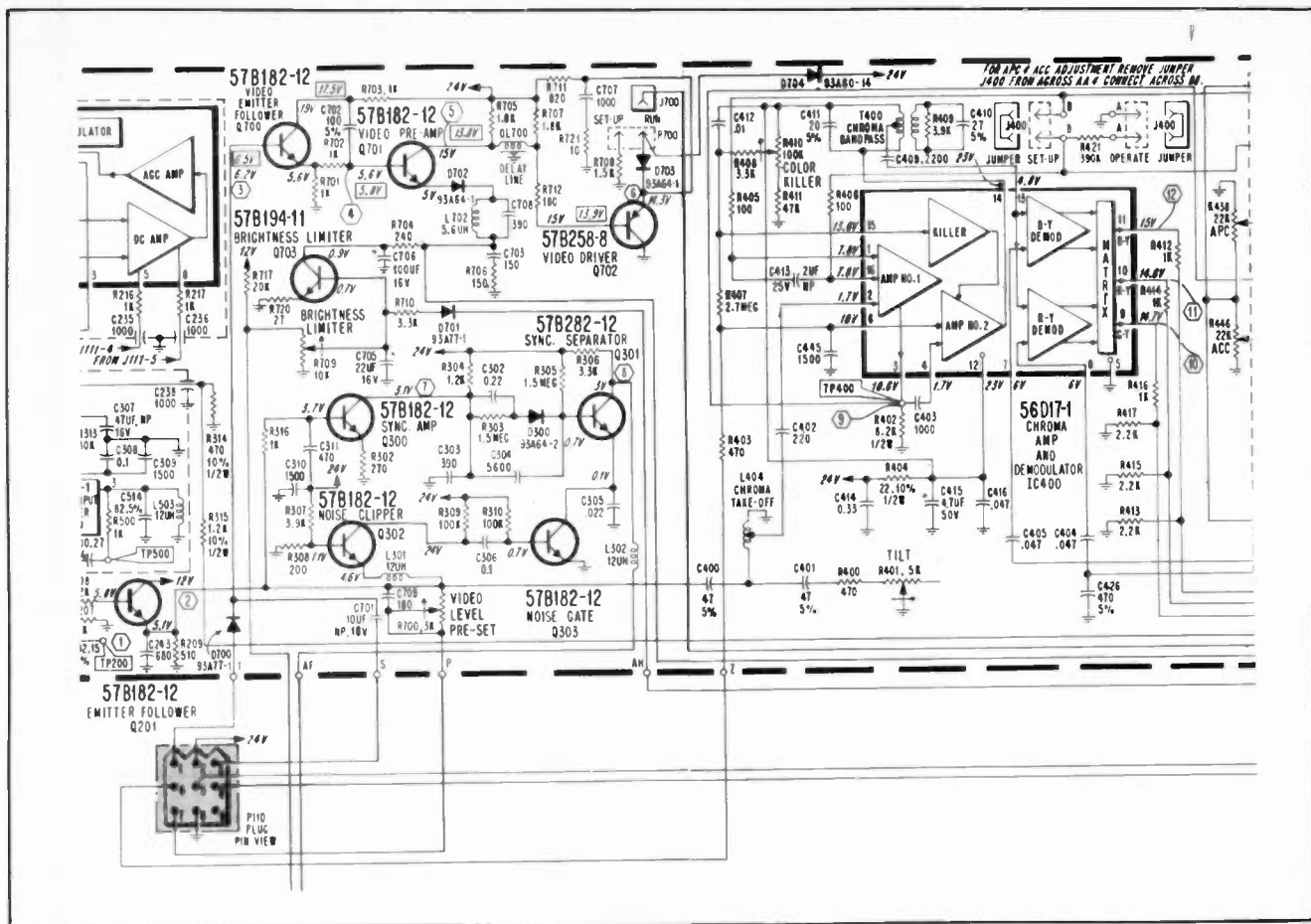

Fig. 4—A portion of the 25M55M schematic that contains pre-set controls for tint, color and brightness.

the H.V tripler, M100, (Fig. 2) and is obtained from the flyback pulse input return winding at pin 12 of the horizontal output transformer.

The +250 voltage supply described earlier is used as the R,G, and B collector source for cut-off of the CRT guns. A +145 volt supply was used for this purpose in the earlier M45 chassis.

PRE-SET CONTROLS

When the Admiral color control (ColorMaster) system is in operation, pre-set adjustments for tint, color and brightness are substituted for manual customer controls. The connections from the control assembly to the chassis are made through jack J110 and plug P110.

Brightness

Whether pre-set or manual, the brightness control varies the positive DC voltage at pin 1 of P110 (Fig. 4). This voltage is applied to the anode of the Video-Emitter/Follower, Q700. Because of DC coupling through the remainder of the "Y" channel, the DC bias voltage is altered at the CRT cathodes which in turn changes the average

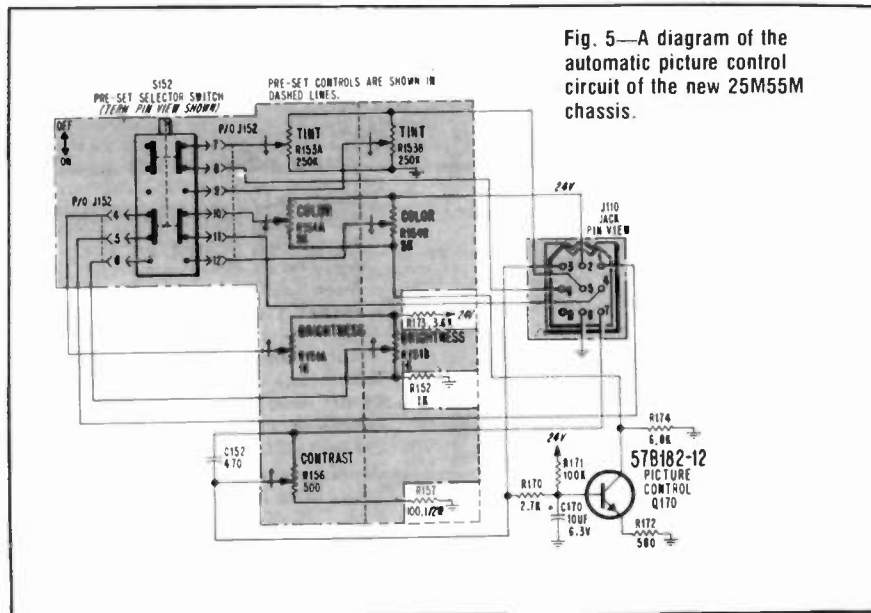

Fig. 5—A diagram of the automatic picture control circuit of the new 25M55M chassis.

CRT gun conduction and, therefore, brightness.

Color

The color gain control (Fig. 4) varies the DC voltage on pin 4 of P110. The voltage is then applied to pin 6 of the Chroma Amp and Demodulator IC400 which, in turn, varies the gain of the 2nd chroma amplifier in the IC. The

color gain increases as the voltage is decreased toward zero volts.

Tint

Depending on the ColorMaster setting by the customer, either the manual or pre-set tint control arm (Fig. 4) is connected to pin 6 of P110. This connection shifts the 3.58MHz oscillator output phase, which in turn, changes the de-

modulation angle of the demodulators in IC400. The source DV voltage for the tint control potentiometers appears on pin 5 of P110. The altered tint voltage from the arm of either manual or pre-set tint control is applied to pin 1 of Subcarrier Regenerator IC401.

CONTRAST CONTROL

In Admiral's 25M55M chassis, the contrast control is not pre-set. It is a manual control in series with a video level pre-set, which is a service adjustment. The video

level control selects the proper peak-to-peak composite video for the "Y" channel input. Admiral's service literature for the 25M55M chassis points out that this video level control is necessary because there is no signal loop gain level adjustment for the front-end AGC gain loop, and thus the composite video can vary widely from set to set.

The contrast control center arm (Fig. 4) is connected to pin 3 of P110 and then through a 10 mfd coupling capacitor (C701) to the

base of the video emitter follower, Q700. DC coupling is used in all "Y" circuits from C701 to the CRT cathodes.

AUTOMATIC PICTURE CONTROL

A device, Q170, in the 25M55M chassis known as "picture control" automatically changes the color level of the set in accordance with the amplitude of the "Y" video content. By observing the circuit of Q170 (Fig. 5), you'll notice that the base has a 10 mfd capacitor to ground to bypass any signals that might be present. This means that Q170 is only a DC device. Its collector voltage is the source voltage for the color gain control potentiometers.

Three resistors, R171, R170 and R157, and the contrast control, R156, make up a voltage divider from the +24 volt supply to ground. However, as Admiral's technical literature points out, "a calculation of the maximum change in voltage from this divider that would result at the arm of the contrast control over the full range of the control would show it to be less than .1 volt. Thus, a larger voltage source must be involved for the picture control device."

This larger voltage comes from the emitter of the 1st video stage, Q201, which varies slightly with black content, but is inversely proportional to the energy level of the IF signal. This source voltage, with a DC value of about +3.5V with normal signals, appears across the divider made up of the video level pre-set, R700, the contrast control, R156, and resistor R157 to ground.

When the contrast control is turned down, a less positive (or more negative) DC voltage appears at the arm of R156 as well as at the base of Q170. As a result, less collector current flows through Q170, and a higher (or more positive) voltage appears at the collector, and along any point on the divider in the collector circuit. This divider connects from the +24 volt supply and through the color gain control and finally through R174 to ground. The more positive voltage from the arm of the color control is applied through pin 4 of J110-P110 to pin 6

continued on page 45

LETTERED UNIFORMS OPEN DOORS!

To prove it, we'll send you
SIX SHIRTS
Lettered to Advertise
Your Business
for only **\$39⁹⁰** postpaid!

Imagine! ... Six long wearing short-sleeve shirts LETTERED to tell your community WHO you are, WHAT you sell and WHERE to buy it — all for just \$6.65 a shirt! Discover the selling power of work garments that advertise. They open doors! They make all your advertising more effective. They'll make your name a "BUY WORD" in your community. And if you are or aren't renting uniforms, you'll SAVE MONEY when you deal direct with Elin, the mail order uniform store since 1938.

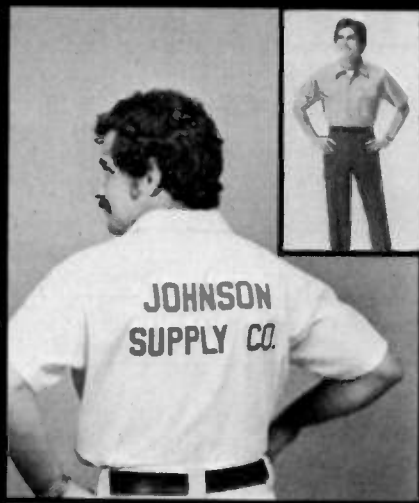

PERMANENT PRESS
65% Dacron Polyester/35% cotton.

SELECT COLORS, SIZES, LETTERING ... HERE!

Shirt Colors: White, Light Green, Light Blue, Spruce Green. **Lettering colors:** Blue, Red, Green, Yellow. **Lettering:** See spaces provided in coupon below.

FREE CATALOG! When you order, we'll send you our multi-color catalog with coveralls, jackets, jump suits, shop coats. All lettered. All finest quality. All low priced. And all tax deductible.

Sizes: S(14-14 1/2) M(15-15 1/2)
L(16-16 1/2) XL(17-17 1/2) XXL(18-18 1/2)

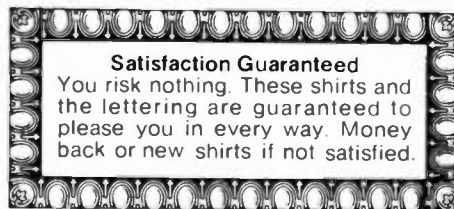

ORDER HERE! COMPLETE SATISFACTION GUARANTEED!

ELIN UNIFORM MFG. CO.
Dept. 940
Rochester, Indiana 46975

Here's my check for \$39.90. Ship 6 guaranteed shirts postpaid. Sizes, colors, lettering & lettering colors are checked at right.

QTY.	SIZE	SHIRT COLOR	LETTER BACKS AS FOLLOWS
	S		
	M	LETTERING COLOR	
	L		
	XL		

NOTE: This offer valid only for lettered shirts.

FIRM NAME _____

YOUR NAME _____

PHONE _____

ADDRESS _____

CITY _____

STATE _____

ZIP _____

...for more details circle 111 on Reader Service Card

Modular chroma circuits, part two: Adding luminance

After last month's discussion of the different methods of sub-carrier regeneration, we go a step further to show circuit variations after demodulation.

By Bernard B. Daien

■ In the TV receiver, the red and blue demodulators drive the red and blue amplifiers which in turn drive the grids of the CRT, as shown in figure 4A. To derive the green signal voltage (only red and blue voltages are transmitted) we combine voltages from the red and blue amplifiers in the proper proportion at the green amplifier. (This proportion is minus 51% of the red signal voltage plus minus 19% of the blue amplifier output). Notice that the *input* to the red amp is labeled $-R-Y$, and the blue amp $-B-Y$. Thus a phase reversal occurs as the signal passes through the amplifier stages. This, of course, is easily obtained due to the addition of the extra stage of gain employing a common cathode (or common emitter) configuration.

This is important, because by noting the signs on the signal labels going into a module or IC it is possible to analyze the circuit and its defects, with the aid of the schematic diagram.

In the circuit of 4A it is usual to apply the color signals to the CRT grids, and the luminance signals to the CRT cathodes. But now look at figure 4B. It is similar to 4A, except that the color amp outputs are now $R+Y$, $G+Y$, and $B+Y$, indicating that *both color and luminance signals are present* in the outputs of the color amps. Look again, and notice that there is also a Y input to the color amps. Since the Y is not inverted in the color amps, the input is probably to the *emitters* of the color amps, hence is not inverted. Trinitron tubes, which had one grid and 3 cathodes,

had all the inputs applied to the cathodes via the color amps, in similar manner, except, since the *cathodes* were driven the signals were inverted to $-R+Y$, $-G+Y$, and $-B+Y$. So you see that there are many variations of the basic color circuits.

ADDITIONAL CONSIDERATIONS

The previous examples should enable the reader to follow the signal paths and phases, and understand them. So let's proceed to apply what we have read to some actual color sets. First, however, we must make a few general comments about some other things you will find on modules, which might cause problems, if you fail to keep them in mind.

Many modules have jumpers on spare terminals, which are wired to form interlocks on the power sources in the set. Removing a module often turns off all, or part of the set, to prevent damage, or for safety reasons. A dead, or partly dead set is often due to a dirty module contact...so a good point to start on a modular set is by cleaning contacts. Lift the module partly off the contact, spray the contacts with tuner spray, and reseat the module. Do it a few times if necessary. It's surprising how often the set is "repaired". Remember, the average set uses about 8 modules, with a dozen or more contacts active, so we have one hundred or more *metal contacts* which can sit there for years, tarnishing. A 99% "good" rate is not enough with 100 contacts!

In addition, many modules have built in "on board" voltage reg-

ulators. Older TV sets used main regulators, or voltage dividers to supply all circuits. Today, many integrated circuits have regulators on the chip, for three reasons. It spreads the heat, eliminating the need for heavy, heat-sunked power regulators and high power resistors. Second, each module can run at a different voltage as required. Third, it reduces the need for big decoupling filters in the supply leads, since the regulators wipe out ripple, signals, and noise on the power leads. But we now have many little regulators, and sooner or later we have failures due to sheer numbers involved. Since the regulators control the internal voltages on an IC, you may have to probe the pins to see if the dc voltages are ok, *even if the supply line to the module is good.*

TEST EQUIPMENT

I have evolved a little technique that helps in this regard. It consists of wiring up one of those little retractable probe type miniclips to a two-foot insulated test lead terminating in an alligator clip. The module can be removed, the miniclip clipped on the desired point, the module replaced, and you have a lead brought out for test purposes with power on the module. These insulated miniclips can actually clip onto one IC lead without touching the adjacent one! Probing such closely spaced terminals with your meter test leads often results in shorting two pins together and blowing out the circuit.

To get back to the chroma modules, remember the chroma is 3.58 MHz, so if you wish to see the signals on a scope you must have a scope flat to 4 MHz. You will also have to take your sync from either the sync separator, or the horizontal keying or blanking pulses (say, the keyed agc pulses), using the external sync on your scope, and adjusting the frequency to the horizontal rate of 15,750 to see one line. You should hook up your color bar generator, set for color bars, so that you have a steady signal with a consistent information pattern.

The RCA CTC 76 is a recent chassis, which illustrates many of the things we have discussed. (See

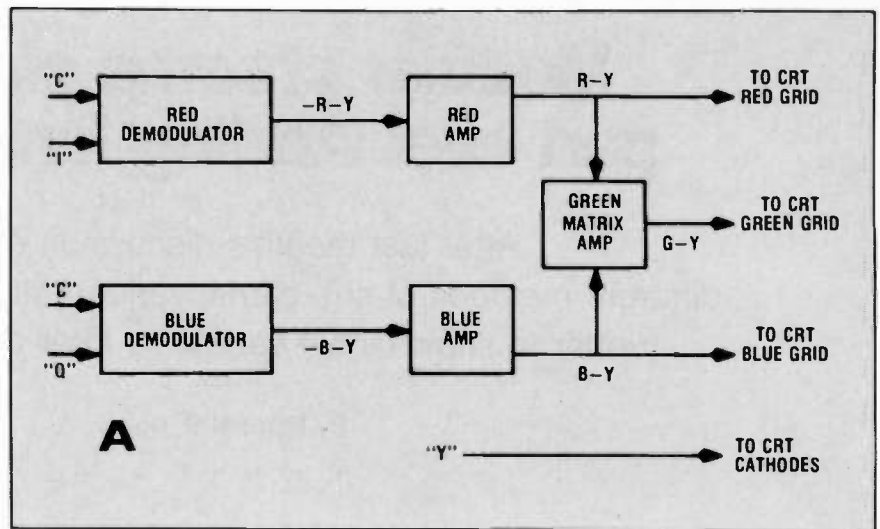

April 1977 TEKFAK #1689). Since the chroma in this set is spread over five modules, I suggest you obtain the schematic, in order to obtain the most from this section. Chroma I module is an MAC002 and contains the chroma bandpass amplifier, ACC, color killer, burst amp, 3.58 MHz oscillator, and the zener diode used as a reference for the voltage regulator used on another chroma module (the MAE001B). In addition there is a tint centering control, and a 3.58 MHz oscillator frequency trimmer, on the module.

WHICH BOARD IS BAD?

The output of the Chroma I amplifier module drives the Chroma II module, (the MAE001B), which contains the 90 degree phase shifter, the red and blue demodulators, and the R-Y, G-Y, and B-Y low level color amplifiers. This board has a voltage regulator on it, which uses the reference from the Chroma I module. *Thus a defect in the Chroma I module, or its removal, will drastically affect the dc voltages on the Chroma II module.*

Each of the three color amplifiers drive an output color amp, on a separate module. Thus there are three identical MAD001 modules. The relatively high voltage of 150 volts dc is applied to these amplifiers, as well as horizontal blanking pulses, for horizontal retrace blanking. Each MAD001 module drives one of the cathodes of the color CRT. The video (luminance, "Y") signal is also applied to the cathodes of the CRT. The three

CRT grids are tied together, and bias applied.

Thus we have a total of five modules involved in the chroma, plus the CRT tube's elements, which also affect the color. It should be noted that when a color defect occurs, the CRT should be tested as a matter of routine, and if good, the CRT socket should be removed and the operating voltages at the socket measured. Quite often chroma modules are replaced when the actual problem is a bad connection to the CRT, a bad potentiometer in the screen circuits, a shorted spark gap capacitor, or defects in the PC board.

At this point it is advisable to stress the common sense fact the modules should not be removed or replaced with the power on the set. Further, modules with large capacitors should have the capacitors discharged with a 5000 ohm 5 watt resistor before reinserting in the set, as the heavy discharge current from a large capacitor can destroy other components.

LOSS OF COLOR

Since we know that the ACC and color killer circuits are in the Chroma I module, along with tint centering, defects in these functions would indicate this module likely to be at fault. Loss of color could be due to loss of input, failure of the 3.58 MHz oscillator, loss of voltage applied, or failure of the Chroma II module. It is unlikely that all three MAD001 modules would fail, but loss of one color may indicate a defect in one of them.

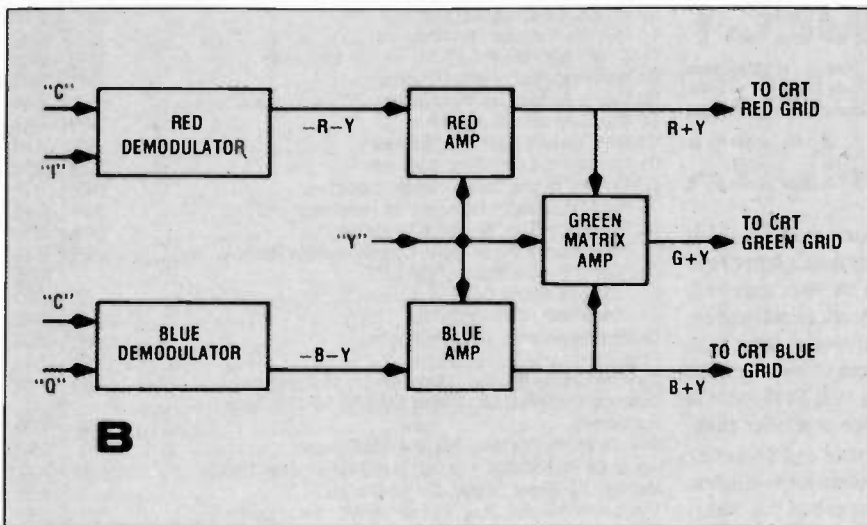

The most important lesson to be learned from this popular set, which has a chroma system similar to many other RCA modules receivers, is that servicing modular chroma is not very different from servicing a set with one large PC board. You still have to use a schematic, and you still have to understand chroma theory. The big advantage of the module is that you can trade in a piece of the set. This is a lot better than pulling a chassis into the shop, or hauling a console down the stairs! It still requires a skilled tech, a schematic, and some reasonable amount of test equipment.

In this regard, you should be aware that some set manufacturers have over-simplified the problems of modular set repair, as a selling point for the customer, as well as the service-dealer. This leaves the service tech, who must face the customer, stuck with the customer relation problem of telling the customer that his modular, instantly repairable set, will cost close to \$50 to repair. Consider an intermittent, for instance. It could be on either of two modules. Replace two modules at \$16 each, plus tax, plus service call. Time in house 20 minutes! (No module tester available). Alternative;...replace each module in turn, wait for intermittent to act up, charge for time in house. The bill will be the same. It is a fact that a large percentage of modules turned in as defective are actually good!

"EDUCATED GUESS" PAYS OFF

Since neither the set manufac-

turers nor the semiconductor manufacturers have felt any obligation to market testers for modules, or linear IC's, (to replace the tube testers), the service tech will have to make some "educated guesses", and consequently some mistakes, without these needed diagnostic instruments. More about this after looking at another set.

The General Electric MC chassis (see TEKFAK #1614 in Nov. 1975), uses modules which have a high percentage of discrete parts, and some ICs. Like the Zenith, RCA, and Magnavox sets of the same year, the CRT cathodes are driven elements, with both color and video applied, (R+Y, G+Y, and B+Y).

The large number of accessible discrete parts in this set makes it attractive to attempt module repairs. The Chroma module has a voltage regulator on it, a color killer threshold control, ACC control, and a chroma gain equalization control. There are two ICs on the board, one a chroma processor with the burst regeneration function in it, the other is a color demodulator and matrix which delivers R-Y, B-Y, and G-Y outputs to the "R G B Amplifier" module. There is also an input from the video section, which is combined with the color inputs. As a result, the output of the RGB Amp is R+Y, G+Y, and B+Y, driving the crt cathodes. Three drive controls are on the board. This set has both positive and negative supply voltages, with minus 21 volts, and positive 23

volts applied to this module. Following a recent trend, some of the sources are derived from the horizontal output transformer.

MAKE VISUAL CHECKS

Before trading in a module, especially one with mostly discrete components, it is advisable to closely examine the board under a good light, with a magnifier. Modern resistors must meet certain safety standards, and unlike the older composition resistors, they crack before showing much discoloration. You must look for these cracked components, as well as defective semiconductors. All voltage regulator transistors seem to have a high failure rate, so it is advisable to test them first if the voltages are incorrect on the board.

Now for diagnostics. With a color bar generator hooked up to the antenna terminals of the set, tune for the best presentation of the bars, and then look for the waveforms from each of the color amplifiers, using horizontal sync from the sync separator, or some other convenient point in the set. If one or more is missing, go to the inputs of the color amps, which are almost always accessible. This will determine if the problem is in the color amps, or further front in the receiver. If the color demodulators have chroma in, and if the burst regenerator is running, there should be output from the color demods, otherwise, the problem is in the demods. Lack of burst regenerator output, "I" is readily noted on the scope, as is loss of "C", (chroma).

ADDITIONAL CHECKS

Be sure to check for color killer action. Often "C" is lost because the killer threshold is set wrong, or has drifted over a period of time. The waveforms involved are very easy to recognize after you have seen them. Unfortunately troubles in the picture I.F., or automatic fine tuning can lead to loss of chroma by putting the color carrier too far down the slope of the IF response curve. If the fine tuning on the tuner does not have enough range, the same thing happens. I have restored color on many sets

continued on page 45

ET/D 1977 SUBJECT REFERENCE INDEX

To make the articles easier to find in the back issues, we have coded the listings in the following manner: first the subject, then a letter code in parenthesis indicating the department in which the item appeared, and finally a number code indicating, first, the month of publication, and secondly, the page in the magazine. The departmental letter code used is as follows: (NP) New Products; (NI) News of Industry; (SS) Service Seminar; (TR) Test Instrument Report; and (DS) Dealer Showcase. Feature articles are indicated by the absence of a letter code.

Information on subjects covered in the November and December issues of ET/D was not available until after presstime for this index. Thus, they are listed under the months at the end of this index.

ANTENNAS (Including Systems & Accessories)

Antenna Coupler, Model CA-2830, Winegard	(NP)	3/53
Antenna Preamplifiers, Winegard	(NP)	4/42
Characteristic Impedance of TV Transmission Lines		6/37
Flexible Replacement Antennas for TV, Models P-34, P-35	(NP)	8/41
Indoor TV Antennas, Models 2SL20, 2SL40 and 2SL60, RCA	(DS)	9/44
Indoor TV/FM Antennas, Antennacraft	(DS)	5/53
Matching Transformer, Blonder-Tongue	(NP)	2/48
MATV Amplifiers for VHF, Jerrold Electronics	(NP)	9/51
Solid-State U/V Converter, Jerrold Electronics	(NP)	5/49
Twenty Uses for Field Strength Meter in TV-Service		3/20
UHF Broadband Amplifier, Model DA-4300, Winegard	(NP)	7/40
Vehicular TV Antenna, RCA Sales Corp.	(NP)	9/46
VHF-UHF-FM Preamplifiers, Winegard	(NP)	8/40
VSWR in MATV		2/8
Wide Band MATV Amplifier, Jerrold Electronics	(NP)	1/41

AUDIO

AM/FM Stereo Receivers, Marantz	(NP)	6/44
Audio Load Kit, Model 1D-5252, Heath Co.	(NP)	7/40
Audio Testing, with Spectrum Analyzer, Part 1		1/14
Audio Testing, with Spectrum Analyzer, Part 2		5/22
Ceiling Loudspeakers, Atlas Sound	(NP)	3/48
Centralized Stereo Demonstrators, Model 640R, Switchcraft	(DS)	9/44
Flame Retardant Loudspeaker, Quam-Nichols	(NP)	4/42
Home & Office Intercom System, Model 30-6025, GC Electronics	(DS)	7/38
Loudspeaker Systems, Models SR112, SR116, Shure Bros.	(NP)	9/50
Low-Distortion Oscillator Kit, Model 1G-1272, Heath Co.	(NP)	6/45
Mini-Synthesizer, Model 350S, Audio Arts	(NP)	9/46
Stereo Interference Filter, Electronic Specialists	(DS)	6/1
Twin Bi-directional Loudspeaker, Atlas Sound	(NP)	3/50
Voice Reinforcement System, Model S-230, Perma Power	(DS)	7/38

AUTO ELECTRONICS (Radios, Tape Players & Security Devices)

Battery Warmer, Dynamic Instruments	(DS)	9/45
Car Radio That Seeks and Scans		8/16
Delco Digital Car Radios for 1977		2/28
Ignition Noise Filter, Model CBFT315D, Cornell-Dubilier	(NP)	9/47
Noise Sources in Auto Electronics		1/36
Radar Detector Test Set, Prime Electronics	(NP)	1/45
Telephone Acoustic Coupler, Model 50AC, Shure Bros.	(NP)	10/38
Under-Dash Cassette Tape Player, Model 15-0738, Arthur Fulmer Co.	(NP)	8/43
Universal DC Adapter, Dynamic Instruments	(NP)	1/40

BUSINESS MANAGEMENT

Effective Advertising for Electronic Sales & Service Dealer—Part 1		6/21
Effective Advertising for Electronic Sales & Service Dealer—Part 2		7/32
Service Pricing Guides, Tech Spray	(NP)	8/40
TV Warranty Servicing, What Servicers Say		1/10
Warranty Law in Force in Rhode Island	(NI)	7/6

COMMUNICATIONS ELECTRONICS (Including CB)

AC Line Filter for CB, Model AV-820, Avanti	(NP)	3/54
CB Accessory Merchandising Program—GC Electronics	(NP)	10/37
CB/AM/FM Antenna with Signal Lamp, EV Game	(NP)	7/44
CB/AM/FM Disguise Antenna, Model 11004, Antenna, Inc.	(NP)	6/45
CB Antenna/Accessory Merchandiser, Avanti	(DS)	8/36
CB Base Station Antenna, GTE Sylvania	(NP)	2/45
CB Base Station Antenna, Model 27-TD, New Tronics	(NP)	3/52
CB Base Station, Model FS-2340, Sonar Radio	(DS)	4/38

CB Carrier Frequencies		1/40
CB Carrying Case, Motorola	(NP)	10/38
CB DC Power Supply for Servicing, Hickok	(NP)	2/47
CB Dealer Sales Training Program, Motorola	(NP)	4/45
CB Dummy Antenna Load, Gold Line	(NP)	2/48
CB Filter Merchandiser, Bell Industries	(NP)	10/40
CB & FM Traps, Model CBT-300, Jerrold Electronics	(NP)	6/42
CB High Pass Filter, Avanti Research	(NP)	2/42
CB Mike & Accessories Merchandiser, GC Electronics	(NP)	4/46
CB Mike Card Selector, Belden	(NP)	4/43
CB Mike, Variable Gain, GTE Sylvania	(NP)	2/44
CB Microphone Connectors, Workman	(DS)	7/38
CB Monitor, In-Line Digital, Hickok Instruments	(NP)	1/40
CB Noise Suppression Filter, Marline Technology	(NP)	2/46
CB Power Line Filter, Electronic Specialists	(NP)	3/50
CB Power Supply, Model PS-5, Communications Power	(NP)	9/46
CB Sales & Service Status, 1976-1977		2/15
CB Servicer's Source Guide		2/20
CB Slide Mount, RMS Electronics	(NP)	2/42
CB Window Antenna, RMS Electronics	(NP)	1/39
Co-ax Extension Cord, Gold Line	(NP)	7/43
Communications Receiver, Model DR-22, McKay-Dymek	(NP)	7/40
Computer-Controlled CB, Models SM-172, SB-173, Texas Instruments	(DS)	7/38
Dual CB Antenna System, Model AV-535, Avanti	(NP)	5/46
Indoor CB Base Station Antenna, Model HP-27, New-Tronics	(NP)	7/42
Magnetic CB Mount Display, Cornell-Dubilier	(DS)	4/38
Microphone Shorting Plug, Part No. N3MS, Switchcraft	(NP)	8/39
Microprocessor-Controlled Mobile Telephone, Pulsar II, Motorola	(DS)	8/36
Mobile CB Antenna, S&A Electronics	(NP)	4/45
Mobile Communications, Hands-Free, Shure Bros.	(NP)	1/40
Noise Filtering CB Hookup Harness, Model 1106, Gold Line Connector	(NP)	9/51
Noise Suppressor Dealer Program, GC Electronics	(DS)	6/1
PA Speaker for CB, Model CBS-20, Audlovox Corp.	(DS)	8/37
PC-77 Show Report		4/24
Portable CB Power Pack, Globe-Union	(DS)	4/38
Power Mike for CB, Model SDX-100, GTE Sylvania	(NP)	8/42
Preamplified Base Station Mike, Astatic	(NP)	4/44
Receive Multicoupler, Hamtronics	(NP)	3/51
Rechargeable Batteries for CB, Globe-Union	(DS)	5/53
Terminal Stud Kit for 2-Way, Radio, Gold Line Connectors	(NP)	1/39
Theft-Proof CB Transceiver, Hy-Gain	(NP)	1/39
Three-Piece CB Radio, Model 14T275, RCA	(NP)	8/42
TV/CB Interference Filter, HME	(NP)	5/46
TV1 Filter Cable for CB, Vitek Electronics	(NP)	5/49
Two-Way CB Alternate, Motorola	(DS)	6/1

MERCHANDISING

All-Channel TV Remote System, Universal, Jerrold		3/13
Kansas City's Audio Mart		4/30
R. S. Green & Son: Offering a Little More In West Chester		8/30

RADIO (Home Broadcast Receivers)

AM/FM Stereo Receiver, Model G-3000, Sansui	(DS)	8/37
Radio Impact to be Greater by 1985, NAB Says	(NI)	6/5

SECURITY & SURVEILLANCE SYSTEMS

CC TV Digital Control System, Motorola	(NP)	1/39
Home Smoke Alarms, General Electric	(DS)	7/38
Intercom Panels for Building Lobbies	(DS)	9/44
Long-Range Detection System, Mountain West Alarm	(NP)	6/44
Radar Intruder Alarm, Radar Control Systems	(DS)	8/37
Shoplifting Alarm, Mountain West Alarm	(DS)	5/53
Solar Temperature Controller, Model 976, Pak-Tronics, Inc.	(NP)	9/46
TV Theft Alarm, Mountain West Alarm	(DS)	8/36
Wireless Radio Link Alarm System, Mountain West Alarm	(NP)	3/48

SEMICONDUCTORS (General)

Beta Overview—Beta, Alpha & Transistors		5/10
Caution: CMOS IC's!		4/10
Industrial Semiconductors, Part 1		6/25
Industrial Semiconductors, Part 2		7/13
Replacement Semiconductor Packaging, Raytheon	(DS)	4/39
Semiconductor Replacements, GTE Sylvania	(NP)	7/40

SERVICE AIDS (Including Chemicals & Solder)

Aerosol Fire Extinguisher, A-20, Mountain West Alarm	(DS)	7/39
Aerosol Refrigerant, Sprayway	(NP)	1/45
Copper Desoldering Braid, Soder-Wick	(NP)	4/45
De-Soldering Braid, Wik-it Electronics	(NP)	9/50
Emergency Solder, Multicore	(NP)	4/46
Epoxy Cable Tie Mount Kits, Panduit Corp.	(NP)	8/40
Instant Chill Spray, Tech Spray	(NP)	4/43
Integrated Circuit Replacement, General Electric	(NP)	5/46
Pulsating Cleaner & Degreaser, Chem-Tronics, Inc.	(NP)	7/42
Rechargeable Nine-Volt Battery, General Electric	(DS)	5/53
Signal Samplers, Coaxial Dynamics	(NP)	10/43
Solder Removal System, Air-Vac	(NP)	2/46
Test Lead Bench Racks, Herman Smith, Inc.	(NP)	3/54
Triple Banana Plugs, ITT Pomona	(NP)	2/42

Tuner Cleaner, Rawn Co.	(NP)	5/46	Forty-Channel RF Generator, Model 256, Hlckok	(NP)	7/42
TV Tuner Cleaner, Chemtronics	(NP)	8/39	Frequency Counter Accessories, Sencore	(NP)	9/51
Universal AC Adapters, Dynamic Instruments	(DS)	6/1	Frequency Counter Kits, Models 1M-4110, 1M-4120 & 1M-4130, Heath Co.	(NP)	9/48
Voltage Spike Protector, Model GESP-752, General Electric	(DS)	8/36	Frequency Counter, Model Count 40, Telco Products	(NP)	5/51
Wire Dispenser, O.K. Machine	(NP)	7/40	Frequency Counter, Model FC-45, Sencore	(NP)	5/50
Wire Marker Tape, Panduit Corp.	(NP)	10/44	Frequency Counter, Model 6202B, Systron-Donner	(NP)	2/45

SERVICING TECHNIQUES (General)

Amplifier Noise	8/21
Caution CMOS IC's! Servicing Techniques	4/10
Facts About Soldering	4/36
External Sources of Auto Radio, Tape Player & CB Noise	7/21
How to Read—and Draw—a Schematic	8/24
Phased Locked Loops—Some Basic Applications	9/25
Prolonging the Life of TV Picture Tubes	7/26

SERVICING TECHNIQUES (Service Seminar)

Audible Hum & Vibration—Zenith Digital Clock Radio, H472W	(SS)	10/17
Failures Due to Lightning—GE SF & XB Chassis	(SS)	10/15
Horizontal Frequency Drift—Admiral 3K19	(SS)	10/15
Interference Pattern When Using a Built-In Antenna—Magnavox T997	(SS)	10/16
Low Remote Receiver Sensitivity—Magnavox Videomatic Touch Tune Models	(SS)	10/16
No Side Pincushion Correction and Raster Pulled in at Sides—Admiral M10	(SS)	10/15
Replacement Capacitor in Horizontal Yoke Circuit—Zenith B&W TV	(SS)	10/17
Shrunken Horizontal Picture—GTE Sylvania E21	(SS)	10/16
Small Picture and Low B+—GTE Sylvania E21	(SS)	10/16
Weak Video, Vertical Retrace Lines & Very Little or no Control of Brightness—Admiral 3K19	(SS)	10/15

SHOP EQUIPMENT

Dry RF Coaxial Load, Model 4260, Coaxial Dynamics	(NP)	5/49
Hookon Test Probes, Herman H. Smith, Inc.	(NP)	9/52
Isolation Auto Transformer, Model TR-100, B&K Precision	(NP)	8/43
Low-Voltage Soldering Station, Weller-Xcelite	(NP)	6/44
Oscilloscope Mounting Kit, No. RM-14, B&K Precision	(NP)	10/41
Powered Hand Truck, Escalera, Inc.	(NP)	6/42
Resistance Substitution Unit, Phipps & Bird	(NP)	5/51
Service & Assembly Benches, Advance Engineering	(NP)	7/40
Service Bench Setup	9/32	
Shielded Power Cords, Belden	(NP)	3/48
Slideproof Work Pad, Kager International	(NP)	10/44
Special Effects Projector—Roctronics, Inc.	(NP)	10/37

TELEVISION (Color)

Color TV Sales To Become Mostly Replacement Sales in Future	(NI)	1/4
GE Color TV for 1978—Part Two	10/32	
Giant Screen Television, Projecta-Vision, Inc.	(DS)	5/53
Luminance Circuits In Modular Color TV	3/16	
Raster Problems In Solid State Color TV Chassis	10/22	
Zenith Color TV for 1978	10/28	

TELEVISION (General)

Average Hourly Wages of TV Technicians In U.S.	(NI)	2/4
Color TV Module Repair The PTS Way	4/22	
Effect of TV Games on TV CRT	(NI)	2/4
Giant Screen Video Projector, Model Epic 100, Amtron Video	(DS)	7/39
Home Video Game, Bally Co.	(DS)	8/36
IC's for TV, General Electric	(NP)	1/39
Outlook '78—Review of TV Circuits and Models for 1978	9/14	
Solid-State Vertical Sweep System, From GE	6/16	
Three-Year Warranty on TV Parts & Labor—Canada	(NI)	5/6
TV OEM Replacement Parts Source Directory	5/34	
TV OEM Replacement Parts Directory, Part 2	6/31	
Understanding & Servicing IC-Equipped AGC Systems	5/28	

TEST INSTRUMENTS

Autoranging Digital Multimeter, Model 6000, Weston	(TR)	3/46
Autoranging Frequency Counter, Model 1827, B&K-Precision	11/40	
CB Analyzer, Model CB42, Sencore	(TR)	1/32
CRT Recovery/Test Set, Model 84-1/A, SYT Electronics	(NP)	3/50
CB Service Monitor, Model CB-2700, Com-Ser Laboratories	(NP)	10/43
CB Service System, CommLine, Hlckok	(TR)	5/44
CB Transceiver Tester, Model MT, Robyn, Inc.	(NP)	10/41
Delayed Timebase Oscilloscope, Model PM 3214, Philips	(NP)	5/49
Digital Frequency Counter, Model FC-1, Siltronix	(NP)	7/42
Digital Frequency Counter, Model 710, Simpson Electronic	(TR)	7/36
Digital Multimeter, Model 283, B&K-Precision	(TI)	2/40
Digital Multimeter, Model 3028B, Ballantine	(TR)	10/36
Digital Multimeter, Model 1455, Data Precision	(TR)	6/40
Digital Multimeter, Model 8020A, Fluke Manufacturing Co.	(TR)	8/32
Digital Multimeters, Models 172 & 173, Keithley Instruments	(NP)	3/52
Digital Multimeter, Model 461, Simpson	(NP)	10/37
Digital Temperature Probe, Valhalla Scientific	(NP)	9/47
Digital Voltmeter, 5½ Digit, Model 5100, Dana Laboratories	(NP)	2/44
Distortion Measurement System, Sound Technology	(NP)	2/47
Dual Channel Oscilloscope, Model 1010A, Ballantine	(NP)	3/53
Dual Trace Triggered-Sweep Oscilloscope, Model 452, Simpson	(NP)	5/48
FET VOM, Portable, Model WV-543A, Viz Manufacturing	(TR)	7/36
Field Strength Analyst, Model 5001, PTS Electronics	(NP)	7/43

Frequency Counter Kits, Models 1M-4110, 1M-4120 & 1M-4130, Heath Co.	(NP)	9/48
Frequency Counter, Model Count 40, Telco Products	(NP)	5/51
Frequency Counter, Model FC-45, Sencore	(NP)	5/50
Frequency Counter, Model 6202B, Systron-Donner	(NP)	2/45
Function Generator, Model 12, AE Corp.	(NP)	3/53
Handsize Portable VOM, Model 3000, Triplett	(NP)	4/44
Hand-Size VOM, Model 390, Triplett	(NP)	7/44
Log Sweep Function Generator, Model 508, Exact Electronics	(NP)	9/48
Logic Probe, Control & Information Systems	(NP)	3/48
Megohm Insulation Tester, Models 510 & 520, Sperry Instruments	(NP)	6/42
Miniature Oscilloscope, Model MS-15, Non Linear Systems	(NP)	10/42
Mobile CB Tester, Model 422, Hlckok	(TR)	11/40
Oscilloscope Probe, Model PR-35, B&K-Precision	(NP)	2/42
Portable Digital Multimeter, Model 22, Data Tech	(NP)	5/51
Portable DMM, Model 2800, B&K-Precision	(NP)	5/50
Portable DMM Kit, Model 270 DMM, Eico	(NP)	8/41
Portable Frequency Counter, Model 585, Data Precision	(TR)	9/42
Portable 30 MHz Frequency Counter, Model 1827, B&K-Precision	(NP)	4/42
Pulse-Sweep Function Generator, Model L-15, Heletronix	(NP)	3/51
Scope Facts for Techs—a TAB Book Review	3/36	
Self-Service Tube Tester, Model 660, Eico	(DS)	4/39
Semiconductor Tester, Battery-Powered, Model TF46, Sencore	(TR)	7/36
Solid State Tester, The Tracker—Huntron Instruments	(NP)	10/39
Spectrum Monitor, Model CE-15, Cushman Electronics	(NP)	10/42
Test Instrument Source Guide for Electronic Servicers	3/27	
Three-Way Oscilloscope Probe, Valor	(NP)	4/44
Time/Frequency Counter, Model TF-1000, Pride Electronics	(NP)	9/52
Triggered Sweep Oscilloscope, Model 480, Eico	(TR)	9/42
TV Tuner Substitute/Tester, Ferret Model, Telematic	(TR)	4/40
Voltage Tester With LED, Siemens	(NP)	8/41
Wideband Test Probe, Model PR-37, B&K-Precision	(TR)	7/37

TOOLS

Alignment Tool Kit, Model AK-6, Chemtronics, Inc.	(NP)	10/38
Antenna Hole Saw Kit, Utility Tool	(NP)	5/46
Blade Service Kit, Interchangeable, Hunter Tools	(NP)	1/41
Cordless Soldering Gun, Wahl Clipper	(NP)	2/42
Cordless Soldering Gun, Wahl Clipper	(NP)	7/44
Cordless Soldering Station, Model 200, Ungar	(NP)	5/46
Cutting/Crimping Plier, Model D213-9 NECR, Klein Tools	(NP)	10/43
D-I-P Extractor & Desolderer, Edsyn	(NP)	4/47
Insulation Slitter & Stripper, Lumia Products	(NP)	5/46
Midget Driver Sets, Xcelite	(NP)	8/40
Nibbling Tool, GC Electronics	(NP)	8/39
Polyethylene Tool Case, Model 615T, Platt Luggage	(NP)	7/44
Service Kit for Electronic/Appliance Work, Weller-Xcelite	(NP)	1/45
Small-Shank Electric Drill, Wahl Clipper	(NP)	8/42
Soldering Iron Tip Cleaner, Model 481, American Beauty	(NP)	4/42
Soldering Station, American Beauty	(NP)	6/42
Staple Gun Tacker, Model T-37, Arrow Fastener	(NP)	10/39
Tap Wrenches, General Hardware, Inc.	(NP)	10/41
Temperature Controlled Soldering Iron, Model 50-3, Oryx, Inc.	(NP)	10/40
Wire Cutter-Crimper Tool, Clauss Cutlery	(NP)	3/51
Wire-Wrapping Tool, Model P160-9, Vector Electronic	(NP)	6/42

ARTICLE TITLE INDEX

ABC's of VSWR in MATV	2/10
Amplifier Noise	8/21
Audio Tests & Measurements With an LF Spectrum Analyzer	1/14
Beta Overview	5/10
Car Radio That Seeks and Scans	8/16
Caution: CMOS IC's!	4/10
CB Sales & Service, 1976-77, State of Industry Report	2/15
CB Servicer's Source Guide	2/20
Class-D CB Frequencies, A Chart	2/26
Color TV Module Repair the PTS Way	4/22
Common Discrete Industrial Electronic Semiconductors, Part 1	6/25
Common Discrete Industrial Electronic Semiconductors, Part 2	7/13
Convention Time—1977	8/14
Delco Goes Digital, In Car Radios	2/28
Digital Primer, Part 1	11/21
Digital Primer, Part 2	
Effective Advertising for Electronic Sales & Service Dealers—Part 1	6/21
Effective Advertising for Electronic Sales & Service Dealers—Part 2	7/32
Electronics Self-Test: Capacitor Replacement Selection	5/18
Electronic Servicing in the 1980's—A Look Ahead	10/18
External Sources of Auto Radio, Tape Player and CB Noise	7/21
Facts About Soldering	4/36
GE Color TV for 1978—Part 1	9/38
GE Color TV for 1978—Part 2	10/34
GE's Solid-State Vertical Sweep System	6/16
GE Television, 1978, Part 1	9/38
How to Read—and Draw—a Schematic	8/24
Kansas City's Audio Mart	4/30
Luminance Circuits & Problems In Modular Color TV	3/16
Magnetic Tape Recorders—A Prelude to Video	11/36
Modular Chroma Servicing—Part 1	11/32
Modular Chroma Servicing—Part 2	

Noise Sources in Auto Electronics	1/36	Soldering Guns & Irons, Weller	(NP)	11/49
Outlook '78	9/14	Radio Transmission Tester, Comm. Power	(NP)	11/49
PC-77 Show Agenda	2/39	Crimping Tool, Klein Tools	(NP)	11/49
PC-77 Show Report	4/26	Digital VOM, Triplett	(NP)	11/50
Phased Locked Loops	9/25	Vehicular CB Antenna, Phelps Dodge	(NP)	11/50
Professional Audio Tests & Measurements Using an LF Spectrum Analyzer—Part 2	5/22	Two-Meter Transceiver, Hallicrafters	(NP)	11/50
Prolonging the Life of TV Picture Tubes	7/26	Capacitance Meter, Valhalla	(NP)	11/51
Raster Problems In Solid State Chassis	10/22	FET Multimeter, Heath Co.	(NP)	11/51
RCA Color Television for 1978	11/27	Tweezer Tool, Light, Tweezer-Lite	(NP)	11/51
R. S. Green & Son: Offering "A Little More" in Westchester	8/30	Nylon Cable Ties, Waldom	(NP)	11/51
Scope Facts for Techs	3/36	20,000 Ohm/Volt VOM, B & K-Precision	(NP)	11/52
Service Bench Setup	9/32			
TEKFAX Index (1966-1976)	1/49			
Test Instrument Source Guide for Electronic Servicers	3/27			
TV OEM Replacement Parts Directory—Part 1	5/33			
TV OEM Replacement Parts Source Directory—Part 2	6/31			
TV Warranty Servicing, What Servicers Say About It	1/10			
20 TV-Related Uses for a Field-Strength Meter	3/20			
Understanding Impedance of TV Transmission Lines	6/37			
Understanding & Servicing IC-Equipped AGC Systems	5/28			
Universal Warranty Claim/Service Ticket	4/34			
Zenith Color TV for 1978	10/30			

IN THE DECEMBER ISSUE				
Portable Changeable Sign, Berloc Sign	(DS)	12/36		
Phono Cartridge Maintenance Kit, Robins	(DS)	12/36		
Microprocessor Crystals, U.S. Crystal	(DS)	12/36		
CB Antenna for Cycles, Antler	(DS)	12/36		
Record Cleaner Roller, Rotel	(DS)	12/37		
Acoustic Padding, Speakers, Audiotech	(DS)	12/37		
AM Radio Amplifier, Model AMA-51, Extronix	(DS)	12/37		
VOM with 5-ohm Mid-scale Range, Model 115, B&K-Precision	(NP)	12/39		
Magnetic CB Antenna Mount, Channel Master	(NP)	12/39		
Receptacle Tester, Etcon	(NP)	12/39		
IC Test Clips, ITT Pomona	(NP)	12/39		
CB Base Station Antenna, Winegard	(NP)	12/40		
Tungsten Halogen Light Bulb, Westlinghouse	(NP)	12/40		
Remote Control Transmitter Tester, Zenith Radio	(NP)	12/41		
Coll-spring Fuse Holder, Oneida	(NP)	12/41		
High Voltage Probe, Model 851, Polaris	(NP)	12/41		
UHF/VHF Field Strength Meter, Blonder-Tongue	(NP)	12/42		
Soldering Iron Stand/Tip Cleaner, American Beauty	(NP)	12/42		
Inside CB Antenna, Microwave Filter	(NP)	12/43		
Clamp-on DMM, James G. Biddle Co.	(NP)	12/43		
Tuner Cleaner & Lubricant, Rawn Co.	(NP)	12/44		
Wrapped-wire Tool, Vector Electronic	(NP)	12/44		
Digital Troubleshooting Course, Hewlett-Packard	(NP)	12/44		
Universal Replacement CRT, GTE Sylvania	(NP)	12/44		
Desoldering Tool, Mohawk	(NP)	12/44		
Log Sweep Function Generator, Model 508, Exact Electronics	(NP)	12/44		
Frequency Counter, Model FC45	(TR)	12/34		
Biomedical Electronics Servicing	(NP)	12/18		
Admiral Color TV for 1978	(NP)	12/22		
Servicing Modular Chroma—Part 2	(NP)	12/27		

IN THE NOVEMBER ISSUE				
CB Trouble Tape, GC Electronics	(DS)	11/42		
Tape Head Cleaner, Nortronics	(DS)	11/42		
Home Entertainment System, Channel Master	(DS)	11/42		
Frequency Counter, Model 700, EICO	(DS)	11/42		
CB Antenna Hardware Display, GC Electronics	(DS)	11/43		
Universal AC Adapter, Dynamic Instrument	(DS)	11/43		
RV/TV Antennas, Winegard	(DS)	11/44		
Closed Circuit TV, Security, Sharp	(DS)	11/44		
Pushbutton Remote CB, Hy-Gain	(DS)	11/44		
Ultrasonic Alarm System, Delta	(DS)	11/45		
Scope Frequency Converter, Sencore	(DS)	11/45		
Desoldering System, Pace	(NP)	11/47		
Solid State Devices, GTE Sylvania	(NP)	11/47		
Automatic Battery Charger, Ault, Inc.	(NP)	11/47		
Omni-directional CB Antenna, S & A	(NP)	11/48		
Portable DMM, B&K-Precision	(NP)	11/48		
Tool Kit, Hunter Tools	(NP)	11/48		
UHF/VHF Distribution Amplifier, Blonder-Tongue	(NP)	11/48		

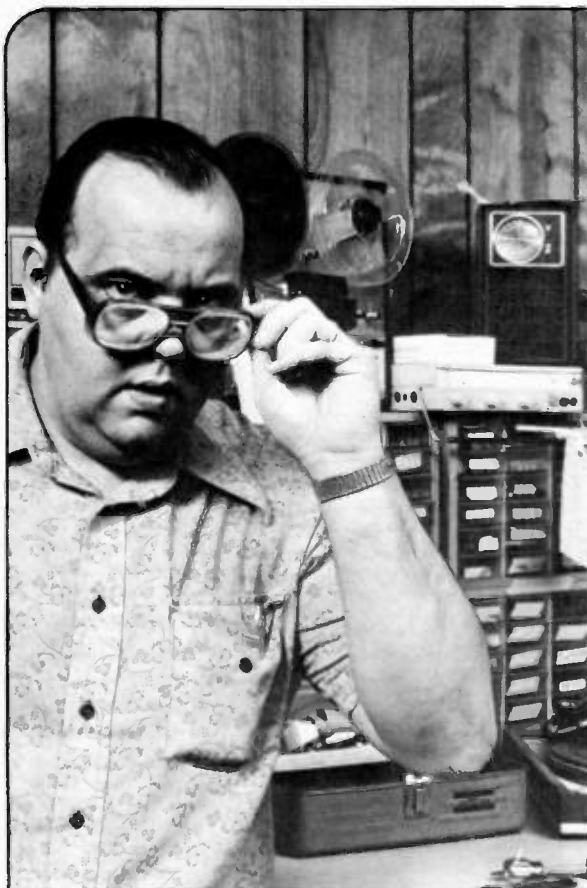

Q. What will WOW your customers, add to your test bench capabilities and FLUTTER your heart with more profits?

A. **FIDELIPAC®** WOW & FLUTTER METER

For only \$350.00 you can have a portable, solid-state device that quickly and accurately measures the wow, flutter and drift characteristics of any sound reproducing device . . . reel-to-reel, 8-track or cassette tape deck, turntable, film projector, etc. It's easily connected to your equipment and comes complete with standard phone output jack for oscilloscope or other suitable recording device. It has an internal precision 3,150 Hz reference oscillator, too. In fact, Fidelipac's Model 65-390 Wow and Flutter Meter is indispensable for your test bench as well as your profit picture.

To order, just send us a purchase order or other authorization along with your BankAmericard, VISA or Master Charge number and expiration date. Or, for more information, call us today or circle the reader's service number below.

ELECTRONICS by FIDELIPAC®



109 Gaither Drive • Mt. Laurel, NJ 08057
(609) 235-3511

DISTRIBUTOR INQUIRIES INVITED

® Trademark

...for more details circle 112 on Reader Service Card

An Extraordinary Offer to introduce you to the benefits of Membership in

ELECTRONICS BOOK CLUB

take any **4** of these unique electronics books (values to \$65⁸⁰) for only **99¢** each

with a Trial Membership in the Book Club that guarantees to save you 25% to 75% on a wide selection of electronics books



101-416 p.—Electronic Circuit Design Handbook—4th Edition (\$17.95)

ELECTRONIC CIRCUIT DESIGN HANDBOOK

The Complete Handbook of Electrical & House Wiring

913-478 p.—The Complete Handbook of Electrical & House Wiring (\$10.95)

950-396 p.—Illustrated Dictionary of Broadcast-CATV-Telecommunications (\$14.95)



754-238 p.—Practical CB Radio Troubleshooting & Repair (\$8.95)

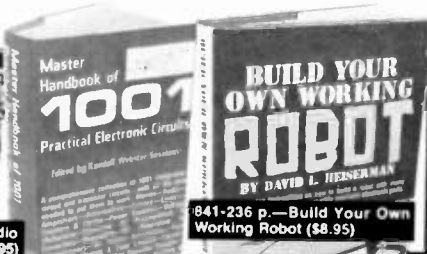

841-236 p.—Build Your Own Working Robot (\$8.95)



678-278 p.—Modern Communications Switching Systems (\$17.95)

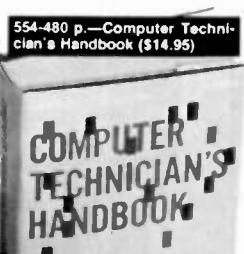

554-480 p.—Computer Technician's Handbook (\$14.95)



800-602 p.—Master Handbook of 1001 Practical Electronic Circuits (\$12.95)



975-322 p.—The "Computor" Book—Build Super Calculators & Minicomputer Hardware With Calculator Chips (\$10.95)



934-288 p.—Photo Guide to AM/FM Stereo Repair (\$9.95)



709-296 p.—Modern Guide to Digital Logic: Processors, Memories & Interfaces (\$9.95)



921-170 p.—The ABC Book of Hi-Fi/Audio Projects (\$7.95)



955-308 p.—Modern Digital Communications (\$10.95)

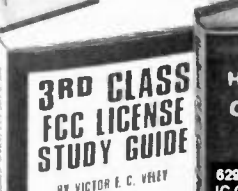

893-322 p.—Third Class FCC License Study Guide (\$9.95)

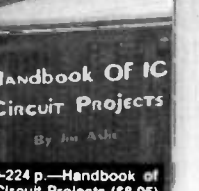

829-224 p.—Handbook of IC Circuit Projects (\$8.95)



885-294 p.—How to Repair Home Kitchen Appliances (\$8.95)

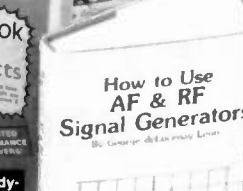

868-168 p.—CBER's Handybook of Simple Hobby Projects (\$6.95)



952-382 p.—Microprocessor Programming for Computer Hobbyists (\$12.95)

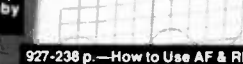

927-238 p.—How to Use AF & RF Signal Generators (\$8.95)

May we send you your choice of 4 of these practical, time-and-money-saving books as part of an unusual offer of a Trial Membership in Electronics Book Club?

Here are quality hardbound volumes, each especially designed to help you increase your know-how, earning power, and enjoyment of electronics. Whatever your interest in electronics, you'll find Electronics Book Club offers practical, quality books that you can put to immediate use and benefit.

This extraordinary offer is intended to prove to you, through your own experience, that these very real advantages can be yours...that it is possible to keep up with the literature published in your areas of interest, and to save substantially while so doing. As part of your Trial Membership, you need purchase as few as four books during the coming 12 months. You would probably buy at least this many anyway...without the substantial savings offered through Club Membership.

To start your Membership on these attractive terms, simply fill out and mail the coupon today. You will receive the 4 books of your choice for 10-day inspection. **YOU NEED SEND NO MONEY!** If you are not delighted, return the books within 10 days and your Trial Membership will be cancelled without cost or obligation.

ELECTRONICS BOOK CLUB, Blue Ridge Summit, Pa. 17214

Facts About Club Membership

- The 4 introductory books of your choice carry publishers' retail prices of up to \$65.80. They are yours for only 99¢ each (plus postage and handling) with your Trial Membership.
- You will receive the Club News, describing the current Selection, Alternates and other offerings, every 4 weeks (13 times a year).
- If you want the Selection, do nothing; it will be sent to you automatically. If you do not wish to receive the Selection, or if you want to order one of the many Alternates offered, you simply give Instructions on the reply form (and in the envelope) provided, and return it to us by the date specified. This date allows you at least 10 days in which to return the form. If, because of late mail delivery, you do not have 10 days to make a decision and so receive an unwanted Selection, you may return it at Club expense.
- To complete your Trial Membership, you need buy only four additional monthly selections or alternates during the next 12 months. You may cancel your Membership any time after you purchase these four books.
- All books—including the introductory Offer—are fully returnable after 10 days if you're not completely satisfied.
- All books are offered at low Member prices, plus a small postage and handling charge.
- **Continuing Bonus:** If you continue after this Trial Membership, you will earn a Dividend Certificate for every book you purchase. Three Certificates, plus payment of the nominal sum of \$1.99, will entitle you to a valuable Book Dividend of your choice which you may choose from a list provided Members.

ELECTRONICS BOOK CLUB

Blue Ridge Summit, Pa. 17214

Please open my Trial Membership in ELECTRONICS BOOK CLUB and send me the 4 books circled below. I understand the cost of the books I have selected is only 99¢ each, plus a small shipping charge. If not delighted, I may return the books within 10 days and owe nothing, and have my Trial Membership cancelled. I agree to purchase at least four additional books during the next 12 months, after which I may cancel my membership at any time.

101	554	629	678	709	754	800
841	868	885	893	913		
921	927	934	950	952	955	975

Name _____ Phone _____

Address _____

City _____

State _____ Zip _____

(This offer valid for new Members only. Foreign and Canada add 10%.) T-127

...for more details circle 110 on Reader Service Card

TEST INSTRUMENT REPORT



For more information about this instrument, circle 133 on the Reader Service Card in this issue.

Sencore's model FC45 frequency counter

■ Sencore's FC45 frequency counter would be a versatile welcome addition to any test bench whether you're into digital clock circuits, CB, land mobile and marine, ham or FM-TV servicing. An optional prescaler extends the range into UHF.

While you'll feel perfectly at home using it as a permanent bench top accessory, it is light enough (6.5 pounds) to be picked up and carried out to the car where you can plug it into the 12-volt cigarette lighter for on-the-spot testing.

It's completely push button operated for quick adjustment of operating modes and the eight large ½-inch LEDs make the display easily readable whether used in the shop or on the car seat in the light of day.

In addition to its 30 Hz to 230 MHz standard range, the PR47 prescaler (optional at \$125) can extend the range of the counter to 600 MHz for UHF coverage. Loaded with 15 ICs, the state-of-the-art counter is designed to provide average 25 millivolt sensitivity across the VHF band and when used with the prescaler, 225 millivolts in the 450-to-600 MHz range. Sencore reports that all measurements exceed FCC specifications for communications work with 1 part per million accuracy.

Some of the features of the FC45 which you should find especially useful are:

—A built in high power (12-watt fuse protected) 50-ohm dummy load for direct connection of the FC45 to the transmitter (for use in reading frequencies above 100 KHz only).

—A front panel universal crystal socket for checking any crystal with a fundamental frequency of 1-to-20 MHz. Tests on 500 KHz, 3.58 MHz, and 4 MHz crystals came out right on the button.

—Mini clip counter probe with a switch right on the probe for either direct or isolated connection to the test point. With the probe in the "isolated" mode, a 33pf isolation capacitor is placed in series with the test lead to prevent detuning that may occur in many sensitive circuits when a direct connection is made. (The 12 VDC power lead and the direct/isolation probe are supplied with the FC45).

One accessory I found most useful with the FC45 was the PL207 RF pick-up loop for \$9.95. It's especially handy for probing in low-level circuits where direct connections will upset the oscillator frequency even with the direct/isolation probe. Just lay the pick-up loop next to a coil preferably, but sometimes a transistor or capacitor will do the trick, and you can verify, for instance, the presence of your 3.58 MHz CW in chroma troubleshooting. The same goes for frequency checks in the horizontal or vertical oscillator sections of the TV, although direct connections also worked in the latter two circuits.

But the PL207 isn't for low level circuits exclusively. It'll also see

you through frequency checks in higher power transmitters where voltages exceed the FC45's 1 Meg input rating or the 12 watt rating of the 50 ohm dummy load.

The FC45 is operating from seven front panel push buttons. Frequency range buttons of 30 Hz to 30 MHz and from 30-to-230

SPECIFICATIONS

INPUT FREQUENCY

1 Meg Input: 30 Hz-230 MHz

50 Ohm Input: 100 KHz-230 MHz

Crystal Check: 1-20 MHz Fundamental Frequency—overtone crystals read at approximate fundamental frequency.

ACCURACY

±timebase accuracy, ±1 count

RESOLUTION

30 Hz-30 MHz: 1 Hz (1 S timebase) 10 Hz

(.1 S timebase). 30 MHz-230 MHz: 10 Hz

(1 S timebase) 100 Hz (.1 S timebase).

SENSITIVITY

50 Ohm Load: 10 milliWatts average (see graph 1)

1 Meg Input: 30 Hz-30 MHz: 20 mV. 30 MHz

to 100 MHz: 25 mV. 100 MHz-230 MHz: 25 to

400 mV (see graph 2).

INPUT PROTECTION

50 Ohm: Diode protected to 12 Watts. Fuse protected over 12 Watts.

1 Meg Input: 250 VP-P to 10 KHz. 50 VP-P to 30 MHz. 8 VP-P to 230 MHz.

DC Blocking: 250 Volts.

TIMEBASE

Crystal Frequency: 10 MHz—oven controlled.

Setability: ±0.1 ppm (.00001%).

Temperature stability: 1 ppm (.0001%),

0-40° C ambient after 10-minute warmup.

Time Stability: 2 ppm/year after 30 days

GENERAL

DISPLAY: 8 digit, 0.5" LED, Auto decimal, "Hz" and "MHz" indicators.

SIZE: 5.5" x 7.83" x 9" HWD (14 cm x 19.9 cm x 22.9 cm).

WEIGHT: 6.5 lbs. (3 Kg).

POWER: 105-130 VAC, 50/60Hz, 30 W max.

(220 VAC conversion available) 12 VDC, 2.2 Amps maximum.

FUSE REQUIREMENTS: .5 A, 3 AG Fastblow

for 50 Ohm input, 2 A 3 AG Fastblow for 12

VDC leads. Two spare fuses supplied. AC

line: transformer internally fused.

ACCESSORY OUTPUT VOLTAGE: 9-12 VDC

through front panel jack to power PR47 Pre-

scaler.

ACCESSORIES

Supplied: 39G112 Direct/Isolated Counter

Probe

39G111 Fused DC Supply Lead

Optional: PR47 UHF Prescaler

NE206 Noise Eliminator

PL207 RF Pick-Up Loop

39G80 10:1 Lo Cap Probe

Specifications subject to change without notice.

MHz; input buttons of 50 ohm, 1 meg. and the "crystal" check button. Two other "read rate" push buttons will give you updated reading either once every second or 10 times a second.

The special crystal check connector is located in the front as well as the on-off and a special 9-volt output to power the optional prescaler. A back panel connection is for the 12-volt DC supply input.

The manufacturer's specified maximum input in the 30 Hz to 10 KHz range is 250 volts pp; from 10 KHz to 30 MHz, 50 volts pp; and 8 volt pp (3 volts rms) in the 30-to-230 MHz range. However, these input limitations may be exceeded by a factor of 10 when the FC45 is used in conjunction with a 10-to-1 low capacity scope probe, which incidentally increases the 1 meg input impedance to 10 Megs. ■

Intervox miniatures speak quality at unheard of prices.

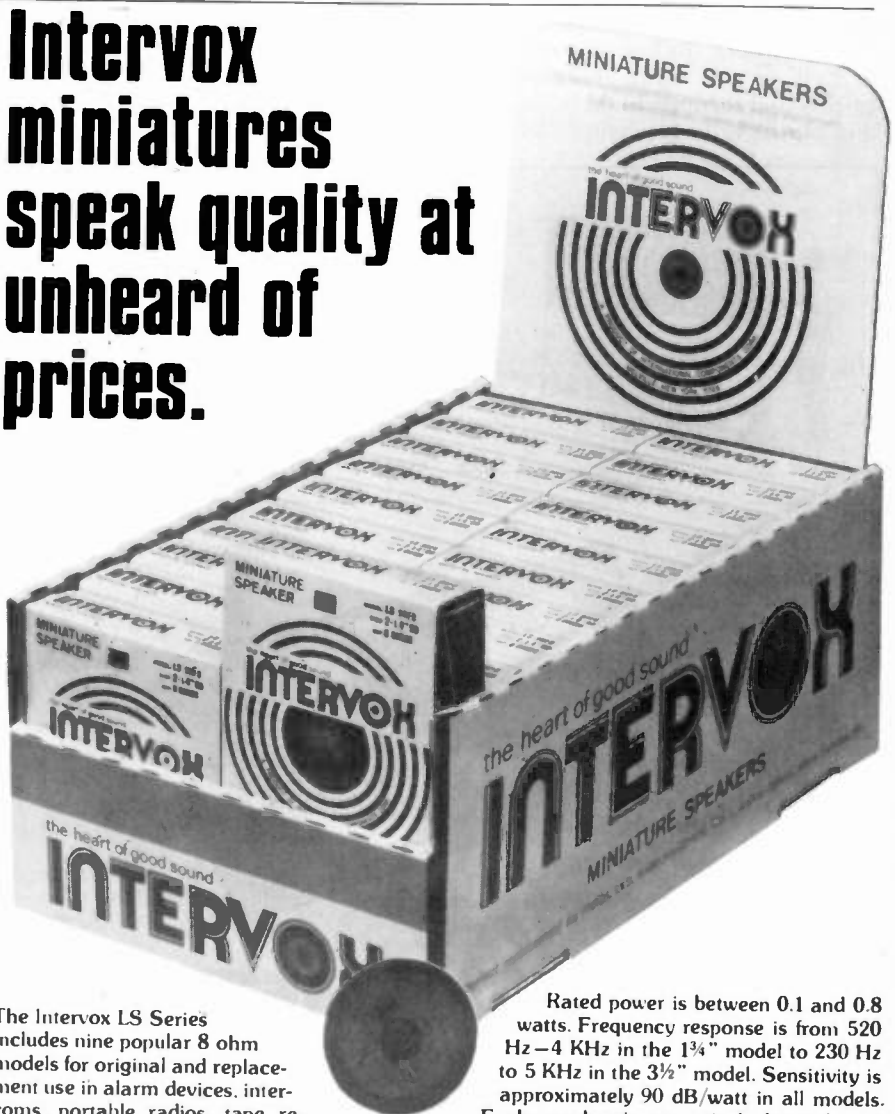

The Intervox LS Series includes nine popular 8 ohm models for original and replacement use in alarm devices, intercoms, portable radios, tape recorders, TV, TV games and CB Radios. Other impedances including 3.2, 4, 16, 40 & 100 ohms are also available.

Choose from 1 $\frac{3}{4}$ " 2" 2 $\frac{1}{4}$ " 2 $\frac{1}{2}$ " 2 $\frac{3}{4}$ " 3 & 3 $\frac{1}{2}$ " round frames plus 3" & 3 $\frac{1}{2}$ " square frames. All with a fully enclosed 0.34 oz. Alnico V magnet.

Cone material is weatherproof paper with the frame of cadmium plated steel.

Rated power is between 0.1 and 0.8 watts. Frequency response is from 520 Hz-4 KHz in the 1 $\frac{3}{4}$ " model to 230 Hz to 5 KHz in the 3 $\frac{1}{2}$ " model. Sensitivity is approximately 90 dB/watt in all models.

Each speaker is attractively housed in a secure, shrink-wrapped package. And their versatile shipping container, which holds twenty speakers, can be used as a colorful counter display or stock bin carton.

We don't know of any other miniature speaker series of this quality that is priced better. We'd be happy to give you all the facts. Write or call us today.

International ©

International Components Corporation

105 Maxess Road, Melville, New York 11746 (516) 293-1500/TELEX # 143130

MINIATURE, GENERAL REPLACEMENT & PROFESSIONAL AUTO SPEAKERS

...for more details circle 115 on Reader Service Card

DECEMBER 1977, ELECTRONIC TECHNICIAN/DEALER / 35

DEALER SHOWCASE

Descriptions and specifications of the products included in this department are provided by the manufacturers. For additional information, circle the corresponding numbers on the Reader Service Card in this issue.

PORTABLE CHANGEABLE SIGN 134

A new double-faced, portable and changeable sign unit is now available from *Berloc Sign Co.* Each side of the sign offers five complete lines of copy and comes with a font of 200 heavy-gauge aluminum letters. Lightweight and unbreakable, the complete set of 6½ inch letters, file box and index can be held in one hand. Letters slip quickly and securely in place, permitting messages to be changed in min-

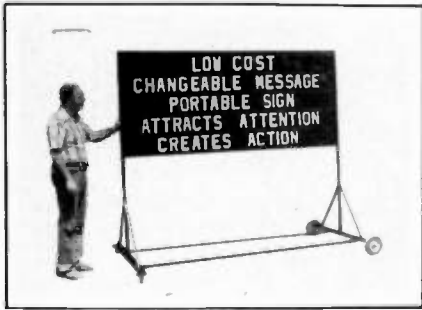

utes. The panels are 8 feet wide by 3½ feet high. The steel frame is 7 feet high. Front wheels are included for portability. Priced at \$595.

PHONO CARTRIDGE MAINTENANCE KIT 135

A new kit that allows the consumer to inspect, maintain, install and replace delicate phono needles and cartridges is available now from *Robins Industries*. Called the 'Stylee' kit,



components included are: precision stylus handheld microscope, screwdriver, tweezers, and stylus cleaning fluid and brush, all packaged in a permanent plastic storage case. The nucleus of the kit is the hand-held microscope with precision optically de-

signed lens of sufficiently high powered magnification to reveal imperfections and wear points. The kit has a suggested list price of \$10.

MICROPROCESSOR CRYSTALS 136

A new line of "time-base" microprocessor crystals for use in TV games, toys, home computers and advanced commercial and industrial computer applications is announced by *United States Crystal Corp.* Marketed under the name of "Synclock", the new crystals are precision made, high quality crystals engineered to close tolerance specifications for stability and lower resistance levels. They are aged, individually tested and factory sealed in protective packages for in-store merchandising. A display unit is also available, on a 'no-risk'



deal for dealers. A full credit return plan allows dealers to trade-in any frequencies which prove to be slow-movers.

CB ANTENNA FOR CYCLES 137

A new CB antenna, called the "Super-Broad", that delivers broad band coverage over the entire 40 channel CB range with low SWR readings is available now from *Antler Antennas*. The antenna, Model 1C40, has an adjustable clamping bracket that



GO DIGITAL, GO DANAMETER®

(The New VOM For Today's Needs.)

- 0.25% Accuracy
- Full Overload Protection
- Really Drop-Proof
- Full One Year Battery Life

DANA®

Dana Laboratories, Inc.

2401 Campus Dr, Irvine, Ca 92715, (714) 833-1234

...for more details circle 107 on Reader Service Card

locks onto tubing or bars up to one inch in diameter. It is made of heavy-duty, chrome-plated steel and is finished to eliminate sharp edges or corners. The antenna is a 'center-load' style that is precision tuned at the factory. The whip is made of 17-7 stainless spring steel and is adjustable for fine tuning.

RECORD CLEANER ROLLER 138

A new roller-type record cleaner which lifts dirt, fingerprints, dust and smudges from within the ridges of phonograph records and renews itself by simple washing in warm water and detergent is being introduced by *Rotel*. The new roller/cleaner uses a rubber-elastomer material which is said to



never lose its original surface tackiness, and will not affect the record surface or label in any way. Comes with a protective plastic collar that slips over the roller to prevent nicks, mars and cuts that would affect the surface. It is offered in a see-through, polymer container with a pre-formed, plush velvet platform/liner. Retail for \$20.

ACOUSTIC PADDING FOR SPEAKERS 139

An easy-to-handle, non-irritating material for the acoustic padding of speaker cabinets is being introduced by *Audiotex*. Designed for sale to do-



it-yourselfers, the new product, called *Tufflex*, is made of natural wood fibers, and is said not to irritate skin like fiberglass. *Tufflex* provides total damping of standing sound waves and

prevents cavity resonance in the speaker enclosure. It will also help to eliminate undesirable echos, feedback and reverberations. It is available in 55 inch by 24 inch by 1 inch sheets.

AM RADIO AMPLIFIER 140

A new AM radio amplifier, Model *AMA-51*, which will boost radio sales by providing clear, static-free reception in showrooms is now available from *Extronix, Inc.* The new unit amplifies signals received by a rooftop antenna and retransmits them to overcome the poor receptions in steel-frame buildings, and the electrical in-

terference generated by fluorescent lights, elevators and appliances. The amplifier boosts the whole AM radio band (540-1600 KHz) to a satisfactory reception level without tuning. Composite output is rated at 3.0 volts in 75 ohms with all distortion at least 40 dB down. Installation is made with ordinary TV cable.

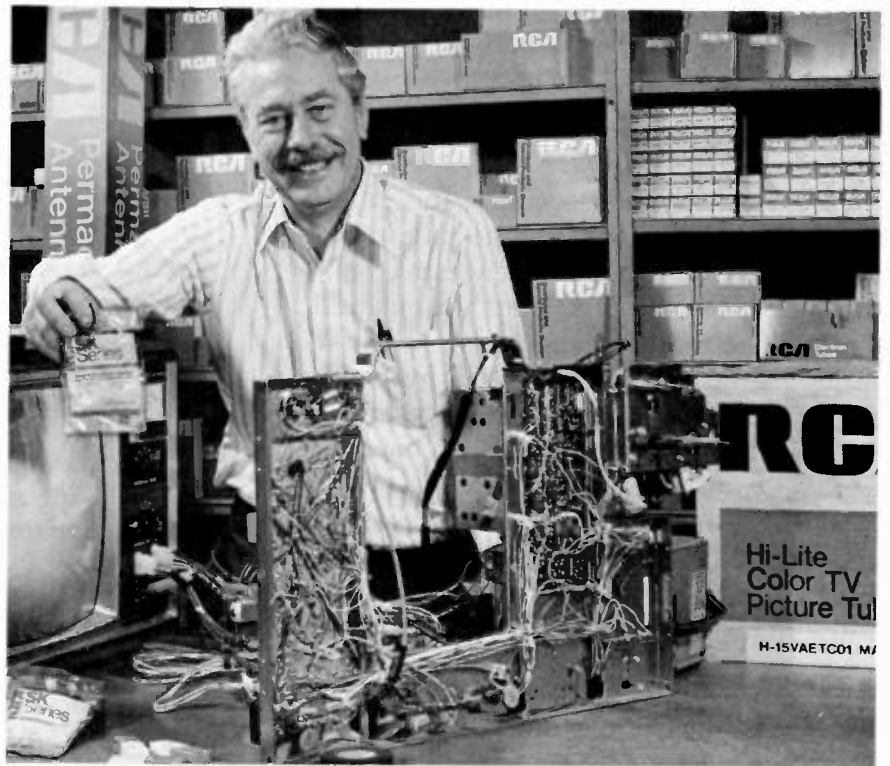
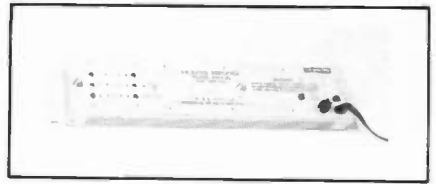

RCA helps you do it all - faster and more profitably.

RCA knows what you need for fast efficient service. Your RCA Distributor can quickly solve your stocking and ordering problems because he represents RCA's Distributor and Special Products Division — one of the industry's largest single sources for your electronic servicing needs.

You name it — we'll supply it. Receiving tubes; color and black-and-white picture tubes; SK replacement semiconductors; exact replacement parts; antenna hardware; outdoor and indoor antennas; antenna rotators; industrial tubes; test jigs; reception and servicing aids ... and the list goes on.

And that's not all. The size and scope of RCA's activities in electronics means you can get the latest, most advanced products. Backed with extensive promotional support; advertising programs; handy directories, catalogs and cross-reference library.

Get the full story from your RCA Distributor. Or write RCA Distributor and Special Products Division, 2000 Clements Bridge Road, Deptford, N.J. 08096. Attn: Sales Promotion Services.

RCA Distributor and Special Products Division

...for more details circle 126 on Reader Service Card

If you are an executive and have not heard of Drake-Beam & Associates... You should have.

Drake-Beam & Associates, Inc. is a consulting organization specializing in the application of behavioral sciences to the solution of "people-problems" in business.

Drake-Beam is particularly skilled in the design and implementation of innovative approaches aimed at increasing the utilization of its clients' most valuable resource — people.

D-B's clients, comprised largely of Fortune 500 (17 of the top 25) speak well about Drake-Beam's ability to produce results that have tangible impact on profit.

Those services include:

Out-Placement Counseling (OPC) . . .

Assisting the terminated individual and the organization in making a smooth transition.

Training & Development . . .

Custom designed learning experiences in management and sales skills.

Executive Search . . .

Through a unique, dynamic and demonstrably successful approach, finding the right person for a key position in your organization.

Mid-Career Guidance . . .

Revitalizing a valued employee whose performance is failing within your organization: improving the performance of a key management member who has high potential.

Personnel Research & Assessment . . .

Providing sound recommendations about organization and individual problems by means of attitude surveys and individual psychological assessments. Drake-Beam also validates hiring and test selection procedures.

Organization Development

Making individuals and groups more productive through team building and job design.

For information, call or write:

NEW YORK:

William J. Morin, Group Vice President
277 Park Avenue, New York, N. Y. 10017
(212) 826-8890

CHICAGO:

Phil Simshauser, Vice President
1001 East Touhy Avenue, Box 26
Des Plaines, Illinois 60018
(312) 299-2286

LOS ANGELES:

Steve Savage, Vice President
5900 Wilshire Blvd.
Los Angeles, California 90036
(213) 938-9111



DRAKE-BEAM & ASSOCIATES, INC.

Human Assessment and Development Group/HARCOURT BRACE JOVANOVICH, INC.

...for more details circle 132 on Reader Service Card

NEW PRODUCTS

Descriptions and specifications of the products included in this department are provided by the manufacturers. For additional information, circle the corresponding numbers on the Reader Service Card in this issue.

VOM WITH FIVE-OHM MID-SCALE RANGE

141

A new 30,000 ohm/volt compact VOM has been introduced by *B&K Precision*. The new instrument, Model 115, features a five-ohm mid-scale range for checking the low-resistance of coil, transformer and motor windings. All four resistance scales (0-500Ω, 50k, 500k, 5MΩ) are fuse protected. For checks of the thermocouples and oil burner controls, four DC current ranges are included (0.03, 0.06, 60, 60mA). DC and AC voltage measurement extends to 1200 volts, or 12kVDC with the optional HV-12 high-voltage probe adapter. The color-coded meter scales are uncluttered and simplified. A full-arc mirrored scale eliminates parallax errors. The 115 is small enough to fit into most tool kits. Test leads and instruction are included. Priced at \$37.50.



MAGNETIC MOUNT CB ANTENNA 142

Two new magnetic mount CB antennas—Models 5029A and 5030—are announced by *Channel Master*. Called the 'Mag-Ne-Tenna', the new models were tested on a plane going 140 mph and a vinyl top car at 100 mph. They are said to be the only magnetic mount CB antennas that use an in-line ferrite choke, mounted in the base housing, to stabilize SWR, boost efficiency, and enable the antennas to perform on vinyl top cars. Both antennas have epoxy-dipped,

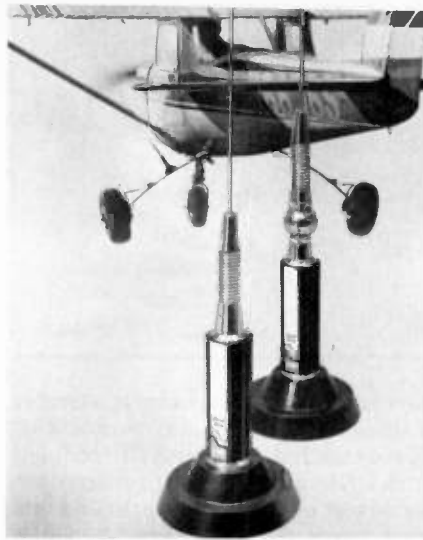

base-loaded coils protected by weatherproof housing, plus a stainless steel shock spring and high-capacitance stainless steel whip. Model 5030, which is adjustable, comes with a triple chrome-plated universal ball-joint. Model 5029A sells for \$29.95 and Model 5030, \$33.95.

RECEPTACLE TESTER

143

A new, pocket-sized tester for correct wiring of 15 or 20 amp, 115V single-phase 3-wire receptacles is now

available from *Etcon Corp.* To test, simply plug the unit into the receptacle. A combination of colored lights indicates whether the receptacle is properly wired. It is a lightweight and compact enough to be carried in a shirt pocket. Called the CT 102 Circuit Tester, it incorporates the same blades as a standard 15 amp U-ground plug, and fits either 15 or 20 amp U-grounded receptacles.

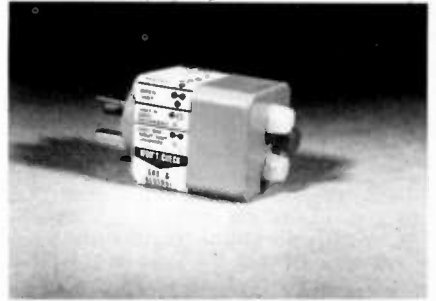

IC TEST CLIPS

144

A new 40-pin, dual-in-line test clip for attachment of test probes to IC packages has been announced by *ITT Pomona Electronics*. Designated Model 4140, the new clip is designed to permit handfree testing while maintaining a good electrical connection. Special features include solid, non-

INTERMITTENT PROBLEM?

FREEZ-IT AND FIND IT

Thermal intermittent? Freez-It and find it. PC board crack? Freez-It and find it. Even if Chemtronics Freez-It did only these two things, it would be a winner. By cutting hours from your troubleshooting chores. But it does even more!

Freez-It is a fail-safe heat sink for soldering delicate components. It cools down overheated parts to save them from damage. Prevents cold solder joints. Helps you put tight-fitting metal parts together. Even aids in removing adhesives.

Freez-It is 100% pure Freon* 12, the instant-evaporating chilling agent with no liquid residue or noxious odors. Chills parts instantly down to -65°F. And comes complete with pinpoint extender tube, for work on densely-packed circuits.

Ask for Freez-It by name from your Chemtronics distributor.

CHEMTRONICS
INCORPORATED
45 Hoffman Avenue, Hauppauge, N.Y. 11787
(516) 582-3322 (212) 895-1930
In Canada: Paco Electronics, Ltd., Montreal, Quebec H4N 2E1

Meets all applicable Federal and Military Specifications
Reg. Dupont Trademark.

...for more details circle 105 on Reader Service Card



NEW EICO 480 TRIGGERED SWEEP 10 MHz SCOPE

100% Solid State • Includes 10:1 Probe

More Professional scope performance for your money! DC to 10 MHz bandwidth, AC and DC coupling, 11 position calibrated attenuator, 10 mV/cm sensitivity, push-button operation. Outstanding features: Built-in TV Sync Separator; Digitally controlled trigger circuits; reference baseline display; calibrated 21 step sweep speed; Fully regulated power supply; Custom Bezel for standard camera mounting. **Assembled \$425.00**

FREE '78 EICO CATALOG

Check reader service card or send 75¢ for first class mail. See your local EICO Dealer or call (516) 681-9300, 9:00 a.m.-5:00 p.m. EST. Major credit cards accepted.

EICO—108 New South Rd.
Hicksville, N.Y. 11802



...for more details circle 108 on Reader Service Card

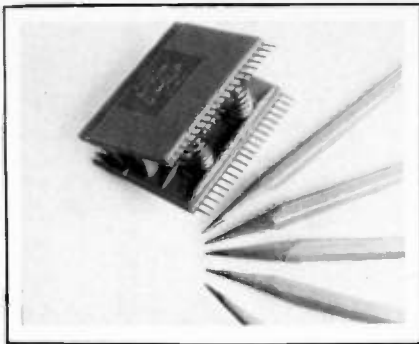

tarnish nickel silver contacts; serrated 1.02mm (.04 inch) side contacts on lower end that mate with DIP contacts and 0.63mm (.025 inch) squared serrated test points on the upper end that will accept mini test clips. A molded barrier between each contact allows connection to be made on live boards without accidental shorting of adjacent contacts. It can also be used as a DIP removal tool. Priced at \$19.95 each.

CB BASE STATION ANTENNAS 145

A new line of high performance, ground plane base station antennas for CB has been announced by *Winegard Industries*. Bearing the "Wavemaster" tradename, the new antennas are small in size, yet are said to provide the performance expected of

larger models. Gain of the six models in the line ranges from 3.5dB to 5.0dB. They are engineered for 40 channel operation. Installation is easy with the four basic parts of each antenna as-



sembled without tools. They feature twist-lock sockets which hold the radiator and radial elements firmly in place, assuring solid electrical contact between the elements and the transmission cable.

TUNGSTEN HALOGEN LIGHT BULB 146

A tiny tungsten halogen light bulb designed for use as a light source for microfilm readers, optical comparators, medical and dental lighting fixtures, scientific instruments, and other low voltage lighting equipment has been introduced by *Westinghouse*.

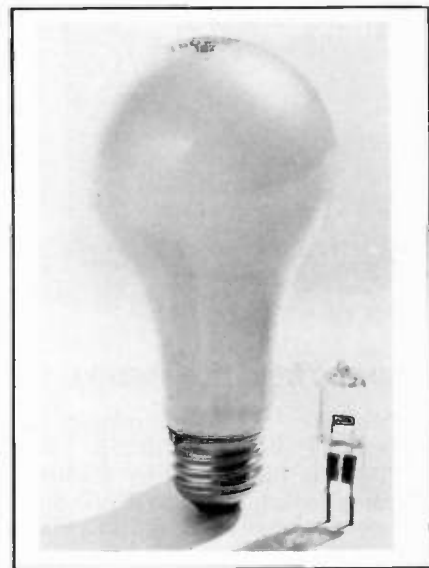

The 24 volt quartz bulb, containing a pressurized halogen atmosphere, provides a high brightness level (4500 lumens) and excellent color rendering ability (3400° Kelvin). It offers 100% lumen maintenance throughout its

QUICK CHARGE IRON- QUICK CHANGE TIPS

ISO-TIP® Quick Charge Cordless Soldering Iron recharges in 3-4½ hours. Uses any of Wahl's 16 snap-in tips.

Low voltage, battery powered, ground free isolated tip design.

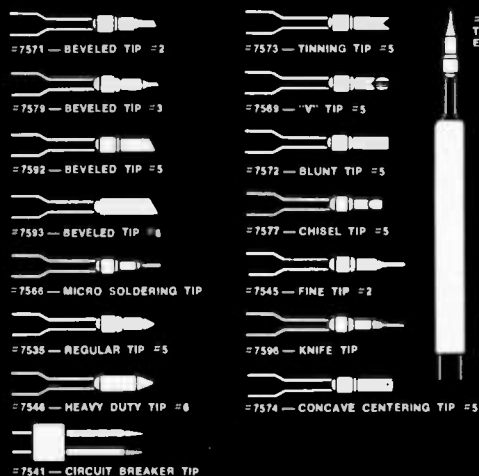

WAHL CLIPPER CORPORATION
ORIGINATORS OF PRACTICAL CORDLESS SOLDERING.

Sterling, Illinois 61081 (815) 625-6525
"Manufacturing Excellence Since 1919"

...for more details circle 129 on Reader Service Card

life. As a result of a tightly wound oval filament, the new lamp provides illumination clarity with a minimum of imaging in optical projection systems. It features a bi-pin base. The suggested list price is \$11.25.

REMOTE CONTROL TRANSMITTER TESTER 147

A new tester for checking television remote control signals from handheld remote transmitters is available now from *Zenith Radio*. Designated Model 852-240, the new instrument is designed for use both by sales and service



people. It is capable of testing all Zenith Space Command remote transmitters, both mechanical and electronic units. It will also check output on other brand transmitters emitting a continuous sinewave to 50,000 Hz. Operation is simple. When remote transmitter is held about six inches from the tester, a red LED indicates whether or not there is sufficient output to operate the TV receiver.

COIL-SPRING FUSE HOLDER 148

A new type of coil-spring fuse holder that eliminates the need to pull a chassis or tuner for fuse replacement is being introduced by *Oneida Electronic*. The new holder, which is per-



manent, is constructed of tempered spring steel with dip soldered leads. It is said to eliminate the need for O.E.M.'S for using more costly pig-tail fuses, and does away with cutting and resoldering pig tail leads. Available at distributors.

MINIATURE ROTARY ATTENUATOR 149

A new line of miniature rotary attenuators for low cost applications has been announced by *Kay Elemetrics*.

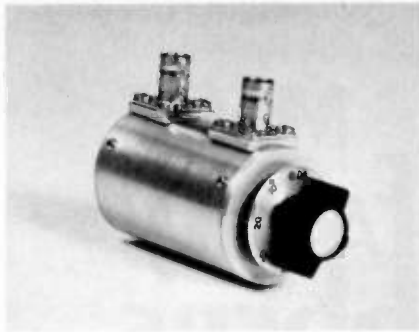

Designated the 200 series, the new attenuators are designed specifically for operation from DC-750 MHz (75Ω impedance) and DC-1GHz (50Ω impedance). They have gold plated double contacts, glass epoxy rotor wafers with gold circuitry, silver plated rotor, woven RF gaskets and precision metal film resistors. There are four models in the series with an overall attenuation range of 0 to 70 db. Priced at \$85.

HIGH VOLTAGE PROBE 150

A full-size dual range high voltage probe that breaks down to fit into a convenient caddy case is new from *Polaris New York*. Designated the '851' Caddy-Probe, the new tool is a dual range instrument with a voltage capability of 400 Ma DC with ± 2% accuracy. The meter movement has a sensitivity of 50 Ua. It is manufac-

Includes Functional Tilt Stand!

NEW EICO 270 3½ DIGIT DMM KIT ONLY \$79.95

Introductory Offer—FREE AC ADAPTOR

The first and only lab accuracy portable DMM Kit featuring MOS/LSI IC economy and reliability. Measures DC/AC Volts, Kilohms, DC/AC milliamps in 21 ranges. Polarity indicators and overload protection are provided, and 0.5 inch LED displays give easiest-to-read digital readout to 1999. The 270 features a basic 0.5% DC accuracy, 10 Megohm input impedance, low voltage drop in all current ranges and automatically-flashing overrange indicator. **Assembled \$109.95**

FREE '78 EICO CATALOG

Check reader service card or send 75¢ for first class mail. See your local EICO Dealer or call (516) 681-9300, 9:00 a.m.-5:00 p.m. EST. Major credit cards accepted.

EICO—108 New South Rd. Hicksville, N.Y. 11802

...for more details circle 109 on Reader Service Card

SUBBER®

MARK IV-CUVB

A TIMESAVING INSTRUMENT BY CASTLE

UHF-VHF TV tuner and i-f signal analyst
Incorporates these important features:

- Tunes all UHF & VHF Channels
- Electronic Fine Tuning
- Dual 40 MHZ IF Output Jacks
- Battery Condition Indicator

MARK IV-CUVB Net \$64.95
(BATTERY POWERED ONLY)

CASTLE ELECTRONICS

5233 Old South Highway 37 Bloomington, Indiana 47401

For More Details and Specifications Contact Your Nearest Distributor
In Canada: Len Finkler Ltd; Ontario

...for more details circle 101 on Reader Service Card

MEET OUR family of GRABBERS



MODEL 4233 MICRO GRABBER
Tests high density packaging



MODEL 3925 MINI GRABBER
Tests conventional packaging



MODEL 4011 THREADED GRABBER
Accepts 6-32 threaded leads



MODELS 3780 - 3789 GRABBER LEADS
10 choices of connectors other end



MODEL 4225 MAXI GRABBER
Tests high rise packaging

All Grabbers shown actual size

Our Grabber family is five years old now, and we're adding new members to keep pace with the complexities of state-of-the-art electronic packaging. Grabber is our name for a series of test clips designed to simplify testing of electronic packages from conventional components to maximum density DIP's. They're rugged, dependable, versatile, and very easy to use. Write for our catalog and get the complete story on the whole family of Grabbers. Find out why they are your best solution to your electronic testing problems.

AVAILABLE THROUGH YOUR
FAVORITE ELECTRONIC
PARTS DISTRIBUTOR

ITT POMONA ELECTRONICS

1500 East Ninth St., Pomona, Calif. 91766
Telephone (714) 623-3463, TWX: 910-581-3822



tured from high impact styrene with high dielectric strength. When assembled, overall length is 15 inches. The entire package, with case, weighs 16 ounces.

UHF/VHF FIELD STRENGTH METER 151

A new UHF/VHF field strength meter with a digital display window is new from *Blonder-Tongue Labs*. The window contains a half-inch 3-digit LED readout that is photo transistorized to adjust brightness for optimum visibility under changing ambient lighting. There is also an analog



meter and scale to facilitate tuning for maximum levels and a status display comprised of four LED's to indicate over or under range, picture carrier tuning and battery charge warning. The new meter provides 90 db total range with 0.1 db resolution. An auto-ranging attenuator automatically programs the display to the proper range. Selectable detector mode of operation includes accurate pulse peak detection, quasi-peak detection or noise detection for S/N ratio measurement.

SOLDERING IRON STAND/TIP CLEANER

152

A new safety stand and tip cleaner for pencil-type soldering irons is being introduced by *American Beauty*. Des-

...for more details circle 125 on Reader Service Card



ignated Model 483, the new device protects irons from overheating damage while at rest by surrounding the iron's tip with a pool of molten solder. The solder acts as a heat sink and keeps tip tinned ready for use. An integral part of Model 483 is the tip cleaner which has its own water reservoir and wick-fed sponge. A hole in the sponge and the stainless steel supporting shelf provides an ample wiping edge. Excess solder, dross and burnt flux drop thru the hole, leaving wiping edge free of contaminants.

INSIDE CB ANTENNA 153

A new CB antenna that, installed inside the vehicle, utilizes a vehicle's metal frame as a slot-fed metal ground plane antenna has been introduced by *Microwave Filter Co.* Called the "In-



tenna," the new device thwarts CB equipment rip-off, eliminates exterior damage encountered with conventional outside antennas, and is said to have from 3 to 6 dB less noise pickup than typical outside antennas. It may be used on cars, vans, station wagons, pick-up trucks—in fact, any vehicle with a metal skin. All components in-

NEW & DAZZLING!!!
MS-15 Miniscope—\$289.00 from NLS



- Features Include:
- Bandwidth: 15 MHz.
 - External & internal trigger.
 - Automatic & line sync modes.
 - Input sensitivity: vertical - 10 mV; horizontal - 1V.
 - Vertical gain: .01 to 50V/div - 12 settings.
 - Time base: .1 μSec to .5 Sec/div - 21 settings.
 - 3% accuracy on all functions.
 - Power consumption: <15 W.
 - Battery or line operation with batteries and charger unit included.
 - Weighs only 3 lbs & dimensions are 2.7" H x 6.4" W x 7.5" D.
 - Options include a 10 to 1, 10 megohm probe and leather carrying case.



Non-Linear Systems, Inc.
Originator of the digital voltmeter.
Box N. Del Mar, California 92014
Telephone (714) 755-1134 TWX 910-322-1132

...for more details circle 122 on Reader Service Card

CORNELL ELECTRONICS COMPANY
4213 N. UNIVERSITY AVE. SAN DIEGO CALIF. 92105

THE ORIGINAL HOME OF

36¢ PER TUBE
UNLESS OTHERWISE PRICED
33¢ PER TUBE
100 TUBES OR MORE

Same Low Price East or West Coast!

- ★ Bargain Tools
- ★ Transistor Tester
- ★ Technician's Library

ONE YEAR GUARANTEE
INDIVIDUALLY BOXED
5 DAY MONEY BACK OFFER
LAB TESTED USED

SEND FOR FREE NEW 48 PAGE COLOR CATALOG

- ★ Dumont Picture Tubes
- ★ Diodes—Transistors—Kits
- ★ Tube Cartons

SPECIAL OFFER
ON ALL ORDERS OVER \$10.00
25¢ PER TUBE (NO LIMIT)
FROM THIS LIST
6AG5 6CB6
6AU6 6J6
6AX4 6SN7

Your Order FREE if Not Shipped in 24 Hours

...for more details circle 106 on Reader Service Card

FREE! GTS-10 two-volume owner's manual.

Get all the facts on the new GTS-10 General Television Servicer - the concept that is changing the course of TV servicing!
Advanced yet sensibly priced at \$349.00 the GTS-10 is the ultimate instrument on the TV service equipment market.
In addition to free two-volume set of GTS-10 owner's manuals you will receive a comprehensive 6 page full color brochure - describing its profit making potential and its many unique patterns as well as information on our 30 day shop trial of GTS-10 General Television Servicer.

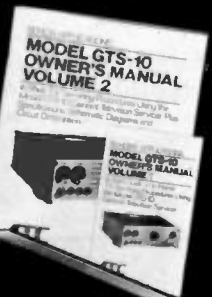

SEND TODAY!
Limited time offer on FREE manuals.

Telephone orders of GTS-10 General Television Servicer on VISA and MASTER CHARGE accepted for same day shipment. (303) 275-8991.

ATC AMERICAN TECHNOLOGY CORP.
225 Main Street
Canon City, CO 81212

Send \$1.00 if First Class delivery is desired.

Name _____ Phone _____
Company _____
Address _____
City _____ State _____ Zip _____

ETD12

cluding a tunable matching section and 8 feet of RG-58-U coax cable are furnished. Price is \$24.90.

TUNER CLEANER & LUBRICANT

154

A new tuner cleaner and heavy lubricant for use in coastal areas and other locations with high humidity has been introduced by the *Rawn Company*. Named Blue Magic, the new product



has undergone extensive field tests and is intended for use by professional technicians for tuner servicing. It is said to be not harmful for plastics or other tuner components and is non-inflammable. It has been formulated to provide resistance to oxidation and gumming.

WRAPPED-WIRE TOOL

155

A newly developed wrapped-wire tool that makes gas-tight interconnections with standard Tefzel insulated wire without time-consuming measuring, cutting and stripping is available from *Vector Electronic Co.* Polyure-



thane-Nylon wire only could previously be slit and wrapped. With the new tool, 'daisy-chain' terminations require about 5 seconds per post. A special bit uses 28-gauge silver-plated copper wire with Tefzel insulation fed

from a spool on the tool's shaft. A cutting edge, adjacent to the wrapping bit, slits the insulation longitudinally along the wire at the point a wrap is to be made. Life of the cutter edge is said to exceed 10,000 wraps. Three models are priced at \$29.50, \$80.00 and \$89.00.

DIGITAL TROUBLESHOOTING COURSE

156

A new color videotape program for those wanting to learn 'Digital Troubleshooting' is now available from *Hewlett-Packard*. Equivalent in coverage to a two-day live seminar, this 14 section videotape program has a total running time of 5 hours and 31 minutes, and includes a 180-page textbook, lab workbook and study guide. The curriculum is designed to provide instruction for individuals learning digital troubleshooting for the first time and for technicians needing a refresher course on digital techniques. Topics include: introduction to



digital electronics and the binary system; the basics of transistors and IC's; logic gates and symbols; digital IC families; troubleshooting digital IC's; flip flops; counters; shift registers; combinational logic circuits; display technologies; IC manufacturing and memories. Individual videocassettes are priced individually from \$250 to \$375, and the entire course, textbooks and all, is available for \$3,600.

UNIVERSAL REPLACEMENT CRT

157

GTE Sylvania is introducing a new line of eight universal picture tubes that can be used as replacements for 385 industry types. The tubes are metal bonded types which can be used as direct replacements for bonded

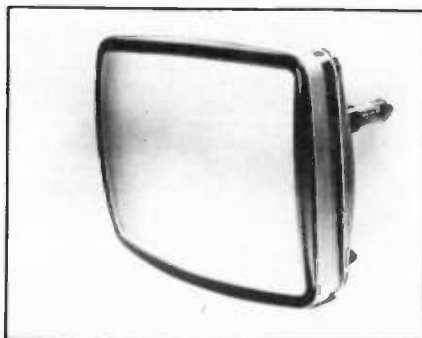

safety plate picture tubes. They have a new copper ground strap attached to the metal band in the corner of the tube which facilitates a safely-grounded installation. When used as replacements for safety plate types, they are said to provide a brighter picture since no safety plate is required. New labels on Sylvania picture tube cartons identify Universal Color Bright 85 types and list the tube which they replace. They carry a five-year limited warranty.

DESOLDERING TOOL

158

A new hand-held desoldering tool that utilizes a heat resistant plastic dispenser is being introduced by the *Mohawk Co.* Called the Tech-Wick,

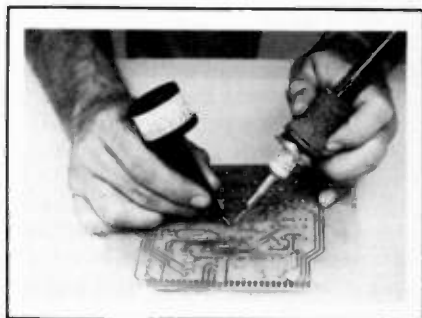

the new device is said to allow for steady, pin-point positioning of the pure copper wick on the connection to be desoldered. The wick, constructed of fine strands of pure copper treated with non-conductive, non-corrosive rosin flux, is designed to eliminate the hazard of burned fingers or electrical shock. Tech-Wick is available in two styles—Model S-16, with 10 feet of No. 16, gauge wick—and Model R-20, with 20 feet of No. 20 gauge wick. S-16 is priced at \$2.75 each, and R-20 is \$3.75 each.

LOG SWEEP FUNCTION GENERATOR

159

A new 5MHz, 100,000:1 log sweep function generator, designated Model 508, is available now from *Exact Electronics*. The new instrument is actu-

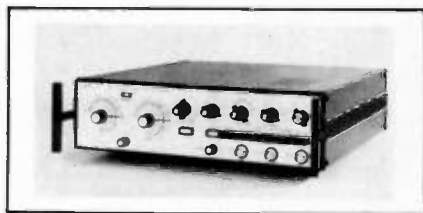

ally two generators in one package—a VCF generator covering 0.0001Hz to 5.5MHz and producing sine, square, triangle, pulse, haversine, and haver-triangle waveforms, and a Ramp generator, producing ramps with periods from 10µsec to 100 sec. The Ramp generator is used for direct out-

put and for sweeping, triggering, and gating the main generator. A V:f output is provided for driving analog devices such as horizontal drive to oscilloscopes or X-Y recorders. Priced at \$745. ■

ADMIRAL

continued from page 26

of color IC400. It also reduces the color gain when the picture contrast is reduced.

With this control circuit, color and contrast track one another as the controls are varied. If the contrast control is turned up to produce more contrast, the opposite polarities will result, Q170 will conduct more, collect voltage will fall, and color gain will increase.

SWEEP CIRCUITS

The vertical sweep circuit in the 25M55M chassis is almost identical to that used in the previous 7M45 chassis. The horizontal sweep circuit is also basically the same as the M45 chassis. There is some difference, however, in the use of pincushion correction and a convergence panel. The convergence voltage for horizontal is derived across an added winding on the horizontal output transformer between pins 9 and 5.

For pincushion correction, the winding between pins 3 and 6 of the pin reactor, T600, is placed in series with the horizontal yoke in order to produce maximum horizontal sweep width when the vertical scan is in the CRT center and minimum width on the top and bottom of the picture.

Pincushion correction is maximum but opposite on the top and bottom of the CRT and gradually decreases toward the center. It is zero in the CRT center.

The convergence panel is similar to that used in the M50 chassis but is not directly interchangeable. It should be noted that a 4 pin socket for connections in the 25M55M is used, as compared to a 3 pin socket in the M50. ■

MODULAR CHROMA

continued from page 29

by spacing the oscillator coil in the tuner to put the fine tuning range where it belonged! This problem usually shows up on one or two channels only, and is due to tuner drift.

Finally, weak chroma, and poor contrast can result by poor "set up" of the picture tube. Excessive negative bias on the CRT results in washed out pictures. Turning up the IF gain by tweaking the

AGC only results in overload symptoms such as poor sync.

I think it is important to remember that troubleshooting chroma is less difficult than handling IF problems, (chroma can be viewed directly on a scope). The signal levels are fairly high and using a color bar generator gives an easily recognizable display. As for modular sets, they are nothing but a PC board broken up into smaller pieces. Take out the connector problems, and there's no difference. ■

FORDHAM

BEST BUYS

TV Test Equipment

CRT Restorer/Analyzers

- Test and restore CRT's faster with fewer callbacks
- Exclusive multiplex technique tests all three guns of color CRT simultaneously under actual operating conditions even CRT's with common G1 and G2
- Uses the most powerful restoration method known with minimal danger to CRT—guarantee with confidence!
- All CRT's checked identically—including all "inline" and "one-gun" types

Television Analyst Model 1077B

- Cuts troubleshooting time in half
- Provides signal substitution for the entire range of signals present in any TV set, black-and-white or color
- Horizontal and vertical drive for solid state and tube type circuits
- Audio output
- Built-in scanner for test-pattern slides (supplied) or any 3 x 4" positive transparency
- High-voltage indication
- 8 VHF channels... all UHF channels 14-83

Model 467

Model E 2000

Model 1248

Digital IC Color Generator/Analyst

- Generates 9 patterns and logic functions
- Locate dead IF stages
- Check operation of mixer, RF and local oscillators
- Check stages sequentially
- Locate color shifts and internal ghosts from RF, mixer, IF or video stages. Plus all standard color generator uses
- Switchable horizontal and vertical sync output
- Sync level independent of video level control
- Crystal controlled RF and IF outputs

Model 415

Solid State Sweep/Marker Generator

- Four Instruments in one: sweep generator, marker generator, marker adder, bias supply
- Complete accessory pack
- All intercabling changes and generator selections accomplished internally with master function switch and front panel controls
- Concentrates all TV alignment tools (except oscilloscope and VTVM) into one, easy-to-use instrument.

FOR PRICING AND TO PLACE YOUR ORDER

CALL TOLL FREE (800) 645-9518 (Outside N.Y. State)

For N.Y. State call (516) 752-0050

Master Charge, BankAmericard & C.O.D.'s accepted.

FORDHAM

RADIO SUPPLY CO., INC.
855R Conklin St.
Farmingdale, N.Y. 11735

YOUR ONE STOP DISCOUNT CENTER

FREE

148 page catalog of over 3000 items test equipment, CB, tools, tubes, components and a full line of electronic supplies

FREE ALARM CATALOG

Huge selection of burglar & fire systems, supplies, Motion detectors, infrared beams, controls, door switches, bells, sirens, 900 items, 64 pp. packed with technical details, notes.

Phone (602) 263-8831



mountain west alarm

4215 n. 16th st., phoenix, az. 85016

...for more details circle 121 on Reader Service Card

...for more details circle 113 on Reader Service Card

CLASSIFIED

RATES: 40 cents per word (minimum charge, \$10). Bold face words or words in all capital letters charged at 50 cents per word. Boxed or display ads charged at \$46 per column inch (one inch minimum). For ads using blind box number, add \$3 to total cost of ad. Send ad copy with payment to: Dawn Anderson, ELECTRONIC TECHNICIAN/DEALER, 1 East First Street, Duluth, MN. 55802.

BOX NUMBER REPLIES: Mail box number replies to: ELECTRONIC TECHNICIAN/DEALER, Classified Ad Department, One East First Street, Duluth, MN 55802. Please include box number in address.

Business Opportunities

ELECTRONICS/AVIONICS EMPLOYMENT OPPORTUNITIES. Report on jobs now open. Details **FREE.** Aviation Employment Information Service, Box 240 Y, Northport, New York 11768. 8/78

"Drive-in" TV Repair Shop in Florida. Good location, low rent—One man can make \$20K yearly. \$5,000 buys it all. P. O. Box 125, Palatka, FL 32077. 12/77

MECHANICALLY INCLINED INDIVIDUALS—BUILD ELECTRONIC DEVICES IN YOUR HOME. GET STARTED IN YOUR SPARE TIME. \$300 TO \$600/WK POSSIBLE. EXPERIENCE NOT NECESSARY. WRITE FOR FREE LITERATURE. ELECTRONIC DEVELOPMENT LAB., BOX 1535 (B), PINELLAS PARK, FLA., 33565. TF

INCREASE YOUR INCOME! Rent Lease TVs: Anyone can! Easy to start and operate, part or full time; even from your home. Basic preliminaries \$4.00. Perry's TV Leasing, 308 N. McClelland, Santa Maria, Calif. 93454. 12/77

TRANSFERRED airline pilot has lucrative TV repair shop in beautiful colonial on 1/3 acre. \$49,900 for home, TV business **FREE.** Bruce Electronics, 10 White Birch Drive, Centereach, NY 11720, 516-585-6260. 12/77

SELLING, FLORIDA—ZENITH T.V. SALES & SERVICE: 16 YEARS SAME LOCATION—PARTS, FIXTURES, EQUIPMENT & CUSTOMERS—\$7000.00. BILL ELLIS, 5688 OAK-HURST DR., ST. PETERSBURG, FL. 33542. 12/77

2 way radio service shop, CB and FM Sales and Service. Six years in business, all up to date test equipment. Inventory is 40K and price 30K. Details write: P.O. Box 611, Delta, Colo. 81416. 12/77

WORK AND PLAY IN THE FABULOUS FLORIDA RAYS—Radio—TV—Communications Sales and Service. \$125,000. For further information write ET/D, Box 113. 12/77

T. V. Business for sale. 20 years in large shopping center in So. Fla. Zenith-Sony-RCA sales and rental service. Year round. Over \$100,000 gross. Excellent opportunity. Write to Jeff Cohen, 19 B Madeira Ave., Coral Gables, Fla. 33134. 12/77

"TV Repair Shop in Bakersfield, California. Well established, low overhead, plenty of customer goodwill, excellent stock of tubes, parts, etc. Well equipped van. Lots of test equipment. Same coverage from 1946 to current. \$29,000. Technician willing to help train. 805-871-3580." 12/77

In The Best Of Greater Miami. TV & Comm Sales & Service. \$15,000 Buys Everything. Televideo, 380 E. 14 Street, Hialeah, FL 33010. 1/78

**send a message...
...write here.**

1. Number of insertions: (circle) 1 2 3 6 12
 2. Start with (month) _____ issue (Copy must be in by 1st of month preceding)
 3. Amount enclosed: \$ _____

PAYMENT MUST ACCOMPANY ORDER. WE'LL BILL RATED FIRMS. NO AGENCY COMMISSION.

NAME _____ COMPANY _____

STREET _____

CITY _____ STATE _____ ZIP _____

MAIL AD COPY TO: DAWN ANDERSON, ELECTRONIC TECHNICIAN/DEALER, 1 EAST FIRST STREET, DULUTH, MN. 55802.

RATES: 40 cents per word (minimum charge, \$10). Bold face words or words in all capital letters charged at 50 cents per word. Boxed or display ads charged at \$46 per column inch (one inch minimum). For ads using blind box number, add \$3 to total cost of ad.

**ELECTRONIC
TECHNICIAN/DEALER** **Classified**

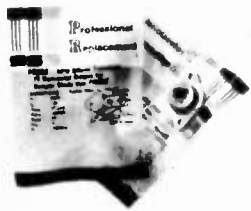
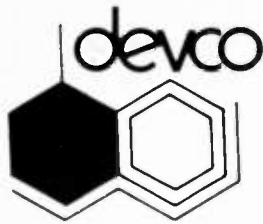

DEVCO

ATTENTION SERVICE DEALERS

Buy directly—Top Line Solid State Replacements

40% Off Dealer Cost 2 Year Warranty Devices

These are *professional devices* which replace over 130,000 industry types, and you buy them at substantial savings.

To Order: Send us the ECG, SK, or GE numbers and we will promptly ship you the premium PR direct Replacements, —plus a free PR Replacement Guide. Remember, these are top quality, no culls, no seconds. Orders over \$25.00 shipped free. Orders up to \$25.00 add \$1.00 UPS. All orders over \$100.00 receive 5% discount. To approximate amount of your order, deduct 40% from dealers cost of ECG, SK, or GE types. All orders shipped within 24 hours.

P.O. Box 270, Garwood, NJ 07027 (201) 688-0222

Vermont Radio-TV Sales & Service. Best product line. Long established. New building with rental potentials. Price \$280,000 w/terms. Marble City Realty, P.O. Box 265, Rutland VT 05701. 1277

Wanted

PICTURE TUBE MACHINE

We buy and sell NEW AND USED CRT rebuilding machinery. COMPLETE TRAINING. Buy with CONFIDENCE from the ORIGINAL MFR. For complete details, send name, address and zip code to:

LAKESIDE INDUSTRIES

3520 W. Fullerton Ave., Chicago, IL 60647
Phone: 312-342-3399

For Sale

TRANSISTOR REPLACEMENT. PHYLTRON ELECTRONICS LX REPLACEMENT LINE REPLACES THE MOST POPULAR REPLACEMENT TYPES AT OR BELOW DISTRIBUTOR COST. One year unconditional guarantee. Buy direct and save. Write for free catalog. Phyltron Electronics, 487 Springfield Ave., Summit, N.J. 07901. TF

Collector's Item For Sale. Electronics Books. Riders Manuals Volumes 2 thru 27 plus Index. SAMS Photofacts Service 1-150 plus Index. Write ET/D, Box 114. 178

REPLACEMENT COLOR YOKES—DEALERS ONLY. Zenith 95-2501-2532-2638-2667-S89633 etc. \$14.95. Magnavox 361380-1 \$18.95 etc. Sylvania, G.E. etc. \$14.95 to \$19.95. Request for price list on your letterhead. David Sims Enterprises, Inc., 665 Jericho Turnpike, Huntington Station, N.Y. 11746. TF

Tuners—DEALERS ONLY—Sylvania SS 54-35054-1, 54-29331-3, 54-29332-2, Zenith—175-1122 (3HA5-6EA8) \$4.95 ea. Magnavox SS—340226-2, 340184-3, 340187-1, Quasar—77G10249A30-A31-A36-A37-A38-A41, Varactor-77G10728A01 7.95 ea. UPS-COD, David Sims Enterprises, Inc. 665 E. Jericho Tpke., Huntington Sta., N.Y. 11746. 1277

Seeking original Japanese transistors, IC, FET and diodes for CB repair use? Write or call for our list and compare prices. Fuji-Svea Enterprise, Dept. ET, P.O. Box 40325, Cincinnati, OH 45240. (513) 874-0220. 278

Cartrivision color VTR with 29 tapes, zoom black and white camera, professional built cabinet, all shop manuals with interface for hook-up. \$450. Gil Foley, 115 Dixie Way No., South Bend, Indiana 46637 (219) 272-1512. 1277

REPAIR TV TUNERS—High earnings, Complete Course Details, 12 Repair Tricks, Many Plans, Two lessons, all for \$2. Refundable. Frank Bocek, Box 3236, Ent., Redding, CA 96001. TF

Japanese Transistors at Substantial Savings—One year unconditional guarantee. Write or call for free catalog. DEVCO, P.O. Box 270, Garwood, NJ 07027, (201) 688-0300. 178

TV AND RADIO TUBES .36e EA!! Send for free color parts catalog. Your order free if not shipped in 24 hours. Cornell Electronics 4215-17 University San Diego California 92105. TF

RECORDACALL—Auto60-up to 120 calls, 24 hours, monitor, dictation, ff, rewind, erase, microphone, warranty. \$130.00 Postage cod. Illinois residents add sales tax. TERRY'S, Box 209A, Park Ridge, Illinois 60068. 1277

For Sale: Sencore MU150 \$250.00, SG165 \$425.00, CR168 \$175.00. All Like New. Hugh M. Adams, 286 Beachview Dr., Ft. Walton Beach, FL 32548. 1277

FREE MONTHLY LISTING of IC's, transistors, regulators, opamps at super savings e.g. SN7400-.08, 2N2222-.03, LM309K-.50, LM709C-.13. Many, many more great buys. Write us to be put on our monthly m/l and we'll send you free one of each of the above parts. Industrial Semiconductors Inc., 97 Rantoul St., Beverly, MA 01915. 278

Alarm Systems

DON'T PURCHASE any burglar-fire alarm equipment before getting our free value packed catalog. Super savings on dialers, master controls, infrared detectors, wireless panic buttons and much more. No shipping charges. Sasco, 5619-E St. John, Kansas City, Mo. 64123 (816) 483-4612. 1277

ELECTRONIC TECHNICIAN/DEALER is not responsible for any of the items, plans, courses or quality of products offered through our classified section.

Qualitone

SEND FOR OUR BIG

FREE WHOLESALE CATALOG

FOR DEALERS ONLY!
We do not sell the consumer!

SAVE ON
THOUSANDS
OF AUDIO AND
ELECTRONIC PARTS,
TEST EQUIPMENT
AND
ACCESSORIES.

QUALITONE INDUSTRIES, INC.
696 Locust St., Mt. Vernon, N.Y. 10552
Please send FREE Catalog to:
(Please use your business letterhead.)

Name.....
Company.....
Address.....
City.....State/Zip.....

Don't cut yourself out of a career as a two-way radio technician...

MTI offers the only training for professional FM two-way radio available. Qualified technicians are employed in government, industry, and public service. But training is your key.

You could cut out a career as a two-way radio technician by cutting out this coupon. We'll send you information on how you can learn more about this specialized field, at home.

Name _____
Address _____
City _____
State/Zip _____

MM9

MTI

formerly

MOTOROLA TRAINING INSTITUTE

Summerdale, Pennsylvania 17093

...for more details circle 117 on Reader Service Card

READER SERVICE INDEX

ADVERTISER'S INDEX

American Technology Corp.	..43
101 Castle Electronics41
105 Chemtronics Inc.39
106 Cornell Electronics Co.43
107 Dana Laboratories Inc.36
132 Drake Beam38
108 Eico Electronic Instruments Co.40
109 Eico Electronic Instruments Co.41
110 Electronics Book Club33
111 Elin Uniform Mfg. Co.26
112 Fidelipac32
113 Fordham Radio Supply Co.	..45
114 Fuji-Svea Enterprise7
GC Electronics15
GTE Sylvania/Consumer RenewalCov. 3
General Electric/Tube Div.	...9
General Electric/TV Dealer	..21
115 International Components Corp.35
116 Leader Instruments Corp.	...6
117 Motorola Training Institute	..48
118 Mallory Distributor Products	..10
119 Modular Electronics Services17
120 Motorola/Semiconductors	...3
121 Mountain West Alarm Supply Co.45
122 Non-Linear Systems Inc.	...43
123 Oneida Electronics Mfg. Inc.	..16
124 Optima Electronics12
125 Pomona Electronics42
102 PTS Electronics Inc.	..Cov. 2, 1
Qualitone Industries Inc.48
126 RCA Distributor & Special Products37
127 Sencore Inc.13
103 Triplett Corp. (for info.)	..Cov. 4
104 Triplett Corp. (for demo.)	Cov. 4
128 VIZ Mfg. Co.16
129 Wahl Clipper Corp.40
130 Workman Electronic Products Inc.48
131 Zenith Radio Corp.4, 5

This Index is furnished for the readers' convenience. However, the publisher can not guarantee its accuracy due to circumstances beyond our control.

we specialize in GLOBARS,[®] THERMISTORS, VARISTORS

and over 3,000 other quality products for the electronic trade available through fine Electronic Distributors everywhere in the U.S.A.

WORKMAN *Electronic* PRODUCTS, INC.
SARASOTA, FLA. 33578

P.O. Box 3828 (813) 371-4242
TWX 810-864-0401 Workman Sará

...for more details circle 130 on Reader Service Card



you're whistling in the dark.

... if you haven't had your blood pressure checked lately. You could have high blood pressure and not know it. It can lead to stroke, heart and kidney failure. See your doctor—only he can tell.

Give Heart Fund
American Heart Association



In replacement parts nothing is foreign to us.

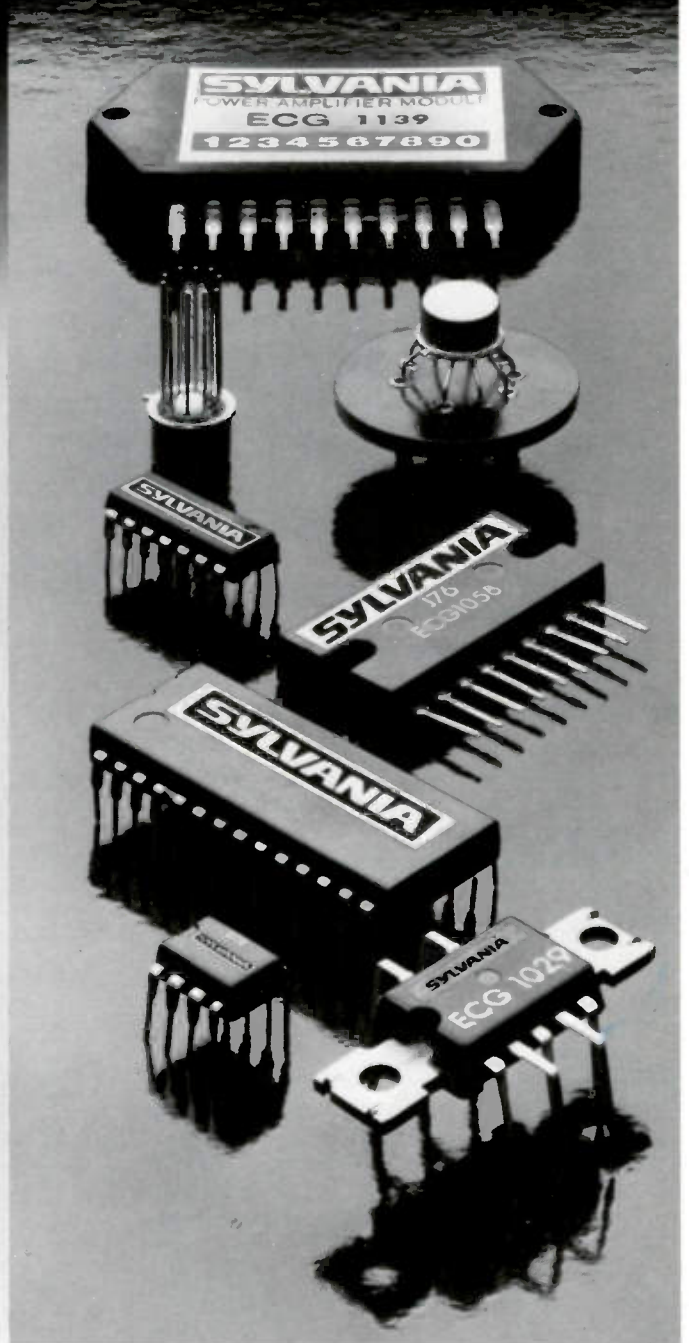
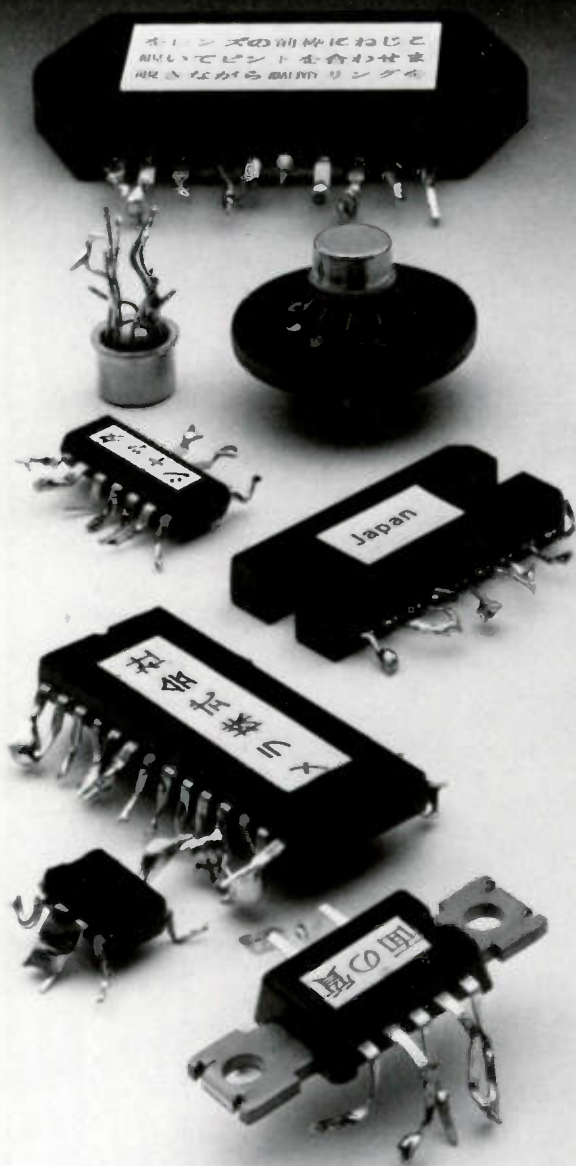

We know the problems in finding the right semiconductor replacements for imported TV, CB and other electronic equipment.

That's why we have a line of thick-film modules and ICs that will replace over 3,000 devices in 139 brands of foreign-made equipment.

And we've made them easy to find in two ways. One is through our new Module and IC Replacement Guide that cross references the original part number with

our ECG® semiconductor part number.

The other way we've made it easy is by making sure your local Sylvania distributor has access to a full stock of semiconductor replacements.

Pick up a copy of the replacement guide at your distributor today, so you'll be able to pick up all the parts you need in just one stop tomorrow.

GTE SYLVANIA

a New Family of VOMs

The Model 60 Series

MODEL 60

- RANGES
- 8 DC VOLTS
- 4 DC CURRENT
- 6 AC VOLTS
- 5 OHMS
- 5dB



\$99



MODEL 60-NA

- 16 DC VOLTS, 10 DC CURRENT,
- 10 AC VOLTS, 6 OHMS, **\$136**
- AND 8 dB RANGES

The new 60 Series has been designed for the value conscious users in industrial production and maintenance, communications, vocational training and hobbyists, airconditioning, appliance and automotive service, R & D and application engineering . . . anyone who wants to be more productive with the latest in V-O-M technology.

The large, "simplified" 4 1/2" scale is an "easy reader". This combined with a single range selector switch minimizes the possibilities of error. Detented handle position, only 2 recessed input jacks and 48" safety engineered test leads are just a few of the many other user benefits of the 60 Series. Compare them with other V-O-Ms and you'll know why the new Triplet family of V-O-M's eliminate over 90% of the costly repairs from V-O-M misuses. Cultivate a profitable habit for selecting Triplet designed products.

For more technical data and a demonstration of the Model 60 Series, see your local Triplet distributor or a Triplet sales representative. Triplet Corp., Bluffton, Ohio 45817, (419) 358-5015.

**X'TRA™ RUGGED
OVERLOAD PROTECTED
SAFETY DESIGNED FOR YOU**

MODEL 64

- RANGES
- 8 DC VOLTS
- 8 AC VOLTS
- 7 OHMS
- 6 Low Power
- JUNCTION TEST

\$136



TTT TRIPLETT

BLUFFTON, OHIO 45817

Triplet. The easy readers.

...for FREE demonstration circle 103 on Reader Service Card
...for more details circle 104 on Reader Service Card